

Electronic Design 26

FOR ENGINEERS AND ENGINEERING MANAGERS

VOL. 21 NO.

DEC. 20, 1973

Silicon photosensors dominate the radiation sensing field. They range from transistors and diodes to linear or planar image arrays having millions of elements. But

where there is need for higher sensitivity and a tailored spectral response, photomultiplier tubes are still used. For design insight on latest sensors, see page 34.

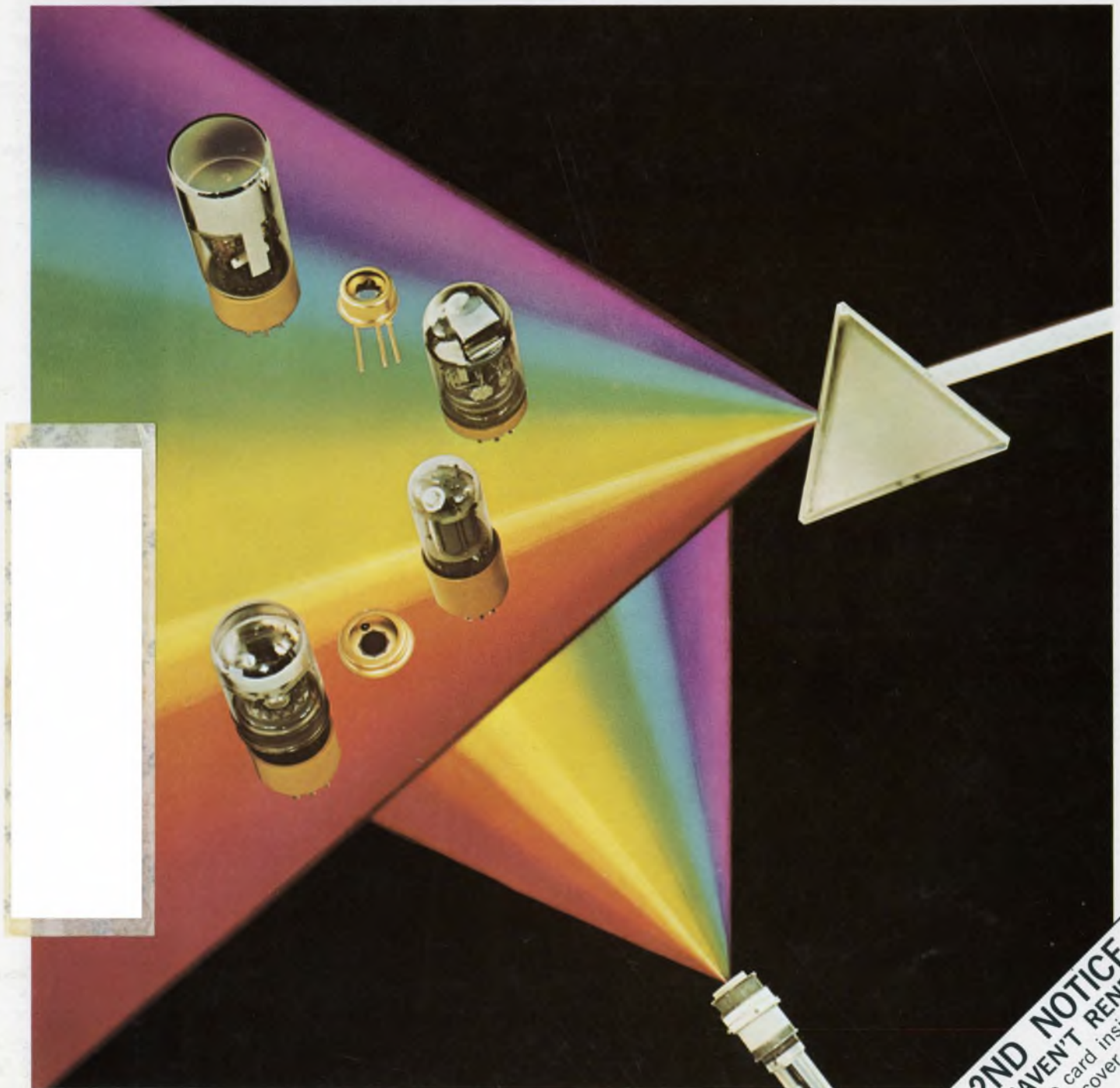

2ND NOTICE
YOU HAVEN'T RENEWED!
Use card inside
cover

“We wanted to go right from keyboard to disc, right? But space was critical. GP relay specs were OK, but I didn't have any

room. Besides, we had to flow solder and dip clean the assemblies to get volume up and cost down.

What I needed was a new kind of relay--

and some help-- right now...”

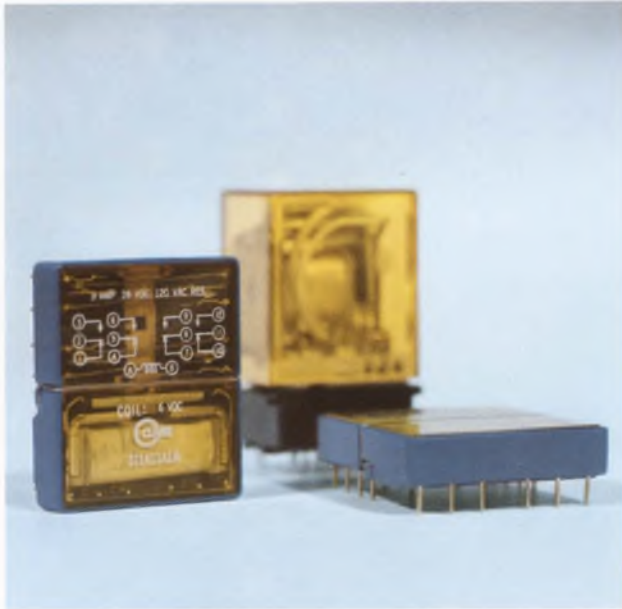

PROBLEM: The market for computer periphery is wide open. And equipment that takes you directly from keyboard to disc is a fantastic idea—if you can make it small enough and cheap enough to sell. And that's tough. Relays are one problem. They've got to be dependable (nothing radical, something available) yet small enough to fit your P.C. design. And they've got to maintain reliability under the effect of high speed production. You can't afford any weak links in your final package, but you have to make your decision fast because of competition.

SOLUTION: Clare's new 311 Series General Purpose Relays saved the day.

They offer 3 amp switching in an extremely low-profile package with .5" mounting centers. They sit a mere 0.350" above the board and take up less than 0.7 cubic inch space. The Lexan® dust cover and pins molded in the base fully protect the relay during wave soldering and partial dip cleaning. And the pins are mounted on a .1" center grid, to add flexibility and save you money. The new 311 also has excellent voltage breakdown ratings and shock resistance, gold plated steel terminals, and fine silver contacts.

Clare's expertise lies in the design and manufacture of relays. That's why we can give you so

much in a single low-profile relay. Right now.

But our energy lies in the application of relays to help you solve specific problems. We specialize in getting down to work.

If you need help—or just some specific information about our new low-profile 311 series relay—get in touch with us. The “right now bunch” is ready to go to work for you.

Contact your local Clare Distributor or Sales Engineer. C. P. Clare & Co., 3101 Pratt Avenue, Chicago, Ill. 60645. 312/262-7700.

QUALITY/SERVICE/RELIABILITY

we help. get in touch with us.  CLARE the “right now” bunch.

a GENERAL INSTRUMENT company

GENERAL PURPOSE RELAYS MERCURY-WETTED RELAYS REED RELAYS SOLID STATE RELAYS TELEPHONE RELAYS STEPPING SWITCHES

INFORMATION RETRIEVAL NUMBER 245

THE FIRST OF THE BIG COUNT TIMERS

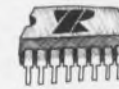
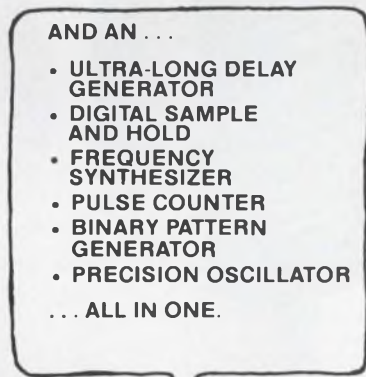
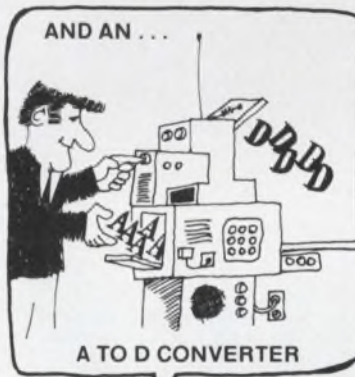
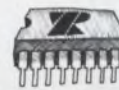
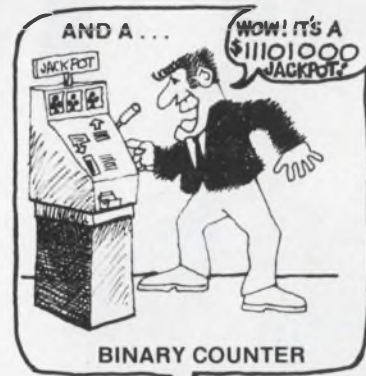
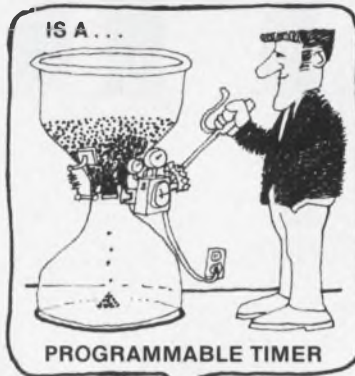
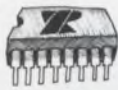
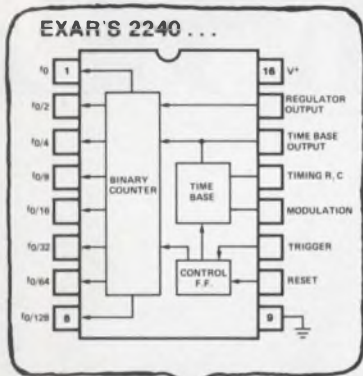

Exar's new XR-2240 counter/programmable timer solves so many tough problems that designers will unanimously agree that it's really the universal timer.

With its unique combination of analog and digital timing methods, you can now replace inadequate and complex assemblages of monolithic and electromechanical timers with the much simpler XR-2240. As a bonus, you get greater flexibility, precision operation, and a reduction in components and costs for most applications.

Because of built-in programmability, you can also use the XR-2240 for frequency synthesis, electronic music synthesis, digital sample and hold, A to D conversion, binary counting and pattern generation, and more.

With a single XR-2240 you can now generate pre-

cision time delays programmable from 1RC to 255RC, a range of microseconds to 5 days. By cascading only two XR-2240 timers, you can extend the maximum delay by a factor of 2^N , where $N = 16$ bits, resulting in a total delay of 3 years!

The XR-2240 operates over a 4V to 15V supply range with an accuracy of 0.5% and a 50 ppm/°C temperature stability. It's available in either a 16-pin ceramic or plastic dual-in-line package for military or commercial applications. Prices start at \$3.00 in 100 piece quantities.

For the more conventional timing applications, look to our other timers: the XR-220/230 timing circuit and the XR-2556 dual timers. Call or write Exar, the timer leader, for complete information.

EXAR SPEAKS YOUR LANGUAGE



EXAR INTEGRATED SYSTEMS

750 Palomar Sunnyvale, California 94086 (408) 732-7970 TWX 910-339-9233

EXAR DISTRIBUTORS: Semiconductor Concepts: Woodland Hills: (213) 884-4560 Hauppauge, L. I.: (516) 273-1234 EEP Corporation: Culver City (213) 838-1912 Intermark Electronics: Sunnyvale: (408) 738-1111 San Diego: (714) 279-5200 Santa Ana: (714) 540-1322 Denver: (303) 963-8284 Seattle: (206) 767-3160 Graham Electronics: Indianapolis (317) 634-8202 Lafayette: (317) 742-4006 Ft. Wayne: (219) 742-4346 Cincinnati: (513) 733-1661 Radio Electric Service Co.: Baltimore: (301) 823-0070 Gerber Electronics: Dedham: (617) 329-2400 Yankee Electronics Supply: Londonderry: (603) 625-9746

INFORMATION RETRIEVAL NUMBER 2

SURPRISE!

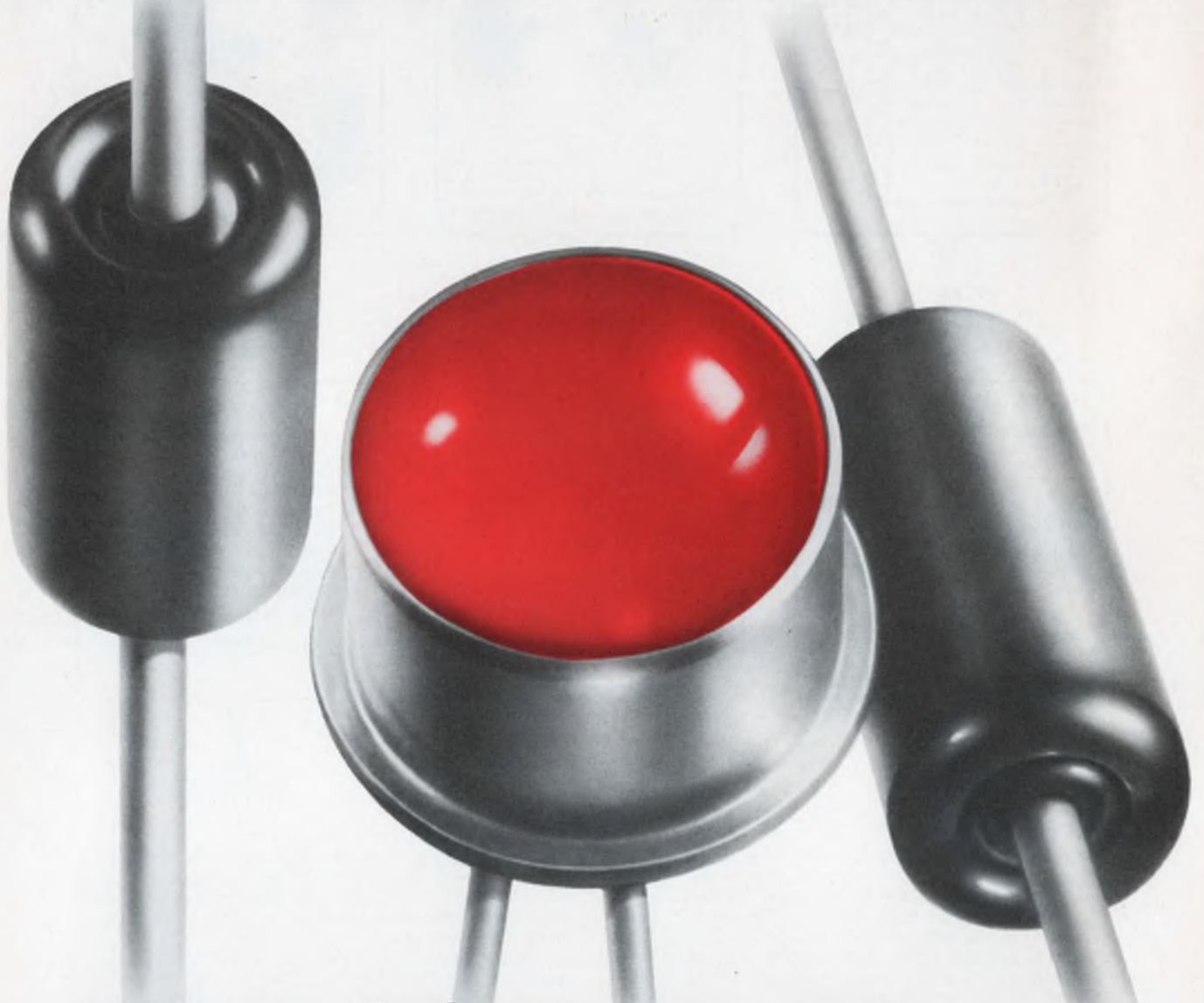

MIL-qualified LEDs, PINs and Schottkys right off the shelf.

Now HP can offer you military-qualified LED lamps, PIN diodes and Schottky diodes right from stock. Our LEDs are just right for applications needing a brilliant, long-life indicator. Our PIN diodes are ideal for attenuating and our Schottkys are designed for high level detection, switching or gating. In addition to military-qualified devices, HP provides standard high reliability test programs, patterned after MIL-S-19500, for many more products. For more information, contact your nearby HP field engineer.

| TYPE | PART NO. | GOV'T DESIGNATION | MIL SPECIFICATION |
|----------|-----------|-------------------|-------------------|
| SCHOTTKY | 5082-2800 | JAN/JANTX 1N5711 | MIL-S-19500/444 |
| PIN | 5082-3001 | JAN/JANTX 1N5719 | MIL-S-19500/443 |
| LED LAMP | 5082-4420 | JAN/JANTX 1N5765 | MIL-S-19500/467 |

01334

HEWLETT  PACKARD

Sales and service from 172 offices in 65 countries.
1501 Page Mill Road, Palo Alto, California 94304

INFORMATION RETRIEVAL NUMBER 3

NEWS

- 31 **News Scope**
- 34 **Photosensors are taking off**, with something that's old and something that's new.
- 42 **A News Appraisal—Japanese electronics:** An industry currently in a state of transition.
- 52 **It's a tree . . . a light pole . . . a man;** No! It's a short-range hf antenna.
- 59 **Washington Report**

TECHNOLOGY

- 68 **Expand counter capability.** Add parallel enabling to boost size; economize on circuitry with enabled MSI sections.
- 78 **Measure vhf-FM receiver sensitivity** in any of three ways. The choice among the 'quieting,' SINAD or noise-figure method depends on your design needs.
- 86 **Don't be strangled by EMI-filter test specs.** Performance curves on data sheets may not agree with reality, even though obtained as per MIL-STD-220A.
- 92 **Improve optical measurement accuracy** without ultra-stable lamps. A ratio technique tracks and compensates for variations in the optical source.
- 96 **Integrate with a function generator.** By combining a VCF generator with a counter, you can sum a signal over periods ranging from milliseconds to years.
- 102 **Managers promote engineering 'digestion'** in this year-end round-up of interviewees' opinions on the best ways to develop good engineers.
- 108 **Ideas for Design:** Detector gives computer warning of ac power-line failure in 150 μ s . . . Opto-isolators replace relays for the injection of time-mark signals . . . Wideband nonsaturating multivibrator features nanosecond rise and fall times.
- 114 **International Technology**

PRODUCTS

- | | | | |
|-----|-------------------------|-----|---------------------|
| 117 | Instrumentation | 130 | Power Sources |
| 122 | Modules & Subassemblies | 132 | Microwaves & Lasers |
| 126 | ICs & Semiconductors | 136 | Data Processing |

Departments

- | | | | |
|-----|-----------------------------------|-----|----------------------------|
| 65 | Editorial: It's one world. | | |
| 7 | Across the Desk | 146 | Advertisers' Index |
| 140 | New Literature | 148 | Product Index |
| 143 | Bulletin Board | 150 | Information Retrieval Card |

Cover: Photo by Mike Pazur and Bruce Hull, courtesy of RCA Electronic Components Div., Harrison, N.J.





We make components for guys who can't stand failures.

By the time they find the problem, the entire factory will be buried under ping pong balls. And there'll be a few thousand more applicants for advanced membership in the can't-stand-electronic-failures club.

If Corning had only been there in time. You see, we make components for guys who can't stand failures. Reliable components like our metal film resistors—both standard and flameproofs. Components like our glass, ceramic and glass/ceramic capacitors. Like our solid tantalum capacitors—hermetic and non-hermetic, polar and non-polar, miniature and microminiature. And like our discrete component networks—available with custom combinations of discrete microminiature resistors, capacitor chips and diodes in a dual in-line package.

Consider tantalums:

Take our tantalum capacitors, for example. We make a wide range of extra reliability solid tantalum capacitors in a wide variety of shapes, sizes, and styles to fit virtually every packaging requirement:

Our miniminiature MINI-TANS[®], encased in polyester sleeves

and sealed with special moisture resistant epoxy resin, are for use where space is at a premium. Both the cylindrical Cordwood Series and the rectangular Modular Series are available with either axial or radial leads.

Our ECONOTAN[®] CC Series features metal case construction and is sealed with moisture resistant epoxy resin. Polyester insulating sleeves are standard. This series finds wide application in high volume commercial and industrial equipment. Since the epoxy end seal construction makes a package extremely resistant to shock and vibration, these parts are frequently used in artillery and rocket fuses and in air-dropped anti-infiltration devices.

Corning also supplies a complete line of government approved, Established Reliability, solid tantalum capacitors. Our MILITAN[®] series includes the CSR13 and CSR91 which meet or exceed the requirements of MIL-C-39003. The commercial equivalents of these Series are the TS and TN Series. Miniature size, established reliability, and excellent electrical char-

acteristics make these units the most widely applied of all solid tantalum capacitors.

Our DIPATAN[®] TD Series capacitors feature rectangular anode construction sealed with a high stability epoxy resin. Intended specifically for commercial and industrial applications, this series has long shelf life, superior electrical performance, and radial lead construction for use in miniature printed circuit applications.

We'd like to show you more:

But this is only a small part of our extra reliability components story. Get it all by writing for our new "General Design Guide" to: Corning Glass Works, Electronic Products Division, Corning, New York 14830.

And for information on availabilities, call your local authorized Corning distributor or D.I.A.L. EEM: (800) 645-9200, toll free. Or in New York state, call collect: (516) 294-0990.

CORNING
ELECTRONICS



Type LS8 Metalized Polystyrene Capacitors are Smaller and Lighter with No Sacrifice in Performance

Dearborn® Type LS8 Metalized Polystyrene Capacitors are $\frac{1}{3}$ the size and $\frac{1}{4}$ the weight of their "non-metalized" foil-electrode counterparts. Yet their performance characteristics (low negative temperature coefficient of capacitance, extremely high insulation resistance, freedom from dielectric absorption) are every bit as good, making them ideally suited for applications such as low-frequency tuned circuits, an-

alog and digital computer reference, timing and integrating circuits, and high-Q tuned circuits.

Capacitance values range from .0027 μF to 2.2 μF . Voltage ratings are 50, 100, and 150 WVDC. Capacitance tolerances as close as $\pm 1\%$ are available. Operating temperature range is -65C to $+85\text{C}$.

For complete data, write for Engineering Bulletin 401.

SPRAGUE ELECTRIC COMPANY
Dearborn electronics division

P.O. BOX 1076, LONGWOOD, FLORIDA 32750
INFORMATION RETRIEVAL NUMBER 5



Vice President, Publisher

Peter Coley

Editors

Editorial Offices
50 Essex St.
Rochelle Park, N.J. 07662
(201) 843-0550
TWX: 710-990 5071
Cable: Haydenpubs Rochellepark
Editor-in-Chief George Rostky

Managing Editors:

Ralph Dobriner
Michael Elphick

Associate Editors:

Dave Bursky
Jules H. Gilder
Morris Grossman
Seymour T. Levine
John F. Mason
Stanley Runyon
Edward A. Torrero
Richard L. Turmail

Contributing Editors:

Peter N. Budzilovich
Steven A. Erenburg

Editorial Field Offices

East

Jim McDermott, Eastern Editor
P.O. Box 272
Easthampton, Mass. 01027
(413) 527-3632

West

David N. Kaye, Senior Western Editor
2930 West Imperial Highway
Inglewood, Calif. 90303
(213) 757-0183
Northe K. Osbrink, Western Editor
112 Coloma St.
Santa Cruz, Calif. 95060
(408) 426-3211

Washington

Heather M. David, Bureau Chief
2506 Eye St., N.W.
Washington, D.C. 20037
(202) 338-3470

Editorial Production

Marjorie A. Duffy

Art

Art Director, William Kelly
Richard Luce
Anthony J. Fischetto

Production

Manager, Dollie S. Viebig
Helen De Polo
Anne Molfetas
Christopher G. Hill

Circulation

Manager, Nancy L. Merritt

Information Retrieval

Peggy Long

Promotion

Manager, Jeffrey A. Weiner
Karen Kerrigan

across the desk

'Safe' bugging band is anything but safe

Thanks for the interesting article on electronic bugs in the Sept. 27 issue ("Designers Compete for that Snug Electronic Bug in a Rug," ED No. 20, pp. 22-30). Please publish a correction of a dangerous error in the statement about the use of so-called "safe" frequencies in the aircraft band for bugging operations.

The Instrument Landing System used by aircraft in bad (and sometimes good) weather operates on frequencies every 0.2 MHz from 109.1 to 110.9 MHz. Low-altitude navigation in the vicinity of airports uses omnirange stations every 0.1 MHz from 108.1 to 108.9 and from 111.0 to 117.9 MHz. Both these systems use amplitude modulation, and the aircraft receivers can be badly fouled even by an unmodulated carrier anywhere in this band.

I am sure that no one who decides to experiment with bugging would want to jeopardize the safety of an airline full of people. Pick a "safe" frequency in the commercial FM band.

Frederick L. Hiltz, E. E.
92 Mount Pleasant Rd.
Ithaca, N.Y. 14850

I must point out something very disturbing in your Sept. 27 article concerning electronic bugging. Regarding commonly used frequencies for these devices, you state that "the aircraft band is safe" and note that Gene Levette uses frequencies between 109 and 114

MHz, except for 113 MHz, "which is used by aircraft landing in bad weather."

Perhaps your aircraft uses only 113 MHz, but mine uses all the 0.1-MHz channels between 109.0 MHz and 117.9 MHz for en-route navigation and instrument approaches. The odd tenths between 109.0 and 113.0 are assigned for the localizer component of the Instrument Landing System, which provides alignment with the runway centerline. The even tenths are used for VOR and VORTAC stations, many of which serve both as en-route and approach facilities.

Mr. Levette exhibits gross irresponsibility in tuning his bugs to these frequencies. A spurious signal on or near the frequency to which an aircraft navigation receiver is tuned can easily disrupt its operation, with potentially disastrous results. His 2-W model has the potential to interfere with aircraft for several miles. I would hardly call that safe.

Roger A. Grady
Test Engineer

General Motors Corp.
Kokomo, Ind. 46901

In the article "Designers Compete for That Snug Electronic Bug In a Rug," the grossly incorrect statement that the aircraft band is "safe" is an apparent oversight. The article should have noted that aircraft navigational aids (vhf) operate between 108 and 118 MHz. In addition those frequencies from 108 to 112 MHz are normally util-

(continued on page 16)

Electronic Design welcomes the opinions of its readers on the issues raised in the magazine's editorial columns. Address letters to Managing Editor, Electronic Design, 50 Essex St. Rochelle Park, N.J. 07662. Try to keep letters under 200 words. Letters must be signed. Names will be withheld on request.

giga-trim capacitors for microcircuit designers

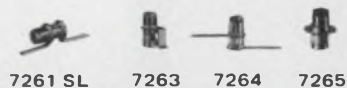

Giga-Trim® (gigahertz-trimmers) are tiny variable capacitors which provide a beautifully straight forward technique to fine tune RF hybrid circuits and MIC's into proper behavior. They replace time consuming cut-and-try adjustment techniques and trimming by interchange of fixed capacitors.

Applications include impedance matching of GHz transistor circuits, series or shunt "gap-trimming" of microstrips, external tweaking of cavities, and fine tuning of crystal oscillators.

Johanson

MANUFACTURING CORPORATION

BOONTON, NEW JERSEY 07005
201 / 334-2676

The \$5,600
computer you
don't have to
talk down to.

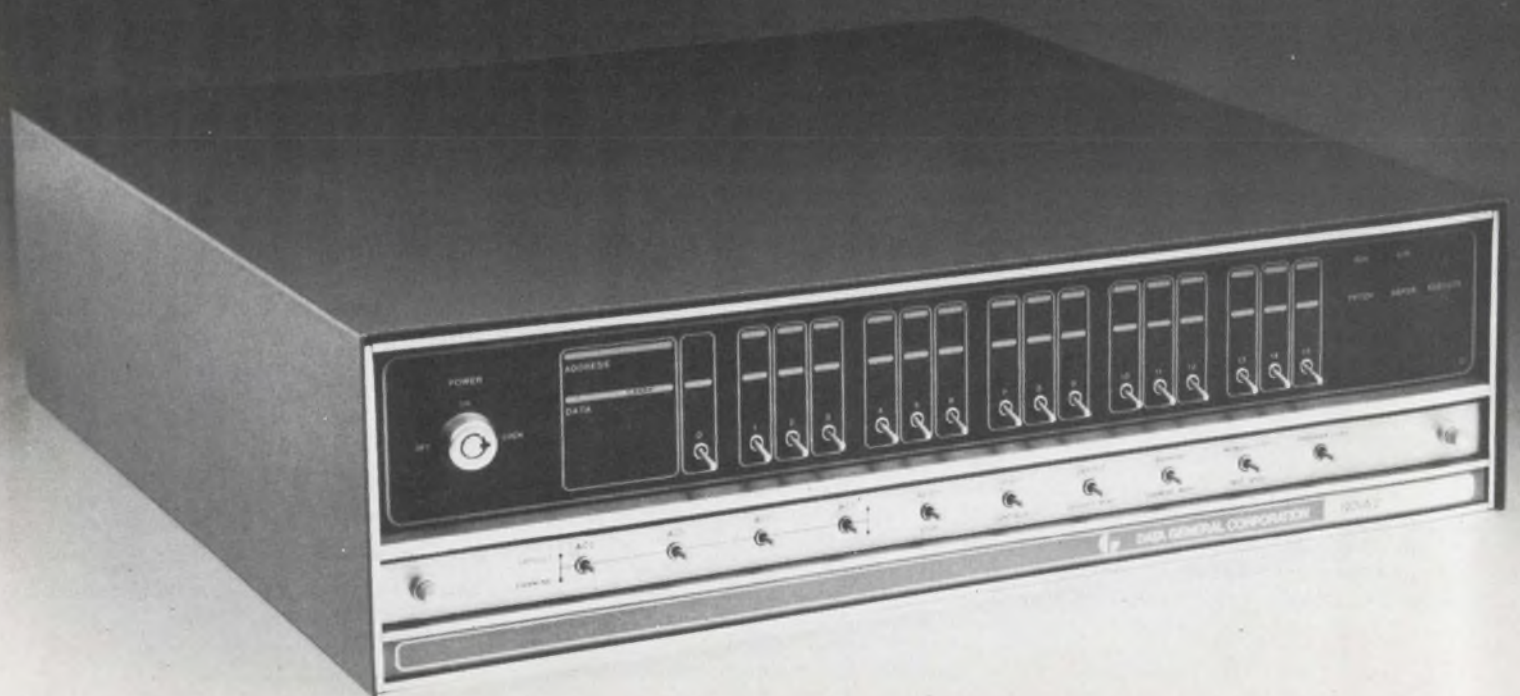

We've got an idea that ought to interest any OEM who's trying to bring down the price of his product.

Go buy yourself 5* Nova 2's with the new 16K memory boards. (Yes, we know you can probably get away with less memory. Bear with us.)

Now take a look at what you get: a high speed multi-accumulator 16 bit CPU, an I/O system with programmed data transfer, 16 levels of programmed priority interrupt, high speed Direct Memory Access, programmer's console, 4-slot mainframe, power supply and 16,384 words of 1 microsecond memory, expandable to 32K. With 4K and 8K memory modules also available.

That, you'll have to admit, is an awful lot of computer for the money. With twice the memory of other computers in that price range.

Hold on. It gets even better.

With that 16K memory, you won't have to talk down to the computer in machine language. You're going to be able to program in higher level languages.

So your programmers will be able to spend more time on what they want it to do and less on how to say it.

Which means they'll get the job done faster. And you'll get your product out on the market faster.

Both of you are going to save yourselves a lot of time and money.

Think about that for a minute.

Consider how your system costs go down when your programming time goes down.

The \$5,600 price tag looks even better now, doesn't it?

And that's before the quantity discounts get figured in.

*Five systems is the minimum order.

The 16K Nova 2

Data General

Southboro, Massachusetts 01772 (617) 485-9100.



Three New For Phase-Locked Expand

MC12060 Crystal Oscillator (100 kHz to 2.0 MHz)

MC12061 Crystal Oscillator (2.0 MHz to 20 MHz)

The devices are monolithic circuits designed specifically for use with an external crystal to provide a very stable oscillator. Oscillator stability is essentially the same as the crystal. Performance and flexibility are built in with an internal voltage regulator, AGC circuitry, and translators. Three outputs are available: complementary sine wave, complementary ECL, and single ended TTL.

MC12040 Phase-Frequency Detector

The MC12040 is designed for systems requiring zero phase and frequency difference at lock. The circuit accepts MECL waveforms at the inputs and generates an error voltage that is proportional to the frequency and/or phase difference of the input signals. In combination with a voltage controlled oscillator (such as the MC1648), the MC12040 is useful for PLL systems requiring reference frequency or channel spacing of 80 MHz or less.



Options Loop Systems Design Capabilities!

Motorola's modular, or building block digital concept, offers the designer all the options to build phase-locked loops; phase detection, frequency division, filtering, and voltage-controlled signal generation. By applying the modular approach, the designer may more readily meet ultimate design objectives of speed, performance, economy, and power.

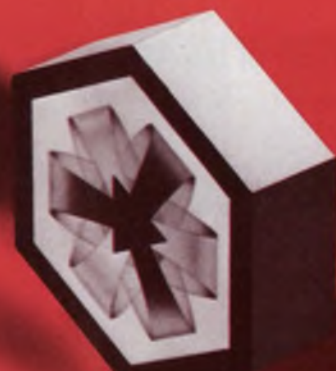

Check Your Options

| FUNCTION | DEVICE NUMBER | LOGIC FAMILY | SPEED (TYP) MHz | CHARACTERISTICS |
|---|------------------|--------------|--------------------|---|
| Phase-Frequency Detector | MC4044 | MTTL | 10 | Consists of two digital phase detectors, charge pump, and amplifier |
| Phase-Frequency Detector | MC12040 | MECL | 80 | Operation similar to MC4044 |
| Voltage-Controlled Multivibrator | MC4024 | MTTL | 25 | Contains two independent voltage-controlled multivibrators with output buffers |
| Voltage-Controlled Oscillator | MC1648 | MECL | 200 | Emitter-coupled oscillator with output levels compatible with MECL III |
| Digital Mixer/Translator | MC12000 | MECL | 250 | A "D" flip-flop with MTTL to MECL and MECL to MTTL translators |
| Two-Modulus Prescaler | MC12012 | MECL | 200 | $\div 2, \div 5/\div 6, \div 10/\div 11, \div 10/\div 12$ |
| Two-Modulus Prescaler | MC12013* | MECL | 400 | $\div 10/11, \div 10/12$ |
| Counter Control Logic | MC12014 | MTTL | 25 | Used with MC12012 and MC74416 to accomplish direct high-frequency programming |
| Crystal Oscillator | MC12060 | MECL | 100 kHz to 2 MHz | Provide complementary sine wave, complementary ECL logic levels, and single ended TTL logic level outputs. Frequency stability provided by external crystal (fundamental, series mode). |
| Crystal Oscillator | MC12061 | MECL | 2 MHz to 20 MHz | |
| COUNTER OPTIONS | | | | |
| Programmable Divide By N Decade Counter | MC74416 (MC4016) | MTTL | 10 ⁰⁰ | $\div 0$ through 9 |
| Two Programmable Divide By N Counters | MC74417 | MTTL | 10 ⁰⁰ | $\div 0-1, \div 0$ through 4 |
| Programmable Divide By N Hexadecimal Counter | MC74418 (MC4018) | MTTL | 10 ⁰⁰ | $\div 0$ through 15 |
| Two Programmable Divide By N Counters | MC74419 | MTTL | 10 ⁰⁰ | $\div 0$ through 3 |
| Universal Counter | MC4023 | MTTL | 30 | -2 through 12 except 7 and 11 |
| Decade Counter | MC7490 | MTTL | 20 | $\div 2, \div 5, \div 10$ |
| Bi-Quinary Counter | MC1678 | MECL | 325 | $\div 2, \div 5, \div 10$ |
| UHF Prescaler Type D Flip-Flop | MC1690 | MECL | 500 | $\div 2$ |
| Universal Hexadecimal Counter | MC10136 | MECL | 150 ⁰⁰⁰ | 0 to 15 |
| Universal BCD Decade Counter | MC10137 | MECL | 150 ⁰⁰⁰ | $\div 10$ |
| Decade Counter-Divider | MC14017 | McMOS | 5 | $\div 10$ |
| Binary Counter | MC14040 | McMOS | 10 | $\div (2^{12})$ |
| BCD Presettable Up/Down Counter | MC14510 | McMOS | 6 | $\div 10$ |
| Binary Up/Down Counter | MC14516 | McMOS | 6 | $\div 16$ |
| Dual BCD Up Counter | MC14518 | McMOS | 6 | -10 or $\div 100$ |
| Dual Binary Up Counter | MC14520 | McMOS | 6 | $\div 16$ or $\div 256$ |
| BCD Programmable Divide By N | MC14522 | McMOS | 5 | $\div 0$ through 9 |
| Binary Programmable Divide By N | MC14526 | McMOS | 5 | $\div 0$ through 15 |
| (*) To be announced. | | | | |
| (**) Speed can be increased to 25 MHz (typ) when used with MC12014 | | | | |
| (***) When used as a prescaler, it is possible to extend the input frequency to over 200 MHz with the MC10231; to 300 MHz with the MC1670; or to over 500 MHz with the MC1690 | | | | |

The new options are available at your nearby Motorola distributor (MC12040L, \$15.00 — MC12060L, MC12061L, \$6.50 each; 1-24 qty.). For complete specifications write to Motorola Semiconductor Products Inc. P.O. Box 20912, Phoenix, Arizona 85036.

The Option Is Yours!

MOTOROLA DIGITAL
— Advanced Concepts In System Design

OPTOELECTRONIC DESIGNERS CHOICE

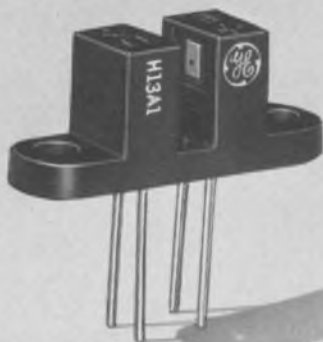

INTERRUPTER MODULES

4 new models require no contact pressure, offer high reliability, compatibility with integrated circuits

H13A1, H13A2 FOR HIGH SPEED



- min $I_O = 200\mu A$ at $I_F = 20mA$
- $5\mu sec$ t_{ON} , t_{OFF}
- \$1.35*

H13B1, H13B2 FOR GAIN



- min $I_O = 2.5mA$ at $I_F = 20mA$
- \$1.45*

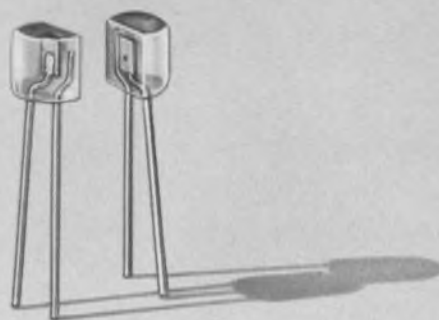

MATCHED LED/DETECTOR PAIR

2 new TO-92 configured gallium arsenide LED / detector pairs offer low cost, side looking packages

H17A1 LED/TRANSISTOR DETECTOR



- min $I_O = 50\mu A$ at $I_F = 20mA$ ($d = .125''$)
- $5\mu sec$ t_{ON} , t_{OFF}
- \$1.25*

H17B1 LED/DARLINGTON DETECTOR



- min $I_O = 1mA$ at $I_F = 20mA$ ($d = .125''$)
- \$1.35*

*Suggested resale price 1,000 lot quantities

TYPICAL APPLICATIONS

- Shaft encoders
- Tachometers
- Counters
- Position sensing
- Key boards
- Level sensing
- Limit switch and micro switch replacement

For more information, contact your authorized GE distributor, any GE Electronic Components Sales office, or write on company letter-head to:

GE Semiconductor Products Department
Electronics Park, Bldg. #7, Mail Drop #49
Syracuse, N.Y. 13201

GENERAL  ELECTRIC

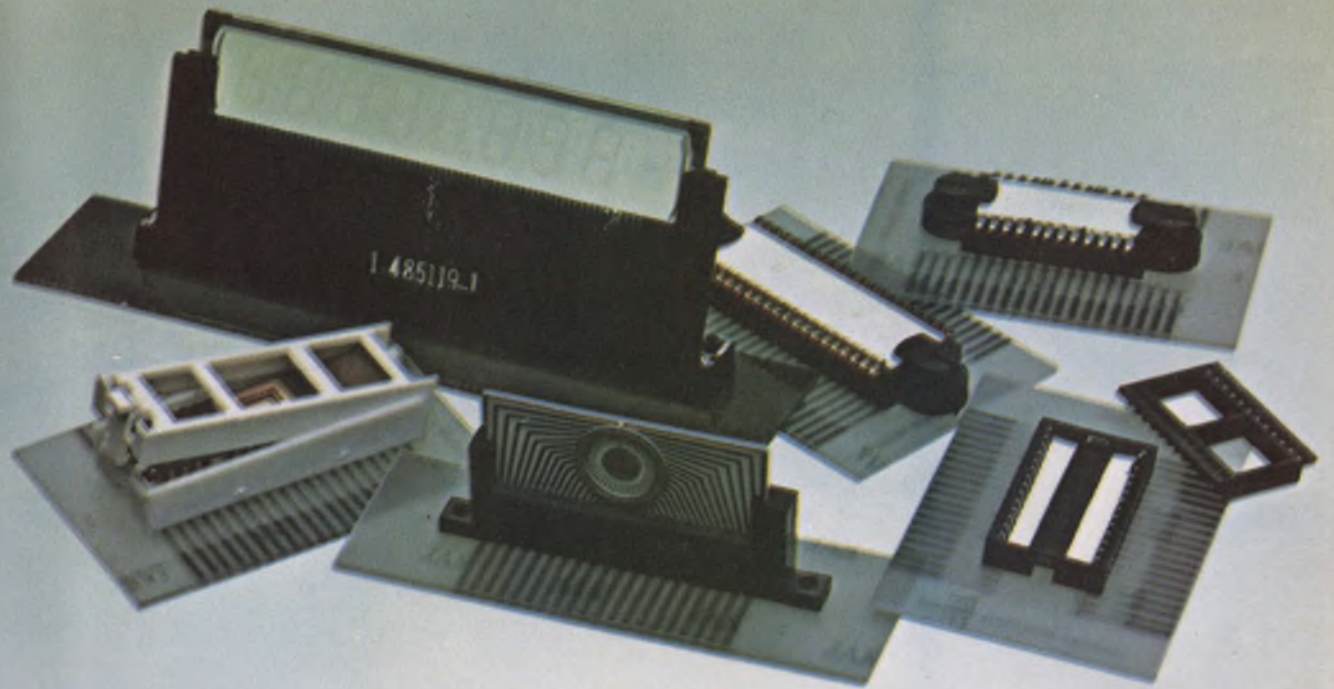

AMP is making things smaller,

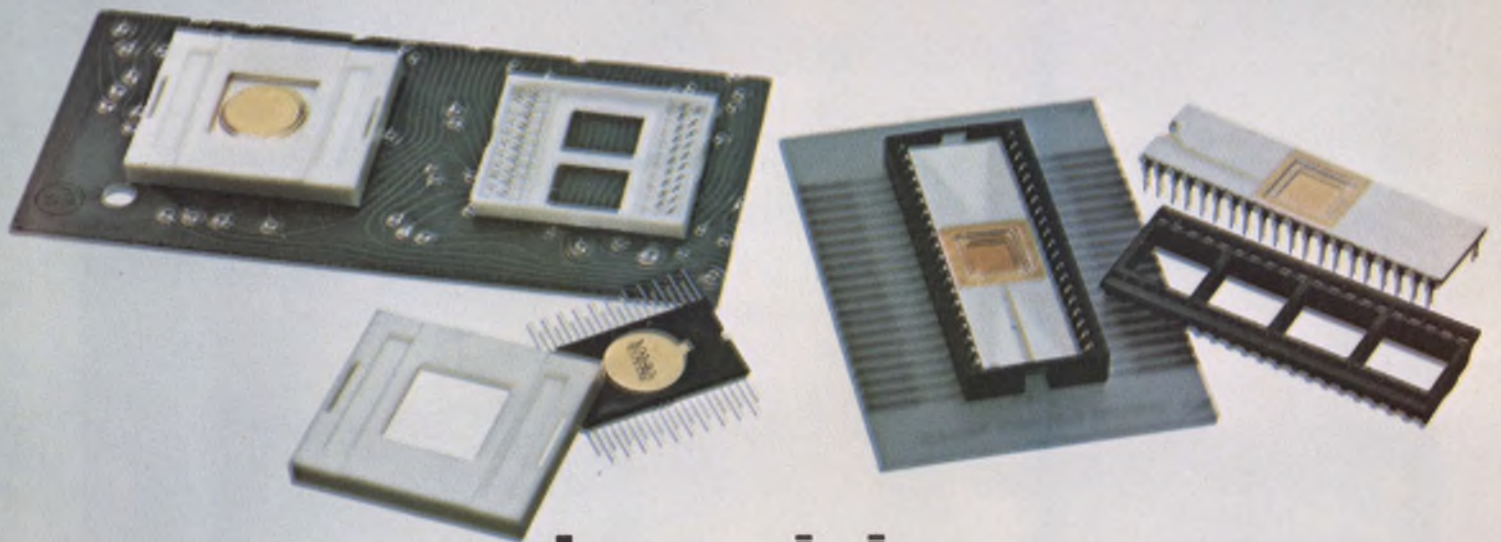

**easier and denser
for interconnecting MOS.**

Take the 42-position connector in the foreground, for example. It's less than .250-inch high, with lid installed. And only .050-inch lead centers! Simple, easy to use. With zero entry force.

Then, there's our 40-position connector (far right, foreground). It's only .235-inch high, .100-inch lead centers and— with its snap-on

adapter— converts in seconds to accept leaded as well as leadless packages. Also available for 24 and 28 package configurations.

We have others, too. Bottom metallized arrays, liquid crystal connectors, etc. But that's another story. To get the AMP microelectronics story, write AMP Incorporated, Harrisburg, Pa. 17105.

AMP microelectronics: doing small things in a big way.

AMP
INCORPORATED

AMP is a trademark of AMP Incorporated.

ENI

The world's leader in solid state rf power amplifiers

Once upon a time if you wanted broadband RF power, you had to settle for bulky tube-type power amplifiers. No more. Because ENI has developed a full line of all-solid-state Class A power amplifiers, covering the frequency spectrum of 10 kHz to 560 MHz, with power outputs ranging from 300 milliwatts to over 1000 watts. And there's more to come.

Driven by any signal generator, frequency synthesizer or sweeper, ENI's compact portable amplifiers, like the ones shown below, are versatile sources of power for general laboratory work, RFI/EMI testing, signal distribution, RF transmission, laser modulation, data transmission, NMR, ENDOR, ultrasonics and more.

Completely broadband and untuned, our highly linear units will amplify inputs of AM, FM, SSB, TV and pulse modulations with minimum

distortion. Although all power amplifiers deliver their rated power output to a matched load, only ENI power amplifiers will deliver their rated power to any load regardless of match.

We also designed our amplifiers to be unconditionally stable and failsafe—you need never fear damage or oscillation due to severe load conditions (including open or short circuit loads).

ENI instrumentation amplifiers come complete with an integral AC power supply and an RF output meter. Ruggedized amplifiers capable of operating under severe environmental conditions are available.

For a **complete** catalog of power amplifiers and multicouplers, write: ENI, 3000 Winton Road South, Rochester, New York 14623. Call 716-473-6900. TELEX 97-8283 ENI ROC.



40 WATT/ MODEL 240L

- 20KHz to 10MHz coverage
- More than 40w linear power output
- Up to 150w CW & pulse output
- Works into any load impedance
- Metered output

Extraordinary performance in a wide range of transducer drive applications. Deliver up to 150w into any load regardless of its impedance. Compatible with all signal and function generators, the 240L is a high quality laboratory instrument for ultra-sonics, biological research & electro-optic modulation.

100 WATT/ MODEL 3100L

- 250 KHz to 105MHz coverage
- More than 100w linear output
- Up to 180w CW & pulse
- Works into any load
- Unconditionally stable

Designed to replace bulkier and less efficient tube type amplifiers, the Model 3100L will provide reliable and maintenance free operation. NMR, ENDOR, ultra-sonics and laser modulation are just a few of the applications for this versatile source of RF energy.

20 WATT/ MODEL 420L

- 150KHz to 250MHz coverage
- 20 Watts power output
- Low noise figure
- 45dB \pm 1.5dB gain
- Class A linearity

The widest band solid state power amplifier available at its 20w power level, the ENI 420L is a truly state-of-the-art instrument. As a drive source for high resolution acousto-optic modulators and deflectors the Model 420L is invaluable. Its Class A linearity will amplify AM, FM, TV and pulse signals with minimum distortion.

.3 WATT/ MODEL 500L

- Flat 27dB gain 2MHz to 500 MHz
- 1.7MHz to 560MHz usable coverage
- Thin film construction
- 8dB noise figure
- Failsafe

This compact unit can deliver more than 300 milliwatts from 1.7MHz to 560MHz at low distortion. A thin film microelectronic circuit is the heart of this general utility laboratory amplifier. Extremely wide band response at a very modest price.

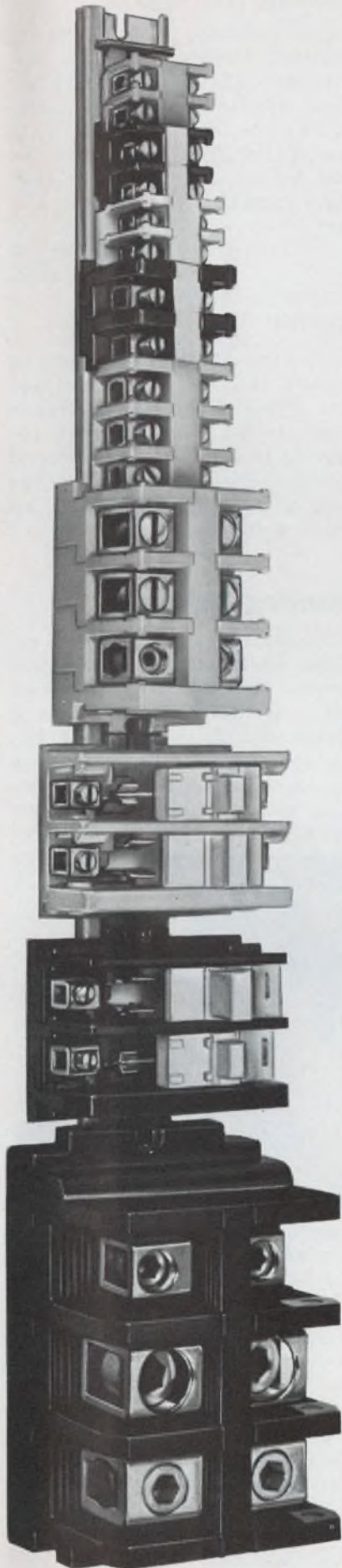

More terminal blocks

Only from Buchanan . . . a complete line of space-saving sectional terminal blocks with a wide variety of sizes to handle a wire range of 30 AWG to 600 MCM. And, your choice of materials: phenolic, nylon, or polypropylene.

More accessories

Only from Buchanan . . . a complete line of accessories, too. They make BUCHANAN® blocks even more versatile and easier to use. There are jumpers to make adjacent contacts common; see-thru covers for dead-front safety; sectional fanning strips for connecting and disconnecting groups of wires for easier field wiring; and more.

More mounting methods

Here's more from Buchanan . . . a choice of flat base or channel mounting. Flat base blocks can be mounted directly on a flat surface. Channel-mounted blocks have a dovetail base that slides or snaps onto a rigid steel or aluminum channel. Great for bridging over other components.

More marking methods

Buchanan lets you take your choice of 4 ways to mark circuits. Direct marking on the block, on a painted area on the block, on a vinyl strip, or on pressure sensitive tape. And, all marking areas are located over the center of the circuit, right out in the open for easy readability.

More contact types

What do your specs call for? Tubular screw? Tubular clamp? Strap clamp? Buchanan has them . . . with no lugging. Or, if you go with ring or spade terminations, strap screw contacts are available. And now, Buchanan offers aluminum as well as copper contacts.

More design freedom from Buchanan

You'll never again have to fit your design to anyone's terminal blocks. Buchanan has the terminal blocks to fit your design. Now, that's what you can call design freedom. For all the facts write for "Electrolog" by Buchanan. It's the catalog that's really the Design Engineer's Freedom Handbook. You'll also receive a free booklet that spells out "How To Select Terminal Blocks."

BUCHANAN® TERMINAL BLOCKS
are marketed by:



**CONTROL PRODUCTS
DIVISION**

Amerace Corporation
2330 Vauxhall Road
Union, New Jersey 07083
(201) 964-4400.

479A

FIRST

AGAIN IN SOLID STATE IMAGE SENSING

Our new *RL-1024* self-scanned array contains 1024 photodiodes on 1 mil centers and offers aperture widths from 1 mil to 24 mils. Contained within the same monolithic chip are the shift registers and multiplex switches to allow serial readout. Standard two-phase clock drive will generate data rates up to 40 MHz. The high speed, low power (4 mW) on-chip shift register is just one of the many new outstanding features.



The *RL-512*, another first of nearly two years ago, is still only surpassed by the *RL-1024*. Both arrays are designed for OCR, facsimile, page/document reader, point-of-sale terminal, real time spectroscopy and non-contact industrial measurement applications. Both devices are in gold/ceramic packages sealed with optical quality quartz windows. They fit into standard DIP sockets.

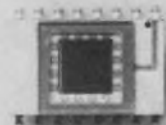

The *RA-50x50A*, introduced about a year ago, is still the only 2500 element commercially available area array. Here the 50x50 matrix of photodiodes are spaced on 4 mil centers. Designed for optical memories, guidance, surveillance applications, it also is self-scanned and operates in the charge storage mode for high sensitivity.

These and more than a dozen other photodiode array types are available from inventory.

RETICON®

450 E. Middlefield Road
Mountain View, CA 94040
(415) 964-6800 TWX: 910-379-6552

NOTE: All products are shown actual size

ACROSS THE DESK
(continued from page 7)

ized for localizers (part of the Instrument Landing System) and terminal VORs—both of which are most important during foul weather. The frequency of 113 MHz, if any of the frequencies must be used for bugs, is a lot safer than those immediately above the FM band.

Fred Storwell
Frankford Arsenal

717 Station Ave.
Cornwells Heights, Pa. 19020

Ed. Note: The statement that the aircraft band is "safe" for bug-gers reflected the bug designer's point of view, not that of ELECTRONIC DESIGN or the Federal Communications Commission or the pilots using the aircraft band. No approval was intended.

Growing by leaps

To illustrate that it has extended its MARK III Information Service Network to cover Australia—as well as North America, Europe and Japan—General Electric in Bethesda, Md., sent along this photo. GE reports that the network now covers four continents and more than 300 cities.



Operator demonstrates message transmission to an Australian friend at a local field office.

Businessmen in Sydney and Melbourne, Australia, will have access to the time-sharing service with a local telephone call. Calls will go through Sydney to a ground station in Moree, then will be beamed via Intelsat satellite to a ground station in California. The ground station will transmit the data via land lines to GE's computer center near Cleveland, Ohio.

Do you face
a make or buy
decision on
power supplies?

BUY LAMBDA'S LZ SERIES THE ONLY FIELD REPAIRABLE P-C MOUNTABLE POWER SUPPLY.

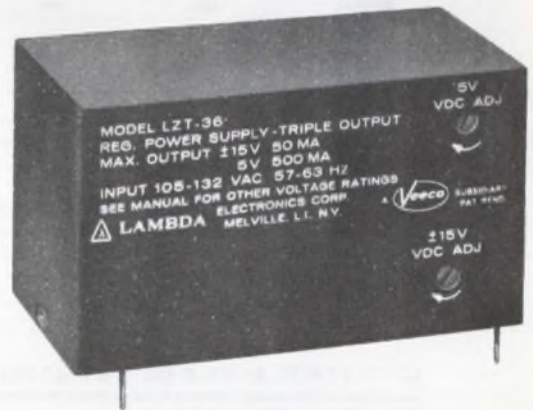
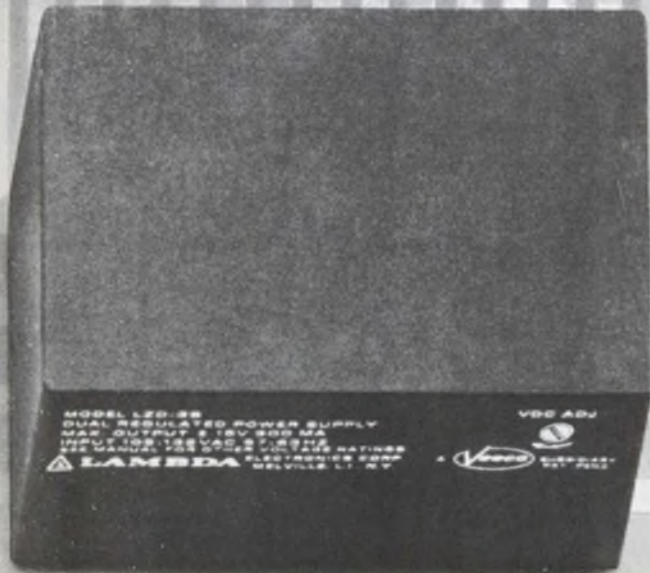
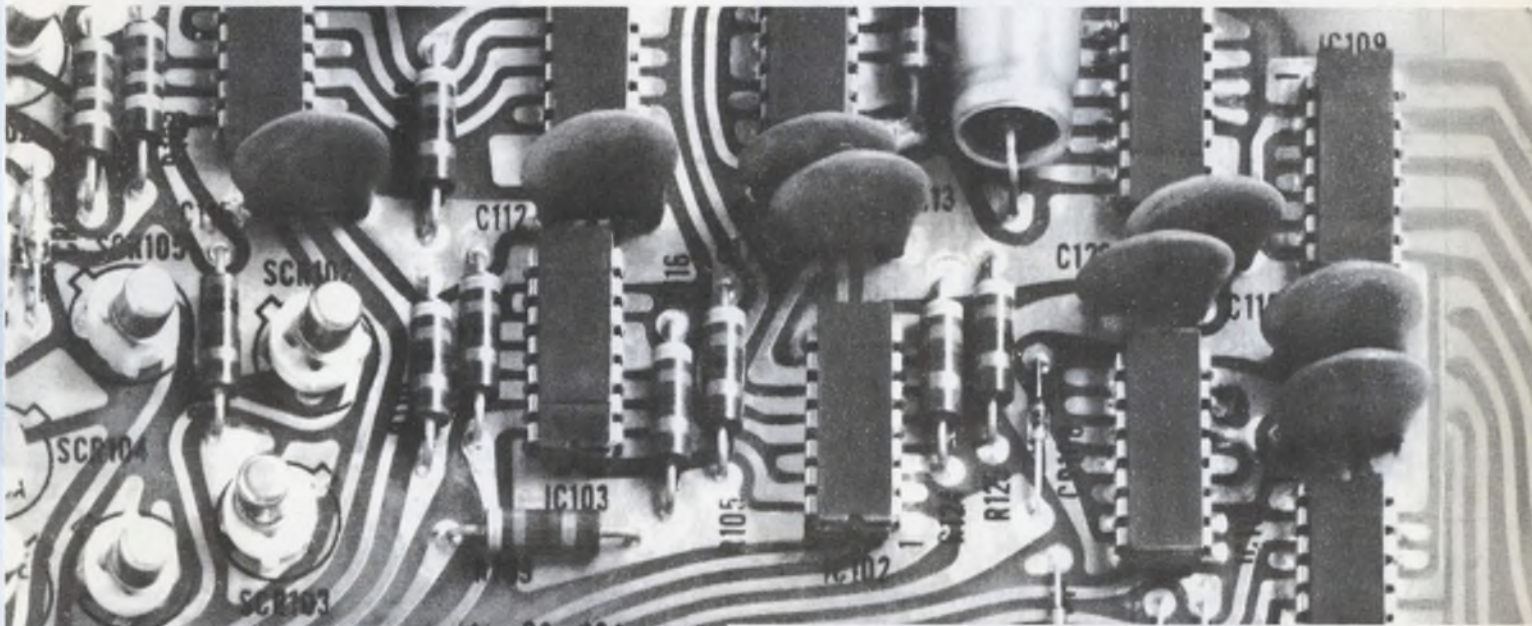

**LZ SERIES
NOW AVAILABLE IN
NEW TRIPLE OUTPUT MODEL**

| MODEL | VOLTAGE ⁽¹⁾ VDC | CURRENT mA | PRICE ⁽²⁾ |
|--------|-------------------------------|---------------|----------------------|
| LZT-36 | 5V ±15V | 500 50 | \$70 |

1-DAY DELIVERY

14 SINGLE, DUAL TRACKING PRINTED-CIRCUIT



LZS-10 5V, 450mA, \$35



LZS-11 12V, 195mA, \$35

NEW

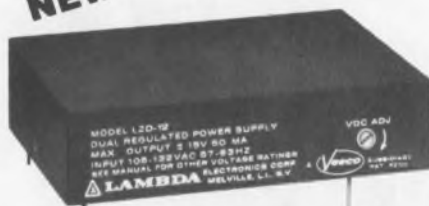

LZD-12 ±15V, 50mA, \$35



LZD-21 ±5V, 300mA, \$55



LZD-22

LZ-10 SERIES SINGLE OUTPUT MODELS

2 1/2" x 3 1/2" x 7/8"

| MODEL | VOLTAGE ⁽¹⁾ VDC | CURRENT mA | PRICE ⁽²⁾ |
|--------|-------------------------------|---------------|----------------------|
| LZS-10 | 3 | 317 | \$35 |
| LZS-10 | 4 | 384 | 35 |
| LZS-10 | 5 | 450 | 35 |
| LZS-11 | 10 | 225 | 35 |
| LZS-11 | 12 | 195 | 35 |
| LZS-11 | 15 | 150 | 35 |

LZ-10 DUAL TRACKING OUTPUT MODEL

2 1/2" x 3 1/2" x 7/8"

| MODEL | VOLTAGE ⁽¹⁾ VDC | CURRENT mA | PRICE ⁽²⁾ |
|--------|-------------------------------|---------------|----------------------|
| LZD-12 | ±15V | 50 | \$35 |

LZ-20 SERIES SINGLE OUTPUT MODELS

2 1/2" x 3 1/2" x 1 1/4"

| MODEL | VOLTAGE ⁽¹⁾ VDC | CURRENT mA | PRICE ⁽²⁾ |
|---------|-------------------------------|---------------|----------------------|
| LZS-20 | 10 | 247 | \$55 |
| LZS-20 | 12 | 268 | 55 |
| LZS-20 | 15 | 300 | 55 |
| *LZD-22 | 24 | 73 | 40 |
| *LZD-23 | 24 | 129 | 55 |
| *LZD-22 | 28 | 84 | 40 |
| *LZD-23 | 28 | 143 | 55 |

LZ-20 SERIES DUAL TRACKING OUTPUT MODELS

2 1/2" x 3 1/2" x 1 1/4"

| MODEL | VOLTAGE ⁽¹⁾ VDC | CURRENT mA | PRICE ⁽²⁾ |
|--------|-------------------------------|---------------|----------------------|
| LZD-21 | ± 3 | 217 | \$55 |
| LZD-21 | ± 4 | 258 | 55 |
| LZD-21 | ± 5 | 300 | 55 |
| LZD-22 | ±10 | 61 | 40 |
| LZD-23 | ±10 | 114 | 55 |
| LZD-22 | ±12 | 73 | 40 |
| LZD-23 | ±12 | 129 | 55 |
| LZD-22 | ±15 | 90 | 40 |
| LZD-23 | ±15 | 150 | 55 |

LZ-30 SERIES DUAL TRACKING OUTPUT MODELS

2 1/2" x 3 1/2" x 1 7/8"

| MODEL | VOLTAGE ⁽¹⁾ VDC | CURRENT mA | PRICE ⁽²⁾ |
|--------|-------------------------------|---------------|----------------------|
| LZD-31 | ± 3 | 333 | \$65 |
| LZD-31 | ± 4 | 417 | 65 |
| LZD-31 | ± 5 | 500 | 65 |
| LZD-32 | ±10 | 163 | 65 |
| LZD-32 | ±12 | 186 | 65 |
| LZD-32 | ±15 | 220 | 65 |
| LZD-35 | ±10 | 200 | 95 |
| LZD-35 | ±12 | 240 | 95 |
| LZD-35 | ±15 | 300 | 95 |

*Single output ratings for dual output models connected in series

NOTES: (1) LZ models are adjustable between the following limits: LZS-10 2.5 to 6V LZS-11 8 to 15V LZS-20 8 to 15V LZS-30 2.5 to 6V LZS-33 8 to 15V LZS-34 2.5 to 6V LZD-12 ±14.5 to ±15.5V LZD-21 ±2.5 to ±6V LZD-22 ±8 to ±15V LZD-23 ±8 to ±15V LZD-31 ±2.5 to ±6V LZD-32 ±8 to ±15V LZD-35 ±8 to ±15V LZT-36 2.5V-6V for +5V output only, ±14.5 to ±15.5 for ±15V output only. Contact factory for current ratings at voltage settings not indicated in the tables. (2) All prices and specifications are subject to change without notice.

MODELS IN 3 PACKAGE SIZES POWER SUPPLIES



15V, 400mA, \$65

NEW



LZS-34 5V, 1400mA, \$95

NEW

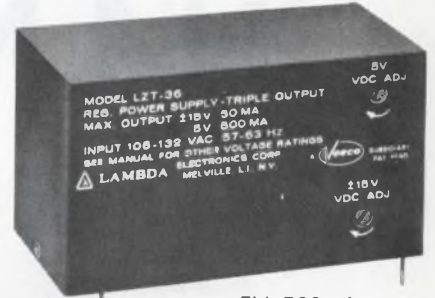

LZT-36 5V, 500mA, \$70
±15V, 50mA



LZD-32 ±15V, 220mA, \$65

NEW



LZD-35 ±15V, 300mA, \$95

COMPETITOR COMPARISON CHART

| Lambda-Pak | Competitors' Model | |
|------------|--------------------|---|
| YES | NO | Fully repairable |
| YES | NO | Continuously adjustable voltage |
| YES | NO | Multivoltage rated |
| YES | NO | Foldback current limiting |
| YES | NO | Wide input voltage range—105-132 Vac |
| YES | NO | Short-circuit proof |
| YES | NO | Vacuum-impregnated transformer |
| YES | NO | Three different power packages |
| YES | NO | Single and dual (tracking) outputs |
| YES | NO | Designed for series operation |
| YES | NO | Stocked and distributed from Los Angeles, Montreal and New York |

OUTLINE DRAWING

| MODEL | A | B | C | D | E |
|-------------------------|-----|-------|-------|-------|-------|
| LZS-10 SERIES | 7/8 | 17/32 | 3/8 | - | - |
| LZD-12 | 7/8 | 43/64 | 17/32 | - | - |
| LZ-20 SERIES | 1/4 | 17/32 | 3/8 | - | - |
| LZS-30 LZD-31 SERIES | 7/8 | 17/32 | 3/8 | - | - |
| LZT-36 | 7/8 | 17/32 | 3/8 | 43/64 | 15/32 |

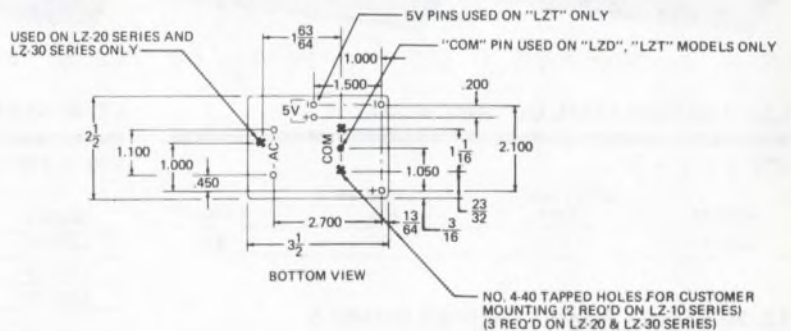
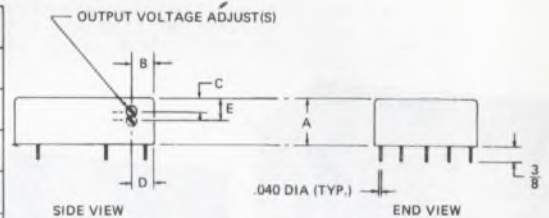

LAMBDA'S LZ SERIES NOW AVAILABLE IN 4 NEW MODELS

Specifications

Regulation

0.15%—line or load, models LZS-10, LZS-30, LZS-34, LZD-21 and LZD-31 have load regulation of 0.15% + 5mV; model LZD-12 has line or load regulation of 0.25%, LZT-36 line regulation 0.15% (+5V) 0.25% (±15V), load regulation 0.25% (±15V), 0.15% + 10mV (+5V).

Ripple and noise

1.5mV RMS, 5mV, pk-pk

Temperature coefficient

0.03%/°C

Overshoot

no overshoot on turn-on, turn-off, or power failure

Tracking accuracy

2% absolute voltage difference (dual output models only) only for the ±15V output in LZT-36 0.2% change for all conditions of line, load and temperature

Ambient operating temperature range

continuous duty from 0°C to + 50°C

Wide AC input voltage range

105 to 132 Vac, 57-63 Hz

Options

AC input

add suffix "V" to model for operation at 187-242 Vac, 47-63 Hz and add \$5.00 to LZ-10 and LZ-20 series prices and \$10.00 to LZ-30 series prices. Derate current 10%. "V" option is available for models LZS-10, LZS-30, LZS-33, LZS-34, LZD-12, LZD-23, LZD-32, and LZD-35.

Storage temperature range

-25°C to + 85°C

Overload protection

fixed automatic electronic current limiting circuit limits the output current upon external overloads, including short circuit, thereby providing protection for load as well as power supply.

Input & output connections

printed circuit solder pins on lower surface of unit. For model LZT-36 the 5V and ±15V outputs are independent.

Controls

screwdriver voltage adjustment over entire voltage range.

Mounting

two 4 x 40 tapped holes on lower surface of LZ-10 series; three 4 x 40 tapped holes on lower surface of LZ-20, and LZ-30 series.

Physical data

Size

see tables and outline drawing

Weight

LZ-10 series 10 oz, net 18 oz, ship.
LZ-20 series 17 oz, net 25 oz, ship.
LZ-30 series 24 oz, net 32 oz, ship.

60-day guarantee

60-day guarantee includes labor as well as parts



LZS-34 5V, 1400mA, \$95

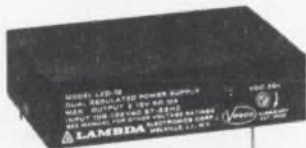

LZD-12 ±15V, 50mA, \$35



LZD-35 ±15V, 300mA, \$95



LZT-36 5V, 500mA, ±15V, 50mA, \$70

LZ-10 SERIES DUAL OUTPUT MODEL

2 1/2" x 3 1/2" x 7/8"

| MODEL | VOLTAGE ⁽¹⁾ VDC | CURRENT mA | PRICE ⁽²⁾ |
|--------|-------------------------------|---------------|----------------------|
| LZD-12 | ±15 | 50 | \$35 |

LZ-30 SERIES SINGLE OUTPUT MODELS

2 1/2" x 3 1/2" x 1 7/8"

| MODEL | VOLTAGE ⁽¹⁾ VDC | CURRENT mA | PRICE ⁽²⁾ |
|--------|-------------------------------|---------------|----------------------|
| LZS-34 | 3 | 950 | \$95 |
| LZS-34 | 4 | 1180 | 95 |
| LZS-34 | 5 | 1400 | 95 |

LZ-30 SERIES DUAL OUTPUT MODELS

2 1/2" x 3 1/2" x 1 7/8"

| MODEL | VOLTAGE ⁽¹⁾ VDC | CURRENT mA | PRICE ⁽²⁾ |
|--------|-------------------------------|---------------|----------------------|
| LZD-35 | ±10 | 200 | \$95 |
| LZD-35 | ±12 | 240 | 95 |
| LZD-35 | ±15 | 300 | 95 |

LZ-30 SERIES TRIPLE OUTPUT MODELS

2 1/2" x 3 1/2" x 1 7/8"

| MODEL | VOLTAGE ⁽¹⁾ VDC | CURRENT mA | PRICE ⁽²⁾ |
|--------|-------------------------------|---------------|----------------------|
| LZT-36 | 5 | 500 | \$70 |
| | ±15 | 50 | |

1-DAY DELIVERY

NG AND TRIPLE OUTPUT MO CUIT BOARD MOUNTABLE POW



LZS-20 15V, 300mA, \$55



LZS-30 5V, 900mA, \$65



LZS-33



±15V, 90mA, \$40



LZD-23 ±15V, 150mA, \$55



LZD-31 ±5V, 500mA, \$65

LZ-30 SERIES SINGLE OUTPUT MODELS

2 1/2" x 3 1/2" x 1 7/8"

| MODEL | VOLTAGE ⁽¹⁾ VDC | CURRENT mA | PRICE ⁽²⁾ |
|---------|-------------------------------|---------------|----------------------|
| LZS-30 | 3 | 633 | \$65 |
| LZS-30 | 4 | 767 | 65 |
| LZS-30 | 5 | 900 | 65 |
| LZS-33 | 10 | 293 | 85 |
| LZS-33 | 12 | 336 | 65 |
| LZS-33 | 15 | 400 | 65 |
| LZS-34 | 3 | 950 | 95 |
| LZS-34 | 4 | 1180 | 95 |
| LZS-34 | 5 | 1400 | 95 |
| *LZD-32 | 24 | 186 | 65 |
| *LZD-32 | 28 | 208 | 65 |
| *LZD-35 | 24 | 240 | 95 |
| *LZD-35 | 28 | 280 | 95 |

*Single output ratings for dual output models connected in series

LZ-30 SERIES TRIPLE OUTPUT MODELS

2 1/2" x 3 1/2" x 1 7/8"

| MODEL | VOLTAGE ⁽¹⁾ VDC | CURRENT mA | PRICE ⁽²⁾ |
|--------|-------------------------------|---------------|----------------------|
| LZT-36 | 5 | 500 | \$70 |
| | ±15 | 50 | |

OVERVOLTAGE PROTECTOR ACCESSORIES

| MODEL | FIXED VOLT RANGE VDC | FOR USE WITH | PRICE ⁽²⁾ |
|----------|-------------------------|-----------------|----------------------|
| LZ-OV-13 | 6.8 ± 10% | All 5V units* | \$10 |
| LZ-OV-14 | 16.8 ± 1.3V | All 15 V units* | 10 |

*LZ dual units require 1 overvoltage accessory for each output. LZ Triple unit requires LZOV-13 for 5V output and the LZOV 14 for the ±15V output.

1-DAY DELIVERY

FIRST CLASS
PERMIT NO. 350
MELVILLE, N. Y.

BUSINESS REPLY MAIL

NO POSTAGE STAMP NECESSARY IF MAILED IN THE UNITED STATES

POSTAGE WILL BE PAID BY

LAMBDA

Electronics Corp.
515 Broad Hollow Road
Melville, New York 11746

Lambda-staffed sales and service offices



How To Order

All information necessary to order a power supply is given on each individual page. Send your order directly to your nearest Lambda sales office or call for more specific information. In U.S., orders may be mailed or telephoned directly to the main office in New York.

1 MID-EASTERN REGION
Melville, New York 11746
 515 Broad Hollow Road
 Tel. 516-694-4200 • TWX: 510-224-6484

Rochester, New York
 Tel. 716-454-6770

Norristown, Pennsylvania
 Tel. 215-279-5644

Greensboro, North Carolina
 Tel. 919-274-5745

McLean, Virginia
 Tel. 703-356-0141

2 NEW ENGLAND REGION
Lexington, Massachusetts 02173
 2 Militia Drive
 Tel. 617-861-8585 • TWX: 710-326-7558

3 SOUTHEAST REGION
Largo, Florida 33540
 11580 Oakhurst Rd.
 Tel. 813-595-6500

Baltimore, Maryland
 Tel. 301-465-1133

Dallas, Texas 75231
 6950 Winchester
 Tel. 214-341-5130

SOUTHEAST REGION (Cont'd)
Houston, Texas
 Tel. 713-464-6554

Oklahoma
 Tel. Enterprise 2-183

4 CENTRAL REGION
Arlington Heights, Ill. 60005
 2420 East Oakton St., Unit O
 Tel. 312-583-2550
 TWX: 910-222-2856

Minneapolis, Minnesota
 Tel. 612-935-6194

Cleveland, Ohio
 Tel. 216-771-7447

5 FAR-WESTERN REGION
North Hollywood, Calif. 91605
 7316 Varna Ave.
 Tel. 213-875-2744
 TWX: 910-499-2651

Phoenix, Arizona
 Tel. 602-996-1010

6 NORTHWESTERN REGION
Sunnyvale, California 94086
 599 N. Mathilda Ave., Suite 260
 Tel. 408-738-2541 • TWX: 910-339-9243

International

Lambda Electronics Corp., Export Dept.
 515 Broad Hollow Road, Melville, N.Y. 11746
 Tel. 516-694-4200 • TWX: 510-224-6484
 Cable: Lambdatron, Melville, N.Y.

ENGLAND

Lambda Electronics
 Abbey Barn Road, Wycombe Marsh
 High Wycombe, Bucks HP11-1RW
 Tel. High Wycombe 36386/7/8 • TWX: 837153
 Cable: VEELAM HIWYC

CANADA

Veeco Lambda Ltd.
 100C Hymus Blvd., Pointe-Claire, Quebec-730
 Tel. 514-697-6520 • TWX: 610-422-3029

Veeco Lambda Ltd.
 P.O. Box 501, Postal Station K
 Toronto 12, Ont., Canada • Tel. 416-486-0794

FRANCE

Lambda Electronique, S.A.
 64 a 70 rue des Chantiers, 78004, Versailles, France
 Tel. 950-2224

After Jan. 1, 1974

Lambda S.A.
 Route de Grivery
 91 Gometz le Chatel
 Address Postale: BP 77 91403 Orsay

GERMANY

Lambda Netzgeräte GmbH
 759 Achern-Fautenbach
 Im Holzboch 14
 Tel. 078-41-5527

ISRAEL

Elacint Ltd.
 Post Office Box 5258 Haifa, Israel
 Tel. 724314, 722925 • Telex: 004-774 Haifa

JAPAN

Pan Electron Inc.
 1 Higashikata-Machi, Midori-Ku, Yokohama, Japan
 Tel. 045-471-8811

MEXICO

Mexitek, S.A.
 Eugenia 408, Departments 1 & 5
 Mexico 12, D.F. Mexico Tel. 5-36-09-10 or 5-43-03-77

Lambda Distribution Centers:

Melville, N.Y.
 North Hollywood, Calif.
 Gouldsboro, Pa.
 Versailles, France
 Achern-Fautenbach, W. Germany
 Montreal, Canada
 Yokohama, Japan
 Haifa, Israel

Calibration and Repair Facilities

Melville, N.Y.
 North Hollywood, Calif.
 Portsmouth, Hants, England
 Versailles, France
 Achern-Fautenbach, W. Germany
 Montreal, Canada
 Yokohama, Japan
 Haifa, Israel

Lambda Transformer Plant:

Gouldsboro, Pa.
 Tel. 717-842-7611

Please send me your new 1973 Power Supply Catalog & Application Handbook.

Please have your sales engineer call.

Name _____

Title _____

Company _____

Mail Code _____

Address _____

City _____

State _____ Zip _____

Phone _____

L-7

5 books that should be in your personal library... order now for 15-day free examination!



DURABILITY AND RELIABILITY IN ENGINEERING DESIGN

by Gilbert Kivenson

A unique combination of materials science, reliability, and design. Examines crucial concepts of material strength, service longevity, and reliability and describes the fundamentals of breakdown analysis. Covers new materials, design techniques and fabricating methods. 200 pp., #5851-9, cloth, \$9.95.

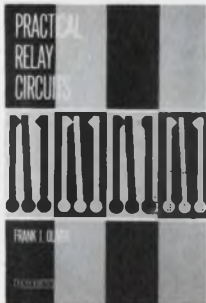

PRACTICAL RELAY CIRCUITS

by Frank J. Oliver

Logically groups relay circuits according to the functions they perform, to help you quickly select the best circuit for your purposes. Covers the whole gamut of relay circuits and is illustrated with many circuit diagrams. 363 pp., #5802-0, cloth, \$14.95.



PRACTICAL DESIGN FOR ELECTROMAGNETIC COMPATIBILITY

Edited by Rocco F. Ficchi

A convenient manual giving electronic designers techniques for analyzing, predicting, controlling, and reducing unwanted signals. Gives advantages and disadvantages of latest methods for reduction and control. Provides ways of selecting equipment for interference reduction. 272 pp., #5685-0, cloth, \$13.95.

PRACTICAL VALUE ANALYSIS METHODS

By John H. Fasal



An applications-oriented guide offering a working knowledge of the latest methods and techniques in value engineering and value analysis. Provides ways of evaluating and supplementing the internal cost reduction techniques that enable a company to keep pace with competition. 272 pp., #5845-4, cloth, \$11.95.

ELECTRICAL/ ELECTRONIC CHECKLISTS

Written and edited by W. B. Rossnagel

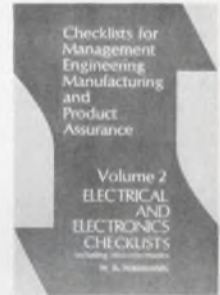

Twenty-two detailed checklists on subjects including cables and connectors, communication radios, multi-coders, GSE/AGE/TSE, EMI/RFI, lasers, radar, systems, transmitters and transponders, as well as other subjects. 172 pp., #9181, cloth, \$14.00.



HAYDEN BOOK COMPANY, INC.

50 Essex St., Rochelle Park, N.J. 07662

Please send the book(s) checked on 15-day free examination. At the end of that time, I will remit payment plus postage, or return the book(s) with no further obligation.

5851-9 5802-0 5685-0 5845-4 9181

\$10.00 minimum for free exam orders.

Because of higher billing and collection costs, we must ask for payment in full with any order for less than \$10.00. Books will be shipped postpaid. Same 15-day return privilege for full refund if not satisfied.

Save Money! On all prepaid orders Hayden pays postage — same return privilege.

Name _____

Firm _____

Address _____

City/State _____ Zip _____

ISBN Prefix 0-8104

73-65b



Who has the broadest line of Potentiometers?

It stands to reason that we wouldn't ask the headline question unless we were certain of the answer.

And we are. Unquestionably, the answer is **BOURNS**

Compare catalogs if you like. You'll find over 12,000 model/terminal/resistance combinations offered in our **TRIMMER POTENTIOMETER** section. Single-turn and multi-turn . . . round, square and rectangular — BOURNS has them all, in wirewound or cermet models.

No need to look elsewhere for a complete line of **PRECISION POTENTIOMETERS**. Check the precision section of the Bourns catalog. Over 20 different standard bushing mount models are displayed, including the unique KNOBPOT® integral dial/potentiometer family. If you have servo-mount requirements, or need "something special" . . . our fully staffed custom design and manufacturing organization is at your service. Promptly.

More? You bet.

Bourns popular "SPACE SAVER" line of cermet **CONTROLS** are finding wide acceptance in cost-conscious consumer and industrial applications. You can expect to see exciting developments in this line.

Our cermet and composition open frame **VARIABLE RESISTORS** are super for budget PC board applications. They're priced as low as 10¢ in production quantities. They're from Bourns, so you can count on cost-effective quality and service . . . even at such low prices.



When you think of variable resistive components . . . look no farther than your Bourns Master Catalog. It's your supermarket of quality, cost-effective resistive components.



TRIMPOT PRODUCTS DIVISION • 1200 COLUMBIA AVE., RIVERSIDE, CALIF. 92507

**TRW makes
electronic components for
telephones and
mobile communications and
automobiles and
computers and
television sets and
instrumentation and
aircraft and missiles
and...**

So?

So...

We are one of the few companies producing *both* high-volume and high-technology electronic components for today's growth industries.

Only a company that can cut a broad swath across the fields of all major electronics users has the cross-over capability in manufacturing to handle all your needs, whatever they are.

We are that kind of company. We can give you what you need. High-technology, high-volume—or both. Because we specialize in both, and in a big way. We make over 300 different kinds

of electronic components for the major OEM's in all the major industries. We have the technology and production savvy—plus the sheer size—to be the source for whatever you need.

Perhaps we already make it in one of our 30 plants. Certainly, we *can* make it, even building a new plant if necessary. As we have for others.

In short, we can do more for you precisely because we do so much for so many others in such a range of industries. And because we are TRW.

TRW[®] ELECTRONIC COMPONENTS

10880 Wilshire Blvd., Los Angeles, CA. 90024

Connectors • Resistors • Semiconductors • Capacitors • Motors • Functions and Assemblies • PC Boards • Potentiometers • Transformers • Coils and Inductors • Wire and Cable

Integrated Circuits

SIGNETICS CORPORATION



"Where advanced technology is just part of the service."

Main Office and Manufacturing Plant:
811 E. Arques,
Sunnyvale, Cal. 94086
(408) 739-7700

AUTHORIZED DISTRIBUTORS

ARIZONA

Phoenix: Hamilton/Avnet Electronics
2615 S. 21st Street . . . (602) 275-7851
Phoenix: Kierulff Electronics
2633 East Buckeye Road (602) 273-7331

Put more into your lines, tie into your neighborhood distributor.

CALIFORNIA

Culver City: Hamilton Electro Sales
10912 W. Washington . . . (213) 870-7171
El Monte: G. S. Marshall
9674 Telstar Avenue . . . (213) 686-0141
Los Angeles: Wesco Electronics
5650 Jillson Street . . . (213) 685-9525
Mountain View:
Hamilton/Avnet Electronics
340 E. Middlefield Road. (415) 961-7000
Palo Alto: Wesco Electronics
3973 E. Bayshore Road . . (415) 968-3475
San Diego: Hamilton/Avnet Electronics
8917 Complex Dr. (714) 279-2421
San Diego: Cramer Electronics
8975 Complex Dr. (714) 565-1881
San Diego: Kierulff Electronics
8797 Balboa Avenue (714) 278-2112
Sunnyvale: Cramer Electronics
720 Palomar (408) 739-3011



A telephone call to your distributor is one of today's best bargains.



CANADA

Downsview, Ontario: Cesco Electronics
24 Martin Ross Ave. . . . (416) 661-0220
Downsview, Ontario: Cramer Electronics
920 Alness Ave. Unit 9 . . (416) 661-9222
Montreal, Quebec: Cesco Electronics
4050 Jean Talon West. . . (514) 735-6393
Montreal, Quebec: Hamilton/Avnet
935 Montee des Liesees. (514) 735-6393
Ottawa, Ontario:
Hamilton/Avnet Electronics
880 Lady Ellen Place . . . (613) 725-3071
Ottawa, Ontario: Cesco Electronics
1300 Carling Avenue. . . (613) 729-5118

COLORADO

Denver: Hamilton/Avnet Electronics
5921 N. Broadway (303) 534-1212
Denver: Cramer Electronics
5465 E. Evans Place at Hudson (303) 758-2100

Integrated Circuits — Distributors (Cont'd)

CONNECTICUT

Hamden: Arrow Electronics
295 Treadwell Street . . (203) 248-3801
Georgetown: Hamilton/Avnet Electronics
643 Danbury Road (203) 762-0361
North Haven: Cramer Electronics
35 Dodge Avenue (203) 239-5641

FLORIDA

Hollywood: Hamilton/Avnet Electronics
4020 N. 29th Ave. (305) 925-5401
Hollywood: Schweber Electronics
2830 N. 28th Terrace . . (305) 927-0511
Orlando: Hammond Electronics
911 W. Central Blvd. . . . (305) 241-6601

Signetics takes a back seat to no one in ECL 10K. Call us on it.

GEORGIA

Atlanta: Schweber Electronics
4126 Pleasantdale Road, Suite 14 (404) 449-9170
Norcross: Hamilton/Avnet Electronics
6700 Interstate 85 Access Road, Suite 2B (404) 448-0800

SCHOTTKY ON THE DOUBLE.
Promote the telephone, call your distributor.

NEW MEXICO

Albuquerque: Cramer Electronics
137 Vermont, N.E. (505) 265-5767

NORTH CAROLINA

Greensboro: Hammond Electronics
2923 Pacific Avenue . . . (919) 275-6391

NORTHERN NEW JERSEY

Cedar Grove: Hamilton/Avnet Electronics
218 Little Falls Road. . . (201) 239-0800
Saddlebrook: Arrow Electronics
285 Midland Avenue. . . (201) 256-7331

Dip into 0.15% AQL, with Signetics SUPR DIP digital circuits.

SOUTHERN NEW JERSEY AND PENNSYLVANIA

Moorestown: Arrow/Angus Electronics
Pleasant Valley Road . . (609) 235-1900
Mt. Laurel, N.J.:
Hamilton/Avnet Electronics
113 Gaither Dr., East Gate Industrial Park (609) 234-2133
Cherry Hill, N.J.: Milgray-Delaware Valley
1165 Marlkriss Rd. . . . (609) 424-1300

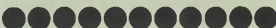

Here's a direct line to the shelves of your Comparator Supermarket.



CENTRAL NEW JERSEY AND PENNSYLVANIA

Somerset, N.J.: Schweber Electronics
43 Belmont Drive (201) 469-6008

Integrated Circuits — Distributors (Cont'd)

OHIO

Beechwood: Schweber Electronics
23880 Commerce Park Road (216) 464-2970
Cleveland: Arrow Electronics
23945 Mercantile Rd. . . (216) 464-2000
Cleveland: Pioneer Standard Electronics
4800 E. 131st Street . . (216) 587-3600
Dayton: Hamilton/Avnet Electronics
118 Park Road W. (513) 433-0610
Kettering: Arrow Electronics
3100 Plainfield Rd. . . . (513) 253-9176

TEXAS

Dallas: Hamilton/Avnet Electronics
4445 Sigma Road (214) 661-8661
Dallas: Cramer Electronics
2970 Blystone Ave. . . . (214) 350-1355
Houston: Component Specialties
7315 Ashcroft, Suite 113 (713) 771-7237
Houston: Hamilton/Avnet Electronics
1216 West Clay Street . (713) 526-4661

JAN/Hi-Rel ICs.

Use? Buy? Specify?

Your distributor qualifies.

UTAH

Salt Lake City: Alta Electronics
2280 S. Main St. (801) 486-7227
Salt Lake City:
Hamilton/Avnet Electronics
647 W. Billinis Rd. . . . (801) 262-8451

WASHINGTON

Bellevue: Hamilton/Avnet Electronics
13407 Northrup Way . . (206) 746-8750
Seattle: Cramer Electronics
5602 6th Ave., South . . (216) 762-5722

No-Hitch Schottky Comparators.
So easy to shop by telephone.



ILLINOIS

Elk Grove: Schweber Electronics
1380 Jarvis Ave. (312) 593-2740
Elmhurst: Semiconductor Specialists
195 Spangler Ave., Elmhurst Industrial Park (312) 279-1000
Schiller Park: Hamilton/Avnet Electronics
3901 N. 25th Ave. . . . (312) 678-6310

INDIANA

Indianapolis: Semiconductor Specialists
P.O. Box 41630, Weir Cook Airport (317) 243-8271

KANSAS

Lenexa: Hamilton/Avnet Electronics
37 Lenexa Industrial Center (913) 888-8900

INSTANT 883.

Consult this page for instant 883 and JAN IC's

Integrated Circuits — Distributors (Cont'd)

MARYLAND

Hanover: Hamilton/Avnet Electronics
7255 Standard Drive . . (301) 796-5000
Rockville:
Pioneer Washington Electronics
1037 Taft Street (301) 424-3300
Rockville: Schweber Electronics
5640 Fisher Lane (301) 881-2970

MASSACHUSETTS

Burlington: Hamilton/Avnet Electronics
185 Cambridge St. . . . (617) 273-2120
Needham Heights: Kierulff Electronics
14 Charles Street (617) 449-3600
Newton: Cramer Electronics
85 Wells Avenue (617) 969-7700
Waltham: Schweber Electronics
213 Third Avenue (617) 890-8844



OPTIMIZED PROMs and ROMs:



call for optimized service.

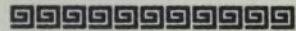

MICHIGAN

Livonia: Hamilton/Avnet Electronics
12870 Farmington Rd. . (313) 522-4700
Detroit: Semiconductor Specialists
25127 W. Six Mile Rd. . (313) 255-0300

☆☆ 555: ☆☆☆
The timer of 1001 uses. Promote the telephone shopping habit.

MINNESOTA

Minneapolis: Semiconductor Specialists
8030 Cedar Ave., South . (612) 854-8841
Edina: Hamilton/Avnet Electronics
7683 Washington Avenue, South (612) 941-3801

One-stop shopping: call your distributor for total TTL needs.

MISSOURI

Hazelwood: Hamilton/Avnet Electronics
392 Brookes Lane (314) 731-1144

Your distributor brings the world to your door . . . with Bipolar ROMs and RAMs.

NEW YORK

Buffalo: Summit Distributors
916 Main Street (716) 884-3450
Farmingdale, L. I.: Arrow Electronics
900 Broad Hollow Road . (516) 694-6800
Rochester: Schweber Electronics
999 Buffalo Road (716) 328-4180
Syracuse: Hamilton/Avnet Electronics
6500 Joy Road (315) 437-2642
Westbury: Schweber Electronics
Jericho Turnpike (516) 334-7474
Westbury: Hamilton/Avnet Electronics
70 State Street (516) 333-5800

TRW LVA diode... the sharpest knee below 10 Volts.

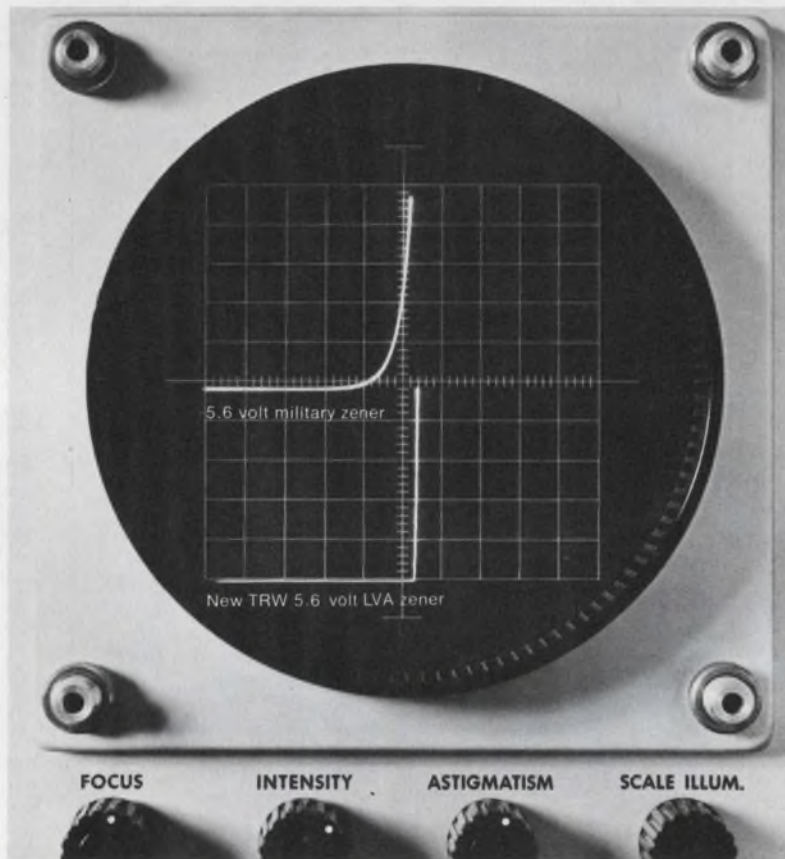

The current saver.

No other zener can approach TRW's LVA performance below 10 volts. Available for operation down to 4.3 volts, TRW LVA diodes minimize power consumption in portable-battery operated equipment. They're also ideal for instrumentation, where, as reference elements, they draw as little as 50 μ Amps. TRW LVA's are available in various package configurations, including passivated chip form for hybrid-

compatible packages. If you have a need for a low current voltage regulator or any other product that demands low current consumption, you should check out TRW LVA zeners. When it comes to current, they're really misers!

For product information and applications assistance write TRW Semiconductors, an Electronic Component Division of TRW Inc., 14520 Aviation Boulevard, Lawndale, California 90260. Phone (213) 679-4561.

These products are available through the following authorized distributors:

Almo Electronics
Bell Industries
Cramer Electronics Inc.
De Mambro Electronics

Eastern Radio Corp.
Electronics Marketing Corp.
Elmar Electronics Inc.
Hall-Mark Electronics Corp.

Harvey-Michigan Inc.
Liberty Electronics
Powell Electronics
Pytronics

Semiconductor Concepts Inc.
Summit Distributor
R. V. Weatherford Co.
Westates Electronics Corp.

TRW[®] SEMICONDUCTORS

INFORMATION RETRIEVAL NUMBER 19

U.S. speeding weapons R&D to match Soviet advances

The U.S. is stepping up its development of strategic weapons as a hedge against Soviet advances and Russian superiority in numbers of ICBMs.

Defense Secretary James R. Schlesinger says the fiscal 1975 defense budget, being prepared for submission to Congress next month, will carry increased funding for an ICBM with a larger payload, work on a mobile strategic missile, technology for placing more warheads on existing missiles and an assortment of new armaments for the bomber force.

But any new weapons developed, other Pentagon sources point out, will go into production only if the current Strategic Arms Limitation Talks fail. Many of the proposals could ultimately become bargaining chips at the SALT table.

The Air Force, the military branch primarily involved, has been conducting low-cost studies of a new intercontinental missile that could be launched from an aircraft, from tracked or rail vehicles, or from present Minuteman silos.

The new ICBM would depend upon advances in guidance technology that would make it possible to update the inertial platform after the missile had been launched. Improved navigation and guidance schemes would also be necessary.

Studies of such systems, including stellar-inertial, doppler-inertial and digital terrain-contour-matching schemes, have been funded at modest levels by the Air Force in the Advanced Ballistic Re-entry Systems program. Contractors are hoping for a boost in funds next year, with perhaps hardware demonstration flyoffs of the various technologies.

In addition to the new ICBM, the Pentagon also has been considering a Minuteman III-A or IV—an updated version of the Minute-

man III's now being deployed with improved electronics—and perhaps a new re-entry system with either more MIRVs (multiple, independently targetable re-entry vehicles) per missile or improved MIRVs with each equipped with its own guidance system for greater accuracy.

Present MIRVs are carried on a guided "space bus," which maneuvers to preselected spots in space, where each re-entry vehicle can be launched to travel to its target by ballistic trajectory.

The Air Force also has proposed putting the Minuteman missile on the 747 jetliner for air launching. Improvements in solid propellants and weight savings with new materials for casings and other structures would make it possible to develop a much smaller ICBM, more suited for such a scheme, military sources say.

Proposals for putting the Minuteman on tracked or rail vehicles on military reservations were entertained in the Pentagon, starting in 1967, but they were shelved when the U.S. decided to limit the number of land-based ICBMs to 1000 silo-based Minuteman missiles, and the SALT bargaining solidified this position.

Air Force officials indicate they want to start contracting this spring for development of a multipurpose missile for the B-1 bomber force and for ground launching. Like the canceled Scud (Subsonic Cruise Armed Decoy) missile, it would be a cruise missile. However, it would be supersonic, using ramjet technology.

The Air Force will transfer some funds from Scud to the Navy's Strategic Cruise Missile program so common technology efforts can be pressed. Both the Scud and Navy program have involved terrain-contour-matching inertial

guidance.

However, the Air Force also is proposing to spend \$2.1-million more for separate navigation and guidance technology for the advanced multipurpose missile.

SOS central processor makes debut in a mini

The first single-chip central processor to be built with silicon-on-sapphire technology—a combination that provides more speed and greater circuit density than any previous chip—is making its debut in a general-purpose, 8-bit minicomputer being built by General Automation of Anaheim, Calif.

Designated the LSI-12/16, the entire computer fits on a single 7.75-by-10-in. board along with up to 2 k of memory. The computational power is said to be equivalent to a 12-bit minicomputer because of such features as 12-bit parallel addition and special two-byte instructions that can be packed into one-byte of storage. The instruction cycle time is 2.64 μ s.

Silicon-on-sapphire technology was used for the CPU to get the entire processor on a single chip. Compared with n-channel MOS, SOS substrates introduce minimal stray capacity and reduce power requirements through lower allowable load resistances, according to Lawrence A. Goshorn, president of General Automation. This gives more speed and greater circuit density. The resulting CPU chip measures .016-by-.016 in and contains 2000 gates. Reliability is enhanced, since the entire CPU is on one chip instead of seven or eight.

The LSI-12/16 provides performance that is comparable to General Automation's SPC-12, an 8-bit mini, yet the new mini is four times smaller and costs about \$1500-\$1700 less, Goshorn reports. The LSI-12/16 can run all SPC-12 software, is compatible with the company's SPC-16 line and has two input-output capabilities—a 16-bit parallel bus and a bit-serial input-output bus.

The CPU mask is custom-designed by General Automation, and the chip fabricated by the Microelectronics Div. of Rockwell International, Anaheim, Calif. But the CPU will not be sold separately. The user can purchase a complete

computer on a single board with a 1-k RAM for \$495 in quantities over 1000. A packaged system that contains the computer board, power supply and battery back-up is also offered. The company says the LSI-12/16 will be available by the end of January.

New IR source offered for air pollution testing

A new source of stable infrared energy in the 3.4 and 4.7 μm region of the IR spectrum has been developed for air-pollution monitoring instrumentation.

The unit is intended to replace open nichrome-wire heating elements now used as IR sources in instruments for the detection of carbon monoxide at 4.7 μm and unburned hydrocarbons at 3.4 μm .

The device, developed by Chicago Miniature Lamp Works, uses a ceramic element one-half inch square and 0.040 inch thick for the infrared radiator. Mounted in an inert-gas-filled glass envelope, the ceramic element is heated by an adjacent tungsten filament to a temperature at which the ceramic produces a maximum energy peak in the 4.7- μm region, according to Conrad Rendina, director of engineering at the Chicago company.

Rendina sees several advantages of the unit over the nichrome wire device. They are:

- Spectral characteristics of the radiation are more stable because fluctuations in movement of the air that passes the open nichrome heating element can vary element temperature, and consequently its spectral output.

- Lower power is required for the Chicago Miniature device because, being in a sealed environment, minimal heat is lost to the ambient air.

- Operating life—predicted at 5000 hours—is several times higher than that of the open element, which is subject to oxidation by the air and vapors.

- The new device is safer, because no flammable vapors can touch the hot tungsten filament or the ceramic radiating element.

The device dissipates 33 W with the filament operating at 12 V, according to Rendina. Its glass envelope is about 2-1/2 inches high

by an inch in diameter. The bulb is mounted on a two-prong metal base.

CAD methods for ICs are called inadequate

Despite the fact that computer-aided design is used extensively throughout the semiconductor industry current CAD techniques for integrated circuits are wholly inadequate, according to an IBM physicist.

In a talk at the recent international Electronic Devices Meeting held in Washington, D.C., David P. Kennedy, senior physicist at IBM, East Fishkill, N.Y., observed that CAD techniques are presently more applicable for discrete circuits than for LSI. "The circuit analysis programs we are using are inadequate to characterize active semiconductor devices."

Kennedy called for the development of equivalent circuits that incorporate the physics of device operation. "We must be able to determine the impurity profiles that are going into these structures, which means that we must have a better understanding of impurity diffusion." The physicist called for circuit analysis programs that are fast and that can be used to evaluate the manufacturability of an IC, using Monte Carlo or other techniques. He called for multivariable optimization methods to convert circuit analysis programs to computer-aided circuit design programs.

With these optimization techniques, Kennedy noted, it would be possible not only to optimize IC circuit design but to optimize the manufacturing process to obtain maximum yield.

He observed that, ideally, computer-aided design of an integrated circuit device should provide an ability to predict the electrical characteristics of a structure prior to the fabrication of experimental circuits.

Liquid-crystal cell used for sonic viewing

A new opto-acoustic liquid-crystal cell permits the viewing of acoustic patterns in real time.

According to J. F. Dreyer, director of research for the Vari-Light Corp., Cincinnati, Ohio, developer of the sonic viewing technique, the system could be used eventually in nondestructive testing and medical diagnostic work.

A prototype system is comprised of a tank with water in it. In one end of the tank, Dreyer explains, is an acoustic transducer that puts sonic energy into the water, while in the opposite end there is a flat homeotropic, nematic liquid-crystal cell. All the molecules of such a crystal are normally oriented perpendicular to the face of the tank in which the cell is mounted. The crystal cell, Dreyer says, is also mounted between two cross polarizers, and the cell is sensitive to changes in polarization because of the pressures of ultrasonic waves. When light is passed from the inside of the tank out through the cell, diffraction patterns produced in the water by the ultrasonic transducer—as well as patterns of objects interposed between the transducer and the cell—can be readily seen in the cell.

These pictures are generated by sonic wave fronts that rotate the molecules of the liquid-crystal cell according to the phase direction of the waves that hit it. This action produces wave retardations that change cell polarization.

Images are obtained by control of the collimation and the direction of the sonic rays that come from the transducer by use of a liquid-lens system. Spatial filters are needed to eliminate diffraction patterns normally produced by the transducer alone.

The opto-acoustic liquid-crystal cell is to ultrasonics, Dreyer says, what a fluoroscope is to X-rays.

Frequencies used until now, Dreyer reports, have ranged from 0.12 to 17 MHz, although he points out that most of the imaging work has been done at 3 MHz.

The response speed of the cell is somewhat faster than the flicker rate of the eye, Dreyer says. Sensitivity of the cell is theoretically 10^{-14} W per centimeter², he says. Dreyer points out that light from a 100-W bulb is adequate to view images.

The distance between the transducer and the liquid-crystal cell may vary from a few inches up to four or five feet.

**This member
of our family
is still the
thriftiest ASR
terminal
around.**

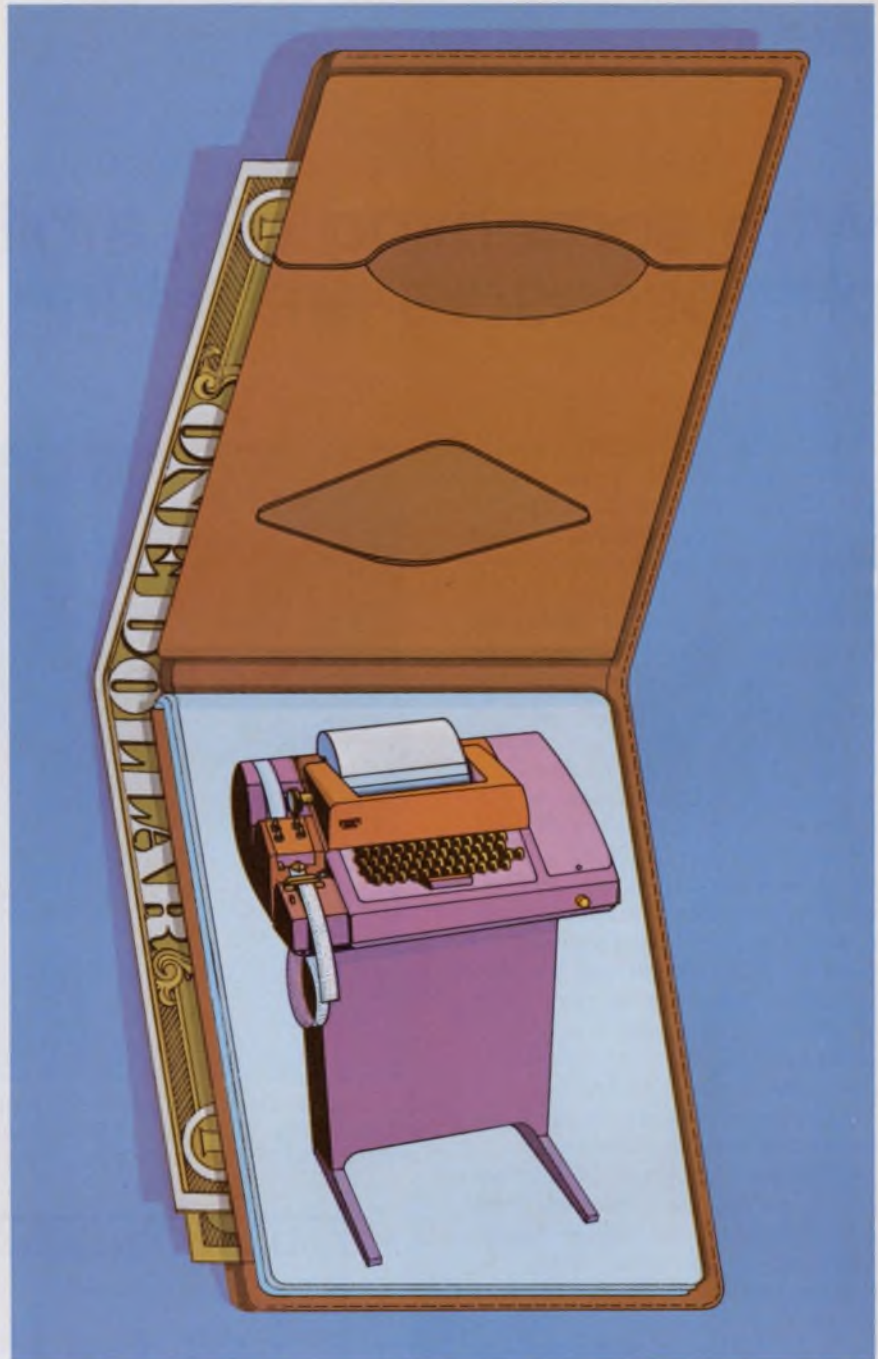

Teletype is a trademark registered in the United States Patent Office.

Dollar for dollar, the Teletype® model 33 is the least expensive, most reliable data terminal in its class. Because once you see how well it performs, you won't believe its price.

That's one reason why the model 33 is the most popular terminal in the industry. But it's hardly the only reason.

The model 33 is designed and built for extremely reliable operation at 100 wpm. And since

it operates on the eight-level ASCII code, it speaks the language most computers understand. Both mini-computers and maxi-computers. Which makes compatibility another reason behind its popularity.

Then there are some reasons you can't see. But they're there just the same. Like complete technical sales and service back-up to help you with installation and maintenance.

Available in three basic configurations, the model 33 is a lot of machine. At a very small price.

It takes more than manufacturing facilities to build the machines Teletype Corporation offers. It also takes commitment. From people who think service is as important as sales. In terminals for message communications and computers.

That's why we invented a new name for who we are and what we make. The computerations people.



The computerations people.

For more information about any Teletype product, write or call: **TERMINAL CENTRAL:** Teletype Corporation, Dept. 89P, 5555 Touhy Avenue, Skokie, Illinois 60076. Phone 312/982-2500

INFORMATION RETRIEVAL NUMBER 20

With something old, a bit of new, photosensors are taking off

Two years ago vacuum phototubes—originally developed in the late 1920s—were written off by manufacturers and designers as all but dead. New solid-state devices were crowding them out. Today the tubes are reported selling at their highest rate in history.

This unusual development is but one offshoot of a boom that is sweeping the optoelectronics industry. Vacuum phototubes are making a strong comeback in pollution-monitoring equipment and medical instrumentation because of their superior linearity of response, long-term stability and relative freedom from adverse temperature effects. Spurred by this demand, at least one manufacturer has brought out a new line of low-voltage tubes that is compatible with solid-state circuitry.

Other developments in optoelectronics include the following:

- Silicon technology is saturating the photosensor field, with devices ranging from silicon photodiodes and phototransistors to complex linear and planar imaging arrays.

- New twists in packaging are combining phototransistors, photodiodes and Darlington or op amps in TO cans and hybrid packages. The net result is higher gain sensitivity and greater power output. Sensors are also being integrated with other types of circuits, such as Schmitt triggers, amplifiers and oscillators, to produce light-activated switches and devices that provide an output that varies in frequency with the level of incident light. Some of the hybrid outputs are TTL-compatible.



Operational amplifiers and video output amplifiers are combined, along with photosensors, in these hybrid packages by Meret. Designed for use in optical communications systems, they provide high sensitivity and power output.

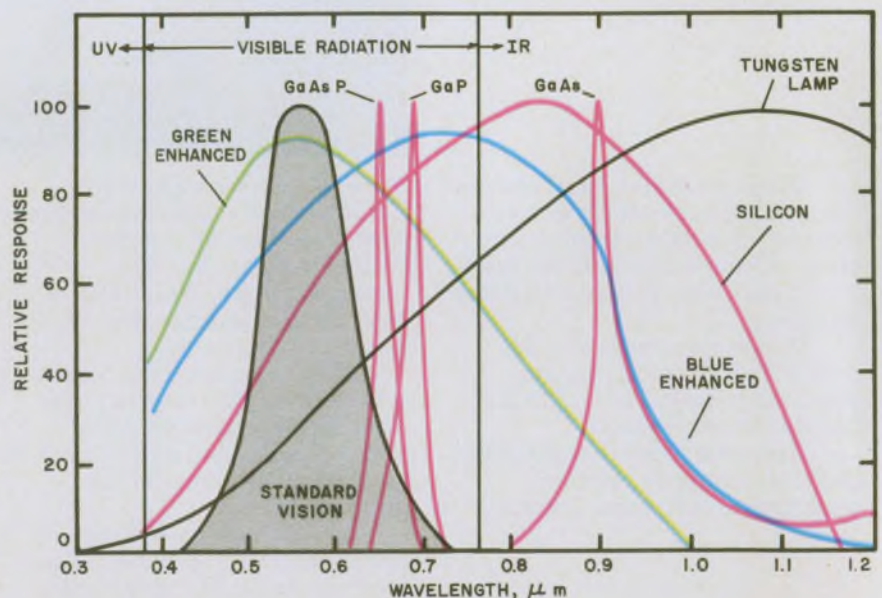

1. The spectral response of silicon has been modified by several manufacturers to improve shorter-wavelength sensitivity. One of Vactec's cells has the blue-enhanced curve while one of Sensor Technology's has the green.

Jim McDermott
Eastern Editor

■ A new generation of bulk photoconductive devices—silicon photoconductive sensors—has been developed. Providing high sensitivity, and low noise, they are particularly suited for low-frequency operation in analytical instrumentation.

■ Manufacturers are modifying the inherent red and infrared spectral response of silicon sensors and tailoring photovoltaic cells to provide high sensitivity in the green and blue regions of the optical spectrum.

■ Photovoltaic solar cells, adapted from space technology, are being used in panel arrays to power monitoring instrumentation, communications equipment and navigation equipment at remote land and sea installations.

■ While p-i-n silicon diodes are challenging photomultipliers in some low-level, optical-signal applications, photomultiplier manufacturers are improving the performance of their products. A new photomultiplier design by DuMont reduces dark current by a factor of 10. Other photomultipliers, using gallium-arsenide compounds for photocathodes or secondary emitters, are demonstrating substantially improved sensitivity over a spectral bandwidth from about 0.2 to 0.93 μm . Previously this was unattainable with other cathode materials.

■ Linear arrays are being incorporated into a new kind of solid-state photomultiplier tube that competes directly with the most sensitive photomultipliers in such applications as single photon counting.

A comeback for tubes

At Cetron Electronic Corp., Geneva, Ill., one of the country's oldest and largest manufacturers of vacuum photosensors, Thomas R. Sweet, vice president of marketing says: "We're selling more vacuum photodiodes today than we ever have."

Cetron's chief of phototube engineering, Frank Putz, explains:

"There are a number of reasons for choosing vacuum photodiodes over solid-state units. First, the spectral wavelength at which the tubes will be used can be optimized by selecting the right cathode material. With solid-state cells, the

optimum response is not always in the region desired.

"Second, the interception area of the light can be very small in a silicon sensor. Some of our tubes, on the other hand, have a usable cathode area an inch square. This makes it easy to work with a light slit which may be a half-inch long and 20 or 40 thousandths of an inch wide.

"For the silicon photodiodes, it's necessary to reduce the slit size or

to add an optical element to image the slit on the silicon diode's sensitive area. This complicates the system and increases its cost."

Samuel Gray, a consulting engineer in photosensitive devices at Cetron, sees other advantages in the use of vacuum diodes. "An important feature of these tubes is their extreme linearity of response," he says. "They will remain linear over many more decades of light than the solid-state de-

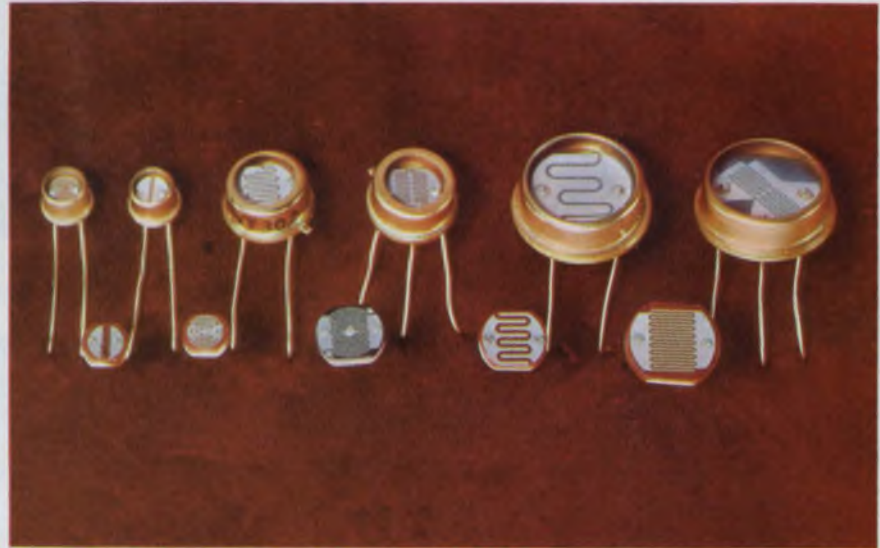

Cadmium sulfide and cadmium selenide photoconductive cells provide the highest sensitivity per unit cost of any photosensor. Some types of these cells, like these by Vactec, are more sensitive than photomultiplier tubes.

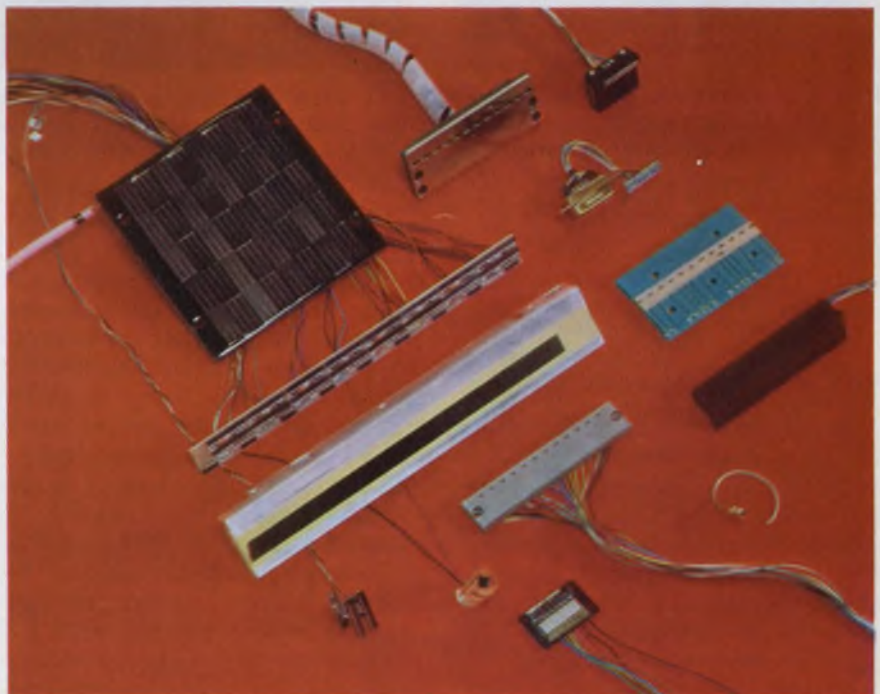

Simple and complex photosensing devices and arrays, by Sensor Technology, are used for optical decoders and for computer punched card and punched tape readers. Some devices have hybrid amplifiers for TTL interfacing.

vices. In fact, tubes are being used as optical-measurement standards."

Another big advantage is the phototube's long-term stability, Gray points out. Where measurements must be made over extended periods, as in a pollution monitor, solid-state cells have a tendency to drift and to need zeroing more often. Their leakage, or dark, current with respect to temperature is orders of magnitude higher than that of the tubes.

Because the operating voltages of many vacuum phototubes are too high to be compatible with solid-state circuits, the Tung-Sol Div. of Wagner Electric, Livingston, N.J., has developed a line of tubes that operates at about 9 V. Dark currents are extremely low, ranging from 2 to 20 pA.

"The low-voltage characteristics make our tubes ideal for mating with solid-state operational ampli-



Panels of solar cells, by Solar Power, will provide electricity for horns and lights on this offshore platform.

fiers," says Richard DuBois, manager of Tung-Sol's design and development.

Rise of second-sourcing

In silicon technology, problems in fabricating diffused junction and planar photodiodes and phototransistors have been pretty well solved. Device design and production has matured enough so that, like computer ICs, these devices are being second-sourced by a half dozen or more manufacturers.

Within the last two and a half years the silicon photosensor field has expanded rapidly, with a number of firms—Clairex, Fairchild,

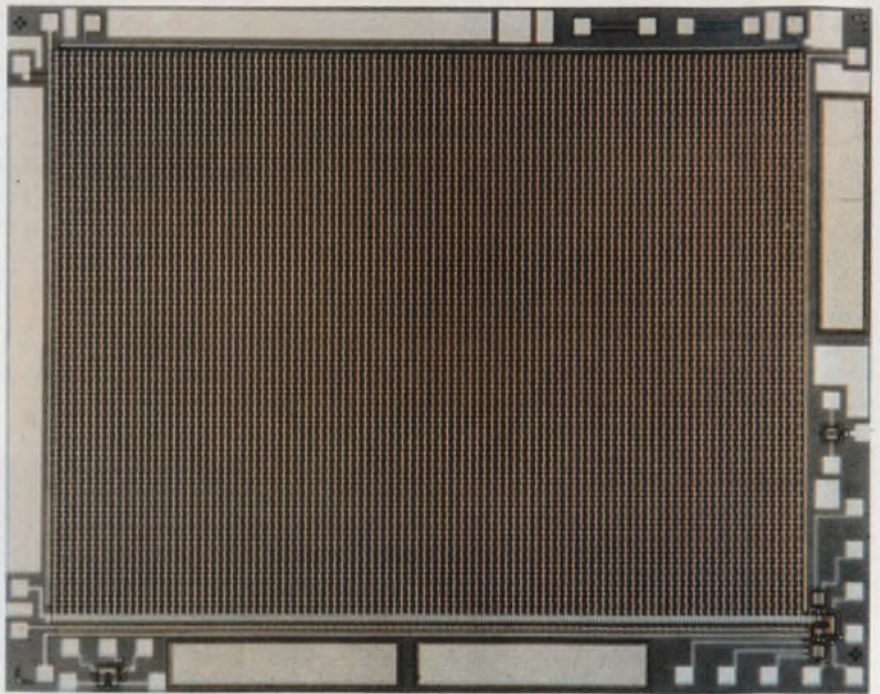

This 100 × 100-element self-scanned charge-coupled array, by Fairchild, has an image aspect ratio of 4 × 3. The charge coupling uses buried channels.



This linear 1024-element self-scanning array, by Reticon, uses gated diodes. The diodes are sampled by shift registers that open into common drains. Linear arrays like these have been used in line-scan and area-scan cameras.

General Electric, Motorola, Optron, Spectronics, Quantum Sensing and Texas Instruments—now second-sourcing one another on a broad line of low-cost photodiodes and phototransistors. A major factor in the widespread use of these devices is the inherent spectral response of silicon, which is in the red and near-infrared, peaking at about 0.8 μm (Fig. 1).

Because of their unique response, silicon sensors are admirably suited for use with the companion technology of visible gallium-arsenide and gallium-arsenide-phosphide LEDs, as well as invisible IR gallium-arsenide LEDs and lasers. Also, much of the spec-

tral output of tungsten-filament lamps, as well as that of neon bulbs, falls within the basic silicon response curves.

Packaging improves performance

As for packaging, by combining a silicon planar phototransistor and a Darlington amplifier in the same plastic container, manufacturers have boosted the sensitivity and power outputs of the sensors to levels high enough for direct operation of small relays or thyristors.

Sensitivities achieved with present photosensor-Darlington devices range to 10 times or more that of the phototransistor itself.

VACTEC optoelectronics



New High Speed Silicon Photovoltaic Cells

Ten times faster with excellent linearity, high temperature stability, and high low-light sensitivity.

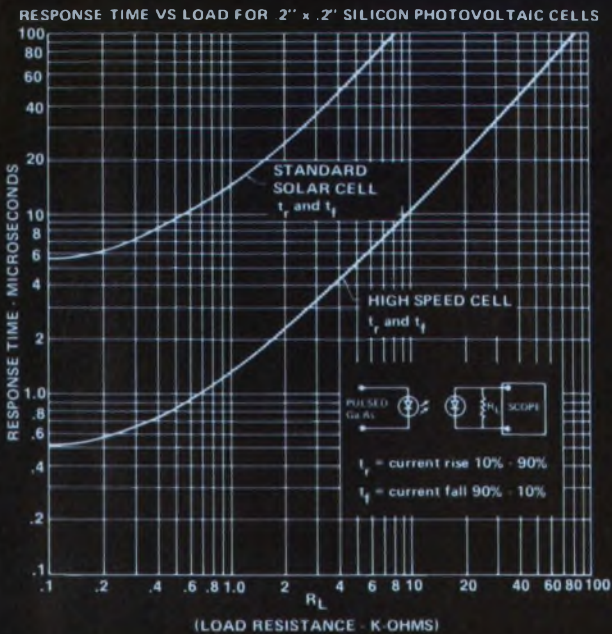

THE INDUSTRY'S BROADEST LINE:

- A. Standard and high speed silicon photovoltaic cells.
- B. Phototransistor and photodarlingtons.
- C. Opto-Couplers (three types).
 LED/Photoconductor
 LED/Phototransistor
 Lamp/Photoconductor
- D. Selenium photovoltaic cells.
- E. C-MOS and Bi-polar custom I-C's.
- F. CdS and CdSe Photoconductors.

Write today for more details.



Vactec, Inc.
 2423 Northline Industrial Blvd.
 Maryland Heights, Mo. 63043
 Phone (314) 872-8300

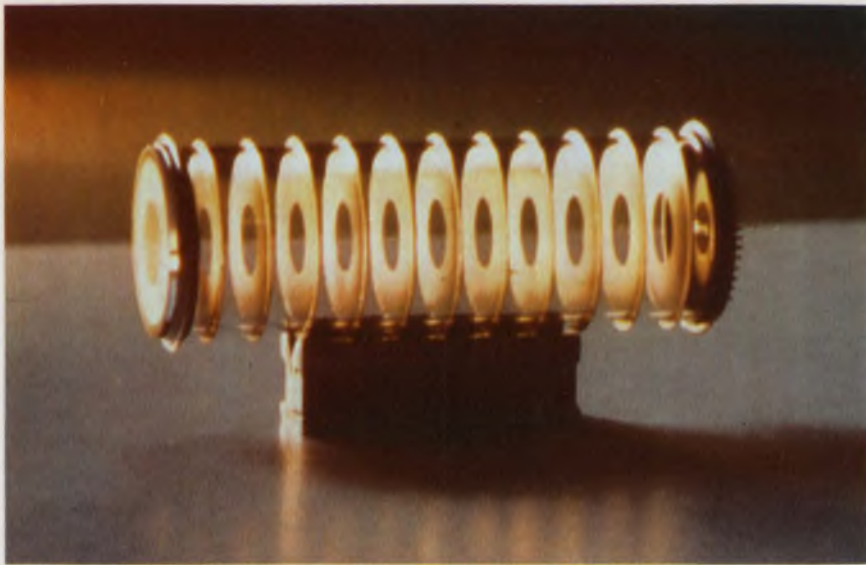

A new supersensitive solid-state photomultiplier, by Electronic Vision Corp. focuses electrons from a photocathode onto a silicon array. Each of the electrons striking the silicon is multiplied by several thousand.

Maximum collector currents reach 150 to 250 mA, though normal operating current is but a fraction of this.

However, the penalty for this improvement in performance is a substantial increase in the rise time—20 or 30 times that of the transistor alone, or on the order of 100 μ s or more.

Today new large-area, high-performance p-i-n photodiodes are being packaged by a number of companies together with hybrid op amps. The frequency response of these units is in the tens of megahertz, making them suitable for optical communication receivers, point-of-sale registers and scientific and environmental analysis instrumentation.

An example of the new packaging is a combined p-i-n detector and op amp with an integral feedback resistor. It is being offered in a 10-lead, TO-5 can by Control Products Div. of Bell & Howell, Bridgeport, Conn.

"The small size and low operating power permit its use in portable, battery-operated equipment," says Ian Isdale, Control Products' microcircuits sales manager. "The shielded construction provides exceptionally low noise and freedom from electromagnetic and electrostatic pickup as well as thermal stability."

Probably the widest variety of packages produced by a single manufacturer are those by Meret,

Inc., Santa Monica, Calif.—a line of integrated hybrid assemblies for optical communications (see photo).

"We use p-i-n detectors in our modules," says David Medved, Meret's technical director, "plus low-noise operational preamps, followed by video amplifiers, to obtain the highest gain and widest bandwidth with the lowest noise. For example, an output of 300 mV/ μ W can be obtained with our DDV235, with a bandwidth of 100 kHz to 10 MHz. Substantially higher outputs can be obtained with reduced bandwidths."

The most complicated Meret unit is a five-channel optical receiver with a five-element p-i-n diode sensor array, plus preamplifiers and video amplifiers.

Not all of the photosensor packages are sensor-amplifier combinations. Monolithic devices containing a photosensor, level-sensing circuits and an output stage that provides a logic output when the light level reaches a preset threshold have been fabricated in an eight-lead TO-5 can by Ferranti, Plainview, N.Y., and in a TO-18 by Integrated Photomatrix, Mountainside, N.J. The latter company also produces a unique light-to-frequency converter on a chip mounted in a TO-18 device. A planar photovoltaic sensor plus an amplifier and triggering circuits provide, from a 27-V supply, an output of 20-V, 1- μ s pulses. Pulse repetition



The flared input end of this channel multiplier, by Galileo Electro-optics, minimizes the device size.



High sensitivity is characteristic of these Westinghouse camera tubes, and low-light level devices.

rates range from less than 10 Hz in darkness to greater than 100 kHz maximum for a light input of 30 mW/cm².

New device has high sensitivity

Where high sensitivity is desired over a spectrum ranging from the vacuum ultraviolet, at about 0.25 μ m, to the near-infrared, beyond 1.0 μ m, Sanders Associates, Inc., Nashua, N.H., has developed a unique solution: a bulk silicon photoconductive sensor.

"The frequency response of our silicon photoconductor (SPC) devices is substantially below that of photodiodes," says Robert Murphy, manager of detector products. "Typical time constants are in the range of 3 to 7 μ s.

"But the sensitivity is high—about an order of magnitude greater than that of a photodiode. And for low-frequency operation,



ONE KEY to your rf measurement problems

One key unlocks the full potential of the new GR 2260 Automatic Network Analyzer — a fully automatic system for detailed measurements of transmission, reflection, magnitude, phase, and group delay from 200 kHz to 500 MHz.

One key for rapid go/no-go production testing. The 2260 eliminates the need for multiple test stations by producing simultaneous measurements of multiple rf parameters against individually tailored limits — all at the push of a button and in little more time than it takes to connect the device.

One key for high-precision R & D work. The 2260 provides real-time displays of interactive rf parameters for visual interpretation of design changes and allows modification of test conditions in seconds — all by ultra-simple keyboard commands.

The key —



General Radio

300 Baker Ave., Concord, MA 01742



there's nothing can touch this device. We've tested the silicon photoconductor devices against p-i-n diodes in a number of applications, and at low frequencies the SPC devices are much better.

"Another advantage of SPC units is that they can be cooled. For a 2×2 -mm device cooled to -40 F—the temperature of a thermoelectric cooler—the responsiveness in terms of volts per watt increases from 10^6 at 80 F to 4×10^7 at -40 F.

Silicon response tailored

The poor inherent response of silicon to radiation in the green and blue portions of the spectrum has almost prohibited its use in devices operating in the visual range—illumination meters, camera exposure meters and colorimeters. But advances in fabrication technology by a number of manufacturers, including Ferranti, Sharp, Sensor Technology, Vactec and United Detector Technology, have allowed the production of photovoltaic diodes with good sensitivity in the green and blue.

For example, Sensor Technology, Inc., Van Nuys, Calif., has a silicon photovoltaic cell that peaks at $0.555 \mu\text{m}$ in the green, as well as others that have an enhanced response at $0.4 \mu\text{m}$ in the blue.

Harold Weinstein, technical director at Sensor Technology, explains how the company tailors the cell's spectral response.

"For our 555 green cell," he says, "we modify the band structure in the region in the silicon chip where we don't want red response. But in the green region, where we want absorption to take place, we leave the band structure unmodified.

"For the blue cell, the red response is untouched but the shorter wavelength sensitivity is enhanced. Some five steps are needed to accomplish this.

Solar cells charge batteries

The recent impact of the energy crisis has focused attention on new sources of energy. One important photosensitive source for electronics is the electrical energy from the sun produced by solar cells. At present six suppliers of solar-cell panels are producing units for one

principal application—charging the batteries for electronic signaling or navigation equipment at remote installations. The suppliers are International Rectifier, El Segundo, Calif.; Centralab Semiconductor, El Monte, Calif.; Spectrolab, Sylmar, Calif.; Solar Systems, Skokie, Ill.; Sharp, New York City, and Solar Power Corp., Braintree, Mass.

While the cost of these solar installations is high today, the economic tradeoffs in supplying power to remote sites make solar the least expensive for up to about 120 Wh a day. Above that, according to George Ewald, manager of marketing services at Centralab, propane-fired thermoelectric plants are more cost-effective.

Silicon solar cells have been used for years as a source of energy for spacecraft. For earthbound applications, Sharp began selling solar battery-charging modules in Japan in 1962 at about \$200 per peak watt. The peak watt is the standard maximum output that the sun produces on earth. This sun power is defined as 100 mW/cm^2 of solar intensity at a 25-C ambient at sea level.

Today the cost of solar panels ranges from about \$20 to \$70 a peak watt, according to Elliot Berman, president of Solar Power Corp.

The ultimate sensitivity of photomultipliers depends on the value of the tube's dark current, and the DuMont Electron Tubes Div., Clifton, N.J., has reduced the dark current by an order of magnitude by use of S1 and S20 cathodes—suitable for Raman spectroscopy and pollution-monitoring instrumentation.

New approach used

"We use a different approach, which we call a limited-access cathode," says Ronald Goehner, DuMont's manager of photosensitive devices. "We take an inch-and-a-quarter-diameter photomultiplier and selectively deposit the photocathode only over a half-inch-diameter circle in the center of the tube's face.

"This now limits thermionic emission to the half-inch circle. Dark current is reduced not only by the ratio of the cathode diameters of one-and-one-quarter to

one-half inch, but also by the additional volume difference along around the tube periphery.

"With this technique, we reduce dark current by almost a factor of 10, where predictions had indicated only a factor of 6."

The newest materials being applied in photomultipliers to upgrade their performance are the III-V compounds, according to Frank Keefe, manager of market planning for electro-optic products at RCA Electronic Components, Lancaster, Pa.

"Gallium phosphide or gallium arsenide are being used as photocathodes or as secondary emitters," he says. "These materials have three distinct advantages over conventional phototube surfaces.

"One is extremely high cathode sensitivity. The second is a broad spectral response, ranging from about $0.2 \mu\text{m}$ in the ultraviolet to over 0.9 in the near-infrared.

"The third advantage accrues when you use these materials as a secondary-emitter, or dynode, surface. It provides very high gain stages, so that the tube can be simplified by using fewer stages."

A wristwatch camera?

New products with the new optoelectronics? The "Dick Tracy" wristwatch camera—once a comic strip fantasy—may not be too far off, according to guarded reports from manufacturers like General Electric, Fairchild, RCA and Texas Instruments. These firms, working on their own competitive versions of the miniature silicon self-scanning imaging arrays, already show promise of reducing the size of a vidicon TV camera to that of a pack of cigarettes.

RCA's Keefe reports in Lancaster: "We have a major development program under way to design, develop and produce a CCD camera with a performance equivalent to that of a two-thirds-inch vidicon. We expect customer sampling in 1974."

Michael Tompsett, supervisor of the charge-coupled image sensor group at Bell Telephone Laboratories, Murray Hill, N.J., sees the basic approach used by RCA, Texas Instruments and Fairchild as most attractive for the 500×500 CCD broadcast-TV arrays. ■■

All computers should be this simple.



For a long time it's been possible to make powerful computers small. What hasn't been so simple is to take all that computer power and make it easy to use. That's what the Uncomputers are all about.

Imagine all the horsepower of a room full of second generation computer hardware... simultaneous equations, hundreds of registers, symbolic logic, thousands of program steps... all of it together in a package that fits on the corner of a desk. And designed even with peripherals so that anybody who understands algebra or trigonometry or even simple arithmetic can make it work with just a little common sense.

Vest Pocket programs.
We're offering the

Uncomputers with a library of hundreds of programs covering engineering, science, statistics and business just so you don't have to re-invent the wheel. But every Uncomputer is a self-contained system, capable of creating its own programs on little magnetic cards the size of your driver's license.

Powerful isn't expensive.
The Uncomputers are

for sale of course, and are backed by service with over 1500 technicians in 365 cities in the U.S.A. and Canada. They're for lease too. Starting at about \$20-a-week.

Proof is in the using.

Nobody has ever let you try a computer before, without making you buy it first. With all the complexity it just didn't make sense. The Uncomputers herald a new era, bringing "try it before you buy it" to the computer industry. In any of our 365 cities in the U.S.A. and Canada we'll let you use an Uncomputer for a week, free. And with no obligation, of course. That's not a lot of time. But with a computer this simple, it's enough. Just return the coupon or call your local man from Monroe.

- Gentlemen, I'm interested. Call for an appointment.
- Please send complete information by return mail.

Name _____
Business Name _____
Address _____ Business Phone _____
City _____ State _____ Zip _____

ED 12
Monroe.
The Calculator
Company.

Orange, New Jersey 07051

NEWS APPRAISAL

Japan's electronics: Industry in transition

From a "cheap goods" manufacturer a mere 20 years ago, Japan has emerged as a powerful manufacturer of a wide variety of high-quality goods for her own population and for the rest of the world. Though in some technologies—like LSI—she is behind nations like the United States, she is second only to the U.S. in production of electronics. Her electronics output in 1972 was worth almost 3.8 trillion yen (about \$14.6-billion at the recent conversion rate of 260 yen per dollar), or almost 5% of her Gross National Product of 78 trillion yen (\$299-billion). U.S. electronics output, by comparison, was about \$28-billion, about 2.2% of the U.S. GNP of \$1.26-trillion.

Because she was forced to refrain from military buildup after World War II, Japan concentrated her electronics industry on consumer products—with telling effect.

She has become a dominant supplier of radios, TV, open-reel and cassette recorders, and high-fidelity and stereo components.

But the concentration is changing. Already there is a heavy pene-

tration of color TV in Japan, with more than 75% of Japanese families owning receivers. And color TV sales—713 billion yen in 1972—represented the largest portion (46.4%) of the total consumer



The Japan Electronics Show officially opens with traditional ribbon cutting by Masaharu Matsushita, president of Matsushita Electric Industrial Co., while Masajiro Oikawa, president of Oikawa Kogeisho Co., lends a hand.

George Rostky
Editor-in-Chief

FUJITSU quality on sale in By-pass Capacitors for High-speed TTL and ECL.

HIGH-SPEED SPACE-SAVING LOW-COST BY-PASS CAPACITORS

FUJITSU Fujitsu's newly developed by-pass capacitors for high speed logical circuits enable TTL and ECL printed-circuit-boards to eliminate additional ceramic/film capacitors and result in high density mounting.

Two types are available.

(1) Aluminum solid electrolytic capacitor. . . . High speed pulse. (TTL)

(2) Tantalum solid electrolytic capacitor. . . . Ultra high speed pulse. (ECL)

○ These solid electrolytic capacitors have been developed as by-pass capacitors to by-pass noises generated in power supply by logical elements during rise and fall of high speed pulse in the circuit.

○ High density mounting in printed circuit board.

○ Low Equivalent-Series-Resistance (E.S.R.) against rise and fall of high speed pulse.

○ Low inductance.

○ Small in size yet large in static capacity.

○ Lead pitch the same as that of terminals for Dual-In-Line package IC.

○ Widely utilized in Fujitsu FACOM computers with excellent results and outstanding reliability.

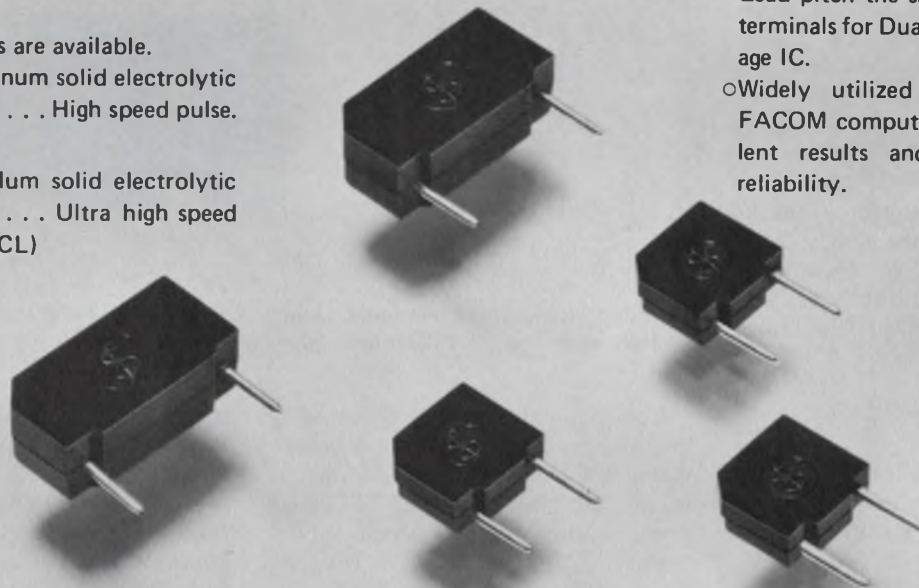

RATINGS AND SPECIFICATIONS:

| Capacitors | Static Capacity | Static Capacity Tolerance | Rated Voltage | Body Dimensions (Terminal pitch) | Operating Temp. Range | Permissible R.H. | Dissipation Factor (Tan δ) | Leakage Current | E.S.R. | Inductance |
|-----------------------------|-----------------|---------------------------|---------------|----------------------------------|-----------------------|------------------|------------------------------------|-----------------|-----------------------------|-------------------------|
| High Speed (Aluminum) | 1.0 μ F | -20% +not specified | 16V DC | 12.5 x 6.2 x 4.4 mm (0.40 inch) | -55°C | 95% Max. | 8% Max. at 120Hz. | 3 μ A Max. | 1.5 Ω Max. at 10MHz. | Typical 10nH at 200MHz. |
| Ultra High Speed (Tantalum) | 3.3 μ F | | 10V DC | 7.0 x 6.35 x 2.54mm (0.20 inch) | +85°C | | 10% Max. at 120Hz. | 1 μ A Max. | 0.5 Ω Max. at 10MHz. | Typical 5nH at 200MHz. |

FUJITSU LIMITED
Communications and Electronics
Marunouchi, Tokyo, Japan

For further information, please contact:
Head Office: 6-1, Marunouchi 2-chome, Chiyoda-ku, Tokyo 100, Japan Telex: J22833
New York Office: 680 Fifth Avenue, New York, N.Y. 10019, U.S.A. Phone: (212) 265-5360
Fujitsu California Inc.: 1135 East Janis Street, Carson, California 90746, U.S.A. Phone: (213) 636-0858, (213) 537-8930

MAIN PRODUCTS □ Telephone Exchange Equipment □ Carrier Transmission Equipment □ Radio Communication Equipment □ Space Electronics Systems □ Electronic Computers & Peripheral Equipment (FACOM) □ Telegraph & Data Communication Equipment □ Remote Control & Telemetry Equipment □ Electronic Components

electronics output of 1.54 trillion yen—which, in turn, was 40.4% of the total electronics output.

Further, liberalization of import restrictions (and their planned complete removal in 1975), coupled with currency revaluations and import restrictions in other countries, are forcing the Japanese to shift their emphasis to industrial electronics, which in 1972 had reached a level of 1.24 billion yen—32% of the total electronics output.

Show lacked the new

One would have expected to see this new emphasis at the 1973 Japan Electronics Show in Osaka. It was not apparent. Further, if visitors expected many dramatic new products at the Oct. 1-7 show, they would have been disappointed—just as they would have been at Wescon in September, the Paris Components Show in April and the IEEE Show in March.

The 220 Japanese exhibitors and 110 exhibitors from 11 other countries showed rather little that would hurry an engineer back to his drawings. There were a few innovations, mainly in cosmetics, among the 30 exhibitors of consumer electronics, but little from others.

Getting the picture

The Japan Electronics Show was not completely bare of new developments, however. The most dramatic may have been the MV 100 TV camera from TDK-Fairchild. Its camera "tube" includes a 100-by-100-element, charge-coupled device, the CCD 201, with video preamplifier, compensation circuit and two-phase clock on the chip—all housed in a 24-pin DIP with an optical glass window. The chip's power consumption is 50 mW typical and the camera is sensitive enough to provide respectable pictures from light levels ranging from 5 foot-candles to full daylight.

Cameras, in fact, were rather popular, along with other light-sensitive devices. One of the more dramatic was a small color camera from Toshiba. Intended for home use, it has 250-line resolution in the center, measures 320 by 165 by 90 mm and, without lens, weighs 2.5 kg.



All solid state, this Metronix supply delivers up to 500 V and 500 mA.

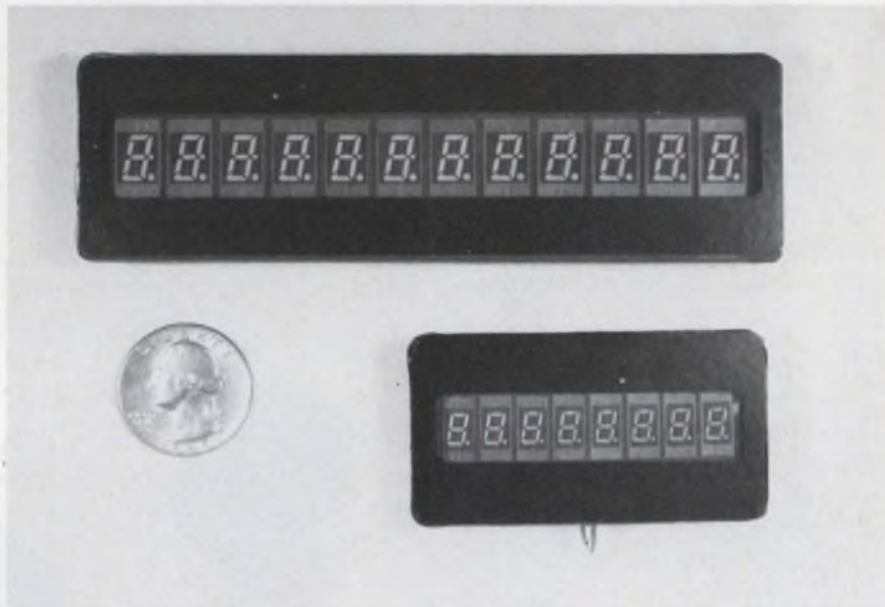

Multidigit fluorescent readouts from Ise Electronics lend themselves to easy multiplexing and provide a soft green glow.

Professional video equipment dominated the exhibit of Hamamatsu TV. The company showed a range of closed-circuit TV systems, mainly for industrial applications, along with an array of photosensors and camera tubes.

Another important development was a miniature TV camera tube, the Saticon, from Hitachi. The tube, jointly developed with the Japan Broadcasting Corp., has a maximum diameter of 20 mm, a length of 103 mm and a weight of 22 g. It's about 30% smaller and lighter than competing Plumbicons. It uses magnetic deflection and focus and can provide 750-line-per-

To prepare this appraisal, editor-in-chief George Rostky spent more than two weeks touring Japan, including visits to the Japan Electronics Show and scores of engineers and executives at more than 25 companies.

inch resolution. Dark current is a mere 1 nA, and the latent image doesn't exceed 4%.

Not quite as dramatic, and certainly not as crowd gathering, was a power-semiconductor curve tracer from Kokuyo Electronics. The instrument costs 1.65 million yen, or about \$6350 at the recent exchange rate. It can deliver 200- μ s pulses to 400 A at 20 V and 40 A at 200 V. It displays the E-I curves on a 100-by-100-mm CRT screen.

While the Kokuyo curve tracer is useful for measuring power devices, another show instrument delivers power. It's the S-6207 power supply from Metronix. The all-solid-state supply delivers 0 to 500 V at 0 to 500 mA in a constant-voltage or constant-current mode, with positive or negative terminal grounded or floating as much as 500 V off ground.

The convection-cooled instrument is short-circuit-proof and offers 15-mV line regulation, 20-mV load regulation (zero to full

Frame them any old way

Or any new way.

Then sit back and watch your Ise display electronics get your ideas across. Beautifully.

In an eye-easy fluorescent green glow.

At the same time, they're low on voltage and current drain.

High on stability.

Pick the readouts that offer more of everything, including variety, for a whole host of digital display ideas.

They're a difference you can see.

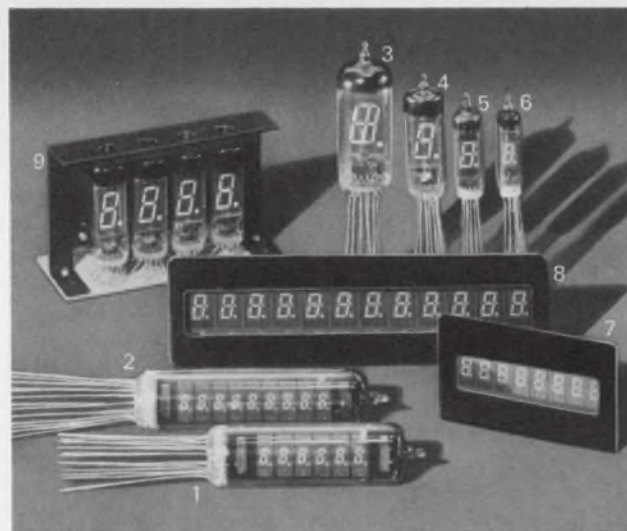

- 1 DP60A
- 2 DP90A
- 3 DG19E
- 4 DG12H
- 5 DG10F1
- 6 DG8F
- 7 DP 89A
- 8 DP127F
- 9 DMCL12H NEW

Display module w/counter & latch
 • Fluorescent green glow.
 • 12-pin connector
 • Three performance perfect models
 • Custom ROM programming with other than BCD and seven-segment output.

International Div.

ISE INTERNATIONAL CORP.

No.2-7-7, Higashi-Shinbashi, Minato-ku, Tokyo, Japan
 Tel: 433-6616~9 Telex: J26546



The Brighter Side of Electronics

ISE ELECTRONICS CORP.

P.O. Box 46 Ise-city, Mie Pref., Japan

Representative: Los Angeles, Paris, Munich, Amsterdam, Stockholm, Vienna, Milan, Bombay, Hong Kong, Taipei.

INFORMATION RETRIEVAL NUMBER 26



Dual-gap disc-drive head pieces from TDK Electronics have gap widths of only 125 micrometers.



An engineer at Matsushita tests some of the company's new, monolithic Hall-effect ICs.

load) and 20-mV pk-pk ripple and noise. Complete with voltmeter and ammeter, the 22-kg unit costs 160,000 yen.

The broadest test-equipment line, the National line, was shown by Matsushita Communication Industrial, Electronic Measurement Dept. The line includes scopes with bandwidth from 1.5 MHz (for the VP-311C) to 200 MHz (VP-556A), scope plug-ins, counters, digital multimeters, signal generators and oscillators, distortion meters and vacuum-tube voltmeters.

Readouts drew viewers

As a class, the most popular product was the liquid-crystal display, which is relatively new to Japan. At least 10 companies showed LX displays or products using them. A prominent example was a hand-held calculator using a liquid-crystal display and offering 100-hour life from a single AA cell. It was featured by Sharp.

Others showing LX displays, mainly transmissive, dynamic-scattering types, included Toshiba, Oki Electric, Kyodo Electronic Labs, Asahi Glass, Nissei Electric, Taiyo Yuden, Matsushita Electric Industrial, Hitachi and, of course, RCA, Somerville, N.J.

While the greatest interest was in liquid-crystal displays, and the popularity of single-digit, gas-discharge displays seemed to be waning, interest remained high in light-emitting diodes and LED displays. Most were gallium arsenide phosphide, but several manufacturers showed gallium-phosphide types, including green and yellow emitters.

As for fluorescent readouts, which have been dominant in Japan

for many years, predictions of their demise appear very premature. Ise Electronics, pioneer of the Itron fluorescent display, is doubling its capacity to 4-million digits a month. The increased capacity will include 8, 10 and 12-digit readouts with metal backs to reduce susceptibility to static electricity. They are used in a multiplexed mode to cut the number of connections. They can be plugged into a pair of 14-pin DIP sockets and, in quantities of 10,000, they cost \$1.05 to \$1.10 a digit, FOB Japan.

IC drivers for these displays were shown by Kyodo Electronic Labs, along with a wide line of other ICs, mainly digital.

Like other manufacturers, Ise doesn't want to bank on a single type of product. The company is doing some fascinating work in liquid crystals and low-voltage electroluminescent displays.

For the liquid-crystal display, a field-effect type, Ise uses an interdigitated structure for the electrodes. Instead of being a solid rectangle, each segment in a seven-segment display is composed of fine horizontal lines, about 20 to 40 μm wide and 20 to 40 μm apart. They are spaced about 6 to 12 μm from the rear glass, whose front surface is coated with a transparent tin-oxide film with vertical fine lines.

This structure, Ise says, increases the viewing angle to 100 degrees from the usual 30 or 40 and eliminates the rainbow effect that's common in other field-effect liquid crystals.

While Ise hopes to have its LX displays in production by next April, its work in electroluminescence is much less advanced.

EL readouts have traditionally suffered from a requirement for high voltage (upwards of 100 V) and high frequency (from 60 Hz to 5 kHz), coupled with relatively low brightness. But they have the advantages, in multidigit structures, of low cost and low power consumption.

Ise hopes to improve brightness, cut voltage and operate with dc. A phosphor dot with an area of 5 mm^2 emits a bright yellow when driven by 20 V dc at 8 mA. The current drain, Ise says, can be cut to 3 mA, but life still remains a problem—a tough one that the company feels can be licked in less than two years. The phosphor now used is a zinc sulfide doped with manganese and copper.

Components old and new

The emphasis throughout the show was on consumer electronics, but it was most apparent in the components exhibits. The newer stress was on keyboards for portable and desk-top calculators. But even older components were displayed, often revised and improved.

For example, Alps Electric, Toko and Mitsumi Electric all showed older miniature tuning capacitors for portable radios. In these the plates are coated with polyethylene, so they can be much closer than they would be in a conventional air-variable, cutting volume by a factor of seven.

But Mitsumi showed a new version of its Polyvaricon, with plates coated with a 10- μ thickness of a proprietary plastic whose composition the company does not disclose. The new tuner, still smaller, is suitable for industrial, rather than consumer, temperature ranges and is priced "slightly higher" than the older version.

Capacitors everywhere

There were, of course, plenty of capacitors and resistors at the show. Matsuo Electric showed a line of polyesters and polycarbonates and a line of wet-slug and solid tantalums. The highlight was a new molded tantalum chip that's suitable for mounting on a PC board as well as a ceramic substrate.

Alps showed rather few capacitors, except for air and air-poly-

GOING TO EXTREMES TO INSURE QUALITY

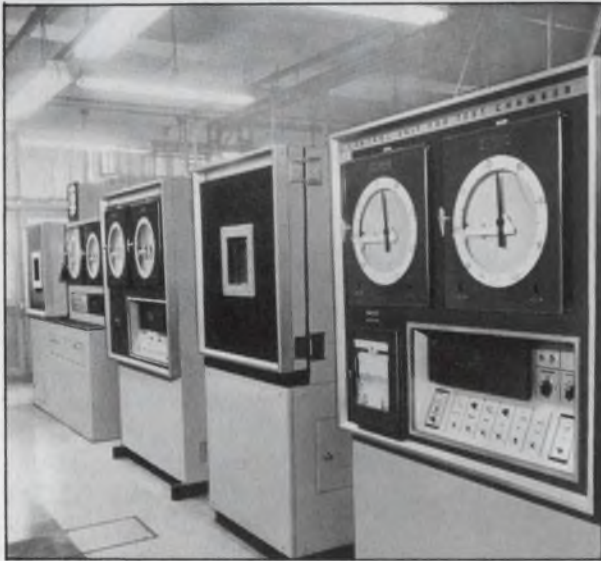

Product Testing Laboratory

If you could take an express trip from the North Pole to the equator, you'd experience roughly the same effect as our special environmental testing has on the fingertip-size "Toko Pulse Transformer." More than a thousand hours of exhaustive testing in temperatures ranging from -55°C to $+85^{\circ}\text{C}$ and humidity increasing from zero to 98% allow no rest for these electronic machine parts. In addition, anti-vibration and anti-shock tests are repeatedly performed to satisfy uncompromising Toko standards.

Only after repeated and severe testing can we determine if the quality of each piece of circuitry is acceptable. From the radio and TV components that brighten our everyday lives to the electronic miracles that will enable man's exploration of the universe, even a single flaw in the smallest electronic part could spell failure . . . even disaster.

No wonder, then, we strive to maintain such strict standards for all Toko products. Achievements like the development of the Pulse Transformer, Delay Lines, Wire Memories, Super-Miniature Coil and other innovative Toko products require this conscientious attitude, combined with a pioneering spirit, ready to meet every demand placed on the Toko brand wherever it appears in the world.



EXCELLENT SET WITH TOKO PARTS

TOKO, INC.

For further information, just call or write:

Head Office: 1-17, 2-chome, Higashi-Yukigaya, Ohta-ku, Tokyo, Japan

Toko America Inc.: 350 Fifth Avenue, New York, N.Y. 10001 U.S.A. Tel: 212-565-3767

Toko America Inc. Los Angeles Branch: 3440 Wilshire Blvd., Los Angeles, Cal. 90010 U.S.A. Tel: 213-380-0417

Toko Elektronik GmbH: 4000 Dusseldorf, 1. Grafenberg Burgmuellerstr. 7, F.R. Germany Tel: 0211-682281-3

Toko (U.K.) Ltd.: Shirley Lodge, 470 London Road, Slough, Bucks, England Tel: Slough 48444

INFORMATION RETRIEVAL NUMBER 27

ethylene variables. It showed, instead, a wide range of switches, keyboards, variable resistors, vhf-uhf tuners, magnetic tape heads and decks.

One of the broadest lines of capacitors was shown by Nichicon Capacitor. It featured aluminum electrolytics, ceramics, papers, films and micas. In addition the company showed thick and thin-film hybrids, positive-TC thermistors and trimming potentiometers.

Susumu Industrial showed an extensive line of thin-film resistors, resistor networks and RC networks, including networks in dual-inline packages.

Capacitors were almost lost at the exhibit of Fujitsu. The company showed some solid aluminum electrolytics and polystyrenes. But its exhibit included also pushbutton switches, fixed resistors, rack/panel and PC connectors, reed switches, a wide variety of relays—general-purpose, telephone, reed and mercury-wetted contact—and an array of high-frequency power transistors.

Transistors, except for special units, drew rather little attention at the show. But ICs, especially LSI and special-purpose devices, created great interest, mainly because complex devices are still rather new in Japan.

Hitachi, for example, announced that it had begun mass production of silicon-gate p-channel MOS chips for calculators, and it hailed the fact that it could provide 40% greater density than that in aluminum-gate chips, a third to one-half the power consumption and five times the speed.

In its laboratories, Hitachi is now using ion implantation in a process it calls EDMOS to provide enhancement and depletion-mode devices on the same chip. This is intended to reduce chip power consumption without the price penalty of CMOS.

At the same time Matsushita Electronics, a subsidiary of Matsushita Electric Industrial, showed a silicon-gate chip for a 16-digit calculator with memory. The company also introduced two Hall-effect ICs—one for digital and one for linear applications.

The linear device, the DN 831, includes a Hall generator and an op amp with 10-mA drive capability on one chip. It is particularly

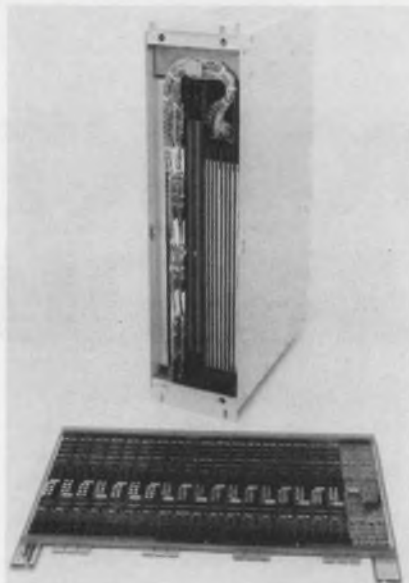

A 65-kilobyte core memory from Toko offers maximum access time of 180 ns and max cycle of 250 ns.

suitable as a speed and position detector. The DN 830, with a Hall sensor and a monolithic switch with a fanout of 8 for TTL/DTL drive, can be used for keyboard and other switches as well as speed and position sensing. Sample-quantity price of each device is about 300 yen, about a third to half the cost of comparable two-element units.

Things to remember

While most of the emphasis in Japanese electronics remains on consumer-related equipment, con-

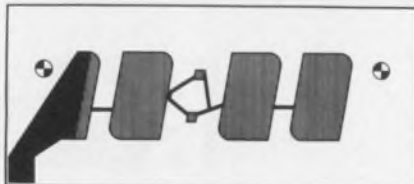
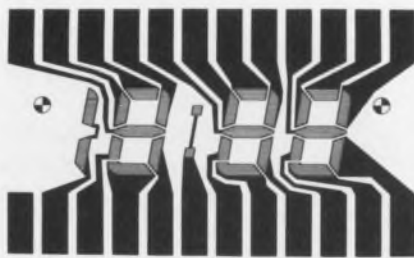

The comb-like structure in new field-effect liquid-crystal readouts from Ise Electronics more than doubles the viewing angle to 100° and eliminates the rainbow effect that's common in other liquid-crystal displays.



An instrument setup in Matsushita's National line occupies a small part of the company's large exhibit.

cern with computers and computer-related equipment is growing rapidly. Large semiconductor memories are being offered by Toko, the exclusive agent in Japan for Advanced Memory Systems, Sunnyvale, Calif. Now using the AMS 6002, a 1-k metal-gate, p-channel device, Toko offers a 4-k × 18-bit memory board and a basic memory system that's expandable from 32-k × 18 bits. At show time, Toko was planning to build its own 6002's at the rate of 40,000 to 50,000 a month by early November.

Toko was planning, too, to manufacture 7001's, n-channel 1-k devices; 6003's, p-channel 2-k memories; and 6004's, p-channel 4-k ICs, and to build these into large-scale memory systems.

At the same time the company is continuing to manufacture its core-memory systems. One of the most popular is the HS-200S, a 65-kbyte core memory with 180-ns maximum access and 250-ns maximum cycle time. Consuming 1/2 mW/bit, the memory is expandable to 1 megabyte.

Core memories, in fact, are very much alive in Japan. Hitachi, for example, has a module, the ME 7216, that's larger than Toko's HS-200S, but slower. The 128-kbyte memory has a cycle time of 1.5 μs, and Hitachi boasts new structural design and new production techniques that have cut volume to a tenth that of conventional core



microscopic but **MIGHTY** news...

SPECIFICATIONS
 M Used as a master or secondary. A high degree of flatness is featured.
 C Used as a copying or working mask.
 Standard size 2 x 2, 2-1/2 x 2-1/2, 3 x 3, 3-1/2 x 3-1/2, 4 x 4, 4 x 5 (inch)
 Pinhole grading ... Standard grade or Selected grade

FEATURES
 The MF-MASK is a metallic photo mask made from a thin film of chromium oxide. Surface reflectivity is low, resolution is excellent, and cost is moderate. Color properties are second to none.
 Low cost, ideal for mass production. Very low surface reflectivity yields one micron patterns. Material withstands a variety of chemical actions. Mechanical strength is very high. Etching properties are outstanding, giving very sharp patterns.

OTHER PRODUCTS
 Using the zone melt method, purity of the aluminum is maintained above 99.999%. Zero sodium content is featured, making this material highly suited to the manufacture of IC's.

ULVAC SURFACE INSTRUMENT DIVISION
ULVAC CORPORATION

Tokyo Office: 1-1, Kyobashi, Chuo-ku, Tokyo 104, Japan Tel: 03-535-6381 Cable Address: "VACTEC" Tokyo Telex No.: 252-2215 ULVAC

INFORMATION RETRIEVAL NUMBER 28



Photo-Electric Components
MUCH MORE THAN MEETS THE EYE!



SHARP offers an entire new spectrum for applications in Computers and Peripheral Equipment, Industrial or Medical Instrumentation, Communications, and Controls.

- Silicon Photo-Detecting Diodes • Silicon Blue Cells
- Silicon Readout Cells • NPN-Type Silicon Photo Transistors • Photo-Coupling Diodes—GaAs Electro-Luminescent • Full Range of LED's including GaAs Infrared, GaAsP Visible & GaAs Negative Resistance Types

Write or call. Technical Literature available.
MARKETED EXCLUSIVELY IN THE U.S.A. BY SHIGOTO...
 one of the world's largest Manufacturing Importers

Shigoto Industries Ltd.
 350 Fifth Avenue, Empire State Bldg., N.Y., N.Y. 10001
 (212) 695-0200/TELEX 224219

INFORMATION RETRIEVAL NUMBER 29

ELECTRONIC DESIGN 26, December 20, 1973



16K BYTES MEMORY CARD

CMS2803



The Second Best Seller
 Doesn't necessarily imply second best

CMS2802



CMS2802: EMM micro 3000
 CMS2803: AMPEX 1800 series

Plug-to-plug compatible.
 A clear system using our own hybrid circuit ICs.

| | Access time | Cycle time | Temp. range | Power supply voltage |
|---------|-------------|------------|-------------|---|
| CMS2802 | 300 ns. | 650 ns. | 0° ~ +50°C | +5V ± 3%, 4.0A max. +15V ± 3%, 4.0A max. -15V ± 3%, 0.9A max. |
| CMS2803 | 340 ns. | 850 ns. | 0° ~ +55°C | +5V ± 5%, 3.5A max. -15V ± 3%, 4.5A max. |

FUJI ELECTROCHEMICAL CO., LTD.

Head Office: Hamagomu Bldg., 5-36-11, Shinbashi, Minato-ku, Tokyo, Japan TEL: 434-1271
 Overseas Office:
 New York, TEL: (212) 532-5630/Los Angeles, TEL: (213) 620-1640/Düsseldorf, TEL: (211) 89031

INFORMATION RETRIEVAL NUMBER 30

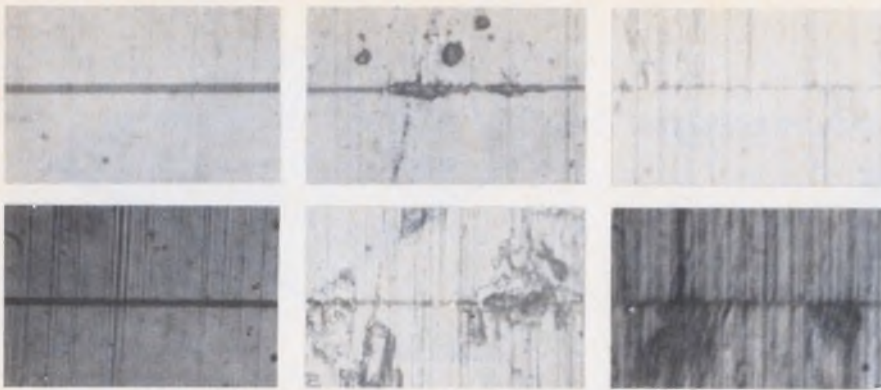

Photomicrographs of the surfaces of single-crystal (left), polycrystalline (center) and permalloy tape heads before (top) and after 500 hours of running time with Crolyn tape.

Record/playback frequency response of audio single-crystal, polycrystalline and permalloy tape heads.

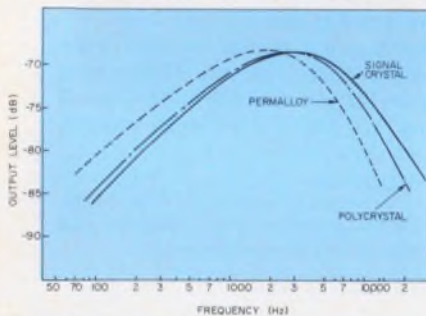

Wear characteristics of three tape-head materials with Crolyn tape running against the heads at 4.76 cm/s.

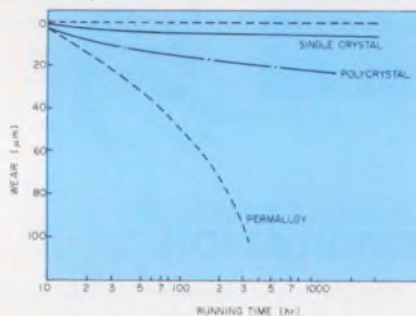

Single-crystal ferrite tape heads from Fuji Electrochemical provide much longer life than conventional polycrystalline ferrite or permalloy heads and extend record/playback response to higher frequencies at a small sacrifice in the lower frequencies.

stacks and weight to one-seventh.

Another major core-memory vendor is Fuji Electrochemical, a leader in plated-wire memories as well as ferrite cores, planes, stacks and complete memories. Still another major manufacturer is TDK Electronics. TDK is best known for its magnetic tape for audio and digital cassettes, open reels and video recorders, but it's also a powerful vendor of all sorts of ferrite components, ceramic capacitors, chokes and filters, thermistors, ultrasonic transducers and microwave absorbers.

But the outstanding developments from Fuji and TDK were not in memories but in tape heads. The excitement at Fuji centered on heads of single-crystal manganese zinc, which is expected to prolong life significantly while providing more uniform performance.

Single-crystal ferrite heads have no grain boundaries, so they don't develop voids that reduce the life of polycrystalline heads and alter response over life.

In an audio tape recorder, Fuji says, the single-crystal head, which costs 2500 yen in small quantities, can operate for 20,000 hours at a tape speed of 7-1/2 ips without need for cleaning. Polycrystalline heads may require cleaning every

Want more information?

Readers interested in further information on the developments discussed in this report may wish to write to the manufacturers. They are listed here (with their U.S. headquarters, where available) under the main products cited in this report. Or, simpler yet, circle the Information Retrieval Number.

Displays

- Asahi Glass Co., Ltd., 1-2, Marunouchi 2-chome, Chiyoda-ku, Tokyo. **Circle 410**
- Hitachi, Ltd., 2-6, Otemachi 2-chome, Chiyoda-ku, Tokyo. (U.S.: 111 E. Wacker Dr., Chicago 60601) **Circle 411**
- Ise Electronics Co., 700 Aza Wada, Ise, Mie. (U.S.: 1472 W. 178 St., Gardena, Calif. 90249) **Circle 412**
- Kyodo Electronic Laboratories, Inc., 11-18, Sonan 2-chome, Sagami-hara, Kanagawa. **Circle 413**
- Matsushita Electric Industrial Co., Ltd., 1006, Kadoma, Osaka. (U.S.: Pan Am Bldg., 200 Park Ave., N.Y. 10017) **Circle 414**
- Nissei Electric Co., Ltd., 3-18, Hiroo 1-chome, Shibuya-ku, Tokyo. **Circle 415**
- Oki Electric Industry Co., Ltd., 10-3, Shibaura 4-chome, Minato-ku, Tokyo. **Circle 416**

- Sharp Corp., 22-22, Nagaike-cho, Abeno-ku, Osaka. (U.S.: 10 Keystone Pl., Paramus, N.J. 07652) **Circle 417**
- Taiyo Yuden Co., Ltd., 2-12, Ueno 1-chome, Taito-ku, Tokyo. **Circle 418**
- Toshiba (Tokyo Shibaura Electric Co.) 2-1-Ginza 5-chome, Chuo-ku, Tokyo. (U.S.: 280 Park Ave., N.Y. 10017) **Circle 419**

Memories

- Fuji Electric Co., Ltd., Shin Yuraku-cho Bldg., 11, Yuraku-cho 1-chome, Chiyoda-ku, Tokyo. **Circle 420**
- Hitachi (see Displays) **Circle 421**
- TDK Electronics Co., Ltd., 14-6, Uchikanda 2-chome, Chiyoda-ku, Tokyo. (U.S.: 23-73 48th St., Long Island City, N.Y. 11103) **Circle 422**
- Toko, Inc., 1-17, Higashi-Yukigaya 2-chome, Ohta-ku, Tokyo. (U.S.: 350 Fifth Ave., N.Y.C. 10001) **Circle 423**

Passive Components

- Alps Electric Co., Ltd., 1-7, Yukigaya Otsuka-cho, Ota-ku, Tokyo. (U.S.: One World Trade Center, Suite 4811, N.Y. 10048) **Circle 424**
- Fujitsu Ltd., 6-1, Marunouchi 2-chome, Chiyoda-ku, Tokyo. (U.S.: 680 Fifth Ave., N.Y. 10019) **Circle 425**
- Matsuo Electric Co., Ltd., 3-5, Sennari-cho 3-chome, Toyonaka, Osaka. (U.S.: 12818 S. Western Ave., Gardena, Calif. 90249) **Circle 426**
- Mitsumi Electric Co., Ltd., 8-2, Kokuryo 8-chome, Chofu, Tokyo. (U.S.: One Lefrak City Plaza, Flushing, N.Y. 11368) **Circle 427**

- Nichicon Capacitor Ltd., Uehara Bldg., 3rd Floor, Oikedor, Karasuma-Higashiru, Nakagyo-ku, Kyoto. **Circle 428**
- Susumu Industrial Co., Ltd., 14, Umamawashi-cho, Kamitoba, Minami-ku, Kyoto. (U.S.: 226 Inza St., Highland Park, N.J. 08904) **Circle 429**
- TDK (see Memories) **Circle 430**
- Toko (see Memories) **Circle 431**

Semiconductors

- Fujitsu (see Passive Components) **Circle 432**
- Hitachi (see Displays) **Circle 433**
- Kyodo (see Displays) **Circle 434**
- Matsushita (see Displays) **Circle 435**

Tape heads

- Fuji (see Memories) **Circle 436**
- TDK (see Memories) **Circle 437**

Test Equipment

- Kokuyo Electric Co., Ltd., 36-15, Ookayama 1-chome, Meguro-ku, Tokyo. **Circle 438**
- Matsushita (see Displays) **Circle 439**
- Metronix Corp., 14-3, Chidori 1-chome, Ota-ku, Tokyo. **Circle 440**

Video Equipment

- Hamamatsu TV Co., Ltd., 1226, Ichino-cho, Hamamatsu, Shizuoka. (U.S.: 120 Wood Ave., Middlesex, N.J. 08846) **Circle 441**
- Hitachi (see Displays) **Circle 442**
- TDK (see Memories) **Circle 443**
- Toshiba (see Displays) **Circle 444**

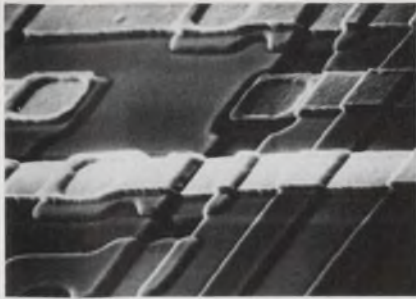

This is the surface of Hitachi's silicon-gate MOS chip for an 8-digit calculator with memory.

300 hours, and the cleaning process can be abrasive enough to damage the heads. The newer heads are particularly useful with chromium dioxide tape, which can be more abrasive than the more common iron oxide tape.

In a video tape recorder the single-crystal heads, which cost about 20% more than polycrystalline, can be used typically for 3000 hours—and for a minimum of 2000 hours—without deterioration. Conventional nickel zinc, polycrystalline heads may have to be replaced after 100 to 800 hours.

While Fuji's heads are aimed at audio and video applications, TDK's are intended for the digital world. Using new glass-bonding and processing techniques, the company has developed disc-drive dual-gap heads with gap widths of only 125 microinches. The thin-gap heads make possible cleaner recording and playback with extremely high data density.

Seat belts when you need them

While many developments made their first appearance at the show, inevitably many did not. One of the most impressive is a new seat-belt system that allows an automobile driver or passenger to sit with his belt completely loose—until an emergency makes belt tightening necessary.

Designed by Matsushita Electric Industrial, the system uses electromagnetic sensing of shock and acceleration to trigger the belt-tightening mechanism in case of emergency. The response time is a mere 7 ms, and the production cost is estimated at less than \$10. One major Japanese manufacturer will include the system as an option in 1974 autos. ■■

FUJI

BIGGEST SINGLE CRYSTAL SPINEL FERRITE IN THE WORLD

The world biggest spinel ferrite single crystal has been developed by Bridgeman method and come into the market. The dimension of the ingot is 2.5 inches in diameter and 20 inches in length and weight of 18 pounds.

Segregation of composition has been minimized by special method of production and a perfect manganese zinc ferrite single crystal having a homogenous structure can be produced.

Great deal of attention has been arisen in the world to the material of magnetic head which features high permeability, superior frequency response, and no grain boundary and pores.



HUGE FERRITE SINGLE CRYSTAL

"GEMS" HEAD

High resolution video tape recording, high fidelity audio recording and precise digital heads have been introduced with easy machinability and high yield.

Since single crystal is mono-crystal so, she has no grain boundary, no pores and no inclusion, thus she has wonderful performance such as superior wear resistance, wide frequency range. Moreover good machinability bring out a clear air gap of under 1μm.

These heads have a life of more than 100 times that of conventional permalloy heads and 10 times that of polycrystalline ferrite heads.

Typical products for VTR and stereo heads are shown bellow.

VIDEO TAPE RECORDER HEAD

High sensitivity, low noise and long life, video recording-playback head.

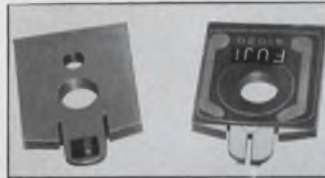

| | |
|------------------------------|---------------|
| Output | Rubbing noise |
| 450μv (p-p) | 12μv (p-p) |
| MEASURED FREQUENCY at 4.5MHz | |

AUDIO CASSETTE STEREO HEAD

High fidelity, low noise, two-channel, four-track stereo head.



| | Items | Specifications | Test Conditions |
|------------------------|-----------------------------|--------------------------|--|
| Playback | Sensitivity | -73dBv ±3dB (333Hz) | Reference Level: 250nwb/m |
| | Channel output differential | 3dB Max. | |
| | Frequency characteristics | +11dB ±3dB (10kHz/333Hz) | — |
| Recording/ Playback | Channel output differential | 3dB Max. | Bias Current: 0.1mA Bias Frequency: 100kHz Recording Current: 0.04mA |
| | Sensitivity | -72dBv ±3dB (1kHz) | |
| | Frequency characteristics | -5dB ±5dB (10kHz/1kHz) | |
| | Channel output differential | 3dB Max. | |

FUJI ELECTROCHEMICAL CO., LTD.

Head Office: Hamagomu Bldg., 5-36-11, Shinbashi, Minato-ku, Tokyo, Japan TEL: 434-1271
Overseas Office: New York, TEL: (212) 532-5630 / Los Angeles, TEL: (213) 620-1640
Düsseldorf, TEL: (211) 89031

METRONIX

Metronix's modular power supplies can cover most applications and special requirements for a wide selection of voltages and currents.

| MODEL | 503 | 504 | 505 | 506 | 507 |
|------------|----------------|----------------|----------------|-----------------|-----------------|
| VDC | AMPERES | | | | |
| 5~6.3 | 2 | 3.2 | 5 | 8 | 12.5 |
| 9~12.5 | 1.4 | 2.2 | 3.5 | 5.6 | 9 |
| 12.5~18 | 1 | 1.6 | 2.5 | 4 | 6.3 |
| 18~25 | 0.8 | 1.25 | 2 | 3.2 | 5 |
| 25~35 | 0.56 | 0.9 | 1.4 | 2.2 | 3.5 |
| 35~50 | 0.4 | 0.63 | 1 | 1.6 | 2.5 |
| Dimensions | 50×120 ×130 | 40×120 ×175 | 92×120 ×200 | 132×120 ×250 | 200×120 ×350 |
| Weight | 1.7kg | 2.3 | 2.7 | 4.3 | 7.1 |

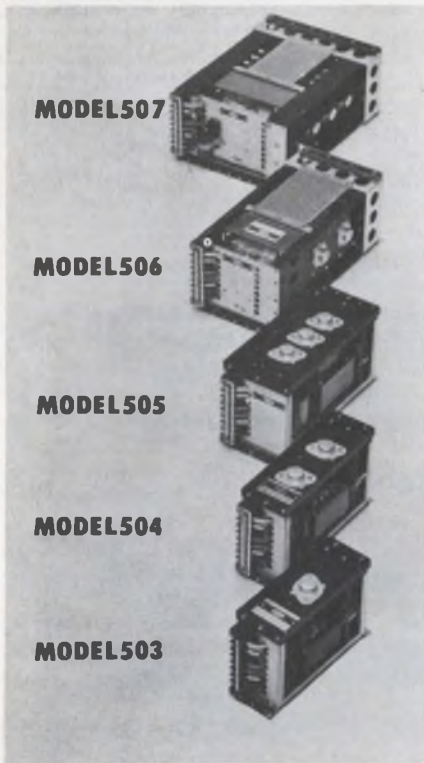

"VENTURE" INVITED

Here is a chance for your products to avail of our sales channel, covering whole Japan. Don't hesitate to call upon us.

METRONIX CORPORATION

14-3, 1-CHOME, CHIDORI, OHTA-KU,
TOKYO, JAPAN.

PHONE: TOKYO 03-752-2211

INFORMATION RETRIEVAL NUMBER 32

It's a tree . . . a pole . . . a man; No! A short-range hf antenna

Need an antenna for short-range communications in a lossy environment where a whip won't work? Then put the environment to work. Use a tree, a light pole, a building or even yourself.

That's what Dr. Kurt Ikrath, an Army research physicist and expert in the development of rf antennas made of trees and artificial metal structures, advises.

"Whenever we have an environment that detrimentally loads a regular whip antenna, we can couple

a transmitter or receiver to the environment and make it work well as a substitute," says Ikrath, who is with Army Electronics Command, Ft. Monmouth, N.J.

An example he points to is his use of trees as rf radiators in forests.

"You can get radiation out and over the forest," he says, "and the improvements have been measured at up to 22 dB over that of a comparable whip antenna, particularly in wet jungles. We've used two



The tree above is radiating a signal at 10.803 MHz. Energy from the transmitter, operated by Kurt Ikrath, is coupled into the tree by means of a matching network in the box on the tree and the toroidal Hemac.

What this country needs is a good \$1,000 full-scale computer.



Introducing the computer for everybody. NAKED MINI™/LSI.

It's the computer for people who never thought they could afford a computer for their product.

It's also for people who have always been able to afford more, but have always gotten less computer than this.

NAKED MINI/LSI is the first OEM mini-computer designed for widespread, multi-level use. The first computer able to do more jobs than any computer could ever do before.

To do this, we had to give it an unheard of combination: extensive 16-bit computing power, large memory, and a small price tag. Specifically, NAKED MINI/LSI is the first computer powered to satisfy 90% of all potential minicomputer applications — and yet be priced as low as \$990 in OEM quantities of 200. And that price includes 4K words of memory.

Imagine it. For a price less than most hardwired circuitry or even a microcomputer,

your product can benefit from a general purpose computer having powerful arithmetic capabilities, up to 256K 16-bit words of memory, both byte and word processing, and uniquely flexible input/output.

Without going into all the jazzy widget features, let's just say that the NAKED MINI/LSI gives your product all the performance it could need to monitor, sequence, and control effectively. Which means your product will be more competitive, more flexible, and more immune to obsolescence.

And because we used LSI technology to make our new computer, you can add all this clout simply by plugging in a single card that measures 1" x 15" x 17" and weighs only 4 pounds.

For full details on the NAKED MINI/LSI (or its stand-alone counterpart, ALPHA/LSI), write Computer Automation, Inc., 18651 Von Karman, Irvine, Calif. 92664. Or call: (714) 833-8830. TWX 910-595-1767.

The NAKED MINI™/LSI from Computer Automation.

Oak presents a short course in keyboard switch selection you can't afford to miss.

Our course could be called "Basic Economics in Keyboard Switch Design." It sums up more than 40 years of leadership in switch design and manufacture at Oak. Take a look at our course:



At the top: the Oak Series 400 Standard Keyboard Switch. It's what you're looking for if you want economy plus reliability. Millions are in use today in every kind of keyboard application.

And our Series 475 Compact Keyboard Switches (bottom) are about the shortest premium quality units you can buy. And, like the Series 400, they're ultra-reliable and economical.



We make so many types and sizes, you can specify Oak across the keyboard. Call on us for complete assemblies to your specifications or standard keypads. The most frequently used 10, 12 or 16 button arrays are stocked in quantity by Oak distributors.



Next subject: Oak Series 415 Low-Profile Keyboard Switches designed for calculators, security devices and data entry equipment. Note the streamlined silhouette. Select colors, custom caps and legends, $\frac{5}{8}$ " or $\frac{3}{4}$ ", single and double keys to fit your needs exactly.



We can say that because our automated manufacturing and test equipment ensures quality. And we design our keyboard switches with the operator feel, reliability, and economy it takes for such applications as data terminals, calculators, business machines, and more.

That's it. Just be sure to follow up on what you've learned. Write for Oak Keyboard Bulletins. Class dismissed.

OAK Industries Inc.

SWITCH DIVISION / CRYSTAL LAKE, ILLINOIS 60014
TELEPHONE 815-459-5000 ■ TWX 910-834-3353 ■ TELEX 72-2447

Who to call for fast delivery on Oak Keyboard Switches



Oak Series 400 and Series 415 Keyboard Switches are available from a distributor near you. He'll supply your desired quantities and ship standard 10, 12 and 16-button keypads as well. It's the way to get Oak quality switches fast!

DEMAMBRO ELECTRONICS
MASSACHUSETTS, Boston.....(617) 787-1200

DRW
MASSACHUSETTS, Watertown....(617) 923-1900
NEW YORK, Farmingdale.....(516) 249-2660

EDMAR ELECTRONICS
ILLINOIS, DesPlaines.....(312) 298-8580

FEDERATED PURCHASER
NEW JERSEY, Springfield.....(201) 376-8900

GRAHAM ELECTRONICS
INDIANA, Indianapolis.....(317) 634-8486

G. S. MARSHALL
ALL BRANCH LOCATIONS—HOME OFFICE:
CALIFORNIA, El Monte.....(213-686-1500)

HALL-MARK
ALL BRANCH LOCATIONS—HOME OFFICE:
TEXAS, Dallas.....(214-231-6111)

HERBACH & RADEMAN
PENNSYLVANIA, Philadelphia.....(215) 426-1700

INDUSTRIAL COMPONENTS
MINNESOTA, Minneapolis.....(612) 831-2666

MILGRAY/WASHINGTON
MARYLAND, Hyattsville.....(301) 864-1111

OHM/ELECTRONICS
ILLINOIS, Palatine.....(312) 359-5500

RADAR ELECTRIC CO.
WASHINGTON, Seattle.....(206) 282-2511

SCHOMBURG SALES
NEW YORK, Rochester.....(716) 244-0920

SOLID STATE ELECTRONICS
TEXAS, Dallas.....(214) 352-2601

OAK Industries Inc.
SWITCH DIVISION / CRYSTAL LAKE, ILLINOIS 60014

trees, four meters apart, as an hf phased array in the Ft. Monmouth area."

By changing the phase difference between the 4.650-MHz cw voltages driving the two trees, Ikrath explains, he was able to vary the radiation pattern. This, he points out, is in contrast with a fixed radiation pattern controlled by local terrain and forest structure.

The key to the use of trees, poles and other environmental features as antennas is the coupling of energy into and out of them. To do this, the Army command has developed a flexible toroid-shaped hybrid electromagnetic coupler called Hemac. This can be used with any slender structure around which it can be mounted (see photo). Other types of structures, like automobiles, require different kinds of coupling, Ikrath notes.

Hemac, the physicist explains, is a leaky rf transformer. It is hybrid because it can both sense and generate magnetic, or low-impedance fields, and electric, or high-impedance fields. And it can also sense diffusely polarized radiation.

In contrast, Ikrath points out, the whip antenna is linearly polarized and can sense only radiation of a single polarization. And it is also very sensitive to changes in field impedances, making it hard to tune in certain environments.

Hemac is being used to couple the nominal 50-Ω source impedances of transmitters and receivers to trees. A variable tuning and impedance-matching circuit is used with the coupler.

The Hemac-tree antenna requires less skill to tune than the PRC-74 whip antenna, Ikrath reports.

Experiments with the Hemac and a PRC-74 transmitter feeding rf to metal light poles in the Ft. Monmouth area demonstrated, the physicist says, that the poles outperformed all other radiators on frequencies between 6 and 11 MHz. For example, radiation from the PRC-74's whip antenna was from 2 to 12 dB lower than that of the poles.

The role of large metal-frame buildings as radiators was established at hf and lf frequencies. Between 8 and 12 MHz, transmission from Hemac-coupled metal window frames, relative to a resonant dipole mounted across the panes, was substantially superior,

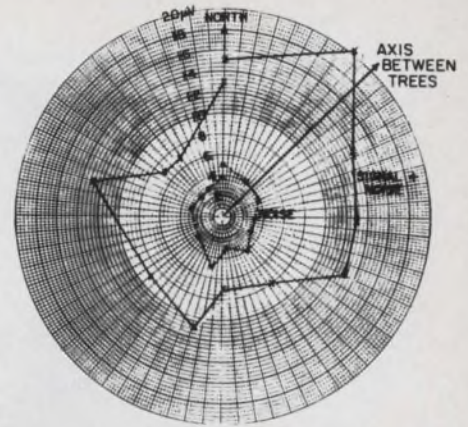

This directional pattern from two trees was obtained by controlling the phase of the energy fed them. Two Hemac couplers were used here.

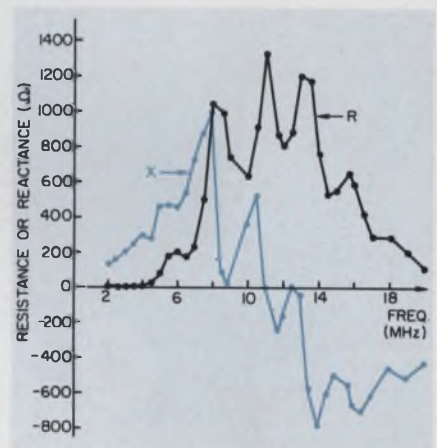

Tree-antenna resistance and reactance are shown here for an oak tree with a Hemac 2.3 m above moist ground in a forest.

Ikrath reports.

Methods of coupling signals to the human body have also been developed, the researcher says. The problem here, he notes, is that "you cannot couple to the belly; you have to couple to other parts of the body." Also, there's a difference from person to person. Fat, heavy people, it has been found, make better antennas than slim, small ones.

Experiments with human antennas have been conducted on 4.2 and 8.25 MHz, Ikrath says. Power input was limited to 1 W. The efficiency of the body as an antenna, Ikrath notes, corresponds to that of a matched, center-coil loaded whip antenna 1.2 meters long at 4.2 MHz. While the whip antenna is omnidirectional, the pattern from the body is highly directional. ■■



Do you spend your vacations at home because that's all you can afford?

Vacations are something special.

Only it takes a little savings to get out and enjoy them.

So why not do the smart thing. Join the Payroll Savings Plan now where you work and start buying U.S. Savings Bonds. You'll build up a vacation fund sooner than you think.

Bonds are a dependable way to save. They are guaranteed against theft, loss or destruction, and your savings earn a good rate of interest, too.

Buy U.S. Savings Bonds

through the Payroll Savings Plan. You'll find you won't be sitting at home anymore thinking about how good your vacations could be.



Take stock in America.

Buy U. S. Savings Bonds

Now E Bonds pay 5 1/4% interest when held to maturity of 5 years, 10 months (4% the first year). Bonds are replaced if lost, stolen, or destroyed. When needed they can be cashed at your bank. Interest is not subject to state or local income taxes, and federal tax may be deferred until redemption.



The U. S. Government does not pay for this advertisement. It is presented as a public service in cooperation with The Department of the Treasury and The Advertising Council.

Imagination and Stackpole ferrites can cut a power supply down to size

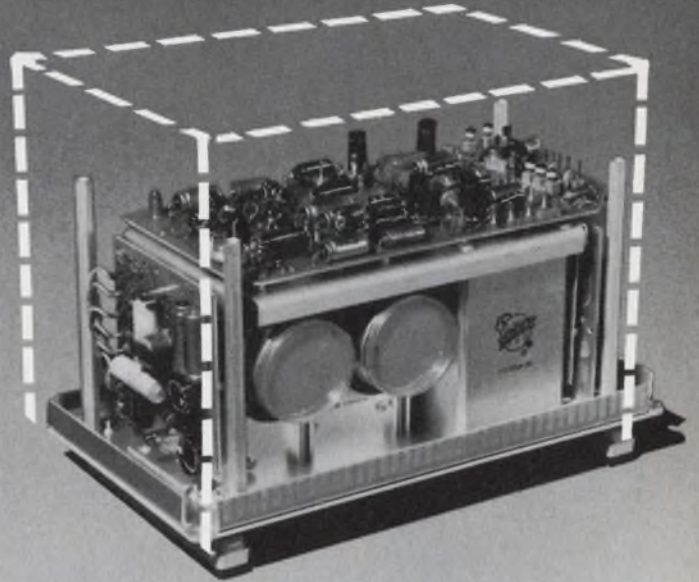

Tektronix, Inc. uses Ceramag® ferrite materials to achieve efficiency and significant savings.

Conventional power supplies are bulky, heavy and inefficient. Tektronix, Inc. changed all that. With ferrites and a fresh idea.

By rectifying line voltage, converting it to 25kHz and rectifying it again, Tektronix, Inc. engineers produced a power supply that was 50% lighter, over 25% smaller and consumed 1/3 less power. And the overall operating efficiency of 70% is a big improvement over the 50% typical of conventional power supplies.

Ferrites can offer the unique advantages, design freedoms and electronic characteristics that produce exciting new ideas. Stackpole Ceramag ferrites were used throughout the power supply design. Because Stackpole has a wide variety of materials and configurations, designers can unleash their imaginations.



Tektronix, Inc. selected 24B for their "U" and "E" cores. This proven material has seen years of service in flybacks for television. Ideal for power applications, it can be operated at higher frequencies than laminated steel. It is cool running, due to low losses under power conditions and controlled power permeability. Tooling is available for a wide range of "U", "E" and "I" configurations.

Ceramag 24



Toroids of Ceramag 24 were used by Tektronix, Inc. for transformer cores. Again, this is a proven material, widely used by the computer industry for pulse transformer cores. It has a tightly controlled initial permeability, and tooling for a variety of sizes is also available.

Ceramag 7D and 27A

Multiple material selection for coil forms allowed Tektronix, Inc. maximum flexibility and design freedom. Proper inductance values could be achieved in the allotted amount of room. In addition, the high resistance of 7D

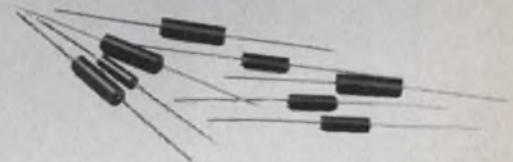

material prevents accidental shorting on printed circuit boards.

Great new designs happen when you *start* with the idea of ferrites. Particularly Stackpole Ceramag ferrite components. Why? Because Stackpole offers the variety of materials, numerous tooled configurations and the technical back-up you need. Twenty-four years of television and computer experience makes Stackpole one of the largest and most experienced domestic suppliers of quality ferrites.

Consider ferrites on your next prototype or redesign. But give us a call when you start. Perhaps we (and some Ceramag® ferrites) can help you cut a problem down to size. Stackpole Carbon Company, Electronic Components Division, St. Marys, Pa. 15857. Phone: 814-781-8521. TWX: 510-693-4511.



STACKPOLE
ELECTRONIC COMPONENTS DIVISION

Semiconductor Heat Sinks & Thermal Products

Phone for Wakefield Distributor
Products Catalog #103 today.



AUTHORIZED ELECTRONIC DISTRIBUTORS

| | | | | | |
|---------------------------------|------------------|--|--|--|--|
| ALABAMA | | | | | |
| ▶ CRAMER/EW/Huntsville | (205) 539-5722 | | | | |
| ▶ Hall-Mark/Huntsville | (205) 539-0691 | | | | |
| ARIZONA | | | | | |
| ▶ CRAMER/Phoenix | (602) 263-1112 | | | | |
| ARKANSAS | | | | | |
| ▶ CARLETON-BATES/Little Rock | (501) 562-9100 | | | | |
| CALIFORNIA | | | | | |
| ● CALIFORNIA ELECT/Los Angeles | (213) 477-8561 | | | | |
| ▶ CRAMER/Irvine | (213) 771-8300 | | | | |
| ▶ CRAMER/San Diego | (714) 565-1881 | | | | |
| ▶ CRAMER/Sunnyvale | (408) 739-3011 | | | | |
| ● ELMAR/Mountain View | (415) 961-3611 | | | | |
| ▶ NEWARK ELECT/Inglewood | (213) 678-0441 | | | | |
| COLORADO | | | | | |
| ▶ CRAMER/Denver | (303) 758-2100 | | | | |
| ▶ NEWARK ELECT/Denver | (303) 757-3351 | | | | |
| CONNECTICUT | | | | | |
| ▶ CRAMER/North Haven | (203) 239-5541 | | | | |
| ▶ NEWARK ELECT/Westport | (203) 226-6921 | | | | |
| FLORIDA | | | | | |
| ▶ CRAMER/EW/Hollywood | (305) 923-8181 | | | | |
| ▶ CRAMER/EW/Orlando | (305) 894-1511 | | | | |
| ● HALL-MARK/Orlando | (305) 855-4020 | | | | |
| ▶ NEWARK ELECT/Ft. Lauderdale | (305) 587-2372 | | | | |
| GEORGIA | | | | | |
| ▶ CRAMER/EW/Atlanta | (404) 448-9050 | | | | |
| ILLINOIS | | | | | |
| ▶ CRAMER/Mt. Prospect | (312) 593-8230 | | | | |
| ▶ NEWARK ELECT/Chicago | (312) 638-4411 | | | | |
| ● OHM ELECT/Palatine | (312) 359-5500 | | | | |
| INDIANA | | | | | |
| ● FORT WAYNE ELECT/Ft. Wayne | (219) 742-4346 | | | | |
| ● GRAMAM ELECT/Indianapolis | (317) 634-8202 | | | | |
| ▶ PIONEER/Indianapolis | (317) 632-5676 | | | | |
| KANSAS | | | | | |
| ● HALL-MARK/Lenexa | (913) 888-4747 | | | | |
| ▶ RADIO SUPPLY/Great Bend | (316) 793-3507 | | | | |
| ▶ RADIO SUPPLY/Salina | (913) 823-6353 | | | | |
| ▶ RADIO SUPPLY/Wichita | (316) 267-5216 | | | | |
| MARYLAND | | | | | |
| ▶ CRAMER/EW/Hanover | (301) 354-0100 | | | | |
| ▶ CRAMER/EW/Gaithersburg | (301) 948-0110 | | | | |
| ▶ NEWARK ELECT/Beltsville | (301) 937-5085 | | | | |
| ▶ PYTTRONIC/Savage | (301) 792-7000 | | | | |
| MASSACHUSETTS | | | | | |
| ▶ CRAMER/Newton | (617) 969-7700 | | | | |
| ▶ NEWARK ELECT/Woburn | (617) 935-8350 | | | | |
| ● RUSH IND/Woburn | (617) 935-2400 | | | | |
| MICHIGAN | | | | | |
| ▶ CRAMER/Livonia | (313) 425-7000 | | | | |
| ▶ NEWARK ELECT/Oak Park | (313) 548-0250 | | | | |
| ▶ NEWARK ELECT/Wyoming | (616) 241-6681 | | | | |
| ● RS ELECT/Detroit | (313) 491-1012 | | | | |
| ▶ WEDEMEYER/Ann Arbor | (313) 665-8611 | | | | |
| MINNESOTA | | | | | |
| ▶ CRAMER/Edina | (612) 835-7811 | | | | |
| ● GOPHER/St. Paul | (612) 645-0241 | | | | |
| ▶ NEWARK ELECT/Minneapolis | (612) 331-6350 | | | | |
| MISSOURI | | | | | |
| ● HALL-MARK/St. Louis | (314) 521-3800 | | | | |
| NEW JERSEY | | | | | |
| ▶ CRAMER/Cherry Hill | (609) 424-5993 | | | | |
| ▶ CRAMER/Moonachie | (201) 935-5600 | | | | |
| ● GENERAL RADIO/Camden | (609) 964-8560 | | | | |
| ▶ NEWARK ELECT/Kenilworth | (201) 272-8410 | | | | |
| ● ROUTE ELECTRONICS/Springfield | (201) 379-7710 | | | | |
| NEW MEXICO | | | | | |
| ▶ CRAMER/Albuquerque | (505) 265-5767 | | | | |
| NEW YORK | | | | | |
| ● CAR-LAC ELECT/Bohemia | (516) 567-4200 | | | | |
| ▶ CRAMER/East Syracuse | (315) 437-6671 | | | | |
| ▶ CRAMER/Endwell | (607) 754-6661 | | | | |
| ▶ CRAMER/Hauppauge | (516) 231-5600 | | | | |
| ▶ CRAMER/Rochester | (716) 275-0300 | | | | |
| ● GENESEE RADIO/Buffalo | (716) 873-9661 | | | | |
| MILGRAY/Freepoint | (516) 546-6000 | | | | |
| ▶ NEWARK ELECT/Plainville | (516) 822-5000 | | | | |
| ▶ NEWARK ELECT/Rochester | (716) 473-6600 | | | | |
| NORTH CAROLINA | | | | | |
| ▶ CRAMER/EW/Winston-Salem | (919) 725-8711 | | | | |
| ▶ KIRKMAN ELECT/Winston-Salem | (919) 724-0541 | | | | |
| ▶ PYTTRONIC/Raleigh | (919) 782-6370 | | | | |
| OHIO | | | | | |
| ● JOHN BECKER ELECT/Dayton | (513) 226-1341 | | | | |
| ▶ CRAMER/Cincinnati | (513) 771-6441 | | | | |
| ▶ CRAMER/Cleveland | (216) 248-8400 | | | | |
| ● HUGHES-PETERS/Cincinnati | (513) 351-2000 | | | | |
| ● HUGHES-PETERS/Columbus | (614) 294-5351 | | | | |
| ▶ NEWARK ELECT/Cincinnati | (513) 874-5115 | | | | |
| ▶ NEWARK ELECT/Cleveland | (216) 361-4700 | | | | |
| ▶ PIONEER/Cleveland | (216) 587-3600 | | | | |
| ▶ PIONEER/Dayton | (513) 236-9900 | | | | |
| ▶ RPC ELECTRONICS/Cleveland | (216) 461-4700 | | | | |
| OKLAHOMA | | | | | |
| ▶ HALL-MARK/Tulsa | (918) 835-8458 | | | | |
| OREGON | | | | | |
| ● CENTRAL DIST/Portland | (513) 234-0711 | | | | |
| PENNSYLVANIA | | | | | |
| ▶ PYTTRONIC/Carnegie | (412) 276-6722 | | | | |
| ▶ PYTTRONIC/Harrisburg | 1-(800) 232-0640 | | | | |
| ● PYTTRONIC/Montgomeryville | (215) 643-2850 | | | | |
| ● RPC ELECTRONICS/Pittsburgh | (412) 782-3770 | | | | |
| PUERTO RICO | | | | | |
| ▶ CRAMER/San German | (809) 892-1130 | | | | |
| TEXAS | | | | | |
| ▶ CRAMER/Dallas | (214) 350-1355 | | | | |
| ▶ HALL-MARK/Dallas | (214) 231-5101 | | | | |
| ● HALL-MARK/Houston | (713) 781-6100 | | | | |
| ▶ NEWARK ELECT/Dallas | (214) 271-2511 | | | | |
| ▶ NEWARK ELECT/Houston | (713) 782-4800 | | | | |
| UTAH | | | | | |
| ▶ CRAMER/Salt Lake City | (801) 487-3681 | | | | |
| ▶ NEWARK ELECT/Salt Lake City | (801) 486-1048 | | | | |
| WASHINGTON | | | | | |
| ▶ CRAMER/Seattle | (206) 762-5755 | | | | |
| ● STERLING ELECT/Seattle | (206) 762-9100 | | | | |
| WEST VIRGINIA | | | | | |
| ▶ RPC ELECTRONICS/Wheeling | (304) 232-7630 | | | | |
| WISCONSIN | | | | | |
| ▶ CRAMER/Oak Creek | (414) 764-1700 | | | | |
| ▶ NEWARK ELECT/Brookfield | (414) 781-2450 | | | | |

● Principal stocking points ▶ These distributor's catalogs contain listings for Wakefield's thermal products.



WAKEFIELD ENGINEERING, INC.

WAKEFIELD, MASS. 01880 • 617-245-5900 • TWX 710-348-6713

washington report



Heather M. David
Washington Bureau

Solar power proposals explored

Two missions that could help provide energy to the United States in the 1980s and 1990s have been proposed for the space shuttle. Arthur D. Little Co. has proposed the Sunsat, a satellite composed mostly of solar cells. Placed in geosynchronous orbit, the cells would collect solar energy, convert it to microwaves and beam it to a collector, which would convert it to direct current for industrial and home use. NASA experts say, however, that drastic improvements in solar-cell efficiency over the present 16% will be necessary to make such a satellite feasible. A second proposal, explained to the Senate Space Committee by Rockwell International's Kraft Ehrlicke, would involve orbiting a giant microwave reflector that would beam energy converted from solar energy to the earth wherever needed.

Defense Dept. upgrading test range for electronic warfare

The Defense Dept. is creating its largest simulated combat operations range by upgrading electronics at Nellis Air Force Base in Nevada. Special communications equipment, to integrate existing simulated enemy radars and to return range data to a central control facility, is being installed along with wideband receivers for scoring electronic countermeasures results. Soviet SAM-6 missiles and radars captured in Egypt are believed to be at Nellis already. The facility, to be named the Continental Operations Range, will be capable of testing the entire range of electronic countermeasures, electronic counter countermeasures and other penetration aids developed for the B-1 bomber in a simulated, long-distance penetration mission. The facility will also be useful in testing a variety of tactical missiles and other aircraft.

Avionics to pave way for Navy copter

The Navy is taking a new approach to the design of a carrier-based helicopter called the Light Avionics Multipurpose System (Lamps), which it will use for a variety of missions from antisubmarine to electronic warfare. The avionics payloads will be designed first, and the Navy will choose the helicopter to carry them later, when the packages have been fully defined. The Navy expects to ask industry soon to bid on a contract to integrate the various avionics systems, which include five new antisubmarine warfare subsystems: a magnetic anomaly processor, acoustic processor, data link, signal data converter and displays. Other avionics

for the advanced Lamps, designated the Mark III, include an electronic countermeasures receiver, search radar, doppler navigation radar and a sonobuoy receiver.

ECM drone being developed

The AQM-34 target drone is getting a new mission as a tactical electronic warfare system. The drone is being modified with special wings to carry electronic countermeasures equipment and chaff to jam enemy radars. The Air Force will modify 56 drones, at a cost of \$16.4-million, to serve as interim replacements for the ancient EB-66 ECM jamming aircraft used in Vietnam. The EB-66 electronic warfare equipment does not cover the higher frequencies now used in Soviet-built radars. Later the Air Force will replace the drones with EF-111 ECM jamming aircraft now under development, if that program works out.

Memory circuit for Harm missile pushed

The Navy is considering putting a memory circuit in the High-Speed Antiradiation Missile (Harm) to enable the missile to continue on toward enemy surface-to-air missile radars even after they are shut off. Operators of Soviet-built SAM radars in Vietnam and the recent Mideast conflict have been able to foil a large percentage of U.S. built Shrike and Standard antiradiation missiles simply by shutting down the radars after firing the missiles. The higher speed of the Harm missile would solve part of the problem, but there is a growing feeling that a memory circuit is imperative.

Capital Capsules: Aerospace companies are continuing to lobby among Congressmen and White House officials to reverse the Administration's decision to stop further Government R&D on communications satellites. They are working to get funds put into the NASA fiscal 1975 budget, which will go to the Office of Management and Budget in December. . . . As anticipated in these columns, **Emilio Q. Daddario has been named staff director of the Congressional Office of Technology Assessment.** The panel will select a 12-member technology assessment advisory council of nationally known experts in the various scientific disciplines and a professional staff reaching about 40 by the end of the fiscal year. . . . The U.S. Dept. of Commerce has chosen **aviation electronics and instruments as one of 15 industries with potential for a global export drive in fiscal 1976.** Market surveys on foreign countries will be made next year, and the results will be released to help industry. . . . The Air Force has decided to buy one prototype backscatter over-the-horizon radar to start its 414 L Continental U.S. aircraft warning system. **Companies interested in receiving a request for proposal have been asked to submit qualifications,** including evidence of capability in high frequency (3 to 30 MHz) over-the-horizon radio frequency propagation backscatter phenomenology and large phased-array antenna design and signal-processing capabilities under contaminated propagation conditions. The radar probably will be placed in Maine. . . . The National Bureau of Standards will **distribute a computer program package to help manufacturing companies convert to metric units.** It is based on a program developed by Caterpillar Tractor Co. that converts metric units on engineering drawings to U.S. equivalents.



Here's technical achievement for you... better living for you and your family

We are particularly anxious to meet you if you are a Circuit Design Engineer; Packaging and Mechanical Engineer; Electron Optics, Vacuum Technology or Materials and Process Specialist. But whatever your technical strengths, if "roll-up-the-sleeves" engineering appeals to you, we'd like to hear from you.

Here you'll find an environment that emphasizes the individual, and his personal contribution to technical development—contribution by working on projects, not writing about them. Your work will benefit advanced engineering throughout the world. You will benefit from technical association with specialists experienced in developing state-of-the-art instrumentation, components and devices.

All Tektronix R & D—financed entirely from our annual sales of approx. \$200 million—is directed toward commercial products. Our community is prosperous, balanced, with a stability of employment not typical of every industrial center. And as for the Green Land we live in—it speaks for itself.

If you're seeking technical advancement and better living for you *and* your family, why not investigate Tektronix?

Write Tektronix, Inc., P.O. Box 500ES, Beaverton, Oregon 97005, or send in the coupon.

Professional Placement Mgr., Tektronix, Inc.

P. O. Box 500ES, Beaverton, Oregon 97005

Please send me an application form

NAME _____

ADDRESS _____

CITY _____ STATE _____ ZIP _____



Tektronix TM 500 Series puts it all together

Tektronix has taken a new approach to test and measurement instruments. The TM 500 Series is modular, multifunctional, synergistic, cost effective, and more. It includes the features you've been looking for.

Presently, the TM 500 Series includes 24 general purpose plug-in test instruments. All new ways to think of Tektronix. Digital counters to 550 MHz. Signal sources ranging from below 1 millihertz to above 1 GHz. Pulse generators to 250 MHz. Digital multimeters with 4½ digit LED readout and temperature measurements from -55° C to +150° C. Plus signal processors, power supplies, and CRT monitors.

All the modules are interchangeable. So you can make combina-

tions of instruments to meet your particular needs. When new instruments are introduced (and many will be soon), you simply plug them into the power unit. You can use a single compartment (TM 501), a triple compartment power unit (TM 503), or two 503's combined for a standard rackmount installation.

Connections between modules and/or external equipment are made through the power unit rear interface board and optional rear panel connectors. Approximately 30 input-output lines are available in each compartment for special set-ups you might want to make. This intracompartiment interface feature also permits multifunction applications resulting in a synergistic effect. Instruments working

together perform more functions than the same instruments working independently. Many modules include serial BCD so information can be transferred directly to a computer or calculator.

The TM 500 is compact too. A three-compartment power unit is only 6"x8.7"x15.3". That means the TM 500 is two to six times smaller than comparable instruments. So you save bench space. And it's light weight, easy to carry. A package including a general purpose counter, multimeter, and power supply weighs 14 to 18 pounds!

Cost? All TM 500 plug-in modules are competitively priced with instruments of comparable capabilities. Because TM 500 instruments share the fixed costs of

**Modular, compact, synergistic,
multifunctional, versatile,
cost effective and more.**

power supplies, cabinets, etc., they consistently provide the lowest cost per test/measurement function. And, because the instruments are modular, cost of maintenance is lower too.

For complete details, contact your Tektronix Field Engineer. Or write or phone for our new 12 page, full color brochure and 24 data sheets. They show why the TM 500 is the finest test and measurement series available today. Tektronix, Inc. P.O. Box 500, Beaverton, Oregon 97005. In Europe, write Tektronix Ltd., Guernsey, C. I., U.K.



INFORMATION RETRIEVAL NUMBER 35
FOR DEMONSTRATION, CIRCLE 150

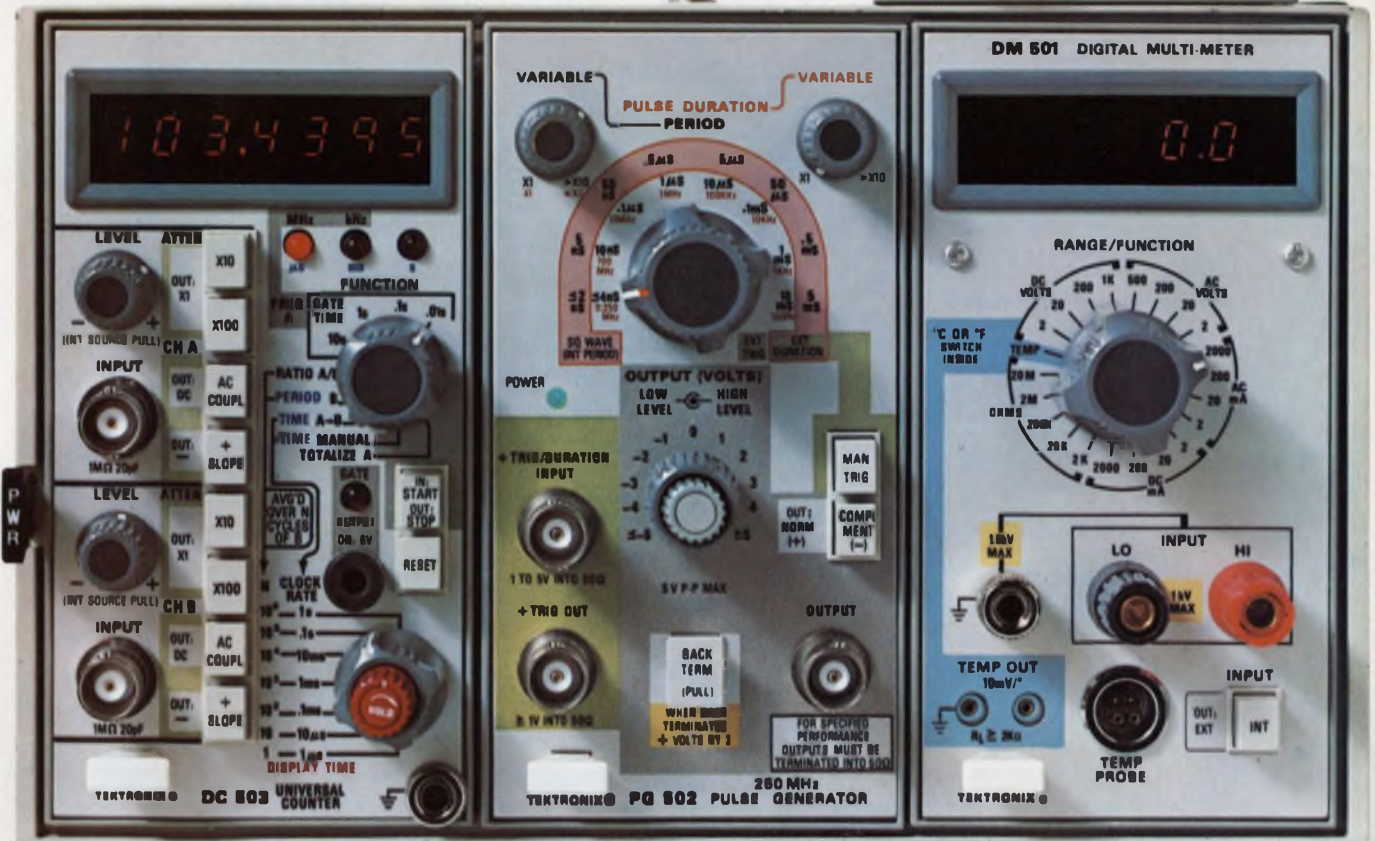

150 Microwatt Triple Op Amp

The L144 monolithic triple op amp draws only $50\mu\text{A}$ of current per amplifier, from a $\pm 1.5\text{ V}$ supply. What's more, it is

AVAILABLE NOW FROM YOUR LOCAL DISTRIBUTOR!

L144 features include:

- Monolithic triple op amp in DIP or Flatpac packages
- Wide power supply range— $\pm 1.5\text{ V}$ to $\pm 15\text{ V}$
- Internal compensation
- Programmable power dissipation
- Programmable input bias current
- Single programming resistor
- 80 dB gain with $20\text{ K}\Omega$ load
- Cost effective: \$1.63 per single op amp⁽¹⁾

⁽¹⁾L144CJ 100-piece price

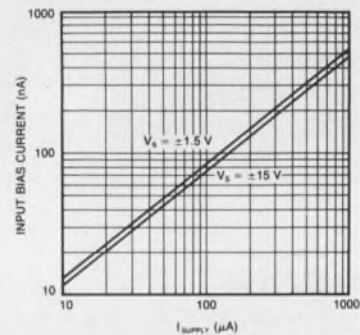

Applications examples:

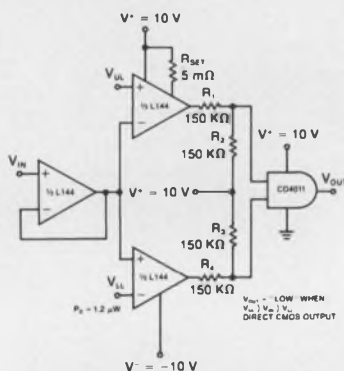

DOUBLE-ENDED LIMIT COMPARATOR

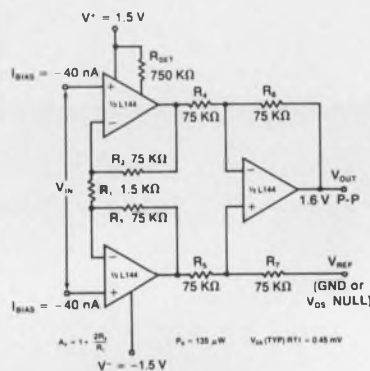

INSTRUMENTATION AMPLIFIER

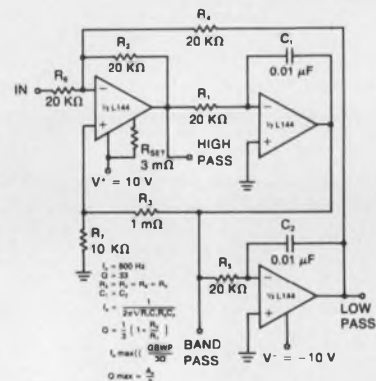

ACTIVE FILTER

The L144 is a practical industry-standard operational amplifier for use when low current drain, low voltage, low power, or very small physical size are controlling criteria. If your circuit requirements are unique—and whose aren't—our applications people are eager to help.

For complete information

write for data

IC Applications: (408) 246 8000, Ext. 120



Siliconix incorporated

2201 Laurelwood Road, Santa Clara, California 95054

INFORMATION RETRIEVAL NUMBER 36

It's one world

It wasn't too long ago that most of us lived on little islands. Japanese engineers lived on their little island, and they were pretty good at designing consumer electronic equipment. German engineers lived on their little island, and they were pretty good at making optical goods. Englishmen, on their island, designed a pretty nifty postal system. And Americans, on their island, got pretty good at designing computers, test equipment and complex semiconductors.

The situation is changing—fast. While intra-island competition has been the way of the past, the way of the future is worldwide competition. The American engineer will no longer be able to clash wits and ingenuity with other American engineers alone. His competition will be engineers throughout the world. I learned this in recent trips to Japan and Western Europe, but I should have known it all along. I could have seen it in the shops in New York that are flooded with calculators from Japan and from the United States. I saw it in Japan, where instruments contained—side-by-side—capacitors from Matsuo, Nichicon and Sprague; where equipment used semiconductors from Hitachi, Matsushita and Texas Instruments; where lab benches had power supplies from Metronix and Lambda and test equipment from National, Tektronix and Hewlett-Packard. I saw the very same togetherness all over Europe.

And while governments may impose all sorts of restrictions in an attempt to enforce a “buy from your own island” policy, the trend is inexorable. Engineers will buy the components, equipment and systems that provide the best performance at the best price. The challenge to engineers throughout the world—to create the best performance at the best price—is greater than ever before.



Renew your ELECTRONIC DESIGN subscription today! Turn to inside the front cover, fill out card completely, affix peel-off label and mail. Do it now—don't miss a fact-packed issue of ELECTRONIC DESIGN.

A handwritten signature in cursive script that reads "George Rostky".

GEORGE ROSTKY
Editor-in-Chief

Move your product with TRW/Globe

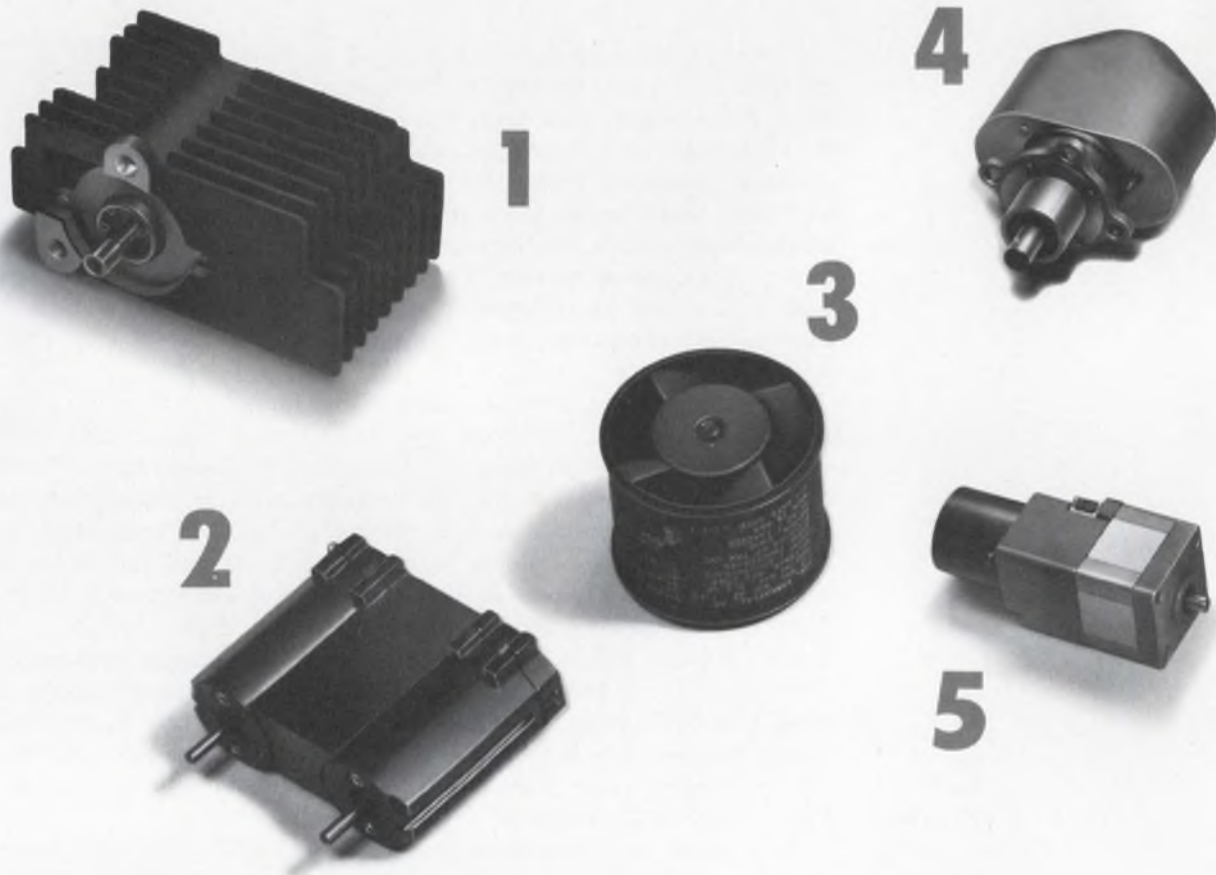

You can dramatically increase the efficiency of your powered product by asking TRW/Globe to combine multiple motion functions in one compact package, as you see here.

We'll not only get you maximum power per cubic inch; we'll eliminate the costs of second assembly and parts inventory. And we'll deliver your prototype in short order.

These examples demonstrate that, though there may be many manufacturers of motors, TRW/Globe has a unique capability to produce motion packages:

1. Integrally cast heat sink enables this high torque drive for a banking terminal carriage to operate

at 30% above normal power levels. Speed is accurately stabilized so system can operate open loop.

2. Cassette drive avoids assembly costs plus the problem of aligning the output shafts. Center to center distance on shafts is matched to standard Philips cassette.

3. TRW/Globe designed this blower to fit available space in an already-designed transceiver, and helped determine the system's air flow resistance.

4. Fin control motor for the Mark 46 torpedo operates in a "bang bang" mode, performs under severe environments, and has actually been reduced in cost since the 1960's.

more efficiently motion packages

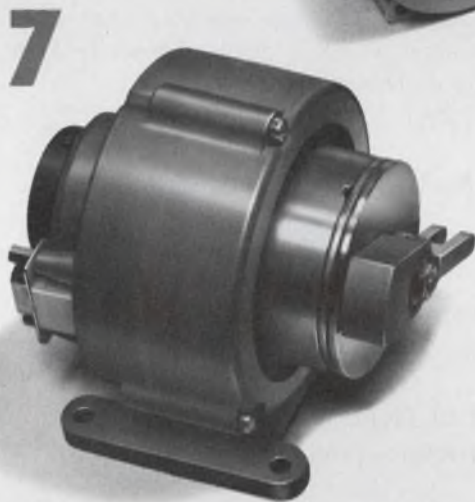
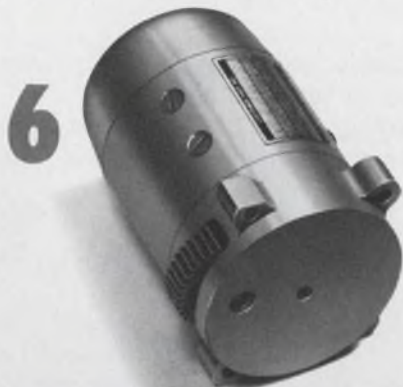

5. Drive for a serial printer indexes the printing ball horizontally, provides feedback through a tach generator, and accommodates vertical indexing through the hollow shaft.

6. Fin control motor for the Standard missile performs under high impact loads, yet sells for 15-20% under the next bidder.

7. Torquer for the Maverick "super smart bomb" positions each axis of its camera platform and develops 17.5 in. oz./amp. Brake, slip clutch, and position pot are also in the same motion package.

8. Rotary actuator for switching bands on a military transceiver includes motor, gearing, slip clutch, limit switches, and brake in minuscule space.

9. Drive for a computer tape reader assures smooth motion even though torque changes constantly. An encoder for the optical tachometer is part of the device.

10. In this drive for a facsimile scanner, hysteresis synchronous motors assure that both transmitter and recorder are synchronized.

Think "motion packages" rather than motors, and call TRW/Globe Motors, an Electronic Components Division of TRW Inc., Dayton, Ohio 45404 (513-228-3171).

TRW GLOBE MOTORS

INFORMATION RETRIEVAL NUMBER 37

Expand counter capability:

Add parallel enabling to boost size; economize on circuitry with enabled MSI sections.

This is the second of two articles on counter enabling. The first article discussed serial-enabling techniques and their application to J-K flip-flop circuits.

Of the two basic enabling techniques for counters, parallel enabling gives the designer the greater increases in counter size. When applied fully, it can boost counter size from, say, four sections to 84 with the same logic family—a far greater increase than serial enabling would yield. Even limited parallel enabling can raise the section count from four to nine.

Further, by combining both parallel and serial enabling with standard MSI sections, you get circuit economy.

And both techniques work with up/down counters.

The time required for the 0-to-1 transition of a counter's first stage to ripple through succeeding sections limits the number of sections that can be cascaded with serially enabled counters. But you can remove the F_1 signal from the serial-enable chain and apply it in parallel to each of the remaining sections (Fig. 1). The limiting factor then becomes the delay associated with the F_2 signal.

Successful operation of the counter requires the following:

- That the output of F_2 be present to enable the k^{th} section two clock pulses after a 0-to-1 transition of F_2 .
- That the signal from F_2 not be present after two additional clock cycles. Otherwise unwanted enabling occurs.

These conditions are met if:

$$T_{PD1(F2)} + T_{PD0(G1)} + (k-2) [T_{PD1(I)} + T_{PD0(G)}] + T_{PD1(Gk)} + T_{CW} \leq 2 T_{CP2} \quad (1)$$

and

$$T_{PD0(F2)} + T_{PD1(G1)} + (k-2) [T_{PD0(I)} + T_{PD1(G)}] + T_{PD1(Gk)} + T_{CW} \leq 2 T_{CP} \quad (2)$$

The term $T_{PD1(Gk)}$ represents the delay of the NOR gate that feeds the k^{th} section; T_{CW} , the

clock pulse width, is the setup time of the first flip-flop in the k^{th} stage.

Rearrangement of Eqs. 1 and 2 to solve for the maximum number of sections allowed in the counter gives

$$k_{TPD1} \leq 2 + \frac{\{[2 T_{CP} - (T_{PD1(F2)} + T_{PD0(G1)} + T_{PD1(Gk)} + T_{CW})] / [T_{PD1(I)} + T_{PD0(G)}]\}} \quad (3)$$

and

$$k_{TPD0} \leq 2 + \frac{\{[2 T_{CP} - (T_{PD0(F2)} + T_{PD1(G)} + T_{PD0(Gk)} + T_{CW})] / [T_{PD0(I)} + T_{PD1(G)}]\}} \quad (4)$$

In the case of the 11-stage counter that uses the relatively slow 74LXX gates (described in the first article of this series):

$$k_{TPD1} \leq 2 + \frac{2(833) - (75 + 60 + 60 + 200)}{60 + 100} = 9.95,$$

$$k_{TPD0} \leq 2 + \frac{2(833) - (150 + 60 + 60 + 200)}{60 + 60} = 11.96.$$

The numbers 9.95 and 11.96 represent sizable increases from their previous values—4.48 and 5.02, respectively. With the faster 74XX gates,

$$k_{TPD1} \leq \frac{2(833) - (150 + 22 + 60 + 200)}{15 + 22} = 37.6,$$

an increase of 21 from 16, and

$$k_{TPD0} \leq \frac{2 + 2(833) - (150 + 22 + 60 + 200)}{22 + 15} = 34.4,$$

an increase of 20 from 14.

Since $k_{TPD0} < k_{TPD1}$, we can increase the number of allowable sections from 34 to 37 by parallel injection of the 1-to-0 transition of F_2 at a point that eliminates at least three gate delays.

The next step to increase speed is obvious: Remove F_2 from the serial-enable chain and add it to the parallel enabling. The equations are the same as Eqs. 1 through 4, except that $2T_{CP}$ and the ripple delay of stage F_3 must now be included. Therefore

$$k \leq 1 + \frac{4T_{CP} - (T_{PD0(F2)} + T_{PD1(F3)} + T_{CW})}{T_{PD0(G)} + T_{PD1(I)}} \quad (5)$$

The above equation assumes that

$$T_{PD0(G1)} + T_{PD1(Gk)} \approx T_{PD0(G)} + T_{PD1(I)}.$$

In addition, F_3 is injected downstream if k_{TPD0} is the limiting factor. Use of three-input J-K flip-flops—in all sections after the first—eliminates the NOR gates (Fig. 1b).

The wire-by-wire approach works until all terms in the first section are used to parallel-

E. Michael Meahl, Senior Engineer, Jet Propulsion Laboratory, California Institute of Technology, 4800 Oak Grove Dr., Pasadena, Calif. 91103.

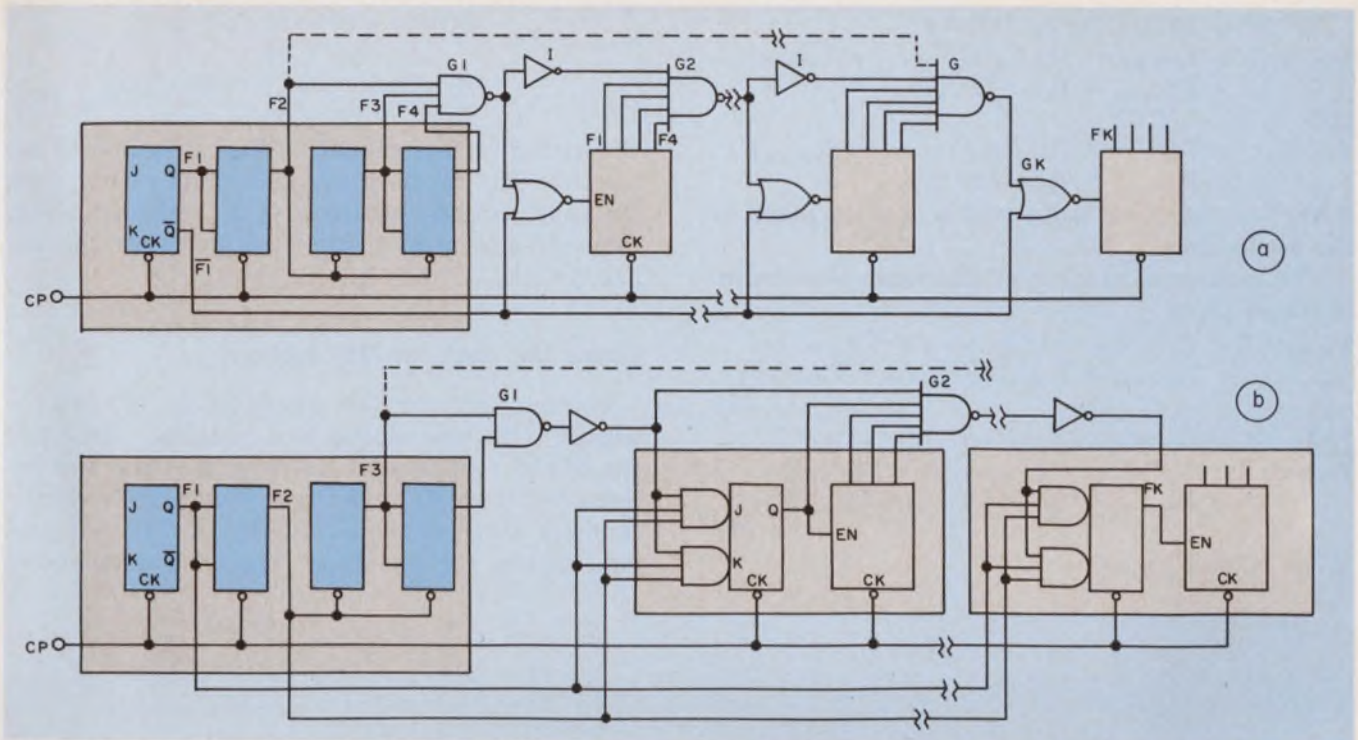

1. Counter size with parallel enabling is double or almost quadruple that for serial enabling. Parallel injection of F_1 eliminates the ripple delay of the first stage's 0-to-1 transition (a); parallel injection of F_1 and F_2 de-

creases ripple delay still further (b). With 74L30 gates and 74L04 inverters the first circuit can be expanded to 12 sections. Injection of F_2 or F_3 minimizes the 1-to-0 propagation delay.

enable the succeeding sections. And at that point—and one term earlier—the first gate and inverter are no longer necessary. And their removal eliminates unnecessary propagation delays.

Parallel-enable with the terminal count

However, the technique of parallel enabling with all stages of the first section is equivalent to the use of the terminal count of that section. So why not form the terminal count (Fig. 2) and apply the signal to the succeeding sections?

Let's consider the timing requirements. Assume that prior to the terminal count of the preceding $k - 1$ sections, the carry enable from

all but the first section has rippled down to the input gate of the last section. The output of the first section must be present at the input to the last section on the clock pulse that follows the terminal count of the first $k - 1$ sections. But the output of the first section must not be present on the next clock pulse.

The above timing situation is identical to that at the input to the second section. If the second section is enabled properly, then the last section will be enabled properly—no matter how many sections there are. And the limitation will be due to the ripple delay of the intermediate $k - 2$ sections. This delay must be less than the time between terminal counts of the first section.

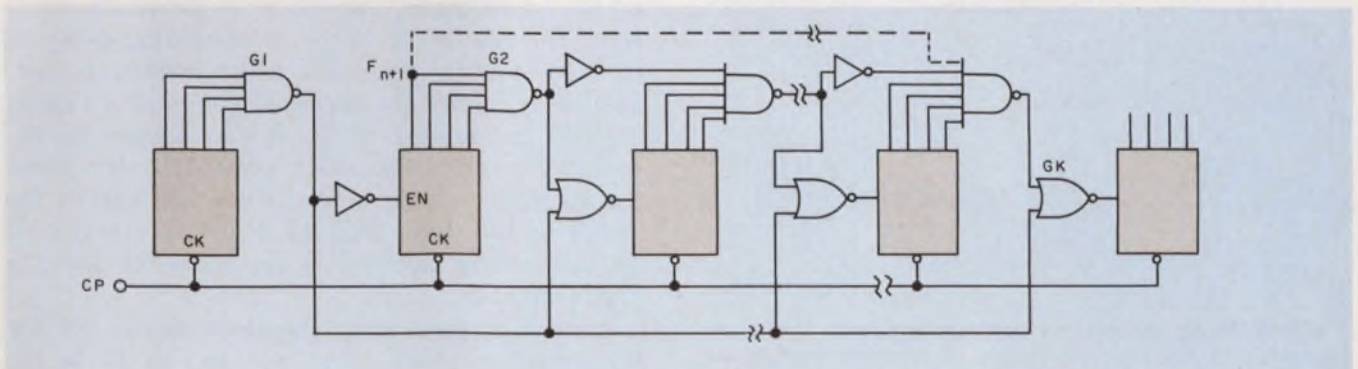

2. Apply parallel enabling from all flip-flops in a single section and you are using the terminal count—as generated by the multi-input AND gate. The same 74L30

gates and 74L04 inverters as in Fig. 1 permit the circuit to be 110 sections long. With proper design, the limiting ripple delay is that of sections 2 to $k - 1$.

The constraints are as follows:

$$T_{PD1(F_{n+1})} + T_{PD0(G_2)} + (k-3)[T_{PD1(I)} + T_{PD0(G)}] + T_{PD1(G_k)} + T_{CW} \leq 2^n T_{CP}$$

and

$$T_{PD0(F_{n+1})} + T_{PD1(G_2)} + (k-3)[T_{PD0(I)} + T_{PD1(G)}] + T_{PD0(G_k)} + T_{CW} \leq 2^n T_{CP},$$

with T_{CW} the clock pulse width used in place of the setup time.

The maximum number of allowable sections, k , is found from:

$$k_{TPD1} \leq 3 + \left\{ \frac{[2^n T_{CP} - (T_{PD1(F_{n+1})} + T_{PD0(G_2)} + T_{PD1(G_k)} + T_{CW})]}{[T_{PD1(I)} + T_{PD0(G)}]} \right\} \quad (6)$$

and

$$k_{TPD0} \leq 3 + \left\{ \frac{[2^n T_{CP} - (T_{PD0(F_{n+1})} + T_{PD1(G_2)} + T_{PD0(G_k)} + T_{CW})]}{[T_{PD0(I)} + T_{PD1(G)}]} \right\}. \quad (7)$$

With 74LXX gates:

$$k_{TPD1} \leq 3 + \frac{16(833) - (75 + 60 + 60 + 200)}{60 + 100} = 84$$

$$k_{TPD0} \leq 3 + \frac{16(833) - (150 + 60 + 60 + 200)}{60 + 60} = 110.$$

The configuration shown in Fig. 2 is indeed attractive. The capacity is 84 sections rather than the four sections obtained with serial enabling. Downstream injection of F_{n+1} increases the capacity to k_{TPD1} when $k_{TPD0} < k_{TPD1}$.

Enable the clock for MSI sections

Counter sections are available in IC form—usually with four stages to a package. Their use can afford considerable savings in space and interconnections. However, many are simple ripple-counters (such as the 54/74L93) and do not provide inputs for enabling. The only alternative

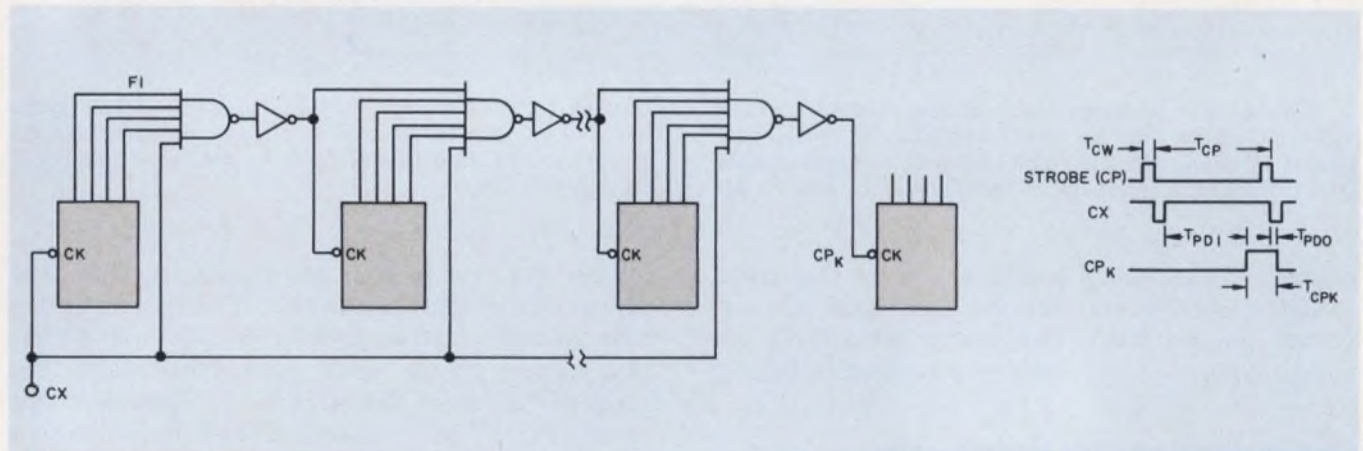

3. Serial-enabling scheme allows use of MSI ripple-counter packages that do not afford access to the J-K inputs of individual flip-flops. The clock pins are used

as the enabling inputs. A separate clock signal is necessary and the waveforms must conform to those shown in the timing diagram.

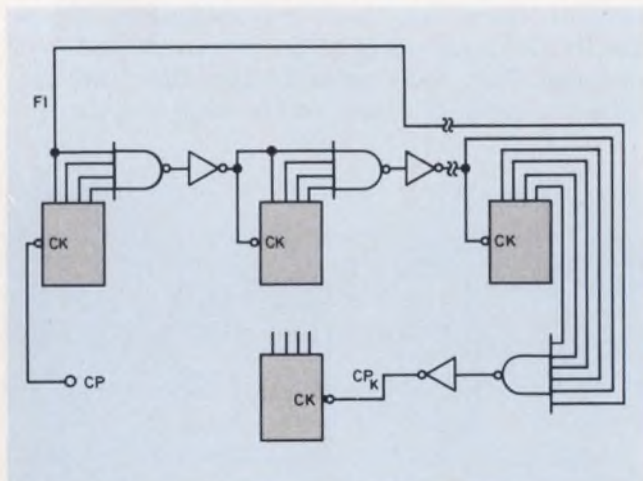

4. Clock-timing restrictions are removed with this configuration of MSI ripple-counters. The signal from F_1 —the first flip-flop stage of the first section—becomes the virtual or secondary clock for the counter. The addition of F_1 to each counter section eliminates the 1-to-0 ripple delay of the gates.

left is to enable the clock line.

One possible configuration is shown in Fig. 3. The leading edge of the clock pulse ripples down through the series gates, but the trailing edge does not. Since each gate delay reduces the width of the clock pulse, the clock pulse width must equal the sum of the 0-to-1 propagation delay of the gates and the minimum width needed to operate the IC. Since the terminal count of a ripple-counter is bounded by F_1 , it can always be decoded. Therefore the clock pulse into the gates can be made as wide as you wish—so long as the width is less than that of F_1 . The number of counter stages allowed is the same as for the ripple-counter.

Instead of generating the clock signal CX for the serially-enabled string, you can let F_1 be the virtual clock for the counter (Fig. 4). The worst-case condition occurs here on the 2^n count (the count that follows the terminal count).

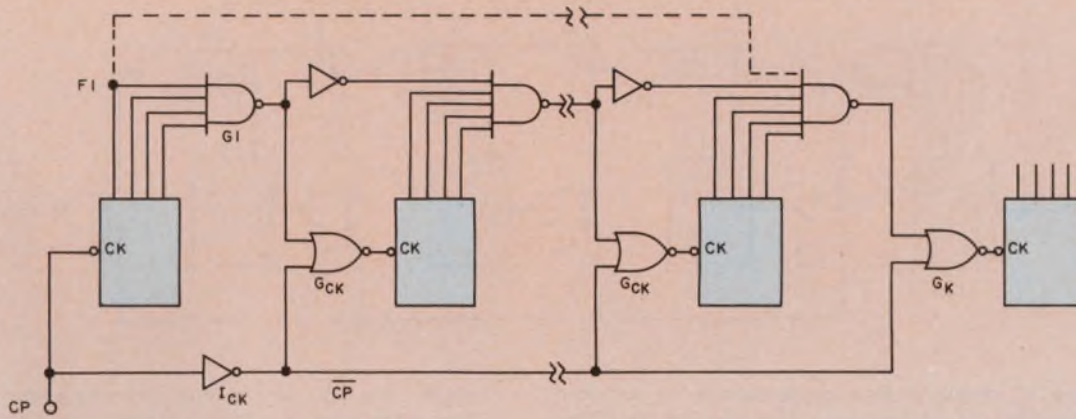

5. Greater clock speeds can be used if the clock-line is also enabled. Both the gate-inverter delay and the 1-to-0 transition delay of F_1 —at each clock pin—are elimi-

On the 2^n count, the 1-to-0 transition of F_1 must ripple down through all the gates, then through all the stages in the last counter section. You can eliminate the ripple delay of the gates by addition of F_1 to each section of the counter. If any count is to be decoded, and the decoded pulse is to be at least as wide as the clock pulse, then the necessary conditions for each section that follows the first is given by:

$$T_{CP} \cong T_{PD0(F1)} + T_{PD1(G)} + T_{PD0(I)} + n T_{PD0(F)} + T_{CW} \quad (8)$$

Based on data-sheet parameters for a SN54/74L93 counter, calculate:

$$\frac{1}{f_{max}} = T_{CP} = (150 + 60 + 60 + 450 + 200)$$

or 900 ns.

Therefore $f_{max} = 1.09$ MHz.

Note that f_{max} is less than the value previously calculated for a four-stage enabled section—even though the maximum $T_{PD0(F)}$ delay of the counter is only 450 ns compared to the 600 ns for four stages of the 74L-series flip-flops. The number of allowable sections is given as

$$k \leq 2 + \frac{T_{CP} + T_{PD0(F1)} - (T_{PD1(F1)} + T_{CW})}{T_{PD0(G)} + T_{PD1(I)}} \quad (9)$$

The enabling of the clock line increases the maximum counting rate of the sections (Fig. 5). The procedure eliminates clock delays due to $T_{PD0(F1)}$ and the AND gate. The maximum rate is

$$\frac{1}{f_{max}} = T_{PD1(ICK)} + T_{PD0(GCK)} + n T_{PD0(F)} + T_{CW} \quad (10)$$

or 1.3 MHz for the 54/74L93 counter. (The injection of F_1 is also used if $k_{TPD0} < k_{TPD1}$.) And the allowable number of stages is:

$$k \leq 2 + \frac{T_{CP} - (T_{PD1(F1)} + T_{CW})}{T_{PD1(I)} + T_{PD0(G)}} \quad (11)$$

Use of the terminal count provides for additional increases in counter size (Fig. 6). The equation for the maximum operating frequency of each section is similar to that of Fig. 5:

ated. The allowable clock rate for a SN54/74L93 counter is 1.3 MHz as compared with 1.09 MHz for the circuit in Fig. 4.

$T_{CP} \cong T_{PD1(G1)} + T_{PD0(GCK)} + n T_{PD0(F)} + T_{CW}$. (12)
The number of allowable sections is given by

$$k \leq 2 + \frac{2^n T_{CP} - (T_{PD1(F_{n+1})} + T_{CW})}{T_{PD1(I)} + T_{PD0(G)}} \quad (13)$$

As before, the downstream injection of F_{n+1} removes the limitation caused by T_{PD0} .

More speed with synchronous sections

There is one more combination to consider—the serial connection of synchronous (parallel-enabled) sections. In a synchronous section, the delay of the enabling signal to the input of each flip-flop (except the first and the second) consists of the delay through the first flip-flop and one AND gate. Therefore the maximum operating frequency is

$$T_{CP} \cong T_{PD1(F1)} + T_{PD1(G)} + T_{CW} \quad (14)$$

and

$$T_{CP} \cong T_{PD0(F1)} + T_{PD0(G)} + T_{CW} \quad (15)$$

The simplest arrangement is a ripple-counter (Fig. 7a). Since each stage in the section (including the last) is toggled by the clock, the delay through each section is only $T_{PD0(F)}$. And the delay through the entire counter is $kT_{PD0(F)}$. Therefore the operating equations for the counter are identical to those for the ripple-counter except that n is replaced by k . Thus

$$\frac{1}{f_{max}} = T_{CP} = T_{PD0(F)} + T_{CW} \quad (16)$$

and

$$k \leq \frac{T_{CP} - T_{CW}}{T_{PD0(F)}} \quad (17)$$

All stages in a section toggle “simultaneously” on the fall of the clock signal, so the speed of the counter is essentially unaffected by the number of stages in the section—only by the number of sections in the counter.

Since each of the stages in a synchronous section is toggled by the clock, enabling them direct-

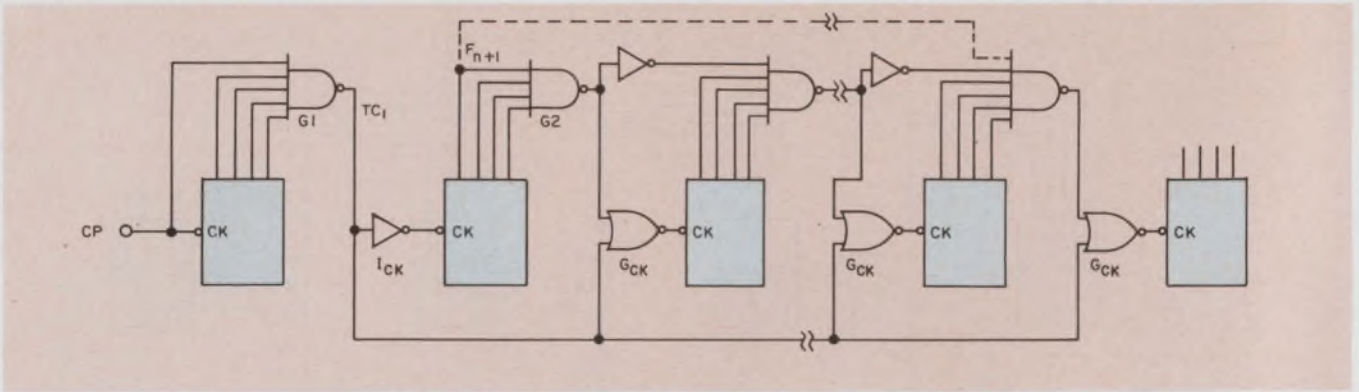

6. Maximum IC ripple-section performance is obtained by a combination of techniques. The parallel injection of the terminal count, as in Fig. 2, maximizes the counter

length. The use of the enabled clock-line affords operating rates similar to those of the circuit shown in Fig. 5. Downstream injection of F_{n+1} can also be used.

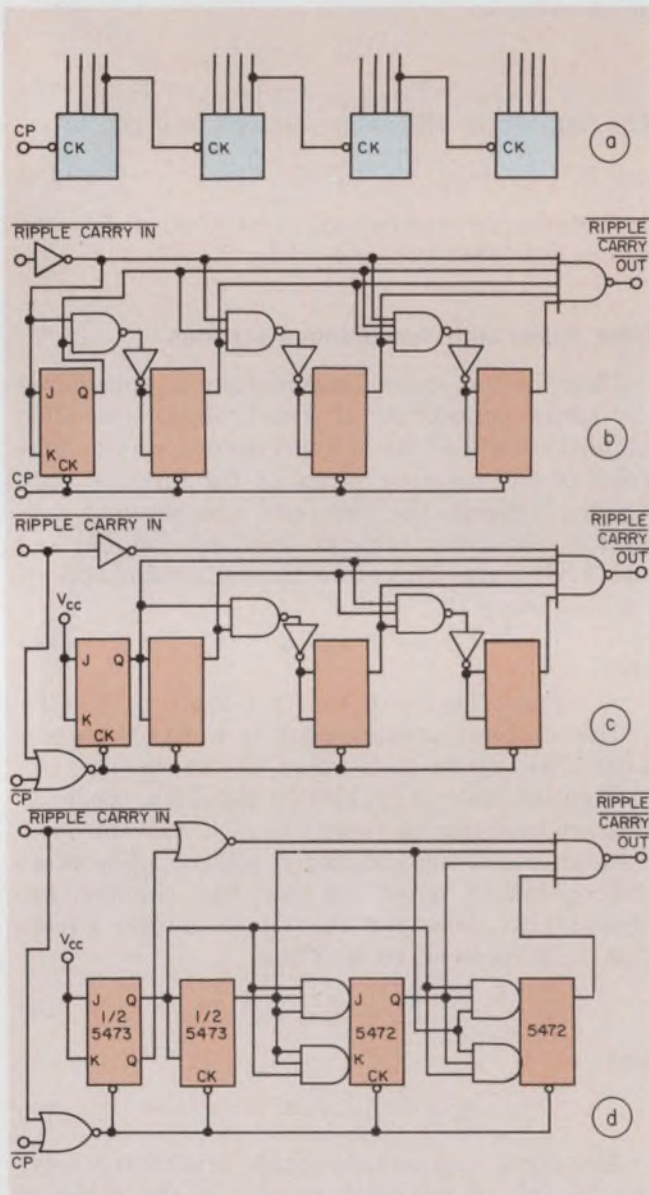

7. Synchronous sections boost speed. The ripple connection (a) is the simplest for multisection counters. Each stage (flip-flop) must be enabled at the same time since they are all toggled by the clock (b). Enabling the clock simplifies the circuitry (c) and (d). Similar circuits are available as MSI sections.

ly requires that the enable line go to each stage (Fig. 7b). Because of the increased complexity, the usual scheme is to enable the clock line as shown in Fig. 7c. (This arrangement is identical to the clock-enabling configuration shown in Figs. 5 and 6 for ripple sections.) The four-stage synchronous section of Fig. 7c eliminates the internal gates and can be built with available IC flip-flops as shown in Fig. 7d. Similar configurations are available in a single package in some IC-logic families (for example SN74161 and SN74163).

How do you choose the optimum balance between the number of stages per section vs the number of sections in the chain? Since the number of stages in a synchronous section is not limited by the clock rate (as it is in the case of the ripple sections), the choice must be based on other criteria. Usually one or more of the following three items will dictate the selection:

- (1) Decoding requirements.
- (2) Clock rate and total number of stages in the counter.
- (3) Number of stages per package in available IC synchronous counters.

Item 1 was discussed in the first article of this series. Item 3 is self-evident. Let's examine item 2. Suppose that the clock rate is close to the maximum toggling frequency of the flip-flops and that we are limited to three sections by the delays in the serial-enable chain. If a total of m stages are needed in the counter, then the minimum number of stages that must be put in the longest section is obviously $m/3$.

The configurations available are essentially the same as those shown in Figs. 3 to 6 for ripple-section counters. The configuration of Fig. 3 is not very suitable for serial enabling. A better choice is shown in Fig. 4. In a synchronous section, the last stage goes to "0" as quickly as the first; the first gate and inverter can be eliminated and the clock of the second section can be connected directly to the last stage of the first sec-

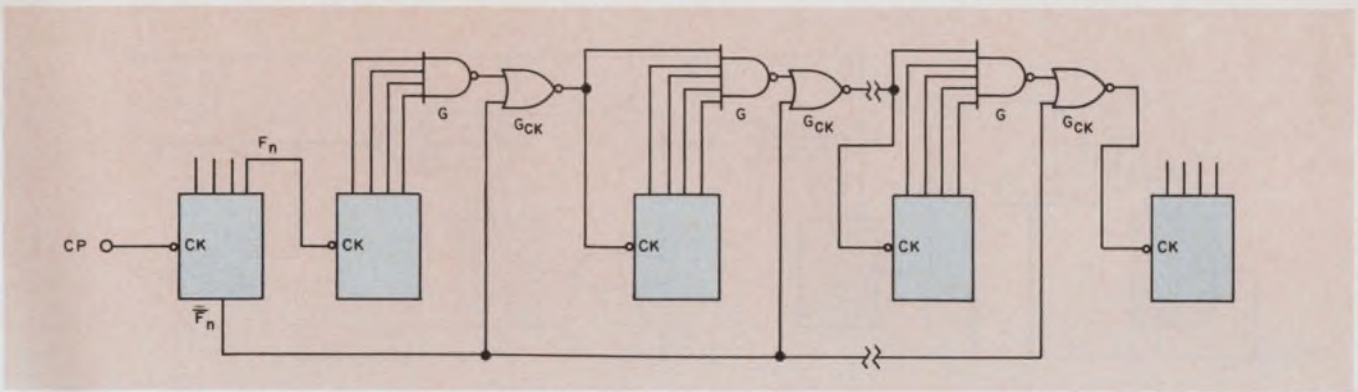

8. Synchronous sections can be used in a serial-enabled counter configuration (a). The first gate-inverter pair—required for ripple sections—can be eliminated. The last

stage makes a 1-to-0 transition as quickly as the first. If more sections are needed, then use synchronous sections in the circuit shown in Fig. 6.

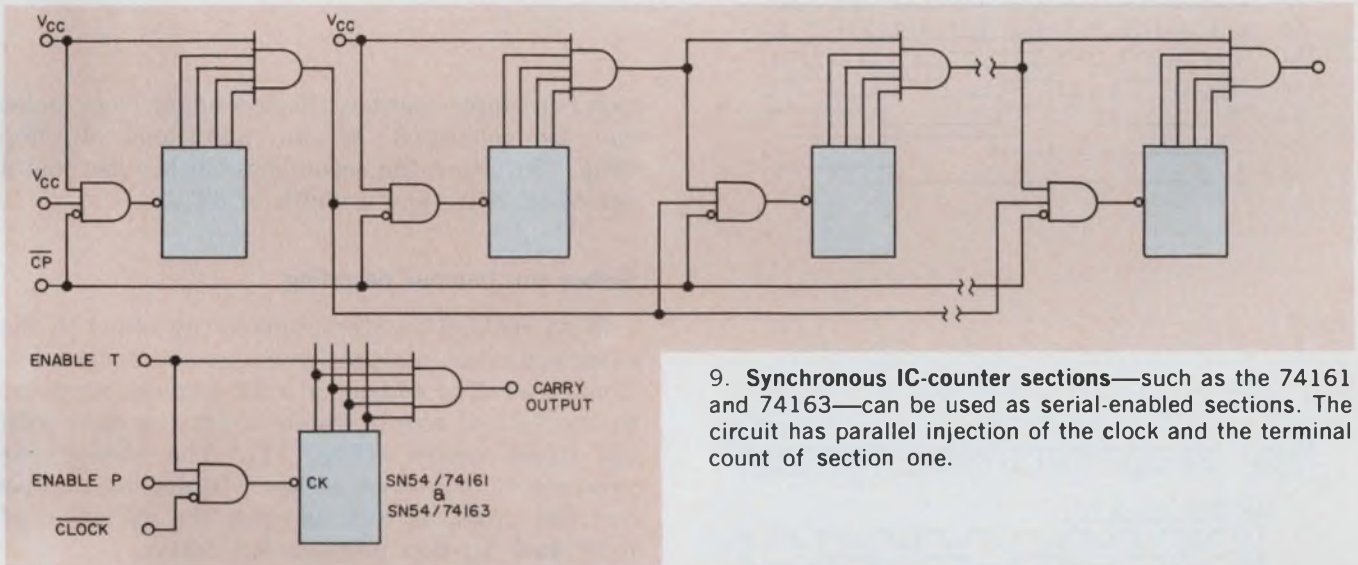

9. Synchronous IC-counter sections—such as the 74161 and 74163—can be used as serial-enabled sections. The circuit has parallel injection of the clock and the terminal count of section one.

tion. The final circuit is rearranged somewhat to maximize speed (Fig. 8). The operating equations are:

$$T_{CP} \cong T_{PD1(F_n)} + T_{PD0(GCK)} + T_{PD(F)} + T_{CW} \quad (18)$$

$$k \leq 3 + \frac{2^{n-1} T_{CP} + T_{PD1(F_1)} - (T_{PD0(F_n)} T_{CW})}{T_{PD0(G)} + T_{PD1(GCK)}} \quad (19)$$

And for 74L series logic: $f_{max} = 2.06$ MHz and $k = 17.7$ sections.

The configuration of Fig. 6 can be used with synchronous sections. Eqs. 12 and 13 apply if n in Eq. 12 is set equal to 1. With synchronous sections, the configuration in Fig. 6 allows almost twice as many sections as that of Fig. 8. This is because there is a factor-of-two difference in the coefficients of T_{CP} between Eqs. 13 and 19.

Complete synchronous counter sections are available in IC form. The SN74161 and SN74163 are typical examples. The general form of these circuits and a possible counter configuration that uses them is shown in Fig. 9. The maximum counting rate will be determined by the maxi-

mum allowable clock frequency into a section (as given on the data sheet).

Intermixing logic families

With the simple ripple-counter, you can take advantage of the differing speed/power quotients of different (but compatible) logic families. Use faster flip-flops in the early stages of the counter and slower flip-flops in later stages. If you try to intermix logic families in enabled counters, the clock pulse required for the early stages is not wide enough for use by the lower-speed logic used in the later stages. In a configuration like Fig. 4, the pulse width may or may not present a problem. The signal at F_1 becomes the virtual clock for all sections that follow the first and its width is equal to T_{CP} rather than T_{CW} .

If the first section is synchronous, the output of any stage can be used as the virtual clock for the following sections in any of the enabled counter configurations which we have discussed. For example, the virtual clock from F_n (Fig. 8) has a width of $2^{n-1} T_{CP}$. The operating equations have to be modified accordingly. If the first sec-

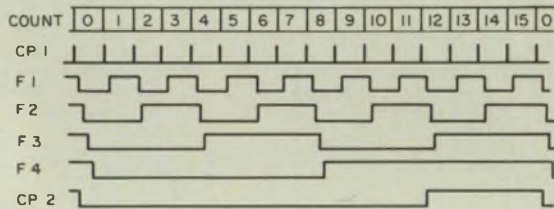
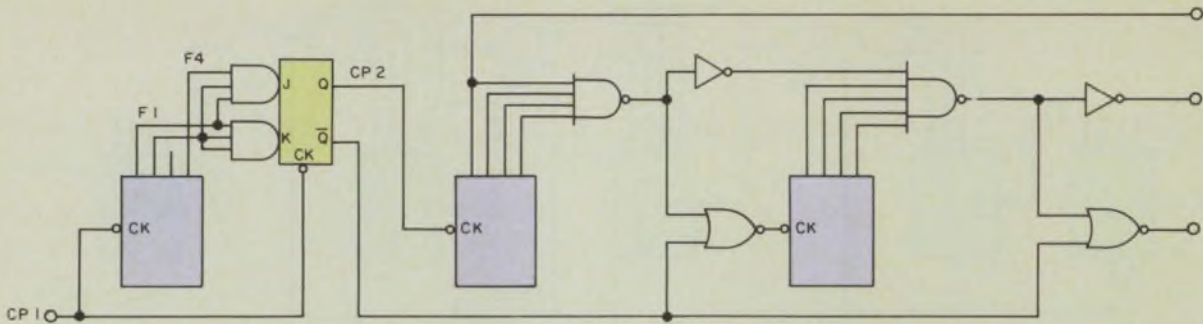

10. Secondary clock pulses should be tailored to the speed requirements of succeeding sections. The secondary clock pulse, taken from a ripple section, is modified in period and width.

tion is a ripple-counter, the secondary clock pulse can be generated by an additional flip-flop (Fig. 10). Here the secondary clock pulse has a period of $16T_{CP}$ and a width of $4T_{CP}$.

Spikes can hamper decoding

With enabled counters, spikes can occur in the same places as in ripple-counters and some additional ones. The additional spikes can occur prior to the desired count, which is not the case with the ripple-counter (Fig. 11). The absence or presence of particular spikes will depend on rise and fall times, as well as upon the variation of individual flip-flop propagation delays.

Each "prior" spike can occur only if a stage of the counter makes a 0-to-1 transition before the other stages—which change state at the "same time"—make their 1-to-0 transition. If T_{PD1} is always greater than T_{PD0} , then such spikes cannot occur. In most TTL flip-flops, T_{PD0} is greater than T_{PD1} . Therefore—as pointed out by Priel*—if you use the complementary outputs of the flip-flops and decode the "bar" terms with a NOR gate, then the "prior" spikes will be eliminated. If the decoded count is the terminal count of the section, "trailing" spikes will not exist.

To protect against variations in delay between individual flip-flops, the safest procedure is to add the undelayed clock signal (strobe) into each decoding gate. The clock signal bounds the output and eliminates any possibility of spiking.

Enabling up/down counters

The binary output of a down-counter is merely the ONE's complement of the corresponding

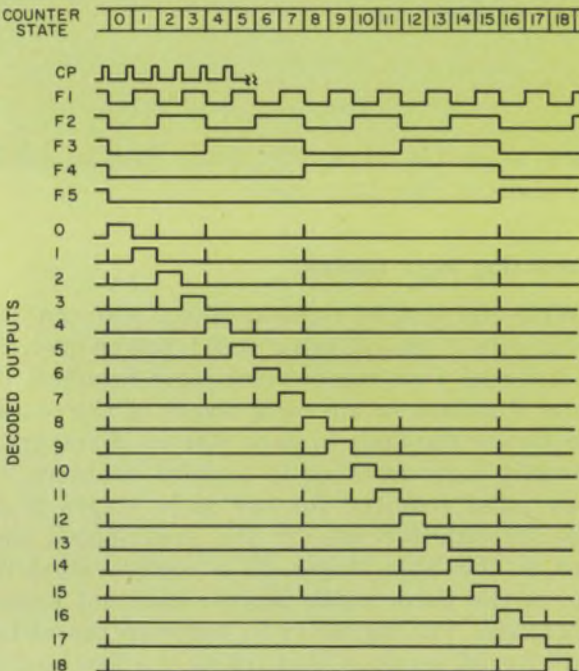

11. Glitches can occur in the identification (or decoding) of synchronous counter sections. Some of these spikes can occur on counts that precede the identified state, which is not the case with simple ripple-counters. Any of the enabling techniques gives rise to the possibility of such spikes.

*Priel, U., "To decode counter state, use a NOR gate instead of an AND," Electronic Design No. 17, August 17, 1972, p. 96.

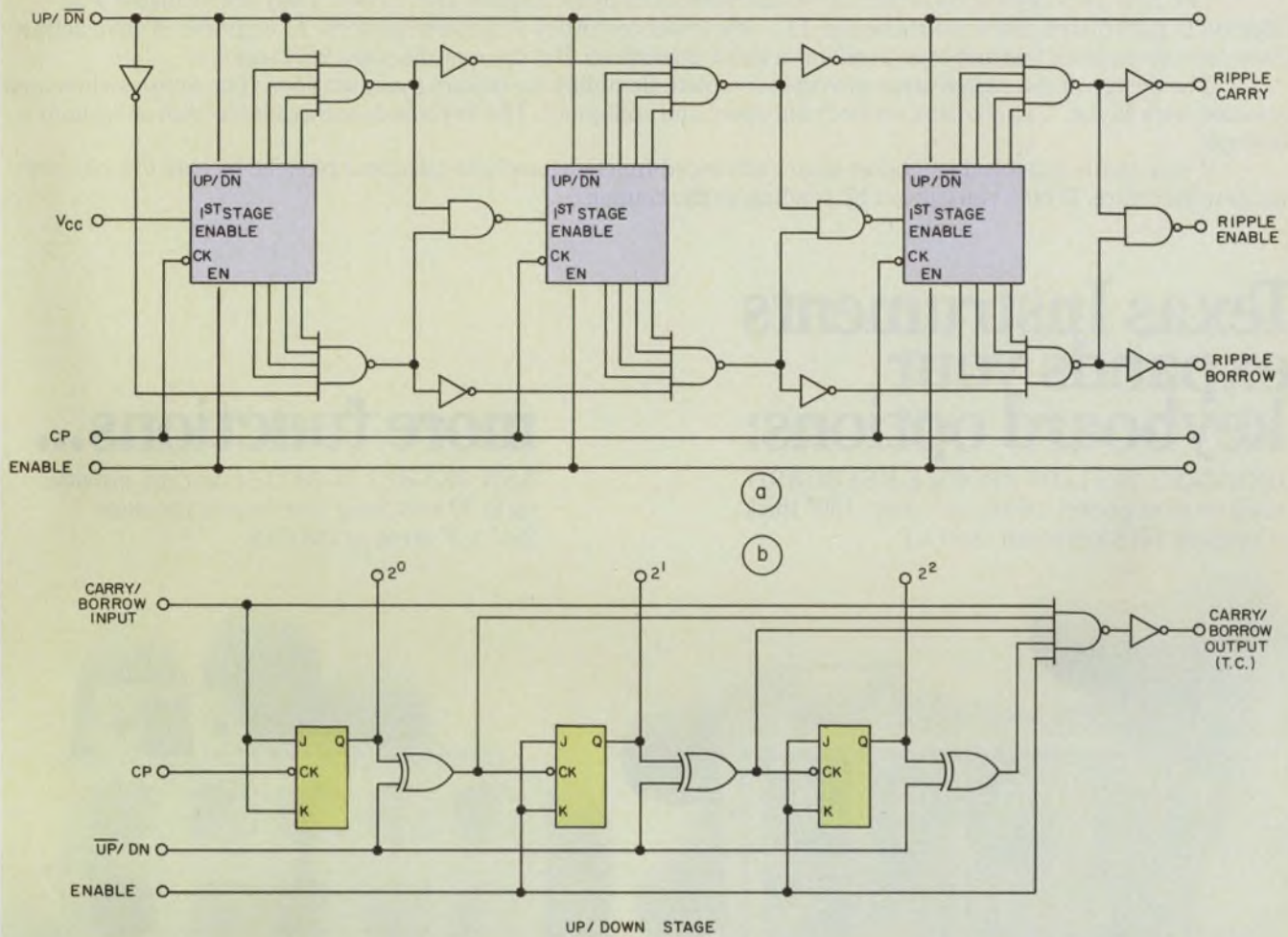

12. Circuits for the enabling of up/down counters are similar to those used with "up" counters. The main difference is that a second enable chain is used for the

down-count (a). Use of the up/down control gates—to form the terminal count—eliminates the second chain (b). A serial enabling technique is shown.

output of the up-counter (see table). Thus an up-counter becomes a down-counter merely by the inversion of the outputs. These outputs can be obtained from the \bar{Q} terminal of the flip-flops. An up-counter can be switched to count down if the input to each flip-flop is switched from the Q to \bar{Q} output of the preceding flip-flop. Since the switching is merely a polarity inversion, it may be accomplished with EXCLUSIVE-OR circuits.

The enabling technique may be applied to up/down counter sections in a manner similar to those used with simple up-counter sections. Fig. 12a shows three enabled, four-stage up/down sections. This is the same scheme as used for the basic serial-enabled counter except that a second enable chain has been added for the "down-count." The second enable chain may be eliminated when the "terminal count" is formed from the outputs of the up/down control gates of a section (as shown in Fig. 12b). Except for

Comparison of counter states

| UP-COUNTER | | | DOWN-COUNTER | | | | |
|---------------|--------|-------|--------------|----------------|--------|-------|-------|
| DECIMAL COUNT | BINARY | | | DECIMAL OUTPUT | BINARY | | |
| | 2^2 | 2^1 | 2^0 | | 2^2 | 2^1 | 2^0 |
| 0 | 0 | 0 | 0 | 7 | 1 | 1 | 1 |
| 1 | 0 | 0 | 1 | 6 | 1 | 1 | 0 |
| 2 | 0 | 1 | 0 | 5 | 1 | 0 | 1 |
| 3 | 0 | 1 | 1 | 4 | 1 | 0 | 0 |
| 4 | 1 | 0 | 0 | 3 | 0 | 1 | 1 |
| 5 | 1 | 0 | 1 | 2 | 0 | 1 | 0 |
| 6 | 1 | 1 | 0 | 1 | 0 | 0 | 1 |
| 7 | 1 | 1 | 1 | 0 | 0 | 0 | 0 |

the requirement that a line be provided to allow disabling of the counter during the mode switching, the up/down sections now look identical to the up-sections. Serial and parallel-enabling techniques may be applied to the up/down counter. Since most up/down sections are internally enabled, the mode control line need only remain fixed when the clock signal is high. ■■

Now you can design a *true* shirt-pocket size calculator. Or handheld calculator with 30 or more functions. All with the same snap-through feel and sound that have made Klixon® low profile keyboards the number one sellers.

The new 3KS keyboards retain all the characteristics of the original 1KS model. They are available with selectively gold plated disc construction or TI's new lower cost Alloy A material system. TI engineered snap-acting discs provide uniform feel and over 1 million reliable operations. But the new discs are 25% smaller.

The design of the switch array provides complete flexibility for custom configurations. The entire switch area is sealed with Mylar™, so contacts are both lint-proof and spill-proof. The keyboards are available with or without keytops.

If your plans include shirt-pocket size or advanced-function handheld calculator models, be sure to look over our new literature. Which you can get by sending us the coupon.

Texas Instruments expands your keyboard options:

ORIGINAL 1KS LOW PROFILE KEYBOARD
used on most pocket calculators, only .150" thick.
(Complete 6KS keyboard shown.)

more functions...

NEW 3KS KEYBOARD design can provide
up to 30 switching functions in the same
2½" x 3" areas as the 6KS.

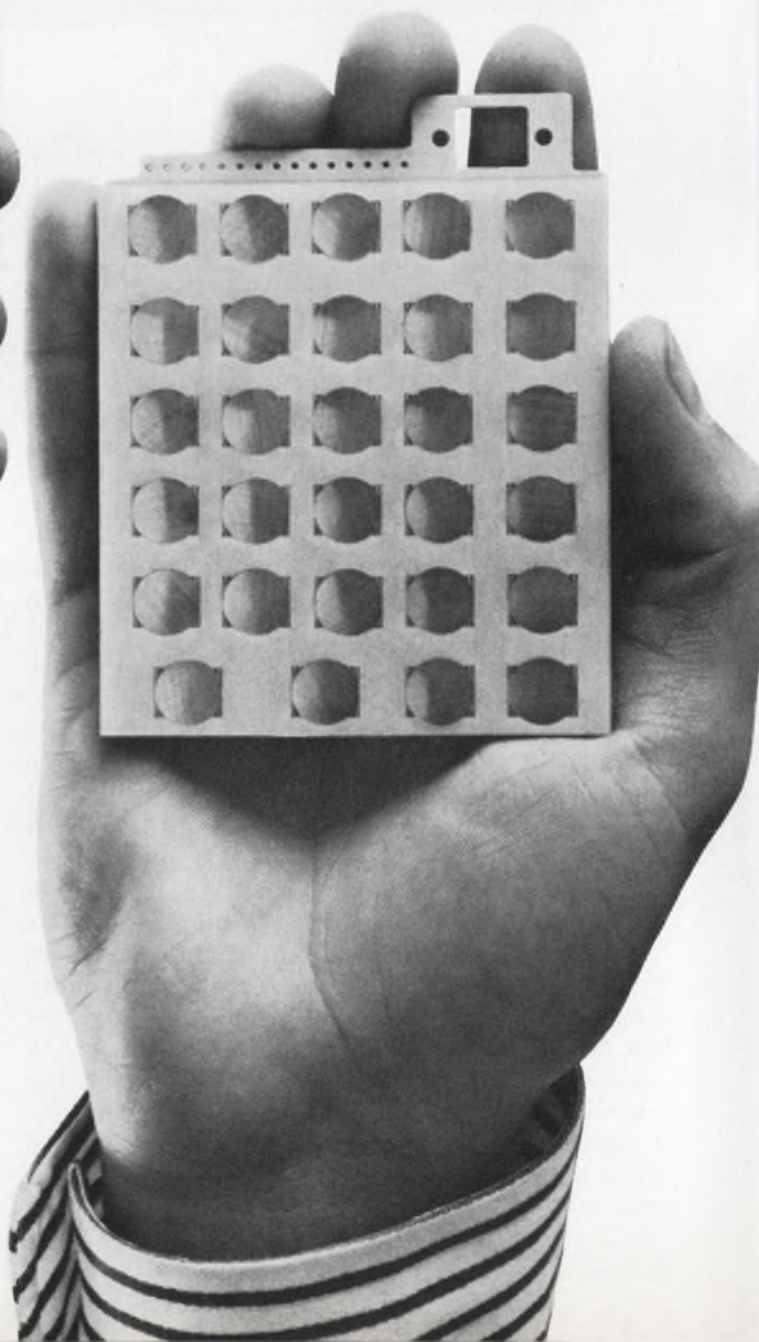

Texas Instruments Incorporated
Keyboard Products Marketing
MS 12-33
Attleboro, Mass. 02703

Name _____

Title _____

Company _____

Address _____

City _____ State _____ Zip _____

Keyboard application:

- Pocket Calculator Computer Terminal
 Desk-top Calculator TV Controls

Other _____

- Application is new or existing

Approx. annual usage _____ units

Application requires:

- Basic 1KS or 3KS keyboard array
 Complete keyboard assembly
 Please have a TI Sales Engineer call



TEXAS INSTRUMENTS
INCORPORATED

smaller size...

OR 3KS KEYBOARDS can shrink
20 switching functions into 2¼" x 2½"
shirt-pocket size array.

thinner.

NEW 2KS KEYBOARD
is only .050" thick.

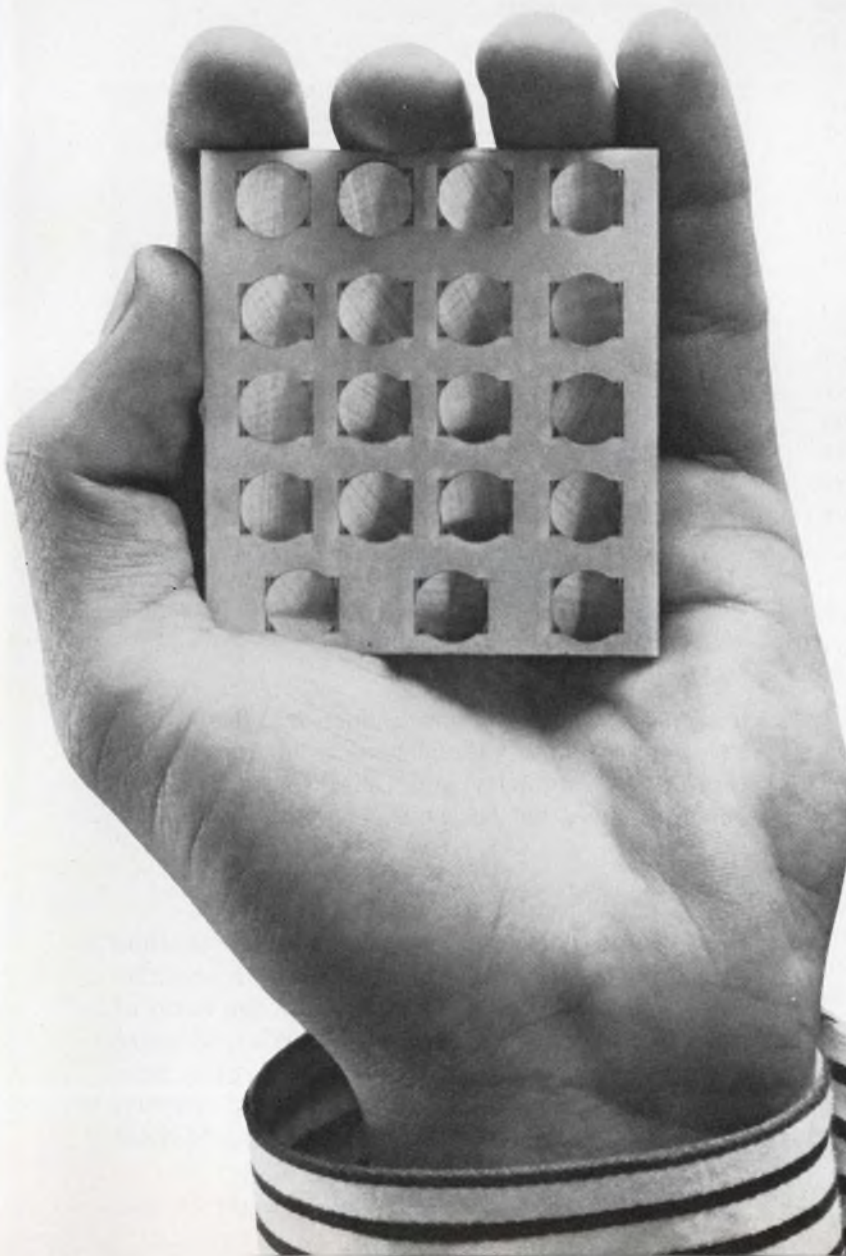

Measure vhf-FM receiver sensitivity

in any of three ways. The choice among the 'quieting,' SINAD or noise-figure method depends on your design needs.

When it comes to measuring vhf-FM receiver sensitivity, you have a choice of three major methods. The one you pick partly depends on whether you are designing new equipment or making production tests.

The "quieting" method is simple, but can't distinguish between i-f and audio response. The SINAD method overcomes the problem at the expense of a more elaborate setup. The third technique—noise-figure measurement—provides the most information about front-end stages.

The choice is easier if you know how these methods relate to one another and the snags to avoid in making measurements.

In the quieting method—probably the oldest method of sensitivity measurement—an unmodulated rf signal input to a receiver produces a specified amount of noise reduction at the output. The method provides a measure of the minimum rf level that eliminates, by limiting action, the bulk of the noise in the receiver output.

The test requires a cw rf generator with a calibrated output control and an output audio power meter or voltmeter, as shown in Fig. 1. To perform the measurement, adjust the receiver output for a reference audio-noise power output. Then increase the rf input level in discrete steps and note the corresponding drop in noise output.

The resulting behavior can be plotted (Fig. 2). Eventually a point is reached so that further increases in input level produce no further significant decrease in noise output. The dB difference between this level and the reference—or no-signal—output represents the "maximum quieting" for the receiver.

Quieting sensitivity—usually stated as the rf input necessary for either 20 or 30-dB quieting—thus corresponds to one point on the quieting curve. However, another receiver with the same i-f bandpass, but different audio-rolloff characteristics, produces a different quieting curve. This inability of the quieting method to distinguish between i-f and audio response limits its

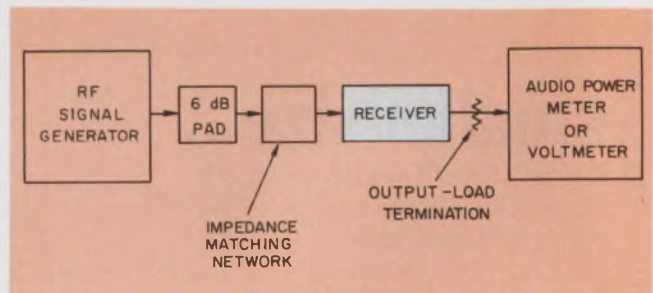

1. Receiver quieting can be measured from a simple setup. However the technique can't distinguish between i-f and audio response.

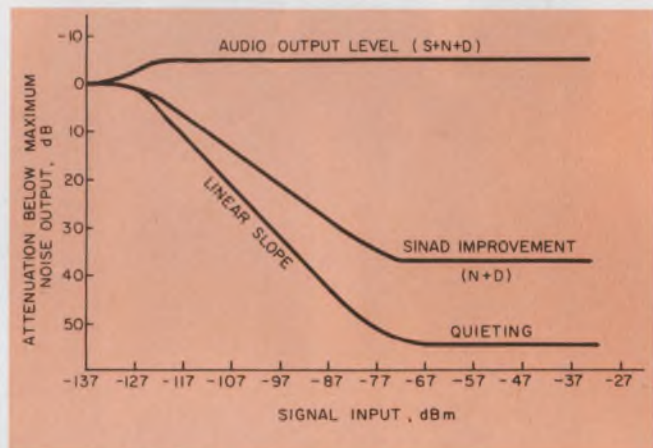

2. Typical SINAD and quieting curves exhibit a leveling off in output noise. The linear region in the quieting curve, beyond the start of limiting, permits a simplification of the noise-figure measurement.

usefulness. Only receivers of identical design can be compared. The method's main advantage centers on its simplicity and the fact that an FM generator need not be used.

SINAD sensitivity: A systems method

For the system designer, the SINAD method probably represents the most acceptable sensitivity measurement. SINAD stands for the ratio of measured signal + noise and distortion to noise and distortion, expressed in dB. The ratio provides a measure of audio output-signal quality, at a given audio-power level. Usually the SINAD

Receiver vs antenna noise

Receiving systems are vulnerable to noise from two main sources: the antenna and the receiver itself.

Noise picked up by the antenna can be either natural or man-made. Natural noise, from cosmic sources, has a fairly constant level, while man-made noise, such as vehicle ignition, varies widely, depending on the closeness of the noise source.

Receiver noise can be caused by anything from component to line fluctuations. Added to the signal and noise coming from the antenna, receiver noise degrades the over-all signal-to-noise ratio.

At the lower end of the vhf band—around 30 MHz—antenna noise may exceed receiver noise by many decibels. Thus if you have a sensitive antenna, you may not have to worry much about receiver noise at these frequencies.

In low-vhf mobile and portable applications, however, the size of the antenna is usually only a fraction of that needed for high efficiency. Such an antenna picks up less signal and less noise, so the receiver's noise performance becomes important here.

At the higher vhf frequencies, the antenna noise falls off anyway, so the limiting factor on system performance becomes, again, the receiver noise itself.

sensitivity is expressed as the level of frequency-modulated rf input necessary to produce a 12-dB SINAD ratio at the output.

The required test equipment includes an FM signal generator with an output control calibrated to $0.1 \mu\text{V}$ and with provision for frequency modulation of the carrier at the required deviation (Fig. 3). You'll also need an audio-distortion analyzer with a tunable notch filter and capability for indicating the af output level. The modulating signal usually a 1-kHz tone, must be adjusted for an FM deviation equal to the maximum expected for the receiver—or for the standard test deviation, if known.

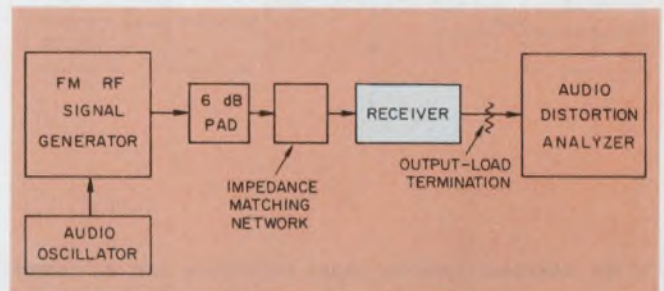

3. The SINAD measuring setup, similar to that for quieting, uses a modulated rf signal and distortion analyzer to notch out the recovered audio tone.

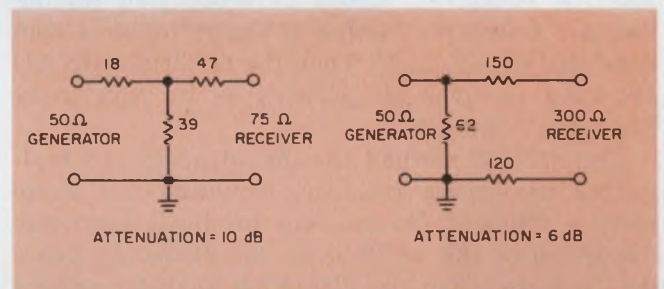

4. Simple impedance matching pads can be built to provide a wide range of attenuation values.

To perform the measurement, begin with the receiver "unquieted" and the modulated signal generator at minimum output. Set the receiver af gain so that the noise produces the rated af power output. Then increase the rf input in discrete steps—say, 1 dB apart.

At each input level, switch the distortion analyzer to read first the total audio output—1-kHz signal + noise + distortion. Notch out the 1-kHz tone and read the remaining output—noise + distortion. Record the dB ratio between the two quantities as the SINAD ratio for the rf input level. To obtain the entire SINAD performance curve, as in Fig. 2, continue the measurements until no further significant change in SINAD occurs for further increases in rf input.

Usually the sensitivity in commercial receivers is expressed as the input level for a 12-dB SINAD ratio and in military receivers as 10-dB SINAD. In either case only a single point on the curve

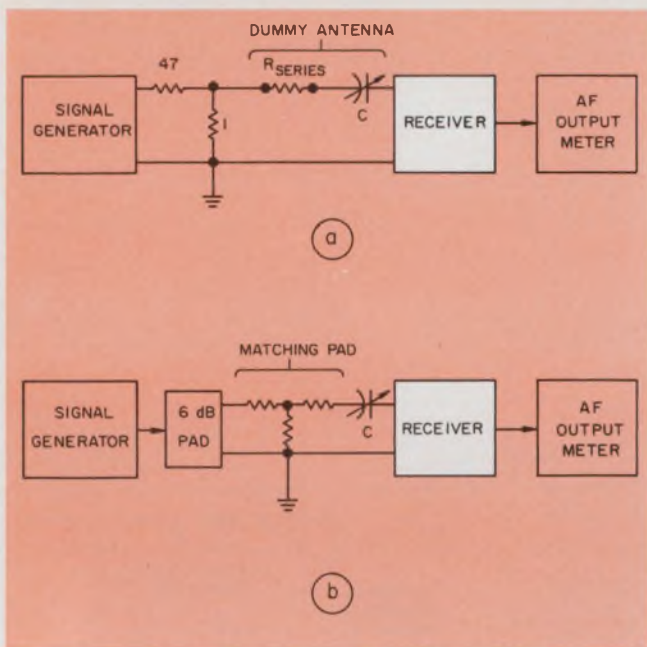

5. An unknown receiver input resistance can be found by measurement (a). The value found can then be used to build a matching pad that ensures maximum power transfer between generator and receiver (b).

need be measured. Often in production testing the test simplifies further if the rf input is held constant at, say, $1 \mu\text{V}$. Then the resulting SINAD for each receiver is specified as its sensitivity for a $1\text{-}\mu\text{V}$ input.

The SINAD method has the advantage of evaluating the entire receiver, including the audio section. Thus if the receiver produces harmonic distortion of the 1-kHz tone, the distortion products remain when the distortion analyzer rejects the 1-kHz fundamental signal. The SINAD ratio decreases accordingly.

Watch the impedance matching

For both the SINAD and quieting methods, ensure a proper impedance match between the generator and the receiver. An attenuator pad should be used at the signal-generator output. The pad tends to smooth out reflected impedance variations. And it reduces the effect of generator-output setting error caused by stray signal leakage at low output levels. Six dB of attenuation is usually enough.

For a $50\text{-}\Omega$ generator and $50\text{-}\Omega$ receiver input, use a standard attenuator pad. If the receiver has a $75\text{-}\Omega$ unbalanced or $300\text{-}\Omega$ balanced input, make up a simple pad, as shown in Fig. 4. Keep lead lengths as short as possible and don't forget to take the specified pad attenuation into account.

Input matching becomes more tricky with hand-held receivers or transceivers. In this case the antenna—mounted directly on the set—is the only input connection. To obtain maximum power

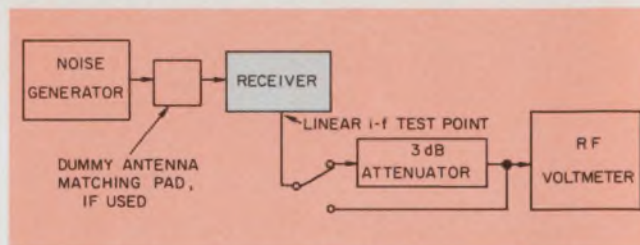

6. When an i-f prelimiter test point is available, this setup can measure receiver noise figure.

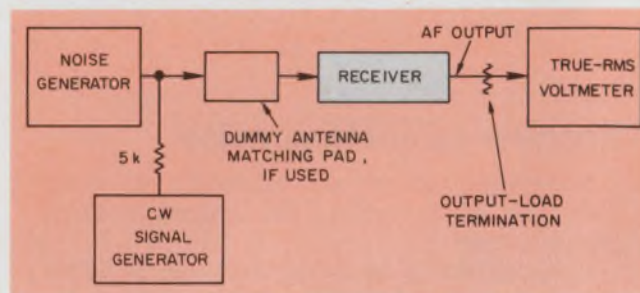

7. When only the audio output is accessible, this setup can measure receiver noise figure. The measurement is made on the linear portion of the quieting curve. Even an FM receiver has a small range of linear relation.

transfer, we generally make the receiver input impedance equal to the complex-conjugate impedance of the antenna. A dummy antenna—consisting of series C or L components—must be used to simulate the antenna.

The antenna length usually equals a quarter wavelength or less. If less, the antenna impedance has a small, series-capacitive reactance component in addition to its resistive component—radiation resistance plus ground losses. In the rarer case of an antenna that is longer than a quarter wavelength, the reactance is inductive. In either case make the C or L variable and tune for maximum signal transfer.

Hopefully the manufacturer's data sheet gives the impedance seen looking into the receiver. If it doesn't, the impedance can be found by trial and error (Fig. 5a). The attenuator pad creates a signal source with an impedance that is close to zero. Set the generator for enough output to give about 10-dB receiver quieting, with no series resistor and with the capacitor, or inductor, tuned for maximum quieting. Then insert trial values of series resistance. Continue until you find a value that requires doubling the generator output to obtain the same receiver quieting.

The value found equals the resistive component of the receiver input impedance; the resistor, together with the C or L component, forms the dummy antenna. Knowing the receiver input resistance you can design a matching pad (Fig. 4a) to match the generator to it. Remember to calculate and include the dB loss of the pad when making the sensitivity measurements.

Noise-figure measurement is one of the most useful to the receiver designer, especially for the front-end stages. It can be related directly to the active and passive device characteristics that the designer uses. But it isn't as useful as SINAD to evaluate a receiver as part of a system or for production checkout.

Noise figure defines ratio of ratios

Noise figure, F , is defined as a ratio of ratios. The ratios are the signal-to-noise at the input and output of a four-terminal network. In our case, the network represents the receiver.

Noise figure, a nondimensional quantity, can be stated mathematically as follows:

$$F = \frac{S_i/N_i}{S_o/N_o} = \frac{N_o}{N_i G_o}, \quad (1)$$

where S_i = input signal power, $S_o = S_i G_o$ = output signal power, N_i = input noise power, N_o = output noise power and G_o = receiver power gain.

Since noise power, N_i , results from the source impedance, $N_i = kT_o B$ for the following simplification:

$$F = \frac{N_o}{kT_o B G_o}, \quad (2)$$

where N_o = output noise power in watts, k = Boltzmann's constant, T_o = standard noise temperature—absolute room temperature in our case—and B = effective noise bandwidth in Hz.

The total output noise power, N_o , has two components: the amplified reference noise power due to the source impedance and the noise power generated in the receiver. Calling the receiver noise component N_r , we can write:

$$F = \frac{G_o N_i + N_r}{G_o N_i} = 1 + \frac{N_r}{G_o N_i} = 1 + F_r, \quad (3)$$

where F_r is the contribution caused by receiver noise. If we have a noiseless receiver, F_r would be zero and $F = 1$. Thus $F = 1$ represents the lowest possible noise figure.

Noise figures are most often expressed in dB:

$$F_{dB} = 10 \log_{10} F. \quad (4)$$

Thus a receiver having $F = 1$ has a 0-dB noise figure. In vhf receivers, noise figures are commonly in the range of 5 to 10 dB.

In measuring receiver noise figure, the most convenient approach uses a generator that puts out white noise in the required frequency range. The approach also employs an output meter that can measure the actual noise-power output of the receiver. Or any type of indicating meter can be used with an attenuator.

Sometimes the noise generator and output indicating functions are combined in a noise-figure meter. The noise generator usually consists of a special thermionic diode connected in series with a resistor equal to the system impedance—for example, 50 Ω . A dc current forward-biases the

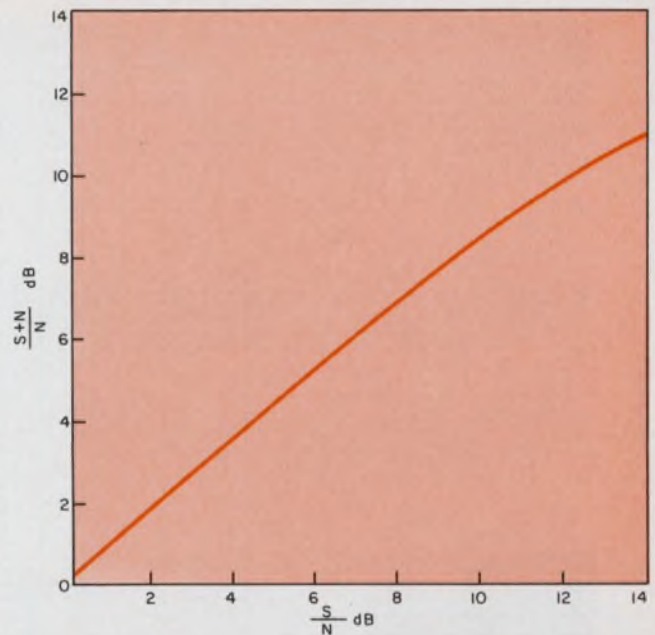

8. $(S + N)/N$ to equivalent S/N ratio can be converted with this graph. Above about 10 dB, little error results if one is assumed equal to the other.

diode and can be varied to control the noise output power.

A milliammeter connected to indicate diode current can also be calibrated in terms of noise figure, since

$$F = 20 R_o i_p, \quad (5)$$

where R_o is the noise generator output characteristic impedance and i_p is the diode plate current in amperes.

One test setup appears in Fig. 6. It requires that an i-f test point, preceding the limiters, be available. The noise figure measurement must be made within the linear transmission range of the receiver. The i-f signal goes to the rf voltmeter through a 3-dB attenuator that can be switched in or out.

If you are fortunate enough to find that the i-f test point not only exists but also has a 50- Ω impedance, a standard 50- Ω attenuator will do. In the more usual case the test point is there, but it has an unknown impedance; you have to rig up a suitable 3-dB attenuator.

The test procedure is simple: With the noise source switched off and the 3-dB i-f attenuator bypassed, note the residual noise reading on the rf voltmeter. Then put in the 3-dB attenuation and increase the noise diode current until the voltmeter reading is the same as before: The output noise power doubles, meaning that the noise generator power equals the noise power of the receiver itself. As a result, the noise figure can be read from the noise-generator meter.

If a dummy antenna has to be used its attenuation in dB must be subtracted from the noise figure reading. Use of the 3-dB i-f attenuator

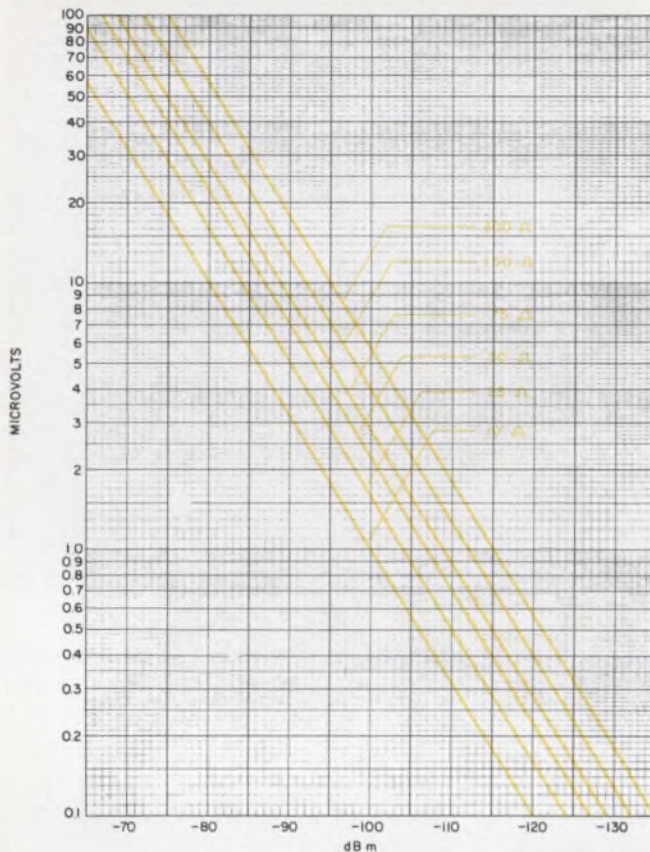

9. Conversion of dBm to μV for a given receiver impedance can be performed with this graph.

avoids the need for a linear rms-reading output meter. Of course, if such a meter is available and the attenuator method is inconvenient, use the meter without the attenuator. Simply adjust the noise generator for a 3-dB increase in the output-meter reading, so that the increase corresponds to a doubling of the input noise power.

What if there is no i-f test point at all? Then you must use the setup of Fig. 7. It takes advantage of the fact that even an FM receiver has a small range of linear relation between input level and signal-to-noise ratio.

The linearity can be seen in the quieting curve in Fig. 2. It exists because the noise-phase deviation decreases as the carrier voltage increases, since the noise power at the input remains constant. There is no AM noise left, because of limiter action. The output indicator can be any af indicator in conjunction with a 3-dB attenuator, as before, or a true-rms voltmeter without the attenuator.

Decouple the signal generator sufficiently from the receiver input to avoid impedance mismatch of the noise generator to the receiver. Adjust the signal generator output for an amount of quieting that corresponds to a point somewhere in the middle of the linear slope in Fig. 2. Now, to make the noise-figure measurement, feed in enough additional noise power from the noise generator to

give an extra 3-dB of receiver noise output. Read the receiver noise figure from the noise generator scale, as before.

Although the noise generator's AM noise components are eliminated by the receiver limiter, this method is a valid one: The AM noise generated in the receiver is rejected also.

Since the noise generator puts out a wide spectrum of noise, the use of a receiver with poor image rejection can result in measurement errors. In most good receivers this problem doesn't occur. Where it does, use an image-frequency trap at the receiver input.

Often it's useful to calculate a receiver's sensitivity when its noise figure is known, or vice versa. From Eq. 2, we rewrite noise figure as follows:

$$F = \frac{N_o}{S_o} \frac{S_i}{k T_o B} \quad (6)$$

Note that S_o/N_o refers to signal-to-noise ratio, whereas receiver sensitivity is usually specified in terms of signal plus noise to noise ratio. The graph in Fig. 8 provides a means of converting from one to the other. Actually, if the $(S + N)/N$ ratio is 10 dB or greater, the two ratios are almost equal and can be interchanged with only small error.

The bandwidth, B , used in the calculations is the noise bandwidth, defined as

$$B_n = \int_0^{\infty} \frac{G}{G_o} df, \quad (7)$$

where G = relative power gain of the receiver and G_o = the maximum value of G . Obviously the noise bandwidth is difficult to calculate or measure in a receiver. Fortunately most vhf-FM receivers have either a crystal filter or enough cascaded double-tuned circuits in the i-f so that the passband frequency response shape is essentially rectangular. For this case, we can assume the noise bandwidth to be equal to the receiver's 3-dB bandwidth without much error.

Suppose a receiver has a 10-dB noise figure, a 6-kHz noise bandwidth and a 50- Ω input impedance. What is the rf-input level required for a 10-dB $(S + N)/N$ ratio?

To find the answer, insert the appropriate values into Eq. 6, letting $S_o/N_o \approx (S + N)/N$, and solve for S_i :

$$S_i = F B k T_o S_o / N_o = (10) (6 \times 10^3) (1.38 \times 10^{-23}) (290) (10) = 2.4 \times 10^{-16} \text{ W.}$$

The calculated value can also be expressed as $S_i = -116$ dBm. In turn, this can be converted into an equivalent voltage level, for a 50- Ω line, with the aid of Fig. 9. The final result is $S_i = 0.35 \mu\text{V}$. ■■

Bibliography:

"IEEE Test Procedure for Frequency-Modulated Mobile Communications Receivers," IEEE Transactions on Vehicular Technology, Vol. VT-18, No. 2, August, 1969, pp. 85-99.

Use Raytheon CRTs and be choosy.

Because Raytheon offers one of the most complete lines in the business. Whether your requirement is Military, Commercial, Airborne, Medical, or any other sophisticated application, there is probably a Raytheon CRT to do your job. See what we mean. Check these 6 major reasons why using Raytheon lets you be choosy.

- Choice of size — from 1" to 23" . . . shapes — round, rectangular, square.
- Choice of deflection — magnetic or electrostatic tubes. Plus a full range of anode caps, shields and sockets for the electrostatic tubes.
- Choice of phosphors — covers full range of brightness and persistence requirements. Plus penetration color tubes.
- Choice of high resolution flying spot scanner tubes.

- Choice of CRT or packaged subassembly (ready for monitor installation).
- Choice of choice — stock units (with immediate delivery of sample quantities) or fast turn-around special engineering services for custom requirements.

Look into the line that gives you choice all the way. Raytheon. For complete details on the full range of Raytheon and Telefunken CRTs, contact Raytheon Company, Industrial Components Operation, 465 Centre St., Quincy, Mass. 02169. (617) 479-5300.

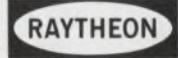

INFORMATION RETRIEVAL NUMBER 39



THE BRIGHT GUYS' NEW QUAD ISOLATOR SAVINGS PLAN



Distributors
Arizona: Hamilton/Avnet, Phoenix (602) 275-7851
 Kierulff, Phoenix (602) 273-7331
California: Hamilton/Avnet, Mountain View (415) 961-7000
 San Diego (714) 279-2421
 Hamilton Electro, Culver City (213) 559-4111
 Kierulff, Palo Alto (415) 968-6292
 San Diego (714) 278-2112
 Wesco Electronics, Los Angeles (213) 685-9525
Colorado: Hamilton/Avnet, Denver (303) 534-1212
 Kierulff, Denver (303) 343-7090
Connecticut:
 Arrow Electronics, Hamden (203) 246-3801
 Hamilton/Avnet, Georgetown (203) 762-0361
Florida: Hamilton/Avnet, Hollywood (305) 925-5401
Georgia: Hamilton/Avnet, Norcross (404) 448-0800
Illinois: Allied, Chicago (312) 421-2400
 Hamilton/Avnet, Schiller Park (Chicago) (312) 678-6282
 Kierulff, Rosemont (Chicago) (312) 678-8560
Kansas: Hamilton/Avnet, Lenexa (913) 888-8900
Maryland: Hamilton/Avnet, Friendship Int'l Airport (Baltimore) (301) 796-5000
 Pioneer/Washington Rockville (301) 424-3300
Massachusetts:
 Cerber, Dedham (617) 329-2400
 Hamilton/Avnet, Burlington (617) 273-2120
 Kierulff, Needham Heights (617) 449-3600
 Wilshire Electronics, Cambridge (617) 491-3300
Michigan: Hamilton/Avnet, Livonia (313) 522-4700
Minnesota: Hamilton/Avnet, Minneapolis (612) 941-3801
Missouri: Hamilton/Avnet, Hazelwood (St. Louis) (314) 731-1144
New Jersey: Arrow, Moorestown (609) 235-1900
 Hamilton/Avnet, Mt. Laurel (609) 234-2133
 Cedar Grove (201) 239-0800
New Mexico:
 Century, Albuquerque (505) 265-7837
 Hamilton/Avnet, Albuquerque (505) 765-1500
 Kierulff, Albuquerque (505) 247-1055
New York: Semiconductor Concepts, Hauppauge (516) 273-1234
 Hamilton/Avnet, Syracuse (315) 437-2642
 Westbury, L.I. (516) 333-5800
 Arrow, Farmingdale (516) 694-6800
 Summit, Buffalo (716) 884-3450
North Carolina:
 Pioneer/Carolina Greensboro (919) 273-4441
Ohio: Arrow, Dayton (513) 253-9176
 Hamilton/Avnet, Dayton (513) 433-4055
Texas: Hamilton/Avnet, Dallas (214) 661-8661
 Houston (713) 526-4661
 Kierulff, Garland (Dallas) (214) 271-2471
Utah: Hamilton/Avnet, Salt Lake City (801) 262-8451
Washington:
 Hamilton/Avnet, Bellevue (206) 746-8750
 Kierulff, Seattle (206) 763-1550
Canada: Preico, Montreal (514) 389-8051
 Ottawa (613) 237-6150
 Electro Sonic Ind. Sales, Toronto (416) 924-9301
 Hamilton/Avnet, Montreal (514) 735-6193
 Mississauga (416) 677-7432
 Ottawa (613) 725-3071
 Varah's, Vancouver, B.C. (604) 873-3211
 Future Electronics, Montreal (514) 735-5775
 Ottawa (613) 232-7757
 Toronto (416) 677-7820

Only the Bright Guys can give you the threefold, planned savings that you get with their new opto-isolator — the Quad Iso-Lit 74.

Money: The ILQ-74's price per channel is only 83¢ in 1K quantities.

Time: You save time because you're handling only one part instead of four.

Space: You save P.C. board space because of reduced package count.

The ILQ-74 features a minimum 1500 volt isolation with 35% typical current transfer

ratio. Coupling capacitance is only 0.5pF, and it's TTL compatible.

Replace those outmoded transformers and relays with solid-state, highly efficient, low cost opto-isolators which isolate high voltage transients and eliminate both ground loop feedthrough and common mode noise in long lines.

Only the Bright Guys offer all three configurations—single, dual and quad—as part of a full line of opto-isolators.

Call or write for complete information.

the bright guys
litronix

Litronix, Inc. • 19000 Homestead Road • Cupertino, California 95014 • (408) 257-7910 TWX: 910-338-0022

European Headquarters: Litronix, U. K. Branch • Bevan House, Bancroft Court • Hitchin, Hertfordshire SG5 1LW England • Tel: Hitchin 2676 Telex: 825 497

INFORMATION RETRIEVAL NUMBER 40



New HP 9821: More Straight Talk... More Memory.

Here's a no-nonsense approach to problem solving, a computing calculator that talks your language – the algebraic symbols, formulas, and English language notations you use in your work. Just enter your problem as you'd write it, press the Execute key, and there's your answer on the alphanumeric display or on the clearly labeled printer tape. Programming this new 9821 is as easy as jotting down a formula.

More memory – 167 registers for user storage, plus an internal cassette, make the basic 9821 not just conversational, but powerful. Powerful enough to solve 16 simultaneous equations – without the cassette. Slip in the cassette and you're only limited by your programming ingenuity. You can store programs and data on the

same tape. And a program linkage lets you handle any size program because it automatically calls in each segment for processing at the proper time.

And you'll find other features that make the 9821 your kind of calculator: A modular keyboard that lets you define the functions of the keys. Complete syntax error checking to prevent erroneous entries. Expandable up to 1,447 registers for program or data storage (according to the way you allocate it). A programmable tone signal for error alerts and progress monitoring. And – especially important – a complete line of Series 9800 peripherals.

Perhaps best of all, this computer-like capability comes at a calculator price – \$4975*. So take a good look at the 9821.

Send in this coupon for more information or a hands-on demonstration.

09478

*Domestic U.S.A. Price Only.



Sales, service and support in 172 centers in 65 countries.
P.O. Box 301, Loveland, Colorado 80537

Please Tell Me More About The HP 9821
 Info Only Hands-on Demo
 I think I can use an HP 9821 for _____

Name _____
 Company _____
 Address _____
 City _____ Phone _____
 State _____ Zip _____

Hewlett-Packard Co.
 P.O. Box 301, Loveland, Colo. 80537

EO-12-73

Don't be strangled by EMI-filter test specs. Performance curves on data sheets may not agree with reality, even though obtained as per MIL-STD-220A.

A statement most often attributed to a rough, but pragmatic, Navy Chief goes something like this: "Aww right you guys, let's do something! The wrong thing is better than nothing."

Perhaps no better example of this salty philosophy exists than does the present-day attitude toward EMI filter testing.

As individual voices—be they from military or commercial users, or from manufacturers—almost everyone agrees that EMI filter test specifications are woefully inadequate and misleading.

Collectively, however, only one voice emerges. It says: "We will never be able to reach agreement on a truly definitive specification. And, though MIL-STD-220A doesn't really work, it's still a useful tool to compare the performance of various filters. So let's leave it alone."

The logic of the collective voice appears to be self-evident and unquestionable. But if you read between the lines, the message might sound more like this: "I have selected (or manufactured) a filter to meet certain specs. When tested per MIL-STD-220A, my filter meets these specs. If nobody rocks the boat, I won't get into trouble."

Progress steps in

Perhaps at one time "the wrong thing" was better than nothing. A few years ago, an EMI filter (it was called an RFI filter then) was added to your equipment much like you'd add a rabbit's foot to your key chain. You didn't know exactly what it was going to do for you, but as there really wasn't any definite task required of it, whatever it actually did do was a bonus.

Progress spoiled all of that. Progress: With its sophisticated circuitry, high-speed switching, low voltages, highly regulated power supplies, nanosecond data pulses, and ever so many super sensitive circuits on a single PC card. Suddenly you needed that RFI filter.

Sometimes you needed interference suppression down into the audio range; and sometimes up into the uhf region, and beyond. The suppression

of RFI alone became inadequate, so the term EMI was used to designate the entire electromagnetic spectrum. So RFI filters became EMI filters, and a specification—MIL-STD-220A—was written to standardize test methods.

What are the problems with MIL-STD-220A that appear so formidable as to defy solution by the collective talents of the entire industry? Basically, there are five main areas of concern:

- Testing exclusively with 50- Ω source and load impedances.
- Inaccurate results from comparison testing of various networks and filters.
- Using dc for full-load tests of filters used in ac circuits.
- Testing that doesn't simulate actual operating conditions.
- No provisions for testing line-to-line type filters.

The first two problems are easily recognized as such: Tests on an L-C network with the standard 50- Ω /50- Ω configuration will indicate the performance only for the 50- Ω /50- Ω condition.

But the typical user of power-line EMI filters is concerned with equipment performance—not filter performance. To provide interference suppression and isolation, he relies upon a filter catalog, with filter performance faithfully tested and documented as per MIL-STD-220A.

Does the catalog throw you a curve?

He will probably use a performance curve to select a filter that will later be bolted to the frame of his equipment and then cabled to his power source on one side and to his circuitry on the other.

Even if the filter user realizes that the catalog doesn't indicate the exact performance he'll achieve in his equipment, he usually assumes it will be close. But will it?

Impedance counts

Let's examine the theoretical performance of two 3-element filters—a Pi configuration and a T configuration. Both networks are derived from

Arlen Peterson, Chief Filter Design Engineer, ADC Products, 4900 W. 78th St., Minneapolis, Minn. 55435.

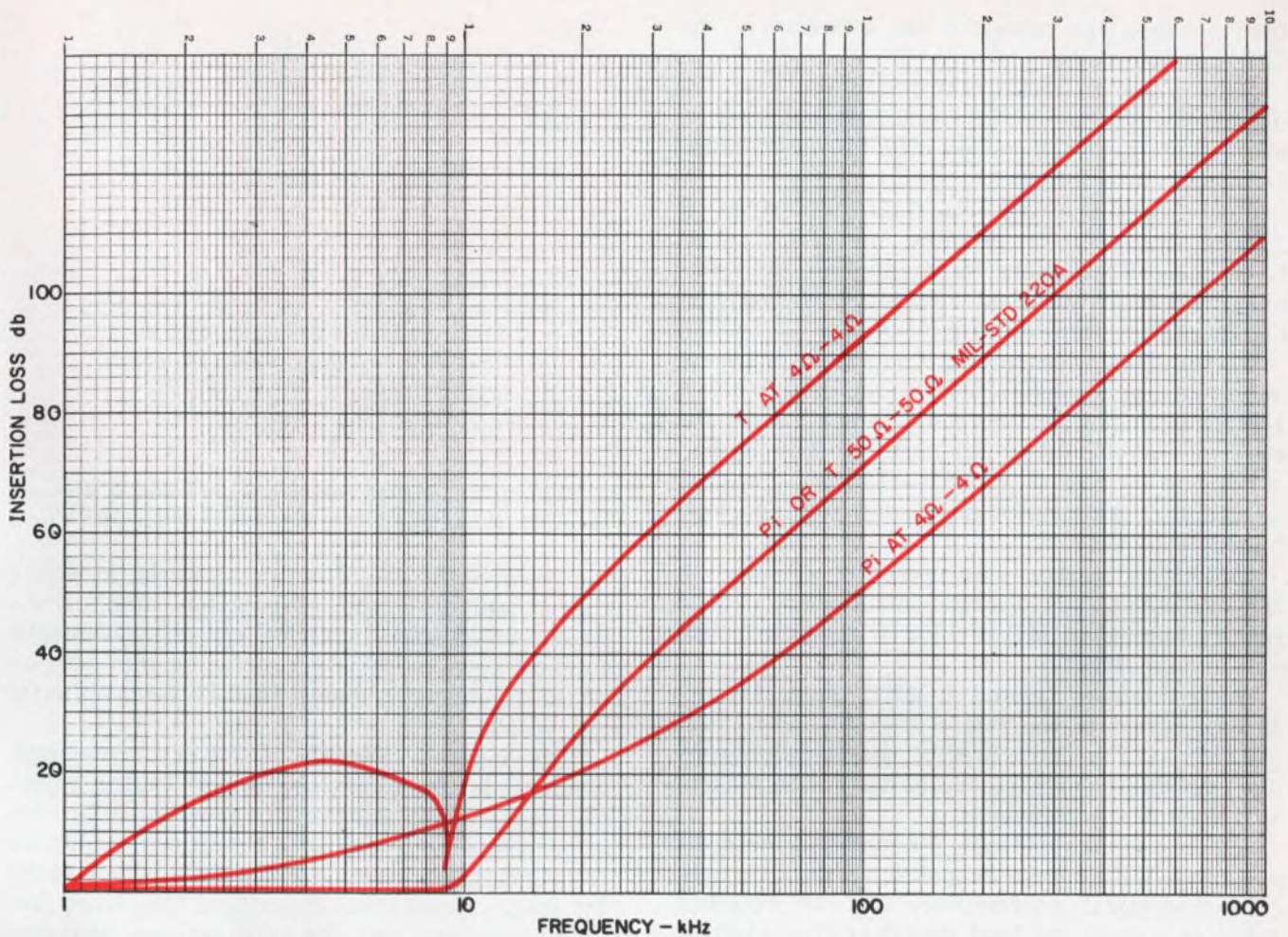

1. Although filter attenuation is usually measured between 50- Ω impedances, as specified by MIL-STD-220A,

attenuation at the actual line and load impedances can vary greatly from that at 50 Ω .

the same design parameters; both networks are down 3 dB at 10 kHz; and both roll off at 18 dB per octave when tested between 50 Ω and 50 Ω . A catalog curve of performance—when tested to MIL-STD-220A—would be identical for each unit.

Unfortunately, in the actual application, the filters don't see 50 Ω in either direction. We don't know exactly what the source impedance is, but we know it's low—say, 4 Ω .

If we test the performance of the filters between a 4- Ω source and a 50- Ω load, we would find that, at 80 kHz, the Pi filter yields about 15 dB less attenuation than a catalog curve might indicate, while the T yields 5 dB more than indicated.

If we test the filters between 4- Ω impedances, we would find that the Pi yields 20 dB less attenuation at 80 kHz than anticipated, while the T yields 20 dB more. This is a difference of 40 dB at this relatively low frequency (Fig. 1).

At higher frequencies, where MIL-STD-220A performance might indicate 100-dB attenuation, 80 dB would usually be quite satisfactory. However, if 45 dB of attenuation is required to bring

interference down to a tolerable level, and only 25 dB can be achieved, the wrong network has been selected.

Is the filter manufacturer responsible for this apparent misinterpretation of performance criteria? It must be remembered that he did produce and document his product to the accepted and established spec.

The solution of this problem is worthy of an extended debate. To determine line and load impedances from power-line frequencies up to several hundreds or even thousands of megahertz is probably a hopeless task. And the variations that can be expected throughout such a broad range would nullify any attempt to determine a nominal value of impedance.

Estimate your impedances

Possibly the best solution is to estimate line and load impedances at the lowest expected interfering frequencies. These frequencies, typically in the kilohertz region, probably contain the most energy, and are therefore the most troublesome. An estimation of frequency and impedance

then becomes the basis for the selection of the filter configuration.

This is not to mean that interference in the megahertz region is to be ignored; nor does it mean that there will be no attenuation of high-frequency interference.

Most filters are well into their stop bands at 1 MHz, and even though line impedance variations cause fluctuations in attenuation, performance is usually sufficient regardless of the configuration-line impedance relationship.

Fortunately, accurate attenuation measurements can be accomplished at frequencies below 1 MHz with the test method commonly used for electric wave, or information, filters. The method is shown in Fig. 8 of MIL-F-18327C, and is adaptable to any combination of source and load impedances (Fig. 2).

If full-load testing—as presently specified in MIL-STD-220A—is desired, this feature can be readily applied to MIL-F-18327C circuitry without adverse effect.

At frequencies beyond 1 MHz, the tests may as well revert to the MIL-STD-220A, 50-Ω/50-Ω method, as you can't predict the actual power-line impedances or perform the tests with reasonable accuracy or economy.

As a reasonable substitute for dual-test methods, you can obtain computer-generated data to indicate theoretical performance to any specified value of source and load impedance, in addition to the performance per MIL-STD-220A.

Dc tests may not be valid

Another point to consider when you evaluate per MIL-STD-220A is the effect of using dc instead of ac to simulate full-load testing. It must be realized that core materials can behave differently when subjected to excitation at various frequencies.

For example, a typical core material, used in power-line filter inductors, exhibits a marked decrease in permeability with the application of a dc bias, but yields increased permeability when excited to high flux densities at power-line frequencies.

While measurement of insertion-loss characteristics with dc will supposedly yield worst-case test conditions, the impedances of filter inductors at the actual power-line frequency will differ from those at dc.

This can lead to improvement or degradation of electrical performance, and can also present unexpected problems with regard to temperature rise, voltage drop, or voltage regulation. These parameters must be carefully monitored at the operating line frequency for the tests to be meaningful.

The MIL-STD-220A method of full-load test-

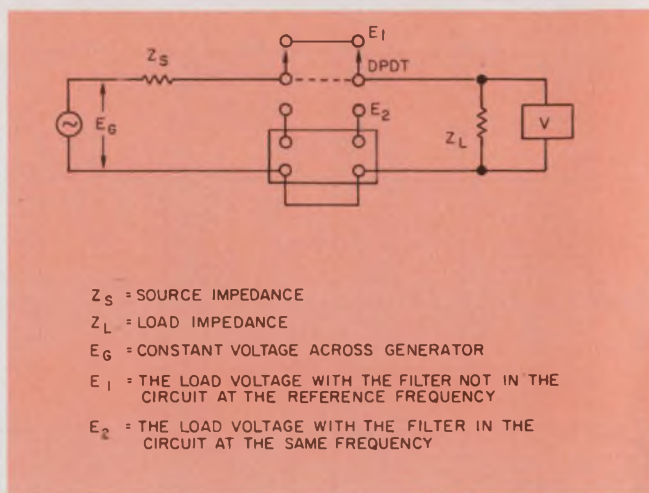

2. Accurate attenuation measurements below 1 MHz can be made using the method outlined in MIL-F-18327C.

ing requires the use of buffer networks to isolate the ac and dc circuitry from one another. As these buffers can influence the measurements, full-load tests must be restricted to that portion of the frequency response that gives meaningful test results.

This normally occurs at lower frequencies, where inductor variations under loaded conditions can yield a substantial reduction in attenuation, compared to unloaded conditions. At higher frequencies, the attenuation pattern is influenced by stray resonances, capacities, couplings between elements, and coupling between elements and the case.

At this point, it becomes academic as to which condition—unloaded testing or extraneous circuitry—is most likely to produce erroneous data. Also, note that MIL-STD-220A does not require full-load testing below 100 kHz, even though today's more important attenuation requirements are often at frequencies below that.

Why do we continue to test power-line filters with direct current? Because there is no other universally acceptable test method. The key word here is, acceptable. There are methods that offer improvements, but these have not been generally agreed upon.

Other problems stem from the noticeable lack of similarity between actual operating conditions and those called out in MIL-STD-220A.

Is MIL-STD-220A realistic?

In practice, for instance, line filters are normally bolted to a mainframe and then connected to the frame by a grounding strap; and, in practice, incoming power lines usually consist of heavy-gauge, multiconductor cable, terminated in lugs that are connected to the filter.

In addition, the lines from the filter to the equipment circuitry are, typically, single-conductor wires that may or may not be shielded and

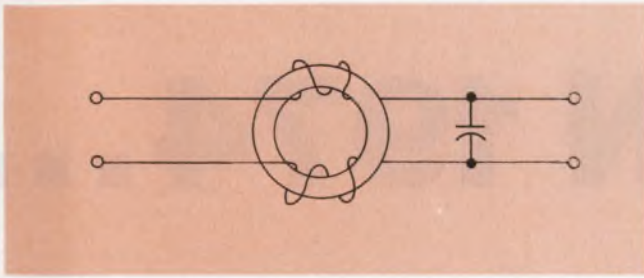

3. Common-mode interference can be reduced with a simple, "common-core" line-to-line filter.

may or may not be bundled together.

But what does the MIL-STD-220A test fixture look like? It has a heavy brass base and mounts, thoroughly shielded cables and connectors, massive brass couplings that completely surround the filter terminals with a grounded shield, and "wall-to-wall" chrome plating.

In addition, performance is often measured in a power-line-filtered screen or shielded room to further eliminate any conducted or radiated interference.

With this sterile environment, one "proves" that the filter under test can provide a specified attenuation at frequencies ranging from a few kilohertz to 1000 or even 10,000 MHz. In reality, it's unlikely that the actual performance will approach that obtained under the test conditions at 1000, 100 or possibly even 10 MHz.

Missing specs

Here's another problem—The effectiveness of MIL-STD-220A is reduced by its lack of specs to cover line-to-line filters. Without established guidelines, much confusion exists as to how to properly evaluate these useful components (Fig. 3).

Thus MIL-STD-220A not only lacks content and authenticity, but it has helped to create a situation where products are designed, evaluated and documented to satisfy synthetic test conditions, rather than to provide interference suppression. Until much-needed specification improvements appear, users of power-line filters must tune in to all methods used to evaluate filter performance.

To do this effectively, some understanding of filter network characteristics is required. If the needed filter-evaluation data are not published, ask the manufacturer for it. Regard controlled-condition, catalog performance curves as representative of both the filter and the condition.

Weigh the value of such published data against the performance that can be realized in your equipment, under fully loaded operating conditions. Then, select the network and the evaluation method that most effectively satisfies your requirements. ■■

Sensitrode.

the most reliable rectifier available today!

HERMETICALLY SEALED—195°C TO +300°C TEMPERATURE RANGE

SENSITRODE RELIABILITY FEATURES:

- **LOWEST LEAKAGE**
The Sensitrode process provides reverse leakage currents as low as 0.1 microamps at peak inverse voltage.
- **TRUE AVALANCHE CHARACTERISTICS**
Due to the extremely low surface leakage, avalanche breakdown in the Sensitrode rectifier occurs uniformly across the entire junction area offering the best protection possible against transient voltage spikes.
- **HIGH OPERATING AND STORAGE TEMPERATURE**
Sensitrode glass passivated rectifier chips are metallurgically brazed to the leads allowing maximum operating junction temperature of 200°C and maximum storage temperature of 300°C. Conventional rectifier chips are soldered to the leads and passivated with organic materials limiting their maximum operating temperature to 150°C and storage temperature to 200°C.
- **TEMPERATURE CYCLING AND THERMAL SHOCK**
The unique Sensitrode method of glass passivation makes possible the widest range of temperature cycling available. The glass formula used provides the closest match to the thermal coefficient of silicon.

LIFE-TIME WARRANTY
The Sensitrode rectifier is unconditionally warranted for the life of the equipment. For specific warranty conditions, write or call factory.

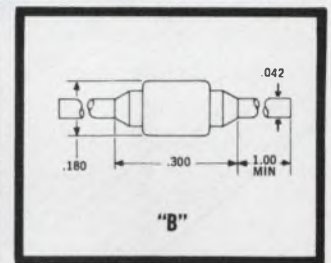
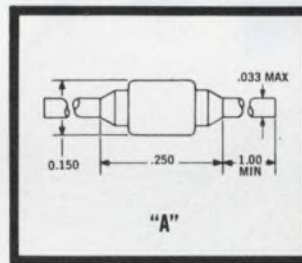

GENERAL PURPOSE

| Type | Peak Inverse Voltage (Volts) | Max. Fwd. Curr. @ 75°C (Amps) | Max. One Cycle Surge (Amps) | Trr Micro-Sec-ands | Pack- age Out- line |
|-----------------------|------------------------------|-------------------------------|-----------------------------|--------------------|---------------------|
| SRS 105 thru SRS 1100 | 50 thru 1000 | 1.0 | 60 | 5 | A |
| SRS 205 thru SRS 2100 | 50 thru 1000 | 2.0 | 100 | 5 | A |
| SRS 305 thru SRS 3100 | 50 thru 1000 | 3.0 | 150 | 5 | B |

FAST RECOVERY

| Type | Peak Inverse Voltage (Volts) | Max. Fwd. Curr. @ 75°C (Amps) | Max. One Cycle Surge (Amps) | Trr Micro-Sec-ands | Pack- age Out- line |
|---------------------------|------------------------------|-------------------------------|-----------------------------|--------------------|---------------------|
| SRSFR 105 thru SRSFR 1100 | 50 thru 1000 | 1.0 | 50 | .1 | A |
| SRSFR 205 thru SRSFR 2100 | 50 thru 1000 | 2.0 | 80 | .15 | A |
| SRSFR 305 thru SRSFR 3100 | 50 thru 1000 | 3.0 | 125 | .2 | B |

SENSITRODE SAMPLES: For your free Sensitrode evaluation sample, write request on your company letterhead.

Sensitron Semiconductor Division
221 West Industry Court • Deer Park, N. Y. 11729
Tel: (516) 586-7600 Telex: 96-7737

COMING IN 1974...

**THE
GOLD
BOOK**



**Electronic Design's 1974
Master Directory**

THE LARGEST COMPENDIUM OF PRODUCT INFORMATION EVER PUBLISHED

THE GOLD BOOK will change your mind about the value, use, and importance of a master directory

THE GOLD BOOK—WHAT IT IS

The purpose of THE GOLD BOOK is:

- TO PROVIDE AN ESSENTIAL COMPENDIUM OF SUPPLIERS TO THE ELECTRONIC ORIGINAL EQUIPMENT MARKET.
- TO ENABLE ENGINEERS, ENGINEERING MANAGERS, AND PURCHASING MANAGERS TO CONVENIENTLY DETERMINE WHAT COMPANIES SUPPLY WHAT PRODUCTS.
- TO ENABLE THEM TO DETERMINE THE SPECIFICATIONS AND OPERATING CHARACTERISTICS OF THOSE PRODUCTS AND TO LOCATE AND CONTACT THE SUPPLYING COMPANIES QUICKLY AND CONVENIENTLY.
- TO EXCEED ALL CURRENTLY AVAILABLE DIRECTORIES IN COMPREHENSIVENESS AND UTILITY.

WHO GETS IT

THE GOLD BOOK will be distributed to *Electronic Design's* request-controlled and paid circulation in the U.S.A. and overseas, including 5,000 purchasing managers. More than 10,000 circulation will be concentrated in Europe. Total distribution exceeds 85,000 copies!

Employing Hayden Publishing Company's advanced publishing techniques, THE GOLD BOOK is designed to be the largest, most complete, most comprehensive one-step purchasing and reference tool ever produced in this industry.

THE GOLD BOOK contains more information and data for the specifier/purchaser; more useful listings, more detailed listings, in its directories; more directory pages; more catalog pages, divided into more product classifications than ever assembled into one convenient package.

THE GOLD BOOK is a data source where you can find what you want to find, and find it easily. If you've never used a directory before, this will be your opportunity to see how useful it can be.

CONTENTS INCLUDE:

Product Index Directory • Directory of Manufacturers and Sales Offices • Directory of Trade Names • Catalog Data and Technical Information Section • a massive compendium organized by Product Category. Watch for it . . . it's coming your way July, 1974.

THE GOLD BOOK

ANOTHER INFORMATION SERVICE—
FREE—FROM *Electronic Design*

Save thousands of dollars for your company

Alert your advertising people to the marketing opportunity of the century

GET FREE AD PAGES IN THE GOLD BOOK

To introduce THE GOLD BOOK, we're giving away 4,000 ad pages *FREE* to companies that advertise in *Electronic Design*. For every page of space your company places in *Electronic Design* in 1974, it earns a page *FREE* in THE GOLD BOOK. It's the marketing opportunity of the century! \$4,000,000 worth of space is up for grabs—and some of it can be yours.

Tell your top management and advertising people about this offer—but tell them soon. *They'll have to act fast.* Ad forms close February 19, 1974. For complete information they can call their local *Electronic Design* rep. or Tom Carr, V.P./Sales at 201-843-0550.



Electronic Design



A Hayden Publication

Peter Coley, Vice President/Publisher • Tom Carr, Vice President/Sales Manager
50 Essex Street, Rochelle Park, New Jersey 07662 • Tel: 201-843-0550

Improve optical measurement accuracy

without ultra-stable lamps. A ratio technique tracks and compensates for variations in the optical source.

In most electro-optic test systems, measurement accuracy is ultimately limited by the stability of the optical source. The brute-force approach to high system accuracy calls for regulation of the source. But another, often less costly, approach is to track and compensate for variations in the source.

The compensation technique works for an electromechanical or an all-electronic system, making relative optical-transmission measurements so long as the following hold true:

- The source variations about the average are small.
- A linear relationship exists between the measured-signal level and the reference-signal level. (The reference signal is the varying source.)

Developing the reference signal

The optical-transmission measurement system of Fig. 1 can be used to compare the optical transmission of a sample with that of a calibrated reference—in this case, free space.

The absolute optical transmission, T , can then be defined as

$$T = \frac{I_{\text{transmitted}}}{I_{\text{incident}}}$$

The relative optical transmission, T' , is directly proportional to the output of the photodetector system (if we assume that the detector output is linear). In other words, $T' \propto I_{\text{transmitted}} \propto e_1$.

The measurement accuracy is limited by the variations in the source intensity—in this case, a small HeNe laser—and the detector drift. Lasers with an intensity stability on the order of $\pm 2\%$ are realizable, while photodiode/operational amplifier combinations have a stability that is typically an order of magnitude better. Thus the measurement accuracy is limited by the stability of the optical source.

To nullify the effects of the optical source fluctuations, use the configuration of Fig. 2. With

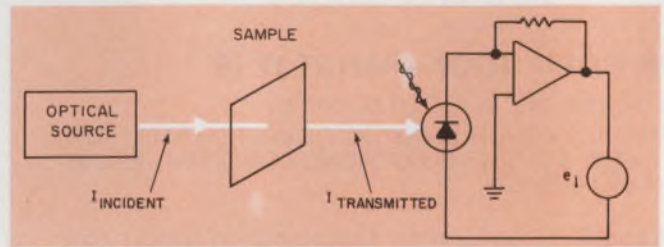

1. A conventional system can be used to make relative optical-transmission measurements without correction for component instability or drift. Typically a laser is used as the optical source and a photodiode with a FET-input operational amplifier as the detector system.

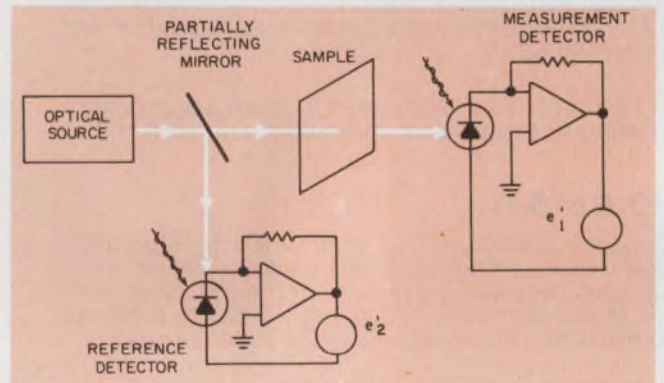

2. A reference detector, which delivers a signal proportional to the incident-intensity level, has been added to the straightforward system of Fig. 1. The new signal can generate a source-variation correction term.

this system, the relative transmission is proportional to the ratio of the two detector outputs, e_1 and e_2 . Should the incident source intensity change slightly to a value that causes the reference detector output to be e_2' , the indicated transmitted intensity will change proportionally to e_1' .

Note that the ratio of these two quantities, and thus the relative transmission, will remain unchanged. In other words,

$$T' \propto \frac{e_1}{e_2} = \frac{e_1'}{e_2'}$$

The change in the reference level can be considered as a small variation about the average reference level, giving

$$T' = \frac{e_1'}{e_2'} = \frac{e_1'}{e_2(1 \pm \Delta e_2/e_2)}$$

William H. Havens, Research Associate, Technisch Physische Dienst TNO-TH (Institute of Applied Physics), P.O. Box 155, Delft, the Netherlands.

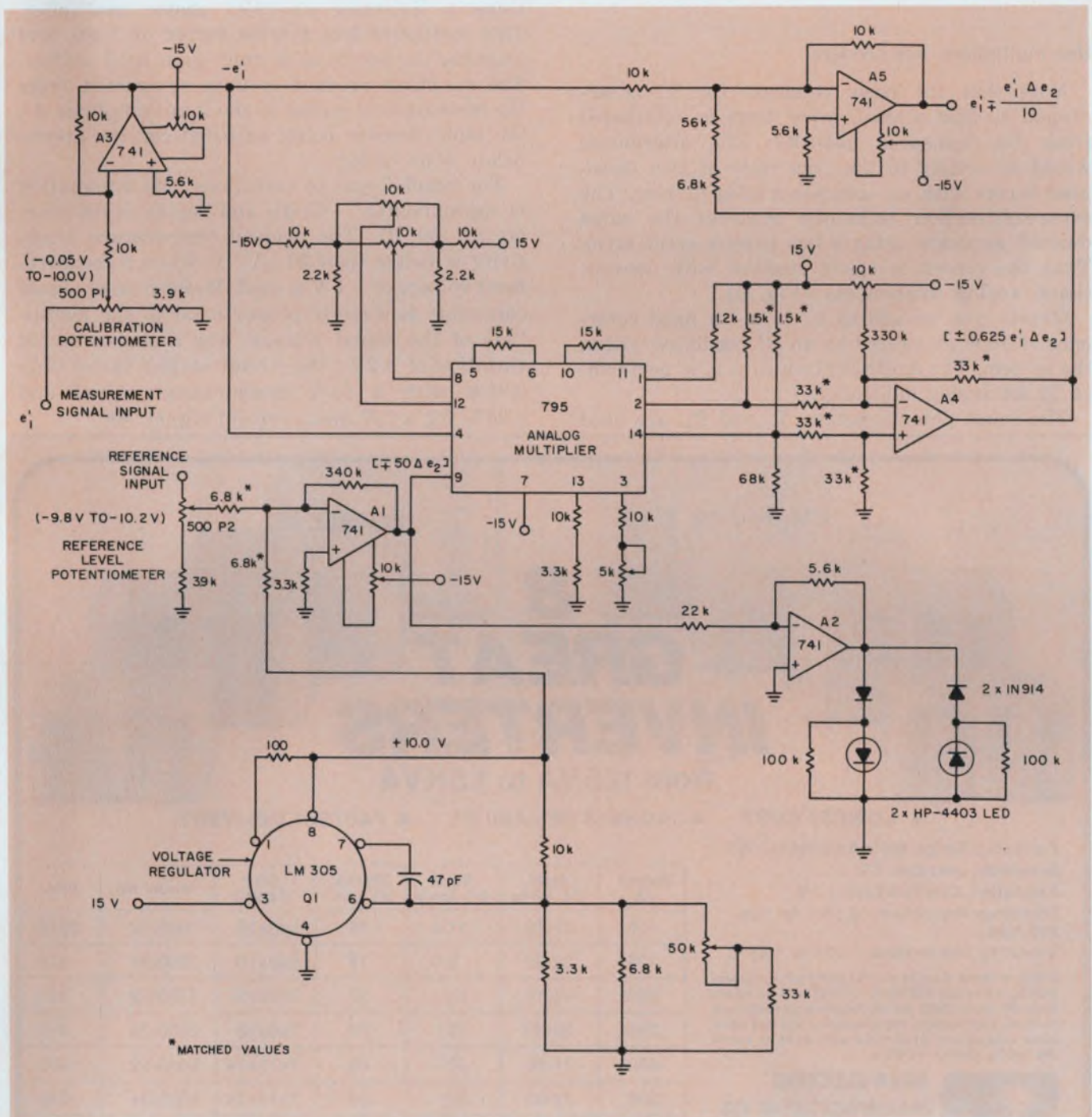

3. In the complete analog system that corrects the measured-signal level for variations in source intensity, voltage regulator Q₁ acts as the reference voltage-source,

e₂. When e₂ is added to the reference-signal input, e₂' the combination produces Δe₂. The two LEDs indicate when reference-signal input variations exceed ±2%.

$$\text{or } T' \propto \frac{e_1'}{(1 \pm \Delta e_2/e_2)}$$

This quotient can then be expanded in a power series expansion:

$$T' \propto e_1' (1 \mp \Delta e_2/e_2 + \frac{1}{2} (\Delta e_2/e_2)^2 \dots \dots),$$

or to the first-order approximation

$$T' \propto e_1' \mp e_1' \Delta e_2/e_2.$$

The higher-order terms may be neglected for small values of Δe_2 . So long as the change in the source reference can be tracked, the indicated relative transmission becomes independent of small variations in e_2' .

Use multipliers, not dividers

Note that the basic equation for T' is arranged so that a small error term is subtracted from the measured quantity. The alternative would be simply to take the ratio of two measured terms with an accurate analog divider. The error-subtraction technique achieves the same over-all accuracy using a less precise error term. Thus the circuit is easily realized with conventional analog components (Fig. 3).

Obtain Δe_2 by adding e_2' to e_2 —a fixed reference of 10 V generated by an IC regulator within the system. The multiplication $e_1' \Delta e_2$ is performed by an analog multiplier.

The input potentiometers, P_1 and P_2 , are used

for adjusting the initial signal levels. The National LM-305 (Q_1) is used as a series voltage regulator to generate the +10-V reference voltage, e_2 . The negative incoming reference signal is then summed with this +10-V reference voltage at the inverting input of A_1 to obtain the error signal. The two LEDs at the output of A_2 indicate when the reference-signal variations exceed $\pm 2\%$ of the reference voltage. When they do, a zeroing and recalibration of the system is required.

Buffer the measurement signal with amplifier A_3 and then multiply it with the error signal, using a Fairchild $\mu A-795C$ analog multiplier. This multiplier has a scale factor of 1/80, and amplifier A_1 serves as a unity-gain level shifter. The resulting product is then subtracted from the measurement signal at the input amplifier A_3 , the input resistor being adjusted for the appropriate scale factor.

For small-signal ac variations, the attenuation is approximately -60 dB and begins to deteriorate at 100 Hz. The over-all temperature sensitivity is better than $20 \mu V/^\circ C$ when a measurement voltage of -1 V is used. Measurement-signal correction is directly proportional to the magnitude of the signal voltage. For a source signal variation of $\pm 2\%$, the circuit output varies only 0.01% with a 10-V measurement signal and 0.06% for a 1-V measurement signal. ■■

8 GREAT INVERTERS
from 125 VA to 1.5KVA

■ LOWEST COST ■ HIGHEST RELIABILITY ■ FASTEST DELIVERY

Frequency Range: 60Hz Adjustable $\pm 5\%$
Distortion: Less than 6%
Regulation, Line and Load $\pm 1\%$
Frequency Regulation $\pm 0.15\%$ for line and load
Operating Temperature: -20° to $+55^\circ C$

If any of these 8 units won't satisfy your requirements, we've got 250 more — standard inverters from 30 VA to 3000 VA or choose a custom unit to meet your special requirements. Get our complete catalog and price lists; call, write or circle the reader service number.

| Output VA | Input DC Volts | Input DC Amps | Approx. Wt. Lbs. | Size HxWxD | Model No. | Price |
|-----------|----------------|---------------|------------------|------------|-----------|-------|
| 125 | 11-16 | 17.4 | 19 | 5x6x10 | 1260-12 | \$315 |
| 125 | 22-32 | 8.0 | 19 | 5x6x10 | 1260-24 | 315 |
| 250 | 11-16 | 35 | 37 | 7x9x13 | 2560-12 | 475 |
| 250 | 22-32 | 16 | 37 | 7x9x13 | 2560-24 | 445 |
| 500 | 11-16 | 70 | 60 | 7x11x14 | 5060-12 | 690 |
| 500 | 22-32 | 32 | 60 | 7x11x14 | 5060-24 | 635 |
| 1000 | 22-32 | 64 | 100 | 9x14x16 | 1K60-24 | 1070 |
| 1500 | 22-32 | 96 | 145 | 9x17x17 | 1.5K60-24 | 1450 |

NOVA ELECTRIC MANUFACTURING CO.
263 Hillside Avenue
Nutley, New Jersey 07110
(201) NOVA-1-3434

BARGAINS GALORE on LEDs from DIALIGHT

FEATURES:

- High luminous intensity
- Low cost
- Low power consumption
- IC compatible
- Vibration/shock resistant
- Solid state reliability
- Life measured in years
- Wide viewing angle



Dialight's high brightness 521-9200 LED is an intense large area light source that has this typical luminous intensity:
@ $I_F = 20 \text{ mA}$ $I_0 = 2.0 \text{ mcd}$.

APPLICATIONS:

Panel lighting • Circuit-status indicators • Back lighting of annunciators • Alpha-numeric displays • Automobile dashboards • Appliances • Desk-top calculators • Housewares



9¢

Quality LEDs are 9¢ each when purchased in million piece quantities



21¢

LEDs from 100 to 999 are only 21¢ each.

17¢



If you need LEDs from 1000 to 9999, Dialight has them for 17¢ each.

28¢



Even if you only need LEDs from 1 to 99, Dialight has them for 28¢ each.



16¢

Quantities from 10,000 are a low 16¢ each and Dialight can fill your order today

FREE!

With this coupon you can get a free LED sample. Send this coupon to your nearest Dialight distributor or give him a call.

DIALIGHT DISTRIBUTORS

ARIZONA
Moltrons of Arizona, Inc.
602-272-7951

CALIFORNIA
Western.
Electromotive
213-870-7621
Bell Electronics Corp.
415-323-9431
Fisher/Brownell
408-244-6182
Richey Electronics, Inc.
213-875-2862
Westates
Electronics Corp.
213-341-4411

COLORADO
Meter Master
Instrument Corp.
303-722-5766

FLORIDA
Hammond
Electronics, Inc.
305-241-6601

ILLINOIS
Newark Electronics
312-638-4411

INDIANA
Graham Electronic
Supply, Inc.
317-634-8486
Radio Distributing Co.
219-287-2911

MARYLAND
Pioneer Washington
Elect. Co.
301-424-3300
Radio Electric
Service Co.
301-823-0070

MASSACHUSETTS
Cramer Electronics,
Inc.
617-969-7700
DeMambro Supply
Co., Inc.
617-787-1200
Gerber Electronics, Inc.
617-329-2400
Sager Electrical
Supply Co.
617-542-2281

MICHIGAN
RS Electronics
313-491-1000

MINNESOTA
Gopher Electronics Co.
612-645-0241

MISSOURI
Lcomp-St. Louis, Inc.
314-647-5505

NEBRASKA
Scott Electronic Supply
402-434-8308

NEW JERSEY
Federated Electronics
201-376-8900
Resco Electronics
609-662-4000

NEW YORK METROPOLITAN AREA
Arrow Electronics,
Inc.
516-694-6800
Harvey Radio Co.,
Inc.
516-921-8700
Melville Radio Corp.
914-592-7100
Peerless Radio Corp.
516-593-2121

NEW YORK STATE
Summit Distributors,
Inc.
716-884-3450

NORTH CAROLINA
Hammond
Electronics of
Carolina, Inc.
919-275-6391

OHIO
Pioneer-Cleveland
Div.
Pioneer-Standard
Electronics
216-587-3600
Stotts-Friedman Co.
513-224-1111
Sun Radio Co., Inc.
216-434-2171

PENNSYLVANIA
Almo Electronics
Corp.
215-676-6000
George D. Barbey Co.
215-376-7451
Cameradio Co.
412-288-2600

TEXAS
Harrison Equipment
Co., Inc.
713-224-9131

UTAH
Standard Supply Co.
801-355-2971

WASHINGTON
Almac/Stroom
Electronics
206-763-2300

WISCONSIN
Parts Mart Corp.
414-276-4160

CANADA
Saynor Electronics Ltd.
416-445-2347
L. A. Varah Ltd.
604-736-9252

All prices are domestic and subject to change without notice.

FREE!



Ask for free LED Product Selector Guide. 60 pages of LEDs: discretes, indicators, displays, fault indicators, opto-isolators, etc.

DIALIGHT

Dialight Corporation, A North American Philips Company
60 Stewart Avenue, Brooklyn, N.Y. 11237 (212) 497-7600

INFORMATION RETRIEVAL NUMBER 44

Integrate with a function generator.

By combining a VCF generator with a counter, you can sum a signal over periods ranging from milliseconds to years.

If you own a function generator with a voltage-controlled-frequency (VCF) input, you can perform area-under-the-curve integrations. Properly applied the generator can integrate voltages over time spans ranging from milliseconds to years.

The function generator converts the input quantity (volts) to a varying output speed or rate (frequency), directly proportional to the input quantity. The output cycles are accumulated and displayed over a set time period by a digital counter-timer operating in the TOTALIZE mode. The counter display, therefore, registers the integral of the input.

In most cases, signal conditioners will be needed to match the signal to be integrated to the input requirements of the function generator.

The technique is analogous to a watt-hour meter which integrates the product of the input quantities—voltage and current—by means of a special motor with an output speed that is directly proportional to the inputs. The motor output is accumulated on a series of turns-counting dials that register and display the total number of motor revolutions over a period of time.

One limitation: dynamic range

One of the limitations of the proposed system has to do with its dynamic range, that is, the minimum to maximum (full scale) input span that the system can handle.

Generally speaking, system performance should be excellent over a dynamic range of one decade; nearly as good over a range of two decades; and somewhat less over a range of three decades of maximum to minimum input-signal ratio.

Practically, the dynamic range will be of little concern in most applications since the input data are usually limited in range.

For example, a flowmeter might measure a system having a minimum capacity of two gallons/hour and a maximum of ten gallons/hour. The dynamic range would then be 5:1. The voltage-controlled frequency, or sweep range, of the func-

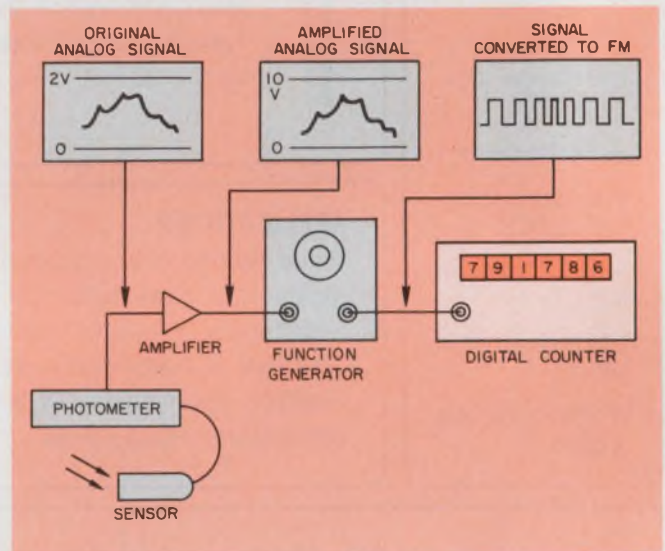

1. In a scheme to integrate the light falling on a photo-sensor, the sensor's output signal, after conditioning, is used to control the frequency of a function generator. A digital events counter then accumulates—or integrates—the frequency over the period of interest.

tion generator—as well as the transducer and conditioning limitations—can also affect the dynamic range.

To construct a practical system, you must consider both the quantity to be measured and the availability of usable instruments. A light-measuring system provides an example to illustrate the general approach (Fig. 1).

Here, the quantity to be integrated is the light power incident at a surface. A photometer provides an output signal proportional to the instantaneous illuminance. This output, after conditioning, controls the function-generator frequency. When the function generator completes a cycle, the digital events counter advances one count. Over any time interval, the increase in the counter reading is directly proportional to the total incident energy during that interval. The counter can be reset to zero when necessary.

The practical problems in building such a system fall into the following categories:

- Conditioning the signal to match function generator VCF requirements.

Warren Collier, Project Manager, Tektronix, Inc., P.O. Box 500, Beaverton, Ore. 97005.

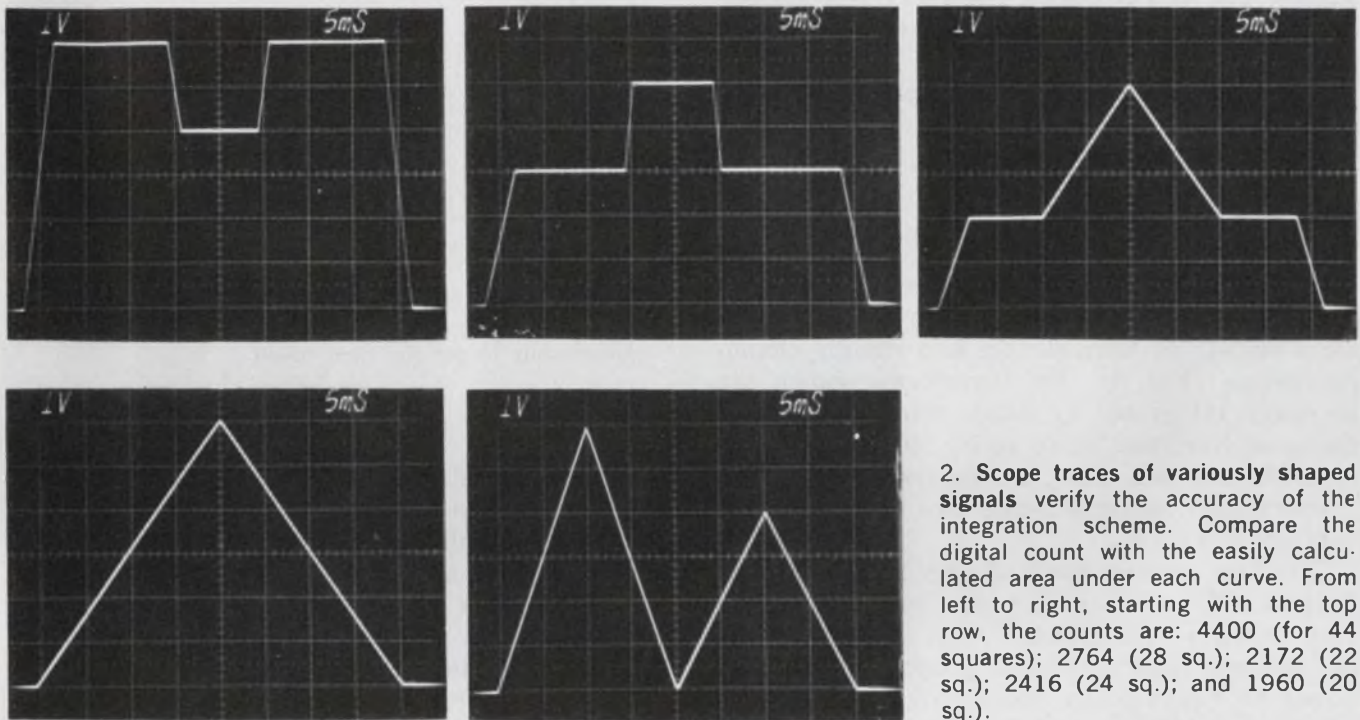

2. Scope traces of variously shaped signals verify the accuracy of the integration scheme. Compare the digital count with the easily calculated area under each curve. From left to right, starting with the top row, the counts are: 4400 (for 44 squares); 2764 (28 sq.); 2172 (22 sq.); 2416 (24 sq.); and 1960 (20 sq.).

- Setting the function generator frequency controls for an appropriate full-scale value.
- Normalizing the system reading relative to the input quantity.

Looking at the first problem many function generators require a nominal 10-V signal to control frequency over the specified VCF range. In the light-measuring system, the transducer output is a dc voltage or current proportional to illuminance. The conditioning amplifier must amplify or attenuate this signal so that the function-generator input is 10 V when the cumulative photometer output has reached full scale, or maximum value.

Note that the 10-V input requirement is a nominal value and probably lies somewhere between 9 and 11 for an individual instrument.

Besides providing the proper gain factor, the amplifier may have to introduce offset so that the generator input signal also has the appropriate dc level. This is important if the transducer has inherent offset or, as is probably the case, if the transducer and generator don't have the same dynamic range.

Full-scale value determines resolution

The next problem involves the full-scale value—the full-scale frequency you select depends on

the desired resolution and the total measurement interval. Generally speaking, the greater the resolution, the higher the frequency; the longer the measurement interval, the lower the frequency. Of course, you should avoid an output that exceeds the capacity of the digital events counter.

As an example, suppose that the measurement interval is one day and that the counter has a 6-digit capacity (999,999 events, maximum). The product of full-scale frequency (hertz) and 86,400—the number of seconds in a day—should not exceed the counter capacity.

A full-scale frequency of 10 Hz would produce a maximum one-day count of 864,000—comfortably within the counter's capacity, but close enough to capacity to ensure good resolution.

In most cases, system resolution will easily outstrip system accuracy, but the extra resolution may be helpful when monitoring short-term intervals within the total measurement interval.

The final problem—that of normalizing the system—is related to that of setting the full scale. For instance, in the light-measuring system, suppose that the full-scale exposure for a one-day period is 1,728,000,000 foot-candle-seconds. Since the maximum reading is 684,000, the accumulated energy cannot be read directly on the counter.

One solution is simply to calculate the proper value with the appropriate conversion factor.

Another is to fudge the full-scale frequency for inherent calibration, albeit at the expense of resolution or dynamic range.

To avoid such a compromise, you can modify the timing circuits in the function generator. A full-scale frequency of 10 Hz can be converted to 20 Hz by halving the timing capacitor or resistor values. The new full-scale frequency will normalize the reading which then requires only correct placement of the decimal point.

Another possibility is to digitally process the counter input or output. Or, you can use a computer or calculator to normalize the output.

Hand calculation demonstrates technique

Integration of several electronically generated waveforms illustrates the system's ability to handle a variety of form factors and rapidly changing values (Fig. 2). The waveforms shown can be easily integrated by hand, using simple geometry and arithmetic, to verify system performance. Actual data taken by the system, based on proportional measurements, are listed in the caption of Fig. 2.

The first measurement of Fig. 2 (top left) is normalized to correspond to the number of graticule squares encompassed by the waveform. Subsequent readings, when proportionally compared to the visually measured areas show a maximum deviation of 1.3% between visual and instrument measurements.

Note that the arbitrary calibration in square divisions is easily changed to watt-seconds, cubic feet, or any other desired units.

Because of limited dynamic range, the function generator may continue to oscillate at the minimum frequency when the input signal calls for a zero output. If this occurs, unwanted counts will accumulate before and after the intended measurement interval.

In cases where the input is likely to be continuous anyway (such as the example of Fig. 1), the system should have some way of interrupting data flow before and after the measurement interval. In applications with relatively long measurement intervals, this can be accomplished easily with manual controls.

The digital events counter used will most likely have a START-STOP switch, as well as a manual RESET switch for returning the display to zero. If not, a manually operated switch can be inserted between the generator output and the counter input.

Even fairly short intervals can be successfully controlled manually, as long as the function generator has a dynamic range of at least 1000:1. This will ensure a rate of "data leakage" low enough to introduce only a small error.

Best results will be obtained if the system in-

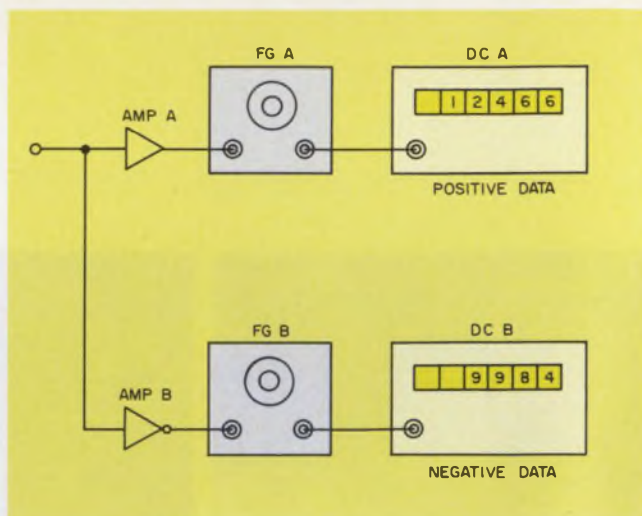

3. To integrate bipolar signals, two duplicate channels can be used. The counts of each channel are then added algebraically to get the final result.

cludes a fast electronic switch that can be gated during the measurement interval. Such a switch, or gate, may already be included in the function generator or counter.

The types of integrations shown in Fig. 2 can be made using source generators that output a gate signal coincident with the main output signal. Since the function generator used in the system can be gated, as well as frequency swept, it's a simple matter to gate the generator on at the beginning, and off at the end of the measurement interval.

Several interesting system variations can be achieved using a scope as an additional conditioning instrument. For example, you can integrate a portion of a curve by defining the time segment of interest with an intensified DELAY-ING/DELAYED SWEEP.

Here, the DELAYED GATE OUT coincides with the brightened area, and is used to gate the function generator. If it's necessary to offset the waveform vertically, this can be done with the scope POSITION or OFFSET controls, using the VERTICAL SIGNAL OUT to drive the integrator system. Repetitive signals that are too fast for direct integration can be time-scaled using a sampler with a VERTICAL SIGNAL OUT.

What about bipolar signals?

So far, we have considered only the case in which the input signal has a single sign, or polarity. But some integrations deal with positive and negative values, which must be added algebraically to determine the net area under the curve. Since the positive and negative values occur sequentially, they cannot be summed with simple network or amplifier techniques.

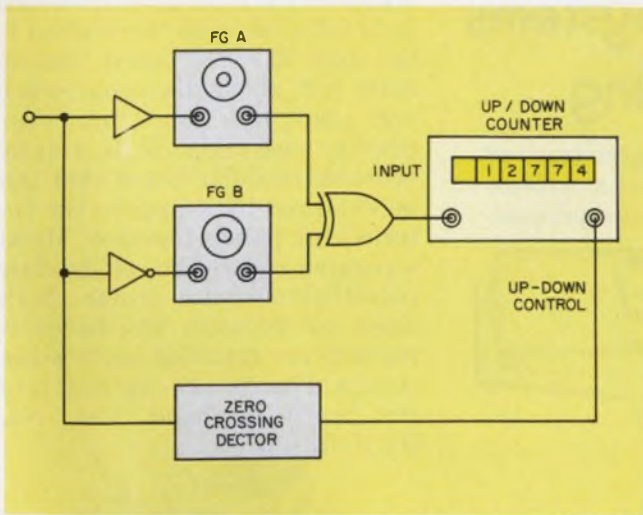

4. An up-down counter gives a direct integration of a bipolar voltage when controlled by a polarity-sensitive signal derived from the input.

One solution is to use two channels—one to integrate positive data, and the other negative data (Fig. 3). The two subtotals are then added algebraically to get the final answer. A somewhat more elegant approach uses an up/down counter to provide the final answer (Fig. 4). A large variety of configurations can be devised to handle this requirement.

In any case, the minimum measurement interval of the integrating system is somewhat indefinite, and depends on the user's requirements. A 10-MHz function generator can give a full-scale output of 10 counts per microsecond. If a waveform averages 20% of full scale, 50 μ s would be the shortest interval for 1000-count resolution.

In addition to the maximum output frequency, the function generator's VCF speed limitations must be taken into account. Most VCF circuitry requires linear, precise amplification, such as provided by op amps. But op amps introduce a frequency response, or slew-rate, limitation.

For example, if the specified slew-rate of the amplifier is 0.5 V/ μ s, and the full-scale VCF range is 10 V, the function generator is likely to require 20 μ s to go from minimum to full-scale output, or vice versa. Therefore, it is reasonable to assume that accuracy and resolution deteriorate rapidly as the measurement interval goes below 1 ms.

Maximum measurement intervals are determined by the function generator's minimum full-scale frequency and by the capacity of the events counter. System capacity can easily be extended by adding a scaler between the function generator and the counter. Even without a scaler, however, some instruments permit the interval to extend to several years. ■■

A 1/9 ad page size for only \$300 including production charges

Quick Ads will be placed in their own special section, attractively laid out to insure maximum attention. Each will have its own Information Retrieval Number, assuring many inquiries, many sales leads. You simply provide an 8 x 10" glossy photograph, plus approximately 40 words of copy. We do the rest at no cost to you.

For full information, including even lower frequency rates, mail the form at right to
 Tom W. Carr
 Sales Manager
 Electronic Design,
 50 Essex Street,
 Rochelle Park, N.J. 07662

Quickads

PLEASE RUSH ME FULL DETAILS ON QUICK ADS IN ELECTRONIC DESIGN

NAME _____ FIRM _____ STREET _____ CITY _____ STATE _____ ZIP _____

TITLE _____

Tooling Technology Offers Systems Approach to Production Wiring

With over 14 years of experience plus the world's largest team of wire tying and harnessing specialists T&B has developed a systems approach to wiring that makes harnessing a cost-controlled proposition.

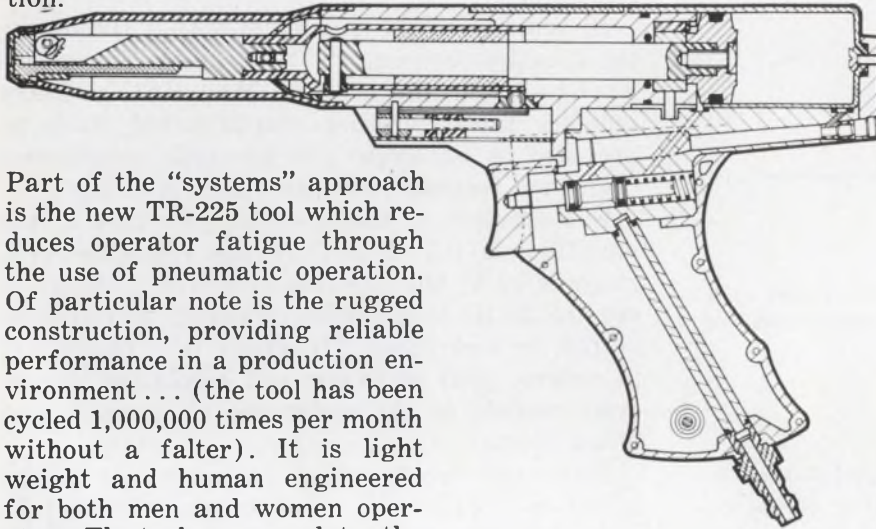

Part of the "systems" approach is the new TR-225 tool which reduces operator fatigue through the use of pneumatic operation. Of particular note is the rugged construction, providing reliable performance in a production environment... (the tool has been cycled 1,000,000 times per month without a falter). It is light weight and human engineered for both men and women operators. The tool accommodates the majority of TY-RAP® tie sizes... 16 in all... with bundle ranges from 1/16" to 4". A further convenience for the operator is that the long narrow nose gets into confined areas easily. If your production volume is such that it does not require the exclusive use of the TR-225 perhaps the new WT-193 hand tool would supplement your operation.



This tool accommodates the same bundle range as the TR-225. With a similar narrow nose and long barrel, it is well suited for close-up work, breakout points and in tough to reach places. This particular design gives the operator the convenience of a long tying stroke with one squeeze of the trigger... the tie is cinched to a preset tension and trimmed flush with the head. The speed of tying is good for smaller volume tying.

If an evaluation of your tying requirements reveals a high volume of tying bundles in 1/16" to 5/8" diameter, consideration of our new automatic production tool (TR-300) would be wise.



Used in conjunction with our complete series of harnessing aids (routing clamps, corner posts, breakout springs) wires are routed with few nails to facilitate both fabrication and tying.

With good harness board preparation, the TR-300 can offer 4-5 times quicker installation than hand tying. This tool slides a TY-RAP tie under and around the bundle, cinches it to a preset tension, locks it and trims it flush with the head... all in 8/10 of a second.

Our harnessing specialists will review your tying operation and recommend appropriate tooling.

Another TY-RAP product which facilitates harness fabrication is the new harness board. Set-up costs just about disappear when you adapt this board into your present operation. It is a fully reusable modular board that can be enlarged by snapping the interlocking panels together. Metal screening covers the self-healing polyethylene foam center. Both sides can be used. The harnessing aids are installed easily since standard nails are pushed into the board by hand. Cat. No. HBF-02-03.



One of the most important considerations in using plastic ties is the reliability of the tie's locking device. Only TY-RAP self-locking ties have a patented, non-magnetic, stainless steel,



locking wedge embedded in the cable tie head. You get a grip of steel every time with TY-RAP self-locking ties.

The TY-RAP system was developed by T&B to answer all types of production wiring and harness fabricating needs whether large volume or small. Your production rates, system flow and total installed costs are major concerns of ours. In our evaluations of harness fabricating techniques used across the country, operator performance, fatigue factors and process convenience appeared as major considerations in the cost structure of harnessing. Our harnessing specialists are equipped to study these costs as well as all pertinent factors involved in your wiring and harnessing operations. Write or call us today.

The Thomas & Betts Co., Elizabeth, New Jersey 07207, (201) 354-4321. In Canada, Thomas & Betts Ltd., P.Q.



THOMAS & BETTS

Division of Thomas & Betts Corporation



We specialize in flat cable and flexible circuit problems nobody else can crack.

A lot of people make flat cable. A lot of people make flexible circuits. We're one of the few who make both.

But the big difference isn't only what we can manufacture, it's what we can design.

Hughes CONTOURTM Cable solved problems for the Viking Mars probe. We worked out solutions for the Minuteman missiles. We cracked tough packaging problems for shipboard and airborne systems, radar, sonar, high-speed computers.

And we can crack your tough ones, too.

Not wild-eyed, super-expensive,

forever-and-a-day solutions. Practical solutions. Maybe even less-expensive-in-the-long-run solutions.

And once we design it, we'll make it. In one of the industry's newest, most complete facilities.

Think of it this way. If it's simple and easy, anybody can do it, including us. But the tough nut is our specialty.

A tour? Or a consultation to discuss your design requirements? Just call (714) 548-0671 and ask for Dave Cianciulli.

Or write: 500 Superior Ave., Newport Beach,

California 92663.



Cables, circuits, connectors . . . only Hughes puts it all together.

INFORMATION RETRIEVAL NUMBER 47

Managers promote engineering 'digestion'

in this year-end round-up of interviewees' opinions on the best ways to develop good engineers.

Richard L. Turmail, Management Editor

It has been said that a person's growth depends not so much on how many experiences he devours, but on how many he digests.

In the last year ELECTRONIC DESIGN has presented the views of many successful managers to promote engineering "digestion." Regardless of the subject of the interview, nearly every manager interviewed had something to say about the engineer's development: his self-awareness, attitudes and methods, responsibilities and opportunities.

Here is a roundup of ideas on developing engineers from eleven engineering managers who were interviewed for the series, "Challenges to the Engineer Who Manages."

How many ways can an engineering manager help make an engineer aware of himself? Obviously there's no definitive answer. But if an engineer is made conscious of his creativity, his own image on the job and his potential, chances are he'll have the edge on his competition.

Some engineers are completely unaware of their own creativity, according to R. Donald Gamache, president of Innotech, Norwalk, Conn. He says: "Everyone has some creativity; creativity is the ability to come up with lots of ideas that are new to the guy who's coming up with them."

In other words, "new to the world" is not a necessary ingredient in a creative person's make-up. The word "value" is not part of the definition of creativity either, because an invention doesn't have to be valuable or even practical to be creative.

Classically, engineers operate in the judgmental mode, Gamache says, and their training has instilled definite judgments in them. But when a person is creating, Gamache goes on, he has to suspend judgmental thinking. Judgmental and creative thinking can't operate in parallel; the two must be in series.

Gamache concludes that if you want to be creative, generate ideas at random—as many as you can. They needn't all be great ideas; if you get one really good one in a field of 50 or 100, it's well worth the effort. When you've got

enough ideas to sift, Gamache says, turn on your judgmental mind and find out what kind of progress you've made. "Most engineers err," he says, "in that they try to operate their creative mind and their judgmental minds at the same time."

Improving job cooperation

A pinch of creativity can make an engineer more cooperative on the job, too. With a little imagination he can put himself in the other guy's shoes and understand what his problems are.

One division head, though, makes his engineers aware of colleagues' problems in a different way. Mort D. Margolis, president of the Autonetics Div., Rockwell International, Anaheim, Calif., put every man on one of his projects into one big area.

"We built a three-foot wall around the factory part of the cell," Margolis says, and "we put three or four offices across one wall for the program manager and a few other key people. We told our program manager that he was now in business for himself—just as if he had his own small company."

What did this approach do? According to Margolis, supporting personnel could see the effect of their activities on production. The purchasing employee, for example, could envision production grinding to a halt if he failed to buy parts on time. Engineers could appreciate how their failure to resolve a technical problem rapidly would interfere with production. They became aware of a personal challenge to meet the needs of workers who were rubbing elbows with them daily. People began to talk to one another instead of writing; they began to understand one another's problems and contributions.

"Many engineers have a tendency to look down their noses at logistics men," Margolis says. "Eye to eye, however, they learned to respect the logistics man's expertise."

How sensitive are you?

As to becoming aware of his potential, the engineer can do no better than to enroll in a sensi-



Carl Turner, Director of Power Transistor Operations, RCA Solid State Div., Somerville, N.J.

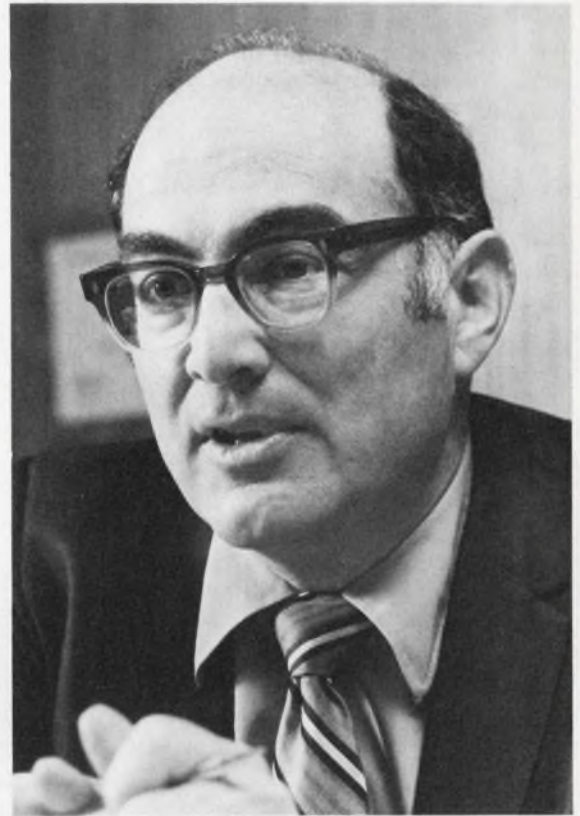

Mort D. Margolis, President, Autonetics Div., Rockwell International, Anaheim, Calif.



Ray Stata, President, Analog Devices, Norwood, Mass.

tivity training course, according to Thomas J. Frampton, manager of engineering for Signetics, Sunnyvale, Calif. Frampton says: "The approach we're using at Signetics is the managerial grid seminar, which is focused on understanding how the organization can most effectively integrate its tasks, goals and long-range objectives with the needs of the people performing them."

Through this approach, he reports, managers can gain more insight into people.

"I can look within my engineering group now, for example," Frampton says, "and spot those with managerial talents; I couldn't do that be-



Bernard M. Gordon, Chairman of the Board, Analogic Corp., Wakefield, Mass.

fore I took the seminar. Most engineers do well if you sit down with them once every six months and tell them where their relationship is within the group, why you see it that way and how you feel about it. I tell them why someone gets a promotion; I tell them how I preceded them in the organization and what I think of their career goals."

Should an engineer who wants to be a manager attend a grid seminar? Definitely, Frampton advises. After a week he'll be better qualified to determine whether or not he's management material. And should an engineer attend even

though he doesn't want to be a manager? Frampton feels he should.

"Grid offers a common base for communications," Frampton says. "People who've been exposed to the seminar have a common set of experiences, and they can realize their potential quicker."

Developing attitudes and methods

One company president, Ray Stata of Analog Devices, Norwood, Mass., believes that a main job of a manager is to develop his subordinates so they ultimately become as good as he is—hopefully even better.

Such management of people, Stata says, can be broken down into these broad areas of responsibility:

- Develop subordinates' judgment.
- Share the project objective with subordinates.
- Use the ideas that subordinates support.

Stata believes that it takes a long time to develop people and that the hardest and most important part is to develop judgment. Judgment, he concludes, is developed through the experience of making decisions, in suffering the anguish of weighing alternatives, in feeling the remorse of making mistakes and in building the confidence that comes from making correct decisions.

"To develop people," Stata says, "a manager must let them make mistakes, and this can cost time and money. The trick is for you, as a manager, to identify those areas that are critical to the success of your job and your company and to make sure that the decisions in these areas are as correct as you know how to make them.

"In all other areas force your subordinates to make their own decisions and be willing to live with a few more mistakes than perhaps you

would have made yourself. You must constantly balance your impulse to get the job done in the best way against your responsibility to develop your subordinates."

Bernard M. Gordon, chairman of the board of Analogic Corp., Wakefield, Mass., says that the most important things his engineering managers teach engineers are the economics of their business, self-development and the problems to expect in their work.

Gordon also deems it important that the new

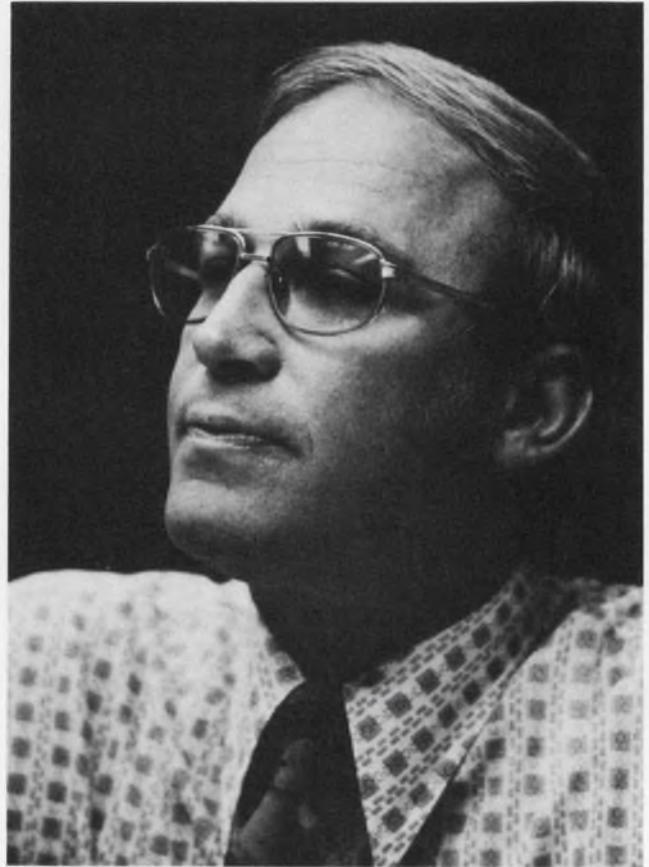

Don Sorchych, Vice President-Semiconductor Group, Harris Semiconductor, Melbourne, Fla.



Joseph J. Sacco, Jr., Vice President, General Manager, Instrument Systems Div., Gould Inc., Cleveland, Ohio.

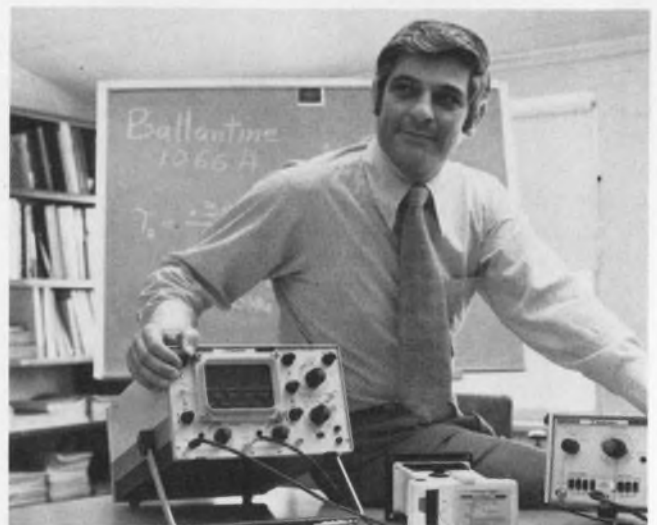

Fred L. Katzmann, President, Ballantine Laboratories, Boonton, N.J.

engineer understand that his boss will give him the maximum opportunity to develop himself professionally. But he must remember that he is still an apprentice; he must understand that there are many things that are beyond his comprehension. He has to be taught to ask for help when he needs it.

"From the manager's point of view," Gordon says, "it's just as important for the engineer's success that the manager know what he can't do as what he can do. Very often a guy who's limited can be extremely valuable to the company, provided everyone knows what his transfer function is."

But, as E. W. Bush, vice president and general manager of Cubic Industrial Corp., San Diego, Calif., observes: "You can't go to your supervisor with every little problem; there are certain problems that even the lowest managerial aide should handle himself."

The question is when does the beginning engineer go to his supervisor and say: "Look I've got a problem I can't handle; I need some help?" Normally he thinks that if it's a technical problem, he's closer to it, and he hesitates to go to a supervisor—especially if he thinks the supervisor may feel that the staff engineer himself should know the solution.

"One of the first things that a beginning engineer learns," Bush says, "is that if he has a problem that's going to delay his project to any extent, he'd better go to his supervisor and find out what to do."

Holding the engineer responsible

Fred Katzmann, president of Ballantine Laboratories, Boonton, N.J., says that it's time technical people were trained to do a job in economics as well as in science.

"That's what engineering is really all about,"



E. W. Bush, Vice President and General Manager, Cubic Industrial Corp., San Diego, Calif.

Katzmann says, "bringing science efficiently to the user. The engineer should always ask if what he's designing can be done better—not just the circuitry but also the handling of the product before it is delivered to the customer."

Joseph J. Sacco, vice president and general manager of the Instrument Systems Div., Gould, Inc., Cleveland, also holds engineers responsible for meeting the business plans that the directors of marketing, engineering, operations and quality control formulate for new products or ideas. A business plan, he notes, is broad. It says, in effect: "This is what the market wants; this is what the product must look like; this is how we're going to produce it; this is the investment we're going to make in it; and this is the profit we expect on it." The job of the program manager is to see to it that this business plan is met.

Under Sacco, the engineer in charge now realizes that his sole responsibility is to make the project go. He has assets available to him that he never had before, and he begins to understand things like gross market and expense levels and how they rate. He learns about cash flow and profits before taxes, and what these mean to the division.

"In fact," Sacco says, "he's running his own business—with all the tools he needs to do it—and he's relating to the two major goals in business: to make a profit and to satisfy the customer."

Putting an engineer in charge of a design project is also a favorite tactic of Carl Turner, director of power transistor operations for the RCA Solid State Div., Somerville, N.J. Only he gives just one man the responsibility wherever possible.

Turner says that he seldom assigns four or five engineers to design, say, a power transistor.

"I assign one engineer to work on it," he notes, "and he's almost completely independent of anyone else. That's not to say that he doesn't need support of people, but he usually will work smarter and harder on that project alone than if he were part of a larger team. Why? Because it's all his."

According to Turner, it doesn't hurt to get the new engineer involved in a project as soon as possible and to make him reach.

"Rather than have him function as a junior member of a rather complex project," Turner says, "we'd rather have him run his own show on a relatively simple problem."

When opportunity knocks

After the engineer has learned self-awareness, winning attitudes and methods, and responsibility, opportunities open up, managers agree.

Don Sorchych, vice president-semiconductor group, Harris Semiconductor, Melbourne, Fla.,



Robert P. Owen, Manager of Mechanical Design, Medium Systems Plant, Burroughs Corp., Pasadena, Calif.

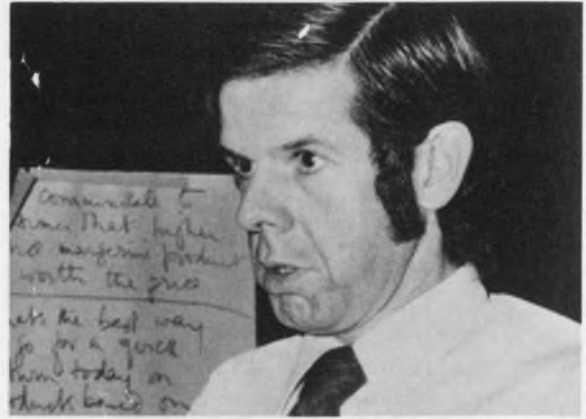

R. Donald Gamache, President, Innotech, Norwalk, Conn.



Thomas J. Frampton, Manager of Engineering, Signetics, Sunnyvale, Calif.

offers promising engineers recognition and guidance to spark their managerial opportunities.

"Of most interest to us concerning an engineer who shows managerial ability," Sorchych says, "is how he handles his aides, how he accepts responsibility of the work of others and how flexible he is."

Sorchych says that the engineer's decisions become tougher later on, because he has professional engineers to supervise in addition to other employees. He has to learn to evaluate these people, judge them, develop them and be responsible for their work.

"As a supervisor who has been responsible for the development of many up-and-coming management-bound engineers," Sorchych notes, "I think it's important to know that every engineer has different needs, biases, knowledge, edu-

cation, fixations, and neuroses. You have to find a different key to open up each individual so he can realize his future. Sometimes you find the key, and sometimes you don't. Usually when you don't, it's a failure of both parties. Any time you have to terminate an employee, it's a failure of management.

"Constant and objective critiques of past management methods, particularly with respect to failures, is essential. It's all too true in the management microcosm that a man who fails to learn from past mistakes is likely to repeat those same mistakes."

A chairman must lead

Opportunities to get ahead have been missed by many an engineer who didn't know how to chair a meeting. Robert P. Owen, manager of mechanical design at the Medium Systems Plant of Burroughs Corp., Pasadena, Calif., points out that a manager or manager-to-be can't afford to conduct meetings that waste the participant's time or that accomplish little. As the leader of a group discussion—large or small—the chairman's effectiveness is on display in real time and subject to instant evaluation by associates.

Owen advises: "Call people together only to give or to get information—and remember that the information-givers must be forewarned to be prepared properly. Post the agenda before the meeting to give those attending a chance to refresh themselves. If you've chaired meetings as I have, you've probably concluded that their conduct generally boils down to these three basic challenges: (1) Keeping the discussion focused on the subject; (2) letting everyone have his moment, and (3) making it your meeting."

Owen says that, on the whole, short but productive meetings result not from mystical management skills but from the chairman's commitment to brevity and accomplishment, and his unmistakable projection of these goals to the participants. ■■

"Packaging for FOX 2 process computer systems had to be fast, flexible, reliable and low in overall cost.

"Only one company met all our requirements. Augat."

John Hatch, Packaging Engineer,
The Foxboro Company

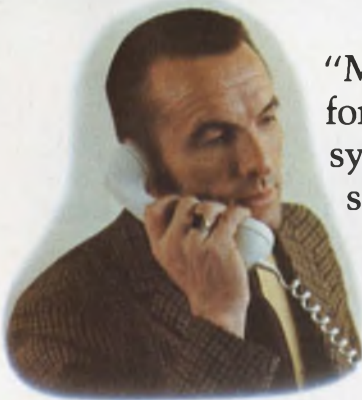

John Hatch

"My responsibility for the new FOX 2 systems was to help select the packaging and connection system providing top reliability plus the fastest possible development time.

On top of that, we wanted maximum density for the system.

"We chose the Augat Company for a variety of reasons. They were willing to work with us in developing new plug-in panels to meet our special requirements. Also, Augat offered the broadest range of I.C. interconnection products (from panels to frames to tools). This combination enabled us to design our packaging to meet our density needs. In fact, with Augat we succeeded in saving almost 90% in space. And access to both front and back planes was easier.

"I was most impressed with Augat's reliability and quality. Because Augat precision-machines the sockets used in their panels, we found our components and D.I.P.'s were easier to insert,

had greater positive contact retention and better corrosion resistance.

"True, Augat panels were probably a little more expensive initially. But from an overall systems standpoint, Augat's superior quality more than offset this small difference. We're sold on the Augat packaging system."

More and more companies like Foxboro are discovering that the name Augat is synonymous with quality, reliability, and service. With good reason. Augat pioneered the wire-wrapped socket panel concept. So Augat has more experience than anyone else in the business.

We'd like to show you how we can provide your company with a better interconnection system at a lower overall cost. Call or write us today. We'll send a free catalogue and complete product information. Augat, Inc., 33 Perry Ave., Attleboro, Mass. 02703. Represented and distributed internationally.



The FOX 2

Plug into Augat. Foxboro did.

Detector gives computer warning of ac power-line failure in 150 μ s

A power-failure detector gives an ultra-early warning—150 μ s compared with the usual 10 to 20 ms. The circuit, built with a zero-voltage switch, allows more time for computers to execute emergency routines while the dc power is still good.

Switch IC₁ provides an output pulse when the instantaneous ac-line voltage (input) lies between -3 V to 3 V. The pulse width is about 100 μ s for normal line voltage (120 V).

An opto-isolator couples the pulse to the computer logic. The slowly rising pulse is squared by Schmitt-trigger IC₂ and triggers one-shot MM₁. The one-shot is set to time out in 150 μ s—well after the end of the zero-voltage pulse.

In case of a power failure, the ac-line voltage goes to and remains at zero. IC₁ generates a pulse

whose width exceeds the 150- μ s timeout of MM₁. The one-shot times out and the 0-1 transition at its \bar{Q} terminal sets FF₁. The power-failure signal is taken from the Q output of FF₁.

The circuit is reset when the magnitude of the instantaneous line voltage exceeds 3 V. The absence of a pulse input to the optical coupler allows the input to IC₁ to go high; the output goes low and provides the clear signal to FF₁ at pin 1.

The CA3059 has its own internal voltage limiter and can operate directly off the ac line. Capacitor C₁ and internal rectifiers provide the 6.5-V-dc power.

Robert W. Wedwick, Senior Engineer, Honeywell Information Systems, Inc., 13430 N. Black Canyon Highway, Phoenix, Ariz. 85029.

CIRCLE NO. 311

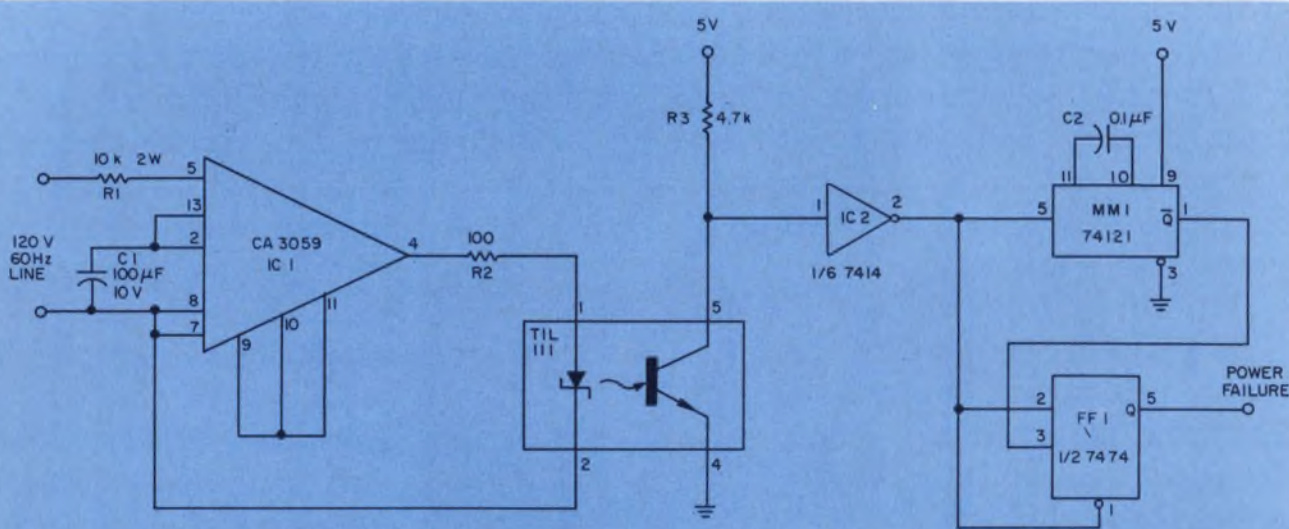

Zero-voltage switch minimizes reaction time of a power-failure detector. MM₁ times out and sets FF₁

because the pulse width from switch IC₁ exceeds 150 μ s when the ac line voltage drops to zero.

1. Pneumatic Cable Tie Installation Tool



Fast, Continuous High-volume Production with new pneumatic cable tie installation tool ■ Lightweight PPTS air tool requires minimum force, reduces fatigue; no training required ■ Installs 36 different PAN-TY® and STA-STRAP® cable tie products ■ Uses standard 70 to 80 psi air to automatically tighten ties to pre-set tension and cut flush ■ No sharp edges—no metal barbs—no twisting ■ Ask for demonstration and lease arrangements

CIRCLE NO. 141

2. Fully Pre-insulated Female Disconnects



Speed Connection with New Fully Pre-insulated PAN-TERM™ Disconnects by eliminating costly, time-consuming addition of separate insulation ■ Complete line of fully insulated disconnects with full vinyl insulation protects against shorting across exposed disconnect termination ■ No need to stock and handle separate insulating parts ■ Female disconnects for .250 and .187 male tabs; wire ranges #22 to #14 ■ Convenient packaging in handy dispenser box with clear, see-through, snap-open, snap-closed lid ■ Free samples

CIRCLE NO. 142

4
new ideas
from
PANDUIT
to Save
Assembly Time

New PAN-TERM™ Female Disconnects added to Panduit's extensive terminal line ■ New disconnects with vinyl insulation or non-insulated for .187 and .110 tabs ■ Wire ranges: #22-18 and #16-14 ■ Also available, full selection of disconnects with vinyl and nylon insulation for .250 tabs ■ All packaged in convenient dispenser boxes ■ Free samples

CIRCLE NO. 143

Secure Small Diameter Wire Bundles in Limited Space with new miniature adhesive backed mount ■ ABMM-A mount is just 3/4" x 3/4" and accommodates all miniature cross-section PAN-TY and STA-STRAP cable ties ■ Pressure sensitive adhesive backing.

Simply peel off the mount from paper dispenser strip and apply to surface ■ Saves cost and time of drilling holes for fixed diameter clamps ■ Free samples

CIRCLE NO. 144

3. Complete Line of Female Disconnects

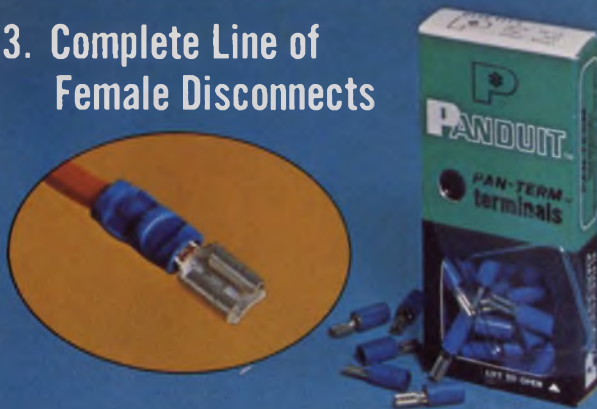

4. Miniature Adhesive Backed Mounts on Easy Dispenser Strip



Full Line of Wiring Components Sold Through Authorized Panduit Distributors

PANDUIT CORP.

Tinley Park, Ill. 60477 • Phone: (312) 532-1800
In Canada: Panduit (Canada) Limited

Opto-isolators replace relays for the injection of time-mark signals

Optically coupled isolators provide almost ideal means for the simultaneous addition of time marks to several chart recorders. Each LED-phototransistor combination provides isolation between recorder and timing source; the transistor generates the necessary potential to deflect the recording pen.

Ordinarily time marks are generated by the injection of a small potential onto one of the recorder lines (Fig. 1a). The resistor, battery and relay combination can be replaced by a phototransistor (Fig. 1b). Light that falls on the base-emitter and base-collector junctions causes a current flow from base to emitter. Typical voltages developed across a 100- Ω resistor range from 720 μ V to 1.2 mV, the latter with 35-mA LED currents. A 10-in. recorder—set for 10-mV, full-scale deflection—will respond with a 1-in. deflection to such a signal.

A potentiometer allows adjustment of the desired potential to insert in series with the recorder signal (Fig. 2). The additional diode, CR₁, in the emitter leg of the phototransistor protects against large reverse-bias surges that could damage the base-emitter diode. No protection is included in the collector leg. The allowable reverse voltage there is high enough to preclude surge damage.

Many devices—up to the available power-supply current—can be connected with LEDs that operate in parallel. And the quiescent current of the entire circuit is zero. Almost any LED-phototransistor combination may be used, so long as a connection to the phototransistor base is available.

W.W. Gile and R.A. Taylor, *Seismological Laboratory, California Institute of Technology, Pasadena, Calif. 91109.*

CIRCLE NO. 313

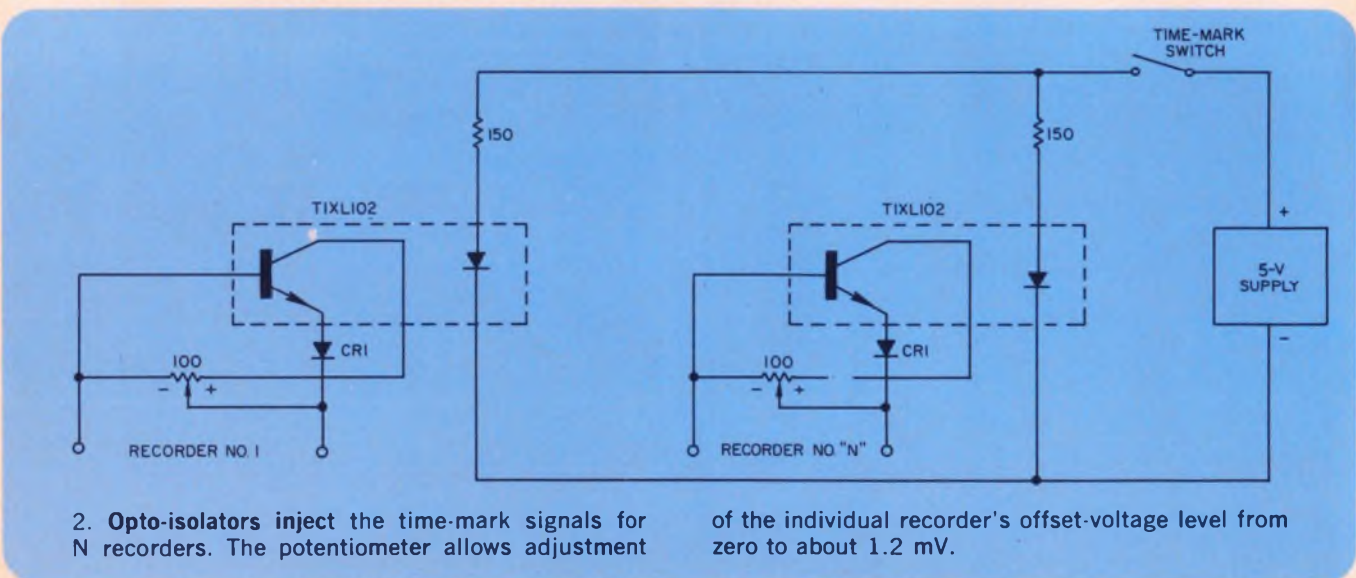
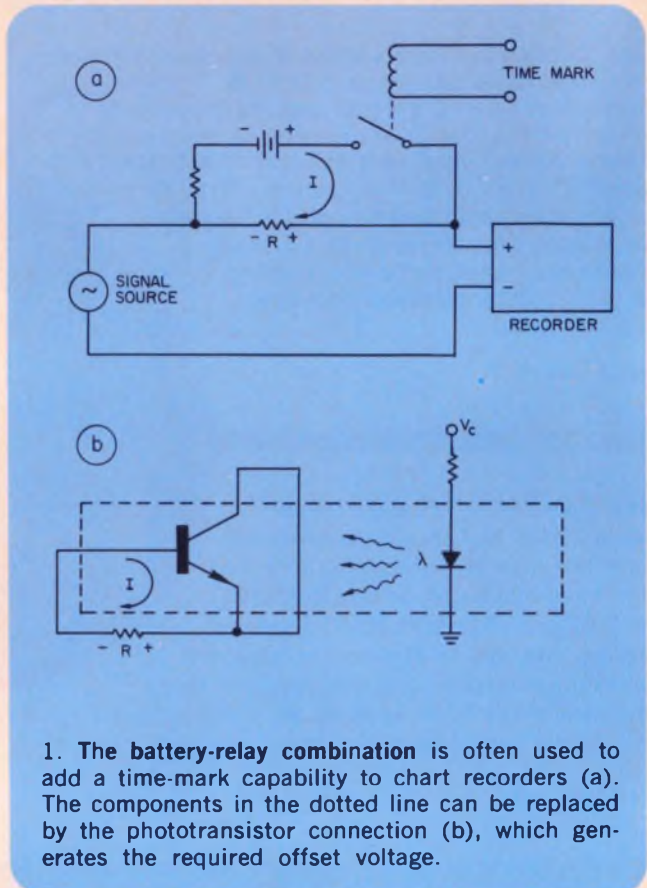

Need a DMM with a difference? ...Keithley's got 'em!

Tired of "general purpose" Digital Multimeter performance? Want that something extra that'll make your job easier? Then we've got the Multimeters for you. Take our new 5-1/2 digit, $10\ \mu\text{V}$ resolution, \$750, ac/dc Model 190...or our new 5-function, 32-range Model 165. It's even got a built-in 1 mA source for semiconductor testing. Then there's our model 171...a real do-it-all DMM. $4\frac{1}{2}$ digits, $1\ \mu\text{V}$ resolution, dc volts, ac volts, ac/dc amps, ohms too.

But the Keithley family doesn't end there. We can give you resolution to 30 nanovolts, or let you measure currents of 10^{-15} amp, or resistances to over 10^{14} ohms...we've even got a DMM that has the read-out in a probe.

If you have a job that needs a DMM and then some, we can help. Send for our Digital Multimeter selector guide or call us for a demo now.



Our latest "How sweet it is" proclamation is on a marble base paperweight. It's free when you request a DMM demo. Get one now!



**KEITHLEY
INSTRUMENTS**
U.S.A.: 28775 AURORA ROAD, CLEVELAND, OHIO 44139
EUROPE: 14, AVENUE VILLARDIN, 1009 PULLY, SUISSE

INFORMATION RETRIEVAL NUMBER 50

Wideband nonsaturating multivibrator features nanosecond rise and fall times

An overdriven differential amplifier and a single energy-storage element help build an astable oscillator that offers the following advantages:

- A frequency range of a fraction of a Hz to several MHz.
- Rise and fall times of a few nanoseconds over the entire frequency range.
- Frequency stability of 0.1%.

Capacitor C, the sole energy-storage unit, provides positive feedback from one of the collectors to the base of the other transistor. An overdriven differential amplifier, of the configuration shown, will generate relaxation oscillations—provided there is sufficient amplifier gain. And the pk-pk output is limited to $I_E R_L$.

During the first part of the cycle which lasts for a time t_1 , given as

$$t_1 \approx (R_{E1} + R_{L2})C$$

$$\times \ln \left[\frac{I_E R_{L2} + I_{b1} R_{E1}}{(R_{E1} + R_{L2})(I_{b1} - I_{b2})} \right].$$

Q_1 is on and Q_2 is off. And C charges toward the supply voltage through R_{L2} and R_{E1} . During the second half of the cycle which lasts for a time t_2 given as

$$t_2 \approx (R_{E1} + R_{L2})C \times \ln \left[1 + \frac{I_E R_{L2}}{R_{E1}} \right].$$

Q_1 turns off and Q_2 turns on and C discharges through Q_2 .

None of the transistors in the chip saturates during the conduction period. Therefore the gain always remains high, ensuring reliable starts.

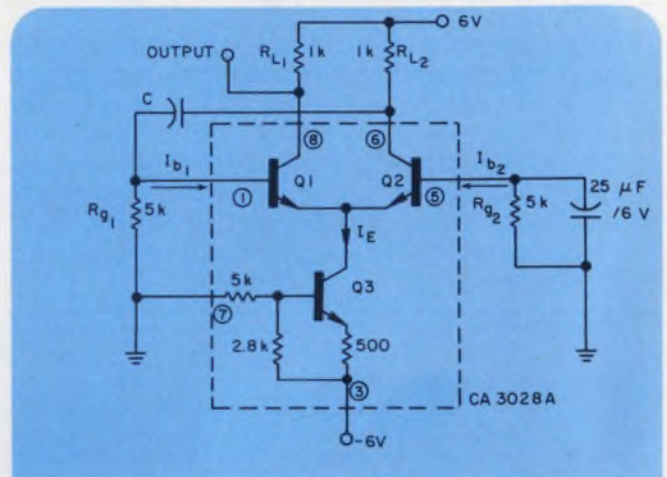

Capacitor C provides positive feedback for this astable multivibrator. Positive starts are assured since Q_1 and Q_2 do not saturate during their conductive periods.

And the output, taken from the collector of Q_1 , is quite clean.

The frequency of oscillation is 5.5 Hz with $R_{E1} = R_{E2} = 100 \text{ k}\Omega$; $C = 1 \text{ }\mu\text{F}$, and 2.22 MHz with $R_{E1} = R_{E2} = 5 \text{ k}\Omega$ and $C = 12 \text{ pF}$. The output voltage swings from V_{cc} , or 6 V, to $V_{cc} - I_E R_{L1}$, about 2 V.

Dr. D. K. Basu and R. Dattagupta, Computer Center, Jadavpur University, Calcutta, India 700032.

CIRCLE No. 314

IFD Winner of August 16, 1973

S. A. Mageswaran, Senior Research Assistant, School of Automation, Indian Institute of Science, Bangalore 560012, India. His idea "ICs give automatic selection of range for frequency counters" has been voted the Most Valuable of Issue Award.

Vote for the Best Idea in this issue by circling the number for your selection on the Information Retrieval Card at the back of this issue.

SEND US YOUR IDEAS FOR DESIGN. You may win a grand total of \$1050 (cash)! Here's how. Submit your IFD describing a new or important circuit or design technique, the clever use of a new component or test equipment, packaging tips, cost-saving ideas to our Ideas for Design editor. Ideas can only be considered for publication if they are submitted exclusively to ELECTRONIC DESIGN. You will receive \$20 for each published idea, \$30 more if it is voted best of issue by our readers. The best-of-issue winners become eligible for the Idea of the Year award of \$1000.

ELECTRONIC DESIGN cannot assume responsibility for circuits shown nor represent freedom from patent infringement.

Don't miss an issue of ELECTRONIC DESIGN; Return your renewal card today.

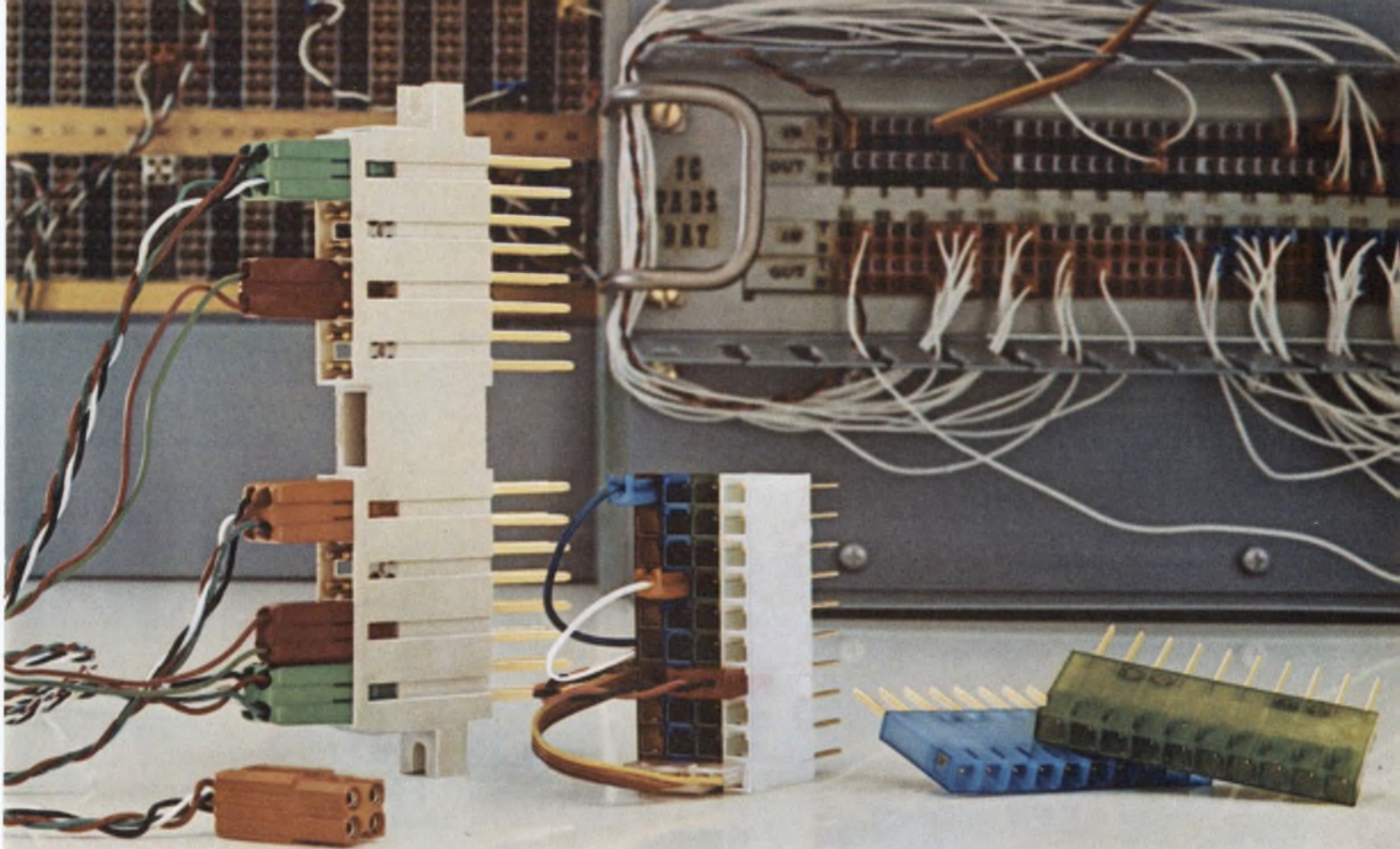

Update your telecommunications cross-connects—and save.

AMP pluggable modules make cross-connect programming easier, and save space and materials. Being modular also means that AMP can provide completed panels or provide the means for building your own.

Two kinds of modules are available; quad layout and in-line. Both have pins on .200-inch centers. Both are posted for wrap-type, rear-bay wiring. Quad types have eight 4-socket, or sixteen 2-socket, snap-in patch plugs. In-line modules are presently available in 1 through 5 positions. Cabling by twisted pair, shielded twisted pair and coaxial can be accommodated.

Both plug types have locking features, with the in-line type having the additional benefit of not requiring dedicated removal tools. Color-coded plug and receptacle housings provide quick lead length and circuit identification, and are polarized for accurate installation.

Snap-in plug contacts are designed for volume production and maximum serviceability. They're available in strip form or loose piece, and can be applied with high-speed machines or hand tools.

For more information on either type module or on AMP Circuit Concentration Panels, write AMP Incorporated, Harrisburg, Pa. 17105.

AMP
INCORPORATED

AMP is a trademark of AMP Incorporated.

INFORMATION RETRIEVAL NUMBER 51

New breadboard system eases circuit prototyping

Circuits for test or prototype purposes can be prepared quickly and accurately with a method developed by Siemens of West Germany. The system uses basic circuit boards in a variety of sizes, wire-threading combs, clip-on bus



A special pen that issues wire from its tip speeds up circuit construction in Siemen's new breadboard system.

bars and insulated wires in different colors to interconnect the components.

The boards have a standard 2.5-mm hole matrix; the holes have a diameter of 1.2 mm. The bus bar consists of tinned strips of conductor with tags at intervals, so that supply voltages can be distributed with the minimum of wiring. The combs, which are pressed in place on the wiring side of the boards, help to route the wires by acting as channels.

Wire threading is done by a special pen that holds a reel of wire. This issues from the tip of the pen, and simplifies both the winding of the wire around terminals and the routing along the guiding combs.

The wire is double-insulated, solderable lacquered copper with a diameter of 0.2 mm. The insulation can withstand 650 V, and is designed to melt at soldering temperatures and to act as a fluxing agent to help the soldering process.

CIRCLE NO. 318

state memory unit and a shift register built on a single amplifier frame assembly. By using a time-compression technique, the unit overcomes the inherent problems of incompatibility between echo signals and phonocardiograms, which severely limit the diagnostic value of the recording.

Each pulse output of the echoscope is recorded in the module's memory and played back at a higher speed—about 50 μ s—into the recorder. The quality of the echo data is comparable to that of the Polaroid method, but it maintains the continuous high quality of phonocardiograms and other tracings.

The monitor oscilloscope built into the recorder displays all tracings—including the echo M-mode



Echo interference module is used with a fiber-optic medical recorder to measure heart valve movements.

Echo module simplifies diagnoses in heart cases

An echo interface module developed by Kent Cambridge Medical Ltd. in England is said to represent a major advance in the use of echo techniques for diagnosing heart conditions. Echocardiography bounces very-high-frequency sound waves off various parts of the heart to achieve precise measurements of heart-valve movements.

The module is a preamplifier unit that converts the output from any commercially available echo-

cardioscope into a signal that is compatible with the Cambridge fiber-optic medical recorder, without the need for interface equipment.

The echo interface uses only one of the recorder's 12 channels, and allows the others to be used to monitor and to record other physical readings from the patient—such as blood pressure, electrocardiogram, pulse and temperature.

The design incorporates a solid-

scan—continuously on an ultra-long persistence CRT. The A mode can be presented on the echoscope simultaneously with the M-mode display on the recorder monitor. Instantly readable records can be produced on ultraviolet paper, or high-resolution, black-on-white photographic tracings can be made at paper speeds of up to 100 mm/sec.

The echo display may be positioned anywhere on the recording—relative to the other tracings. Display size can be varied, density adjusted and any portion selected for recording.

CIRCLE NO. 319

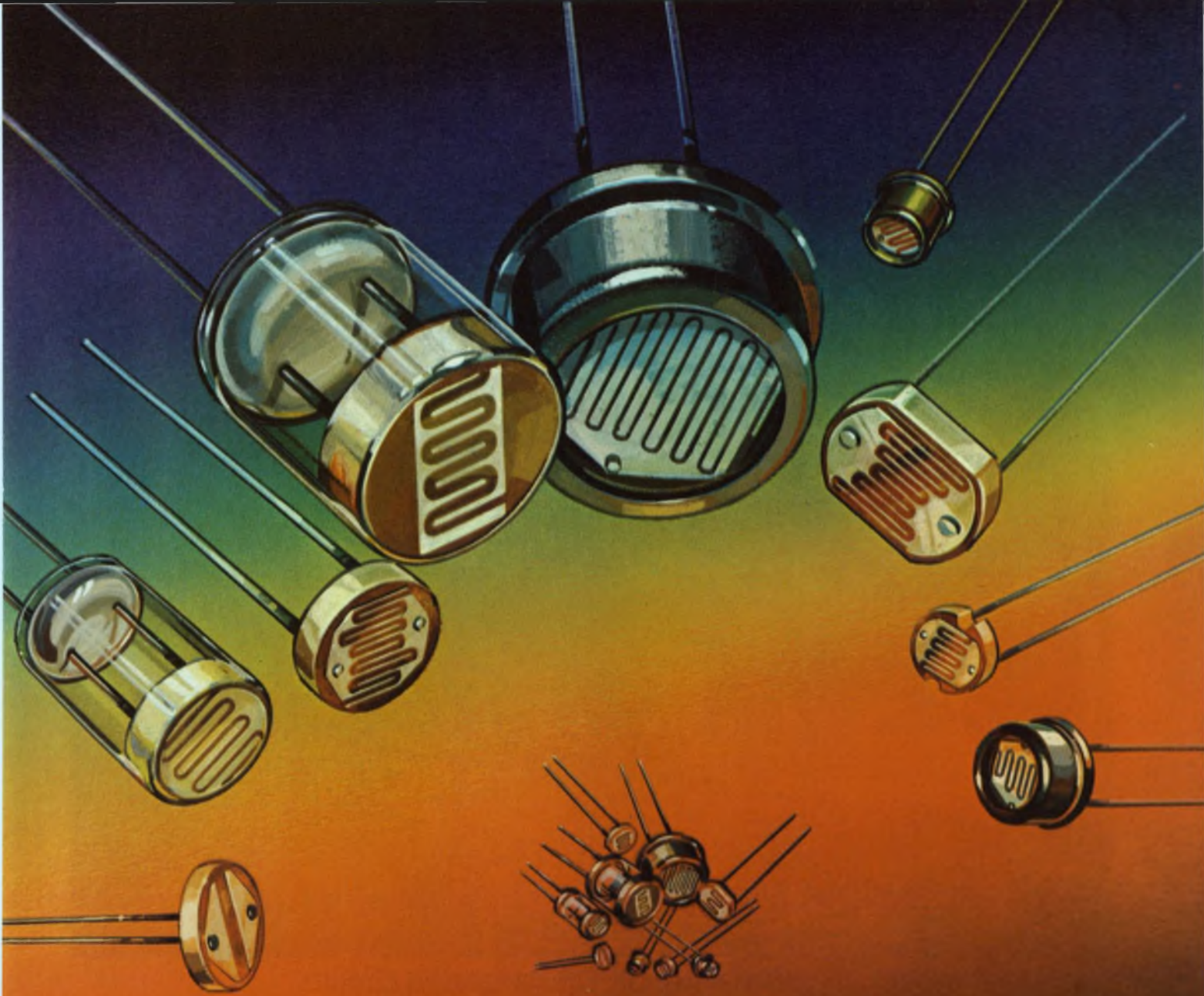

Photoconductors

Because Clairex makes them all, you can get exactly what you need.

Clairex will select the right photoconductive material and package it properly to give you exactly the photoconductor you need for your application. Clairex can provide cells:

1. With spectral response in the UV, visible spectrum, or near infra-red range.
2. Hermetically or non-hermetically sealed.
3. In plastic, metal, or glass packages.

4. With low or high resistance.
5. In large or small diameter configurations.

Clairex can provide cells from stock or design cells specifically for your application. For complete data or special assistance with your "light" problems, call (914) 664-6602 or write Clairex,[®] 560 South Third Avenue, Mount Vernon, New York 10550.

CLAIREX ELECTRONICS
A DIVISION OF CLAIREX CORPORATION

If you've got the timepiece, we've got the electronics.

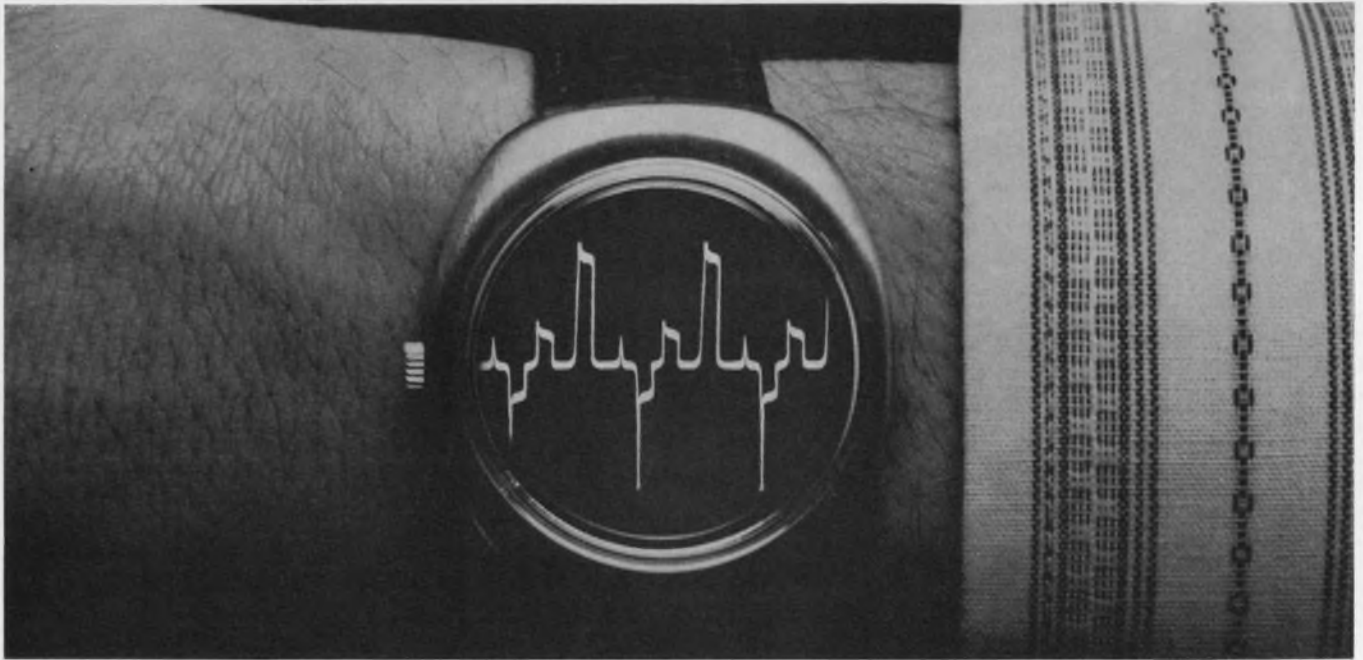

We've got CMOS integrated circuits.
quartz crystals.
liquid crystals.
micro stepping motors.
digital systems.
analog systems.

We help solve your problems by being a single, reliable source for virtually all of your electronic timepiece needs. Please call or write : Marketing Director, Motorola Timepiece Electronics, 3102 North 56th Street, Phoenix, Arizona 85036. (602) 244-4406.

MOTOROLA
Timepiece Electronics

*Bringing more than 45 years of
electronic experience to
the world's watch makers.*



new products

Voltmeter measures true rms, peak and average



B & K Instruments, 5111 W. 164th St., Cleveland, Ohio 44142. (216) 267-4800. \$755; 60-90 days.

The Electronic Voltmeter, Type 2425, is a small, general-purpose voltmeter that indicates \pm peak, true rms and average value of signals. The unit is suitable for measurements on signals with complex waveforms. Frequency range is 0.5 Hz to 500 kHz, and full scale ranges from 1 mV to 300 V. A peak hold and a maximum peak function with manual reset are included for measurement of impulse signals. The amplification of the voltmeter is calibrated and adjustable in 10-dB steps.

CIRCLE NO. 250

Logic test system handles 1024 pins

Hughes Aircraft, P.O. Box 90515, Los Angeles, Calif. 90009. (213) 670-1515. \$50,000 to \$100,000; 60 days.

The 1024 is a new computer-operated digital logic test system, designed for high-speed functional testing and troubleshooting of PC assemblies. The system permits fault diagnostic troubleshooting of complex logic modules with up to 1024 external input/output pins. Static functional test rate approaches 100 kHz and dynamic response measurements are automatically sampled at rates to 10 MHz within each static step.

CIRCLE NO. 251

Miniature scope gives 5-MHz bandwidth



Tektronix, P.O. Box 500, Beaverton, Ore. 97005. (503) 644-0161. \$745.

Designated the 221, this 3.5-lb. portable scope with 5-MHz bandwidth, 5 mV/div sensitivity and 1 μ s/div sweep speed is aimed at the computer maintenance field. Size is 3 \times 5.2 \times 9 in. The 221's battery recharges while operating on line power.

CIRCLE NO. 252

5-in. chart recorder operates in the field



Hewlett-Packard, 1501 Page Mill Rd., Palo Alto, Calif. 94304. (415) 493-1501. \$985.

Protected against adverse environments, this portable 5-in. strip-chart recorder, the Model 7155A, operates up to 9 hours on internal rechargeable batteries. Input sensitivity is from 1 mV to 100 V full scale in 16 ranges with an overlapping vernier. Input resistance is 1 M Ω over the full range. The input is floating, single-ended. Seven chart speeds range from 20 seconds per inch to 60 minutes per inch. Chart speed is changed electronically with a digital divider, eliminating mechanical gear changes.

CIRCLE NO. 253

Decade resistance box is miniaturized



Julie Research Labs, 211 W. 61st St., New York, N.Y. 10023. (212) 245-2727. \$285 (.01%).

The ultra-small MDR-106 decade-resistance box provides an accurate adjustable resistance from 1 Ω per step to 100 k Ω per step, up to 1,111,110 Ω . These instruments, accurate to 0.0025%, are the companion to the company's new miniature voltage divider.

CIRCLE NO. 254

Level meter handles 6 kHz to 18.6 MHz



Siemens, 186 Wood Ave. S., Iselin, N.J. 08830. (201) 494-1000. D 2007: \$7300; W 2007: \$6300; stock.

The D/W 2007 compact level-measuring setup is for selective measurements, from 6 kHz to 18.6 MHz, on carrier transmission systems and equipment using balanced or coaxial lines. The unit measures level, attenuation and gain. Pilot and channel levels can be covered without interrupting the system operation. Cross-talk and harmonic distortion can be determined too. Featured are an automatic tuning system for frequency control of the level oscillator, AFC and scale-spread indication.

CIRCLE NO. 255

Switch switches fast

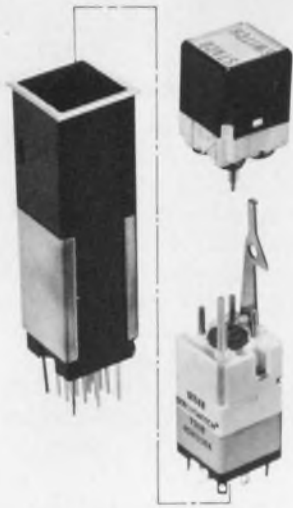

On those rare occasions when a switch malfunction shuts down equipment, STACO's Model 49 Illuminated Push-button Switch, with its plug-in switch module, can have things running again in less than 60 seconds. Simply flip a lever to remove the display pushbutton, and pull out the toilworn switch module. Slip in the plug-in replacement unit and reinsert the display pushbutton. It's that simple... and that fast!

No need to touch the behind-the-panel wiring. Once terminations are wired into the system, plug-in modules can be removed and replaced from front of panel. Choice of economical, dependable solder or wrap type terminations.

If your operation cannot tolerate downtime, then STACO's Model 49 can help keep the wheels turning. Its proven switch mechanism assures long service life and when at long last it needs replacing, a new module quickly plugs in. There's a choice of switch action and circuitry to meet your requirement.

When you think switch... think STACOSWITCH.



1139 BAKER STREET, COSTA MESA, CALIF. 92626
(714) 549-3041 TWX: 910 395-1507

Other STACO Company products: Fixed Ratio Transformers. STACO, INCORPORATED, Richmond, Indiana; Variable Transformers. STACO, INCORPORATED, Dayton, Ohio.

INFORMATION RETRIEVAL NUMBER 54

INSTRUMENTATION

Integrating tachometer tests stepper motors



Dahmen Burnett Electronics, Grenier Industrial Village, Londonderry, N.H. 03053. (603) 668-2777. \$590; 2 wk.

The IT-1 Integrating Tachometer lets you study stepper-motor overshoot, ringing and step error while system adjustments are made. The unit integrates velocity from a rotary or linear tachometer, then after a suitable delay, zeros the integrator. A stable scope trace of successive steps displayed on top of each preceding step allows you to study the effects of system changes. The IT-1 is suitable for viewing rotary steps of 1.8° to 180° and linear steps of .001 to 0.1-in.

CIRCLE NO. 256

Transient recorder resolves to 0.1%



CMP Industries, 23660 Research Dr., Farmington, Mich. 48024. (313) 477-1750. Base price: \$2500; 30-45 days.

The basic 3100 Transient Recorder consists of two channels, each 1024 words long, that can be combined to one channel 2000 words long. The system is expandable to eight channels with existing power. Expansion beyond eight channels can be accomplished in 1024 word increments by using a separate mating enclosure with power supply. A switch is provided to connect all eight channels in series for increased time resolution. The recorder uses 10 bits to achieve 0.10% resolution.

CIRCLE NO. 257

Unit digitizes and processes signals



Analogic, Audubon Rd., Wakefield, Mass. 01880. (617) 246-0300.

The AN7000 P(C)³ (for programmable converting, computing, controlling) includes an analog-to-digital converter, processor, random-access and read-only memories, and input/output bus. Size is less than 6 × 8 × 10-in. and weight is 7 lb. Heart of the device is a processor with a four-bit accumulator, 10- μ s cycle time and a complete input/output bus subsystem. The random-access memory contains 160 four-bit bytes and the programmable read-only memory (pROM) contains 768 eight-bit bytes. The a/d converter is of the dual-slope, integrating type, with resolution of one part in 40,000 and accuracy of 0.01%. The input/output subsystem consists of a 10-line bus, buffers, drivers and related circuitry.

CIRCLE NO. 258

Unit controls temperature to ± 0.05 C



Yellow Springs Instrument, P.O. Box 279, Yellow Springs, Ohio 45387. (513) 767-7241. \$80; stock.

The Model 63RC Temperature Controller controls to an accuracy of ± 0.05 C over a range from -70 to +260 C. Temperature is sensed by a thermistor probe forming one leg of an ac bridge. Control temperature is set with coarse and fine controls calibrated in arbitrary units. Using a reference standard, control temperature can be set to ± 0.05 C.

CIRCLE NO. 259

Who said Burr-Brown only makes OP Amps?

Sure we make op amps. A lot of them in all shapes and sizes...and for all applications. But, we also make Analog Circuit Functions!! These versatile, proven functions are available off-the-shelf to assist the designer in both simple or complex systems. Simply select the functions you need, connect them up, and "Voila," you have a working system at the lowest overall cost. We offer a wide range of Analog:

- MULTIPLIERS
- DIVIDERS
- SQUARE ROOTERS
- RMS-TO-DC CONVERTERS
- LOGARITHMIC AMPLIFIERS
- SINE/COS FUNCTION GENERATORS
- PRECISION OSCILLATORS
- VOLTAGE & WINDOW COMPARATORS
- PEAK DETECTORS

Just look at a few examples from our new product line catalog.

MODEL 4203 ANALOG MULTIPLIER

This exceptional little four-quadrant IC multiplier not only offers a 1 MHz bandwidth and a slew rate of $25V/\mu\text{sec.}$, but it is *completely self contained*. Hermetically sealed and internally laser trimmed in a TO-100 package, this unit requires no external components to deliver an untrimmed accuracy of up to 1%. Available in temperature ranges of from 0°C to $+70^{\circ}\text{C}$ and -55°C to $+125^{\circ}\text{C}$, it can divide, and square-

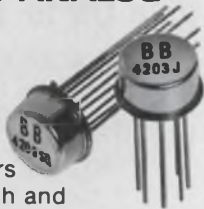

root, too, without the use of additional amplifiers. Prices start at \$17.00 in 100's.

MODEL 4290 ANALOG DIVIDER



Optimized for one-quadrant division, this unit offers 0.5% maximum error for a 100:1 range of denominator voltage (100mV to 10V) *without external trimming*. Output scale factor can be varied over the 100:1 range. Drift is only $0.02\%/^{\circ}\text{C}$ over the wide temperature range of -25°C to $+85^{\circ}\text{C}$. By using external trimming, you can extend the denominator range to 1,000:1 (10mV to 10V) without sacrificing any accuracy. External trimming can improve the output accuracy to 0.01% over the range of 100mV to 10V. And, just one single op amp turns the unit into a two-quadrant divider and the 100:1 denominator range still applies. Prices start at \$65.00 in 100's.

MODEL 4128 TRUE RMS-TO-DC CONVERTER



This unit, just one of our growing family of true RMS converters, provides an untrimmed accuracy of 0.5% and can be externally trimmed to 0.2%. A low pass filter with a time constant of 0.5 seconds is built right into the 4128. If you need

to increase the averaging time for very low frequency input signals, an additional capacitor will increase the time constant. This unit is ideal for measuring the RMS value of pulse trains, SCR output, random noise, and distorted sine waves. It will accept almost any waveform, as well as DC. Price is just \$95.00 in 100's.

GET THE ENTIRE PICTURE



All these products and many more are listed in our new Analog Circuit Functions Catalog. For your copy, use this publication's reader service card or contact your Burr-Brown Representative.

YES, BURR-BROWN MAKES OP AMPS... AND CONVERTERS, MULTIPLIERS, FILTERS, POWER SUPPLIES...



BURR-BROWN
RESEARCH CORPORATION

International Airport Industrial Park • Tucson, Arizona 85734
Telephone: (602) 294-1431 • TWX: 910-952-1111 • CABLE: BBRCORP
Chicago Office: (312) 832-6520
United Kingdom Office: Watford WD1 8BT Phone: 33837
French Office: Le Chesnay Phone: 954.35.58

amplifiers / DAC-ADC / multipliers-dividers
analog functions/modular power supplies
active filters/data conversion products

ATC 100 UHF/MICROWAVE LOW-LOSS PORCELAIN CAPACITORS



- High Q thru Microwaves
- 0.1 pF to 1000 pF standard
- High R.F. current capability
- Rugged Terminations
- Absolute Retrace
- Hermetic Construction
- Close Tolerances standard
- High Reliability
- Completely Characterized:
Full RF and DC test data

IMMEDIATELY AVAILABLE



The RF Capacitor Handbook for miniature chip and leaded capacitors is a UHF/Microwave designer's guide in disguise. Graphs of Q, Insertion Loss, VSWR, Reflected Power Loss, Equivalent Series Resistance, and Reactance, versus capacitance value and versus frequency are presented on the ATC 100 low-loss microwave porcelain series. Also covered are the capacitor's high power capability, Low Noise Figure contribution, stability, ruggedness, hermeticity, and self-encapsulation. American Technical Ceramics, Huntington Station, New York 11746, U.S.A.

**american
technical
ceramics**

ONE NORDEN LANE
HUNTINGTON STATION, N.Y. 11746

516/271-9600 • TWX 510-226-6993

INSTRUMENTATION

DPMs offer green LEDs



Electronic Research Co., P.O. Box 913, Shawnee Mission, Kan. 66201. (913) 631-6700. Model 2611 (3 digits): \$257; 8 wk.

A green LED option has been added to the company's entire Digital Panel Instrument line. One of the first instruments to be so offered is the Series 2600 Digital Stopwatch. The new stopwatches will find special application in darkrooms where red-sensitive film is processed, and in high light-level environments, as the green LEDs provide increased visibility and faster recognition of displayed information.

CIRCLE NO. 260

Analyzer measures probability to $\pm 3\sigma$



Quan-Tech, Div. of KMS Industries, 43 S. Jefferson Rd., Whippany, N.J. 07901. (201) 887-5508. \$1900.

Model 317C Probability Density Analyzer provides statistical analysis of random data. Accurate within $\pm 2\%$ of full scale, the unit analyzes the amplitudes of complex, random, periodic or aperiodic waveforms. Measured are both Probability Density and Cumulative Probability Distribution over a range of ± 3 sigma, where a simple adjustment calibrates sigma to the true rms value of a random input signal.

CIRCLE NO. 261

Pulsers troubleshoots ICs or PC cards



Kurz-Kasch, 2876 Culver Ave., Dayton, Ohio 45429. (513) 296-0330. \$89; stock.

Model HL-582 Hi-Lo pulser is an in-circuit stimulator used to exercise ICs and cards. By pressing the built-in switch once, the unit pulls an existing LOW state to a HIGH state, or vice versa. The pulser is designed for use with DTL and TTL logic circuits and can be applied to any input or output to pull it HIGH and LOW. Duration of state change is approximately $1 \mu\text{s}$. A two-mode switch selects single cycle or 5-Hz rep rate in continuous mode. Output is HIGH, LOW or off (a high-Z state).

CIRCLE NO. 262

Tunable filters give Qs to 10,000



Edmac Associates, 333 W. Commercial St., East Rochester, N.Y. 14445. (716) 385-1440. From \$750.

Two basic models, with automatic tracking, are available in this new line of tunable electronic filters. The Hi-Q Tunable Filter (Model 8010) offers circuit Qs to 1000. The Super Hi-Q Tunable Filter (Model 8020) offers Qs to 10,000. The units are general-purpose, active two-pole filters, usable in either bandpass or band-reject configurations. Center frequency is tunable from 1 Hz to 10,000 Hz. Bandwidth at any frequency is controllable over a two-decade range.

CIRCLE NO. 263

Function gen sweeps, gives (sine)² pulse

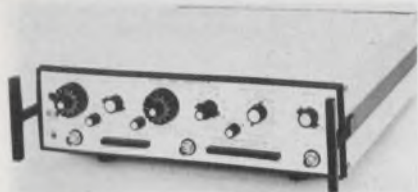

Exact Electronics, 455 S.E. 2nd Ave., Hillsboro, Ore. 97123. (503) 648-6661. \$895; 2 wk.

The 0.0001-Hz-to-20-MHz bandwidth is just one of the features of the Model 7260 function generator. The unit also offers pulse, sweep and transmission line testing. Pulses have widths variable from 25 ns to 1000 s. For sweep operation, two Kelvin-Varley dividers let you set start-stop frequencies with a 1000:1 range, and give an instant frequency reading. For transmission line testing, the Model 7260 can produce the 125-ns-wide sine² pulse (8-MHz equivalent) used in testing TV transmission systems.

CIRCLE NO. 264

Three probes added to photometer line



Tektronix, P.O. Box 500, Beaverton, Ore. 97005. (503) 644-0161. J6511: \$250; J6512: \$250; J6514: \$150.

With three new probes, the J16 Photometer/Radiometer now has eight interchangeable probes to meet light measurement requirements. The new probes are the J6511, an Illuminance Probe with readout in foot-candles or lumens/m² (lux); the J6512, an Irradiance Probe corrected to provide a flat spectral response within 7% over 450 to 950 nm; and the J6514 Uncorrected Probe, designed for applications where only relative measurements need to be made.

CIRCLE NO. 265

Who said you can't beat the option game when buying a true-rms voltmeter?



The one with the works

At \$1,200, our Model 93AD gives you the best price and the best performance. It's not just priced 20 to 32 percent under competition. It's complete

with standard performance and convenience features that the other manufacturer tags on as costly options . . . or can't give you at all.

Take remote programming and BCD outputs. They are a necessity for any kind of test automation. We don't ask you to pay an extra \$450 . . . we've made them standard.

If you're doing low-frequency work, spurious high-frequency signals are always a problem . . . but not with Boonton's selectable bandwidth. On the 100 kHz setting, you get immunity from spurious pickup; on the 20 MHz position, you get twice the full-performance bandwidth of the older designs at lower cost.

We've even removed the conflicting advantages of digital and analog readouts. We give you both — a 3½ digit LED display for absolute readings, and a special analog dB meter for easy peak/null adjustments . . . as standard.

Our dB option is not only \$100 less than the higher-priced spread but also gives you an ex-

tra digit for a constant
costs
\$300
less.

tra digit for a constant 0.01 dB resolution . . . available in your choice of 50 Ω, 75 Ω, 600 Ω, or 1 V references.

And we have a low-cost 10 MΩ, low-capacitance probe for negligible circuit loading at high frequencies — not available from the competition.

What don't we do?

Well, our autoranging option costs \$25 more than the competition and we don't go down to 2 Hz or up to 100 MHz. But unlike some, we don't pretend to "cover" a frequency range beyond our capability. Their advertised 100 MHz bandwidth is useable on only the 0.1 and 1 volt ranges. On all other ranges, their upper frequency is 10 MHz or less. The 93AD has a 10 Hz to 20 MHz bandwidth specified down to 300 μV with full calibrated accuracy.

But see for yourself. Before you pay more for less, write or call for the full specs or a demonstration: Boonton Electronics Corporation, Rt. 287 at Smith Road, Parsippany, New Jersey 07054; (201) 887-5110.

**DON'T
NEED DIGITAL?
OUR FULLY-PROGRAMMABLE
ANALOG MODEL 93A GOES
FOR A LOW
\$600.**



BOONTON

25 WATT DC-DC REGULATED CONVERTERS

High power
in a compact, low
profile package

FEATURES

- 25 Watts output (greater than 1 watt/cu. in.)
- Triple, dual or single outputs
- Short circuit protected by current limiting
- Low output impedance by post regulation
- High powered addition to the proven 9500 series

SPECIFICATIONS

- 28 VDC input, outputs available from 5 to 24 VDC in single, dual, or triple output models.
- regulation: line, 0.1% load, 0.2%
- meet MIL-E-5400K specifications (selected)
- low profile package (4 x 4 x 1.5 inches)
- output impedance: 0.02 ohms, 0 to 10 kHz
- EMI: Input filtering included
- MTBF: Calculated per MIL-HDBK-217

Prices:

Single output, \$240.00.
Dual output, \$270.00.
Triple output, \$330.00

For immediate delivery call
(303) 442-3837

tecnetics, Inc.
Box 910
Boulder, Colorado 80302



tecnetics

INFORMATION RETRIEVAL NUMBER 58

MODULES & SUBASSEMBLIES

D/s converter resolves down to 0.17 degree

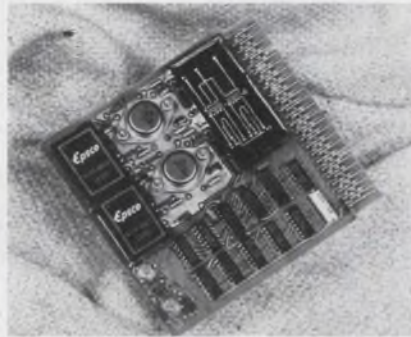

Epsco Inc., 411 Providence Highway, Westwood, Mass. 02090. (617) 329-1500.

Model 1010 digital-to-synchro converter combines high accuracy (± 6 min of arc) and high resolution (0.17°) in a low impedance unit designed to drive 100 Ω . This unit is transformer-isolated with a four-bit binary address and 11-bit resolution. The binary angle input is DTL/TTL compatible. The unit also meets MIL-specs.

CIRCLE NO. 266

Tone encoder offers mini size and wide range

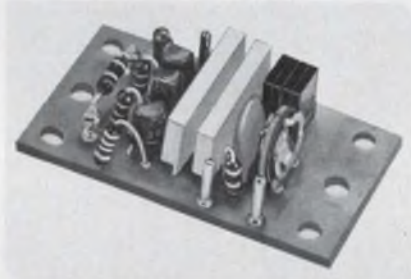

Alpha Electronic Services, Inc., 8431 Monroe Ave., Stanton, Calif. 90680. (714) 821-4400.

The AE-50 tone encoder produces a burst or pulse of tone on any factory preset frequency from 20 Hz to 3000 Hz. Pulse duration can be varied from 100 ms to 15 s or the unit can be strapped for continuous tone which also makes possible field conversion to sub-audible continuous tone encode. The operating temperature range is -40 to $+100$ C for the $1.25 \times 0.9375 \times 0.5$ in. module. Up to eight tone frequencies can be used with one AE-50 by the plug-on addition of a Model 166 carrier board which is also available from the manufacturer.

CIRCLE NO. 267

Eighth-order elliptic filters offer low ripple

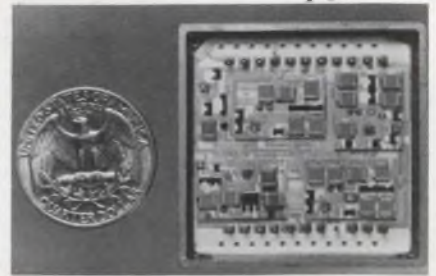

General Instrument Corp., Integrated Circuits Div., 600 W. John St., Hicksville, N.Y. 11802. (516) 681-8000. Under \$100 (100-up).

Eighth-order Causer elliptic filters are designed for the 3 to 6 kHz range. Typical characteristics of the low-pass filter are: A low-pass ripple of ± 0.5 dB, 300 Hz to 4.6 kHz; 50 dB drop to 5.3 kHz and no peaks in the stop band up to at least 50 kHz. Gain is 0 dB, ± 0.5 dB at 1 kHz. Harmonic distortion is -50 dB below an output signal of 300 mV for frequencies between 0.3 and 3 kHz. The high-pass version has similar characteristics starting at 3 kHz. Power supply requirements are ± 15 V at 15 mA max. Output voltage is 5 V rms into a 2 k Ω load. The operating temperature range is 0 to 70 C. The 1.6 by 1.6 by 0.25 in. package is hermetically sealed.

CIRCLE NO. 268

Resistance sensors can control high current

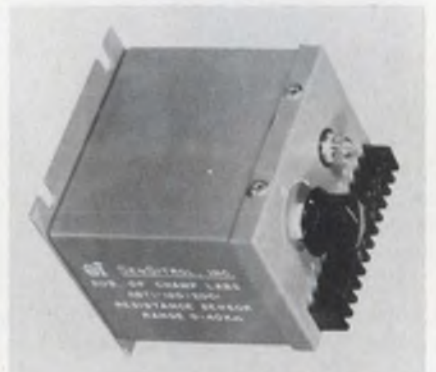

SenSitrol, Inc., 200 S. 4th St., P.O. Box 150, Albion, Ill. 62806. (618) 445-2323.

The ABTI-Series resistance sensor can sense a minute ac current flowing between probes. Built-in indicators show the output relay operations. The output relay is rated at 10 A, 120 V ac resistive operation.

CIRCLE NO. 269

UNICORP

The one source for **CAPTIVE PANEL HARDWARE**

Panel Screws,
Washers, Retainers.

MORE: Standard Metal and Plastic
Materials
MORE: Platings and Finishes
MORE: Configurations, Slotted and
Unslotted
MORE: Standard Lengths, Diameters,
Thread Sizes

All precision machined to exact-
ing tolerances.
Get your guide to the broadest,
most comprehensive range of
Captive Panel Hardware.
Write or phone today for Cata-
log H-3.

And check our Prices!

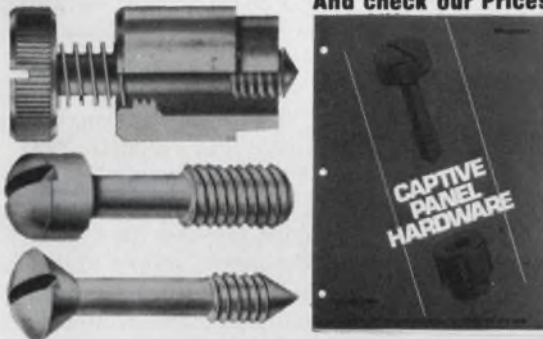

UNICORP

585 Nassau Street, Orange, New Jersey 07050
(201) 674-1700

INFORMATION RETRIEVAL NUMBER 59



*** Forget the others! At the new low price of \$695, you won't find a better value in wide range DMM's anywhere.**

High resolution, high current Fluke 8120A DMM measures volts, amps and ohms anywhere on line or battery.

- Twenty-five ranges, five modes, 4½ digits, \$695
- 0.008% resolution on all functions
- Current from 10 nanoamps to 1.2 amps
- Voltage from 10 microvolts to 1200 volts
- Resistance from 100 milliohms to 12 megohms
- Rugged overload and environmental specs
- Guaranteed range, accuracy, resolution and 10,000 hour MTBF specs



P.O. Box 7428, Seattle, WA 98133
Get all the details from your nearest
Fluke sales office. Dial toll-free
800-426-0361 for address
of office nearest you.

INFORMATION RETRIEVAL NUMBER 60

*Call the
HOTLINE
today
for complete
information:
(201) 843-0550
extension 203*

**PERSONNEL
RECRUITMENT
ADVERTISING
IN
Electronic Design
REACHES THE
RIGHT PEOPLE
AT A LOWER COST
PER THOUSAND**

Dc power amplifier delivers 110 W



Control Technology Co., Inc., 41-14 29th St., Long Island City, N.Y. 11101. (212) 361-2133.

Model 916 dc power amplifier has differential inputs and differential outputs. The internal power sharing circuitry allows the amplifier to deliver 110 W. Adjustable current limiting is provided to prevent motor demagnetization due to the back EMF when reversing at high speed. This circuit also protects the amplifier against momentary short-circuits across the output terminals. Stable operation with either voltage feedback or current feedback is achieved even with very high open loop gain. The unit is supplied with a removable component board mounted on top of the amplifier. Input impedance, amplifier gain, voltage or current feedback, and current limiting can be set by adjusting the value of the resistors on the board. The amplifier measures only 4.7 by 2.75 by 0.94 in. Power requirements are 15 V at 10 mA and 28 V dc.

CIRCLE NO. 270

Interval timer offers six adjustable delays

Matrix Research & Development Corp., 533 Main St., Acton, Mass. 01720. (617) 263-2986. \$89.50.

Model BF4347 push-button timer offers six adjustable settings for quick, repeatable timing of industrial equipment. Each can be quickly reset to other times as required. The button pops out automatically at the end of the timing cycle. Different colored illuminated buttons simplify operator instruction. The unit is fused and all solid state construction is used. It operates from 120 V ac, 50 to 60 Hz and has contact ratings of 2 A and 200 W. Accuracy is $\pm 1\%$ while the range for each button covers 2 s to 5 min.

CIRCLE NO. 271

Solid state computing modules have many uses

Transmagetics, Inc., 210 Adams Blvd., Farmingdale, N.Y. 11735. (516) 293-3100. \$495 (1 to 9); stock to 6 wk.

The C670 series of computing modules offer coordinate rotation, polar to rectangular or rectangular to polar conversion, sine-cosine generation and trigonometric computing functions. These units provide continuous resolution, require no calibration, adjustments or warm-up. All models are short-circuit proof. They measure only 3.19 by 3.44 by 1 in., are hermetically sealed for total protection and are designed for PC board mounting.

CIRCLE NO. 272

Transducer amplifiers are compact and light

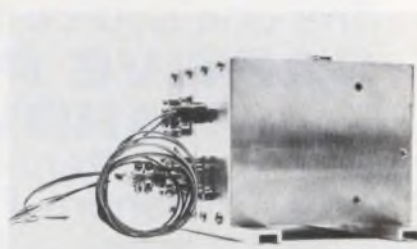

Automotive Test Industries, Endeveco, 801 S. Arroyo Pkwy., Pasadena, Calif. 91109. (213) 681-2401.

The line of vehicle borne signal conditioners and a power supply unit consist of Models 7440 and 7460 for conditioning the signal from piezoresistive triaxial accelerometers, and Models 7441 and 7461 for conditioning uniaxial devices. The various models can be assembled together in a rack, along with the power supply unit. Models 7440 and 7441 have manual zeroing and calibration. Models 7460 and 7461 have automatic zeroing and calibration. The manual and automatic calibrations are accomplished with accessory, external calibration boxes. All units are compact and lightweight. The 7460 is 10 oz. and the 7461 is 11 oz. They are 1.25 x 4.4 x 5.63 in., excluding connectors. This means that a rack of 10 units would be only 12.5 x 4.4 x 5.63 in. and weigh less than 7 lb. The units have gain ranges of 2 to 20 and 20 to 200, and a frequency response of dc to 5 kHz. Common-mode voltage is 5 V. The units operate over a temperature range of 15 to 150 F.

CIRCLE NO. 273



ANALOG
YOU'RE A WINNER EVERYTIME WITH THE A-852 12-BIT, HIGH SPEED BINARY A/D. IT HAS A 4µS. CONVERSION TIME, ± 5 PPM/°C TEMPERATURE STABILITY AND LINEARITY OF $\pm 1/2$ LSB. INSENSITIVE TO SUPPLY VARIATION. FOR COMPLETE ANSWERS, WRITE ANA.

intech INCORPORATED
(408) 244-0500
1220 COLEMAN, SANTA CLARA CA 95050

Hybrid power regulators handle up to 240 W

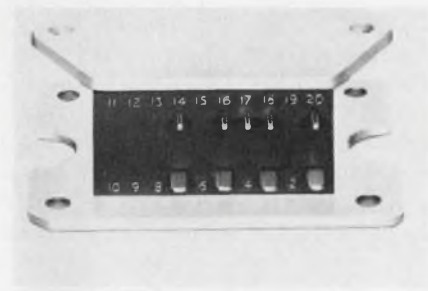

Lambda Electronics Corp., 515 Broad Hollow Rd., Melville, N.Y. 11746. (516) 694-4200. \$32 to \$38 (1000 up).

The LAS 4000 series of hybrid positive regulators is available in five and nine pin models. They deliver output voltages of 5, 6, 12, 15, 20, 24 or 28 V dc in current ratings from 4 to 15 A. Wattages for these models range from 170 to 240 W. There are 79 different models in the LAS 4000 series of power hybrid regulators.

CIRCLE NO. 274

Delay equalizer works in 0.3-to-3-kHz range

Polyphase Instrument Co., Bridgeport, Pa. 19405. (215) 279-4660.

Model 4028 group delay equalizer provides adjustment of a telephone line characteristic to improve communications quality and performance. It introduces an additional propagation delay to a particular region in the nominal 300-to-3000-Hz frequency range. The operator can select the magnitude (250 to 1250 μ s) and frequency location (300 to 3000 Hz) of the additional delay, thus equalizing the incremental delay. Frequency selection and delay magnitude controls are operated independently and have no interaction. The delay control selection has no effect on the signal amplitude; the equalizer has unity gain for any control setting. Some specifications include: max input voltage, 1 V rms; output voltage, 1 V rms; broadband gain, 0 dB; frequency range, 0 to 20 kHz \pm 1 dB; input impedance, greater than 25 k Ω (single ended); output impedance, 10 Ω (single ended) and the output load can be 600 Ω or more. Power supply requirements are \pm 15 V at \pm 12 mA.

CIRCLE NO. 275

If the timing diagram says your logic should look like this...

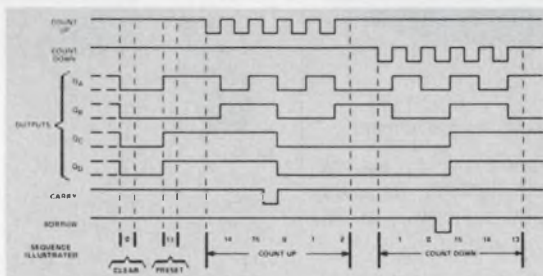

...now you can see if it does.

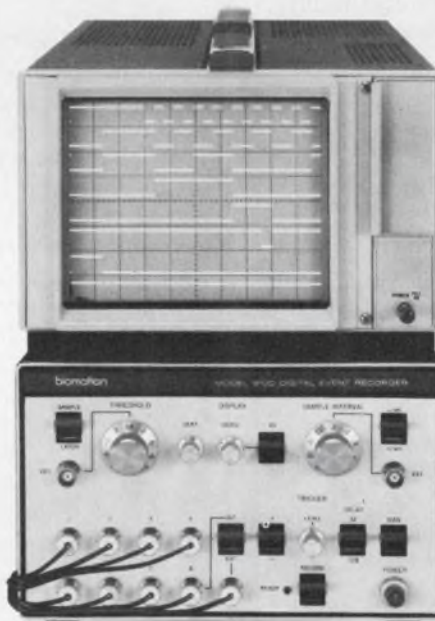

Introducing the Glitch Fixer: Biomation's new 810-D Digital Logic Recorder makes any scope a data stream display.

Analyzing a complex logic circuit—especially asynchronous logic—used to be a tough assignment. No longer. Not if you put Biomation's new Glitch Fixer—the 810-D Digital Logic Recorder—between your troubled circuit and any oscilloscope. It lets you record up to eight digital signals simultaneously. Presents them in the same format you're used to seeing on data sheets. And lets you expand the 250-bit data line (x5) to get a closer look at what you've got.

Best of all, it features an input latch that grabs hold of any random logic pulse—the glitch you're looking for—as narrow as 30 nanoseconds.

Here are some other features to null

over: records 8 logic channels using 1 M Ω inputs selectable logic thresholds, including TTL and EIA levels synchronous clock input to 10 MHz or internal clocking selection from 20Hz to 10MHz storage of selected data ahead of trigger digital output for computer analysis or mass storage.

The Glitch Fixer is a new basic piece of diagnostic instrumentation designed for (and at the request of) logic circuit designers and troubleshooters. If you work with logic circuits, our 810-D Digital Logic Recorder will do the job. For \$1950 (without display). Get the product literature and see for yourself. Write, wire, or phone Biomation at 10411 Bubb Road, Cupertino, CA 95014, (408) 255-9500, TWX 910 338 0226.

biomation

INFORMATION RETRIEVAL NUMBER 63

news
from
pire

Far IR Quantum Detectors

Today there's another valuable supplier of quality HgCdTe detectors with wavelength response in the important 8-14 μ window.

This is PIRE. And PIRE is also the place to turn for immediate availability of the once hard-to-find detectors with peak response in the 15-24 μ region.

These detectors, grown and fabricated right in PIRE's own facility, provide fine performance —

$$D^*(12\mu, 10\text{ kHz}, 1, 60^\circ, 77^\circ\text{K}) \geq 2 \times 10^{10} \text{ cm Hz}^{1/2} / \text{watt}$$

$$D^*(21\mu, 10\text{ kHz}, 1, 60^\circ, 77^\circ\text{K}) \geq 1 \times 10^{10} \text{ cm Hz}^{1/2} / \text{watt}$$

New Flexibility

PIRE detectors offer you greater flexibility in designing optoelectric systems, whatever the application.

For Pollution Control: extreme speed and high sensitivity.

For Medical Thermography: top performance in thermal scanning systems.

For Optical Communication: high speed for high data rates.

For Industrial Process Control: non-contact temperature measurement to interface with your control system.

Call on PIRE's experts for ideas as well as outstanding products.

pire

Quality mercury cadmium telluride photodetectors

PRINCETON INFRARED EQUIPMENT, INC.

221 Nassau Street, Suite 300
Princeton, N.J. 08540 • (609) 924-8052

INFORMATION RETRIEVAL NUMBER 64

ICs & SEMICONDUCTORS

Regulator ICs control voltage locally

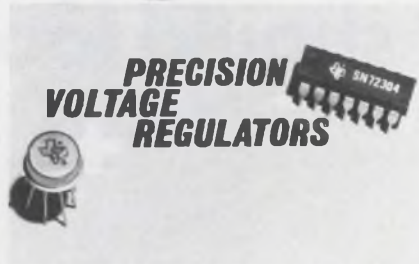

Texas Instruments, P.O. Box 5012, M/S 308, Dallas, Tex. 75222. (214) 238-3741. SN52105L and SN-52104L: \$4.44 (100); 12 wk.

A positive and a negative precision regulator IC can be used for local regulation where required. The positive regulator is the SN52105/72305/72305A/72376, a pin-for-pin replacement for the LM105/LM305/LM305A/LM-376. The negative voltage regulator is called the SN52104/72304, a pin-for-pin replacement for the LM104/LM304. The positive regulator features adjustable positive output voltage level, low standby current drain and output currents up to 45 mA. The negative voltage regulator features typically 1-mV load regulation and 0.06% per volt input regulation. It also features a constant or fold-back current limit.

CIRCLE NO. 276

IC contains core memory driver

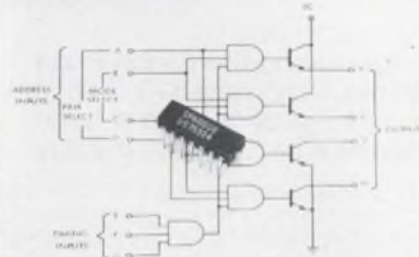

Sprague Electric, 347 Marshall St., North Adams, Mass. 01247. (413) 664-4411. \$3.50 (100-999).

A core memory driver IC, the Type US-75324A, can be used as a pin-for-pin replacement for the SN-75324N driver. Logic decoding is performed by four 3-input AND gates. A fifth 3-input AND gate is used for control and timing. The IC dissipates 800 mW.

CIRCLE NO. 277

64-bit ECL RAM accesses in 5 ns

Signetics, 811 E. Arques Ave., Sunnyvale, Calif. 94086. (408) 739-7700. \$24 (100).

An ECL 64-bit random-access memory, the Model 10145, is organized into 16 words of 4 bits each and is fully compatible with the ECL 10,000 series. The access time varies from a typical 5.0 ns for a chip enable mode to a typical 8.5 ns for an address mode. Typical write cycle time is 11.5 ns. For memory systems larger than 16 words, the 10145 features a chip-enable input and open-emitter outputs that allow a wired-OR configuration.

INQUIRE DIRECT

Quad driver/rcvr ICs ease line problems

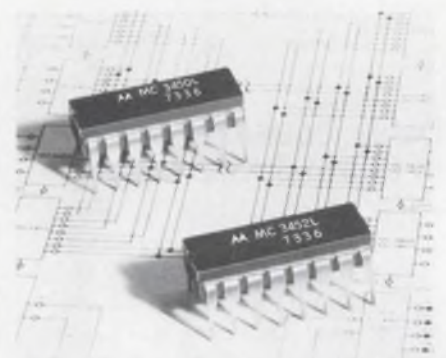

Motorola, P.O. Box 20924, Phoenix, Ariz. 85036. (602) 244-3466. \$4 to \$5 (100 up); stock.

Total IC package count in a line driver/receiver system can be reduced by a factor of two with the MC3450-53 quad devices. The new series consists of two line receivers and a line driver. The MC3450 receiver offers active-pull up, TTL compatible outputs, and a three-state strobe input common to all four devices. The MC3452 is a similar receiver, but with open-collector outputs that simplify the implied-AND connection. The MC-3453 is a 12-mA current driver and a quad version of the MC75110 dual driver. The MC3452 is similar to the MC3450 except that the outputs are open-collector types. It is a quad version of the MC75108 device. Both receivers feature ± 25 -mV sensitivity. Propagation delay of these units is 25 ns maximum.

CIRCLE NO. 278

IC series controls clocks

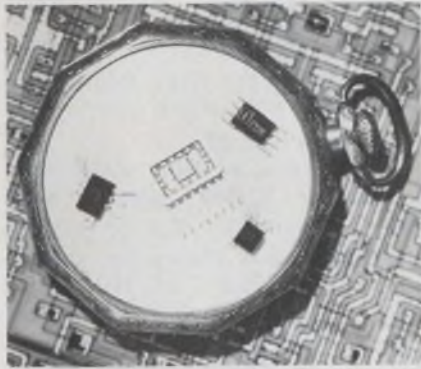

Intersil, 10900 N. Tantau Ave., Cupertino, Calif. 95014. (408) 257-5450.

A line of ICs contain the essential electronics for the operation of watches and clocks. The line includes three circuits for use in electronic quartz wristwatches—the ICM7035, ICM7036 and ICM7037—and two for use in electronic clocks—the ICM7028 and ICM7038A.

CIRCLE NO. 279

Sensor assembled on compact header



Spectronics, 830 E. Arapaho, Richardson, Tex. 75080. (214) 234-4271. \$3.50 (1000); stock.

A reflective LED and sensor assembly comes mounted on a compact TO-72-type header. The assembly consists of a GaAs infrared LED and a silicon npn photo-transistor. Called the SPX-1396, it is offered in three typical current ranges: I_L of 0.7, 1.5 and 2.5 mA with I_F at 25 mA and V_{CE} at 5 V. Dark current is typically 0.15 mA with V_{CE} at 5 V. Saturation voltage is typically 0.3 V.

CIRCLE NO. 280

Three basic lamp solutions from General Electric for your design problems.

Immediate delivery on Solid State Lamps (LED's).

GE has a complete line of competitively priced infrared and visible SSL's now ready for off-shelf delivery from your GE distributor or GE representative. The line includes a new small infrared SSL-65 with a .050" diameter. Our visible

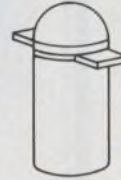

SSL's feature high efficiency GaP pellet material and the GE-patented light reflector for bright, uniform light. GE will refund your cost or provide a replacement lamp for all lamps not meeting published specifications.

Improve your product communications with Green Glow Lamps.



Our Green Glow Lamp (G2B) has exactly the same electrical and physical characteristics as our high-brightness C2A red/orange/yellow glow lamp. You can use the G2B alone for 120 volt green indicator service. Or together with the C2A to emphasize multiple functions with colors.

Uses include: safe-unsafe functions, dual state indications and multiple operations in up to 5 colors (with color caps). They can be operated in series with any appropriate current limiting resistor. Both the G2B and C2A can save money because of their low cost, small size and rugged construction.

Simplify circuitry with these newest Wedge Base Lamps.

Now you can design simple, low-cost, non-complex socketry by using these GE Wedge Base Lamps. They're available in two sizes, the GE T-1 $\frac{3}{4}$ with a .240" max. diam. and the GE T-3 $\frac{3}{4}$ with a .405" max. diam. These all-glass sub-miniature



lamps are small enough to solve the space problem posed by indicator lights. Their wedge-based construction virtually ends corrosion problems because they won't freeze in the socket. And the filament is always positioned in the same relation to the base.

Send today for information.

For free technical information on any or all of these lamps, just write: General Electric Company,

Miniature Lamp Products Department, #4454-L, Nela Park, Cleveland, Ohio 44112.

GENERAL ELECTRIC

INFORMATION RETRIEVAL NUMBER 65

LED's

High-efficiency, solution-grown epitaxial gallium arsenide



SE-2460

Standard pill package
Replaces TIL-23, TIL-24; OP 100, 122, 123



SE-1450

For high-density applications
Replaces SSL-15, SSL-315



SE-5455

Recessed chip mount for improved performance.
Replaces TIL-31, SSL-55 Series

Phototransistors



SD-1441

For high-density applications
Replaces TIL-613-616



SD-1440

Ideal for single-sided PC boards. Replaces L15E



SD-2440

Standard pill package
Replaces TIL, MRD & OP 601-604; LS 600



SD-5443

Replaces TIL-81, CLT 2130 thru 2160; L14F Type; MRD 300 and 3000 Series

**IMMEDIATE
DELIVERY
FROM
COMPLETE
STOCK**

WRITE FOR
CATALOG ON
COMPLETE LINE



Spectronics
INCORPORATED

830 E. Arapaho • (214) 234-4271
Richardson, Texas 75080

INFORMATION RETRIEVAL NUMBER 66

ICs & SEMICONDUCTORS

CCD area image sensor arrives

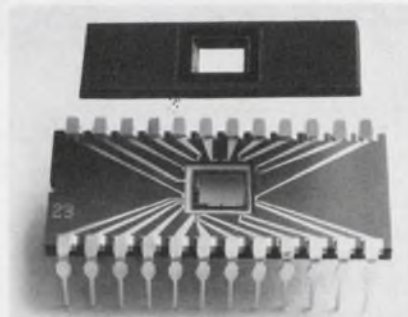

Fairchild Semiconductor, 464 Ellis St., Mountain View, Calif. 94042. (415) 962-3816. \$965.

The first commercially available charge-coupled area image sensor, the CCD-201, uses an array of 100×100 solid-state elements to create a television-picture signal directly from light focused on the surface of the sensor. The sensor operates from a 20-V power supply, compared with 2000 V for typical vacuum-tube image sensors. Nominal power consumption of the CCD-201 is 50 mW. Each light-sensitive element measures only 1.2×0.8 mils. Inherent spatial accuracy is 1 part in 10,000. The device comes in a 24-lead DIP with an optical glass window over the sensor area.

CIRCLE NO. 281

800-V rectifier handles 750 A

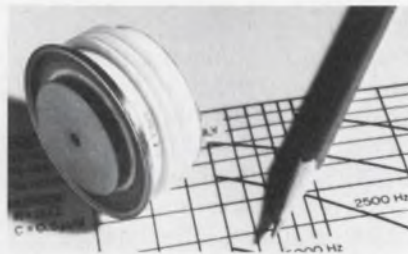

General Electric, Electronics Park, Bldg. #7, Mail Drop 49, Syracuse, N.Y. 13201. (315) 456-2021. \$96 (10-99).

A high current, fast recovery rectifier features average forward current rating of 750 A and dc blocking voltages up to 1200 V. Called the A596, the 800-V rectifier has a frequency rating up to 5 kHz. The A596 comes in the company's ceramic Press-Pak—a reversible package that eliminates the need for special reverse polarity units.

CIRCLE NO. 282

CMOS RAM holds 256 bits

RCA Solid State Div., Route 202, Somerville, N.J. 08876. (201) 722-3200. \$37.50 (1-99).

A 256-word by 1-bit static random-access NDRO memory uses CMOS technology for low-power dissipation and high-noise immunity. Called the COS/MOS CD-4061A, the RAM has an access time of typically 300 ns. The output circuit permits arrays to be wire-OR connected. Outputs and inputs are TTL compatible.

CIRCLE NO. 283

CMOS inverter replaces 2 ICs

Solid State Scientific, Montgomeryville Industrial Center, Montgomeryville, Pa. 18936. (215) 855-8400. 75¢ (1000); stock.

A CMOS hex inverter, the SCL 4449A, can be used as an economical in-socket replacement for 4009 and 4049-type CMOS inverters. The new device cuts the cost for that function by more than one half, with a reduced level of current as the only trade-off, according to the company. Features include 2 mA typical sink and source currents at a supply voltage of 10 V.

CIRCLE NO. 284

Nine-bit parity circuit has a 6-ns max delay

Signetics, 811 E. Arques Ave., Sunnyvale, Calif. 94086. (408) 739-7700. \$5.85 (100 up).

The 10170 nine-bit ECL parity circuit can make up to a nine-bit check in 4 ns and up to a 27-bit check in 6 ns with no additional gating required. Its features include propagation delay times of 4 ns (input to output A), 6 ns (input to output B) and 2 ns (carry to output B). Power dissipation is only 280 mW per package with no load. The 10170 checker can drive 50 lines and the high-impedance inputs contain 50 kΩ pulldown resistors. The circuit comes in a 16-pin ceramic DIP and is rated for normal operation over a temperature range of -30 to $+85$ C.

INQUIRE DIRECT

3,500,000,000 WATTS

(3.5 BILLION)

THAT'S THE POWER HANDLING
CAPACITY OF THE POWER TRANSISTORS
STC DELIVERED IN 1973

STC delivers the widest
line of hermetically sealed
power transistors. Over
1000 standard types span
50mA to 200 Amps at
up to 800 Volts
and 350 Watts

At STC Silicon,
Germanium NPN, PNP
and Darlington Power
Transistors are built with
the optimum of every major
process in a modern
facility totally committed to
power transistors

Building power supplies, regulators,
amplifiers, controllers or whatever?
Compare our specs and prices. If you
look to STC first you will seldom need
to look further.

For your free copy of the STC power
transistor catalog circle below or
contact



THE POWER SOURCE

SILICON TRANSISTOR CORPORATION KATRINA ROAD, CHELMSFORD, MASS. 01824
TEL. (616) 256-3321

INFORMATION RETRIEVAL NUMBER 67



**NEW HIGHS
in Performance,
in Reliability...**

LITHOCON® II SCAN CONVERTER

**Sharper, clearer images
for your display system
...at no price increase**

Step up your electronic information display system with the new PEP-400-R . . . today's most advanced low-cost scan conversion and image storage unit.

It's complete, self-contained . . . combining both improved circuitry and our unique, enhanced LITHOCON® II silicon-silicon oxide image storage tube.

Consider these new features for your display system application:

- Higher resolution . . . over 2,300 TV lines
- Improved corner resolution
- Unmatched image uniformity
- High-speed erase — one to two frames
- Extended image retention time
- Stability over 0° to 50° C temperature range
- More stable frame grabbing, slow-scan input/output
- Easier operational adjustments—top accessible.

Plus, of course, all the other features which have made the PEP Lithocon® series of imaging systems your first choice for storage and display of video and graphics, x-y dot writing and waveforms. Now, better than ever with the Lithocon® II.

Phone or write us today for more information: Princeton Electronic Products, Inc., P.O. Box 101, North Brunswick, New Jersey 08902, (201) 297-4448.



**PRINCETON
ELECTRONIC
PRODUCTS, INC.**

INFORMATION RETRIEVAL NUMBER 68

POWER SOURCES

Dc supplies come with or without regulator

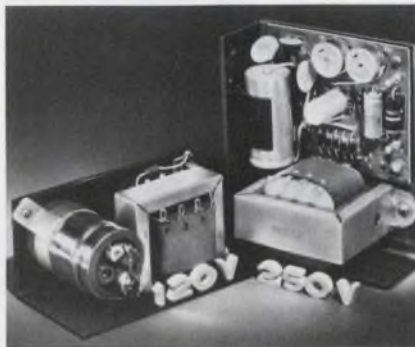

Standard Power, Inc., 1400 S. Village Way, Santa Ana, Calif. 92705. (714) 558-8512. SPS series from \$49 to \$135; black line series from \$19.50 to \$64.

The SPS series of high voltage power supplies offer outputs in the 120 to 250 V dc range. Line and load regulation of the supplies is $\pm 0.1\%$. The ripple is 0.1% (typically 0.5 to 2.0 mV rms). SPS supplies are made in 30, 60 and 120-W models. Also available are the "Black Line" power supplies that have no regulation at all. They come in 15, 30, 100 and 200-W versions. Taps provide for $\pm 10\%$ output voltage adjustments to compensate for line and load variations.

CIRCLE NO. 285

High power regulator has fast transient response

Sola Electric, 1717 Busse Rd., Elk Grove Village, Ill. 60007. (312) 439-2800. LZR: \$0.20 to \$0.40 per VA.

The LZR regulator can handle power in the 5 to 300 kVA range with an average 11 ms response to both line and load transients. Output voltage is not affected by line frequency variation between 57 and 63 Hz, or by lagging load power factors. The LZR can supply 120 V ac $\pm 1\%$ with input voltages that vary from 50 to 150 V. Correction for input transients is typically completed within one half cycle. When large step changes in input voltage occur, a minimum of 80% of the correction is complete in 1-1/4 cycles or less.

CIRCLE NO. 286

Modular PC mounting supplies offer variety



Lambda Electronics Corp., 515 Broad Hollow Rd., Melville, N.Y. 11746. (516) 694-4200. LZS-34: \$95; LZS-35: \$95; LZS-12: \$35.

Three additional models in the LZ series of regulated supplies mount on PC cards, have continuously adjustable voltage, are multi-voltage rated and are foldback current limiting. They have an input voltage range of 105 to 132 V ac, are short-circuit proof, have a vacuum-impregnated transformer, and are designed for series operation. The LZS-34 is a 5 V dc, 1.4 A unit with 0.15% regulation; the LZD-12 is a ± 15 V dc, 50 mA unit with 0.25% regulation and the LZD-35 is a ± 15 V dc, 300 mA unit with 0.15% and +5 mV regulation. For all models ripple and noise is 1.5 mV rms, 5 mV pk-pk and the temperature coefficient is 0.03%/°C over an operating temperature range of 0 to 50 C.

CIRCLE NO. 287

Small card supplies provide high voltage

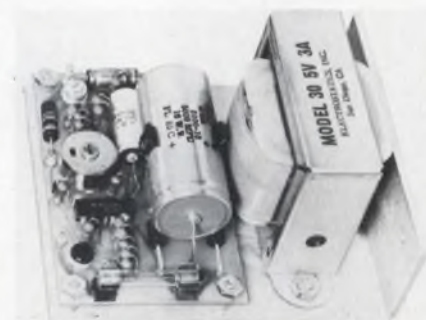

Electrostatics, Inc., 7718 Clairemont Mesa Blvd., San Diego, Calif. 92111. (714) 279-1414. \$26; stock.

The circuit card Model 30 dc power supply delivers 5 V at 3 A. This unit is factory preset, but options permit any voltage up to 30 V to be set. The supply also has 0.05% load regulation, foldback current limiting, and optional overvoltage protection. Circuit card size is 4.5 x 4 x 2.75 in.

CIRCLE NO. 288

Rack mounting supplies deliver up to 60 A



Acopian Corp., Easton, Pa. 18042. (215) 258-5441. From \$230 to \$590; 9 day.

The PT series of rack-mounting power supplies includes models with outputs ranging from 1.5 to 50 V dc and from 5 to 60 A. Most models are regulated to $\pm 0.005\%$ and have a ripple of 0.25 mV rms. Standard features include foldback current limiting and an illuminated ac power switch. Options include metering, overvoltage protection, and 230 V input. The supplies are housed in 3.5 and 5.25 in. high assemblies sized for mounting in standard 19 in. wide RETMA racks.

CIRCLE NO. 289

Lab power supplies allow easy hook-up



Instant Instruments Inc., 306 River St., Haverhill, Mass. 01830. (617) 373-9260. \$39 to \$69 (1 to 9 qty).

Pocket-size power supplies provide preset voltages of ± 15 or 5 V. The 2.5 x 3.5 x 1.25 in. units include an on-off switch and three-wire line cord. Six-way binding posts permit immediate hook-up to discrete component and IC circuits. Rated for continuous operation, these supplies offer short-circuit and overvoltage protection. Specifications include: 105 to 125 V ac, 50 to 400 Hz input voltages; 5 V dc at 1000 mA or 15 V dc with either 100 or 200 mA dc outputs; 0.05% max (0 to 100%) load regulation and 1 mV rms max ripple and noise.

CIRCLE NO. 290

Can a high-quality socket-maker produce a good, low-cost IC Socket?

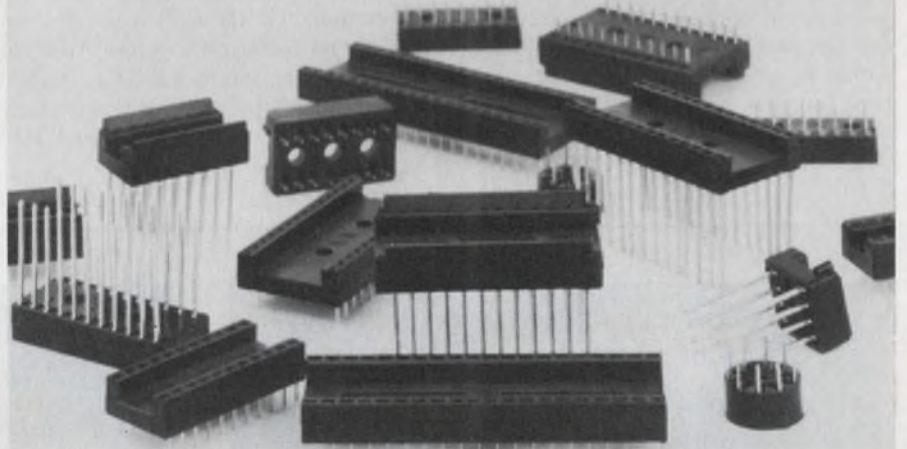

RN does.

We use our know-how and experience to make quality IC sockets at competitive prices. We call them the inflation fighters. They're for production applications where gold plating isn't really needed. Nor its cost. Where glass-filled nylon gives you all the body required. And where typical R-N quality can give you an edge. Interested? See the Socket People.



ROBINSON NUGENT INC.
800 EAST EIGHTH STREET
NEW ALBANY, INDIANA 47150
(812) 945-0211/TWX 810-540-4082

Rf line provides induction heating



Westinghouse Electric Corp., Westinghouse Building, Gateway Center, Pittsburgh, Pa. 15222. (412) 255-3693.

A low-impedance, rf transmission line can be used with rf generators for induction-heating applications. Voltage drops per foot of length are about one-fifth of equivalent copper tubing, according to the company. The line is available in straight sections of various lengths, 45-degree bends and 9-degree elbows. All configurations have a 4-inch outside diameter.

CIRCLE NO. 291

Octave-bw isolators cover 2-12.4-GHz range



Solid State Technology, 3650 Charles St., Santa Clara, Calif. 95050. (408) 247-8620. 60 days.

Octave-bandwidth isolators operate over the frequency ranges of 2 to 12.4 GHz with isolation in excess of 20 dB and insertion loss less than 0.5 dB. Called the SSI series, the isolators are specified for 2-to-4-GHz, 2.6-to-5.2-GHz, 4-to-8-GHz and 8-to-12.4-GHz operation. VSWR is less than 1.3:1 and load ratings are 5 W average.

CIRCLE NO. 292

Multithrow switches span 17-GHz range

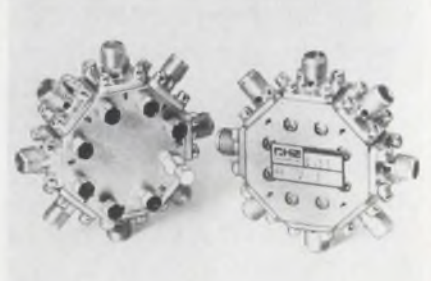

GHz Devices, 16 Maple Rd., Chelmsford, Mass. 01824. (617) 256-8101.

A series of solid-state switches provide both fast and slow speed switching from 1 to 18 GHz in octave bandwidths. The single-pole, multithrow switches are supplied with drivers (GC-77100 Series) or without (GC-74100 Series). Five basic types consist of SP3T through SP7T. The multithrow switches exhibit a minimum of 30-dB rf rejection at the control input. Power handling capability is up to 5 W cw at 25 C.

CIRCLE NO. 293

Sensitive Research*

Volt-Amp Wattmeters



The MODEL VAW, Volt-Amp-Wattmeter, is a multirange transformed-coupled indicating instrument that (1) makes tare-free measurements of AC power, voltage and current, (2) measures all circuit parameters without the necessity of changing circuit connections, (3) has a field current rating for use down to 50% PF or 100% overload and (4) is completely self-contained in a standard portable case.

The MODEL DW is a single phase AC/DC wattmeter for use down to power factors of 50% and frequencies up to 800 Hz. Its overall accuracy, ruggedness and stability make it ideally suited for use as either a calibration standard or general purpose testing instrument.

The MODEL DLW is a single phase AC/DC wattmeter designed for use with low power factors. Standard instruments have field coils that are rated for maximum currents down to 20% PF (5 X normal current).

* Manufactured under license from the Singer Company by:

ELECTRICAL INSTRUMENT SERVICE, INC.

25 Dock Street, Mt. Vernon, N. Y. 10550 • 914 699-9717

INFORMATION RETRIEVAL NUMBER 70

SALON INTERNATIONAL DES

composants électroniques

PARIS 1-6 / 4 / 74

COMPONENTS
MEASURING
MATERIALS
EQUIPMENT



Organisation S.D.S.A. - 14, rue de Presles 75740 Paris Cedex 15,

FRENCH TRADE SHOWS
1350 Avenue of The Americas, NEW YORK, N.Y. 10019
Tel.: (212) 582.4960.1

INFORMATION RETRIEVAL NUMBER 71

ELECTRONIC DESIGN 26, December 20, 1973

Co₂ laser delivers up to 400 W



Korad, Div. of Hadron, 2520 Colorado Ave., Santa Monica, Calif. 90406. (213) 829-3377.

The Model KG45 CO₂ industrial laser features an output power rating up to 400 W. It provides both continuous and pulsed power outputs up to 1 kHz and up to 300 W in the TEM₀₀ mode. The new laser also includes a special plasma-discharge initiation concept that assures trouble-free startup at all power levels, according to the company. Pushbutton operation offers a choice of hand-held control or automatic, remote-control operation. Prealigned resonator mirrors and continuously flowing gas are said to assure low maintenance costs.

CIRCLE NO. 294

900-MHz tube/cavity produces 150 W



RCA/Electronic Components, 415 S. Fifth St., Harrison, N.J. 07029. (201) 485-3900. A2965A: \$290; Y1261: \$366; 60 day.

The A2965A Cermolox tube and the Y1261 cavity combination yields over 150 W of power in the uhf frequency band. The tube delivers its rated power from 806 to 960 MHz. According to RCA, the tube's construction assures optimum performance with minimal tube inductances and feed-thru capacitances.

CIRCLE NO. 295

Waveguide windows seal WG-229-to-42 types

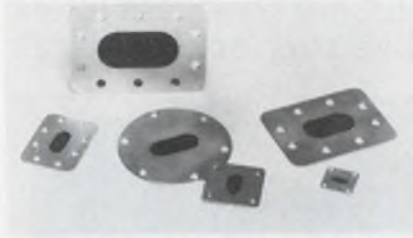

Microwave Associates, South Ave.,

Burlington, Mass. 01803. (617) 272-3000.

A series of pressure windows are available for waveguide systems operating over the 3.3-to-26-GHz frequency range. The corresponding waveguides span WG-229 to WG-42 types. The VSWR is 1.04 for sizes WR-75 to WR-229; the VSWR is 1.1 for the WR-42 window.

CIRCLE NO. 296

OUR ANGLE: More Synchro Conversion For Less Cost



with our
S/D and
D/S modules

How does a choice of 14-bit resolution (greater for 2-speed S/D), 60 or 400 Hz data frequency, high accuracy, 11.8V to 90V line-line voltages and all kinds of self-protection circuitry — look from your angle? Not to mention that as few as 5 modules make up a complete S/D or D/S converter, or that all modules are replaceable one-for-one without trimming! And, economically too!

New 2-speed S/D sets are now available with accuracies typically better than 20 seconds from all error sources including resolution. D/S specifications include 4 minute accuracy, 1.25 VA output with optional 20 VA output for torque receiver applications.

Key performance specifications for both converters include 14-bit (0.022°) resolution over 360°, 4000°/sec analog data rates and 0-70°C operation. Some units available for operation from -55°C to +105°C. All units are DTL and TTL compatible.

Prices start at \$650.00 for a set of modules. Delivery from stock. Call toll-free (800) 645-9200 for the name and address of your local sales engineering representative.



NORTH ATLANTIC industries, inc.

200 Terminal Drive, Plainview, New York 11803 • Phone (516) 681-8600

California District Office: 13418 Wyandotte Street, N. Hollywood, CA 91605 • Phone (213) 982-0442

Amplifier response spans 0.02 to 200 MHz



Verité Scientific, 4060 W. 226th St., Torrance, Calif. 90505. (213) 378-2294.

The Veri/Amps line of wide-band amplifiers are available with frequency-response ranges as broad as 20 Hz to 200 MHz and with typical flatness of ± 0.5 dB. Most of the 12 models have 20 dB gain and 1 V pk-pk output capability at 1-dB gain compression. Equivalent input noise ranges from 10 to 50 μ V, depending on the model. Input and load impedances are 50 Ω .

CIRCLE NO. 297

15%-bw bandpass filters tune over octave ranges

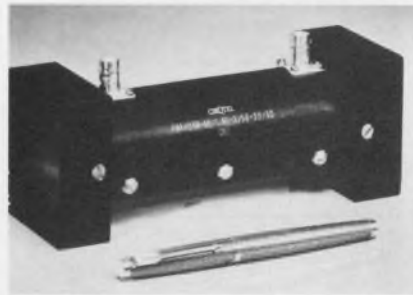

CIR-Q-TEL, 10504 Wheatley St., Kensington, Md. 20795. (301) 946-1800.

Standard models of FBA/23 tunable bandpass filters are offered with a choice of 3-dB bandwidths ranging from 0.5 to 15%. The bandwidths are essentially constant over octave tuning ranges between 10 and 300 MHz. The 10 and 15% filters are 3-resonator models. Tubular in shape, the filters are 1-7/8 inches in outside diameter and about 6-1/2 inches long.

CIRCLE NO. 298

Optical filters come with custom patterns

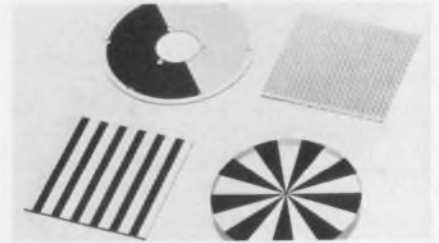

Scientific Coating Laboratories, 360 Martin Ave., Santa Clara, Calif. 95050. (408) 296-2295.

Multilayered hard dielectric optical filters are available with custom patterns and designs, including dots or bands. Shortwave, longwave and bandpass filters can be applied to lenses in patterns to allow separation of colors and discrete wavelengths. The filters cover the entire visible spectrum as well as near infrared wavelengths. And more than one filter design can be coated on a single optical element and can reproduce patterns as small as 0.001 inch.

CIRCLE NO. 299

New Solid State Audio Indicator

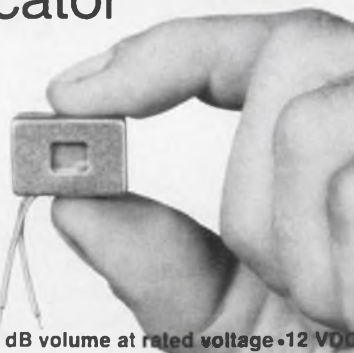

New rugged steel case • 80 dB volume at rated voltage • 12 VDC

Small size (.89" x .61" x .47") makes the Model AI 112 an ideal component for all types of solid state systems • Solid state means no moving contacts, no arcing or RF noise • Low current consumption of 30mA prolongs battery life • Sound output of 80 dB at 400 Hz makes this audio indicator impossible to ignore • Other models available to fit your needs: AI 101 3 VDC, and AI 103W 3 VDC with third wire collector for output of audio signal to remote location • Engineering sample available for \$5.95 handling charge. Please enclose check or money order. D.I.A.L. 800-645-9200 for nearest rep.



projects
unlimited

3680 Wyse Road
Dayton, Ohio 45414
Tel. 513-890-1918
TWX 810-450-2523
D.I.A.L. 800-645-9200 toll free

INFORMATION RETRIEVAL NUMBER 73

PUSH.

The great American switch.

Sub- and micro-miniature pushbuttons by C&K. They're tough. And they're priced right. And they can beat anybody's delivery to any place in the world. Now there's a switch. Get the catalog.

C&K COMPONENTS, INC.
103 Morse Street, Watertown, Mass. 02172
TEL: (617) 926-0800 - TWX: 710 327 0460
The great American switch.

Engineering samples on request.

INFORMATION RETRIEVAL NUMBER 74

Dipole antenna performs tests for FCC spec

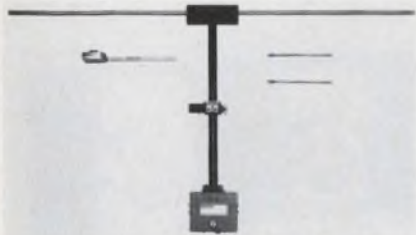

Singer Instrumentation, 3211 S. La Cienega Blvd., Los Angeles, Calif. 90016. (213) 870-2761. \$360; stock.

The Model KT-5-105A dipole antenna performs radiation measurements required by FCC Part 76 Sub-part K, when used in conjunction with a suitable rf voltmeter. It operates from 20-to-300 MHz into meters with input impedances of either 50 or 75 Ω . Calibration curves are provided.

CIRCLE NO. 300

SMA attenuators provide 0.5-dB accuracy to GHz



Elcom Systems, 127F Brook Ave., Deer Park, N.Y. 11729. (516) 667-5800. AT-50-SET/SMA: \$72; AT-51-SET/SMA: \$60; stock to 30 days.

Two sets of 50- Ω coaxial SMA attenuators each contain a 3, 6, 10 and 20-dB attenuator. They are available in calibrated (AT-50-SET/SMA) or uncalibrated (AT-51-SET/SMA) models. Attenuation accuracy is 0.5 dB from dc to 1 GHz and 1 dB from 1 to 1.5 GHz. VSWR is less than 1.35:1 at 1.5 GHz, averaging 1.2:1 over the band. They can dissipate 0.5 W cw or 1 kW peak power.

CIRCLE NO. 301

The Non-forgettable Memory

Why Non-forgettable?

Because a digital cassette tape recorder should not ever forget unless it is programmed to forget - and it should remember nothing extra.

The things that make it forget - capstans, pinch rollers, solenoids, belts - are simply not there. The patented constant tape speed motor control system eliminates noise susceptibility. Please call or write now for all the details.

Spend less for less . . . and get more.



ROSS CONTROLS CORPORATION

257 Crescent Street, Waltham, Massachusetts 02154, Tel. (617) 891-9600
An Affiliate of American Research & Development Corp. (ARD)

INFORMATION RETRIEVAL NUMBER 75

Silicon photo detector and pre-amplifier in one miniature package



The Bell & Howell 509 Optical Detector combines a large area silicon photodiode, low-noise operational amplifier and a gain determining network - all hermetically sealed in a miniature TO-5 size transistor package. Units available for extremely low level light sensing, fast rise time light pulses, and high resolution applications.

- Sensitivities to 10⁻¹² watts
- Spectral Range 0.35 to 1.12 microns
- 7 Decade Linear Dynamic Range
- Bandwidths from DC to 10 MHz
- Output Noise less than 1 millivolt over full bandwidth
- NEP's to 10⁻¹² watts/ $\sqrt{\text{Hz}}$
- Large Detector Active Area, 10 MM²
- Other diode sizes available.

Modification of these units can be made to meet specific requirements on volume orders.

CONTROL PRODUCTS DIVISION

706 Bostwick Ave., Bridgeport, Conn. 06605 (203) 368-6751



BELL & HOWELL

...delivered in volume to meet your production requirements.

INFORMATION RETRIEVAL NUMBER 76

Calculator adds time as well as numbers



Texas Instruments, 13500 N. Central Expressway, Dallas, Tex. 75222. (214) 238-3741. Under \$100.

Flick a switch and the TI-3510 displays the correct time instead of the answer to your computation. The unit performs the four functions, (+ - × ÷) and provides a 10-digit display. Other features include the choice of fixed (with roundoff) or floating point operation and a constant key. The unit operates on ac only.

CIRCLE NO. 302

Low cost CRT terminal has forms capability



Lear Siegler, Inc., Electronic Instrumentation Div., 714 N. Brookhurst St., Anaheim, Calif. 92803. (714) 774-1010. \$1000 to \$1600.

The ADM-1 CRT terminal can transmit data that completes a standardized form. Protected form data are displayed at lower intensity than the data to be transmitted. Editing capability includes the deletion and correction of single characters or complete lines. The ADM-1 has a 53-key or optional 60-key keyboard and can display 12 lines of 80 characters each, on the 12-in. CRT. A 24-line version is also available.

CIRCLE NO. 303

Cartridge tape system mates with PDP-11 minis



Applied Data Communications, 1501 E. McFadden Ave., Santa Ana, Calif. 92705. (714) 547-6954. From \$3150; 45 days.

Up to six tape cartridge drives can be added to a PDP-11 with the Series 42 tape system. The controller is installed in the PDP-11 small-peripheral-controller slot and cabled to the drive chassis. The chassis contains one or two 3M cartridge transports. Cartridge capacity is 720-k byte/track in one or four-track formats. Transfer rate is 48-k bit/s. The system is compatible with DEC cassette software. Driver subroutines and diagnostics are provided.

CIRCLE NO. 304

Call Kathy collect at (201) 542-1902 to get all the facts (prices, delivery, samples) on our 2 through 25 amp bridges, and especially our 40 amp full wave rectifier. The Power Physics 40PPR series can significantly reduce your assembly costs. They replace two discrete devices, are electrically isolated and easily handle high cyclic loading rates.

If you're really serious, call Kathy now; or, circle the reader service number to obtain a data sheet.

Power Physics –
Specialists in Power
Semiconductor
Technology
Industrial Way West,
Eatontown,
N.J. 07724



INFORMATION RETRIEVAL NUMBER 77

Our Amps Don't Quit in a Mismatch!

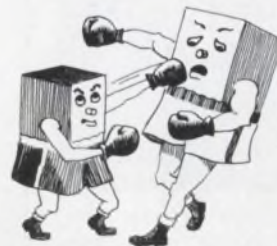

Amplifier Research has a tough line of broadband amplifiers -- all unconditionally stable and built to take on any mismatched load. These amplifiers sweep the spectrum from DC to 700 MHz and provide up to 5000 watts of RF power. Rugged design makes them perfect for antenna and component testing, equipment calibration and EMI susceptibility testing -- you'll never have to throw in the towel! Amplifier Research will also provide custom OEM packaging to meet your special requirements. Get the facts, contact:

Amplifier Research, 160 School House Road,
Souderton, Pa. 18964 • Phone: 215-723-8181



INFORMATION RETRIEVAL NUMBER 78

ELECTRONIC DESIGN 26, December 20, 1973

Calculator output now shown on graphic CRT



Tektronix, Inc., Information Display Div., P.O. Box 500, Beaverton, Ore. 97005. (503) 292-2611. \$7500; Jan.

The Tek 31/10 system, a combination of the Tek 31 calculator and 4010-1 graphics terminal, gives graphic displays of calculator data and allows the attachment of peripheral devices, such as a hard copy unit. The system includes software (on a magnetic-tape cartridge) that allows the user to plot mathematical functions, generate histograms or plot data arrays.

CIRCLE NO. 305

Tape cleaner/evaluator handles up to 6250 BPI



General Kinetics, 12300 Parklawn Dr., Rockville, Md. 20852.

The CE-70 series of computer tape cleaner/evaluators include the CE-70E for handling 6250-byte/in. tapes. A patented blade cleaner removes dust, oxide lumps and dust, with cleaning process repeated in two directions. An optional error recorder provides for automatic stop at the point of defect or error. Error detection is adjustable—for each track—from 10% to 90% of signal remaining.

CIRCLE NO. 306



Who said a digital-readout signal generator has to be hard to handle, hot and heavy, and cost \$4,450?

Not us!

Our Model 102A, at \$2,975, has everything you need for just about any AM/FM application — plus seven performance and convenience features you won't get in the \$4,450 design.

What did we leave out?

Phase-lock synchronization, for one (but our dc-coupled FM channel can be externally locked if you need better stability than our typical 4 ppm); and narrow-pulse modulation (belongs in a different class of generators).

What did we add?

Four different signal-generation techniques — for optimum performance in each band, from 4.3 to 520 MHz, without the usual compromises in noise, stability, or residual-distortion characteristics.

The most logical panel layout and convenient control setup you've ever seen. And a unique adjustable "feel" main drive mechanism for narrow-band receiver setting with ease — even without our electrical vernier.

Separate meters for modulation and output — no annoying auto-ranging or out-of-range annunciators . . . we don't need them.

15 minute warmup to typically

meet 10 ppm/10 minute stability — made possible by low internal dissipation (only 30 watts; no fan!)

Wider FM deviation at low carrier frequencies than any other design in this class (how does 2 MHz peak-to-peak grab you?)

A detected-AM-output option, to verify our negligible phase-shift for VHF-omni testing.

Versatile modulation features — like five internal frequencies, 30% and 100% AM scales, and true-peak-responding AM and FM metering.

All these performance pluses are coupled with low spurious and close-in noise, excellent low-frequency phase integrity, really effective leveling, a low and flat VSWR curve, accurate wide-range attenuation, high output power . . . all of it buttoned up tight for low leakage in a lightweight 30 pound package.

. . . and it's all yours for \$2,975. Get the full specs today — before you spend 50% more .

For complete data or a demonstration write or call Boonton Electronics Corp., Rt. 287 at Smith Road, Parsippany, N. J. 07054, (201) 887-5110.

BOONTON

Buffered card-reader repeats on request



Chatsworth Data Corp., 9732 Cozy-croft Ave., Chatsworth, Calif. 91311. (213) 341-9200. From \$3410.

The Model 3600-RECOM can use telephone lines to transmit card data. The 3600 reads marked, punched, and pre-printed cards. Cards are read singly on demand at a rate of one card per 100 milliseconds. The card-data are transferred to a buffer and then transmitted at 110 to 2400 baud in ASCII or EBCDIC format. If an "Acknowledge" is received, the reader repeats the cycle for the next card; however, if a "Not Acknowledge" is received, the old data are retransmitted.

CIRCLE NO. 307

Core-memory system expands to 256-k x 72



Lockheed Electronics Co., Data Products Div., 6201 Randolph St., Los Angeles, Calif. 90040. See text, 45 days.

A variety of core-memory systems can be built with the Sentinel modules. A single chassis contains up to 16 memory modules. The modules can be obtained in 4k, 8k or 16k-by-18-bit configurations—with cycle times between 650 to 750 ns. Memory sizes of 256-k words can be constructed with word sizes that range from 18 to 72 bits—in multiples of 18. The price: under 1¢ a bit in OEM quantities.

CIRCLE NO. 308

Disc system adds 20 M of storage to processor



Standard Logic Inc., 2215 S. Standard Ave., Santa Ana, Calif. 92707. (714) 556-1400. From \$9750; 30 days.

Three configurations of the MDP-8 disc systems provide up to 20-Mbytes of storage for the Data-point 2200 processor. The configurations allow for 2.5 to 5 Mbytes of storage on a single removable disc. A MOS buffer memory stores temporary information—up to four, 256-byte sectors—between the disc and the processor. Up to four disc drives can be used with a single formatter.

CIRCLE NO. 309

start cooking with Ga As

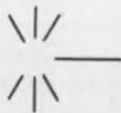

A NEW RECIPE TO SOLVE YOUR LASER SYSTEM PROBLEMS

Complete Ga As Laser Transmitter

- Beam centered on optical axis
- Built-in wideband current probe
- High repetition rate
- Internally or externally clocked

Complete Silicon Avalanche PhotoReceiver (with Bias Supply)

- Higher S/N than conventional PIN receivers
- High gain bandwidth product
- External photodetector gain control
- Low noise and high sensitivity

Call Chuck Spafford at (805) 967-0423 or write us now.

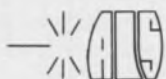

AMERICAN LASER SYSTEMS, INC.

106 JAMES FOWLER ROAD, SANTA BARBARA AIRPORT, GOLETA, CA. 93017

INFORMATION RETRIEVAL NUMBER 80

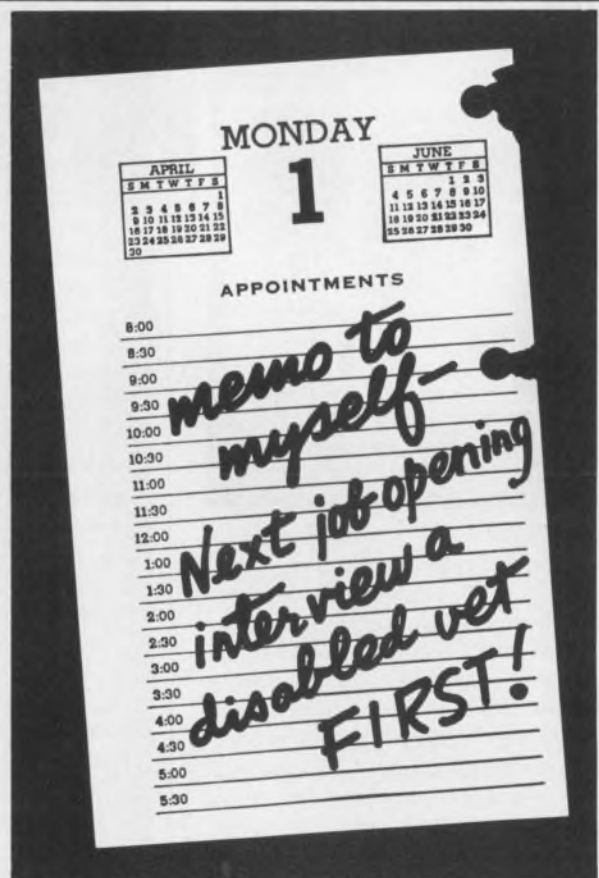

The President's Committee on Employment of the Handicapped
Washington, D.C. 20210

Digital interface puts calculator on-line



Fluidyne Instrumentation, 1631 San Pablo Ave., Oakland, Calif. 94612. (415) 444-2376. See text; stock.

The 7200 series interface systems act as couplers between the input/output bus of Wang programmable calculators and laboratory or process instruments. The system consists of a mainframe and PC cards for the specific calculator model to be used together with card-rack assembly that accommodates 8, 10 or 16 plug-in function cards. Standard function cards include a/d converters, multiplexers, six-digit parallel BCD data input, a six-digit high-speed counter, and a 10-channel, four-digit counter. A special card provides simulated interrupt capability for the calculator. Prices of the interface systems range from \$1950 to \$2450 for the mainframe assembly with most function cards priced at \$250.

CIRCLE NO. 310

Single PC card contains 4-k × 9-bit memory

Intel Memory Systems, 345 Middlefield Rd., Mountain View, Calif. 94041. (408) 246-7501. See text; stock.

A single PC card contains 4-k words of 9-bit memory. All necessary timing, control address and data registers are provided on the same card. Cycle time of the in-36 n-channel memory system is 300 ns; access time is 150 ns. A refresh cycle is required every 10 μ s, but can be aborted upon demand by the processor. Dc power requirements are -5.2 V at 3 A, 12.6 V at 0.5 A and 5 V at 0.33 A. Unit price is less than two cents a bit.

CIRCLE NO. 320



Now! All you need! CTS MINIATURE TTL COMPATIBLE HYBRID CRYSTAL OSCILLATORS

NEW CTS TO-8 crystal oscillators eliminate one of your biggest design headaches . . . size . . . they're in a compact .07 cu. in. package. They feature a coldweld enclosure and reliable hybrid circuitry. Frequency range is 500 KHz to 25 MHz. Available as complimentary, multiple binary related outputs capable of driving 5TTL. Temperature stability: ± 25 ppm 0°C to 70°C.

(sine wave outputs optional)

(Optional: ± 100 ppm -55°C to 125°C.) Excellent long term stability.

Prototype units are immediately available with minimal start-up time for production quantities. And, these new oscillators are low in cost. Interested? Call or write: CTS Knights, Inc., 222 Reimann Ave., Sandwich, Illinois 60548. Phone: (815) 786-8411.

CTS CORPORATION
Elkhart, Indiana



INFORMATION RETRIEVAL NUMBER 82

PICTURE, PATTERN, OR PLOT



Now you can afford to add instant graphic hard copy output to your data terminals, storage tubes, computer outputs, SSTV, scanning sensors.

- Get low cost hard copy by instant graphic recording on ALFAX Type A electrosensitive paper where electricity is the ink.
- Interface ALDEN "Flying Spot" Component Recorders by simple synchronizing with your sweep circuit or scanning sensors and record directly from your target or cathode signal current.

Send for free brochure:
"ALDEN Components to Picture,
Pattern or Plot"



IMPULSE RECORDING EQUIPMENT CO. INC.

Westboro, Mass. 01581 Tel: (617) 366-8851 TELEX: 94-8404

INFORMATION RETRIEVAL NUMBER 83

HELP from

THE PEOPLE DOING
THINGS THAT MATTER...
IMAGINATIVELY

electronic research co. • •

SERIES
9400
SCANNER

erc



- 10 Channel System - \$484
- Capacity - 1000 Channels
- Multi Mode Operation
- Scan rates to 100 Channels Per Second
- High Channel to Channel Isolation
- System Building Blocks

Telephone (913) 631-6700

7618 Wedd
Overland Park, Kansas 66204

Mail to: P.O. Box 913, Dept. 136
Shawnee Mission • Kansas 66201

TWX: (910) 749-6477

new literature



Knobs and dials

Control knobs and custom dials are illustrated with photographs and drawings in a 28-page catalog. Rogan Corp., Northbrook, Ill.

CIRCLE NO. 321

Charge amplifier

A specification table, schematic drawing and description of a Swiss-made charge amplifier are given in an illustrated data bulletin. Kristal Instrument Corp., Grand Island, N.Y.

CIRCLE NO. 322

Power supplies

Dc power supplies, overvoltage protection devices and ac line conditioners and regulators are described in a 36-page catalog. A two-page chart simplifies type selection. Tele-Dynamics/Wanlass, Fort Washington, Pa.

CIRCLE NO. 323

Magnetic sensors

A 32-page combination magnetic sensor catalog and technical handbook contains information on how noncontact magnetic sensors function and how they are used in timing, synchronizing, tachometry and machine-control applications. Electro Corp., Sarasota, Fla.

CIRCLE NO. 324

Drafting equipment

A catalog shows the company's line of output-increasing radius tension drafting tables and chairs designed for engineers and draftsmen. Huey Paper Material, Franklin Park, Ill.

CIRCLE NO. 325

Chip capacitors

Standard chip capacitors as well as hermetically sealed axial glass units in NPO, Z5U and BX dielectrics are illustrated in a six-page catalog. The catalog features technical data and six characteristic charts. Johanson, Burbank, Calif.

CIRCLE NO. 326

Data-logging system

A system for measuring and recording temperature, pressure, strain, flow, voltage and current is featured in a 12-page catalog. Kaye Instruments, Bedford, Mass.

CIRCLE NO. 327

Incremental encoders

A handbook on the theory, selection and system applications of incremental encoders outlines the do's and don'ts on their use and the ease of incorporating them into digital systems. Trump-Ross Industrial Controls, North Billerica, Mass.

CIRCLE NO. 328

Function generators

The 5-MHz, 10-MHz and 20-MHz function generators with built-on sawtooth generator are featured in a four-page bulletin. Ailtech, City of Industry, Calif.

CIRCLE NO. 329

Consumer ICs

A review of consumer integrated circuits, "Quick Guide to Consumer Entertainment Integrated Circuits," lists standard off-the-shelf products which fit a particular function economically. Sprague, North Adams, Mass.

CIRCLE NO. 330

Heat pipes

The series 7000 and 7100 heat pipes, heat-transfer devices capable of moving quantities of heat quickly and economically, are detailed in a bulletin. Astrodyne, Wilmington, Mass.

CIRCLE NO. 331

COS/MOS

An illustrated 20-page brochure provides information on COS/MOS and linear circuits processed in accordance with MIL-STD-883 and MIL-M-38510 high-reliability specifications. RCA, Somerville, N.J.

CIRCLE NO. 332

Mercury relays

A booklet offers specifying data and technical information on mercury relay spin out—its cause and cure. The Adams and Westlake Co., Elkhart, Ind.

CIRCLE NO. 333

Rf capacitors

Rf ceramic capacitors that exhibit very low losses and high Q are described in a 16-page catalog. Performance and design information are provided. ITT Jennings Monrovia Plant, Monrovia, Calif.

CIRCLE NO. 334

Gear-train system study

A six-year study entitled, "Gear Train System Studies for Use with Synchronous Timing Motors," covers tooth-form proportions, wear and materials, surface endurance data, cyclic bending stress data and a statement-of-the-art in plastic materials. Industrial Controls Div., General Time, Thomaston, Conn.

CIRCLE NO. 335

Electronic component ovens

An eight-page brochure gives specification data for 94 electronic component ovens. Fully proportional dc, ac zero-crossing and thermostatically controlled ovens for general components, crystals, microwave components and high-stability applications are illustrated. Temperature stabilities up to 1/2 millidegree/°C are shown. Oven Industries, Mechanicsburg, Pa.

CIRCLE NO. 336

Environmental chambers

More than 100 environmental chamber models for research, testing, production and medical applications are shown in a 48-page catalog. Webber Manufacturing Co., Indianapolis, Ind.

CIRCLE NO. 337

Fixed composition resistors

An eight-page color brochure is a guide to performance characteristics and application criteria for fixed composition resistors. Included are dimensional data for 1/4, 1/2, 1 and 2-W sizes, construction features, dimensions for various types of cut and formed leads, packaging options and performance and testing curves. Stackpole Carbon, Kane, Pa.

CIRCLE NO. 338

Peripheral review

The Peripheral Review is a quarterly publication covering developments within the company and the computer peripheral field. Pertec, Chatsworth, Calif.

CIRCLE NO. 339

Connectors

A 32-page catalog is filled with photos, specifications and ordering information on card-edge, PC and rack-and-panel connectors; PC contacts and terminals; PC-card enclosures; standard connectors; transistor and tube sockets and tooling. Elco, Willow Grove, Pa.

CIRCLE NO. 340

Transducers and indicators

Four data sheets cover digital magnetic pickups, magnetic pickups, head position transducers and power supply demodulator indicators. Transducer Systems, Willow Grove, Pa.

CIRCLE NO. 341

Instrumentation

Telemetry, instruments and industrial monitoring and control product lines are described in a catalog. The catalog contains sections on frequency-division and time-division multiplex systems design as well as IRIG reference data. The IRIG data are conveniently printed on a perforated card for easy removal. EMR-Telemetry, Sarasota, Fla.

CIRCLE NO. 342

DOUBLE-BALANCED MIXERS

Great Value at

\$7⁹⁵
500 piece quantities.

\$9.95 in 6-piece quantities.

DC-500MHz
6dB conversion loss
40dB isolation
EMI shielded case



A breakthrough in technology and high production volume enables Mini-Circuits Laboratory to offer these new products at an unprecedented low price.

In today's tough competitive market can you afford not to use these remarkably low priced and high performance units?

Ruggedness and durability are built in the SRA-1. These new units are packaged within an EMI shielded metal enclosure and hermetically sealed header. They use well matched hot-carrier diodes and uniquely designed transmission line transformers.

We invite you to convince yourself. Place your order now and check our delivery, product performance and reliability.

Mini-Circuits Laboratory

2913 Quentin Rd., Brooklyn, N.Y. 11229
(212) 252-5252, Int'l Telex 620156
A Division Scientific Components Corp.

*FRANCE: S.C.I.E., *31, rue George-Sand, Palaiseau 91, France *GERMANY, AUSTRIA, SWITZERLAND: Industrial Electronics GMBH, *Klüberstrasse 14, 6000 Frankfurt/Main, Germany *UNITS IN STOCK

ENGLAND: Dale Electronics: Dale House, Wharf Road, Frimley Green, Camberley, Surrey. JAPAN: Denisho Kaisha, Ltd.: Eguchi Building, 8-1, 1-Chrome, Hamamatsucho, Minato-Ku, Tokyo. ISRAEL: Hamashbir Electronics, 76 Giborei Israel St., Tel-Aviv, Israel. *UNIT IN STOCK.

INFORMATION RETRIEVAL NUMBER 84

DO COLLEGES HELP BUSINESS AS MUCH AS BUSINESS HELPS COLLEGES?

Yes, they do. But not in the same proportion.

Business contributes about 15% of the total voluntary support received by colleges.

But today, business gets half the college-trained people who are employed. Tomorrow, it will need even more.

As a result, businessmen should think seriously about increasing the level of corporate giving to education. Can you, as a businessman, think of a better investment?

For the latest national figures on corporate giving to higher education, write on your letterhead for "CFAE Survey of Corporation Support of Higher Education," and enclose \$2.00 to help cover costs. Mail to: Council for Financial Aid to Education, 6 East 45th Street, New York, N.Y. 10017.

Give to the college of your choice. Now.



Advertising contributed for the public good.

NEW LITERATURE

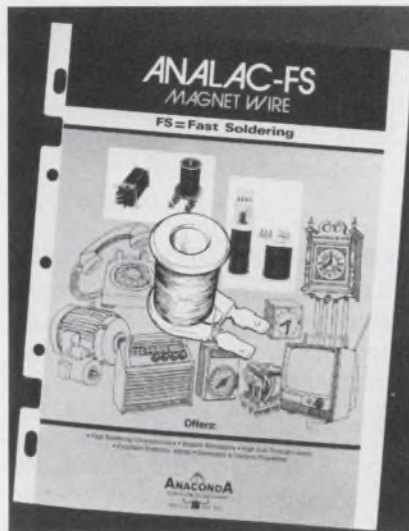

Fast-solder magnet wire

Fast soldering magnet wire is featured in a bulletin. The bulletin includes data covering thermo-plastic flow, heat shock, adhesion and flex, solderability and dielectric values. Anaconda Wire and Cable, Hodgkins, Ill.

CIRCLE NO. 343

Power supplies

The LX-E series of power supplies—61 models and 10 package sizes—is featured in a six-page bulletin. Specifications and photographs are shown for the UL-listed, MIL-spec supplies. Lambda, Melville, N.Y.

CIRCLE NO. 344

Jack panel strips

Horizontal jack-panel designation strips, which are double the height of normal strips, give quicker, easier identification of jack, lamp and switch functions on miniaturized panels. Details are presented in a two-page bulletin. Switchcraft, Chicago, Ill.

CIRCLE NO. 345

Instrumentation

High-performance instrumentation is described in a 40-page reference. Descriptions, photos and specifications for frequency counters, oscilloscopes, power supplies, digital multimeters, recorder systems, an analog-digital instrument teaching system and Heath/Malmstadt-Enke lab station are included. Heath/Schlumberger, Benton Harbor, Mich.

CIRCLE NO. 346

Standard knobs

Standard plastic knobs that may be molded quickly from stock molds are described and illustrated in a six-page brochure. The Carr Co., Cambridge, Mass.

CIRCLE NO. 347

Calculating system

A brochure features the series 6000 programmable calculating system, an alternative to expensive on-line and time-sharing systems. Wang Laboratories, Tewksbury, Mass.

CIRCLE NO. 348

Brightness meter

The Spectra Spotmeter photometer with digital readout (Model UBD) or analog meter (Model UB) and many accessories are described in a four-page folder. Photo Research, Burbank, Calif.

CIRCLE NO. 349

Ultraminiature capacitors

Data on ultraminiature solid-electrolyte Tantalex capacitors as well as performance characteristics are given in a 12-page catalog. Sprague, North Adams, Mass.

CIRCLE NO. 350

Temperature recorders

A 12-page brochure describes temperature recorders. The brochure details recorder features and lists options, specifications, standard scales and charts, weights and dimensions, ordering instructions and prices. West Instrument, Schiller Park, Ill.

CIRCLE NO. 351

Measuring instruments

The Model BAM-1 universal strain-measuring instrument and signal conditioner and its uses are described in a two-page bulletin. Vishay Instruments, Malvern, Pa.

CIRCLE NO. 352

Silicon rectifiers

Miniature high-voltage silicon rectifiers, suited for applications including high-voltage power supplies, electrostatic applications, CRTs, oscilloscopes, TV, display, X-ray and laser, are described in a two-page bulletin. Edal Industries, East Haven, Conn.

CIRCLE NO. 353

bulletin board

RCA Solid State has introduced a line of ceramic packages for standard COS/MOS devices that provide hermeticity and the full military temperature range at commercial prices. The CD4000AF series ceramic devices have specifications identical with the CD-4000AD welded-seal ceramic devices.

CIRCLE NO. 354

Com-Share, Inc., has released DATAFORM II, an advanced new reporting system for subscribers of the firm's Commander II computer time-sharing software.

CIRCLE NO. 355

Mosfet * Micro * Labs has developed a self-aligned gate MOS/LSI wafer process which allows the use of standard MOS mask sets.

CIRCLE NO. 356

Fairchild Camera & Instrument Corp. is supplying engineering quantities of a self-contained, solid-state pressure module developed for automotive applications. When connected to a pressure source, the module provides an accurate analog voltage that is linearly proportional to the absolute pressure at the source. Evaluation quantities are available at \$250 each.

CIRCLE NO. 357

ITT Semiconductors has introduced a series of monolithic dual sense amplifiers designed for use with high-speed coincident current memory systems.

CIRCLE NO. 358

Silicon General is introducing the SG120/220/320 negative spot voltage regulator, a direct replacement for National Semiconductor's LM120 series. The regulators operate at fixed outputs of -5, -5.2, -12 and -15 V at currents to 1.5 A. Output voltages are factory preset to within 3%. A single output capacitor is the only additional component required for most uses.

CIRCLE NO. 359

Two new standard hardware/software minicomputer systems—a disc-based and a real-time operating system—have been introduced by General Automation, Inc.

CIRCLE NO. 360

Hewlett-Packard has released a new version of its multiprogramming executive operating system for HP-300 system computers. Its language capability includes high-level COBOL, FORTRAN, BASIC and a Systems Program Language.

CIRCLE NO. 361

Price reductions

Electronic Arrays has reduced prices of three popular MOS ROMs about 48% on the average. The EA4800, 16-k bits, 1.2 μ s access, 0.032 mW/bit power, is reduced from \$52.50 to \$28; the EA4000, 5-k bits, 725 ns access, 0.04 mW/bit power, is reduced from \$26.50 to \$13; and the EA-3800, 12-k bits, 3.3 μ s access, 0.02 mW/bit power, is reduced from \$43.75 to \$22.50. The prices are for 100 quantities. All three ROMs are available in ceramic packages at slightly higher prices.

CIRCLE NO. 362

Versatec has announced a 20% price reduction on four of the Matrix plotters and printer/plotters. The Model 200 plotter has been reduced from \$6200 to \$5100; Model 200A printer/plotter from \$7300 to \$5900; Model 1100 plotter from \$6900 to \$5700 and Model 1100A printer/plotter from \$8300 to \$6500. These prices are for single units. Quantity and OEM discounts are available.

CIRCLE NO. 363

Motorola has reduced prices almost 50% on some of its high-band land mobile linear devices.

CIRCLE NO. 364

Price reductions averaging 40% on Schottky TTL have been announced by Texas Instruments. The price reductions apply to all military (series 54S) ceramic DIP and ceramic flat-pack parts and to commercial (series 74S) ceramic and plastic DIP SSI parts.

CIRCLE NO. 365

WIDE BAND RF TRANSFORMERS

Great Value at

\$ **2**⁹⁵
10 piece quantities

Some Models \$3.45

0.1 - 500 MHz
50 Ohm impedance
1:1 to 16:1
impedance ratio
micro-miniature case



A breakthrough in technology and high production volume enables Mini-Circuits Laboratory to offer these new products at an unprecedented low price.

In today's tough competitive market can you afford not to use these remarkably low priced and high performance units?

Ruggedness and durability are built in the T-series transformers. These new units are packaged within a 1/3 D.I.P. package. They use uniquely designed transmission line transformers for extra wide bandwidth.

We invite you to convince yourself. Place your order now and check our delivery, product performance and reliability.

Mini-Circuits Laboratory

2913 Quentin Rd., Brooklyn, N.Y. 11229
(212) 252-5252, Int'l Telex 620156
A Division Scientific Components Corp.

*FRANCE: S.C.I.E., *31, rue, George-Sand, Palaiseau 91, France *GERMANY, AUSTRIA, SWITZERLAND: Industrial Electronics GMBH, *Klüberstrasse 14, 6000 Frankfurt/Main, Germany. ENGLAND: Dale Electronics, Dale House, Wharf Road, Frimley Green, Camberley, Surrey. JAPAN: Densho Kaisha Ltd, Eguchi Building, 8-1 I-Chrome, Hamamatsucho, Minato-Ku, Tokyo. *ISRAEL: Hamashbir Electronics, 76 Giborei Israel St., Tel-Aviv, Israel

*UNIT IN STOCK

INFORMATION RETRIEVAL NUMBER 86

Design Data from Manufacturers

Advertisements of booklets, brochures, catalogs and data sheets. To order use Reader-Service Card (Advertisement)

Electronic Design

ELECTRONIC DESIGN's function is:

- To aid progress in the electronics manufacturing industry by promoting good design.
- To give the electronic design engineer concepts and ideas that make his job easier and more productive.
- To provide a central source of timely electronics information.
- To promote communication among members of the electronics engineering community.

Want a subscription? ELECTRONIC DESIGN is sent free to qualified engineers and engineering managers doing design work, supervising design or setting standards in the United States and Western Europe. For a free subscription, use the application form bound in the magazine. If none is included, write to us direct for an application form.

If you do not qualify, you may take out a paid subscription for \$30 a year in the U.S.A., \$40 a year elsewhere. Single copies are \$1.50 each.

If you change your address, send us an old mailing label and your new address; there is generally a postcard for this bound in the magazine. You will have to requalify to continue receiving ELECTRONIC DESIGN free.

The accuracy policy of ELECTRONIC DESIGN is:

- To make diligent efforts to ensure the accuracy of editorial matter.
- To publish prompt corrections whenever inaccuracies are brought to our attention. Corrections appear in "Across the Desk."
- To encourage our readers as responsible members of our business community to report to us misleading or fraudulent advertising.
- To refuse any advertisement deemed to be misleading or fraudulent.

Microfilm copies are available of complete volumes of ELECTRONIC DESIGN at \$19.00 per volume, beginning with Volume 9, 1961. Work is now in process to complete the microfilm edition of Volumes 1-8. Reprints of individual articles may be obtained for \$2.00 each, prepaid (\$.50 for each additional copy of the same article) no matter how long the article. For further details and to place orders, contact the Customer Services Department, University Microfilms, 300 North Zeeb Road, Ann Arbor, Michigan 48106 telephone (313) 761-4700.

Want to contact us? If you have any comments or wish to submit a manuscript or article outline, address your correspondence to:

Editor
ELECTRONIC DESIGN
50 Essex Street
Rochelle Park, N.J. 07662

Dual Hi-Speed FFT Processor Easy to Operate



Conceived from the point of view of the operating engineer rather than the computer programmer, the new Omniferous™ FFT Analyzer operates like an instrument, calculates like a computer. This Series OF-400 Analyzer is a universal digital signal analysis system for real-time viewing of changing functions, a complete instrument with all signal conditioning and display calibration built-in. For the first time an operator can observe transfer function, cross-spectra or coherence as the signal is changing without waiting for the analyzer to perform successive laborious calculations.

Features include high speed of 60,000 samples/sec throughput, and high resolution with a 2048 transform size and extra-sharp input anti-aliasing filtering. Calculates FFT, IFFT, power spectra, auto-correlation, cross correlation, and signal enhancement (time averaging), as well as the averaging of any calculated function in sum, peak or exponential mode.

The system excels in high dynamic range, ease of use, display flexibility with two simultaneous display outputs, frequency coverage to 100 kHz, and reasonable cost. Designed by the originators of the famous Ubiquitous® family of real-time spectrum analyzers.

Federal Scientific Corp.

An affil. of Nicolet Instrument

615 West 131st St., New York, N.Y. 10027 (212) 286-4400

CIRCLE NO. 171

POWER CONVERSION SPECIALISTS 1974 CATALOG



TECNETICS INC., the Power Conversion Specialists, presents its 1974 catalog. Included are recently introduced products including 400 Hz, high efficiency DC-DC converter and a miniaturized, fully regulated converter with dual output. Complete product lines are also included.

CIRCLE NO. 172

tecnetics inc.®

Box 980 • Boulder Industrial Park • Boulder, Colorado 80302 • (303) 442-3837

DIGITAL FOURIER ANALYSIS SYSTEM 306



Provides complete spectral, cross spectral, correlation, cross correlation and related analysis.

- One Push Button per function eliminates programming.
- Simultaneous display of two spectra or phase and magnitude.
- Digital storage provides uninterrupted display (flicker-free).
- Drives two XY Plotters simultaneously (doubles throughput).
- Zoom FFT analysis for super high resolution.
- Unique Fourier-Fortran™ for your own non-standard or automated analysis.
- 1/3 and 1/15 octave analysis.

OPTIONAL: Magnetic tapes and discs, high speed plotters, multi processor configurations, multi channel analog multiplexer, teletypes and CRT Terminals.

ALSO AVAILABLE: Medium and high speed hardwired FFT and general purpose array processors for Data General Nova Computers.

CIRCLE NO. 173

ELSYTEC INC.

212 Michael Drive, Syosset, N.Y. 11791
Phone (516) 364-0560

Electronic Design

Advertising Sales Staff

Tom W. Carr
Vice President &
Sales Manager

Rochelle Park, N.J. 07662

Robert W. Gascoigne
Daniel J. Rowland
(Recruitment, Quick Ads, Classified)
Allen Weinberg
50 Essex Street
(201) 843-0550
TWX: 710-990-5071

Philadelphia

Thomas P. Barth
50 Essex Street
Rochelle Park, N.J. 07662
(201) 843-0550

Boston 02178

Gene Pritchard
P.O. Box 379
Belmont, Mass. 02178
(617) 489-2340

Chicago 60611

Thomas P. Kavooras
Berry Conner, Jr.
200 East Ontario
(312) 337-0588

Cleveland

Thomas P. Kavooras
(Chicago)
(312) 337-0588
(call collect)

Los Angeles 90303

Stanley I. Ehrenclou
Burt Underwood
2930 Imperial Highway
Inglewood, Calif.
(213) 757-0183

San Francisco 94022

Jerry D. Latta
P.O. Box 1248
Los Altos, Calif.
(415) 965-2636

London

For United Kingdom and Europe
John Ashcraft
John Ashcraft & Co.
12, Bear St.
Leicester Square
London WC2H 7AS England
Phone: 01-930-0525
W. J. M. Sanders
John Ashcraft & Co.
Herengracht 365
Amsterdam C., Holland
Phone: 020-24-09-08

Tokyo

Haruki Hirayama
Electronic Media Service
5th Floor, Lila Bldg.,
4-9-8 Roppong
Minato-ku
Phone: 402-4556
Cable: Electronicmedia, Tokyo



The Blow Hard. It's 10" in diameter, only 3 1/2" in depth, yet produces a gale force of 575 cfm. We call it, "The Condor."



Now available in 9 new models, 50/60 Hz, 115 or 230 VAC versions. The Condor speaks softly, noise level just 49 db (SIL), but carries away loads of hot air. 575 cfm for intake or exhaust.

It's ideal for cooling and flushing in computers, relay racks, transmitter packages or wherever space-weight considerations are critical. Equipped with long-life stainless steel ball bearings.

Other airmovers? Of course!

Send for our full-line catalog No. ND4r. It's free, and contains performance data, electrical and mechanical specifications on more than 100 units.

And valuable application information too.

For immediate service, contact us at IMC Magnetics Corp., New Hampshire Division, Route 16B, Rochester, N.H. 03867, tel. 603-332-5300. Or the IMC stocking distributor in your area. There are more than 50 nationwide and overseas.



INFORMATION RETRIEVAL NUMBER 87

Breadboard a Circuit In Less Than 5 Minutes

You must agree that our MINI-MOUNTS™ give you the fastest, easiest, most flexible, no-hole, no-drilling DC to GHz breadboarding system, or we'll refund your

\$75 within two weeks. (And you keep the layout pad.)

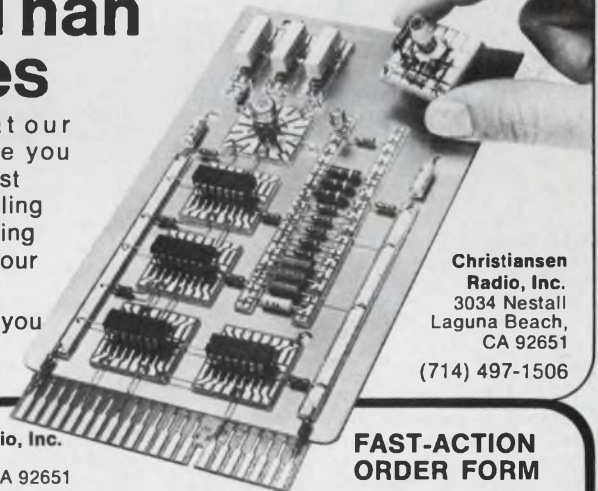

Christiansen
Radio, Inc.
3034 Nestall
Laguna Beach,
CA 92651
(714) 497-1506



Christiansen Radio, Inc.
3034 Nestall
Laguna Beach, CA 92651

FAST-ACTION ORDER FORM

Yes, old-fashioned breadboarding is a drag, and I'm desperate enough to order your \$75* breadboarding system with 150 assorted reusable Mini-Mounts, 4" x 8" ground plane, and easy-to-follow illustrated instructions. But hurry, please! If you've pulled my leg, I'll return it within two weeks, and you'd better smile as you tear up the invoice. I'll keep the 4 x 8 layout pad in any event. (*All orders F.O.B. factory, plus sales tax where applicable.)

Name _____ Title _____
Company _____ Dept _____
Address _____
City, State, ZIP _____
Signature _____ P.O. No. _____

INFORMATION RETRIEVAL NUMBER 88

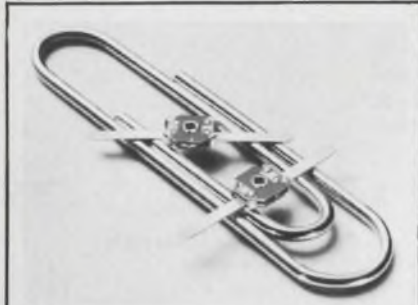

Thin-Trim variable capacitors provide a reliable means of adjusting capacitance without abrasive trimming or interchange of fixed capacitors. Series 9401 has high Q's and a range of capacitance values from 0.2-0.6 pf to 3.0-12.0 pf and 250 WVDC working voltage. Johanson Manufacturing Corporation, Boonton, New Jersey (201) 334-2676.

INFORMATION RETRIEVAL NUMBER 181



Low cost, high performance Logic Probe Model HS 50A for 5 volt logic. Detects and identifies polarity of single pulses to 20 nanoseconds, pulse trains to 25 Mhz. Indicates symmetry/non symmetry of pulse patterns. \$59.00. DIGI-TRONIX, 2309 Saidel Dr., San Jose, CA 95124. (408) 371-4764.

INFORMATION RETRIEVAL NUMBER 182



400 Ideas for Design, Vol. 2, Edited by Frank Egan. Ready to borrow, modify, or adapt, the top recent contributions to Electronic Design's popular "Ideas for Design" column range from amplifiers to switching circuits. 288 pp., illus., cloth, \$11.95. Circle below for 15-day examination copies. Hayden Book Co., New York, N.Y. 10011.

INFORMATION RETRIEVAL NUMBER 183



20 CRYSTAL FREQUENCIES IN STOCK. 10 to 250 kHz. Offered in TO-5s. Competitive with RC/LC oscillators. 25,000 qty. in 8 wks. From \$1.02 ea. Calibration accuracy 0.01%. MIL SPEC temp range. 1000g shock. 50g vibration. STATEK CORP., 1233 Alvarez Ave., Orange, Calif. 92668, (714) 639-7810, TELEX 65-5430.

INFORMATION RETRIEVAL NUMBER 184

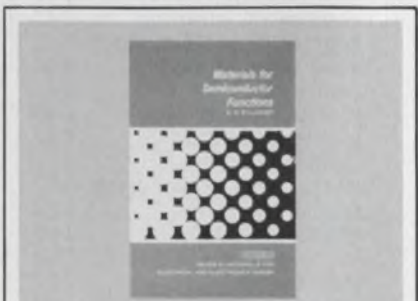

Materials for Semiconductor Functions, by E. G. Bylander. Practical handbook for selecting materials for diodes and transistors for applications in amplifiers, generators, and multi-junction devices. 220 pp., 6 x 9, illus., cloth, \$13.50. Circle number below for 15-day examination copy. Hayden Book Company, Rochelle Park, N.J. 07662.

INFORMATION RETRIEVAL NUMBER 185

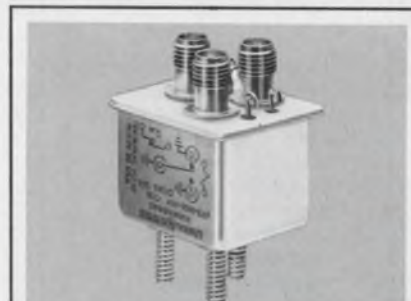

For critical RF switching GE offers space-proven relays with co-axial connections. Welded construction, hermetically sealed, removes dangers of exposed arcing of open relays. Reliability failure rates to .01%/10,000. RF switching up to 150 watts and auxiliary contacts for microvolt signals to 2 amps. Less than 1 cu. in. GE, Waynesboro, Va.

INFORMATION RETRIEVAL NUMBER 186

Advertisers wishing to reserve Quick Ad units should note the following mechanical requirements: Specs—Supply glossy photo of product and approximately 40 words which will set no more than 10 lines of 34 characters each. AFTER SUBMISSION NO COPY CHANGES CAN BE ACCEPTED. Quick Ads cost only \$300 per insertion, less for frequency advertisers.

RATES:

1x
\$300

7x
\$280

13x
\$255

19x
\$250

26x
\$245

39x
\$240

52x
\$235

104x
\$230

product index

Information Retrieval Service. New Products, Evaluation Samples (ES), Design Aids (DA), Application Notes (AN), and New Literature (NL) in this issue are listed here with page and Information Retrieval numbers. Reader requests will be promptly processed by computer and mailed to the manufacturer within three days.

| Category | Page | IRN | Category | Page | IRN | Category | Page | IRN |
|---------------------------------|------|-----|------------------------------------|------|-----|----------------------------------|------|-----|
| Components | | | Instrumentation | | | Packaging & Materials | | |
| capacitors | 6 | 5 | analyzer, probability | 120 | 261 | blocks, terminal | 15 | 12 |
| capacitors | 7 | 6 | controller, temperature | 118 | 259 | breadboard | 145 | 88 |
| component | 4 | 7 | DMM | 111 | 50 | cable, flat | 101 | 47 |
| components | 132 | 71 | DMM | 123 | 60 | hardware | 123 | 59 |
| converter, scan | 130 | 68 | data acquisition | 118 | 258 | interconnectors | 13 | 10 |
| displays | 45 | 26 | detectors, quantum | 126 | 64 | modules, pluggable | 113 | 51 |
| fan | 145 | 87 | filters, tunable | 120 | 263 | packaging | 107 | 48 |
| ferrites | 150 | 89 | generator, function | 121 | 264 | packaging system | IV | 248 |
| image sensing | 16 | 13 | generators, function (NL) | 140 | 329 | paper, electrosensitive | 140 | 83 |
| indicator, audio | 134 | 73 | indicator, audio | 136 | 77 | photomask | 49 | 28 |
| isolator, quad | 84 | 40 | instruments, measuring (NL) | 142 | 352 | socket, IC | 131 | 69 |
| LEDs | 95 | 44 | instruments, test and measurement | 62 | 35 | tool, pneumatic | 100 | 46 |
| lamps, solid-state | 127 | 65 | measurement, rf | 39 | 23 | wire | 109 | 141 |
| mixer | 141 | 84 | oscilloscope | 117 | 252 | Power Sources | | |
| motors | 67 | 37 | photometer | 121 | 265 | inverters | 94 | 43 |
| optoelectronics | 37 | 22 | recorder, chart | 117 | 253 | PC mounting supplies, modular | 130 | 287 |
| relay, general-purpose | II | 246 | recorder, digital logic | 125 | 63 | regulator, high power | 130 | 286 |
| switches, keyboard | 54 | 34 | recorder, transient | 118 | 257 | supplies, hv dc | 130 | 285 |
| switches, multithrow | 132 | 293 | resistance box | 117 | 254 | supplies, lab | 131 | 290 |
| switches, pushbutton | 118 | 54 | stopwatch, digital | 120 | 260 | supplies, power | 52 | 32 |
| switches, pushbutton | 134 | 74 | tachometer, integrating | 118 | 256 | supplies, power (NL) | 142 | 344 |
| timers | 1 | 2 | tester, IC | 120 | 262 | supply, dc | 130 | 288 |
| transformers, rf | 143 | 86 | tester, level | 117 | 255 | supply, high power | 131 | 289 |
| transmitter, laser | 138 | 80 | tester, logic | 117 | 251 | supply, power | 17 | 14 |
| Data Processing | | | Microwaves & Lasers | | | new literature | | |
| calculating system (NL) | 142 | 348 | amplifiers, wideband | 134 | 297 | amplifier, charge | 140 | 322 |
| calculator | 136 | 302 | antenna, dipole | 135 | 300 | COS/MOS | 141 | 332 |
| calculators | 115 | 52 | attenuators | 135 | 301 | calculating system | 142 | 348 |
| computer | 8 | 7 | filters, bandpass | 134 | 298 | capacitors, chip | 140 | 326 |
| computer, full-scale | 53 | 33 | filters, optical | 134 | 299 | capacitors, rf | 141 | 334 |
| data terminal | 33 | 20 | isolators | 132 | 292 | capacitors, ultramin. | 142 | 350 |
| interface, calculator | 139 | 310 | laser, CO ₂ | 133 | 294 | connectors | 141 | 340 |
| memories | 135 | 75 | transmission line, rf | 132 | 291 | data-logging system | 140 | 327 |
| memory card | 49 | 30 | tube/cavity | 133 | 295 | encoders, incremental | 140 | 328 |
| memory, core | 138 | 308 | windows, waveguide | 133 | 296 | environmental chambers | 141 | 337 |
| memory, disc | 138 | 309 | Modules & Subassemblies | | | equipment, drafting | 140 | 325 |
| memory, MOS | 139 | 320 | amplifier, power | 124 | 270 | gear train system study | 141 | 335 |
| memory, tape | 136 | 304 | amplifier, transducer | 124 | 273 | generators, function | 140 | 329 |
| microcomputer | III | 247 | amplifiers, power | 14 | 11 | heat pipes | 141 | 331 |
| reader, card | 138 | 307 | circuits, analog | 119 | 55 | ICs, consumer | 140 | 330 |
| system, calculator | 137 | 305 | converter, a/d | 124 | 62 | instrumentation | 142 | 346 |
| tape evaluator | 137 | 306 | converter, d/s | 122 | 266 | instrumentation | 141 | 342 |
| terminal, CRT | 136 | 303 | converters, dc-dc | 122 | 58 | instruments, measuring | 142 | 352 |
| ICs & Semiconductors | | | encoder, tone | 122 | 267 | jack panel strips | 142 | 345 |
| CMOS ICs | 116 | 53 | equalizer, delay | 125 | 275 | knobs and dials | 140 | 321 |
| diodes | 30 | 19 | filter, active | 122 | 268 | knobs, standard | 142 | 347 |
| diodes | 49 | 29 | modules | 12 | 9 | magnet wire | 142 | 343 |
| driver, core memory | 126 | 277 | modules, computing | 124 | 272 | meter, brightness | 142 | 349 |
| driver/receiver, quad | 126 | 278 | modules, s/d and d/s | 133 | 72 | ovens, electronic comp. | 141 | 336 |
| ICs | 127 | 279 | op amp | 23 | 15 | peripheral review | 141 | 339 |
| ICs, consumer (NL) | 140 | 330 | op amp, microwave | 64 | 36 | recorders, temperature | 142 | 351 |
| ICs, regulator | 126 | 276 | op amps | 136 | 78 | rectifiers, silicon | 142 | 353 |
| inverter, CMOS | 128 | 284 | oscillators, crystal | 139 | 82 | relays, mercury | 141 | 333 |
| phase-locked loop | 11 | 8 | regulator, hybrid | 125 | 274 | resistors, fixed comp. | 141 | 338 |
| photoconductor | 41 | 24 | sensor, resistance | 122 | 269 | sensors, magnetic | 140 | 324 |
| photodetector | 135 | 76 | timer, interval | 124 | 271 | supplies, power | 140 | 323 |
| RAM, CMOS | 128 | 283 | | | | supplies, power | 142 | 344 |
| rectifier | 128 | 282 | | | | transducers, indicator | 141 | 341 |
| sensor, area image | 128 | 281 | | | | | | |
| sensor assembly | 127 | 280 | | | | | | |

recruitment and classified ads

Opportunities in Orlando, Florida CHIEF ENGINEER MILITARY POWER SUPPLIES

Position requires comprehensive knowledge of military power supply design, including electrical mechanical, and thermal. Capable of directing design group and offering guidance and support in the design of high and low voltage power supplies and inverters. Knowledgeable in state-of-the-art components, circuits and switching design techniques required in aerospace, shipboard, mobile and airborne power supply design.

POWER SUPPLY DESIGN ENGINEER

Responsible for design and development from initial specification through release to manufacturing. Requires capability of project management, EE degree and at least 2 years experience in design of high volume commercial or military power supplies.

Please send resume and include salary history, in confidence, or call Mr. E. W. Bushnell, Director of Industrial Relations.
(305) 295-5850



**SCOTT ELECTRONICS
CORP.**

P.O. Box 7637
Orlando, Florida 32804

An Equal Opportunity Employer M/F

Recruitment Advertising gets READ ... in Electronic Design

RATES

| | |
|----------------------|----------|
| 1 page | \$2,040. |
| 3/4 page (3 cols.) | 1,530. |
| 1/2 page (2 cols.) | 1,020. |
| 1/4 page (1 col.) | 510. |
| 1/8 page (1/2 col.) | 255. |
| 1/16 page (1/4 col.) | 127.50 |
| One column inch | 51. |

DATA

Four column make-up. Column width: 1-3/4". Each issue mails two weeks prior to the issue date. Closing dates for camera-ready mechanicals or film is one week before mailing date. If desired, Electronic Design will set type at no charge (closing date is 2 weeks prior to mailing date).

84,000 DESIGN ENGINEERS AND ENGINEERING MANAGERS

Call the Recruitment Hotline: (201) 843-0550 X209 or clip & mail this coupon to: Recruitment Manager, Electronic Design, 50 Essex St., Rochelle Park, N.J. 07662.

I'm interested in placing recruitment
advertising in electronic design.

Issue _____ Size of ad _____
 My copy is enclosed I need more information
 Name _____ Title _____
 Company _____ Telephone _____
 Address _____
 City _____ State _____ Zip _____

SAN DIEGO

Specializing in recruitment & placement of engineers, scientists and managers in electronics, communications, optical, electro-mechanical and physics. Openings in Calif. & nationwide. \$15-30,000. No fee to applicant. Contact Jerry Halloran in confidence. (714) 299-7820.

RAFTERY & KING, INC.

Agency, 2384 San Diego Ave., San Diego, Ca. 92110

RATED X

For Xcellent opportunities
BSEE \$12,000 to \$35,000
EMPLOYER PAID FEES

Contact Jim Hanlon in confidence
HALLMARK PERSONNEL OF WISCONSIN, INC., 633 W Wisconsin Ave., Suite 512, Milwaukee, Wisconsin. 414-271-3344.



Take stock in America.

Buy U.S. Savings Bonds

Now E Bonds pay 5 1/4% interest when held to maturity of 5 years, 10 months (4% the first year). Bonds are replaced if lost, stolen, or destroyed. When needed they can be cashed at your bank. Interest is not subject to state or local income taxes, and federal tax may be deferred until redemption.



The U. S. Government does not pay for this advertisement. It is presented as a public service in cooperation with The Department of the Treasury and The Advertising Council.

Biomedical Electronics Engineer

Position available as in-house consultant to researchers in Psychology and Biology departments. Experience in electro-physiology, sensory mechanisms, digital and analog control techniques and mini-computer interfacing desired. Opportunities for research and teaching. Good benefits. M.S. required. Salary 15-20K. Call or write direct to Dr. Daniel R. Kenshalo, Co-director, Psycho-biology Research Center, Florida State University, Tallahassee, Fla. 32306. 904-599-3052.

IMMEDIATE DELIVERY Minis & Peripherals

DEC-HIS-NOVA
SEL-HP-MOHAWK
CPU, Card, Printer, Tape,
Disk

NEW-MOHAWK
4320 PRINTERS

DATA PRINTER V132C
DEC & HONEYWELL
MODULES

PDP8 CPU \$1,500
\$750 MINIS

TELETYPE 35 & 37
For Sale/Rent
617/261-1100

Send for Free Report
"Maintenance of Computers"

AMERICAN USED
COMPUTER CORP.

P. O. Box 68, Kenmore Station
Boston, MA 02215

Member COMPUTER
DEALERS ASSOCIATION

Engineers / Technicians

We are representing several suburban N.Y.C. electronics firms who are currently seeking many qualified Engineers and Technicians on all levels with diverse Analog/Digital, Hydraulic and optical backgrounds.

R. W. STERLING LTD.
140 MAMARONECK AVE.
WHITE PLAINS, N.Y. 10601 (SUITE 6)
(914) 428-5140

Think of what just one company can do to stop pollution. We have.

**WHAT
INDUSTRY
IS DOING
TO STOP
POLLUTION**



Keep America Beautiful, Inc.
99 Park Avenue
New York, New York 10016

Please send me a free copy of
"What industry is doing to stop pollution."

Name _____

Street _____

City _____

State _____ Zip _____

Twenty years ago some farsighted businessmen had an idea. To establish an organization to combat littering. They called it Keep America Beautiful, Inc.

Since then, KAB, Inc. has led a national movement to stop not just littering. But pollution as well. A movement that involves

almost 70 million Americans.

To show you what companies like yours are doing to fight pollution, we've put together this folder, "What industry is doing to stop pollution."

It's a special way to celebrate our first twenty years.

People start pollution. People can stop it.



A Public Service of
This Magazine &
The Advertising Council

Keep America Beautiful
99 Park Avenue, New York, New York 10016



Most of your design problems can be solved by an unknown.



Put down your pencil. Give the pocket calculator to your kids. Stop waiting in line at the EDP department.

If you've got problems, we've got a solution. The very first and only programmable hand-held micro computer in the world. The CompuCorp Micro Scientist. The professional's machine.

It thinks the way you think. It does stress analyses. Works design problems. Breezes through drafting calculations. Solves systems headaches. Plucks the best engineering solution out of a dozen possibilities.

The Scientist allows you to have two different 80-step programs in memory at the same time. Which means repetitive calculations are a snap. And you can take it wherever you go because it's battery operable.

The CompuCorp Scientist is the first hand-held machine with 13-digit accuracy and a big, bright 10-digit display. And it's the first one with an algebraic keyboard and nested parentheses.

It's also the first one with built-in polar to rectangular; rectangular to polar; trig functions; \log_{10} ; \log_e ; 10^x and e^x . It also handles different forms of angle entry.

You can do register arithmetic in and out of ten storage registers. And you can set the decimal point anywhere you want it and change it whenever you want to.

Get all the facts on CompuCorp Micro Computers. We may be an unknown to you, but we're already solving tough problems for thousands of design engineers around the world.

See your local CompuCorp dealer. Or write Computer Design Corporation, 12401 Olympic Boulevard, Los Angeles, California 90064.



CompuCorp®
The Unknown Factor in 63 countries.

INFORMATION RETRIEVAL NUMBER 246

RCA's new plastic package is 100 times better...

We call it the E-55 Plastic Packaging System: But you don't have to remember the name — because every plastic LINEAR IC you buy from RCA is packaged in this new system that features **IMPROVED RELIABILITY OF TWO ORDERS OF MAGNITUDE... at no extra cost.**

Just look at the results of five real-time indicator tests. They tell the story.

- Temperature Cycling (at 200 cycles) — 1600 times improvement.
- Thermal Shock — 610 times improvement.
- Pressure Cooker — 250 times improvement.
- Bond Pull Strength — 10 times improvement.
- Hot intermittent opens — 250 times improvement.

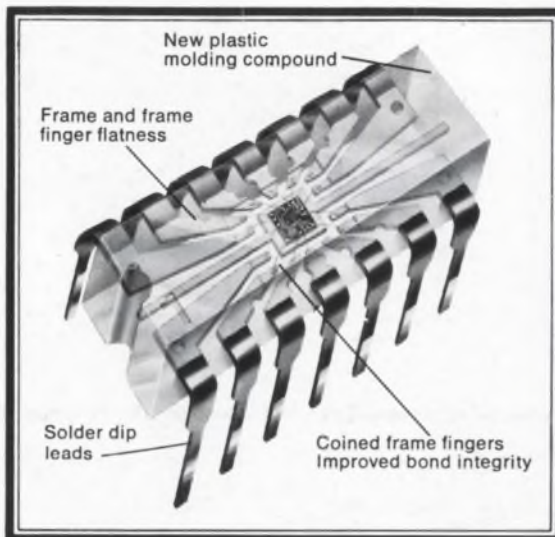

E-55 is a totally new system of plastic packaging. RCA has improved materials, handling procedures and process controls to bring you a low-cost state-of-the-art IC plastic package that matches the reliability of hermetic

packages under severe environmental stress. And it offers operation in the full temperature range of -55° to $+125^{\circ}\text{C}$. So design in a real package of reliability... RCA's 100 times improved E-55 Plastic Packaging system.

Want more details on the E-55 plastic package system and reliability test data?

Write RCA Solid State, Section 57L-20, Box 3200, Somerville, New Jersey 08876. Or phone: (201) 722-3200.

RCA Solid State
products that make products pay off