

Electronic Design 20

VOL. 21 NO.

FOR ENGINEERS AND ENGINEERING MANAGERS

SEPT. 27, 1973

Slice through small-motor specs and pick a workhorse for your electronic system. The choices are many: Permanent magnet or wound field, variable speed

or synchronous, cogless or low inertia, continuous duty or high torque, fan or fin cooled. The selection is not easy. So for a complete guide see page 52.

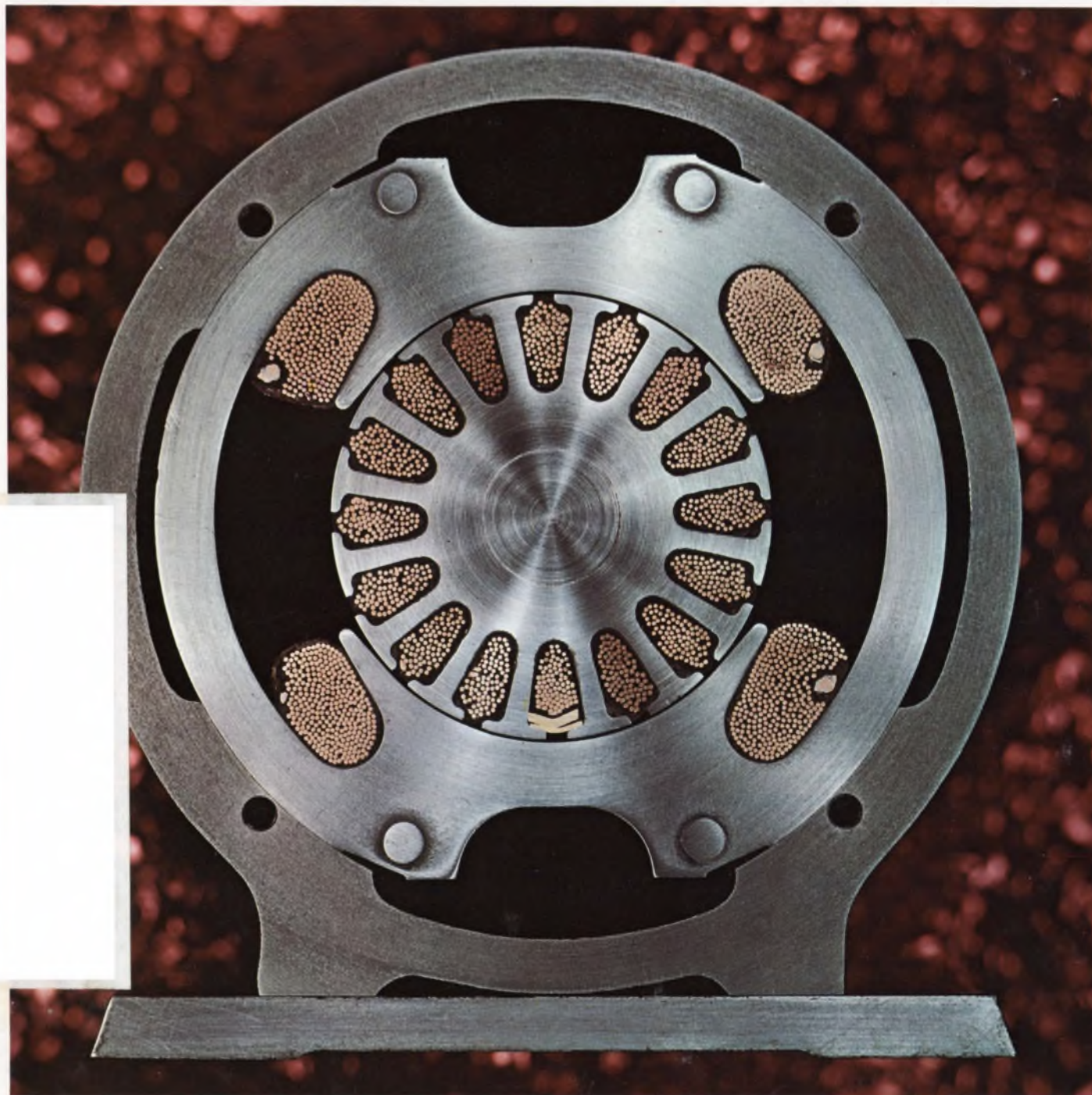

Do you face
a make or buy
decision on
power supplies?

BUY LAMBDA'S LT SERIES 25 MODELS, 3 PACKAGE SIZES, ALL 5-YEAR GUARANTEED.

Line regulation: 0.02%; Load regulation: 0.15%;
Ripple and noise: 1.5 mV RMS;
Temp. coef.: 0.01%/°C; AC input: 105-132Vac.

LTS-CA SINGLE OUTPUT MODELS

4²⁹/₃₂" x 4¹⁵/₁₆" x 9⁵/₁₆"

MODEL	FIXED VOLT. RANGE VDC	MAX. AMPS AT AMBIENT OF:				PRICE
		40°C	50°C	60°C	71°C	
LTS-CA-5-OV*	5±1%	7.0	6.5	5.8	4.8	\$80
LTS-CA-6	6±1%	6.6	6.2	5.5	4.6	80
LTS-CA-12	12±1%	4.4	4.1	3.8	3.2	80
LTS-CA-15	15±1%	4.0	3.7	3.4	3.1	80
LTS-CA-20	20±1%	3.1	2.9	2.7	2.4	80
LTS-CA-24	24±1%	2.6	2.4	2.2	2.0	80
LTS-CA-28	28±1%	2.2	2.2	2.0	1.8	80

*Includes fixed overvoltage protection at 6.8V±10%

LTS-DC SINGLE OUTPUT MODELS

4²⁹/₃₂" x 7¹/₂" x 10¹/₂"

MODEL	FIXED VOLT. RANGE VDC	MAX. AMPS AT AMBIENT OF:			PRICE
		40°C	50°C	60°C	
LTS-DC-5-OV*	5±1%	17.0	14.5	12.0	\$150
LTS-DC-6	6±1%	16.0	14.0	12.0	150
LTS-DC-12	12±1%	11.0	9.7	8.6	150
LTS-DC-15	15±1%	10.0	8.8	7.7	150
LTS-DC-20	20±1%	8.0	7.1	6.0	150
LTS-DC-24	24±1%	7.1	6.4	5.4	150
LTS-DC-28	28±1%	6.0	6.0	5.0	150

*Includes fixed overvoltage protection at 6.8V±10%

LTD-CA DUAL OUTPUT MODELS

4²⁹/₃₂" x 4¹⁵/₁₆" x 9⁵/₁₆"

MODEL	FIXED VOLT. RANGE VDC	MAX. AMPS AT AMBIENT OF:				PRICE
		40°C	50°C	60°C	71°C	
LTD-CA-152	±15±1%	2.0	1.8	1.7	1.5	\$110
LTD-CA-122	±12±1%	2.0	1.8	1.7	1.5	110

LTS-DB SINGLE OUTPUT MODELS

4²⁹/₃₂" x 7¹/₂" x 10¹/₂"

MODEL	FIXED VOLT. RANGE VDC	MAX. AMPS AT AMBIENT OF:			PRICE
		40°C	50°C	60°C	
LTS-DB-5-OV*	5±1%	12.0	10.8	9.0	\$130
LTS-DB-6	6±1%	11.0	9.9	8.2	130
LTS-DB-12	12±1%	7.6	6.7	5.7	130
LTS-DB-15	15±1%	7.2	6.4	5.4	130
LTS-DB-20	20±1%	6.0	5.3	4.5	130
LTS-DB-24	24±1%	5.5	4.9	4.1	130
LTS-DB-28	28±1%	4.0	4.0	3.7	130

*Includes fixed overvoltage protection at 6.8V±10%

LTD-DB DUAL OUTPUT MODELS

4²⁹/₃₂" x 7¹/₂" x 10¹/₂"

MODEL	FIXED VOLT. RANGE VDC	MAX. AMPS AT AMBIENT OF:			PRICE
		40°C	50°C	60°C	
LTD-DB-152	±15±1%	3.8	3.2	2.6	\$160
LTD-DB-122	±12±1%	4.0	3.4	2.8	160

1-DAY DELIVERY



\$80 **\$130** **\$150**
LTS-CA-5-OV LTS-DB-5-OV LTS-DC-5-OV
5V, 7A 5V, 12A 5V, 17A

Send for free
LAMBDA POWER SUPPLY
APPLICATION HANDBOOK
& CATALOG



△ LAMBDA
ELECTRONICS CORP.
A Company

MELVILLE, NEW YORK 11746 515 Broad Hollow Road Tel. 516-694-4200
ARLINGTON HEIGHTS, ILL. 60005 2420 East Oakton St., Unit Q Tel. 312 593-2550
NORTH HOLLYWOOD, CALIF. 91605 7316 Varna Ave. Tel. 213-875-2744
MONTREAL, QUEBEC 100C Hymus Blvd., Pointe Claire, Quebec 730 Tel. 514-697-6520
PORTSMOUTH, HANTS, ENG. Marshlands Road, Farlington Tel. Cosham 73221
VERSAILLES, FRANCE 64a 70 rue des Chantiers 78004 Tel. 950-2224

INFORMATION RETRIEVAL NUMBER 211

THE NEW XR-2207 IS A PRECISION VOLTAGE CONTROLLED OSCILLATOR WITH SIMULTANEOUS SQUARE AND TRIANGULAR WAVE OUTPUTS, EXCELLENT FREQUENCY STABILITY, SUPER-WIDE SWEEP RANGE, MINIMAL FREQUENCY DRIFT, AND ULTRA-LINEAR SWEEP DRIVE.

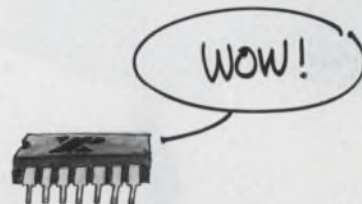

By providing 30 ppm/°C frequency stability, 3000:1 sweep range, and 0.15%/V frequency drift in the XR-2207, Exar produced a precision VCO that can easily do those tough FSK, FM generation jobs. With a minimum of external circuitry, you can use the XR-2207 in applications such as two-channel FSK generation for modems, as the VCO portion of phase-locked loop systems, and voltage to frequency conversion that formerly required crystal controlled oscillators.

With only one capacitor and four resistors, four discrete precision frequencies are generated; two TTL keying inputs enable selection between frequencies. You can also sweep your frequency over a wide 3000:1 range with the use of one extra resistor and a little voltage.

So, if you've been putting together lots of parts

for tough waveform generation, the XR-2207 can save you time and money. It's the easy way to generate variable-frequency square and triangular waves (pulse and sawtooth too!) for every application.

The XR-2207 operates with either single or dual supplies from $\pm 4V$ to $\pm 13V$ over a 0.1 to 1 MHz frequency range. Seven device types are available in 14 pin ceramic and plastic packages for both commercial and military applications. Call or write for the XR-2207 data sheet and application notes.

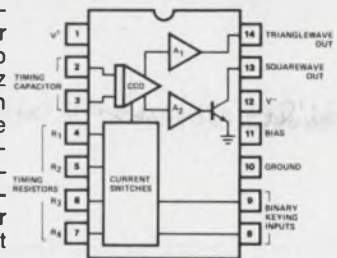

EXAR SPEAKS YOUR LANGUAGE



EXAR INTEGRATED SYSTEMS

750 Palomar Sunnyvale, California 94086 (408) 732-7970 TWX 910-339-9233

EXAR DISTRIBUTORS Semiconductor Concepts: Woodland Hills: (213) 884-4560 **Hauppauge, L. I.:** (516) 273-1234 **EEP Corporation:** Culver City: (213) 838-1912 **Intermark Electronics:** San Carlos: (415) 592-1641 San Diego: (714) 279-5200 Santa Ana: (714) 279-1322 Denver: (303) 963-8284 Seattle: (206) 767-3160 **Graham Electronics:** Indianapolis: (317) 634-8202 Lafayette: (317) 742-4006 Ft. Wayne: (219) 742-4346 Cincinnati: (513) 733-1661 **Radio Electric Service Co.:** Baltimore: (301) 823-0070 **Gerber Electronics:** Dedham: (617) 329-2400 **Yankee Electronics Supply:** Londonderry: (603) 625-9746

INFORMATION RETRIEVAL NUMBER 2

Here's A Great Way To Make Waves- And Save Money.

With One

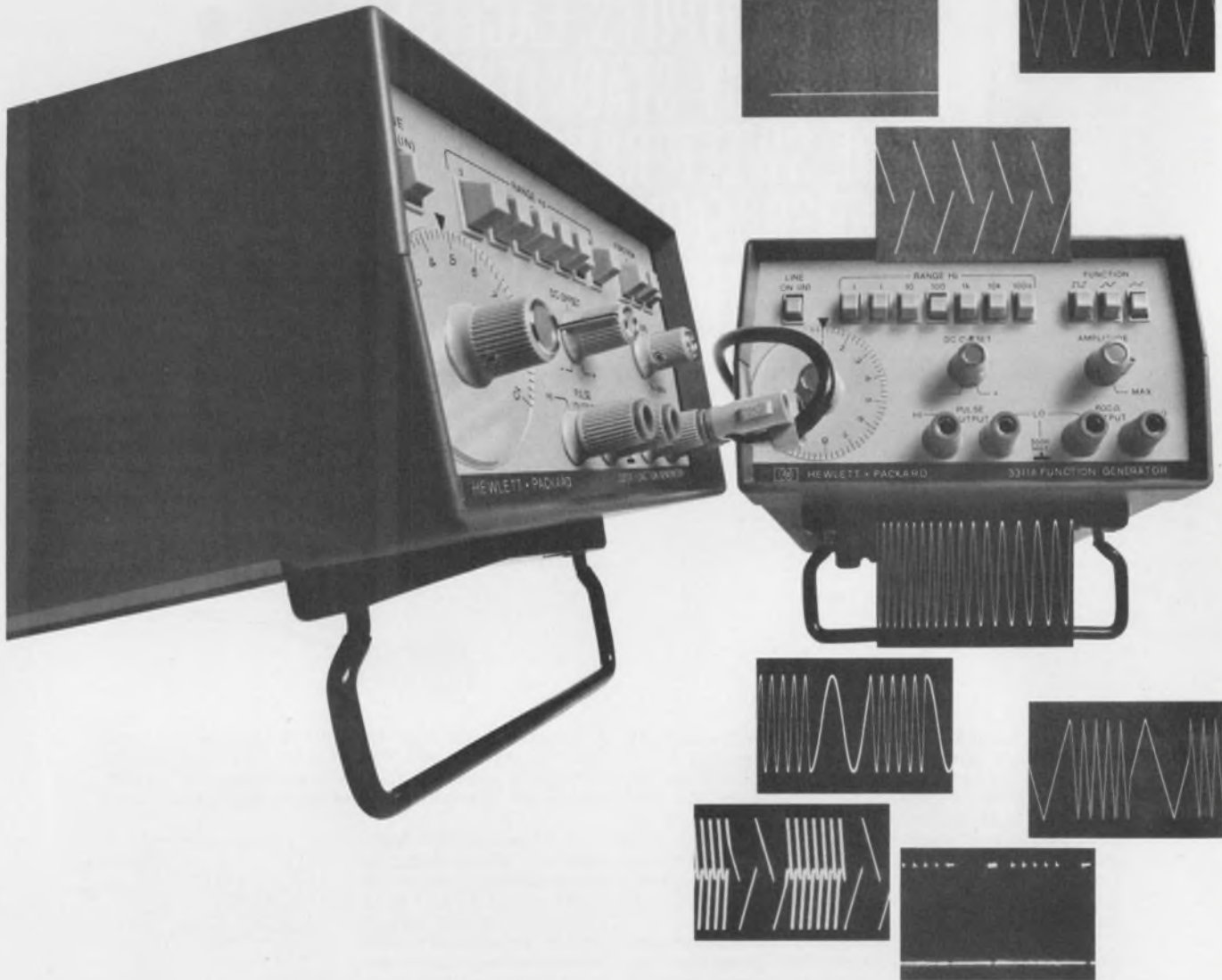

With Two

Sine Waves. Square waves. Triangular waves. You get them all — from 0.1Hz to 1MHz — with our new 3311A Function Generator. It gives you both dc offset and external sweep capabilities, and even lets you sum the square- and triangular-wave outputs. But there's another reason why the 3311A is making such a splash — it sells for only \$249.*

Use the separate pulse output to provide current sinking for up to

20 TTL loads. It has a 15% duty cycle, and 25nsec rise time. That's a lot of versatility for \$249.*

At that price you can afford to put two 3311A's together and do even more... Then you can sweep the outputs. Or frequency shift key the sine- or triangular-wave outputs or even their sum. You'll get full 10V p-p over the 3311A's frequency range. And dc offset is continuously variable from -5 to +5V into 600 ohms. Applying an exter-

nal 0 to 10V dc will give a 10 to 1 shift in frequency.

* Domestic USA prices only.

**For New Standards
In Signal Sources,
Think HP.**

HEWLETT  PACKARD

Sales, Service and support in 172 centers in 65 countries.
Palo Alto, California 94303 Offices in principal cities throughout the U.S.

INFORMATION RETRIEVAL NUMBER 3

NEWS

- 19 **News Scope**
- 22 **Is someone bugging you?** The 'science' of secret surveillance has been getting increasing attention of late and bugging devices are being used to a greater extent than ever before.
- 33 **Remote shore-based radar** system increases harbor safety.
- 39 **Washington Report**

TECHNOLOGY

- 52 **FOCUS on small motors:** This special report updates the engineers' knowledge of motors, highlights new types, provides guidelines for selection and points out possible specification pitfalls.
- 68 **Improve op-amp audio circuits** by mating op-amp dynamic characteristics and compensation to the circuit application.
- 76 **Clear the hurdles of microprocessors** with orderly design procedures that provide the right interface and develop the software efficiently.
- 84 **Check coil windings for correct turns** and direction, without eyestrain or errors. Here is a simple electrical test fixture that allows rapid inspection.
- 90 **Don't overload those connectors!** Temperature rise under load, if overlooked, can lead to unreliable performance and shortened connector life.
- 94 **Boost CMR in differential applications** with a special transformer that cancels common-mode currents but permits differential signals to pass unhampered.
- 100 **Determine noise of dc/dc converters.** In terms of techniques and required equipment, the measurements are like those used in high-frequency work.
- 104 **You'll turn out good products for less,** says this company president, if you build a computer storehouse of the fixed information your business needs to function.
- 110 **Ideas for Design:** Variable-speed, synchronous-motor control operates from 12-V battery or 120-V-ac line . . . Fast clock helps convert 2-phase encoder signals to positional data . . . Optical Schmitt reduces photodetector uncertainties.
- 116 **International Technology**

PRODUCTS

- 120 ICs & Semiconductors: Quad op-amp operates from a single power supply.
- 122 ICs & Semiconductors: 30-MHz power transistors yield more watts per dollar.
- 125 Modules & Subassemblies
- 129 Power Sources
- 133 Instrumentation
- 138 Components
- 144 Packaging Materials

Departments

- 45 Editorial: Did I say, "Women"?
- 7 Across the Desk
- 148 Application Notes
- 152 New Literature
- 155 Bulletin Board
- 158 Advertisers' Index
- 160 Product Index
- 162 Information Retrieval Card

Cover: Photo by A & B Photography, Inc., courtesy of Bodine Electric Co.

Here's how we help jumbo jets get off the ground.

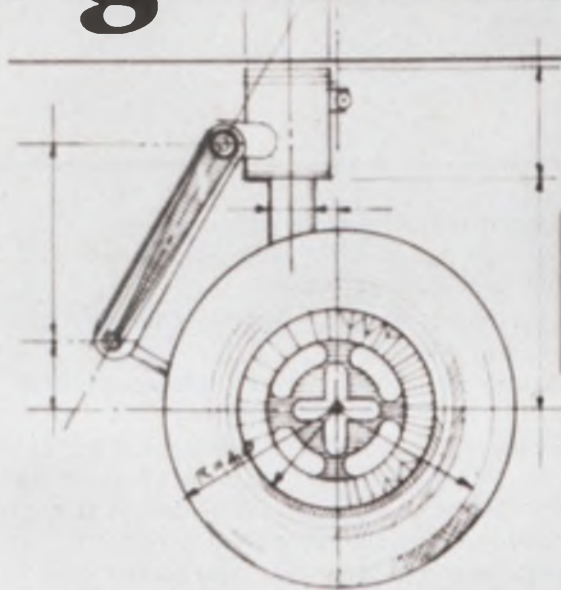

SOLID-STATE FW PROXIMITY HAS SWITCHING & SENSING ELEMENTS SEALED IN SINGLE UNIT. PROVIDES RELIABLE, NO-TOUCH SWITCHING FOR LANDING GEAR AND CONTROL SURFACE POSITION DETECTION. VARIATIONS OFFER SURFACE OR THRU-PANEL MOUNTING, HIGH-SPEED SENSING AND CIRCUITRY OUTPUT OPTIONS.

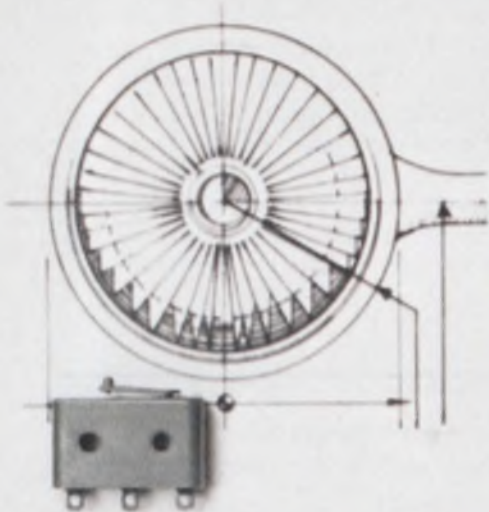

HERMETICALLY-SEALED HM FUNCTIONS IN PRESSURE SWITCH CONTROLS AND CONTROL VALVES. LARGER, HERMETICALLY-SEALED HS OPERATES IN TEMPERATURE RANGE FROM -100° TO $+500^{\circ}$ F AND TO 25 AMP DC

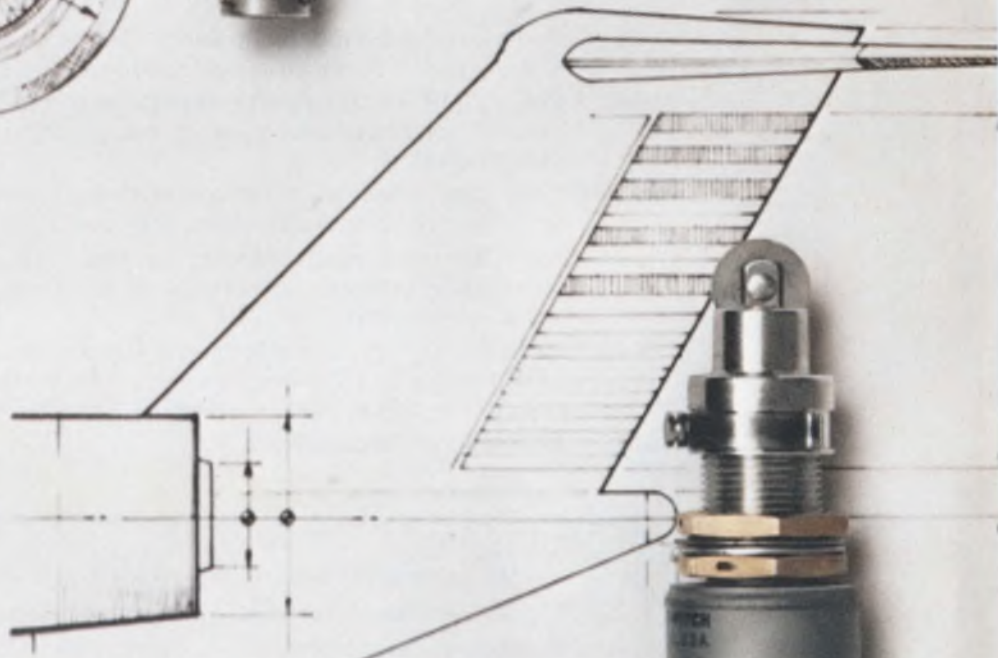

ENVIRONMENTALLY-SEALED EN'S CAN SENSE POSITION OF DOORS & CONTROL SURFACES INDICATE STATUS OR INITIATE ACTUATOR CONTROL. OFFER WIDE ELECTRICAL RANGE, CHOICE OF TERMINATIONS & OPERATING CHARACTERISTICS. COMPLEMENTARY PRODUCTS OFFER HERMETIC SEALING AND TEMPERATURE RANGES TO $+600^{\circ}$ F.

THE TOGGLES WORK AS COCK-
 PIT CONTROLS AND IN MANUAL
 INPUT PANELS. MEET MIL-S-3950.
 AVAILABLE WITH UP TO FOUR SPDT
 CIRCUITS & WITH
 SCREW, SOLDER,
 OR INTEGRATED
 WIRING TERMINA-
 TIONS. COMPLE-
 MENTARY TOGGLES
 OFFER VARIETY
 OF ACTUATORS,
 HERMETIC SEAL-
 ING, UP TO 10
 POLES, SPECIAL
 CIRCUITRY AND
 ROCKER ACTION.

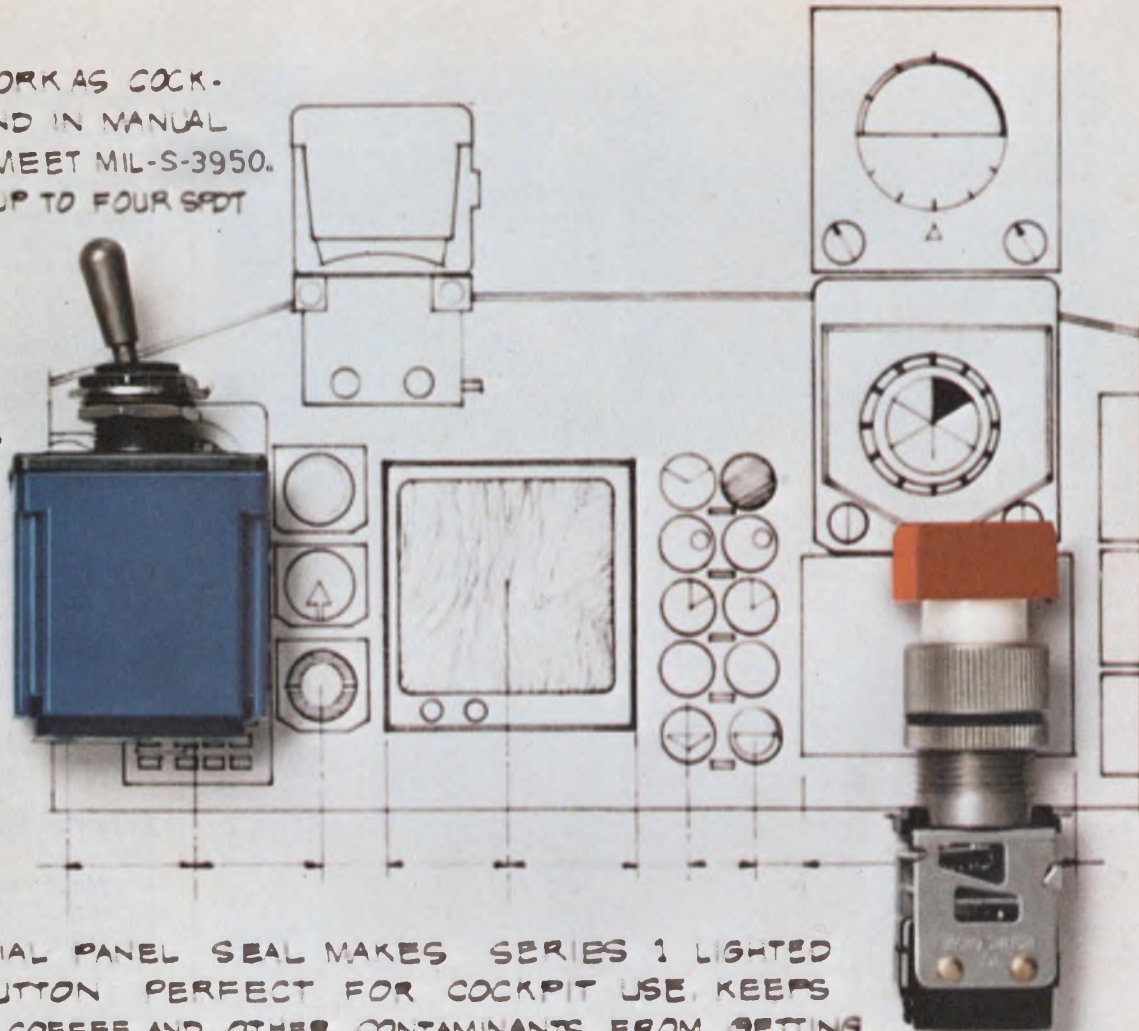

A SPECIAL PANEL SEAL MAKES SERIES 1 LIGHTED
 PUSHBUTTON PERFECT FOR COCKPIT USE. KEEPS
 WATER, COFFEE AND OTHER CONTAMINANTS FROM GETTING
 THROUGH PANEL. MIL APPROVED UNDER M-22885-81. OTHER MIL
 APPROVED PUSHBUTTONS OFFER MULTI-POLE,
 MULTI-LAMP OPTIONS.

ENVIRONMENTALLY-
 SEALED SE AND
 XE SWITCHES
 HANDLE SENSING AND
 MONITORING FUNCTIONS
 AT LOW COST. APPLICA-
 TIONS INCLUDE VALVE
 MONITORING AND EMER-
 GENCY EXIT CONTROL.
 UNSEALED SM AND SX
 OFFER GREATER COST
 SAVINGS. UNSEALED
 HT OPERATES TO
 +1000°F. IDEAL FOR
 THRUST REVERSERS
 AND VALVE CONTROL
 MONITORING.

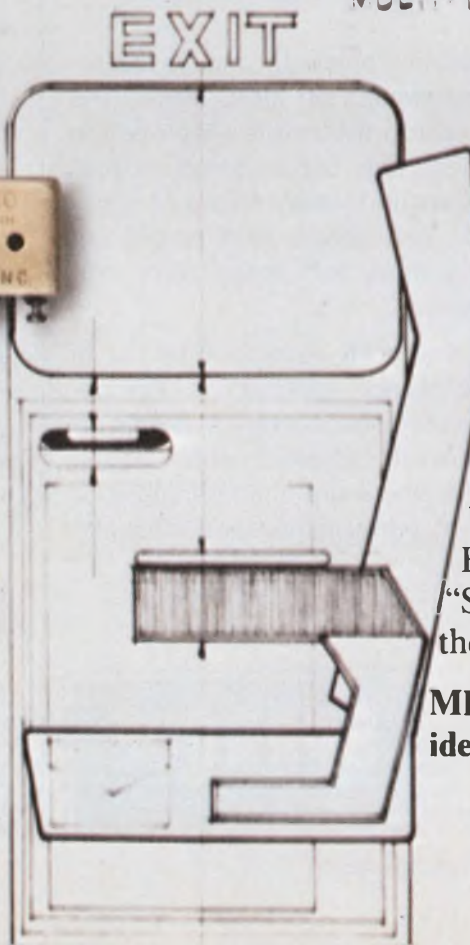

Aerospace applications present
 special problems.

So MICRO SWITCH has
 designed entire families of special
 switches to handle them.

The result is one of
 industry's most complete lines of
 rugged high-performance
 switches for both military and
 civilian use.

A few examples are shown
 here. But your MICRO SWITCH
 Branch Office (Yellow Pages,
 "Switches, Electric") can provide
 the full story. Contact them today.

MICRO SWITCH makes your
 ideas work.

MICRO SWITCH

FREEPORT, ILLINOIS 61032
 A DIVISION OF HONEYWELL
 INFORMATION RETRIEVAL NUMBER 4



seal of improval

Improved reliability through the use of a glass-to-tantalum true hermetic anode seal is the prime feature of new Type 138D gelled-electrolyte sintered-anode Tantalex® Capacitors. This new construction eliminates all internal lead welds while retaining the strength of conventional internal lead-welded parts. In addition, the new construction offers outstanding resistance to extensive temperature cycling.

Type 138D Tantalox Capacitors are designed to meet or exceed

the environmental and life test requirements of MIL-C-39006. The gelled-electrolyte employed in these new capacitors gives premium performance for all capacitor parameters with respect to frequency and temperature variations.

Originally developed for use in aerospace applications, this capacitor design is now available for general industrial and aviation use where the utmost in component performance and reliability are primary necessities.

For complete technical data, write for Engineering Bulletin 3704A to: Technical Literature Service, Sprague Electric Co., 347 Marshall St., North Adams, Mass. 01247.



THE BROAD-LINE PRODUCER OF ELECTRONIC PARTS

INFORMATION RETRIEVAL NUMBER 5

Vice President, Publisher

Peter Coley

Editors

Editorial Offices

50 Essex St.

Rochelle Park, N.J. 07662

(201) 843-0550

TWX: 710-990 5071

Cable: Haydenpubs Rochellepark

Editor-in-Chief: George Rostky

Managing Editors:

Ralph Dobriner

Michael Elphick

Associate Editors:

Dave Bursky

Jules H. Gilder

Morris Grossman

Seymour T. Levine

John F. Mason

Stanley Runyon

Edward A. Torrero

Richard L. Turmail

Contributing Editors:

Peter N. Budzilovich

Steven A. Erenburg

Editorial Field Offices

East

Jim McDermott, Eastern Editor

P.O. Box 272

Easthampton, Mass. 01027

(413) 527-3632

West

David N. Kaye, Senior Western Editor

2930 West Imperial Highway

Inglewood, Calif. 90303

(213) 757-0183

Northe K. Osbrink, Western Editor

112 Coloma St.

Santa Cruz, Calif. 95060

(408) 426-3211

Washington

Heather M. David, Bureau Chief

2506 Eye St., N.W.

Washington, D.C. 20037

(202) 338-3470

Editorial Production

Marjorie A. Duffy

Art

Art Director, William Kelly

Richard Luce

Anthony J. Fischetto

Production

Manager, Dollie S. Vleblg

Helen De Polo

Anne Molfetas

Christopher G. Hill

Circulation

Manager, Nancy L. Merritt

Ron Deramo

Information Retrieval

Peggy Long

Promotion

Manager, Jeffrey A. Welner

Karen Kerrigan

Avalanche vs p-i-n: Which device is best?

In the article "Improve Avalanche-Photodiode Designs" (ED No. 15, July 19, 1973, pp. 68-74), the author, Anthony E. Barelli, says: "When the APD [avalanche photodiode] is compared with the p-i-n photodiode, approximately one to three decades of improvement in signal-to-noise ratio can be expected for the system." This type of comment is not only an unjustifiable generalization but, more interestingly, Mr. Barelli sets up the equations and provides the data to disprove the claim.

His predominant noise term is given by Eq. 10, which states that the noise voltage, e_n , is proportional to

$$[M^d \times I_{DC}]^{1/2},$$

and since the signal current is proportional to

$$[M \times I_s],$$

the signal-to-noise proportionally becomes

$$S/N \propto \frac{M \times I_s}{[M^d \times I_{DC}]^{1/2}},$$

where d is given as 2.3. Hence

$$S/N \propto \frac{I_s}{M^{0.15} [I_{DC}]^{1/2}}.$$

For a p-i-n photodiode, the equivalent expression is

$$S/N \propto \frac{I_s}{(I_{DC})^{1/2}}.$$

Since M is typically 200 for the detector quoted in the article, the p-i-n diode shows greater performance by a factor of 2.2. This is not quite a fair comparison, since in the case of the avalanche device, the internal gain provides some immunity from preamplifier noise because of the higher current

levels at the preamp input for equivalent optical powers. However, I have constructed preamplifiers with averaged "equivalent input noise currents" of 5×10^{-14} amps/ $\sqrt{\text{Hz}}$, and better performance is to be expected, according to the literature (Hamstra and Wendland, *Applied Optics*; July '72, Vol. 11, No. 7). What is being traded off is the inability to buy or design a good low-noise preamplifier vs the ability to control temperature and bias voltage very precisely. Given this choice, I know what I would opt for!

Brian Kelly
Chief Engineer

United Detector Technology, Inc.
1732 21st St.
Santa Monica, Calif. 90404

The author replies

Mr. Kelly ignores the central point of my article: The system must be analyzed as a whole. In situations where an optimal system is necessary at low light levels, my original "generality" must stand—and could even be strengthened, if high frequencies were considered.

Mr. Kelly has carefully prepared his "proof" to reflect his company's long-standing policy of specifying the noise produced by its detectors as noise equivalent power (NEP). This practice, as I point out in my article, is misleading and can trap the unwary designer. NEP is a system attribute, by definition, and must reflect the noise contributed by the amplifier. Any given detector system can

(continued on page 11)

Electronic Design welcomes the opinions of its readers on the issues raised in the magazine's editorial columns. Address letters to Managing Editor, Electronic Design, 50 Essex St. Rochelle Park, N. J. 07662. Try to keep letters under 200 words. Letters must be signed. Names will be withheld on request.

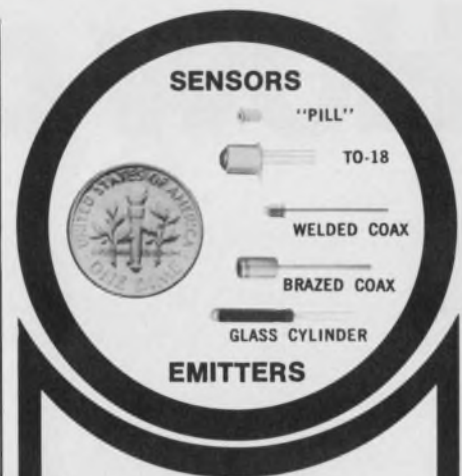

OPTRON OPTOELECTRONIC COMPONENTS

STANDARD DISCRETE PACKAGES
IMMEDIATE DELIVERY
COMPETITIVE PRICING

OPTRON'S competitively priced broad line of standard optoelectronic components range from solid state gallium arsenide emitters to silicon photodiodes, phototransistors, and photodarlingtons. They are immediately available in microminiature "pill," TO-18, welded or brazed coax, and glass cylinder packages.

OPTRON silicon photodetectors are compatible with either tungsten light sources or infrared LED's. The solution-grown epitaxial gallium arsenide LED's offer high efficiency and compatibility with the silicon photodetectors.

All OPTRON discrete components are available in other packages in moderate scale line quantities using standard chips. In addition, these units may be purchased as either standard or custom chips, monolithic arrays, printed circuit board assemblies, or molded assemblies.

Detailed technical information on discrete components and other OPTRON optoelectronic products . . . chips, assemblies and PC board arrays . . . is available from your nearest OPTRON sales representative or the factory direct.



NEW CONDENSED CATALOG

contains technical data on these and other OPTRON products. Request your copy today!



OPTRON, INC.

1201 Tappan Circle
Carrollton, Texas 75006
214/242-6571

How do you want

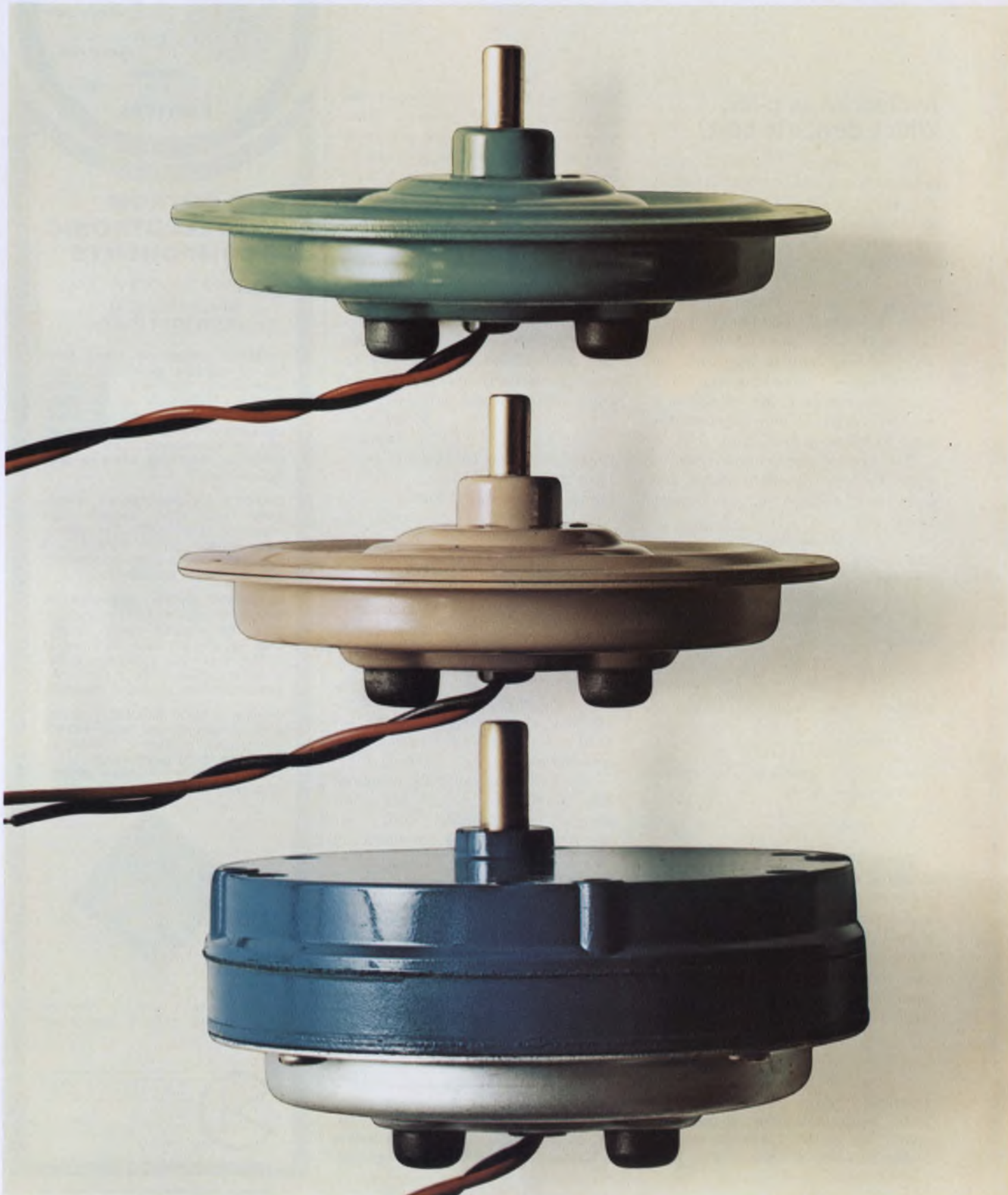

your Pancakes?

Less than a year ago you couldn't think about incorporating the benefits of a printed motor into your product design. Unless you had an application requiring high precision. One which could justify a correspondingly high price.

Now the low mass, high torque dc motor with the low profile and matching price is being used in a wide range of variable speed applications. In fact, the Pancake has been so well received that we can now offer it to you in a number of ways. In 1/30, 1/13, and 1/8 horsepower. Pick the one that comes closest to your needs.

Pancakes plain.

This is the Pancake that brought the copper-disc armature motor within the realm of so many low-cost applications. It is quick starting, and smooth acting with speed continuously variable from zero to as high as 3600 rpm. The multiple segment commutator design results in low-ripple operation and high reliability.

Output speed is directly related to dc input voltage and high current pulses at the input will produce correspondingly high pulse torque at the output without demagnetization. And like all Pancake motors you get long life (as much as 10,000 hours from one set of brushes).

Pancakes with ball bearings.

While the basic Pancake incorporates a sleeve bearing, this model offers ball bearings. Which makes it particularly ideal for applications where you have a higher radial load.

The ball bearing Pancake also can operate at higher temperatures and put out more watts when compared model for model with the sleeve bearing Pancake.

Either way, sleeve or ball bearing, the Pancake can help you design lighter weight, greater compactness and improved performance into your product.

Pancakes with gears.

Here's our 5-inch Pancake with a built in gear-train. It uses spur gears and is available with ratios ranging from 15 to 1 all the way to 150 to 1. Output speeds down to 20 rpm or lower and up to 200 rpm are available, dependent of course on gear ratio. Shaft torque is smooth. And high.

We've incorporated the gearhead with very little increase in overall depth, too. To give you a compact package, at a surprisingly compact price. The Pancake with gears is just 2" deep (overall). Which makes it ideal for tight places. In automobiles, boats, camping gear. Or anywhere a 12-volt dc supply is used or readily available.

Now that you know which Pancake is right for you, or which you'd like to know more about, call our Customer Service Group at 516-676-8000. Or write PMI, 31 Sea Cliff Avenue, Glen Cove, New York 11542.

The Pancakes are as flat as dc motors can get.

Made by Printed Motors Division. Kollmorgen Corporation.



Join the Amphenol fan club.

We've got fans in all shapes and sizes, just waiting for your call. Stock fans listed in our catalog are actually in stock. The most complete in-stock selection of sizes and performance ratings in the industry. On our shelves and at our distributor locations. We can fill most of your normal fan requirements on standard items within three working days. And we can give you fast service on large quantity or non-standard orders, too.

Because we know that when you order fans, you want them now. Not six weeks from now.

When you call Amphenol for fans you'll get strong, but quiet, "cool power". Amphenol

fans use ball bearings instead of sleeve bearings. And an aluminum frame for better heat dissipation. And a balanced lightweight impeller for smoother, quieter air flow with less wear on the bearings.

All of which results in a greater CFM flow rate at typical back pressures, better cooling for your equipment and lower maintenance costs. Write or call (collect) George Wolf at Amphenol Sales Division, Component Marketing Services, Bunker Ramo Corporation, 2875 S. 25th Ave., Broadview, Illinois 60153. 312/345-4260.

BUNKER RAMO **AMPHENOL**

Amphenol Fan Club

Where to join.

DISTRIBUTORS

East

DRW ELECTRONICS CORP.

Watertown, MA
617-923-1900

Farmingdale, NY
516-249-2660

FEDERAL ELECTRONICS, INC.

Binghamton, NY
607-748-8211

PYTRONIC INDUSTRIES, INC.

Montgomeryville, PA
215-643-2850

PRIEST ELECTRONICS

Norfolk, VA
703-855-1041

Midwest

LAKELAND ELECTRONICS, INC.

Elk Grove Village, IL
312-595-1000

SCHUSTER ELECTRIC CO.

Cincinnati, OH
513-984-1600

South Central

SOLID STATE ELECTRONICS COMPANY

Dallas, TX
214-352-2601

West

W. H. BINTZ COMPANY

Salt Lake City, UT
801-363-5821

MOLTRONICS

South Gate, CA
213-773-6521

Phoenix, AZ
602-272-7951

STERLING ELECTRONICS

San Carlos, CA
415-592-2353



AMPHENOL

ACROSS THE DESK

(continued from page 7)

have many values of NEP, depending on many conditions, as indicated in my article. Specifying a detector's NEP alone results in fraudulently low values and commercially attractive devices.

The S/N for the APD-amplifier system is derived in Eq. 17, not Eq. 10. Also overlooked is the fact that this same equation is shown to be transformed quickly to provide the S/N for the p-i-n amplifier system. (Let gain $M = 1$ and $I_{DB} + I_{DS} = I_{PIN}$). Thus an objective comparison of the APD to the p-i-n detection system is easily obtained.

Let

$$n = \frac{S/N (APD)}{S/N (PIN)}$$

be the figure of merit. After the algebra is performed,

$$n = \frac{M^2(I_{DC} + I_{PIN} + i_{AB}) + K}{M^d(I_{DC} + i_{DB}) + (i_{DS} + i_{AB}) + K}$$

where

$$K = \frac{i_{nA}}{2q} + \frac{2KT}{qR_f} + \frac{e_{nA}^2}{2qR_f^2}$$

This figure of merit does not reflect the great frequency advantage of the APD.

To get Mr. Kelly's result (except for $M = 200$), the following seven approximations must be made: $I_{PIN} = 0$, $i_{AB} = 0$, $i_{DB} = 0$,

$$i_{DS} = 0, i_{nA} = 0, \frac{KT}{R_f} = 0, \text{ and}$$

$$\frac{e_{nA}}{R_f} = 0.$$

This artificial situation represents a case in which there is an inordinate amount of background light. Consequently optimal photo-detection is limited by the shot noise of the light and not necessarily by the quality or type of photodetector. A reasonably poor quality detector in such a case could provide optimal photodetection.

Also neglected in Mr. Kelly's analysis is the fact that the optimal gain of the APD must decrease with increasing I_{DC} (Eq. 18). Therefore in the case of large I_{DC} , the enlightened designer would choose a value much below $M = 200$. The question now becomes: At what light level does the APD fail to improve the optimal sys-

tem performance? By reference to Fig. 8 in my article and extrapolation of the $R_f = 10^6 \Omega$ curve until it crosses at $M_{opt} = 1$ (the p-i-n case), the APD system improves the situation until $I_{DC} \approx 10^{-5}$ Amp ($\sim .05$ mW of light power at $\lambda = 632.8$ nm—plenty of light). Now, with extrapolation of Fig. 9 out to the value of $I_p = 10^{-5}$ A, the system NEP is found to be $\sim 8 \times 10^{-10}$ W/ $\sqrt{\text{Hz}}$. Thus the APD system can provide optimal system performance with a range of NEPs from 8×10^{-10} W/ $\sqrt{\text{Hz}}$ to 1.8×10^{-14} W/ $\sqrt{\text{Hz}}$ for the example in my article.

Amplifiers with very low input noise can look good on paper, but tradeoffs of gain-bandwidth products and input-noise voltage usually stifle further consideration.

Anthony E. Barelli

Department of Surgery

Case Western Reserve University
Cleveland, Ohio 44106

Correction

In "Improve Avalanche-Photo-diode Designs" (ED No. 15, July 19, 1973, pp. 68-74), the log scales are upside down in Figs. 7 and 9, resulting in erroneous readings.

In Fig. 7, the value 2.9×10^{-13} should be 3.6×10^{-14} and 5.6×10^{-13} should be 1.8×10^{-14} . In Fig. 9, the value 5.6×10^{-13} should also be 1.8×10^{-14} .

In the third from the last paragraph on p. 74, 20% should be 40%, and in the last paragraph, 5.6×10^{-13} should be 1.8×10^{-14} .

It's not a man's degrees, but work, that counts

In his letter "The Manpower Crisis: It Seems Inevitable," John M. Mealing Jr. outlines points that affect engineers in Britain just as much as they do in the States. (see ED No. 11, May 24, 1973, p. 7). But what's wrong with "nondegreed engineers" if they don't quit learning and don't over-

(continued on page 16)

Collection of
The Art Institute of Chicago
"Brusset's Construction," 1958
Jose di Rivera



new dimensions in Bodine drive capabilities

For office machines / machine tools / industrial equipment / processing apparatus / electronic equipment /
electrical control devices / medical apparatus / data processing equipment /
recording instruments / graphic arts equipment / scientific apparatus / and many other uses.



The people at Bodine are doing exciting things in fractional hp drives. Putting more power into smaller, lighter packages. Creating greater control capabilities than you might believe possible. Developing "specials" to meet the most demanding design criteria. Motors that keep their cool in hottest application environments. That run whisper quiet. And

deliver long-haul reliability and economy. Adding to an extensive line of standards to provide a virtually unlimited range of fhp motors, gearmotors and speed/torque controls. Talk to Bodine about your stock and built-to-order fhp drive requirements. We can help you get what you need. Over 3500 catalog specifications, 340 stock types and sizes. Ratings from

1/2000 thru 1/2 hp . . . torques from 0.18 oz.-inches to 350 lb.-inches . . . speeds from 0.6 to 10,000 Rpm. Write or call Bodine Electric Company, 2500 W. Bradley Place, Chicago, Ill. 60618. Phone 312/478-3515. Telex: 25-3646.

BODINE
ELECTRIC
COMPANY

World's biggest MOS ROM

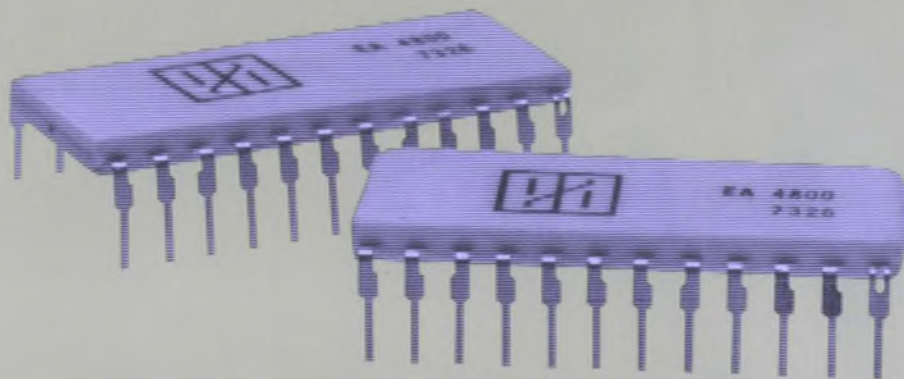

Stores 16,384 bits at lowest cost per bit ever

The EA4800 P-channel read-only memory has twice the storage capacity of any other ROM on the market. Using it, you can program calculators, minicomputers, data terminals and similar equipment at the lowest cost per bit ever achieved.

And you will find it very simple to use.

No clocks are required—operation is static.

No address decoding is

required—it's on the chip.

No input pull-up resistors are required for connection to TTL—they're on the chip.

You have your choice of 2048 x 8 or 4096 x 4 organization. You can OR-wire the outputs to expand the memory, and you need only two supplies: +5v and -12v.

The ROM has a maximum access time of 1.2 μ sec and a low power dissipation of .032 mW per bit. It comes in a

24-pin metal ceramic or silicone-molded DIP.

Price is \$28 in 100-piece quantities in a silicone package.

We can make a mask and deliver the first good ROMs to you in 6 to 8 weeks.

Contact Electronic Arrays, Inc., 501 Ellis Street, Mountain View, California 94040. Phone (415) 964-4321.

electronic arrays 

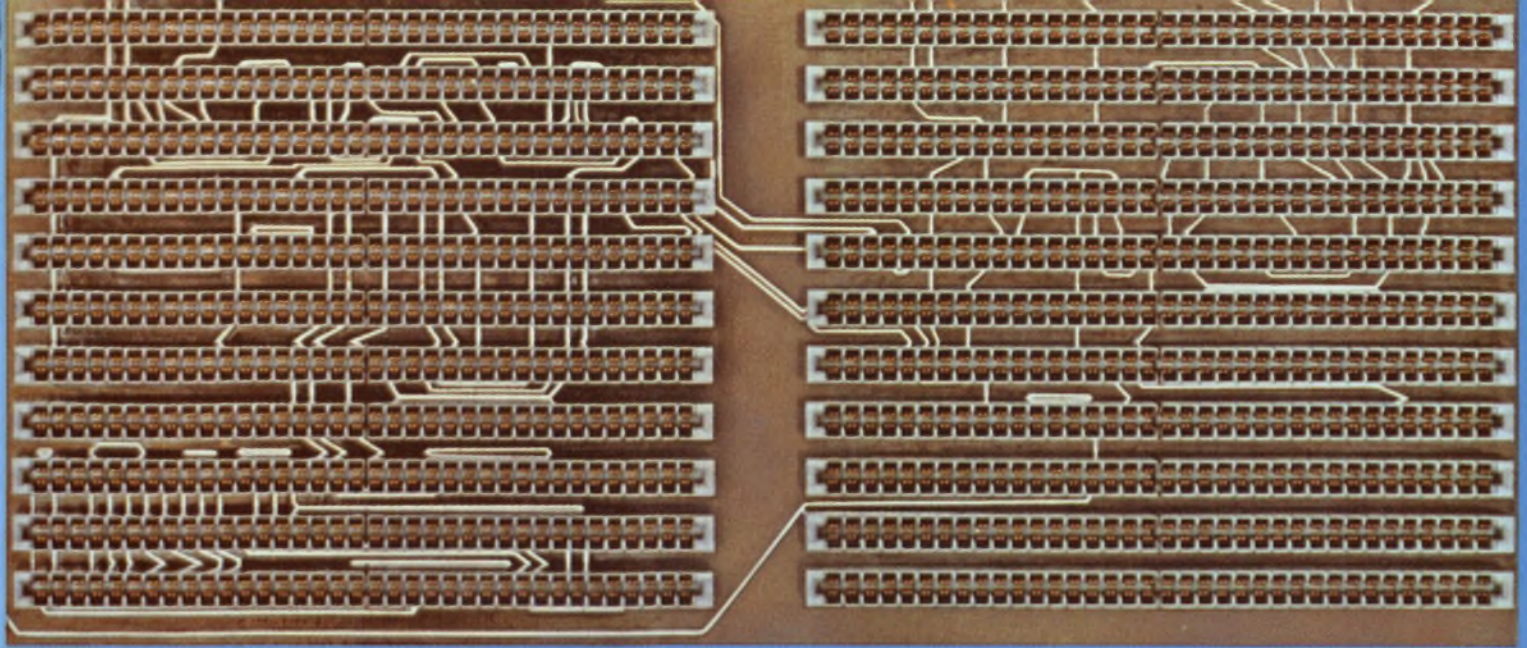

REDUCE INTERCONNECTING COSTS 50-75%

... using Elco's Series 6317*, 6320* and 6321* card edge connector systems. These new problem-solvers from Elco help you beat the "wrap-or-not-to-wrap" syndrome that crops up when you're designing a new circuit. Formerly you had one of two choices. Go the wire-wrapping route for design flexibility. Or choose p.c. wiring for manufacturing economy. Either way, you've had to accept trade-offs.

Wire wrapping lets you make circuit changes throughout the life of your equipment. But, at roughly 10¢ for each pair of terminations, a densely wrapped board can be expensive. On the other hand, committing all signal interconnections to p.c. wiring is the less costly alternative, but you're married to the circuit on your multi-layer board. So when a design change is called for, you have to discard the board and design anew.

That is, up until now.

Because Elco's press-fit card edge connector systems give you the best of both approaches.

In a typical application, you can specify 50 to 75% of your interconnections as p.c. wiring, including all grounds and voltage distributions. And thus cut as much as 75% from your overall interconnecting costs. Your interconnections will be made by press-fitting the contacts of our connectors into the plated-through holes of the board. The remaining interconnections will be made by wire wrapping the appropriate contacts.

Since your p.c. wiring is exposed, you now have the ability to make circuit changes and repairs using the wire wrap tail available on each contact. You're also able to replace damaged contacts without disturbing or removing the insulator or adjacent contacts. And you needn't worry about the integrity of the press-fit connection because it's mechanically stronger and electrically more reliable than the best soldered connection. Furthermore, circuit reliability in general is improved because the p.c. board is not subjected to the heat shock that accompanies most soldering processes.

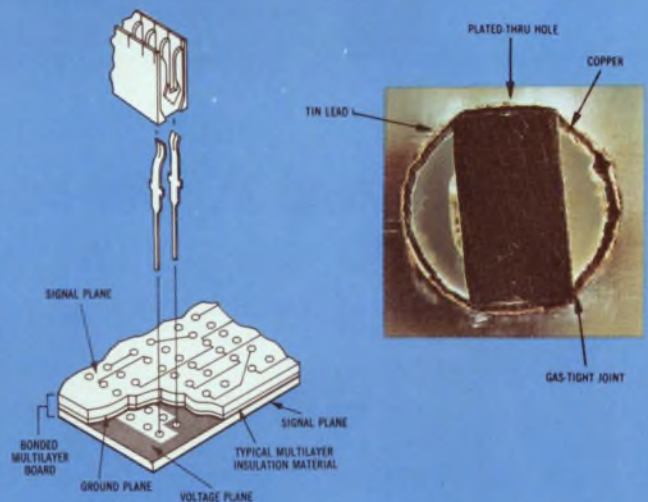

And Elco will go you even two better.

Give us your p.c. back panel laid out to our hole specs (.125" x .125" — Series 6317; .100" x .200" — Series 6320; .125" x .250" — Series 6321), and we'll fill the board with our "Economist" Series connectors. Or send us your specifications, and we'll even supply the board. In either case, we'll also complete the wire wrapping.

Just two more services in keeping with CONNECTRONICS, Elco's Total Connector Capability.

For full details and specifications on the "Economist," contact your local Elco representative, or:

Elco Corporation
Willow Grove, Pa. 19090
(215) 659-7000

Elco Corporation
2200 Park Place
El Segundo, Calif. 90245
(213) 675-3311



INFORMATION RETRIEVAL NUMBER 11

SR-300 . . . the only complete unit for measuring shaft angle and displaying your actual engineering units. The economical SR-300 synchro converter from DDC. With output already scaled to display the engineering units you need to measure—so you don't have to take the time to read angle, then scale. The SR-300 does it for you with custom scale factors—in psi, miles, degrees, temperature, pounds, velocity . . . any engineering unit you require.

Features include: bright .6-inch display in compact (2x4.5x7.5-inch) panel meter configuration; 3 or 4 decade resolution; all solid state reliability; accepts 11.8V or 90V L-L, 50-440Hz and synchro or resolver format; BCD output for computer interface and/or remote readout, and self-contained power supply. Input is transformer isolated and transient protected. Accuracy is $\pm 30'$ or $\pm 6'$ and is specified worse case over full environmental range.

So, whether your application is in industrial machine controls, batch weighing, processing systems, or data logging, such as utilized in maritime and industrial data recorders, why not select the indicator that speaks your language!

It's from DDC. The people who are shaping the future of data conversion and high speed signal conditioning equipment. Send for free brochure.



A subsidiary of ILC Industries, Inc.

ILC DATA DEVICE CORPORATION

100 TEC STREET, HICKSVILLE, N. Y. 11801 • PHONE: (516) 433-5330

Shaping the future of data conversion.

APPLICATION CENTERS

Long Beach, Calif.
(213) 597-5744

Washington, D. C.
(703) 536-2212

Bruxelles, Belgium
Tel. 62.01.59

At last! A low-cost synchro angle indicator that speaks your language.



INFORMATION RETRIEVAL NUMBER 12

ACROSS THE DESK

(continued from page 11)

specialize? Any qualification on paper is surely only a reference to a prospective employer. How a man progresses afterwards should not depend on his "letters" but on what he does and how competent he is.

I am myself nondegreed and in my mid-40s. I did not go to grammar school or high school—as you would call it. I studied one day and one evening a week at college. Subsequently I got engineering institution membership on the basis of the work I have done.

R. J. Isaacs, T. Eng.

29 Sebright Rd.
Barnet, Herts
EN5 4 HR
England

Anti-skyjack searches held a possible threat

The article "Fighting the Skyjacking Menace: Anyone Have a Bomb Detector?" in the April 12 issue (ED No. 8, pp. 36-40) raises some issues of the relation of search technology to our society.

I believe our Constitution grants us freedom from governmental interference. We have the right to try to walk down any street and the right to seek, individually or collectively, punishment of those who interfere. The Constitution does not guarantee our success or safety, and I do not believe any government can protect us against individual acts of terrorism.

Your article describes very well the measuring equipment that screens people at airports. But could this technology be the start of slavery? What are we offered for our right of privacy?

Kirtland H. Olson

The Harvard Group
Bolton Rd.
Harvard, Mass. 01451

Correction

In the Idea for Design "Simple Algorithm Computes Square Roots on a Four-Function Calculator" (ED No. 15, July 19, 1973, p. 104), the equation should read:

$$X_2 = \left(\frac{N}{X_1} + X_1 \right) / 2.$$

The National Anthem

A review of New Products and Literature from National Semiconductor

IC TRANSDUCCERS: 1st FULL FAMILY OFF THE SHELF.



SANTA CLARA, CA — The industry's first full family of Integrated Circuit Transducers is now available off the shelf from National Semiconductor.

Specific features include:

3 pressure types — gage, differential, and absolute (0-30 and 0-300 psi.)

Field interchangeability — all units meet one guaranteed characteristic curve. Maximum calibration error band $\pm 1.5\%$ of span.

New Rugged Package — Zinc cast external housing with 1/8" NPT fitting available as LX17XX series.

Temperature compensated — transducer temperature effects offset by computerized laser trimming.

Flexibility — arithmetic functions, digital format, multiplexing are easily attainable because of single ended op amp configuration.

Reliability — low mass, no moving parts, good frequency response. Input overvoltage and output short circuit protection. Temperature measurement capability at point of pressure sensing.

(Continued on page A4)

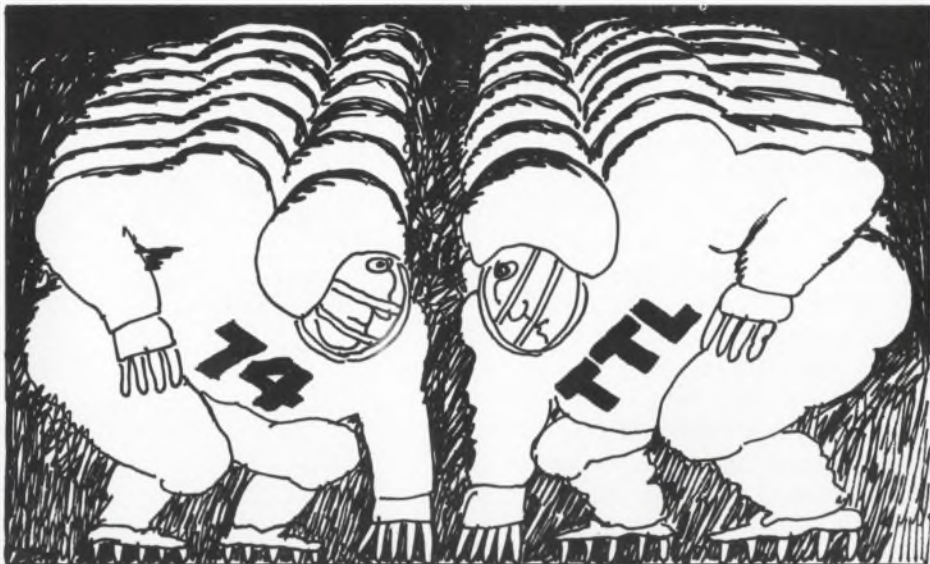

9 more new members to the 54C/74C line.

A complete line of TTL compatible CMOS products — National's 74C series — is now available.

Designed to simplify system design and reduce system costs, the 74C series products are pin-for-pin and function-for-function equivalents of the TTL 7400. They offer the cost savings features of CMOS (smaller power supply, less power supply regulation, fewer bypass capacitors, simpler design, and simplified power distribution) and provide the following important advantages over the 4000 CMOS series:

- Same pin-outs as 7400 TTL. Hence the experience acquired with the 7400 series can be applied directly to 74C.
- Standardization: The 74C series is designed for standard products; the input and output characteristics of devices in the 74C family are standardized. In contrast, most of the devices in the 4000 CMOS series were brought out as custom products, and the input and output characteristics in this series differ from device to device. As a result,

(Continued on page A4)

END THE INFLEXIBILITY OF COSTLY "IN-HOUSE" HARD-WIRED SYSTEMS: Industry's first one-card, 16 bit microprocessor.

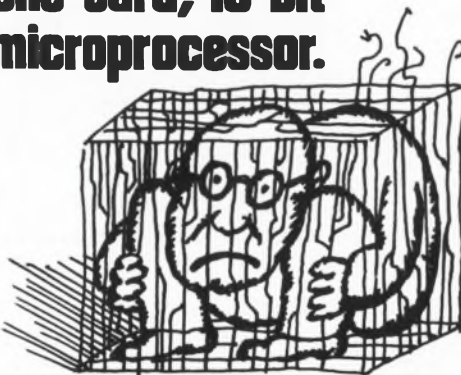

SANTA CLARA, CA. . . The semiconductor industry's first single-card 16-bit microprocessor system, the IMP-16C, has been announced by National Semiconductor.

IMP-16C, a low-cost system on an 8½"x11" pc card, consists of a 16-bit microprocessor; clock system; i/o bus drivers; 256 words of read/write memory (RAM); and provisions for 512 words of ROM/PROM memory.

IMP-16C represents the first use of another significant National development — the GPC/P family of LSI functional building blocks for configuring parallel processors.

Product Marketing Manager Gene Carter said the IMP-16C, a proven totally debugged system, is a dramatic

(Continued on page A3)

Twice the brightness. Half the power.

NSL 5027 LED lamp.

NSL5027 LED Lamp, which offers twice the brightness at half the power is available from National Semiconductor.

The lamp is a red diffused-lens, narrow angle GaAsP LED in a plastic package. It is ideal for indicator lamp applications for back-lit panels; as a front viewed pilot lamp; for optical coupling, and for other narrow beam applications.

Light intensity of the NSL5027 at 10 mA is 4 mcd (typ.) and 2 mcd (min.); approximately twice the brightness of competitive devices. Average brightness is 100 fL at 10 mA.

NSL5027 is available off the shelf.

Circle 241 on Bingo Card



It's a new core memory driver-- up to 400 milliamps at up to 14 volts.

SANTA CLARA, CA — A new core memory driver circuit from National Semiconductor, called the LM75324, offers memory designers the flexibility of sourcing or sinking up to 400 milliamps at up to 14 volts in a single dual in-line package.

The LM75324 is a bipolar monolithic integrated circuit with two 400 milliamp source/sink switch pairs along with four address gates and one 3-input timing gate. Two of the input gates are used for mode selection — sourcing or sinking current — and the other two are employed for selecting one of the two output pairs. The 3-input timing gate provides additional versatility in selecting the proper word or bit line in a core memory system.

Propagation delay for the LM75324 memory driver ranges from a low of 40 nanoseconds max. for the delay time to logical "0" at the sink output, to 110 nanoseconds max. for the delay time to logical "1" at the sink output. For protection, input clamping diodes are included on all input lines — both timing and address lines. The LM75324 is specified for operation over the 0°C to 70°C temperature range and is completely DTL and TTL compatible.

The LM75324 is available in either a 14 pin dual in-line Epoxy B package (the LM75324N) or a 16 pin ceramic DIP package (the LM75324J). Delivery is from stock.

Circle 231 on Bingo Card

mm5316 clock: self-contained digital alarm clock circuit.

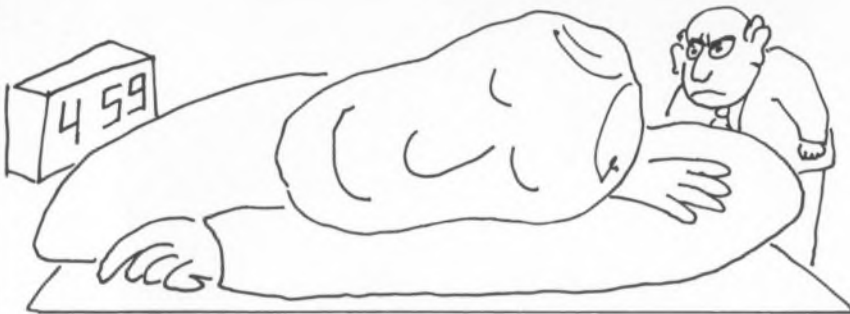

A complete self-contained digital alarm clock circuit capable of directly driving fluorescent tube or liquid crystal displays has been announced by National Semiconductor Corporation.

Called the MM5316, the clock is a monolithic MOS integrated circuit that employs both low threshold P-channel enhancement mode, and ion implanted depletion mode devices. It provides all of the logic and decoding necessary to build several types of clocks and timers. These include 12 or 24 hour alarm clocks and desk clocks, clocks for radios and automobiles, stop watches, appliance timers, and industrial timers.

The MM5316 also contains an interval timer which can be set for up to 59 minutes. This is used in clock radios, for example, to allow the user to fall asleep to music; the radio will then shut off after the pre-set interval. In desk clocks, the interval timer can be employed to sound the alarm after a preset interval, to remind the user of an event — the end of a three minute phone call, for example.

The MM5316 operates over an unregulated supply of from 8 to 29 volts and is available in a 40 pin Epoxy B package.

Circle 244 on Bingo Card



The long-awaited Linear Quad Design Contest is here!

Put on your thinking caps. The contest is for the best utilization of all four devices in a National quad linear IC. For full details send for our contest booklet containing quad data sheets, application notes and entry blank.

Circle No. 200 on Bingo Card



Introducing Programmable Logic Array available from stock.

National's recently-introduced Programmable Logic Array (PLA) is available from stock.

In the past, digital processors were designed with gates and flip-flops. Then along came read only memories (ROMs) which enabled the designer to program logic in memory, thus simplifying system design. And now, National Semiconductor Corporation has gone one step further with the Programmable Logic Array (PLA).

Called the DM7575/DM8575 and the DM7576/DM8576, the new bipolar monolithic integrated circuits are mask-programmable logic arrays intended to implement random logic. The PLA's have 14 data inputs and 8 outputs. Each output provides a sum of product terms where each product term can contain any combination of 14 variables or their complements. The total number of product terms which can be provided is 96. If the equivalent function were to be implemented in ROM, it would take a 128,000 bit memory.

Logically, the PLA looks like a bank of input inverters and two programmable logic matrices which transform the 14 inputs into 8 outputs. The first



3 DESIGN KITS: \$6.45, \$6.45, \$4.95



matrix forms the AND products and the second matrix OR's these products, forming the 8 outputs.

Each variable or its complement may appear in any product term, and every product may appear in any of the 8 output functions. Any product term which is repeated is counted only once, and since some functions are more easily represented in their inverted form, an option is provided to allow for either the true or complement of the function on each output.

The PLA is intended for use as the control logic in digital systems. Applications range from fairly slow appliance sequencers and traffic light controllers for complex intersections, to the control logic for high speed digital processors. The PLA features a typical delay of only 90 nanoseconds and dissipates about 550 milliwatts. Two output formats are available. The DM7575/DM8575 has a conventional totem-pole output and the DM7576/DM8576 has a passive pull-up output which is used in systems requiring more than one PLA.

The arrays are available in a 24 pin Epoxy B dual in-line package for operation over the 0°C to 70°C temperature range (DM8575 and DM8576), or a 24 pin ceramic DIP for operation over the -55 to 125°C temperature range (DM7575 and DM7576).

Circle No. 220 on Bingo Card

Fixed positive/negative voltage regulators for digital designers.

The industry's only set of positive (LM340) and negative (LM320) fixed voltage regulators are offered in this kit — designated SK1001 — for digital designers.

The kit, to give digital designers the opportunity to evaluate the industry's only such set at low cost, is being made only through distributors to control distribution and to benefit customers who may be in trouble because of parts shortage by other suppliers.

Each kit contains a +5 volt regulator (LM340) and a -5.2 volt regulator (LM320), plus product specifications and applications information.

Price of the kit is \$6.45 in the U.S.; overseas price is comparably low.

Circle No. 237 on Bingo Card

Fixed positive/negative voltage regulators for linear designers.

The LM340 is a 3-terminal positive voltage regulator ideal for all applications.

The LM320 is the only negative fixed voltage regulator available today.

For Linear designers, National offers the SK1002 kit — fixed positive (LM340) and negative (LM320) voltage regulators.

The SK1002 contains a +15 volt regulator (LM340) and a -15 volt regulator (LM320), as well as the product specs and applications information.

This kit, too, is offered only through National distributors. Price is \$6.45 each domestically; overseas price is comparably low.

Circle No. 238 on Bingo Card

Op amp/pre-amp evaluation kit at bargain prices: SK1003N

An excellent opportunity to evaluate National's LM308 operational amplifier and LM321 pre-amp at low cost is afforded by this design kit — the SK1003N.

Available through distributors only, the kit contains product, data sheets and applications information.

Price is \$4.95 in the U.S., with overseas prices offering comparable savings.

LM308 is a precision op amp featuring input currents nearly a thousand times lower than industry standards like the LM709C.

LM321, a new product, features low drift and is designed specifically for use with operational amplifiers for greatly increased dc accuracy. Drift is guaranteed to be less than $1\mu\text{V}/^\circ\text{C}$. It has been called the perfect pre-amp.

Circle No. 239 on Bingo Card

54C/74C CMOS products

(Continued from page A1)

the 74C series is much easier to design with than is the 4000 series.

Guaranteed 1V Noise Margin: Like the 4000 series, the 74C series has 45% noise immunity. Unlike the 4000 series, the 74C has a guaranteed 1V noise margin. This means that 1V of noise at the input will not cause the output to rise beyond the TTL levels, and a logic error is less likely to occur.

A military version of the 74C series the 54C series — is also available. The two series differ only in their operating temperatures — 0°C to 70°C for the 74 —55°C to 125°C for the 54C.

Following are descriptions of eight 54C/74C devices. All are monolithic CMOS ICs, N and P channel, which feature a wide supply voltage range (3.0V to 15V), a high noise immunity (typically 0.45V_{CC}), and all are tenth power TTL compatible and can drive two LPTTL loads.

The MM54C42/MM74C42 One-of-Ten Decoder

Produces a logical "0" at the output corresponding to a four-bit binary input from zero to nine, and a logical "1" at the other outputs. For binary inputs from ten to 15, all outputs are logical "1".

Circle No. 222 on Bingo Card

The MM54C95/MM74C95 Four-Bit Right-Shift Left-Shift Register

The MM54C95/MM74C95 is composed of four D flip-flops and performs right-shift or left-shift depending on the logical input level to the mode control.

Circle No. 223 on Bingo Card

The MM54C151/MM74C151 Eight Channel Digital Multiplexer

This device contains on-chip binary decoding. Two outputs provide true (output Y) and complement (output W) data. A logical "1" on the strobe input forces W to a logical "0" and Y to a logical "1".

Circle No. 224 on Bingo Card

The MM54C154/MM74C154 Four-Line to Sixteen Line Decoder/Demultiplexer

The MM54C154/MM74C154 one-of-sixteen decoder is provided with two strobe inputs, both of which must be in the logical "0" state for normal operation. If either strobe input is in the logical "1" state, all 16 outputs will go to the logical "1" state.

Circle No. 225 on Bingo Card

IC Transducers

(Continued from page A1)

Low cost — design simplicity and solid state production economies.

National transducers contain in a single small package all four of the basic transducer elements: diaphragm and vacuum reference; piezoresistive sensor; signal discriminator and conditioner; and signal amplifier and processor. The first three are contained on a single die, the fourth provided by standard IC operational amplifiers.

All products are available from National distributors.

Circle No. 221 on Bingo Card

The MM54C157/MM74C157 Quad Two-Input Multiplexers

The MM54C157/MM74C157 consists of four 2-input multiplexers with a common select and common enable inputs. When the enable input is a logical "0", the four outputs assume the values as selected from the inputs. When the enable input is a logical "1" the outputs assume logical "0". Select decoding is done internally, resulting in a single select input only.

Circle No. 226 on Bingo Card

The MM54C164/MM74C164 Eight-Bit Parallel Out Serial Shift Register

The MM54C164/MM74C164 eight-bit shift register has gated serial inputs and clear. Each register bit is a D-type master/slave flip-flop.

Circle No. 227 on Bingo Card

The MM54C173/MM74C173 TRI-STATE® Quad D Flip-Flop

This device has four D-type flip-flops that operate synchronously from a common clock. The TRI-STATE output allows the device to be used in bus-organized systems. The outputs are placed in the TRI-STATE mode when either of the two output disable pins are in the logic "1" level.

Circle No. 228 on Bingo Card

The MM54C192/MM74C192 Synchronous Four-Bit Up/Down Decade Counter and the MM54C193/MM74C193 Four- Bit Up/Down Binary Counter

The MM54C192 and MM74C192 are BCD counters; the MM54C193 and MM74C193 are binary counters. Counting up and counting down are performed by two clock inputs, one being held high while the other is clocked. The outputs change on the positive-going transition of this clock.

Circle 229 on Bingo Card

IC timer now available on command.



SANTA CLARA, CA . . . An integrated circuit timer with an output capable of sourcing or sinking up to 200 milliamps, is now available from National Semiconductor Corp. Called the LM555, the monolithic integrated circuit may be employed as a monostable one-shot time delay or as an astable oscillator.

In the time delay mode of operation, the delay time is precisely controlled by one external resistor and one external capacitor. For astable operation as an oscillator, the free running frequency and the duty cycle are accurately controlled by two external resistors and a single capacitor. Temperature stability of the LM555 is better than 0.005% per degree C, and both the output and the power supply are TTL compatible. Maximum supply voltage is 18 volts and the trigger voltage is a maximum of 5 volts (with a 15 volt supply). Trigger current is typically 0.5 microamps.

Applications for the LM555 include pulse generation, sequential timers, time delay generators, pulse width and pulse position modulators, and linear ramp generators. The LM555 (-55°C to 125°C operation) is available in an 8 lead TO-5 can. The LM555C (0°C to 70°C) is available in an 8 lead TO-5 can or an 8 pin Epoxy B dual in-line package. Delivery is from stock.

Circle 230 on Bingo Card

Our popular little DH 6375 NPN transistors can be delivered as quads.



National's popular DH6375 (2N6375 and 2N6376) NPN transistors for driving core memory are now available in space-saving quad form.

The units, ideal for any industrial application where high speed saturated switching is required, offer the same high performance as in singles.

Feature include extremely fast turn-on and turn-off times, with minimum as well as maximum guaranteed values. This thorough specification eliminates much guess work in designing core memory driver circuits. Turn-on time is 10 ns (min.) and 25 ns (max.); turn-off time is 15 ns (min.) and 35 ns (max.).

The DH6375 and 6376 are characterized up to 1 amp.

Circle 242 on Bingo Card



Recent additions to National literature line-up are these new product handbooks — for Digital, Linear and CMOS ICs. All feature complete listing of all National products in the subject product areas, with product selection guides, and cross-reference charts, in an easy-to-use format.

Circle 245 on Bingo Card



NATIONAL ENTERS THE NUMBERS RACKET.

We've got a lot of awfully nice numbers for sale.

Some 2's. 7's. A bunch of swell 6's.

And when you put them together you can get nice numbers like 276.

Or 672.

Or 897146.19.

Our numbers racket is otherwise known as the LEDs business.

Otherwise known as light emitting diodes.

So now you electronic calculator people have another source. Which is kind of

nice to know for something in as short supply as LEDs are today.

We're making a three-digit LED (NSN 33, a pin-for-pin compatible second source for the Litronix DL 33).

Also an eight-digit LED with a minus sign, NSN 199, and a nine-digit LED, NSN 299, both in matched brightness sets of guaranteed light uniformity.

In addition, we're now producing a line of lamps.

NSL 5020 series, compatible with Monsanto's MV 5020 series. And

NSL 100 series, compatible with Fairchild's FLV 100 series.

We're into LEDs in a big way. An all-out effort on our part to supply this important market. With a new LEDs plant just completed in Malacca, Malaysia.

Our people have a little motto tacked on their gym lockers: "If you can't make 'em first...make 'em best!"

Join the National Library

Ask for your official National Library Card and current selection bibliography. Your passport to a veritable wealth of Digital,

Linear, MOS and Transistor/FET design information from a single source. We'll selflessly

throw in a LED Lamp Cross Reference Guide and Data Sheets. Write: National Semiconductor, 2900 Semiconductor Dr., Santa Clara, Ca. 95051.

National

16 bit microprocessor

(Continued from page A1)

example of the cost and system advantages made possible by the GPC/P products. GPC/P (for general purpose controller/processor) is a flexible, low-cost, full-capability building block family aimed specifically at computer-oriented equipment such as: data terminals; test systems; communications equipment; machine tools; process control systems; and peripheral device control systems.

In most cases, these functions are now performed by inflexible and costly in-house-developed systems, using "hard-wired" or permanent logic. In other cases — probably 10 per cent — the functions are performed by minicomputers which represent "overkill" from a capability standpoint.

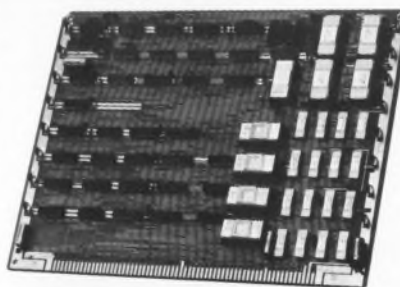

Carter pointed out that National's GPC/P blocks allow the system designer to build into his system precisely the capability he needs, and to customize it to his immediate application by programming, rather than hard-wiring. This means flexibility never before possible to this type of user.

Carter said that by utilizing these building blocks, the IMP-16C now offers all these advantages in a proven, totally debugged system.

IMP-16C uses a standard set of 42 instructions and operates on a micro-cycle of 1.5 microseconds. It can address up to 65,000 words of memory. The system uses a simple bus structure; memory address bus; and separate memory and i/o data bus.

The microprocessor section of the system is composed of two basic GPC/P functional blocks — a register and arithmetic-logic (RALU) and a control and read-only memory (CROM).

The RALU provides seven general purpose registers, a 16-word stack and an ALU. Each RALU contains logic to implement a 4-bit slice of each of these functions. The system uses four RALUs to achieve its 16 bit configuration.

Circle No. 201 on Bingo Card

NEW LITERATURE



FET BRIEF 2: WHY USE CASCODE DUAL FETs? This paper by National's Jim Sherwin discusses the advantages of designing with the FM1100A Cascode FETs compared with standard FET triodes. FM1100A devices are specified at $1G < 1$ pA under operating conditions, and they exhibit operating G_{fs} of 400 μV typical. Competitive 1 pA duals offer operating G_{fs} of 100 μV typical. *Circle No. 232 on Bingo Card*

AN-84: DRIVING 7-SEGMENT GAS DISCHARGE DISPLAY TUBES WITH NATIONAL SEMICONDUCTOR CIRCUITS. Circuitry for driving high voltage cold cathode gas discharge 7-segment displays, such as Sperry Information Displays and Burroughs Panaplex II, is greatly simplified by a new line of monolithic ICs from National. The products and their design advantages are discussed in detail in this application note. *Circle No. 233 on Bingo Card*

AN-80: MOS KEYBOARD ENCODING. The use of MOS large scale integration has made it possible to provide, in a single IC, all of the components necessary for economic implementation of the keyboard encoding function. National's MM5740 is a complete keyboard interface system capable of providing quad mode 90 key keyboard encoding. Use of the MM5740 and its design advantages are discussed. *Circle No. 234 on Bingo Card*

AN-79: IC PREAMP CHALLENGES CHOPPERS ON DRIFT. Discusses the applications of the LM121, a new IC preamplifier designed for use with general purpose op amps which improves DC accuracy to where the drift is lower than many chopper stabilized amplifiers. The LM121 gives drifts as low as 0.2 $\mu V/^\circ C$; and improves loop-gain. *Circle No. 235 on Bingo Card*

AN-78: STATIC RAM SYSTEM CAN ALSO BE BUILT WITH DYNAMIC RAM ELEMENTS. Discusses the proper use of dynamic RAMs in small systems. The MM5260 dynamic RAM is highlighted, including operational requirements, advantages, and applications techniques. *Circle No. 236 on Bingo Card*

3 AMP REGULATOR FOR HIGH CURRENT USERS.



SANTA CLARA, CA — The LM123, the highest current monolithic integrated circuit in production, has been introduced by National Semiconductor Corp. The LM123 is a 3 amp, 5 volt regulator circuit intended for on-card use in digital logic systems. It is a three terminal device (input, output, and ground) and doesn't require any external components for operation.

With a three amp output capability, the LM123 can easily handle the voltage regulation requirements of large logic cards, and it can even handle the total voltage regulation requirements of some small systems.

Like the smaller 5-volt regulators such as the one amp LM109, the LM123 is virtually blowout proof. On-chip current limiting, power limiting and thermal shut-down circuitry protect the device from overloads and shorts.

The LM123 is designed for operation over the junction temperature range of from $-55^\circ C$ to $150^\circ C$; LM223 is intended for operation over the $-25^\circ C$ to $150^\circ C$ junction temperature range; and the LM323 has a junction temperature range of from $0^\circ C$ to $150^\circ C$. Delivery is from stock.

Circle No. 243 on Bingo Card

2N3954 dual JFETs: superior tracking

2N3954 family of N-channel matched dual JFETs are in good supply at National and National distributors.

The products (2N3954/5/6/7/8) are single-chip duals made through National's exclusive Process 83 — which means superior tracking regardless of bias point (typ. $5\mu V/^\circ C$).

2N3954-8 are aimed at high slew rate operational amplifier applications; balanced modulation; and balanced mixer applications.

Features include low offset voltage (2 mV); low leakage (50 pA); and high gain (3,000 $\mu mhos$).

All are available in the TO-71 package.

Circle No. 240 on Bingo Card

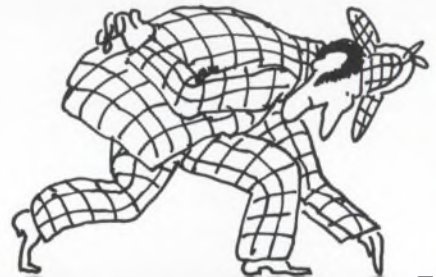

BINGO!

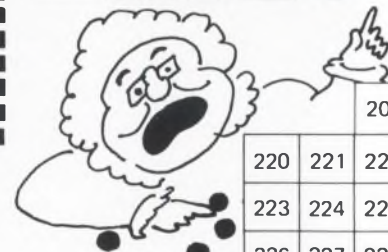

		200
220	221	222
223	224	225
226	227	228
229	230	231
232	233	234
235	236	237
238	239	240
241	242	243
244	245	201

Complete card and mail to
NATIONAL SEMICONDUCTOR Dept D
 2900 Semiconductor Drive, Santa Clara, Ca 95051
 Att: Marketing Services

For FREE technical data, circle the numbers that correspond to the Bingo numbers at the bottom of the articles.

Please print clearly. This will be used as a mailing list.

NAME _____ TITLE _____

COMPANY _____

ADDRESS _____

CITY _____ STATE _____ ZIP _____

Specify GE Bulk-Effect Diodes & Oscillators

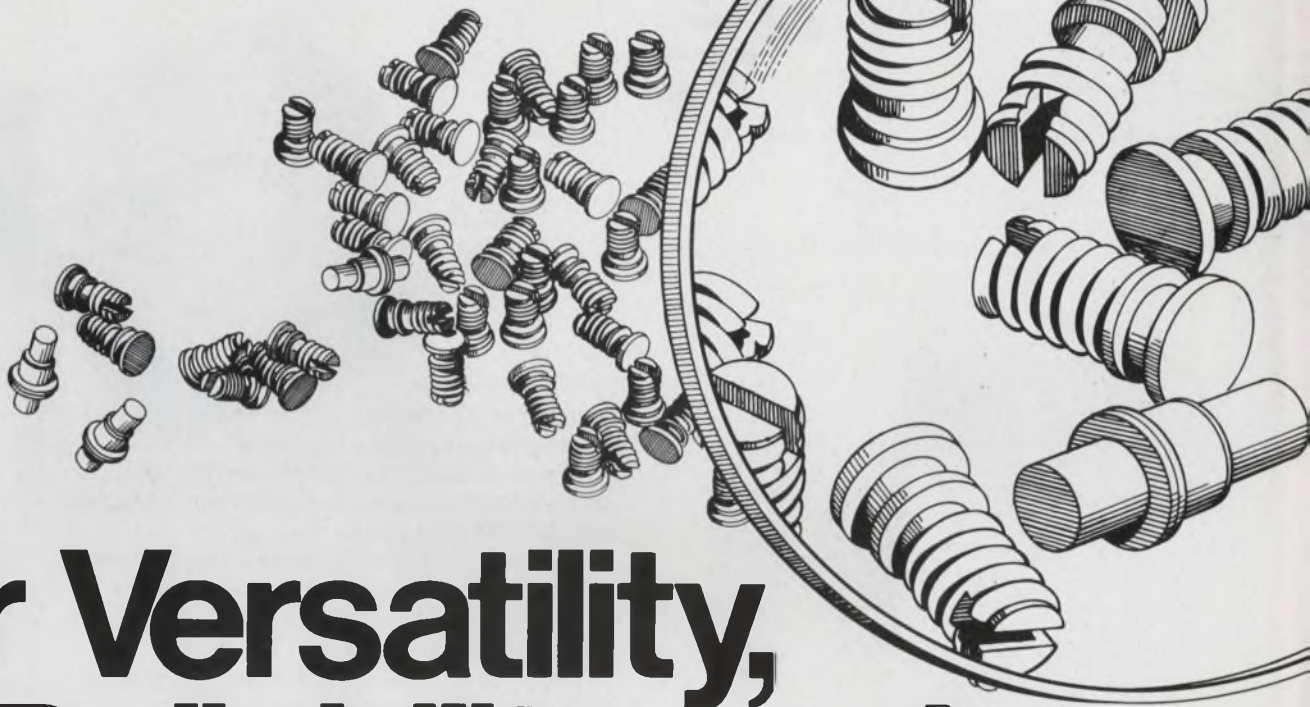

for Versatility, Reliability and Application Design Assistance.

Versatility? General Electric's capability allows you to choose a bulk effect diode or oscillator with a threaded or unthreaded case, power output levels of 5 to 250 mW and frequencies from 5 to 18 GHz.

Reliability? In-house life tests show over 1/2 million device-hours without failure or significant performance changes. These tests include cycling and monitoring of RF, DC and noise changes with time.

Application Design Assistance? Just let us know how we can help you! Odds are we already have the precise diode or Microwave Circuit Module (MCM) you need. If not, we'll design and build it. Call us at (502) 683-2401, Ext. 422, or write Jim Rush, Microwave Devices Products Section, General Electric, 316 East 9th Street, Owensboro, Kentucky, 42301. Or use the reader service card.



GENERAL  ELECTRIC

362-04

INFORMATION RETRIEVAL NUMBER 13

Anything aluminum can do...gold can do longer!

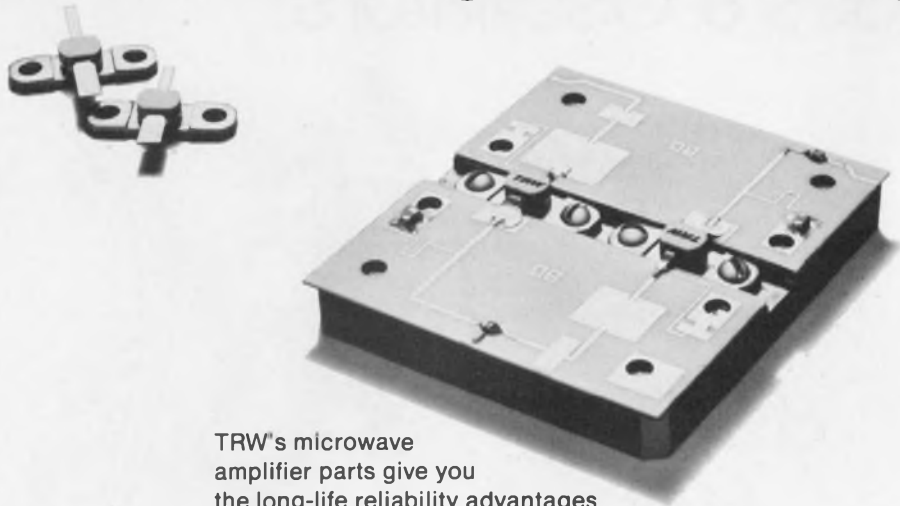

TRW's microwave amplifier parts give you the long-life reliability advantages of gold metalization for your present designs. Wherever you are now using aluminum parts, you can use TRW gold parts.

The performance is the same — maybe better. And the performance certainly lasts longer, with greater reliability, thanks to TRW's exclusive gold metalization process.

The price is the same as for the old aluminum parts. So it's like getting...free gold!

There is a TRW gold part for every ordinary aluminum one you are now using:

Aluminum Part No.	Gold Part No.	Power	Frequency
MSC2001	TRW2001	1W	2 GHz
MSC2003	TRW2003	3W	2 GHz
MSC2005	TRW2005	5W	2 GHz
MSC2010	TRW2010	10W	2 GHz
MSC3001	TRW3001	1W	3 GHz
MSC3003	TRW3003	3W	3 GHz
MSC3005	TRW3005	5W	3 GHz

You can improve your present designs *now*. TRW gold-metalized microwave parts are available, off-the-shelf, from any TRW distributor.

For full information use the reader service card. Or, if you can't wait to get started, phone (213) 679-4561. Ask for Don Comm.

TRW Semiconductors, 14520 Aviation Boulevard, Lawndale, California 90260.

These products are available through the following authorized distributors:

Almo Electronics
Bell Industries
Cramer Electronics Inc.
De Mambro Electronics

Eastern Radio Corp.
Electronics Marketing Corp.
Elmar Electronics Inc.
Hall-Mark Electronics Corp.

Harvey-Michigan Inc.
Liberty Electronics
Powell Electronics
Pyttronics

Semiconductor Concepts Inc.
Summit Distributor
R. V. Weatherford Co.
Westates Electronics Corp.

TRW[®] SEMICONDUCTORS

Piezoelectric relay runs on only 1 W of power

An electrostatic relay that requires about 1 μ W for its operation has a programmable time delay from 300 μ s to about one hour and is CMOS-compatible, according to its developers. The best sensitive magnetic reed relays require about 15 mW and are 50% larger, says Yujiro Yamamoto, president of Y Square Associates, Inc., of Santa Ana, Calif., which developed the new device with H. R. Enterprises, Inc., also of Santa Ana.

The new relay, a piezoelectric device, doesn't improve the 0.5-to-1-A current-handling capacity of present reed relays, Yamamoto points out. But, unlike present types, it can be driven by MOS circuits without a buffer.

The prototype units operate at 28 V, but Yamamoto insists that further improvements in the relay structure, stability and fabrication will minimize temperature and environmental effects and reduce the operating voltage from 5 to 15 V.

Several prototype configurations have been fabricated. In one, Yamamoto explains, two flat, reed-like bimorph elements with deposited electrodes are mounted, facing each other. They are secured at one end, while contacts are mounted on the other end. The bimorph structure of these devices consists of multiple layers, as contrasted with two layers of conventional bimorphs.

When a voltage is applied across the two electrodes, the elements bend. Contact pressure of the face-to-face elements ranges from 4 to 8 g, depending on the applied voltage. The deflection is a few mils, which is comparable to standard sensitive reed relays.

The material acts like a capacitor, Yamamoto notes, with a dielectric constant of about 210. Upon application of voltage, an instantaneous current of 2.7 mA is

drawn, which drops to 0.01 μ A within 1 ms. While the theoretical switching time of the material is about 2 μ s, Yamamoto says that the realistic times range between 300 and 500 μ s. The performance is limited by structural loading caused by the electrodes and contacts.

A second basic prototype design has a circular element of about 15 mm O.D. and 4.5 mm I.D. It is equivalent to a straight element 42 mm long.

Although the concept is not new, Yamamoto points out that previous piezoelectric relays required 100 V or more for their operation, had small contact pressure and suffered from lack of repeatability during their operation.

The use of new piezoelectric materials and fabrication technology—borrowed from the semiconductor industry—together with improvements in structural design, have produced the significant advances in the new devices, Yamamoto says.

Hydrogen fuel cells for cars passes tests

A pollution-free hydrogen fuel cell that has been getting a skeptical brushoff from experts for 30 years has passed a series of tests conducted by the Gollub Analytical Service Corp. in Berkeley Heights, N.J.

Invented in Bolivia in the early '40s by Frank Pacheco, who now lives in Upper Greenwood Lake, N.J., the fuel cell consists of sea water, thin plates of magnesium and an electrode of steel or carbon that is connected by a wire to form a circuit.

The primary application of the cell, Pacheco says, would be to power an automobile. The principle

could also be used to generate electricity for an urban utility.

Use of the hydrogen cell to operate a car would cost about the same as gasoline does now, Pacheco says.

The gas produced by the cell, the analytical report states, was more than 98% hydrogen. There were traces of nitrogen, oxygen, argon and carbon dioxide, but no chlorine, which is toxic and could therefore be a problem.

CMOS makes possible digital navigation system

A CMOS microprogrammed computer is credited with making possible the development of a fully digital area-navigation system for general-aviation aircraft.

"We couldn't have done this with conventional bipolar logic," says Gene Grillot, group leader at King Radio Corp., Olathe, Kan., developer of the system, "because the heat generated would have been too much for the size of the packages needed."

The panel unit measures 4-1/8 inches high by 5-3/8 inches wide and weighs a little over 13 pounds. The system is the first all-digital area-navigation one for general-aviation (light) planes.

An area navigation system permits flights directly across country—instead of from one navigation station to another—by electronically displacing these stations to line up with the desired flight path.

The computer built with National Semiconductor CMOS, is a serial processor that uses 76-bit words. The system has a 1,000-bit register for storing vector navigational information and a scratchpad memory for entering and checking data loaded into the system.

Another feature is a navigational receiver in which the output is digital rather than analog. The receiver has a bearing resolution of 0.025 degrees. The computer uses data of this resolution for calculations, but the pilot can only enter a course in 1-degree increments from 0 to 360 degrees.

The computer converts polar information received from the DME/VOR navigation station to

rectangular coordinates. These are then converted to the rectangular equivalence corresponding to "way stations"—points the pilot is to fly over. Finally the computer converts these rectangular coordinates back into polar coordinates for display.

A CMOS look-up table with the sines and cosines of angles from 0 to 360 degrees is part of the system.

The system—which sells for \$23,695, compared with up to five times that for military versions—is being introduced at the National Business Aircraft Association convention in Dallas Sept. 25-27.

Fivefold growth forecast for specialized carriers

Rapid growth for specialized communication carriers—private systems like Datran, MCI and Western Tele-Communications—is predicated in the next seven years by Frost & Sullivan. The market for such services will increase 5.2 times—from \$1.45-billion in 1972 to \$7.6-billion in 1980—says the New York-based market research organization.

Along with the growth of the specialized carriers, there will be an increased demand for independent communication-equipment manufacturers, notes Harry Newton, project director of the study. In fact, he continues, independent suppliers are expected to dominate the market in the new technologies, such as short-haul, through-the-air communications. In addition to short-haul equipment—which Newton says will account for \$30-million in sales by 1980—long-haul microwave equipment and modems are expected to account for \$500-million and \$132-million, respectively.

In a survey of over 200 major communication users, the report notes that 85% believe that one or more of the specialized carriers will eventually serve their organizations.

Three ways outlined to ease energy crisis

Three solutions to the energy crisis, all designed to augment

energy derived from fossil and nuclear fuel sources, were proposed last week—Sept. 17 to 19—at the Institute of the Electrical and Electronics Engineers' Eascon 73 in Washington, D. C.

One suggested source was water-temperature differences found in the Gulf of Mexico. Currents near the surface are often 80 F, while those in deep are about 40 F. Under the energy proposal, the surface water would be pumped into a surface structure, where it would vaporize propane gas to operate a turbine that generated electrical power. Under certain conditions—mainly proper pressurization—propane boils at 80 F. The gas would then be cooled and recondensed by the 40 F below-surface water, which would also be pumped up to the surface structure. The technique was described by J. Hilbert Anderson, a consulting engineer of York, Pa.

Three areas of solar energy were discussed by Prof. Martin Wolf of the National Center for Energy Management and Power, at the University of Pennsylvania. He described the use of flat-plate collectors of solar energy, not only for thermal heating but also for cooling through the heating of ammonia and water. The heat would be stored in water or in fused salt.

A second technique would be the use of the sun to produce new renewable fuel—methane gas. This would be produced by growing a crop and allowing it to ferment.

Also, Professor Wolf said, an oil could be produced by pyrolysis—a destructive distillation out of air of organic materials. The technique would produce a very rich methane gas and crude oil suitable for use in power plants, he noted, and electrical power could be produced.

Wind power was described as a near-time partial solution by Prof. William F. Heronemus of Dept. of Civil Engineering at the University of Massachusetts.

CO₂ laser heat gives better glass fibers

By use of a carbon-dioxide laser as a heat source, scientists at Bell Laboratories, Murray Hills, N.J., have found a new way to produce

more efficient glass fibers. According to Ray Jaeger, a member of the technical staff at Bell, a 250-W laser is used as a highly controllable source of clean heat in place of conventional heaters.

Conventional heaters that are used to draw glass fibers introduce impurities into the glass and thus lower its light transmission capability. These impurities, notes Jaeger, come from both the gas and the oxidizing metal in conventional heaters.

Although the use of a laser seemed exotic at first, Jaeger says that it looks like it will be a very practical way to go for production because operating costs are very low.

Monitor determines caller's phone number

Would you like to know who's calling you when your telephone rings before you pick up the receiver? With a new system developed by Telident Inc., Los Angeles, this may soon be possible, provided the manufacturer gets the cooperation of the telephone company.

The new system, says Donald White, president of Telident, uses a hierarchy of scanners to monitor all the lines coming into a telephone exchange. The scanners determine, at the telephone exchange, the number of the calling party; the calling number is then converted into a series of tone codes which are introduced into the phone line and sent to the receiving party. At the receiving end, the subscriber unit decodes the tone codes and displays the calling number on a digital readout.

The receiving unit comes in two models, notes White—one that displays the number after the receiver is lifted, and one that displays the number before a ringing phone is answered. The latter option, White reports, is the one that seems to attract the most interest.

Telident is currently trying to get approval from American Telephone and Telegraph for the use of this telephone monitoring equipment. White claims that if the telephone company approves, consumers would be able to lease the display unit for only a few dollars a month or possibly even buy it for about \$150.

signetics mos

DEVICE SELECTOR

INSTRUCTIONS

Set arrow in lower window at Register Length, Bit Capacity, Character Size or Function.

Read Device Type and Specification in upper windows.

SIGNETICS MOS DEVICE SPECIFICATION

TYPE	V _{SS}	V _{DD}	V _{GG}	V _{BB}	PROCESS	PKGS.
2580	+5	0	-12	-	P-SG	N, I

SHIFT REGISTERS	REGISTER LENGTH	ORGANIZATION	SPEED (MHz)	
STATIC — METAL GATE	16	16 x 2	1.0	
	25	25 x 2	1.0	
	32	32 x 2	1.0	
	50	50 x 2	1.0	
	100	100 x 2	1.0	
	100	100 x 2	3.0	
STATIC — SILICON GATE	50	50 x 2	1.5	
	100	100 x 2	1.5	
	200	200 x 2	1.5	
	32	32 x 6	2.0	
	40	40 x 6	2.0	
	80	80 x 4	1.5	
	240	240 x 2	1.5	
	250	250 x 2	1.5	
	256	256 x 2	1.5	
	128	128 x 2	1.5	
	132	132 x 2	1.5	
	1024	1024 x 1	1.5	
DYNAMIC	100	100 x 2	3.0	
	512	512 x 1	2.5	
	1024	1024 x 1	2.5	
	512	512 x 1	3.0	
	1024	1024 x 1	3.0	
	256	256 x 4	8.0	
	512	512 x 2	8.0	
1024	1024 x 1	8.0		
MEMORIES	BIT CAPACITY	ORGANIZATION	ACCESS TIME (ns)	
	RAM STATIC	256	256 x 1	1000
		1K	1024 x 1	1000
	RAM DYNAMIC	1K	1024 x 1	310
2K		2048 x 1	330	
ROM	1K	256 x 4	750	
	1K	128 x 8, 256 x 4	750	
	2K	256 x 8, 512 x 4	750	
	1K	256 x 4	950	
	1K	128 x 8, 256 x 4	950	
	2K	256 x 8, 512 x 4	950	
	4K	512 x 8	700	
8K	2048 x 4	700		
CHARACTER GENERATOR	CHARACTER SIZE	ORGANIZATION	ACCESS TIME (ns)	
	7 x 5	64 x 7 x 6	600	
	5 x 7	64 x 6 x 8	600	
SPECIAL CIRCUITS	FUNCTION	ORGANIZATION	SPEED (MHz)	
	RECEIVER TRANSMITTER	8 BIT	0.32	
FIRST-IN, FIRST-OUT BUFFER	FIFO	32 x 8	1.0	

PACKAGE DESCRIPTIONS

A Package: 14-Pin Silicone DIP	TA Package: 8-Pin TO-99
B Package: 16-Pin Silicone DIP	V Package: 8-Pin Silicone DIP
I Package: Ceramic DIP	XA Package: 18-Pin Silicone DIP
K Package: 10-Pin TO-100	XC Package: 22-Pin Silicone DIP
N Package: Silicone DIP	Y Package: 24-Pin Ceramic DIP
T Package: 8-Pin TO-99	

© 1973, PERRYGRAF Div, Hushua Corp., L.A., Cal. 90064 Printed in U.S.A.

FREE

Pick up a FREE MOS SELECTOR SLIDECHART and dial yourself the broadest MOS line in the industry. On one side, you choose a function (say, an 8k ROM), set the pointer, and read off all the major specs. The reverse side, a cross-reference guide, instantly converts any of 114 "Brand X" devices to the Signetics part number. Makes ordering our MOS as easy as getting and using them.

From Signetics you get everything you want, with no blue sky. Super. So's the slidechart. Send. Get. Quick.

CLIP COUPON TO YOUR LETTERHEAD SAVE TIME & TROUBLE

Signetics/MOS Selector
811 E. Arques Ave., Sunnyvale, Calif. 94086

I deserve to have a FREE MOS SELECTOR SLIDECHART, and I shall use it well and sincerely.

Name	Title
Company	Mail Stop
Address	
City	State
Zip	Phone

Signetics Corporation. A subsidiary of Corning Glass Works.

signetics

Designers compete for that snug electronic bug in a rug

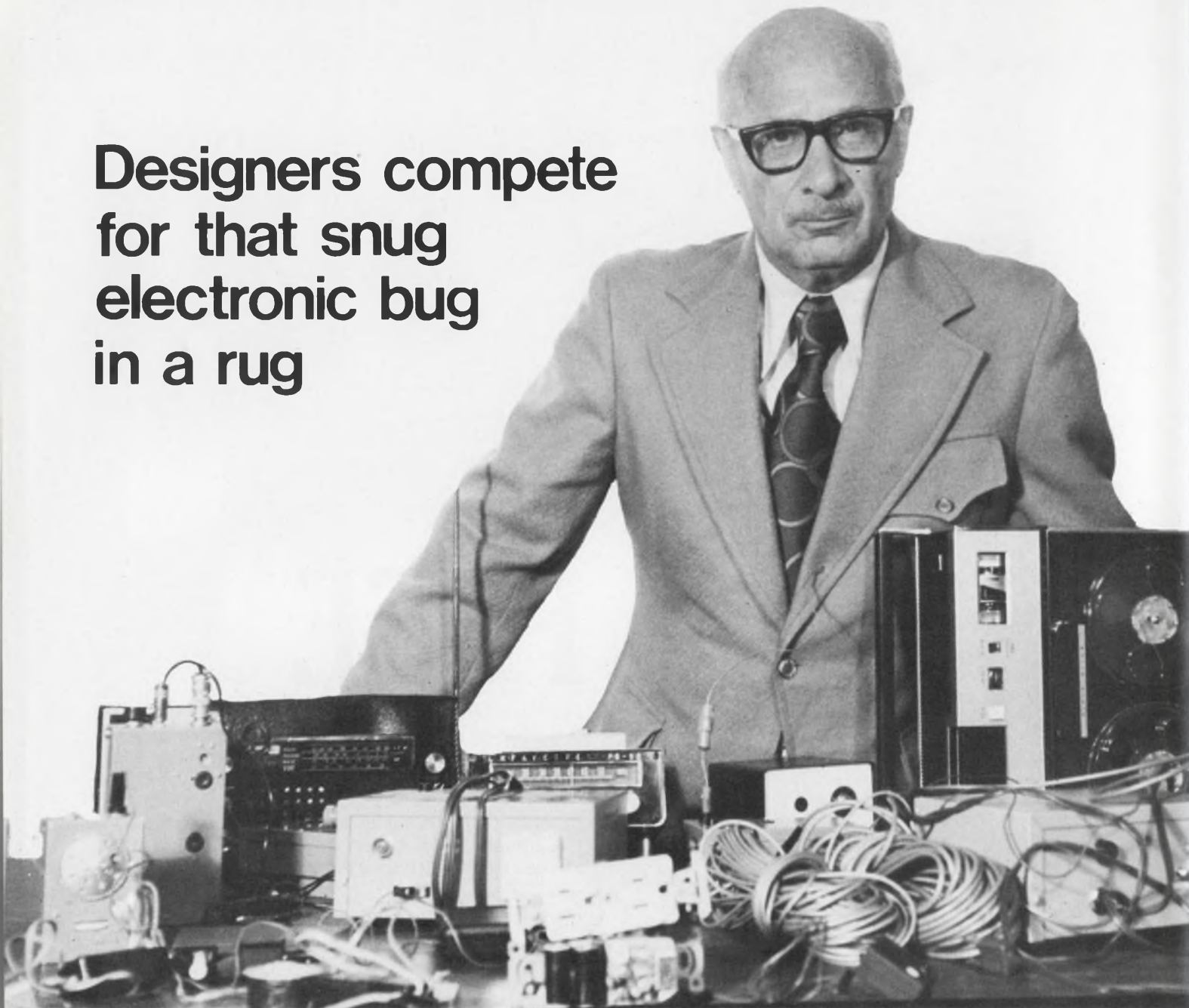

Gene Levette, one of the old-time pros, builds bugging devices in Windsor, Canada, where it's legal, and anti-

bugging equipment in Southfield, Mich., where that's legal. If Canada bans the bug, Levette will move on.

Just how far have we really come, technically speaking, since master bug builder Manny Mittleman stuffed that tiny eavesdropping transmitter inside a plastic martini olive back in 1966?

The toothpick was the antenna, you will recall, and the little transmitter, submerged in two inches of watered-down gin, don't forget, was supposed to broadcast your conversation to a disguised enemy sitting somewhere with a receiver.

The whole thing made a big pub-

John F. Mason
Associate Editor

licity splash. Life Magazine did a cover story on all kinds of eavesdropping devices and personalities, and electronic bugs were soon literally crawling out of the showroom windows on New York's 42nd St., and on its local equivalents across the land. Eavesdropping was suddenly the hottest thing around—hot in the sense that it was popular.

In 1968 it became hot because it was outlawed, and several old pros went to jail.

Passage of the Omnibus Crime and Safe Streets Act in 1968 banned bugging except by law en-

forcement officers with court orders. Who could legally make the devices even for the law was never really cleared up. But people making them exclusively for government agencies were not locked up. But now bugging has emerged once more as a major issue, thanks to Watergate. It's still illegal, but very active. And it has been all along.

What has been achieved as far as the state of the art is concerned?

TV's Mission Impossible has kept us somewhat up to date on advances such as bumper beepers

Do you sometimes wonder if someone's bugging you?

Is there a tiny, concealed microphone somewhere in your life—hidden, perhaps, behind that abstract painting on the conference room wall? It may well be relaying those marginally funny warm-up jokes you usually tell at meetings to an unsmiling, even impatient, audience in a car parked just outside the plant.

And then do those same uninvited guests hear, with considerably more interest, your plans for solving engineering design problems that could make or break the company next year? *Why those plans in the right hands would be worth thousands!*

It's possible that your picture is bugged. Maybe someone did pay thousands—say two thousand—to bug your conference room. Maybe the bugger (you're the buggee) didn't plant the transmitter behind the picture. He could have replaced your electrical wall plug with one of his own that contained a transmitter. The wall plug would work normally—you wouldn't suspect anything—and the transmitter would operate on *your* electrical power.

A lousy trick!

But then that's what industrial bugging is.

You'd better check the phone

Or maybe your telephone is bugged. That's more likely, more the way things are done nowadays. While microphones are still a definite part of the eavesdropping scene, telephones are more popular as vehicles for tuning in on other people's lives.

With the telephone, the bugger and his client don't have to sit in a car down the street listening to a transmission that only travels a quarter of a mile and that might be intercepted by the buggee's own secretary searching for the ball game on her FM transistor radio. They can sit in an office anywhere within the direct dialing system

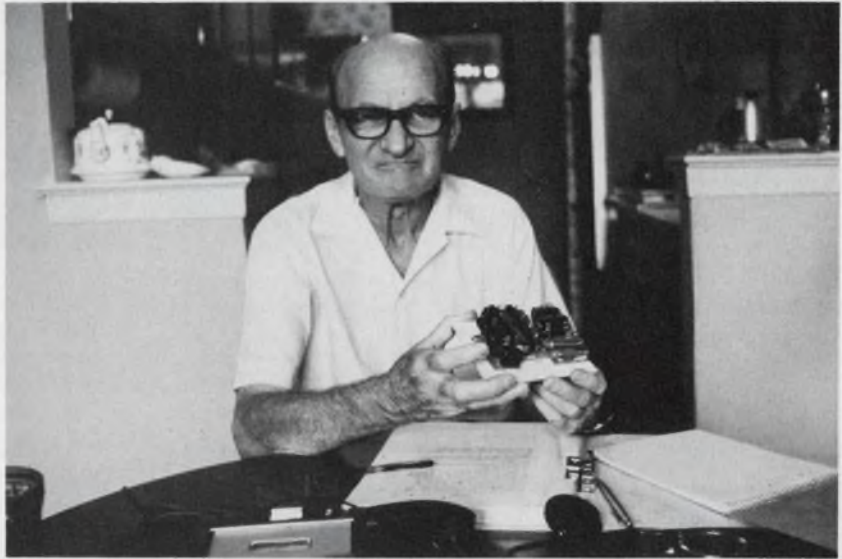

Mickey "Cheesebox" Callahan has built bugging devices for Al Capone, Lucky Luciano and legitimate business. He invented this telephone switching device—originally housed in a cheesebox—to help bookies "lose" the police by transferring the call to an unknown number.

of your telephone and tune in the entire room.

Monday morning paranoia? Not at all. Industrial eavesdropping is booming, rising faster than any other category of illegal surveillance, according to the Chief Assistant District Attorney and head of the Rackets Bureau in Manhattan, New York City, Alfred J. Scotti.

"Bugging has quadrupled since 1966 when bugging expert Manny Mittleman's transistorized olive-in-a-martini transmitter," says Robert M. Brown in a revised edition of his 1967 exposé, "The Electronic Invasion," scheduled to be published by the Hayden Book Co. early next year.

No expert disagrees that bugging is on the rise. "There's more (bugging) going on today than there ever was, and it's for corporations, not for organized crime," says Gerard Michael "Cheesebox" Callahan, whose clients ran the gamut from Al Capone to Lucky Luciano and later to legitimate business.

Callahan earned the name "Cheesebox" for an early invention, still flourishing under other

names, that automatically transfers a call received by one telephone to another one miles away.

But bugging is big, and Watergate has started people thinking about it again. "It has created a new awareness of bugging," Brown will say in his new book. "A lot of people now think they're under some kind of electronic surveillance and want to have their offices or homes swept. Debugging is now big business."

The equipment and techniques used in Watergate, however, were a design disaster—an embarrassment to the bugging community. "An incredibly dumb job," says Gene Levette, one of the country's leading experts on bugging and debugging.

Mickey Callahan gets very emotional when Watergate is brought up—the old fire horse syndrome. "If they'd only hired me to do it," he says sadly. "They didn't even have to break in. They should have tapped the wires downstairs in the bridge box or outside the building, put a tape recorder on it and that would have been it. They were a bunch of stupid....s."

for cars that tell a direction finder where the car is. But what about things like those lasers that use a distant window pane as a sensitive diaphragm to capture the conversation inside a room? Do they exist?

Alfred J. Scotti, Chief Assistant District Attorney and head of New York's Rackets Bureau, says the bureau ran into one such device "a couple of years ago" but he wasn't saying where, whose or anything else about it. A leading laser manufacturer queried on the matter made it clear that eavesdropping wasn't his or his company's bag but that, of course, such a thing could be done. "An infrared laser could be beamed against a window to pick up the window pane's movements caused by the acoustic waves created by people talking inside. Then using another laser beam as a reference you'd get a beat frequency. This could be demodulated to reveal the conversation." This technique, he explains, is used in acoustic holography to measure very small motions.

There are many ways to do it

There are, of course, any number of expensive military devices that everyone knows about that could be used if one had the money: light intensification devices, low-



Tiny drop-in microphone, being held, is an exact copy of the telephone's carbon button, lying on the table. The device uses the telephone's power to transmit a third of a block.

light-level television, infrared binoculars and even people sniffers. But these things are too expensive for anyone but the government.

The real action is still with telephone taps and bugs. And progress has been made with these. Despite claims by surveillance equipment designers that sophistication is not necessary, they have done some interesting things.

Details are hard to extract because many talented designers don't like to talk. Many of them, of course, are making products that are illegal, or marginally so, an aspect that generally dampens the desire for publicity.

And also, competition is fierce. Manufacturers are not only reluc-

tant to discuss new innovations, they usually pot their circuits so competitors will tear them into unreadable pieces if they try to study the secrets inside.

One manufacturer recalls once receiving an urgent order from a mail order house for a debugging device to be delivered as soon as possible. A mail order house doesn't manufacture; it buys from manufacturers and sells by mail for a considerable markup. To comply with the request for speed he decided to forego potting and sent it on. Several months later he ran across a brochure from the company showing a device surprisingly similar to the one he had sold them. He ordered it, under an assumed name, and sure enough it was a fairly good copy of his own design.

Designs have improved

But despite security wraps improvements are known to have been made with bugs and telephone taps. A bug, as you will remember, is a device that consists of a microphone, a transistor and an antenna. Telephone taps are wires or circuits to intercept a telephone conversation or use the telephone to listen in on a conversation in the room.

Over the past few years the telephone has become more popular for

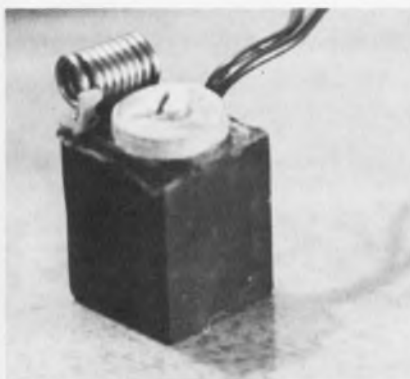

James W. McCord Jr.—an embarrassment to the entire bugging community—shows the Senate Watergate committee his "inept" techniques for eavesdropping the telephone conversations of the Democratic committee. The transmitter, which is similar to the one shown above, is a parasitic unit; it operates at 107 MHz with an output so low it took McCord two days to find the signal from across the street.



12 ways to tap a telephone

To record a conversation a tape recorder is activated by the normal voltage drop that takes place when a telephone receiver is lifted off its hook. The drop from 48 V to between 6 and 9 V (1) activates a relay which turns the tape recorder on. The recorder is connected to the telephone either inductively or directly.

An important component to this tap, not shown in the diagram, is supplied in equipment built in Windsor, Canada, by the Research Electronics Co. A filter is included to clear up any extraneous noise on the line. Noise comes from a frayed line, from lightning or a bad transformer—factors that have nothing to do with a phone's being tapped. But if the bug-gees get suspicious—even for the wrong reasons—the whole operation could fail. To avoid this, clearing filters are used.

Another tap, shown in the diagram (2) is a series-connected transmitting bug, which draws its power from the telephone line. It transmits both sides of a conversation when the phone is off the hook. The advantage of this kind of tap is that once the bug has been installed physical access to the telephone line is not necessary again. The bug is placed anywhere along the line from the handset to the central office.

A parallel-connected transmitter (3) may be used in conjunction with a battery. Since this device is isolated from the

telephone lines by a capacitor it doesn't disturb the electrical parameters of the line. A disadvantage, however, is that it must transmit continuously, which, of course, shortens the battery life. It, too, can be connected anywhere along the line.

Another technique used to bug telephones is rf flooding (4). What it amounts to is flooding the telephone with high level rf signals and retrieving the signals which have been modulated by the carbon microphone.

Tuning in on the room

The famous infinity transmitter, also known as the harmonica bug, can be inserted into the telephone at either of two points, (5) or (10). When the bugger wishes to listen to your room conversation he dials your number, then blows on a harmonica or pitch pipe before your phone rings. The high tone prevents the ring as well as activates the room microphone.

Refinements have outmoded the harmonica in some cases. Now circuits are activated by a signal from a small electronic tone generator.

The ringer coils in some telephones (6) are used to pick up audio in a room. These coils transmit voice signals over the lines to a high-gain, low-noise audio amplifier.

There are a number of ways to rewire the telephone by us-

ing a good amplifier somewhere between the central office and the telephone that will enable a listener to pick up a room conversation while the phone is on the hook. He can short one side of the hookswitch and:

- Put a resistor (7) across the other hookswitch so that a small amount of current will trickle through the carbon microphone.

- Use a capacitor (8) across the second hookswitch and rewire the receiver. Now the room audio will be available on the line.

- Place a neon bulb (9) across the second hookswitch. A high voltage pulse of about 100 V will now defeat the hookswitch.

- Use an infinity transmitter as either the receiving or transmitting element in the handset as the microphone. Or a small separate microphone may be hidden inside the phone instrument.

An inductive tap (11), probably the most commonly used technique, involves placing a flat coil or suction-cup mounted coil next to the network. Since the network has coils inside it, a magnetic field containing the conversation may be sampled by inductive coupling.

A cheap, quick and effective way to tap a phone is the drop-in transmitter (12). The mouthpiece is unscrewed, the original carbon mike removed and the transmitter dropped in.

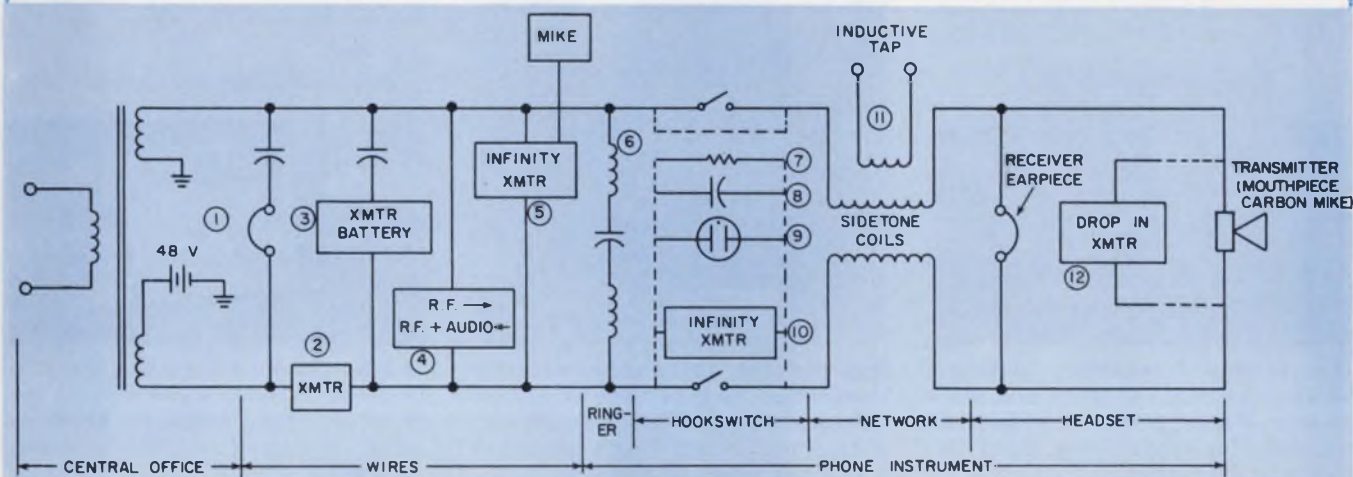

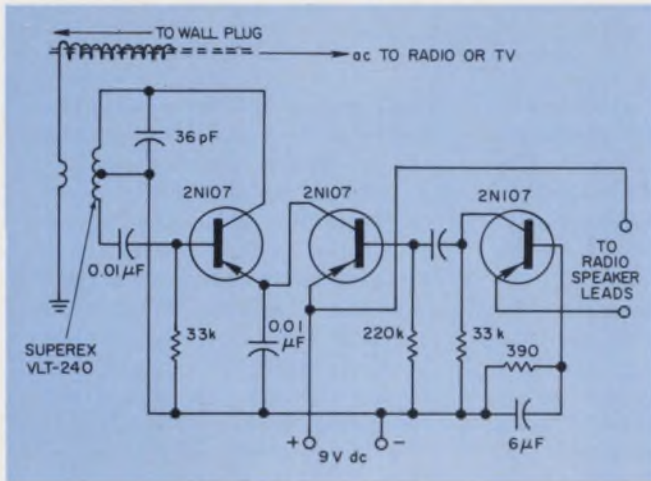

By using the speaker as a microphone and the ac power line as an antenna, an AM radio can be converted into a bug that picks up room conversation.

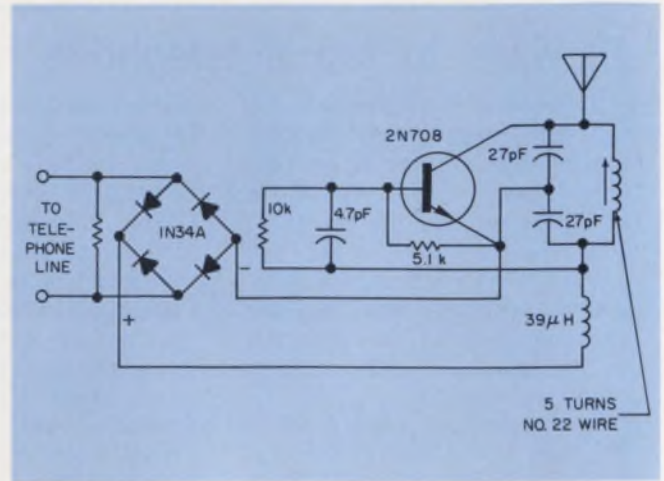

A series-connected bug draws its power from the telephone line and transmits both sides of the conversation. The bug can be installed anywhere on the line.

eavesdropping than the bug. The ways it can be used depend on the ingenuity of the expert who wants to move into someone's conference room or private life.

For starters, 12 basic ways to tap a phone are described in the box on page 25 with a circuit diagram and description prepared by the Communication Control Corp. of New York, a maker of antibugging devices.

But when there are no phones bugs are used. They're very handy for conference rooms, cars and concealed under lapels. They're all transistorized these days and some even use ICs, although for the most part, "we still don't need all that sophistication," says Gene Levette, who builds bugging devices in Windsor, Canada, where it's

legal, and antibugging equipment in Southfield, Mich., where that's legal. Levette also provides a sweeping, or debugging, service to corporations and individuals. The company name in both Canada and the U.S. is the same, Research Electronics. If bugging is ever banned in Canada, Levette says he will set up shop where it is permitted.

The aircraft band is safe

The frequencies used are relatively fixed. Most bugs transmit in the FM band, just below or above the standard commercial broadcast frequencies—below 88 MHz or above 108 MHz. The devices built by Levette operate in the aircraft band between

109 and 114 MHz. The only frequency to avoid is 113 MHz which is used by aircraft for landing in bad weather.

Levette sells four different transmitters ranging in power from 99 milliwatts to a 2-W device. If they're used in a room to pick up sound, they're hooked into a microphone. If they're to broadcast a telephone conversation they're attached to the telephone line.

And if they're to tail an automobile, the transmitter is packaged with two 14-pound magnets which can be slapped onto the car's gas tank. This is called a Bumper Beeper and can be followed by a direction finding receiver.

The bugs now available are either untuned or they are crystal-controlled. The ones with crystals are much larger and cost four times as much. Their advantage, of course, is that they don't drift. They are used, however, when they can be concealed—"maybe under a big coat."

Bug designers are looking for-



Tiny wiretap transmitter, built by Mickey Callahan, is about one inch square. Planted in a telephone, it transmits the conversation about six blocks at 88.5 MHz.

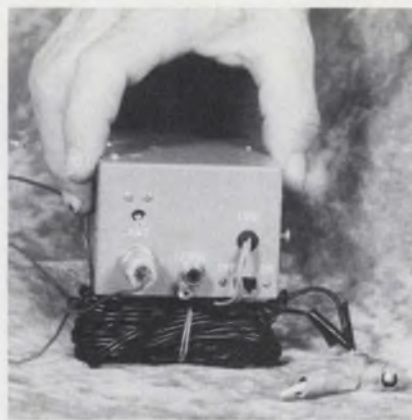

High-powered telephone wiretap transmitter, built by Gene Levette in Canada, has a 2-W power output and a two-mile range. Filters eliminate suspicious noise.



Tele-Watchman, a burglar alarm sold by Gene Levette, is similar to the harmonica bug. When the phone is dialed, it doesn't ring but activates a room transmitter.

Pease Talks.

Wonderful World of V/F's.

Voltage to frequency converters are not new. You could always buy a good V/F converter in a big, rack-sized module. In fact, H-P and others made huge, monstrous things that cost a thousand dollars each. And they featured pretty good performance, considering.

Nowadays, we're talking about modern, small, reliable hybrid modules that don't cost you an arm and a leg. And don't need half-a-house worth of power to run. Say ± 15 volts at a dozen or so mA. With the kind of linearity, 0.01%, and ultra-low TC you used to have to buy racks-worth for.

Why build it if you can't fly it?

Sure you could construct your own V/F converter. But the garden variety are usually pretty crummy. It's hard to get better than 1% linearity. And you just can't make a good V/F easily using the circuits you find in magazines today.

On the other hand, by putting together non-state-of-the-art components in a tricky circuit, we regularly succeed in producing a state-of-the-art V/F converter.

So I guess the big reason for buying and not doing it yourself is that you get more experience, more development, more of everything that makes it work. And less of the guesswork.

The one and only.

Our competitors in the V/F and F/V area are few and far between. A couple of guys offer one, maybe two versions of V/F converters. But linearity is not one of their strongest features. And that's being charitable.

We have a standard line and we've been making a lot of specials, too. And some of the specials we're trying to trade up to standards. Like micropower ones and ultra-low TC ones and all the way up to 10MHz and weird stuff like that.

We've got the 4701—a 0 to 10kHz V/F, the 4703—a 100kHz V/F, and the big gun—the 4705—a 1MHz V/F. Once we mastered the V/F, the other side of the coin—the F/V—was easy. So we've got the 4702 10kHz and the 4704 100kHz F/V.

Robert A. Pease, Sr. Engineer



We use a precision charge dispensing technique. Which means if you dump a certain value of charge from a capacitor, $Q = CV$, the frequency at which you do this determines the current and the amplifier sort of integrates this value and circles around the loop until you get the correct frequency. It's easy in theory, tricky in execution. Another standard approach is $Q = IT$ which is a little more difficult and not nearly as good.

After you've got it what are you going to do with it?

We've got loads of standard applications literature on V/F and F/V use. In such areas as telemetry, tachometry, A/D converters, common-mode isolation, integration and how you can offset them or shift the full scale value or filter things. And how to work with different frequencies.

We discovered that several of our customers are using them in pollution monitoring where essentially you have to integrate for a long time without drift.

There are some people in photospectrometry who integrate the area under a curve.

Voltage to frequency conversion and vice versa has been in use a long time. Our Teledyne Philbrick V/F Converters make it easier and less tricky to use V/F conversion in a lot of new ways.

Don't be afraid, ask us.

If V/F or F/V sounds like it may answer your problem. Or if you don't know you have a problem, you really ought to get our Application Notes and spec sheets anyway. Just give us a call toll-free at (800) 225-7883, in Massachusetts (617) 329-1600 or write us. Dedham, Massachusetts 02026 We make your problems disappear.

 **TELEDYNE
PHILBRICK**

INFORMATION RETRIEVAL NUMBER 16



The **Snooper**, built by Gene Levette, is small enough (3-1/2-inches high) to be easily hidden. It transmits between 85 and 108 MHz for 1/4 mile. Its 9-V battery lasts 60 hours.



FM transmitter, high-powered and battery-operated, has a fountain-pen microphone, to be worn in the breast pocket. The antenna can be wrapped around the wearer's neck.

ward to the emergence of miniaturized crystals. "With such devices we would definitely go to drift-free, crystal-controlled bugs," Levette says.

Some bugs use batteries, which last anywhere from 24 to 60 hours, while others are parasites, using the buggee's own 110-V current. If batteries have to be used and the listening room is difficult to enter, a microphone, even a hearing aid, can be planted in the room and wired to a battery outside in a more accessible place.

Receivers are not a big problem. Commercial receivers are often bought from discount stores and modified. "We buy Lafayette's very sensitive PB-50 low-band, mobile police radio, which operates between 30 and 50 MHz. By adding a converter and crystal control we can kick it up to the low end of the aircraft band, 108 to 135 MHz, where it works well with our transmitters," Levette says.

To detect hidden transmitters the antibugging expert uses an rf detector that is untuned. It picks up signals transmitted anywhere

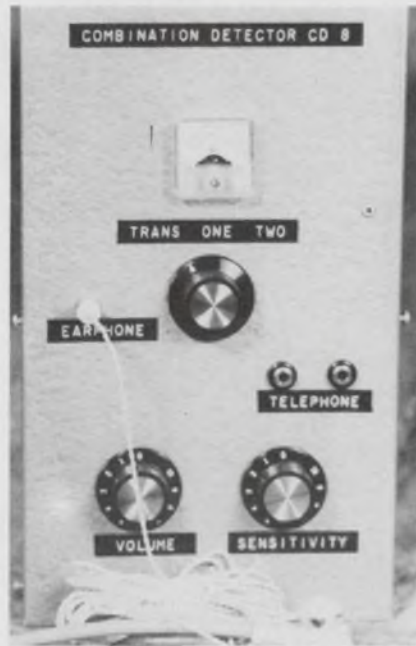

Debugging device is an untuned rf receiver that picks up signals between 1.75 and 900 MHz. When the receiver squeals, it has picked up a hidden, active transmitter.

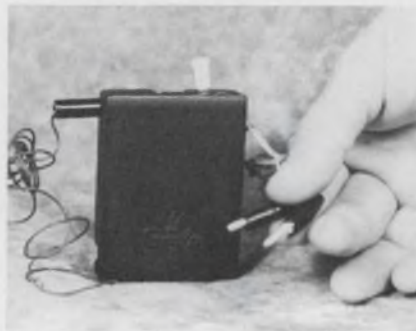

Medium-powered transmitter wire-tap, built with ICs, is planted in a telephone's base, draws power from the telephone company's line—though not enough to call attention to its presence—and transmits a conversation up to a mile.

between 1.75 and 900 MHz. "To sweep a room you extend the telescope antenna of the detector, or receiver, just like that of a transistor radio, and move with it around the suspected area," Levette says. "When the detector begins to squeal you start collapsing the antenna slowly so that it loses sensitivity, causing you to close in on the transmitter. When you're on top of it you start tearing down whatever lies between you and the bug—the wall, ceiling or whatever," Levette says.

A good sweep also includes searching the room with a metal

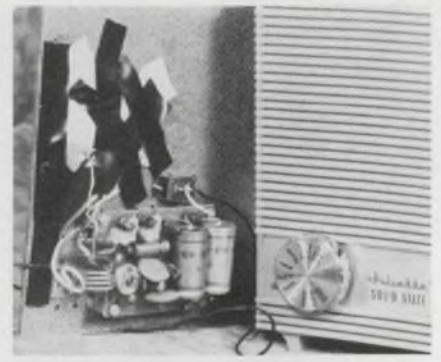

The quality of this radio will be so poor you'll soon stop using it, even though it's a gift. Good! That's when the hidden transmitter (left) can operate, loud and clear.



Small, wearable FM transmitter measures 1-1/4 by 2 by 1/2 inches. It operates on 0.5-W power for 1/4 mile. The battery lasts seven days. It's built by Gene Levette.

detector as well as an rf receiver. "If the transmitters are temporarily off and you give the room a clean bill of health, you look pretty foolish when the bug goes on just before the conference begins," Levette says.

Onward and upward

Design improvements in bugging devices have not been dramatic but progress has been made. The devices are generally smaller than they were. They are more reliable, less breakable and more powerful.

The rf power transistor, for example, has been an important element in new design. It has a resistance in the emitter that makes it burn-out proof in case of antenna mismatch. And with lower voltages no heat sinks are required. Also, with more powerful transistors available now fewer have to be used and the finished product is therefore smaller.

Other new developments under way by the bugging community include receivers that are built with FET transistors in the front

How to get stronger, more reliable flat-cable connections...fast.

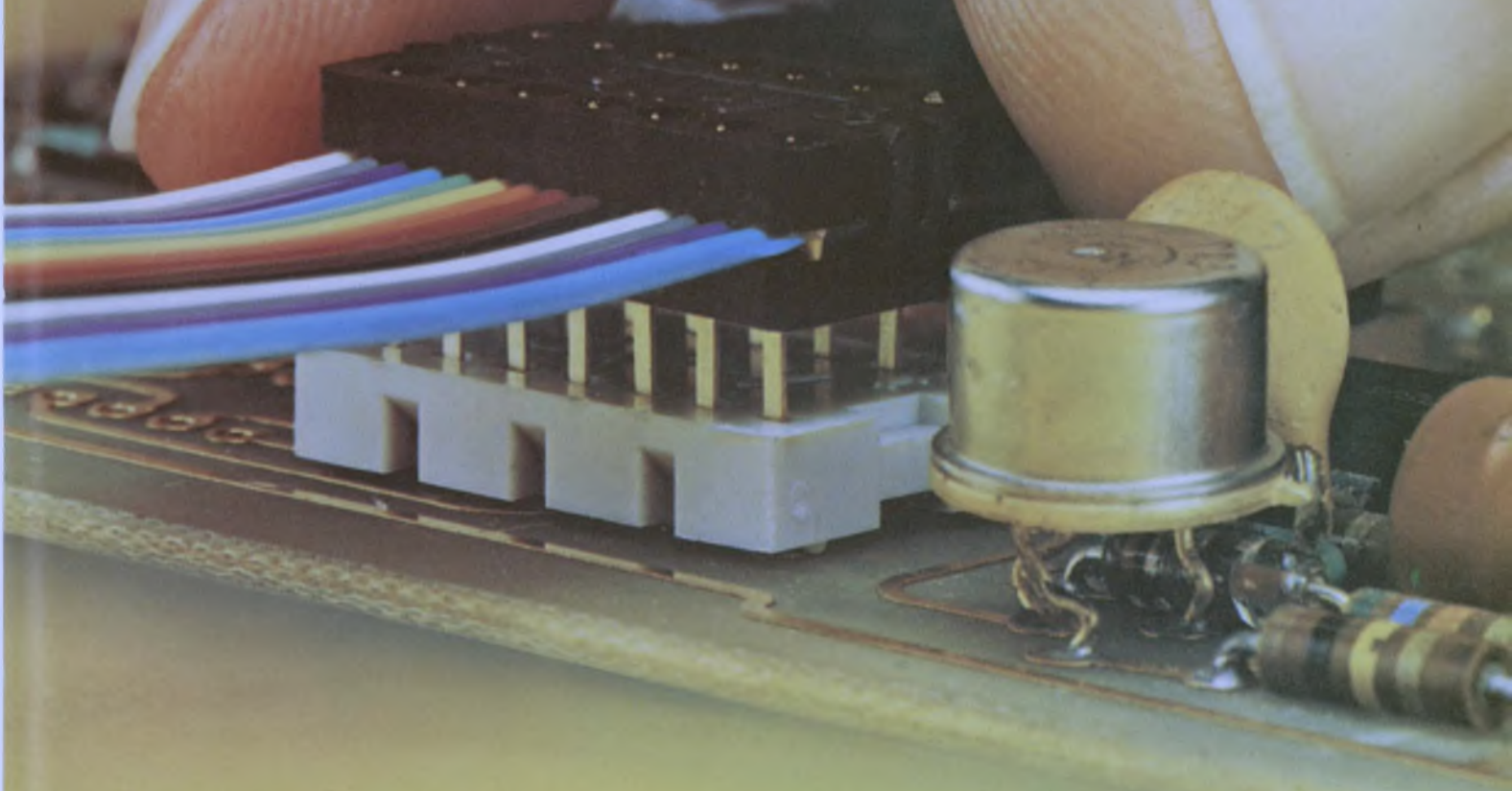

Use the new AMP Latch connector. It lets you terminate all leads on multiconductor flat cable simultaneously. Without prestripping or soldering.

Inspection is simple, whether of individual contacts through special ports, or of the termination itself before the cover is applied. So you can see that each fork-type contact is locked into the cover, ensuring maximum pressure at point of contact.



These foldover forks make contact with conductors at four points—not just two—to provide true redundancy. The cover also locks to both sides of the connector housing with



Dual camming and latching ears on AMP contacts provide 4-point contact and grip for each conductor.

auxiliary plastic latches. AMP Latch connectors will not bow or warp. And, a strain-relief detent in the cover eliminates the need for accessory hardware in most applications.

An inexpensive hand press lets you terminate AMP Latch connectors in seconds—to round-conductor flat cable, ribbon cable, woven cable... even two discrete wires. You can interconnect to pc board spring sockets, DIP headers, or directly to the board itself... wherever you want to interface on high-density, .100-inch centers.

See it for yourself.

Try it for yourself. Ask your AMP representative for an in-plant demonstration. Or write for Latch connector literature to AMP Incorporated, Harrisburg, Pa. 17105.

AMP INCORPORATED

AMP is a trademark of AMP Incorporated.

INFORMATION RETRIEVAL NUMBER 17

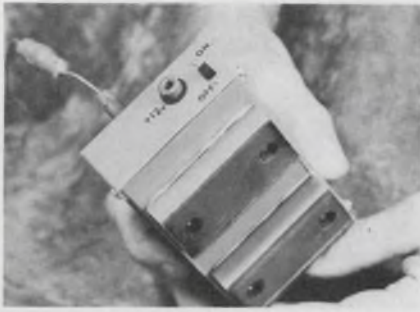

Bumper beeper is built with two 14-pound magnets, which stick to the gas tank of a car to be tailed. A direction finder can pick up the beeper's 100-cycle signals.

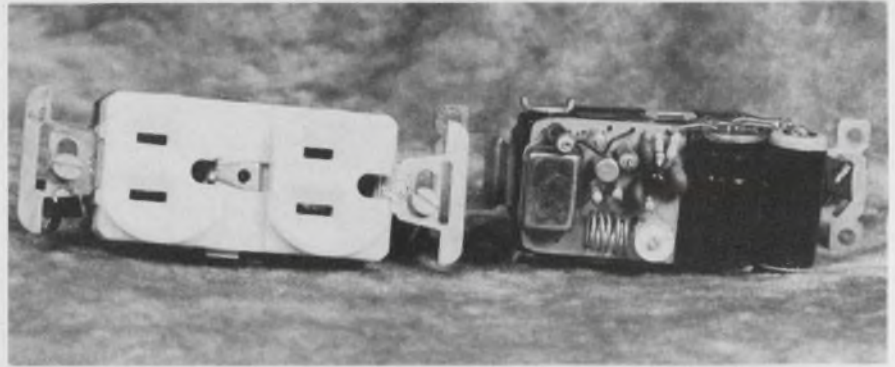

The bug in the plug pulls juice from the wall plug it's slipped into, and it will transmit indefinitely all room conversations to a receiver 800 feet away. The unit can still be used as an electric plug while transmitting.

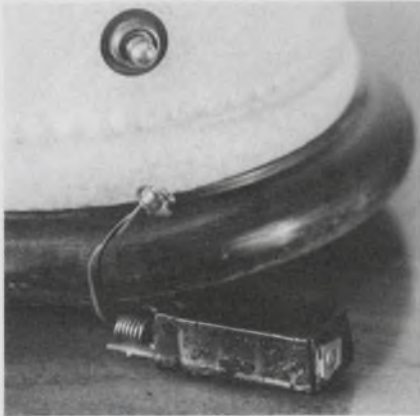

Room bug can be hidden almost anywhere, picking up voices 30 feet away. It broadcasts over an adjustable frequency for one or two blocks for up to three days.

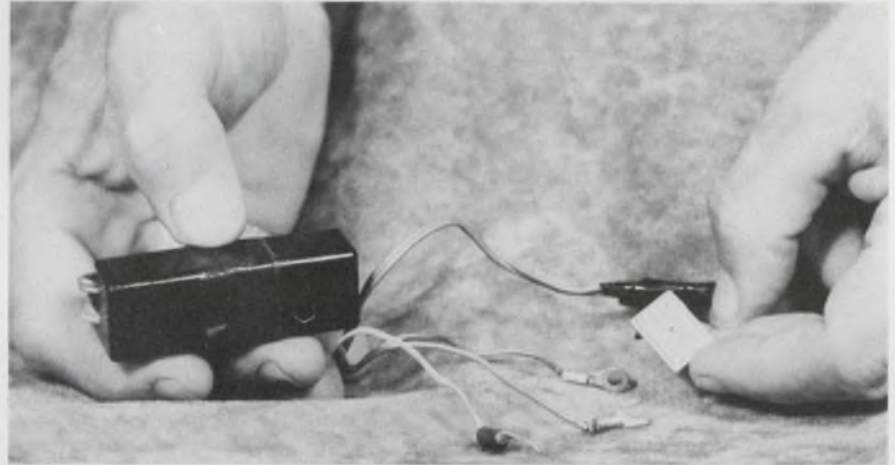

Three-wire bug can be placed in a telephone base and transmit both room and telephone conversations up to 800 feet under good conditions. It measures 2-1/2 by 1/2 by 1/2 inches and can be installed in five minutes.

end and with MOS semiconductors. Some of the equipment uses ceramic filters in i-f stages and ICs in the audio and limiting sections. "We have ICs smaller than a dime that house a complete transmitter—audio section, modulation, everything," Levette says. "All that's needed is a miniaturized crystal. When we have this we will go to crystal control.

"Soon, we'll be moving a lot of our equipment to uhf," Levette says. "Why? Because the band is less crowded. We can't do it yet, because we don't have receivers. Also, the antennas are going to have to be very small."

Like everyone else, bug makers have joined that ever growing club that wants smaller, more powerful batteries but can't get them.

One of Levette's transmitters, already very small, is going to be even smaller in time—"small enough to be worn comfortably in the lining of a coat." How? The

coil used conventionally to determine frequency band no longer has to be perpendicular to the unit's base and thus take up an entire half-inch of bulky, eye-catching space. It can now be built on a printed circuit board.

Who makes all those bugs?

Where do they all come from, those little transmitters and taps? Thin air, according to most reliable sources. Japan? Junk! Europe? Junk! Canada? Yes, very good stuff. The best, however, are made in the U.S. By whom? This is not so easily discovered.

It is always custom built, designed, fabricated and installed on a made-to-order basis. This is where the money is, the experts agree. And, of course, these are the orders no one will discuss. They go to government agencies and to individuals being tailed by government agencies.

Then there are the fast-buck, mail-order houses which buy from the pros, either in the U.S. or in Canada. Some of these also buy from electronics discount houses and modify the equipment enough to call it their own and double the price.

Another source, according to Alfred J. Scotti, Chief Assistant District Attorney and head of the Rackets Bureau in Manhattan, New York City, is the manufacturer of harmless devices, such as guitar amplifiers, which can be used for eavesdropping devices.

And then there are the young electronics engineers who build bugging devices for fun and profit. This group even includes the bright high school student who'd rather build his own infinity bug than assemble a color TV. And with components themselves so easy to buy—there's nothing sinister in itself about a transistor—it doesn't look like bugging is about to go away. ■■

PRICED TO FIT YOUR WALLET

BOURNS LOW COST FAMILY

OF INDUSTRIAL TRIMPOT® POTENTIOMETERS

POWER: ½ WATT (OR BETTER) AT 70°C

TEMPCO: CERMET— AS LOW AS 100 PPM/°C
WIREWOUND — AS LOW AS 70 PPM/°C

TEMPERATURE RANGE: -55° UP TO +150°C

Join the growing population of industrial equipment designers who have discovered that *Bourns quality has never cost so little.*

Bourns LOW-COST FAMILY of industrial TRIMPOT® potentiometers was designed specifically to give cost-conscious industrial electronics equipment manufacturers superior product quality and performance . . . AT LOWER PRICES.

We invite you to compare price and specs on Bourns LOW COST FAMILY models with those of our prime competitors.

AVAILABILITY

The Cermet and Wirewound models shown are stocked in-depth . . . RIGHT NOW, so delivery is off-the-shelf from your local Bourns distributor or factory-direct.

Complete data, price and delivery details on all LOW-COST FAMILY models is available upon request. Just write, or call, your local Bourns Sales Office, representative, or distributor.

BOURNS, INC., TRIMPOT PRODUCTS DIVISION • 1200 COLUMBIA AVENUE, RIVERSIDE, CALIFORNIA 92507

INFORMATION RETRIEVAL NUMBER 18

ELECTRONIC DESIGN 20, September 27, 1973



AVAILABLE FOR IMMEDIATE DELIVERY
FROM YOUR LOCAL BOURNS DISTRIBUTOR



Oak presents a short course in keyboard switch selection you can't afford to miss.

Our course could be called "Basic Economics in Keyboard Switch Design." It sums up more than 40 years of leadership in switch design and manufacture at Oak. Take a look at our course:



At the top: the Oak Series 400 Standard Keyboard Switch. It's what you're looking for if you want economy plus reliability. Millions are in use today in every kind of keyboard application.

And our Series 475 Compact Keyboard Switches (bottom) are about the shortest premium quality units you can buy. And, like the Series 400, they're ultra-reliable and economical.



We make so many types and sizes, you can specify Oak across the keyboard. Call on us for complete assemblies to your specifications or standard keypads. The most frequently used 10, 12 or 16 button arrays are stocked in quantity by Oak distributors.



Next subject: Oak Series 415 Low-Profile Keyboard Switches designed for calculators, security devices and data entry equipment. Note the streamlined silhouette. Select colors, custom caps and legends, $\frac{1}{2}$ " or $\frac{3}{4}$ ", single and double keys to fit your needs exactly.



We can say that because our automated manufacturing and test equipment ensures quality. And we design our keyboard switches with the operator feel, reliability, and economy it takes for such applications as data terminals, calculators, business machines, and more.

That's it. Just be sure to follow up on what you've learned. Write for Oak Keyboard Bulletins.

Class dismissed.

OAK Industries Inc.

SWITCH DIVISION / CRYSTAL LAKE, ILLINOIS 60014
TELEPHONE: 815-459-5000 ■ TWX: 910-834-3353 ■ TELEX: 72-2447

Remove the Oak Keyboard Switch insert that follows for your files. If insert is missing, circle Information Retrieval No. 19 for a personal copy.

Who to call for fast delivery on Oak Keyboard Switches



Oak Series 400 and Series 415 Keyboard Switches are available from a distributor near you. He'll supply your desired quantities and ship standard 10, 12 and 16-button keypads as well. It's the way to get Oak quality switches fast!

DEMAMBRO ELECTRONICS
MASSACHUSETTS, Boston.....(617) 787-1200

DRW
MASSACHUSETTS, Watertown.....(617) 923-1900
NEW YORK, Farmingdale.....(516) 249-2660

EDMAR ELECTRONICS
ILLINOIS, DesPlaines.....(312) 298-8580

FEDERATED PURCHASER
NEW JERSEY, Springfield.....(201) 376-8900

GRAHAM ELECTRONICS
INDIANA, Indianapolis.....(317) 634-8486

G. S. MARSHALL
ALL BRANCH LOCATIONS

HALL-MARK
ALL BRANCH LOCATIONS

HERBACH & RADEMAN
PENNSYLVANIA, Philadelphia.....(215) 426-1700

INDUSTRIAL COMPONENTS
MINNESOTA, Minneapolis.....(612) 831-2666

INTERFACE ELECTRONICS
WASHINGTON, Seattle.....(206) 285-3500

MILGRAY/WASHINGTON
MARYLAND, Hyattsville.....(301) 864-1111

OHM/ELECTRONICS
ILLINOIS, Palatine.....(312) 359-5500

RADAR ELECTRIC CO.
WASHINGTON, Seattle.....(206) 282-2511

R. V. WEATHERFORD CO.
CALIFORNIA, Glendale.....(213) 849-3451
CALIFORNIA, Palo Alto.....(415) 493-5373

SCHOMBURG SALES
NEW YORK, Rochester.....(716) 244-0920

SOLID STATE ELECTRONICS
TEXAS, Dallas.....(214) 352-2601

OAK Industries Inc.
SWITCH DIVISION / CRYSTAL LAKE, ILLINOIS 60014

Remote radar system raises harbor safety

A new high-resolution, remotely operated radar system, custom-designed for harbor surveillance, is giving mariners in San Francisco Bay added protection from collisions and groundings.

The shore-based, long-range system, called the Vessel Traffic System Radar, is reported to offer a number of improvements over the modified shipboard radars previously used for this work. It provides:

- Uniform illumination of the harbor.
- Antenna beamwidth that is less than half that of ship radars.
- A 50-ns pulse, permitting separation of targets as close together as 30 feet.
- A choice of antenna polarizations to match sea and weather conditions.

There are two radar sites in the San Francisco installation, which was developed under Coast Guard contract and built by the AIL Div. of Cutler-Hammer, Deer Park, N.Y. One, at a traffic center on Yerba Buena Island, covers the harbor; the other, 12 miles away at Point Bonita, covers the seaward approach to the harbor.

Both radars are identical, except for antenna polarization, and are operated unattended. They are controlled and monitored from a display-console setup on Yerba Buena Island. The Point Bonita installation provides video, bearing and triggering information to the consoles via a C-band microwave link while the radar is controlled via a uhf link.

The Point Bonita antenna is on a 60-foot tower, 330 feet above sea level, while the antenna on Yerba Buena is on a 90-foot tower, 415 feet above sea level. The seaward radar uses vertical polarization to match the long, rolling swells of the open waters, while the harbor

radar uses horizontal polarization to match the choppy swells of the confined area. Both antennas can be switched to circular polarization for maximum penetration of clutter during rain. Both antennas are 25 feet wide, have a beamwidth of 0.3 degree and rotate at 20 rpm.

The characteristics of the radar transmitters include:

- Frequency—9.3 to 9.5 GHz (spot).
- Output power—50 to 75 kW.
- Pulsewidth—50 or 200 ns.
- PRF—1000, 2500, 4000 PPS.

The receivers have these characteristics:

- Noise figure—7 dB maximum.
- Bandwidth—22 or 10 MHz.
- Response—logarithmic.

In the operations center there are five console positions, four of which are manned and can be switched to either of the two radars. The fifth console is currently unmanned and equipped with a movie camera, which photographs the pictures from the two radars. This permits later study of traffic patterns and possible legal protection in case of litigation arising from accidents.

Each console has a 16-inch round CRT that has 1000-line resolution and a selectable scale of 2, 4, 6, 8, or 16 nautical miles. Electronic cursors and leading lines may be added to the display to help establish traffic lanes and to ensure accurate determination of vessel headings and distances.

System dependability is assured by redundancy for the key elements, except for the antennas.

The system depends on the voluntary compliance of vessel captains with the advice supplied from the operations center. The radar operators can advise of the established traffic lanes and movement patterns but it is up to the captain to follow the advice. ■■

EITHER OF OURS WILL COVER FIVE OF THEIRS.

5 volt powered, 5 ranges—from 20mV through 200V full scale, the Model 253 changes ranges almost as fast as you can change your mind. Without rewiring. More OEM delights: the 253 comes standard with BCD output, 200-volt overload protection, autopolarity, and big, bright LED digits. All of this fits into a neat, small ANSI cutout, 3.32" x 1.14".

And if you want line power, it's optional. Ratio, too.

Our 256 is the 253 with 1/2" Sperry readout and character serial BCD output. Saves a few bucks.

Both models are covered by a strong warranty that guarantees these DPM's even if you've peeked inside to see how cunningly everything's packaged.

Prices are \$95 for the 253 in OEM quantities, and less for the 256. For complete details on the 5V DPM's that do everything an OEM wants, call John Welte collect at (714) 540-4914. Or write Newport Laboratories, Inc., 630 East Young Street, Santa Ana, California 92705.

NEWPORT



IN EUROPE: Newport Laboratories B.V., P.O. Box 7759, Schiphol—O, Holland, Tel: 020-45-20-52

INFORMATION RETRIEVAL NUMBER 21

DECODERS/DEMULPLEXERS

SN54LS/74LS138
3-line-to-8-line
decoder/demultiplexer
SN54LS/74LS139
Dual 2-line-to-4-line
decoder/demultiplexer
SN54LS/74LS155
Dual 2-line-to-4-line
decoder/demultiplexer

ARITHMETIC ELEMENTS

SN54LS/74LS83 4-bit full adder
SN54LS/74LS86 Quadruple exclusive-OR gate
SN54LS/74LS136 Quadruple exclusive-OR-Gate
(with open collector output)
SN54LS/74LS181 Arithmetic logic unit/function
generator
SN54LS/74LS266 Quadruple exclusive-NOR Gate
open-collector

COUNTERS

SN54LS/74LS190 4-bit up/down decade counter
(with down/up control)
SN54LS/74LS191 4-bit up/down binary counter
(with down/up control)
SN54LS/74LS192 4-bit up/down decade counter
(dual clock with clear)
SN54LS/74LS193 4-bit up/down binary counter
(dual clock with clear)
SN54LS/74LS196 4-bit decade counter ($\div 10$)
SN54LS/74LS197 4-bit binary counter ($\div 16$)

DATA SELECTORS/ MULTIPLEXERS

SN54LS/74LS151
8-input data selector/
multiplexer (with strobe & comp)
SN54LS/74LS152
8-input data selector/
multiplexer
SN54LS/74LS153
Dual 4-line-to-1-line data
selector/multiplexer
SN54LS/74LS251
Three-state version of
SN54LS/74LS151
SN54LS/74LS253
Three-state version of
SN54LS/74LS153

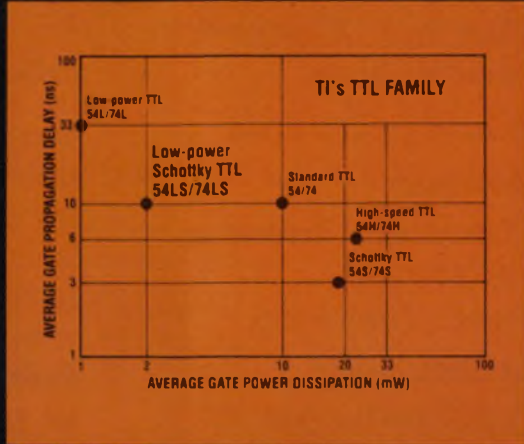

NAND/NOR/AND/OR/GATES, INVERTERS, BUFFERS

SN54LS/74LS00 Quad-2 input NAND gate
SN54LS/74LS01 Quad-2 input NAND gate (with open-
collector output)
SN54LS/74LS02 Quad-2 NOR gate
SN54LS/74LS03 Quad-2 input NAND gate (with open-
collector output)
SN54LS/74LS04 Hex inverter
SN54LS/74LS05 Hex inverter (with open-collector
output)
SN54LS/74LS08 Quad-2 input AND gate
SN54LS/74LS09 Quad-2 input AND gate (with open-
collector output)
SN54LS/74LS10 Triple-3 input NAND gate
SN54LS/74LS11 Triple-3 input AND gate
SN54LS/74LS15 Triple-3 input AND gate (with open-
collector output)
SN54LS/74LS20 Dual-4 input NAND gate
SN54LS/74LS21 Dual-4 input AND gate
SN54LS/74LS22 Dual-4 input NAND gate (with open-
collector output)
SN54LS/74LS26 Quad-2 input hi-voltage interface
SN54LS/74LS27 Triple-3 input NOR gate
SN54LS/74LS28 Quad-2 input NOR buffer
SN54LS/74LS30 Single-8 input NAND gate
SN54LS/74LS32 Quad-2 input OR gate
SN54LS/74LS33 Quad-2 input NOR buffer (with open-
collector output)
SN54LS/74LS37 Quad-2 input NAND buffer
SN54LS/74LS38 Quad-2 input NAND buffer (with open-
collector output)
SN54LS/74LS40 Dual-4 input NAND buffer
SN54LS/74LS51 Dual 2 wide 2 input AND-OR-invert gate
SN54LS/74LS54 4 wide 3-2-2-3 AND-OR-invert gate
SN54LS/74LS55 2 wide 4 input AND-OR-invert gate

SHIFT REGISTERS

SN54LS/74LS95A
4-bit right-shift left-shift
register (PI-PO)
SN54LS/74LS194
4-bit bidirectional universal
shift register (PI-PO)
SN54LS/74LS195
4-bit parallel-access shift
register (PI-PO)
SN54LS/74LS295
Three-state version of
SN54LS/74LS95AN

DUAL FLIP-FLOPS

SN54LS/74LS73 JK F/F with clear
SN54LS/74LS74 D F/F
SN54LS/74LS76 JK F/F with preset & clear
SN54LS/74LS78 JK F/F with common clock
& clear
SN54LS/74LS107 JK F/F with clear
SN54LS/74LS109 JK F/F with preset & clear
SN54LS/74LS112 JK F/F negative edge triggered
with preset & clear
SN54LS/74LS113 JK F/F negative edge triggered
with preset
SN54LS/74LS114 JK F/F negative edge triggered
with common clock & clear

LATCHES

SN54LS/74LS174 Hex D-type flip-flop with clear
(no complement)
SN54LS/74LS175 Quadruple D-type flip-flop with
clear



SCHOTTKY

Functions in abundance.

Design at $< 2\text{mW}$ per gate and 10 ns speeds
...with **low-power Schottky**.

Low-power Schottky offers new system designers four outstanding benefits: Speed. Low power. Full TTL Compatibility. And fast off-the-shelf delivery.

Sixty functions are available now – and 25 more MSIs will be ready before the year ends.

Low-power Schottky has the

best speed/power relationship in the TTL family, reducing power requirements as much as 80%. Also, high stability over a broad range of temperatures qualifies the functions for military applications.

All 60 low-power Schottky 74LS functions are pin compat-

ible with 7400 Series. In fact, low-power Schottky can drive up to five TTL 7400 Series loads.

For data sheets, please indicate by type number and write: Texas Instruments Incorporated, P. O. Box 5012, M/S 308, Dallas, Texas 75222.

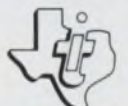

TEXAS INSTRUMENTS
INCORPORATED

SAVE TIME...

locating sources of supply, make better buying decisions with **MICROWAVES' PRODUCT DATA DIRECTORY**

- 484 pages thick, loaded with time-saving information.

- 358 pages of data sheets, inserts from 110 microwave OEM manufacturers. Names of their presidents, marketing/sales managers, all sales offices. Also their complete rep list with addresses and phone numbers.

- Over 2,000 manufacturers listed with addresses and phone numbers.

- More than 125 pages of informative listings.

- 8 major product areas

Antennas

Materials and Processing Equipment

Passive Components

Semiconductors

Solid-State Components

Systems and Subsystems

Test Instruments

Tubes and Tube Amplifiers

- 171 product categories.

- Direct-response cards for immediate action.

MicroWaves' Product Data Directory is the most current, up-to-date, comprehensive compilation of microwave product information available anywhere, at any price. **Use the directory often — let it work for you!**

 **MICROWAVES**

50 Essex Street, Rochelle Park, NJ 07662

Qualified MicroWaves magazine subscribers receive the Product Data Directory at no charge. If you are involved in microwave design, check Reader Service No. 22 for our circulation card. Fill out and return to us. You will receive the Directory along with regular issues of MicroWaves. (Limited supply of the Directory are available . . . act now.) Cost of the Directory for non-qualified requests is \$10 (domestic), \$18 (foreign).



BIG 4K PROM

MMI—first with 1K and 2K P.ROMs—is doing it again: Announcing another industry first: 4096-bit TTL P.ROM.

- The part number: Commercial—6340 Military—5340.
- Fan-in: a low 250 μ A.
- Access: 90ns guaranteed over temp and Vcc.
- Configuration: 512 x 8 bits.
- ROM-Mate: pin-compatible 4K TTL masked ROM.

- And a faster (60ns) 4K ROM, too—H6240.
- Availability: **NOW.**
- Price: \$95 (100-999) for the 6340.
\$140 (100-999) for the 5340.

If you need parts, call, TWX or write Dale Williams. 1165 East Arques Avenue, Sunnyvale, CA 94086, (415) 739-3535/TWX 910-339-9229.

Monolithic Memories, Inc. 

EASTERN AREA SALES OFFICE: (617) 653-3158 • NEW ENGLAND REGION: (603) 883-1520 • NEW YORK REGION: (607) 748-3211 • CENTRAL AREA SALES OFFICE: (317) 844-3241 • WESTERN AREA SALES OFFICE: (213) 595-5651

Representing your best buy in memories: ALABAMA, Huntsville (205) 539-1771; ARIZONA, Phoenix (602) 264-7971; CALIFORNIA, San Diego (714) 747-3015; Palo Alto (415) 369-4671; COLORADO, Denver (303) 623-8713; CONNECTICUT, North Haven (203) 239-9762; FLORIDA, Orlando (305) 423-7615; ILLINOIS, Chicago (312) 593-0200; INDIANA, Ft. Wayne (219) 744-4331; KENTUCKY, Louisville (502) 893-7303; MARYLAND, Baltimore (301) 825-3330; MASSACHUSETTS, Boston (617) 444-2484; MICHIGAN, Detroit (313) 358-2020; Grand Rapids (616) 451-8901; MINNESOTA, Minneapolis (612) 929-6721; NEW JERSEY, Teaneck (201) 692-0200; NEW MEXICO, Albuquerque (505) 265-6794; NEW YORK, N.Y./L.I. (201) 692-0200; NORTH CAROLINA, Raleigh (919) 834-6591; OHIO, Cincinnati (513) 521-2290; Dayton (513) 298-9546; Cleveland (216) 228-7525; OKLAHOMA, Tulsa (918) 627-4159; OREGON, Portland (503) 292-5656; PENNSYLVANIA, Willow Grove (215) 674-3850; Pittsburgh (412) 242-0100; TEXAS, Dallas (214) 239-9148; Houston (713) 721-1054; WASHINGTON, Seattle (206) 455-2778.

INFORMATION RETRIEVAL NUMBER 23

Some people buy
our MOD POT[®]
just to save
panel space

Others cut
time and costs
with its versatility



If you're really
serious about cost,
be serious about quality.

The first square deal in potentiometers. Compact size solves the shrinking panel space race. Modular design saves the extra charges and delays many manufacturers add for non-standards. MOD POT offers a whole family of pre-engineered, pre-tested modules that combine to form millions of single, dual, triple and

quadruple section controls. Cermet or hot-molded composition resistance elements, switch options and vernier drives with single or concentric shafts. Solder terminals or .100 grid pin terminals. Backed by the fast delivery of our distributor assembly MOD POT ACTION CENTERS. Ask for Publications 5217 and 5217S. At

your Allen-Bradley electronics distributor, or write: Allen-Bradley Electronics Division, 1201 South Second Street, Milwaukee, Wisconsin 53204. Export: Bloomfield, New Jersey 07003. Canada: Allen-Bradley Canada Limited, Cambridge, Ontario. United Kingdom, Jarrow, County Durham NE32 3EN.

INFORMATION RETRIEVAL NUMBER 24



Allen-Bradley
Milwaukee, Wisconsin 53204

washington report



Heather M. David
Washington Bureau

Awacs nears a final hurdle

Next month, the Air Force's Airborne Warning and Control System (Awacs) will face another challenge in its much-delayed and frequently-attacked struggle from concept to hardware. The Defense Dept. must decide whether the time is right to let prime contractor Boeing take the big plunge into production of the costly program.

Going for Awacs is its success to date. Officials report happily that the look-down doppler radar designed by Westinghouse has been able to track more than 250 targets at a time during test flights, it did it successfully through the ground clutter that early detractors said would defeat look-down radar, and it has proved resistant to electronic countermeasures tests put to it by the Navy's EA-6B and Air Force F-4. This has been accomplished by techniques built into the radar computer's signal processing system.

To help push Awacs into production, the Air Force has brought one of its prototype planes to Washington to show the Pentagon and Congress how well it works. The Air Force would eventually like 42 of the Awacs aircraft systems.

Postal service trying computers

The U.S. Postal Service is installing computer terminals in two sites, either of which could be prototypes for adoption on a nationwide basis. National Cash Register is providing the Flushing, N.Y., post office with point-of-sale terminals that will operate with an NCR Century 101 computer. The terminals will calculate postal fees. RCA is providing specially designed point-of-service terminals to the San Jose, Calif., post office, concentrating more on back-room postal operations.

A missile for all services

The Pentagon's new cruise missile project, which started life as a submarine-launched cruise missile (SLCM), is also being eyed by the other services for a variety of roles. According to Deputy Defense Secretary William Clements, the Navy is considering the missile for a surface-to-surface weapon as well as submarine-to-surface; by the Air Force for air launch; and by the Army for firing from mobile vehicles. Although only about 20 feet long, the cruise missile will be designed to hit strategic targets and could even carry Multiple Independently Targeted Reentry Vehicles (MIRV), Clements says. Industry sources point out that fitting MIRV warheads on the missile, with an expected diameter of around two

feet, would require intensive miniaturization and neat packaging of electronics, but Defense officials say it is nevertheless a possibility.

The Navy, which is the lead service for the program, is reported ready to issue requests for proposals for design and development of the missile as soon as Congress okays it.

FCC scrutinizing AT&T operations

The operations of Western Electric, a manufacturing subsidiary of AT&T, are being investigated by the Federal Communications Commission as part of its investigation into the fairness of the communications giant's rate structures. The FCC sent AT&T a 3-page list of questions it wants answered, including many on Western Electric's design and production activities. One of the things the Government wants to determine is whether other manufacturers could supply communications equipment more cheaply. Thus far, the FCC probes report, other foreign and domestic telecommunications manufacturers have been reluctant to discuss problems of competing with AT&T, possibly because many supply as well as compete with the Bell System. ITT alone has indicated it will furnish data to the FCC staff. The investigation is expected to take until early 1976—and perhaps longer, if AT&T uses delaying tactics.

Capital Capsules: The Senate Aeronautics and Space Sciences Committee is considering holding **hearings on the state of the aerospace industry**—its health, impact on the economy, employment and trade. . . . **Imports of semiconductors produced by U.S. manufacturers and assembled abroad rose sharply** during the first half of 1973, reaching a value of \$195-million, compared with \$118-million for the same period last year. Legislation for higher tariffs on the devices is expected to be acted upon by Congress in the next two months. . . . **The results of an Air Force review of the B-1 bomber program are due this fall**, but already it has been acknowledged that the cost of the bomber has risen \$1.1-million more per plane to \$56-million. Although installation of electronic systems on the prototype plane is behind schedule, Air Force officials say no major technical problems have been encountered. . . . **A radio transmitter pill that can monitor deep body temperatures and other internal conditions has been developed** at NASA's Ames Research Center in California. The pill, consisting of sensors, an FM transmitter and associated electronics, detects local variations while passing through the alimentary tract. . . . **Dr. John S. Foster Jr., for almost eight years the country's Director of Defense Research and Engineering, has been named winner of the 1973 WEMA Medal of Achievement** for contributions to the advancement of electronics. . . . The Flanning Systems and Sciences Co., acting for the Army, is undertaking **a basic study of the design of fixed and rotary-wing aircraft and electronic countermeasures to see if they can be made less "detectable."** The Army would like aircraft to be "invisible" to radar, infrared and eyes. Other industry contracts are expected to be awarded. . . . Rockwell International has sent out **requests for proposals to seven electronics firms for a transducer system to collect data from pressure and temperature sensors on the outer skin of a space-shuttle orbiter.** The information would be fed into the guidance and navigation computer to determine the shuttle's altitude, flight angle and airspeed. . . . The Naval Electronic Systems Command is planning to develop **a new family of towed sonar array systems for surface ships.** Requests for proposals are expected around Oct. 15.

INTRODUCING THE TEKTRONIX TRANSIENT DIGITIZER



The new way to look at transients.

Not all transients are created equal.

But then again, neither are all transient measurement systems.

Some transients don't need much more than just normal methods of observation.

Others require something special. Because the faster the transient, the more difficult it is to observe.

How, what, where and when it all happened is a tough job when it's your responsibility to come up with fast answers.

But no device can help you quite like the Tektronix R7912 Transient Digitizer: the revolutionary, new addition to our versatile 7000-Series measurement instruments.

It puts you on the right track to fully analyzing the transient within seconds of its occurrence. And all you get blamed for is saving time and money.

The Tektronix Transient Digitizer can digitize single events with subnanosecond risetimes. It lets you focus accurately on transients with speed and convenience never before attainable.

It gives you complete waveform data. Fast and easy. By offering more resolution than ever before. By providing a writing rate equivalent to 8 div/ns. And an optional local memory of 4096 words. By generating an electronic graticule

which increases visual measurement accuracy. By displaying visually on a large, bright TV monitor. By expanding to multi-channel performance for low cost-per-channel operation. And by eliminating slow, tedious camerawork.

See how much more you can see with the Tektronix Transient Digitizer.

It's the new way to look at transients.

For many transients, it's the only way.

Prices vary with options and plug-ins selected.

An operating system is available for as low as \$10,460. To obtain a copy of "New Ways to See Fast Transients" contact your Tektronix Field Engineer or use the reader service card or write TEKTRONIX, Inc., PO Box 500A, Beaverton, Oregon 97005. Phone: 503/644-0161. In Europe: TEKTRONIX Ltd. Guernsey, C.I., U.K.



INFORMATION RETRIEVAL NUMBER 25

The Same HP That Instruments Now Makes Them

Take signal sources for example...

You can't see the automated testing and the other manufacturing advances that help lower the price of HP's quality signal sources. But you sure can see the versatility and extra performance you get for your money. From the simplest function generator to the most capable synthesizer, HP technology has brought the price of quality way down.



Brand New Function Generator 3311A shows what a performance plus you get from this technology in action. Priced at only \$249, it adds sweep capability and a separate high-power pulse output to the usual sine, square and triangular wave outputs. Sweep it over any 10 to 1 span within its 0.1 Hz to 1 MHz range. The pulse output drives up to

20 TTL loads. Note that price again. It's 15% lower than its nearest major competition.

Wide Range Function Generators 3310A/B deliver general-purpose waveforms with extended low-frequency response. These 0.0005 Hz to 5 MHz instruments equip you with a linear very-low-frequency ramp, in addition to sine, square, triangle and pulse waveforms. Prices are a modest \$595 for the 3310A, and \$735 for the 3310B that also provides free-run, single-cycle and multiple-cycle operating modes.



Technology Makes Better... Cost Less



Lowest Cost Frequency Synthesizers 3320A/B bring you synthesizer quality for as little as \$1,900. You get 1 part in 10^6 frequency resolution over the entire 0.01 Hz to 13 MHz range. Also, on the 3320B, HP's thermopile control of amplitude level gives 0.01 dB level resolution. If precise amplitude setting and calibration aren't required, get the 3320A for \$1,900. Or, get *both* frequency and amplitude precision in the 3320B for \$2,550 (add \$595 for full ASCII programmability). How's that for a blend of quality, performance and low price!

Top-of-the-line Automatic Synthesizers 3330A/B have a built-in "brain" that lets you avoid tying up a computer. They're like the 3320A/B, only these can be programmed to automatically sweep their frequency spectrum (and, on the 3330B, its precision amplitude level). With the 3330B you're getting a synthesizer, a sweeper, a marker generator, a counter, a programmable attenuator, a built-in controller and a precision level generator—in other words a lab-in-a-box—for just \$6,000. Or, cut that to \$5,100 for the manual-amplitude-control 3330A.

Whatever your needs in signal sources, satisfy them with one of HP's technology-leader instruments. They're packed with more capability than ever before—and priced lower, too. For more information on the entire family of HP signal sources, contact your local HP field engineer. Or, write



Hewlett-Packard, Palo Alto, California 94304. In Europe: HPSA, P.O. Box 85, CH-1217 Meyrin 2, Geneva, Switzerland. In Japan: Yokogawa—Hewlett-Packard, 1-59-1, Yoyogi, Shibuya-Ku, Tokyo, 151.

093/43A

HEWLETT  **PACKARD**

SIGNAL SOURCES

INFORMATION RETRIEVAL NUMBER 26

CMOS Analog Switches

TTL-controlled switches handle full $\pm 15V$ signal swing with only $\pm 15V$ supplies.

New DG200 and DG201 devices provide channel and gain selection for analog signals up to $\pm 15V$ power supply levels without exceeding switch signal handling levels (see typical applications circuit below). Devices feature:

- Monolithic CMOS construction; drivers and gates on a single chip.
- Low r_{DS} over full temperature and signal range.
 - < 100 Ω for DG200 (dual SPST)
 - < 250 Ω for DG201 (quad SPST)
- Static protection on all terminals.
- Break-before-make switching action.
- Independent pairs of sources and drains for maximum flexibility.
- Direct TTL, DTL and CMOS compatibility.

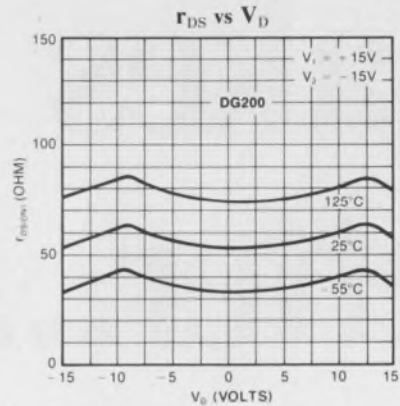

With supply voltage levels less than $\pm 15V$, the maximum analog signal always equals supply voltage.

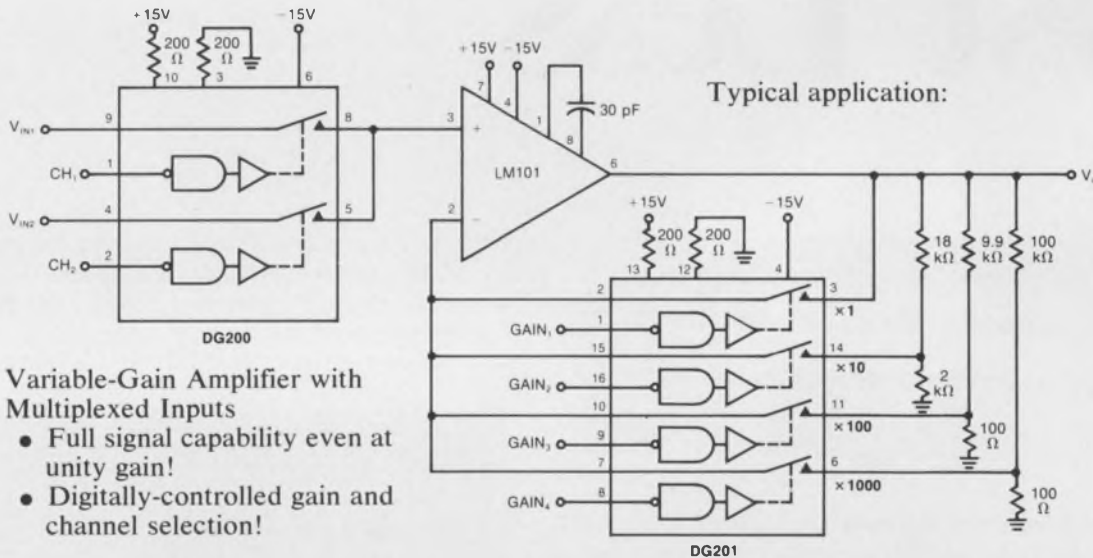

Variable-Gain Amplifier with Multiplexed Inputs

- Full signal capability even at unity gain!
- Digitally-controlled gain and channel selection!

The DG200 and DG201 are ideal devices for digital computer interface with this analog world. If your switching problems are unique—and whose aren't—our applications people are eager to help. For complete information

write for data

Applications Engineering: (408) 246-8000 Ext. 802



Siliconix incorporated

2201 Laurelwood Road, Santa Clara, California 95054

INFORMATION RETRIEVAL NUMBER 140

Did I say, "Women"?

I feel like the ping-pong ball in a fierce match. When I wrote the editorial, "Women," in the August 16th issue, I tried to express my hatred for censorship. I was responding to readers who feel I ought to stop "pornography," "bad taste" or "exploitation of women" in electronics advertising. Then came the mail.

Some readers made me feel I ought to run for king. Others made me want to crawl under a snake. Many applauded my conviction that engineers don't need the protection of censors. One fellow jestingly took a firm stand in favor of smut. Others, in a similar vein, wrote that they'd looked through several issues and apparently missed the pornography. Would I kindly send same right away—in a plain, brown wrapper, please?

A British reader sent a newspaper clipping about an unmarried girl who was more than a bit upset to discover a much retouched photo of herself—markedly pregnant—in a laxative ad. "See what I mean?" he wrote. But I didn't. I doubt that he meant that a girl can become pregnant—if only in print—by appearing in an ad for a computer, relay or IC socket.

The sharpest condemnation came from an anonymous reader who lashed me with a quotation from Webster on "pornography," and with copious quotations from the Scriptures. The man seemed driven to defend Christianity against the Rostky peril—or, perhaps, against the insidious danger of male engineers being subjected to images of women. Had he included his name, I would have assured him that, if I were the great threat to Christianity, it had little to fear.

By far the loveliest letter came from a kind, sweet, sensitive, astute, admirable, abundantly intelligent and eminently beautiful woman who wrote that the only thing in ELECTRONIC DESIGN more erotic than a pair of mating connectors was the picture, on the editorial page, of me.

Much as I admire her impeccable judgment, I think we can all see that "the message" is often in the mind of the beholder. When I convey, or try to convey, one message, lots of readers receive many others.

Are most of us more clear? In the complex intercourse that forms the unnoticed background for any design or, for that matter, any endeavor, how often do we brake progress and how often do we divert it because we transmit or receive noisy messages?



A handwritten signature in dark ink, which appears to read "George Rostky". The signature is fluid and cursive.

GEORGE ROSTKY
Editor-in-Chief

More ideas from Amphenol's

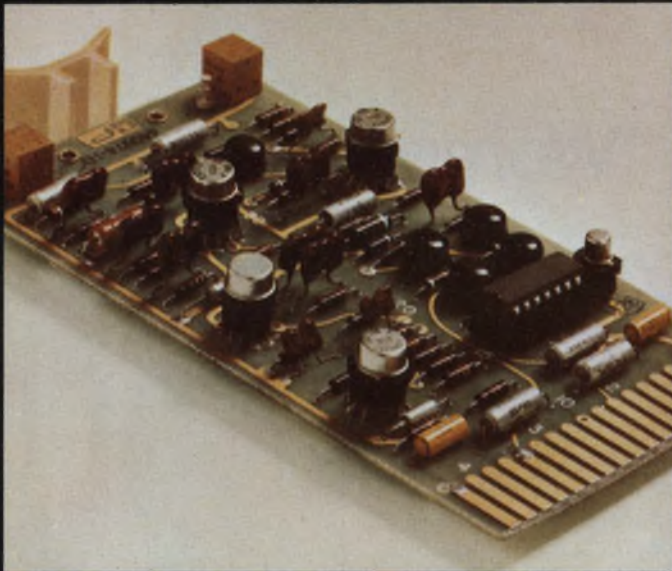

level

1

Low-cost sockets for transistors in TO packages (above) allow easy replacement and service. ■ New IC sockets are end and side stackable for maximum single board density. Low profile design also allows maximum multi-board density.

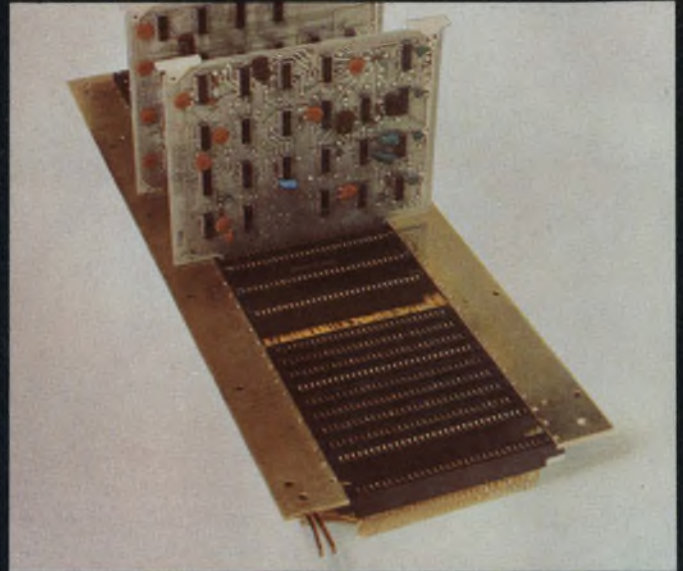

level

2

Back panel edge board connectors with bifurcated contacts (above) can be wire wrapped or clip-terminated. ■ Bellows contact PC connectors (below) cut interconnection costs without sacrificing performance.

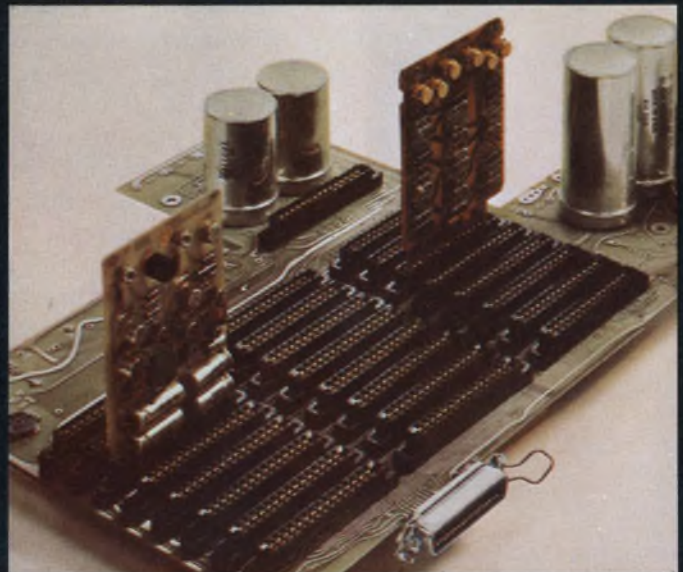
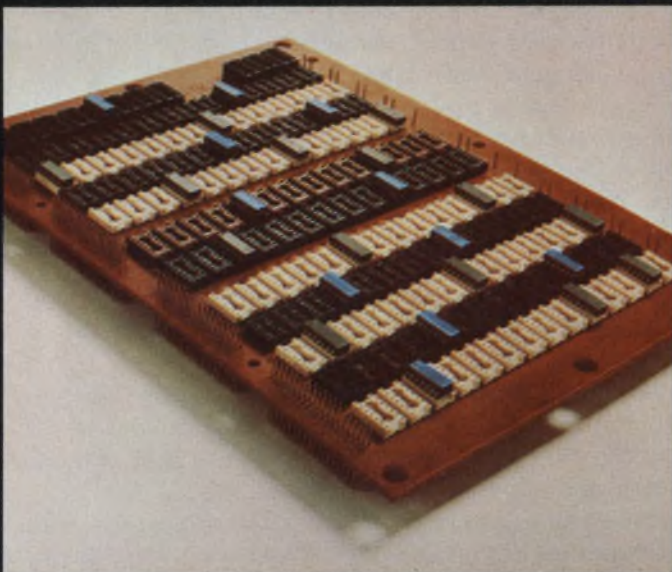

Above are seven new ideas from Amphenol Industrial Division's Spectrum of interconnection capability.

Amphenol's SPECTRUM offers you *all four* levels of interconnections from our unmatched breadth of product line:

Level 1 . . . DEVICE TO BOARD OR CHASSIS. We offer interconnections for components such as tubes, relays, transistors, IC packages, trimmers, resistors or capacitors to a PC board or chassis.

Level 2 . . . BOARD TO MOTHERBOARD OR BACK PLANE. We offer interconnections for PC boards or

other sub-circuit modules to a motherboard or to a back plane.

Level 3 . . . MOTHERBOARD OR BACK PLANE WIRING. We offer interconnections for levels to each other and to other sub-circuits with multi-layer circuit boards, wire wrapping, clip terminations, jumper techniques and dip-soldering.

Level 4 . . . INPUT/OUTPUT CONNECTIONS. We offer interconnections for power and signals to and from a system. This interface may be between sub-assemblies within the same enclosure or between individual units.

Spectrum of interconnections.

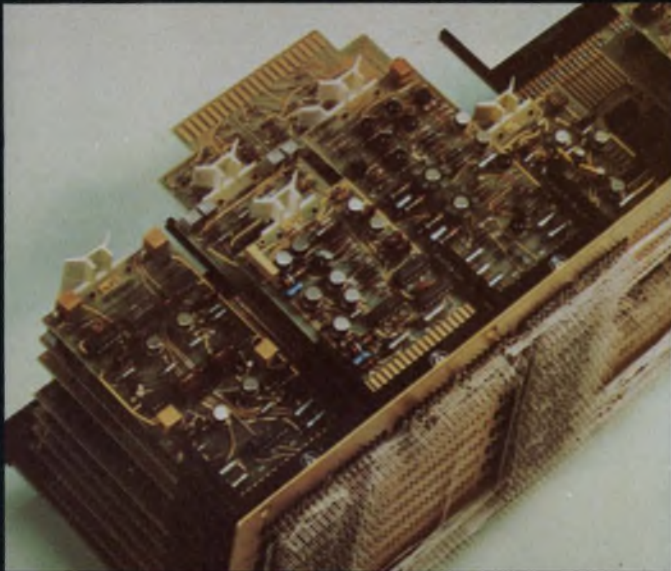

level 3 Direct entry plate assembly offers modular packaging flexibility. Custom designed plates accommodate any size or style PC board with no tooling cost to you. Rectangular posts are true positioned for automatic wire-wrapping.

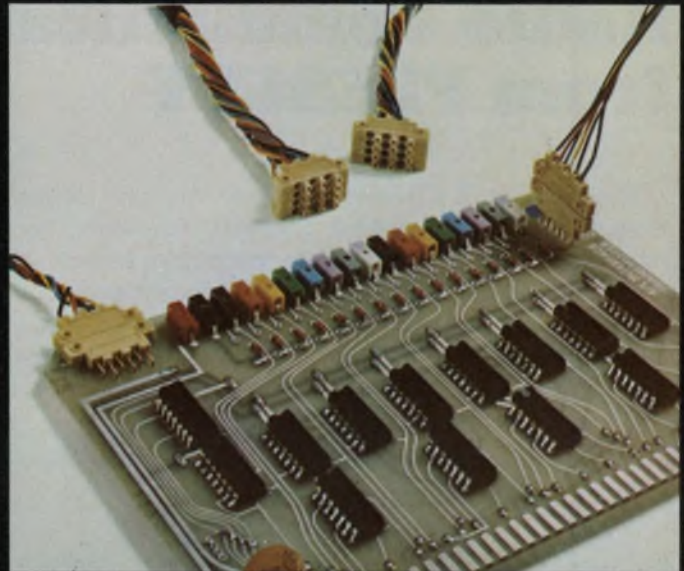

level 4 Miniature contact (3 input, 3 output) hermaphroditic connectors can be snapped together to connect as many circuits as required. ■ Single finger-tip mounting of low cost connector saves assembly time. Available in UL Class SE-1 flammability rated material.

Write for our **Spectrum** brochure covering all levels of interconnections.

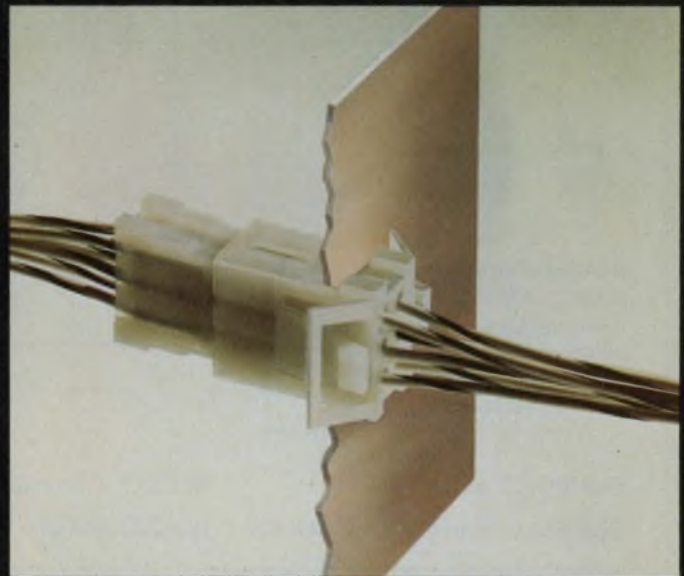

From the simple tube socket—to a myriad of electrical/electronic connectors—to complete and complex termination systems . . . SPECTRUM.

But SPECTRUM is far more than products. It is a depth of capability in engineering, manufacturing and quality control. Amphenol's SPECTRUM is a new height of service, availability and distribution backed by seven Amphenol interconnection-oriented divisions.

Amphenol can fulfill your total interconnection requirements because we are not limited to specifics such as one or two product lines, one or two levels.

Therefore we approach your interconnection needs with complete open-mindedness.

For more new ideas and specific information, write for your copy of "SPECTRUM." Amphenol Industrial Division, Bunker Ramo Corp., 1830 South 54th Ave., Chicago, Illinois 60650.

**BUNKER
RAMO**

AMPHENOL

Simple Solution to SSB/AM Transceiver Problems

Radio Communications IC's from PLESSEY

Put Plessey's SL600 series together. You have all the circuits to design an 60MHz SSB/AM transceiver. For military or commercial applications. Without any hassle.

Functionally integrated, these fully-compatible circuits replace troublesome discrete components 30 to 1. For less time and money. Yet with better reliability and performance than you thought possible.

Or use each circuit separately. The SL600 series includes a comprehensive range of IF and RF amplifiers with full AGC and bandwidths to 140MHz. VOGAD, audio and AGC amplifiers are available too. Plus double balanced modulators and mixers with carrier leaks as low as -60db. All operating with low power consumption from a single 6 volt supply . . . over a temperature range of -55°C to +125°C.

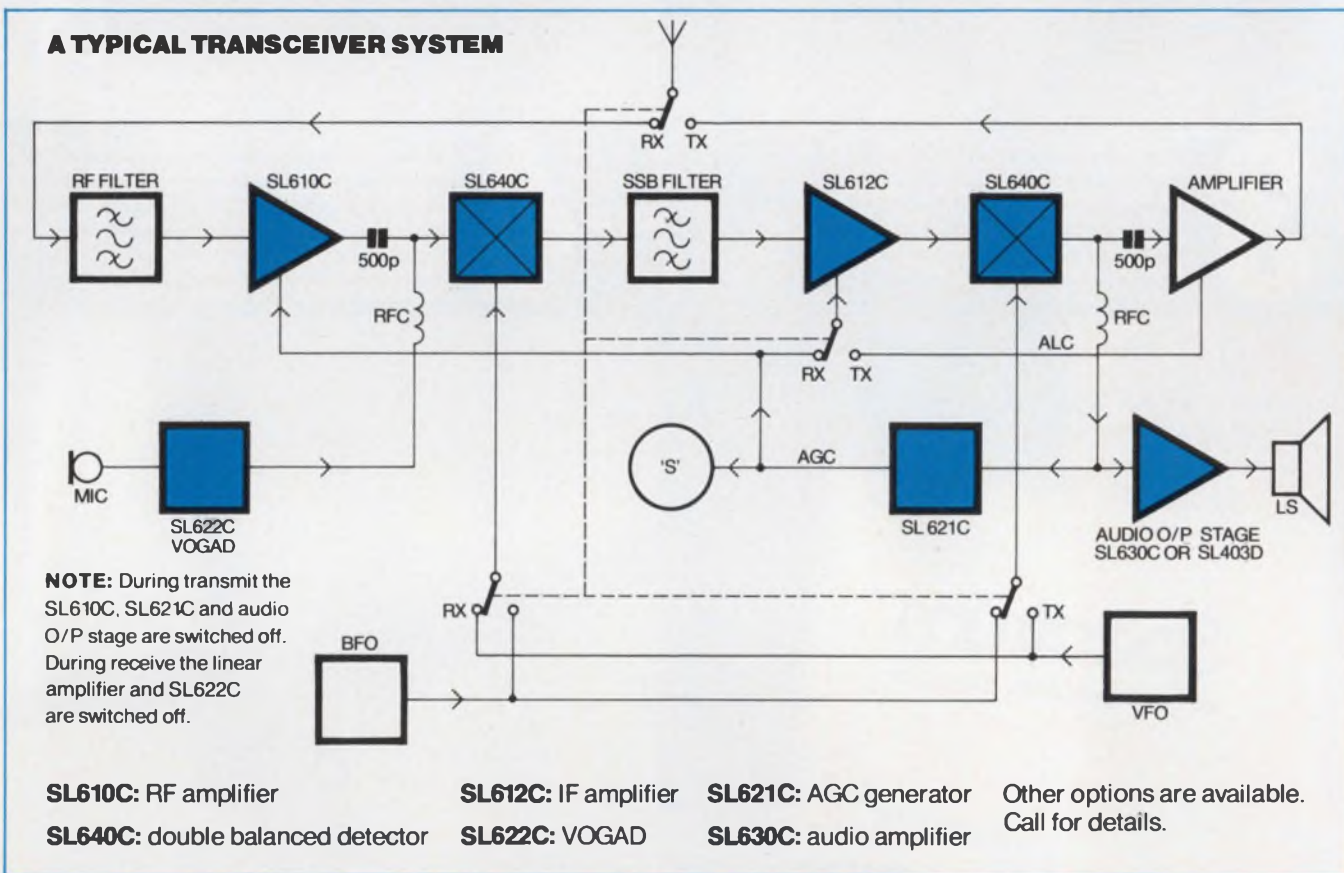

FREE APPLICATIONS MANUAL

Ask for all the facts in our 56-page problem-solving applications manual on integrated circuits for radio communications. Call today. Or write to Plessey on your company letterhead. **You'll find it pays to specify Plessey.**

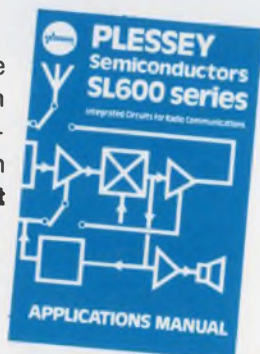

PLESSEY SEMICONDUCTORS

1674 McGaw Avenue, Santa Ana, California 92705
 (714) 540-9945

170 Finn Court, Farmingdale, New York 11735
 (516) 694-7377

Dial (800) 645-9200 toll free
 for name of local representative.



CUTLER-HAMMER SNAPS INTO ACTION WHEN YOU NEED PROTOTYPES.

Just watch our action when you call for service! The old-fashioned, dependable kind that just could be brand new to you. With fast application help, fast action on prototypes, and delivery dates you can count on.

Fact is, we have snapped into action in a big way. Coming up with new lines of precision snap-action switches, designed and manufactured

in the Cutler-Hammer quality tradition. We have samples in stock for immediate inspection.

But remember. If we don't have exactly what you want already, tell us and we'll snap into action to get you a prototype promptly.

Call your Cutler-Hammer Sales Engineer or Switch Distributor and ask him how our snap-action switches (and service) can help you meet your product development schedules on time.

Miniature—Five different types with U.L. rating up to 15 amps. Four terminal styles. Choice of actuators—straight lever, roller lever, simulated roller lever.
Sub-miniature—Four basic types with U.L. rating up to 10 amps. Four terminal styles. Same actuator choice as above.
Sub-subminiature—Four basic types with U.L. rating up to 7 amps. Four terminal types. Actuators—a variety of lever, leaf and roller lever types.

Switch
to No.1

More than just switches;
prompt availability,
field help, innovation,
quality assurance, too.

Action you want.
Action you'll get!

INFORMATION RETRIEVAL NUMBER 32



CUTLER-HAMMER
SPECIALTY PRODUCTS DIVISION, Milwaukee, Wis. 53201

Focus on Small motors

The motor does the work, however sophisticated the electronics.

It moves almost anything—magnetic tapes, chart paper, print wheels, drums and discs, fan blades and almost anything else that needs turning, pushing or pulling. Yet most engineers understand too little of what they're getting when they specify a motor—or what they can get. They don't know all the available options and trade-offs.

For most electronic applications, "motors" mean small motors, generally with an output rating of 1/4 horsepower or less. Though there are no firm definitions, small motors are generally classified loosely as either "high-performance" or "high utility," the latter meaning usually "not high-performance."

High-performance motors, often custom-designed for special applications, are generally characterized by tightly defined electrical and mechanical characteristics, such as efficiency, speed, torque and rotor inertia—and by relatively high cost.

In contrast, high-utility motors, often called "garden-variety" or "general-purpose" and almost never called "low-performance," are characterized by generally looser tolerances and much lower cost.

Before you delve into the details of motor specs, take a look at the table with this article. It describes the major characteristics of motors. Most of the listed types are generally regarded as high utility, but some of the types are also available in high-performance versions. High-performance types, though, will probably have some special feature, like a permanent-magnet rotor or stator, an integral tachometer, a low-inertia rotor or a brushless design, and, of



Though out of sight, electric motors are the workhorses of many computer peripherals. This Texas Instruments Silent 700 data terminal uses ten motors. Warner Electric Brake & Clutch stepping motors advance and return a thermal print head and advance the paper roll. Permanent-magnet dc torque motors provide mag-tape tension and fast forward and rewind, and servo-controlled capstan motors provide constant read/write tape speeds under phase-lock loop servo control.

Morris Grossman
Associate Editor

course, tight tolerances.

Many companies, like Eastern Air Devices, Barber-Colman, AEG-Telefunken, GE and Bodine, supply high-utility motors, but most also build high-performance versions. Others like TRW/Globe, Servo-Tek and Singer's Kearfott division specialize in instrument, servo or other high-performance types.

Motor specs reviewed

Even though you may order a motor from the catalog, it is safest to supply complete applications details to the motor manufacturer so that he can catch anything you may have overlooked. Most manufacturers will furnish a form to guide you in providing the information.

Regardless of the type you need—your application will dictate the choice—there are several specs you must consider. Torque is one of the

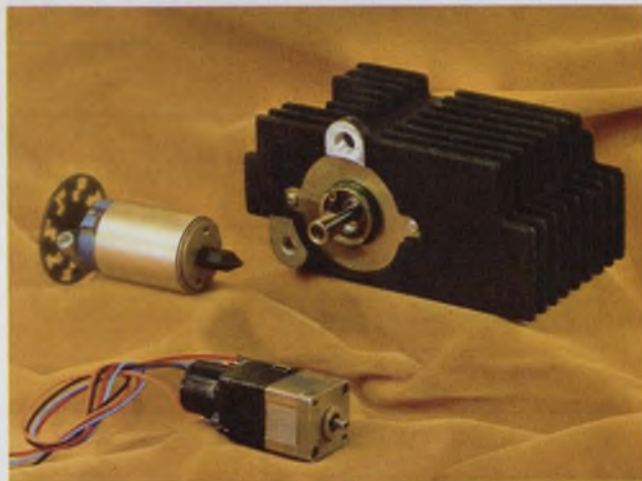

Special motors for special purposes are illustrated in these TRW/Globe selections: a finned high-torque motor for the carriage return on a data terminal, an anti-cogging, tape drive motor for a cassette unit and a space-saving printer drive motor (bottom).

most important—and one of the trickiest. It's true that torque, the product of force and the lever arm, must be able to overcome the load friction. But, to move a load, the torque must overcome inertia as well as friction. A freely moving but high-inertia load may take so long to reach operating speed that severe motor overheating results.

In the case of synchronous motors a high-inertia load may never achieve synchronous speed, though it can start and reach near-synchronism. This is because the pull-in torque (that required to attain synchronism) is often less than the starting torque. Yet the torque at or near synchronism should be large enough to accelerate the load adequately in less than 1/2 cycle—about 8 ms at 60 Hz.

The best way to spec a motor's torque is to provide complete plots of torque vs each of the other operational parameters, such as speed, current and efficiency. Many manufacturers do give you this information. But if torque specs are merely listed as numbers, at least the start and rated running torque should be given. And in the special case of synchronous motors, pull-in and pull-out torques should also be provided.

Though a synchronous motor may be delivering a speed whose average is perfectly locked into the line frequency, the instantaneous angular velocity may be far from constant. Instantaneous speed of any synchronous motor can oscillate rapidly or drift slowly about the average. These variations have many causes, such as mechanical tolerance errors in pole spacing, eccentricities in gears, dragging bearings and nonuniform loading or unbalanced loads.

If the motor drives a chart, the result is non-

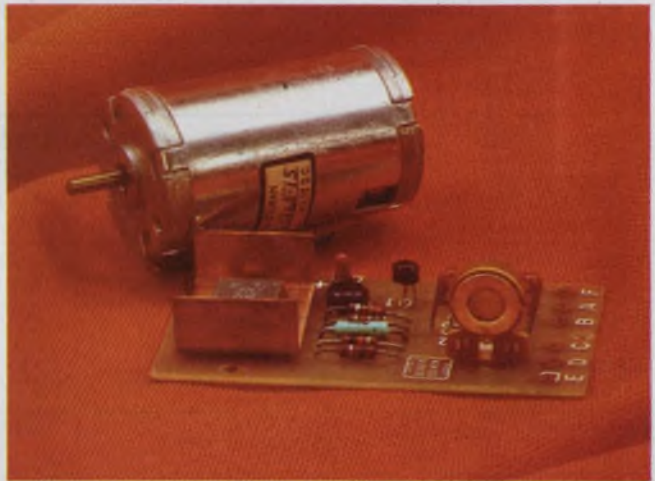

This speed-regulated dc automotive stereo tape-deck motor made by Barber-Colman keeps wow and flutter to 0.1%. And the speed can easily be adjusted over the range of 400 to 4800 rpm with regulation held to 1%. The motor can deliver 1.5 oz-in. at 3000 rpm.

uniform chart spacing. A motor driving an optical chopper can introduce undesirable modulation products into the chopped signal. Therefore, when the application calls for a uniform instantaneous speed, as in phonograph turntables, select a motor with a high rotor inertia (large diameter and weight). This will provide a flywheel effect to reduce speed pulsations. But start, stop and pull-in problems will be aggravated.

To help overcome the problem of accelerating high-inertia loads, engineers often add a clutch or belt between motor and load. This permits some slip and avoids the need for a larger motor merely to handle pull-in.

Similarly a load having a high starting friction may be driven by a relatively small motor. It need only be large enough to provide the con-

Motor Characteristics

AC Stators

Polyphase —Generally used for integral-sized motor. Reversible while in motion. Generates rotating field directly. More efficient (over 80% in large sizes) than single phase. Some servo systems use two-phase motors.				
Single phase —Suitable for fhp and low-hp applications. Some types must be stopped to reverse, or very special arrangements provided. Moderately efficient (40-70%). Phase splitting needed to generate sweeping field for action on rotor.				
Phase splitting methods (fig/curve)	Reversing ability	Starting current	Starting torque	Operating features
Split phase —starting winding generates field, phase displaced from main field by inductance difference. (A/1)	from rest	5 to 10X rated, normal induction rotor	1.5X rated, normal induction rotor	Simple, inexpensive, general purpose for blowers, pumps, compressors, unidirectional work.
Capacitor start —starting winding generates field, phase displaced from main field by capacitor. Produces more ideal phase relation. (B/2,3)	from rest	2 to 3X	2 to 3X	Somewhat more expensive, but better starting characteristics than split phase, general purpose.
Permanent capacitor —capacitor connected at all times (C)	while running	1X	1X	For easy reversing while running, generally < 1/4 hp servo applications, efficient, similar to two-phase motor.
Capacitor start/run —larger capacitor starts, permanent capacitor runs motor. (B)	generally from rest	2 to 3X	2 to 3X	More efficient running than capacitor start.
Shaded pole —shorted turn (or slug) on portion of field pole produces displaced field. (D)	unidirectional	1X	2X	Least efficient, low cost, flea power < 1/25 hp, fans, vending machines, cheap phono tables. Fig. D
Repulsion start —not generally used on small motors. (E)	from rest	5 to 10X	3 to 5X	General purpose for industrial main-power source.

Synchronous and Induction rotors

Synchronous —The sweeping field interacts directly with magnetic poles of the rotor to produce motion locked to the speed of the field. The field's speed is determined by the power source's frequency. Stepping-motors rotors are similar in construction to some types of synchronous motors.			
Rotor types (fig.)	Torque start/pull-in/pull-out	Efficiency/damping/inertia	Operating features
Reluctance (F)	low/low/low	low/low/low	low cost, used on timing, clock and stepping motors, tends to cog, low power
Magnetic (G)	low/high/high	high/good/high	Uses PM in small motors, requires squirrel-cage bars to start and reach near synch, used in heavy duty stepping motors.
Hysteresis (H)	fair/fair/fair (fair=100% rated)	good/fair/fair	Most popular instrument type synch motor, quiet, smooth running, suitable for turntables, tape drives.
Induction —The sweeping field of stator induces currents in rotor which then react against stator field to produce motion. Speed flexibility is limited by line frequency, speed control difficult. See curve 4.			
Squirrel cage —Good general-purpose workhorse.			
Double squirrel cage —Extra set of conductive bars embedded deep in iron core of rotor. High resistance bars near surface increases starting torque. Compromise in performance between efficient, low-slip running characteristics and high starting torque.			
Wound rotor —Rarely used in small motors. Combines high-starting torque with efficient running properties.			

DC Stators/Rotors

Speed flexible, adaptable to wide range of loading conditions, efficient (70 to over 90% in larger units) reversible while running, suitable for electronic speed control and regulation, lends itself to high-performance versions and precision servo applications. Stators or rotors may be PM.			
Stator type (fig./curve)	Starting torque	Speed characteristics	Operating features
Shunt wound (I/7) PM (L/9)	2 to 3X rated	Wound type relatively constant with load. Variable by varying resistance in field or rotor. PM provides linear falling speed/torque curve.	Poor low-speed torque on wound type, electronic control can provide more uniform torque over wide speed range (up to 100:1). PM often used in high-performance, servo applications.
Series (J/6)	5 to 10X rated	Steep speed/torque droop. Limited speed control.	Low-speed torque good. Loss of load may allow dangerous speeds on some motors. Used on train or trolley traction, cranes.
Compound differential/cumulative (K/5, 8)	5 to 10X rated	Can be adjusted to near flat or rising speed vs load with differential winding. Cumulative winding produces steep speed droop similar to series motor.	Flexible combinations of speed-torque characteristics with simple resistor controls. Expensive.
Universal ac or dc (J/6)	high	Same as series wound.	Used for many household appliances, hand tools, train or trolley traction, general utility.

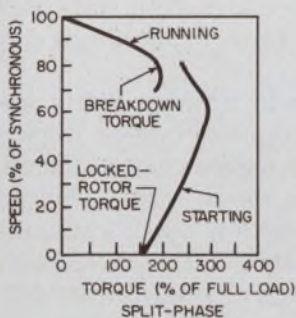

1

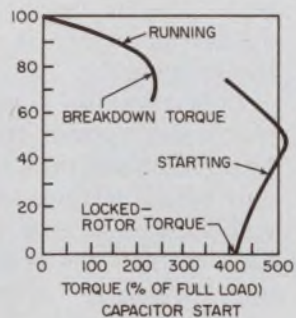

2

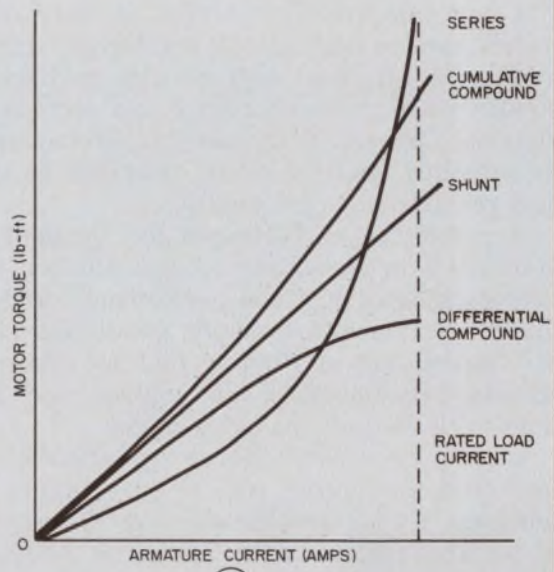

5

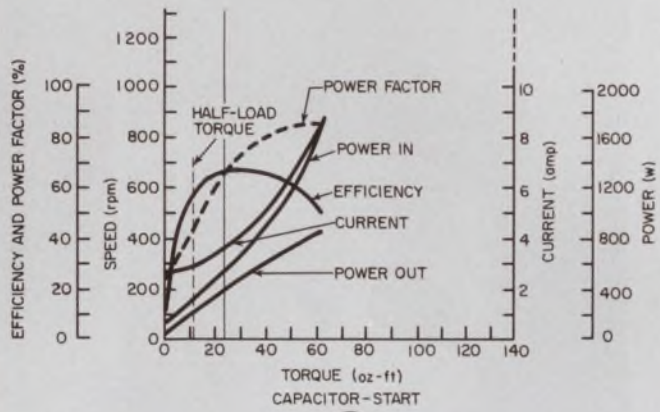

3

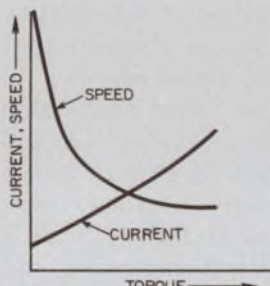

6

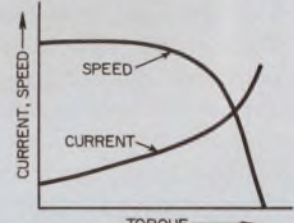

7

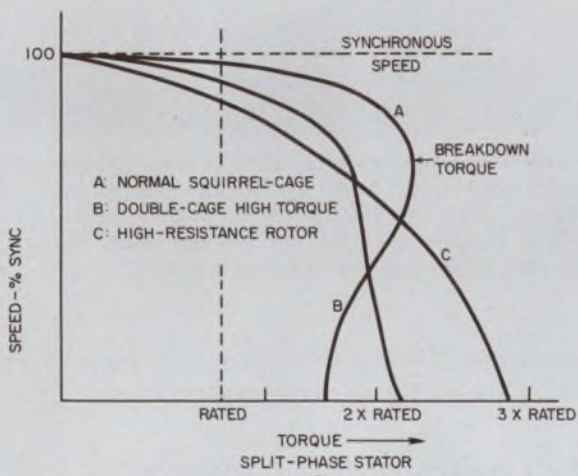

4

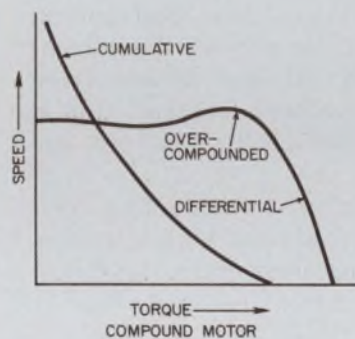

8

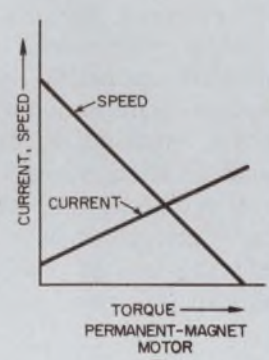

9

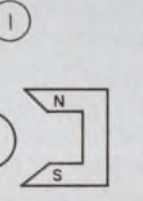
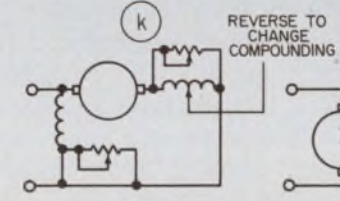
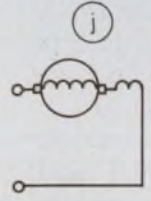
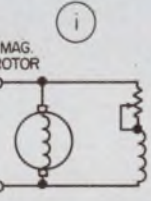
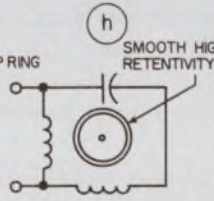
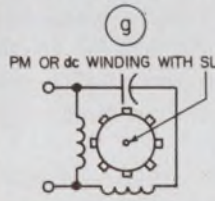
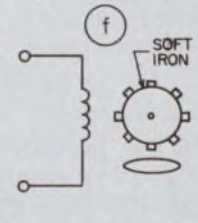
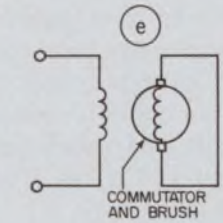
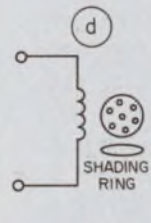
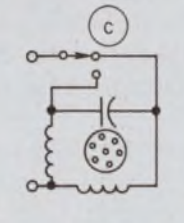
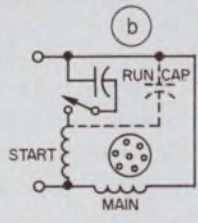
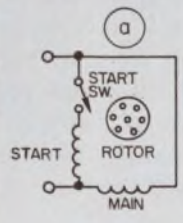

tinuous-duty running torque. For starting, special intermittent-duty windings or other arrangements can provide the extra torque. However, such a motor must also be able to handle the sudden severe current surges and attendant mechanical stresses. Also, overload protection must be provided, and the motor shouldn't be stopped and restarted too frequently.

A motor that is optimized for frequent start/stop use won't generally be very efficient in continuous operation. Good performance under frequent starting and breaking conditions requires a different type of winding than an efficient continuous-duty machine. So analyze and specify duty cycle before you buy a motor.

Inadequate heat-removal specifications can lead to a slower but just as sure failure as inadequate torque specification. A 10-to-15-C rise above the recommended operating temperature can halve the life of a motor. Every motor has an upper temperature limit that depends upon the class of insulation and method of lubrication. The motor itself often contributes a major portion of the heat that has to be removed.

Most small motors rely on heat conduction through mounts and on natural convection and radiation for cooling. Air must be able to freely flow around the motors to maintain a safe temperature; they can't be packed tightly into a confined space. A thermal joint compound and generous contact area between the motor and mount aids cooling.

Many small motors have finned surfaces, while others may have a built-in fan. Self-cooling motors, with fans, must be run at the recommended operating speed. At low speeds these motors will probably overheat because, for a given nominal rating, self-cooling motors are smaller than others.

Remember, too, that altitude can affect cooling. Convection is less effective at high altitudes, and the loss of cooling becomes quite significant at altitudes over 10,000 feet.

Long life costs more

Motors are available in a staggering variety of quality levels. Inexpensive motors for toys may cost as little as 25 cents and last a few hours. A motor of the same horsepower and speed but precision built and rated for a 10,000-hour life can easily cost 100 times more.

But the definitions of motor life are often vague. Excessively high temperature, duty cycle, number of starts, shock loading and load inertia can all shorten a motor's life. A motor can have a -55-to-125-C temperature rating and list a 1000-hour life. But tests may show, for example, a life of 500 hr at 55 C, 1000 hr at 20 C and only 100 hr at 125 C. Thus a single-number life

rating seldom tells the whole story. On the other hand, if you insist on a guaranteed and well-defined motor life, it may boost the cost and slow the delivery.

It is rare for a motor to operate safely and continuously over the complete ranges implied by a manufacturer's performance curves. Usually only small portions of the speed, torque, current and voltage ranges fall within the continuous-duty rating. The rest of the ranges cover start-up, temporary overload or intermittent-duty

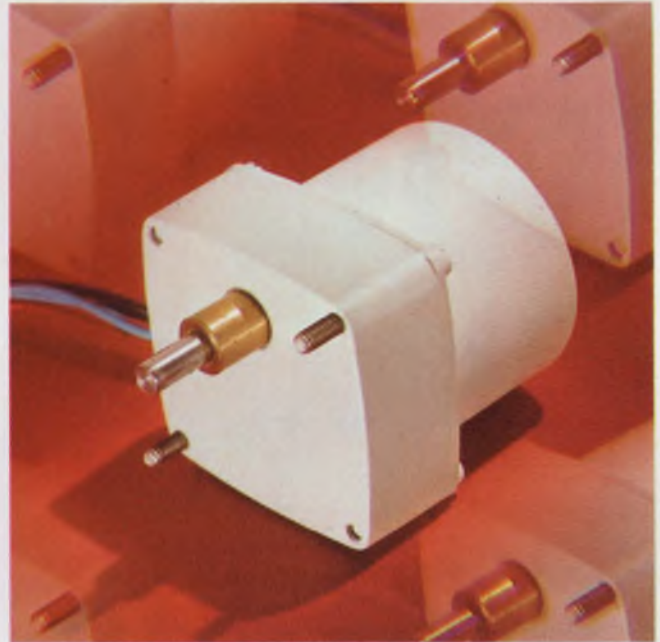

Heavy-duty timing motors, such as this 600 rpm 86600-series unit from North American Philips, can handle rugged load conditions more safely than light-duty timing motors, even though the light-duty motors may be able to develop the required torque.

operation. The continuous-duty region is rarely indicated on the performance curves.

Don't overlook mechanical limitations

Quite often, even with tiny motors, the motor's torque capability under some conditions is larger than can be handled by its gear box without damage. The safe torque may be less than half the torque that the motor can develop, especially for motors with high-ratio gear trains. Addition of a slip clutch or shear pin can often save an expensive gear box.

Loads on the motor shaft are not always tangential. Overhung loads (at right angles to the shaft) and thrust loads (along the shaft) also occur—and these may cause problems. Some low-cost motors can't take any thrust load, and they may also be able to handle only small overhung loads. Thus, applications that present more than

just rotational loads require motors with suitable bearings.

Ordinary motors may be adequate

Many applications don't justify the cost of high-performance motors and often don't need the performance either. Sophisticated new motors may cost 10 to 100 times more than an alternative motor having satisfactory characteristics—one selected from the many "high-utility" types.

If you can use a motor right out of a catalog and order it in quantity, you will probably be able to get generous discounts and timely deliveries.

The next least expensive solution is to adapt a standard design. Often the manufacturer will readily supply modified voltages, speeds, mountings or temperature ranges for the basic designs shown in his catalog.

For special requirements and very large quantities, however, the best over-all solution may be a motor designed integrally with the device.

Let's examine some specific motors used in electronic systems. Advances in electronics have sparked the need for improved motors. The greatest advances in motor design have involved permanent magnets, solid-state speed control, built-in tachometers and controls, brushless designs, and improved stepping motors and torque motors.

A look at PM motors

The permanent magnet (PM) motor poses a classification problem. Permanent magnets now appear across the board in many categories of motors—from ac synchronous motors to the latest brushless dc motors. So there is no type that you can call simply a PM motor. The term "PM" must be used with some other designation—brushless, stepping, synchronous, speed controlled, etc.

In the design of SCR or transistor speed-controlled motors, the PM approach has the advantage of a linear-speed/torque/ampere characteristic, which most servo-system analyses assume. In general, when compared with a wound-field motor for ac or dc, the advantages of a PM design include greater reliability, since there is no winding to fail; lower cost, because windings are expensive to make; rapid deceleration and dynamic braking, even in power-off conditions; and, in dc motors, the possibility of two-terminal input and a simple control circuit. Also, of course, PM types feature lighter weight, smaller size and higher efficiencies than wound-field designs.

Indiana General takes full advantage of these design potentials with its line of PM, SCR-rated,



Brushless dc motors from Siemens (top) and IMC Magnetics have mechanical lives determined mainly by the life of the bearings.

dc motors. This recently expanded NEMA-standard line now ranges from nominal sizes of 1/8 to 1 hp.

But even as Indiana General uses a designation like 1/8 hp, the company immediately warns: Beware of horsepower figures for variable-speed motors. A horsepower rating that is based on a steady dc supply can be very misleading when the motor is, in fact, used with pulsating current, like that provided by an SCR control. The input power calculation must include a form factor (ratio of rms to average) for the input current. Thus, the form factor is, in a sense, a derating factor for a given motor size. It is not unusual in a motor with SCR control to obtain peak input currents of over three times those needed with steady dc.

Average current determines the motor torque, but rms current establishes motor power output and heating. Because the value of a form factor is greater than unity for complex waveshapes,

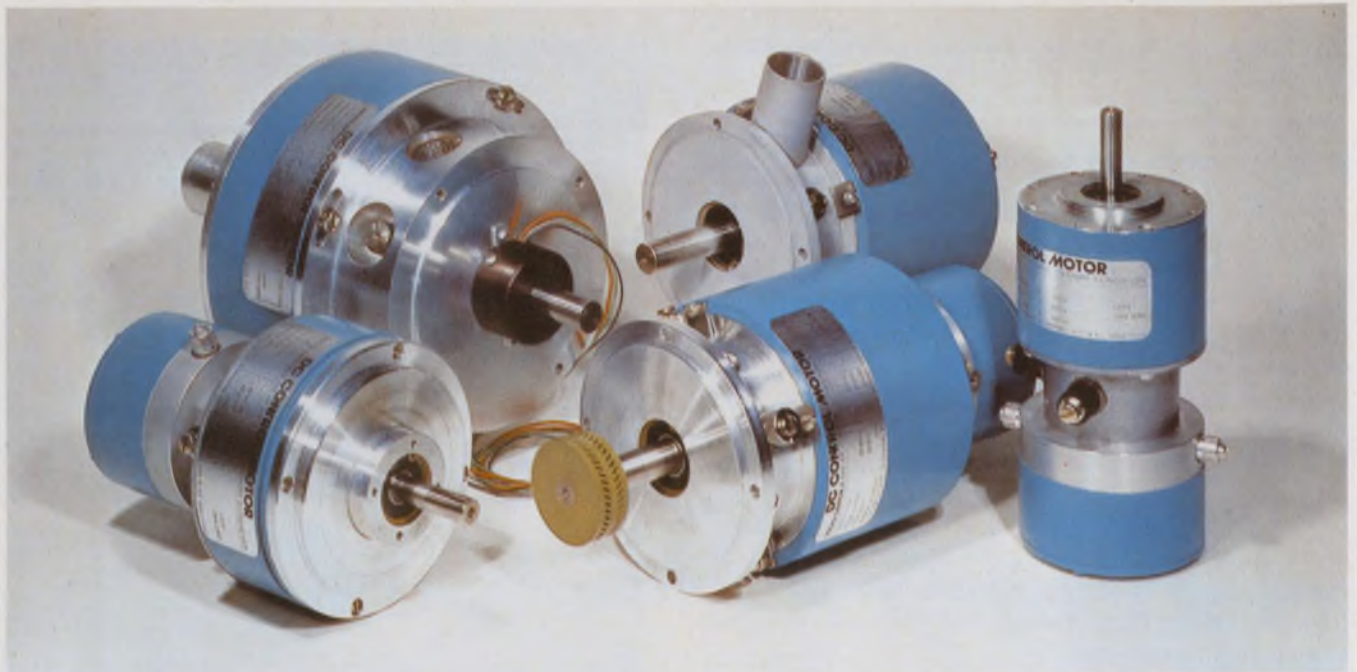

Low-inertia motors with built-in tachometers, such as these Micro Switch VM series units, meet the needs of

closed-looped servo systems. Thin-walled hollow rotors provide their high torque-to-inertia ratios.

motor temperature can rise faster than torque. So under operating conditions accurate SCR motor ratings are difficult to calculate. To compare the motors of several manufacturers, you must consider the speed control that will be used. For SCR speed control, some companies recommend that you buy motors, rated by the manufacturer for SCR operation.

Further, motors for use with SCRs should have superior insulation, rugged brush and commutator assemblies, and thin laminations that are securely put together to take peak currents.

Bodine also has a PM dc motor line—Series 42A with NEMA 42 frames. These motors cover the 1/8-to-1/4-hp range (at 2500 rpm). The 42A-E versions include parallel-shaft gear reducers in 11 ratios—10:1 to 300:1. Interestingly, a companion line, the 42R series—a more conventional induction type—requires cooling fins and a totally-enclosed fan to handle similar loads with the same frame sizes. The PM type has no fins or fan.

Controlling motor speed

A class of high-performance dc motors is designed for stable operation at continuously variable or preselected speeds. For example, Varo's Model 20707 PM dc motor operates at selected speeds that hold constant to within $\pm 0.5\%$ for a 30% variation of input voltage (28 V nominal), a load change from zero to 0.5 oz-in., and a temperature range from -40 to 70 C. Speeds between 6000 and 13,000 rpm are selected by an external adjustment. The motor achieves these impressive specs with the help

of a built-in optical-tachometer system. The system includes a LED, phototransistor and all the necessary ICs.

Micro Switch also has a line of high-performance PM dc speed-controlled motors—its VM series. The series offers a choice of built-in tachometers. Either a moving-coil analog tachometer (Series 2 VM) or digital-optical (Series 33 VM) is available.

Especially interesting are the motors' low-inertia, hollow rotors. These consist of thin-walled copper windings without cores. Only these light coils rotate. Rotation of the usually heavy iron core is eliminated. Besides reducing inertia, this type of construction also provides low inductance. The result: The motor can accelerate from a dead stop to 2000 rpm in less than 1 ms.

A comparison of inertia and inductance for various types of rotor construction, as provided by Micro Switch, shows the advantage of the hollow-coil rotor:

Rotor types	Inductance henries	Inertia oz-in.-s ²
<i>Conventional</i> —Laminated steel with conductors in slots	10×10^3	10.0×10^{-3}
<i>Slotless</i> —Conductors on face of cylindrical steel rotor	0.1×10^3	5×10^{-3}
<i>Pancake</i> —Radial conductors in epoxy glass disc	0.1×10^3	5×10^{-3}

Hollow —Cylindrical basket of wire reinforced with glass and epoxy 0.1×10^3 0.4×10^{-3}

The Kearfott division of Singer also has a line of low-inertia motors. The rotor inertia of its HD series ranges from about 0.5 to 9×10^{-3} oz-in.-sec².

But the Magnetic Components Div. of Control Data warns that the inertia of the rotor should be specified to include all the rotating mass. And this means that the effect of the inner race of the bearings—half the mass of the balls and half the ball cage—should be included. Unfortunately most specs never reveal whether or not these items are included.

Specify with transfer functions

Micro Switch engineers suggest that the conventional parameters used to specify motors are inadequate for high-performance dc motors, such as used in closed-loop servo systems. Instead of the old hp, speed and voltage values, a better and more useful description is obtained with transfer-function parameters like torque constant (oz-in./A), torque-inertia ratio (rad/s²), damping constant (oz-in./rad/s) and thermal resistance (°C/W). Also, duty cycle—acceleration, run, deceleration and dwell times—should be fully spelled out.

And Control Data adds terminal resistance to this list of needed parameters for high-performance motors. But the terminal resistance of a motor is generally nonlinear. The value you get depends upon how you measure it. You can either stall the motor and measure the terminal resistance at a specific current or run the motor as a generator and load it to a specific current. The latter method provides more consistent resistance results. The value you get will vary with the current—higher resistance at lower currents. Most manufacturers don't specify terminal resistance, and those that do don't tell how it was measured.

Brushes get the brushoff

For decades, motor engineers have dreamed of building a motor without brushes, commutators or sliding contacts of any kind. Sliding contacts are a prime source of problems, with limited life and added cost. Improvements in solid-state devices that can handle motor voltages and currents have now made brushless and commutatorless dc motors practical.

The life of these motors depends primarily on how long the bearings last. With ball bear-



The external appearances of Bodine's permanent-magnet dc motors (top) and the more conventional ac induction motors (bottom), both in NEMA 42 sized frames, demonstrate the contrast in efficiency between the two motors. The induction motor needs fins and a totally enclosed fan to keep it cool.

ings, they can run for 20,000 hours. And although the initial motor cost may be higher than that for conventional designs, the absence of brush dust and commutator wear and the elimination of periodic maintenance may, in many applications, provide for lower over-all cost—with a bonus of superior characteristics. With high-volume production, the initial cost of the brushless motor may eventually even match that of the more conventional types.

Additional advantages include safety in hazardous areas, with a complete absence of arcing, and the potential for an extremely quiet motor. And since the commutation and rotor position functions are electronically provided, it is natural also to provide speed control and load-output/torque matching via the electronic solid-state circuitry.

Another inherent bonus in the design of the commutating circuit for brushless motors: The back emf of the motor can be conveniently and inexpensively derived and used to regulate the motor speed. According to Peter G. Hotz, production manager at Siemens: "With this simple, closed-loop control—without an external tachometer—speed regulations of better than $\pm 2\%$ can

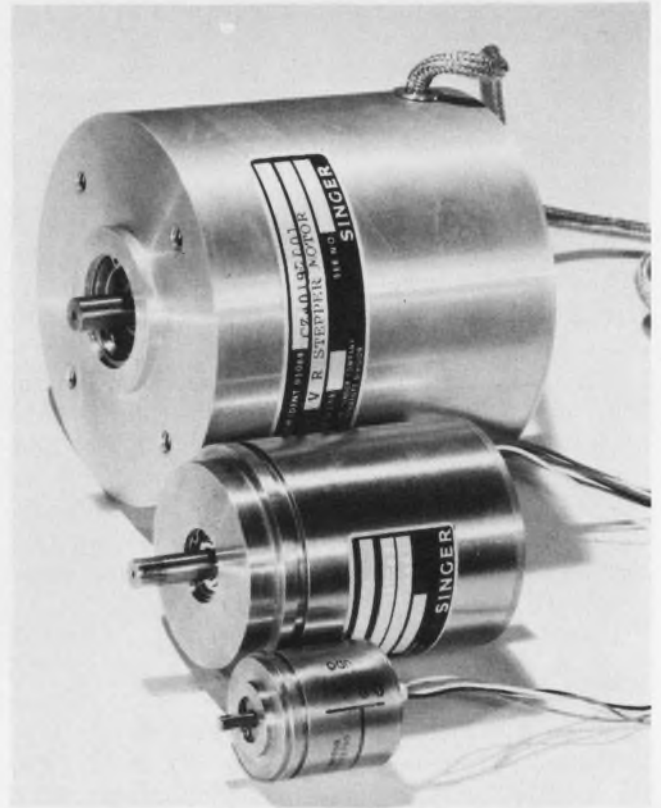
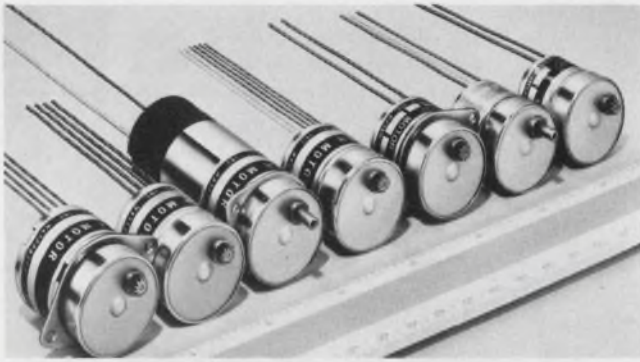

easily be achieved. For tighter speed-regulation, the brushless dc motor can, of course, be used with any type of tachometer and conventional servo control."

With a permanent-magnet rotor, the electronic commutator can be conveniently applied to the stator windings—a configuration similar to that of one form of ac synchronous machine. However here the stator is driven with what amounts to a dc-to-ac inverter. The rotor position is sensed electronically. Thyristors (SCRs) or, in small motors, transistors, can then switch and sequence the current in the stator windings. In general, the motor has the characteristics of a high-performance PM dc motor with speed control.

Siemens makes a complete line of brushless dc transistor-controlled motors. Sizes ranging from 0.28 to 28 oz-in. continuous-running torque are available off the shelf. Hall generators monitor the rotor position and control the transistor commutator—thus the often-used designation "transistor motor."

Pioneer Electronic also uses a Hall position sensor and transistor drive to control its small (about 0.5 oz-in. at 2000 rpm and 12 V) PMH-1002F brushless motor.

Hotz predicts that Siemens brushless motors will, in the near future, have all the electronics integrated within the motor. The commutator circuit will be a thin/thick-film IC circuit that will easily fit inside the motor housing.

Another development that Siemens is working on is a brushless very-high-speed motor. The

company has operated some versions to 60,000 rpm. And because a PM rotor is not a low-inertia configuration, Siemens is also working on a low-inertia-rotor version of the brushless motor.

IMC Magnetics Corp. makes a broad line of conventional ac and dc motors and also the IMCom series of brushless dc motors. The brushless motors range in size from NEMA 7 (3/4 in. diameter) to NEMA 46 (5-3/8 in. diameter).

The IMCom motors use an electromagnetic type of rotor-position sensor instead of the Hall-effect device that Siemens employs. IMC contends that its type is less temperature-sensitive and that it provides more uniform performance over the temperature range of -55 to 125 C.

Fenimore Fisher, vice president of IMC Magnetics Corp., points out that a brushless motor's dynamic speed range (high-to-low speed ratio) deserves more attention than it usually gets on the spec sheet. It is very inefficient, both in cost and performance, to use a variable-speed motor continuously at its very lowest speed settings.

It may be better, Fisher says, to use a gear box for low speeds. Besides, at the low end of their dynamic range, the motors tend to cog. This nonuniform motion is unacceptable in many applications, such as phonograph turntables and analog tape drives. Many high-performance motors are specially designed to reduce cogging, and to provide a smooth and quiet motion for such demanding applications as these, but the problem becomes increasingly difficult at the low-speed end of the range.

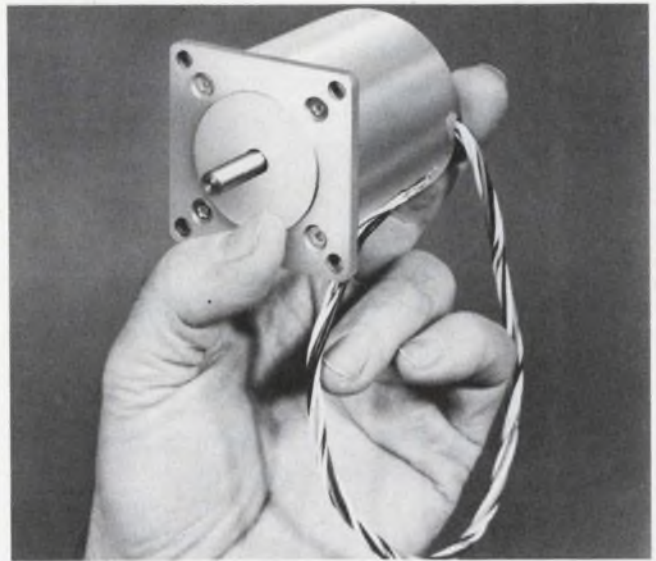
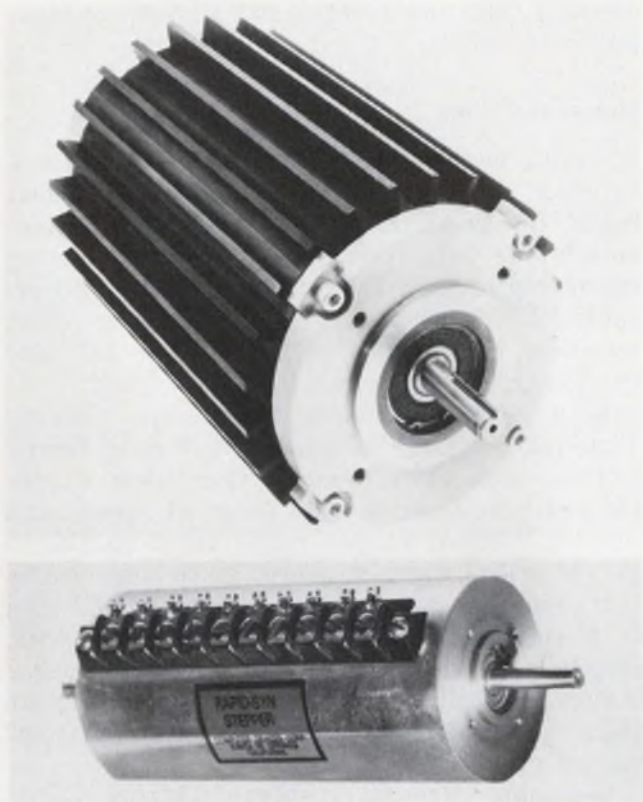

Families of stepping motors are proudly posed by their manufacturers: the Big Inch by Haydon Switch and Instrument (top left), IMC Magnetics' steppers with controllers and pulse source (bottom left) and Singer's VR stepper-motor line (center left). Other manufacturers single out some favorites from their stepping-motor lines: Warner Electric's SM-081-0750 (center top), Computer Device's Rapid-Syn unit (center bottom) and Superior Electric's M061 (right).

While cogging is anathema to most of the motors discussed thus far, in stepping motors this vice is turned into a virtue.

Motors that step

A stepping motor provides controlled rotational steps in response to sequential pulses or an ac input. A major application is in open-loop positioning systems that can replace, in many instances, more expensive and complex closed-loop servo systems. A stepping motor can start rapidly (within about half a cycle), slew at high rates and stop almost instantaneously without the use of brakes or clutches. Closed-loop servos can also effectively use stepping motors.

However, as John T. Wallace, product engineer at Superior Electric, points out: "Torque and rotor inertia are particularly vital parameters in the specification of stepping motors. Nevertheless this is a gray area and the least understood of the specifications."

Wallace says that to make a motor start rapidly and stop precisely, as stepping motors are required to do, you need high torque and low rotor inertia, or a high torque-to-inertia ratio.

But stepping-motor manufacturers surely don't help to clarify matters when they list torque and inertia specs in confusing, if not erroneous, ways. One company lists torque this way:

"Starting torque at the 3600 rpm rotor shaft is approx. 5mm-grams; with 60 rpm gear train, 10 inch-grams; and with 3.6 rpm gear train, 5 in-oz. Synchronous torque is somewhat greater

than starting torque."

Note the use of mixed dimensions (English and metric), a different set for each speed and the listing of force and length in incorrect order—all in one sentence. It couldn't be worse. The established way to specify torque is by force-length—oz-in., not in-oz, which is used for the dimension of energy.

Several other companies rate their motors' rotor inertia in g-cm² units and torque in oz-in. And one uses oz-in. and lb-in², and then provides a torque-to-inertia ratio without any dimension. Mixed dimensions are difficult to work with, and the nonuniformity of dimensions among manufacturers makes it tough to compare them.

One company, to its credit, lists compatible oz-in. and oz-in.-s² units for torque and rotor inertia. And it even provides metric equivalents. Even this company's data are marred by what is apparently a printer's error. The dimension Kp designates force (Kp-cm and Kp-cm-s²) rather than kg for kilograms.

Motor inductance is another important parameter for stepping motors—and one widely misunderstood. Most manufactures don't supply it. Those that do, don't define it carefully. There is no widely accepted standard for measuring or specifying inductance.

During the recent Second Annual Symposium on Incremental Motion Control Systems and Devices held at the University of Illinois and co-sponsored by Warner Electric, Dr. B. C. Kuo of Illinois University said:

"We do a great deal of inductance measurement on stepping motors, because we feel this is one way of predicting performance. But when you read in a catalog that the inductance is 5 mH, what does this mean? Is it average or incremental inductance? We have found that the incremental inductance that is measured with a dc bias is the important parameter."

Few manufacturers, however, provide inductance values of any kind for their stepping motors.

Steppers come in PM and VR types

Variable-reluctance (VR) stepping motors are simpler in construction, have low rotor inertia and, when lightly loaded, have high-speed capability. When not energized, VR motors can rotate freely. On the other hand, steppers of a given frame size can deliver more power with a PM rotor. And PM versions are more efficient, have better damping characteristics and more holding torque when not running. Also motors with small step angles—typically 1.8, 2.5, 7.5 and 15 degrees per step—are usually available in PM designs. Steps for VR types are usually larger, such as 7.5, 15 and 30 degrees. However, very large angles, like 45 and 90 degrees per step are again generally PM.

At the low-power end of the PM stepping-motor range, Haydon Switch and Instruments' Big Inch series is only 1-1/16 in. in diameter, has an integral gear train and rotor assembly and very closely resembles the construction of heavy-duty timing motors. Some of the motors are reversible, and they come in two and three-wire versions.

In the large PM motor category (35-840 oz-in. at 1.8°/steps) Superior Electric manufactures the Slo-Syn line of synchronous stepping motors, controls and drives. Some of these motors have enough power to position machine-tool slides and rotary tables in numerical-control machines. They can be controlled from single steps to over 20,000 steps per second.

In between these small and large stepper lines, Computer Devices offers its Rapid-Syn series, with dynamic torque outputs of 1 to 500 oz-in. at 200 steps/revolution in Bu. Ord. sizes 23 and 34. Other smaller units provide steps of from 5 to 90 degrees in both PM and VR versions.

And Eastern Air Devices—now the owners of the Holtzer-Cabot instrument motor and Janette motor products—has added stepping motors to its broad line. It is offering PM versions also in sizes 23 and 34 and a variable-reluctance motor, in size 20. In addition, Eastern offers an extensive line of driver-circuit boards.

All stepping-motor companies are anxious to help the design engineer. Take them up on it. Stepping motors can be very difficult to apply

correctly, but they offer a way of solving many problems, simply.

Motors that time

Timing motors are a special class of small synchronous motors, usually having integral gear boxes. But these have found many applications outside the pure timing field. When they were introduced in the 1930s, they were used to drive clocks. Now they drive everything from chart recorders to animated displays. They fall into two general groups—light and heavy-duty.

Both North American Philips and General Time make a large variety of light-duty timing motors—with and without clutches, some reversible and they cover a wide range of speeds and torques. Output torques range from roughly 6 to 200 oz-in. when measured with gear ratios that produce 1 rpm. Torque at the speed of 1 rpm is a convenient way of rating gear motors, especially of the flea-power variety. This makes it easy to calculate the torque of any other gear train. And it aids comparison of the torque capabilities of different motors.

Companies like Hurst Manufacturing Corp., Molon Motor and Coil and Hansen Manufacturing also make this class of motor. But while Hansen, a division of P. R. Mallory, specializes in its light-duty Synchron line, Hurst's line extends to the heavy-duty region (1/35 hp) with its Model HB Honey Bee. Molon has its Model LMO synchronous motor that provides 7 oz-in. at 300 rpm with a PM, 24-pole rotor and permanent-capacitor stator.

For heavy-duty timing applications, General Time offers its MP20, 200 oz-in. at 1 rpm with a rated life of 10,000 hours and Paragon (a division of AMF) offers its HI and HP permanent-magnet motors. The HP has a 550 oz-in. torque at 1 rpm. And Philips' heavy-duty unit is its NEMA 2-11, 86600 series. The torque of the 86600 at its shaft speed of 600 rpm is 5.5 oz-in., so that if it were geared down to 1 rpm, neglecting losses, it would deliver 3300 oz-in. But gear trains available for the motor can safely handle only 200 oz-in. Thus great caution must be used at the higher gear ratios (greater than 16.5:1) and the motor must not be stalled.

"In general, there is a great temptation to use light-duty timing motors to drive heavy-duty loads, because the available high gear ratios can develop the needed torque," notes Lawrence Wojak, applications engineer at Paragon. "For a reasonable life, both gear train and motor must match the duty level."

Motors that provide torque

Torque motors develop high torque and high acceleration, but some types operate over only

a limited rotation range of less than 360 degrees. Many are directly coupled to the load without gears. They often operate in a stalled condition. They position control valves, apply tape tension and drive indicating devices. In most cases the speed is controlled by means other than the motor. For instance, the spring-drive in a clock acts like a torque motor. The spring supplies the torque, and an escapement mechanism determines the clock's speed.

Both Vernitron with its Vernitorg line of brushless dc limited-motion torque motors and Singer with its continuous motion dc torquers, among many other motor companies, can fill such applications. Peak torque and the torque constant (oz-in./A) are the two important parameters in specifying a torque motor. And to ensure that the load follows accurately, the rotor inertia should be low to allow rapid acceleration. ■■

Available literature

1. *Fractional Horsepower Motor and Control Handbook*, Bodine Electric Co.—A very good reference guide to small high-utility motors, their selection and application.

CIRCLE NO. 380

2. *DC Motors/Speed Controls/Servo Systems*, Electro-Craft Corp.—An engineering handbook that covers high-performance types of motors. Theory and practice of dc motor applications to servo systems are very well covered. Conversion and terminology tables, many practical applications—plus only a few pages devoted to Electro-Craft's products—make this handbook a worthwhile acquisition.

CIRCLE NO. 381

3. *Stepping Motor Handbook*, Sigma Instruments, Inc.—This handbook provides a thorough treatment of a complex subject. Both practical examples and theoretical discussions introduce a class of motors that are finding a rapidly expanding field of applications. It is full of useful charts, circuits and conversion tables. The rotary-inertia conversion table on page 58 should be particularly useful in unscrambling those widely differing and often confusing units supplied by motor manufacturers.

CIRCLE NO. 382

4. *Proceedings, Second Annual Symposium, Incremental Motion Control Systems and Devices*, Prof. B. C. Kuo, Editor, Department of EE, University of Illinois—Copies of the symposium proceedings can be obtained from Warner Electric Brake & Clutch Co. The volume is a mine of information for engineers who work with stepping motors.

CIRCLE NO. 383

Need more information?

We wish to thank the companies that provided information for this report. The products cited in the report have been selected for their illustrative, or in some cases, unique qualities. However, manufacturers not mentioned in the report may offer similar products. Readers may wish to consult manufacturers listed here for further details. Code numbers listed after each company refer to motor types manufactured: fractional-hp, high-utility ac (1) and dc (2), brushless (3), timing (4), servo (5), stepping (6), torque (7), variable speed (8).

- AEG-Telefunken Corp., 570 Sylvan Ave., Englewood Cliffs, N. J. 07632. (201) 568-8570. (1) **Circle No. 384**
- Abrams Instrument Corp., 606 E. Shiawassee St., Lansing, Mich. 48901. (517) 484-9441. (6) **Circle No. 385**
- Aeroflex Laboratories Inc., So. Service Rd., Plainview, N. Y. 11803. (516) 694-6700. (3, 6, 7) **Circle No. 386**
- American Design Components, 39 Lispenard St., New York, N. Y. 10013. (212) 966-5650. (1, 2, 5) **Circle No. 387**
- Ametek-Lamb Electric, 627 Lake St., Kent, Ohio 44240. (216) 673-3451. **Circle No. 388**
- Applied Motors Inc., P.O. Box 106, 4801 Boeing Dr., Rockford, Ill. 61105. (815) 397-2006. (2, 5, 8) **Circle No. 389**
- Aristo Craft Distinctive, 314 Fifth Ave., New York, N. Y. 10001. (212) 279-9036. (1) **Circle No. 390**
- Ashland Electric Products Inc., 32-02 Queens Blvd., Long Island City, N. Y. 11101. (212) 392-4010. (1, 2, 4, 7, 8) **Circle No. 391**
- B & B Motor Control Corp., 96 Spring St., New York, N. Y. 10012. (212) 966-5777. (1, 2, 4, 5, 6, 7, 8) **Circle No. 392**
- Barber-Colman Aircraft Marine, 1300 Rock St., Rockford, Ill. 61101. (815) 968-6833. (1, 2, 8) **Circle No. 393**
- Beckman Instruments, Inc., Cedar Grove Operations Div., Cedar Grove, Essex County, N. J. 07009. (201) 239-6200. (5) **Circle No. 394**
- Bergen Laboratories Inc., 60 Spruce St., Paterson, N. J. 07501. (201) 278-3020. (6) **Circle No. 395**
- Bodine Electric Co., 2500 W. Bradley Pl., Chicago, Ill. 60618. (312) 478-3515. (1, 2, 3, 4, 5, 7, 8) **Circle No. 396**
- Bowmar Instrument Corp., 8000 Bluffton Rd., Ft. Wayne, Ind. 46809. (219) 747-3121. (5, 6, 7, 8) **Circle No. 397**
- Braileford & Co. Inc., 670 Milton Rd., Rye, N. Y. 10580. (914) 967-1820. (4) **Circle No. 398**
- Brelval Motors Div., Ingraham Industries of McGraw-Edison Co., Broad & 16th Sts., Carlstadt, N. J. 05072. (201) 933-0220. (1, 2, 8) **Circle No. 399**
- Bulova Watch Systems & Instruments Div., Green Acres Rd. West, Valley Stream, N. Y. 11582. (516) 561-2600. (6) **Circle No. 400**
- Cambridge Thermionic Corp., 445 Concord Ave., Cambridge, Mass. 02138. (617) 491-5400. (6) **Circle No. 401**
- Carter Motor Co., 2714 W. George St., Chicago, Ill. 60618. (312) 588-7700. (2, 7, 8) **Circle No. 402**
- Century Electronics & Instrument, Inc., 11616 E. 51st St., Tulsa, Okla. 74145. (918) 663-0110. (1, 4) **Circle No. 403**
- Clifton Precision, Litton Systems, Marple at Broadway, Clifton Heights, Pa. 19018. (215) 622-1000. (1, 2, 5, 8) **Circle No. 404**
- Cole-Parmer Instrument Co., 7425 N. Oak Park Ave., Chicago, Ill. 60648. (312) 647-0272. (8) **Circle No. 405**
- Computer Devices of Calif., 11901 Burke St., Sante Fe Springs, Calif. 90670. (213) 723-6593. (1, 6) **Circle No. 406**
- Control Data, Magnetic Components Div., 7801 Computer Ave., Minneapolis, Minn. 55435. (612) 920-8600. **Circle No. 407**
- Control Products Corp., 4429 W. Division St., Chicago, Ill. 60651. (312) 235-1131. (2, 5, 6, 8) **Circle No. 408**
- Conrac Corp., Cramer Div., 600 N. Rimsdale Ave., Covina, Calif. 91722. (213) 966-3511. (1, 2, 4, 6) **Circle No. 409**
- Dale Electronics Inc., 1360 28th Ave., Columbus, Neb. 68601. (402) 564-3131. (1) **Circle No. 410**
- Designatronics Inc., 55 S. Denton Ave., New Hyde Park, N. Y. 11040. (516) 328-3300. (1, 2) **Circle No. 411**
- Doerr Electric Corp., 1201 Doerr Way, Cedarburg, Wis. 53012. (414) 377-0500. (1, 2, 5, 6, 7) **Circle No. 412**
- Dynamics Research Corp., Components Div., 50 Concord St., Wilmington, Mass. 01887. (617) 438-3900. (5, 8) **Circle No. 413**
- Dynetic Systems Corp., 8740 49th Ave. North, Minneapolis, Minn. 55428. (612) 535-4338. (2, 4, 5, 8) **Circle No. 414**
- EEMCO Div. of Datron Systems, 4585 Electronics Place, Los Angeles, Calif. 90039. (213) 247-7060. (1, 2, 3, 4, 5, 7, 8) **Circle No. 415**
- Eastern Air Devices, Inc., Washington St., Dover, N. H. 03820. (603) 742-3330. (1, 5, 6, 7) **Circle No. 416**
- Eaton Corp., Industrial Drives Div., Dynamatic Plant, 3122 14th Ave., Kenosha, Wis. 53140. (414) 656-4011. (1, 2, 7, 8) **Circle No. 417**

(continued on page 64)

Edison, Thomas A., Instrument Div., McGraw-Edison Co., 2 Babcock Place, W. Orange, N.J. 33307. (201) 736-1000. (1, 2, 5, 6, 8) **Circle No. 418**

Electric Indicator Co., Inc. EDO Corp., 195 Danbury Rd., Wilton, Conn. 06897. (203) 762-8655. (1, 2, 3, 5, 6, 7, 8) **Circle No. 419**

Electro-Craft Corp., 1600 So. 2nd St., Hopkins, Minn. 55343. (612) 935-8226. (2, 5, 7, 8) **Circle No. 420**

Esterline Angus, Div. of Esterline Corp., P.O. Box 24000, Indianapolis, Ind. 46224. (317) 244-7611. (5, 8) **Circle No. 421**

Fema Corp., 11023 Glenoaks Blvd., Pacoima, Calif. 91331. (213) 899-5910. (7) **Circle No. 422**

Franklin Electric, 400 E. Spring St., Bluffton, Ind. 46714. (219) 824-2900. (1) **Circle No. 423**

General Electric Co., General Purpose Motor Dept., 2000 Taylor St., Ft. Wayne, Ind. 46804. (219) 743-7431. (1, 2) **Circle No. 424**

General Scanning Inc., 80 Coolidge Hill Rd., Watertown, Mass. 02172. (617) 924-6620. (7) **Circle No. 425**

General Time Corp., Industrial Controls Div., 135 S. Main St., Thomaston, Conn. 06787. (203) 482-4481. (1, 2, 4) **Circle No. 426**

Gerbing Mfg. Corp., S. State Rd., Elgin, Ill. 60120. (312) 741-2790. (8) **Circle No. 427**

Graham Transmissions Co., Div. of Stowell Industries Inc., W161N9116 Hayes Ave., Menomonee Falls, Wis. 53051. (414) 251-2400. (2, 8) **Circle No. 428**

Hale Instruments Inc., P.O. Box 7487, Houston, Tex. 77008. (713) 861-7574. (1, 4) **Circle No. 429**

Hankcraft Motors Div., Hankcraft Co., 728 Booster Blvd., Reedsburg, Wis. 53959. (608) 524-4341. (2) **Circle No. 430**

Hansen Mfg. Co., Inc., P.O. Box 23, Princeton, Ind. 47670. (812) 385-3415. (2, 4) **Circle No. 431**

Harowe Servo Controls, Inc., Westtown Rd. at W. Chester Pike, W. Chester, Pa. 19380. (215) 692-2700. (5, 6) **Circle No. 432**

Haydon Switch & Instrument, Inc., 1500 Meriden Rd., Waterbury, Conn. 06720. (203) 756-7441. (1, 2, 4, 5, 6) **Circle No. 433**

Heller, G.K. Corp., 17 Mayflower Place, Floral Park, N.Y. 11001. (516) 775-7170. (2, 8) **Circle No. 434**

Honeywell Inc., Industrial Div., 1100 Virginia Dr., Ft. Washington, Pa. 19034. (215) 643-1300. (5) **Circle No. 435**

Howard Industries, Div. MSL Industries, Inc., One Dixie Highway, Milford, Ill. 60953. (815) 889-4105. (1, 2, 7, 8) **Circle No. 436**

Howell Electric Motors Div., SFM Corp., 900 N. Ave., Plainfield, N. J. 07601. (201) 756-8800. (1) **Circle No. 437**

Hurst Mfg. Corp., Road 64 East, Princeton, Ind. 47670. (812) 385-2564. (1, 4) **Circle No. 438**

IMC Magnetics Corp., 570 Main St., Westbury, N.Y. 11591. (516) 334-7070. (1, 2, 5, 6, 7, 8) **Circle No. 439**

Icon Corp., Subsidiary, USM Corp., 156 6th St., Cambridge, Mass. 02142. (617) 868-5400. (5, 6) **Circle No. 440**

Indiana General, 405 Elm St., Valparaiso, Ind. 46383. (219) 462-3131. (1, 2, 4, 5) **Circle No. 441**

Inland Motor Div., Kollmorgen Corp., 501 1st St., Radford, Va. 24141. (703) 639-3973. (2, 3, 4, 5, 7, 8) **Circle No. 442**

Intermatic, Intermatic Plaza, Spring Grove, Ill. 60081. (815) 675-2321. (1, 4) **Circle No. 443**

Jones Motorola Corp., 433 Fairfield Ave., Stamford, Conn. 06904. (203) 327-6440. (2, 5, 7, 8) **Circle No. 444**

Kendrick & Davis Inc., 12 Water St., Lebanon, N.H. 03766. (603) 448-1113. (2) **Circle No. 445**

Kollmorgen Corp., Photocircuits Div., 31 Sea Cliff Ave., Glen Cove, N.Y. 11542. (516) 676-8000. (2, 5, 7, 8) **Circle No. 446**

Lear Siegler, Inc., Power Equipment Div., 17600 Broadway Ave., Maple Heights, Ohio 44137. (216) 662-1000. (1, 2) **Circle No. 447**

MPC Products Corp., 4200 W. Victoria, Chicago, Ill. 60646. (312) 583-5100. (1, 5, 6, 7, 8) **Circle No. 448**

MPH Electronics, 9654 Alpaca St., S. El Monte, Calif. 91733. (213) 442-7818. (5) **Circle No. 449**

Magnedyn, Inc., Div. of Axial Corp., 5550 El Camino Real, Carlsbad, Calif. 92008. (714) 729-7191. (1, 2, 5, 7) **Circle No. 450**

McLean Engineering Laboratories, 70 Washington Rd., Princeton Junction, N.J. 08550. (609) 799-0100. (1, 7) **Circle No. 451**

Merkle-Korff Gear Co., 11500 Melrose Ave., Franklin Park, Ill. 60131. (312) 455-8333. (1, 4, 7) **Circle No. 452**

Mesur-Matic Electronics Corp., 50 Grove St., Salem, Mass. 01970. (617) 745-7000. (6) **Circle No. 453**

Micro Mo Electronics, Inc., 3691 Lee Rd., Cleveland, Ohio 44120. (216) 752-5599. (2, 5, 7) **Circle No. 454**

Micro Switch, a div. of Honeywell, Inc., 11 W. Spring St., Freeport, Ill. 61032. (815) 232-1122. (2, 5, 6) **Circle No. 455**

Molon Motor & Coil Corp., 3737 Industrial Ave., Rolling Meadows, Ill. 60008. (312) 259-3750. (1, 4, 6) **Circle No. 456**

Morse Chain, Div. of Borg-Warner Corp., South Aurora St., Ithaca, N.Y. 14850. (607) 272-7220. (1, 2, 8) **Circle No. 457**

Motoresearch Mfg. Co., Inc., 1600 Junction Ave., Racine, Wis. 53403. (414) 632-5131. (1) **Circle No. 458**

Nash Controls Inc., Simmonds Precision Products, 1275 Bloomfield Ave., Caldwell, N.J. 07006. (201) 278-0880. (1, 2, 5) **Circle No. 459**

North American Philips Controls Corp., Cheshire Industrial Park, Cheshire, Conn. 06410. (203) 272-0301. (1, 2, 4, 8) **Circle No. 460**

Novatronics, Inc., P.O. Box 878, Pompano Beach, Fla. 33061. (305) 942-5200. (1, 5, 6) **Circle No. 461**

Pamotor, Div. of Wm. J. Purdy Co., 770 Airport Blvd., Burlingame, Calif. 94010. (415) 347-1203. (1, 7) **Circle No. 462**

Paragon Electric Co., Inc., AMF Inc., 1600 12th St., Two Rivers, Wis. 54241. (414) 793-1161. (1, 4) **Circle No. 463**

Parametrics Inc., 284 Racebrook Rd., Orange, Conn. 06477. (203) 799-2333. (2, 8) **Circle No. 464**

Pioneer Electronic Corp., c/o Imal Marketing Assoc. Inc., 525 W. Remington Dr., Sunnyvale, Calif. 94087. (408) 245-3511. (3) **Circle No. 465**

The Pittman Corp., Sellersville, Pa. 18960. (215) 257-5117. (2, 5, 8) **Circle No. 466**

Porterscap U.S., Porterscap Switzerland, 730 Fifth Ave., New York, N.Y. 10019. (212) 245-7716. (2, 4, 5, 6) **Circle No. 467**

Rae Corp., 5801 W. Rt. 120, McHenry, Ill. 60050. (815) 385-3500. (1, 2) **Circle No. 468**

Reliance Electric Co., 24701 Euclid Ave., Cleveland, Ohio 44117. (216) 266-7000. (1, 2, 8) **Circle No. 469**

Reliance Instrument Mfg. Corp., 143 Lawrence St., Hackensack, N.J. 07602. (201) 343-3500. (1) **Circle No. 470**

Robbins & Myers Inc., Electric Motor Div., Moyno Pump Div., 1345 Lagonda Ave., Springfield, Ohio 45501. (513) 323-6461. (1, 2) **Circle No. 471**

Rotating Components, Div. of ISC, 770 Park Ave., Huntington, N.Y. 11743. (516) 423-6200. (1, 2, 4, 7, 8) **Circle No. 472**

Sankyo Seiki (America) Inc., 149 5th Ave., New York City, N.Y. 10010. (212) 260-0200. (2, 3, 6) **Circle No. 473**

Sawyer Industries, Inc., 5445 Peck Rd., Arcadia, Calif. 91006. (213) 447-5981. (1, 2, 5, 7, 8) **Circle No. 474**

Scot Inc., 2525 Cortiss St., Downers Grove, Ill. 60515. (312) 969-0620. (5) **Circle No. 475**

Sequential Information Systems, Inc., 249 N. Sawmill River Rd., Elmsford, N.Y. 10523. (914) 592-5930. (2, 5, 7, 8) **Circle No. 476**

Servo-Tek Products Co., 1086 Goffle Rd., Hawthorne, N.J., 07506. (201) 427-3100. (2, 5, 8) **Circle No. 477**

Servotronics, Inc., 3901 Union Rd., Buffalo, N.Y. 14225. (716) 633-5990. (5, 7) **Circle No. 478**

Shigoto Industries Ltd., Empire State Bldg., 350 Fifth Ave., New York, N.Y. 10001. (212) 695-0200. (1, 2, 4, 7) **Circle No. 479**

Siemens Corp., 186 Wood Ave. So., Iselin, N.J. 08830. (201) 494-1000. (2, 3, 8) **Circle No. 480**

Sigma Instruments, Inc., 170 Pearl St., Braintree, Mass. 02185. (617) 843-5000. (6, 7, 8) **Circle No. 481**

Singer Co., Kearfott Div., 1150 McBride Ave., Little Falls, N.J. 07424. (201) 256-4000. (1, 2, 5, 6, 7) **Circle No. 482**

Sodeco Div., Landis & Gyr, Inc., 4 Westchester Plaza, Elmsford, N.Y. 10523. (914) 592-4400. (2, 4) **Circle No. 483**

Sonceboz Corp., 210 Newtown Rd., Plainview, N.Y. 11803. (516) 249-0330. (2, 4) **Circle No. 484**

Sperry Marine Systems Div., Charlottesville, Va. 22901. (703) 973-3371. (3, 7) **Circle No. 485**

Stettner-Trush, Inc., 67 Albany St., Cazenovia, N.Y. 13035. (315) 655-8141. (7) **Circle No. 486**

Summitt Engineering Corp., 1820 S. Seventh St., Bozeman, Mont. 59715. (406) 587-0636. (6) **Circle No. 487**

Superior Electric Co., 383 Middle St., Bristol, Conn. 06010. (203) 582-9561. (6) **Circle No. 488**

TRW Globe Div., TRW Inc., 2275 Stanley Ave., Dayton, Ohio 45404. (513) 228-3171. (1, 2, 4, 5, 6, 7, 8) **Circle No. 489**

Tech Serv. Inc. BRS-Foringer Div., 5451 Holland Dr., Beltsville, Md. 20705. (301) 474-3400. (6) **Circle No. 490**

Teledyne Systems Co., Lewisburg Div., Industrial Park, Lewisburg, Tenn. 37091. (615) 359-4531. (1, 5) **Circle No. 491**

Thor Power Tool Co., 175 N. State St., Aurora, Ill. 60507. (312) 898-8000. (1) **Circle No. 492**

Transicoil, Inc., Trooper Rd., Worcester, Pa. 19490. (215) 277-1300. (1, 5, 6, 7) **Circle No. 493**

UMC Electronics Co., 460 Sackett Point Rd., North Haven, Conn. 06473. (203) 288-7731. (1, 4, 8) **Circle No. 494**

USM Corp., Gear Systems Div., Route 128, Wakefield, Mass. 01880. (617) 245-4900. (6) **Circle No. 495**

Uriel Corp., 53 Union Ave., Ronkonkoma, N.Y. 11779. (516) 588-6010. (1, 2, 4, 5, 7, 8) **Circle No. 496**

Varo Inc., Electrokinetics Div., P.O. Box 1500, 402 E. Gutierrez St., Santa Barbara, Calif. 93102. (805) 963-2055. (1, 2) **Circle No. 497**

Vernitron Control Components, Vernitron Corp., 2440 W. Carson St., Torrance, Calif. 90501. (213) 328-2504. (2, 3, 5, 6, 8) **Circle No. 498**

Von Weise Gear Co., Home Office, 9353 Watson Industrial Park, St. Louis, Mo. 63126. (314) 968-2100. (1) **Circle No. 499**

Warner Electric Brake & Clutch Co., 449 Gardner St., Beloit, Wis. 53511. (815) 389-3771. (6) **Circle No. 500**

Wertronix, 2673 Culver Ave., Dayton, Ohio. 45429. (513) 299-5586. (2, 4, 5, 7, 8) **Circle No. 501**

Westinghouse Electric Corp., Small Motors Div., Box 566, Lima, Ohio 45802. (419) 227-2141. (1, 2) **Circle No. 502**

Zero-Max Co., 2845 Harriet Ave. So., Minneapolis, Minn. 55408. (612) 827-6261. (8) **Circle No. 503**

From the land of "click, click, click" comes "whirrrr."



ONCE UPON A TIME, MICRO SWITCH was only a manufacturer of precision, snap-action switches. As your needs expanded, so did our product line. From switches, to keyboards, to precision DC control motors.

Starting with Honeywell punch card equipment, we've been supplying the computer peripheral field with high performance motors for more than six years. Now our line is broad enough to meet both your needs and delivery dates.

Along with a unique motor, we've developed a unique computer time-sharing program. It helps us analyze your specifications and tells our application engineers which motor is right for your specific job. Be it tape drive, punch card positioning, disc drive system or . . . you name it.

For assistance or more information, contact your MICRO SWITCH Branch Office. And live happily ever after.

MICRO SWITCH

FREEPORT, ILLINOIS 61032
A DIVISION OF HONEYWELL

MICRO SWITCH makes your ideas work.

MICRO SWITCH products are available worldwide through Honeywell International.

INFORMATION RETRIEVAL NUMBER 33

SPECIAL GROUP TOUR



1973 JAPAN ELECTRONICS SHOW

With the cooperation of ELECTRONIC DESIGN and PAN AMERICAN AIRWAYS, a special tour program has been tailored by Imperial Travel Service of New York for exhibitors and visitors to the 1973 JAPAN ELECTRONICS SHOW to be held in Osaka, Japan, October 1 through 7. Far and above regular sightseeing tours, this program will offer you many opportunities to witness at first-hand the growing Japanese electronics industry and provide free time to do business in Japan and the Orient. If you are taking your wife along, you will find this tour ideal with its many side trips and excursions.

Departure from West Coast:
Return to the United States:

Saturday, September 22, via Pan American
Monday, October 8, via Pan American

Tour Fare: \$945 per person on sharing basis
\$150 per person for single supplement

The above includes:

Air transportation from West Coast to Tokyo, round trip,
Economy on GIT fare.

Accommodations for 15 days at first class hotels.

Full American breakfasts during the tour

Transfers by chartered motorcoaches between airports and hotels.

Sightseeing tours in Tokyo, Nikko, Kyoto and Osaka.

Special plant tours designed for the participants.

Services of tour couriers and guides.

Features: Interpreter/Secretarial services will be available upon request.
Extension trips to Taiwan, Korea and Hong Kong available.

For detailed information, complete and mail the coupon below.



To: Imperial Travel Service
50 Essex Street, Rochelle Park, NJ 07662

I am interested in your Special Group Tour to
the Japan Electronics Show, October 1-7, 1973.
Please send me detailed information as soon as
possible.

Name _____

Title _____

Company _____

Address _____

FREE! 48-Page Booklet

“How to write effectively”

This time- and work-saving booklet can give your memos, letters, speeches, reports, a new clarity, brevity and impact. Included are guides to grammar, style vocabulary building... plus mistakes to avoid, and tips on organizing and outlining that make writing a breeze. Free when you order a free-trial copy of any book below.

WHEN YOU ORDER A FREE-TRIAL COPY OF ANY OF THESE **WILEY** BOOKS



① **All the Data You Need to Design the Best Possible Low-Noise Circuit**

LOW-NOISE ELECTRONIC DESIGN

By Motchenbacher and Fitchen

See this practical guide on noise mechanism, noise models, and the analysis of noisy circuits and systems. This includes amplifier noise, and noise in sensors, transistors and ICs. It also helps you with design problems, and gives you new information on noise in passive components, biasing without noise, power supplies, and cascaded stages and feedback. And you'll see many design examples, information on computer-aided design, and noise measurement methods. **\$19.95**



④ **Over 200 Ready-Made Circuits To Save You Time and Work—Help Solve Design Problems**

MODERN OPERATIONAL CIRCUIT DESIGN

By John I. Smith

You get a valuable collection of tested circuits and design techniques—complete with data, formulas, and graphs—involving the modern operational amplifier. You'll find many of the more advanced circuits completely new. Included are circuits for unity-gain inverter, inverting amplifier, dynamic error and stability, integrator and differentiator, follower, precise diode, instrumentation, voltage- and current-meter applications... plus data on circuits that enable you to construct autonomous electronic systems. **\$16.95**



② **Simplifies Analyses of Performance-Speed-Cost Trade-Offs for Optimum Device Selection**

USER'S HANDBOOK OF INTEGRATED CIRCUITS

By Eugene R. Hnatek

To help you pick the best device for a given job, this guide gives you performance characteristics of bipolar ICs and MOS ICs, and how to combine them for maximum benefits from both. You'll also find details on structure and applications of operational amplifiers and voltage regulators, and design and applications of digital bipolar ICs. In addition, you'll get approaches to design of thin-film and thick-film hybrid circuits, and techniques of monolithic and hybrid packaging and assembling. **\$24.95**



⑤ **The Non-Specialist's Guide to Analysis, Design, and Application**

OPTICS: A Short Course for Engineers and Scientists

By Williams and Becklund

This practical, instant-reference manual will give you a wealth of information on the properties of waves and optical materials, and ideal optical systems. Designed specifically for those with no experience in this area, it gives you details on such standard topics as radiometric and photometric units... diffraction... stops and pupils... lens aberrations... image "brightness"... evaluation of optical systems, and radiant energy detectors. You'll also get the math background you need, plus tables of typical optical quantities. **\$17.95**



③ **Proven Techniques to Pinpoint and Eliminate Noise Problems or to Design Around Them**

GROUNDING AND SHIELDING TECHNIQUES IN INSTRUMENTATION

By Ralph Morrison

In this practical, detailed treatment you'll see what causes unwanted noise and why. The author gives you a complete rundown on noise sources, explains where the problems are, and offers you proven techniques for avoiding noise pickup. Using electrostatics and mutual capacitance as the basis, this realistic worksaver gives you general rules for shielding signal paths and grounding signal lines. It features the author's original treatments of the shield enclosure, the differential amplifier, and the use of multi-shielded transformers in instrumentation. **\$12.00**

⑥ **Instant Answers to 1,001 Questions—Those That Pop Up Daily in Actual Practice**
THE ENGINEER'S COMPANION

By Mott Souders

\$11.95

⑦ **Ways to Solve Special-Purpose Digital Problems with Commercially-Available Micro-Digital Circuits**

LOGIC DESIGN WITH INTEGRATED CIRCUITS

By William E. Wickes

\$11.95

----- MAIL COUPON TODAY FOR FREE BOOKLET -----

Please send me, to use FREE for 10 days, the book(s) I've circled below. For those I keep, I'll send the amount(s) shown, plus postage and handling. I'll owe nothing for any book(s) I return during the trial period. Include my FREE writing booklet, which is mine to keep whether or not I buy any books.

Bill me Bill company

1 (1-61950-7)
 3 (1-61617-6)
 5 (1-94830-6)
 7 (1-94275-8)
 2 (1-40110-2)
 4 (1-80194-1)
 6 (1-81395-8)

JOHN WILEY & SONS, INC., P.O. BOX 4192
GRAND CENTRAL STATION, NEW YORK, N.Y. 10017

NAME _____
 FIRM _____
 ADDRESS _____
 CITY _____
 STATE _____ ZIP _____

Offer good in U.S.A. only.

063

A-4248 NP

INFORMATION RETRIEVAL NUMBER 35

Improve op-amp audio circuits

by mating op amp dynamic characteristics and compensation to the circuit application.

Some of the most useful op-amp applications occur in audio frequency circuits—but only if you use the right op amp and the right compensating components.

If you do this, the inherently high gain of the op amp can greatly boost the performance of the audio circuit. Distortion can be reduced to vanishingly small levels. Frequency response can be shaped at will by suitable selection of external passive components. And simpler, smaller and more economical circuits can be built with today's compact op amps.

But though many IC op amps possess excellent dc characteristics, their high frequency characteristics (≈ 15 kHz) are not always adequate in audio circuits, particularly when high gain and high output levels are required.

The most important dynamic specification for any amplifier, including an IC op amp, is open-loop gain. This affects the quality of all closed-loop parameters—distortion, output impedance, input impedance, gain variation, frequency response and frequency response variations. In fact, the degree of improvement due to feedback is directly related to the loop gain—the difference, expressed in dB, between open-loop and closed-loop gain in a given circuit configuration.

Analysis of a simple inverting amplifier circuit (Fig. 1a) illustrates the effects of loop gain. Assume, for the moment, ideal amplifier characteristics—infinite gain, infinite input impedance, infinite bandwidth and zero output impedance. Then for any combination of resistors R_1 and R_2 , the gain is simply $-R_2/R_1$. And any desired value can be realized merely by plugging in the proper values for these resistors.

Now to burst the bubble: The open-loop gain of the op amp (a 741 in this example) is only 40 dB at 10 kHz (Fig. 1a), and there is no spare gain left for corrective feedback. Therefore use of an amplifier such as the 741 is restricted to lower gain values—20 dB, say—even for modest audio spectrum coverage of zero to 10 kHz if the benefits of feedback are to be retained.

Walter G. Jung, AAI Corp., Building E156, York Rd. and Industry Lane, Cockeysville, Md. 21030.

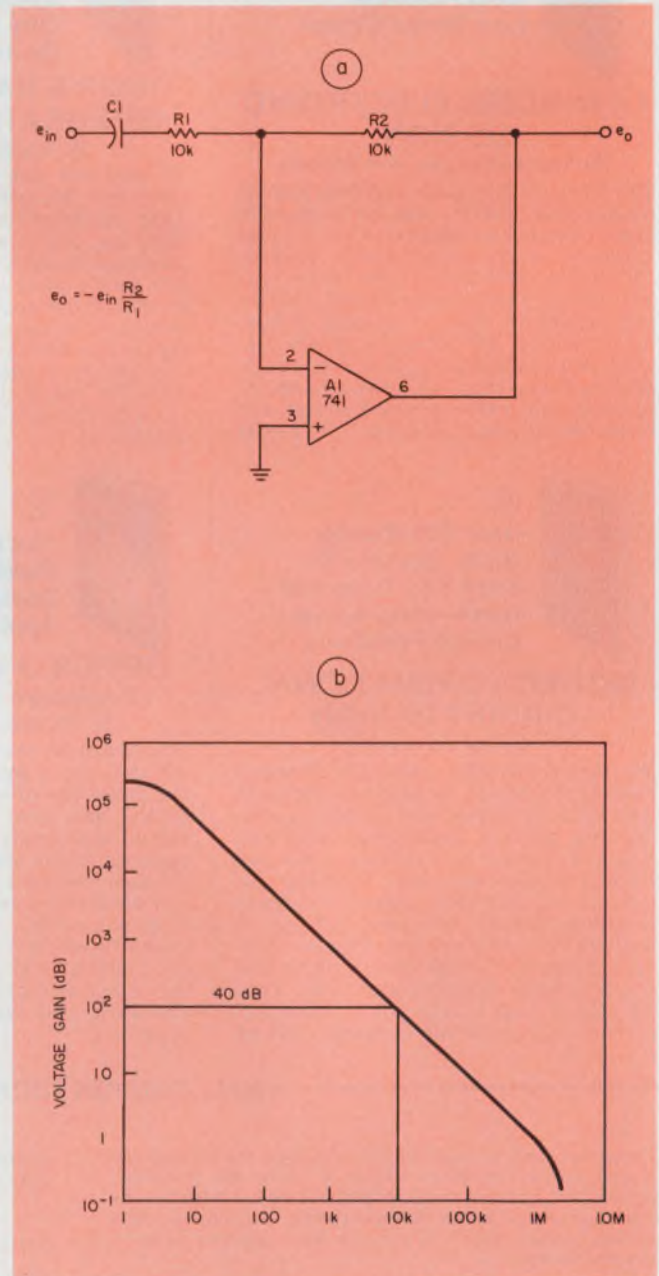

1. At unity gain the simple op-amp inverter (a) can provide a 500-kHz bandwidth. The maximum upper corner frequency of the circuit for a selected value of gain equals the open-loop gain of the amplifier itself (b), as shown by the horizontal line for a noise gain of 40 dB. Vertical lines indicate the maximum circuit gain at any given frequency.

Generally speaking, inspection of the open-loop response (Fig. 1b) yields the available gain at a particular frequency (vertical line) or the available bandwidth for a given value of closed loop gain (horizontal line). A popular method for expressing the inverse relationship between gain and bandwidth is the gain-bandwidth product (GBP).

Choose the correct gain-bandwidth

The requirements for any audio-frequency amplifier may be analyzed in terms of required open-loop gain and GBP with the chart in Fig. 2. Plot a vertical line at the upper frequency limit of the amplifier required for the application. The PL/1 height of the line in dB equals the desired closed-loop gain plus the loop gain to achieve a stated accuracy. The formula

$$\text{error (in percent)} \approx \frac{1 \times 100}{1 + \text{loop-gain}}$$

relates the loop gain to the allowable error.

Then choose an op amp whose open-loop gain at the upper frequency limit equals or exceeds this value. For example if a 60-dB gain amplifier with 1% accuracy at 10 kHz is required—say for a microphone preamplifier—then a loop gain of 40 dB is needed. The vertical line would extend to 60 + 40 = 100 dB at 10 kHz (point A on the graph).

At this point the frequency-limit line intersects the 100-dB horizontal gain line and also a line sloping at 20 dB/decade—namely the required gain-bandwidth curve. Following this line to where it intercepts the frequency axis gives the required GBP, or 1000 MHz.

In many cases the low frequency gain exceeds 100 dB, then rolls off towards zero at frequencies above some corner frequency. But all you need is the computed value of open-loop gain at the highest frequency. Any additional gain at lower frequencies is a bonus—one that serves to increase the low-frequency accuracy of the circuit.

The example chosen represents an extreme case—few IC op amps can provide a 1000-MHz GBP. If a single IC cannot furnish the required GBP, use of two cascaded feedback stages will ease the specifications required of each amplifier. In the example, the use of two 30-dB stages, each with an open-loop gain of 70 dB (30 + 40) at 10 kHz, reduces the GBP requirement to 32 MHz.

Select compensation to boost GBP

Higher effective GBP (specified frequency times open-loop gain) can be realized by several methods, the most direct being selection of an IC with inherently large GBP. For example, the 715 and 118 feature a 15-MHz, unity-gain frequency,

while the 2620 has a 12-MHz, unity-gain frequency. But many of the popular 1-MHz GBP op amps can be custom-compensated for larger effective GBP at the particular gain chosen for circuit operation. This is true of the 709, 725, 748, 101/101A, 531 and 540. GBP improvement in some cases is almost proportional to the reduction of compensation capacitance. And the same option is available with high-speed types, such as 715 and 2620.

The open-loop response curves (Fig. 3) illustrate the improvement in gain available with low-

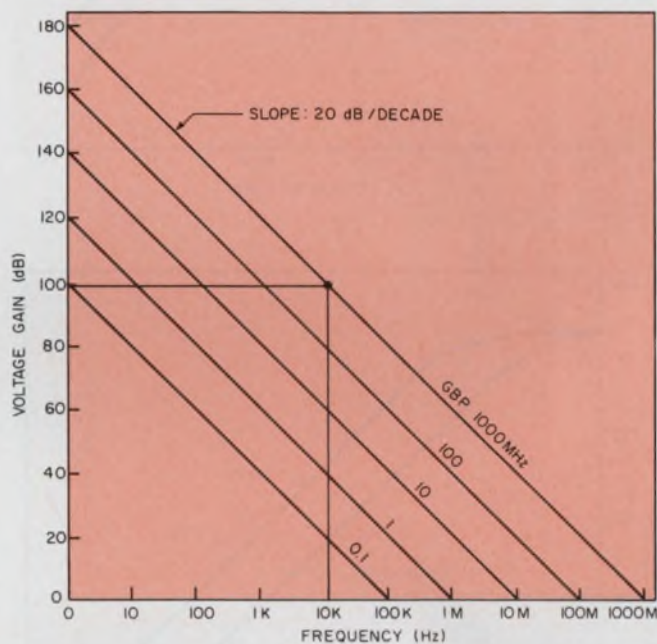

2. Nomogram for estimating required gain-bandwidth product (GBP). Select the highest operating frequency and draw a line equal to the operating gain plus the desired loop gain, both expressed in dB. The intersection of this line with one of the constant GBP curves yields the required amplifier GBP.

ering of compensation impedance. The lower values stated are the manufacturer's recommended values for the stated closed-loop operating gains, or more precisely, the noise gain.

The attainable improvement varies from amplifier type to amplifier type. A 748, 101/101A or 531 affords a tenfold increase in GBP between unity-gain compensation to 20-dB compensation. Stray capacitance usually reduces the effect of reduced compensation above the 20-dB figure. However, the 709's GBP continues to improve at the same rate because of larger initial compensation capacitors. For 60-dB gain, the effective GBP is about 300 MHz—a most respectable figure. The 540 with 40 dB offers a 100-MHz GBP, but the 715 provides the most dramatic increase—to 3000 MHz for 60 dB (Fig. 3e). Finally the 2620 features a 100-MHz GBP, for a gain of 40 dB, but maintains an 8-MHz GBP at unity gain.

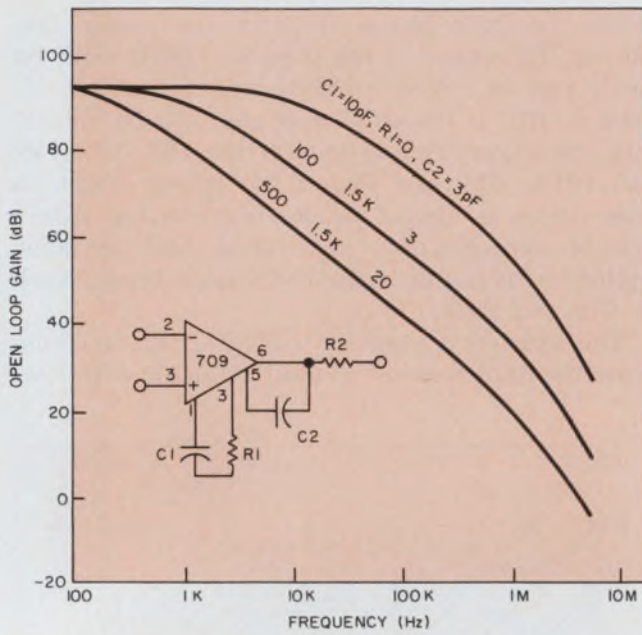

(a)

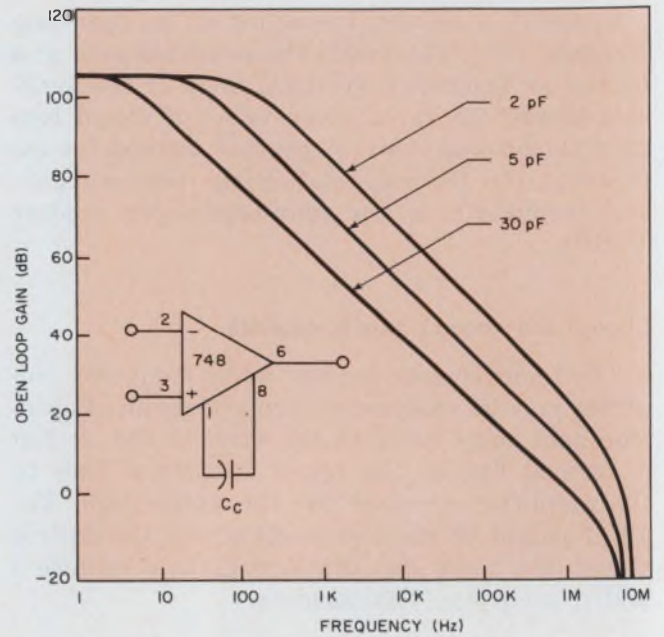

(b)

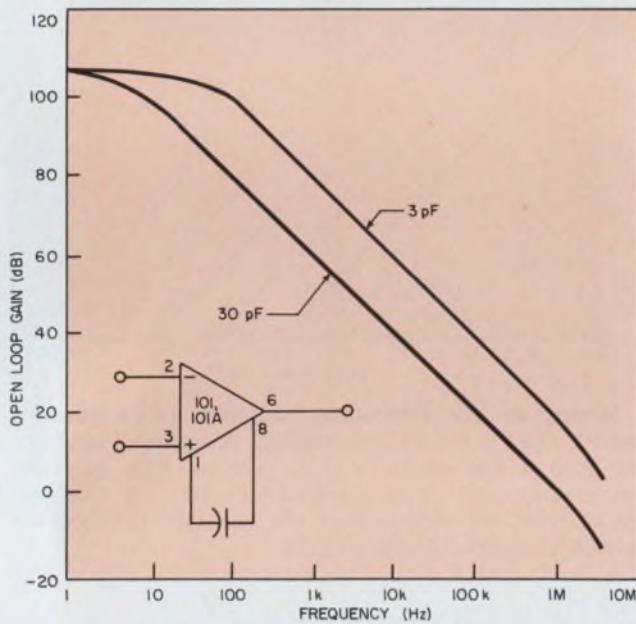

(c)

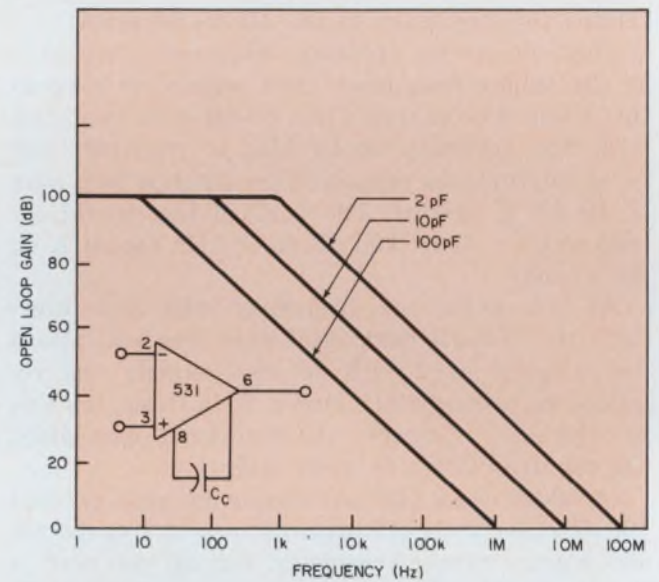

(d)

In general, high dc gain and GBP do not go hand-in-hand. The 715 (which has the highest GBP) has a dc gain of 90 dB, whereas the 725 offers 130 dB. Therefore, for high accuracy at frequencies up to 1 kHz, use the 725; it provides at least 40-dB loop gain from zero to 1 kHz.

Consider β attenuation in the feedback loop

Optimum frequency compensation results in maximum ac accuracy. But, as a rule, the manufacturer's values are conservative; they provide ac stability under the worst-case conditions of temperature and supply-voltage variations and assume the maximum loop gain.

Unless otherwise specified, the manufacturer's compensation values refer to noninverting configurations (Fig. 4b) where the feedback attenuation factor, β , is unity or feedback is 100%. Less compensation is needed when β is less than unity. For β changes of about one decade, the required compensation capacitance, C_r , can be calculated from the unity-gain value, C_c , with the equation

$$C_r = C_c \cdot \beta.$$

In fact, the compensation required by a feedback amplifier is dictated by β , or actually its reciprocal $1/\beta$, which is called the noise gain rather than the closed-loop circuit gain. And the two are not always the same.

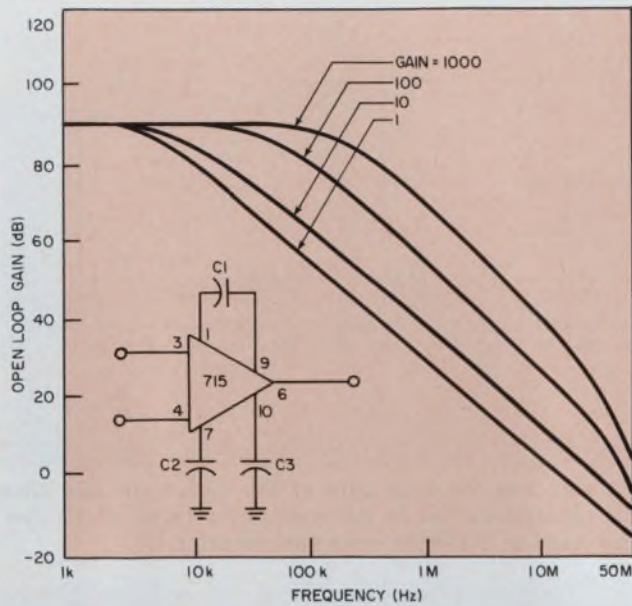

CLOSED LOOP GAIN	C ₁	C ₂	C ₃
1000	10 pF	—	—
100	50 pF	—	—
10	100 pF	500 pF	1000 pF
1	500 pF	2000 pF	1000 pF

(e)

3. Typical amplifier frequency characteristics as a function of compensation used. Reductions in compensating capacitor values increase the GBP. The reduction in compensating capacitance applies to the use of higher noise gain.

Unity-gain inverters, for example, have a noise gain of two, or 6 dB, since the two resistors (Fig. 4b) reduce the amplifier feedback signal by two at the summing point.

The β -scaling formula usually holds for noise gains up to 10. Beyond this point β -scaling may not hold for the particular amplifier because of stray capacity effects. And use of the noise gain is recommended. If you refer to the manufacturer's data sheets, use the noise gain of the circuit, rather than its signal gain to determine the recommended compensation.

Some cases of feedback appear tricky at first glance. In Fig. 5a feedback is derived from a volt-

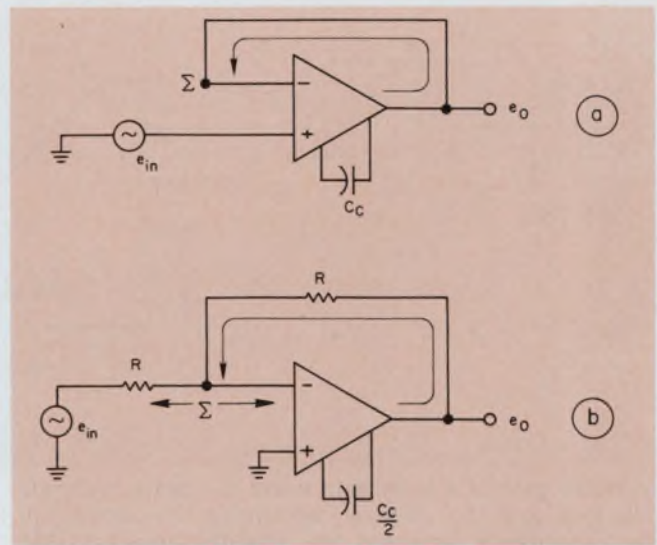

4. Both circuits provide unity operating gain. But the loop gain of the inverter (b) is half that of the voltage follower (a) because of the presence of the divider in the feedback path. The 50% reduction in loop gain with the inverter permits use of smaller compensating capacitors.

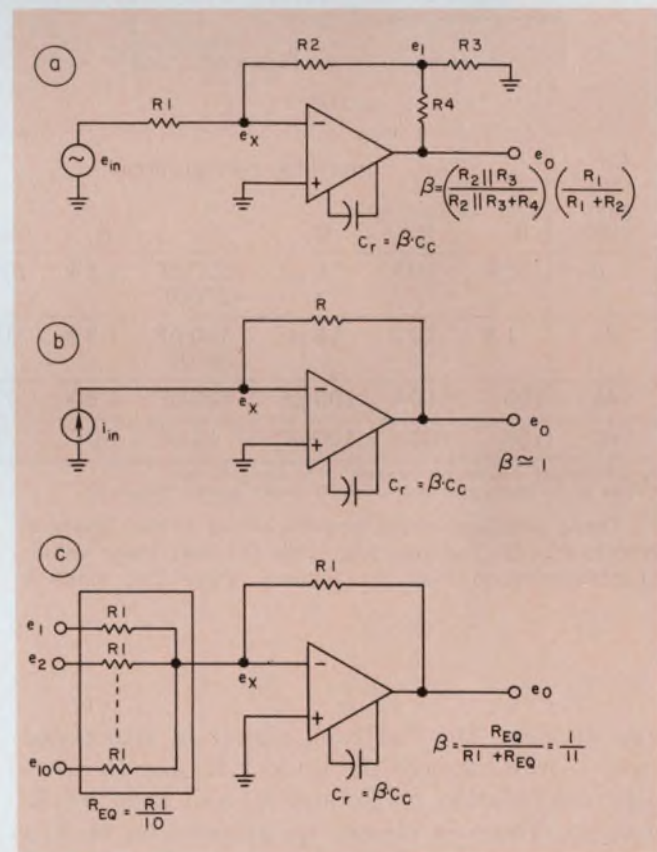

5. The compensating capacitance can be scaled by the feedback attenuation, β . The three circuits often present difficulty in computing β . In the first case (a) the feedback signal is attenuated twice before reaching the input terminal. Op amps driven from high impedance sources, such as phototransistors, have a β approaching unity (b), since there is little attenuation between the output and inverting terminal. Although the gain is unity for the audio mixer circuit (c), the load presented by the mixing network yields a β of 1/11.

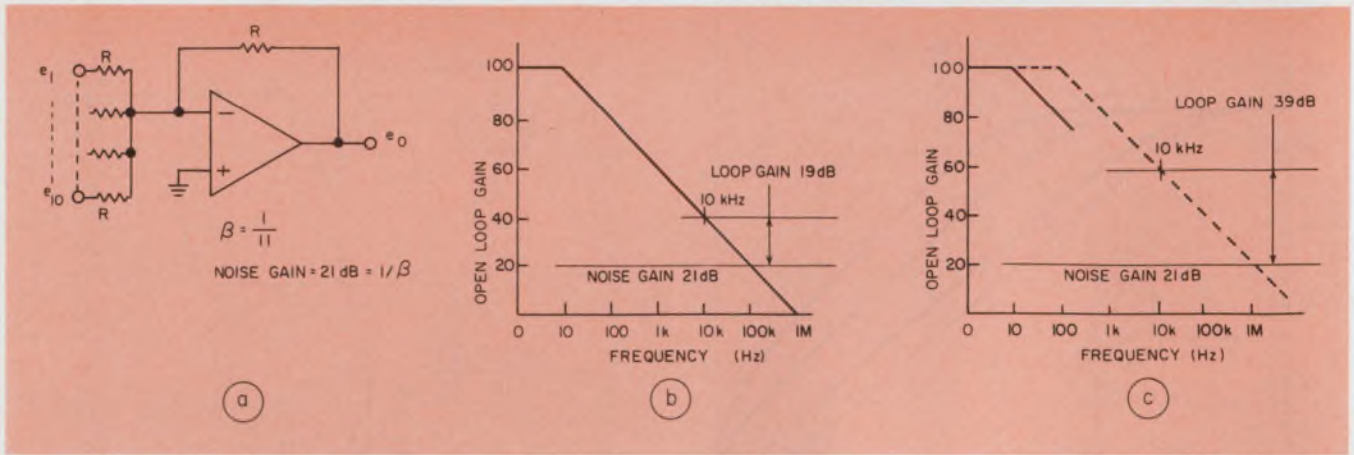

6. Noise gain of a unity gain mixer (a) limits the available loop gain (b). However, decreasing the compensating capacitance increases the available amplifier GBP

(c) and thus the loop gain of the circuit. In this case the capacitance can be decreased by a factor of 10 over that used in a simple unity-gain inverter.

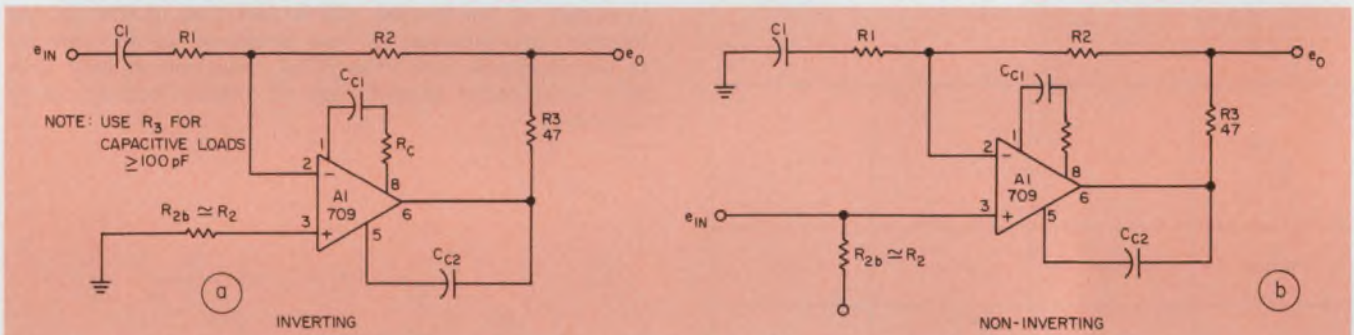

Circuit gain (dB)	Inverting configuration						Noninverting configuration					
	R ₁	R ₂	C ₁	C _{c1}	R _c	C _{c2}	R ₁	R ₂	C ₁	C _{c1}	R _c	C _{c2}
0	10 k	10 k	1 μF	2500 pF (2700)	1.5 k	100 pF	∞	0	0	5000 pF (5600)	1.5 k	200 pF (220)
20	1 k	10 k	10 μF	450 pF (470)	1.5 k	18 pF	1 k	9 k	10 μF	500 pF (560)	1.5 k	20 pF (22)
40	100	10 k	100 μF	100 pF	1.5 k	3 pF	100	9.9 k	100 μF	100 pF	1.5 k	3 pF
60	100	100 k	100 μF	10 pF	0	3 pF	100	99.9 k	100 μF	10 pF	0	3 pF

Parenthesized values are nearest 10% components. Values of C₁ chosen to give 15.9 Hz lower corner frequency

7. These practical audio circuits afford circuit gains of zero to 60 dB. The inverting stage (a) uses lower values of compensation than the follower stage (b), since it

has one-half the loop gain. The tabulated component values are exact, but the nearest commercial values can be used instead.

age divider. The feedback signal is attenuated twice—once through the divider R₁ and the parallel combination of R_c and R₂, and then by R₁ and R₂. There is almost no attenuation with a current-source input like the collector electrode of a transistor or photocell (Fig. 5b); so β ≈ 1. Even though the circuit or signal gain is unity for each of the 10 inputs (Fig. 5c), the noise gain equals 11 because of the attenuation of feedback signal by the equivalent resistance, R/10, of the summing network.

Design of such a 10-input, unity-gain inverter, a common audio application, illustrates the inter-

play between noise gain, compensation and bandwidth. The circuit (Fig. 6a) operates with unity gain but has a noise gain of 11. With unity-gain compensation, the op amp has a GBP of 1 MHz and an open-loop gain of 40 dB at 10 kHz. Since the noise gain is 21 dB, this leaves only 19 dB of loop gain (Fig. 6b)—not too respectable a figure. Choosing compensation for 20 dB, based on the noise gain, increases the GBP to 10 MHz (Fig. 6c) and the loop gain to 39 dB.

One further point: There is a “shrinkage” of available bandwidth resulting from the noise gain. In fact, the maximum available bandwidth

is no greater than that point where the horizontal line representing noise gain intersects the open-loop curve (Figs. 6b and 6c).

Watch the slew rate

The slew rate, SR, for a specified output, E_{op} , at frequency f_p is given by

$$SR = 2\pi E_{op} f_p.$$

With an output swing of 10 V (peak) at 20 kHz, a slew rate of 1.256 V/ μ s is needed. However, many standard op-amp types cannot meet this figure, particularly when operated with unity-gain, noninverting compensation.

Slew-rate limiting occurs because of the inability of the amplifier's internal bias circuits to charge and discharge the compensating capacitance. With the popular types, the slew rate is limited by the current I_E that the input differential pair can deliver to the compensating capacitor. The slewing rate is given by I_E/C_c volts/sec.

The most direct way to increase slew rate is to reduce the value of compensation capacitance—as with custom compensation. Some manufacturers boost slew rate by using a class-B design. For example, the input stage of the 531 can supply current peaks of up to 40 times the small signal idling current—with corresponding improvement in slewing rate—30 V/ μ s for a unity-gain follower, and 35 V/ μ s as a unity gain inverter.

FET inputs, rather than bipolar, remove the limitation on I_E caused by the relationship between input and bias current. In a FET there is no H_{FE} relationship between I_E and input current. And a FET-input amplifier like the 8007 can provide a slew rate of 6 V/ μ s—10 times greater than for the 741.

If custom compensation cannot provide the necessary slew rate—as for example with internally compensated types—then you must select an alternative amplifier, using the manufacturer's or other suitable comparative data.

Practical amplifier circuits

Two simple circuit designs help summarize the relationship between GBP, compensation and slewing rate (Fig. 7). The inverting and non-inverting configurations supply stage gain of 0 to 60 dB with the resistors shown in the accompanying chart (Fig. 7c). Although specific amplifier types are called out, the chart applies to any IC, provided the compensation is adjusted accordingly. The reader may select and use the configurations shown as simple gain blocks in an over-all system.

Components C_1 , R_1 and R_2 are general and apply to any amplifier used in either the inverting or noninverting configurations. Capacitor C_1 should be selected, depending on stage gain, to

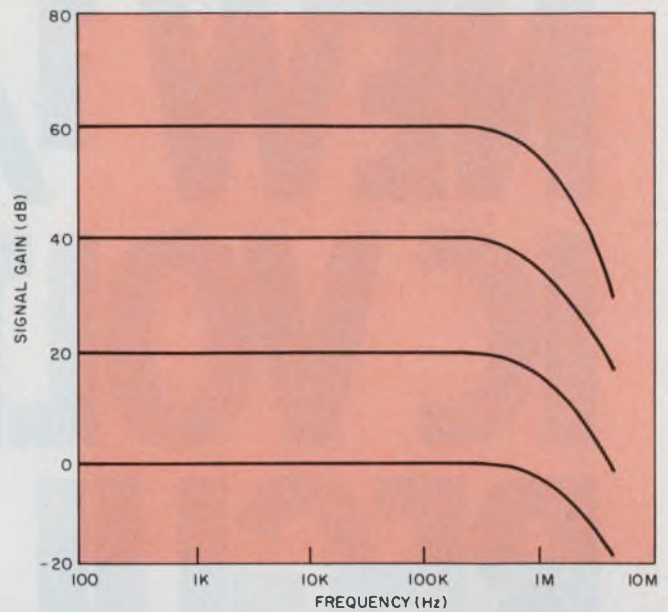

8. Use of optimum compensation for the 709 permits operation with almost constant bandwidth—a characteristic of circuits having adequate loop gain.

keep the 3-dB, low-frequency corner point constant. The values shown provide a 15.9-Hz corner frequency, but the user can choose C_1 for any suitable value. For optimum performance with the 709, use values of R_1 and R_2 as close as possible to the tabulated value.

Selection of compensating components C_{c1} , C_{c2} and R_c depends on the desired operating gain and mode of operation (inverting or noninverting). These values are less for the inverting mode than for the noninverting mode, because of the difference in noise gain; the differences are most pronounced at the lower gains (0 to 20 dB).

Resistor R_3 provides ac circuit stability for capacitive loads in excess of 100 pF. Increasing the value to 180 Ω also protects the 709 against short-circuits.

Bias resistor R_{2b} reduces output offset. Its use depends on the grade of 709 used. Without it, worst-case output offsets as high as $100 \text{ k} \times 2 \mu\text{A}$ or 0.2 V can occur. The value of R_{2b} needn't be precise. And its use, while optional in the non-inverting configuration, is required for the non-inverting circuit if the input is ac coupled.

The typical 709 frequency-response curves (Fig. 8) show almost constant high-frequency roll-off points, indicating the effectiveness of the custom compensation. Low-end roll-off is not shown, since it is selected by the user.

One note of caution: Because of slew-rate limitations, 709 operation at unity gain does not afford full-power output at high frequency, but it performs very well at the higher gains. ■■

Acknowledgment

This article is based on a section from the author's forthcoming book, "The IC Op Amp Cookbook," to be published by Howard W. Sams & Co., Inc., Indianapolis, Ind.

**NEW 1/2-AMP
IC VOLTAGE
REGULATORS
AVAILABLE
IN VOLUME.**



New 78M Series: 0.5 Amp Monolithic 3-Terminal Positive Voltage Regulators. Now available in production quantities.

We've got new 78M medium current voltage regulators. And we've got lots of them.

The 78M series is available in 7 fixed output voltages: 5, 6, 8, 12, 15, 20, 24 Volts. It's a pin-for-pin replacement for all popular 3-terminal voltage regulators (including our own 7800 series). It's available in TO-220 and TO-5 packages.

Improved system design. The 78M reduces system design time, eliminates outboard transistors and resistors, reduces board space, protects on-card circuitry, increases reliability.

Simple to use: Complete, self-contained, one chip in one package. Insert, connect 3 terminals, and add the normal line decoupling capacitor. Requires no other external components. Optimum operation with no design time.

Superior performance: In addition to improved temperature coefficient and ripple rejection, the 78M series provides output

voltage tolerance better than $\pm 5\%$. Line regulation 0.01%/Volt. Output impedance 0.03Ω . Output current rated at 0.5 Amp (usable to 0.75 Amp, depending on input voltage and heat sinking considerations).

Self protecting: Internal current limiting thermal shut-down and safe area compensation protect device and circuit from current, power, and temperature fluctuations. Resets automatically.

Versatile & compact: Use locally, at the power source, on a remote chassis, on PC cards, whatever is most convenient and efficient. Because it's compact, you can miniaturize your design. Result: simpler, smaller, cheaper, easier-to-use power supply and circuitry.

LOW COST: In time and money, less than any other alternative. The 78M series is the lowest cost 3-terminal voltage regulator available today.

1 Amp version: For those systems that require 1.0 Amp output, our improved 7800 series (usable to 1.5 Amps with proper heat sinking) is now in volume production. It offers all the features of the 78M at slightly higher prices.

Write for: Complete data package and new 80-page voltage regulator handbook.

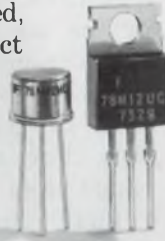

PERFORMANCE COMPARISON: DISCRETES VS. NEW 78M

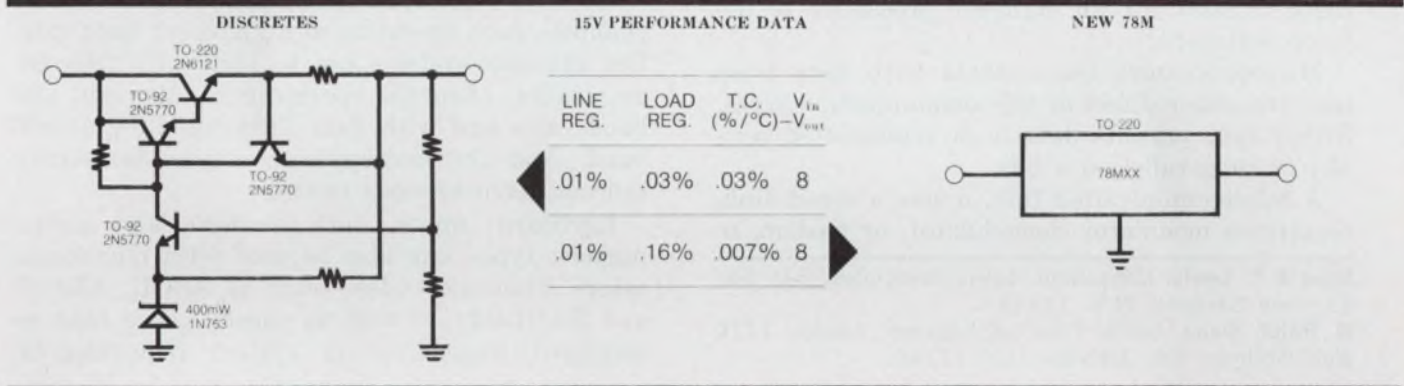

MADE IN FAIRCHILD

Clear the hurdles of microprocessors

with orderly design procedures that provide the right interface and develop the software efficiently.

Last of three articles on microprocessors.

The foundations of successful microprocessor use are the choice of the right interface and efficient software development.

As with any computing system, the peripheral devices for use with microprocessors must meet system requirements. They require an interface to the microprocessor. The right choice ensures that the advantage of minimal hardware—gained by the use of microprocessors—will not be lost because of an overdesign of the interface.

Similarly software can be the largest single cost in any computer. With microprocessors, the ratio of software-to-hardware costs can easily exceed that of conventional computers. Hence there is need for an efficient procedure to develop software.

Microprocessors can operate with data links that are either direct or telecommunication types. Either type permits data to be transmitted serially or in parallel on a bus.

A telecommunication link, unlike a direct link, requires a modulator/demodulator, or modem, to

Donald R. Lewis, Consultant, Lewis Associates, P.O. Box 33, Kew Gardens, N.Y. 11415.

W. Ralph Siena, Senior Principal Engineer, Litcom, 1770 Walt Whitman Rd., Melville, N.Y. 11746.

interface the system to the link. Modems supply the carrier frequency and decode transmitted information. Modem designs can be simplified by the use of universal asynchronous receivers and transmitters, or UARTs (Fig. 1). These are available as single MOS/LSI chips, featuring MOS or DTL/TTL-compatible inputs and outputs. For serial transmission, baud rates can range from dc up to 40 kHz.

Baud rates on the input channels also affect both the design of the interface and the handling of channels. A telecommunication channel can operate with baud rates up to 2400 without conditioned telephone lines. But higher rates of 4800 and 9600 baud need conditioned lines.

A single microprocessor can handle several channels, each operating at a different baud rate. For example, systems can be built with telecommunication channels operating at 300 and 600 baud rates and with data links handling 10,000 baud. And the microprocessor provides simultaneous, asynchronous control.

Keyboard inputs, both numeric and alphanumeric types, can also be used with microprocessors. Standard codes—such as ASCII, EBCDIC and BAUDOT—as well as special codes may be employed, depending on system requirements.

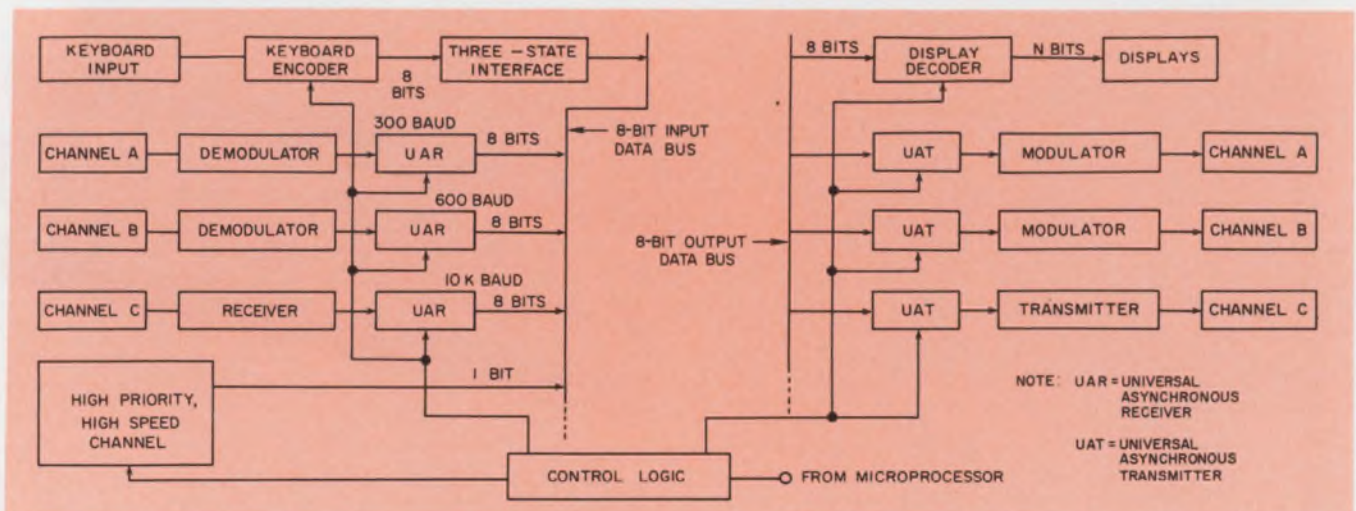

1. The determining factors in the interface design are word length, speed and priority. Transmission of dif-

ferent baud rates and priorities can be handled by the I/O channels of a single microprocessor.

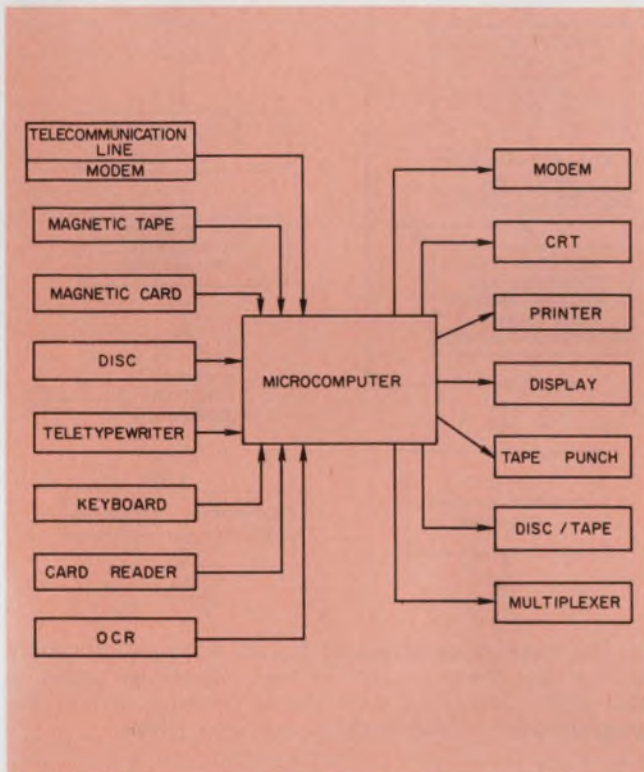

2. Any computer peripheral can work with microprocessors. Interface requirements are determined by word length and any additional hardware needed.

When the microprocessor is interfaced with a keyboard, the code can be written in the instruction format. For example, all 48 instructions of an 8-bit parallel microprocessor can be derived from a single keyboard.

Microprocessors permit direct operation from teletypewriters. The prime consideration is one of level shifting to obtain a TTL-compatible input. Most teletypewriters operate from either current-loop or EIA RS232C interfaces, and each requires level shifting to TTL levels. The program of the microprocessor must be written to accept teletypewriter codes.

Generally any input device that can interface with a minicomputer can also interface with a microprocessor. The possible inputs include light pens—if a CRT is used—optical readers, sensors and card readers. In addition storage inputs,

such as tape or disc, can be readily handled (Fig. 2).

Microprocessor outputs may pose problems if the system requires high-capacity, high-speed data channels. The relatively slow speed of operation, compared with that of minicomputers, seriously limits the number of such channels that can be processed by a single microprocessor. However, all types of output devices can still be used.

Interfaces: Check format compatibility

In the design of the interface, format compatibility is important. This includes both word length and field arrangement. The right selection can minimize data-transmission time and circuit complexity, and simplify the necessary software.

The word length affects the amount of hardware required at the interface. A fixed word length can be standardized for a number of I/O devices. It is much easier to implement and control than a variable word length, which differs for each device.

A field-oriented data word can offer further improvements. Words with 4-bit fields or words with one 2-bit and two 3-bit fields can be used within the same system and sometimes even within the same channels. Use of field-oriented words results in decreased transmission times and increased efficiencies.

Another major consideration—channel priorities—depends on the data and traffic rates. Many channels have varying levels of importance to the system. Some channels may have to be processed faster or more often than others. This would call for higher data rates.

Where many inputs and outputs are serviced, varying data rates are obviously preferable to a processor overload. However, this approach reduces the data that can enter the system at any one time, as well as the time for processing of the data. For example, an 8-bit serial data word with a start bit, a stop bit and a parity bit—a total of 11 bits—operating at a 300-baud rate, requires 36.6 ms to transmit one word. A channel

with the same data at 600 baud requires only 18.3 ms. Hence twice as much data can be transmitted in the same time frame in the second case. However, both conditions require a long time between words for processing.

A channel with considerable traffic often requires more frequent processing than a low-volume data channel. The more frequent processing implies less backup of data at the output and less storage at the input prior to processing.

Software brings its own problems

Generally software costs make up the major cost component with computers. In some cases they far exceed the outlay for hardware. Microprocessors are no exception.

The software phase of the design (Fig. 3) calls for performance of the following major tasks:

- System definition.
- Equating definition to programs.
- Program design.
- Charting of functional flow and detailed flow.
- Instruction writing, or coding.
- Debugging.
- Editing.
- Final program layout, or ROM stacking.

Program design tends to be more detailed than that for a conventional computer. The basic assumption here is that the microprocessor functions in a stand-alone application and that, as a result, ROMs will be used to store the entire program. This restriction limits the total program unless bank-switching techniques are used. These increase the apparent size of the memory beyond the maximum rating for a microprocessor.

System definition involves the major tasks to be performed by the microprocessor—which is assumed to be the central control device of the system. Data formats should be established to maximize processor control. The over-all system timing is included in this design phase to ensure that all functions can be handled within the timing constraints.

Based on the system definition, the basic program structure can now be defined. Each input channel to the microprocessor represents a major program, assuming the use of more than one input device. In addition an Executive program should be written to control the over-all operation of the system. Various routines—based on the different functions or command codes supplied—further subdivide the main program.

Since most microprocessors are designed around an 8-bit bus, the program can be made more efficient if it operates with a maximum of 8 bits per message. This eliminates the need for multiple-word processing for data control. And

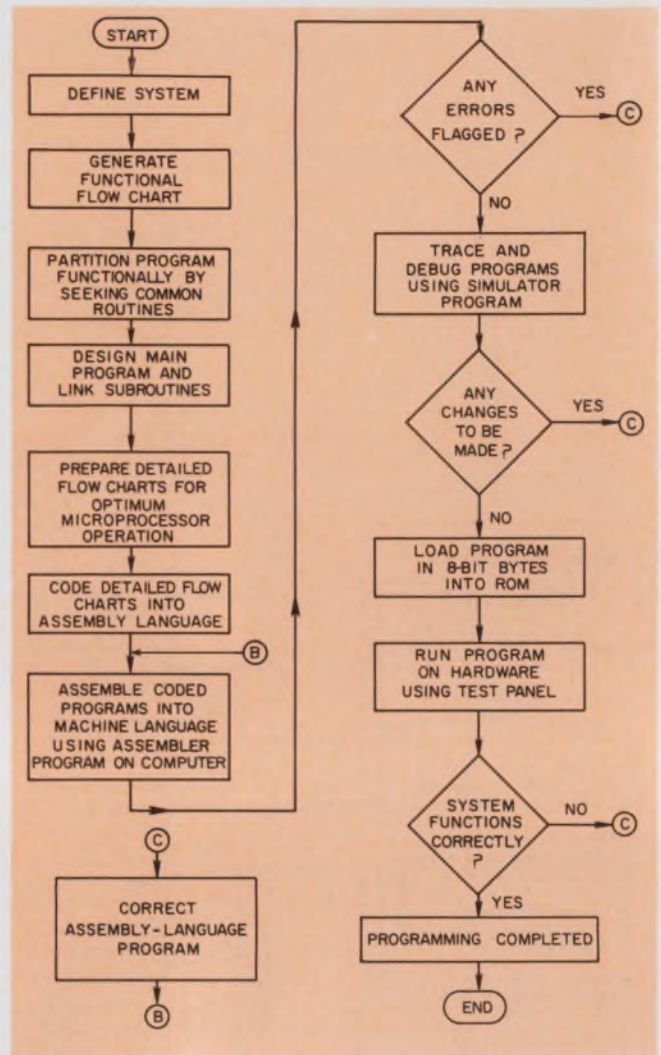

3. The software development can be achieved efficiently with a flow chart. As part of the final design steps, a test panel, or control unit, should be built to test the program after it has been loaded into ROMs.

the control of command codes as a function of input devices allows flexibility and efficiency. The same data word can have a different meaning, or subroutine, for each input device or channel.

The program design, the single most important part of the software development, bridges the gap between hardware and software—or firmware when the program is put into ROMs. Involved here are the over-all system operation, the hardware design and the kind of programs to be written.

The program design should define every step of the system operation from the point-of-view of the microprocessor. It should establish the necessary “handshaking” between the peripherals and the microprocessor and between the peripherals and external circuitry. Some of the specifics that the program design should include are as follows:

- System-timing requirements.
- Code structures between the system and external circuitry.

PAGE LINE	0	1	2	3	4	5	6	7
0	INTERRUPT ROUTINES	TABLE OF CONSTANTS	BCD TO BINARY	UTILITY ROUTINES	PROCESS CONTROL FOR EXTERNAL HARDWARE	LOG CONVERSION	CRT DISPLAY DRIVER	BUFFER AREA (FOR RAM)
1			BINARY TO BCD					
2		EXECUTIVE PROGRAM	DOUBLE PRECISION MULTIPLICATION AND DIVISION			INPUT ROUTINE		
3	PRINTOUT ROUTINE			MODEM CONTROL				
4	UNUSED	UNUSED	ERROR ALARM ROUTINE		UNUSED	UNUSED	A/D CONVERSION	
5			UNUSED					
6	UNUSED	UNUSED	UNUSED	UNUSED	UNUSED	UNUSED		
7			UNUSED					
255 ₁₀								

4. In a typical 2-kbit memory allocation map (ROM or RAM), an 8-bit word permits a page and line orientation.

The upper 6 bits of address define one of 64 pages; the lower 8 bits, one of 256 lines per page.

- Code structures to and from the microprocessor.
- Sources of microprocessor data during all phases of its operation.
- Method of Executive and other program control.
- Method of program interface and interaction.
- Memory structure and operation.

A functional flow chart defines the functional operations sequentially. But it does not contain sufficient detail to allow program writing or coding.

Detailed charts overcome this limitation. They are derived from the functional flow charts, the established command codes and the manner in which each command code works within the system. The detailed flow charts tell, step by step, every operation that must be performed. For the instruction writing, or coding, the programmers need only know how to program the microprocessor. Any engineer trained in assembly language for any computer fulfills this requirement.

Program debugging—generally a difficult task—can be simplified by software aids. Most computer manufacturers supply fairly complete software packages with their computers, but not all microprocessor manufacturers do. But some software aids are available, and they include Fortran IV assemblers and simulation programs on some time-sharing services. When obtained from the manufacturer, simulation programs may require modifications to fit the computer used.

Program editing sets the proper sequences

within a program. It also combines the various programs into one suitable for firmware, and adds the proper address locations to the sub-routines that have been developed.

The over-all program now takes on its final shape and can be tested within the system. If ROMs are to store instructions, an erasable field-programmable type can be used initially. Erasable pROMs permit full program test and correction prior to the use of top-mask memories. Erasable pROMs are also a more economical alternative when there are too few systems to warrant the high cost of top-mask development.

In the final program layout, the total program can be re-edited and stacked into one large program for final ROM commitment (Fig. 4). ROMs are available with up to 16 kbits on a single chip.

Programs placed on large ROMs can result in significantly reduced size. For example, two 16-kbit ROMs can replace sixteen 2-kbit pROMs. In addition to the hardware reduction, there is an appreciable saving in power. And expected shortly are larger capacity ROM and RAM ICs that require even less power per bit.

Several ways to program pROMs

The programming of pROMs can be done by the pROM supplier, service organizations or by the user himself. When the manufacturer fills the need, the information must be presented in a specialized format, which can be quite different from that used in developing the programs. The

DO-IT-YOURSELF grabber



NEW

- Simplified Assembly
- Versatile
- Comfortable Finger Grip Action
- Completely Field Serviceable
- Molded of Tough Lexan*

Model 3925
Mini Test Clip
Shown Actual Size

This test clip with gold plated hook is excellent for rapid testing of components and Wire Wrap† pins. Clip is completely insulated to point of connection. Build any combination of test leads with wire up to .090 dia. Easy and comfortable to operate. Molded of rugged Lexan to resist melting when soldering. Write for literature and prices.

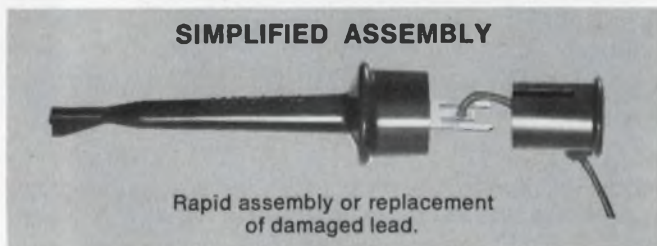

MODEL 3925
hooks onto components or slips over square Wire-Wrap pins

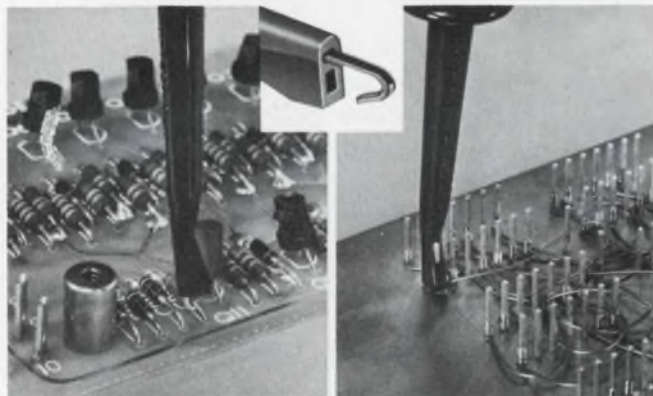

*Lexan is a General Electric trade-mark. †Registered trade-mark of Gardner-Denver Co.



POMONA ELECTRONICS

A Subsidiary of ITT

1500 East Ninth St., Pomona, Calif. 91766
Telephone (714) 623-3463

INFORMATION RETRIEVAL NUMBER 37

format usually requires a 10-character scheme for each byte to be programmed. The first character of the format is a start bit characterized by the ASCII character B. The next eight characters, listed as P for positive or N for negative, denote the ONE and ZERO bits for each byte. The final character, F, signals the end of the 8-bit word.

Service organizations that perform pROM programming can accept almost any format of the program. For example, programs can be supplied on format paper with only ZEROS entered for each address location. The program sheets are read optically and the program printed out for verification. The most sophisticated method—one that also costs the least—uses punched paper tape in an 8-bit code. Each line of the tape corresponds to an address location. The codes for each address are listed sequentially, 000 through 255.

For maximum flexibility, pROMs should be programmed by the designer. The aids available allow both initial program writing into the pROM and copying from a completed pROM to a new one. Where the program instruction set takes up more than one-quarter of the total memory space, in-house programming has minimal effect on testing time. At this phase of design, the testing time can be critically short. ■■

The first article in this series appeared in the Sept. 1 issue and discussed microprocessors vs random logic. The second article, in the Sept. 13 issue, dealt with the operation of a microprocessor.

Who makes microprocessors?

For details on specific microprocessors, readers may get in touch with the following manufacturers:

Fairchild Semiconductor, 464 Ellis St., Mountain View, Calif. 94040. (415) 962-3816.

CIRCLE 375

Intel, 3065 Bowers Ave., Santa Clara, Calif. 95051. (408) 246-7501.

CIRCLE 376

Microsystems International, P.O. Box 3529, Station C, Ottawa, Canada K1Y 4J1 (613) 828-9191.

CIRCLE 377

National Semiconductor, 2900 Semiconductor Dr., Santa Clara, Calif. 95051. (408) 732-5000.

INQUIRE DIRECT

Rockwell Microelectronic Device Div., P.O. Box 3669, 3430 Miraloma Ave., Anaheim, Calif. 92803. (714) 632-6768.

CIRCLE 378

Toshiba Transistor Works, 1-Komukai, Toshiba-Cho, Kawasaki-Chi, Japan.

CIRCLE 379



Still paying for oscillator stability you don't need?

Plug in our K1065A instead. Medium stability and price. 1 to 5 MHz range: 3×10^{-8} stability for 20° to 55°C; less than 5×10^{-9} aging per day. Prototype quantities available for immediate delivery in 1.0 MHz and 5.0 MHz. Details available from Motorola Component Products Dept., 2553 No. Edgington, Franklin Park, Ill. 60131.  **MOTOROLA**

THE BRIGHT GUYS' NEW QUAD ISOLATOR SAVINGS PLAN



Distributors

Arizona: Hamilton/Avnet, Phoenix (602) 269-1391
Kierulff, Phoenix (602) 273-7331

California: Hamilton/Avnet, Mountain View (415) 961-7000
San Diego (714) 279-2421
Hamilton Electro, Culver City (213) 870-7171
Kierulff, Palo Alto (415) 968-6292
San Diego (714) 278-2112
Wesco Electronics, Los Angeles (213) 685-9525

Colorado: Hamilton/Avnet, Denver (303) 534-1212
Kierulff, Denver (303) 343-7090

Florida: Hamilton/Avnet, Hollywood (305) 925-5401

Georgia: Hamilton/Avnet, Norcross (404) 448-0800

Illinois: Allied, Chicago (312) 421-2400
Hamilton/Avnet, Schiller Park (Chicago) (312) 678-6310
Kierulff, Rosemont (Chicago) (312) 678-8560

Kansas: Hamilton/Avnet, Prairie Village (Kansas City) (913) 362-3250

Maryland: Hamilton/Avnet, Hanover (Baltimore) (301) 796-5000
Pioneer, Rockville (301) 427-3300

Massachusetts: Electrical Supply, Cambridge (617) 491-3300
Gerber, Dedham (617) 329-2400
Hamilton/Avnet, Burlington (617) 273-2120
Kierulff, Needham Heights (617) 449-3600

Michigan: Hamilton/Avnet, Livonia (313) 522-4700

Minnesota: Hamilton/Avnet, Bloomington (612) 854-4800

Missouri: Hamilton/Avnet, Hazelwood (St. Louis) (314) 731-1144

New Jersey: Arrow, Saddlebrook (201) 256-7331
Hamilton/Avnet, Cherry Hill (609) 662-9337
Cedar Grove (201) 239-0800
Haddonfield (609) 429-1526

New Mexico: Century, Albuquerque (505) 265-7837
Kierulff, Albuquerque (505) 247-1055

New York: Semiconductor Concepts, Hauppauge (516) 273-1234
Hamilton/Avnet, Syracuse (315) 437-2642
Westbury, L.I. (516) 333-5812
Arrow, Farmingdale (516) 694-6800
Summit, Buffalo (716) 884-3450

North Carolina: Pioneer, Greensboro (919) 273-4441

Ohio: Arrow, Dayton (513) 253-9176
Kierulff, Dayton (513) 278-9411

Texas: Hamilton/Avnet, Dallas (214) 638-2850
Houston (713) 526-4661
Kierulff, Garland (Dallas) (214) 271-2471

Utah: Hamilton/Avnet, Salt Lake City (801) 262-8451

Washington: Hamilton/Avnet, Seattle (206) 624-5930
Kierulff, Seattle (206) 763-1550

Canada: Preico, Montreal (514) 389-8051
Ottawa (613) 237-6150
Electro Sonic Ind. Sales, Toronto (416) 924-9301
Hamilton/Avnet, Montreal (514) 735-6393
Toronto (416) 677-7432
Ottawa (613) 725-3071
L. A. Varah, Vancouver, B.C. (604) 736-6411
Future Electronics, Montreal (514) 735-5775
Ottawa (613) 232-7757
Toronto (416) 677-7820

Only the Bright Guys can give you the threefold, planned savings that you get with their new opto-isolator — the Quad Iso-Lit 74.

Money: The ILQ-74's price per channel is only 83¢ in 1K quantities.

Time: You save time because you're handling only one part instead of four.

Space: You save P.C. board space because of reduced package count.

The ILQ-74 features a minimum 1500 volt isolation with 35% typical current transfer

ratio. Coupling capacitance is only 0.5pF, and it's TTL compatible.

Replace those outmoded transformers and relays with solid-state, highly efficient, low cost opto-isolators which isolate high voltage transients and eliminate both ground loop feedthrough and common mode noise in long lines.

Only the Bright Guys offer all three configurations—single, dual and quad—as part of a full line of opto-isolators.

Call or write for complete information.

the bright guys
litronix

Litronix, Inc. • 19000 Homestead Road • Cupertino, California 95014 • (408) 257-7910 1WX; 910-338-0022

European Headquarters: Litronix, U. K. Branch • Bevan House, Bancroft Court • Hitchin, Hertfordshire SG5 1LW England • Tel: Hitchin 2676 Telex: 825 497

INFORMATION RETRIEVAL NUMBER 39

2 to 4, 4 to 8 and 5 to 10 GHz.



The Avantek Fundamentals.

Only Avantek, among all YIG oscillator suppliers, offers fundamental YIG-tuned oscillators covering 2 GHz to 10 GHz. What's more, we back our statement with the thousands of Avantek oscillators currently operating in our customers' spectrum analyzers, sweepers, synthesizers and tuners. Our YIG's have met the rigid requirements of E.W. system manufacturers to whom maximizing sweep rates and high reliability are paramount.

And now you can leave the driving to us, since we have just introduced YIG-drivers to complement these YIG oscillators and ease the design burden of the system engineer.

Avantek's leadership in transistor design and manufacture, coupled with total mastery of thin film circuit techniques, has spearheaded these wideband oscillator breakthroughs and set the stage for developments into even higher frequencies.

Avantek . . . years ahead today

Write or call Avantek, 3175 Bowers Avenue, Santa Clara, California 95051 Phone (408) 249-0700



INFORMATION RETRIEVAL NUMBER 40

Check coil windings for correct turns and direction, without eyestrain or errors. Here is a simple electrical test fixture that allows rapid inspection.

Even if you don't mind the eyestrain, it's extremely difficult to check the number of turns in coils and the direction of their windings. The odds are high that you will miscount, and the task becomes impossible if there is more than one layer of wire. But accuracy is virtually guaranteed if you build a coil test fixture that can compare a sample coil with a coil known to be wound correctly.

Once a coil has been inspected and found to be correct—or once one has been wound with special care for use as a standard—large batches of coils can be compared with it rapidly. With use of the fixture, the good and bad coils produce different characteristic patterns on an oscilloscope.

Principles of operation

The physical principle behind the coil comparator is the basic transformer law

$$V_s/V_p = N_s/N_p,$$

in which *s* refers to the secondary, *p* the primary and *N* the number of turns.

Fig. 1 illustrates this principle for a toroid with a three-turn primary and a one-turn secondary. Ideally any voltage applied to the primary appears across the secondary, but with only one-third the magnitude. Also, phase is preserved.

To find the polarity of the output voltage, all you have to do is note the direction of the windings. Thus if the primary lead entering the top of the core is positive, the secondary lead that emerges from the top is also positive. This law applies to the instantaneous voltage of any waveform, so long as polarity reverses before the core can saturate.

Fig. 2 shows the circuit that uses this principle to compare two coils. Two identical coils driven by the same voltage will induce the same voltage in a single turn through each core. If the two single turns are phased correctly (wired in series-opposition), the two voltages will can-

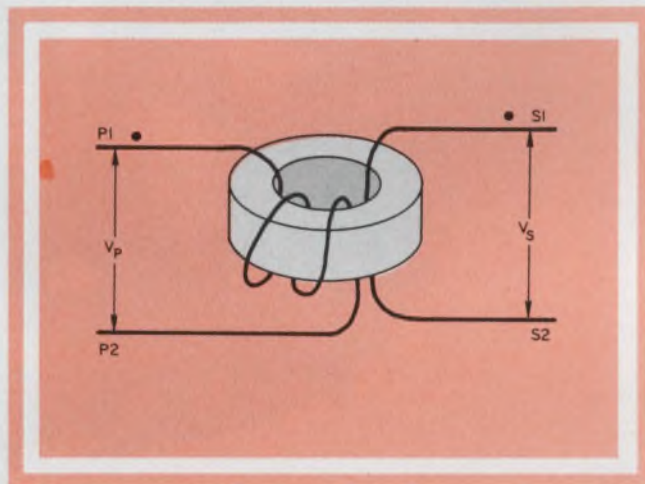

1. Basic toroidal coil obeys the simple transformer law.

cel and the output voltage will be zero. On the other hand, if the two coils have a different number of turns, they will induce different voltages into their secondaries, and a net voltage difference will appear on the scope monitor. If the coils have the same number of turns but are wound in different directions, the induced voltages will add.

In printed-circuit applications the main concern in coil winding is that the leads come out at points that are near the correct holes in the circuit board. Fig. 3 shows two possible directions for winding a toroid, and since a winding's circumference is fairly reproducible, the starting and ending leads come out of the core in pretty much the same spot coil after coil.

Using the test fixture

Fig. 4 shows a typical test jig that allows easy and rapid insertion of coils to be tested. The only items on top of the test box are the test coil and the connections to it. This results in an uncluttered working area. A stainless-steel rod (with ends rounded to prevent scratches to the insulation) forms the single turn secondary that goes through both coils. Secure the rod in the center of the insulating panel that forms

John A. Carroll, Project Engineer, Analog Devices, Route 1 Industrial Park, P.O. Box 280, Norwood, Mass. 02062.

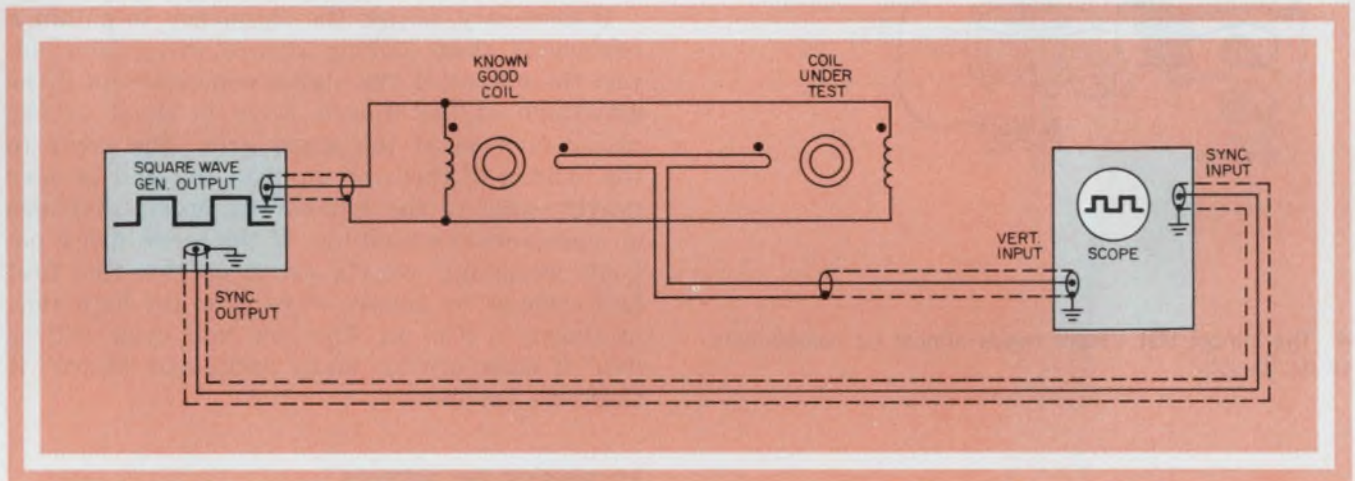

2. Coils are tested with a very simple circuit, a scope and a square-wave generator.

the top of the test jig. This allows it to be used as a holder for the coil to be tested. An alligator clip can secure the standard coil in the lower half of the box—an arrangement that allows the coil to be changed very easily. On the top of the box it is easier to use a hand-held wire contact to speed testing, but another clip can be used if desired.

To complete the test jig, the standard coil should be mounted carefully (Fig. 4) so that the primary leads are reversed. To ease the mounting, spring-loaded connectors can be used underneath, with the mounting studs smoothed off on top. These smoothed areas are used as contacts for the coils to be tested.

Setup and calibration procedures

In use, the operator just drops a coil over the post, holds the primary leads against the smoothed contact area with one hand and holds the secondary wire with the other hand. A glance at the scope gives the verdict.

Notice that the leads of the standard coil must be reversed to get the pair into series opposition. With the straight pin as a common secondary, the secondaries are forced to be in series-aiding. Thus the primaries must be placed out

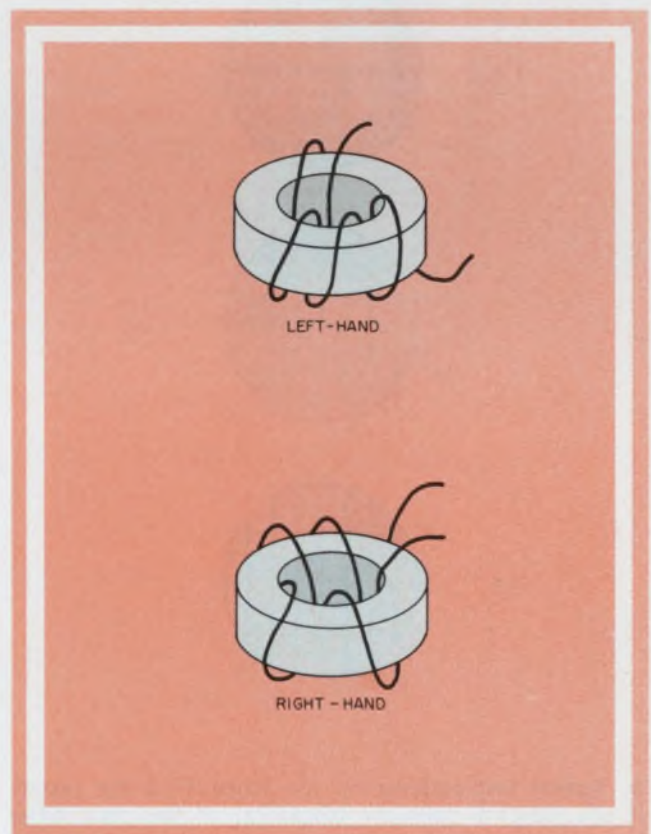

3. A toroidal coil can be wound in either of two directions and still deliver correct voltages.

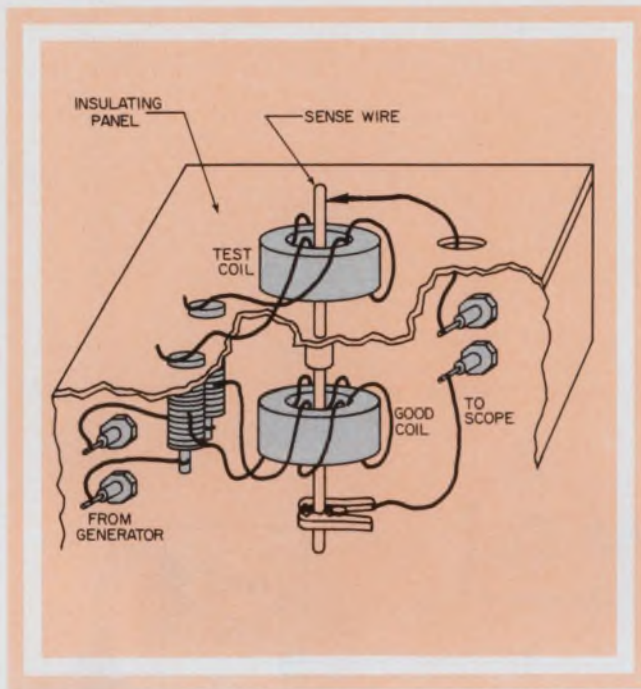

4. The simple test fixture needs almost no components to do its job.

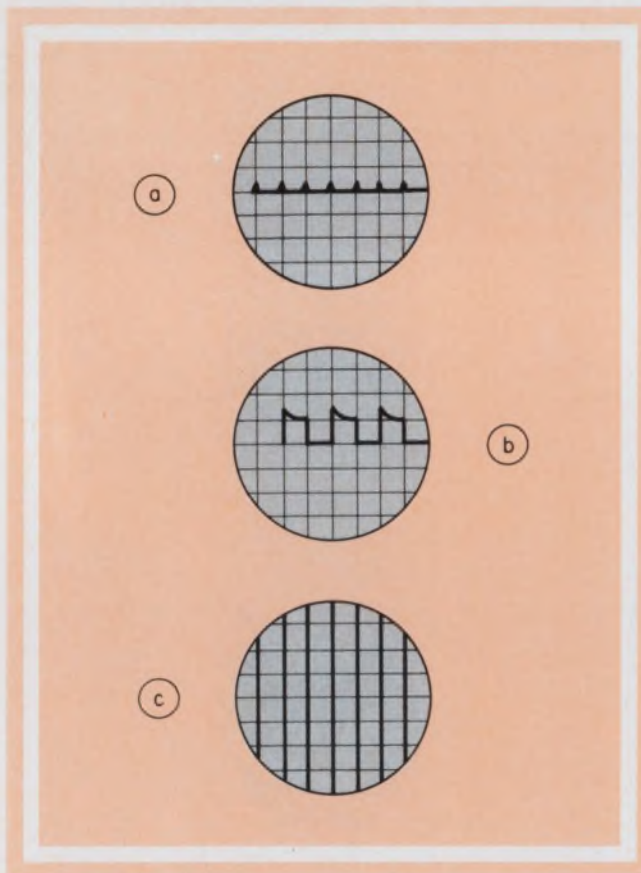

5. Typical test patterns on the scope show the results if two identical coils are tested (a). If two coils differ by a small number of turns, a square-wave pattern results (b). If the two coils are connected wrong or wound in opposite directions, a vertical grid appears (c).

of phase with each other.

To calibrate the test set, mount a standard coil in the box, making sure there are no shorts. Next set the scope to its most sensitive range and turn up the square-wave generator so that a moderate output of, say, 1 V is available. The test frequency isn't critical and can usually be set for any frequency between 100 kHz and 1 MHz. Now test a few coils until the pattern shown in Fig. 5a appears. Add one turn to that coil. The pattern shown in Fig. 5b should appear on the scope.

If necessary, adjust the frequency to obtain a reasonably clean looking square wave. Now adjust the output of the signal generator until the amplitude of the square wave is equal to one major division of the scope grid. The error in the number of turns on any bad coil will be very nearly equal to the number of major divisions of square-wave amplitude. If the scope has a polarity reversing switch, set it so that the first half cycle of the square wave is on the high side, as shown in Fig. 5b. The first half cycle will be "up" if there are too many turns and "down" if there are too few.

Interpreting the patterns

Referring to Fig. 5a, note that the small spikes that might appear in the output are due to stray coupling effects between the circuits in the test fixture. Don't confuse them with the square wave that will appear in Figs. 5b and 5c. If there is any sort of mismatch, the waveforms of either Figs. 5b or 5c will appear.

In Fig. 5b the coils don't match; the spikes are still there, but the horizontal portions of the waveform show a vertical separation. The square-wave voltage is caused by a small difference voltage resulting from a one or two-turn difference in the windings.

If the single turn is connected but the coil under test is not, the single turn will pick up the secondary voltage of one coil, and the pattern of Fig. 5c will result. Here the induced voltage is so large that the horizontal portions of the squarewave go way offscale on the scope, and all you can see are the vertical transitions. A coil that gives the patterns of Fig. 5b when the leads are reversed should not be accepted.

As an example, assume that a known good coil has 50 turns. The coil under test gives the waveform of Fig. 5c when first connected. Then, when the leads are reversed, the pattern looks like that of Fig. 5b turned upside-down. The pattern has a height of three major divisions. Therefore the coil being tested has an error of three turns on the low side. Thus the coil has 47 turns and is wound in the wrong direction. ■■

if it's a meter or meter relay,

Stock or Special...

Simpson

makes it.



Stock:

Simpson distributors nationwide stock over 1,500 types, ranges, styles and sizes of panel meters, relays and controllers. They're all listed in Catalog 4200. Write for your free copy.

Special:

Need a special or unusual meter? Let Simpson help you custom design it. Send us your specs and we'll send you a quote. But check our catalog first—that "special" may be a standard Simpson stock item.

Get off-the-shelf delivery from your local electronics distributor.



SIMPSON ELECTRIC COMPANY

853 Dundee Avenue, Elgin, Illinois 60120
(312) 695-1121 • Cable: SIMELCO • Telex: 72-2416

IN CANADA: Bach-Simpson, Ltd., London, Ontario

IN ENGLAND: Bach-Simpson (U.K.) Limited, Wadebridge, Cornwall

IN INDIA: Ruttonsha-Simpson Private, Ltd., Vikhroli, Bombay

KATY INDUSTRIES



ELECTRICAL EQUIPMENT
GROUP

INFORMATION RETRIEVAL NUMBER 41

Tri-Data's "integrated peripheral"

tape & disk in one unit.



An intriguing concept turned into a powerful performer: the CartriFile[®] 211 system. It integrates two tape cartridge drives and a sealed, movable-head disk into a single, versatile peripheral—addressed and controlled through one I/O slot in your minicomputer. The whole system, including the controller, data electronics, interface, and power supply, is packaged in one enclosure 7" high by 17" wide by 20" deep. And it uses standard Tri-Data 1000 Series tape cartridges.

Put your data where you want it. On either of two tapes or on the disk. Swap data back and forth through the mini, into the mini, out of the mini. Use a tape to load the disk, as a backup, or as a dump. Use the disk and tapes for program development, then store it on tape for future use. Use less core. With up to 14 million bits on-line and unlimited off-line storage in Tri-Data cartridges, you'll have a high-performance, economical, magnetic memory system at your command. And "economical" doesn't mean "slow." Each cartridge drive transfers data at 48,000 bits/second; the disk at 1.36 million bits/second. In parallel 8-bit bytes.

"Integrated" means the controller, data, and interface electronics are shared by the tapes and disk—not duplicated. Same for the mechanical drive system. It means using common addresses, commands, statuses, and error checking to program and operate the tapes and disk. It also means less equipment, less rack space, less installation, less programming, less money.

And "economical" and "integrated" doesn't mean "compromise," either. The CartriFile 211 system is all Tri-Data, which means the same high quality, the same high reliability, the same outstanding performance that characterizes all Tri-Data equipment. With the Tri-Data PolyDrive transport (field-proven for five years in all kinds of installations) integrated with the inherent reliability of a sealed disk (no field adjustments, no periodic cleaning, no filter changes), the CartriFile 211 system offers you bulk data storage and fast random access, all in one system, all for \$5995.

Specifications	Cartridge Drives	Disk Drive
Data transfer rate	48,000 bits (6,000 bytes)/sec.	1.36 million bits (170,000 bytes)/sec.
Data capacity	5.75 million bits (720,000 bytes) maximum per 150-foot tape (times two tapes)	2.5 million bits (317,000 bytes), formatted
Number of tracks	2 per tape (Bi-Track II)	64 (Bi-Track II)
Start-stop time/ access time	24 milliseconds (0.25 inch interrecord gap)	10 milliseconds track-to-track, 10 milliseconds settling, 16.7 milliseconds average latency
Record length/ sectors	variable	1, 2, 4, 8, or 16

OEM and quantity discounts available, with or without interface.

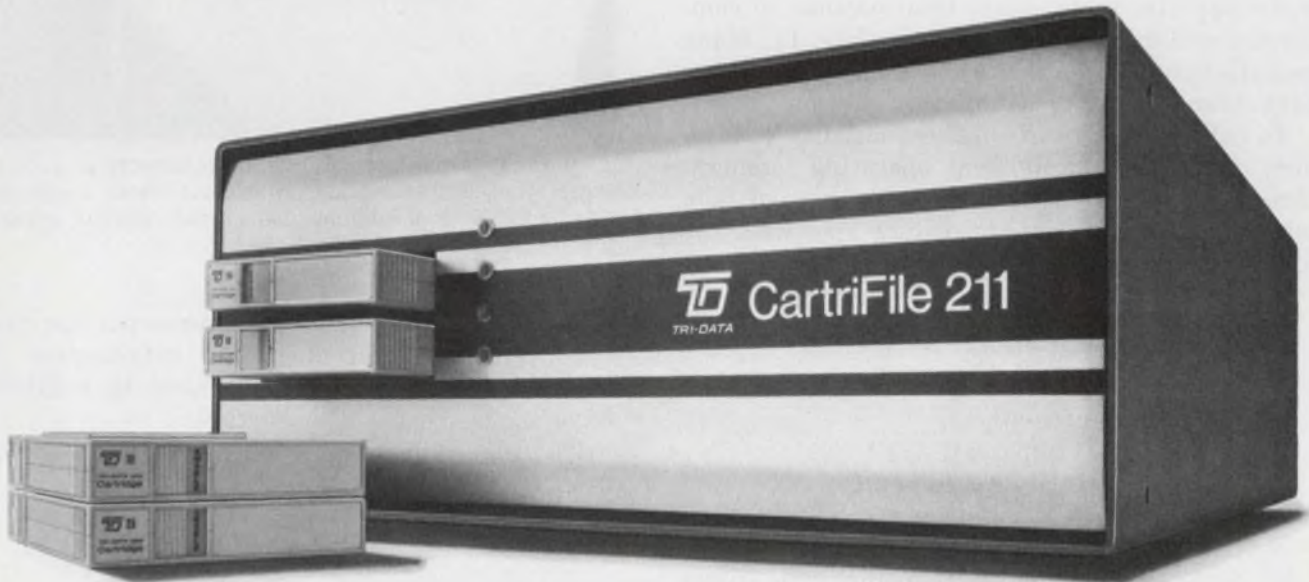

800 Maude Ave., Mountain View, CA 94043
Phone (415) 969-3700, TWX 910-379-6978

Don't overload those connectors!

Temperature rise under load, if overlooked, can lead to unreliable performance and short connector life.

Of all the parameters that engineers use to select an electrical connector—size, weight, contact density and serviceability—the one that is most often overlooked is the connector's heat rise under load.

Heat rise is a critical consideration. Fail to consider heat rise, and the selected connector can either be badly overloaded or unnecessarily over-designed. Heating characteristics of connectors are especially important in high-density multipin connectors, where the closeness of contacts and their small size limits the allowable current per contact. The closer and greater the number of contacts, the larger the heat rise and the larger the connector shell size that is needed.

Calculating heat rise

Round, multipin connectors, with hard dielectric inserts to hold the pins, and metal outer shells have for many years been popular in commercial and military applications (Fig. 1). Many manufacturers make them, and shell and pin sizes have been standardized by the military.

To calculate heat rise in these circular connectors, start with the ambient operating temperature and the load-current requirements and then calculate the allowed temperature rise with the following current/thermal equation:

$$\Delta T = \frac{3.41 C_m I^2 R}{4\pi L R_o k h} (R_o h + 2k),$$

where

- C_m = number of contacts,
- I = current (amperes),
- R = contact resistance (ohms),
- L = connector length (feet),
- R_o = shell radius (feet),
- k = thermal conductivity of dielectric insert BTU/hr-ft²-°F,
- h = heat transfer coefficient by both convection and radiation BTU/hr-ft²-°F



1. If you're using circular multipin connectors, such as these MIL-C-81511 versions, you must select a size that can handle your maximum load current without exceeding the temperature rating.

The temperature rise, ΔT , represents the heat rise in degrees Fahrenheit. The information required to solve the equation should be available from the connector manufacturer.

If, instead of contact resistance, pin millivolt drop, V_p , is supplied, the equation becomes

$$\Delta T = \frac{(3.41 \times 10^{-3}) C_m I V_p}{4\pi L R_o k h} (R_o h + 2k).$$

In either case the connector should be selected to take the most severe operating conditions. The conditions to design for are as follows:

- Steady-state continuous operation.
- Current flow through all contacts.
- Sea level to 110,000 foot altitude.
- Natural convection currents.
- A dc current.

Bruno Buszkiewicz, Project Manager, Amphenol Connector Div., Bunker Ramo Corp., 2801 S. 25th Ave., Broadview, Ill. 60153.

Factors such as forced-air ventilation, ac current and heat-sink connector mounting will improve the connector's thermal capability.

Tests on the popular MIL-C-81511 connector family reveal that actual temperature measurements fall within 15% of the calculated figures. Because of the widespread use of this class of connectors, and because they are offered by many vendors, special temperature-current graphs (Fig. 2) are plotted for them. The maximum allowed connector operating temperature is plotted on the Y axis and current flow through all contacts on the X axis. The graphs cover MIL-C-81511 requirements for standard shell sizes 8 to 24 and contact sizes 22 and 23. The graph in Fig 2a is for sea level and that in Fig. 2b is for 110,000-foot operation.

To obtain the allowed temperature rise, ΔT ,

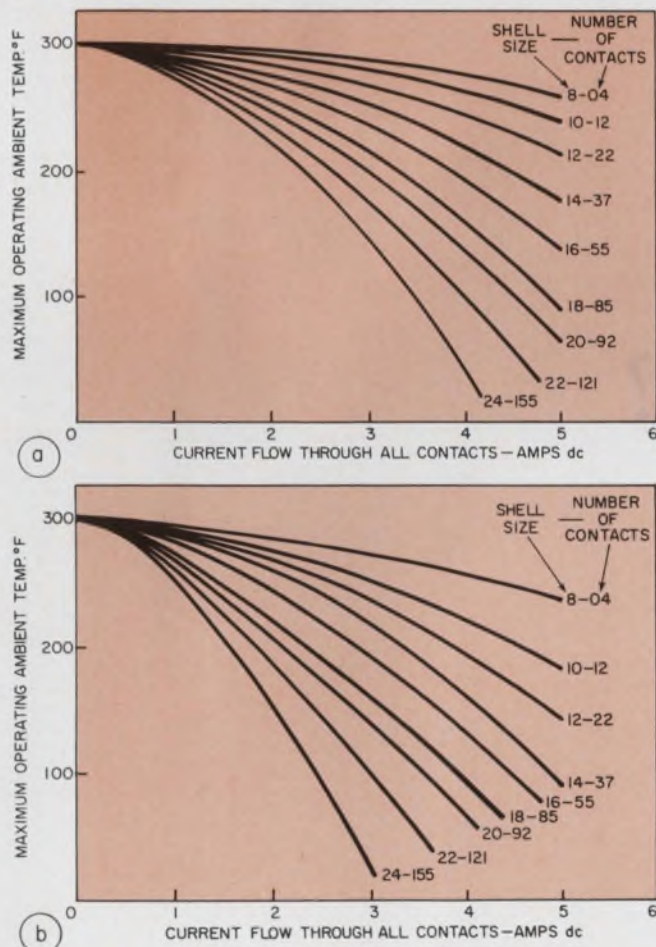

2. Maximum operating ambient temperature at sea level (a) and 110,000 foot altitude (b) with the connector cooled by natural convection.

subtract the maximum operating temperature (read from the graphs) from 300 F. The 300-F value is the maximum temperature a MIL-C-81511 connector should be exposed to with no current through its contacts. Other classes of connectors may, of course, withstand a higher maximum temperature. For instance, MIL-C-26500 connectors can operate to 392 F ambient temperature with current loading such that the internal connector temperature does not exceed 460 F.

Using the graphs

Consider a circuit that requires a connector for 35 conductors, with each conductor carrying 3.5 A. The connector will operate in an ambient temperature of 175 F at both sea level and 110,000 feet. The problem is to find a suitable type of connector. A connector with No. 23 contacts has a current-carrying capacity of 5 A, which amply satisfies the current requirement. From the graphs, we see that a connector with a size 14 shell and 37 contacts at 3.5 A can operate at a maximum ambient of 238 F at sea level and 193 F at 110,000 feet. Obviously this connector safely meets the needed current and thermal conditions.

When all the contacts in a connector do not carry the same current, a weighted average of the currents provides a more realistic way to calculate the connector's temperature rise. Thus:

$$I^2 = \frac{N_1 I_1^2 + N_2 I_2^2 + \dots + N_n I_n^2}{N_{\text{total}}}$$

As an example, consider the following:

A MIL-C-81511 connector with 85 contacts will operate in an ambient temperature no higher than 125 F at sea level. Groups of contacts carry the following current:

- $N_1 = 25$ contacts carry $I_1 = 5.0$ amperes,
- $N_2 = 16$ contacts carry $I_2 = 4.0$ amperes,
- $N_3 = 20$ contacts carry $I_3 = 3.0$ amperes,
- $N_4 = 12$ contacts carry $I_4 = 2.0$ amperes,
- $N_5 = 8$ contacts carry $I_5 = 1.0$ amperes,
- $N_6 = 4$ contacts carry $I_6 = 0$ amperes,
- $N_{\text{total}} = 85$ contacts.

The weighted average current is 3.62 A. From Fig. 2, for a connector with a size 18 shell and 85 contacts, the maximum allowable ambient is about 187 F—safely above the expected ambient of 125 F. ■■

**TRW makes
electronic components for
telephones and
mobile communications and
automobiles and
computers and
television sets and
instrumentation and
aircraft and missiles
and...**

So?

So...

We are one of the few companies producing *both* high-volume and high-technology electronic components for today's growth industries.

Only a company that can cut a broad swath across the fields of all major electronics users has the cross-over capability in manufacturing to handle all your needs, whatever they are.

We are that kind of company. We can give you what you need. High-technology, high-volume — or both. Because we specialize in both, and in a big way. We make over 300 different kinds

of electronic components for the major OEM's in all the major industries. We have the technology and production savvy—plus the sheer size—to be the source for whatever you need.

Perhaps we already make it in one of our 30 plants. Certainly, we *can* make it, even building a new plant if necessary. As we have for others.

In short, we can do more for you precisely because we do so much for so many others in such a range of industries. And because we are TRW.

TRW[®] ELECTRONIC COMPONENTS

10880 Wilshire Blvd., Los Angeles, CA 90024

Connectors • Resistors • Semiconductors • Capacitors • Motors • Functions and Assemblies • PC Boards • Potentiometers • Transformers • Coils and Inductors • Wire and Cable

Boost CMR in differential applications with a special transformer that cancels common-mode currents but permits differential signals to pass unhampered.

Common-mode signals are the bane of differential measurements. Great pains are taken to remove them before they destroy a meaningful measurement or damage sensitive circuit elements.

Here's a device that removes the common-mode signal. Called a common-mode cancellation transformer, the device allows ac or dc differential currents to pass unhampered.

But should a pulsed or ac common-mode signal attempt to sneak through, the transformer will, in effect, use the energy of the two common-mode currents to cancel the unwanted signals.

Acts like a balun

In operation, the transformer device is similar to a balun, or common-mode choke. A balun is a bifilar-wound, broadband transformer that allows equal and opposite currents to flow through its windings while it suppresses unequal and opposite currents, such as those caused by ground noise.

Because of the bifilar windings, no net flux is generated in the balun when its two currents are balanced; balanced signals therefore encounter no inductance when passing through the device. For unbalanced currents, however, the device acts as an inductance and, in effect, breaks up the ground current path.¹

The common-mode cancellation transformer is used in a similar way, in that the ac or dc current in both windings are equal and opposite. In fact, the impedance to equal and opposite currents is just the dc resistance of the windings, except possibly when the frequency response of the transformer is exceeded.

An interesting quality of the common-mode device is that a differential ac or dc current can be transferred through the transformer, with a differential load as the major circuit impedance—the same as with the balun.

And, like the balun, the common-mode transformer is bifilar wound. However, cancellation in the device occurs because the windings are connected in phase opposition.

Fig. 1 shows the setup to determine the common-mode pulse response of the circuit with a differential battery current of 9 A. Pulse rejection from input to output, with a differential ac signal of 10 MHz, is determined with the test circuit of Fig. 2. The 10-MHz differential signal shows no noticeable attenuation, whereas the device dramatically attenuates the common-mode pulse.

References:

1. Condon, Gilbert P., "Baluns Cut Ground Noise," *Electronic Design*, July 22, 1971.
2. Kerchner and Corcoran, "Alternating Current Circuits," Ch. VII, Wiley, New York, 1948.

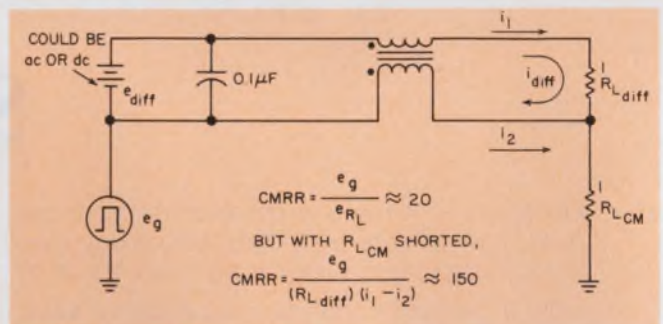

1. The CMCT "rejects" an unwanted common-mode pulse, e_c , but passes the desired dc differential current.

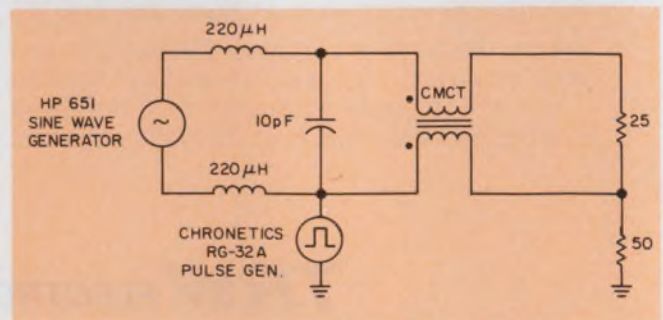

2. 10-MHz differential signal is unattenuated, but the common-mode pulse is rejected.

Dayle R. Smith, Research Scientist, Kaman Sciences Corp., Colorado Springs, Colo. 80907.

Derivation of differential and common-mode impedances

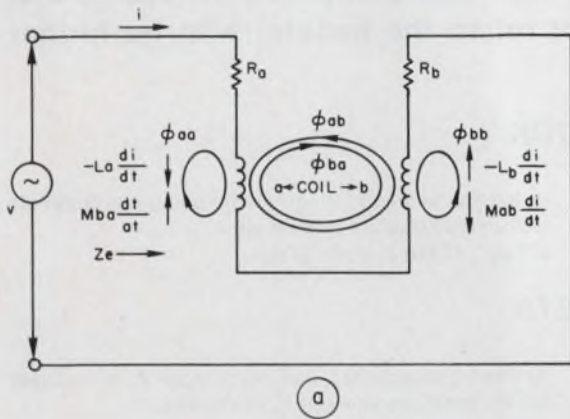

(a) Impedance of series circuit with mutual inductance subtracting.

$$v = R_a i + L_a \frac{di}{dt} - M_{ba} \frac{di}{dt} + R_b i + L_b \frac{di}{dt} - M_{ab} \frac{di}{dt}$$

or:

$$V = (R_a + R_b) I + j\omega (L_a + L_b - 2M) I$$

$$Z_e = \frac{V}{I}$$

$$= \sqrt{[R_a + R_b]^2 + [\omega (L_a + L_b - 2M)]^2}$$

$$\theta_z = \tan^{-1} \frac{\omega (L_a + L_b - 2M)}{R_a + R_b}$$

$$L_e \text{ (ADD)} = L_a + L_b + 2M$$

$$L_e \text{ (SUB)} = L_a + L_b - 2M$$

$$M = \frac{L_e \text{ (ADD)} - L_e \text{ (SUB)}}{4} \cong \frac{4L}{4} \cong L$$

$$\therefore Z_e = R_a + R_b \cong 0.$$

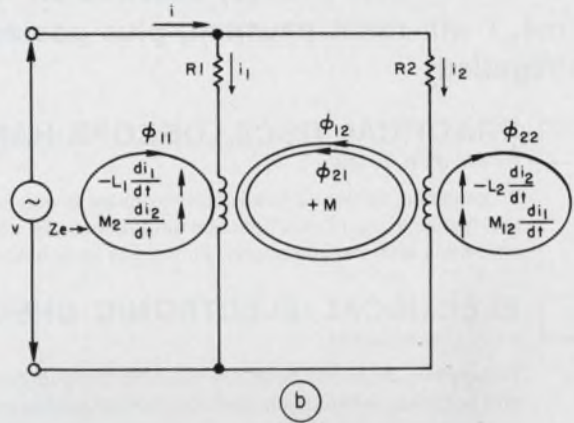

(b) Impedance of parallel branches with mutual inductance adding² (assuming constant circuit parameters).

$$v = R_1 i_1 + L_1 \frac{di_1}{dt} + M_{21} \frac{di_2}{dt};$$

$$V = (R_1 + j\omega L_1) I_1 + j\omega M I_2;$$

$$v = R_2 i_2 + L_2 \frac{di_2}{dt} + M_{12} \frac{di_1}{dt};$$

$$V = (R_2 + j\omega L_2) I_2 + j\omega M I_1;$$

$$Z_e = \frac{V}{I} = \frac{V}{I_1 + I_2} = \frac{V}{\frac{V}{Z_1 + Z_2 - 2ZM}}$$

$$= \frac{Z_1 Z_2 - ZM^2}{Z_1 + Z_2 - 2ZM}$$

$$Z_e = \frac{(R_1 + j\omega L_1)(R_2 + j\omega L_2) - (j\omega M)^2}{(R_1 + j\omega L_1) + (R_2 + j\omega L_2) - 2j\omega M} \cong j\omega L$$

How to build the device

The common-mode cancellation transformer was constructed by Robert Gardner of Pulse Engineering, Inc., San Diego, Calif. The device's specifications are as follows:

Primary inductance:	70 μ H min.
Turns ratio:	1:1
Pri/sec winding capacitance:	20 pF max.
Pri/sec leakage inductance:	0.1 μ H max.
L_p/L_s :	750
Primary dc resistance:	0.080 Ω max.
Secondary dc resistance:	0.080 Ω max.

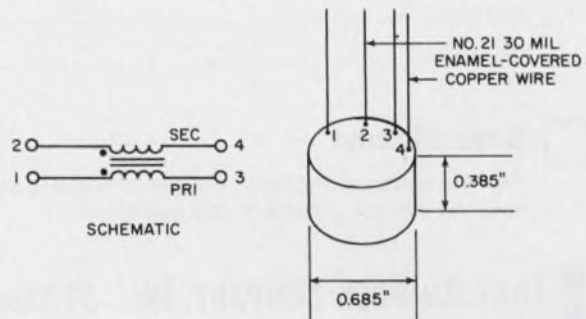

Save time... just clip this coupon to examine any of these valuable guides

Please send the book(s) checked on 15-day free examination. At the end of that time, I will remit payment, plus postage, or return the book(s) with no further obligation.

PRACTICAL OSCILLOSCOPE HANDBOOK
BY RUFUS P. TURNER

A combined edition of two valuable guides giving you the whole array of oscilloscope techniques for specific tests and measurements. Eliminates jargon while

giving you scores of diagrams mapping out complete instrument structure and circuits. 225 pp., #0478-8, cloth, \$7.95.

ELECTRICAL/ELECTRONIC CHECKLISTS
BY W. B. ROSSNAGEL

Twenty-two detailed checklists insuring thoroughness and accuracy when using such devices as cables and connectors, communication radios, multicoders, GSE/AGE/TSE, EMI/RFI, lasers, radar, systems, transmit-

ters and transponders, and many more. Also included are microelectronics and IC checklists. 190 pp., #9181, cloth, \$14.00.

PRACTICAL RELAY CIRCUITS
BY FRANK J. OLIVER

Uniquely groups various relay circuits according to the functions they perform, enabling designers to quickly select the best circuit for a specific purpose.

Covers the whole gamut of relay circuits and is illustrated with many circuit diagrams. 384 pp., #5802-0, cloth, \$14.95.

ADVANCED ELECTRONIC INSTRUMENTS AND THEIR USE
BY SOL D. PRENSKY

An illustrated guide to the highly sophisticated new instruments for sensing, measurement, and control monitoring currently used in industry and research.

Covers operating techniques and applications of femtometers, digital voltmeters, oscilloscopes, and other devices. 208 pp., #0797-3, cloth, \$9.50.

PRACTICAL INSTRUMENTATION TRANSDUCERS
BY FRANK J. OLIVER

A valuable, all-inclusive guide to transducer selection and application. Describes basic operating techniques of virtually every known transducer for the

entire range of industrial and aeronautical use. Stresses topics not covered in other references. 352 pp., #5833-0, cloth, \$20.00.

Check here to receive a copy of our new catalog.

Name _____
Firm _____
Address _____
City/State _____ Zip _____

Save Money!

Payment enclosed. Publisher will pay all shipping and handling charges — same 15-day guarantee.

\$10.00 minimum for exam orders. Because of higher billing and collection costs, we must ask for payment in full with your order if less than \$10.00. Same 15-day guarantee.



HAYDEN BOOK COMPANY, INC., 50 Essex Street, Rochelle Park, New Jersey 07662

ISBN Prefix 0-8104

73-64

Careful there . . .
you're likely
to start
something.



Just a
"flutter" of pressure
. . . and SNAP!

Less than 2 grams of force actuates this Cherry snap-action miniature switch. Outside, the external aluminum actuator is purposely $2\frac{3}{8}$ " long to provide this unusually low operating force. Inside, an extra internal actuator further reduces operating force while maintaining solid contact mating pressure for reliable performance.

The "flutter force" switch is only one of Cherry's E22 series of unique miniatures. All are rated 3 amps, 125 VAC. All are also available in gold "crosspoint" configuration for low energy solid state circuits.

A switch in your hand is worth two in the tree, so . . . SNAP UP A FREE SNAP-ACTION SAMPLE.

Just TWX 910-235-1572 . . . or PHONE 312/689-7704 and ask Frank to give you facts on miniature switches . . . or circle appropriate reader service number.

E22-75HX
5 grams LIGHT
FORCE actuation
Circle No. 144 for
Free Sample



E22-55HX
3.5 grams LIGHTER
FORCE actuation
Circle No. 145 for
Free Sample



E22-85HX
Less than 2 grams
"FLUTTER
FORCE" actuation
Circle No. 146 for Free Sample



CHERRY 

CHERRY ELECTRICAL PRODUCTS CORP.
3600 Sunset Avenue, Waukegan, Illinois 60085



Cherry affiliates worldwide • Hirose Cherry Precision Co., Ltd., Tokyo • G. W. Engineering Pty. Ltd., Sydney
Cherry Electrical Products (U.K.) Ltd., St. Albans, Herts • Cherry Mikroschalter GmbH, Bayreuth, Germany

Is this another bum wrap?

If you've been getting more than your share of faulty plug-in and wire-wrapped panels lately, you should talk to us: Garry Manufacturing.

At Garry, we take extra care to insure that you get a better wire-wrapped panel. Whether you buy a plug-in panel from us (and wrap it yourself). Or, whether you let us wrap it for you.

Either way, you get a better panel. Because our unwrapped panels are more "wrappable" (squareness, for example, is exactly .025 inch.

It never varies). Our precision beryllium spring clip has the most consistent I.C. insertion/withdrawal ratio in the industry. All this because our facilities are among the world's best.

This attention to quality is nothing new to Garry. For 25 years we have been supplying contacts to the connector field. We have the largest facilities for making contacts and do not rely on outside suppliers for our parts. We have plants in the U.S. and Switzerland. And we have a long list of very satisfied customers, including the 5 largest electronics manufacturers in the United States.

Why not find out more about Garry panels? About our ultra-reliable contacts. Our design and engineering service. Our extra-fast delivery/turnaround. And our technically-oriented sales staff.

They just might help you beat a bum wrap.

Garry's panels are available for less cost, with up to three levels of wire wrap, in any quantity. Get all the details. Send for Garry's literature.

Garry Manufacturing Co., 1010 Jersey Ave., New Brunswick, New Jersey 08902.

*Denver-Gardner

Garry

Manufacturing Co.

**We won't
pin a bum wrap
on you.**



Everything you always wanted to know about Drive Motors.



Into these five booklets we've crammed 156 pages of the latest information on Kearfott's line of Drive Motors.

Kearfott, as you probably already know, is a primary supplier of drive motors. And has a reputation for quality, service and on-time delivery.

We can furnish you with drive motors in individual units or in packages to fit any of your aerospace or industrial applications. From counters to computers. From business machines to printers and tape readers.

Let's take a look at the type and range of motors we're talking about.

DC TACHOMETERS



Kearfott Tachometers are designed specifically for precision speed sensing and as rate generators to help velocity servos achieve fast response.

Features include: outputs to 100V dc/1000rpm;

minimum ripple at high commutation frequency; high linearity; low friction torque.

These are ideal for computer tape transports where efficient data retrieval is a must. And for business machine and numerical control machine tools.

DC TORQUERS

You can get sizes 12 through 42, uncased for gimbal mount applications and cased for direct drive torque motor positioning.

Kearfott can also supply them with a variety of integral feedback elements such as potentiometers, synchros and tachometers—in a single housing.

You've a choice of standard design, inverted construction (inner member is magnetic and transfers power to an outer armature) and brushless Limited Rotation design.



DC MOTORS

These are Moving Coil Motors used for high-response DC servos such as High-Speed Printer and Capatan drives.

One of their unique features is that they need less cooling than equivalent competitive units. The reason: low internal impedance which allows a high cooling flow rate at low developed pressures.

Permanent magnet and wound-field types are available for standard

aerospace and industrial applications, including high acceleration motors with integral tachometers for terminal printers.



AC MOTORS



Kearfott induction or synchronous motors of the hysteresis or reluctance type come in a broad range of frame sizes. And from sub-fractional power to 15 HP.

We can furnish motors that run on up to 440 volts ac, single, 2 or 3 phase. Induction motors that operate on 2, 4, 6, 8 or 12 pole design. And dual speed motors such

as needed for driving memory discs in large computers.

You can also get: high-slip motors for aircraft requirements at 400 cps; synchronous motors for constant rotating speeds with varying loads; gear motors for extremely low speeds or speeds incompatible with the power supply frequency.

STEPPER MOTORS

If you want precision control—for example for small peripheral devices, small line printers and tape readers—Kearfott Steppers provide it via discreet steps and high slew rates. And in a wide choice of stepping rates and torque levels.

Typical Kearfott units have 15° stepping angles, compatible with all 24-tooth sprockets. They give high holding torque, high stepping speed and fast response.

Units with other step angles, such as 1.8°, 7.5°, 10°, 30°, 45° and 90° are readily available in frame sizes through 50.

But why not get all the details? Mail the coupon for our new booklets now. The Singer Company, Kearfott Division, 1150 McBride Avenue, Little Falls, N.J. 07424.



SINGER

AEROSPACE & MARINE SYSTEMS

The Singer Company, Kearfott Division
1150 McBride Avenue
Little Falls, New Jersey 07424

Gentlemen:

Rush me your new booklets on Kearfott Drive Motors.

Name _____

Title _____

Company _____

Address _____

City _____ State _____ Zip _____

ED-10

Determine noise of dc/dc converters.

In terms of techniques and required equipment, the measurement is like those used in high-frequency work.

Noise measurements of dc/dc-converter power supplies are far more demanding than those for conventional 60-Hz power supplies. Proper measurement of the high-frequency components of a converter's switching spikes more closely parallels techniques used in high-frequency pulse or square-wave measurements.

A single noise measurement doesn't tell the whole story. Output noise voltage, reflected input-ripple current and output "common-mode" noise current should all be measured to evaluate a switching supply.

True rms is necessary

Rms measurements of converter noise are valid only with a true-rms responding device, such as Hewlett-Packard's Model 3400 (an instrument with a crest factor of 10:1) or the Ballantine 323. The instrument should have a bandwidth of at least 5 Hz to 10 or 20 MHz. An average responding device, scaled to read rms, cannot handle the switching components, nor give adequate accuracy with non-sinusoidal components.¹

Present-day converters have switching frequencies ranging from a few kilohertz to 100 kHz. Input and output switching spikes are generally from 50 ns to a few hundred nanoseconds in duration, and have amplitudes from a few millivolts to several hundred millivolts.

Thus, a system noise bandwidth of at least 20 MHz (with proper termination) is needed to produce a meaningful peak-to-peak measurement.

To compare the noise specs of two ostensibly equivalent isolated converter supplies, consider the following:

- Are the switching frequencies in the same general region?
- Are the frequencies above the audible range (> 20 kHz)?
- Does a measurement-system noise-bandwidth spec accompany the noise-level spec; if so, is the bandwidth adequate? (> 20 MHz).
- Can the system bw be verified, using the

manufacturer's test setup and recommended equipment?

- Has the test setup been properly terminated, and are these terminations specified?

Note that the unit with the higher switching frequency may exhibit a larger wideband noise level than its lower-frequency counterpart but may actually have less noise, as a proportion of bw.

A noise level that is not accompanied by both a bw spec and the termination value is, at best, misleading and, at worst, useless. The manufacturer should be able to supply details of suitable equipment and test circuits.

Ask another question: To what degree will the noise affect my application? Perhaps your particular circuitry and hardware are bandwidth insensitive to a 50 or 100-ns, 10-mV pk-pk, switching spike, yet can't bear more than a millivolt of true-rms noise. The reverse might be true with a wideband, high-accuracy device. Many of the supply rejection-vs-frequency specs are characterized on a sinusoidal basis. Since it is difficult to correlate sinusoidal behavior with switching spikes, it's best to make actual hardware measurements.

To cite a common application, let's consider powering a $\mu A741$ unity-gain inverter with a converter supply (Fig. 1). A Bode plot shows that unity-gain crossover occurs at one MHz. The supply rejection specifications are $30 \mu V/V$

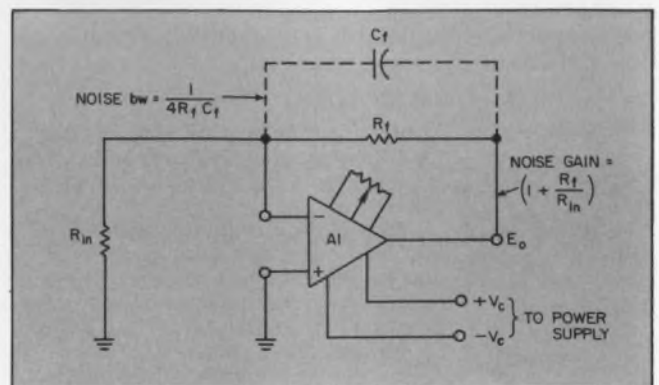

1. Op amp powered by dc/dc converter passes negligible converter switching spikes because of narrow bandwidth and slow response.

Dan Sheehan, Chief Applications Engineer, Stevens/Arnold, Inc., 7 Elkins St., Boston, Mass. 02127.

(6666:1). With a 10-mV pk-pk noise spike on the power-supply output, the rejection of the μ A741 is much greater than 1000:1.

To get more rejection, the amplifier's gain can be increased to 100 or more but at the expense of bandwidth. The bw will now roll off to 10 kHz or less—too narrow to pass high-frequency spikes.

Thus, because of the 741C's speed and bw limitations, it passes only a minute amount of the high-speed converter switching spikes. Effectively, therefore, spike rejection is far in excess of

of the 191 until the pk-pk amplitude is 3-dB down (70.7%) at 2.8-cm pk-pk. Then, read the system bandwidth on the 191's scale. Thus,

$$\text{measurement system bandwidth} = \frac{0.35}{\text{system } t_r} \quad (1)$$

where system t_r is

$$\text{system } t_r = [(t_r \text{ source})^2 + (t_r \text{ probe})^2 + (t_r \text{ scope})^2 + (t_r \text{ preamp})^2]^{1/2} \quad (2)$$

Similarly, the -3 dB low-end rolloff can also be verified by using a Krohn-Hite 4200 constant-amplitude generator, or equivalent. Thus,

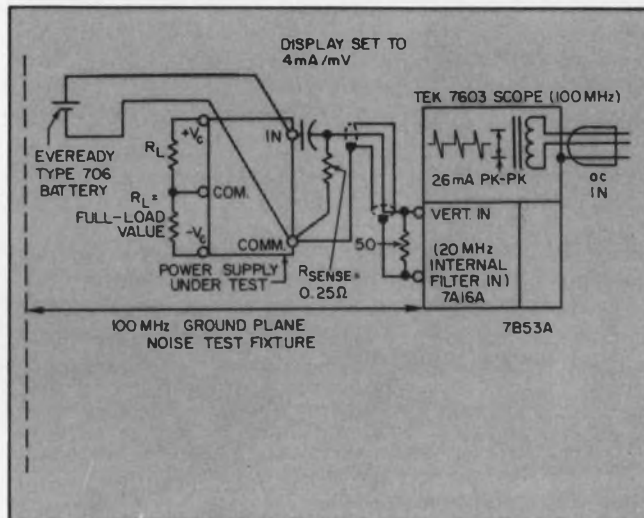
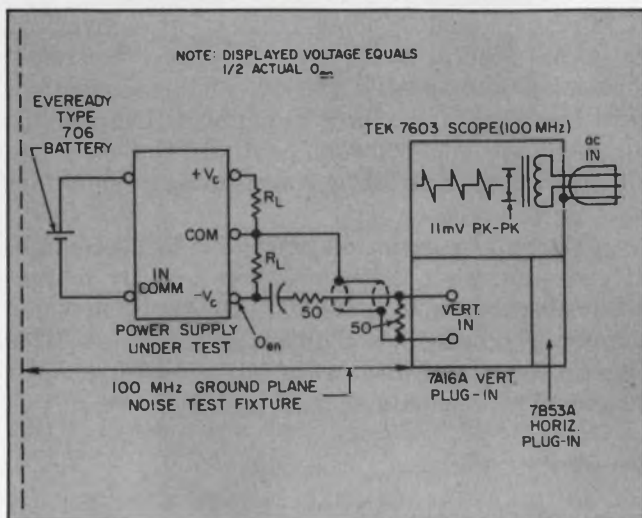

2. Converter output noise measurements, like those for high-frequency EMI, require a wide system bandwidth, 50- Ω termination and a shielded ground plane.

3. A converter's input current spikes, known as reflected input ripple current, are measured at the input terminals by sampling current with a nonreactive resistor.

1000:1. This would not be the case if the device had a few hundred volts per microsecond slew rate, with an f_c at least an order of magnitude greater.

Use ground plane

One method of making wideband pk-pk noise measurements is to arrange a shielded ground-plane as close to the oscilloscope's input connector as possible (Fig. 2), and to use nonreactive 50- Ω terminations and high-speed wiring.

An isolated battery source should be used to power the dc/dc converter. This will minimize line-coupling and ground-loops. Make the noise measurements as close to the converter module's pins as possible.

The scope should have a system bandwidth of 100 MHz or more; for example, the Tektronix 400 or 7000 series. The measurement system bandwidth should be verified by unplugging the supply module, and connecting a Tek 191 constant-amplitude sinewave generator at the output socket. Set the small-signal amplitude for 4-cm pk-pk on the scale you will be using for the actual noise measurement. Increase the frequency

$$-3 \text{ dB low-end bw} = \frac{1}{2\pi C (R_r + R_s)} \quad (3)$$

To confirm that the scope is not displaying ripple or pickup from ground currents, unplug the power supply and short the supply output socket to output common. When this is done, the scope should display its own residual noise—which should not be excessive. If it is, you have a ground current or pickup in series with the scope input.

To determine the source of the residual, remove the socket short, plug the supply back in, and shut off the input power source. Presence of noise signals under these conditions indicates pickup between the power supply and the scope.

The scope's third pin (case ground) should be connected to earth ground. Note that noise should be specified for the worst case, non-reactive loading condition (not necessarily full load).

Watch for current spikes

Reflected input-ripple current—sometimes called spike feedback current—is the unfiltered portion of the input circuitry switching spike. If such a current spike is of large enough magni-

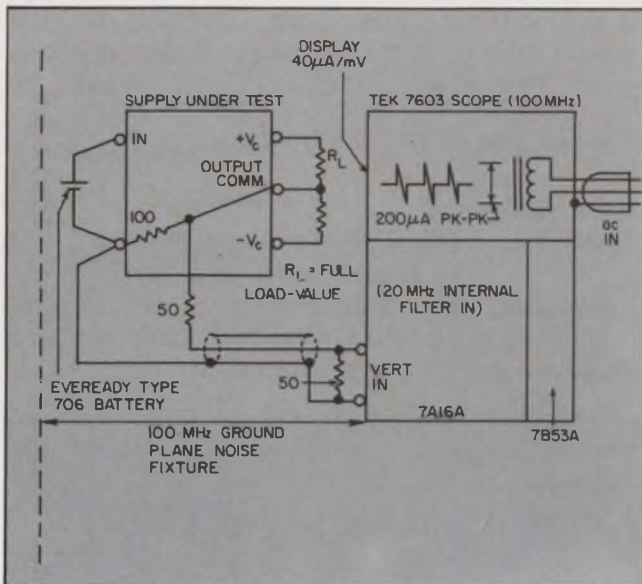

4. "Common-mode" current noise between a converter's output and input common terminals should also be measured. This unwanted noise can saturate a differential-input op-amp being powered by the converter.

tude, it can trigger other circuitry, such as flip-flops, gates, and counters—commonly powered from the converter's input voltage source.

Reflected input ripple current should be measured directly at the supply input terminals, using a dc decoupling capacitor (with adequate hf

characteristics) and a current-sampling nonre-active resistor (Fig. 3). The time constant of these components should be a minimum of five—and preferably 10 or more—times larger than the duration of the switching spike to be measured. Current-sampling should be cross-checked by using a current probe, or by setting an R-value below and above the value specified. This will verify that the measurement is being made in the linear current region.

Again, the measurement system bandwidth should be a minimum of 20 MHz, and the sampling resistor value should be specified.

"Common-mode" noise current of converters is a differential noise current spike normally present at the isolated output, common terminal, with respect to the input common. The magnitude of this noise current partially indicates the quality of a converter's design and shielding techniques.

If the spike-current magnitude is large enough, it can saturate a differential op amp or instrumentation-amplifier powered by the converter supply. The noise also requires at least a 20-MHz measuring bandwidth (Fig. 4); termination—usually 50 Ω —should also be specified. ■■

Reference:

1. Hewlett-Packard *Application Note AN124*, "True RMS Measurements."

a new choice in Plug-In Rotaries

Start with Stackpole's exclusive environment proof rotary. Then add terminal pins facing front or rear, ready to plug in instantly to your PC board. Or design in a Stackpole PC board rotary switch with 12 terminals ending at a common junction point for vertical or horizontal mounting or mating to an edge-board connector.

Eliminate wiring harnesses, hand wiring errors, costly intermediate assembly. Pin termination switches are available as standard off-the-shelf switches as well as with binary codes and special switching sequences. Yet they cost less than \$2.00.

Call Stackpole. They're plugged in to your needs. Stackpole Components Company, P.O. Box 14466, Raleigh, N.C. 27610. Phone: 919-828-6201.



STACKPOLE
COMPONENTS COMPANY

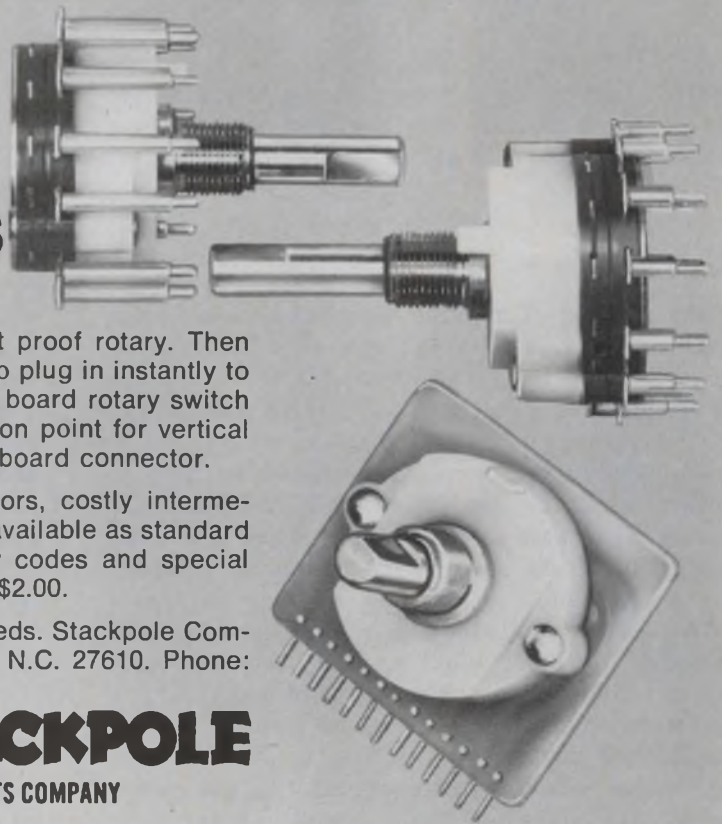

A new concept in packaged power circuits as convenient as the TV dinner.

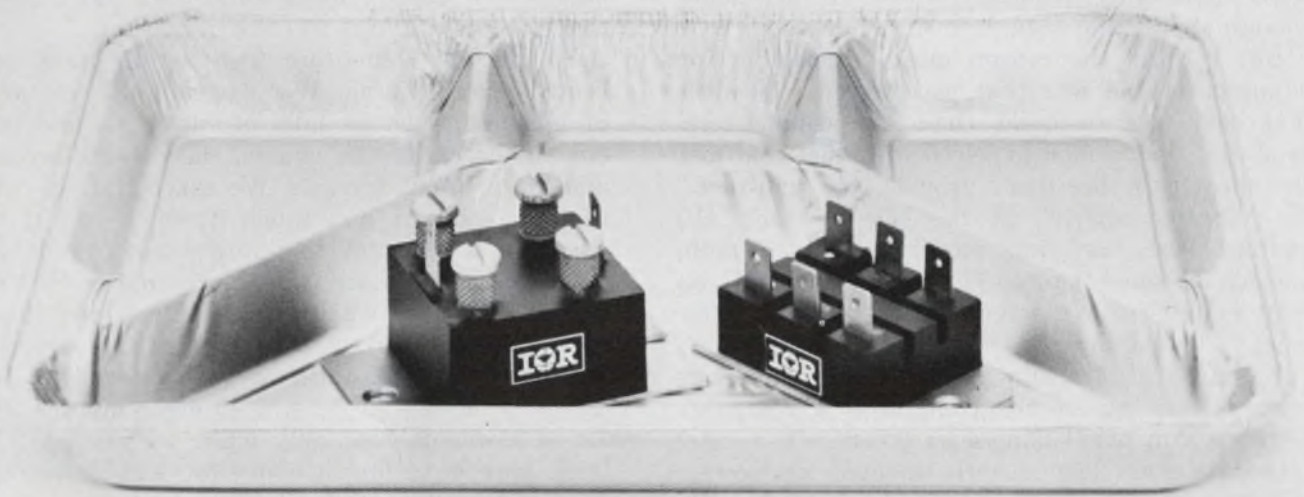

The International Rectifier PACE/pak™ is the device behind this new concept.

They are power integrated circuits, made up of SCRs, diodes, triacs, etc. which give you a complete control circuit function in a single package. And like the TV dinner, they take most of the shopping and assembly times out of the job.

But that's just the beginning of the benefits they offer.

Smaller size. PACE/paks (Passivated Assembled Circuit Elements) are electrically isolated up to 2.5 kV. There's no need for a separate isolated heat-sink, so you get up to 60% reduction in space requirements.

A better designed system. With the smaller size of these power hybrid control circuits you get more design and packaging flexibility. And since you don't have to spend time designing with discrete components, you have more time to make other improvements.

One-fifth the assembly time. No more do you have to assemble five to seven devices for single and 3-phase functions. With the PACE/pak there is just one part to mount, one part to interconnect with push-on or screw terminals. Your system reliability is higher, too.

Just think of the other savings you can make in testing, inspection and field servicing.

Lower inventory costs. We estimate a 7-to-1 reduction in inventory, plus savings in procurement time and costs. Standard PACE/pak circuits now cover 90% of single-phase power circuit requirements, with more in development for 3-phase applications.

They are available as standards with 25 or 42.5 Amp current ratings, in either 120 or 230 Volt RMS versions.

Find out how PACE/paks will revolutionize your designs like dc motor controls, inverters, chopper drives, generator exciters, solid-state circuit breakers, battery chargers and variable dc power supplies.

Call your local IR sales office for details or contact the factory: *International Rectifier • 233 Kansas Street, El Segundo, CA 90245 • (213) 678-6281 • TELEX: 67-4666.*

International Rectifier

... the innovative power people



You'll turn out good products for less, says this company president, if you build a computer storehouse of the fixed information your business needs to function.

People have asked me how a small, \$2-million company like ours managed to outbid a couple of giants like Tektronix and Hewlett-Packard for an Air Force oscilloscope contract. One reason is that we entered a field that our organization understood thoroughly. Another is that we are small enough and mobile enough to ship quickly.

But I think the reason most responsible for winning the bid was that we entered a product that cost less to build than our competitors' products. We decided to select a product that met the specs fully but don't provide the "sun-roof," the "chrome strips" on the side or the "410 engine." The "car" was required to go 60 mph, and we designed it to go 60 mph—very safely on four cylinders. We gave the customer exactly what he asked for.

A major key to our ability to minimize our costs is our use of the computer. A computer helps us run our business as effectively as any corporate giant loaded with talented manpower. What's more, we don't even own a computer. We rent one.

Programming company data—step by step

When three of us started the company a year and a half ago, we knew that we'd have to build products for less to compete. To do that, we knew that we'd need a storehouse of fixed information to operate on a daily basis.

The obvious answer to that need was to use a computer to store the data that we'd have access to repeatedly—such as the description of a part and where we could buy it. We realized, too, that we could use that information not only in engineering but also in purchasing, inventory control and bills of material.

Of course, any company can store data. But perhaps most companies our size hadn't had the exposure we'd had: All three of us have engineering degrees, and two of us have business degrees, and we've all worked for a lot of companies in the past. Also, we had several months

to write business plans, obtain money and determine what the needs of the business were.

We quickly determined that the company didn't need a computer, partly because we didn't want to worry about the hardware but mainly because we wanted to draw on much more talent than we could afford to own in-house.

So we did something a little different—we rented programming. We programmed one area of business, such as bills of material, and laid out all the cards and charts, the column layouts and the printout formats. We asked the guy who rented computers how much it would cost if we gave him a sheet of this information, had him keypunch it and place it in the computer. He said that it would cost \$250 and that he'd have it for us in a week. So we programmed one area of business at a time, until we were able to put our company on data processing in eight months. We found a way to rent only what we needed. The trick here is to find a computer service bureau with a guy who talks your language.

Calculating where to cut corners

In programming each area of business we had to know how much money and time it would take to generate the program data and how much of each program to put into data form. We also had to know who was going to be using the data. One of the frequent mistakes that small companies make is generating more data than they can use. A two-inch stack of printout is useless to a small business. We decided that we weren't here to read material; we're here to make decisions, and we need information that is easily obtained. Some of the areas we programmed are: a parts list, a bill of material and a where-used list.

We knew that engineering needed a parts list sorted by value so standardized parts could be specified. Standard parts are cheaper, and they cut down on the number of different parts in the stockroom—which makes for quicker accessibility. When engineering releases a part, it is fully described as to vendor and vendor part number and electrical description—information that we can put into the computer. We selectively use the

Fred Katzmann, President, Ballantine Laboratories, Bonton, N.J. 07005.

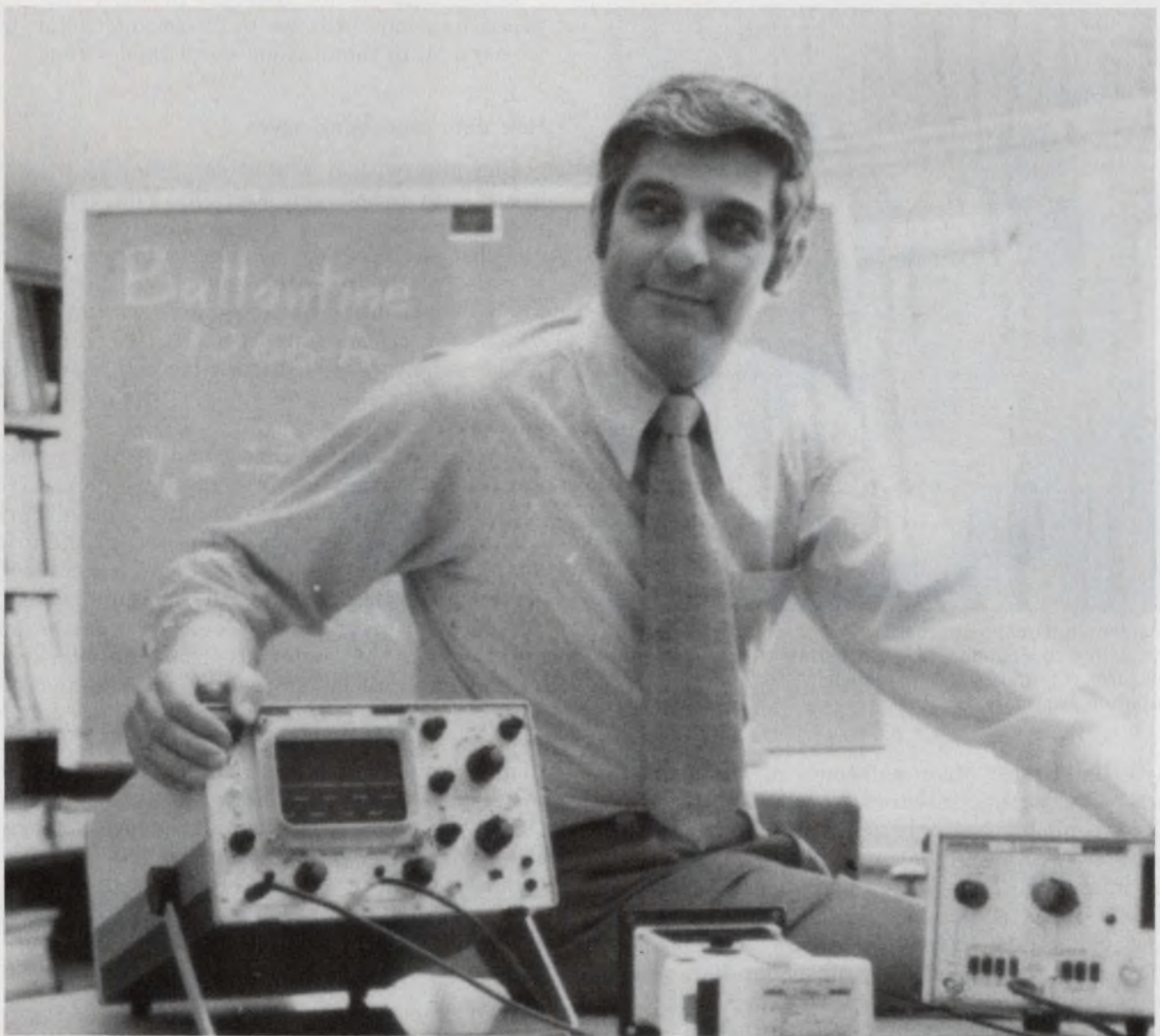

Fred Katzmann

Education: BEE, City College of New York; MSc in Industrial Management (MBA equivalent) Stevens Institute of Technology, 1962.

Experience: President of Ballantine Laboratories, Inc.; Vice President of Marketing—The Singer Company/Electronic Products Division—Instrumentation Operation; Director and General Manager of Monsanto Company, Electronic Instruments; Operations Manager responsible for sales, engineering and manufacturing of oscilloscopes and associated instruments, Fairchild Camera and Instrument Co., Instrumentation Division, Clifton, New Jersey.

Memberships and Activities: IEEE technical committee on oscilloscope specifications—contributed to International Electro-technical Commission; American Physical Society, APICS; United Fund; Cedar Grove Planning Board (Secretary); and vice president and camping chairman, Eagle Rock Council Boy Scouts of America.

Patents: Sweep Circuit; Cathode-ray Oscilloscope; Oscilloscopes; Read Out Injection; Time Sharing; and Traveling Wave CRT.

Publications and Technical Papers: New York IEEE Convention—Papers, 1963, "A Time Shared Oscilloscope With Precise Digital Read Out," "Starting an Electronic Instrument Business," "Marketing Electronic Instruments"; WESCON Symposium, 1965, paper—"The Fiber Optics Oscilloscope: ELECTRONIC DESIGN, 1965, "Oscilloscope Progress—A Tool With Many Faces"; Application Note—Fairchild Instrumentation, 1964, "Fiber Optics Transient Recording."

Employer: Ballantine Laboratories, Boonton, N.J. Originated in 1929 and specialized in radio communication and instrumentation. Purchased from the Singer Co. in 1971 by three engineers and set up as an independent company, the company produces a line of precision meters, calibrators, scopes and counters. It employs 48 people, including eight engineers.



President Katzmann discusses two of Ballantine's products with Lou Foundos, V. P., Operations and Company Treasurer (L), and Milt Lichtenstein, V. P., Marketing and Corporate Secretary.

parts list to get other printouts of the existing data—like sorting resistors by value.

If a company has only a few hundred parts on its lists—we have 12,000—the lists can be written manually. Few small companies under \$5-million have a detailed data-processing base. Most companies haven't made this approach a priority of their operation. With our data base, we can operate our business for less cost and with greater accuracy, and we can get a better mix of information faster to make better business decisions.

We also use data processing as a corner-cutter in the purchasing department. We knew that the purchasing department shouldn't use bills of material as the basis for making its purchases; what it really needed was a composite listing of all our customers and how many of them used how many units of the same part. We wanted to have a way of merging the lists so that the purchasing department could buy the same parts in quantity. That way two people could do all the purchasing for our business.

How did we generate "where used" lists? We have more than 80 active designs being used by thousands of companies. It cost us only \$600 to have a computer programmed to take the data bank that we created. The computer researches the bills of material that we have in memory and gives us a list in five minutes. We get a print-out twice a year, and it costs us \$175. With the "where used" list, we can buy parts in quantity, and it's a great help in sales forecasts.

Going back to our original premise that data processing can help us build products for less, let me add up the obvious ways this is true.

How data processing saves

One plus with a rented computer is that you use it only when you need it. You can't treat people the same way. It's wrong to hire people and then lay them off whenever there's no work. It's also costly to train people. The computer is tamed but not trained. We hire people permanently for permanent work. If we hire them temporarily, we tell them the job won't last. Remember, with a computer, "what you see is what you get."

Another advantage that I find in data processing is that it supplies information quickly from a perfect data bank. A computer doesn't print out information in error. If you put in the information correctly, it's going to come out correctly. That's not necessarily so with a manual system.

With data processing we can arrange the pulling sequence of material from the stockroom when we're putting an instrument together. The stockroom is organized on a computer coding sequence. The computer is told once how to make that pull sheet and then prints it out each time so the girl on the assembly line who prints the parts gets them in the same sequence. This pull sheet saves two or three intermediate steps in handling parts in the overhead operation. It also cuts down on the humdrum work and gets the assembly work done as efficiently as possible.

The art of economics engineering

The engineer is the key to making a logical presentation of the existing facts and entering them into the pool of data. Part of his responsibility is making money for the establishment. He should take the leadership in this and provide guidance. Most engineers don't do this. They're more interested in how the central processor works than what it can do for them.

It's time that we trained our technical people to do a job in economics as well as in science. That's what engineering is really all about—bringing science efficiently to the user. The engineer should always ask if what he's designing can be done better—not just the circuitry but also the handling of the product before it is delivered to the customer.

That's what a good engineer must know, and a small company can only afford to hire good engineers. A good engineer isn't the one who knows only how to work higher mathematics; he sees the breadth of the problem at hand, which involves science and economics, and the needs of the end user. ■■

an unbeatable combination... 350 MHz and 1ns/div in a portable!

Dual trace, 350 MHz bandpass, high writing speed, 5 mV/div full bandwidth and 1 ns/div sweep together with many operator conveniences assure fast accurate high-speed oscilloscope measurements. This combination is now available in a portable—the 485 from Tektronix. It weighs just 24 pounds, allowing you to move it in the lab and shop, or you easily take it with you on installation and repair jobs.

HIGH-SPEED MEASUREMENTS WITH SELECTABLE INPUT IMPEDANCE

Full capability 50 Ω and 1 M Ω measurements are available at your fingertips. The 5 mV/div deflection exists to the full bandwidth of 350 MHz in 50 Ω , and 250 MHz in 1 M Ω . The 50 Ω input is protected against the inadvertent application of excessive signal strength. When it happens, you simply press the reset.

SINGLE-SHOT FAST PULSE RECORDING

If your application involves high-speed single shot phenomena, an optional P11 CRT phosphor and the TEKTRONIX C-31 Camera allow you to record on film at 6.0 div/ns. Use of the Writing Speed Enhancer substantially increases this speed.

ACCURATE TIME RESOLUTION MEASUREMENTS

In many of today's pulse applications, accurate time measurements are vital. An unmagnified sweep speed of 1 ns/div permits time resolution measurements in the vicinity of 200 picoseconds. This high-speed accuracy combined with horizontal sweep switching present time measurement capability unheard of in a portable oscilloscope.

BONUS FEATURES

Some of the operator conveniences are: A-external trigger view, delayed sweep, automatic scale factor read-out, horizontal sweep switching, A-trigger hold-off, bandwidth limit, beam finder, frequency selectable fast-rise calibrator, automatic focus, and battery operation with the TEKTRONIX 1105.

Full realization of these many ease-of-operation features can only be gained through actual hands-on experience. Your local Tektronix field engineer has a 485. Call him for a personal demonstration.

If you'd like additional literature, write Tektronix, Inc., P.O. Box 500, Beaverton, Oregon 97005. In Europe, write Tektronix Ltd., P.O. Box 36, St. Peter Port, Guernsey, C.I., U.K.

485 Oscilloscope \$4200



TEKTRONIX
committed to
technical excellence

INFORMATION RETRIEVAL NUMBER 51

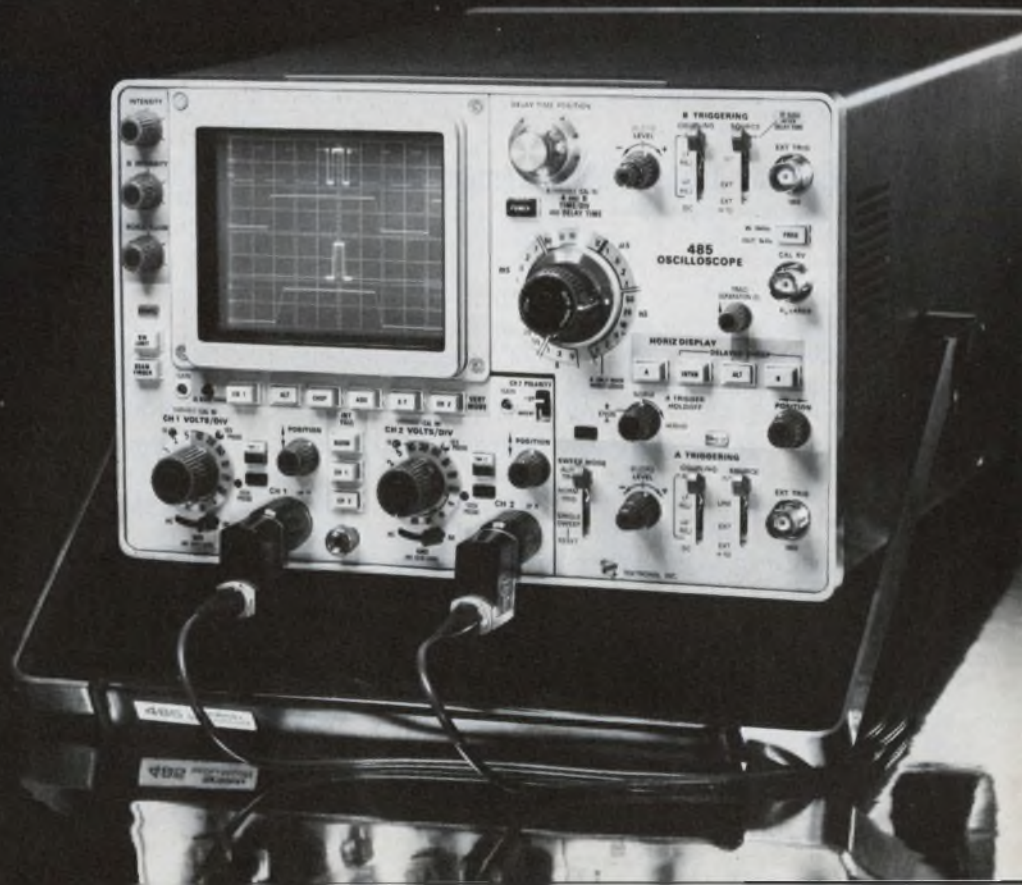

New and recent Spartan Books . . .

Introduction to Defense Radar Systems Engineering

JAMES N. CONSTANT, *President, RCS Associates, Inc.*

Just Published! The first book to bring together all aspects of radar systems and integrate them in a systematic and logical pattern offers all the background needed to specify a system for a given application. Each chapter presents analyses and equations in engineering terms. Among this comprehensive volume's many unique features are: the most extensive treatment of the effects of Electronic Counter Measures (ECM); coverage of the theory of trajectory predictions and array theory; and an in-depth treatment of data processing in radar systems. 260 pp., 6 x 9, illus., #9194, cloth, \$20.00

Checklists for Management, Engineering, Manufacturing, and Product Assurance

W. B. ROSSNAGEL, *Rossnagel and Associates*

Technically accurate and ready to be applied, these checklists are an excellent means to ensure that a given specification, contract, design, etc., is complete in every respect.

Volume I, Management Checklists

22 checklists cover computers, engineering, finance, labor relations, manufacturing, marketing, personnel, product assurance, proposals, publications, small business, and other subjects. 192 pp., 6 x 9, illus., #9178, cloth, \$14.00

Volume II, Electrical and Electronic Checklists

22 detailed lists encompass cables and connectors, communication radios, multi-coders, lasers, microelectronics, integrated circuits, and much more. 192 pp., 6 x 9, illus., #9181, cloth, \$14.00

Vibration and Acoustic Measurement Handbook

MICHAEL P. BLAKE, *Development Engineer, and*
WILLIAM S. MITCHELL, *Vibration and Acoustical Consultant, both of Lovejoy, Inc.*

This original 700-page illustrated guide closes the great technological gap between theory and operations in the field. Developed through years of practical testing, it demonstrates the value of vibration and acoustic measurement in terms of actual situations and machine problems. It clearly shows how these measurements can give warning months in advance of 90 percent of equipment problems, allowing time to take corrective action before trouble starts. The net-result: less production stoppage, fewer lost man-hours, better quality control, and lower maintenance costs. 656 pp., 6 x 9, illus., #9195, cloth, \$30.00

Analysis of Plates

D. E. McFARLAND, B. L. SMITH, and
W. D. BERNHART, *Wichita State University*

This comprehensive text presents both classical and computer-oriented solutions for the analysis of thin plates for stresses, strains, and lateral deflections. The coverage includes orthotropic plates, continuous plates, various shapes, plates on elastic foundations, large deflections, and laminated plates. The authors add new insight to the variational approach to plate theory, including many illustrative examples. Although intended as a text in mechanical engineering, the book should be of great interest to engineers in industry. 296 pp., 6 x 9, illus., #9191, cloth, \$18.50

Control Theory, Volume 1

Elements of Modern Control Theory

ARTHUR L. GREENSITE, *Convair Division of General Dynamics*

The first of these two volumes on flight control provides the practicing engineer and advanced student with a comprehensive, modern, and up-to-date exposition of all facets of modern control theory. Based on a series of monographs written for NASA, it is recommended as a primary or supplementary reference text. Extensive sample problems and exercises included. 896 pp., 6 x 9, illus., #9154, \$29.95

Control Theory, Volume 2

Analysis and Design of Space Flight Vehicle Control Systems

The companion volume treats applications to aerospace vehicles in detail. It examines techniques and methods for the design of launch vehicle control systems, and presents an analytical framework for the study of the performance of satellite attitude control systems. 752 pp., 6 x 9, illus., #9163, cloth, \$29.95

Modeling of Thinking and the Mind

N. M. AMOSOV, *Academy of Medical Science, U.S.S.R.*

An exciting work on the theory and techniques of simulating the functions of the human intellect by one of the Soviet Union's leading cyberneticists and Lenin Prize winner. Presenting his original hypothesis concerning programs of man's psychic functions, the author outlines methods for modeling these on the computer. 208 pp., 6 x 9, illus., #9147, cloth, \$12.00

SPARTAN BOOKS / HAYDEN BOOK COMPANY, Inc., New York

... now available from Hayden

Pattern Recognition

M. BONGARD, *Translated from the Russian by T. Cheron; Edited by J. K. Hawkins, Robot Research*

Although primarily directed toward specialists in computers and artificial intelligence, this volume is of importance to engineers and others attempting to understand such brain functions as the ability to "find similarity," "create abstract ideas," and "act by intuition." The Soviet scientist clarifies the meaning of pattern recognition and problem solving. 256 pp., 6 x 9, illus., #9195, cloth, \$12.95

The Future of Science

MORRIS GORAN, *Roosevelt University*

A provocative, well documented investigation of the scientists' relationships with society, government, and money. It examines three current problems of the scientists: communication, education, and financing. Throughout, discussions are supported by facts rather than moralistic statements. 168 pp., 6 x 9, #9190, cloth, \$8.50

Technology Gap in Perspective

Strategy of International Technology Transfer

DANIEL LLOYD SPENCER, *Morgan State College*

An original strategy for visualizing and coping with the technological variants of the modern world. Presenting a novel systems vision, the author deals with the problems of incessant waves of technological impact, and holds that we must view them as a world technology system. 192 pp., 6 x 9, illus., #9180, cloth, \$10.00

Character Readers and Pattern Recognition

Edited by V. A. KOVALEVSKY, *Institute of Cybernetics, Kiev, U.S.S.R.*

This collection of articles focuses on problems of pattern recognition and computer simulation of various algorithms

and recognition systems. All methods discussed and all work examined are based on procedures used in the development of actual equipment at the Institute of Cybernetics. 280 pp., 6 x 9, illus., #9150, cloth, \$12.00

Durability and Reliability in Engineering Design

GILBERT KIVENSON

This thought-provoking work places at your disposal highly relevant findings from a variety of technical areas. It examines materials properties, breakdown mechanisms and phenomena, and failure modes along with steps to counter them; provides a capsule course in reliability theory; relates design considerations to the user's needs. 200 pp., 6 x 9, illus., #5851-9, cloth, \$9.95

Materials Science and Technology for Design Engineers

Edited by ALEX E. JAVITZ

The fundamentals of materials integrated with the hard facts of day-to-day engineering practice. The coverage offered you ranges from basic structure and behavior through new materials and applications, to environmental effects, reliability concepts, and cost effectiveness. 560 pp., 6 x 9, illus., #5640-0, cloth, \$23.95

The Successful Engineer-Manager

A Practical Guide to Management Skills for Engineers and Scientists

Edited by ROBERT C. HAAVIND and RICHARD L. TURMAIL

A well-organized, realistic guide to the critical areas of technical management — career, decisions, people, projects, finances, and communications. Articles carefully chosen from *Electronic Design* offer you valuable pointers on financial analysis, person-to-person dealings, project scheduling, promoting new ideas, and much more. 176 pp., 7 1/8 x 9 3/4, illus., #5879-9, cloth, \$8.95

15-DAY FREE EXAMINATION

Please send the book(s) circled on 15-day free examination. At the end of that time, I will remit payment, plus postage, or return the book(s) with no further obligation.

9194	9195	9163	9150	5851-9
9178	9191	9147	9190	5640-0
9181	9154	9195	9180	5879-9

Save Money!

Payment Enclosed. Publisher will pay all shipping and handling charges — same 15-day guarantee.

Name _____

Firm _____

Address _____

City/State _____ Zip _____

\$10.00 minimum for free exam orders. Because of higher billing and collection costs, we must ask for payment in full with any order for less than \$10.00. Same 15-day guarantee.



HAYDEN BOOK COMPANY, INC., 50 ESSEX STREET, ROCHELLE PARK, N.J. 07662

ISBN Prefix 0-8104

72-87

Variable-speed, synchronous-motor control operates from 12-V battery or 120-V ac line

A timer IC and a few inexpensive components provide an accurate variable-speed control for small synchronous motors. The circuit can operate from a 12-V battery or 120-V ac lines, and it affords an adjustable frequency range of 35 to 86 Hz.

Transistor Q_1 and diode CR_1 comprise a conventional series-pass regulator to provide 5 V dc to FF₁, and the timer IC₁. The IC timer operates in the astable mode with a frequency given by

$$f = \frac{1.46}{[(R_3 + R_4) + 2(R_2 + R_1)] C}$$

The nominal value is 120 Hz. Resistors R_2 and R_3 provide, respectively, coarse and fine frequency adjustments.

The flip-flop divides the frequency by two and drives the push-pull output stage consisting of Q_2 , Q_3 , Q_4 and Q_5 . Filament transformer T_2 couples the circuit output to the motor. A 2- μ F capacitor removes some of the high-frequency components that result from the square-wave driving signal.

With the components shown, the frequency deviation is less than 0.3% for dc inputs of 10.5 to 15 V or ac inputs of 95 to 125 V. The maximum motor-load limit is 15 W, a limit determined by the transformer primary current and the IR drop in the emitter resistor of Q_1 and Q_5 .

R. Dale Hefner, Electronics Director, The University of Tucson, College of Liberal Arts, Dept. of Chemistry, Tucson, Ariz. 85721.

CIRCLE NO. 311

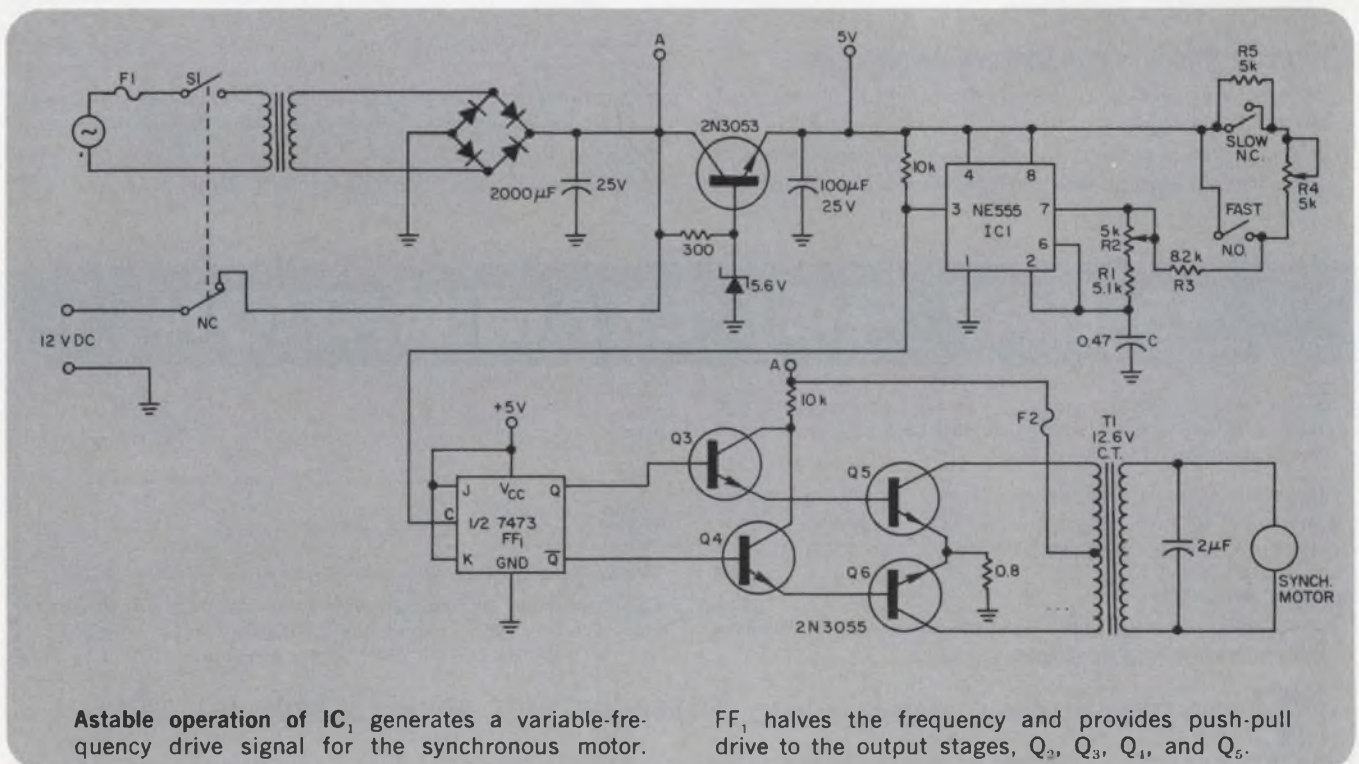

Astable operation of IC₁ generates a variable-frequency drive signal for the synchronous motor.

FF₁ halves the frequency and provides push-pull drive to the output stages, Q_2 , Q_3 , Q_4 , and Q_5 .

191 FLAVORS OF BECKMAN DIPS



All 191 flavors of RESNET™ DIPs offer system compatibility because we use the same packages you use for I.C.s; plus you get ceramic dependability at plastic prices.

Whether you're inserting resistors automatically or by hand — call your local Beckman/Helipot representative and ask how you can save money using RESNET DIPs. He stocks locally for immediate delivery.

If you need immediate technical literature or the telephone number of your local Beckman/Helipot representative, call H.E.L.P. (Helipot Express Literature Phone) toll-free (800) 437-4677.

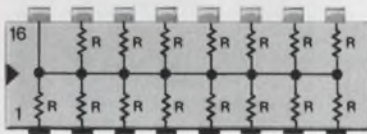

898-1 (15 resistors)
Price (1,000-4,999) \$.85

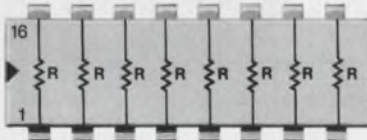

899-3 (8 resistors)
Price (1,000-4,999) \$.76

STANDARD RESISTANCE VALUES
(± 2% or ± 2Ω)

62*	110	330	1.0K	2.2K	6.0K	15.0K
68	150	470	1.5K	3.3K	6.8K	22.0K
100	220	680	2.0K†	4.7K	10.0K	

* Standard in 898-3 only.
† Standard in 898-1 only.

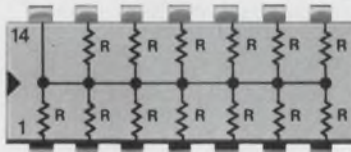

899-1 (13 resistors)
Price (1,000-4,999) \$.81

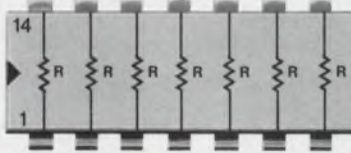

899-3 (7 resistors)
Price (1,000-4,999) \$.72

STANDARD RESISTANCE VALUES
(± 2% or ± 2Ω)

22	62	180	510	1.5K	4.3K	11K
24	68	200	560	1.6K	4.7K	12K
27	75	220	620	1.8K	5.1K	13K
30	82	240	680	2.0K	5.6K	15K
33	91	270	750	2.2K	6.0K	16K
36	100	300	820	2.4K	6.2K	18K
39	110	330	910	2.7K	6.8K	20K
43	120	360	1.0K	3.0K	7.5K	22K
47	130	390	1.1K	3.3K	8.2K	
51	150	430	1.2K	3.6K	9.1K	
56	160	470	1.3K	3.9K	10K	

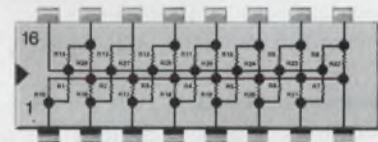

898-5-R220/330
Pulse squaring TTL terminator.
Price (1,000-4,999) \$1.45

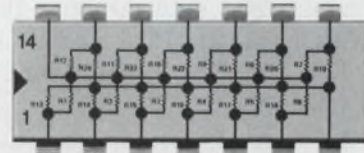

899-5-R220/330
Pulse squaring TTL terminator.
Price (1,000-4,999) \$1.35

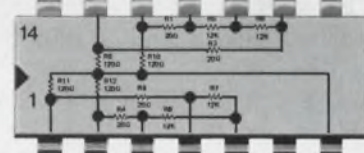

899-19
DIP interface network providing resistors for μA711 core sense amplifier configuration.
Price (1,000-4,999) \$1.18

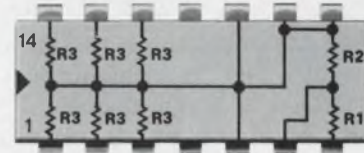

899-40
DIP network provides six line terminators and the threshold setting divider for the Intel 3208A sense amplifier.
Price (1,000-4,999) \$1.35

Beckman

HELIPOT DIVISION

INFORMATION RETRIEVAL NUMBER 53

Fast clock helps convert 2-phase encoder signals to positional data

Three 16-pin chips and a fast clock can extract both direction and magnitude from the quadrature pulse trains of an incremental encoder. Two outputs provide separate count pulses for either the forward or reverse direction.

The typical incremental encoder generates two quadrature pulse-train signals, A and B in Fig. 1. Directional information is available from the phase relationship between the pulse trains. If B lags A by 90 degrees, the encoder is moving in the forward direction; if B leads A by 90 degrees, the encoder is moving in the reverse direction. The number of transitions indicates the amount or magnitude of the motion.

The designer can write logic equations to separate the forward and reverse directions by examining the state of the stable waveform at the transition points of the other waveform. There are four transition points to consider in writing the logic equations:

$$\text{Forward} = A \uparrow B + A B \uparrow + A \downarrow B + \bar{A} B \downarrow \quad (1)$$

$$\text{Reverse} = A \uparrow \bar{B} + A \bar{B} \downarrow + A \downarrow \bar{B} + \bar{A} \bar{B} \uparrow.$$

The symbols \uparrow and \downarrow denote up or down transitions, respectively.

A two-stage shift register provides the mechanism for determining the transitional quantities (Fig. 2). If A and A' denote the output of FF₁ and FF₂, respectively, then

$$\begin{aligned} A \uparrow &= A \bar{A}' \\ A \downarrow &= \bar{A} A'. \end{aligned} \quad (2)$$

Similarly

$$\begin{aligned} B \uparrow &= B \bar{B}' \\ B \downarrow &= \bar{B} B'. \end{aligned} \quad (3)$$

Substituting Eqs. 2 and 3 into Eq. 1 and rearranging, we get:

$$\text{Forward} = A \bar{A}' \bar{B} + \bar{A} A' B + A B \bar{B}' + \bar{A} \bar{B} B' \quad (4)$$

$$\text{Reverse} = A \bar{A}' B + \bar{A} A' \bar{B} + A B B' + \bar{A} \bar{B} \bar{B}'.$$

The 74195 IC, connected as shown in Fig. 3, provides the two two-stage shift registers for generating A, A', B and B'. Two three-to-eight-line decoders mechanize the product terms for the forward and reverse output terms, respectively. ORing is accomplished by wiring the appropriate pins to a pull-up resistor.

Any clock whose operating frequency is at least eight times that of the maximum A or B pulse train frequency will work with this circuit.

Duane Elms, Systems Engineer, Universal Drafting Machine Corp., 5200 Richmond Rd., Bedford Heights, Ohio 44146.

CIRCLE NO. 312

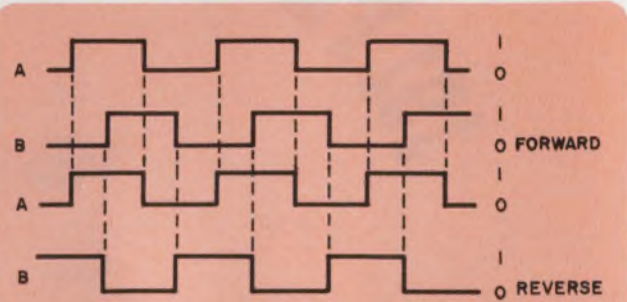

1. Forward or reverse movements of an incremental encoder cause waveform B either to lag or lead waveform A.

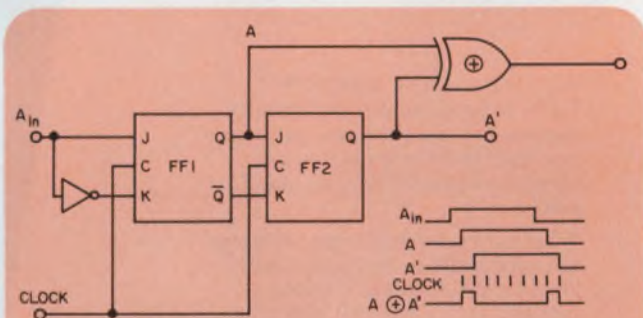

2. The EXCLUSIVE-OR of signals A and A' determines the transition points of the transducer signal A_{IN}.

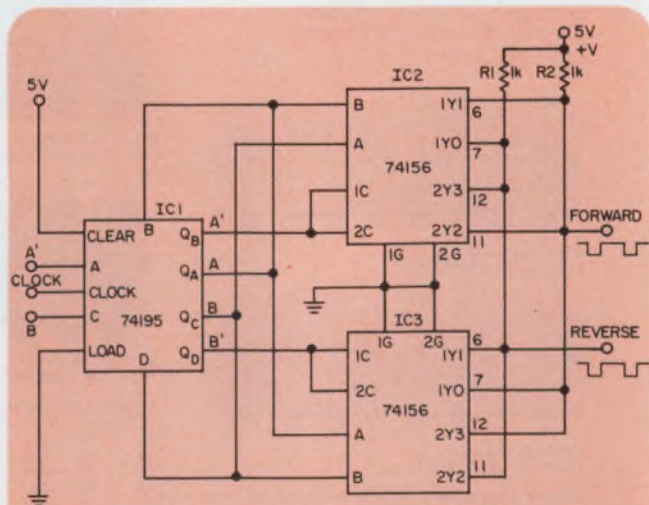

3. Pulse trains appear at the output of IC₂ or IC₃, in the quadrature decoder, depending on whether the transducer motion is in the forward or reverse direction. The number of pulses generated is proportional to the transducer displacement. The clock rate should be set for at least eight times the pulse frequency of the input.

Greater RFI/EMI shielding in new, narrow-width contact strips from Instrument Specialties

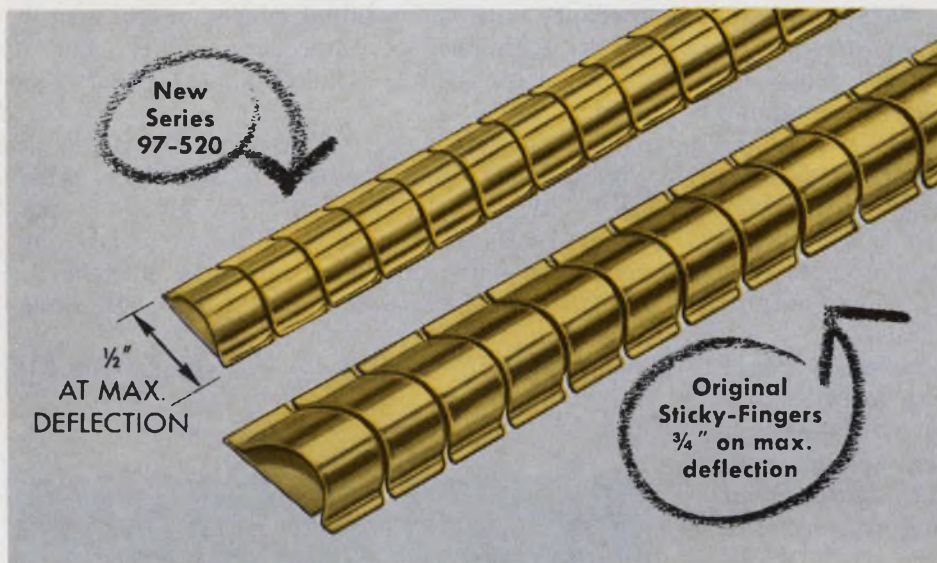

Latest addition to **stickyn fingers**® line!

Instrument Specialties now offers Sticky-Fingers self-adhesive, beryllium copper contact strips in three variations to solve your most critical RFI/EMI problems.

Comparable to the shielding effectiveness of the original Sticky-Fingers, our newest series 97-520* offers shielding effectiveness of 92 dB at 10 GHz plane wave or greater than 92 dB at 1 MHz magnetic, and has a dynamic range of 0.10". Yet, it measures a scant 3/8" wide, and 1/2" at maximum deflection.

Supplied in standard 16" lengths, series 97-520 is ideal for metal cabinets and electronic enclosures where variations exist in the space to be shielded, and where high shielding effectiveness must be maintained in narrow spaces, even with frequent opening and closing of the cabinet.

Select the exact series that fits your application best. Write today for a complete catalog, list of finishes available, and our latest Independent Shielding Evaluation Report. Address: Dept. ED-68

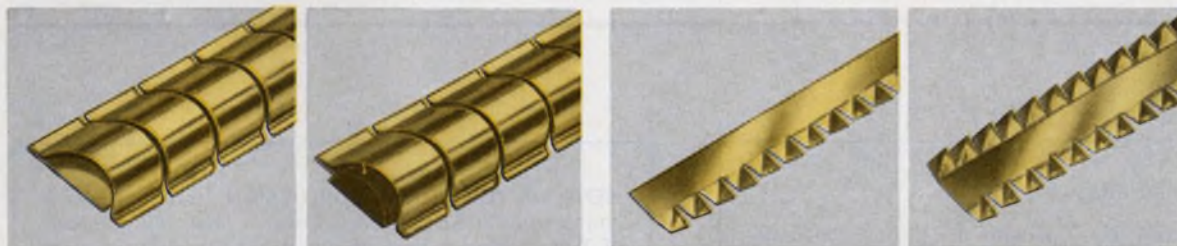

Series 97-500*—the original 3/4" wide Sticky-Fingers. Specify when you require greatest possible shielding and where space permits. Also, supplied as 97-510 with Magnifil® for optimum magnetic shielding.

For those all-purpose applications where economy and space are both factors, specify the 3/8" wide single-twist series 97-555, or 1/2" wide double-twist series 97-560 Sticky-Fingers.

Specialists in beryllium copper springs since 1938

*Patented

INFORMATION RETRIEVAL NUMBER 54

ELECTRONIC DESIGN 20, September 27, 1973

INSTRUMENT SPECIALTIES CO., INC.
Little Falls, New Jersey
Phone 201-256-3500



Optical Schmitt reduces photodetector uncertainties

Infrared LED-phototransistor pairs find frequent use in applications where beam interruptions generate a binary signal. Not infrequently infrared noise produces false output pulses as the accompanying transistor current amplifier enters the active region between cutoff and saturation. Use of a Schmitt trigger instead of a current stage prevents false triggering during the transitions between ON and OFF. The circuit (Fig. 1) uses only two resistors and part of a hex inverter package to give TTL level outputs with externally selectable hysteresis.

The two threshold currents are selected from a graph (Fig. 2). For proper circuit operation, the phototransistor must have a $V_{CE(SAT)}$ of less than 0.4 V at a collector current equal to the upper value of the hysteresis current. Most phototransistors, but few photo-Darlingtonts, meet this requirement.

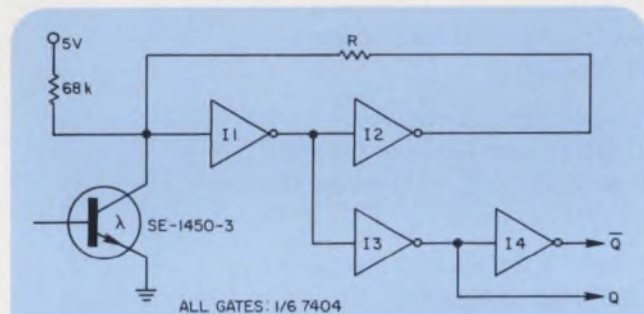

1. Optical Schmitt trigger operates with upper and lower threshold currents determined by resistor R. The controlled hysteresis prevents noise triggering during the time the beam is broken.

Most 7404 inverter packages operate in accordance with the nominal curves on the graph, resulting in good IC interchangeability. And if the logic sense at I_3 is acceptable, I_1 needn't be used.

The Spectronix SE-1450-3 phototransistor in Fig. 1 yields reliable operation at 1.5 cm when used with an SD-1440-3 LED driven at 20 mA. Other LEDs may require different drive currents, depending on their conversion efficiency.

Claude Mott, Hewlett Packard, Box 301, Loveland, Colo. 80537.

CIRCLE No. 313

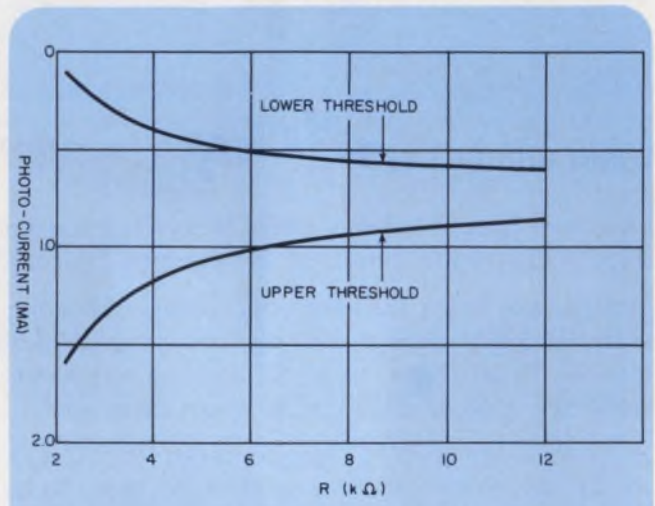

2. Select the operating thresholds from these curves. The saturation voltage of the phototransistor must be less than 0.4 V at the upper threshold current.

IFD Winner of May 24, 1973

D. Newton and H. Yasothorn, Abbot Transistor Laboratories, Inc., 5200 W. Jefferson Blvd., Los Angeles, Calif. 90016. Their idea "Circuit applies power at precise phase angle" has been voted the Most Valuable of Issue Award.

Vote for the Best idea in this issue by circling the number for your selection on the Information Retrieval Card at the back of this issue.

SEND US YOUR IDEAS FOR DESIGN. You may win a grand total of \$1050 (cash)! Here's how. Submit your IFD describing a new or important circuit or design technique, the clever use of a new component or test equipment, packaging tips, cost-saving ideas to our Ideas for Design editor. Ideas can only be considered for publication if they are submitted exclusively to ELECTRONIC DESIGN. You will receive \$20 for each published idea, \$30 more if it is voted best of issue by our readers. The best-of-issue winners become eligible for the Idea of the Year award of \$1000.

inverter rated™

cool
power!

Ferramic® components
guarantee circuit
performance

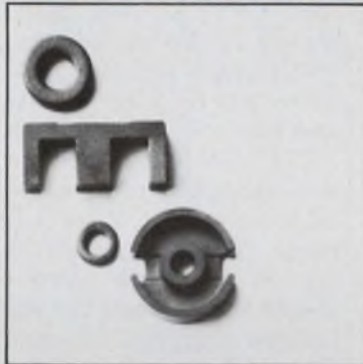

Ferrites for inverters

Inverter-Rated components were developed specifically for inverter circuits. This advanced ferrite technology gives you components optimized for low power loss. They keep their cool to 150°C.

Specs that make sense

The improved characteristics of *Inverter-Rated* components are spelled out in terms of their circuit performance under both maximum and recommended conditions. You get design flexibility and data you can use directly—not just routine magnetic parameters.

You can design precisely with guaranteed component characteristics. And you can select optimum components without using trial-and-error approximations in meeting your power conditioning re-

quirements in computers, motor controls, lighting, telephone systems, ignition systems, displays, watches, appliances, etc.

Circuit performance

We test *Inverter-Rated* components as *inverters* to assure performance in your circuit. These new components meet specified electrical characteristics in addition to closer magnetic tolerances.

The performance you design in—stays in. And the production version of your design meets *your* circuit conditions.

Expanded line

You get design flexibility with the full range of Cross Cores, Pot Cores, Toroids, U Cores, and E Cores. *Inverter-Rated* components are available now in production quantities. All with factory-ready hardware.

New design guide

Our new design guide speaks your language and gives you complete component specifications, temperature characteristics, application data. Key information you need in applying the latest ferrite technology to your inverter designs.

The reader service card will get you a copy of our design guide and (201) 826-5100 will put you in touch with the men who wrote it. Either way, if you're talking inverters, talk to the ferrite experts.

That's us.

Indiana General,
Electronic Products,
Keasbey, N.J. 08832.

*National distribution
through eight Permug
locations.*

indiana general 

a division of Electronic Memories & Magnetics Corp.

INFORMATION RETRIEVAL NUMBER 55

Unconventional modem can be used on 240 channels

By adopting a new communications design concept, Philips Telecommunications Industries of the Netherlands has come up with a modem that can be used for all channels in identical form, except for one variable circuit component.

The patented system provides up to 240 channel ends on a single frame. It operates with frequency modulation in the voice-frequency band but uses carriers in the megahertz range. It can operate in any system meeting CCITT standards.

The approach used in the Philips equipment is quite different from that of conventional equipment. In most FM telegraph channels, modems use binary-to-analog and analog-to-binary frequency-conversion techniques, which require LC circuits for signal generation and frequency discrimination. As a widely different range of channel center frequencies are commonly used, many highly stable and often expensive LC components are needed to construct a multichannel system with acceptable stability and distortion levels.

With the new Philips system, called the 29TR 3002, a single unit can be used for any center fre-

quency in the allocated range for all telegraph and data speeds from 50 to 200 baud, in both two-wire and four-wire configurations.

The modulator and demodulator are controlled by the same crystal clock operating in the megahertz range. The clock covers all channels of the same speed and of speeds whose frequency shifts are integral multiples of each other. The total frequency shift can be varied at will if the clock frequency is varied.

Because a digital frequency modulator and a digital speed selector are used, the working speed can be changed by a mere change in the quartz crystal associated with the carrier modulator circuit to obtain different operating frequencies and to set the divider division ratio in the speed selector.

The immediate result of the fundamental design idea is to give the same value of isochronous distortion for all channels and all working speeds. LSI techniques have been used to reduce power-to-weight ratios and to increase the life and reliability of the equipment.

CIRCLE NO. 317

40-GHz tunnel diodes announced by Siemens

P-type germanium tunnel diodes with resistive cutoff frequencies of more than 40 GHz and a gain-bandwidth product exceeding 3 GHz have been developed by Siemens of West Germany. The tunnel diode, designed for low-noise front-end amplifiers, has reportedly been tested in amplifier circuits up to 15 GHz.

The device is expected to find use in the amplifier of the Franco-German satellite *Symphonie*.

CIRCLE NO. 318

rupt capability.

Nine light pipes are used in the pen in a 3-by-3 array to determine the position of a displayed spot on a CRT relative to the center of the pen. Associated electronics generate a signal directly that indicates the spot movement required for tracking.

Since only a single spot is required to be displayed on the tube, tracking calls for a minimum of computer time. A cross can be superimposed on the spot for visual convenience without any effect on performance.

The speed of tracking depends on the frequency and magnitude of the spot's movement. In practice, the spot can follow very rapid pen movements. Another feature is the simultaneous use of a variable number of light pipes for light-pen pointing. The aperture of the pen can be varied by a switch to give a wide-angle view for quick, approximate work or a narrow angle for more precision.

The pen is subject to UK patent application No. 19582/72, and is available for manufacture under license.

CIRCLE NO. 319

Low-cost light pen developed

A light pen for computer graphics that can be built for about \$75 allows high tracking speed and variable resolution to be achieved without excessive hardware or software. The pen, which has been developed at the University of Sussex in Britain, is particularly useful for tracking on computers without—or with limited—inter-

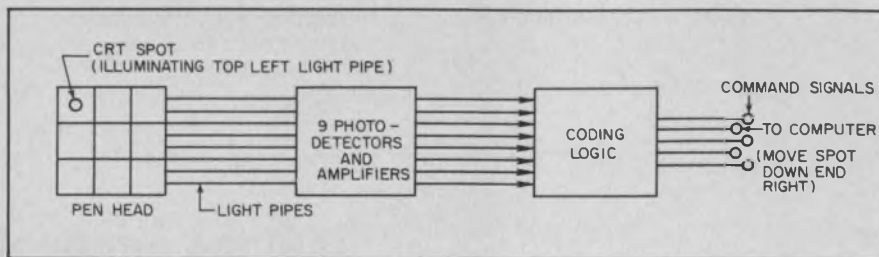

Light pen can be built for about \$75.



Where space is at a premium you need Piher

We're experts in the design and manufacture of small signal, silicon epitaxial plastic encapsulated transistors. Every transistor in our 40 product range is ideal when high density packaging is essential – and the range is three times greater than that from any competitor.

When you select from Piher you not only know what you're getting, but where it came from. From the most modern semiconductor plant in Europe. You will have noticed more than once that an efficient, reliable back-up service from a European source is sometimes worth its weight in gold.

Piher is a high technology company. You will appreciate that when you look at our work in carbon film resistors and trimming potentiometers. And now, when you think of small signal, silicon epitaxial transistors, think of the name Piher.

Find out more about us. It pays.

A Typical Selection From the Piher Range

Part No	Type	Application Feature
2N 3794	PNP	High Gain
2N 4286	NPN	High Gain
2N 4288	PNP	Low Leakage
2N 4289	PNP	Low Leakage
2N 4290	PNP	General Purpose
2N 4291	PNP	General Purpose
SF 173	NPN	TV IF Amplifiers
SF 115	NPN	RF Amplifiers & Oscillators

Head Office—Spain—Riera Cañado, s/n. Apartado de Correos, 53 Badalona (Barcelona) Spain. Tel: 389 03 00. Telex: 59521



Computer builders get more than a motor from TRW/Globe

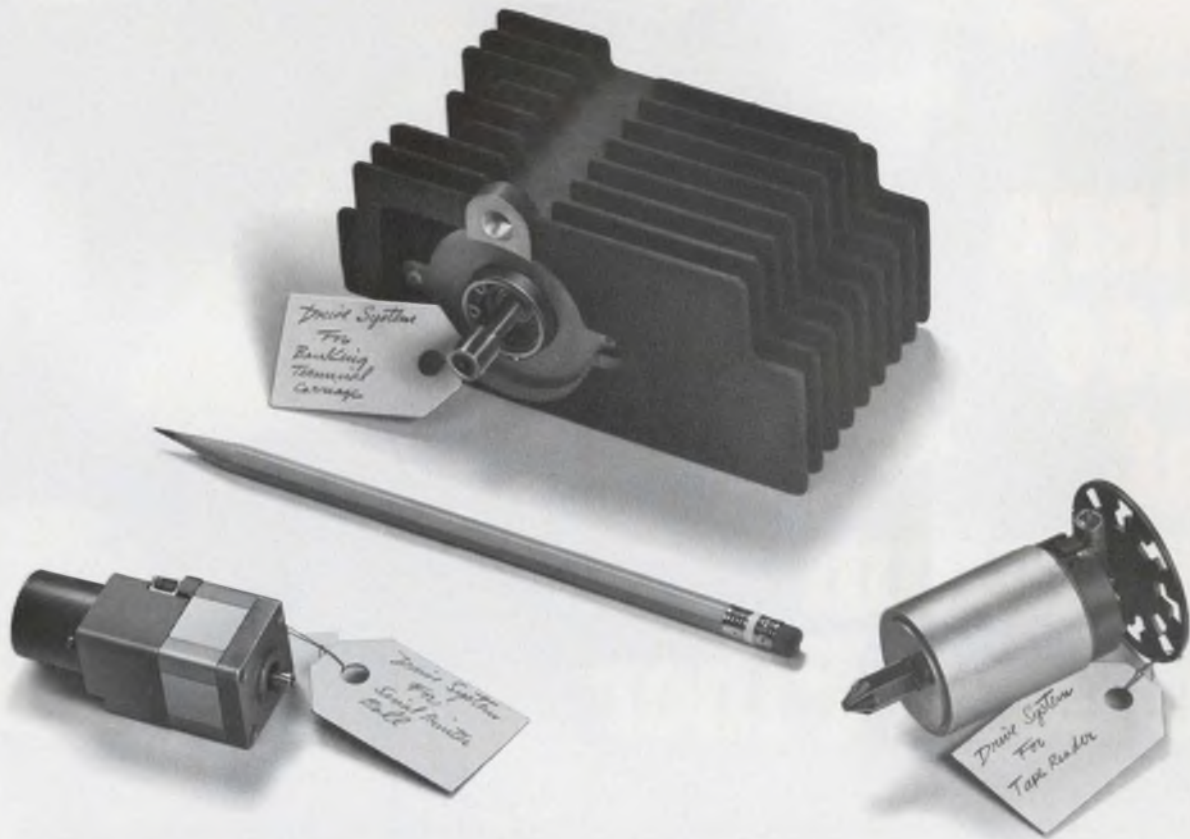

TRW/Globe customers can achieve a combination of motorized functions in minimum space while eliminating unnecessary assembly operations and simplifying inventory requirements.

They do it by ordering a Globe functional "package" instead of just a motor. For example, take the items above, produced for three of the leading builders of business machines and computers:

The package on the left drives the printing ball on a serial printer and indexes it horizontally, with a DC motor. A DC tach generator provides feedback to the rest of the system. And a hollow motor shaft permits another shaft from a linear solenoid to index the ball vertically.

At the top is a drive for a banking terminal carriage. Globe's integrally cast heat sink permits the high torque motor to operate reliably without burning up and causing costly downtime.

The third package drives a computer tape reader. Widened poles and spiralled armature slots assure smooth motion even though torque changes constantly. The tach wheel is read by an electric eye for feedback, and Globe supplies the drive hub.

When you can't afford the cost of failure, call or write: TRW/Globe Motors, an Electronic Components Division of TRW Inc., Dayton, Ohio 45404 (513-228-3171).

TRW[®] GLOBE MOTORS

INFORMATION RETRIEVAL NUMBER 57

How to solve your precision power resistor problems:

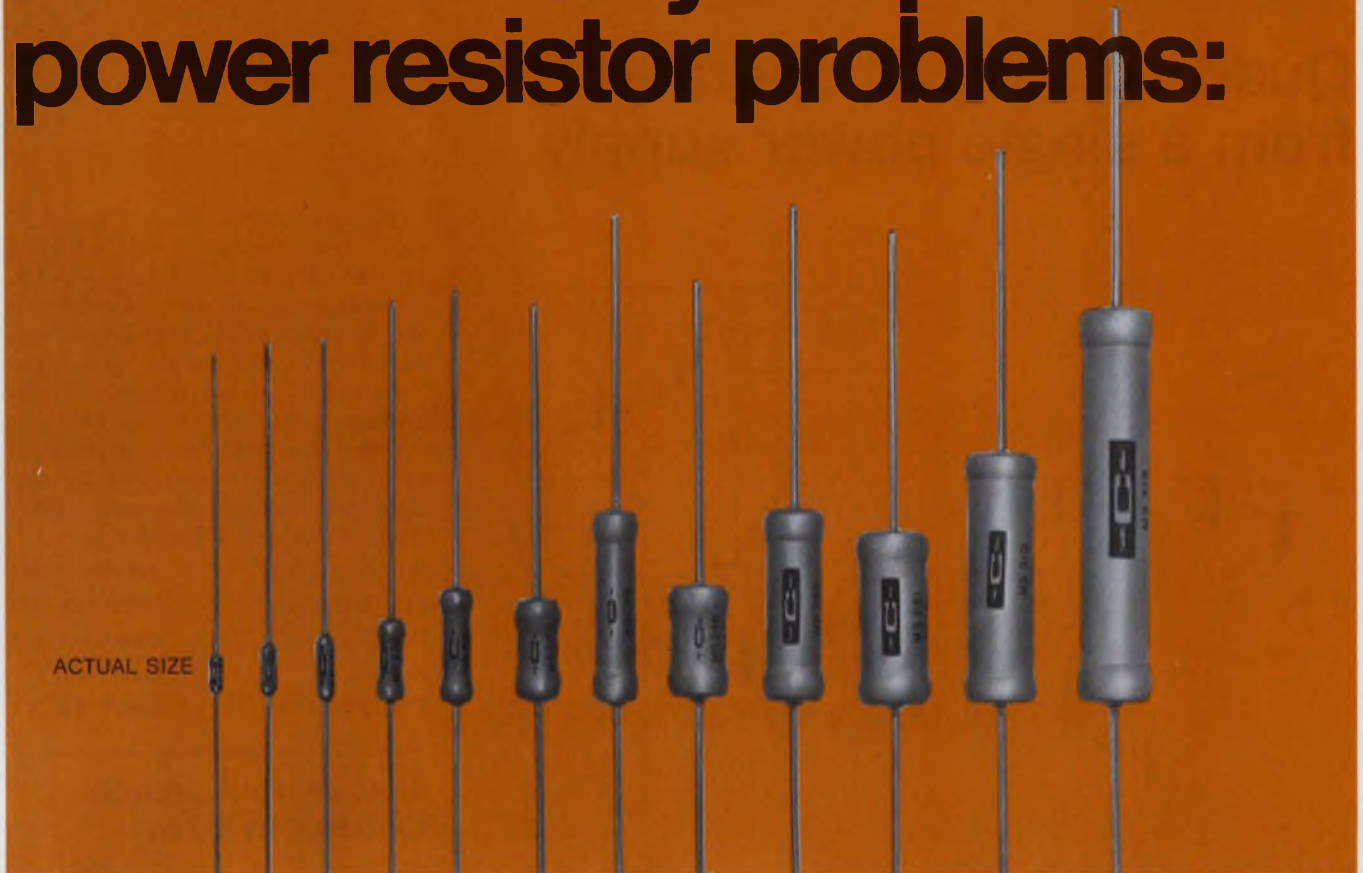

Move up to Caddock power film.

Delivery. Performance. Quality. The three greatest problems facing specifiers of precision power resistors. Here is Caddock's solution to these problems:

Delivery. We normally quote four week delivery on standard catalog MS type Power Film Resistors.

Performance. Compare our specs against any wirewound you may have been using recently: Power ratings up to 12.5 watts. Voltages up to 6 KV. Resistance values to 30 megohms (to 3 megohms without derating power). Standard temperature coefficient: 50 PPM/°C. Non-Inductive construction available in most models, and at no additional cost.

Quality. Quality starts with Micronox, a proprietary resistance film produced exclusively by Caddock Electronics. High performance characteristics include: Resistance tolerances from 1.0% (standard) to 0.1% (on special order). Extremely stable at ambient temperatures as high as 275°C. Available in matched sets for ratio tracking with temperature to within 2 PPM/°C.

All type MS Power Film Resistors feature Micronox film on high strength core. End cap construction. Silicone conformal encapsulation. Gold plated Dumet leadwire. All MS models except MS126, MS151, MS176 derated to zero at 275°C from 25°C. MS126, MS151, MS176 derated to zero at 275°C from 125°C.

For complete specifications, application information, quantity pricing and general catalog, circle the Reader Service No. below.



Non-Inductive construction available in most models. Specify with N suffix on Model No.

Model No.	Wattage	Max. Voltage	Body Length	Body Dia.	Lead Dia.	Resistance	
						Min.	Max.
MS 126	.25	200	.188	.070	.020	10Ω	1 Meg
MS 150	.5	—	.188	.070	.020	10Ω	2 K
MS 151	.5	300	.250	.094	.025	10Ω	2 Meg
MS 175	.75	—	.250	.094	.025	10Ω	2 K
MS 176	.75	500	.313	.094	.025	20Ω	5 Meg
MS 210	1.0	—	.313	.094	.025	20Ω	3 K
MS 220	2.0	1000	.400	.140	.025	20Ω	10 Meg
MS 221	3.0	1000	.575	.165	.030	30Ω	10 Meg
MS 223	3.0	800	.480	.230	.040	10Ω	4 Meg
MS 244	4.0	2000	.950	.230	.040	30Ω	15 Meg
MS 245	4.0	800	.570	.300	.040	10Ω	6 Meg
MS 260	6.0	2000	.970	.300	.040	20Ω	15 Meg
MS 281	8.0	2000	.910	.350	.040	10Ω	8 Meg
MS 310	10.0	4500	1.25	.350	.040	30Ω	20 Meg
MS 313	12.5	6000	2.00	.350	.040	50Ω	30 Meg

CADDOCK In film resistors, a new dimension

CADDOCK ELECTRONICS 3127 Chicago Ave., Riverside, CA 92507 • Tel: (714) 683-5361 • TWX: 910-332-6108

new products

Quad op amp IC operates from a single power supply

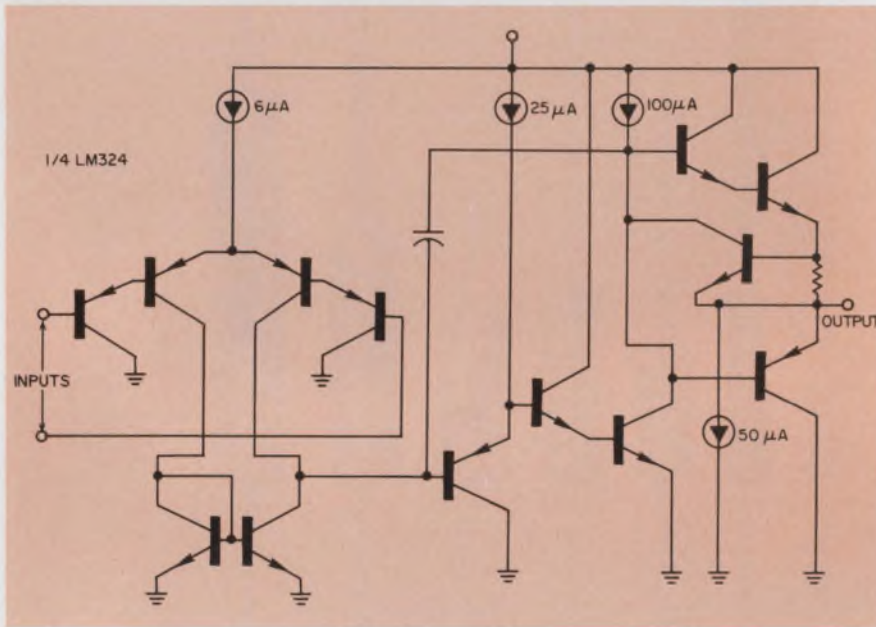

National Semiconductor Corp., 2900 Semiconductor Dr., Santa Clara, Calif. 95051. (408) 732-5000. \$2.50 (100).

The latest multiple amplifier IC—National Semiconductor's LM 324—offers four operational amplifiers in a single package. With no less than four other manufacturers developing compatible devices, it is bound to become an industry standard.

The new circuit has true op amps rather than the "Norton" circuits used in earlier quad amplifiers. And unlike the recently announced 4136 from Raytheon—a quad 741 which operates from dual supplies only—the new National device was designed to operate either from dual supplies of ± 1.5 to ± 15 V dc or from a single power supply of 3 to 30 V dc.

Because it was designed to operate from a single supply, the input common-mode voltage range of the LM 324 allows sensing of input signals that are near zero or ground potential. And the output level can swing all the way to zero. This type of operation is impossible when a conventional 741 style

amplifier is operated from a single supply.

Although the input common-mode voltage can go to zero, it cannot go all the way up to the positive supply voltage. The limit on the input common-mode voltage is 1.5 V less than the positive supply.

Each of the four op amps within the new IC is internally compensated by a 5-pF capacitor. This contrasts with the 30-pF capacitors used in the 741s. The reduction in capacitor size results from a new transconductance technique that uses multiple rather than single-collector lateral transistors.

The input offset voltage, offset current and bias current for the LM 324 have maximums of 7 mV, 50 nA and 500 nA, respectively; the equivalent values for Raytheon's 4136 are 6 mV, 200 nA and 500 nA. Neglecting load current, the total current required for the LM 324 (all four op amps) is 2 mA maximum. For the 4136, 7 mA is needed.

In quantities of 100, the LM 324 costs \$2.50—somewhat higher than the \$1.76 price tag for the 4136.

The pinouts of the new quad IC have been designed to simplify printed circuit board layouts; the inverting inputs are adjacent to the outputs for all four amplifiers. In addition, the output pins have been placed at the corners of the package (pins 1, 7, 8 and 14).

Other manufacturers developing pin-compatible competitors for the LM 324 include Motorola, Raytheon, RCA and Fairchild.

For National	INQUIRE DIRECT
For Motorola	CIRCLE NO. 250
For Raytheon	CIRCLE NO. 251
For RCA	CIRCLE NO. 252
For Fairchild	CIRCLE NO. 253

4-bit current source switches in 40 ns

Fairchild Semiconductor, 464 Ellis St., Mountain View, Calif. 94040. (415) 962-3816. \$4 (100-999).

The μ A9650 4-bit current source features a switching time of only 40 ns and a 12-bit settling time of 125 ns. The device operates from standard +5 and -15-V power supplies and is fully compatible with TTL logic circuitry. Applications include 8, 10 and 12-bit a/d and d/a converters. The device comes in a 16-pin DIP.

CIRCLE NO. 257

Dual diode leakage spec'd at 0.1 pA

Intersil, 10900 N. Tantau Ave., Cupertino, Calif. 95014. (408) 257-5450. \$1.35 (100 up); stock.

The ID100 and ID101 monolithic dual diodes boast a reverse leakage current at 1 V of 0.1 pA typical, and at 10 V of 2.0 pA typical and 10 pA maximum. Differential leakage current between the matched pair is 3 pA max. Reverse breakdown voltage is 30 V minimum, while total reverse capacitance is 1 pF max.

CIRCLE NO. 258

**Ω Micaply
hmega™**

A new way to design with resistors.

Micaply Ohmega is a unique resistor-conductor circuit material that provides circuit designers with a new way to design with resistors. It's available in 10" x 36" sheets with 25 or 100 ohms per square sheet resistivity.

This unique material is an epoxy glass substrate completely covered on one or both sides with a bi-layer cladding. The thin film type layer against the substrate is resistive, the top layer is copper. Using conventional printed circuit produc-

tion techniques, patterns of conductors and resistors can be etched to produce circuits complete with integral resistors. The entire process is subtractive—no screening, firing, or vacuum equipment is required.

Micaply Ohmega is ideally suited for high resistor density, low resistor value circuits; multilayer circuits where the resistors can be put between layers; circuits where economical step and repeat methods can be used on large sheets of Micaply

Ohmega; and designs previously impractical or uneconomical with other materials.

Let's talk about your potential applications.

The **Mica** Corporation
Culver City, California
(213) 870-6861 and
Micaply International, Silloth, England

We can assist in design and provide prototype circuit production.

Multilayer printed circuit boards

High resistor density circuits

Hybrid microelectronics

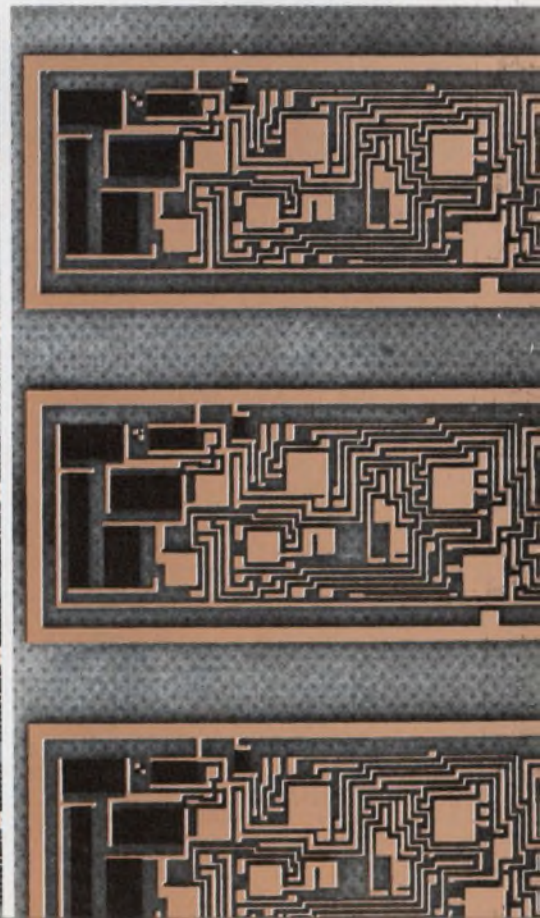
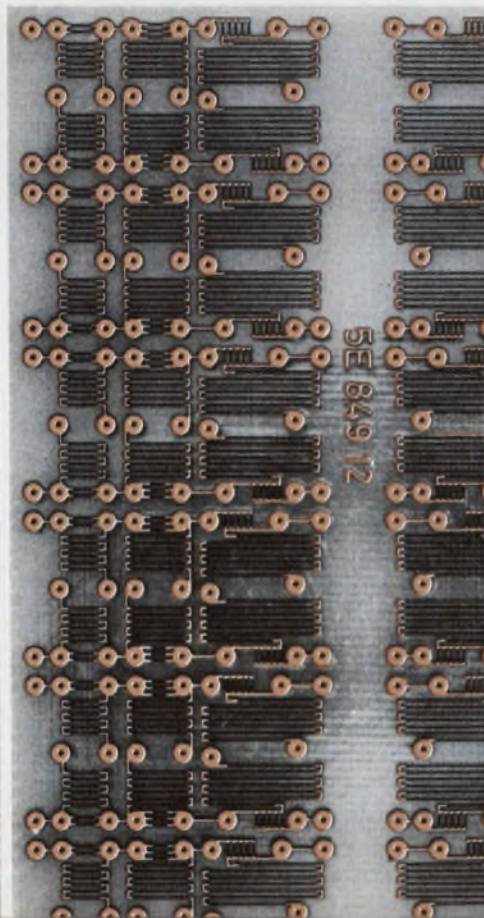
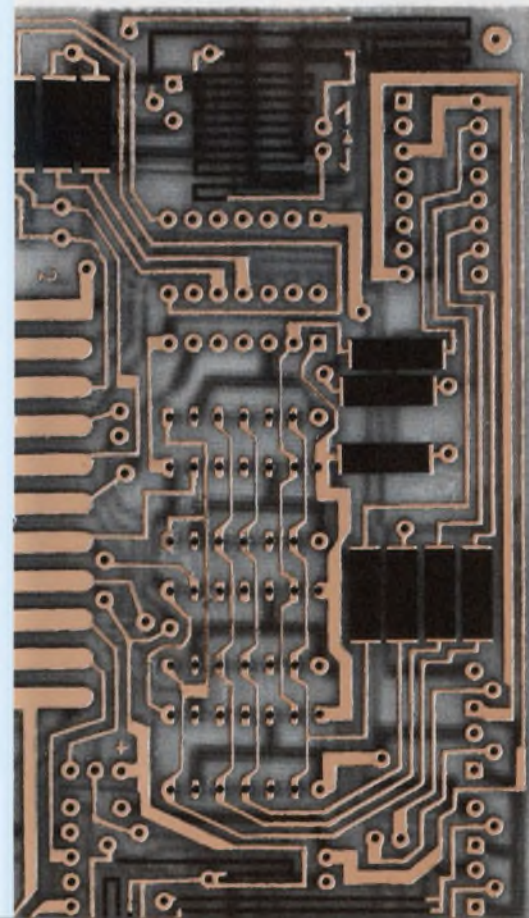

**step up
to greater
reliability...
at reduced cost**

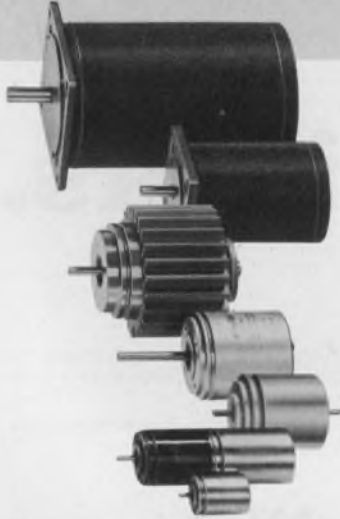

RAPID/SYN
**STEPPING AND
SYNCHRONOUS
MOTORS**

COMPUTER DEVICES deliberately set out to manufacture highest quality Steppers and Synchronous motors at lower costs — and our rapidly growing list of satisfied customers proves that we are accomplishing our objectives.

Standard RAPID-SYN Steppers include frame sizes of 3/4 inch diameter and up with stepping angles of 1.8°, 5°, 7.5°, 45°, and 90° — all designed to operate from solid state logics with DC input.

Heat sinks, dampers, gearheads, pulse sources, optical encoders, preset indexers and a wide range of solid state drivers, are also offered from stock.

RAPID-SYN Synchronous 72 and 200 RPM motors with torque of 25 oz-in and up are stock items and are rated for 110 VAC, 60 HZ. These high torque, low speed synchronous motors with permanent magnet rotors eliminate the need for gear reducers, clutches, and brakes used on conventional synchronous motors.

Computer Devices offers the greatest flexibility in modification of standard units and welcomes the challenge of developing new units for your special requirements.

Call or write for free Catalog!



COMPUTER DEVICES OF CALIFORNIA
11901 Burke St., Santa Fe Springs, Calif. 90670
(213) 698-2595 • TELEX: 65-7478
For local offices see EEM 72-1R

INFORMATION RETRIEVAL NUMBER 59

**30-MHz power transistors
yield more watts per dollar**

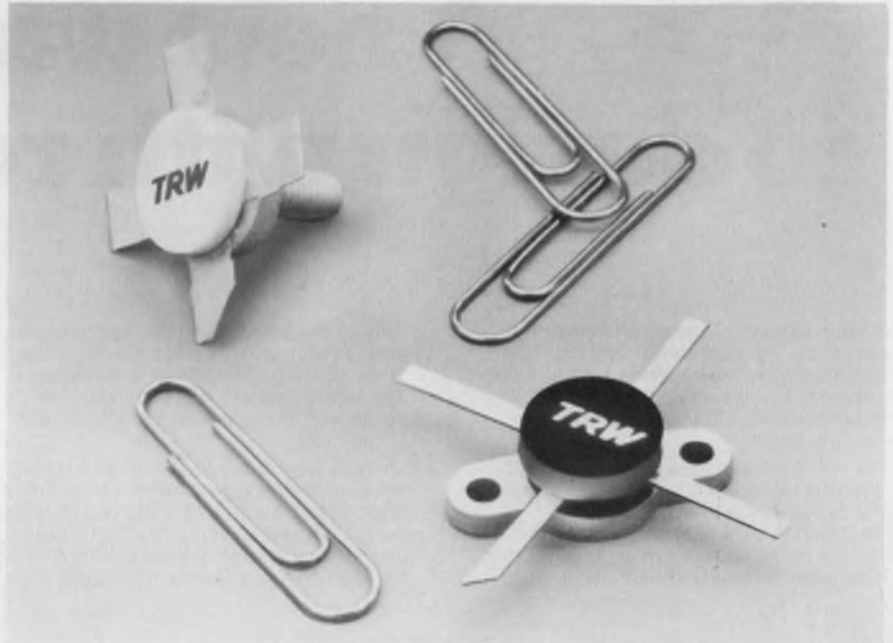

TRW Semiconductor Div., 14520 Aviation Blvd., Lawndale, Calif. 90260. (213) 679-4561. \$38.50 (100-up); stock.

More bang per buck is an old cliché in the selling business. The TRW PT5788 and PT6665A give 2.67 watts per dollar at 100-quantity pricing, and offer 100 W of power over a frequency range of 1.5 to 30 MHz.

Closest competitors are the S150-28 from Communications Transistor Corp. at 1.63 W/\$ and the 2N5942 from Motorola at 1.61 W/\$. All three are 28-V rf transistors.

The CTC unit is the most powerful at 150 W. It is spec'd from 1.6 to 30 MHz. The Motorola unit puts out 80 W from 2 to 30 MHz. The 100-up prices are \$92 for the S150-28 and \$49.50 for the 2N-5942.

All three achieve intermodulation distortion down at least 30 dB. TRW claims a maximum of -32 dB.

The PT5788 is a stud-mounted transistor and the PT6665A is a flange-mounted version.

Although power transistors are normally rated only for peak en-

velope power, these units are also rated at 100 W for Class-B CW operation.

The devices have a minimum power gain of 14 dB across the band. Typical gain at frequencies below 18 MHz is more than 20 dB.

Maximum junction temperature coefficient is 0.875°C/W. Collector efficiency is at least 50% and maximum collector current is 15 A. Collector-emitter breakdown for 100-mA collector current is 70-V min. Collector-base breakdown is the same.

TRW engineers enhanced the reliability of the transistors by using individually ballasted emitter sites and thermally isolated cells. Up to 200 W is available in an amplifier by the combination of two of the devices and up to 320 W can be achieved with four devices. The 320 W building block has a power-gain of 17 dB.

For TRW **CIRCLE NO. 254**

For Communications Transistor Corp. **CIRCLE NO. 255**

For Motorola **CIRCLE NO. 256**

The Book of MOS.

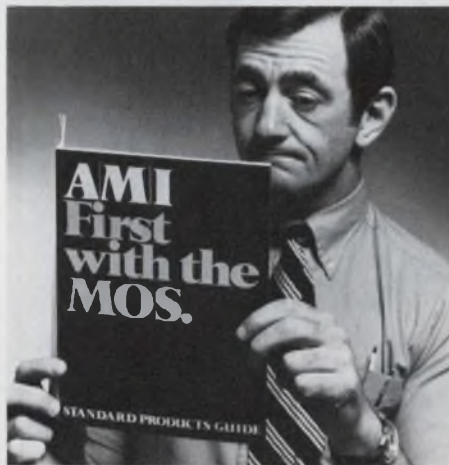

It's incredible. Some people still think we're just a custom MOS supplier. When here we are with the broadest range of standard MOS products on the market.

To help spread the word about these off-the-shelf items, we've printed a new standard products guide. This little book lists our RAMs, ROMs, shift registers, multiplexers, timing circuits, discretes, music circuits, UARTs, keyboard encoders and character generators. Even off-the-shelf LSI circuits for things like programmable processors, digital clocks and calculator kits.

Our distributors have all these ready and waiting for you in quantity. And they also have plenty of our booklets to give away. If one doesn't land on your desk soon, call your nearest distributor and

It'll make a believer out of you.

demand a copy. Or write us.

And if our standard products aren't exactly what you're looking for, we'll be happy to discuss designing a custom circuit for you.

We've already created more than 800 of them. That makes us number one

in the business.

We also have more MOS production processes going for you than anyone else in the world. P-Channel, N-Channel, Silicon Gate, Ion Implant and C-MOS.

So there you have both sides of our story: standard and custom. Whichever you choose, you'll be getting MOS products you can really have faith in.

AMI
AMERICAN MICROSYSTEMS, INC.

American Microsystems, Inc.,
3800 Homestead Road,
Santa Clara,
California 95051.

INFORMATION RETRIEVAL NUMBER 60

MODULES & SUBASSEMBLIES

Low profile keyboards are only 0.293 in. thick



Flex-Key Corp., 18 Sargent St., Gloucester, Mass. 01930. (617) 281-2040. From \$3.50 (prod qty).

The 12SK series of tone encoding keyboards is available as either spst (12SK-52) or 2-of-8 (12SK-53) outputs, making it compatible with most tone encoding ICs. Pin terminals are standard on 0.1 in. centers, keys are on 0.65 in. centers and allow for 0.075 in. key travel with overtravel. The patented conductive elastomer concept allows for contact bounce of 1 ms, over 1-million switching cycles at 250 mW, sealed construction and a lightweight compact design (only 0.293 in. thick). Beveled edges and four heat staking posts allow for easy mounting either behind or in front of a panel. Clear cap keys permit choice of custom key legends at minimal tooling costs.

CIRCLE NO. 259

D/a converters resolve from eight to 14 bits

Phoenix Data, 3384 W. Osborn Rd., Phoenix, Ariz. 85017. (602) 278-8528. From \$195; stock.

Modules in six series—ADC1300 through ADC1800—range from eight to 14-bit resolution with conversion times from 2 μ s for eight bits to 10 μ s for 14-bits, and accuracy to 0.01%. All units are RFI/EMI shielded and have guaranteed monotonicity. They are factory pretrimmed for the specified input range and, unless the input range is changed, no adjustments are required to maintain specified accuracy and monotonicity over 10 to 40 C for up to 12 bit resolution and 15 to 35 C for 13 and 14 bit models. All converters require only ± 15 and +5 V external power.

CIRCLE NO. 260

A/d converter offers full differential input

Zeltex, 1000 Chalomar Rd., Concord, Calif. 94518. (415) 686-6660. 30 day.

A fully differential, floating-input, analog-to-digital converter has a resolution of eight to 13 binary bits. Model 770-780 ADC uses Tri-State logic, a feature which eliminates the need for externally supplied output latch circuitry when strobing data in arithmetic processors. In addition, it offers a common-mode rejection of 180 dB (from dc to 60 Hz) at a common-mode voltage of ± 500 V (± 2000 V maximum common-mode voltage). The entire converter, including its reference supply, is housed in a case measuring 4.25 by 4.25 by 1.1 in.

CIRCLE NO. 261

Time delay relay meets military temp range

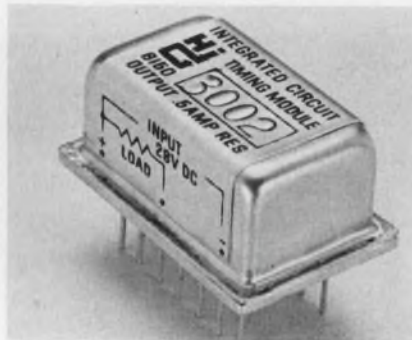

Hi-G, Inc., Spring St. & Rt. 75, Windsor Locks, Conn., 06096. (203) 623-2481. \$45 (1 to 9); 4 to 6 wk.

A hybrid thick-film device, Model 6150, provides a fixed time delay when energized, ranging from 0.05 to 60 s. Units have standard pin spacing for a 14-pin DIP socket, or can mount directly on a PC board. Delays are factory fixed at specified set points. However, a trimming feature to increase or decrease timing is standard. Delay tolerance of $\pm 10\%$ is standard over the input voltage range of 18 to 32 V dc, and a temperature range of -55 to $+125$ C. The output is a single-pole normally-open closure to ground, rated at 0.3 A with derating to 0.1 A at 125 C. Transient protection is to MIL-STD-704A, Figure 9, Limit 1, Category B and the unit meets all applicable requirements of MIL-R-83726.

CIRCLE NO. 262

TRUE OR FALSE

1. You can get immediate delivery on bridges from these stocking General Instrument distributors.

True False

EAST	
ALABAMA, Huntsville	
Cramer Electronics	(205) 538-5722
CONNECTICUT, Stratford	
Greene/Shaw	(203) 378-0485
FLORIDA	
Hollywood	
Cramer Electronics	(305) 823-8181
Orlando	
Cramer Electronics	(405) 884-1511
MARYLAND	
Galtherburg	
Cramer Electronics	(301) 848-0110
Baltimore	
Radio Electric Service Co.	(301) 823-0070
MASSACHUSETTS, Newton	
Greene/Shaw	(617) 868-8900
NEW YORK	
Buffalo	
Summit	(716) 884-3450
Elmsford	
Zelus Components	(914) 592-4120
Frankfort	
Milgray Electronics	(518) 548-6000
Hauppauge	
Semiconductor Concepts	(516) 273-1234
Johnson City	
Wilshire Electronics	(607) 797-1238
Plainview	
Fairmont Electronic Sales Co.	(516) 684-8200
NORTH CAROLINA, Winston-Salem	
Cramer Electronics	(919) 725-8711
PENNSYLVANIA	
Philadelphia	
Herbach & Rademan	(215) 426-1700
Philadelphia Electronics	(215) 568-8288
Pittsburgh	
Semiconductor Specialists	(412) 781-8120
MIDWEST	
ILLINOIS, Elmhurst	
Semiconductor Specialists	(312) 278-1000
INDIANA, Indianapolis	
Semiconductor Specialists	(317) 243-8271
IOWA, Cedar Rapids	
Deeco, Inc.	(319) 385-7551
KANSAS, Lenexa	
Hallmark Electronics	(913) 888-4747
MICHIGAN	
Detroit	
Semiconductor Specialists	(313) 255-0300
Grand Rapids	
Stotts Friedman Co.	(616) 241-6731
MINNESOTA	
Minneapolis	
Hallmark Electronics	(612) 825-2944
The Bergquist Co., Inc.	(612) 825-2322
Semiconductor Specialists	(612) 854-8841
MISSOURI, St. Louis	
Semiconductor Specialists	(314) 428-6100
OHIO	
Cincinnati	
Newark Electronics	(513) 421-5282
Dayton	
Semiconductor Specialists	(513) 278-8455
Solon	
Recco	(216) 248-8900
WEST	
ARIZONA	
Phoenix	
Cramer Electronics	(602) 263-1112
Mico Electronic Dist.	(602) 844-2281
CALIFORNIA	
Culver City	
Avnet Electronics	(213) 636-7200
Newport Beach	
Semicon Sales	(714) 833-3070
San Jose	
Intermark Electronics	(415) 540-1322
San Diego	
Intermark Electronics	(714) 278-5200
Bunnysville	
Intermark Electronics	(408) 738-1111
Woodland Hills	
Semiconductor Concepts	(213) 884-4560
COLORADO, Denver	
Intermark Electronics	(303) 938-8264
NEW MEXICO	
Albuquerque	
Century Electronics	(505) 265-7838
Cramer Electronics	(505) 265-5787
TEXAS	
Addison	
Computer Components	(214) 239-0271
Dallas	
Semiconductor Specialists	(214) 356-5211
Houston	
Component Specialists, Inc.	(713) 771-7237
Lenart Co.	(713) 225-1485
UTAH, Salt Lake City	
Alta Electronics	(801) 488-7227
WASHINGTON-OREGON, Seattle	
Intermark Electronics	(206) 767-3180



TRUE OR FALSE

1. The AQL is lower using a bridge than four discrete rectifiers.
2. You can get 30-day delivery on 1.5A bridges.
3. The lowest-priced 1.5A, 400V bridge rectifier you can buy is 40¢ (in quantities of 10,000).

True False

True False

True False

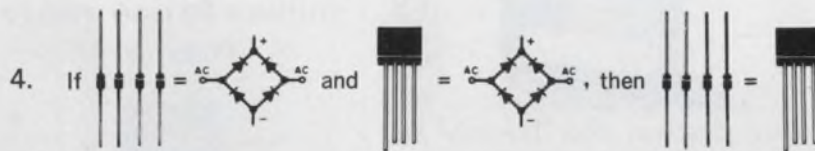

True False

ANSWERS:

1. True. Rectifiers and bridges are shipped to 1% AQL. Since there are four discrete rectifiers in a bridge, the effective AQL is reduced to 0.25%.
2. True. Because General Instrument maintains a minimum domestic inventory of 250,000 bridges at all times.
3. False. The lowest-priced is 25¢ and is only available from General Instrument (the 40¢ price is that of our nearest-priced competitor).
4. False. Because it will cost you more to buy and assemble the rectifiers into a bridge than to buy an assembled bridge from General Instrument.

(If you scored high, you probably know us. If you didn't, you should.)

For your choice of bridge rectifiers at the lowest prices (and fastest delivery) anywhere, call toll-free 800-645-1247. In New York State call 516-733-3357.

For complete information write: General Instrument Corporation, Dept. M, 600 West John Street, Hicksville, N.Y. 11802, or call, in New York: 516-733-3333; in Chicago: 312-338-9200; in Van Nuys: 213-781-0489. In Canada, call or write: General Instrument Canada, Ltd., 61 Industry Street, Toronto 337, Ontario, Canada, Tel: 416-763-4133. In Europe, write: General Instrument Europe S.P.A., Piazza Amendola 9, 20149 Milano, Italy. In the U.K., write General Instrument (U.K.) Ltd., Cock Lane, Highwycombe, Buckinghamshire, England. In the Far East, write General Instrument of Taiwan Ltd., P.O. Box 22226, Taipei, Taiwan.



GENERAL INSTRUMENT CORPORATION • 600 WEST JOHN STREET, HICKSVILLE, L. I., NEW YORK 11802

INFORMATION RETRIEVAL NUMBER 61

Programmer switch offers 24 rotary stops

Cole Instrument, 2034 Placentia Ave., Costa Mesa, Calif. 92627. (714) 642-8080.

The thumbwheel Miniprogrammer makes practical front panel programming combined with the space saving advantages of a drum programmer. The 10-section model requires a panel opening only 1-1/2-in. high by 4-in. long. Each separate drum section controls one snap action switch which can be actuated in any or all of 24 rotary positions. Other models of the Miniprogrammer are available with manual, solenoid, pulsed, or synchronous motor drives and a wide variety of switching characteristics including fluidic, pneumatic, and rolling wave snap action switches for low-level logic circuits. Precision rotary switch decks can be combined with programming drum sections to provide a wide selection of remote readout and control capabilities.

CIRCLE NO. 263

Wideband op amp settles to 0.1% in only 200-ns

ILC Data Device Corp., 100 Tec St., Hicksville, N.Y. 11801. (516) 433-5330. \$125 (1 to 9).

Model HFS-23-2 is an inverting amplifier that settles to 0.1% of full scale in only 200 ns, and to 1% in only 75 ns. The case can be grounded for rf shielding and the noninverting input is available for low frequency noise rejection and a dc biasing network. It is claimed to be the smallest commercially available amplifier offering such performance. Open loop dc voltage gain at a rated load of 500 Ω is 96 dB minimum. Slewing rate is typically 500 V/ μ s, and 400 V/ μ s minimum. Rated output is ± 10 V at 30 mA and is short circuit protected. Input offset is adjustable to zero mV and input current is only 150 nA maximum. Operating temperature range with proper heat sinking is -55 to $+95$ C. Processing to MIL-STD-883 method 5004 level B is available at extra cost.

CIRCLE NO. 264

Servo amplifier delivers 60-A peak current

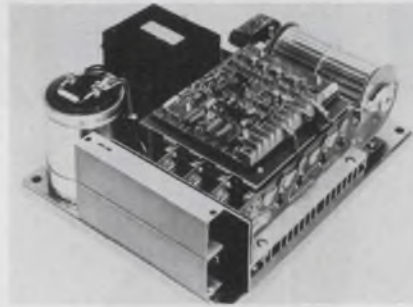

Westamp, 1542-15 St., Santa Monica, Calif. 90404. (213) 393-0401.

The Model A5284 dc servo amplifier has a high peak current capability of 60 A. It is a linear transistor amplifier for applications where a switching amplifier is undesirable. The unit provides for either voltage or current feedback, three signal inputs, and system compensation. The continuous power output is 540 W.

CIRCLE NO. 265

Instrumentation amp has 25-MHz gain-bandwidth



Datel Systems, 1020 Turnpike St., Canton, Mass. 02021. (617) 828-6395. \$33 (100 up); stock.

Model AM-200 is a low level, differential-input instrumentation amplifier. It is gain programmable with a single resistor over the range of 2 to 1000. Differential input impedance is $10^7 \Omega$ while input common-mode impedance is specified at $10^{10} \Omega$. Common-mode rejection at 60 Hz is 100 dB with a common-mode voltage range of ± 18 V. Other specifications include a closed-loop gain accuracy and linearity of $\pm 0.05\%$ over an operating temperature range of 0 to 70 C. Input bias current and offset current are specified at 50 nA and 5 nA, respectively. The amp has a 25-MHz gain-bandwidth product at a gain of 1000 and a slew rate of 2 V/ μ s. Full-scale output voltage is ± 10 V at ± 7 mA. Input power requirements are ± 14 to ± 19 V at ± 7 mA.

CIRCLE NO. 266

Unidirectional counter has a 1-MHz count rate



Electronic Research, P.O. Box 913, Shawnee Mission, Kan. 66201. (913) 631-6700. \$275. (six digits).

Industrial digital counter Model 2320 offers a 1-MHz count rate. The unit features: parallel BCD, TTL-compatible outputs and input compatibility with a wide variety of input sources . . . TTL/DTL, RTL, low-power TTL, 5 V CMOS, or contact closures. Control is either manual or remote. It has a three to six-digit LED display and the display and outputs can be held at a fixed value while the instrument continues to count. External gating for events-per-unit-time measurement is also a standard feature.

CIRCLE NO. 267

V/f converter delivers million-to-one range

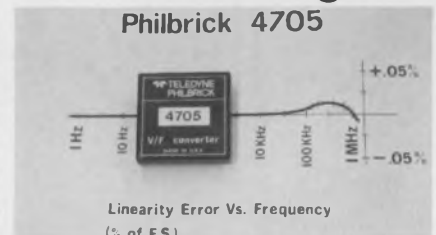

Teledyne Philbrick, Allied Dr. at Rt. 128, Dedham, Mass. 02026. (617) 329-1600. \$125 (1 to 9); stock.

The voltage-to-frequency converter Model 4705 guarantees a 1,000,000 to 1 dynamic range. The module provides TTL-compatible 1 MHz pulses for a +10 V input, and maintains typical non-linearity to $\pm 0.0002\%$ of full scale $\pm 0.012\%$ of signal, all the way down to a 1 Hz output for a 10 μ V input. Other features include resolution equivalent to 14 bits, 44 ppm/ $^{\circ}$ C stability, 10 TTL-load fan-out, and an input stage that permits unipolar or bipolar voltage inputs and current inputs. The scale factor can be trimmed for precision applications.

CIRCLE NO. 268

Total resistor capability spoken here

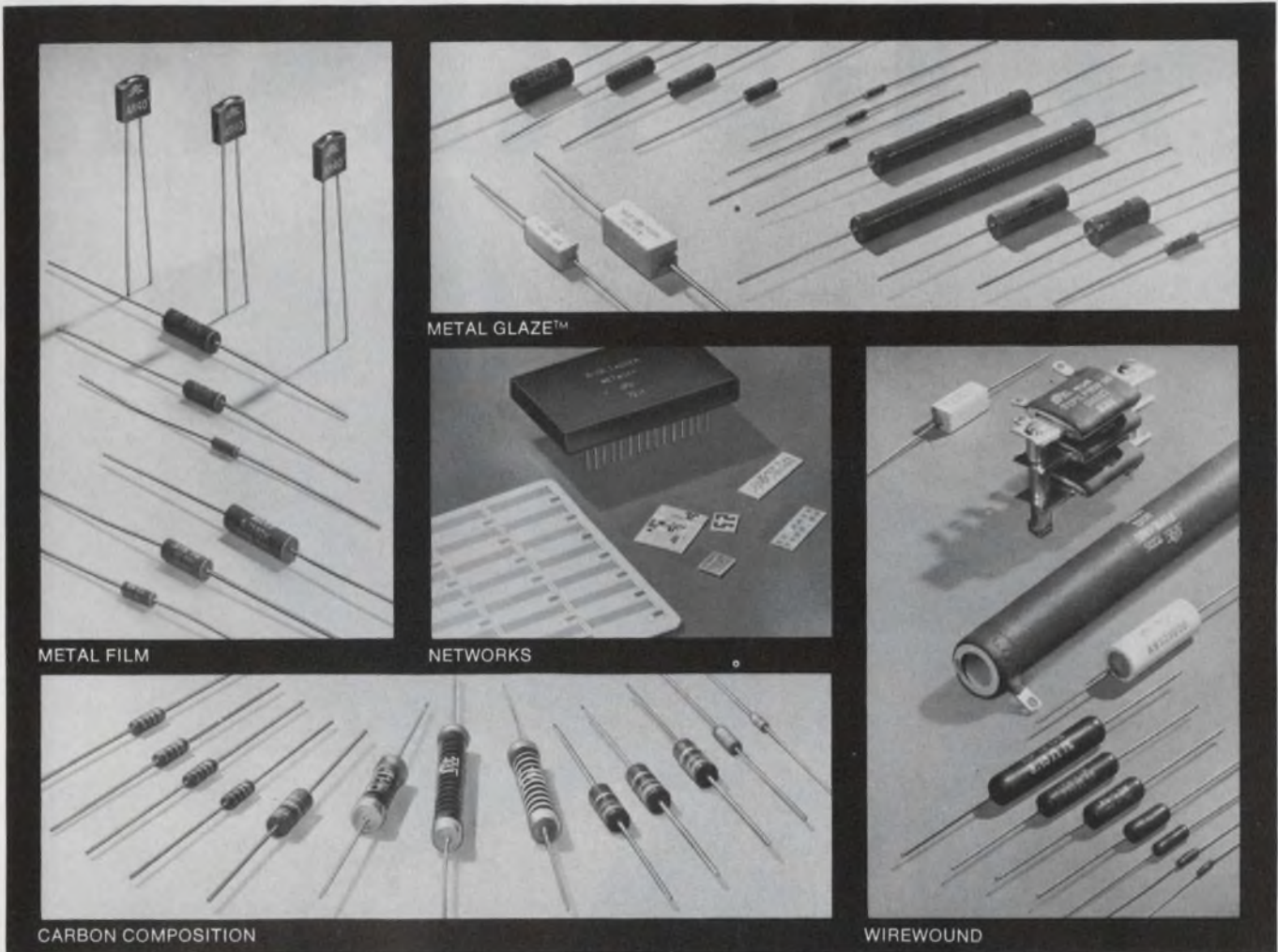

TRW/IRC Carbon Composition Resistors

Used by *billions* in consumer, industrial and military applications, TRW/IRC carbon composition capability ranges from standard commercial type through established reliability RCR's, to ultra-high range (10^{11} ohms). Where you are using carbon comp.'s in automated assembly, TRW/IRC packaging techniques can help cut the cost of interfacing with your machines. Card packs, lead tape reels, cut and formed leads . . . we'll be glad to explore the potential economies with you.

TRW/IRC Metal Glaze™ Resistors

This is TRW/IRC's thick-film technology—for every type of low power resistor application. Metal Glaze is widely accepted for its built-in power handling reliability, resistance range, and cost effectiveness. Available in numerous standard and special designs—precision, semi-precision, flameproof, high-reliability, high-voltage.

TRW/IRC Wirewound Resistors

The line starts with molded wirewound resistors—"space-savers" that bridge the cost-performance gap between composition resistors and precision wirewounds. It proceeds to standard, non-insulated types for appliance/automotive use . . . to precision subminiatures offering high power density . . . to ceramic, flameproof units for TV and computer applications . . . to tubular and flat power wirewounds with ratings to 250 W.

TRW/IRC Metal Film Resistors

TRW/IRC has brought the state-of-the-art in thin-film resistors to an equal performance level with high-stability wirewounds. Capabilities here include resistors with tolerances to $\pm 0.01\%$. . . high-reliability units to MIL and aerospace specs . . . precision subminiatures . . . and standards, of course. You can also look at alloy films offering high-temperature and high-voltage capability at low cost.

TRW/IRC Resistive Networks

Advanced resistor technology here. These IC compatible, precision tantalum-film circuits provide inherent low noise, excellent stability, and hermetic performance without hermetic cost. Tolerances from 5% to 0.05% are available in custom designs. TRW/IRC also offers the industry's most complete line of discrete fixed resistors.

All types . . . all technologies . . . from one source

To wrap it up, TRW/IRC offers you the broadest line of fixed resistors in the business, with extensive, nationwide distribution. All available from one source—your local TRW/IRC distributor. With a direct pipeline to each of our plants, he can give you fast delivery. Contact your local TRW/IRC sales office for application assistance, custom designs, and special engineering help when you need it. TRW/IRC Fixed Resistors, 401 N. Broad Street, Philadelphia, Pa. 19108 — (215) 922-8900 • Greenway Road, Boone, N.C. 28607 — (704) 264-8861 • 2850 Mt. Pleasant Street, Burlington, Iowa 52601 — (319) 754-8491.

TRW[®] IRC RESISTORS

INFORMATION RETRIEVAL NUMBER 62

SURPRISE!

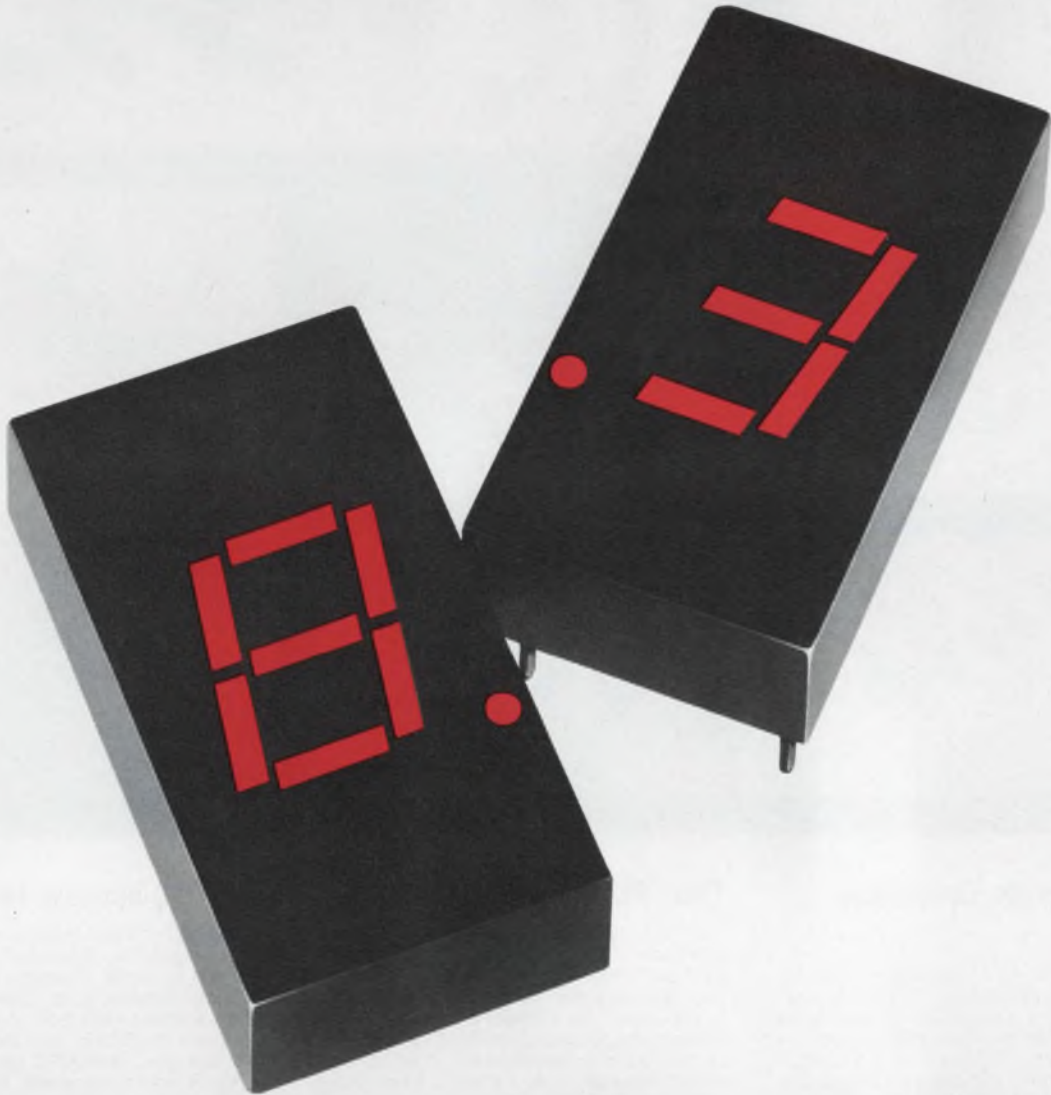

New common cathode display just \$2.70*

Now, the great-looking HP display is available in either common cathode and common anode configuration. Both at the new low price of just \$2.70* in 1K quantities. Both have the same wide viewing angle and large 0.3 inch character and uniform segment illumination that assures excellent readability.

Specify either the 5082-7730 series (common anode) or -7740 (common cathode) for any commercial application. Reduce your display system costs by choosing the display that complements your drive electronics.

And get traditional HP quality.

Contact your HP distributor for immediate delivery. Or, write us for more details.

These displays are worth a closer look.

HEWLETT  PACKARD

Sales, service and support in 172 centers in 65 countries
Palo Alto, California 94304. Offices in principal cities throughout the U.S.

01332

*1K quantity; Domestic USA Price Only

INFORMATION RETRIEVAL NUMBER 63

SURPRISE! SURPRISE!

Now your HP distributor
has still another way to keep
you looking good.

Distributor Stocking Locations:

HALL-MARK ELECTRONICS

Huntsville, Alabama
(205) 539-0691

Lenexa, Kansas
(913) 888-4747

St. Louis, Missouri
(314) 521-3800

Raleigh, North Carolina
(919) 832-4465

Tulsa, Oklahoma
(918) 835-8458

Dallas, Texas
(214) 231-6111

Houston, Texas
(713) 781-6100

SCHWEBER ELECTRONICS

Toronto, Canada
(416) 925-2471

Hollywood, Florida
(305) 927-0511

Elk Grove Village, Illinois
(312) 593-2740

Rockville, Maryland
(301) 881-2970

Waltham, Massachusetts
(617) 890-8484

Troy, Michigan
(313) 583-9242

Edina, Minnesota
(612) 941-5280

Somerset, New Jersey
(201) 469-6008

Rochester, New York
(716) 328-4180

Westbury, New York
(516) 334-7474

Beachwood, Ohio
(216) 464-2970

WYLE DISTRIBUTION GROUP

Liberty Electronics/Arizona
Phoenix, Arizona (602) 264-4438

Liberty Electronics
El Segundo, California (213) 322-8100

Elmar Electronics
Mt. View, California (415) 961-3611

Western Radio
San Diego, California (714) 235-6571

Elmar Electronics
Commerce City, Colorado (303) 287-9611

Liberty Electronics/Northwest
Seattle, Washington (206) 763-8200

EUROPE

Celdis Ltd.
37-39 Loverock Road, READING, Berks, England
Tel.: READING 58 22 11

I.S.C. France
20, rue Gambetta, 92-Boulogne, France
Tel.: 604.52.75

Ingenieurbüro Dreyer
238 Schleswig, Flensburger Strasse 3, Germany
Tel.: (04621) 2 31 21

EBV Elektronik
8 Munich 2, Gabriel-Max-Strasse 90
Tel.: (0811) 644055-8

6 Frankfurt/Main 1, Mslusstasse 54
Tel.: (0611) 720416-18

B. V. Dinde
Hollantlaan 22, Utrecht City, The Netherlands
Tel.: (03088 42 14)

Interelko A. B.
Sandsborgsvägen 50, 12 233 Enskede, Sweden
Tel.: (08) 49 25 05

HEWLETT  PACKARD

POWER SOURCES

Drive sonic horns with 1200 W sonic converter



Branson, Eagle Rd., Danbury,
Conn. 06810. (203) 744-0760.

The model 160 sonic power converter can supply up to 1250 W at 20 kHz to a piezoelectric converter. Ultrasonic vibrations produced by the mechanical motion of the converter expanding and contracting at 20 kHz can be channeled into a horn and applied to thermoplastic materials. This vibratory energy creates enough frictional heat to produce a molecular interaction to weld plastic to plastic, stake metal to plastic, insert metal into plastic and spot weld plastics.

CIRCLE NO. 269

Fuel cell refuels in 2 min, delivers 100 W



Whiteley Industries, Inc., 833 Wo-
burn St., Wilmington, Mass. 01887.
(617) 658-5583.

A new lightweight portable fuel cell, the Wicel-500, can deliver 75 W for 11 h at a nominal 28 V or 100 W for 11 h at 12 to 14 V on a single fuel charge. The fuel cell takes less than two minutes to refuel and it is essentially noiseless. Weight is 16 lb. Models with higher ratings are under development.

CIRCLE NO. 270

High voltage dc-to-dc supply delivers 1.5 kV

Spellman High Voltage Electron-
ics, 1930 Adee Ave., Bronx, N.Y.
10469. (212) 671-0300. \$200; 8 wk.

Model UHM1.5PN75 dc-to-dc supply is rated for an output voltage of 1.5 kV dc max at 50 mA. Input requirements are 28 V dc, 3.5 A max. The ripple on this power supply is 5 V p-p at a converter frequency of 20 kHz. It measures only 4 by 6-1/2 by 2 in., is equipped with positive and negative leads for both input and output and is current limited to 70 mA under short-circuit conditions. A 5 A input fuse is provided for catastrophic failures.

CIRCLE NO. 271

Deuterium-lamp power supply has three steps



Schoeffel Instrument, 24 Booker
St., Westwood, N.J. 07675. (201)
664-7263. \$370; stock to 30 day.

Model LPS 301 three-step deuterium power supply has three power outputs of 15, 30 and 60 W. Specs include line regulation better than 0.01% with a 10% line change and current ripple less than 0.01% pk-pk.

CIRCLE NO. 272

IC regulated supplies boast 50% efficiency

Power-One, 6324 Variel Ave.,
Building E, Woodland Hills, Calif.
91364. (213) 887-5730. From
\$31.96 (100 up).

A series of single output dc power supplies has IC regulation, 50% efficiency and full rating to 50 C. Three Series C models are: 5 V at 6 A, 15 V at 3 A and 24 V at 2.4 A units. Others are available on special order. All models provide current limiting/foldback, reverse voltage protection and remote sensing. Input is 105 to 125 V ac, 47 to 440 Hz. Line and load regulation is $\pm 0.01\%$ and 0.02% , respectively. Output ripple is 1.5 mV, p-p.

CIRCLE NO. 273

QUALITY • EFFICIENCY • RELIABILITY

ELINCO

Fractional horsepower motors, generators, and special rotary units are crafted to highest standards of reliability and quality. For technical description ask for catalogs and data sheets.

AC & DC GENERATORS



over 150 permanent magnet, sine wave, tachometer, and other type generators and alternators. **Circle 101**

AC & DC COMMUTATOR MOTORS



over 200 different models including universal, series, split field, shunt, permanent magnet. **Circle 102**

AC INDUCTION & TORQUE MOTORS



over 100 designs of one, two, or three-phase induction and torque motors for standard or special frequencies and voltages. **Circle 103**

SYNCHRONOUS MOTORS



over 200 hysteresis, salient pole, and special types for 50 to 400 cycles, one to three phases. **Circle 104**

AC SELF-SYNCHRONOUS MOTORS



differential motors and one, two, or three-phase and phase-shifting rotary transformers. **Circle 105**

STEPPING MOTORS



available as permanent magnet or variable reluctance with wide selection of rates, angles and torques. **Circle 106**

ELINCO

New Address
272-F MAIN AVENUE
NORWALK, CONN. 06851

Tel: (203) 847-5861

ELECTRIC INDICATOR COMPANY, INC.

POWER SOURCES

Programmable supply drives electrohydraulics

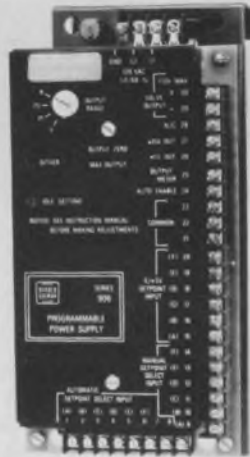

Barber Colman, Industrial Instruments Div., 1300 Rock St., Rockford, Ill. 61101. (815) 968-6833.

The 906-series programmable power supply for electrohydraulic valves delivers predetermined voltages selected by a sequence-control system. The basic unit can provide six different values of current output signals, each of which may be individually sequenced into operation. The supply is designed for sub-panel mounting in machine control panels. The current-output levels are preadjusted by means of external setpoint potentiometers.

CIRCLE NO. 274

Triple output supplies have only 250 μ V ripple



Electrostatics, 7718 Clairemont Mesa Blvd., San Diego, Calif. 92111. (714) 279-1414. From \$60 to \$159; stock.

Triple output dc power supplies have outputs from 5 V at 1 A and ± 12 or 15 V at 0.25 A to 5 V at 15 A and ± 12 or 15 V at 2 A. All units have low ripple (250 μ V at full load), excellent regulation (line 0.005%, load 0.05%) and full rating to 71 C ambient temperature.

CIRCLE NO. 275

Rechargeable battery does not leak



Elpower Corp., subsidiary of Eldon Industries, Inc., 2117 S. Anne St., Santa Ana, Calif. 92704. (714) 540-6155. \$5 to \$18.95.

Solid-Gel rechargeable leak-proof batteries can be applied to either standby or cyclic power. Both types are available in a wide variety of sizes—6 or 12 V and 3 to 8 A-h. Other sizes, voltages and amperages can be made to specifications. Because of their leak-proof quality, the U.S. Postal Service allows shipping them by mail without special packaging.

CIRCLE NO. 276

Dual output supply delivers ± 15 V at 0.3 A

Intronics, 57 Chapel St., Newton, Mass. 02158. \$98 (1 to 9); stock.

The SM300/15 modular power supply delivers an output current of 300 mA with dual ± 15 V dc outputs. These units have an internal transformer and a solid state regulation circuit that provides an input/output isolation of 50 M Ω , line regulation of 0.01% and load regulation of 0.05%. Input regulation is achieved over an ac line input of 105 to 125 V, with optional input voltages from 90 to 252 V ac. The dual dc outputs are preset to 0.5% accuracy and are short-circuit protected. Case size of the SM300/15 is 3.5 by 2.5 by 1.56 in. and 40 mil diameter pins are provided for mounting on a printed-circuit board or optional socket.

CIRCLE NO. 277

The Tektronix programmable calculator! At \$2,850, it's a natural!

If you know the math language, you're ready to program our Model 31. No computer language is needed . . . that's how natural it is! It lets you write the way you think. Sequentials stay the same.

It's powerful! A problem-solver close at hand. You have over 30 math functions built into our keyboard. Plus 24 more keys and an exclusive plug-in PROM for functions you define. The 31's memory is expandable up to 8,192 program steps and 1,010 data registers. And it interfaces with

peripherals . . . including our 4010 graphic terminal. That's power.

It's much less expensive. We think when you compare our 31 (or our 21, at \$1,850!) in price and function, you'll decide to own a Tektronix programmable calculator.

Prices do not include silent alphanumeric printer (\$700—TEK 31; \$450—TEK 21) and additional memory. The next step is to send this coupon to Dwain Quandt at P.O. Box 500, Beaverton, Oregon 97005. Dwain will send you our 16-page brochure and a free demonstration, naturally, if you like.

I am in the market for a calculator within
 30 days 60 days 90 days or more
 I would like to have a sales engineer call Yes No

My professional activity is _____

Calculators I am considering are _____

Name _____

Title _____ Firm _____

Address _____

City _____ State _____ Zip _____

Please add me to your mailing list _____

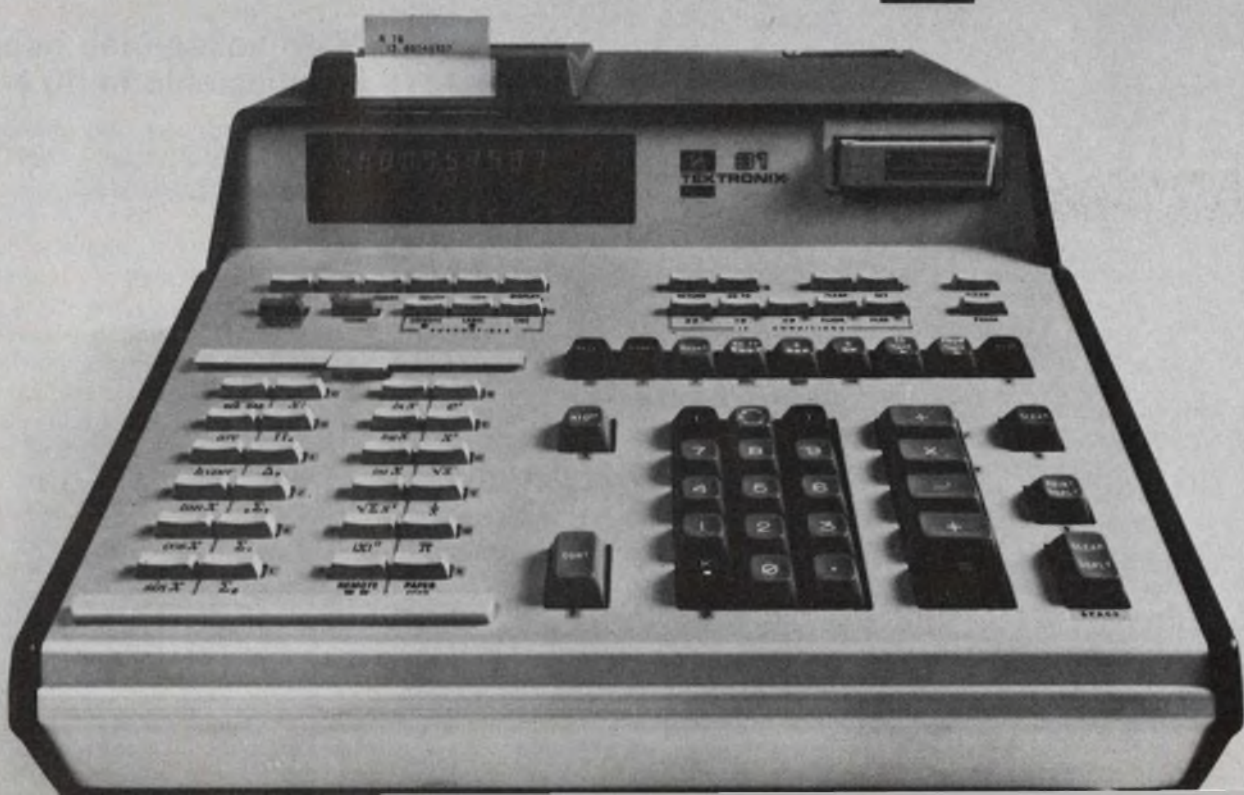



Our Driver Manual.

(It's a free license to control all driving situations.)

Fault-free control of load driving can be yours when the motor matches (or exceeds) your product or system requirements and avoids the performance compromises inherent in common motors.

The Motor Catalog offers you literally thousands of choices — size, type, horsepower, torque, input — to obtain exactly the motor you need. In addition, there's comprehensive theory and applications information.

IMC Magnetics Corp., Eastern Division, 570 Main Street, Westbury, N.Y. 11591, Tel. (516) 334-7070, TWX 510-222-4469



POWER SOURCES

Slot voltage supplies deliver up to 3 A

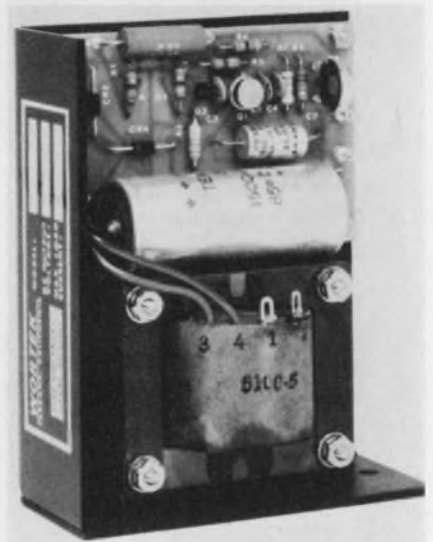

Wortek, 5971 Reseda Blvd., Tarzana, Calif. 91356. (213) 881-1644. \$19.75 (100 up); stock.

Six models of the PRS Series of dc modular supplies cover the 5 to 24 V dc range and deliver up to 3 A load current. The specifications of these units are as follows: line and load regulation of $\pm 0.15\%$, p-p output ripple of less than 0.05% of dc output or 5 mV, whichever is greater and operation rated for 0 to 40 C but usable to 70 C by derating load current. Size of these units is 4 × 5 × 1-7/8 in. with open frame construction for easy installation.

CIRCLE NO. 278

High voltage lab supply is adjustable to 50 kV

Bertan Associates, 180 Miller Pl., Hicksville, N.Y. 11801. (516) 433-3110. From \$450; stock.

The Series 205 high voltage laboratory power supplies deliver up to 50 kV dc output. Models are available with outputs from 0 to 1 kV dc at 30 mA to 0 to 50 kV dc at 0.3 mA. Features include a digital readout, front panel meter, remote programming and reversible polarity. Regulation and ripple are 0.001% and temperature coefficient is 50 ppm/°C. The unit is 3-1/2 in. high and comes in a standard 19 in. wide rack mounting configuration. Options available include remote computer programming and remote metering.

CIRCLE NO. 279

INSTRUMENTATION

Signal analyzer performs dozen analysis functions

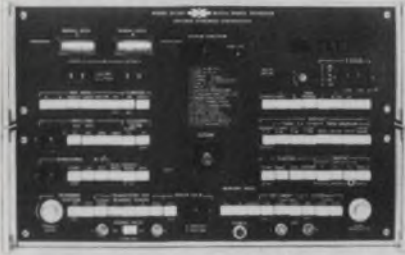

Spectral Dynamics, P.O. Box 671, San Diego, Calif. 92112. (714) 278-2501. Under \$32,000.

Operating in real time over the entire audio spectrum, the SD360 Digital Signal Processor conditions and analyzes two signals, correlates their mutual properties and displays the results in a variety of forms and formats. Through a "joystick" on the front panel, the operator can control a cursor to automatically follow data displayed on a scope for direct, calibrated frequency, amplitude and phase readout by means of a 6-digit LED display. Offered are 57 analysis ranges from 10 Hz to 150 kHz fs, with resolution as narrow as 0.01 Hz.

CIRCLE NO. 280

2-MHz function gen costs just \$250



Syston-Donner, Datapulse Div., 10150 W. Jefferson Blvd., Culver City, Calif. 90230. (213) 871-0410. \$250; Sept.

Model 400 function generator features 0.02-to-2-MHz frequency range; dial accuracy of $\pm 2\%$ of full scale; 1000 to 1 frequency modulation; sine, square and triangle waveforms with sine distortion less than 1% and dc offset variable from -10 to +10 V open circuit. Amplitude is 20 V pk-pk (open circuit) and 10 V into 50 or 600 Ω . Output impedance is internally selected for 50 or 600 Ω .

CIRCLE NO. 281

Who said you can't beat the option game when buying a true-rms voltmeter?



The one with the works

costs \$300 less.

At \$1,200, our Model 93AD gives you the best price and the best performance. It's not just priced 20 to 32 percent under competition. It's complete

with standard performance and convenience features that the other manufacturer tags on as costly options . . . or can't give you at all.

Take remote programming and BCD outputs. They are a necessity for any kind of test automation. We don't ask you to pay an extra \$450 . . . we've made them standard.

If you're doing low-frequency work, spurious high-frequency signals are always a problem . . . but not with Boonton's selectable bandwidth. On the 100 kHz setting, you get immunity from spurious pickup; on the 20 MHz position, you get twice the full-performance bandwidth of the older designs at lower cost.

We've even removed the conflicting advantages of digital and analog readouts. We give you both — a 3½ digit LED display for absolute readings, and a special analog dB meter for easy peak/null adjustments . . . as standard.

Our dB option is not only \$100 less than the higher-priced spread but also gives you an ex-

tra digit for a constant 0.01 dB resolution . . . available in your choice of 50 Ω , 75 Ω , 600 Ω , or 1 V references.

And we have a low-cost 10 M Ω , low-capac-

itance probe for negligible circuit loading at high frequencies — not available from the competition.

What don't we do?

Well, our autoranging option costs \$25 more than the competition and we don't go down to 2 Hz or up to 100 MHz. But unlike some, we don't pretend to "cover" a frequency range beyond our capability. Their advertised 100 MHz bandwidth is useable on only the 0.1 and 1 volt ranges. On all other ranges, their upper frequency is 10 MHz or less. The 93AD has a 10 Hz to 20 MHz bandwidth specified down to 300 μ V with full calibrated accuracy.

But see for yourself. Before you pay more for less, write or call for the full specs or a demonstration: Boonton Electronics Corporation, Rt. 287 at Smith Road, Parsippany, New Jersey 07054; (201) 887-5110.



DON'T NEED DIGITAL? OUR FULLY-PROGRAMMABLE ANALOG MODEL 93A GOES FOR A LOW \$600.

BOONTON

CIRCUIT-STIK introduces

GP BOARDS

GENERAL PURPOSE
CIRCUIT BOARDS
Plug-in & Chassis Mounting
and ELECTRONIC
PACKAGING MATERIALS

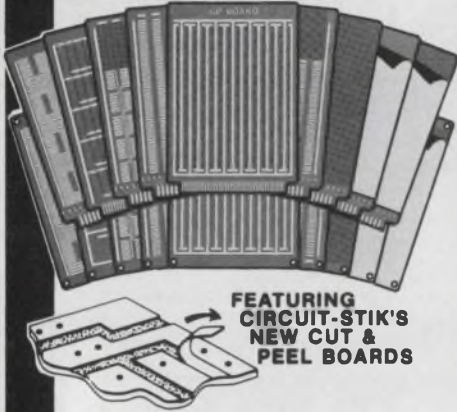

FEATURING
CIRCUIT-STIK'S
NEW CUT &
PEEL BOARDS

GP CIRCUIT BOARDS

HIGH QUALITY

- FR-4 Blue Epoxy Glass
- Computer "DRILLED", High Accuracy Holes (not punched)
- Mil-Spec Plating
- Precision Routed Edges

VERSATILITY

- Mix All Types of DIP Sockets (8 to 40 Leads)
- Low, Medium and High Profile Interconnections
- Hybrid Designs for Mixing Discretes and Sockets
- Designed for Edge Connector "Plug-In" or Chassis Mounting
- RFI Shielding

HIGHEST DENSITY

- Up to 50 DIP's on one 4½" x 6½" Plug-In Card Plus Space for 50 Decoupling Capacitors

COMPLETENESS of STANDARD DESIGNS

- Choose from 74 Off-the-Shelf Boards
- 4 Sizes of Boards available

APPEARANCE

- Beautiful Gold, Blue and Bright Tin

FULL LINE of ACCESSORIES (HIGH QUANTITY PRICING AVAILABLE)

- Sockets - Low and Standard Profile, P.C. and Wire Wrap
- Molded Nylon and Highest Quality Gold Contacts
- Adapterplugs
- Connectors
- Card Pull Handles

EPOXY GLASS BOARD MATERIALS

- 76 Standard off-the-Shelf Boards
- Including Unclad, Copper Clad, Cut & Peel Copper Clad, Pre-etched "X-Y" Pattern and Plated thru Hole Copper Clad
- .100" Grid Hole Pattern or Undrilled

SEND FOR YOUR FREE CATALOG

circuit-stik

P.O. BOX 3396
Torrance, California 90510
Phone (213) 530-5530

INSTRUMENTATION

Magnetometer measures milligauss on 3 axes



Develco, Inc., 530 Logue Ave., Mountain View, Calif. 94043. (415) 969-1600. \$5000; 60 days.

Model 9210 Three-Axis Fluxgate Magnetometer System is designed for precision vector magnetic-field measurements, up to ± 1 gauss. Features include 0.0025 milligauss sensitivity; frequency response from dc to 500 Hz; field nulling within 0.04 milligauss; and a selectable range in six steps from 3 to 1000 milligauss. Readout is via a digital LED display or as an analog signal. The instrument has both high-pass and low-pass filters, and a 60-Hz notch filter.

CIRCLE NO. 282

Portable counter handles 515 MHz



John Fluke Manufacturing Co., Inc., P.O. Box 7428, Seattle, Wash. 98133. (206) 774-2211. \$795; stock to 30 days.

First model in the new Fluke counter line is the 1980A, a vhf/uhf telecommunications frequency counter, designed for portable operation. The six-digit unit operates from 5 Hz to 515 MHz with 50 mV sensitivity over the entire range. An optional snap-on battery pack and carrying case provides up to 4.8 h of continuous use. Weight is 4.75 lb., and size is 6.51 x 2.94 x 7.85 in.

CIRCLE NO. 283

Unit checks incoming ICs at 10/min.



Testline, N. Brevard Industrial Park, P.O. Box 5671, Titusville, Fla. 32780. (305) 267-7212. \$6745; 30 days.

AFIT (Automated Fault Isolation Tester) tests every IC in-circuit at 10 per minute to find the faulty IC—not just node or bus. TTL, DTL, RTL and CMOS families are 100% parametric and margin tested in or out-of-circuit automatically. No operator knowledge of ICs or board circuitry are required. Incoming inspection is as fast as the handler. The unit is composed of the Model 203 IC Analyzer, the Model 2030 Computer Controller, and the Model 2035 Paper Tape Drive.

CIRCLE NO. 284

Unit generates any time code format



Moxon Inc./SRC Div., 2222 Michelson Dr., Irvine, Calif. 92664. (714) 833-2000. Starts at \$2300; 4-6 wk.

Designated the Model 540, this time code translator/generator features two instruments in one chassis, providing simultaneous and independent generation and translation of any time code format. In operation, the unit generates all time code formats for output to related equipment. It simultaneously translates these outputs to parallel and/or serial for input to recorders or magnetic tape in pulse or parallel BCD form.

CIRCLE NO. 285

Versatile, low cost plug and socket connectors for electronic systems

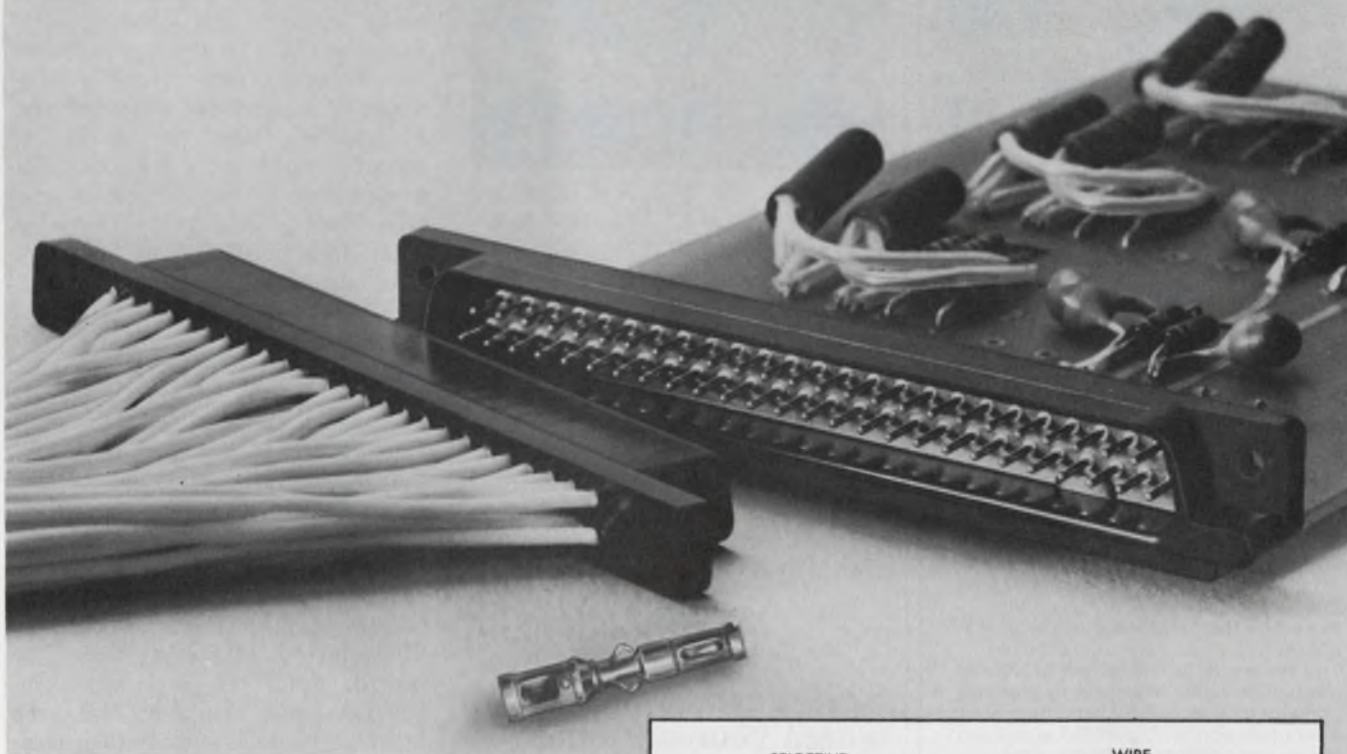

CONTINENTAL SERIES J CONNECTORS
provide high density in small areas of computers, control applications, instrumentation and printed circuitry.

FEATURES:

- .100 Contact Centers
- High Strength, Single Piece Molded Shells
- Removable Socket Contacts
- Right Angle or Straight Thru Wiring
- Molding Configuration Polarized
- Integrally Molded Plug Contacts

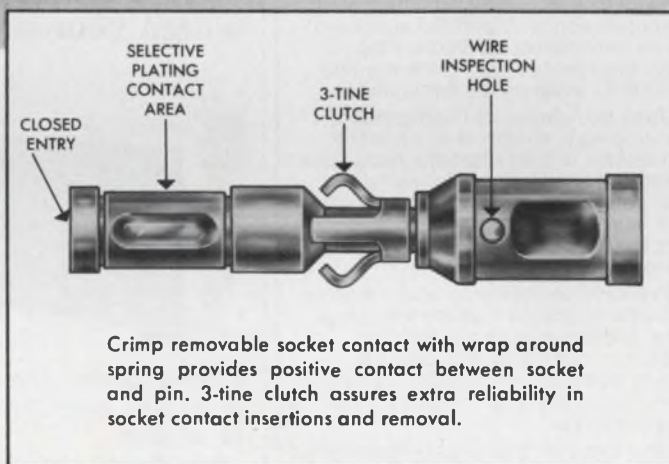

For a free brochure on Series J Connectors, write or phone sales department, Continental Connector Corporation, 34-63 56th Street, Woodside, N.Y. 11377, (212) 899-4422.

For the Sales Representative Nearest You, See Our Listings in EEM and VSMF Directories.

CONTINENTAL CONNECTORS

CONTINENTAL CONNECTOR CORPORATION • WOODSIDE, NEW YORK 11377

INFORMATION RETRIEVAL NUMBER 67

What you should know about



Reconstituted Mica . . .

A recent survey of 10,000 EEs indicated only 10% demonstrated a working knowledge of **reconstituted mica** as a capacitor dielectric.

Reconstituted mica is not "recycled" or "second-hand" mica. It is natural capacitor grade mica formulated into continuous sheets of uniform thickness. After removal of soluble contaminants, this "paper like" structure is maintained by the natural cohesive forces characteristic of natural mica itself. The **reconstituted mica** "paper" dielectric is then capable of being wound on conventional capacitor winding machines in conjunction with purified aluminum foil as the conducting media. Flag leads are inserted during the winding process to serve as the terminations.

Upon completion of impregnation, the winding is compressed while the impregnant is in an unpolymerized state. Pressure is maintained during curing until polymerization is complete, whereupon, a totally solid capacitor section is now ready for packaging to customer requirements.

Excellent performance under environmental extremes is a prime advantage of **reconstituted mica** capacitors. At Custom each step of production begins and ends with Quality Control because we know our customers can not afford failures.

Now that you know what **reconstituted mica** capacitors are, let us show how we can meet your requirements. See our page in EEM and write for **FREE** product sheets today.



CUSTOM ELECTRONICS, Inc.

4 Browne St., Oneonta, N. Y. 13820
PH: 607-432-3880 TWX 510-241-8292

P. S. Oil exploration personnel; Custom can help you with your logging tool problems.

INSTRUMENTATION

Temperature indicator uses liquid crystals



RdF Corp., 23 Elm Ave., Hudson, N.H. 03051. (603) 882-5195. \$169-\$259; 6 wk.

This digital temperature indicator features a 1/2-in.-high liquid-crystal display, either illuminated (transmissive) or reflective. Models TD-736J ("J" thermocouple) or TD-736K ("K" thermocouple) feature range spans up to 1900 F, with accuracies to ± 1 F and a resolution of ± 1 F. These 3-1/2-digit meters are available for operation with 120 V ac, 60 Hz or 5 V dc power sources.

CIRCLE NO. 286

\$299 buys 50-MHz 6-digit counter/timer



Newport Labs, 630 E. Young St., Santa Ana, Calif. 92705. (714) 540-4914. \$299.

The 50-MHz Model 730 Counter-Timer features an input sensitivity of 50 mV rms and a six decade LED readout with storage, storage override and LED overflow indicator. Accuracy is controlled by an internal crystal-controlled oscillator having an aging rate of less than 2 ppm per month. A multi-range time-base selector switch permits maximum resolution of the frequency being measured. The 730 also features accumulate and digital stopwatch modes.

CIRCLE NO. 287

Coupler interfaces DVMs to tape transports

Digi-Data Corp., 4315 Baltimore Ave., Bladensburg, Md. 20710. (301) 277-9378. Starts at \$2400.

The 1649/Ultra Incremental Coupler interfaces DVMs, counters and a/d converters to Digi-Data buffered tape transports. The coupler-buffered transport combination features input sample burst rates as high as 100 k characters per second, switch-selectable automatic or commanded data transfer to magnetic tape, and ability to accept variable word lengths up to a maximum of 32 four-bit characters. Twelve thumbwheel switches allow insertion of fixed data for tape labeling.

CIRCLE NO. 288

Seven scopes in a row—line 'em up and read 'em

Vu-Data Corp., 7170 Convoy Ct., San Diego, Calif. 92111. (714) 279-6572. \$2695; 30 days.

Series 1200 monitor scope consists of seven channels on the same horizontal line. Thus, it's easy to compare any two channels. The 2-inch high display is said to provide twice the vertical resolution previously available. The seven separate modules plug into a common power supply/rack adapter, resulting in an instrument only 3-1/2-in. high. Other specs include: dc to 5-MHz bw, 50 mV/div to 25 V/div sensitivity, 2 μ s/div to 20 ms/div time base.

CIRCLE NO. 289

Rf power meter handles pulses and cw power

Pacific Measurements, 940 Industrial Ave., Palo Alto, Calif. 94303. (415) 328-0300. \$3500; 60 days.

Model 1018A rf power meter measures peak power of rf pulses, as well as cw power. The measured pulse may be a single isolated pulse or the individual pulses in a train. The unit also has a pulse-height averaging feature that permits measuring the average peak power of a pulse train. Pulses can be as short as 0.20 μ s and pulse repetition frequency can range from a single pulse to above 1 MHz. Rf range is 100 MHz to 12.4 GHz.

CIRCLE NO. 290

100 to 1 says this divider is at least twice as accurate as the divider you're using now.

Analog Devices introduces the Model 434B, $\frac{1}{4}\%$ accuracy in a variable gain $Y(Z/X)$ divider that works with current or voltage inputs.

It's a one quadrant divider that guarantees accuracy of $\frac{1}{4}\%$ over a 100:1 dynamic range — from 100mV to 10V. That's twice as much accuracy as any other divider available.

And twenty times more than you can get from any conventional 0.1% multiplier/divider operating over the same range.

In addition, the Model 434 has two sets of inputs for either current or voltage, or a combination of each. So it simplifies rms or vector computations.

For added versatility, the Model 434 has an internal reference that holds any of the input variables at a constant value.

Noise performance of the Model 434 is virtually independent of the signal level. And error, which decreases with output level, is accurate within 1mV at 25°C. With no external trimming.

However, an optional external trim will eliminate all DC offset errors in the -25°C to $+85^{\circ}\text{C}$ temperature range.

On top of that, every component is hermetically sealed, to insure greater reliability.

It all adds up to \$87 (1-9) for the Model 434B. Or, if $\frac{1}{2}\%$ accuracy is good enough, \$75 for the Model 434A. They're each available in a modular package that's 1.5" x 1.5" x 0.62".

Either way, you get a divider that's the best in the business. So send for the specs and our Product Guide.

The Model 434 is just one of the many non-linear function modules we bring you to help cut your costs and make circuit design a lot easier. We also have a complete log/antilog module. Multiplier/dividers. Multifunction modules. Log transconductance elements.

Coming: A module that lets you take true RMS measurements at a truly low price. And more.

Analog Devices, Inc., Norwood, Mass. 02062.



Call 617-329-4700

for everything you need to know about non-linear circuits.

COMPONENTS

Tachometer generates low-ripple output



Portescap U.S., 730 Fifth Ave., New York, N.Y. 10019. (212) CI 5-7716. \$13.47 (1000 up).

The new 26PC14 series tachometer-generator provides an output of 2.2 V/krpm, a ripple of less than 3.5% p-t-p and a linearity of better than 0.1%. It has a speed range from 100 to 4000 rpm. The tachometer has been tested for over 5000 h at average speeds of 2000 rpm without a measurable increase in the output dc ripple and noise.

CIRCLE NO. 291

Indicator lights dim with mechanical shutter



Dialight Corp., 60 Stewart Ave., Brooklyn, N.Y. 11237. (212) 497-7600. 174 series: \$2.04, 801 series: \$1.57 (1000 up); stock.

An operator can control the light from these indicator lights to suit his needs under varying light conditions by turning a knurled cap. A mechanical shutter regulates the light output. The line includes a sub-miniature 174 series through the large size 210 series. A press-to-test model, the 801 series, is also available.

CIRCLE NO. 292

the world's largest selection of **EMI FILTERS** FREE CATALOG becomes the easiest to spec.

Only ADC offers 400 established standard EMI filter designs. And now, with our new, unique catalog selection guide, finding the one that's best for your specific need is easier than ever. Just count to four.

- 1 choose one of four current ratings
- 2 select from five circuit configurations
- 3 pick one of four filter network configurations
- 4 spec one of five capacity to ground/loss characteristics combinations

That's all there is to it. In four simple steps you've eliminated 399 of your possible choices and now have the 4-digit model number of the one EMI filter that's best for your job. Now, all you do is check the table in the catalog for the available case sizes and you're home free.

And free is how you get this unique spec guide. Just circle the appropriate number on the Reader Service Card and your guide will be on its way.

Special Requirements? We would be pleased to assist in developing a special design for you.

ADC PRODUCTS 4900 West 78th Street, Minneapolis, Minnesota 55435
Tel: (612) 836-6800 - TWX: 910-678-2832 - TELEX: 29-0321



Polycarbonate capacitor features small size



Electrocube, 1710 S. Del Mar Ave., San Gabriel, Calif. 91776. (213) 283-0511.

Size reductions of nearly 40% of conventional packages are claimed for Electrocube's series 650 line of metallized polycarbonate capacitors. They are offered in six case styles and in both axial and radial-lead versions. Voltage ratings are 50, 100, 200, 400 and 600 V dc for capacitances from 0.0010 to 50 μ F with tolerances to $\pm 1\%$ for operation over a temperature range from -55 to 125 C. Insulation resistances of 100,000 M Ω min. at rated voltage and 25 C are available.

CIRCLE NO. 293

KEMET® Capacitors:



When you consider total cost these kudos mean a lot.

These are a few of the "Supplier Awards of Excellence" and "Certified Supplier" Certificates KEMET Capacitors have earned from our customers. Which include outstanding companies such as Raytheon and Univac.

In fact, some of our customers put KEMET Capacitors directly in their stores—without costly incoming inspection.

These companies know the importance of total cost of purchased components. Not just the cost of purchasing. But the cost of inspecting. The cost of rejecting and reordering. The cost of production downtime and rescheduling. And the cost of excess inventory to allow for possible defective parts or delayed shipments.

Obviously, if you can reduce or eliminate any

of these costs, you can also cut your total cost.

That's why KEMET Capacitors are so important. Because you're assured of superior quality, consistent performance, reliability, and all-out cooperation in scheduling and delivery.

But don't take our word for it. Ask our customers.

 **COMPONENTS DEPARTMENT**

P.O. Box 5928, Greenville, South Carolina 29606
Phone: (803) 963-7421 TWX 810-287-2536

In Europe: Union Carbide Europe, S.A.
5, Rue Pedro-Meylan, Geneva 17, Switzerland
Phone: 022/47 4411 Telex: 845-222-53

KEMET is a registered trademark of Union Carbide Corporation.



everything you've wanted to know about extended capability nickel-cadmium batteries...

Here's a book with more information on nickel-cadmium batteries. This new handbook supplements the first Nickel-Cadmium Battery Application Engineering Handbook with new application information on extended capability batteries. To find out how you can order this comprehensive engineering handbook circle the number below on the reader service card, or write: General Electric Company, P. O. Box 114, Gainesville, Florida 32601. 453-25

But didn't know where to look

GENERAL  ELECTRIC

INFORMATION RETRIEVAL NUMBER 72

COMPONENTS

Time-delay relay breaks into \$6-to-\$8 range

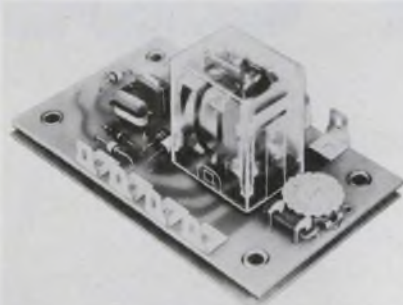

Syracuse Electronics Corp., P.O. Box 566, Syracuse, N.Y. 13201. (315) 488-4915. See text; 8 wks.

Suitable for budget applications, the delay-on-energization, transistorized, Series SAR, time-delay relay is in the \$6-to-\$8 range and may be generally substituted wherever mechanical, pneumatic and thermal timers are used. It provides a wide choice of fixed time delays ranging from half a second to five minutes, and remote, operator-adjustable delays of 0.5 to 5, 0.5 to 30, 0.6 to 30, 1.2 to 120 and 3 to 300 s. This open-board DPDT timer has a typical repeat accuracy of $\pm 2\%$. Life is given as one-million operations, and the reset time is 100 ms, during and after timing. It is available in ac and dc models and for any voltage values from 24 V ac to 230 V ac or from 12 V dc to 110 V dc. Maximum power consumption is 2 W. Its output contacts are rated at 5 A resistive at 115 V ac or 28 V dc.

CIRCLE NO. 294

Tantalum-nitride chip resistors track to 1 ppm

Semi-Films Technology Corp., Box 188, West Hurley, N.Y. 12491. (914) 338-7714.

Sixteen tantalum-nitride chip resistors for use in terminating networks are tightly positioned on a heat-equalizing silicon substrate measuring 50 by 60 mils. The resistors provide tracking to 1 ppm, have low capacitance (less than 0.5 pF), operate to 150 C and have a high pulse power capability. Available resistance values range from 50 to 2200 Ω with tolerances of 1 to 10%.

CIRCLE NO. 295

Load cell provides 3 mV/V output

Interface, Inc., 7210 E. Acoma Dr., Scottsdale, Ariz. 85254. (602) 948-5555. SM-50: \$150, SM-1000: \$295; stock.

Available in standard ranges of 0 to ± 50 , ± 100 , ± 250 , ± 500 and ± 1000 lb, the Super-Mini load cell's output is 3 mV/V. And all models are guaranteed a $\pm 0.03\%$ nonlinearity, $\pm 0.02\%$ hysteresis and $\pm 0.01\%$ nonrepeatability. The unit's deflection for a full-scale reading is from 0.003 to 0.007 in. Though the Super-Mini is intended for use in a controlled environment, it is protected against humidity, normal atmospheres and the specified temperature ranges.

CIRCLE NO. 296

Voltage-varied capacitor provides 2200 pF

MSI Electronics Inc., 34-32 57th St., Woodside, N.Y. 11377. (212) 672-6500. \$12 (100-999); 2 wk.

The new MD1663 series voltage-variable capacitors provide values to 2200 pF at 4 V. They are particularly suitable for low-frequency applications. Their low profile, rectangular $1/2 \times 5/8 \times 7/16$ in. cases conveniently mount on PC boards. The capacitor diodes have a capacitance ratio of 2.3:1 when biased over the range of 2 to 15 V, and the diode Q is over 100 when measured at 20 MHz and 4-V bias.

CIRCLE NO. 297

Thermal reed switches use Curie effect

National Micrometetics, Inc., Route 28, West Hurley, N.Y. 12491. (914) 338-0333.

Thermally activated reed switches, designated the TRS series, operate on the Curie principle. They contain a reed switch, a permanent magnet and a heat-responsive ferrite. The permanent magnet operates the switch at a predetermined temperature through the ferrite. Off-the-shelf units operate at 45, 60, 75 or 90 C. Special-order units are also available over the range of -10 to $+120$ C in five-degree increments. They come in four configurations and a variety of sizes.

CIRCLE NO. 298

Which air movers for your system?



Rotron® has the answer.

There are at least three major reasons why you can rely on Rotron to provide the best possible answer to your air moving need.

1. Rotron makes the widest selection of fans and blowers in the industry.
2. Rotron has a reputation for producing only the finest air movers. It's a reputation well earned, and one Rotron intends to keep.
3. Rotron offers you this superior selection and quality at hard-nosed competitive prices.

What's more, Rotron field application engineers will be glad to work directly with you where custom solutions may be required. You get the benefit of more than 20 years experience in developing specific answers to specific air moving problems.

Finally, Rotron products are available through a large, nationwide network of stocking distributors, to meet your needs in fast off-the-shelf delivery time.

Next time an air moving question arises, check Rotron. You'll like the answer. Get more information now by writing for Rotron's Quick Reference Catalog.

Why settle for less when the best costs no more?



ROTRON INC., Woodstock, N. Y. 12498 ☐ 914 • 679-2401 ☐ TWX 510-247-9033
Pacific Div., Burbank, Cal. 91506, 213•849-7871 • Rotron B.V., Breda, Netherlands, Tel.: 79311, Telex: 844-54074

INFORMATION RETRIEVAL NUMBER 73

COMPONENTS

Edge-reading meter is only 1/2-inch thin

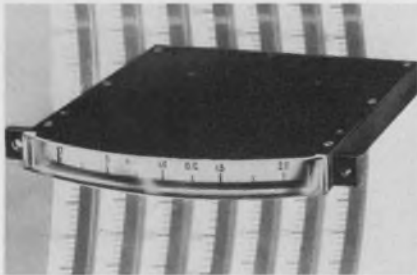

Airpax Electronics, Inc., 6801 W. Sunrise Blvd., Fort Lauderdale, Fla. 33313. (305) 587-1100. \$24 (100 up); 5 wk.

Ultra-thin, Series E45 edge-reading meters have a usable scale length of 4-11/32 in. These meters can be stacked on 1/2-in. centers for applications with limited panel space. A high degree of reliability is provided by resistance to shocks up to 240 g and continuous electrical overloads to 100 times full scale. A variety of current and voltage ranges are available in standard 2% tolerances.

CIRCLE NO. 299

Pushbutton switch operates on Hall-effect



Micro Switch, 11 W. Spring St., Freeport, Ill. 61032. (815) 232-1122. \$1.25 (OEM qty); September.

Panel-mounted and solid-state, the 11SN line of pushbutton switches operate on the Hall-effect. They are magnet-actuated and designed to eliminate contact bounce and intermittent switching at low levels. The switch line features gold-plated, solder-eye terminals for easier wiring, and they are available in lighted and unlighted versions. Outputs from the new pushbuttons are compatible with most logic families.

CIRCLE NO. 300

Hollow-rotor motor provides low inertia



Information Magnetics Corp., 5743 Thornwood Dr., Goleta, Calif. 93017. (805) 964-6828.

Model 7422 tape-transport capstan-drive motors can move 1/2-in. magnetic tape at velocities from 100 to 300 in/s. In the IBM series 3400 and 2400 tape units, these motors drive 6250 b/in. systems with 0.3-in. interblock gaps. To achieve the required control, the motors have a rotor inertia of only 0.41×10^{-3} in-oz-s² and a torque constant of 8.6 in-oz/A, which results from their hollow-rotor design. The motor has a built-in capstan and tachometer assembly.

CIRCLE NO. 301

The Non-forgettable Memory

Why is the Ross Digital Cassette Recorder the best recorder?

- Because it is the simplest
- Because it is the most rugged
- Because it is solidly built
- Because the design is versatile
- Because of patented constant speed drive
- Because there are no moving parts except the motors
- Because it is low cost

• ALL OF THE ABOVE



ROSS CONTROLS CORPORATION
 257 Crescent Street, Waltham, Massachusetts 02154 Tel. (617) 891-9600
 An Affiliate of American Research & Development Corp. (ARD)

INFORMATION RETRIEVAL NUMBER 74

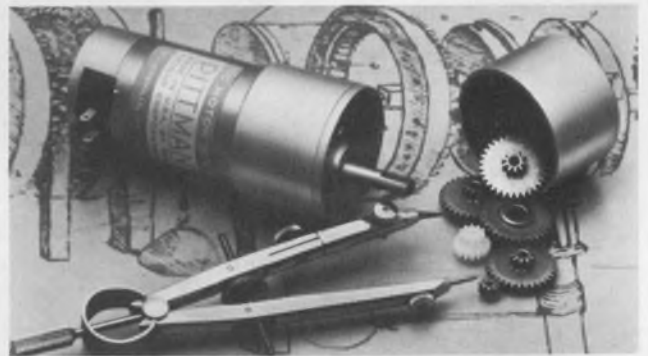

New Pitmo® Gearmotors

offer d-c servo motor performance combined with a rugged spur gear reducer which provides four standard ratios from 6.6:1 to 197:1. The GM8200 series, now in production, has a gearbox diameter of 1.375" and lengths from 3" to 3.4", excluding output shaft extension.

Gears are sintered iron to AGMA 9E tolerances except for the first gear after the armature pinion which is molded acetal resin to AGMA 8E tolerances. Torque limit on the gearbox is 250 oz. -in.

Three standard motor lengths combined with many possible variations in armature windings permit tailoring of outputs to a wide range of performance requirements.

©1973

For more information, write now.

114



THE PITTMAN CORPORATION

A Subsidiary of Penn Engineering & Manufacturing Corp.

SELLERSVILLE, PENNSYLVANIA 18960

Phone: (215) 257-5117 • TWX: 510-661-5086

INFORMATION RETRIEVAL NUMBER 75

ELECTRONIC DESIGN 20, September 27, 1973

ATTENTION PROGRAM MANAGERS:

How to win a \$10 million government contract with the new \$20,250 Rolm Ruggednova:

For \$20,250 you can meet Mil Specs E-5400 airborne environment, E-16400 shipboard environment, eliminate software and interfacing problems . . . and still buy the world's toughest computer system with 8K of memory and teletype.



If you're in the business of producing military systems, we don't have to tell you about budgets, risks, deliveries and design problems. Instead, let's talk about the Ruggednova 1602 . . . and how Rolm can help you win those big contracts.



A new technique for armchair control of RPVs (Remotely Piloted Vehicles) has been developed by Motorola Government Electronics Division for the Navy. The Ruggednova in the background helps provide either discrete or proportional control for up to six RPVs of any variety at ranges exceeding 250 nautical miles.

SOFTWARE IS THE FIRST SAVING

You can effectively reduce the most expensive and longest lead-time item in a system's task with our wide selection of proven and documented software. You'll see your program working on the 1602 in less time because the Rolm software set includes assemblers, compilers, debugging aids, utility routines, math libraries and powerful operating systems. A significant benefit of our system is the availability of a compatible commercial equivalent. Any program written on the Data General Corporation's Nova series will operate on the Ruggednova. Our licensing agreement with Data General allows us to provide more software than any other mil spec computer.

OUR EXPANDED INSTRUCTION SET GIVES GREATER FLEXIBILITY

With the Ruggednova 1602 your applications programming task has been simplified with a new extended instruction set. For example, our file search instruction enables you to do an "in limits / out of limits" comparison on a file up to 64,000 words long with one single instruction. Other examples include 1602's stack processing capability, auto-

matic branching and nesting of interrupts, immediate mode instructions and double precision arithmetic.

INTERFACING IS MADE EASY

Over 30 general purpose interfaces to select from gives you another edge on that contract. No design costs. No technical risks. The I/O interfaces range from series and parallel digital interfaces to communication interfaces to D/A and A/D converters all the way to NTDS interfaces. If you have your own special interface it can be placed inside the 1602 chassis. You save money by not having to design a rugged chassis or rugged power supply.

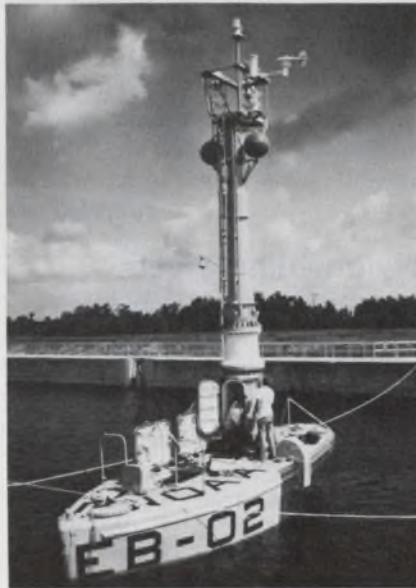

This new prototype, 30-ton buoy, built by Lockheed Missile & Space Company for the National Oceanic and Atmospheric Administration, has been placed in the Gulf of Mexico to record meteorological and oceanographic data. It is equipped with a Rolm Ruggednova for data acquisition and communications processing.

MIL SPECS ARE ALREADY MET

We supply you with a qualification test report free. You don't have the hassle, risk, or expense of qualification testing. The 1602 meets Mil-E-5400 airborne environments, Class II; Mil-E-16400 shipboard environments, Class I; Mil-Std-461A electromagnetic interference and Mil-S-901 for high impact shock. It has

an operating temperature range of -55° to $+95^{\circ}\text{C}$ case temperature, at altitudes from sea level to 80,000 feet. The 1602 meets shock specifications of 15 g's with 11 ms duration and vibration tests of 10 g's, 5 to 2000 Hz.

AND THERE'S A SUPPORT PACKAGE AT NO EXTRA COST

Rolm's program doesn't stop with just hardware and software. We also help you reduce your budget and design risk with a number of back-up items. These include detailed reliability reports, two weeks of training, complete documentation and a 90-day warranty. For software support there's also a "how-to" software manual, individual software write-ups, and full diagnostic software.

NEW DEBUGGING FEATURE

Within the first 15 minutes of loading a program into the 1602 you can localize most program errors. A new "panel breakpoint" switch allows you to execute your program until it hits the address located on the 16 data switches. This allows you to verify good routines and identify program bugs. No more single stepping through 2,000 word subroutines or keying halts. It's a great time-saving software feature.

Now that we've told you about all the ways Rolm can help you get that multi-million dollar contract, there's no space left to describe a host of other features about the Ruggednova 1602. So, drop us a line and we'll send you complete data on the world's toughest computer. If you're interested in getting a head start on that contract . . . give us a call.

ROLM

CORPORATION

18922 Forge Drive, Cupertino, Ca. 95014
(408) 257-6440 • TWX 910-338-0247

REGIONAL SALES OFFICES: Los Angeles 213-784-8500; Palo Alto 415-965-2224; Washington D.C. 703-893-2696; Boston 617-237-5752; New York 914-297-9533; Texas 214-661-8905.

DOMESTIC REPRESENTATIVES: Kansas 913-362-0919; Minnesota 612-941-5400; Missouri 314-895-4100; Washington 206-762-2310; Canada 416-742-8015.

INFORMATION RETRIEVAL NUMBER 76



POWER

- FOR YOUR
- OP AMPS
- LINE RECEIVERS
- COMPARATORS

Convenient, money saving, practical — V-PAC* power sources give you needed voltages for linear ICs from standard +5v source. Operate as many as 25 linear devices from a single V-PAC power source!

Standard DIP pin configuration, and less than a third cubic inch volume, lets you use V-PAC sources right on the PC card, with minimum length interconnections.

TYPE:	VA 12-12	VA 15-15	VA 12-6
VOLTAGES:	+12 -12	+15 -15	+12 -6

Write or call for full specifications.

WEST:	EAST:
213-843-5200	513-761-5432
214-231-6181	201-992-2505
505-265-6794	803-288-4450
312-654-8645	416-743-9130
415-593-2189	617-272-7655
206-747-9424	305-941-5544



Reliability, Inc.

5325 Glenmont, Houston, Texas
77036 • 713-666-3261

Europe and the Far East: TISCO (TI Supply Co.)

TWX: 910-881-1739 *TM, Reliability, Inc.

INFORMATION RETRIEVAL NUMBER 77

PACKAGING & MATERIALS

New LSI packaging line uses no gold

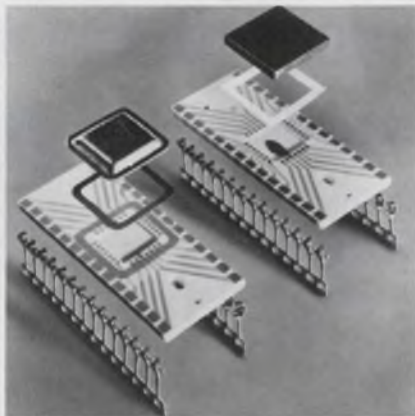

Du Pont Co., Wilmington, Del. 19898. (302) 774-2358.

Du Pont's new line of gold-free LSI ceramic semiconductor packages can be readily assembled with conventional techniques. A palladium-silver metallized cavity permits bonding with either a eutectic or epoxy die. The package can be sealed by either using a silver-tin preform and silver-plated Kovar lid or by using a ceramic, plastic, quartz or metal lid. Lead frame terminals, which are tin/lead-solder coated, are clipped onto the substrate last—a feature of Du Pont's "lead-frame-last" packaging system that enables both leaded and unleaded semiconductor packages to be handled on the same assembly line.

CIRCLE NO. 302

Nylon blind rivets fasten with one blow

Product Components Corp., 36 Lorraine Ave., Mount Vernon, N.Y. 10553. (914) 699-8640.

These self-expanding nylon rivets install from one side of the work. Its one-piece body consists of a pronged head, a hollow shank, and a securing pin. The prongs compress to snap into a panel hole. A single blow then drives the pin through the shank, which wedges the prongs apart to provide a positive lock. Standard rivets are molded of natural-color nylon, but they are also available in decorator colors at a nominal added charge. Shank diameters are from 1/8 to 1/4 in., clamp thicknesses from 1/32 to 5/32 in. and they come with round or binding heads.

CIRCLE NO. 303

Kit packages Navy SHP level-2 modules

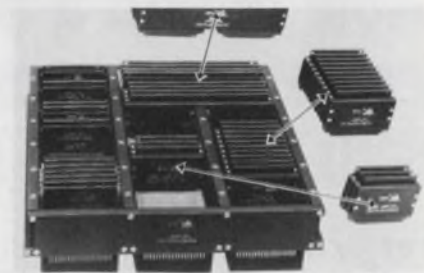

International Electronic Research Corp., 135 W. Magnolia Blvd., Burbank, Calif. 91502.

Multiple increment modules for the Navy standard hardware program allow the packaging of such functions as power supplies in single plug-in replaceable units. Standard components in kit form adhere to strict Navy SHP level-2 packaging requirements. Modules in the Alpha series can provide both the basic circuit-board substrate and room needed for transformers and large ICs.

CIRCLE NO. 304

Bench-top rework center comes in single package

Pace, Inc., 9329 Fraser Ave., Silver Spring, Md. 20910. (301) 587-1696.

The Pace Model PRC-150 bench-top rework center is completely equipped to perform all kinds of rework, repair and modification operations on complex microelectronic assemblies. The package features, as standard components: the PPS-100A Power Source, which provides all needed forms of power, control and sequencing functions; Sodr-X-Traction system for desoldering; the MiniChine, a miniature machining system for milling, drilling, cutting and abrading during circuit-board repair; the ThermoPart conformal coating removal system, and the LapFlo reflow soldering system. The PRC-150 also features a "quick-connect" capability to its mechanical and electrical power outputs as well as to its vacuum and pressure outputs. In addition, the PRC-150 comes with a special aids kit to provide the user with many other useful accessories such as: the ConForm I component lead forming tool; multipurpose ProVise, and the Hot Cubby Tool Rack. The system operates on 115 V, 50/60 Hz.

CIRCLE NO. 305

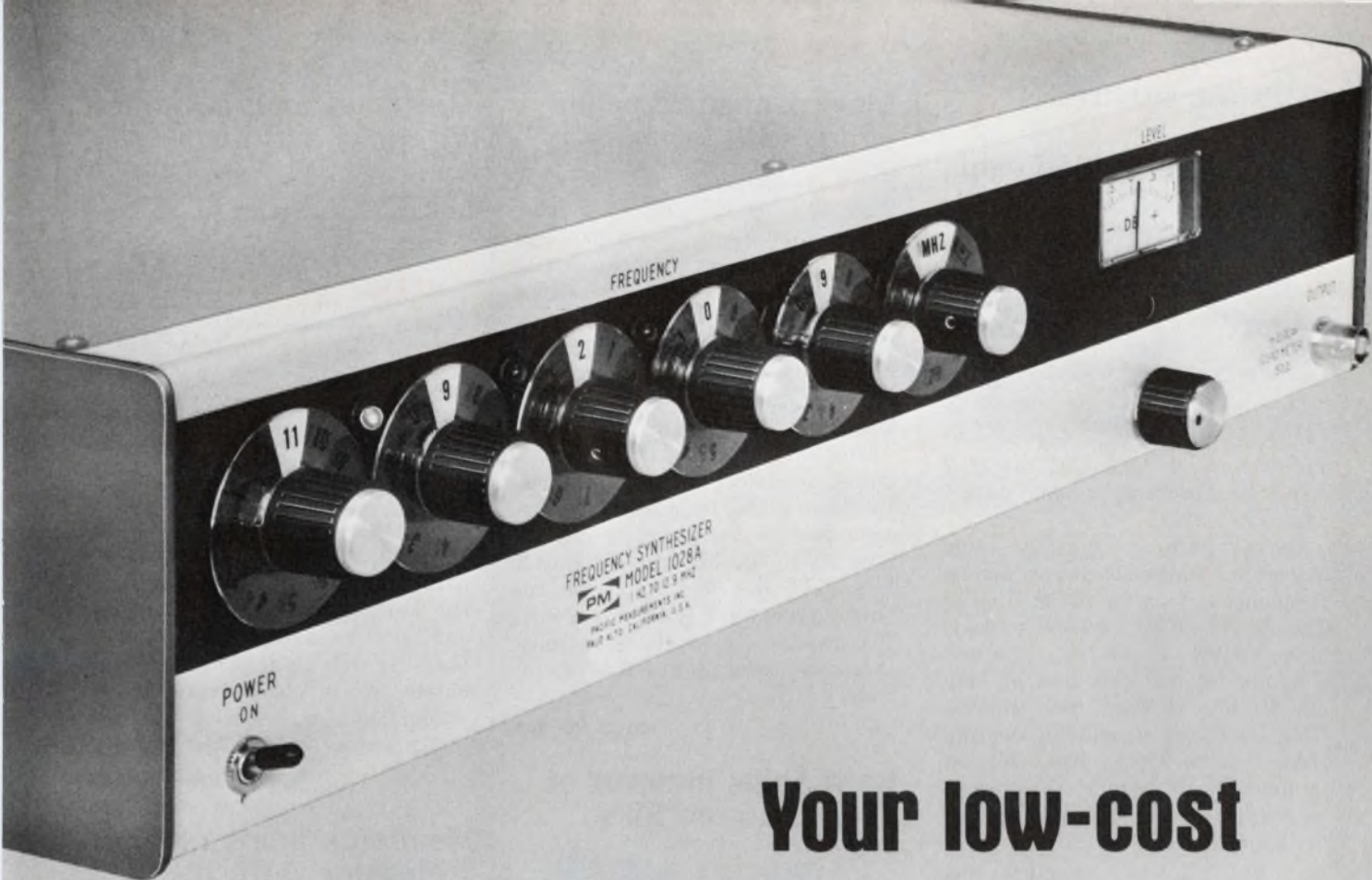

Your low-cost Programmable Signal Source

1 Hz TO 13 MHz

Here's a new programmable signal source that gives you both amplitude and frequency programming at *no extra cost*.

Not only that, but the price is already hundreds of dollars below similar instruments — only \$2,200. Even lower in one version.

4- OR 5-DIGIT RESOLUTION

The Pacific 1028 uses indirect synthesizer techniques and gives you 4- or 5-digit frequency resolution over the 1 Hz to 13 MHz range. A 30% overrange gives 5- and 6-digit resolution. Crystal stability is 10^{-6} /month.

100 dB OUTPUT RANGE

If programmable amplitude is your

special interest, one version of the instrument gives you control from +20 dBm to -80 dBm in 0.01 dB steps. With high accuracy.

Both frequency and amplitude digits are programmed by four-line BCD. All control lines operate from TTL levels.

SINE OR SQUARE OUTPUT

The Pacific 1028 also gives you sine and square wave outputs. Square wave amplitude is 0 to +4 volts for driving TTL.

And the output signals are clean: spurious is at least 60 dB below output.

CALL TODAY

Call Dean Armann today for more information on this new low-cost source.



Pacific Measurements

i n c o r p o r a t e d

940 INDUSTRIAL AVE., PALO ALTO, CA. 94303

(415) 328-0300 / TWX: (910) 373-1171

MICROWAVE POWER METERS / AC DIGITAL VOLTMETERS / POWER SUPPLY TEST SETS
MICROWAVE MEASUREMENT SYSTEMS / LOGARITHMIC CONVERTERS / CRT DISPLAY CONVERTERS

INFORMATION RETRIEVAL NUMBER 78

Factory assembled cable handles 2 to 12.4 GHz

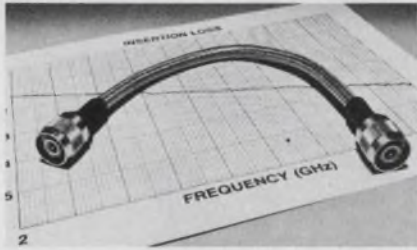

Times Wire & Cable Co., 358 Hall Ave., Wallingford, Conn. 06492. (203) 269-3381.

General-purpose flexible cable assemblies, called Ti-Swept, handle frequencies from 2 to 12.4 GHz. The specifications include a maximum VSWR of less than 1.35 and a maximum insertion loss of only 4.5 dB per 10 feet, both at 12.4 GHz. Ti-Swept assemblies operate from -65 to 200 C. The cable assemblies are factory terminated with type N and TNC connectors to 12.4 GHz and type SC to 8 GHz.

CIRCLE NO. 306

Machinable ceramic cures to steel hardness

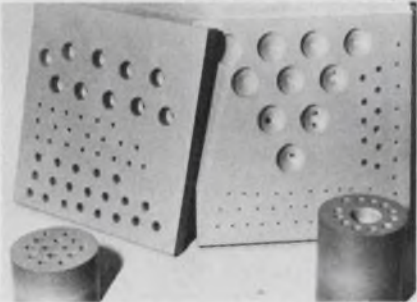

Aremco Products, Inc., P.O. Box 145, Briarcliff Manor, N.Y. 10510. (914) 762-0685. Stock to one wk.

Aremcolox grade 502-1100 machinable ceramic is an alumina silicate that cures to the hardness of tool steel and can be used to 1100 C. The ceramic is readily machined with conventional tooling. Then the ceramic is slowly heated to 2000 F in an air oven to cure. Tolerances of $\pm .002$ in. can be attained after curing and the material can then be ground to tolerances as close as $\pm .0001$ in. Surface finishes of 40 microinch are also possible. The ceramic has the low thermal expansion rate of 1.5×10^{-6} in/in/ $^{\circ}$ F after curing, and it is suitable for high thermal-shock applications.

CIRCLE NO. 307

Electrosensitive paper writes with low volts

Atlan-Tol Industries Inc., W. Warwick, R.I. 02893. (401) 828-7010.

Astro-150 and Astro-300 are new low-voltage electrosensitive print-out papers with surfaces that vaporize in microseconds when an electrical current flows through them. The substrate, which shows through the vaporized area, is black to contrast with the silvery-white surface. The writing produces no smoke or toxic fumes. Electrodes can be a single stylus or a matrix for printing characters. Astro-300 operates on only 3 V and 75 mA and Astro-150 requires 12 to 30 V with only 1 mA. The papers are available in rolls, sheets or packs from 1/2 to 40 in. wide.

CIRCLE NO. 308

Card holds intermix of 14 and 16-pin DIPs

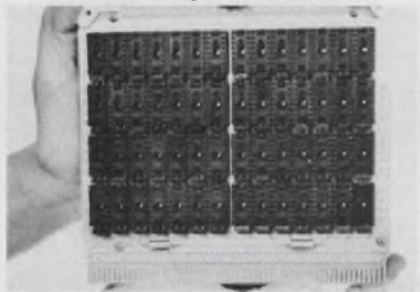

Electronic Engineering Company of California, 1441 E. Chestnut Ave., Santa Ana, Calif. 92701. (714) 835-6000. \$96 (10 up); stock to 2 wks.

Any combination of 14 and 16-pin DIP sockets for a total of 56 units can be mounted on these socket cards. Model 3D2005 is for two-level wire wrapping and 3D-3005 for three-level. The cards feature a low-noise power distribution system that employs one ceramic bypass capacitor per socket and two low-frequency decoupling capacitors per card. Power can be connected to any socket pin with convenient wire loops that snap firmly into place for easy soldering. The 5.8×6.25 in. cards are made of 1/16-in. flame-retardant glass epoxy with special lock-in-place and removal tabs, plated thru-holes, 120 gold-plated connector pins, 22 test points and a plastic shield to protect pins and wires.

CIRCLE NO. 309

Precision tools to pull, lift, poke and push

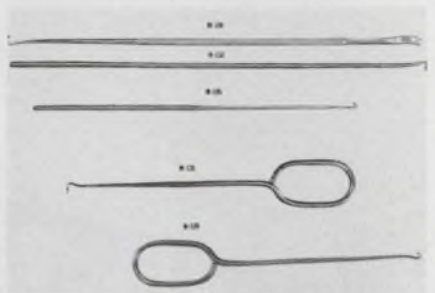

Jonard Industries Corp., 3047 Tibbett Ave., Bronx, N.Y. 10463. (212) 549-7600. \$1.50 to \$1.90; stock.

This series of precision hooks and picks can be used for pushing, pulling or lifting delicate springs and other components in electronic and electromechanical devices in hard-to-reach areas. They are very handy for precision work in the production and service of fine instruments.

CIRCLE NO. 310

Heat sink holds plastic transistor vertically

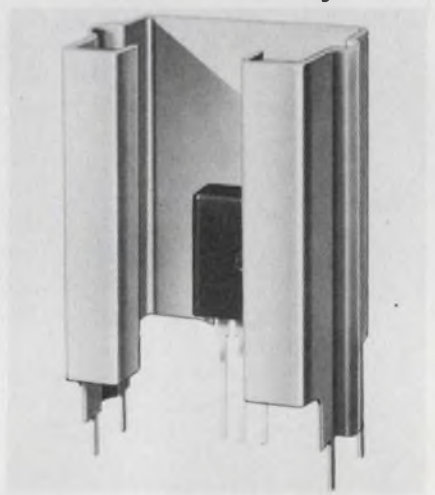

Wakefield Engineering Inc., Audubon Rd., Wakefield, Mass. 01880. (617) 245-5900. \$0.08 to \$0.145 unit qty); stock.

Type 295 coolers allow the vertical mounting of plastic transistors that have a screw hole. The sink is inserted into 0.050 in. holes in the PC board and four lugs automatically attach the sink to the card when it is wave soldered. Four sizes provide a case rise of 75 C above ambient at 3 W dissipation for No. 295-1 and 295-4; a 50 C rise for No. 295-2; and a 38 C rise for No. 295-3. The sink material is tin-plated aluminum 1100-H14.

CIRCLE NO. 320



Looking for one relay to do the work of four?

Our class W relay can transfer as many as 51 circuits at one time. And do it with communications system reliability. That's why it's used for telephone switching and computer peripheral equipment applications. Write us for details on other ways to use it. GTE Automatic Electric, Industrial Sales Division, Northlake, Ill. 60164.

THE SOURCE

GTE AUTOMATIC ELECTRIC
INFORMATION RETRIEVAL NUMBER 79

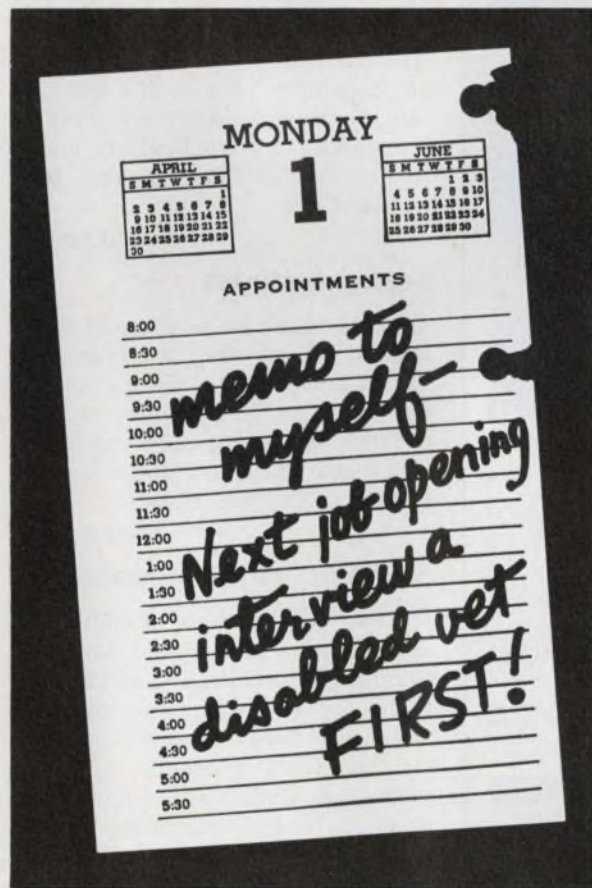

The President's Committee on Employment of the Handicapped
Washington, D.C. 20210

WHEN YOU NEED READOUTS READ THIS

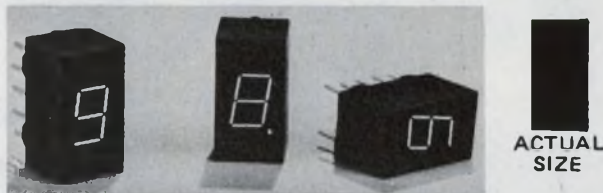

LED (GaAsP) SEGMENTED

Low Power — 125mW per digit typical brightness
Small Size — 10 digits per 3" width
High Legibility — ¼" character with 140° viewing angle
Low Cost — \$2.50 each in quantities of 1000



NUMERIC



BAR INDICATOR



ALPHA NUMERIC

INCANDESCENT

Miniature — Overall: .88 x .46 x .36
Character: .36 x .20
(Also available .50 character height)
Low Power — 5 Volts at 8, 10, or 15 ma per segment
Long Life — 100,000 to 250,000 hours
Bright — 700 to 4500 foot lamberts
Mounting — Standard 16 pin DIP socket
Color — Any color filter may be used.
Low Cost — \$2.70 each in quantities of 1000

LATCH/DECODER/DRIVER

#9368 Drives LED 7015 (No resistors required)
#9370 Drives INCANDESCENT (Constant current)
Low Cost — \$2.15 each in quantities of 1000

Distributed by **CRAMER ELECTRONICS**

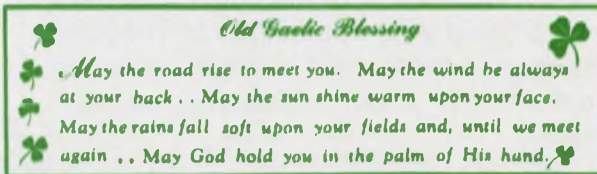

Our Business IS Readouts
write or call for latest specs.

Phone: (714) 755-2641
(714) 755-0145 Telex 69-7992

READOUTS, INC.

P.O. Box 149, Del Mar, California 92014

INFORMATION RETRIEVAL NUMBER 81



to step, turn, push or pull

actuating & positioningsimplified!

incremental action



unidirectional



stepping motors

55 shelf models

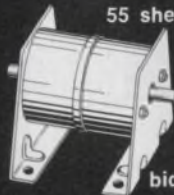

bidirectional

Drive high inertial loads in increments of 10, 15, 20, 30 or 36 degrees. Positive drive clutch doubles as a brake to stop overdrive. Ledex stepping motors follow simple square wave pulses, so you don't need complex logic circuitry. Self-pulsing models also available.

rotary & linear action



life: 100,000,000 cycles

Get direct rotary action, without complicated motion converters, linkages, and the like. Keeps design simple, compact, easy to install and maintain. The uniform output of a Ledex rotary solenoid also makes it a practical solution for many linear actuating applications.

rotary solenoids

250 shelf models

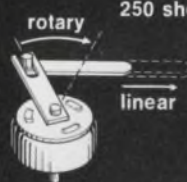

linear action

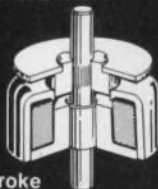

short stroke



medium stroke

push-pull solenoids

72 shelf models



long stroke

Response in less than 5 milliseconds, force to 350 pounds, or strokes to .750" and more . . . At Ledex we vary the shape, the pole face contour, the size, or whatever it takes to give you the exact performance you need. Wide choice of variations make it easy to pick the solution best for you.

Altogether, at Ledex you'll find some 375 simplified actuating and positioning solutions on the shelf. But that's just a starting point. Should your application fall beyond the range of these shelf models, we're the people to see about a simplified custom solution.

LEDEX INC.

123 Webster Street
Dayton, Ohio 45401/513-224-9891

Positioning • Switching • Interface Circuits

Toll free number for name of your nearest representative: 800-645-9200; New York firms call 316-245-0990.



Over 375 ways to step, turn, push or pull, plus interface circuits to control acceleration and deceleration, program pulses and work from logic level sources.



application notes

Measuring LEDs

"Measuring Light-Emitting Diodes with the Model 580/585 Spectroradiometer" describes the unit's capability of measuring both dc and pulsed LEDs over a spectral range of 200 to 3200 nm. Operating procedures are outlined and tables are included. EG&G, Electro-Optics Div., Salem, Mass.

CIRCLE NO. 321

TV tube guide

Television picture tube interchangeability guide lists more than 325 color tubes which can be replaced by 62 Sylvania types and 495 monochrome tubes which can be replaced by 155 Sylvania types. All part numbers are cross-referenced to the company's counterparts in alphanumeric order. GTE Sylvania, Seneca Falls, N.Y.

CIRCLE NO. 322

Picture digitizers

A series of reconstructed digitized pictures which typify the output capability of a high-speed picture digitizer model 108 system is highlighted in Application Memo No. 11. Spatial Data Systems, Inc., Goleta, Calif.

CIRCLE NO. 323

Sealed batteries

A 44-page battery application manual is written by engineers for engineers and covers design features and performance characteristics of hermetically sealed rechargeable batteries. Gates Energy Products, Denver, Colo.

CIRCLE NO. 324

Switches, circuit breakers

Nine "Applications in Industry" notes include background data and technical illustrations on applications for environmental switches and circuit-breaker protection seals ranging from hydraulic lift controls and underwater demolition timers to control instrument meters and refrigeration transport units. APM-Hexseal Corp., Englewood N.J.

CIRCLE NO. 325



Beautiful
New Babies

BOTH TRULY REMARKABLE

CDI's New Baby: Series SL, Linear Slide Switch (Pat. Pending)



Positions: **ANY NUMBER DESIRED** up to 100 (unique feature)

APPLICATIONS: CONTROL FUNCTIONS REQUIRING RAPID POSITION SELECTING

- CATV channel selecting
- High & Low limit switches
- Process equipment controls
- Computers & peripherals
- NC applications
- Many others

OTHER REMARKABLE FEATURES:

Mounts EITHER left/right OR up/down (versatile).
Single or multiple position selectors.
Solder lugs or dip solder termination for p.c. use.
1 or 2-Poles, or coded outputs available.

ELECTRICAL CHARACTERISTICS:

200 megohms min. insulation.
1000 volts min. dielectric strength.
2 amps @ 115 VAC current carrying capability.
125 ma @ 115 VAC current breaking capability.

CDI earns its reputation every day for Consistently High Quality, Consistently Good Delivery, Designing to Your Needs.



CHICAGO DYNAMIC INDUSTRIES, INC.

PRECISION PRODUCTS DIVISION

1725 Diversey Blvd., Chicago, Illinois 60614, Phone (312) 935-4600 TELEX 25-4689

INFORMATION RETRIEVAL NUMBER 83

Free

Bead's New Electronic Components Buyers Guide

Here's "must reading" for design engineers and buyers of electronic components. Complete specs on contact pins, terminals, straight pins, cord tips, eyelets, spacers, special pins, wire leads, 4-slide wire products and Wire Wrap® pins. And it's yours for the asking. Just call or write.



BEAD ELECTRONICS
58 Mountain Grove St.
Bridgeport, Connecticut
06605 (203) 334-4124

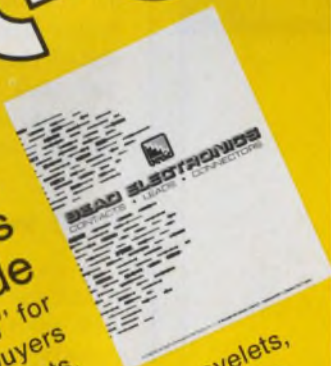

Need a small relay that will take punishment?

Our class H relay may be just the answer. Its unique actuating card assures contact reliability — over 100 million operations are standard. Available from stock too. Write for information, GTE Automatic Electric, Industrial Sales Division, Northlake, Illinois 60164.

THE SOURCE

GTE AUTOMATIC ELECTRIC

INFORMATION RETRIEVAL NUMBER 85

INFORMATION RETRIEVAL NUMBER 84

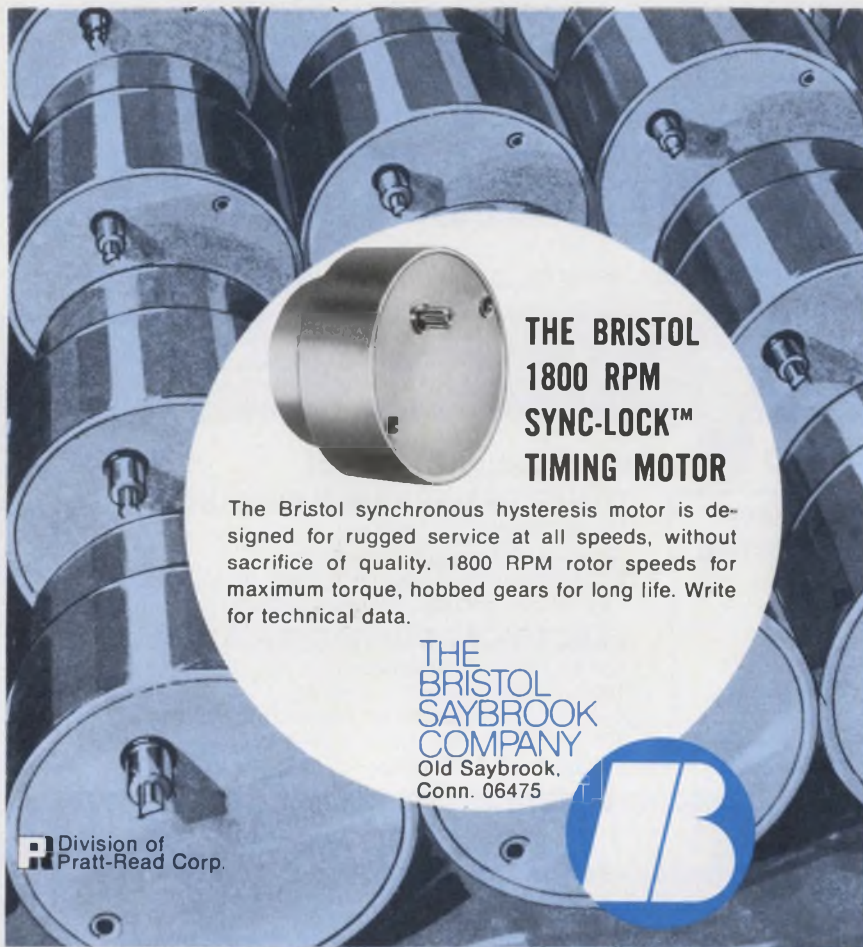

**THE BRISTOL
1800 RPM
SYNC-LOCK™
TIMING MOTOR**

The Bristol synchronous hysteresis motor is designed for rugged service at all speeds, without sacrifice of quality. 1800 RPM rotor speeds for maximum torque, hobbled gears for long life. Write for technical data.

**THE
BRISTOL
SAYBROOK
COMPANY**
Old Saybrook,
Conn. 06475



R Division of
Pratt-Read Corp.

INFORMATION RETRIEVAL NUMBER 86

ANALOG - TO - DIGITAL CONVERTER
15 BINARY BITS - 1.0 MICROSECOND



SERIES 2000 — from 8 bits in 100 nanoseconds to 15 bits in 1.0 microsecond.

SERIES 2100 — from 8 bits in 500 nanoseconds to 15 bits in 3.0 microseconds.

Complete data systems featuring multiplexers and sample and hold amplifiers are available. Up to 256 channels may be provided in one 5¼" high by 19" wide cabinet. High level, low level and simultaneous sample and hold systems are available.



TUSTIN ELECTRONICS CO.
1656 South Minnie Street
Santa Ana, Calif. 92707
(714) 835-0677

INFORMATION RETRIEVAL NUMBER 87

APPLICATION NOTES

Thermistors

A 20-page Thermistor E-I Curve Manual presents a complete story on the use of thermistors in the self-heat mode and is complemented with detailed graphs, charts, working tables and practical problems with solutions and/or answers. Fenwal Electronics, Framingham, Mass.

CIRCLE NO. 326

Power hybrid ICs

Applications for 10-amp power hybrid integrated circuits (PACE/paks) are described in an eight-page application note. Included are 11 circuit diagrams, three graphs and electrical specifications. International Rectifier, El Segundo, Calif.

CIRCLE NO. 327

Metric conversion chart

A pocket-size metric/pressure conversion card makes it possible to read direct pressure conversions from standard US units to their metric equivalents. On the reverse side is a list of metric conversion factors for length, weight, liquid volume and temperature. Rotron, Woodstock, N.Y.

CIRCLE NO. 328

Cycle chart

An easy-to-read chart is designed to show the various plating cycles used in the production of plated throughhole printed circuits for multilayer, conventional and semi-additive boards. The Sel-Rex Co., Nutley, N.J.

CIRCLE NO. 329

Reed switches

A guide to the selection and application of temperature-sensing reed switches includes a detailed description of sensor functions, complete with cross-section drawings. It includes charts showing the relationship of inductance with temperature variations of typical switches and thermal lags or response time vs temperature differentials when a sensor is located in liquid vs one in circulating air. It reports on effects of vibration tests, various chemicals upon the leads and potting material. Hamlin, Inc., Lake Mills, Wis.

CIRCLE NO. 330



Need push-button data entry or control?

Use our Touch Calling, tone generating keysets and receivers. Their reliability has been proven in our telephone systems. Available from stock, too. GTE Automatic Electric, Industrial Sales Division, Northlake, Illinois 60164.

THE SOURCE

GTE AUTOMATIC ELECTRIC
INFORMATION RETRIEVAL NUMBER 88

Precision stainless steel flexible shaft couplings for \$6.!

That's right! One Electron Beam welded, precision, stainless steel bellows shaft coupling for \$6. In fact, we'll sell you all the precision



shaft couplings you request at fantastic savings.

For complete specs and data on the CIL precision couplings.

FILL OUT AND MAIL COUPON TODAY FOR IMMEDIATE RESPONSE

NAME _____

ADDRESS _____

CITY _____

STATE _____

ZIP _____

COMPRESSIVE INDUSTRIES INC.



1342 W. McNab Road
Fort Lauderdale,
Florida 33309
(305) 974-9600



INFORMATION RETRIEVAL NUMBER 89

ELECTRONIC DESIGN 20, September 27, 1973

PIONEER DC BRUSHLESS MOTORS

Reliability and Performance

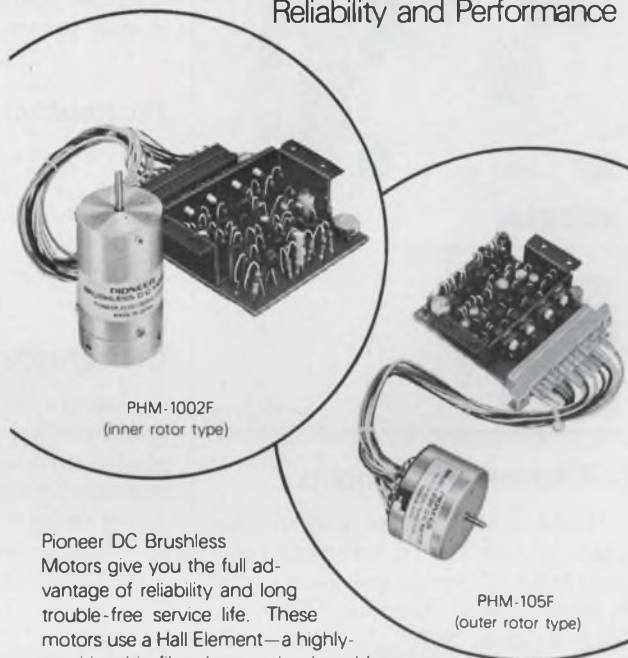

PHM-1002F
(inner rotor type)

PHM-105F
(outer rotor type)

Pioneer DC Brushless Motors give you the full advantage of reliability and long trouble-free service life. These motors use a Hall Element—a highly-sensitive thin film element developed by Pioneer—to sense position of the rotor. The design gives reliability, noiseless and sparkless operation, and a service life 5 to 10 longer than that of brush motors. Fast starting time and stabilized "custom" speeds make them performance-right for a full range of equipment applications. If you design printer, data recorders, documentation recording equipment, etc.—stake your claim in brushless drives now!

* A wide variety of other DC Brushless Motors are also available.

● ELECTRICAL SPECIFICATIONS:

	PHM-1002F	PHM-105F
Operating voltage	10-16V	10-16V
Rated torque	30gr-cm	30gr-cm
Rated revolutions	2,000rpm	2,000rpm
Rated current	350mA	350mA
No-load current	80mA	80mA
Starting torque	70gr-cm (at 10V)	70gr-cm (at 10V)
Speed range	1,000-3,000rpm	1,000-3,000rpm
Operating temp.	-10°C~+60°C	-10°C~+60°C

● OUTSIDE DIMENSION (SIZE IN INCH)

	PHM-1002F	PHM-105F
Rotor	1.18" x 2.05"	1.72" x 1.18"
Electronics circuit	3.19 x 3.15"	3.19 x 3.15"
Shaft diameter	0.0982"	0.0982"

● Write for full technical data:

IMAI MARKETING ASSOCIATES, INC.

525 West Remington Drive, Sunnyvale, California 94087. Phone (408) 245-3511

● Manufacturer:



PIONEER®

PIONEER ELECTRONIC CORPORATION

15-5, 4-chome, Ohmori-Nishi, Ohta-ku, Tokyo 143, Japan
PHONE: (03) 763-2111

INFORMATION RETRIEVAL NUMBER 90

new literature



Coil forms and bobbins

Mechanical drawings and specification charts for transformer bobbins and coil forms are given in a 24-page catalog. Electrical Plastics, Long Branch, N.J.

CIRCLE NO. 331

Hardware kit

A low-cost LED lamp panel-mounting hardware kit designed to simplify panel layout, assembly and installation of LED solid-state lamps is described in a data sheet. Mounting options and physical dimensions are provided. Eldema Div., Genisco Technology Corp., Compton, Calif.

CIRCLE NO. 332

Wire strippers

A catalog includes information on strippers for extruded insulation, automatic wire and tubing cutters, hand wire strippers and wire and solder. The Eraser Co., Syracuse, N.Y.

CIRCLE NO. 333

Optical filters

A designer's guide and catalog describes and lists standard optical filters as well as outlining products and services offered on a custom basis by the company. Infrared Industries, Waltham, Mass.

CIRCLE NO. 334

Data-acquisition system

The SY-257 digital data-acquisition system, signal-conditioning and scanning devices are described in a six-page brochure. B & F Instruments, Cornwells Heights, Pa.

CIRCLE NO. 335

Pushbutton switches

Data necessary to select and order uniform-panel-appearance pushbutton switches are given in a four-page bulletin. Control Switch, Folcroft, Pa.

CIRCLE NO. 336

Conography

Conography, a patented hardware method of generating curve shapes directly from computer data and displaying them on cathode-ray tubes or hard copy, is described in a four-page catalog. Hughes Industrial Products, Oceanside, Calif.

CIRCLE NO. 337

Real-time analyzers

A tutorial brochure, "11 Questions You Should Ask When Buying A Real-Time Spectrum Analyzer" answers such questions as: Why do I need real time? How much resolution do I really need? Can I calibrate frequency and amplitude quickly and accurately? Do I need spectrum averaging? How can I compare past data with new data? How do I know I am analyzing valid data? Can I interface to my computer? Federal Scientific, New York, N.Y.

CIRCLE NO. 338

CATV drop cable shielding

A bulletin covers technical details of the SEED comparative testing technique for accurately measuring shielding effectiveness of CATV service drop cables. The four-page summary presents the purpose and advantages of the technique, outlines the type of data provided, describes the special test fixture and required instruments and provides a step-by-step analysis of the test procedure. Belden Corp., Geneva, Ill.

CIRCLE NO. 339

Switch applications

"Uses Unlimited," an eight-page quarterly, reports on a variety of useful and unusual switch applications. Micro Switch, Freeport, Ill.

CIRCLE NO. 340

Single-sideband transceiver

Design characteristics of 20-W, rugged, single-sideband (2 to 18 MHz) model SBT-22-18 para-military transceiver with break-in cw operation for manpack, portable, mobile and base-station use, are detailed in a four-page catalog. The Hallicrafters Co., Rolling Meadow, Ill.

CIRCLE NO. 341

Linear i-f amplifiers

A short-form catalog describes linear, limiting and logarithmic i-f amplifiers. Included are both commercial and military-grade units covering the frequency range of 2 to 400 MHz. Data are also given for coax cable assemblies. Pasternack Enterprises, Huntington Beach, Calif.

CIRCLE NO. 342

Snap-action switches

A guide to 12 basic series of snap-action switches is contained in a catalog. Product listings, drawings, specifications and operating characteristics are included. Cherry Electrical Products, Waukegan, Ill.

CIRCLE NO. 343

Thyristor design ideas

A 60-page Thyristor New Design Idea brochure contains 22 circuit designs using SCRs, gate-turn-off SCRs, photo-SCRs, light-activated SCRs, nanosecond SCRs and programmable unijunction transistors. All circuits included are fully characterized and explained and are actual working configurations. Unitorde, Watertown, Mass.

CIRCLE NO. 344

Component sockets

A 30-page catalog contains electrical and physical descriptions of component sockets. The catalog lists sockets for ICs, transistors and other semiconductor devices, tubes, capacitors and sockets for other applications. TRW/Cinch Connectors, Elk Grove Village, Ill.

CIRCLE NO. 345

MOTORS AND SPEED CONTROLS



SEND FOR CATALOG

Hundreds of different speed controls, thousands of different motors from the largest stocks in the country. From .02 to 10,000 RPM; Torques to 2000 lbs. Speed ranges to 1000:1. Immediate delivery. Low prices. Bodine, G.E., Electrocraft, and Superior motors. Also torque, synchronous, stepping and permanent magnet motors. A full line of power transmission components too: mechanical speed drives, clutches, brakes, couplings, indicators.

SEND FOR CATALOG

BB B&B Motor & Control Corp.
96 Spring Street, New York, N. Y.
3259 Winton Road S., Rochester, N. Y.

INFORMATION RETRIEVAL NUMBER 91

LOOK to

THE PEOPLE DOING THINGS THAT MATTER... IMAGINATIVELY

electronic research co. • a **tyco** div.

In
Hermetically Sealed
.200 Inch High
Crystal Oscillators

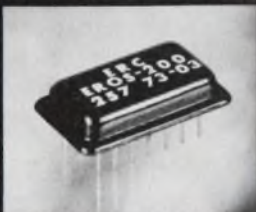

Actual Size

- 30 KHz to 15 MHz
- Ambient Range: up to -50°C to $+105^{\circ}\text{C}$
- Ambient Stability: as good as $\pm .002\%$

Telephone (913) 631-6700
7618 Wedd
Overland Park, Kansas 66204
Mail to: P.O. Box 913, Dept. 119
Shawnee Mission • Kansas 66201
TWX: (910) 749-6477

THE LITTLE DEVICES THAT CAN...

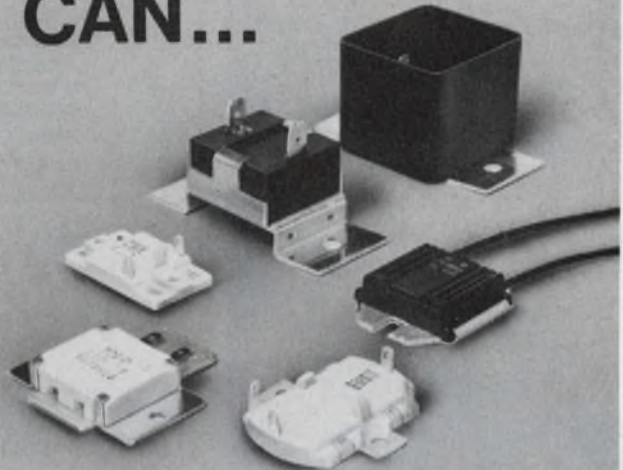

- Start Motors
- Heat Appliances and Ovens
- Control Temperature

MURATA'S NEW POSISTORS!®

What's more, Murata's new Posistors can perform all of these functions with pure, solid state reliability. No contacts. No bi-metal strips. No centrifugal switches. No complex semiconductor circuitry.

Posistors are powerful positive temperature coefficient devices that can switch motor starting windings in and out at up to 12 amps. They can generate enough heat for small appliances and ovens while precisely controlling temperature at the same time. All without moving parts or exotic expensive circuitry.

And, we're sure that you will find applications that we've never dreamed of. Why not find out exactly what Posistors can do for you. Write for complete technical information today.

muRata

MURATA CORPORATION OF AMERICA

2 Westchester Plaza, Elmsford, New York 10523

Telex: MURATA EMFD 137332

Phone: 914/592-9180

A Subsidiary of
Murata Mfg. Co., Ltd., Japan

INFORMATION RETRIEVAL NUMBER 92

TOP QUALITY Still at LOW PRICE

Thermostatic DELAY RELAYS

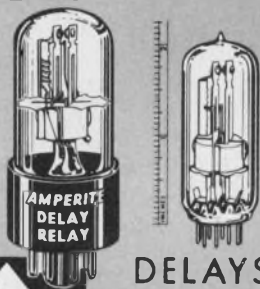

DELAYS:
2 to 180
SECONDS*

Actuated by a heater, they operate on A.C., D.C., or Pulsating Current. Being hermetically sealed, they are not affected by altitude, moisture, or climate changes

... SPST only — normally open or normally closed... Compensated for ambient temperature changes from -55° to $+80^{\circ}$ C... Heaters consume approximately 2 W and may be operated continuously. The units are rugged, explosion-proof, long-lived, and inexpensive!

TYPES: Standard Radio

Octal and 9-Pin Miniature... List Price, \$4.00
*Miniatures Delays: 2 to 120 seconds.

All Amperite Delay Relays are recognized under component program of Underwriters' Laboratories, Inc. for all voltages up to and including 115V.

PROBLEM? Send for Bulletin No. TR-81.

AMPERITE BALLAST REGULATORS

Hermetically sealed, they are not affected by changes in altitude, ambient temperature (-50° to $+70^{\circ}$ C), or humidity... Rugged, light, compact, most inexpensive.

List Price, \$3.00

Write for 4-p. Bulletin No. AB-51.



AMPERITE

600 PALISADE AVE., UNION CITY, N.J. 07087

Telephone: 201 UNION 4-9503

In Canada: Atlas Radio Corp., Ltd.,
50 Wingold Ave., Toronto 10

NEW LITERATURE



Ceramic capacitors

Subminiature ceramic capacitors are described in a 12-page catalog. Republic Electronics Corp., Paterson, N.J.

CIRCLE NO. 347

Rocker switches

Double-wipe rocker switches featuring offset mounting brackets for easier installation are described in a four-page brochure. Switchcraft, Chicago, Ill.

CIRCLE NO. 348

Bridge rectifiers

Miniature, silicon, single-phase bridge rectifiers that offer a reduction in space requirements are described in a two-page bulletin. Edal Industries, East Haven, Conn.

CIRCLE NO. 349

Standard or custom closures

A 20-page illustrated catalog describes standard and custom closures of push-in and screw-in types. Clover Industries, Tonawanda, N.Y.

CIRCLE NO. 350

Semiconductor packaging

A four-page illustrated folder describes semiconductor packaging materials such as solder glasses, passivating glasses, glass preforms and diode tubing. Charts are used to list properties of selected solder, passivating and preform glass. Corning Glass Works, Corning, N.Y.

CIRCLE NO. 351

Traveling wave tubes

A 28-page catalog describes traveling wave tubes, amplifiers and power supplies. Operating characteristics of representative low-noise TWTs, low, medium and high-power cw TWTs, pulsed TWTs, amplifiers, power supplies and amplifier subsystems are detailed. Varian, Palo Alto, Calif.

CIRCLE NO. 352

Temp measurement systems

Automated on-line temperature measurement, monitoring and control systems, as well as portable, low-cost thermometers, are detailed in a catalog. Specifications table, temperature-conversion chart and a summary of infrared radiometry are supplied. Williamson Corp., Concord, Mass.

CIRCLE NO. 353

Opto-electronic products

Technical data on opto-electronic products are given in a catalog. Parameters, photographs, package configurations and dimensional drawings are included. Optron, Carrollton, Tex.

CIRCLE NO. 354

Thermal switches

Compact thermal switches capable of activating at preset temperatures between -65 and $+1850$ F are illustrated in a four-page brochure. Control Products, East Hanover, N.J.

CIRCLE NO. 355

Pressure transducers

A short-form catalog describes pressure transducers and strain-gauge transducers. Selection of the proper range, type, accuracy and transducer price is condensed into a four-page catalog. Sensotec Inc., Cols., Ohio.

CIRCLE NO. 356

Slide and rocker switches

A design and specification catalog covers slide and rocker switches. Included are case dimensions, schematic diagrams, PC-board patterns and ratings for slide, rocker and miniature switches. Special sections feature TV-rated switches and double-wipe slide switches. Stackpole, Raleigh, N.C.

CIRCLE NO. 357

bulletin board

Analog Devices has announced price increases affecting most major models in its DPM line. The AD2002 has been increased from \$50 to \$59 (100 qty); the AD2003 increased from \$93 to \$99 (100 qty); the AD2004 increased from \$189 to \$199 (100 qty); and the AD2010 increased from \$79 to \$89 (100 qty).

CIRCLE NO. 358

Sola Electric Div. of Sola Basic Industries has announced a 4.5% price increase on power supplies, line-voltage regulators and constant-voltage transformers.

CIRCLE NO. 359

A 50-cents-a-pound price reduction in truckload quantities of Tefzel 200 fluoropolymer—a melt-processible thermoplastic for electrical, chemical and mechanical applications—has been announced by DuPont.

CIRCLE NO. 360

Hewlett-Packard has reduced the prices on two microwave beam-lead Schottky diodes. Price of the Ku-band, 12.4 to 18 GHz, Model 5082-2716 is dropped from \$15 to \$9.50 (1-99), from \$12.75 to \$8.15 (10-99), and from \$10.50 to \$7.50 (100 up). The X-band, 8.2 to 12.4 GHz, Model 5082-2709, has been reduced to \$5.75 from \$8.50 (10-99). In quantities of 100, prices are dropped from \$7 to \$5.25.

CIRCLE NO. 361

Conrac Corp. has announced a 22% price reduction on its CM series certified metal computer cassettes. The cassettes cost \$4.25 (1000-up).

CIRCLE NO. 362

Intel Corp. has introduced a line of microcomputer modules for expanding the capability of its Inteltec modular microcomputer development systems as well as providing off-the-shelf modules for preproduction systems.

CIRCLE NO. 363

Compact package...
dual speed capabilities
and 5.5 oz-in.
synchronous
torque at
600 rpm.

Meet the 86600...workhorse of our economy-priced synchronous motor family.

Designing medical or scientific instruments, computer peripherals, environmental control units or other devices needing a better synchronous drive? Take a look at our new, compact 86600 economy-priced synchronous motor. Its increased power can open up whole new design possibilities for you.

Greater Torque

A UL recognized component and built to NEMA type 2-11 configuration, the 86600 gives you 5.5 oz-in at 600 rpm rotorspeed. You have a selection of 10 gear trains to handle torque loads up to 200 oz-in.

Dual Speed Capabilities

High torque isn't the only advantage you'll gain. You can use the

86600 either as a single speed electrically reversible motor, or you can specify it in a variety of unidirectional dual speed combinations. Either way, the 86600 is reliable, efficient and compact. A real space saver! Models are available for 120 VAC, 24 VAC, or 230 VAC.

All in the Family

If your requirements call for something else, remember that NAPCC offers a full range of synchronous motors—starting at .75 oz-in at 300 rpm rotor speed. Chances are we can fill your needs off the shelf. If not, we have the capabilities to design and build a motor to your specifications. Try us.

Write for details today!

A. W. HAYDON CO. PRODUCTS

NORTH AMERICAN PHILIPS CONTROLS CORP.

A NORTH AMERICAN PHILIPS COMPANY
Cheshire, Conn. 06410 • (203) 272-0301

INFORMATION RETRIEVAL NUMBER 95

The Servo-Tek World of DC Servomotors



Wide range of permanent-magnet dc models available.

Servo-Tek's Permanent-Magnet DC Servomotors are precision made to give highly reliable performance. Their stability, high output to size ratio and speed range from 0-10,000 rpm with output torques to 2.0 oz-in make them ideal as prime movers in servomechanisms. Diameter 1.135 in. lengths up to 3.253 in. A unique field structure of Alnico VI results in minimized cogging (slot lock), a prerequisite to optimum servo performance. Models are available with a variety of operating voltages and with various mountings and integral gearing. Moderately priced with quantity discounts.

FREE CATALOG of rotating components available.

Be Selective. Turn To...

SERVO-TEK
PRODUCTS COMPANY

1086 Goffle Road, Hawthorne, NJ 07506 · 201-427-3100

Servo-Tek of California, Inc.

8155 Van Nuys Blvd., Van Nuys, CA 91402 · 213-786-0690

INFORMATION RETRIEVAL NUMBER 96

Who should know more about using semiconductor fuses than a semiconductor company?

No one. That's why IR wrote the book on it.

For 25 years we've specialized in semiconductors. We know how to get the most out of them. We know what they need in the way of protection.

Now we're introducing what we think is the finest semiconductor fuses available — AMPKLIP fuses, rated at 130 to 700-Volts, with all-welded construction and a ceramic body. And we wrote the book on how to apply them.

This 100-page handbook lets you do



a better job of selection, because we tell you more about fuse behavior than anyone else. Our fuses are rated by semiconductor experts. We give you curves and graphs on every single rating. We tell you exactly what happens under "worst case" conditions.

This book can spell the end of trial and error fuse selection. To get your copy, call your local IR sales office or distributor, or write on company letterhead to International Rectifier, 233 Kansas Street, El Segundo, California 90245.

... the innovative power people

INTERNATIONAL RECTIFIER



INFORMATION RETRIEVAL NUMBER 97

Electronic Design

ELECTRONIC DESIGN's function is:

- To aid progress in the electronics manufacturing industry by promoting good design.
- To give the electronic design engineer concepts and ideas that make his job easier and more productive.
- To provide a central source of timely electronics information.
- To promote communication among members of the electronics engineering community.

Want a subscription? ELECTRONIC DESIGN is sent free to qualified engineers and engineering managers doing design work, supervising design or setting standards in the United States and Western Europe. For a free subscription, use the application form bound in the magazine. If none is included, write to us direct for an application form.

If you do not qualify, you may take out a paid subscription for \$30 a year in the U.S.A., \$40 a year elsewhere. Single copies are \$1.50 each.

If you change your address, send us an old mailing label and your new address; there is generally a postcard for this bound in the magazine. You will have to requalify to continue receiving ELECTRONIC DESIGN free.

The accuracy policy of ELECTRONIC DESIGN is:

- To make diligent efforts to ensure the accuracy of editorial matter.
- To publish prompt corrections whenever inaccuracies are brought to our attention. Corrections appear in "Across the Desk."
- To encourage our readers as responsible members of our business community to report to us misleading or fraudulent advertising.
- To refuse any advertisement deemed to be misleading or fraudulent.

Microfilm copies are available of complete volumes of ELECTRONIC DESIGN at \$19.00 per volume, beginning with Volume 9, 1961. Work is now in process to complete the microfilm edition of Volumes 1-8. Reprints of individual articles may be obtained for \$2.00 each, prepaid (\$.50 for each additional copy of the same article) no matter how long the article. For further details and to place orders, contact the Customer Services Department, University Microfilms, 300 North Zeeb Road, Ann Arbor, Michigan 48106 telephone (313) 761-4700.

Want to contact us? If you have any comments or wish to submit a manuscript or article outline, address your correspondence to:

Editor
ELECTRONIC DESIGN
50 Essex Street
Rochelle Park, N.J. 07662

Electronic Design

Advertising Sales Staff

Tom W. Carr
Vice President &
Sales Manager

Rochelle Park, N.J. 07662

Robert W. Gascoigne
Daniel J. Rowland
50 Essex Street
(201) 843-0550
TWX: 710-990-5071

Philadelphia

Thomas P. Barth
50 Essex Street
Rochelle Park, N.J. 07662
(201) 843-0550

Boston 02178

Gene Pritchard
P.O. Box 379
Belmont, Mass. 02178
(617) 489-2340

Chicago 60611

Thomas P. Kavooras
Berry Conner, Jr.
200 East Ontario
(312) 337-0588

Cleveland

Thomas P. Kavooras
(Chicago)
(312) 337-0588
(call collect)

Los Angeles 90303

Stanley I. Ehrenclou
Burt Underwood
2930 Imperial Highway
Inglewood, Calif.
(213) 757-0183

San Francisco 94022

Jerry D. Latta
P.O. Box 1248
Los Altos, Calif.
(415) 965-2636

London W. 1

For United Kingdom and Holland
Brayton C. Nichols

For Eastern Europe
Peter Kehr

The American Magazine Group

9 Warwick Street
London, W. 1, England
Phone: 437 5462
Cable: Ammagnic, London

Tokyo

Haruki Hirayama
Electronic Media Service
5th Floor, Lila Bldg.,
4-9-8 Roppong
Minato-ku
Phone: 402-4556
Cable: Electronicmedia, Tokyo

Recruitment, Quick Ads, Classified

Allen Weinberg
50 Essex Street
Rochelle Park, N.J. 07662
(201) 843-0550



OUR CLAIM TO FAME... TRIMLINE ENCLOSURES

- RUGGED—FUNCTIONAL CONSTRUCTION
- ESTHETICS KEYED TO MODERN SYSTEMS
- ECONOMICAL PRICING
- PROMPT SERVICE & AVAILABILITY

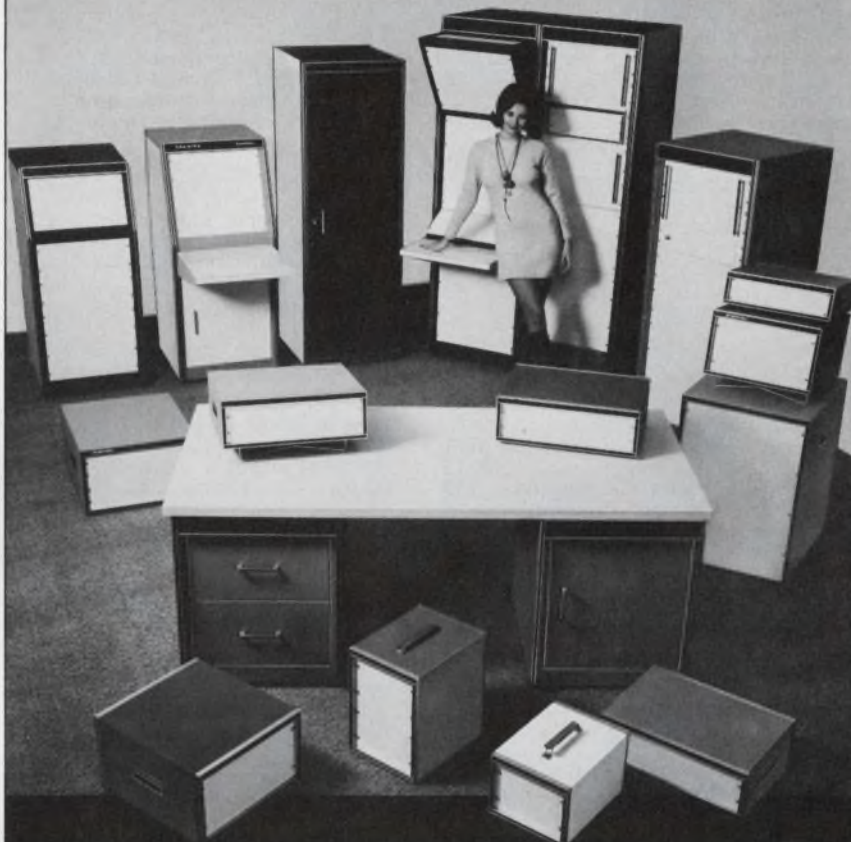

INSTRUMENT CASES—TIC SERIES

TVA Series Vertical Assembly—
Construction Details
(1 Frame, 2 End Panels, Rear Door)

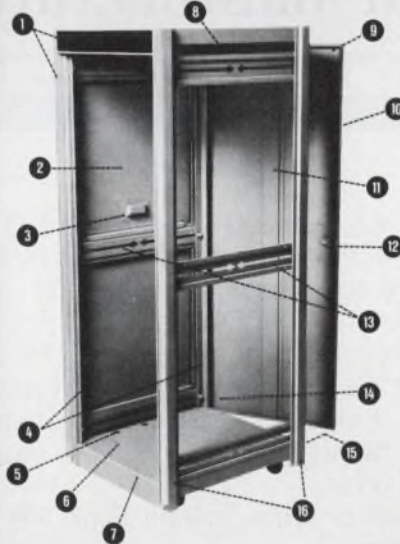

1. Trim: extruded anodized aluminum with textured vinyl inlays
2. Outside removable flush end panels (16 ga.)
3. Recessed hand grip for panel removal
4. 2 pr. panel mounting angles, fully adjustable front to rear with tapped 10-32 holes on EIA & WE Standards spacing (12 ga.)
5. 1" dia. holes for cable entry beneath base
6. Recessed caster mounting holes
7. 1 piece formed steel base provides for heavy equipment mounting area and concealed caster mounting (14 ga.)
8. 1 piece solid top for extra rigidity and squareness (14 ga.)
9. Foam gasketing (3 sides)
10. Magnetic closure gasket
11. Door stiffener channel
12. Keyed latch and brushed aluminum pull handle
13. Horizontal cross-brace and panel mounting angle supports
14. Quick release, spring loaded door hinges (top and bottom)
15. 1 1/8" dia. knock-outs for rear cable entry underneath rear door
16. Formed steel uprights (14 ga.) provide 1/2" recess to panel mounting angles

All features shown are standard in the Trimline TVA Series
Welded, formed steel construction

Complete catalog and prices on request



PREMIER METAL PRODUCTS COMPANY
337 Manida St., Bronx, N.Y. 10474/(212) 991-6600

advertiser's index

Advertiser	Page
ADC Products, A Division of Magnetic Controls Company.....	138
AMP, Incorporated	29
Allen Bradley Co.	38
American Microsystems, Inc.....	123
Amperite Co., Inc.	154
Amphenol, The Bunker-Ramo Corporation	10, 11
Amphenol Industrial Division, The Bunker-Ramo Corporation	46, 47
Analog Devices, Inc.....	137
Arnold Magnetics Corp.....	161
Avantek, Inc.	83
B & B Motor & Control Corp.....	153
Bead Electronics	149
Beckman Instruments, Inc., Helipot Division	111
Bodine Electric Company.....	12, 13
Boonton Electronics Corporation.....	133
Bourns, Inc., Trimpot Products Division	31
Bristol Saybrook Company.....	150
Caddock Electronics	119
Cherry Electrical Products Corp.....	97
Chicago Dynamics Industries, Inc.....	149
Circuit Stik, Inc.	134
Compressive Industries, Inc.....	151
Computer Devices, Inc.	122
Continental Connector Corporation.....	135
Custom Electronics, Inc.....	136
Cutler-Hammer, Specialty Products Division	51

Advertiser	Page
Data Precision Corporation.....	161
Elco Corporation	15
Electric Indicator Co.....	130
Electronic Arrays, Inc.....	14
Electronic Research Co.....	153
EMC Motor Company.....	161
Exar Integrated Systems.....	1
Fairchild Semiconductor, A Division of Fairchild Camera and Instrument Corporation.....	74, 75
Federal Scientific Corporation.....	158
GTE Automatic Electric, Industrial Sales Division.....	147, 149, 151
Garry Manufacturing Co.....	98
General Electric Company.....	17, 140
General Instrument Corporation	124, 125
Hayden Book Company, Inc.	96, 108, 109, 161
Hewlett-Packard	2, 42, 43, 128, 129
Hico	161
ILC Data Devices, Inc.....	16
IMC Magnetics Corporation.....	132
Imperial Travel Service	66
Indiana General, Electronic Products	115
Instrument Specialties Company, Inc.	113
International Rectifier	103, 156
Johanson Manufacturing Corp.....	161

Advertiser	Page
Kollmorgan Corporation, Printed Motors Division.....	8, 9
Lambda Electronics Corp.....	Cover II
Ledex, Inc.	148
Litronix, Inc.	82
Magnecraft Electric Company.....	162
Mica Corporation	121
Microswitch, A Division of Honeywell	4, 5, 65
MicroWaves Directory	36
Molex, Incorporated	Cover III
Monolithic Memories, Inc.....	37
Motorola Components Products Dept.	81
MuRata Corporation of America.....	153
National Connector	161
National Semiconductor Corporation	16 A1—16 A6
Newport Laboratories, Inc.....	34
North American Philips Controls Corp.	155
Oak Industries, Inc.	32, 32 A1—A8, 33
Optron, Inc.	7
Pacific Measurements	145
Philips Industries	48
Phoenix Data, Inc.....	160
Photocircuits	8, 9
Piher International	117
Pioneer Electronic Corporation.....	151
Pittman Corporation, The.....	142
Plessey Semiconductors	48
Pomona Electronics	80
Power/Mate Corp.	161
Premier Metal Products Company.....	157
RCA Solid State Division.....	Cover IV
Readouts, Inc.	147
Reliability, Inc.	144
Rolm Corporation	143
Ross Controls Corporation.....	142
Rotron, Inc.	141
Servo-Tek Products Company.....	156
Signetics Corporation	21
Siliconix, Incorporated	44
Simpson Electric Company.....	87
Singer Company, Inc., Kearfott Division	99
Sorensen Company, A Unit of Raytheon Company.....	49, 50, 82A—F
Sprague Electric Company.....	6
Stackpole Components Company.....	102
TRW Electronics Components.....	92, 93
TRW Globe Motors.....	118
TRW/IRC Fixed Resistors.....	127
TRW Semiconductors	18
Tektronix, Inc.	41, 107, 131
Teledyne Philbrick	27
Teledyne Semiconductors	96
Texas Instruments, Incorporated.....	35
Tri-Data Corporation	88, 89
Tustin Electronics Co.....	150
Union Carbide Components Dept.....	139
Wiley & Sons, Inc., John.....	67

Design Data from Manufacturers

Advertisements of booklets, brochures, catalogs and data sheets. To order use Reader-Service Card (Advertisement)

Free FFT Report

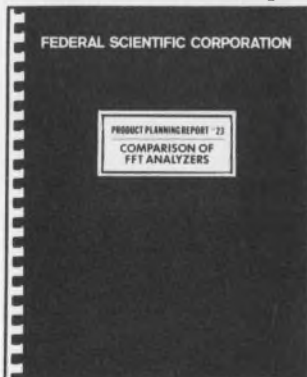

Recently we analyzed in detail the FFT systems currently on the market, spec by spec, so that we could design a better unit . . . our own Omniferous™ FFT Analyzer.

This comparison report, Product Planning Report #23, is available to you if you're interested. It includes comparisons of speed, dynamic range, usable resolution, ease-of-use, and price.

Please call or write Joseph Flink, VP Data Processing.

CIRCLE NO. 171

Federal Scientific Corp.

An affil. of Nicolet Instrument
615 West 131st St., New York, N.Y. 10027. (212) 286-4400

Servo-Tek Products Company.....	156
Signetics Corporation	21
Siliconix, Incorporated	44
Simpson Electric Company.....	87
Singer Company, Inc., Kearfott Division	99
Sorensen Company, A Unit of Raytheon Company.....	49, 50, 82A—F
Sprague Electric Company.....	6
Stackpole Components Company.....	102
TRW Electronics Components.....	92, 93
TRW Globe Motors.....	118
TRW/IRC Fixed Resistors.....	127
TRW Semiconductors	18
Tektronix, Inc.	41, 107, 131
Teledyne Philbrick	27
Teledyne Semiconductors	96
Texas Instruments, Incorporated.....	35
Tri-Data Corporation	88, 89
Tustin Electronics Co.....	150
Union Carbide Components Dept.....	139
Wiley & Sons, Inc., John.....	67

COMING NOV. 22

A MAJOR, IN-DEPTH ISSUE
OF YEAR-LONG REFERENCE VALUE

INSTRUMENTATION '73

On November 22, **Electronic Design's** editors will go all out to provide readers with an exceptional issue: INSTRUMENTATION '73. Emphasis will be both on the **design** and **use** of test and measuring instruments. The report covers both **conventional instruments**—oscilloscopes, spectrum analyzers, voltage-current-resistance measuring instruments, time and frequency measuring instruments, signal sources, recording instruments, and circuit testers, and **newer unconventional instruments**—such as logic analyzers, logic probes and clips, digital memory oscilloscopes, etc. You'll find latest state of the art information, latest advances in component and circuit design that have made new performance levels both possible and practical. New approaches to packaging are also covered.

The user will be given tips on the problems that surround buying and using test and measuring instruments. Special attention is given to systems and computer compatibility. Trade-offs, and details on manufacturers' specs are included. It's an issue that will be extremely valuable for months to come.

Note: If your company has made significant new developments in instrumentation, be sure our editors know about it. (You may also want to tip off your own ad department if you are involved in this field. It's going to be a red hot issue!)

Electronic Design

*Call the
HOTLINE
today
for complete
information:
(201) 843-0550
extension 209*

**PERSONNEL
RECRUITMENT
ADVERTISING
IN
Electronic Design
REACHES THE
RIGHT PEOPLE
AT A LOWER COST
PER THOUSAND**

NOW!

42 NEW MODULAR A/D converters



One of two compact cases (2" x 4" x .39") that contain the 42 new Phoenix Data modules.

All 42 units in Phoenix Data's six new series of modular A/D converters—ADC1300 through ADC1800—employ the highly reliable and stable voltage switching successive approximation conversion technique. Note these features:

- 8 through 14 bit resolution.
- Overall T.C. to 2.5PPM/°C.
- No adjustments over 10°C to 40°C range.
- Factory calibrated and pre-trimmed.
- RFI and EMI shielded.
- Pin selectable input ranges.
- Conversion time to 2 μ sec: 8 bits; 4 μ sec: 12 bits; 10 μ sec: 14 bits.
- Optional temperature ranges from -55°C to +125°C.
- Guaranteed monotonicity.
- Accuracy to 0.01%.

If it's stability, accuracy, speed, or all-around quality you need in Data Conversion, contact Phoenix Data *now!*



PHOENIX DATA, INC.

3384 W. OSBORN RD. PHOENIX, AZ 85017
Ph. (602) 278-8528, TWX 910-951-1364

product index

Information Retrieval Service. New Products, Evaluation Samples (ES), Design Aids (DA), Application Notes (AN), and New Literature (NL) in this issue are listed here with page and Information Retrieval numbers. Reader requests will be promptly processed by computer and mailed to the manufacturer within three days.

Category	Page	IRN	Category	Page	IRN
Components			heat sink	146	320
capacitor, poly-carbonate	138	293	modules, Navy SHP	144	304
capacitor, volt-var.	140	297	packaging, gold free	144	302
capacitors, ceramic	154	347	paper, electrosensitive	146	308
indicators	138	292	rework kit	144	305
load cell	140	296	rivets, nylon	144	303
meter, edge-reading	142	299	semiconductor packaging (NL)	154	351
motor, tape-drive	142	301	tools, hooks and picks	146	310
opto-electronic products (NL)	154	354	wire strippers (NL)	152	333
rectifiers, bridge (NL)	154	349	Power Sources		
relay, time-delay	140	294	batteries, rechargeable	130	276
resistors, chip	140	295	converter, sonic power	129	269
sockets, component (NL)	152	345	fuel cell	129	270
switch applications (NL)	152	340	supplies, open-frame	129	273
switch, pushbutton	142	300	supplies, slot 3 A	132	278
switch, thermal reed	140	298	supply, deuterium lp	129	272
tachometer generator	138	291	supply, dual output	130	277
transducers, pressure (NL)	154	356	supply, high voltage	129	271
			supply, high voltage	132	279
			supply, programmable	130	274
			supply, triple output	130	275
ICs & Semiconductors			new literature		
current source	120	257	amplifiers, i-f	152	342
diodes, monolithic, dual	120	258	analyzers, real-time	152	338
thyristor design ideas (NL)	152	344	CATV drop cable		
transistor, rf power	122	254	shielding	152	339
			capacitors, ceramic	154	347
Instrumentation			closures	154	350
analyzer, signal	133	280	coil forms, bobbins	152	331
counter	134	283	conography	152	337
counter	136	287	data acquisition system	152	335
generator, function	133	281	filters, optical	152	334
generator, time code	134	285	hardware kit	152	332
IC tester	134	284	opto-electronic products	154	354
interface	136	288	rectifiers, bridge	154	349
magnetometer	134	282	semiconductor		
meter, rf power	136	290	packaging	154	351
scopes	136	289	sockets, component	152	345
temperature indicator	136	286	switch applications	152	340
temp. measurement system (NL)	154	353	switches	154	357
			switches, pushbutton	152	336
			switches, rocker	154	348
			switches, snap action	152	343
			switches, thermal	154	355
			thyristor design ideas	152	344
			transceiver	152	341
			traveling wave tubes	154	352
			wire strippers	152	333
Modules & Subassemblies			application notes		
amplifier, high freq.	126	264	batteries, sealed	148	324
amplifier, instr.	126	266	cycle chart	150	329
amplifier, servo	126	265	ICs, amp power hybrid	150	327
amplifiers, i-f (NL)	152	342	measuring LEDs	148	321
converter, a/d	125	261	metric conversion		
converter, V to F	126	268	chart	150	328
converters, d/a	125	260	picture digitizers	148	323
counter, unidirectional	126	267	switches, circ. breakers	148	325
keyboard, 12-key	125	259	switches, reed	150	330
programmer, switch	126	263	TV tube guide	148	322
relay, time delay	125	262	thermistors	150	326
Packaging & Materials					
cables, high frequency	146	306			
card, DIP	146	309			
ceramic, machinable	146	307			
coil forms, bobbins (NL)	152	331			
hardware kit (NL)	152	332			



***FREE: 10-1000 Design Motor Idea Data Pamphlets;** sub-miniature, low inertia, Swiss precision, ironless rotor; PM motors; 10 sizes 12-32mm; eff. 80-90%; starting torque to 6-8 oz"; Blowers 1" & 1½" diam; 5-15CFM. **HICO**, 716 Willow Road, Menlo Park, Ca. 94025. 415-328-1111.

INFORMATION RETRIEVAL NUMBER 181

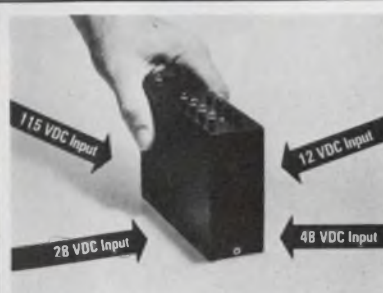

DC-DC Regulated Power Converters—packaged into pretested, encapsulated miniature packages with 6 watts/in³. Modular design allows you to specify your own custom system without engineering charges. Inputs of 12, 28, 48, & 115 VDC with up to 6 outputs. Immediate delivery. Arnold Magnetics, Culver City, Ca. 90230. (213) 870-7014.

INFORMATION RETRIEVAL NUMBER 182



Thin-Trim variable capacitors provide a reliable means of adjusting capacitance without abrasive trimming or interchange of fixed capacitors. Series 9401 has high Q's and a range of capacitance values from 0.2-0.6 pf to 3.0-12.0 pf and 250 WVDC working voltage. Johanson Manufacturing Corporation, Boonton, New Jersey (201) 334-2676.

INFORMATION RETRIEVAL NUMBER 183



Permanent Magnet Synchronous Motor. Low cost motor provides torque to 10 in-lbs at 300 RPM rotor. Features electric reversability, instant start/stop, permanent lubrication, quiet operation, and compact size—2-1/4" dia. x 1-1/8" long. For computer peripherals, control devices, chart drives, and similar applications. ECM Motor Co., 1301 E. Tower Rd., Schaumburg, Ill. 60172.

INFORMATION RETRIEVAL NUMBER 184



Thick Film Technology—Fundamentals and Applications in Microelectronics, by Jeremy Agnew. From design to finished product, this book details each processing phase, describing what to do and what pitfalls to avoid. 176 pp., 6 x 9, illus., cloth, \$8.50. Circle number for 15-day examination copy. Hayden Book Company, Rochelle Park, N.J. 07662.

INFORMATION RETRIEVAL NUMBER 185

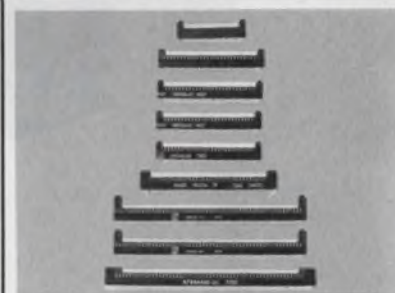

New headers—Here's our new top line of nine right angle molded printed circuit headers for use with 0.100" center wire wrapped plates. One 34-pin model, four 56-pins, one 70-pin and three 112-pins. Your National Connector salesman has all the details. NATIONAL CONNECTOR, 5901 So. County Rd. 18, Mpls., Mn. 55436. (612) 935-0133.

INFORMATION RETRIEVAL NUMBER 186



Auto-ranging 4-1/2 digit DMM, \$675. Model 2440 measures 100 μ V to 1000 VDC (accuracy $\pm 0.007\%$ of reading ± 1 l.s.d.); 100 μ V to 500 VAC; 2-wire & 4-wire resistance; DC/DC & AC/DC ratio. Includes auto-range, auto-zero, remote range & trigger, & isolated BCD output. Data Precision Corp., Wakefield, MA 01880. (617) 246-1600

INFORMATION RETRIEVAL NUMBER 187

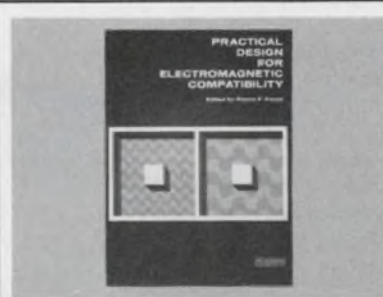

Practical Design for Electromagnetic Compatibility, edited by Rocco Ficchi. An on-the-job manual giving designers practical techniques for analyzing, predicting, controlling, and reducing unwanted signals. 272 pp., 7-1/8 x 9-3/4, illus., cloth, \$13.95. Circle number for 15-day examination copy. Hayden Book Company, Rochelle Park, N.J. 07662.

INFORMATION RETRIEVAL NUMBER 188

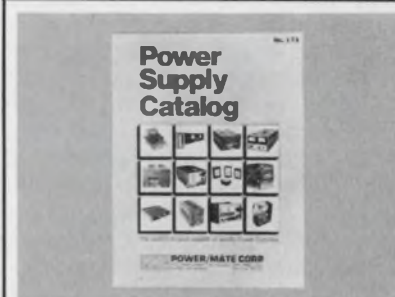

Free catalog of 34,500 power supplies from the worlds largest manufacturer of quality Power Supplies. New '73 catalog covers over 34,500 D.C. Power Supplies for every application. All units are UL approved, and meet most military and commercial specs for industrial and computer uses. Power Mate Corp. (201) 343-6294.

INFORMATION RETRIEVAL NUMBER 189

WE'VE GOT THE

TIME



FOR YOUR APPLICATION . . . in all shapes, sizes, and timing ranges. Time Delay Relays with slow operate or slow release and time repeat accuracy to $\pm 1\%$. At Magnecraft we take great pride in the broad line of Time Delay Relays available from stock for immediate delivery and even more on special order.

Solid State Hybrid, Solid State-Static Output, Air Dash-pot, Copper Slug are some of the types to name just a few. Features such as plug-in, surface mount, printed circuit, screw terminals, solder terminals, quick connect terminals, panel mount, power switching, remote pot, knob adjust, screwdriver adjust, allen head adjust, open type, dust covered, hermetically sealed, economy, manually actuated, multiple contacts, auxiliary output, extended voltage, special purpose . . . the list is almost endless.

Maybe you don't need contacts rated to 100 amperes or timing repeatability to $\pm 1\%$ but we have them available just in case. That's where a broad line can save you money, you don't have to take more than you need. We have just the one to fit your needs . . . and if we don't, we'll make it.

Magnecraft ELECTRIC COMPANY

5575 NORTH LYNCH AVENUE • CHICAGO, ILLINOIS 60630 • 312 • 282-5500 • TWX 910 221 5221

FREE!



TIME DELAY
RELAY
HANDBOOK

Do you know how to properly specify a time delay relay? We have a dandy 92-page handbook that can help you. It describes applications you've never thought of. It offers suggestions on how to specify, testing procedures, comparisons of one type to another, principles of operation, and a glossary of terms. This is yours for the asking.

INFORMATION RETRIEVAL NUMBER 100

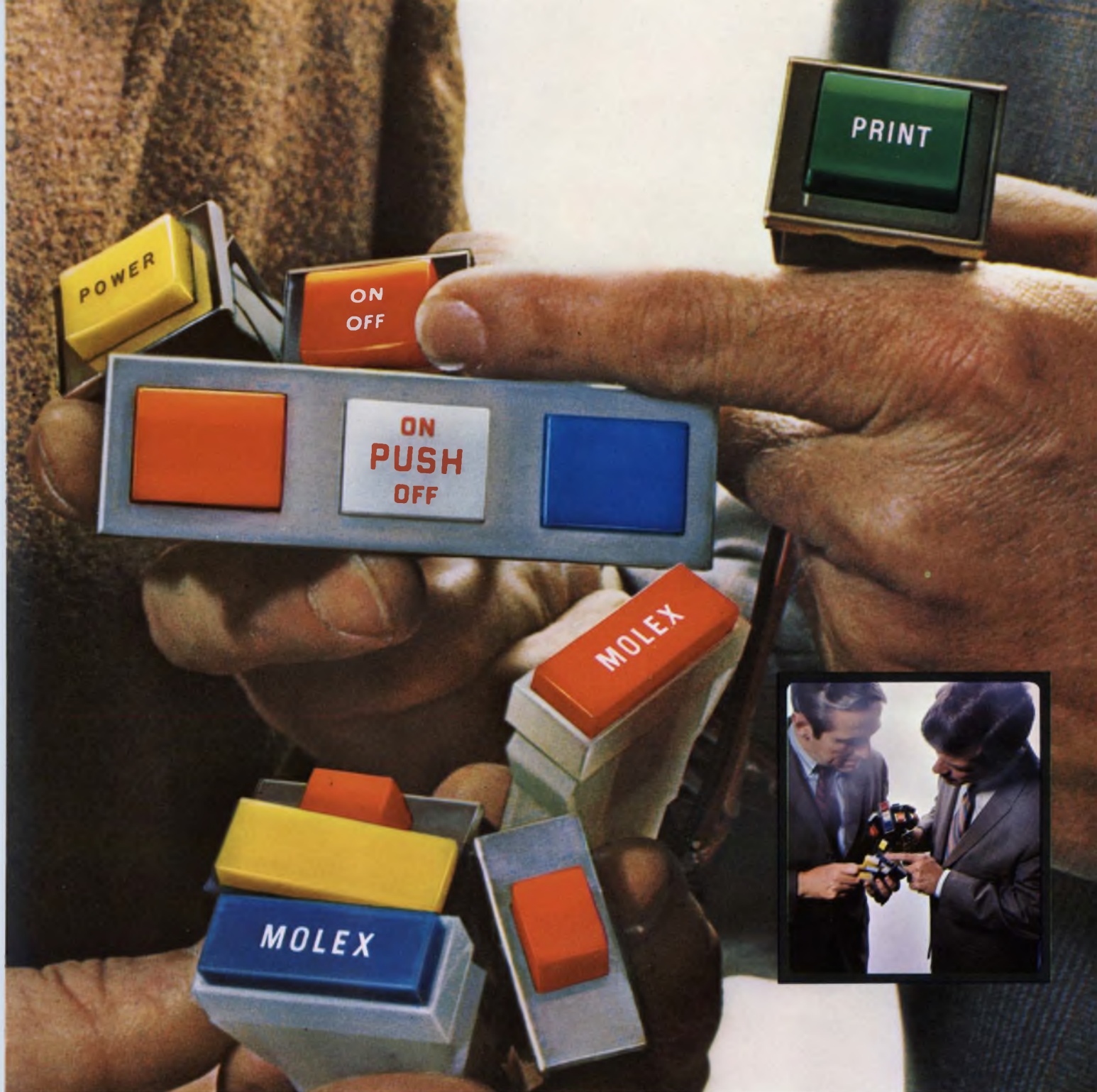

HERE ARE TWO EASY WAYS TO SOLVE LIGHTED PUSH BUTTON SWITCH PROBLEMS. Economically. Reliably. Fast. The Molex 1175 snap mounts. Offers spade or wire terminals for fast, easy assembly. A choice of nine colors, 500 variations. And look at the Molex 1820. You can use one, or a gang of them, for an infinite variety of applications. Lighted push button can be wired to light independently of the switch. And it's available in colors galore. Best of all . . . both switches are priced considerably under one

dollar in quantity. ■ These components are good examples of the Molex creative approach to design problems. And we have the ability to design reliability and ease of assembly into a product without letting costs run wild due to over-engineering. ■ If this makes sense, and you would like a *free sample* of either the 1175 or 1820 switch, write: Molex Incorporated, Lisle, Illinois 60532. Or phone (312) 969-4550.

...creating components that simplify circuitry

The digital world is a COS/MOS world.

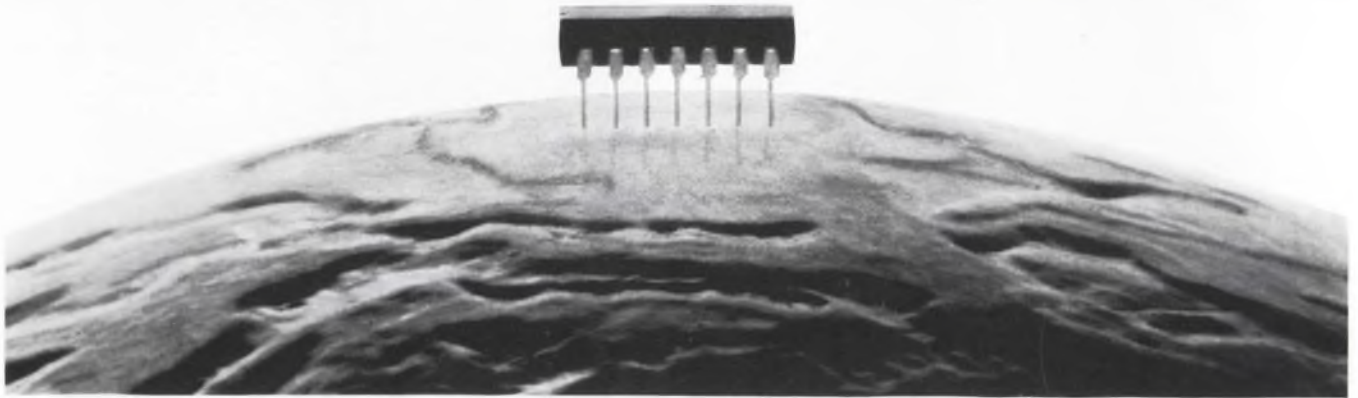

RCA COS/MOS widens your world of digital applications. It offers a combination of features that can't be matched by other digital technologies.

Features like ultra-low power consumption... 10 microwatts per gate! This permits high chip-packing density, use of small power supplies, and a money-saving reduction in cooling requirements.

So COS/MOS is ideal for battery-operated equipment. No longer do you need to be tied down by the power cord.

COS/MOS circuits work great from 3 to 15 volts. That means you can use inexpensive power supplies without fancy regulators. You can use long wires and simple low cost P.C. boards without worrying about signal attenuation.

COS/MOS noise immunity is among the highest of any technology (typically 45% of supply voltage), making it suitable for use in high noise environments such as the automotive and industrial control industries.

The stable transfer character-

istics of COS/MOS typically change less than 3.0% over the full military temperature range. So you can place COS/MOS circuits just about anywhere without worrying about them being overheated.

And you get more system cost effectiveness in the broad selection of COS/MOS circuits: from simple gates like the CD4011 Quad NAND to highly complex functions like the CD4057 Arithmetic Logic Unit.

Let RCA, originator and the world's largest producer of the industry standard CD4000 Series, introduce you to the world of digital COS/MOS. We believe you'll soon be convinced that RCA COS/MOS is the best answer for your digital system designs.



Send for complete data packet, including the new 1973 COS/MOS Product Guide. Write: RCA Solid State, Section 57I-27 Box 3200, Somerville, N.J. 08876. Or phone: (201) 722-3200.

RCA Solid State
products that make products pay off