

Electronic Design 18

VOL. 21 NO.

FOR ENGINEERS AND ENGINEERING MANAGERS

SEPT. 1, 1973

Here comes the **DDMM**—the diminutive digital multimeter. It's a complete instrument built into a palm-sized probe. Tuck the unit into your shirt pocket

and take it anywhere. Read it upside down, or flip a button and read it right side up. Though tiny, this DMM has 15 ranges of ac/dc volts and ohms. Details on page 82.



**WESCON
ISSUE**

Do you face
a make or buy
decision on
power supplies?

BUY LAMBDA'S LT SERIES 25 MODELS, 3 PACKAGE SIZES, ALL 5-YEAR GUARANTEED.

Line regulation: 0.02%; Load regulation: 0.15%;
Ripple and noise: 1.5 mV RMS;
Temp. coef.: 0.01%/°C; AC input: 105-132Vac.

LTS-CA SINGLE OUTPUT MODELS

4²⁹/₃₂" x 4¹⁵/₁₆" x 9⁵/₁₆"

MODEL	FIXED VOLT. RANGE VDC	MAX. AMPS AT AMBIENT OF:				PRICE
		40 °C	50 °C	60 °C	71 °C	
LTS-CA-5-OV*	5±1%	7.0	6.5	5.8	4.8	\$80
LTS-CA-6	6±1%	6.6	6.2	5.5	4.6	80
LTS-CA-12	12±1%	4.4	4.1	3.8	3.2	80
LTS-CA-15	15±1%	4.0	3.7	3.4	3.1	80
LTS-CA-20	20±1%	3.1	2.9	2.7	2.4	80
LTS-CA-24	24±1%	2.6	2.4	2.2	2.0	80
LTS-CA-28	28±1%	2.2	2.2	2.0	1.8	80

*Includes fixed overvoltage protection at 6.8V±10%

LTS-DC SINGLE OUTPUT MODELS

4²⁹/₃₂" x 7¹/₂" x 10¹/₂"

MODEL	FIXED VOLT. RANGE VDC	MAX. AMPS AT AMBIENT OF:			PRICE
		40 °C	50 °C	60 °C	
LTS-DC-5-OV*	5±1%	17.0	14.5	12.0	\$150
LTS-DC-6	6±1%	16.0	14.0	12.0	150
LTS-DC-12	12±1%	11.0	9.7	8.6	150
LTS-DC-15	15±1%	10.0	8.8	7.7	150
LTS-DC-20	20±1%	8.0	7.1	6.0	150
LTS-DC-24	24±1%	7.1	6.4	5.4	150
LTS-DC-28	28±1%	6.0	6.0	5.0	150

*Includes fixed overvoltage protection at 6.8V±10%

LTD-CA DUAL OUTPUT MODELS

4²⁹/₃₂" x 4¹⁵/₁₆" x 9⁵/₁₆"

MODEL	FIXED VOLT. RANGE VDC	MAX. AMPS AT AMBIENT OF:				PRICE
		40 °C	50 °C	60 °C	71 °C	
LTD-CA-152	±15±1%	2.0	1.8	1.7	1.5	\$110
LTD-CA-122	±12±1%	2.0	1.8	1.7	1.5	110

LTS-DB SINGLE OUTPUT MODELS

4²⁹/₃₂" x 7¹/₂" x 10¹/₂"

MODEL	FIXED VOLT. RANGE VDC	MAX. AMPS AT AMBIENT OF:			PRICE
		40 °C	50 °C	60 °C	
LTS-DB-5-OV*	5±1%	12.0	10.8	9.0	\$130
LTS-DB-6	6±1%	11.0	9.9	8.2	130
LTS-DB-12	12±1%	7.6	6.7	5.7	130
LTS-DB-15	15±1%	7.2	6.4	5.4	130
LTS-DB-20	20±1%	6.0	5.3	4.5	130
LTS-DB-24	24±1%	5.5	4.9	4.1	130
LTS-DB-28	28±1%	4.0	4.0	3.7	130

*Includes fixed overvoltage protection at 6.8V±10%

LTD-DB DUAL OUTPUT MODELS

4²⁹/₃₂" x 7¹/₂" x 10¹/₂"

MODEL	FIXED VOLT. RANGE VDC	MAX. AMPS AT AMBIENT OF:			PRICE
		40 °C	50 °C	60 °C	
LTD-DB-152	±15±1%	3.8	3.2	2.6	\$160
LTD-DB-122	±12±1%	4.0	3.4	2.8	160

T-DAY DELIVERY



\$80 \$130 \$150
LTS-CA-5-OV LTS-DB-5-OV LTS-DC-5-OV
5V, 7A 5V, 12A 5V, 17A

Send for free
LAMBDA POWER SUPPLY
APPLICATION HANDBOOK
& CATALOG



LAMBDA
ELECTRONICS CORP.

A Company

MELVILLE, NEW YORK 11746 515 Broad Hollow Road Tel. 516-694-4200
ARLINGTON HEIGHTS, ILL. 60005 2420 East Oakton St., Unit Q Tel. 312-593-2550
NORTH HOLLYWOOD, CALIF. 91605 7316 Varna Ave. Tel. 213-875-2744
MONTREAL, QUEBEC 100C Hymus Blvd., Pointe Claire, Quebec 730 Tel. 514-697-6520
PORTSMOUTH, HANTS, ENG. Marshlands Road, Farlington Tel. Cosham 73221
VERSAILLES, FRANCE 64a 70 rue des Chantiers 78004 Tel. 950-2224

WHAT THIS COUNTRY NEEDS IS ONE GOOD DUAL 555 TIMER

Generation of Two Independent Time Delays

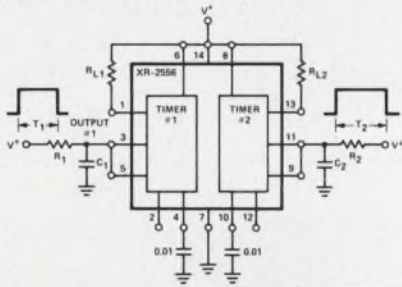

Functional Block Diagram

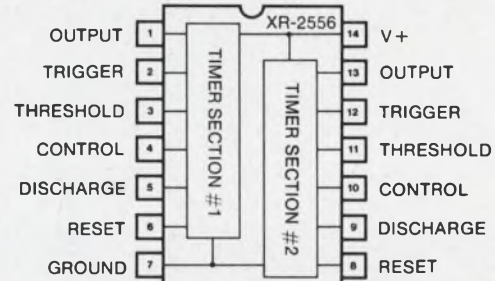

2001 Uses, including:

- Precision Timing
- Pulse Generation
- Sequential Timing
- Pulse Shaping
- Time Delay Generation
- Clock Pattern Generation
- Missing Pulse Detection
- Pulse-Width Modulation
- Frequency Division
- Clock Synchronization
- Pulse-Position Modulation



Synchronized Oscillator Outputs



The XR-2556 is a monolithic dual timer IC. It contains two independent 555-type timers on a single chip which exhibit matching and tracking characteristics far superior to those obtainable from two separate timer packages.

The XR-2556 can be used for time delays from microseconds to hours. Each timer section is a stable controller capable of producing highly accurate time delays or oscillations. Additionally, each section has independent output and control terminals and each output can source or sink 200 mA and drive TTL.

In the monostable mode of operation, the time delay for each timer section is precisely controlled by a single external RC combination. For a stable operation as an oscil-

lator, the free-running frequency and duty cycle of each section are accurately controlled with two external resistors and one capacitor.

If you're using two 555's where you could be using one XR-2556, you can now cut your costs. The XR-2556 replaces two 555 type timers for applications such as Sequential Timing, Clock Pattern Generation, Missing Pulse Detection, Precision Timing and Time Delay Generation, and a "2001" odd applications.

The XR-2556 is available in both hermetic and plastic dual-in-line packages. Call or write and ask about our two-timer and get a data sheet.

EXAR SPEAKS YOUR LANGUAGE



EXAR INTEGRATED SYSTEMS

750 Palomar Sunnyvale, California 94086 (408) 732-7970 TWX 910-339-9233

EXAR DISTRIBUTORS Semiconductor Concepts: Woodland Hills: (213) 894-4560 Hauppauge, L. I.: (516) 273-1234 **EEP Corporation:** Culver City: (213) 838-1912 **Intermark Electronics:** San Carlos: (415) 592-1641 San Diego: (714) 279-5200 Santa Ana: (714) 279-1322 Denver: (303) 963-8284 Seattle: (206) 767-3160 **Graham Electronics:** Indianapolis: (317) 634-8202 Lafayette: (317) 742-4006 Ft. Wayne: (219) 742-4346 Cincinnati: (513) 733-1661 **Radio Electric Service Co.:** Baltimore: (301) 823-0070 **Gerber Electronics:** Dedham: (617) 329-2400 **Yankee Electronics Supply:** Londonderry: (603) 625-9746

INFORMATION RETRIEVAL NUMBER 2

**ASSURE
PRECISE
OUTPUT
CONTROL**
for
**EVERY
APPLICATION**



**SPECIFY
BOURNS®
PRECISION
POTENTIOMETERS**

10, 5, 3, and Single Turns

Less than 0.5% Return Rate

Exclusive SILVERWELD®
Termination

1 1/16" • 1 1/16" • 1/8" • 3/4" • 1/2" Diameters

Wirewound and Nonwirewound Types

Competitive Pricing

Bourns matchless precision potentiometers are stocked in-depth at your local Bourns Distributor. Contact the one nearest you for price and fast delivery.



BOURNS, INC., TRIMPOT PRODUCTS DIVISION • 1200 COLUMBIA AVE., RIVERSIDE, CALIF. 92507

INFORMATION RETRIEVAL NUMBER 3

NEWS

- 25 **News Scope**
- 28 **MNOS memory is upstaging MOS** and fixed-head disc and drum memories in some areas.
- 32 **Acoustic-wave structure** blends digital MOS and hybrid features.
- 34 **400 W average power reported with new inorganic liquid laser.**
- 38 **Fort Monmouth is stressing cost, design, speed and planning** in Post-Vietnam era.
- 55 **Washington Report**

WESCON '73—A special section Pages 62 to 105

TECHNOLOGY

- 106 **Microprocessor or Random Logic?** The 'computers on a chip' allow increased capabilities with software, but they're also slower and more complex.
- 112 **Build a wideband phase-locked loop** that uses standard CMOS and can be tailored to meet your application requirements exactly.
- 118 **BCD Logic—Part 6** BCD logarithms and exponentials: You can interpolate between stored values, but a few selected constants used iteratively can supply greater accuracy.
- 124 **Simplify sequencers with an improved counter.** Self-correction—with minimal hardware—makes the residue counter attractive for many programmer designs.
- 130 **Automate your Smith-Chart plots** and relax while these programs accurately draw and label your gain circles, reflection-coefficients and impedances.
- 138 **'Born' managers don't exist!** You have to learn the skills, this president says, and force your subordinates to make their own decisions.
- 144 **Ideas for Design:** Additional codes extend full-scale range of DAC . . . High-speed shift registers use TTL RAMs and counters to do all the shifting . . . Get square-wave tone bursts with a single timer IC . . . Jeff Duerr of Hewlett-Packard Wins Annual 'Ideas for Design' Award.
- 152 **International Technology**

PRODUCTS

- | | |
|---------------------------|-----------------------------|
| 104 Instrumentation | 168 ICs & Semiconductors |
| 160 Packaging & Materials | 171 Microwaves & Lasers |
| 164 Data Processing | 173 Modules & Subassemblies |

Departments

- | | |
|--|--------------------------------|
| 59 Editorial: My friend's a thief | |
| 7 Across the Desk | 179 Vendors Report |
| 175 Evaluation Samples | 192 Advertisers' Index |
| 175 Application Notes | 194 Product Index |
| 176 New Literature | 196 Information Retrieval Card |
| 179 Bulletin Board | |

Cover: Photo by Alan Howe, courtesy of Hewlett-Packard, Loveland, Div.

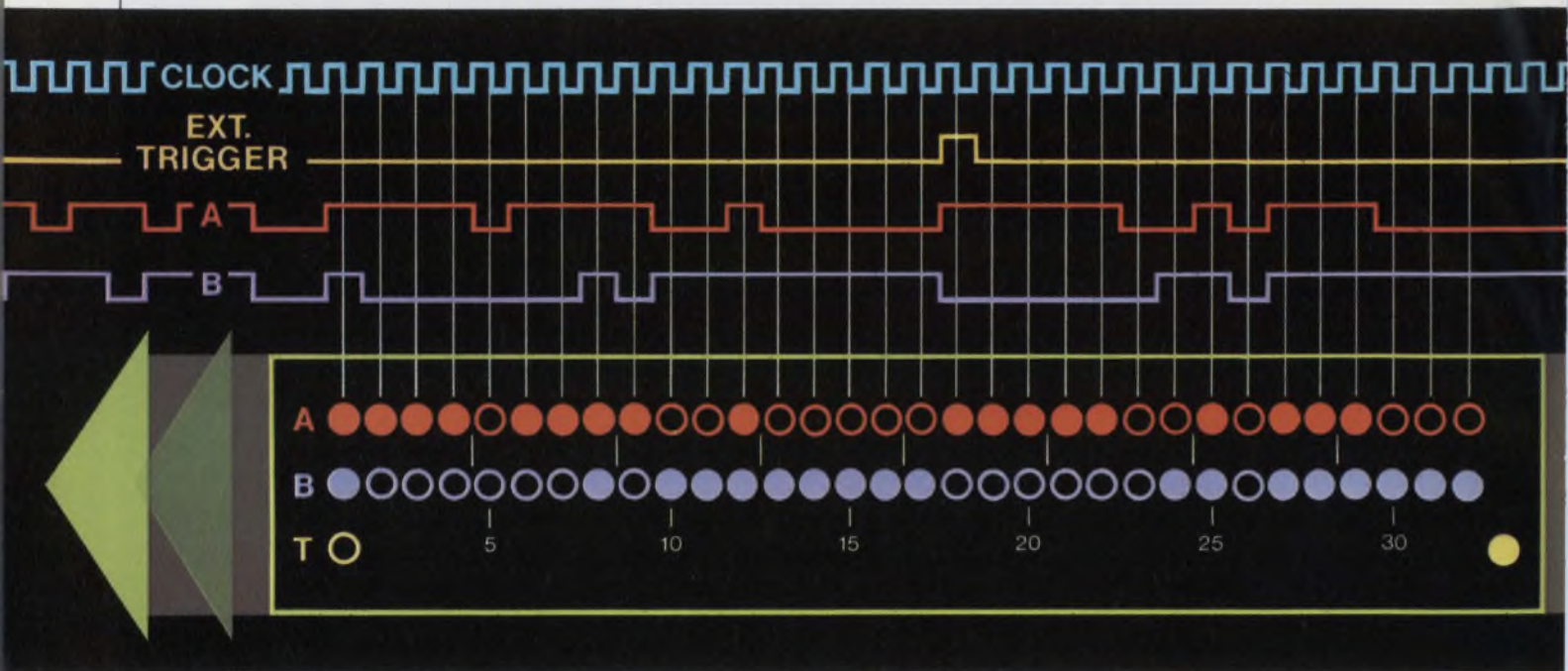

The ordinary way of looking at digital

Introducing the HP 5000A Logic Analyzer. At last, a fast, simple, easy – and above all – accurate way to look at digital signal streams. Highs and lows are displayed by “on” and “off” states of LED’s that make intuitive sense when you’re working with truth-tables or timing diagrams.

For the first time ever you can look backwards as well as forwards in time from a trigger event. Plus, fast, easy-to-use waveform storage lets you conveniently capture single-shot or transient bit streams. Add to this straight-forward, almost self-explanatory controls and you have an ease of operation and display interpretation unmatched by any other method of monitoring digital bit streams.

The HP 5000A can be effectively applied anywhere digital signals are used. A capture rate of up to 10 Megabits/sec., adjustable threshold, and 1 megohm impedance let you use it with any existing logic family. In addition, its unique digital triggering lets you select any AND combination of three inputs as the trigger word. This feature gives you wide

latitude in defining the event or failure state to which you wish to key the display.

Precise digital delay makes algorithm-checking and accessing of particular data in long streams incredibly easy. Simply by dialing delay into the front panel thumb-wheels, you can move the 32- or 64-bit display “window” forwards from your selected trigger up to 999,999 clock pulses – or backwards as many as 64 clock pulses. Because timing and display are keyed to your clock signal, absolute repeatability is assured. You’re always certain exactly which pulses you’re looking at in the data sequence.

That’s a lot of performance for \$1900.* But the HP 5000A has still more features to make your work easier in the lab, on the production line, or in the field. The facing page tells more of the Logic Analyzer’s revolutionary story and what it can do for you. To arrange for a demonstration, call your local HP field engineer today. Or, write us for complete specifications.

*Domestic USA prices only.

02304

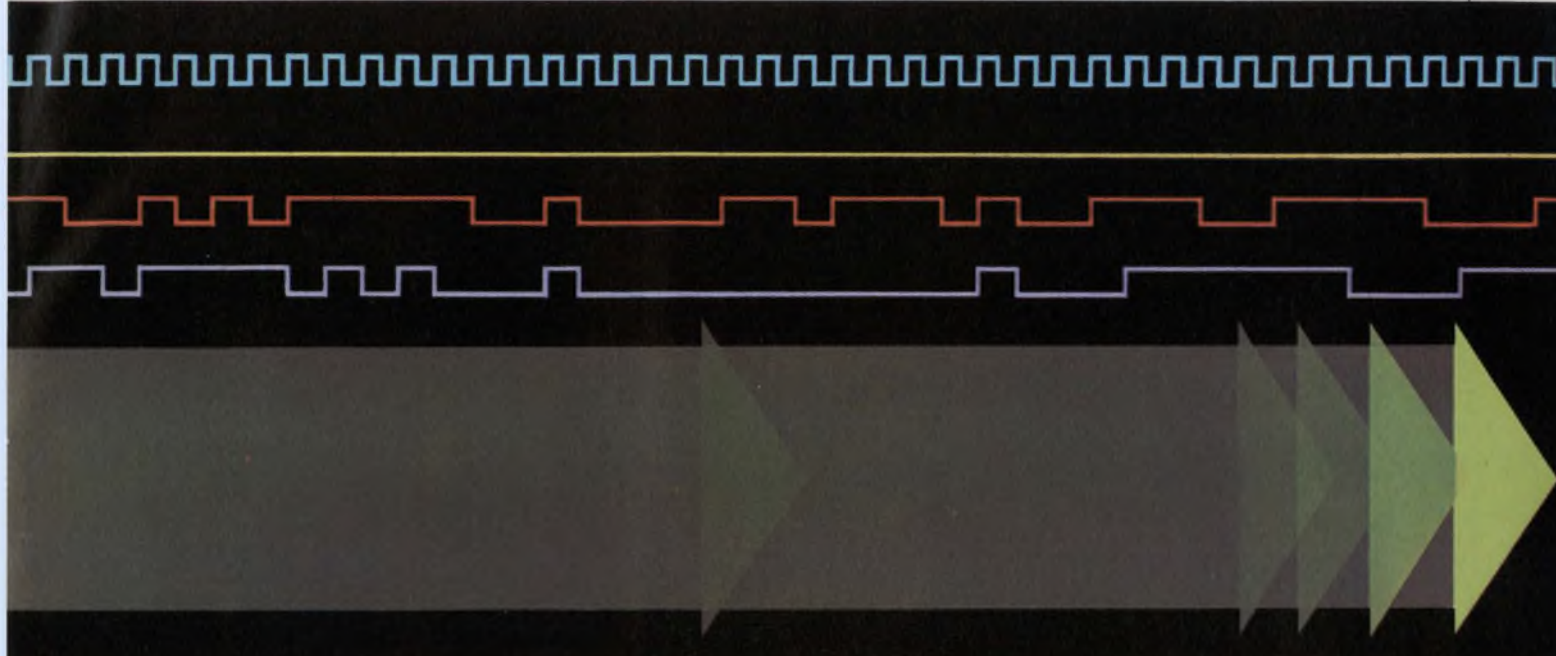

bit streams has just become obsolete.

What led up to a failure?
 What resulted from it?
 The HP 5000A can be quickly set up to show data both immediately preceding and following your selected trigger.

Keep the display as long as you need it; store it indefinitely at full brilliance or just until the signal changes.

The LED display can show you *simultaneous* 32-bit segments of any two signal streams. Or, you can set it up to look at one 64-bit stream.

Another display mode allows you to hold a data pattern in one channel while continuously monitoring an on-going data stream in the other. If you choose to use the HP 5000A for pro-

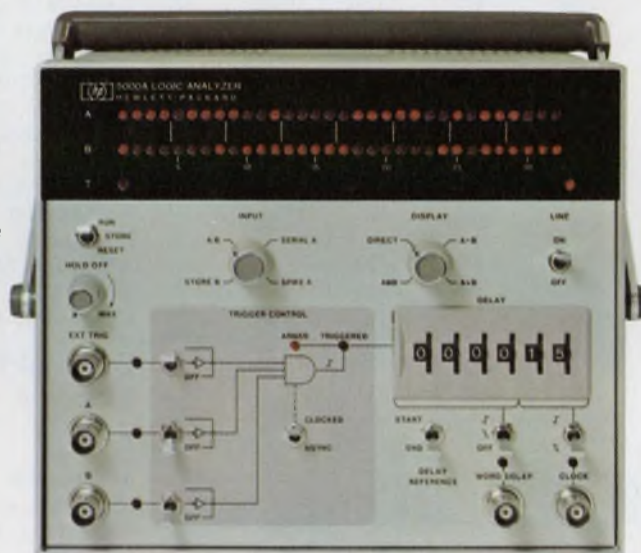

duction or quality control instead of in the lab, yet another feature permits you to compare production units against a known good circuit

and have only the "bad" data bits show up on the display.

Short pulses due to noise or other causes are no problem for

the 5000A. It not only detects these "spikes," it indicates where in the data stream they occur, and even tells you their polarity.

Portable, the 5000A is ideal for field service. With its negative delay and single-shot storage capabilities, you can perform "on site" analysis of the causes of intermittent errors — even those frustrating once-an-hour, or once-a-day events.

You get safeguards against wasted effort too. LED's light up at each input connector to show signal activity; two other LED's indicate arming and triggering. You never spend time looking for pulses that aren't there.



Sales, service and support in 172 centers in 65 countries.
 Palo Alto, California 94304. Offices in principal cities throughout the U. S.

Cut package count . . . Simplify board layout . . .
Reduce equipment size . . . with

DIP MULTI-COMP[®] RESISTOR-CAPACITOR NETWORKS



(Metanel[®] Film Resistors, Monolithic[®] Ceramic Capacitors)

STANDARDIZED DESIGNS * FOR BETTER AVAILABILITY, BETTER PRICES

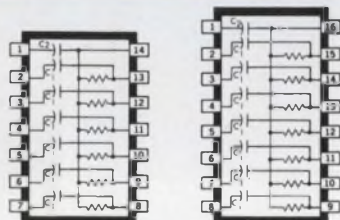

R (Ω)			C ₁
100	470	2000	100pF
150	500	2200	330pF
200	680	3300	0.01μF
220	1000	4700	C ₂
330	1500	6800	

BYPASSED PULL-UP AND R-C COUPLING NETWORKS

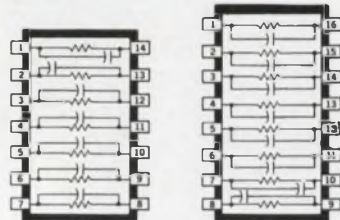

R (Ω)			C
100	470	2000	1000pF
150	500	2200	
200	680	3300	3300pF
220	1000	4700	0.01μF
330	1500	6800	

SPEED-UP NETWORKS

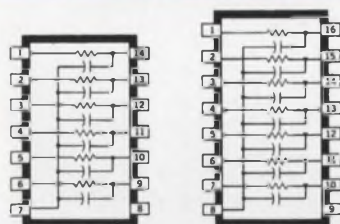

R (Ω)			C (pF)
100	470	2000	100
150	500	2200	
200	680	3300	330
220	1000	4700	
330	1500	6800	

ACTIVE TERMINATOR NETWORKS

* OTHER PACKAGES, CIRCUIT CONFIGURATIONS, AND RATINGS AVAILABLE ON SPECIAL ORDER

**Sprague puts more passive component families into
dual in-line packages than any other manufacturer:**

- TANTALUM CAPACITORS
- CERAMIC CAPACITORS
- TANTALUM-CERAMIC NETWORKS
- RESISTOR-CAPACITOR NETWORKS
- PULSE TRANSFORMERS
- TOROIDAL INDUCTORS
- HYBRID CIRCUITS
- TAPPED DELAY LINES
- SPECIAL COMPONENT COMBINATIONS
- THICK-FILM RESISTOR NETWORKS
- THIN-FILM RESISTOR NETWORKS
- ION-IMPLANTED RESISTOR NETWORKS

For more information on Sprague DIP components,
write or call Ed Geissler, Manager,
Specialty Components Marketing,
Sprague Electric Co., 347 Marshall St.,
North Adams, Mass. 01247. Tel. 413/664-4411.

THE BROAD-LINE PRODUCER OF ELECTRONIC PARTS



Vice President, Publisher
Peter Coley

Editors

Editorial Offices
50 Essex St.
Rochelle Park, N.J. 07662
(201) 843-0550
TWX: 710-990 5071
Cable: Haydenpubs Rochellepark
Editor-in-Chief: George Rostky
Managing Editors:
Ralph Dobriner
Michael Elphick
Associate Editors:
Dave Bursky
Jules H. Gilder
Morris Grossman
Seymour T. Levine
John F. Mason
Stanley Runyon
Edward A. Torrero
Richard L. Turmail
Contributing Editors:
Peter N. Budzilovich
Steven A. Erenburg

Editorial Field Offices East

Jim McDermott, Eastern Editor
P.O. Box 272
Easthampton, Mass. 01027
(413) 527-3632

West

David N. Kaye, Senior Western Editor
2930 West Imperial Highway
Inglewood, Calif. 90303
(213) 757-0183
Northe K. Osbrink, Western Editor
112 Coloma St.
Santa Cruz, Calif. 95060
(408) 426-3211

Washington

Heather M. David, Bureau Chief
2506 Eye St., N.W.
Washington, D.C. 20037
(202) 338-3470

Editorial Production

Marjorie A. Duffy

Art

Art Director, William Kelly
Richard Luce
Anthony J. Fischetto

Production

Manager, Dollie S. Vlobig
Helen De Polo
Anne Molfetas
Christopher G. Hill

Circulation

Manager, Nancy L. Merritt
Ron Deramo

Information Retrieval

Peggy Long

Promotion

Manager, Jeffrey A. Weiner
Karen Kerrigan

across the desk

WOM details aired

Further details have been disclosed about one of the most revolutionary products of the decade, the write-only memory (WOM), which was unveiled by Signetics on April 1st. Circuit details and specifications were disclosed in *ELECTRONIC DESIGN* No. 13, June 21, 1973, pp. 67-75. But recently, for the first time, Dr. John G. Curtis, inventor of the WOM, disclosed details of the package and chip construction in a private press conference.

In Fig. 1 he shows details of the chip, which was designed with the cooperation of a famed Egyptologist whose name Dr. Curtis forgot. In the same photo, he unveils a newly developed chip-handling tool. In Fig. 2 he shows the first completed WOM. It is packaged in a rather large TO can, a 9-lead unit with a center post for grounding or for conveying liquid coolant. Dr. Curtis pointed out, however, that most WOMs are installed out of doors, in the manner shown, to take advantage of natural air-cooling. They are often difficult



Fig. 1. WOM chip disclosed for the first time. Note redundancy used in some of its cells.



Fig. 2. Dr. John Curtis, world acclaimed inventor of the Signetics WOM, shows the first WOM package, an oversized TO can that Signetics has dubbed the Maxi-Can.

to identify as WOMs; they are almost always relabeled. But the one pictured here is not labeled at all because it was custom-made under contract to a government agency whose name has been forgotten.

"Many communities and a number of large plants," Dr. Curtis pointed out, "are now using our WOMs for DDS, or Discarded Data Storage. Since WOMs read data in but never read them out, this enhances the electronic ecology in which we and our computers live. As repositories for used electronic data, they help keep the environment clean and neat."

(continued on page 11)

Electronic Design welcomes the opinions of its readers on the issues raised in the magazine's editorial columns. Address letters to Managing Editor, *Electronic Design*, 50 Essex St. Rochelle Park, N. J. 07662. Try to keep letters under 200 words. Letters must be signed. Names will be withheld on request.

THIN-TRIM[®] CAPACITORS FOR HYBRID-CIRCUIT DESIGNERS



ACTUAL SIZE



THIN-TRIM capacitors are a new development in miniaturized variable capacitors for application in circuits where size and performance is critical. The Thin-Trim concept provides a variable device to hybrid circuit designers which replaces fixed tuning techniques and cut and try methods of adjustment.

FEATURES

- Low profile for HYBRID CIRCUIT applications.
- High capacity values for BROADBAND applications.
- High Q - low capacity values for MICROWAVE applications.

U.S. Patent 3,701,932

Johanson

MANUFACTURING CORPORATION

ROCKAWAY VALLEY ROAD
BOONTON, N.J. 07005
PHONE (201) 334-2676
TWX 710-987-8367

128 WAYS TO SAVE MONEY ON OEM D.C. POWER SUPPLIES RIGHT NOW!



And it doesn't make any difference whether your requirements are ones, dozens, hundreds or thousands, Powertec's open case D.C. power supplies can save you money. Plus you get Powertec's quality performance at full ratings, lowest cost and 24 hour delivery from stock.

Powertec continues to increase its lead in the design and production of open case OEM D.C. power supplies. We offer 10 case sizes, 128 output voltage combinations in single or

multiple output configurations. Ideally suited for computer, peripheral, instrument and test equipment applications.

Our production quantity buys of computer and military grade components, used throughout our OEM series, insure top quality and reliable performance at the lowest possible prices in the industry. We build with proven "no frills" designs, solid engineering and production competence backed up by proven warranty and customer satisfaction.

Spec Powertec. Powertec delivers... More power to you!

SINGLE OUTPUT MODELS

Model Number	Depth	Width	Height	-(5)		-(15)		-(24)			Unit** Price
				5V	6V	12V	15V	18V	20V	24V	
2B-	4.00	4.87	1.62	3A	2.5A	1.5A	1.3A	1.0A	1.0A	1.0A	\$29.00
2C-	4.87	5.62	2.50	6A	5A	3.0A	2.8A	2.0A	2.3A	2.3A	\$49.00
2D-	4.87	9.00	2.75	12A	10A	6.5A	6.0A	4.5A	5.0A	5.0A	\$79.00
2E-	4.87	16.75	4.87	25A	23A	15A	14A	10A	12A	11A	\$139.00
2F-	10.00	16.75	4.87	50A	46A	30A	28A	20A	24A	22A	\$229.00
2G-	15.38	16.75	4.87	75A	68A	45A	42A	30A	36A	33A	\$299.00

- REGULATION: Line \pm .1%
Load \pm .1%
- INPUT: 115 VAC \pm 10V, 47-63Hz
- RIPPLE: 1mv RMS (5 & 15V), 3mv RMS (24V)

- O.L. PROTECTION: Current limit/foldback
- RESPONSE: 50 μ sec typical
- TEMPERATURE: 0°C to 40°C derated to 71°C
- OPTIONAL OVP: All Models

• ALL MODELS ARE U.L. LISTED •

MULTIPLE OUTPUT MODELS

MODEL NUMBER	DEPTH	WIDTH	HEIGHT	OUTPUT POWER			UNIT** PRICE	
				OUTPUT #1	OUTPUT #2	OUTPUT #3		
2K DUAL OUTPUT	2.50	7.87	4.00	2K15D-1.3 * 2K5D-3.0 * 2K5, 15D * 2K5, 24D	+12V, 1.5A or +15V, 1.3A 5V, 3.0A or 6V, 2.5A 5V, 3.0A or 6V, 2.5A 5V, 3.0A or 6V, 2.5A	-12V, 1.5A or -15V, 1.3A 5V, 3.0A or 6V, 2.5A 12V, 1.5A or 15V, 1.3A 18V, 1.0A or 20V, 1.0A or 24V, 1.0A	NA NA NA NA	\$49.00
2L DUAL OUTPUT	2.75	9.38	4.88	2L15D-2.8 * 2L5D-6.0 * 2L5, 15D * 2L5, 24D	+12V, 3.0A or +15V, 2.8A 5V, 6.0A or 6V, 5.0A 5V, 6.0A or 6V, 5.0A 5V, 6.0A or 6V, 5.0A	-12V, 3.0A or -15V, 2.8A 5V, 6.0A or 6V, 5.0A 12V, 3.0A or 15V, 2.8A 18V, 2.0A or 20V, 2.3A or 24V, 2.3A	NA NA NA NA	\$79.00
2R TRIPLE OUTPUT	2.87	11.00	4.88	2R-70T * 2R-72T * 2R-74T * 2R-76T	+12V, 1.5A or +15V, 1.3A 5V, 3.0A or 6V, 2.5A 5V, 3.0A or 6V, 2.5A 12V, 1.5A or 15V, 1.3A	-12V, 1.5A or -15V, 1.3A 12V, 1.5A or 15V, 1.3A 18V, 1.0A or 20V, 1.0A or 24V, 1.0A 18V, 1.0A or 20V, 1.0A or 24V, 1.0A	5V, 6.0A or 6V, 5.0A 5V, 6.0A or 6V, 5.0A 5V, 6.0A or 6V, 5.0A 5V, 6.0A or 6V, 5.0A	\$89.00
2S TRIPLE OUTPUT	4.00	15.00	4.88	2S-140T * 2S-142T * 2S-144T * 2S-146T	+12V, 3.0A or +15V, 2.8A 5V, 6.0A or 6V, 5.0A 5V, 6.0A or 6V, 5.0A 12V, 3.0A or 15V, 2.8A	-12V, 3.0A or -15V, 2.8A 12V, 3.0A or 15V, 2.8A 18V, 2.0A or 20V, 2.3A or 24V, 2.3A 18V, 2.0A or 20V, 2.3A or 24V, 2.3A	5V, 12A or 6V, 8.0A 5V, 12A or 6V, 8.0A 5V, 12A or 6V, 8.0A 5V, 12A or 6V, 8.0A	\$149.00

All outputs can be connected in any common configuration. Other voltages and currents available, consult factory for price and delivery.
* Non-stocked. ** Contact factory for quantity discounts at 25, 50, 100 units and others.

If you don't see the exact model on the chart, we'll build an OEM from stocked sub assemblies in any voltage/current combination. Let us know and we'll quote within 24 hours. Stay within the same size and power rating and the price won't change.

Write for Powertec's new 44 page catalog and you'll find a lot more than 128 ways to save money and solve all your power supply problems.

POWERTEC INC. an Airtronics Subsidiary

9168 DeSoto Ave., Chatsworth, California 91311 • (213) 882-0004 • TWX (910) 494-2092

POWERTEC

INFORMATION RETRIEVAL NUMBER 7

We've been making digital voltmeters since 1953.

But not at these prices.

SPECIAL 20TH ANNIVERSARY SALE.



MX-1. The biggest bargain in the industry becomes an almost incredible buy. Our base price now includes AC, DC and ohms. And we do it without sacrificing NLS quality on any feature. Price includes five voltage ranges from .100000 volt full scale (1 microvolt sensitivity), to 1000.00 volts full scale; plus auto-ranging and wide-range ratio. Five full digits (with a sixth for 20% over-ranging). Options include BCD inputs and ratio to +100 VDC reference. (Mil Spec version designated as AN/GSM-64).

\$1000.



LX-2. We do not believe there is a competitive instrument that can match the LX-2's quality for the price. The standard model comes with four full digits—plus a fifth for over-ranging; and measures DC volts, AC volts, resistance, and multi-function ratios — automatic ranging included. Automatic polarity and range selection. Options permit BCD outputs and battery operation. The LX-2 is our fastest selling four plus digit multimeter. Mil Spec (Class II) version is designated as AN/USN-341.

\$550.



Non-Linear Systems, Inc.

Our 20th Anniversary 1953-1973

Post Office Box N, Del Mar, California 92014

Call your local distributor for off-the-shelf, or our toll-free number 800-854-2758 (Californians call 714-755-1134 collect).

INFORMATION RETRIEVAL NUMBER 8

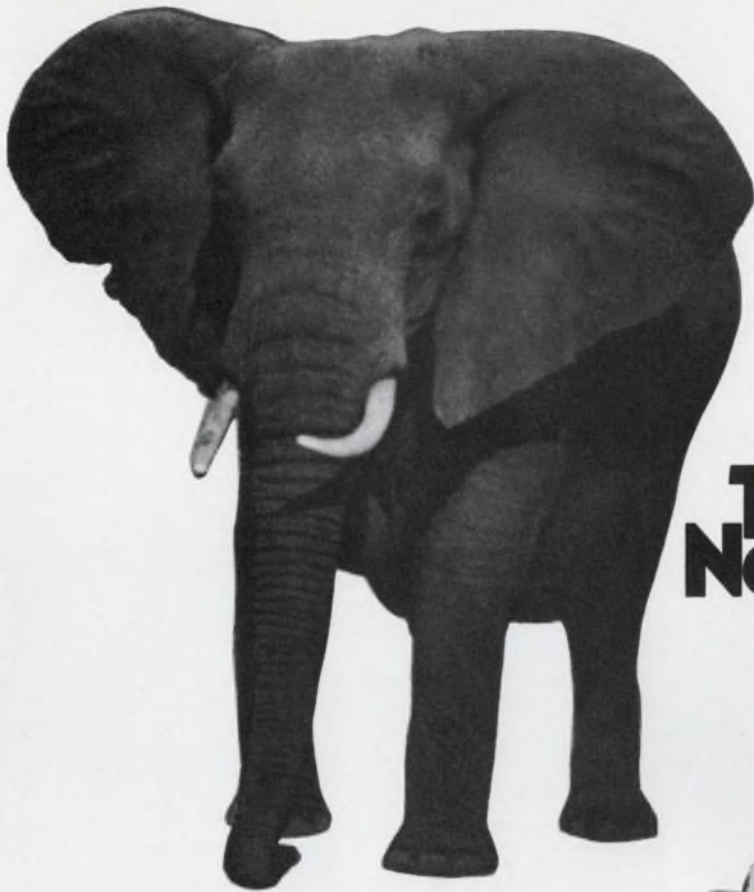

The Non-forgettable Memory

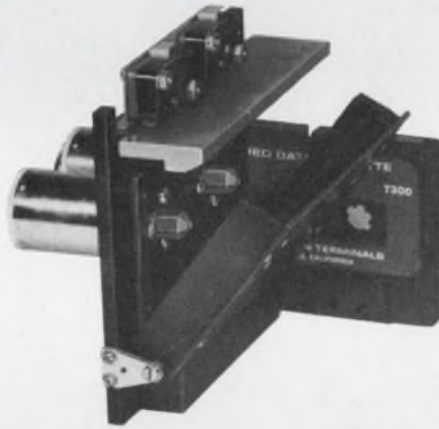

Why is the Ross Digital Cassette Recorder the best recorder?

- Because it is the simplest
- Because it is the most rugged
- Because it is solidly built
- Because the design is versatile
- Because of patented constant speed drive
- Because there are no moving parts except the motors
- Because it is low cost

• ALL OF THE ABOVE

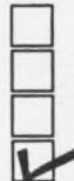

ROSS CONTROLS CORPORATION

257 Crescent Street, Waltham, Massachusetts 02154, Tel. (617) 891-9600
An Affiliate of American Research & Development Corp. (ARD)

INFORMATION RETRIEVAL NUMBER 9



We make components for guys who can't stand failures.

By the time they find the problem, the entire factory will be buried under ping pong balls. And there'll be a few thousand more applicants for advanced membership in the can't-stand-electronic-failures club.

If Corning had only been there in time. You see, we make components for guys who can't stand failures. Reliable components like our metal film resistors—both standard and flameproofs. Components like our glass, ceramic and glass/ceramic capacitors. Like our solid tantalum capacitors—hermetic and non-hermetic, polar and non-polar, miniature and microminiature. And like our discrete component networks—available with custom combinations of discrete microminiature resistors, capacitor chips and diodes in a dual in-line package.

Consider tantalums:

Take our tantalum capacitors, for example. We make a wide range of extra reliability solid tantalum capacitors in a wide variety of shapes, sizes, and styles to fit virtually every packaging requirement:

Our miniminiature MINITANS[®], encased in polyester sleeves

and sealed with special moisture resistant epoxy resin, are for use where space is at a premium. Both the cylindrical Cordwood Series and the rectangular Modular Series are available with either axial or radial leads.

Our ECONOTAN[®] CC Series features metal case construction and is sealed with moisture resistant epoxy resin. Polyester insulating sleeves are standard. This series finds wide application in high volume commercial and industrial equipment. Since the epoxy end seal construction makes a package extremely resistant to shock and vibration, these parts are frequently used in artillery and rocket fuses and in air-dropped anti-infiltration devices.

Corning also supplies a complete line of government approved, Established Reliability, solid tantalum capacitors. Our MILITAN[®] series includes the CSR13 and CSR91 which meet or exceed the requirements of MIL-C-39003. The commercial equivalents of these Series are the TS and TN Series. Miniature size, established reliability, and excellent electrical char-

acteristics make these units the most widely applied of all solid tantalum capacitors.

Our DIPATAN[®] TD Series capacitors feature rectangular anode construction sealed with a high stability epoxy resin. Intended specifically for commercial and industrial applications, this series has long shelf life, superior electrical performance, and radial lead construction for use in miniature printed circuit applications.

We'd like to show you more:

But this is only a small part of our extra reliability components story. Get it all by writing for our new "General Design Guide" to: Corning Glass Works, Electronic Products Division, Corning, New York 14830.

And for information on availabilities, call your local authorized Corning distributor or D.I.A.L. EEM: (800) 645-9200, toll free. Or in New York state, call collect: (516) 294-0990.

CORNING
ELECTRONICS

our printers will get under your skins

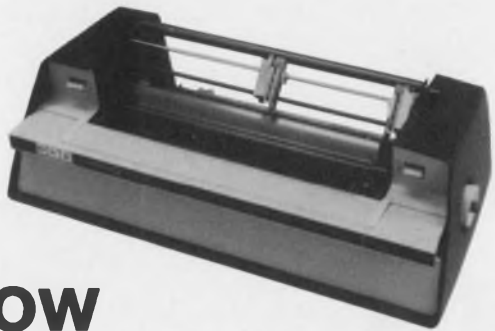

now

you can buy our new Model 30 printer complete for as little as \$1123 (OEM quantities)

Check the specs. Average 30 cps print speed. Ruggedized print carriage assembly. 47 print characters (26 alpha, 10 numeric, 11 special). Available with split platen; front form feed; pin-feed platens; special stepping motors for printing and tabulation; form out control; red and black ribbon; electronic addressable forward and reverse tabulation; IC control electronics and keyboards.



print head assembly

but for you we'll go to pieces

If you value your skins more than ours, we'll sell you the pieces. Any or all. Also, at OEM quantity prices.



"naked" printer complete

paper carriage and printer



keyboard



**oem
model
120**

OEM Model 120 is an asynchronous serial impact printer which may serve as a communications terminal, a billing printer for accounting systems, a computer output printer, or a data entry device.

OEM Model 120 is available in a variety of forms, ranging from the basic print mechanism alone, with a parallel interface operating at 120 cps, to a complete KSR with serial interface and operator-selectable speeds of 10, 15, 30, 60 and 120 cps.

OEM Model 120 is compatible with nearly all low and medium speed teletypewriters and an unlimited variety of other peripheral devices.

The basic coding is ASCII. It is also available as an EBCDIC printer, and an option provides both codes in a single printer. The entire 128-character ASCII code is generated by the OEM Model 120 keyboard; all 96 ASCII graphics are printed.



The complete OEM Model 120 printer contains mechanical and electromechanical components, interface, control logic, character generators, motor drive circuitry, and a tractor feed paper transport.



OEM Model 120 produces up to five copies and an original on standard perforated paper stock.

The OEM 120 printhead employs 35 needles and solenoids in the standard 5 x 7 matrix.



so will our ROYTRON line of 60 punches and readers



OEM PRODUCTS DIVISION

LITTON ABS

Automated Business Systems

34 Maple Avenue, Pine Brook, N.J. 07058/(201) 575-8100

INFORMATION RETRIEVAL NUMBER 10

Optimized 80A SCRs. But you'll have to pay less for them.



Lots of you are using 110 A SCRs in designs where 70 or 80 A would do. Or managing with 55 A SCRs where performance is marginal.

Stop.

The MCR80/81/82 *hermetic SCR* series is the optimized answer to both designs from now on.

In fact, there's no reason for continuing to plug in 55 A SCRs because this new 80 A $\frac{1}{2}$ " stud series gives you more than $\frac{1}{3}$ greater current capability . . . at less price.

Right.

Less price.

At 100 volts, a 55 A unit costs about \$10, 10-99. The 80 A MCR81-10 costs \$7.50.

At 400 volts, a 55 A unit prices out at \$13.50. The 80 A MCR81-40 is just \$10.13.

At 600 volts, the comparison is \$27.50 for 55 A, \$20.63 for 80 A.

At 800 volts, it's \$32.50 and \$29.25.

You'll realize even more significant cost savings replacing 110 A types with the MCR series — at 200 volts, for example, the 110 A device costs \$16.75. The MCR81-20 is only \$7.87. About half the cost.

You get the idea.

Technologically speaking, this new SCR is quality all the way. Stud or unique, design-simplifying *isolated* stud packaging — pressfits whose prices are even more

economical — center-fired gate for excellent di/dt performance — reliable, double hermetic packaging with glassivated die inside a metal pressfit — outside epoxy-coated for long voltage creepage paths.

Electrically, the 50-800 volt series carries 1,000 A surge and 70 mA max. trigger characteristics.

New data sheets and "Guide to Thyristors" can be quickly had through Box 20912, Phoenix, Arizona, 85036.

Evaluation units through distributors.

Direct quotes through the coupon.

But only if you like the price.

Quote me an optimized price . . . on the optimized MCR80/81/82 series SCR in the voltage, quantity and package style I've indicated:

Pressfit $\frac{1}{2}$ " Stud $\frac{1}{2}$ " Isolated Stud

Voltage _____ Quantity _____

Name _____

Title _____

Company _____ Phone _____

Address _____

City _____ State _____ Zip _____

Cost-conscious

From Motorola, the thyristor producer.

INFORMATION RETRIEVAL NUMBER 11

COMPUTER-COMPATIBLE PROGRAMMABLE ANALOG FILTER 16 CHANNELS



SYSTEM 816

- DIRECT INTERFACE WITH COMPUTER, PROGRAMMER OR SWITCH CLOSURES
- PLUG-IN CARDS PROVIDE UP TO 16 INDEPENDENT FILTER CHANNELS IN 5¼" HIGH PANEL
- LOCAL, REMOTE, AND ON-CARD PROGRAMMING OF CUTOFF FREQUENCY
- CUTOFF FREQUENCY RANGE: 10 Hz to 150 KHz
- FUNCTIONS: Low pass, high pass, bandpass, band reject
- ATTENUATION SLOPE: 48 db/octave/channel
- DYNAMIC RANGE: 80 db
- PASSBAND GAIN: 0 db
- OUTPUT SIGNAL: 20 volts p-p
- IMPEDANCES: 1 Meg input, 50 ohm output

SOME APPLICATIONS:

- BAND LIMITING ANALOG SIGNALS PRIOR TO A/D CONVERSION (ANTI-ALIASING)
- NOISE ELIMINATION IN DATA CHANNELS
- TRANSDUCER OUTPUT FILTERING
- FAST FOURIER ANALYSIS

See us at Booth 1427

WESCON SEPT 11-14
1973 WESTERN ELECTRONIC SHOW AND CONVENTION BROOKS HALL SAN FRANCISCO

ROCKLAND

Rockland Systems Corporation 230 W. Nyack Road, West Nyack, N.Y. 10994 • (914) 623-6666 • TWX 710-575-2631

INFORMATION RETRIEVAL NUMBER 12

Micro-mini pc connectors can have contacts on .025-inch centers.

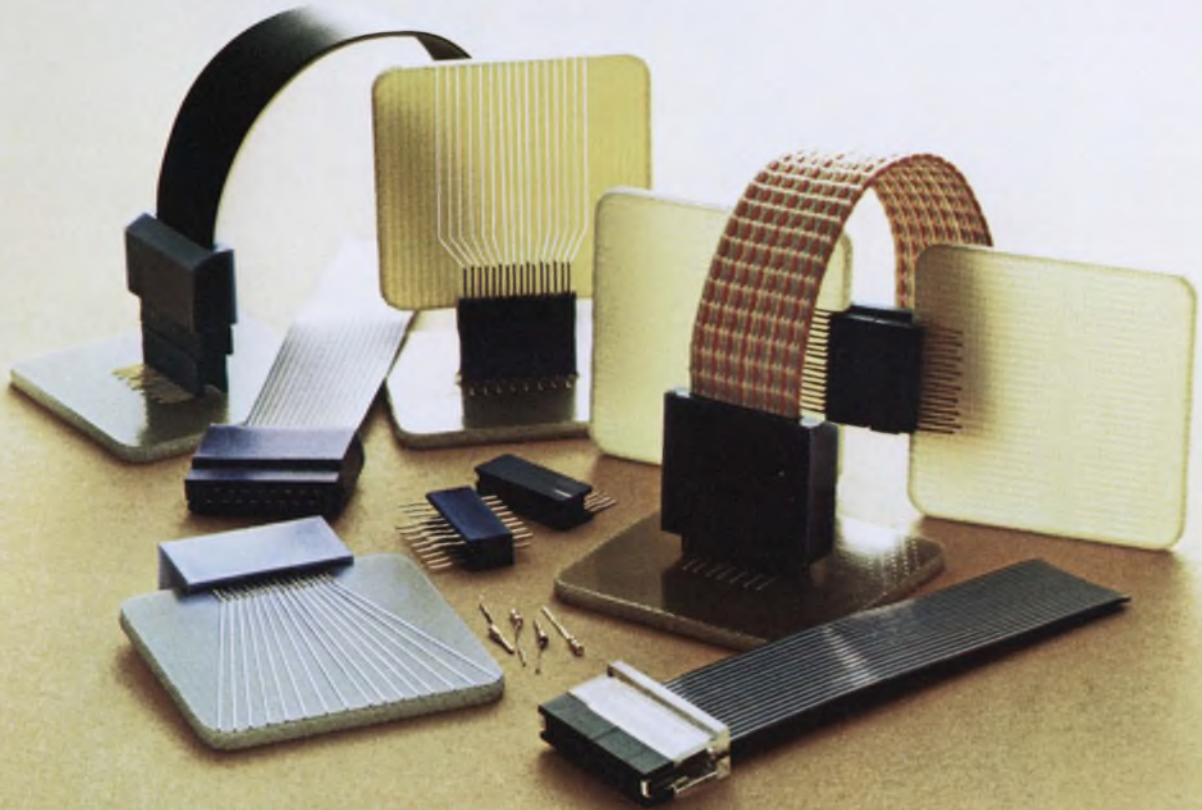

AMP chevron-shaped-contact connectors are specially designed to ensure the maximum density—and reliability—demanded in next generation microelectronic packaging designs. Chevron contact tails are suitable for .050-inch centerlines on double-sided boards or can be easily arranged to suit .025-inch centerline spacing on single-sided boards. They are available in a wide range of connector configurations for board-to-board, board-to-wire and board-

to-flat cable interconnection, including transmission cable to match 75 ohm impedance.

The unique receptacle contacts have chevron-shaped springs for positive, redundant contact with mating pins. Connectors are easily “stacked” or modularized, and built-in misalignment allowance compensates for wide mounting tolerances. Gold over nickel plating on beryllium copper contacts provides maximum performance reliability in the most critical environments.



Dual chevron-shaped springs provide positive contact and grip between receptacle and pin, and minimize overall length and diameter of mated contacts.

AMP has the pc connector to meet your density and design requirements.

TERMI-TWIST connectors can be mounted on a chassis or in open-frame and slotted-plate panels, and can be used in almost any panel arrangement with single- or double-sided pc boards.

We offer a wide variety of printed circuit connector types and configurations... in standard and special designs that let you match packaging design parameters to required standards of reliability and economy. Connectors include high-density types for microelectronics, as well as one or two-piece edge, posted, mother/daughter board, or special header types.

Choice of contact styles include bifurcated leaf, cantilever, tab or fork type, each in crimp snap-in form or eyelet style for solder termination. Posted types can also be provided for automatic point-to-point or wrap methods.

The AMP line of connectors offers many innovative designs for board interconnection of high density rectangular connectors, MSI, LSI and LED substrate circuitry, including liquid crystal display packages.

Only a representative sample of versatile and reliable AMP pc connectors are shown on these pages. We'd like to acquaint you with the product to fit your specific needs. Talk to an AMP Sales Engineer about your connector requirements.

Two-piece connector with blade-type contacts ensures maximum electrical conductivity; receptacle housing accepts crimp snap-in contacts or posts for point-to-point wiring.

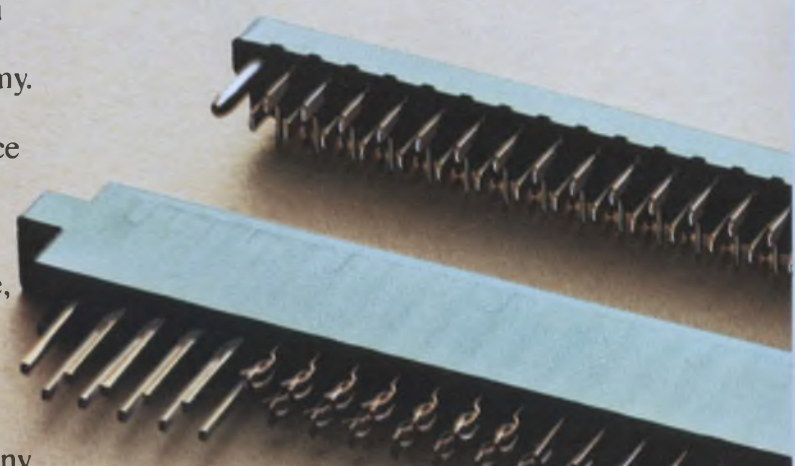
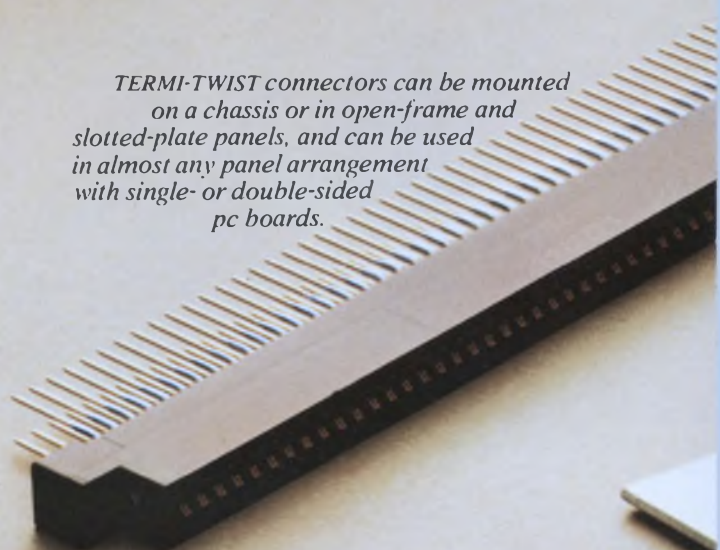

AMP modified fork connector provides high reliability at low applied cost for board-to-wire and board-to-board applications.

80-position edgemount connector provides practical pluggability for leadless liquid crystal display substrate.

Special lightweight automotive pc connector offers unique latching system for positive wire retention and back loading design to simplify wire or contact replacement.

This one-piece edge connector with bifurcated leaf-type contacts offers firm wiping action and redundant points of contact.

Multi-tap connector combines a pc board edge connector and a terminal block with individual screw/clamp terminals or FASTON tabs for quick connect/disconnects.

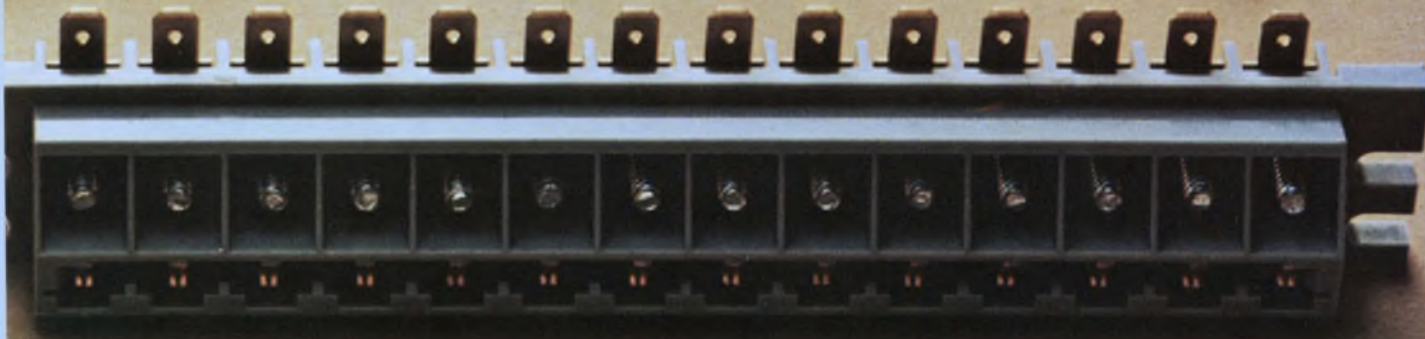

All you need for cable-to-board connections.

With flat or round cable, AMP can give you just the connector you need to get on or off a printed circuit board.

Flat cable-to-board.

These AMP connectors and headers are all you need to take advantage of the savings in weight and space, and the opportunities for eliminating wiring errors and reducing costs which flat flexible cable can provide.

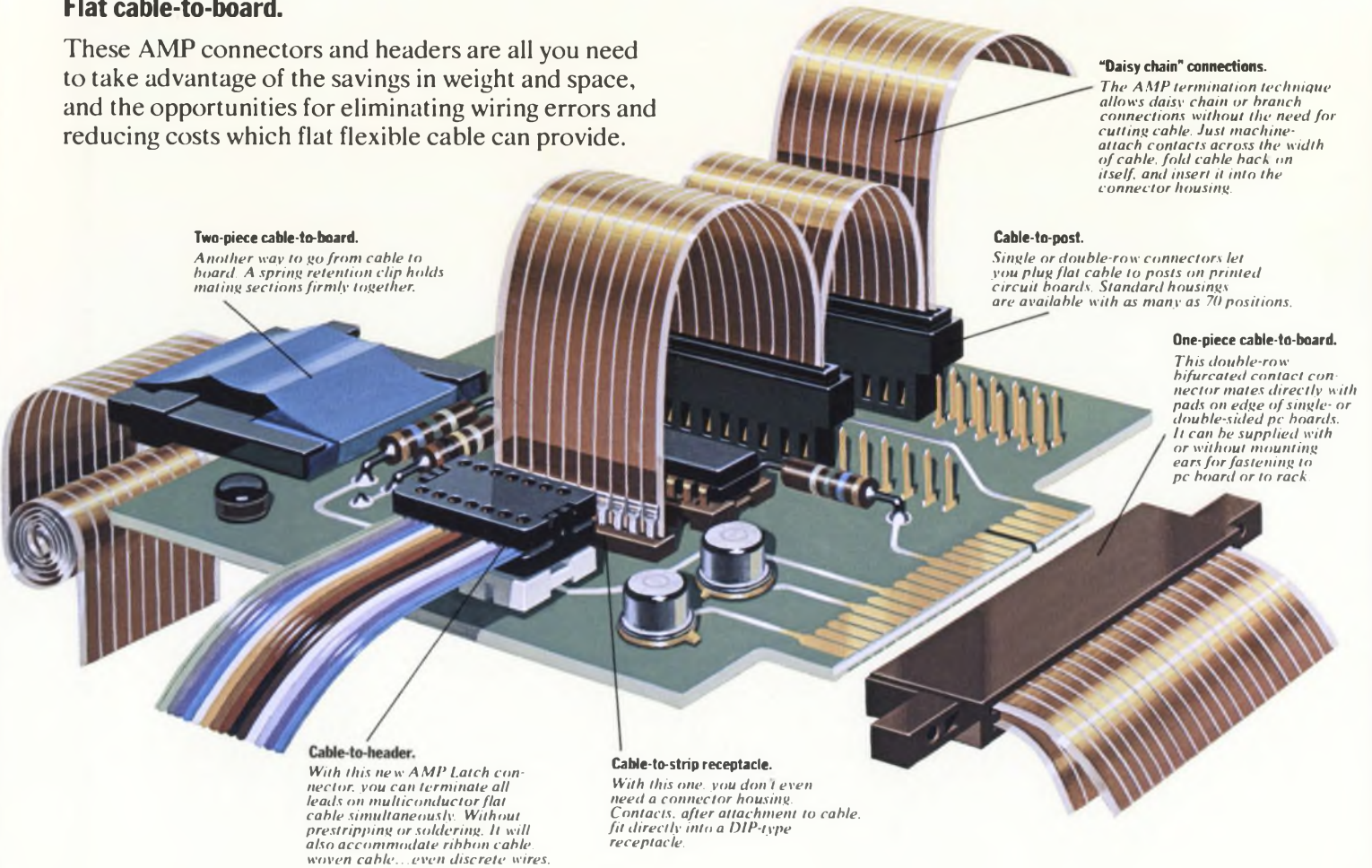

Two-piece cable-to-board.

Another way to go from cable to board. A spring retention clip holds mating sections firmly together.

"Daisy chain" connections.

The AMP termination technique allows daisy chain or branch connections without the need for cutting cable. Just machine-attach contacts across the width of cable, fold cable back on itself, and insert it into the connector housing.

Cable-to-post.

Single or double-row connectors let you plug flat cable to posts on printed circuit boards. Standard housings are available with as many as 70 positions.

One-piece cable-to-board.

This double-row bifurcated contact connector mates directly with pads on edge of single- or double-sided pc boards. It can be supplied with or without mounting ears for fastening to pc board or to rack.

Cable-to-header.

With this new AMP Latch connector, you can terminate all leads on multiconductor flat cable simultaneously. Without prestripping or soldering. It will also accommodate ribbon cable...even discrete wires.

Cable-to-strip receptacle.

With this one, you don't even need a connector housing. Contacts, after attachment to cable, fit directly into a DIP-type receptacle.

Round wire cable-to-board.

All it takes is a gentle pull to separate our miniature rectangular connector from its pc board header. And it only detaches when you want it to, because of positive locking pawls built into the connector housing.

A full selection of circuit configurations on .165-inch centerlines lets you design for maximum miniaturization.

In 1 through 36 positions.

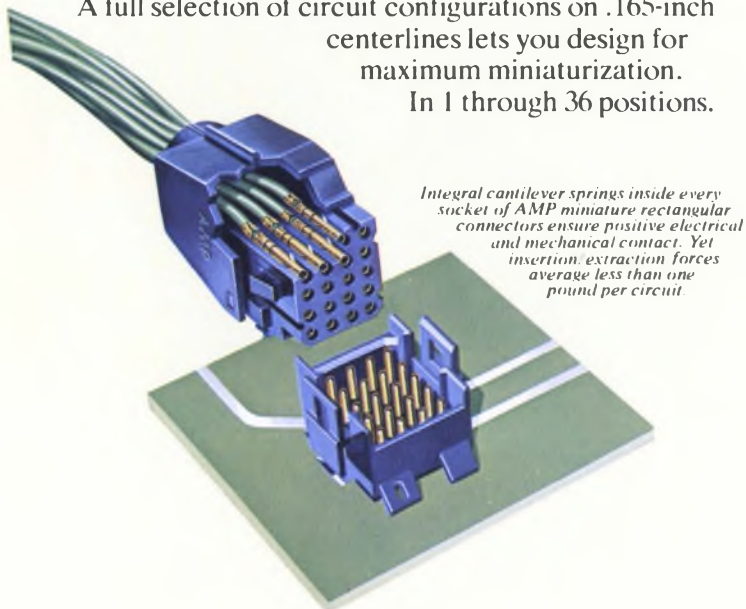

Integral cantilever springs inside every socket of AMP miniature rectangular connectors ensure positive electrical and mechanical contact. Yet insertion, extraction forces average less than one pound per circuit.

Engineering backup...worldwide.

Some 900 application, service and sales engineers are prepared to assist you with every design and production application involving AMP pc connectors and interconnection systems. At your domestic manufacturing plant, or wherever you use AMP products and machines throughout the world. You'll find AMP manufacturing and service facilities in 16 major international markets. In the United States, district offices are located in Weston, MA, Cranford, NJ, Berwyn, PA, Washington, DC, Atlanta, GA, Columbus, OH, Southfield, MI, Elk Grove Village, IL, Minneapolis, MN, Dallas, TX, and in Compton and Cupertino, CA.

For more information on chevron-shaped connectors, circle Reader Service Number 150. For information on flat cable connectors, circle Reader Service Number 151. Information may also be obtained by contacting the AMP office in your area. Or by writing AMP Incorporated, Harrisburg, Pa. 17105.

AMP
INCORPORATED

Another FIRST from DDC

DDC, the company that developed the first synchro converter module back in 1969, has now introduced the first line of microminiature hybrid synchro converters.

Included are a hybrid multiplexed S/D (Model HMSDC) and hybrid tracking S/D and D/S (H-Series) converters . . . specifically designed for applications requiring microminiature size, low power (cmos), high accuracy, and single or multispeed operation. In addition to avionics applications, their extreme low power and high reliability make them ideal for remote data gathering stations and man-portable equipment. They are available as modules for you to package, on cards to your specifications or as NAFI SHP circuit cards.

Both the HMSDC and H-Series feature high reliability (MIL-883 processing) and stability—with no trims, adjustments or calibrations.

Hybrid synchro converters. Latest in a whole line of "firsts" from DDC.

For product or technical applications information, write or call Jim Sheahan or Hans Schloss. They're engineers, so they talk your language.

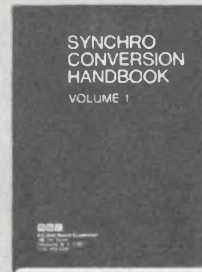

If you work with Shaft Encoders you will want this REFERENCE BOOK . . . Written for circuit and systems designers, "Synchro Conversion Handbook" is the first, most complete, and only authoritative text on synchro conversion. Prepared and published by DDC, this 96-page book helps you understand and meet your specific synchro problems. Ample references, tables and supporting illustrations. Covers tracking vs sampling converters, error analysis, converter selection criteria, applications ideas, test circuits, etc. Send \$2.00. Or, if you work in synchro conversion, you may qualify for a free copy.

ILC Data Device Corporation
100 Tec Street, Hicksville, N. Y. 11801

My synchro application merits a free copy of your new book. Please qualify me.

Enclosed is \$2.00 in check or money order. Please rush my copy of "Synchro Conversion Handbook."

Name _____ Title _____

Company _____

Address _____

City _____ State _____ Zip _____



A subsidiary of ILC Industries, Inc.

ILC DATA DEVICE CORPORATION

100 TEC STREET, HICKSVILLE, N. Y. 11801 • PHONE: (516) 433-5330

Shaping the future of data conversion.

APPLICATION CENTERS

Long Beach, Calif.
(213) 597-5744

Washington, D. C.
(703) 536-2212

Bruxelles, Belgium
Tel. 62.01.59

Shaping the future of synchro conversion.

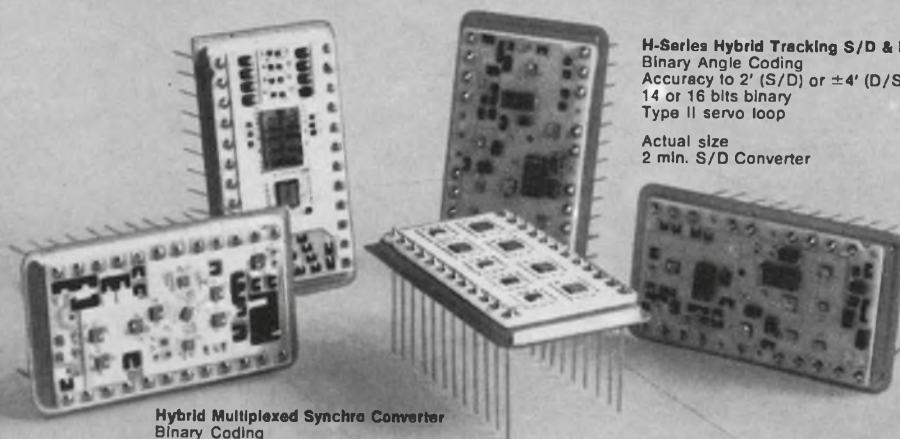

Hybrid Multiplexed Synchro Converter
Binary Coding
Accuracy to 5.3'
Resolution 1.3'
150 μ s conversion time
(not shown)

H-Series Hybrid Tracking S/D & D/S
Binary Angle Coding
Accuracy to 2' (S/D) or $\pm 4'$ (D/S)
14 or 16 bits binary
Type II servo loop

Actual size
2 min. S/D Converter

GENERAL PURPOSE RELAYS—Open or enclosed. Large, small, miniature or new "mini." AC or DC. You name it, Guardian's got it—in as large an array as you'll find anywhere in the industry.

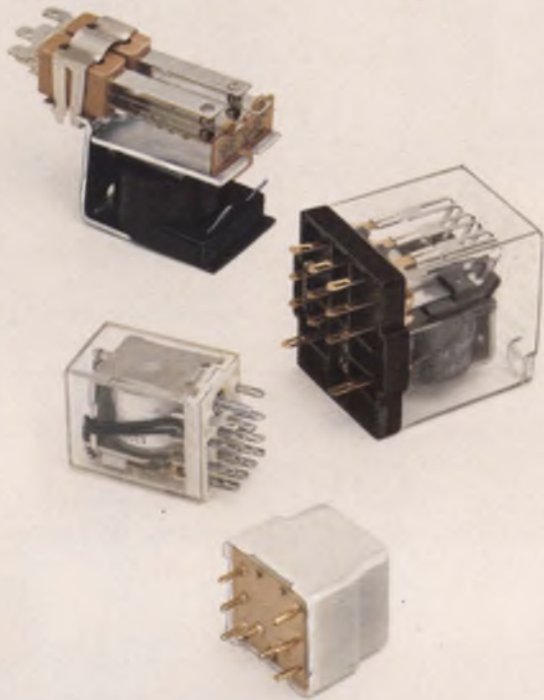

STEPPING RELAYS—Guardian "Steppers" come in 11 basic series, including continuous rotation, electrical reset, add-and-subtract, sequence and on/off.

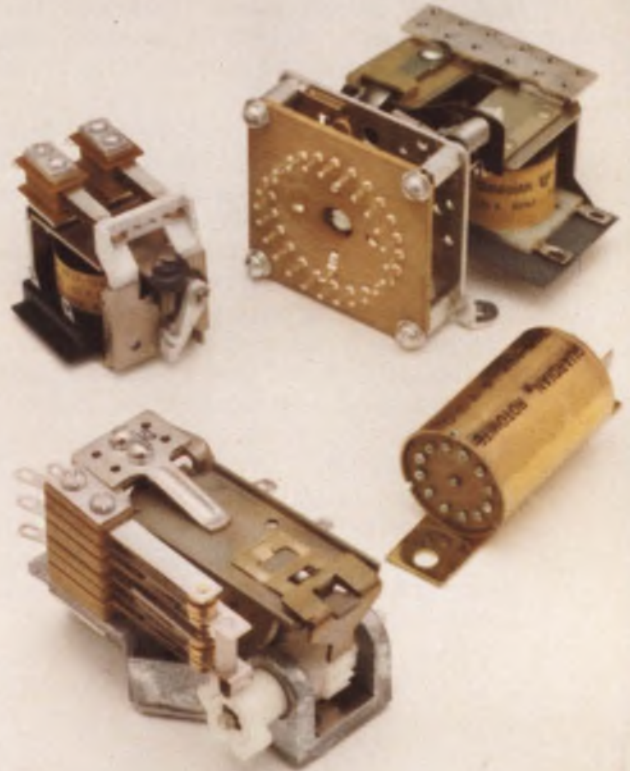

SURE, others make relays that look

...but not with Guardian Dependability

Isn't it time you let the Guardian Angel hand you a reliable relay line . . . and then relax and enjoy it? Whatever relay will solve your particular design problem, Guar-

dian's got it . . . at the right price . . . with the right delivery . . . and the right design assistance. Plus, that special Guardian dependability that's built right in.



GUARDIAN®

GUARDIAN ELECTRIC MANUFACTURING CO. • 1550 West Carroll Ave., Chicago, Illinois 60607

In a hurry? Call your Guardian Distributor.

SOLID STATE RELAYS—Relays and time delays that perform the function of electro-mechanical relays with total isolation between control circuit and switching output. Right off-the-shelf or in custom designs.



REED RELAYS—Six miraculous series of newly-improved reed relays for low level to 15 watt applications. Form A or multiple switching combinations. Encapsulated or economy open-frame types.

like these

*It's a
promise...
from your
Guardian
Angel*



A startling announcement:

TRW's new
Schottky Power
Rectifier



gives a
0.5V forward
voltage drop



at 50 amps

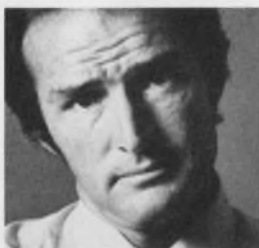

at a T_j of...125°C!



If that doesn't startle all power supply designers, nothing will.

Here's the first, and only, Schottky power rectifier that doesn't fsst-out at 100°C—let alone, higher! In fact, TRW's new device actually operates at a T_j of 125°C with a 0.5V_f at 50 amps.

Maybe you have heard discouraging talk about similar devices made by other companies. Or tried one, yourself. If so, you may have experienced "mysterious failures." Certainly you had

failure when T_j reached 100°C. And it was no mystery: the thing melted!

But this is different. This is made by TRW. After 5 years R&D to be sure it would work. And it does! At 100° At 125° With 35V reverse operating voltage.

Ask the nearest distributor for TRW's new Schottky power rectifier. Part number SD 51. Or contact John Powers, TRW Semiconductors, an Electronic Components Division of TRW, Inc., 14520 Aviation Boulevard, Lawndale, California 90260.

TRW SEMICONDUCTORS

These products are available through the following authorized distributors:

Almo Electronics
Bell Industries
Cramer Electronics Inc.
De Mambro Electronics

Eastern Radio Corp.
Electronics Marketing Corp.
Elmar Electronics Inc.
Hall-Mark Electronics Corp.

Harvey-Michigan Inc.
Liberty Electronics
Powell Electronics
Pyttronics

Semiconductor Concepts Inc.
Summit Distributor
R. V. Weatherford Co.
Westates Electronics Corp.

INFORMATION RETRIEVAL NUMBER 15

Rockwell slide rule to make its debut

The long-awaited electronic slide rule from Rockwell Microelectronics will make its first appearance in retail stores in the next month or so under Lloyd's label.

According to a Rockwell spokesman, the price will be about \$200, and this will probably sink to \$100 within a year (see "\$100 Electronic Slide Rule Could Make it This Year," ED 8, April 12, 1973, p. 25). The competitive Hewlett-Packard HP-35 sells for \$295.

The Lloyd's slide rule, known as the Accumatic 1000, has an 8-digit fluorescent tube readout and operates off four penlite cells. Each of the 20 keys on the new calculator performs a dual function. The F key controls selection of which function is performed.

The Accumatic 1000 has no provision for scientific notation. However, a second model is planned before the year is out. John Spence, designer of the Rockwell slide-rule chip, indicates that algorithms and instructions used in the current chip are being optimized for a new design to provide the extra programming required for scientific notation. The improved

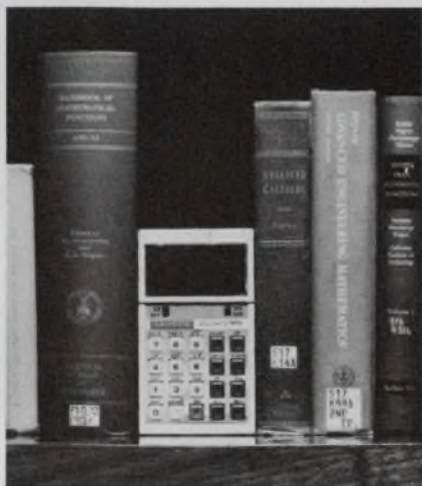

Electronic slide rule from Rockwell will make its first appearance under the Lloyd's label within a month.

electronic slide rule could be either an 8 or 10-digit machine, he says. Pricing information is not yet available.

At the same time Rockwell engineers are developing a low-cost printing calculator. The new desk-top unit will use a thermal print head and is expected to be significantly lower in cost than presently available units. According to Harold L. Edge, vice president and general manager of the Microelectronic Product Div., the chips for the thermal print head have already been fabricated. He says production of the calculators will begin early in 1974.

Digital watch advances disclosed by Intersil

A number of advances in electronic digital watch technology were disclosed recently with the introduction of Intersil's Cronus I, a stopwatch with a LED display.

For the first time, an AT-cut, 6.5536-MHz crystal was used for the time base. Such a crystal has better aging rate and shock resistance compared with that of the usual low-frequency, bar-cut crystals. AT-crystal cost is also substantially lower.

In a second achievement, the 6.5536-MHz operation—impossible to attain with CMOS static dividers—is obtained by use of dynamic CMOS for the first four dividers in the chain and static CMOS for the last 10. This type of system can be used for a 1-to-10-MHz, 3-V watch or clock, according to Murray Siegel, director of special projects and systems at Intersil Inc., Cupertino, Calif.

In a third advance, all the electronic circuitry—including the oscillator-divider chain and display multiplexers, decoders and driver

transistors for the seven-segment LEDs—is incorporated on a single chip.

The Cronus I, intended for timing sports events, uses three 1.5-V rechargeable batteries with the watch circuits capable of operating over the range of 2.5 to 4.5 V. The stopwatch can operate as a 24-hour clock in addition to its functions of stop-start timing and sequential, split and event timing. The latter function has a protective circuit that prevents accidental erasure of the time before the event is finished. The display is presented to hundredths of a second with a maximum of 23 hours, 59 seconds, 59 tenths of a second and 99 hundredths of a second.

Chopper-stabilized op amp goes monolithic

Chopper stabilized op amps used to be available only in hybrid or modular forms. Now with the introduction of Harris Semiconductor's HA-2900—the first monolithic chopper amplifier—designers have a single-chip alternative for low offsets and low-offset drifts.

The monolithic amplifier was achieved by using dielectric isolation techniques to combine npn, pnp and n-channel MOSFET elements on a single chip measuring 93×123 mils. It follows close on the heels of Texas Instruments' two-chip chopper-stabilized op amp (ED 13, June 21, 1973, p. 136).

The key features of the HA-2900 include a typical offset voltage of $50 \mu\text{V}$, typical drift as low as $0.2 \mu\text{V}/^\circ\text{C}$ and open-loop gain of 5×10^5 .

The HA-2900 comes in a TO-99 package. A commercial temperature range version sells for \$55 in 100-up quantities.

Materials seminar due in semiconductor field

A three-day seminar on the processing and fabrication of solid-state materials and devices—silicon, gallium arsenide phosphide and alumina substrates; integrated circuits, RC elements, LEDs and metallized interconnection circuitry—will be held Oct. 31 to Nov. 2 at the Playboy Club Hotel Great Gorge, N.J. It will be the

16th materials seminar to be conducted by Materials Research Corp., Orangeburg, N.Y., in five years and the first devoted exclusively to semiconductor materials and their application.

Tiny CCD TV camera offered commercially

The first commercial charge-coupled-device television camera is a palm-sized unit that contains a 100-by-100 array of photosensitive CCDs.

Called the MV100, the camera was developed by Fairchild Camera and Instrument Corp., Mountain View, Calif. Louis H. Pighi, vice president and general manager of the company's Federal Systems Group, says it is the first of a series of CCD TV cameras that eventually will replace vidicon tube TV cameras in many applications.

The army in the MV100, which replaces the conventional vidicon, is mounted in a 14-pin, dual in-line package, developed originally under a Navy contract.

The announcement is another CCD first for Fairchild, which earlier this year announced the first commercially available CCD linear sensor.

The new camera, according to Pighi, is intended for applications in security systems, medical instrumentation and process control. It has many advantages over the conventional vidicon cameras, he says, noting that it doesn't require the special lighting that conventional cameras do. Because it has a sensitivity of 0.1 foot candle, the CCD camera can operate under a broad range of lighting conditions, from bright sunlight to subdued room light.

The camera is much smaller than vidicon equivalents, it measures 3.5 by 1.5 by 2.25 inches. It weighs only six ounces and consumes only 1 W of power.

The MV 100 does, however, have some disadvantages. It has a lower resolution than that of a conventional TV camera—only 16 lines per millimeter—and can't be used directly on a conventional TV monitor. To accommodate the CCD camera, the vertical synch frequency must be changed. But this



First charge-coupled television camera produced by Fairchild.

simply involves changing one resistor.

The camera comes with a wide range of accessories, including lenses, a battery pack for portable operation and a short-range transmitter. Price and availability will be announced before the end of the year.

'See all' Navy radar tracks multiple targets

The Navy's first fully steerable phased-array radar—a system that looks in all directions almost simultaneously to detect and track multiple targets—has been demonstrated.

Called Aegis, the AN/SPY-1 system provides data for missile fire-control computations. It was demonstrated at RCA's Missile and Surface Radar Div., in Moorestown, N.J., where the system was built.

Measuring 12 by 12 feet, the AN/SPY-1 changes beam direction almost instantly by using more than 4000 radiating elements that shape and direct the beam. These elements also act as receivers of the reflected energy from the object being tracked and provide the basis for precision missile-control monopulse tracking.

Four optimally pointed arrays, each covering 90 degrees in azimuth and horizon to zenith, are used in an Aegis-equipped missile escort destroyer to maintain coverage of the entire airspace surrounding the force.

This fall the radar will be installed on a Navy test ship. Eventually it will go into opera-

tion on a guided-missile ship. RCA has developed the system under contract with the Naval Ordnance Systems Command.

The laser gets hotter in military applications

Funding for high-energy laser research for military thermal weapon applications—still in the experimental stage and termed "revolutionary" by Defense Dept. spokesmen—is estimated to be over \$85-million, according to a research study made by Frost & Sullivan, a New York-based research organization.

Phototype experiments are expected by fiscal year 1975, with useful hardware "probably six to 10 years away," the report continues.

The thermal weapons are envisioned as replacements for surface-based anti-aircraft and anti-missile systems and air-to-air weapons for fighters and bombers.

Companies said to be engaged in this work, include Avco, United Aircraft, Raytheon, Holobeam and GE.

Laser weaponry, along with other less dramatic applications, will boost laser sales to an average of \$317-million a year over the next five years, the report states.

The military also uses lasers in range finders, designators, trackers and seekers for aiming and guiding weapons to targets.

The next volume production market might be for laser countermeasures, F&S reports. Three laser countermeasure systems are being tested by the three military branches and research is to be accelerated. Companies to benefit include Itek, RCA, Calspan, EG&G and GTE/Sylvania.

Also, laser radars and interrogators are termed "promising" by Defense and industry officials. Development contracts are already held by ITT, Aerospace Corp., Honeywell, Hughes, MIT, Lockheed and others.

On a lesser scale, laser devices for illumination and surveillance have taken a new lease on life with the Defense Dept.'s renewed interest in remotely piloted vehicles and drones for surveillance and reconnaissance.

A reliable way to come in under budget.

Our commercial Series 8 miniature manual switches provide quality construction and reliable performance at a low cost.

The positive detent action is a good example of our quality construction. It assures you of excellent tactile feedback.

For safer operation, there's maximum separation between the terminals and the metal mounting and operating elements. And our case, using superior arc-resistant materials, has excellent compartmentation to isolate individual internal circuits.

There's a choice of toggles (select from lever styles and colored, slip-on caps), paddles and rockers (snap-in mounting and choice of colored buttons), and lighted rockers. Also select from pushbuttons with colored buttons in two sizes.

All this makes the Series 8 perfect for jobs where money and space are limited, but performance standards aren't. Communications equipment, test and measuring devices, computer peripheral and business equipment are examples. Series 8 switches are rated 6 amps, 125 VAC.

For additional information, see your MICRO SWITCH Branch Office or Authorized Distributor (Yellow Pages, "Switches, Electric"). Or write for our Series 8 Product Brochure.

MICRO SWITCH makes your ideas work.

MICRO SWITCH

FREEPORT, ILLINOIS 61032
A DIVISION OF HONEYWELL



Shown 20% oversize

MNOS memory upstaging MOS and fixed heads in some areas

Although it is new on the market, the metal oxide nitride semiconductor (MNOS) memory promises to replace MOS and fixed-head disc and drum memories in certain applications.

A nonvolatile semiconductor memory, MNOS is being pushed by both the Army and the Navy. According to Charles Beltz, supervising engineer for the solid-state applications group at Sperry Univac Defense Systems, St. Paul, Minn., the Navy is looking for a block-oriented, random-access memory (BORAM) for use with its All Application Digital Computer. The memory will be used to store microprograms.

Univac, says Beltz, has received a contract from the Navy to pro-

duce a 1.15-megabit MNOS BORAM memory module organized into 32,000 words of 36 bits each. The module, he continues, will be composed of 2-k chips that have been specially optimized for the BORAM application.

2-k MNOS RAM developed

Univac has already developed a 2-k MNOS RAM, Beltz notes, but it was built as a research tool and is not intended for production. The new 2-k MNOS BORAM differs markedly from the RAM and is scheduled to be in production in about 10 months. The chip will have a MOS shift register on the front end that will serve as an input/output buffer. Within the chip, explains Beltz, data will be transferred in parallel between the memory cells and the shift register. Since data will be read out of

the shift register in a serial mode, the effective transfer rate will be very high, even though the MNOS memory cells themselves are relatively slow. The write time for the memory will be about 1 ms, but it will retain its information for about one year.

Beltz notes that data in the BORAM are transferred in blocks—in this case 256 words at a time. The access time to a block of data is 2 μ s. During this time the information is loaded into the shift registers on the chip. It is then read out of the memory module at a data rate of 6.6 MHz. This works out to a transfer time for the whole block of data of slightly more than 42 μ s.

MNOS is a very high density technology, Beltz notes. The memory is formed by a single transistor that does not require any other circuitry, such as a storage capacitor, or the additional transistors that are used in dynamic MOS memories. Another advantage is that it can be operated in a low power mode. Because it is nonvolatile and block organized, major portions of the memory can be shut down when not in use.

How it works

Information is stored in a MNOS memory cell as variations in the threshold voltage of the transistor that forms that cell. The threshold voltage is the voltage required to turn the transistor ON.

If the threshold is set in the high state (15 V), the state corresponds to a ONE. If it is in the low state (2 or 3 V), the state corresponds to a ZERO. The memory cell is read by application of a read voltage (8 V) on the gate. Those transistors that turn

Jules H. Gilder
Associate Editor

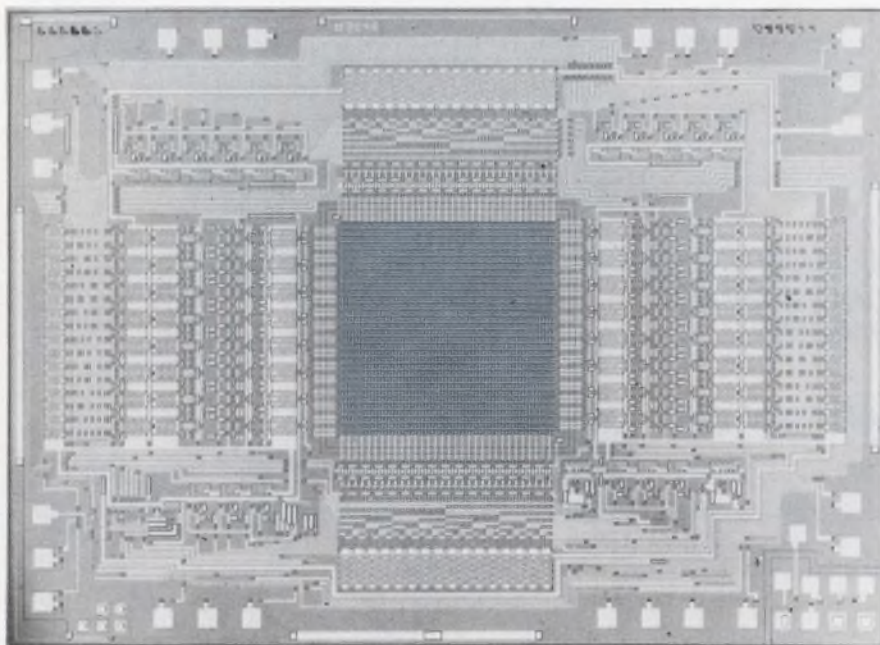

Experimental 2-k MNOS memory chip developed by Univac is organized into a 32-by-64 array (center). Peripheral circuitry includes drivers and buffers.

**He bought his tape transports from company A.
He bought his disk drives from company B.
He bought his printers from company C.**

**He should have
talked to Pertec.**

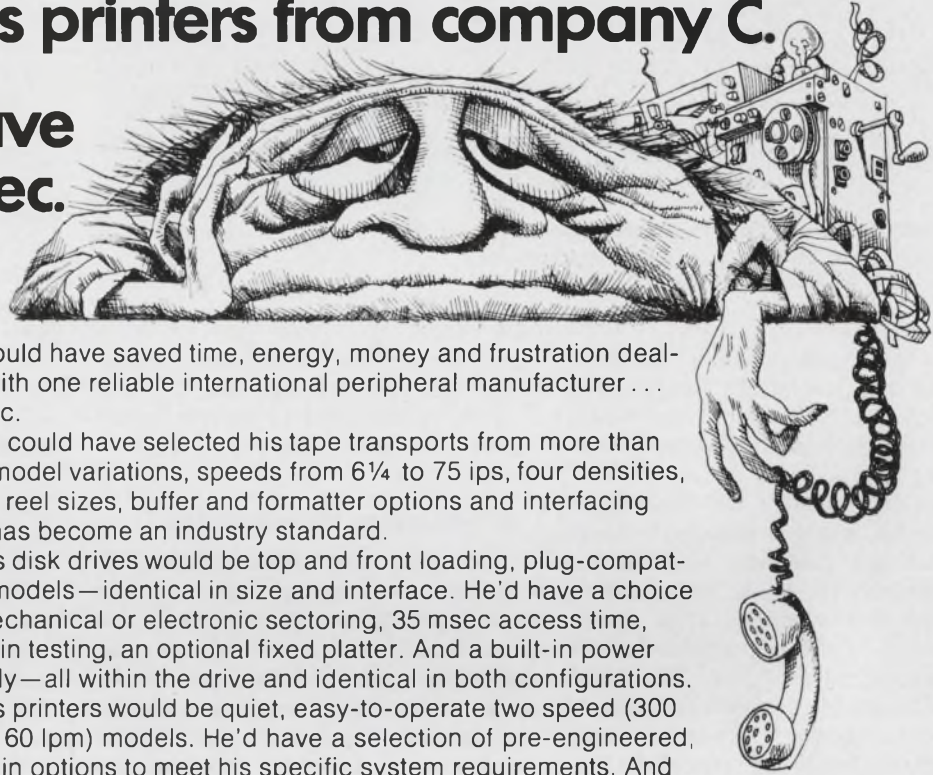

He could have saved time, energy, money and frustration dealing with one reliable international peripheral manufacturer . . . Pertec.

He could have selected his tape transports from more than 400 model variations, speeds from 6¼ to 75 ips, four densities, three reel sizes, buffer and formatter options and interfacing that has become an industry standard.

His disk drives would be top and front loading, plug-compatible models—identical in size and interface. He'd have a choice of mechanical or electronic sectoring, 35 msec access time, margin testing, an optional fixed platter. And a built-in power supply—all within the drive and identical in both configurations.

His printers would be quiet, easy-to-operate two speed (300 and 160 lpm) models. He'd have a selection of pre-engineered, plug-in options to meet his specific system requirements. And features like electronic top-of-form, skip-over perforation, and full fault protection.

He'd have personal and professional assistance in the design, development and maintenance of his system. Factory training for his service people. Back-up by a service and support network in 30 U.S. cities and 20 foreign countries.

You could benefit too—from the quality products, unparalleled support and surprisingly low prices from Pertec.

Find out more. Call us collect in the area nearest you: Boston (617) 890-6230; Chicago (312) 696-2460; Los Angeles (213) 996-1333; London (Reading) 582-115. Or write us at 9600 Irondale Avenue, Chatsworth, California 91311.

INFORMATION RETRIEVAL NUMBER 17



The best values in
computer peripherals
come from

PERTEC

Already the world's
largest independent
manufacturer
of tape transports.

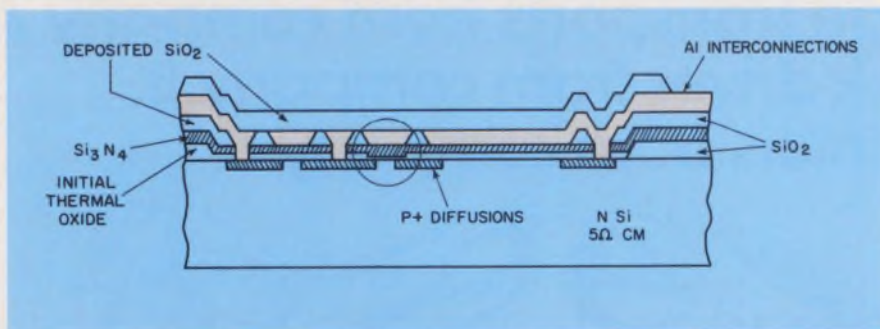

A MNOS inverter with the memory element in series (circled) is used in a Westinghouse automatic utility meter reader.

ON (those that have a threshold set in the low state) represent a ZERO, while those that remain OFF (have a high threshold) represent a ONE.

The threshold of the MNOS cell is varied when a charge is trapped in the interface between the nitride and the oxide. If a positive charge is trapped, it adds to the potential when a positive voltage is applied to the gate. The effect is to lower the threshold voltage of the transistor. Conversely if a negative charge is trapped in the interface, the threshold of the transistor is increased.

To write information into a MNOS cell, a large voltage—about 35 V—is applied to the gate. That is sufficient to produce a voltage gradient across the oxide that causes a charge to move through the oxide by a tunneling effect.

Army seeks larger memory

While the Navy is funding work for the 1.15-megabit module, the Army is interested in a much larger MNOS memory and has awarded a contract to the Westinghouse Defense and Electronic Systems Center, Baltimore, to produce an 18-million-bit MNOS memory module.

According to Joe E. Brewer, a project engineer at Westinghouse, the module will contain 1024 blocks of data. Each block will have 2048 characters 9 bits long. Access time for the memory will be 10 μ s, he continues, and the data rate 2 MHz once a block has been accessed. The memory will have a retention time of about 4000 hours.

Like the Univac memory, the one being developed by Westinghouse will use 2-k chips that consist of a RAM and on-board shift

registers. But unlike the Univac system, the Westinghouse memory is being designed to replace fixed-head disc and drum memories.

MNOS teams up with CCDs

Not all the work on MNOS memories is being done for the military. Rockwell Microelectronics, Anaheim, Calif., is working on a replacement for disc and drum memories that combines both charge-coupled devices and MNOS.

Rockwell has built preliminary models of a CCD MNOS structure, the largest being a 128-bit shift register, notes John Frost, an engineer on the project. The structure, he says, uses an overlapping gate set in an attempt to get good transfer of charge. There is an upper gate set and a lower gate set, notes Frost. Every other lower gate has the oxide removed and replaced by an appropriate thickness of silicon nitride and a 20-Å layer of oxide. This forms the nonvolatile memory cell.

To write information into the device, charge is transferred in, just as it would be with a normal CCD. A write voltage is then applied to the storage gate. This voltage puts the charge underneath the memory gate, where it tunnels through the oxide into the nitride and shifts the threshold of the MNOS device.

To read information out of the CCD MNOS memory, ONEs are transferred into all cells and a read voltage is applied. The resulting readout pattern is complimentary: Wherever there was a ONE in memory, there is now a ZERO in the output and vice versa.

Like the Navy and Army MNOS memories, this one is block-

organized. While the present devices operate at 25 kHz, the goal of this program is to produce a device that operates between 5 and 10 MHz. The final design will probably be a 16-k chip that will be roughly 3 mm on a side.

Bob Koppel, Rockwell's memory product manager, notes that the CCD MNOS memory will be competitive with bubble memories now under development. While there will be a cost disadvantage—sources indicate the CCD MNOS memory will cost about 0.005 cent/bit—there will also be a performance advantage. CCDs can operate faster than bubbles can.

Rockwell also is working on a MNOS RAM, Koppel notes. It will be organized as a 256-by-4 array and is intended for use in Rockwell's parallel processor set. That set is currently using a MOS RAM, the product manager notes, and will be replaced with the pin-compatible MNOS device when it comes out. The main application for the microcomputer set is for point-of-sale terminals.

The MNOS memory, says Koppel, will have a 5- μ s cycle time and will be able to retain data for about three months. The memory will have an unusual feature not provided in other MNOS devices: It will be able to accept multiple write pulses if a longer storage time is needed. With use of these multiple pulses or a write time of 1 ms, a retention time of one year can be guaranteed, Koppel says.

There are problems

But a major problem with MNOS, Koppel concedes, is that "we don't have enough experience with the technology to know how long a retention time we could get."

"Accelerated life testing is good," he notes, "but when you come right down to it, until you have operating hours on the devices, it is very difficult to speculate on what it might have done or how good it might be. We don't fully understand the failure modes of the device."

Other problems, according to Univac's Beltz, are that the MNOS memory is not TTL-compatible, buffer amplifiers are needed on the outputs and high voltage drivers are needed on the inputs. ■■

World's Best Bipolar RAMs

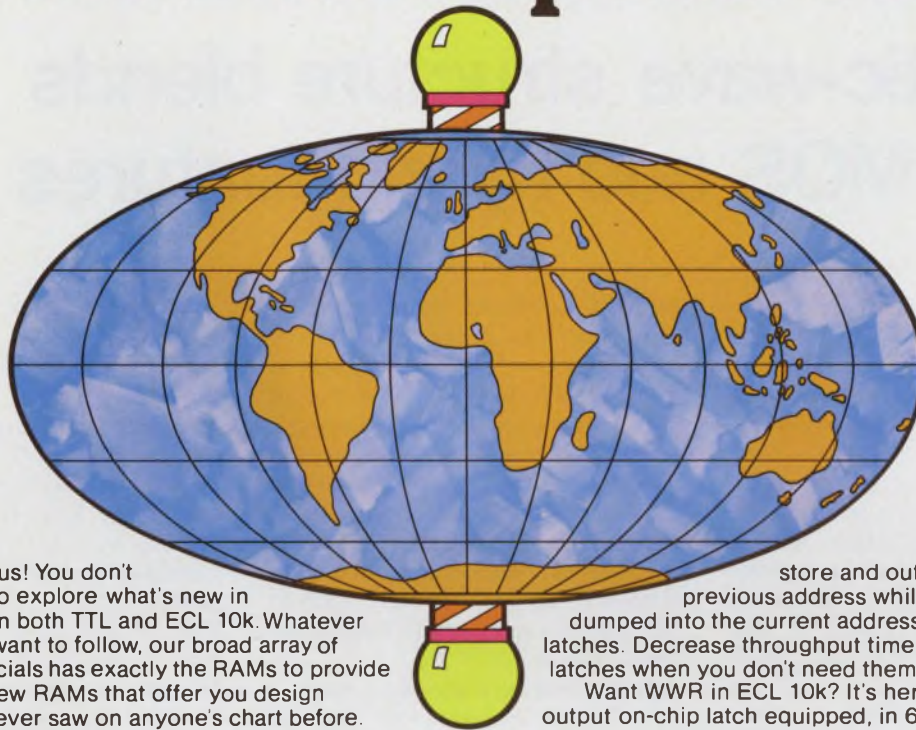

Goodbye, Columbus! You don't need a navigator to explore what's new in RAMs. Here it is, in both TTL and ECL 10k. Whatever design route you want to follow, our broad array of standards and specials has exactly the RAMs to provide it. Plus, we have new RAMs that offer you design possibilities you never saw on anyone's chart before.

Get up on high speed industrial standards. The 256-bit RAM comes MIL and commercial, ceramic and plastic, open collector and tri-state, fast and faster. You'll find all the permutations of the 256-bit RAM on the chart opposite 82S06/07/16/17.



How about a write-while-read memory? That's the 82S21, a 32 x 2 example of schizophrenia, with two on-chip latches. They

store and output data from a previous address while data are being dumped into the current address. Forget separate latches. Decrease throughput time. And bypass these latches when you don't need them.

Want WWR in ECL 10k? It's here. Specify the 10145, output on-chip latch equipped, in 64 x 1. Just the first of a long list of ECL RAMs to come.

Now think of a device that acts like 8 independent 4-bit registers, any two of which can be accessed simultaneously. We call it the 82S12, a multi-port register that replaces 8 separate registers in smart designers' systems.

And think of other benefits, such as output blanking for pcb simplification, Content Addressable Memory (CAM) for eliminating a lot of logic circuits, high speed ECL for 10k compatibility—these and many more user-oriented benefits are spelled out in the data sheets for the charted devices. Get some and bone up.

SIGNETICS "MAKE-IT-EASY-FOR-YOURSELF" TABLE:

TYPE	BITS	PRODUCT	FEATURES	Access Time (ns)	ADVANTAGES	BENEFITS
Std TTL	64	8225	Industry standard w/output blanking	50	Simplified pcb layout	Lower system cost
	256	82S06/07	Industry standard	65	Lowest cost per bit	Lower system cost
	256	82S16/17	High speed Industry standard	50	TTL compatible	High performance
Spi TTL	8	8220	Content Addressable Memory	45	Associative capability	Simplifies design
	64	82S21	On-chip latches	50	Eliminates external latches	Simplifies design
	32	82S12/112	Simultaneous access	30	Replaces registers	Simplifies design
Std ECL	64	10140/148	High speed ECL	15	10k compatible	Design flexibility (64 x 1)
	64	10145	Super speed ECL	15	10k compatible	High speed ECL. Scratch pad. (16 x 4)
Spi ECL coming soon	64	10151	On-chip latch Read-while-write	15	Eliminates external latch	Simplifies design, lower cost (64 x 1)

CLIP THIS COUPON TO YOUR LETTERHEAD FOR IMMEDIATE ATTENTION

Signetics—RAMs
811 E. Arques Avenue
Sunnyvale, Calif. 94086

Okay fellows, produce some data. Specifically, I'd like the data sheets on the following RAMs:

Name _____ Title _____

Firm _____

Address _____

City _____ State _____ Zip _____

Telephone _____

Signetics Corporation, a subsidiary of Corning Glass Works.

signetics

Acoustic-wave structure blends digital MOS and hybrid features

A new, simple acoustic-wave structure combines the signal-processing capability of digital MOS circuits with the advantages of hybrid acoustic surface-wave devices.

In this structure zinc-oxide (ZnO) piezoelectric transducers are overlaid on an n-type silicon wafer. The wafer has an array of p-channel MOSFET transistors aligned along the path of the surface wave, between two ZnO transducers.

The MOSFETS sample the traveling wave directly. It is this feature that both simplifies device structure and overcomes two drawbacks of present hybrid-fabricated elements—high fabrication costs and reduced reliability.

The new device was produced experimentally for the Air Force

by RCA Advanced Technology Laboratories, Van Nuys, Calif.

Present devices, which consist of a metallized interdigital array of fingers overlaid on a piezoelectric substrate—like lithium niobate—need numerous wires, or beam leads, to connect the multiple fingers on the piezoelectric substrate to external solid-state switching elements, to bias circuits and to input-drive and output transducer terminations.

In typical surface-wave devices the wave is generated by application of an rf voltage or pulse to the input transducer structure. As the acoustic wave travels the length of the substrate surface, variations in the elastic strain in the crystal, caused by the waves, produce piezoelectric voltages in the interdigital array.

With the RCA device, the silicon substrate is nonpiezoelectric. But the elastic strain from the ZnO transducer surface waves varies the mobility of the carriers in the MOSFET transistors, according to George D. O'Clock Jr., one of the RCA researchers.

The variation in mobility changes the resistance of the p channel, the researcher explains, and consequently the drain current varies in phase with the surface wave. The effect is similar to that employed in some solid-state pressure transducers.

With some size reduction and improvements in the design of the new device, the ZnO structures are expected to be useful in static and programmable matched filters, such as for phase-coded radar and spread spectrum communications.

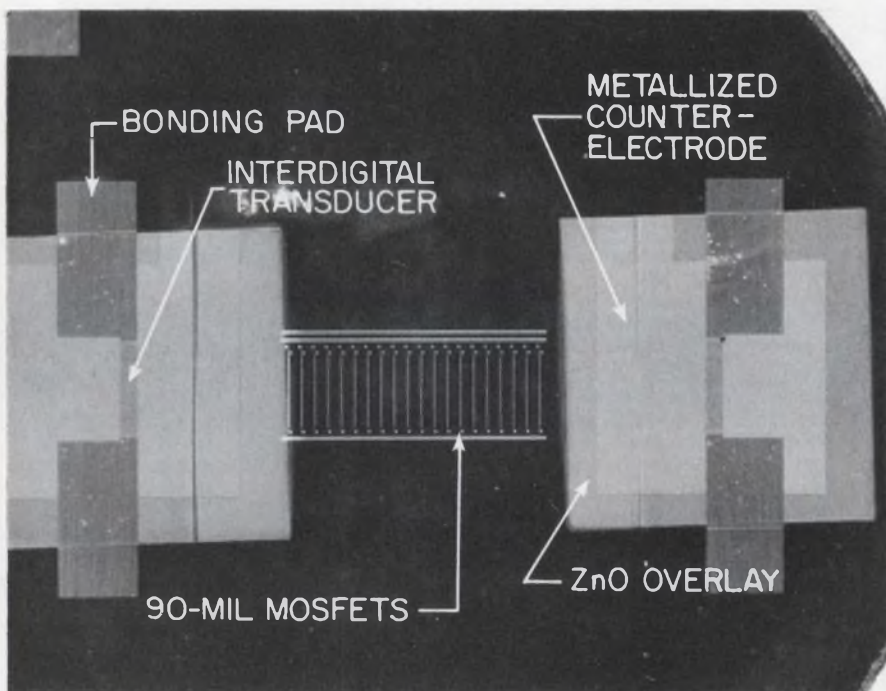

Experimental surface-wave correlator is produced by use of piezoelectric zinc-oxide overlay transducers to generate the surface wave in nonpiezoelectric silicon, in which a MOSFET array has been diffused. The MOSFETs detect the surface-wave energy with a detection loss of about 65 dB.

ZnO transducer is planar

While acoustic surface-wave energy has been detected at 15 MHz with a wedge-transducer-and-MOSFET combination, the polycrystalline ZnO overlay transducer has an advantage in that its planar fabrication technique is compatible with MOS technology. Also, the planar overlay is inherently suitable for coupling surface waves to nonpiezoelectric substrates, like silicon.

In describing RCA's device, O'Clock points out that the input is through the interdigital pattern of the ZnO deposited-film transducer. This interdigital transducer layer is approximately 3 μm thick, and the polycrystalline ZnO film is deposited on a 0.2- μm chrome-gold-chrome counterelectrode on silicon. The ZnO interdigital pattern is a 0.2- μm chrome-gold layer deposited on top of the ZnO. ■■

A Cambion Double "QQ" Product Line

Cambion Makes Millions.

You can build a wealth of design ideas from CAMBION's expanding line of digital products. Our extensive variety makes even your most advanced IC packaging concepts practical. And, we can meet your needs with repeatable Quality no matter how great the Quantity.

CAMBION produces literally millions of IC accessories. Advanced new Cambi-Cards®, card files, drawers, universal panels with and without pre-mounted socket strips and power planes, specific logic function cards, general purpose and discrete component cards, plus strip connectors, cable assemblies, integrated socket strips, component socket adapters, cable cards and card extenders. They're all featured in our new Catalog 119.

We also offer expanded NC wire-wrapping service to speed economical production of your IC system designs.

Make the most of your system ideas *without component restriction*. Get your copy of the new CAMBION Catalog 119. It has 22 more pages than its predecessor showing all the new products to enhance your designs. They all have the CAMBION Double "QQ" approach: The Quality stands up as the Quantity goes on. Order your copy today. Cambridge Thermionic Corporation 445EM Concord Avenue Cambridge, Mass. 02138. Phone (617) 491-5400. In Los Angeles, 8703 La Tijera Blvd. 90045. Phone (213) 775-0472.

Standardize on

CAMBION[®]
... the guaranteed Digital Products.



400 W average power reported with new inorganic liquid laser

The highest average power for pulsed operation yet produced by a solid-state or liquid laser—over 400 W from five long pulses per second—has been reported by researchers at the GTE Laboratories, Inc., in Waltham, Mass.

In demonstrating the first successful high-powered inorganic liquid laser, the researchers—Dr. Harold Samelson, Robert Kocher and Dr. Alexander Lempicki—solved problems that had previously limited the performance of solid-state and liquid lasers.

One problem overcome is a characteristic drop in the output of a solid-state (neodymium glass or YAG) or a liquid laser with continued pulsing—that is, the temperature rise of the laser rod or liquid produces severe thermal

gradients in the materials that distort the optical quality of the laser medium, thereby reducing laser gain and output.

The researchers also demonstrated that a sensitive inorganic laser liquid material—neodymium ions dissolved in a solution of phosphorus oxychloride and zirconium tetrachloride—could be handled and put into a laser circulating system to provide long-term, reliable performance with no apparent deterioration.

The researchers established the design principles for the high-average-power pulsed liquid laser.

“The prime advantage of the inorganic liquid laser,” says Samelson, “is not only can you get power out, but you can produce it under high-average-power input condi-

tions for long periods.”

Samelson sees possible use of this type system in hole drilling and for long-pulse welding.

The system has been working on a pulse length of some 0.5 to 0.6 ms, Samelson explains, which, with the energy per pulse approaching 100 joules, gives a peak power of about 200 kW per pulse.

“This,” he notes, “is sufficient to melt and vaporize metal, which is why it can be used for drilling.”

Pulse stretching possible

For welding, Samelson says, the pulse can be stretched considerably.

“While we haven’t done this experimentally,” he reports, “we know that we can make a pulse-forming network to extend the pulse to about 5 ms. In this case the peak power of the lengthened pulse will be down to about 20 kW, although the same total energy will be in the pulse.”

As a result, the 20 kW will not vaporize but only melt the metal, so the 5-ms pulses are suitable for welding.

“We’re producing 80 to 85 joules per pulse at 5 pulses per second, and we’ve run this as long as 20 seconds,” Samelson says. “On repetitive pulsing, we’re getting about 80 to 90% of the single-pulse energy—that is, the thermal conditions each pulse sees are close to what it would see for a single isolated pulse.”

“We can keep that up for hundreds of seconds, the only reason we haven’t done so is to extend flash-tube life. We’ve obtained all the information we’ve needed with the 20-second runs.”

Compared with other high-powered lasers, the inorganic liquid laser is reported to be generally superior. For example, for a 10-kW

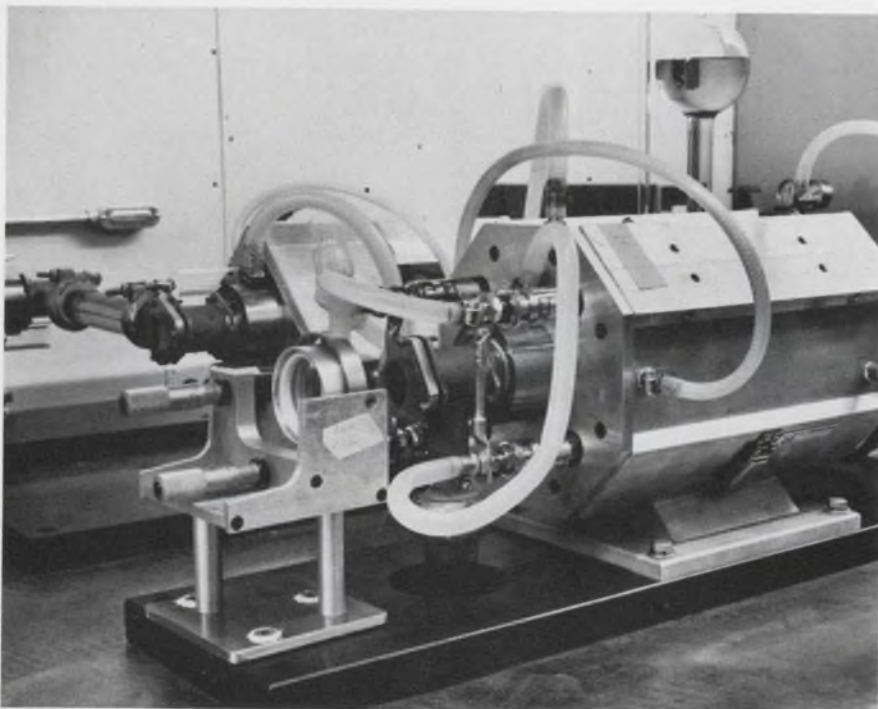

Degradation of output under high-power conditions is prevented in this high-energy liquid laser, right foreground, by using two cooling systems. One cools the laser liquid, the other cools the laser tube and flash lamps.

CO₂ laser operating in the cw mode, both average and peak powers are the same. And while the laser can be run intermittently, it's not generally suitable for operating in a pulsed mode.

Samelson compares the inorganic laser with competing solid-state types of neodymium glass and YAG.

"On a cw basis," he says, "the YAG laser has produced about 1 kW average power. But again, the peak power is only 1 kW.

Compared with the glass laser, the liquid laser has a higher efficiency in the pulsed mode of operation. About 400 W of average power has been produced with the neodymium glass lasers with a 30-kW input. The inorganic laser is producing the same average power with but 20 kW.

The key to the high power operation of the inorganic laser is the design of a cooling system that holds the temperature differential in the laser liquid to a small value, thus minimizing optical distortion.

Pyrex construction used

The major design innovation is the construction of the laser cell through which the liquid laser material is circulated and which lases under the pumping of radiation from four surrounding flash-lamps. Pyrex has been used for both the cell and a water jacket around it. The system of the water jacket, the cell and the laser liquid is, Samelson explains, equivalent to the clad rod of a solid-state laser.

The cooling system in the final design is reported capable of dissipating the 30-kW output of the flash-lamp power supply, although only 20 kW has been used to date. The cooling system uses a laser-liquid-to-water heat exchanger. The coolant for the laser cell jacket is deionized water, which is also circulated through the flash lamps in a closed-cycle system.

The laser liquid itself is cooled by circulation through an independent heat exchanger. Platinum resistance temperature sensors and two independent controllers regulate the flow of water from the city lines through the heat exchangers. ■■

INFORMATION RETRIEVAL NUMBER 20 ►

Don't cost much for all they do... and we deliver fast!

A whole family of switchlights from out of the West.

monoform

Back in 1860, when you had a Colt .44 it gave you more service for the money than anything else around. Designed right for the job. Reliable. Available. And that's the way it is with the Monoform family of switchlights.

Monoform I (the single lamp, momentary & alternate, rated 2 amp 120 Vac).

Monoform II (two independent lamps for horizontal split legends, mom. & alt., 2 amp 120 Vac).

Monoform III (10 amp, 1/4 H.P. power switch).

A whole, low-cost range of models to fit your specifications in a thousand different ways. Cost? In the neighborhood of two bucks... and with Clare-Pendar that's a mighty good neighborhood.



CLARE-PENDAR

Phone 208-773-4541

P.O. Box 785 Post Falls, Idaho 83854 Telex 32-6448

Lighted pushbutton switches this good should cost dollars more.

Our prices:

\$125*

\$160†



OAK SERIES 300.

Get premium performance—at much less than a premium price. Oak Series 300 lighted pushbutton switches give you tested-for-reliability operation and long life. The economical solution to pushbutton applications for bank terminals, calculators, copiers, and more.

Modular design simplifies panel design. Oak Series 300 switches are relampable from the front, with

replaceable lenses, legend plates, and button assemblies. The snap-on lamp holders withstand physical shock, help prolong lamp life.

Choose from single, dual, or four-lamp display, as well as indicators and non-lighted types. Specify one to twelve station banks, with momentary, interlock, alternate action, or any switching combination available on the same bank.

Colors? Your choice of any one of the following for single-legend switches (or any combination for split-legend switches): lunar white, white, red, green, amber, yellow, orange, blue.

Get the complete details. Write for our Series 300 brochure.

* Single-legend, single-lamp, normal latch, 2P2T, glass alkyl insulation, no engraving, less lamps. OEM quantities.

† Split-legend, four-lamp, normal latch, 2P2T, glass alkyl insulation, no engraving, less lamps. OEM quantities.

OAK Industries Inc.

SWITCH DIVISION / CRYSTAL LAKE, ILLINOIS 60014
TELEPHONE: 815-459-5000 ■ TWX: 910-634-3353 ■ TELEX: 72-2447

INFORMATION RETRIEVAL NUMBER 21

Who to call for fast delivery on Oak Series 300 Switches.



Now you can order Oak Series 300 Lighted Pushbutton Switches and assemblies (single-legend/single-lamp or non-illuminated) in quantities up to 149 from your regional Oak distributor. These distributors are equipped to assemble custom units and ship within 3 days.

DRW

MASSACHUSETTS, Watertown. (617) 923-1900
NEW YORK, Farmingdale. (516) 249-2660*

EDMAR ELECTRONICS

ILLINOIS, Des Plaines. (312) 298-8580*

G. S. MARSHALL

CALIFORNIA, El Monte. (213) 686-1500*
CALIFORNIA, San Diego. (714) 278-6350
CALIFORNIA, Sunnyvale. (408) 732-1100
COLORADO, Arvada. (303) 427-5858
OHIO, Dayton. (513) 278-9496

HALL-MARK

ALABAMA, Huntsville. (205) 539-0691
FLORIDA, Orlando. (305) 855-4020*
GEORGIA, Atlanta. (404) 963-9728
ILLINOIS, Chicago. (312) 437-8800
KANSAS, Kansas City. (913) 888-4747
KANSAS, Wichita. (316) 682-2073
MARYLAND, Baltimore. (301) 265-8500
MINNESOTA, Minneapolis. (612) 925-2944
MISSOURI, St. Louis. (314) 521-3800
NORTH CAROLINA, Raleigh. (919) 832-4465
NEW YORK, New York. (516) 293-7500
OHIO, Dayton. (513) 278-6963
OKLAHOMA, Okla. City. Enterprise 50094
OKLAHOMA, Tulsa. (918) 835-8458
PENNSYLVANIA, Philadelphia. (215) 355-7300
TEXAS, Austin. (512) 454-4839
TEXAS, Dallas. (214) 231-6111*
TEXAS, Houston. (713) 781-6100
WISCONSIN, Milwaukee. (414) 476-1270

INTERFACE ELECTRONICS

WASHINGTON, Seattle. (206) 285-3500*

*Assembly Locations

OAK Industries Inc.
Crystal Lake, Illinois 60014

Thin-film effect points to new photodetectors

A new electrical effect promises to lead to the development of inexpensive photodetector arrays with better temperature characteristics than present silicon-based devices.

Discovered by two scientists at IBM's Thomas J. Watson Research Center, Yorktown, N.Y., the effect is found in thin films of molybdenum and tungsten.

According to Dr. Robert J. von Gutfeld, one of the discoverers, when the surface of a thin film of one of these metals is irradiated with brief pulses of laser light, pulses of up to 0.05 V are generated in the plane of the film for 1 kW of incident power.

Such pulses, von Gutfeld notes, can readily be detected without special amplification, and the planar direction of the voltage makes for simple attachment of electrical connections on the film surface.

Another unusual characteristic of the effect, von Gutfeld reports, is that the polarity of the generated voltage remains the same for fixed contacts, no matter how the film is rotated in its own plane around the axis of the laser beam. The only way to reverse polarity, he continues, is to shine the laser beam on the other side of the film.

Application of the new effect could result in inexpensive arrays of fast photodetectors, responsive over a broad optical spectrum and operable over a wide temperature range, notes the IBM researcher.

Experiments with different laser wavelengths, varying from blue to the near-infrared, have shown that the output voltages for these different frequencies are comparable.

In addition detectors based on the new effect would be resistant to the heat-degradation characteristic found in silicon-based photodetectors. Whereas the performance of silicon photodetectors declines as ambient temperature rises, experiments at IBM, von Gutfeld says, show that a molybdenum thin-film detector actually increased in sensitivity as the ambient temperature rose. At an ambient temperature of 250 C the voltage produced for a given laser energy is about 15% higher than when the film is at room temperature. This increase is linear.

In contrast with silicon photodetectors, which can be used to produce either a continuous or pulsed output—depending on how they are excited—the thin-film detector operates only in a pulsed mode. The reason, von Gutfeld explains, is that the voltage generated in the thin film appears to result from a temperature gradient between the near and far sides of the film. Continuous irradiation of the film would "wash out" such a temperature gradient. Elimination of the temperature gradient would also result if pulses were lengthened or rise times became longer. Best results for this type of detector result from pulses only a few nanoseconds long. ■■

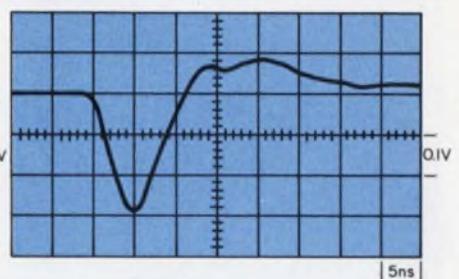
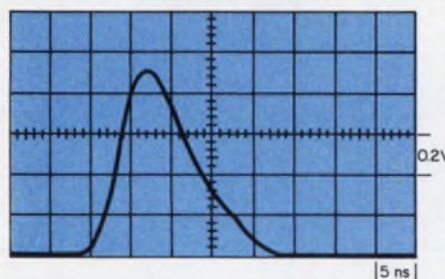

When pulsed laser light strikes the surface of a molybdenum thin film (left), a voltage pulse arises in the plane of the film. When the laser strikes the bottom side of the film through a transparent substrate (right), voltage polarity is reversed.

It's a leaner Fort Monmouth today —but a better R&D operation

From the outside it looks like many another Army base. Inside there is a difference. This is Fort Monmouth—a fountain of electronic innovation that has guided the industry from telephone wires to portable radios and on to satellites; from vacuum tubes to transistors, printed circuits and microelectronics. Since 1918, when a muddy piece of land some 90 minutes by bus from New York City became the site for turning ideas into battlefield electronics, the Army Electronics Command at Fort Monmouth, N.J., has been an inspiration to electronics designers and a hub for marketing men.

But how is the command at the fort doing in the austere post-Vietnam War era?

John F. Mason
Associate Editor

First, the bad news: "We're a little leaner than we were [down from 13,000 employees worldwide to 10,810], and inflation has taken a bite out of the buying power of the approximately \$100-million-a-year we have to spend," says Col. E. L. Bowman, deputy director for operations of the command's Research, Development and Engineering Directorate.

New directions apparent

But on the positive side, the colonel adds: "We're able to operate in a more organized way now. We no longer have to react to an immediate requirement—having to get something developed, built and into the hands of the troops quickly, often at a higher-than-usual cost."

These trends are evident as

Fort Monmouth continues to push back the frontiers of electronics today:

- Cost has become a dominant consideration in the development of new equipment. "Cost is now the first test a project must pass before it is started," says George Uchirin, an electronics engineer in the Electronic Technology and Devices Laboratory at Monmouth. Can the Army afford it? If the answer is no, the project stops, regardless of how desirable it might be.

- R&D has been speeded dramatically. "It used to take 20 years for a project to move from a concept to the battlefield," Uchirin notes. "Now it's supposed to take 12."

- Every project must undergo rigorous reviews to determine its practicality and ultimate cost. The

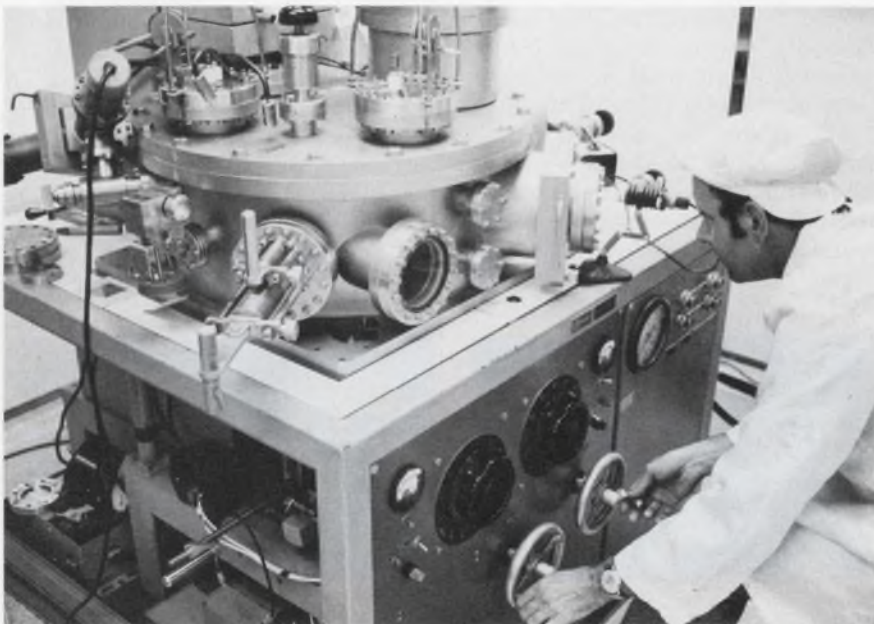

The Army's ultra-high vacuum system for processing quartz resonators for frequency control can bake, plate and seal them without venting between operations. Most systems require a machine for each step.



Specialized ICs are a big R&D effort at Fort Monmouth. The technician here is putting a tray of MOS IC wafers into a diffusion furnace.

CINCH CONNECTORS

IRC RESISTORS

UTC TRANSFORMERS

GLOBE MOTORS

HOLYOKE WIRE & CABLE

CINCH-GRAPHIK

IRC POTENTIOMETERS

SEMICONDUCTORS

SUPERMET PRODUCTS

CINCH-MONADNOCK

CAPACITORS

ELECTRONIC FUNCTIONS

CONSUMER INTERNATIONAL

You know us well enough to call us by our first name...

procedure is called electronic systems planning, or ESP. "Twice a year every project in every laboratory is formally reviewed for its importance and for the number of different systems it can be used in," Uchrin explains. "These reviews are, of course, tied in directly to the budget."

Future looks solid

On balance, the Fort Monmouth Electronics Command is doing well. It survived the storm of military base closings, realignments and drastic reductions in force that have taken place over the last year. And the future of all seven of its research-and-development laboratories looks good.

What has happened to R&D in speeding it from 20 years to 12? The whole cycle has been compressed. "For example," Uchrin says, "the development stage of a project used to be indefinite. Now it's limited to six years. Approval to start developing a project used to take two to three years. Now this is squeezed down to 45 days."

Exploratory development has been cut to two years, Uchrin says. If the technical problems haven't been solved by then, the whole project must be re-examined. "The project will either be scrapped or started over," Uchrin says.

Updating the periodic reviews of projects, or ESPs, is a mammoth job Uchrin adds, and should be done by computer. "At present, though," he points out, "we don't have a computer here at Monmouth with sufficient memory capacity to handle it."

For its next generation of system families, the Army Electronics Command plans to stay in the forefront of every technology the Army needs—a goal that is now "realistically coordinated with other services to avoid duplication," says Colonel Bowman.

Circuit development pushed

The development of functional circuits is proceeding on a number of fronts:

The main work on MOS arrays is aimed at producing LSI arrays with the density of PMOS circuits and the low power characteristics of CMOS. These LSI circuits will be applicable to communication

security modules for an upcoming tactical radio communication system.

Schottky-barrier gallium-arsenide FET amplifier efforts are being aimed at X and Ku-band power amplifiers, featuring octave-bandwidth and power-combining techniques. Future efforts will investigate new devices in other materials, such as indium phosphide. These circuits will be applicable to avionics and communication receivers and electronic-warfare noise jammers.

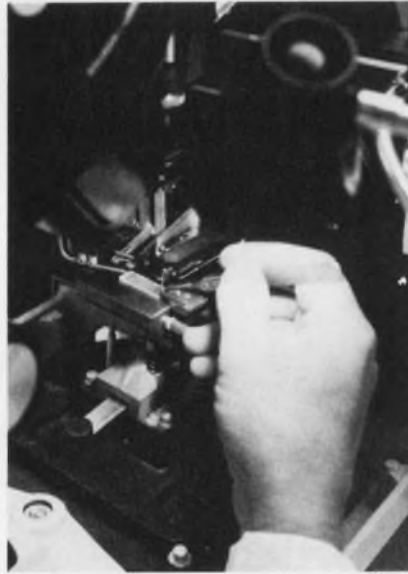

In a special clean room at Fort Monmouth a technician bonds leads to two transducers on a surface-wave dispersive delay line. The device might be used in a radar to determine range resolution.

Work on charge-coupled devices is concerned with the development of lightweight, low-power, self-scanned photosensor arrays for a tactical page reader and facsimile system.

A variety of microwave ICs are being developed to improve receiver sensitivity and output power for such systems as the airborne radar-warning target locator and electronic-warfare countermeasure equipment.

Linear/digital circuits programs are concerned with the increased complexity of ICs, with improved reliability, decreased cost and lower power requirements. The first goal is to provide for fabrication of novel custom LSI circuits through use of standard cell de-

signs and standard gate arrays. Later LSI programs will concentrate on the development of CCD arrays for high-density, low-cost, dynamic memories to be used in tactical computers.

Next, the Army will develop an infrared sensor signal-processor array for weapon locators.

A major new program is planned for developing low-loss fiber-optic communication cables, which are to be extremely lightweight, flexible, rugged and impervious to electromagnetic interference or damage from high-level electromagnetic and nuclear radiation.

The main shortcoming of available fibers and fiber bundles, the Army says, is that they're too fragile. For example, it is typical in bundles of 61 fibers to have all but a few of the fibers break in the bundling process.

The long-range goal, to be emphasized through 1976, is to achieve tactical cables with low-loss (20 dB per kilometer and better) fibers. These will be used in lengths of one to three kilometers without repeaters. They must support data rates of 10 to 50 megabits.

TWT improvements sought

The Army wants a reduction in the cost, size and weight of broadband microwave traveling-wave tubes for phased-array radars and electronic warfare applications. The advent of the rare-earth cobalt permanent-magnet system, such as the samarium-cobalt composition, suggests the possibility for design of such tubes to one-fifth the size and for one-tenth the cost of conventional tubes.

To meet the Army's future computer needs, existing electromechanical peripheral equipment—such as magnetic disk units, magnetic drum units and magnetic tape transports—must be replaced. Moving parts in electromechanical devices must absolutely be replaced, the Army says, if data-processing equipment is to be used in the field without the need for accompanying large vans.

Candidates being explored to achieve this computer goal include magnetic-bubble memory-logic devices, amorphous semiconductors and metal-oxide switching devices of high nuclear and thermal hardness. ■■

TRW[®] CINCH CONNECTORS

TRW[®] IRC RESISTORS

TRW[®] UTC TRANSFORMERS

TRW[®] GLOBE MOTORS

TRW[®] HOLYOKE WIRE & CABLE

TRW[®] CINCH-GRAPHIK

TRW[®] IRC POTENTIOMETERS

TRW[®] SEMICONDUCTORS

TRW[®] SUPERMET PRODUCTS

TRW[®] CINCH-MONADNOCK

TRW[®] CAPACITORS

TRW[®] ELECTRONIC FUNCTIONS

TRW[®] CONSUMER INTERNATIONAL

We all have the same first name.

More important, we all operate under the same philosophy, with the same standard of quality, reliability and service. Each of us specializes in a particular area of manufacturing. But not as separate companies. As the operating units of one entity. TRW Electronic Components.

That means you can enjoy all the unarguable advantages of having a single, reliable source for your electronic needs.

Between us, we make over 300 different kinds

of electronic components. And, among us, we have the ability to make whatever you want. High-technology, high-volume—or both. It's all in the family. Or can be.

So it will pay you to get familiar with us, to think of us on a first name basis. In this case familiarity breeds... contentment. With TRW reliability, quality, and service for the components you need. Because we can supply them.

And because we are TRW.

TRW[®] ELECTRONIC COMPONENTS

10880 Wilshire Blvd., Los Angeles, CA. 90024

INFORMATION RETRIEVAL NUMBER 24

We packed even more circuitry into CTS cermet resistor networks.

*8,-14,-16 and -18 lead styles
Series 760 Dual In-Line Packages.*

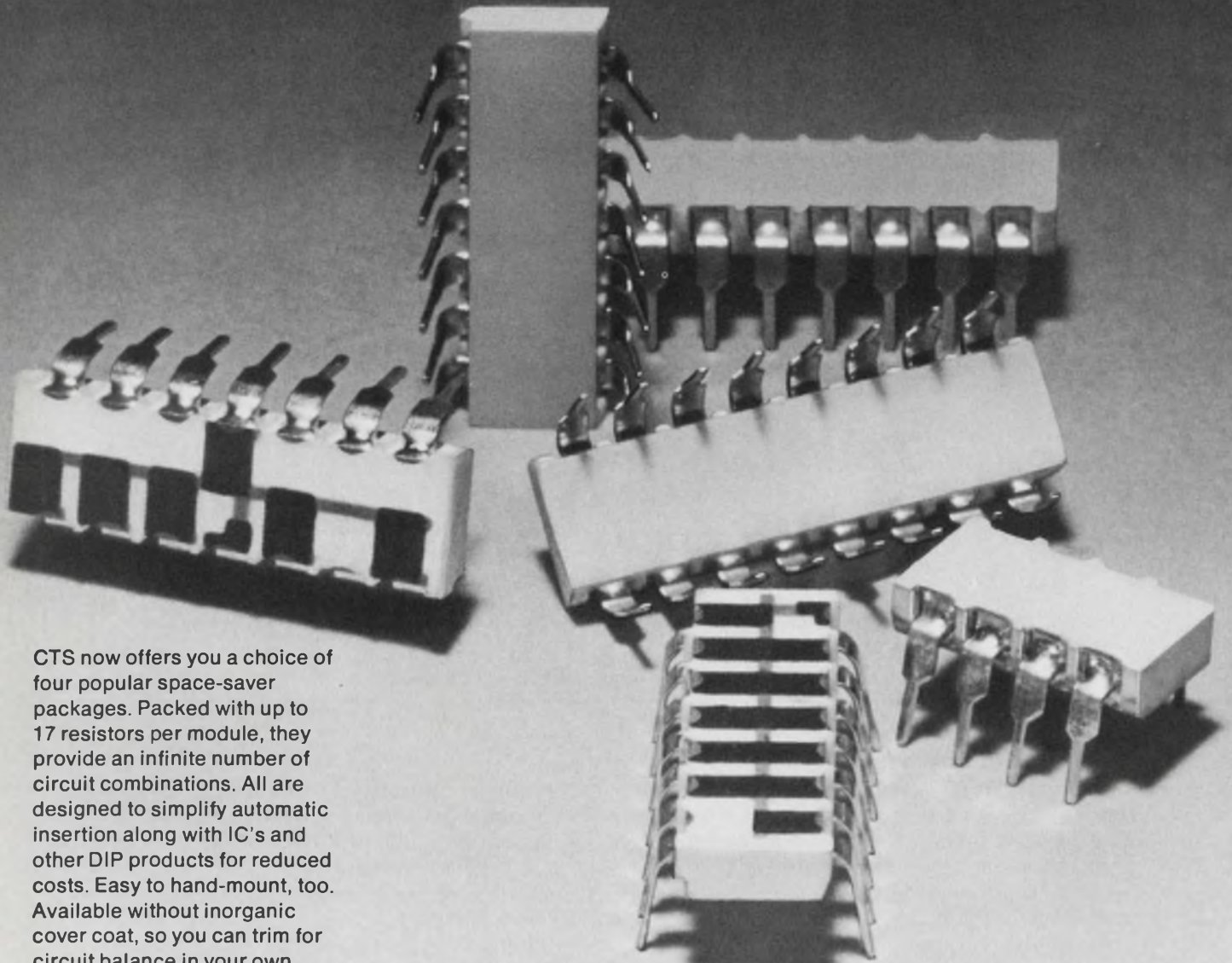

CTS now offers you a choice of four popular space-saver packages. Packed with up to 17 resistors per module, they provide an infinite number of circuit combinations. All are designed to simplify automatic insertion along with IC's and other DIP products for reduced costs. Easy to hand-mount, too. Available without inorganic cover coat, so you can trim for circuit balance in your own plant. 5 lbs. pull strength on all leads; .100" lead spacing; rated up to 2 watts on 18 lead style. Choose from standard circuit available for immediate delivery (see data sheet 3760 . . . or custom design to specifications).

CTS of Berne, Inc., Berne, Indiana 46711. (219) 589-3111.

Series 750 edge mount cermet resistor packages available in infinite number of resistor patterns and wide selection of package configurations.

CTS CORPORATION

Elkhart, Indiana



A world leader in cermet and variable resistor technology

INFORMATION RETRIEVAL NUMBER 231

CTS put the squeeze on 3 more cermet resistor networks.

*Now 23 standard CTS designs—3 lead styles
Series 750 Edge Mount Packages.*



Choose from 23 CTS Space Saver Cermet Resistor Networks to Increase Circuit Density . . . At Economical Prices

You'll like how much they can save you, and your circuit. Less space . . . fewer components . . . greater system reliability . . . quicker, easier installation . . . reduced handling costs . . . and faster inspection. Consolidate up to 13 discrete resistors into one compact in-line Saver Pac resistor module.

CTS can do it easily with an expanded line of 23 modules . . . available in .100", .125", or .150" lead centers . . . including NEW 10 and 12-pin .125" and low profile 8-pin .100" designs. High power capabilities to 4.3 watts @ 70°C per module.

CTS 750 series cermet thick-film resistors assure proven performance—ultra high stability and reliability—backed by over 700,000,000 hours of test data. Hand install or use automatic assembly equipment . . . they're designed for either. Pick a CTS SAVER PAC resistor network today. Large or small orders welcome. CTS of Berne, Inc., Berne, Indiana 46711. Phone: (219) 589-3111.

CTS CORPORATION
Elkhart, Indiana



A world leader in cermet and variable resistor technology

INFORMATION RETRIEVAL NUMBER 232

Some of the best things about our new Digivac[®] 1000 are what you can't see.

When you look at our vacuum fluorescent readout, you won't see the low voltage requirements making it directly compatible with available MOS IC logic packages.

You won't see the exclusive mica substrate which supplies mechanical strength and helps emphasize lighted segments through a desirable halo effect.

You won't see the low cost, lower than competing readouts with fewer customer advantages.

Of course, there are things about our Tung-Sol[®] Digivac 1000 you can see.

Like the Digivac 1000's brightness. 50% more brightness and greater uniformity than ever before.

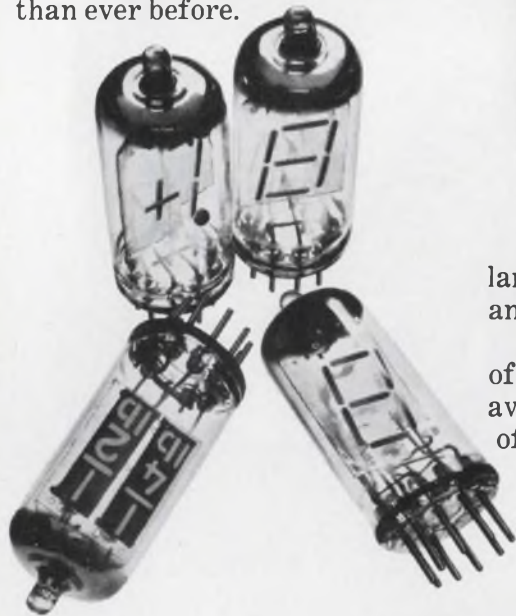

You can see the flexible language with alpha, numerical and symbolic figures.

You can see the wide range of colors, including white, available with common types of filters.

And because of the unique construction, you can see the accurate viewing assured from virtually any angle.

With the Digivac 1000 readout, whether you see it or you don't . . . it's still nice to know it's all there.

For additional information on the Digivac 1000, write to: Wagner Electric Corporation, 1 Summer Avenue, Newark, New Jersey 07104.

Wagner makes other quality products in volume for the electronics industry, including bridges, power supplies and subsystems, silicon rectifiers, resistors, miniature lamps and status indicators. And Wagner offers contract manufacturing.

WAGNER[®]

We've got a lot more riding for you.



DIFFERENTIAL LINE RECEIVER FOR NOISY ENVIRONMENTS

R_1 sets positive threshold
 R_2 sets negative threshold

Try any other Schmitt Trigger in this type of application, and short pulses of common mode noise cause false triggering.

Motorola's unique MC14583 CMOS* Dual Schmitt Trigger avoids this problem by internally connecting an exclusive OR output and its three-state enable.

With the two inputs at different levels, the exclusive OR output is "hi," enabling the three-state output. When sufficient noise occurs on either or both lines to put the two inputs in the same state, the exclusive OR goes "lo," temporarily disabling the three-state output. The three-state load capacitance holds the existing level to generate correct outputs despite the noise seen at the inputs.

Each of the triggers on this monolithic chip is functionally independent of the other, except for the common three-state input and the internally connected exclusive OR provided for line receiver applications. External resistors determine input trigger levels. Other readily recognizable applications include pulse shaper, level detector, level comparator and speed-up of a slow waveform edge in interface receivers.

Schmitt trigger input noise immunity for the MC14583 is typically 60% of V_{DD} , and quiescent power dissipation is 25 nW/package typical. Otherwise, general CMOS family characteristics describe each of the three versions of this device. Single supply operation is standard.

The CL suffix version is ceramic and costs (100-999) \$3.34. Supply voltage range is +3 to +16 V, and operating temperature range is -40 to +85°C. The MC14583CP has the same supply voltage and operating temperature range as the CP, but it costs only \$3.00. It's plastic, of course. The ceramic AL version is distinguished by a wide +3 to +18 V supply voltage range and -55 to +125°C operating temperature range. Price is naturally the highest of the three at \$6.50.

New Priority Encoder Unique In CMOS

Another of Motorola's recent CMOS introductions of note is the MC14532 8-bit Priority Encoder, unique in CMOS, yet a versatile addition to any complex logic family. Applications include A/D and D/A converters, 1 of n operation code checkers, code converters, and priority encoders. Same three versions, same two packages. CP is \$4.05, CL is \$4.50, and AL is \$8.75.

Get data from Motorola Semiconductor Products Inc., P.O. Box 20912, Phoenix, Arizona, 85036. And while the supply lasts, we also will send the up-to-date 1973 CMOS Product Directory in response to your data requests. Your franchised Motorola distributor and local Motorola sales office have parts to sell. Try them.

*Trademark of Motorola Inc.



Put 6 volts into a matchbox and get 10,000 out?



**It wasn't easy
(but we did it)**

We'll take on just about any power supply job. Especially the kind we can sink our teeth into. The tougher, the better — even jobs other companies don't want. Like building a matchbox-size power supply to convert a 6V input to a 10KV output.

From high-volume, low cost commercial to highly sophisticated, ultra-dependable military power supplies. From high-voltage to low-voltage, high power to low power.

Give us the specs for the supply you need and we'll design it, build it, test it; freeze it, heat it, test it; we'll shake it, kick it, test it... We'll build you the power supply you want, from start to finish. And it will work... and work... and work.

Our power supplies are matchless.

 **Scott ELECTRONICS CORPORATION**
P.O. Box 7637 • 2525 Shader Rd. • Orlando, Florida 32804 • (305) 295-5850



Announcing Better Frequency Synthesis Options than the MC12012 or the 95H90

Fixed and Programmable Prescalers from PLESSEY

Versatile. Stable. Economical. That's Plessey Semiconductors new SP600 series high-speed binary integrated circuits. Whether you use two-modulus or fixed prescaling, the SP600 series has the best product for your application.

÷ 10, 11 Programmable Prescaler

Specify Plessey's SP640 series... a range of electronically variable divide-by-10/11 prescalers. Our SP646B is a functional replacement of Motorola's MC12012 two-modulus prescaler. The SP641B is a direct replacement of Fairchild's 95H90. But ours are better. Much better.

FREQUENCY SYNTHESIS OPTIONS

Type*	Modulus	Speed (MHz)**	Power Drain (mA typ)
SP601A & B	÷ 4	150	18
SP602A & B	÷ 2	500	12
SP603A & B	÷ 2	400	12
SP604A & B	÷ 2	300	12
SP607B	÷ 2	600	12
SP613B	÷ 4	700	60
SP614B	÷ 4	800	60
SP615B	÷ 4	900	60
SP616B	÷ 4	1000	60
SP640A & B		200	50
SP641A & B	÷ 10/11 programmable	250	50
SP642A & B		300	50
SP643B		350	50
SP646A & B	÷ 10/11 programmable w/TTL outputs	200	50
SP647B		250	50
SP648B		300	50
SP650B	÷ 16	600	60
SP651B	÷ 16	500	60
SP652B	÷ 16	400	60
SP655A & B	÷ 32	150	10
SP657A & B	÷ 20	150	10
SP659A & B	÷ 16	150	10
SP670A & B	÷ 8	600	50
SP671A & B	÷ 8	500	50
SP672A & B	÷ 8	400	50

*Guaranteed operating temperature for "A" types -55°C to +125°C;

"B" types 0°C to +70°C.

**Guaranteed input frequency range (square wave).

Higher Frequency, Lower Power Drain

No one else comes close to our maximum input frequency of 350MHz. Motorola specifies 200MHz typically. Fairchild says 270MHz. But not at our guaranteed -55°C to +125°C temperature range. And the Plessey devices use just half the power drained by the competition.

More State-of-the-Art

Request our data sheet with all the facts. Whatever your frequency synthesis requirement, we bet you'll find Plessey has the best approach. If not, don't worry. Let us quote you on your custom requirement... whether it be a special design, or variations of temperature and frequency on standard units. Call or write today. **You'll find it pays to specify Plessey.**

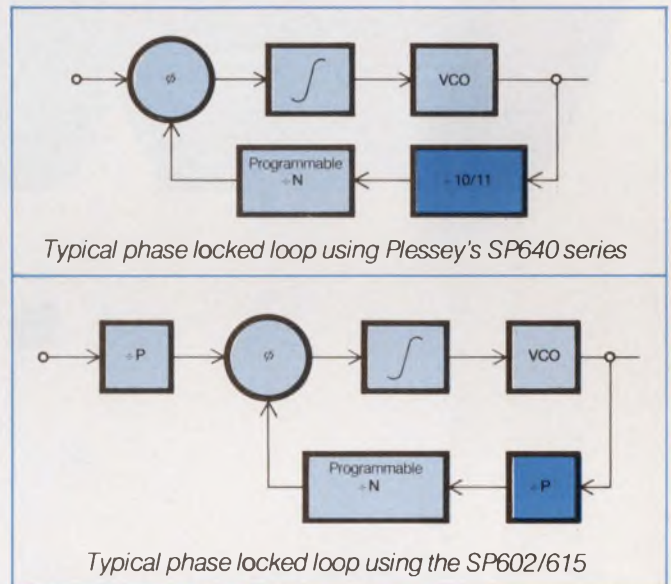

PLESSEY SEMICONDUCTORS

1674 McGaw Avenue, Santa Ana, California 92705
(714) 540-9945

170 Finn Court, Farmingdale, New York 11735
(516) 694-7377

See you at Wescon Booth Number 1840

INFORMATION RETRIEVAL NUMBER 29

think small



... with TRW metallized film capacitors. For example, metallized polycarbonate ultra-miniatures (Type X463). Real problem solvers in precision circuitry where stability with small size is essential. Capacitances: .001 to 10.0 mfd in 50, 100, 200, 400 VDC. High IR, low DF, fully rated from -55 to $+125^{\circ}\text{C}$ —with less than $1\frac{1}{2}\%$ capacitance change. Rugged, plastic film case. For similar performance in a metal enclosed unit, ask about Type X482. And for real space savings in a rigid pre-molded case, check the X440.

And then there are X601PE subminiatures in metallized Mylar* construction with dipped epoxy coating. Capacitances: .01 to 10.0 mfd—in 100 and 200 VDC. Temp.: -55 to $+100^{\circ}\text{C}$ (to 125°C with derating). Tough, self-healing. Great for high-density PC's, humid environ-

ments, precision applications. (Metallized Mylar units also available tape-wrapped or metal enclosed.)

One other thing. We figure you can't make quality capacitors and me-too capacitors under the same roof. Because sooner or later, one operation will goof the other one up. So we take the quality route. Count on it.

Write for catalog or application engineering assistance. TRW Capacitors, an Electronic Components Division of TRW, Inc. Box 1000, Ogallala, Nebraska 69153. (308) 284-3611.

*Du Pont T.M. for Polyester Film

TRW[®] CAPACITORS

INFORMATION RETRIEVAL NUMBER 30

New

Type 7529 Preamplifier

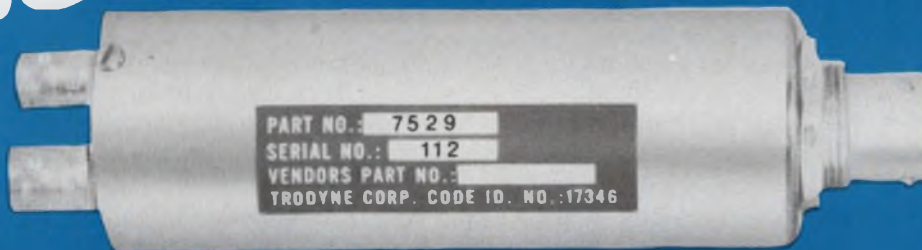

ACTUAL SIZE

Type 7529 General purpose Low-noise...wide-band PRE-AMPLIFIER

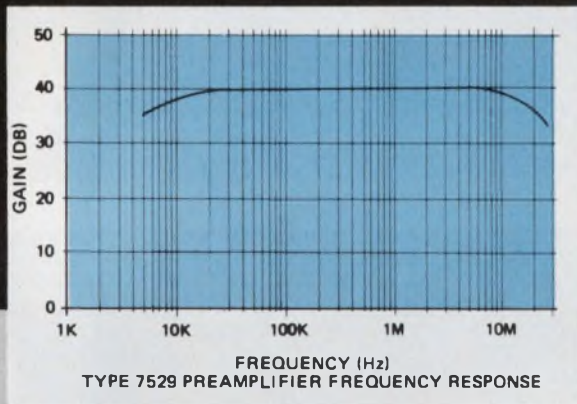

Featuring low noise and wide bandwidth at low cost, the 7529 Preamplifier is a general-purpose unit with a 40 db fixed gain. Its dual BNC input connectors accept both single ended or differential transducer inputs or voltage signals from a multitude of high frequency sources. The output of the preamplifier utilizes a Burndy connector to supply the power required to turn-on the unit and to obtain the output signals through the interconnecting cable. The preamplifier is provided with protection against overvoltages and requires no adjustments or calibration. Compact and rugged, it can function with in-line or bench-type systems and is supplied with calibration curves. Special connectors will be supplied upon request.

Additional accessories are also available to extend the gain to as much as 100 db, 60 db of which is variable in 1 db steps in addition to various filters for narrow-band applications

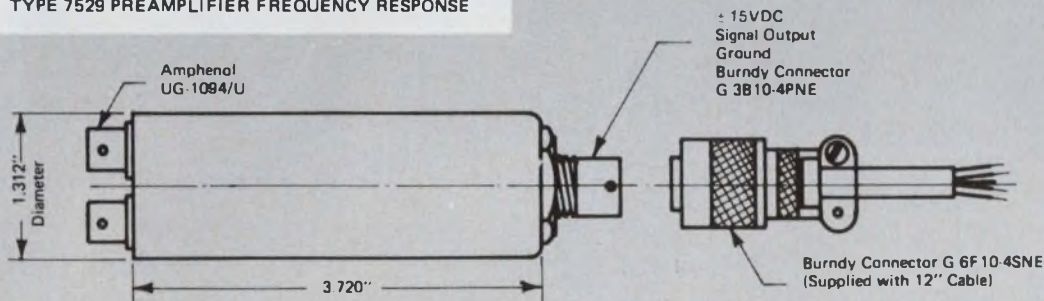

SPECIFICATIONS (At T=25°C.)

Gain: 40 db \pm 1 db
Dynamic Range: 40 db
Bandwidth: 8 KHz to 15 MHz at -3 db
Input Impedance: 10,000 Ω
Output Impedance: 50 Ω
Common Mode Rejection: 70 db typical
Max Undistorted Output: 400 mV peak-to-peak
Broadband Noise: 7.5 μ V rms referred to the input
Power Source: \pm 15 V DC
Weight: Net, 4.5 ozs. - Shipping, 11 ozs.
Price: \$175.00, F.O.B. Teterboro, New Jersey

TRODYNE

CORPORATION

39 Industrial Avenue,
Teterboro, New Jersey 07608
Tel: 201-288-4400
TWX: 710-990-6122

ANNOUNCING A LOT LESS TO GO WRONG.

We've got a 50 MHz frequency meter with simpler circuitry and better performance than anything anywhere near its price range.

It's the Newport 730 Counter-Timer and it only costs \$299.

The new 730 offers 50 mV input sensitivity. A count range from 10 Hz to 50 MHz. Frequency, accumulate and digital stopwatch modes. Five selectable gate times. Six-digit LED readout. Internal crystal controlled time base.

It also has many features you wouldn't expect in a low-cost instrument. Including readout display storage with storage override control. Precision crystal oscillator accurate to two parts per

million. And a multi-range time base selector switch which permits maximum resolution of the frequency being measured.

For easy maintenance, we made the ICs socket-mounted. For ease of replacement, we offer an optional IC spares kit.

For more information, just circle reader service number 232 or write Newport Laboratories, Inc., 630 East Young Street, Santa Ana, California 92705. For immediate information, call collect. Dial (714) 540-4914. Ask for Walt Boris. Or TWX: 910-595-1787

NEWPORT



THE LESS WE PUT INTO IT THE MORE YOU GET OUT OF IT.

In Europe:

Newport Laboratories B.V., P.O. Box 7759, Schiphol-0, Holland, Tel: 020-45-20-52

INFORMATION RETRIEVAL NUMBER 32

ELECTRONIC DESIGN 18, September 1, 1973

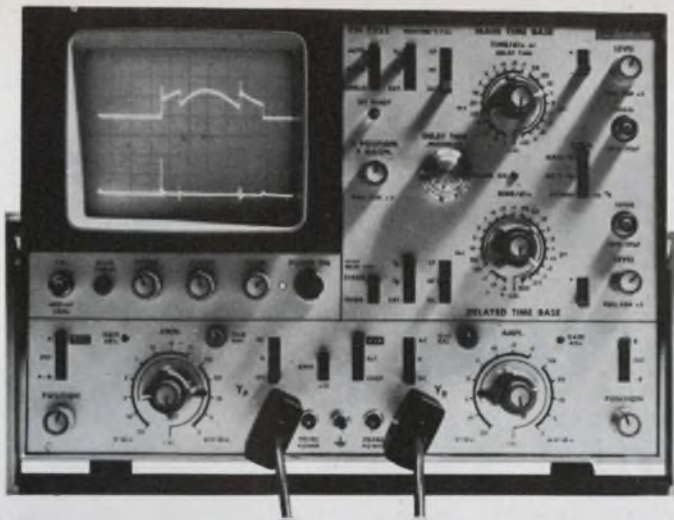

THIS IS THE ONLY SCOPE
THE NEW PHILIPS PM3252
THAT CAN DISPLAY
A x B

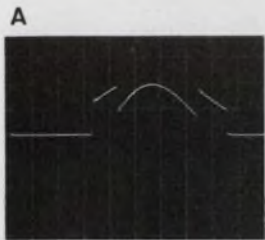

A
 Collector voltage of the power transistor in a DC-DC converter is displayed on channel A of the PM3252.
 (200 V/div, 0.5 μ sec/div.)

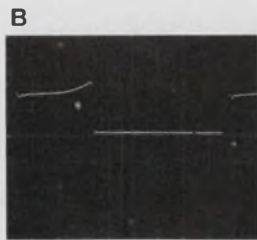

B
 Collector current displayed on channel B (0.1 A/div.)

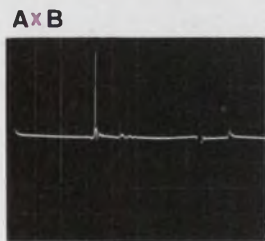

A x B
 Flicking the mode selector switch to A x B now displays instantaneous collector dissipation with vertical calibration of 20 W/div. (200 V/div, x 0.1 A/div. = 20W/div.) A x B display reveals sharp power transient (70 W) not directly detectable on conventional scopes.

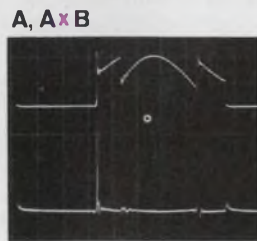

A, A x B
 Simultaneous, two-channel display (A and A x B) reveals that the 70 watts is dissipated when transistor switches from current to voltage mode.

Displaying the product of two signals up to now has required an expensive, complex bench-test setup... and even then you were limited to less than 5 MHz working bandwidth.

Not any more!

Now, with the Philips PM3252—a 60 MHz high-performance general-purpose dual trace scope—you can display the product of two signals as easily as their sum or difference, and you can do it at 30 MHz bandwidth. With the PM3252 you can easily switch back and forth among A x B, A - B, and A + B... and you can display a second channel along with any of them.

- The PM3252 allows you to display instantaneous power. And its analog output converts an ordinary DC voltmeter into a wattmeter.
- It allows you to make precise phase adjustments... for example, in aligning heads on a multi-channel recorder.
- Its 30 MHz multiplication bandwidth allows you to make precise dynamic measurements of phase variations caused by wow and flutter.
- In physical investigations, the PM3252 can display the instantaneous product of two rapidly changing transduced properties such as force and displacement or torque and angular rate.

In addition to its unique capability for multiplication, the PM3252 which sells for \$1995 offers top performance as a conventional dual trace scope. It has sensitivity of 2 mV/div at 60 MHz (or 200 μ V at 5 MHz). DC drift is a negligible 1 div/week. Triggering for the main and delayed time bases is completely independent... and automated for simple operation. The vertical channel delay is 65 nsec, 30 nsec of which is visible so that leading edges can be fully investigated.

If your application involves single-shot or fast rise time events, a sister-instrument, PM3253, offers identical multiplication performance and adds variable-persistence and storage capability.

The PM3252 will be demonstrated at our Booths, 1327 and 1429, at WESCON. If you're working or expect to be working on cybernetics, DC to DC converters, pulse and switching circuits, audio and video output stages, switching regulators, logic and integrated circuits, power control circuits, SCR's, or transient studies... you won't want to miss this comprehensive demonstration of the world's first multiplier scope. For more information or personal demonstration, write: Test & Measuring Instruments Inc., 224 Duffy Avenue, Hicksville, New York 11802 Telephone: 516-433-8800.

TEST & MEASURING INSTRUMENTS INC.
 A NORTH AMERICAN PHILIPS COMPANY

INFORMATION RETRIEVAL NUMBER 33

SPECIAL GROUP TOUR



1973 JAPAN ELECTRONICS SHOW

With the cooperation of ELECTRONIC DESIGN and PAN AMERICAN AIRWAYS, a special tour program has been tailored by Imperial Travel Service of New York for exhibitors and visitors to the 1973 JAPAN ELECTRONICS SHOW to be held in Osaka, Japan, October 1 through 7. Far and above regular sightseeing tours, this program will offer you many opportunities to witness at first-hand the growing Japanese electronics industry and provide free time to do business in Japan and the Orient. If you are taking your wife along, you will find this tour ideal with its many side trips and excursions.

Departure from West Coast:

Saturday, September 22, via Pan American

Return to the United States:

Monday, October 8, via Pan American

Tour Fare: \$945 per person on sharing basis
\$150 per person for single supplement

The above includes:

Air transportation from West Coast to Tokyo, round trip,
Economy on GIT fare.

Accommodations for 15 days at first class hotels.

Full American breakfasts during the tour

Transfers by chartered motorcoaches between airports and hotels.

Sightseeing tours in Tokyo, Nikko, Kyoto and Osaka.

Special plant tours designed for the participants.

Services of tour couriers and guides.

Features: Interpreter/Secretarial services will be available upon request.
Extension trips to Taiwan, Korea and Hong Kong available.

For detailed information, complete and mail the coupon below.



To: Imperial Travel Service
50 Essex Street, Rochelle Park, NJ 07662

I am interested in your Special Group Tour to
the Japan Electronics Show, October 1-7, 1973.
Please send me detailed information as soon as
possible.

Name _____

Title _____

Company _____

Address _____

Metal fastening is one thing, but what do you do about new materials, like plastics, and particleboard and...

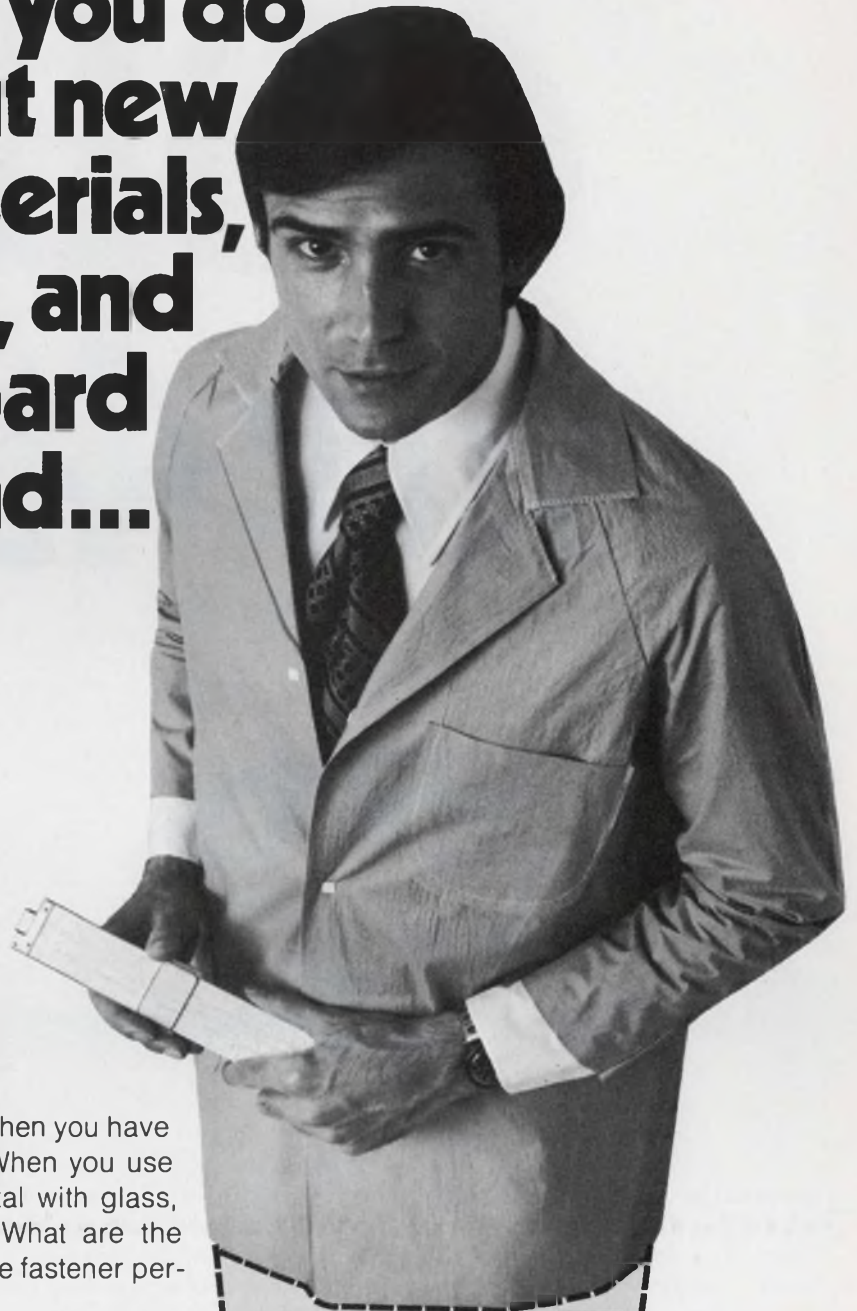

It's a whole new bag of problems when you have to fasten different materials together. When you use plastic with wood, for example, or metal with glass, there are lots of things to consider. What are the physical properties of each? How will the fastener perform? What about cost?

Shakeproof has compiled a number of examples of how fasteners have been used to meet these new problems. They are contained in a folder called "BRINGING TOGETHER DISSIMILAR MATERIALS." It shows how Shakeproof can help solve your problems.

Send in the coupon today. Prepare to meet your next challenge successfully.

Please send me a copy of
**"BRINGING TOGETHER
DISSIMILAR MATERIALS."**



Name _____
Title _____
Company _____
Address _____
City _____
State _____ Zip _____

it **SHAKEPROOF**[®]
DIVISION ILLINOIS TOOL WORKS INC.
ST. CHARLES ROAD • ELGIN, ILLINOIS 60120

INFORMATION RETRIEVAL NUMBER 38

6 GHz for 45¢



Here's the first sub-miniature connector that can give you low price and top performance in your mobile radio, telecommunications and other medium to high frequency applications. The revolutionary ALC-5* connector. As low as 45¢ a mated pair in thousand piece quantities. And the assembly cost is far less than that of a phono plug. Performance? VSWR for a mated pair with 2' of RG 58C/U cable is less than 1.22:1

at 1 GHz. Under 1.40:1 at 6 GHz.

That's not all. A completely crimped assembly makes possible the use of automated procedures rather than time-consuming and messy soldering, further cutting your costs. And with push-on or snap-on mating and short length (just 1" for standard mated pair), installation is a breeze.

We don't believe any other sub-miniature high frequency connector can offer so much at

so small a price. In a wide variety of shapes and sizes to meet your individual needs.

Consider it for your next application. It's something that should change your mind about what you've been using up to now. The ALC-5 connector. Only from Amphenol. For more information, write: Amphenol RF Division, Bunker Ramo Corporation, 33 East Franklin Street, Danbury, Connecticut 06810. Phone: 203/743-9272.

**BUNKER
RAMO**

AMPHENOL

washington report



Heather M. David
Washington Bureau

Battle pressed to save cruise-missile program

The Pentagon and several industry teams are lobbying intensely to save the Submarine-Launched Cruise Missile program. The Senate Armed Services Committee voted just before Congress recessed in August to eliminate the \$15.2-million Navy request for the project. The House voted earlier to keep it, however, and there appears a good chance House committee members, who have had a long-standing concern about cruise missiles, will persuade the Senate members in conference to yield. The Submarine-Launched Cruise Missile concept originated in the National Security Council, which wanted it as an extra bargaining chip for the Strategic Arms Limitation Talks. The Navy has since grown quite attached to the program, despite Air Force protests that the Navy is further encroaching on the strategic weapons area. Top pentagon officials, however, see the missile as a weapon that also could be carried on the B-52 and B-1 bombers. The Navy design calls for an all-digital, terrain-contour-matching guidance system. Lockheed, LTV, General Dynamics and McDonnell Douglas are vying for the contract.

Senator asks halt in IC sales to Eastern Bloc

Sales of integrated-circuit technology to Poland by the French company Sescosem, and a rumored similar potential sale by a British company, has provoked the ire of Sen. John Tower (R-Tex.). He is trying to convince the Executive Branch and industry that such sales should be vetoed by the U.S. at the Coordinating Committee of Consultive Nations. The committee is an international cooperative council of Western nations that agree on exports of strategic items to the Soviet Union and Eastern-bloc countries. Tower points out that the capability of the MIRV (Multiple Independently Targetable Re-entry Vehicle), which represents the U.S. technological edge over the Soviet Union in strategic weapons, is absolutely dependent upon integrated circuits.

New AWACS fund slash to be attempted

One of the first orders of business facing the Senate on Sept. 5 will be the military procurement and R&D authorization bill. Sen. Thomas Eagleton (D-Mo.) plans to try to cut funds for the Airborne Warning and Control System (AWACS) on the grounds that the AWACS aircraft, with its look-down radar, would not be effective as part of a defense against Soviet bomber attack. The plane is vulnerable to at-

tack by radar-homing missiles, Eagleton charges. The Senator has urged the Defense Dept. to continue its work on the over-the-horizon-backscatter (OTH-B) radar network, and an advanced manned interceptor. The radar, by bouncing impulses off the ionosphere, is potentially capable of detecting low-flying aircraft over three million square miles of territory. Eagleton's attempt to cut AWACS is not expected to succeed, but the publicity on the radar could help that long-delayed program.

Aerosat: An international argument over vhf

The U.S. proposal for an international aeronautical satellite (aerosat) has touched off an argument over whether the satellite should include both vhf and L-band communications. Despite a ruling in 1971 by the White House Office of Telecommunications Policy that such satellites should operate at L band—and a similar ruling later by the International Telecommunications Union—many airlines want to continue using vhf because of their tremendous investment in existing equipment.

The French delegation to the Aerosat Program Board has vigorously opposed the inclusion of vhf transponders in the experimental satellite design plan, but a final decision by European members of the board may not come until mid-September. The U.S. represented by the Federal Aviation Administration, is trying to calm the troubled waters by agreeing to pay for any extra cost if vhf is included in the experimental satellite. Other costs are to be split 50-50 between the U.S. and European members.

The situation is critical to the future of the aerosat, FAA officials say, since Congress may not approve U.S. participation unless the airlines get what they want—and they want vhf.

Capital Capsules: The Air Force's uhf Satellite Data System is being developed by Hughes Aircraft Co. and is based upon that company's experimental tactical communications satellite work. It will consist of two satellites to be used for communications and command and control of strategic aircraft in the north polar region The IEEE is pushing for Treasury Dept. approval of a pension plan for engineers that, among other features, could be transferred from job to job. At present four out of five engineers never get any benefits from pension plans, the organization says The current copper shortage has been having impact on electric wire and equipment industries. A bill to authorize the sale of copper from the national stockpile has been introduced by Sen. John Pastore (D-R.I.) Sen Frank Moss (D-Utah), chairman of the Senate Space and Aeronautical Sciences Committee, has sponsored legislation to create an Office of Earth Resources Survey Systems within NASA. Moss says there is a need for more push to turn remote sensing technology into operational usefulness The Senate Judiciary Subcommittee on Patents, Trademarks and Copyrights will hold hearings this month on patent-law revisions aimed at removing artificial restraints on the use of technology The Advanced Research Project Agency at the pentagon is looking for contractor technical support for its ARPANET Computer Network, which links 20 different computer sites Rumored in Washington, Clay Whitehead, director of the Office of Telecommunications Policy in the White House will announce his resignation later this year. There are no plans to abolish the office.

storage does more...

... like letting you view changes in characteristics while you vary operating conditions. As pictured here, the zero temperature coefficient of a junction F.E.T. is easily found by observing the curve that changes least with changing temperature.

Storage also extends your measurement capability at low currents where device capacity normally limits a curve tracer to DC operation and a set of dots on the display. With storage you can trace and retain complete characteristics by slowly varying the DC conditions.

Plug-in test fixtures provide the flexibility required to keep your testing capability in stride with the ever-advancing semiconductor industry.

When equipped with the 177 Standard Test Fixture, the 577 displays the characteristic curves of transistors, FET's, tunnel diodes, SCR's, Zeners, or any device which current-versus-voltage plots are desired.

Measuring parameters of linear IC's such as op-amps, diff-amps, comparators and regulators becomes an inexpensive, simple task with the plug-in 178 Linear IC Test Fixture.

The 577 system prices range from \$1850 to \$3200.

Let us assist you in solving your measurement needs. Call your local Tektronix Field Engineer for added information and a demo, or if you prefer, write Tektronix, Inc., P.O. Box 500, Beaverton, Oregon 97005. In Europe, write Tektronix Ltd., P.O. Box 36, St. Peter Port, Guernsey, C.I., U.K.

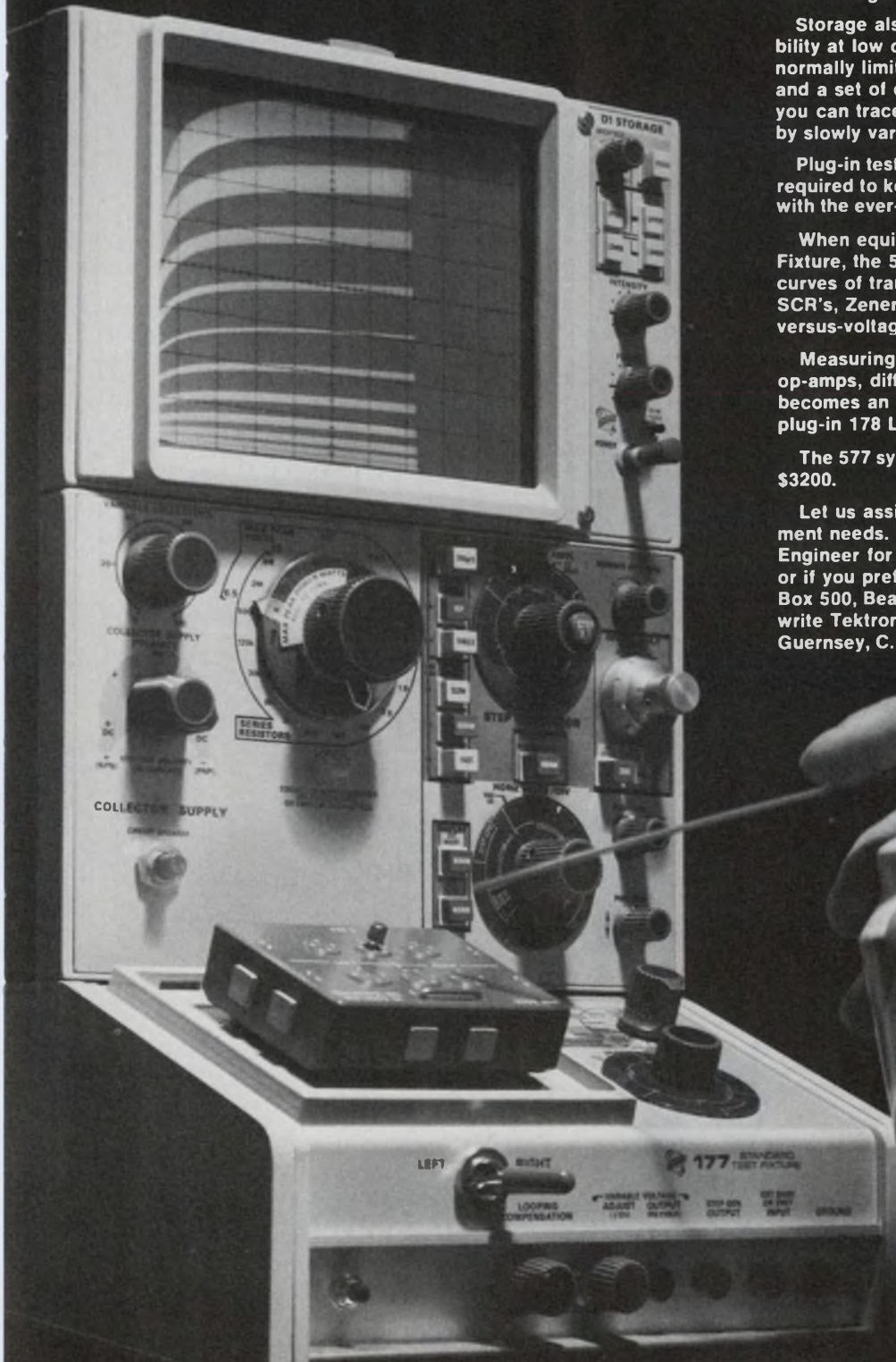

TEKTRONIX®

committed to
technical excellence

CMOS Analog Switches

TTL-controlled switches handle full $\pm 15V$ signal swing
with only $\pm 15V$ supplies.

New DG200 and DG201 devices provide channel and gain selection for analog signals up to $\pm 15V$ power supply levels without exceeding switch signal handling levels (see typical applications circuit below). Devices feature:

- Monolithic CMOS construction; drivers and gates on a single chip.
- Low r_{DS} over full temperature and signal range.
 - <100 Ω for DG200 (dual SPST)
 - <250 Ω for DG201 (quad SPST)
- Static protection on all terminals.
- Break-before-make switching action.
- Independent pairs of sources and drains for maximum flexibility.
- Direct TTL, DTL and CMOS compatibility.

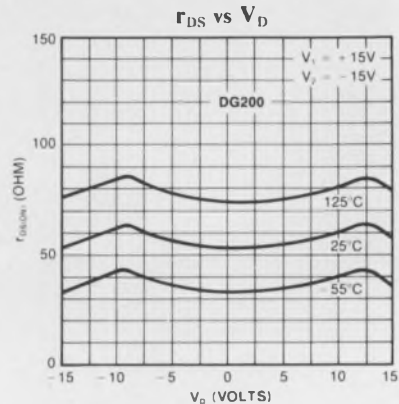

With supply voltage levels less than $\pm 15V$, the maximum analog signal always equals supply voltage.

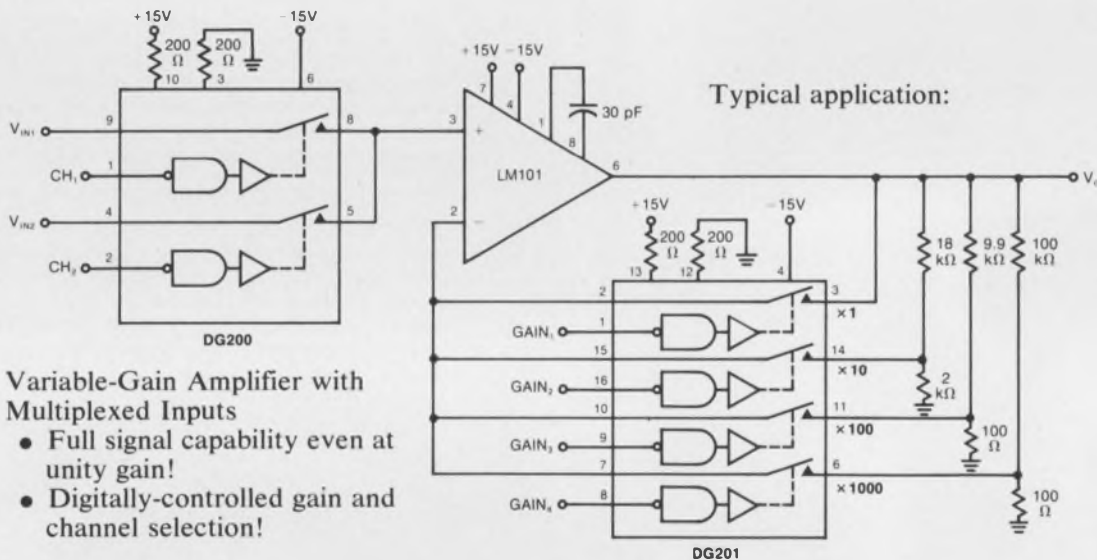

Variable-Gain Amplifier with Multiplexed Inputs

- Full signal capability even at unity gain!
- Digitally-controlled gain and channel selection!

The DG200 and DG201 are ideal devices for digital computer interface with this analog world. If your switching problems are unique — and whose aren't — our applications people are eager to help. For complete information

write for data

Applications Engineering: (408) 246-8000 Ext. 802



Siliconix incorporated

2201 Laurelwood Road, Santa Clara, California 95054

INFORMATION RETRIEVAL NUMBER 41

My friend's a thief

I was shocked, but only briefly, to learn that an old buddy was a crook. He was stealing long-lead-time ICs from his employer, a leading IC manufacturer, and selling them to people who paid a stiff premium to get them fast. This kind of crime is not unique; it's been going on at several semiconductor companies. And a few of the thieves have already been caught. What bugged me in this case was the fact that the thief was a man I knew personally, a respected and trusted engineering manager. He wasn't some stranger who's just a name in a newspaper.



After I simmered down, I began to wonder if my annoyance with my friend's dishonesty was justified. After all, if an attorney-general of the United States, a great exponent of law and order, doesn't know that burglary is illegal and unethical, should my friend know? If the closest advisors selected by the President are involved in burglary—and they are men of high moral standing—why shouldn't my friend steal a bit? Why shouldn't any of us?

There have been so many jokes about the Watergate scandal ("Impeachment—with honor," "Free the Watergate 500," "The best government money can buy," etc.), that we begin to wonder if our reaction should be outrage or laughter. But maybe crime is acceptable in high places. So maybe my friend will be punished because his crime was on too small a scale.

His thefts helped him buy a huge, beautiful home, but he can't claim it's in the interest of national security. He can't say he's ethical because he's promoting a presidential candidate. He can't lie, then denounce those who call him a liar. And he can't prepare an "enemies list" to punish those who criticize him.

So maybe he's guilty and deserves punishment. But is the guilt all his? Should it not be shared by "patriots" who set rotten examples of morality, by "upright officials" who condone stealing, justify it, and cover it up? And should not his guilt be shared, also, by those of us so desperate for scarce components that we'll pay others to steal?

GEORGE ROSTKY
Editor-in-Chief

Centralab perspectives

FOR USERS OF ELECTRONIC COMPONENTS



CENTRALAB

Electronics Division
GLOBE-UNION INC.

5757 NORTH GREEN BAY AVENUE
MILWAUKEE, WISCONSIN 53201

Covering Detroit's needs for thick film hybrids is a big order.

Whether you're in autos, computers, music, data processing, business machines, telecommunications or industrial electronics . . . Centralab can now provide the thick film hybrid circuits you need.

Tight schedules. Exacting specs. Volume orders for millions of pieces. Anyone who has supplied the nation's auto manufacturers with component parts knows this is the kind of mission he faces.

Centralab has run this fast track for some years, providing assembly plants throughout the U.S. with thick-film hybrid circuits for Detroit end use. These have included circuits for car radios, stereo tape players, fuel controls, headlight dimmers and dashboard instrumentation such as tachometers and sequential turn controls.

Why Centralab hybrids? Obviously, the auto makers are getting the high performance specs they ordered, and in the enormous quantities they demand.

Take the specs, for example. Package power up to 4 watts per square inch. Rugged ceramic substrates with special form factors. Compare resistor tolerances as low as $\pm 0.5\%$ and TC of 0 ± 100 PPM/ $^{\circ}$ C and you get an idea of the customized circuitry Centralab thrives on. Capacitor dielectrics range through NPO & N5250 to Hi K. Designs include plastic and glass encapsulated transistors and diodes, as well as chip devices.

Happily, this type of spec is also

required in other industries. Manufacturers of musical instruments, sound equipment, radio and TV come regularly to Centralab for custom hybrids. Typical circuits produced are tuner, IF, color and audio-circuitry. Electronic organ manufacturers are using Centralab thick-film circuits for staircasing networks, passive filters, keyers, frequency dividers, amplifiers, MOS protection and tone control circuitry.

Among the fastest growing fields is data processing. Here Centralab has produced such circuits as pull-up networks, voltage regulators, dis-

play drivers, one shot, multi-vibrators, hammer drivers and interface devices.

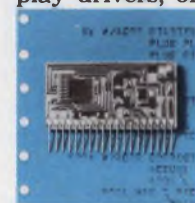

Centralab's programmed for thick-film usage in computers.

Also worth singling out are business machine and point-of-sale equipment manufacturers who specify circuits such as clock drivers, video amplifiers, high voltage bleeders, and motor speed regulators.

The list goes on and on. Telecommunications and the requirements for attenuator pads, passive filters and mixing networks. Industrial electronics and circuits such as motor speed control, solid state switches and frequency control networks.

But you get the idea by now. You set the spec. Centralab will set the precedent. It's virtually that easy when you deal with a leader. If you've a special application for hybrids, or you'd like to consider their adoption in your line, get in touch. Write A. R. Wartchow, Marketing Manager, Electroceramic Products. Ask for Centralab Bulletin No. 1429H.



Hybrids sound good to music makers, too.

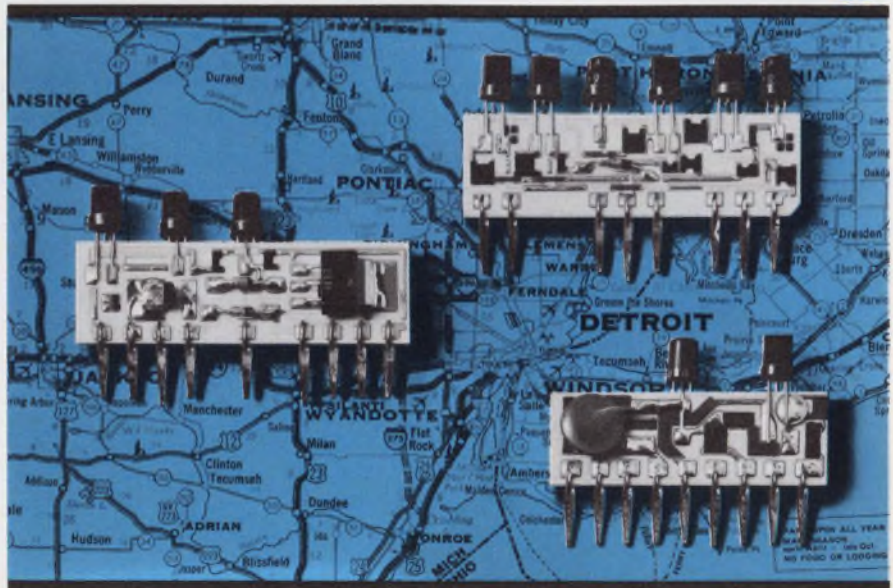

Centralab perspective:

Ultra-Kap™ capacitors. Low dissipation. High insulation.



A dissipation factor as low as 3 percent maximum and high insulation resistance up to 1,000 megohms are only two critical design parameters met by Centralab Ultra-Kap capacitors. Also important is Y5F stability which is a maximum capacitance change of $\pm 7.5\%$ from $+25^\circ\text{C}$ over a temperature range of -30°C to $+85^\circ\text{C}$.

Centralab Ultra-Kap capacitors cost far less than Mylar® and multi-layer monolithic types. With all the function you want. In substantially smaller space, too. For example, you can get a $.05\ \mu\text{FD}$, 16 V capacitor in a .375 diameter disc.

Ultra-Kap capacitors are available in voltage ratings of 3, 12, 16, 25, and 50 V, with a choice of lead size and configuration, and in a selection of coating controls. Ask about the ratings, sizes and shapes you need.

Write Centralab for
Bulletin No. 1106CA.



Centralab perspective:

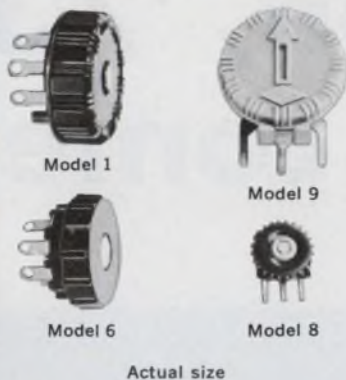

Actual size

Miniature pots at a mini-price.

Centralab gives you more to choose from in miniature potentiometers. Take the $\frac{1}{5}$ watt, $\frac{45}{64}$ " dia. **Model 9** for example. Typical pricing, in production quantities of 1000, is 34¢. That's economy because you also get:

- Rotational life in excess of 25,000 cycles.
- Choice of mountings — perpendicular or parallel plug-in.
- Resistance Range — 100 ohms to 10 megohms.
- Adjustability — Knob edge or screwdriver slot.
- Tolerance — $\pm 20\%$

For quantities under 250 contact your local Centralab Distributor.

Three other miniature potentiometers in the Centralab line of standard controls are:

- **Model 1** — $\frac{5}{8}$ " dia. $\frac{1}{5}$ watt (Available with switch)
- **Model 6** — $\frac{1}{2}$ " dia. $\frac{1}{10}$ watt (Available with switch)
- **Model 8** — $\frac{9}{32}$ " dia. $\frac{1}{10}$ watt

Get complete specifications on all four. Write Centralab for Bulletin No. EP2184.



Centralab perspective:

Ceramic Trimmer Resistors. Double the wattage of phenolics.

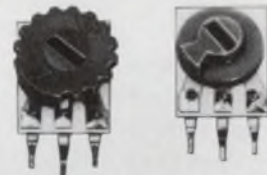

Centralab Slim-Trim carbon and Centrim cermet trimmer resistors give twice the wattage capability of phenolics, yet cost no more. Ceramic substrates mean higher wattage in a smaller space. Plus the ability to withstand high operating temperatures without shrinkage. No flux migration during flow soldering either.

Centralab design and smooth positive adjustment eliminate erratic "slip-stick" effect in setting. Choose from single or multiple sections; $\frac{1}{2}$ to $\frac{3}{4}$ watt; TC low as 150 PPM/ $^\circ\text{C}$. And if you want we can add fixed resistors to any of our standard trimmers. Easy.

See your Centralab Distributor or write Centralab for Bulletin No. 1096.



Wescon, '73: Year of the comeback?

After years of declining attendance and exhibits, this year's Western Electronic Show and Convention (Wescon) is looking for a turnaround. Among the reasons for it: A significant upturn this year in the U.S. electronics market, particularly on the West Coast. Sales of components and equipment are expected to total close to \$33-billion—a healthy 10% over last year's figure.

Attendance at the show, which is being held in the San Francisco Civic Center Sept. 11-14, is expected to approach 30,000. This would compare with nearly 25,000 in 1971, the last time Wescon was held in San Francisco.

Brooks Hall, the site of the exhibit area, contains 489 booths, which, according to Wescon officials, is the maximum capacity.

One important change this year is that the Wescon board of directors has amended the organization's bylaws to permit buyer-seller transactions—but with a maze of restrictions. Products can now be sold, but delivery cannot be made on the exhibit floor. Delivery rooms have been set aside on the upper level of the San Francisco Civic Auditorium, and these rooms must be rented by Wescon exhibitors. In addition no purchaser can return to the exhibit floor with the products in his possession. Check rooms are provided in the auditorium where products may



be left if buyers wish to resume their tour of the exhibits.

The technical program consists of 34 half-day sessions and is being held concurrently with the product exposition in San Francisco Civic Auditorium.

Seven half-day sessions are in the panel format, without formal papers. One session is a hybrid microelectronics "clinic," and one—organized by Bay Area women technologists—is a workshop on fuller use of human resources. For the first time, a university engineering papers competition will be presented as a regular Wescon session.

Most of the sessions deal with design trends and applications in technical areas and also with

Design trends in major engineering areas as reflected in the technical papers

Instrumentation	64
Medical Electronics	66
Computers and Calculators	68
Technical Program Listing	69
Microelectronics	70
Microwaves	72
Electro-Optics	76

Outstanding new products

Instrumentation	82
Modules & Subassemblies	94
Packaging & Materials	98
Components	100
Data Processing	104
Microwaves & Lasers	105



marketing. There are five sessions on marketing, management and finance, and four in different aspects of medical electronics and biomedicine. Other areas being emphasized are computer-related components and equipment, semiconductor technology, microwave applications and communications systems.

Among the more important papers are those in Session 18, "Multi-Capability Instruments" — a discussion of the growing trend toward putting several instruments in one package. One paper describes a package that contains a pulse generator, square-wave generator, frequency counter, multimeters and power supplies.

Session 17, "The Medical Instrument Industry — Fact or Fantasy," explains the pitfalls that

can be encountered by new medical electronic companies trying to develop products for the specialized, and often fickle, medical market. The session stresses the need for an informed approach.

Should industrial control systems be run by a dedicated minicomputer or programmable calculator? Session 1, "Programmable Controllers—Logic, Industrial, Utility," zeroes in on the various applications of minis and programmable controllers. Session 27 takes a deep look at the problems associated with selecting and applying calculators as industrial controllers.

The emergence of the microprocessor as a component for the logic designer is covered in Session 11, "Microprocessors and Their Application," while "The Impact of New Semiconductor Memories on Systems Design" is the subject of papers in Session 16.

New developments in microwave solid-state sources and their application in a variety of commercial and industrial products are covered in Sessions 15, 20 and 24.

Finally, progress in the development of improved ferroelectric materials and devices is covered in Session 30.

A special two-day seminar on component and printed-wiring board manufacturing is being presented during Wescon in cooperation with the Manufacturing Technology Group of the IEEE.

WESCON, '73 The technical sessions

INSTRUMENTATION

Multi-testers have many benefits, but there are disadvantages, too

Major attention on instruments this year is focused on three sessions which deal with new developments and applications of test equipment—from bench-type multi-element testers (with two or more instruments in a package) to monster computer-operated automatic test systems. The sessions are: 18, “Multi-Capability Instruments;” 22, “Intelligence in Instrumentation;” and 10, Computer-Aided Test Design for Automatic Test Equipment.”

One fast growing trend, the packaging of several test instruments in one bench unit or portable case is discussed by the speakers in Session 18. They refer to this trend as synergistic in that the benefits of an integrated collection of instruments are greater than the sum of the individual ones.

Jim Horner, project leader, Hewlett-Packard, Santa Clara, Calif., and author of a Session 18 paper, “Synergistic Instrument Design,” explains how the synergism comes about.

“There are obvious cost-reduction advantages in combining instruments in one package,” he says. “For example, the HP 5326 and 5327 line has a counter system plus a digital voltmeter.”

Savings are made, he points out, in combining the readouts for both instruments into one, having one power supply, and using a single chassis for both. All of this results in more capability per dollar, he concludes.

“But there’s a synergistic effect,” he says, “whereby you get extra measurement capability. It’s sort of a cross-product effect that gives you more capability than either alone.”

As an example, he points to the 5326, -27 line with the counter and DVM. In this unit, he explains, we have an added function which allows us with the flip of a switch, to measure with the DVM, the trigger levels of the time-interval of the counter.

“For the first time,” he says, “the user can get really good trigger-level values and know exactly where he’s triggering. But with separate instruments,” he emphasizes, “it would be a hassle to set it up.”

One of the limitations, however, of having



Bread-board gated oscillator is being evaluated on Systron-Donner's Versatester I. Five test instruments are contained in the Versatester—a pulse generator, sine-wave oscillator, frequency counter, multimeter and three test power supplies (Session 18).

several instruments in one case is that you give up a certain amount of versatility, Horner notes. “You can’t take it apart and give one user a counter and the other a DVM.”

Howard Mette, marketing manager, Datapulse Div. of Systron Donner Corp., Culver City, Calif., agrees with the basic all-in-one philosophy in his Session 18 paper, “Diverse Capability in Bench Instrumentation.”

Five instruments in a single package

This concept has been carried out, Mette explains, in the Datapulse Versatester I. Here, five test instruments—a pulse generator, square-wave generator, sine-wave oscillator, frequency counter, multimeter—and three test power supplies (± 15 V, 5 V), are incorporated in one unit 3-1/2 in. high, and 16-3/4 in. square. The frequency range of signal sources and measurements is 20 Hz to 20 MHz.

The objective here, Mette says, was to put the most-needed most-used test signal sources and measuring equipment in one easily accessible unit. “We think we have most of the equipment needed in a typical test bench setup,” he argues.

Tektronix agrees with the synergism of multi-instruments in one package, but it believes it should be possible to replace instruments in the package, as is done with the plug-ins used in the company's scopes.

"The first modular general instrumentation test system," the Tektronix TM-500, is described by Jerry Shannon of Tektronix, Beaverton, Ore., in his Session 18 paper, "Will Interconnect Plug-Ins Meet Your Test and Measurement Needs Better?"

Bob Metzler, program supervisor for the TM-500 system at Tektronix, comments on the system.

"It's the first plug-in system," he says, "the first time that the plug-in and mainframe concept has been used to supply counters, sine-wave generators, pulse generators, function generators, digital voltmeters and power supplies—a total of 24 units. All of these, he explains, plug into a couple of standard mainframes."

One unique byproduct of the plug-in philosophy is the ability of the instruments to "talk to one another" through the backplane or interface wiring, Metzler says.

"Rather than having to make front-panel connections for all of the instruments in a plug-in system, many of them—like the counter and the digital voltmeter—have front panel switches that control the input signal path. They provide the option of bringing in the signal from the front panel, or from a rear-panel connection. This rear connection can be jumpered, in the mainframe, to another instrument."

With this design, Metzler points out, the output of a signal source can be monitored by a counter through the backplane wiring. Or a power supply can be monitored by the voltmeter without external connections.

The basic mainframe is one-half of a standard 5-1/2 in. rack package, Metzler points out, and it carries three plug-in units. Typically, it weighs about 18 pounds, he says, depending upon the types of instruments plugged in.

Metzler sees a prime use of this equipment in a quality assurance setup, where a test station monitoring and testing several quantities must be continuously "on the air." With spare plug-ins on standby, should one unit fail, the plug-in feature permits rapid return to operation.

Rapid sampling requires automated systems

The level of testing associated with the multi-instrument, single-package systems of Session 18 is one that requires a single qualified operator responsible for handling a relatively small number of test points and with an extended time in which to perform the tests.

But the higher levels of testing associated with

rapid, multiple sampling and analysis of many points—even hundreds or thousands—demand automated systems with the intelligence to carry out the functions of data acquisition, processing and display.

The degree of intelligence needed is dependent not only on the problem at hand, but also the practical economic tradeoffs between automation and cost, according to Leo J. Chamberlain, president, Time/Data Corp., Palo Alto, Calif., in his Session 22 paper, "The use of the minicomputer in digital signal-processing systems."

There are other restraints on designing more intelligence into instrumentation than is needed, Chamberlain points out. One such restraint is the time required to provide such a solution. Keeping up with the competition hurries designs, Chamberlain explains, and consequently decreases the amount of designed-in intelligence.

If the system has a wide variety of inputs, of processing speeds, user interfaces and output, the use of a minicomputer for the system intelligence is a good solution, says Chamberlain.

"The great majority of minicomputers today are going into measurement systems," says Bruce Hamilton, software project leader at Tektronix, and author of a Session 22 paper, "Data Acquisition, Processing and Display—Minicomputer Based." Hamilton also notes that "almost the entire output of microcomputers is being integrated into instrumentation systems."

The use of intelligence in these systems, he says, improves the measurement capabilities of the instrumentation. For instance, "it does many things that humans typically can't do. In data acquisition, for example, it can change the acquisition rates according to an input waveform."

"With intelligence in the system," Hamilton argues, "you can have an instrument that functions as if it were a number of different nonintelligent instruments."

He points to the Tektronix digital processing oscilloscope system as an example. This system consists of three instruments: The A7704 acquisition unit, the P-7001 processor, and the D-7704 display unit and a minicomputer.

The P7001 processor interfaces with a PDP-11, which is the system's intelligence." Hamilton explains. "The processing oscilloscope system duplicates several instruments. It can add, subtract, multiply and divide waveforms. It can work as an integrator and differentiator as well as make rms measurements, duplicating some voltmeters."

The ultimate in the automation of an oscilloscope has been produced by Dumont Oscilloscope Laboratories, Inc., West Caldwell, N.J. Described by Richard H. Blackwell Jr., engineering manager at Dumont, in a Session 22 paper, "An Automatic Oscilloscope." The new scope, which

is a part of Dumont's new 3100 System, is a 100-MHz real-time, delayed-sweep, dual-channel oscilloscope that is programmable. It has 30 controls that are under the command of its intelligence, an Interdata Model 4 minicomputer.

The scope, Blackwell explains, is a programmable, bidirectional, fully automatic building block for an automatic test system that is computer centered. It's the first programmable scope with the central processor twisting the knobs, he says.

It has bidirectional communication with the processor because the data acquisition returns to the processor. As a special feature, a manual front panel can be provided, so that if an operator wants to use it as a regular 100-MHz lab scope he can take control with his own set of knobs.

The manual control unit, however, was primarily designed as a system function, Blackwell explains.

The scope can operate in the automatic mode as a front-end transducer on a processor. This is the analysis side of the system. When the scope finds a pulse that doesn't have the right rise time or is out of limits, it can sound an alarm and switch automatically to manual control.

An operator can then manually operate the scope to troubleshoot the situation. Or, as an alternative, he can push a "learn" button and have the software pick up and follow the manual control settings. Once he's finished troubleshooting and has changed the original settings in order to overcome the problem, the operator then flips the learn button back to "program" and the system picks up the new control settings and continues with automated operation.

Blackwell sees the automatic oscilloscope being used in automatic test systems, where a central processor performs a system management function. This reduces software complexity. ■■

MEDICAL ELECTRONICS

Design may be a success, but product may die unless you're qualified

Is the medical electronics industry really as promising as we have been led to believe? This is a question that will be tackled at two of the four sessions on medical electronics.

In Session 17, "The Medical Instrument Industry—Fact or Fantasy," chairman Dr. Harold B. Rose, president of Bio-Optronics, Inc., Los Angeles, notes that for many years reports of a \$100-billion national health services market by 1975 have given the impression that anyone who entered the medical electronics business would make a killing. But in reality, Rose explains, this is not so. "To succeed in the medical electronics industry one must specialize in a narrow market. If you try to develop another electronic thermometer or patient monitoring system, in all probability you are headed for disaster," he goes on.

One of the major pitfalls of new medical electronics companies is that all too often an engineer will go to his family physician and ask, "What can I invent for you?" This is not the way you do product planning and analysis, he continues. The physician, says Rose, is not qualified to specify requirements for complex medical

equipment because he has no engineering training. Nor is the engineer without medical training qualified to design medical equipment.

The point is simple and seems obvious, notes Rose, but many would be medical electronics companies failed to succeed because they ignored it.

More problems for manufacturers

There are other problems for the manufacturer of medical electronic equipment, reports George A. Bekey, a professor of electrical engineering and computer science at the University of Southern California. In his Session 17 paper, "Clinical Engineering as a Resource for New Product Development," Bekey notes that obstacles to innovation and new product development include government regulations, obtaining venture capital, the uncertain nature of the customer (the hospital), and interdisciplinary communication.

Medical electronics, he continues, has all the problems of the electronics industry plus a few more which derive from the fact that this field is regulated by several government agencies and

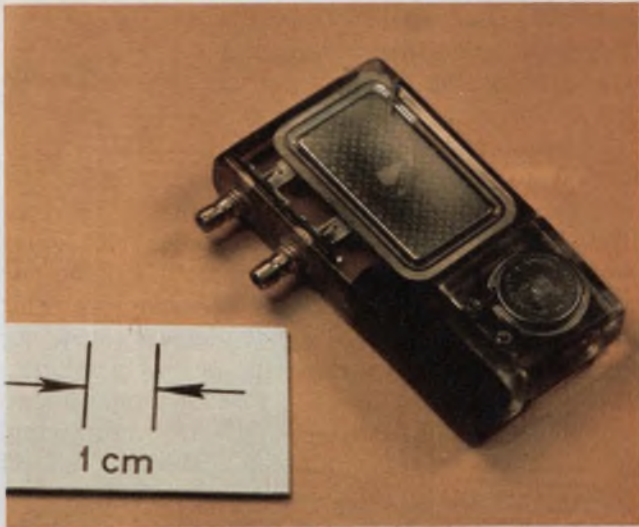

Implantable microminiature radio-telemetry system has been used to measure instantaneous blood flow in the arteries of animals (Session 7).

that products must be approved by insurance companies.

Another problem is that the hospital is a very different type of customer than that ordinarily encountered in the electronics industry. "I have seldom if ever found a hospital that does acceptance testing on new instruments," Bekey reveals. In the electronics industry, he goes on, the first thing the customer does when he receives a new instrument is to test it and make sure it conforms to specifications. "Most hospitals buy without specifications because the physician who places the order doesn't understand them," Bekey notes.

In another paper at the same session, Donley J. Valiquette, vice president of product development for Spacelabs, Inc., Chatsworth, Calif., describes the problems encountered in transferring technology from aerospace/defense applications to commercial/industrial medical applications.

One of the biggest problems, according to Valiquette, was orienting to the needs of a commercial company. When you're a small company working for the government, they more or less control your business. You don't have to worry about setting up standards or searching out markets. However when a company enters the commercial market, these things are no longer so.

As far as the design engineers are concerned, he notes, once the characteristics of the new product were determined, they had no problems applying their aerospace experience and background to the commercial field.

Marketing techniques also changed with the switch to commercial medical electronics. Where the marketing organization was highly technical, with engineers interfacing directly with the customer, the lack of technical sophistication in the medical field necessitated the use of marketing representatives. This makes it difficult to main-

tain the customer engineer interface.

Implantable blood flow meter described

Several new developments in electronic instrumentation are described in Session 7, "The Electronic Engineers' Contribution in Bio-Medical Research."

In his paper, "Integrated Circuits for an Implantable Blood Flow Meter," David M. Di Pietro, formerly with Stanford University and now with Hewlett-Packard, Santa Clara, Calif., describes an implantable telemetry system for measuring instantaneous blood flow in the major arteries of animals.

Because it can be implanted in the body, notes Di Pietro, the need for wires penetrating the skin has been eliminated and so has the problem of infection associated with them. The unit is a microminiature radio-telemetry system with a remote control feature that permits long battery life, virtually rules out the need for battery recharging and allows automatic data collection.

According to Di Pietro, small size (3.8 cc) and low power consumption (10 mW) are achieved through the use of the Doppler effect at ultrasonic frequencies. Using this technique, blood velocity information is converted to an electrical analog by means of two ultrasonic transducers. This information is then transmitted by an internal 100 MHz FM transmitter to an external commercial receiver.

Separate chips for the internal receiver, transmitter and oscillator were developed, and along with discrete component chips, were combined into a single hybrid unit.

The resultant unit, says Di Pietro, occupies 5 to 10 times less volume and requires an order of magnitude less power than earlier attempts at wireless blood flow telemetry systems.

Another way of measuring blood flow is described at the same session by Jay R. Singer, a researcher from the University of California at Berkeley. In this system, explains Singer, nuclear magnetic resonance is used as a noninvasive blood-flow measuring technique.

The system uses a split coil and a patient's arm is placed between the two halves. In operation, Singer explains, the water molecules in the blood in the arm are polarized by a magnetic field of one coil. The other coil is energized by a pulse of rf energy which causes a reverse polarization of the hydrogen nuclei near that coil. The hydrogen nuclei are thus effectively tagged and the rate of flow can then be measured.

A reading aid for the blind is also discussed at Session 7. The new device, called a One-Hand Optacon, is a smaller version of the earlier Optacon developed at Stanford Electronics Laboratory in Calif.

According to Roger D. Melen, a scientist at the laboratory, the new device contains a 24×6 custom array of phototransistors that is used to detect printed letters. An array of piezoelectric vibrators of equal dimension is used to present a tactile image of the letter being read to the fingertip. It is a direct translation device, notes Melen, that displays one character at a time.

Contrary to earlier devices, he says, the new device requires only one hand to perform the reading task. In tests performed on previously trained Optacon readers it was found that after less than two hours of familiarization, people could learn to read at their previous two hand rates.

Session 13 addresses the subject of "Needs and Trends in Medical Electronics—1973." At this session Malcolm Ridgeway, assistant director of the Biomedical Engineering Institute at the University of Southern California at Los Angeles, describes the recent spread of shared biomedical engineering services for groups of hospitals. In his paper, "Clinical Engineering

and the Medical Instrumentation Markets," Ridgeway notes that nonprofit hospital cooperatives are forming to help hospitals overcome their lack of technical sophistication.

At present there are nine such groups, reports Ridgeway, and four more are being planned. The hospital engineering coops will have a significant effect on the marketing of medical electronic equipment, he goes on, because they will be responsible for the purchase of new devices. The sale of gadgets—nonessential devices such as electronic thermometers—will probably suffer, Ridgeway predicts, but the sale of replacement equipment should increase. With an engineering group in charge of equipment, obsolete equipment will be easier to pinpoint and replace.

Other subjects discussed at Session 13 include "Medical Products Spin-Off—Present and Future" by John Dimeff of NASA's Ames Research Center and "Recent Commercial Medical Electronic Developments in Cardiovascular and Cancer Treatment" by Norman A. Austin of Gould Inc., Sunnyvale, Calif. ■■

COMPUTERS AND CALCULATORS

As industrial control systems grow, problems arise in controller choice

Designers of industrial control systems and automatic measurement systems face a controller dilemma. Should the system be run by a dedicated minicomputer or by either a dedicated or nondedicated programmable calculator?

Two sessions at Wescon attempt to shed light on the problem. Session 1, "Programmable Controllers—Logic, Industrial, Utility," looks at dedicated, special-purpose minicomputers or programmable controllers in a variety of applications. Session 27, "Calculator-Based Systems," discusses the elements of a calculator-controlled system and shows how these systems can be designed for several types of applications.

Dr. Stuart P. Jackson and Fred Biesecker, both of Process Control Inc., Columbus, Ohio, lay the groundwork for Session 1. Dr. Jackson, the session chairman, defines programmable controllers and places them in historical perspective. Biesecker follows up by outlining the current state-of-the-art, noting the progress of the controller from "an organized set of solid-state logic

that replaced relays to a set of logic that controls complete industrial and utility systems."

In the same session, a panel of experts will field questions from the session chairman and the audience. Answers will be sought to such questions as:

- What are the significant differences between a minicomputer-based control system and a programmable controller?
- How will the programmable controller market grow relative to the total automation market?
- What control applications may be best served by a programmable controller?
- In what specific applications can programmable controllers be used to advantage?
- In what applications should programmable controllers not be used?
- What future advances are envisioned for programmable controllers?

In addition to Biesecker, questions will be fielded by: Tom Stout, an independent software consultant with Profimatics Software and Sys-

tems in Woodland Hills, Calif.; Al Fanthorp, a consultant in such fields as material handling and chemical processing from PE Development Industrial Consultants in Cincinnati, Ohio; Dick Emerson of Bechtel Power Utility consultants in Norwalk, Calif.; and Jack Bleser, a manufacturer of programmable controllers with Modicon Corp. in Andover, Mass.

Calculators; Slow but easy to use

"There is a very large class of instrumentation applications that require a controller that is slower than a speeding bullet." So says Jack D. Grimes and Ronald V. Hill of Tektronix, Beaverton, Ore., in their Session 27 paper, "Data Acquisition, Processing and Display." Rudolf Panholzer, the session chairman from the Naval Postgraduate School in Monterey, Calif., agrees. He notes that there are also many industrial control applications where, "easy-to-use but slower-than-a-speeding-bullet controllers are necessary."

Roger Jennings, president of Fluidyne Instrumentation in Oakland, Calif., takes a deep look into the nitty-gritty problems of calculator-based industrial control systems. His paper, "Calculator-based Data Acquisition and Process Control Systems," provides a checklist to aid in determining the appropriate type of programmable



Model 31 programmable scientific desk-top calculator from Tektronix is operated with the company's 40101 graphic display terminal (Session 27).

calculator, memory capacity and peripheral equipment for any application.

One of the more interesting applications that Jennings describes is an automatic cement plant in Mexico in which a programmable calculator controls the composition of cement going into the kilns. In addition, he covers such topics as: electro-hydraulic fatigue testing, soil-testing data acquisition, sewage treatment and pollution moni-

Timetable to the technical sessions at Wescon '73

TUES. Sept. 11 10 AM	1. Programmable Controllers—Logic, Industrial, Utility	2. Readouts for Instrumentation & Test Equipment	3. Successful Marketing and New Product Introduction	4. Women in Technical Industries	5. Medical Device Standards
TUES. Sept. 11 2 PM	6. Developments in Point-of-Sale Terminals, Systems, & Markets	7. EEs Contribution in Bio-Medical Research	8. Hybrid LSI Microelectronics Clinic	9. Workshop—Full Utilization of Human Resources	10. Computer-Aided Test Design for ATE
WED. Sept. 12 10 AM	11. Microprocessors and Their Applications	12. International Markets—Their Rising Importance	13. Needs and Trends in Medical Electronics 1973	14. Bipolar Device Modeling	15. Solid State Microwave Sources for Telecommunications
WED. Sept. 12 2 PM	16. Impact of New Semiconductor Memories on Systems Design	17. Medical Instruments Industry—Fact or Fancy	18. Multi-Capability Instruments	19. Triangle for Success: Engineering, Purchasing, Mktg.	20. Microwave Transistors and TEA Devices
THURS. Sept. 13 10 AM	21. Low-Power Logic—Today & Tomorrow	22. Intelligence in Instrumentation	23. Raising Capital in Northern California	24. Commercial Applications for Microwave Technology	25. Power Technology for Electronic Systems
THUR. Sept. 13 2 PM	26. High-Speed LSI	27. Calculator-Based Systems	28. Conversion of Technology into Wealth	29. Data Distribution Networks, as User Will See Them	30. Ferroelectric Ceramic Electro-Optic Devices
FRIDAY Sept. 14 10 AM	31. LEDs & Liquid Crystal Displays—Facts & Fancies	32. Electronics and the Single Engineer	33. Circuits for Consumer Electronics		34. IEEE Region 6 Student Papers Competition

toring, and remote data acquisition.

Jennings believes that a programmable calculator is very easy for most users to operate. "If its speed and memory capacity are sufficient to do a given job, it is often the easiest and cheapest way to go."

Grimes and Hill of Tektronix restrict themselves to a discussion of automatic instrumentation systems. They break the system down into three areas: acquisition of information; processing the information; and display or use of the information.

Acquisition of information in an instrumentation system is accomplished by such familiar information sources as oscilloscopes, counters and digital voltmeters. Processing of information involves the programmable calculator. Displays or use of the information gets into display and hard copy devices.

Peter Stone of Hewlett-Packard in Loveland, Colo., looks at automatic instrumentation systems in his Session 27 paper, "Systems Type Measurements In The Laboratory Using Programmable Bench Instruments Under Calculator Control." Stone restricts his systems to the laboratory, observing that all are "flexible enough so that they can be easily reconfigured for a variety of measurements."

Minicomputer-controlled systems in the past

have usually been impractical for laboratory measurements, he says. "The variety of digital control formats in various instruments, as well as the different I/O requirements of various minicomputers has usually made it necessary to use a special piece of interface hardware between each instrument in the system and the minicomputer." Stone notes that the development that really makes the marriage of a powerful calculator and smart instruments into a truly flexible system is a standard bidirectional digital interface for controlling and communicating with all programmable instruments. Stone describes such an interface. He also describes several typical systems performing such functions as: measuring battery charging characteristics; zener diode temperature-coefficient measurement; instrument temperature rise measurement; and oil bath temperature stability measurement.

Finally, Session 27 is placed in perspective by Dr. Allen Peterson of Stanford University in Stanford, Calif., with his paper, "Future Trends In The Application Of Programmable Calculators, Minicomputers And LSI Microprocessors." Built-in computing power, he notes, will open up whole new areas of application. Peterson gives examples in the area of geophysical data acquisition systems, navigational systems and signal processing systems. ■■

MICROELECTRONICS

Microprocessors, building blocks for logic design, maintain hot pace

Equipped with ROMs or RAMs, the microprocessor chip forms the basis of a computer system, or microcomputer. Emerging as a powerful new component for the logic designer, it has already been incorporated into a number of products and will be designed into many future products.

The number of ways that microcomputers can be used is described by Hank Smith of Intel Corp., Santa Clara, Calif., in his Session 11 paper on "Impact of Microprocessors on the Designer." The microcomputer is something that is here now—not something to wait for, says Smith. "It is being designed into literally hundreds of OEM products right now. It is being used to replace random logic, custom MOS/LSI and in some cases minicomputers in applications for which

they were oversized."

He cites many examples of current microprocessor applications in point-of-sale terminals and electronic cash registers, inventory control systems, business and accounting systems, process and machine controllers, digital instruments, communications systems and even game machines. Smith notes that there are thousands of microcomputers installed in machines.

Programming skill is required

Smith also points to some of the difficulties that confront the designer familiar with conventional logic. "Perhaps the most significant difference between designing with a microcomputer and with conventional logic is that some pro-

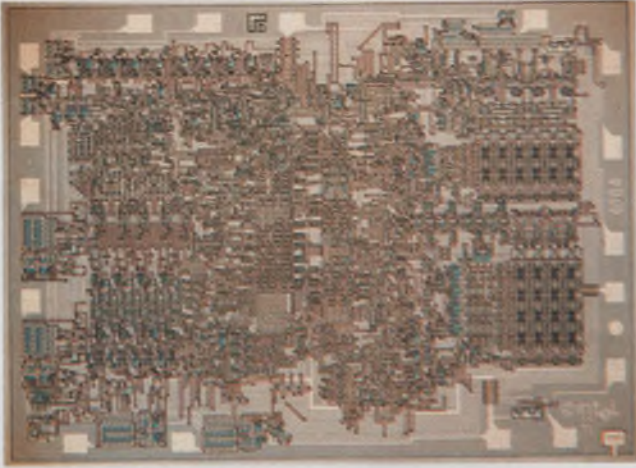

Microprocessor chips, such as Intel's 4004 CPU, are being incorporated into a growing number of products. (Session 11).

programming skill is required. Although programming experience is more common among engineers today than it was a few years ago, a significant number of engineers are still unfamiliar with programming techniques, particularly in machine or assembler language." He explains that because today's processors have relatively simple instruction sets, and because development aids are becoming available to the engineer, the writing and debugging of microcomputer programs need be no more difficult than conventional hardware design.

For all his enthusiasm for microcomputer applications, Smith does recognize that there are some instances where custom logic can still be the choice over microcomputers. "If you have 9 to 18 months for a logic development cycle, and can be sure that the production run of a piece of equipment will be long enough for the cost of development to be absorbed, and provided there is no need to modify the internal logic, the custom LSI logic can be cheaper," Smith says.

Some systems need microprocessors

"Applications of Microprocessors," are discussed in Session 11 by Dr. Bala Parasuraman, National Semiconductor Corp., Santa Clara, Calif. One application is in a data communication system analyzer in which a microcomputer has full control of monitoring duplex communication channels, and performing line measurements, signal transparency tests, spectrum analysis and amplitude, distortion and noise measurements. The microcomputer assumes the total work load of all the monitoring and calculation involved in making the necessary measurements. "This is an example of a system," Dr. Parasuraman explains, "that couldn't be without the microcomputer."

The other system he discusses is a "smart

cash register" for food markets which, in addition to keeping running totals, also can compute partial inventories, can be interfaced with automatic price scanners, change and trading stamp dispensers and can take over other repetitive tasks for the cashier. This system could be designed with custom logic, Parasuraman explains. "However, it would be more expensive in the short term and the unit would not be nearly so flexible. All the tasks that the machine would be eventually required to do would have to have been known before the design was started."

Microcomputers vs minicomputers

Tradeoffs between minicomputer and microprocessor are discussed in another Session 11 paper, "How about the Low Cost (under \$1000) Minicomputer" by Philip Kaufman of Computer Automation Inc., Irvine, Calif. Kaufman explains that a minicomputer consists of the processor, power supply, memory, chassis and software. "With a minicomputer you can generally interface with any peripheral you want. A microprocessor, on the other hand, is traditionally just a CPU chip and the designer must start from there. The two have been gradually approaching each other."

There are stripped minicomputers now available, says Kaufman, which do away with some of the hardware and help bring down the price to the OEM, while a number of microprocessor manufacturers are producing complete computer systems. There is still a gray area, he notes, but the predominant difference now is in the type of support that comes with the unit. "The designer should ask if he can get an assembler, FORTRAN or BASIC. If he needs a card reader—can he buy an interface or must he design one?"

Kaufman points out that many microcomputer houses are, in effect, producing low performance minis. "Once an OEM buys a microprocessor chip, designs a controller and writes some software, the cost for the whole thing may be higher than if he paid \$900 for a bare minicomputer—with all these functions already provided."

Kaufman feels that the view that the microprocessor will cut into the mini market is unrealistic, and that the microprocessor is opening the eyes of the traditional logic designer to the power that computers can bring to their products. Many of these designers, he feels, will look at the microcomputer and find insufficient power.

As the computing power becomes available and the price becomes reasonable, designers can always think of new and more demanding tasks for their products to handle—the market remains very elastic for both the mini and microcomputer houses, Kaufman observes. ■■

Transistors and solid-state sources spur new commercial applications

With recent improvements in microwave transistors and solid-state sources a whole new world of commercial applications of microwaves is opening up. Outstanding examples include: microwave landing systems, gigabit data transmission, intrusion alarms and automotive radar. Sessions 15 and 20 review the new technology and Session 24 describes the commercial applications.

"Impatt Amplifiers for Communication Systems" is the subject of a Session 15 paper by H. C. Bowers and W. H. Lockyear of Hughes Aircraft's Electron Dynamics Div. in Torrance, Calif. According to the authors, single gallium-arsenide Impatt diode amplifiers can achieve 3 to 5 W of output power. Using silicon Impatt diodes and several diodes per amplifier, 3 W of output have been attained. Using several silicon diodes and combiner circuits, outputs up to 32 W have been reached. At higher frequencies, they report laboratory results of 0.5 W at 35 GHz and 0.25 W at 60 GHz with single-chip silicon diodes.

Bowers and Lockyear also describe a fairly simple test to determine whether an amplifier is stable or not. "If the resistance of the load line is greater than the magnitude of the negative resistance of the package device at resonance, the device will be stable," they say. Furthermore, the gain of a stable amplifier is determined by the ratio of the load resistance to the device resistance.

A 2-W Gunn source described

In another Session 15 paper, Gary Lindgren, from Litton Electron Tube Div., San Carlos, Calif., describes a 2-W Gunn source in the frequency range of 10.7 to 11.7 GHz. Lindgren says that the source is directly tuned by use of a varactor. The output power is derived from eight diodes mounted in parallel in a waveguide cavity. Efficiency of the source is about 2-1/2 %. This source is aimed at the telecommunications market with particular emphasis on cable TV, Lindgren says.

"Present Capabilities of Phase Locked Oscil-

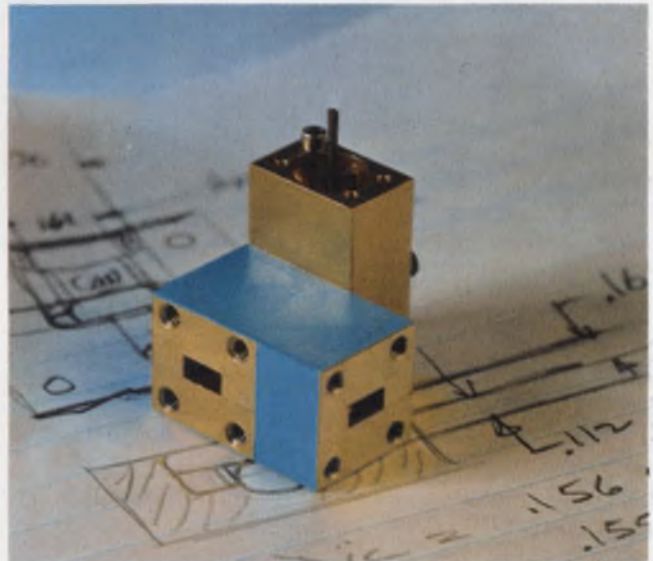

GaAs transferred-electron amplifier from Varian operates at 35 GHz and delivers more than 110 mW with less than 20 mW drive (**Session 20**).

lators" is the subject of a Session 15 paper by Dr. Irvin H. Solte Jr. of California Microwave in Sunnyvale, Calif. Solte covers phase-locked transistor oscillators with single-stage multiplier outputs that operate at 4, 6 and 11 GHz. In a discussion of device modulation characteristics, he notes that high quality modulation of up to 1800 channels of voice is possible. These oscillators, he claims, have exhibited an operating life of up to 12 years and a stability of $\pm 0.0005\%$ using oven-controlled crystals. The sources are particularly suited for use in satellite ground stations, Solte observes.

Automated transistor oscillator design is discussed in a Session 15 paper by Les Besser of Farinon Electric in San Carlos, Calif. Methods of optimizing oscillator Q for maximum output power are shown for voltage-tuned as well as fixed oscillators. Oscillators at 2.5 and 5 GHz are used as examples of the optimization procedures. These include circuit mapping and computer-aided design, simultaneous value optimization and circuit measurement techniques.

"Microwave Transistors and TEA Devices"



Over 15,000 delivered in less than a year

Get your edition of the most popular digital multimeter ever made now. Get low cost of ownership, immediate delivery and super reliability.

Value and reliability are two important reasons why the Fluke 8000A has become the most popular digital multimeter ever and the standard of excellence in the low cost field.

For the money, \$299, you can't buy a better multimeter. No one gives you higher accuracy (basic dc accuracy is 0.1%), greater sensitivity or more protection. Here's an instrument with 26 ranges to measure ac/dc volts from 100 microvolts to 1200 volts, currents from 100 nanoamperes to 2 amperes and resistance from 100 milliohms to 20 megohms.

Reliability

You can expect your 8000A to work day-in, day-out, year after year. We guarantee 20,000 hours mean-time-before-failure, but with 15,000 units delivered, our own studies indicate a MTBF

of 56,000 hours—the equivalent of 15 years. Only Fluke uses both analog and digital LSI circuitry in one instrument. And to top everything off, we put everything in a high impact case with securely mounted internal electronics.

Expanded capability

Wide choice of low cost options including rechargeable battery pack, digital printer output, deluxe test leads, high voltage probe, RF probe, 600 ampere ac current probe, carrying case, dust cover, and rack mount to make your 8000A the most powerful and versatile low-cost multimeter available anywhere.

Stock delivery and local service

You can get your Fluke 8000A from local sources today. Fluke backs the 8000A with service centers conveniently located throughout the United States, Canada, Europe and the Far East for fast 48-hour turnaround repair service.

Order yours today on a 15 day no obligation trial basis. Use your American Express, BankAmericard, Mastercharge, company purchase order or even money.

In the continental U.S., dial our toll free number 800-426-0361 for the name and address of your nearest local source. Or contact us directly by addressing, John Fluke Mfg. Co., Inc., P.O. Box 7428, Seattle, Washington 98133. Phone (206) 774-2211. TWX: 910-449-2850. In Europe, address Fluke Nederland (B.V.), P.O. Box 5053, Tilburg, The Netherlands. Phone 013-67-3973. Telex: 844-52237. In the U.K., address Fluke International Corp., Garnett Close, Watford, WD2 4TT. Phone, Watford, 33066. Telex: 934583. In Canada, address ACA, Ltd., 6427 Northam Drive, Mississauga, Ontario. Phone 416-678-1500. TWX: 610-492-2119.

"See us at Wescon"

INFORMATION RETRIEVAL NUMBER 43



are discussed in Session 20. Two papers will treat two types of microwave transistors. Low-noise bipolar transistors are discussed by Dr. Sandy Kakihana of Hewlett-Packard in Palo Alto, Calif., while low-noise field-effect transistors are covered by John Eisenberg of Watkins Johnson in Palo Alto. Both agree that below 6 GHz bipolar transistors are the way to go. In the range of 6 to 8 GHz it's a toss-up. And above 8 GHz it's definitely FETs. Kakihana feels that the best that bipolar transistors will ever be able to do in the way of noise figure at the higher frequencies will be 3 dB at 6 GHz and 3.3 dB at 8 GHz.

Eisenberg looks, in a couple of years, to FET transistors leading to 20-GHz amplifiers with noise figures approaching 6 dB. He believes that, "FETs are just coming of age."

Eisenberg also describes a 5.9-to-6.4-GHz FET amplifier with 30-dB gain and a 4.8-dB noise figure, as well as an 8.9-to9.1-GHz FET amplifier designed for active filter use. It has 24-dB gain and a 9-dB noise figure.

Also in Session 20, Dr. Robert Goldwasser and James F. Caldwell of Varian Associates in Palo Alto discuss various aspects of a 37-GHz TEA, or Gunn amplifier. Goldwasser discusses the amplifier and Caldwell sticks to the diode. The amplifier has a 100-mW output, 13-dB gain and a 16.2-dB noise figure. Goldwasser says this is the highest frequency Gunn amplifier ever built. Using a coaxial hybrid structure the 3-dB, full power bandwidth of the amplifier is 3 GHz. Caldwell points out that the diode uses flip-chip construction and is usable to at least 40 GHz.

Commercial applications abound

Competition for FAA contracts for microwave landing systems are hot and heavy right now.

In a Session 24 paper, "New Component Technology for Gigabit Data Transmission," C. Louis Cuccia of Philco-Ford in Palo Alto reviews the component requirements and looks at the current state-of-the-art. He notes that 1/2-ns switching transistors are required as well as phase shifters, multipliers, video amplifiers with 2-GHz video bandwidth and matched filters.

In the same session, Dr. John Bryant of Omni-Spectra in Farmington, Mich., looks at the alternatives for microwave intrusion alarms. He reviews all types of intrusion alarms and describes the differences in requirements for indoor versus outdoor use. He also reviews the FCC and Underwriters Laboratory regulations covering such devices.

Prof. Dale Grimes of the University of Michigan at Ann Arbor closes out the session with a talk on "Automotive Applications of Microwave Technology." The main subject of his talk is collision avoidance auto radars. ■■

Exclusive

Technical session order form

Please send me the following Wescon technical session preprints at \$2.00 per session (average: four papers per session), plus \$1 mailing charge per complete order. I understand this order will be mailed to my address within two weeks after receipt. Offer good until Dec. 1, 1973.

Session No.	Quantity	Session No.	Quantity
3		18	
5		20	
6		22	
7		24	
10		25	
11		27	
12		28	
13		29	
14		30	
15		31	
16		32	
17		33	

Total Session × \$2.00 = \$ _____

Plus \$1.00 Mailing Charge = \$ _____

Total Cost = \$ _____

Make check payable to Wescon technical papers and mail with this form to:

Wescon
3600 Wilshire Blvd.
Los Angeles, Calif. 90010

DATE _____

NAME _____

FIRM _____

STREET ADDRESS _____

CITY, STATE, ZIP CODE _____



PROGAN
CORPORATION

CONTROL KNOBS • CUSTOM DIALS

PLEASE SEND FOR OUR NEW 28 PAGE CATALOG

PROGAN CORPORATION, 2455 WOODHEAD DRIVE, NORTHURBOK, ILL. 60062 (312) 433-2322, TELEX 240 632 2322

Ferroelectric ceramics: New ways to exploit an old material emerge

The engineer who is actually designing PLZT electro-optic devices is the audience that Juan R. Maldonado of Bell Laboratories, Murray Hill, N.J., had in mind when he put Session 30 together, "New Developments in Ferroelectric Ceramic Electro-optic Devices."

The session begins by asking how to get the best contrast ratio in PLZT materials, how to minimize the amount of electric field, and what is the best chemical combination?

One solution—the scattering mode of operation of PLZT ferroelectric materials—is described in the first paper, which was prepared by three engineers from Honeywell's Systems and Research Center in Minneapolis, Aida S. Khalafalla, J. Furisson and D. Burbank. The paper is entitled "PLZT Electro-optic Characteristics Relevant to Display Applications."

The scattering mode has several advantages over the alternate approach that requires the use of polarized materials, Khalafalla says. "You avoid the light losses generally associated with polarizers, you minimize the complexity of the whole system since no transverse electric field or strain bias is required on the PLZT plate ceramic. And the plate thickness and polarization switching required to obtain maximum contrast ratio cease to be critical parameters.

"The disadvantage is that you get less contrast ratio with the scattering mode but we are working to overcome this," Khalafalla says.

Commercial applications under consideration

In a paper by three engineers from Sandia Laboratories, Albuquerque, N.M., PLZT ceramic materials are discussed with an eye toward their adaptability to commercial application. The materials involved can be characterized by the quadratic transverse electro-optic effect. Entitled "Electro-optic Devices Utilizing Quadratic PLZT Ceramic Elements," the paper was prepared by J. Thomas Cutchen, J. O. Harris, Jr., and G. R. Laguna.

The isotropic state of quadratic PLZT electro-optic materials in zero-field conditions is especially significant in devices requiring high con-

trast ratios and a good "OFF" state. The industrial and commercial exploitation of the materials in shutter and light-gate applications appears imminent, the authors say.

Devices now being developed include glasses to protect the eyes from flashblindness, a page composer for use in a holographic memory system and a display system where memory is not required.

An effort to close the information gap is the reason for Session 31, "LEDs and Liquid Crystal Displays—Facts and Fancies."

"What's true one day may not be true the next in this quickly evolving field," says session organizer and chairman Thomas F. Prosser, of PD Laboratories, Santa Clara, Calif. And what's true for one company might not be true for another a few miles away.

An example: Company A, Prosser recalls, developed a LED that turned out to have a very poor life expectancy; it failed at once. At about the same time, Company B came out with one it claimed would last 20,000 hours.

Which one was the real LED? Or how long does a LED last?

The answers aren't easy.

Rapid changes can be expected in LEDs, according to a basically tutorial paper entitled "Light Emitting Diodes" by Bob Johnston and Dave Laws, Litronix, Inc., Cupertino, Calif.

"We can expect more efficient devices, lower power devices, and devices combining more electronics on the same substrate in the case of displays," Laws says. "This is a continually evolving process.

"Many people are working with LEDs who don't really understand them," Laws says. "They don't seem to realize they're diodes; they think of them as incandescent lamps. They plug them in and watch them blow up. They hadn't realized they had to limit the current."

Also, many people don't use multiplexing sufficiently when designing with LEDs. "The amount and therefore the cost of electronics can be reduced drastically when multiplexing is used," Laws says. "The basic rules in multiplexing should be followed." ■■

The GI book club



Here's a book club for capacitor guys. Almost everything you want to know about capacitors. Types. Specifications. Cross references. A real "how to" manual in an easy-to-use three ring binder. A binder we register in your name and periodically update. It's not a club for everybody, but if you're a qualified capacitor guy, membership is yours for the asking. From General Instrument . . . the people who wrote the book on capacitors. Capacitor Division, General Instrument Corporation, 165 Front Street, Chicopee, MA 01014. Phone (413) 594-4781.



**General
Instrument**
the capacitor company

Off the shelf delivery from Miconics/G.I. distributors coast to coast.
Call (N.Y.) 212/361-2266 or (Calif.) 213/769-6782 for the name of the distributor nearest you.

FROM DELCO, THREE POWER TRANSISTORS.

	TYPE	V _{CEO}	V _{CEV}
	DTS-708	900V	900V
	DTS-709	900V	900V
	DTS-710	900V	—

We'd like to simplify your life while you simplify your high energy circuits.

These three new devices are all NPN,

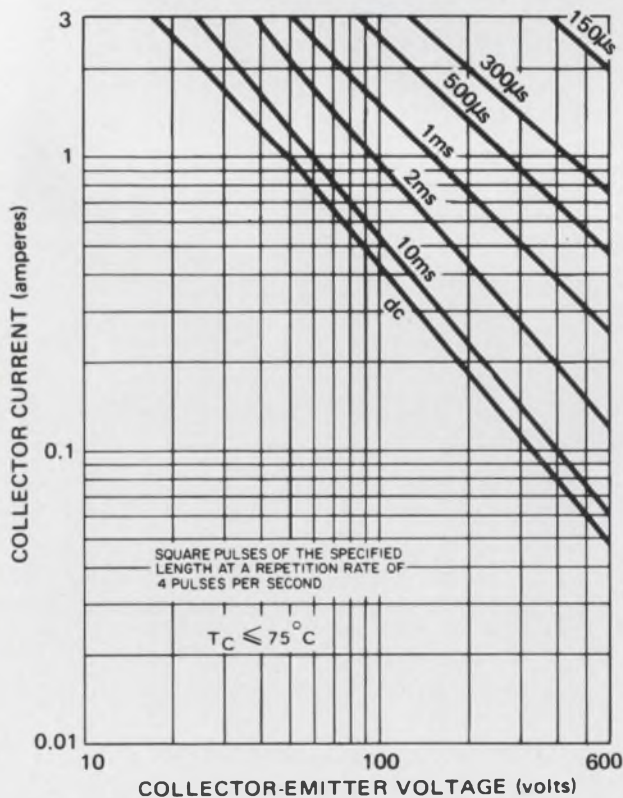

SAFE OPERATING CURVES

triple diffused and packaged in Delco's solid copper TO-204MA packages (TO-3 to you old-timers) for man-sized power handling.

DTS-708 and 709 are designed for use in high voltage switching applications—where inductive loads or fault conditions may be giving you problems now. The DTS-710 is ideal for linear regulators and power amplifiers.

Safe Operating Curves on the data sheets let you know where it's at. And our applications engineering assistance is available, too.

You probably know about our reputation for making really tough transistors—for high peak energy handling. You'll find we can deliver, too.

All of the Delco distributors listed have the DTS-700 series in stock.

Give yours a call now for the prices you'll like and the data you'll need.

NOW AVAILABLE FROM THESE DISTRIBUTORS IN PRODUCTION QUANTITIES.

ALABAMA, Birmingham 35233
Forbes Distributing Co., Inc.
1416 Fourth Ave., South
(205) 251-4104

ALABAMA, Huntsville 35807
Powell Electronics
803 Oster Dr.
(205) 539-2731

ARIZONA, Phoenix 85005
Sterling Electronics, Inc.
1930 N. 22nd Ave.
(602) 258-4531

CALIFORNIA, Goleta 93017
Radio Product Sales, Inc.
350 E. So. Kellogg Ave.
(805) 964-4764

CALIFORNIA, Los Angeles 90022
Kieruff Electronics, Inc.
2585 Commerce Way
(213) 685-5511

CALIFORNIA, Los Angeles 90015
Radio Products Sales, Inc.
1501 South Hill Street
(213) 748-1271

NEW 900-VOLT SILICON

V _{CEO(sus)}	I _C = 1A	V _{CE(sat)}	h _{FE} Min/Max	I _C
600V		2.0V (I _C = 1A, I _B = 250mA)	—	3A
600V		1.0V (I _C = 2A, I _B = 800mA)	—	3A
600V		—	10/50	3A

CALIFORNIA, Palo Alto 94303
Kierulff Electronics, Inc.
3969 East Bayshore Road
(415) 968-6292

CALIFORNIA, Redwood City 94063
Cramer/San Francisco
695 Veterans Blvd.
(415) 365-4000

CALIFORNIA, San Diego 92123
Kierulff Electronics, Inc.
8797 Balboa Avenue
(714) 278-2112

CALIFORNIA, San Diego 92111
Radio Products Sales, Inc.
7889 Clairemont Mesa Blvd
(714) 292-5611

COLORADO, Denver 80222
Cramer/Denver
5465 E. Evans Place
(303) 758-2100

CONNECTICUT, Norwalk 06851
Harvey/Connecticut
112 Main Street
(203) 853-1515

FLORIDA, Miami Springs 33166
Powell/Gulf Electronics
1740 N.W. 69th Avenue
(305) 885-8761

FLORIDA, Orlando 32809
Powell/Gulf Electronics
2032 Palm Ridge Way
(305) 859-1450

ILLINOIS, Rosemont 60018
Kierulff Electronics, Inc.
9340 William Street
(312) 678-8560

ILLINOIS, Skokie 60076
Bell Industries
Electronics Distributors Div.
7701 N. Austin Ave
(312) 282-5400

INDIANA, Indianapolis 46204
Graham Electronics Supply, Inc.
133 So. Pennsylvania St
(317) 634-8202

MARYLAND, Baltimore 21204
Radio Electric Service Co.
1026 Cromwell Bridge Road
(301) 823-0070

MASSACHUSETTS, Needham Heights 02194
Kierulff Electronics, Inc.
14 Charles Street
(617) 449-3600

MASSACHUSETTS, Newton 02195
The Greene-Shaw Co., Inc.
Chapel Bridge Park
70 Bridge Street
(617) 969-8900

MICHIGAN, Farmington 48024
Harvey/Michigan
23461 Industrial Park Dr.
(313) 477-1650

MINNESOTA, Minneapolis 55401
Stark Electronics Supply Co.
112 3rd Ave. North
(612) 332-1325

MISSOURI, North Kansas City 64116
LCOMP Kansas City
1520 Taney Street
(816) 221-2400

MISSOURI, St. Louis 63144
LCOMP-St. Louis
2605 S. Hanley Road
(314) 647-5505

NEW JERSEY, Clifton 07015
Wilshire Electronics/New Jersey
312 Clifton Avenue
(201) 365-2600 (212) 244-8930

NEW YORK, Binghamton 13902
Harvey/Federal
P.O. Box 1208
(607) 748-8211

NEW YORK, East Syracuse 13057
Cramer/Syracuse
6716 Joy Road
(315) 437-6671

NEW YORK, Rochester 14623
Cramer/Rochester
3259 Winton Road South
(716) 275-0300

NEW YORK, Woodbury 11797
Harvey/New York
60 Crossways Park West
(516) 921-8700 (212) 895-9260

OHIO, Cincinnati 45237
United Radio, Inc.
7713 Reinhold Drive
(513) 761-4030

OHIO, Cleveland 44125
Pattison Supply Co.
Industrial Electronics Division
4550 Willow Parkway
(216) 441-3000

OHIO, Dayton 45414
Kierulff Electronics, Inc.
2030 Drill Avenue
(513) 278-9411

PENNSYLVANIA, Philadelphia 19114
Almo Electronics
Roosevelt Blvd. at
Blue Grass Road
Northeast Industrial Park
(215) 676-6000

PENNSYLVANIA, Pittsburgh 15328
RPC Electronics
620 Alpha Drive
RIDC Park
(412) 782-3770

SOUTH CAROLINA, Columbia 29202
Dixie Radio Supply Co., Inc.
1900 Barnwell Street
(803) 253-5333

TEXAS, Dallas 75201
Adleta Electronics Company
1907 McKinney Ave.
(214) 741-3151

TEXAS, Fort Worth 76102
Adleta Electronics Company
South Expressway at E. Vickery
(817) 336-7446

TEXAS, Garland 75041
Kierulff Electronics, Inc.
2815 National Drive
(214) 271-2471

TEXAS, Houston 77004
Harrison Equipment Co., Inc.
1616 McGowen St
(713) 224-9131

UTAH, Salt Lake City 84115
Cramer/Utah
391 West 2500 South
(801) 487-3681

VIRGINIA, Richmond 23220
Meridian Electronics, Inc.
1001 West Broad Street
(703) 353-6648

WASHINGTON, Seattle 98108
Kierulff Electronics, Inc.
5940 6th Ave. South
(206) 763-1550

IN CANADA

ONTARIO, Scarborough
Lake Engineering Co., Ltd.
123 Manville Rd.
(416) 751-5980

Delco Electronics Regional Sales Offices

Union, New Jersey 07083
Box 1018 Chestnut Station
(201) 687-3770

El Segundo, California 90245
354 Coral Circle
(213) 640-0443

General Sales Office
700 E. Firmin, Kokomo, Ind. 46901
(317) 459-2175
Operator (317) 457-8461



Delco Electronics, Division of General Motors.

Try the great pushbutton

Multiple station mechanical pushbutton switches probably aren't the most important thing in your life—until you have to specify one within tight performance or cost specifications. Then they can get a little complicated.

That's why this little game might be helpful. And interesting. Take three or four minutes and see if your "pushbutton switch I.Q." is up to par.

Be careful. Some of the questions are tricky.

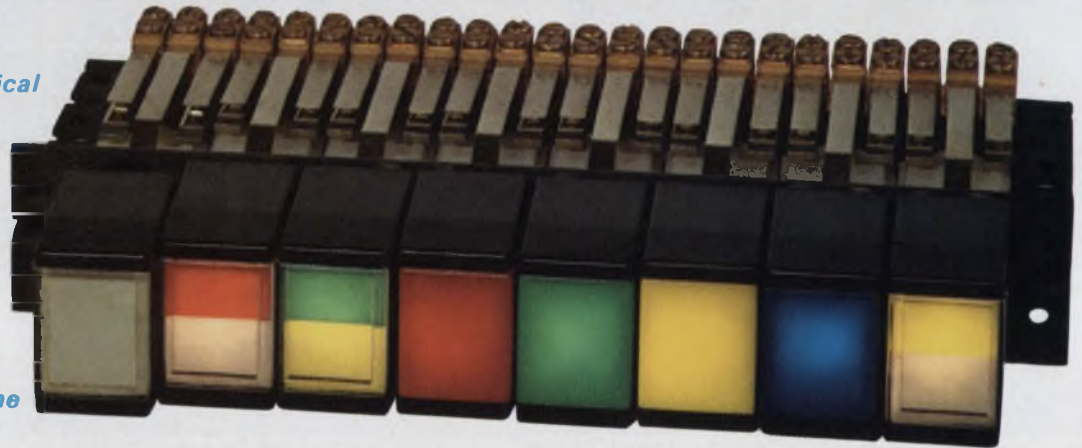

1. YOU CAN'T HAVE EVERYTHING. OR CAN YOU?

Which of the following pushbutton switch functions CAN be intermixed on a single frame of a multiple station switch?

- Interlock and non-lock
- Interlock and push-lock/push-release
- All-lock and non-lock
- All-lock and push-lock/push-release
- Push-lock/push-release and non-lock
- All of the above
- None of the above



TRANSMITTED COLOR
PROJECTED COLOR

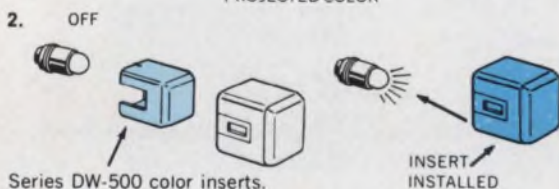

2. SOME TRIVIA THAT MIGHT MAKE YOU A HERO

In lighted pushbutton switches, when should you specify "transmitted" color instead of "projected" color?

- A) When you REQUIRE the color to be distinguishable in an unlighted display.
- B) When you DON'T REQUIRE color to be distinguishable in an unlighted display.
- C) When you have limited power available to achieve lighted display.
- D) None of the above, transmitted color is obsolete.

3. GET DOWN TO THE NITTY-GRITTY

You're working with low-level signals and are specifying dry circuits—circuits with voltages and currents too low to break down contact surface films or corrosion. What kind of contacts should you specify in your pushbutton switches?

- Silver
- Cadmium oxide
- Gold
- None of these

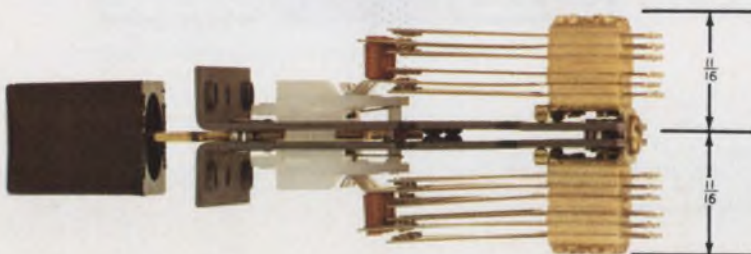

4. A POWERFUL PROBLEM

Pushbutton switches with leaf-type switching give you extremely long life and lots of circuit flexibility in limited space—but they're limited to relatively low-current applications.

- True
- False

switch quiz.

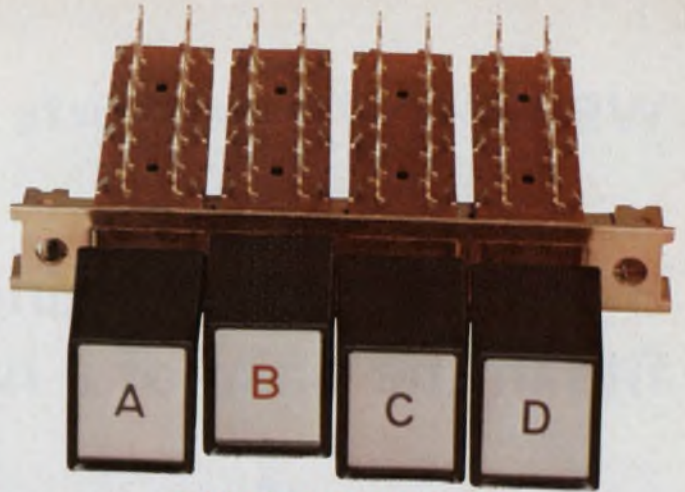

5. WATCH OUT FOR THIS ONE

"Push-lock/push-release" and "alternate action" are identical functions—with one important difference. Which is it?

- A) Pushbutton is depressed once to actuate switch.
 B) Pushbutton falls back only slightly from the "in" position.
 C) Pushbutton is depressed again to return switching circuits to normal.
 D) Pushbutton is depressed twice to return switching to normal position.

6. THE BEST OF BOTH WORLDS

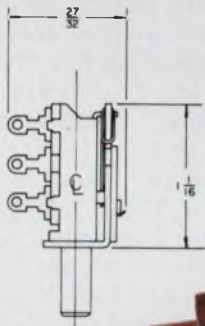

Mechanical multiple-station pushbutton switches give you the flexibility you need, but they're too bulky for your miniaturized design. Your best bet is to design a custom switch from a basic series.

- True False

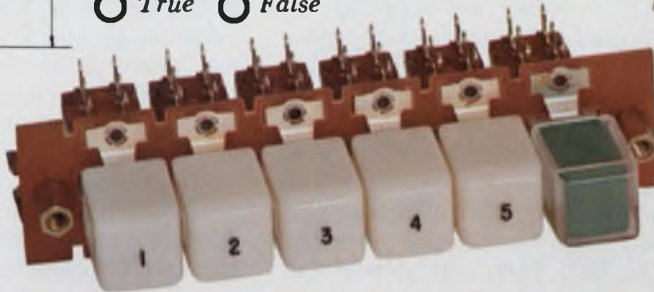

7. YOU CAN LOOK AT THIS TWO WAYS

What is the mechanical function whereby the actuated switch station stays in the "in" position when operated and releases ONLY when the "release station" pushbutton is depressed or a release solenoid is operated?

- A) Lock-out B) All-Lock
 C) Accumulative Lock D) Interlock

A LITTLE "YANKEE INGENUITY" GOES A LONG WAY



Switchcraft makes more ways to solve your problems with pushbuttons and mechanical pushbutton switches than anybody else. And what you consider custom might just be a standard item. In any case, we provide you with complete and

easy-to-use technical literature to help you sort through the possibilities. Contact your local Switchcraft representative for your free dictionary of switching and contact terminology. Or send the coupon for your basic engineering specification file and your free dictionary. See what a little yankee ingenuity can do to help boost your "pushbutton switch I.Q." Switchcraft Inc., 5555 N. Elston Ave., Chicago, Illinois 60630.

We'll be at WESCON booth 1816-1817

Switchcraft Inc.
 5555 N. Elston Ave., Chicago, Illinois 60630.

SWITCHCRAFT

Please send me your engineering file plus your glossary of technical terms.

- Pushbutton switches (illuminated and non-illuminated single-station pushbutton and cord pendant switches).
 Multi-Switch® switches (illuminated and non-illuminated multiple station pushbutton switches).

NAME _____

TITLE _____

COMPANY _____

ADDRESS _____

CITY _____ STATE _____

ZIP _____

ANSWERS:

1. ALL can be intermixed. Switchcraft's DW Multi-Switch® switches lets you mix functions of switching stations anywhere on the frame on all fourteen different types of series.
 2. A is correct. And Switchcraft has both types. With single or twin lamp display. Plus filters and silicone boots for greater color flexibility.
 3. GOLD is what you want. Silver oxidizes at the surface. Cadmium Oxide is designed for higher voltages. Of course, we have all of these.
 4. FALSE. Switchcraft's standard welded cross-bar palladium contacts handle up to 2 amps, 200 watts max. A.C. non-inductive load. Fine Silver goes up to 3 amps; silver cadmium oxide goes up to 5 amps.
 5. B is the difference. The switching function is identical, but the push-lock/push-release gives you a clear visible indication that the switch is actuated. Alternate action switches don't. We have both types.
 6. FALSE. Switchcraft's little "Multi-Switch" switches give you up to six pole, double throw per station in .6 square inch panel space—with no sacrifice in features or functions. The DW Multi-Switch switch gives double pole, double throw circuitry with only 1 1/2" depth behind panel.
 7. B AND C are both right. They're the same.
 If some of these questions throw you a little, send for Switchcraft's glossary of technical terms.

WESCON '73 products

3-1/2-digit autoranging multimeter fits in the palm of a hand

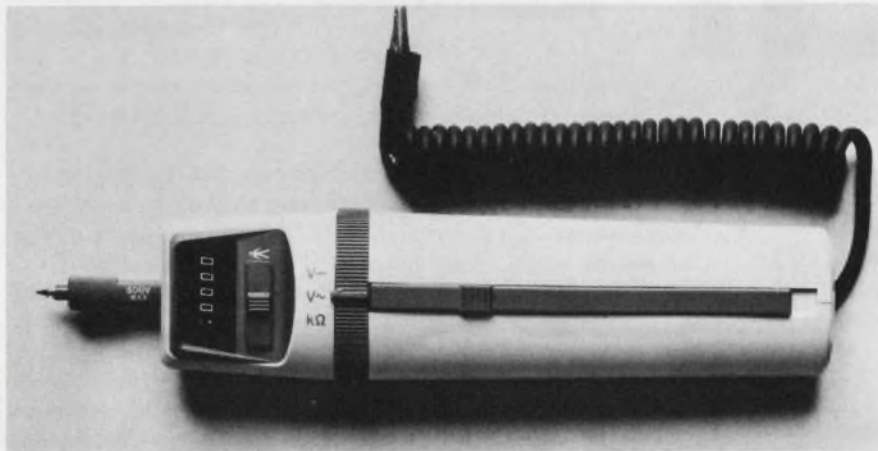

Hewlett-Packard, 1501 Page Mill Rd., Palo Alto, Calif. 94304. (415) 493-1501. \$275.

Not only is Hewlett-Packard's Model 970A the world's smallest digital multimeter, it's also the only one of its size class that has autoranging. And, at \$275, the tiny hand-held unit is less expensive than most other 3-1/2-digit meters.

Volume of the 6-1/2 H \times 1-3/4 W \times 1-1/4 D HP unit is only slightly over 14 cubic inches, and this includes the battery pack. This makes the 970A much smaller than the closest size contender—Data Precision's 4-1/2-digit Model 245—though, of course, the 245 offers an extra digit.

With dimensions of 1-3/4 \times 5 \times 3-1/2, the 245's volume is about 31 cubic inches, making it over twice as large as the 970A. And the 245 weighs twice as much as the 970A—14 oz. vs 7 oz.

But, the Data Precision unit operates from the line as well as internal batteries, while the HP meter is strictly battery operated. Also the 970A measures ac and dc volts and resistance only, while the 245 throws in ac and dc current as well.

In design philosophy and use, however, the HP 970A can't be compared with any other unit, except possibly with Keithley's 167

—an autoranging unit with a 3-1/2-digit display built into a hand-held probe.

HP has jumped a few steps further, however, and squeezed the whole shooting match—measuring electronics, converter, display and batteries—into one tiny, hand-held probe.

Just one function selector sets ac V, dc V or k Ω on the 970A. The user simply attaches the ground lead, touches the probe tip to the test point and presses the push-to-read bar. The probe has a folded storage position, as well as three detented working positions.

Range, decimal point and polarity are then automatically set or displayed by the meter. And since the display is close to the point of measurement, the user needn't turn his head—with the risk of shorting closely packed terminals or points.

If the meter must be turned upside down to get to a measuring point, there's no problem: A touch of a button electronically inverts the display.

A five-digit LED cluster is used in the display, so readings are always in volts or kilohms; consequently, there are no scales to read or misinterpret.

The 970A offers five ranges of dc V, from 0.1 to 1000-V full scale;

five ranges of ac V, from 0.1 to 1000 V; and five ohms ranges, from 1 to 10,000 k Ω , full scale. However, maximum inputs are 500 V on dc and 500 V rms (sine wave) on ac.

Basic accuracies, between 20 and 30 C, are as follows: on dc V, \pm (0.7% reading + 0.2% range); on ac V, from 45 Hz to 1 kHz, \pm (2% reading + 0.5% range); and on ohms, accuracy is \pm (1.5% reading + 0.2% range).

Accuracies are less for ac voltages below 3 mV and for frequencies between 1 and 3.5 kHz. Tempco of the dc V function is \pm (0.05% reading + 0.02% range)/ $^{\circ}$ C over 0 to 40 C.

Other important specs of the 970A include a 10-M Ω input impedance on dc V shunted by a maximum of 30 pF on ac V. Input protection is to 1000 V, peak, on volts; and, on ohms, the meter can withstand up to 300 V rms for up to 10 s without damage. Greater overloads will blow a clip-mounted fuse. If accidentally dropped, the unit is protected against damage by a high-impact, stress-relieved plastic case.

With the HP 970A come the battery pack, the battery charger, (appropriate for the power in any location or country), three interchangeable probe tips of various sizes, a belt-clip case and a sun hood.

At least 2-1/2 hours of continuous operation at 25 $^{\circ}$ C, or more than 2000 press-to-read measurements can be obtained on a full charge.

Soon-to-follow options include a current shunt/cradle (\$45), which converts the DMM to bench use and adds ac/dc current measuring, from 0.0001 mA to 1 A, full scale.
For Hewlett-Packard
Booth No. 1735 Check No. 250
For Data Precision Check No. 251
For Keithley Check No. 252

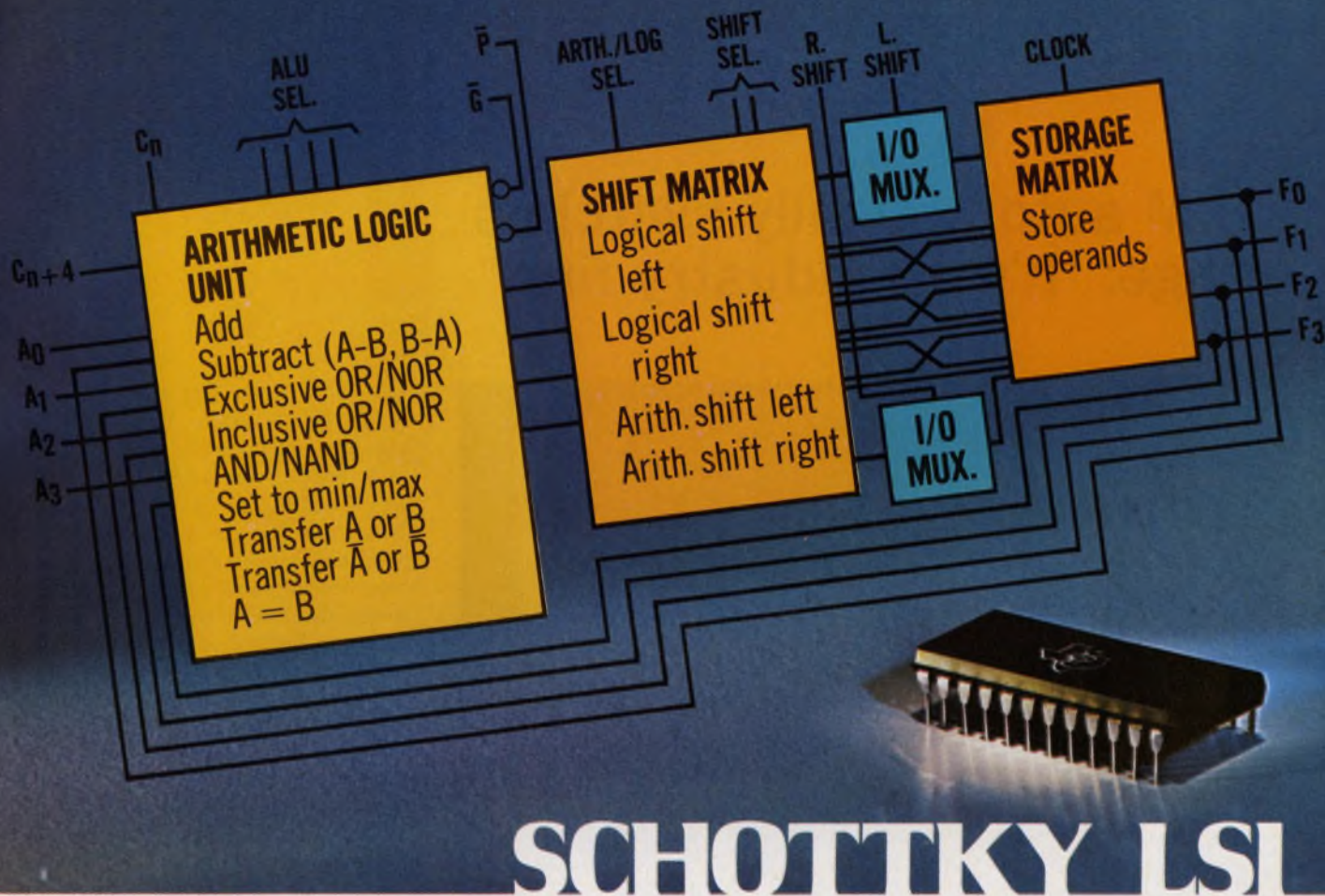

Processor Power

With TI's new SN54S/74S281 high performance monolithic accumulator.

Functionally, TI's new SN54S/74S281 Schottky LSI accumulator is the most powerful bi-polar monolithic IC available today.

Designed to operate as the "heart" of digital processors, the S281 integrates a 4-bit arithmetic logic unit/function generator with a universal left/right shift/storage matrix featuring multiplexed 3-state output/input cascading lines...all in a 24-pin package.

Unmatched versatility, economy

We feel the S281 is a milestone device...with versatility and economy that cannot currently be achieved in any other way. The S281 can perform 20 arithmetic/logic operations on

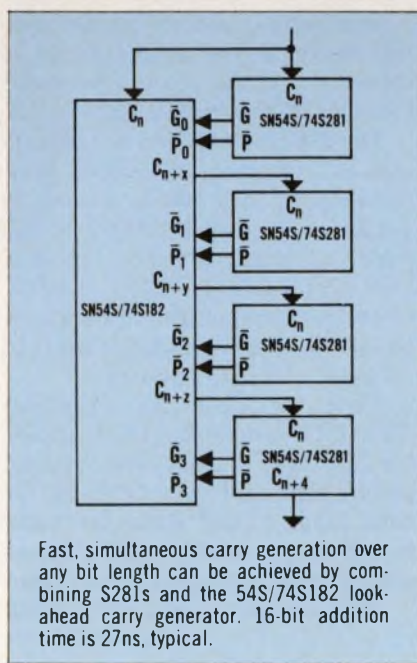

two binary numbers (see above) and can be used in multiples of 4 bits to construct whatever system size desired. It can improve performance, lower costs and reduce board space in "intelligent" terminals, machine/process controllers, minicomputers, and specialized and medium-size main-frame computers.

And at \$15.23 in 100-piece quantities, the cost is lower than that of less complex ICs organized to perform similar functions. System level savings are even greater.

For data sheet, write: Texas Instruments Incorporated, P. O. Box 5012, M/S 308, Dallas, Texas 75222.

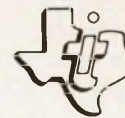

TEXAS INSTRUMENTS
 INCORPORATED

DPM automatically switches range: It's an industry first



Datel Systems, 1020 Turnpike St., Canton, Mass. 02021. (617) 828-6395. \$149; stock.

Datel's new autoranging digital panel meter—the world's first—is sure to accelerate the trend towards replacement of mechanical meter movements with DPMs in the scientific, systems and process-control industries.

At \$149 in single quantities, the 3-1/2-digit DM-2000AR eliminates manual switches and often-forgotten multipliers and scale factors. It automatically switches between the three full-scale ranges of ± 0.1999 , ± 1.999 and ± 19.99 V.

In effect, this automatic "shifting of gears" increases the instrument's dynamic range by 40 dB and provides readings from 20 V down to 100 mV.

And, since the single-ended unit always displays at least three significant digits within the 200-mV-to-20-V full-scale ranges, reading uncertainty is no more than 0.1%.

Despite its additional circuitry for autoranging, the DM-2000AR occupies only 12 cubic inches (3 W \times 1.75 H \times 2.25 D). This is less volume than many meter movements, Datel claims. And power

consumption from a 5-V supply—the only one necessary—is less than 5 W.

The autoranging circuitry operates by first sampling an input on the most sensitive range ($\pm .1999$ V). An overrange indication recycles the circuitry to the next higher range, and on to the highest range if the second range is exceeded. Worst case conversion time is 25 ms, maximum.

The DM-2000AR has a 1-M Ω input, and is protected against overvoltages up to ± 100 V. Listed accuracy of the unit is $\pm 0.1\%$ of full scale ± 1 digit, and the temperature coefficient is ± 100 ppm/ $^{\circ}$ C. Operating temperature range is 0 to 60 C. An extended range of -25 to $+85$ C is optional.

Since the Datel unit provides TTL/DTL-compatible BCD outputs for all digits, sign and decimal points, the unit can be used for data logging and computer processing of physical variables represented by an analog voltage input.

And because conversion, with range indication, occurs within 25 ms, at least 40 readings per second are possible.

Besides decimal point position

and sign, the DM-2000AR indicates an overflow by displaying the letters "OF."

A contact is available to hold any reading as long as desired. This can be arranged either as a manual pushbutton switch on an instrument panel or as a programmed pulse associated with a "read" function of a digital recorder. Another contact is available to test all digit sections by displaying the number +1888.

Also, two TTL/DTL-compatible inputs are available to select the three ranges; and still another digital input selects the ranging mode—either manual or automatic.

The DM-2000AR is packaged in a high-impact Lexan case, featuring snap-apart construction. That is, the front bezel snaps off to reveal three calibration potentiometers, and to permit complete removal of all electronics, including connector board, through the front. Thus the case doesn't have to be removed from the front panel for complete access.

Readout of the Datel unit is via LEDs, with a character height of 0.3 inch.

Booth Nos. 1321-22 Check No. 253

60-MHz scope displays parameters on CRT

Tektronix, P.O. Box 500, Beaverton, Ore. 97005. (503) 644-0161. 5403: \$1175; 5A48: \$450, 5B42: \$575.

The 5400 is a new series of 60-MHz scopes comprised of a three-plug-in mainframe and, at present, 17 different plug-ins. ICs are used throughout. Featured in the series are an optional CRT readout of plug-in parameters and, since the CRT can also be accessed externally, the units have the ability to read out dates, picture numbers, digital clock times, etc.

Booth No. 1818-20 Check No. 254

a new STANDARD for JUMPERS

FLAT

ROUND

from
Ansley

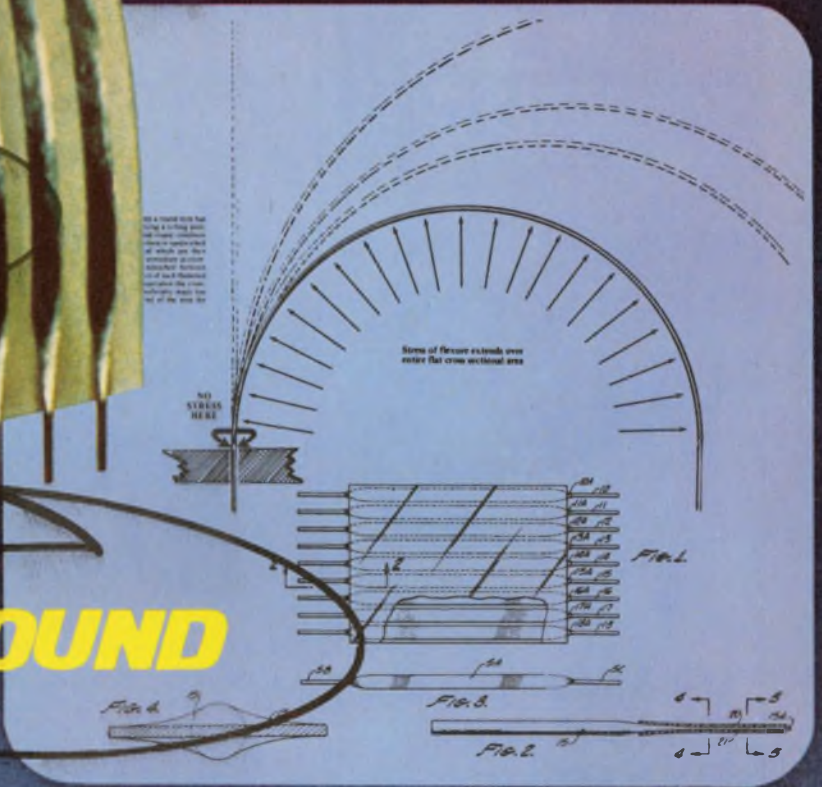

Ansley's new patented FLEX-STRIP Jumpers have flat conductors laminated between high performance insulating materials and are available from stock in thousands of part numbers. The flatness gives them flexibility where it's needed ... the round contacts insert easily into p.c. board holes or sockets. This combination of flat/round provides a generous radius when flexed, thus eliminating stress from the contacts.

Here's what this means to you ... no broken conductors ... easy insertion of ready to solder contacts ... no fault

assemblies ... reliable interface ... lower installed cost ... available from stock.

Specify FLEX-STRIP Jumpers. Flex them a hundred or a thousand times and there'll be no failures.

Ansley's FLEX-STRIP Jumpers come in standard lengths; four options of insulation; 2 to 60 conductors; .050, .100, .125, .150 or .200 conductor center distances and four pin configuration options. Specials, too, of course.

Contact your Ansley representative.

Pin configurations to suit your requirements. Another exclusive feature of FLEX-STRIP Jumpers.

No worry about flexing during processing or assembly. Conductors pre-coated ... ready to solder.

Nomex[®], Mylar[®], Teflon[®] or Kapton[®] insulations available for environmental compatibility.
*DuPont Trademark

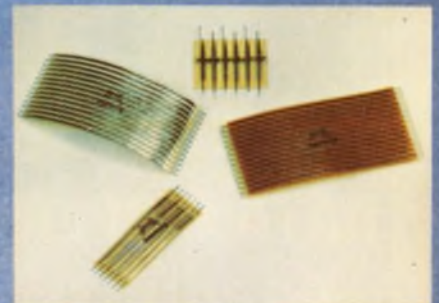

Ansley

ANSLEY ELECTRONICS CORP.

Subsidiary of Thomas & Betts Corporation
Old Easton Road, Doylestown, Pa. 18901 (215)345-1800
2828 N. Figueroa St., Los Angeles, Ca. 90065(213)223 2331
TWX: Doylestown 510-665-8105 Los Angeles 910-321 3938

THE LOGICAL PCB LIGHTS

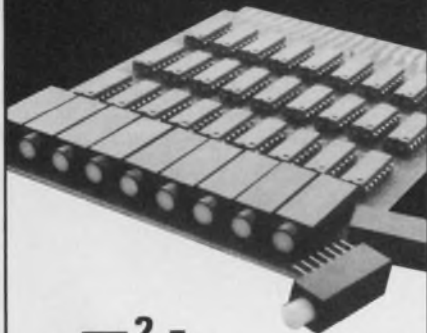

T² Lite

LED & Incandescent Lights with Built-in TTL or ECL Integrated Circuits

- Standard Dual-In-Line package contains complete logic I.C. plus visual indication
- Choice of standard 74 or 74H Series I.C.
- LED's feature built-in series resistor
- Long life incandescent lamps include built-in keep alive bias

Convenient combination package reduces cost, saves space and speeds up assembly. Units are available for immediate delivery with a wide choice of lens colors.

Call or write for more information today!

the little light people

DATA DISPLAY PRODUCTS

5428 W. 104th St., Los Angeles, Ca. 90045
(213) 641-1232

INSTRUMENTATION

Portable DMM responds to rms instead of average

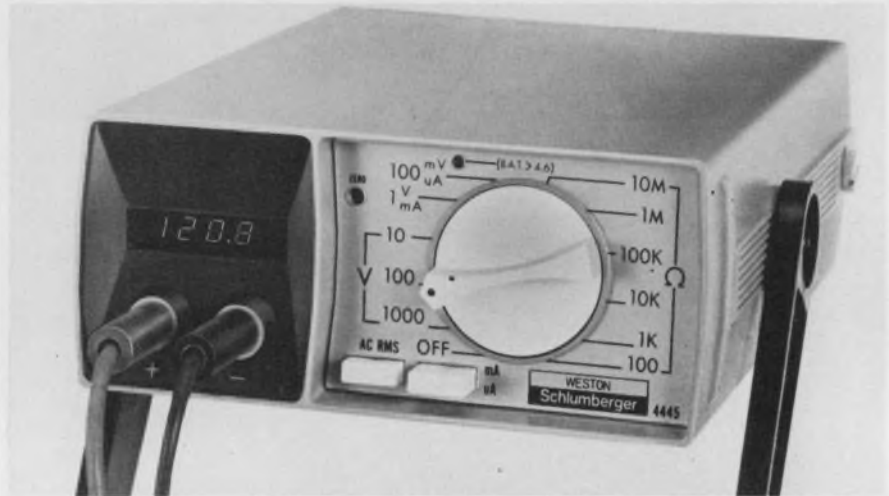

Weston Instruments, 614 Frelinghuysen Ave., Newark, N.J. 07114. (201) 243-4700. Under \$500.

Weston's 4445 is the first battery-operated digital multimeter that responds to the rms value of the input waveshape. And at less than \$500, it's the least-expensive rms unit on the market.

Most meters available today respond to the average value of an input. This is fine if the input is a pure sinusoid. But if the input is a square wave, triangle, distorted sinusoid or any other shape, then the average-sensing meter won't read the correct voltage.

For example, square waves will be read about 11% high, and triangle readings will be about 4% low. Waveshapes with random harmonics will have mostly indeterminate errors, depending on relative phases as well as magnitudes.

Why aren't all voltmeters and DMMs rms responding? Simple. Up till recently, rms sensing circuits have been too expensive to use in low-cost instruments.

The 3-1/2-digit 4445, however, takes advantage of recent developments in solid-state rms converters to keep costs down. These devices operate, essentially, by performing the mathematical root mean sum.

Of course, some industry ob-

servers feel that the only true rms converter is one that actually responds to rms—such as a filament lamp coupled to a temperature sensor, or a thermistor.

However, the 4445 reads rms—with an accuracy of 0.5% of full scale ± 1 digit—of waveforms having a crest factor of four to one at full scale, and within a frequency range of 50 Hz to 5 kHz.

Full scale input ranges are 100.0 mV, 1.000 V, 10.00 V, 100.0 V and 1000 V. Accuracy on the 1000-V scale is 1% of full scale ± 1 digit over 50 Hz to 2 kHz.

Higher crest factors (ratio of rms to peak value) are handled by the Weston unit, provided the maximum peak value of any range isn't exceeded. Peaks range from 400 mV on the 100-mV range, to 400 V on the 100-V range. Thus, crest factor is 8:1 at half scale and 40:1 at tenth scale. On overrange, which is 100%, crest factor is limited to 2:1.

The 2-1/2-pound 4445 comes in a high-impact plastic case and is supplied with four NiCad "C" cells, plus the charger.

Specifications for dc and ohms are similar to the company's Model 4442. Twenty ranges cover ac/dc current, 200 mV to 1000 V ac/dc and 200 Ω to 20 M Ω of resistance. *Booth No. 1018-19 Check No. 258*

designer series
CASES

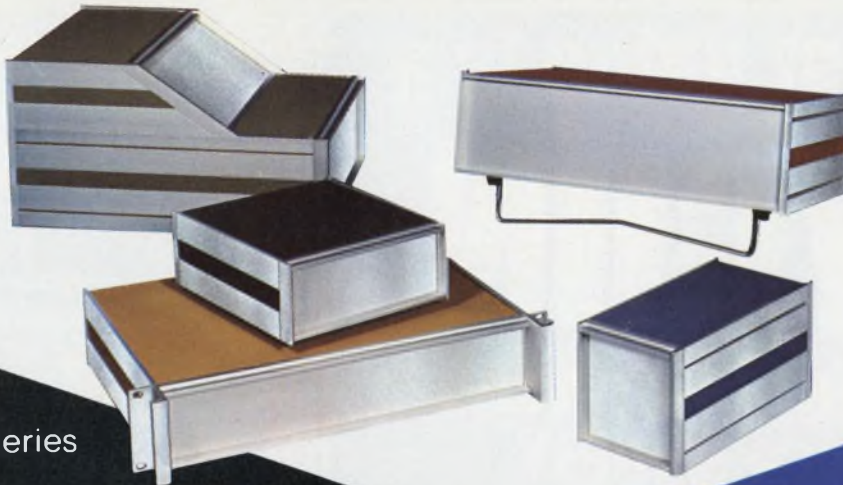

Buckeye's ingenious assembly concept of anodized aluminum extrusions gives these instrument cases strength and flexibility for configurations in all industry standard heights from 3½" to 10½". For rack mounting or bench work, using retractable locking tilt-stand.

designer series
FRONT-LOADING CASES

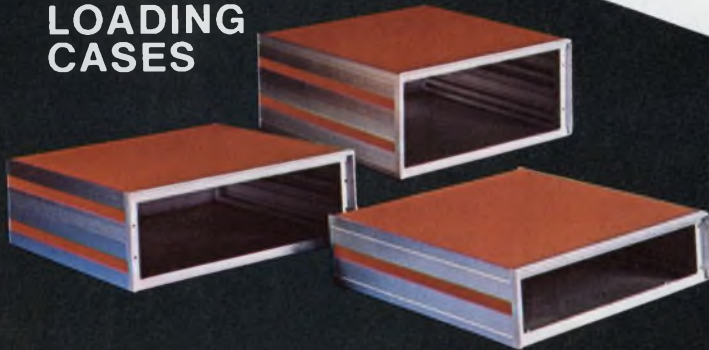

Decorative 19" cases to house existing instruments in custom fashion at off-the-shelf cabinet cost. Stock units in five sizes from 5¼" to 12¼". Durable anodized aluminum trimmed with suede-finish colors. Each case complete with four nylon feet and retractable, self-locking tilt-stand.

buck-i-pak



The first truly portable instrument case designed for travel. Removable chassis for assembly line component installation. Hinged control cover and handle fold neatly underneath. Top access panel opened by flush mounted push buttons. Extruded aluminum design with suede-finish colors. 11½" h x 18" w. x 5¼" d.



CABINETS



Newest professional-look for instrument enclosures. The strength of the anodized aluminum extrusions and colorful suede-finish panel construction meet the rigid standards to which Buckeye has adhered since 1902.

Universal 19" front panels, with heights 12.25" to 28", give packaging versatility at a budget price. All models have integral handles, extrusions with thread-tracks, to mount braces and brackets, and easy access back panels. Slip-in front panel or open-front models available from stock.

SEE US AT WESCON -- BOOTH #1807-1808

BUCKEYE enclosures

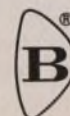

the BUCKEYE stamping co.
555 Marion Rd., Columbus, Ohio 43207

Quality Products Since 1902

Buckeye Stamping also manufactures: modular Card Guides. Matching Instrument Knobs. Bord-pak Racks, retractable self-locking Bails and maintains full facilities for metal working, injection moulding and custom fabrication, as well as silk-screening, hot stamping and etching.

your best value is a

TRYGON

**SYSTRON - DONNER
POWER SUPPLY**

QUALITY/RELIABILITY/SERVICE

VPH Series

Up to 30VDC

Up to ~~50~~⁶⁰ AMPS

\$400 to \$425



The ValuPower Half Rack . . . There is nothing like it in size or performance at that price! A truly unique innovation in DC Power Supply Technology . . . it's your best value in a half rack.

- Low noise for IC & Systems use
- Very low output impedance
- Optional Self-Test output indicator
- Choice of six slot range outputs
- Front panel voltage & Current Meters available

20% more current at the same price!

FEATURES • Standard Ratings are; 5V/⁶⁰50A, 12V/35A, 15V/31A, 24V/22A, 28V/19A, Dual $\pm 15V/13A$ • 0.02% Regulation • less than 1mV RMS ripple • 5mV Peak-to-Peak Ripple • 0.05% Stability • Unique patented Automatic non-linear current foldback overload protection circuit • Thermostatic Thermal Protection • Remotely Programmable • Remote Sensing • Compatible with rack adapters for multiple output power applications. • Designed to meet UL Recognized Component Index Requirements.

Write directly or call your local Scientific-Devices sales office for complete specifications and applications.

TRYGON ELECTRONICS
SUBSIDIARY

SYSTRON  DONNER
CORPORATION

1200 Shames Drive, Westbury, N.Y. 11590 (516) 997-6200

The Systron-Donner Instruments Group:

Concord Instruments Computer Systems Datapulse Kruse Electronics Microwave Trygon Electronics

INFORMATION RETRIEVAL NUMBER 52

INSTRUMENTATION

Multichannel filter can handle up to 16 channels

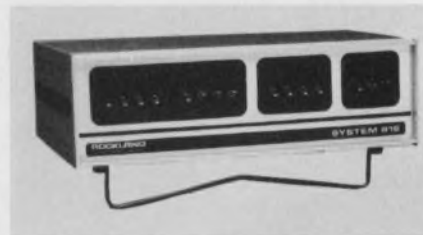

Rockland Systems, 230 W. Nyack Rd., West Nyack, N.Y. 10994. (914) 623-6666. \$1500 (main-frame); \$650 (each filter card); 4 wk.

The System 816 multichannel filter is in a 5-1/4 x 19 in. cabinet that can contain up to 16 independent filter channels—each mounted on its own plug-in PC card. Local, remote or on-card programming is TTL compatible, with over the frequency range of 10 Hz to 150 kHz may be accomplished rapidly with the 816. Remote programming is TTL compatible, with the filter channels driven individually or simultaneously. The programming delay is less than 3 ms. Stability of cut-off frequency is ± 200 ppm/ $^{\circ}C$. LEDs provide visual indication of cut-off frequencies in both local and remote modes. Standard cards are low-pass, 48 dB/octave, Butterworth configuration, and are easily convertible to high-pass mode by a simple rearrangement of on-card jumper plugs. Combined channels then produce either bandpass or band-reject functions. Dynamic range is 80 dB, maximum, signal level is 20 V p-p, impedances are 1 M Ω input and 50 Ω output.

Booth No. 1427 . . . Check No. 259

Digital storage scope looks back in time

Nicolet Instrument Corp., 5225 Verona Rd., Madison, Wis. 53711. (608) 271-3333. \$2500; 60 days.

With the two-input Model 92 plug-in, the 1090 can record equal amounts of signal time on either side of an unpredictable trigger and display the results with the trigger in the center of the screen. Sweep speeds as fast as 1 μs , with 12-bit resolution, are possible.

Booth No. 1231 Check No. 260

Network analyzer works down to 1 Hz



Hewlett-Packard, 1501 Page Mill Rd., Palo Alto, Calif. 94304. (415) 493-1501. \$16,250; 90 days.

Model 3043A, a system for amplitude and phase measurements, has a frequency range from 13 MHz down to 1 Hz. Input signal range is 0.2 mV to 20 V rms. Input impedance is 1 M Ω , shunted by 30 pF. The stimulus output impedance can be either 50 or 75 Ω . Maximum output level is 5 V rms. For amplitude measurements, display resolution is 0.1 dB. For phase measurements, the display resolution is 0.1°.

Booth No. 1518-20, 1618-20, 1536-38, 1634-36 Check No. 261

Power sources are set by 16-bit program



Moxon Inc./SRC Div., 2222 Michelson Dr., Irvine, Calif. 92664. (714) 833-2000. \$1495; 30 days.

Designated the Models 3535 and 3537, these computer-controlled dc power sources offer plug-in modules that permit any programming. Interface or isolation circuits can be selected and easily changed in the field. They are for direct interface and operation with computers, data generators, TTL binary inputs, automatic controllers, etc. Ac-input-to-dc-output isolation is 10,000 M Ω and 10 pF. Output resolutions as fine as 500 μ V are available.

Booth No. 1631, 1632

Check No. 262

INFORMATION RETRIEVAL NUMBER 53 ►



Who said a digital-readout signal generator has to be hard to handle, hot and heavy, and cost \$4,450?

Not us!

Our Model 102A, at \$2,975, has everything you need for just about any AM/FM application — plus seven performance and convenience features you won't get in the \$4,450 design.

What did we leave out?

Phase-lock synchronization, for one (but our dc-coupled FM channel can be externally locked if you need better stability than our typical 4 ppm); and narrow-pulse modulation (belongs in a different class of generators).

What did we add?

Four different signal-generation techniques — for optimum performance in each band, from 4.3 to 520 MHz, without the usual compromises in noise, stability, or residual-distortion characteristics.

The most logical panel layout and convenient control setup you've ever seen. And a unique adjustable "feel" main drive mechanism for narrow-band receiver setting with ease — even without our electrical vernier.

Separate meters for modulation and output — no annoying auto-ranging or out-of-range annunciators . . . we don't need them.

15 minute warmup to typically

meet 10 ppm/10 minute stability — made possible by low internal dissipation (only 30 watts; no fan!)

Wider FM deviation at low carrier frequencies than any other design in this class (how does 2 MHz peak-to-peak grab you?)

A detected-AM-output option, to verify our negligible phase-shift for VHF-omni testing.

Versatile modulation features — like five internal frequencies, 30% and 100% AM scales, and true-peak-responding AM and FM metering.

All these performance pluses are coupled with low spurious and close-in noise, excellent low-frequency phase integrity, really effective leveling, a low and flat VSWR curve, accurate wide-range attenuation, high output power . . . all of it buttoned up tight for low leakage in a lightweight 30 pound package.

. . . and it's all yours for \$2,975. Get the full specs today — before you spend 50% more .

For complete data or a demonstration write or call Boonton Electronics Corp., Rt. 287 at Smith Road, Parsippany, N. J. 07054, (201) 887-5110.

BOONTON

relays rewarded



Our congratulations, and the **GRAND PRIZE**, a 1923 Model T Ford Station Wagon from the Struthers-Dunn 50th Anniversary Relay Contest go to:

Marshal K. Kessie

for this solution to a relay problem, independently judged the most imaginative, and of wide interest to users of relays:

ONE RELAY TALLIES "MAJORITY VOTE" OUT OF 3 RELAYS

One relay replaces three in this high reliability control circuit that requires closure of at least 2 pilots A, B, C before closing the relay output contacts. Fig. 1 shows the conventional circuit using 3 relays and associated wiring complications. By contrast, the prize-winning circuit of Fig. 2 greatly simplifies wiring and improves reliability, since power failure or an open circuit in the relay coil or resistor segment will de-energize the relay.

The circuit requires a dc coil relay because only dc coils draw the same current under both inrush and sealed conditions and will operate down to about 80% of rated voltage. In Fig. 2, opening any two NC pilot contacts inserts enough resistance in the coil circuit to exceed the drop-out point of the relay. Each resistor segment should be about .15 times the coil resistance and be able to dissipate about .15 times the coil wattage.

Since the drop-out voltage is critical in this application, adjustable sensitive relays are preferable to standard relays whose operating voltage range may vary from unit to unit. For precise matching of coil to voltage use S-D type A112XAX. Specify operating voltage with all pilot switches closed. Then the relay will hold in with one switch open, but will drop out with two switches open.

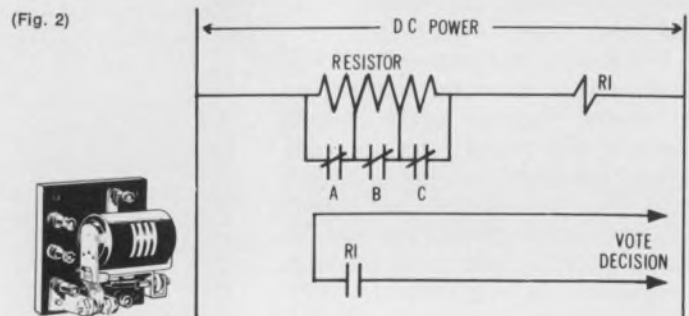
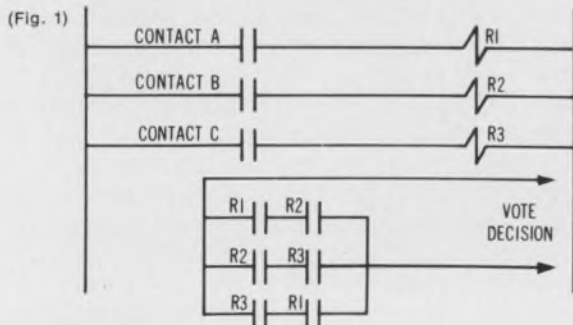

R-C NETWORK CUTS RELAY "OPERATE" TIME 40-50%

Without overdriving, the simple network of Fig. 3 gives an essentially constant series path impedance, a constant coil current, and much faster switching of conventional reed relays such as S-D type MRRNIA. Even though driven at a voltage much higher than the coil rating, coil current may be limited to the small amount needed to *maintain* closure, not pull-in. During pull-in ("operate") current flows principally through the capacitor. Our thanks and \$50 to T. E. S., Easton, Pa.

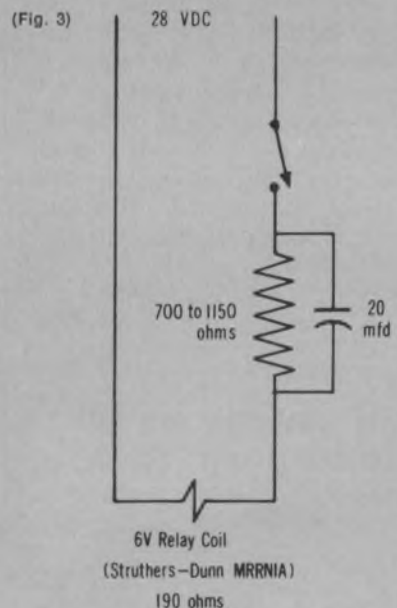

STRUTHERS-DUNN, INC.

PITMAN, NEW JERSEY 08071

Canada: Struthers-Dunn Relay Div., Renfrew Electric Co., Ltd.

Over 100 Basic Relay Types, even more modifications. Check reader service number for your catalog.





Celebrating our 50th year.

SOLID STATE ALCHEMY & THE COMMON RELAY



It may not turn lead into gold. But solid state does some dramatically useful things to fairly conventional relays. Like making relays sense minute phase differences between two ac signals. Or operating a 10 watt dry reed on 1 μ A signals. Or responding to a 1% change of signals as low as 1V and/or 1 mA. Or making a precision time delay with all sorts of inexpensive circuit options.

Sure, solid state could do it alone. But not so cheaply as hybrids considering their load capacity and total input/output isolation. Circle reader service number to learn more of the expanding S-D line of hybrid relays: time delay, null sensing, metering, sensitive on-off or latching, ac load switches, over & under voltage relays.

One pound of
relay wrap-up.
Check reader
service card number
for your catalog.



STRUTHERS-DUNN, INC.
Plitman, New Jersey 08071
Canada: Struthers-Dunn Relay Div.,
Renfrew Electric Co. Ltd.

INFORMATION RETRIEVAL NUMBER 55

ELECTRONIC DESIGN 18, September 1, 1973

INSTRUMENTATION

Function generator outputs 30 MHz



Wavetek, P.O. Box 651, San Diego, Calif. 92112. (714) 279-2200. \$845; 30 days.

Model 162 is said to be the first 30-MHz function generator. This advanced generator adds a trapezoidal waveform with variable width and slope controls; therefore, pulses may be generated with variable rise/fall times. This is in addition to the variable-symmetry control, which produces fixed rise/fall pulses and sawtooth waveforms.

Booth No. 1430-31 Check No. 263

Programmable analyzer displays stored program

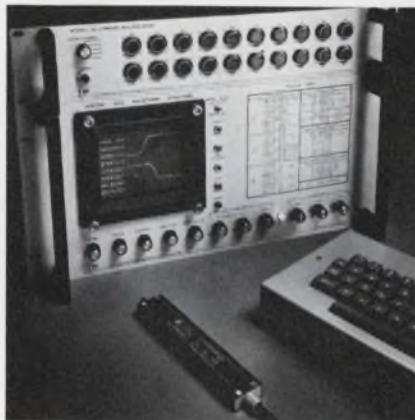

E-H Research Labs, Box 1289, Oakland, Calif. 94604. (415) 834-3030. \$15,500; 30-60 days.

The EH/AMC System 1010 is a dual-channel digital waveform analyzer with a 1-GHz bandwidth and a sampling rate from 50 Hz to 100 kHz. The analog waveforms, digital readout and stored program information are displayed on the CRT. Completely programmable functions plus the CRT display eliminate Nixie tubes, knobs and thumbwheel switches. Programming is via a keyboard, computer or tape reader providing ASCII outputs.

Booth No. 1331 Check No. 264

Logic probe indicates seven states

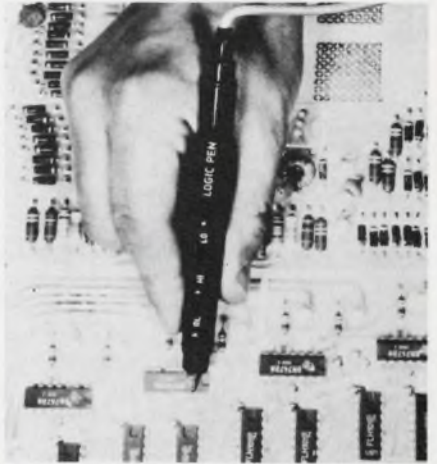

Technology in Production, 8 Kevin Dr., Danbury, Conn. 06810. (203) 746-2525. \$75; 60 days.

READ-A-PIN logic probe features LED readouts of seven states: ZERO, ONE, indefinite levels, positive overload, pulse trains and short-duration signals, both plus and minus. HIGH input impedance equals one TTL load. Minimum pulse width detected is 30 ns. Size is 5.3 in. long by 0.5 in. diameter, and weight is 1 oz.

Booth No. 1451-52 Check No. 265

OEM strip-chart recorder sells for just \$250

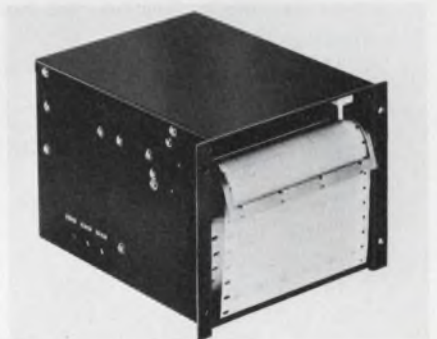

Esterline Angus, P.O. Box 24000, Indianapolis, Ind. 46224. (317) 244-7611. \$250.

This dedicated, 10-cm servo strip-chart recorder is intended for quantity OEM customers. The unit offers a guaranteed operation of 10 million cycles, a foolproof disposable pen and ink cartridge, two circuit cards which contain all the electronics, and a wide range of chart speeds. Basic sensitivity is to 100 mV fs (10 mV optional), response of 0.5 s fs, and accuracy of $\pm 0.5\%$ span.

Booth No. 1027 Check No. 266

The HS-200S

... a wire memory offering speed, capacity, cost and reliability of ample proportions.

This is our latest wire memory. It gives you access time of 180 ns and cycle time of 250 ns. Memory elements, of course, consist of our own special development, magnetic wires. Non-destructive read-out is featured. HS-200S means maximum reliability at minimum cost. In fact, you get a 65 kilo-byte assembly with an MTBF figure of 10,000 hours. HS-200S is a component precisely matched to computers of the new age.

Wire Memory System HS-200S Specifications

1. **Memory elements** Non-destructive read-out
2. **Storage capacity** 8 kwords/80 bits, 16 kwords/40 bits, 32 kwords/20 bits
3. **Access time** 180 nanoseconds
4. **Cycle time** Write-in Read-out 250 nanoseconds
5. **Interface levels** TTL logic ... H +2.4—+5V L —0.5—+0.5V
6. **Dimensions** 500 x 300 x 112mm (Basic unit capacity is 65 Kbytes. Expansion to one megabyte is possible.)
7. **Required power** +30V, +15V, +5V, —15V

Please contact our sales department if you have special requirements.

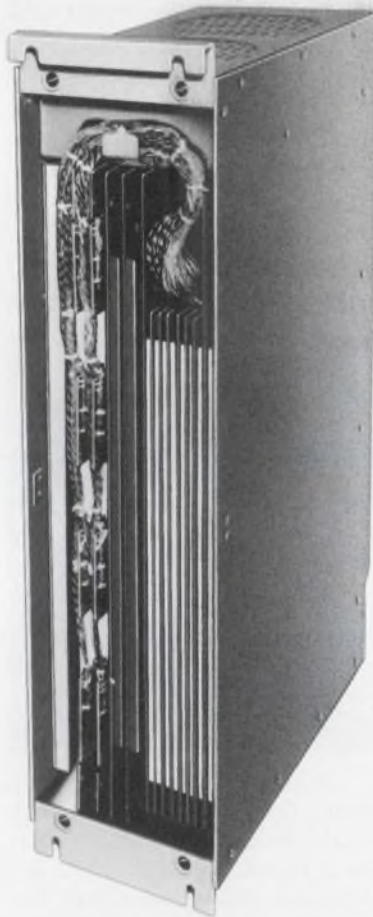

TOKO, INC.

Head Office: 1-17, 2-chome, Higashi-Yukigaya, Ohta-ku, Tokyo, Japan
New York: Toko New York Inc.
 350 Fifth Avenue, New York, N.Y. 10001 U.S.A. Tel: 565-3767
Los Angeles: Toko, Inc. Los Angeles Liaison Office
 3440 Wilshire Blvd., Tishman Building, Suite 1106 Los Angeles, Calif. 90010, U.S.A. Tel: 380-0417
Düsseldorf: Toko Elektronik G.m.b.H.
 4 Düsseldorf, Lakronstrasse 77, W. Germany Tel: 0211-284211

INFORMATION RETRIEVAL NUMBER 56

INSTRUMENTATION

Logic checker shows DIP functions

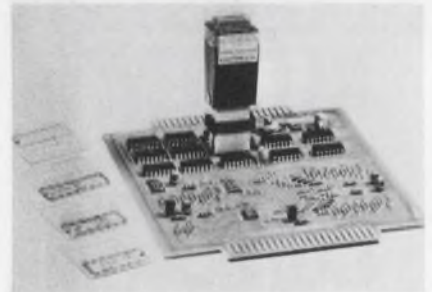

Technology in Production, 8 Kevin Dr., Danbury, Conn. 06810. (203) 746-2525. \$125; stock.

This new improved version of the READ-A-DIP logic checker features all pins available at the top for scope testing, pulse injection or set-reset applications. A clear plastic overlay with a logic symbol decal may be fitted over the top of the unit. LEDs are read directly through the overlay. Two versions are available: the standard 4-to-8-V, and the 8-to-18-V high-level model.

Booth No. 1451-52 Check No. 267

11 plug-ins added to modular instrument line

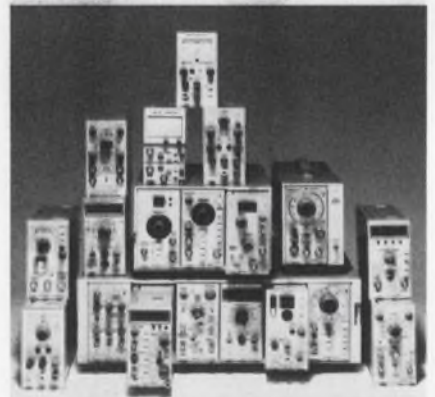

Tektronix, P.O. Box 500, Beaverton, Ore. 97005. (503) 644-0161. See text; stock.

With the addition of 11 new modules, the TM 500 Series includes a total of 24 general-purpose instruments. The new modules include a high-gain op amp, a two-channel, 225-MHz universal counter, an 11-MHz function generator, a 250-MHz pulse generator, and a 2-MHz, X-Y CRT monitor. Prices range from \$225 for the op amp, to \$425 for the function generator.

Booth No. 1818-20 Check No. 268

Barebones recorder lets you dial any speed



Astro-Med, Atlan-Tol Industrial Park, West Warwick, R.I. 02893. (401) 828-7010. \$3388.

The Super 8 is said to be the lightest, most compact, and lowest cost eight-channel recorder of its type. The user can dial any speed, from 0.25 to 100 mm/s. The speeds are set with a 10-turn pot, and readout is on a meter, calibrated directly in mm/s. In addition, the Super 8 has full 50-mm wide channels and includes the stylus in its standard one-year warranty.
Booth No. 1632 Check No. 269

Pulse generator offers choice of programming



E-H Research Labs, Box 1289, Oakland, Calif. 94604. (415) 834-3030. \$3500 w/o controls.

Model 1501A Programmable Pulse Generator is a family of pulse sources having common output characteristics. A wide variety of programming options in parallel, ASCII, or serial-by-16-bit form, allow them to be interfaced to almost any data source, including computer, punched tape reader, keyboard, or parallel storage register. Pulse parameters include: less than 3-ns rise/fall times, ± 10 -V backmatched output and repetition rates to 50 MHz.

Booth No. 1331 Check No. 270

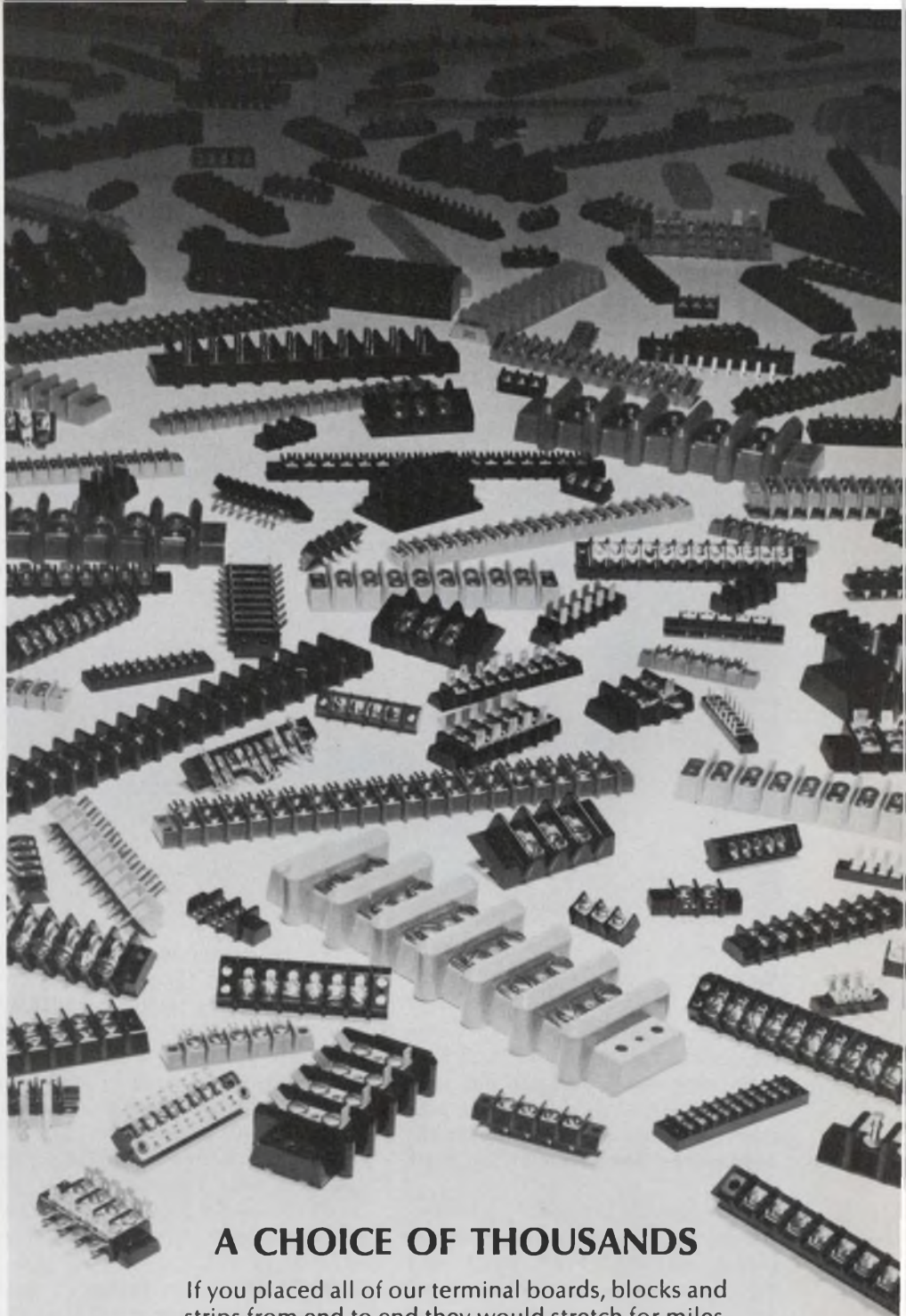

A CHOICE OF THOUSANDS

If you placed all of our terminal boards, blocks and strips from end to end they would stretch for miles.

After all, we make more variations than any other manufacturer. So why compromise, we can meet your exact specifications. Delivery? Allow a few weeks for our good old standards, longer for the oddballs. So plan ahead and get the best.

Kulka

A NORTH AMERICAN PHILIPS COMPANY

SE UL

Kulka Electric Corp., 520 South Fulton Avenue, Mount Vernon, New York 10551

Tiny modular op amp slews and settles in a hurry



Hybrid Systems, 87 Second Ave., Burlington, Mass. 01803. (617) 272-1522. \$24.

You can get modular op amps that settle faster than Hybrid Systems' new A956. You can get ones with higher slew rates. And still other op amps have similar high-impedance, low-bias FET input stages.

But Hybrid Systems' differential-input A956 gives you all three—fast settling, FET input and high slew rate—in the smallest-available module. The unit measures only $1.4 \times 0.6 \times 0.5$ inches and plugs into a 16-pin DIP socket.

True, monolithic op amps are smaller; some have faster slew rates than the $40 \text{ V}/\mu\text{s}$ rate of the Hybrid unit; other have FET input stages; and at least one has identical settling time: $1 \mu\text{s}$ to 0.01% of final output value. But no one IC op amp combines fast slew, fast settling and a FET input.

Also, IC op amps require external components for frequency compensation. In contrast, the A956 is fully compensated internally and needs no external components for this purpose.

Several larger modular op amps offer superior performance. For example, the Zeltex ZA910M1 claims what is probably the fastest slew rate of any op amp: a scorching $2000 \text{ V}/\mu\text{s}$. And it settles in less time than Hybrid Systems' unit: 400 ns to 0.01% .

But the Zeltex (a FET unit) needs a bias current of 100 pA at 25 C —vs 50 pA for the Hybrid Systems unit. The ZA910M1 is also bigger— $1.2 \times 1.8 \times 0.6$ —and its \$99 price makes it over four times more expensive than the \$24 price of the A956.

In the IC category, Teledyne Philbrick offers the fastest available settling time of $1 \mu\text{s}$ to $.01\%$ in its Model 1324. But the 1324's slew rate is $25 \text{ V}/\mu\text{s}$ and its bias current is 200 nA . The small-signal, unity gain bandwidth of the 1324 is 8 MHz vs 5 MHz for the Hybrid A956.

The Hybrid Systems' unit is the first of a new family of amplifiers specifically designed and optimized for CRT-graphic displays and data conversion requirements—not as a general-purpose op amp. As such, the A956 was designed with speed in mind.

Other specifications of the A956 include an open-loop gain of 5×10^5 , an input impedance of 10^{12} ohms and a voltage offset drift of $40 \mu\text{V}/^\circ\text{C}$. Bias current, of course, doubles every 10 C . Operating temp range is 0 to 70 C .

Output of Hybrid's unit is a respectable $\pm 20 \text{ mA}$ at $\pm 10 \text{ V}$. And the unit can operate from power supply voltages anywhere from ± 12 to $\pm 18 \text{ V}$. Only 10 mA of quiescent current is drawn.

Output impedance is less than 0.1Ω ; the unit can drive a 500-pF load. Short-circuit protection of the output is also a feature—the output can be grounded indefinitely with no deterioration of performance.

As for input protection, common-mode voltage is limited to $\pm 10 \text{ V}$. The CMRR is 3000 .

For Hybrid Systems

Booth No. 1204 Check No. 255

For Zeltex Check No. 256

For Teledyne Check No. 257

Fast FET op amps operate to 140 V

Datel Systems, 1020 Turnpike St., Canton, Mass. 02021. (617) 828-6395. AM-301A: \$75; stock.

The AM-300 series of FET-input op amps combine high-voltage operation with high-speed response. The AM-301 A/B, a low-cost version, operates with output swings to $\pm 110 \text{ V}$ at 20 mA while providing a common-mode tolerance of 100 V . The AM-302 A/B operates with output swings as high as $\pm 140 \text{ V}$ at 20 mA with a common-mode voltage to V_{cc} . A further choice is offered in temperature coefficients: Model numbers with suffix A have a $50 \mu\text{V}/^\circ\text{C}$ tempco, those with a suffix B, a $20 \mu\text{V}/^\circ\text{C}$ tempco. The settling time of all models is less than $2.0 \mu\text{s}$ while slew rates exceed $100 \text{ V}/\mu\text{s}$.

Booth No. 1321-22 Check No. 271

THE SWISS CONNECTION.*



The Quick-Lok Multicontact Connector.

To engage the connector, just push it straight in. To disengage it, pull straight out until the lock releases, then continue pulling to remove the plug from the receptacle. No twisting or turning is necessary.

The Quick-Lok feature;

Saves space because finger clearance is required on only two sides.

Reduces wear on the connector and cable because no twisting is necessary.

Grips firmly and remains locked until intentionally released.

The Lemo multicontact connector is versatile. Miniature sizes are available with 2, 3, 4, 5, 6, 8 or 10 contacts. In addition to standard cable terminating plugs and panel mounting receptacles, adapters, couplers and right angle plugs are available.

With a satin chrome finish, Lemo connectors complement the clean, modern design of instruments, components and systems. They are ruggedly constructed of machined brass components.

A complete catalog is available on request.

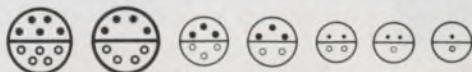

* Manufactured in Switzerland



LEMO U.S.A. INC.

2015 SECOND STREET • BERKELEY, CA 94710
(415) 548-1966 • TELEX 335-393

Protect against transients with clamping/crowbars



**specialist
or
general
practitioner?**

Specialist, of course... in the art of reducing or eliminating unwanted, troublesome signals from electronic circuits. Rtron specializes in the design and manufacture of RFI/EMI filters to cure virtually every electronic interference problem. UL Recognized data processing filters, MIL-F-15733 types and filters for every industrial application are readily available... from stock to custom designed, tubular, rectangular or bathtub types, in single or multi-circuit units.

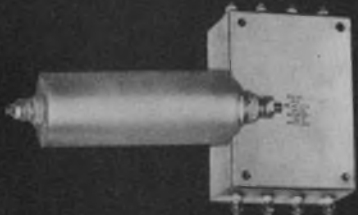

If you like our specialist, you'll like our treatment... phone or write...

Rtron

Dept. ED-10

P.O. Box 743 Skokie, Illinois 60076

Phone 312 • 679-7180

INFORMATION RETRIEVAL NUMBER 59

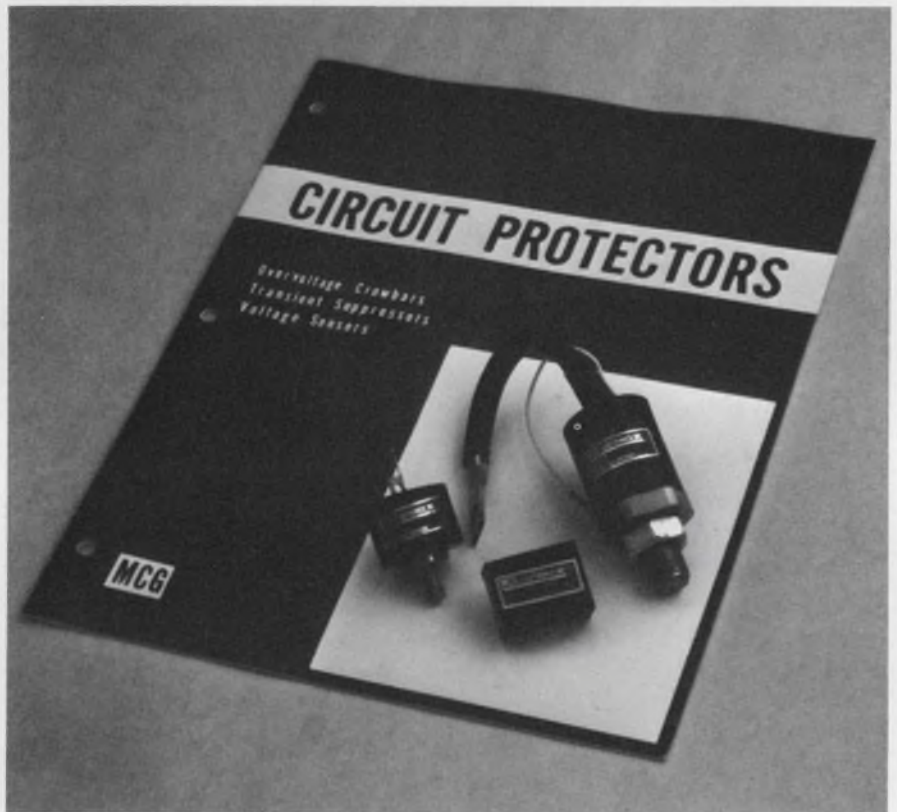

MCG Electronics, 279 Skidmore Rd., Deer Park, N.Y. 11729. (516) 586-5125. \$16 to \$42; stock to 2 wk.

Avoidance of damage to circuits due to transient overvoltages has usually called for the use of either zener or crowbar devices. Zeners respond quickly—in nanoseconds—but suffer from limited power-handling capability. Crowbar devices, on the other hand, can handle high-energy transients. But with typical response times of about 10 μ s, crowbars generally aren't fast enough to prevent some circuit damage.

Now MCG Electronics has a solution to the problem of adequate transient protection—the LVC-10 series that combines the best features of both zeners and crowbars in a single compact package. An added advantage over conventional protectors is the elimination of "nuisance" tripping from low-energy, 20-to-100 μ s transients that oc-

cur in noisy environments.

For short-duration transients, the LVC-10 clamps the transient within 50 ns to a preselected level in the 5-to-40-V range. It can safely absorb 475 W for 10 μ s, 120 W for 100 μ s, or 25 W for 10 ms. The unit recovers automatically when the transient expires.

For longer-duration transients, the LVC-10 acts initially like a zener clamp. But within 10 μ s, the device switches to the shorting, or crowbar, mode that can handle from 3 to 110 A continuously. In this mode, power must be removed momentarily to reset the unit.

The duration of clamping before crowbarring is determined by an external capacitor. The delay in microseconds approximately equals 30 times the capacitance in microfarads. With the right capacitor, the delay can be adjusted to eliminate "nuisance" tripping.

Booth No. 1741 Check No. 272

“Scotchflex” Flat Cable Connector System makes 50 connections at a time.

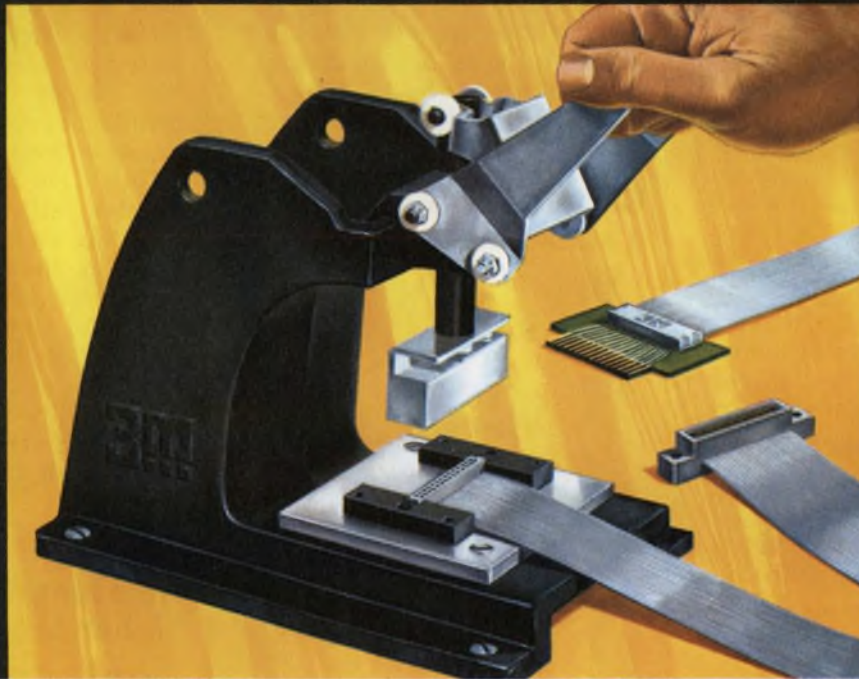

“SCOTCHFLEX” IS A REGISTERED TRADEMARK OF 3M CO.

Build assembly cost savings into your electronics package with “Scotchflex” flat cable and connectors. These fast, simple systems make simultaneous multiple connections in seconds without stripping or soldering. Equipment investment is minimal; there’s no need for special training. The inexpensive assembly press, shown above, crimps connections tightly, operates easily and assures error free wiring.

Reliability is built in, too, with “Scotchflex” interconnects. Inside of connector bodies, unique U-contacts strip through flat cable insulation, grip each conductor for dependable gas-tight connections.

“Scotchflex” offers you design freedom, with a wide choice of cable and connectors. From off-the-shelf stock you can choose: 14 to 50-conductor cables. Connectors to interface with standard DIP sockets, wrap posts on standard grid patterns, printed circuit boards. Headers for de-pluggable connection between cable jumpers and PCB. Custom assemblies are also available on request.

For more information, write Dept. EAH-1, 3M Center, St. Paul, Minn. 55101.



“Scotchflex”.
**Your systems approach
to circuitry.**

INFORMATION RETRIEVAL NUMBER 60

IN STOCK

DISC THERMISTORS WITH CROSSED LEADS

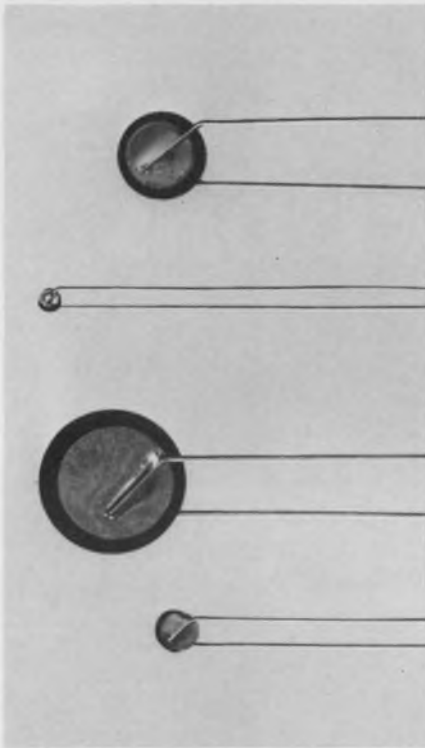

Consistent uniformity—unit after unit, lot after lot—that's what you can count on with Keystone's thermistor experience, which dates back to 1938. Whether the quantity is one thousand or one million pieces, the quality remains the same. Keystone stocks disc type thermistors with crossed leads in 34 types with resistance values from 5 ohms to 200,000 ohms. Higher values are available on special order. Get all the facts on quality thermistors... write for Bulletin T-501.



Keystone
CARBON COMPANY
Thermistor Division
St. Marys, Pa. 15857
Phone 814/781-1591

INFORMATION RETRIEVAL NUMBER 61

PACKAGING & MATERIALS

Card frames simplify locking



Vero Electronics, 171 Bridge Rd.,
Hauppauge, N.Y. 11787. (516) 234-
0400. 3D: \$57.40; 2-3 wk.

The Model 3D and 3E card-frame systems feature the company's Verolock retainers that permit all cards or modules to be locked or unlocked with a single operation. Both systems incorporate module panels for frame heights of 5-1/2, 7 and 8-3/4 inches. Widths are 1/2 and 1 inch in the 3D model, and 1, 2, 4, 5, 6 and 8 inches in the 3E.
Booth No. 1804-05 Check No. 273

Close any opening with a selection from stock



Moeller Manufacturing Co., P.O.
Box 1318, Greenville, Miss. 38701.
(601) 335-2325.

From an inventory of some 5000 stock closures, Moeller is often able to select the right one for a company's immediate need, thus saving the customer money for tool and die work. They are made in all sizes—miniature to giant—to meet most any need. A patented design feature enables the closures to expand or retract to give a tight, positive seal to most apertures. Moeller engineers are available to consult in solving closure problems.

Booth No. 1409 Check No. 274

Shock indicator priced under one dollar

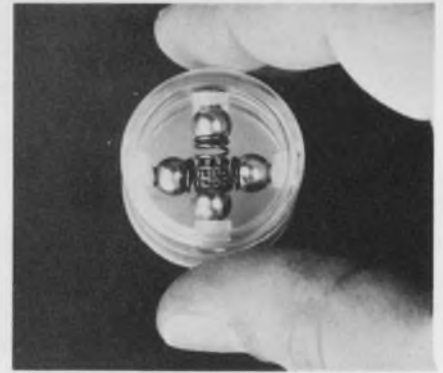

Impact-O-Graph Corp., 181 North-
field Rd., Bedford, Ohio 44146.
(216) 439-6116. See text.

An all-directional shock indicator for less than one dollar in quantity, the Protect-A-Pak, is intended for impact and shock monitoring of equipment and machinery during shipment. Any direction of shock or impact above the factory preset value will permanently trip the unit and give a clear indication of excessive shock exposure. In application, the unit attaches with its own self-stick mounting strip. At each transfer point in shipment, the indicator would be checked by looking through a view port in the carton or crate. Each carrier would sign off on its status before assuming responsibility for the goods. The g rating can be factory preset over the range of 2 to 500 g's.

Check No. 275

New laminate resists higher temperatures

The Mica Corp., 4031 Elenda St.,
P.O. Box 2578, Culver City, Calif.
90230. (213) 839-5283.

Micaply polyimide glass laminates can exceed the operational properties of epoxy-glass laminates. A continuous operating temperature of 240 C and increased dimensional stability are two of the products most important characteristics. Additional advantages include high flexural retention at elevated temperatures, superior electrical properties and reduced smearing of drilled holes. The laminate is currently available in rigid, multilayer and prepreg forms, and also with special foil claddings.

Booth No. 1309 Check No. 276

Flexible heat pipes can cool moving parts



Hughes, *Electron Dynamics Div., Thermal Products, 3100 W. Lomita Blvd., Torrance, Calif. 90509. (213) 534-2121.*

Hughes complete line of heat-pipe devices, which include flexible and rigid axial heat pipes, and a cold mounting plate, are completely self-contained. They have no moving parts, nor do they need external power. They operate reliably over long periods of time and transfer thermal energy with little temperature gradient over their entire length. The flexible pipes are constructed of stainless steel with methanol as the working fluid and they are designed for applications that have relative motion between the heat source and heat sink. The rigid axial pipes are available in several envelope and wick combinations, such as stainless steel and methanol, stainless steel and ammonia, and copper and water. They are offered in a variety of lengths from 6 to 12 in., and they have heat load capacities of 10 to 1000 W. The cold mounting plate consists of several axial heat pipes mounted between two aluminum plates.

Booth No. 1226 Check No. 277

PC card carrier adjusts to suit part heights

Parsons Manufacturing Corp., 1066 O'Brien Dr., Menlo Park, Calif. 94025. (415) 324-4726. \$5 per carrier; (OEM qty).

Parsons recently developed multi-use PC card carrier is adjustable to fit various card sizes and to allow for desired spacing between cards and differing component heights. The carrier material is a blue, high-impact resistant plastic with plated-steel fittings for maximum durability and light weight. The carrier can handle 25 cards with two plastic spacers and up to 50 cards with four spacers.

Booth No. 1751 Check No. 278

Small multipin connector locks/releases easily

Lemo U.S.A. Inc., 2015 Second St., Berkeley, Calif. 94710. (415) 548-1966. \$3.21 to \$6.62; plug, \$2.48 to \$5.35; receptacle (1000 up); stock.

A versatile family of miniature multipin connectors with from two to 10 contacts offers engineers many design alternatives. A simple self-locking mechanism makes them

well suited where connectors must be frequently engaged and disengaged. Except for the insulator, all components are made of machined brass. The outer shell has a satin chrome-plated finish. The insert dielectric is Nylotron, although other materials are available on special order. All inserts are polarized with a hermaphroditic design to prevent incorrect mating.

Booth No. 1814 Check No. 279

WHEN YOU MAKE THE BEST CMOS IC'S IN THE BUSINESS, IT'S HARD TO BE MODEST.

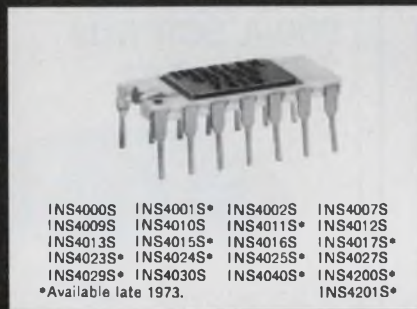

INS4000S	INS4001S*	INS4002S	INS4007S
INS4009S	INS4010S	INS4011S*	INS4012S
INS4013S	INS4015S*	INS4016S	INS4017S*
INS4023S*	INS4024S	INS4025S*	INS4027S
INS4029S*	INS4030S	INS4040S*	INS4200S*
Available late 1973.			INS4201S

Who says we make the best? We do and our customers do. What's more, we can prove it. Only Inselek offers you C/MOS with the most optimum combination of higher speed (3 times faster than monolithic C/MOS) and lower power dissipation (typically less than 10 nW) than any other logic family. Pin-for-pin compatible with the CD4000 series too!

You can select from over 25 standard circuits and our own INS4201S - 4x4 cross point switch, or, INS4200S - 256x1 C/MOS RAM. We'll even custom fabricate an IC for your own LSI application in production quantities.

Get the density and power of MOS with the speed of bipolar in a package designed to meet your most critical military and commercial requirements. In addition, Inselek's cost/performance ratio is one of the best around.

Modesty forbids us from discussing high noise immunity, temperature ranges, etc., but you can contact us for the latest technical specs. If you do, we'll include a "It's Hard To Be Modest" button.

For detailed information on C/MOS, RAM's or other Inselek IC's, or our new do-it-yourself SOS wafer kit, call or write Inselek, Inc., 743 Alexander Road, Princeton, N.J. 08540 (609) 452-2222.

INSELEK



Need rotary switches? 2-million combinations, 72-hr. delivery from your Oak Moduline™ distributor.



Quick-and-easy ordering of Oak-quality rotary switches in lots of 1 to 99. The Moduline system lets you specify switch components by number (no drawings needed). Your order is shipped within 3 days. Contact these Moduline distributors:

DRW

MASSACHUSETTS, Watertown. (617) 923-1900*
NEW YORK, Farmingdale..... (516) 249-2660*

HALL-MARK

ALABAMA, Huntsville..... (205) 539-0691
FLORIDA, Orlando..... (305) 855-4020*
GEORGIA, Atlanta..... (404) 963-9728
ILLINOIS, Chicago..... (312) 437-8800
KANSAS, Kansas City..... (913) 888-4747
KANSAS, Wichita..... (316) 682-2073
MARYLAND, Baltimore..... (301) 265-8500
MINNESOTA, Minneapolis... (612) 925-2944
MISSOURI, St. Louis..... (314) 521-3800
NORTH CAROLINA, Raleigh... (919) 832-4465
NEW YORK, New York..... (516) 293-7500
OHIO, Dayton..... (513) 278-6963
OKLAHOMA, Okla. City... Enterprise 50094
OKLAHOMA, Tulsa..... (918) 835-8458
PENNSYLVANIA, Philadelphia. (215) 355-7300
TEXAS, Austin..... (512) 454-4839
TEXAS, Dallas..... (214) 231-6111
TEXAS, Houston..... (713) 781-6100
WISCONSIN, Milwaukee..... (414) 476-1270

INDUSTRIAL COMPONENTS

MINNESOTA, Minneapolis... (612) 831-2666*

SOLID STATE

TEXAS, Dallas..... (214) 352-2601*
TEXAS, Houston..... (713) 785-5205

WEATHERFORD

CALIFORNIA, Glendale..... (213) 849-3451*
CALIFORNIA, Palo Alto..... (415) 493-5373

*Assembly Locations

OAK Industries Inc.
Crystal Lake, Illinois 60014

COMPONENTS

Line of transformers matches telephone net

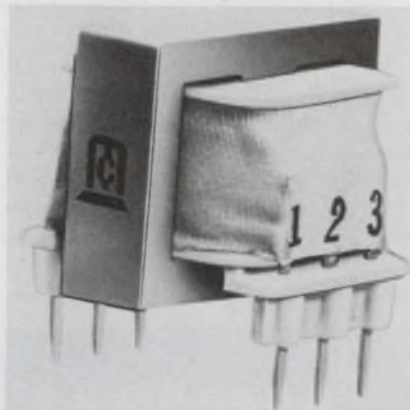

Microtran Company, Inc., 145 E. Mineola Ave., Valley Stream, N.Y. 11582. \$3.10 to \$7.85; stock (100 up).

Data-modem telephone-coupling transformers, designed for interconnect to the telephone network system, permit optimum use of voice-grade telephone lines. Eleven catalog items in this new series are designed for isolation, hybrid, bridging and holding coil applications. Use of high-permeability core material permits a frequency response of 300 to 3500 Hz which is flat to ± 0.5 dB, to be maintained at signal levels to -45 dBm.

Booth No. 2206 Check No. 280

900-A SCR lists 2.5-kV rating



Brown Boveri Corp., 1460 Livingston Ave., North Brunswick, N.J. 08902. (201) 932-6066. P: See below; stock.

A 900-A rms SCR features a voltage range of 800-to-2500 V. Packaged in ceramic pressure pack the SCR—called the CS 401—has a turn-off time of less than 120 μ s and surge rating of 7000 A. Devices rated at 1800 V are priced at \$114 in 100-piece quantities.

Booth No. 1811 Check No. 281

Quartz accelerometer couples low impedance



Kistler Instrument Co., Overlake Industrial Park, Redmond, Wash. 98052. (206) 885-3737. \$290 to \$390; stock.

Kistler's 815 series piezoelectric accelerometers can provide the vibration signature necessary for vibration analysis as well as the high-level signal needed for industrial applications. Four models are offered with a wide choice of ranges, sensitivities and time constants. Special provisions for low output impedance have been incorporated in this series. This provides signals able to drive long and moving cables. The need for charge amplifiers is thus eliminated.

Booth No. 1020 Check No. 282

Needle printer supplies full ASCII symbol set



Practical Automation, Inc., Trap Falls Rd., Shelton, Conn. 06484. (203) 929-1495. \$30; molded case, 50 cps (50,000 up); 12 wk.

Model DM 101 needle printer measures only 2 in. in diameter by 3/4 in. thick, yet prints a full ASCII set of letters, numbers and symbols in a 7 x 5 dot matrix at rates up to 150 characters per second. With a needle stroke of 0.025 in., response time is less than 600 ms. The special geometry and efficiency of the magnetic circuit and its low weight of only 2-1/2 oz allows both portable applications and desk use. The unit can produce up to eight legible copies.

Booth No. 1132-33 Check No. 283

Relay can handle lamp and capacitance loads

Guardian Electric Manufacturing Co., 1550 W. Carroll Ave., Chicago, Ill. 60607. (312) 243-1100.

Thinpak, the new series 1435 miniature electromechanical relay in a choice of SPDT or DPDT contact combinations, is specifically designed for demanding applications—either limited space (0.6 in. center-to-center PC card mounting) or difficult operating requirements that cannot be met by reed or conventional relays. Thinpak's high pressure contacts, that operate at 26 V and 1 A dc, can switch capacitance or lamp loads with current spikes that would normally weld the contacts of reed relays. In addition, a sensitivity of 125 mW for pull-in and an insulation resistance of more than 10^{10} Ω makes the relay suitable for galvanic separation between electronic circuits. Contact resistance is less than 50 m Ω and the unit can handle 2500 V rms contact to coil. Standard coil voltages available are 5 to 48 V dc and the expected mechanical life is 10^7 operations. The enclosure is blue plastic cover with a Mylar bottom plate.

Booth No. 1546 Check No. 284

Rocker switch mounts and relamps from front

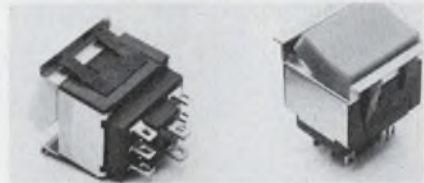

C & K Components, Inc., 103 Morse St., Watertown, Mass. 02172. (617) 926-0800. \$1.56 to \$1.95 (100-499).

C & K's illuminated miniature rocker switch fits a 3/4 in. square hole from the front of the panel. Reduction of behind-the-panel projection makes high-density equipment packaging easier. All midget screw-base bulbs in T-1 1/2 and T-1 3/4 sizes can be used in these SPDT or DPDT rocker switches. Bulbs are replaceable from the front, and no special tools are required. Snap-off actuator lenses in red, green, amber and white are currently available. A trim bezel in all popular colors of nylon will be available soon.

Booth No. 1217 Check No. 285

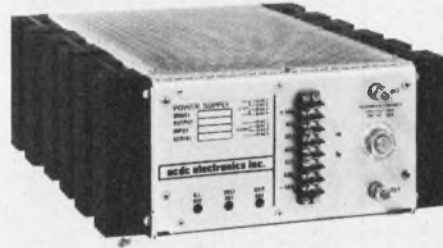

high current
OEM power
supplies

5 volts @ 100 amps: \$315

Volts	Amps	Size	Model No.	Price
5	65	5x11x15	HCM5N65	\$245
	100	5x15x18	HCM5N100	\$315

10 new high current power supplies: 5-, 12-, 15-, 24- and 28-volts. Current ratings from 5V @ 100 amps to 28V @ 16 amps. 0.1% regulation. Overvoltage protection available. UL recognized. GSA listed. Stock delivery on 5V models. 4-week delivery on 12-, 15-, 24- and 28-volt models. Write for new catalog with over 100 standard OEM power supplies.

acdc electronics inc.

Oceanside Industrial Center, Oceanside, Calif. 92054. (714) 757-1880

INFORMATION RETRIEVAL NUMBER 64

J-B-T SWITCHES*

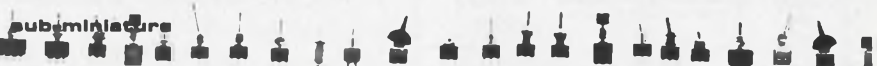

— All sizes to fit your needs — with hardware to match and dress up your panel; electrical characteristics to fit your circuitry, ST, DT, 1-, 2-, 3-, and 4-pole; and compatible terminals. When you need switches, give us a try — we'll be waiting at (203) 772-2220.

* We used the dollar sign \$ instead of the plain S because the typesetter didn't charge any more for it — and that gives us the chance to point out that we don't charge, either, for the many points of superiority of our switches, such as UL listings, longer useful life, and shipments from stock, to name a few.

J-B-T INSTRUMENTS, INC.

424 CHAPEL STREET • NEW HAVEN, CONNECTICUT 06508

BOOTH # 1617 WESCON

INFORMATION RETRIEVAL NUMBER 65



The U. S. Government does not pay for this advertisement. It is presented as a public service in cooperation with The Department of the Treasury and The Advertising Council.

"We are such stuff as dreams are made on..."

W. Shakespeare



Life would be pretty dull if people couldn't dream. Take that boat you're always dreaming about. Just thinking about it makes you feel pretty good. But you won't just have to dream if you buy U.S. Savings Bonds. Because Bonds can make your dream boat a reality.

Now Bonds mature in less than six years. Which means maybe it won't take forever for your ship to come in.

Just knowing you've got the safety and security of U.S. Savings Bonds working for you can make dreaming for anything a lot more fun. Because, with Bonds, the good times and the good things can really happen.

So, don't give up dreaming. Just keep buying U.S. Savings Bonds—they're the stuff dreams are made of.



Now E Bonds pay 5 1/8% interest when held to maturity of 5 years, 10 months (4% the first year). Bonds are replaced if lost, stolen, or destroyed. When needed they can be cashed at your bank. Interest is not subject to state or local income taxes, and federal tax may be deferred until redemption.



Take stock in America.
Now Bonds mature in less than six years.

COMPONENTS

Pushbutton switch meets MIL requirements



Jay-El Products, Inc., 1859 W. 169 St., Gardena, Calif. 90247. (213) 321-3260.

Splash proof, high-impact shock resistant and illuminated, the Mark II pushbutton switch is available in sizes of 1 x 0.75 in., 0.812 in. sq. and 0.75 in. sq., and all sizes feature an integral seal. The seal will meet splash and drip proof requirements of MIL-STD-108 and MIL-STD-202, and the complete switch meets impact shock requirements of MIL-S-901C. The seal does not require prelubrication, and it has no metal to rubber wear points. The Mark II is available in front-unpluggable, individual and matrix configurations.

Booth No. 1612 Check No. 286

Connector can change its gender

Switchcraft, 5555 N. Elston Ave., Chicago, Ill. 60630. (312) 792-2700. \$0.80 to \$2.50.

Slim-Line II audio connectors are a series of miniaturized connectors with interchangeable inserts that allow any plug or receptacle to be male or female. They are designed so that the housing provides both a shield for the internal connections and a ground, or common, without using a pin or contact. Plugs may be specified with inserts of two to five male pins or two to four female contacts with each having 2 NO shunts. Slim-Line II cord plugs accept cables up to 9/32 in. diameter. Receptacles are designed for flange mounting with a rear or front-panel locknut.

Booth No. 1816-17 Check No. 287

Rotary switch mounts on PC board

Grayhill, Inc., 651 Hillgrove Ave., La Grange, Ill. 60525. (312) 354-1040.

A new multideck rotary-switch design allows all 12-position terminals and the common of a single switch deck to be terminated in a single PC board. Previous designs permitted termination of only half of the positions in a single board. The remaining half required a parallel board or two switch decks. As many as 12 decks can be stacked on a single switch. The Series 71 contact system is used in this design, and it is rated to make or break 300 mA for 10,000 cycles of operation. It measures 0.875 in. at the widest point of the in-line terminals and stands approximately 1 in. above the PC board. Design variations include a choice of 30 degree (12 positions) angle or 36 degree (10 positions) angle-of-throw, 0.250 or 0.125 in. diameter shafts, and one or two poles per deck.

Booth No. 1439, 1440, 1441

Check No. 288

Magnet blows out arc, protects relay contact



Magnecraft Electric Co., 5575 N. Lynch Ave., Chicago, Ill. 60630. (312) 282-5500. \$9.02 to \$11.61; stock (1 to 9).

A new version of the Class 99 power relay with blowout magnets enables the relay to switch higher dc voltages without encountering a sustained arc. The photo shows how the arc is lengthened by being drawn toward the magnet. This action quickly extinguishes the arc and protects the contacts. Coil voltages from 24 to 230 V ac and 6 to 220 V dc are available. The SPST-NO double-make contact is rated at 20 A, 110 V dc.

Booth No. 1338 Check No. 289

Electrolytic capacitor operates to 100 C



Advanced Filmcap, Ltd., Rhosymedre Wrexham, Denbighshire, North Wales.

A new series of high-reliability electrolytic capacitors has an extended operating temperature range from -55 C, beyond the usual 85 C, to 100 C. The Prosec 100C series offers units with operating voltages from 10 to 63 V. The Prosec E 100C series has a range of capacitance values from 2200 to 220,000 μF with a ripple current capability that runs to 7.5 A at 100 C. The 100 C versions offer the same CV/volume as the older 85 C units. As an example of size, a new 220,000 μF capacitor with a 10 V working voltage measures 73 mm in diameter by 123 mm high including terminals.

Check No. 290

Low dark-current photo tube counts photons

DuMont Electron Tubes & Devices Corp., 750 Bloomfield Ave., Clifton, N.J. 07015. KM3054-1: \$390; KM-3054-20: \$375.

Two newly developed photomultipliers for photon counting, which feature high quantum efficiency and low anode dark current, are designated KM3054-1 (S1 spectral response) and KM3054-20 (S20 response). Both tubes are 1.25-in. in diameter and have a 0.5-in. diameter active cathode. The KM3054-1 has a luminous sensitivity of 30 $\mu\text{A}/\text{lm}$ and a dark current of 5×10^{-8} A. The KM3054-20 has a luminous sensitivity of 200 $\mu\text{A}/\text{lm}$ and a dark count rate of 25 counts/s at 20 C.

Booth No. 1609-10 Check No. 291

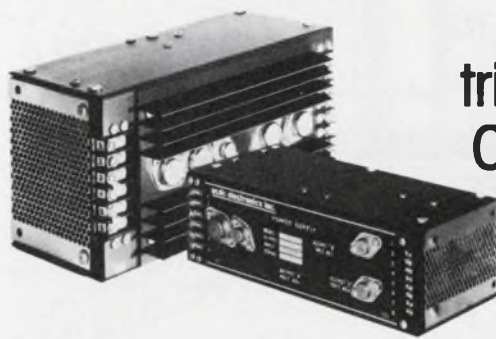

triple output
OEM power
supplies

5 volts and ± 15 volts: \$109

Single output	Dual output (Tracking)	Size	Wt. (Lbs.)	10-pc. Price
5V @ 5 Amps	$\pm 12\text{V}$ or $\pm 15\text{V}$ @ 1 Amp	3x5x10	7.5	\$109
5V @ 10 Amps	$\pm 12\text{V}$ or $\pm 15\text{V}$ @ 1 Amp	5x5x10	12.0	\$129

Single voltage output for driving IC logic; dual voltage output for driving op amps and A/D converters. Overvoltage protection built-in on 5V, optional on dual. 0.1% regulation. Small and compact to fit tight computer packages. Off the shelf delivery. GSA listed.

Write for new catalog with over 100 standard OEM power supplies.

acdc electronics inc.

Oceanside Industrial Center, Oceanside, Calif. 92054. (714) 757-1880

INFORMATION RETRIEVAL NUMBER 67

Fer- rights!

The right Ferramic™ for the right application... everytime!

With Permag supplying application-rated Indiana General Corp. Ferramics, you'll always get exactly what you need. Complete fabricating facilities. Prototype quantities available. Engineering assistance. Annealing and field testing. Prompt 24-hour delivery. Extensive stock of ferrite parts at all locations. Catalog available.

FERRAMICS™ FROM PERMAG

Consult your Yellow Pages
for address and telephone number of Permag near you.
Cable Address: MAGNETS NEWYORK



INFORMATION RETRIEVAL NUMBER 68

FREE!

LAFAYETTE 1974 CATALOG 740



474 Pages

The World's Largest
Consumer Electronics Catalog

Everything In Electronics for
Home, Business, Industry

Tools and Test Equipment • Cameras and
Photographic Equipment • Walkie-Talk-
ies • CB and Amateur gear • Stereo/Hi-Fi
Components • Musical Instruments •
Radio and TV • Books • Public Address
and Paging Systems • Plus Much More

Send Today!

For your FREE 1974
Lafayette Catalog 740

Your Complete
Electronics Buying Guide

Stores From Coast-to-Coast

Lafayette Radio Electronics
P.O. Box 10, Dept. 45093
Syosset, L.I., N.Y. 11791

Send FREE 1974 Catalog	45093
NAME _____	
ADDRESS _____	
CITY _____	
STATE _____	ZIP _____

INFORMATION RETRIEVAL NUMBER 69

DATA PROCESSING

Miniature reader accepts 3 badge types



Sealectro Corp., 225 Hoyt St.,
Mamaroneck, N.Y. 10543. (914)
698-5600. P&A: See below.

A miniature badge reader can accept and read three types of punched badges. The reader senses up to 264 bits of data in any matrix of 12 rows and up to 22 columns. Readers can also be made available for Hollerith coding. Units are available for manual or solenoid operation and require minimum front-panel space. Manual-operated readers are priced at below \$90 each in quantity.

Booth No. 1417 Check No. 292

Printing mechanism is said to last 10 years



Victor Comptometer Corp., 3900 N.
Rockwell St., Chicago, Ill. 60618.
(312) 539-8200. \$275.

The IPM 130 dot-matrix printer is said to combine durability, print quality and versatility. It prints at a rate of 110 char/s giving 34 characters to the line and six lines to the inch. A ten-year life is claimed under normal use without periodic maintenance. The printer easily handles alphanumeric characters in 5 x 7 and 9 x 7 fonts. It prints in two colors and can be adjusted for tape widths ranging from 2.28 to 3.75 in.

Booth No. 1211, 1212

Check No. 293

Data logger records or outputs data



Gould, Inc., Instrument Systems
Div., 3631 Perkins Ave., Cleveland,
Ohio 44114. (216) 361-3315. \$3950;
Sept.

The Brush 6000 data logger monitors and records multiple inputs of low-frequency data. The instrument scans up to 128 inputs (up to 48 digital and 80 analog), converts them to digital form and stores the results on 0.25-in. computer grade tape. The unit provides six pushbutton-selected scanning rates (1, 5, 10, 50, 100 and 200 channels/s) plus a choice of continuous, intermittent or externally-triggered recording. The analog channels can be operated on one of four programmable gain scales (± 10 mV, ± 100 mV, ± 1 V and ± 10 V). Direct output is available for interfacing to display units, peripherals or minicomputers.

Booth No. 1318, 1319

Check No. 294

Scan converter selectively erases



Tektronix, Information Display
Div., P.O. Box 500, Beaverton,
Ore. 97005. (503) 644-0161. \$2950.

The 4503 scan converter accepts alphanumeric and graphic data in analog form and converts it for display on TV receivers and monitors. Important features include gray-scale storage, variable persistence, selective erase and frame freeze. The unit provides 500-line resolution at 50% modulation with an optional capability of 1000 lines. Plug-in hardcopy is available with the use of the 4632 unit.

Booth No. 1719, 1720

Check No. 295

Scope allows tests to 1 GHz

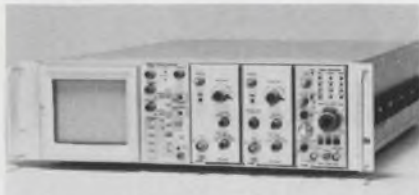

Tektronix, P.O. Box 500, Beaverton, Ore. 97005. (503) 644-0161. \$2900.

The R7903 oscilloscope—reportedly the widest bandwidth, real-time oscilloscope available in a 5-1/4-inch rackmount—provides general purpose measurements up to 500 MHz at 10 mV/div when using the 7A19 amplifier plug-in. This can be extended to 1 GHz at less than 4 V/div via direct access with the 7A21N plug-in. The CRT read-out and vertical amplifier are bypassed and inoperative when direct access is used.

Booth No. 1818-20, Check No. 296 1832-35

Source offers frequency agile phase locking

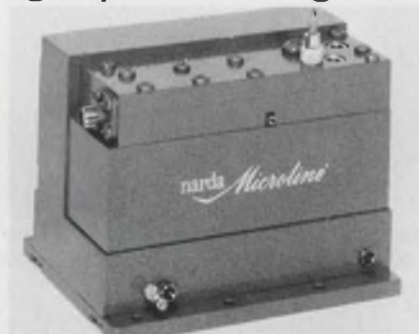

Narda Microwave, 75 Commercial St., Plainview, N.Y. 11803. (516) 433-9000.

A series of low-noise, frequency agile phase-locked signal sources cover the frequency band of 4.5 to 4.8 GHz and 4.5 to 5.3 GHz with approximately +10 dBm output. The input reference may be provided by a switched crystal bank or a frequency synthesizer. Each source tracks a sweeping input signal, or if switched to a new input signal, locks onto it within 0.1 second and provides the specified noise performance within 300 ms. The sources feature an acquisition range of 500 MHz.

Booth No. 1336-37 Check. No. 297



low current OEM power supplies

5 volts @ 3 amps: \$32

Volts	5V	6V	12V	15V	24V
Amps	3A	2.7A	1.7A	1.5A	1.0A
Model No.	OEM 5N3.0	OEM 6N2.7	OEM 12N1.7	OEM 15N1.5	OEM 24N1.0

The newest addition to our OEM series. 5 models from 5V @ 3A to 24V @ 1A, all priced at \$32 in 10-24 piece quantity. 0.1% regulation. Optional overvoltage protection. Excellent stability. UL recognized. GSA listed. Off-the-shelf delivery.

Write for new catalog with over 100 standard OEM power supplies.

acdc electronics inc.

Oceanside Industrial Center, Oceanside, Calif. 92054 (714) 757-1880

INFORMATION RETRIEVAL NUMBER 70

TRIMLINE ENCLOSURES BY PREMIER METAL PRODUCTS CO.

337 Manida St., Bronx, N.Y. 10474/(212) 991-6600

OVER 1300 ITEMS IN OUR CATALOG



Complete catalog and prices on request.



INFORMATION RETRIEVAL NUMBER 71

Microprocessor or Random Logic?

The 'computers on a chip' allow increased capabilities with software, but they're also slower and more complex.

First of three articles on microprocessors.

They're called MOS/LSI "computers on a chip." And they're giving designers a new systems building block to replace or upgrade random-logic systems. They're microprocessors, and they're growing in number commercially.

Among other advantages, microprocessors permit a tradeoff of software for hardware to achieve increased system capability and versatility. They can perform many functions and efficiently handle multiple inputs.

But there are disadvantages, too.

When compared with a random-logic design, microprocessors are much slower. Their initial use requires designers to grapple with relatively unfamiliar disciplines—primarily software. And the complexity and wide-ranging capabilities of microprocessors demand increased system design to ensure that the over-all design functions properly. The result: Choosing between a microprocessor or random-logic approach for complex logic systems requires a careful analysis of the tradeoffs.

Before the introduction of microprocessors, complex logic systems used discrete and random logic to perform the necessary functions. Integrated circuit families, such as TTL and ECL, developed small and medium-scale integrated functions that simplified random-logic designs. General and special-purpose computer manufacturers used such devices to build their systems. Now third-generation computers use large numbers of these devices, coupled with various types of separate memory systems, to complete their architecture.

Microprocessors find growing uses

However, this computer architecture is too cumbersome and costly for most large digital systems, compared to microprocessors. Such systems include CRT terminals, point-of-sale and other

Donald R. Lewis, Consultant, Lewis Associates, P.O. Box 33, Kew Gardens, N.Y. 11415.

W. Ralph Siena, Senior Principal Engineer, Litcom, 1770 Walt Whitman Rd., Melville, N.Y. 11746.

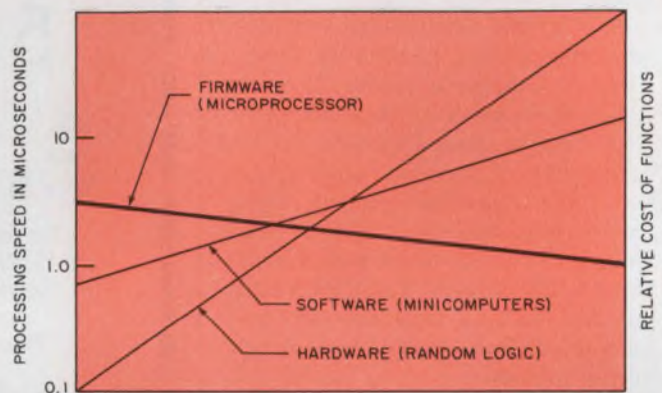

1. Microprocessors offer the lowest cost, but at the lowest speed, with system control provided by firmware. For the highest speed, but at the highest cost, random logic is the way to go. Minicomputers fall between the two approaches in this speed-cost tradeoff.

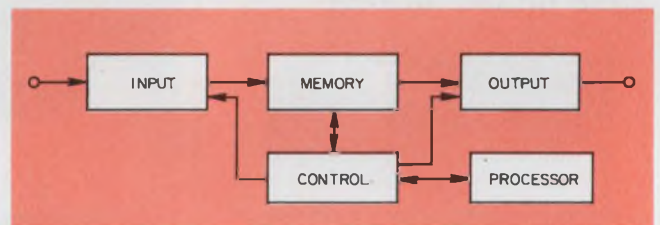

2. The basic architecture of a microprocessor. This functional diagram covers a wide range of industrial and process-control systems.

table-top equipment, as well as lightweight airborne equipment. A more complete listing of microprocessor applications is shown in Table 1.

A new direction was launched with the emergence of calculator chips. The present calculator can be defined as a small, highly specialized computer. The memory structure consists of both a fixed and a variable memory. The fixed portion, a read-only memory (ROM), provides a system control program called firmware—meaning non-changeable instructions. This contrasts on the one hand with general-purpose computers programmed by software, and on the other hand with random-logic systems that use hard-wired circuitry. The tradeoffs for the three are indicated in Fig. 1.

An extension of calculator design has been the

Table 1. Typical applications for microprocessors.

Desk-top computers	Processing oscillographic data
Automatic typesetting	Banking terminals
Inventory control	Automobile diagnostic testers
Point-of-sale terminals	Intelligent data terminals
Telecommunication switching and control	I/O channels for large computers
Chemical analyzers	Medical electronic systems
Manufacturing control systems	Low-cost radio navigation equipment
Smart instruments	Optical character recognition (OCR) devices
Machine control	Automated test fixtures
Multiprocessor minicomputers	Automatic time clocks and payroll systems
Adaptive traffic-control signals	

development of larger word-length systems that are closer to true computer architecture. This evolution has resulted in the microprocessor, for computation and control applications besides calculators.

Most microprocessors are 8-bit machines, while calculators use 4-bit word lengths but are flexible enough to handle longer words. In addition parallel and serial machines are available, so that a variety of memory configurations can be used.

Basic considerations in system designs

Regardless of which approach is taken—random logic or microprocessor—the design of a system calls for a preliminary evaluation of the requirements. Some of the general considerations are as follows:

- Functions to be performed.
- Amount of hardware required.
- Timing specifications.
- Memory requirements.

The number and type of functions to be performed determine the basic architecture of the system. Systems that operate continually on new data can be built easily and cheaply with random logic, especially where the decisions are few and simple. But in systems with related functions, which require arithmetic, logic control or de-

cision-making operations, microprocessors are the way to go. For systems requiring a knowledge of past operations to perform succeeding operations, microprocessors allow a greater reduction in hardware.

Generally any system that can be laid out functionally like a computer (Fig. 2) can use a microprocessor as the basic building block. The basic computer architecture allows continuous and repetitive use of a minimum of hardware to perform a maximum of functional operations. And the use of semiconductor memories boosts efficiencies, thanks to simplified memory addressing. Also, systems that can operate on a bus structure for data flow further permit microprocessors to minimize hardware.

Hardware requirements determine the physical size of the system. An estimate of the amount of hardware needed can be determined by answering questions like these:

- How many input and output channels are required for data acquisition and transmission?
- Do all input and output channels use the same data rates?
- Are all input and output channels handling equal amounts of traffic?
- Do input and output channels operate serially or in parallel?
- Are the input and output channels randomly

selectable or do they operate in some predetermined sequence?

Based on a detailed analysis of these questions, a preliminary layout of the system should be made, with both random logic and microprocessor circuitry. The differences in the hardware required will become apparent, and for some systems, the differences will be startling enough to point to substantial savings with a microprocessor approach.

System expansion needs should also be kept in mind during this phase of design. Often first estimates of hardware requirements are conservative, because design details are not available. With a random-logic approach, addition of hardware for increased capabilities may not be possible without a complete redesign. But with microprocessors, the expansion can often be readily accomplished by minor changes in the software.

Timing requirements can pose special problems when microprocessors are used. They are slower than most computers and nowhere near as fast as random-logic circuits. To determine these requirements, consider: How much time can be allotted to service input and output devices before data is lost?

For example, microprocessors cannot supply the continuous output data for a CRT display—especially one that is continuously changing. However they can supply updated information to an output device that services the CRT. But high-speed data channels have to be serviced so often that they can consume an excessive percentage of the over-all processing time.

The over-all timing includes the percentage of time required for each operation (allowing for maximum and minimum values). In some cases the system requires buffer storage of input or output data to meet timing specifications.

Other questions to be answered for a timing analysis include the following:

- How soon does data have to be available?
- How quickly do system functions have to be performed?
- What are the system priorities—which channels have to be processed immediately or more often than others?

Both random-logic and microprocessor systems require some memory storage. A checklist for this part of the design should contain the answers to the following questions:

- How much variable information is required?
- What type of programs are to be used?
- Can programs be selected from such storage as tape or disc or be handled as firmware?
- How many file registers are required?
- How many flag registers are required?

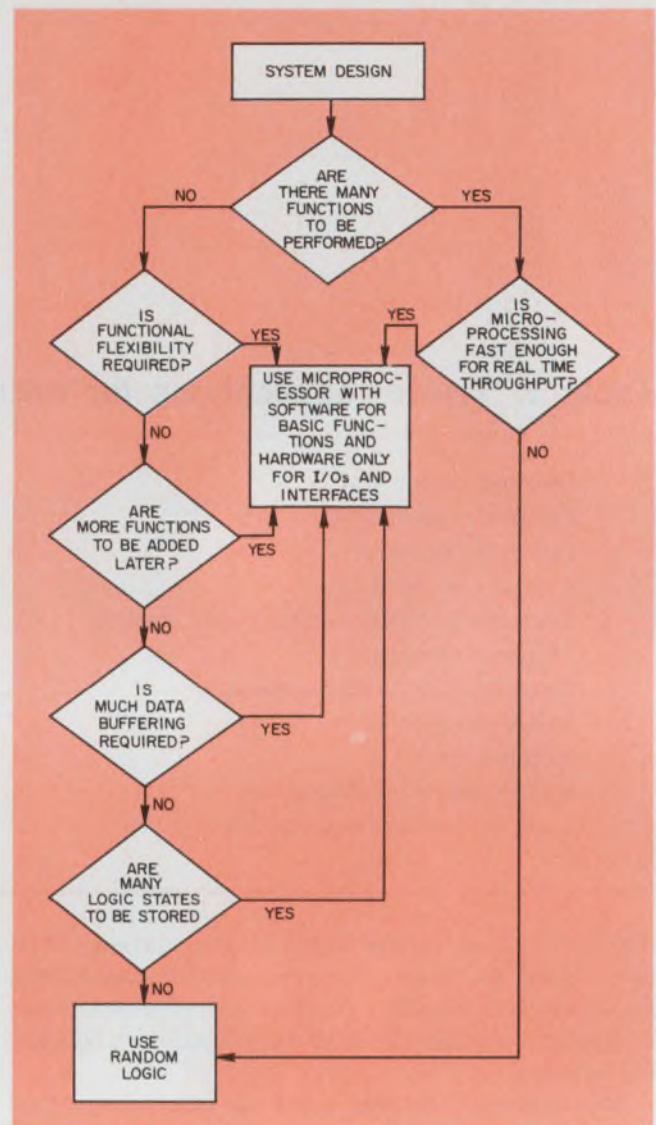

3. Choose between microprocessors or random logic. A flow diagram can be used to analyze the tradeoffs.

- Are other memory uses unique to the system required?

Large memory systems make the use of random logic very unwieldy. Standard microprocessor chips may not be the answer either. In those cases you may have to design a high-speed processor, using small and medium-scale-integration logic ICs, such as those found in TTL families.

Microprocessors vs random-logic

Once the system-design specifications have been determined, the selection of either random logic or microprocessors can be made. While there is a range of applications where either will do, at the extremes one approach is clearly superior to the other (Fig. 3). Random logic offers design advantages when one or more of the following are true:

- The functions to be performed are minimal.
- The input and output consist of single channels.

- The system operates on only one function at any time (though there may be multiple inputs), or the system has a single-word transmission structure.

- A small system has to be custom designed.
- High-speed operation is required.

Microprocessors offer advantages over random logic when one or more of the following are true:

- Software can be traded off for additional hardware, so that system capabilities can be expanded readily without system redesign.

- Multiple inputs are needed.
- A large number of functions must be performed.
- Multidecision paths are required.
- Large memories are involved.

The disadvantages of random logic are, not surprisingly, related to the advantages of microprocessors. A random-logic system requires substantial hardware increases for multiple inputs and outputs, or to line up data, or when multiple decisions are required for a given output. Moreover many operations require separate logic for each operation, and variable data must be stored before the required function can be performed—as in arithmetic operations.

Many of the disadvantages of microprocessors are confined to their initial use. Increased development costs and a new learning cycle for designers, for example, are nonrecurring. Generally the use of microprocessors—which really are multiple subsystems—requires system considerations at all design levels. And their use involves a wider variety of design disciplines. Of course, once a design is completed, these aspects with their problems are understood, and thus, no longer disadvantages.

Types of microprocessors available

Available microprocessors can be classified in two ways: by the size of the data-word length by which they perform their processing, and by the type of processing used—either serial or parallel. The most common word lengths are 4 and 8 bits. Some manufacturers state that the word length can be expanded, in multiples of 4 or 8 bits, by combining processor chips.

Four-bit chips are especially useful for systems that perform many arithmetic operations. Originally designed for simple calculators, these circuits later evolved to perform more complex mathematical functions—such as trigonometric or exponential functions. The 4-bit processors can also be used for larger word lengths. However,

Table 2. Data processing involves different codes.

Code	Character Length (bits)	Applications
BCD	4	Calculators
BAUDOT	5	International teletype transmission
BCDIC	6	Second generation computers
USASCII	7 (parity optional)	Data transmission standard
EBCDIC	8	Third generation computers

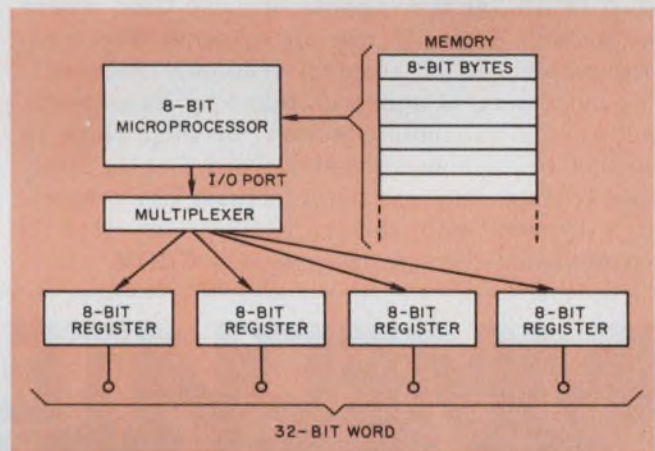

4. An 8-bit microprocessor produces a 32-bit word with external logic. Each 32-bit word uses 4-bytes of memory and four time cycles.

the words must be composed and formatted with external, and generally cumbersome, hardware.

Most microprocessors, including those expected shortly, are 8-bit circuits. These are designed for terminal or stand-alone operation, although they are not limited to this use.

Most data transmission, primarily asynchronous, requires data-word lengths of 8 bits or less (Table 2). The longer word lengths permit the use of standard codes, such as ASCII, EBCDIC and BAUDOT. And operation with standard codes simplifies the interface with other equipment, like teletypewriters or the more common types of computers and modems. Moreover standard or special codes with up to 8-bit word lengths allow the use of full alphanumeric keyboards. Display outputs are more easily handled, too, particularly where decoders of more than 4 bits are required.

Usually computers of more than 8 bits are

preferred because of their greater addressing range and flexibility. Microprocessors are not presently available in word lengths of more than 8 bits. However, manufacturers say that many features of the longer word-length machines can be achieved through the use of external registers and microprogrammable logic.

8-bit processor yields 32-bit word

A typical configuration for implementing a longer word length is shown in Fig. 4. A partitioned word is extracted from memory in 8-bit segments. These words are supplied via the microprocessors to the multiplexer, which routes them to the external registers where they are recomposed and stored. The register outputs now present a longer word length to circuitry external to the processor.

This technique is necessary to achieve greater word length, at the expense of cycle time, where the system does not use an external microprogrammable CROM (control read-only memory). The more general approach taken by some manufacturers is to combine several of their chips in parallel to achieve a greater word length. However, to date, only one manufacturer has presented a system with this capability, and that is accomplished through the use of a CROM.

The second characteristic of microprocessor categorizing is method of processing. Serial processing generally uses a shift-register memory and has the advantage of less hardware. Although the memory shift rate may be operating with a higher speed clock, the access time becomes longer.

Random-access ability is not usable in serial memories. The fetch and execute times are longer. Adding this to the longer access time seriously restricts their application. Where multiple inputs and outputs are used they become impractical. The ability to jump from one part of memory to another is also extremely limited.

Parallel processing overcomes the limitations of serial processing. Parallel processors use a bus for the transfer of data. The bus allows multiparallel paths for data transfer through the system. The fetch and execute cycles, operating on parallel-bussed data, can operate faster. And the use of random accessing of memory is more easily accomplished with a data bus. The waiting time is minimized and the ability to jump from one location to another much simpler to implement with little or no loss of time. ■■

The second article in this series will deal with the operation of a microprocessor.

IMMEDIATE DELIVERY ALLOCHIRAL (A-OK)

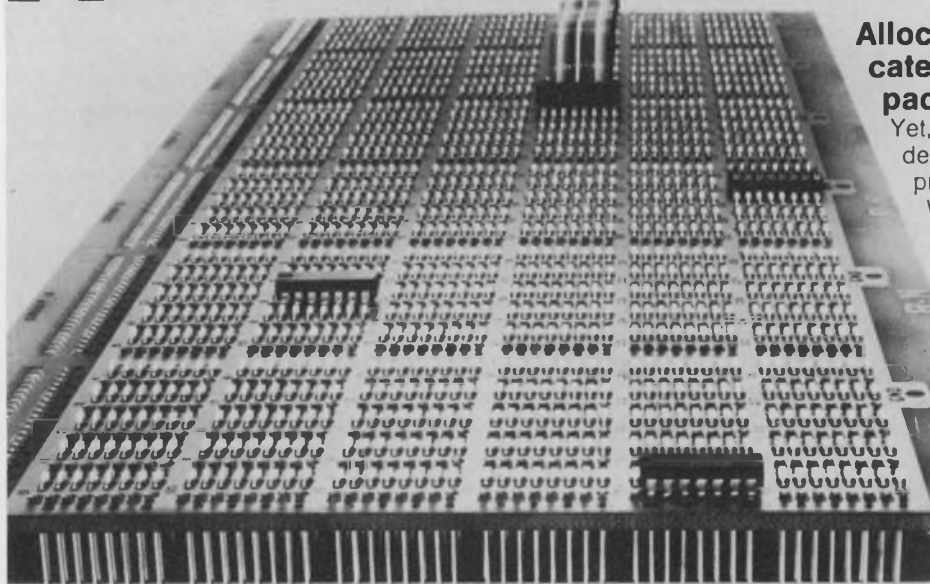

Allochiral is the most sophisticated high-density wirewrap packaging system available.

Yet, it's available for immediate delivery—from factory stocks. And, its price is the lowest.

We back A-OK with our reputation for quality, design and construction. Look at A-OK's super-low profile and longer usable wirewrap tail for space-saving. And, check its exclusive one-piece contact/terminal concept for greater reliability. You get more with Allochiral from Robinson-Nugent!

Want to learn more? Just ask about A-OK! Okay?

The Socket People



**ROBINSON
NUGENT** inc

800 East Eighth Street
New Albany, Indiana 47150
(812) 945-0211/TWX 810-540-4082

**attenuator-
rated™**



quiet!

**Ferramic® components
guarantee circuit
performance.**

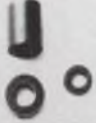

Attenuator-Rated components are new—and they're processed specifically for highest interference suppression.

End guesswork

This new breed of slip-on Ferramic components puts an end to cut-and-try selection. Now you can choose from a full line of our *Attenuator-Rated* components and get known attenuation properties.

Our complete specifications include the data you need to get dependable attenuation characteristics matched to your circuit requirements. And we back our specs with our own testing program.

Highest attenuation

An ordered series of nine components give you total flexibility in optimizing

attenuation to your specific circuit.

With each of these components you can select the attenuation properties you require. The highest suppression in the industry from 10 KHz to 10 Mhz or maximum attenuation from 10 to 250 Mhz.

New design guide

Selection of optimum noise attenuation couldn't be easier. Our complete design guide gives you the facts you need. You get typical attenuation and impedance curves, application data and specs that relate directly to your circuit requirements.

If your circuit impedance is known, you can determine attenuation characteristics directly from our graphs. And once your problem is

solved—it stays solved. Our testing program insures that each *Attenuator-Rated* component will meet its attenuation specs.

For complete design information and the answers to your attenuation requirements, use the reader service card for your copy of our design guide. Or call (201) 826-5100 and talk to the men who wrote it. Either way, if you're talking attenuation, talk to the ferrite experts.

That's us.

Indiana General
Electronic Products
Keasbey, N.J. 08832

*National distribution
through eight
Permag locations.*



indiana general 

a division of Electronic Memories & Magnetics Corp.

Build a wideband phase-locked loop

that uses standard CMOS and can be tailored to meet your application requirements exactly.

Conventional phase-locked loops (PLL) generally cannot meet the performance specifications required by wideband frequency multiplier/dividers or frequency synthesizers without band switching.

But the use of CMOS ICs in an improved PLL circuit allows you to easily meet these specifications and do so with greatly reduced circuit complexity. The circuit has these major advantages:

- It can operate over a five-decade frequency band.
- It can operate from a single power supply of 5 to 15 V dc (and will operate quite nicely with a TTL power supply).
- It can operate from 0.01 to 5 MHz.
- It has output "FMing" below 0.1%.
- It has been designed for an easy implementation (except for the op amp) on a single IC chip.

Understanding PLL operation

In a generalized PLL (Fig. 1) the phase detector generates an error signal proportional to the phase difference between the reference frequency, F_{ref} , and the divided-down voltage-controlled oscillator (VCO) frequency, F_{fb} . This error signal causes the integrator to integrate in a positive or negative direction, depending on the polarity of the phase error. The change in integrator output causes a corresponding change in VCO frequency in the direction that reduces phase error.

In a steady-state condition, the phase difference between F_{ref} and F_{fb} is constant; therefore $F_{ref} = F_{fb}$ and $F_1 = NF_{ref}$. If F_1 is then divided by M , $F_{out} = (N/M)F_{ref}$.

Since a phase detector and integrator are at the heart of every PLL, it is important to understand their functions. During steady-state operation the phase detector and integrator work together to present a nonvarying dc control voltage to the VCO. Under transient conditions, such as for a step change in F_{ref} , the circuit must slew the VCO and quickly re-establish phase lock. This

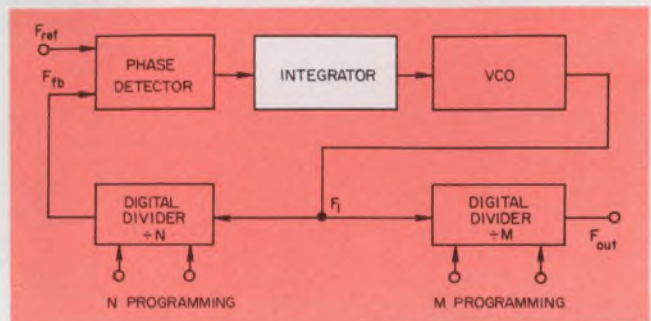

1. Functioning of a phase-locked loop can be best understood from its simplified block diagram.

is achieved by the action of flip-flops A and B (Fig. 2), which are set by a positive transition of F_{ref} or F_{fb} , respectively. When both flip-flops have been set, they are immediately reset by NAND gates U3-A and U3-B.

To enable the circuit to work from a single power supply, resistors R_1 and R_2 set the integrator summing point precisely to V_o , a point midway between the power-supply voltages. This eliminates the need for a power supply with, say, +7.5, ground, and -7.5 V dc outputs. Similarly R_2 and R_3 are matched to ensure negligible current flow into the summing point when both flip-flops are in the same state.

To understand how the phase detector and integrator work together, let's look at their Thevenin equivalent circuit (Fig. 3a). If both flip-flops are in the same state, the switch is in position 2 and the current into the summing point is zero. The integrator output therefore holds its value. If A is set and B reset, the switch is in position 1 and the integrator output slews in a negative direction. Conversely if A is reset and B is set, the integrator output slews in a positive direction.

In operation, any phase difference will cause one flip-flop to set before the other, thus generating a pulse-width modulated signal. The pulse height is $\pm [(V_{dd} - V_{ss})/2]$ with polarity depending on the direction of the phase difference, and the width is equal to the time interval between the positive transients. The gain of the phase detector is therefore $[(V_{dd} - V_{ss})/2]$ volts per 2π

Lester F. Schowe Jr., Circuit Design Engineer, General Electric, Binghamton, N.Y. 13902

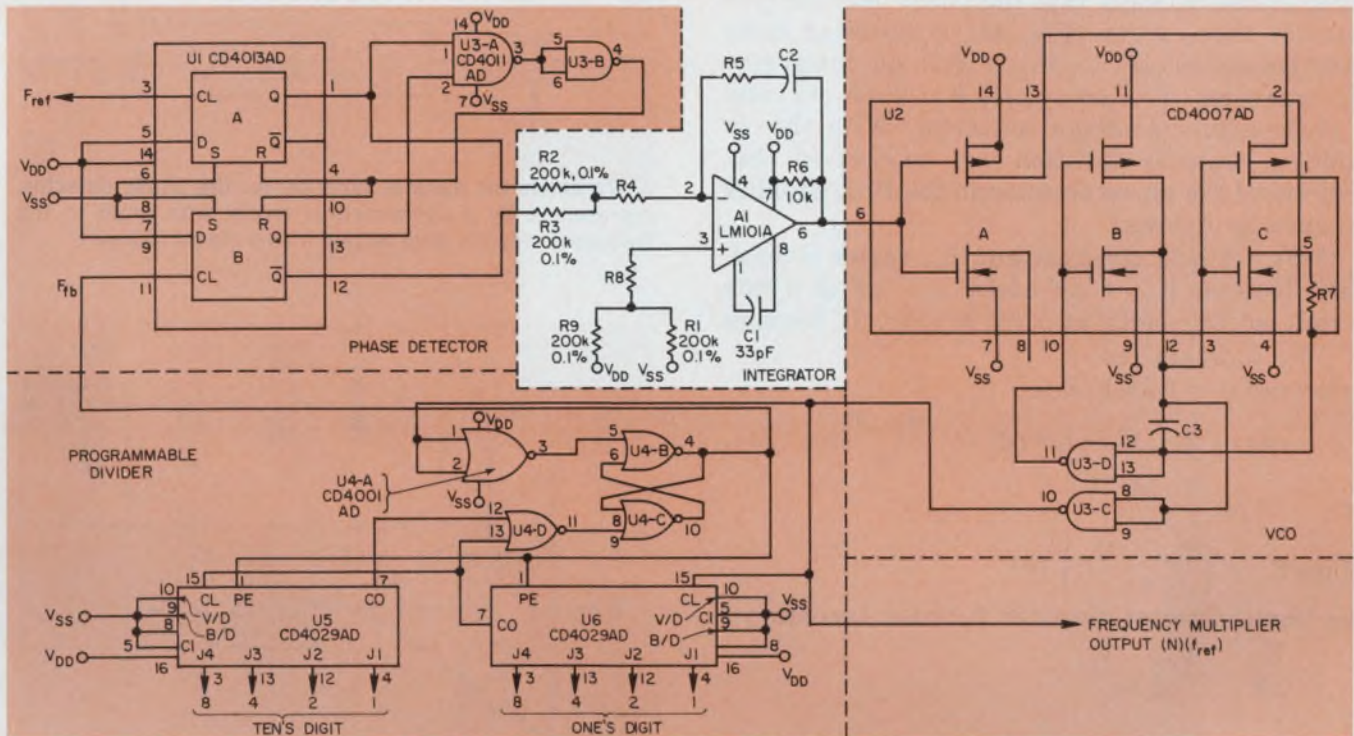

2. The complete schematic of a PLL relates various components to the blocks of Fig. 1. Note that with the

exception of the op amp, all other components can be implemented on a single integrated-circuit chip.

radians or $[(V_{dd} - V_{ss})/4\pi]$ volts/radian.

In the steady state some phase difference must remain to replace the charge lost in C_2 during the hold interval. This loss of charge is due to mismatch of the resistor pairs R_2, R_3, R_1 and R_9 ; to leakage current in C_2 and to amplifier offsets. With careful component selection the steady-state duty cycle of the error pulse can be kept below 0.1%, thereby minimizing ripple at the integrator output and unwanted FM at the VCO output.

The use of an integrator is one of the novel and desirable features of this circuit. Most PLLs merely use a low-pass filter (Fig. 3b) instead of the integrator. To attenuate ripple of conventional PLLs to an acceptable level, the time constant of the filter must be 10 to 100 times greater than the period of $F_{ref\ min}$. This has an undesirable effect on performance, because systems designed for low frequencies will tend to have extremely long response times.

Understanding basic PLL design equations

Transfer function for the phase detector and the integrator, and expressions for the slewing rate, are among the fundamental equations for a PLL. Before we derive them, let's see what is meant by the phase-detector transfer function.

The input to the phase detector (Fig. 1) is a frequency difference ($F_{ref} - F_{fb}$) and the output is a phase difference. These quantities are not directly proportional. To understand this, as-

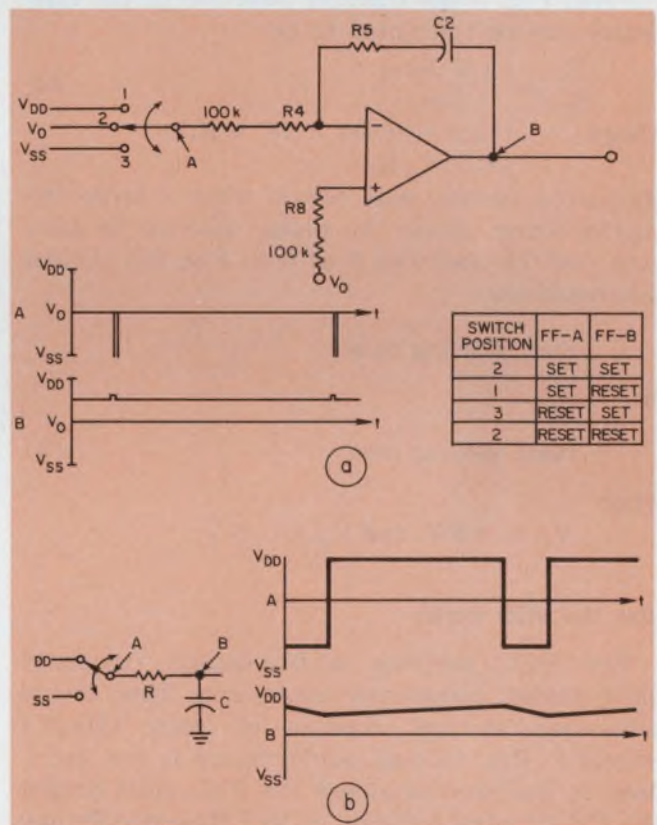

3. The operation of the phase detector and integrator is represented by an equivalent circuit (a). The table shows various states of the phase-detector flip-flops (also see Fig. 2). Note that the sample-and-hold nature of the integrator results in fast slewing and low ripple. By comparison, the low-pass filter circuit used in conventional PLLs sacrifices fast response time for low ripple, because of its inherent averaging nature (b).

sume mathematically that the phase detector consists of three parts (Fig. 4): a summing point that generates $\Delta F = F_{ref} - F_{fb}$; an integrator that converts ΔF to $\Delta\theta$ (where $\theta = 2\pi \int F dt$); and a phase-angle-to-voltage converter. With this in mind, a transfer function can be derived that will model the phase detector in the PLL stability analysis as follows:

If F_{ref} is held constant and F_{fb} varies sinusoidally between $F_{ref} + \Delta F$ and $F_{ref} - \Delta F$ at a rate ω rad/sec, the signal at point A (Fig. 5) becomes

$$F_t = \Delta F \sin(\omega t);$$

and since $\theta = \int 2\pi F_t dt$:

$$\theta = \int 2\pi \Delta F \sin(\omega t) dt = \frac{2\pi \Delta F}{\omega} \cos(\omega t),$$

$$\text{or } \theta = \frac{2\pi \Delta F}{J\omega}.$$

$$\text{Since } E_o = \left(\frac{V_{dd} - V_{ss}}{4\pi} \right) (\theta),$$

the phase detector transfer function becomes

$$\frac{E_o}{\Delta F} = \frac{V_{dd} - V_{ss}}{2J\omega},$$

or

$$\frac{E_o}{\Delta F} = \frac{6}{J\omega}, \text{ with } V_{dd} = +6 \text{ V and } V_{ss} = -6 \text{ V} \quad (1)$$

From Fig. 3 the transfer function of the integrator can be calculated to be

$$\frac{E_o}{E_{in}} = \frac{1 + J\omega\tau_2}{J\omega\tau_1}, \quad (2)$$

where $\tau_1 = C_2 (100 \times 10^3 + R_4)$,
 $\tau_2 = C_2 R_5$.

Maximum slewing rate occurs when a large frequency error causes the phase detector to saturate (switch positions 1 or 3 in Fig. 3a). Under this condition

$$\text{max. slewing rate} = \frac{V_{dd} - V_{ss}}{2\tau_1},$$

or

$$\text{max. slewing rate} = \frac{6}{\tau_1} \quad (3)$$

when

$$V_{dd} = +6 \text{ V, and } V_{ss} = -6 \text{ V.}$$

How the VCO works

The VCO achieves a five-decade frequency band under worst-case conditions. This occurs somewhat at the expense of gain (Hz/V) linearity. But over-all performance is not sacrificed in the process unless the PLL must output the VCO control voltage, as in FM demodulators. The VCO circuit, simplified in Fig. 5, is essentially an astable multivibrator, with a voltage-controlled constant-current source in place of the timing resistor.

During the ramp interval the p-channel transistor in U2-A is biased to operate in the saturated region, thus acting as a constant-current

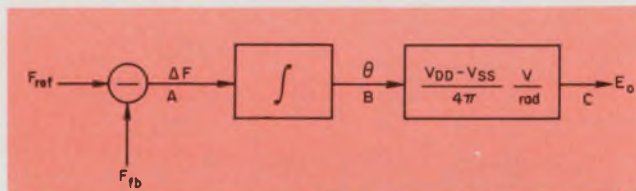

4. To derive the transfer function for the phase detector, represent it by a mathematical model with input in the frequency domain and output in the phase domain.

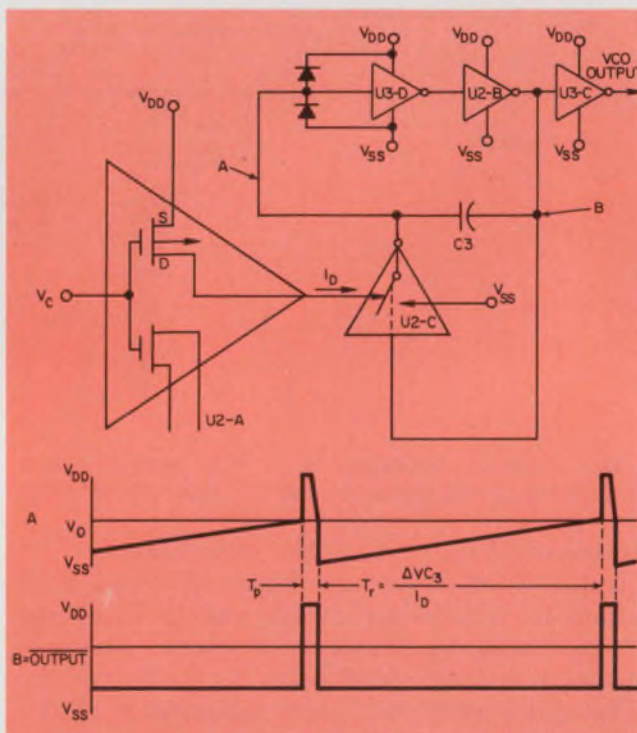

5. The VCO operation is explained by a simplified block diagram and waveforms during one complete cycle. Diodes in the diagram represent the internal CMOS protection circuit.

source. I_d is a minimum when $V_c = V_{dd} - |V_{th}|$, and it is a maximum when $V_c = V_o - |V_{th}|$. Voltage V_{th} is the transistor threshold voltage, while V_c is the VCO control voltage.

Referring to the waveforms in Fig. 5, we see that VCO operation is as follows:

Starting at the origin of waveform A, the output of U2-B is at V_{ss} . This connects one side of C_3 (point A) through U2-C to the constant-current source and presents a low-impedance current sink to the other side of C_3 . The signal at point A is therefore a ramp slewing in a positive direction at (I_d/C_3) V/sec.

As the input to U3-D passes through the logic threshold, located approximately at V_o , positive feedback causes U3-D and U2-B to switch instantly. Point A is driven positive until clipped at $V_{dd} + 1$ volts by the internal CMOS protection circuit. Since the output of U2-B is now at V_{dd} , one side of C_3 (point A) is connected to V_{ss} through U2-C, and the other side to a low-impedance

pedance current supply. Point A therefore slews negatively, at a rate determined by the maximum drain current of the n-channel transistor in U2-C. When the ramp passes through the threshold of U3-D, the circuit again switches, and point A is driven to $V_{ss} - 1$ volts. This completes the cycle.

The minimum output pulse width, T_p , depends on the time constant, $R_7 C_3$, and it must be at least $1.0 \mu s$ to ensure reliable operation of the programmable digital divider at 125 C. The product $R_7 C_3$ determines the discharge time required for point A (Fig. 5) to decay from $V_{dd} + 1$ to V_o , and, in turn, it determines the minimum value of T_p . The following equation may be used to calculate R_7 :

$$R_7 = [T_{p \min} / (0.69) (C_3)] - R_{on}, \quad (4)$$

where R_{on} is the on resistance of the transistor (typically 300Ω).

The value of C_3 is chosen to allow the VCO to attain the maximum frequency (F_{max}) required for an application under worst-case conditions. The VCO operating range is then from F_{max} to five decades below F_{max} . In terms of the total period,

$$F_{max} = 1 / (T_{p \max} + T_{r \max}), \quad (5)$$

where $T_{p \max}$ is the maximum value of T_p , and $T_{r \max}$ is the maximum value of T_r at $V_c = V_o - |V_{th}|$.

$T_{p \max}$ is a function of C_3 and of the minimum drain current of the n-channel transistor in U2-C (R_7 is assumed to be zero for this portion of the analysis). With $V_{dd} = 6$ V and $V_{ss} = -6$ V, the transistor operates with $V_{gs} = 12$ V and with V_{ds} slewing from 13 to 6 V. From the CD4007AD specifications:

$$I_{d \text{ sat min}} = 5 \times 10^{-3} \text{ A at 25 C.}$$

$I_{d \text{ sat min}} = 3.5 \times 10^{-3}$ A at 125 C. The discharge ramp is characterized by

$$IT = C_3 (V_{dd} + 1 - V_o)$$

and, at $I = I_{d \text{ sat min}}$,

$$T_{p \max} = 2 \times 10^3 C_3. \quad (6)$$

$T_{r \max}$ is a function of C_3 and the minimum I_d of the p-channel current source at $V_c = V_o - |V_{th}|$. For $V_{dd} = +6$ V and $V_{ss} = -6$ V, the transistor operates with $V_{gs} = -7.7$ V and with V_{ds} slewing from -13 V to -6 V. From the CD-4007AD specifications:

$$I_{d \text{ min}} = 2.5 \times 10^{-3} \text{ A at 25 C,}$$

$$I_{d \text{ min}} = 1.75 \times 10^{-3} \text{ at 125 C,}$$

and

$$T_{r \max} = \frac{(C_3) (V_{ss} - 1 - V_o)}{I_{d \text{ min}}}. \quad (7)$$

Combining Eqs. 5, 6 and 7:

$$F_{max} = \frac{1}{6 \times 10^3 C_3} \text{ Hz at 125 C}$$

$$C_3 = \frac{167 \times 10^{-6}}{F_{max}} \text{ farad.} \quad (8)$$

We can now proceed with the derivation of the

VCO transfer function, since the variation of VCO gain vs frequency will be required for a stability analysis. To this end, we set T_p to zero, since it has negligible effect on gain at low frequencies and tends to improve gain linearity at high frequencies. Eq. 5 can be rewritten as

$$f = \frac{1}{T_r} = \frac{I_d}{C_3 (V_{ss} - 1 - V_o)}. \quad (9)$$

The current-voltage relationship of a saturated p-channel CMOS transistor is

$$I_d = k [V_{gs} - |V_{th}|]^2 = K [V_{gs}^2 - 2V_{gs} |V_{th}| + |V_{th}|^2] \quad (10)$$

By substituting Eq. 10 into 9 and differentiating, we get

$$\frac{\delta F}{\delta V_{gs}} = \frac{2K [V_{gs} - |V_{th}|]}{C_3 (V_{ss} - 1 - V_o)}. \quad (11)$$

From Eq. 10,

$$V_{gs} - V_{th} = \sqrt{\frac{I_d}{K}}. \quad (12)$$

Substituting Eq. 12 into 11, we get

$$\frac{\delta F}{\delta V_{gs}} = \frac{2\sqrt{KI_d}}{C_3 (V_{ss} - 1 - V_o)}. \quad (13)$$

Since F_{max} occurs at $I_{d \max}$, Eq. 9 can be rewritten as

$$C_3 = \frac{I_{d \max}}{F_{max} (V_{ss} - 1 - V_o)}.$$

Substituting back into Eq. 9, we get

$$I_d = I_{d \max} [F/F_{max}]. \quad (14)$$

And substituting Eq. 14 into 13, we obtain

$$\frac{\delta F}{\delta V_{gs}} = \frac{2\sqrt{KI_{d \max}}}{C_3 (V_{ss} - 1 - V_o)} \sqrt{F/F_{max}}. \quad (15)$$

From CD4007AD specifications, $K = 0.2 \times 10^{-3} \text{ A/V}^2$.

With $I_{d \max} = 1.75 \times 10^{-6}$ and $V_{ss} = -6$ V, Eq. 15 reduces to

$$\frac{\delta F}{\delta V_{gs}} = \frac{170 \times 10^{-6}}{C_3} \sqrt{F/F_{max}}. \quad (16)$$

By multiplying Eq. 16 by 3, we get

$$\text{PLL slewing rate} = \frac{1020 \times 10^{-6}}{\tau_1 C_3} \sqrt{F/F_{max}}. \quad (17)$$

Programmable digital divider uses CMOS logic

The divider in Fig. 2 consists of two CMOS pre-settable up/down counters and associated preset logic. The counters are connected to function as a two-digit countdown decade counter. The J inputs of U5 and U6 are programmed in binary-coded decimal (BCD), with the 10s and ones digits of N, respectively, causing the counter to be preset to N whenever the preset enable input is high. NOR logic is used to generate the preset enable pulse whenever the counter reaches zero.

To understand the operation, assume that the counter is preset to N initially. With a clock applied (VCO output), the counter will count down to zero in N clock periods. When zero is reached,

the NOR logic will preset the counter back to N and the sequence will start again. In this way one preset enable pulse is outputted for every N clock pulses, thereby generating the 1/N transfer function.

This type of CMOS counter requires a 1- μ s minimum positive and negative pulse width at 125 C and $V_{dd} - V_{ss} = 12$ V, thus limiting the upper frequency to 500 kHz. If a higher PLL output frequency (up to the VCO limit of 5 MHz) is required, a TTL programmable divider or discrete CMOS flip-flops can be used.

Analyzing the PLL stability

Once the values of C_3 , N, and the output frequency range are selected, the PLL can be made stable by choosing τ_1 and τ_2 so that open-loop gain curve (Bode plot) will cross the 0-dB axis with ample phase margin over the required range of output frequency and N.

This procedure can be best demonstrated by an actual design example. Suppose we have to design a PLL to meet these specifications:

F_{max} output	100 kHz
F_{min} output	20 Hz
N_{min}	1
N_{max}	100
F_{min} input	20 Hz
F_{max} input	100 kHz

We calculate C_3 from Eq. 8 to be

$$C_3 = (167 \times 10^{-6}) / (0.1 \times 10^6) = 0.00167$$

μ F, or, using the closest lower value,

$$C_3 = 0.0015 \mu\text{F}.$$

The digital divider attenuates the VCO output frequency by N. With the VCO and divider lumped together, maximum gain occurs at $N = 1$ and $F_{out} = 100$ kHz. Minimum gain occurs at $N = 100$, and $F_{out} = 2000$. Using Eq. 16, we get (omitting arithmetic):

$$\text{Gain}_{max} = 113,000 = 101 \text{ dB},$$

$$\text{Gain}_{min} = 160 = 44 \text{ dB},$$

after dividing the VCO transfer function by N to allow for the divider.

The gain (Hz/V) of the VCO and divider is therefore 72.5 dB \mp 28.5 dB.

Fig. 6a is the block diagram of an open-loop PLL and Fig. 6b is the Bode plot, with the vertical axis representing the open-loop gain. The horizontal axis represents the rate of change of F_{in} in radians per second. Curve A is the nominal combined transfer function of the phase detector, VCO and divider. This curve can move up or down by 28.5 dB, depending on various combinations of N and VCO frequency.

In selecting the system time constants, τ_1 and τ_2 , bear in mind the following constraints:

1. System response time is inversely proportional to τ_1 (Eq. 17), so that τ_1 must be as small as possible for fastest response time.

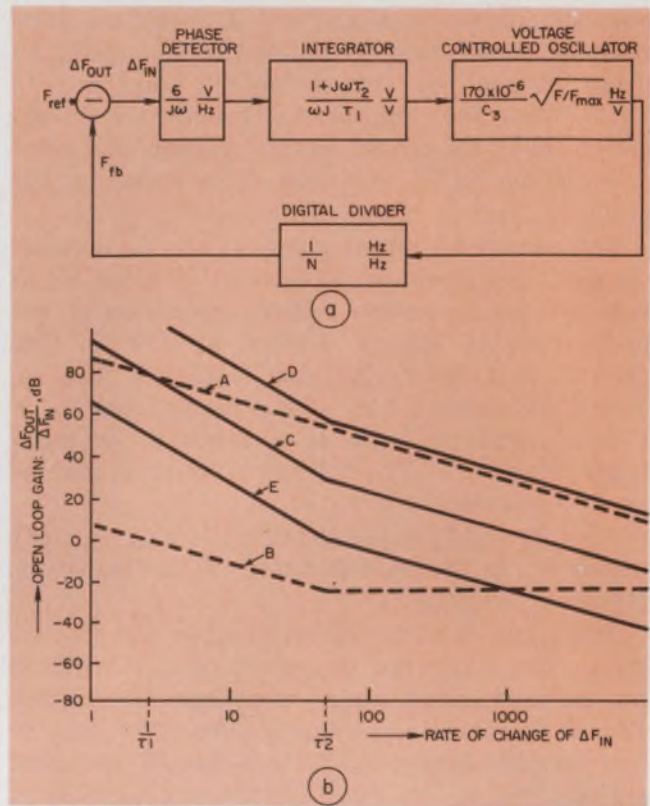

6. In PLL stability analysis, the PLL can be represented by its open-loop block diagram (a). The corresponding Bode-plot is shown in (b). The open-loop gain, F_{out}/F_{in} , varies as a function of the rate of change of F_{in} in radians per second.

2. Excessive FMing due to the integrator gain occurs if F_{ref} is less than $1/\tau_2$.

3. The high frequency (above $1/\tau_2$) integrator gain should be as low as possible (below -20 dB) to attenuate the phase error pulse.

As a result of these considerations, τ_2 is chosen so that $1/\tau_2$ is less than the minimum value of F_{ref} , and high-frequency integrator gain is chosen so that it attenuates the minimum value of curve A (nominally -28.5 dB) at $\omega = 1/\tau_2$ to 0 dB (this is to maintain 45° margin). The τ_1 is then the point where the integrator transfer function (curve B in Fig. 6b) crosses 0 dB.

In this example, let $\tau_2 = (1/50)$ rad/sec. The high-frequency integrator gain becomes -26 dB, and τ_1 is determined to be (1/2.6) rad/sec.

Then if C_2 is 2 μ F, other component values are calculated to be

$$R_1 = (\tau_1/C_2) = 100 \times 10^3 = 92 \text{ k}\Omega$$

$$R_3 = \tau_2/C_2 = 10 \text{ k}\Omega$$

$$R_4 = 92 \text{ k}\Omega$$

$$R_7 = [1 \times 10^{-6} / (0.69) (0.0015 \times 10^{-6})] - 300 = 665 \Omega.$$

The PLL slewing rate from Eq. 17 is

$$\text{PLL slewing rate} =$$

$$1.74 \times 10^6 \sqrt{F/0.1 \times 10^6} \text{ Hz/s.}$$

Curves E, C, and D in Fig. 8 are the minimum, nominal and maximum open-loop gain curves, respectively ■■

SURPRISE!



Free! 100 page optoelectronic designer's catalog.

HP's new 100 page Optoelectronic Designer's Catalog is here! It's absolutely free and comes loaded with detailed specifications and complete application notes on our broad line of optoelectronic products, including our LED displays, LED lamps, high-speed optically-coupled isolator and PIN photodetectors.

Mail the coupon today so we can get your copy on its way to you now.



Sales, service and support in 172 centers in 65 countries.
Palo Alto, California 94304. Offices in principal cities throughout the U.S.

Hewlett-Packard
640 Page Mill Road, Palo Alto, California 94304

Surprise me with your free 100 page HP Optoelectronic Designer's Catalog.

NAME _____

TITLE/POSITION _____

COMPANY _____

ADDRESS _____

CITY _____ STATE _____ ZIP _____

01331

BCD logic – Part 6

BCD logarithms and exponentials:

You can interpolate between stored values, but a few selected constants used iteratively can supply greater accuracy.

This is the sixth in a series on binary-coded-decimal logic. The first five articles discussed the four basic arithmetic operations, how to handle the decimal and how to extract the square root.

Logarithms have long been an essential tool to simplify manual multiplication, division and root extraction. But since computers can perform arithmetic without the logarithm, relatively little effort has been expended to implement the logarithm function and its corollary, the exponential function, with digital techniques. When the "electronic slide rule," or calculator, entered the picture, however, it became important to develop simple circuits for generating logarithms and exponentials of binary-coded-decimal numbers for both bases e and 10.

Logarithmic and exponential functions are, of course, related to each other. Thus

$$Y = \log_a X, \text{ and } X = a^Y, \quad (1)$$

where a is the base of the logarithm. And since the conversion from one base to another involves only a constant, there is little effect on the algorithm and circuit when the base is changed.

Thus

$$\log_e X = 2.30259 \log_{10} X$$

$$\log_{10} X = 0.43429 \log_e X$$

and

$$10^X = e^{2.30259X}$$

$$e^X = 10^{0.43429X}$$

Logarithmic and exponential functions are plotted in Fig. 1.

Look up and interpolate

The simplest and most general approach for generating almost any function, $Z = f(X)$, is to store values of the function, Z , for specific values of the input variable, X , and then interpolate between these values (Fig. 2). Linear interpolation between two successive points of a function, Z_i and Z_{i+1} , requires a solution of the classic interpolation equation

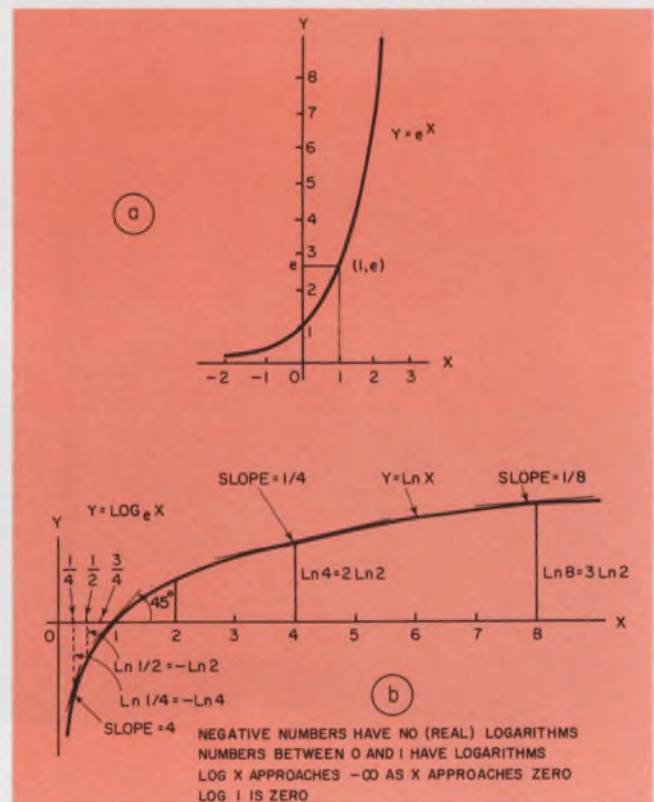

1. There is a close relationship between the exponential function (a) and the logarithm (b), both mathematically and when a BCD calculator is implemented.

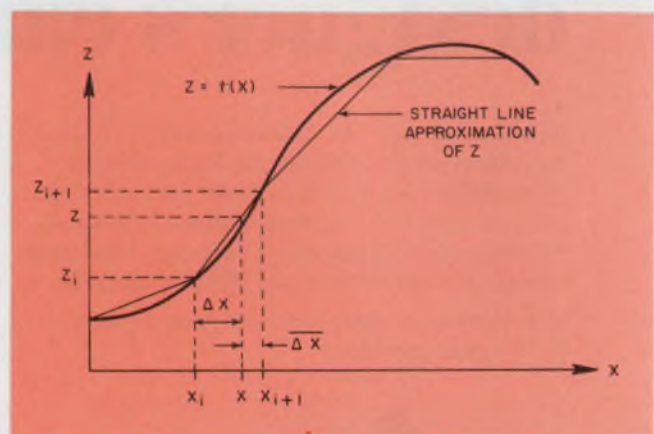

2. Interpolation is a useful technique for providing a limited number of additional decimal places of accuracy between stored values of a function.

Hermann Schmid, General Electric Co., Box 5000, Binghamton, N.Y. 13902.

$$Z = Z_i + \Delta X \frac{Z_{i+1} - Z_i}{X_{i+1} - X_i}, \quad (2)$$

where $\Delta X = X - X_i$.

Rearrange the terms and you obtain

$$\begin{aligned} Z &= Z_i \frac{X_{i+1} - X}{X_{i+1} - X_i} + Z_{i+1} \frac{X - X_i}{X_{i+1} - X_i} \\ &= Z_i \frac{\Delta \bar{X}}{C} + Z_{i+1} \frac{\Delta X}{C}, \end{aligned} \quad (3)$$

where $\Delta \bar{X} = X_{i+1} - X$ and C is a constant that represents a unit interval of the variable, X , for

C_x is then added to X_i . Hence when $C_x = 1$, the ROM row address advances from X_i to X_{i+1} .

As an example of this process let

$$X = 4867.$$

Since $X = X_i + \Delta X$,

then $X_i = 48$ and $\Delta X = 67$.

Therefore, since $C = 100 = \Delta X + \Delta \bar{X}$, then $\Delta \bar{X} = 33$.

Apply Eq. 3, and you get

$$Z = Z_i \frac{33}{100} + Z_{i+1} \frac{67}{100}.$$

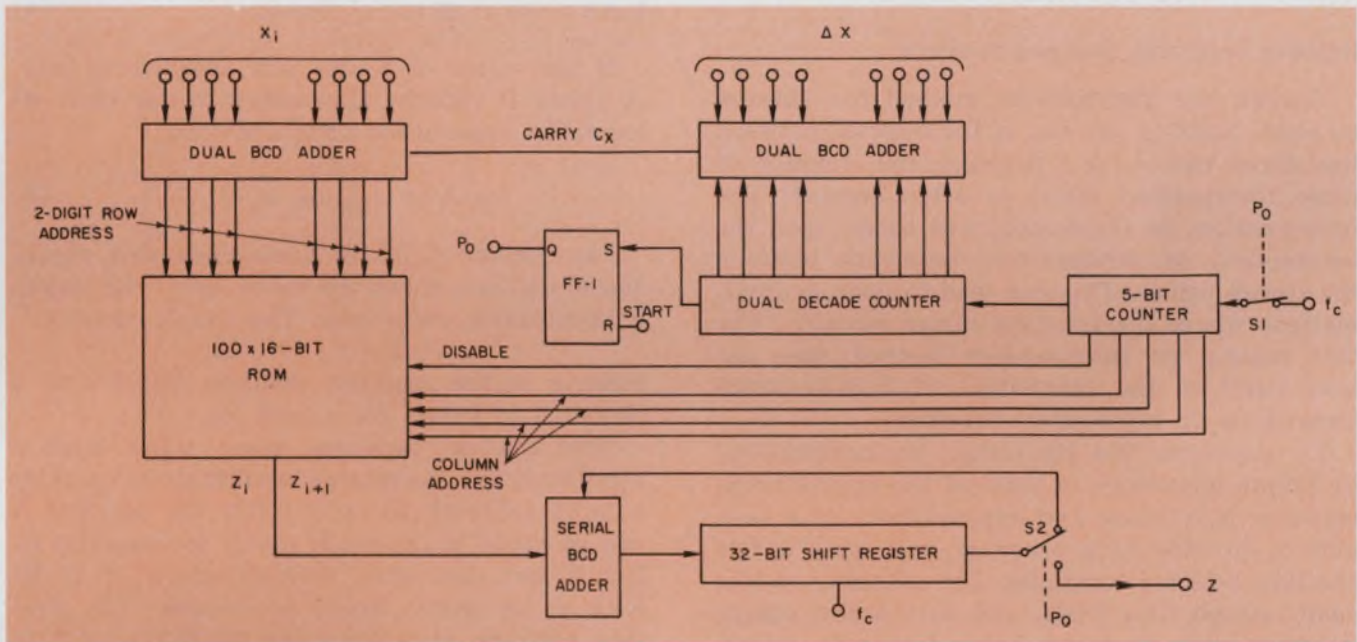

3. Interpolation can be used to generate almost any well-behaved function, such as the logarithm and the expo-

ponential. However, to obtain high accuracy requires the use of ROMs with large storage capacity.

the specific stored values, Z_i . Obviously, then, $C = \Delta X + \Delta \bar{X}$.

An interpolative log circuit

To generate the logarithm of, say, a four-digit number X with the help of Eq. 3 requires a 1600-bit ROM to store the values of the logarithmic function (Fig. 3). The ROM is organized into bit cells of 100 rows and 16 columns. The 16 columns are read out sequentially by the column address derived from the five-bit counter to produce a serial 16-bit word. Each word has the weighting of $1/100$ th of the final value of Z_i or Z_{i+1} in Eq. 3. The constant C in Eq. 3 has thus conveniently been made to equal 100.

The two most-significant digits of the four-digit number X , which we shall call X_i , address the rows of the ROM. The two least-significant digits, designated ΔX , are, however, added to the output of a two-decade counter. When the sum of the output of a two-decade counter and ΔX exceeds the value of 100, a carry C_x is generated.

The ROM starts with the row address $X_i = 48$ and selects a corresponding 16-bit Z_i , which is serially and successively added into the 32-bit register, once for every count of the dual-decade counter. Since $X = 67$, when the dual-decade counter reaches a count of 33, a carry C_x is generated. Then the row address becomes X_{i+1} , which selects the next-higher row in the ROM, and its output now becomes Z_{i+1} . When the dual-decade counter counts another 67 steps, and thus adds $67Z_{i+1}$ quantities to the 32-bit register, the dual-decade counter reaches its maximum and sets FF, to stop the process and deliver the answer.

Note that this circuit requires a parallel input,

$$X = X_i + \Delta X_i,$$

which must be held constant for the complete root extraction cycle. And the dual-decade counter, which counts between zero and 99, advances at a frequency of $f_c/32$. Also, while the four least-significant-bit outputs from the five-bit counter provide the row address, the most-significant output is used to disable the ROM output every second 16 clock periods. This permits the

32-bit register, which accumulates the answer, to circulate its contents to align for the next addition of a partial input, Z_i or Z_{i+1} , from the ROM.

When the dual-decade counter counts to 99, the next count sets FF_1 to generate signal P_0 which opens S_1 to stop the log algorithm and deliver the answer Z . To start a new algorithm, the operator must provide a new input, X , and reset FF_1 with a start pulse.

The time required to generate one value of Z is 3200 clock periods or 3.2 ms if f_c is 1 MHz.

Iterative constants improve accuracy

Though the interpolation method can squeeze an extra digit or two out of the interval between the stored values for a function, the accuracy of these interpolated digits is often suspect. The interpolation, as illustrated, was based upon the assumption of straight-line segments between the stored values. This can lead to poor approximations where the function curves strongly. For this reason, an interpolation method does not lend itself to the calculation of high-accuracy logarithms or exponential functions.

To overcome this limitation, mathematicians, by taking advantage of some of the unique properties of logarithms and exponentials, have been able to provide high accuracy with only a few specially selected constants. The constants can be easily stored in a ROM, and with a few simple iterative steps, they can be used to generate accurate logarithms and exponentials.

Let's review some of the properties of the logarithm. If the operand X is defined as

$$X = 10^K \cdot A,$$

where $0.1 < A < 1$, then

$$\log X = K \log 10 + \log A.$$

The first term in this equation is usually referred to as the characteristic and the second as the mantissa. The value of the characteristic is simply $2.3026K$ if the base of the logarithm is e . The objective is to find the value of the mantissa. The characteristic is taken care of separately by the decimal-point locating circuit of the calculator.

To compute the mantissa, $\log A$, first consider the additive properties of the logarithm. If a number

$$P = a_0 \cdot a_1 \cdot a_2 \cdot \dots \cdot a_n = \prod_{i=0}^n a_i,$$

where a_i are a set of specially selected constants, then,

$$\begin{aligned} \log_e P &= \log_e a_0 + \log_e a_1 + \log_e a_2 + \dots + \log_e a_n \\ &= \sum_{i=0}^n \log_e a_i. \end{aligned}$$

Hence the following relationship can be set down:

Table 1. Short list of values for iterative constants

i	a_i	$\log_e a_i$
0	2.00000	0.695147
1	0.90000	-0.105360
2	1.01000	0.009950
3	0.99900	-0.001000
4	1.00010	0.000099
5	0.99999	-0.000010

$$\log_e A = \log_e A \prod_{i=0}^n a_i - \sum_{i=0}^n \log_e a_i. \quad (4)$$

If the values of a_i are now selected so that A times P rapidly approaches unity, then its logarithm approaches zero, and thus

$$\log_e A = - \sum_{i=0}^n \log_e a_i. \quad (5)$$

The constants, a_i , to accomplish this result, should oscillate about the value $|one|$ with rapidly diminishing excursions. The simple equation

$$a_i = 1 + (-1)^i \cdot 10^{-i}$$

behaves in the required manner. Table 1 is a short list of values for a_i and $\log_e a_i$.

Note that a_i oscillates about unity with a logarithmically decreasing amplitude to provide a rapid approach to unity. Now the operand A can be made to approach unity, as required by Eq. 4, but successive multiplications of A by each a_i as many times as needed. The first step, however, must bring the magnitude of A to between 0.1 and 1. This is done in the circuit, as will be seen, by a delay equal to the number of digits that A must be shifted. This is equivalent to successive division by 10. For each such shift, or division by 10, the quantity 2.30259 is added as part of the summation in Eq. 5. Thus, to find $\log_e 2.1$, as in Table 2, only one divide-by-10 is required, and 2.30259 is added only once into the summation.

Thereafter the resulting quantity is multiplied by values of a_i , starting with $a_0 = 2$ (Table 1), with each a_i repeatedly used until the product passes through unity and the desired degree of accuracy is attained. Even values of i produce a_i numbers that are larger than one, and these numbers make the term $-\log a_i$ negative, and they subtract from the summation. Odd values of i produce fractional value of a_i , and thus the $-\log a_i$ term becomes positive and adds to the summation.

Only 17 steps as shown in Table 2, provide six-digit accuracy for $\log_e 2.1$.

Approach zero for exponentials

By a process of reasoning similar to that for logarithms, an exponential can be expressed as

Table 2. Using iterative constants to find $\text{Log } 2.1 = 0.74193$

i	a_i	$A \prod a_i$	$\Sigma -\log a_i$
Initial conditions		$\rightarrow 2.100000$	0.00000
-	0.1	0.210000	2.30259
0	2.0	0.420000	1.60944
0	2.0	0.840000	.91629
0	2.0	1.680000	.22314
1	0.9	1.512000	.32850
1	0.9	1.360800	.43386
1	0.9	1.224720	.53922
1	0.9	1.102248	.64458
1	0.9	0.992024	.74994
2	1.01	1.001944	.73999
3	0.999	1.000943	.74099
3	0.999	0.999943	.74199
4	1.0001	1.000042	.74189
5	0.99999	1.000032	.74190
5	0.99999	1.000022	.74191
5	0.99999	1.000012	.74192
5	0.99999	1.000002	.74193

Table 3. Using iterative constants to find $e^{4.23845} = 0.692987 \times 10^2$

i	b_i	$\prod b_i$	$X - \Sigma \ln b_i$	p	
Initial conditions			$\rightarrow 1.000000$	4.23845	0
-	0.1	1.000000	1.93586	1	
-	0.1	1.000000	-0.36673	2	
0	0.9	0.900000	-0.26137	2	
0	0.9	0.810000	-0.15601	2	
0	0.9	0.729000	-0.05065	2	
0	0.9	0.656100	0.05471	2	
+1	1.01	0.662661	0.04478	2	
+1	1.01	0.669287	0.03481	2	
+1	1.01	0.675970	0.02486	2	
+1	1.01	0.682738	0.01491	2	
+1	1.01	0.689565	0.00496	2	
+1	1.01	0.696460	-0.00499	2	
+2	0.999	0.695764	-0.00399	2	
+2	0.999	0.695069	-0.00299	2	
+2	0.999	0.694374	-0.00199	2	
+2	0.999	0.693680	-0.00099	2	
+2	0.999	0.692987	0.00001	2	

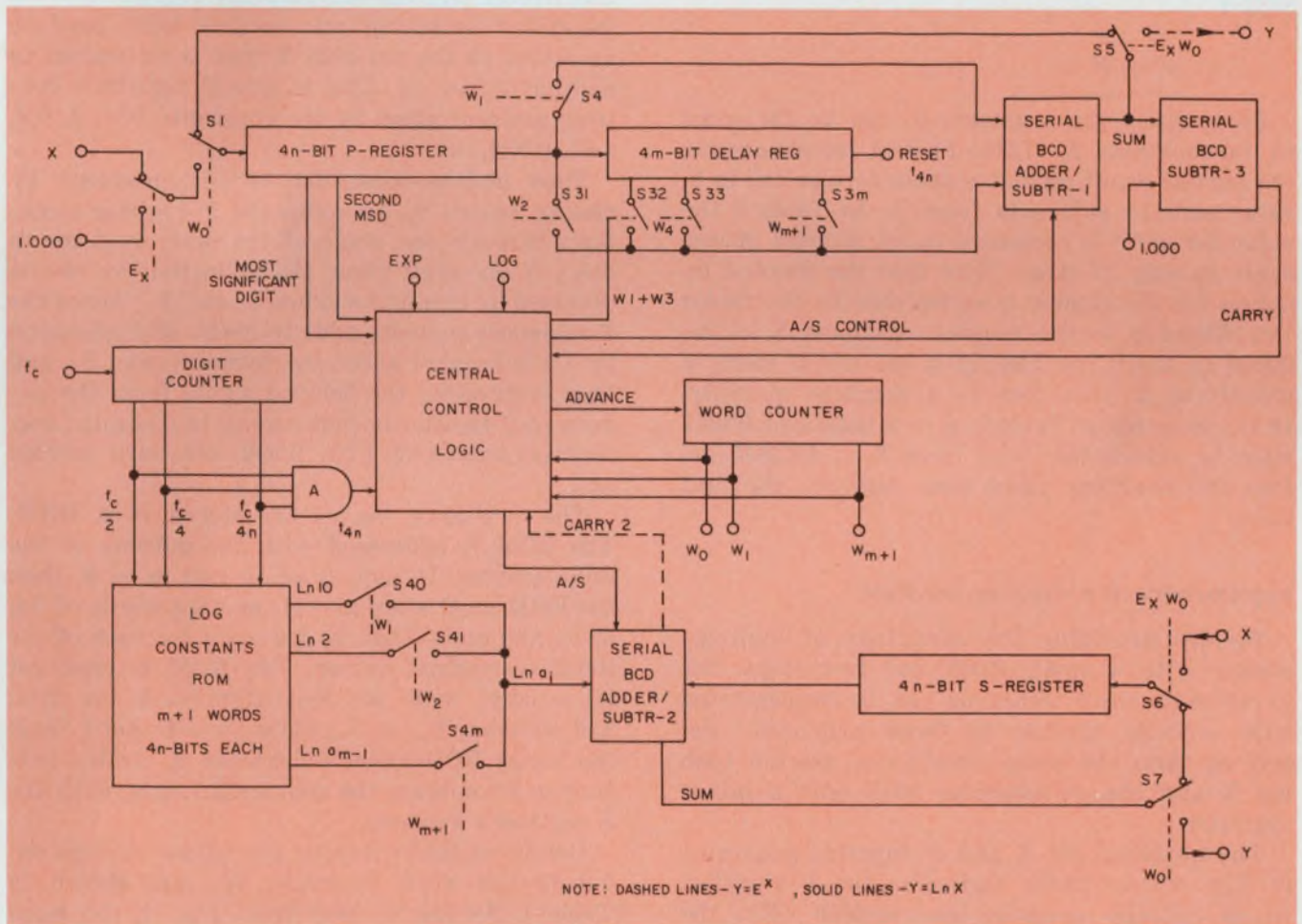

4. With only a short table of iterative constants stored in a ROM, both the logarithm and exponential functions

can be generated to high accuracy with minor modifications to essentially the same circuit.

Table 4. Switching chart for Fig. 4

Word time period	Switches closed		Operation performed	
	Delay register	ROM output	P-register	S-register
W ₁	S32	S40	Multiply by 10 ⁻¹	Sum ln 10
W ₂	S2, S31	S41	Multiply by 2	Sum ln 2
W ₃	S2, S32	S42	Multiply by 0.9	Sum ln 0.9
W ₄	S2, S33	S43	Multiply by 1.01	Sum ln 1.01
⋮	⋮	⋮	⋮	⋮
W _{m+1}	S2, S3m	S4m	Multiply by 1 + 10 ^{-(m-1)}	Sum ln a _{m+1}

follows:

$$e^x = \left(\prod_{i=-1}^n b_i \right) (e^{x - \sum_{i=-1}^n \ln b_i}) \quad (6)$$

If the exponent $(X - \sum \ln b_i)$ is made to approach zero by making $X = \ln b_i$, Eq. 6 becomes simply

$$e^x = \prod_{i=-1}^n b_i.$$

Fortunately the constants b_i can be the same as the constants a_i (Table 1). But for exponents, the partial result oscillates about zero as the $\ln b_i$ value adds or subtracts from X . In Table 3 the value for $e^{4.2385}$ is computed to six decimal places, again in only 17 steps. Note that the decimal location for the answer is established by the factor 10^p , where p is the number of times X is reduced by the value 2.30259 in the initial steps to transform X past zero to a negative quantity. In the example of Table 3, $p = 2$ because 2.30259 must be subtracted twice from $X = 4.23845$ before the resulting value goes negative the first time.

Implementing the iterative constant

Besides providing the advantage of high accuracy with a small ROM and few steps, the iterative-constant technique can be implemented with circuits similar to those previously described. And the same circuit can execute both $\log X$ and the e^x functions with only a minor variation.

The bit-serial $\log X$ and e^x function generator in Fig. 4 uses three registers: the P register, which initially receives the variable (X), the S register, which finally ends up with the answer (Y), and the delay register which helps

generate the a_i constants. The P and S registers are $4n$ stages long and the delay register is $4m$ stages long. The number of digits in X or Y each equal n , and m is the number of iterations required to obtain the desired accuracy. All registers operate at the clock rate, f_c .

The digit counter divides the clock frequency f_c in binary steps to $f_c/4n$, and the word counter provides unit steps to $m + 2$. The outputs of the digit counter address the ROM, which stores the logarithms of the iterative constants, a_i . The length of the digit counter and the P and S registers are coordinated so they have the same circulation periods. The end of each circulation period is indicated by the narrow pulse t_{im} , which is derived from the digit counter outputs. And the two word times, W_0 and W_1 , provide time slots to load the input X and deliver the output Y and to take care of the decimal point.

Each word interval, W_i , can consist of several circulation periods. The exact number depends on the number of steps needed to pass the comparison criterion (unity for logs and zero for exponents) for a specific value of X .

The constants a_i are not actually generated in this circuit. But the $4m$ -bit delay register and its associated switching and control logic produce an action on the variable X that is equivalent to multiplying by a_i —that is, the P register's contents are multiplied by the constants 10^{-1} , 2, 0.9, 1.01, 0.999, etc.

Thus multiplication by 10^{-1} is produced by closing switch S_{32} to route the P register's contents through one stage of the delay register to delay it one digit time. Multiplication by two is obtained by closing switches S_2 and S_{31} ; hence the P-register's contents adds to itself. Multiplication by 0.9 is brought about by closing S_2 and S_{32} and thus subtracting the delayed signal from the undelayed P-register output signal. In a similar way multiplications by 1.01, 0.999, etc., are carried out.

The constants, $\log a_i$, are stored in a ROM. The ROM is addressed with the outputs of the digit counter. If, say, $n = 16$ and $m = 8$, then the ROM must store $m + 1$, or nine words of $4n$, or 64-bits each—that is, one word for each of the iterative-constant values. The ROM is read out bit-serially, with the least-significant bit first, and switches S_{10} to S_{1m} select which word feeds the serial BCD adder/subtractor 2. Adder/subtractor 2 combines the constants $\log a_i$ with the S register's contents.

Details of the switching operations carried out during the word intervals, W_i , are shown in Table 4. As can be seen from Fig. 4, the word counter controls the switching for the sequence of log constants that enter the S register and the

Table 5. Central control logic for Fig. 4 in logarithm mode

Word period	Constant a_i	Function of:			Word counter advanced when:
		A/S #1	A/ #2	A/S #3	
W_0	—	—	—	—	t_{n1} occurs
W_1	10^{-1}	$+0.1X$	$+\ln 10$	—	$10^n = 0$; $10^n \neq 0$
W_2	2.0	$X+X$	$-\ln 2$	$X-1$	Polarity of X changes
W_3	0.9	$X-0.1X$	$-\ln 0.9$	$X-1$	Polarity of X changes
W_4	1.01	$X+0.01X$	$-\ln 1.01$	$X-1$	Polarity of X changes
W_5	0.999	$X-0.001X$	$-\ln 0.999$	$X-1$	Polarity of X changes

X represents the input signal or the content of the P-register (Π a X)

Table 6. Central control logic for Fig. 4 in exponential mode

Word period	Constant b_i	Function of:			Word counter advances when:
		A/S #1	A/S #2	A/S #3	
W_0	—	—	—	—	t_{n1} occurs
W_1	10^{-1}	P	$-\ln 10$	—	Polarity of A/S #2 changes
W_2	2.0	—	—	—	t_{n1} occurs
W_3	0.9	$P-0.1P$	$-\ln 0.9$	—	Polarity of A/S #2 changes
W_4	1.01	$P+0.01P$	$-\ln 1.01$	—	Polarity of A/S #2 changes
W_5	0.999	$P-0.001P$	$-\ln 0.999$	—	Polarity of A/S #2 changes

P represents the content of the P-register (Πb_i).

multiplying actions that correspond to the constants a_i (or b_i).

The central control logic—with inputs from the P register, the adder/subtractors, the digit and word counters and the other sources—provides control for the operation of the adder/subtractors and the advance of the word counter. The different functions performed by the control logic in executing the log and exponential modes of operations are listed, respectively, in Tables 5 and 6.

The seventh article will discuss the BCD generation of trigonometric functions.

Why settle for less than Preston?

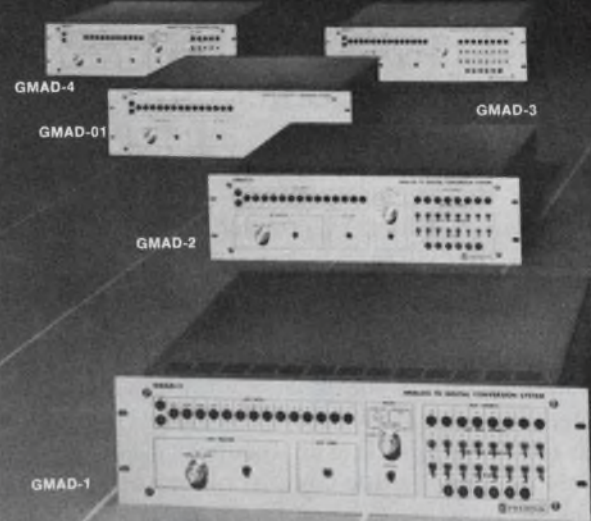

Preston's A-D Conversion Systems Combine Higher Speed, Lower Cost, and All the System Flexibility You Need!

Five models of Preston's GMAD Series cover the entire range of resolution and speed. Everything from 8 bits in 20 microseconds to 15 bits in 1.5 microseconds, including the world's fastest ADC - the GMAD-01 — with 9 bits in 100 nanoseconds!

And you can choose the sub-system components that match your special system requirements —

SAMPLE-AND-HOLD AMPLIFIERS — for both simultaneous sequential signal acquisition, and 1 nanosecond aperture errors!

DC COUPLED AMPLIFIERS — for broadband signal conditioning and 0.01% specs on accuracy, linearity and stability.

MULTIPLEXERS — High Level, Low Level, and Amplifier-per-Channel designs can be intermixed with 0.01% crosstalk!

LOGIC CONTROL CIRCUITS — for front panel first- and last-channel selection of short-cycle "quick-looks" that can increase system speed and efficiency!

DELIVERED COMPLETE — with integral power supplies and all the input and output control signals you need!



This time, be sure you get the world's best ADCs into your system — the ADCs from Preston — the only company that has the know-how and the experience to deliver all these advantages!

Write to us at 805 East Cerritos Avenue, Anaheim, Calif. 92805, — or call us at (714) 776-6400. We'll put all our years of experience on the line!



Simplify sequencers with an improved counter. Self-correction—with minimal hardware—makes the residue counter attractive for many programmer designs.

The residue counter is seldom used due to its lack of recovery from external transient-induced false states. If this deficiency is removed, however, the residue counter has several important potential advantages over more popular counters in some design situations. Compared with the ripple, Johnson (twisted feedback ring), and shift ONE or ZERO (no feedback) counters, a self-correcting residue counter offers one or more of these benefits:

- Fewer inputs for each state-decode gate.
- Faster recovery from an illegitimate state.
- Fewer counter memory elements.
- No need to strobe counter decode gates to prevent false outputs.

The residue counter excels particularly when many machine states are required. Good applications are in home appliance sequencers (automatic washing machines and dishwashers), in many industrial control systems that require programming of a machine or process, and where many parametric data are sequentially transmitted.

Understanding the principle

The operating principle of the residue counter is based on a segment of mathematical theory that deals with linear simultaneous congruences.¹ Let's quickly cover some of this theory.

In number theory, an integer b is said to be congruent with an integer a if it differs from a by a unique positive or negative multiple k of m , where m is another integer. That is:

$$a - b = km, \quad (1)$$

$$\text{or } a \equiv b \pmod{m} \text{ and } b \equiv a \pmod{m}. \quad (2)$$

The "mod" in Eq. 2 stands for modulus—often called modulo or, less frequently, modul. The words, "congruence" and "modulus," when used together, denote agreement relative to a unit of measure.

When the generalized congruence stated in Eq. 1 is constrained to a positive integer, $b < m$:

$$b = a - km, \quad b < m \quad (3)$$

then b is said to be the residue after subtracting km from a .

Consider a numerical example:

$$17 \equiv 5 \pmod{6}$$

$$17 - (2 \times 6) = 5 = b,$$

and

$$-14 \equiv 2 \pmod{8}$$

$$-14 - [(-2) \times 8] = 2 = b.$$

The first example relates to a counter as follows: For a modulus-6 counter initially set to ZERO, the residue, or state of the counter, is 5 after 17 count inputs. Thus the operation (cycling of states) of a counter can be described by a linear (first degree) congruence equation

$$x \equiv b \pmod{m}, \quad (4)$$

$$\text{or } b = x - km. \quad (5)$$

One important result from the calculus of congruences is that if all pairs of the members of a set of *simultaneous* congruences are solvable, then there is one and only one solution for these congruences with respect to that modulus which is the least-common multiple of the given moduli—that is, if

$$x \equiv a \pmod{m}, \quad x \equiv b \pmod{n} \quad (6)$$

are together solvable, then

$$x \equiv x_0 \pmod{mn/d}, \quad (7)$$

where mn/d is the least-common multiple of m and n (smallest number divisible by m and n) and x_0 is the required solution.

Accordingly a counter of modulus mn/d can be replaced by two counters that count identical events. One of the counters will have modulus m and the other modulus n . To arrive at counter state (residue) a for the counter of modulus m , and counter state b for the counter of modulus n , there is a unique (if integers greater than mn/d are disregarded) number, x_0 , of count inputs that must be simultaneously inputted to these counters. To put it differently, after a given number of count inputs, x_0 , there is a unique state a for the counter of modulus m and a unique state b for the counter of modulus n . Generalizing Eq. 6, we have

$$x \equiv a_i \pmod{m_i} \quad i = 1, 2, \dots, r. \quad (8)$$

When all the elements of a set of numbers are relatively prime in pairs, the least-common multiple of these numbers is their product. There-

Robert P. Harris, Senior Group Electronics Engineer, McDonnell Douglas Astronautics Company-East, St. Louis, Mo. 63166.

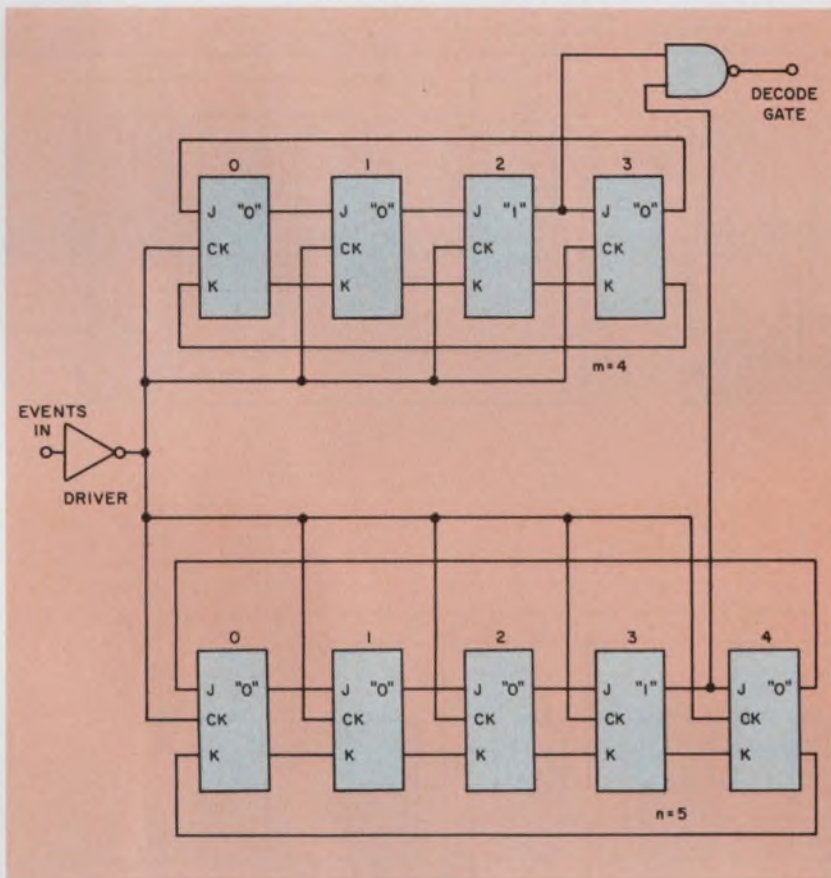

Event	m = 4	n = 5
1	1	1
2	2	2
3	3	3
4	0	4
5	1	0
6	2	1
7	3	2
8	0	3
9	1	4
10	2	0
11	3	1
12	0	2
13	1	3
14	2	4
15	3	0
16	0	1
17	1	2
18	2	3
19	3	4
20	0	0
21	1	1
22	2	2
23	3	3
24	0	4

1. The simplest residue counter consists of two small-moduli counters. The counter state shown corresponds

to the instant after 18 events have been counted. The table assumes both counters were initialized to ZERO.

fore, for the special case where all moduli in the simultaneous congruences in Eq. 8 are relatively prime in pairs, there is a unique solution to these congruences with respect to a modulus that is equal to the *product* of all the given moduli.

There is no incentive to replace one larger-modulus counter with two or more small-moduli units, unless some advantage can be realized. One benefit occurs when many counter states must be decoded and the number of inputs to each state-decode gate is, as a result, significantly important. For each of the smaller moduli counters, circuits with simple state decode requirements can be selected. Then these requirements multiplied by the number of the counters determine the over-all counter decoding complexity.

For example, suppose we need a machine with 139 sequential states. We can use a modulus-4 counter simultaneously with modulus-5 and modulus-7 counters. We could choose, for each of the counters, a shift register circulating a single logic ONE (or ZERO). Then 139 counter decode gates of the modulus 140 ($4 \times 5 \times 7$) counter need only three inputs per gate. Each input will correspond to an output from one of the small-modulus counters.

A simple residue counter is shown in Fig. 1. Each of the two sections of this modulo-20 counter has only one storage element in a logic ONE state at any time. Both sections of this counter are ring shift registers. The table in Fig. 1 shows the 20 unique combinations of $m = 4$ and

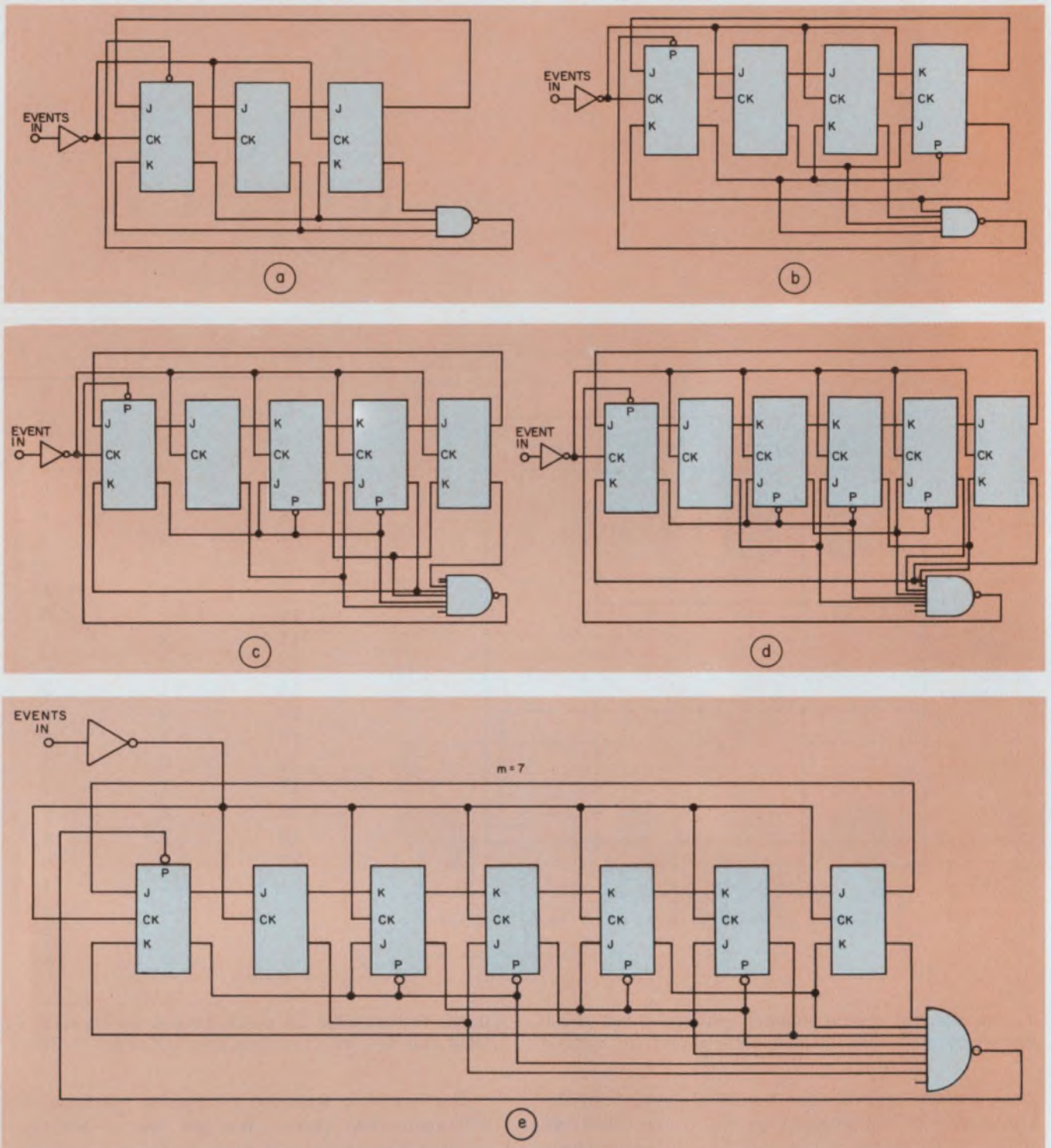

2. Self-correction is added to a residue counter in two ways: by the configuration of its connections and by the

addition of a single NAND gate for each small-modulus counter.

$n = 5$ states and the beginning of repetition of these 20 residues.

When the moduli of the small-moduli counters are not relatively prime in pairs, a residue counter may need unnecessary memory elements and more complex decode gates. Therefore, moduli which are relatively prime in pairs are dictated, and the number of unique counter states is equal to the product of the moduli.

The correlation between inputs counted and

output decode gates (counter residues) can be seen at a glance from a residue table, such as the one in Fig. 1. While the tabular method is simple, there is another way to determine this correlation. From Eq. 8, the number of events counted, x_o , is

$$x_o \equiv a_i \pmod{m_i}, \quad (9)$$

so that

$$x_o = m_i u + a_i, \quad a_i < m_i, \quad (10)$$

where u is the largest integer, such that the re-

Residue vs conventional counters

Modu- lom	Counter type	Flip- flops	Gates	TTL SSI packages
210	2N-1 Johnson	106	210 × 2-input	106
210	Ripple	8	210 × 8-input	214
210	5 × 6 × 7 "residue"	18	210 × 3-input + 3 × 8-input	82
59	2N-1 Johnson	30	59 × 2-input	30
59	Ripple	6	59 × 6-input	62
59	3 × 4 × 5 "residue"	12	59 × 3-input + 2 × 4-input and 1 × 8-input	28
35	2N-1 Johnson	18	35 × 2-input	18
35	Ripple	6	35 × 6-input	38
35	5 × 7 "residue"	12	35 × 2-input + 2 × 8-input	17
13	2N-1 Johnson	7	13 × 2-input	8
13	Ripple	4	13 × 4-input	9
13	3 × 5 "residue"	8	13 × 2-input + 1 × 8-input	9

mainder, a_i is positive and smaller than the small-counter modulus, m_i , and so that Eq. 10 is satisfied.

Suppose we want to build a 210-state machine using three counters with the moduli 5, 6, and 7. We can write

$$x_o = 5u + a_1,$$

$$x_o = 6u + a_2,$$

$$x_o = 7u + a_3,$$

and solve for a_1, a_2, a_3 corresponding to any number, x_o , of input events counted. For $x_o = 179$,

$$179 = (5 \times 35) + a_1 \quad a_1 = 4$$

$$179 = (6 \times 29) + a_2 \quad a_2 = 5$$

$$179 = (7 \times 25) + a_3 \quad a_3 = 4$$

Thus the residue counter state decode is (4, 5, 4).

Calculation of the required input count from a known counter state is more tedious. One procedure based on the Chinese Remainder Theorem¹ is

$$x \equiv \sum a_i b_i (M/m_i) \pmod{M}, \quad (11)$$

where M is the product of the m_i .

The multipliers, $b_i(M/m_i)$ remain the same throughout the computation on the same set of moduli. Therefore the method lends itself to tabulation. Using the counter of the previous example, we have

$$M/m_1 = 210/5 = 42,$$

$$M/m_2 = 210/6 = 35,$$

$$M/m_3 = 210/7 = 30.$$

If we take advantage of the relatively prime moduli, the following expression is true:

$$b_i(M/m_i) \equiv 1 \pmod{m_i}, \quad (12)$$

so that

$$b_1(42) \equiv 1 \pmod{5} \quad b_1 = 3$$

$$b_2(35) \equiv 1 \pmod{6} \quad b_2 = 5$$

$$b_3(30) \equiv 1 \pmod{7} \quad b_3 = 4.$$

Thus we have

$$b_1(M/m_1) = 126, \quad b_2(M/m_2) = 175, \quad b_3(M/m_3) = 120$$

From Eq. 11, we can write the solution as

$$x \equiv (126a_1 + 175a_2 + 120a_3) \pmod{210}, \quad (13)$$

where $a_1 < 5$, $a_2 < 6$, and $a_3 < 7$.

For counter state decode (4, 5, 4), we have

$$x \equiv [(126 \times 4) + (175 \times 5) + (120 \times 4)] \pmod{210}$$

$$x \equiv 1859 \pmod{210} \quad \text{and} \quad 1859 \equiv X \pmod{210}$$

$$1859 - (210u) = x$$

$$1859 - (210 \times 8) = x = 179 \text{ input counts.}$$

The u in this calculation has been defined in Eq. 10. When many calculations are involved, we can tabulate the various factors of Eq. 13 for ease of substitution into this equation.

Residue counter made self-correcting

The counter in Fig. 1 suffers from one bad feature: In either the modulo- m or modulo- n sections, more than one logic ONE can occur simultaneously, due to a noisy environment or due to a power turn-on. When this happens, the whole counter fails to work properly.

A minimal hardware solution to this problem is shown by Figs. 2a through 2e which depict self-correcting counters of moduli 3, 4, 5, 6 and 7, respectively. The only component added for self-correction is a NAND gate to cover the case when there is no logic ONE in a small counter memory. These circuits, by virtue of their connections, force the counter from multiple logic ONEs to a single logic ONE in a maximum of three input counts for $m = 3, 4, 5, 6$ and in a maximum of four input counts for $m = 7$. The logic to initialize at power turn-on is not shown, since the method is the same as for other types of counters.

In general, the self-correcting residue counter becomes more attractive as the number of required machine states increases. This is demonstrated in the table, which, however, not show the maximum input counts that would be required for self-correction. The 35-state machine, for instance, implemented as a residue counter, will self-correct in a maximum of four input counts, while the 2N-1 Johnson counter may typically need more than 20 input counts to arrive at a good state from one of the $(2^{18} - 35)$ undesirable states. ■■

Reference

1. Oystein, Ore. "Number Theory and Its History," McGraw-Hill, 1948.

**SCHOTTKY TTL:
A MILLION UNITS
DELIVERABLE
NOW.**



Available in quantity today: A broad line of Schottky TTL parts, including functions never before available in Schottky.

Our Schottky TTL Family: 39 SSI and MSI devices available now, 8 more on the way. These super, high speed devices can be used to upgrade existing TTL systems or to design the next generation TTL system. Completely compatible with standard 9300 and 7400 TTL series, and 3 times as fast (3 ns typical gate propagation delays, 125 MHz typical input clock frequency for J-K flip-flops, 90 MHz typical input clock frequency for counters and registers).

TTL Today: Our total TTL family is the most complete mix available anywhere. Schottky for super speed, Standard 9300 and 7400 at super prices, low power 93L MSI for reduced power consumption.

For the Design Engineer Schottky means an increase in overall system speed by a factor of 2 or 3, with a minimum of redesign and increased power. By using Schottky TTL devices, for example, critical path delay problems can be reduced or eliminated, processing time can be reduced, computer and peripheral control systems can communicate faster. Our Schottky TTL family is not only broad and diversified, but includes some unique complex MSI functions, such as:

- *93S05 Variable Modulo Counter.* This low cost 4-bit counter can be programmed, without external components, for division by 2, 5, 6, 7, 8, 10, 14, or 16. Typical count rate is 100 MHz.
- *93S10/93S16 Synchronous Counters* bring the most popular counter function up to Schottky speeds of 90 MHz and clock-to-output delays of less than 9 ns.
- *93S43 Super high speed 4-bit by 2-bit multiplier* performs #2s complement multiplication without correction at very high speeds. (For example two 12-bit numbers can be multiplied in 125 ns.)
- *93S62 9-bit Parity Generator/Checker.* Will generate a parity bit for an 8-bit word in 20 ns. Two 93S62 devices will generate a parity bit on a 16-bit word in 29 ns.

Also outstanding is our *93S46 6-Bit Identity Comparator.* Compares two 6-bit words in less than 10 ns with one device; or compares two 12-bit words in less than 15ns with just two devices.

Contact your friendly Fairchild distributor or your neighborhood Fairchild Regional Sales Office.

SUPER AVAILABLE SCHOTTKY DEVICES

<u>TTL/SSI</u>		Prices
		100-999
NAND Gates/Hex Inverter		
9S00 (54/74S00)	Quad 2-Input NAND	.86
9S03 (54/74S03)	Quad 2-Input NAND (O/C)	.86
9S04 (54/74S04)	Hex Inverter	1.05
9S04A	High Speed Hex Inverter	1.05
9S05 (54/74S05)	Hex Inverter (O/C)	1.05
9S05A	High Speed Hex Inverter (O/C)	1.05
9S10 (54/74S10)	Triple 3-Input NAND	.86
9S20 (54/74S20)	Dual 4-Input NAND	.86
9S22 (54/74S22)	Dual 4-Input NAND (O/C)	.86
9S133 (54/74S133)	13-Input NAND	.86
9S134 (54/74S134)	12-Input NAND (3-State Output)	.86
AND Gates		
9S11 (54/74S11)	Triple 3-Input AND	.86
9S15 (54/74S15)	Triple 3-Input AND (O/C)	.86
9S41	Quad 2-2-3 Input AND	.86
NAND Buffer/Driver		
9S40 (54/74S40)	Dual 4-Input Buffer	.86
9S140 (54/74S140)	Dual 4-Input Line Driver	1.12
AND-OR-Invert Gate		
9S64 (54/74S64)	4-2-3-2 Input A-O-I	.86
9S65 (54/74S65)	4-2-3-2 Input A-O-I (O/C)	.86
AND-OR Gate		
9S42	Dual 4-2 Input	.86
Dual D-Type Flip-Flop		
9S74 (54/74S74)	Positive Edge Triggered	1.73
Dual JK Type Flip-Flop		
9S109	Positive Edge Triggered JK	1.95
9S112 (54/74S112)	Negative Edge Triggered	1.95
9S113 (54/74S113)	Negative Edge Triggered	1.95
9S114 (54/74S114)	Negative Edge Triggered	1.95
<u>TTL/MSI</u>		
Arithmetic Operators, Comparators, Multipliers		
93S41 (54/74S181)	4-Bit Arithmetic Logic Unit	14.00
93S42 (54/74S182)	Carry Look Ahead For ALU	3.25
93S43 (25S05)	2s Complement Multiplier	12.00
93S46	High Speed 6-Bit Comparator	4.75
93S47 (71S60/81S60)	High Speed 6-Bit Comparator (O/C)	Sept. 7.60
93S62 (82S62)	9-Bit Parity Generator/Checker	Sept. 7.60
Counters, Registers, and Latches		
93S00 (54/74S195)	4-Bit Parallel Access Shift Register	Oct.
93S05	High Speed Variable Modulo Counter	10.50
93S10	Edge Triggered, Fully Synchronous Decade Counter	7.25
93S16	Edge Triggered, Fully Synchronous 4-Bit Binary Counter	7.25
93S174 (54/74S174)	Hex D-Type Flip-Flop	Sept. 7.40
93S175 (54/74S175)	Quad D-Type Flip-Flop	7.40
93S194 (54/74S194)	4-Bit Bidirectional Shift Register	7.15
Decoders/Demultiplexers		
93S137	1-of-8 Decoder With Input Latches	Oct.
93S138 (54/74S138)	1-of-8 Decoder/Demultiplexer	Oct.
93S139 (54/74S139)	Dual 1-of-4 Decoder/Demultiplexer	Oct.
Multiplexers		
93S12	8-Input Multiplexer	6.50
93S153 (54/74S153)	Dual 4-Input Multiplexer	4.75
93S157 (54/74S157)	Quad 2-Input Multiplexer	4.75
93S158 (54/74S158)	Quad 2-Input Multiplexer	4.75
93S253 (54/74S253)	Dual 4-Input Multiplexer With 3-State Outputs	Nov.
93S257 (54/74S257)	Quad 2-Input Multiplexer With 3-State Outputs	Nov.
93S258 (54/74S258)	Quad 2-Input Multiplexer With 3-State Outputs	Sept.

**MADE IN
FAIRCHILD**

Automate your Smith-Chart plots

and relax while these programs accurately draw and label your gain circles, reflection-coefficients and impedances.

The Smith-Chart is widely used for the solution of transmission-line problems and the design of microwave amplifiers, oscillators and two-part networks. Preparation of these charts can now be computerized with a program package that performs any and all of the following:

- Draws and spaces the required number of charts on a digital plotter.
- Plots admittance, impedance or reflection-coefficient data on any number of charts in any combination.
- Draws input or output gain circles on the chart, and plots impedance data for external input or output (coupling) networks.

The user controls the five subroutines in the program package—SMITHFRM, SMITHMOD, ADMTPLT, IMPED and GAINCRC—by writing his own mainline program. The subroutines are

used as two separate groups: one plots impedance, admittance and reflection-coefficients; the other draws gain circles and plots input or output impedance (see Table 1).

All controls for data input and plotting are implemented in the main program, which the user supplies. Concentrating data input and control in the mainline program simplifies reruns with new data and parameters. The subroutines are written in Fortran IV, and are used on a CDC 3800 computer in conjunction with a Calcomp or Gerber plotter.

At the author's installation, the user initiates the plotting routines by a subroutine call to PLOTS, and closes with STOPPLOT. Both subroutines are part of the plotter software. The parameters (PLTARRAY, 254,18) for PLOTS set the buffer PLTARRAY to 254 words, and select logical output unit 18. STOPPLOT closes the magnetic-tape file on which the plot data were written.

Only two subroutines are needed to draw a

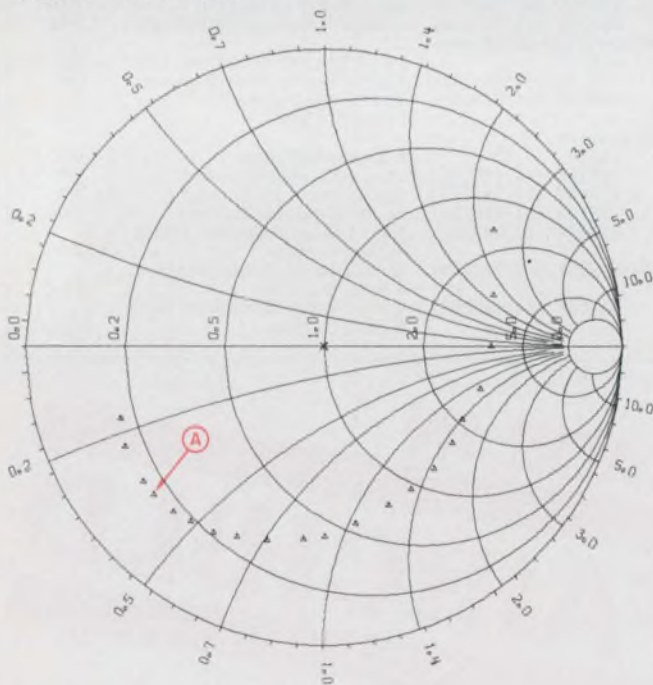

1. The Smith Chart drawn by SMITHFRM has most susceptance circles stopping at the $G = 10$ conductance circle. Data for the admittance plot (A) were stored in the ADMT array.

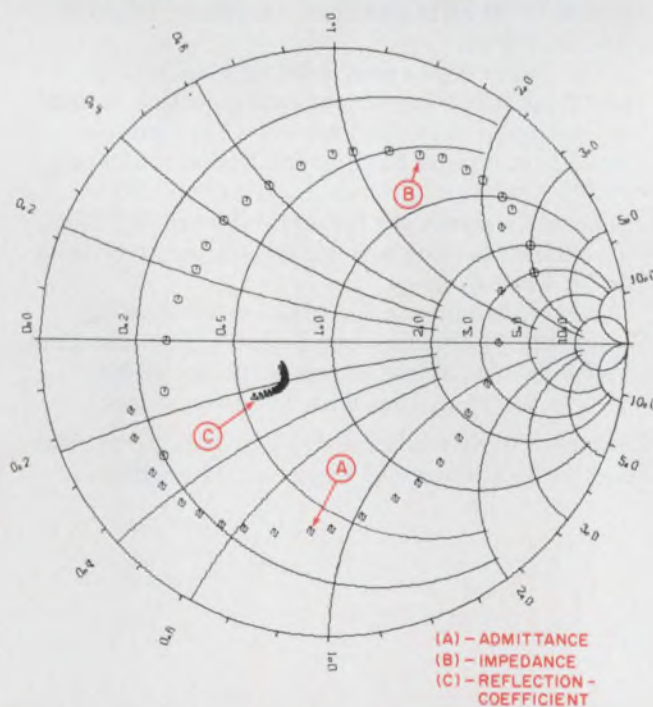

2. Any number of plots can be drawn on a single chart and identified with a separate symbol. Charts drawn by SMITHMOD have abbreviated circles at user-specified boundaries, so they give a neater appearance.

Smith-Chart and to plot any combination of admittance, impedance or reflection-coefficient. Either SMITHFRM or SMITHMOD draws the chart, while ADMTPLT plots the input data.

SMITHFRM draws a complete chart (Fig. 1) with most susceptance circles stopping at the $G = 10$ conductance circle. On the other hand, SMITHMOD draws a neater form (Fig. 2) of the chart by limiting the extent of the conductance and susceptance circles at user-selected intercepts. Either subroutine can plot data on the current chart, or draw a new chart before plotting. Both subroutines allow changes in chart size by selecting the scale-factor variable XM and vertical offset SY.

The subroutine ADMTPLT plots impedance, admittance or reflection-coefficients on the chart, as selected by integer control LN. It can only be called from SMITHFRM or SMITHMOD. The data to be plotted are transferred from the main program through the statement:

COMMON/ADREF/AMPED, AMDT, REF, ZC, in which AMPED, ADMT and REF are complex arrays containing the data to be plotted.

Any combination of admittance, impedance or reflection-coefficient data can be plotted on a single chart (Fig. 1) or on multiple charts. In-

Table 1. Subroutine groupings

Type of plot desired	Subroutines used	Subroutine function
Admittance, impedance or reflection-coefficient	<ul style="list-style-type: none"> • SMITHFRM or SMITHMOD • ADMTPLT 	<ul style="list-style-type: none"> • Draw chart • Plot data
Gain circles	<ul style="list-style-type: none"> • SMITHFRM or SMITHMOD • IMPED • GAINCRC 	<ul style="list-style-type: none"> • Draw chart • Plot impedance • Draw gain circles

teger KL controls where the data are plotted. KL should be zero only for the initial chart, positive for plotting data on an existing chart, and negative for drawing a new chart with desired data. However, each plot requires a call from a user-supplied mainline program to SMITHFRM or SMITHMOD, with parameters selected according to Table 2.

Data to be plotted must be entered in rectangular form, in one of the three one-dimensional arrays—AMPED, ADMT or REF—depending on the type of material plotted. The array used depends on which quantity—impedance, admittance or reflection-coefficient—is to be plotted

Table 2. Summary of program input and controls

Real data	CAD	Input data ARRAYS	Integer data				Integer controls				Data plotted	Type of plot
			NF	JP	JFR	NIM	KL	LN	KZ	MSELX		
Characteristic impedance	Characteristic admittance; use CAD=1.0/ZC	AMPED (I) ADMT (I) REF (I)	Number of points to be plotted	Number corresponding to symbol plotted	DNA*	DNA*	Zero for initial chart only; > 0 for plotting on existing chart; < 0 to draw new chart and plot data	0 < 0 > 0	DNA*	Not zero	Impedance Admittance Reflection-coefficient	Circuit parameter plot
As above	As above	FREQ (55) S11 (55,10) S22 (55,10) ZINOUT (55,10) ZOUTIN (55,10)	Number of frequency points	As above	Frequency point (1 to 55)	column number of data set to be plotted (1-10)	Same	< 0 = 0 > 0	zero for output impedance; Zero negative for input impedance; positive for no impedance plot		Input gain circles with or without input network impedance output gain circles with or without output network impedance network impedance only	"S" parameter plots

*Does not Apply

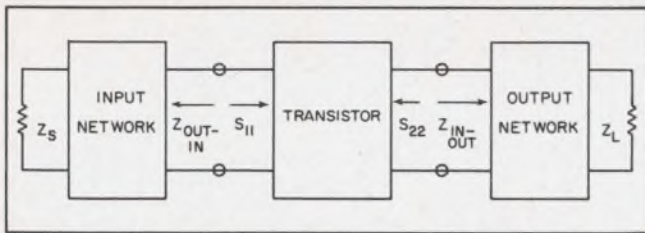

3. Source and load impedances, named Z_{out-in} and Z_{in-out} , form part of the input data for plotting against the corresponding input and output s parameters—the latter being shown as gain circles.

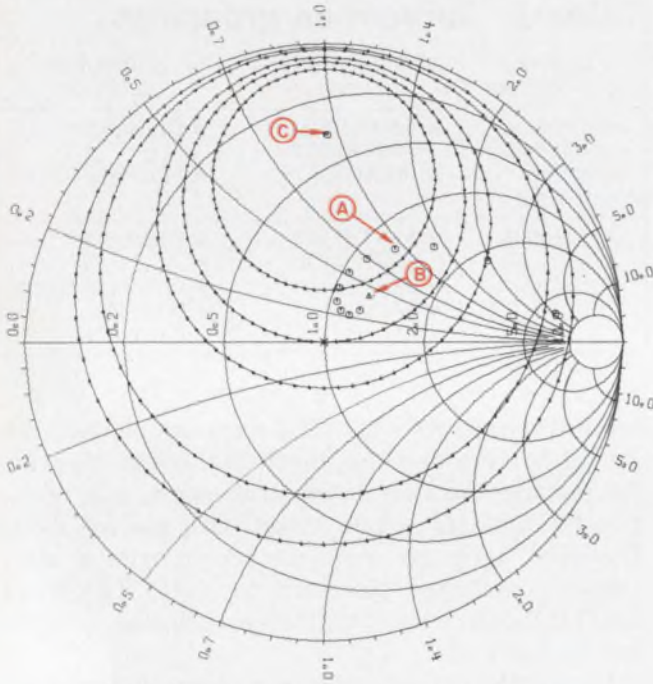

4. Smith Chart plus input gain-circles for 1, 0, -4 and -6 dB. The five circles are plotted for s_{11} and s_{22} values at one particular frequency, but the effective source impedance (A) is plotted over a range of frequencies. The largest circle corresponds to -6 dB. The start of the impedance plot is marked by the triangle symbol (B); the lone symbol (C) lies on the line-of-centers (between itself and the center of the chart).

(Table 2). Variable LN controls the selection; and ZC provides normalization, if the data used are actual circuit impedances. Subroutine ADMTPLT converts the inputs to reflection-coefficient for plotting.

Spacing and size of plot is controlled by SMITHFRM and SMITHMOD—as in the previous case—when analyzing two-port networks. However, the subroutines used are GAINCRC and IMPED.

Gain circle plots

The gain circles drawn by GAINCRC assume that of the four "s" parameters, the value of s_{12} is negligible. In this case, the power gain of the

device being analyzed is given by the product of three terms, G_o , G_1 and $G_2^{1,2}$ where

$$G_o = |s_{21}|^2,$$

$$G_1 = \frac{1 - |\Gamma_s|^2}{|1 - s_{11}\Gamma_s|^2}$$

$$G_2 = \frac{1 - |\Gamma_L|^2}{|1 - s_{22}\Gamma_L|^2}$$

The terms Γ_s and Γ_L are the reflection-coefficients of the external source impedance and external load impedance, respectively, (Fig. 3).

The locus of points for which G_1 and G_2 are constant forms a circle on the Smith-Chart, whose center lies on a line joining the center of the chart to s_{11}^* or s_{22}^* . Values of complex load or source impedance which lie on a particular gain circle result in a value of G_1 or G_2 corresponding to that circle—one of the objectives in broadband circuit matching.

The five gain circles plotted represent dB values of G_1 and G_2 of 1, 0, -4 and -6 dB, respectively, and are selected in the one data statement that appears in GAINCRC. The plot includes s_{11}^* or s_{22}^* as well as the five circles—the largest radius corresponds to -6 dB.

The calling sequence begins with the main program, then SMITHFRM or SMITHMOD, which, in turn, calls IMPED. Then, IMPED passes control to GAINCRC. IMPED's purpose is to convert the values of Z_{in-out} or Z_{out-in} , as defined in Fig. 3, to corresponding reflection-coefficient values for plotting on the chart. The corresponding complex arrays are ZINOUT and ZOUTIN.

Integer variable KZ permits plotting of the corresponding Z_{in-out} or Z_{out-in} , (Table 2), along with the appropriate gain circles (Fig. 4). But, NF specifies the number of frequency points—one to NF—that plot against the given gain circle plot. The parameters s_{11} and s_{22} are input through complex arrays S11 (55,10) and S22 (55,10), respectively. These arrays hold up to 10 sets of points for each of 55 frequencies. The variable NIM selects the set to be plotted. A dimension FREQ (55), a COMMON/GCRC/S11 (55,10), S22 (55,10), ZINOUT (55,10), ZOUTIN (55,10), and a complex ZINOUT, ZOUTIN, S11, S22, SS1, SS2 card must appear in the main program. The FREQ or frequency array may contain dummy data, since it is a leftover from previous CAD programs.

The entire job, which includes the demonstration mainline and the five subroutines, occupies 3527 (48-bit) words and requires one minute 25 seconds to compile. The average running time per plot is three minutes. ■■

References

1. "S-Parameter Techniques for Faster, More Accurate Network Design," Hewlett-Packard, Application Note 95-1.
2. "Transistor Parameter Measurements," Hewlett-Packard, Application Note 77-1.

Control program and Smith-Chart routines

Sample mainline program for data input and control

```

C* * * * *
C* J. R. BRINSON - SEARCH RADAR BRANCH - RADAR DIVISION - N.R.L.
C* CODE 5334 B PHONE (221) 767 - 2309
C* COMPUTED FOR JRM - FORTRAN IV - * * * * *
C* VERSION OF - JULY 10, 1972
C* * * * *
C* THIS SUBROUTINE GRAB DATA'S A SMITH CHART, AND PLOTS COMPUTED VALUES
C* OF IMPEDANCE (AMPE), ADMITTANCE (ADMT) OR REFLECTION COEFFICIENTS
C* (REF) ON THE SMITH CHART.
C* ALSO COMBINED WITH THE DEMONSTRATION PROGRAM IS A SUBROUTINE SET
C* WHICH PLOTS EITHER INPUT (S1) OR OUTPUT (S2) GAIN CIRCLES.
C* * * * *
C* THE REQUIRED INPUTS (ALL OF WHICH ARE IN THE MAIN PROGRAM) ARE -
C* 1. NF - THE NUMBER OF DATA POINTS TO BE PLOTTED.
C* 2. JP - NUMBER FOR SYMBOL USED IN PLOTTING DATA.
C* 3. KL - A PLOT CONTROL NUMBER (SEE BELOW).
C* IF KL IS ZERO - PLOTS INITIAL CHART WITH DATA
C* -- KL EQUALS ZERO IS USED ONLY ONCE AT THE BEGINNING OF THE SMITH
C* CHART PLOTTING ROUTINES.
C* IF KL IS POSITIVE - PLOTS DATA ON PRESENT CHART.
C* IF KL IS NEGATIVE - MOVES TO NEW LOCATION-PLOTS CHART #/DATA
C* 4. ZC - THE CHARACTERISTIC IMPEDANCE.
C* USE ZC = 1.0 WHEN THE IMPEDANCE OR ADMITTANCE ARE NORMALIZED.
C* 5. CAD = 1.0/ZC = THE CHARACTERISTIC ADMITTANCE.
C* * * * *
C* FOR THE IMPEDANCE, ADMITTANCE OR REFLECTION COEFFICIENT PLOTTING
C* THE FOLLOWING ADDITIONAL INPUTS MAY BE REQUIRED -
C* 1. AMPE - ARRAY OF COMPLEX IMPEDANCE IN RECTANGULAR FORM,
C* 2. ADMT - ARRAY OF COMPLEX ADMITTANCE IN RECTANGULAR FORM,
C* 3. REF - ARRAY OF COMPLEX REFLECTION COEFFICIENTS.
C* 4. LN - A DATA PLOT CONTROL NUMBER (SEE BELOW).
C* IF LN IS ZERO - THE IMPEDANCE IS PLOTTED.
C* IF LN IS POSITIVE - PLOTS REFLECTION COEFFICIENTS
C* IF LN IS NEGATIVE PLOTS COMPUTED ADMITTANCE
C* * * * *
C* FOR THE GAIN CIRCLE PLOTTING - THE FOLLOWING ADDITIONAL INPUT
C* DATA IS REQUIRED -
C* 1. S11 - ARRAY OF S11 PARAMETERS IN RECTANGULAR FORM.
C* 2. S22 - ARRAY OF S22 PARAMETERS IN RECTANGULAR FORM.
C* 3. ZINPT - THE INPUT IMPEDANCE OF THE OUTPUT CIRCUIT.
C* 4. ZOUTIN - THE OUTPUT IMPEDANCE OF THE INPUT CIRCUIT.
C* 5. LN - FOR THE GAIN CIRCLE SUBROUTINE - CONTROLS WHICH CIRCLES ARE
C* PLOTTED.
C* LN = ZERO - THE OUTPUT GAIN CIRCLES ARE PLOTTED.
C* IF LN IS POSITIVE - THE INPUT GAIN CIRCLES ARE PLOTTED.
C* IF LN IS NEGATIVE - NO DATA IS PLOTTED.
C* 6. KZ - A CONTROL FOR WHICH IMPEDANCE IS PLOTTED. (SEE BELOW)
C* IF KZ IS POSITIVE - NO DATA IS PLOTTED.
C* IF KZ IS ZERO - OUTPUT IMPEDANCE IS PLOTTED.
C* IF KZ IS NEGATIVE - THE INPUT IMPEDANCE IS PLOTTED.
C* 7. JFM - WHICH FREQUENCY IS USED TO PLOT GAIN CIRCLES.
C* MSELX IS A CONTROL FROM WHICH PLOTTING GROUP IS TO BE USED.
C* MSELX IS EMPLOYED ONLY FOR THIS COMBINED SAMPLE - NOT NORMALLY USED
C* * * * *
C* IF MSELX EQUALS ZERO - GAIN CIRCLES ARE DRAWN ON THE SMITH CHART
C* IF MSELX OTHER THAN ZERO - ADMITTANCE, IMPEDANCE OR REFLECTION
C* COEFFICIENTS ARE PLOTTED.
C* * * * *
C* THE FOLLOWING CARDS SHOULD APPEAR IN MAIN PROGRAM BEFORE
C* A CALL TO SMITHFNM IS MADE.
C* 1. DIMENSION PLTARRAY (254,18)
C* 2. COMPLEX AMPE (NF), ADMT (NF) NF SHOULD BE SPECIFIED
C* 3. CALL PLOTS (PLTARRAY, 254, 18)
C* 4. CALL TO SMITHFNM ON TO SMITHFNM ( NIM, NF, JP, LN, KL, KZ, JFR, MSELX )
C* IS REQUIRED FOR EACH SET OF DATA TO BE PLOTTED.
C* 5. CALL TO STOPPLOT SHOULD APPEAR AT THE END OF ALL PLOTTING.
C* * * * *
DIMENSION PLTARRAY (254)
DIMENSION FREQ (50)
DIMENSION AMPE ( 21 ), ADMT ( 21 ), REF ( 21 )
COMMON /ADREF /AMPE, ADMT, REF, ZC
COMMON /ZGAIN /ZGAIN, ZLD
COMMON /GCRCL /S11 (50,10), S22(50,10), ZINPT(50,10), ZOUTIN(50,10)
COMMON /ZGAIN /ZGAIN, ZLD
COMMON /ZGAIN /S11, S22, S51, S52
TYPE COMPLEX AMPE, ADMT, REF
DATA (AMPE=(150.,150.), (100.,127.), (80.,125.), (50.,115.),
1 (40.,100.), (35.,90.), (30.,70.), (28.,70.), (25.,60.), (22.,50.),
2 (21.,45.), (20.,37.5), (19.,30.), (18.,22.5), (17.,20.),
3 (16.,15.), (15.,11.), (12.,11.), (10.,10.), (13.,-7.),
4 (10.,-15.))
DATA (ADMT=(0.00333,-0.00333), (0.00308,-0.00462), (0.00312,
1 -0.0069), (0.00312,-0.00731), (0.00344,-0.00862), (0.00375,
2 -0.00969), (0.0042,-0.01161), (0.00493,-0.01232), (0.00592,
3 -0.0142), (0.00748,-0.01663), (0.00899,-0.01851), (0.01167,
4 -0.02074), (0.01307,-0.02249), (0.01497,-0.02634), (0.02467,
5 -0.02833), (0.0318,-0.03017), (0.04106,-0.02797), (0.05749,
6 -0.0231), (0.07143,0.0), (0.05963,0.0321), (0.0367,0.0462))
DATA ((EF(1),101,21), (202,190), (241,186), (225,182),
1 (211,177), (199,172), (189,167), (182,163), (176,
2 158), (171,153), (167,149), (164,143), (161,139),
3 (159,133), (159,128), (156,127), (156,116), (159,

```

(continued on next page)

```

DATA (R(K),K=1,8) = 0.7,0.4,0.6,1.3,2.0,3.0,5.0,10.0
DATA (R(K),K=1,8) = 0.0,0.2,0.5,1.0,2.0,3.0,5.0,10.0
XM = 3.0000000
SY = 2.0000000
NN=100
PI = 3.141592654
C * * * * *
C SET CENTER POINT
XL=XM
YL=YM+SY
PHINT 100,KL
WRITE (6,101) XM
K=1
I1 ( KL ) 1,2,51
C * STATEMENT 1 HELM IS THE SPACING BETWEEN CHARTS.
1 CALL PLBT (12.0,0.0,-31)
C GENERATE CONDUCTANCE CIRCLE
2 DO 10, K=1,8
K=1
X1=X1+XM
Y1=Y1+YM
CALL PLBT(X1,Y1,3)
C R = RADIUS OF CONDUCTANCE CIRCLE
R1 = 1./((1.-R(K)))
C X1 = CENTER OF CONDUCTANCE CIRCLE
X1 = X1/(1.-R(K))
XINC2 = R1/X1
C * THE FOLLOWING ROUTINE ALLOWS THE CONDUCTANCE CIRCLES TO BE
C * TERMINATED AT THE SELECTED SUSCEPTANCE CIRCLES.
C * FIND THE INTERSECTION POINTS FROM BEGINNING OR ENDING
C * SUSCEPTANCE CIRCLES.
C * R(K) = THE VALUE OF THE SELECTED SUSCEPTANCE CIRCLES AT WHICH
C * THE CONDUCTANCE CIRCLES TERMINATE (ANY CHANGE REQUIRES
C * CALCULATING A NEW VALUE FOR R1).
A1 = R1
B1 = R1
C1 = 1.0 / R(K)
R12 = R1 * C1
C *
C * EC2 = R12 / (C1 * C1)
S12 = 0.0
J=0
JC = 0
I1 (K,EC,2.0, R1, EC,3) EC2 = 4.0 * R12
I1 (K,EC,4) R12 = 25.0 * R12
I1 (K,EC,5, AND, K, LT, 8) R12 = 100.0 * R12
XTEST = ( 1.0 + 2.0 * R12 / ( 1.0 + R12 ) )
PHINT 100, XTEST
DO 11, J=1,2
K=K+(-1)
X1 = -X1
I1 (J, EC, 2) X1 = 1. - 2. * R12 * X1
I=0
DO 12, I = 1, N1
A1 = A1 + (X1 - X1) * C1
Y1 = SORT(AUG) * X1
Y1 = Y1 + X1 * Y1
X1 = X1 + X1 * Y1
I1 (K, EC, 1) GO TO 6
I1 (K, EC, 2) GO TO 4
/ I1 (K, EC, XTEST) GO TO 5
GO TO 6
5 CALL PLBT ( X1, Y1, 3 )
JL = 1
GO TO 13
6 CALL PLBT ( X1, Y1, 2 )
102 FORMAL (1,0,1) X1 = XTEST = *F10.01
11 X1 = X1 + XINC * K
12 CONTINUE
11 CONTINUE
C NUMBER THE CONDUCTANCE CIRCLES
XN(K) = 2./((1.-R(K)))
XN(K) = X1 * XN - (X1 * XN(K) * 0.00 )
TH = 0.0
CALL NUMBER ( XN(K) , Y1 , Y * 0.02 , R(K) , TH , 4HF4.1 )
10 CONTINUE
C GENERATE SUSCEPTANCE CIRCLES
C DRAW NORMAL AXES
CALL PLBT(XC=XM, YC=3)
CALL PLBT(XC=XM, YC=3)
K=1
DO 20, K=1,8
K=1
YINC = 2. * R(K) / ((1.-R(K)) * 2) * XN
J=0
C * THE FOLLOWING ROUTINE ALLOWS THE SUSCEPTANCE CIRCLES TO BE
C * TERMINATED AT THE SELECTED CONDUCTANCE CIRCLES.
C * R(K) = THE VALUE OF THE SELECTED CONDUCTANCE CIRCLES AT WHICH
C * THE SUSCEPTANCE CIRCLES TERMINATE. (CHANGE TO SUIT).
C * SELECT THE DESIRED ELEMENTARY CIRCLES.
I1 (K, EC, 1, AND, K, LT, 4) EK = 2.0
I1 (K, EC, 4) GK = 5.0
I1 (K, EC, 5, AND, K, LT, 8) GK = 10.0

```

```

C * LEIFERLINE AND INTERSECTION POINTS FOR PRESUPERTENING
C * CONDUCTANCE CIRCLES;
TESTY = 2.0 + 0.0K / ((1.0+0.0K) + (0.0K) * R(K))
C * COMPUTE FROM POSITIVE AND NEGATIVE CIRCLES
DO 21, J=1,2
CALL PLBT(XC=XM, YC=3)
K=K+(-1)
Y1=Y1+0.0K
BL = R1/R(K)
JL = 0
I=0
DO 22, I=1, N1
AUGRAB(S(Y1, 2, *R1-C))
R1 = -SORT(AUG)
C LEIFERLINE BETWEEN INTERSECTION POINTS
YTEST = 2.0 / (1.0 + R1 * R1)
23 X1 = X1 + X1 * XC
Y1 = Y1 + X1 * YC
C * * * * *
I1 (K, EC, 1) GO TO 24
Y1 = AHS (Y1)
I1 (Y1, GT, YTEST) GO TO 24
C 41 PHINT 100, YTEST, YTEST
110 FORMAL (1,0,5) XTESTY = *F10.0, 5 * YTEST = *F10.01
27 CALL PLBT ( X1, Y1, 3 )
GO TO 28
C DRAW THE SUSCEPTANCE CIRCLES
29 CALL PLBT (X1, Y1, 2)
C USE THE FURTHEST POINT TO LOCATE NUMBERS
20 I1 (K, EC, AN) GO TO 25
Y1 = Y1 + YINC * K
22 CONTINUE
C NUMBER THE SUSCEPTANCE CIRCLES
23 X1 = X1 * XN
C * * * * *
C * THE NEXT TWO IF STATEMENTS ALLOW A CHART UP TO 5 INCHES RADIUS
C * TO BE PLOTTED.
I1 ( X1, GT, 4. ) GO TO 24
GO TO 26
24 IF (X1, EQ, 0.0) GO TO 21
25 Y1 = Y1 * XN
C = SORT ( X1 **2 + Y1**2 )
F = 0.03
G = 0.50
C THETA = ANGLE OF NUMBERS IN RADIAN'S
THETA = ATAN2(Y1, X1)
C * R = RADIUS OF CIRCLE FROM WHICH NUMBERING STARTS
TH = PI * (0.0F)
I1 (X1, LT, 0.0) TH = 0.0
E1 TH = TH * G
TH = TH * (-1.0)
THETA = THETA * PI
26 X1 = TH * COS(THETA)
Y1 = TH * SIN(THETA)
27 DEG = ANGLE IN DEGREES
28 DEG = THETA * 57.2957795131
C X1, Y1 = X, Y COORDINATES OF NUMBERS
X1C = X1 * XC
Y1C = Y1 * YC
29 CALL NUMBER ( X1C , Y1C , N * 0.02 , R(K) , DEG , 4HF4.1 )
21 CONTINUE
26 CONTINUE
CALL PLBT(XC=XM, YC=3)
X1 = X1 * 0.05
TH = 0.0
C1 = X1
D1 = X1
C * GENERATE 10 DEGREE TICK MARKS
THINC = PI / 10.0
M=0
DO 50, M=1, 72
LX1 = 0.1 * COS ( TH ) * XC
Y11 = 0.1 * SIN ( TH ) * YC
LX2 = 0.2 * COS ( TH ) * XC
Y12 = 0.2 * SIN ( TH ) * YC
CALL PLBT ( LX1, Y11, 3 )
CALL PLBT ( LX2, Y12, 3 )
TH = TH + THINC
50 CONTINUE
C * * * * *
C * IF MSELX EQUALS ZERO - GAIN CIRCLES ARE DRAWN ON THE SWITH CHART
C * IF MSELX OTHER THAN ZERO - ADMITTANCE, IMPEDANCE OR REFLECTION
C * COEFFICIENTS ARE PLOTTED.
21 I1 (MSELX) = 0.0
20 CALL ADMPLOT (M1, M2, J1, L1, K1, K2, J2, MSELX)
GO TO 29
23 CALL IMPEL ( N1, M1, J1, L1, K1, K2, J2, MSELX )
100 FORMAL (1,0,5) X1 = *F10.01
101 FORMAL (1,0,5) X1 = *F10.01
50 END

```

Plotting routines

```

SUBROUTINE ADMPLOT ( N1, M1, J1, L1, K1, K2, J2, MSELX )
C N1 = NUMBER OF DATA POINTS
C ZC = CHARACTERISTIC IMPEDANCE
C LAC = CHARACTERISTIC ADMITTANCE
C -P = NUMBER FOR SYMBOL TO BE PLOTTED
C ZN = NORMALIZED IMPEDANCE OR ADMITTANCE
C Z7A = REFLECTION COEFFICIENT
DIMENSION AMPED ( 21 ), ADMT ( 21 ), REF ( 21 ), DATPLT ( 50 )
COMMON /BRC/ XC, YC, XM, SY
COMMON /ADMP/ AMPED, ADMT, REF, ZC
TYPE COMPLEX AMPED, ADMT, REF, ZN, Z7A, DATPLT
C * * * * *
I = 1
K = 1
DLR = 1.02 * X1
I1 ( NAD ) 1, 2, 3
1 WRITE (6,190) NF, JP, CAP
DO 21, I = 1, N1
21 DATPLT ( I ) = ADMT ( I )
CNR = CAP = 1.0 / ZC
WRITE (6,191)

```

```

CALL SYMBOL (DLB, 1.2, 0, 140, 15, ADMITTANCE PLBT, 0, 0, 19)
GO TO 4
2 WRITE (6,180) NF, JP, ZC
DO 20, I = 1, N1
20 DATPLT ( I ) = AMPED ( I )
CNR = ZC
WRITE (6,181)
CALL SYMBOL (DLB, 0.9, 0, 140, 14, IMPEDANCE PLBT, 0, 0, 14)
GO TO 4
2 WRITE (6,185) NF, JP
WRITE (6,196)
CALL SYMBOL (DLB, 0.6, 0, 140, 23, REFLECTION COEFFICIENT, 0, 0, 23)
DO 10, I = 1, N1
I1 ( NAD ) 0, 6, 7
ZN = DATPLT ( I ) / CNR
Z7A = ( 1.0 - ZN ) / ( 1.0 + ZN )
GO TO 8
7 Z7A = REF ( I )
8 YNR = REAL ( Z7A )
9 YNR = A ( MAG ( Z7A ) )

```

(continued on next page)

```

XCR = -1.0*XR*YMAXC
YCI = -1.0*YR*YMAXC
C * * * * *
AMXD = SQRT (XRR*XR+YRR*YR)
AND = ACOS (XR/AMXD)
IF (YMR.LT.0.0)ANG = 0.2831953072*ANG
CALL SYMBL(XCR,YCI,0.08,JP,0.0,-1)
IF (NAD.LE.N) GO TO 5
WRITE (6,197) ZZN,AMXD,ANG
GO TO 10
WRITE (6,198) ZN,ZZN,AMXD,ANG
10 CONTINUE
CALL PLOT (XC,YC,3)
180 FORMAT(1M0,2X=NUMBER OF DATA POINTS = 015,/,3X=NUMBER OF THE SYMBL
1 FOR PLBT = 012,/,3X=CHARACTERISTIC IMPEDANCE = 0F7.3//)
181 FORMAT (7X=NORMALIZED IMPEDANCE REFLECTION COEFFICIENT REF
*LECTION COEFFICIENT=//,2(X=REAL*0X*IMAG*),12X=MODULUS*7X=PHASE=//)
190 FORMAT(1M0,2X=NUMBER OF DATA POINTS = 015,/,3X=NUMBER OF THE SYMBL
1L FOR PLBT = 012,/,3X=CHARACTERISTIC ADMITTANCE = 0F7.3//)
191 FORMAT (7X=NORMALIZED ADMITTANCE REFLECTION COEFFICIENT REF
*LECTION COEFFICIENT=//,2(X=REAL*0X*IMAG*),12X=MODULUS*7X=PHASE=//)
192 FORMAT(2(2X,CIF,2.5,F12.5))
193 FORMAT (1M0,2X=NUMBER OF DATA POINTS = 015,/,3X=NUMBER OF THE SYM
*BL FOR PLBT = 012,//)
194 FORMAT (5X=REFLECTION COEFFICIENT MODULUS REFLECTION COEFFICIENT=//,
17X= REAL IMAG MODULUS PHASE =// )
197 FORMAT (2X,CIF,2.5,F12.5),2(2X,F12.5))
198 FORMAT (2(2X,CIF,2.5,F12.5),2(2X,F12.5))
199 FORMAT (75X,2(2X,F12.5))
RETURN
END

```

```

SUBROUTINE IMPED ( NIM,NF,JZ,LN,ML,KZ,JFR,MXX )
DIMENSION GAMMA(20),XCR(20),YCI(20)
DIMENSION ZZ(120),ZP(20)
COMMON /GCRC/ S11 (55,10),S22(55,10),ZINBUT(55,10),ZOUTIN(55,10)
COMMON /BND/ XC,YC,XM,XY
COMPLEX ZINBUT,ZOUTIN,GAMMA
COMPLEX S11,S22
C * * * * *
WRITE (6,121) N7
ZC=50.0
N = NIM
NF = 14
DLR = 1.92 * XM
DB 10 1=1,N
DB 10 1=1,NF
IF (KZ) 1,2,3,0
1 Z = ZINBUT(J,I)
WRITE (6,195) Z
CALL SYMBL (DLB,0.0, 0.149, 11,INPUT DATA , 0.0 , 11)
GO TO 3
C * * * * *
2 Z = ZOUTIN(J,I)
WRITE (6,196) Z
CALL SYMBL (DLB,0.0, 0.149, 12,OUTPUT DATA , 0.0 , 12 )
3 GAMMA(J) = (Z-ZC) / (Z+ZC)
PRINT 2(4,GAMMA (J)
XCR(J) = REAL (GAMMA(J))*XM*YC
YCI(J) = IMAG (GAMMA(J))*XM*YC
PRINT 14,XCR(J),YCI(J)
IF (J.GT.11) GO TO 21
4 DIFFERENT SYMBOL IS USED FOR THE FIRST POINT OF EACH PLOT.
CALL SYMBL (XCR(J),YCI(J),0.04, JZ+1.0,0,-1)
GO TO 10
21 CALL SYMBL (XCR(J),YCI(J), 0.08,JZ, 0.0 -1)
10 CONTINUE
30 CONTINUE
12 FORMAT (////,7X=KZ = 013,////)
14 FORMAT (1M0,7X=XCN = 0F10.5,5X=YCI = 0F10.5)
16 FORMAT(2(2X,CIF,2.5,F12.5,9))
195 FORMAT (1M0,5X=ZINBUT = 0C(F10.5,F14.5))
196 FORMAT (1M0,5X=ZOUTIN) = 0C(F12.5,F14.5))
24 FORMAT (1M0,3X=GAMMA (J) = 0C(F10.5,F12.5))
CALL PLOT (XC,YC,3)
CALL GAINCR ( NIP, NF, JZ, LN, ML, KZV, JFR, MXX )
END

```

```

SUBROUTINE GAINCR ( NIM,NF,JZ,MN,ML,KZV,JFR,MXX )
DIMENSION Z(51(20),G1(10),PHI1(20)
DIMENSION Z2 (55,10)
DIMENSION GMAX (20)
COMPLEX SS (20)
COMMON /ZGLI/ ZGEN,ZLU
COMMON /GCRC/ S11 (55,10),S22(55,10),ZINBUT(55,10),ZOUTIN(55,10)
COMMON /BND/ XC,YC,XM,XY
COMPLEX S11,S22
COMPLEX ZGEN,ZLU
COMPLEX Z2,ZINBUT,ZOUTIN,CJS1,GAMMA
C * * * * *
DATA ((G1(K),K=1,5)=1,0,0,-1.0,-4.0,-6.0)
ZC=50.0
J = NIM
PI = 3.141592653589
J = JFR
WRITE (6,101) MN,JZ
IF (MN)1,2,99
C FIND CONJUGATE FOR DETERMINING LINE OF CENTERS
1 CJS1(J) = CONJG (S11(J,I))
SS (J) = S11(J,I)
XS1 = REAL (CJS1(J))
YS1 = IMAG(CJS1(J))
C DETERMINE ANGLE OF LINE OF CENTERS
PHI1(J) = ATAN2 (YS1,XS1)
IF ( XS1.EQ.0.0.AND.YS1.NE.0.0 ) PHI1(J) = PI / 2.0
XGM1 = XS1 * XM * YC
YGM1 = YS1 * XM * YC
CALL SYMBL ( XGM1, YGM1, 0.04 , 5 , 0.0 , -1)
GO TO 3
2 CJS1(J) = CONJG (S22(J,I))
SS (J) = S22(J,I)
XS2 = REAL (CJS1(J))
YS2 = IMAG(CJS1(J))
PHI1(J) = ATAN2 (YS2,XS2)
IF ( XS2.EQ.0.0.AND.YS2.NE.0.0 ) PHI1(J) = PI / 2.0
XGM2 = XS2 * XM * YC
YGM2 = YS2 * XM * YC
CALL SYMBL ( XGM2, YGM2, 0.04 , 7 , 0.0 , -1)
GO TO 4
3 Z2 (J) = ZINBUT (J,I)
CJS = CABS (S11(J,I))
GO TO 7
4 Z2 (J) = ZOUTIN (J,I)
CJS = CABS (S22(J,I))
C COMPUTE REFLECTION COEFFICIENTS
5 GAMMA = (Z2(J) - ZC) / (Z2(J) + ZC)
AM1 = CABS (GAMMA)
ASW1 = ASIN(AM1)
DS1 = (1.0 - ASR1)
IF (MN) 6,7,99
6 PH0 = CABS ((1.0-(G4*MA*S11(J,I))) / (1.0-(GAMMA*S11(J,I))))
7 PH1 = CABS ((1.0-(G4*MA*S22(J,I))) / (1.0-(GAMMA*S22(J,I))))
CJS = CJS * CJS
GMAX (J) = 1.0 - (SS(J) + SS(J))
C CALCULATE CAPITAL G
CALG1 = LFSQ / PH1
DC2S = 1.0 - C2S
WRITE (6,48) DC2S
IF (DBZ.LT.0.0) GO TO 21
GO TO 15
21 WHITE (6,54)
C LIFT PEN BETWEEN CIRCLES.
15 CALL PLOT ( XC, YC, 3)
C PRINT ANGLE OF CENTERS WITH HORIZONTAL AXIS.
WRITE (6,52) PHI1(J)
C DRAW REQUIRED NUMBER OF GAIN CIRCLES.
DB 10 * 41.5
C CENTER ON TO POWER RATIO
PH = 10.0*(G1(K) / 10.0)
C CALCULATE SMALL G1
SMG = PH * DC2S
WRITE (6,49) SMG,PH
PH00 = C2S*(1.0 - PH)
C FIND DISTANCE TO CENTER OF CIRCLES
R01 = SMG/CSS / (1.0-PH00)
DS0 = 1.0*SMG
WRITE (6,41) USQ
C FIND RADIUS OF EACH CIRCLE
R01 = (SQRT(LSQ))+(1.0-C2S) / (1.0-PH00)
WRITE (6,42) R01,R01
C FIND X,Y COORDINATES OF THE CENTER
XCP = R01 * COS(PHI1(J))
YCP = R01 * SIN(PHI1(J))
C PRINT 31,XCP,YCP
IF ( PH1.GT.1.0,PH.NE1.GT.1.0) GO TO 20
17 XCP = XCP * XM * YC
YCP = YCP * XM * YC
C THETA = ANGLE FOR GENERATING GAIN CIRCLES.
THETA = 0.00
C GAIN CIRCLES ARE PLOTTED BY FOLLOWING DB LOGP
DB 20 * = 1,73
XAC = R01 * COS (THETA)
YAC = R01 * SIN (THETA)
RXY = R01 * PH
RXY = YAC * PH
XGC = XAC + YSC
YGC = RXY + YSC
C THIC = INCREMENT USED IN DRAW CIRCLES.
THIC = PI / 36.00
THETA = THETA + THIC
C DRAW SPECIFIED GAIN CIRCLES.
C * * * * *
IF (N.EQ.1) 0,11
11 CALL SYMBL ( XGC,YGC, 0.04, 14 , 0.0 , 11 )
GO TO 20
12 CALL SYMBL ( XGC,YGC, 0.04, 14 , 0.0 , -2 )
10 CONTINUE
46 FORMAT (////,2X,5M0 = 0F12.5,5X=PH = 0F12.5,////)
41 FORMAT (1M0,5X=DS0 = 0C(F10.5,F12.5))
42 FORMAT (1M0,5X=R01 = 0F10.5,5X=PH1 = 0F10.5)
44 FORMAT (1M0,20X=DC2S = 0F14.5,/)
52 FORMAT (1M0,15X=PH1 = 0F10.5)
54 FORMAT (////,3 NEGATIVE ARGUMENT FOR SQRT HAS DEVELOPED,////)
161 FORMAT (1M0,3X=CAPITAL NUMBER MN = 013,9X=NUMBER OF SYMBL FOR PL
-01 JZ = 013,////)
CALL PLOT ( XC, YC, 3)
RETURN
END

```

If you've been looking for a miniature crystal-controlled clock oscillator in a 14 pin DIP package to fit standard PC board sockets, stop looking and start ordering. Get details on model K1091A from Motorola Component Products Dept. 2553 No. Edgington Franklin Park, Ill. 60131



MOTOROLA

INFORMATION RETRIEVAL NUMBER 77

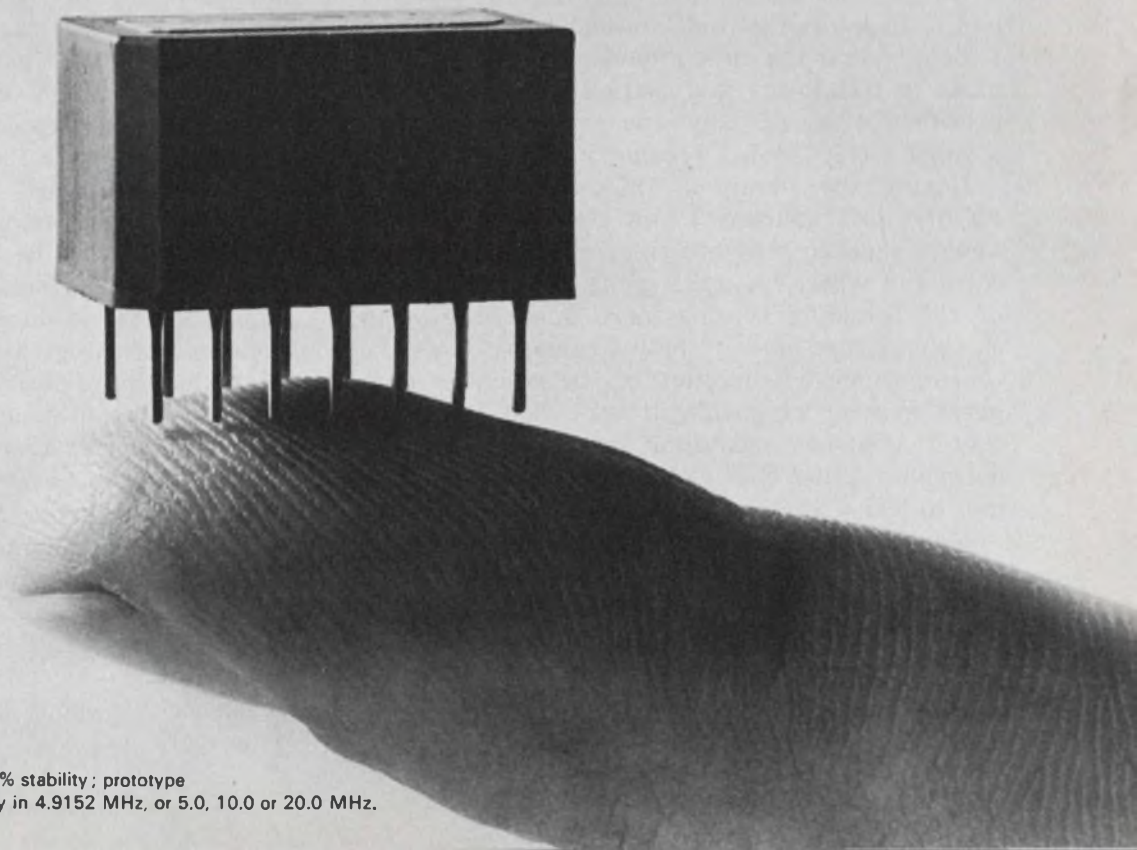

Specifications: 4 to 20 MHz range; 0.01% stability; prototype quantities available for immediate delivery in 4.9152 MHz, or 5.0, 10.0 or 20.0 MHz.

'Born' managers don't exist! You have to learn the skills, this president says, and force your subordinates to make their own decisions.

Natural-born managers are usually related to the chairman of the board. All others have to work at it because managing isn't really "doin' what comes naturally."

The ad-lib manager solves an endless progression of problems and reacts to situations as they occur. But the trained manager identifies opportunities and puts his best people to work on them, even if some of the problems don't get solved. A wise man once said that profits come from responding to opportunities, not from solving problems.

Necessity—the mother of management

Many people still think that management is an intuitive skill that you're born with. Don't believe it. You have to study management, just like any of the engineering subjects. Through books, schools and training, you have to acquire the fundamental management tools that are constant, and then practice with them for several years before you're really good at managing.

But I must admit that early in my career I had a disdainful attitude toward administrators. I thought that the most important decisions were made in technology and marketing and that the president of a company was nothing more than a super clerk. Then I became a president.

During the slump of 1970, Analog suffered its first loss quarter. I saw our stocks plunge, and it shocked me into figuring out where we were and where we were going. The weaknesses of the company became more apparent during the slump, and one of these weaknesses was the coordination and direction of the activities of a great number of people. It was then I realized that I could no longer limit myself to marketing decisions; I also had to lead the company. I began to learn what management was all about.

Many leaders of electronics companies who rose from a technical background have never given up the idea that the technical part of the

business is the only part that really counts. They should know that learning the skills to become a manager is a very important part of their job. But what usually happens is that when a company needs a manager, it places a technical man in the spot in hopes that he'll become a good manager through trial and error.

Developing your subordinates

What is the job of a manager?

First, he must get results in his area of responsibility. But, equally important, he must develop his people so they ultimately become as good as—and hopefully even better than—he is. The management of people can probably be broken down into these broad areas of responsibility:

- Develop subordinates' judgment.
- Share the project objective with subordinates.
- Use the ideas that subordinates support.

If you receive a promotion this usually means you're more competent technically than those now reporting to you. The natural thing to do therefore is to tell your subordinates what to do and how to do it. That is what most managers do, one way or the other. One approach is to manipulate your people into accepting your view as their own to get the job done.

In some situations—usually crisis situations—the only sensible management approach is authoritarian: that is, based on your superior knowledge and experience, you tell your subordinates what to do and how to do it and then monitor their progress toward the results you're after. But this is successful only as a short-term expedient, because subordinates don't grow in this environment; they merely become a mirror image of the manager's experience.

It takes a long time to develop people, and the hardest and most important part is to develop judgment. Judgment is developed through the experience of making decisions, in suffering the anguish of weighing alternatives, in feeling the remorse of making mistakes and in building the confidence that comes from making decisions and being right.

Ray Stata, President, Analog Devices, Norwood, Mass. 02062.



Ray Stata

Education: BSEE and MSEE, MIT

Experience: Design engineer; sales engineer; vice president, marketing; president, co-founder of Solid State Instruments Corp., and Analog Devices, Inc.

Personal: Married, two children. Hobbies and interests: tennis, watching the Boston Bruins, music, dancing and high performance cars.

Employer: Analog Devices, Inc., was founded in Cambridge, Mass., in 1965, originally to produce operational amplifiers. The definition of Analog Devices' business has since broadened to include a wide range of analog components, devices, and subsystems. These products include d/a and a/d converters, instrumentation amplifiers, multipliers, linear integrated cir-

cuits, digital panel meters, modular instruments and data communication modules. Sales have risen from \$500,000 in 1965 to an estimated \$20,000,000 in 1973.

Analog Devices' growth plans call for continued expansion of more than 25 percent per year. The main plant is located in a 100,000 square foot facility in Norwood, Mass. Analog Devices designs and manufactures its own linear ICs at its microcircuits operation in Wilmington, Mass. CMOS ICs and dual transistors are designed and produced at the microcircuits facility in Santa Clara, California. Thin film resistor networks and hybrids are manufactured at the Resistor Products Division in Rochester, New York. Worldwide, Analog Devices employs about 800 people.

In the short term, there is conflict between the manager's responsibility for getting results and his responsibility for developing his people. To develop people, he must let them make mistakes, and this can cost time and money. The trick is for you, as a manager, to identify those areas that are critical to the success of your job and your company and to make sure that the decisions in these areas are as correct as you know how to make them.

In all other areas, force your subordinates to make their own decisions and be willing to live with a few more mistakes than perhaps you would have made yourself. I'm not saying that you shouldn't coach your subordinates on the alternatives. Just don't make the decisions for them, implicit or otherwise.

This is an extremely difficult discipline and one that not everyone can learn. When you're good, you know the right answers, and it takes practice to guide someone who doesn't. You must constantly balance your impulse to get the job done in the best way against your responsibility to develop your subordinates.

Of course, if subordinates are going to think on their own and make decisions, they must know what the game is all about. As a manager, you must have clear objectives and goals for your area of responsibility, hopefully both long-term and short-term, and you must be able to communicate your objectives and how they relate to the objectives and success of your company.

Now you are beginning to manage—to point the direction that you and your group are trying to go; to indicate when you must get there; to clarify a standard of performance that is acceptable, and to define the resources and the constraints you have to work with. But how many managers really do this? It's a lot easier to go along handing out assignments day by day as problems arise than it is to plan ahead and let everyone in on the plan.

Motivation is crucial

Another aspect of management responsibility is motivation. I am convinced that most people work at a fraction of their capacity because they are not properly motivated. A manager can enforce discipline in getting people to carry out his ideas, but he can't enforce motivation.

There is overwhelming evidence that people work very enthusiastically to implement their own ideas but that it is extremely difficult to get good people excited about your ideas. Have you ever considered that it might be better to live with a second-class idea that has the support of those who must implement it, than with a first-class idea (yours, of course) that only you

believe in? Ideas need a life-support.

The problem of motivation is shaping up as one of the biggest that managers must face today. Young people in our affluent, mobile society don't need the money or a job, particularly when they're talented. They want to do their own thing; they want their piece of the action, and the manager had better listen to them. They don't care how smart the manager is or how much experience he's had. They want to contribute and they want to work—but on something that has a little bit of them in it. How you, as the manager, handle your people determines how they're motivated and what results they will get for you and your company. As the English author Thomas Fuller once said: "Let not thy will roar when thy power can but whisper."

Overcoming employee resistance

Recently a corporate decision helped our managers develop judgment in their subordinates, share our objectives with them and use their ideas. We had an objective of improving the methods by which our factory was scheduled and by which our inventories were controlled. We thought we needed consultants who could give us expert opinions. So consultants suggested to line managers how they could change their behavior and their approach to running the factory. This met with enormous resistance, and the whole program—the consultant firm and I—became very unpopular.

Eventually we realized that that approach wasn't getting us anywhere. So we took a suggestion from one of the individuals in the factory. He said that we should educate the people in the company in the principles of a properly managed factory and a properly controlled inventory. This would give them the knowledge they could apply to the problems we were having. It has been very successful. The factory is operating on schedule, and our inventory has been controlled.

The most important decision you make as an engineer is whether or not you really want to become a manager. Technical companies like ours are highly dependent on the technical knowledge and skill of their professional people. Since an increasing number of companies are offering to technical contributors the recognition and reward that formerly prevailed only in management ranks, don't feel that you must become a manager to be successful.

But if you do decide to accept management responsibility and to progress in that role, get the tools you need to do the job. Don't try to substitute your technical knowledge in areas where management knowledge is required. ■■

DIGITEC'S NEW DATA LOGGERS



HAVE ALL THIS **VERSATILITY**

- Models to measure Voltage, Current, Resistance, Temperature & other transduced parameters.
- 20 selectable scan points standard, expandable to 200.
- Real-time digital clock with program interval for unattended operation, standard.
- Digital printout arranged for quick, easy reading.
- BCD and system interlocks brought out to interface peripherals such as: comparators, tape punch, and mini-computer.
- Loss of power indication.
- All LED long-life displays.

WITH PRICES **UNDER \$1900**

To see the DigiTec 1200 or 1500 series Data Loggers, simply contact your DigiTec representative. Or, you can call or write: **United Systems Corporation**, 918 Woodley Rd., Dayton, Ohio 45403 Phone (513) 254-6251.

All DigiTec instruments are available for rental or lease through Rental Electronics, Inc.

DIGITEC
UNITED SYSTEMS CORPORATION
subsidiary of **Monsanto**

A MINI-LIBRARY OF SEMICONDUCTOR GUIDES FROM HAYDEN...

THICK FILM TECHNOLOGY

By Jeremy Agnew

This volume constitutes an actual working guide to hybrid circuit manufacture and packaging. It begins with an overview of the processes and equipment used, compares them, and underscores the advantages of each. The book details each processing phase, fully describing what to do and what pitfalls to avoid. Other valuable sections cover packaging schemes and processing hazards and cautions. The volume's abundance of practical advice and data make it ideal as an on-the-job reference. **176 pages, 6 x 9, illus., #5803-9, \$8.50**

TRANSISTOR AND DIODE NETWORK PROBLEMS AND SOLUTIONS

By Harry E. Stockman

This guide demonstrates the latest mathematical solutions for the entire field of transistor and tunnel diode calculations, including linear as well as non-linear applications. It shows how to select the best type of solution, set up the network equations, and carry out the solutions. It also uses new theories — including the author's "Equivalent Generator Theorem" — in the treatment of function sources. In addition, a valuable "do" or "don't" list enables you to avoid any time-wasting calculations. **352 pages, 6 x 9, illus., #5694-x, cloth, \$9.95**

TRANSISTOR AND DIODE LABORATORY COURSE

By Harry E. Stockman

A practical, self-learning course that progresses systematically from simple fundamentals to highly intricate experiments. The experiments in the first half of the course lay a working foundation in transistor technology with twoport-theory viewpoints applied continuously to give all the experiments a practical engineering slant. One valuable feature is the negative resistance demonstration — the first presentation of this device ever to appear in print. All experiments can be performed on very low-cost equipment. **128 pages, 7 3/8 x 10 1/8, illus., paper, #5671-0, \$3.95**

MATERIALS FOR SEMICONDUCTOR FUNCTIONS

By E. G. Bylander

This comprehensive reference enables you to select semiconductor materials aimed at optimum performance, reliability, and profitability. It provides complete selection criteria for a variety of functional applications: diodes and transistors, solar cells, thermoelectric devices, transducers, etc. The guide also covers material processing techniques and device design and manufacturing, listing variables in material manufacturing that influence device performance. **220 pages, 6 x 9, illus., #5638-9, cloth, \$13.50**

FUNDAMENTALS OF INTEGRATED CIRCUITS

By Lothar Stern

Here is a book offering complete coverage of the various techniques of IC fabrication and their importance to circuit performance. Included is a valuable marketing discussion comparing the relative qualities of the IC's currently available in terms of economics and logistics. The guide focuses on basic semiconductor principles, monolithic integrated circuits, thin-film circuits, and hybrid and other integrated structures. Here too is a discussion of packaging, design, and layout principles, and large-scale integration. **208 pages, 7 x 10, illus., #5695-8, cloth, \$8.95**

DURABILITY AND RELIABILITY IN ENGINEERING DESIGN

By Gilbert Kivenson

A unique combination of materials science, reliability, and design, this book examines crucial concepts of material strength, service longevity, and reliability, and describes the fundamentals of breakdown analysis. It covers new materials, design techniques, and fabricating methods and focuses on their probable uses in future products. Current trends in design "philosophies" are outlined, as well as practical design considerations relating to the requirements of the end user. **200 pages, 6 x 9, illus., #5851-9, cloth, \$9.95**

15-DAY FREE EXAMINATION

Please send me the book(s) circled below on 15-day free examination. At the end of that time, I will remit payment, plus postage, or return the book(s) with no further obligation.

5803-9 5671-0 5695-8
5694-x 5638-9 5851-9

Save Money!

Payment enclosed. Publisher will pay all shipping and handling charges — same 15-day guarantee.

Name _____

Firm _____

Address _____

City/State _____ Zip _____

\$10.00 minimum for free exam orders. Because of higher billing and collection costs, we must ask for payment in full with any order for less than \$10.00. Same 15-day guarantee.



HAYDEN BOOK COMPANY, INC., 50 Essex Street, Rochelle Park, N.J. 07662

73-64

ANNOUNCING A SMALL SURPRISE.

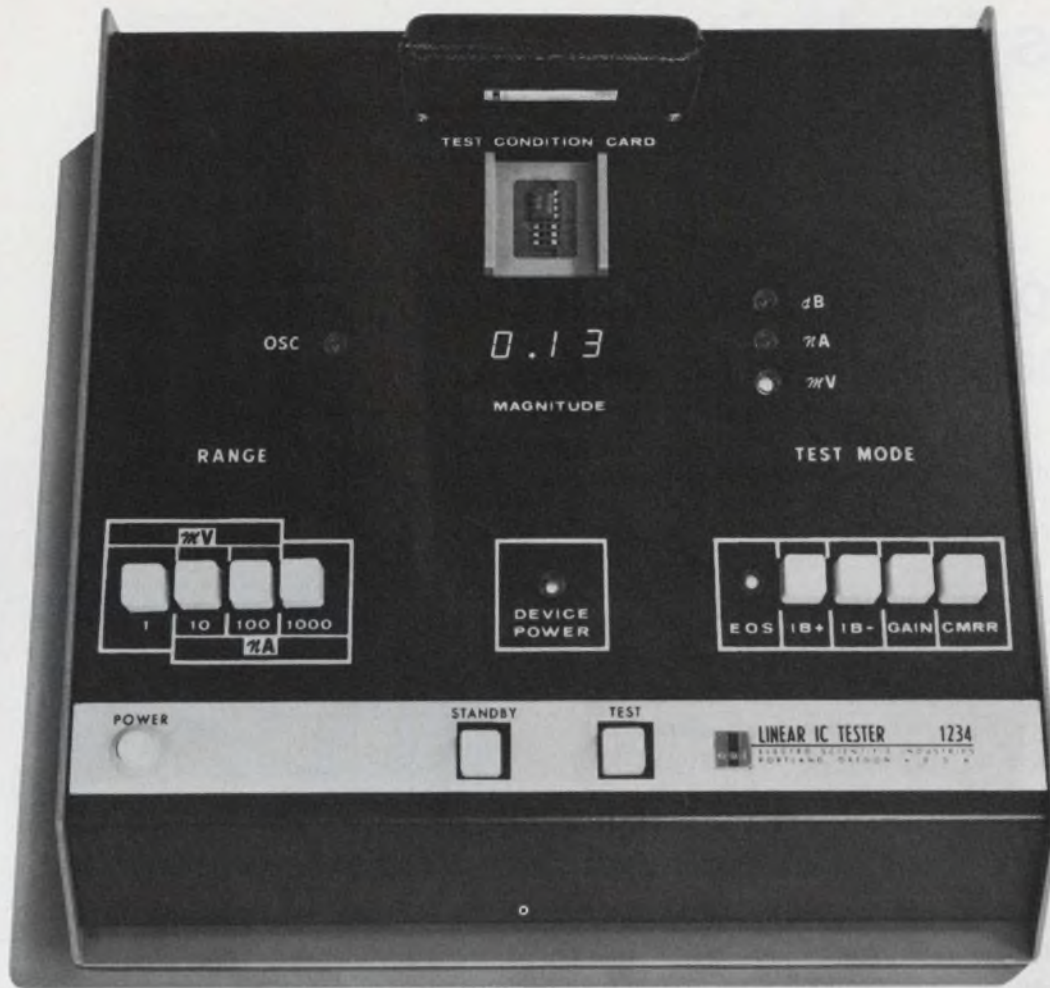

A NEW BENCH TOP IC OP AMP TESTER FOR UNDER \$700 THAT MAKES THE SIX CRITICAL TESTS AT THE TOUCH OF A BUTTON.

All you really need to know about our new Model 1234 IC Op Amp Tester is the following:

1. It tests virtually all IC op amps, monolithic and hybrid.
2. It costs under \$700 but it performs the six most important tests accomplished by earlier testers costing thousands.

Here are the test results the 1234 puts up on its direct reading digital display (3 places):

- A. input offset voltage.
- B. bias current, inverting input.
- C. bias current, non-inverting input.
- D. dc open-loop gain.
- E. dc common-mode rejection ratio.

In addition each device under test is monitored full-time for unity gain oscillations, which will light an oscillation detector lamp.

The 1234 accepts the common package styles, DIP and TO-5, with or without plastic carriers. Test conditions for each op amp are established by a small plug-in pc board ("Test Condition Card"). Not only does the Model 1234 eliminate your incoming disasters, it allows you to sort your op amps and vendors by accurate test results for most efficient and least costly circuit design.

Measurement ranges are:
Offset voltage: 1, 10, and 100 millivolts full scale, minimum resolution 1 microvolt.
Bias currents: 10, 100, 1000 nanoamperes full scale, minimum resolution 10 picoamperes.
Common-mode rejection ratio and gain: 120 dB full scale, minimum resolution 1 dB.

Write for the complete information on this new tester, the companion instrument to our Model 1248 functional tester for digital ICs.



WESCON Booth No. 1721

Electro Scientific Industries
13900 NW Science Park Drive
Portland, Oregon 97229
Telephone: 503/646-4141
Telex: 36-0273

esi

Additional codes extend full-scale range of DAC

The range of a binary-coded-decimal d-to-a converter can be boosted 60% if you make it respond to additional codes. A few extra logic gates are required.

The gates modify the three most-significant bits of the DAC's most-significant decade. The input to the DAC is standard BCD until the hundreds bit of the source equals ONE. Instead of starting again from zero, the most-significant decade continues to increase by ONE until the hundreds decade of the source reaches 50. As shown in the figure, a two-decade DAC handles a maximum BCD input of 159. Similarly a three-decade DAC counts to 1599.

Full-scale accuracy with this technique remains the same as that of the basic DAC, but with a twist. For example, an eight-bit DAC with 0.5 LSB linearity and 10-V full-scale output has a maximum error of

$$\frac{10V}{100} \times \frac{1}{2} = 50 \text{ mV}$$

or 0.5%.

Since the logic forces the DAC to respond to additional codes but does not modify the error voltage, the resulting higher voltage ($10 \text{ V} \times 1.59 = 15.9 \text{ V}$) results in a maximum error of only 0.33% relative to the extended full-scale voltage. The schematic shows noninverting gates, but standard NAND and NOR gates or a four-bit full adder chip can be used to mechanize the logic equations. However, the output of the DAC must comply with the 60% overrange. For current output DACs, reduce the value of the terminating resistor to keep its compliance voltage within permissible limits.

Another alternative is to use an op-amp current-to-voltage converter. In the case of voltage-output DACs, be sure that the output capability and gain adjustments meet the 60% overrange requirement.

William D. Miller, Applications Engineer, Hybrid Systems Corp., 87 Second Ave., North-west Park, Burlington, Mass. 01803.

CHECK NO. 311

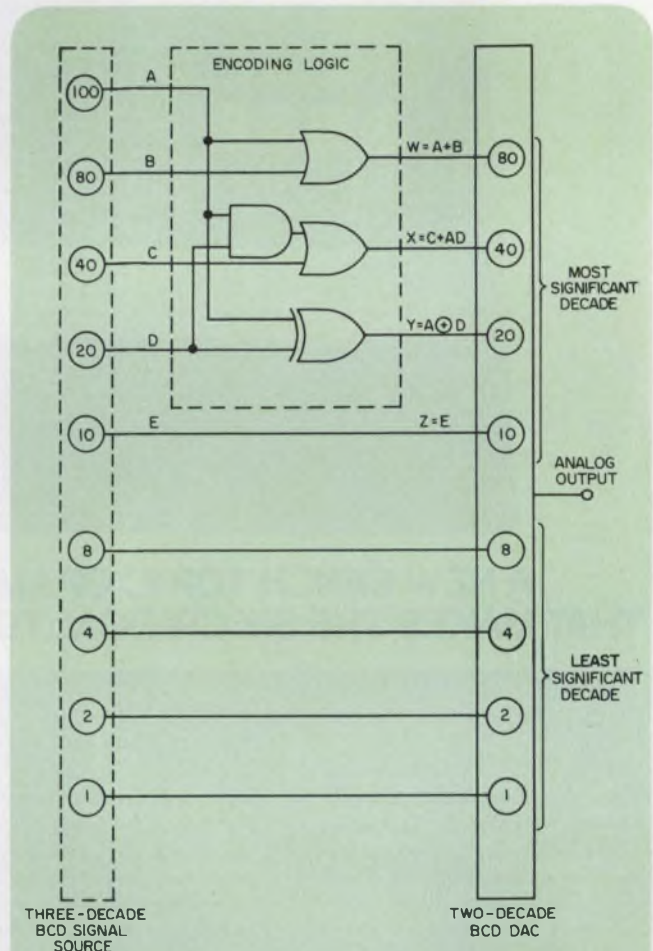

SIGNAL VALUE	W	X	Y	Z
90 - 99	1	0	0	1
100 - 109	1	0	1	0
110 - 119	1	0	1	1
120 - 129	1	1	0	0
130 - 139	1	1	0	1
140 - 149	1	1	1	0
150 - 159	1	1	1	1

Two-decade DAC provides 60% overrange capability, because all possible states of its most-significant digit are used. The encoding logic maps the BCD data, as shown.

Need an unusual cable? You've come to the right place!

**TIMES
WIRE & CABLE
PROTOTYPE
GROUP**

**PLEASE
DISTURB**

Most cable companies would just as soon duck small prototype jobs.

Not Times Wire & Cable.

Working with customers in the design and development phase is the best way we know to stay technically sharp and ahead of our competitors. That's what our special prototype group is all about.

Just tell us what you need. High strength or low strength? Extra stiffness or extra flexibility? High or low radiation? Short or long time delay? High or low loss? Water blocked or fluid transmitting?

We'll come up with a cable to fit the bill. We'll also recommend connectors . . . even do the assembly if you desire.

Camera cables, data transmission cables, underwater cables, down hole cables, tamper proof cables . . . we've produced them all. You may have a requirement we've already solved. We've solved quite a few.

Maybe the only thing that's unusual about your application is the length of the run. But that's not unusual for us. We're interested in orders as low as \$1,300.

If you've got an application coming up, call

Joe Lanoue, head of our Prototype Group (203) 265-2361. It won't cost you a cent for an application analysis.



TIMES
WIRE & CABLE CO.
Wallingford, Conn. 06492

High-speed shift registers use TTL RAMs and counters to do all the shifting

Many logic systems require high-speed serial storage of data, such as might be provided by bipolar shift registers. However, bipolar registers are limited in size, and many packages are needed if much data must be stored. MOS registers, while providing high density, require an extra power supply and are slow relative to bipolar devices. For high-speed serial storage, the best solution is often a random-access memory (RAM) accessed sequentially by counters, as illustrated in the schematic. This system looks like a quad 64-bit shift register.

The data storage occurs in four 16-word-by-four-bit RAMs. All four RAMs are connected in parallel (except for the chip select line, which goes to a four-bit ring counter), thus forming a

64-word-by-four-bit memory system. The 16-words in each RAM are accessed sequentially by a hexadecimal presetable counter. The counter is enabled by a four-bit ring counter, built with a four bit shift register. On each clock the ring counter shifts one place, thus selecting a different chip. After four shifts the counter increments to a new address. The combination of the two forms a mod-64 counter.

When the clock is LOW the write-enable line goes LOW and the information is written into the selected location. When the clock goes HIGH the counter increments, selecting the next address in the RAMs. The memories then go into the read mode. The RAM outputs are fed through a quad two-input multiplexer. In this way the multi-

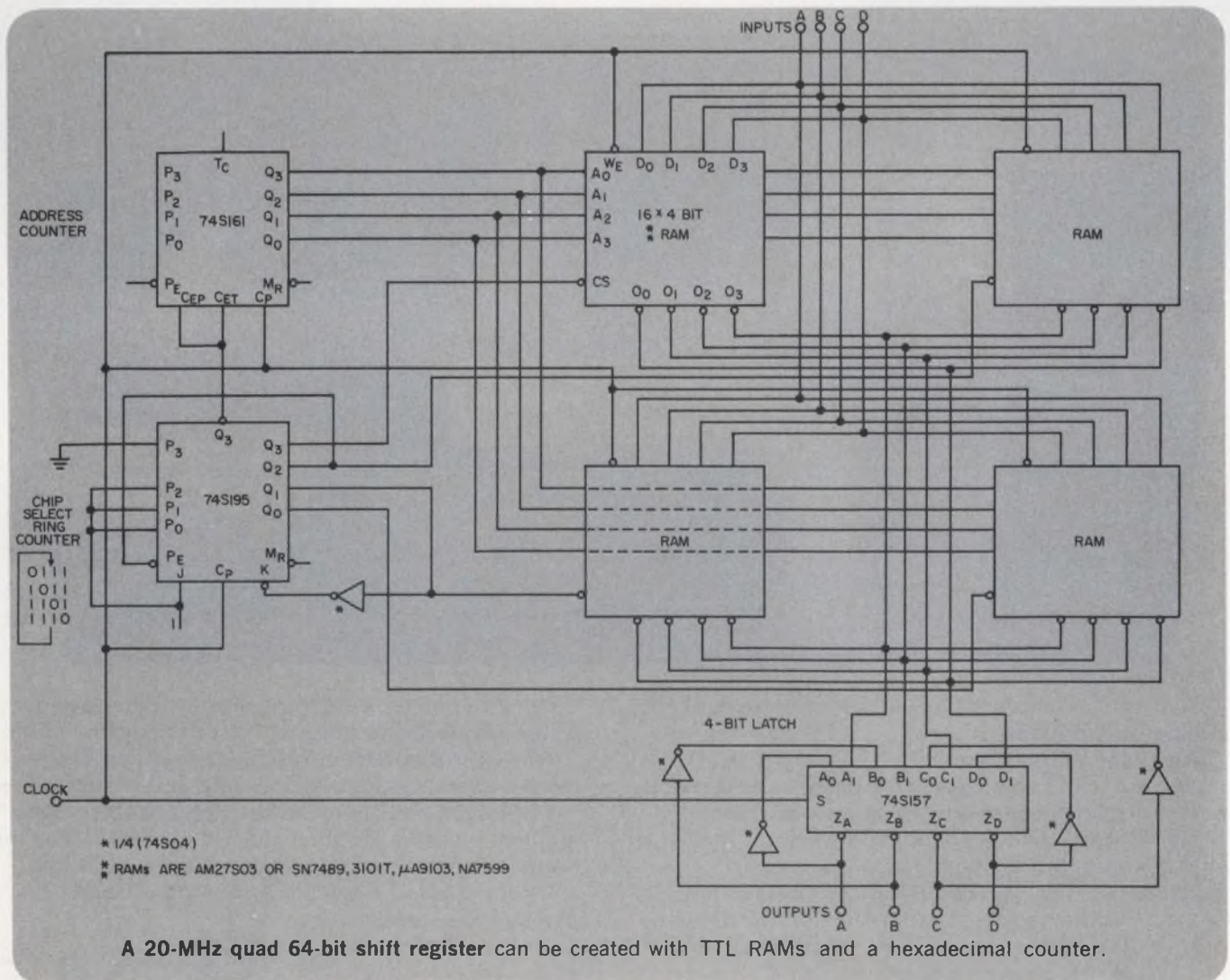

A 20-MHz quad 64-bit shift register can be created with TTL RAMs and a hexadecimal counter.

If you need
a tester
with **special**
scales, ranges,
accessories
or any
combination...

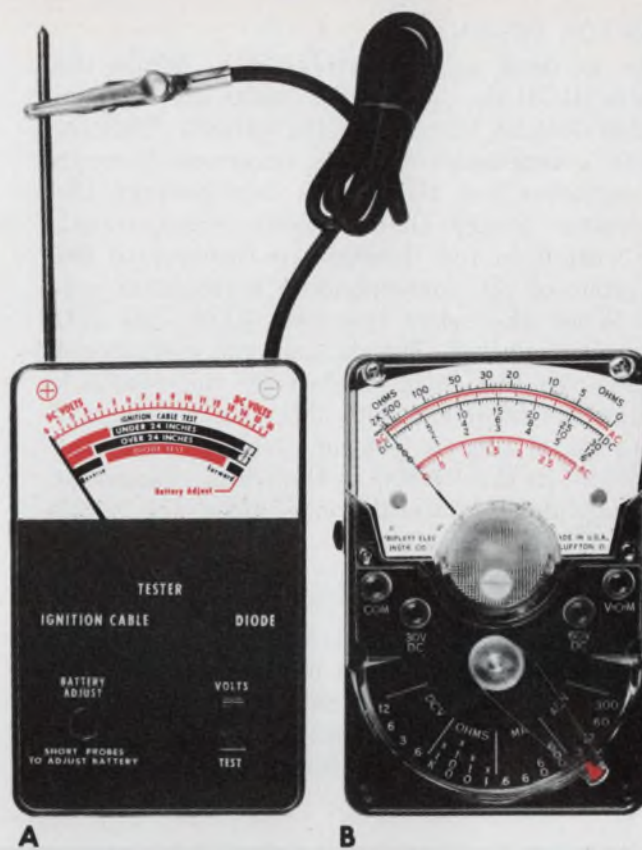

A

B

Buy a
Triplet tester
custom-designed
for you

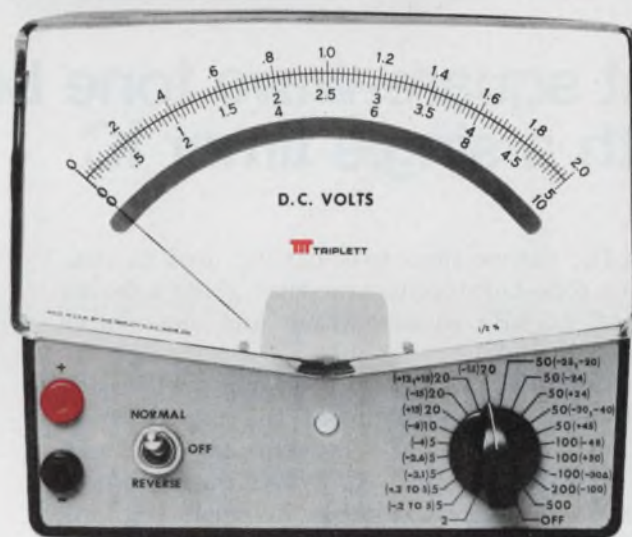

C

Triplet, manufacturer of the World's most complete line of V-O-M's, is ready, willing and able to design and manufacture special testers of virtually any size, style or type to meet your specifications.

Tester A (above) was designed to give auto mechanics a simple, rugged tester for "go/no go" tests that would otherwise be measured in electrical units unfamiliar to them.

Tester B is a modification of a

standard Triplet tester incorporating only the specific ranges needed by the field service engineers for whom it was designed.

Tester C has special ranges and special input connectors and cables to permit a single-point connection for trouble-shooting and servicing all the circuits of a complex business machine.

Several other buyers of standard Triplet test equipment request their company name on the dial to personalize their testers.

If you think a custom tester may solve some problems for you, contact your Triplet representative. He'll put you in touch with the Tester Designers and Engineers at Triplet who'll help you analyze the problem and suggest the optimum cost/result solution. Triplet Corporation, Bluffton, Ohio 45817

TTT TRIPLET
BLUFFTON, OHIO 45817

*Manufacturers of the World's
most complete line of V-O-M's*

INFORMATION RETRIEVAL NUMBER 81

IDEAS FOR DESIGN

plexer is used as a four-bit latch. While the clock is HIGH the data on the inputs are inverted and fed directly through to the outputs. This inversion compensates for the inversion through the memories and also passes data through the multiplexer faster than a noninverted signal. Each output is fed through an inverter to the I/O input of the corresponding multiplexer section. When the select line goes LOW, the I/O inputs are selected. The data on the multiplexer outputs are then held latched by the feedback through the inverters. This latch at the memory output acts like a set of "slaves" for the "masters" in the RAMs, so that data changes at the multiplexer outputs only after the clock LOW-to-HIGH transition.

During a given clock cycle the following sequence of events occurs: The cycle is initiated by a clock LOW-to-HIGH transition. The counter increments, selecting a new location in the RAMs. The data stored in that location are read out and appear on the output of the multiplexer. The clock goes LOW, simultaneously latching the

data at the multiplexer outputs and lowering the write enable on the memories; this allows the data to be written into the RAMs. When the clock goes HIGH, the memories return to the read mode, the multiplexer is unlatched and the counter increments to the next address.

When the counter has gone through its full count cycle (64 in this example), the same RAM location will be addressed again, and the data stored during the last access of that location will be read out.

The "length" of the shift register is controlled by the address counter. If a shorter shift register is desired, just change the modulus of the address counter. For example, a quad 60-bit register is formed by loading 0001 into the presetable counter. The counter would then count from 1 to 15 instead of 0 to 15 and, with the four-bit ring counter, would form a mod-60 counter. Four locations in each RAM would never be used.

John Springer, Applications Engineer, Advanced Micro Device, 901 Thompson Pl., Sunnyvale, Calif. 94086. CHECK NO. 312

Get square-wave tone bursts with a single timer IC

One IC, rather than two, can be used to construct a tone-burst generator that gives a 50-ms burst of 1.5-kHz square waves and can source or sink 200 mA.

The timer IC produces a tone burst with each operation of the pushbutton. In the quiescent state the voltage at pin 4 is below the threshold level, approximately 0.7 V. When the button is depressed, C_2 begins to charge. The charging current through the voltage-divider resistors R_3 and R_1 causes the pin-4 voltage to exceed the threshold, and astable operation of the timer begins.

Astable operation continues until the charging current of C_2 ceases to draw enough current to maintain the voltage at pin 4 above the threshold value. Resistor R_5 provides a discharge path for C_2 when the button is released to allow for succeeding bursts.

The burst waveform is a square-wave starting with a positive-going edge and ending with a negative-going edge. The tone frequency f can be calculated from the equation

$$f \approx \frac{1.44}{C_1 (R_1 + 2R_2)}$$

R_1 must be small compared with R_2 to obtain a 50% duty cycle. The output voltage varies with

V_{cc} and is typically 10 V for a V_{cc} of 15 V.

The value shown for R_5 permits initiation of equal-duration bursts every 500 ms.

Sol L. Black, Western Electric, Dept. 355, 6200 E. Broad St., Columbus, Ohio 43213.

CHECK NO. 313

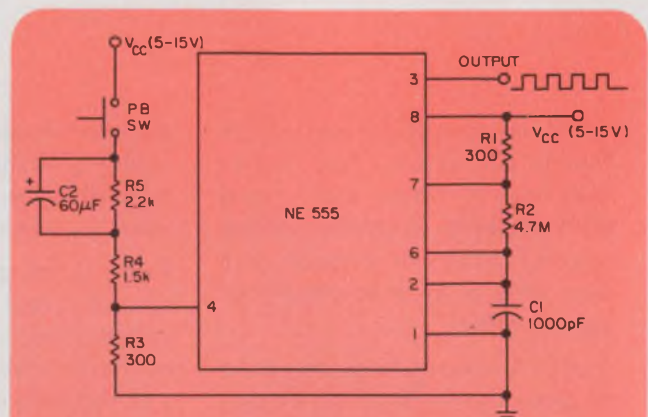

Depressing the pushbutton provides square-wave tone bursts whose duration depends on the duration for which the voltage at pin 4 exceeds a threshold. Components R_1 , R_2 and C_1 cause the astable action of the timer IC.

Burndy's tin-plated answer to the gold crisis.

Good-as-gold connections at a lower installed cost.

In 1971 gold sold for about \$46 an ounce. In 1972 the average price rose to \$85 an ounce. And today gold prices are well over \$100 an ounce and still going up.

Since gold has always been considered indispensable in making reliable connector contacts, connector prices have also been rising steadily. Something had to be done about it. And Burndy has done it.

We couldn't control the price of gold. So we came up with the first high reliability connector system that doesn't require gold. It's the revolutionary new Burndy GTH principle and it uses tin instead of gold — without sacrificing performance or reliability.

How did we do it? By substituting the principle of plastic deformation for the traditional wiping mode of making electrical contact. Utilizing the plastic deformation principle the hard, sharp, tin-plated tip of our contact penetrates the soft solder target of the mating component. The result is a gas-tight, high-pressure connection which prevents the formation of oxides. With no possibility of oxidation, there's no need for gold. Either in the connector or the mating component. *With no need for gold in the connector we can cut connector costs by at least 33%.* With no need for gold in the mating component you can save a considerable amount of money here as well. And the Burndy GTH connector permits a virtually unlimited number of mating and unmating operations without sacrificing reliability.

Burndy GTH connectors are available in all types of designs for all types of applications. IC, printed circuit and input/output to name just a few. And they're now being used by some of the most famous names in electronics.

For more information on how our new GTH connectors can help save you a fortune, write Burndy Corporation, Norwalk, Connecticut 06856. Or call (203) 838-4444. We'll show you how we turned gold into tin. And how it can turn tin into gold for you.

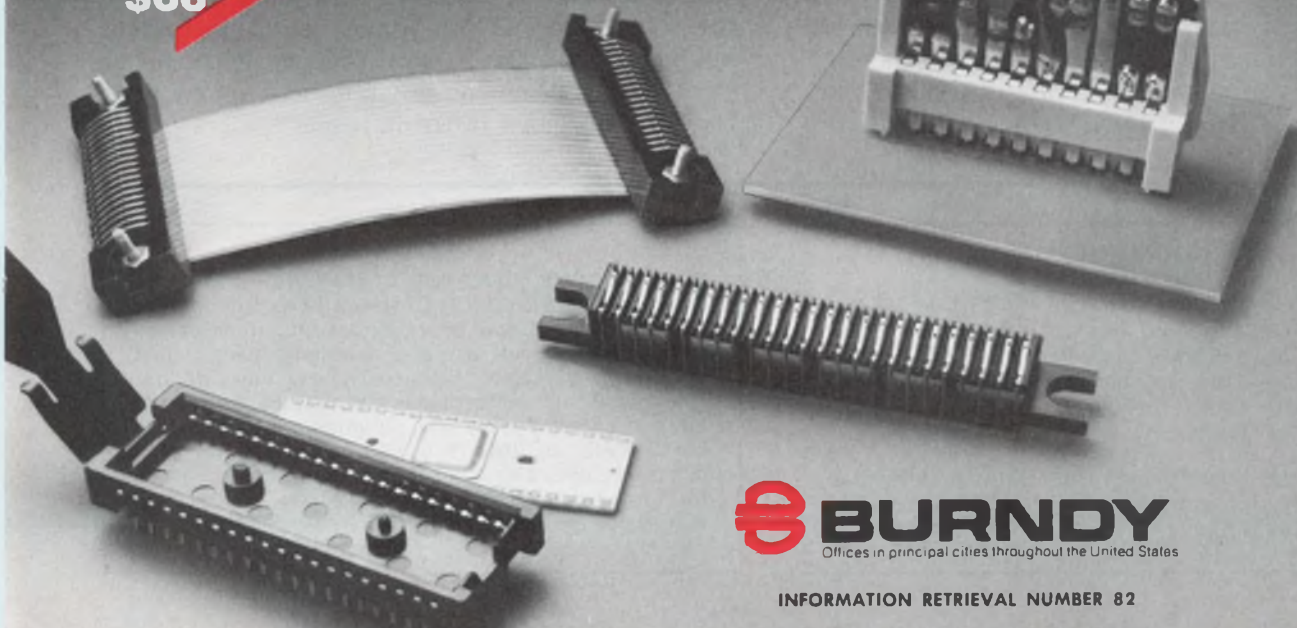
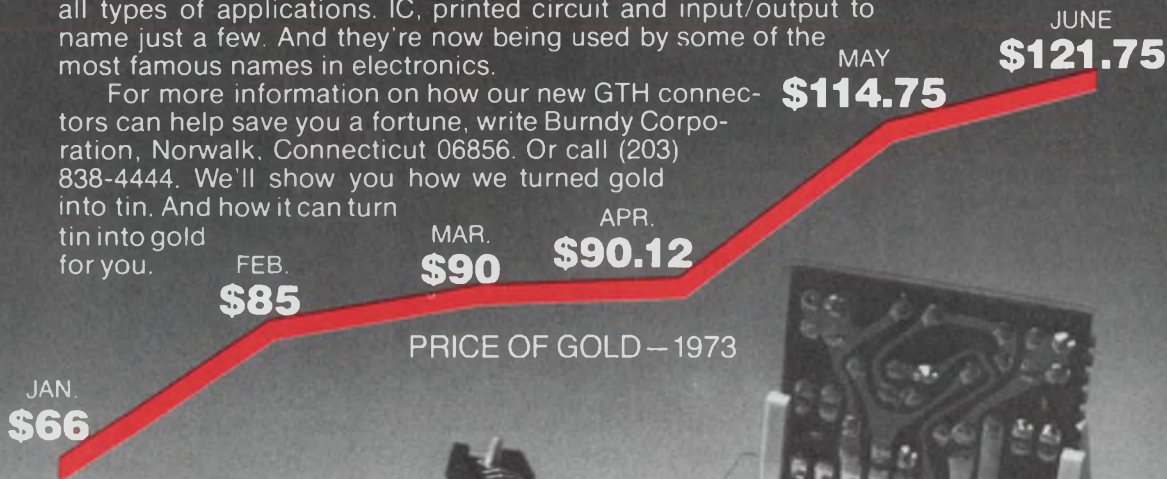

BURNDY
Offices in principal cities throughout the United States

INFORMATION RETRIEVAL NUMBER 82

BURNDY
International Sales and Manufacturing: Brussels, Barcelona, Paris, Rotterdam, Stockholm, Stuttgart, Turin, Zurich, St. Helena (Eng.), Toronto, Sydney, Tokyo, Mexico City, Sao Paulo.
CONNECTS

Jeff Duerr of Hewlett-Packard Wins Annual 'Ideas for Design' Award

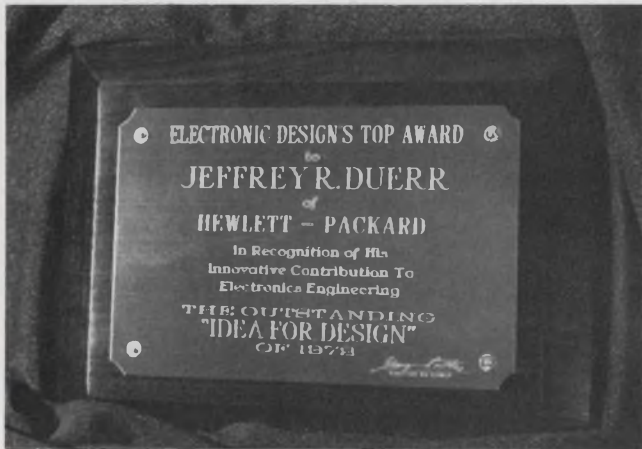

When he walked into the conference room, Jeffrey R. Duerr, a development engineer at Hewlett-Packard in Colorado Springs, Colo., was more than a bit suspicious. He had been invited to speak about his new project with a visiting editor from *ELECTRONIC DESIGN*. But he found what looked like HP's chain of command, lacking only David Packard and William Hewlett. Duerr saw his boss, Engineering Group Manager Eddie Donn; his boss's boss, Engineering Section Manager Chuck House; his boss's boss's boss, Engineering Manager Floyd Siegel; and his boss's boss's boss's boss, Division Manager Hal Edmonson.

In addition there was Product Manager Bruce Farly, Technical Editor Art Pettis, Advertising and Promotion Manager Dave Dayton and a photographer, Bill Bowers. Finally the crowd scene was completed by *ELECTRONIC DESIGN*'s publisher, Peter Coley, and editor-in-chief, George Rostky.

Before Duerr could voice his perplexity, Rostky added to it with, "Jeff, I understand you're a pretty good circuit designer," then dispelled it with, "Jeff, you've won *ELECTRONIC DESIGN*'s annual Ideas for Design award for 1972." Before



Duerr could recover, Rostky presented a walnut-mounted, gold-toned brass plaque, handsomely engraved with the inscription:

ELECTRONIC DESIGN's top award to Jeffrey R. Duerr of Hewlett-Packard. In recognition of his innovative contribution to electronics engineering. The outstanding "Idea for Design" of 1972.

It was while Duerr was gaping that Rostky interrupted with, "Gosh, I almost forgot," then handed him a \$1000 check. Duerr spent the next few minutes saying something about being surprised, honored and pleased.

Duerr's award-winning idea, "Pulse Stretcher Indicates Presence and Polarity of TTL Pulses to 20 MHz," (*ED* No. 22, Oct. 26, 1972), started as a home project for a sonic probe. Duerr's hobbies include backpacking, banjo playing and, from the moment he learned of his \$1000 prize, photography.

Duerr received his award one day before he was to leave on a vacation with his wife, Dorothy, and 4-year-old son, Dana Lee. Asked about his immediate plans, Duerr replied: "I've got to work up a scheme for breaking this to my wife the way you guys broke it to me."

IFD Winner of April 26, 1973

Robert D. Baird, Manager, Solid State Commercial Engineering, RCA Solid State Div., Route 202, Somerville, N.J. 08876. His idea "Intruder alarm is based on electrostatic charge detection" has been voted the Most Valuable of Issue Award.

Vote for the Best Idea in this issue by circling the number for your selection on the Information Retrieval Card at the back of this issue.

SEND US YOUR IDEAS FOR DESIGN. You may win a grand total of \$1050 (cash)! Here's how. Submit your IFD describing a new or important circuit or design technique, the clever use of a new component or test equipment, packaging tips, cost-saving ideas to our Ideas for Design editor. Ideas can only be considered for publication if they are submitted exclusively to *ELECTRONIC DESIGN*. You will receive \$20 for each published idea, \$30 more if it is voted best of issue by our readers. The best-of-issue winners become eligible for the Idea of the Year award of \$1000.

150 watts at 70 MHz

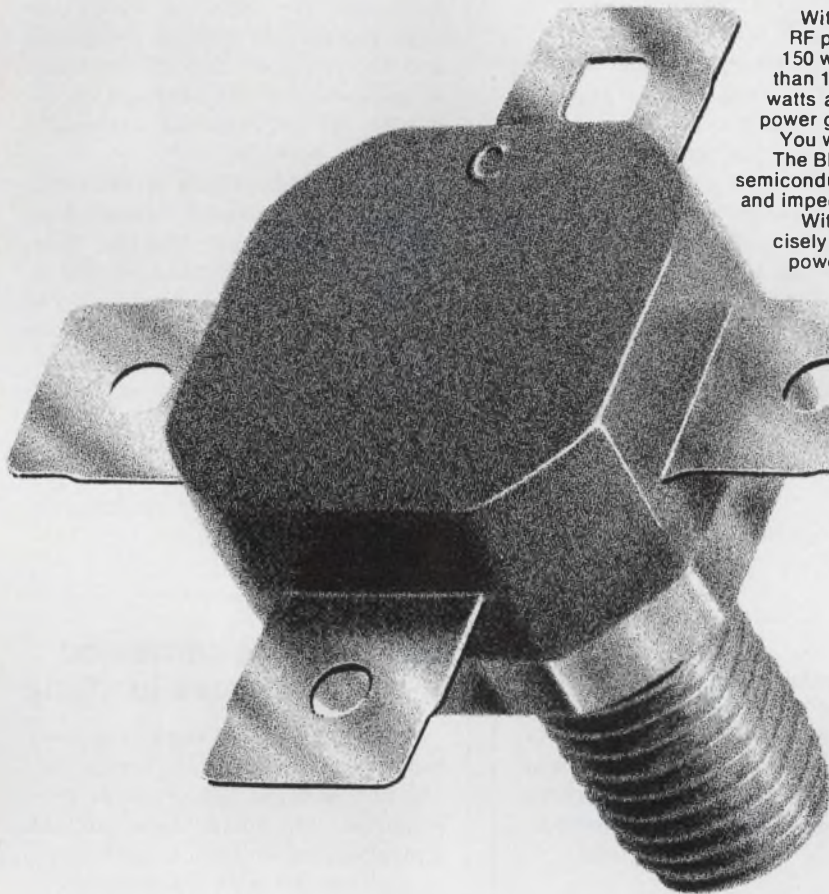

With the BLX15, Amperex has advanced the state of the art of RF power semiconductors. This is the device that produces 150 watts CW at 70 MHz, Class B, with input power of less than 19 watts... and develops peak envelope power of 150 watts at 30 MHz single sideband, Class AB operation, at a power gain of more than 14 dB.

You won't find anything like it anywhere else.

The BLX15 is only one of a whole family of Amperex RF power semiconductors. The family includes individual power transistors and impedance-matched, cascadeable, UHF amplifier modules.

With each device you get a special set of curves that precisely define the Safe Operating Area as a function of total power dissipation. We call them "SOAR" curves; use any

Amperex RF power semiconductor within its designated Safe Operating Area and we'll guarantee you specified performance... or your money back!

There's an Amperex RF power semiconductor to fill virtually any RF amplification need in fixed and mobile transmitting equipment... from 30 MHz single sideband through 470 MHz UHF FM. For details, including expert applications engineering assistance, contact:

Amperex Electronic Corporation, Hicksville Division, Hicksville, New York 11802.
Telephone: 516-931-6200.

Amperex®

TOMORROW'S THINKING IN TODAY'S PRODUCTS

Sold through
North American Philips Electronic Component Corporation

P out (watts)	SSB	VHF		UHF	
	30 MHz	175 MHz FM		470 MHz FM	
	28 V	13.5 V	28 V	13.5 V	28 V
				Ampl. Modules	
2.0			2N3553	BLX65	
2.5				BLX66	
3.0		2N3924		BLX67	BLX92
4.0		BFS22A	BFS23A		BGY22
6.0			2N3375		
7.0		2N3926		BLX68	BGY23
8.0	BLX13	BLY87A	BLY91A		
12.0		2N3927			
13.0			2N3632		
15.0		BLY88A	BLY92A		BGY24
20.0				BLX69	
25.0		BLY89A	BLY93A		
40.0					BLX95
50.0	BLX14	BLY90	BLY94		
150.0	BLX15				

New recording tape reported to improve s/n ratio 12dB

A new recording tape that uses submicroscopic iron particles as the recording medium has a signal-to-noise ratio that is reported 12 dB better than the best iron oxide tape at frequencies of 10 to 12 kHz and a tape speed of 4.75 cm/s.

The new tape is produced by a process developed by several Philips plants in the Netherlands for the large-scale output of very fine iron particles. Because of the high magnetic remanence of the new material, the thickness of the magnetic

layer can be made much less than for conventional oxide tapes.

The reduction in thickness does not reduce the output of low frequencies, while at high frequencies a much higher output is obtained. The noise level remains constant, and so the signal/noise ratio improves, Philips says.

The higher coercivity of the iron means that the bias field has to be 6 dB higher for recording.

CHECK NO. 441

A transistor in closeup

Clearly defined surface structure of a 3-to-4-GHz, 3-W broadband power transistor mounted on a 0.6-by-0.6-mm film substrate was photographed with an Autoscan sampling electron microscope. The in-

strument has a greater depth of field than an optical microscope and a resolution that is several orders of magnitude higher. Wires connect emitter and base of the transistor, which is made by Siemens.

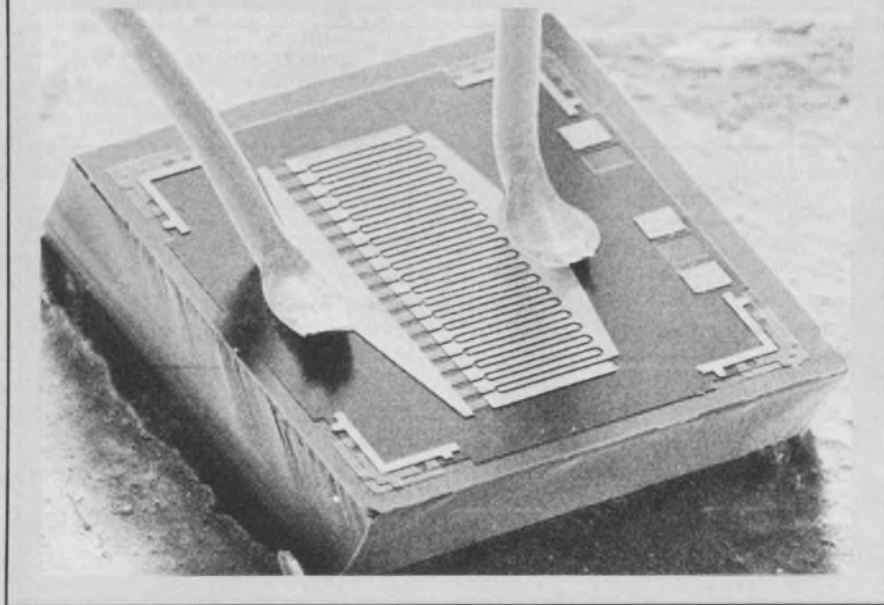

Chameleon-like devices are versatile semis

Electroluminescent devices that exhibit switching, memory and color-changing properties have been fabricated at the University of Manchester in England. The devices are of the metal-insulator-semiconductor type, in which the semiconductor is gallium phosphide and the insulator is a native oxide of gallium phosphide formed by exposure of the material to boiling hydrogen peroxide.

The devices exhibit green electroluminescence under forward bias and orange under reverse bias. With an oxide thickness of 450 Å, the devices show a transition from a high to a low conductivity state of certain reverse-bias voltage. Nonvolatile memory properties are also present, in the sense that any conductivity state can be retained over long periods without the need for a retaining bias. Switching occurs in less than 1 μ s.

Sound fields converted to visual images in study

Visual images of high-frequency sound fields, using the Bragg diffraction of light beams, have been produced by researchers at the University of Valenciennes, France, in conjunction with Thomson-CSF. The experiments were carried out at 150 to 300 MHz with a lead molybdenate acousto-optic delay line and lithium niobate wideband transducers.

The delay line is used as a deflector for the beam of a 5-mW He-Ne laser, which is scanned by a rotating mirror. When the beam strikes the acoustic beam at the Bragg angle, diffraction occurs, and the diffracted light is picked up on a photodetector.

The use of optical heterodyning allows a sensitivity improvement of more than 20 dB, so that acoustic waves inside crystals can be accurately observed. An acoustic microscope operating between 150 and 300 MHz has also been developed.

We at Ise have decided to do something about those hard-to-see displays which result in tired eyes and frayed nerves.

Our digital readouts, which include the extremely compact and lightweight Multi-Numerical Indicator with 8, 10 and 12 digit readout, offer the advantages of low current drain, high stability and widely visible phosphorescent digit segments aligned on a single plane for clear viewing from as far away as 35 feet. The soft, stable green glow eliminates annoying flicker.

Applications cover a wide range including calculators, digital clocks, voltmeters and counters.

These readouts are not only easy on your eyes but also on your purses. Look to Ise.

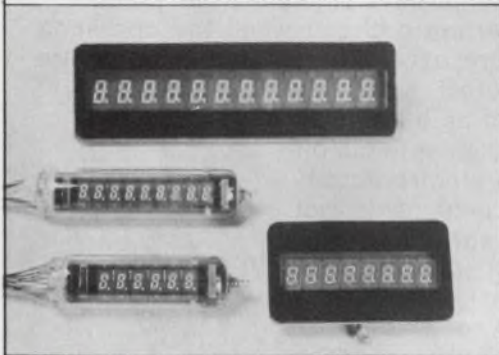
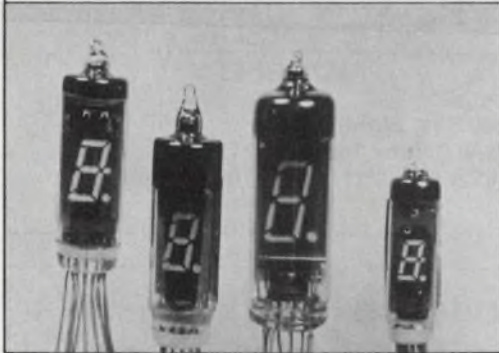

The Brighter Side of Electronics

ISE ELECTRONICS CORP.

P.O. Box 46 Ise-city, Mie Pref., Japan

ISE INTERNATIONAL CORP.

Shinbashi Kokusai Bldg.,
No.2-7-7, Higashi-Shinbashi, Minato-ku,
Tokyo, Japan

Tel: 433-6616 ~ 9 Telex: J26546

Representative

U.S.A.: Ise Corp. of America
(The Former Legi Electronics Corp.)
1472 West 178th Street, Gardena Calif.,
Tel. (213) 5320470

Italy: Edoardo Viola
Tel. 90.43.024



Sweden: AB Nordqvist & Berg
Tel. 08/44 99 80

West Germany: Neumüller GMBH
8 München 2, Karlstrasse 55
Tel. 59 24 21

Taiwan: C.S.Liao
Tel. 555419

Hong Kong: Kong Tak Chuen
Tel. K-224125

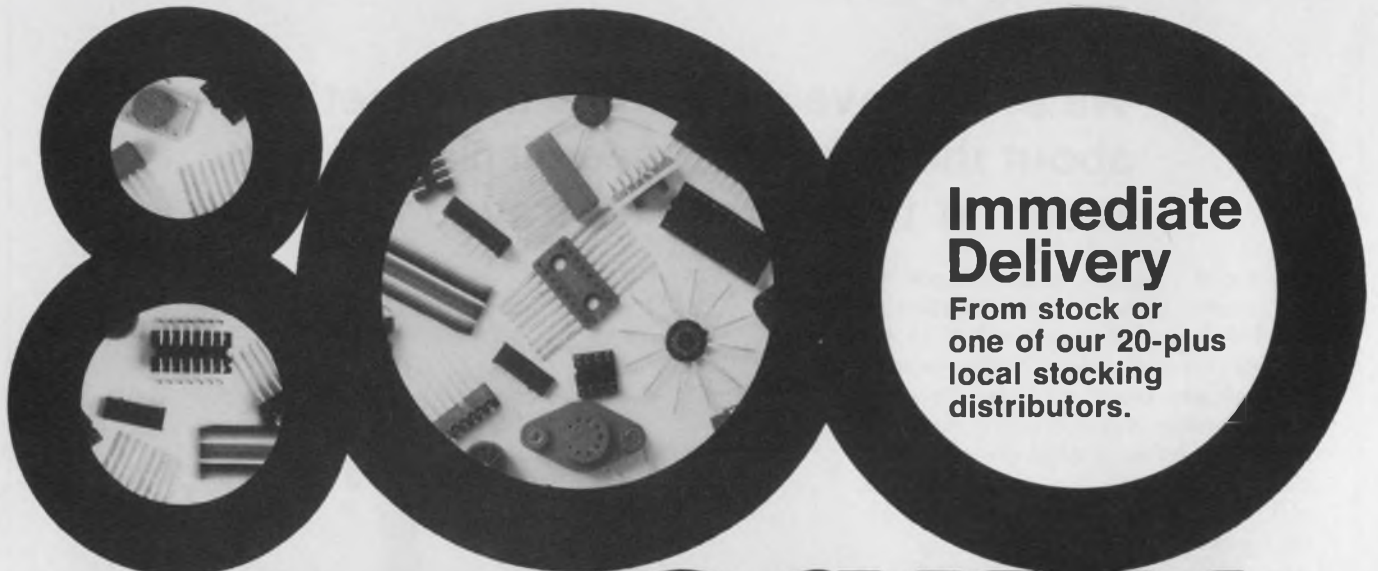

Immediate Delivery

From stock or one of our 20-plus local stocking distributors.

HIGH-QUALITY SOCKETS

We make everything from IC sockets to a total IC interconnect system. Any size or configuration you might require. All backed by R-N's reputation for quality. All at substantial savings. Whatever your connection need, we can fill it . . . fast! **The Socket People**



ROBINSON NUGENT inc.
 800 East Eighth Street
 New Albany, Indiana 47150
 (812) 945-0211/TWX 810-540-4082

INFORMATION RETRIEVAL NUMBER 85

Single Shot SOLID STATE TIMER

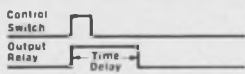
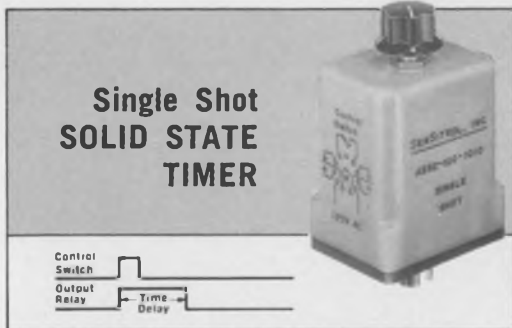

SENSITROL, INC.

Designed for systems where voltage is applied continuously to the input. Control relay energizes and timing period starts when a control switch is closed (either momentarily or maintained). Relay de-energizes at the end of delay time.

The delay time can be set with the knob or by adjusting the external resistor to any period of .1 through 10 seconds, or 2.0 through 200 seconds. Delay time can also be pre-determined by customer and set at the factory from .1 through 200 seconds. **\$28.50 - 35.50**

200 S. 4th Street
 P. O. Box 150
 Albion, Illinois 62806

INFORMATION RETRIEVAL NUMBER 86

mi·cro·temp (mī'krō tēmp')

A patented, positive safety thermal cutoff.

It will interrupt a circuit when the operating temperature exceeds the rated temperature of the cutoff. Normally employed as a back-up safety protector to cut off power to electronic circuits or components that develop abnormal temperature build-up, this device is fast, reliable and accurate to $\pm 3^\circ\text{F}$.

MICROTEMPS are CSA listed and insure product safety. Costing as little as 7.5¢ each, MICROTEMPS are available in a wide range of configurations, ratings and terminations to suit your individual applications. MICROTEMPS are hermetically sealed; unaffected by vibration, shock, aging or positioning, and meet UL standard 1020. For specific details, call or write:

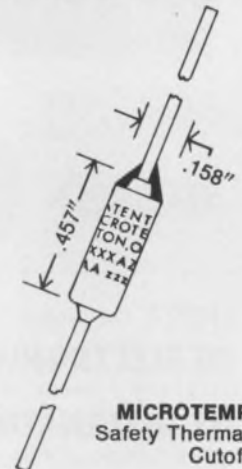

MICRO DEVICES CORP.
 1881 Southtown Blvd. Dayton, Ohio 45439
 Ph. (513) 294-0581 Telex: 28-8087

INFORMATION RETRIEVAL NUMBER 87

ELECTRONIC DESIGN 18, September 1, 1973

new products

5-Hz-to-50-kHz analyzer has digital storage

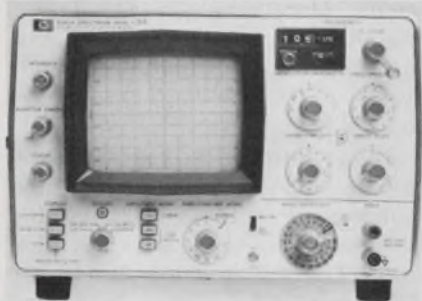

Hewlett-Packard, 1501 Page Mill Rd., Palo Alto, Calif. 94304. (415) 493-1501. \$3800.

Model 3580A spectrum analyzer displays very slow sweeps using digital storage techniques. A standard, nonstorage CRT is used—its trace is refreshed at high speed from a digital memory. The display, however, is a sharp, continuous line that looks like an analog display. Sweep times of the Model 3580A can be set from 0.1 to 2000s and minimum bw is 1 Hz. Five additional bandwidths to 300 Hz are provided. Amplitude range in the linear mode is 100 nV to 20 V fs; in the log mode from -155 dB to +30 dB. Dynamic range is 80 dB. Input sensitivity is 30 nV max.

CHECK NO. 298

Function generator doubles as filter

Dytech Corp., 391 Mathew St., Santa Clara, Calif. 95050. (408) 241-4333. \$195 (assembled); \$145 (kit).

This function generator/filter, the Model 765, uses a tracking active filter to generate high-purity sine, triangle, and square waves from 1 Hz to 100 kHz. Sine wave distortion is less than 0.1%. The active filter is switch-selectable, and can be used as a bandpass (nominal Q of 50) or as a notch filter (40-dB notch depth). Output impedance is 600 Ω and output amplitude is adjustable from 0 to 10 V pk-pk, at no load. A control provides -5 to +5-V output offset.

CHECK NO. 299

50-MHz counter-timer has 8 digits, costs \$575



Eldorado Electrodata Corp., 935 Detroit Ave., Concord, Calif. 94518. (415) 686-4200. \$575; 4 wk.

Model 1608 countertimer features eight digits and 50-MHz operation. The unit has two input channels, with channel "A" providing frequency, totalize, and rpm measurements up to 50 MHz and channel "B" providing period and multiple period capabilities up to 2 MHz. Time interval (TIM) and ratio use both channels. Input range is from 50 mV rms through 1 V rms (X1) and 10 V rms (X10) with nondamaging input of 100 V rms.

CHECK NO. 300

Dual-channel averager has 100-ps resolution



Princeton Applied Research Corp., Box 2565, Princeton, N.J. 08540. (609) 452-2111. 162: \$2250; 90 days.

This dual-channel boxcar averager can provide 100-ps resolution, said to be one hundred times faster than previously obtainable. The Model 162 uses plug-in signal channel modules and function logic. For example, an economical single-channel boxcar averager can be obtained by adding the Model 164 gated integrator to the Model 162 main frame. Dual-channel operation requires only the addition of the second plug-in module.

CHECK NO. 301

Microscope aims at semiconductor industry

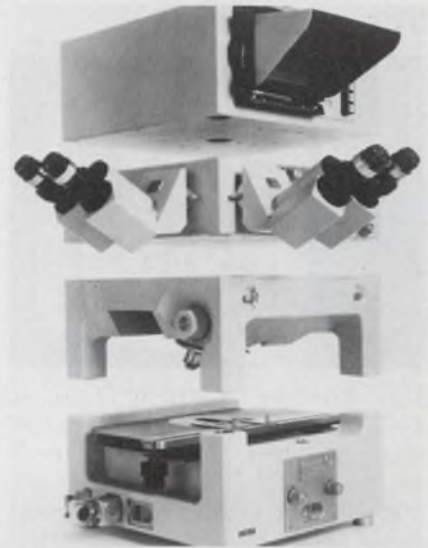

Carl Zeiss Inc., 444 Fifth Ave., New York, N.Y. 10018. (212) 736-6070. \$27,000.

The Axiom microscope accommodates specimens up to 90-mm high. The exceptionally large mechanical stage, with a range of 120 \times 60 mm, is designed to accommodate large wafers and masks. The stage remains in a fixed position and focusing is done by moving only the objectives, giving exceptional stability.

Booth No. 1115 Check No. 302

System measures part size without contact

Reticon Corp., 450 E. Middlefield Rd., Mountain View, Calif. 94040. (415) 964-6800. From \$2150; stock to 4 wk.

Said to be a first, this all solid-state system measures without contact and with up to 512-point resolution. The system, consisting of the LC600 line-scan camera and RS600 series controller, measures size, position, gap and automatically inspects mass-produced parts. Any field of view from less than one inch to several feet may be divided into as many as 512 parts and measured with up to a fraction of a mil accuracy. It also has provisions for setting high and low limits for automatic grading of parts, has BCD output for printers or computer input, can provide feedback for closed loop process control and can be programmed to recognize a desired pattern.

CHECK NO. 303

Portable unit reads true phase jitter



SEG Electronics, 120-30 Jamaica Ave., Richmond Hill, N.Y. 11418. (212) 441-3200. \$925; stock to 2 wk.

Model FA-1743 measures total phase jitter, the frequency of jitter components, and differentiates between true phase jitter, broadband noise and spurious tones. The unit features a test tone frequency range of 800 to 1800 Hz, with an amplitude of -40 to $+10$ dBm. Jitter frequency range is 20 to 300 Hz with an amplitude range of 0 to 100° peak-to-peak. Accuracy is $\pm 2\%$, $\pm 0.2^\circ$.

CHECK NO. 304

110-MHz generator costs just \$490



Test & Measuring Instruments, 224 Duffy Ave., Hicksville, N.Y. 11802. (516) 433-8800. \$490.

The PM5324 hf generator features pushbutton selection of nine frequency ranges from 100 kHz to 110 MHz, as well as of modulation functions and calibration frequencies. Frequency stability is 1% and internal crystal calibration accuracy is 0.1%. Electronic stabilization provides accurate output amplitudes in five ranges from $5 \mu\text{V}$ rms fs to 50 mV rms fs. Output impedance is 75Ω on all scales and at all frequencies.

CHECK NO. 305

Photometer/radiometer eliminates corrections



Alphametries, 532 Berry St., Winnipeg, Manitoba, Canada. (204) 786-1476. Under \$2500.

The DC1010 Photometer/Radiometer offers two outstanding features: First, the source, geometry, detector probe and indicator are considered as a total system; second, the unit measures and displays directly in several types of optical units. Each probe automatically selects the desired measurement units and range limits, which are displayed on an illuminated multicolor panel. Thus there's no need for calculations or connections for filters, apertures, geometry or measurement units. Radiometric sensitivity ranges from 10^{-11} to 1 W, depending on probe. Photometric sensitivity ranges from 10^{-8} to 10^3 lumens.

CHECK NO. 306

Autoranging DMM spans 31 V/I/ Ω ranges



Keithley Instruments, 28775 Aurora Rd., Cleveland, Ohio 44139. (216) 248-0400. \$495; 30-45 days.

$10\text{-}\mu\text{V}$ ac and dc resolution, ac/dc amps, ohms, high-level overload protection without fuses, and a 3-1/2-digit LED display describes the Model 165 autoranging digital multimeter. There are 31 ranges in all. As a dc voltmeter, the unit covers $10 \mu\text{V}$ to 1000 V with six full-scale ranges. Most dc-voltage ranges offer $\pm 0.1\%$ reading accuracy plus a nominal digitization error. The 165 also has a built-in 1-mA current source that is activated with a front-panel pushbutton.

Booth No. 1522 Check No. 307

Synthesizer outputs both sines and squares

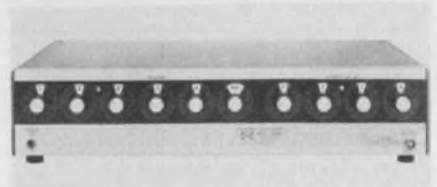

Pacific Measurements, 940 Industrial Ave., Palo Alto, Calif. 94303. (415) 328-0300. 1028A: \$1800; 1028B (with attenuator): \$2200; 30-60 day.

Programmable frequency and amplitude and both sine and square-wave outputs describe the 1028—a 1-Hz-to-13-MHz synthesizer. The square-wave levels are TTL compatible. Frequency and amplitude settling times are 50 and 30 ms, respectively. Full frequency stability and accuracy are always available, along with full five-digit resolution. Frequency stability is 1×10^{-6} /month; accuracy is 2 parts in 10^6 . Output range is from $+20$ to -80 dBm from a $50\text{-}\Omega$ source. Spurious signals are 60-dB down.

CHECK NO. 308

15-MHz scope offered as kit



Heath Co., Benton Harbor, Mich. 49022. (616) 983-3961. \$329.95.

Feel ambitious? Seven evenings is all that's needed to build the IO-104, a solid-state scope, with a bandwidth of dc to 15 MHz. Other specs include a vertical sensitivity of 10 mV/cm, and 12 calibrated vertical attenuator positions up to 50 V/cm. Any one of 22 calibrated time bases from 2 s/cm to $0.2 \mu\text{s/cm}$ can be selected. The horizontal amplifier accepts external inputs from dc to 1 MHz.

CHECK NO. 309

New High Voltage Rectifiers

Are you working with 10,000 volts, 100,000 volts, 1,000,000 volts or even more?

Do you need a special high voltage rectifier package?

Do you have a high frequency application?

Is a more economical high voltage rectifier desirable?

Would higher voltages in smaller rectifier packages help?

If your answer to any of these questions is yes, you'll find an off-the-shelf or custom solution at Semtech — the leader in "power electronics."

KV-PAC

We cooked up a good one for Microwave ovens!



With P.I.V. from 5000 to 15000 volts, new corona free KV-PAC is designed to operate at 0.6 amp when utilized as a half-wave rectifier and 1.2 amps in center-tap, doubler or bridge applications.

KV-PAC offers insulated aluminum mounting slots and universal 3-way electrical connections for easy assembly.

KV-PAC is an economical rectifier for many commercial and Industrial applications, including microwave oven power supplies.

CIRCLE NO. 141

SLIMPAC®

Their all in the family!



The entire SLIMPAC family consists of high density axial lead silicon assemblies, molded into rugged compact rectangular configurations. Internally, SLIMPAC has double heat sink junctions welded together for mechanical strength.

SLIMPAC offers PIV of 2,500 or 45,000 volts and average rectified current ratings between .050 amp and 2 amps (at 55°C free air) depending on PIV.

The entire SLIMPAC family has corona free construction and meets the most stringent life and environmental requirements.

CIRCLE NO. 142

STACPAC

They stack up for the BIG jobs!

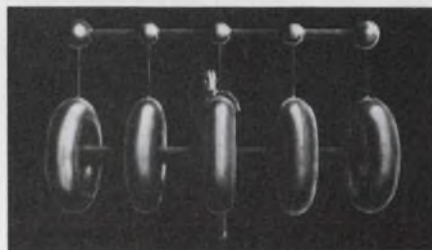

820,000 volt fast recovery device.

STACPAC completely eliminates all external component parts and solder joints — all components are encapsulated and connected to aluminum discs. These discs serve as compensation, cooling fins and corona protection.



By utilizing silicon rectifiers only, the number of temperature sensitive components have been reduced and the overall configuration simplified.

STACPAC is available in 4kV, 5kV, 25kV and 32kV as well as larger devices.

CIRCLE NO. 143

STICPAC "X"-rayed!



Faced with the problem of selecting high voltage rectifiers for X-ray generators or other stringent applications? Solve these problems with STICPAC silicon rectifiers.

Measuring .695 inches in diameter by 3.38 to 8.50 inches in length, STICPAC is ideal for replacement of vacuum tube type rectifiers.

STICPAC is available in a range of voltages: 50, 75, 100, 125, 150, 175 and 200 kV. Average output is 100mA @ 55°C in an oil environment.

CIRCLE NO. 144



H.V.M.

Building blocks to high voltage assemblies!

Semtech's High Voltage Modules (H.V.M.) allows the designer to construct either high voltage assemblies or other circuit configurations such as doublers, center taps and bridges. To assemble, simply screw appropriate modules together to form desired device.

Metal discs serve as compensation, cooling fins and corona protection.

Modules are offered in P.I.V. from 2.5 to 15kV. Average rectified current from 0.5 to 7.5 amps.

Fast recovery H.V.M. available — (Trr) 250ns.

CIRCLE NO. 145

MINISTIC®

"MAXI" voltage in a "MINI" package!



MINISTIC rectifiers are multipurpose assemblies, ideally suited for low current high voltage applications and multiplier circuits.

MINISTIC has a molded cylindrical case with axial leads. The case is insulated for easy handling.

Offering PIV from 10kV to 40kV, MINISTIC has low reverse leakage and is corona free.

CIRCLE NO. 146

"We're number 1 because we try harder"



652 Mitchell Road, Newbury Park, California 91320
(805) 498-2111, (213) 628-5392 / TWX: 910-336-1264

CHICAGO: (312) 352-3227
DALLAS: (214) 253-7644
FLORIDA: (305) 644-5404
NEW JERSEY: (201) 654-4884
SAN FRANCISCO: (415) 328-8025
EUROPEAN SALES: (Switzerland) (042) 323-242

®SLIMPAC AND MINISTIC ARE REGISTERED TRADEMARKS OF THE SEMTECH CORPORATION.

Pulser yields 500 V at 0.5-ns rise time



SPI Co., P.O. Box D, 10 Railroad Ave., Bedford, Mass. 01730. (617) 275-1070. \$1195; 60 days.

SPI-PULSE Model 25 transmission-line pulser is designed for high-voltage calibration and sub-nanosecond time work, but can be used for component burnout testing, laser diode pulsing and transient response investigations. The unit produces square pulses of up to 500 V with a rise time of less than 0.5 ns into a matched 50- Ω load. Pulse duration is selected with variable lengths of charge line and can be varied from a few nanoseconds to more than one microsecond.

CHECK NO. 320

Thermal tester checks component sensitivity



RHO Corp., 9 Colburn St., Nashua, N.H. 03060. (603) 882-6677. \$229 ea. w/one probe; stock (small qty.).

The RHO thermotester provides heat to individual components to determine temperature sensitivity. The unit has a plug-in, hand-held, heat/detect probe with several different tips for LSI, MSI, DIPs, TIPs and TOs, as well as diode and resistor components. The probe is stable within 2 C. Temperature can be selected from 30 to 150 C. Rise time is 50 C per minute.

CHECK NO. 321

Test set measures line noise

TM Systems, 25 Allen St., Bridgeport, Conn. 06604. (213) 366-4571. \$385; 30 days.

Model 510 test set is a self-contained, battery-operated, transistorized unit measuring signal and VU levels from +23 to -95 dBm, and noise from +113 to -5 dBm. Longitudinal balance is maintained in excess of 85,000 Ω across the line while maintaining close tolerances when bridging or terminating lines under test. Frequencies are maintained flat from 30 Hz to 20 kHz as well as modified by active circuitry for C-MSG, high-pass, 3-kHz and 15-kHz weighting.

CHECK NO. 322

Transistor/FET tester is accurate to $\pm 3\%$

RCA Corp., 415 S. Fifth St., Harrison, N.J. 07029. (201) 485-3900. \$159.

Featuring a 6-1/2-in. meter and two plug-in transistor-socket adapters, the WT-524A dynamic transistor/FET tester measures the ac beta of bipolar transistors, including Darlington and dual types, with an accuracy of $\pm 3\%$. Transconductance of FETs can also be measured up to G_m values of 100,000. Accuracy in these tests is $\pm 3\%$. Zero-bias drain current, dc drain current, and out-of-circuit gate leakage measurements can also be made.

CHECK NO. 323

Modular memory tester line offered

Fairchild Systems Technology Div., 3500 Deer Creek Rd., Palo Alto, Calif. 94304. (415) 493-5011. Starts at \$15,000.

Ranger 1 is a dedicated, functional pattern memory exerciser designed for incoming inspection and wafer testing. The unit is said to permit a 50% increase in throughput over competitive products. Ranger series testers feature a 20-MHz hardware-oriented pattern generator capable of executing N or N² type patterns programmed by any of 10 available ROM programs.

CHECK NO. 324

Unit measures to ± 5 -kV automatically



Matrix Research & Development Corp., 533 Main St., Acton, Mass. 01720. (617) 263-2986. \$745.

Model 721 measures up to ± 5000 V dc with automatic ranging, polarity and nulling (infinite input impedance at null). DVM terminals provide a low-impedance readout, which is scaled from the measured voltage (1/1000). Accuracy is 0.05% of reading. Flip a switch and Model 721 is a programmable ± 5000 -V-dc power supply with 0.5% regulation, a 50- μ s/V slew rate and 75- μ A output.

CHECK NO. 325

Compact freq. counter has 5 ranges



Integrated Systems, 6528 Interstate 85, Norcross, Ga. 30071. (404) 448-8302. \$195 with battery.

Lightweight, compact, 9-V-battery-or-ac-adaptor powered, this frequency counter, Model 80, has full-scale accuracy of $\pm 0.125\%$ to 1 MHz, and five preset frequency ranges that can be switch selected. The unit counts pulses or waveform peaks with an adjustable trigger-level control. The Model 80 will also accept an external signal to open/close the counting gate, allowing it to be used as a remote-controlled pulse accumulator.

CHECK NO. 326

NEW STANDARD

simplifies precise calibration of thermocouple measuring instruments

MODEL 1100 Thermocouple Simulator/Calibrator . . . you simply select the thermocouple type and dial a temperature directly in degrees. The proper voltage automatically appears on output terminals constructed of the appropriate thermocouple material.

APPLICATIONS

Calibration of:
Thermocouple Temperature Indicators
Thermocouple Data Acquisition Systems
Thermocouple Temperature Transmitters
Thermocouples (requires bath)
Thermocouple Amplifiers & Linearizers
Millivoltmeters (optional Linear Mode)
Temperature Controllers

FEATURES

Switches read directly in degrees C or F
Millivolt output conforms to NBS tables
Conformity to NBS tables 0.1°
Output through stable reference junction
Alternate copper terminals
0.1° Resolution (C or F)
Optional remote programming
Optional ramp output
Optional linear output



Ectron
CORPORATION

8133 Engineer Rd., San Diego, CA 92111
Ph. (714) 278-0600/TWX 910-335-1259

"SEE US AT WESCON
BOOTH NO. 1223"

INFORMATION RETRIEVAL NUMBER 131

A digital tape recorder requires a better solution

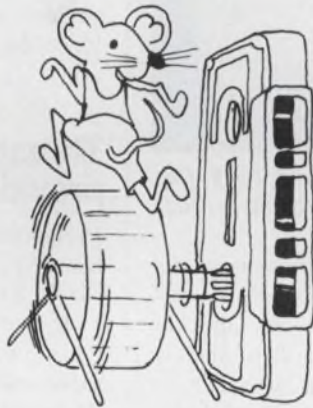

Many schemes are offered in an attempt to produce a less expensive digital tape recorder.

But, the plain, simple truth is that reliable data handling **requires a capstan drive and precision tape guiding.**

The Raymond Engineering Raycorder digital cassette recorder utilizes a simple, reliable capstan drive with precise guiding for the most repeatedly accurate data handling in the industry.

If you **really** care about your data, get the facts on Raycorder digital cassette recorders.



RAYMOND ENGINEERING INC.
217 Smith Street, Middletown, Connecticut 06457
Telephone: (203) 347-5611
a subsidiary of Raymond Precision Industries Inc.

INFORMATION RETRIEVAL NUMBER 132

ELECTRONIC DESIGN 18, September 1, 1973

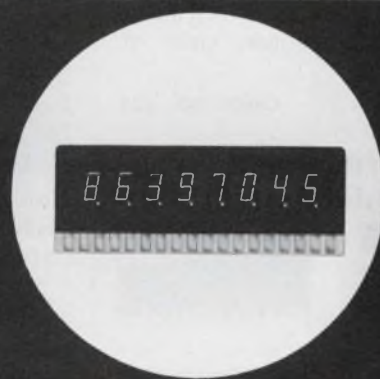

New NDP 1255-8

from **NATIONAL ELECTRONICS**
featuring

Gas Discharge Display Panel

- Large Character (.3")
- Edge Connector Plug In
- Multiplexed • Low Cost



NATIONAL ELECTRONICS
a varian division
geneva, illinois 60134 (312) 232-4300

INFORMATION RETRIEVAL NUMBER 133

Solderless spring clips aid breadboarding



Vector Electronic Co., 12460 Gladstone Ave., Sylmar, Calif. 91342. (213) 365-9661. \$0.09 per quad; (packages of 100).

Designated Klip-Strip, a new breadboard terminal system provides solderless assembly. It consists of connected spring clips assembled in groups of four, called quads, and in groups of 32 and 48, called bus strips. Unlike more expensive terminal blocks, which generally waste terminal area, Klip-Strips are placed on P-pattern Vectorboard only where needed. Bus strips of eight (T45-32) and 12 (T45-48) connected quads supply common signals and power. Components can be inserted into the quads from either the top or bottom and they are interconnected with ordinary jumper wire of sizes 20 to 24 AWG. Larger wire can be plugged into the open ends of quads.

CHECK NO. 327

Solder wires together with a match

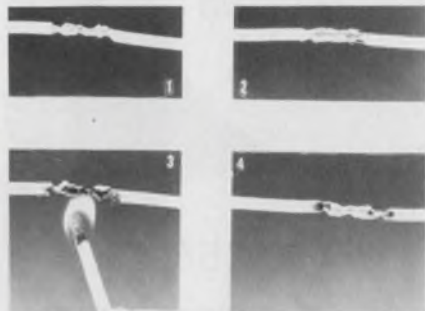

H. L. Siegel, 2617 W. Seventh St., Fort Worth, Tex. 76107. (817) 335-3711. \$0.89 (100 pieces).

Now you can solder a connection with a match. Simply twist the wires together, wrap them with a piece of Archer tape solder, and melt it with a match, candle or cigarette-lighter flame. No soldering iron is needed. It is very handy for emergency and on-the-spot field repairs.

CHECK NO. 328

Harness board heals self for reuse

Thomas & Betts Co., 36 Butler St., Elizabeth, N.J. 07207. (201) 354-4321.

A reusable harness fabrication board, which is filled with self-healing polyethylene foam, readily accepts routing nails and other harnessing aids. The new Ty-Rap board is reversible and features interlocking borders that can snap to additional boards to provide larger working surfaces. Routing nails and other harnessing aids can easily be pushed by hand through the outer galvanized-steel screening into the foam inner lining. The modular boards are available in two sizes: 25 × 37 and 37 × 49 in. There is no limit to the number of boards that may be interconnected.

CHECK NO. 329

Dispenser accurately meters liquids

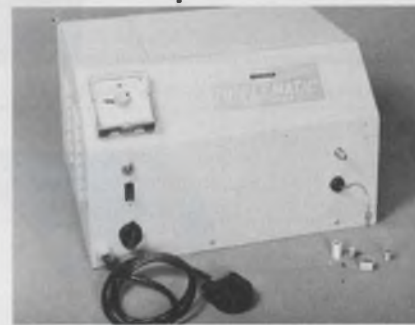

Hardman, Inc., 67 Sand Park Rd., Cedar Grove, N. J. 07009. (201) 751-3000. \$2200.

Series 189 Micro Dispenser meters and dispenses single-component epoxy, silicone, oil, dye or pigmented materials. The dispenser offers a metering accuracy to better than 1% for Newtonian-type liquids, and it can accurately dispense abrasive or nonabrasive materials. The dispensed shot size is adjustable from 0.02 to 0.3 and 0.25 to 1.2 cm³ in two different models. Changes in air pressure, temperature or material viscosity do not alter shot size. Shot rates can be adjusted from 1 to 70 shots per minute. The dispensed material can be heated in the reservoir or at the nozzle. Viscosities from 1 to 100,000 cps can be handled, though above 30,000 cps, a pressurized reservoir may be required.

CHECK NO. 330

Tapes provide quick-connect body contacts



Technical Wire Products, 129 Dermody St., Cranford, N.J. 07016. (201) 272-5500. \$25 for 15/32 in. by 15 ft; stock.

Confuzz is a combination of two special silver-impregnated tapes. One tape is covered with a myriad of finely woven monofilaments that are formed into permanent hooks, and the other is covered with a soft loop pile. When pressed together, the two tapes provide a highly conductive, tightly fastened bond that can be separated and repositioned quickly to re-establish both conductivity and the mechanical bond. Confuzz is suitable as electrodes for psychogalvanometers and other electrical body-contact use. The material is available in various size rolls—from 3/8 to 2 in. wide and up to 100 ft. long.

CHECK NO. 331

Threads in soft material provided by press nuts

Precision Metal Products Co., 41 Elm St., Stoneham, Mass. 02180. (617) 438-3650.

A new line of press nuts provides wear-resistant threads for soft-brass, aluminum, mild-steel or thermoplastic panels and chassis. Designated the NK Series, the miniature nuts are available in either stainless or carbon steel and feature a behind-the-panel extension that provides constant thread depth regardless of material thickness. Threads are class 2B, MIL-S-7742. Stainless-steel nuts are for mounting in materials of Rockwell hardness 70 or less, and carbon-steel nuts for 85 or less. Thread sizes range from 0-80 to 3-48. The material sheet thicknesses should be a minimum of 0.032 in.

CHECK NO. 332

Thick-film resistor ink stable after laser trim

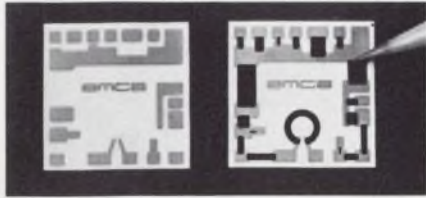

Electro Materials Corp. of America, 605 Center Ave., Mamaroneck, N.Y. 10543. (914) 698-8434. \$35 to \$40 per oz. (OEM qty).

EMCA 5000 series inks allow unusually stable laser trimming, according to the manufacturer. Test results showed that inks trimmed on a Q-switched YAG laser had no drift after 10 min. at 400 C. The 10-Ω ink had no resistivity change, and the 1-MΩ only 0.25% change after 60 min. The inks are formulated for use on 96% alumina. They cover the resistivity range of 10 Ω/sq. to 10 MΩ/sq. The use of other types of ceramics are also possible. Firing temperatures between 750 and 1000 C will cause little, if any, resistivity variation.

CHECK NO. 333

Edge strip protects PC edge connectors

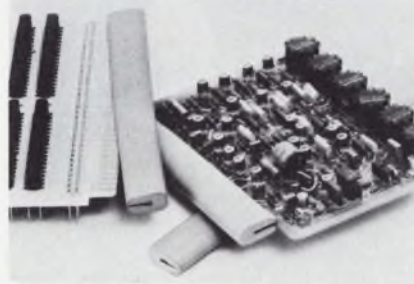

Webtek Corp., 4326 W. Pico Blvd., Los Angeles, Calif. 90019. (213) 937-3511. \$1.25 per strip (12 up).

PC edge connectors can be protected during soldering, in storage or when handling and shipping with edge-protector strips. These neoprene strips firmly grip the card edge and don't mar critical surfaces. They are extruded from nonstaining, carbon-free neoprene and they can be reused many times. Strips are offered with slot width/depths of 0.050/0.160, 0.062/0.312 and 0.062/0.437 in. They are supplied in 30-in. lengths and they can be cut as required with a scissors or knife.

CHECK NO. 334

Screws, nuts, clamps from nonburning nylon



Weckesser Co., Inc., 4444 W. Irving Park Rd., Chicago, Ill. 60641. (312) 282-8626.

Seolon, nonburning nylon screws and nuts, and Seo-Grip, nonburning cable clamps, are made of flame-retardant nylon with a UL rating Type 1 and an SE-0 classification. They have a UL temperature rating equivalent to standard nylon 6/6 of 105 C for both electrical and mechanical properties. These items are of special interest to manufacturers who must meet critical safety standards.

Booth No. 1408 Check No. 335

the standard power supply is a minor consideration... until it fails!

OEM's are getting a little tired of 'power failures'. And many have decided it's better to pay the difference to be sure their products are powered reliably. The cost isn't that much more -- and it may save some valuable reputations.

This concept puts North Electric squarely in the picture, because reliability is our stock in trade.

We've been the leading custom power producer for more than 40 years -- and our modular power supplies follow the same quality standards... including rugged Life Tests, EMI analysis, shock, vibration, humidity, and temperature tests -- and most are UL recognized.

Another point - if you are presently making your own power, let us show you (through a make or buy analysis) why it might be to your advantage to have North handle this specialized area of production.

When you buy power supplies, standard or custom, buy from the one big name that makes both.

NORTH 
ELECTRIC COMPANY

Electronics Division/Galion, Ohio 44833
A United Telecommunications Company
419/468-8874
Ask for Product Manager/Standard Power

MODEL	11000	12000	13000	14000	15000	16000	17000	18000
VDC	AMPERES							
5.0	3.9	5.3	11.3	13.0	20.0	32.5	49.0	82.0
12.0	2.8	4.2	8.0	10.5	15.0	23.0	36.0	58.0
15.0	2.4	3.7	7.5	9.5	14.0	20.5	27.0	47.0
18.0	2.1	3.3	6.0	8.0	13.0	18.0	26.0	40.0
24.0	1.5	2.8	4.2	7.0	11.0	15.0	21.0	33.0
28.0	1.4	2.4	4.0	6.3	9.0	14.0	20.0	29.0
36.0	1.2	2.2	3.1	5.6	8.0	11.0	14.0	23.0
48.0	.95	1.8	2.6	4.2	6.0	8.0	10.0	18.0

Listed here are the more popular models-- many other voltages are available.

DUAL OUTPUT SUPPLIES	
MODEL	N03052
VDC	AMPS
±15-12	400MA
MODEL	N60052
VDC	AMPS
±15-12	1.0A

MODEL 10000	
VDC	AMPS
0-7.5	2.10
0-16	1.25
0-25	0.85
0-33	0.68

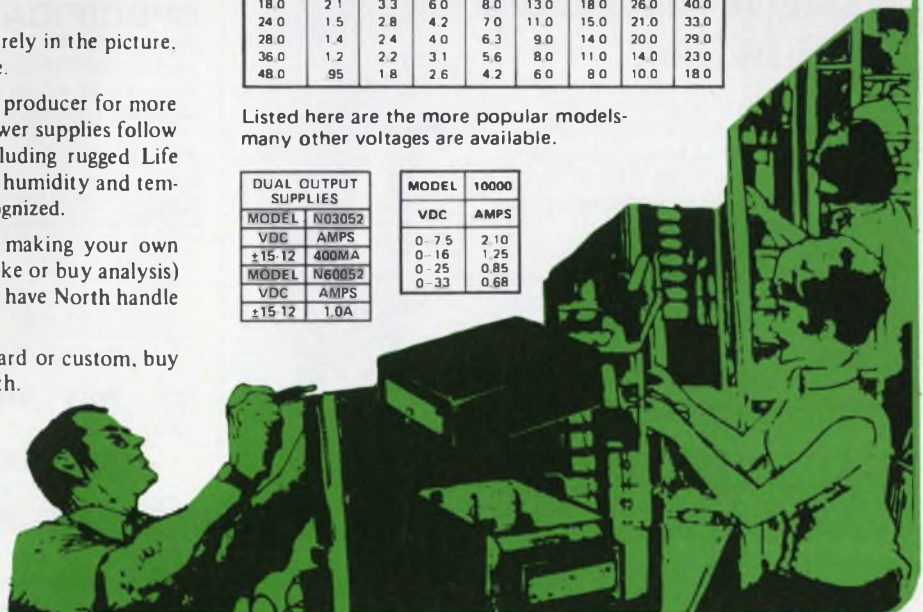

Ionized-air gun removes static electricity

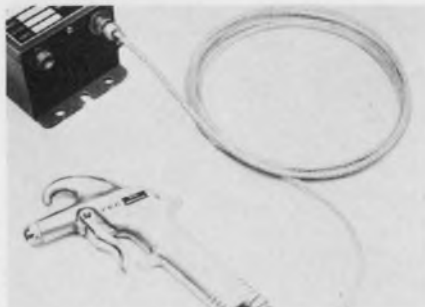

Testone Electrostatic Corp., Alpha Industrial Park, Chelmsford, Mass. 01824. (617) 256-3911.

The Model 190 ionized-air gun effectively neutralizes static electricity, and at the same time, removes dust and dirt particles with one blast of ionized air. And since the treated area is electrically neutralized, dust and dirt particles are not reattracted. Two air guns can be operated at the same time from one J-series power supply. Each gun has 8 ft. of shielded cable. Longer cable lengths are available.

CHECK NO. 336

Casting resin weighs half of common types



Emerson & Cuming, Inc., Canton, Mass. 02021. (617) 828-3300. \$36.25 per gallon; stock.

Stycast 1090SI is a low-viscosity (1800 cps), lightweight (specific gravity is 0.78), epoxy casting or potting compound that has a high resistance to moisture absorption. Weight is less than half that of conventional casting resins. Low shrinkage under cure and a low thermal expansion coefficient ($54 \times 10^{-6}/^{\circ}\text{C}$) are other important properties. Because of its low viscosity, Stycast is recommended for the module potting of delicate or closely packed components.

CHECK NO. 337

Multipin plugs come in ultra-miniature size

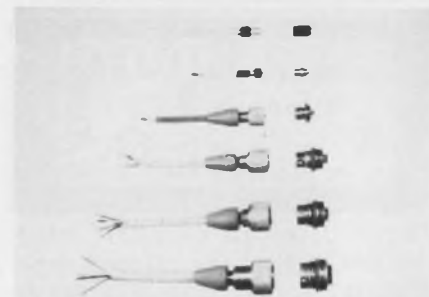

Microtech, Inc., 777 Henderson Blvd., Folcroft, Pa. 19032. (215) 532-3388. From \$0.95 (1000 up); stock.

A new line of ultra-miniature co-axial connectors meets the needs of high-density packaging. The connectors are available with outer diameters as small as 1/8 and 1/4 in. Multicontact connectors come with four, seven or 12 pins and outer diameters of 1/4, 5/16 and 7/16 in., respectively. Over-all length of the plugs are less than 1/2 in. The bodies and pins are gold-plated brass, the sockets are gold-plated beryllium copper and the insulators are Teflon.

CHECK NO. 338

LIGHTED DECORATOR
PUSH BUTTON SWITCHES.

**250,000
colorful operations
per button.**

These Grayhill 1/4 amp lighted decorator push button switches offer a wide selection of popular styles and colors. Square or round, front or sub-panel mounts. Full range of colors, single or two-tone. Legends to order.

And that's only on the surface of things. There's an equally imposing variety in the circuitry available. SPST, momentary N.O. or N.C.; SPDT, momentary or alternate action; and DPDT, momentary or alternate action.

And every Grayhill lighted decorator push button switch variation has a tested life expectancy of 250,000 operations.

To learn more about these and other Grayhill quality products, write for our latest Engineering Catalog. Grayhill, Inc., 565 Hillgrove Avenue, La Grange, Illinois 60525. (312) 354-1040.



DIRECT FROM STOCK
5V 1.2A

\$27⁰⁰

SPECIFICATIONS

Size: 4.5 x 4.5 x 1.5

Input: 105-125V, 47-420 Hz

Output: Any DC voltage 3 to 30

Regulation: Line 0.005%
Load 0.05%

Ripple: Less than 250 microvolts

Recovery Time: 25 microseconds

Temperature:

Operating -20 to +71°C

Storage -65 to +85°C

Coefficient 0.01%/°C Max

Current Limiting:

Fixed-foldback type

Overvoltage: Optional

MODEL	VOLTAGE	AMPS	MODEL	VOLTAGE	AMPS
10-5	4.5 to 5.5	1.2	10-28	26 to 30	0.35
10-12	11 to 13	0.8	10-1212	±11 to 13	0.35
10-15	14 to 16	0.6	10-1515	±14 to 16	0.35
10-24	23 to 25	0.4	10-1818	±17 to 19	0.35

For Overvoltage Models, add -0 to Model number

QTY.	PRICE	WITH OVERVOLTAGE	DUAL SUPPLIES	WITH OVERVOLTAGE
1-9	\$27	\$32	\$35	\$45
10-24	\$24	\$28	\$32	\$41

**CALL (714) 279-1414 FOR DELIVERY
DIRECT FROM STOCK**

Electrostatics, Inc.

7718 CLAIREMONT MESA BLVD. • SAN DIEGO, CA 92111 • (714) 279-1414

**Drawer pulls mount
without screws**

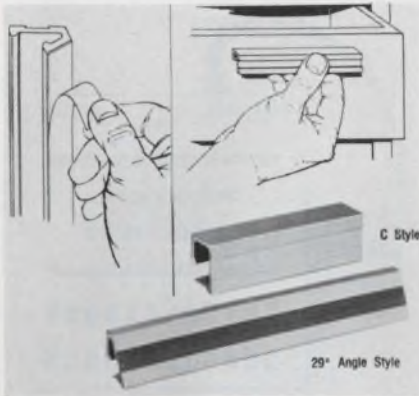

Southco, Inc., 200 Industrial Hwy.,
Lester, Pa. 19113. (215) 521-0800.

It's now easier than ever to install a stylized door or drawer pull to match modern industrial cabinetry. The C and 29°-angle style pulls are available with a pressure-sensitive adhesive backing for instant mounting. After the protective paper is peeled from the adhesive backing, the pulls are securely installed by simply pressing them into position. The pulls can be mounted on such materials as glass, plastic and ceramic.

Booth No. 1507-08 Check No. 339

**Drill operates from
line or batteries**

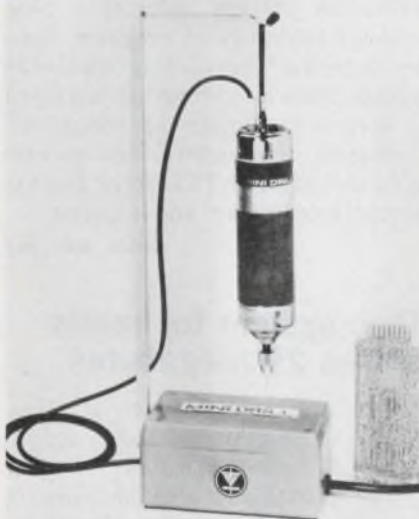

Micro Electronic Systems, Inc., 8
Kevin Dr., Danbury, Conn. 06810.
(203) 746-2525. \$27.50; 60 days.

An improved version of the Mini-Drill uses an ac/dc converter, hanging stand and foot switch for easier and more accurate performance. Batteries can be used in portable applications.

CHECK NO. 240

**IT DOESN'T TAKE
A MATHEMATICIAN
TO SOLVE THIS
EQUATION!**

$$Q + LP = \underline{RFPL}$$

Where Q = QUALITY
LP = LOW PRICE
and RFPL = WIDEBAND AMPLIFIERS

Just check these values:

Model FK-250-145
100 Watts — 45dB Gain —
5KHz to 250MHz* \$5750



*Up to 300MHz Optional

Model FK-250-10B
10 Watts — 35dB Gain —
200KHz to 250MHz* \$1375



Model FK-250-1K60L
1000 Watts — 60dB Gain —
10KHz to 220MHz
Price? You'll have to
call us to believe it.

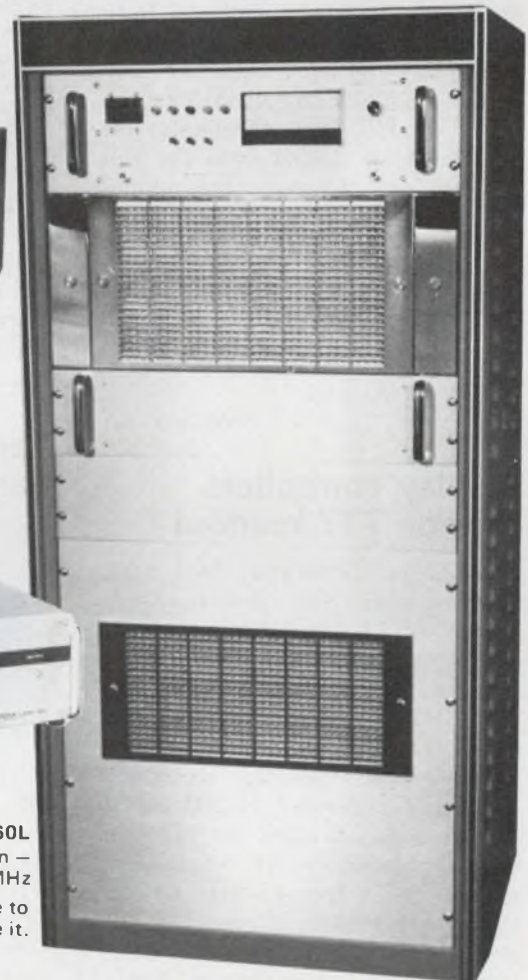

*Do yourself a favor —
Beat the price "freeze"
By calling RFPL today at
(206) 454-3886 —
You'll be glad you did!*

R.F. POWER LABS, INC. Bellevue, Washington 98004

INFORMATION RETRIEVAL NUMBER 93

Graphics terminal has 19-in. display



Tektronix, Information Display Div., P.O. Box 500, Beaverton, Ore. 97005. (503) 644-0161. See text.

A high-density alphanumeric display and a 19-in. screen highlight the performance features of the 4014 or 4015 CRT terminals. Both display up to 8500 alphanumeric characters and more than 1,000,000 graphic points. Model 4015 is the APL version. The terminals use 128-character ASCII code for full upper and lower case alphanumeric characters and have extensive interactive-graphics capability. PLOT-10 software interfaces the terminals with the host computer. The 4014 costs \$8450 and the 4015 costs \$8950.

CHECK NO. 341

Display controllers provide TTY readout

Ann Arbor Terminals, Inc., 6107 Jackson Rd., Ann Arbor, Mich. 48103. (313) 769-0926. See text; 15 days.

Series R0200D controllers provide CRT data display from serial sources such as teletypewriter channels and cassette recorders. The unit operates with serial ASCII data at rates up to 9600 baud asynchronous. The controllers store a full screen of data (up to 1920 characters) and provide composite video compatible with EIA-standard 525-line monitors. Three display formats are available 32 × 16, 80 × 16 and 80 × 24 and the respective controllers cost \$860, \$1010 and \$1140. The display set is 64 alphanumeric ASCII characters. The controllers also provide cursor control and an optional vhf output port to drive conventional TV receivers.

CHECK NO. 342

Sonic digitizer adds graphics to calculator



Science Accessories Corp., 65 Station St., Southport, Conn. 06490. (203) 255-1526. \$3750; 4 wks.

Designed for inputting graphic information to the Hewlett-Packard Series 9800 programmable calculators, the Model 2098 digitizer converts pictorial coordinates to digital coordinates with 0.007-in. resolution. Model 2098 uses the Graf/Pen system. Hypersonic signals generated at the point of ballpoint pen or steel stylus are detected by sensors placed along two adjacent sides of a display surface such as a flat glass tablet, blackboard or CRT screen. Graf/Pen sensors, available in lengths up to 72-in., provide digitization for graphics sizes up to 6 ft. by 6 ft. The choice of operating modes includes single-shot, remote-control and free-run. In the latter mode, coordinates are generated continually at a user-selectable rate.

CHECK NO. 343

Tape duplicator handles Mylar or paper

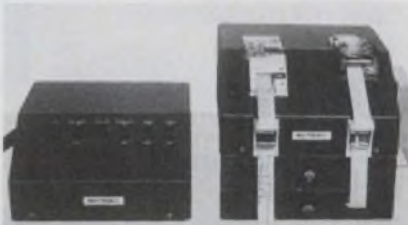

Litton, ABS, OEM Products Div., 600 Washington Ave., Carlstadt, N.J. 07072. (201) 935-2200. See text.

A combination reader/punch station plus a separate control unit—model 535—permit continuous duplication of punched paper, Mylar or metalized Mylar tapes. Output speeds are 50 char/s and 60 char/s, respectively, depending on whether the control unit is used with the 592 or the 692 reader/punch. The controller costs \$560 and the reader/punch stations cost \$1288 for the model 592 and \$1338 for the model 692.

CHECK NO. 344

Portable analyzer logs microcomputer actions

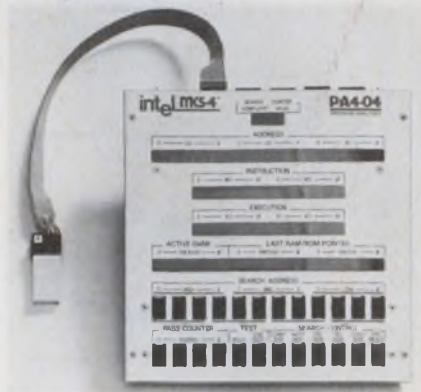

Intel Corp., Microcomputer Group, 3065 Bowers Ave., Santa Clara, Calif. 95051. (408) 246-7501. \$495; July.

A portable analyzer, the PA 4-04 provides real-time analysis for the manufacturer's MCS-4 microcomputer set. The unit clips to the MCS-4 CPU and displays significant CPU parameters. In the free-running mode, a 12-bit address display provides a continuous indication of the program counter value and a sync pulse at a selected location. In the search mode, "Address," "Instruction," "Execution Data," "Active Bank" and "Last RAM/ROM pointer" are latched and displayed as the CPU accesses a preselected search address. A switch selectable pass counter interrogates program loops by delaying the display until the preset search address is accessed a specified number of times. All displayed parameters are accessible in buffered TTL form for external monitoring and logging.

CHECK NO. 345

Disc system for minis stores 29 megabytes

Diva, Inc., 607 Industrial Way West, Eatontown, N.J. 07724. (201) 544-9000. \$12,800.

The DD-14 disc system consists of a single spindle drive, controller, software and cabling and provides at least 29 Mbytes of storage capacity. The average access time is 35 ms with a 312 k byte/s transfer rate. Mini or IBM format compatibility can be chosen as a user option. The drive is a 2314-type and uses a removable 2316-type disc pack.

CHECK NO. 346

Power Supplies

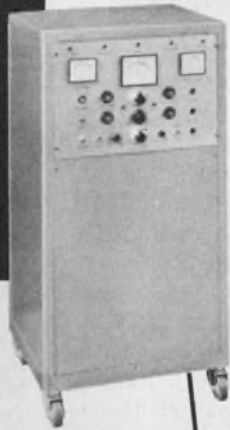

- Power supplies for all electromagnets from 1.2 to 10 kW. Current stabilized up to 10^{-6} .
- Power supplies from 10 to 100 kW for any application. Standard and custom designed.

Bruker Scientific, Inc.
1 Westchester Plaza
Elmsford, N. Y. 10523
(914) 592-5470



INFORMATION RETRIEVAL NUMBER 94

MK-654 means simple measurement of harmonic distortion to the order of 0.003%. MK-654 takes the guesswork out of amplifier check-outs, gives you an accurate assessment of your amplifier's worth.



MK-654 Data Distortion Measurement:	
Measuring range	Input under 3V: 0.01~30%
	Input over 3V: 0.003~30%
Frequency.....	Ten spots in 20Hz to 20kHz range
Fundamental rejection	More than 90dB down
Level Measurement:	
Range.....	+40~-80dB
Frequency.....	20Hz~60kHz

Combination with our MCR-402 Low-Distortion Oscillator gives a highly effective measuring configuration.



MEGURO DENPA SOKKI K.K.
No. 5, 1-2-chome, Chuo-cho, Meguro-ku, Tokyo, Japan
TEL: 710-1211 Cables: MEGURODENPA TOKYO

INFORMATION RETRIEVAL NUMBER 95

ELECTRONIC DESIGN 18, September 1, 1973



Check in one direct move with Brandenburg's new HV meter

We thought it was about time somebody supplied *direct reading* meters for high voltage, so we've produced three—one for up to 5kV, one for 15kV and one for 30kV to complement our range of HV power supplies.

The meters are operated by two 9V internal batteries (800 hours life) linked with a built-in checking facility. Positive or negative ground is available, selected by a front panel switch. And, as with all Brandenburg products, there is a 12 months unconditional guarantee.

- Accuracy of 1% fsd over voltage range of 0.30kV d.c.
- Less than $1\mu\text{A}$ drawn at 30kV d.c.
- 4.5in (114 mm) scale mirror-backed meter.
- Temperature range 5-35°C.
- Dimensions only 7 x 8 x 5½in high (200 x 145 x 178mm).
- Recorder output.

Yet another Brandenburg piece in the high voltage game

brandenburg

STABILISED HIGH VOLTAGE

Brandenburg Limited, 939 London Road, Thornton Heath, Surrey, CR4 6JE, England. Tel: 01-689 0441 Telex: 946149

Agents or distributors in most principal countries.

P6437

INFORMATION RETRIEVAL NUMBER 96

165

Video graphic recorder gives dry writeable copy



Tektronix, Inc., P.O. Box 500, Beaverton, Ore. 97005. (503) 292-2611. \$2950; Dec.

The model 4632 graphic recorder provides dry paper copies of standard or digital video signals. An 8.5 x 11-in. copy is delivered in a matter of seconds. The unit is plug-compatible with many of the graphic or alphanumeric terminals that use a refreshed video raster. Copies cost 5 to 7 cents, depending on usage and can be erased or written on with pen or pencil.

CHECK NO. 347

Modem uses coherent detection technique

Intertel, Inc., 6 Vine Brook Park, Burlington, Mass. 01803. (617) 273-0950. \$1115; stock.

Contained on a single 9.5-by-12-in. printed circuit card, the Model 2011 modem provides Bell 201A compatible operation at 2000 bit/s over dial-up telephone lines. Standard features of the Model 2011 include answer-back tone, automatic answering, carrier detect, clear-to-send delay, external/internal transmitter timing, receiver squelch, and MARK-hold-on-receive-data when the carrier is lost. The Model 2011 error rate is less than one bit in 10⁶ for a signal-to-noise ratio of 15 dB on worst-case lines that have 20-degree pk-pk phase jitter at rates from 0 to 180 Hz. The unit uses a coherent demodulation technique in which a stable reference carrier derived from the incoming signal is used for demodulation. This approach is said to improve error rate performance by approximately 3 dB over incoherent methods.

CHECK NO. 348

Intelligent terminal gains disc storage



Incoterm Corp., 6 Strathmore Rd., Natick, Mass. 01760. (617) 655-6100. See text; Nov.

The SPD D-250 Diskette provides users of the company's SPD10/20 intelligent terminal with over 500-kbytes of storage. Single or dual flexible discs each store more than 250-kbytes. Track-to-track search time is 10 ms, and the average latency is 10 ms. Data are transferred at the rate of 31.25-k byte/s. A single-disc system costs \$2700 and a dual unit costs \$3700. Either system includes a controller, power supply and support software.

CHECK NO. 349

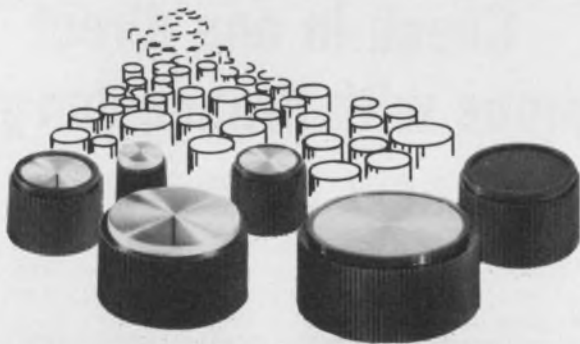

1,500,000
KNOBS TO CHOOSE FROM...
 and they're "Warranted for Life"

Kurz-Kasch has over 1½ million low cost, high quality knobs in inventory, ready to ship to you. (You save . . . no tooling cost on stock knobs, specials 4 to 6 weeks delivery.) Your local distributor's stock is available at factory prices. Select instrument and control knobs from 24 families with 367 basic sizes and shapes in general purpose phenolics, melamines and ureas. All Kurz-Kasch knobs are warranted for the life of the product on which they're used. Send now for free 20 page catalog. (Also found in THOMAS REGISTER "THOMCAT.")



Kurz-Kasch, Inc.
 2876 Culver Ave.
 Dayton, Ohio 45429
 (513) 296-0330

INFORMATION RETRIEVAL NUMBER 97

ATLAS positively guarantees . . .

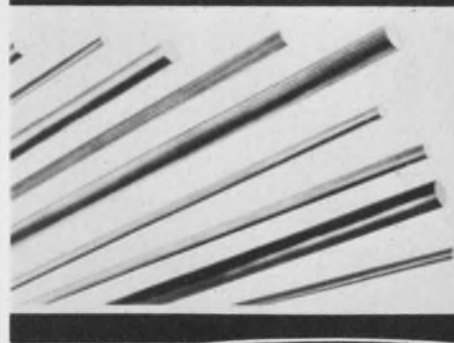

fastest delivery

unsurpassed accuracy

lowest prices

on Turned and Precision-Ground
PHENOLIC RODS

EPOXY

BAKELITE

Glass Supported TEFLON

- Stock sizes in any diameter from 3/32" to 3/8"
- Increments of .001 at no extra charge
- Most sizes available for immediate delivery
- Accuracy guaranteed to ± .001"

Plus . . . the largest inventory in the world!

SEND FOR COMPLETE PRICE LIST

ATLAS FIBRE COMPANY

6980 N. Central Pk Ave. Chicago, Ill 60645
 (312) 465 1234

INFORMATION RETRIEVAL NUMBER 98

Data acquisition units work at low levels

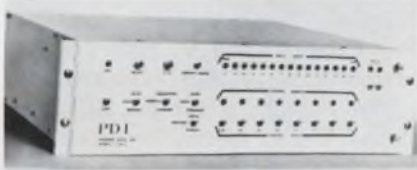

Phoenix Data, Inc., 3384 W. Osborn Rd., Phoenix, Ariz. 85017 (602) 278-8528. From \$1710; 6 wks.

All three equipment groups (6000, 7000 and 8000 series) of data acquisition units offer resolutions of eight to 15 binary bits and will accommodate 256 single-ended or 128 differential inputs on a single chassis. The lowest cost 6000 series (from \$1710) do not have programmable gain amplifiers. And their throughput rates range from 1 M channels/s with 8-bit resolution to 250 k channels/s with 15-bit resolution. Units in the 7000 series have four gain ranges, with automatic or programmable gain selection. Throughput rates range from 10 to 50 kHz. The 8000 series features 11 binary gain ranges from 10 mV to 10.24 V, full scale, along with autoranging. An eight-channel 15-bit unit in the 7000 series costs \$4950, while an eight-channel 12-bit unit in the 8000 series costs \$3450.

CHECK NO. 350

Tape-drive series has 48 variations



Caelus Memories, Inc., 12621 Chadron Ave., Hawthorne, Calif. 90250. (213) 644-9881. \$2000 to \$2960; 6 wk.

Three tape drives—models 700, 800 and 1000—provide the user with up to 48 variations to choose from. These include: 7, 8.5 or 10-in. reel; recording speeds to 45 in/s; 7 or 9-track format and NRZI or phase-encoded recording methods. Recording densities range from 200 to 1600 bytes/in. Overwrite or edit capability is standard.

CHECK NO. 351

PL/M language helps program microcomputer

Intel Corp., Microcomputer Group, 3065 Bowers Ave., Santa Clara, Calif. 95051. (408) 246-7501. \$1250; July.

PL/M, a high level language based on PL/I, permits efficient coding of microcomputer programs in high level source language. As an example the company cites a prime number program coded in assembly language and PL/M. The program in PL/M took 15 min. to code and used 114 bytes; the assembly coding required seven hours and used 110 bytes. The PL/M compiler is written in ANSI standard Fortran IV and will execute on most machines. All future eight-bit processor chips developed by Intel will be compatible with this new language. And the manufacturer will maintain a program library. The language can also be implemented on the company's MCS-8 microcomputer system or accessed on time-sharing services such as GE, Applied Logic Corp. and Tymshare. Purchase price is \$1250.

CHECK NO. 352

Scientific calculator offered in two versions

Hewlett-Packard, 1501 Page Mill Rd., Palo Alto, Calif. 94304. (415) 493-1501. See text; 30 days.

Two calculators, one battery powered, the other a printing desk top unit, provide the next step up in scientific computing power from the HP-35. The HP-45 and the HP-46 calculators have nine addressable memory registers, perform 40 functions, provide polar/rectangular conversion and metric/U.S. conversion constants. Both the HP-45 and HP-46 operate in any three trigonometric input modes—degrees, radians or grads and can convert between decimal angles and degrees, minutes and seconds. The HP-45, costing \$395, uses a 15-character LED display which can display up to 10 significant digits, a two-digit exponent and appropriate signs. The same information is printed on paper tape by the HP-46 desk top model, which costs \$695. Both calculators handle numbers between 10^{-99} to 10^{99} .

CHECK NO. 353

innovation yesterday

First Morse Telegraph

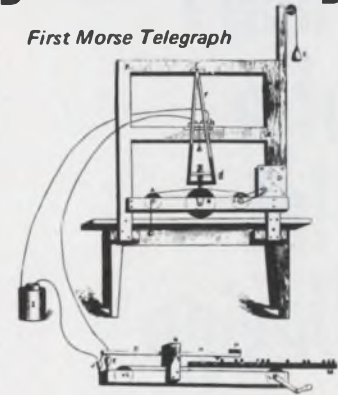

innovation today



SEALED THUMBWHEEL SWITCHES Now QPL Approved

The Morse telegraph was innovative. And while it didn't put the mail man out of business, it filled a very special need.

Our Series 200 and 700 MINI-SWITCH[®] and our Series 9000 DIGISWITCH[®] fill the special need for sealed Thumbwheels. They're excellent for machine tool applications, various environmental military applications and many others where sealing is imperative. Now, they're QPL approved to MIL-S-22730 (slash numbers 15C, 20A (EC) and 12B). So, write for a catalog. Or a copy of our QPL approval letter. Those are good ideas too.

THE **DIGITRAN** COMPANY
A Division of Becton, Dickinson and Co. [B-D]
855 So. Arroyo Parkway, Pasadena, Ca. 91105
Tel. (213) 449-3110 • TWX 910-588-3794

INFORMATION RETRIEVAL NUMBER 99

Heart of a Hot Design



Design in Elmwood's fast, dependable snap-acting thermostats . . . artery to more reliable temperature control. Some are available for "world-trade" applications with U.L., C.S.A. and European listings. Many offer a choice of narrow or wide differentials to minimize cost. All are pre-set, tamperproof, and 100% checked for years of trouble-free performance. Phone, TWX, or write for prototypes, specs and prices

ELMWOOD SENSORS, INC.
1675 Elmwood Ave.
Cranston, R. I. 02907, U.S.A.
Phone (401) 781-6500
TWX 710-381-6413

ELMWOOD SENSORS

INFORMATION RETRIEVAL NUMBER 100

ICs & SEMICONDUCTORS

CMOS generates time base from 60-Hz line

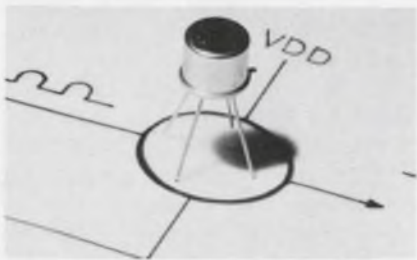

LSI Computer Systems, 55 Central Ave., Farmingdale, N.Y. 11735. (516) 293-3850. \$4.75 (100 up); stock to 4 wk.

Three standard CMOS dividers generate one of three time bases: 10 pulses per second, 1 pulse per second or 1 pulse per minute. These rates are achieved with a 50% duty cycle when operated from a 60-Hz line. The dividers—called the D3600, D60 and D6—are not limited to 60 Hz. They can operate with input frequencies up to 2 MHz and can be used wherever a divide by 3600, 60 or 6 circuit is required. The divider circuits are packaged in a 4-pin TO-5 hermetically sealed can.

CHECK NO. 354

IC contains two timing circuits

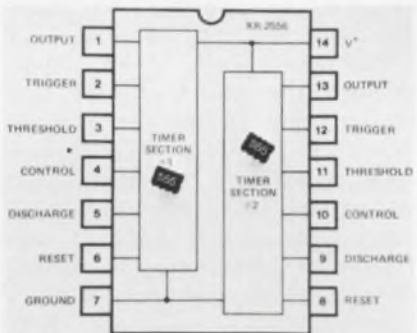

Exar Integrated Systems, 750 Palomar Ave., Sunnyvale, Calif. 94086. (408) 732-7970. \$1.50 (100-up).

The XR-2556 dual-timer IC, a replacement for two 555-type timers, has two independent outputs and control terminals capable of providing externally set time delays ranging from microseconds to one hour. The XR-2556 is compatible with TTL, DTL and ECL logic levels and operates from 4.5-to-20-V supply voltages. Output current from each timer section is capable of providing 200 mA.

CHECK NO. 355

128-bit ECL RAM accesses in 12 ns

Fairchild Semiconductor, 464 Ellis St., Mountain View, Calif. 94040. (415) 962-3816. \$48 (100-999).

The F10405, a 128-bit ECL Iso-planar RAM, boasts a typical access time of 12 ns and a typical chip-select access of 3 ns. Maximum read-write access time is guaranteed at 15 ns over a $\pm 5\%$ variation in power-supply voltage and over a 0 to 75 C temperature range. The F10405 is organized in a 128-bit by 1-word format and is fully decoded on-chip. It comes in a standard 16-pin ceramic DIP.

CHECK NO. 356

Npn phototransistor provides 3.5-mA output



Optron Inc., 1201 Tappan Circle, Carrollton, Tex. 75006. (214) 242-6571.

The OP 700 npn phototransistor has a typical output of 3.5 mA with irradiance of 20 mW/cm². Its spectral response is compatible with either tungsten-lamp or LED-light sources. A small 0.080 in.-diameter hermetically sealed brazed coax case permits high-density array applications.

CHECK NO. 357

IC VCO offers 10 ppm/°C max drift

Intersil, 10900 N. Tantau Ave., Cupertino, Calif. 95014. (408) 257-5450. \$42 (100).

A version of the 8038 precision waveform generator and VCO, called the 8038PC, has a guaranteed stability of 10 ppm/°C maximum from 0 to 70 C. The output of the 8038PC consists of three simultaneous high-level sine, square and triangular-waveforms, tunable from 0.001 Hz to 1.5 MHz. They can be swept or frequency modulated up to 100 kHz. The square-wave duty cycle is adjustable from 2 to 98%. The 8038PC operates from any 10 to 30-V supply.

CHECK NO. 358

2-to-35-V regulator has 100-W rating



Motorola, P.O. Box 20924, Phoenix, Ariz. 85036. (602) 244-3466. \$11.50 (100-999); stock to 8 wk.

A 100-W hybrid silicon voltage regulator, the MPC1000, offers a line regulation of 0.10% and load regulation of 0.15%, with output voltage adjustable from 2 to 35 V. The regulator provides 10A positive or negative series regulation and can operate from voltages as high as 60 V. With external pass transistors, currents in excess of 50 A can be obtained. The regulator includes current limiting protection.

CHECK NO. 359

Dual npn device has 1-Ω log conformance

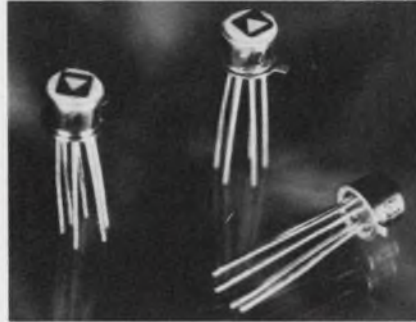

Analog Devices, Route 1 Industrial Park, P.O. Box 280, Norwood, Mass. 02062. (617) 329-4700. \$6 (1-99); stock.

A monolithic dual npn transistor, the Model AD818, features a log conformance tracking error of typically 1.0 Ω with collector currents up to 1 mA. It also provides tight matching characteristics of 1 mV maximum offset voltage, low voltage noise of 2 nV/Hz at 10 Hz and low collector saturation voltage of 0.1 V. The AD818 comes in a TO-52 package and operates over the -55-to-125-C temperature range.

CHECK NO. 360

S-TTL dual VCO operates to 85 MHz

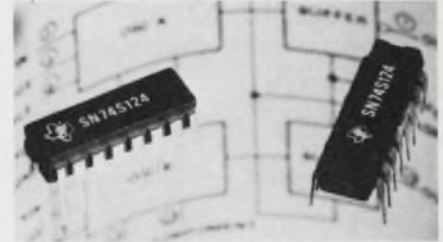

Texas Instruments, P.O. Box 5012, M/S 308, Dallas, Tex. 75222. (214) 238-3741. SN74S124N: \$2.61 (100); 16 wk.

A Schottky-TTL dual VCO, the SN54S/74S124, functions as a self-starting, free-running dual square-wave generator. The oscillator can be set to operate at any output center frequency between 0.12 Hz and 85 MHz typically. A single external component—either a crystal or a capacitor—determines the center frequency. Output frequency drift is 50 ppm per °C or less over the full operating temperature range. Stability over the supply-voltage range is typically ±0.1% for the SN74S124 and typically ±0.3% for the SN54S124.

CHECK NO. 361



NEW BENCHMASTER... 5 CUBIC FEET OF BENCH-TOP TEST SPACE!

Economical, portable, and compact, this all-new front-opening temperature and humidity test chamber is only 4 feet wide!

It's extremely versatile, too. Benchmaster offers medium or extreme temperature ranges—with or without humidity. Benchmaster is available in 4 performance variations:

Model BTH: 0°F to 200°F with humidity

Model BTRS: -40°F to 350°F with humidity

Model BTR: -100°F to 350°F with humidity

Model BTC: -100°F to 350°F without humidity

Write for complete information.



1090 Springfield Rd., Union, N.J. 07083 (201) 686-7870 • (212) 962-0332
Western Division: 15721 Texaco St., Paramount, Calif. 90723.

INFORMATION RETRIEVAL NUMBER 101

ELECTRONIC DESIGN 18, September 1, 1973

encapsulated snap-mount LEDs in red or green!



SoLiCo solid state GAP light emitting diodes are designed for low-voltage applications where panel space and speed of installation are important. Light output is exceptional: 3 milli-candelas at 20 milli-amps. Molded nylon bodies snap-fit into panel front with no tools required. Model D-503 provides a resistor in series, and forward voltages 5-6V, 12-14V, 18V or 28V can apply directly. Color-coded 6" insulated leads save valuable assembly time. Write: SORENSON LIGHTED CONTROLS, INC., Suite 810, 1428 Brickell Ave., Miami, Florida 33131. Tel. (305) 358-6112.

SoLiCo

INFORMATION RETRIEVAL NUMBER 102

128-bit ECL RAM accesses in 12 ns



Texas Instruments, P.O. Box 5012, M/S 308, Dallas, Tex. 75222. (214) 238-3741. \$39 (100-999); stock.

A 128-bit ECL RAM, the SN-81003, features an access time of 12 ns maximum and is a pin-for-pin equivalent of the AMS1003. The RAM is organized to provide 128 words of one bit each. Full address decoding and output-sense amplification are included on the chip, along with open-emitter follower outputs that can drive transmission lines with as low as 50-Ω impedances. The RAM operates from 5.2 V ±10% supplies. Maximum output current is -50 mA.

CHECK NO. 362

IC has thyristor, rectifier for TV



RCA Solid State Div., Route 202, Somerville, N.J. 08876. (201) 722-3200. \$2.05 to \$2.80 (1000); stock.

The 41017 through 41023 ICs contain an SCR and silicon rectifier for use in TV horizontal-deflection circuits. The devices can deflect beams in color and monochrome picture tubes with deflection angles up to 114°. They supply as much as 7 millijoules of stored energy to the deflection yoke. Types 41017 through 41019 are used as bipolar switches to control horizontal yoke current during the beam-trace interval; types 41020 through 41023, as commutating switches to initiate trace-retrace switching. The devices handle average beam currents up to 1.6 mA and can operate from nominal supply voltages of 150 to 270 V.

CHECK NO. 363

PLLs form dual tone-decoder ICs

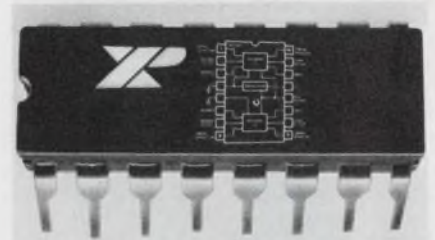

Exar Integrated Systems, 750 Palomar Ave., Sunnyvale, Calif. 94086. (408) 732-7970. \$4.60 (100 up).

The XR-2567 dual monolithic tone decoder contains two 567-type PLL tone decoders that can be used independently or interconnected for dual operation. The IC operates over a frequency range of 0.01 Hz to 500 kHz with power supply voltages ranging from 4.5 to 12 V. The circuit contains internal voltage regulation for supplies between 7 and 12 V. Each section consists of a phase-locked loop (PLL), a quadrature AM detector, a voltage comparator and an output current driver. Each output can sink up to 100 mA of load current.

CHECK NO. 364

FUJI

8K bytes complete memory card & 65K bytes drawer for Add-on memory

MB2000

CMS2400 series

The CMS2401 and CMS2402 are 3 wire-3D core memory systems, fully contained on a single printed circuit card. The dimensions are 10" x 15" x 0.5". It mounts on 0.6" connector centers. The single memory card has a maximum capacity of 4096 words x 18 bits per word, smaller capacity by means of depopulation. Eight cards can be bussed to provide up to 32K words x 18 bits capacity. Also byte control is standard so that the 4K-18 can be logically alterable as 8K-9. Low power consumption, high reliability and rugged structure are key advantages of the CMS2400 series.

Specifications:

	Access time	Cycle time	Temp. range	Power supply voltage
CMS2401	330 ns	1 μs	0°C to +50°C	+5V ±3% 1.6A max -5V ±3% 0.2A max
CMS2402	280 ns	750 ns		+15V ±3% 3.5A max

FUJI ELECTROCHEMICAL CO., LTD.

Head Office: Hamagomu Bldg. 5-36-11, Shinbashi, Minato-ku, Tokyo, Japan TEL. 434-1271
Overseas Office:
New York, TEL: (212) 532-5630/Los Angeles, TEL: (213) 620-1640/Düsseldorf, TEL: (211) 89031

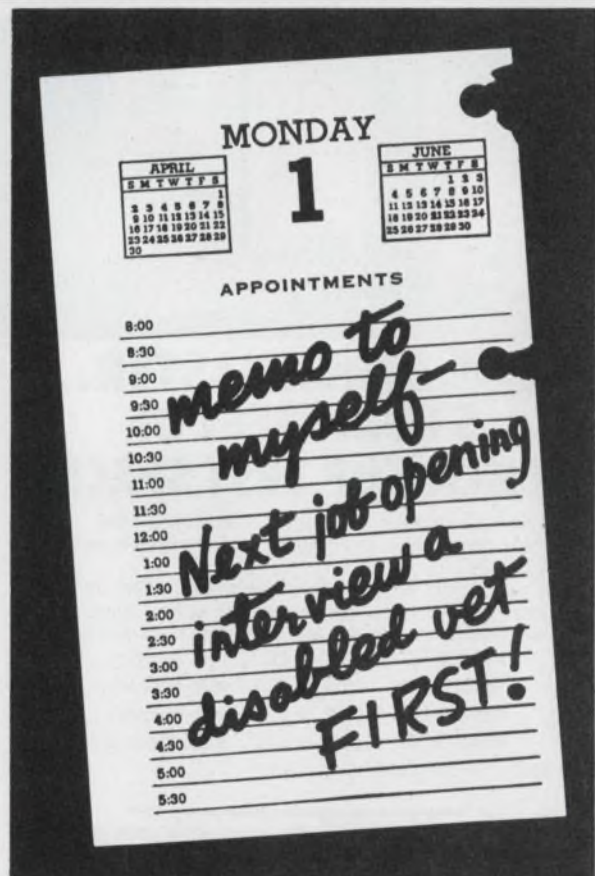

The President's Committee on Employment of the Handicapped
Washington, D.C. 20210

MICROWAVES & LASERS

Precision couplers have multi-octave BW



Hewlett-Packard, 1501 Page Mill Rd., Palo Alto, Calif. 94304. (415) 493-1501. HP 11691D; \$650; HP 11692D: \$1175; 60 days.

The 11692D dual and 11691D single coaxial directional couplers feature wide frequency range—2 to 18 GHz—high directivity—> 30 dB to 8 GHz, > 26 dB to 18 GHz—and flat response—±1-dB variation full band. When these couplers are used with a broadband detection and display system, simultaneous swept reflection and transmission measurements can be performed on microwave components over a 9-to-1 bandwidth.

CHECK NO. 365

Sweeper/sig-gen covers 1-to-18-GHz range



Narda Microwave, 75 Commercial St., Plainview, N.Y. 11803. (516) 433-9000.

The 9535 sweeper/signal-generator provides full sweep coverage of L through KU bands from 1 to 18 GHz. The sweeper can be programmed for amplitude and frequency from an analog source or a straight BCD-type power supply. The frequency input is directly correlated in 1 V per GHz. The rf power capability provides a 30-dB dynamic range for a 0-to-2-V input. Booth No. 1336-37 Check No. 366

6-GHz upconverter tunes in 10-kHz steps

California Microwave, 455 W. Maude Ave., Sunnyvale, Calif. 94086. (408) 732-4000.

A frequency-agile upconverter can be tuned in 10-kHz steps over the frequency range of 5.925 to 6.425 GHz. Called the Model UC64, it includes a synthesizer and dual conversion downconverter that accepts FM-FDM or FM-video signals in the 70-MHz band and translates them to a 6-GHz output signal. The UC64 transmit frequency can be changed remotely with BCD logic or locally with thumbwheel switches. It changes from one frequency to another in less than two seconds after a command is given.

CHECK NO. 367

Preamp simplifies CATV tests



Tektronix, P.O. Box 500, Beaverton, Ore. 97005. (503) 644-0161. \$550.

The 7K11 CATV preamp plug-in can be used with the 7L12 spectrum analyzer plug-in, in a 7000-series mainframe, to provide the following: 75-Ω measurement environment, noise-free gain for proof-of-performance testing, and CRT readout of spectrum analyzer reference level in dBmV. Intermodulation distortion is more than 85-dB down and VSWR is 2:1. Built-in 75-Ω attenuation is provided in 1-dB steps from 79 dBmV to 0 dBmV. The preamp covers the 40-to-890-MHz frequency range.

Booth No. 1818-20 Check No. 368
1832-35

MICRO-MINIATURE DOUBLE- BALANCED MIXERS

Great Value at

\$12⁹⁵
500 piece quantities

\$15.95 in 6-piece quantities

DC-600 MHz
6dB conversion loss
40 dB isolation
EMI shielded case

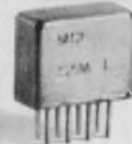

A breakthrough in technology and high production volume enables Mini-Circuits Laboratory to offer these new micro-miniature products at an unprecedented low price.

Only 0.2 x 0.5 inches in PC board area, the SAM-1 requires less PC area than even a flat-pack or TO-5 can.

Ruggedness and durability are built in the SAM-1. These new units are packaged within an EMI shielded metal enclosure and hermetically sealed header. They use well matched hot-carrier diodes and uniquely designed transmission line transformers.

We invite you to convince yourself. Place your order now and check our delivery, product performance and reliability.

Mini-Circuits Laboratory

2913 Quentin Rd., Brooklyn, N.Y. 11229
(212) 252-5252, Int'l Telex 620156
A Division Scientific Components Corp.

*FRANCE: S.C.I.E., *31, rue, George-Sand, Palaiseau 91, France. *GERMANY, AUSTRIA, SWITZERLAND: Industrial Electronics GMBH, *Klüberstrasse 14, 6000 Frankfurt/Main, Germany. ENGLAND: Dale Electronics, Dale House, Wharf Road, Frimley Green, Camberley, Surrey. JAPAN: Densho Kaisha Ltd, Eguchi Building, 8-1 1-Chrome, Hamamatsucho, Minato-Ku, Tokyo. *ISRAEL: Hamashbir Electronics, 76 Giborei Israel St., Tel-Aviv, Israel

*UNIT IN STOCK

INFORMATION RETRIEVAL NUMBER 105

Less than 1 μ V Offset!

New Ultra-Low Thermal emf Reed Relays!



- Unique new method (pat. pend.) virtually eliminates thermal offsets, permits use of almost any type reed switch... Hg wet, dry, high voltage.
- Remarkably independent of ambient temperature, environment.
- Many contact forms, pin configurations available.
- Units also available at less than 500 nanovolts per switch, or less than 1 μ V differentially between switches.
- Greater than 10¹¹ ohms isolation resistance.
- Rugged molded package. Moderate price.

Write for Complete New Catalog MR-6.1



COTO-COIL COMPANY, INC.
59 Pavilion Avenue, Providence, R. I. 02905
Tel: (401) 941-3355

INFORMATION RETRIEVAL NUMBER 134

WHY PAY MORE AND GET LESS?

DELAY LINES SPIRADEL®

The world's most advanced Delay Lines, featuring low cost, highest quality and small size.

We manufacture the **HIGHEST** Time Delay to Rise Time Ratios in Lumped Constant Delay Lines.

WRITE FOR NEW
20-PAGE CATALOG



FAST PROTOTYPES!

L-C FILTERS

An economical source for Lowpass, Highpass & Bandpass prototypes... often SHIPPED IN 3 DAYS!

WRITE FOR NEW
12-PAGE CATALOG



SEE US AT WESCON
BOOTH 1109

AA Allen Avionics, Inc.

224 E. 2nd STREET, MINEOLA, N.Y. 11501
Phone: 516-248-8080

INFORMATION RETRIEVAL NUMBER 106

MICROWAVES & LASERS

Radiation monitor spans 0.3 to 18 GHz



Narda Microwave, 75 Commercial St., Plainview, N.Y. 11803. (516) 433-9000.

Hand-held battery-operated isotropic radiation monitors—the Model 8300 series—permit far-field power-density measurements from 300 MHz up to 18 GHz. The monitors, together with the 8321 probe, provide a dynamic range capability of 23 dB with full-scale ranges of 2 and 20 mW/cm². Minimum measurable density is 0.1 mW/cm². Booth No. 1336-37 Check No. 369

Sweeper covers 32-to-90 GHz range



Hughes Electron Dynamics Div., 3100 W. Lomita Blvd., Torrance, Calif. 90509. (213) 534-2121. About \$7000 up; 30-60 days.

A solid-state millimeter-wave sweep generator uses plug-in modules to convert an HP mainframe into a sweep-test system in the 32-to-90 GHz frequency range. Possible features include leveled or unleveled systems, with and without 1-kHz-modulation capability over any 10-GHz bandwidth between 40 and 90 GHz and any 4-GHz bandwidth between 32 and 40 GHz. The mainframe adapter—Model 4415H, for an HP 8620B mainframe—contains all the necessary power supplies and accepts one Impatt plug-in with its associated source and one modulator/leveler plug-in with its associated modulator.

CHECK NO. 370

Low-cost transistor offers 10 W at 1 GHz

RCA Solid State Div., Route 202, Somerville, N.J. 08876. (201) 722-3200. P: See below; stock.

The 41025 and 41026 transistors, when operated at 28 V, deliver 3 W with 7-dB gain and 10 W with 6-dB gain, respectively, at 1 GHz. Types 41027 and 41028, when operated at 22 V, deliver 3 W with 6-dB gain and 10 W with 5.5-dB gain, respectively. In 100-unit quantities, the 41025 and 41027 are priced at \$9, while the 41026 and 41028 cost \$24. All units use the company's HF-41 stripline package for low parasitic capacitances and inductances.

CHECK NO. 371

3-mW laser system uses zirconium tube



C W Radiation Inc., 111 Ortega Ave., Mountain View, Calif. 94040. (415) 969-9482. \$350.

The Model S-303 helium-neon laser system lists an output of 3 mW and has a zirconium cathode plasma tube for longer life. The TEM₀₀ laser system is guaranteed for 18 months regardless of hours of operation. The separate laser head is weatherproof and can be furnished with various power-supply options including a 12-V-dc supply. Optional output frequencies of 1152 and 3391 nm are available.

CHECK NO. 372

2-GHz transistors use nichrome ballasting

Communications Transistor Corp., 301 Industrial Way, San Carlos, Calif. 94070. (415) 591-8921. \$52 to \$98.75 (25-99).

The company's popular E series of 2 GHz, 28-V microwave transistors now have nichrome emitter ballasting for greater ruggedness. The new units include the 1-W E1-28R, the 2.5-W E3-28R and the 5-W E5-28R. The devices cover the 1-to-2-GHz frequency range and can be used for class A and AB operation.

CHECK NO. 373

MODULES & SUBASSEMBLIES

FET input wideband amp slews at 1000 V/ μ s

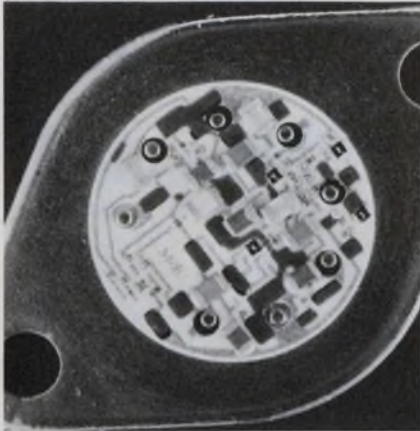

M. S. Kennedy, Pickard Dr., Syracuse, N.Y. 13211. (315) 455-7077. \$125 (1-9), \$112.50 (10-24); stock.

The model 850 eight-pin TO-3 hybrid FET amplifier is designed for radar system applications. It has a 1000 V/ μ s slew rate, a full-power output to 12 MHz, a unity gain bandwidth of 100 MHz and an output current of 100 mA at ± 10 V.

CHECK NO. 374

Multiplying DAC shrinks spiking and feedthrough



Hybrid Systems, 87 Second Ave., Burlington, Mass. 01803. (617) 272-1522. From \$115 (1 to 9).

The DAC 316 series are four-quadrant multiplying d/a converters. They are designed to eliminate spikes that occur when applying multiplying DACs to CRT display systems. Feedthrough is 0.05% at 20 kHz. The output settles to within 0.05% of its final value in under 2 μ s for the worst-case digital change. Likewise, for a full 20 V change, the reference settles in under 2 μ s. The units are available with 10, 11 or 12-bit binary resolution, three decades of BCD or two's complement coding and a ± 5 V output. Accuracy vs temperature is better than 30 ppm/ $^{\circ}$ C.

CHECK NO. 375

1000:1 dividers have high accuracies

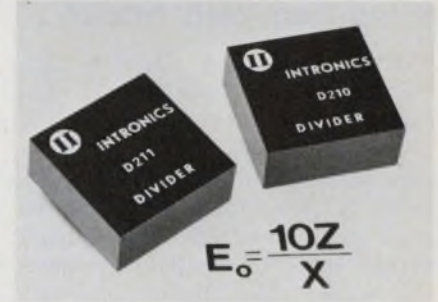

Intronics, 57 Chapel St., Newton, Mass. 02158. (617) 332-7350. D210: \$70; D211: \$80.

The D210 and D211 two-quadrant analog-divider modules achieve high accuracies over a range of 1000:1 divisor voltages. Maximum error for the D210 is 1% of full-scale output; for the D211, maximum error is 1/2% of full-scale output. The modules can be operated with a divisor X voltage from 10 mV to 50 V and a numerator Z voltage from ± 10 mV to ± 12 V. They are packaged in a 1.5 \times 1.5 \times 0.63-inches epoxy case with 40-mil diameter pins.

CHECK NO. 376

NEW!



FREE! 11 x 17 WALL CHART
(Folds to standard file folder size.)

Use to cross-check over 70 basic specs against each of our 17 military switch "families". Narrow your application down to a few logical possibilities in just *minutes!* Saves hours of catalog search and research. Covers multipole selector switches, snap-action switches and quick-connect linear switches. Electrical ratings range from 2A to 200A. Send for your free copy today.



ELECTRO SWITCH CORP.
Weymouth • Massachusetts 02188
Telephone: 617/335/5200 TWX: 710/388/0377

INFORMATION RETRIEVAL NUMBER 107

ELECTRONIC DESIGN 18, September 1, 1973

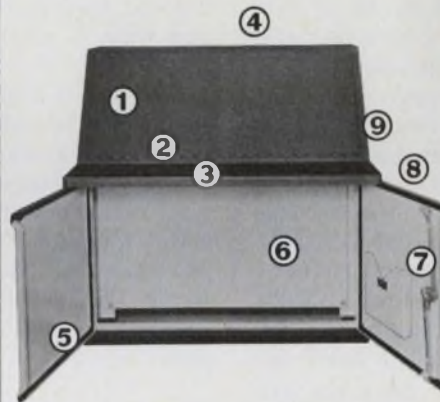

1. 24", 36", 48", or 60" width. 2. Hinged sloping control panel. 3. Optional writing desk. 4. Instrument panel top available. 5. Neoprene gaskets for complete oil tightness. 6. Accessory subpanel. 7. Three-point latches and key-locking handles. 8. Doors on both front and back. 9. All seams continuously welded. 10. NEMA-12 construction. 11. Many modifications available. Write for Bulletin C-14.

CONSOLES

Hoffman
HOFFMAN ENGINEERING COMPANY
Division of Federal Cartridge Corporation
Anoka, Minnesota, Dept. ED52

ELECTRICAL ENCLOSURES

INFORMATION RETRIEVAL NUMBER 108

MODULES & SUBASSEMBLIES

Reflections to 0.032 measured with bridge

Wiltron Co., 930 E. Meadow Dr., Palo Alto, Calif. 94303. (415) 321-7428.

The Model 66G precision reflection bridge combines a 70-dB directivity and 1.02 test-port match over any specified octave band within the 1-to-400-MHz frequency range. The bridge permits measurements of reflection coefficients to 0.032 with accuracy of 1% or better. If more than a one-octave band is required, a directivity of 66 dB and a test port match of 1.05 can be provided over approximately two decades of frequency.

Booth No. 1528-29 Check No. 377

Proportional controller is stable to 0.005 C/°C

Oven Industries, 1106 E. Simpson Rd., P.O. Box 229, Mechanicsburg, Pa. 17055. (717) 766-0721. From \$62.50.

The series 5C1 ac powered proportional temperature controllers uses a zero voltage firing circuit that will operate from 50 to 400 Hz. Resistive heaters from 150 mA to 10 A can be controlled over a -65 to +425 C range with the various available probes. All controller models are capable of maintaining the desired set temperature to ±0.05 C at the probe. The set point stability of this series is ±0.005 C/°C for ambient changes from -20 to + 70 C and ±0.0025 C/V for an input line change of 100 to 140 V ac or 200 to 240 V ac.

CHECK NO. 378

Instrumentation amp has dual guarded inputs



McKee-Pedersen, P.O. Box 322, Danville, Calif. 94526. (415) 937-3630. \$300; stock.

The MP-1041 instrumentation amplifier has differential inputs, each of which can be guarded. A reference jack allows subtraction of a voltage so that small changes in a large output signal may be observed. The gain is settable from 1 to 1100 using a switch and a 10-turn precision potentiometer. Typical specifications include drift less than 5 μV/°C, input current less than 10 pA, common-mode rejection ratio greater than 100 dB and input impedance (differential or common-mode) equal to 10¹² Ω. The input voltage range is ±10 V, and rated output is 100 mA at ±2 V, 50 mA at ±10 V, and 25 mA at ±15 V. Slew rate at a gain of 100 is 2 V/μs. Power requirements are ±20 V and the dimensions are 4 × 5 × 5 in.

CHECK NO. 379

Dc motor speed control handles currents to 90 A



Power Technology, P. O. Box 4403, Little Rock, Ark. 72204. (501) 565-1750. \$91.85 (32A), \$96.50 (33A).

Models M32A and M33A are solid-state motor speed controls for 12 and 24 V permanent magnet dc motors. They can handle currents to 90 A and feature infinitely adjustable speed. They also have a high efficiency circuit capable of delivering armature currents greater than twice the battery current at low speeds. The units measure only 2-1/2 × 4 × 10 in.

CHECK NO. 380

Resistance sensor works with loads up to 0.1 MΩ

Intercontinental Dynamics, 11441 S. Wentworth Ave., Chicago, Ill. 60628. (312) 568-8090.

Model RSA-126 resistance sensor can be activated by a small resistance change in a total resistance as high as 0.1 MΩ. Sensor relay dpdt contacts are rated for 1/4 hp at 10 A, and 120 V or 1/3 hp at 10 A and 240 V. It has an operating temperature range of 0 to 60 C and generates a probe current of 1 mA into the maximum rated load. Power consumption totals 3 W from a 120/240 power line.

CHECK NO. 381



ANALOGY

GOTTA GET UP EARLY IN THE A.M. TO BEAT THE 3010 IC TONE ALARM. EXCEED ITS DC REFERENCE BY 5mV, AND IT TURNS ON BOTH AC AND DC. DC OUTPUT DRIVES TTL, LED OR LAMP LOADS. AC OUTPUT DRIVES A SPEAKER, LIGHT OR TONE. 5 TO 15V SUPPLY. LOW STANDBY CURRENT.

intech INCORPORATED (408) 244-0500 1220 COLEMAN, SANTA CLARA CA 95050

evaluation samples

Heat-transfer washers

Heat-transfer washers for semi-conductors incorporate a disc of high-purity beryllium oxide molded into a plastic surround which has a TO-3 outline and provides a thermal performance of 0.1 °C/W. Jermyn.

CHECK NO. 382

Warning cards

"Equipment Under Test—Do Not Disturb" cards come in a bright orange color and warn unauthorized personnel who might accidentally disturb test equipment. Nationwide Electronic Systems.

CHECK NO. 383

Drilled boards

Epoxy-glass board material with 0.043 in. diameter holes on 0.100 in. grid pattern assures quality appearance of finished circuit boards as well as clean, accurate hole diameters. The drilled boards have increased bending strength and provide rigid support for sockets, terminals and wrapped-wire pins. It is available in 8-1/2-by-11 in. sheets or as prerouted boards designed to mate with the company's nickel/gold-plated connector subelements as well as standard edge connectors and card cages. Circuit-Stik.

CHECK NO. 384

PC layout system

A printed-circuit layout system, called PUPPETS, reduces the schematic-drawing-to-final-layout time. PUPPETS are individually die-cut, transparent layout patterns that represent commonly used electronic components, adhere to any clear nonmatte drafting film and are reusable. They meet MIL specifications in a choice of 2X or 4X scale. Bishop Graphics.

CHECK NO. 385

Carbon-based coatings

Conductive carbon-based coatings offer low-cost protection for MOS devices. Wescorp.

CHECK NO. 386

application notes

RAM microcircuits

A six-page brochure entitled "256-Bit Bipolar Random-Access Storage Applications" describes a number of uses for the 82S06 and 82S07 high-speed RAM ICs. The text, complete with footnotes, gives a description of several memory configurations and includes applications. Signetics, 811 E. Arques Ave., Sunnyvale, Calif. 94086.

INQUIRE DIRECT

Power amplifier

An application note describes the design, construction and performance of a two-device 100-W, 28-V, 225 to 400-MHz broadband power amplifier. Communications Transistor Corp., San Carlos, Calif.

CHECK NO. 388

Analog switching

Switching high-frequency wide-band rf signals with analog-switch integrated circuits is covered in an application note. The paper notes that signals to 100 MHz can be switched with excellent OFF isolation characteristics and very small insertion loss, and with greater convenience than is possible with p-i-n diodes or electromechanical switches. Two graphic design aids are included to simplify the analysis of OFF isolation in rf signals of both sinusoidal and pulse nature. Four specific types of analog switches are compared in performance, with each type representing a different IC structure, including n-channel junction FETs with bipolar driver; p-channel MOS FETs with p-channel bipolar driver; n-channel JFETs with PMOS/bipolar drivers; and a monolithic CMOS switch/driver combination. Siliconix, Santa Clara, Calif.

CHECK NO. 389

Overvoltage protectors

The concepts of overvoltage protectors used in regulated power supplies to protect voltage sensitive loads are described in a bulletin. Deltron, North Wales, Pa.

CHECK NO. 390



I'm a Capitol Switch

I get specified for QUALITY and DEPENDABILITY

We're just part of the gang

Top quality, dependable circuit selector push-button and lever switches . . . many custom combinations and assemblies

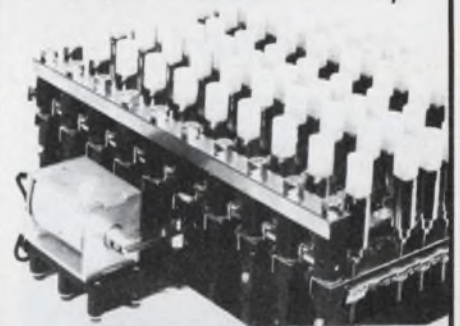

ALTERNATE ACTION PUSH BUTTON SWITCHES
ILLUMINATED, NON-ILLUMINATED
SINGLE POSITION, MULTIPLE POSITION

LEVER SWITCHES
ILLUMINATED, NON-ILLUMINATED

MOMENTARY PUSH BUTTON SWITCHES
ILLUMINATED, NON-ILLUMINATED
SINGLE POSITION

INTERLOCKING PUSH BUTTON SWITCHES
ILLUMINATED, NON-ILLUMINATED

INDICATOR LITES
SINGLE POSITION, MULTIPLE POSITION

Write for our 24 page catalogue
Representatives in principal cities.

CAPITOL SWITCHES

THE CAPITOL MACHINE & SWITCH CO.
87 NEWTOWN RD. DANBURY, CONN. 06810

WESTERN REPRESENTATIVES

Frauman Assoc.
110 First St.
Los Altos, Calif. 94022
Tel: 415-941-0660

Tauber & Assoc. Inc.
3650 Clairmont Drive
San Diego, Calif. 92117
Tel: 714-274-7242

John McClamrock Co.
127 SW 156th St.
Seattle, Wash. 98166
Tel: 206-244-9391

Trimarco Inc.
PO Box 368
Altadena, Calif. 91001
Tel: 213-681-7760

WESCON BOOTH 1238

INFORMATION RETRIEVAL NUMBER 110



**our products
are more fully
developed...**

Standard Condenser capacitors are indeed fully developed to produce the optimum in performance and durability. Standard is in one business only, the design and manufacture of the world's finest capacitors. We have designed and delivered thousands of specialized capacitors for industry. In fact, what you think of as "special" may be among the many designs already available from stock at Standard. However, if you require capacitors of unusual shape, size, value and material, our engineering department will help you design and produce them to your exact specifications at stock prices. For immediate action, send us a sketch and complete details.

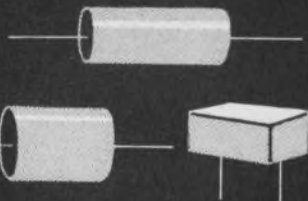

Write or phone for catalog and details.

Standard

CONDENSER CORPORATION

Dept. ED-10 1065 West Addison Street
Chicago, Illinois 60613 • (312) 327-5440

INFORMATION RETRIEVAL NUMBER 111

176

new literature

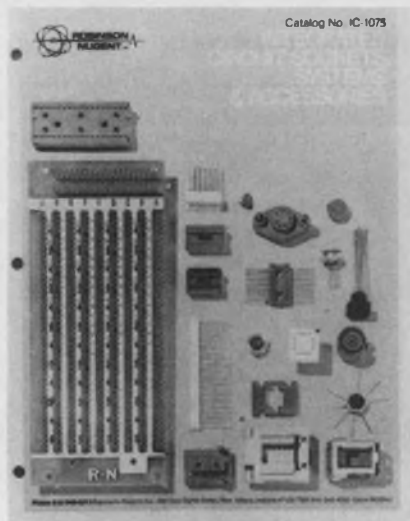

IC connection products

A 40-page catalog describes over 800 IC connection products. It provides details and test data on the company's DIP, Flat Pak and TO-patterned IC sockets, socket-boards, systems and accessories for production, breadboarding and testing applications. The catalog is liberally illustrated with photographs, line drawings and charted specifications. Robinson-Nugent, New Albany, Ind.

CHECK NO. 391

Insulated wires

A 12-page specification sheet covers Vylink irradiated polyvinyl chloride insulated wires. The document lists physical and electrical properties, applicable UL styles and compares the wires with MIL-W-16878 types. Brand-Rex Co., Willimantic, Conn.

CHECK NO. 392

Capacitors

A capacitor summary brochure outlines representative segments of the firm's products in miniature metallized Mylar and polycarbonate capacitors, high-voltage capacitors and standard and heavy-duty RC networks. The four-page brochure includes a brief description of custom EMI filters, aluminum foil-wound transformers and lamp ballasts. Electrocube, San Gabriel, Calif.

CHECK NO. 393

Material science products

Descriptions and photographs of material science products are shown in a six-page catalog. Included are metal, rare-earth and semiconductor crystals, Bridgman and Czochralski crystal-growth systems, saws and polishing machines for semiconductors, laboratory furnaces and spark-discharge equipment for low-damage metal fabrication. Image Analysing Computers, Monsey, N.Y.

CHECK NO. 394

Microwave diodes, switches

Microwave diodes including silicon tuning varactors, multiplier varactors, high-power Gunn high-speed p-i-n and high-voltage switching diodes are described in a six-page short-form catalog. GHZ Devices, Chelmsford, Mass.

CHECK NO. 395

Audio-response unit

A brochure for the 640 speech-maker describes digital voice-generation systems. Cognitronics, Stamford, Conn.

CHECK NO. 396

Wire, cable and tubing

A 48-page catalog describes more than 2500 cable, wire and tubing products in more than 13,000 different sizes, packages and colors. The catalog is sectionalized by product, fully indexed and planned for quick reference. Alpha Wire Corp., Elizabeth, N.J.

CHECK NO. 397

Flexible shafts

Flexible Shaft Handbook includes information on standard, pre-engineered and custom-designed flexible shafts, adaptors and accessories and their applications. An appendix illustrates screw-thread systems, metric equivalents and temperature-conversion formulas. S. S. White, Piscataway, N.J.

CHECK NO. 398

Trimming potentiometers

A two-page publication describes the Model 86P dual inline cermet trimming potentiometer. The data sheet provides electrical, mechanical and environmental specifications, outline drawings and pricing information. Helipot Div., Beckman Instruments, Santa Ana, Calif.

CHECK NO. 399

Dc power supplies

OEM dc power supplies are presented in a 44-page catalog which includes specifications, prices and delivery schedules. A dc output-range selector is provided as well as outline drawings and mounting-hole dimensions. Powertec, Chatsworth, Calif.

CHECK NO. 400

Isolators and circulators

A four-page bulletin contains specifications and installation details on standard plug-in isolators and circulators. Raytheon, Waltham, Mass.

CHECK NO. 401

Electron tubes

A directory lists over 5000 industrial, entertainment and military tube types in alphanumeric order with quantity discount prices for quick reference. Also listed are the manufacturer of each type and the availability of the tubes. Metropolitan Supply Co., New York, N.Y.

CHECK NO. 402

Fuses

An eight-page Cross-Reference Catalog lists comparable Littelfuse and Bussman parts numbers for hundreds of standard fuses, fuseholders, fuse clips and fuse blocks. An array of voltages, amperages and fuse types are identified and cross-referenced. Littelfuse, Des Plaines, Ill.

CHECK NO. 403

S/d converters

Application information on synchro-to-digital converter modules is included in an eight-page bulletin. Tables, associated with schematic diagrams, provide information for ordering components for each conversion output. Astrosystems, Lake Success, N.Y.

CHECK NO. 404

Power supplies for CATV

Three technical bulletins describe standby power supplies, ac power supplies and constant-voltage transformers designed for CATV applications. Sola Electric, Elk Grove Village, Ill.

CHECK NO. 405

Terminals and splices

A 54-page terminal and splice catalog for OEM applications features open-barrel strip terminals and closed-barrel vinyl-insulated, nylon-insulated and uninsulated terminals and splices for copper wire sizes No. 26 to 4/0 AWG. Also included are cable ties and tooling. Burndy Corp., Norwalk, Conn.

CHECK NO. 406

Computer interfacing

Interfacing methods for recent additions to the company's line of noise and vibration analysis equipment, shock analyzers and their related units are described in a guide. Both on-line and off-line situations are discussed. Spectral Dynamics Corp. of San Diego, San Diego, Calif.

CHECK NO. 407

Planar plug-in connectors

A flat-mount planar plug-in connector for leadless MOS/LSI circuits—designed to reduce total interconnection costs of the soldered-in approach to MOS/LSI packaging—is described in a brochure. Amphenol Industrial Div., Chicago, Ill.

CHECK NO. 408

JFET selection guide

A 37-page brochure allows selection of an appropriate JFET from any one of three criteria. The guide consists of a cross-reference index, locator charts, locator curves and family charts. Selection is facilitated by a method of tabulating the data in family charts. Instead of listing parts in alphanumeric sequence, the company lists the best-performance JFET first followed by others in descending order of spec performance. Outstanding parameters for each device are highlighted. Teledyne Semiconductor, Mountain View, Calif.

CHECK NO. 409

NEW IDEA!

TIP-DIP™ DOUBLE-DENSITY

WIRE-WRAP®
I.C. PANELS
Pat. Pending

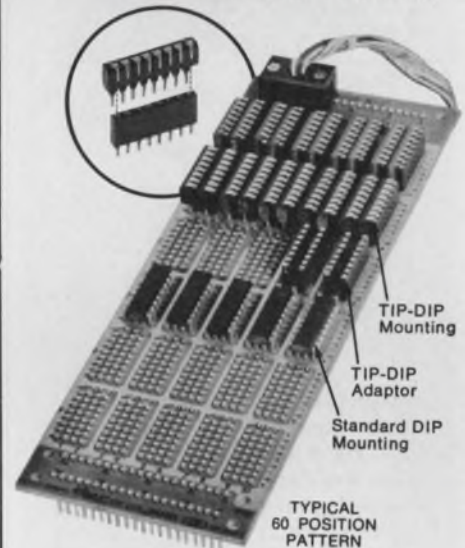
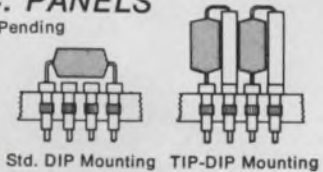

Add more IC's (up to twice as many) on Wire-Wrap panels that fit your present racks! The TIP-DIP concept: reformed DIP leads + Adaptor = more DIP's per inch and shorter wire lengths for faster switching. Standard or Custom Panels. Press available for bending leads.

ELECTRONIC MOLDING CORP.
96 Mill St., Woonsocket, R. I. 02895
(401) 789-3800



INFORMATION RETRIEVAL NUMBER 112

Plamec Switch has made miniature, ultra-thin mechanical parts, the major element in making sets compact, a reality. This Plamec Switch which has made low price and high reliability possible by miniature, ultra-thin design as compared to conventional keyboard switches, is active in electronics and a wide range of other fields.

plamec switch

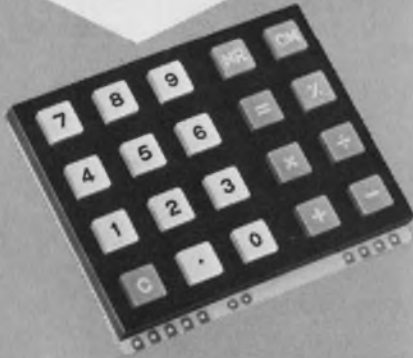

Ultra-thin type exhaustively pursued!

CHARACTERISTICS:

- Rated capacity: DC30V 20mA • ON load: 35g \pm 20g • Contact resistance: 1 Ω or less (including lead pattern) • Chattering: 1m sec. or less • Insulation resistance: DC25V 100M Ω or greater • Dielectric strength: AC100V for 1 minute • Life: 1,000,000 operations or greater • Key pitch: 11mm~each type • Operating temperature range: -10 $^{\circ}$ ~+60 $^{\circ}$ C • Storage temperature: -20 $^{\circ}$ ~+70 $^{\circ}$ C • Key stroke: 1.5, 2.5, 3mm each type.

★ SEE US AT WESCON
BOOTH No.1310

*Designed and manufactured in accordance with the user's specifications

• For information please contact our connecting office: SHOWA MUSEN KOGYO CO. LTD
743 W GARDENA BLVD. GARDENA, CALIF. 90247
Tel: (213) 770-8915 Cable Address: SHOWACO GDNA
Telex: 69-1144

**SHOWA MUSEN KOGYO
CO., LTD.**



No 5-5, 8-chome, Togoshi, Shinagawa-ku,
Tokyo 142, Japan
Phone: 785-1111
Cable: "SHOWAMUSEN TOK"
Telex: 2466301 SMK TOK J

bulletin board

Interdesign, Inc. has announced the availability of an integrated Hall-effect generator in its Monochip series. The four-terminal device is sensitive to magnetic fields and is used for switching, coupling and sensing.

CHECK NO. 410

The Digital Products Div. of Fairchild Camera & Instrument Corp. has introduced an improved version of its 95H90 vhf pre-scaler that is now available in military as well as commercial grade. The 95H90 can be used with TTL or ECL logic designed for +5 or -5.2-V power supplies. It is packaged in a 16-pin ceramic DIP.

CHECK NO. 411

SofTech has announced the addition of half-a-dozen built-in models to enlarge and extend its AEDCAP computerized electronic circuit simulation system.

CHECK NO. 412

Hughes Aircraft Co.'s Electron Dynamics Div. has extended its modular building-block concept of selling laser components to include single unit sales. This concept is designed to eliminate laser head and power-supply interface and integration problems by making all components of a laser system available from one source.

CHECK NO. 413

A trio of Advanced Micro Devices multiplexers meets JAN specifications under MIL-M-38510. The Am9309, Am9312 and Am9322 are available in both dual-inline and flat packs.

CHECK NO. 414

Perkin-Elmer Corp.'s Industrial Products Div. has introduced a line of trigonometric computing transformers. The transformers are designed for operation at 400 Hz and provide a fixed angle shift between input and output. The price ranges from \$58 to \$68 (100-up).

CHECK NO. 415

Raytheon Semiconductor has introduced a monolithic timing circuit designated the RC/RM555. The circuit is a highly stable controller that can produce accurate time delays in increments ranging from microseconds to hours. The timer is packaged in TO-5 cans for both commercial and military applications and in an eight-pin plastic mini-DIP for commercial temperature ranges. Prices begin at \$1.44 (100-up).

CHECK NO. 416

Price reductions

Price decreases averaging about 17% on solid-state lamps have been announced by GE's Miniature Lamp Products Dept.

CHECK NO. 417

Inselek has announced an across-the-board price reduction on 64 and 256-bit silicon-on-sapphire random-access memories—Models AO 1 and A5503, respectively. The AO 1 has been reduced to \$7.70 from \$20 (1-24); \$6.60 from \$16 (25-99); \$5 from \$12 (100-999). The A5503 has been reduced to \$23 from \$40 (1-24); \$17.40 from \$32 (25-99); \$12.50 from \$26 (100-999).

CHECK NO. 418

Burr-Brown has cut prices 20% on its 16-bit/4-digit integrating a/d converter. Prices now start at \$175.

CHECK NO. 419

Boeing Computer Services has announced an average reduction of 10% in the pricing of its Mainstream remote computing service. The reduction in price is in connect charges, changes to core factor, discounts for on-line storage and in off-line storage for 2316 disc packs.

CHECK NO. 420

Intersil, Inc., has reduced prices on its IM5503/23/33 bipolar 256 x 1-bit static RAMs. The commercial temperature, 0 to 75 C, IM-5503/23/33C has been reduced to \$15 (100 qty) from \$26.50. The military-temperature, -55 to 125 C, IM5503/23/33M has been reduced to \$29.50 (100 qty) from \$36.

CHECK NO. 421

vendors report

Annual and interim reports can provide much more than financial-position information. They often include the first public disclosure of new products, new techniques and new directions of our vendors and customers. Further, they often contain superb analyses of segments of industry that a company serves.

Selected companies with recent reports are listed here with their main electronic products or services. For a copy, circle the indicated number.

Zenith. Consumer electronics.

CHECK NO. 422

Wakefield Engineering, Inc. Heat sinks, burn-in equipment and thermal test equipment.

CHECK NO. 423

Interdyne. Digital cassette recorders, IC packaging and Wire-Wrapping.

CHECK NO. 424

Conrac. Aerospace, telecommunications, broadcast equipment, computers, timers, event counters, instrument motors and audio-visual devices.

CHECK NO. 425

Comsat. Global satellite systems.
Raytheon. Avionics, semiconductor and microwave devices, data handling and communication systems, medical electronics, marine electronics, power supplies and consumer electronics.

CHECK NO. 426

Midtex. Relays, timers, components for telephone industry, switches, digital and instrumentation magnetic heads, keyboards and calculators, computers, electronic material and equipment, displays and microwave components.

CHECK NO. 427

Belden Corp. Welding cable, magnet and motor lead wire and cords.

CHECK NO. 428

Triangle Industries Inc. Wire and cable.

CHECK NO. 429

AMP Inc. Solderless terminals, splices, multiple and coaxial connectors, circuitry, packaging and interconnection devices, capacitors and programming systems.

CHECK NO. 430

Philip A. Hunt Chemical Corp. Etching systems, photoresists and medical electronics.

CHECK NO. 431

RCA. Consumer electronics, components, broadcast equipment, global communications, aerospace and avionics.

CHECK NO. 432

Honeywell. Control systems, aerospace, military electronics, computers, software and optics.

CHECK NO. 433

Aydin Corp. Display terminals, data-communication equipment, voice-communication and radio-frequency products and components.

CHECK NO. 434

Porta Systems Corp. Telecommunications equipment.

CHECK NO. 435

General Dynamics. Aerospace and missiles, marine electronics, telecommunications, data products and airport surveillance equipment.

CHECK NO. 436

Computer Machinery Corp. Computer-controlled data entry.

CHECK NO. 437

Oak Industries Inc. Switches and solenoids, TV tuners, illuminated products, crystal products, potentiometers, materials, controls, CATV products and security systems.

CHECK NO. 438

COMRESS, Inc., Software.

CHECK NO. 439

Texas Instruments Inc. Semiconductors, ICs, components, avionics, air traffic control, computers and peripherals.

CHECK NO. 440

The Electron Machine Corp. X-ray thickness gauges, automatic controls and process instrumentation.

CHECK NO. 442

Now staggered fingers let you pour the power to IC's and hybrids safely

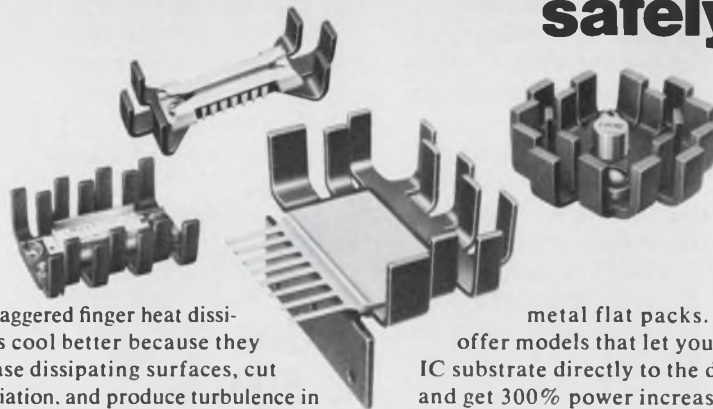

Our staggered finger heat dissipators cool better because they increase dissipating surfaces, cut re-radiation, and produce turbulence in forced air, and now they're available for IC's and microcircuits in special packages as well as standard. TO's, DIP's, .500" and .650" wide ceramics, 1"-square sealed

metal flat packs. We even offer models that let you pot your IC substrate directly to the dissipator and get 300% power increases easily. Ask for our new catalog. IERC, 135 W. Magnolia Blvd., Burbank, Calif. 91502, a subsidiary of Dynamics Corporation of America.



Heat Sinks

INFORMATION RETRIEVAL NUMBER 114

Buy Bonds where you work ...now that you can.



1903—a time of no credit, a 12-hour workday, and no Payroll Savings Plan.

It's sort of like your grandfather telling you he used to walk 15 miles through the snow to get to school.

But it's true: today's working men and women have more advantages than their grandparents.

One of them is the Payroll Savings Plan—the easy, safe, automatic way to build a nest egg for the future.

When you sign up for the Payroll Savings Plan, an amount you specify is automatically set aside from your paycheck and used to

buy U.S. Savings Bonds.

That way, even if you spend all your take-home pay, you're still building a steady savings.

Grandpa would approve.



Take stock in America.

Buy U. S. Savings Bonds

Now U.S. Bonds pay 5 1/2% interest when held to maturity of 5 years, 10 months (4% the first year). Bonds are replaced if lost, stolen, or destroyed. When needed they can be cashed at your bank. Interest is not subject to state or local income taxes, and federal tax may be deferred until redemption.

 The U. S. Government does not pay for this advertisement. It is presented as a public service in cooperation with the Department of the Treasury and The Advertising Council.

Electronic Design

ELECTRONIC DESIGN's function is:

- To aid progress in the electronics manufacturing industry by promoting good design.
- To give the electronic design engineer concepts and ideas that make his job easier and more productive.
- To provide a central source of timely electronics information.
- To promote communication among members of the electronics engineering community.

Want a subscription? ELECTRONIC DESIGN is sent free to qualified engineers and engineering managers doing design work, supervising design or setting standards in the United States and Western Europe. For a free subscription, use the application form bound in the magazine. If none is included, write to us direct for an application form.

If you do not qualify, you may take out a paid subscription for \$30 a year in the U.S.A., \$40 a year elsewhere. Single copies are \$1.50 each.

If you change your address, send us an old mailing label and your new address; there is generally a postcard for this bound in the magazine. You will have to requalify to continue receiving ELECTRONIC DESIGN free.

The accuracy policy of ELECTRONIC DESIGN is:

- To make diligent efforts to ensure the accuracy of editorial matter.
- To publish prompt corrections whenever inaccuracies are brought to our attention. Corrections appear in "Across the Desk."
- To encourage our readers as responsible members of our business community to report to us misleading or fraudulent advertising.
- To refuse any advertisement deemed to be misleading or fraudulent.

Microfilm copies are available of complete volumes of ELECTRONIC DESIGN at \$19.00 per volume, beginning with Volume 9, 1961. Work is now in process to complete the microfilm edition of Volumes 1-8. Reprints of individual articles may be obtained for \$2.00 each, prepaid (\$.50 for each additional copy of the same article) no matter how long the article. For further details and to place orders, contact the Customer Services Department, University Microfilms, 300 North Zeeb Road, Ann Arbor, Michigan 48106 telephone (313) 761-4700.

Want to contact us? If you have any comments or wish to submit a manuscript or article outline, address your correspondence to:

Editor
ELECTRONIC DESIGN
50 Essex Street
Rochelle Park, N.J. 07662

Revolutionary New!!

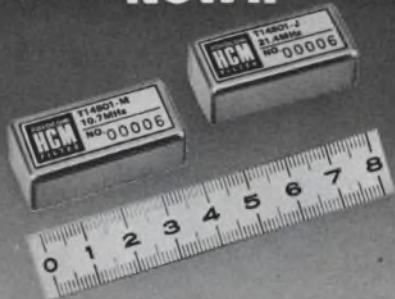

TOYO HCM FILTER T-1 SERIES

● FEATURES:

- These filters provide guaranteed rejection of 90dB. Their volume is 48.3% that of widely used 8-element conventional filters. Their height is only 12mm.
- Terminating conditions are uniform, allowing these filters to be used in a wide range of applications. These filters are fully compatible with other filters in terms of electrical characteristics. Ample consideration has been given to mechanical compatibility.
- Stringent environmental tests (shock and vibration tests) assure adequate quality control levels.



REPORT DEPARTMENT:
TOYO BUILDING, NO. 6-13-20, JINGUJIMAE
SHIBUYA-KU, TOKYO, JAPAN
CABLE: EREPORTOYOCOMTOKYO
TEL: 103-405-3385
TELEX: 62423001

INFORMATION RETRIEVAL NUMBER 115

The pollution problem.

Maybe your engineers deserve a little help.

The engineers will be the ones to find the technical solutions to pollution problems. There's no doubt about it.

But pollution is a people problem, too. And the engineers' technological approach to pollution isn't going to solve people problems.

Maybe this booklet can help. It lists some of the things all people can do to fight pollution. And with all the people supporting your engineers we'll have a better chance of winning the fight.

For a free copy or a list of bulk rates write to Keep America Beautiful, Inc., Box 1771, Radio City Station, New York, New York 10020.

Keep America Beautiful

Advertising contributed for the public good

Electronic Design

Advertising Sales Staff

Tom W. Carr
Vice President &
Sales Manager

Rochelle Park, N.J. 07662

Robert W. Gascoigne
Daniel J. Rowland
50 Essex Street
(201) 843-0550
TWX: 710-990-5071

Philadelphia

Thomas P. Barth
50 Essex Street
Rochelle Park, N.J. 07662
(201) 843-0550

Boston 02116

50 Essex Street
Rochelle Park, N.J. 07662
(201) 843-0550
(617) 482-7989

Chicago 60611

Thomas P. Kavooras
Berry Conner, Jr.
200 East Ontario
(312) 337-0588

Cleveland

Thomas P. Kavooras
(Chicago)
(312) 337-0588
(call collect)

Los Angeles 90303

Stanley I. Ehrenclou
Burt Underwood
2930 Imperial Highway
Inglewood, Calif.
(213) 757-0183

San Francisco 94022

Jerry D. Latta
P.O. Box 1248
Los Altos, Calif.
(415) 965-2636

London W. 1

For United Kingdom and Holland
Brayton C. Nichols

For Eastern Europe
Peter Kehr

The American Magazine Group

9 Warwick Street
London, W. 1, England
Phone: 437 5462
Cable: Ammagnic, London

Tokyo

Haruki Hirayama
Electronic Media Service
5th Floor, Lila Bldg.,
4-9-8 Roppong
Minato-ku
Phone: 402-4556
Cable: Electronicmedia, Tokyo

Recruitment, Quick Ads, Classified

Allen Weinberg
50 Essex Street
Rochelle Park, N.J. 07662
(201) 843-0550



LOOK

to

etc

electronic research co. • a division

THE PEOPLE DOING
THINGS THAT MATTER
IMAGINATIVELY

IN FREQUENCY CONTROL PRODUCTS:

Quartz Crystals, TCXO's, VCXO's,
TCVCXO's, Hybrid Oscillators,
and Frequency Standards • **DIGITAL
INSTRUMENTS:** Clocks, Timers, Com-
parators, Counters, Panel Meters,
Thermometers, Scanners, and Sys-
tems Components •

IN FACT: For anything concerned with
time, temperature or frequency... **CALL,
WRITE,** or **TWX** your SOUL SOURCE at:

Telephone (913) 631-6700

7618 Wedd
Overland Park, Kansas 66204

Mail to: P.O. Box 913, Dept. 341
Shawnee Mission • Kansas 66201

TWX: (910) 749-6477

TRUE Miles-Per-Gallon Meter

MEASURES
GAS MILEAGE
AT ALL
SPEEDS



SpaceKom's *new* mpg meter uses patented photo-electronic flow and speed sensors, and a miniature computer for instantaneous mpg readout on a 2 1/4-inch meter. Quick and simple to install, it fits all US and most foreign cars and trucks. By monitoring gas mileage, you can detect problems, increase engine efficiency, and reduce gas consumption. *Order now or request more information from SpaceKom.*

SpaceKom P.O. Box 10
Goleta, California 93017

Please send _____ MPG meters @ \$34.50 ea.

Enclosed is \$ _____ Ship Ppd. / COD

Vehicle make/year _____

Name _____

Address _____

INFORMATION RETRIEVAL NUMBER 116



Thin-Trim variable capacitors provide a reliable means of adjusting capacitance without abrasive trimming or interchange of fixed capacitors. Series 9401 has high Q's and a range of capacitance values from 0.2-0.6 pf to 3.0-12.0 pf and 250 WVDC working voltage. Johanson Manufacturing Corporation, Boonton, New Jersey (201) 334-2676.

INFORMATION RETRIEVAL NUMBER 181

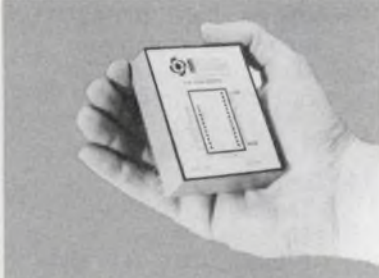

"Synchro to digital converters - 10, 12, or 14 bit output, errorless tracking up to 4 r.p.s., accuracy ± 4 min. of arc $\pm .9$ LSB, resolution - 1.3 minutes, 60 or 400 Hz input, Module 2.6 x 3.1 x .82" H, Price From \$350 in qty. Computer Conversions Corp., East Northport, N.Y. 11731 (516) 261-3300."

INFORMATION RETRIEVAL NUMBER 182

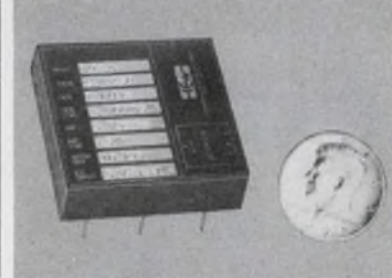

VCXO at freqs. from .00005 Hz to 50 MHz freq. tol. $\pm .0005\%$ 0°C to +50°C, control voltage range +4V to -4V changing freq. 20 ppm/V, linearity $\pm 2\%$, 1.75" sq. x 0.5", Supply 5Vdc $\pm 1\%$, Sq. wave 2.4V into 200 Ω at Vdd = 5V, stock to 5 weeks; Connor-Winfield Corp., West Chicago, Ill. 60185, Tel. 312-231-5270.

INFORMATION RETRIEVAL NUMBER 183

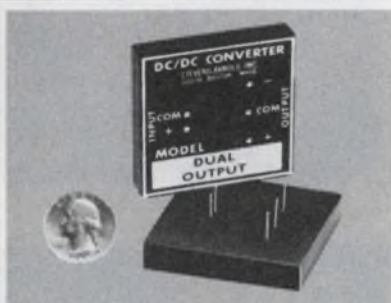

DC/DC converter power supply. 4.5 watts of isolated, regulated ± 15 VDC, ± 150 mA from a 5, 12, 24, 28 or 48 VDC Input. Low noise, multiple transformer shielding and 6 sided case shield. No derating required; -25°C to 71°C. Ultra-miniature 2" x 2" x 0.375" module. \$79 (1-9). Stevens-Arnold Inc., South Boston, Mass. (617) 268-1170.

INFORMATION RETRIEVAL NUMBER 187



Thick Film Technology—Fundamentals and Applications in Microelectronics, by Jeremy Agnew. From design to finished product, this book details each processing phase, describing what to do and what pitfalls to avoid. 176 pp., 6 x 9, illus., cloth, \$8.50. Circle number for 15-day examination copy. Hayden Book Company, Rochelle Park, N.J. 07662.

INFORMATION RETRIEVAL NUMBER 188



New free catalog containing specifications for over 60 models of single, dual and triple output AC to DC power modules. MIL Electronics, Inc., Lowell, Mass. 01854. (617) 453-4142.

INFORMATION RETRIEVAL NUMBER 189

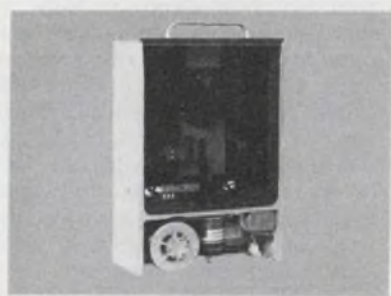

Memorex's 652 flexible disc file is a direct access unit that reads and writes data on media interchangeable with IBM 3740 Diskettes. For information about the 652, or the non-compatible 651, write or call Memorex OEM Division, Santa Clara, CA 95052, (408) 987-3677.

INFORMATION RETRIEVAL NUMBER 193

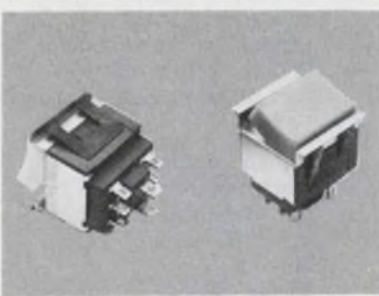

Front Relampable Illuminated Rocker Switches! Snap new SPDT or DPDT Switches in .750 opening. Coin Silver contacts Elec.life is 100,000 cycles. Choose RED, GREEN, AMBER or WHITE Snap-off Actuator/Lens. American-made, competitive prices. C & K Components, 103 Morse St., Watertown, MA 02172 (617) 926-0800, At WESCON Booth 1217.

INFORMATION RETRIEVAL NUMBER 194

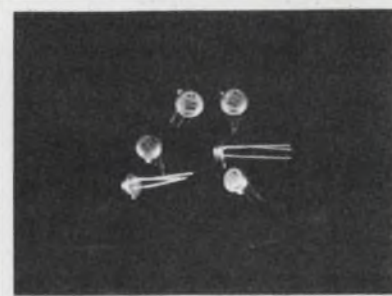

Microwave Oscillator Transistors. NEC types V926 and V020 are in popular TO-46 package, and use gold metallization. The V926 is rated at 400 mV output power at 1.7 GHz and the V020 is rated at 300 mW output power at 2 GHz. California Eastern Laboratories, One Edwards Court, Burlingame, California, 94010. (415) 342-7744.

INFORMATION RETRIEVAL NUMBER 195

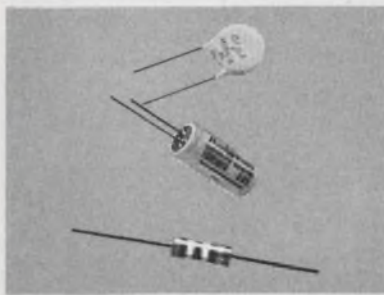

Capacitors available from stock OEM quantities immediate delivery ceramic, printed circuit axial electrolytics, mylar, sub-miniature trimmer capacitors. Resistors available carbon composition and film 1/4 and 1/2 watt. Competitively priced. Mouser Corporation, 11511 Woodside, Lakeside, CA 92040 714-449-2221.

INFORMATION RETRIEVAL NUMBER 184

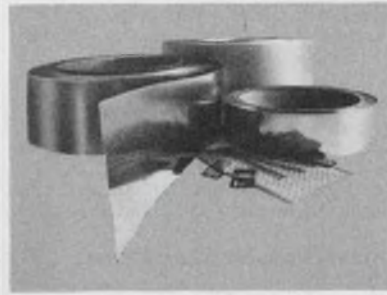

IN ELECTRONIC ALLOYS, WE SPEAK YOUR LANGUAGE, EXACTLY. We specialize in magnetic and controlled expansion alloys. Nickel-irons, stainless steels, beryllium, copper, down to .0005" thick. Rigid chemical and physical property control. Lots 5 lbs. - 5 tons. Photoetching also our specialty. Magnetics, Butler Pa. 16001.

INFORMATION RETRIEVAL NUMBER 185

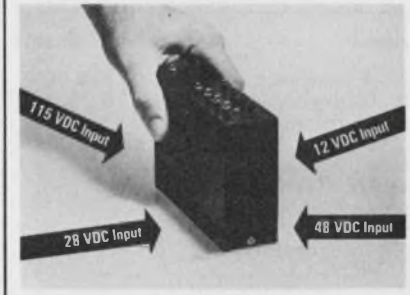

DC-DC Regulated Power Converters —packaged into pretested, encapsulated miniature packages with 6 watts/in². Modular design allows you to specify your own custom system without engineering charges. Inputs of 12, 28, 48, & 115 VDC with up to 6 outputs. Immediate delivery. Arnold Magnetics, Culver City, Ca. 90230. (213) 870-7014.

INFORMATION RETRIEVAL NUMBER 186



Free catalog of 34,500 power supplies from the worlds largest manufacturer of quality Power Supplies. New '73 catalog covers over 34,500 D.C. Power Supplies for every application. All units are UL approved, and meet most military and commercial specs for industrial and computer uses. Power Mate Corp. (201) 343-6294.

INFORMATION RETRIEVAL NUMBER 190



10 KHz-250 KHz quartz crystals in TO-5's. Use them for oscillators, filters, tone generators, timers. They're rugged * accurate * highly resistant to vibration & shock. Prices low as \$.95 in 100 k qty's. Send your written applications. We'll send a sample. Or, write for literature. Statek Corp., 1233 Alvarez Ave., Orange, Calif. 92668 (714) 639-7810

INFORMATION RETRIEVAL NUMBER 191

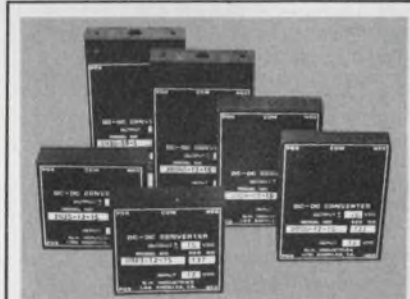

Modular DC/DC Converters. 1.5 W to 30 W. Miniature easy to use P.C.B. mtg. Hundreds of standard variations are available. All have low-noise filtered inputs and outputs. Inputs are reverse voltage protected. Regulated units have current limited outputs. (1 to 9) qty from \$37.25 B. H. INDUSTRIES, Los Angeles, Ca. 213-937-4763.

INFORMATION RETRIEVAL NUMBER 192



400 Ideas for Design, Vol. 2, Edited by Frank Egan. Ready to borrow, modify, or adapt, the top recent contributions to Electronic Design's popular "Ideas for Design" column range from amplifiers to switching circuits. 288 pp., illus., cloth, \$11.95. Circle below for 15-day examination copies. Hayden Book Co., New York, N.Y. 10011.

INFORMATION RETRIEVAL NUMBER 196

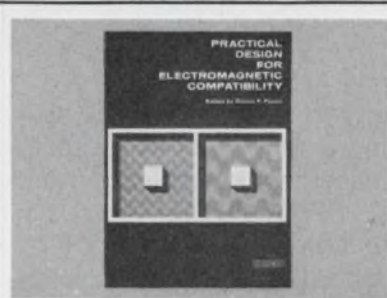

Practical Design for Electromagnetic Compatibility, edited by Rocco Ficchi. An on-the-job manual giving designers practical techniques for analyzing, predicting, controlling, and reducing unwanted signals. 272 pp., 7-1/8 x 9-3/4, illus., cloth, \$13.95. Circle number for 15-day examination copy. Hayden Book Company, Rochelle Park, N.J. 07662.

INFORMATION RETRIEVAL NUMBER 197



***FREE: 10-1000 Design Motor Idea Data Pamphlets;** sub-miniature, low inertia, Swiss precision, ironless rotor; PM motors; 10 sizes 12-32mm; eff. 80-90%; starting torque to 6-8 oz; blowers 1" & 1 1/2" diam; 5-15CFM. HICO, 716 Willow Road, Menlo Park, Ca. 94025 415-328-1111.

INFORMATION RETRIEVAL NUMBER 198

advertiser's index

Advertiser	Page
ACDC Electronics, Inc.	101, 103, 105
AMP, Incorporated	17, 18, 19, 20
Alco Electronic Products, Inc.	187
Allen Avionics, Inc.	172
Amperex Electronic Corporation	151
Amphenol RF Division, The	
Bunker-Ramo Corporation	54
Ansley Electronics Corp.	85
Arnold Magnetics Corp.	183
Atlas Fibre Co.	166
B & H Industries	183
Boonton Electronics Corporation	89
Bourns, Inc., Trimpot	
Products Division	2
Brandenburg Limited	165
Buckeye Stamping Company, Inc.	87
Brucker Scientific, Inc.	165
Burdny Corporation	149
C & K Components	182
CTS Corporation	42, 43
California Eastern Labs	182
Cambridge Thermionic Corporation	33
Capital Machine & Switch Co., Inc., The	175
Centralab, The Electronics	
Division of Globe-Union, Inc.	60, 61
Clare-Pendar	35
Computer Conversions	182
Conner-Winfield Corp.	182
Corning Glass Works, Electronic	
Products Division	12, 13
Coto Coil Company, Inc.	172
Data Display Products	86
Datak Corporation, The	187
Delco Electronics, Division of	
General Motors Corporation	78, 79
Digitran Company, The	167

Advertiser	Page
Ectron Corp.	159
Electro Scientific Industries	143
Electro Switch Corp.	173
Electronic Molding Corporation	177
Electronic Research	181
Electrostatics, Inc.	162
Elmwood Sensors, Inc.	168
Exar Integrated Systems	1
Fairchild Semiconductor, A	
Division of Fairchild Camera	
and Instrument Corporation	128, 129
Federal Scientific Corporation	184
Fluke Mfg. Co., Inc., John	73
Fuji Electrochemical Co., Ltd.	170
General Instrument Corporation	77
Grayhill, Inc.	162
Guardian Electric Manufacturing	
Company	22, 23
Hayden Book Company, Inc.	51, 142, 182, 183
Hewlett-Packard	4, 5, 117
Hoffman Engineering Company	173
Horizon International	183
ILC Data Devices, Inc.	17
ISE Electronics	153
Imperial Travel Service	52
Indiana General	111
Inselek	99
Intech, Incorporated	174
International Electronic	
Research Corporation	179
J.B.T. Instruments, Inc.	101
Johanson Manufacturing Corp.	7, 182
Keystone Carbon Company	98
Kulka Electric Company	93
Kurz-Kasch, Inc.	166
Lafayette Radio Electronics	104
Lambda Electronics Corp.	Cover II
Lemo USA Inc.	95
Litton OEM Products Division	14

Advertiser	Page
3M Company	97
Magnecraft Electric Company	188
Magnetics, Inc.	183
Meguro Denpa Sokki, K.K.	165
Memorex	182
Micro Devices Corp.	154
Microswitch, A Division	
of Honeywell	27
Mil Electronics	182
Mini-Circuits Laboratory	171
Molex, Incorporated	Cover III
Motorola Components	
Products Dept.	137
Motorola Semiconductor	
Products, Inc.	15, 45
Mouser Corp.	183
National Electronics, A	
Varian Division	159
Newport Laboratories, Inc.	50
Non-Linear Systems, Inc.	10
North Electric Company	161
Oak Industries, Inc.	36, 37, 100
Permag	103
Pertec Corporation	29
Philips Industries	47
Plessey Semiconductors	47
Power/Mate Corp.	183
Powertec, Inc.	8, 9
Premier Metal Products Company	105
Preston Scientific	123
RCA Solid State Division	Cover IV
R. F. Power Labs, Inc.	163
Raymond Engineering, Inc.	159
Robinson Nugent, Incorporated	110, 154
Rockland Systems Corporation	16
Rogan	75
Ross Controls Corporation	11
Rotron Corporation	96
Scott Electronics Corporation	46
Semtech Corporation	157
SenSitol, Inc.	154
Shakesproof, Division Illinois	
Tool Works, Inc.	53
Showa Musen Kogyo Co., Ltd.	178
Signetics Corporation	31
Siliconix, Incorporated	58
Sorensen Lighted Controls, Inc.	169
SpaceKom	181
Sprague Electric Company	6
Standard Condenser Corporation	176
Statek Corp.	183
Stevens, Arnold, Inc.	182
Struthers-Dunn, Inc.	90, 91
Switchcraft, Inc.	80, 81
TRW Capacitors	48
TRW Electronics Components	39, 41
TRW Semiconductors	24
Tektronics, Inc.	57
Tenney Engineering, Inc.	169
Test & Measuring Instruments, Inc.	51
Texas Instruments, Incorporated	83
Times Wire & Cable Company	145
Toko, Inc.	92
Toyo Communication Equipment	
Co., Ltd.	181
Triplett Corporation	147
Trodyne Corporation	49
Trygon Electronics	88
United Systems Corporation	141
Wagner Electric Company	44

Design Data from Manufacturers

Advertisements of booklets, brochures, catalogs and data sheets. To order use Reader-Service Card (Advertisement)

Free FFT Report



Recently we analyzed in detail the FFT systems currently on the market, spec by spec, so that we could design a better unit... our own Omniferous™ FFT Analyzer.

This comparison report, Product Planning Report #23, is available to you if you're interested. It includes comparisons of speed, dynamic range, usable resolution, ease-of-use, and price.

Please call or write Joseph Flink, VP Data Processing.

CIRCLE NO. 171

Federal Scientific Corp.

An affil. of Nicolet Instrument
615 West 131st St., New York, N.Y. 10027. (212) 286-4400

Help college help you.

Businesses like yours gave over \$340,000,000 to higher education last year.

It was good business to do so. Half of all college graduates who seek work go into business. The more graduates there are, and the better educated they are, the more college serves the business community.

Your money was vital to colleges. It relieved financial pressures, made planning more flexible, and contributed to the kind of basic and applied research that puts new knowledge and technology at the service of industry.

So that colleges can continue to help you, give to the college of your choice now. For information on ways to do it, please fill in and mail the coupon.



Council for Financial Aid to Education, Inc.
6 East 45th Street, New York, N.Y. 10017

Please send me your free booklet, "How Corporations Can Aid Colleges and Universities."

Name _____

Company _____

Address _____

City _____ State _____ Zip _____



Council for Financial Aid to Education, Inc.

Advertising contributed for the public good.



Council for Financial Aid to Education, Inc., 6 E. 45th St., N.Y.C., N.Y. 10017

product index

Information Retrieval Service. New Products, Evaluation Samples (ES), Design Aids (DA), Application Notes (AN), and New Literature (NL) in this issue are listed here with page and Information Retrieval numbers. Reader requests will be promptly processed by computer and mailed to the manufacturer within three days.

Category	Page	IRN	Category	Page	IRN	Category	Page	IRN
Components			generator, pulse	92	270	drill	163	340
accelerometer	100	282	generator, pulse	158	320	edge protector	160	334
capacitors (NL)	176	393	generator, signal	156	305	filter system, plating	98	275
connector	102	287	logic checker	92	267	harness boards	160	329
fuses (NL)	177	403	logic probe	91	265	heat pipes	99	277
potentiometers (NL)	177	399	memory tester	158	324	laminate, polyimide glass	98	276
printer head	100	283	microscope	155	302	nuts, press	160	332
relay	101	284	network analyzer	89	261	resin, casting	162	337
relay, mag. blowout	102	289	photometer	156	306	resistor ink	161	333
capacitor, electrolytic	103	290	power supplies	89	262	screws, nuts, clamps	161	335
photomultiplier	103	291	recorder	91	266	shafts, flexible (NL)	176	398
switch, illuminated	101	285	recorder	93	269	solder	160	328
switch, pushbutton	102	286	scanning system	155	303	terminals and splices (NL)	177	406
switch, rotary, PC	102	288	scope	84	254	wire, cable, tubing (NL)	176	397
transformers, phone	100	280	scope	156	309	wires, insulated (NL)	176	392
			signal averager	155	301			
Data Processing			storage scope	88	260	Power Sources		
analyzer, microcomputer	164	345	synthesizer	156	308	power supplies (NL)	177	400
calculator	167	353	test set	158	322	power supplies (NL)	177	405
computer interfacing (NL)	187	407	thermal tester	158	321			
copier, video	166	347	transistor tester	158	323	new literature		
controller, disc	164	346	voltmeter	158	325	audio-response unit	176	396
controller, display	164	342				capacitors	176	393
converter, scan	104	295	Microwaves & Lasers			computer interfacing	177	407
data acquisition	167	350	couplers	171	365	connectors, IC	176	391
data logger	104	294	diodes, switches (NL)	176	395	connectors	177	408
digitizer, graphics	164	343	laser system	172	372	diodes, switches	176	395
modem, data	166	348	oscilloscope	105	296	electron tubes	177	402
PL/M language	167	352	preamp	171	368	fuses	177	403
printer, dot matrix	104	293	radiation monitor	172	369	isolators, circulators	177	401
punched tape dup.	164	344	signal source	105	297	JFET selection guide	177	409
storage disc	166	349	sweeper	172	370	material science products	176	394
tape drive	167	351	sweeper/sig gen	171	366	potentiometers	177	399
terminal, graphic	164	341	transistor	172	371	power supplies	177	400
			transistors	172	373	power supplies	177	405
ICs & Semiconductors			upconverter	171	367	s/d converters	177	404
dividers, CMOS	168	354				shafts, flexible	176	398
IC, dual timer	168	355	Modules & Subassemblies			terminals and splices	177	406
JFET selection guide (NL)	177	409	amp, instrumentation	174	379	wire, cable, tubing	176	397
PLLs	170	364	amp, wideband	173	374	wires, insulated	176	392
phototransistor, npn	168	357	badge reader, miniature	104	292			
RAM, ECL	168	356	bridge, reflection	174	377	application notes		
RAM, ECL	170	362	controller, dc motor	174	380	amplifier, power	175	388
regulator	169	359	controller, proport.	174	378	analog switching	175	389
thyristor/rectifiers	170	363	DAC, multiplying	173	375	overvoltage protectors	175	390
transistor, npn	169	360	modules, analog-divider	173	376			
VCO, IC	168	358	op amp	94	255	evaluation samples		
VCO, S-TTL	169	361	op amps, FET	94	271	carbon-based coating	176	386
			SCR	100	281	drilled boards	175	384
Instrumentation			s/d converters (NL)	177	404	PC layout system	175	385
analyzer	156	304	sensor, resistance	174	381	warning cards	175	383
analyzer, spectrum	155	298	zener/crowbar	96	272	washers	175	382
analyzer, waveform	91	264						
counter	158	326	Packaging & Materials					
counter/timer	155	300	air gun, ionized	162	336			
DMM	84	250	card carrier, PC	99	278			
DMM	86	258	card-frame systems	98	273			
DMM	156	307	closure devices	98	274			
DPM	84	253	connector, miniature	162	338			
filter, multichannel	88	259	connectors (NL)	177	408			
generator, function	91	263	connectors, IC (NL)	176	391			
generator, function	92	268	connectors, multipin	99	279			
generator, function	155	299	connectors, solderless	160	327			
			contact tapes	160	331			
			dispenser, liquid	160	330			
			drawer pulls	163	339			

**PERSONNEL
RECRUITMENT
ADVERTISING
IN
Electronic Design
REACHES THE
RIGHT PEOPLE
AT A LOWER COST
PER THOUSAND**

*Call the
HOTLINE
today
for complete
information:
(201) 843-0550
extension 209*



PERFECT REGISTRATION because you position patterns first, then rub them down.

CORRECTIONS ARE EASY because you can lift patterns with a knife and reuse them.

TOUGHER THAN STICK-ONS because the ink is underneath a hard plastic over-coat.

Try the JotDraft Sampler and convince yourself. It's an assortment of 746 patterns and pads (2X scale) for \$4.50. Or write for a free sample and catalog. You'll be glad you did!

The DATAK Corporation

65 71st St.

Guttenberg, New Jersey 07093

INFORMATION RETRIEVAL NUMBER 119

RELIABLE SPACE SAVERS...

NEW! IMPROVED DESIGN
provides a longer life and greater dependability - check these outstanding features

"EXCLUSIVE" MOLDED IN TERMINALS
eliminate staking and epoxy seals

LEVER STOP feature
prevents "push-in" of toggle

HIGH TORQUE BUSHING
withstands mechanical abuse

NEW FRAME DESIGN
allows use on 250VAC circuits

GOLD FINISH
for easier soldering and longer shell life

FINE SILVER CONTACTS
and heat sinks provides a conservative 6 Amp rating

ISOLATION BARRIERS
between poles and terminals, inside and out

CASE MATERIAL of D A P for strength and better arc resistance

These STANDARD FEATURES provide the ultimate in switching devices at competitive prices because there are no hidden costs. Write or call today for our new "PRODUCT SELECTION GUIDE" containing listings of all series, options and prices



**INVESTIGATE & COMPARE
ALCOSWITCH**

Mfd. by ALCO ELECTRONIC PRODUCTS, INC. NORTH ANDOVER, MASS.

WE'VE GOT THE

TIME



FOR YOUR APPLICATION . . . in all shapes, sizes, and timing ranges. Time Delay Relays with slow operate or slow release and time repeat accuracy to $\pm 1\%$. At Magnecraft we take great pride in the broad line of Time Delay Relays available from stock for immediate delivery and even more on special order.

Solid State Hybrid, Solid State-Static Output, Air Dashpot, Copper Slug are some of the types to name just a few. Features such as plug-in, surface mount, printed circuit, screw terminals, solder terminals, quick connect terminals, panel mount, power switching, remote pot, knob adjust, screwdriver adjust, allen head adjust, open type, dust covered, hermetically sealed, economy, manually actuated, multiple contacts, auxiliary output, extended voltage, special purpose . . . the list is almost endless.

Maybe you don't need contacts rated to 100 amperes or timing repeatability to $\pm 1\%$ but we have them available just in case. That's where a broad line can save you money, you don't have to take more than you need. We have just the one to fit your needs . . . and if we don't, we'll make it.

Magnecraft[®] ELECTRIC COMPANY

5575 NORTH LYNCH AVENUE • CHICAGO, ILLINOIS 60630 • 312 • 282-5500 • TWX 910 221 5221

SEE US AT WESCON. BOOTH 1338

FREE!



TIME DELAY RELAY HANDBOOK

Do you know how to properly specify a time delay relay? We have a dandy 92-page handbook that can help you. It describes applications you've never thought of. It offers suggestions on how to specify, testing procedures, comparisons of one type to another, principles of operation, and a glossary of terms. This is yours for the asking.



KONEKTCON® MAKES THIS EASY! It's the Molex system that solves the most complex board-to-board, board-to-component, chassis-to-board interconnection problems. It's economical. Reliable. Quick. Versatile. Uses only four basic connectors. Unique rigid square wire male terminals permit stacking of multiple board connections to the same circuits. Molex vibration assembly method stakes up to 300 terminals per minute for wave soldering. Preassembled round male

terminal wafers also available for 2 to 18 circuits. Three female terminal assemblies provide incomparable flexibility: cable-to-board; board-to-board, parallel; board-to-board, perpendicular; and board-to-chassis. Plus a variety of options, including a 3-circuit power transistor. For technical specs call (312) 969-4550. Or write: Molex Incorporated, Lisle, Illinois 60532.

*...creating components that
simplify circuitry*



The digital world is a COS/MOS world.

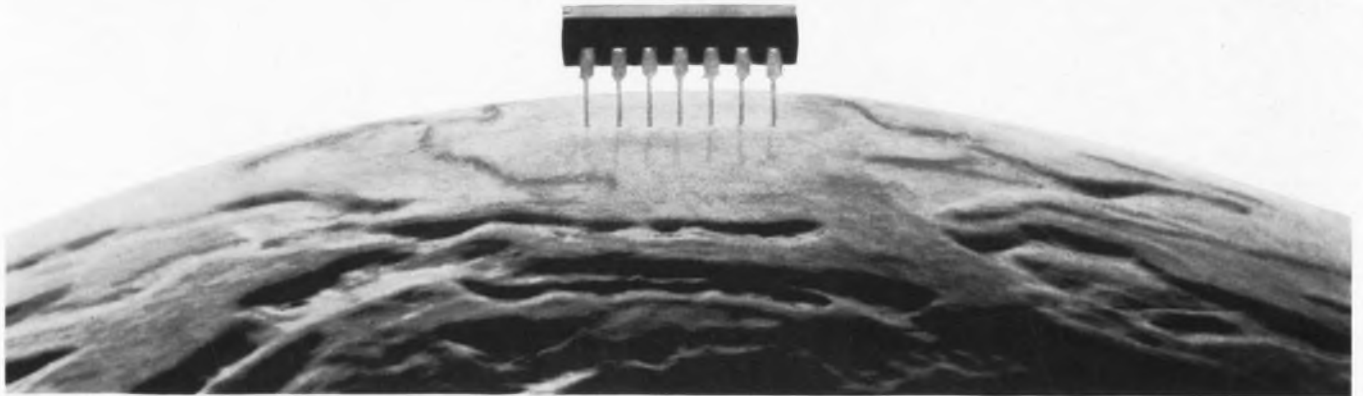

RCA COS/MOS widens your world of digital applications. It offers a combination of features that can't be matched by other digital technologies.

Features like ultra-low power consumption... 10 microwatts per gate! This permits high chip-packing density, use of small power supplies, and a money-saving reduction in cooling requirements.

So COS/MOS is ideal for battery-operated equipment. No longer do you need to be tied down by the power cord.

COS/MOS circuits work great from 3 to 15 volts. That means you can use inexpensive power supplies without fancy regulators. You can use long wires and simple low cost P.C. boards without worrying about signal attenuation.

COS/MOS noise immunity is among the highest of any technology (typically 45% of supply voltage), making it suitable for use in high noise environments such as the automotive and industrial control industries.

The stable transfer character-

istics of COS/MOS typically change less than 3.0% over the full military temperature range. So you can place COS/MOS circuits just about anywhere without worrying about them being overheated.

And you get more system cost effectiveness in the broad selection of COS/MOS circuits: from simple gates like the CD4011 Quad NAND to highly complex functions like the CD4057 Arithmetic Logic Unit.

Let RCA, originator and the world's largest producer of the industry standard CD4000 Series, introduce you to the world of digital COS/MOS. We believe you'll soon be convinced that RCA COS/MOS is the best answer for your digital system designs.



Send for complete data packet, including the new 1973 COS/MOS Product Guide. Write: RCA Solid State, Section 571-1 Box 3200, Somerville, N.J. 08876. Or phone: (201) 722-3200.

RCA Solid State
products that make products pay off