

Electronic Design 14

VOL. 21 NO.

FOR ENGINEERS AND ENGINEERING MANAGERS

JULY 5, 1973

IC voltage regulators abound, and they're getting cheaper to use. But with positive, negative and now dual-tracking devices, picking the right one isn't easy.

On top of that, automated testing and a lack of standardization in specifications usually result in misleading data sheets. Get the facts. See Focus on page 46.



Do you face
a make or buy
decision on
power supplies?

BUY LAMBDA'S LZ SERIES THE ONLY FIELD REPAIRABLE P-C MOUNTABLE POWER SUPPLY.

Available in 3 package sizes,
in 26 single output and 19 dual output models
from \$35, up to 28 volts, up to 1400 mA.

COMPETITOR COMPARISON CHART

Lambda-Pak	Competitors' Model		Lambda-Pak	Competitors' Model		Lambda-Pak	Competitors' Model	
YES	NO	Fully repairable	YES	NO	Wide input voltage range—105-132 Vac	YES	NO	single and dual (tracking) outputs
YES	NO	Continuously adjustable voltage	YES	NO	Short-circuit proof	YES	NO	Designed for series operation
YES	NO	Multivoltage rated	YES	NO	Vacuum-impregnated transformer	YES	NO	Stocked and distributed from Los Angeles, Montreal, Chicago and New York
YES	NO	Foldback current limiting	YES	NO	Three different power packages			

LZ SERIES SINGLE OUTPUT MODELS

MODEL	VOLTAGE VDC	CURRENT mA	PRICE
LZS-10	5	450	\$35
LZS-11	12	195	35
LZS-20	15	300	55
LZS-30	5	900	65
LZS-33	15	400	65
NEW LZS-34	5	1400	95

LZ SERIES DUAL TRACKING OUTPUT MODELS

MODEL	VOLTAGE VDC	CURRENT mA	PRICE
NEW LZD-12	±15V	50	\$35
LZD-21	± 5	300	55
LZD-22	±15	90	40
LZD-23	±15	150	55
LZD-31	± 5	500	65
LZD-32	±15	220	65
NEW LZD-35	±15	300	95

For additional voltages, send for Lambda's 1973 catalog supplement L-3.

**1-DAY DELIVERY
60-DAY GUARANTEE**

LZ SERIES AVAILABLE IN 3 NEW MODELS



Regulation 0.15%—line or load; models LZS-10, LZS-30, LZS-34, LZD-21 and LZD-31 have load regulation of 0.15% ± 5mV; model LZD-12 has line or load regulation of 0.25%.

Ripple and noise 1.5mV RMS.

Temp. Coefficient 0.03%/°C

Tracking accuracy 2% absolute voltage difference (dual output models only) 0.2% change for all conditions of line, load and temperature

AC input 105 to 132 Vac, 57-63 Hz

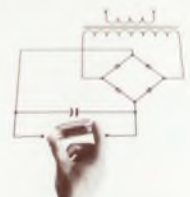

**WHETHER
YOU MAKE
OR BUY...**

**LAMBDA
ELECTRONICS CORP.**

MELVILLE, NEW YORK 11746 515 Broad Hollow Road Tel. 516-694-4200
ARLINGTON HEIGHTS, ILL. 60005 2420 East Oakton St., Unit Q Tel. 312 593-2550
NORTH HOLLYWOOD, CALIF. 91605 7316 Varna Ave. Tel. 213-875-2744
MONTREAL, QUEBEC 100C Hymus Blvd., Pointe Claire, Quebec 730 Tel. 514-697-6520
PORTSMOUTH, HANTS, ENG. Marshlands Road, Farlington Tel. Cosham 73221
VERSAILLES, FRANCE 64a 70 rue des Chantiers 78004 Tel. 1950-2224

INFORMATION RETRIEVAL NUMBER 245

WHAT THIS COUNTRY NEEDS IS ONE GOOD DUAL 555 TIMER

Generation of Two Independent Time Delays

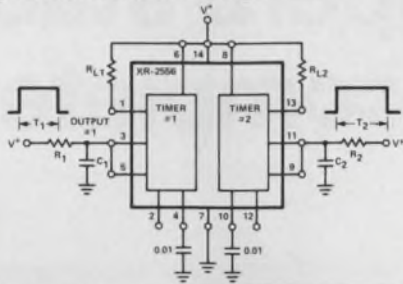

Functional Block Diagram

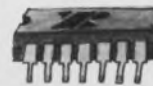
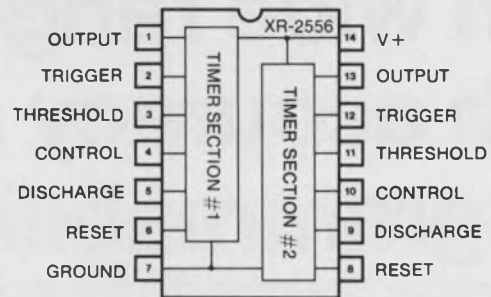

2001 Uses, including:

- Precision Timing
- Pulse Generation
- Sequential Timing
- Pulse Shaping
- Time Delay Generation
- Clock Pattern Generation
- Missing Pulse Detection
- Pulse-Width Modulation
- Frequency Division
- Clock Synchronization
- Pulse-Position Modulation



Synchronized Oscillator Outputs



The XR-2556 is a monolithic dual timer IC. It contains two independent 555-type timers on a single chip which exhibit matching and tracking characteristics far superior to those obtainable from two separate timer packages.

The XR-2556 can be used for time delays from microseconds to hours. Each timer section is a stable controller capable of producing highly accurate time delays or oscillations. Additionally, each section has independent output and control terminals and each output can source or sink 200 mA and drive TTL.

In the monostable mode of operation, the time delay for each timer section is precisely controlled by a single external RC combination. For a stable operation as an oscil-

lator, the free-running frequency and duty cycle of each section are accurately controlled with two external resistors and one capacitor.

If you're using two 555's where you could be using one XR-2556, you can now cut your costs. The XR-2556 replaces two 555 type timers for applications such as Sequential Timing, Clock Pattern Generation, Missing Pulse Detection, Precision Timing and Time Delay Generation, and a "2001" odd applications.

The XR-2556 is available in both hermetic and plastic dual-in-line packages. Call or write and ask about our two-timer and get a data sheet.

EXAR SPEAKS YOUR LANGUAGE



EXAR INTEGRATED SYSTEMS

750 Palomar Sunnyvale, California 94086 (408) 732-7970 TWX 910-339-9233

EXAR DISTRIBUTORS Semiconductor Concepts: Woodland Hills: (213) 884-4560 Hauppauge, L. I.: (516) 273-1234 EEP Corporation: Culver City: (213) 838-1912 Intermark Electronics: San Carlos: (415) 592-1641 San Diego: (714) 279-5200 Santa Ana: (714) 279-1322 Denver: (303) 963-8284 Seattle: (206) 767-3160 Graham Electronics: Indianapolis: (317) 634-8202 Lafayette: (317) 742-4006 Ft. Wayne: (219) 742-4346 Cincinnati: (513) 733-1661 Radio Electric Service Co.: Baltimore: (301) 823-0070 Gerber Electronics: Dedham: (617) 329-2400 Yankee Electronics Supply: Londonderry: (617) 890-0011

Fluke problem solvers

A new AC calibration system with wide range, superb stability, high accuracy and complete programmability.



Here's the best ac calibration system you've ever seen. It's designed to give you state-of-the-art performance in the cal lab, in the factory or in automatic test systems.

The new system consists of the Model 5200A AC Calibrator and the Model 5205A Precision Power Amplifier.

Covering a frequency range of 10 Hz. to 1.2 MHz, the Model 5200A output is from 100 microvolts to 120 volts at current levels up to 50 milliamperes. Mid-band accuracy is ± 0.02 percent. Short term amplitude stability is ± 10 ppm. Six month stability, ± 0.01 percent. Working with the 5200A, the Model 5205A provides output voltages from 100 volts to 1200 volts at current levels up to 200 milliamperes. Combined 5200A/5205A amplitude accuracy is ± 0.03 percent.

The 5205A can also be used as a stand-alone amplifier providing programmable gains of X10 and X100 for frequencies from dc to 120 kHz. Output amplitudes from 1 millivolt to 1700 volts peak are offered for a wide variety of waveforms including pulses, sawtooths and triangles. All functions are remotely programmable with standard TTL logic levels. Uniquely, the 5205A can be programmed by both the 5200A and another control source so that it can be time-shared in an automatic system to perform a multitude of functions.

Price of the Model 5200A AC Calibrator is \$3,995. The Model 5205A sells for \$2,495.

To arrange a demonstration or get more details just dial 800-426-0361 for the location of your nearest Fluke sales office. Call it free anywhere in the contiguous United States.

For details call your local Fluke sales engineer. In the continental U.S., dial our toll free number, 800-426-0361 for his name and address. Abroad and in Canada, call or write the office nearest you listed below. John Fluke Mfg. Co., Inc., P.O. Box 7428, Seattle, Washington 98133. Phone (206) 774-2211. TWX: 910-449-2850. In Europe, address Fluke Nederland (B.V.), P.O. Box 5053, Tilburg, Nederland. Phone 13-673973. Telex: 844-52237. In the U.K. address Fluke International Corp., Garnett Close, Watford, WD2 4TT. Phone, Watford, 33066. Telex: 934583. In Canada, address ACA, Ltd., 6427 Northam Drive, Mississauga, Ontario. Phone 416-678-1500. TWX: 610-492-2119



Electronic Design 14

VOL 21 NO

FOR ENGINEERS AND ENGINEERING MANAGERS

JULY 5, 1973

NEWS

- 19 **News Scope**
- 22 **Two offbeat technologies**—capacitive read-only and beam-addressable storage—are invading the burgeoning field of memories.
- 26 **A major advance in optical integrated circuitry** is hastening the day of optical communications.
- 28 **Electronic anti-skid systems for trucks** are under development by at least a dozen firms to beat 1975 Federal deadlines.
- 30 **Paramp soars to the millimeters: 5.9-dB noise figure at 60 GHz.**
- 36 **Technology Abroad**
- 39 **Washington Report**

TECHNOLOGY

- 46 **Focus on IC voltage regulators:** An increasing availability of different types is resulting in growing acceptance for local regulation to keep equipment costs down.
- 56 **Acoustic-wave filters improve radar** by processing signals in the system with fewer and smaller components. Time-domain matching boosts S/N ratios.
- 62 **BCD multiplication:** You can multiply digits by successive addition, or use a ROM multiplication table. Bit serial or bit parallel, here's how it's done.
- 70 **Generate low-distortion sinewaves.** Analysis of the error sources shows how to modify the classic Wien-bridge oscillator to get less than 0.001% harmonics.
- 76 **Ideas for Design:** Matrix approach cuts component count for decoding digital words . . . Transistor and 2 resistors reduce noise and widen bandwidth of 101/748 op amps . . . Simple dc current controller adapts easily to any supply voltage and load current.

PRODUCTS

- 83 **Data Processing:** Tape and disc share package and electronics.
- 87 **Packaging & Materials:** Wrap-around cabinets meet tight production tolerances.
- 88 ICs & Semiconductors
- 92 Components
- 90 Instrumentation
- 94 Modules & Subassemblies

Departments

- 43 **Editorial:** Shall we buck the Establishment?
- 7 Across the Desk
- 100 Advertisers' Index
- 95 Design Aids
- 102 Product Index
- 96 New Literature
- 104 Information Retrieval Card

Cover: Photo by Lennie Zbiegien, courtesy of Motorola Semiconductor

ELECTRONIC DESIGN is published biweekly by Hayden Publishing Company, Inc., 50 Essex St., Rochelle Park, N. J. 07662. James S. Mulholland, Jr., President. Printed at Brown Printing Co., Inc., Waseca, Minn. Controlled circulation postage paid at Waseca, Minn., and New York, N. Y., postage pending Rochelle Park, N. J. Copyright © 1973. Hayden Publishing Company, Inc. 84,392 copies this issue.

Another FIRST from DDC

DDC, the company that developed the first synchro converter module back in 1969, has now introduced the first line of microminiature hybrid synchro converters.

Included are a hybrid multiplexed S/D (Model HMSDC) and hybrid tracking S/D and D/S (H-Series) converters . . . specifically designed for applications requiring microminiature size, low power (cmos), high accuracy, and single or multispeed operation. In addition to avionics applications, their extreme low power and high reliability make them ideal for remote data gathering stations and man-portable equipment. They are available as modules for you to package, on cards to your specifications or as NAFI SHP circuit cards.

Both the HMSDC and H-Series feature high reliability (MIL-883 processing) and stability—with no trims, adjustments or calibrations.

Hybrid synchro converters. Latest in a whole line of "firsts" from DDC.

For product or technical applications information, write or call Jim Sheahan or Hans Schloss. They're engineers, so they talk your language.



A subsidiary of ILC Industries, Inc.

ILC DATA DEVICE CORPORATION

100 TEC STREET, HICKSVILLE, N. Y. 11801 • PHONE: (516) 433-5330

APPLICATION CENTERS

Long Beach, Calif.
(213) 597-5744

Washington, D. C.
(703) 536-2212

Bruxelles, Belgium
(Tel. 62.01.59

Shaping the future of synchro conversion.

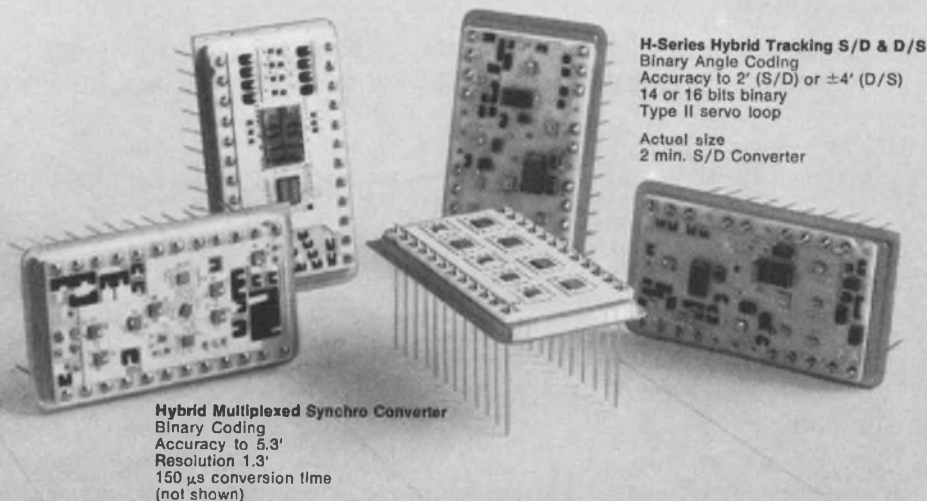

H-Series Hybrid Tracking S/D & D/S

Binary Angle Coding
Accuracy to 2' (S/D) or $\pm 4'$ (D/S)
14 or 16 bits binary
Type II servo loop

Actual size
2 min. S/D Converter

Hybrid Multiplexed Synchro Converter

Binary Coding
Accuracy to 5.3'
Resolution 1.3'
150 μ s conversion time
(not shown)

Get all the flux from rare earth magnets by putting it in right

To get all the flux available with high coercive force magnets you need magnetizing equipment designed for their higher field strength requirements.

Magnetizing and calibrating materials such as rare earth cobalt also require close control of field shape and direction to achieve optimum properties.

	saturation requirements	electrical resistivity
Alnico	3-6 K oersted	low
Indox	10-12 K oersted	high
Incor*	35-100 K oersted	medium

*Indiana General's rare earth magnets.

Getting the flux in

Both amplitude and width of the magnetizing pulse must be designed to match the requirements of rare earth materials. Because of their conductivity, these materials require magnetic fields of sufficient intensity and duration to overcome the eddy currents produced.

Magnet calibration

Uniform flux for a group of magnets or magnet assemblies can be achieved automatically through partial demagnetization to a specific level. Testing of each magnet is performed after saturation and calibration pulses are used to achieve uniform magnet strength.

The system approach

Indiana General high field intensity pulse magnetizing systems provide magnetizing, testing and calibration for all types of rare earth magnet materials.

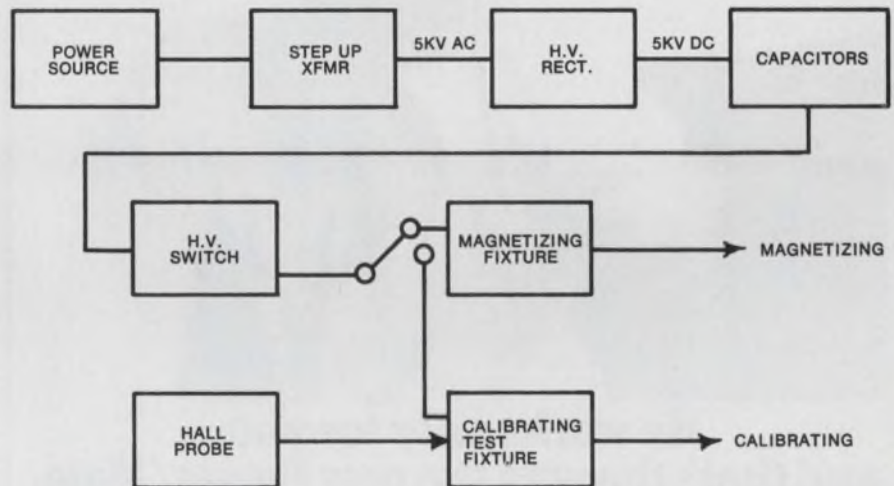

The magnetizing power unit in a typical system charges in as little as 30 seconds and delivers calibration pulses up to 20,000 watt-seconds.

Plug-in magnetizing coils are matched to your requirements and deliver up to 100,000 oersted to fully saturate all high coercive force materials.

Calibrating coils matched to the energy source provide plug-in operation and minimal heat generation.

Digital readout with Hall effect generator supplies accurate measurement of magnet strength for testing and calibration.

Our experience in rare earth magnet technology can assist you in selecting the magnetizing and calibrating system that best meets your material and production requirements.

Your source for rare earth magnet technology

Indiana General can assist you in applying high coercive force magnets to your most demanding requirements. We will work with you in developing rare earth magnet designs and can supply samples for your evaluation.

For specifications on our complete line of magnetizing and calibrating equipment or for any assistance you may require in applying rare earth magnet technology, please call: (219) 462-3131 or contact:

Indiana General, Magnet Products, Valparaiso, Indiana 46383.

indiana general 

a division of Electronic Memories & Magnetics Corporation

INFORMATION RETRIEVAL NUMBER 5

Our Bill Shuart doesn't work for Power/Mate.



**He works only for you...
and that's the way the new Power/Mate
wants it.**

Bill is the Power/Mate Quality Assurance Manager and he has 34 supervisors and perfectionists under him.

They also work for you.

The result is unexcelled and consistent quality that we at Power/Mate are genuinely proud of.

Bill does a lot more than making sure our products are produced in accordance with his high standards of workmanship. (He wrote the book on that too.)

Bill has developed a series of courses for all our employees on soldering techniques and workmanship standards.

□ He has developed a computer failure analysis program to insure that our vendors also maintain the consistent high quality you should expect when you use our power supply in your product.

□ He oversees the continuing MTBF studies (by computer of course) and worst case calculations on all our power supplies to insure the long life and trouble free performance you should expect.

□ He has developed a thermally cycled burn-in rack in which we subject *all* of our power supplies for 24 hours before shipment to insure there are no premature field failures.

□ He oversees the random sampling of all production-run power supplies. These are subject to a continuous night and day life test . . . for your continued assurance of a long-lived trouble free product.

We could go on . . . but we at Power/Mate are glad he works for you. That's why we can give a five year no-holds warranty.



THE NEW

POWER/MATE CORP.

514 S. River Street, Hackensack, N. J. 07601. Phone (201) 343-6294
TWX 710-990-5023

Vice President, Publisher

Peter Coley

Editors

Editorial Offices

50 Essex St.

Rochelle Park, N.J. 07662

(201) 843-0550

TWX: 710-990 5071

Cable: Haydenpubs Rochellepark

Editor-in-Chief: George Rostky

Managing Editors:

Ralph Dobriner

Michael Elphick

Associate Editors:

Dave Bursky

Jules H. Gilder

Morris Grossman

Seymour T. Levine

John F. Mason

Stanley Runyon

Edward A. Torrero

Richard L. Turmail

Contributing Editor:

Peter N. Budzilovich

Editorial Field Offices

East

Jim McDermott, Eastern Editor

P.O. Box 272

Easthampton, Mass. 01027

(413) 527-3632

West

David N. Kaye, Senior Western Editor

2930 West Imperial Highway

Inglewood, Calif. 90303

(213) 757-0183

Northe K. Osbrink, Western Editor

112 Coloma St.

Santa Cruz, Calif. 95060

(408) 426-3211

Washington

Heather M. David, Bureau Chief

2506 Eye St., N.W.

Washington, D.C. 20037

(202) 338-3470

Editorial Production

Marjorie A. Duffy

Art

Art Director, William Kelly

Richard Luce

Anthony J. Fischetto

Production

Manager, Dollie S. Vieblg

Helen De Polo

Maxine Correal

Anne Molfetas

Circulation

Manager, Nancy L. Merritt

Ron Deramo

Information Retrieval

Peggy Long

Promotion

Manager, Jeffrey A. Weiner

Karen Kerrigan

across the desk

LED application note offered to designers

I would like to add another LED application note to the bibliography of the April 12 article "Shedding Light on LED Luminance" (ED No. 8, p. 92). Tektronix has an application note available on luminous intensity and visible LED measurements. This note is concerned primarily with the practical aspects of visible LED measurements.

It also might be advisable to mention the author's affiliation with California Optoelectronic Industries, since this company was mentioned twice in the article.

Pete Keller

Marketing, Analytical Instruments
Tektronix, Inc.

Delivery Station 48-188

P.O. Box 500

Beaverton, Ore. 97005

Ed Note: The author, Joe Horwath, is a principal of California Optoelectronic Industries. ELECTRONIC DESIGN was unaware of this affiliation when the article was published; otherwise it would have been mentioned.

Amsa: Here's what it means

Your item concerning the American Satellite Corp. in "Capital Capsules" (Washington Report, ED No. 8, April 12, 1973, p. 60) is producing confusion. The American Satellite Corp. is not abbreviated "Amsat," because of conflict and confusion with Amsat, trademark of the Radio Amateur Satellite Corp.

The Radio Amateur Satellite Corp. is a nonprofit, Washington-based organization created four years ago to provide communica-

tions satellites for amateur radio operators throughout the world. Six satellites, called Oscar's (for Orbiting Satellites Carrying Amateur Radio), have been launched since 1961. The first four were put into orbit by the Air Force as piggyback payloads, and the most recent two were launched by NASA on a similar basis through arrangements made by our organization. Oscar 6 is now in regular use by thousands of radio operators in over 50 countries, including the Soviet Union and East European nations.

Dr. Perry I. Klein
President

Radio Amateur Satellite Corp.

P.O. Box 27

Washington, D. C. 20044

Correcting the score on sig-gen outputs

In "Focus on Signal Generators and Synthesizers" (ED No. 10, May 10, 1973, p. 62), I wish to suggest a correction to the statement that the HP-8660 synthesized signal generator offers "the highest frequency available in any synthesizer." Watkins-Johnson has three standard synthesizers with significantly higher frequency outputs. The multi-octave WJ-1154, WJ-1154-7 and WJ-1187 synthesizers provide frequencies of 1 to 12.4 GHz, 1 to 18 GHz and 0.5 to 18 GHz, respectively. W-J also offers a number of single-octave and narrow-band synthesizers within the frequency range of 500 MHz to 18 GHz.

Charles E. Foster 2d
Applications Engineer

Watkins-Johnson Co.

Systems Div.

3333 Hillview Ave.

Palo Alto, Calif. 94304

(continued on page 11)

Electronic Design welcomes the opinions of its readers on the issues raised in the magazine's editorial columns. Address letters to Managing Editor, Electronic Design, 50 Essex St. Rochelle Park, N. J. 07662. Try to keep letters under 200 words. Letters must be signed. Names will be withheld on request.

THIN-TRIM[®] CAPACITORS FOR HYBRID-CIRCUIT DESIGNERS



ACTUAL SIZE



THIN-TRIM capacitors are a new development in miniaturized variable capacitors for application in circuits where size and performance is critical. The Thin-Trim concept provides a variable device to hybrid circuit designers which replaces fixed tuning techniques and cut and try methods of adjustment.

FEATURES

- Low profile for HYBRID CIRCUIT applications.
- High capacity values for BROADBAND applications.
- High Q - low capacity values for MICROWAVE applications.

U.S. Patent 3,701,932

Johnson

MANUFACTURING CORPORATION

ROCKAWAY VALLEY ROAD

BOONTON, N.J. 07005

PHONE (201) 334-2676

TWX 710-987-8367

The NAKED MINI/LSI™

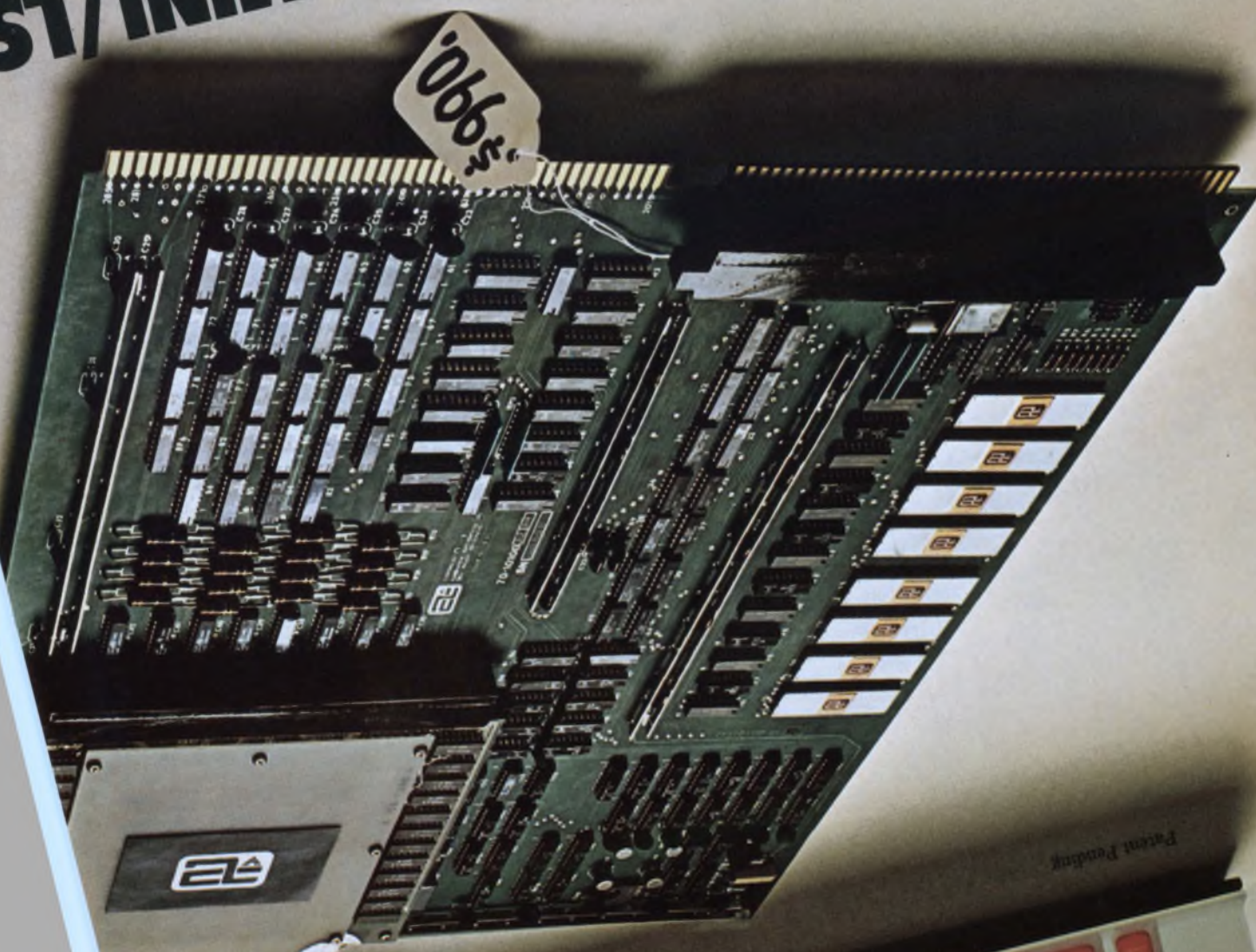

What this country needs is a good \$1,000 full-scale computer.



Introducing the computer for everybody. NAKED MINI/LSI.™

It's the computer for people who never thought they could afford a computer for their product.

It's also for people who have always been able to afford more, but have always gotten less computer than this.

NAKED MINI/LSI is the first OEM computer designed for widespread, multi-level use. The first computer able to do more jobs than any computer could ever do before.

Jobs that computers were too expensive to do. Jobs that were, consequently, always left to old-fashioned hardwired circuitry. Which meant that products weren't as flexible or immune to obsolescence as they could have been.

Or jobs that were done by more expensive computers. Which meant that products cost more and were less competitive than they should have been.

To make a computer capable of handling this kind of range, we had to give it an unheard of combination: extensive 16-bit computing power and a small price tag. Specifically, NAKED

MINI/LSI is the first computer powered to satisfy 90% of all potential minicomputer applications — and yet be priced as low as \$990 in OEM quantities of 200.

Imagine it. For a price less than most hardwired circuitry, your product can benefit from a computer having arithmetic capabilities, full byte and 16-bit word processing, and extremely flexible input/output. Without going into all the jazzy widget features, let's just say that the NAKED MINI/LSI gives your product all the intelligence it needs to monitor, sequence, and control effectively.

At this point, you may be wondering why a computer with all this clout was ever named the NAKED MINI/LSI. Actually, the name is very appropriate.

The NAKED MINI means that we designed it without all the over-design found on other minicomputers. All the extra, redundant features that make other minis too unwieldy and costly for OEM use have been purposely left off. (But everything you need has been deliberately built in.)

The LSI stands for large-scale integration, the latest technological advance in electronics. It enabled us to build a complete computer that fits on a single 1" x 15" x 17" card, weighs only 4 lbs., and uses 89% fewer components for unequalled reliability.

For full details on the NAKED MINI/LSI (or its stand-alone counterpart, ALPHA/LSI™), write Computer Automation Inc., 18651 Von Karman, Irvine, California 92664. Or call: (714) 833-8830. TWX 910-595-1767.

from Computer Automation.



Silicone-packaged devices: The answer to a hot problem.

Within seconds after the match flame was applied to both the epoxy (left) and the silicone ICs (right), the epoxy burst into flame.

The hot issue in electronics today is flame retardancy. While epoxies and other plastics support combustion, silicone-packaged devices are virtually nonflammable. So, they don't need flame-retardant additives that alter the electrical and mechanical properties of epoxies and other materials.

And there are several other good reasons to specify silicone packaging compounds:

- excellent performance under thermal cycling
- low thermal expansion minimizes damage to components and lead wires
- basic electrical, physical, and chemical properties that remain constant over the widest temperature (-55 to 250 C), time, and frequency ranges
- uniform, lifetime electrical characteristics
- superior performance in 85 C/85% RH (biased) test
- total compatibility with *all* kinds of devices, including ICs, both digital and linear, MOS, CMOS, power transistors, SCRs, high-voltage rectifiers, etc.
- optimum reliability reduces manufacturing and repair/warranty costs
- safe, clean, inert, and require no special handling

Whether you are a device manufacturer or user, these advantages are important in semiconductor devices. Make the switch to nonburning silicone packaging compounds now. Write or call Jack Broser, Product Market Supervisor, Dow Corning Corporation, Department A-3312, Midland, Michigan 48640.

Silicones; simply the best way to protect electronic circuits

DOW CORNING

DOW CORNING

Six good reasons why Dow Corning should be your primary packaging-materials supplier.

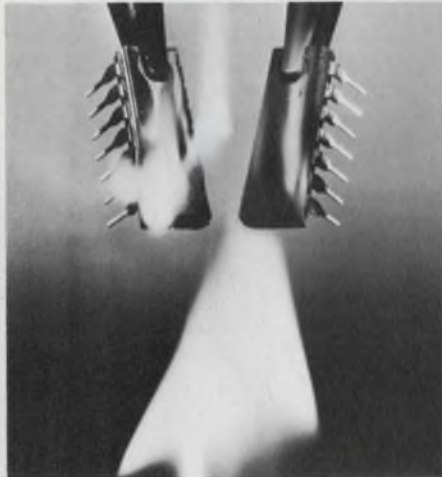

In addition to the many important advantages of silicone molding compounds, there are other good reasons why it is to your advantage to plan your growth in the electronics market with help from Dow Corning.

1. We are helping to develop the market for you. Extensive publicity, promotion, direct mail, and trade-show appearances are all educating your customers about the very substantial advantages of silicones in all kinds of harsh electronic/electrical environments.

2. Since service is extremely important in helping manufacturers in the development of advanced packaging systems, we have Technical Service & Development men strategically located worldwide to help solve your problems.

3. Your competitive advantage with Dow Corning molding compounds is a complete family of products, totally compatible with each other and with most other materials used in electronic systems, devices, or components.

4. Product-line breadth gives you the ability to design or produce the most reliable and economical packaging to protect any system, regardless of its sophistication or environment.

5. Technical leadership constantly applied in our own laboratories and with our customers results in the development of product modifications and new technologies to handle the needs and requirements of next generation devices.

6. Worldwide delivery from strategically located distribution points enables us to work with you to supply standard or special molding materials as required.

Major commitments like these indicate the kinds of things we are doing to earn your business. We'd like to discuss with you in more detail how we can grow together in this rapidly expanding area. Call or write Jack Broser, Product Market Supervisor, Dow Corning Corporation, Department A-3313, Midland, Michigan 48640. Phone: (517) 636-9460

Silicones; simply the best way to protect electronic circuits.

DOW CORNING

DOW CORNING

ACROSS THE DESK

(continued from page 7)

Outside testing backed for medical electronics

With reference to your timely article on medical electronic equipment in the March 1, 1973, issue, (ED No. 5, pp. 26-30), I would like to comment as follows:

A single group, such as the Emergency Care Research Institute, may not always be perfect and correct in its evaluation of equipment, but its findings are a lot better than none at all. If some companies keep on manufacturing unreliable and marginal equipment, we need someone to expose them. The user must be very careful of any company that objects to having its product evaluated and tested by someone else. Is such a company in a position to "know it all" and make perfect equipment? Most likely it doesn't want to expose its shortcomings.

Can the Government do a better evaluation job? I am very doubtful about this.

Mort Arditti

Senior Biomedical Engineer

Cedars-Sinai Medical Center
Los Angeles, Calif. 90029

Round or flat symbol: Which for amps?

In the words of Chris Columbus, "It's round, not flat!" And so it should be said of the flat-fronted op-amp symbol that appears once more in the May 10 article "Protect Op Amps From Overloads" (ED No. 10, p. 96). Although the flattened form is consistent with current symbol "slang," the well-rounded version is consistent with symbol standards. Standards from IEEE and others distinguish the op-amp symbol with a rounded front, as opposed to the flat front of the inverter symbol.

Without this distinction, it becomes difficult to distinguish an op-amp symbol from that of a logic inverter (differential input variety, of course). Let's put more into our op-amp symbols by using the rounded front (7% more area

(continued on page 16)

BOURNS®

POTENTIOMETERS
QUALITY · DELIVERY
PRICE ·

83 DISTRIBUTOR INVENTORIES

CONTROLS AND VARIABLE RESISTORS

- CHOOSE FROM 6 POPULAR "SPACE SAVER" CONTROLS
- LOWEST PROFILE IN THE INDUSTRY
- CERMET... FOR BETTER STABILITY AND POWER
- 3 POPULAR VARIABLE RESISTOR MODELS; HORIZONTAL AND VERTICAL MOUNT EITHER CERMET OR COMPOSITION ELEMENTS
- COMBINED FACTORY/DISTRIBUTOR CONTROLS STOCK: 167,000 PCS.
VARIABLE RESISTORS: 715,000 PCS.

TOTAL SOURCE... BUILT ON BASICS!

COMPONENTS FOR LOW-PRICED COMMERCIAL . . . TO MAN-ON-THE-MOON APPLICATIONS!

PRECISION POTENTIOMETERS

- ◆ SELECT FROM OVER 20 DIFFERENT STANDARD MODELS INCLUDING THE FAMOUS KNOBPOT® FAMILY
- ◆ 260,000 UNITS IN COMBINED FACTORY/DISTRIBUTOR STOCK
- ◆ CUSTOM PRECISIONS FOR EVERY SERVO-MOUNT APPLICATION

TRIMPOT®

ADJUSTMENT POTENTIOMETERS

- ◆ WORLD'S LARGEST LINE OF ADJUSTMENT POTENTIOMETERS!
- ◆ SELECT FROM OVER 60 MODELS . . . WIREWOUND OR CERMET!
- ◆ SINGLE-TURN . . . MULTI-TURN! ROUND, SQUARE AND RECTANGULAR!
- ◆ OVER 12,000 "MODEL/TERMINAL/RESISTANCE" COMBINATIONS!
- ◆ OVER 3,500,000 UNITS IN COMBINED FACTORY/DISTRIBUTOR STOCK

BOURNS
INC.
TRIMPOT PRODUCTS DIVISION
1200 COLUMBIA AVENUE
RIVERSIDE, CA. 92507

INFORMATION RETRIEVAL NUMBER 11

A MINI-LIBRARY OF SEMICONDUCTOR GUIDES FROM HAYDEN...

THICK FILM TECHNOLOGY

By Jeremy Agnew

This volume constitutes an actual working guide to hybrid circuit manufacture and packaging. It begins with an overview of the processes and equipment used, compares them, and underscores the advantages of each. The book details each processing phase, fully describing what to do and what pitfalls to avoid. Other valuable sections cover packaging schemes and processing hazards and cautions. The volume's abundance of practical advice and data make it ideal as an on-the-job reference. **176 pages, 6 x 9, illus., #5803-9, \$8.50**

TRANSISTOR AND DIODE NETWORK PROBLEMS AND SOLUTIONS

By Harry E. Stockman

This guide demonstrates the latest mathematical solutions for the entire field of transistor and tunnel diode calculations, including linear as well as non-linear applications. It shows how to select the best type of solution, set up the network equations, and carry out the solutions. It also uses new theories — including the author's "Equivalent Generator Theorem" — in the treatment of function sources. In addition, a valuable "do" or "don't" list enables you to avoid any time-wasting calculations. **352 pages, 6 x 9, illus., #5694-x, cloth, \$9.95**

TRANSISTOR AND DIODE LABORATORY COURSE

By Harry E. Stockman

A practical, self-learning course that progresses systematically from simple fundamentals to highly intricate experiments. The experiments in the first half of the course lay a working foundation in transistor technology with twoport-theory viewpoints applied continuously to give all the experiments a practical engineering slant. One valuable feature is the negative resistance demonstration — the first presentation of this device ever to appear in print. All experiments can be performed on very low-cost equipment. **128 pages, 7 3/8 x 10 1/8, illus., paper, #5671-0, \$3.95**

MATERIALS FOR SEMICONDUCTOR FUNCTIONS

By E. G. Bylander

This comprehensive reference enables you to select semiconductor materials aimed at optimum performance, reliability, and profitability. It provides complete selection criteria for a variety of functional applications: diodes and transistors, solar cells, thermoelectric devices, transducers, etc. The guide also covers material processing techniques and device design and manufacturing, listing variables in material manufacturing that influence device performance. **220 pages, 6 x 9, illus., #5638-9, cloth, \$13.50**

FUNDAMENTALS OF INTEGRATED CIRCUITS

By Lothar Stern

Here is a book offering complete coverage of the various techniques of IC fabrication and their importance to circuit performance. Included is a valuable marketing discussion comparing the relative qualities of the IC's currently available in terms of economics and logistics. The guide focuses on basic semiconductor principles, monolithic integrated circuits, thin-film circuits, and hybrid and other integrated structures. Here too is a discussion of packaging, design, and layout principles, and large-scale integration. **208 pages, 7 x 10, illus., #5695-8, cloth, \$8.95**

DURABILITY AND RELIABILITY IN ENGINEERING DESIGN

By Gilbert Kivenson

A unique combination of materials science, reliability, and design, this book examines crucial concepts of material strength, service longevity, and reliability, and describes the fundamentals of breakdown analysis. It covers new materials, design techniques, and fabricating methods and focuses on their probable uses in future products. Current trends in design "philosophies" are outlined, as well as practical design considerations relating to the requirements of the end user. **200 pages, 6 x 9, illus., #5851-9, cloth, \$9.95**

15-DAY FREE EXAMINATION

Please send me the book(s) circled below on 15-day free examination. At the end of that time, I will remit payment, plus postage, or return the book(s) with no further obligation.

5803-9	5671-0	5695-8
5694-x	5638-9	5851-9

Save Money!

Payment enclosed. Publisher will pay all shipping and handling charges — same 15-day guarantee.

Name _____

Firm _____

Address _____

City/State _____ Zip _____

\$10.00 minimum for free exam orders. Because of higher billing and collection costs, we must ask for payment in full with any order for less than \$10.00. Same 15-day guarantee.



HAYDEN BOOK COMPANY, INC., 50 Essex Street, Rochelle Park, N.J. 07662

73-57

Raytheon Semiconductor announces two super products that just made us No.1 in voltage regulators.

No gimmicks. Just proof.

Here they are. Adjustable and fixed dual-tracking voltage regulators that are so simple to design into your system you can forget about your slide rule and calculator. They require fewer external components so they take up less space. Compared to other voltage regulators, they provide more than twice as much current. Which means you can supply a lot more systems for a lot less money in the long run. And they are the first voltage regulators to provide thermal shutdown protection for both outputs at a junction temperature of $+175^{\circ}\text{C}$.

Adjustable 4194

With the 4194 you get both positive and negative outputs from 50mV to 42V — the widest range available today. All it takes is one external resistor (R_0) to ground for setting the desired output voltage. And to find out the value of R_0 you just use this simple formula: $2.5 \times V_0 = R_0 (K\Omega)$.

Or if you want to program the outputs simultaneously, use one pot calibrated for 2500 ohms/volt.

Depending on the application, you'll only need from 4 to 6 external components — compared to 8 to 12 for other regulators.

The 4194 provides 200mA at both outputs simultaneously, with

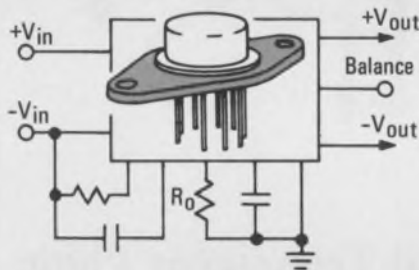

4194

0.2% load regulation over the entire voltage range. You need just one resistor to provide asymmetrical tracking voltages for the popular 710, 711, 702, 106 or the like. And with external pass transistors the 4194 can supply output currents to 10A.

Fixed 4195

Check these features against competition. The 4195 provides positive and negative 15V outputs at 100mA each. And it does it with only two bypass capacitors, compared to competition's six external components. That

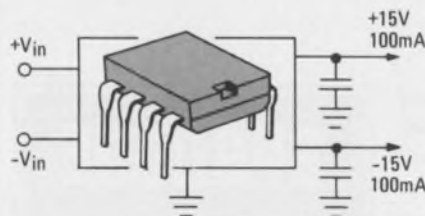

4195

means you can power a lot more amps for a lot less money.

The 4195 can be used as a single supply with an output of up to +50 volts. It comes in 3W and 900mW packages or — and this is another first — an 8-pin plastic mini-DIP!

RAYTHEON

Raytheon Semiconductor
350 Ellis Street
Mountain View
California 94040
Phone (415) 968-9211.

Send me information right away on the voltage regulators checked below.

- | | |
|--|-------------------------------|
| <input type="checkbox"/> LM104/204/304 | <input type="checkbox"/> 723 |
| <input type="checkbox"/> LM105/205/305 | <input type="checkbox"/> 4194 |
| <input type="checkbox"/> LM109/209/309 | <input type="checkbox"/> 4195 |

NAME _____

TITLE _____

COMPANY _____

ADDRESS _____

CITY/STATE/ZIP _____ ED

Best for Hybrid Circuits



Silicon Planar Epitaxial Transistor Chips

Sprague makes a broad, diversified line of drivers, switches, and general-purpose types in both small-signal and power geometries, available for off-the-shelf delivery!

- Gold backed for easy die-bonding to substrates.
- 100% d-c parameter probed.
- 100% visually inspected.
- Non-standard types also available.
- Packaged and shipped three different ways: bulk-packed in glass vials; in compartment plastic boxes with see-through covers; as wafers in padded boxes, ready for scribing in your plant.

For more information, write for Short-form Catalog CN-164B to: Technical Literature Service, Sprague Electric Co., 347 Marshall Street, North Adams, Mass. 01247.



THE BROAD-LINE PRODUCER OF ELECTRONIC PARTS

INFORMATION RETRIEVAL NUMBER 14

ACROSS THE DESK

(continued from page 11)

and 4% more circumference)!

Another note on symbols in the article mentioned: The transistors of Fig. 4a are pointless, or arrowless, or of neuter "gender." While such neuter representations are socially nondiscriminative, distinctions of "gender" remain useful in schematics. The upper pair of transistors should be pnp's and the lower pair npn's. In each case the emitter terminal is that which connects to a resistor.

Jerald Graeme

*Manager, Monolithic Engineering
Burr-Brown Research Corp.
Airport Industrial Park
Tucson, Ariz. 85706*

Ed. Note: The flat-fronted symbol used by ELECTRONIC DESIGN and other magazines is now almost universal throughout the industry. Among op-amp manufacturers, Burr-Brown is practically alone in clinging to the older, rounded-front symbol. Nevertheless Mr. Graeme makes a strong case for the rounded symbol. Which do readers prefer?

Caution on 'typical' seconded by user

This is a resounding second to the letter on "typical" specs by Michael I. Wier ("A Word of Caution on 'Typical' Designs," ED No. 10, May 10, 1973, p. 17). Considerable experience on the user side of the semiconductor manufacturer/user interface has taught many of us at HP that you do yourself a favor when you ignore what is adorned with the picturesque, but meaningless, adjective "typical."

This is especially true in the CMOS area, where marketing wordsmiths appear to have found it necessary to misrepresent rather more extensively than is customary the distinction between what's real and what's not real.

Lawrence W. Johnson

*Manager, Materials Engineering
Hewlett-Packard
5301 Stevens Creek Blvd.
Santa Clara, Calif. 95050*

Metal fastening is one thing, but what do you do about new materials, like plastics, and particleboard and...

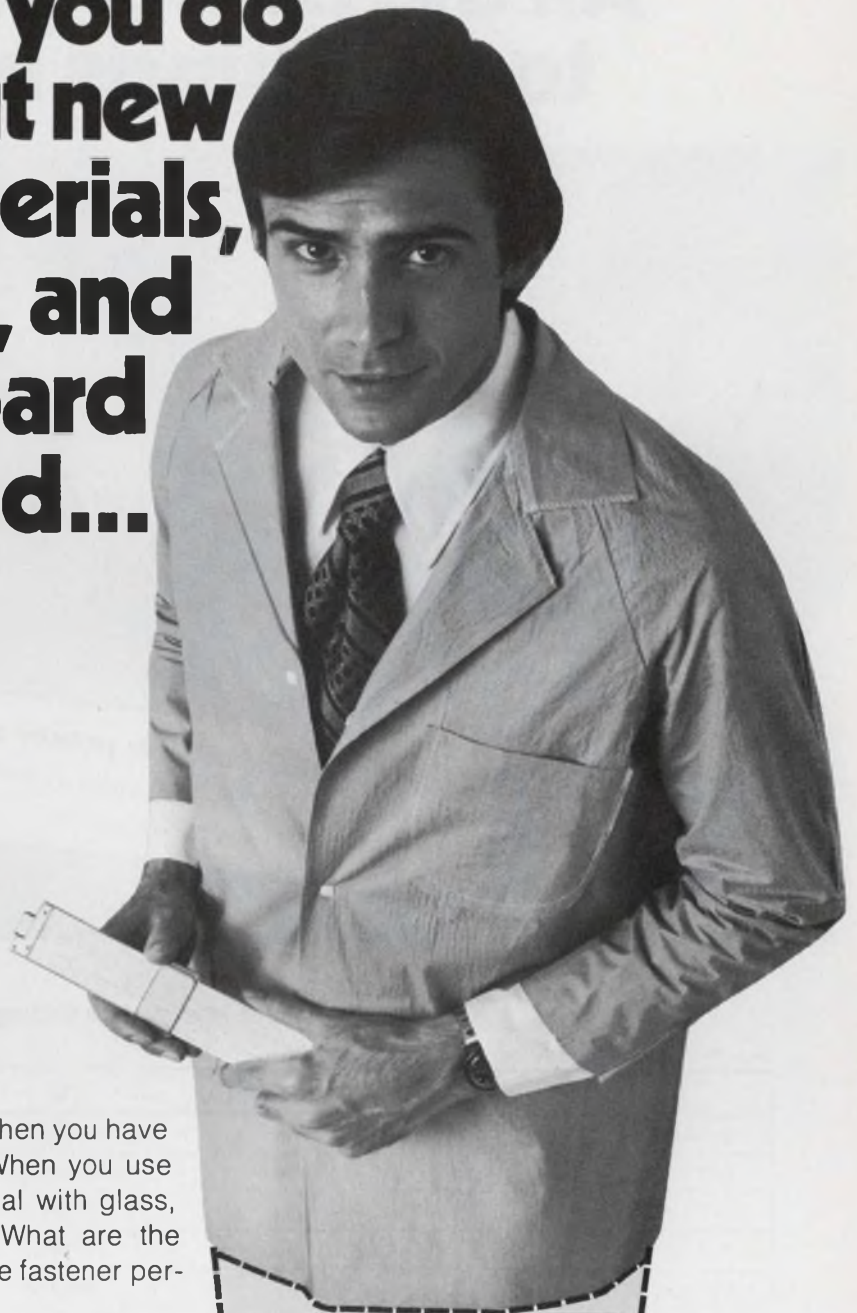

It's a whole new bag of problems when you have to fasten different materials together. When you use plastic with wood, for example, or metal with glass, there are lots of things to consider. What are the physical properties of each? How will the fastener perform? What about cost?

Shakeproof has compiled a number of examples of how fasteners have been used to meet these new problems. They are contained in a folder called "BRINGING TOGETHER DISSIMILAR MATERIALS." It shows how Shakeproof can help solve your problems.

Send in the coupon today. Prepare to meet your next challenge successfully.

Please send me a copy of
**"BRINGING TOGETHER
DISSIMILAR MATERIALS."**



Name _____
Title _____
Company _____
Address _____
City _____
State _____ Zip _____

it **SHAKEPROOF®**
iw DIVISION ILLINOIS TOOL WORKS INC.
ST. CHARLES ROAD • ELGIN, ILLINOIS 60120

INFORMATION RETRIEVAL NUMBER 15

TRW's SVT Series Darlington.

All the power you need to get things moving.



TRW's Monolithic High Voltage Darlington Family

BV_{cbo} to 650 Volts... Switch times typ. 300 NanoSec.

	BV_{ce} (Sustaining)	I_c	V_{ce} (Sat)
SVT 6060	300 Volts	20 Amps	2.0 Volts ($I_c=20A, I_b=2A$)
SVT 6061	350 Volts	20 Amps	2.0 Volts ($I_c=20A, I_b=2A$)
SVT 6062	400 Volts	20 Amps	2.0 Volts ($I_c=20A, I_b=2A$)
SVT 6000	300 Volts	10 Amps	1.4 Volts ($I_c=10A, I_b=500_mA$)
SVT 6001	350 Volts	10 Amps	1.4 Volts ($I_c=10A, I_b=500_mA$)
SVT 6002	400 Volts	10 Amps	1.4 Volts ($I_c=10A, I_b=500_mA$)
SVT 6251	350 Volts	5 Amps	1.4 Volts ($I_c=5A, I_b=500_mA$)
SVT 6252	400 Volts	5 Amps	1.4 Volts ($I_c=5A, I_b=500_mA$)

Available in quantity—now, from your local distributor. For additional information, call Pete Wood, collect, at (213) 679-4561; or write TRW Semiconductors, an Electronic Component Division of TRW Inc., 14520 Aviation Blvd., Lawndale, California 90260. In Europe, contact Mr. C. Thompson, TRW Composants, Electroniques, S.A. Rue René-Magne, Zone d'Entrepôts, 33 Bordeaux-Nord, France. Telephone (56) 297870. Telex: 842-57179.

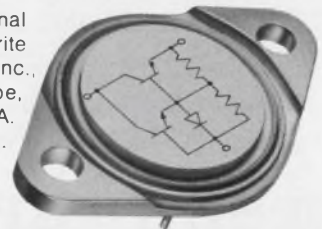

TRW[®] SEMICONDUCTORS

INFORMATION RETRIEVAL NUMBER 16

Navy to try fiber optics instead of wiring

The Navy has taken the first steps toward replacing conventional electrical wires for carrying data with fiber-optic cables.

The small glass, light-transmitting cables weigh less and need less space than electrical wires. They are free from electromagnetic interference, producing no cross talk. They are more neutrally buoyant than electrical wires—an advantage for underwater work—and silica cables are temperature-resistant up to 1200 C.

The first major rewiring will be in an A-7 attack aircraft. Eventually the Navy plans to install fiber optics in ships and underwater vehicles and installations.

A total of 302 wires in the A-7 will be replaced by 52 fiber-optic cables. The electric wires are 4832 feet long; the fiber-optic cables, 832. The electric wires weigh 82 pounds; the fiber-optic cable, 13. The electric wires cost \$7900, while the cables will cost \$2100.

IBM in Owego, N.Y., has successfully bench-tested a portion of an A-7 installation for the Naval Electronics Laboratory Center, San Diego, and expects to install it in the plane soon.

The break in fiber optics came when attenuation losses were cut from 1000 dB per kilometer to 20 dB, according to Don Albares, a research physicist and head of the Command Control Branch of the Navy center's Electro-Optics Technology Div.

Attenuation losses as low as 4 dB per kilometer have been reported, Albares says, but the Navy is testing systems with attenuation losses of 100 dB and lower.

A second experiment the Navy plans—to be carried out before September—is to replace a closed-circuit television cable on board a ship with a fiber-optic cable.

Also within the next three

months, the Navy will install a six-terminal telephone system on a ship.

Other applications that Albares foresees are fiber-optic cables for telemetry systems to towed television cameras or hydrophones. And the Marine Corps plans to use them for carrying signals to and from computers in its tactical data links.

"With a 4-dB-per-kilometer system we could comfortably transmit for distances up to 25,000 feet without a repeater," Albares says.

The bandwidth of a multimode fiber bundle is 50 MHz over a distance of one kilometer with use of an incoherent light source, such as a LED. Under development at the Navy center, as well as at Bell Laboratories in New Jersey and at various universities, are single-mode, fiber-optic channels with much smaller cores—a few wavelengths in diameter. "These will provide a broader bandwidth—something in the neighborhood of 10 GHz over a distance of one kilometer," Albares says.

\$13-billion spending by Pentagon forecast

The Pentagon will spend approximately \$13-billion between now and fiscal 1978 for command, control and communications systems, according to a Frost & Sullivan market research study.

The peak in annual expenditures should occur next year, the report says, when an estimated \$2.691-billion will be requested. This total is expected to drop to \$1.17-billion by 1978.

The Air Force, which is the biggest spender for command, control and communication systems, will ask for \$869-million for such equipment in 1973, according to the

report, and \$237-million of this will go for surveillance and warning systems. The Awac (airborne warning and control) aircraft system is expected to receive \$310-million in 1974 and \$771-million in 1976.

The second largest spender in the field, the Navy, has about 40% of its budget going into equipment for the S3A ship-based antisubmarine aircraft, the land-based P3C sub chaser and the electronic-warfare aircraft, the E2C, which is also used for command and control of air operations. All these systems use sensors, computers, displays and communications gear to serve as extensions of ship and shore-based systems.

Other key Navy programs include the ULMS/Trident submarine for launching ballistic missiles, work on a new submarine-launched ballistic missile and modifications on the Poseidon missile.

Much of the Army's funding in this category goes to the Safeguard antiballistic missile system, site defense of Minuteman, the SAM-D surface-to-air missile, the improved ground-to-air Hawk missile and STANO, a surveillance target-acquisition and night-operations system.

Seminar to consider electronic thievery

As the use of commercial computer systems rises in the country, a new type of crime is spreading with it: electronic theft. To bring manufacturers and users together to discuss problems and solutions, the IEEE has organized an Electronic Security Systems Seminar, to be held Sept. 25 and 26 at the Statler Hilton Hotel in New York City.

J. Howard Schumacher, organizer of the seminar, says there will be eight technical sessions and a small display area for about 30 exhibitors.

Of the eight sessions, one of the more popular is expected to be an all-day meeting on data-center security. Organized by Robert Wilk, security manager for Grumman Data Systems Corp., the session will consist of two panels, one composed of manufacturers, the other of users.

Members of the panels, which

will include representatives from such companies as Honeywell, IBM, Motorola, Radio Frequency Laboratories, Grumman Data Systems, Chase Manhattan Bank and Merrill Lynch, Pierce Fenner & Smith, will discuss the shortcomings of present security systems and offer suggestions for new devices to overcome the problems.

"We'd like to bring to the attention of manufacturers, areas where security people need help," Wilk explains. The biggest problem, he says, is data-center access control. One reason for this is that all current control systems are transferable. They all use some sort of device—such as a card, key or combination—that can be stolen or given to an unauthorized person to gain entrance.

A nontransferable means of identification is needed, Wilk notes, and researchers are looking into palm identification and voice identification, but neither has reached the point where it is accurate enough for use.

Accessing data from a remote terminal is also a big problem. Unless some sort of data scrambler is used, there isn't much a company can do to protect data being transmitted by phone, Wilk points out. And there isn't much hardware around that will stop unauthorized remote use of the computer. Here again, voice identification is being considered, as is closed-circuit television.

Alarm devices and systems will be discussed in a half-day session that will include presentations on the growing problem of false alarms, the proper place of closed circuit television in alarm systems, and a review of electronic innovations in central station alarm systems.

Other sessions at the seminar will focus on security requirements for the financial, industrial, retail and transportation industries, and auto theft and credit and banking-card fraud.

European data traffic headed for huge rise

The use of data communications in Europe is expected to increase tenfold by 1985, according to a joint study completed by Quantum

Science Corp. of New York City and P.A. International Management Consultants, London.

The survey, which was commissioned by 17 West European national telecommunications authorities and which reportedly queried over 4000 European companies, forecast that there would be more than 1.4 million data terminals in Europe by 1985—about three times the number in the U.S. last year.

The study indicated that by 1985 data-communication terminals would exceed the number of Telex stations in use.

Quadrasonic systems getting better pickups

A major problem with discrete quadrasonic recording and playback systems—the making of pickups that can respond to 20-to-50-kHz grooves—appears well on the way to solution. More than half a dozen manufacturers demonstrated improved pickups at the Consumer Electronics Show in Chicago.

When quadrasonic equipment was introduced about three years ago manufacturers faced a perplexing problem: whether to go to discrete four-channel systems or to use the matrix approach. In the discrete setup, four channels of recorded music feed four amplifiers and loudspeakers. In the matrix, portions of the sound are electronically mixed and fed to the four speakers in the proper magnitudes, with speaker signals at the proper phase angles.

There has been a universal agreement that discrete systems give the best quadrasonic performance, but so far only one company—JVC America, Inc., of Maspeth, N.Y.—has manufactured four-channel discrete recording systems. It is recording two additional channels on a 33-1/3-rpm stereo record.

JVC's playback system—called the CD-4—requires a bandwidth of 45 kHz, which poses technical problems in playback-cartridge development. The original JVC pickups are made by Shibata of Japan and use a difficult-to-manufacture stylus that has severely limited the supply but a number of firms in the past two years have started making these pickups using their own approach.

Manufacturers displaying improved CD-4 cartridges—magnetic, semiconductor and ceramic—at the consumer show included Stanton Magnetics, Shure Bros., Inc., Micro/Acoustics Corp., Pickering, Pioneer, Audio Technica, Empire, Panasonic, JVC and Glenburn/McDonald.

Micro/Acoustics displayed a semiconductor IC pickup that, it said, has superior characteristics over the magnetic type, including separation between the 20-to-45-kHz channels. The solid-state pickup requires no voltage supply; it operates on the "electret principle," according to Sandy Drellinger, vice president of the Elmsford, N.Y., company.

"Our QC-1 transducer," Drellinger explains, "puts out a linear signal from 5 Hz to 50 kHz without the phase shift normally encountered with inductive pickups."

The high cost of the CD-4 reproducers—\$75 to \$150—has been another barrier to wide acceptance.

'Largest' TV tube developed by AF

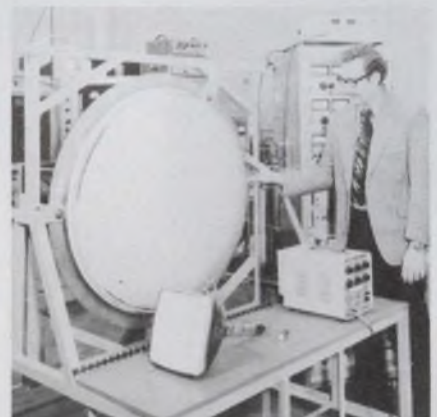

What is described as "the world's largest TV tube"—a 226-pound, 36-inch CRT—has been developed by the Air Force Human Resources Laboratory at Wright-Patterson Air Force Base, Ohio. It will be used to train Air Force pilots in a new type of advanced simulator. Seven of these giant CRTs will be combined to provide a panoramic field of view.

The CRT is said to deliver more light output than any previously manufactured tube with an output exceeding 5000 lumens. By contrast, the typical 60-W bulb used in normal house lighting produces 870 lumens.

Comparator Supermarket

Variety that lets you pick exactly what you need.

SIGNETICS COMPARATOR SELECTION LIST								
Check Need	Part Type	Operating Supp Range (V)	TTL Fan Out Capability	I Offset (μ A)	I Bias (μ A)	V Offset (mV)	Propagation Delay (nS)	
							Typical	Maximum
	NE521	± 5	10	5.0	20.0	7.5	8	12
	NE522	± 5	10	5.0	20.0	7.5	10	15
	NE526	± 5	10	5.0	35.0	5.0	40	48
	NE527	± 5 to ± 12	10	0.75	2.0	6.0	16	26
	NE529	± 5 to ± 12	10	5.0	20.0	6.0	12	22
	μ A710	+12, -6	1	5.0	25.0	5.0	40	—
	μ A711	+12, -6	1	15.0	100.0	5.0	40	—
	LM311	+5, GND to ± 15	5	0.05	0.250	7.5	200	—

Life sweetens a little. When you can get everything in comparators, from the fastest TTL to the finest precision with one call, you save a lot of migraine and a lot of bucks.

The chart also tells you something else. You can choose exactly the device you want for each of many different requirements. So you can optimize your systems, which gives you one kind of economy. And you can combine your comparator orders to get more economy. Known as smart-money thinking.



Say one of your interests is speed. You look at the four listed comparators that go from the NE527 with 16nS propagation delay down to the NE521, an 8nS dual. That's a spectrum you'd be looking in if you're building MOS memory sense amps, or maybe a Schottky line receiver.

If you turn around and go to the other end, precision, the nastiest you'll probably specify is the LM311. When you want it, you've got it.

The middle ground is where you trade off. For speed versus precision, as in glitchless voltage comparison and peak detection, the versatile NE526 hits the right balance. If it's straight price you're fighting, for applications that are pretty much standard, grab the μ A710/711.

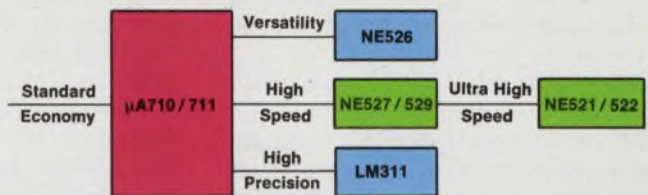

It just makes sense for a supplier of comparators to build the full line in quantity. Signetics figures it ought to make the same sense to a design engineer to check first with the supplier who has that philosophy.

So check. The left hand column is reserved for you.

CLIP THIS COUPON TO YOUR LETTERHEAD FOR IMMEDIATE ATTENTION.

Signetics—Comparators
811 E. Arques Avenue
Sunnyvale, California 94086
(408) 739-7700



I'm sending the coupon instead of the "bingo card" because I'd like some technical details reasonably promptly. Please send the data sheets on the full comparator line, plus any applications information you have lying around.

Name _____ Title _____

Company _____

Address _____

City _____ State _____ Zip _____

Signetics Corporation, a subsidiary of Corning Glass Works

signetics

Two offbeat technologies invade the burgeoning field of memories

Two unusual memory technologies are pushing hard to replace present technology in memory applications.

In the area of rotating memories, discs and drums are being challenged by a new electron-beam memory, while semiconductor ROMs and pROMs are being threatened by the CROM, a capacitive read-only memory.

Although they have been talked about for years, beam-addressable memories have, until now, not become commercially viable. Now the Micro-Bit Corp. of Lexington, Mass., is preparing to offer such a system.

Using an electron beam to read and write data in a specially designed storage tube, the company has come up with a system that can provide several megabits of

storage—depending on configuration—with an access time of between 5 and 10 μ s at a cost of 0.01 cent/bit.

Early deliveries due

According to Robert White, one of the system's designers, the first system will be delivered in August or September to Control Data Corp. It will contain nine storage tubes, each capable of storing one million bits of data. Since it is the first system, White notes, it will be more expensive—0.1 cent/bit. However, by the end of the year that will drop to 0.01 cent/bit, he adds.

Two more beam-addressable systems will be delivered later this year, White says. The second, an 18-megabit system, will go to Honeywell and the third to Univac.

In describing how the new electron-beam memory works, White notes that, at the start, all the lo-

cations in the memory contain a logical ONE. Information is entered in blocks by scanning the memory target with an electron beam and selectively erasing the ONEs by blanking the beam on and off. To re-enter a ONE into memory, the target is brought to the proper potential and scanned by the electron beam.

The reading mechanism, White explains, is essentially the same as the write mechanism, except that the driving voltage on the target changes to a value that is almost nondestructive. The beam is then swept over the target and an output signal is generated.

In explaining "almost" nondestructive, White says that for about 10 or 20 accesses to a block of data, the memory can be considered nondestructive. However, if the same block of data is going to be accessed several hundred times, it is definitely destructive, and at some point the data must be restored, he adds.

Since the data rate for reading information out of a storage tube is 0.5 μ s and the restore time is the same, the effective data rate of a tube with the restore mechanism is 1 μ s or 1 MHz.

Customer option available

The restore circuitry is a customer option, White notes. If the usual operation doesn't call for repetitive accesses to a given block, the customer can eliminate it and double the memory's speed.

The write mode of operation is slower, White continues. Data can be written in at 10 μ s/bit. "That's really a conservative figure, though," he says. "We can easily write at 8 μ s but would like to do it at 5 μ s. That's not easy."

The memory, reports White, is

Jules H. Gilder
Associate Editor

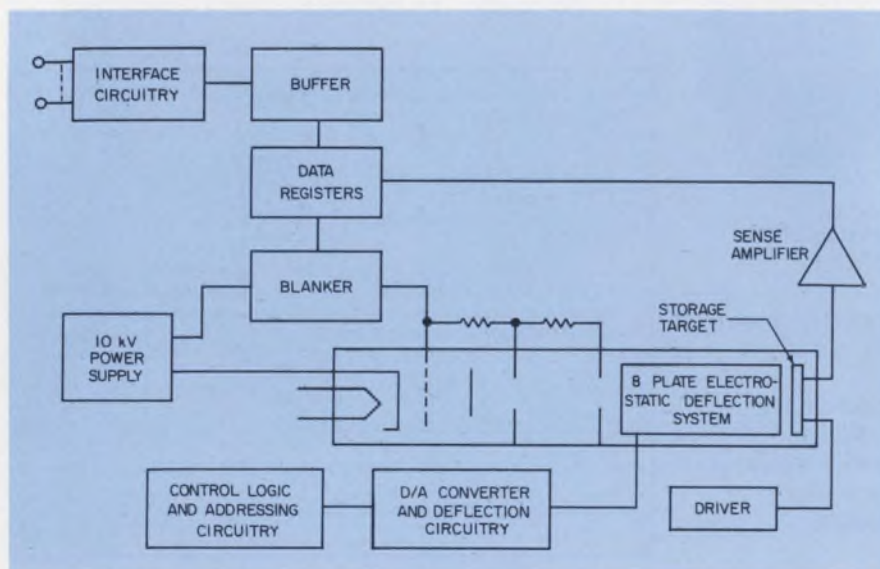

Micro-Bit's new electron-beam memory stores one million bits of data on the tube's target. An eight-plate deflection system is used to control the astigmatism and the ellipticity of the spot produced by the electron beam.

Remember



1953 . . . It was high noon for the bad guys when this famous movie ran. 1953 . . . President Eisenhower had just arranged a truce in Korea. 1953 . . . An American firm successfully demonstrated the first full color video tape recording. And engineering and purchasing were having a hard time getting electronic parts and components. Distributors were taking care of their best customers, and delivery of large piece quantities of discrettes was out of sight.

1973 . . . We remember. We're U. S. Capacitor Corporation (a subsidiary of Centralab) and we know history repeats itself. During the intervening years, capacitor technology advanced exponentially, but the component market

place still fluctuates with the economy. Another bit of history . . . after each shortage and pipeline filling, the market place has restored to a higher level of consumption . . . 1953, 1973.

USCC/Centralab is preparing to meet the current delivery crunch. We've made a substantial commitment to new, automated production machinery so that our customer's needs will be satisfied, and we're also expanding our facilities.

We know the history of our industry and we're investing in it.

We make excellent high-rel and commercial monolithic ceramic capacitors and EMI/RFI filters.

Remember. USCC/CENTRALAB.

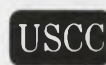

USCC/Centralab

Electronics Division • Globe-Union, Inc.



2151 North Lincoln Street • Burbank, California 91504

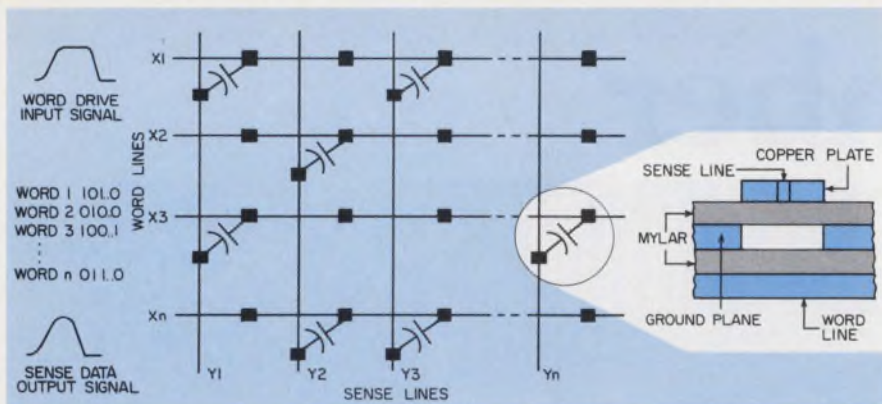

Information is entered into the CROM by placing a capacitor where a ONE is required. A cross-section of the memory (right) illustrates its simple construction. The sense line is perpendicular to the word line.

block-oriented, but within each block it is random access. Work is under way, he notes, to make the entire memory random access.

Another development that he predicts is a 144-million-bit system for a large computer like Control Data manufactures. This could come as soon as the end of next year, he says, adding that the problem is primarily packaging, not technology.

CROMs moving ahead

Meanwhile capacitive-memory technology, developed two years ago by Integrated Memories of Wilmington, Mass., is scoring points against semiconductors and even core.

The latest system from Integrated Memories, according to John H. Kefalas, president, is a 40-kilobit unit designed to replace core in point-of-sale applications. Since it is replacing core, speed is not as important as low power operation.

To achieve low power and increased versatility, Kefalas notes, the designers borrowed from core technology. The new system is a stackable memory, with the memory and the electronics separate, much the same as in core stacks.

He says a CROM is constructed from a copper-coated Mylar sheet that is etched and then laminated onto a printed-circuit board. The pattern on the coated Mylar consists of sense lines and small rectangular plates. The plates are present at a memory location and connected to the sense line only if there is a ONE at that particular

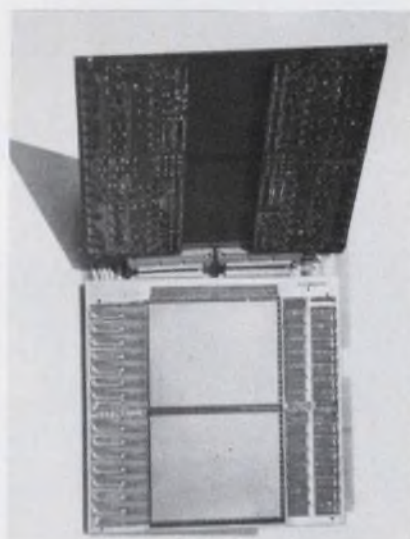

A new 40-kilobit CROM stack borrows from core technology. The memory boards plug into the mother board (not shown), which contains interface and power-supply circuitry.

site. In addition wherever there is a plate, the manufacturer has punched a hole in a ground plane that is also part of the laminate. In this way a signal can be coupled to a word line that is etched onto the PC board directly under the plate.

Absence of both this copper plate and a hole in the ground plane indicates the presence of a ZERO at that location.

According to Kefalas, CROMs are cheaper than their semiconductor counterparts. The cost is about 0.5 cent/bit, while pROMs cost about 1 cent/bit.

Reprogramming for the CROM costs about 0.1 cent/bit, while most semiconductor devices are not reprogrammable.

Those that are, Kefalas notes, are expensive.

The new stackable CROM, Kefalas reports, eliminates the driving and decoding ICs used in previous CROM systems; instead a resistor-diode matrix is used, similar to the diode matrix used with core. While this slows the system, it does reduce power dissipation. "Where the decoders require power all the time, the resistor diode pair draw power only when energized," Kefalas says.

Cores are not the only competitors for CROMs. In fact, Kefalas says, CROMs will have their biggest impact in applications now handled by pROMs and ROMs.

"CROMs are less expensive, faster and reprogrammable," he points out. "The reason we can compete with pROMs is that the minute a pROM user must change even one bit in the memory, he has to throw it away. That's at least \$15 each time."

A problem with size

Kefalas admits that there are some problems with CROMs, the biggest being size. The CROM is inherently larger than a semiconductor, and the memory boards must be the same size as the pROM boards they will replace.

Kefalas points out, however, that while some memories can be constructed on smaller boards with ICs, they may not be fast enough. In that case, he continues, the pROM memory designer must go to smaller devices and the size advantage of semiconductors is lost.

He explains this by noting that the more bits put on an IC, the slower it becomes. With the CROM, the delay in the memory itself is only 3 ns. The decoding electronics bring it up to about 60 ns. The trend, Kefalas notes, is toward more bits and faster memories.

Michael Graff, memory products marketing manager for Harris Semiconductor, Melbourne, Fla., disagrees. He says that CROM technology is bucking the trend, which is toward smaller, denser monolithic devices.

Graff does admit, however, that pROM speed may be a problem in some cases. That should change soon, he says, with the availability of 40-ns, 1-k pROMs. ■■



You don't have
to give up
carbon composition
performance to
save space.

If you're really
serious about cost,
be serious about quality.

Are you cramped for board space but not in power handling capabilities? Is reliable performance vital? Then use Allen-Bradley 1/8 watt carbon composition resistors. Get the pulse handling and overload capabilities that are superior to resistors manufactured by other technologies. Exclusive hot molded construction for a

dense resistance element which reduces noise, and results in a consistent performance. Most importantly, our 1/8 watt resistors have all of the quality and reliability common to our larger sizes. Quality that really can cut your fixed resistor costs. If you think resistors are identical, write for "7 Ways to Tell the Difference in

Fixed Resistors." Available from your Allen-Bradley Electronic Distributor, or: Allen-Bradley Electronics Division, 1201 South Second Street, Milwaukee, Wisconsin 53204. Export: Bloomfield, N.J. 07003. Canada: Allen-Bradley Canada Limited, Cambridge, Ontario. United Kingdom: Jarrow, Co. Durham NE32 3EN.

Actual size

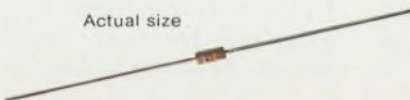

Allen-Bradley

Milwaukee, Wisconsin 53204

INFORMATION RETRIEVAL NUMBER 19

A major advance in OICs hastens the day of optic communications

Before a fiber-optic communications system can become reality, optical integrated circuits must be developed to provide the interfaces between the system's various transmission links. A major advance toward achieving this is reported by scientists at the Naval Electronics Research Center in San Diego.

D. B. Hall, a physicist at the center, says that optical integrated circuits fabricated there are able to guide laser energy in passive waveguide structures as well as modulate the energy in electro-optically active waveguides. Unique elements that the center has been working on—three dimensional channel waveguides made with diffusion techniques—have shown losses of less than 3 dB/cm.

Optical integrated circuits—called OICs by researchers—perform the tasks of repeaters, amplifiers, modulators and switching devices to process the optical signals and to switch them between operational optical communication channels.

Work at the naval center has focused not only on the diffused OIC waveguides but also on planar epitaxial structures.

The diffused elements are mixed, single-crystal layers formed by the diffusion of cadmium or selenium into single crystal substrates of zinc selenide (ZnSe), cadmium sulfide (CdS) and zinc sulfide (ZnS).

The planar structures are hetero-epitaxial layers of ZnS and ZnSe deposited on gallium-arsenide (GaAs) substrates.

"To my knowledge, we are the only one fabricating waveguides on a regular basis that have controlled

lateral dimensions," says William E. Martin, another physicist at the center who is engaged in OIC work. "These devices also turn out to be efficient electro-optical modulators with lengths on the order of 0.5 cm."

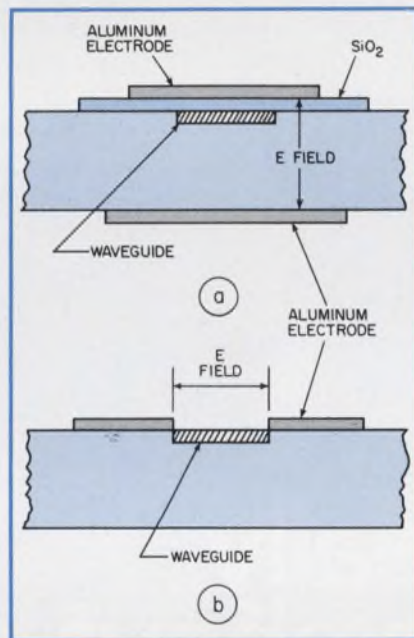

1. Arrangement of modulator electrodes for (a) transverse and (b) parallel electric (E) fields.

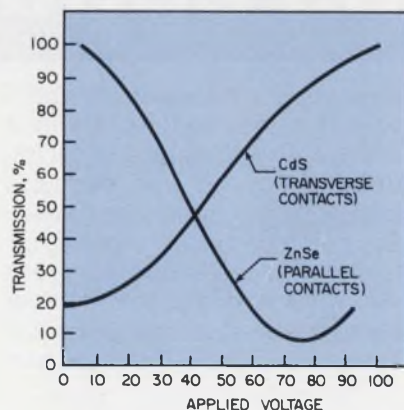

2. Energy transmitted for variations in voltage applied to diffusion-type waveguide modulators.

A significant feature of the diffused waveguide modulators is that they can be fabricated by standard photoresist technology.

The diffused modulators are much faster than the epitaxial Zn and ZnSe on GaAs, Martin points out. "In the epitaxial," he says, "we're talking about rise times around 100 ns, depending upon how big the area is."

In the diffused modulator, which have parallel electrodes—aluminum strips running along both sides of the waveguide (Fig. 1b)—the rise time is less than 5 ns.

This fast modulation capability is necessary for the ultimate development of OICs, Martin says, adding: "There's no intrinsic reason why subnanosecond response is not possible."

The diffused-waveguide dimensions, Martin says, are typically 1.6 by 2 by 19 μm . Electrodes are placed so that the electric field is at right angles to the thickness of the waveguide (Fig. 1a) or is at right angles to the width (Fig. 1b). With this construction, Martin points out, the electric field across the waveguide can be very large for reasonably low voltages because of the small dimensions of the waveguide.

The waveguide with the E-field at right angles to its thickness requires low substrate resistivity to form a ground plane. To get the highest modulating frequency, Martin says, electrodes are deposited on each side of the waveguide, thereby substantially reducing capacitance.

The percentage of laser energy transmitted through a polarized/analyzer system—as the voltage applied to a CdS transverse-electrode modulator and to a ZnSe parallel-electrode modulator is varied—is shown in Fig. 2. ■■

Jim McDermott
Eastern Editor

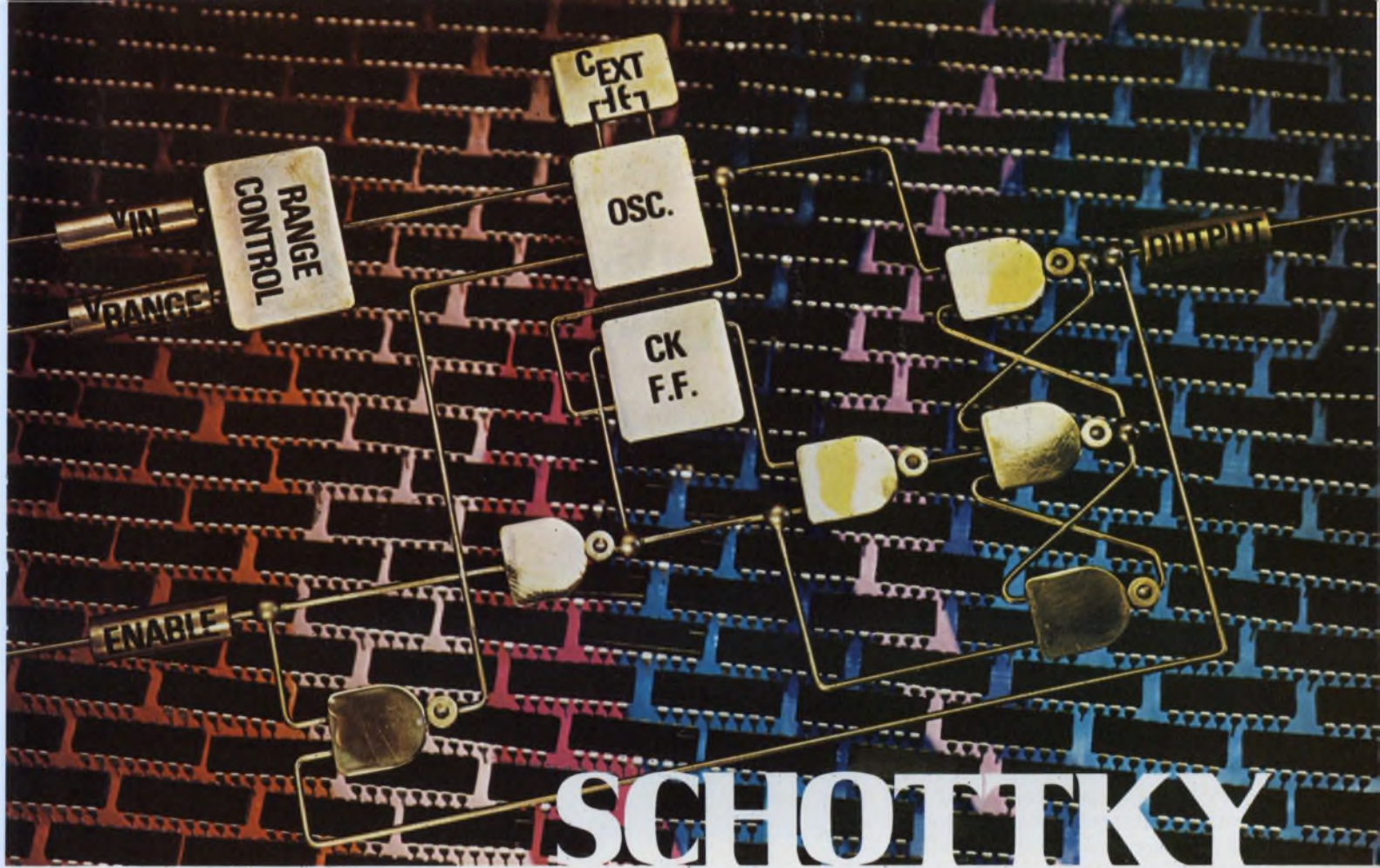

SCHOTTKY

Versatile. Stable. Economical. TI's new dual voltage controlled oscillator.

SN54S/74S124 VCO is here — an excellent match of cost and capability.

Made possible only through TI's broad Schottky TTL technology and experience.

The S124 is a self-starting, free-running dual symmetrical, square-wave generator, very useful as a clock generator in digital systems.

Center frequency is determined by an external component — either a crystal for a fixed frequency, or a capacitor for variable frequency operation. There are 2 voltage-sensitive inputs. One varies output frequency from the capacitor-set center. The other determines frequency range.

Set it to operate at any frequency between 0.12 Hz and 85 MHz. Use a capacitor and your control fre-

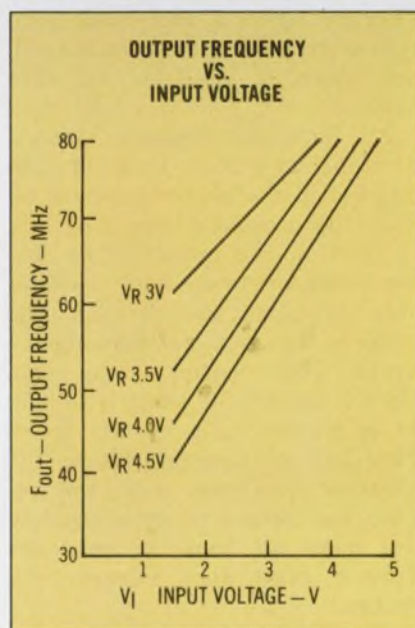

quency range will be $\pm 1\%$ to $\pm 100\%$. A single 5-volt supply operates it.

Operating at a center frequency of 1 Hz, the change in output frequency from -55° to 125°C is a stable $\mp 0.5\%$ with V_r at 5 volts and V_i at 3 volts.

S124 is available in a plastic or ceramic 16-pin dual-in-line-package, or ceramic flat pack.

The 74S124N is priced at \$2.61 in 100 piece quantities.

Order SN54S/74S124 from your local authorized TI distributor or directly from TI. For data sheets, specify by type number and write: Texas Instruments Incorporated, P. O. Box 5012, M/S 308, Dallas, Texas 75222.

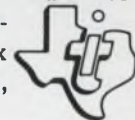

TEXAS INSTRUMENTS
INCORPORATED

INFORMATION RETRIEVAL NUMBER 20

84089

U.S. regulation opens a new field: electronics for antiskid braking

A battle is stirring among a dozen or so manufacturers to snare as much as possible of the estimated \$100-million market for electronic antiskid braking systems for trucks. And that's probably only the beginning. An even bigger market in such systems for cars does not appear far off.

The truck market has suddenly emerged, full blown, because of a new regulation of the U.S. Dept. of Transportation. It requires such strict stopping performance of all air-brake-equipped trucks, buses and trailers manufactured after Sept. 1, 1974, that some kind of antiskid braking system will be needed.

Besides a complex table of required stopping distances, based on combinations of vehicle weight, speed and road conditions, the regulation stipulates that the vehicle must stop within a 12-foot-wide lane and not jackknife across adjoining lanes.

Cars may be next

By Sept. 1, 1975, vehicles equipped with hydraulic brakes—which, of course, include passenger cars—must also meet certain stopping specifications. While the 12-foot-lane requirement holds for hydraulically braked cars, the stopping distances are not as severe, “and whether or not manufacturers go to automatic systems is up to them,” a spokesman for the Dept. of Transportation says.

“Eventually, however,” he adds, “we will get stronger regulations—similar to those for air-braked vehicles—and automatic systems will then be the only solution.”

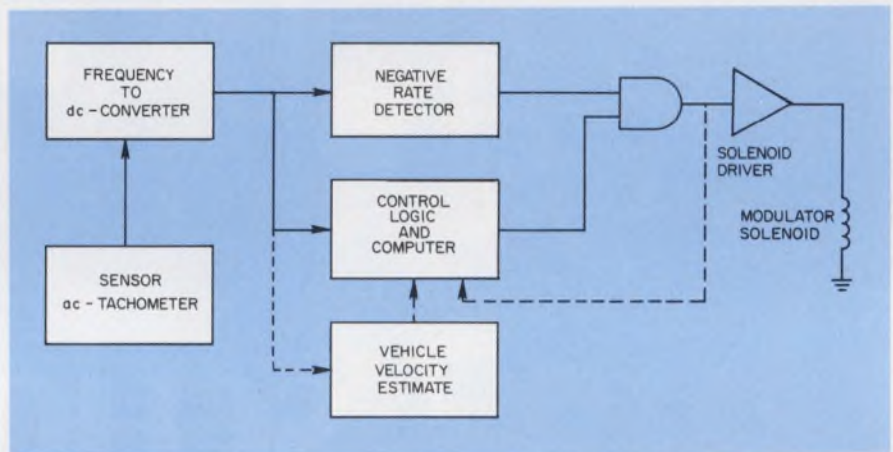

Kelsey-Hayes system senses average rear wheel speed. The speed is checked by computer for sudden deceleration, which means a skidding condition.

General Motors and Ford are already offering antiskid systems in cars on a limited basis. Ford, for example, provides them as an option with its Lincoln, Thunderbird and Continental Mark IV models. Chrysler offers a four-wheel anti-skid system on its Imperial but will not make it available on 1974 models.

All antiskid braking systems have the same goal: To avoid skidding when the brake is applied by detecting a wheel's impending lack of traction and automatically easing up on the brake until the skidding condition has stopped. The brake is then automatically applied again. This sequence may take place a number of times a second. In a system built by AC Spark Plug Div. of General Motors, the sequence continues until the vehicle has slowed to approximately five miles an hour, or until the driver manually releases the brakes.

Most systems have several things in common. A magnetic sensor reads wheel velocity several times each second and transmits the in-

formation by electrical pulses to a logic unit. When sudden deceleration is noted, the unit concludes that skidding has begun and automatically activates a variable valve that releases some of the air pressure going to the brakes. The wheel unlocks momentarily—long enough to start spinning freely.

The main difference in competing systems is in the logic unit: Is it analog or digital?

Eaton Corp.'s Brake Div., Southfield, Mich., uses an analog computer laid out compactly on two circuit boards. The computer is supplied by Sylvania and Magnavox.

Rockwell-Standard Div. of Rockwell International, Detroit, uses a microcellular chip that works digitally. Although this is expensive—40% of the total system's cost—Rockwell feels its compatibility and reliability will pay off in the long run.

RCA is working both approaches. The company's Solid State Div. in Somerville, N.J., is designing the electronics control portion of

5000 production-line types make us dominant in discretes

Our standard line of discrete semiconductor devices includes more than 5000 separate types. More than 2000 of them have been introduced within the last two years. Newer entries include 3 A rectifiers with PRVs to 1200 V; tuning diodes; 400 mW, 500 mW and 1 W zeners in glass hermetic packages and monolithic 16-diode arrays in ceramic DIPs made with the latest ion implantation techniques. Among the old standbys are silicon transistors, 4-layer diodes and just about every type of silicon and germanium switching diode ever offered by anybody anywhere. Get with the people who still think discretes are important — write for details today!

We're doers, not talkers!

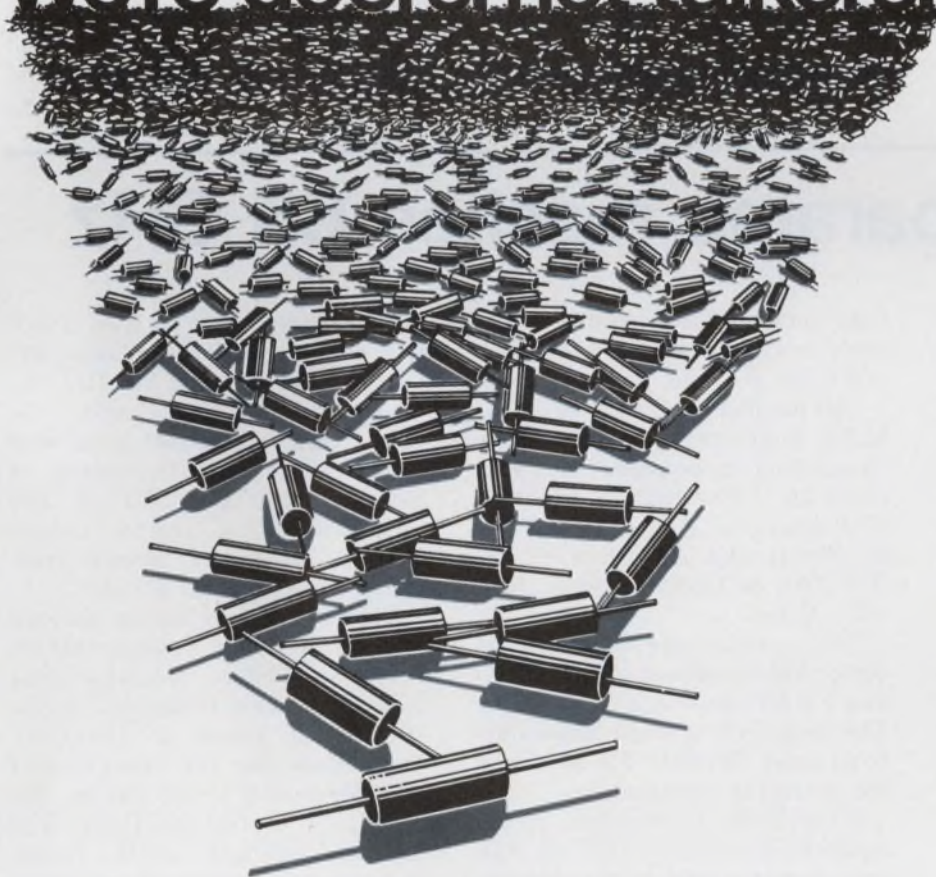

semiconductors

ITT

ITT Semiconductors is a division of International Telephone and Telegraph Corporation, 500 Broadway, Lawrence, Mass. 08142. Phone 617-688-1881.
Factories in West Palm Beach, Florida • Lawrence, Massachusetts • Footscray, England • Colmar, France • Freiburg, Germany • Cascais, Portugal • Sydney, Australia.

two systems, one using a digital computer and another analog—both for the same undisclosed customer.

"The digital approach has several advantages," according to Ralph Hartz, manager of packaged circuit functions in the RCA division. "Digital systems can perform more functions than analog systems can; they have better resolution; they can operate over wide ranges of voltages and draw very little power; and they have excellent noise immunity because they're built with CMOS digital ICs.

"I'm convinced that the heart of future systems will be digital, to which analog data will be converted and transmitted."

The president of Rockwell-Standard Div., William P. Panny, agrees: "Everyone will have to go to digital in the future. It's just that much better."

Panny adds: "If an analog system were capable of performing everything our digital system can, it would be the size of a breadbox, while ours is the size of a couple of packs of cigarettes."

Rockwell claims other advantages for its system: Its digital computer is 30% more reliable than analog systems, and it has four times the computational capability of bigger analog computers. An analog system has a 30% vari-

ation in response time when subjected to extreme cold, while the digital antiskid has only a 5% change. And the digital system is not affected by random radio signals or even a brake squeal, which frequently gives false brake-release information to an analog system.

Panny anticipates a failure rate of approximately 3% with a digital system, as opposed to 5 to 7% for an analog.

Front-wheel braking, too

Either antiskid system will eliminate one current hazard. Many trucks now operate without front brakes, because their drivers know that a front-wheel lockup could be fatal. When antiskid systems are installed, front brakes will be used again.

The AC Spark Plug Air Brake Wheel Lock Control system consists of two-speed sensors, a modulator assembly mounted on the vehicle frame between the wheels, an electrical harness, pneumatic plumbing and a warning light mounted in view of the driver.

The speed sensor at each wheel consists of two parts: A toothed rotor revolves at wheel speed. A magnetic pickup device reacts to the speed of the rotor and produces an ac voltage that carries

information to the electronic controller.

Another difference in antiskid systems is in the number of wheels the system controls. A system built by Kelsey-Hayes Corp., Romulus, Mich., now installed on some 120,000 Ford vehicles, uses one controller for a rear-wheel-only system. The unit operates by sensing the average rear wheel speed. Chrysler, on the other hand, is using a four-wheel system built by Bendix-Westinghouse Air Brake Div., Elyria, Ohio.

Kelsey-Hayes says that its system costs the consumer about \$180 to \$200, "while a four-wheel system would be roughly double that amount."

A more sophisticated approach to an antiskid system is under study by several companies. It would trade in the magnetic wheel-revolution counter for a doppler radar to provide accurate "ground speed" continuously, even after a vehicle began to skid. The radar was developed by RCA's Microwave Technology Center in Princeton, N.J.

Other companies working on antiskid systems for the September, 1974, deadline include B. F. Goodrich, Troy, Mich., and Wagner Electric Corp.'s Automotive Products Div., Newark, N.J. And in Europe, Fiat, Daimler-Benz and Robert Bosch are in the race. ■■

Low-noise paramp reaches 65 GHz

A nondegenerate (single-sideband) millimeter-wave parametric amplifier that incorporates a solid-state pump source has been developed and tested for operation in the 55-to-65-GHz band. The highest frequency heretofore for a nondegenerate paramp is reported to have been in the 20-to-25-GHz region.

The new device is expected to find use in high data-rate communications systems. Also, since the oxygen in the upper atmosphere has a high absorption rate at this frequency range, applications are seen in interference-free high-alti-

tude communications systems—aircraft to aircraft or satellite to aircraft, for example.

The paramp was described at the IEEE International Microwave Symposium in Boulder, Colo., in a paper by J. Whelehan, E. Kraemer, H. Paczkowski, F. Bourne, J. Taub, E. Wendt and A. Larsen of the AIL Div. of Cutler-Hammer, Melville, N.Y.

The single-stage double-tuned device has a midband gain of 14 dB and a 1-dB bandwidth of 670 MHz. The measured average single-sideband noise figure is 5.9 dB across the operating passband.

Jesse Taub, a consultant in the Applied Electronics Div. of AIL says that the key to the development of the paramp was a new

AIL-produced varactor with a 0-V bias cut-off frequency of over 600 GHz, as measured at 70 GHz. An unpackaged gallium-arsenide varactor chip is mounted on a stud holder. The series inductance of the varactor is about 0.1 nH. The capacitance of the varactor is about 0.02 pF. It has a natural resonance of from 50 to 60 GHz.

The pump power for the paramp was produced by a fundamental 35-GHz, Gunn-effect oscillator that feeds a varactor tripler to provide 30 mW of power at 105 GHz. Taub notes that the same type of varactor that is in the paramp has been used in the multiplier. The measured efficiency of the tripler is greater than 20%. An avalanche oscillator was also tried as a pump

David N. Kaye
Senior Western Editor



This three year old \$3.00 thumbwheel switch is still pretty revolutionary.

We called it revolutionary then and indeed it still is. The 1776 was the first thumbwheel with a revolving coded disc that lowered prices. It was the first with switch terminals that plugged into PC mother boards. You got efficient terminal bussing and high density mounting. It eliminated interface wiring and, because it's dip soldered, lowered assembly costs. It went for a bargain counter price of \$3.00 and less than \$2.00 in quantity. It was revolutionary because of all these good things, plus large, easy-to-read dial characters, plastic window readout protection, and

double width switches with triple legend area. Its large range of available codes, along with fast delivery from our nationwide sales and distribution system quickly made it an "off-the-shelf" switch. You got into the spirit of '76 and bought a bundle of them. Now, the 1776 has a skinny little brother that's only .350" wide. We call it the 1976 because it's a little ahead of its time. It's been designed for minimum package dimensions but has all the features of its big brother. It fills a real need when your design gets tight dimensionally. So get in the spirit of the

new '76 and check both of these switches. Write for our thumbwheel switch catalog. ELECTRONIC ENGINEERING COMPANY of California, 1441 East Chestnut Avenue, Santa Ana, California 92701.

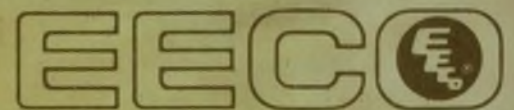

First in design
Distributed by G. S. Marshall Company,
Hall-Mark Electronics and Schweber
Electronics.

source, Taub points out, but the AM noise out of the oscillator limited the paramp's noise figure.

Signal above idler frequency

Taub describes the mount as single-ended (one varactor) with and idler resonance below the signal frequency. In this paramp the idler frequency is the difference between the pump and the signal frequencies.

The varactor was mounted in the center of a reduced-height waveguide in which the series resonance of the varactor was used for the signal circuit in the 55-to-65-GHz range. A homogeneous quarter-wave transformer converted the nominal waveguide characteristic impedance to that required for proper operation of the paramp. The reduced-height waveguide was cut off at the idler frequency, and the equivalent inductance of the waveguide, presented in series with the varactor, formed the idler resonant circuit.

Pump power was coupled through a waveguide that allowed the pump frequency to propagate, but the waveguide was cut off at both the signal and the idler frequencies. A resonant iris at the input to the reduced-height varactor mount prevented propagation of the pump power in the signal circuit.

The paramp was then double-tuned by an iris-coupled filter whose susceptance slope was chosen to obtain a maximally flat, double-tuned response. A five-port circulator was used on the signal input to separate the incoming signal from the outgoing amplified signal.

Temperature stabilization was built into the paramp system, which was operated from -5 to $+40$ C with a measured gain variation of less than ± 1 dB.

Taub notes that with higher pump frequencies—at least 200 GHz—he expects an additional 1.5-dB reduction in paramp noise figure.

Up to 94 GHz

A paper by Herman Okean, J. Asmus and L. Steffek of LNR Communications, Farmingdale, N. Y., described research in the development of a nondegenerate 94-GHz

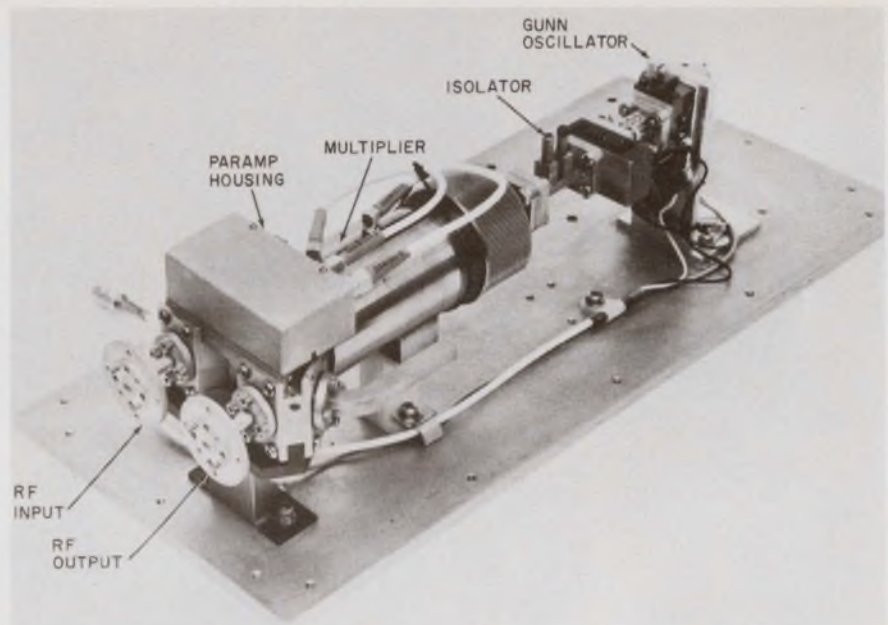

Millimeter-wave paramp from the AIL Div. of Cutler-Hammer has a gain of about 14 dB with a 1-dB bandwidth of over 600 MHz and an average noise figure of 5.9 dB.

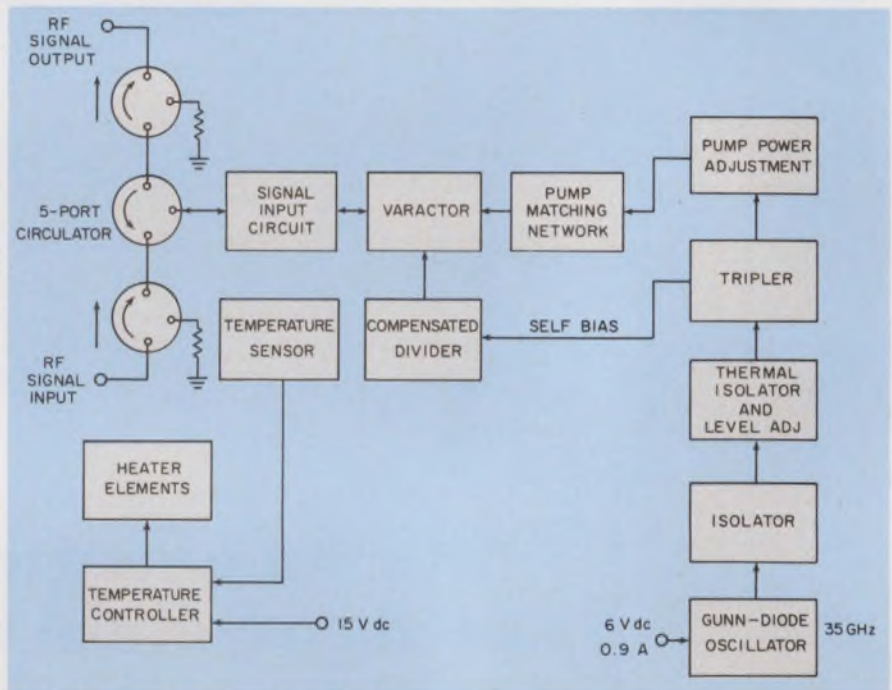

A 55-to-65-GHz paramp pumped at 105 GHz is reported to be the highest-frequency, nondegenerate paramp in existence. With a temperature stabilization system, it operates from -5 to $+40$ C with gain variation of less than ± 1 dB. The pump is a Gunn oscillator at 35 GHz, tied to a varactor tripler. About 30 mW is produced.

paramp. Okean, director of research and development at LNR, has told ELECTRONIC DESIGN: "We are still at an early stage of development. We have produced a varactor that has a cut-off frequency of about 700 GHz as measured at 94 GHz and -0.5 -V bias. We have characterized the paramp

mount and we have decided on a klystron pump source at about 170 GHz. However, we have not yet optimized the paramp for best gain, bandwidth or noise figure."

He says that solid-state pumps are being considered but have not yet been developed to work at 170 GHz. ■■

GI is capacitors

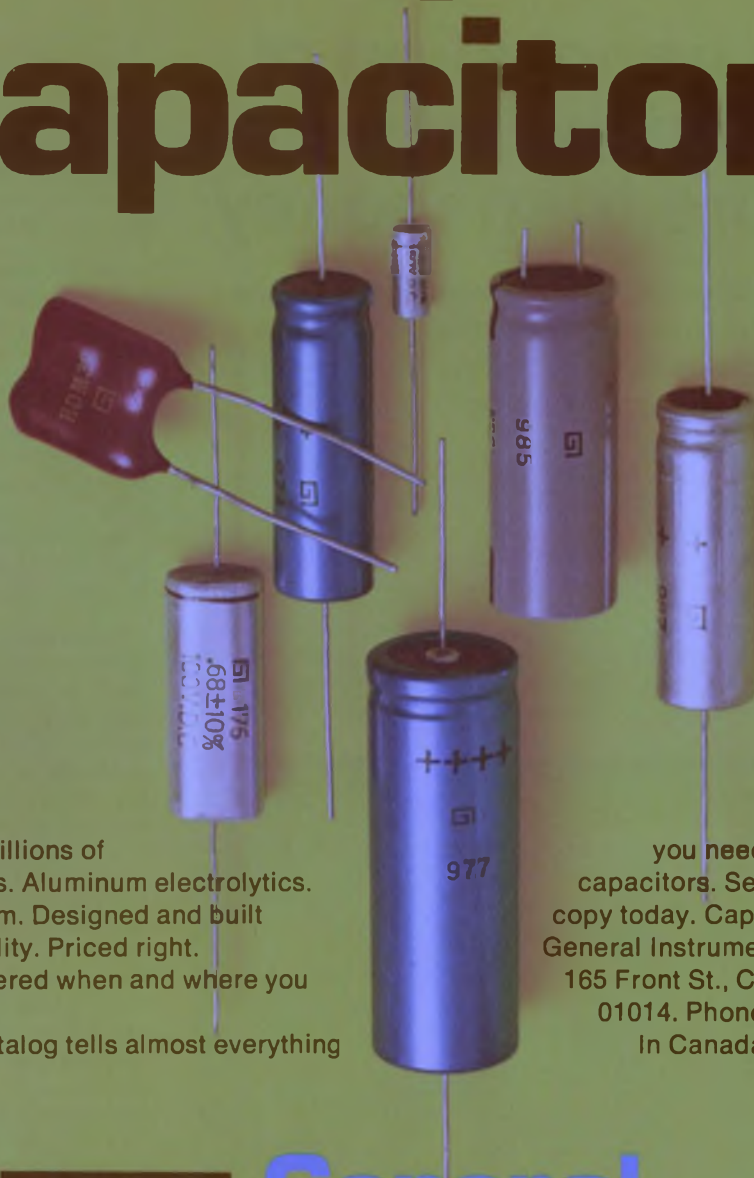

Literally billions of capacitors. Aluminum electrolytics. Micas. Film. Designed and built for reliability. Priced right. And delivered when and where you want 'em. The GI catalog tells almost everything

you need to know about capacitors. Send for your free copy today. Capacitor Division/General Instrument Corporation, 165 Front St., Chicopee, Mass., 01014. Phone 413/592-7795. In Canada 416/763-4133.



**General
Instrument**
the capacitor company

Off the shelf delivery from Miconics/G.I. distributors coast to coast.
Call (N.Y.) 212/361-2266 or (Calif.) 213/769-6782 for the name of the distributor nearest you.

Centralab perspectives

FOR USERS OF ELECTRONIC COMPONENTS



CENTRALAB

Electronics Division
GLOBE-UNION INC.

5757 NORTH GREEN BAY AVENUE
MILWAUKEE, WISCONSIN 53201

This new generation of push button switches saves more than money.

Designers are discovering the new configurations of Centralab push button switches deliver all the functions of most conventional types, but in half the space and at 1/10th the cost per pole or less.

Can a domestic producer of push button switches compete with imports? Centralab customers will answer with a resounding yes!

Centralab spokesmen readily admit their automated process of manufacture makes Centralab push button switches prudent choices on a competitive basis vs. both imported

and other U.S. types. They hasten to add, however, that prompt availability, a reliable sampling service, and unique design are equally important advantages over imports.

Sophisticated users are looking into Centralab's new generation of push button switches because they require so little space — highly im-

portant considerations in aircraft instrumentation, computers and oscilloscopes, for example. The fact that the terminal pins interface with printed circuit boards (optionally available with selective pin cutting or solder lug terminations) simplifies installation.

As for functions, Centralab push button switches feature momentary, push-push, and push-pull actions. Standard interlock with 4 optional lockouts are offered for ganged assemblies. The switches can also be horizontally or vertically ganged, rear coupled, or coupled back to back allowing 16 poles to be operated by a single button. And as an example of versatility, Centralab push button switches can be coupled to a potentiometer.

Centralab can lay claim to several other unique product properties, such as gold contacts and terminals, especially important in dry circuitry. Similarly, Centralab provides diallyl phthalate for the highest possible insulation resistance, as well as phenolic or glass alkyl.

Other salient features of the line include epoxy sealed terminals to preclude flux penetration. Up to 29 individual modules can be ganged on a common bracket with optional module spacing of 10, 12.5, 15, 17.5, and 20mm. You can choose from a wide range of button colors, sizes, shapes and legends. Both lighted and non-lighted types are available. The line switch can be gang mounted with or without interlock and is interchangeable with other modules in any position.

Why not consider Centralab push button switches in your upcoming applications by requesting samples. Write Centralab for complete information.

*Isostat licensed.

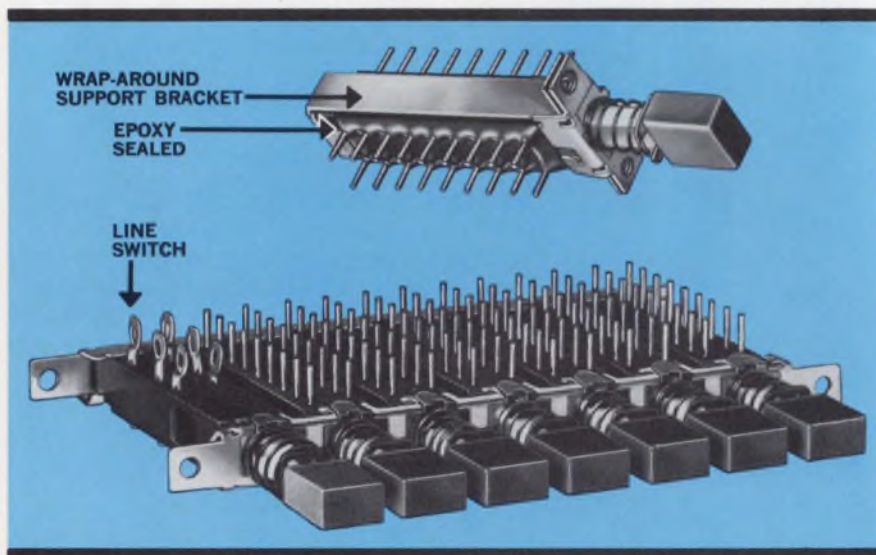

Centralab push button switches* are available as single modules (wrap-around support bracket optional) or as ganged assemblies. They are rated .45 Amp at 115 VAC or 1 Amp at 28 VAC. Other options include epoxy seal and modular size line switches.

INFORMATION RETRIEVAL NUMBER 141



Centralab perspective:

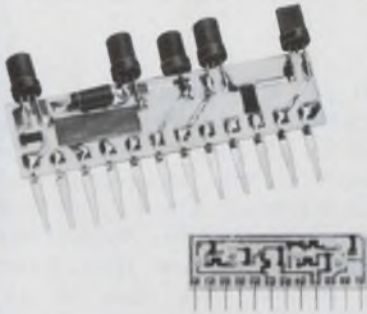

Two thick film hybrid systems. PEC and MEC.

Centralab offers the flexibility to design and fabricate thick film modules to fit virtually any application and cost parameter.

Low-cost silver/carbon or  systems for consumer applications:

- Resistor Range..... 10 ohms to 10 megohms
- Resistor Tolerance... $\pm 10\%$ preferred minimum
- Ratio Matching..... $\pm 5\%$ minimum
- Capacitor Types..... Ceramic and tantalum
- Active Devices..... Diodes, transistors & IC's
- Operating Temp. Range... -55°C to $+85^{\circ}\text{C}$

Noble metal/cermet or MEC systems for commercial and industrial uses:

- Resistor Range..... 3 ohms to 3 megohms
- Resistor Tolerance..... $\pm 5\%$ minimum
- Ratio Matching..... $\pm 1\%$ minimum
- Capacitor Types..... Ceramic and tantalum
- Active Devices..... Diodes, transistors & IC's
- Operating Temp. Range... -55°C to $+150^{\circ}\text{C}$

For more information write A. R. Wartchow, Marketing Manager, Electroceramic Products. Or ask for Centralab Bulletin No. 1429H.



Centralab perspective:

Ceramic Substrates/ ScoreStrates.[®]



Get your circuits started right.

Need ceramic substrates for your hybrid circuits? For resistor networks? Capacitor networks? Centralab's got them in every shape and size. In aluminas of 99.5% and 95%. Plain or metallized. With holes, slots, notches, scorelines or plain. With accurate dimensions and a surface finish compatible with your particular needs.

The pay off with Centralab is high performance reliability right from the start. So start right and specify Substrate/ScoreStrate ceramics from Centralab. You'll end up with the same high reliability substrate found in Centralab thick-film circuits (we're using them at the rate of 50 million per year).

For assistance on specifications, price and delivery, call Chuck Thompson, 414/228-2942 or write Centralab for Bulletin No. 1057TC.



Centralab perspective:

Ceramic Trimmer Resistors. Double the wattage of phenolics.

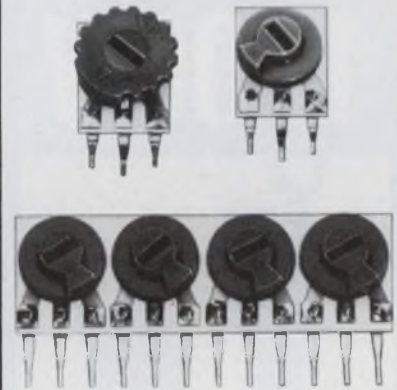

Centralab Slim-Trim carbon and Centrim cermet trimmer resistors give twice the wattage capability of phenolics, yet cost no more. Ceramic substrates mean higher wattage in a smaller space. Plus the ability to withstand high operating temperatures without shrinkage. No flux migration during flow soldering either.

Centralab design and smooth positive adjustment eliminate erratic "slip-stick" effect in setting. Choose from single or multiple sections; $\frac{1}{2}$ to $\frac{3}{4}$ watt; TC low as 150 PPM/ $^{\circ}\text{C}$. And if you want we can add fixed resistors to any of our standard trimmers. Easy.

See your Centralab Distributor or write Centralab for Bulletin No. 1096.



TRIACS

NEW POWER SERIES

60 Amp
200 to
1000 V



Hutson's advanced thyristor technology has produced a new power triac series in hermetically sealed $\frac{3}{4}$ " press fit and stud mount packages.

This series features:

- 60 Amps (I_{IRMS})
- 200 V to 1000 V (V_{DROM})
- 100 V/ μ sec, (dv/dt) (min)
- 600 Amps (I_{TSM}) at $T_C = 75^\circ\text{C}$
- 0.64°C/W ($R\theta_{JC}$)
- 42 W for 10 μ sec (P_{GM})
- Operating temperature range (T_C) -40 to $+125^\circ\text{C}$
- Center gate design for faster turn-on, lower switching losses and improved di/dt characteristics



Call or write for complete information.

HUTSON INDUSTRIES

BOX 34235 • 2019 W. VALLEY VIEW, DALLAS, TEX. 75234 (214) 241-3511 TWX 910-860-5537

Distributed by:

In Canada: WEBER-SEMAD ELECTRONICS, Downsview, Ont. 416/635-9880

Vice-President, European Operations:

30 Rue Pierre Semard, Yerres, 91 France Tel: Paris 925-8258 • TELEX 21-311

Distributed in Europe by:

Belgium: C. N. ROOD S.A. Brussels 02-352135
■ Denmark: E. V. JOHANSEN A/S, Copenhagen (01) 295622 ■ Norway: INTELCO, Box 158, 47 2 207451, Sentrum, Oslo ■ Spain: BELPORT, Madrid 234.62.62 ■ Sweden: ELEKTROFLEX, Sundyberg 08-28-9290 ■ Switzerland: D. LEITGEB, Dubendorf 051 85 9666 ■ UK: CLAUDE LYONS, LTD, Hoddeston, Hertfordshire (09924) 67161

INFORMATION RETRIEVAL NUMBER 25

technology abroad

A fast, high-input-impedance, unity-gain buffer store without passive components is provided by the interconnection of a monolithic matched FET pair and a high-frequency bipolar transistor array. Developed at Portsmouth Polytechnic, Portsmouth, England, the circuit is designed for applications where operational-amplifier slew rates of only a few

volts per microsecond make such amplifiers unsuitable. Typical application of the new circuit is as a fast, high-impedance comparator in an internally timed linear sawtooth-wave generator. Typical performance figures are: input direct bias current, less than 50 pA; output impedance, less than 50 Ω ; power consumption, below 60 mW.

CHECK NO. 441

The Schottky contact line—a form of microstrip on a semiconducting substrate—behaves in the same manner as a parallel-plate waveguide under small-signal conditions, workers at the University of Munster in West Germany have learned. The contact line consists of a large-area, Schottky-barrier diode fabricated in strip form. The strips have nearly ideal recti-

fying properties. The German experiments have shown that phase-delay tuning is achieved by variations in the bias voltage applied to the line. It is suggested that this property could have applications for this type of microstrip in components where transmission-line constants have to be adjusted continually.

CHECK NO. 442

A device that combines the properties of a temperature sensor and a switch has been developed at Standard Telecommunication Laboratories in Harlow, England. The device, made from vanadium phosphate glass, is in the form of a bead, or thin film, of glass and two electrodes. It has a high and a low resistance state. The switching voltage between the two states is linearly dependent on temperature, decreasing at a rate of 1.4% per degree Celsius. The

switch may be used in three ways. First, the variation of transition voltage with temperature may be compared with a fixed voltage, with the difference voltage used as a control signal. Second, a dc bias may be applied to switch the device at a specified temperature. Or, third, ac may be applied, in which case the device switches at a predetermined point in the ac cycle to control a heating or cooling element through a thyristor circuit.

CHECK NO. 443

Surface-acoustic-wave oscillators with fundamental frequencies of up to 490 MHz have been made at the Royal Radar Establishment in England. Because of the frequency-modulation capability of such devices, they are potentially useful as high-frequency sources. By conventional photolithographic techniques, the fundamental fre-

quencies can be extended to about 1 GHz, while for still higher frequencies, the Royal Radar Establishment scientists are looking at other possibilities, such as electron-beam fabrication or the use of surface-acoustic-wave transducers at harmonics of the fundamental frequency.

CHECK NO. 444

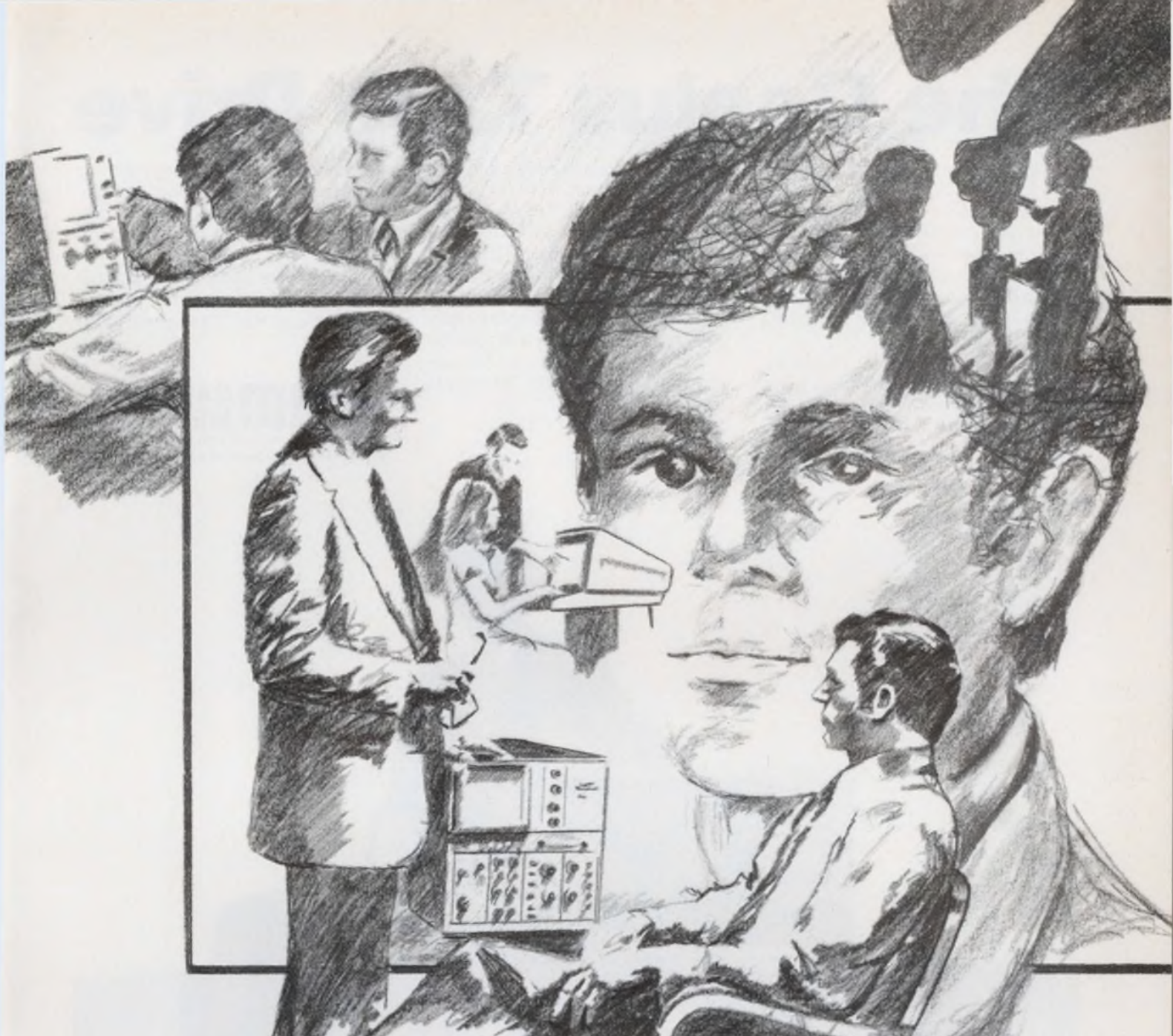

Tektronix field engineer

a man of business & science

The TEKTRONIX Field Engineer is a man of business and science, able to relate across many technical and business disciplines. He is an innovator, a self starter and a professional salesman. He provides products, measurement solutions and support to our customers. Interested? We'd like to hear from you. We'll keep your response confidential.

Write: Dan Thompson
Marketing/Engineering
Personnel Manager
Tektronix, Inc.
P.O. Box 500
Beaverton, Oregon 97005



TEKTRONIX®
committed to
technical excellence

An Equal Opportunity Employer

INFORMATION RETRIEVAL NUMBER 901

The Caelus Tape Drive

We're very proud of our reputation for quality at Caelus. So when we developed a line of tape transports, we started where everyone else stopped. Analyzed every competitive model. Improved the good features. Avoided the mistakes. Simplified design to simplify maintenance.

The results? Gratifying even by our stiff standards. Data error rates less than one bit in 10^8 , computer verified. 4000-hour MTBF. 7000-hour head life. Semi-automatic

loading. Direct drive reels and capstan. Instantaneous and long term speed variation $\pm 1\%$. And we left the options open: 7, 8½ or 10½ inch reel size; speeds from 12.5 to 45 ips, bi-directional; choice of NRZI and/or phase encoded recording; 7 or 9 track formats; single or dual gap read/write head configuration.

Whichever model you choose, you get Caelus quality. Backed by

the full resources and engineering capabilities of Electronic Memories and Magnetics—the world's foremost independent memory company.

If you'd like complete technical and pricing information, please write or call Ken Collins at (408) 298-7080.

**EMM CAELUS
MEMORIES**

Box 6297, San Jose, California 95150

A Division of Electronic Memories & Magnetics Corporation



washington report



Heather M. David
Washington Bureau

The plane that refuses to die

The Air Force's F-111 aircraft, with which the adjective "controversial" has been synonymous, now promises a last round of fireworks. Although Deputy Defense Secretary William Clements has ordered the production line closed this year, both the House Armed Services chairman Rep. F. Edward Hebert (D-La.), and the House Appropriations Committee chairman, Rep. George Mahon (D-Tex.), have protested the action, pointing out that Congress is likely to add funds to the budget to continue production. The Defense Secretary-designate, James Schlesinger, has not made his current feelings known, but as a Bureau of the Budget official in years back, he urged continuance of the program as a hedge against failure of the B-1 bomber design to meet approval. Another argument being posed for building more F-111s is the fact that 42 of the current aircraft fleet will be outfitted with electronic countermeasure equipment and shifted to jamming missions in the EF-111 program.

New radio service seems assured

The Federal Communications Commission will make a final decision around the end of the year on the establishment of a new Citizens Band "E class" radio service. It would be on the 224-to-225 MHz band. Forty channels would be available, with 25-kHz spacing. Although amateur radio operators, some of whom have used some of these frequencies, have opposed the allocation, the Office of Telecommunications has thrown its weight behind the proposal. Comments from interested parties will be received until Sept. 20 and reply comments until Oct. 22. The Electronic Industries Association has predicted that the allocation will result in annual sales of several hundred million dollars worth of new equipment, with receiving and transmitting equipment in the \$200-to-\$300 range.

New entries backed in race to replace F-14

Two new entries have been suggested in the race for a low-cost substitute for the Navy's F-14 Grumman Tomcat fighter aircraft. Deputy Defense Secretary William Clements, who is proving to be a strong administrator in the absence of a Congressionally confirmed Secretary of Defense, told the Navy to build two models each of a stripped-down F-14, a Navy version of the Air Force's F-15 McDonnell-Douglas fighter, and an uprated F-4M, also built by McDonnell-Douglas. These are to be flown competitively and a choice between them made within two or three years.

However, the House Appropriations Committee reportedly is extremely interested in getting the Navy to consider also the two aircraft being built by General Dynamics and Northrop Corp. for the Air Force's light-weight fighter program.

Clements' decision to curtail purchase of the fully loaded F-14 to only 50 this year and to permit only a few more in future years, along with the decision to look for a low-cost substitute, puts electronic subcontractors in a whole new round of competition. Hughes and Westinghouse are once again pitted against each other as radar and fire-control subcontractors.

Much of the F-14 cost problem was due to the ambitious, high-performance AWG-9 fire-control and Phoenix missile systems built by Hughes. They were designed to track 24 incoming aircraft or missiles and attack as many as six targets simultaneously.

Job outlook for EEs: Growth in some areas

The Dept. of Labor forecasts very rapid growth in the employment of electrical engineers for the automation and mechanization of industrial production processes, especially in work on computers and numerical controls for machine tools. Demand for electrical and electronic consumer goods also will play an important part in generating approximately 12,200 new engineering job openings a year to 1980, the department says in its biannual handbook, "Occupational Outlook." The outlook for aerospace engineers is not so good, with more engineers than jobs at present.

Capital Capsules: The Federal Aviation Administration has issued a new ruling that will **require aircraft to carry identity and automatic altitude reporting equipment.** Data from the aircraft radar beacon transponders and altitude encoders will appear in digital form on ground-based radar systems in the FAA system. . . . The International Coordinating Committee, which regulates technology exports to Eastern Europe and Red China, has **failed to agree on lifting export controls of computer products to mainland China.** The decision is a blow to computer companies who already are planning an exhibit in China this fall. . . . A General Accounting Office report prepared at the request of Sen. Walter F. Mondale (D-Minn.) **differs with the cost figures used by NASA to justify the space-shuttle program.** The GAO's conclusion that NASA may have underestimated shuttle costs is being used in the Congressional fight over NASA funding. . . . **The Air Force has award Raytheon Corp. a \$39.6-million contract for a new phased-array radar station, code-named Cobra Dane, to be built in the Aleutian Islands.** The radar will be part of the space-tracking network. . . . Honeywell's V.P. for science and engineering, Dr. Van Beringer, told the House Space Committee's subcommittee on energy that **the basic technology to generate electric power from solar energy is available.** More Federal leadership is needed, he said. . . . **The next generation Worldwide Military Command and Control System will be run by computers that are larger and faster than any now in use,** according to Rear Admiral J. E. Langille 3d, deputy director of the program to devise such a system. Built with hybrid architecture, the computer will have both associative and serial processing capability.

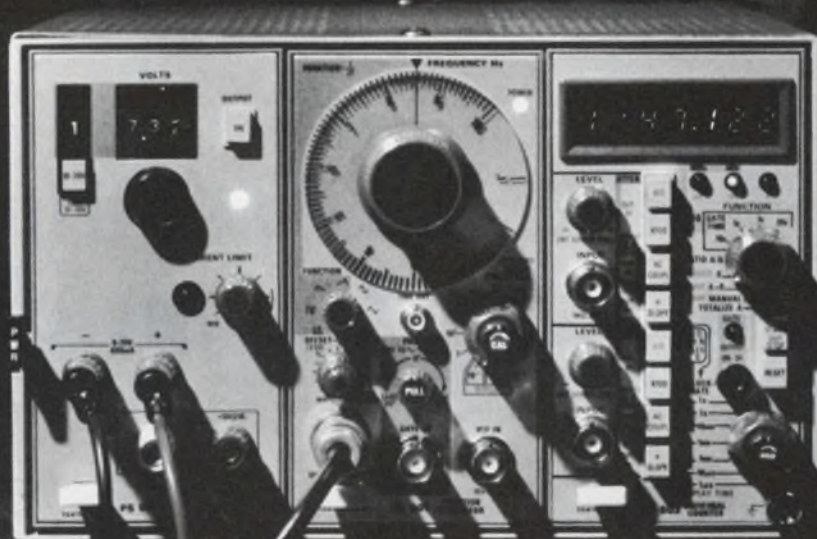

Take a close look at this new approach in test instruments . . .

The Tektronix counter, signal generator, and power supply plug ins shown in the versatile TM 503 power unit represents a new approach in test and measurement instrumentation. Additional Tektronix digital counters, multimeters, signal generators, oscillators, and power supplies cover a wide range of measurements.

They're modular

Each module is interchangeable. They plug in the three compartment TM 503 power unit or a single compartment TM 501 power unit. Cabinet-to-rackmount conversion kits enable either one or two TM 503's to become a standard 5¼" installation.

They're compatible

An intra-compartment interface permits multi-function applications. The modules "talk to each other". This results in a synergistic effect: modules working together perform more functions than the same modules working independently.

They're expandable

As new modules are introduced, you simply plug them into your existing power unit. So your equipment never becomes obsolete.

They're compact

That saves you valuable space on your work bench. And imagine a light weight portable test system with flexibility to suit your special needs.

They're by Tektronix

That means latest circuitry, finest packaging, quality and service you can rely on. And the TM 500 series gives you more performance per dollar than any other test and measurement system.

. . . now take a closer look.

Call your Tektronix Field Engineer for a demo or write us for detailed specifications:

Tektronix, Inc., P.O. Box 500,
Beaverton, Oregon 97005.



TEKTRONIX



P-channel
J FET



N-channel
J FET

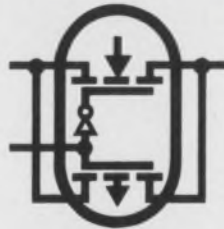

CMOS
FETs



P-channel
MOS FET



N-channel
MOS FET

Since 1962, Siliconix has evolved FET technology and applied it to a complete range of singles, duals, arrays, and ICs. So what's new?

Industrial Analog Switch: 80¢ Per Channel

Now available: analog switches specially selected for industrial control service, at per-channel prices as low as 80c (DG501CJ) and 90c (DG172CJ) in 1000-unit quantities.

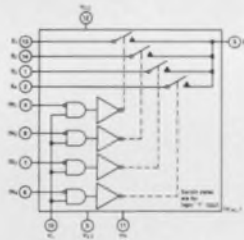

DG172CJ

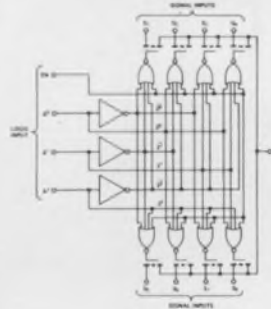

DG501CJ

You can't go wrong with our epoxy analog switches if you're a designer of industrial control circuits. Choose from a variety of switch configurations and structures:

- PMOS monolithic—DG501CJ, 8 channels, break-before-make switch action, ± 5 V analog signal range
- PMOS/bipolar—DG172, 4 channels, 20 V peak-to-peak signal capability, PMOS FETs and bipolars on a single chip

All of these FET switch/driver combinations are *off-the-shelf* and at your nearest Siliconix distributor *right now*. They're priced to compete with reed relays and other electromechanical devices—and they switch 1000 times faster, last far longer, require less drive power and associated hardware, and operate directly from industrial computer logic.

Our catalog line of FET analog switches will cover most applications.

If your switching problems are unique—and whose aren't—call our applications people. They're eager to help. For complete information

write for data

Applications Engineering (408) 246-8000. Ext. 501



Siliconix incorporated

2201 Laurelwood Road, Santa Clara, California 95054

INFORMATION RETRIEVAL NUMBER 29

Shall we buck the Establishment?

A buddy of mine went to a platoon of conventional doctors before a chiropractor cured his ulcer. Another chap I know barely survived a half-life, half-death existence that doctors prescribed for his bad heart. A man in his 50's, he now trots around like a youngster while he's taking the vitamins, minerals and additive-free foods prescribed by a nutritionist. And a gal I know almost accepted surgery before an acupuncturist healed her bad knee.

These and other "miracle cures" by nonconventional "healers" may all be lucky accidents. Maybe chiropractic is a hoax. The nutritionists, who feel that most of us are vitamin-starved and poisoned by food additives—perhaps they're all wet, too. Perhaps they appeal only to the psychological needs of "health nuts." Maybe acupuncture is just for the Chinese. They've used it as a painless healing method for thousands of years, but maybe they were too primitive to recognize the "advantages" of Western surgery and drugs.

Maybe not. Maybe the off-beat healers have a great deal to offer. But maybe there's an Establishment that's trying to still their voices. Maybe there's an Establishment similar to the one that drove Ignaz Semmelweiss to suicide when, in the 19th century, he introduced the absurd notion that doctors should clean their hands and instruments before they deliver babies. Perhaps there's an Establishment (or more than one) with sufficient power to mold people's attitudes—not only on medical matters—but on dozens of other issues, too.

Aren't we fortunate that in the electronics industry there is no Establishment to pressure us into design conformity? We can design as we like, giving full rein to our imaginative powers. And if our design meets the needs of the marketplace and the specifications of a customer, we are successful designers. We don't have to worry about pressure from an Establishment. Or do we?

Within ourselves—in each of us—there is an Establishment. Bred and nourished by the experiences of a lifetime, that Establishment molds everything we do—personally and professionally. Is it always for the best?



A handwritten signature in dark ink, which appears to read "George Rostky". The signature is fluid and cursive.

GEORGE ROSTKY
Editor-in-Chief

With ever-changing technology and increasing demands for innovative products, more precise safety guidelines are a must.

Belden knows the codes, standards, requirements and limits of acceptability in the wide world of industrial wire, cable and cord. As supplier of thousands of standard items for electrical, electronic and automotive needs we can readily help you select the right product for the job. Belden products meet or exceed industry code needs. And we can custom design and manufacture complex cable configurations to meet the most demanding specifications. If a code is puzzling you, or you have an application where you're not sure what the standards are, check with Belden. We cope with codes every day.

If you want answers right now, phone:
(312) 887-1800, Transportation Division
(312) 681-8920, Electrical Division
(317) 966-6681, Electronic Division
Or write Belden Corporation, 2000 South Batavia Avenue,
Geneva, Illinois 60134.

H-3-3

BELDEN 

INFORMATION RETRIEVAL NUMBER 234



F

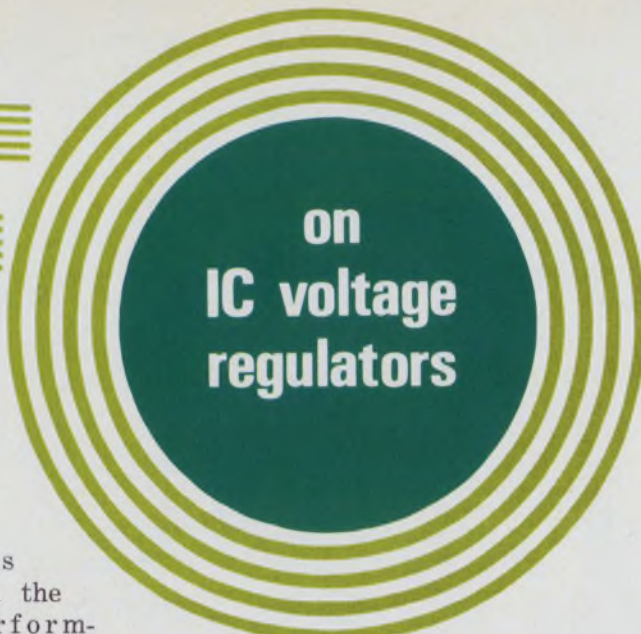

OCUS

on
IC voltage
regulators

Designers faced with the many performance claims promoted for monolithic voltage regulators might conclude that one of these little gems can solve all their power-supply problems. After all, if a tiny IC can dissipate over 20 W and deliver about 2 A of regulated power, who needs a conventional power supply?

With objective examination of the data sheets, however, a different picture emerges. That high dissipation can be tolerated only at 25-C case temperature. The free-air dissipation is considerably lower. And you can't draw the 2 A if you exceed the dissipation rating.

That's just one problem in choosing the right regulator for the job. Adding to the task are the different types of regulators: positive, negative and now dual-tracking (or dual-voltage) devices. You can't always eliminate one type simply because the required output voltage happens to be, say, negative. Often a simple connection of positive regulators results in an equivalent negative-voltage regulator. And you can combine a positive and negative regulator for dual-voltage applications, though the output voltages don't track each other, as they do with a device designed for dual voltages.

Spec sheets may not help the selection process either. The universal use of automatic test equipment to keep costs down is a case in point. Such equipment can test a regulator in less than a second; so there's little heating of the device during the test period. Manufacturers therefore specify most parameters at a constant-junction temperature, while temperature drift is specified separately. But a user performing bench tests will seldom have the regulator at a constant-junction temperature. One result: The line and load

regulation that you measure, both temperature-dependent, probably isn't what you see on the data sheet.

Still the advantages of IC regulators easily outweigh the problems of selection. Their use permits tailoring of voltage level and regulation to the requirements of individual system stages and also improves the isolation and decoupling of these stages.

And use of local regulators rather than a large central regulator means that unregulated voltage can be distributed to parts of the system that can tolerate it. Hence the regulators keep equipment costs down.

Monolithic regulators offer tight load and input-regulation specs, a wide range of output voltages and package styles, and soon several will be able to supply up to 3 A of load current. The emergence of low-cost, three-terminal devices

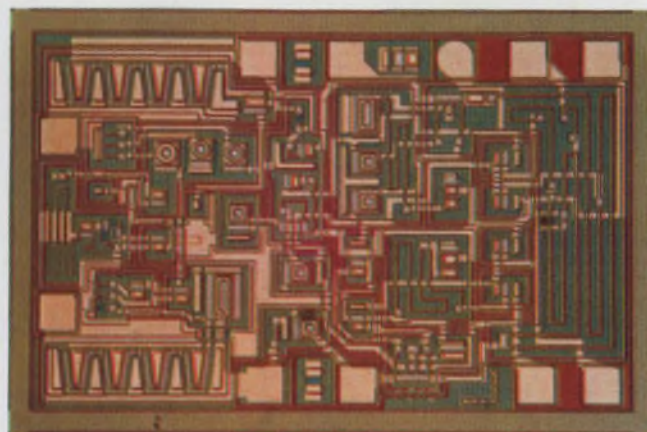

Silicon General's dual-voltage regulator—the SG1501A—provides ± 15 -V outputs with load currents up to 200 mA. Output levels ranging from 8 to 23 V can be obtained with an external resistor. The chip has a built-in thermal shutdown feature that takes effect above 170 C.

Edward A. Torrero
Associate Editor

with short-circuit overload protection built into the chip makes monolithic regulators easier to use.

Find out what's left out

A major consideration in buying an IC regulator is not what's inside the package but what's left out. The newer three-terminal devices generally don't require external components. But others do. Some manufacturers leave you the job of providing the bulk of the circuitry with external discrete components—and these can take up several times as much board space as the basic regulator.

Here are some additional components that you may need:

- Power transistors for higher-than-rated load currents.
- Potentiometers or resistance dividers for external voltage adjustment.
- Capacitors for stabilization, ripple reduction, noise reduction and improved transient response.
- Series resistors to calibrate the overload protection circuit.
- Differential amplifiers for even tighter-than-rated regulation.
- External voltage references to replace the internal zener diode for higher and lower voltages or for improved stability.

And don't forget that you must always supply the dc for the device. Some regulators may be promoted as capable of working from an unfiltered, rectified ac input, but most require at least partial filtering at the input. For optimum regulator performance, you may even have to provide a stable input or constant reference supply.

Specifying IC regulators poses special problems beyond those introduced by automated test-

ing, because of the lack of uniform standards in defining key parameters. For example, on some data sheets the critical spec—load regulation—may be listed for a small change in load current rather than for a no-load-to-full-load change. This may not be a problem for relatively constant loads, but it makes a comparison of different regulators more difficult.

Most definitions of load regulation are based on output voltage. But in some cases you may find output impedance instead. The advantage: Output impedance, which depends on the frequency of the load fluctuations, provides a more critical measurement of regulator performance for varying output voltages.

Watch those specs

The problems associated with specs aren't limited to load regulation. Here are some others:

- Maximum current, voltage and dissipation ratings may not correspond. Some manufacturers list separate specs for these parameters but when you multiply the maximum voltage drop and the maximum load current, you may find the maximum allowable dissipation has been exceeded. The solution is to do some cross-checking to find the allowable load current.
- Shunt, or standby, current to operate the regulator circuitry may be defined as the minimum input current or the minimum allowable voltage across the device. In either case, allow for sufficient current—it can be significant in the case of older regulator designs. When external feedback resistors are required, the feedback current must be subtracted from the load current to obtain the reduced allowable current.
- Temperature changes can cause voltage variations in excess of those from all other causes. A check of the temperature coefficient will de-

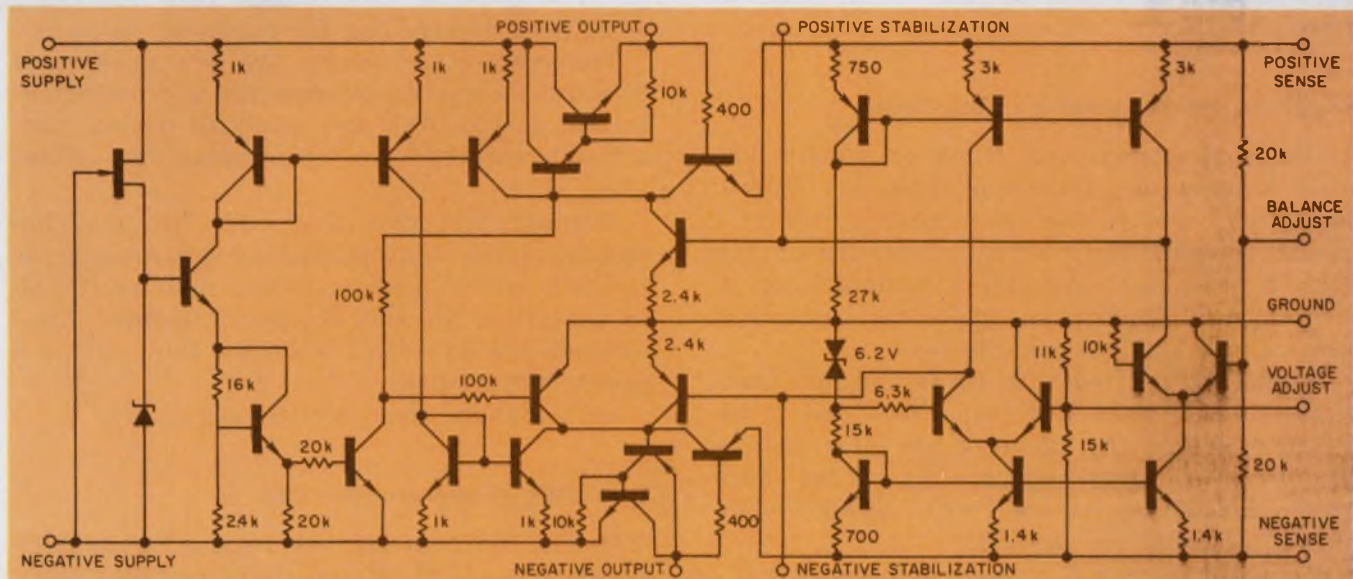

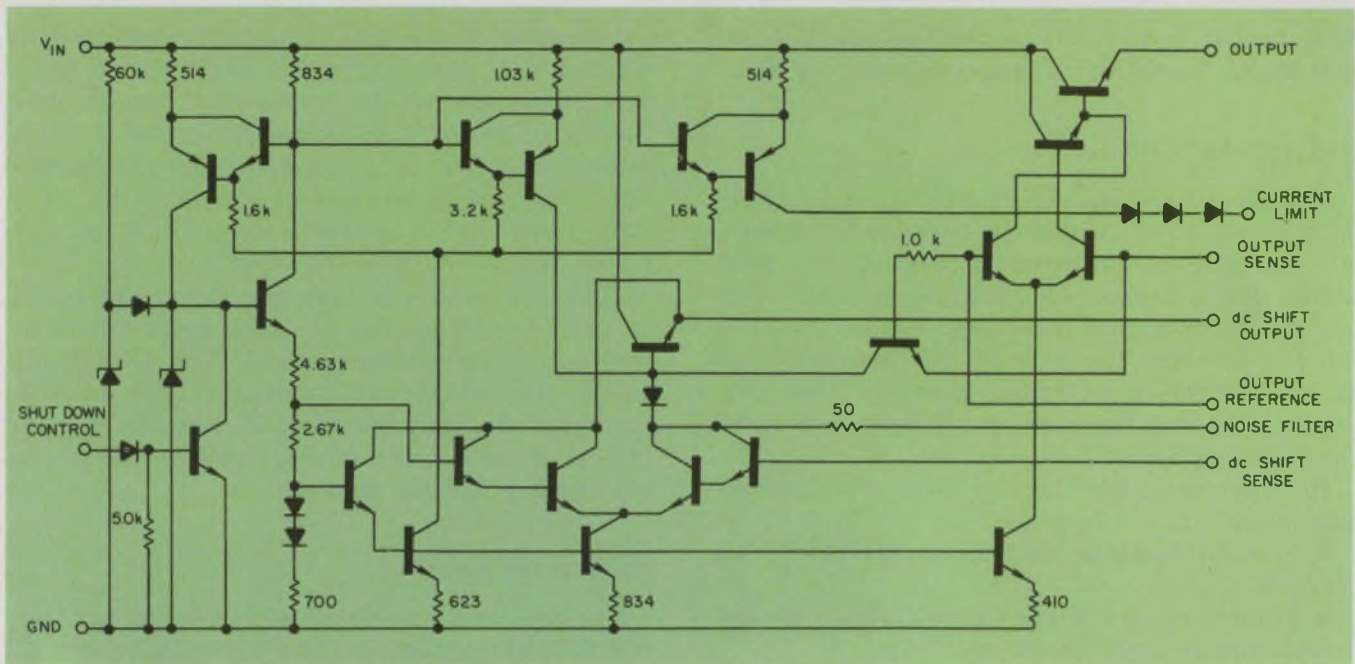

Motorola's MC1560 voltage regulator features load currents up to 500 mA and a typical tempco of only 0.002% per °C. The IC has an output impedance that is

relatively constant over a wide range of output voltages. The Motorola regulator can provide regulated voltages ranging from 2.5 to 17 V.

termine what to expect. But watch out for tempcos measured at low load currents only. At high load currents, temperature stability can be several times worse than the value listed.

- Ripple reduction may be incompletely specified. If you don't see it on the spec sheet, don't assume dc information can be applied instead. Usually the regulator's response to an ac signal will be quite different from that for a dc signal. Most manufacturers assume that the input ripple is a 120-Hz sine wave.

Because ripple rejection generally gets worse at higher frequencies, published specs may be impossible to achieve if the input-voltage waveform has high-frequency spikes superimposed on it. Also, check to see whether the ripple-reduction spec assumes the use of an external filter capacitor.

Regulator designs growing in complexity

Continually improving regulator designs are more complex and functional than ever before. Monolithic construction has made possible a greater number and variety of devices on the chip. It costs very little for a manufacturer to add, say, additional circuitry for higher current ratings in a single-voltage device.

Bipolars are mixed with FETs and npn transistors with pnp's. MOS capacitors and pinch resistors extend the range of available passive devices. And zener diodes—even SCRs—have been included or replaced with improved circuitry in monolithic designs.

Regulator designs also use the inherent match-

ing of monolithic devices. Many active elements, for example, are used to balance out variations in operating conditions caused by other devices. And some devices may operate only under special conditions: in the event of overload, for example; or when the circuit is initially turned on; or when the circuit regulates negative instead of positive voltages; or when the device is operated in a switching mode. Of course, many IC regulators are externally programmable to be turned on or off by IC logic signals.

The resulting improvements have also overcome some of the limitations of early models.

The annoying variations of load regulation with operating voltage have been reduced or minimized. Gone, too, are the adverse effects of overload-protection circuits that caused poor regulation at currents approaching the maximum value.

Temperature coefficients are now guaranteed over wider operating-temperature and operating-current ranges. And just about all models have a MIL-temperature version covering the -55-to-125-C range.

Overload protection now built into the chip includes either conventional current-limiting or foldback current-limiting. Some regulator ICs also provide a thermal shutdown feature: Load currents are turned off when the chip reaches a preset temperature.

Let's examine some specific regulators.

Fairchild's general-purpose 723

One of the most popular regulators has been Fairchild's μ A723. Many of its features result

Table 1. Representative adjustable voltage regulators

Company	Type no. (temperature range)	Output volts, V dc	Input volts (V _{IN}), V dc	Maximum load current, mA	Maximum dissipation in free air at 25 C, W	Maximum load regulation	Maximum line regulation	Temperature coefficient or stability	Price (25-99)/package							
Fairchild Semiconductor	μA 723 (-55 to 125 C)	2 to 37	9.5 to 40	150	0.8	0.6%	0.3%	0.015% per °C (MAX)	\$4.74/TO-5							
					0.9				\$5.10/DIP							
	μA 723 C (0 to 70 C)				0.8				\$2.34/TO-5							
					0.9				\$2.34/DIP							
Motorola Semiconductor	MC 1560 (-55 to 125 C)	2.5 to 17	8.5 to 20	500	0.68	0.13%	0.015% per volt	±0.002% per °C (TYP)	\$8.75/602A (TO-100 type)							
					3.0	0.05%			\$10.65/614 (TO-66 type)							
					MC 1460 (0 to 70 C)	9 to 20			0.68	0.13%	0.030% per volt	\$3.10/602A (TO-100 type)				
									3.0	0.05%	\$4.35/614 (TO-66 type)					
	MC 1561 (-55 to 125 C)	2.5 to 37	8.5 to 40	500	0.68	0.13%	0.015% per volt	±0.002% per °C (TYP)	\$10.65/602A (TO-100 type)							
					3.0	0.05%			\$12.50/614 (TO-66 type)							
					MC 1461 (0 to 70 C)	9.0 to 35			0.68	0.13%	0.030% per volt	\$4.35/602A (TO-100 type)				
									3.0	0.05%	\$5.60/614 (TO-66 type)					
	MC 1563 (-55 to 125 C)	-3.6 to -37	-8.5 to -40	500	0.68	0.13%	0.015% per volt	±0.002% per °C (TYP)	\$6.55/602A (TO-100 type)							
					2.4	0.05%			\$8.15/614 (TO-66 type)							
					MC 1463 (0 to 70 C)	-3.8 to -32			-9 to -35	0.68	0.13%	0.030% per volt	\$3.45/602A (TO-100 type)			
										2.4	0.05%	\$4.40/614 (TO-66 type)				
National Semiconductor	LM 105 (-55 to 125 C)	4.5 to 40	8.5 to 50	40	0.8	0.1%	0.03% per volt	1% (MAX)	\$18.00/TO-5							
					0.5				\$3.90/TO-5							
	LM 104 (-55 to 125 C)				-0.015 to -40				-8 to -50	40	0.5	5 mV	0.1% (ΔV _{IN} = 0.1V _{IN})	1% (MAX)	\$18.00/TO-5	
															LM 304 (0 to 70 C)	-0.035 to -30
RCA	CA 3085 (-55 to 125 C)	1.8 to 26	7.5 to 30	12	0.63	0.1%	0.15% per volt	0.0035% per °C (TYP)	\$0.98/TO-5							
									CA 3085 A (-55 to 125 C)	1.7 to 36	7.5 to 40	100	0.15%	0.1% per volt	\$2.39/TO-5	
									CA 3085 B (-55 to 125 C)	1.7 to 46	7.5 to 50	100	0.15%	0.08% per volt	\$6.52/TO-5	
Transitron	TRV 2000 (-55 to 125 C)	3 to 37.8	8 to 40	200	0.8	Output impedance 50 mΩ	0.05% per volt	0.102% per °C (MAX)	\$3.65/TO-5							
									TRV 2001 (0 to 70 C)	3 to 37.5	8 to 40	200	Output impedance 100 mΩ	0.1% per volt	0.015% per °C (MAX)	\$2.50/TO-5
									TRV 2002 (0 to 70 C)	3 to 27	8.5 to 30	100	Output impedance 100 mΩ	0.2% per volt	0.02% per °C (MAX)	\$2.45/TO-5

from the inclusion of a greater variety of devices on the chip. It contains an n-channel JFET and an MOS capacitor, along with conventional bipolar devices. The JFET acts as current source, maintaining a constant reference that is independent of the input voltage. The MOS capacitor provides frequency compensation.

The μA723 offers a typical tempo of 0.002% per degree C and capability for device shutdown by an external signal. The regulator lists a maximum load current of 150 mA, and has a standby current drain of about 2 mA and a ripple re-

jection of 74 dB (with no reference capacitor) over the frequencies of 50 Hz to 10 kHz.

In addition the μA723 can operate as a positive or negative regulator with the appropriate circuitry. It can also be used as a floating regulator for outputs up to 100 V or as a switching regulator. It comes in either a TO-5 or dual-in-line package.

Because of its versatility, Fairchild's 723 has achieved wide acceptance as a general-purpose regulator. However, for higher load currents and ease of use, Fairchild has come out with the 7800



National Semiconductor's regulator line includes several three-terminal, fixed voltage ICs. The LM340 series provides output voltages ranging from 5 to 24 V; the LM320

series, from -5 to -15 V. The newest three-terminal regulator is the LM323 with a maximum load current of up to 3 A at 5 V.

series of fixed-voltage, three-terminal regulators.

The series covers the 5-to-24-V range with load currents of 1 A (the 7800 models) and 0.5 A (the 78M00 models). The package styles are standard transistor types, since input, output and ground are the only terminals. The 0.5-A regulators come in TO-5 cans and the 1-A in TO-3 and TO-220.

Another part of the 7800 series—the 78N00 models—offer negative voltages ranging from -2 to about -5 V. Available in TO-3 packages, these regulators provide voltage levels commonly required for emitter-coupled logic circuits. Their load current is listed as 3 A.

Overload protection of all the regulators in the series is provided by internal thermal shutdown and internal current-limiting circuitry.

The regulator chips include a 3-A npn power transistor that is protected against short circuits and secondary breakdown effects. A 30-pF MOS capacitor is also included for internal compensation.

The new regulators don't use zener diodes as voltage references. These diodes are generally noisy and have a sharp breakdown voltage above 6 V that tends to limit the regulator's minimum output. The zeners have been replaced by an emitter-base junction. Temperature compensation is achieved by the balancing of positive and negative tempcos among active devices. The temperature-compensated emitter-base voltage is then multiplied on the chip to the required reference level.

Motorola's MC1560

Motorola's entry into the monolithic regulator field began with the introduction of the MC1560

—a positive regulator capable of delivering load currents up to 500 mA with a typical tempco (like the 723) of only $\pm 0.002\%$ per degree C. The maximum input regulation is only 0.015% per volt, and the worst-case output impedance is a low 100 m Ω .

The output impedance of the MC1560 is essentially constant with increasing output voltages, in contrast with regulators that exhibit increasing impedances. The device achieves constant impedance by comparing the output voltage directly with a reference provided by a separate, low-level series regulator on the chip. Since there is no resistive voltage divider across the output of the main regulator, the feedback—and hence the output regulation—doesn't depend on output voltage.

Another feature of the MC1560 is shutdown control. Both the load and regulator bias current can be turned off by an external signal, supplied by standard digital ICs.

The MC1560 and its higher-voltage version—the 1561—never quite caught on as some of its early promoters expected. For many applications, the high-frequency characteristics of the device could not be controlled against oscillations without the use of special rf techniques.

The result was the introduction of the 1569, an easier-to-use 1560. The 1569 differed from its predecessor only in its metallization pattern at the output. It allowed the user to adjust the device's response time externally with a capacitor, thus avoiding the stability problems of the 1560.

Other versions are available to regulate negative voltage levels: the MC1563 for MIL-temperature ranges and the MC1463 for commercial ranges. More recently, Motorola has introduced

Table 2. Three-terminal, fixed-voltage regulators.

Company	Type no. (Temperature Range)	Typical output Volts (V_o), V dc	Input volts, V dc	Maximum load current, A	Maximum dissipation in free air at 25°C, W	Maximum load regulation	Maximum line regulation	Prices (25-99)/package	
Fairchild Semiconductor	* μ A78XX (-55 to 125°C)	5,6,8,12,15 18,24	**	1	3.5	1%	1%	\$28.25/TO-3	
	μ A78XC (0 to 85°C)		($2+V_o$) to 35		2.0	2%	2%	\$2.70 to \$2.85/TO-220	
					3.0			\$2.85 to \$3.70/TO-3	
	μ A78MXX (0 to 85°C)	5,6,8,12,15 20,24	($2+V_o$) to † 30	0.5	1	1%	1%	NOT AVAILABLE/TO-39	
	μ A78NXX (0 to 70°C)	-2, -5.2	($-7\frac{1}{2}+V_o$) to -15	3	3.5	1%	1%	NOT AVAILABLE/TO-3	
National Semiconductor	LM 340-XX (0 to 70°C)	5,6,8,12 15,18,24	** ($2+V_o$) to 35	>1	2.0 3.5	2%	2%	\$2.70/TO-220 \$2.85/TO-3	
	LM 120-XX (-55 to 150°C)	-5, -5.2, -12, -15	*** ($1+V_o$) to -25	0.2	1	80 mV	25 mV	\$11.35/TO-5	
	LM 320-XX (0 to 125°C)			1	3.5			\$11.95/TO-3	
					0.2	1	100 mV	50 mV	\$4.40/TO-5
					1	3.5			\$4.75/TO-3
	LM 123 (-55 to 150°C)	5	20 (MAX)	3	3.5	100 mV	25 mV	\$6.00/TO-3	
LM 323 (0 to 125°C)	\$18.00/TO-3								
Teledyne Semiconductor	829 (-30 to 85°C)	12	15 to 40	0.05	1	24 mV	18 mV	\$1.10/TO-39	
	830 (-30 to 85°C)	15	18 to 40						

*XX denotes the typical output voltage.

**For $V_o = 24$ V, the maximum input voltage is 40 V.

***For $V_o = -12$ and -15 V, the respective maximum input voltages are -35 and -40 V.

†For $V_o = 12$ and 15 V, the maximum input voltage is 35 V; for $V_o = 20$ and 24 V, it's 40 V.

three-terminal regulators. These supply over 1 A of load currents in the 5-to-24-V range. The maximum input voltages reach 40 V.

National Semiconductor broadens line

At National Semiconductor the IC regulator line began with the LM100—a 2-to-30-V device with better than 1% line and load regulation. Output currents exceeding 5 A are possible with the aid of external transistors.

The LM100, however, has been largely superseded by newer circuits. For tighter regulation, higher input voltages and higher output currents, National has the pin-compatible LM105 for positive-voltage levels. For negative levels, the LM104 is available. Compared with the LM100, the LM105 has an extra stage of gain, permitting load and line regulations of 0.1% and 0.03% per volt, respectively. Inputs can range from 4.5 to 40 V, and output currents can reach 10 A if external transistors are added.

Without the external transistors, both the LM100 and LM105 can handle currents only up to about 40 mA. Both devices have comparable load regulations at low load currents. However, the LM105 has much lower internal power con-

sumption; so it's more efficient. It needs no minimum preload current and can work at higher input voltages. Moreover the overload-protection circuit has sharper turnover characteristics and thus does not constrain regulator performance before load currents reach a preset limit.

More recently, efforts at National Semiconductor have concentrated on even higher-current, easier-to-use devices. The LM109 series, which preceded the 7800 series, pioneered three-terminal regulator ICs. It reduced the number of terminals to the minimum and provides 5 V of regulated voltage with 1 A of load current. The LM109 has internal current limiting as well as thermal shutdown circuitry.

National now has a complementary line of positive and negative three-terminal, fixed-voltage regulators—the LM340 and LM320 series, respectively—in the same package types that the 309 and 7800 ICs come in. The positive regulators require an external capacitor, and they cover the same ranges as positive-voltage 7800 devices. The negative regulators extend from -5 to -15 V. Both types have the same overload protection features as the LM109.

National has also announced a 3-A version of its LM109 regulator. Called the LM123 series, it

is a three-terminal device for 5-V applications and can be used without external components. Available in a TO-3 package, the power dissipation is specified as 30 W.

RCA regulates low voltages

The CA3085 family of positive-voltage regulators from RCA features a low reference voltage of 1.7 V, which allows regulation of voltages down to that level. The ICs can supply up to 100 mA over the -55 -to- 125 -C temperature range, and they have a 50-V input voltage capability.

The basic circuit consists of a frequency-compensated error-amplifier that compares an internally generated reference voltage with a sample of the output voltage. The error-amplifier also controls a series-pass amplifier to regulate the output, while a starting circuit on the chip provides a stable latch-in of the voltage-reference circuitry. Overload protection is provided by an external current-limiting resistor.

A maximum current of 250 μ A from the internal source can be supplied for external use without adverse effects on the reference-voltage stability. To regulate currents in excess of 100 mA, the collector of the series-pass output transistor is brought out to a separate terminal to drive the base of an external pnp transistor.

The maximum load regulation is 0.15% for a maximum output voltage of 46 V (suffix-B version). Load regulation can be decreased to 0.1% in the CA3085, but the maximum output current drops to 12 mA and the output voltage to 26 V. The family is supplied in eight-lead, TO-5 packages and also with the dual-inline, formed leads.

Dual-tracking regulators emerge

For dual-voltage applications, monolithic voltage regulators that provide tracking of positive and negative voltages are available from three manufacturers—Motorola, Raytheon and Silicon General. The tracking capability is achieved by employing a single reference diode on the chip to regulate one voltage polarity and using that output for the other polarity.

Motorola offers the MC1568 and 1468 for MIL-temperature and commercial ranges, respectively. The MC1568 provides ± 15 V outputs within $\pm 1.3\%$ without the use of voltage-calibration resistors. The output levels match within $\pm 1.0\%$.

These Motorola regulators require two external, current-limiting resistors. The current at which limiting begins can be set by the user to fit the application. In addition these resistors allow remote voltage sensing of variations caused by supply-line resistance when the load is re-

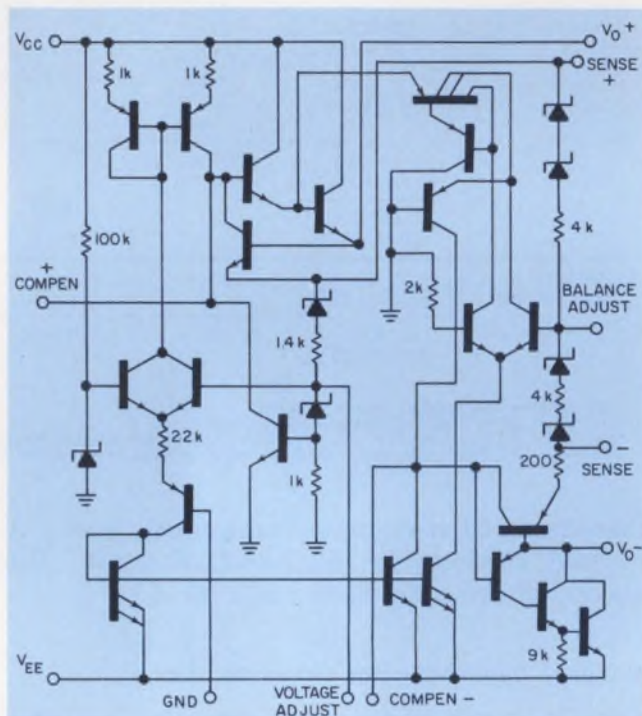
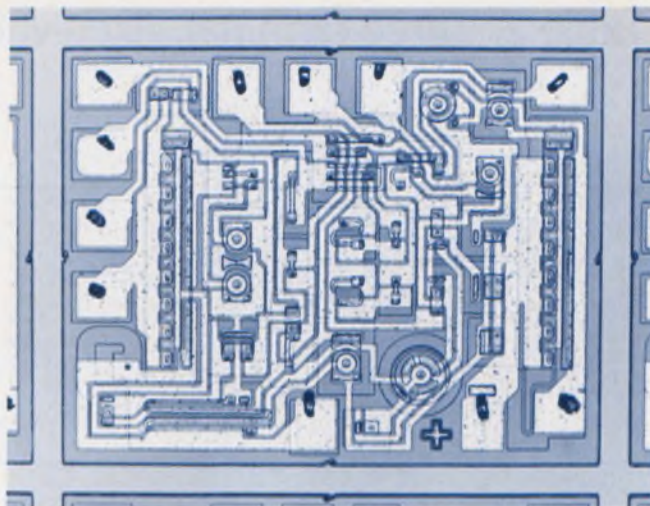

The MC1568 dual-voltage regulator from Motorola offers ± 15 -V levels balanced to 1% at currents to 100 mA. Input voltages up to ± 30 V can be handled and there is provision for adjustable current limiting. Maximum load regulation is listed at 30 mV; line regulation, 20 mV.

mote from the regulator. The MC1568 also requires four external capacitors for operation.

While the Motorola regulators are intended as ± 15 V op-amp supplies, an additional variable resistor can be used to obtain from ± 14.5 to ± 20 V (suffix R and G models). In one model (suffix L), the minimum can go to ± 8 V with additional resistors and some sacrifice in the temperature coefficient of the output voltage.

Raytheon has a variable, dual-voltage regulator—the RM/RC4194—as well as the fixed ± 15 V RC4195. The variable voltage regulator accepts inputs of ± 45 V. Load currents reach 200 mA while maintaining rated load regulation.

The output voltage of the 4194 is set by an

Table 3. Dual-tracking regulator ICs.

Company	Type No. (temperature range)	Output volts, V dc	Input volts, V dc	Maximum load current, mA	Maximum dissipation in free air at 25 C, W	Maximum load regulation	Maximum line regulation	Temperature coefficient or stability	Price (25-99)/package
Motorola Semiconductor	MC 1568 (-55 to 125 C)	± 14.8 to ± 15.2	± 30 (MAX)	100	0.8	30 mV	20 mV	1% (MAX)	\$7.88/TO-100
					2.4				\$8.75/614 (TO-66 type)
					1.0				\$8.12/Ceramic DIP
	MC 1468 (0 to 75 C)	± 14.5 to ± 15.5	± 30 (MAX)	100	0.8	30 mV	20 mV	1% (MAX)	\$3.50/TO-100
					2.4				\$4.68/614 (TO-66 type)
					1.0				\$3.62/Ceramic DIP
Raytheon Semiconductor	RM 4194 (-55 to 125 C)	0.05 to ± 42	± 9.5 to ± 45	150	0.9	0.002% per mA	0.1% ($\Delta V_{IN} = 0.1V_{IN}$)	0.015% per °C (MAX)	\$8.00/Ceramic DIP
				250	3.0				\$11.70/TO-66
	RC 4194 (0 to 70 C)	0.05 to ± 32	± 9.5 to ± 35	150	0.9	0.004% per mA	0.1% ($\Delta V_{IN} = 0.1V_{IN}$)	0.015% per °C (MAX)	\$3.20/DIP
				250	3.0				\$4.70/TO-66
	RM 4195 (-55 to 125 C)	± 14.8 to ± 15.2	18 to 30	150*	0.8	30 mV	20 mV	0.015% per °C (MAX)	\$6.50/TO-99 type
					2.4				\$10.00/TO-66
					0.8				\$3.00/TO-99 type
	RC 4195 (0 to 70 C)	± 14.5 to ± 15.5	18 to 30	150*	2.4	30 mV	20 mV	0.015% per °C (MAX)	\$4.10/TO-66
					0.6				\$2.60/8-pin DIP
					0.8				\$2.60/8-pin DIP
Silicon General	SG 1501 A (-55 to 125 C)	± 14.8 to ± 15.2	± 35 (MAX)	200	0.68	30 mV	20 mV	1% (MAX)	\$8.10/TO-100
					1.0				\$9.30/Ceramic DIP
	SG 3501 A (0 to 70 C)	± 14.5 to ± 15.5	± 30 (MAX)	200	0.68	30 mV	20 mV	1% (MAX)	\$4.75/TO-100
					1.0				\$5.95/Ceramic DIP
	SG 4501 (0 to 70 C)	± 14.25 to ± 15.75	± 30 (MAX)	100	0.600	30 mV	20 mV	1% (MAX)	\$2.35/DIP or TO-100
	SG 1502 (-55 to 125 C)	± 10 to ± 28	± 12 to ± 30	100	1.0	0.3%	0.2%	1% (MAX)	\$8.35/Ceramic DIP
SG 3502 (0 to 70 C)	± 10 to ± 23	± 12 to ± 25	100	0.6	\$4.20/DIP				

*Maximum load current reaches 200 mA in TO-66 package

external resistor. Its value is calculated from the calibration factor 2.5 k Ω /V; the user simply multiplies the required voltage by 2.5 to get the resistance in k Ω . The regulator also requires capacitors and another external resistor that allows a matching of tempcos for both resistors.

An internal reference section performs thermal shutdown. At about 175 C, there is a complete shutdown of the regulator. Internal short-circuit limiting takes effect when the current for either voltage level reaches a preset level.

A balance terminal permits asymmetrical as well as symmetrical voltage combinations between 50 mV and 42 V. For unbalanced outputs, an additional resistor is required.

For ± 15 -V applications, the RC4195 delivers these voltage levels within a tracking spec of 50 mV. Line regulation is listed at 2 mV and load regulation at 5 mV, with a $\pm 0.005\%$ drift per degree centigrade.

The RC4195 can deliver 100 mA at each output, and it has the same thermal-shutdown feature as the 4194. Two bypass capacitors are required for operation.

From Silicon General comes the variable, dual-

voltage SG1502 and the ± 15 -V SG1501A ICs. The 1502 accepts input voltages of ± 12 to ± 30 V and provides regulated output levels of ± 10 to ± 28 V. External calibration resistors set the output-voltage levels. Output currents reach 100 mA, while line and load regulation are 0.1%.

Current-limit inputs are not connected to the pass transistors in the 1502. The availability of these inputs simplifies the use of foldback current limiting for overload protection. This can be an important advantage when the major portion of the power is dissipated in external pass transistors.

The 1501A delivers load currents up to 200 mA. And with an external resistor connected to the chip, outputs can be obtained in the range of ± 8 to ± 23 V. This device can be used with inputs of ± 35 V, and it has provisions for adjustable current limiting. A built-in sensing circuit shuts down the 1501A when junction temperatures exceed 170 C.

Both the 1501A and 1502 are designed to minimize the effects of temperature gradients across the chip. Over the full -55-to-125-C temperature range, maximum variations in the out-

FREE...



1973 Heath/Schlumberger electronic instrumentation catalog.

The new '73 Heath/Schlumberger instrumentation catalog is here... 52 pages of high performance electronic equipment ... all at budget-stretching prices. Whatever it is that you need in electronic equipment for test and design work, R&D applications or for teaching, Heath/Schlumberger has it...



at less than you planned to spend. 600 MHz frequency counter with 7-digit LED readout and complete programmability for only \$795* (left)... dual trace 15 MHz scope only \$595*... multi-range, multi-speed strip chart recorder system just \$675*

...a patchable mini-computer interface system, just \$1250* ... the famous Malmstadt-Enke Lab Stations... dozens of plug-in circuit cards... power supplies... generators... digital multimeters... and hundreds of other instruments. To get your FREE copy of this catalog now, visit your local Heathkit Electronic Center or use the coupon below.

HEATH		Schlumberger
Heath/Schlumberger Scientific Instruments Dept. 531-266 Benton Harbor, Michigan 49022		
<input type="checkbox"/> Please send 1973 Electronic Instrumentation catalog.		
Name _____		
Title _____		
Company/Institution _____		
Address _____		
City _____	State _____	Zip _____
*Mail order prices; F.O.B. factory.		EK-355

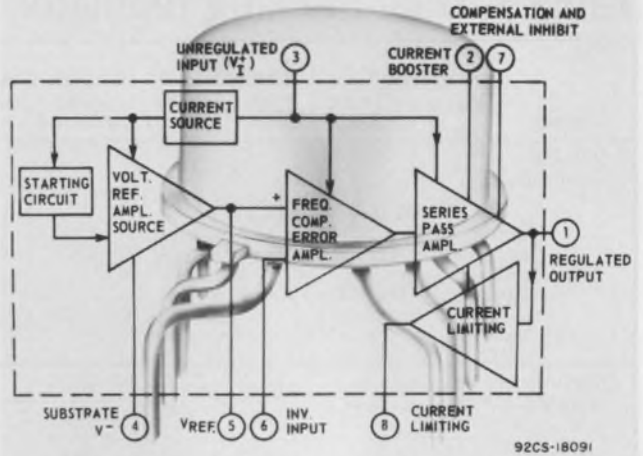

RCA's CA3085 family consists of positive-voltage regulators with an output voltage range of 1.7 to 46 V. Maximum load currents can reach 100 mA, and all ICs operate over the -55-to-125-C temperature range. Packaging for the CA3085 family includes 8-lead TO-5 types with dual-inline formed leads.

put are held to 1%. And from low to full regulator power, less than 2-mV change due to temperature gradients can be achieved.

Silicon General plans to join other manufacturers with regulators equivalent to the Fairchild 7800 and National Semiconductor LM340/320 three-terminal, spot-regulator lines. Silicon General is also alternate-sourcing Motorola's 1568 dual regulator. ■■

Need more information?

The products cited in this report don't represent the manufacturers' full lines. For additional details, check the appropriate information retrieval number:

- Advanced Micro Devices, 901 Thompson Pl., Sunnyvale, Calif. 94086. (408) 732-2400. (Leonard Brown) **Check 429**
- European Electronic Products, 10150 W. Jefferson Blvd., Culver City, Calif. 90230. (213) 838-1912. (Willi Bacher) **Check 430**
- Fairchild Semiconductor, 464 Ellis St., Mountain View, Calif. 94040. (415) 962-5011. (Max Gilbert) **Check 431**
- ITT Semiconductor, 3301 Electronics Way, West Palm Beach, Fla. 33407. (305) 842-2411. (Suhael Ahmed) **Check 432**
- Intersil, 10900 N. Tantau Ave., Cupertino, Calif. 95014. (408) 257-5450. (Ron Marfil) **Check 433**
- Microsystems International, P.O. Box 3529, Station C, Ottawa, Canada K1Y 4J1. (613) 828-9191. (Ron Hlavinka) **Check 434**
- Motorola Semiconductor, 5005 E. McDowell Rd., Phoenix, Ariz. 85036. (602) 244-6900. (Ron Campo) **Check 435**
- National Semiconductor, 2900 Semiconductor Dr., Santa Clara, Calif. 95051. (408) 732-5000. (Art Fury) **INQUIRE DIRECT**
- RCA Solid State, Route 202, Somerville, N.J. 08876. (201) 722-3200. (Abel Sheng) **Check 436**
- Raytheon Semiconductor, 350 Ellis St., Mountain View, Calif. 94040. (415) 968-9211. (John F. Norton) **Check 437**
- Signetics, 811 E. Arques Ave., Sunnyvale, Calif. 94086. (408) 739-7700. (Eugene Hnatek) **INQUIRE DIRECT**
- Silicon General, 7382 Bolsa Ave., Westminster, Calif. 92683. (714) 892-5531. (Steve Thompson) **Check 438**
- Teledyne Semiconductor, 1300 Terra Bella Ave., Mountain View, Calif. 94040. (415) 969-9112. (Joel Scheinberg) **Check 439**
- Transitron, 168 Albion St., Wakefield, Mass. 01880. (617) 245-4500. (Al Berry) **Check 440**

innovation today

The broadest line of Digital Input Rotary Switches in the world. A switch for any digital input requirement.

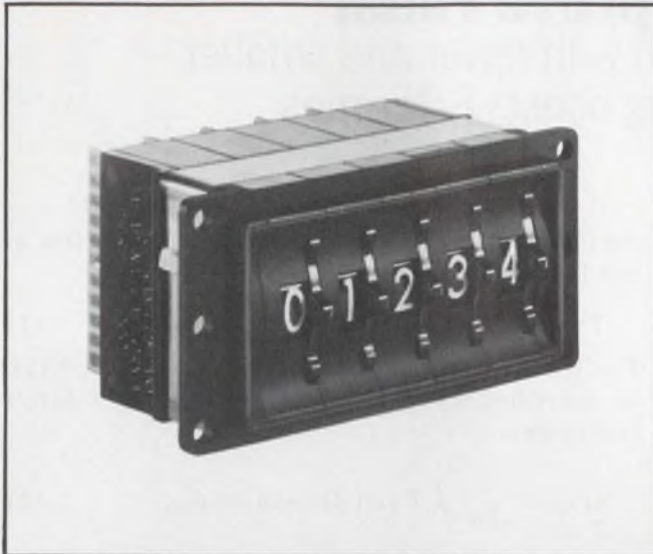

new innovations in switch design reduces costs significantly.

Series 29000

Order as many switch units as you require and we snap them all together with a simple stainless steel locking strap. The Series 29000 comes with 10 dial positions and numerous standard output codes available. It's a miniature switch. Ideal, both from a cost, human engineering and aesthetic standpoint to replace those old rotary switches. They're sealed against normal exposure to dust and other contaminants, too. So, ask us about the Series 29000. Ask about our new, low prices. And ask for a catalog sheet. That would be innovative too.

Series 25000

Save assembly time. Stamp a rectangular cut-out in a panel and simply "snap" our new Series 25000 Thumbwheel into position. No screws or end flanges needed. Or stamp one large cut-out in a panel and "snap" a row of 4 or 5 of these miniature switches into position.

What's more, these switches are removeable. And from the front of the panel.

So, ask about the Series 25000. Ask about our low prices. Ask for our catalog sheet. We'll get you the information you need in a "snap".

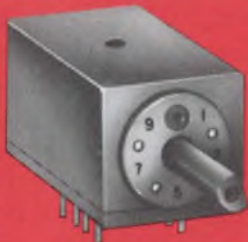

"Digidip" new 10 position P/C board switch

This new little innovative switch plugs into any standard 14 or 16 pin I.C. socket. Or, it can be dip or wave soldered to a printed circuit board. You can add a knob to the shaft or we can give you a screwdriver slot if you wish. Ask for our catalog sheet.

See us in
EEM 1972-73
Vol. 2 Pages
2116-2117

THE **DIGITRAN**® COMPANY
A Division of Becton, Dickinson and Company **B-D**

855 So. Arroyo Parkway / Pasadena, Ca. 91105 / Tel. (213) 449-3110 / TWX 910-588-3794

Acoustic-wave filters improve radar

by processing signals in the system with fewer and smaller components. Time-domain matching boosts S/N ratios.

The development of acoustic surface-wave devices can provide significant advances in the design of radar systems. As matched filters for analog signal processing, they are smaller, cheaper and require less power than equivalent digital-processing systems.

When the devices are used in a correlator/sequence-generator combination (Fig. 1), further benefits result. In a radar receiving subsystem, the correlator processes the received signal at the i-f, or subcarrier frequency. There is no need to convert to baseband until after the received signal has been correlated.¹ Thus the designer can avoid some of the problems associated with signal-to-noise degradation caused by the baseband conversion required in conventional digital processing.²

In a radar transmitting subsystem, the acoustic surface-wave sequence generator—physically almost identical to the correlator—provides its own rf signal, generated by a narrow video input pulse. Hence the expensive and bulky local oscillators normally required with conventional sequence generators can be eliminated.

Moreover acoustic surface-wave devices allow analog-signal processing of coded rf waveforms. As a result, the processing gain can be improved by 3 dB, compared with the standard digital signal-processing techniques. This improvement helps to reduce the high power levels normally required in a radar transmitter.

Acoustic-wave devices as matched filters

In general, a matched filter maximizes the signal-to-noise ratio prior to detection, by shaping the received pulses.³ This is done by restricting the bandwidth of the matched filter to the reciprocal of the pulse width. In this context, "noise" means any unwanted signal from any source, including thermal noise, intentional jamming and adjacent channel interference.

A matched filter can be described as a delayed

reproduction, $H(\omega)$, of the spectral properties of the transmitted pulse, $F(\omega)$:

$$H(\omega) = F(\omega)e^{-j\omega t_0} \quad (1)$$

For example, the output signal of a filter, $S(t)$, is described by the following inverse Fourier transform:

$$S(t) = \frac{1}{2\pi} \int_{-\infty}^{\infty} F(\omega) H(\omega) e^{j\omega t} d\omega, \quad (2)$$

where $F(\omega)$ is the Fourier transform of the input signal and $H(\omega)$ is the filter frequency response. In the case of a matched filter,

$$|S(t_0)| \sim \int_{-\infty}^{\infty} |F(\omega)|^2 df \sim E, \quad (3)$$

indicating that the peak signal power is proportional to the energy, E , of the received waveform. In the case of a rectangular rf or video pulse, Eq. 3 says that the matched filter output waveform, $|S(t_0)|$, will be a triangular waveform with twice the pulse width of the original waveform (Fig. 2a).

Now apply the matched-filter condition (Eq. 3) to the Schwarz inequality, which expresses the relationship between the integrals of products involving complex functions. The result is that the output signal-to-noise ratio, SNR_L , of the matched filter is a function of the energy of the received signal and the input noise spectral density, N_0 :

$$SNR_L = 2E/N_0 \quad (4)$$

Eq. 4 indicates that the output signal-to-noise ratio for a simple rf or video-pulse matched filter is twice the input signal-to-noise ratio. Therefore the rf or video-pulse matched filter will improve the signal-to-noise ratio by 3 dB, resulting in a higher probability of detection and a lower probability of error compared with conventional filter techniques.

A wide selection of matched filters is available. Simple R-C low-pass or L-C bandpass matched filters can be synthesized in the frequency domain to provide a signal-to-noise enhancement of approximately 1.5 to 2.5 dB.

Time-domain, or dispersive, matched filters can

George D. O'Clock Jr., Senior Member, Engineering Staff, RCA Advanced Technology Laboratories West, 8500 Balboa Blvd., Van Nuys, Calif. 91409.

also provide matched-filter capability by correlating long phase-modulated, or frequency modulated, rf sequences. However, conventional matched filters require sampling and conversion to baseband. Also, they are very sensitive to waveform distortion, interference and noise.

Acoustic surface-wave technology offers a method to build time-domain matched filters that is not limited by standard filter techniques using conventional R-L-C circuit elements. Instead the entire response of the matched filter is synthesized by a metallized pattern deposited on a piezoelectric substrate' (see box). Two acoustic surface-wave matched filters with this basic configuration are shown in Fig. 2.

Fig. 2a shows a 60-MHz, rf-pulse matched filter with 0.1- μ s input pulse and 0.2- μ s output triangular pulse. The matched filter consists of aluminum interdigital elements on a lithium-niobate substrate. In the output pulse, note the absence of ripple normally associated with conventional matched filters.

A multi-element (32-bit), 60-MHz, biphas-coded matched filter on quartz is shown in Fig. 2b. The input sequence bit time is 0.1 μ s, and the output waveform has a basewidth of 0.2 μ s.

A radar system using acoustic surface-wave devices is shown in block form in Fig. 1. The diagram represents an S-band, search radar requiring the following key specifications: a multi-

ple target-range discrimination capability of approximately 40 ft, or a signal-return time-delay difference of approximately 0.04 μ s, and a dynamic range—or ratio of maximum to minimum signal levels that can be unambiguously and simultaneously processed—of greater than 13 dB with a transmitter peak output power of less than 100 kW.

The radar-range equation reflects the effect of the matched filter:

$$R_{MAX} = \sqrt[4]{\frac{P_o G^2 \lambda^2 \sigma_o \Delta (S/N)_M}{B F L (S/N)_D}}, \quad (5)$$

where $\Delta(S/N)_M$ is the signal-to-noise improvement provided by the matched filter.

Other parameters are defined as follows: P_o = transmitter output power (less than 100 kW, or 87 dBm), G = antenna gain (30 dB), λ = center frequency wavelength (12 cm), σ_o = radar cross-section (1.0 m² for a typical small fighter aircraft), B = bandwidth (10 MHz), F = receiver noise figure (10 dB), L = additional propagation-path losses (4 dB) and $(S/N)_D$ = required signal-to-noise ratio at detection input (at least 14 dB).

The 0.1- μ s pulsed filter of Fig. 2a could provide more than the dynamic range and multiple-target discrimination specified. But from the radar-range equation, the pulsed rf matched filter would require a transmitter power of approxi-

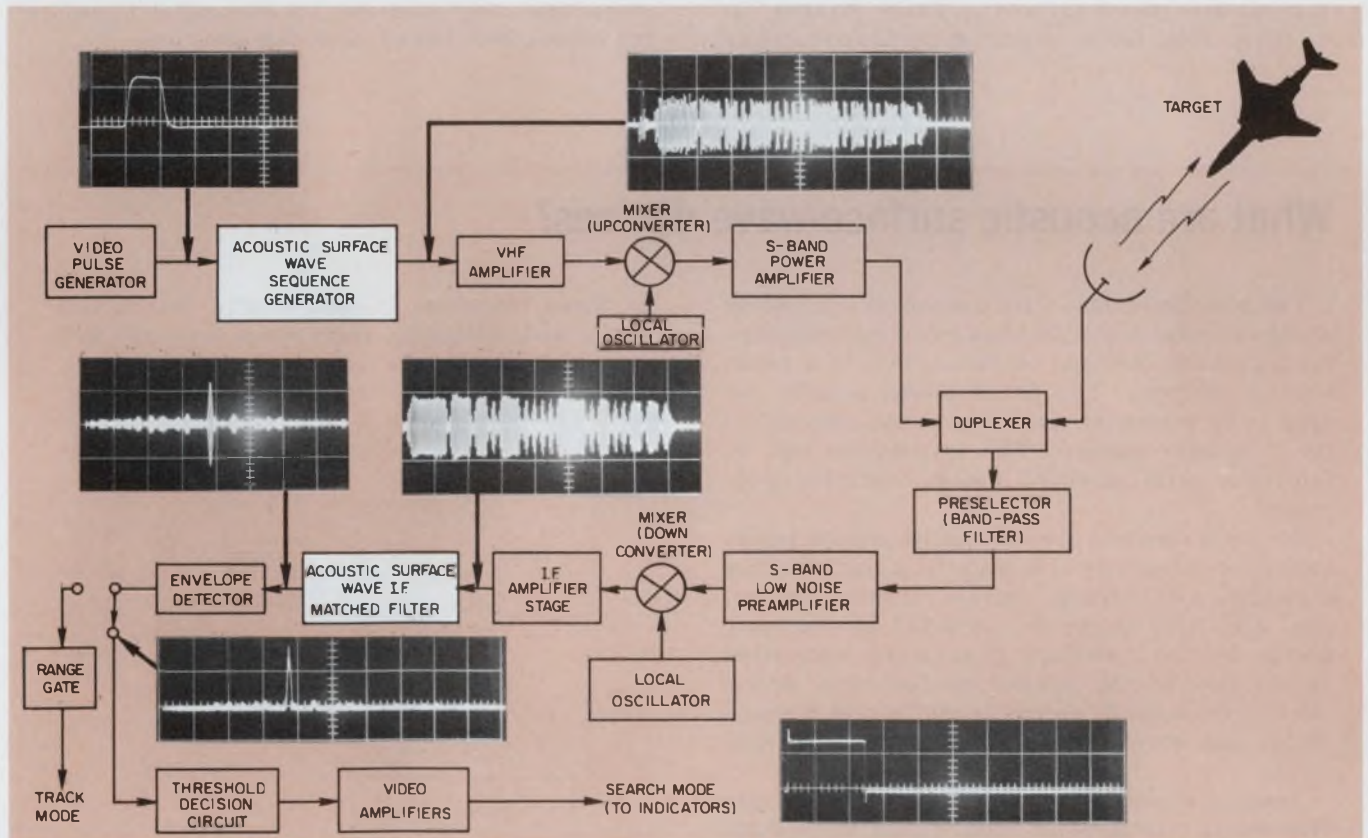

1. Phase-coded S-band radar uses an acoustic surface-wave device for the sequence generator and the correlator. At the sequence generator, a narrow video pulse produces a 60-MHz center frequency, 10-MHz bit rate

phase-coded rf sequence subcarrier that modulates an S-band carrier. The return signal reflected from a target is demodulated with the original phase-coded sequence extracted and subsequently correlated.

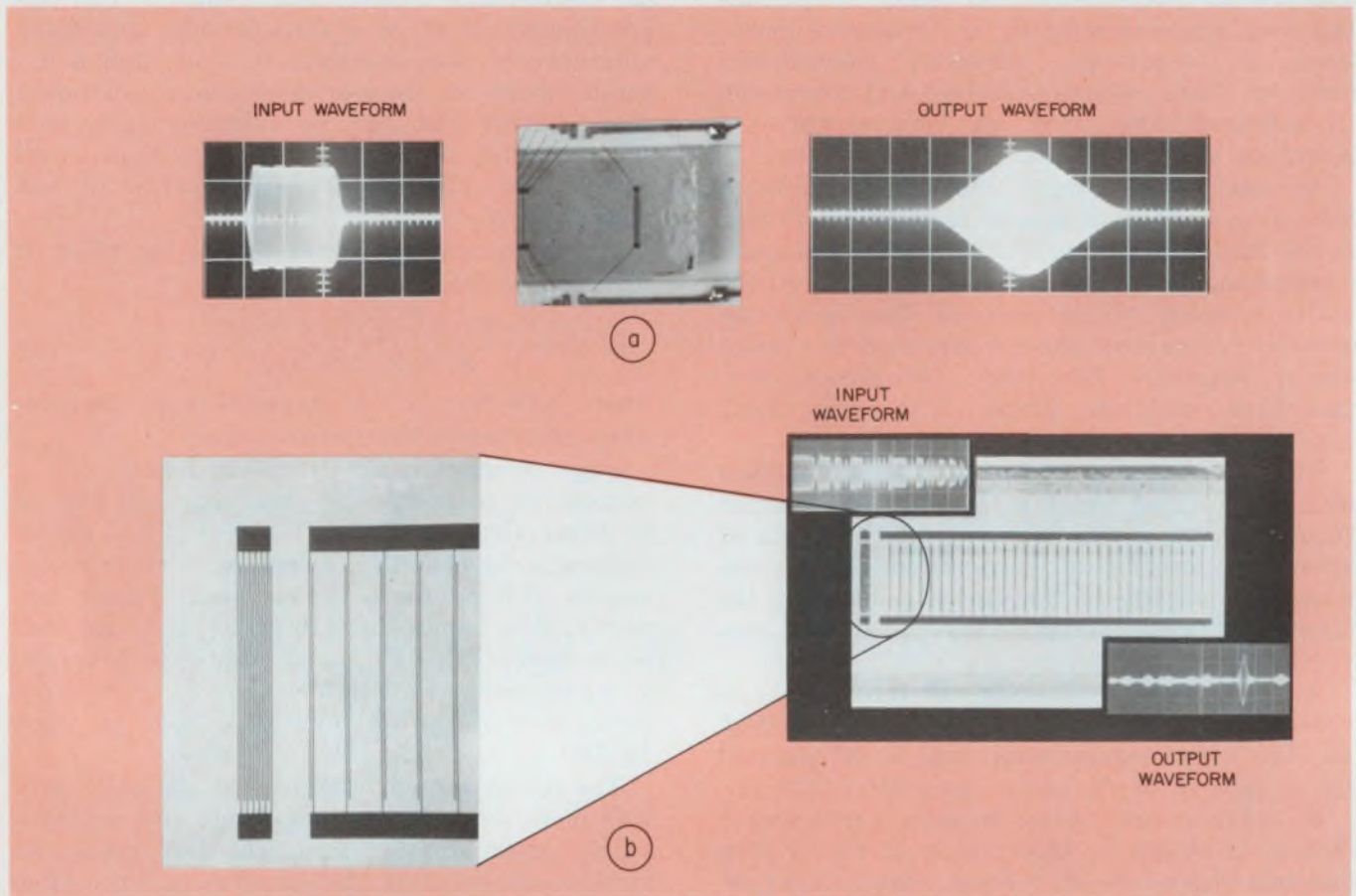

2. Two acoustic surface-wave matched filters: a simple 0.1- μ s, 60-MHz device (a) and a 32-bit, 60-MHz, bi-phase-coded filter on an aluminum nitride-on-sapphire

composite structure (b). An expanded ($\times 20$) view of the phase-coded filter illustrates its interdigital transducer and phase-coded, tapped, delay-line structure.

What are acoustic surface-wave devices?

The acoustic surface-wave component is a passive electro-acoustic device that has metallized interdigital transducer elements on the surface of a piezoelectric substrate. The device allows acoustic energy to be generated, manipulated and detected on the substrate surface. The transducers can be fabricated with standard photolithographic techniques.

An electro-acoustic device employs phonon propagation, or vibrations of a material's crystal lattice structure, as the basic energy-transport mechanism. Electrical energy is converted into acoustic energy by the material's piezoelectric properties. In the case of the acoustic surface-wave device, most of the acoustic energy is confined to a region within one wavelength of the surface of the substrate.

Acoustic surface waves propagate with a velocity five orders of magnitude smaller than the velocity of electromagnetic waves in free space. The size of many signal-processing devices depends directly on wavelength. Hence acoustic surface-wave technolo-

gy allows reductions in size, weight, design complexity and, ultimately, costs when compared with conventional techniques.

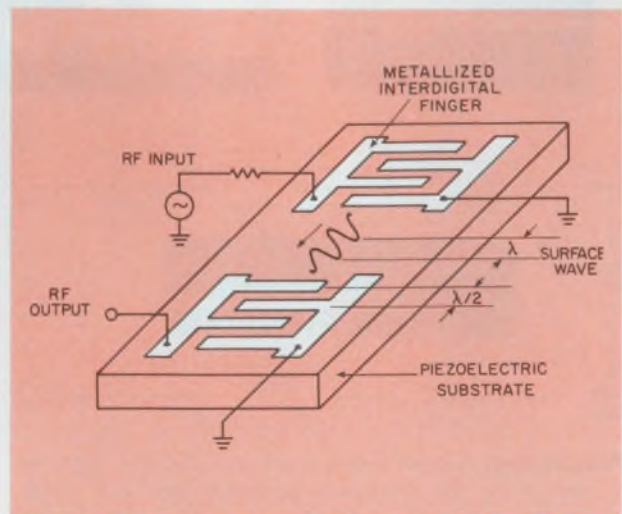

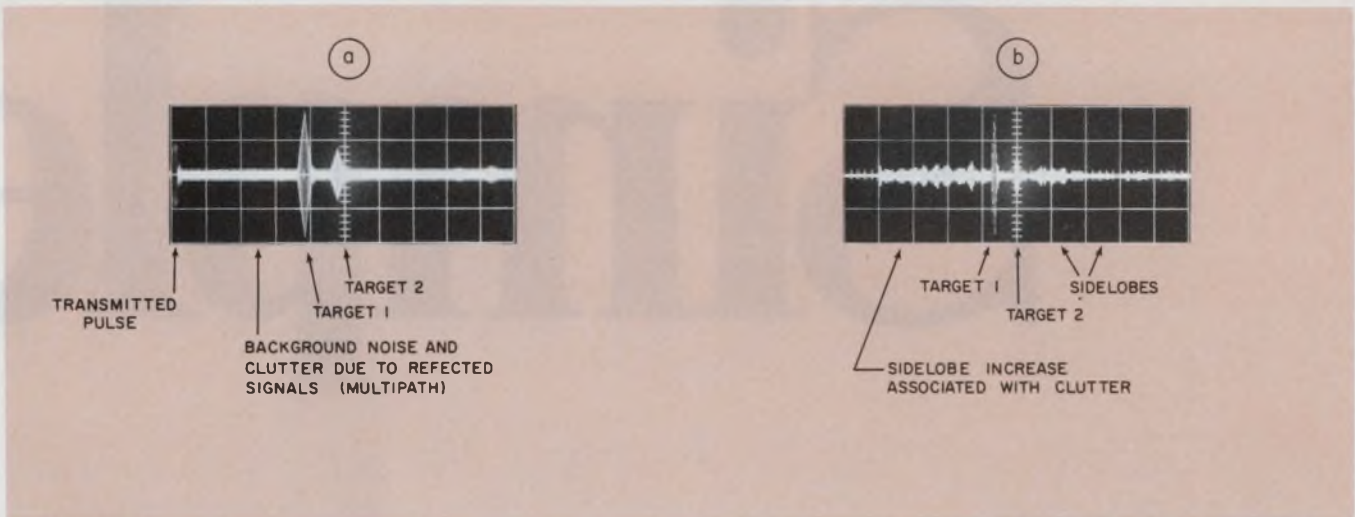

3. Simulated radar return signals for the two filters are shown for the simple device (a) and the 32-bit, phase-coded filter (b). Although the input waveforms have

the same pk-pk voltage levels, the signal-to-noise ratio of the 32-bit filter is about 12 dB higher than the ratio for the rf pulse matched filter.

mately 1.0 MW, which is much higher than the transmitter power specified.

To get around this problem, we turn to the matched filter of Fig. 2b, which uses pulse-compression techniques. It provides an effective increase in transmitter power by correlating long phase-coded or linear-FM sequences.⁵ In this example a long rf pulse is divided into contiguous subpulses, with the phase of each modulated by a coded binary sequence.

The simulated radar signal return for this type of matched filter is shown in Fig. 3. Fig. 4 provides an indication of the signal-to-noise improvement offered by a filter that is matched to a long phase-coded rf sequence. If the rf sequence is of a sufficient length, the matched filter can

provide a detectable signal level, even when the input rf sequence is below the input noise level.

For the waveform of the phase-coded matched filter, signal-to-noise improvement is given by the following expression:

$$SNR_M = N (SNR)_i, \quad (6)$$

where N is the number of coded subpulses and SNR_i is the signal-to-noise ratio at the input to the matched filter.⁶ With the 32-bit filter replacing the simpler design, the resulting increase in the SNR_M of about 12 dB reduces the transmitter power requirement to approximately 62 kW.

A disadvantage of phase-coded matched filter techniques is their susceptibility to doppler variations. For the waveform shown in Fig. 2b, a 175-kHz variation in the center frequency reduces the SNR_M by approximately 3 dB. Where doppler effects become significant, a linear frequency-modulated sequence can be used to reduce the matched filter's sensitivity to frequency variations. ■■

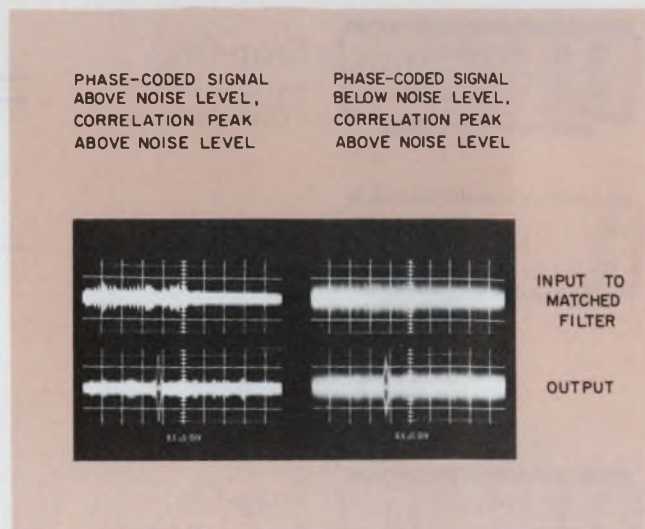

4. The effect of input noise levels on the acoustic surface-wave, matched filter output for two noise conditions. With a long-enough rf sequence, the matched filters can provide a detectable signal level when the rf sequence is below the matched-filter input noise level.

References:

1. O'Clock Jr., G. D.; Gandolfo, D. A.; and Loose, J. R., "Performance of Acoustic Surface Wave Signal Processing Devices in Communication Systems," 1972 IEEE Ultrasonics Symposium Proceedings, pp. 237-240, Boston, Mass., October 4-7, 1972.
2. Schwartz, M., *Information Transmission, Modulation and Noise*, McGraw-Hill, New York, 1959.
3. Middleton, D., "Communication and Statistical Decision Theory," *Electro-Technology*, Vol. 71, pp. 65-82, November, 1964.
4. O'Clock Jr., G. D.; Gandolfo, D. A.; and Sunshine, R. A., "Sixteen Bit Switchable Acoustic Surface Wave Sequence Generator/Correlator," *Proc. IEEE (L)*, Vol. 60, pp. 732-733, June, 1972.
5. Taylor, S. A., and MacArthur, J. L., "Digital Pulse Compression Radar Receiver," *APL Technical Digest*, pp. 2-10, March-April, 1967.
6. Collins, J. H., and Hagon, P. J., "Surface Wave Delay Lines Promise Filters for Radar, Flat Tubes for Television, and Faster Computers," *Electronics*, Vol. 43, pp. 110-122, Jan. 19, 1970.

Simple



Display 4 digit \$325



Display 5 digit \$550



Display 4 or 5 digit



Snap-On DC



Display 4 or 5 digit



Snap-On DC/AC/OHMS



Display 4 or 5 digit



Snap-On Sensitive DC/DC CURRENT/OHMS

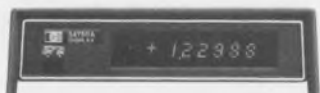

Display 4 or 5 digit



Snap-On DC/AC/OHMS

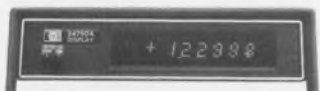

Display 4 or 5 digit



Snap-On Sensitive DC/DC CURRENT/OHMS



Addition

— lets you match your exact needs and budget. Any combination can grow with battery pack (\$200) or BCD (\$175). Contact your local HP field engineer. Or, call Hewlett-Packard, Palo Alto, California 94304. In Europe: HPSA, P.O. Box 85, CH-1217 Meyrin 2, Geneva, Switzerland. In Japan: Yokogawa - Hewlett - Packard, 1-59-1, Yoyogi, Shibuya-Ku, Tokyo, 151.



DC Voltmeter 4 digit \$475
5 digit \$700



Multimeter 4 digit \$600
5 digit \$825



Multifunction Meter 4 digit \$875
5 digit \$1100



Battery Pack =



Portable Multimeter 4 digit \$800
5 digit \$1025



BCD =



BCD Data Center 4 digit \$1050
5 digit \$1275

HEWLETT  PACKARD
DIGITAL VOLTMETERS

093/45

BCD multiplication: You can multiply digits by successive addition, or use a ROM multiplication table. Bit serial or bit parallel, here's how it's done.

This article, the second of a series on BCD logic, shows how BCD multiplication is performed.

To multiply two n -digit decimal numbers, a BCD system, like any other, must be able to:

- Store the multiplicand and multiplier.
- Generate the product of two individual digits.
- Shift the multiplicand to correspond to the decade of the multiplier digit.
- Accumulate the partial results.
- Present the output in an accumulator that holds $2n$ digits for a so-called double-precision product or n digits for a single precision product.

Although the circuit details of a BCD multiplier differ for bit-parallel and bit-serial inputs and outputs, the over-all organization does not. Hence the same system block diagram (Fig. 1) can describe both cases.

In the diagram, the inputs to a multiplier are designated as multiplicand X and multiplier Y , and both numbers are BCD digit-serial pulse trains. However, each digit may be either in bit-serial or bit-parallel form. The output signal, or product Z , then follows suit—it is a digit-serial pulse train in a corresponding bit-serial or bit-parallel format.

In general, an n -digit BCD multiplier needs three $4n$ -stage registers, an adder-multiplier unit (AMU), control logic and a timing generator. The multiplicand and the multiplier are stored in the input MC and MR registers, respectively. The input registers each feed the AMU one digit at a time, and the AMU multiplies them to form a partial product. Then the AMU sums each partial product with the content of the P register and shifts the result back into the P register. After n such operations, the total product is stored in the P register.

The AMU holds each multiplier digit, Y_i , for one word period, W_i , while it multiplies the multiplicand to generate the partial product, XY_i . The partial product is then added to the contents of the P register.

Though specific details of the timing generator can vary considerably for different multiplier types, many features are common to all. The timing generator must always include a divide-by- n counter to generate the digit intervals, D_0 to D_{n-1} . Also, a divide-by- $(n + 1)$ counter generates the word intervals, W_0 to W_n . In a bit-serial multiplier, the timing chain must include a divide-by-four counter to generate the four intervals, B_0 to B_3 —one for each BCD bit. Finally, a divide-by- K counter may be needed to keep track of the number of times the multiplicand is added into the output accumulator, as repeat-addition multipliers must.

The three $4n$ stage registers shift at the clock frequency, f_c . The output of each register is circulated back to the input, and the contents make a complete circuit once every n -digit interval, T_{ci} . During each D_0 interval the contents of the three registers will be in the original position. In the MC and MR registers the least-significant digit is at the right-hand end of the register and the most-significant at the left. During D_0 the least-significant digit is shifted out to the AMU and also back to the register's input. Similarly all the digits are successively shifted until at D_{n-1} the most-significant digit is presented to the AMU.

The time required to generate one partial product is one word period, W_i . And the number of T_{ci} periods in one word period varies from one, for a table look-up multiplier method, to several for repeated-addition multipliers. Generation of the total n -digit product requires n word periods. However, to allow register loading, $n + 1$ word periods must be provided. During W_0 , or the first word period, the new inputs are shifted into the MC and MR registers and the contents of the P register are presented to the output.

The MR and P shift registers have auxiliary outputs. These provide a signal before it appears at the final output. The $n - 1$ output from the P register compensates for a one-digit delay in the AMU and the $n - 2$ divides the partial product by 10 to properly position it for addition to the next AMU output. In the MR register, the $n - 1$ out-

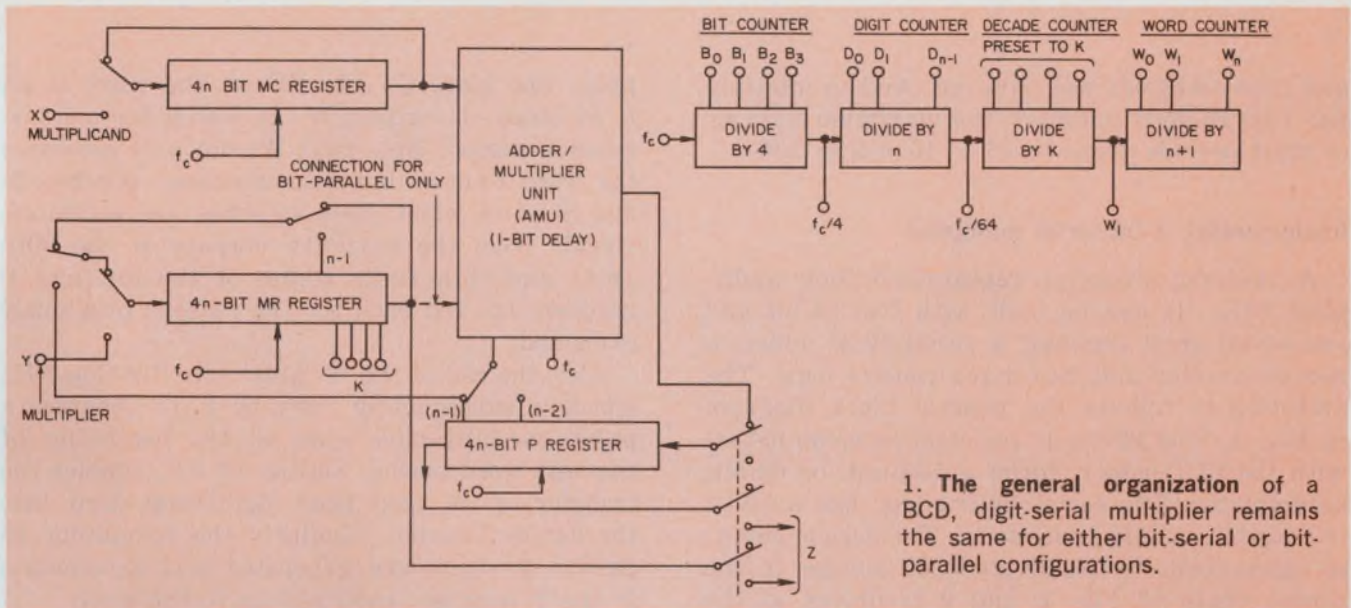

1. The general organization of a BCD, digit-serial multiplier remains the same for either bit-serial or bit-parallel configurations.

put is fed back to the input to advance the next least-significant digit into the MR final output stages.

The system of Fig. 1 is a double-precision multiplier; thus with two n -digit inputs, the output has $2n$ digits, and storage for $2n$ digits must be provided. This is done by using the MR register to store the n least-significant digits, while the n most-significant are in the P register.

The register configuration, of course, changes with the form of the input/output signal. For bit-parallel signals, each of the three registers has four n -bit registers that operate in parallel. Thus in Fig. 1 each line that enters or leaves a register is then really four parallel signal lines. Similarly four-pole switches are needed instead of the single-pole switches shown. And the circulation time, T_{ci} , is n -clock periods, not $4n$, as shown.

Examining the multiplying process

The digit multiplier is the most important part of an AMU. It generates the product of two single BCD digits. For example, if $X_i = 6$ and $Y_i = 7$, the digit multiplier generates the two-digit product Z_i and Z_{i+1} , which is equal to 42. For BCD, the digit multiplier has eight inputs—four for each X_i and Y_i —and eight outputs—four for each Z_i and Z_{i+1} . And bit-serial signals must be first converted to parallel format before they can be applied to a digit multiplier.

In the simplest type of multiplication, the number representing the multiplicand X is added to an accumulator Y times, where Y is the number representing the multiplier. This repeated-addition technique can be applied at these levels:

- The digit-digit level. For example, the product of 789×234 is obtained by adding 789 to itself 234 times.

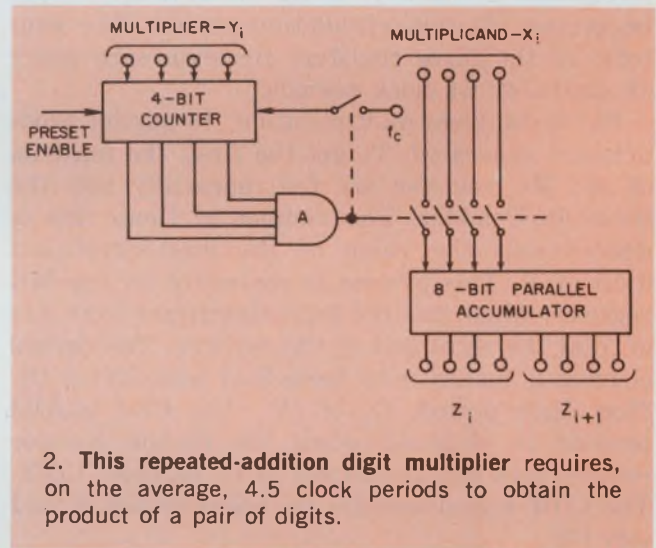

2. This repeated-addition digit multiplier requires, on the average, 4.5 clock periods to obtain the product of a pair of digits.

- The word-shift level. For example, the product of 789×234 is obtained by first adding 789 four times, then adding the shifted multiplicand, 7890, three times, and finally adding the twice-shifted multiplicand, 78900, two times.

Such a repeat-addition multiplier for single digits needs only an accumulator, a counter and some control logic (Fig. 2). The multiplier Y_i is preset into a counter. The counter is counted down at the clock frequency, and the multiplicand X_i is added to the accumulator—once for each clock pulse until the output of the counter is zero. Both the clock and X_i are then disconnected, and the accumulator contains the product.

But the execution time for the digit-digit approach is very long—as long as $n \times 10^n$ digit periods. Thus two 16-digit numbers may require a maximum of 16×10^{16} digit periods. However, significant improvement in execution time results with the word-shift approach. Thus, in the example 789×234 , only two shift operations

and nine additions are required. And to multiply any two 16-digit numbers, the maximum number of digit periods drops to $16 \times 16 \times 9 = 2304$.

Implementing a bit-serial multiplier

A 16-digit, bit-serial, repeated-addition multiplier (Fig. 3) can be built with two 64-bit and one 60-bit shift register, a serial BCD adder, a decade counter and associated control logic. The architecture follows the general block diagram in Fig. 1. The 60-bit P register, in combination with the BCD adder, forms a 16-digit, or 64-bit, accumulator. The serial BCD adder has a built-in four-bit, or one-digit, delay. The decade counter corresponds to the divide-by-K counter in the timing chain of Fig. 1, and it is driven at the circulation frequency, $f_c/64$, to advance at the beginning of each circulation period. The contents of the three registers circulate once every 16 digits, or 64 clock periods.

For a complete multiplication, 16 partial products are generated. To get the first, the contents of the MC register are fed repeatedly into the serial BCD adder. The number of times this is done equals the value of the least-significant digit of Y. This process is controlled by the MR register, which has the least-significant four bits of Y at the right end of the register. The decade counter is loaded with these four bits during the first digit period, D_0 , of W_1 . The first partial product is obtained when the decade counter reaches zero and the output of G_1 becomes LOW. The LOW signal disables G_2 , opens switch S_1 and sets FF_1 .

Flip-flop FF_1 resets at the end of each $f_c/64$

pulse, and since G_1 sets FF_1 at the start of an $f_c/64$ pulse, its output, W_1 , is HIGH for one circulation period. Note that W_1 not only advances the word counter but also operates switches S_3 and S_5 . And when these switches are activated, signals from the auxiliary outputs of the 60th ($n-1$) and 56th ($n-2$) stages of the MR and P registers are fed back for the reasons previously explained.

Also, the end of the W_1 pulse sets flip-flop FF_2 , which is subsequently reset by f_c to generate a pulse, one-bit-period wide, at the beginning of the next word period. Setting of FF_2 enables the transfer of the next least significant digit into the decade counter. Similarly the remaining 15 partial products are generated and accumulate in the P register; each adding to the next.

This circuit requires a maximum of 9216 clock periods— $64 \times 9 \times 16$ —to multiply two 16-digit numbers, or an average of 4608. Thus even with a clock frequency of only 100 kHz, multiplication will take only 46 ms on the average—fast enough for use in most calculators.

The doubling method needs half the steps

Whereas the digit-digit, repeated-addition technique requires an average of 4.5 additions to multiply two single digits, the doubling technique requires only 2.5. The principle here is, once again, repeated addition. But instead of adding only the multiplicand, X_i , either X_i or the doubled value, $2X_i$, is added to the accumulator in the successive addition operations. The magnitude of the multiplier digit, Y_i , determines whether X_i or $2X_i$ is added (Table 1a).

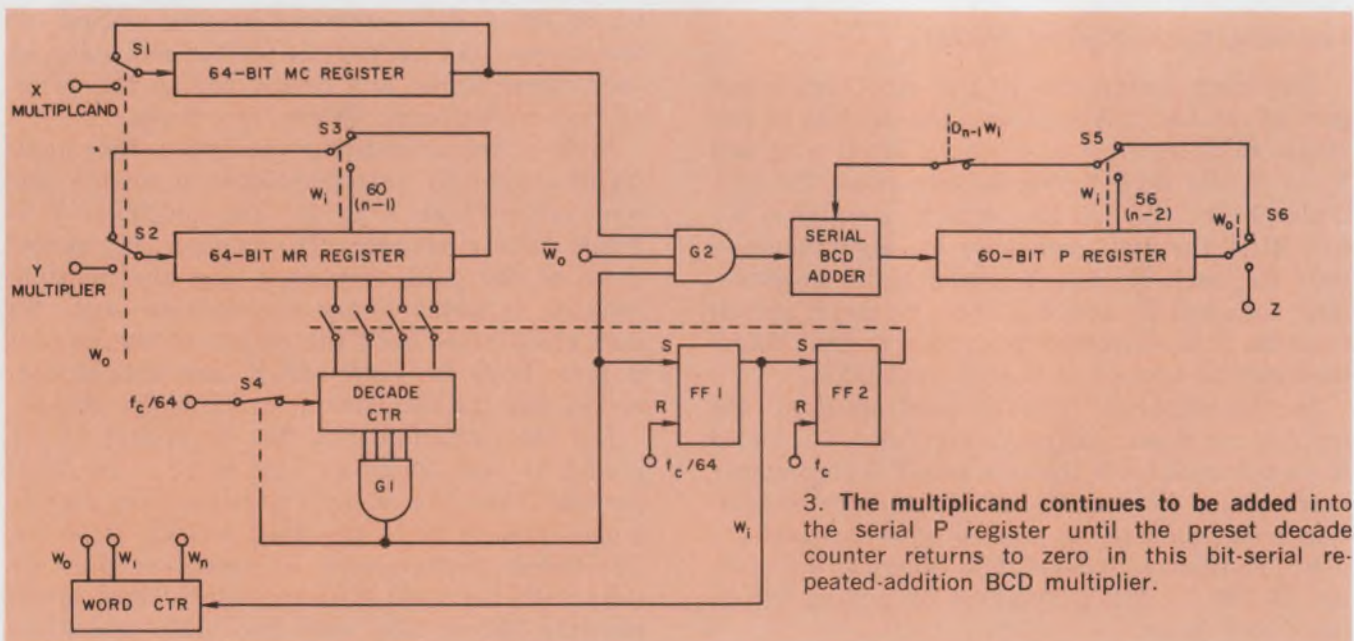

Since a binary number is doubled simply by shifting it one-bit position to the left, a four-bit BCD binary number is doubled in the same way. Of course, the result must be corrected if the doubled value is larger than 9 (as explained in the first article of this series, "BCD: Logic of Many Uses," ED No. 13, June 21, 1973, p. 90).

Though the shift-and-correction process is easy to understand, it is more complex for BCD numbers than the static-logic method described by the following logic equations. They express each bit, D_i , of the doubled value, $2X_i$, in terms of bits X_i and the previous carry bit, C_p :

$$\begin{aligned} D_1 &= C_p \\ D_2 &= X_1 \bar{C}_n + \bar{X}_1 C_n \\ D_3 &= X_2 \bar{C}_n + X_2 X_1 + X_1 \bar{X}_1 \\ D_4 &= X_3 \bar{C}_n + X_3 X_2 + X_2 X_1 \\ C_n &= X_3 + X_3 X_2 + X_3 X_1 \end{aligned}$$

These equations can be derived directly from the truth table (Table 1b), and they are easily implemented, as in Fig. 4. Other variations of this configuration are also possible. With additional control circuits, the circuit of Fig. 4 can be added ahead of the multiplicand input to the digit multiplier of Fig. 2.

The repeated-addition technique can also work with the value $5X_i$. However, the number of required additions still averages 2.5 per digit, as in the doubling method. And though generating $5X_i$ may be somewhat simpler than generating $2X_i$, the control logic is much more complex when the quintupler is incorporated into a digit multiplier. Thus the method is not particularly advantageous.

Also, though a nines-multiples technique can multiply two BCD digits in one addition time,

the hardware requirements are too extensive to be practical for most calculator type applications. So let's move on to bit-parallel BCD multipliers.

Bit-parallel BCD multipliers are fast

Bit-parallel multipliers are simpler to understand than bit-serial circuits because fewer operations are sequenced; they also operate faster. But bit-parallel multipliers use more hardware. Four parallel signal lines require four times as much circuitry, and four-bit parallel adders are

Table 1a. Multiply-by-two addition schedule

Value of multiplier Y_i		Number of additions
0	—	0
1	X_i	1
2	$2X_i$	1
3	$2X_i + X_i$	2
4	$2X_i + 2X_i$	2
5	$2X_i + 2X_i + X_i$	3
6	$2X_i + 2X_i + 2X_i$	3
7	$2X_i + 2X_i + 2X_i + X_i$	4
8	$2X_i + 2X_i + 2X_i + 2X_i$	4
9	$2X_i + 2X_i + 2X_i + 2X_i + X_i$	5

Table 1b. Multiply-by-two truth table

C_p	Value of X_i				C_n	Value of $2X_i$			
	X_1	X_2	X_3	X_4		D_1	D_2	D_3	D_4
0	0	0	0	0	0	0	0	0	0
0	0	0	0	1	0	0	0	1	0
0	0	0	1	0	0	0	0	1	0
0	0	0	1	1	0	0	0	1	1
0	0	1	0	0	0	1	0	0	0
0	0	1	0	1	0	1	0	0	1
0	0	1	1	0	0	1	0	1	0
0	0	1	1	1	0	1	0	1	1
0	1	0	0	0	1	0	1	1	0
0	1	0	0	1	1	1	0	0	0
1	0	0	0	0	0	0	0	0	1
1	0	0	0	1	0	0	0	1	1
1	0	0	1	0	0	0	0	1	0
1	0	0	1	1	0	0	0	1	1
1	0	1	0	0	0	1	0	0	1
1	0	1	0	1	1	0	0	0	1
1	0	1	1	0	1	0	0	1	1
1	0	1	1	1	1	0	0	1	0
1	1	0	0	0	1	0	1	1	1
1	1	0	0	1	1	1	0	0	1

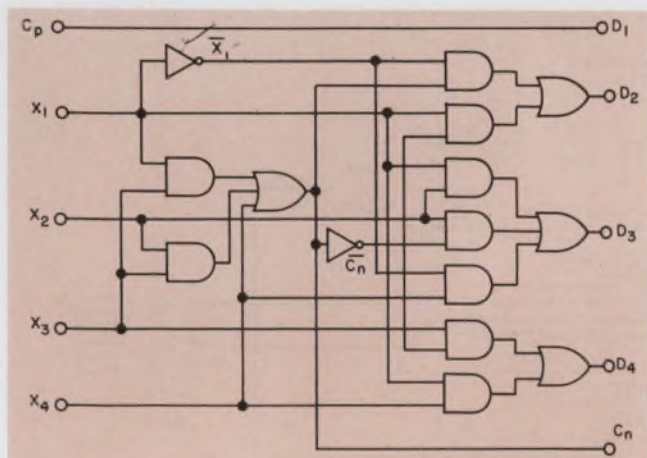

4. This multiply-by-two circuit is implemented with combination logic only. The outputs D_1 to D_4 and the carry C_n have exactly twice the value of inputs X_1 to X_4 and carry C_p .

convenient to use two modulo-17 counters to divide the clock frequency, f_c , into both the word frequency, $f_c/17$, and the over-all cycle frequency $f_c/289$. One cycle period, therefore, has 17 words with each word 17-digit-periods long. And only the digit period, D_n , and the word period, W_n , are needed to control the multiplier operation.

Timing is important

During the input or output functions, which take place during the word interval W_n , the numbers X and Y are loaded into the MC and MR registers. Simultaneously the contents of the two product registers, U-P and L-P, are shifted to the output and thus also cleared for the next multiplication. Further, the switches S_1 to S_n , S_6 and S_7 are in their lower position. Thus at the end of the period W_n the two product registers are empty, and the MC and MR registers are loaded, with the least-significant digits at the right ends of the registers.

The multiplication function can be subdivided into 16 identical subfunctions, each of one word length. During each subfunction a new partial product is generated when the digit multiplier output is added to the previous partial product. The 16 subfunctions occur during word intervals W_1 to W_{16} . The timing and control operations for multiplication must ensure the following:

- That corresponding digits of the multiplicand and multiplier reach the digit multiplier.
- That the digit multiplier's outputs are summed with the proper partial product.
- That the resulting new partial product is properly fed back to the U-P register.
- That the least-significant digit of the new partial product is shifted into the L-P register.

During each word time all 16 digits of the multiplicand are multiplied with one digit of the multiplier. To achieve this, the multiplicand is shifted at the clock frequency, f_c , and the multiplier at the word frequency, $f_c/17$. The MR output is constant during digit intervals D_1 to D_{16} , and its contents are shifted only at the beginning of each digit period, D_n .

The detailed functions performed by the adders and multiplier during each clock period can be seen from Fig. 6, which uses the example $789 \times 987 = 778743$.

To simplify the illustration, only three-digit numbers are used for the multiplicand and the multiplier. Consequently only three stages would be needed for the MC, MR, U-P and L-P registers, and only four digit times, D_n to D_3 , and four word times, W_n to W_3 are shown.

For simplicity, the time is plotted from right to left—the way it would be if multiplication were done with paper and pencil. With a pencil,

you proceed as follows:

$$\begin{array}{r} 987 \\ \times 789 \\ \hline 5523 \\ 6312 \\ 7101 \\ \hline 778743 \end{array}$$

Thus the multiplication operation starts at the right of Fig. 6 (D_n of W_1) where the outputs of the MC and MR registers are 9 and 7. The digit multiplier generates the number 63. But the more-significant digit has a one-bit delay; thus only the 3 is presented to parallel BCD adder 2 via adder 1. Note that the contents of the product register U-P, is still zero and that thus the output of adder 1 is simply 3.

During the next interval (D_1 of W_1) the MC and MR register outputs are 8 and 7. Thus the digit multiplier output is 56. But the one-bit delay causes adder 2 to see a $6 + 6$. The adder-1 output is 6, since the product register output is still zero. However, the adder-2 output becomes 12—the 6 from adder 1 and the delayed 6 from the previous multiplication. Thus adder-2 output is a 2 plus a carry stored in adder 2.

Similarly during D_2 of W_1 , the MC, MR and digit multiplier outputs are, respectively, 7, 7 and 49. The carry from the previous 12 is stored in adder 2. Since the adder-1 output is $9 + 0 = 9$, the adder-2 output, together with its stored carry and previously delayed 5, becomes $1 + 5 + 9 = 5$, plus a carry stored in adder 2.

During D_3 of W_1 the MC and MR register outputs are zero and 7. Thus the digit multiplier output is zero. But there is still the delayed 4 from the previous digit, and a carry is stored in adder 2. Accordingly adder 1's output is zero, and adder 2's is $4 + 1 = 5$.

Each digit output from adder 2 is shifted into the U-P product register. But since the register is now only three digits long, when the 5 gen-

Table 2. ROM multiplier products

		Multiplier Y									
		0	1	2	3	4	5	6	7	8	9
Multiplicand X	0	0	0	0	0	0	0	0	0	0	0
	1	0	1	2	3	4	5	6	7	8	9
	2	0	2	4	6	8	10	12	14	16	18
	3	0	3	6	9	12	15	18	21	24	27
	4	0	4	8	12	16	20	24	28	32	36
	5	0	5	10	15	20	25	30	35	40	45
	6	0	6	12	18	24	30	36	42	48	54
	7	0	7	14	21	28	35	42	49	56	63
	8	0	8	16	24	32	40	48	56	64	72
	9	0	9	18	27	36	45	54	63	72	81

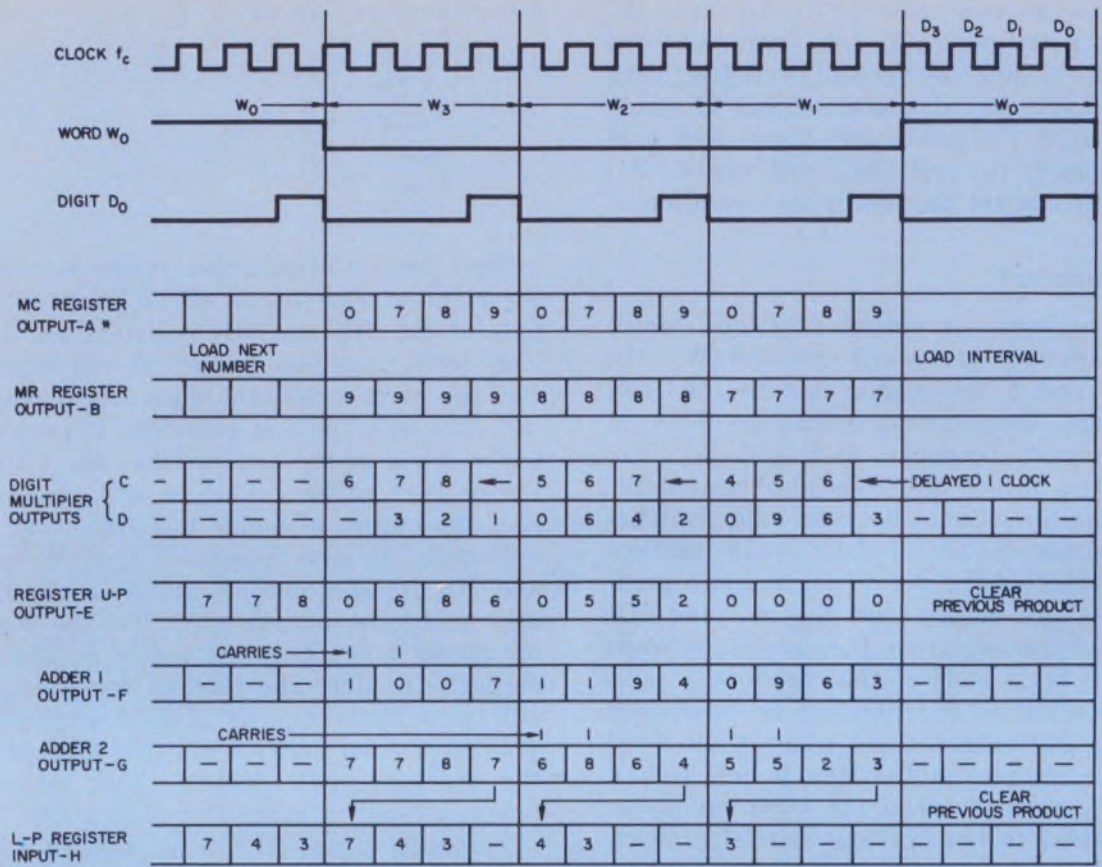

* LETTERS A THRU H ARE KEYED TO FIG. 5

6. Timing schedule for multiplying 789 and 987.

erated during D_3 is shifted in, the 3 generated during D_0 of W_1 emerges from the output end and goes to the L-P register.

The time intervals that follow now have sub-products other than zero in the U-P register. Thus, during D_0 of W_2 , the outputs of the MC and MR registers are 9 and 8. The digit multiplier output is 72, the seven is delayed and only the 2 is transferred to adder 2. But the U-P register output is 2; thus the adder-1 and adder-2 outputs are both 4.

During D_1 of W_2 the MC and MR outputs are both 8, and the digit multiplier output is 64. But because of the one-bit delay, $7 + 4$ is transferred to the adders. With a U-P register output of 5, the adder-1 output is $4 + 5 = 9$, and the adder-2 output is $7 + 9 = 6$, plus a carry. In a similar fashion the subsequent steps of Fig. 6 are carried out.

When two new numbers are presented to the multiplier system during W_0 of the next multiplication period, the new data enter the MC and MR registers, and the contents of the U-P and L-P registers are shifted out, least-significant bit first. In the conventional order the output reads 778743, which is the correct result.

To speed slow all-bit-serial multipliers, you can use a bit-parallel, table look-up digit multiplier (Fig. 7).

Other methods are possible

Many control details, such as the process that divides partial products by 10, have been left out of the figure, since they are similar to the methods used in the previously described multiplier systems. Thus we can concentrate on the salient points and differences more effectively. The required timing chain in the table look-up approach must provide 17 word intervals, W_0 to W_{16} , with 16 digit intervals, D_0 to D_{15} each. To multiply two 16-digit numbers, the circuit generates 16 partial products, and for each, 16 digit multiplications are performed. Thus, with one-digit multiplication executed every four bit intervals— B_0 to B_3 —1024 clock periods ($4 \times 16 \times 16$) are required. Hence, with a 100-kHz clock, one multiplication takes about 10 ms.

The last four stages of the MC register provide half of the ROM address signal. The ROM outputs are preset into buffers at the beginning of the second half of B_0 ; thus no input gating

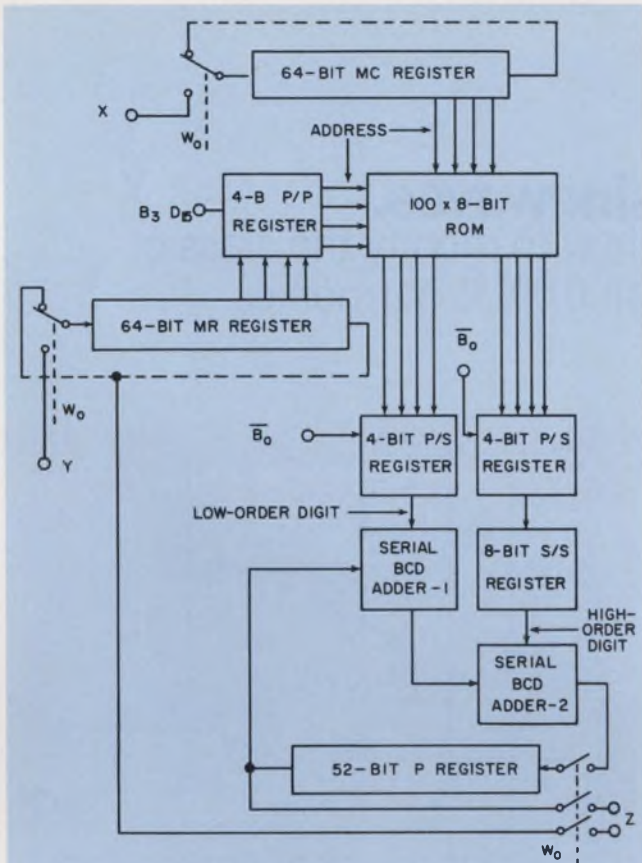

7. A good compromise between speed and hardware is to use a parallel-configured look-up table for the digit multiplier and serial circuits for the shift registers, adders and control logic.

or buffering of the MC outputs is needed.

And the last four stages of the MR register provide the other half of the ROM address. Because this half must be constant for one word duration, it is loaded into a buffer register. This transfer is carried out one-half bit interval before the next word starts—at the beginning of the second half of bit-time B_4 and digit-time D_{15} . The ROM outputs are thus constant for one clock period—more than ample time to load them into the two four-bit registers at the beginning of the second half of B_0 . The content of these two registers is then serially shifted to the two BCD adders. The low-order digit is connected directly to the first adder and the high-order goes to the second adder, but via an eight-bit delay.

From the previously described multiplier system, one might expect the high-order digit to be delayed only one digit time (four-bit intervals). In this implementation, however, it must be delayed two digit intervals, because the first BCD adder introduces a four-bit delay. And with two BCD adders in cascade, a total delay of eight-bit times is produced. Thus, the P register is only 52 stages long. ■■

The third article will discuss BCD dividers.

Dialight sees a need:

(Need: A space-saving thumbwheel switch)

See Dialight.



These miniature thumbwheel switches, available in both BCD or decimal format, with positive detents for easy action, snap together side by side on $\frac{1}{8}$ " centers to provide any number of desired decades. No tools are required to put them together or take them apart. Large $\frac{3}{16}$ " white numerals, set in a black background, make it easy to read the digits from a distance and the assembly has a modern low profile design—recessed on the face of the panel to eliminate accidental activation. Each switch has a gold-plated track on glass epoxy base to insure long life. Gold-to-gold contacts between wipers and tracks obviates electrolytic action, and long wipers insure constant pressure. Send for free catalog on Dialight's full line of miniature and standard thumbwheel switches.



DIALIGHT

Dialight Corporation, A North American Philips Company
60 Stewart Avenue, Brooklyn, N.Y. 11237 (212) 497-7600

INFORMATION RETRIEVAL NUMBER 34

Generate low-distortion sinewaves.

Analysis of the error sources shows how to modify the classic Wien-bridge oscillator to get less than 0.001% harmonics.

Oscillators are widely used as sources of low-distortion test signals. But what do you do if standard circuits don't yield low enough distortion? There are two approaches you can take: You can use special measurement techniques to circumvent the intrinsic distortion of the best-available oscillator, or you can design your own low-distortion oscillator.

Let's assume you decide on the latter approach. You can design a circuit that has a harmonic distortion of less than 0.001% over most of the audio band, an output impedance of less than $1\ \Omega$ (which means you can drive low impedance or nonlinear loads), and a power-supply feedthrough of only 0.0002% of the output.

By contrast a typical commercial oscillator has a distortion of 0.5%, a $75\text{-}\Omega$ output impedance and a power-supply feedthrough of 0.1% of the rated output.

Basic oscillator is Wien bridge

Basically the oscillator (Fig. 1) is a Wien-bridge circuit in which ultra-low distortion is achieved by reducing nonlinearities in both the input and output stages, reducing the output level and impedance, and taking special pains to analyze and reduce drastically distortion caused by the amplitude stabilizing network.

The amplifier portion of the oscillator (Fig. 2) is actually a high-gain, power op amp. The large dc gain (10^5) reduces both output impedance and nonlinearities in the output stage. Even so, the output is operated in Class A to avoid the higher harmonics produced by crossover distortion.

In the input stage two FETs (Q_5 and Q_6), matched for similar gate and drain characteristics, minimally load the feedback network. However, since the feedback network attenuates the output voltage by a factor of only three, a

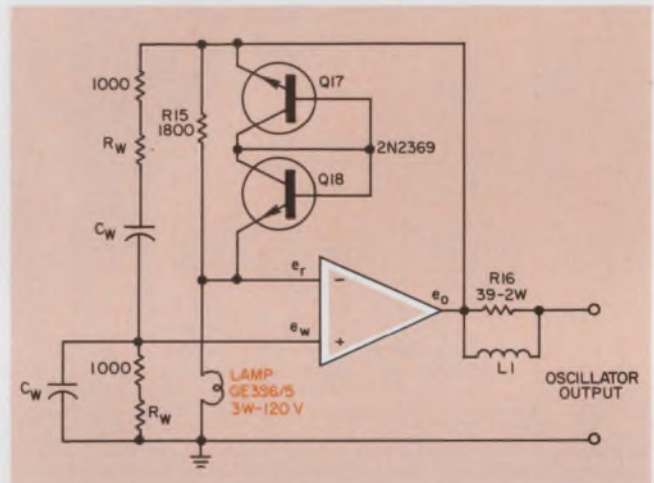

1. Complete Wien-bridge oscillator uses a lamp for amplitude stabilization. The frequency-determining network consists of R_W and C_W .

large common-mode signal can appear at the inputs. Any nonlinearities in the common-mode error signal will thus cause distortion.

To prevent this, the input FETs are boot-straped in cascode fashion with a bipolar transistor, Q_1 . The actual drain-to-source voltage of Q_5 and Q_6 is about 6.5 V, as determined by the emitter-base zener voltage of Q_9 . The zener is operated at a constant current—set by R_1 and Q_5 to 1 mA—so as not to influence the constant-current condition of the input stage. Adjustment of R_1 allows the dc offset of the amplifier to be nulled.

The differential-current signal from the collectors of Q_1 is converted to a single-ended current source by the current mirror, Q_2 , Q_3 , and Q_4 . This signal is amplified by the Darlington driver stage, Q_{10} and Q_{11} , which has single-pole compensation because of capacitor C_1 and high gain because of the dynamic load, Q_{15} . To reduce loading of the driver, the output stage is a Darlington emitter-follower with a gain of nearly unity. Current-source Q_{16} biases the output stage into Class-A conditions at about 250 mA.

Various protective elements are used in the circuit: R_2 , R_8 and R_6 limit the currents to Q_3 , Q_{11} and Q_{10} , respectively. Components R_{10} and Q_{14} limit the current in Q_{12} and Q_{13} to 500 mA,

John Vanderkooy and Cameron J. Koch, Physics Dept., University of Waterloo, Ontario, Canada (Dr. Koch is presently with the Laboratory of Radiobiology, University of California Medical Centre, San Francisco)

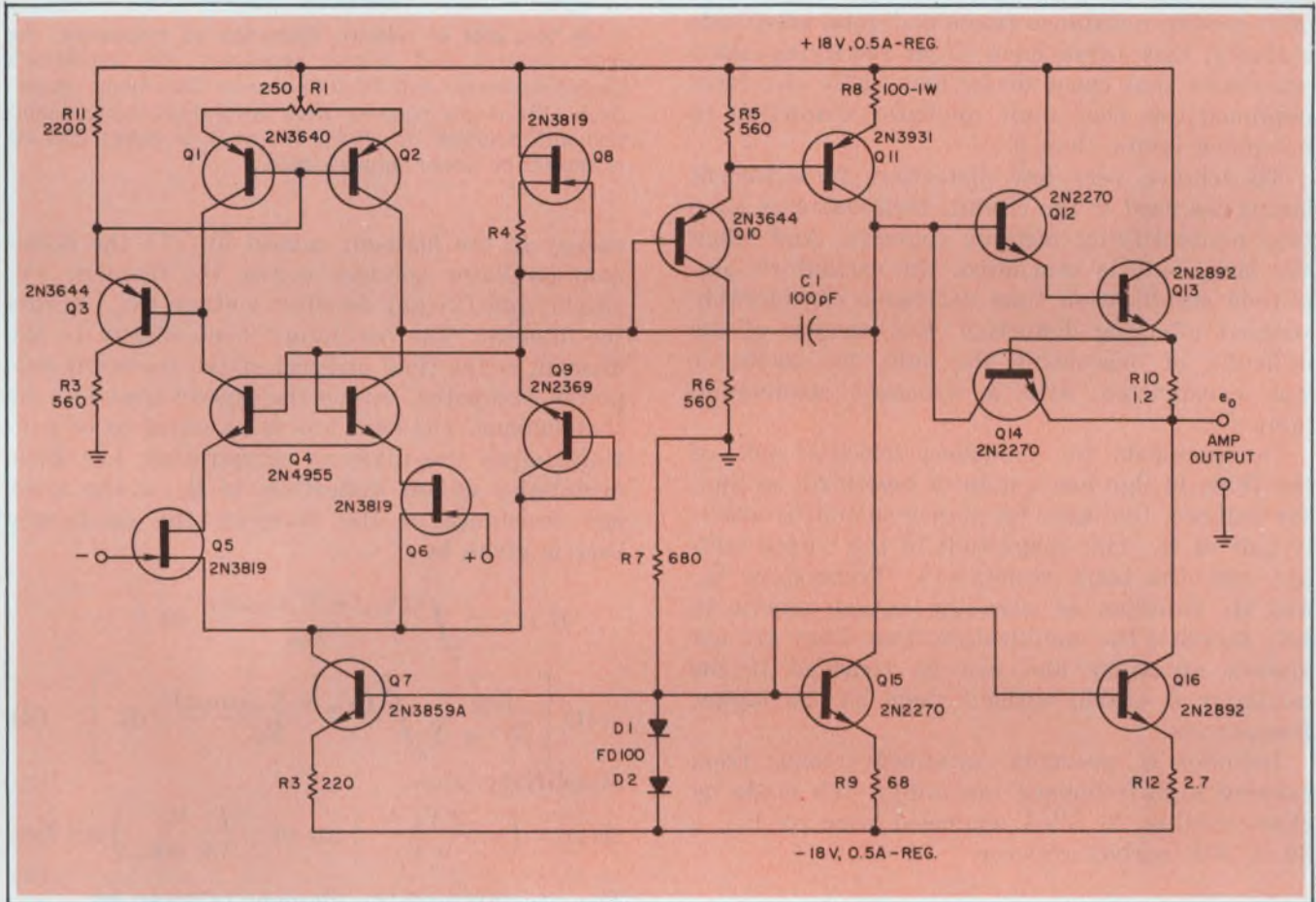

2. Schematic of power op amp used in oscillator. The design of input and output stages is critical—nonlineari-

giving an output capability of 250 mA.

The oscillator thus has an output impedance of less than 1 Ω and is capable of driving a load as low as 30 Ω at 5 V rms with very little increase in distortion. This often obviates the need for auxiliary amplifiers, which inevitably contribute distortion.

Since all transistors are high-frequency types, care must be taken to lay out the circuit properly and to decouple the power supply.

The amplifier has high common-mode and power-supply rejection factors (greater than 110 dB) and gives good performance even with simple capacitor-input power-supply filters and

ties in these stages plus output impedance are reduced to minimize distortion.

a power-supply ripple voltage of 0.5 V pk-pk. But for highest performance, regulated supplies should be used. All current-carrying lines should be grounded at a single point. And it's especially important to use either a magnetically shielded power transformer or to place the transformer as far as practical from the oscillator circuit to avoid hum.

Unity gain bw is high

The measured unity-gain frequency of the amplifier is over 10 MHz, and its slewing rate is 20 V/ μ s, as determined from the 2-mA output-

current capability of the input stage and the 100-pF compensation capacitor, C_1 .

In the complete oscillator, the amplifier of Fig. 2 is replaced by the conventional op amp symbol. The frequency is changed by varying R_w , a dual 10-turn potentiometer of 10 k Ω that gives an 11-to-1 frequency ratio. Ganged capacitors, C_w , are switchable from 10 to 0.01 μf in four decade ranges. The total frequency range is 12 Hz to 120 kHz.

Amplitude stability is achieved by use of a power-sensitive, variable resistance in a negative-feedback loop. Thermistors or FETs are often used for this purpose. But although thermistors offer a wide resistance range and good amplitude stability, they often have slight rectifying characteristics that cause distortion. FETs also have nonlinearities that limit oscillator distortion to not much better than 0.1%.

To achieve very low distortion, incandescent lamps are used in the circuit. Incandescents have true nonrectifying metallic contacts. And when the lamp bulb is evacuated, the oscillator's amplitude stabilization time decreases considerably without affecting distortion. But because of the difficulty of evacuating the bulb, the oscillator was constructed with a standard commercial lamp.

In operation, the frequency-selective side of the Wien bridge has a gain of one-third, so that, for balance, the lamp resistance should be exactly half of R_{15} (the magnitude of the output voltage sets the lamp resistance). Transistors Q_{17} and Q_{18} function as ultra-low-leakage zeners, to help decrease the stabilization time. They are not always necessary and can be removed if the oscillator is stable without them at the higher frequencies.

Inductor L_1 prevents capacitive loads from causing high-frequency instability. It's made by close-winding 20 SWG enameled wire on R_{16} , a 39- Ω , 2-W carbon resistor.

Thermal modulation causes distortion

Analysis of the oscillator shows that thermal modulation of the lamp resistance causes third-harmonic distortion and that a dc bias across the lamp produces second-harmonic distortion as well.

Consider the voltages e_o , e_w , and e_r (Fig. 1). Let the output voltage e_o be described by

$$e_o = 3 V_o (\sin \omega t + a_1 \sin 2\omega t + b_1 \cos 2\omega t + a_2 \sin 3\omega t + b_2 \cos 3\omega t), \quad (1)$$

to first order, where a_1 , b_1 , a_2 and b_2 are quite small. The factor three is used so that the voltages e_w and e_r (which are forced to be equal by the amplifier) have dominant terms of $V_o \sin \omega t$.

To determine just how the resistance of the lamp fluctuates, calculate the oscillatory heat

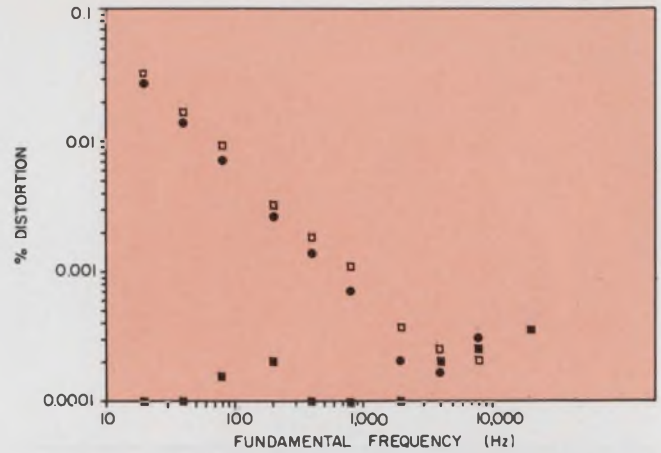

3. In this plot of relative distortion vs frequency, the solid squares and circles represent the oscillator's second-harmonic and third-harmonic distortion, respectively. The empty squares show second-harmonic distortion with adjusted dc offset. The peak at about 200 Hz is caused by power-supply ripple.

energy in the filament caused by (1) the dominant oscillator voltages across the filament ($V_o \sin \omega t$), and (2) any dc-offset voltage (V_{dc}) across the filament. The oscillatory heat energy in the filament is the time integral of the instantaneous power dissipated, minus the steady heat loss by the filament. The heat loss is assumed to be constant, since the filament temperature has little modulation at low distortion. If R_{av} is the average resistance of the filament, the oscillatory heat is given by

$$H(t) = \int_0^t \frac{(V_{dc} + V_o \sin \omega t)^2}{R_{av}} dt - (t) \left[\lim_{T \rightarrow \infty} \frac{1}{T} \int_0^T \frac{(V_{dc} + V_o \sin \omega t)^2}{R_{av}} dt \right]. \quad (2)$$

Simplifying gives

$$H(t) = \left(-\frac{2 V_{dc} V_o}{\omega R_{av}} \right) \cos \omega t - \left(\frac{V_o^2}{4 \omega R_{av}} \right) \sin 2\omega t. \quad (3)$$

The resistance of the filament is given by

$$R(t) = R_{av} + \frac{\gamma H(t)}{\kappa}, \quad (4)$$

where γ is the temperature coefficient of resistance and κ is the heat capacity of the filament. This gives

$$R(t) = R_{av} [1 - \alpha \cos \omega t - \beta \sin 2\omega t], \quad (5)$$

where $\alpha = \frac{2 V_{dc} V_o}{\omega \kappa R_{av}^2}$ and $\beta = \frac{\gamma V_o^2}{4 \omega \kappa R_{av}^2}$.

Now the average lamp resistance must equal one-half of R_{15} so that

$$e_r = \left(\frac{R(t)}{2R_{av} + R(t)} \right) e_o.$$

Substituting for $R(t)$, we get: $e_r = V_o [\sin \omega t - \frac{\beta}{3} \cos \omega t + (a_1 - \frac{\alpha}{3}) \sin 2\omega t + b_1 \cos 2\omega t + a_2 \sin 3\omega t + (b_2 + \beta/3) \cos 3\omega t]$. (6)

By using the transfer function of the frequency-selective side of the Wien bridge, we obtain:

$$e_w = V_o \left[\sin \omega t + \left(\frac{4 a_1}{5} + \frac{2 b_1}{5} \right) \sin 2\omega t + \left(-\frac{2 a_1}{5} + \frac{4 b_1}{5} \right) \cos 2\omega t + \left(\frac{81 a_2}{145} + \frac{72 b_2}{145} \right) \sin 3\omega t + \left(-\frac{72 a_2}{145} + \frac{81 b_2}{145} \right) \cos 3\omega t \right] \quad (7)$$

The enforcing condition, $e_r = e_w$, leads to two sets of coupled linear equations that give:

$$a_1 = \frac{\alpha}{3}, b_1 = \frac{2\alpha}{3}, a_2 = -\frac{3\beta}{8}, b_2 = -\frac{\beta}{3} \quad (8)$$

The term in e_r of $\beta/3 \cos \omega t$ represents a small frequency shift that was not previously allowed for. Although it changes all the coefficients in e_w very slightly, the error is of second order and therefore negligible. In fact, the relative frequency shift can be shown to be

$$\frac{\Delta\omega}{\omega} = \frac{\beta}{2}$$

Since in this oscillator β is less than 10^{-3} , the frequency shift is too small to measure.

The total second and third-harmonic distortions from the coefficient equations (8) are

$$D_2 = \frac{\sqrt{5}}{3} \alpha; D_3 = \frac{\sqrt{29}\sqrt{5}}{24} \beta, \text{ respectively.} \quad (9)$$

$$\frac{D_2}{D_3} = \frac{8\alpha}{\sqrt{29}\beta} = \frac{64}{\sqrt{29}} \left(\frac{V_{dc}}{V_o} \right) = 11.9 \left(\frac{V_{dc}}{V_o} \right) \quad (10)$$

Thus we see that to eliminate the second harmonic, the amplitude-stabilizing lamp should have a negligible dc offset, compared with the peak output voltage across the lamp.

Measurements substantiate theory

Measurements of distortion have confirmed the theory (Fig. 3). The oscillator's fundamental signal was nulled by a switchable twin-T filter, and the harmonics were measured by a Hewlett-Packard 302A wave analyzer. As expected, the transfer characteristic of the twin-T filter was found to attenuate the second and third harmonics by factors of 2.86 and 1.79, respectively.

In Fig. 3, the shaded circles represent third harmonics and the shaded squares second harmonics when the dc offset is carefully trimmed to zero. A distortion of 0.0001% represents the limit of the measuring apparatus, corresponding to a measured wave-analyzer signal of about 2 μ V for a 5-V oscillator output.

Note that the third-harmonic distortion varies inversely with frequency at the lower frequencies. Mathematically, this is illustrated by the single integration necessary to calculate the oscillatory heat energy of the filament. Beyond 1 kHz, the distortion is mainly third harmonic and well below 0.001%. At higher frequencies distortion begins to rise slightly, perhaps because of

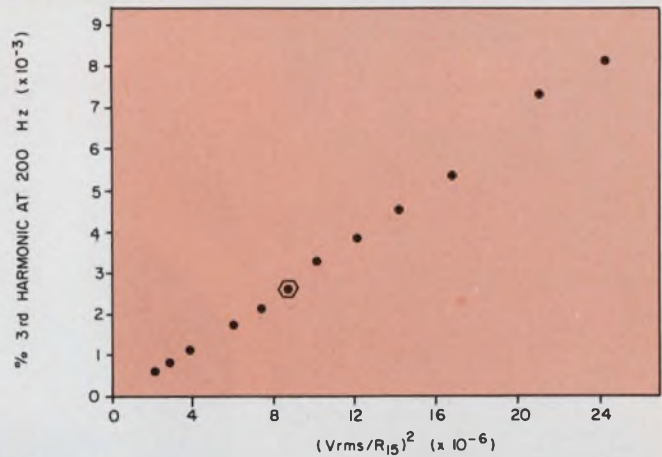

4. Measured variation of third-harmonic distortion with output voltage verifies the dependence of the lamp's thermal modulation on $(V_o/R_{av})^2$.

the decreasing gain of the op amp with frequency.

The empty squares of Fig. 3 represent second-harmonic distortion when the amplifier is offset with R_1 , so that $V_{dc}/V_o = 0.089$. Eq. 10 predicts approximately equal second and third-harmonic distortion. In this case, the measured third harmonic was not significantly different, and the second harmonic rose 20% higher than expected.

Distortion at the lower frequencies can be further reduced by decreasing the output voltage. This is achieved by reducing R_{15} . Fig. 4 shows a plot of the third-harmonic distortion at 200 Hz vs $(V_{rms}/R_{15})^2$, which is proportional to $(V_o/R_{av})^2$. Eq. 5 predicts that the plot should be a straight line. The hexagon shows the normal operating point for the lamp chosen. The circles fit a straight line reasonably well.

As the distortion gets lower, the oscillator takes longer to stabilize, especially at low frequencies, and this dictated the choice of operating point.

Oliver has shown that some distortion is essential to provide amplitude stability when using this type of amplitude-stabilizing network.^(1,2)

With the present design, envelope instabilities have been observed only at frequencies of greater than 100 kHz. Transistor Q_{17} and Q_{18} suppress these instabilities. However, the oscillator can't be used at frequencies of greater than 150 kHz, unless a thermistor is used as the amplitude stabilizer. The resulting increase in distortion substantiates Oliver's theory.

For audio frequencies, even the lowest operating points of Fig. 4 are usable, with the inconvenience only of long stabilization times and with none of the instabilities noted by Oliver. ■■

References

1. Oliver, B.M., *Hewlett-Packard Journal*, Vol. 7, No. 6, February, 1956.
2. Oliver, B.M., *Hewlett-Packard Journal*, Vol. 8 to 10, April to June, 1960.

YOU'LL BE THE SECOND TO KNOW!

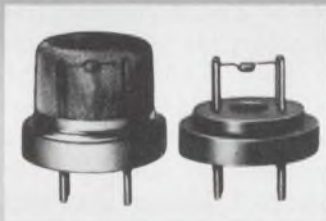
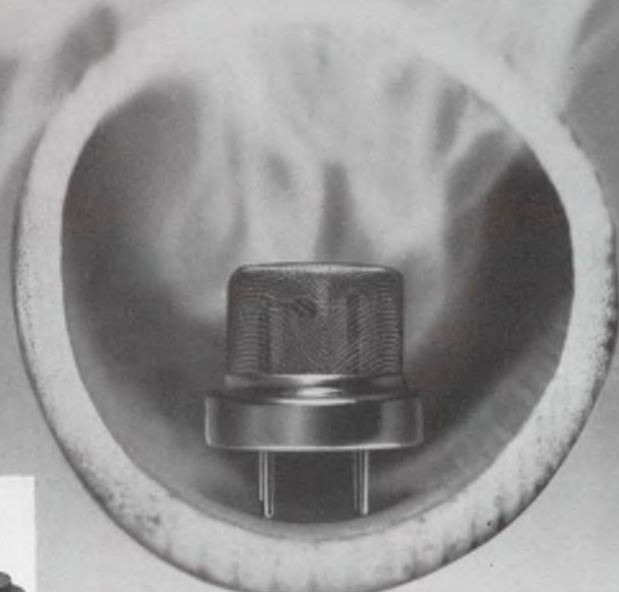

TGS WILL BE THE FIRST!

TGS is first of its kind . . . an internationally patented semi-conductor to convert deoxidizing gas or smoke to an electric signal.

TGS is first in safety . . . even a trace of exhaust gas, fire smoke, hydrocarbons, cigarette smoke or alcohol can't get past this sensitive sensor.

TGS is first in versatility . . . activates alarm or fire control systems, ventilating systems, or measures alcohol in drunken driver tests.

TGS is first in quality . . . remains stable after prolonged exposure to steam or even after 50,000 exposures to gas, and yet only the simplest circuitry is required.

TGS is first in experience . . . more than three million units have been installed in Japan over the period of four years.

SENSITIVITY

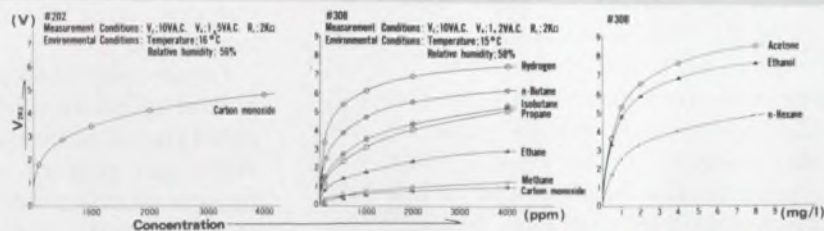

RESPONSE

- ① Point at which sensor is exposed to gas/air mixture.
- ② Point at which sensor is removed from gas/air mixture.

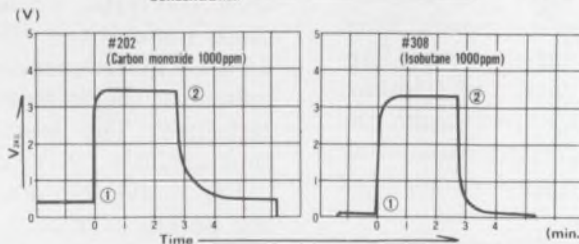

CIRCUIT

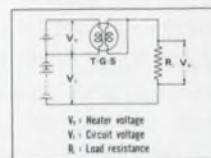

For further information, please write to:

FIGARO ENGINEERING, INC.

3-7-3, Higashitoyonaka, Toyonaka City, Osaka 560, Japan / Tel: (06) 849-2156 / Cable: FIGARO TOYONAKA

Applicants in U.K. & Ireland kindly requested to write to:

FIGARO ENGINEERING (IRELAND) LTD.

Shannon Co. Clare, Ireland / Tel: Shannon 61493 / Cable: FIGARO SHANNONAIRPORT

A Sample Shipment

10 pcs. (2 each of 5 types) set by air parcel post against US\$22 (\$2 x 10 plus \$2 of airmailing charge). This contains 2 pcs. each of sockets and resistor (4 and 2k Ω) for user's convenience. Please send us a banker's check in advance.

OEM MODULAR POWER SUPPLIES: LOW COST, LONG LIFE, FAIL-SAFE PERFORMANCE, ZERO MAINTENANCE AND TOTALLY INTERCHANGEABLE.

You shouldn't have to buy cheap modular power supplies just because you can't afford expensive components. The risk is that it'll cost you later.

That's why Sola engineered the new OEM line of modular power supplies for OEM designs. It works just as reliably as the Sola premium line, but you don't pay for anything you don't really need. We've eliminated some of the extras.

For example, maybe you don't have to have overvoltage protection; overcurrent will do. Maybe rated

current is sufficient and temperature compensation isn't essential. Or the cover may not be necessary.

What we've done is made the most advanced power supply module also the most economical. What we've tried to do is make the state-of-the-art a lot more practical.

All Sola Modular Power Supplies—OEM, Premium and CV lines—are interchangeable with other units you may be using. Thirty-eight models in all are standard and immediately available for off-the-shelf delivery.

Contact your local Sola representative or Sola Electric directly for catalog #617. See what's new in the state-of-the-art in voltage regulation.

Sola Electric, 1717 Busse Road, Elk Grove Village, Ill. 60007, 312/439-2800.

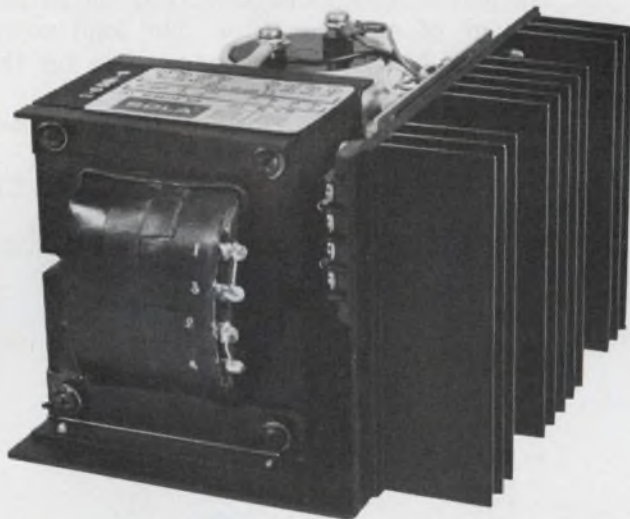

NEW OEM MODULAR POWER SUPPLIES—Series regulated
 Regulation—0.05% + 1mV line or load PARD—0.01% RMS Convection cooled Constant voltage Remote sensing Completely protected—short circuit proof, automatic current limiting Complete serviceability Designed for both bench or rack

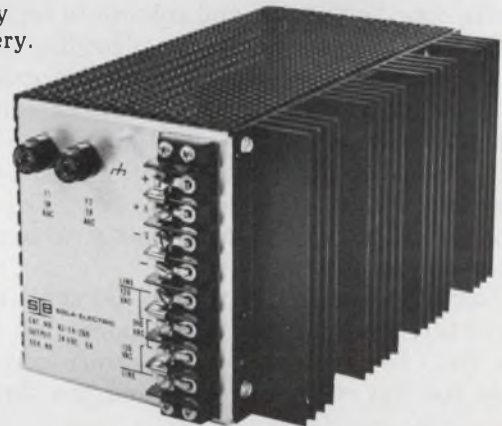

NEW PREMIUM MODULAR POWER SUPPLIES— I-C regulated
 Regulation—0.01% + line or I_{oad} PARD—0.01% RMS Integrated circuit for increased stability Convection cooled Remote sensing Completely protected—short circuit proof, automatic current limiting Overvoltage protection Overtemperature shutdown Complete serviceability



NEW MODULAR POWER SUPPLIES—CVDC
 Regulation—1% line, 4% to 10% load PARD—3% RMS Convection cooled Completely protected—short circuit proof Ferroresonant design, highly reliable Complete serviceability

SOLA BASIC DIVISIONS ANCHOR ELECTRIC · BISHOP ELECTRIC · DIELECTRIC COMMUNICATIONS · DOWZER ELECTRIC · GUTH LIGHTING
 HEVI-DUTY ELECTRIC · LINDBERG · NELSON ELECTRIC · SIERRA ELECTRIC · SOLA ELECTRIC · TEMPRESS
 WARREN G.V. COMMUNICATIONS

INFORMATION RETRIEVAL NUMBER 36

For reliability, we stick to the basics.

You're looking at a cut-a-way of one of our least expensive lighted pushbuttons. The Series 4.

Inside, you can see what also makes it one of our most reliable: a precision SM snap-action basic switch. The time-proven SM assures you of mechanical and electrical dependability throughout the long life of the Series 4.

See those two mounting clips? They allow you to snap the Series 4 into the front of your panel. In seconds. Notice too, that the terminals are quick connect for ease of wiring.

Relamping is just as fast and simple. Pull out the display screen and the lamp is automatically extracted. The display screens themselves are bright, vivid rectangles of color that do wonders for the front of your panel.

Something we can't show here are all our options: low energy (1 amp, 125 VAC max.) and power load (5 or 10 amp, 250 VAC max.) all UL listed, bezel and barrier housings, matching indicators and a wide variety of display techniques.

For the complete list of options, contact your MICRO SWITCH Branch Office or Authorized Distributor (Yellow Pages, "Switches, Electric"). They're reliable, too. You'll see.

MICRO SWITCH makes your ideas work.

MICRO SWITCH
FREEPORT ILLINOIS 61032
A DIVISION OF HONEYWELL



Shown 2½ times actual size.

Transistor and two resistors reduce noise and widen bandwidth of 101/748 op amps

Two of the biggest drawbacks of general-purpose IC op amps such as the 101 and 741/748 families are poor frequency response and relatively high input noise. The frequency response is generally limited to a 1-to-2-MHz unity gain frequency, because of the excess phase shift of the lateral PNP transistors used in the input stage for level shifting. This stage also has a low slewing rate of $0.5 \text{ V}/\mu\text{s}$ with unity-gain compensation, because of the low emitter current used to obtain small input bias currents. For many ac applications, low input currents are of secondary importance to the need for adequate gain bandwidth and an input noise low enough to allow good S/N operation with small signals. A 101 or 748 amplifier can be adapted to satisfy both of these requirements with little added complexity and cost.

The simplified diagram of a 101 or 748 is shown in Fig. 1. As can be seen, all internal circuit nodes required to gain access to the input and second stages are available at pins 1, 2, 3 and 5. If pins 2, 3 and 5 are tied back to V^- (pin 4), the entire input stage is effectively removed from the circuit and the second stage can be used as a buffered common-emitter amplifier.

This allows the high-gain second stage to be retained, with its bipolar output swing, good current capability and short-circuit protection.

The addition of a simple common-emitter PNP input stage (Fig. 2) restores a ground-referred input-voltage bias by driving the 101/748 second stage via pin 1. Compensation is added by a single capacitor, C_2 . In this case the slewing rate is increased approximately thirtyfold because the emitter current in Q_1 has been raised and the direct capacitance reduced. The gain-bandwidth product is raised to nearly 100 MHz by this substitution, and the circuit has a typical input noise voltage of $0.5/\mu\text{V}$ rms for a 10-kHz bandwidth with a 600- Ω source resistance.

An interesting sidelight of the circuit is the fact that its improved performance is accomplished with only three components— R_3 , Q_1 , and R_5 —more than those required for a circuit that has only the op amp. If fully differential-input operation is required, a second transistor may be used; however, this trades off speed and noise performance.

Walter Jung, 1946 Pleasantville Rd., Forrest Hill, Md. 21050.

CHECK NO. 312

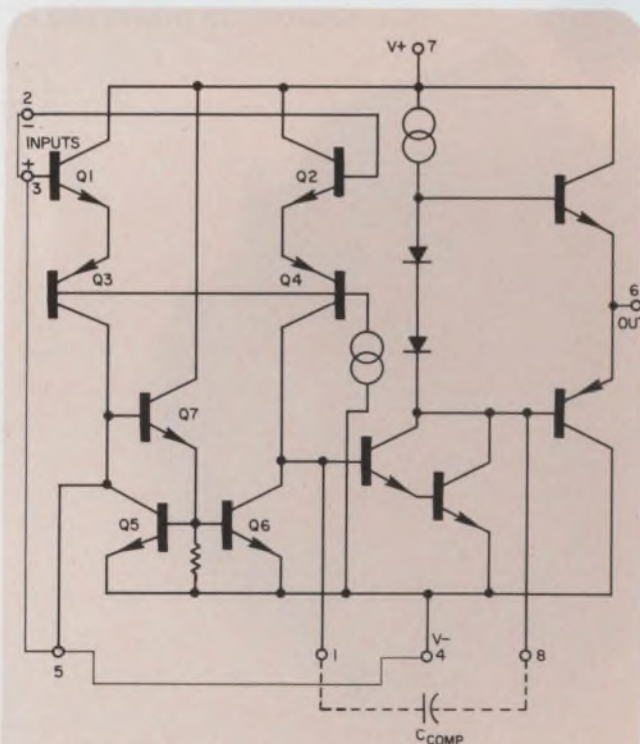

1. Simplified 101/748 diagram has pins 2, 3 and 5 tied to V^- to eliminate the input stage.

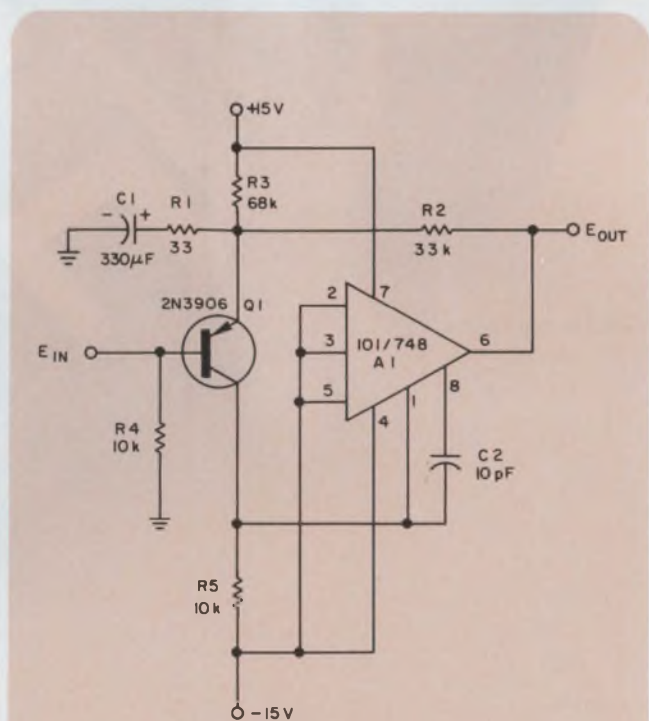

2. Low noise input stage, consisting of Q_1 , R_3 and R_5 , replaces the internal differential amplifier.

Not all 327's are created equal.

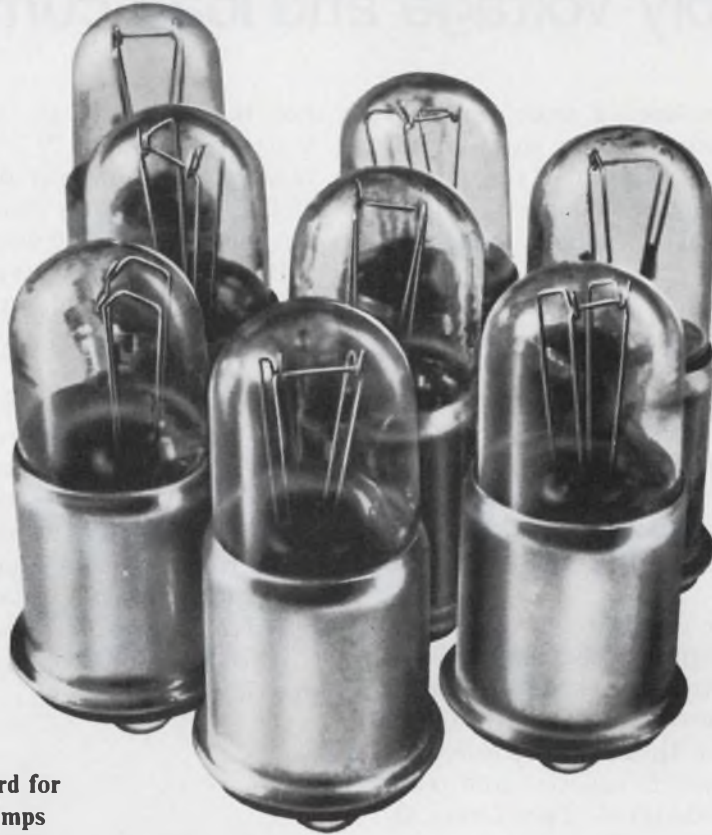

Face it. The industry standard for subminiature incandescent lamps only establishes a minimum level of acceptable performance. There's a big difference between Chicago Miniature and other "acceptable" alternatives.

And we can prove it.

Customer tests—as well as our own—show surprising variations in brightness, stability and life characteristics. For example,

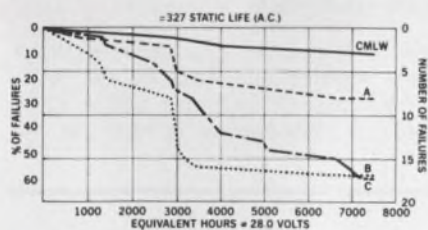

Chicago Miniature's 327, tested under static life conditions, rated an average life of 7,000 hours. Another "standard" lamp doesn't even provide 3,500 hours. That means means Chicago Miniature's 327 gives you more than twice the life.

Obviously, the static life test doesn't guarantee performance under really tough operating conditions. But we can show the same kind of optimum

performance test data under shock and vibration conditions.

The big difference is in how carefully you make things. Chicago Miniature designs and manufactures for optimum—not minimum—performance. And we go a lot farther in quality control than some people might think necessary. We do that for everything—683's, 715's, 385's, 387's, etc.—just to make sure there is a difference.

The way we figure it, there's no standard for quality. And since it doesn't cost anything more, you might as well start at the top.



CHICAGO MINIATURE
LAMP WORKS
4433 N. Ravenswood Ave.
Chicago, Illinois 60640
(312) 784-1020

a GENERAL INSTRUMENT company

THE LIGHTING BUGS

We've published a general discussion of subminiature lamp performance under various operating conditions—complete with text data. Send for your free copy.

Name _____

Title _____

Company _____

Address _____

City _____ State _____ Zip _____

Simple dc current controller adapts easily to any supply voltage and load current

Dc current controllers have a wide range of applications—from power-supply short-circuit protection to surge protection—and the circuit shown can meet these optimum circuit characteristics: rapid overload tripping; near-zero voltage drop; acceptance of capacitive or inductive loads; stable trip level regardless of temperature, power-supply voltage changes and trip time; and low cost.

Typically the trip time is 1.5 μ s and the voltage drop 0.1 V. Loads of 24 μ F don't affect operation. The trip level is stable to within 5% for a -25-to-+220-F temperature change, with almost no change over the 50-to-200-F range. And, for power-supply variations of 1%, the trip level varies 0.75%.

Transistor Q_3 detects an over-current condition by sensing the voltage between the base and collector of Q_1 (the voltage at those points changes polarity as Q_1 goes from the active to the saturation region). When Q_1 is in saturation, its base is more positive than its collector and transistor Q_3 is then forward-biased. This forces Q_2 to stay on and latch, thus holding Q_1 in saturation. If load current should increase, Q_1 becomes active (due to current starving) and its collector voltage goes higher than its base voltage. Thus Q_3 is forced off, since its base-emitter junction becomes reverse-biased. Because Q_3 is now off, Q_2 also turns off, and the base current to Q_1 is removed. Transistor Q_1 then turns off, and the load current drops to zero. To reset the circuit, the switch S_1 is momentarily closed, causing Q_2 to turn on and latch Q_1 on and the circuit then returns to operation.

Resistor R_b determines the overload trip current. It is calculated by

$$R_b = \frac{V_{CC} - V_{CE(Q2)} - V_{BE(Q1)}}{I_{b(Q1)}}$$

For this current and with silicon transistors, $V_{CE(Q2)}$ is 0.5 V and $V_{BE(Q1)}$ is 1 V. Therefore the value of R_b is directly dependent on the inverse of I_b . For the values shown, I_{load} can be set for a 1-A nominal current with a 12-V supply.

If other supply voltages and output currents are needed, the design criteria are as follows:

$$R_f = \frac{V_{CC} - (V_{CE(Q2)} + V_{BE(Q1)} + V_{CE(Q3)})}{I_{b2}}$$

Resistors R_1 and R_2 must be large enough so the effect on base-emitter currents is negligible. Q_1 and Q_2 must handle the required collector current and cause $V_{CEsat(Q1)}$ to be less than 0.5 V. Q_3 is selected to handle the current required in or near the active region and must be capable of withstanding a reverse voltage between emitter and base that is greater than V_{CC} .

A. Borges de Oliveira, 14615 S. E. 37th, Bellevue, Wash. 98006.

CHECK NO. 313

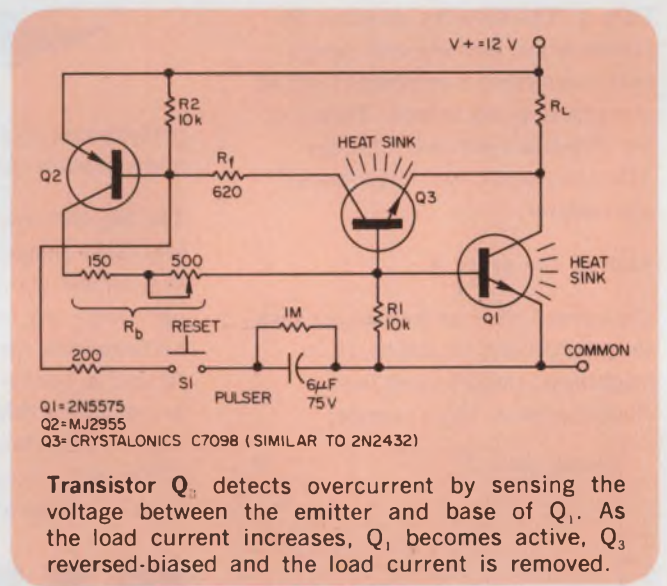

IFD Winner of March 1, 1973

T. W. James, Project Engineer, Medical Electronics Div., Hewlett-Packard, 175 Wyman St., Waltham, Mass. 02154. His idea "Single diode extends duty-cycle range of astable circuit built with timer IC" has been voted the Most Valuable of Issue Award.

Vote for the Best Idea in this issue by checking the number for your selection on the Information Retrieval Card at the back of this issue.

SEND US YOUR IDEAS FOR DESIGN. You may win a grand total of \$1050 (cash)! Here's how. Submit your IFD describing a new or important circuit or design technique, the clever use of a new component or test equipment, packaging tips, cost-saving ideas to our Ideas for Design editor. Ideas can only be considered for publication if they are submitted exclusively to ELECTRONIC DESIGN. You will receive \$20 for each published idea, \$30 more if it is voted best of issue by our readers. The best-of-issue winners become eligible for the Idea of the Year award of \$1000.

ELECTRONIC DESIGN cannot assume responsibility for circuits shown nor represent freedom from patent infringement.



**Cambion
Catalog 119:
72 pages of good news**

Our new Catalog 119 offers 72 illustrated pages of advanced digital components and IC accessories. It gives you all specifications and dimensions, fresh ideas, sensible solutions. Card files, IC socket cards, integrated arrays, test devices, interface hardware, production and breadboarding aids for using ICs... nobody recognizes your growing product needs like Cambion. The best news in the market is still our Double "QQ" approach, repeatable Quality in any Quantity. Get the whole story by ordering your free copy of Catalog 119. Cambridge Thermionic Corporation, 445ED Concord Avenue, Cambridge, Mass. 02138. Phone (617) 491-5400. In Los Angeles, 8703 La Tijera Blvd. Phone (213) 776-0472.

Standardize on
CAMBION
the guaranteed digital products

INFORMATION RETRIEVAL NUMBER 39



**Interval
On Operate
SOLID STATE
TIMER**



SENSITROL, INC.

Timing period begins when input voltage is applied and internal control relay energizes. Control relay de-energizes at the end of time delay period. Time delay resets when input voltage is removed. If the input voltage is removed before timing period is completed, control relay de-energizes and time delay resets.

The delay time can be set with the knob or by adjusting the external resistor to any period of .1 through 10 seconds, or 2.0 through 200 seconds. Delay time can also be pre-determined by customer and set at the factory from .1 through 200 seconds. **\$28.50-35.50**

200 S. 4th Street
P. O. Box 150
Albion, Illinois 62806

A Subsidiary of Champion Laboratories

INFORMATION RETRIEVAL NUMBER 40

ELECTRONIC DESIGN 14, July 5, 1973

You can't tease



**the Marco-Oak
670 series**

**latching
Presslite**



**The latch
controls the
switch.**



- 10.5 amp, 28 volt DC, 115/230 volt AC
- 1 or 2 poles, single or double throw
- Relampable from front of panel
- Contact module U.L. Listed

*Lighten your decisions
contact . . .*

MARCO-OAK

Subsidiary of OAK Industries Inc.

P.O. Box 4011
207 S. Helena Street, Anaheim, Calif. 92803
Tel. (714) 535-6037 • TWX — 910-591-1185

INFORMATION RETRIEVAL NUMBER 41

Now! Get rid of the captive screw. Use the new Dzus "Space-Saver."

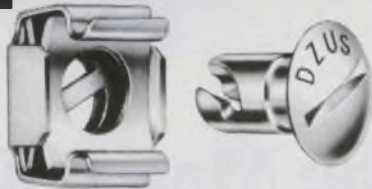

Exclusive Dzus cam-action stud engages cross-bar in receptacle

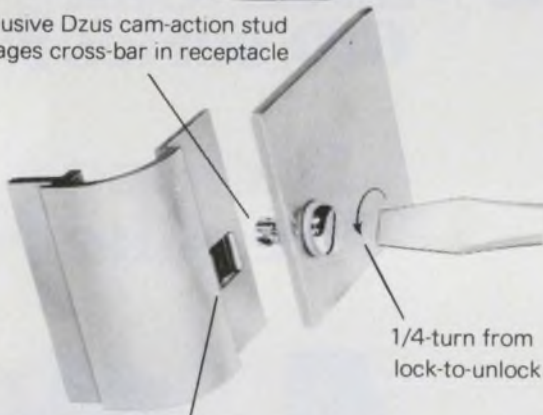

Snap-in receptacle needs no mounting hardware

Here is the SQA4, a quick access fastener receptacle designed specifically for today's electronics packages. Ideal for enclosure fastening, module mounting and the many former duties of the time-consuming and cumbersome captive screw.

1/4-turn lock-to-unlock...real rapid access

Snap-in receptacle...for reduced assembly time—no tapped hole needed

Inexpensive...assembly time reduced

Will not scratch or mar panel surfaces

Reliable for thousands of operations

From Dzus who invented the first 1/4-turn fastener over 40 years ago.

Dzus Fastener Co. Inc.

425 Union Boulevard, West Islip, New York 11795
516/669-0494/Telex 96-1454 Dzus Fast Wslip
West Coast: 910 S. Brookhurst, Anaheim, California 92804
714/635-0830/Telex 65-5461 Dzus Fast Anh.

DZUS

means
quick release
fastening

INFORMATION RETRIEVAL NUMBER 42

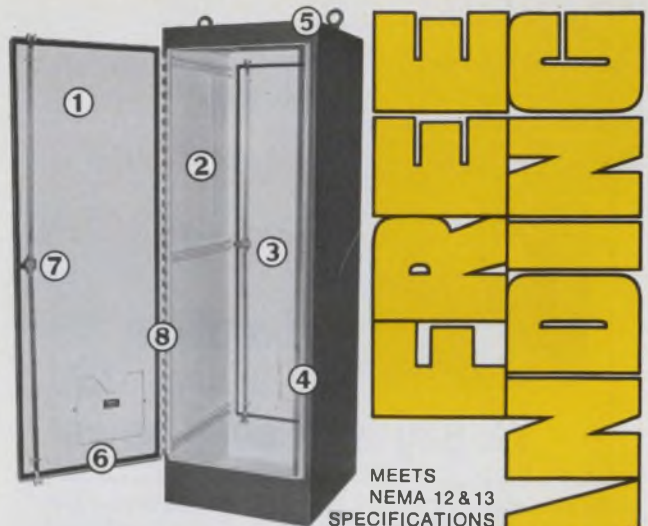

MEETS
NEMA 12 & 13
SPECIFICATIONS

1. Single door or double doors on front or front and back. 2. Numerous interior panels/relay rack angles available. 3. Heavy gauge steel. 4. All seams continuously welded. 5. Lifting eyes for easy handling. 6. Neoprene door gasket with oil resistant adhesive and steel retaining strips. 7. 3-point latching mechanism, oil tight key locking handle. 8. Heavy gauge continuous hinges. For detailed specifications on over thirty different sizes, write for latest bulletins.

Hoffman

HOFFMAN ENGINEERING COMPANY
Division of Federal Cartridge Corporation
Anoka, Minnesota, Dept. ED-72

**ELECTRICAL
ENCLOSURES**

INFORMATION RETRIEVAL NUMBER 43

**Test record not required!
Designed for CD-4
demodulator measurements**



MSG-321

CD-4 System Record Signal Generator

The MSG-321 is a record signal generator of the discrete four-channel system type. It generates a signal corresponding to left and right components of one side of the groove of a CD-4 record, thereby eliminating the need for a test record. Applications include research, adjustment, and inspection for demodulator isolation, distortion, and signal-to-noise ratio.

Please see our catalog for details.



MEGURO DENPA SOKKI K.K.

No. 5, 1, 2-chome, Chuo-cho, Meguro-ku, Tokyo, Japan
TEL: 715-1211
Cables: MEGURODENPA TOKYO

INFORMATION RETRIEVAL NUMBER 44

new products

Tape and disc share package and electronics



Tri-Data, 800 Maude Ave., Mountain View, Calif. 94040. (415) 969-3700. \$5995; August.

Two can live as cheaply as one, they say. So can two kinds of magnetic storage—tape cartridges and a disc, both in the same enclosure and sharing a single controller. The tape cartridges (two) provide a bulk data availability of 1.44 Mbytes; the disc affords 312-k bytes of random-access storage with a transfer rate of 170-k bytes/s.

With the CartriFile 211 and 201 systems, the user has on-line tape and disc without the cost of separate peripherals. Sharing the controller between the two devices also helps keep the price down.

The CartriFile 211 sells for \$5995; separate tape and disc systems with controllers average a total of \$9000. The CartriFile 201, also \$5995, provides compatibility with Tri-Data's existing CartriFile 40, 20 and 10 systems, which use lower cartridge recording densities than the new 211.

A single, direct-memory-access port or I/O slot of PDP-11 minis can address and control the system. (Interfaces to other minis are scheduled.) The user can read or

write on the disc while simultaneously load-point searching the two tapes. Or he can read or write on one tape, load-point search the other and position the disc head.

One motor drives both the tape transport and the sealed movable-head disc unit. Two read/write heads (for odd and even bits) fly 75 microinches above the disc surface, which rotates at 1800 rev/min. The disc has a data capacity of 2.5 to 2.9 Mbits (312 k bytes formatted, 362 k bytes unformatted). There are 64 tracks per head with variable sectoring (1, 2, 4, 8 or 16) and a maximum recording density of 1600 bits/in. Data-access time includes 10-ms track-to-track motion, 10-ms settling time and an average rotational latency of 16.7 ms.

The tape drive in the CartriFile 211 provides a 6-k byte transfer rate with standard Tri-Data cartridges. The drive operates two cartridges, each capable of storing 720-k bytes on 150 feet of 1/4-in. tape. A 15 in/s tape speed and 1600-bit/in. recording density provide a 6-k byte/s data-transfer rate.

The slower CartriFile 201 operates at a 10-in/s, 900-bit/in. re-

coding density for a transfer rate of 1800 bytes/s. Each cartridge is capable of storing 324-k bytes on a 150-ft. tape. Both tape units use Tri-Data's two-track, interlaced recording technique. And both systems have the same disc unit.

A 7-in.-high-by-17-in.-wide-by-20-in.-deep enclosure houses an entire system. A belt and idler assembly, which drives the disc, allows the user to swing transport outward from the front of the unit without need to disconnect and realign the belt.

The disc unit's head carriage is positioned by a stepper motor. The sealed unit features an integral air-pumping and filtering system. No field maintenance or adjustments are needed, Tri-Data says.

The 211 and 201 operate at temperatures from 32 to 120 F with relative noncondensing humidity of 10 to 90%. Tri-Data also supplies driver software and diagnostic routines.

CHECK NO. 250

Adapter mates 5-level terminals to Telex

Multiplex Communications, Inc., 123 Marcus Blvd., Hauppauge, N.Y. 11787. (516) 213-5350. \$133 (qty); 90 days.

The Multiplex Communications CU 300 Adapter, as it is called, interfaces any five-level teletypewriter or other terminal with the Telex network. The system contains both the operator control panel (rotary dial, sonalert and operating switch indicators) and an electronic line interface, which provides all the controls and signals necessary for normal Telex operation.

CHECK NO. 251

Roll your own mini from logic cards

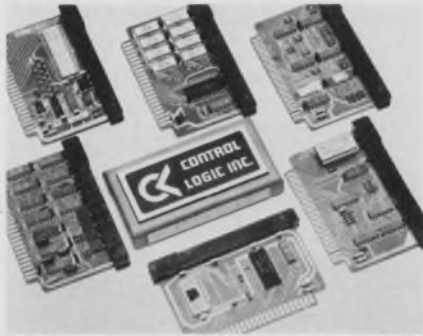

Control Logic, Inc., Nine Tech Circle, Natick, Mass. 01760. (617) 655-1170. See text; 30 days.

A set of 11 small (approx. 3 by 5 in.) logic cards allows the user to assemble a wide variety of mini-computers. The basic eight-bit processor (three cards) has a repertoire of 48 instructions with a typical execution time of 20 μ s and is based on the Intel 8008 computer chip. Other members of the L-500 series include pROMS, RAMs priority interrupt controls, serial interface and a buss port. The basic processor is supplied with one 256-byte (eight-bit) pROM and costs \$400. Additional memory, for example, RAM costs \$150 for 256 bytes or \$420 for 1024 bytes. The L series is compatible with the manufacturer's C-series logic as well as the I series. The latter's 21 logic modules are designed for industrial applications in severe environments.

CHECK NO. 252

Fixed-head disc system offers 8.35 ms access

Progress Electronics Co. of Oregon, 5160 N. Lagoon Ave., Portland, Ore. 97217. (503) 285-0581. From \$8575; 90-120 days.

A single controller handles up to four fixed-head discs for a total storage capacity of up to 33 M words. The discs provide an average word-transfer rate of 3.8 μ s at rotational speeds of either 3600 rev/min. or 1800 rev/min., but with average access times of 8.35 or 16.7 ms, respectively. The units are compatible with Data General's Nova 800, 1200 and Supernovas, Digital Computer Controls D-116 and the Interdata 70, 74 and 80 minicomputers.

CHECK NO. 253

Process-control display features graphics

Ramtek Corp., 292 Commercial St., Sunnyvale, Calif. 94086. (415) 941-8860. See text.

The GX-1000 is an industry-oriented raster system with complete graphics capability—color, grey scale or black-and-white. Standard black-and-white and RGB TV monitors provide the output display, and the system is field expandable. Key capabilities of the GX-1000 include alphanumeric generation, graphic plotting, cartesian graphics, selectable erase and reverse background. All the functions are accomplished in the system controller. Available resolutions are 256 elements by 256 lines and 512 elements by 256 lines. The GX-1000 operates in hostile environments where acid, fumes or dust can damage more conventional systems. In quantity, GX-1000 costs (per channel) \$4500 for color or grey scale and \$1500 for black-and-white graphics.

CHECK NO. 254

Microprogrammed mini includes pROM writer



Hewlett-Packard, 1501 Page Mill Rd., Palo Alto, Calif. 94304. (415) 493-1501. \$16,000; July.

Microprogramming hardware and software support complement the Model 2100-S minicomputer. The computer configuration includes a 16-k \times 16-bit memory, communications-control channel, hardware floating point and two direct-memory-access channels. Users can store 256, 24-bit, micro-instructions on each of three writable control-store cards. Micro-processor cycle time is 196 ns. Debugged microinstructions can be transferred to pROMS, by a card temporarily inserted into the computer's I/O slot. Microprogrammed chips are automatically verified and any missed bits are fused immediately.

CHECK NO. 255

Optical mark reader gives input flexibility

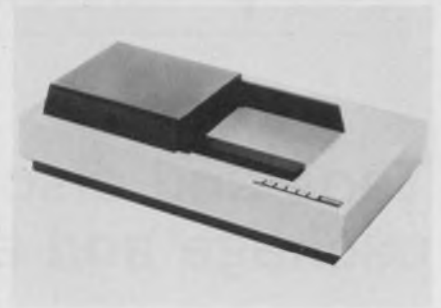

Decision, Inc., 5601 College Ave., Oakland, Calif. 94618. (415) 654-8626. From \$4900; see text.

Paper may be fed manually or, if desired, automatically with the OMR-6500 optical mark reader. Optical scanning devices read the fixed page. According to the manufacturer, even folded, mutilated and spindled paper can be read. The OMR 6500 reads data off-line or can be placed under program control. The unit operates as a remote terminal or attaches directly to a computer through standard EIA or teletypewriter ports. It reads 9 by 11 in. documents at rates up to 400/hr. and 3 by 5-in. cards at speeds to 900/hr. The OMR 6500 accepts data in such forms as pencil and ink marks, punched holes, block numerics and pre-printed data. The manual feed version costs \$4900 (delivery; 60-90 days) and the "auto-feed" version costs \$7000 (delivery: 90-120 days).

CHECK NO. 256

Baseplate attachment mates typewriter to mini

Terminal Equipment Corp., 26 Just Rd., Fairfield, N.J. 07006. (201) 227-4141.

Users of PDP-8E and M mini-computers can have quality typewriter hardcopy for use with the DEC text editor and other business-oriented programs. The computer interface, Model CSR-8E, uses an IBM Selectric typewriter supplied by the customer, the Holmes Tycom baseplate, a power supply, and an omnibus interface. The factory-installed baseplate operates at 15 char/s using standard DEC TTY software. All 128 ASCII characters can be generated from the typewriter keyboard.

CHECK NO. 257

Cassette recorder gives flexible operation

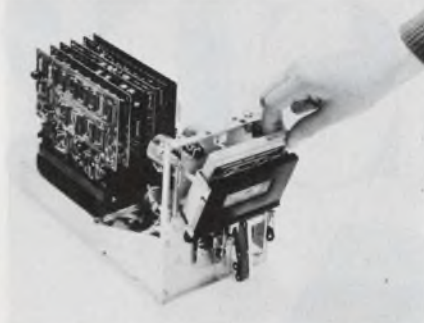

Bell & Howell, 360 Sierra Madre Villa, Pasadena, Calif. 91109. (213) 796-9381. \$360 (51-100); stock.

Available in single or dual-track models, the Autoload digital cassette recorder provides 2 to 20 in/s selectable operating speed (forward or reverse) and search speeds of 50 in/s. The unit operates in either incremental or continuous mode and can be used in synchronous or asynchronous environments as a replacement for paper-tape units or reel-to-reel magnetic-tape equipment. The packing density is 800 bit/in. Recordings can be made in biphase or NRZ formats with simultaneous read or write operations occurring on each of two data channels.

CHECK NO. 258

TTY-compatible terminal displays white-on-black

Applied Digital Data Systems Inc., 100 Marcus Blvd., Hauppauge, N.Y. 11787. (516) 231-5400. \$1795; 60 days.

Called the Consul 580, this TTY-compatible CRT displays 24 lines of data with 80 characters per line. It displays black characters on a white background—which is said to reduce eye fatigue. An EIA RS232C interface, with switch selectable transmission speeds of 110, 300, 1200, 2400 and 9600 baud, is standard on the 580. An optional 20-mA current-loop interface is also offered. Operators of the terminal can manually inhibit or enable upward scrolling of data across the screen. They can also control the flow of data to the printer interface which drives any serial ASCII printer having an EIA interface. Cursor controls and various erase functions are available.

CHECK NO. 259

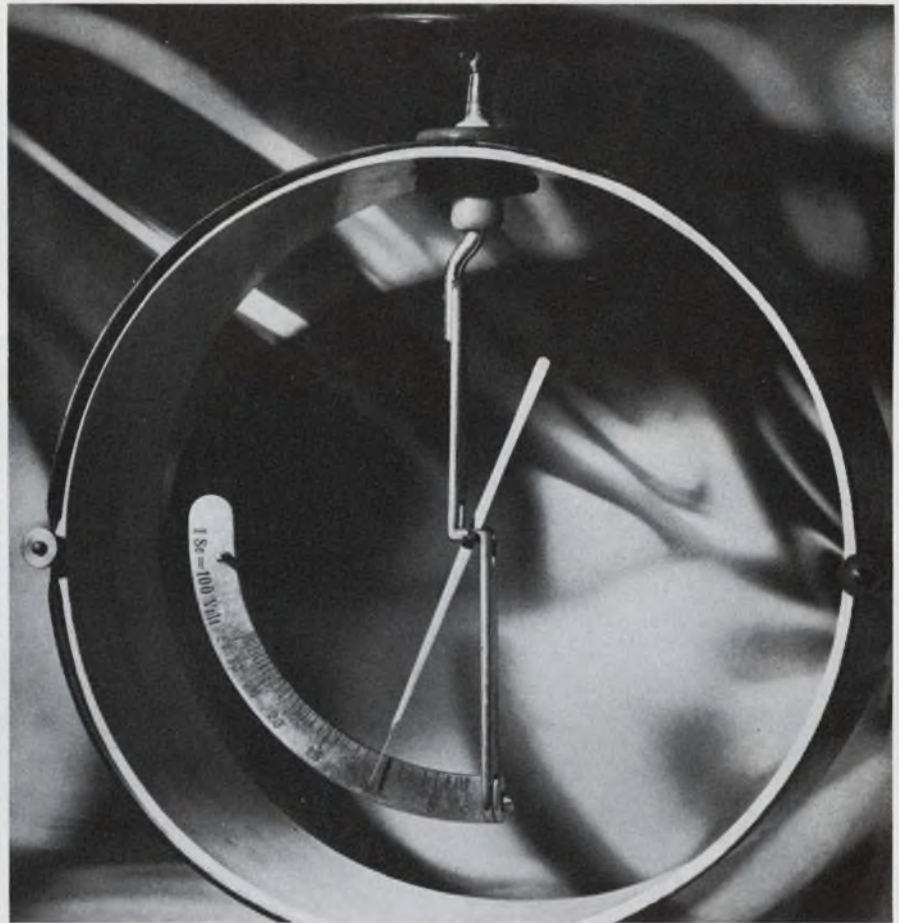

How would you get a measureable signal from only 6,000 electrons per second?

Most people do it Victoreen's way

With just 6,000 electrons, our 10^{12} RX-1 will give you a good clean one millivolt signal . . .

We've been making hi-meg resistors for over 30 years, making it possible for engineers like you to make big things out of little things. And with Victoreen RX-1 resistors, hi resistance is just one of the nice things you get . . . how about accuracy to $\pm 1\%$, good stability, and ranges from 10^7 to 10^{14} ohms . . .

Victoreen . . . where else can you get so many accurate ohms for your money?

DMA 722

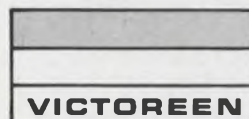

VICTOREEN
INSTRUMENT DIVISION
10101 Woodland Avenue
Cleveland, Ohio 44104

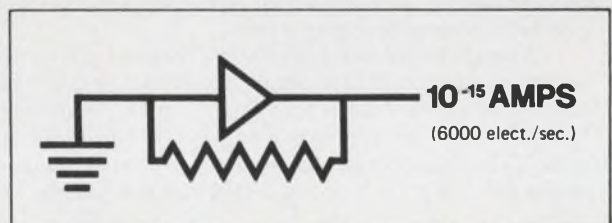

INFORMATION RETRIEVAL NUMBER 45

SURPRISE!

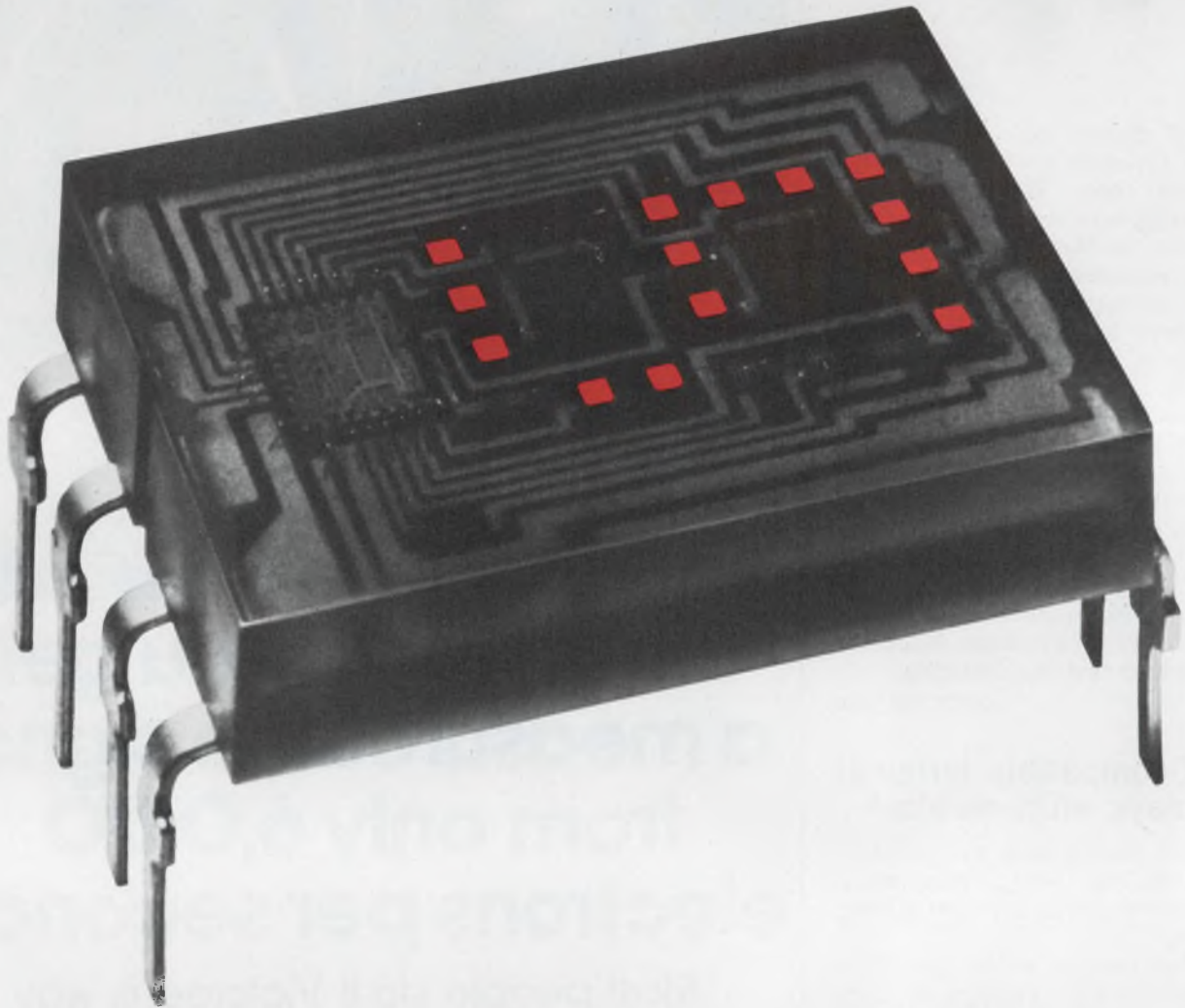

We built in the decoder/driver so you don't have to.

Not only the decoder/driver, but the memory too! It's all in the HP 5082-7300 series solid state display. Available *now*. In quantities to meet your production needs.

It's completely TTL compatible. All you do is address it directly with four-line BCD input. The on-board IC allows for either the storage of input data or real-time display. You save design time, space and money, and get a completely reliable integrated display system.

A bright 0.290 inch high, shaped character gives excellent readability over a wide viewing angle in a compact 0.600 inch by 0.400 inch package.

And best of all, the price is only \$8.25* in 1K quantities. If you need a larger character write for information on our 1.5" 5082-7500 solid state display. It's also TTL compatible and has the decoder/driver built in. For immediate delivery on the HP 5082-7300 or 5082-7500 call your nearby HP distributor today.

01329

* Domestic USA price only

HEWLETT  PACKARD

Sales, service and support in 172 centers in 65 countries.
Palo Alto, California 94304. Offices in principal cities throughout the U.S.

INFORMATION RETRIEVAL NUMBER 46

SURPRISE! SURPRISE!

The solid state display with
the built in decoder/driver
is at your nearest
HP distributor now.

Distributor Stocking Locations:

SCHWEBER ELECTRONICS

Hollywood, Florida
(305) 927-0511
Elk Grove Village, Illinois
(312) 593-2740
Troy, Michigan
(313) 583-9242
Rockville, Maryland
(301) 881-2970
Waltham, Massachusetts
(617) 890-8484
Rochester, New York
(716) 328-4180
Westbury, New York
(516) 334-7474
Somerset, New Jersey
(201) 469-6008
Beachwood, Ohio
(216) 464-2970

WYLE DISTRIBUTION GROUP

Liberty Electronics/Arizona
Phoenix, Arizona (602) 264-4438
Liberty Electronics
El Segundo, California (213) 322-8100
Elmar Electronics
Mt. View, California (415) 961-3611
Western Radio
San Diego, California (714) 235-6571
Elmar Electronics
Commerce City, Colorado (303) 287-9611
Liberty Electronics/Northwest
Seattle, Washington (206) 763-8200

HALL-MARK ELECTRONICS

Huntsville, Alabama
(205) 539-0691
Lenexa, Kansas
(913) 888-4747
St. Louis, Missouri
(314) 521-3800
Raleigh, North Carolina
(919) 832-4465
Oklahoma City, Oklahoma
Enterprise 50094
Tulsa, Oklahoma
(918) 835-8458
Austin, Texas
(512) 454-4839
Dallas, Texas
(214) 231-6111
Houston, Texas
(713) 781-6100

EUROPE

Celdis Ltd.
37-39 Loverock Road, READING, Berks, England
Tel.: READING 58 22 11
I.S.C. France
20, rue Gambetta, 92-Boulogne, France
Tel.: 604.52.75
Ingenieurbüro Dreyer
238 Schleswig, Flensburger Strasse 3, Germany
Tel.: (04621) 2 31 21
EBV Elektronik
8 Munich 2, Gabriel-Max-Strasse 90
Tel.: (0811) 644055-8
6 Frankfurt/Main 1, Myliusstrasse 54
Tel.: (0611) 720416-18

HEWLETT  **PACKARD**

Wrap-around cabinets meet tight production tolerances

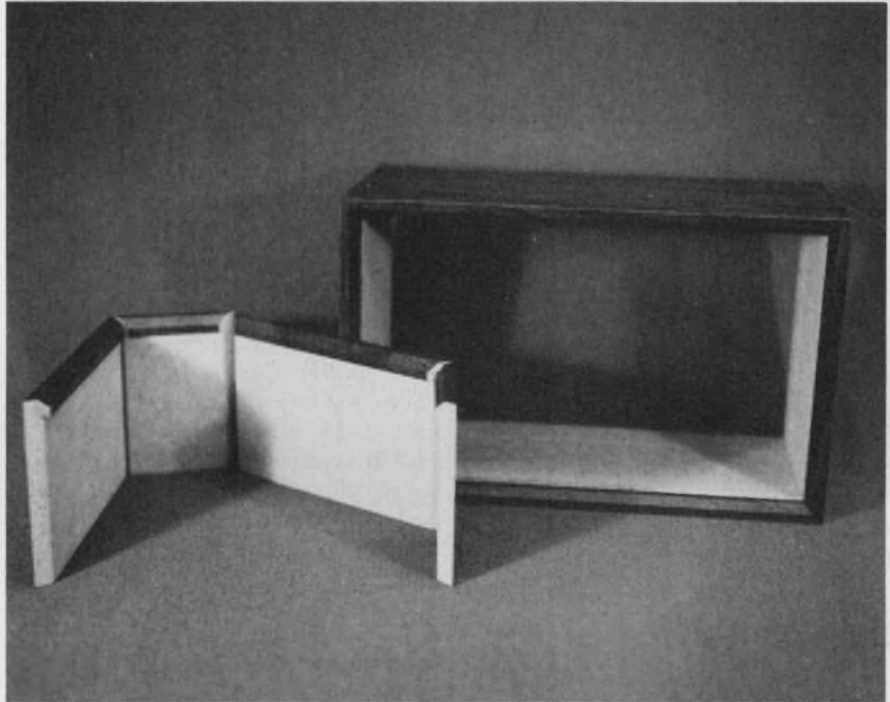

*Iota Corp., 46 Old Camplain Rd.,
Somerville, N.J. 08876. (201) 722-
4511. P&A: see text.*

Making one-piece, wrap-around wooden (particle board) enclosures for electronic equipment is not new. Most manufacturers, though, assemble several separately machined pieces and cannot guarantee consistently tight production-line industrial tolerances.

The Iota Corp. has developed a new process machine that controls mitre-grooving tolerances to within ± 0.001 in. Due to the controlled tolerances and one-piece construction of the new enclosures, a user can cut his assembly costs by as much as 60%.

Because of the close control, a thinner vinyl skin can be laminated to the particle board. Thus Iota uses 6-mil vinyl instead of the commonly used 8 or 10-mil material. The result is a large reduction in material cost.

There are no standard stock items, since each enclosure is custom-designed. Iota examines all of a customer's production factors—

his design engineering, production methods, even the way the finished product is shipped.

The particle-board thicknesses can run from 0.125 to 0.75 in., while lengths and widths of any standard boards up to about 5 by 10 feet can be accommodated. Prices depend heavily upon size, quantity and delivery schedule, but they range from as little as 75 cents each for a 5000-piece contract.

Iota can supply all phases of production, if desired. The company can ship knocked-down units ready for assembly, or assembled shells ready for equipment mounting, or it can handle full production—including assembly, wiring, testing and packaging for delivery.

Traditionally, when a cabinet is made from four or eight pieces, the user must contend with the tolerance errors of each piece. This usually involves a high labor cost. Also, it may not produce the almost airtight seal that results from the one-piece construction process.

CHECK NO. 260

LSI-chip has calendar and clock circuitry

Cal-Tex Semiconductor, 3090 Alfred St., Santa Clara, Calif. 95050. (408) 247-7660. \$8 (50 k).

The CT7001 is a MOS/LSI digital clock/calendar circuit in a 28-pin DIP. It has many features which can be selected by wiring to selected pins. The chip can use either a four or six-digit display of either common-anode luminescent display tubes or common-cathode LEDs. Outputs of the chip can be wire-ORed to other chips thus allowing the clock to share a display with another chip. The circuit operates from either a 50/60 Hz line or an external 100.8 kHz signal. If a battery backup is available, a 50/60 Hz on-chip backup oscillator provides timing to continue operation in the event of power failure. Also included on the chip are a "snooze" alarm and an auxiliary timer that can be used for a clock-radio.

CHECK NO. 261

Decoder supplies up to 300 mA @ 30 V/output



IEE Inc., 7720 Lemona Ave., Van Nuys, Calif. 91405. (213) 787-0311. \$17 (1000-up); 4 to 6 wk.

The 20673 is an "all in one" decoder in a 24-pin DIP-like package, with a drive capability of 300 mA at 30 V for each output. Operating on a 5-V logic supply, the chip decodes standard 8421 BCD data to 12 outputs, or, if only 10 decoded outputs are required, the two remaining may be connected as lamp buffers. The 20673 is DTL/TTL compatible, with or without memory and features lamp blanking as standard. The hybrid chip differs from previous IEE decoders in that a logic "ONE" on data inputs is represented by a low state rather than a high.

CHECK NO. 262

9 x 64-bit digital buffer largest yet

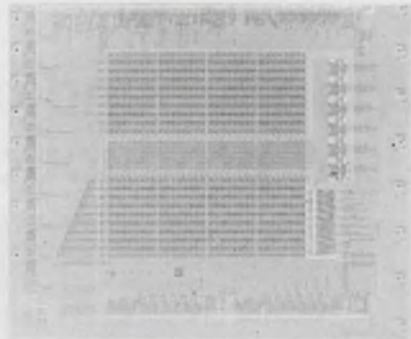

Texas Instruments, P.O. Box 5012, M/S 308, Dallas, Tex. 75222. (214) 238-3741. TMS4024NC: \$13.80 (100-999); stock.

The TMS4024 digital storage buffer, at 9 bits wide and 64 bits deep, is the largest first-in/first-out (FIFO) buffer currently available. The buffer can be used as a link between two digital systems operating at different data rates. A RAM-type organization permits zero ripple-through time. Data written at the input when the register is empty is immediately available at the output. The device processes data at any rate from dc to one-half the continuous clock frequency. Minimum guaranteed data rate is 250 kHz, with processing in a parallel format, word by word.

CHECK NO. 263

3-W zeners conserve board space

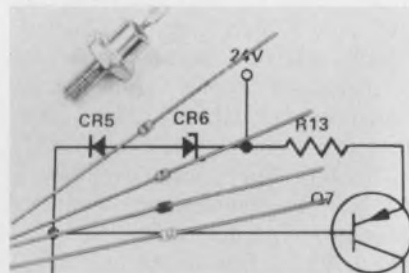

Microsemiconductor Corp., 2830 S. Fairview St., Santa Ana, Calif. 92704. (714) 979-8220. 70¢ to \$1.40 (100 up).

Measuring only 0.155 inch long by 0.085 inch in diameter, the IN5063 through IN5117 zener diodes can dissipate up to 3 W in 25 C free air with normal mounting. Reverse current limits can be specified as low as 25 nA at 70% of zener voltage. The line consists of 70 devices with breakdown voltages from 6.8 to 400 V.

CHECK NO. 264

8k-bit character generator at 1/4¢/bit

Motorola Semiconductor Products, P.O. Box 20924, Phoenix, Ariz. 85036. (602) 244-3466. P: See below; stock.

The MCM6570L, an 8192-bit programmable-ROM/character-generator, contains 128 characters in a 7 x 9 matrix and has capability for internally shifting characters that ordinarily extend below the normal base line (y, g and p, for example). A pre-programmed version of the MCM6570L, the MCM6571L, is available with a modified USASCII code. This device sells for \$18 (100 up) for a cost per bit of \$0.0022. Access time is typically 300 ns with power dissipation typically 600 mW. The static ROM uses n-channel MOS, metal-gate technology. Operation is possible from a single 5-V supply.

CHECK NO. 265

Op amps span 741, 108 performance gap



Teledyne Semiconductor, 1300 Terra Bella Ave., Mountain View, Calif. 94040. (415) 968-9241. LM 141: \$4.25; LM 142: \$3.95. (100-up); stock.

A general-purpose op amp series, the LM 141/142, fills the performance gap between the 741 and 108-type op amps. The series features a slew rate of 2 V/μs and provides a full output voltage swing through the audio frequency range. Input bias current is 30 mA maximum and input offset current is 5 mA maximum. The LM 141 series offers full internal compensation and is compatible with existing designs using the 741, 107 and 1556 op amps. The uncompensated LM 142 series can replace 101A, 748 and 777 op amps. The LM 141/142 operates over the -55 to 125 C temperature range.

CHECK NO. 266

Multiplier/divider needs no trimming

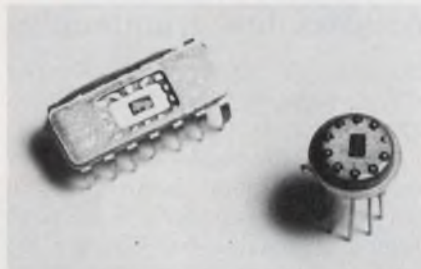

Analog Devices, Route 1 Industrial Park, P.O. Box 280, Norwood, Mass. 02062. (617) 329-4700. AD-532J: \$25 (1-24); stock to 3 wks.

A multiplier/divider provides a guaranteed maximum multiplying error of 1.0% and a ± 10 V output swing without the need for any external trimming resistors or an output op amp. Called the AD532, the device multiplies in four quadrants with a transfer function of $XY/10$, divides in two quadrants with a transfer function of $\pm \sqrt{10Z}$. The AD532J and AD532K feature maximum full scale multiplying errors of two percent and one percent, respectively, at +25 C, and are rated for operation from 0 to +70 C.

CHECK NO. 267

Transient suppressor has 5 ns response time

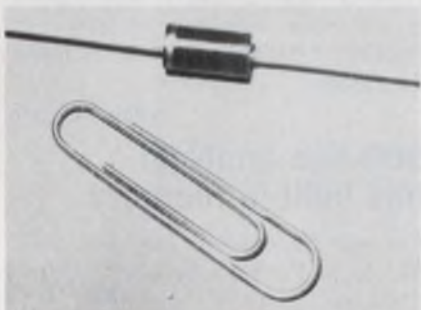

Transtector Systems, 532 Monterey Pass Rd., Monterey Park, Calif. 91754. (213) 283-9278. \$4.75 (100 up); stock to 4 wk.

Available in two models, the VZ series of transient suppressors is rated for a peak power of 1200 W for 1 ms at 25 C, and responds to rising transients in less than 5 ns. The clamp point of the VZ6 is 6.5 V dc, and for the VZ16 it is 16.5 V dc, $\pm 5\%$ tolerance. Peak pulse current for 1 ms is 20 A. The operating temperature range is -55 to $+100$ C.

CHECK NO. 268

Another Sprague Breakthrough!

PRODUCTION-ORIENTED SOLID TANTALUM CAPACITORS

Solid flame-retardant epoxy with precise dimensions for automatic insertion. Completely shock and vibration resistant.

Flat surface permits clear easy-to-read marking.

No rundown to interfere with seating of capacitors on printed wiring board.

Rugged 0.025" dia. tinned leads maintain alignment. 0.100" lead spacing for standard PWB grids.

Top flat for easy identification of positive lead either visually or by touch.

Standoff feet on base to eliminate moisture entrapment and facilitate cleaning of wiring boards.

Formed leads with either 0.200" or 0.250" spacing to permit interchangeability with dipped capacitors.

ACTUAL SIZE

Type 198D Low-cost Econoline* Tantalum Capacitors Lead in Performance!

When it comes to low-cost solid tantalum capacitors, the new Sprague Type 198D Econoline Capacitors outperform all other designs. Here are some additional advantages:

- Low d-c leakage
- Low dissipation factor
- Wide voltage range, 4 to 50 VDC
- Capacitance range from 0.1 to 100 μ F
- Withstand severe temperature cycling and temperature shock over -55 C to $+85$ C
- Speedier handling for insertion
- Easier-to-read markings

The new Sprague Type 198D epoxy-encased Econoline Capacitor is tooled for mass production and priced competitively with imported dipped units. Investigate this new Sprague breakthrough without delay.

Call your nearest Sprague district office or sales representative, or write for Engineering Bulletin 3546 to: Technical Literature Service, Sprague Electric Co., 347 Marshall Street, North Adams, Mass. 01247.

*Trademark

THE BROAD-LINE PRODUCER OF ELECTRONIC PARTS



Silicon Avalanche Integrated Bridge Rectifiers



Where space and reliability are major design considerations.

Varo's IBR features: 200V, 400V and 600V PRV with 250V, 450V and 650V min. avalanche voltages at 10A and 25A (I_{O}). Fast recovery versions; (200ns, t_{rr}). 15A and 36A (I_{O}). 3 ϕ full-wave bridges also available.

The electrically isolated case (circuit-to-case, 2kV min.) and

less than 1°C/W thermal impedance ($Z_{\theta JC}$) allow operation at full rated load to 100°C (T_C). The controlled avalanche characteristics permit the use of lower PRV safety factors in design considerations.

Three mounting options; press-fit, stud and TO-3 outline flange are available.

\$2.50 ea., 10A, 200V, TO-3 outline (1000 qty.)

Also from Varo:

EBR, Epoxy Bridge Rectifiers: with 100, 200, 400 and 600V PRV; 1, 2 & 6 Amp (I_{O}). Controlled avalanche and fast recovery series.



Design us in; we'll stay there

VARO

VARO SEMICONDUCTOR, INC.

P.O. BOX 676, 1000 N. SHILOH, GARLAND, TEX. 75040, 214/272-4551, TWX 910-860-5178

ALLIED ELECTRONICS, Chicago, Ill. 312/421-2400. **THE ALTAIR CO.**, Houston, Tex. 713/781-5300; Richardson, Tex. 214/231-5166. **BELL INDUSTRIES**, Menlo Park, Cal. 415/323-9431; Skokie, Ill. 312/965-7500; Bellevue, Wash. 206/747-1515. **BLUFF CITY DIST. CO.**, Memphis, Tenn. 901/725-9500. **BRIDGEFIELD SUPPLY**, Chesterland, Ohio 216/729-9451. **CRAMER ELECTRONICS**, Nationwide; Newton, Mass. 617/969-7700; **ELECTRONIC PARTS CO.**, Denver, Colo. 303/266-3755. **MILGRAY ELECTRONICS**, Freeport, N. Y. 516/546-6000; Hyattsville, Md., 301/864-1111; Cherry Hill, N. J., 609/424-1300. **WESTATES ELECTRONICS**, Chatsworth, Calif. 213/341-4411.

In Canada:

ELECTRO SONIC, Toronto, Ont. 416/924-9301. **R.A.E. IND. ELECTRONICS**, Vancouver, B. C. 604/687-2621. **PRELCO ELECTRONICS, LTD.**, Montreal, Quebec 514/389-8051. **WESTERN RADIO SUPPLY**, Hamilton, Ont. 416/528-0151.

INFORMATION RETRIEVAL NUMBER 48

Noise sensitivity problems go away

Topaz Ultra-Isolation Transformers eliminate power-line noise problems associated with sensitive equipment

Box-welding techniques achieve maximum coupling between windings while offering a very low impedance for common-mode noise to ground. Primary to secondary effective interwinding capacitances of:

- 0.005 picofarads
- 0.001 picofarads
- 0.0005 picofarads

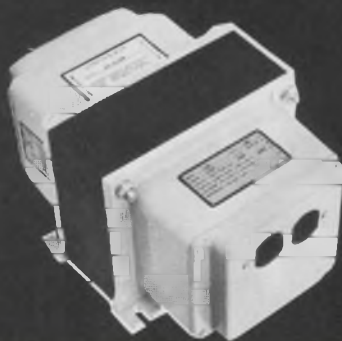

SPECIFICATIONS:

Common-Mode Noise Rejection: to more than 145 dB.

Transverse Noise Suppression: greater than 125 dB at 1 kHz.

Input/Output Voltages Available: 115, 230, 240 and 480 VAC at 50 or 60 Hz.

Models Available: 125 VA to 20 kVA 1 phase; 3 kVA to 60 kVA 3 phase.

Priced from \$75.00

TOPAZ
ELECTRONICS

SOLUTIONS TO
POWER PROBLEMS

3855 Ruffin Road, San Diego, CA 92123 Phone (714) 279-0831 TWX (910) 335-1526

INFORMATION RETRIEVAL NUMBER 49

INSTRUMENTATION

Frequency multiplier handles low frequencies

Valhalla Scientific, 7707 Convoy Ct., San Diego, Calif. 92111. (714) 277-2732. \$295; stock.

Model 2100 wideband low-frequency multiplier is immune to noise and zero-crossing distortion. Hence, it reduces measuring time by several orders of magnitude. For example, a 10-Hz signal is easily resolved to 0.1% in 1 s, essentially error free. Engineering units such as rpm, gallons/hour, etc., are conveniently generated with multiplication factors of 2, 4, 5, 6, 10, 12, 20, 30, 60, 100, 120, etc., are conveniently generated nique is a phase-lock loop/frequency comparator-multiplier combination.

CHECK NO. 269

5-digit DMM snaps on to counter, costs \$450

Hewlett-Packard, 1501 Page Mill Rd., Palo Alto, Calif. 94304. (415) 493-1501. \$450; stock.

Here's a snap-on module that converts HP's lowest-cost electronic counter, the 5300A, into a five-digit multimeter that measures volts (ac or dc), ohms and frequency. The 5306A measures frequency to 10 MHz and can show voltage from 1 mV to more than 99 V on one scale. Accuracy is 0.03% of reading $\pm 0.003\%$ of scale on lower dc ranges.

CHECK NO. 270

500-line analyzer has built-in memory

Federal Scientific, 615 W. 131st St., New York, N.Y. 10027. (212) 286-4400. UA500: \$10,800; UA-500-1: \$12,800; July.

Claimed to be the most powerful analyzer of its type, the UA-500 real-time spectrum analyzer-averager offers a standard, dual-memory averager. A digital cursor reads directly in hertz. The UA-500's 8-3/4-in. size allows use in the field. Additional features include: real-time speed to 10 kHz with a maximum range of 100 kHz and 20 sweeps/sec display rate; a 24 dB/octave filter slope, so that the 500-line analyzer has 650 lines, effectively.

CHECK NO. 271

COMPONENTS

Liquid-level switch resists corrosion



AgTronics Manufacturing Co., P. O. Box 1248, Barstow, Calif. 92311. (714) 256-4755. \$24.50 (unit qty).

The A-180 liquid-level switch combines the sensing probe and all circuitry in one hermetically sealed package. The unit is fabricated from corrosion-resistant 316 stainless steel, Teflon, and CPVC, which allows its use in most corrosive liquids. And although the A-180 is a conductance-actuated control, its extremely high sensitivity (10 MΩ/cm) permits the unit's application to liquids of low electrical conductivity. Probe current is limited to 5 μA for safe operation and long life.

CHECK NO. 274

Cermet trimmer meets MIL-R-22097 specs



Weston Components, Archbald Pa. 18403. (717) 876-1500. Stock to 6 wks.

Model 567-105HS, a single-turn, round, 1/4-in. cermet trimmer meets MIL-R-22097 for style RJ50 with both C and F characteristics. Resistance values range from 10 Ω through 100 kΩ.

CHECK NO. 275

Sensor detects excess equipment vibrations

Endevco Dynamic Instrument Div., 801 S. Arroyo Parkway, Pasadena, Calif. 91109. (213) 681-2401. \$95 (unit qty).

Based on the same principles as piezoelectric accelerometers, the Models 7281-25/100 vibration sensors are designed to detect changes in the vibration levels of equipment, and via a relay, provide a warning or initiate corrective action. The sensors weigh 2 oz, have a 1.25 in. diameter and are 1.7 in. high. They operate in temperatures of 0 to 150 F and can survive without damage in temperatures up to 210 F. The Model 7281-25 operates to 480 g peak and its sensitivity is 25 mV/g. The Model 7281-100 has a range to 120 g peak and a sensitivity rating of 100 mV/g. The typical frequency response for both models is 1 to 2000 Hz. Both units have an aluminum-alloy case.

CHECK NO. 276

Indicator latches magnetically



Minelco, 135 S. Main St., Thomaston, Conn. 06787. (203) 283-8261.

Model MI51LP, a manually-resettable, magnetic-latching indicator, requires only a 50 mW, 25 ms pulse to operate. The indicator displays a red or white color upon actuation. The unit magnetically latches until a knob is rotated 60-degrees clockwise to reset the display to an all black color. The device is available for 1.5, 3, 6, 12, 24 and 28 V dc operation in a temperature range from -65 to 125 C. It weighs 6.5 g, and it is enclosed in a black anodized-aluminum case with a sealed-glass window. Display colors can be in any combinations of black, white and red.

CHECK NO. 277

Mercury-wetted relay has 250 × 10⁶ life



Fifth Dimension Inc., Box 483, Princeton, N.J. 08450. (609) 924-5990. \$4 (OEM qty); stock to 8 wks.

The Series LC2R mercury-wetted relay is built around a hermetically sealed switching capsule that is rated for 250 million operations. Loads of 1 A at 24 V dc or 0.1 A at 200 V dc can be switched for the rated life. Dry-circuit loads can also be switched reliably. Contact resistance remains less than 0.05 Ω whether measured at power level or at 50 mV, and the resistance is stable, varying by less than 0.002 Ω over the life of the switch. Operate time is less than 2.5 ms, and there is no contact bounce. The LC2R is available in SPST form-A nonlatching model. Coil voltages of 5, 12 and 24 V dc are standard.

CHECK NO. 278

Tungsten-halogen lamps feature quartz bulbs

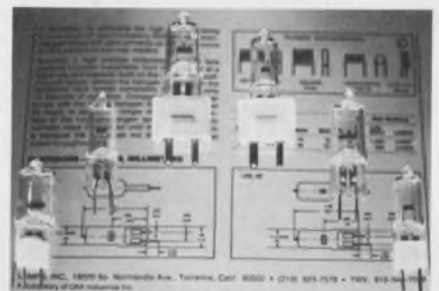

Lamps, Inc., 19220 S. Normandie Ave., Torrance, Calif. 90502. (213) 323-7578.

Six new tungsten-halogen lamps can operate at high ambient temperatures—650 C on the bulb. Thus they do not have to be cooled in many applications. Quartz bulbs reduce breakage, because of greater resistance to thermal shock, and they also improve ultra-violet and infrared transmission over that provided by glass. Ratings of 6 to 24 V, 10 to 200 W are offered, and life is 50 to 5000 hr. Color temperature ratings range from 2000 to 3400 K.

CHECK NO. 279

Flexible Circuitry?



THINK ABOUT IT.

- SPEEDS PRODUCTION, SAVES SPACE, WEIGHT
- IMPROVES ACCURACY, REPEATABILITY
- REDUCES ASSEMBLY COSTS

Flexible circuitry is often thought of as an exotic technology for critical electronic applications. It is. It's also an attractive alternative for many conventional wiring needs. An alternative that can simplify assembly, reduce costs, and greatly improve wiring accuracy and reliability.

BMC's experience with many demanding flexible circuitry applications gives us technical depth unique in the industry. This expertise is available to you whether your circuitry requirements are simple or stringent.

The BMC Flexible Circuitry Division provides engineering service from preliminary drawings through testing to finished products. We can help define your problem, then develop a solution. Give us a call on your inter-connection and harnessing needs. You may be surprised at the advantages of flexible circuitry.

**FLEXIBLE
CIRCUITRY
DIVISION**

BUCKBEE-MEARS COMPANY
bmc
245 EAST SIXTH STREET
ST. PAUL, MINNESOTA 55101 612/228-6253

INFORMATION RETRIEVAL NUMBER 51

ELECTRONIC DESIGN 14, July 5, 1973

Good Books-

They're Still a Sound Investment

MICROWAVE SEMICONDUCTOR DEVICES:

Fundamentals and Radiation Effects

By **R. J. Chaffin**, *Sandia Laboratories*

Written to provide electronic circuit designers and system planners with the understanding needed to design radiation-tolerant microwave semiconductor devices, this is the first book to present a comprehensive discussion of radiation effects in microwave semiconductor devices.

1973

In press

INTRODUCTION TO COMPUTER-AIDED MANUFACTURING IN ELECTRONICS

By **Douglas A. Cassell**, *Control Logic Incorporated*

"This is a skillful, highly practical book in a fast-growing field where there has been virtually no guidance of this caliber before. . . . The orientation is toward both the engineer and manager who might get involved in developing and installing a system involving both computer-aided design (CAD) and computer-aided manufacturing (CAM). Through examples and illustrations he shows how many of the central engineering or selection decisions can be handled. . . . We recommend it highly whether your shop is in the electronics or any other industry."

—*Computer Decisions*

1972

248 pages

\$13.95

INTEGRATED CIRCUITS IN DIGITAL ELECTRONICS

By **Arpad Barna**, *Hewlett-Packard Laboratories*, and
Dan I. Porat, *Stanford University*

This up-to-date text provides the digital electronic engineer with a link between the theoretical bases for the design of digital electronics and their practical implementation. The book's self-contained chapters cover topics ranging from number systems to sequential circuits to large scale integrated circuits.

1973

In press

MODERN FILTER THEORY AND DESIGN

Edited by **Gabor Temes**, *University of California, Los Angeles*, and **Sanjit K. Mitra**, *University of California, Davis*

Written for senior- and graduate-level students as well as industrial circuit design engineers, *Modern Filter Theory and Design* is the first book to present papers on both the theory and design techniques of electric filters. Discussions are included not only on conventional passive analog filters, but also on digital, switched, active, and microwave filters—filters which previously had never been discussed together in a single volume.

1973

In press

Prices subject to change without notice.

Available at your bookstore or from

Dept. 093-A-4021-W1

WILEY-INTERSCIENCE

a division of JOHN WILEY & SONS, Inc.
605 Third Avenue, New York, N.Y. 10016

In Canada: 22 Worcester Road, Rexdale, Ontario



INFORMATION RETRIEVAL NUMBER 52

MODULES & SUBASSEMBLIES

Four decades of BCD are converted by small DAC

Hybrid Systems, 87 Second Ave., Burlington, Mass. 01803. (617) 272-1522. \$69 (1-9); stock to 2 wk.

The DAC328-4-BCD is a complete 4-decade BCD current-output d/a converter in a $2 \times 2 \times 0.4$ in. module. It is TTL/DTL compatible, operates from ± 15 V power supplies and is complete with an internal reference. Other specifications include linearity of $\pm 0.01\%$, compliance of +1.25 V, settling time of 1 μ s, accuracy vs temperature of 30 ppm/ $^{\circ}$ C and an operating temperature range of 0 to 70 C.

CHECK NO. 300

Use one resistor to vary delay from 1 to 1000 s



Artisan Electronics, 5 Eastman Rd., Parsippany, N.J. 07054. (201) 887-7100.

A solid-state electronic timing device, called the universal time capsule, can delay any ac or dc load between 24 and 240 V. The unit can generate a delay from 1 to 1000 s with a current capacity of up to 1 A. It is UL recognized and can replace any ac or dc timing device within the ranges specified.

CHECK NO. 301

Pattern generator sends Bell T-1 test pattern

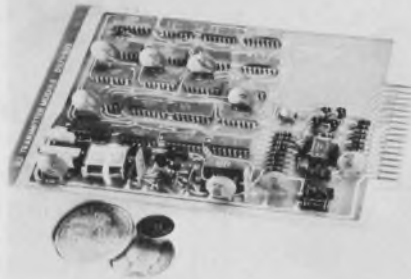

Bowmar/AIL, 531 Main St., Acton, Mass. 01729. (617) 263-7756.

A quasi-random T-1 pattern generator on a 5×7 in. circuit card uses all solid state devices to generate signals compatible with Bell Systems 1,048,575-bit test pattern. The generator has four T-1 bipolar outputs with undershoot and uses a standard 18-pin edge-connector as its input/output access.

CHECK NO. 302

Decode multifrequency pairs into an 8-bit code

Comex Systems, 720 Union St., Manchester, N.H. 03104. (603) 669-3600.

The model TD500 tone decoder can decode 16 frequency pairs as used in pushbutton telephone systems. The use of a programmable read-only memory provides any desired eight-bit output code, including BCD, ASCII, two of eight, and Baudot. The unit is available as a plug-in card for integration into OEM and special systems or with a card-cage/power module. The model TD500 with rotary-dial option card, converts tone signals to dial pulsing for interfacing with standard telephone systems.

CHECK NO. 303

Amplifier can mix 18 or more audio channel

Solid State Electronics, 15321 Rayen St., Sepulveda, Calif. 91343. (213) 894-2271. \$98 (100 up); 2 wk.

The MA-531 mixer/amplifier can mix from two to 18 (or more) separate subcarrier signal frequencies (frequency multiplexing) onto a single channel. It has a bandwidth of 30 Hz to 800 kHz. It can also be used as a linear wideband general purpose ac amplifier for low-level signals or as an ac summing amplifier from 100 Hz to 1 MHz. The MA-531 uses a single 28-V supply and has variable gain from 2 to 100.

CHECK NO. 304

XY switching matrix uses latching reed relays

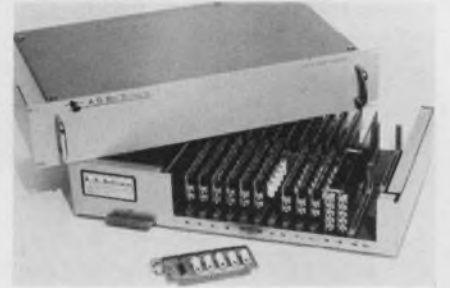

Analog Digital Data Systems, 830 Linden Ave., Rochester, N.Y. 14625. (716) 381-2370. From \$895.

A 19-in. rack-mounting coaxial reed-relay switching matrix, model 56-005, has a 50- Ω characteristic impedance to 15 MHz. Its insertion loss is less than 0.5 dB. Crosstalk isolation is better than 60 dB. It is controlled with either DTL or TTL logic levels. Access time for latching and unlatching is less than 5 μ s per crosspoint.

CHECK NO. 305

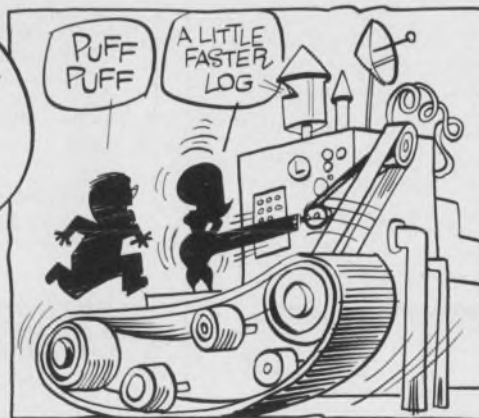

ANALOGY
 WHEN YOU WANT DIRECT CONVERSION FROM DC LEVEL TO A SERIES OF TTL COMPATIBLE PULSES ACCURATELY AND CONVENIENTLY, USE AN A-847. OUTPUT IS 0 TO 10 KHz INPUT IS 0 TO 10V. 0.008% LINEARITY AND 10% OVER-RANGE. ADJUSTABLE FROM 9.900 TO 10.000V AT 10 KHz OUT. CONVERT NOW, WRITE ANA-

intech INCORPORATED
 (408) 244-0500
 1220 COLEMAN, SANTA CLARA CA 95050

design aids

Conversion chart

An easy-to-read chart for retaining-ring users converts fractions and decimals to millimeters. The 8-1/2 x 11-in. laminated chart lists conversions for sizes ranging from 0.01 millimeters to 20 inches. Anderton Darby Inc.

CHECK NO. 306

Pressure-sensitive tapes

Structure, backing, tensile strength, adhesion properties, elongation, color, printability of pressure-sensitive tapes are shown in a swatch and data chart. Armak Co.

CHECK NO. 307

Metric drafting aids

A line of metric templates includes circles, squares, diamonds, ellipses, triangles, hex bolts and nuts, screw threads, parallel spacers, radius guides. RapiDesign.

CHECK NO. 308

Ceramic materials chart

A properties chart outlines typical physical, electrical, mechanical and thermal characteristics of the company's technical ceramic materials. Included are four grades of beryllia, thoria, three grades of alumina and three grades of Carberlox, a proprietary ceramic material containing beryllia and silicon carbide. National Beryllia Corp.

CHECK NO. 309

Guide to MOS ICs

A combination cross-reference guide and selector of MOS devices comes in a handy slide rule. One side contains a MOS device selector that provides the user with key specifications on any standard Signetics MOS circuit. Categories include shift registers, RAMs, ROMs, character generators and special circuits, such as a universal asynchronous receiver transmitter and a FIFO buffer register. On the reverse side is a directory to identify alternate sources for MOS devices. Signetics, 811 E. Arques Ave., Sunnyvale, Calif. 94086.

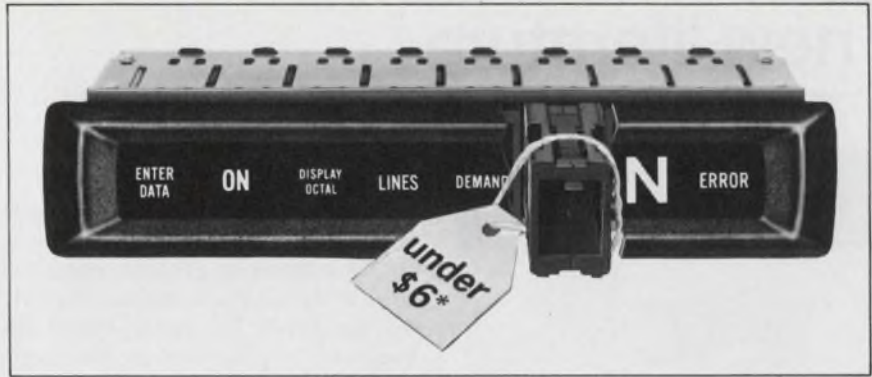

NOW!

A REAR-PROJECTION DISPLAY FOR UNDER \$6

IEE introduces the Series 1100 Readout, the first Rear-Projection display under \$6. Series 1100 costs far less than equivalent Rear-Projection models, yet packs all the similar features. We're talking of a .6" character displaying bright, crisp messages, numerals, symbols or colors, easily read from 20 feet. The total plug-in package (12 positions per readout) offers quick front panel removal for lamp and film servicing. Series 1100 accepts 5, 14 or 28 volt lamps compatible with DTL/TTL input

with a light output of 100 ft-L. Equally inexpensive is the mating Driver Decoder, the long life Series 7800.

The Series 1100, low cost . . . high reliability . . . from the world leader in Rear-Projection displays. Give us a call. Industrial Electronic Engineers, Inc., 7740 Lebona Ave., Van Nuys, Ca. 91405, Telephone: (213) 787-0311. TWX 910-495-1707. Our European Office: 6707 Schifferstadt, Eichendorff-Allee 19, Germany, Phone: 06235-662.

*In quantities of 1000



INFORMATION RETRIEVAL NUMBER 54

WHAT PRICE STABILITY?

Tracor Model 308-A Rubidium Frequency Standard. \$5,900.

Atomic accuracy at near crystal prices. Utilizes stable quartz crystal oscillator whose frequency is controlled by atomic resonance of rubidium 87. Low cost, high reliability, modular construction.



Tracor Model 304-D Rubidium Frequency Standard. \$7,300.

For general lab and field use. Almost entirely unaffected by environmental factors. Provides stable, accurate source of standard frequencies. Integral time scale selector. Modular construction.



Tracor has more manufacturing and engineering experience in Rubidium standards than anyone else. Write or call for full technical and application information.

Tracor, Inc.

Industrial Instruments
6500 Tracor Lane • Austin, Texas 78721 • AC 512/926-2800

INFORMATION RETRIEVAL NUMBER 55

new literature



Push-button switches

Bulletin 2803 provides description, applications and specifications for standard pushbutton switches. Airpax Electronics, Fort Lauderdale, Fla.

CHECK NO. 320

Silicone molding compounds

"Silicone Semiconductor Molding Compounds and Selection Guide," an eight-page bulletin, describes a line of silicone molding compounds that can be transfer or injection-molded. Dow Corning, Midland, Mich.

CHECK NO. 321

Capacitors

A 60-page catalog covers glass, ceramic and solid-tantalum capacitors, metal-film resistors and Cor-dip discrete-component networks. Physical specifications for all products are presented in English and metric units. Performance specifications and curves are presented. Corning Glass Works, Corning, N.Y.

CHECK NO. 322

Programmable controllers

Mark I Un-Computer Programmable Controller Systems are described in a two-color, 20-page bulletin. The bulletin is illustrated with block diagrams and half-tones. It includes specifications for the basic controller. FX Systems, Saugerties, N.Y.

CHECK NO. 323

Display technique

Basic information on a new technique called Direct Digital Graphics, developed to present organized digital data in a combined digital/analog form for rapid visual inspection, is described in an eight-page catalog. Digicom, North Chelmsford, Mass.

CHECK NO. 324

Maxi-memories

A 24-page, spiral-bound manual includes schematics and specifications of the Data Miser moving-head disc drives and the Data Miser controller. International Memory Systems, Scottsdale, Ariz.

CHECK NO. 325

Circuit breakers

Technical specifications and Mil-spec compliance details of the series HE ruggedized, subminiature hydraulic-magnet circuit breakers are detailed in a 12-page bulletin. In addition to showing time-delay curves, applications information and dimensional data, the bulletin gives a tabulation of specifications as they relate to specific MIL-C-39019 requirements. Heinemann Electric Co., Trenton, N.J.

CHECK NO. 326

Instrumentation modules

Specifications, illustrations and prices for instrumentation modules are provided in an eight-page catalog. Two housings with power supplies and 19 plug-in units are described. Over 60 measuring and control applications are listed. McKee-Pedersen Instruments, Danville, Calif.

CHECK NO. 327

Circular connector

An all-plastic circular connector that combines the features of metal cylindricals with the cost and weight advantages of plastic-bodied commercial connectors is featured in a 16-page data sheet. A full complement of application tooling, from hand-crimping tools to semiautomatic presses and automatic lead-making machines, is described. AMP, Harrisburg, Pa.

CHECK NO. 328

Wire and cable

A 112-page wire and cable catalog includes the following five sections: technical information, glossary of terminology, coaxial cable, comparison chart and general wire tables, charts and conversion factors. Standard Wire and Cable Co., Los Angeles, Calif.

CHECK NO. 329

Pinhole apertures

A four-page brochure describes standard pinhole apertures, optical slits and X-Y positioning equipment. PBL/International/Inc., Newburyport, Mass.

CHECK NO. 330

Linear Xenon flashtubes

Electrical and mechanical ratings for linear Xenon flashtubes together with spectral output data, explosion-energy and life expectancy curves, typical operating circuits and simple formulas for calculating impedance and circuit constants are given in an eight-page catalog. EG&G, Salem, Mass.

CHECK NO. 331

High-intensity LED lamps

A data sheet describes narrow-beam, high-intensity LED lamps for photoelectric applications. Genisco Technology Corp., Eldema Div., Compton, Calif.

CHECK NO. 332

Wire and cable sealants

A 15-page brochure describes DPR-based wire and cable sealants used in both strand and valley sealing. Hardman, Belleville, N.J.

CHECK NO. 333

Dc magnetic hysteresigraphs

"Direct-Current Magnetic Hysteresigraphs—STP 526" presents state-of-the-art dc recording hysteresigraphs. Contents of the 62-page book are recording fluxmeter of high-accuracy and sensitivity with galvanometer-photoelectric integrators, all-electronic magnetic hysteresigraph, electronic hysteresigraphs, some measurements of inhomogeneous permanent magnets by the pole-coil method and an integrating type of electronic hysteresigraphy. The book costs \$6. American Society for Testing and Materials, 1916 Race St., Philadelphia, Pa.

Data terminals

Data-communications terminals that provide a solution to the high operating costs of today's corporate communications networks are described in a 24-page brochure. Text and simple diagrams explain that the company's buffers incorporated into the terminals are the key to this breakthrough. The brochure describes features and provides a description of system maintenance capability. Wiltek, Inc., Norwalk, Conn.

CHECK NO. 334

Cylindrical connectors

Cylindrical high-density connectors are featured in a 32-page catalog. The publication contains descriptions of the 100% no-scoop connector design, along with information on shell styles, dimensions, contacts, insert arrangements, performance characteristics, accessories and adaptors. Assembly and disassembly instruction procedures are included. Cinch Connectors div. of TRW, Elk Grove Village, Ill.

CHECK NO. 335

Instrument rental

A 68-page catalog contains specifications and rental prices of all electronic equipment offered by the company. Amplifiers, power supplies, generators, attenuators, meters and oscilloscopes are among the equipment listed. Rental Electronics, Inc., Lexington, Mass.

CHECK NO. 336

Shaft encoders

Electrical and mechanical specifications for the English/metric incremental shaft encoder are detailed in a four-page bulletin. Trump-Ross, North Billerica, Mass.

CHECK NO. 337

Measurement equipment

Automatic electro-optical inspection and control systems that provide practical solutions to such problems as edge sensing, dimensional inspection, parts positioning, tracking and defect detection are described in a four-page brochure. New Jersey Div. of Conrac, Caldwell, N.J.

CHECK NO. 338

Modem

A six-page brochure describes the model 2011, a Bell 201A compatible modem capable of synchronous operation at 2000 bits per second over dial-up telephone lines. Included are descriptions of features, theory of operation and specifications. An outline drawing of the PC card is included, as well as a block diagram, a data-mode timing diagram, an illustration showing transmitted signal-frequency spectrum, and a block diagram of both calling and answering station call-procedure sequences. Intertel, Inc., Burlington, Mass.

CHECK NO. 339

Signal sources

Seventeen versatile signal sources for applications from dc to 2 GHz are described in a 20-page booklet. Featured are nine models of synthesizers including a high-performance 500-MHz unit, six low-noise oscillators and two standard-signal generators. General Radio, Concord, Mass.

CHECK NO. 340

Frequency Synthesizer

The NEW
B-FS 100

300 Hz to
100 MHz

FOR:

- Narrow band communication systems
- Telemetry instrumentation
- Doppler radar
- Automatic testing of frequency-sensitive devices
- NMR spectroscopy • EPR spectroscopy

Features extreme frequency stability, broad frequency range and high spectral purity.



Bruker Scientific, Inc.
1 Westchester Plaza
Elmsford, N. Y. 10523
(914) 592-5470



OUT OF THE ORDINARY PERIPHERALS...

call for MCD Custom Power Supplies for precise, dependable performance.

YOU CAN TAKE ADVANTAGE of Magnetic Components Divisions' 15 years of **Control Data®** "inside" computer experience. The talent that supplied CDC with unique power-supply packages—with MTBF's to 100,000 hours, sophisticated regulation techniques (ferroresonant, linear, hi-frequency switching, and phase controlled, for example), pure EDP design applications—**can engineer a custom power source for your own creative design!**

IT'S EASY TO DO—send today for the facts. See how you can build-in low cost-performance to the user over the life of your product!

MAGNETIC COMPONENTS DIVISION **CONTROL DATA CORPORATION**

7801 Computer Ave. So., Minneapolis, Minn. 55435
(612) 920-8600 TWX 910-576-2978



FREE TUTORIAL ON REAL-TIME ANALYZERS

11
QUESTIONS
YOU SHOULD
ASK WHEN
BUYING A
REAL-TIME
SPECTRUM ANALYZER

federal scientific

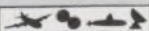

For application in the fields of
VIBRATION—diagnose complex machinery.
NOISE—identify sources.
UNDERWATER—detect faint signals.

Federal's latest Tutorial Brochure answers such meaningful questions as:
Why do I need real time?
How much resolution do I really need?
Can I calibrate frequency and amplitude quickly and accurately?
Do I need spectrum averaging?
How can I compare past data with new data?
How do I know I am analyzing (or averaging) valid data?
Can I interface to my computer?

FEDERAL SCIENTIFIC CORP.

CIRCLE NO. 171

An affil. of Nicolet Instrument
615 West 131st St., New York, N.Y. 10027 (212) 286-4400

400 IDEAS FOR DESIGN Volume 2

Edited by Frank Egan



A unique sourcebook of practical design techniques and approaches using the latest components, representing the best contributions to *Electronic Design's* "Ideas for Design" column. All selected for their practical value in solving the design engineer's most common, everyday problems. They have proved useful as parts of larger designs or as aids in measuring the parameters and testing the effectiveness of existing designs. 288 pp., 7 1/8 x 9 3/4, illus., cloth, \$11.95. Circle the reader-service number to order a 15-day examination copy.

CIRCLE NO. 172



HAYDEN BOOK COMPANY, INC., 50 Essex St., Rochelle Park, N.J. 07662

PRACTICAL RELAY CIRCUITS

By Frank J. Oliver



Uniquely groups various relay circuits according to the functions they perform, enabling the systems designer to quickly select the best circuit for his specific purposes. Includes arc and RFI suppression systems; time delay function; audio tone control and resonant-reed relays; sequential relays; protective functions of relays against overload overvoltage, and overcurrent, pulse generation and detection; logic circuits; and more. Particularly important is coverage of pulse-operated relay systems now extensively used with automated control systems. Illustrated with many circuit diagrams using the latest American National Standard graphical symbols. 363 pp., 6 x 9 1/4, illus., cloth, \$14.95. Circle the reader-service number to order a 15-day examination copy.

CIRCLE NO. 173



HAYDEN BOOK COMPANY, INC., 50 Essex St., Rochelle Park, N.J. 07662

ELECTRONIC DESIGN's function is:

- To aid progress in the electronics manufacturing industry by promoting good design.
- To give the electronic design engineer concepts and ideas that make his job easier and more productive.
- To provide a central source of timely electronics information.
- To promote communication among members of the electronics engineering community.

Want a subscription? ELECTRONIC DESIGN is sent free to qualified engineers and engineering managers doing design work, supervising design or setting standards in the United States and Western Europe. For a free subscription, use the application form bound in the magazine. If none is included, write to us direct for an application form.

If you do not qualify, you may take out a paid subscription for \$30 a year in the U.S.A., \$40 a year elsewhere. Single copies are \$1.50 each.

If you change your address, send us an old mailing label and your new address; there is generally a postcard for this bound in the magazine. You will have to requalify to continue receiving ELECTRONIC DESIGN free.

The accuracy policy of ELECTRONIC DESIGN is:

- To make diligent efforts to ensure the accuracy of editorial matter.
- To publish prompt corrections whenever inaccuracies are brought to our attention. Corrections appear in "Across the Desk."
- To encourage our readers as responsible members of our business community to report to us misleading or fraudulent advertising.
- To refuse any advertisement deemed to be misleading or fraudulent.

Microfilm copies are available of complete volumes of ELECTRONIC DESIGN at \$19.00 per volume, beginning with Volume 9, 1961. Work is now in process to complete the microfilm edition of Volumes 1-8. Reprints of individual articles may be obtained for \$2.00 each, prepaid (\$.50 for each additional copy of the same article) no matter how long the article. For further details and to place orders, contact the Customer Services Department, University Microfilms, 300 North Zeeb Road, Ann Arbor, Michigan 48106 telephone (313) 761-4700.

Want to contact us? If you have any comments or wish to submit a manuscript or article outline, address your correspondence to:

Editor
ELECTRONIC DESIGN
50 Essex Street
Rochelle Park, N.J. 07662

Electronic Design

Advertising Sales Staff

Tom W. Carr
Vice President &
Sales Manager

Rochelle Park, N.J. 07662

Robert W. Gascoigne
Daniel J. Rowland
50 Essex Street
(201) 843-0550
TWX: 710-990-5071

Philadelphia

Thomas P. Barth
50 Essex Street
Rochelle Park, N. J. 07662
(201) 843-0550

Boston 02116

50 Essex Street
Rochelle Park, N. J. 07662
(201) 843-0550
(617) 482-7989

Chicago 60611

Thomas P. Kavooras
Berry Conner, Jr.
200 East Ontario
(312) 337-0588

Cleveland

Thomas P. Kavooras
(Chicago)
(312) 337-0588
(call collect)

Los Angeles 90303

Stanley I. Ehrenclou
Burt Underwood
2930 Imperial Highway
Inglewood, Calif
(213) 757-0183

San Francisco 94022

Jerry D. Latta
P.O. Box 1248
Los Altos, Calif.
(415) 965-2636

London W. 1

For United Kingdom and Holland
Brayton C. Nichols
For Eastern Europe
Peter Kehr
The American Magazine Group
9 Warwick Street
London, W. 1, England
Phone: 437 5462
Cable: Ammagnic, London

Tokyo

Haruki Hirayama
Electronic Media Service
5th Floor, Lila Bldg.,
4-9-8 Roppong,
Minato-ku
Phone: 402-4556
Cable: Electronicmedia, Tokyo



It's logical

Panasonic's new R-relay makes a lot of sense. It's the smallest reed-type relay you can buy with a latching function (memory). And it's available in a form C (SPDT) contact closure.

When we set out to build our logical relay, we decided not to refine old ideas. Instead we invented (and patented) a relay of revolutionary design and construction with features no other relay has. We used an easily manufactured plastic bobbin instead of the expensive glass capsule used in every other reed relay. We included a barium ferrite permanent magnet to provide latching (logic) function. And we molded it together in one piece of hermetically sealed heat-resistant epoxy resin that occupies less than one-sixth of a cubic inch. Our relay

has a mechanical life of over a billion operations performed as rapidly as 500 Hz. It operates with an extraordinarily wide range of currents — from a few microamps up to a full amp. It's even available in a two-coil bi-stable configuration.

Do you need to mount a relay on a circuit board with a high parts density? Do you need a relay that needs no maintenance over an extra long life? One with higher sensitivity in low power semiconductor circuits? Or one that can withstand currents up to a full amp? Perhaps you need a relay with negligible contact bounce, rapid response, and high operational frequency. If you do, send for more information about Panasonic's unique R-relay. It's the logical thing to do.

**Matsushita Electric Corp. of America
Industrial Division**
200 Park Avenue, N. Y., N. Y. 10017

Attn: Tom Gottlick
 Please send R-relay literature.
 Please have an engineer call.

Name _____ Title _____
Company _____
Address _____
City _____ State _____ Zip _____

Panasonic

our technology is all around you

INFORMATION RETRIEVAL NUMBER 59



Two week
delivery
from stock,
pre-assembled or
in kit form.

**Multiple function
+ contemporary
styling
+ affordable
prices.**

(1) Vertical Nestable; (2) Vertical Interlockable; (3) Horizontal Interlockable; (4) Rack Mountable; (5) Briefcase Portable; (6) Tilttable... in 14 standard sizes.

Call or write for free VIP Design Guide and Prices.

Zero Manufacturing Co.

Zero-West (213) 846-4191 • 1121 Chestnut St. • Burbank, Ca. 91503
Zero-East (413) 267-5561 • 288 Main St. • Monson, Mass. 01057
Zero-South (813) 531-8991 • Int'l Airport • St. Petersburg, Fla. 33732

INFORMATION RETRIEVAL NUMBER 60

advertiser's index

Advertiser	Page
Allen Bradley Co.	25
Arnold Magnetics Corp.	103
Belden Corporation	44, 45
Bourns, Inc., Trimpot Products Division	12, 13
Bruker Scientific, Inc.	97
Buckbee-Mears Company	93
Cambridge Thermionic Corporation	81
Centralab, The Electronics Division of Globe-Union, Inc.	34, 35
Chicago Miniature Lamp Works.	79
Computer Automation, Inc.	8, 9
Dialight Corporation	69
Digitran Company, The	55
Dow Corning Corporation	10, 11
Dzus Fastener Co., Inc.	82
Electronic Engineering Company of California	31
Electronic Memories & Magnetics ...	38
Exact Electronics, Inc.	100
Exar Integrated Systems	1
Federal Scientific Corporation	98
Figaro Engineering, Inc.	74
Fluke	2
General Instrument Corporation ...	33
Glenair, Inc.	103
Hayden Book Company, Inc.	14, 98, 103
Heath/Schlumberger Scientific Instruments	54
Hewlett-Packard	60, 61, 86, 87
Hoffman Engineering Company.	82
Hutson Industries	36
ILC Data Devices, Inc.	4
ITT Semiconductors	29
Indiana General, a division of Electronic Memories & Magnetic Corporation	5
Industrial Electronic Engineers, Inc.	95
Intech, Incorporated	94
Johanson Manufacturing Corp.	7, 103
Lambda Electronics Corp.	Cover II
Magnecraft Electric Company	104
Magnetic Components Division, Control Data Corporation	97
Marco-Oak, Subsidiary of Oak Industries, Inc.	81
Meguro Denpa Sokki, K.K.	82
Microswitch, A Division of Honeywell	77
Molex, Incorporated	Cover III
Panasonic Matsushita Electric	99
Power/Mate Corp.	6, 103
RCA Solid State Division.	Cover IV
Raytheon Semiconductor	15
SenSitrol, Inc.	81
Shakeproof, Division Illinois Tool Works, Inc.	17
Shredmaster Corporation, The.	100
Signetics Corporation	21
Siliconix, Incorporated	42
Sola Electric, Division of Sola Basic Industries	75
Sprague Electric Company	16, 89
TRW Semiconductors, An Elec- tronic Component Division of TRW, Inc.	18
Tektronics, Inc.	37, 41
Texas Instruments, Incorporated	27
Thermalloy Company	102
Topaz Electronics	90, 100
Tracor, Inc.	95
USCC/Centralab Electronics Division, Globe-Union, Inc.	23
United Detector Technology, Inc.	103
Varo Semiconductor, Inc.	90
Victoreen Instruments Division	85
Wiley-Interscience	93
Zero Manufacturing Co.	99



Uninterruptible Power Systems Totally Self-Contained

Compact package includes battery charger, batteries, inverter, automatic transfer switch and all required control circuitry. Back up time can be extended by external batteries. Many optional features are available.

VA	Part No.	Back-Up Time	List Price	Typical Delivery
500	3151-1	15 minutes	\$1825	2 weeks
1000	3152-1	20 minutes	2450	2 weeks
2000	2529-1	15 minutes	3950	4 weeks

Other models from 300 VA to 10,000 VA

TOPAZ

ELECTRONICS

SOLUTIONS TO
POWER PROBLEMS

3855 Ruffin Road, San Diego, CA 92123 Phone (714) 279-0831 TWX (910) 335-1526

- Internal sealed batteries
- Proven dependability
- 95 to 130 Vac input
- High efficiency

INFORMATION RETRIEVAL NUMBER 61

DO-IT-YOURSELF WAVEFORMS



Exact waveform synthesizer lets you build your own custom waveforms bit-by-bit

The Models 201 and 202 Waveform Synthesizers generate complex waveforms — either analog or digital — for many applications, including distortion compensation, cardiac simulation, acoustics, general research, waveform analysis, sturstep and code transmission, PCM-PWM telemetry, PAM and shock table drive.

Forty selectable bits, each independently controlled in amplitude, width and slope, are available. Instrument can be free-run, triggered or gated for one shot or burst operation, or stepped through the waveform one bit at a time.

Model 201 \$1995.00
Model 202 (incorporates cycle length counter with 0-to-40 selectable steps) \$2495.00

Box 160, Hillsboro, Ore.
97123 • (503) 648-6661

a subsidiary of Danalab, Inc.

EXACT electronics, inc.

an affiliate of DANA Laboratories, Inc.

INFORMATION RETRIEVAL NUMBER 62

100

How long must you keep records

Write for
**FREE
Record
Retention
Schedule**

*Suggested
minimum retention
periods and
when to destroy
important papers*



the
SHREDMASTER
CORPORATION

248 Buffalo Ave.
Freeport, L. I., N. Y. 11520

INFORMATION RETRIEVAL NUMBER 63

ELECTRONIC DESIGN 14, July 5, 1973

Does he...or doesn't he? Only BPA knows for sure.



Qualify, that is. Qualify as being in the kind of business, kind of job, that makes him important to the buyer of advertising. That's why more than 650 business newspaper publishers have their circulations audited by BPA.

BPA member publishers require qualification of all recipients — whether they pay for the magazine or get it free. They must qualify as to business or industry; they must qualify as to title or function. BPA audits the qualification records.

BPA member publishers re-qualify all recipients on a regular basis. BPA has

rules regarding the frequency and manner of such re-qualification, and renews the original audit accordingly.

Businessmen move about, as we well know. When you advertise in a publication that's BPA-audited, you can be sure that — except for the *most recent* moves — all the circulation you've been promised is *there*.

BPA

Business Publications Audit of Circulation
360 Park Avenue So., New York, N.Y. 10010

This symbol means:

edited for businessmen, *audited* for advertisers

LEAD SPREADERS

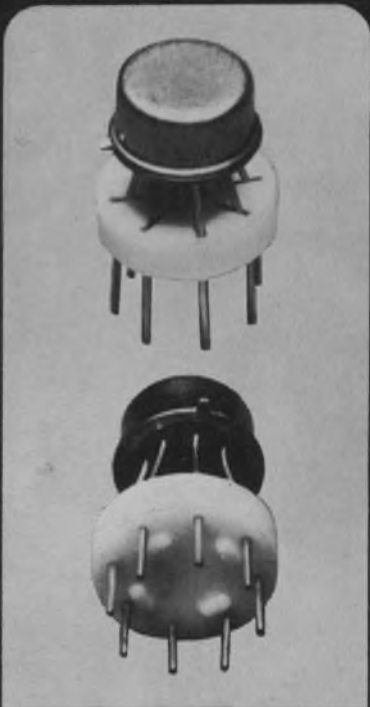

for INTEGRATED CIRCUITS

Thermalloy lead spreaders reduce your production cost and improve reliability. Wide lead-in grooves accurately align leads with circuit board holes for fast assembly. Spreading leads to a larger diameter prevents solder bridges and allows visual inspection of topside solder joints for improved reliability.

Thermalloy stocks 13 lead spreaders for 6, 8, 10 and 12 lead I.C.'s. The newly expanded line now includes 57 mounting pads and converters for TO-5, TO-18, I.C. and Epoxy cases.



FREE
Samples and
Catalog
on request

Thermalloy

P. O. Box 34829
2019 W. Valley View
Dallas, Texas 75234
Phone: 214/243-4321
TWX: 910/860-5542

INFORMATION RETRIEVAL NUMBER 64

product index

Information Retrieval Service. New Products, Evaluation Samples (ES), Design Aids (DA), Application Notes (AN), and New Literature (NL) in this issue are listed here with page and Information Retrieval numbers. Reader requests will be promptly processed by computer and mailed to the manufacturer within three days.

Category	Page	IRN	Category	Page	IRN
Components			clock, LSI chip	88	261
capacitors (NL)	96	322	controllers,		
connector, circular (NL)	96	328	programmable	96	323
indicator, mechanical	92	277	converter, d/a	94	300
LED lamps, high intensity (NL)	96	332	display driver	88	262
lamps, quartz bulb	92	279	frequency multiplier	90	269
relay, mercury-wetted	92	278	generator, random	94	302
sensor, vibration	92	276	indicator, mechanical	92	277
suppressor, transient	89	268	instrumentation modules	96	327
switch, liquid-level	92	274	interface, computer	84	257
switches, push-button	96	320	matrix, relay switch	94	305
trimmer, resistor	92	275	minicomputer	84	252
Data Processing			relay, mercury-wetted	92	278
adapter, terminal	83	251	sensor, vibration	92	276
controllers, program- mable (NL)	96	323	switch, liquid-level	92	274
disc drive	84	253	time delay, solid-state	94	301
display, graphic	84	254	tone decoder	94	303
display technique (NL)	96	324	Packaging & Materials		
generator, random	94	302	cabinets	87	260
interface, computer	84	257	ceramic materials chart (DA)	95	309
maxi-memories (NL)	96	325	circuit breakers (NL)	96	326
minicomputer	84	252	connector, circular (NL)	96	328
minicomputer	84	255	conversion chart (DA)	95	306
reader, optical mark	84	256	metric drafting aids (DA)	95	308
recorder, cassette	85	258	molding compounds (NL)	96	321
tape and disc	83	250	sealants (NL)	96	333
terminal, CRT	85	259	tapes, pressure-sensi- tive (DA)	95	307
timer, digital	91	272	wire and cable (NL)	96	329
tone decoder	94	303			
ICs & Semiconductors			new literature		
buffer, digital	88	263	capacitors	96	322
character generator	88	265	circuit breakers	96	326
clock, LSI chip	88	261	connector, circular	96	328
diodes, zener	88	264	controllers, program- mable	96	323
display driver	88	262	display technique	96	324
LED lamps, high intensity	96	332	instrumentation modules	96	327
multiplier/divider	89	267	LED lamps, high intensity	96	332
op amps	88	266	maxi-memories	96	325
suppressor, transient	89	268	molding compounds	96	321
Instrumentation			pinhole apertures	96	330
DMM	90	270	sealants	96	333
frequency multiplier	90	269	switches, push-button	96	320
generator, random	94	302	wire and cable	96	329
instrumentation modules (NL)	96	327	Xenon flashtubes	96	331
oscillator, programmable	91	273			
spectrum analyzer	90	271	design aids		
timer, digital	91	272	ceramic materials chart	96	309
Microwaves & Lasers			conversion chart	95	306
lamps, quartz bulb	92	279	metric drafting aids	95	308
pinhole apertures (NL)	96	330	tapes, pressure-sensi- tive	95	307
Xenon flashtubes (NL)	96	331			
Modules & Subassemblies					
adapter, terminal	83	251			
amplifier, mixer	94	304			
circuit breakers (NL)	96	326			



Thin-Trim variable capacitors provide a reliable means of adjusting capacitance without abrasive trimming or interchange of fixed capacitors. Series 9401 has high Q's and a range of capacitance values from 0.2-0.6 pf to 3.0-12.0 pf and 250 WVDC working voltage. Johanson Manufacturing Corporation, Boonton, New Jersey (201) 334-2676.

INFORMATION RETRIEVAL NUMBER 181



Free catalog of 34,500 power supplies from the worlds largest manufacturer of quality Power Supplies. New '73 catalog covers over 34,500 D.C. Power Supplies for every application. All units are UL approved, and meet most military and commercial specs for industrial and computer uses. Power Mate Corp. (201) 343-6294.

INFORMATION RETRIEVAL NUMBER 182

UDT PHOTOPS 600



UDT PHOTOPS 600 high speed detector/amplifier combination has response to 10 megahertz with sensitivity to 5×10^{-12} watts. All PHOTOPS utilize latest FET circuitry and are available to 1cm^2 active area. PHOTOPS may be used as replacements for photomultipliers. United Detector Technology, Inc., 1732 21st Street, Santa Monica, CA.

INFORMATION RETRIEVAL NUMBER 183

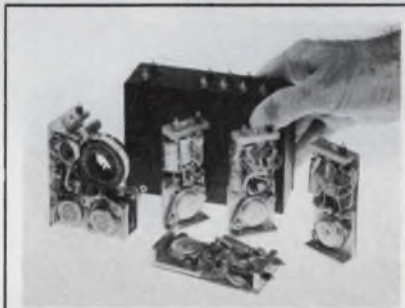

Design as you order modular power supplies. Complete, fully tested high efficiency power supply in a miniature package. Available with AC or DC inputs with up to 6 isolated and regulated DC outputs to 150 watts. No engineering charges! Arnold Magnetics, 11520 W. Jefferson Blvd., Culver City, Ca. 90230. Phone (213) 870-7014.

INFORMATION RETRIEVAL NUMBER 184

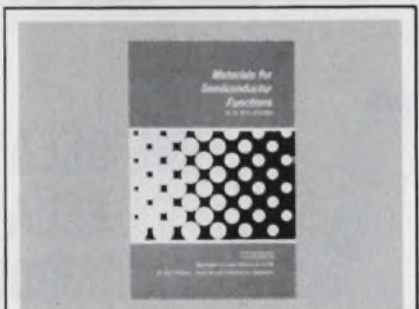

Materials for Semiconductor Functions, by E. G. Bylander. Practical handbook for selecting materials for diodes and transistors for applications in amplifiers, generators, and multi-junction devices. 220 pp., 6 x 9, illus., cloth, \$13.50. Circle number below for 15-day examination copy. Hayden Book Company, Rochelle Park, N.J. 07662.

INFORMATION RETRIEVAL NUMBER 185

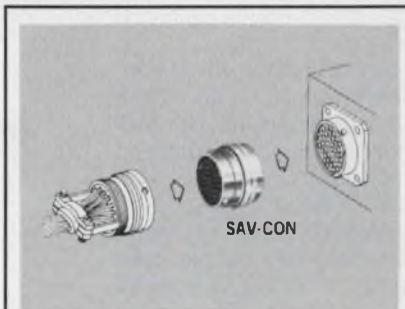

New connector saver. A double ended interface connecting device with a one piece pin/socket contact. Called SAV-CON. Prolongs service life of test cable connectors and saves wear and tear on equipment connectors. Available for all popular circular connectors. Glenair Inc., 1211 Air Way, Glendale, California, 91201. (213) 247-6000.

INFORMATION RETRIEVAL NUMBER 186

Advertisers wishing to reserve Quick Ad units should note the following mechanical requirements: Specs—Supply glossy photo of product and approximately 40 words which will set no more than 10 lines of 34 characters each. AFTER SUBMISSION NO COPY CHANGES CAN BE ACCEPTED. Quick Ads cost only \$300 per insertion, less for frequency advertisers.

RATES:

1x
\$300

7x
\$280

13x
\$255

19x
\$250

26x
\$245

39x
\$240

52x
\$235

104x
\$230

WE'VE GOT THE

TIME



FOR YOUR APPLICATION . . . in all shapes, sizes, and timing ranges. Time Delay Relays with slow operate or slow release and time repeat accuracy to $\pm 1\%$. At Magnecraft we take great pride in the broad line of Time Delay Relays available from stock for immediate delivery and even more on special order.

Solid State Hybrid, Solid State-Static Output, Air Dash-pot, Copper Slug are some of the types to name just a few. Features such as plug-in, surface mount, printed circuit, screw terminals, solder terminals, quick connect terminals, panel mount, power switching, remote pot, knob adjust, screwdriver adjust, allen head adjust, open type, dust covered, hermetically sealed, economy, manually actuated, multiple contacts, auxiliary output, extended voltage, special purpose . . . the list is almost endless.

Maybe you don't need contacts rated to 100 amperes or timing repeatability to $\pm 1\%$ but we have them available just in case. That's where a broad line can save you money, you don't have to take more than you need. We have just the one to fit your needs . . . and if we don't, we'll make it.

Magnecraft ELECTRIC COMPANY

5575 NORTH LYNCH AVENUE • CHICAGO, ILLINOIS 60630 • 312 • 282-5500 • TWX 910 221 5221

FREE!



TIME DELAY RELAY HANDBOOK

Do you know how to properly specify a time delay relay? We have a dandy 92-page handbook that can help you. It describes applications you've never thought of. It offers suggestions on how to specify, testing procedures, comparisons of one type to another, principles of operation, and a glossary of terms. This is yours for the asking.

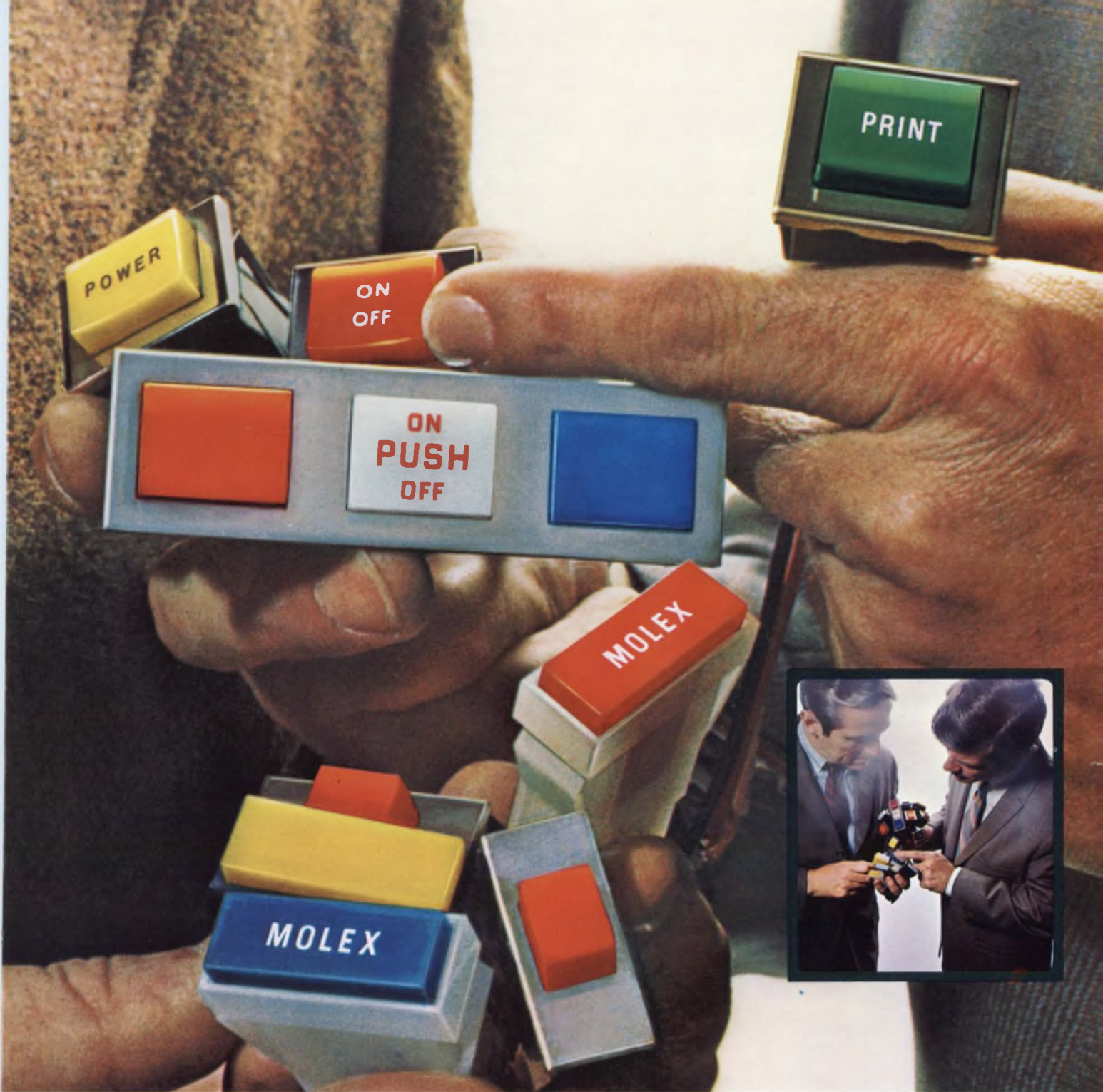

HERE ARE TWO EASY WAYS TO SOLVE LIGHTED PUSH BUTTON SWITCH PROBLEMS. Economically. Reliably. Fast. The Molex 1175 snap mounts. Offers spade or wire terminals for fast, easy assembly. A choice of nine colors, 500 variations. And look at the Molex 1820. You can use one, or a gang of them, for an infinite variety of applications. Lighted push button can be wired to light independently of the switch. And it's available in colors galore. Best of all . . . both switches are priced considerably under one

dollar in quantity. ■ These components are good examples of the Molex creative approach to design problems. And we have the ability to design reliability and ease of assembly into a product without letting costs run wild due to over-engineering. ■ If this makes sense, and you would like a *free sample* of either the 1175 or 1820 switch, write: Molex Incorporated, Lisle, Illinois 60532. Or phone (312) 969-4550.

...creating components that simplify circuitry



RCA LINEAR COS/MOS
RCA LINEAR COS/MOS
RCA LINEAR COS/MOS

LINEAR COS/MOS?

That's right . . . LINEAR Complementary-Symmetry MOS. RCA — the originator of COS/MOS — is now applying the advantages of COS/MOS technology to linear IC's to bring you a new dimension in linear circuit design.

Why LINEAR COS/MOS? For the equipment designer who needs high speed, precision, high packaging density, low power consumption, high impedance, RCA — through LINEAR COS/MOS — can make these significant breakthroughs in system performance and partitioning:

- linear and digital sub-systems on the same chip
- low power consumption of COS/MOS allows more complex functions to be cost-effectively placed on a single chip
- high circuit bandwidth capability — through the use of matched, complementary, high-frequency, high-impedance devices
- extremely low bias current or

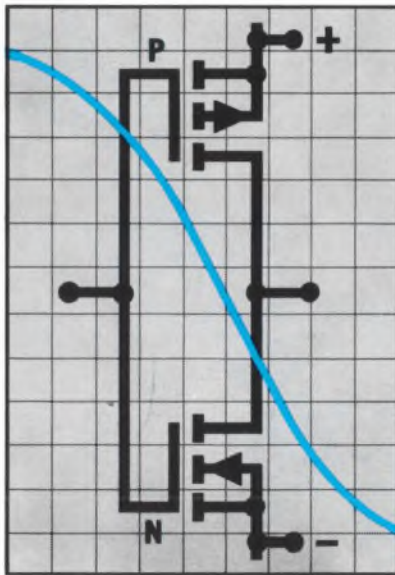

drain-to-source offset voltage — as a result of RCA's insulated-gate MOS technology

- the performance advantages of MOS — square-law characteristics, superior cross-modulation performance, and greater dynamic range than bipolar transistors

To the digital designer COS/MOS has opened up a new world of practical, flexible, economical IC functions. Now RCA places the linear designer on the threshold of the LINEAR COS/MOS era. In the months to come, you'll be hearing more from us, as we announce our first LINEAR COS/MOS circuits. Meanwhile, let us send you further information. Write section 57G5 RCA Solid State, Box 3200, Somerville, N.J. 08876.

RCA Solid State
products that make products pay off