

Electronic Design 7

VOL. 21 NO.

FOR ENGINEERS AND ENGINEERING MANAGERS

APRIL 1, 1973

RECEIVED
MAY 20 1973
ELECTRONIC DESIGN

Watch your logic in action. See one pulse, bursts or continuous data to 10 Mb/s, 32 bits at a time, in each of two channels. See what's up or down anyplace

in your logic stream. Combine channels logically or cascade them to see 64 bits. Hold the data in one channel and update the other. Learn how on p.89.

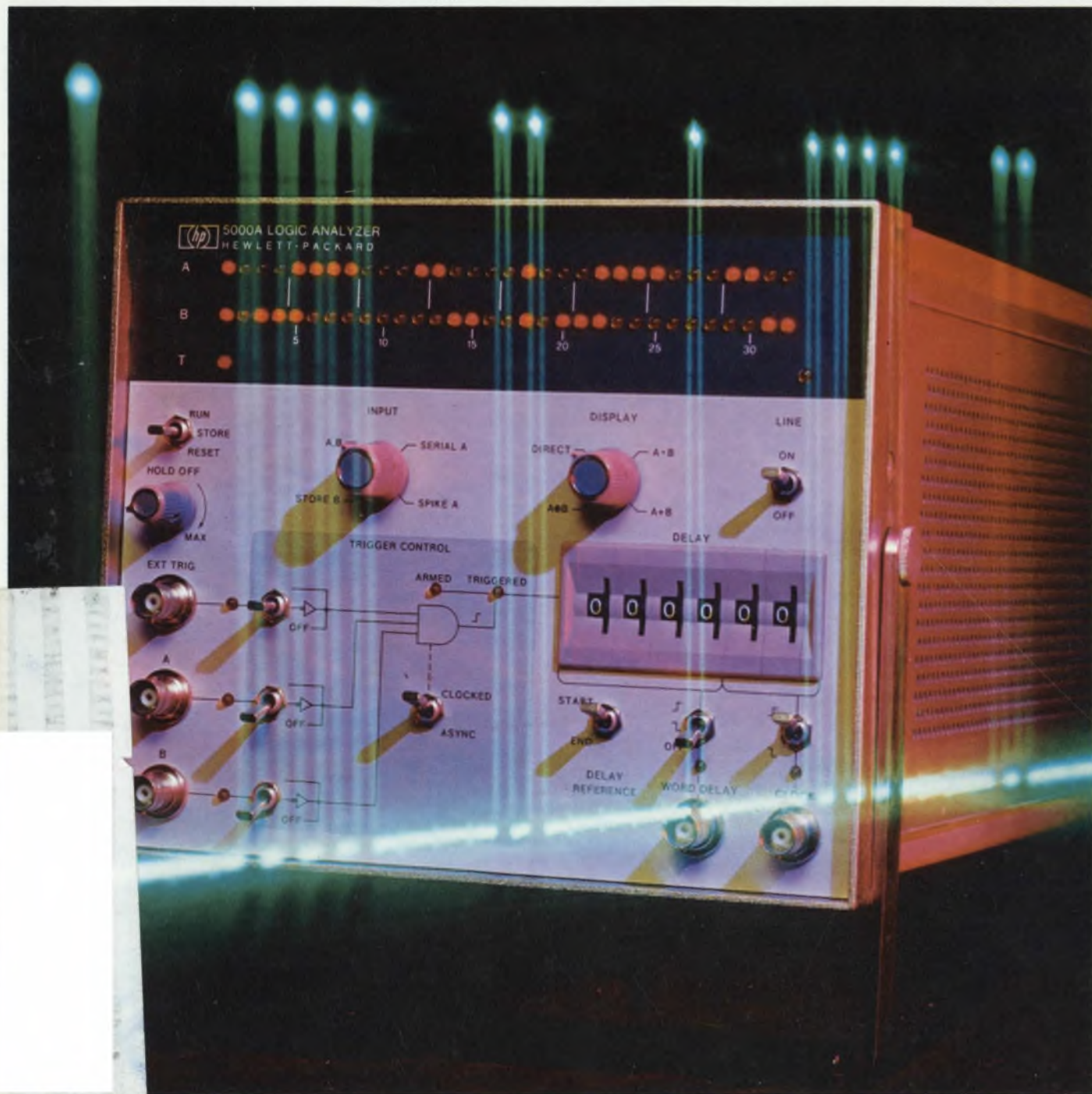



Shape up faster with Dale resistors

We offer more ways to
keep your current in shape
without bothering your budget.

Dale NS-2 is a vital non-inductive wirewound resistor used in the highly-regarded Micromemory 3000. *Electronic Memories & Magnetics Corporation* selected it for ability to control voltage while permitting the generation of fast rise time currents. But if resistors are your concern, the important thing is that the NS-2 is only one of 108 standard coated, molded and housed non-inductive styles readily available from Dale. Make sure you're taking advantage of all the time and dollar savings available from our broad wirewound line. Here's how:

SEND FOR FREE WALL CHART

Big, new, comprehensive wirewound resistor chart details all Dale precision, industrial, commercial wirewound styles.

Write today or circle reply card.



DALE ELECTRONICS, INC.
1300 28th Avenue, Columbus, Nebr. 68601
A Subsidiary of The Lionel Corporation
In Canada: Dale Electronics Canada, Ltd.

INFORMATION RETRIEVAL NUMBER 241

The RCA line of RF devices is expanding in all directions. New types, higher frequencies, broader bandwidths and new packages . . . all aimed at improving your system performance. That's why we call them the RF performance expanders.

Here are ten of the new types now available up to 3.5 GHz. They include such features as emitter ballasting; multi-cell structure for low thermal resistance

and . . . micromatch (microstrip package with partial input and output impedance matching).

Type	Freq. (MHz)	Output Power (W)	Gain (db)	Supply (Volts)
TA7992/TAB778	3500	4.5/1.5	5	28
TAB807/8/9	3000	1/3/5	5	28
2N6390/1/2	2000	3/5/10	7	28
RCA2003/05/10	2000	3/5/10	7	28
TAB340	1700	0.5	Oscillator	20
TAB695	1300	30	8	28
R44M 10/13/15	390-440	10/13/15	20	12.5

So if you want to design reliability and high performance into your system, de-

sign in RCA's RF performance expanders.

Want more information? Write RCA Solid State, Section 57D-1, Box 3200, Somerville, N.J. 08876. Or phone: (201) 722-3200.

RCA State Solid

RF performance expanders.

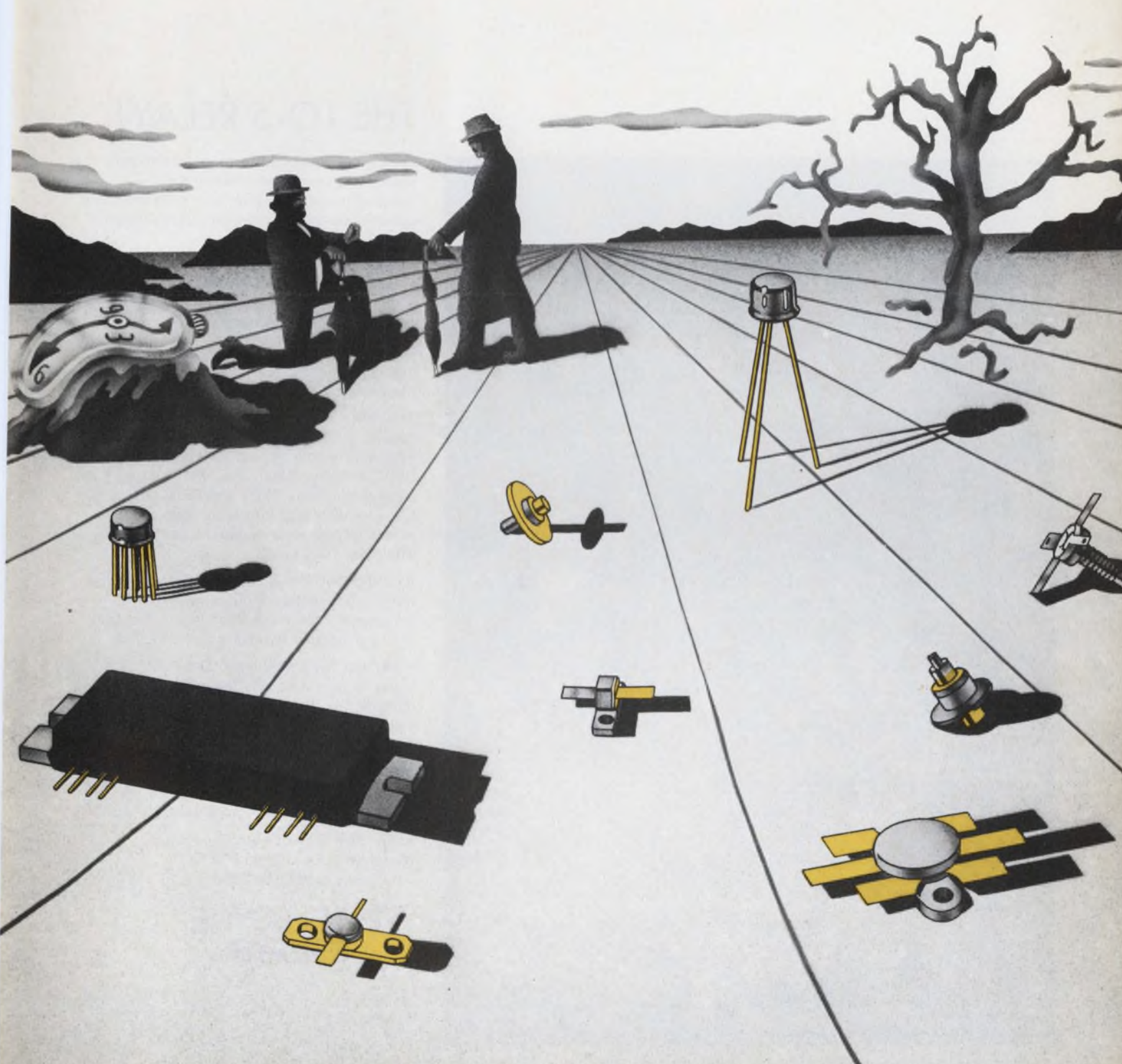

WHAT MADE CRYSTAL CAN RELAYS OBSOLETE?

THE TO-5 RELAY!

Crystal can relays (full size and fractional sizes) have been obsoleted by the outstanding performance, high reliability, low power requirement and cost effectiveness of the TO-5 Relay.

All possibility of contamination is eliminated in the TO-5 Relay. It is completely welded, including the coil termination. This cannot be said for crystal can relays.

Reliability and long life, over ten times greater than the crystal can units, have been designed into the TO-5 Relay.

Teledyne's TO-5 Relays come in hundreds of models, all in the same basic configuration. Typical available models include SPDT, DPDT, sensitive SPDT and DPDT and magnetic latching SPDT and DPDT. Units are also available with transistor drive and diodes for arc suppression, all packaged within the TO-5 case.

By using the TO-5 Relay, reduction in size, weight and number of circuit board components can be realized in your product — all measurable in dollars and cents.

When you buy a Teledyne TO-5 Relay, you buy a 10-year record of remarkable reliability, superior performance, on-time delivery and service from people who really care. Teledyne provides experienced application engineers anxious to assist you with your relay problems.

Send for complete technical data.

3155 West El Segundo Boulevard
Hawthorne, California 90250
Telephone (213) 679-2205

 **TELEDYNE
RELAYS**



NEWS

- 19 **News Scope**
 - 22 **Active microwave diodes** are crowding Gunn-effect devices in noise, power and efficiency.
 - 26 **Single laser rod yields 4 beams** for high-speed holographic work.
 - 28 **Electronics for cars** is seen as posing a bigger challenge than the nation's space programs.
 - 34 **Technology Abroad**
 - 37 **Washington Report**
-

TECHNOLOGY

- 42 **Boost counting speed to 110 MHz** with ECL universal counters. These programmable devices are ideal for phase-locked loops and frequency synthesis.
 - 48 **Lift afc discriminator performance** by up to 10 dB. Hybrid signal processing offers advantages over conventional resonant and pulse-counter circuits.
 - 54 **Give it a whack!** Calibrated tap-tester, an adaptation of a familiar technique, spots defective parts. Simple and inexpensive, it finds those elusive intermittents.
 - 58 **Try getting it all together**, suggests this overseer of projects. The one-cell approach to a program can give you the control to meet schedules and cut costs.
 - 61 **'Top Ten'** prize-winning advertisements.
 - 82 **Ideas for Design:** Quad op-amp comparators allow continuous monitoring of two inputs . . . Shift option improves handling of binary counter data . . . Two amplitude measurements determine unknown phase angle.
-

PRODUCTS

- 89 **Instrumentation:** Logic analyzer displays up or downstream data bits.
 - 91 **Instrumentation:** Signal source? DMM? Counter? It's all three.
 - 92 **Data Processing:** Line printer for minicomputer offers high speed at low cost.
 - 94 **Data Processing:** Serial-data modules simplify automation of process measurement and control.
 - 98 Modules & Subassemblies
 - 100 Packaging & Materials
 - 102 Microwaves & Lasers
-

Departments

- 41 **Editorial:** Don't show me your camera; Show me your picture
- 7 Across the Desk
- 104 New Literature
- 110 Advertisers' Index
- 112 Product Index
- 112 Information Retrieval Card

Cover: Photo by Hal Smith Photography, courtesy of Hewlett-Packard, Santa Clara, Calif.

THE POSITIVES TO OUR NEW FIXED VOLTAGE REGULATORS.

If you're looking for a simple regulator, this may turn you on.

Our new LM340 series TO-220 fixed voltage regulators.

Available in the plastic package and also the TO-3 package, in all temperature ranges, and in 5, 6, 8, 12, 15, 18 and 24 volts (see the page on the right, also).

They're the height of simplicity (no additional circuits to perform the function). Short circuit proof. And virtually indestructible (can't be destroyed by having inadequate heat sink).

Another thing. Our LM340's have a package with a plastic material and mounting material that results in an excellent matching coefficient of expansion and contraction. It'll withstand thousands and thousands of temperature cycles.

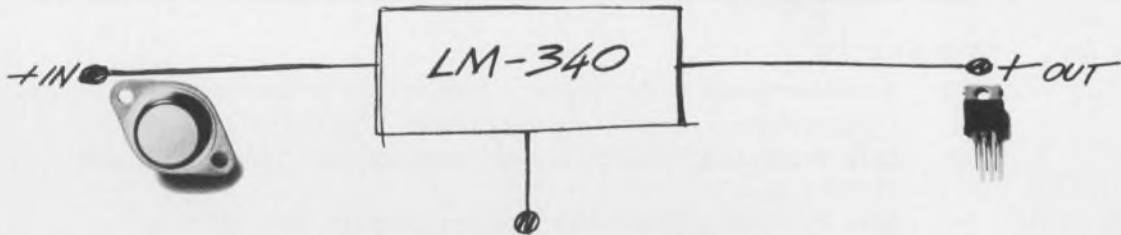

A third positive advantage is that we have a big supply on the shelf, ready to go. (A bird in the hand...)

So much for positives.

THE NEGATIVES TO OUR NEW FIXED VOLTAGE REGULATORS.

Minus 5 volts and minus 5.2 volts (how 'bout that, ECL users), minus 12 volts, and minus 15 volts. The LM320 series, available in the TO-3 package in all temperature ranges.

And by the way, these are the only negative fixed voltage regulators available today.

Which is another positive.

Want to try 'em out? A Digital Designer's Sample Kit, containing a +5, and -5.2 volt regulator, in the TO-3, and a Linear Designer's Sample Kit, containing a +15 and a -15 volt regulator are available for \$6.45 each. That's 1/3 off the standard list price. They're available from distributors.

For further fascinating details write:
National Semiconductor Corporation,
2900 Semiconductor Drive, Santa Clara,
California 95051.

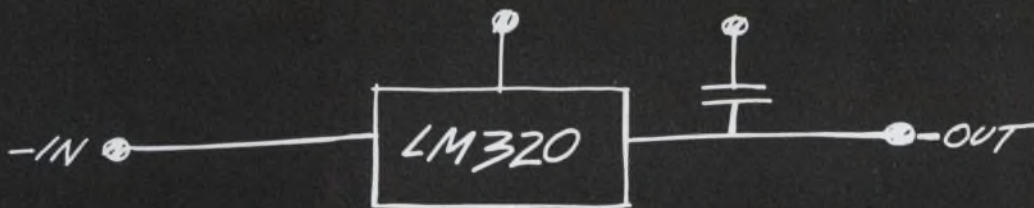

NATIONAL

*Regulator Designers Kits are available from the following distributors: Almac/Stroum Electronics • Cameradio • Carlton Bates
Century Electronics, Inc. • Elmar Electronics • Fort Wayne Electronics Supply, Inc. • Gibson Electronics Components
Graham Electronics Supply, Inc. • Hall-Mark Electronics • Hamilton/Avnet Electronics • Hammond Electronics • Harvey Electronics
Kierulff Electronics East • Liberty Electronics • Mace Electronics • Newport Industries • Pioneer Standard Electronics
Powell/Gulf Electronics • Radio, Inc. • Taylor Electric Company • Western Radio Corporation.

A Smart Way to Beat Your Power Supply Size Problem

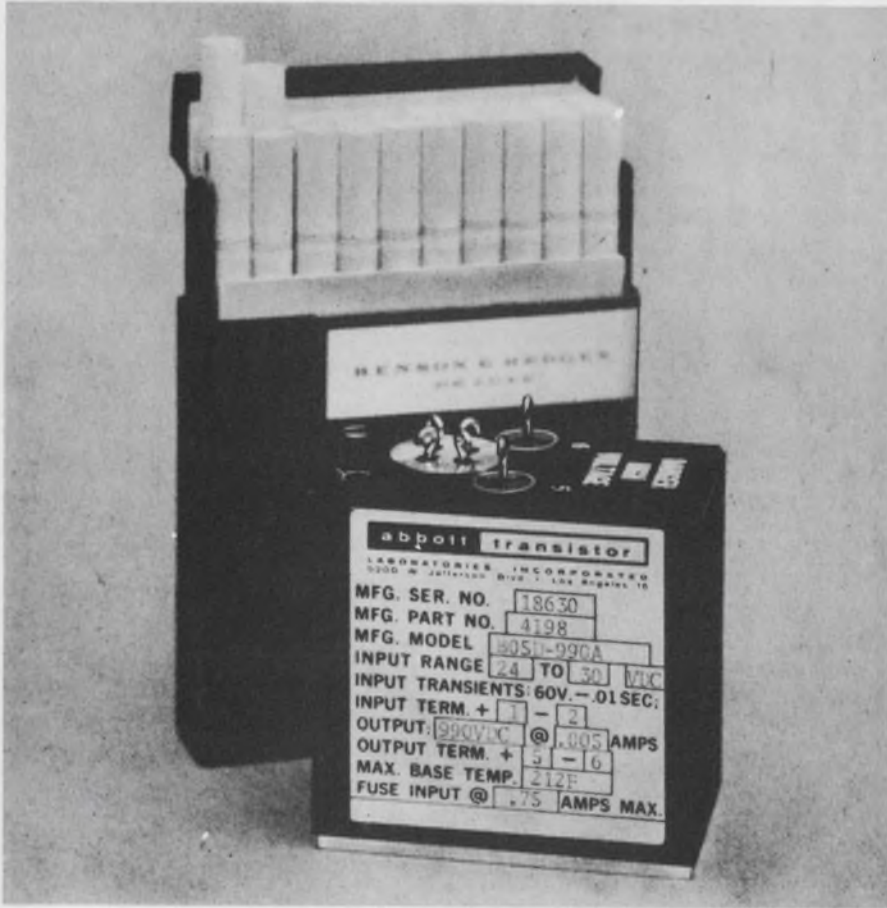

1½" thin, 2¾" narrow, 2¾" short

yet this converter produces 1000 volts DC, regulated, from a battery input of 28 VDC! It weighs less than 15 ounces. This is only one of our wide variety of many small light weight converters, inverters and power supplies — there are over 3000 models listed in our newest catalog, including size, weight and prices. If you have a size problem, why not send for an Abbott catalog?

MIL SPEC ENVIRONMENT — All of the power modules listed in our new catalog have been designed to meet the severe environmental conditions required by modern aerospace systems, including MIL-E-5272C and MIL-E-5400K. They are hermetically sealed and encapsulated in heavy steel containers. New all silicon units will operate at 100°C.

Please see pages 930 to 949 of your 1970-71 EEM (ELECTRONIC ENGINEERS MASTER Catalog) for complete information on Abbott modules.

Send for our new 68 page FREE catalog.

RELIABLE — Highest quality components are used in Abbott power modules to yield the high MTBF (mean time between failure) as calculated in the MIL-HDBK-217 handbook. Typical power modules have over 100,000 hours MTBF — proving that the quality was built in from the beginning.

WIDE RANGE OF OUTPUTS — Any voltage from 5 volts DC to 3,650 VDC is available by selecting the correct model you need from our catalog with any of a variety of inputs including:

- 60 Ω to DC, Regulated
- 400 Ω to DC, Regulated
- 28 VDC to DC, Regulated
- 28 VDC to 400 Ω , 1 ϕ or 3 ϕ
- 24 VDC to 60 Ω , 1 ϕ

abbott

transistor

LABORATORIES, INCORPORATED

5200 W. Jefferson Blvd./Los Angeles 90016
(213) 936-8185

1224 Anderson Ave./Fort Lee, N.J. 07024
(201) 224-6900

INFORMATION RETRIEVAL NUMBER 5

Vice President, Publisher

Peter Coley

Editors

Editorial Offices
50 Essex St.
Rochelle Park, N.J. 07662
(201) 843-0550
TWX: 710-990 5071
Cable: Haydenpubs Rochellepark

Editor-in-Chief: George Rostky

Managing Editors:

Ralph Dobriner
Michael Elphick

Associate Editors:

Dave Bursky
Jules H. Gilder
Morris Grossman
Seymour T. Levine
John F. Mason
Stanley Runyon
Edward A. Torrero
Richard L. Turmail

Contributing Editor:

Peter N. Budzilovich

Editorial Field Offices

East

Jim McDermott, Eastern Editor
P.O. Box 272
Easthampton, Mass. 01027
(413) 527-3632

West

David N. Kaye, Senior Western Editor
2930 West Imperial Highway
Inglewood, Calif. 90303
(213) 757-0183

Washington

Heather M. David, Bureau Chief
2506 Eye St., N.W.
Washington, D.C. 20037
(202) 338-3470

Editorial Production

Marjorie A. Duffy

Art

Art Director, William Kelly
Richard Luce
Anthony J. Fischetto

Production

Manager, Dollie S. Viebig
Helen De Polo
Maxine Correal
Anne Molfetas

Circulation

Manager, Nancy L. Merritt
Ron Deramo

Information Retrieval

Peggy Long

Promotion

Manager, Jeffrey A. Weiner
Karen Kerrigan

across the desk

Future for engineers seen as less than rosy

Congratulations on Richard Turmail's futuristic article, "Engineering Jobs: What, Why, Where?" (ED 1, Jan. 4, 1973, p. 68), in which he has painted an exciting picture of the future of the engineer: More jobs, more money, a major shortage of engineers.

That's right. Beat the drums, blow the bugles, march out with pennants flying. Try your level best to stampede the young into wasting their best learning years studying to become proficient in a trade that will enable them to give their most productive earning years to companies (at a fraction of the salary made by former school-fellows as doctors or lawyers and even as accountants, realty agents, etc.), after which, at a relatively young age, they will be laid off, thrown on the rubbish heap, while their places are taken by fresh columns of younger men newly out of college. The cycle continues, thanks to rosy articles like this one.

On taking a closer look at the "sources" cited—namely, "30 representative companies," the College Placement Council, the director of placement at an engineering school, a "manpower expert" with the Engineers Joint Council and a technical manpower agency—it is clear where the problem lies. Not one of these sources has a vested interest in the economic or social status of the working engineer. In fact, their interests lie in quite the opposite direction.

The companies naturally thrive on a large pool of engineers who are willing to work for lower

wages in competition with each other. The universities depend on a large influx of students for their very survival as ivory towers of power, politics and "research." And the job-shoppers need lots of bodies to fit to jobs.

Dr. T. Reginald Garfield
Moore School of Electrical
Engineering
University of Pennsylvania
Philadelphia, Pa. 19104.

The superficiality of the article on engineering jobs in the Jan. 4 issue is, I believe, potentially very harmful to engineers, present or future, if it is read uncritically. To give you an idea of what I mean, I will comment on just two statements in the article that I find misleading.

The first is a "highlight" that emerged from the ELECTRONIC DESIGN study: "The over-all rate of unemployment among engineering graduates is only about 3%, or about half the national average." Such a statement carries the implication that the ratio of the engineering unemployment rate to that of the general working population is a valid criterion for judging its comparative severity. Among its other defects, that implication ignores the very substantial investment an engineer has made, and often continues to increase, in his education. The national average unemployment rate is almost entirely governed by unemployment of skilled, semi-skilled and nonskilled workers. Most begin their earning periods six to eight years sooner than an engineer with a master's degree, and they make comparatively little in-

(continued on page 11)

Electronic Design welcomes the opinions of its readers on the issues raised in the magazine's editorial columns. Address letters to Managing Editor, Electronic Design, 50 Essex St. Rochelle Park, N. J. 07662. Try to keep letters under 200 words. Letters must be signed. Names will be withheld on request.

THIN-TRIM[®] CAPACITORS FOR HYBRID-CIRCUIT DESIGNERS



ACTUAL SIZE

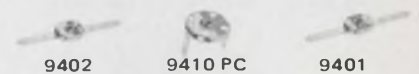

THIN-TRIM capacitors are a new development in miniaturized variable capacitors for application in circuits where size and performance is critical. The Thin-Trim concept provides a variable device to hybrid circuit designers which replaces fixed tuning techniques and cut and try methods of adjustment.

FEATURES

- Low profile for HYBRID CIRCUIT applications.
- High capacity values for BROADBAND applications.
- High Q - low capacity values for MICROWAVE applications.

U.S. Patent 3,701,932

Johanson

MANUFACTURING CORPORATION

ROCKAWAY VALLEY ROAD
BOONTON, N.J. 07005
PHONE (201) 334-2676
TWX 710-987-8367

Here are 10 new reasons to specify **MECL 10,000**

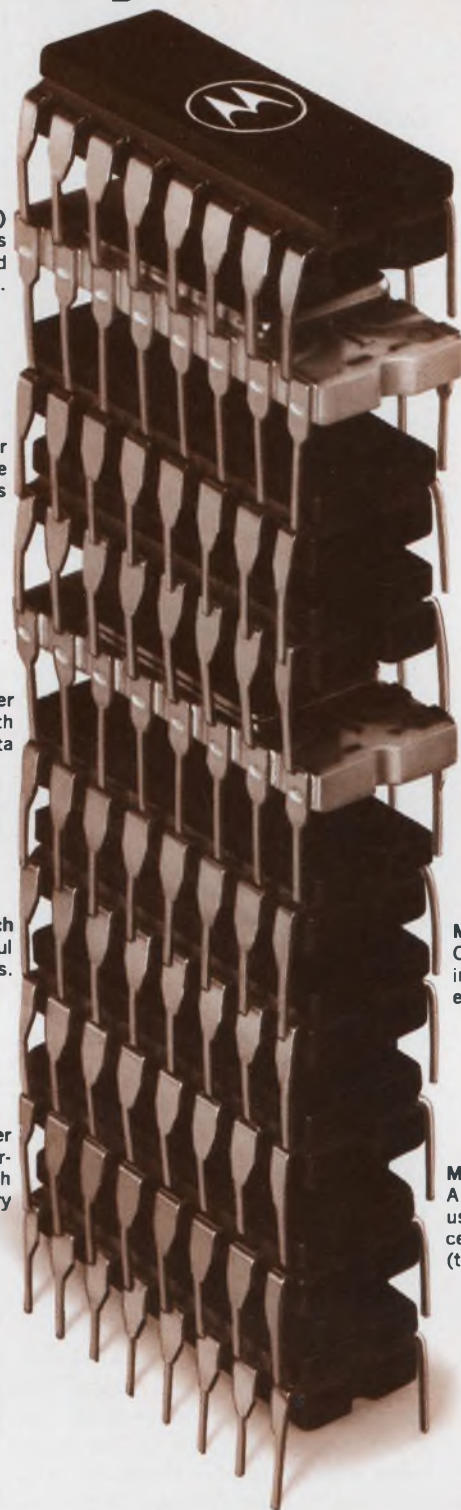

MCM10140AL 64-Bit RAM (90 ohm Drive)
Performs at a fast 15 ns max. access time (10 ns typical). Organization is 64 one-bit words. Designed for 90 ohm (or higher) transmission line systems.

MC10128L Dual Bus Driver
Interfaces with TTL or IBM level buses. Can be used for MECL/MOS interfacing where the MOS is TTL compatible.

MC10171L Dual 4-Line Decoder
A binary coded 2 line to dual 4 line decoder with selected outputs low. For general purpose data routing at speeds to 4 ns typically.

MC10175L Quint Latch
Provides 5 bits of temporary storage and is useful for accumulator and register file applications. Speed is a fast 2.5 ns through the latch.

MC10129L Quad Bus Receiver
Receives TTL or IBM Bus levels and converts information to MECL 10,000 compatible levels. Latch features in MC10128 and 10129 provide temporary storage.

MC10104L Quad 2-Input AND Gate
Performs the AND gating function in an ECL system thereby saving an additional stage of OR/NOR gating.

MC10114L Triple Line Receiver
Features common mode noise rejection of ± 1 volt at inputs. Added noise immunity facilitates receiving differential signals over long lines.

MCM10148AL 64-Bit RAM (50 ohm Drive)
Similar to MC10140AL except with 50 ohm drive. Both memories offer full binary decoding, two chip enable inputs, and separate data input and data output pins.

MC10173L Quad 2-Input Multiplexer/Latch
Combines two functions on one chip — a real savings in package count. Data delay, with the latch enabled, is typically 2.5 ns.

MC10180L Dual High Speed Adder/Subtractor
A general purpose high speed adder/subtractor for use in arithmetic unit applications of central processors and fast multiplier arrays. Add time 4.5 ns (typ).

Now you have 48 ways to increase system performance

It takes some doing to become the industry's #1 high speed logic family. And MECL 10,000 comes well qualified considering the critical mass of parts available for design *now* . . . commercial and military device options . . . compatibility with MECL III for increased speed requirements . . . adequate second sourcing . . . aggressive new product R & D . . . expanding production capability.

Discover the many ways MECL 10,000 can upgrade your system's performance. Begin by writing to Motorola Semiconductor Products Inc., P. O. Box 20912, Phoenix, Arizona 85036 for specifications on the new devices. And for immediate evaluation of MECL 10,000 call your local Motorola distributor. You'll find the many reasons why MECL 10,000 is specified for new designs . . . and upgrading of present systems.

MECL 10,000 — The comprehensive line available for design . . . *NOW*

GATES		MULTIPLEXERS	
MC10101	Quad OR/NOR Gate with Strobe	MC10132	Dual Multiplexer With Latch (Common Reset)
MC10102	Quad 2-Input NOR Gate	MC10134	Dual Multiplexer With Latch (Separate Select)
MC10104	Quad 2-Input AND Gate	MC10164	8-Line Multiplexer
MC10105	Triple 2-3-2 Input OR/NOR Gate	MC10173	Quad 2-Input Multiplexer/Latch
MC10106	Triple 4-3-3 Input NOR Gate	MC10174	Dual 4 to 1 Multiplexer
MC10107	Triple Exclusive OR/NOR Gate	DRIVERS AND RECEIVERS	
MC10109	Dual 4-5 Input OR/NOR Gate	MC10114	Triple Line Receiver
MC10110	Dual 3-Input 3-Output OR Gate	MC10115	Quad Line Receiver
MC10111	Dual 3-Input 3-Output NOR Gate	MC10116	Triple Line Receiver
MC10117	Dual 2-Wide 2-3 Input OR-AND/OR-AND-INVERT Gate	MC10128	Dual Bus Driver
MC10118	Dual 2-Wide 3-Input OR-AND Gate	MC10129	Quad Bus Receiver
MC10119	4-Wide 4-3-3-3-Input OR-AND Gate	MC10216	High Speed Triple Line Receiver
MC10121	4-Wide OR-AND/OR-AND-INVERT Gate	FLIP-FLOPS AND LATCHES	
MC10210	High Speed Dual 3-Input 3-Output OR Gate	MC10130	Dual D Latch
MC10211	High Speed Dual 3-Input 3-Output NOR Gate	MC10131	Dual D Flip-Flop
COUNTERS		MC10133	Quad Latch
MC10136	Universal Binary Counter	MC10135	Dual J-K Master-Slave Flip-Flop
MC10137	Universal Decade Counter	MC10175	Quint Latch
MEMORIES		MC10231	High Speed Dual D Flip-Flop
MCM10140	64-Bit RAM (64 x 1) (90 ohm Drive)	ARITHMETIC FUNCTIONS	
MC10145	64-Bit RAM (16 x 4)	MC10179	Look Ahead Carry Block
MCM10148	64-Bit RAM (64 x 1) (50 ohm Drive)	MC10180	Dual High Speed Adder/Subtractor
TRANSLATORS		MC10181	4-Bit Arithmetic Logic Unit
MC10124	Quad TTL-TO-MECL Translator	OTHER LOGIC FUNCTIONS	
MC10125	Quad MECL-TO-TTL Translator	MC10141	4-Bit Universal Shift Register
		MC10160	12-Bit Parity Generator-Checker
		MC10161	Binary to 1-8 Line Decoder (Low)
		MC10162	Binary to 1-8 Line Decoder (High)
		MC10165	Priority Encoder
		MC10171	Dual 4-Line Decoder

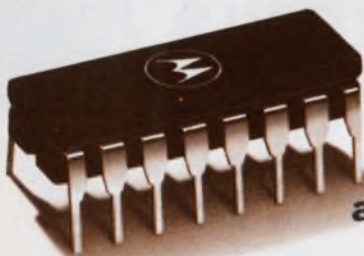

MECL 10,000 eliminates the alternatives. Evaluate and compare!



MOTOROLA MECL

. . . for faster computers & systems

Some people buy
our MOD POT[®]
just to save
panel space

Others cut
time and costs
with its versatility



If you're really
serious about cost,
be serious about quality.

The first square deal in potentiometers. Compact size solves the shrinking panel space race. Modular design saves the extra charges and delays many manufacturers add for non-standards. MOD POT offers a whole family of pre-engineered, pre-tested modules that combine to form millions of single, dual, triple and

quadruple section controls. Cermet or hot-molded composition resistance elements, switch options and vernier drives with single or concentric shafts. Solder terminals or .100 grid pin terminals. Backed by the fast delivery of our distributor assembly MOD POT ACTION CENTERS. Ask for Publications 5217 and 5217S. At

your Allen-Bradley electronics distributor, or write: Allen-Bradley Electronics Division, 1201 South Second Street, Milwaukee, Wisconsin 53204. Export: Bloomfield, New Jersey 07003. Canada: Allen-Bradley Canada Limited, Cambridge, Ontario. United Kingdom, Jarrow, County Durham NE32 3EN.



Allen-Bradley
Milwaukee, Wisconsin 53204

ACROSS THE DESK

(continued from page 7)

vestment in formal training for their jobs. Their skills generally obsolesce at a much slower rate, if at all, and often only under union protection.

Second, the article gives this year's national freshman engineering class as 50,600 students, and it says that "with normal attrition, fewer than 29,000 engineers will be graduated in 1976—a total far short of the 48,000 that the Presidential Manpower Commission has predicted will be the yearly need through the end of the decade." At a time when so little else is normal, why is "normal attrition" assumed?

Mark Smith

MIT Draper Laboratory
37 Cambridge Parkway
Cambridge, Mass. 02142

'Something for nothing' is nothing but folly

I would like to comment on Robert Bruce's reply ("A Cheer for Less Work," ED 2, Jan. 18, p. 7) to your editorial in the Nov. 9, 1972 issue—"Get Enriched (If Not Rich) With Those High Flyers."

I fail to understand the logic of Mr. Bruce's statement that a man's work should be "emotionally rewarding" after Mr. Bruce stated that a man "should not be married" to his work. It appears to a few of us that if a man's work is emotionally rewarding, the man must first be involved emotionally with his work. And how can he be involved emotionally with his work and not be accused of being married to his career?

Some of us would like to believe that the majority of us still have pride in ourselves and our work. Please keep the excellent editorials flowing and do not be discouraged by the few "something for nothing" freaks.

Leven H. Goree

Transmitter Engineering
Group Leader

Electronic Communications, Inc.
1501 72nd St. N.
Box 12248
St. Petersburg, Fla. 33733

(continued on page 14)



seal of improval

Improved reliability through the use of a glass-to-tantalum true hermetic anode seal is the prime feature of new Type 138D gelled-electrolyte sintered-anode Tantalox® Capacitors. This new construction eliminates all internal lead welds while retaining the strength of conventional internal lead-welded parts. In addition, the new construction offers outstanding resistance to extensive temperature cycling.

Type 138D Tantalox Capacitors are designed to meet or exceed

the environmental and life test requirements of MIL-C-39006. The gelled-electrolyte employed in these new capacitors gives premium performance for all capacitor parameters with respect to frequency and temperature variations.

Originally developed for use in aerospace applications, this capacitor design is now available for general industrial and aviation use where the utmost in component performance and reliability are primary necessities.

For complete technical data, write for Engineering Bulletin 3704A to: Technical Literature Service, Sprague Electric Co., 347 Marshall St., North Adams, Mass. 01247.

45C-2126
SPRAGUE[®]
THE MARK OF RELIABILITY

THE BROAD-LINE PRODUCER OF ELECTRONIC PARTS

INFORMATION RETRIEVAL NUMBER 9

WHAT'S IN PLESSEY'S MNOS SANDWICH? ADVANCED TECHNOLOGY. THE SPECIALTY OF THE HOUSE.

There's only one Metal-Nitride-Oxide-Silicon sandwich commercially available now. And Plessey has it.

The Plessey MNOS transistor is a non-volatile electrically-alterable semiconductor memory. It is specifically designed to meet the most difficult user requirements. Like small memory applications where it is necessary to achieve long-term data retention in power-off conditions... for a hundred years.

They come many ways. Single, dual and quad transistors. And together in arrays. They can be used in a wide variety of applications—micro-programming, numerical control, data logging, domestic control systems, automatic repertory dialers, frequency synthesizers, and airborne systems, etc.

As more and more users are finding out, it pays to specify Plessey.

PLESSEY SEMICONDUCTORS

1674 McGaw Avenue, Santa Ana
California 92705 (714) 540-9945

MNOS

Please send me a complete literature packet.
Now.

I would like information only at this time.

I would like to talk to your representative personally.

Name _____

Title _____

Firm _____

Address _____

City _____ State _____ Zip _____

Phone No. _____

Minneapolis, Minnesota
(612) 835-2717

Framingham, Massachusetts
(617) 879-7920

San Diego, California
(714) 295-2500

Los Altos, California
(415) 941-4080

Houston, Texas
(713) 462-4077

Farmingdale, New York
(516) 694-7377



We're everything you need in cermet trimmers. We're TRW/IRC Potentiometers.



These infinite resolution pots cover the complete size range from 1/4" round to 1 1/4" rectangular in the industry's widest selection of mounting configurations.

The exclusive Metal Glaze® element results in a cermet trimmer with higher power rating and wider temperature range than other manufacturers' units of the same size. Maximum temperature coefficients

of ± 100 ppm/°C. are standard, with TCs of ± 50 ppm available on most types.

For fast delivery, from stock, call any TRW/IRC Potentiometer distributor listed on the adjacent page. For information of the complete line, contact your distributor or TRW/IRC Potentiometers, an Electronic Components Division of TRW Inc., 2801-72nd Street North, St. Petersburg, Florida 33733; phone (813) 347-2181.

TRW[®] IRC POTENTIOMETERS

CPI-7305

DOES THIS PESTY "TRACK TEAM" HAVE YOU BEATEN BEFORE YOU START?



ALLIED HAS A GUARANTEED CURE!

... Immediate Shipment of Thousands of Items—Partial List Below

The sure cure for production line ills—our Guaranteed Shipment Program covering thousands of popular and often hard to get items. Check your open order files, then check the list below—it's just a sample of our IN-DEPTH inventory—parts from Amprobe, Bogen, Chicago Miniature Lamp Works, Curtin Development, Electrovert, Hamlin, ITT General Controls, Littelfuse, Mueller, Power Instruments,

RCA, Simpson, Sylvania, T-BAR, USECO, and Weston. All ready to be shipped to you today! And, you get what you order from our published list or we give you a Credit Voucher for 10% of your total order (good for 90 days) to be applied to your next order. See the next issue of this publication for more Guaranteed Shipment items. Call Allied Electronics now for total service!

AMPROBE	CHICAGO MINIATURE	HAMLIN	LITTELFUSE	LITTELFUSE	MUELLER	RCA	SYLVANIA
RS-1	253	H 34 507	JAG 1/2 Amp	350288 JAG 1 Pole	70S5	807	1296 33071 01
RS-3	313	DRG 2 425	JAG 3/4 Amp	356001 JAG 1 Pole	70S	811A	2458 3355 01
IM 63	327	DRR 1 425	JAG 1 Amp	357001 JAG 1 Pole	72 Black	812A	24PSB 32472 01
VT 100	327	DRT 5 425	JAG 2 Amp	357002 JAG 2 Pole	72 Red	866A	281 SR 32900 01
W7 124	328	HG 1 515	JAG 2 1/2 Amp	357003 JAG 3 Pole	85	872A	28PSB 32972 01
850A	330	MMRR 2 185	JAG 3 Amp	357004 JAG 4 Pole	85C	931A	48FSR 34861 01
	334	MRR DT 175	JAG 4 Amp	JAG 100-125V	87 Black	2050	60PSB 38072 01
BOGEN	334	MRR 2 185	JAG 5 Amp	JAG 5 Amp (32V)	87 Red	2050A	81 3081 01
IE-45	344	MSRR 2 185	JAG 6 Amp	JAG 6 Amp (32V)		5557	120MB 35108 01
IE-7	345	MTRR 2 185	JAG 6 Amp (32V)	JAG 6 Amp (32V)		5557A	120SB 32072 01
RIE-1	381	MLC-D1-186	JAG 6 Amp (32V)	JAG 10 Amp (32V)		5557B	30100 01
T0-6A	382		JAG 10 Amp (32V)	JAG 15 Amp (32V)		5557C	30102 01
CT60	387		JAG 15 Amp (32V)	JAG 25 Amp (32V)		5557D	30104 01
	388		JAG 25 Amp (32V)	JAG 30 Amp (32V)		5557E	30111 01
	389		JAG 30 Amp (32V)	JAG 30 Amp (32V)		5557F	30112 01
	390		JAG 30 Amp (32V)	JAG 30 Amp (32V)		5557G	30113 01
	391		JAG 30 Amp (32V)	JAG 30 Amp (32V)		5557H	30114 01
	392		JAG 30 Amp (32V)	JAG 30 Amp (32V)		5557I	30115 01
	393		JAG 30 Amp (32V)	JAG 30 Amp (32V)		5557J	30116 01
	394		JAG 30 Amp (32V)	JAG 30 Amp (32V)		5557K	30117 01
	395		JAG 30 Amp (32V)	JAG 30 Amp (32V)		5557L	30118 01
	396		JAG 30 Amp (32V)	JAG 30 Amp (32V)		5557M	30119 01
	397		JAG 30 Amp (32V)	JAG 30 Amp (32V)		5557N	30120 01
	398		JAG 30 Amp (32V)	JAG 30 Amp (32V)		5557O	30121 01
	399		JAG 30 Amp (32V)	JAG 30 Amp (32V)		5557P	30122 01
	400		JAG 30 Amp (32V)	JAG 30 Amp (32V)		5557Q	30123 01
	401		JAG 30 Amp (32V)	JAG 30 Amp (32V)		5557R	30124 01
	402		JAG 30 Amp (32V)	JAG 30 Amp (32V)		5557S	30125 01
	403		JAG 30 Amp (32V)	JAG 30 Amp (32V)		5557T	30126 01
	404		JAG 30 Amp (32V)	JAG 30 Amp (32V)		5557U	30127 01
	405		JAG 30 Amp (32V)	JAG 30 Amp (32V)		5557V	30128 01
	406		JAG 30 Amp (32V)	JAG 30 Amp (32V)		5557W	30129 01
	407		JAG 30 Amp (32V)	JAG 30 Amp (32V)		5557X	30130 01
	408		JAG 30 Amp (32V)	JAG 30 Amp (32V)		5557Y	30131 01
	409		JAG 30 Amp (32V)	JAG 30 Amp (32V)		5557Z	30132 01
	410		JAG 30 Amp (32V)	JAG 30 Amp (32V)		5557AA	30133 01
	411		JAG 30 Amp (32V)	JAG 30 Amp (32V)		5557AB	30134 01
	412		JAG 30 Amp (32V)	JAG 30 Amp (32V)		5557AC	30135 01
	413		JAG 30 Amp (32V)	JAG 30 Amp (32V)		5557AD	30136 01
	414		JAG 30 Amp (32V)	JAG 30 Amp (32V)		5557AE	30137 01
	415		JAG 30 Amp (32V)	JAG 30 Amp (32V)		5557AF	30138 01
	416		JAG 30 Amp (32V)	JAG 30 Amp (32V)		5557AG	30139 01
	417		JAG 30 Amp (32V)	JAG 30 Amp (32V)		5557AH	30140 01
	418		JAG 30 Amp (32V)	JAG 30 Amp (32V)		5557AI	30141 01
	419		JAG 30 Amp (32V)	JAG 30 Amp (32V)		5557AJ	30142 01
	420		JAG 30 Amp (32V)	JAG 30 Amp (32V)		5557AK	30143 01
	421		JAG 30 Amp (32V)	JAG 30 Amp (32V)		5557AL	30144 01
	422		JAG 30 Amp (32V)	JAG 30 Amp (32V)		5557AM	30145 01
	423		JAG 30 Amp (32V)	JAG 30 Amp (32V)		5557AN	30146 01
	424		JAG 30 Amp (32V)	JAG 30 Amp (32V)		5557AO	30147 01
	425		JAG 30 Amp (32V)	JAG 30 Amp (32V)		5557AP	30148 01
	426		JAG 30 Amp (32V)	JAG 30 Amp (32V)		5557AQ	30149 01
	427		JAG 30 Amp (32V)	JAG 30 Amp (32V)		5557AR	30150 01
	428		JAG 30 Amp (32V)	JAG 30 Amp (32V)		5557AS	30151 01
	429		JAG 30 Amp (32V)	JAG 30 Amp (32V)		5557AT	30152 01
	430		JAG 30 Amp (32V)	JAG 30 Amp (32V)		5557AU	30153 01
	431		JAG 30 Amp (32V)	JAG 30 Amp (32V)		5557AV	30154 01
	432		JAG 30 Amp (32V)	JAG 30 Amp (32V)		5557AW	30155 01
	433		JAG 30 Amp (32V)	JAG 30 Amp (32V)		5557AX	30156 01
	434		JAG 30 Amp (32V)	JAG 30 Amp (32V)		5557AY	30157 01
	435		JAG 30 Amp (32V)	JAG 30 Amp (32V)		5557AZ	30158 01
	436		JAG 30 Amp (32V)	JAG 30 Amp (32V)		5557BA	30159 01
	437		JAG 30 Amp (32V)	JAG 30 Amp (32V)		5557BB	30160 01
	438		JAG 30 Amp (32V)	JAG 30 Amp (32V)		5557BC	30161 01
	439		JAG 30 Amp (32V)	JAG 30 Amp (32V)		5557BD	30162 01
	440		JAG 30 Amp (32V)	JAG 30 Amp (32V)		5557BE	30163 01
	441		JAG 30 Amp (32V)	JAG 30 Amp (32V)		5557BF	30164 01
	442		JAG 30 Amp (32V)	JAG 30 Amp (32V)		5557BG	30165 01
	443		JAG 30 Amp (32V)	JAG 30 Amp (32V)		5557BH	30166 01
	444		JAG 30 Amp (32V)	JAG 30 Amp (32V)		5557BI	30167 01
	445		JAG 30 Amp (32V)	JAG 30 Amp (32V)		5557BJ	30168 01
	446		JAG 30 Amp (32V)	JAG 30 Amp (32V)		5557BK	30169 01
	447		JAG 30 Amp (32V)	JAG 30 Amp (32V)		5557BL	30170 01
	448		JAG 30 Amp (32V)	JAG 30 Amp (32V)		5557BM	30171 01
	449		JAG 30 Amp (32V)	JAG 30 Amp (32V)		5557BN	30172 01
	450		JAG 30 Amp (32V)	JAG 30 Amp (32V)		5557BO	30173 01
	451		JAG 30 Amp (32V)	JAG 30 Amp (32V)		5557BP	30174 01
	452		JAG 30 Amp (32V)	JAG 30 Amp (32V)		5557BQ	30175 01
	453		JAG 30 Amp (32V)	JAG 30 Amp (32V)		5557BR	30176 01
	454		JAG 30 Amp (32V)	JAG 30 Amp (32V)		5557BS	30177 01
	455		JAG 30 Amp (32V)	JAG 30 Amp (32V)		5557BT	30178 01
	456		JAG 30 Amp (32V)	JAG 30 Amp (32V)		5557BU	30179 01
	457		JAG 30 Amp (32V)	JAG 30 Amp (32V)		5557BV	30180 01
	458		JAG 30 Amp (32V)	JAG 30 Amp (32V)		5557BW	30181 01
	459		JAG 30 Amp (32V)	JAG 30 Amp (32V)		5557BX	30182 01
	460		JAG 30 Amp (32V)	JAG 30 Amp (32V)		5557BY	30183 01
	461		JAG 30 Amp (32V)	JAG 30 Amp (32V)		5557BZ	30184 01
	462		JAG 30 Amp (32V)	JAG 30 Amp (32V)		5557CA	30185 01
	463		JAG 30 Amp (32V)	JAG 30 Amp (32V)		5557CB	30186 01
	464		JAG 30 Amp (32V)	JAG 30 Amp (32V)		5557CC	30187 01
	465		JAG 30 Amp (32V)	JAG 30 Amp (32V)		5557CD	30188 01
	466		JAG 30 Amp (32V)	JAG 30 Amp (32V)		5557CE	30189 01
	467		JAG 30 Amp (32V)	JAG 30 Amp (32V)		5557CF	30190 01
	468		JAG 30 Amp (32V)	JAG 30 Amp (32V)		5557CG	30191 01
	469		JAG 30 Amp (32V)	JAG 30 Amp (32V)		5557CH	30192 01
	470		JAG 30 Amp (32V)	JAG 30 Amp (32V)		5557CI	30193 01
	471		JAG 30 Amp (32V)	JAG 30 Amp (32V)		5557CJ	30194 01
	472		JAG 30 Amp (32V)	JAG 30 Amp (32V)		5557CK	30195 01
	473		JAG 30 Amp (32V)	JAG 30 Amp (32V)		5557CL	30196 01
	474		JAG 30 Amp (32V)	JAG 30 Amp (32V)		5557CM	30197 01
	475		JAG 30 Amp (32V)	JAG 30 Amp (32V)		5557CN	30198 01
	476		JAG 30 Amp (32V)	JAG 30 Amp (32V)		5557CO	30199 01
	477		JAG 30 Amp (32V)	JAG 30 Amp (32V)		5557CP	30200 01
	478		JAG 30 Amp (32V)	JAG 30 Amp (32V)		5557CQ	30201 01
	479		JAG 30 Amp (32V)	JAG 30 Amp (32V)		5557CR	30202 01
	480		JAG 30 Amp (32V)	JAG 30 Amp (32V)		5557CS	30203 01
	481		JAG 30 Amp (32V)	JAG 30 Amp (32V)		5557CT	30204 01
	482		JAG 30 Amp (32V)	JAG 30 Amp (32V)		5557CU	30205 01
	483		JAG 30 Amp (32V)	JAG 30 Amp (32V)		5557CV	30206 01
	484		JAG 30 Amp (32V)	JAG 30 Amp (32V)		5557CW	30207 01
	485		JAG 30 Amp (32V)	JAG 30 Amp (32V)		5557CX	30208 01
	486		JAG 30 Amp (32V)	JAG 30 Amp (32V)		5557CY	30209 01
	487		JAG 30 Amp (32V)	JAG 30 Amp (32V)		5557CZ	30210 01
	488		JAG 30 Amp (32V)	JAG 30 Amp (32V)		5557DA	30211 01
	489		JAG 30 Amp (32V)	JAG 30 Amp (32V)		5557DB	30212 01
	490		JAG 30 Amp (32V)	JAG 30 Amp (32V)		5557DC	30213 01
	491		JAG 30 Amp (32V)	JAG 30 Amp (32V)		5557DD	30214 01
	492		JAG 30 Amp (32V)	JAG 30 Amp (32V)		5557DE	30215 01
	493		JAG 30 Amp (32V)	JAG 30 Amp (32V)		5557DF	30216 01
	494		JAG 30 Amp (32V)	JAG 30 Amp (32V)		5557DG	30217 01
	495		JAG 30 Amp (32V)	JAG 30 Amp (32V)		5557DH	30218 01
	496		JAG 30 Amp (32V)	JAG 30 Amp (32V)		5557DI	30219 01
	497		JAG 30 Amp (32V)	JAG 30 Amp (32V)		5557DJ	30220 01
	498		JAG 30 Amp (32V)	JAG 30 Amp (32V)		5557DK	30221 01
	499		JAG 30 Amp (32V)	JAG 30 Amp (32V)		5557DL	30222 01
	500		JAG 30 Amp (32V)	JAG 30 Amp (32V)		5557DM	30223 01

Call Your Nearest Allied Facility Today!

Garden Grove, Calif. (213) 598-6605	Washington, D.C. (301) 345-4600	Chicago, Ill. (312) 421-2400	Boston, Mass. (617) 848-4150
Detroit, Mich. (313) 846-7720	Fort Lauderdale, Fla. (305) 772-6464	Fort Worth, Texas (817) 336-5401	

NEW CATALOG

1973 Edition. Write or phone for your copy today.

ALLIED ELECTRONICS

DIVISION OF TANDY CORP.

2400 WEST WASHINGTON BLVD., CHICAGO, ILL. 60612

INFORMATION RETRIEVAL NUMBER 12

ACROSS THE DESK

(continued from page 11)

DEAD breakthrough

GI is capacitors



Literally billions of capacitors. Aluminum electrolytics. Micas. Film. Designed and built for reliability. Priced right. And delivered when and where you want 'em. The GI catalog tells almost everything

you need to know about capacitors. Send for your free copy today. Capacitor Division/General Instrument Corporation, 165 Front St., Chicopee, Mass., 01014. Phone 413/592-7795. In Canada 416/763-4133.



**General
Instrument**
the capacitor company

"Off the shelf" delivery from your GI/MI distributor.

Until recently, if you wanted broadband RF power, you had to settle for bulky tube-type power amplifiers. No more. Starting at the top, we developed a full line of all-solid-state Class A power amplifiers, covering the frequency spectrum of 100 kHz to 560 MHz, with power outputs ranging from 300 milliwatts to over 100 watts. And we're still climbing.

Driven by any signal generator, frequency synthesizer or sweeper, these compact, portable amplifiers are versatile sources of power for general laboratory work, RFI/EMI testing, signal distribution, RF transmission, laser modulation, data transmission, NMR, ENDOR, ultrasonics and more.

Completely broadband and un-

tuned, our highly linear units will amplify inputs of AM, FM, SSB, TV and pulse modulations with minimum distortion. Although all power amplifiers deliver their rated power output to a matched load, only ENI power amplifiers will deliver their rated power to any load regardless of match.

We also designed our amplifiers to be unconditionally stable and failsafe—you need never fear damage or oscillation due to severe load conditions (including open or short circuit loads).

ENI instrumentation amplifiers come complete with an integral AC power supply and an RF out-

put meter. Ruggedized amplifiers capable of operating under severe environmental conditions are available.

To find out more about our RF power amplifiers write: ENI, 3000 Winton Road South, Rochester, New York 14623. Call 716-473-6900. TELEX 97-8283 ENI ROC.

RF Amplifiers. We started at the top. Then worked our way up.

INFORMATION RETRIEVAL NUMBER 14

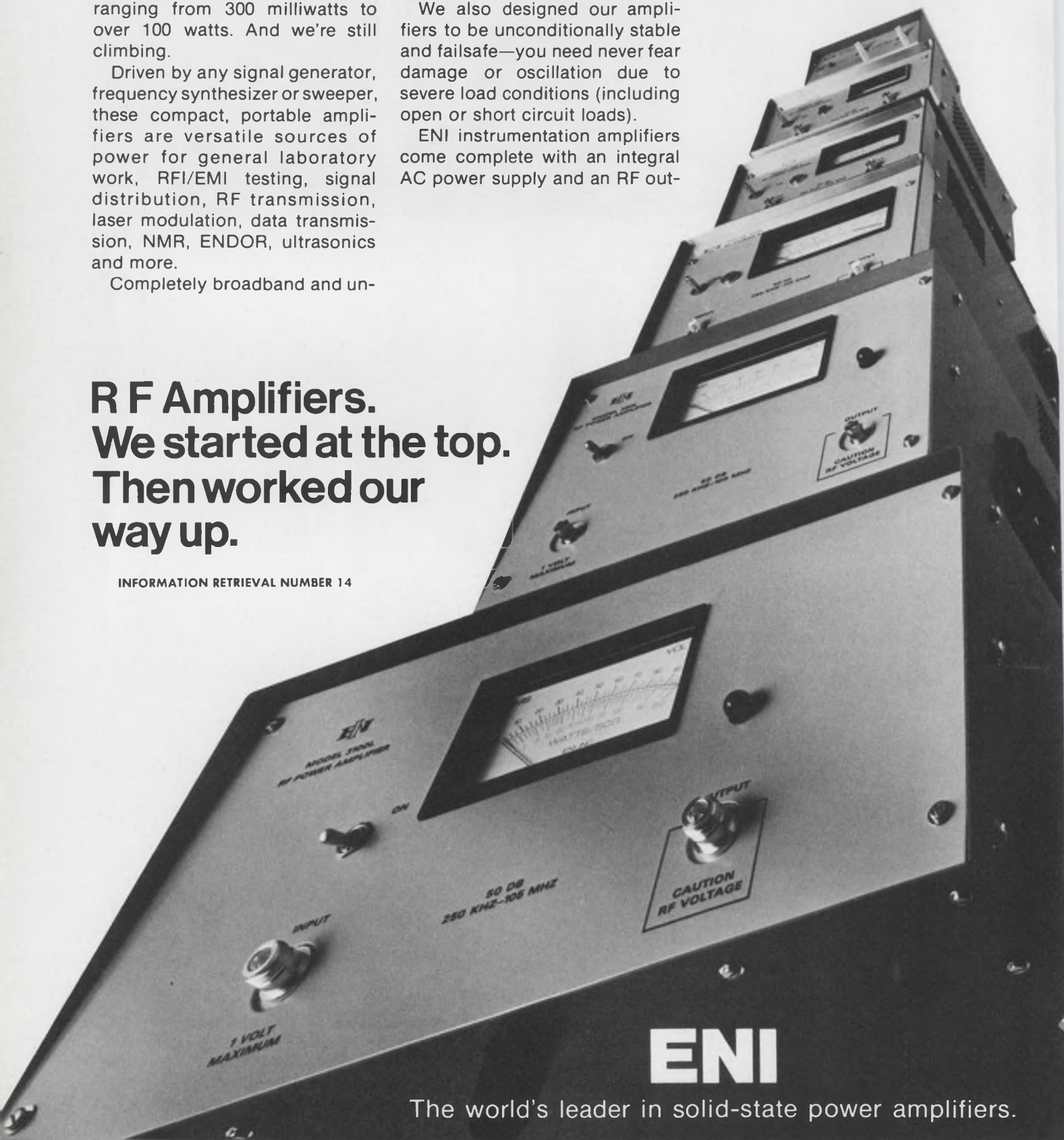

ENI

The world's leader in solid-state power amplifiers.



“Putting a minicomputer inside your new product? You’ve got problems.”

1. You’ve got to get your product on the market as fast and economically as possible.
2. You want lots of money left over for profit.
3. Your product (and all components) must be reliable.
4. You have to deliver on time.
5. You have to start out and stay price competitive.
6. You don’t want any surprise problems when Version II is ready.
7. You want the right internal hardware, software, and all the rest.
8. You have to have good technical service back-up when you need it.
9. You’re getting into bed with your major suppliers and want to play it as safe as possible.
10. You need all the help you can get from your vendor.
11. You don’t want suppliers who end up competing with you.

Big problems. And we have some unique solutions proven by some of the biggest minicomputer buyers in the country. Our customers ran us through some of the toughest competitive bidding you ever saw. Against every name competitor you can mention.

We solved their problems. Partly, because we’re not newcomers. Five years and thousands of minicomputers later, we’re still solving problems. Successfully. And economically. How about yours?

Call or write me personally. I’ll answer by phone or by airplane.

Dave Methvin
President



COMPUTER AUTOMATION, INC.
the naked mini™ company

18651 Von Karman, Irvine, California 92664, (714) 833-8830, TWX 910-595-1767

INFORMATION RETRIEVAL NUMBER 15

CORE MEMORIES

WE BUILD THEM
ANY WAY YOU WANT THEM

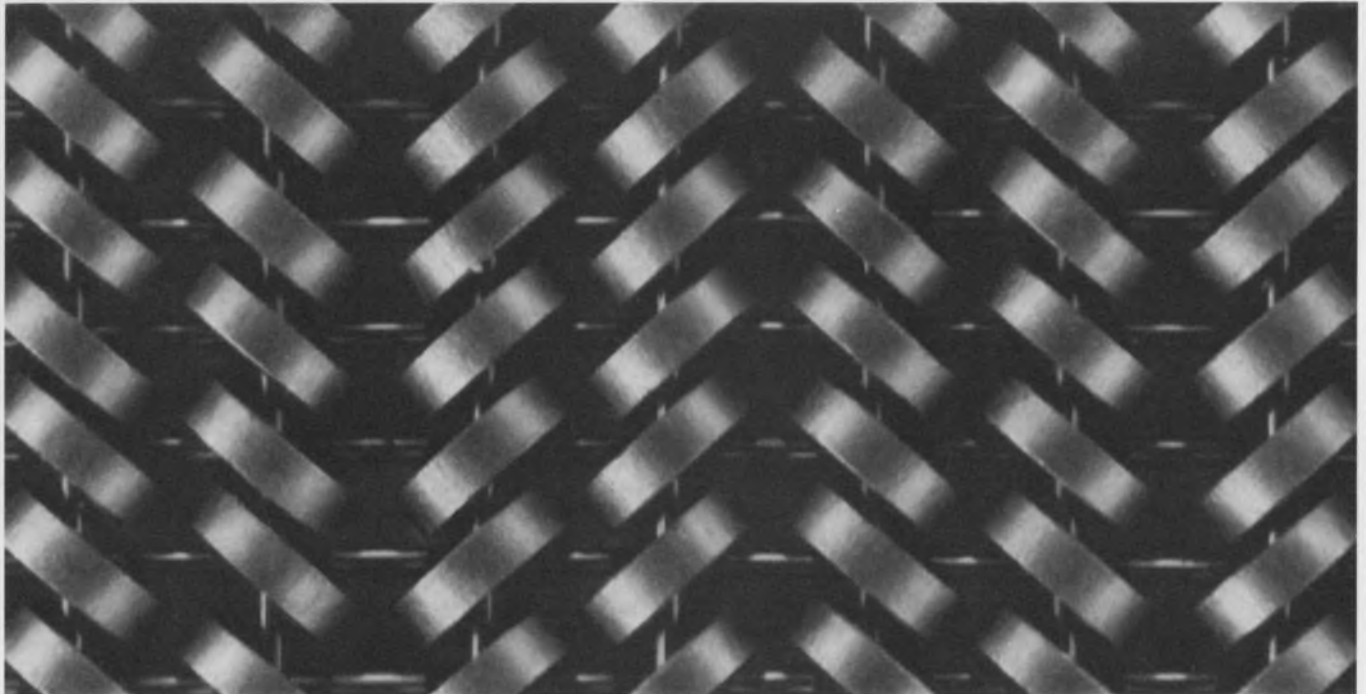

CUSTOM OR STANDARD; MODULES OR SYSTEMS.

We can meet all of your core memory requirements; most with our standard modules. For speed, capacity, reliability, delivery and price, look to the Ampex 2065, 4090 or 1800, as modules or systems.

THE NEW AMPEX 2065.

The fastest, most compact 20-bit memory available. Access time—260 ns, cycle time—650 ns. 8K words of up to 20 bits per module. Modules can be combined to give you up to 65,436 words. Size: only 8" x 10" x 2".

THE NEW AMPEX 4090.

Everything you need in a large-capacity memory. Unmatched size and speed. Access time—350 ns, cycle time—900 ns. 16K words of up to 40 bits per module. Modules can be combined to give you up to 131,072 words. Size: only 11.6" x 15" x 2".

THE AMPEX 1800.

The working man's memory for use in industrial non-computer-room environments. Access times—230, 250 or 340 ns, cycle times—600, 650 or 850 ns. 8K words of up to 18 bits per module. Modules can be combined to give you up to 64K words. Size: only 8" x 10" x 2".

But, for those unique needs everyone has from time-to-time, just tell us what you require. We'll design and build a core memory module, stack or system especially for you at prices you can afford. Because Ampex is the World's largest producer of magnetic core memory products. We got that way by filling your orders. All of them.

Call the Ampex Core Memory Specialist at 800-421-6554.

AMPEX

AMPEX COMPUTER PRODUCTS DIVISION
13031 West Jefferson Boulevard
Marina del Rey, Ca. 90291 (213) 821-8933

Visit Ampex at National Computer Conference Booth 2417

INFORMATION RETRIEVAL NUMBER 16

Exporting of technology stirs a protest by labor

Most transistor radios sold in the United States come from either Taiwan or Japan. In a few years maybe U.S. space boosters will, too. And what happens to the aerospace industry then?

These thoughts were expressed recently by labor and in Congress when McDonnell Douglas disclosed that it planned to sell the old space workhorse, the Thor-Delta rocket, to Japan.

The AFL-CIO's legislative director, Andrew J. Biemiller, appearing before a Senate subcommittee, described such sales of advanced technology as "devastating" and said that they would "eventually have serious effects on the U.S. labor market." At present some 1200 to 2000 skilled aerospace workers in California are involved in manufacturing the Thor Delta rocket.

Sen. Abraham Ribicoff (D-Conn.) agreed with Biemiller. He asked "why this technology created at great expense to the American taxpayer is being sold to foreign companies for production abroad."

Processor for radar made more versatile

A new associative processor called Staran, incorporating what its developer describes as a "breakthrough in the logic design," is said to be more practical, economical and faster than the usual data-processing portions of large ground radars.

The system was developed by Goodyear Aerospace in Akron, Ohio, and its hardware is a general-purpose, stored-program computer that has—instead of a single central-processing unit, which processes targets one at a time or serially—a number of small, economical processing elements that

Ribicoff also pointed out that there was also a "serious national security implication in the sales." The Senator said that the Senate Finance Committee's Subcommittee on International Trade would dig further into the matter.

Besides the rocket sale to Japan, Biemiller cited other examples of foreign acquisition of American technology that labor opposes: the manufacture of Safeguard missile-system memory components in Hong Kong, the licensing of Mitsubishi in Japan to build the F-4 fighter aircraft and the licensing of Taiwan to build the F-5E fighter.

Also, Biemiller said, Boeing is training 200 Italians to build short-take-off-and-landing aircraft. They will then go home and tool up to sell STOL planes in Europe in competition with the U.S.

In contrast to selling technology abroad, Biemiller pointed out how lucrative it has been for the United States to launch satellites with our own systems for foreign countries, including Canada, France and northern Europe.

accept targets in parallel.

"We get significantly higher speeds this way," says Wayne Brubaker, manager of Goodyear's digital systems marketing. "And we don't run up against the natural speed limit of a single-processing-unit computer."

One Staran system was shipped to Patrick Air Force Base, Fla., late in February for testing of a collision-avoidance control system. A second was delivered March 15 to the Air Force's Rome (N.Y.) Air Development Center to see how well it serves as a surveillance and control system.

Theoretically there's no limit to the number of processing elements a Staran system can have. "But

8000 seems to be about the practical limit, due to such things as propagation delays," Brubaker says. The system sent to Rome has more than 1000 units.

How did Goodyear do it? "We made a breakthrough in the logic design—the hardware portion—which enables us to come up with software that would do the trick," Brubaker says. The breakthrough is proprietary, he adds, declining to give details.

The Staran system in Florida is working with radar. The one at Rome will operate at first with a Honeywell 645 computer that will simulate a radar output.

New avionics may help counter jet noise

The National Aeronautics and Space Administration is tackling the problem of jet noise through a revised approach that may lead to new avionics for the nation's airliners. The agency has been testing a new, two-segment landing-approach pattern, in which the noise is considerably reduced.

Rather than making a long, three-degree final approach and prolonging the 90-dB noise over 5.5 square miles, jetliner pilots would use a two-segment landing approach. The first portion would be steeper—a six-degree slope—and the second would be the usual three-degree angle at the end. This would limit the noise to two square miles.

The new landing approach would call for some heavy spending.

A new, two-segment instrument landing system would cost approximately \$42,000 per aircraft, NASA estimates, and a conventional ground-based, distance-measuring system (DME), which would be required on each runway, would cost about \$40,000.

Aircraft now equipped with three-navigation systems would have to be modified for the two-segment landing system, and this would cost about \$18,000 per plane. And installation of a completely new, compatible 3-D navigation system would come to close to \$200,000.

Collins Radio and United Air Lines have just completed development and evaluation of a two-seg-

ment guidance system in a Boeing 727 and are to start tests this month. The same two companies plan to start work this fall on modifying an existing three-dimensional navigation system in a DC-8 for the two-segment approach.

Optical devices get JEDEC numbers

If receiving a JEDEC registration number is an indication of device maturity, optical isolators have finally come of age. Although they've been available for some time, there was no industry standardization. Designers had to order devices by house numbers.

Now two companies, Texas Instruments and Motorola Semiconductor, have registered a total of seven devices under the JEDEC 4N classification. The new numbers are 4N22, 4N23 and 4N24 for TI and 4N25, 4N26, 4N27 and 4N28 for Motorola.

The 4N classification, established in 1970, means that there are five active terminals on the devices. The seven optical isolators are the first devices to be registered under the classification.

The TI isolators are housed in a hermetically sealed TO-5 six-lead can. The Motorola units came in a six-lead plastic DIP.

While the TI devices were the first to be registered, the Motorola isolators are the first available off the shelf. TI has not yet put its devices on the market.

Comsat planning 2 new satellites

The U. S. maritime fleet and the Navy may soon be sharing communications satellites—one in synchronous orbit over the Atlantic, the other over the Pacific.

The Communications Satellite Corp. Comsat proposes to launch and operate the satellites and says it will ask the Federal Communications Commission for authority to do so soon. The Navy has already signed a contract for close to \$28-million for use of portions of the satellites for two years. After this the Navy expects to have its own satellite network in operation.

The Comsat satellites would be designed to last five years. They would use three frequency bands: uhf, 240 to 400 MHz, for the Navy between Navy-provided terminals and the satellites; L-band, 1533 to 1660 MHz, for links between commercial maritime ships and the satellites; and C-band, 4 to 6 GHz, for commercial links between the satellites and Comsat earth stations on each U.S. coast.

Comsat estimates investment costs at approximately \$70-million, including two satellites in orbit and one spare on the ground.

New fears plaguing μ W-oven industry

Ever since microwave ovens started to become popular, their promoters have waged a big public-relations battle to combat widespread fears of injury by the device. Then, in 1968, the Government wrote standards for the maximum allowable radiation from ovens. Manufacturers met them, fears were allayed and sales soared to an estimated 280,000 units last year. But now trouble has flared up again.

Last month the Consumers Union contended that the Government standards were inadequate, that it would be better for consumers not to use these ovens. Manufacturers have been on the defensive since then.

If the Government standards are unsafe, it's up to the Government to take further action, a Litton spokesman told ELECTRONIC DESIGN. At the same time a spokesman for the Food and Drug Administration's Bureau of Radiological Health said that the bureau's standard for microwave ovens—5 mW per square centimeter at a distance of two inches—was adequate for safe home use.

The safety situation is far from clear. Scientific evidence exists, the bureau spokesman noted, that

changes in testicular function can be caused by a 60-minute exposure to 5 mW/cm of microwave energy.

Why does the bureau say that 5 mW/cm is safe? There are two reasons, the spokesman told ELECTRONIC DESIGN. First, the Government assumes that a user will not generally be closer than 14 inches to the oven while it is operating. At that distance the radiation degrades to 0.1 mW/cm. Second, if a person does get as close as two inches to the oven, it will probably be for only a few seconds to look into the oven.

What the bureau does not take into account, critics note, is that there are no data on the cumulative effects of microwave radiation exposure.

The Consumers Union found that even those ovens that met Government requirements were potentially hazardous. According to Allan Eckhaus, a senior project engineer for the union, dirt can build up on the seals of the oven doors, thereby causing leakage beyond the limits specified by the Government. In addition it is possible for such things as paper towels to get caught in the door, which also could cause an increase in leakage.

When questioned about this, Al Redlar, Litton's Long Island district manager for microwave ovens, said that certain maintenance by the user—the cleaning of seals, for example—was required on the ovens. He acknowledged that it was possible for paper toweling to get caught in the door, but he doubted that many consumers would operate the oven like that.

While microwave radiation from ovens can never be totally eliminated, it can be minimized to a level that equals the ambient radiation, notes Don White of Germantown, Md., a consultant in electromagnetic interference, and compatibility. According to him, there is no technological problem—just an economic one.

News Briefs

CRT displays will be the major type used this year by the Defense Dept., NASA and the Federal Aviation Administration, according to a Frost and Sullivan

report. Matrix displays, (electroluminescent, LED, plasma and liquid-crystal) are, for the most part, still in the R&D stage, the report says.

PIN diode "Micro Pills"

A CURE FOR STRIPLINE AND MICROSTRIP HEADACHES



RUGGED, HERMETICALLY SEALED PIN DIODES ALSO PROVIDE CONTINUOUS RELIEF FROM MICROWAVE CHIP PROBLEMS.

They're immune to shock, dirt, moisture, scratches and other handling hazards, because they're voidless, metallurgically bonded and fused-in-glass for optimum reliability. Though small enough to use like ordinary chips, Unitrode "Micro Pills" can dissipate 15 watts of average power and 60 kilowatts of peak power. And they can withstand thermal cycling from -195°C to +300°C without permanent degradation. Carrier lifetimes exceeding 2.5 μ sec assures low distortion performance. They're ideal for stripline and microstrip applications. Used as switches, duplexers, phase shifters, attenuators, amplitude modulators, or receiver protectors, they operate

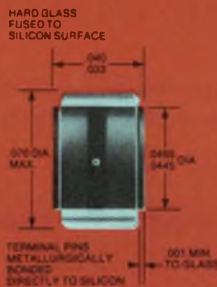

as a variable resistance controlled by a self generated or externally applied bias circuit. The unique construction allows remarkable assembly flexibility, withstanding temperatures up to 400°C when soldering or brazing "Micro Pill" PIN diodes to various circuit media. They're as low as \$4.00 each in 10K quantities. Switch to UM7900 series "Micro Pills" and feel better all day long.

For free samples, call or write Howard Kaepfle at (617) 926-0404 collect, Unitrode Corporation, Dept. 5 X, 580 Pleasant St., Watertown, Mass. 02172. For the name of your local Unitrode distributor or representative, dial (800) 645-9200 toll free, or in New York State (516) 294-0990 collect.



UNITRODE



UNITRODE CORPORATION

Dept. 5 X, 580 Pleasant St., Watertown, Mass. 02172.

Please send technical data on the following PIN diode "Micro Pills"

Type	Voltage Rating (volts)	Series Resistance @ 100 mA (ohms)	Total Capacitance (pF)
UM7901A	100		
UM7902A	200		
UM7904A	400	1.0 MAX	0.8 MAX
UM7906A	600		
UM7910A	1000		

NAME: _____ TITLE: _____

CO.: _____

ADDRESS: _____

CITY: _____ STATE: _____ ZIP: _____

TELEPHONE: _____

Active diodes crowding Gunns in noise, power and efficiency

A new generation of active diodes is emerging to challenge Gunn, or transferred-electron, devices (TEDs) in microwave design.

At present TEDs are leading the pack by a wide margin. They are available from a growing number of manufacturers and are finding increasing uses in low-noise, low-operating-voltage commercial applications. Production quantities of TEDs can be obtained with X-band output powers of 300 mW cw, efficiencies of 2-1/2 to 3% and bandwidths of 5 to 6 GHz.

Leading the challenge to TEDs are Impatts (impact avalanche and transit-time diodes). Commercial single-drift, silicon Impatts offer nearly double the power and efficiency of off-the-shelf TEDs at X-band. And laboratory development of double-drift silicon and gallium-arsenide Impatts promise to widen the power and efficiency advantages further.

Down the stretch are Trapatts—trapped-plasma, avalanche-triggered transit diodes, barely out of the laboratory—and Baritts—barrier-injected transit-time diodes still in the laboratory. Trapatts have very high peak powers and efficiencies, while Baritts exhibit very-low-noise operation.

The leading manufacturers of TEDs are Microwave Associates of Burlington, Mass., and Varian Associates of Palo Alto, Calif. Microwave Associates offers, for such uses as local oscillators and voltage-controlled oscillators, a series of diodes for the 4-to-26-GHz frequency range with power ratings of a few milliwatts. Ratings of several hundred milliwatts are available for medium-power applications. Varian's line has about the

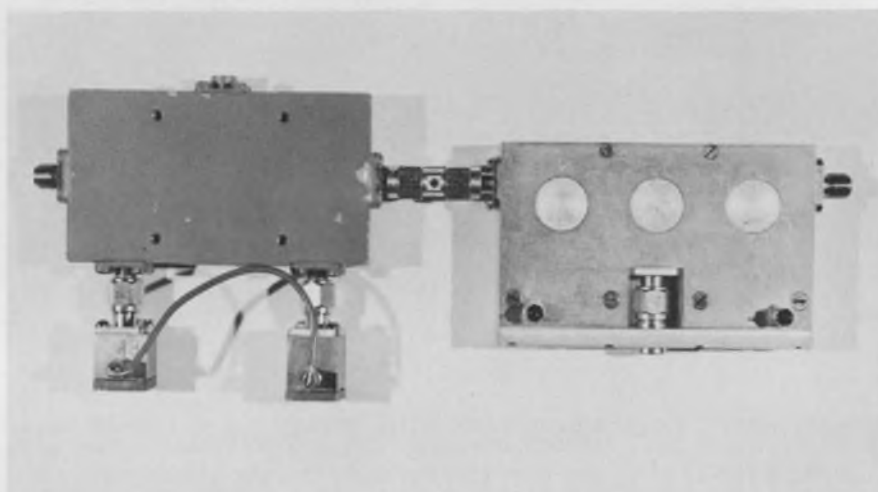

Starting with transferred-electron preamps for low noise, and finishing with Impatt stages, this four-stage RCA design provides 300 mW at 8 GHz. Efficiency is 3%, while noise figure is a low 14 dB.

same power levels for both application areas and extends to about 40 GHz.

TEDs vs Impatts: the tradeoffs

The chief advantages of TEDs over Impatts are lower noise, wider bandwidth and the ability to tolerate open and short-circuit loads safely. But available Impatts, according to Lee MacKenzie, product line engineer at Microwave Associates, have X-band ratings of about 1 W cw (against 300 mW for TEDs) and about 6% efficiency (against 2-1/2 to 3% for TEDs). The spread is wider for laboratory devices. In K_u band, MacKenzie notes, Impatts using GaAs have been developed with output powers of 3 W cw and efficiencies exceeding 20%. For state-of-the-art TEDs, X-band figures are 1 W cw and 12 to 13% efficiencies, he says. The widening power lead accounts for the use of Impatts in high-power amplifiers and transmitters.

The AM and FM noise of both devices depends on bias conditions

and circuitry. For most applications, however, silicon Impatts exhibit a fairly flat noise characteristic over frequency. The noise from TEDs rises as the operating frequency approaches the carrier frequency, and it is generally much less than that of Impatts.

The noise advantages of TEDs have established them in low-power applications, including as a source for local oscillators and as the first stage of low-noise amplifiers. Alone among active diodes, TEDs have a clear commercial beachhead in the applications of intrusion alarms and doppler radars.

Both TEDs and Impatts use negative resistance to generate microwave frequencies, as do all active two-terminal devices. But the negative-resistance bandwidth of TEDs exceeds that of Impatts by a wide margin. According to MacKenzie, commercial TEDs have a 3-dB bandwidth of 5 to 6 GHz at X band, while available Impatts have a corresponding bandwidth of about 3 GHz.

Material represents a funda-

mental difference between the two commercial device types. Most Impatts use the well-established techniques of silicon technology, while the manufacture of TEDs depends on the relatively young gallium-arsenide technology. One result: TEDs from different manufacturers normally have only power and frequency in common, and noise levels can vary markedly even from part to part. Reliability, however, is not in question. Measured mean-time-between-failure values for TEDs are reportedly comparable to those for transistors.

While attention on Impatts has centered on cw devices, pulsed units can be expected shortly from Hewlett-Packard. A leading manufacturer of Impatts, the Palo Alto, Calif. company offers devices rated at 1-1/2 W at 5 to 8 GHz, 1-1/4 W at 8 to 10 GHz and 1 W at 10 to 13.5 GHz—the highest powers at these frequencies for commercial Impatts.

According to David Struthers, product marketing engineer at HP, his company will introduce this year a pulsed Impatt capable of 10 to 20 W of peak power at 10 GHz. Intended for low-duty-cycle operation, its pulse length will be about 100 ns. Also expected is a model with longer pulse widths and relatively high duty cycles. Average power should reach 1-1/2 W at 10 GHz.

Struthers sees the future of commercial Impatts emerging from laboratory developments involving double-drift silicon and GaAs diodes.

The double-drift diode consists of two conventional single-drift diodes in series. One uses electron conduction and the other hole conduction. The increased output power results from the increased impedance levels—twice that of a single diode, since two are in series.

For higher efficiencies, and possibly lower noise from Impatts, a complementary Impatt is being investigated by several researchers, including some at the Hughes Electron Dynamics Div. in Torrance, Calif. The complementary diode—so-called because of a complementary reversal of p and n-type regions in the diode—makes use of holes in the drift region, according to Bob Ying, semiconductor section head at Hughes.

Since the ionization coefficient of holes is much greater than that of the electrons, a much narrower avalanche region can be obtained for increased efficiencies, he says. Efficiency increases of 50% over standard single-drift diodes are projected.

But the most dramatic Impatt results to date have emerged from Raytheon in Waltham, Mass. Grant St. John, assistant operation manager of the company's Special Microwave Device Operation, reports the development of a GaAs Impatt that delivers 3 W cw at 15 GHz with an efficiency of 20%. At lower power levels, he says, an efficiency of 24% can be obtained.

Raytheon achieved the impressive results by obtaining a modified Read profile—the textbook model for the Impatt and the one for maximum performance values. The profile can also be obtained in silicon, a route being investigated at Hughes because of problems associated with gallium arsenide.

According to Ying at Hughes, reliability data for higher-power gallium-arsenide devices are incomplete. There are no data telling what will happen over long periods when the devices must operate con-

tinuously at 200 to 250 C—the temperature range that junctions are subjected to in power devices. However, the GaAs material does have a higher temperature capability than silicon, Ying adds.

For the highest peak powers and for high efficiencies from commercial diodes, the LSA (limited space-charge accumulation) diode can be obtained from Cayuga Associates of Ithaca, N.Y. The LSA diode is actually a special mode of operation of transferred-electron devices.

Cayuga offers LSA devices with peak powers in excess of 100 W and a duty factor of 0.1% (for an average power of 0.1 W) from S through X bands. At C band, an LSA device supplies 250 W of peak power, while at K_u band the peak power drops to 25 W. Efficiency reaches 8 to 10%.

The major problem with these devices is the critical dependence of circuit controls. Bill Camp, senior design engineer at Cayuga, says that load VSWRs must be a maximum of 1-1/4:1 and well-behaved at the fundamental and second harmonic.

Moreover, Camp says, frequency changes with bias and temperature

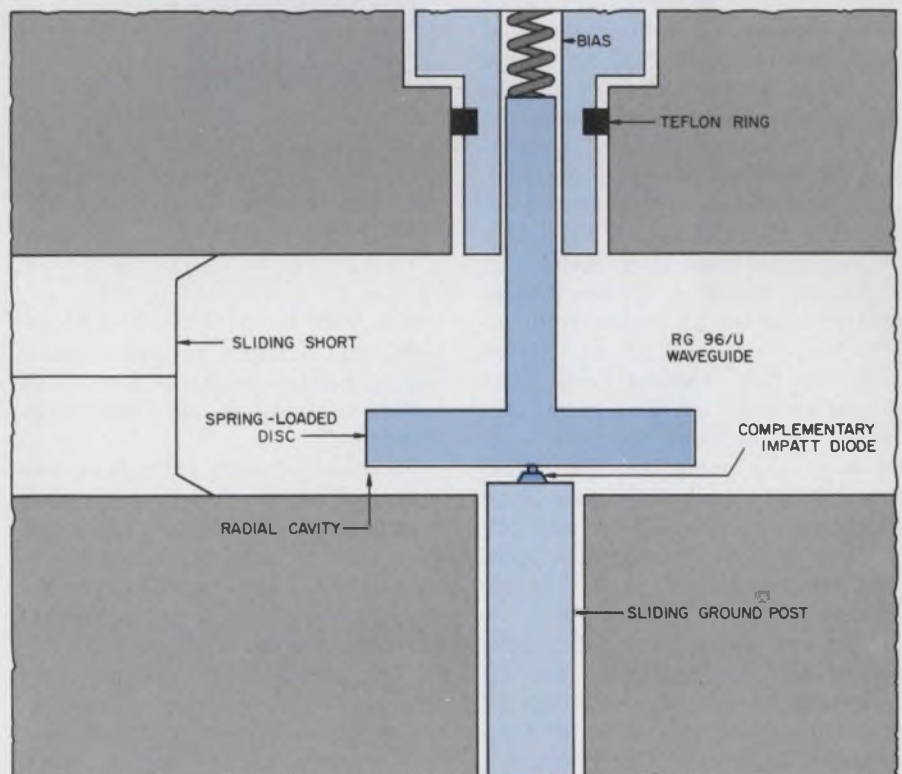

A complementary mm-wave Impatt oscillator from RCA achieves 700 mW at 30 GHz with an efficiency of 9.2%. The diodes operate cw from 20 to 40 GHz, and a 23% tuning is achieved in K-band.

at a rate of about 5 to 10 MHz/V and 3 to 5 MHz/°C. For constant frequency, the associated circuitry must have, at the least, an automatic frequency control loop to sense frequency changes and make the necessary bias-voltage changes.

Present applications for LSA devices, according to Camp, include beacons and short-range radars. A unique feature of these devices makes them very suitable in range measurers. Only LSA devices, of all high-power, solid-state devices, can turn on and off in a nanosecond, Camp says. Hence range resolutions in inches can be obtained.

Trapatts compete with LSAs

Still another method of obtaining pulsed power and high efficiency is to use a Trapatt. In small quantities, S-band Trapatts may be obtained from General Electric at Owensboro, Ky.

GE, the only supplier of these diodes, has a 2-to-4-GHz Trapatt that can deliver 20 to 40 W of peak power in a pulsed mode. Pulse duration is 1 μ s, while pulse rate reaches 10 kHz. Typical pulsed voltage and current are 5 to 75 V and 2 A, and efficiency exceeds 20%.

Much of the laboratory work with Trapatt is taking place at RCA in Princeton, N.J. According to Fred Sterzer, director of the Microwave Technology Center at RCA, Trapatt amplifiers, consisting of several diodes in parallel, have been built with peak powers of 1 kW at 2 GHz. At 3 GHz, 150-W amplifiers have been built.

But in terms of higher powers and efficiencies at higher frequencies for pulsed applications, Sterzer sees the field settling down. The emphasis now, he says, is on secondary performance features, such as low noise, wide bandwidth and low-voltage supply operation. Ying of Hughes agrees. He believes the devices are pretty well developed, and the need now is for better circuits.

The circuitry for Trapatts, which are closely related to Impatts, poses special design problems that have only recently been solved. The chief difficulty—and a major disadvantage when the Trapatt circuitry is compared with that for the other diodes—is the

need for both harmonic and subharmonic tuning. In Trapatt devices an avalanche shockfront must be initiated by a small-signal Impatt mode. As a result, circuits must have the proper impedance and line length at both the Impatt and Trapatt frequencies.

Kurt Gsteiger, engineering manager of semiconductor devices at Sperry in Gainesville, Fla., offers the following example: A 10-GHz Trapatt has to support the third or even the fifth subharmonic, since higher-order subharmonics generally yield higher powers. The fundamental, or Impatt, frequency when the fifth subharmonic is used

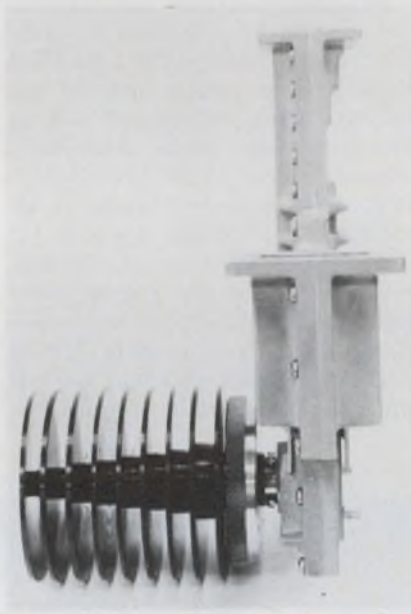

Silicon Impatt amplifier finds application in AT&T's microwave repeaters. The amp provides 1 W at 6 GHz with 30 dB of gain.

must then be at 50 GHz. And associated circuitry, as well as package parasitics, must be compatible with oscillations at that high frequency.

Because of such difficulties, major applications for Trapatts have yet to develop. However, Jim Rush, manager of applications engineering at GE, says that Trapatts are being seriously investigated for use in phased-array systems.

The applications picture may change with the recent development at Sperry of a high-power, cw Trapatt in the low X band. Breaking the pattern of building Trapatt diodes for pulsed applications, Sperry has come up with a

Trapatt diode capable of 3 W cw at 7.6 GHz, and with an efficiency of 16%—the highest cw power at the highest efficiency.

Noise measure for the Sperry device was 70 dB at 6.2 GHz—10 kHz away from the carrier in a 100-Hz bandwidth and with a circuit Q of about 50. The noise values are higher than for other diode types. However, Trapatts are generally conceded to be the highest-noise device.

The 3-W Trapatt uses a ring geometry, rather than the more familiar mesa geometry, and a diamond heat sink. Gsteiger says the Sperry breakthrough was obtained by achieving low-threshold power to excite the Trapatt mode and by overcoming the problems associated with efficient heat sinking. Previous attempts had failed, he notes, because of thermal-barrier difficulties at the diamond interface. The new Trapatt can safely dissipate up to about 20 W.

Baritts promise low noise

The noise limitations of active diodes—specifically TEDs—could be overcome practically by Baritts if their efficiency and frequency range could be increased. So thinks Bob Ryder, head of the Microwave Diode Dept. at Bell Telephone Laboratories. He cites typical state-of-the-art results: At 8 GHz, a laboratory Baritt has an output power of 150 mW but an efficiency of only 2 to 3%. And since just "shot" noise is present, noise figures of 10 to 15 dB have been obtained from the experimental samples.

Ryder feels that Baritts could compete with TEDs for use in low-noise receiving oscillators but that higher efficiencies would have to come first. Moreover the full frequency range of these devices would have to be found.

Ryder notes that TEDs operate to about 50 to 60 GHz and Impatts to nearly 100 GHz. But Baritts don't seem to have broken out of X band yet.

On the plus side, Baritts are the simplest diodes—simpler even than transistors, says Ryder. Hence they are potentially the lowest in cost. In addition they are made of silicon rather than GaAs, so the fabrication techniques are fully established. ■■

POWER-MOV™ VARISTOR

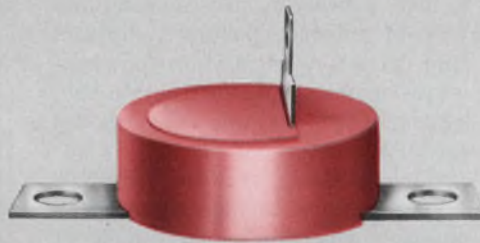

FOR BETTER VOLTAGE TRANSIENT PROTECTION IN A POWER PACKAGE

General Electric POWER-MOV™ varistors are the newest addition to our growing line of superior metal oxide suppressors which provide better breadth of protection than selenium, silicon carbide, zeners, spark gap, or other older technologies. This new chassis-mount package is ideal for applications requiring high power dissipation and added ruggedness.

Forty-six models are being offered initially including the following:

MODEL	AVG. PWR. DISSIP. (WATTS)	MAX. VOLTAGE		SUGGESTED RESALE PRICE		
		AC	DC	1-99	100-999	1000-9999
V130PA20A	15	130	170	4.90	3.31	2.94
V250PA40A	13	250	330	7.36	4.97	4.42
V480PA80A	10	480	625	12.10	8.17	7.26
V510PA80A	10	510	655	12.60	8.51	7.56
V550PA80A	9	550	755	13.16	8.88	7.90

Other voltages available from 130V to 570V Rms, 170V to 780V DC



Actual Size

TYPICAL APPLICATIONS

- Inverters
- Welding Equipment
- Reprographic Machines
- Electric Vehicles
- Motor Controls
- Arc Suppression

FEATURES

- 15 WATTS DISSIPATION @ 70° C Tab Temp.
- 2,000 Amps Peak Current
- Low Clamping Ratio (1.7-1.9@ 10.0A)
- Meets NEMA strike and creep distance
- Quick disconnect termination

For your POWER-MOV™ varistor DESIGN KIT, call your local authorized GE semiconductor distributor . . . or write to General Electric Company, Semiconductor Products Department, Building 7, Mail Drop #49, Electronics Park, Syracuse, N.Y. 13201, U.S.A.

GE-MOV™ VARISTORS ASSURE YOUR EQUIPMENT WILL ENDURE

GENERAL ELECTRIC



Single laser rod yields 4 beams for high-speed holographic work

A laser that produces four separate beams from a single laser rod has been developed at Sandia Laboratories in Albuquerque, N. M. The device will be used to obtain holographic sequences of high-speed phenomena, such as an explosion that may last a few billionths of a second, or erosions of materials placed in hot streams of plasma.

Mercury lamps, which were used initially to make such holograms, were not satisfactory because they did not provide enough illumination. And the two conventional solutions to this problem also have flaws: Firing several lasers in sequence calls for a complex and relatively expensive system. And using optical delay lines to split a single beam into multiple beams produces weak beams.

Sandia's multiple-beam system, invented by the laboratory's Murphy J. Landry, solves these problems and also permits multiple holograms to be made on a single frame or plate. This, Sandia says,

eliminates the mechanical movement or beam deflection typically required for multiple-exposure recording.

The prototype uses a combination of prisms, apertures, shutters and reflectors to produce four separate beams or pulses in rapid succession from a single ruby rod 1.9 cm in diameter.

The intensity of light from the lasing medium to the end reflector in each assembly is controlled by a Pockels cell, which is actuated by a trigger output from a central oscillator. The oscillator has four independently variable outputs, permitting complete flexibility in opening the Pockels cells and thus varying the separation between pulses.

The key to the device is a Q-switching arrangement that permits separate, parallel volumes of the lasing medium (rod, liquid or semiconductor) to lase independently of one another. A mirror at the end of each of four Q switches reflects the light back to the laser

rod many times, until it has built up enough energy to escape through both an output mirror and a pyramidal prism to the holographic plate. (see diagram).

Besides the Q switch, another development that made the system possible is the general improvement in laser rods over the last few years. Rods now produce very little small-angle scattering, which helps to establish lasing cavities that are separated by as little as 0.4 mm of lasing medium.

Thus far the Sandia laser has produced four consecutive pulses, each lasting 25 billionths of a second. The time between pulses can be varied from 25 billionths to one-thousandth of a second. The ability to vary the interval between pulses—resulting from the fact that each cavity is independently controlled—is a major advantage of the multibeam system. It permits exposures to be made from a few picoseconds up to 10 ms apart. A patent on the system has been issued to the AEC. ■■

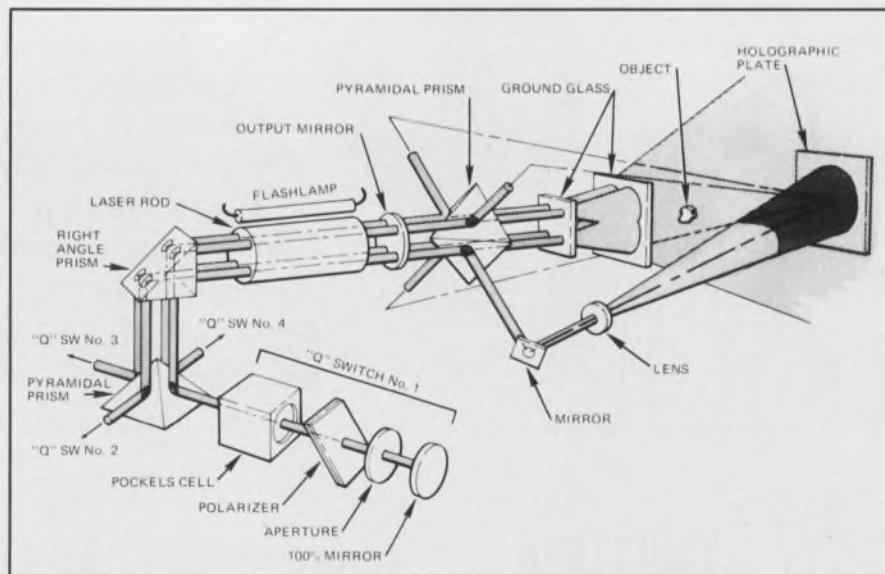

Light from the laser rod travels (left) to the right-angle prism, splits into four beams via a Q-switching arrangement and on to four mirrors. The mirrors reflect the light back many times to the rod, until the light builds up enough energy to escape through the output mirror (right) and on to the pyramidal prisms and the holographic plate.

Bendix puts an end to the bends.



You know the bends. That's when connector pins are bent or damaged during mating by misaligned plug and receptacle.

The bends just can't happen with Bendix SJT connectors. Pins are recessed. Stronger, too. And that makes them 100% scoop proof. You get positive protection whether the pins are in receptacle or plug.

You get five-key polarization, too. And that makes mismatching a thing of the past.

Another key feature: Bendix 100% scoop-

proof SJT connectors conform to the mounting dimensions of low silhouette (JT) series II MIL-C-38999 connectors. They're available in lightweight shell sizes from 8 to 24 with from 3 to 128 crimp type contacts accommodating wire gauges from 12 to 28.

Now then. Like to put an end to the bends? Write for our new SJT catalog.

The Bendix Corporation, Electrical Components Division, Sidney, New York 13838.



Electronics for cars said to pose bigger challenge than space work

Designing electronic systems for automobiles is tougher than designing for spacecraft, the keynote speaker told attendees to the recent Solid-State Circuits Conference in Philadelphia.

Presenting "A View of Automotive Electronics," Dr. Peter A. Schoeck, director of corporate R&D for Robert Bosch GmbH, Stuttgart, West Germany, cautioned companies that feel their work in sophisticated aerospace projects is sufficient background to enter automotive systems engineering. They fail to realize, he said, that the auto is more complicated than a spacecraft because it does not lend itself to the same degree of theoretical treatment.

"For instance," Schoeck pointed out, "the parameters of a curved, slippery road are much more difficult to define than a planetary atmosphere. And the thermodynamics of an internal-combustion car engine are more complicated than those of a rocket engine.

"Also, the effects of salt spray, humidity, frequent temperature changes and mechanical stress from 60-G accelerations are possibly harder to predict than the effects of cosmic radiation."

The difficulties in meeting the tough specifications, the keynote speaker said, have slowed the entry of electronics companies into the automotive field. Components for cars must have exceptional reliability, he noted.

"Failure rates that might look extremely good for TV sets are by far not acceptable in cars," he stressed.

But electronics is performing a twofold role—improving the performance of existing devices and realizing entirely new concepts—in auto ignition systems, Schoeck reported. He predicted a new generation of contactless, breakerless

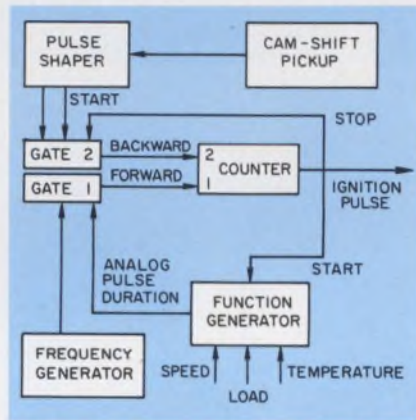

Breakerless electronic ignition timing control system uses an analog function generator to gate digital counts from pickup.

systems to optimize power and fuel consumption.

Taking note of ignition parameters like engine speed and manifold pressure, the R&D director said: "The added requirements of emission control [to minimize pollution] will add criteria like catalytic reactor temperature and exhaust gas recirculation. Conventional ignition timers cannot cope with such a variety of parameters. This requires an electronic function generator."

A possible solution, he went on, is a system in which the parameters determining the spark angle are fed into a function generator (see block diagram).

"The duration of the count timed by the function generator determines ignition timing," Schoeck explained. "The generator produces an analog signal with a duration proportional to the spark angle."

The analog signal controls the number of counts that are fed from the frequency generator into the counter through gate 1. The counter also receives a second sequence of counts from a digital pickup on

the camshaft. The total count is proportional to the angle through which the camshaft has turned.

The second count reverses the first count, and as soon as the net count reaches zero, the high-voltage generator is triggered and the spark occurs. The ignition pulse restarts the sequence.

"The system represents," Schoeck said, "a hybrid that has a digital sensor on the camshaft and an analog processor or function generator transforming the input parameters into a time period. It is possible to replace the analog process by a digital one. But this will not be practical until inexpensive read-only memories are available.

"The next logical step is to incorporate this processor into a central control unit."

CPUs expected in cars

Will Steffe, manager of design and development of analog products at Fairchild Semiconductor, Mountain View, Calif., and moderator of a panel session on automotive electronics, predicted that central processing units eventually would appear in autos for troubleshooting.

"With a CPU in vehicles," he said, "we can have true diagnostics on board. It can print out what's wrong—and possibly the labor rates and also costs required to fix the trouble. Ideally, the automobile electronics should be self-diagnosing to a throw-away level."

Controlling destructive transients

Solutions to a major problem in automotive electronics—the destruction of semiconductors by high transient voltages—were offered by William F. Davis, project

(continued on page 31)

variety is on our side ... CMOS

FROM SOLID STATE SCIENTIFIC

- SCL 4000 SERIES-STANDARD LOGIC
- SCL 4400 SERIES-EXTENDED FUNCTION LOGIC
- SCL 5400 SERIES-TIMEKEEPING CIRCUITS
- SCL 5500 SERIES-RANDOM ACCESS MEMORIES
- CUSTOM AUTOMOTIVE CIRCUITS
- CUSTOM TIMEKEEPING CIRCUITS
- CUSTOM CMOS FOR YOUR APPLICATION



For the ability to design
... to implement ... to
fulfill the exploding demand
for CMOS *quality in quantity* ... look to SOLID STATE
SCIENTIFIC—you'll find
plenty on our side.

SOLID STATE SCIENTIFIC INC.

MONTGOMERYVILLE, PA. 18936 ■ (215) 855-8400 ■ TWX-510-661-7267





The hole story.

The stuff our superior cores and memory products are made of.

We create strips of plastic tape which contain precise amounts of ferrite. This way, the density of magnetic material can be controlled and the material itself easily shaped. We run the tapes through a "cookie cutter" roll-cut press which punches out cores. The plastic is vaporized by firing. What's left are superior cores with exceptionally uniform electrical and mechanical characteristics. We can roll-cut cores to your exact specifications. From 14-mil to 30-mil. Including new wide-temperature ones.

We make stacks of all types, sizes and configurations, too. We can supply sizes from 4K x 18 to 131K x 80 off the shelf. Organizations include 2-wire/2D, 2-wire/2.5D, and 3-wire/3D. If we haven't got what you need, we'll custom-make it for you.

Nothing equals our core memory systems for speed, reliability, and low cost. Certainly not semiconductors. We wrote the book on core quality. From cores to stacks to systems. Call us today for the whole story. And for whatever you need.

DATA
PRODUCTS

OEM National Marketing: Boston (617) 237-1950; Dallas (214) 231-2240; Los Angeles (213) 474-1596; Minneapolis (612) 835-2066; Philadelphia (609) 667-7555; San Francisco (415) 941-5485; Washington, D.C. (301) 652-8120. **U.S. Representatives:** Albuquerque, W. J. Purdy Co. (505) 266-7959; Chicago, L-Tec, Inc. (312) 286-1500; Denver, W. J. Purdy Co. (303) 794-4225; Orlando, Fla., Gentry Assoc., Inc. (305) 894-4401. **OEM International Marketing:** Amsterdam 020-452-457; London 01-579-2917; Munich (0811) 989201; Paris 686.0691; Tokyo 493-6451; Vienna 34.53.61, 34.44.16. **Int'l. Representatives:** Mexico City, Maquinas de Informacion, S.A. (905) 524-9195; Sydney, Delairco 29-2863; Tokyo, Marubeni 501-7421. **Home Office:** 6219 De Soto Ave., Woodland Hills, Calif. 91364 (213) 887-8000.

NEW!



Mini-Store. A compact, modular storage system with a cycle time of 650 nanoseconds. Basic 8K x 18 capacity in a 2" x 7" x 8 3/4" module, expandable to 65K x 18.

NEW!



Plug-Compatibles. Our line of cost-effective card and planar replacement memories includes the Store/1885 (above), a replacement for the Ampex 1885. Also replacements for the Ampex 1865, Electronic Memories' MICRO-MEMORY 2000, and Digital Computer Control's D-112 memory.

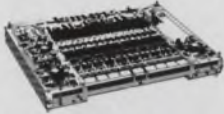

Store/225. This one's brand new. It's a large capacity, economy memory (32K x 18) with a 2-wire/2.5D organization. It features an access time of 475 nanoseconds, and a cycle time of 900 nanoseconds.

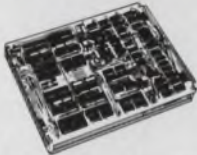

Store/336. Access time is 250 nanoseconds. Capacity is 8K x 18, and you can order compact configurations all the way up to 65K x 18.



Store/333. A basic 8K x 18 memory that's expandable to 32K x 18 in a 5 1/2-in. chassis. It's the industry's standard for quality, with access time of 300 nanoseconds, and cycle time of 750 nanoseconds. 18-mil cores, 3-wire/3D organization.



Store/333-M. Full mil-spec memory system meeting MIL-E-16400.

**The
memory systems
our uniformly
superior cores
make up.**

DATA PRODUCTS

(continued from page 28)

engineer at Motorola Semiconductor Products, Phoenix, Ariz., in a Session XIV paper entitled "Monolithic Bipolar Design Considerations for the Automotive Environment."

Transient voltages caused by "load dump," or a sudden disconnecting of the battery when the alternator is charging, can range from 80 to 120 V, he noted. A zener diode connected between a resistor coming from the main battery supply and the IC chip has been employed to limit these voltage transients to less than the breakdown voltage between the collector and emitter of transistors with the base open (BV_{CEO}). But power dissipation, as well as the cost of the zener, are both high with this arrangement, Davis pointed out.

A new circuit that automatically shorts the base of a transistor to its emitter during transients—and thus increases the breakdown voltage close to the collector-to-base level, which is several times that of the BV_{CEO} value—was described.

It operates (Fig. 2) like this: Transistor Q2 conducts when the supply voltage rises higher than the breakdown voltage of zener Z3. The base of Q1 is thus grounded

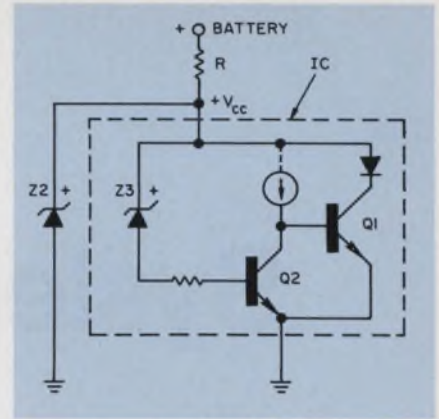

High-voltage transient protection is provided by new circuit where zener Z3 and transistor Q2 increase collector-to-emitter breakdown voltage.

and is effectively at the emitter level.

Zener Z2, which in the usual configuration draws considerable power, has a substantially higher voltage breakdown rating in the new circuit and thus clamps only the low-energy, higher-voltage transients. This is so when the collector-to-base breakdown is higher than that of the transients.

Less expensive external power transistors can be used with this technique, Davis said, because the maximum current densities and safe operating areas will not be exceeded during transients. ■■

Canada claims a digital-data 'first'

While Bell Telephone and specialized carriers like Datan and MCI are rushing to develop a nationwide digital communications network in the United States, the Trans-Canada Telephone System has announced "the first nationwide digital-data system in the world that operates on a commercial basis."

According to J. C. Carlile, president of Trans-Canada, the new system will dramatically reduce the cost of data communications, in some cases by as much as 90%.

Known as Dataroute, the new service begins this month and will cover all major communities in Canada by the end of the year, according to the utility. The network provides full-duplex, private-line, serial digital-data transmission in a broad range of synchronous and asynchronous speeds,

110 to 50,000 bits per second.

Although primarily a private-line service, Dataroute can accommodate dial access at the remote end of a two-point channel. This is done by terminating the line on an analog modem. The dial-access capability, however, is only one way—Originate. Users can dial the near end of the system and have access to a computer at the remote end, but the remote computer cannot dial out of the near end.

In addition to dial access, several other channel arrangements are available, including point-to-point private lines, multipoint private lines and multidrop private lines.

Another feature of the network is a central control and diagnostic operation that monitors the system automatically and diagnoses problems before they can impair service. ■■

Are you a Systems Assembler?

Do you put together systems including
minicomputers,
peripherals and accessories?

If so, you should have a FREE subscription to **COMPUTER DECISIONS**, the magazine devoted to more effective and efficient use of computing and information systems resources.

For example, in December we ran extensive coverage of miniperipherals, including eight tables of suppliers of printers, tape drives, tape cassette units, disk drives, drums, punched card units, add-on memories and punched tape units.

In October, **COMPUTER DECISIONS** surveyed minicomputers, and in September, small business systems.

Don't miss the coverage of minisystems coming up in future issues. **COMPUTER DECISIONS** focuses on costs, comparisons, uses, techniques and software considerations rather than engineering details.

FOR A FREE SUBSCRIPTION, fill out the card opposite and send it to us. If the card is missing, simply circle Reader Service number 246 and we'll send you one.

COMPUTER DECISIONS • A Hayden Publication
50 Essex Street • Rochelle Park, N.J. 07662 • (201) 843-0550

WINDJAMMER

FREE

barefoot adventure

SOMETHING TO STIMULATE YOUR EROTIC PREOCCUPATION

We have a book with color pictures. It's nothing pornographic. But somehow it tends to stimulate erotic thoughts. Especially if you're a free thinking, uninhibited person who wants to be turned on to an unusual vacation experience.

We sail adventurous schooners to several slightly uncivilized islands in the Caribbean. Places like Grenada, Saba, Monserrat, St. Maarten and Antigua. Fortunately these are the few islands that haven't been overrun by jaded tourists.

So you can find a deserted beach and stretch without being seen. Or you can strip down and play under a waterfall. Or you can get into the local color on each island.

And we haven't let our Windjammer cruises become a luxury. We keep things basic. Nice, clean cabins. Good hearty food. And an uninhibited crew that will entertain you until dawn with wild native music. The rest is up to you. There are no formalities, no social pressures, no restrictions. Fish, skin dive soak up the sun and communicate with real people in an unhampered, natural setting.

A 10 day Windjammer cruise starts at \$245 per person. Write for our free book today. It will give you something good to think about.

Windjammer Cruises.
P.O. Box 431, Main Office Department 550 Miami, Florida 33101
Yes, send me the book.

Name _____
Address _____
City _____ State _____

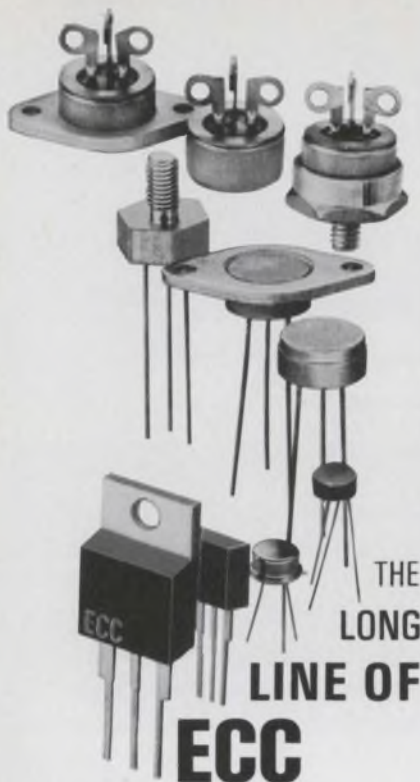

THE
LONG
LINE OF
ECC
LOW AND HIGH CURRENT
TRIACS

World's leading
Triac producer offers
fast delivery,
electrical isolation and
a variety of packages.

LOW CURRENT TRIACS

THERMOTAB® and THERMOPAK*; Swedge and TO-3; 5/8" Hex Stud, and TO-5 Metal and Plastic Packages

$I_{T(RMS)}$ 0.8 - 16 amps
 I_{GT} 1, 111 3, 10, 25, 50 ma max;
with or w/o internal trigger
 I_{TSM} 20 - 150 amps
 V_{DROM} 200 - 800 volts

*trademark of ECC

For more information, circle No. 238

HIGH CURRENT TRIACS

3/4" Press-Fit, Stud and TO-3 Packages
 $I_{T(RMS)}$ 25 - 40 amps
 I_{GT} 1, 111 50 - 100 ma max
 I_{TSM} 230 - 300 amps
 V_{DROM} 200 - 800 volts min

For more information, circle No. 239

All packages are electrically isolated except TO-5 Metal Can. ECC triacs feature heavily glass passivated junctions for high reliability.

Contact your nearest ECC Sales Representative or Authorized Distributor for pricing and technical information.

ECC
CORPORATION

P.O. Box 669 • Euless, Texas 76039
817/267-2601

**technology
abroad**

A gas-discharge panel with a 128-by-128 dot matrix has been introduced by Thomson-CSF of France. The panel, called the Pavane, is a 13-mm-deep array of gas cells sandwiched between sheets of dielectric. The cells are separated by 1.27 mm. The brightness of the display is as high as 1000 cd/m². The power consumption is 1 mW per dot. The over-all size of the display is 215 by 215 mm. The

data can be stored at the panel level, with no need for refreshing. The company is readying a panel of improved resolution that has but 0.635 mm between luminous dots. Also being investigated are a 512-by-512 cell display of higher brightness and contrast, multicolored displays and a manual writing and erasing feature.

CIRCLE NO. 441

Thin-film microwave circuit techniques are being used to fabricate a low-cost doppler radar intruder alarm by Mullard Research Laboratories of Surrey, England. All circuit elements are incorporated in a thin-film circuit on a

single 1-cm² ferrite substrate. Radiated power is from 5 to 7 mW. With an antenna of 20-dB gain, this gives a range of 20 to 30 meters. The design, still in the experimental stage, may be put on the market eventually.

CIRCLE NO. 442

A V-antenna with lumped capacitive loading has been demonstrated to have very broadband characteristics as well as better directional properties than a straight dipole with the same loading. The advantages of the capacitively loaded V-antenna were shown under a multinational project sponsored by the Serbian National Research Foun-

dation in Yugoslavia. Early experiments designed to eliminate the frequency-dependent properties of the V-antenna with resistive loading resulted in high losses. The capacitive loading is in the form of narrow, transverse gaps between the antenna arms. The gaps are set progressively closer together towards the antenna ends.

CIRCLE NO. 443

A method of fabricating two-phase, charge-coupled structures with electrode separations of 0.1 to 0.3 μ m has been developed at the University of Southampton in England. Whereas most scientists have used the double-layer metallization to achieve the very small gaps necessary for charge transfer, the Southampton team has employed a single-layer metallization process. The silicon slice is

mounted at an angle, so that wherever steps in the silicon oxide shield a portion of the silicon surface from the metallizing beam of aluminum atoms, discontinuities in the metallization are produced. This simplifies the pattern of the interconnection mask, and the electrical connection between adjacent electrodes is provided automatically.

CIRCLE NO. 444

2K MOS RAMS

Clear your boards for action.

Try this in your sockets: our industry standard 2K MOS RAM, the 2548, delivers twice the bit storage in less than half the board space required by 1K RAMs. Just the cost/performance edge you're looking for, to give your competition a lot tougher run for the money.

Available now, volume-stocked and field-proven, with over two years of production and testing experience. Much easier to use than previous alternatives, the 2548 jazzes up capability while aggressively lowering system costs. 2K density in a single MOS RAM device gets you out of core memory.

TTL-MOS level shifters? The 2548 requires only

its real potential. That's Signetics' user-dedicated technology every time. Now it's a true 2K MOS RAM that goes you 1024 bits better than ever before.

Call, write, or wire us today for specs and quotes. And profit from our experience.

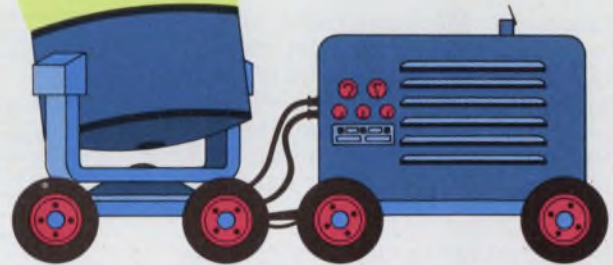
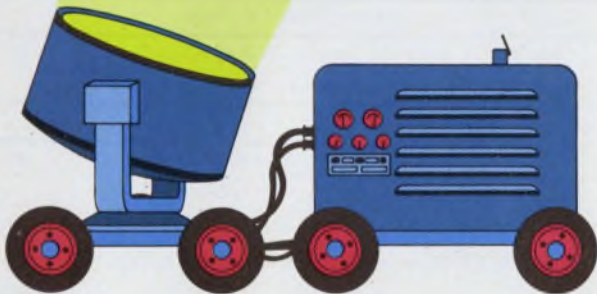

three—the usual 1K requires fourteen. Non-overlapping clocks simplify design and debugging. Fast access time gets processing moving at a livelier clip. Our 8T25 sense amp assures smooth conversion between your 2K MOS RAM and TTL.

Take the most dense RAM available, and unlock

Signetics-MOS
811 E. Arques Avenue
Sunnyvale, California 94086 (408) 739-7700

Please rush complete input on your new 2K MOS RAMs, and 8T25 sense amps.

Name

Title

Company

Address

City

State

Zip

Telephone

Signetics Corporation A subsidiary of Corning Glass Works

signetics

INFORMATION RETRIEVAL NUMBER 21

256-Bit RAMs.

MAX. ACCESS ACROSS TEMP. AND V_{CC}

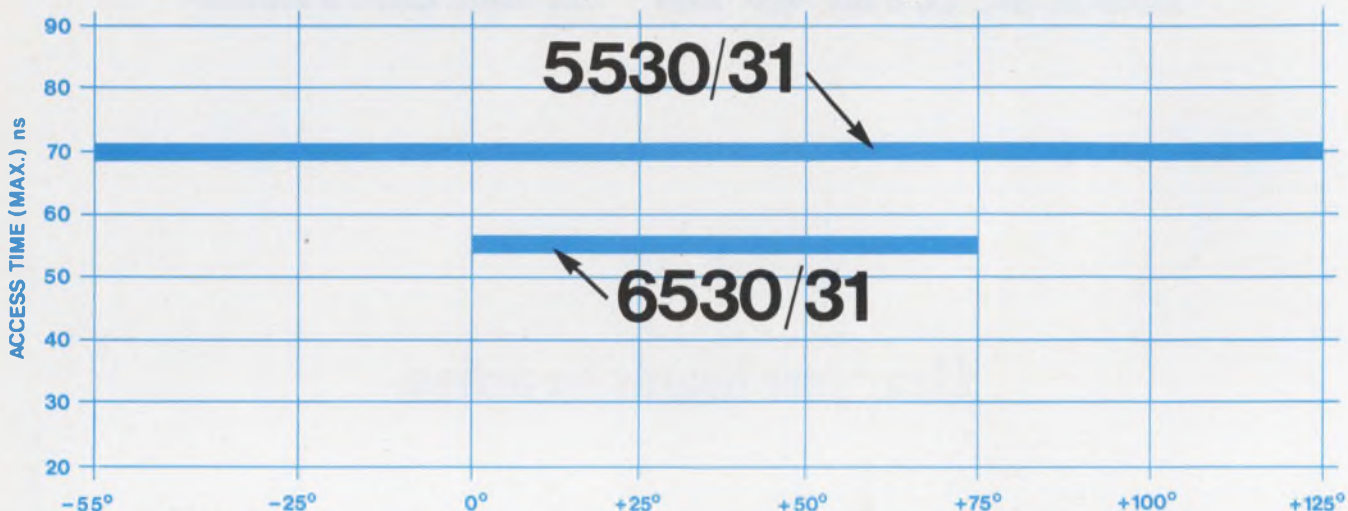

Guaranteed fastest. Across temp and V_{CC} .

Monolithic Memories could have chosen to be your first supplier for 256-bit bipolar RAMs. Instead, we chose to be better. The chart tells how we're better. No gimmicks. No specsmanship. No fooling. The data sheet tells the rest of the story. Get it from our rep or distributor.

If semiconductor memories are your thing, you'll want to know what MMI's up to.

And if delivery's your problem, solve it by looking on our distributors' shelves. Look to MMI for leadership. First with 2K bipolar PROMs. First with 8K, 9K, and 10K bipolar ROMs. Now first with the fastest 256-bit RAMs.

256-Bit RAM sources:

FASTEST—55 ns. (256 x 1) guaranteed across temp & V_{CC} range

Manufacturer	Part No.	Open Collector Tri-State	Guaranteed Max Access @ Conditions	Price (100's)
Monolithic Memories	6530/31	OC/TS	55 ns @ 0° to 75°C, 5.0 V_{CC} ±5%	\$27

Alternate source—60 ns. device (256 x 1)

Intel	3107A/06A	TS/OC	60 ns @ 0° to 75°C, 5.0 V_{CC} ±5%	—
-------	-----------	-------	--------------------------------------	---

FASTEST—Mil Spec 70 ns. (256 x 1) guaranteed across temp & V_{CC} range

Monolithic Memories	5530/31	OC/TS	70 ns @ -55 to +125°C, 5.0 V_{CC} ±10%	\$52
---------------------	---------	-------	------------------------------------------	------

(Note: The TI 54200 and Intersil IM5533M are specified at 80 ns., but only @ +25°C, 5.0 V.)

Alternate sources—80 ns. devices (256 x 1)

Monolithic Memories	6523/33	TS/OC	80 ns @ 25°C, 5.0 V_{CC}	\$17
Texas Instruments	74200	OC	80 ns @ 25°C, 5.0 V_{CC}	—
Intersil	IM5523/33	TS/OC	80 ns @ 25°C, 5.0 V_{CC}	—

If you need parts, call, TWX, or write Dale Williams today.

Want more information? Call your local MMI distributor or rep; for evaluation units, call MMI Customer Service (408) 739-3535.

Monolithic Memories, Inc.



1165 East Arques Avenue, Sunnyvale, CA 94085 • (408) 739-3535 • TWX: 910-339-9229

EASTERN AREA SALES OFFICE: (617) 653-3158 • NEW ENGLAND REGION: (603) 883-1520 • CENTRAL AREA SALES OFFICE: (317) 844-3241 • WESTERN AREA SALES OFFICE: (408) 257-5424 • SOUTHERN CALIFORNIA REGION: (714) 524-5754, (213) 530-1293

Representing your best buy in memories: ALABAMA, Huntsville (205) 539-1771; ARIZONA, Phoenix (602) 264-7971; CALIFORNIA, Los Angeles (213) 398-6239; San Diego (714) 747-3015; Palo Alto (415) 369-4671; COLORADO, Denver (303) 623-8713; CONNECTICUT, North Haven (203) 239-9762; FLORIDA, Orlando (305) 423-7615; ILLINOIS, Chicago (312) 455-5100; INDIANA, Ft. Wayne (219) 744-4331; INDIANAPOLIS (317) 844-3241; IOWA, Cedar Rapids (319) 362-8155; KENTUCKY, Louisville (502) 893-7303; MARYLAND, Baltimore (301) 825-3330; MASSACHUSETTS, Boston (617) 653-3158; Needham (617) 444-2484; MICHIGAN, Detroit (313) 358-2020; Grand Rapids (616) 451-8901; MINNESOTA, Minneapolis (612) 929-6721; NEW JERSEY, Teaneck (201) 692-0200; NEW YORK, N.Y.C./L.I. (201) 692-0200; Utica (315) 735-5566; NORTH CAROLINA, Raleigh (919) 834-6591; OHIO, Cincinnati (513) 521-2290; Dayton (513) 298-9546; Columbus (614) 888-9396; Cleveland (216) 228-7525; OKLAHOMA, Tulsa (918) 627-4159; OREGON, Portland (503) 292-5656; PENNSYLVANIA, Willow Grove (215) 674-3850; Pittsburgh (412) 242-0100; TEXAS, Dallas (214) 239-9148; Houston (713) 721-1054; WASHINGTON, Bellevue (206) 455-2778.

washington report



Heather M. David
Washington Bureau

F-14 subs start up again

Electronics subcontractors on the Navy's F-14 Tom Cat fighter aircraft program have been notified that contracting beyond the first 134 planes will be renegotiated on an annual basis with price adjustments for inflation and other factors. Prime manufacturer Grumman Aerospace also told the subs to go back to work on F-14 avionics, following the company's compromise agreement with the Navy to finish building the 134 planes—an agreement that will result in a loss to Grumman of between \$100-million to \$140-million. Principle subcontractors include Litton Industries for the inertial navigation, Fairchild Industries for armament control, Honeywell for automatic flight control, and Hughes Aircraft, which has a direct contract with the Navy for the Phoenix missile system. The General Accounting Office, in a classified report, said technical problems have been uncovered in the central air data computer and airborne weapon control system, but it said the Navy and its contractors are satisfied that progress is being made in resolving them.

Senate considers antitrust data disclosure act

The Senate Judiciary's antitrust subcommittee will probe into the out-of-court agreement between IBM Corp. and Control Data Corp. which resulted in destruction of a computerized file of documents prepared by CDC for its private suit against IBM. The subcommittee will consider several bills which would require public disclosure of documents relevant to all antitrust settlements. It also is expected to look into the problem of private antitrust action settlements which may affect Government cases. The Justice Dept. continues to proceed slowly in preparing its case against IBM, reaping only a small comfort from a Federal Court decision that IBM violated a court order in persuading CDC to destroy the document.

The flak gets thicker for B-1 program

More Congressional trouble looms for several Air Force programs. Sen. William Proxmire (D-Wis.) promises continued investigations into the growing cost of the B-1 bomber, which he charges will pan out at \$51.5-million each. The Air Force challenges this arithmetic, saying that the figure should be closer to \$46.2-million, but it admits that the aircraft is now 10,000 pounds overweight, which will add to the cost. A group of 10 Congressmen has charged the Air Force with illegal lobbying for the B-1, saying that appropriated funds are being used to take Con-

gressmen on tours of the B-1 plant at Rockwell International.

Trouble in the F-15 Eagle air superiority fighter program cropped up when one test engine acted up. The result: The Defense Dept. allowed the Air Force to release only \$40-million of a previously approved \$421.6-million production contract for the plane. If the engine problem is ironed out—and the Air Force expects it will be by the end of April—the funds will be released making a total buy for fiscal 1973 of 30 planes.

A program too new to have congressional problems is the AX attack aircraft, which has finally been awarded to Fairchild Industries, despite the continued lobbying by Texas interests who favored buying instead the Dallas-based A-7 attack plane, built by Dallas-based LTV. The lobbying included giving Congressmen free rides in a special two-seat A-7 at Andrews AFB near Washington, D.C.

Air Force to move on airborne command posts

The Air Force will choose a contractor in May to move the communications equipment out of the EC-135 airborne command posts operated by the National Military Command System and the Strategic Air Command and install them in the new Boeing 747 B jet transport, which will take over the command-post role. Earlier plans to develop completely new electronic command-and-control equipment for the 747 have been scrapped. The Air Force recently awarded a \$59-million contract to Boeing for two 747 aircraft and an option on a third.

Capital capsules: The Federal Railroad Administration is looking for companies qualified to design, fabricate and install a **computerized wheel and rail dynamic simulator** to test new developments in transportation systems. . . . The Defense Communications Agency will outline its future program plans for industry at a **conference sponsored by the National Security Industries Association**, April 25 and 26, at the National Bureau of Standards in Gaithersburg, Md. . . . NASA will let contracts soon on **technology studies for the design of a highly maneuverable aircraft**. The studies are expected to include new features, such as a fly-by-wire flight control system and computerized and integrated controls. . . . NASA and the Defense Dept. are reportedly wrangling over **the use of a classified high frequency**, which the space agency would like to use to transmit voice, data and TV instructions to the ATS-F satellite. NASA had been given clearance to use the frequency for space-to-space transmission, but the Air Force fears that ground-to-space transmission will interfere with data transmission to earth from its own satellites and high-altitude aircraft. . . . Japan's computer industry is reportedly ready to **end import quotas on integrated circuits and eventually computers**, if the Japanese Government will subsidize the industries to meet competition. The action would not be taken until 1976, however. . . . The discovery that **Saturn's rings are made of solid chunks of material** is causing NASA to revise its earlier idea that spacecraft could fly through them. Jet Propulsion Laboratory scientists made the finding after radar tests in December and January, and, incidentally, they chalked up records for the longest interplanetary radar bounces ever attempted. . . . The Air Force has decided to **share worldwide weather information from its heretofore secret weather satellite** with civilian agencies. The Air Force's satellite flies lower and has sensors with higher resolution than those of the National Oceanic and Atmosphere Administration.

a handful of measurement solutions...

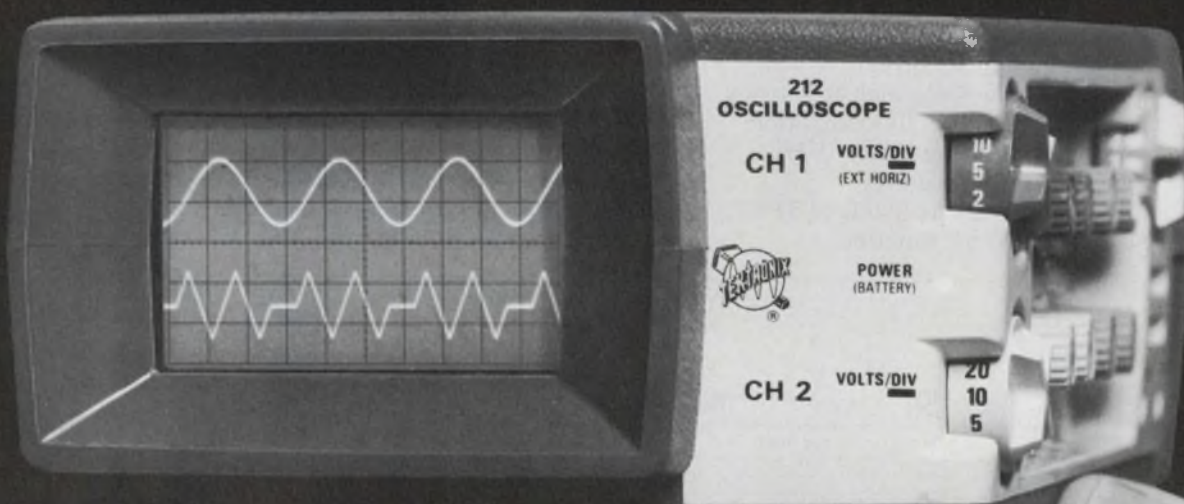

With the 212. A completely new DUAL-TRACE, 500-kHz, 3 x 5¼ x 9-inch scope that weighs only 3.4 pounds and costs just \$725. The high-impact plastic case withstands severe environments — double-insulated construction protects you while floating the scope to make high-voltage measurements.

Many other benefits are available in our first dual-trace mini: (1) 500 kHz and 1 mV/div; (2) Designed, developed and manufactured within the

United States; (3) For clarity, probe bodies and vertical deflection controls are color-matched; (4) When not in use, the permanently connected probes and power cord store in an easy-to-use compartment; (5) There are only two trigger controls, one for level and slope, the other for source selection; (6) Controls are recessed to prevent accidental damage; (7) Up to 5 hours operation are provided from rechargeable internal batteries; (8) Vinyl carrying case . . .

For complete information or to arrange a demonstration, contact your local Tektronix, Inc. Field Office. Or, write Tektronix, Inc., P.O. Box 500, Beaverton, Oregon 97005. In Europe, write Tektronix, Ltd., P.O. Box 36, St. Peter Port, Guernsey, C.I., U.K.

212 Oscilloscope \$725
U.S. Sales Price FOB Beaverton, Oregon



TEKTRONIX
committed to
technical excellence



P-channel
J FET



N-channel
J FET



CMOS
FETs



P-channel
MOS FET



N-channel
MOS FET

Since 1962, Siliconix has evolved FET technology and applied it to a complete line of singles, duals, arrays, and ICs. So what's new?

Switch 10 MHz Signals with better than 60 dB OFF Isolation

The Siliconix DG181-DG191 family of FET switch/IC drivers is well-suited for processing high-frequency signals, and is directly compatible with most computer logic. FET switch/monolithic driver combinations are available in SPST, SPDT, or DPST functions.

Features include:

- Constant ON resistance with signals to ± 10 V and 100 MHz
- 60 dB OFF isolation at 10 MHz with 75 Ω load
- t_{on} and t_{off} = 150 ns typical
- 1 nA max (100 pA typical) leakage from signal channel in either ON or OFF state.

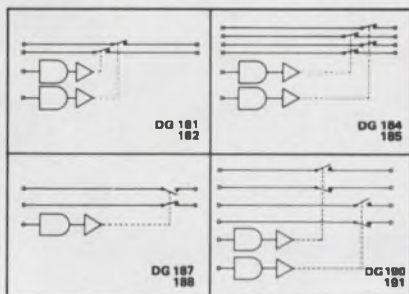

DG181-DG191 Functional Diagrams

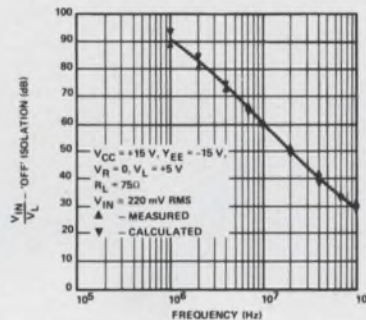

Switch OFF Isolation vs Frequency — DG181

The key to this exceptional performance is the Siliconix concept of monolithic driver design, with careful attention to critical details such as low driver output impedance. DG181-DG191 driver (switch OFF) resistance

to ground is only 200 Ω , providing good a-c by-pass on the FET switch gate. Contrast this with other driver circuits with impedances as high as 26 M Ω , which adversely affect isolation characteristics.

The DG181-DG191 series of FET analog switches is an ideal solution to most switching problems. If your case is unique—and whose isn't—our applications people are eager to help. For complete information

write for data

Applications Engineering (408) 246-8000, Ext. 501



Siliconix incorporated

2201 Laurelwood Road, Santa Clara, California 95054

INFORMATION RETRIEVAL NUMBER 24

Don't show me your camera; Show me your picture

On a recent visit to the Metropolitan Museum of Art, I stood admiring—no, revering—some of Rembrandt's paintings. What that man could do with color and with light and shade has always made a powerful impression on me—and on millions of others. So it's no surprise that museums all over the world treasure their Rembrandt collections and go to great lengths to preserve his paintings. But nobody saves his brushes. And as far as I know, people aren't storming museums asking to see Rembrandt's brushes—or Steichen's cameras.



But in the electronics industry companies often make more noise about their tools than about their engineers. I see many business-solicitation proposals in which companies list all their capital equipment with the minutest detail of make, model and salient features. They list every computer, scope, DVM and counter in the shop. But they forget to say, "Hey, we've got a bunch of awfully bright engineers who know how to use these things."

It's certainly true that you can't do a job if you don't have the right tools. It's not easy to get 0.01% measurements with a 3-digit DVM, and it's tricky to measure 200-MHz waveforms with a 50-MHz scope. But I think that point gets lost when a company's proposal lists every soldering iron.

Where are the engineers? The guys who write proposals often forget them. In itself that's not important because proposals are not the most widely read literary efforts. But they reflect the attitudes of corporate officers who think an equipment list should be more impressive to a customer than a list of engineers and their accomplishments. In thus exposing their attitudes, they expose their failing.

When all other factors are equal, the companies that generate handsome profits and grow are those that respect and depend on their people. Tool worship is no substitute.

GEORGE ROSTKY
Editor-in-Chief

Boost counting speed to 110 MHz with ECL universal counters. These programmable devices are ideal for phase-locked loops and frequency synthesis.

For fast counting of frequencies, the new ECL 10,000 circuits are hard to beat. The range of commercially available circuits includes a series of building blocks for designers of digital systems. The new ICs are universal, programmable counters that can be hooked up to count at 110 MHz. This means that the ECL circuits are about four times faster than TTL counters of similar complexity.

And because they are programmable, the new counters are ideal for phase-locked loops and frequency synthesis—applications in which frequencies usually must be divided or multiplied.

Two types of programmable ECL counters are currently available: a binary unit, in which the divisor (or divide modulus) can be varied from one to 16, and a decade counting unit, whose divisor can be varied from one to 10. In both versions the input, or programmed, number can be either four-wire BCD or hexadecimal. The number preset or loaded into either counter is the initial state from which countdown (decrement) begins. The specific type of counter used

depends, of course, on the required range in the divide modulus (M).

Both versions can be used at input frequencies to over 50 MHz without external gating (Fig. 1). The carry-out (\bar{C}_o) signal controls the counter's mode of operation when it is fed back to the S_1 terminal. Count proceeds down from the number, N , preset into the device. On reaching a count of zero, \bar{C}_o goes LOW and permits the next clock (input frequency) pulse to reload N into the counter. In this case the divide modulus, M , is equal to $N + 1$. The input signal is made common with the carry-in (\bar{C}_{in}) and S_2 control lines to prevent a latch-up state when the counter is reloaded.

If a larger divide modulus is required, two or more devices may be cascaded (Fig. 2) but with a sacrifice in maximum operating frequency. Two cascaded binary or decade counters extend the divide modulus to 256 or 100, respectively. But maximum frequency drops to about 35 MHz.

External decoding speeds the count

Other techniques, such as external decoding and "pulse gobbling" produce programmable-counter systems of higher frequency, but at the

Tom Balph and Howard Gnauden, Application Engineers, Motorola Semiconductor Products, Phoenix, Ariz. 85008.

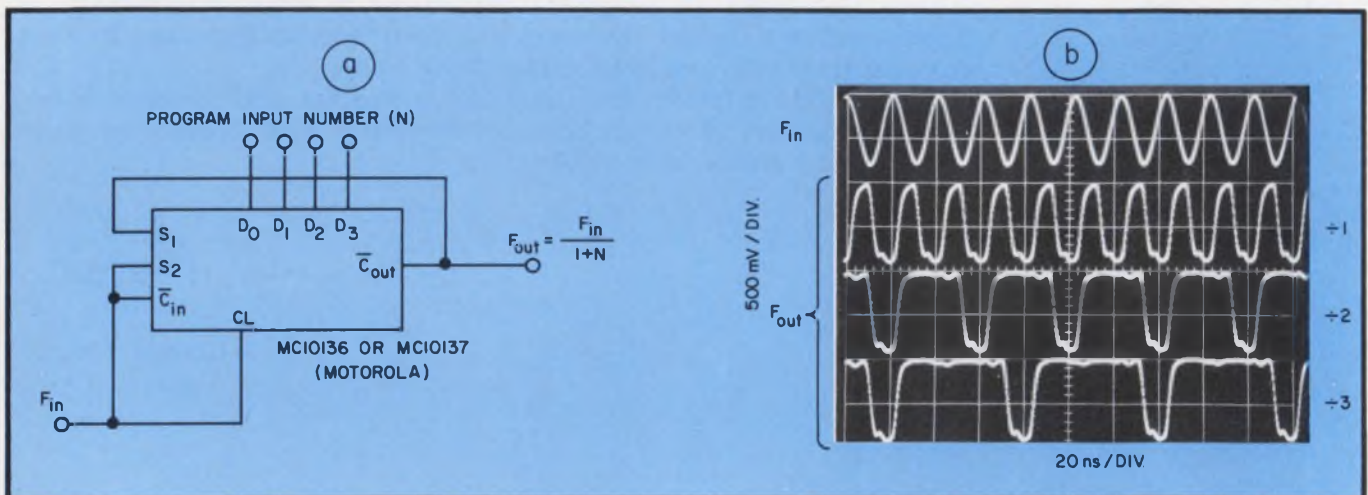

1. Universal, programmable counters on a chip (a) can be hooked up to countdown (or divide) an input frequency, starting from program input number, N . Scope trace

(b) shows input and output frequencies for division by $(N + 1)$ equal to 1, 2 and 3, respectively. Input frequency can range as high as 50 MHz.

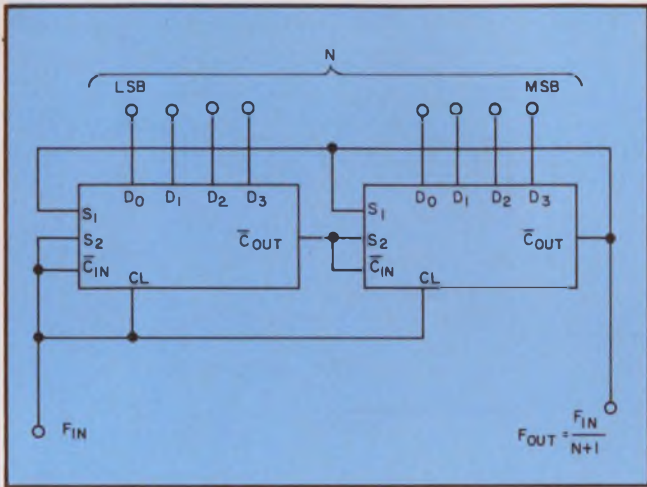

2. Two counters can be cascaded to divide by larger numbers (up to 256) than possible with a single counter. But maximum input frequency drops to 35 MHz.

cost of an increased package count. (Pulse gobbling is a technique in which an external flip-flop is used to hold a pulse, the flip-flop thus acting as an auxiliary counter.) Delay time can decrease by 2 to 3 ns when a gate (Fig. 3a) externally decodes the preset condition for the counter. With an ECL 10,000 gate, the maximum operating frequency is typically 75 MHz.

Since the preset number is decoded one clock pulse before the zero-count state is reached, the clock pulse necessary for preset is included in the programmed input number N . Thus the divide modulus for the externally gated counter is equal to the programmed input number ($M = N$). For the binary counter, M may vary from 2 to 15; and for the decade counter, from 2 to 9.

A wired-OR may be used instead of the OR gate (Fig. 3b) to extend the maximum operating

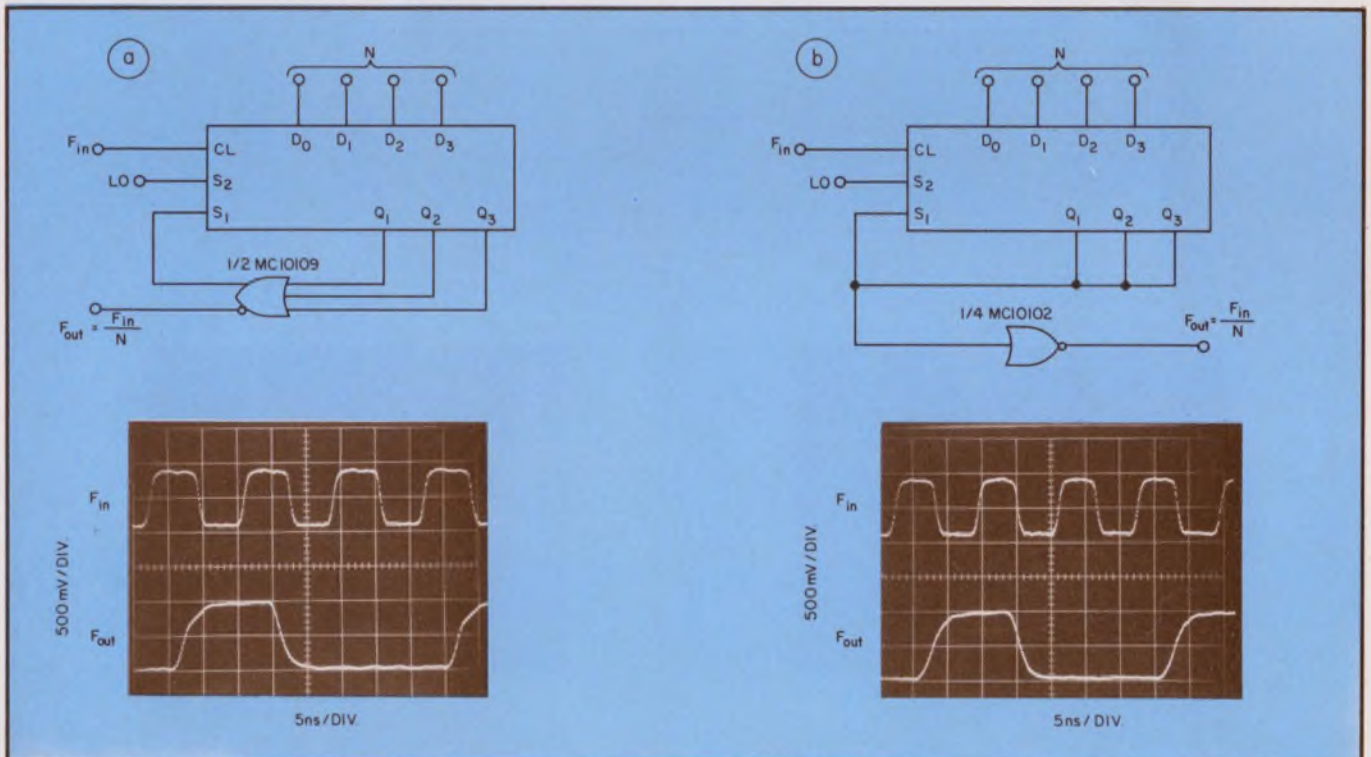

3. Decoding with an external gate (a) reduces delay time and, hence, boosts counting frequency. Inputs up to 75 MHz are possible. Waveforms are for $N = 3$. A wired-OR

configuration (b) extends counting frequency even further to 85 MHz. But a gate is still needed for buffering. Waveforms are for $N = 3$.

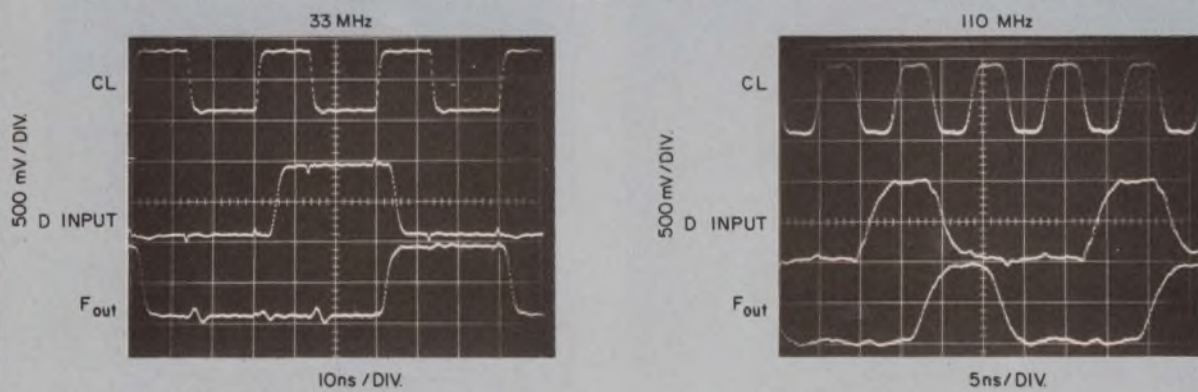
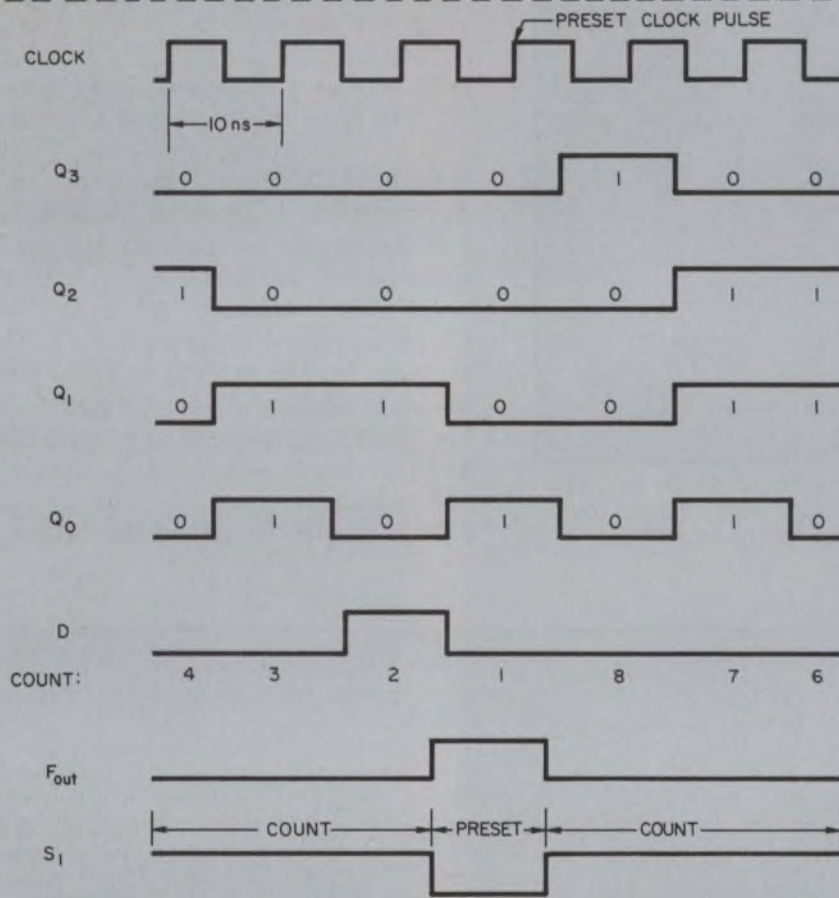
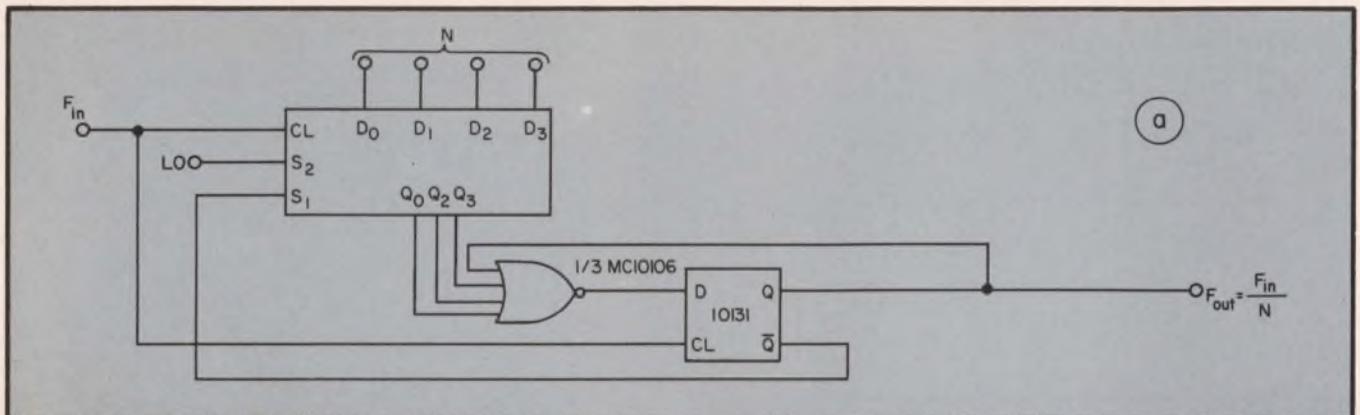

4. **Fastest counting frequency** (about 110 MHz) is obtained with an external flip-flop (a). Counting sequence (b) shows that higher frequencies result from separating

clock periods within which decode delay and counter preset times occur. Waveforms (c) are for $N = 3$, and for inputs of 33 and 110 MHz.

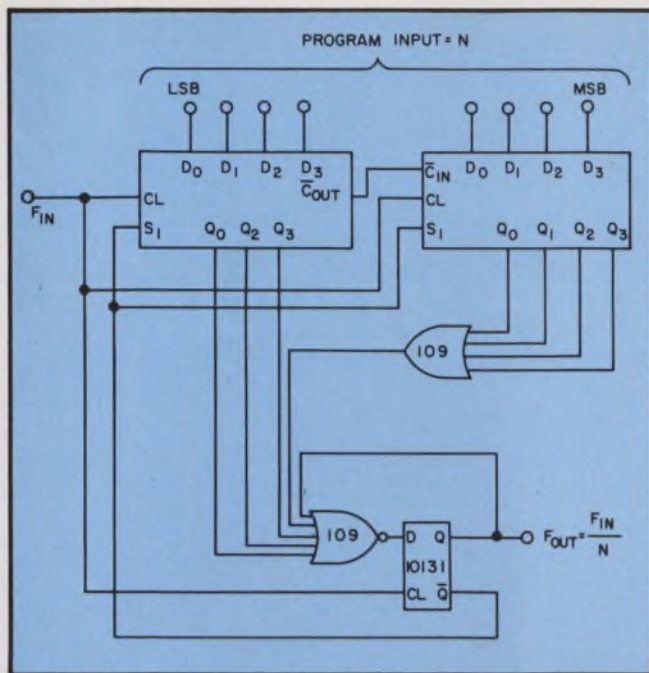

5. Two-stage counter using pulse gobbling extends divide modulus to 255. Maximum frequency is 80 MHz.

frequency to 85 MHz. A gate is still needed, however, to buffer the output signal (F_{out}). The input and output waveforms (Figs. 3a and 3b) for the gated and wired-OR circuits are for a modulus of three.

Pulse gobbling is even faster

A flip-flop added to the external decoder (Fig. 4a), provides an even shorter preset delay time. This pulse-gobbling technique can boost the maximum counting frequency to above 110 MHz (Fig. 4c). A pulse diagram shows the following sequence of signals for division by eight (Fig. 4b):

The S_1 line is HIGH during the countdown phase. When a count of two is reached, the D input line to the flip-flop is forced HIGH. On the next clock pulse a HIGH state is clocked into the flip-flop, causing both the S_1 line and the D input line to go LOW. The succeeding clock pulse presets the counter, and loads a LOW back into the flip-flop, causing the S_1 line to return to a HIGH state. Thus the counter is again ready to proceed in the decrement count mode.

With pulse gobbling, higher operating frequencies are obtained because the decode delay and setup time (for presetting the counter) occur within separate clock periods rather than the same. As in the preceding example, the divide modulus, M , equals the program input, N .

For larger moduli, two counters can be cascaded with the pulse-gobbling technique (Fig. 5). The divide modulus may be extended to 255 by use of two binary counters. However, the maximum frequency will be limited to about 80 MHz. ■■

Celco for CRT DISPLAYS

DEFLECTION YOKES FOCUS COILS



For the CRT Display Designer who NEEDS everything, CELCO makes everything you need. CELCO serves you in a unique capacity; we are the only

DEFLECTION DRIVERS • CIRCUIT CARDS



single source for all the most sophisticated precision display components you'll need for building your

RAMP GENERATORS



entire display system. All CELCO components are designed to perform exactly according to the requirements of your particular display, are fully compatible

POSITIONERS CRT SPOT ANALYZER



with each other, and create a harmoniously performing system.

CRT CAMERA DISPLAY SYSTEMS



Celco

CONSTANTINE ENGINEERING LABORATORIES COMPANY
UPLAND, CAL. 91786 MAHWAH, N. J. 07430

INFORMATION RETRIEVAL NUMBER 25

CTS has the answer in

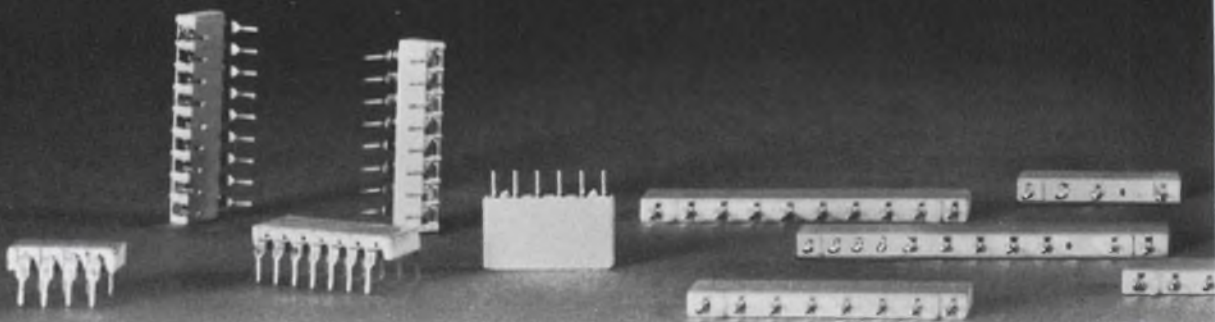

You name it—we have the exact cermet resistor network size and characteristics you need. Here's the choice you get right now: our *750 line* includes: .100" centers with 4, 6 & 8 pins; .125" centers with 2, 4, 6 & 8 pins; and .150" centers with 4 through 13 pins. And we're working on new designs right now!

All compact, extremely stable and highly reliable. Recently we packed even more circuitry into our *760 series*, giving you a choice of four popular space-saver packages: 8, 14, 16 and 18 flat lead styles. Packed with up to 17 resistors per module with flat leads standard (round leads on request).

cermet resistor networks. So ask us!

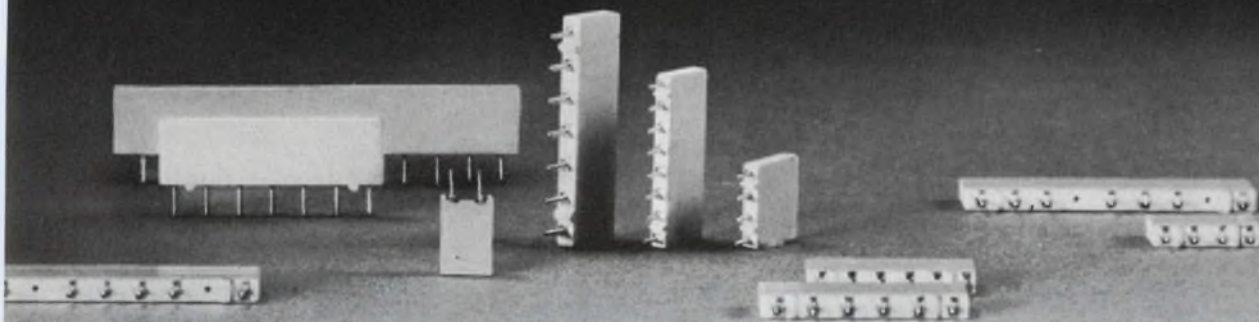

Our broad line provides an infinite number of circuit combinations, all with excellent TC, load and temperature characteristics supported by millions of hours of reliability testing. Ask your CTS sales engineer for data. Or write CTS of Berne, Inc., Berne, Indiana 46711. Phone (219) 589-3111.

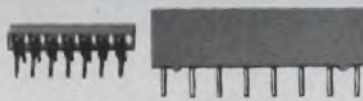

ACTUAL SIZE



CTS CORPORATION *Elkhart, Indiana*

A world leader in cermet and variable resistor technology.

Lift afc discriminator performance

by up to 10 dB. Hybrid signal processing offers advantages over conventional resonant and pulse-counter circuits.

In designing automatic-frequency-control systems, the engineer may feel that he has attained as much performance as is theoretically possible when a conventional discriminator, such as the Foster-Seeley, is used. But by using a hybrid digital discriminator, he can squeeze out a further 10-dB improvement in tolerating a lower signal-to-noise ratio.

This digital approach has been used by the European Space Research Organization (ESRO), and it is also applicable in the afc design of receivers ranging from civilian TV sets and FM tuners to highly demanding communications systems.

In the ESRO design, improvement was needed

in the telemetry receivers. Signals from Highly Eccentric Orbit Satellite (HEOS) were often as weak as -130 dBm, and very tight automatic frequency control was required to avoid tracking the wrong adjacent channel or locking onto a side band only 384 Hz away. The receiver's second i-f channel, nominally at 10 MHz, required that the discriminators be able to detect shifts as low as 300 Hz. Conventional discriminators proved ineffective for these requirements.

The digital discriminator that was used produced a 10-dB noise threshold improvement, not because it represented any advance in discriminator theory, but because the new digital method offers ways around analog component limitations. The advantages of the hybrid digital discriminator include the following:

- Required analog functions are limited to noncritical operations.

G. Pranzo Zaccaria, Dr. Eng., Via Ugo Bignami 61/6, 00136 Rome, Italy.

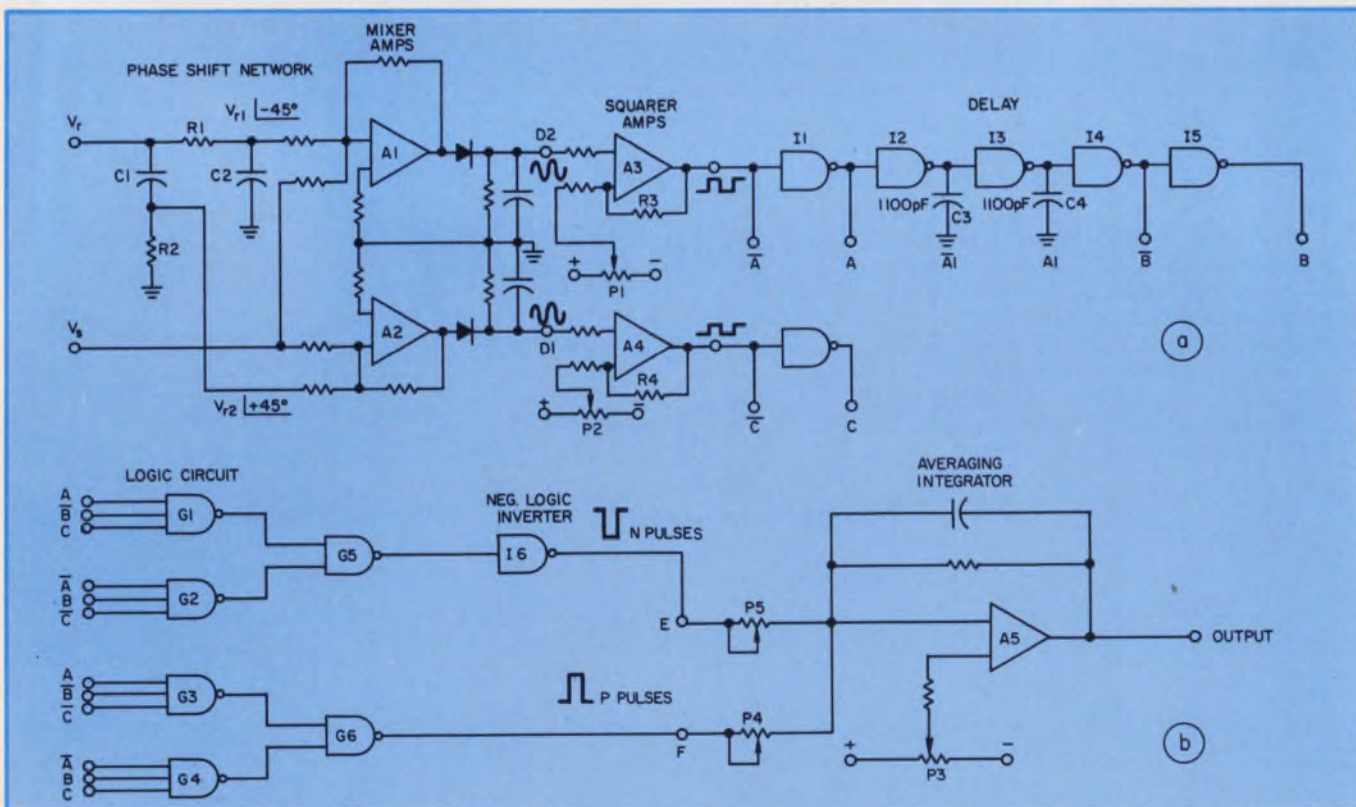

1. This hybrid discriminator combines analog and digital circuits to allow good performance with 10 dB less

signal-to-noise ratio than conventional circuits. No inductances or tuned circuits are used.

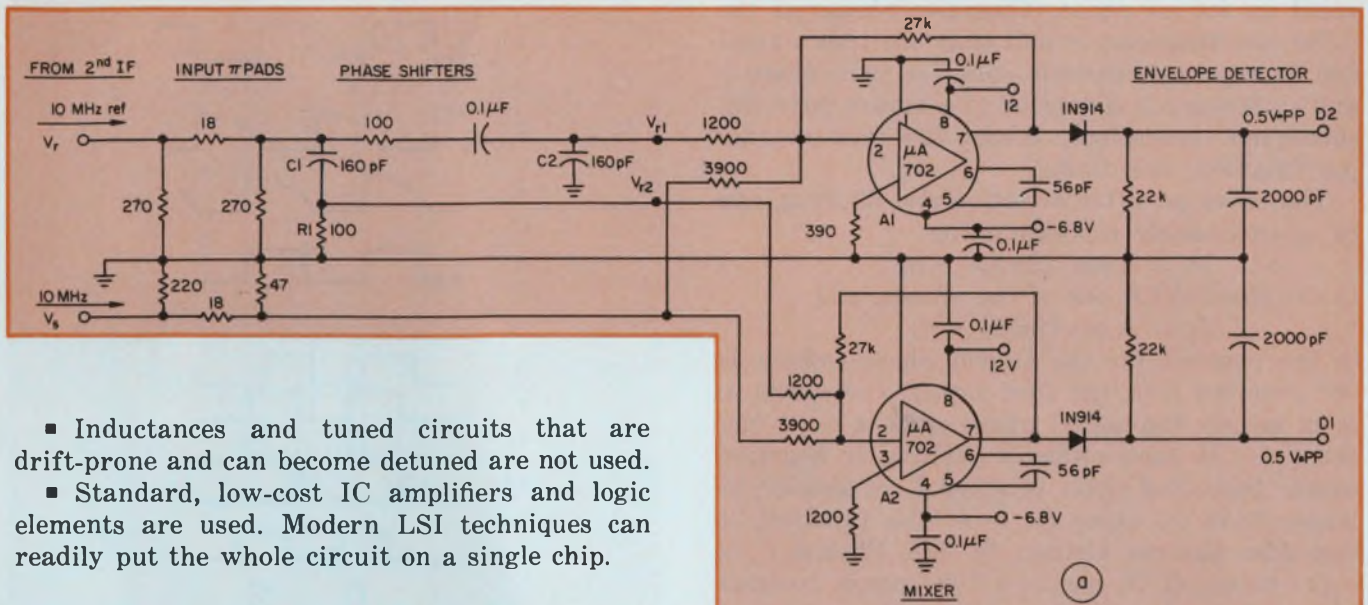

- Inductances and tuned circuits that are drift-prone and can become detuned are not used.
- Standard, low-cost IC amplifiers and logic elements are used. Modern LSI techniques can readily put the whole circuit on a single chip.

Phase splitting employed

How does the circuit work? First, analog operations are performed (Fig. 1a). They include the linear mixing of the weak incoming signal, V_s , which has a frequency, f_s , with a reference frequency, f_r . The resulting signals are then amplified and their envelopes are detected. This produces a difference frequency, $f_d = f_s - f_r$. But prior to mixing, the reference signal, V_r , is split into two signals, V_{r1} and V_{r2} , which are sepa-

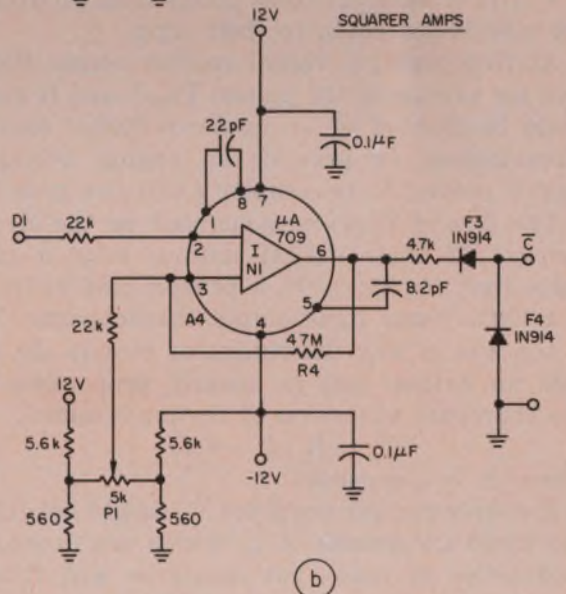
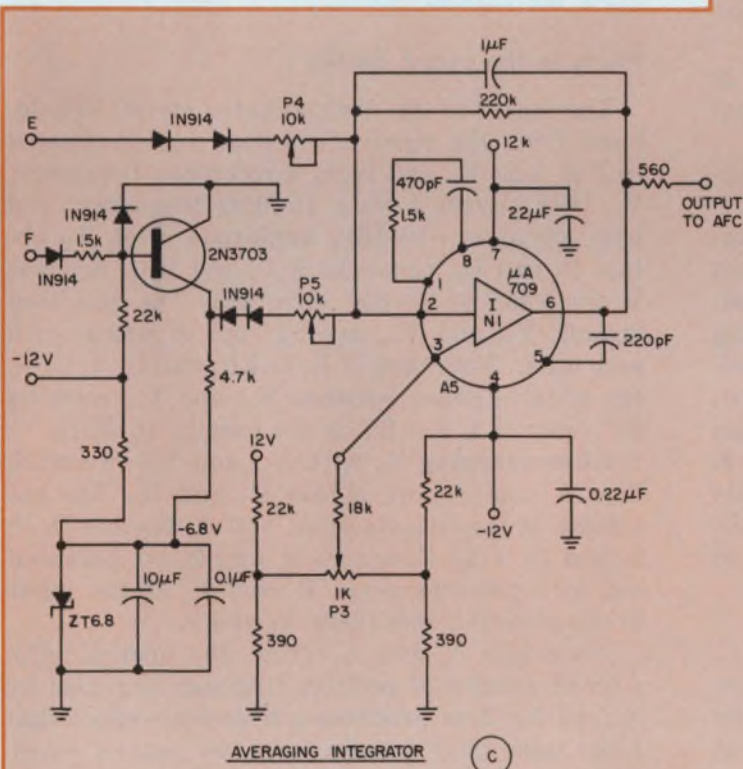
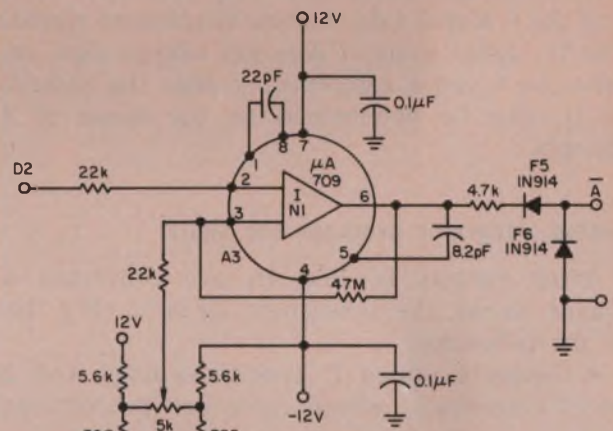

2. Mixing, wave-shape squaring and averaging functions are done with the popular μA 702 and μA 709 op amps.

rated by 90° of phase. Thus two phases of the difference frequency result that are then amplified in separate channels—one for each phase—and each phase is converted to a square wave. All subsequent operations, except the final averaging function, are digital.

The envelope, after detection and filtering, can be approximately represented by

$$D_1 = A \sin(2\pi f_d t + \theta)$$

in the channel for one of the phases, and

$$D_2 = A \cos(2\pi f_d t + \theta)$$

in the channel for the second phase—which is 90° removed from the first signal. The constant, θ , is merely the signal phase when $t = 0$. Because f_d can have either a positive or negative sense, depending upon whether f_s is smaller or larger than f_r , since D_1 is a sine function, it therefore also can change its sign. Physically, a sign change of D_1 means a 180° phase reversal of the D_1 wave. However, D_2 , because it is a cosine function, does not change its sign.

Now we can understand the reason for splitting the f_d signal into the two quadrature signals. The D_2 signal, since it does not change sign, can serve as a phase reference, so that the polarity of D_1 can be determined as the sense of f_d changes.

Analog integrator averages the signal

After signals D_1 and D_2 are converted to square waves, the subsequent circuits (Fig. 1b) do the following:

- Generate pulses P (positive-going) and N (negative-going), whose rates are proportional to f_d .

- Add or subtract these pulses from an averaging circuit according to their sign.

At first sight, a digital counter seems attractive for averaging the pulses. The P and N pulses could be counted by an up-down digital counter. Nevertheless, in practice an analog averaging circuit proved to be simpler and more practical.

The N and P pulses generated by the circuit, because of their digital nature, have a mean value that, for $S \gg N$, is proportional to $f_s - f_r$ —a 100% linear input-output characteristic. This is the aim of any discriminator circuit—to provide an output that is linearly proportional to the frequency excursion of the input signal.

$$V_o = K(f_s - f_r),$$

where K is a constant.

However for our purposes V_o should not follow the rapid excursions of f_s , which are caused by modulation or noise, but should be well filtered so that only the long-term drift component appears in the output. Thus

$$\bar{V}_o = K(\bar{f}_s - f_r)$$

indicates that low-pass filtering, or averaging, is required. Experience shows that an averaging

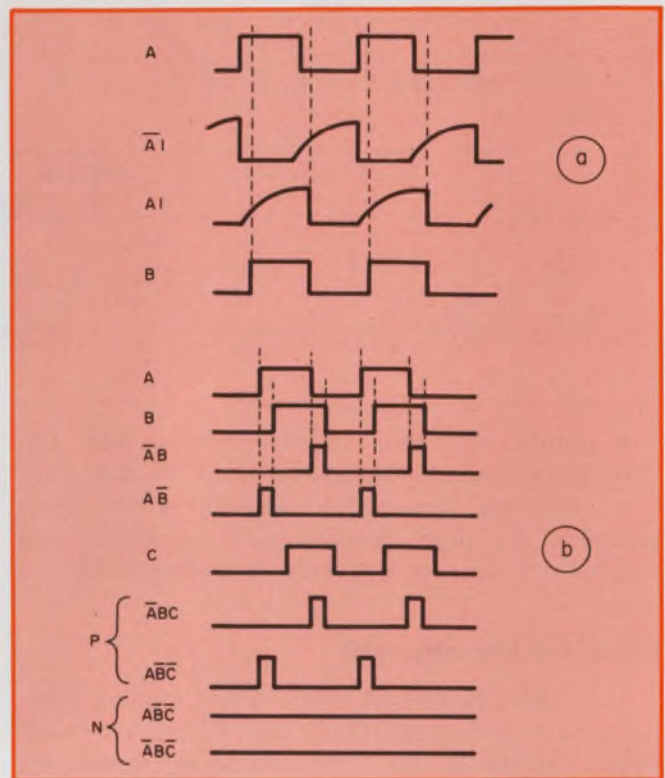

3. The timing diagrams show how the P and N pulses are generated from the square waves A, B and C. Waves A and B are derived from signal D_2 , and C from D_1 .

time constant of about a quarter of a second provides the desired result.

Filling in the circuit details

The inputs to the discriminator circuit are derived from the receiver's second i-f, designated in Fig. 1 as V_s , and from a reference frequency, V_r . Both signals have a 10-MHz frequency, and both are at a -10 -dBm amplitude level. To obtain D_1 and D_2 , networks R_1C_1 and R_2C_2 dephase V_r by $+45^\circ$ and -45° (Fig 2a). The resulting signals, V_{r1} and V_{r2} , are 90° out of phase with each other. Note that, if $R_1 = kR_2$ and $C_1 = C_2/k$, the relative phase between V_{r1} and V_{r2} remains 90° , even if $1/2 \pi RC$ is not exactly 10 MHz.

After summing V_s with V_{r1} and V_{r2} in amplifiers A_1 and A_2 , we obtain D_1 and D_2 . The envelopes of the outputs of A_1 and A_2 become $D_1 + k_1$ and $D_2 + k_2$. Constants k_1 and k_2 are balanced out with potentiometers P_1 and P_2 at the input to the squaring amplifiers A_3 and A_4 .

Amplifiers A_3 and A_4 (Fig. 2b) operate with a small amount of positive feedback provided by R_3 and R_4 . This produces a hysteresis effect that helps make their outputs form two square waves. The logical ONE and ZERO levels can be set to $+5$ V and ZERO, respectively. The setting is done by P_1 and P_2 with the help of diodes F_3 , F_4 , F_5 and F_6 . This makes the logic levels compatible with the standard 7400-Series logic. The square-wave sig-

nals, designated as A and C in Fig. 1, are then combined in NOR gates G_1 through G_4 .

A delayed square wave, signal B, is then derived from signal A. Capacitors C_3 and C_4 load the output of inverters I_2 and I_3 to produce this delay. The timing diagrams in Fig. 3a show how the delay is created.

With signals A, B, C and their complements, \bar{A} , \bar{B} , \bar{C} , the P and N pulses are now generated as shown on Karnaugh maps:

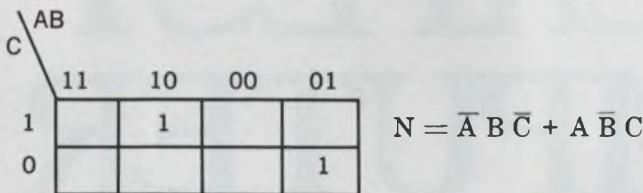
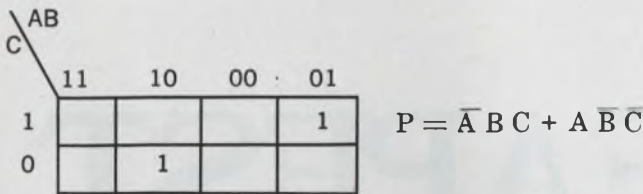

The logic circuit in Fig. 1b can use 7400-Series TTL/NAND logic to implement these equations.

The timing diagram of Fig. 3b illustrates how the variables A, B and C generate the P and N pulses. Inverter I_6 changes the sense of (inverts) the pulses from G_5 to produce a subtractive input for the averaging integrator circuit.

The method of generation of the P and N pulses and their subsequent treatment are the keys to understanding the operation of the discriminator, and they are also the new features claimed for the discriminator's design. Signals A, \bar{A} , B and \bar{B} are derived from D_2 (Fig. 1a) and signals C and \bar{C} are derived from D_1 . Therefore from Fig. 3b, it can be seen that in the absence of noise two P or N pulses are generated whenever $D_2 = 0$ (at the zero crossover points of D_2). When $dD_2(t)/dt > 0$ (positive going crossover), then the generated pulses are treated as having the same phase (sign) as D_1 (or C, as in Fig. 3b). When $dD_2(t)/dt < 0$, then the pulses have the opposite phase to D_1 —they are considered in phase with \bar{C} .

Although the A and C signals are shown 90° apart in phase in Fig. 3b, it is obvious that this phase relationship can vary considerably without affecting the circuit's performance. In fact D_1 and D_2 approach this 90° condition when $|V_{r1}| = |V_{r2}| \gg V_b$. This feature is a key factor in the circuit's ability to resist the effects of modulation and noise.

The P and N pulses are summed and averaged by means of integrator-amplifier A_5 (Fig. 2c), which has a time constant of 0.22 seconds. The P and N pulses that result from modulation and noise cancel each other and contribute little to the output after averaging. ■■

OSCILLATORS

1 Hz to 250 MHz

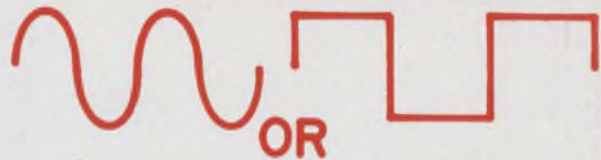

ANALOG **DIGITAL**

ANALOG ENGINEERS — We haven't forgotten you. Accutronics has not devoted all its engineering talents to digital devices which are compatible with TTL, ECL, MECL and COS/MOS logic. In our standard product line we carry a complete line of SINE WAVE oscillators from 1 Hz to 250 MHz. Take for example our Series 110 which is neatly packaged in a 1.5 x 1.5 x 1.5 hermetically sealed can and available from 10 MHz to 250 MHz with +10dbm out into 50Ω. GREAT for your analog application.

INTERESTING? Call Dennis Griffin (312) 232-2600, and he will be glad to fill you in on all the details and send you our new catalog.



FREQUENCY: 10 MHz to 250 MHz
 FREQUENCY TOLERANCE: ±0.001% from 0°C to 60°C
 SUPPLY VOLTAGE: +12V DC
 OUTPUT VOLTAGE: +10dbm ±3db into 50Ω
 SPURIOUS RESPONSE: >70db down
 HARMONICS: >20 db down
 SIZE: 1.5 x 1.5 x 1.5" typical with OSM connector

SEE 1972-73 EEM Pg 1571

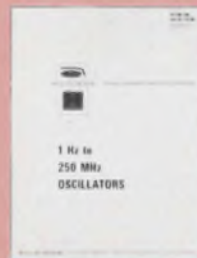

Please write or call for

NEW 1973 CATALOG

Our new catalog covers various types of oscillators: VCXO, LCVCO, RCVCO, high stability, computer clocks, high output power, Navy standard hardware modules and low current drain oscillators from 1 Hz to 250 MHz. We'll even send you three neat conversion charts (3) to hang on your wall and impress your friends.

accutronics

A HAMMOND CORPORATION COMPANY

628 NORTH STREET • GENEVA, ILLINOIS 60134

INFORMATION RETRIEVAL NUMBER 27

**THE CHEAPEST
MINICOMPUTER
VS.
THE CHEAPEST
SOLUTION**

Before you buy a minicomputer, do yourself a favor. Make a very fundamental decision. Do you want the cheapest machine you can find or the cheapest total solution to your problem?

We think it's the latter.

Because the cheapest machine is just that. It's raw hardware at a rock bottom price. And virtually every minicomputer supplier offers a product like this. Including us.

But your goal should be to get the lowest cost total solution for your problems. And paying less now could cost you more later if the machine you buy has been designed for rock bottom price alone. Be careful. You should look beyond raw iron. You need a computer package that saves you money at both ends. One that's been designed with the total solution in mind. A powerful blend of hardware, systems software, and extensive peripherals.

You also should look for a supplier that has built his business on fulfilling this need. That's us.

The world's most powerful mini.

We've developed the most effective minicomputer package you can buy: the SPC-16. Six different models to choose from and the *most powerful* instruction set available anywhere.

The SPC-16 does more things in less time with less memory. That's why it can actually save you money on your total system.

And we've recently enhanced the capability of our SPC-16 family with a number of new products including:

Multi-user BASIC, and the real-time, multi-programming capability of our RTOS-16 operating system. And our new extended FORTRAN IV.

New peripherals like a low speed line printer, head per track disk and a floppy disk.

High speed floating point processor,

8K memory board, heavy duty process I/O boards, A/D and D/A converters and digital I/O boards.

And completely new asynchronous communications multiplexer system.

Here's another reason for choosing us:

We've already had our tryouts.

Today all the big mini manufacturers are announcing that they're "in the systems business."

We've been in it from the start.

And while everybody else was churning out iron, we were building systems and piling up applications know-how.

We got involved with our customers' problems. We listened and we learned. Then we rolled up our sleeves and went to work.

As a result our people don't have to be retrained for this new approach because it isn't new at all. Not to us.

Over the years we've supplied systems to solve some very tough problems in the automotive industry, in production machine control, in electrical testing and communications. And this experience has built a fund of systems expertise no mini manufacturer can match.

There's a good chance we already have a system that fits your needs. If not, we have the know-how to design it for you. Or *with* you.

In fact, we can probably utilize our experience to solve your system problem faster than others can deliver a bid.

Read all about it.

If you're determined to reduce systems cost, we have a book for you. It's titled "The Value of Power." It covers everything you'll need to know to make the right decisions, for the right reasons, to end up with the right system for your specific needs. It's free.

Write for a copy. The address is 1055 South East Street, Anaheim, California 92804. Or phone (714) 778-4800.



General Automation

INFORMATION RETRIEVAL NUMBER 28

Give it a whack! Calibrated tap-tester, an adaptation of a familiar technique, spots defective parts. Simple and inexpensive, it finds those elusive intermittents.

You are testing a newly designed circuit and suddenly it doesn't work right. What's the first thing you do?

Most likely you will give it a whack. Miraculously, the equipment often starts working again the way it should. Frequently several whacks in various places will help you isolate the problem.

Can this approach be adapted to spot faulty components? It can, and it works. Radiography, thermal shock, thermal cycling, centrifuging or conventional vibration analysis are just a few of the widely used techniques that can spot faulty components, but controlled tap testing is cheaper, faster and often more dependable.

Although resistors are used as the main example to describe the tap-test method, other components and assemblies can also be tested successfully. Only small modifications to the setup, coupled with appropriate acceptance and rejection criteria, are needed.

Resistors are connected into the test circuit (Fig. 1) and lightly tapped in four different positions. An oscilloscope monitors the transient noise spikes. Voltage deflection above a certain critical level corresponds to a high probability that the unit is defective.

The idea is, of course, basically primitive. However, some sophistication in its execution is needed to yield consistent, reliable results. Here are some important points:

- Quiescent pickup noise must be as low and constant as possible.
- All leads must be shielded and made short. All connections must be firm.
- The unit under test must be mechanically damped.
- Shocking in several different directions is recommended.

The rejection/acceptance criteria must be carefully defined from statistical correlation with other methods. For resistors, data gathered over a large number of tests have shown a close correlation between certain voltage deflection levels

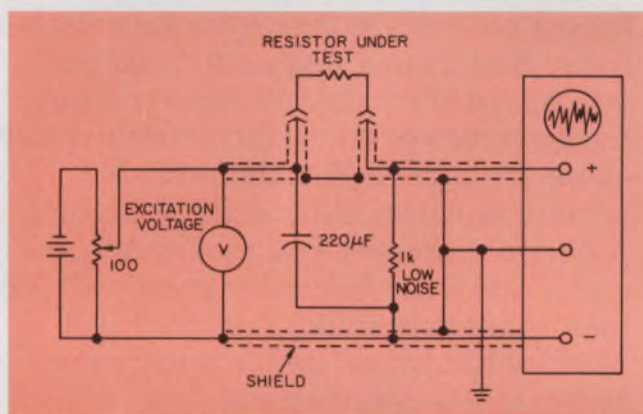

1. A very simple circuit fulfills all the needs for systematic tap-testing. Low-noise parts must be used.

and faulty components. Deflections of less than $25 \mu\text{V}$ indicate a good resistor—above $50 \mu\text{V}$ the probability of a bad resistor increases directly as the deflection level increases.

Supplying the calibrated tap

The test fixture (Fig. 2) includes a padded anvil in direct contact with the component's body. The pad is of 1/4-inch-thick, 50-durometer rubber, and it is bonded to the massive metal base of the test fixture. The clamps for the component leads are air-actuated. This eliminates possible electrical interference that could occur if electrical solenoids were used. Also, air clamps can supply more force than solenoids of the same size for gripping the leads and ensuring that contact noise does not produce false results. A wooden striker—a 10-inch, 1/4-inch-diameter hardwood dowel—is loosely pivoted at one end. The dowel is manually lifted against a pre-positioned stop and then released. A two-inch free fall onto the component provides a controlled tap that is equivalent to that provided by a two-ounce weight dropped two inches.

For testing resistors (Fig. 3), the fixture's excitation voltage is adjusted to 10 V nominal. No resistor is connected to the fixture at this point. Fresh batteries are the best voltage source to keep noise low. The scope sweep is centered, and the residual noise is noted for several

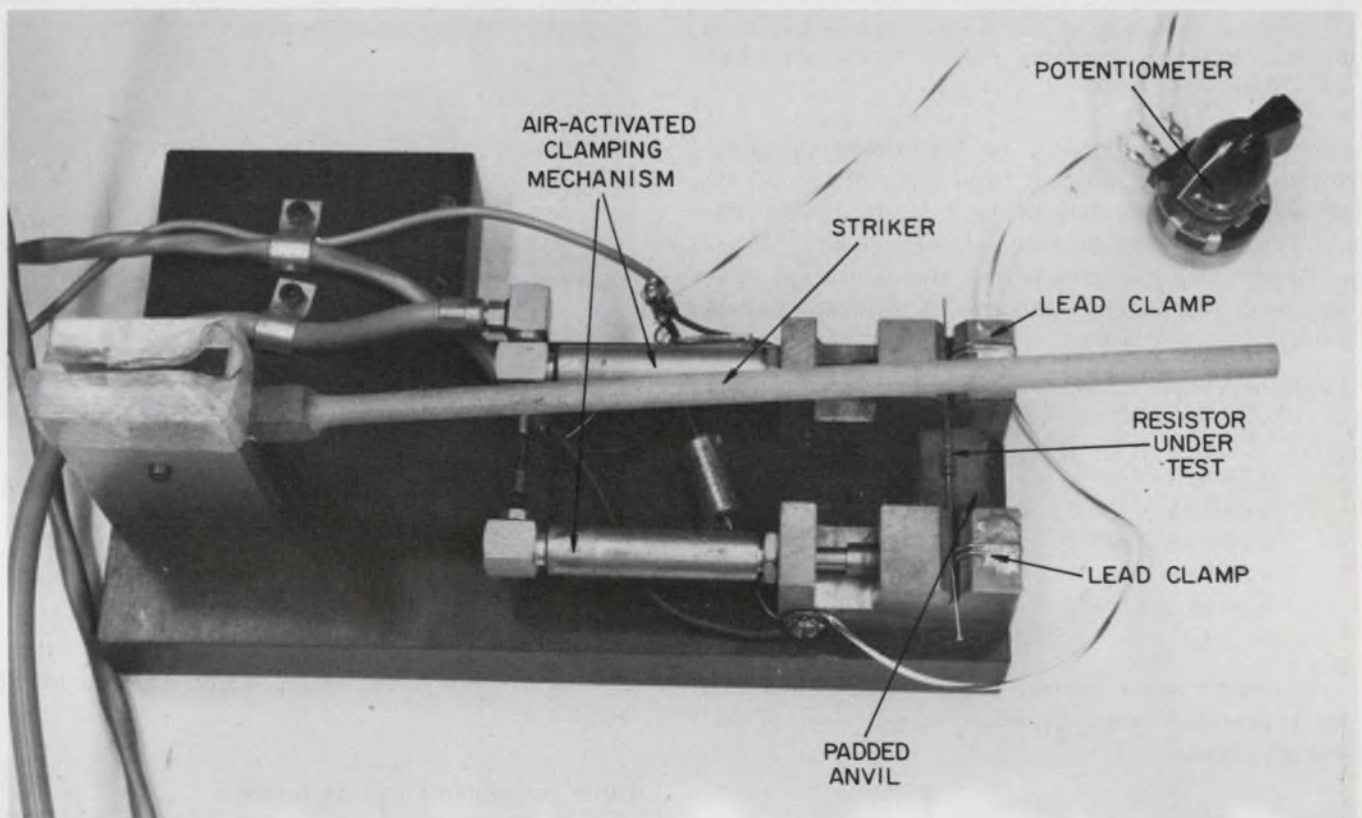

2. The component holding fixture for the tap-tester uses an air-activated clamp to ensure firm electrical

connections, and a padded anvil provides mechanical support for the component under test.

sweeps. The noise measurement is then repeated for several sweeps, with a calibration resistor of at least $10\text{ k}\Omega$ connected to the fixture. The residual noise in both cases should not exceed $30\ \mu\text{V}$. A sensitivity of $200\ \mu\text{V}/\text{cm}$ for the scope, obtained with the help of the proper preamplifier, is adequate.

The resistor under test is centered on the anvil pad and the leads clamped. The pivoted wooden striker is raised to the stop and dropped at least three times. At each tap, the oscilloscope trace is observed for any indication of a discontinuity. The lead clamp is opened, the resistor rotated 90 degrees, and three more taps are administered. This procedure is repeated at 180 and 270 degrees. Bending one of the leads 90 degrees (but not more) $1/4$ inch from the end provides a convenient reference for rotation. The produc-

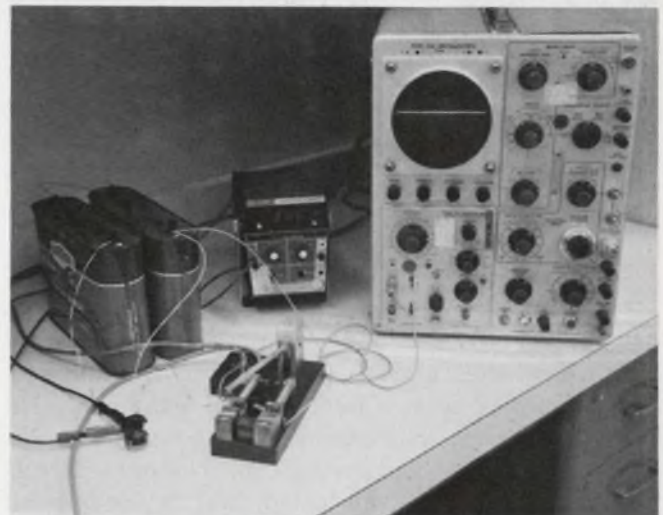

3. Readily available standard instruments needing few adjustments provide easily interpreted results.

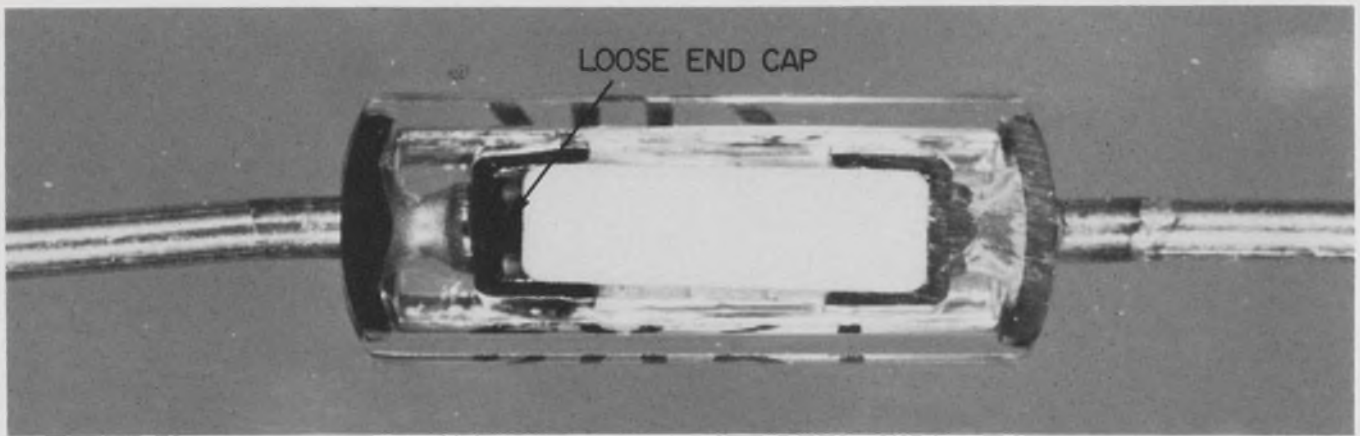

4. Detailed inspection of the faulty components found by the tap-tester invariably reveal serious and often difficult-to-detect faults.

tion department should be instructed to allow for this bending, so that good resistors won't be rejected later because of bent leads. On no account should bent leads be straightened.

Experience has shown that the excitation voltage level for testing resistors of different values should be as follows:

Resistor Value (k ohms)	Excitation Volts (dc)
0.100 to 0.999	3
1 to 2	4
2.05 to 3	5
3.01 to 5	6
5.05 to 6	7
6.04 to 8	8
8.06 to 10	9
10	10

Resistors are accepted provided they indicate no repeatable response above a set level of residual noise.

Evaluating the results

The effectiveness of tap testing has been proved. Tested samples were arranged into three categories of deflection levels. The samples were then microsectioned and carefully inspected for defects. These were the results:

Sample Quantity	Deflection Level (μV)	Quantity Defective
37	< 50	0
15	50-99	5
46	100-2000	38

As further proof, samples were selected from 40 lots of 100,000 metal-film resistors that had been tap-tested and approved for production use. The samples were dissected and examined. No cracked cores, bad welds or loose end caps were found. By contrast, 80,000 resistors directly from stock were tap-tested, and 20% rejection rate was found.

Extensive analysis showed that this rejection

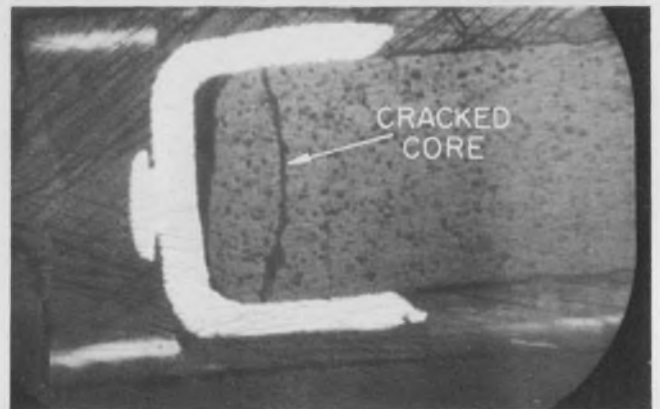

rate could be improved if gold was fire-bonded onto the core under the resistive film. The process not only improved contact resistance between the end cap and the film but also provided lubrication that eased the press fit during capping, thereby reducing the frequency of cracked cores. The result was that the rejection rate dropped to 13.7%.

Other components can be tested

To demonstrate its flexibility, the tap-test setup was modified to test variable resistors, such as the RJ22 series, and CSR13 solid-tantalum capacitors. The variable resistors were needed to set critical voltages in missile-launching test equipment. Under the tap-test procedure, the variable resistor was first driven against its wiper stop, then readjusted to 30% of total resistance and tapped four times. This sequence was then repeated at the 50 and 70% of total resistance settings. The oscilloscope gain was set at 2 mV/cm. A resistor was rejected if a permanent change of more than 4 mV was observed with 2.5 V applied across the resistor.

In tap-testing of the CSR13 solid-tantalum capacitors, a prevalent failure mode—attributed to improper solder bonding to the silver point of the anode—was found. In this case, the dissipation factor was measured instead of voltage. Capacitors that showed an abrupt change were rejected. ■■

If you need
a tester
with **special**
scales, ranges,
accessories
or any
combination...

Buy a
Triplett tester
custom-designed
for you

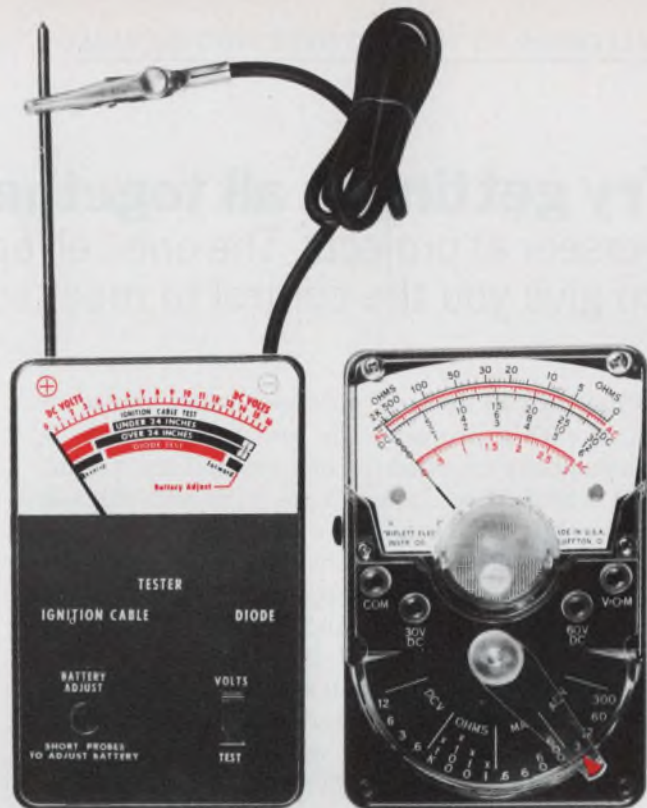

A

B

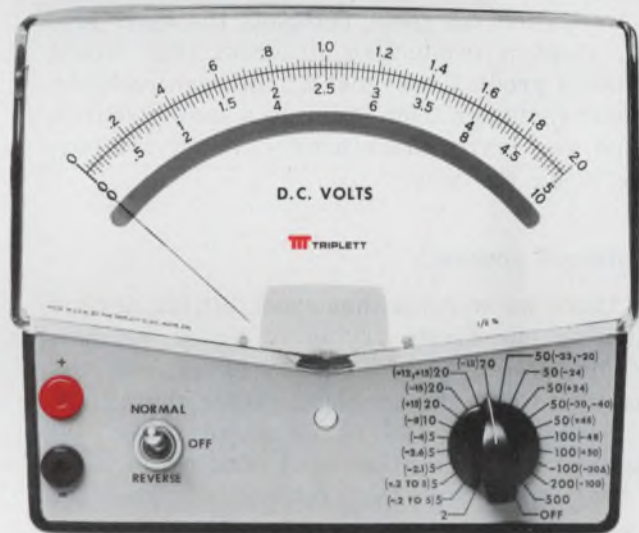

C

Triplett, manufacturer of the World's most complete line of V-O-M's, is ready, willing and able to design and manufacture special testers of virtually any size, style or type to meet your specifications.

Tester A (above) was designed to give auto mechanics a simple, rugged tester for "go/no go" tests that would otherwise be measured in electrical units unfamiliar to them.

Tester B is a modification of a

standard Triplett tester incorporating only the specific ranges needed by the field service engineers for whom it was designed.

Tester C has special ranges and special input connectors and cables to permit a single-point connection for trouble-shooting and servicing all the circuits of a complex business machine.

Several other buyers of standard Triplett test equipment request their company name on the dial to personalize their testers.

If you think a custom tester may solve some problems for you, contact your Triplett representative. He'll put you in touch with the Tester Designers and Engineers at Triplett who'll help you analyze the problem and suggest the optimum cost/result solution. Triplett Corporation, Bluffton, Ohio 45817

TRIPLETT
BLUFFTON, OHIO 45817

*Manufacturers of the World's
most complete line of V-O-M's*

Try getting it all together, suggests this overseer of projects. The one-cell approach to a program can give you the control to meet schedules and cut costs.

What do you do as a manager when you're in trouble with a project? The first thing you do is get everybody together in one room. That's what I did about three years ago with our SRAM (short-range attack missile) program.

It was an R&D program, fixed price, and we were subcontracted to supply the master computer on board the B-52 and FB-111 aircraft. It was behind schedule, and the people who were running it lacked enthusiasm to do what was necessary to make it a good piece of hardware. As a result, our customer was going to take the contract away from us. We asked for time to see if we could straighten our problems out.

The goals were tough. We had to figure out a way to contain the costs, complete the R&D program, start a production program that would turn out a product that met all the requirements, keep our customer from going to a second source, and, oh yes, try to make a little money for ourselves along the way.

The one-cell approach

So there we were in that room, sitting around scratching our heads, trying to figure out how we could, according to company policy, set ourselves up to suit the problem, rather than make the problem suit the organization. Then we thought of something that we'd tried many years ago that would suit the problem to a tee—the cell approach to project management.

It has one basic rule: Put everyone who's working on the project into one area. We're talking about a peak of 350 people working on a project that's worth about \$10-million a year in this case.

With a comparatively small contract for a single, though highly complex, computer unit, we established a special SRAM production group totally responsible for the program. We set up as much of the fabrication and assembly effort as was possible in one location. Around the edge of this manufacturing area, we placed the program manager, the purchasing people, engineers, quality and test people—in fact, all of the people

necessary to make the SRAM production team virtually a self-sustaining unit.

Everything that was factory-oriented on this program that we could possibly strip out, we took to this area. Now obviously it didn't make sense, for example, to move a multilayer-board facility or to move some of the shop equipment, like the milling machine. But we did get as much equipment as we could into the cell.

Then we built a three-foot wall around the factory part of the cell. We put three or four offices across one wall for the program manager and a few other key people. We told our program manager that he was now in business for himself—just as if he had his own small company.

What did this approach do?

First, it eliminated much of the usual paperwork, because the people involved with the program communicated face-to-face.

Second, it eliminated the costly and time-consuming practice of passing the buck. When there was a problem, the program manager brought his specialists together for a quick solution.

Third, it eliminated most of the time consumed in travel from floor to floor or building to building. Almost everything required was local.

Fourth, supporting personnel could *see* the effect of their activities on production. The purchasing employee, for example, could envision production grinding to a halt if he failed to buy parts on time. Engineers could appreciate how their failure to resolve a technical problem rapidly would interfere with production. They became aware of a personal challenge to meet the needs of the workers rubbing elbows with them daily.

Fifth, the program manager was intimately involved and thus in a perfect position to recognize good work and commend people's efforts.

The result was excellent performance, a major cost underrun and a substantial reduction in the price of follow-on orders.

This type of project management works very well in large companies, because they tend to isolate their departments. Smaller companies, emulating large companies, also tend to put up barriers between their departments. This strings out their communication lines and forces them to write memos about memos when they should be talking about the problems eyeball to eyeball and

Mort D. Margolis, President, Autonetics Div., Rockwell International, Anaheim, Calif. 92803.

Mort D. Margolis

Education: BSME, City College, New York.

Duties: Responsible for all activities of the Autonetics Div. from new-business proposals through design, production and logistic support of operation equipment.

Experience: Formerly vice president and general manager of Autonetics Navigation and Computers Div.; vice president and general manager of Autonetics Minuteman Div.; works manager for American Electronics Corp.; ATLAS coordinator and in various other capacities for American Bosch Arma Corp.; design engineer with National Fastener, and project engineer for RCA Victor.

Personal: Married; three children.

Employer: The Autonetics Div. of Rockwell International has designed, developed and produced sophisticated electronic systems and subsystems for both military and civilian agencies of the Federal Government for 17 years.

Some of Autonetics' current principal business activities include Polaris/Poseidon; Minisins (advanced, compact inertial autonavigators for future attack submarines); F-111 avionics; SRAM (see interview); Micron (compact and low-cost micro-navigator for aircraft and medium-range missiles).

Extensive research and development at Autonetics is directed toward advanced systems for ship control and autonavigation, as well as next-generation avionics systems for strategic applications. Autonetics is also applying aerospace technology in the commercial marketplace—including, for example, the tiltmeter, a tiny biaxial level detector that may aid in the prediction of earthquakes.



writing down only the right answers.

The one-cell approach works especially well for certain projects of \$15-million to \$20-million or less. You couldn't use this approach on a \$300-million project; there isn't a room large enough to house it. Maybe you could do it by breaking the project into increments of about \$20-million, but I'm not sure.

Controlling the company con artist

Even though the SRAM project was a great success, I don't want to suggest it was trouble-free. People being people, we had nothing but trouble in the beginning.

Recognize that this is a big organization—over 8000 people. It covers a large complex of buildings, and sometimes it becomes difficult to control those people who don't want to be controlled. People who do their work in a business-like way are not the ones I mean. I'm talking about those who always try to work around the rules on which a business is run. We can't afford that.

I'd tell the people what was to be done, and go away and someone would decide that that wasn't the way it should be done, and, "besides he won't check again." I'd come back and find that the engineers were opposed to the idea, everybody in the program was opposed to it, except me and the key people.

To get the cell idea accepted, we had to select key people very carefully, because if they don't go along with the operation, we're done before we've started. We chose people who weren't afraid to experiment, who were company-oriented and who weren't selfish.

So we had to force it. We said that either you do it our way or someone else will. That got everyone's attention.

Engineers think of themselves as professionals, and they are professionals. But they think there are certain material things that help to make them professionals, and that's ridiculous. Among the things they think make them professionals are private offices. That stems from the time when engineers were in short supply and companies used to build offices for them, put a nameplate on the door and give them a 10% to 15% increase. Now engineers don't like to be in the bullpen. They say it's too noisy, or they ask: "Are you demoting me?" Or: "Why are you setting me back 20 years?" Reasoning like this really doesn't make sense; they just have to adapt—we all do.

Another source of engineer resistance stemmed from the fact that our staff is used to working on more than one project at a time. Some engineers assigned to the cell were afraid they'd be out on the street when this one job was over. I told them that if people had to be let go, it

wouldn't be the people who did a good job. So they said OK, but they didn't like it.

The planning people didn't like the cell either, and neither did the logistics or the contracts people. But we forced it anyway. I went over there every two weeks, watching and checking up to see that our plans were being carried out.

And we put teeth in this thing. We gave the program manager complete authority. To be sure everybody recognized it, we told him that no one could move off or onto the program unless he countersigned the papers. We had to move some people out and we had to fire a few, but we got it going, and some amazing things happened.

People began to talk to one another instead of writing. They began to understand one another's problems and contributions. Many engineers have a tendency to look down their noses at logistics men. Eye to eye, however, they learned to respect the logistics man's expertise.

We found that the people were even developing a comradeship for one another. They were solicitous when a co-worker was sick. They even coined a name for themselves, "Sraminetics" and displayed the sign. They wore little "Sraminetics" buttons.

We finished up the R&D program without additional losses; we managed to get into production, which everyone had said was impossible, and we delivered the first equipment ahead of schedule. We succeeded because of the closely knit organization that we had developed and because we had eliminated all the hanger-ons, and the communication problems.

Learning to sweat until it works

The quick responses saved time and eliminated aggravation. Picture an engineer in an office in another building saying that he'd be down to talk about the problem. Chances are he'd get down later in the day or a day or two later. Then he'd get back to the office, and he'd rationalize that he had three other jobs to do. The project would fall behind because he'd lag on that job.

If you've got only the one job and you're in the area and a fellow comes up to you and says, "Hey, we've got a problem; this thing doesn't work," you're over there and you're sweating until it does work.

As a result of this experiment, we've used the one-cell approach on two other projects. They've both been successful. We have to be very careful in tailoring what we try though, because today everybody thinks that the cell is a panacea for all our problems. It isn't. However, because the cell approach has helped to reduce the actual cost of some projects, we are bidding on certain contracts that we might not have been so quick to bid on previously. ■■

Electronic Design presents the 'top-ten' winners

The following pages display the 10 outstanding advertisements that appeared in our Jan. 4 issue, which featured the "Top-Ten" contest. The contest attracted thousands of readers who attempted to match their ratings of the 10 most memorable advertisements with the "recall-seen" scores from ELECTRONIC DESIGN's regular Reader-Recall survey.

The winning advertisements combine attractive colors, tasteful design and well-written copy. The result: impact. The winners, in order of highest Reader-Recall score, are as follows:

1. Guardian Electric Manufacturing Co.
2. Struthers-Dunn, Inc.
3. John Fluke Mfg. Co., Inc.
4. Motorola Semiconductor Products, Inc.
5. Bourns, Inc.
6. Hewlett-Packard
7. Cherry Electrical Products Corp.
8. Hewlett-Packard
9. Hewlett-Packard
10. Signetics Corporation

If you can't find the lowest-cost optical coupler, relay, switch, translator or interface you want here...

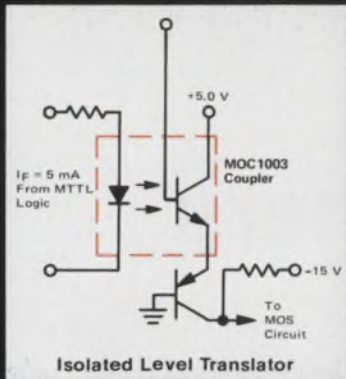

Isolated Level Translator

Type: MOC1003 Coupler
 Price: 99¢
 Features: 500 V Isolation
 30% Transfer Ratio

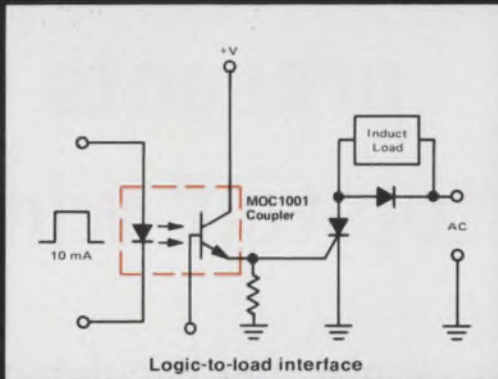

Logic-to-load interface

Type: MOC1001 Coupler
 Price: \$1.95
 Features: 2,500 V Isolation
 60% Transfer Ratio

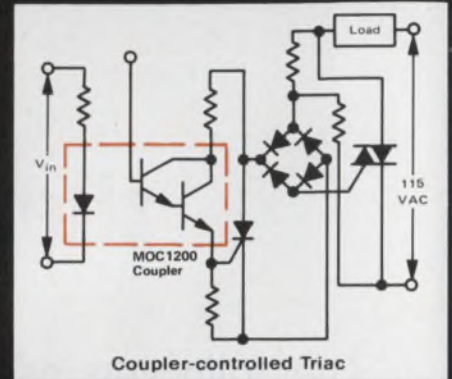

Coupler-controlled Triac

Type: MOC1200 Darlington Coupler
 Price: \$1.95
 Features: 1,500 V Isolation
 200% Transfer Ratio

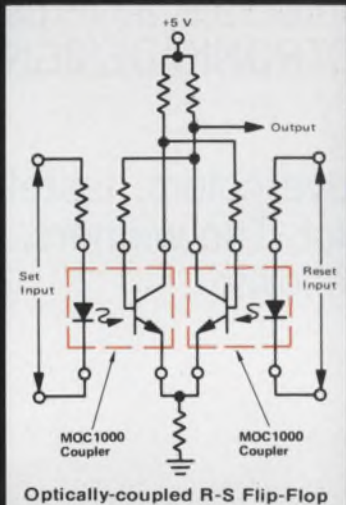

Optically-coupled R-S Flip-Flop

Type: MOC1000 Coupler
 Price: \$1.75
 Features: 1,500 V Isolation
 60% Transfer Ratio

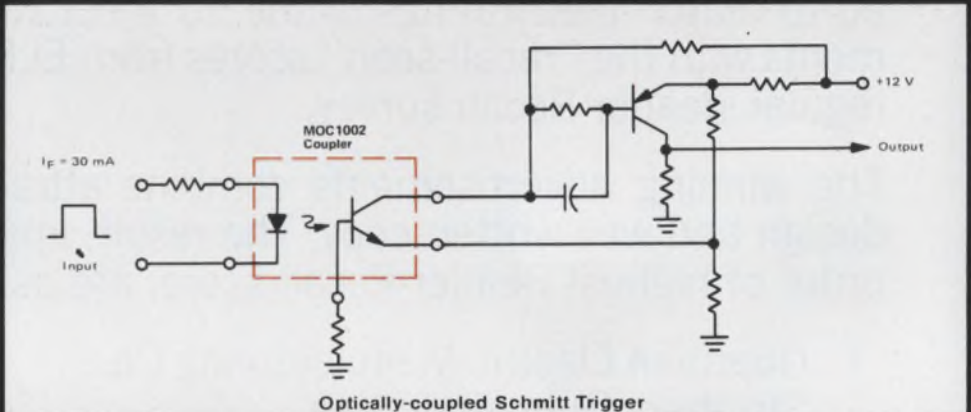

Optically-coupled Schmitt Trigger

Type: MOC1002 Coupler
 Price: \$1.50
 Features: 1,500 V Isolation
 30% Transfer Ratio

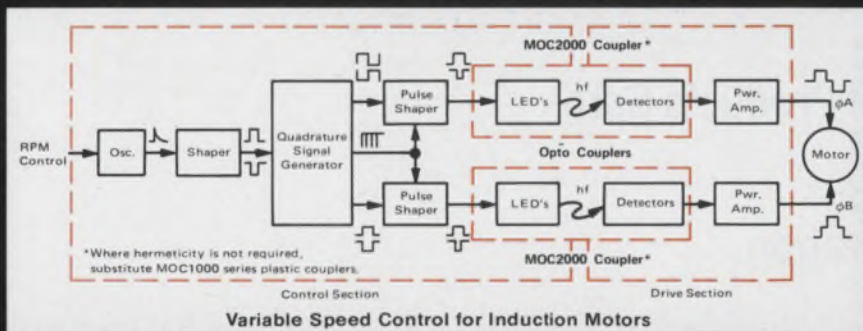

Variable Speed Control for Induction Motors

Type: MOC2000 Hermetic Coupler
 Price: \$3.10
 Features: 1,500 V Isolation
 3.0% Transfer Ratio

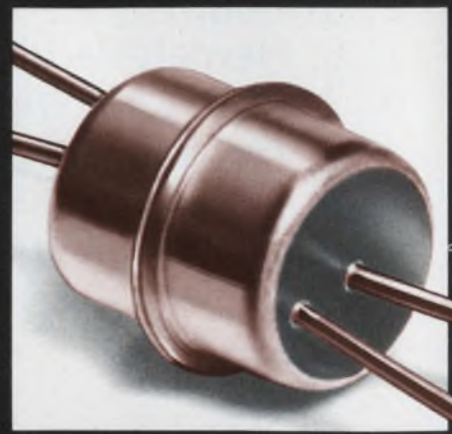

better have your isolation examined.

Optical couplers offer design engineers new freedom in designing circuits and systems. They're the only devices around that transfer, relay, couple, switch or isolate an electrical signal through the medium of light. They offer excellent input/output isolation . . . 100 billion ohms . . . and up to 2,500 V isolation voltage.

Call them what you will, they're versatile, quick, simple, reliable. And more economical than ever — Motorola prices now start at just 99¢, 100-up!

Problems such as ground loop isolation, common mode noise rejection, voltage level translation and many more can be solved or simplified using couplers.

In electro-mechanical relay replacement they offer unbeatable advantages. With no contacts,

they're immune to arcing and pitting and provide half the size and 1,000 times the speed of relays. There's no shock or vibration problems and they can be mounted in any position. Their inherently high isolation voltage permits operation in interface systems at different voltage levels and they're compatible with integrated circuits such as MOS, TTL, op amps and regulators.

Various responses can be achieved through linear modes of operation with feedback possible for inductive and reactive loads such as make/break timing designs. And with non-degrading solid-state operation, they're truly lifetime circuit performers.

Although of closed construction, they're simplicity itself. Coupler input is connected to a light emitter

and the output is a photodetector transistor. The elements are separated by a transparent insulator and housed in a light excluding package. Once assembled, the device is completely electronic in nature, eliminating the designer's need for knowledge of optics.

For information about how they can fit into your system designs, write on your company letterhead to Motorola Semiconductor Products Inc., Box 20912, Phoenix, AZ 85036. We'll send three just-published design aids: OPTOELECTRONICS AT WORK, AN571 — Isolation Techniques Using Optical Couplers and AN575 — Variable Speed Control System For Induction Motors. Circle the reader number for data sheets.

All prices shown are 100-999.



MOTOROLA COUPLERS *— lighten your industrial load*

1 FREE OPTICAL COUPLER

. . . is yours when you contact the Motorola distributor nearest you. Call him or send the coupon for a free MOC-1003 optical coupler ready for evaluation and prototyping — do it now!

To (distributor) _____

Send me my free Motorola MOC1003 optical coupler immediately!

Name _____

Title _____

Company _____

Div. _____

Address _____

City _____

State _____ Zip _____



Until you try HP's new IC Troubleshooting Partners, you'll never know how simple logic circuit testing can be.

Just push a button on the Pulser on the left, and let the Probe on the right automatically monitor the response downstream.

How? HP's new 10526T Logic Pulser injects a single 300 nanosecond pulse anywhere in your TTL and DTL circuitry. Low nodes are momentarily forced high, high nodes automatically pulled low. There's no unsoldering or trace cutting. Just press the button and the pulse is there. \$95.

And HP's new 10525T Logic Probe checks the result. A single, unambiguous light at your fingertips tells you exactly what's going on. If no pulse is detected, something's wrong.

The Probe may be used to look for much more than just pulses. Highs, lows, bad levels, open circuits and pulse trains to 50 MHz are faithfully displayed. Even single shot events as quick as 10 nanoseconds are captured and stretched. And high impedance won't load even low power TTL, yet the Probe is fast enough to keep up with Schottky. \$95. (We also have a high threshold level version, Model 10525H, also \$95.)

For other applications, the HP 10528A Logic Clip monitors all pins of DIP TTL/DTL IC's simultaneously. Use the Clip with the Pulser — the Pulser injects clocks, transfers, shifts, etc. HP 10528A Clip, \$125.

All three troubleshooters team up as the 5015T Troubleshooters Kit for \$285 which gives you a 10% discount and a handy carrying case to boot.

For more information on these and other IC Troubleshooters call your local HP field engineer or write Hewlett-Packard, 1501 Page Mill Road, Palo Alto, California 94304; Europe: P.O. Box 85, CH-1217 Meyrin 2, Geneva, Switzerland; Japan: Yokogawa — Hewlett-Packard, 1-59-1, Yoyogi, Shibuya-Ku, Tokyo, 151.

HEWLETT  **PACKARD**

02206

Fluke problem solvers

The new multimeter with advanced L.S.I. for more function power. 26 ranges, 5 functions.



\$299... Fluke's new 8000A, Try one for fifteen days, no obligation.

Now you can put the unmatched quality of Fluke instrumentation to work for you at the price of an ordinary multimeter.

Here's the DMM with more function power. Its got 26 ranges, including five ranges of ac and dc volts, five

ranges of ac and dc current, and six ranges of resistance. Push button control gives you the simplest most reliable error-free operation possible. The new Fluke 8000A is the only multimeter using an A-to-D converter with inherent self-zeroing to com-

pletely eliminate offset uncertainty. More details are on the next page, but we think you'll want to try this low-priced measurement system now. Fill in the coupon; we'll do the rest.

Circle 240 for more information

Ship me a Fluke 8000A for \$299 plus \$_____ for additional options checked below. I prefer the following payment option:

Charge my Master Charge, BankAmericard, or American Express account for the full amount plus \$5 shipping and handling.

If using Master Charge, please indicate the 4 digit number appearing above your name

Bill against the attached company purchase order for the full amount plus \$5 shipping and handling.

Cash Order. My check for the full amount is enclosed. Fluke pays shipping and handling.

(Washington state residents add 5% sales tax.)

Return within 15 days for full refund if not delighted.

Add the following options:

- Rechargeable Battery — \$50*
- BCD Data Output — \$75*
- RF Probe — \$75
- AC Probe 20A & 200A — \$50
- HV Probe — \$25
- Deluxe Test Leads — \$5
- Carrying Case — \$15
- Dust Cover — \$8
- Rack Kit-Center — \$30
- Rack Kit — 1/2 Rt or Left — \$30
- Send me literature only

Name _____

Company/Institution _____

Address _____

City & State _____ Zip _____

Credit Card No. _____ Phone _____

(Signature authorizing charge to credit card)

For even more convenience, let your nearby Fluke sales office handle the details. For location, dial toll-free 800-426-0361.



*Choose BCD data output or battery pack; both cannot be ordered in the same instrument.

When you look inside you'll find the same high technology and quality we put in our \$3000 DVM's.

Take a look inside. The LSI chips, equivalent to over 3,000 circuit elements, are the most advanced proven semiconductor devices on the market today. Fluke is the only manufacturer using **both analog LSI and digital LSI** to give you increased reliability at lower cost with fewer parts. The Fluke 8000A has only 1/3 the number of parts used in a typical 3 1/2 digit multimeter.

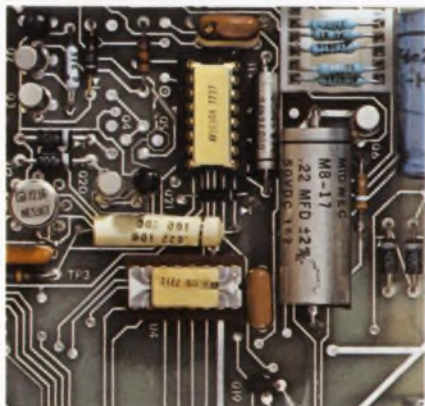

A simple guarantee

You can understand our 12-month guarantee. It's straightforward and honest. And you can believe we live up to it. If anything happens to your 8000A, take it or send it to your nearest factory service center. We'll give you 48-hour turnaround service in the U.S., Canada, Europe and the Far East.

Specs to work by

The new Fluke 8000A has a dc accuracy of 0.1% when you buy it. We guarantee it will still measure within that accuracy without recalibration a year later.

The case is rugged and tough. Drop this multimeter from a bench. Nothing happens to the works inside. We guarantee it.

Wide range of measurements

Measurement flexibility is broad enough to meet all the situations you're likely to encounter. The Fluke 8000A gives you 26 ranges to measure ac and dc voltages from 100 microvolts to 1200 volts, currents from 100 nanoamps to 2 amperes; and resistance from 100 milliohms to 20 megohms.



Wide choice of options

For a few dollars more, you can add a rechargeable battery pack to give you completely portable operation for over eight hours. And when you're back on the line, the batteries will recharge automatically. Other options include digital printer output, deluxe test leads, high voltage probe, rf probe, 200-amp ac probe, carrying case and rack mount kits.



A complete digital multimeter

But with or without options, the Fluke 8000A comes complete with test leads and spare fuses. It all adds up to an instrument you can count on day after day, year after year. Isn't this what you want in a digital multimeter at any price? Fluke thinks so.

FIRST CLASS
Permit No. 5464
Seattle, Wash.

BUSINESS REPLY MAIL

No Postage Stamp Necessary If Mailed in the United States

Postage Will Be Paid By



John Fluke Mfg. Co., Inc.
P. O. Box 7428
Seattle, Wash. 98133





See this beauty at the Struthers-Dunn exhibit during the 1973 Design Engineering Show, Philadelphia, Pa. April 9, 10, 11, 12.

This 1923 Model T FORD as GRAND PRIZE for your most unusual relay application!

Second 50th Anniversary prize: TEN \$50.00 U.S. Savings Bonds.
Third Prize: FIVE \$50.00 U.S. Savings Bonds.

ALL entrants will receive a 9" x 12" four-color print of this photograph by contest end. Perfect for framing.

Yes! A beautifully restored Model T Ford Station Wagon from the same year the first Struthers-Dunn relays came out! It could be yours for telling us about your most unusual or interesting relay application, as detailed in the rules below. You and the car will be the talk of your town from the day it is delivered. Start writing or thinking about your application today! Note those second and third prizes, too! *Be sure to follow the rules below.*

CONTEST RULES

- (1) Entrants must give a clear and complete description of an unusual, but practical and operating, relay application or solution of a relay problem, using electromechanical or reed relays of any make or price. *Entries must contain nonconfidential matter only.* No purchase necessary.
- (2) Winning entries will be judged on basis of the most unusual applications and/or imaginative thinking of widest interest to relay specifiers.
- (3) The three judges, familiar with design and use of relays, will be from the editorial departments of technical trade publications, and their decision will be final.
- (4) Brevity, clarity and completeness will count. Be formal or informal. Schematics welcome.
- (5) No limit on entries, but keep each entry to one application.
- (6) Entries must be postmarked no later than midnight May 15, 1973. Address: 50th Anniversary Contest, Suite 1500, 1201

Chestnut Street, Philadelphia, Pa. 19107. Do not send entries to Struthers-Dunn or its distributors.

- (7) For anonymity in judging, entries will be coded and identification removed insofar as possible.
- (8) Winning entrants will be notified by July 1, 1973 and publicly announced and identified shortly thereafter.
- (9) Grand prize will be delivered to winner's home.
- (10) All entries become property of Struthers-Dunn, Inc. and none will be returned. Struthers-Dunn reserves the right to use all entries in its advertising and promotion on an anonymous basis, but entrants will be paid \$50.00 for each entry used.
- (11) Contest void where prohibited, regulated or limited by law. Winners will be responsible for taxes, if any, on prizes.
- (12) Employees of Struthers-Dunn, Inc., its sales affiliates, distributors, advertising agencies, contest judges and members of their families are not eligible.



STRUTHERS-DUNN, INC.

PITMAN, NEW JERSEY 08071

Canada: Struthers-Dunn Relay Div., Renfrew Electric Co., Ltd.

A NEW KIND OF KEY

with gold "crosspoint" contacts that eliminate the two main causes of contact failure—(1) formation of insulating chemical film on contact surfaces and (2) mechanical interference of foreign particles on contacts. This proven design concept (Gold prisms at right angles to each other) provides high force per unit of contact area and virtually eliminates contact closure interference from foreign particles.

10

IMPORTANT "MOST WANTED" FEATURES

- 1 Low cost
- 2 Long life
- 3 Low profile
- 4 Inherent 2 key rollover
- 5 Wire "OR" able output
- 6 Low power (1.5 watt max.)
- 7 Custom designs
- 8 True typewriter sequencing
- 9 Only one power level input
- 10 High reliability

REST POSITION

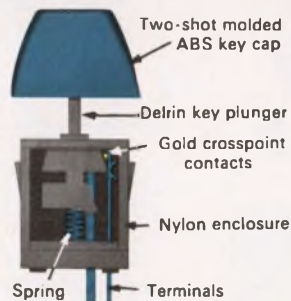

OPERATED POSITION



**Gold "crosspoint"
contacts for
unexcelled reliability**

Mechanical life in excess of
10 Million operations

FOR TECHNICAL DATA: TWX 910-235-1572 or phone (312) 689-7600 ext. 7717. OR write:

CHERRY



CHERRY ELECTRICAL PRODUCTS CORP.
3600 Sunset Avenue, Waukegan, Illinois 60085

Makers of patented Leverwheel/Thumbwheel Switches, Matrix Selector Switches, Snap-Action Switches and Keyboards.

INFORMATION RETRIEVAL NUMBER 150

SCHOTTKY ON



One-stop TTL shopping for 74S MSI, SSI...

At last. Available now, all in one place. The whole mix in Schottky logic—to match every high speed TTL function in demand today. Signetics

broad line of 74S circuits. Plus our compatible 82S series of enhanced MSI devices that help Schottky give you a competitive step-up in speed, in design-ease, in versatility... and of course, in MSI complexity.

And you get it where you want it, when you want it. Fast service directly from distributor stock. Signetics knocks off the waiting list tie-ups, the multi-stop shopping. After all, how can we encourage you to boost system speed by replacing TTL with Schottky equivalents, if you can't get the circuits to work with? All the parts you need—without delays, without runarounds, without making six calls when one should do the job.

Here's where Signetics makes the difference. One call does the job. Completely. SSI Schottky to cover full function range:



SSI SCHOTTKY 74S TTL

74S00	Quad 2-Input NAND Gate
74S03	Quad 2-Input NAND Gate (Open Collector)
74S04	Hex - Inverter
74S05	Hex - Inverter (Open Collector)
74S10	Triple 3-Input NAND Gate
74S11	Triple 3-Input Positive AND Gate
74S15	Triple 3-Input Positive AND Gate (Open Collector)
74S20	Dual 4-Input NAND Gate
74S64	4-2-3-2-Input AND/OR/INVERT Gate
74S65	4-2-3-2-Input AND/OR/INVERT Gate
74S74	Dual D-Type Edge-Triggered Flip-Flop
74S112	Dual J-K Edge-Triggered Flip-Flop
74S113	Dual J-K Edge-Triggered Flip-Flop
74S114	Dual J-K Edge-Triggered Flip-Flop
74S40	Dual 4-Input NAND Buffer
74S140	Dual 4-Input NAND Line Driver

You can make the same call encompass MSI too. Signetics 74S MSI circuits offer the same volume availability as SSI, as well as the same total TTL compatibility—pin-for-pin fits with standard TTL and low-power Schottky. Ten MSI devices in stock now, with more to be announced in the next few months.

MSI SCHOTTKY 74S TTL

74S151	8-Input Data Selector/Multiplexer
74S153	Dual 4-Input-to-1-Line Selector/Multiplexer
74S157	Quad 2-Line-to-1-Line Data Selector/Multiplexer
74S158	Quad 2-Line-to-1-Line Selector/Multiplexer (Inverting)
74S174	Hex D-Type Flip-Flop w/Clear
74S175	Quad D-Type Flip-Flop w/Clear
*74S181	Arithmetic Logic
*74S194	4-Bit Bidirectional Shift Register
*74S195	4-Bit Parallel Access Shift Register
74S251	8-Input Data Selector/Multiplexer w/tri-state
74S253	Dual 4-Input-to-1-Line Selector/Multiplexer w/tri-state
74S257	Quad 2-Line-to-1-Line Data Selector/Multiplexer w/tri-state outputs
74S258	Quad 2-Line-to-1-Line Selector/Multiplexer (Inverting) w/tri-state

*January-February announcement

Complementing 74S, Signetics 82S series MSI circuits offer significant advantages in sophisticated Schottky systems designs. The conventional TTL input circuit found in all Schottky logic, other than Signetics 82S, suffers from low input impedance.

Signetics advanced PNP structure produces significantly higher input impedance. You can drive far more devices from one output since input current is one-fifth that of standard Schottky inputs. With Signetics 82S MSI you need not worry about noise when driving long lines since, in addition to 10 PNP loads, a termination resistor can be accommodated when needed without fan-out reduction.



THE DOUBLE.

...and now optimized 82S MSI too.

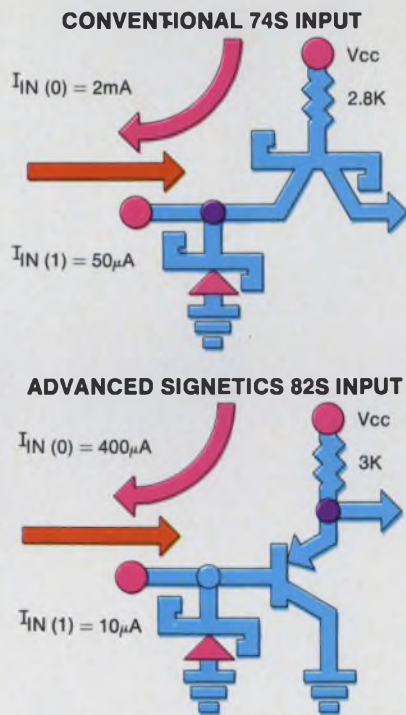

The growing line of 82S includes ultra high speed pin-for-pin replacements for the popular 8200 series MSI. In addition, the 82S90/91 100 MHz counter will replace the 74196/197, and the 82S70/71 70 MHz shift register will replace the 74178/179 in systems requiring improved speed performance.

The BCD arithmetic unit 82S82 replaces at least six MSI packages previously needed for the same function while at the same time operating speed is improved by a factor of 3. For BCD applications that only require addition, the 82S83 adder will replace three MSI circuits, and double operating speed. The 82S62 parity generator/checker is unsurpassed in speed.

Of course the 82S MSI line interfaces with 74S logic directly, operating in the same design environment as all 7400 circuitry but with the added advantage of direct replacement without violating fan-out rules.

MSI SCHOTTKY 82S TTL		SPEED
82S30/31/32	8-Input Digital Multiplexer	15 ns
82S33/34	2-Input, 4-Bit Digital Multiplexer	15 ns
82S41/42	Quad Exclusive-OR/Quad Exclusive-NOR	5 ns
82S50/52	Binary-to-Octal/BCD-to-Decimal Decoder	12 ns
82S62	9-Bit Parity Generator / Checker	17 ns
82S66/67	2-Input, 4-Bit Digital Multiplexer	15 ns
82S70/71	4-Bit Shift Register	70 MHz
82S82	BCD Arithmetic Unit	20 ns
82S83	BCD Adder	20 ns
82S90/91	Presetable Decade/Binary Counter	100 MHz

74S/82S Schottky TTL. Just one call to one of our distributors, reps or salesmen. And Signetics puts it on the line. Your line.

Signetics-Schottky
811 East Arques Avenue
Sunnyvale, California 94086

High speed response requested on Schottky TTL data, specs, applications and delivery for 74S SSI, 74S MSI and 82S MSI.

Name

Title

Company

Address

City

State

Zip

Telephone

Signetics Corporation, a subsidiary of Corning Glass Works.

signetics



The New Snap-On...

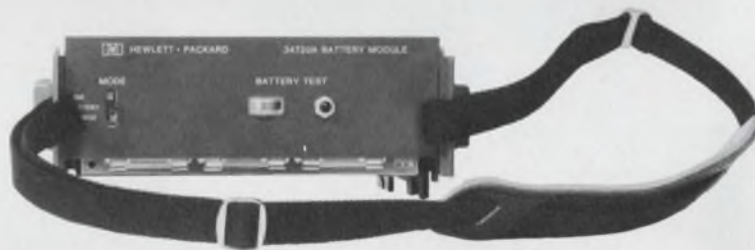

Low-Cost, 4-Digit Measurement System 3470.

- Bright LED Display section has 100% overranging.
- AC/DC/OHMS snap-on with display. (\$600 complete)
- DC snap-on with display. (\$475 complete)
- Snap-together expandability with sandwich centers – battery pack (\$200); BCD (\$175).
- H-P's exclusive self-test accessory reduces down time (\$50).

If you need one of these low-cost DMM's, there's no time like the present. Pick up the phone and call your nearest H-P Representative, now. Or, write to Hewlett-Packard, Palo Alto, California 94304; Europe; P.O. Box 85, CH-1217 Meyrin 2, Geneva, Switzerland. In Japan: YHP, 1-59-1, Yoyogi, Shibuya-Ku, Tokyo, 151.

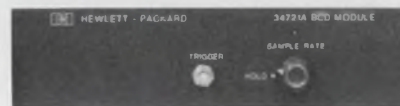

HEWLETT  PACKARD

DIGITAL VOLTMETERS
INFORMATION RETRIEVAL NUMBER 152

ELIMINATE RESISTOR STOCKPILES

WITH... BOURNS

SFR™

SELECTABLE FIXED RESISTOR*

90 SELECTABLE RESISTANCE VALUES IN 1 TINY UNIT.

Model
4002

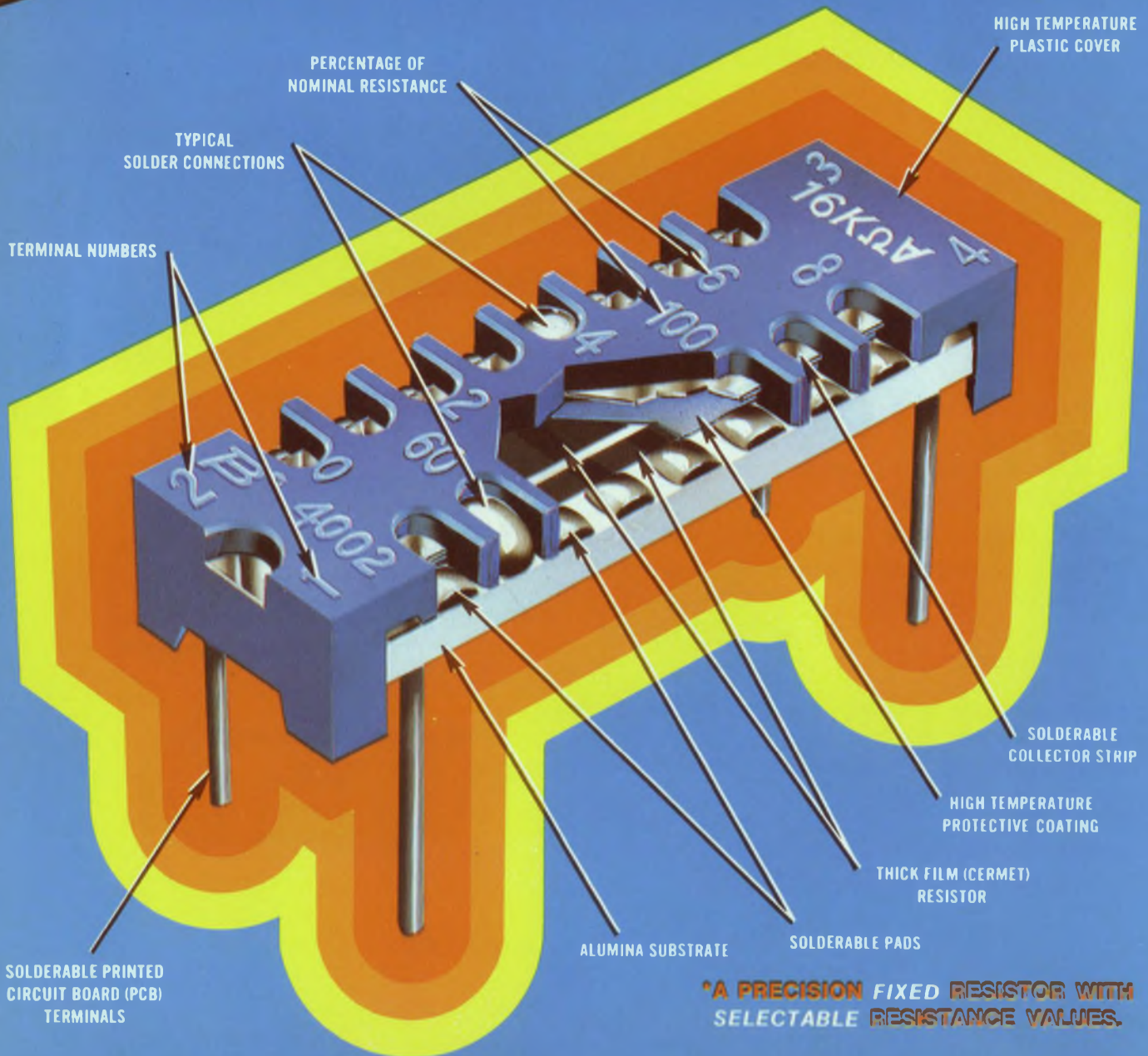

*A PRECISION FIXED RESISTOR WITH
SELECTABLE RESISTANCE VALUES.

BOURNS NEW... UNIQUE CONCEPT IN RESISTIVE COMPONENTS ALSO OFFERS

- * 33 ohm to 1.25 megohm combined resistance range over 15 units
- * Selectability within $\pm 1\%$ of required resistance value over the entire range

BOURNS
SFR™
 SELECTABLE FIXED RESISTOR

- ... IS A STABLE, THICK-FILM, FIXED RESISTOR WITH ADJUSTABILITY OF $\pm 1\%$ OR BETTER
- ... REPLACES STANDARD FIXED RESISTORS IN APPLICATIONS WHERE FINAL RESISTANCE VALUE REQUIRED CAN'T BE PRECISELY DETERMINED AT THE DESIGN STAGE
- ... REPLACES "ONE-TIME ADJUST" VARIABLE RESISTORS IN APPLICATIONS REQUIRING LONG-TERM STABILITY
- ... RESISTANCE VALUE IS SELECTED, THEN PERMANENTLY, RELIABLY SET BY SOLDERING

LOOK AT THE \$\$ YOU SAVE ON INVENTORY!!

FOR EXAMPLE: Your application requires selection of individual resistance values from 550 ohms to 1000 ohms, or 40 different resistors at 10¢ each. One Model 4002 provides the same resistance selection within $\pm 1\%$ at 76¢*.

Result: 40 different resistor values: $40 \times 10¢ = \$4.00$
 One Model 4002: $1 \times 76¢ = .76$

YOU SAVE... \$3.24!!

*1,000 piece quantity price U.S. dollars, F.O.B., U.S.A.

it's easy to use

After mounting on PCB; probe the COARSE and FINE adjustment taps (Figures 1 and 2) to determine the precise resistance required. Solder the selected taps (Figure 3) and the SFR RESISTOR is permanently set.

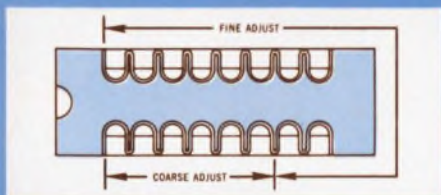

Figure 1



Figure 2



Figure 3

FOR COMPLETE DETAILS AND A BROCHURE:

- CONTACT YOUR LOCAL BOURNS REPRESENTATIVE.

FOR A FREE SAMPLE... write to the factory answering the following on your company letterhead.

- (a) My application for the Bourns SFR Resistor is ...
- (b) It will replace (number) of fixed resistors in my inventory
- (c) Approximate anticipated annual quantity usage: (number)



*SFR™ is a trademark of Bourns, Inc. Patents Pending

BOURNS, INC., TRIMPOT PRODUCTS DIVISION • 1200 COLUMBIA AVE., RIVERSIDE, CALIF. 92507

INFORMATION RETRIEVAL NUMBER 153

Solid State vs.

**Your
Guardian Angel
puts it
all together!**

Control confusion? Contact Guardian. Perhaps the solution will be a solid state device. Or, an electromechanical relay. Or, a money-saving assembly combining both! Our vast experience in solid state, hybrid and electromechanical devices assures you the most effective possible solution.

**Choose the one best
solution to your control
design problems:**

- Solid State
- Hybrid
- Electromechanical
- All of the above
- None of the above
- Ask your Guardian Angel!

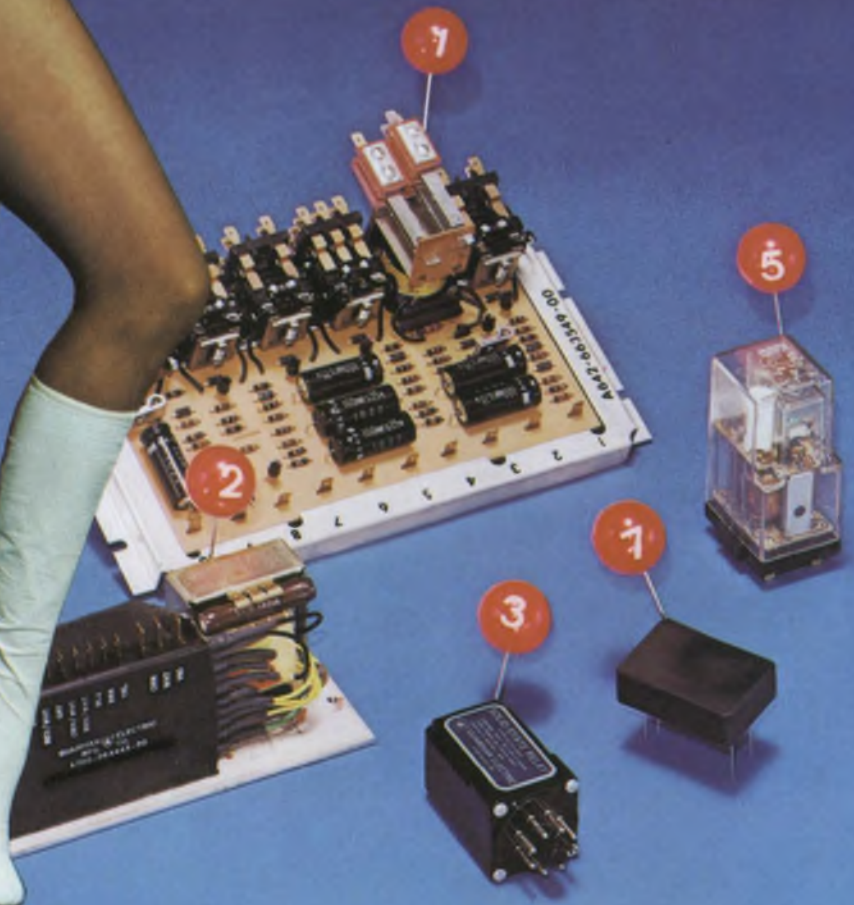

Hybrid vs. Electromechanical?

1 CUSTOM CONTROL PACKAGES for sequential switching at precise intervals. In most cases, numerous standard Guardian solid state devices could do the job. But, to lower total cost, Guardian can combine electromechanical and solid state into a single package. The result? Unique solutions to specific control problems demanding adjustable time delay, priority logic, voltage sensing, circuit isolation, or virtually any switching problem your system might demand.

2 CUSTOM SOLID STATE CONTROL PACKAGES that put a dozen functions ranging from temperature sensing to time delay and voltage regulation in a single, miniaturized, low-cost module.

3 SOLID STATE RELAYS that perform the function of electromechanical relays with total isolation between control circuit and switching output. Standard designs for most applications—custom designs at near-standard prices!

4 SOLID STATE TIME DELAYS in just about any size, shape, form or delay range your application can demand. Need 30 minute delay? Guardian's got it. A 25 millisecond delay? We've got that, too. And they're yours right-off-the-shelf or in custom designs.

5 HYBRID TIME DELAYS AND RELAYS for low-cost, dependable solutions to perplexing design problems. At Guardian they're yours in standard and custom designs.

6 SOLID STATE VOLTAGE SENSORS that protect other controls and motors from the damaging effects of under-voltage or phase loss during power outages and "brown outs."

7 ELECTRONIC "ZERO CROSSOVER" SWITCHES that form an electrical "cushion" between signal input and load power by switching at $0.0VAC \pm 10V$.



COMPLETE APPLICATION DATA IS IN THESE TWO FREE CATALOGS.



GUARDIAN ELECTRIC MANUFACTURING CO. • 1550 W. Carroll Ave. • Chicago, Illinois 60607

INFORMATION RETRIEVAL NUMBER 154



Think Twice:

When is a portable really portable?

HP's 1700 Series Portable Scopes Always Are...

They're tough go-anywhere scopes: weatherproof, dustproof, completely self-contained. Not the kind of "portable" that's gently moved from bench to bench, trailing a power cord. With a 1700 Series scope you don't worry about the rain. Or the rough ride. Or whether, when you get there, you'll find ac or dc power—or no line power.

An HP portable gives you features you'd expect only in a big lab scope. Like a large, bright CRT that lets you see even difficult signals in high ambient lighting. ECL trigger circuits and a trigger hold-off control, and sweep linearity over the full 10 divisions of horizontal display—ideal for maximum resolution in making those critical timing measurements.

But that's just the beginning. Then the 1700 Series allows you to pick the specific features you need for your field service application: conventional or variable-persistence storage CRT; bandwidths of 35, 75, or 150 MHz; sweep speeds as fast as 2 ns/div; delayed or non-delayed sweep; selectable input impedance; bright-scan viewing mode; and a built-in rechargeable bat-

tery pack for complete measurement independence.

And we're just as proud of the things you don't get with a 1700 Series portable. No heat sinks. No fans. No ventilation holes to let in dust and moisture. That's because our circuits are designed for very low power consumption—and for long, trouble-free operation. And there's no challenge in servicing our portables. In fact, you can completely recalibrate some models in an hour or less, even if all the internal adjustments are misaligned. It's not very sporting, but this ease of servicing quickly adds up to impressive savings.

So before you choose a scope, check your requirements. Then think twice about costs and benefits. Remember, Hewlett-Packard portables let you make any measurement you need—and they cost from \$100 to \$250 less than comparable scopes. These 1700 Series portables are priced from \$1475 to \$2300 for non-storage models and from \$2375 to \$2725 for models with variable-persistence storage. For help in choosing the HP portable that's best for you, send for a free copy of our "No-Nonsense Guide to Oscilloscope Selection." Or contact your local HP field engineer. Hewlett-Packard, Palo Alto, California 94304. In Japan:

Yokogawa—Hewlett-Packard, 1-59-1, Yoyogi, Shibuya-Ku, Tokyo 151, Japan. In Europe: HPSA, P.O. Box 85, CH-1217 Meyrin 2, Geneva, Switzerland.



**Scopes Are Changing;
Think Twice.**

083/1

HEWLETT  PACKARD

OSCILLOSCOPE SYSTEMS

LITRONIX UNVE



The Beautiful Bugs: This is the year of the DL-4 line of high brightness, low power 0.19 inch digit displays. Its integrated magnifier construction provides a handsome, clear, readable digit. It's bright: 500 ft-L at 10 mA per segment and carries many optional features; electrically isolated decimal point, left or right, pin for pin compatibility with either the MAN-1 or MAN-4. Priced at \$3.90 in 100 quantities.

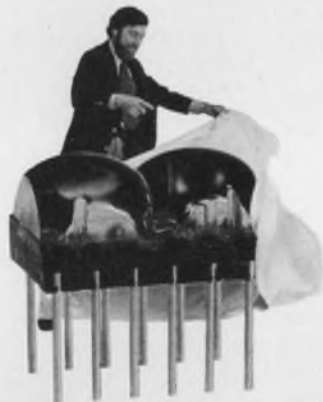

The Two-Seater Coupe: DL-44 is a matching two digit display in a single package. The integrated magnifier construction provides a 0.19 inch economy digit. Designed for multiplexing,

the desired digit is displayed by selecting the appropriate cathode. Offers 500 ft-L high brightness at a low power of 10 mA and shipments are categorized for uniform brightness. Priced at \$6.80 in 100 to 999 quantities.

The Sporty Model: RL-50 is a small, solid-state lamp with pick-up to 750 ft-L at 20 mA. Its rugged body construction allows superior lead-to-package integrity. The 80 mil package



Lights Mounted Where You Can See Them: The RL-4403/4440 have a viewing area that extends .140 inch beyond the face of the mounting clip. Its full flood 0.2 inch diameter viewing area allows extra wide, off-angle viewing. And it's bright, .8 mcd (minimum) at 20 mA on only 1.7 volts. It can be easily soldered directly to the PC board, or mounted from the front of a panel with a snap-in clip. Direct replacement for the 5082-4403/4440. Priced at \$.49 to \$.65 in 1,000 quantities.

the bright guys

width permits mounting within .087 mil centers of a common card reader. Operates from 5 volt IC supply and will give you many years of carefree operation. Options: red diffused, red color or white diffused. Priced at \$.39 in 1,000 quantities.



The Little Old Lady from Burbank loves her tiny T1 solid-state lamp. It will last forever, requires no gas, it flashes, and is IC compatible. Such a little

Litronix, Inc. • 19000 Homestead Road • Cupertino, California 95014 • (408) 257-7910 TWX: 910-338-0022

Distributors

Arizona: Hamilton, Phoenix (602) 269-1391
Compar, Scottsdale (602) 947-4336
California: Hamilton, Mountain View (415) 961-7000
 Culver City (213) 870-7171
 San Diego (714) 279-2421
Compar, Burlingame (415) 347-5411
 Gardena (213) 327-6550
Colorado: Hamilton, Denver (303) 534-1212
 Intermark Electronics, Denver (303) 936-8284

Florida: Hamilton, Hollywood (305) 925-5401
Georgia: Hamilton, Norcross (404) 448-0800
Illinois: Allied Electronics, Chicago (312) 421-2400
 Hamilton, Schiller Park (Chicago) (312) 678-6310
Kansas: Hamilton, Prairie Village (Kansas City) (913) 362-3250
Maryland: Hamilton, Hanover (Baltimore) (301) 796-5000
 Pioneer, Rockville (301) 427-3300
 Compar, Baltimore (301) 484-5400

Massachusetts: Electrical Supply, Cambridge (617) 491-3300
 Gerber, Dedham (617) 329-2400
 Hamilton, Burlington (617) 273-2120
 Compar, Newton Highlands (617) 969-7140
Michigan: Hamilton, Livonia (313) 522-4700
Minnesota: Hamilton, Bloomington (612) 854-4800
Missouri: Hamilton, Hazelwood (St. Louis) (314) 731-1144

New Jersey: Arrow Electronics, Totowa (201) 256-7331
 Hamilton, Cherry Hill (609) 662-9337
 Cedar Grove (201) 239-0800
 Compar, Clifton (201) 546-3660
 Haddonfield (609) 429-1526
New Mexico: Century Electronics, Albuquerque (505) 265-7837
New York: Semiconductor Concepts, Inc., Hauppauge (516) 273-1234
 Hamilton, Syracuse (315) 437-2642
 Westbury, L.I. (516) 333-5812

Compar, Albany (518) 489-7408
 Arrow, Farmingdale (516) 694-6800
 Summit, Buffalo (716) 884-3450
North Carolina: Compar, Winston-Salem (919) 723-1002
 Pioneer, Greensboro (919) 273-4441
Ohio: Arrow, Dayton (513) 253-9176
Texas: Hamilton, Dallas (214) 638-2850
 Houston (713) 526-4661
Utah: Hamilton, Salt Lake City (801) 262-8451

NEW 1973 MODELS

thing giving off .5 mcd at 20 mA, imagine! Has standard 1 inch leads. Options: red clear, white diffused, water clear. Priced low at \$.33 to \$.42 in 1,000 quantities.

with minimum CTR's from 2% to 50%. Now you can rid yourself of those Model-T relays and transformers with sleek solid-state opto-isolators. The new IL-74 is optimized for easy steering in and out of TTL. It's especially useful for elimination of noise and ground loop problems. Prices from \$1.19 to \$1.75 in 1,000 quantities.

drive for power relays, solenoids, triacs, SCR gates and power transistors. They turn on in 10 μ s, stop in 35 μ s. Solid-state reliability with 2500 volts of isolation. Second source for MCA2-30/MCA2-50 models. Prices from \$1.70 to \$1.95 in 1,000 quantities.



No Hassle Delivery on Calculator Displays: If you're building calculators, and you want the standard of excellence, the DL-33 three digit display will allow you to extend battery life, reduce pin count and cost per digit. It draws less than 1 mA (average) at 1.6 volts per segment. Comes in standard 12-pin DIP package designed for multiplexing. Many options available. Prices you gotta hear to believe!

The Swiss Had a Word for it, but we can't print that here because watchmakers are now turning to LED displays. Litronix has a line of low power, high brightness compact digits specifically designed for carrying around on your wrist. Call the factory for timely details.

The Ugly Bugs: They sure don't look like it, but our phototransistor opto-isolators can handle up to 2,500 volts of isolation

litronix



Overdrive Models: The ILCA2-30 and ILCA2-55 photo-Darlingtons can drive up to 100 mA DC load current—plenty of

Pencil Beam Headlights: The sharpest solid-state indicator light you can buy is the new RL-5054. You can select a high brightness beam at low currents—1 mcd at 10 mA or 2 mcd at 10 mA. It projects a 0.25 spot of light that is super for back-lighting applications. Priced at \$.65 to \$.85 cents in 1,000 quantities.

Test Drive Before You Buy: LED solid-state displays, lamps and circuit components will give you years and years of driving pleasure, no gas problems and no maintenance bills. And don't be fooled by the cheapee models, kick the tires.

Nationwide "Honest John" Dealers: We've got the best. Give them a call for your free test drive or write for our new 1973 catalog and your free Bright Guys bumper sticker.

Litronix, Inc. • 19000 Homestead Road • Cupertino, California 95014 • (408) 257-7910 TWX: 910-338-0022

Washington: Hamilton, Seattle (206) 624-5930
Compar: Kirkland (206) 822-4191
Canada: Prelco Electronics, Montreal (514) 389-8051
 Ottawa (613) 237-6150
 Electro Sonic Ind. Sales, Toronto (416) 924-9301
 Hamilton, Montreal (514) 735-6393
 Toronto (416) 677-7432
 Ottawa (613) 725-3071
 L. A. Varah Ltd.
 Vancouver, B.C. (604) 736-6411

Representatives
Alabama: Twentieth Century Marketing, Huntsville (205) 772-9237
Arizona: Q. T. Wiles & Assoc., Scottsdale (602) 947-5791
California:
 Celtec, Inc., San Diego (714) 279-7961
 Trident Assoc., Mountain View (415) 967-7031
 Q. T. Wiles & Assoc., Los Angeles (213) 649-1232
Colorado:
 Parker-Webster, Denver (303) 770-1972

Florida:
 W. M. & M. Assoc., Allamonte Springs (305) 831-4645
 Clearwater (813) 726-8871
 Pompano Beach (305) 943-3091
Illinois: Coombs Assoc., Des Plaines (312) 824-0104
Indiana: Coombs Assoc., Fort Wayne (219) 747-0402
Maryland:
 Mechtronics Sales, Inc., Rockville (301) 622-2420
Massachusetts: Contact Sales, Inc., Burlington (617) 273-1520

Michigan:
 Greiner Assoc., Grosse Pointe Park (313) 499-0188
Minnesota: Comstrand, Inc., Minneapolis (612) 560-5300
Missouri: Coombs Assoc., St. Louis (314) 567-3399
New Mexico: Electronic Marketing, Albuquerque (505) 265-7837
New York: Win-Cor Electronics, Manhasset (516) 627-9474
 Tritech, DeWitt (315) 446-2881
Ohio: E.M.A., Inc., Centerville (Dayton) (513) 433-2800
 Aurora (Cleveland) (216) 562-6104

Pennsylvania: G. C. M., Ambler (215) 646-7535
Texas: Semiconductor Sales, Richardson (214) 231-6181
 Houston (713) 461-4197
Washington: Compar, Kirkland (206) 822-4191
Canada: Cantronic, Montreal (514) 733-0749
 Downsview (416) 661-2494

INFORMATION RETRIEVAL NUMBER 30

From Lambda the LR series...

a line of high performance, high regulation power supplies

regulation: 0.0005%+100 μ V; ripple: 35 μ V RMS;
stability: 0.001%+100 μ V; over 8hr. period
accuracy: 0.01%+1mV; temp. coef.: 0.001%+10 μ V/ $^{\circ}$ C;
up to 250V, up to 2.8A

LR SERIES 1/4-RACK MODELS

5 $\frac{3}{16}$ " x 4 $\frac{3}{16}$ " x 15 $\frac{1}{4}$ "

REGULATION: 0.0005% + 100 μ V
RIPPLE: 35 μ V RMS



MODEL	ADJ. VOLT RANGE VDC	MAX. CURRENT (AMPS) AT AMBIENT OF:				PRICE
		30 $^{\circ}$ C	40 $^{\circ}$ C	50 $^{\circ}$ C	60 $^{\circ}$ C	
LR-602A-FM	0-20	1.1	0.95	0.80	0.64	\$265
LR-603A-FM	0-40	0.60	0.50	0.42	0.33	265

LR SERIES 1/2-RACK MODELS

5 $\frac{3}{16}$ " x 8 $\frac{3}{8}$ " x 10 $\frac{3}{32}$ "

REGULATION: 0.0005% + 100 μ V
RIPPLE: 35 μ V RMS



MODEL	ADJ. VOLT RANGE VDC	MAX. CURRENT (AMPS) AT AMBIENT OF:				PRICE
		30 $^{\circ}$ C	40 $^{\circ}$ C	50 $^{\circ}$ C	60 $^{\circ}$ C	
LR-612A-FM	0-20	1.8	1.6	1.3	1.1	\$305
LR-613A-FM	0-40	1.0	0.9	0.75	0.6	305
LR-615A-FM	0-120	0.33	0.29	0.25	0.21	320
LR-616A-FM	0-250	100 mA	90 mA	80 mA	70 mA	340

LR SERIES 1/2-RACK DIGITAL READOUT MODELS

5 $\frac{3}{16}$ " x 8 $\frac{3}{8}$ " x 10 $\frac{3}{32}$ "

REGULATION: 0.0005% + 100 μ V
RIPPLE: 35 μ V RMS



MODEL	ADJ. VOLT RANGE VDC	MAX. CURRENT (AMPS) AT AMBIENT OF:				PRICE
		30 $^{\circ}$ C	40 $^{\circ}$ C	50 $^{\circ}$ C	60 $^{\circ}$ C	
LR-611-DM	0-10	2.8	2.5	2.1	1.7	\$445
LR-612-DM	0-20	1.8	1.6	1.3	1.1	445
LR-613-DM	0-40	1.0	0.9	0.75	0.6	445
LR-615-DM	0-120	0.33	0.29	0.25	0.21	445
LR-616-DM	0-250	100 mA	90 mA	80 mA	70 mA	445

1-DAY DELIVERY • 5-YEAR GUARANTEE

Send for 1973 Power Supply Catalog and Application Handbook

LAMBDA ELECTRONICS CORP. 515 Broad Hollow Road, Melville, N.Y. 11746 (516) 694-4200

INFORMATION RETRIEVAL NUMBER 86

Solitron "Space Savers" (THE DARLINGTONS)

SINCE WE STARTED TO USE 10 AMP POWER DARLINGTONS WE'VE RECEIVED TWICE AS MUCH FOR OUR MONEY

GOOD WORK, GLEN!

SEE HOW SOLITRON'S NEW 10 AMP NPN AND PNP POWER DARLINGTONS REDUCE THE SIZE, WEIGHT AND COST OF OUR APPLICATION REQUIREMENTS

TELL ME MORE!

JUST ONE OF THESE MONOLITHICS WILL REPLACE TWO OF OUR ORDINARY TRANSISTORS

GREAT!

ALSO THEY ARE COMPACTLY PACKAGED IN TO-66 AND TO-5 CASES AND HAVE SPACE SAVING CHARACTERISTICS WHICH ALLOW US MORE CIRCUIT DESIGN FLEXIBILITY

HERE'S THE KNOW-HOW OF SPACE SAVERS IDENTITY AS TO THE SDM3100-3400 SERIES

ALSO HIGHER RELIABILITY AND SWITCHING POWER

V_{CEO} FROM 40V TO 80V
 MULTIPLE GAIN SELECTIONS @ 2.5A OR 5.0A
 TYPICAL 1.0A H_{FE}, 10,000 MINIMUM
 TYPICAL 5.0A H_{FE}, 1000 MINIMUM
 LOW LEAKAGE PLANAR CONSTRUCTION
 (LESS THAN 100 μA @ 80% OF V_{CB0}, V_{EB0})
 HIGH SPEED (f_t = 40 MHz TYPICAL, RISE AND FALL TIMES 200 ns TYPICAL)
 θ_{J-C} LESS THAN 5° C/W (TO-66) AND 25° C/W (TO-5)

Solitron DEVICES, INC.

1177 BLUE HERON BLVD. / RIVIERA BEACH, FLORIDA / (305) 848-4311 / TWX: (510) 952-7610

- | | | | | | | | |
|-----------------------------------------------------------------------------------------------------------------------------------------------------------------------------------------|-----------------------------------------------------------------------------------------------------------------------------------------------------------------------|-------------------------------------------------------------------------------------------------------------------|------------------------------------------------------------------------------------------------------------------------------------------------------------------|-----------------------------------------------------------------------------------------------------------------------------------------------------------------------|---------------------------------------------------------------------------------------------------------------------|------------------------------------------------------------------------------------------------|------------------------------------------------------------------------------------------------------------------------------------------|
| SAN DIEGO, CALIF.
8808 Balboa Ave.
CMOS, PMOS Circuits
Diodes, Rectifiers, &
Zeners
FET & Dual FET
Transistors
High Voltage Assemblies
Linear & Monolithic IC's | RIVIERA BEACH, FLA
1177 Blue Heron Blvd.
Hi-Rel Power Transistors
SI & Ge. Power
Transistors
Hi-Rel Power Hybrids
PNP-NPN Industrial
Transistors | PORT SALERNO, FLA
Cove Road
Microwave Connectors
Plaxial (R) Cable
Precision RF Coaxial
Connectors | JUPITER, FLA
1440 W. Indiantown Rd
Microwave Stripline
Components
Microwave Diodes
RF and Microwave
Transistors
Hi-Rel Power
Transistors | TAPPAN, N.Y.
256 Oak Tree Road
Diodes & Rectifiers
Ferrite & Ferrite Devices
High Voltage Assemblies
Power Rectifiers
Thick Film
Hybrid Circuits | KENT, ENGLAND
Tubbs Hill House
London Road.
Sevenoaks
Solidev, Ltd.
Full line of
Solitron devices | BEN BARAQ, ISRAEL
51 Hayarkon Street
AEL Israel, Ltd
Full line of
Solitron devices | TOKYO 105, JAPAN
Rm. No. 21,
Kyodo Bldg
No. 4-10, 2 Chome
Higashi Shinbashi
Minato-ku
Full line of
Solitron devices |
|-----------------------------------------------------------------------------------------------------------------------------------------------------------------------------------------|-----------------------------------------------------------------------------------------------------------------------------------------------------------------------|-------------------------------------------------------------------------------------------------------------------|------------------------------------------------------------------------------------------------------------------------------------------------------------------|-----------------------------------------------------------------------------------------------------------------------------------------------------------------------|---------------------------------------------------------------------------------------------------------------------|------------------------------------------------------------------------------------------------|------------------------------------------------------------------------------------------------------------------------------------------|

Quad op-amp comparators allow continuous monitoring of two inputs

A single IC amplifier chip can be used to monitor the high and low limits of two power-supply lines in a system. And the circuit does not require a dual power supply to perform this function.

Individual amplifiers can be used as basic comparators (Fig. 1) for operation in one of two ways. The output makes either a high-to-low transition (Fig. 1a) or a low-to-high transition (Fig. 1b) when the input signal exceeds the set-point level. In each case the 3.3-M Ω feedback resistor adds some hysteresis. But its main function is to narrow the band of uncertainty.

A combination of the two basic comparator circuits provides the bracket-type voltage monitor shown in Fig. 2. Amplifier A₁ determines the lower set point and A₂ the upper set point.

With a reference of 12 V, the set points may be varied from 1 to 11 V. Hysteresis is approximately 10 mV for a set point of 5 V. The individual comparator circuits draw approximately 12 μ A from their respective reference and input circuits and about 4 mA from the power-supply line.

Joseph Kish, Diebold, Inc., Canton, Ohio 44709.

CIRCLE NO. 311

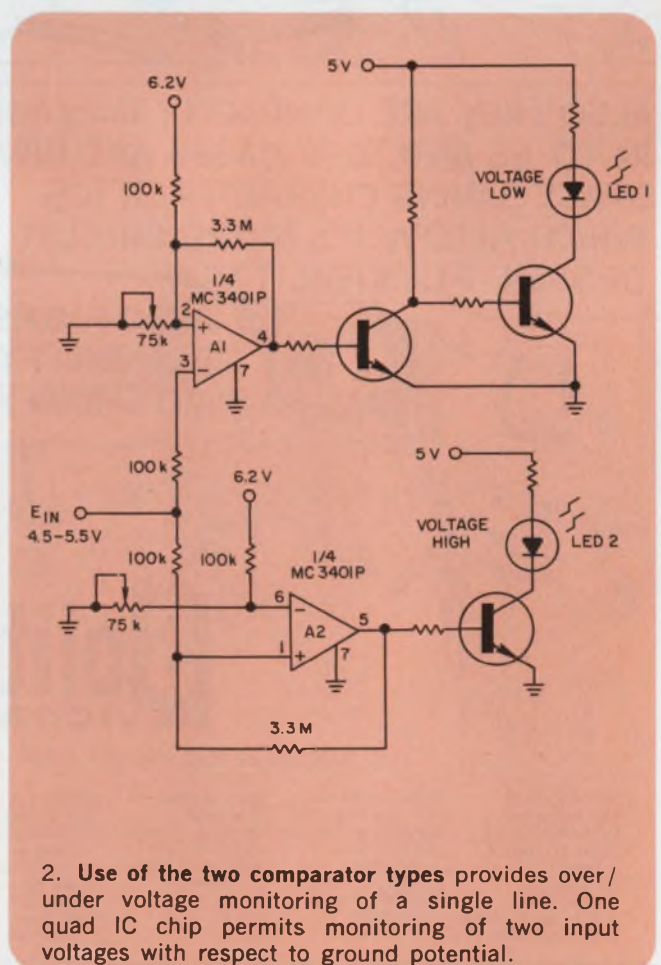
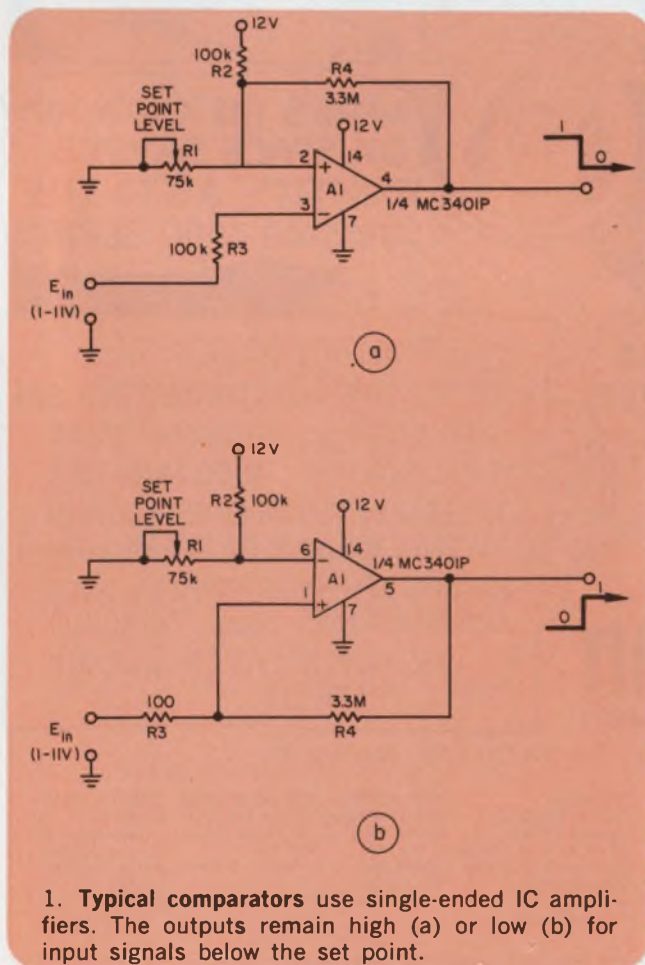

191 FLAVORS OF BECKMAN DIPS



All 191 flavors of RESNET™ DIPs offer system compatibility because we use the same packages you use for I.C.s; plus you get ceramic dependability at plastic prices.

Whether you're inserting resistors automatically or by hand — call your local Beckman/Helipot representative and ask how you can save money using RESNET DIPs. He stocks locally for immediate delivery.

To request technical data, call your local Beckman/Helipot representative. Or write to Beckman Instruments, Inc., Helipot Division, 2500 Harbor Blvd., Fullerton, Calif. 92634.

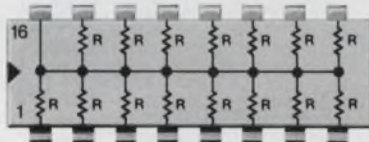

898-1 (15 resistors)
Price (1,000-4,999) \$.85

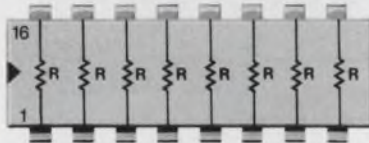

898-3 (8 resistors)
Price (1,000-4,999) \$.76

STANDARD RESISTANCE VALUES
(± 2% or ± 2Ω)

62	110	330	1.0K	2.2K	6.0K	15.0K
68	150	470	1.5K	3.3K	6.8K	22.0K
100	220	680	2.0K†	4.7K	10.0K	

*Standard in 898-3 only.
†Standard in 898-1 only.

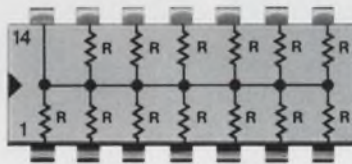

899-1 (13 resistors)
Price (1,000-4,999) \$.81

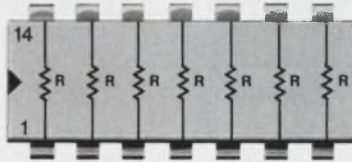

899-3 (7 resistors)
Price (1,000-4,999) \$.72

STANDARD RESISTANCE VALUES
(± 2% or ± 2Ω)

22	62	180	510	1.5K	4.3K	11K
24	68	200	560	1.6K	4.7K	12K
27	75	220	620	1.8K	5.1K	13K
30	82	240	680	2.0K	5.6K	15K
33	91	270	750	2.2K	6.0K	16K
36	100	300	820	2.4K	6.2K	18K
39	110	330	910	2.7K	6.8K	20K
43	120	360	1.0K	3.0K	7.5K	22K
47	130	390	1.1K	3.3K	8.2K	
51	150	430	1.2K	3.6K	9.1K	
56	160	470	1.3K	3.9K	10K	

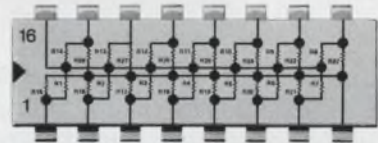

898-5-R220/330
Pulse squaring TTL terminator.
Price (1,000-4,999) \$1.45

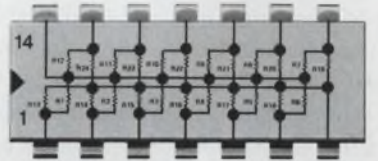

899-5-R220/330
Pulse squaring TTL terminator.
Price (1,000-4,999) \$1.35

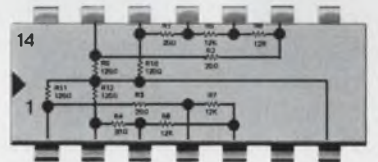

899-19
DIP interface network providing resistors for μA711 core sense amplifier configuration.
Price (1,000-4,999) \$1.18

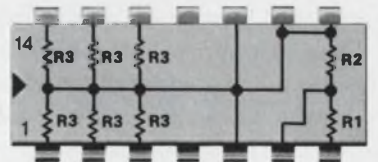

899-40
DIP network provides six line terminators and the threshold setting divider for the Intel 3208A sense amplifier.
Price (1,000-4,999) \$1.35



HELIPOT DIVISION

INFORMATION RETRIEVAL NUMBER 23

Shift option improves handling of binary counter data

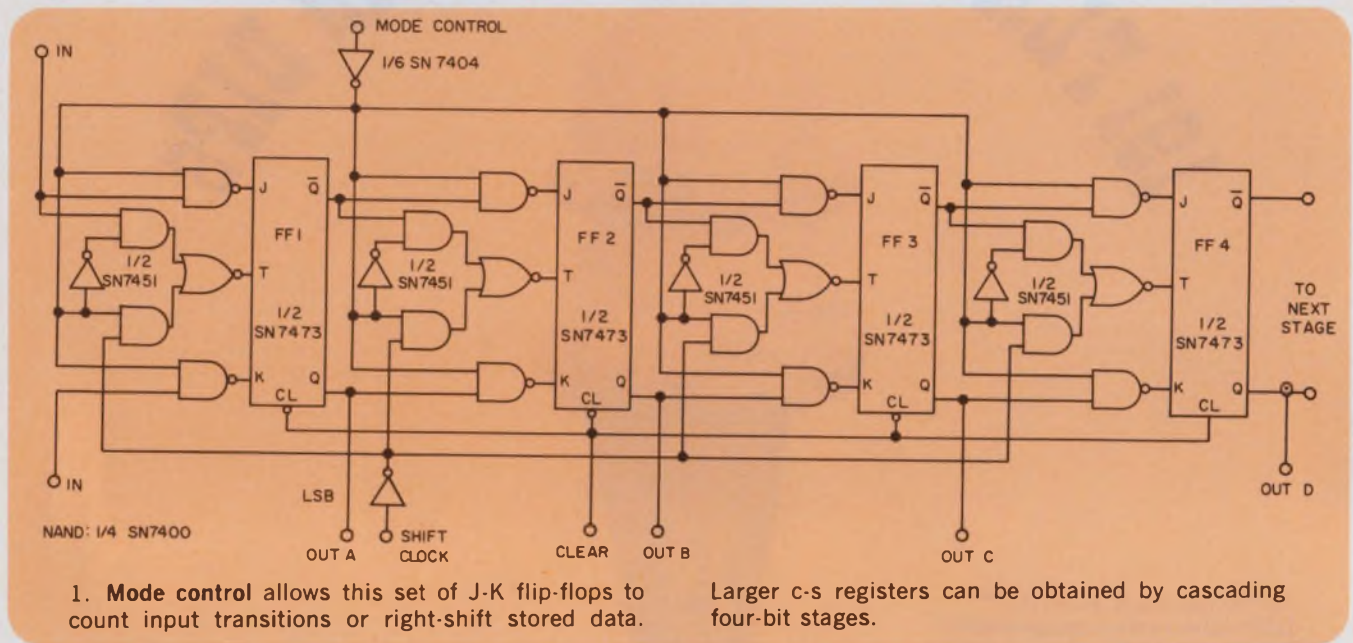

Adding a count/shift mode control to a binary counter improves its usefulness in two ways: (1) Leading zeros need not be transmitted, and (2) Data can be truncated to accommodate any size of parallel channel. Both objectives are achieved by using the count/shift control to right-justify the count data in the register.

When the mode control input (Fig. 1) is a logic ONE, the J and K inputs of each flip-flop are ONE and the Q output is connected to the clock terminal of the succeeding flip-flop. Thus the circuit provides a left-justified binary count of the input transitions.

A logic ZERO on the mode control allows right-shifts via the shift-clock line. The J and K lines of each flip-flop are connected to the preceding flip-flop's Q and Q outputs, respectively; the shift-clock signal is applied to the clocking inputs of all the flip-flops.

Cascaded four-bit counter-shifter (c-s) circuits form a 16-bit binary counter/register (Fig. 2). When the mode control signal is logic ONE, FF₁ is cleared and the circuit provides left-justified binary count data with the least-significant-bit (LSB) at the leftmost position.

After the sampling period, the mode control signal is made a logic ZERO. The leading edge of the next clock pulse then changes the Q output of FF₁ to a logic ONE. This enables shift-clock pulses to the register and to the four-bit counter. The data are shifted to the right until a most-significant bit (MSB) is detected at the register

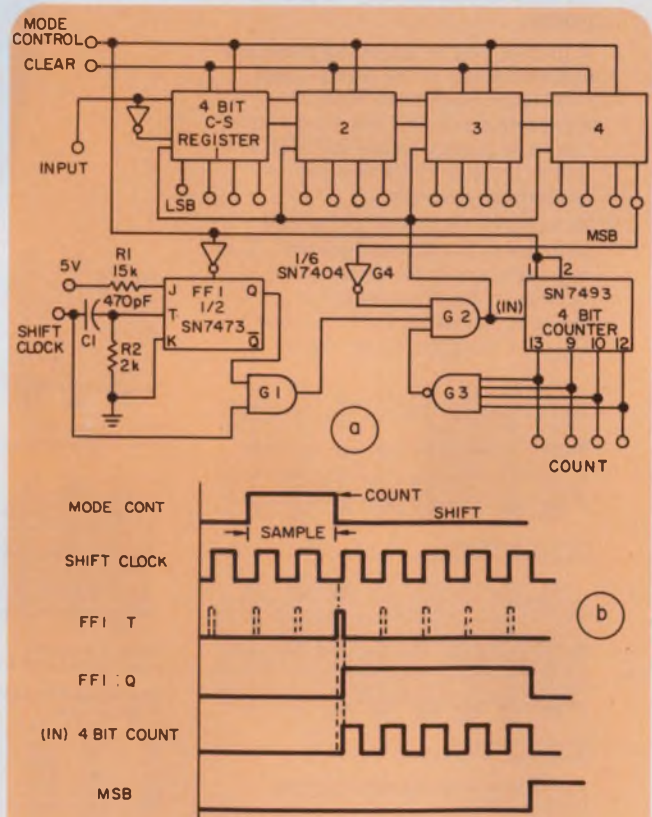



Model 501 5MHz Function Generator

with trigger/gate.

\$395

And that's not our only bargain.

There are a few function generators priced lower than \$395. But not one that offers trigger/gate. And what's so important about trigger/gate? Simple. Trigger/gate allows you to start and stop as you choose for one-pulse, tone bursts or synchronous timing. Not another instrument at this price offers it.

In addition, our built-in, input-summing, high-output wide-band amplifier allows you to add in your own signals.

Model 501 is making more than just economic waves. It makes sine or square waves or triangles with variable offset or DC. With symmetry control it can make pulses or ramps, and you can FM it with our 1000:1 voltage generator control.

Model 501 is only one of our Solid Gold Series values. There's four more models with frequency rates to 20MHz, with or without trigger/gate.

But don't take our word for it. Ask for a demonstration. Or take a 501 home for a test. Or send for our 'Strictly Straight-Arrow Literature.' Do something. After all, the more you know about function generators, the better for us.



INFORMATION RETRIEVAL NUMBER 35

THE GOLD LINE SERIES FROM

AILTECH 
A CUTLER-HAMMER COMPANY CONTROL

EAST COAST OPERATION • 815 BROADHOLLOW ROAD • FARMINGDALE, NEW YORK 11735 • TELEPHONE: (516) 595-6471
WEST COAST OPERATION • 19535 EAST WALNUT DRIVE • CITY OF INDUSTRY, CA. 91748 • TELEPHONE: (213) 965-4911

terminal that is farthest to the right. Detection of the MSB at G_2 inhibits both counting and shifting. If there are no ONEs in the registers, shifting stops after 15 clock pulses are received by the counter.

The MSBs can now be serially shifted out or wired to other devices. Subtracting the number

in the counter from 16 tells the user the required word length of the data to be transmitted in case message size and sending time are important.

Akavia Kaniel, Design Engineer, Digital Equipment Corp., 146 Main St., Maynard, Mass. 01754
CIRCLE No. 312

Two amplitude measurements determine unknown phase angle

An oscilloscope or ac meter with provision for differential inputs can provide phase-angle measurements with accuracies of better than one degree.

If two sinusoidal signals of the same frequency are subtracted, the magnitude of the difference signal will be a minimum when the ampli-

tudes of the two signals are equal. It can be shown that this minimum value, V_{min} , is

$$V_{min} = 2 E \sin (\theta / 2),$$

where θ is the unknown phase angle and E is the amplitude of each sine wave. If both V_{min} and E are measured, θ can be computed from

$$\theta = 2 \sin^{-1}(V_{min} / 2E) \quad (1)$$

A practical method for instrumenting such measurements is shown in the accompanying schematic. First, the selector is set to the null position and the potentiometer adjusted for a minimum reading (V_N). Next, the selector is set to the "cal" position and the reading, V_E , noted. The value of θ is found from

$$\theta = 2 \sin^{-1}(V_N / 4V_E), \quad (2)$$

which for values of θ that are less than 15 degrees can be approximated by

$$\theta \approx 28.6 (V_N / V_E). \quad (3)$$

Where less accuracy is needed, use a differential scope and calculate θ from Eq. 1.

S. J. Pirkle, Project Engineer, Hewlett-Packard Medical Electronics Div., 175 Wyman St., Waltham, Mass. 02154.
CIRCLE No. 313

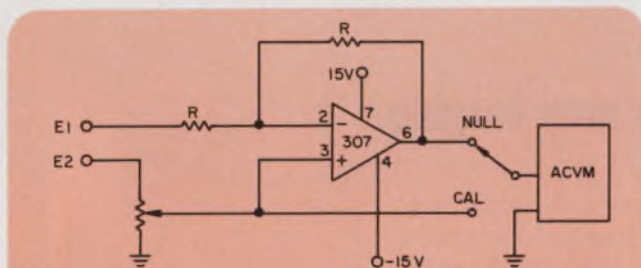

The phase angle between E_1 and E_2 may be determined by measuring signal magnitudes in the null and "cal" positions. Before measurements are taken, the potentiometer is adjusted for a minimum signal at the op-amp output.

IFD Winner of November 23, 1972

Jack Mattis, Linear Product Marketing, Signetics, 811 E. Arques Ave., Sunnyvale, Calif. 94086. His idea "Missing-pulse detector reacts to 100-ns pulse widths" has been voted the Most Valuable of Issue Award.

Vote for the Best Idea in this issue by circling the number for your selection on the Information Retrieval Card at the back of this issue.

SEND US YOUR IDEAS FOR DESIGN. You may win a grand total of \$1050 (cash)! Here's how. Submit your IFD describing a new or important circuit or design technique, the clever use of new component or test equipment, packaging tips, cost-saving ideas to our Ideas for Design editor. Ideas can only be considered for publication if they are submitted exclusively to ELECTRONIC DESIGN. You will receive \$20 for each published idea, \$30 more if it is voted best of issue by our readers. The best-of-issue winners become eligible for the Idea of the Year award of \$1000.

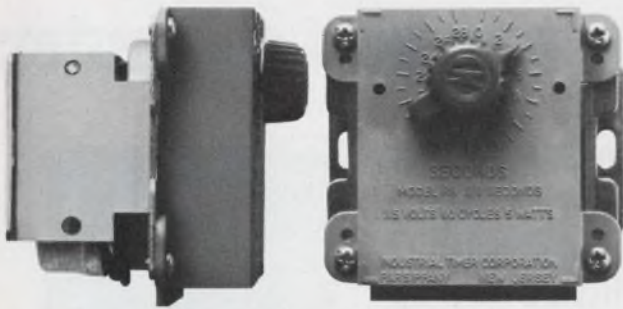

Viewed from every angle, our new R.B. Delay Timer is a great value at \$8.38*

To keep manufacturing costs in line and increase dependability, the R.B. is your answer. Has dial adjustability, automatic reset and guaranteed 100% electro-mechanical reliability and accuracy. Replaces cheaper delay devices of questionable performance.

Except for the motor, it is

completely enclosed in G.E. Noryl SE-1† plastic for total insulation and dimensional stability. Repeat accuracy is $\pm 1\%$ of total time cycle. Load switch capacity is 15 Amps. SPDT-120/240 VAC Non-Ind. snap action.

Choice of 7 time cycles between 5.5 sec. and 4 min.-24 sec. max. Ask for Bul.307.



*Maximum quantity discount
†Trademark G.E. Co.

Industrial Timer Corporation, U.S. Highway 287, Parsippany, N.J. 07054
INFORMATION RETRIEVAL NUMBER 32

power sources

NEED INFORMATION ON
power sources?

PICK UP YOUR PHONE
AND DIAL TOLL FREE
800-645-9200

(or, in New York State, call collect (516) 294-0990)

FOR IMMEDIATE PRODUCT
AND SOURCE INFORMATION

**this service is
FREE**

use it whenever you're about to specify
any **electronic product**

eem

645 Stewart Ave., Garden City, N. Y. 11530

INFORMATION RETRIEVAL NUMBER 33

ELECTRONIC DESIGN 7, April 1, 1973

**The finest
lighted
pushbutton
switches and
indicators are**



**also the easiest
to install**



Snap!

- Snap-in instant panel mounting
- Choice of sizes, colors, and lens styles
- Flush or barrier configurations
- Re-lampable from front of panel.

*Lighten your decisions
contact . . .*

MARCO-OAK

Subsidiary of OAK Industries Inc.

P.O. Box 4011
207 S. Helena Street, Anaheim, Calif. 92803
Tel. (714) 535-6037 • TWX — 910-591-1185

INFORMATION RETRIEVAL NUMBER 34

Introducing the new, faster Rolm 1602 Ruggednova..the world's toughest computer.

Tough enough to meet Mil Specs E-5400 airborne environment and E-16400 shipboard environment with a more powerful interrupt structure, expanded instruction set, extensive I/O interfaces, proven software and upward compatibility with Data General's Nova Series.



Here is the most complete mil spec computer system you can buy. The heart of the 1602 is a 16-bit, rugged and powerful microprogrammed processor with a 1 microsecond core memory cycle time . . . but the total package is a lot more.

MORE SOFTWARE THAN ANY MIL SPEC COMPUTER

Our licensing agreement with Data General Corporation allows us to provide you with a wide selection of proven and documented software. Any program written on the Nova will operate on the 1602 Ruggednova. Our software set includes assemblers, compilers, debugging aids, utility routines, math libraries and powerful operating systems. And to get your software started immediately, we have a 1602 assembler that runs on the Nova series of machines.



This snow cat carries a Ruggednova interfaced with two radar systems to help map the Canadian glacial fields.

OVER 30 GENERAL-PURPOSE INTERFACES

Most military computers are required to interface with more kinds of devices than any other class of computer. That's why Rolm makes available a wide selection of general purpose I/O interfaces for the 1602. These range from serial and parallel digital interfaces to communication interfaces to D/A and A/D converters . . . all the way to NTDS interfaces. They can give you an edge when you go after those contracts. No design costs. No technical risks.

AN EXPANDED INSTRUCTION SET SAVES YOU TIME

Military applications place more rigorous demands on computer execution time

and memory requirements than do commercial applications. That's why we expanded the 1602 instruction set beyond the basic Data General set. This gives you increased computational and memory reference capabilities plus reduced program storage and execution time. New instruction types include: stack-oriented instructions, exclusive and inclusive "or," n-bit shift capability, signed and unsigned multiply-divide, double precision arithmetic, a powerful new file search instruction and a special interrupt branching and nesting feature.

A UNIQUE APPROACH TO YOUR SPECIAL INTERFACES

The 1602 is designed so that you can place your special interface inside the chassis. We can provide you with I/O cards with room for 42 integrated circuits and 55 pins to connect your interface to the outside world or other cards in the chassis. You don't have to design a rugged chassis or power supply, plus your interface is qualified to Mil E-5400 and Mil E-16400 by similarity. One of our customers followed this approach in totally packaging an Omega Navigation Set within a Ruggednova chassis.



Ruggednova, shown above, is aboard a Sabreliner jet performing data acquisition and navigation functions for atmospheric research.

MEETS MIL SPECS E-5400 AND E-16400

The 1602 has been designed to meet Mil-E-5400 airborne environments, Class II; Mil-E-16400 shipboard environments, Class I; Mil-Std-461A electromagnetic interference and Mil-S-901 for high impact shock. It has an operating temperature range of -55°C to $+95^{\circ}\text{C}$ case temperature, at altitudes from sea level to 80,000 feet. It meets shock specifications of 15

g's with 11 ms duration and vibration tests of 10 g's, 5 to 2000 Hz. Then there are the requirements for humidity, sand and dust, salt spray, salt fog and fungus. The 1602 meets or exceeds them all . . . to become the world's toughest computer.

A FULL LINE OF PERIPHERALS

We can provide you with peripheral devices in every major category . . . fully integrated and documented. These include tape and disc storage units, communication interfaces, line printers, and paper tape equipment . . . plus software that enables you to easily use these devices.

PROVEN IN OVER 300 APPLICATIONS

Ruggednovas have been used in over 300 applications in the past 3 years. The software has been used in over 4,000 systems. These range from helicopter transportable communication systems to shipboard fire control to scientific exploration on a snow cat. If it moves, it should be a Ruggednova.

ATTENTION PROGRAM MANAGERS

The Ruggednova is a complete package of hardware and software. Now, let's talk about the support package you get at no cost. These are items which can reduce your budget and design risk at the same time. We can give you detailed reliability reports, provide two weeks of training, supply a complete documentation package and top it off with a 90-day warranty. We also give you a "how to" software manual, individual software write-ups, and full diagnostic software. And you don't have to worry about qualification tests . . . we are doing them for you. All of this adds up to savings and success for your program.

ROLM

CORPORATION

18922 Forge Drive, Cupertino, CA 95014
(408) 257-6440 • TWX 910-338-0247

REGIONAL SALES OFFICES: Los Angeles 213-784-8500; Palo Alto 415-965-2224; Washington, D. C. 703-893-2696; Boston 617-237-5752; New York 914-297-9533.

DOMESTIC REPRESENTATIVES: Kansas 913-362-0919; Minnesota 612-491-5400; Missouri 314-895-4100; Texas 214-233-6809; Washington 206-762-2310.

new products

Logic analyzer displays up or downstream data bits



Hewlett Packard, 1501 Page Mill Rd., Palo Alto, Calif. 94304. (415) 493-1501. P&A: See below.

Here's a new way to troubleshoot or analyze digital logic. Capture the data bits and display them individually with LEDs. An instrument that does that is HP's new logic analyzer. Designated the 5000A, it uses two rows of LEDs to show the HIGH and LOW logic bits for two independent serial inputs, referenced to a system clock.

What can the 5000A do that an ordinary scope or logic probe can't do? It can store data; it can compare data on two independent input channels; it can look at selected bits way downstream—or even upstream—in a data sequence; and it can capture bursts, single-shot or continuous events.

The data input and display sequence go like this: After a trigger is received, the unit simultaneously samples the state of the two input signals on either the positive-going or negative-going transition of each of the next 32 clock pulses. The display advances one LED for each clock cycle until the

32-bit registers are filled.

Digitally controlled triggering lets the user begin the display from a digitally selectable point in the data stream, while clocking in the data synchronizes the analyzer to the circuit under test, thereby ensuring a repeatable display. And since the display shows logic states by clock cycles, it's easy to compare it with truth tables or timing diagrams.

A wide choice of triggering is offered, including an external trigger, either input signal, or logical combinations of all of these. Logic circuitry drawn on the front panel symbolizes the triggering process.

Thus any HIGH-LOW combination of the three signals can be selected as the trigger word. Any input not needed for triggering can be switched to a "don't care" state.

All inputs, including the clock, are monitored by LED annunciators. These act as logic probes to indicate dynamically the input states, including pulse trains.

If the data of interest don't immediately follow the trigger, the 5000A provides a variable digital

delay that moves the 32-bit display an exact number of clock pulses—up to 999,999—relative to the trigger. Just dial the appropriate number into the thumbwheel register.

And since the analyzer always has access to the last 64 bits of input data, events occurring up to 64 clock pulses prior to triggering can be displayed. Thus the display window can be moved back in time as well as forward. This is particularly useful for locating data that cause an error.

You can combine the digital delay, digital triggering and single-shot features of the 5000A to capture and display any portion of a long, single-shot data sequence, such as that occurring in calculator circuits. Also, a "spike" mode detects and relates occurrence of a spike to the exact clock cycle in which it occurs.

Other modes of the 5000A analyzer include a serial mode, in which the two 32-bit display registers are cascaded to form a single 64-bit register; a store mode, in which B-channel data are locked in while the A register is updated at each trigger; and a comparison mode, in which the analyzer logically compares the two inputs, A and B, and displays the results. The functions $A \cdot B$, $A + B$ and $A \oplus B$ are provided.

Because of its variable threshold (± 1.4 V), the 5000A is compatible with all digital logic families. And the 1-M Ω , 25-pF input impedance can be raised to 10 M Ω , 10 pF, with 10:1 probes. When probes are used, the threshold is extended to ± 14 V.

Other specs include a maximum clock rep rate and minimum clock pulse width of 10 MHz and 15 ns, respectively, and a minimum trigger pulse width of 40 ns. Tentative price of the 5000A is currently \$1900. Deliveries are scheduled to begin in mid-April.

CIRCLE NO. 250

\$1095 DMM can be remotely programmed



Dana Laboratories, 2401 Campus Dr., Irvine, Calif. 92664. (714) 833-1234. \$1095.

Model 4700A DMM is a combination systems and laboratory four-digit measuring device. It provides five dc ranges, four ac ranges, six ohm ranges, isolated BCD output and remote programming, all as standard. Also, the 4700A maintains 0.01% dc accuracy for 90 days. The unit includes full autoranging or manual selection of range in every function. By selecting the desired function, the operator can read dc from 10 μ V to 1000 V, ac from 100 μ V to 500 V, and resistance from 10 milliohms to 20 M Ω . 100% overrange is available in all functions. CMR is 100 dB.

CIRCLE NO. 251

Digital filter offers cutoff freq to 0.001 Hz



Multimetrics Industries, 120-30 Jamaica Ave., Richmond Hill, N.Y. 11418. (212) 441-4240. \$1195; stock to 2 months.

The Model AF-420L, digitally-tuned active filter, has Butterworth and time-domain responses of 24 and 48 dB/octave; cutoff frequency range of 0.001 Hz to 9.99 kHz, with $\pm 2\%$ accuracy on all ranges; high-pass, low-pass, band-pass, band-reject and bypass functions. All functions are performed with front-panel switches, eliminating patch cables. Hum and noise are below 100 μ V rms. Operation is from 115/230 V or by battery. The AF-420L offers $\pm 2^\circ$ phase tracking between independent channels, input impedance = 10 M Ω and output impedance = 50 Ω . Attenuation is 80 dB min to 1 MHz.

CIRCLE NO. 252

Function generator is also noise generator



Wavetek, P.O. Box 651, San Diego, Calif. 92112. (714) 279-2200. \$795; 30 days.

In addition to the usual sine, square and triangle waveform outputs, the Model 132 provides two unique noise outputs—digital and analog. By driving the unit with a pseudorandom sequence with selectable clock rates and sequence lengths, the noise output can be used directly at adjustable levels. More significantly, the noise can be added to the signal with selectable calibrated signal-to-noise and noise-to-signal ratios. Frequency range is 0.2 Hz to 2 MHz for the waveforms and noise bandwidth is dc to 100 kHz.

CIRCLE NO. 253

FREE CATALOG

OVER 26,500 POWER SUPPLIES

Over 26,500 models of DC Power Supplies — up to 1000VDC and 100A. Both wide and narrow range modules, plus Bench and Lab units for all applications. Quality power supplies based on industry-proven Power/Mate UniPower principles, featuring low ripple and excellent regulation. Low-cost, high reliability. 5-year warranty. Most models shipped same day.

SEND FOR YOUR FREE CATALOG

PMIC POWER/MATE CORP.

514 S RIVER STREET HACKENSACK, N. J. 07601
Phone (201) 343-6294 TWX (710) 990-5023

Introducing the expensive dual-trace scope that doesn't cost a lot.

The B&K Precision Model 1470.

The compact 5-inch solid-state 1470 is specially designed to meet 80% of all your scope applications.

It has DC to 10 MHz bandwidth with 10 mV/cm sensitivity. Sixteen triggered-sweep speeds range from 1 μ sec/cm to 0.2 sec/cm. Triggers on input signals as low as 5mV.

\$499⁹⁵

Sound good? Our prices become even more remarkable once you see our specs.

Call your B&K distributor. Or write Dynascan Corporation.

Very good equipment at a very good price.



Product of Dynascan Corporation
1801 West Belle Plaine Avenue, Chicago, Illinois 60613

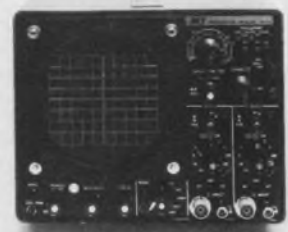

**Signal source? DMM?
Counter? It's all three**



*Systron-Donner, Datapulse Div.,
10150 W. Jefferson Blvd., Culver
City, Calif. 90230. (213) 836-6100.
Approx. \$1250; June.*

One instrument puts it all together. Called the Versatester I, the unit generates sinusoids, square waves and pulses from 20 Hz to 20 MHz; provides ± 15 and +5-V power for TTL, linear and MOS circuits; measures and provides a 4-digit display of ac/dc volts and ohms; and, finally, measures and displays frequency or count to 20 MHz.

As a source, the Versatester provides 3-V rms sinusoids with a setting accuracy of at least $\pm 0.1\%$, and with less than 0.5% distortion to 500 kHz. Distortion to 2 MHz is -40 dB, and to 20 MHz it's -30 dB. Hum and noise are 60 dB down. As for square waves, setting accuracy is also $\pm 0.1\%$, transition times are approximately 5 ns and amplitude is 5 V pk-pk max. Both upper and lower voltage levels are variable.

Pulses can be delayed from 20 ns to 20 ms and width can be varied from 20 ns to 20 ms. Transition times are also about 5 ns. Amplitude is 5 V.

Measurement capabilities include dc V from ± 0.2 to 2000 V with an accuracy of $\pm 0.1\%$ of reading ± 1 digit; ac V from 0.2 to 200 V with 3% accuracy to 1 MHz and $\pm 7\%$ above; ohms from 1 Ω to 20 M Ω , with $\pm 0.2\%$ accuracy ± 1 digit; and frequency or totalize from 20 Hz to 20 MHz with a sensitivity of 100 mV. Time base stability of the 4-digit counter is ± 1 part in 10^6 . Input impedance is 1 M Ω on ac V and count, and 10 M Ω on dc V. All specs are tentative.

CIRCLE NO. 254

INFORMATION RETRIEVAL NUMBER 39 ►



THE ODDBALL

It's our 1690 Insulated Feed-Thru with KT 46, etc. We make it, along with 65,000 other commercial and military variations. Far more than any other manufacturer.

We supply terminal boards, blocks and strips throughout the world and can meet your exact needs too.

There is no need to compromise. Delivery? Allow a few weeks for our good old standards, longer for the oddballs. So plan ahead and get the best.

Kulka

A NORTH AMERICAN PHILIPS COMPANY

SE UL

Kulka Electric Corp., 520 South Fulton Avenue, Mount Vernon, New York 10551

Line printer for minicomputer offers high speed at low cost



Pertec Corp., 9600 Irondale Ave., Santa Ana, Calif. 92705. (213) 882-0030. \$4000-\$6000; Mid-April.

Many important minicomputer applications—such as key-to-tape entry, in-house time-sharing and word processing—call for a modestly priced line printer that can operate at high rates. Pertec's Model P-7330 meets this demand with a 300 line/min, 132 column-printout for \$1000 less than the closest comparable device, Data Products' Model 2230.

Other manufacturers offer 200 line/min units. In moderate quantities the Tally Model 2200 costs \$3000 to \$4000, while Nortek's unit costs \$6000 to \$8000.

The Pertec unit can print an original and five copies with full 132-column width. An ASCII 64-character set is standard, but with an optional 48-character ANSI Fortran subset, the printing speed increases to 385 line/min. Tractor width can be set to accommodate 3.5 to 14-7/8 in. forms.

An electronic top-of-form control is provided, and an operator or the data source can determine pagination. Also, the data source can specify line skips. Perforation skip-over is automatic.

The basic printing mechanism is a high-speed hammer that strikes a thin, circular character band. The character band is a metal strip with etched character and timing marks; it is driven by a closed-loop velocity servo. Each hammer consists of a flat spring of magnetic material, an impacting head and a copper field winding. Hammers have a life expectancy of five years, based on operation at 16 hours a day with a 20% duty cycle.

Data or control-code transfer occurs on a sequential basis with use of seven-bit parallel ASCII coding. A demand line (printer) remains valid except during printing or acceptance of a character. A data strobe (source) indicates to the printer that a character awaits ac-

tion by the printer. Printing occurs when the 132-character printer buffer is full. All logic levels are TTL-compatible.

Character bands are easy to replace. Optional 48 or 96-character units are available. Other options include a paper-tape, vertical-format control, with 12 channels, stylized characters (Open Gothic, 0.095 inch high by 0.065 inch wide, is standard), and a quiet version of the printer.

For Pertec **CIRCLE NO. 255**
 For Data Products **CIRCLE NO. 256**
 For Tally **CIRCLE NO. 257**

CPU operation altered by I/O peripheral

Memory Systems, 3341 W. El Segundo Blvd., Hawthorne, Calif. 90250. (213) 772-4220. from \$4298; 60 days.

On-line alteration of microinstructions is possible with this electrically alterable plated-wire ROM designated the OmniROM. The unit consists of plated wire memory and controller designed to attach to both the I/O bus and the ROM bus of an Interdata Model-70 minicomputer. During the load operation, the unit appears as a standard I/O device to the host computer, and data may be read or written to the OmniRom. Once a program-driven switch sets the unit to the "run" status, connection to the I/O bus is inhibited and the connection to the ROM bus is enabled. Host CPU microinstructions are fetched from the OmniROM instead of the host computer ROM. The result—customized firmware which can alter the host computer's command structure in real time. Units are priced from \$4298 for 1-k memory and \$5500 for 2-k which includes cabinets, controls, cabling, power supply and documentation.

CIRCLE NO. 258

This switch does everything from mother baby chicks to brew fresh coffee.

You've probably used our versatile V3 snap-action switch a thousand times and didn't know it. Since 1947, it's been standard equipment on applications ranging from incubators to vending machines.



handle temperatures down to -100°F . Others with hi-temp construction can operate at up to $+600^{\circ}\text{F}$. And still other specials meet UL standards for TV ratings.

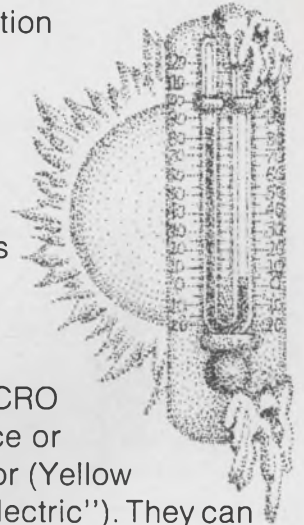

It offers thousands of variations in circuitry, electrical capacity, actuators and terminals.

The V3 offers this versatility without sacrificing quality or low price.



For example, various contact designs provide switching capacities that range from milliamps to a $\frac{1}{2}$ hp rating. A choice of integral or auxiliary actuators turns difficult jobs into routine ones. While a selection of terminals, including

Contact your MICRO SWITCH Branch Office or Authorized Distributor (Yellow Pages, "Switches, Electric"). They can provide everything from more information to actual products.

screw and quick-connect, further uncomplicates your application.

For special jobs, there are special versions. Some can



Actual Case Size:
1.094" long x 0.625" high x 0.4" deep

MICRO SWITCH makes your ideas work.

MICRO SWITCH

FREEPORT ILLINOIS 61032
A DIVISION OF HONEYWELL

MICRO SWITCH products are available worldwide through Honeywell International.

Serial-data modules simplify automation of process measurement and control

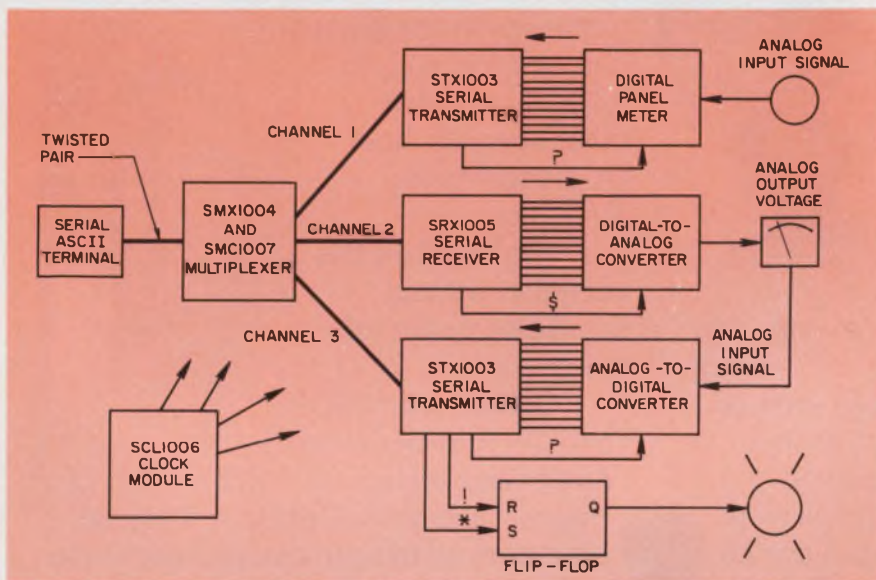

Analog Devices, Inc., Route 1 Industrial Park, P.O. Box 280, Norwood, Mass. 02062. (617) 329-4700. See text; stock.

Automating all or part of a production-process, inventory-control system or a laboratory test setup can be easier than you think. A handful of modules, costing about \$1000, and an ASCII input/output device—a teletypewriter, say—might do the whole job. If you want computer control, just connect the system to the computer's teletypewriter I/O port.

Inexpensive a/d and d/a converters (less than \$100 apiece), placed at each analog data point, are connected to one of Analog Devices' new series of Serdex (Serial Data Exchange) modules. The modules exchange serial ASCII messages, conveying commands or data between a teletypewriter and the converters.

A single twisted-pair cable can hook up from one to 256 converters over distances up to 10,000 feet. Since standard ASCII characters are used, a computer with control programs written in, say, FOCAL or BASIC can replace the keyboard terminal. No assembly or machine-language programming is

necessary.

At present the Serdex modules consist of the STX1003 serial transmitter (\$179), SRX1005 serial receiver (\$179), SMX1004 and SMC1007 multiplexer subassemblies (\$139 and \$75, respectively) and the SCL1006 clock module (\$65). Prices quoted are for quantities of 1-9.

To demonstrate the versatility of the system, Analog Devices has hooked up a sample configuration (see diagram). In response to a character sequence consisting of the symbol # followed by the required channel number, the multiplexer selects the channel over which data will be sent or collected. For example, the two-character sequence #1 selects Channel 1. A given channel remains enabled until another selection sequence is sent. A single multiplexer handles up to 16 channels. The number of channels can be increased by pyramiding multiplexers.

If Channel 2 is selected, the transmission of an equal sign (=), numeric digits and the dollar symbol (\$) will change the DAC output signal. The \$ sign signals the DAC to accept the value specified by the digits. Up

to eight BCD digits can be processed simultaneously by the SRX-1005. These digits are formatted to a maximum of 32 parallel bits and placed on the input lines of the commanded device. Use of serial transmission minimizes the number of connections between the data source and the terminal.

The user reads a given transducer output by sending a question-mark character (?). Receipt of this character provides a Start-Conversion signal for the ADC. After completing the conversion, the ADC signals the STX1003, and that unit sends the result to the teletypewriter in the form of ASCII numeric characters. Another device should not be addressed until this query-response cycle is completed.

Both the transmitter and the receiver can forward decoded digital commands. Individual lines provide an output pulse on receipt of characters !, *, ? or \$. The pulse can activate control or display devices and other circuits, such as the flip-flop shown.

A 20-mA current-loop system links the terminal with the multiplexer (or receiver/transmitter in the case of a single channel). Information is sent by keying the current on and off. This method of communication, in conjunction with opto-electric isolators, ensures reliable operation despite the common-mode noise found in industrial environments. However, the data rate is limited to 50 readings/sec by the photo couplers, though the logic circuits will work at up to 20 k baud.

All modules have 0.025-in. square wire-wrapping pins and require a 5-V dc supply. The largest unit, the multiplexer, measures 4.25 x 3.3 x 0.625 in. Each measuring station requires a clock module (2.1 x 2.1 x 0.6 in.). One clock can serve up to four stations, provided they are near one another.

CIRCLE NO. 259

RCA introduces its one-transistor Darlington.



No we haven't changed the Darlington circuit. We've just turned it into the Darlington transistor. By putting the whole circuit on a single monolithic chip.

In the RCA Darlington transistor design, optimum use of the silicon real estate and single level metallization provide improved performance characteristics. You get greater control over parameters and increased peak current handling capacity . . . up to 15 amps.

It's all spelled out in black and white. I_S/B E_S/B and Thermal Cycle ratings are all specified . . . even the output diode is characterized.

And they don't come any more rugged. All steel (TO-3) package, controlled solder chip mounting and heavy duty clip connections make the RCA Darlington transistor a dependable workhorse in your system.

So if you're working with discretes, you can now get higher packaging densities, lower your overall system cost and, at the same time, increase system reliability by reducing the number of external connections.

Why not give your system the advantage of all these benefits by switching from the Darlington circuit to the RCA Darlington transistor. It's at your

distributor, waiting for you right now in the following configurations:

TO-3 pkg.	$T_D@25^\circ C$	VERSAWATT plastic pkg.	$T_D@25^\circ C$	$V_{CE0(sus)}$ $V_{CE(sus)}$
2N6385	100W	2N6388	40W	80V
2N6384	100W	2N6387	40W	60V
2N6383	100W	2N6386	40W	40V

Want more data? Write RCA Solid State, Section 57D1/UTL37, Box 3200, Somerville, N.J. 08876. Phone (201) 722-3200.

RCA Solid State
products that make products pay off

International: RCA, Sunbury-on-Thames, U.K., or Fuji Building, 7-4 Kasumigaseki, 3-Chome, Chiyoda-Ku, Tokyo, Japan. In Canada: RCA Limited, Ste-Anne de Bellevue 810, Canada.

innovation yesterday

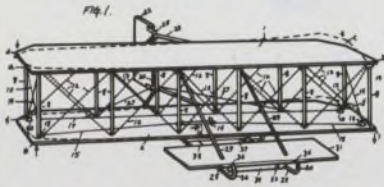

The Wright Brothers Flying Machine

innovation today



DIGIDIP Series 26000 New switch for Flow-Solder and I.C. socket applications

The first airplane startled the world. What an idea. It took a lot of imagination and hard work to get it off the ground. The Digidip is getting off the ground too. A new little 10 position rotary switch that plugs into a standard 14 or 16 pin I.C. socket. Or it can be dip or wave soldered to a P/C board.

You can order it with output codes of BCD with one common or single pole decimal as standard. Other output codes are also available as "special".

So, ask for our new catalog sheet. Ask about the low cost. Those are good ideas too.

THE DIGITRAN[®] COMPANY
A Division of Becton, Dickinson and Co. [B-D]
855 So. Arroyo Parkway, Pasadena, Ca. 91105
Tel. (213) 449-3110 • TWX 910-588-3794

DATA PROCESSING

Mil spec CPU handles tactical assignments



Honeywell Aerospace Div., 13350 U.S. Hwy. 19, St. Petersburg, Fla. 33733. (813) 531-4611. From \$2000 (qty 1000).

Model HDC-301 central-processor unit is designed for direct integration into the chassis of missile guidance or aircraft avionics packages. The CPU is housed on a single 6.25 × 6.35 × 0.5 in. PC board, requires 6 W of power and meets MIL 5400, class II reliability spec. Operating characteristics include 10-bit parallel I/O, direct memory access, a single system interrupt and 16-bit instructions. Multiply and divide speeds are 21 and 65 μ s respectively. A separate memory unit for data and instructions must be supplied by the user.

CIRCLE NO. 260

Desktop digitizer uses ordinary pen as cursor

Elographics, P.O. Box 388, Oak Ridge, Tenn. 37830. (615) 482-4039. \$2990; 30 days.

Touch any coordinate point with a conventional ball-point pen, wait 500 ms and the coordinates will be available in parallel BCD form (TTL compatible). Model E231 displays the coordinates on two DPMs, and in addition furnishes a "print" signal for transferring the above data once digital conversion is completed. Scales for the X and Y coordinates can be set independently of one another. Any arbitrary point can serve as coordinate origin. The work area measures 11 by 15 in. and the system resolution is 0.1 mm.

CIRCLE NO. 261

Graphics terminal mixes data, graphics and TV

Comutek, Inc., 143 Albany St., Cambridge, Mass. 02139. (617) 864-5140. \$3900; 45 days.

The Comutek Series 300 terminals allow the combined display of vector graphics, alphanumeric data and television images. These terminals can receive video signal images and display them as background to characters and graphical data like those derived from a computer. Combined visual data can be edited by the user and directed to other terminals or monitors. An unlimited number of vectors and over 1000 characters may be individually edited on a 256 by 256 grid. A complete Fortran-based software package, furnished with each terminal, enables plotting, formatting, editing and interfacing with the user's programs.

CIRCLE NO. 262

Tape transport meets minicomputer needs



Microdata Corp., 17481 Red Hill Ave., Irvine, Calif. 92705. (714) 540-6730. Under \$3000 in quantity.

Model 9000 operates under any set of diagnostics and has features normally found in larger units. File search and rewind speeds are both 200 in/s. The maximum data transfer rate is 72-k char/s (1600 bit/in. at 45 in./s). The unit uses 10.5-in. reels, has direct-drive motors and offers a seven or nine-track recording system. A dual gap read/write head and an erase head are standard with the drive.

CIRCLE NO. 263

Expertise, schmexpertise. It's good old-fashioned know-how.

That's why people buy so many of our PIN diodes.

Because we make them good, we make them fast, and we make them to sell at a price you can afford.

Like less than 50¢ apiece for our glass MA-47110 in quantities of 10,000. The MA-47110 is hermetically-sealed for reliability and is ideally suited for general-purpose switching and attenuating from VHF well into the microwave range. It's the first of a whole series of other economical control devices.

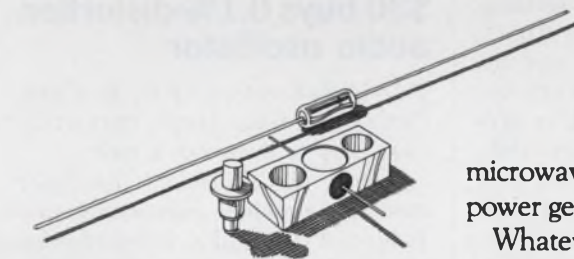

If your application requires it, we can produce PIN diodes to solve your particular power-control problem. Like our silicon-nitride passivated beam leads and hermetically sealed stripline devices. We'll make them in any quantity you want, too. Just a few. Or a whole lot, like the big batch of PIN diodes we successfully delivered for a major phased-array-radar program.

PIN diodes, Schottky barriers, Gunn and Impatt diodes, and lots of other semiconductor devices for

microwave frequency conversion, power generation, and control.

Whatever you want, when you want it, at a nice low price.

Plus the proven understanding of microwave circuits and control applications that we've developed over the years.

And that's what know-how is all about, isn't it?

 **MICROWAVE
ASSOCIATES**

Northwest Industrial Park
Burlington, Mass. 01803
(617) 272-3000

**We're Microwave Associates.
We know how.**

12-bit d/a converter settles in 5 μ s

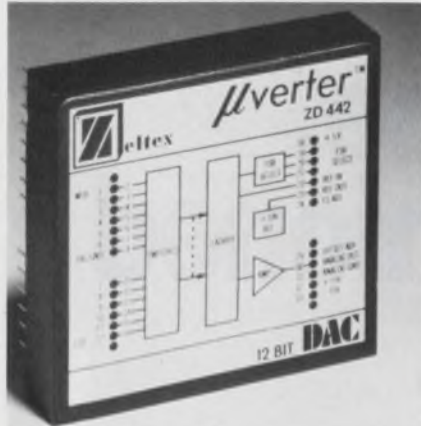

Zeltex, 1000 Chalomar Rd., Concord, Calif. 94518. (415) 686-6660. \$65 (1-24); stock to 2 wks.

Model ZD442 is a 12-bit d/a converter featuring a 5- μ s settling time. Other specs are 0.05% (0.002%/°C) scaling error and zero-offset error and 0.01% (0.002%/°C) linearity. Input coding is offset binary or unipolar binary. Output code can be selected from 0 to +10 V, ± 10 V or ± 5 V. All digital inputs are DTL/TTL compatible. Packaging is in the standard Zeltex microverter case (patent pending). The lead frames are manufactured of beryllium copper with a special tin-plate which meets the salt spray requirement of MIL-T-10727A. The lead dimensions are 0.010 \times 0.021 \times 0.200-in. Leads are spaced 0.1-in. on center—lead rows are spaced 1.8-in. apart for DIP compatibility.

CIRCLE NO. 264

8-bit d/a converter offers storage in DIP

Micro Networks Corp., 5 Barbara Lane, Worcester, Mass. 01604. (617) 756-4635. \$41 (100s); stock to 2 wks.

Micro Networks claims to be the first to offer an eight-bit d/a converter with a storage register in a single DIP package. The MS328B is approximately one-twentieth the size of modular d/a converters containing storage registers. The unit contains an input storage register, monolithic switches, precision ladder network, internal reference and op amps. The unit is housed in a hermetically-sealed 16-pin DIP and requires only ± 15 V and +5 V. Input circuitry is TTL compatible, and the output voltage is linear to 1/2 LSB over 0 to 70 C. The MN328B has an output voltage of +5 to -4.961 V.

CIRCLE NO. 265

\$30 buys 0.1%-distortion audio oscillator

Telesis Laboratory, P.O. Box 387, Chillicothe, Ohio 45601. (614) 773-1414. \$24 to \$33; 2-1/2 wks.

Series F sinusoidal oscillator modules provide regulated-amplitude (4.4 V pk-pk), low-distortion (0.1% max) outputs over the audio range of 20 Hz to 20 kHz. They require 10 mA max and operate over a wide range of power supply voltages (± 5 to ± 18 V). They are available as either fixed-frequency, factory-adjusted packages (prefix F) or as units to which the designer may affix his own external RC frequency-determining network (prefix FE).

CIRCLE NO. 266

Analog integrator is triple-threat device

Optical Electronics, P.O. Box 11140, Tucson, Ariz. 85706. (602) 624-8358. \$67; stock.

Model 9018 analog integrator has three basic modes of operation: as a sample and hold amplifier, as a selectable two-input amplifier/summer and as an analog integrator with or without initial condition and charge amplifier. The 9018 is packaged in a 1.125-in. square by 0.5-in.-high module and features ± 6 V/ μ s maximum slewing rate; 1 μ s min time constant; complete TTL compatibility; internal ± 11 -V bound circuit; ± 10 FS; and $\pm 0.1\%$ maximum error.

CIRCLE NO. 267

16-bit d/a converter is linear to 0.003%

Burr-Brown Research Corp., International Airport Industrial Park, Tucson, Ariz. 85706. (602) 294-1431. \$350 (1-9); 2 wks. ARO.

The DAC45 16-bit d/a converter features maximum drift of only 1 ppm/°C for offset, 1 ppm/°C for linearity and 5 ppm/°C for gain. The current output of this modular unit settles to 0.003% in less than 10 μ s, while the voltage output settles in 50 μ s. The linearity error of the DAC45 is only 0.003%. Thus the DAC45 can operate over a ± 3 C temperature range with less than one part in 65,000 error and over a ± 10 C range with less than one part in 16,000 error. The unit is user programmable to obtain output ranges of 0 to +10 V, -10 to +10 V, or -5 to +5 V.

CIRCLE NO. 268



ANALOGY

THE A-733 IS A MULTIPLE FUNCTION MODULE PROGRAMMED TO MULTIPLY, DIVIDE, SQUARE ROOT, SQUARE, SQUARE OF A RATIO, AND RAISE YOUR RATIOS TO AN ARBITRARY POWER. INPUTS FROM 100 mV TO 10V CAN BE PROCESSED WITH MAXIMUM OUTPUT ERROR OF LESS THAN 0.5% OF FULL SCALE. TAKE IT HOME TO MOTHER.

intech INCORPORATED
(408) 244-0500
1220 COLEMAN, SANTA CLARA CA 95050

0.19-in LED displays cost \$3.90/digit

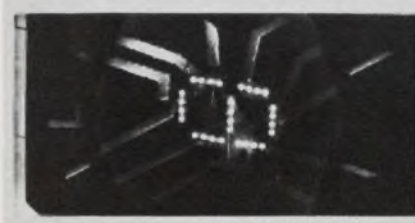

Litronix, 19000 Homestead Rd., Cupertino, Calif. 95014. (408) 257-7910. \$3.90 (100-999); stock.

The Data-Lit are a family of four LED numeric displays that use a "bubble top" integrated lens construction. The devices fall into two basic categories: The Data-Lit 4 and 402 are both 0.19-in. high, common cathode digits offering 300 ft-L brightness at 5 mA per segment. The Data-Lit 4 is pin compatible with the MAN-4; the Data-Lit 402 is a right-hand decimal version of the Data-Lit 4. The Data-Lit 410 and 411 are also 0.19-in. high, but offer a common anode construction pin compatible with the MAN-1/DL-10. The DL-411 differs from the DL-410 in having an electrically-isolated decimal point.

CIRCLE NO. 269

A/d converter gives binary or BCD output

Preston Scientific, Inc., 805 E. Cerritos Ave., Anaheim, Calif. 92805. (714) 776-6400. \$1750; 6 weeks ARO.

A new converter provides either binary or BCD-coded outputs. Model GMAD-3 is designed for use in medium and high-speed data conversion systems. Four levels of resolution are available with binary output, from 11 bits plus sign with 7- μ s conversion time, up to 14 bits plus sign with 10- μ s conversion time. With BCD output, either three digits plus sign resolution in 32 μ s, or four digits plus sign resolution in 40 μ s can be provided. Over a dozen combinations of output codes and logic levels are available in the Model GMAD-3, including TTL-compatible logic and true bipolar, 1s, 2s, 9s and 10s complement output codes.

CIRCLE NO. 270

Status indicator displays 12 messages

Industrial Electronic Engineers, Inc., 7220-40 Lemon Ave., Van Nuys, Calif. 91405. (213) 787-0311. \$14 (1000s); 5-7 wks. ARO.

The Series 0280 is a backlighted, 12-message display for indicating conditions in a system. The 12 message areas in the indicator may be illuminated individually, in combination, or simultaneously. Num-

bers, letters, words, symbols—anything that can be put on film—can be displayed, in any color. Over-all size of the Series 0280 is 2.4 × 9 × 2.6-in. Individual message areas measure 0.437-in. square; however, more than one area may be combined to form larger displays. Lamp replacement or message change is simplified by a removable viewing screen.

CIRCLE NO. 271

Now there's a big name in miniatures.

It's Raytheon. And you know with Raytheon on a miniature switch you get quality, dependability and most important — availability. Popular toggle, push-button, proximity, rotary and rocker-type designs carry the Rayswitch name and Raytheon's reputation for excellence in electronics.

Whatever your application, from test equipment to computer peripherals, there's a Rayswitch for your panel. Switch to the big name in miniatures.

Call your Raytheon representative. Or for a FREE copy of our Rayswitch catalog write Raytheon Company, Fourth Avenue, Burlington, Mass. 01803.



RAYTHEON

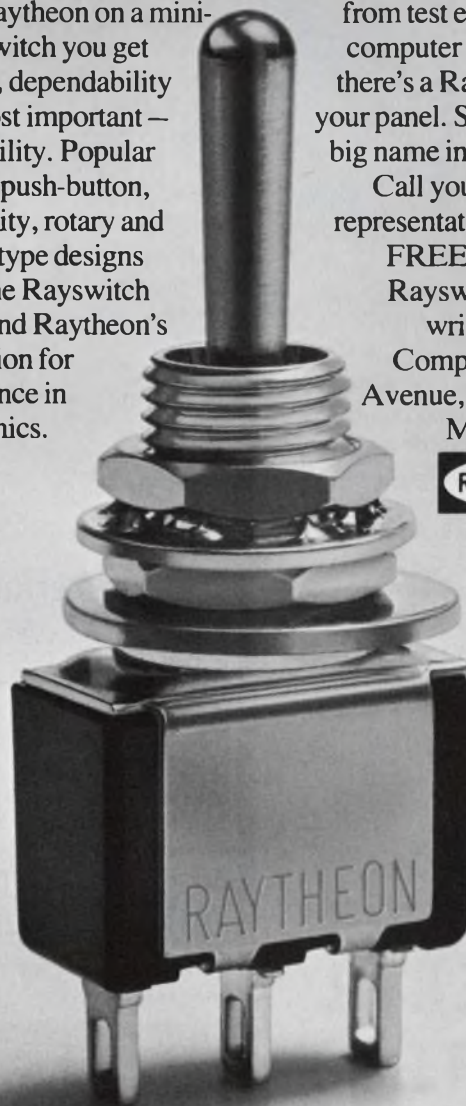

INFORMATION RETRIEVAL NUMBER 45

FREE

1973 Edition...
General Electric's
condensed reference
guide to industry's
broadest line of
microwave devices

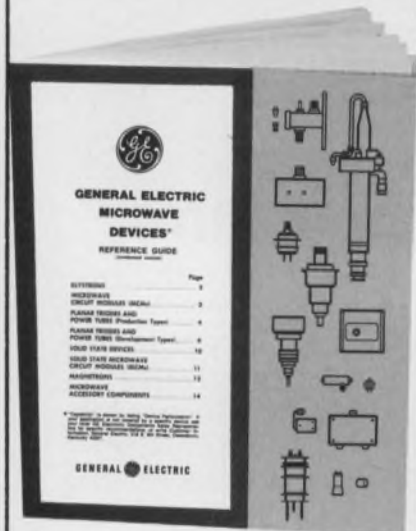

You can "one-stop shop" with this new catalog of microwave devices from General Electric... your source for the most complete line of microwave devices. The new microwave guide is clearly indexed to give fast, easy reference to devices for all popular microwave applications. To get your free copy, use the reader service card or write: General Electric Company, 316 East 9th Street, Owensboro, Kentucky 42301.



GENERAL ELECTRIC

360-08

INFORMATION RETRIEVAL NUMBER 46

PACKAGING & MATERIALS

Cut heat-sink extrusion to desired length



Precision Dipbraze Tor, Inc., 14715 Arminta St., Van Nuys, Calif. 91402. (213) 786-6524.

A 20% to 40% decrease in cost and a 50% reduction in size and weight over comparable units (not specified) are claimed by the manufacturer for its Model 1722 extruded heat sinks. They consist of two identical halves with serrated fins in a tongue-and-groove configuration. The two halves interlock to form a closed, finned channel. A standard 3-1/8-in. fan fastens directly to the unit without any accessories when forced air cooling is required. These extrusions may be ordered in any length, and cut as required. Or a number of individual units, in modular form, can be assembled with threaded rods.

CIRCLE NO. 272

Potting ceramic works to 2800 F, sets in 2 hr.

Aremco Products, Inc., P.O. Box 145, Briarcliff Manor, N.Y. 10510. (914) 762-0685. \$33/qt.; stock.

Ceramacast 511, a magnesium-oxide/zircon formulation is suitable to 2800 F. The castable ceramic is a water-mix material, which after mixing can be poured, dipped or sprayed around components to be potted or end-sealed. The material will setup in two hours and after a bakeout at 200 F is ready for use. The dielectric strength is approximately 265 V/mil at 260 C, and its resistivity at up to 600 C is 10^{10} ohms.

CIRCLE NO. 273

Silver-filled paste cures at room temp

Ablestik Laboratories, 833 W. 182nd St., Gardena, Calif. 90248. (213) 321-6252.

Ablebond 26-2 is a low-cost (price not supplied), electrically-conductive, room-temperature-curing adhesive designed especially for structural bonding where rf attenuation is required. The silver-filled brushable paste has a three-hour work life and produces strong bonds for a variety of materials. Volume resistivity is $0.005 \Omega\text{-cm}$ with no change after 100 hours at 85 C and 85% relative humidity. Ablebond costs about one-third the price of currently available silver-filled adhesives. It is supplied in 1-lb and 4-oz, two-component kits, as well as premixed and frozen in container sizes from 1 cc up.

CIRCLE NO. 274

Transistor sockets have self-aligning lead entry



Method Manufacturing Co., 1700 Hicks Rd., Rolling Meadows, Ill. 60008. (312) 392-3500.

The Six-Pack, a series of transistor sockets for three-lead devices, features a self-aligning lead entry, so there is no need to preform and pre-cut transistor leads. The sockets are assembled in a cluster of six units with a breakaway retaining strip, eliminating the problems inherent in handling individual miniature sockets. This packaging concept also incorporates a stacking feature to protect the terminals. The package can be magazine-loaded for automatic insertion of transistors into sockets. The sockets mount in a 300-mil mounting circle and will accept transistor leads ranging from 14 to 22 mils in diameter.

CIRCLE NO. 275

Modular cooling package works for 7 power semis

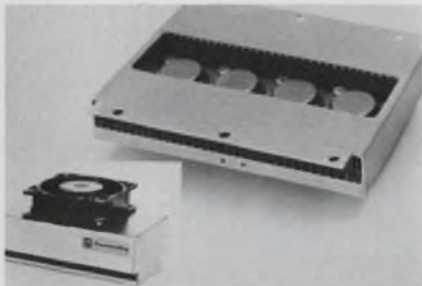

Thermalloy, 2021 W. Valley View Lane, Dallas, Tex. 75234. (214) 243-4321.

A compact package dissipates heat from one to seven case-common power semiconductor devices. Highly effective cooling is provided by air forced through two rows of convoluted fin stock. Cool-pax wells may be mounted on other systems where cooling air is already available, or may be provided in integral assemblies including fan. Where electrical isolation between devices is required, separate wells may be provided. Standard mounting hole patterns include TO-3 and TO-66 and stud-mounted cases.

CIRCLE NO. 276

Solderless-wrap sockets accept 24-lead DIPs

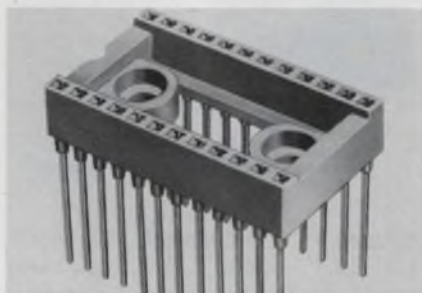

Jermyn, 712 Montgomery St., San Francisco, Calif. 94111. (415) 362-7431. \$1.20 (250 up); stock.

The A23-2043 solderless-wrap socket accommodates ICs and other devices in 24-lead (0.6-in.) packages. The socket is fitted with gold-plated phosphor-bronze contacts and the socket body is glass-filled nylon. The contacts are readily replaceable during service without removing the socket from the board. The over-all dimensions of less than 1.20 x 0.7 inch allow close packing of sockets on a 0.1-inch matrix.

CIRCLE NO. 277

DIP insertion tool averages 4 seconds/IC

Scott Industries, Paramount Bldg., North Chelmsford, Mass. 01863. (617) 251-8595. \$2.94; stock.

Dip-Sert/16 facilitates and speeds the manual insertion of 8 to 16-pin dual-in-line packages in sockets and PC board mounting holes. Operators mounting 16-pin packages on PC cards have been found to average less than four

seconds per package. This compares with typical hand insertion times of 1-1/2 to 2 minutes or more per package under normal conditions. The Dip-Sert can be used for mounting ICs, relays, resistors and other components housed in the popular dual-in-line packages. Unlike many other hand insertion tools, the Dip-Sert requires no special holders for the components.

CIRCLE NO. 278

i'm

I'M A
MAIL-LITE[®]
SHIPPER



lite

THE LIGHTEST CUSHIONED SHIPPING BAG YOU CAN BUY . . .

LIGHT because I'm lined with clean plastic bubbles of air laminated to heavy duty golden kraft. I can reduce your shipping weight by up to 8 ounces versus a mailer box and offer a postal savings of 8 cents an ounce in first class and 4 cents an ounce in third class. Compare the cost to mail:

	Weight	Postage per M First Class	Postage per M Third Class
MAIL-LITE — 14 1/4" x 20"	2.7 ounces	\$240	\$120
Padded Bag — 14 1/4" x 20"	9.7 ounces	\$800	\$400
Mailer Box — 10" x 16" x 2"	10.8 ounces	\$880	\$440

I'm tough, clean, waterproof and heat sealable too. Like all Sealed Air[®] products, my bubbles are barrier coated for better protection.

Write for **FREE MAIL-LITE SAMPLE** . . . and receive the Mail-Lite Guaranteed Postal Savings Chart.



Sealed Air Corporation

19-01 STATE HIGHWAY 208/FAIR LAWN, NEW JERSEY 07410

TEMP-R-TAPE: GREAT ELECTRICAL PROPERTIES

PLUS

MOST ANYTHING ELSE YOU MIGHT WANT IN A TAPE.

Like high tensile or tear strength; excellent abrasion, thermal, and chemical resistance; exceptional dimensional stability; excellent conformability; and a low-friction, easy-release surface. Because Temp-R-Tape® is a complete tape "family" available in a variety of materials like polyester, polyester/rope paper laminate, Teflon*, Kapton*, and fiberglass. Supplied with thermosetting, silicone, or acrylic pressure-sensitive adhesive.

Find your CHR distributor in the Yellow Pages under "Tapes, Industrial" or in industrial directories. Or write for details and sample. The Connecticut Hard Rubber Company, New Haven, Connecticut 06509.

*T.M. of DuPont

a HITCO company

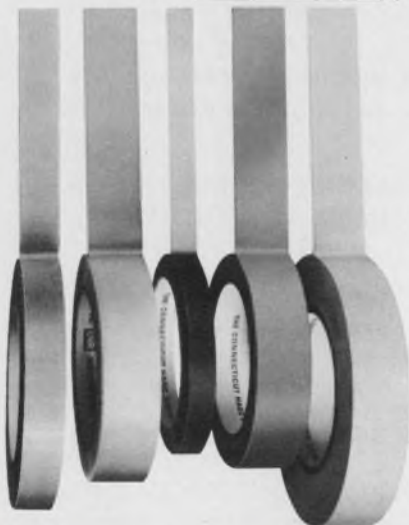

INFORMATION RETRIEVAL NUMBER 48

MICROWAVES & LASERS

Noise sources boost ratios to 42 dB

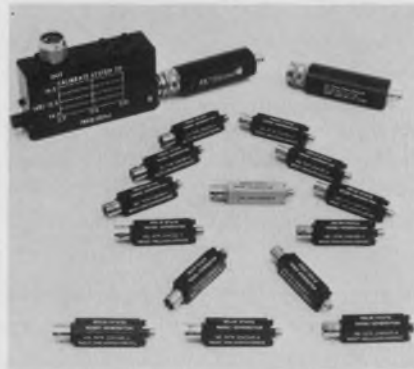

AILTECH, A Cutler-Hammer Co., 815 Broadhollow Rd., Farmingdale, L.I., N.Y. 11735. (516) 595-6471.

High level, solid-state noise sources operate up to 18 GHz with typically a 15% bandwidth. These devices can be provided with excess noise ratios of as much as 42 dB. For the measurement of operating noise temperature or noise figure, the new sources permit the injection of noise into a receiver system through a 20 or 30 dB coupler and still attain a reasonably high, injected noise power in the system.

CIRCLE NO. 300

Detector/log amp has 60-dB linearity range

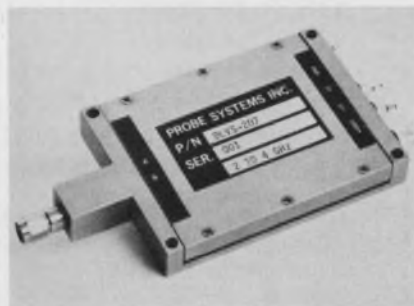

Probe Systems Inc., 655 N. Pastoria Ave., Sunnyvale, Calif. 94086. (408) 732-6550.

A detector/log video amplifier (DLVA) consists of a signal detector matched to a log video amplifier in one small unit measuring $5 \times 2.5 \times 0.5$ inches. Because of the matching, the log characteristic is accurate to ± 1 dB over a 60 dB dynamic range. The DLVA series is available in seven different models covering a variety of bandwidths ranging from 50 MHz to 18 GHz.

CIRCLE NO. 301

Uhf power amp/mod with up to 7 k channels

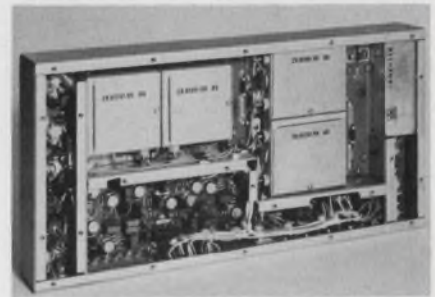

Microwave Power Devices, Inc., Adams Ct., Plainview, L.I., N.Y. 11803. (516) 433-1400. From \$6800; 8-12 wks.

The Model PAM2240 AM Power amplifier/AM Modulator operates in the 225-400 MHz band and can handle up to 7000 channels. The company reports that the unit has low distortion transmissions under all conditions of antenna VSWR, power output levelling, output VSWR protection and remote carrier switching capability. The PAM2240 also features a replaceable module construction that simplifies field replacement or repair.

CIRCLE NO. 302

90°/180° hybrids cover multioctave band

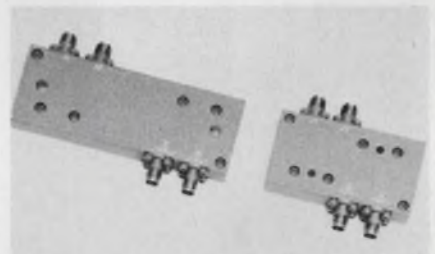

Narda, 75 Commercial, Plainview, L.I., N.Y. 11803. (516) 433-9000. 90° hybrids: \$325; 180° hybrids: \$375.

Broadband 90° and 180° hybrids, 4330 and 4340, feature high isolation and low VSWR. The 90° hybrids provide a balanced division of power into two transmission lines with 90° separation of phase. The two models available cover the 2-to-12.4 GHz frequency range with a VSWR of 1.3 max, isolation of 17 dB and phase imbalance of $\pm 5^\circ$. The 180° hybrids consist of three models covering the 2-to-16-GHz frequency range with a typical VSWR of 1.35 and phase imbalance of $\pm 7^\circ$.

CIRCLE NO. 303

Thin woven

An open and shut case.

The evidence is conclusive. Our **Accordion Fold** fits the back panel-to-drawer connection task to a T. Simple to connect. Free, easy movement. Strain relief tabs minimize wear.

WOVEN ELECTRONICS

P.O. Box 189, Mauldin, South Carolina 29662

INFORMATION RETRIEVAL NUMBER 49



TWO *New* SCRs from **NATIONAL ELECTRONICS** *featuring*

- Patented Regenerative Gate
- High di/dt with low power gate drive

F-390 850 A RMS, 500-1300 V. DC motor control and power supplies.

F-395 700 A RMS, 100-600V. Fast switching, high frequency for inverter use.



NATIONAL ELECTRONICS

a varian division
geneva, illinois 60134 (312) 232-4300

INFORMATION RETRIEVAL NUMBER 50

ELECTRONIC DESIGN 7, April 1, 1973

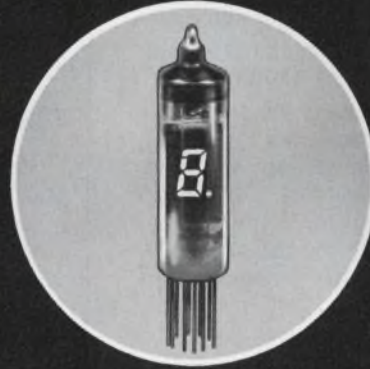

***New* NL-8051** from **NATIONAL ELECTRONICS**

- Segmented Phosphor Display
- Low Cost • Low Power
- Direct Drive from MOS



NATIONAL ELECTRONICS

a varian division
geneva, illinois 60134 (312) 232-4300

INFORMATION RETRIEVAL NUMBER 51

\$189.*

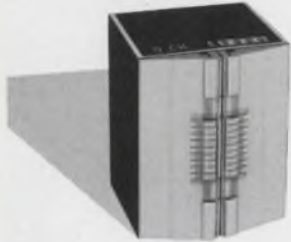

***GI's standard 7- and 9-channel head prices have now been reduced by 20% in OEM quantities.**

Which means you can now purchase our 7-track digital tape heads in quantity for \$189.00 each. While our standard 9-track heads go for only \$196.00 each.

These high-quality read-write-erase heads, designed for IBM compatible tape transports, have a packing density of 800 bpi at tape speeds up to 75 ips. Cross coupling is 29 db minimum. Chrome finish for extended life is an option.

Call or write for full details. And check with us for heads manufactured to your specs.

General Instrument Corporation,
13040 S. Cerise Ave.,
Hawthorne, Calif. 90250.
(213) 772-2351
TWX 910-325-6203.

General Instrument



INFORMATION RETRIEVAL NUMBER 52

new literature

THE TEKTRONIX
FAMILY OF COMPUTER
DISPLAY TERMINALS

1973 CATALOG

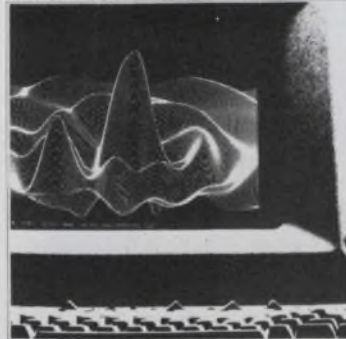

Computer display terminals

Computer display terminals, hard-copy units and peripherals are featured in a 36-page catalog. Included are listings and descriptions of all products in the Plot-10 terminal software line. Purchase and lease terms are described, along with features of the company's after-sale service. Tektronix, Beaverton, Ore.

CIRCLE NO. 320

Electrostatic voltmeters

Data Bulletin SRT-100 covers features, applications and characteristics of electrostatic voltmeters with a range span of from 120 V to 140 kV. Electrical Instrument Service, Mount Vernon, N.Y.

CIRCLE NO. 321

Potentiometers

Over 100 types of wirewound and cermet potentiometers for industrial and military applications are described in the "Potentiometer Buyers Guide." TRW/IRC Potentiometers, St. Petersburg, Fla.

CIRCLE NO. 322

Cylindrical connectors

A 16-page catalog contains electrical and mechanical specifications on cylindrical connectors built to MIL-C-26500 and MIL-C-38300. Cinch Connectors, Minneapolis, Minn.

CIRCLE NO. 323

Mil Spec power supplies

Off-the-shelf Mil Spec dc power supplies are described in a two-color, eight-page catalog. The catalog provides descriptive and specification data, block diagrams, model types, physical data and outline drawings. Also included is environmental test data covering humidity, temperature, shock, acceleration, vibration and RFI testing. ERA Transpac Corp., Moonachie, N.J.

CIRCLE NO. 324

Data-processing equipment

Data sheets and price lists cover the company's data-processing equipment. Qantel, Hayward, Calif.

CIRCLE NO. 325

Synchro/resolver standard

A fully programmable source of three-wire synchro or four-wire resolver signals is described in Data Bulletin SRT-15. The bulletin contains a brief glossary of logic terms used in automatic test systems and full specifications on the instrument. Singer Instrumentation, Los Angeles, Calif.

CIRCLE NO. 326

PM tube shield

Data Sheet 205 illustrates and describes a five-layer, photomultiplier-tube, magnetic-shielding enclosure. Engineering construction details show how alternate layers of alloys and stainless steel are combined to achieve the required shielding. Ad-Vance Magnetics, Rochester, Ind.

CIRCLE NO. 327

MECL design

The second edition of the MECL System Design Handbook provides two additional chapters: one a discussion of the ac noise immunity properties of MECL 10,000; the other guidelines for the use of MECL 10,000 in severe temperature environments. The 240-page handbook costs \$2. Motorola, Inc., P.O. Box 20924, Phoenix, Ariz. 85036.

**SOLDERING +
DESOLDERING +
RESOLDERING =**

SOLDER ABILITY
ELEMENTARY TO ELITE
WORLD'S MOST PRACTICAL SOLDER HANDLING TOOLS

meets industries demands.....

with a COMPLETELY PORTABLE SOLOERING/DESOLDERING/RESOLDERING SYSTEM



EDSYN
15954 ARMINTA STREET
VAN NUYS, CALIFORNIA 91406
PHONE (213) 989-2324
TELEX NO. 65-1469 EDSYNEX VAN

Ads in EEM, MAS, EBG,
AE, TR, and EPAC Catalogs

Send for our FREE 16 page
SOLDER ABILITY
manual

INFORMATION RETRIEVAL NUMBER 53

WORLD'S BEST MINIATURES

Exceptionally high 10 Amp rating and longer operational life. Metal construction, high impact insulation. U/L listed. SPDT, DPDT. 1/4" or 15/32" bushings with conventional toggle, baton or flat levers.

ALCO SWITCH



ALCO MOST-STURDY
ELECTRONIC PRODUCTS, NORTH ANDOVER, MASS.

INFORMATION RETRIEVAL NUMBER 54

PUSH BUTTON MINIATURES

Lighted snap-action DPDT models handle 6A @ 125VAC & feature separate connections to T-1 1/2 lamp. 1/2", 5/8", 3/4" round or square lens/buttons in transparent or translucent colors. Optional guards available.

MSPN SERIES



ALCO ILLUMINATED
ELECTRONIC PRODUCTS, NORTH ANDOVER, MASS.

INFORMATION RETRIEVAL NUMBER 55

ELECTRONIC DESIGN 7, April 1, 1973

NOW Available Without DELAY

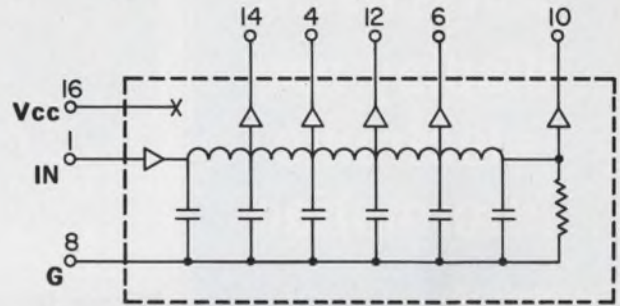

Exclusive from Pulse Engineering
DIGITAL DELAY MODULE

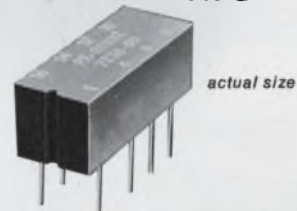

Designed specifically for TTL and DTL compatibility.

Built-in interface allows direct plug-in without additional components.

Module load incorporation reduces number of required components for specific delays, offering your most economical approach to precision digital timing.

Valuable board space saved because all drivers, buffers, terminations contained in the DDM.

PE No.	Delay Time	Delay/Tap	No/Taps	Rise Time
20330	50ns	10ns	5	4ns
20331	100ns	20ns	5	4ns
20332	250ns	50ns	5	4ns

SPECIFICATIONS

Supply Voltage Vcc
Logic 1 Input Current
Logic 0 Input Current
Logic 1 Vout
Logic 0 Vout

+4.5 to 5.5 V DC
50 μ a Max.
-2 ma Max.
2.4V Min.
0.4V Max.

Drive Capabilities:

Logic 0 Output
Logic 1 Output

10 TTL Loads/Tap Max.
(20 TTL Loads/Unit Max.)
20 TTL Loads/Unit Max.

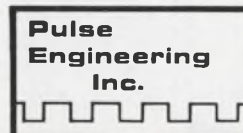

A Varian Subsidiary

Pulse Engineering, Inc.

P.O. Box 12235 • San Diego, Calif. 92112
Phone 714-279-5900 • TWX 910-335-1527

INFORMATION RETRIEVAL NUMBER 56

High resolution, low cost SCAN CONVERTERS display any electronic information

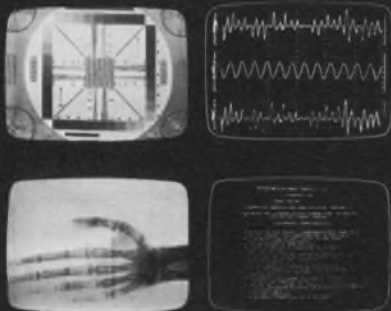

Any electronic information—from computers, lasers, TV cameras, scanners, X-ray, electron microscopes or whatever—can be displayed sharper, brighter, faster and at lower cost with PEP scan converters. Regardless of its format or speed. Even if it's only transient information. The reason: **only** PEP scan converters offer this combination of advantages:

- RESOLUTION to 3000 lines
- GRAY SCALE: 10 Logarithmic levels
- NON-DESTRUCTIVE readout
- WIDE RANGE of reading and writing speeds: video to DC
- WIDE system bandwidth: 30 MHz
- READ, write, selective erase, zoom, other functions
- LONG, trouble-free life

We're the people who developed high resolution, low cost scan conversion and image storage technology. Our Lithocon® silicon storage tube is the heart of all PEP scan converters, and makes them feasible for a whole new world of applications. Like microfilm/microfiche. Industrial process control. Facsimile. CATV systems. And X-ray, ECG and low light level detection systems. And hundreds more. We'll be happy to tell you about them. Write or call today for details. Princeton Electronic Products, Inc., P.O. Box 101, North Brunswick, New Jersey 08902; (201) 297-4448.



INFORMATION RETRIEVAL NUMBER 57

NEW LITERATURE

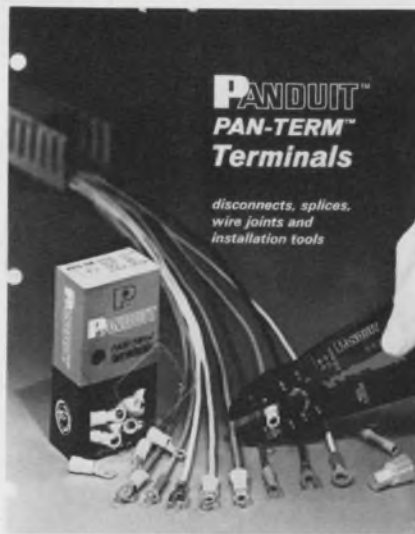

Wiring terminations

Terminals, disconnects, splices, wire joints, installation tools and wiring kits are described in a 20-page catalog. Information, specifications and illustrations of all of the terminating devices are in easy-to-read, color-coded chart form. Panduit, Tinley Park, Ill.

CIRCLE NO. 328

Miniature lamps

Low-voltage miniature lamps for electronic and electrical applications are described in a four-page, two-color brochure which includes photos, diagrams and specifications. Mura Corp., Jericho, N.Y.

CIRCLE NO. 329

Pulse, transient recorder

Specifications, a block diagram and a description of the PTR-9200 pulse and transient recorder are highlighted in a six-page foldout. Inter-Computer Electronics, Lansdale, Pa.

CIRCLE NO. 330

Varicap selection guide

A four-page voltage-variable capacitor diode guide presents design parameters for over 350 devices. A nomograph is included to help determine the capacitance ratio between two operating voltages V_1 and V_2 and/or the capacitance at V_2 when the capacitance at V_1 is known. Codi Semiconductor, Fair Lawn, N.J.

CIRCLE NO. 331

Data-acquisition system

A 20-page catalog describes System 256, a minicomputer-compatible data-acquisition system. Electrical and mechanical specifications, performance data and application data are listed. A wide range of options is outlined. Datel Systems, Canton, Mass.

CIRCLE NO. 332

Waveform generator

An eight-page catalog describes F200 series waveform generators. Complete specifications of the units are provided as well as how-to-do-it information for generating a variety of waveforms. Ailtech, City of Industry, Calif.

CIRCLE NO. 333

Reed switches

An illustrated 12-page catalog includes a guide to the selection of the correct reed switch for any type and magnitude of switching application. It covers various forms of actuation, including proximity switching with permanent magnets, bias switching, shielding and electromagnetic actuation. Hamlin, Lake Mills, Wis.

CIRCLE NO. 334

Test system

A nine-page brochure describes the Z337 zener test system. The brochure includes sections on productivity, device protection, test modes and automatic distribution analysis of test results, plus a section on various testing problems peculiar to zener diodes and how these problems are solved. Included are discussions of self-heating, impedance measurements and the company's ΔV test. Teradyne, Boston, Mass.

CIRCLE NO. 335

Rf shielded rooms

A line of modular, clamp-together rf shielded rooms is described in an eight-page brochure. The literature also covers a series of rf power and signal line filters and includes specifying information for the rooms. LectroMagnetics, Inc., Los Angeles, Calif.

CIRCLE NO. 336



Free catalog of 32,000 power supplies from the worlds largest manufacturer of quality Power Supplies. New '73 catalog covers over 32,000 D.C. Power Supplies for every application. All units are UL approved, and meet most military and commercial specs for industrial and computer uses. Power Mate Corp. (201) 343-6294.

INFORMATION RETRIEVAL NUMBER 181



The Lowest Power, Lightest, Smallest 10½" Reel Digital Magnetic Tape Recorder in the World. Operates on 12 volts ±2 volts DC and writes 700,000 tape characters per ampere hour. Small size and low weight permit a wide variety of packaging options. Digi-Data Corp., Bladensburg, Md. (301) 277-9378.

INFORMATION RETRIEVAL NUMBER 182



Thin-Trim® variable capacitors are designed to replace fixed tuning techniques. Applications include crystal oscillators, CATV amplifiers, communication and test equipment. Series 9410 has high Q's with five capacitance ranges from 1.0 - 4.5 pf to 10.0 - 50.0 pf. Johanson Manufacturing Corporation, Boonton, N. J. (201) 334-2676

INFORMATION RETRIEVAL NUMBER 183

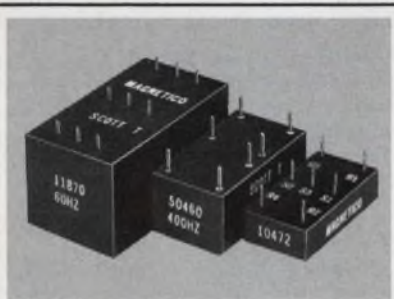

Scott T Transformer. 11870: 60HZ, 90v, L-L In. 1.1x2.1x1.1. 50460: 400HZ, 90v, L-L In. 7/8x1-5/8 x11/16. 50642: 400HZ, 11.8v, L-L In. 7/8x1-5/8x11/16. 10472: 400-HZ, 11.8v, L-L In. 3/4x1-1/2x3/8. All with 6v RMS sine & cosine output. Magnetics, Inc., E. Northport, N.Y. 11731. 516-261-4502.

INFORMATION RETRIEVAL NUMBER 184

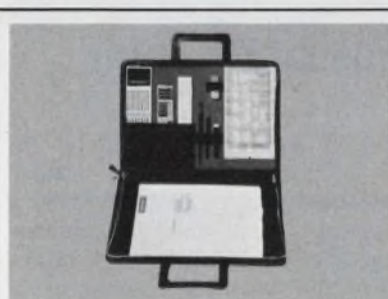

Programmer's tool kit has ten programming tools in a lockable, custom fitted briefcase. Included is a hexadecimal calculator with credit balance and automatic complement features, decimal calculator, slide rule, plus seven other aids. Also available is an octal calculator. Radix Precision Company, Box 13861, Atlanta, Georgia 30324.

INFORMATION RETRIEVAL NUMBER 185

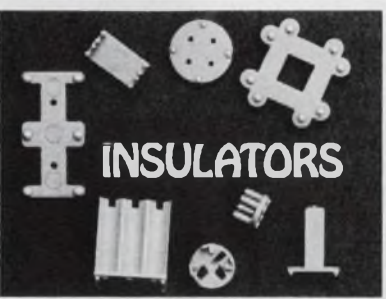

Over 100 component mounting insulators are available from Robison Electronics, Inc. Designed specifically for capacitors, diodes, resistors, DIPs, relays, and transistors, all insulators are illustrated in a new 43-page catalog. For free copy, write or call Robison Electronics, Inc., 2134 W. Rosecrans Ave., Gardena, Calif. 90249. (213) 321-0080, 327-5661.

INFORMATION RETRIEVAL NUMBER 186



400 Ideas for Design, Vol. 2, Edited by Frank Egan. Ready to borrow, modify, or adapt, the top recent contributions to Electronic Design's popular "Ideas for Design" column range from amplifiers to switching circuits. 288 pp., illus., cloth, \$11.95. Circle below for 15-day examination copies. Hayden Book Co., New York, N.Y. 10011.

INFORMATION RETRIEVAL NUMBER 187

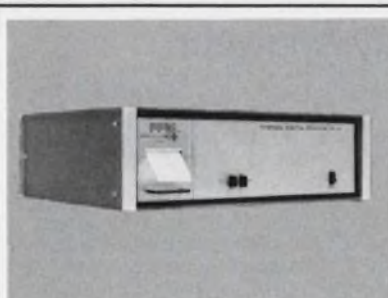

New silent thermal digital printer, TP-10, accepts parallel data (BCD) at DTL/TTL levels. Medium speed, moderately priced, fully buffered data acquisition unit prints on standard thermally actuated paper. Just one moving part. Mechanism available for OEM applications. PPM, Inc., 32 West Monroe Street, Bedford, Ohio 44146. (216) 232-1880.

INFORMATION RETRIEVAL NUMBER 188



Series ARA High Voltage Power Supply Modules for CRTs, image pickup, ion implantation, phototubes and general purpose . . . AC line operated, 50-420Hz . . . Line/load regulated 0.1% . . . 3-22 kV outputs at 15 w . . . Programmable. Advanced High Voltage Co., 14532 Arminta St., Van Nuys, CA 91402. (213) 997-7222.

INFORMATION RETRIEVAL NUMBER 189

Advertisements of booklets, brochures, catalogs and data sheets. To order use Reader-Service Card (Advertisement)

ELECTRONIC DESIGN's function is:

- To aid progress in the electronics manufacturing industry by promoting good design.
- To give the electronic design engineer concepts and ideas that make his job easier and more productive.
- To provide a central source of timely electronics information.
- To promote communication among members of the electronics engineering community.

Want a subscription? ELECTRONIC DESIGN is sent free to qualified engineers and engineering managers doing design work, supervising design or setting standards in the United States and Western Europe. For a free subscription, use the application form bound in the magazine. If none is included, write to us direct for an application form.

If you do not qualify, you may take out a paid subscription for \$30 a year in the U.S.A., \$40 a year elsewhere. Single copies are \$1.50 each.

If you change your address, send us an old mailing label and your new address; there is generally a postcard for this bound in the magazine. You will have to requalify to continue receiving ELECTRONIC DESIGN free.

The accuracy policy of ELECTRONIC DESIGN is:

- To make diligent efforts to ensure the accuracy of editorial matter.
- To publish prompt corrections whenever inaccuracies are brought to our attention. Corrections appear in "Across the Desk."
- To encourage our readers as responsible members of our business community to report to us misleading or fraudulent advertising.
- To refuse any advertisement deemed to be misleading or fraudulent.

Microfilm copies are available of complete volumes of ELECTRONIC DESIGN at \$19.00 per volume, beginning with Volume 9, 1961. Work is now in process to complete the microfilm edition of Volumes 1-8. Reprints of individual articles may be obtained for \$2.00 each, prepaid (\$.50 for each additional copy of the same article) no matter how long the article. For further details and to place orders, contact the Customer Services Department, University Microfilms, 300 North Zeeb Road, Ann Arbor, Michigan 48106 telephone (313) 761-4700.

Want to contact us? If you have any comments or wish to submit a manuscript or article outline, address your correspondence to:

Editor
ELECTRONIC DESIGN
50 Essex Street
Rochelle Park, N.J. 07662

The First 500-Line Real-Time Spectrum Analyzer-Averager

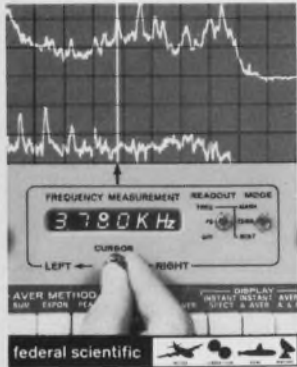

New UA-500, the most powerful analyzer of its type, offers the only standard built-in dual memory averager. Unique digital cursor reads directly in Hz. Portable, small (8-3/4"), for field and lab. **Fastest speed** minimizes test time, presents flicker-free display: real-time to 10 KHz, max. range of 100 KHz, 20 sweeps/sec display rate. **Best possible resolution:** sharpest analysis filter (proprietary 24dB/octave slope) so that 500-line analyzer has effective **650 lines**. Dual memory averager allows simultaneous display of continually updated exponential average & previously stored average. To **verify quality of data**, instantaneous spectra can be viewed on the same CRT as average . . . input time function can also be displayed. Plus other standard features: transient capture, exponential & peak averaging, lin-log scales both vertical & horizontal, complete plotter set-up & recording, computer compatibility with remote sensing or control.

CIRCLE NO. 171

Federal Scientific Corporation

An Affiliate of Nicolet Instrument
615 West 131st St., New York, N.Y. 10027 (212) 286-4400

Giant Free Catalog! 4,000 Unusual Bargains

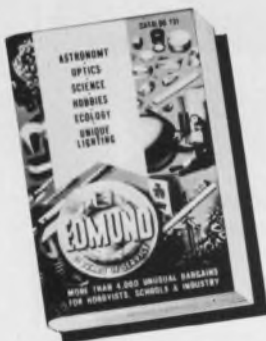

New 164-page catalog! Packed with 1,000's of hard-to-find buys in Optics, Science, Electronics. Loaded with optical, scientific, electronic equipment available from stock. Rare surplus buys. Many "one-of-a-kinds". Ingenious scientific tools. Components galore: lenses, prisms, wedges, mirrors, mounts, accessories. 100's of instruments: pollution test equipment, lasers, comparators, magnifiers, microscopes, projectors, telescopes, binoculars, photo attachments, unique lighting. Shop, save by mail! Request free Catalog "DA".

CIRCLE NO. 172

Edmund Scientific Co.

America's Largest Science-Optics-Electronics Mart
300 Edscorp Bldg., Barrington, New Jersey 08007 (609) 547-3488

New Precision Low Frequency Analyzer



A new brochure describes Quan-Tech's new Model 2449 Wave and Spectrum Analyzer which covers frequency measurements from 10 Hz to 50 KHz in one range with 1 Hz resolution. Frequency readout: 5 digit LED display. Electronic tuning with sweep increments of 5 or 50 KHz can be initiated at any starting frequency in the spectral range. Selectable sweep periods of 50 or 500 seconds. Select a 7 Hz bandwidth for high precision frequency measurements—a 1000 Hz bandwidth for high scan capability—or a 100 Hz bandwidth for a compromise between resolution and scan speed. Dynamic range greater than 75 dB, full scale input signal voltage from 30 μ V to 300 V in 15 ranges. Priced at only \$2050., the instrument is portable—weighs 20 lbs. Option provides 115 VAC for lab use or 12 VDC for field use. Front and rear covers available. Delivery: 30 days.

CIRCLE NO. 173

Quan-Tech

Div. of KMS Industries, Inc.
43 South Jefferson Road
Whippany, N. J. 07981

Electronic Design

Advertising Sales Staff

Tom W. Carr
Sales Manager

Rochelle Park, N.J. 07662

Robert W. Gascoigne
Daniel J. Rowland
50 Essex Street
(201) 843-0550
TWX: 710-990-5071

Philadelphia

Thomas P. Barth
50 Essex Street
Rochelle Park, N. J. 07662
(201) 843-0550

Boston 02116

Richard L. Green
20 Columbus Avenue
Boston, Mass.
(617) 482-7989

Chicago 60611

Thomas P. Kavooras
Berry Conner, Jr.
200 East Ontario
(312) 337-0588

Cleveland

Thomas P. Kavooras
(Chicago)
(312) 337-0588
(call collect)

Los Angeles 90303

Stanley I. Ehrenclou
Burt Underwood
2930 Imperial Highway
Inglewood, Calif
(213) 757-0183

San Francisco 94022

Jerry D. Latta
P.O. Box 1248
Los Altos, Calif.
(415) 965-2636

London W. 1

For United Kingdom and Holland
Brayton C. Nichols
For Eastern Europe
Peter Kehr

The American Magazine Group
9 Warwick Street
London, W. 1, England
Phone: 437 5462
Cable: Ammagnic, London

4800 Verviers, Belgium

For Continental Europe
Andre Jamar
Rue Mallar, 1
(087) 253.85 Telex 41563

Tokyo

Haruki Hirayama
Electronic Media Service
5th Floor, Lila Bldg.,
4-9-8 Roppongi
Minato-ku
Phone: 402-4556
Cable: Electronicmedia, Tokyo



AMERICAN BUSINESS PRESS, INC.

Metal Core Circuit Boards handle circuits 4 to 13 times too hot for G-10

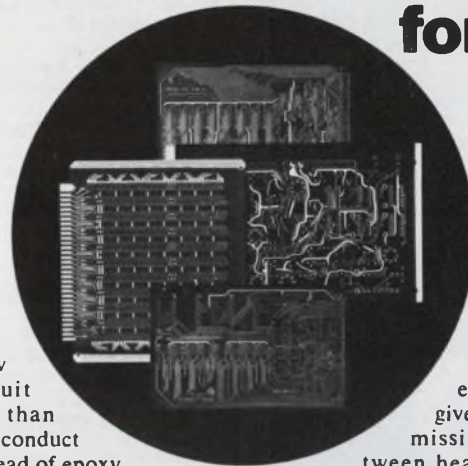

You can load a lot more hot components on our new Metal Core Circuit Boards (MCCB) than G-10 because they conduct heat like metal instead of epoxy.

Here's what you can expect over G-10:

Environment	Power Density Increase
Still air	Four times
Forced air	Eight times
Thermally grounded system	Thirteen times

MCCB's spread the heat around for efficient convection, eliminate hot spots and give you the heretofore missing thermal link between heat producing device and the outside world. If your circuits are too hot to handle, write to IERC, a subsidiary of Dynamics Corporation of America, 135 West Magnolia Boulevard, Burbank, California 91502.



Heat Sinks

INFORMATION RETRIEVAL NUMBER 58



SECOND ARRESTING OFFER...

One MOS Encoded ASR-33 Keyboard with N-Key Rollover for **\$59.00**

Why \$59.00? For the same reasons the \$98.00 ANSI keyboard was offered at \$49.00.

First. Because of the quality and features offered by the fully assembled ASR-33 compatible keyboards • MOS reliability • N-key rollover • 25c BI-PAC switches featuring dual gold spring contacts (used in most all U.S. made electronic calculators) • less than 200 mA power consumption • standard ASCII encoding • tri-state or TTL output compatible • full repeat function, and more.

Second. The keyboard is \$59.00 because that's the cost for 5,000 (\$125 for 1-25). Your first is from stock. Quantities in 6-8 weeks.

Like to try one? See your local CRC rep's keyboards. He'll arrange for you to take the first or second arresting offer.



Controls Research Corporation

2100 South Fairview, Santa Ana, California 92704
Phone: (714) 557-7161 • TWX-910-595-1106

INFORMATION RETRIEVAL NUMBER 59

Plagued by Thyristor Noise?

Tokin SN Coils solve it.

And with enough reason. Take insertion loss: they outperform ordinary noise-absorbing cores and coils by

20dB

(300 kHz-5MHz)

A unique advantage from Tokin design originality. And talking about design, size has been reduced—installation simplified. Is it any wonder, then, that Tokin SN Coils captured

95%

(20,000,000 units)

of the Japanese market in only two years?

Want to know more of Tokin SN Coils? Write to:



Tokin

Tohoku Metal Industries, Ltd.

Los Angeles Representative Office

1277 W. Redondo Beach Blvd.,

Gardena, Calif. 90247, U.S.A.

☎ 213-329-4137, 4138

Telex: 69-8147 TOKINSAN GDNA

Cable address: "TOKINSAN GDNA"

INFORMATION RETRIEVAL NUMBER 60

THE BASICS



Pulse Generator

MODEL 4400 \$165

Ideal for bench and field testing TTL, DTL, MOS logic systems and breadboards.

- * 0.1 Hz - 10 MHz Repetition Rates
- * 0.1 us - 10 ms Pulse Widths
- * 50 ohm Output Capability
- * External and Manual Pulses
- * LSI Circuitry

Available for Immediate Shipment

☐ LINEAR DIGITAL SYSTEMS, inc.
BOX 954 GLENWOOD SPRINGS, CO. 81601
(303)945-6122 TWX 910-929-6681

INFORMATION RETRIEVAL NUMBER 61

advertiser's index

Advertiser	Page	Advertiser	Page
Abbott Transistor Laboratories, Incorporated	6	Kulka Electric Corp.	91
Accutronics, Inc.	51	Lambda Electronics Corp. 80, Cover III	
Advance High Voltage	107	Linear Digital Systems	110
Ailtech, A Cutler-Hammer Company	85	Litronix, Inc.	78, 79
Alco Electronic Products, Inc.	105	Magneto, Inc.	107
Allen-Bradley Co.	10	Marco-Oak, Subsidiary of Oak Industries, Inc.	87
Allied Electronics, A Division of Tandy Corp.	14	MicroSwitch, A Division of Honeywell	93
Ampex Computer Products Division	18	Microwave Associates, Inc.	97
Beckman Instruments, Inc., Helipot Division	83	Monolithic Memories, Inc.	36
Bendix Corporation, The Electrical Components, Division	27	Motorola Semiconductor Products, Inc.	8, 9, 62, 63
Bourns, Inc., Trimpot Products Division	15, 72, 73	National Connector Corporation	107
Burroughs Corporation	Cover IV	National Electronics, A Varian Division	103
CTS Corporation	46, 47	National Semiconductor Corporation	4, 5
CELCO (Constantine Engineering Laboratories Co.)	45	PPM, Inc.	107
Cherry Electrical Products Corp.	66, 67	Plessy Semiconductors	12
Computer Automation, Inc.	17	Power/Mate Corp.	90, 107
Computer Decisions	32, 32A-B	Princeton Electronic Products, Inc.	106
Connecticut Hard Rubber Company, The	102	Pulse Engineering, Inc.	105
Constantine Engineering Labs. Co. (CELCO)	45	Quan-Tech Div. of KMS Industries, Inc.	108
Control Research Corporation	109	RCA Solid State Division	1, 95
Dale Electronics, Inc.	Cover II	Radix Precision Company	107
Data Products Corporation	30, 31	Raytheon Company	99
Digi-Data Corporation	107	Robison Electronics, Inc.	107
Digitran Company, The	96	Rolm Corporation	88
Dynascan Corporation	90	Schauer Manufacturing Corp.	112
ECC Corporation	34	Sealed Air Corporation	101
Edmund Scientific Company	108	Signetics Corporation	35, 68, 69
Edsyn, Inc.	105	Siliconix Incorporated	40
Electronic Associates, Inc.	111	Solartron	32C-F
Electronic Navigation Industries	16	Solid State Scientific, Inc.	29
Federal Scientific Corporation	108	Soliton Devices, Inc.	81
Fluke Mfg. Co., Inc., John	64A-B	Sprague Electric Company	11
General Automation, Inc.	52, 53	Struthers-Dunn, Inc.	65
General Electric Company	100	TRW/IRC Fixed Resistors, An Operation of TRW Electronic Components	13
General Electric Company, Semiconductor Products Department	25	Tektronix, Inc.	39
General Instrument Corporation	15, 104	Teledyne Relays, A Teledyne Company	2
Guardian Electric Manufacturing Company	74, 75	Tohoku Metal Industries, Ltd.	110
Hewlett-Packard	1, 64, 70, 71, 76, 77	Triplett Corporation	57
IERC, A subsidiary of Dynamics Corporation of America	109	United Technical Publications	87
Industrial Timer Corporation	87	Unitrode Corporation	21
Intech, Incorporated	98	Windjammer Cruises	33
Johanson Manufacturing Corp.	7, 107	Woven Electronics	103

**"YOUR
OPPORTUNITY"**

WITH KNOWN DISTRIBUTOR — MANUFACTURER OF TELEPHONY EQUIPMENT SEEKING PRODUCTS TO ADD TO ITS LINE FOR NATIONAL DISTRIBUTION. ALL FACILITIES AVAILABLE FOR COMPLETE DEVELOPMENT.

in confidence reply to
INFORMATION RETRIEVAL NUMBER 901

**Get a jump on tomorrow,
save today.**



Take stock in America.
With higher paying U.S. Savings Bonds.

**PERSONNEL
RECRUITMENT
ADVERTISING
IN
Electronic Design
REACHES THE
RIGHT PEOPLE
AT A LOWER COST
PER THOUSAND**



**How to talk to EAI
eyeball to eyeball...
in New York City**

INTERVIEWS

**March 26, 27, 28 (Mon., Tues., Wed.)
concurrent with the IEEE SHOW**

AMERICANA HOTEL (7th Av., 52-53d Sts.)

**HOURS 9 a.m.-8 p.m. To arrange a talk,
please phone Mr. Roland Hood
during this period at (212) 246-3260.**

EAI clear leadership in many aspects of the analog/digital/hybrid computer field can mean most attractive career potential, the stimulation of being with a noted "idea" company... not to mention pleasing salary, benefits, and working arrangements. Take advantage of these New York interview days. (Or if you can't, send a resume in confidence to our headquarters.)

ENGINEERS

Analog, digital, hybrid, computer graphics, simulation, specialized applications, etc.

FIELD SERVICE ENGINEERS

Openings in various cities, offering more than usual interest and opportunity.



**Electronic Associates, Inc.,
West Long Branch,
New Jersey 07764**

An Affirmative Action Equal Opportunity Employer M/F

INFORMATION RETRIEVAL NUMBER 902

*Call the
HOTLINE
today
for complete
information:
(201) 843-0550
extension 209*

NEW SHORTER CASE! SCHAUER 1-WATT ZENERS



**SAME LOW PRICES FOR
1% TOLERANCE ZENERS**

**ANY VOLTAGE
FROM 2.0 TO 18.0**

Quantity	Price Each
1-99	\$1.07
100-499	.97
500-999	.91
1000-4999	.86
5000 up	.82

IMMEDIATE SHIPMENT

Send for rating data and 20%, 10%, 5% and 2% tolerance prices.

Semiconductor Division

SCHAUER

MANUFACTURING CORP.

4511 Alpine Ave., Cincinnati, Ohio 45242
Telephone 513/791-3030

product index

Information Retrieval Service. New Products, Evaluation Samples (ES), Design Aids (DA), Application Notes (AN), and New Literature (NL) in this issue are listed here with page and Information Retrieval numbers. Reader requests will be promptly processed by computer and mailed to the manufacturer within three days.

Category	Page	IRN	Category	Page	IRN
Components			power amp/modulator	102	302
capacitors (NL)	106	331	Modules & Subassemblies		
connectors, cylindrical (NL)	104	323	a/d converter	99	270
cooling package	101	276	analog integrator	98	267
display	99	271	d/a converter	98	264
LED display	99	269	d/a converter	98	265
lamps, miniature (NL)	108	329	d/a converter	98	268
PM tube shielding (NL)	104	327	detector/log amp	102	301
potentiometers (NL)	104	322	digital filter	90	252
sockets, DIP	101	277	digitizer, graphic display	99	271
sockets, transistor	100	275	hybrids	102	303
switches, reed (NL)	106	334	LED display	99	269
synchro/resolver stand-ard (NL)	104	326	memory, microprogram modules, serial data	94	259
Data Processing			oscillator	96	266
CPU, Mil-Spec	96	260	power amp/modulator	102	302
computer display termi-nals (NL)	104	320	power supplies (NL)	104	324
d/a converter	98	264	signal source/DMM/ counter	91	254
d/a converter	98	265	transport, tape	96	263
d/a converter	98	268	Packaging & Materials		
data-acquisition system (NL)	106	332	connectors, cylindrical (NL)	104	323
data-processing equip-ment (NL)	104	325	cooling package	101	276
digitizer, graphic display	99	271	DIP insertion tool	101	278
line printer	92	255	heat sink	100	272
logic display	89	250	PM tube shielding (NL)	104	327
memory, microprogram modules, serial data	94	259	paste, silver-filled	100	274
recorder, pulse, tran-sient (NL)	106	330	potting ceramic	100	273
terminal, graphics	96	262	rf shielded rooms (NL)	106	336
test system (NL)	106	335	sockets, DIP	101	277
transport, tape	96	263	sockets, transistor	100	275
Instrumentation			wiring, terminations (NL)	106	328
a/d converter	99	270	new literature		
DMM	90	251	capacitors	106	331
digital filter	90	252	computer display termi-nals	104	320
generator, function	90	253	connectors, cylindrical	104	323
generator, waveform (NL)	106	333	data-acquisition system	106	332
line printer	92	255	data-processing equip-ment	104	325
logic display	89	250	generator, waveform	106	333
noise sources	102	300	lamps, miniature	108	329
oscillator	96	266	PM tube shielding	104	327
rf shielded rooms	106	336	potentiometers	104	322
recorder, pulse, tran-sient (NL)	106	330	power supplies	104	324
signal source/DMM/ counter	91	254	rf shielded rooms	106	336
synchro/resolver stand-ard (NL)	104	326	recorder, pulse, tran-sient	106	330
test system (NL)	106	335	switches, reed	106	334
voltmeters, electro-static (NL)	104	321	synchro/resolver stand-ard	104	326
Microwaves & Lasers			test system	106	335
detector/log amp	102	301	voltmeters, electro-static	104	321
hybrids	102	303	wiring terminations	106	328
noise sources	102	300			

Do you face a make or buy decision on power supplies?

BUY LAMBDA'S NEW LOW COST LQ 6000 SERIES

designed to drive Lambda's LAS series
positive and negative point-of-load regulators

SPECIFICATIONS OF LQ SERIES 6000

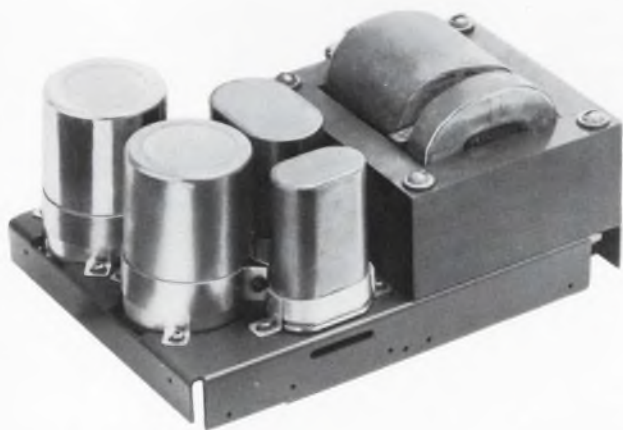

LQ 6000 SERIES	MODEL	DC OUTPUT VOLTAGE	AMPS AT 40°C	PRICE
Dual output voltage models 5" x 7½" x 10"	*LQD-DA-6112	±12V	6A	\$120
	**LQD-DA-6112	19V	6A	120
Ripple and noise 1.5 mV RMS, 5 mV p-p	*LQD-DA-6115	±15V	5A	120
	**LQD-DA-6115	23.5V	5A	120
	*LQD-DA-6312	±12V†	12A	135
	*LQD-DA-6312	12V	24A	135
	**LQD-DA-6312	18.5V	24A	135
	*LQD-DA-6315	±15V†	10A	135
	*LQD-DA-6315	15V	20A	135
	**LQD-DA-6315	22.5V	20A	135

†Same supply is used as single and dual by paralleling output terminals.

*Ratings as measured at output terminals of Lambda LAS 2000 series power hybrid voltage regulator and other microelectronic regulators.

**Ratings as measured at output terminals of LQ series power supply.

These specifications apply to output of a Lambda LAS 2000 series power hybrid voltage regulator connected to the LQ series power supply.

Regulated voltage

regulation, line 0.02% for line changes from 105 to 132 or 132 to 105 for any load between 0 to 100%.

regulation, load 0.2% for 0 to 100% of full load for any line between 105 and 132 VAC.

remote programming resistance ... 1000 ohms per volt/nominal only when used with 14-pin power hybrid voltage regulators LAS-2205 – LAS-2228, LAS-2405 – LAS-2415, LAS-2705 – LAS-2728 and LAS-2905 – LAS-2915.

remote programming voltage ... volt per volt only when used with 14-pin power hybrid voltage regulators LAS-2205 – LAS-2228, LAS-2405 – LAS-2415, LAS-2705 – LAS-2728 and LAS-2905 – LAS-2915.

temperature coefficient 0.007%/°C

AC input

line 105 to 132 VAC; 59 to 61 Hz

Overload protection

all units automatically limit output current upon external overloads, including short circuit, protecting load as well as supply.

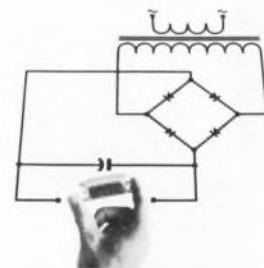

**WHETHER
YOU MAKE
OR BUY...**

LAMBDA
ELECTRONICS CORP.
A  Company

**ALL IN STOCK FOR 1-DAY DELIVERY
GUARANTEED 5 YEARS**

Send for 1973 Power Supply Catalog
and Application Handbook

MELVILLE, NEW YORK 11746 515 Broad Hollow Road Tel. 516-694-4200 ARLINGTON HEIGHTS, ILL. 60005 2420 East Oakton St., Unit Q Tel. 312-593-2550
NORTH HOLLYWOOD, CALIF. 91605 7316 Varna Ave. Tel. 213-875-2744 MONTREAL, QUEBEC 100C Hymus Blvd., Pointe-Claire, Quebec-730 Tel. 514-697-6520
PORTSMOUTH, HANTS, ENG. Marshlands Road, Fartington Tel. Cosham 73221 VERSAILLES, FRANCE 64a 70 rue des Chantiers 78004 Tel. 950-2224

SELLS ON SIGHT



superior readability that competitors can't match

One look at an operating SELF-SCAN[®] panel display and you will know why you should be featuring one in your system. SELF-SCAN displays are a new solution to the operator machine interface that provides advantages to the system builder, to the system user, and to the system operator.

You can offer your customer the advantage of a custom-stylized unit that his operators can use efficiently. SELF-SCAN panels are measurably superior to CRT for operator accuracy while significantly reducing fatigue level in day in-day out high volume production applications.

The 0.2" high characters are in the popular 5x7 dot matrix format and are made up of dots on .040" centers. The unit is ASCII compatible and displays a modified 64-character ASCII character set.

256-character display subsystems are available from stock for immediate delivery. Call or write Burroughs Corporation, Electronic Components Division, Box 1226, Plainfield, New Jersey 07061, Phone: (201) 757-3400. Ask to have a Burroughs sales engineer stop by your office and show you his 256-character SELF-SCAN panel, keyboard, and power supplies packaged in a standard Samsonite[®] briefcase.

Burroughs 