



Do you face a make or buy decision on power supplies?

# BUY LAMBDA LX SERIES

Now 47 models in 8 package sizes...  
single, dual & triple outputs.

new single and dual output models in "EE" package



NEW "EE" PACKAGE  
SINGLE OUTPUT  
LXS-EE-5-OV

**\$425**

5 VOLTS 45 AMPS  
(with O.V.)

NEW "EE" PACKAGE  
DUAL OUTPUT  
LXD-EE-152

**\$435**

±15 TO ±12 VOLTS 12.5 AMPS

all listed in Underwriters'  
Recognized Components Index\*

all designed to meet MIL  
environmental specifications

all in stock for 1-day delivery

all guaranteed 5 years

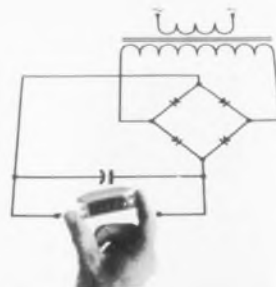

**WHETHER  
YOU MAKE  
OR BUY...**

**△ LAMBDA  
ELECTRONICS CORP.**

A  Company

\*LX-EE models presently undergoing qualifying tests.

MELVILLE, NEW YORK 11746 515 Broad Hollow Road Tel. 516-694-4200 ARLINGTON HEIGHTS, (CHICAGO) ILL. 60005 2420 East Oakton St., Unit Q Tel. 312-593-2550  
NORTH HOLLYWOOD, CALIF. 91605 7316 Varna Ave. Tel. 213-875-2744 MONTREAL, QUEBEC 100C Hymus Blvd., Pointe-Claire, Quebec-730 Tel. 514-697-6520

INFORMATION RETRIEVAL NUMBER 235

# We pack more performance into less space



## and save you up to 50¢ on your dollar.

Amphenol's new 303 Series MINIform coaxial switch line is the answer to today's biggest component problem: Getting higher performance, using less space at the lowest possible cost.

High performance we have. From 0 to 1.0 GHz, the MINIform switches handle up to 150 watts CW, maintain maximum VSWR of only 1.1:1, 80 dB minimum crosstalk attenuation and 0.1 dB insertion loss. Maximum VSWR over the 1.1 through 3.0 GHz range is only 1.2:1 with power handling capabilities up to 70 watts CW.

True to their name, MINIform switches weigh only 1.2 ounces and occupy less than ½ cubic inch of precious space.

Three popular termination styles are available: SMA connectors, Amphenol SUB-Minax 27 Series connectors and pc contacts for solder or solderless wrap terminations.

To find out more about MINIform and how it can cut your switch costs in half, write to Amphenol RF Division, Bunker Ramo Corporation, 33 East Franklin Street, Danbury, Connecticut 06810.



# AMPHENOL



**Behind this counter are 40 million hours of reliability data.**

**That's only one reason it's the world's best seller.**

Only the 5245's have over 40 million hours of operating data behind them — data which is computerized so HP can keep track of the performance of the 20,000 5245's now in use around the world. In addition, they all get torture-tested up to 160° F to make sure they'll operate under the most severe conditions.

The 5245's adapt easily to your needs. 14 plug-ins go from dc to 18 GHz and perform a great variety of functions. You can even order a long-term time-base stability of  $<5 \times 10^{-10}$  — good enough to use as a precision frequency standard.

That's why, in the long run, buying the best all-around counter on the market

— the 5245 — will save you money. Downtime and servicing are minimal. But you can get parts and service around the world. No wonder these counters are the only choice for many leasing companies.

Prove it to yourself. Call your local HP field engineer and find out why these are the most accurate, flexible and economical counters you can get. Anywhere.

Or write Hewlett-Packard, Palo Alto, California 94304; Europe: 1217 Meyrin-Geneva, Switzerland.

HEWLETT  PACKARD

ELECTRONIC COUNTERS



**In November, TI announced  
the 960A industrial  
automation computer**

TI announces  
the leader...



in minicomputer  
price/performance

**Model 960A  
\$2,850**

Quantities 1 to 100 \*  
CPU with 4K memory \$2,850  
CPU with 8K memory \$4,350  
CPU with 16K memory \$7,350

...and other information...

TEXAS INSTRUMENTS  
INCORPORATED



**Now, TI announces the 980A...  
the price/performance leader  
in general purpose computers**

# Model 980A

# \$3,475

Quantities 1 to 100  
with hardware multiply and divide  
and many other built-in standard features

TI continues its leadership in price and performance with the new Model 980A general purpose computer.

The 980A, as with the 960A, is a fast, powerful and flexible 16-bit computer at a low unit price with all the features, built-in and *standard*. Consider these many standard features, compare the price and you'll see why the 980A is the most cost-effective general purpose computer available today.

- Hardware, multiply/divide with 16 or 32-bit add and subtract
- 750-nsec add immediate
- 5.25- $\mu$ sec multiply
- 750-nsec, full-memory cycle time
- Bit / byte / word / byte string data addressing
- Memory parity
- Programmable memory protect and privileged instructions
- Power fail/auto restart
- Power supply to support 65K memory
- Memory biasing (dynamic relocatability)
- I/O bus with 4 ports basic (expandable to 14 in basic chassis, 256 overall)

CPU with 4K memory	\$ 3,475
CPU with 8K memory	\$ 4,975
CPU with 16K memory	\$ 7,975
CPU with 32K memory	\$13,975

(prices are FOB Houston and do not include illustrated tabletop cabinet)

- Main chassis semiconductor memory expandable to 32K. (Up to 65K with memory expansion unit: Two weeks memory protect with optional battery)
- Full, lockable front panel with break point and 4 sense switches
- Switch-initiated ROM bootstrap loader
- Auxiliary processor port
- Direct memory access channel (expandable to 8 ports)
- Four priority interrupts standard (expandable to 64)
- 98 basic instructions (16, 32 or 48 bit)
- 9 addressing modes
- 8 working registers plus status register

A pre-generated standard software system is supplied which allows the user to generate custom system software. Additional soft-

ware for the 980A includes:

- Symbolic assemblers and cross-assemblers for IBM 360/370
- FORTRAN IV
- Link and source editors (object and source)
- Modular executive control routine including disc management
- TI Language Translator (TILT) to extend FORTRAN, assembly, or create special application languages
- Service maintenance, debugging and utility programs.

For applications support, TI offers the resources of its experienced Applications Engineering group. Also, training courses on 980A software and hardware are scheduled regularly, and TI service facilities are located throughout the United States and abroad.

Would you like to know more about the new 980A price/performance leader? Write to Computer Products Marketing Manager, Texas Instruments Incorporated, P.O. Box 1444, Houston, Texas 77001. Or call (713) 494-2168 or any of the sales offices listed below.



Arlington, Va. (703) 525-1444 • Atlanta, Georgia (404) 237-8666 • Boston, Mass. (617) 890-7400 • Chicago, Ill. (312) 593-2340 • Cleveland, Ohio (216) 464-1192 • Dallas, Tex. (214) 238-3881 • Dayton, Ohio (513) 294-0774 • Denver, Colo. (303) 758-5536 • Detroit, Mich. (313) 352-5720 • Los Angeles, Calif. (714) 547-9221 • Minneapolis, Minnesota (612) 831-5094 • Newark, N. J. (201) 467-2670 • New York, N. Y. (212) 233-6890 • Orlando, Fla. (305) 644-3535 • Philadelphia, Pa. (215) 643-6450 • San Francisco, Calif. (408) 732-1840 • St. Louis, Mo. (314) 993-4546 • Bedford, England 58701 • Clamart, France 6450707 • Frankfurt, Germany 726441 • Bad Godesberg, Germany 65534

## TEXAS INSTRUMENTS

INCORPORATED

"SEE THE 980A AT THE FJCC, BOOTH 2500"

INFORMATION RETRIEVAL NUMBER 4

# Our Bill Shuart doesn't work for Power/Mate.



**He works only for you...  
and that's the way the new Power/Mate  
wants it.**

Bill is the Power/Mate Quality Assurance Manager and he has 34 supervisors and perfectionists under him.

They also work for you.

The result is unexcelled and consistent quality that we at Power/Mate are genuinely proud of.

Bill does a lot more than making sure our products are produced in accordance with his high standards of workmanship. (He wrote the book on that too.)

Bill has developed a series of courses for all our employees on soldering techniques and workmanship standards.

□ He has developed a computer failure analysis program to insure that *our* vendors also maintain the consistent high quality you should expect when you use our power supply in your product.

□ He oversees the continuing MTBF studies (by computer of course) and worst case calculations on all our power supplies to insure the long life and trouble free performance you should expect.

□ He has developed a thermally cycled burn-in rack in which we subject *all* of our power supplies for 24 hours before shipment to insure there are no premature field failures.

□ He oversees the random sampling of all production-run power supplies. These are subject to a continuous night and day life test . . . for your continued assurance of a long-lived trouble free product.

We could go on . . . but we at Power/Mate are glad he works for you. That's why we can give a five year no-holds warranty.



THE NEW  
**POWER/MATE CORR.**

514 S. River Street, Hackensack, N. J. 07601/ Phone (201) 343-6294  
TWX 710-990-5023

## Vice President, Publisher

Peter Coley

## Editors

Editorial Offices  
50 Essex St.  
Rochelle Park, N.J. 07662  
(201) 843-0550  
TWX: 710-990 5071  
Cable: Haydenpubs Rochellepark

**Editor-in-Chief:** George Rostky

## Managing Editors:

Ralph Dobriner  
Michael Elphick

## Associate Editors:

Jules H. Gilder  
Richard Lee Goldberg  
Morris Grossman  
Seymour T. Levine  
John F. Mason  
Stanley Runyon  
Edward A. Torrero  
Richard L. Turmail

## Contributing Editor:

Peter N. Budzilovich

## Editorial Field Offices

### East

Jim McDermott, Eastern Editor  
P.O. Box 272  
Easthampton, Mass. 01027  
(413) 527-3632

### West

David N. Kaye, Senior Western Editor  
2930 West Imperial Highway  
Inglewood, Calif. 90303  
(213) 757-0183

### Washington

Heather David  
2506 Eye St., N.W.  
Washington, D.C. 20037  
(202) 338-3470

## Editorial Production

Marjorie A. Duffy

## Art

**Art Director, William Kelly**  
Richard Luce  
Anthony J. Fischetto

## Production

**Manager, Dollie S. Viebig**  
Helen De Polo  
Maxine Correal  
Anne Molfetas

## Circulation

**Manager, Nancy L. Merritt**  
Ron Deramo

## Information Retrieval

Peggy Long

## Promotion

**Manager, Jeffrey A. Weiner**  
Karen Kerrigan



## across the desk

### Anyone care to invest in IR aid for blind?

In a recent letter ("Applied Research Aiding Handicapped," ED 18, Sept. 2, 1972, p. 16B), Donald Selwyn, executive/technical director of the National Institute for Rehabilitation Engineering, properly commended ELECTRONIC DESIGN for its article "Space-Age Technology Opening New Doors for the Blind, Deaf and Crippled" (ED 11, May 25, 1972, pp. 24-32). However, Mr. Selwyn mistakenly implied that *all* of the prosthetic devices described in the article were developed with Government assistance.

With all due respect to Mr. Selwyn, let me set the record straight about at least one of those devices—the eyeglass-mounted infrared aid for the blind, pictured on page 25 of the article and described more fully elsewhere in the same issue ("Use LEDs, Not Lasers, in Rangefinders," pp. 48-50). This aid, the most recent in a series developed over the past seven years, has not received a penny of Government support. In fact, it was developed solely as a spare-time project with the help of a few hundred dollars and some free parts from friendly vendors.

It is the smallest, lightest and least expensive travel aid yet assembled. The Veterans Administration, which has spent hundreds of thousands of dollars to develop a \$3000 laser cane for the blind, is now testing two of the eyeglass units, which it purchased for \$225 each. The aid has just received an IR 100 Award as one of the "top technical products of 1972."

As the inventor of the aid, I would certainly like some financial support to supplement my meager

contribution to the project. The aid is ready for final development and testing at this time. That, of course, is why I appreciate this opportunity to clarify Mr. Selwyn's mistaken assumption.

*Forrest M. Mims*

6901 Zuni SE A-12  
Albuquerque, N.M. 87108.

### A word about words and how to use them

About your editorial "We Communicate. Or Do We?" (ED 19, Sept. 14, 1972, p. 73):

We seem to have two languages—spoken and written. We use the spoken language more for communicating and the written language more for impressing others. Our education and work experiences train us this way. Industry rewards people whose writing sounds good. The idea content is not as important as the sound. This writing usually contains big words, meaningless phrases and sometimes meaningless paragraphs. People give different meanings to the same word.

The reason we try to impress one another seems to be attempts at inflating our egos and satisfying competitive feelings (maybe these are the same). Our system is this way, because nearly all our leaders are selected as leaders partly because of their ability in writing to impress instead of to communicate. Another factor is that the use of meaningless words provides an escape from criticism in the event of the inevitable occasional failure.

Here are some things that seem to work for me:

- Use little words.
- Write the way you talk.

*(continued on page 10)*

Electronic Design welcomes the opinions of its readers on the issues raised in the magazine's editorial columns. Address letters to Managing Editor, Electronic Design, 50 Essex St. Rochelle Park, N. J. 07662. Try to keep letters under 200 words. Letters must be signed. Names will be withheld on request.

## giga-trim capacitors for microcircuit designers

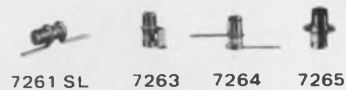
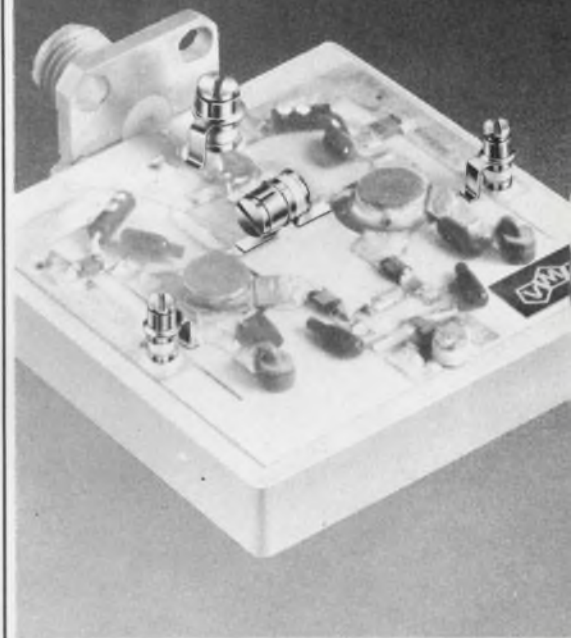

**Giga-Trim<sup>®</sup>** (gigahertz-trimmers) are tiny variable capacitors which provide a beautifully straight forward technique to fine tune RF hybrid circuits and MIC's into proper behavior. They replace time consuming cut-and-try adjustment techniques and trimming by interchange of fixed capacitors.

Applications include impedance matching of GHz transistor circuits, series or shunt "gap-trimming" of microstrips, external tweaking of cavities, and fine tuning of crystal oscillators.

*Johanson*

MANUFACTURING CORPORATION

BOONTON, NEW JERSEY 07005

201 / 334-2676

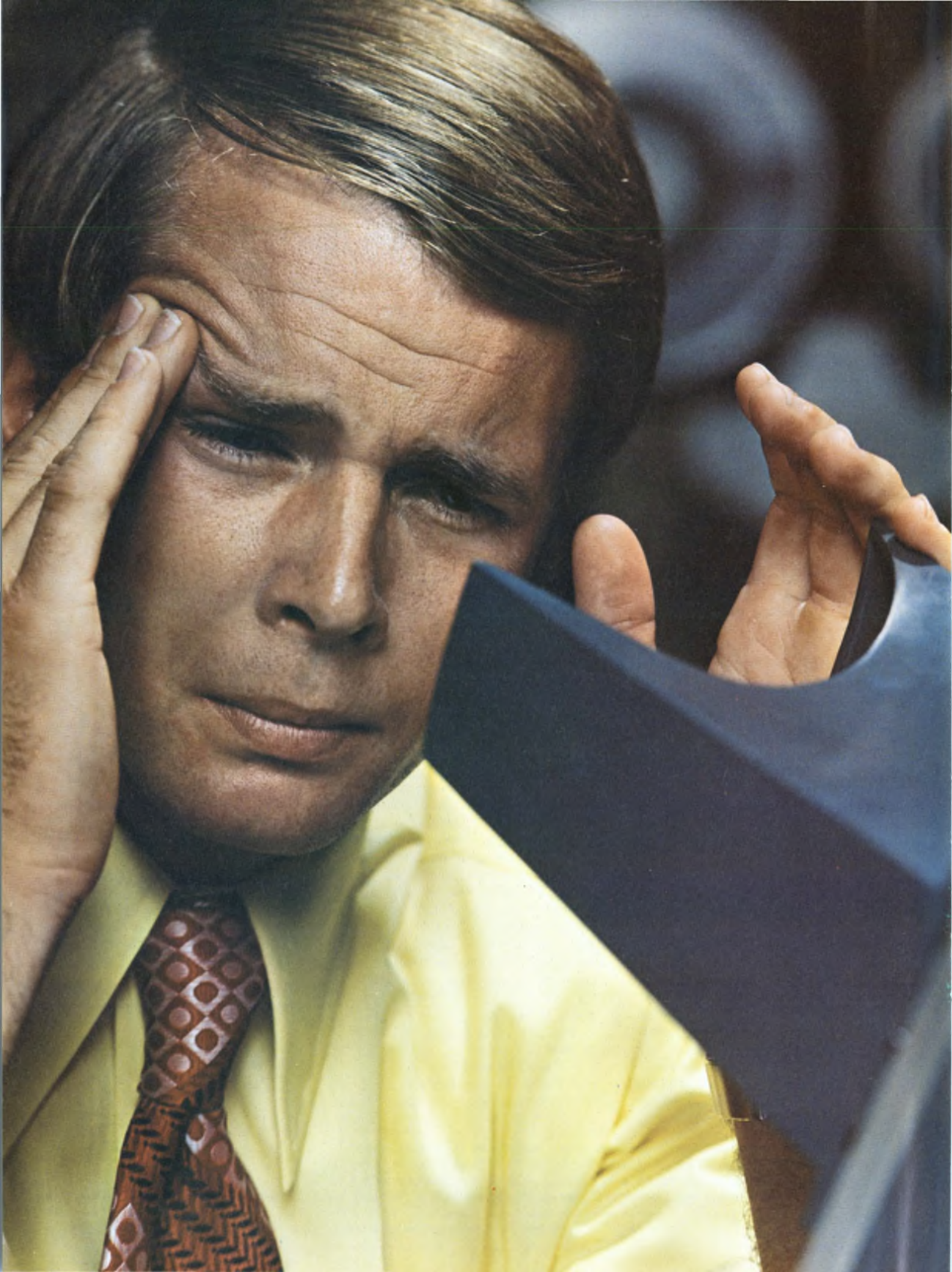

# Think Twice:

## What's one of the biggest measurement problems in the computer industry today?

### Low Duty-Cycle Measurements—

Making timing-pulse adjustments, and finding noise pulses in, or locating missing bits from low duty-cycle digital signals. Countless lost hours and eye-strain have resulted from this problem—trying to view low rep-rate signals like those found in disc, tape, or drum peripheral units. But with your refresh cycle occurring at such long intervals, coupled with short phosphor persistence, it's no wonder that you've spent an inordinate amount of time making such measurements. And it's no wonder that you often came out from under your scope hood rubbing your eyes. Well, no more!

**Storage CRT With Unmatched 400 cm/ $\mu$ s Writing Speed.** Hewlett-Packard just made it possible for you to throw away your scope hood by developing a new bright, burn-resistant, high-speed, variable-persistence CRT—available in either 100 cm/ $\mu$ s or 400 cm/ $\mu$ s writing speeds. Placing these new CRT's into an all new mainframe that's optimized for high-writing-speed storage measurements, HP now gives you a new dimension in storage scopes—the HP 184A. This unique combination offers the highest writing speed available, and a display with brightness as great as you can find anywhere. For the first time you can find those elusive transients that before were too fast for your storage scope to follow—like nanosecond noise pulses.

**Display True Replicas of Your Waveforms.** You'll appreciate being able to adjust persistence down to 0.2 seconds; that's 75 times lower than a major competitive unit. For those measurements that require faster sweep times, you'll know you are displaying true replicas of your waveforms when you're using an HP 184A. Capture low duty-cycle pulse trains, through repetitive sweeps, simply by adjusting the persistence to

"maximum," to build up the intensity of dim traces. This feature in the new 184A oscilloscope lets you do many jobs you previously allocated to expensive, single-shot scope/camera systems.

**Variable-Persistence Storage and Standard in One Scope.** Further, you'll find that your 184A is a true general purpose scope that offers you the capability to choose, by way of plug-ins, all the functional features of the HP 180 Series of oscilloscopes, including such items as selectable-input impedance, and sampling to 18 GHz. And for simplicity of operation, we think you're in for a pleasant surprise when you compare the 184A against the competitive unit.

**Superior Technology.** HP believes the most important part of a scope system is the CRT—the interface between you and your measurement. As the pioneer in practical applications of dome-mesh magnification, HP was first to expand the size of high-frequency CRT's to 6 x 10 cm; first to 8 x 10 cm; and first to 10.4 x 13 cm—all in high-frequency mainframes. HP was also the first to use dome-mesh technology to substantially lower power requirements for CRT deflection (making possible the only line of 35 and 75 MHz portable scopes with built-in battery packs—scopes that really are portable).

**From The Storage Leader.** HP was first with variable-persistence mesh storage for commercial applications—to give you a stored trace many times brighter than bi-stable tubes, and without annoying flicker. Variable-persistence, with its ability to build up waveform brightness, was the first CRT innovation that gave you a trace bright enough to let you tackle most single-shot or low rep-rate measurements problems. All you do is adjust persistence until the integrating storage effect brings your waveform up to a bright, clear display.

**Burn-Resistant CRT's.** HP placed variable-persistence in many of its scopes including the 181A, 1702A, and 1703A storage units. And now HP has developed, for its current line of storage instruments, carefree CRT's so highly burn resistant they require little more care than conventional CRT's. The new 184A high-writing-speed scope also has unprecedented inherent resistance to burns.

**Yes, Scopes Are Changing.** How many times have you wished for a scope that could display a low rep-rate digital signal brightly and clearly, and one that could also be used for a variety of general purpose measurements. That scope is here now in HP's 184A storage mainframe, \$2200 (for only \$500 more, you can boost your 184A's writing speed to 400 cm/ $\mu$ s), with plug-in capability to 100 MHz real time, or 18 GHz sampling. Think twice; put away your scope viewing hood and call your local HP field engineer for a demo today. Or write for our "No Nonsense Guide to Oscilloscope Selection." It covers the other members of HP's variable-persistence storage scopes. Hewlett-Packard, Palo Alto, California 94304. In Europe: P.O. Box 85, CH-1217 Meyrin 2, Geneva, Switzerland. In Japan: YHP, 1-59-1, Yoyogi, Shibuya-Ku, Tokyo, 151.

**Scopes Are Changing;  
Think Twice.**

HEWLETT  PACKARD

OSCILLOSCOPE SYSTEMS

INFORMATION RETRIEVAL NUMBER 7

## ACROSS THE DESK

(continued from page 7)

- Try to transfer ideas instead of impressing others.

- Try to take the reader in little steps—big steps turn the reader off because “if I don’t understand it, it isn’t worthwhile.”

- Try to depress the ego. It allows better communication and also helps organize the mind.

*Newt Crawford*

Skutch Electronics

3751 Dell Rd.

Carmichael, Calif. 95608.

Your editorial on communication reminded me of the following story:

A plumber discovered by accident that the acid used for swimming pools was an excellent grease dissolver, and he wrote a note to his trade magazine expounding the benefits and describing how he had opened kitchen drains just by letting some of the acid stand in the trap for awhile. The magazine editor wrote back and briefly explained that chemical action—indeed, rapid oxidation—was also taking place between the acid and the ferrous material in the pipe. However, the editor’s use of the English language and his selection of words was not at the plumber’s level of understanding.

The plumber failed to understand what was said but concluded that his suggestion had been well accepted because such a fine letter had been written to him. Thus he again wrote the editor, thanked him for the response and concluded by saying he was looking forward to seeing his suggestion in the next issue of the trade magazine.

The editor realized that he had not communicated in his first letter, and so he penned a second: “Don’t use pool acid to open closed drains. It eats hell out of the pipes.”

*Robert J. Young*

McDonnell-Douglas

Box 116

El Toro, Calif. 92630.

Perhaps Lord Kelvin had the answer to the communication problem in this weighty statement, “I

(continued on page 14)

VADC Series  
6 to 13 MHz word rate A/D's  
100pS aperture,  $\pm 5V$

VSSH Series  
Video sample-and-holds  
<100pS aperture.  
50 ns acquisition

NDAC Series  
50 ns settling time D/A's  
20 MHz update rates

Hybrid Amplifiers  
1000 V/ $\mu s$  slew rate  
200 ns settling to 0.1% FS

VMUX Series  
15 MHz multiplexers  
100 ns settling to 0.01% FS

Hybrid Amplifiers  
800V/ $\mu s$  slew rate  
 $\pm 10V$  at 30mA

## When the going gets tough, the tough get going.

That's what established us as a leader in high speed sophisticated data conversion equipment: A/D, D/A converters, multiplexers, sample-and-hold modules, wideband amplifiers. Each product's been specifically designed to satisfy some of the most critical interface requirements you'll run up against. Be it speed, accuracy, size or reliability. Whether your application involves TV digitizing or head-up displays . . . large-screen displays or moving target indicators . . . traffic control or numerical control . . . fire control or pollution control . . . We've solved the tough ones.

Don't forget—we've also solved the easy ones. Write or call our application engineers for our complete data conversion and signal interface catalog.

**DDC**

**ILC DATA DEVICE CORPORATION**  
100 TEC STREET, HICKSVILLE, N. Y. 11801 • PHONE: (516) 433-5330

**APPLICATION CENTERS**

Long Beach, Calif. (213) 597-5744	Washington, D. C. (703) 821-2300	Bruxelles, Belgium (Tel.) 62.01.59
--------------------------------------	-------------------------------------	---------------------------------------

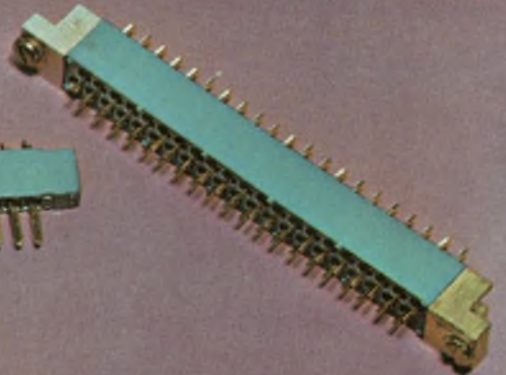
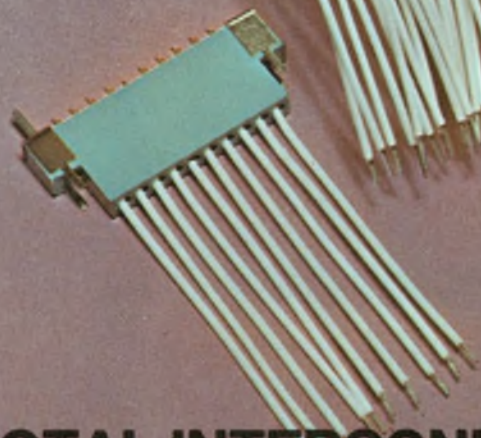
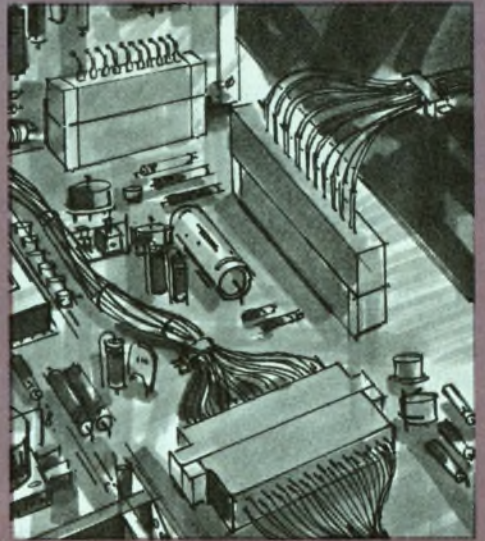

## TOTAL INTERCONNECT SYSTEM WITH VARICON™ CONTACT INTERFACE RELIABILITY...

With a choice of three packaging applications: Board-to-board, cable-to-board, cable-to-cable  
Double row at .100" offset grid; single row at .100" grid

You know the problems: design compromises imposed by connector limitations. Like being stuck with board-to-cable contacts when you want to go cable-to-cable. Or being forced to mount connectors horizontally, when vertical mounting would be better. Chances are, you've been confronted by many similar situations. Elco offers two ends to these problems. With two new miniature crimp, two-piece, metal-to-metal connectors that also mate with their existing termination counterparts. Which means you can mix and match connectors for almost unlimited mounting and terminating flexibility.

The four connectors share many common traits. And a few differences, too. For example:

New Series 8221 crimp and insert connectors are matable with Series 8219 connectors. Both are available in six discrete sizes: 18, 30, 36, 42, 54 and 72 dual row contact positions, on .100" offset grid for high density packaging applications.

Our other new crimp and insert connector, Series 8229, is matable with existing Series 8129 connectors. These series have single row contacts spaced on .100" centers, and are offered in 6, 9, 10, 12 and 15 contact positions.

We build these connectors with high dielectric-strength, glass-filled diallyl phthalate insulators. So they're ideal for critical applications under

severe environmental conditions. All use the new Varicon™ low withdrawal force contact (1-6 ounces per contact pair) for effortless assembly in the tightest places. With MIL-SPEC reliability, too (MIL-C-55302). And all are supplied with the hardware necessary to meet any mounting requirement.

There you have it. Two new crimp and insert style connectors. Two connectors with factory-installed contacts. Available now. In popular sizes. With lots of mounting and terminating combination possibilities. Another better way we serve you with CONNECTRONICS, Elco's Total Connector Capability.

Two most important points—Elco's published prices are much lower than costs for comparable pin and socket or other type connectors; and second, you get immediate, off-the-shelf delivery from our authorized distributors.

For full details, contact your local Elco representative, or:

Elco, Willow Grove Division  
Willow Grove, Pa. 19090  
(215) 659-7000

Elco, Pacific Division  
2200 Park Place  
El Segundo, Calif. 90245  
(213) 675-3311



**LOOKING FOR  
PRODUCTS/  
COMPONENTS?  
FIND THEM HERE!**



V  
CA  
FIND



# having trouble deciding which semiconductor to use?

**Visual Search Micro Film (VSMF)**, the modern technical data retrieval service, helps you decide quickly—helps you choose the one semiconductor that's best for your design.

**The VSMF Service Is Called Parameter Retrieval.** It lists devices by increasing values of important characteristics, letting you know what's available *before* you start your design.

**To Locate Your "Best" Semiconductor,** you turn to the family of devices that meets your *most* important parameter needs. There you'll find other major parameters also listed in increasing order of performance value.

**Quickly,** you satisfy your design needs. You also find second sources, and local sales offices to speed up getting parts for test and evaluation.

**VSMF Keeps Engineers Up-To-Date.** Hundreds of people back at Information Handling Services' Denver Headquarters gather, sort, organize, index and microfilm all this semiconductor product and supplier information, handling thousands of pages daily. Parameter

Retrieval is one of the many services that emerge from this effort, providing frequent updates to keep you current with the fast-changing world of semiconductors. You no longer need to be concerned about out-of-date catalogs, or incomplete and inefficient filing systems.

**Price?** VSMF costs less than a file clerk, and takes up no more space than an office desk. If you would like more information about this modern data retrieval system, or a demonstration at your office, fill out the coupon and mail it today. Or, call (303) 771-2600.

Information Handling Services, Dept. ED-1  
Denver Technological Center  
P.O. Box 1154  
Englewood, Colorado 80110

Please send more information about:

- Design Engineering Service & Parameter Retrieval
- MIL/FED Spec's and Standards Service
- All other VSMF Services
- Please call me for an appointment

Name: \_\_\_\_\_

Title: \_\_\_\_\_

Company: \_\_\_\_\_

Address: \_\_\_\_\_

Phone: \_\_\_\_\_



**Information Handling Services**  
An Indian Head Company

Simplify board layout...  
Cut package count...  
Reduce equipment size...with



## THICK-FILM RESISTOR NETWORKS

<p>maximum safety design* maximum density design</p> <p><b>PULL-UP/PULL-DOWN AND INTERFACE NETWORKS†</b></p>	<p><b>DUAL TERMINATING NETWORKS</b></p>
<p>maximum safety design* maximum density design</p> <p><b>INDIVIDUAL TERMINATING NETWORKS†</b></p>	<p><b>MULTIPLE ISOLATED RESISTORS</b></p>

**POPULAR OHMIC VALUES IN THESE STANDARD RESISTOR NETWORKS ARE AVAILABLE FOR PROMPT DELIVERY FROM YOUR STOCKING SPRAGUE INDUSTRIAL DISTRIBUTOR**

\*This configuration prevents circuit damage if accidentally reversed during insertion  
†Also available in 14-pin package

**Sprague puts more passive component families into dual in-line packages than any other manufacturer:**

- TANTALUM CAPACITORS
- CERAMIC CAPACITORS
- TANTALUM-CERAMIC NETWORKS
- RESISTOR-CAPACITOR NETWORKS
- PULSE TRANSFORMERS
- TOROIDAL INDUCTORS
- HYBRID CIRCUITS
- TAPPED DELAY LINES
- SPECIAL COMPONENT COMBINATIONS
- THICK-FILM RESISTOR NETWORKS
- THIN-FILM RESISTOR NETWORKS
- ION-IMPLANTED RESISTOR NETWORKS

For more information on Sprague DIP components, write or call Ed Geissler, Manager, Specialty Components Marketing, Sprague Electric Co., 347 Marshall St., North Adams, Mass. 01247. Tel. 413/664-4411.



THE BROAD-LINE PRODUCER OF ELECTRONIC PARTS

INFORMATION RETRIEVAL NUMBER 11

### ACROSS THE DESK

(continued from page 10)

often say that when you can measure what you are speaking about, and express it in numbers, you know something about it; but when you cannot measure it, when you cannot express it in numbers, your knowledge is of a meager and unsatisfactory kind; it may be the beginning of knowledge, but you have scarcely, in your thoughts, advanced to the stage of science, whatever the matter may be."

I think the message is: Use precise language, terms that do not have very broad meanings and numbers applied to universally understood units to convey your thoughts, whatever the matter may be. Of course, this language style would be disastrous for a politician.

*Wayne Spani*

Cubic Industrial Corp.  
4285 Ponderosa Ave.  
P.O. Box 769  
San Diego, Calif. 92112.

In response to your editorial of Sept. 14, don't fight it. Editors are prime targets for criticism pro and con. You are baring yourself every month and trying to get across to us by means of the written word. Words do not have meaning. We readers inject meaning. We will crank in the meaning that we think is intended. Some words in our language have as many as 84 meanings. Context has more meaning than words. But don't fight it. Your editorials are excellent. I look for them first in each issue of ED. Keep them coming.

*Harvey E. Sibert*  
*Value Engineer*

General Dynamics  
Convair Aerospace Div.  
San Diego, Calif. 92112

### Thermal printers are better than we said

I would like to raise some points regarding your article "Need a Hard Copy Peripheral?" (ED 18, Sept. 2, 1972, p. 54).

PPM, Inc., produces a thermal printer that not only is odor-free but presents absolutely no permanency problem, unless the paper is exposed to intensities that are not

(continued on page 16)

INFORMATION RETRIEVAL NUMBER 12 ►



# Bendix puts an end to the bends.



You know the bends. That's when connector pins are bent or damaged during mating by misaligned plug and receptacle.

The bends just can't happen with Bendix SJT connectors. Pins are recessed. Stronger, too. And that makes them 100% scoop proof. You get positive protection whether the pins are in receptacle or plug.

You get five-key polarization, too. And that makes mismatching a thing of the past.

Another key feature: Bendix 100% scoop-

proof SJT connectors conform to the mounting dimensions of low silhouette (JT) series II MIL-C-38999 connectors. They're available in lightweight shell sizes from 8 to 24 with from 3 to 128 crimp type contacts accommodating wire gauges from 12 to 28.

Now then. Like to put an end to the bends? Write for our new SJT catalog.

The Bendix Corporation, Electrical Components Division, Sidney, New York 13838.

**Bendix**



If you could save up to 30% without losing anything by using this new 10mm ceramic trimmer capacitor, wouldn't you want to know it?

That's exactly what we can promise you for many applications. All the performance you need for about a third less than you've been spending.

These new trimmers have five capacity ranges from 3.0pF min. to 30.0pF max. Their operating temperature range is  $-30^{\circ}\text{C}$ . to  $+125^{\circ}\text{C}$ . And they mount interchangeably with other ceramic trimmers for PC applications. Four dielectric types available.

But check them out for yourself. Get the coupon in the mail today.

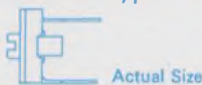

E. F. JOHNSON COMPANY/Waseca, Minnesota 56093. Dept. 3310  
 You bet I'd like literature and a free test sample of your new low cost trimmer capacitor if it can do what you say!

Check capacitance (pF) range needed:

- 3.0 to 8.0       3.0 to 12.0       5.0 to 13.0  
 5.0 to 20.0       5.0 to 30.0

\_\_\_\_\_ Please send them directly.  
 \_\_\_\_\_ Please call me at: \_\_\_\_\_

Name \_\_\_\_\_

Firm \_\_\_\_\_ Title \_\_\_\_\_

Address \_\_\_\_\_

City \_\_\_\_\_ State \_\_\_\_\_ Zip \_\_\_\_\_



**E. F. JOHNSON COMPANY**

INFORMATION RETRIEVAL NUMBER 13

## ACROSS THE DESK

(continued from page 14)

now encountered, nor even considered likely, in the foreseeable future.

The author's comments about low speed and poor record quality are considerably off base so far as the PPM TP-10 is concerned. Speed is five lines per second or 10 lines per second for bursts of 1000 prints. Ten lines per second is not slow.

In contending that thermal printers are inexpensively priced (\$2000-\$3000), the author reckoned without the TP-10, which is priced at less than \$1100 for a 12-column unit.

Frank Spiro  
 President

Frank Spiro & Associates, Inc.  
 Willoughby, Ohio 44094.

Ed. Note:

In our article, we were discussing printers likely to be used as computer peripherals. Printers with 10-column or 12-column capacity don't generally fall in this category.

## Correction correction

In the correction entitled "Wrong picture and . . ." on page 7 of the September 28th issue, we apologized for an error in a July 20th article, "Small, low-cost modular power supplies woo light-minded users." We had inadvertently published a picture of a RO Associates power supply and called it a Trio Labs supply.

To set the record straight, we published pictures of both RO and Trio supplies in our September 28th correction. But—you guessed it—we switched the pictures. We are tempted—but only momentarily—to run both pictures again. But fate apparently isn't with us on this one. So if you have a moment, go back to page 7 of the September 28th issue and mentally transpose RO for Trio and Trio for RO in the pictures. Sorry.

## Sorry

We gave you a wrong phone number in the Monitor Labs product feature on p. 184 of the Sept. 14 issue of ELECTRONIC DESIGN. It should be (714) 453-6260.

(continued on page 166)

# Now tin makes better pluggable IC connections than gold.



## And for the price of a stamp HYPOINT will prove it.

For years the only way to make reliable IC connections has been the expensive way — with gold. But not anymore.

Now after 3 years of research and testing we've developed a way to make better IC connections for a lot less money — with tin plating.

HYPOINT™, a totally new termination concept makes it possible. It has no leads to bend. Now tiny chisel points in the receptacle penetrate metal targets in the ceramic package to make a perfect gas-tight, corrosion-free contact. This low profile terminator is easy to connect (zero entry), the ceramic can be disconnected and reconnected easily for field servicing and each connection is as reliable as the first.

Hard to believe? Take 8¢ and mail us your coupon. We'll send you the proof.

Please send me detailed information on your new HYPOINT tin IC terminators. Please include, too, your complete test data on its performance as compared to gold.



Name \_\_\_\_\_ Title \_\_\_\_\_  
Company \_\_\_\_\_  
Street \_\_\_\_\_  
City \_\_\_\_\_ State \_\_\_\_\_ Zip \_\_\_\_\_

Burndy Corporation  
Norwalk, Connecticut 06856

**BURNDY**  
**CONNECTS**

International Sales Headquarters & Manufacturing Facilities: Canada / England / Belgium / Mexico / Brazil / Australia / Japan. Sales Offices in major cities.

## Only one DIP needed for logic-circuit design

The article "Ring Map Minimizes Logic Circuit" in the Aug. 17 issue (ED 17, p. 80) presents an interesting and potentially useful technique. However, by neglecting the availability of integrated-circuit quad EXCLUSIVE-OR gates (such as the Fairchild 9014, TI 7486, etc.), the author negated the impact of his approach.

In Fig. 7 of this article, the author uses the ring map to reduce a complex function to

$$f = \overline{(A \oplus B) + (C \oplus D)}$$

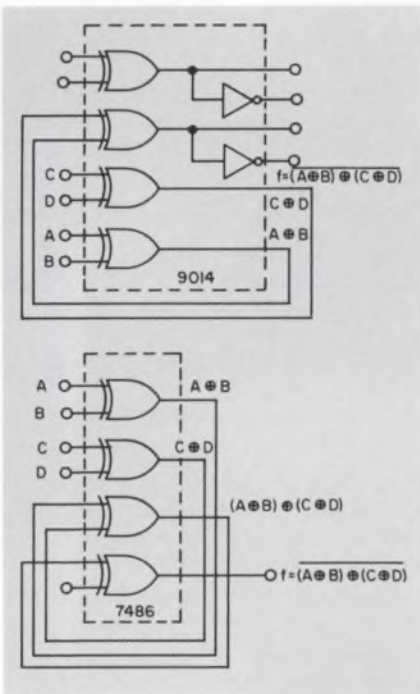

He then implements this, using two DIPs along with several resistors (and implies the availability of complimented inputs). With the aforementioned integrated circuits, the function could be implemented with a single DIP, as this sketch shows:

Dan Barber

Senior Staff Engineer

Fairchild Space and Defense  
Systems  
300 Robbins Lane  
Syosset, L.I., N.Y. 11791

# Where to get Schmitt

## Teledyne Semiconductor Distributors

### Alabama:

Powell Electronics  
Huntsville (205) 539-2731

### Arizona:

Dalis Electronic Supply  
Phoenix (602) 258-8151  
Inland Electronic Supply  
Tucson (602) 624-4402  
Intermark Electronics  
Tempe (602) 968-3484

### California:

Bell Electronic Corp.  
Menlo Park (415) 323-9431  
Hollywood Radio  
Hollywood (213) 466-3181  
Intermark Electronics  
San Carlos (415) 592-1641  
Intermark Electronics  
San Diego (714) 279-5200  
Intermark Electronics  
Santa Ana (714) 540-1322  
Intermark Electronics  
Van Nuys (213) 782-0362  
Kierulff Electronics Co., Inc.  
San Diego (714) 278-2112  
Milo of California  
Los Angeles (213) 478-9854  
Milo of California  
San Diego (714) 232-8951  
Semiconductor Concepts  
Woodland Hills (213) 884-4560  
Wesco Electronics  
Los Angeles (213) 685-9533  
Wesco Electronics  
Palo Alto (415) 968-3475  
Westates Electronics Corp.  
Chatsworth (213) 341-4411

### Colorado:

Intermark Electronics  
Denver (303) 936-8284  
Kierulff Electronics Co., Inc.  
Denver (303) 825-7033

### Florida:

Cramer/E. W., Inc.  
Hollywood (305) 923-8181  
Cramer/E. W., Inc.  
Orlando (305) 894-1511  
Powell Gulf Electronics  
Miami Springs (305) 885-8761  
Powell Electronics  
Orlando (305) 423-8586

### Illinois:

Kierulff Electronics Co., Inc.  
Rosemont (312) 678-8560  
Lakeland  
Elk Grove Village (312) 595-1000

### Kansas:

Milo Connector Center  
Kansas City (913) 287-2100

### Maryland:

Arrow Electronics  
Baltimore (301) 247-5200  
Milgray Electronics, Inc.  
Hyattsville (301) 864-1111  
Pyttronic Industries  
Savage (301) 792-7000  
Technico, Incorporated  
Baltimore (301) 828-6416

### Massachusetts:

DeMambro Electronics  
Boston (617) 787-1200  
Future Electronics Corp.  
Framingham (617) 879-0860  
Milgray Electronics  
Burlington (617) 272-6800

### Michigan:

Northland Electronics  
Farmington (313) 477-3200

### Minnesota:

Electro Com Corporation  
Minneapolis (612) 788-8601  
Industrial Components  
Minneapolis (612) 927-9991

### Missouri:

Hall-Mark Electronics Corp.  
St. Louis (314) 521-3800

### New Jersey:

Milgray Delaware Valley  
Cherry Hill (609) 424-1300

### New Mexico:

Century Electronics  
Albuquerque (505) 265-7837  
Kierulff Electronics Co., Inc.  
Albuquerque (505) 247-1055

### New York:

Lafayette Industrial Electronics  
New Hyde Park, L.I. (516) 488-6600  
Milgray Electronics  
Freeport (516) 546-6000  
Semiconductor Concepts  
Hauppauge, L.I. (516) 273-1234  
Summit Distributor, Inc.  
Buffalo (716) 884-3450

### Ohio:

Arrow Electronics  
Cleveland (216) 464-2000  
Arrow Electronics  
Dayton (513) 253-9176  
Electronic Marketing Corp.  
Columbus (614) 299-4161  
Milgray Electronics  
Cleveland (216) 881-8800

### Pennsylvania:

Arrow Electronics  
Folcroft (215) 534-3200  
Powell Electronics  
Philadelphia (215) 724-1900

### Texas:

Hall-Mark Electronics Corp.  
Houston (713) 781-6100  
Lenert Co., Inc.  
Houston (713) 225-1465  
Solid State Electronics  
Dallas (214) 352-2601  
Solid State Electronics  
Houston (713) 785-5205

### Washington:

Intermark Electronics  
Seattle (206) 767-3160  
Kierulff Electronics Co., Inc.  
Seattle (206) 763-1550

### Canada:

Future Electronics  
Montreal, Quebec (514) 735-5775  
R.A.E. Industrial Electronics Ltd.  
Vancouver, B.C. (604) 687-2621

# Schmitt, the name that made the trigger famous, now makes HiNIL universal.

Schmitt is Teledyne's new HiNIL 367, noise-proof line receiver. It's the new way to go for a universal input-port to logic blocks. In industrial applications, for example, most inputs are either a switch or a relay closure. They usually cause contact bounce. But the most amazing thing about the 367 is that it has a truth table that simply eliminates contact bounce by definition.

And by the way, the noise immunity of the 367 is more than enough to handle any long lines between the logic and input. It has a 5.0 volt worst-case noise immunity and an additional 2.5 volt dead-zone Schmitt Trigger margin.

Because the 367 is a Schmitt Trigger, it holds that 2.5 volt noise immunity even during logic transition. Slow-down

capacitors, as you all know, do not provide true noise immunity during switching. But, with the 367 in there, you can use those slow-down capacitors at the rate of 4msec/uFd and achieve a high guaranteed noise immunity too.

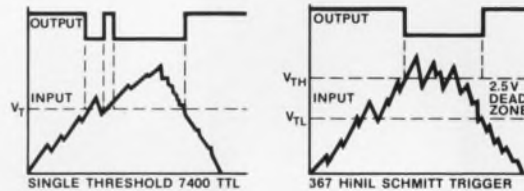

For fussy people, we put an inhibit pin on the 367 that allows information to be accepted only at times of low noise.

The new Quad Schmitt 367 is available now at \$2.98 in 100 up quantities. Order now or get in line.

## the challenger

 **TELEDYNE SEMICONDUCTOR**

1300 Terra Bella Avenue Mountain View, California 94040 (415) 968-9241 TWX: 910-379-6494 Telex: 34-8416

INFORMATION RETRIEVAL NUMBER 212

# Five RCA VOM's\* Priced from \$11.50\*\* to \$48.00\*\*



\*Complete with test leads, batteries and full RCA warranty (12 months parts and labor).

Input resistances from 2000 to 100,000 ohms per volt.

\*\*Optional Distributor Resale Price



# RCA

# Silicone Protectors

A full line of silicone encapsulating, insulating, sealing, coating and dielectric materials is available from Dow Corning Distributors at the following warehouse locations:

## ALABAMA

**Birmingham**  
Electrical Insulation Suppliers  
205 252-9046  
**Mobile**  
Brownell Electro, Inc.  
205 479-5405

## ARIZONA

**Phoenix**  
Essex International Inc.—IWI Div.  
602 278-8568

## CALIFORNIA

**Berkeley**  
C. D. LaMoree  
415 841-0601  
**Culver City**  
E. V. Roberts & Associates, Inc.  
213 870-9561  
**Gardena**  
Specialized Products Co.  
213 532-1230—213 770-8186  
**Los Angeles**  
Essex International Inc.—IWI Div.  
213 264-7000  
C. D. LaMoree  
213 225-5666  
Brownell Electro, Inc.  
213 532-1150  
**Mountain View**  
K. R. Anderson Company, Inc.  
415 961-6007  
**San Diego**  
A. E. Yale Enterprises  
714 296-6148  
**San Francisco**  
Essex International Inc.—IWI Div.  
415 626-5351

## COLORADO

**Denver**  
Waco Enterprises, Inc.  
303 322-7708

## FLORIDA

**Orlando**  
Cramer/Florida, Inc.  
305 841-1550  
Brownell Electro, Inc.  
305 424-5634  
Electrical Insulation Suppliers, Inc.  
305 855-7100  
**Tampa**  
Essex International, Inc.—IWI Div.  
813 245-1651

## GEORGIA

**Atlanta**  
Electrical Insulation Suppliers, Inc.  
404 355-1651  
Essex International Inc.—IWI Div.  
404 691-8520  
**Chamblee**  
Prehler Electrical Insulation  
404 451-4266  
**Hapeville**  
Brownell Electro, Inc.  
404 762-5181

## ILLINOIS

**Chicago**  
Prehler Electrical Insulation  
312-384-6100  
**Mt. Prospect**  
Magnuson Electronics, Inc.  
312 956-0700  
**Niles**  
Essex International Inc.—IMC/IWI Div.  
312 647-0044

## INDIANA

**Fort Wayne**  
Essex International Inc.—IWI Div.  
219 742-7441  
**Hammond**  
Electric Supply Corp.  
219 932-8840

## IOWA

**Marion**  
Ensco Distributing Corporation  
319 377-6313

## KENTUCKY

**Louisville**  
E & H Electric Supply  
502 587-0991

## LOUISIANA

**New Orleans**  
Williamson Distributing Corp.  
504 486-5584  
**Shreveport**  
Williamson Distributing Corp.  
318 424-6638

## MARYLAND

**Baltimore**  
Essex International Inc.—IWI Div.  
301 644-0140  
Pytronic Industries, Inc.  
301 539-6525

## MASSACHUSETTS

**Cambridge**  
Brownell Electro, Inc.  
617 864-7500  
**Newton**  
Cramer Electronics, Inc.  
617 969-7700  
**Peabody**  
Essex International Inc.—IWI Div.  
617 531-7100

## MICHIGAN

**Detroit**  
Essex International Inc.—IMC/IWI Div.  
313 921-6000  
**Madison Heights**  
McNaughton-McKay Electric  
313 399-7500  
**Southfield**  
Sheridan Sales Co.  
313 358-3333

## MINNESOTA

**St. Paul**  
Magnuson Electronics, Inc.  
612 227-8495  
Prehler Electrical Insulation  
612 622-1541—612 622-1542

## MISSOURI

**Kansas City**  
Essex International Inc.—IWI Div.  
816 842-1613  
**St. Louis**  
Ensco Distributing Corp.  
314-542-3935  
Essex International Inc.—IWI Div.  
314 371-2616

## NEW JERSEY

**Livingston**  
Robert McKeown Co., Inc.  
210 922-0700 or 212 267-9264 (NYC)  
**Moonachie**  
Essex International Inc.—IWI Div.  
201 641-4400 or 212 695-7495 (NYC)  
**North Bergen**  
Electrical Insulation Sales  
201 864-2376 or 212 564-6273 (NYC)

## NEW MEXICO

**Albuquerque**  
Waco Electronics, Inc.  
505 268-2409  
Williamson Distributing Corp.  
505 344-3564

## NEW YORK

**Buffalo**  
Summit Distributors, Inc.  
716 884-3450  
**New York City**  
Brownell Electro, Inc.  
212 619-7900 or 212 924-6000

## NORTH CAROLINA

**Charlotte**  
Brownell Electro, Inc.  
704 394-4341  
Electrical Insulation Suppliers, Inc.  
704 392-2306  
Essex International Inc.—IWI Div.  
704 394-1315  
**Winston-Salem**  
Cramer/E. W. Winston-Salem  
919 725-8711

Electrical/electronic materials  
from

# DOW CORNING

DOW CORNING

## OHIO

**Cincinnati**  
Cramer/Tri States, Inc.  
513 771-6441  
Electrical Insulation Suppliers, Inc.  
513 771-4073  
Sheridan Sales Co.  
513 761-5432  
Essex International Inc.—IMC/IWI Div.  
513 771-6500  
**Cleveland**  
Essex International Inc.—IMC/IWI Div.  
216 781-2310  
Prehler Electrical Insulation  
216 267-2650  
Sheridan Sales Co.  
216 524-8210  
**Columbus**  
McGraw-Edison Co.  
National Electric Coil Division  
614 488-1151

## OKLAHOMA

**Oklahoma City**  
Essex International Inc.—IWI Div.  
405 236-5411

## OREGON

**Portland**  
Essex International Inc.—IWI Div.  
503 655-0138  
C. E. Riggs, Inc.  
503 226-3286

## PENNSYLVANIA

**Harrisburg**  
Pytronic Industries, Inc.  
717 233-6591  
**Montgomeryville**  
Pytronic Industries, Inc.  
215 643-2850  
**Philadelphia**  
Brownell Electro, Inc.  
215 632-3030  
Essex International Inc.—IWI Div.  
215 236-7100  
Prehler Electrical Insulation  
215 725-5014  
**Pittsburgh**  
Essex International Inc.—IMC/IWI Div.  
412-242-5560

## TENNESSEE

**Memphis**  
Brownell Electro, Inc.  
901 323-8554  
Electrical Insulation Suppliers, Inc.  
901 947-4176

## TEXAS

**Dallas**  
Essex International Inc.—IWI Div.  
214 339-8346  
Specialized Products Company  
214 358-4663  
Williamson Distributing Corp.  
214 741-5831  
**Houston**  
Essex International Inc.—IWI Div.  
713 227-6358  
Williamson Distributing Corp.  
713 672-1715

## UTAH

**Salt Lake City**  
Hyer/Cramer Electronics  
801 487-3681

## WASHINGTON

**Seattle**  
Atlas Packing & Rubber Co.  
206 623-4697  
Essex International Inc.—IWI Div.  
206 763-8650  
C. E. Riggs, Inc.  
206 623-5707

## WISCONSIN

**Milwaukee**  
Essex International Inc.—IMC/IWI Div.  
414 342-3927

8-2200

# Sooner or later you'll be considering a **MECL 10,000** design.

Since the introduction of MECL 10,000 in March, 1971 engineers have found that designing with MECL is no more difficult than designing high performance equipment with slower forms of logic. In fact, designers found that MECL features such as transmission line capability, complementary outputs and Wired-OR savings added as much to system performance as the short propagation delays and high toggle rates.

To appreciate these system advantages you have to evaluate. And here is a way that will make your job easier:

1. We are introducing four new MECL 10,000 devices bringing the family total to 38. Each new device is highly versatile and could be used for a variety of applications.
2. We have prepared a Design File which includes data sheets describing the new products, an application note covering interconnection techniques, and an application note illustrating varied uses of two of the four new devices.
3. This complete Design File will help you to evaluate the new additions and provide an insight into the application of MECL 10,000 for your future designs.

## And that's not all.

Just to make it interesting, we have included a "Design Idea" sheet in the file so you can explore ways of using the new devices. Just jot down your circuit diagram showing possible applications using any one or more of the following:

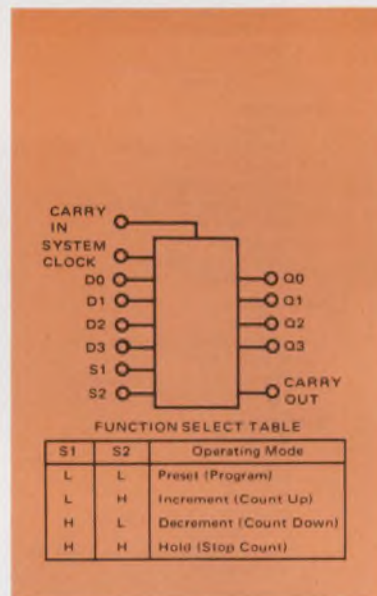

**MC10136 Universal Hexadecimal Counter, MC10137 Universal Decade Counter.** The MC10136 and MC10137 are both fully synchronous counters, MC10136 is a hexadecimal (0 thru 15 binary) counter, and MC10137 is a BCD decade counter. Logic configurations are similar for both counters.

The flexibility of these devices allows the designer to use one basic counter design for all applications. When used with appropriate MECL III prescalers, frequencies can be extended to over 500 MHz.

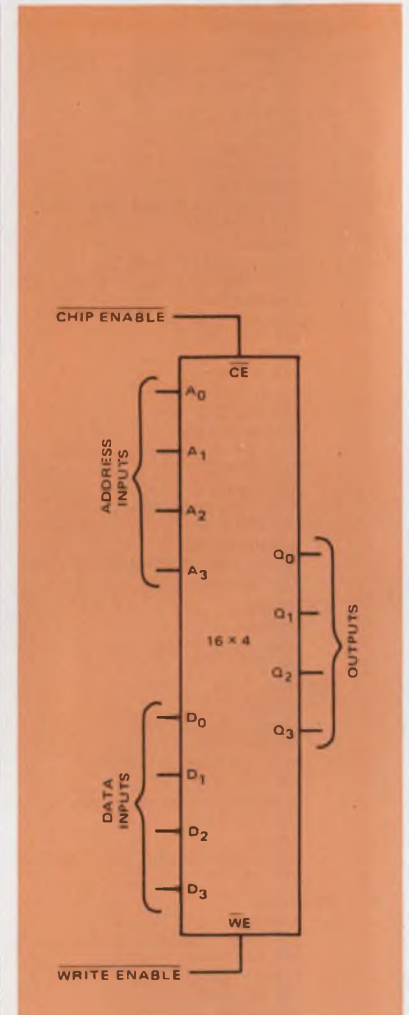

**MC10145 64-Bit RAM** Organized as a 16 x 4 array, the MC10145 is the first of a series of memories to be introduced in MECL 10,000. Fully decoded inputs, together with a chip enable, provide expansion of memory capacity. Access time is typically 10 ns, ideal for register file or small scratch pad applications.



# Here are four ways you can do it... sooner.

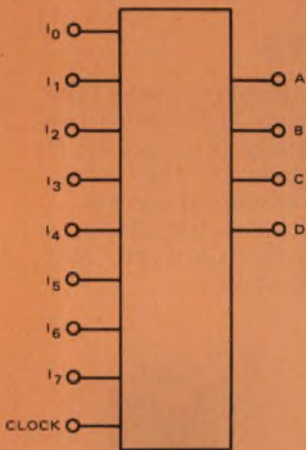

TRUTH TABLE

I <sub>0</sub>	I <sub>1</sub>	I <sub>2</sub>	I <sub>3</sub>	I <sub>4</sub>	I <sub>5</sub>	I <sub>6</sub>	I <sub>7</sub>	A	B	C	D
H	X	X	X	X	X	X	X	L	L	L	H
L	H	X	X	X	X	X	X	L	L	H	H
L	L	H	X	X	X	X	X	L	H	H	H
L	L	L	H	X	X	X	X	H	L	L	H
L	L	L	L	H	X	X	X	H	L	H	H
L	L	L	L	L	H	X	X	H	H	H	H
L	L	L	L	L	L	H	X	H	H	H	H
L	L	L	L	L	L	L	H	H	H	H	H
L	L	L	L	L	L	L	L	H	H	H	H
L	L	L	L	L	L	L	L	L	H	H	H
L	L	L	L	L	L	L	L	L	L	H	H
L	L	L	L	L	L	L	L	L	L	L	H
L	L	L	L	L	L	L	L	L	L	L	L

**MC10165 8-Input Priority Encoder** The MC10165 is designed to encode eight inputs to a binary coded output. The output code is that of the highest order input. Any input of lower priority is ignored. Applications include development of binary codes from random logic inputs, for addressing ROM, RAMs, or for multiplexing data.



**You're now on the way to becoming a high speed logic expert.**

After you have outlined your application, return the "Design Idea" sheet to Motorola Semiconductor Products Inc., Attention: MECL 10,000 Applications, P. O. Box 20912, Phoenix, Arizona 85036.

For each bona fide application submitted, we will send you, without charge, the comprehensive

MECL System Design Handbook and the newly printed, second-edition, MECL Data Book.

Together, these two books list the industry's broadest line of high-speed logic families and offer latest application techniques.

Act now. Send for your Design File today, and call your local Motorola distributor for evaluation devices. The sooner you evaluate — the sooner you'll be convinced.

**MECL 10,000 eliminates the alternatives. Evaluate and compare!**

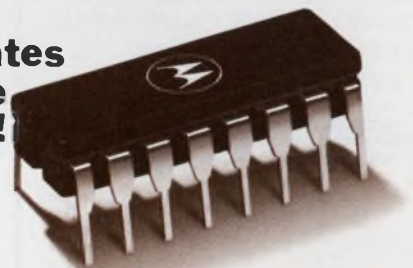

**MOTOROLA MECL**  
... for faster computers & systems

INFORMATION RETRIEVAL NUMBER 14

# YOU'LL BE SURPRISED AT THE SCOPE OF FAIRCHILD'S OPTO LINE

## SENSORS

15 standard phototransistor types to provide matched and standard sensitivity ranges. For large volume users interested in building their own hybrids, die are available.

Standard — Dome Lens  
Phototransistor

FPT 100, FPT 120

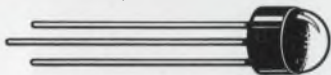

Standard — Flat Lens Precision  
Package Phototransistor

FPT 110, FPT 130

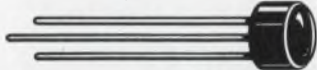

Metal Package — Phototransistor

FPT 101, FPT 102



Matched Sensitivity Dome Lens  
Phototransistor

FPT 220, FPT 320  
FPT 100 A, 100 B

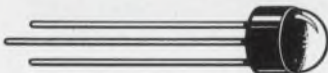

Matched Sensitivity Flat Lens  
Precision Package Phototransistor

FPT 110 A, FPT 110 B  
FPT 230, FPT 330

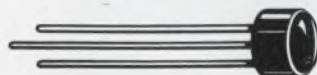

CIRCLE NO. 221

## LED LAMPS

22 types for use as panel status lamps, malfunction indicators, backlighting of push buttons and keys, and narrow beam projection sources. Available with clear, white and red lenses, large light emitting areas and pin point sources.

Point Sources

FLV 100, FLV 111, FLV 118

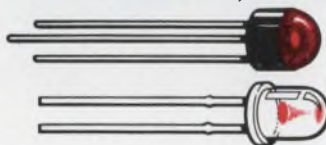

Wide Angle Panel Indicators

FLV 102, FLV 108  
FLV 116, FLV 115

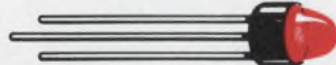

Panel Indicators

FLV 110, FLV 112  
FLV 117, FLV 119

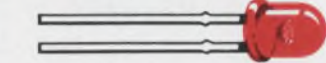

Narrow Beam Emitters

FLV 104

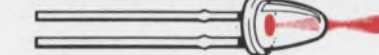

Backlighting Illuminator

FLV 103

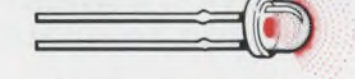

Subminiature Lamps

FLV 107



CIRCLE NO. 222

## DISPLAYS

$\frac{1}{8}$ " LED displays with the bold font that looks twice the size it actually is...  $\frac{1}{4}$ " LED displays made by the industry's most advanced process... *standard* calculator displays with or without drivers and scanners built-in.

FND 10  $\frac{1}{8}$ "

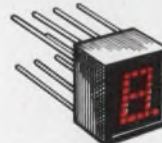

FND 70  $\frac{1}{4}$ "

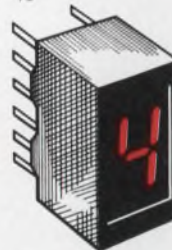

FNA 45 9-Digit DISPLAY  
with drivers

FNA 25 9-Digit DISPLAY  
without drivers

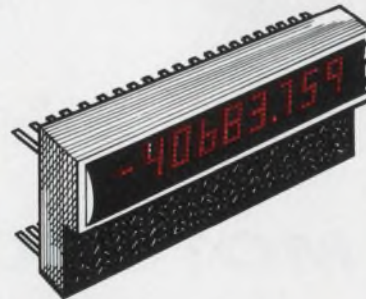

CIRCLE NO. 223

# Its Many Unique Products Offer New Problem Solving Capabilities

Chances are that Fairchild's Applications-Oriented opto line contains many products you did not know existed. These special products were developed to save you design time and expense by permitting you to design around a product line that offers functional as well as package variations.

For example. Developing your own light source/sensor system and need an LED that throws a beam up to 9 feet? Try the FLV 104. Designing keys and buttons with wording that is to be backlit? Order the FLV 103. Know who is the world's

largest manufacturer of phototransistors? Fairchild is the name. Like to develop your own Tape Reader Array and don't want to get involved in the problems and precision required to make one from individual devices? Order the FPA 100. Interested in card readers? Specify the FPA 101 for a 12-element source-sensor reader array. Looking for a linear self-scanned array? Look to Fairchild. Need a combination source-sensing array for detecting objects with reflective surfaces? Call out the FPA 103. Looking for a low cost  $\frac{1}{4}$ " LED

display that is reasonably priced even in small quantities? The number to say is: FND 70. Or, would you like a standard calculator display, with or without internal drivers? Look at the FNA series. Whether you want standard off-the-shelf opto devices, or custom products, the name to call is FAIRCHILD.

To see Fairchild optoelectronic lamps and displays in action, call your local Fairchild Semiconductor Sales Engineer. Many of the Fairchild Semiconductor Distributors also have demonstrators.

## OPTICALLY COUPLED ISOLATORS

Including large volume, moderately priced isolators, high voltage units for special applications and inexpensive isolators for minimum requirement applications.

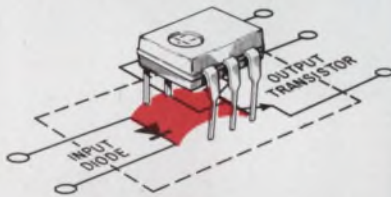

CIRCLE NO. 224

## IR EMITTERS

INFRARED LIGHT

FPE 100

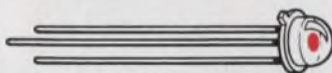

FPE 104

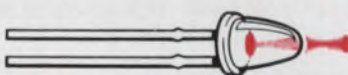

CIRCLE NO. 225

## ARRAYS

Fairchild arrays, such as those shown here, serve specific information-reading needs and also provide broad capabilities for applications requiring edge-, angle-, and position-sensing, counting and controlling as well as specific information reading units.

FPA 100 9-Element Source-Sensor Tape Reader Array

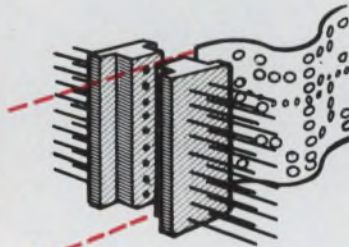

FPA 103 Reflection-type Source-Sensor Array

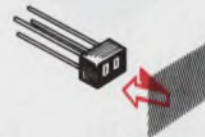

FPA 602 128-Element Linear Self-Scanned Array

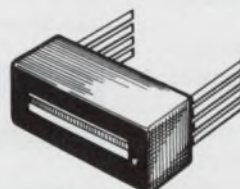

FPA 101 12-Element Source-Sensor Card Reader Array

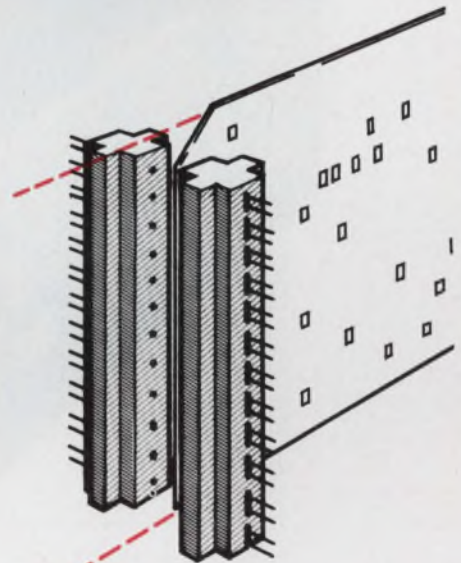

CIRCLE NO. 226

**MADE IN FAIRCHILD**

## FAIRCHILD SEMICONDUCTOR/MICROWAVE AND OPTOELECTRONICS

A Division of Fairchild Camera & Instrument Corp., 4001 Miranda Avenue, Palo Alto, Ca 94304. (415) 493-3100. TWX: 910-373-1278

# The Working Man's memory.

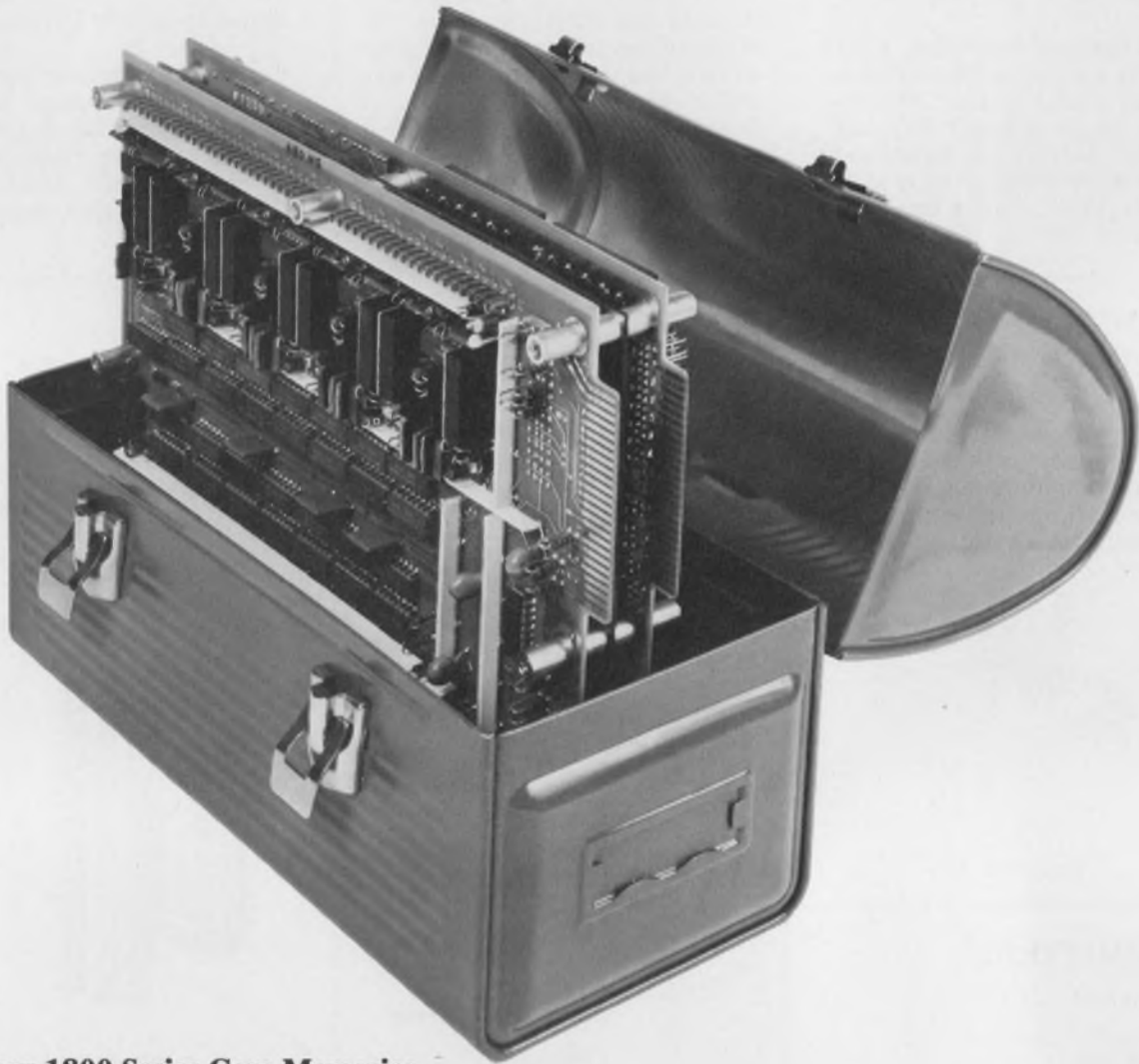

## Put Ampex 1800 Series Core Memories wherever you put people.

Standard Ampex 1800 core memories are designed for computers out where the action is. Where people work. In factories, on the job-site, in non-air-conditioned offices. Anywhere you need a core memory that doesn't constantly have to be babied to operate reliably.

Ruggedized versions of these same mini-modules also are available. They may be used with confidence inside moving vehicles, aboard ships and in most aircraft.

Best of all, access times are 230, 250 or 340 nano-seconds. And, 1800 core memories—standard or ruggedized—are lightweight, compact 4-pounders, measuring only 8" x 10" x 2". The basic module is 8K words x 18 bits, but modules may be combined to provide up to

64 K words in nearly any bit length desired. All modules are completely interchangeable.

Don't forget to call your Ampex specialist for details about the working man's memory. While you're at it, ask him about Ampex tape and disk drives, too.

# AMPEX

## AMPEX COMPUTER PRODUCTS DIVISION

13031 West Jefferson Boulevard  
Marina del Rey, Ca 90291, (213) 821-8933

"VISIT US AT FJCC BOOTH 1056"

## IEEE poll backs changes; pensions and lobbying due

Announcing overwhelming support by members for an amendment on professional activities, the IEEE plans a pension program for members and lobbying in Congress as part of its new activities.

Speaking in Boston earlier this month at the Northeast Electronics Research and Engineering Meeting (NEREM), Robert Tanner president of the IEEE, reported that unaudited ballot returns showed 85% in favor of the new amendment.

"Such a response," he said, "could only be viewed as a strong vote of confidence for new directions in the future of the institute."

Tanner said that 38.4% of the IEEE's members had voted on the amendment. He spoke at a panel session, "IEEE on the Spot."

The announcement drew an outspoken dissent from Walter Fee, vice president of engineering for the Northeast Utilities Service Corp. A critic of the new plan, he contended that in actuality only about 32% of the members had voted for the amendment. He also expressed concern over the recent increase in membership fees and predicted that there would be a significant drop in member participation in the IEEE's technical groups.

Other dissenting voices at the panel session expressed fear that the IEEE's new directions might encourage the formation of engineering unions or that the institute might take on a role similar to that of the American Medical Association, which allegedly exercises some control over the number of people entering the profession each year.

The pension setup envisioned by the IEEE would be "portable"—that is, it would cover members who switched jobs as well as those

who remained with one company indefinitely. According to Donald Fink, executive director of the IEEE, such a pension plan will be drawn up in the next six months.

The lobbying activities are to be centered at the recently opened Washington office of the IEEE and are to start as soon as the society has changed its tax status from a so-called C-3 organization, which is not allowed to influence the legislative process, to a C-6, which is. Contrary to popular belief the change will not seriously affect the tax-exempt status of the organization, Fink said. Members will still be able to deduct their dues as a business expense. But tax-deductible donations to the society will be ruled out. To remedy that, the institute is forming a new organization to be known as the IEEE Foundation. It will have the old C-3 tax status.

Tanner and next year's IEEE officers—Harold Chestnut, president, and John J. Guarrera, vice president—attempted to allay the fears of Fee and others. Tanner denied that the new directions would lead to the formation of engineering unions.

"Quite the contrary," he said, "if the IEEE did not change to meet the changing needs of its members, then a trend towards unionization would have developed."

### Laser printer puts digital data on paper

A nonimpact printer that uses a laser to transfer digital communications onto ordinary paper is being developed for the Army by the RCA Advanced Technology Laboratories in Camden, N.J.

Designated the MTR, for Material Transfer Recorder, the line printer's laser scans its beam across

a dye-coated plastic ribbon to transfer messages onto paper at a speed of 1000 lines—60,000 words—a minute. This is as fast as existing mechanical line printers now operate.

Since there are no keys to break or wear out, there will be fewer maintenance problems, Paul E. Wright, director of the RCA laboratory points out. Also, the use of ordinary paper will cut costs.

The MTR, through its data interface, can receive any type of digital communications from a wide variety of sources—computers, teletypewriters or satellite ground terminals. In operation, the MTR receives the coded digital data, decodes them and stores them in a buffer memory, one line at a time. The buffered input is then restructured so that an electrical signal drives a modulator to change the laser's intensity and to generate the copy.

The character, or letter, is actually made up of many dots resembling those used in a LED display. The result is a very-high-resolution matrix.

The MTR is transportable and can be used in the field in a van or other military shelter. Two feasibility models are scheduled for delivery to the Army Electronics Command, Fort Monmouth, N.J., in December, 1973.

### Thick-film paste narrows line widths

An unconventional photoprintable paste narrows conductive thick-film coatings so that they approach the line widths of thin films. Reducing the present practical limit of 5-mil line widths and 5-mil spaces, duPont's Fodel gold paste forms conductor lines that are 1-mil wide and between 3-mil spaces.

Conventional thick-film processing can be used, thereby avoiding the extra expense of a thin-film approach. Yet the film has a fired thickness of only 0.2 mil, allowing improved uniformity from pad to pad for a flatter surface and consequently easier beam-lead bonding. Sheet sensitivity is 10 to 15 MΩ sq.

Details of Fodel were disclosed in a paper presented at a meeting last month in Washington, D.C. of the International Society for Hy-

brid microelectronics by Dr. David H. Scheiber and Dr. Richard M. Rosenberg of duPont's Photo Products Dept.

Fodel's high bondability to gold or aluminum wire allows bond strength after ultrasonic bonding to be as high as that in many thick-film metalizations, according to duPont. Beam-lead bonding strength is reported to be higher than that of the beams themselves.

For interconnections in multilayer hybrids, a companion dielectric is being developed by duPont for introduction in early 1973. The goals are for 5-mil or smaller vias in a pinhole-free glass with a dielectric constant of 10 or less to minimize capacitance.

Fodel consists of a combination of a special gold powder, an inorganic oxide binder and a photosensitive cross-linkable vehicle. The inorganic oxide is similar to that used in thick films to provide a vitreous binder.

Though conventional thick-film processing may be used with Fodel, special equipment is required to align the mask, to expose the substrate to ultraviolet light and to develop the film.

The processing starts by screen-printing the paste onto a substrate and then drying the coated substrate. Next, the dried substrate is placed in a vacuum frame, masked with either a film or glass mask, and exposed to ultraviolet radiation. Following development in a flowing stream of perchloroethylene, the substrate is dried and fired. The system fires in air, removing the photosensitive vehicle. No carbonaceous residues are left after firing.

## Thin-film optical switch modulates laser beam

Another step toward an operational optical integrated-circuit communication system was taken by Bell Telephone Laboratories scientists at Holmdel, N.J., and Murray Hill, N.J., with the demonstration of a thin-film optical switch for a laser beam.

The new switch, which can potentially transmit a large amount of data on laser beams consists of three elements: a 2.5- $\mu\text{m}$  yttrium gallium scandium iron garnet thin

film, a gadolinium gallium garnet substrate and a conductive pattern deposited on the thin film.

The switch substrate, about 3/4-in. across, has prisms mounted on it at each end. The laser beam is guided into the thin film—which has magneto-optical properties—by one prism, and the beam is extracted by the second prism.

The thin film acts like a waveguide, and the direction at which the beam exits depends on the propagation mode of the laser light through the film.

Without energizing the conductive pattern, the laser beam enters and is conducted by the thin film in the TM mode and exits in that same mode.

To switch the beam direction, the propagation mode is changed by applying a small current to the conductor pattern. This creates a weak magnetic field that converts the laser energy to the TE mode, and the energy is then guided out in that mode by the exit prism.

In Bell's experiment, less than 100 mW of power was required to modulate a 1.15- $\mu\text{m}$  helium-neon laser beam at 80 MHz.

## IEEE show to ease exhibitors' burden

When Don Larson, Wescon show manager, also took over as manager of the Intercon/73 IEEE show, he took along some innovations that have proved successful at the West Coast Shows.

Intercon/73 IEEE will be held next March 26-30 at the New York Coliseum and the Americana Hotel. The exhibits will open on a Tuesday, and they will run through Friday. This differs from the IEEE's usual Monday through Thursday plan for the show. Larson points out that exhibitors will have Monday to set up their displays without need to pay weekend overtime labor rates.

The technical sessions will all be held at the Americana, and they

## News Briefs

**Production on the world's first all-electronic desk clock** has been announced by Ness Clocks, Ltd., of Palo Alto, Calif. The new timepiece incorporates an LSI timing circuit similar to those used in

will start Monday afternoon and continue through Friday morning.

Other IEEE show innovations include the following: preprints of full manuscripts from all technical sessions; guaranteed room rates at selected hotels; a computerized registration system that will produce badges in the form of plastic "inquiry cards;" and special pre-packaged booth units.

## Missile tiltmeter to spot eruptions in the earth

A tiny level-detection device developed nearly 15 years ago for Minuteman I is being readied for installation in volcanoes and along faults in the earth to warn of impending eruptions.

Known as a "down-hole" tiltmeter, several of the devices have been installed by the U.S. Geological Survey in the Kilauea volcano in Hawaii and by the California Div. of Mines and Geology along the San Andreas fault in Calif.

Developed by the Autonetics Div. of North American Rockwell in Anaheim, Calif., the tiltmeter is small enough to be lowered into a three-inch-diameter borehole. It can detect movement as slight as 1/60,000 of a second of arc—the elevation of a half dollar at a distance of 3000 miles. It will measure movements and radio the data to an orbiting Earth Resources Technology Satellite (ERTS). The satellite will relay the signal to NASA's Deep Space Tracking Station at Goldstone, Calif. The data will then be processed by computer.

The tiltmeter is essentially a bubble level using liquid electrolyte that is sealed into a glass disc about an inch in diameter and 1/4-inch thick. Platinum electrodes on the disc detect the presence or absence of the liquid when the disc tilts and activate an electrical signal that is converted to a radio transmission. Plans are to install the device in earthquake and volcanic regions around the world.

the new electronic calculators. Time is displayed digitally on a liquid-crystal readout. Accuracy of several seconds a month is promised with the clock which will sell for \$150.



# Better system protection against transient voltages

## ... Better than selenium

Both DC and AC models now available.

GE-MOV™ metal oxide varistors make use of a new technology. They provide tight voltage clamping and high energy absorption . . . better than selenium. Present models offer AC voltage ratings from 100 to 1000V. Energy absorption ratings range from 10 to 160 watt-seconds (joules).

Prices are as low as \$.70 in quantity lots. For more information, including a FREE EVALUATION KIT, call your local authorized GE semiconductor distributor . . . or write to General Electric Company, Semiconductor Products Department, Building 7, Mail Drop 49, Electronics Park, Syracuse, N. Y., U.S.A.

### GE-MOV SUPERIOR FEATURES:

- Clamping Ratio
- Size
- Peak Current
- Energy Density

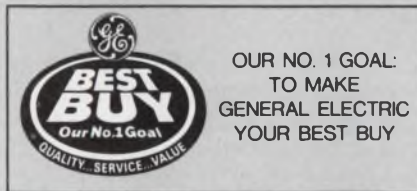

### COMPETING SELENIUM SUPPRESSORS

Mfrs.	Commercial or Trade Names	Device Nomenclature			
		Selenium Suppressors			
		1 inch Square	2 inches Square	4 inches Square	5" x 6"
IR (W)	Klip-Sel Volt-Trap	KSA ----	KSL ----	KSP ----	KSF ----
		SO1, 2AA --	SO3AA ----	SO6AA ----	SO9AA ----
Syntron Sarkes Tarzian	Surge Stop Klip Volt	SD1544 --	SD2650 --	SD2411 --	SD2452 --
		2KV26 ---	5KV26 ---	7KV26 ---	10KV26

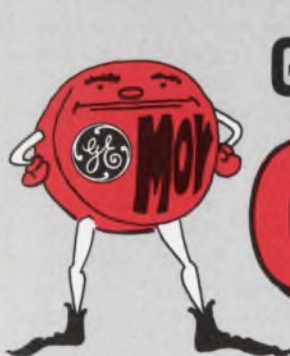

GENERAL  ELECTRIC

# GE-MOV™ VARISTORS

ASSURE YOUR EQUIPMENT WILL ENDURE

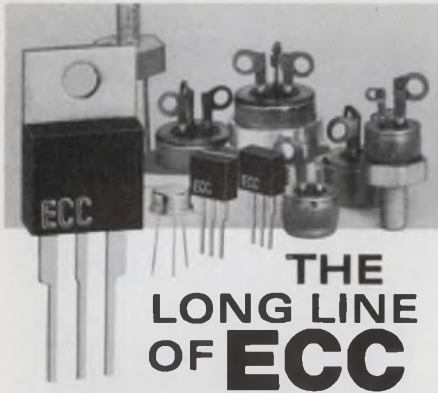

## THE LONG LINE OF ECC

Sensitive and Standard Gate

# SCR's

Fast delivery and competitive prices make ECC's extensive line of SCR's your best buy.

### SENSITIVE GATE SCR's

TO-5 Metal;  $\frac{5}{8}$ " Hex Stud; THERMOPAK\* and THERMOTAB® Packages

$I_{T(RMS)}$  0.8 - 10 amps  
 $I_{GT}$  50, 200, 1500  $\mu$ amps max  
 $I_{TSM}$  50, 100 amps min  
 $V_{DOM}$  30 - 600 volts min

### STANDARD GATE SCR's

TO-5 Metal;  $\frac{5}{8}$ " Hex Stud; THERMOPAK and THERMOTAB;  $\frac{1}{2}$ " Press-Fit and Stud;  $\frac{3}{4}$ " Press-Fit, Stud and TO-3 Packages

$I_{T(RMS)}$  0.8 - 35 amps  
 $I_{GT}$  10, 25 ma max  
 $I_{TSM}$  50 - 325 amps min  
 $V_{DOM}$  30 - 800 volts min

$\frac{5}{8}$ " Hex Stud; THERMOPAK and THERMOTAB;  $\frac{3}{4}$ " Press-Fit, Stud and TO-3 Packages are electrically isolated.

All ECC SCR's feature heavily glass passivated junctions for high reliability. They are available from your nearest ECC Sales Representative or Authorized Distributor.

\*trademark of ECC



New Condensed Catalog contains technical data on these and other ECC semiconductors. To receive your copy, circle No. 240.

**ECC**  
CORPORATION

P.O. Box 669 • Euless, Texas 76039  
817/267-2601

## technology abroad

An on-line, computer-based tele-control system to operate distribution supplies of 43 substations will be produced by Westinghouse Automation of Wiltshire, England. A main benefit of the system, which will be sold to the South Wales Electricity Board, is to be its ability to restore the power supply more rapidly following a failure. The control center will include both central and standby computer systems with disc storage, tape punch and reader, teletypewriters and a data logger. Data will be displayed on a color CRT and will be selected from any one of the 43 substations.

CIRCLE NO. 441

A flying-spot scanner for converting visual information into a form suitable for computer processing is being ordered by the Swedish defense authority from Ferranti, Ltd., of Britain. An essential requirement of the system is that the final geometry of the output display accurately repeat that of the input picture—taken from film—within 0.05%. When the scanner is used in the write mode, feedback is provided by an energy-monitoring system that compares an analog video input signal and the energy output of the CRT screen. The system integrates the power from the screen with respect to time, resulting in a direct measure and control of the energy received by the original film.

CIRCLE NO. 442

Degradation of specimens in an electron-beam microscope under high-intensity electron bombardment has been overcome by use of a low-light-level television camera, according to scientists at Britain's National Physical Laboratory. With this arrangement and the use of a nondestructive low-powered electron beam, extreme-

ly dim images have been observed by the camera. Up to now, the laboratory's scientists say, the electron-beam microscope has been limited to observing specimens by means of a high-intensity electron bombardment. The new system consists of an EMI-Sony MTV-1 closed-circuit television camera with an EMI Ebitron intensifier-vidicon. The sensitivity is some 500 times greater than that of a standard vidicon, according to EMI Electronics of Middlesex, England, the tube manufacturer. Applications for this system range from strain and heating effects on metals to studies of chemical reactions in an environmental cell.

CIRCLE NO. 443

A computer-based interactive graphics system for the design of LSI circuits is being developed by Ferranti, Ltd., of Britain. The aim is to speed and expand the company's custom design service. Ferranti is committed to the collector-diffusion-isolation design process.

CIRCLE NO. 444

A study to develop a high-gain despun antenna system for a proposed Venus orbiter spacecraft will be carried out by the British Aircraft Corp. in Surrey, England. The company will examine the various methods of dispinning the antenna (spacecraft are normally spun during flight for stabilization purposes) and present its recommendations to the European Space Research Organization. Despinning the antenna will be necessary for transmission of telemetry and tracking data to earth stations. The orbiter is designed to measure long-term variations in the Venusian atmosphere.

CIRCLE NO. 445



# The Sperry eye test for display equipment buyers

E  
S P



The above is a printed interpretation of the appearance of the more popular displays. You are encouraged to make the same comparison with actual devices.

The old saying "what you see is what you get" certainly applies to the purchase of equipment incorporating displays — panel meters, DVM's, multimeters, counters, instruments, calculators and other equipment. If you can't clearly and easily read the information being displayed then you're not getting full product value. And, you're obviously not getting equipment supplied with advanced Sperry planar displays†.

How do you tell if they're Sperry displays? Simply take the Sperry eye test.

1. Do the displays appear as uniformly bright, continuous characters with no irritating gaps or filaments and screens to reduce readability?  
 YES  NO
2. Do the displays remain bright and clearly legible with no glare or appreciable fading even under direct sunlight conditions?  
 YES  NO
3. Can you quickly, easily and accurately read the displays from 20 to 40 feet away?  
 YES  NO
4. When the unit is positioned within a 130° viewing angle, can you still clearly read the displayed characters?  
 YES  NO

If you answered YES to all four questions, you already have your eyes on equipment featuring preferred Sperry displays.

If you answered NO to any of the questions, you owe it to yourself to take a comparison look at products equipped with superior Sperry displays.

#### FREE BUYER'S GUIDE —

To help you make the right equipment selection, Sperry offers the handy "Buyer's Guide for Equipment featuring Electronic Displays". It's yours for the asking. Order your copy today by checking the reader service card or phone or write: Sperry Information Displays Division, P.O. Box 3579, Scottsdale, Arizona 85257, telephone (602) 947-8371.

**SPERRY**  
INFORMATION DISPLAYS



Sperry 1/3"

Sperry 1/2"

units are available for use with red filters

## It's a whole new ball game in displays!

 SPERRY RAND

† Patents Pending  
\* NIXIE is the registered trademark of The Burroughs Corporation.

specify the  
**BETTER 3/4" LONG**

10-TURN PRECISION POTENTIOMETER

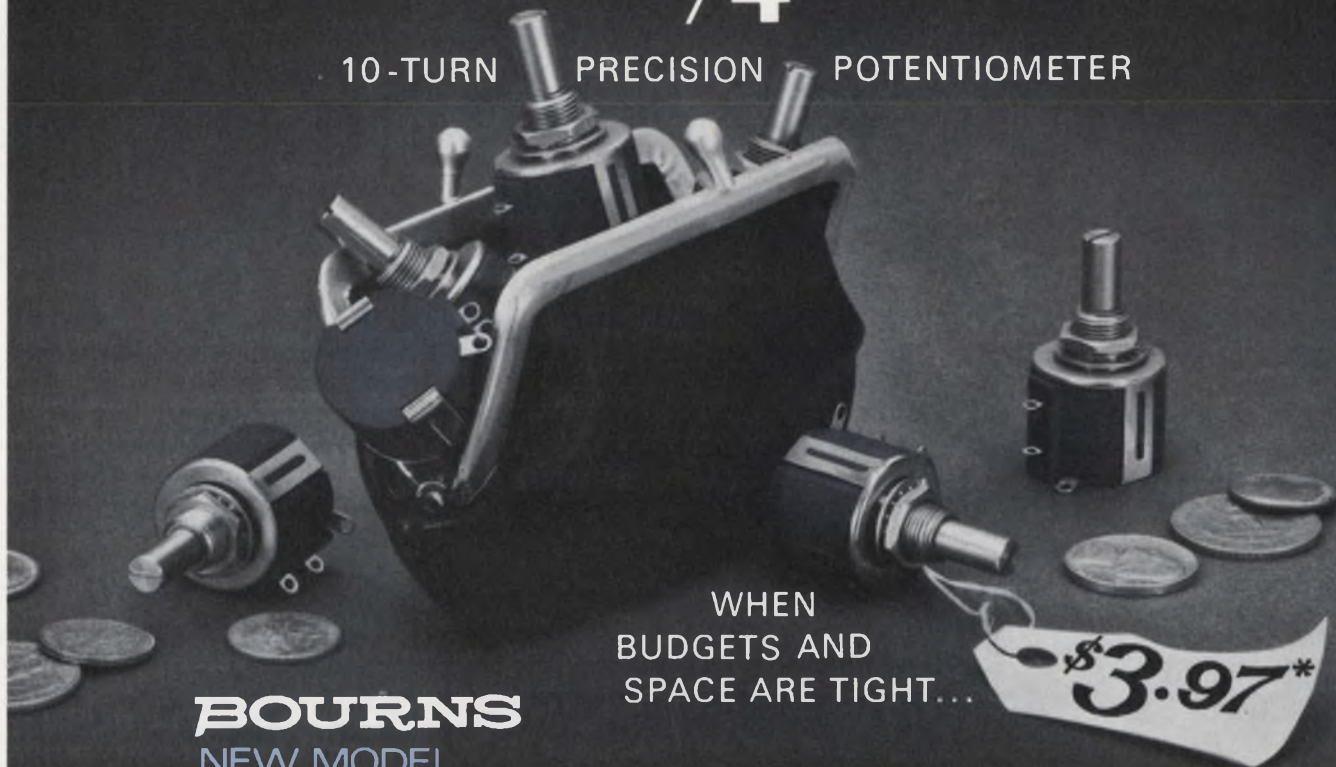

WHEN  
BUDGETS AND  
SPACE ARE TIGHT...

\* 1000-1999 quantity  
U.S. Dollars, F.O.B., U.S.A.

**BOURNS**  
NEW MODEL  
**3540**

*MODEL 3540 IS RUGGED, TOO!  
CHECK THE EXCLUSIVE CONSTRUCTION FEATURES.*

- SILVERWELD® UNITIZED TERMINATION — Why settle for multi-joint, terminal-to-element connection? Get the direct element-to-terminal connection method that guards against catastrophic failures
- MOLDED-IN, SHAFT-TO-ROTOR CONSTRUCTION — This Bourns feature optimizes stop-strength and minimizes accidental rotor/shaft displacement and slippage
- NON-CEMENTED, ALL-MECHANICAL ASSEMBLY. Snap-on straps provide all-mechanical assembly. No cemented joints, heat-forming, or ultrasonic welding

*LOOK AT THE SIGNIFICANT SPECS!*

- LINEARITY: 0.25%
- TEMPERATURE RANGE: -55 to +125°C
- RESISTANCE RANGE: 100 ohms to 100K ohms

*FOR COMPLETE DETAILS AND PRICES...CONTACT YOUR LOCAL BOURNS REPRESENTATIVE, FIELD SALES OFFICE, OR THE FACTORY DIRECT.*



BOURNS, INC., TRIMPOT PRODUCTS DIVISION • 1200 COLUMBIA AVE., RIVERSIDE, CALIF. 92507

# washington report

## **Curbs on foreign trade protested**

Industry executives are voicing impatience with the Government for its "slowness" in lifting trade restrictions with foreign countries. The prospect of vast new markets for electronic gear as a result of recent agreements with the Soviet Union and mainland China has become increasingly frustrating for electronics firms. They're discovering that items they could sell abroad are still on the Government's prohibited list. Making the situation even more intolerable is this finding by members of a recent U.S. communications trade mission to Poland: Products that American manufacturers are forbidden to sell are being sold to Poland by U.S. allies. The Commerce Dept. is reviewing the export controls and promises that some restrictions will be lifted soon.

On the other side of the coin, Commerce Dept. figures show that imports of communications and other electronic equipment are rising faster than exports. For the first six months of this year, imports were up by 28.8%. Communications and electronics imports accounted for \$1.27-billion of the total, while exports of these products totaled only \$915-million.

## **AT&T enters the data-transmission race**

With a new transmission technique called "data under voice," American Telephone & Telegraph has moved to get a hefty chunk of the fast-growing data-transmission market. Competing against the MCI Communications Corp. and Data Transmission Co. (Datran), the communications giant has asked the Federal Communications Commission for permission to build an initial \$1.3-million network linking Washington, New York, Boston, Chicago and Philadelphia. The data-under-voice technique that AT&T would use was developed at Bell Telephone Laboratories. In the system employing it, the data hitchhikes with analog transmission on the lower end of the radio-frequency spectrum.

Meanwhile the FCC continues its investigation of AT&T affairs, including both profits and relationships with subsidiaries.

## **Justice Dept. seeking evidence against IBM**

The Justice Dept. will take depositions from a number of individuals in the computer field in an effort to bolster its charge that International Business Machines has monopolized the computer market. Officials of Control Data and Honeywell, Inc., will give testimony Nov. 27, and an

IBM official will be questioned a few days later. IBM has appealed a court order that would force it to turn over to the Justice Dept. some 1200 documents that the company considers privileged.

Meanwhile IBM continues to press for an immediate trial of the market issues in the Government's antitrust suit in Federal Court in New York City. The company says it is prepared to update market figures showing its position in the field and thereby prove that the Government's proposal to break up IBM is unwarranted.

## **FCC weighs domestic-satellite protests**

Federal Communications Commission officials report they have received several protests against the Communications Satellite Corp.'s proposal to join with MCI Communications and Lockheed in a company to be called the Space Communications Corp. for the purpose of owning and operating a domestic satellite system. The FCC is not expected to rule on the matter until at least the end of the year.

Meanwhile, even as the National Aeronautics and Space Administration prepared to launch Telesat A to give Canada her own domestic satellite system, U.S. companies anxiously awaited FCC rulings on their requests to give this country similar capability. Proposals awaiting rulings included those from a Fairchild Industries/Western Union International team; a General Telephone & Equipment/Hughes team; and Western Union. An RCA Alaska/RCA Global Communications proposal still lacked specific details to qualify for a ruling, FCC said.

## **'Big Brother' network idea rejected**

A White House science adviser, Dr. Edward E. David, says the Administration will never accept a proposal to create a "wired" nation in which the Government could communicate directly, at all times, with its citizens. He responded to a charge by Rep. William Moorhead (D-Pa.), who said that a secret White House document entitled "Communications for Social Needs," describes a "big brother" operation in which the Government would set up a system of transmitters to broadcast to FM receivers mandatorily placed in every car, boat, aircraft, radio and TV set. David, who is head of the White House Office of Science and Technology, said the idea had been proposed by an advisory panel some time ago and had been rejected outright.

**Capital Capsules:** The Electronic Industry Association's satellite telecommunications section is **prodding the Transportation Dept. to get on the job of starting an aeronautical satellite system for communications and navigation services.** The technology is in hand, it indicates. . . . The Federal Aviation Administration has selected the Westinghouse Electric Corp. and General Electric to develop **new concepts for detecting firearms and explosive devices in luggage and handbags.** Westinghouse will explore X-ray absorption and GE X-ray fluorescent techniques. . . . **Sales of receiving tubes for the first seven months of the year, both domestic and foreign produced, declined 7.4%** compared with the same period last year, according to the EIA. Last year's sales totaled 124.9-million units, and this year only 115.7-million.

"...systems manufacturers have told me these speed / measurement capabilities are impossible..."



"... now you tell me I can have them easily with the **TEKTRONIX S-3260 Automated Test System.**"

The TEKTRONIX S-3260 Automated Test System performs Functional, DC and Dynamic Tests **at rates up to 20 MHz with nanosecond response characteristics.** This remarkable performance is the result of **CRITICAL-PATH FIXTURING™** developed by Tektronix, Inc. to do tough jobs, fully testing devices with up to 128 active pins. All tests on a device are performed with a single test fixture. This means one insertion, one program, one system to do all your tests on any one device type.

The S-3260 hardware/software package will test: MOS and bipolar shift registers, random access memories, read-only memories, MOS and bipolar logic arrays, circuit boards, modules and subsystems.

Your TEKTRONIX Field Engineer can arrange a discussion about the S-3260 and Critical-Path Fixturing with a Systems Specialist. Call him or write Tektronix, Inc., P.O. Box 500-A, Beaverton, Oregon 97005.



**S-3260 Automated Test System**



**TEKTRONIX®**

*committed to  
technical excellence*

INFORMATION RETRIEVAL NUMBER 20



## **Still paying for oscillator stability you don't need?**

Plug in our K1065A instead. Medium stability and price. 1 to 5 MHz range:  $3 \times 10^{-8}$  stability for  $-20^{\circ}$  to  $+55^{\circ}\text{C}$ ; less than  $5 \times 10^{-9}$  aging per day. Prototype quantities available for immediate delivery in 1.0 MHz and 5.0 MHz. Details available from Motorola Component Products Dept., 4545 W. Augusta Blvd., Chicago, Ill. 60651.  **MOTOROLA**



Now..... Mini power modules deliver

**5V @ 1.5 amp**  
**or**  
**±15V @ 350mA**

These 3.5" x 2.5" x 1.25" encapsulated power modules may be mounted on p.c. boards. The Model 5E150 delivers 5V @ 1.5A with regulation of  $\pm 0.3\%$  and ripple of 1 mv. Price \$98. The D15-35 provides tracking  $\pm 15V$ ; the D12-35,  $\pm 12V$  (350 ma per output). Regulation  $\pm 0.05\%$ ; ripple 1 mv; price \$105. Standard input 105-125 VAC, 47-420 Hz.

Many other models also available.  
Three-day shipment guaranteed.



Acopian Corp., Easton, Pa. 18042 • Telephone: (215) 258-5441

**Reliability is staggered steps  
and a hunk of DAP.**

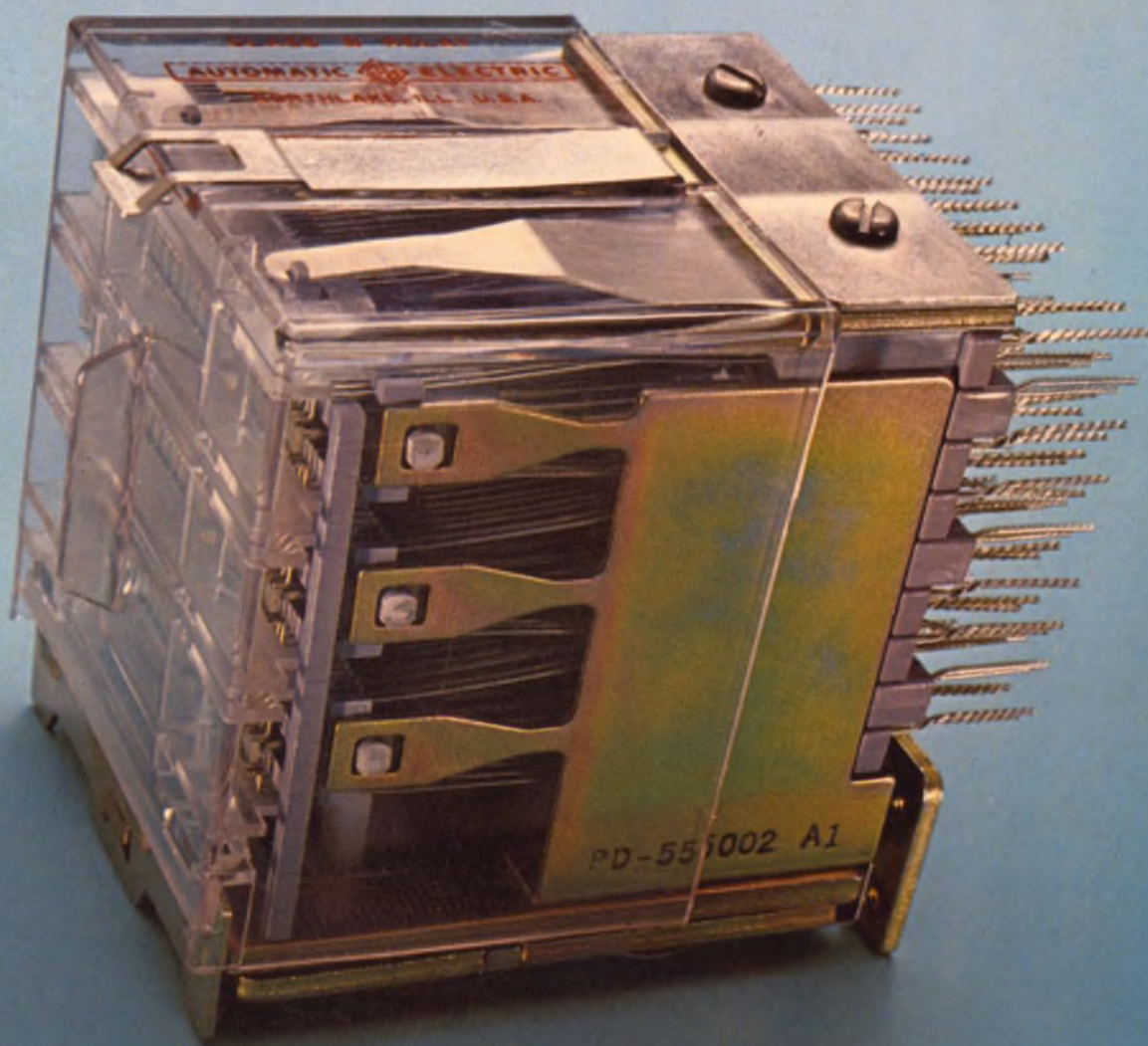



### **Expect over a billion operations.**

Our Class W wire-spring relay is different. In fact, there's nothing like it in the entire industry. Where else can you find a relay with lots of contacts and a mechanical life of more than a billion operations! That's about two and a half times the life of the best conventional relay around.

Another nice thing about our Class W is that it takes up a lot less space and costs less than using a bunch of other relays. That's because we build our Class W relay with one, two or three levels of contact assemblies, with 17 form C combinations per level. By the way, they're available with gold contacts for low-level switching.

### **Making it tough on creepage.**

All those staggered steps you see on the side were put in to raise the breakdown voltage between terminals. These molded steps add extra creepage distance between the terminals. This really counts for high voltage testing, or when using our Class W in unfavorable ambient conditions.

These steps, and all the molding compound used for insulating the contact springs, are made from

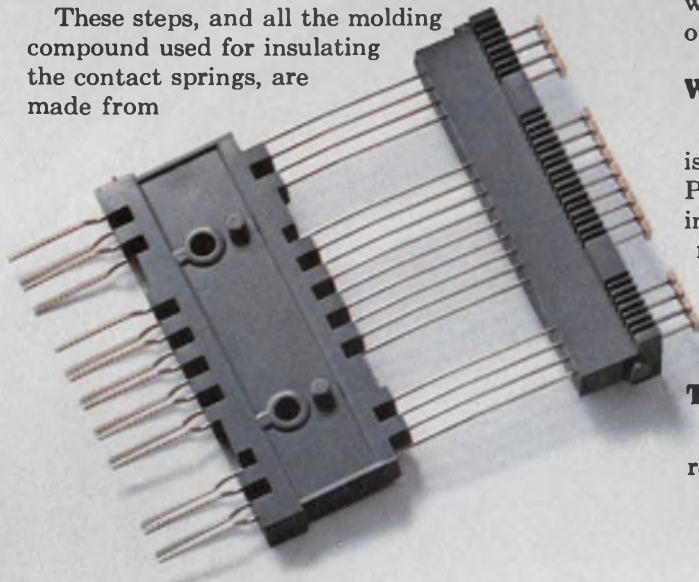

diallyl phthalate. (They call it DAP for short.) It has great insulating properties and it wears like iron. Even if the humidity is high, you have excellent protection.

### **Redundancy—two springs are better than one.**

Each of our long wire-spring contacts has an independent twin with the same function. One tiny particle of dust could prevent contact on other relays. Not with our Class W. You can be sure one of the twins will function. That's back-up reliability.

The twin contacts are twisted together at the terminal end. Then we give them a spanking (you might call it swedging) to provide solderless wrap.

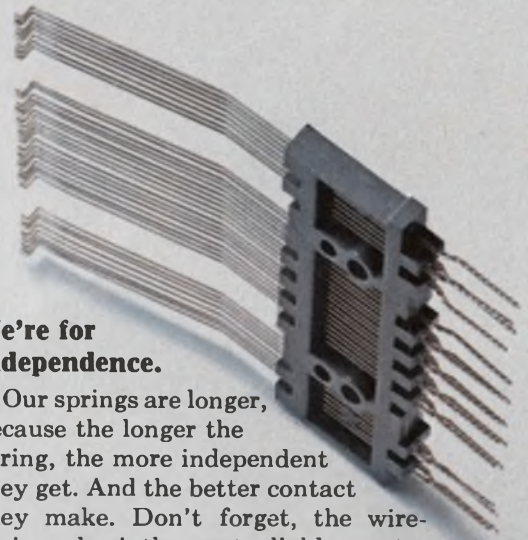

### **We're for independence.**

Our springs are longer, because the longer the spring, the more independent they get. And the better contact they make. Don't forget, the wire-spring relay is the most reliable way to get a permissive make or break contact. You can rely on it.

The middle contact springs have to be stationary. To make sure they stay that way forever, we actually mold them between two thick pieces of DAP on both ends. Just try to move one.

### **When we say flat, it's flat.**

Each frame, banged out by a gigantic machine is extra thick and extra flat. Then they're planished. Planishing is another step we go through in forming the frame to add strength and stability by relieving surface strain.

We've made our spring-loaded pile-up clamp extra thick, too. Once it's tightened down, the whole pile-up is nice and tight, and stays tight.

### **There's more.**

We could tell you a lot more about our Class W relays. Like how the tough high-temp molded

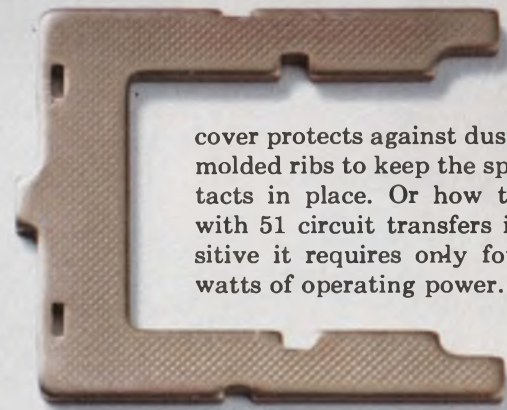

cover protects against dust and has molded ribs to keep the spring contacts in place. Or how this relay with 51 circuit transfers is so sensitive it requires only four to six watts of operating power.

But why don't you let us prove how much reliability we put into our Class W? We'll be waiting to hear from you. GTE Automatic Electric, Industrial Sales Division, Northlake, Ill. 60164.

# **GTE AUTOMATIC ELECTRIC**

# Solid State vs.

**Your  
Guardian Angel  
puts it  
all together!**

Control confusion? Contact Guardian. Perhaps the solution will be a solid state device. Or, an electromechanical relay. Or, a money-saving assembly combining both! Our vast experience in solid state, hybrid and electromechanical devices assures you the most effective possible solution.

**Choose the one best  
solution to your control  
design problems:**

- Solid State
- Hybrid
- Electromechanical
- All of the above
- None of the above
- Ask your Guardian Angel!

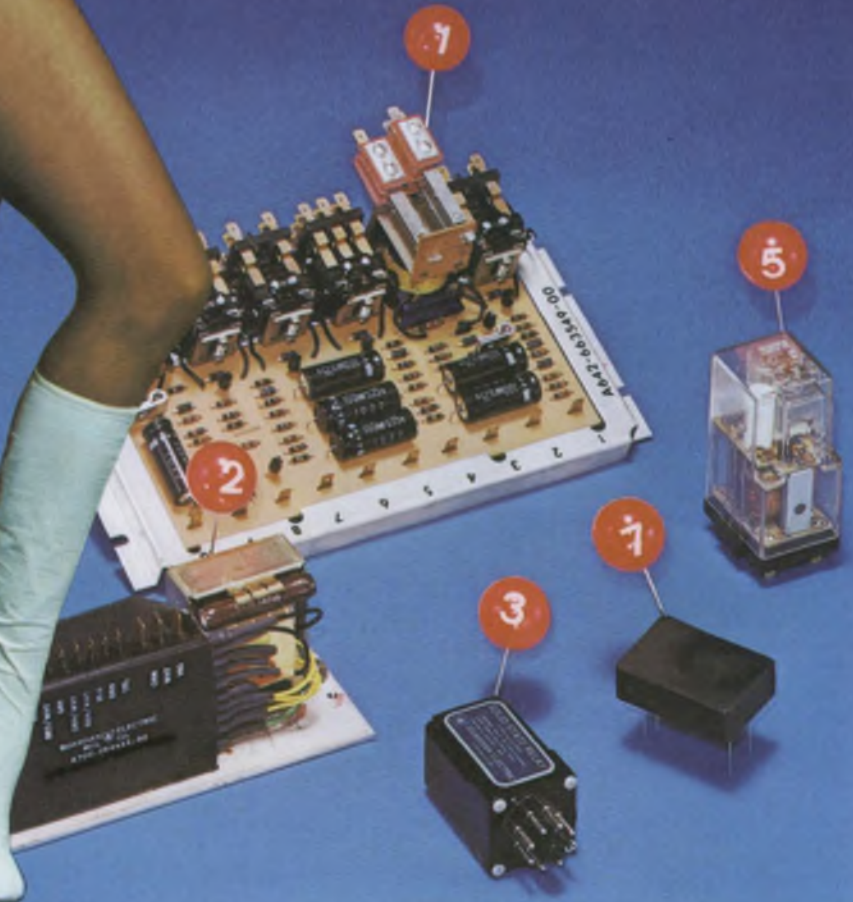

# Hybrid vs. Electromechanical?

**1** CUSTOM CONTROL PACKAGES for sequential switching at precise intervals. In most cases, numerous standard Guardian solid state devices could do the job. But, to lower total cost, Guardian can combine electromechanical and solid state into a single package. The result? Unique solutions to specific control problems demanding adjustable time delay, priority logic, voltage sensing, circuit isolation, or virtually *any* switching problem your system might demand.

**2** CUSTOM SOLID STATE CONTROL PACKAGES that put a dozen functions ranging from temperature sensing to time delay and voltage regulation in a single, miniaturized, low-cost module.

**3** SOLID STATE RELAYS that perform the function of electromechanical relays with total isolation between control circuit and switching output. Standard designs for most applications—custom designs at near-standard prices!

**4** SOLID STATE TIME DELAYS in just about any size, shape, form or delay range your application can demand. Need 30 minute delay? Guardian's got it. A 25 millisecond delay? We've got that, too. And they're yours right-off-the-shelf or in custom designs.

**5** HYBRID TIME DELAYS AND RELAYS for low-cost, dependable solutions to perplexing design problems. At Guardian they're yours in standard and custom designs.

**6** SOLID STATE VOLTAGE SENSORS that protect other controls and motors from the damaging effects of under-voltage or phase loss during power outages and "brown outs."

**7** ELECTRONIC "ZERO CROSSOVER" SWITCHES that form an electrical "cushion" between signal input and load power by switching at  $0.0VAC \pm 10V$ .



COMPLETE APPLICATION DATA IS IN THESE TWO FREE CATALOGS.

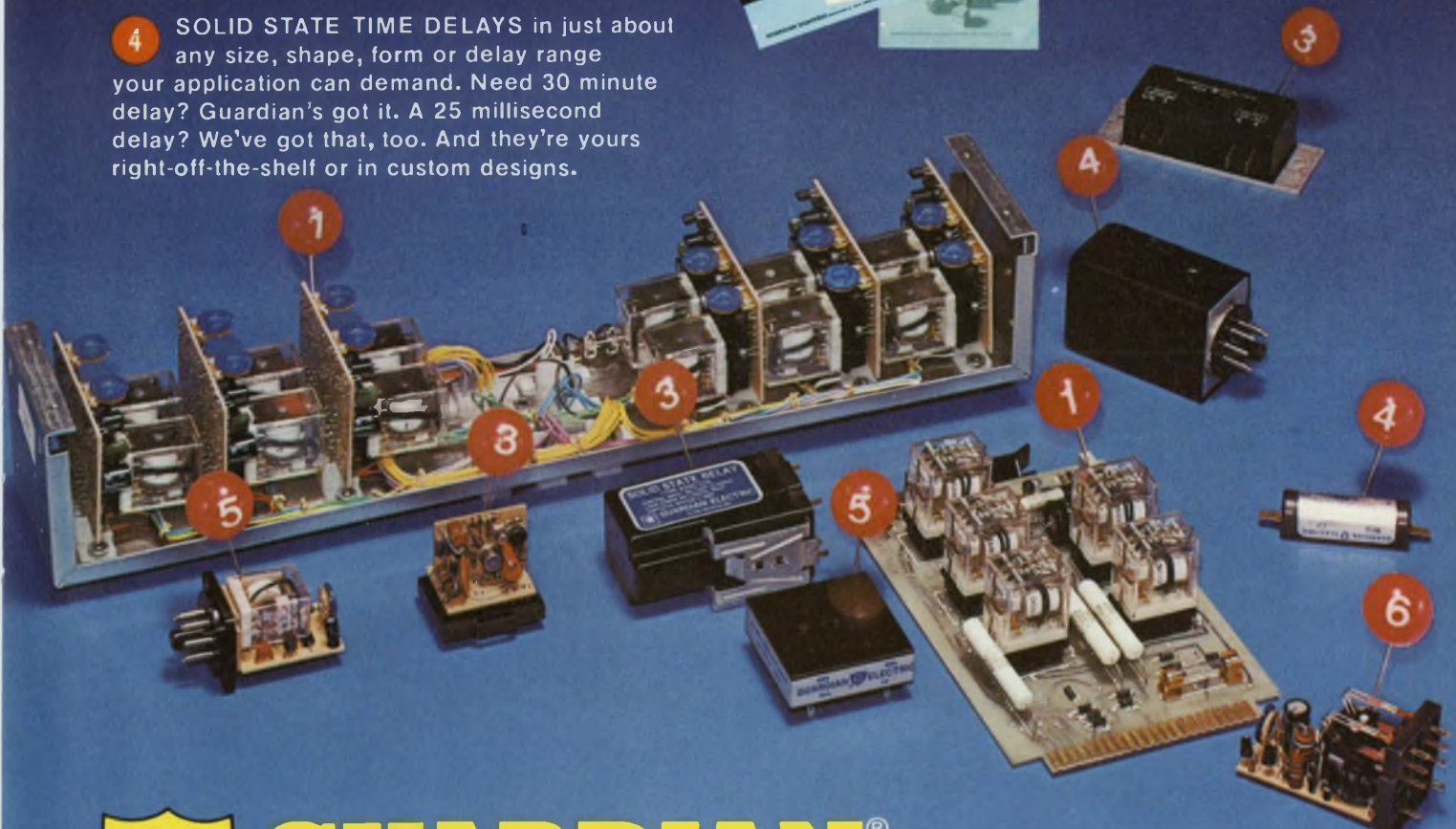

## GUARDIAN®

GUARDIAN ELECTRIC MANUFACTURING CO. • 1550 W. Carroll Ave. • Chicago, Illinois 60607

*Get your copies now!*

# Electronic Design's Special Anniversary Issue

November 23, 1972

A collector's item celebrating the 20th anniversary of *Electronic Design* with the 25th anniversary of the transistor. This issue is a compendium of major milestones in design -- a quarter century of design activity in such areas as consumer electronics, packaging and materials, computers, communications, components and instrumentation. This special issue is must reading for every designer. No engineer should be without it. Order extra copies now, for yourself and your associates, by filling in the order blank below.

**The complete issue  
for only \$2.00**

## Electronic Design 24

FOR ENGINEERS AND ENGINEERING MANAGERS

Electronic Design celebrates its 20th anniversary by saluting the transistor. Its 25th anniversary marks a quarter century of rapid progress. In all areas--consumer

electronics to space, packaging to instrumentation--the transistor and its solid-state descendants have left their indelible marks. Highlights begin on page 66.



William H. Smith, *Electronic Design Magazine*,  
50 Essex Street, Rochelle Park, N. J. 07662

Please send me \_\_\_\_\_ copies of  
*Electronic Design's* anniversary issue.

I enclose \$2.00 for each copy, including  
handling and postage.

- check  
 money order

Checks or money orders only, please.

Name \_\_\_\_\_

Firm \_\_\_\_\_

Street \_\_\_\_\_

City \_\_\_\_\_

State/Zip \_\_\_\_\_

# WANTED:

## Individuals of Demonstrated Ability, Innovation and Leadership:

*The Electronics Systems Group of GTE Sylvania has been extremely successful in securing major systems business. The Needham, Massachusetts Operation of The Electronics Systems Group is comprised of two divisions: The Communications Systems Division and the Eastern Division which can offer assignments from*

*conceptual activities through final equipment delivery. The broad range of tasks underway present a unique opportunity to choose assignments which will satisfy your career interests and goals. Our suburban Boston location affords a unique opportunity for educational, recreational and cultural activities.*

### ADVANCED MODELING TECHNIQUES

Unique opportunities for Engineers to draw on the capabilities of a major company and satisfy their professional ambitions. We seek innovators with experience in any of the following areas: Electromagnetic Propagation and Coupling; Antenna Theory; Network Modeling and Simulation and Systems Modeling. Requires BS in EE or Math and minimum of 10 years experience in system design, network analysis and a familiarity with computer aided network software.

### RESEARCH & DEVELOPMENT ENGINEERING Systems Integration

You will solve system integration problems including functional compatibility, subsystem definition, interconnection, prime power generation and distribution. You will also develop subsystem interface specifications and resolve any interface ambiguities or problems arising during the design and assembly of electronic systems. In addition, responsibilities will involve technical liaison and coordination between functional groups. Requires BSEE or equivalent and 5 years experience, including 2 years of power or signal distribution network design.

### COMMUNICATIONS ENGINEERING RADIO & WIRE COMMUNICATION SYSTEMS

Positions are available at various levels including the design and evaluation of various radio and wire communication systems for military and civilian users, as well as responsibility for preparation of proposals and contract performance. Systems will carry analog and digital voice telegraph and data traffic and will often include communications security. Systems may range in frequency for VLF to SHF. Requires BS or Advanced Degree in EE and minimum 8 years experience in any of the following fields: antennas, modulation systems, analog and digital circuits, radio wave propagation, multichannel point-to-point communication systems and application of digital techniques. Background should include strong personal design experience, supervision and proposal and presentation development.

*To investigate these positions which are with our Communications Systems Division, please forward your resume outlining salary history and specific position of interest to Mr. James B. Bailey.*

### ANALOG CIRCUIT DESIGN

A major design effort will involve analog circuits for hybrid electronic surge arrestors, pulse generators, sophisticated power supplies, low and high pass filters, fault detection and radio communications. You will be responsible for design, build, test and perform worst case analysis. Positions are available at most levels of experience.

### DIGITAL CIRCUIT DESIGN

Major efforts will be to design, build, test, and perform worst case analysis of digital control electronics and computer interface equipment. Positions are available at most levels of experience.

### EMI/TEMPEST ENGINEERING

Will interpret DOD EMI/TEMPEST specification and perform electromagnetic emanation/susceptibility analysis on complex electronic systems/subsystems. Will also perform EMI/TEMPEST analysis, design and test functions on secure communication systems/equipment and write detailed TEMPEST design plans, test plans and test reports for submittal to procuring agency. Requires BSEE and one year experience in Radio Frequency Circuit Design or Electromagnetic Design and practical measurement experience in radio frequency techniques.

### DIGITAL SIGNAL PROCESSING

We are seeking an experienced professional to lead the design and development of advanced digital signal processing systems. Reporting to the Manager of Systems Engineering, you will be able to influence strongly the direction of our future signal processing activities. You will develop a fundamental understanding of customer needs and guide the systems engineering effort directed toward design solutions for these needs. You will develop techniques and designs for such applications as radar signal processing, sonar signal processing and communication modulation/demodulation. Requires an advanced degree in Engineering, Math or Physics and a minimum of 10 years professional experience in the engineering analysis and design of communications, radar or sonar systems. A knowledge of the theory and techniques of digital signal processing and the types of machine architecture suitable to this function is necessary. Some experience in the digital implementation of signal processing functions is essential.

*To investigate these positions which are with our Eastern Division, please forward your resume outlining salary history and specific position of interest to Mr. Richard U. Hawes.*

GTE Sylvania - Central Employment Office  
Industrial Relations Support Organization - Eastern Area  
189 "B" Street, Needham, Massachusetts 02194

**GTE SYLVANIA**  
INCORPORATED

An Equal Opportunity Employer M/F

# "BAREFOOT" VACATIONS

to exotic islands



**WINDJAMMER CRUISES**



**explore Bahamas,  
West Indies,  
Virgin Isles, Mexico.**

**Comfortable  
cabins... good  
"Grub 'n Grog".**

**10 adventurous  
days from \$200**

- Great for employee incentive programs
- Ideal for executive meetings and parties
- Wonderful for customer prizes



**WRITE CAP'N MIKE  
FOR FULL INFORMATION  
AND ADVENTURE BROCHURE  
P.O. BOX 120, DEPT. 787A  
MIAMI BEACH, FLORIDA 33139**

# only from now - logic panels with decoupling capacitor provisions for standard applications...



Decoupling efficiency of better than 98% is achieved from 1.34 kHz through 50 mHz by using Scanbe's suggested capacitor array.

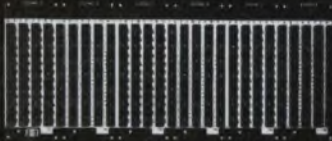

#### UNIVERSAL MODEL LPU

\$35.50 avg./zone (25 pc. quant.)

- 18, 36 or 54 pin rows
- For 14, 16, 24, 36, 40 LEAD DIPS

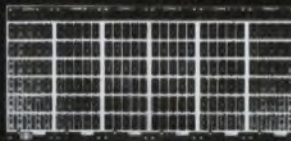

#### STANDARD MODEL LPS

\$35.00 avg./zone (25 pc. quant.)

- 14 or 16 LEAD DIPS
- 30 to 180 sockets in 30 socket zones

All of our universal, standard and custom series logic panels now incorporate this outstanding advance. All of our models are supported by the best, most complete line of quality accessories (including our ME-2 sockets) to optimize and assure top performance and reliability.

So if your logic panel needs call for quality performance, exclusive features and low price, get the best logic panels... only from Scanbe. Call or write for our latest logic panel brochure.

#### SCANBE MANUFACTURING CORP.





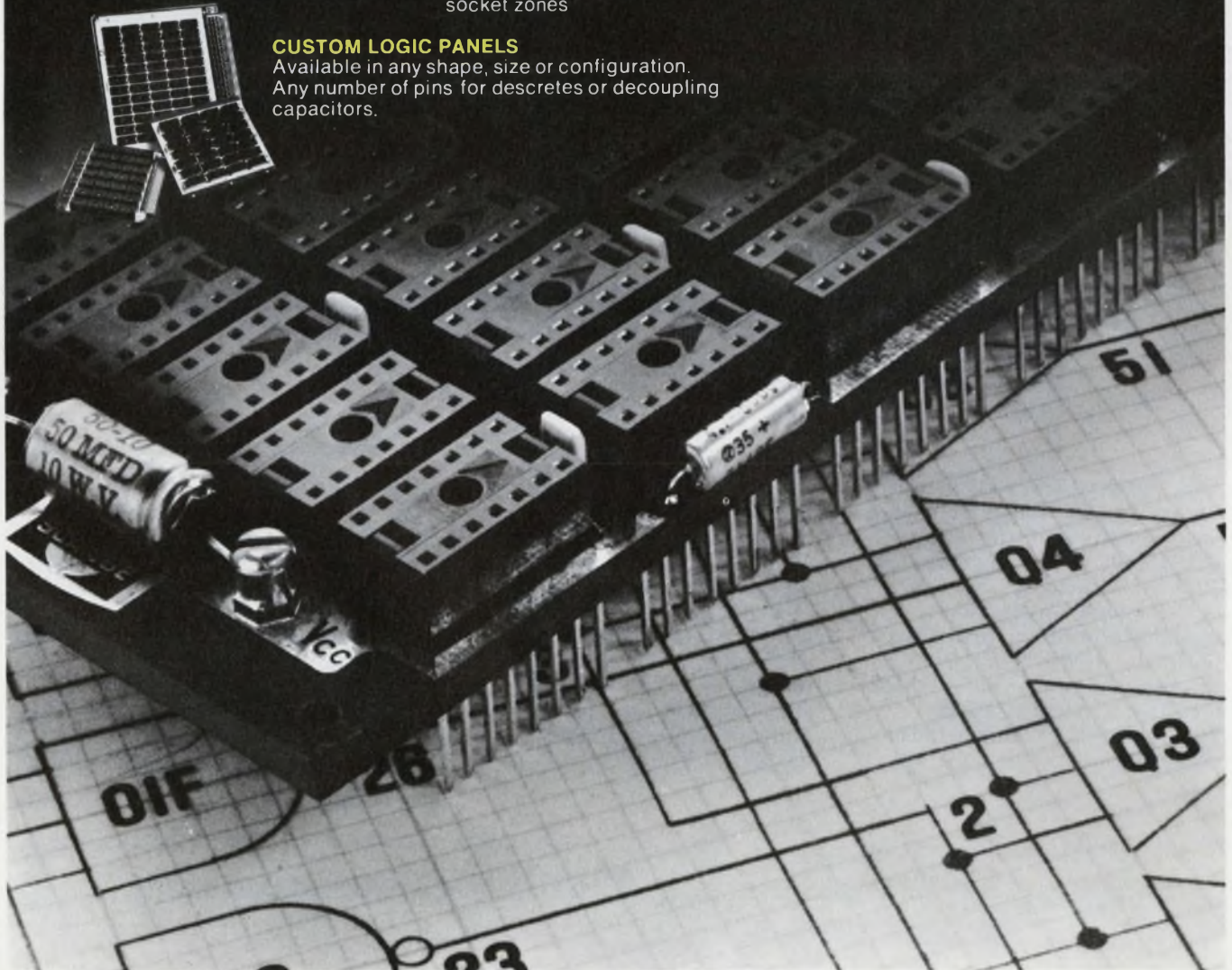

"The Packaging People"

3445 Fletcher Ave. • El Monte, Calif. 91731  
(213) 579-2300 / 686-1202

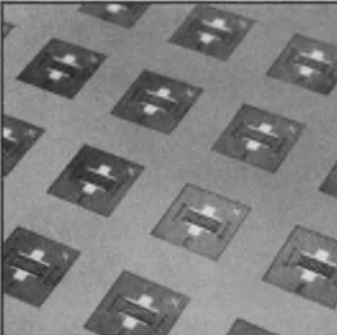
#### CUSTOM LOGIC PANELS

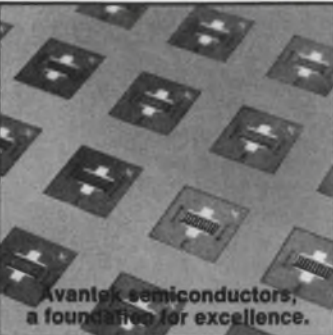
Available in any shape, size or configuration. Any number of pins for descretes or decoupling capacitors.

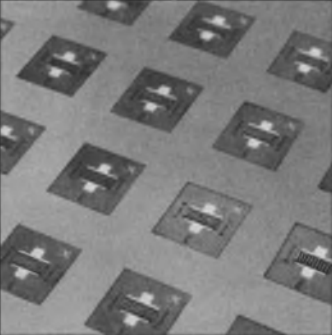

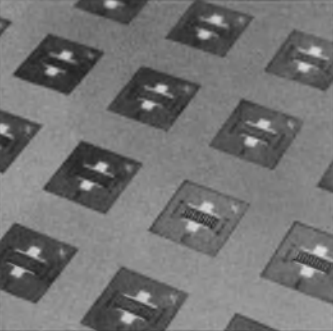
	<p>Avantek's discrete Unit Amplifier family has provided patented modular cascability and broadband performance to design engineers for more than five years. Today, 25 models are available.</p>	 <p>Avantek Unit Amplifier UA-152 SANTA CLARA, CALIF.</p>	 <p>Avantek semiconductors, a foundation for excellence.</p>
 <p>GPD-402 5-400 MHz, 13 dB gain, 6.0 dB N.F., +6 dBm P<sub>o</sub></p>		<p>The introduction in 1970 of Avantek's UTO MIC•amp® Series expanded upon the Unit Amplifier concept by offering miniature thin film MIC modules with frequency coverage to 2 GHz. 25 standard UTO models are currently being produced.</p>	 <p>UTO-2011, 1-2 GHz, 7.5 dB gain, 5.0 dB N.F., -3 dBm P<sub>o</sub></p>
<p>In 1971, Avantek's low-cost GPD Series began replacing up to 15 different components with a single highly reliable unit of gain. Six models operate at frequencies from 5 to 400 MHz.</p>	<p>Now, the UDP-2032 and three-model UDP-4000 Series introduce a new dimension in microwave system design by offering cascable "connectorless" thin-film amplifiers for high-performance applications to 4 GHz.</p>	 <p>UDP-4001, 2-4 GHz, 5.0 dB gain, 8.5 dB N.F., +5 dBm P<sub>o</sub></p>	

# u·nique (ū-nēk'), adj., 1. different from all others; having no like or equal...

U.S. Patent 3493882 covers a unique circuit design developed by Avantek engineers in the mid-1960's. This design has enabled Avantek to develop and deliver a succession of modular amplifiers, featuring flat gain cascability, that have set the pace in solid-state amplifier miniaturization, flexibility and reliability in the years since.

No one else offers a comparable product line. That's unique. Avantek modular units are available for applications from DC to 4 GHz. A wide selection of models allows the circuit designer to match units to exacting gain, noise and power requirements in packages suitable for his needs. Limiter and variable gain modules are also available.

The cascable amplifier concept, and its continuing refinement over recent years, is representative of Avantek's established technology leadership. Find out about Avantek's unique modular amplifiers by phoning your nearby field representative or contacting the factory directly. Be sure to ask for the August 1972 Component Catalog that gives a complete listing of the entire Avantek amplifier/oscillator line.

**Avantek... years ahead today.**



# GI is capacitors



Literally billions of capacitors. Aluminum electrolytics. Micas. Film. Designed and built for reliability. Priced right. And delivered when and where you want 'em. The GI catalog tells almost everything

you need to know about capacitors. Send for your free copy today. Capacitor Division/General Instrument Corporation, 165 Front St., Chicopee, Mass., 01014. Phone 413/592-7795. In Canada 416/763-4133.



**General  
Instrument**  
the capacitor company

"Off the shelf" delivery from your GI/MI distributor.

# Press here to save on lighted pushbutton switches.



**buys all  
the switch  
you need.**

Oak's Series 300 gives you good looks and a small price-tag in lighted pushbutton switches. Plenty of switching performance for most jobs, without paying a premium. Even the Series 300 Split-Legend/4 Lamp Switch is less than \$1.60 (normal latch, 2P2T, glass alkyd insulation, no engraving, less lamps.)

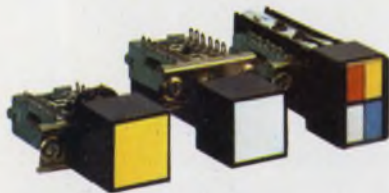

## Three versions with switching up to 4P2T.

Choose from single, dual, or four lamp display as well as non-lighted type. One to twelve station, momentary, interlock, alternate action, or any combination available on the same switch bank. Lockout feature available for all types. Power Module 3A125VAC. Lighted indicators are identical in size and appearance, but without switching.



## Built to take it.

Series 300 is built for reliable performance and long life. Applications galore — bank terminals, calculators, and copy equipment.



## Modular design.

Single-legend/single-lamp, split-legend/4-lamp, and single-legend/redundant lamp switches have snap-on lamp holders. Plus replaceable legend plates, lens caps, and button assemblies. Front-panel relamping, too, without special tools on all types.

## Gang them up by the dozen.

Order up to 12 switching stations on a single channel, any switching mix, with convenient panel-mounting studs. Color selection: white, lunar white, yellow, amber, orange, red, green, blue. Choose silk-screened, hot-stamped, or engraved-and-filled legends. Split-legend switches can be specified with any two, three, or four colors on insertable legend plates.



**Write for our Series 300 Brochure**

**DAK Industries Inc.**

SWITCH DIVISION / CRYSTAL LAKE, ILLINOIS 60014  
TELEPHONE: 815 • 459 • 5000 ■ TWX: 910 • 634-3353 ■ TELEX: 72 • 2447

INFORMATION RETRIEVAL NUMBER 26

# "DRAFTING ROOM DELAYS ARE KILLING US!"

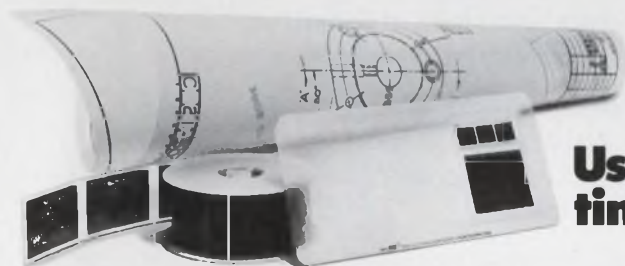

**Use Kodak products for time-saving shortcuts.**

Perhaps you've discovered how much time you can save—and how much more efficiently you can work—when you use Kodagraph films and papers for producing new drawings or revising existing ones. But that's just the beginning of what Kodak products can do for you.

For example, your drawings will be more accessible if they're on Kodak microfilm . . . more convenient to handle, too. And you can get high-quality distribution prints faster—and for lower cost—thanks to other Kodak products.

There's even more. Just fill in and mail the coupon, and we'll send you the complete story.

I'd like to know more about Kodak photoreproduction products. Please send me your free literature.

Name \_\_\_\_\_

Position \_\_\_\_\_

Company \_\_\_\_\_

Address \_\_\_\_\_

City \_\_\_\_\_ State \_\_\_\_\_ Zip \_\_\_\_\_

Eastman Kodak Company  
Business Systems Markets Division  
Dept. DP889. Rochester, N.Y. 14650

**PRODUCTS FOR  
ENGINEERING DATA SYSTEMS**



**60 watt  
signal generator**

**10 to 2,500 MHz  
with six heads**

**solid state for  
high reliability**

**frequency stability  
 $\pm 0.003\%/10$  minutes**

**power stability  
 $\pm 0.2$  db/hour**

Pick a frequency between 10 and 2,500 MHz and the Model 15022 will deliver the reliable power you need for amplifier drive, component testing, calibration, and antenna pattern measurements.

Reliability is built in with conservative design and all solid state components (except osc. tube). So you get frequency and power stability at low cost. Easy servicing. And full protection against mismatch or loss of load.

Front panel meter reads forward power in 15 and 75 watt scales. Single control tuning to 1% of actual frequency can be read directly for rapid setup.

Model 15022 has an internal and external modulation capability. An isolated RF output 20 db down is available for error-free monitoring. Meets MIL specs for RFI shielding.

For complete specifications on today's newest RF power source, call (312) 354-4350 or write: MCL, Inc., 10 North Beach Avenue, La Grange, Illinois 60525.

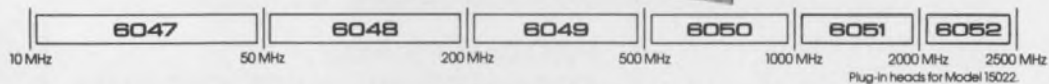

*Opportunities developing now for RF engineers at MCL, Inc. —  
an equal opportunity employer.*

INFORMATION RETRIEVAL NUMBER 28

If you're working in computer peripherals, you want **Semiconductors For Communication Systems**...If you're working in data Modems, you want **Semiconductors For Communication Systems**...If you're working in aircraft/military radio, you want **Semiconductors For Communication Systems**...If you're working in active filters, you want **Semiconductors For Communication Systems**...If you're working in serial/parallel converters, you want **Semiconductors For Communication Systems**...If you're working in land/mobile radio, you want **Semiconductors For Communication Systems**...If you're working in audio power devices, you want **Semiconductors For Communication Systems**...If you're working in phase-locked loops, you want **Semiconductors For Communication Systems**...If you're working in synchronous/asynchronous transmission, you want **Semiconductors For Communication Systems**...If you're working in twisted pair drivers/receivers, you want **Semiconductors For Communication Systems**...If you're working in mixers, you want **Semiconductors For Communication Systems**...If you're working in control logic, you want **Semiconductors For Communication Systems**...If you're working in telephone crosspoint, you want **Semiconductors For Communication Systems**...If you're working in MATV, you want **Semiconductors For**

C  
S



**SEMICONDUCTORS FOR  
COMMUNICATION SYSTEMS**

 **MOTOROLA Semiconductors**

you want **Semiconductors For**  
in IF amplifiers/detectors, you  
working in low-noise preamps,  
**ion Systems**...If you're work-  
**nductors For Communication**  
ing in control logic, you want  
ing in small-signal audio, you  
re working in single-sideband  
**Systems**...If you're working  
**r Communication Systems**...  
ing in marine radio, you want  
orking in D-A/A-D converters,  
re working in data interface  
**ication Systems**...If you're  
**ductors For Communication**  
, you want **Semiconductors**  
in receiver oscillators, you  
orking in receiver front ends  
, you want **Semiconductors**  
working in CATV, you want  
**Communication Systems**...

Write on your company  
letterhead. Box 20912,  
Phoenix, Arizona 85036

**If you're working in communications...**

# “Scotchflex” Flat Cable Connector System makes 50 connections at a time.

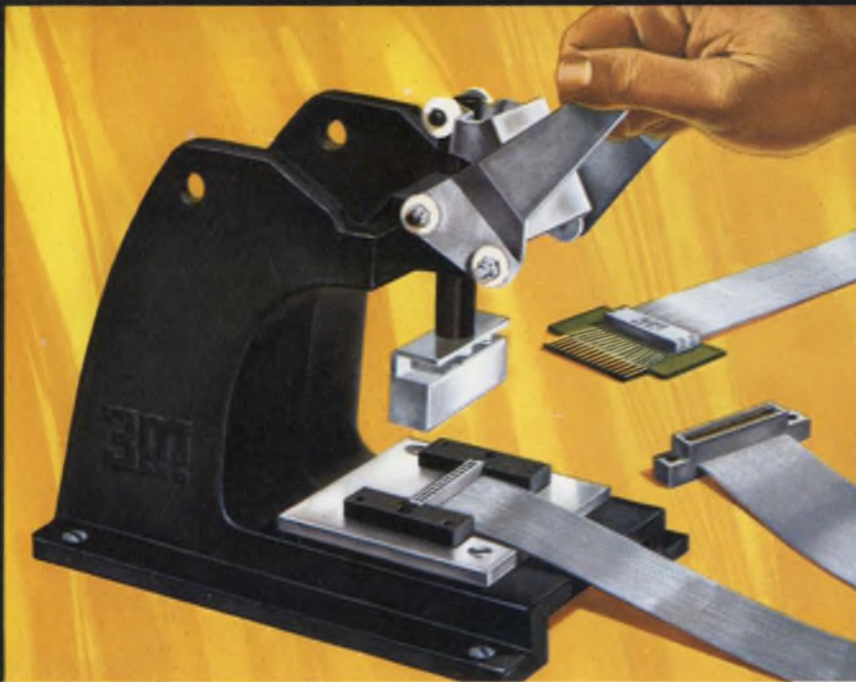

“SCOTCHFLEX” IS A REGISTERED TRADEMARK OF 3M CO.

Build assembly cost savings into your electronics package with “Scotchflex” flat cable and connectors. These fast, simple systems make simultaneous multiple connections in seconds without stripping or soldering. Equipment investment is minimal; there’s no need for special training. The inexpensive assembly press, shown above, crimps connections tightly, operates easily and assures error free wiring.

Reliability is built in, too, with “Scotchflex” interconnects. Inside of connector bodies, unique U-contacts strip through flat cable insulation, grip each conductor for dependable gas-tight connections.

“Scotchflex” offers you design freedom, with a wide choice of cable and connectors. From off-the-shelf stock you can choose: 14 to 50-conductor cables. Connectors to interface with standard DIP sockets, wrap posts on standard grid patterns, printed circuit boards. Headers for de-pluggable connection between cable jumpers and PCB. Custom assemblies are also available on request.

For more information, write Dept. EAH-1, 3M Center, St. Paul, Minn. 55101.



**“Scotchflex”.**  
**Your systems approach  
to circuitry.**

# Here's one for the road.

Our new Model 4440 mini-multimeter is the smallest battery operated digital multimeter on the market.

A true portable in every sense of the word, it's shock-proofed, fully overload-protected, and usable at up to 122°F. Fuses are externally replaceable. (We even throw in an extra set, on the house.)

You get eight to twelve hours of continuous field operation before you have to recharge. In an emergency, you can run it five hours or more on ordinary flashlight batteries!

For all its littleness, this rugged portable features a new 3½-digit LED display with automatic polarity, the latest LSI circuitry for more reliability than ever, and 17 full scale ranges that cover



**(A cordless DMM for only \$285.)**

200 MV to 1000 volts AC/DC, 200 ohms to 2 megohms, plus AC and DC current.

Your local distributor will set you up with a Weston 4440 for \$285—complete with leads, batteries and recharger. Grab one. Weston Instruments Division, Weston Instruments, Inc., Newark, N.J. 07114. **WESTON®**



**Now!  
TIN  
PLATED  
CONNECTOR  
CONTACTS\***

**\*Major  
computer and electronic  
manufacturers have adopted  
this important cost-saving in-  
gredient of tin plated contacts in  
their connector circuit applications.**

Join the growing group of OEMs and save gold where it counts—on the bottom line of your company's financial statement.

Write or phone (212) 899-4422 for a free condensed catalog, plus details on how you can cut costs with our tin plated contacts.

*For the Sales Representative Nearest You, See Our Listings in EEM and VSMF Directories.*

**CONTINENTAL  CONNECTORS**

**CONTINENTAL CONNECTOR CORPORATION ■ WOODSIDE, NEW YORK 11377**

INFORMATION RETRIEVAL NUMBER 32

INFORMATION RETRIEVAL NUMBER 33 ►



It's tough to get lipstick  
to go where it's supposed to go.

But Clare can help. We understand interface technology and we've designed components to meet your requirements. We know how to pluck the right tube of lipstick out of inventory with an automated system. And we've learned a lot about delicate batch processing. And sensitive power control. No matter what you're trying to do, we know how to design and apply components that help you translate computer talk into reliable processing and control.

Clare engineering keeps pace with your interface problems—and your imagination. That's why we refined and developed mercury-wetted, dry and wetted reed relays—then built the most comprehensive lines available in the industry. We make everything,

from the capsule to the completed relay.

Mercury-wetted relays for low-level analog signals. Clareed® for standard dry reed applications. MicroClareed® for subminiature, high-speed performance. Picoreed® relays for high-density mounting situations. All give you fast, reliable performance with total input/output isolation characteristics. All are immediately available in a variety of configurations and combinations.

And if we haven't designed what you need yet, we'll get into that too.

The point is, Clare has the capability to participate with you in interface design, no matter how complex the problem.

We've published a free booklet on interface applications. Six minutes of ideas that may trigger some thoughts for you. Send the coupon for your free booklet, or call your Clare representative directly.



C. P. Clare & Co., 3101 Pratt Blvd., Chicago, Illinois 60645

Name \_\_\_\_\_  
Company \_\_\_\_\_  
Address \_\_\_\_\_  
City \_\_\_\_\_ State \_\_\_\_\_ Zip \_\_\_\_\_



## THE DALLAS MULTIPLE OFFENSE

### Custom hybrids from Collins.

We didn't start out with a fat play book. But now we have one. It took 10 years and a couple of million hybrids. At our Dallas manufacturing facilities, we have:

- Metal Packages: Platform/TO-Can
- Ceramic Packages: Flatpacks/DIP
- Laser Trim
- Beam Leads
- Autotest: Analog/Digital-at temperature
- MIL-STD-883/MIL-M-38510 Compliance

So when you need hybrids, call the team that uses the multiple offense . . . to serve you better. Collins Radio Company, Hybrid Microelectronics Division, Dallas, Texas 75207. Phone: (214) 235-9511.



# New from TI: A line of low-cost relays.

You're an OEM manufacturer. One of your responsibilities is specifying relays. We've got something that could make you look good.

A new line of snap-acting time delay relays costing only \$1.10 to \$3.00 when ordered in quantity – up to 25% less than conventional creep-acting blade relays – 50% less than snap-acting blade relays – less than many conventional magnetic relays or contactors!

They're smaller than ordinary relays, too. They'll operate in any position, and they're resistant to shock and vibration. What's more, they have a proven life of over 100,000 switching cycles.

The secret is our Klixon® snap-acting disc and a new, low-cost electrically heated ceramic element mounted in a compact phenolic housing.

We have technical literature that spells it all out. You should send for it now.



Texas Instruments Incorporated  
MS 10-5/NED  
Attleboro, Mass. 02703

Gentlemen: Please send me your literature on time-delay relays.

Name \_\_\_\_\_

Company \_\_\_\_\_

Address \_\_\_\_\_

City \_\_\_\_\_

State \_\_\_\_\_ Zip \_\_\_\_\_

20 U/L recognized configurations to choose from.

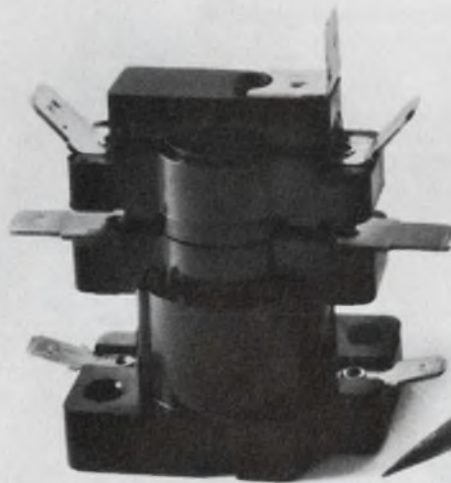

Contact ratings up to 10KW ... 100,000 cycles.

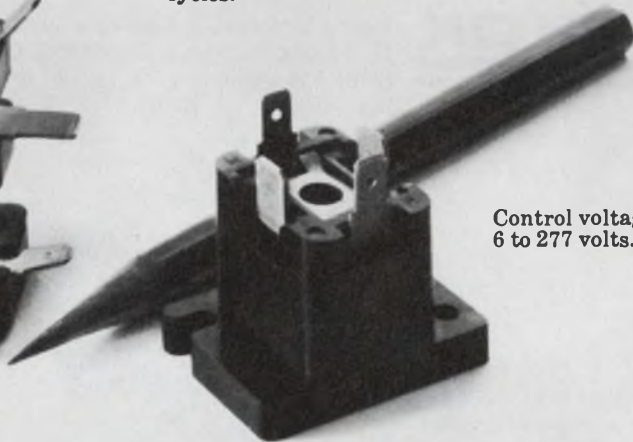

Control voltages from 6 to 277 volts.

Voltage compensated, operates under wide variations in voltage.

Relays can be re-set manually or automatically.

Shown actual size.

**TEXAS INSTRUMENTS**  
INCORPORATED

INFORMATION RETRIEVAL NUMBER 35

# A digital multimeter that measures true RMS and dBm directly.

Look what you can measure with the Hickok 3310 Universal Multimeter: true RMS voltage and current like these —

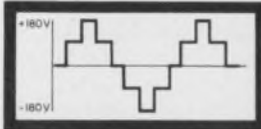

Sine wave synthesis by voltage switching  
ERMS = 110.2 Volts; 43.1 dBm

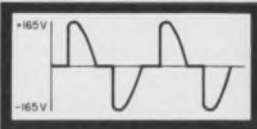

Load voltage using full-wave SCR phase control  
ERMS = 98.6 Volts; 42.1 dBm



Sawtooth waveform  
ERMS = 5.77 Volts; 17.4 dBm

For  
just  
**\$845<sup>00</sup>**

You save money and receive performance with the Hickok 3310. Here are some of its RMS specs — 100- $\mu$ V resolution, 4:1 crest factor, bandwidth from 20 Hz to 50 kHz, RMS current capability from 100 nA to 2 A plus all-solid-state circuits for reliability and ruggedness.

But keep going. The 3310 reads from -40 dB to +60 dB with 0.1-dB resolution directly; no conversion or mental additions are necessary. You can choose between a 600 and 900-ohm internal reference with a front panel switch.

And don't forget the "multi." The 3310 measures DC voltage from 100  $\mu$ V to 1.5 kV, DC current from 100 nA to 2 A, and resistance from 100 milliohms to 200 megohms.

Then, there are the extras. You can add an internal rechargeable battery option with 20 hours consecutive operation or you can add a BCD-output option. Accessories extend ranges to 30 kV or 100 A, and one converts the 3310 to a 20-MHz counter. All accessories will fit into a convenient carrying case along with the 3310.

Try the 3310 for yourself. Call Hickok or your nearest Hickok field engineer for a demonstration and see RMS for yourself.

**HICKOK**  
the value innovator

Instrumentation & Controls Division  
10514 Dupont Ave. Cleveland, OH 44108  
(216) 541-8060



shown  
2/3 actual size

# our OEM power supply is very big in computers



About a year ago, we introduced our new OEM power supply, a low-cost, off-the-shelf, 4-32 volt, 0.9-36 amp series. We sold a lot of them, especially for computer applications: 5v supplies for IC logic and  $\pm 12v$  and  $\pm 15v$  dual supplies for associated op amp circuitry. The price was right — starting at \$57 — and they had the features the industry needed: remote sensing, 0.1% regulation, overcurrent and overvoltage protection, remote programmability, UL approval, 50-60 Hz inputs, modular or rack-mounting capability, and ACDC's "guaranteed forever" performance.

Of course, there were some applications that the OEM series just couldn't handle. But it did open the doors for our specials. Specials with overtemperature or under-voltage protection; with locking fault indicators and interface logic signals for absolute protection of stored data; with dc energy storage for memory retention, on-off sequencing, etc. The point? . . . We make a quality line of standard power supplies — and specials too. So, if you're big in computers, why not talk to the company that's big in computer power supplies?

**acdc electronics inc.**

Oceanside Industrial Center, Oceanside, California 92054, (714) 757-1880

INFORMATION RETRIEVAL NUMBER 37

# STARK\*

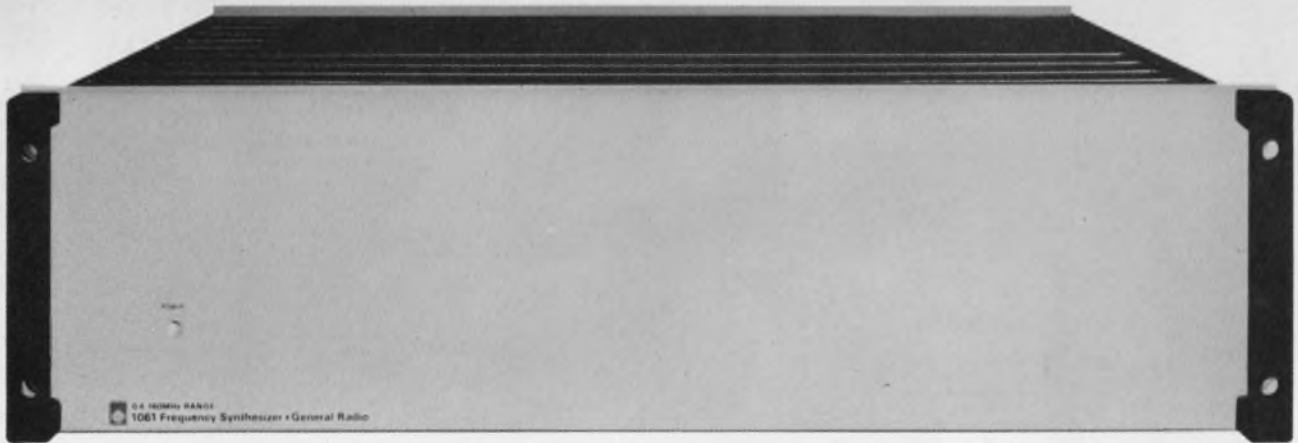

**... but bristling with performance — total performance that is unexcelled by any other frequency synthesizer:**

	GR 1061	Runner-up A	Runner-up B
Frequency	dc to 160 MHz	1 MHz to 160 MHz	10 kHz to 110 MHz
Switching Speed	< 100 $\mu$ s	1 ms	5 to 100 ms
Output Level	+ 20 dBm	+ 13 dBm	+ 13 dBm
Spurious	- 80 dB	- 70 to - 100 dB	- 80 dB
Phase Noise	- 63 dB	- 60 dB	- 50 dB
A-M, FM Capability	standard	no	optional
Search-Sweep	standard	no	optional

Data current as of August, 1972

\* *stark* \stärk\ *adj* ... STRONG, ROBUST ... having few or no ornaments.

For computer-controlled systems or in applications that require special controls, often remote from the instrument, who needs a panel full of knobs? In systems that already include a standard reference oscillator, why buy another one? Where a resolution of only 5 digits is required, why pay for 10?

Of course one man's ornament may be another man's necessity, so we offer an array of options to tailor the 1061 to **your** needs: a full control panel, two different internal reference oscillators, resolution to 10 digits, and phase-modulation capability. We don't offer, as options, search-sweep, a-m and fm capability, wide frequency range, fast switching speed, complete programmability, high output, and low spurious and phase-noise levels — they're all standard, starting at \$4700.



**General Radio**

NEW YORK (N.Y.) 212-964-2722, (N.J.) 201-791-8990 • BOSTON 617-646-0550  
CHICAGO 312-992-0800 • WASHINGTON, D.C. 301-881-5333 • LOS ANGELES 714-540-9830  
TORONTO 416-252-3395 • ZURICH (01) 55 24 20

GR COMPANIES • GRASON-STAOILER • TIME/DATA • TECHWARE COMPUTING CORP.  
GR ASSOCIATE • MICRONETIC SYSTEMS INC.

# new, pocket-size Tri-Phasic™ multimeter



MODEL 245, ACTUAL SIZE

# Try It

The miniature, rugged, lab-quality 4½-digit multimeter with .005% resolution, basic  $\pm .05\%$  accuracy, battery and line operated. Measures DC volts, AC volts, DC current, AC current and resistance.

# \$295

COMPLETE

The performance of Model 245 is so remarkable, the circuitry so stable we offer it on a 30-day trial.

Send me Data Precision Model 245 @ \$295. I prefer the following purchase plan:

- Bill my company. Purchase Order enclosed.
- Check or money order enclosed.  
(Massachusetts residents add 3% Sales Tax)
- Send complete information and specifications

Name \_\_\_\_\_ Title \_\_\_\_\_

Company \_\_\_\_\_

Address \_\_\_\_\_

City \_\_\_\_\_ State \_\_\_\_\_ Zip \_\_\_\_\_

**If the Model 245 does not perform as specified, return it in 30 days for full credit or refund.**

 **DATA PRECISION**

Audubon Road, Wakefield, MA. 01880

(617) 246-1600

\*\*\*

# Model 245 puts .005% resolution in the palm of your hand

- Full 4 1/2 digit laboratory quality instrument
- .005% resolution
- Basic accuracy  $\pm .05\%$
- Rugged impact-resistant case
- Rechargeable 6-hour battery in-spec operation and line/recharge operation (12 hours recharge)
- Weight, less than one pound complete
- Pocket-size, 1 3/4" H x 3 1/2" D x 5 1/2" W
- Measures DCV, ACV, DC and AC current and resistance
- For laboratory, field, bench, production
- One year warranty
- 100% overrange
- Overvoltage protected
- Autopolarity
- Overload indicator
- Power consumption, 0.75 watt
- In-line, plasma high-intensity display
- Calibration guaranteed 6 months minimum
- Flip-off calibration cover, only 6 calibration adjustments

## Functions

**DC Volts, 1 volt to 1000 volts full scale, 100  $\mu$ v resolution.**

**AC Volts, 1 volt to 500 volts RMS full scale, 100  $\mu$ v resolution, 30HZ-50KHZ.**

**DC Current, 1 ma to 1A f.s.\*, 1  $\mu$ A resolution.**

**AC Current, 1 ma to 1A f.s.\*, 1  $\mu$ A resolution, 30HZ-50KHZ.**

**Resistance, 1 K $\Omega$ -10M $\Omega$ \* full scale, 100 milliohms resolution.**

\*plus 100% overrange

## Technical Design Features

Tri-Phasic™ automatic zero. No zero adjustment required anywhere.

Isopolar™ Reference, high stability bi-polar reference supply.

Ratiohm™ Resistance measuring method.

LSI and C-MOS circuitry.

## \$295\* Each, Unit Price and Including:

Carrying strap  
Carrying case  
Fused input probes  
Spare fuse (over current protection)  
Line cord/recharger  
Battery module  
Certificate of Conformance  
Acceptance Test Data  
Maintenance Manual  
Operator Manual

\* Ask about quantity discounts



 **DATA PRECISION**

Data Precision Corporation, Audubon Road, Wakefield, MA. 01880  
(617) 246-1600

Circle reader service card no. 245

FIRST CLASS  
Permit No. 362  
Wakefield, Mass.

## BUSINESS REPLY MAIL

No Postage Stamp Necessary If Mailed in the United States

Postage Will Be Paid By

**DATA PRECISION**

Audubon Road,  
Wakefield, MA. 01880

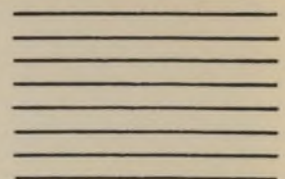



# It only takes two to talk.

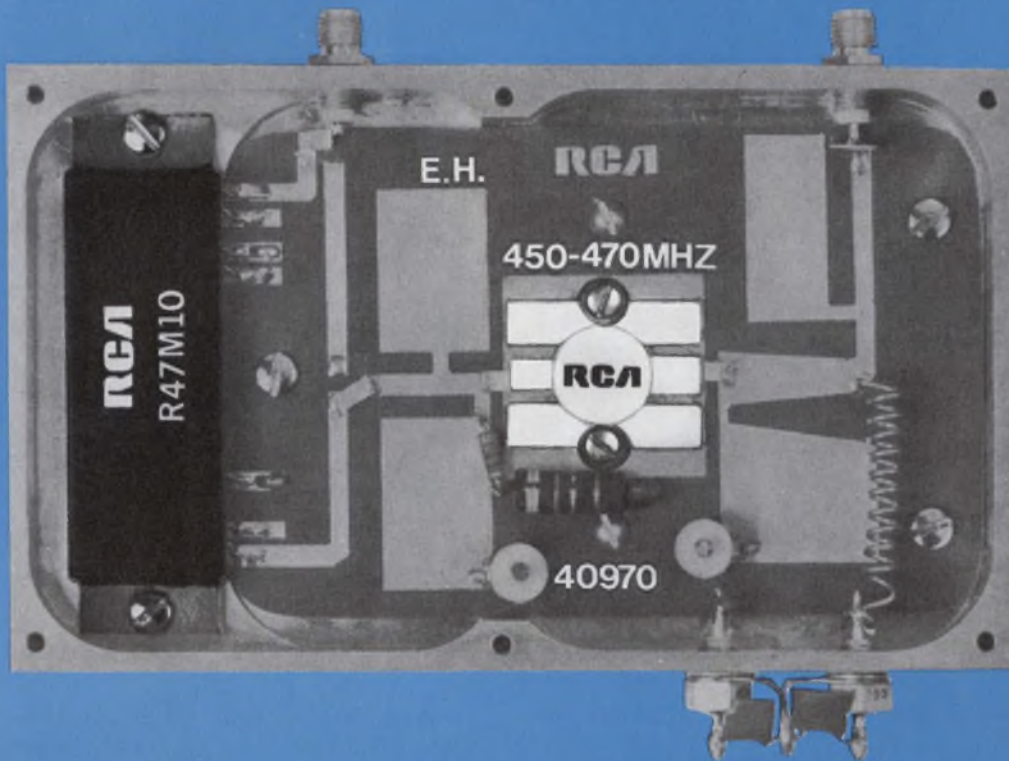

**Just place a couple of standard RCA modules in a box. And you have a UHF mobile transmitter chain.**

The fastest turnaround on your new UHF mobile transmitter is a call to RCA. You need only two devices. The R47M10 integrated power amplifier. And the 40970 mobile power transistor. Both are immediately available.

Take the R47M10. This miniature module, pictured full-size above, permits high packing densities. With an input of 100 mW, it provides a 10 W output over a pass band of 440 to 470 MHz when operated with a 12.5 V supply. Power derating is less than 10% under continuous operation at case temperature of 75°C. Input and output impedance is 50Ω, gain is 20 dB, and over-all efficiency 40%.

Now consider the 40970. This unit is 100% tested under conditions

of ∞:1 VSWR at 10 W input and 15.5 V collector supply. Because of contoured epitaxial construction and true emitter-site and collector ballasting, the unit is protected against both high-current and voltage without tradeoffs. The 40970 delivers a minimum output of 30 W, with a minimum collector efficiency of 60%.

With RCA UHF building blocks, you not only speed reaction time . . . you also eliminate unnecessary DC parameter testing, reduce development expense, slash manufacturing, purchasing, and inventory costs.

Too simple? Not at all.

Send for RCA's new Application Note, "Building Blocks for Mobile Radio Design," and technical bulletins on the R47M10 and 40970. For

your copies, write RCA Solid State, Section 57K-23, Box 3200, Somerville, New Jersey 08876. Or call your local RCA Representative.

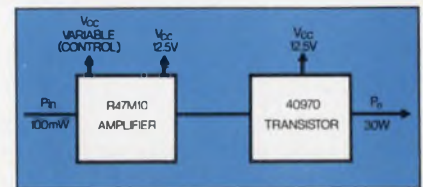

**RCA Solid State**  
products that make products pay off

International: RCA, Sunbury-on-Thames, U. K., or Fuji Building, 7-4 Kasumigaseki, 3-Chome, Chiyoda-Ku, Tokyo, Japan. In Canada: RCA Limited, Ste. Anne de Bellevue 810, Canada.

INFORMATION RETRIEVAL NUMBER 39

# The transistor years: A new design freedom begins

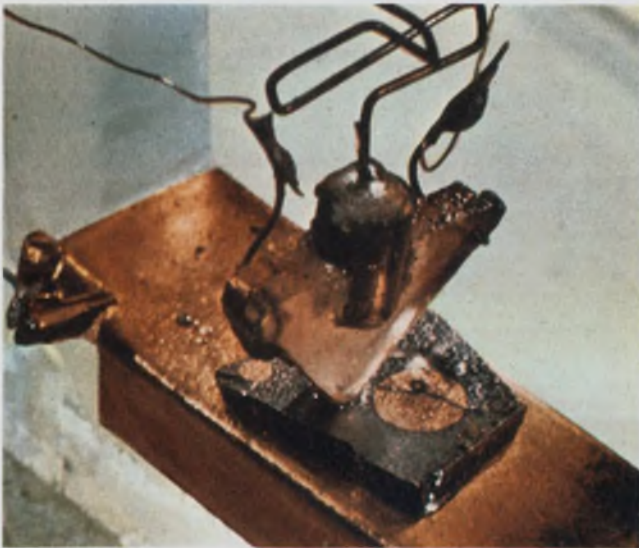

The first transistor, a point-contact, led to . . .



. . . First junction transistor at Bell Labs.

Imagine, for a moment, a world without the transistor:

- There would be no minicomputers. All computers would probably still be on the scale of Eniac, the first large-scale digital computing machine. It contained 18,000 vacuum tubes, 1500 relays, occupied a space 30 by 50 feet and consumed 130 kW to operate.

- A landing on the moon would have been out of the question. Computers would have been too bulky and probably too expensive and unreliable for wide use.

- Communications satellites, pulse-code modulation and electronic switching systems would have been impractical.

- The trend from analog to complex digital instruments would have been impossible.

- Inertial navigation and guidance systems would not exist, precluding the development of today's intercontinental missiles and Polaris submarines.

There are other "lost" achievements, but you get the picture. The electronics industry has been reshaped by the transistor and a host of other solid-state devices that the transistor gave rise to—such as microwave and light-emitting devices and especially integrated circuits.

And yet the era began relatively unspectacularly. On Dec. 24, 1947, the following entry appeared in the notebook of a Bell Telephone Laboratories scientist, Walter H. Brattain, recording the events of an experiment that had taken place the previous day:

*"This circuit was actually spoken over, and by switching the device in and out, a distinct gain in speech level could be heard and seen on the scope presentation with no noticeable change in quality."*

## A new industry emerges

Thus was the transistor effect discovered. And from this first crude point-contact device was born a worldwide semiconductor industry that employs hundreds of thousands of workers and that last year sold nearly 14-billion solid-state devices, of which nine-billion were transistors.

In the pages that follow, the editors of *ELECTRONIC DESIGN* take you on a journey into history. You'll be able to see, at a glance, the major developments in different design areas since the advent of the transistor: computers, communications, test and measuring instruments, military and space, consumer electronics, packaging



Another early semiconductor that Bell made.

and materials, and optoelectronics. Wherever possible, the influence of solid-state technology has been included. In this issue the magazine departs—just once—from its usual editorial approach to indulge in nostalgia. It's a double anniversary celebration for **ELECTRONIC DESIGN**: the transistor's 25th year and this magazine's 20th.

In researching their material for this presentation, the editors returned to the early editions of **ELECTRONIC DESIGN**. The photography that illustrates the various sections was taken from earlier stories of both significant and (as it turned out in some cases) not so significant developments that the magazine covered. The technological fizzles as well as the victories are covered.

In addition the editors got in touch with scientists, engineers and companies that were responsible for many innovations. Shockley, Brattain and Bardeen were interviewed. So was Pat Haggerty, one of the founders of the IC industry, and pioneers like Herman Goldstine, who with Eckert and Mauchly, produced an electronic computing machine that operated several hundred times faster than the electromechanical devices

## Table of contents

- 68 **Interview with Shockley, Bardeen and Brattain.**
- 72 **Solid-state devices**—Trusty transistors and ICs dethrone the power-demanding vacuum tube.
- 82 **Interview with Haggerty of Texas Instruments.**
- 86 **Computers**—An 'amazing' top war secret is bared and a new age begins.
- 94 **Communications**—A scholarly paper and technology start a revolution.
- 102 **Instruments**—The touch of solid-state slims down the bulk and enhances the readability.
- 110 **Military and Space**—A big nonsecret in Washington alters U.S. defenses.
- 114 **Consumer**—Radio and TV waddle into spotlight, and never stop growing.
- 122 **Components**—Devices shrink and their reliability expands.
- 126 **Packaging and Materials**—In the nick of time, automation comes and with it miniature modules.
- 130 **Electro-optics**—A physicist with a mind of his own helps usher in lasers.
- 134 **The promise and the reality**—A pictorial roundup of the news of the past.

of their day. The report is by no means a complete history of the electronics industry, but it does cover major milestones.

### The debt to the past

In putting together this story, the editors rediscovered a truth that many had forgotten—that there are few real "firsts" in the strict sense of the term. There are design breakthroughs, but they depend almost invariably on developments that preceded them. For example, the transistor owed its development in part to work done in 1930 by a German scientist, Julius Lilienfeld; his device could be compared to today's MOSFET. And it is doubtful whether today's PCM system could exist without Claude Shannon's monumental paper, "A Mathematical Theory of Communication." We stand on the shoulders of those who preceded us.

Additional copies of this special anniversary issue are available for \$2.00. Send check or money order to: William H. Smith, **ELECTRONIC DESIGN** Magazine, 50 Essex St., Rochelle Park, N.J. 07662.



Scientists Shockley (lower), Bardeen (upper left) and Brattain (right) in 1948.

## *'We found, as expected...' The birth of transistor, an unforgettable event*

**"***t has today occurred to me that an amplifier using semiconductors rather than vacuum is in principle possible."*

This is the first sentence of an entry in William Shockley's laboratory notebook, dated 12/29/39, 4:15 P.M., Friday at his home in Gillette, N.J. He was working for Bell Telephone Laboratories in New York City at the time.

His initial idea was for a Schottky-barrier, field-effect type of transistor using copper oxide as the semiconductor. Shockley had gone to Bell Laboratories from the Massachusetts Institute of Technology, where he received a PhD in physics in 1936. His thesis was concerned with energy bands in common table salt.

Working at Bell Laboratories at the same time was Walter H. Brattain, who got his PhD from the University of Minnesota in 1929. He worked for about a year at the National Bureau of Standards before moving over to Bell.

"I would have gone to Bell Labs sooner," he recalls today, "but I got an offer from the bureau first and I needed the money. They paid about \$3000 a year at that time for a young PhD."

At Bell Brattain worked on thermionic emission and the effect of impurities on clean tungsten. "We got interested in copper oxide in 1931," he says. "We were trying to understand rectification

in a copper oxide rectifier. I'm a surface-effect man and always have been."

Brattain has a surface-effect way of describing the transistor: "The transistor can be described as three regions, divided by two phase boundaries with electrical connections to all three regions. The two phase boundaries must be so positioned with respect to each other that nonequilibrium phenomena at one phase boundary can influence the flow of current at another phase boundary."

After World War II, Shockley became interested in the behavior of electrons in crystals and was introduced to Brattain.

Meanwhile a young PhD from Princeton had begun to make his mark. After leaving Princeton in 1936, he did post-doctoral work at Harvard and then taught for three years at the University of Minnesota. His name was John Bardeen. From his teaching position, he joined the Naval Ordnance Laboratory in Washington, where he worked through the war till 1945. Bell Laboratories recruited Bardeen in 1945 and moved him into an office with Brattain and Dr. Gerald Pearson.

Brattain and Pearson were both interested in semiconductors, and they turned Bardeen on as well. As avidly as Brattain was a surface-effect man, Pearson liked the bulk effect. Both enjoyed experimental work more than Bardeen, and Bardeen became the theoretician of the trio. Much work had been done with copper oxide semiconductors already, so the three looked to new frontiers to conquer.

"We picked germanium and silicon to work on," says Bardeen, "because they were easier to understand and work with than other semiconductors. We felt that the area was so fertile that you could devise an experiment in the morning, go out in the lab and try it in the afternoon and then write a paper on it in the evening."

Shockley became co-head of a solid-state research group at Bell Laboratories in 1945 and Brattain and Bardeen were in that group. Shockley says today:

"I worked on persuading the group's best experimentalists to try to make transistor structures that would work. What I proposed then are now called insulated-gate, field-effect transistors. They involved evaporated thin layers of silicon or germanium, two semiconductors developed from radar during World War II. A parallel metal plate was used to induce a charge on the semiconductor surface and thus change its resistance and produce the valve action of an amplifier."

#### Surface states were the problem

Shockley's transistor didn't work. The group scrambled around, dug into the literature and spent long hours discussing the alternatives. Bardeen came up with the answer.

"I theorized," he says, "that surface states were holding the electrons of the induced surface charges and preventing them from taking part in amplification."

Brattain tried an experiment in which he attempted to affect the space-charge barrier by applying an electric field through an electrolyte. He fondly describes the series of experiments that followed:

"We covered a metal point with a thin layer of wax, pushed it down on a piece of p-type silicon that had been treated to give an n-type surface. We then surrounded the point with a drop of water and made contact to it. The point was insulated from the water by the wax layer. We found, as expected, that potentials applied between the water and the silicon would change the current flowing from the silicon to the point. Power amplification was obtained that day!"

The group was jubilant and further experiments followed fast and furious.

"Bardeen suggested trying this on n-type germanium, and it worked even better," Brattain recalls. "However, the water drop would evaporate almost as soon as things were working well. Robert B. Gibney, one of our team, suggested that we switch to glycol borate, which hardly evaporates at all. Another problem was that amplification could be obtained only at or below 8 Hz. We reasoned that this was due to the slow action of the electrolyte.

"Optimum results were obtained with a dc nega-

**ELECTRONIC DESIGN** asked the three inventors of the transistor—Dr. William Shockley, Dr. John Bardeen and Dr. Walter H. Brattain—to reminisce about the development of the transistor. What follows is a bit of history as recalled by the men who lived it.

tive bias on the electrolyte when using n-type germanium. Under these conditions we noticed an anodic oxide film being formed under the electrolyte. We decided to evaporate a spot of gold on such a film and, using the film to insulate the gold from the germanium, use the gold as a field electrode to eliminate the electrolyte. The film was formed, the glycol borate washed off, and the gold spot with a hole in the middle for the point was evaporated.

"When this was tried, an electrical discharge between the point and the gold spoiled the spot in the middle. But by placing the point around the edge of the gold spot, a new effect was observed. In washing off the glycol borate, we had inadvertently washed off the oxide film, which was soluble in water. The gold had been evaporated on a freshly anodized germanium surface.

"When a small positive potential was applied to the gold, holes flowed in the germanium surface, greatly increasing the flow of current from the germanium to the point negatively biased at a large potential. Four days later, on Dec. 23, 1947, two gold contacts less than two-thousandths of an inch apart were made to the same piece of germanium and the first transistor was made."

The first amplifier was of the point-contact type and had about 20 dB of gain.

John R. Pierce, a member of the technical staff at Bell named the transistor in Brattain's office the following month. Brattain recalls: "Pierce knew that the point-contact transistor was the dual of a vacuum tube, circuit-wise. After some thought, Pierce mentioned the important parameter of a vacuum tube, transconductance. Then a moment later he mentioned its electrical dual, transresistance. Then he said 'transistor,' and I said, 'Pierce, that is it.'"

In 1956 in Stockholm the three inventors received a Nobel Prize in physics for their work.

What are the three developers of the transistor doing today? Shockley has since been involved with bubble memories at Bell Laboratories and is teaching at Stanford University. Brattain is teaching part-time at Whitman College in Walla Walla, Wash., and is doing research on the biological surface between the cell wall and the body fluids. Bardeen has just become the first man in history to win a second Nobel Prize in a single discipline. The 1972 Nobel Prize in physics has been awarded to him for his work in superconductivity at the University of Illinois. ■■

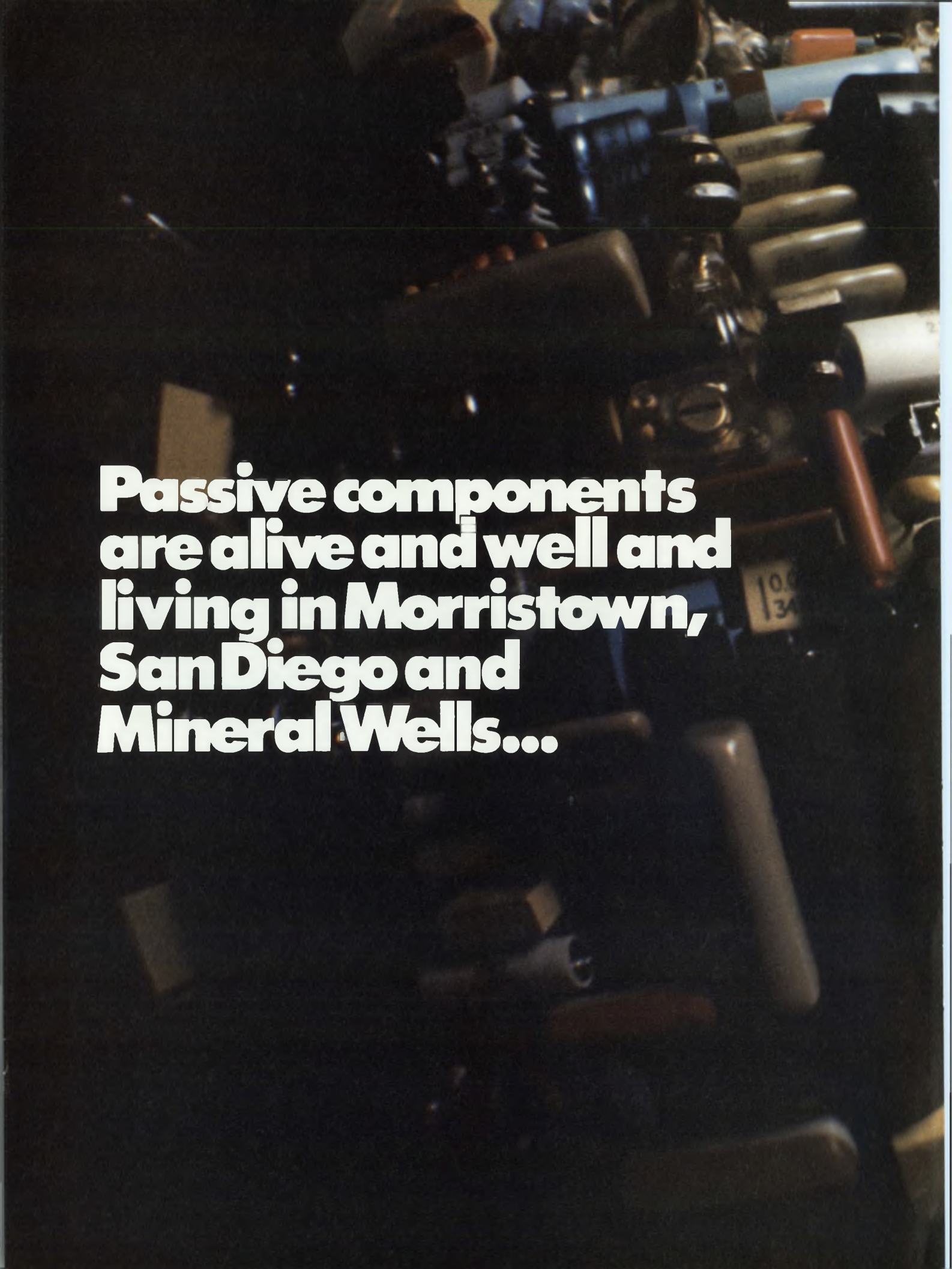

**Passive components  
are alive and well and  
living in Morristown,  
San Diego and  
Mineral Wells...**



In the component OEM jungle, just staying alive is all some companies ask for. At MEPCO/ELECTRA we've got a different story to tell. In the last five years, while a lot of the competition has marked time and worried about the economy, we've tripled our volume.

We've got a lot going for us. Like our service... we can deliver from a 30,000,000 piece shelf inventory. Or if you need it, we've got versatility, too. We can produce almost any volume—from high production runs to the small quantity, high technology jobs. Plus we're big enough to supply your total passive component needs.

So whether you're buying resistors, capacitors or microcircuits for EDP, consumer equipment, communications or military programs, check with the big one, MEPCO/ELECTRA, first. Give us a call today... you'll find out why we're alive and well and really living.

# Talk to the man from MEPCO/ ELECTRA



MEPCO/ELECTRA, INC.

A NORTH AMERICAN PHILIPS COMPANY

SOLD  
THROUGH  
NORTH  
AMERICAN  
PHILIPS  
ELECTRONIC  
COMPONENT  
CORP.

**Factory locations:**  
Columbia Road,  
Morristown, New  
Jersey 07960

11468 Sorrento  
Valley Rd  
San Diego,  
Calif. 92121.

P.O. Box 760 Mineral  
Wells, Texas 76067



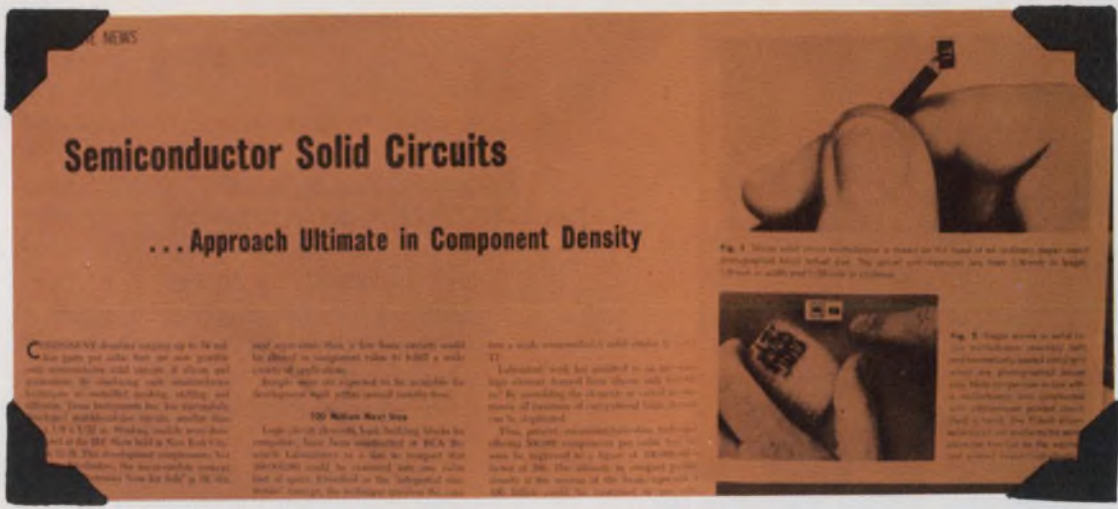

ED, April 15, 1959

Solid-State Devices

# *Trusty transistors and ICs dethrone the power-demanding vacuum tube*

Scientists at Bell Telephone Laboratories looked at the steadily growing telephone industry and didn't like what they saw ahead. There had to be a faster way to perform electronic switching than by using electromechanical relays. And if they were going to cope with the future, they certainly had to come up with a new device to get rid of the power-hungry vacuum tube with its limited reliability. It was the late 1930s, the time of the Great Depression.

What scientists like John Bardeen, Walter Brattain and William Shockley—the three that eventually developed the first transistor—sought was a solid-state device that would be electronic in operation and could amplify and switch. With such a device, the hot thermionic cathode causing problems in telephone systems could be eliminated. And the distant possibilities of electronic switching systems and pulse-code modulation systems would be possible.

Of course, the pioneers at Bell were not alone in their search. Theoreticians and experimentalists contributed to the effort of finding the elusive device. In Britain, for example, A. H. Wilson developed a quantum mechanical theory of semiconductors that included the existence of holes as well as n and p-type materials. Schottky in Germany had a workable theory of semiconductors, but it suffered from the exclusion of holes as carriers.

In another early development—one that passed largely unnoticed at the time—a 1930 patent was issued to Julius Lilienfeld of the University of Leipzig for a device that could be compared to today's MOSFET, or insulated-gate field-effect transistor. The device was reported to provide a means of obtaining amplification in a thin film of copper sulfide. However, a working device was probably never built, since the low mobility of holes in the material and other factors would seem to preclude any amplification.

At Bell Telephone Laboratories Russel S. Ohl tried using silicon crystal diodes, already developed for radar and microwave systems, to amplify rf signals. But the amplifier, depending on a negative resistance effect, proved to be highly unstable.

**Success: a working transistor**

Drawing on some of these developments and others—and from their own discoveries—Bardeen, Brattain and Shockley showed on Dec. 23, 1947, that a small piece of germanium could be made to amplify an audio signal by about 20 dB: The transistor was born.

The success was achieved with a point-contact device (see cover photo). Bardeen and Brattain built the original transistor as a germanium wafer with two closely spaced pointed-wire contacts (cat's whiskers) on one side and a flat metal electrode on the other.

The resistance of one point-contact was found

**Edward A. Torrero**  
Associate Editor



to depend on the current flowing through the other point contact. Since the resistance appeared to be transferable, the name *transistor* seemed a natural one.

Soon afterwards Shockley built the first grown junction transistor, and a major weakness of the first transistor—the cat's whiskers—was eliminated. This achievement reduced the extreme sensitivity to shock and temperature of the point-contact device.

Patents were issued to Bardeen and Brattain in 1950 and to Shockley in 1951 for their respective devices. The three received the Nobel Prize for their accomplishments in 1956. By that time the semiconductor industry was off and running.

## The Processes

Improved versions of the grown junction transistor came at a regular pace in the 1950s. Often a better device resulted from process innovations.

In the early 50s the method of zone refining was developed by William Pfann at Bell. (Along with Jack Scaff, Pfann had developed the first p-n junction.) In the zone refining technique, extremely pure crystals were produced, along with an improvement in the doping process, by sweeping the melted zone through the ingot and the impurities with it. This meant that impurities could be controlled to the point that mass production of transistors was commercially feasible.

In the same period research at General Electric, RCA and Bell Laboratories led to a commercial process for making germanium transistors by alloying techniques. This process, which led to transistors with much higher switching capabilities, involved the alloying of impurity dots on either side of a semiconductor wafer. Penetration was controlled through temperature.

By comparison, the fabrication of grown-junction devices involved the development of impurity layers while the crystal is withdrawn from the melt. The cutting of transistors from the crystal, parallel to the crystal's axis, then resulted in transistors containing the impurity layer. A weakness of the process was limited bandwidth.

Advancing the early-trend toward higher frequencies, Philco developed the jet-etching technique in 1953. Here electrochemical machining was used to fabricate the necessary thin base layers. A major product of this process was the surface-barrier transistor, which boosted the upper frequency limit of transistors into the megahertz region.

The year 1954 saw two milestone advances: a young Dallas-based company, Texas Instruments, introduced silicon-junction transistors, while Bell



Zener diodes using silicon emerged from Bell Telephone Laboratories' work on the semiconductor material.

ED, Feb., 1954

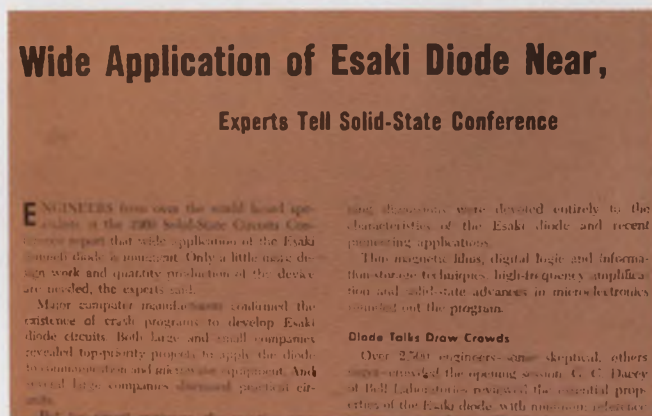

The tunnel diode never quite caught on as some predicted primarily because of high production costs.

ED, March 16, 1960

Laboratories developed oxide masking and diffusion for the fabrication of transistors.

Until now, germanium had been the main semiconductor for transistors. Bell Laboratories had concentrated on it, rather than silicon, in the 1940s because impurities had been easier to control. And Bell's early development of single-crystal growing of germanium was widely used.

A drawback of germanium, however, was its fairly limited temperature range. With TI's development of the silicon types, temperature ranges became suitable for military applications.

Similarly oxide masking and diffusion led to device advances beyond transistors. The immediate effect was to improve quality control and reduce manufacturing costs through increased batch production. The resulting product, introduced initially by Motorola and shortly after by Texas Instruments, was the diffused-base transistor.

Oxide masking and diffusion, along with earlier developments, were to play a major role later in the development of integrated circuits. Moreover they would accelerate the advance toward better solid-state devices other than junction transistors—such as diodes and rectifiers.

## Insulated-Gate Field-Effect Devices Proved Feasible for Production

RCA-Air Force Project Demonstrates All-Semiconductor, Non-Junction FETs Are Simple to Make and Should Prove Versatile in Logic Applications

Donald Christensen

Robert Mersault

**R**esearch at RCA has demonstrated that all-semiconductor, non-junction field-effect transistors (FETs) are simple to make and should prove versatile in logic applications. The RCA-Air Force Project has demonstrated that these devices are simple to make and should prove versatile in logic applications. The RCA-Air Force Project has demonstrated that these devices are simple to make and should prove versatile in logic applications.



ED, March 1, 1963

Insulated-gate FETs could now be manufactured as MOS transistors because of Research at RCA.

By the late 1950s the stage was set for a giant step forward—the introduction of ICs. Engineers at both Fairchild and Texas Instruments saw the possibility of producing on a single chip of silicon not only transistors and diodes but also resistors and capacitors, and of joining them into a complete circuit. The special properties needed for the various circuit elements were to be achieved by selectively diffusing traces of impurities into the silicon or oxidizing it to silicon dioxide. With the techniques of photolithography, selected regions of silicon would be exposed while other regions would be protected.

### Enter the integrated circuit

At first TI used fine wires for bonding the various elements into a functional circuit. Fairchild achieved the same result more simply by evaporating a thin film of aluminum over the circuit elements and etching it selectively to leave a two-dimensional network. The Fairchild technique produced what became known as planar integrated circuits.

Fairchild invented the planar process in 1960. Used initially to produce transistors, the technique spread rapidly to ICs when it was found that passive components could be incorporated as easily as active devices. Fairchild produced another major milestone in ICs two years later when the company commercially introduced the first metal-oxide silicon (MOS) transistor.

The first monolithic integrated circuit came from Texas Instruments. J. S. Kilby developed a phase-shift oscillator from a single silicon bar in 1958. The device required no interconnections from one component to another; the electrical path was through the silicon. TI was also the first manufacturer to announce a product line of ICs. Termed Solid Circuit Series 51, the initial offering in 1960 consisted of simple logic circuits.

Meanwhile at Bell the epitaxial process was developed. With this important tool, junctions could be economically formed in production by grow-

ing one crystal structure on another. It quickly was to become a standard part of transistor and IC fabrication.

## Discrete devices

While ICs were beginning to eclipse the transistor for technical attention—much as transistors did to vacuum tubes a decade earlier—many important advances were achieved around this period with discrete devices as a result of the same processes that led dramatically to the first ICs. Sometimes basically different devices were discovered from related developments.

Diodes and rectifiers, for example, had been around for years when the first point-contact transistor was invented. At that time designers could buy an IN34 germanium diode for as low as 50¢. But these devices were generally limited to low-speed, low-power applications and were not much of a threat to tubes performing similar functions.

By 1956, General Electric had introduced the first commercial silicon-controlled rectifier. The Bell Laboratories' invention—an outgrowth of the work in silicon technology—was immediately hailed as the solid-state replacement for thyatron tubes for control and switching functions.

Other notable devices derived from the Bell work on silicon include zener diodes and p-i-n diodes. (The first commercial zener diodes appeared in 1954; one of the earliest manufacturers was the recently formed division of National Fabricated Products of Evanston, Ill.—National Semiconductor.)

The unijunction, or double-based diode, emerged from experiments on germanium alloy tetrode devices at General Electric in the early 1950s. The discovery of a UJT device was announced by GE in 1953. But it was not until 1956 that commercial devices (using silicon) were marketed. The planar structure was incorporated into

UJT construction in 1966. Later that same year a complementary version added built-in resistor stabilizers.

Commercial field-effect transistors (FETs) were first made available in 1958 in France. A General Electric affiliate, CFTH, offered a germanium-alloy device. In the U.S., the initial introduction came shortly after from Teledyne Crystallonics.

Still other device spinoffs from process or material research, such as the tunnel diode and Gunn diode—important technical advances, to be sure—have yet to achieve the wide acceptance their early promoters envisioned. In many cases high costs have limited wider commercial use.

The first laboratory model of the tunnel diode, or Esaki diode, was built in 1957 at Sony in Japan. At that time some thought it would replace the transistor—which, of course, it never did. An important application at present is as a replacement for special-purpose tubes for amplification and oscillation at very high frequencies.

The Gunn diode—first discovered by IBM in 1963—was one of the first important applications for the semiconducting material gallium arsenide. Researchers at Siemens in Germany—more than a decade earlier—had uncovered this material during work on semiconductors made from elements in the third and fifth groups of the periodic table.

The Gunn diode is one of several very-high-frequency devices that have appeared in the last 10 years. The first microwave gallium-arsenide field-effect transistor (Schottky barrier) was built at IBM, also in 1963. Bell Laboratories introduced the IMPATT diode oscillator in 1965, and in 1966 Bell presented the theory for the TRAPATT oscillator, which RCA developed in 1960. In 1971 the BARITT oscillator emerged from Bell.

Of course, one of the major beneficiaries of improved methods of fabrication was the transistor itself—especially toward higher power ratings.

This trend toward ever higher power capabilities with silicon and germanium transistors was matched by a drive for higher powers at higher frequencies—into the rf and microwave region. The development was made possible by innovations in transistor geometries as much as process innovations. Two important—and still widely used—configurations that resulted were the interdigitated and overlay geometries.

The first to be developed was the interdigitated geometry—only seven years after the first transistor was built. Before this, the closest thing to an rf power transistor was a device handling 7 W at 5 kHz and rated at 0.3 A.

The problem was that increases in power-handling capacity required increases in the size of

## Planar-Structure Transistor Developed By Fairchild

A diffused planar-structure transistor, type 2N1613, will be introduced at the IRE show by Fairchild Semiconductor Corp. The device differs from mesa types in that both the collector-to-base and base-to-emitter junctions are embedded in the top surface of the planar structure.

A significant advantage of the planar structure, the company reports, is reduced reverse leakage:  $0.0005 \mu\text{A } I_{cbo}$  typically at 60 v. A typical noise figure of 5 db is said to allow it to be designed into infrared amplifiers, character recognition preamplifiers, and low-noise video amplifiers. Guaranteed minimum beta of the device is put at 15 at 100  $\mu\text{A}$ .

Fairchild has begun production on a line of

Fairchild announced a transistor fabricated with the planar process. It would soon be applied to ICs.

ED, March 16, 1960

## Crazy like a fox

Some companies get started by making illogical decisions—illogical, that is, to all but visionaries. Texas Instruments traces its beginnings to such a decision by John Clarence Karcher, a physicist.

Karcher started an oil exploration business in 1930—Geophysical Services, Inc.—because he had conceived a process known as reflection seismology for finding oil. The process determined the depth, shape and, to some extent, the texture of subsurface structures by sending sound waves far below the earth's surface.

A good idea for starting a company? Maybe in normal times. But 1930 was the dead of the Depression. The price of oil had skidded to a dime a barrel, and it was said that a scientific approach to oil-finding wasn't even needed. The oil fields of Texas and Oklahoma were brimming, and all wildcatters had to do was puncture the surface and cap the gushers.

Needless to say, Geophysical Services hung on to grow from seismology to space-age technology. But then its name had been changed to Texas Instruments.

the transistor die, and the greater size lowered operating frequencies. The frequency could be raised by going to smaller dies, but the cost would be in power ratings.

In 1954, N. H. Fletcher—an engineer with Transistor Products—hit on the idea of reshaping the emitter and base into long, narrow finger-like structures. This became interdigititation.

In Fletcher's models, interlocking of the fingers (iteration) became the fundamental interdigitated structure, with emitter stripes alternating

with base contact stripes in a comblike fashion.

These models became the basis for Delco's ring-emitter transistor of 1956—the first commercial interdigitated product. The elongated emitters were arranged in a circle, a configuration that manufacturers have since used again and again.

By 1964—the year the overlay geometry arrived on the scene—epitaxial processing had been applied to commercial interdigitated devices. Refinements in the geometry, along with better mask production and alignment techniques, also helped boost power and frequency ratings. A typical interdigitated structure of the day was capable of 5 W at 100 MHz and 0.5 W at 400 MHz.

Then RCA—developer of the overlay transistor—came out with the 2N3375, the first commercially available transistor built with an overlay construction. It produced 10 W of output power at 100 MHz and could handle 4 W at 400 MHz. The distinguishing feature of the overlay was that part of the emitter metal lay over the base, instead of adjacent to it. The emitter current was carried in the metal conductors, or fingers, that crossed over the base. The actual base and emitter areas beneath the pattern were insulated from one another by a silicon dioxide layer.

## Integrated circuits

If the 1950s were the decade of the transistor, to a large measure ICs took over the 1960s. The functions on a chip—either digital or linear—seemed to grow endlessly, while prices kept dropping. By 1970 the industry had moved from medium-scale to large-scale integration (LSI).

Much of the early activity was involved with digital logic families. Almost from the beginning, a host of semiconductor manufacturers were attempting to establish the dominance of one logic family over the other—or were second-sourcing the strong suit of a competitor.

At the start resistor-transistor logic (RTL) seemed to be the way to go; Fairchild and Texas Instruments were strongly promoting it. Then diode-transistor logic (DTL) appeared in 1962 from the recently formed Signetics, and it took off. Transistor-transistor logic (TTL) emerged in Sylvania's Universal High Level Logic (SUHL) in 1963 and again, more permanently, in Texas Instruments' 5400 series in 1964.

The introduction of DTL by Signetics had enormous impact from the beginning, mainly because designers were used to working with the concept. Fairchild, noting the fast rise of the logic family, was not long in following the Signetics lead. In 1964 Fairchild came out with its

930 DTL Series. It was to become the most successful DTL line, almost overwhelming the Signetics 800 DTL Series with better noise immunity and clock-waveform insensitivity.

Meanwhile work on TTL was going on at Pacific Semiconductors, Fairchild and Signetics. The effort at Sylvania was spearheaded by Thomas A. Longo, who pushed it as early as 1961 when he was with Fairchild. The early circuits had high speed, but they suffered from low noise margins, little fanout and poor capacitive drive capability. Longo developed improved versions that emerged from Sylvania as SUHL in 1963. The first practical application, dubbed the Phoenix gate, followed quickly in the Phoenix missile, being built by Hughes.

TI's strategy in 1964, with its just announced

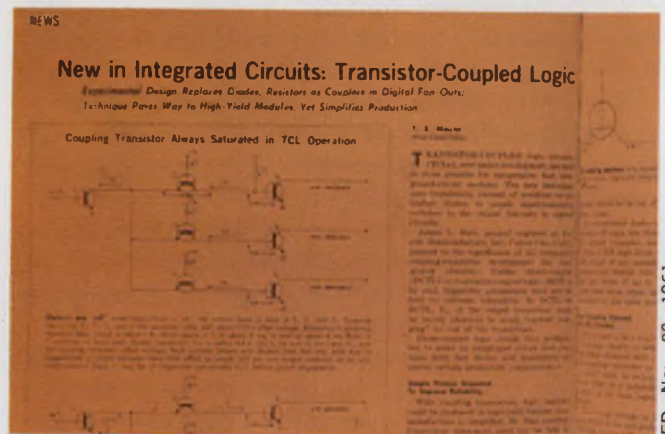

Transistor-transistor logic circuits appeared in the early 1960s from an early manufacturer—Pacific Semiconductors. Other pioneers were Fairchild and Signetics.

TTL series, was a frontal attack on DTL. The Dallas-based manufacturer used DTL-pin configurations, then the same kind of packaging—first ceramic, later plastic (7400 Series).

And very early in the game TI had medium-scale-integration parts. They were a decade counter, quad latch and Nixie driver. With the added feature of parts replacements for several packages, it didn't take long for 54/74 TTL to take over the field.

The beginnings of emitter-coupled logic (ECL) lines actually preceded the 54/74 Series. Motorola introduced MECL I in 1963, and has since upgraded it with faster series.

Standard 54/74 weighed in at 10 ns (typical gate propagation delay) and 10 mW (typical gate power dissipation). It was slower than MECL I (8-ns delay), but it consumed much less than the 31 mW that MECL I did.

Then 54H/74H came along with ratings of a 6-ns gate delay and 22-mW gate dissipation; it

was faster than MECL I and also consumed less power. It, in turn, was challenged in 1966 by the faster MECL II, which had 4-ns delays and about the same dissipation.

This evolutionary process was broken with Motorola's introduction in 1968 of MECL III. With 1-ns typical gate delays and 60-mW gate dissipation, it is today's fastest standard logic line. But it never took off: For many requirements, the speed seemed too high to be useful without special and usually costly packaging techniques, while the power dissipation appeared excessive. The result was the 1971 introduction of MECL 10,000 (some like to call it MECL II $\frac{1}{2}$ ), which offers 2-ns delays at 25 mW dissipation.

Currently MECL 10,000 is competing with Schottky-clamped transistor-transistor logic (S-TTL), the fastest series in the 54/74 family. Called the 54S/74S line, S-TTL boasts 3-ns delays at 20 mW dissipation.

Both MECL 10,000 and 54S/74S S-TTL, spurred by growing computer mainframe applications, are fast becoming second-sourced fairly widely—the usual tip-off that the industry expects a line to move.

The whole story on standard logic lines isn't limited to the bipolar families, however. In 1968, RCA introduced CD4000 COS/MOS, the company's name for its complementary MOS (CMOS). In the short time since then CMOS has attained a strong position as a contender to TTL, especially for low power applications.

CMOS used to be a sort of technological curiosity. It had the lowest dissipation of any technology (below about 10 MHz), very high noise immunity and good switching speeds. But low yields led to high unit costs. And the scarcity of alternate sources tended to limit applications to the military and aerospace.

Within the last few years costs have come down, and a host of semiconductor manufacturers have begun to alternate-source the 4000 Series. Some, like Harris, using dielectric isolation techniques, and Inselek, with silicon on sapphire (rather than silicon substrates), claim substantial improvements in speed over the RCA line.

### Linear ICs make their mark

Linear ICs, too, came into their own in the 1960s. Starting with op amps, linear monolithics grew steadily in complexity and functions.

Monolithic op amps were first introduced in the early 1960s. At least two manufacturers—Texas Instruments and Westinghouse—were selling models. Then Fairchild, in 1964, came out with the 702, the result of the first collaboration between Bob Widlar and Dave Talbert. The 702 found limited acceptance—more significantly,

its development led to the 709, one of the biggest success stories in an industry accustomed to them.

The 709 was a revolution of sorts. Rather than translate a discrete design into a monolithic form, the standard approach, Widlar played the linear microcircuit game by a different set of rules: Use transistors and diodes—even matched transistors and diodes—with impunity, but use resistors and capacitors—particularly those of large value—only where necessary. Even where use of a big resistor seemed inevitable, Widlar put a dc-biased transistor in its place. He exploited the monolith's natural ability to produce matched resistors and only assumed loose absolute values.

The 709 isn't as widely used today as some of its improved versions, like the 741. Internal compensation and short-circuit protection are some of the user benefits that led the changeover. But the op amp and variations or elaborations of it—comparators, voltage regulators and differential amplifiers are some—account for a good chunk of all the linear microcircuits available.

### Memories and processes

Recent developments include improved memories, high-density bipolar processes and whole subsystems on a single chip.

In memories, bipolar types usually implied higher speed and MOS types higher density. But in the competition between semiconductor memories and core, memories had to have the right combination of speed and density.

Something of a breakthrough came with Intel's introduction in 1970 of the 1103, a 1024-bit, fully decoded dynamic MOS random-access memory. It had about the right specs, and the price seemed acceptable.

The 1103 was not the final step. Power dissipation was on the high side, and external devices were required to make it work. But the 1103 signaled that computer manufacturers would hereafter have to regard semiconductor memories more seriously in their designs.

Back on the bipolar side, the Isoplanar process emerged from Fairchild in 1971. Similar to Raytheon's V-ATE and Motorola's VIP processes, which followed shortly, the Isoplanar process achieved substantial reduction in chip real estate by eliminating the empty spaces between devices. One result: The lure of MOS and its characteristic high density was being challenged.

Meanwhile MOS has a strong record in high-density devices. At present a number of MOS/LSI chips are commercially available. The list includes calculator chips (initial introduction by Mostek) and microprocessors (first introduced by Intel). And from the plans that major manufacturers have for future products, this is only the beginning. ■■



# The New Snap-On...

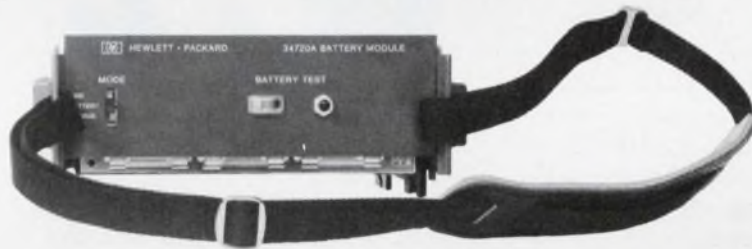

## Low-Cost, 4-Digit Measurement System 3470.

- Bright LED Display section has 100% overranging.
- AC/DC/OHMS snap-on with display. (\$600 complete)
- DC snap-on with display. (\$475 complete)
- Snap-together expandability with sandwich centers — battery pack (\$200); BCD (\$175).
- H-P's exclusive self-test accessory reduces down time (\$50).

If you need one of these low-cost DMM's, there's no time like the present. Pick up the phone and call your nearest H-P Representative, now. Or, write to Hewlett-Packard, Palo Alto, California 94304; Europe; P.O. Box 85, CH-1217 Meyrin 2, Geneva, Switzerland. In Japan: YHP, 1-59-1, Yoyogi, Shibuya-Ku, Tokyo, 151.



HEWLETT  PACKARD

DIGITAL VOLTMETERS  
INFORMATION RETRIEVAL NUMBER 41

THE ADVENTURES OF...

**DEWEY  
MAKEORBUY**



THE ARMY HAS JUST MOVED THE DATE UP BY 2 WEEKS ON THIS PROJECT MEN.

GEE, WE'RE HAVING ENOUGH PROBLEMS GETTING A MIL. SPEC. POWER SUPPLY DELIVERED BY THE OLD DATE GENERAL!



RELAX GENTLEMEN! DEWEY MAKEORBUY HAS THE ANSWER. AT ERA TRANSPAC WE CUT OUR TEETH ON MIL. SPECS. AND HERE'S THE INDEPENDENT LAB REPORT\* TO PROVE IT. AS FOR DELIVERY, WE CAN MEET MOST MIL. SPEC. REQUIREMENTS OFF-THE-SHELF.



WHO? I SAY WHO WAS THAT SUPPLY GUY ANYWAY?



Mil. Spec. environmental requirements and are available at still lower cost.

If the Mil. Spec. DC Modules you are looking for aren't in our catalog, we can supply special designs meeting your exact requirements at low cost.

Whether you design, specify or buy commercial or Mil. Spec. power supplies of any type, you should have a copy of the ERA Transpac Power Supply Catalog with full product specifications. Write to: **ERA Transpac Corporation**, 311 East Park Street, Moonachie, N. J. 07074; Tel: (201) 641-3650; TWX: 710-990-5064.

\* SEND FOR YOUR FREE COPY OF OUR MIL. SPEC. CERTIFICATION REPORT.



When it comes to Mil. Spec. power modules, ERA Transpac has the fullest catalog line—ANYWHERE . . . and at low cost . . . and a 180-page laboratory environmental test documentation at no cost.

In our MS Series of Repairable Modules, we list models from 0-7 V DC to 310 V DC and current ratings

of 50 MA to 8 AMPS, with many available off-the-shelf.

The entire MS Series meets component, workmanship and environmental requirements of MIL-E-16400, MIL-E-4158, MIL-E-5400, MIL-E-5272 and MIL-T-21200.

Our Transpac ME Series of Encapsulated Modules meets the same

TYPICAL MS MODULES		
OUTPUT (VDC)	CURRENT (@ 75°C)	MODEL
0-7	0-8 AMP	MS 078
11.5-12.5	0-4 AMP	MS 124
23-25	0-2 AMP	MS 242
27-29	0-1 AMP	MS 281
200-210	0-100 MA	MS 200P1
TYPICAL ME MODULES		
0-10	0-250 MA	ME 10P3
11-13	0-2 AMP	ME 122
23-25	0-1 AMP	ME 241
27-29	0-500 MA	ME 28P5

Free air operating temperature at full ratings, with no external heat sink or forced air required—MS Series —55° to 75°C, ME Series —20° to 71°C.

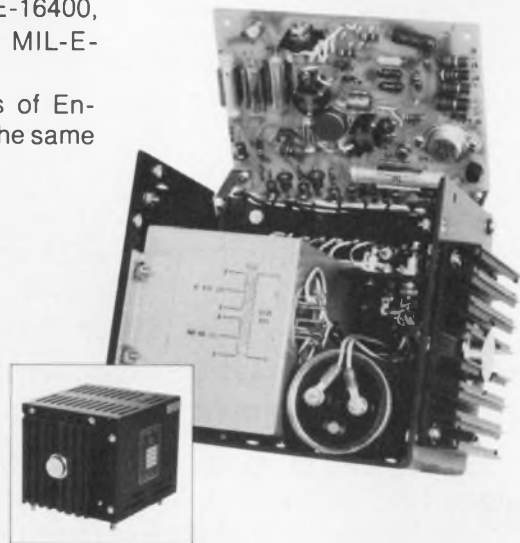

**ERA**  
**ERA**  
**TRANSPAC**  
**CORPORATION**





# TOGGLE TERRITORY.

It's anywhere you are in the whole land.

It's anywhere you have to put your hands on exactly the right toggle switch to complete your design.

Especially if you need extraordinary design flexibility, distinctive appearance and proved performance in your toggle switches.

Cutler-Hammer not only provides the broadest line of toggle switches available, but offers you the greatest selection of ratings, terminations,

hardware, toggle shapes, materials and colors.

AC-rated. AC/DC. Low energy. Dry-circuit capability, or up to 25 amps. One, two and four poles. Select Cutler-Hammer Designer Line, miniature, slow-make/slow-break or hesitation switches from the complete Cutler-Hammer line. We have thousands of varieties ready for delivery. And if the toggle you need isn't among those thousands, we'll work with you to build exactly what you want.

You needn't look very far to get the finest quality in toggle switches. Wherever you are in the U.S.A., get the toggle you want. Because we cover Toggle Territory best. With

more distributors than anyone else. Call your Cutler-Hammer Sales Office or Stocking Distributor. Or write for full-line catalog LC-110A.



Switch  
to No.1

More than just switches;  
prompt availability,  
field help, innovation,  
quality assurance, too.

INFORMATION RETRIEVAL NUMBER 43



**CUTLER-HAMMER**  
SPECIALTY PRODUCTS DIVISION, Milwaukee, Wis. 53201

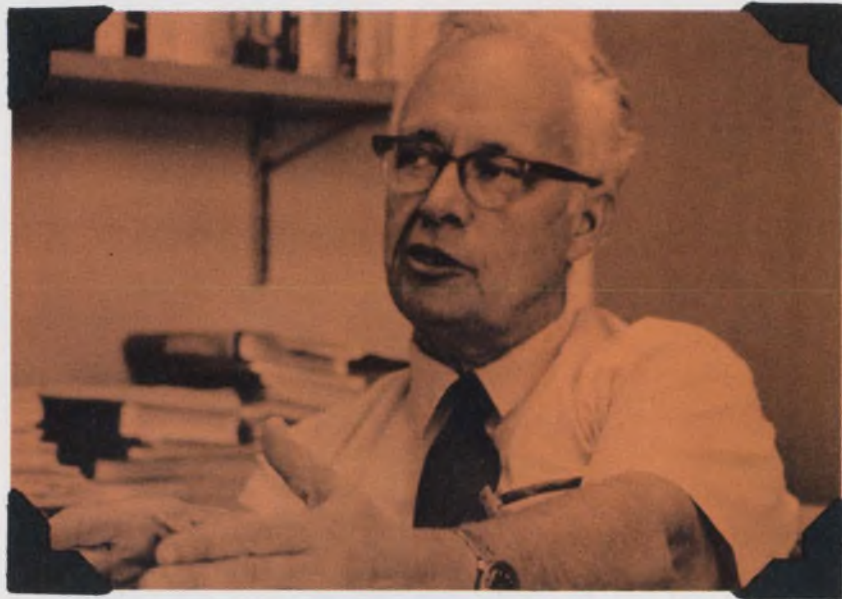

## Haggerty and OST—or how TI grew two-hundred fold in 25 years

**A**t the time the transistor was being developed at Bell Telephone Laboratories in 1947, Patrick Eugene Haggerty was developing the research, engineering and manufacturing phases of Geophysical Services Inc., in Dallas, Tex. GSI grew from a company of \$3.8-million in annual sales in 1947 to an organization known as Texas Instruments, with annual sales of \$764.3-million in 1971. A main reason why TI sales skyrocketed is that Pat Haggerty committed the company to the development, manufacture and marketing of semiconductor devices in 1951.

The electronics executive had begun his career as a student engineer with the Badger Carton Co. and subsequently had become assistant general manager of the company. After three years as a lieutenant in the Navy, Haggerty joined TI in 1945. In 1951 he was elected executive vice president and director; in 1958, president, and, in 1966, chairman of the board, the post he holds at present. He's a graduate of Marquette and is the recipient of seven honorary degrees.

ELECTRONIC DESIGN interviewed Pat Haggerty, and his reminiscences of TI, semiconductor devices and the problems of managing a fast-growing company follow:

Over the years we've formalized a system of management at TI called OST—Objectives, Strategies and Tactics. By strategy I mean the

general action the responsible executive wants his organization to pursue in achieving company goals. By tactics I mean the specific programs that must be carried out successfully to implement the strategy. Our objective in 1949 was to be a good big company instead of a good, medium-sized company, which had been our expressed goal to that point. We defined a good, big company as one that would do about \$200-million per year and earn at least \$10-million a year net on that volume.

In pursuing our company goal, we used several strategies simultaneously, but one accounted for the largest share of our achievement. During 1949 and 1950 it finally became clear to me that the future of electronics would be profoundly influenced by knowledge already attained—such as the development of the transistor—and additional knowledge being rapidly gained about materials at the structure-of-matter level.

In early 1951 we began to formalize our strategy by commitment to develop, manufacture and market semiconductor devices by:

- Seeking a patent license from the Western Electric Co.

- Setting up a project engineering group under Mark Shepherd Jr., (now president of the company) in what was then the laboratory and manufacturing division. The goal was to develop devices and to grow into a full-fledged operating division, including all of the usual functions.

- Establishing research laboratories heavily

---

Interview conducted by  
Richard L. Turmail, Management Editor

oriented toward the chemistry and physics of the solid state, with particular emphasis on semiconductor materials and devices.

We pursued Western Electric, with respect to licensing, all during 1951, but their licensing policy was not established until late in 1951.

Along with many others, four of us from TI—Bob Olson, Mark Shepherd, Boyd Cornelison, and I—attended the now famous transistor symposium held by Bell Telephone Laboratories and Western Electric in the spring of 1952. Following that symposium the project engineering group under Mark Shepherd came into being. Prior to that time not one single hour of effort had gone into research and development on semiconductor devices at Texas Instruments. The research laboratory was established under the leadership of Gordon Teal on Jan. 1, 1953.

Almost from the beginning, in filling out our strategy, we came to the conclusion that the inherent characteristics of semiconductor devices were such as to find widespread application in military equipment but that the temperature limitations of germanium probably would limit severely their use in this field. We also concluded that this would be a mass-production business and we needed soon to find an application that would demand from us relatively large quantities of devices of adequate quality at prices that were economic for the applications involved.

It seemed clear, too, that a dramatic accomplishment by TI in the field of semiconductors was needed to awaken potential users to the fact that the devices were usable now and that TI was ready to supply them.

That was the strategy. The tactical R&D programs that contributed to its fulfillment were many, but I want to identify three specific ones: The development of a small signal transistor for the military, devices and circuitry; the pocket transistor radio; and production processes for silicon material.

The first two R&D programs and their successful implementation in manufacturing and marketing produced exactly the kind of dramatic impact needed both for Texas Instruments and for the industry. I am convinced that the entire cycle of semiconductor-device utilization in the United States and the world was speeded by at least two years because one relatively small company chose the proper strategy and followed through with successful tactics.

Later in 1954 we initiated the third tactical R&D project that was to contribute markedly to the success of our strategy. This was the development of a process to produce the extremely pure silicon material that we felt would be necessary to insure our success with silicon devices.

The strategy was successful, and in 1956 our profits in the semiconductor field were sufficient

to generate a satisfactory accumulative profit for the whole program. Further, we were off to a good lead in the semiconductor industry, and our semiconductor products division was to be the bellwether of the entire company in the attainment of our net sales goal of \$200-million, which we reached in 1960.

### Straddled problems of cost and products

What were some of the management problems along the way? Well, I think that they probably fall into two categories. The early one, from 1954 to 1960, was choices of products or lines of technologies to pursue, as illustrated by the silicon transistor, high-frequency germanium and the integrated circuit. The other class of problems is associated with the peculiar nature of this business, which mixes both extraordinary technology and the constant need for many new products with the most unrelenting pressure for decreasing costs that perhaps any industry in the country has experienced.

In some respects these two problems are at opposite ends of the pole. I think very few people have straddled both of the problem areas as well as we have. Even though we have had our mistakes, I think the results would suggest that we have perhaps managed both to create a sufficient number of new products and to have reacted swiftly in catching somebody else when they created them. The key to that success is OST.

We don't focus much on the rest of the industry. We focus on ourselves. We have to focus on the competition obviously, but each competitor faces us in a certain sector of the market. We find it difficult enough to decide what's right for Texas Instruments.

If any of our management decisions could be changed today, they'd probably be the ones we made during the recessions of 1961-62 and 1969-71, when we didn't always have the strength of our convictions of what we sensed was happening.

Twenty-five years after the birth of the transistor I think we can really see what I have always thought of as the inevitable, eventual pervasiveness of electronics—such as hand calculators, communications from the moon, photographs from Mars. And I think that the rate at which electronics is having an impact on our lives will accelerate.

It seems to me that the reason electronics had to be pervasive is that the first industrial revolution expanded man's muscles, and this one is clearly expanding man's spirit and mind, his ability to see, to hear, to think, to remember and to solve problems. And while it has been clear and fashionable for a long time that that's what data processing is all about, not until now did it begin to apply to almost everything we do. ■■

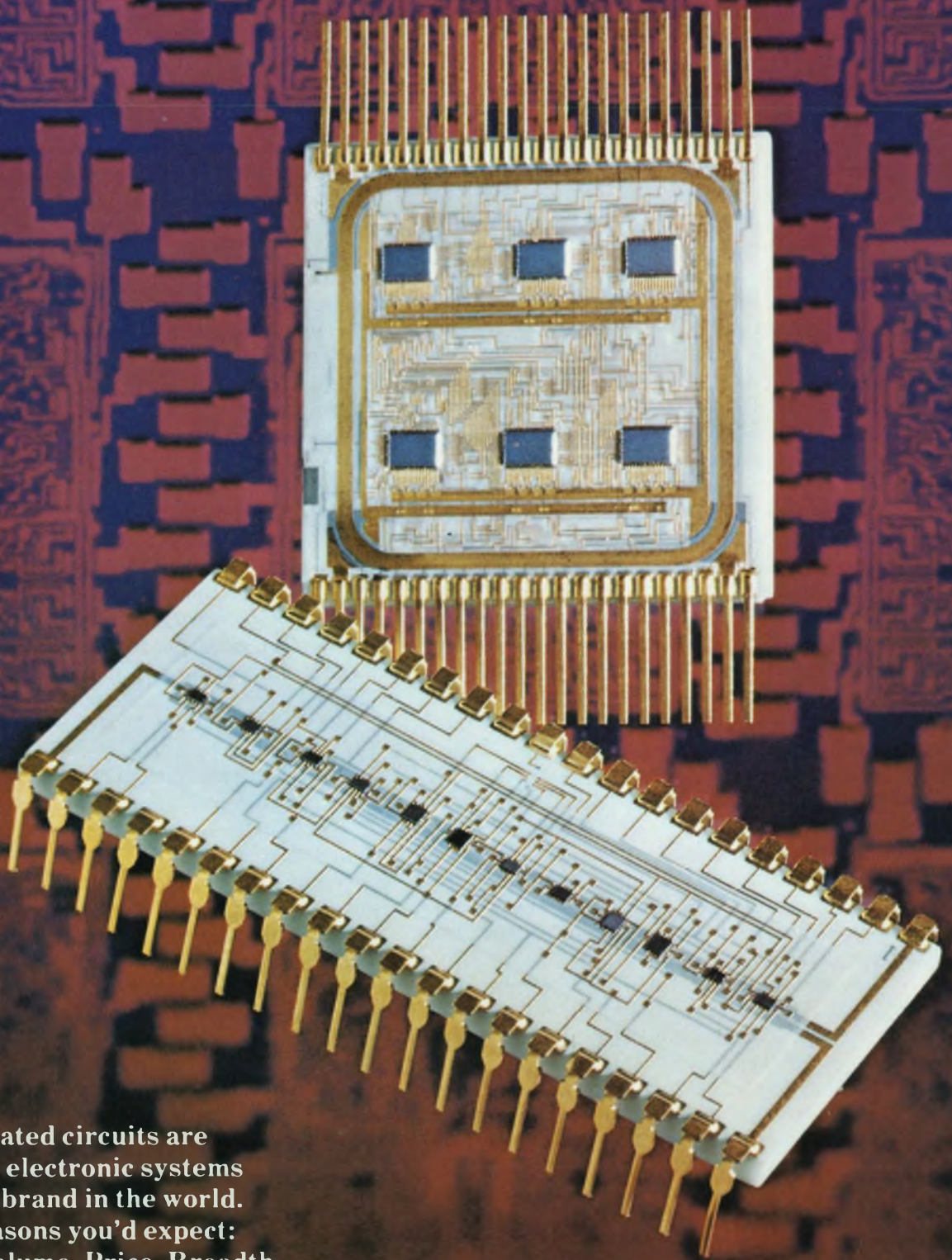

More TI integrated circuits are used in today's electronic systems than any other brand in the world. And for the reasons you'd expect: Technology. Volume. Price. Breadth. Dependability. Service. Quality. Weigh them all when you buy Hi-Rel ICs.

# BEAM-LEAD ICs

# TI announces beam-lead, low-power Schottky TTL/MSI circuits: custom assemblies and standard chips.

Beam-lead reliability. 10ns at less than 2mW/gate performance. Full military temperature range. Custom assemblies of up to 500 gates produced quickly and economically using standard MSI chips and computer-aided design.

These are the major advantages offered by TI's new line of beam-lead, low-power Schottky TTL/MSI circuits—available now in custom beam-lead assemblies or as individual chips.

## Complexities up to 500 gates

High-performance, high-complexity low-power Schottky circuits (and TI's low-power SSI and standard SSI TTL beam-lead circuits) can be combined to produce complete LSI assemblies to your specifications. Bonded directly to multi-level or single-level metalized ceramic substrates, the beam-lead circuits reach complexities of up to 500 gates in a single package. This modular approach typically requires one-half the design and fabrication time normally needed for monolithic custom LSI chips of comparable complexity. The results:

- Fast turnaround.
- Substantially lower development costs.
- High density, reduced package count.
- Reduced system heating.
- Low power supply requirements.
- Lower system costs in production phase.

## Choose from 13 standard MSI functions and a semi-custom random logic bar

Basic building blocks of the line are 13 standard MSI functions with average gate speeds of 10ns at less than 2mW power dissipation. TI's low-power Schottky TTL technology provides a speed/power product of 20 picojoules...MSI design permits high density and lower system costs...and beam-lead fabrication eliminates wire bonds for increased reliability. Hermeticity is accomplished at the chip level by a silicon nitride barrier layer in addition to standard hermetic packaging techniques.

For maximum density in the total system, the beam-lead RLB-60\* random logic circuit offers complexities of up to 60 gates. Average power dissipation is only 1mW/gate with average speeds of 10ns/gate.

\* Trademark of Texas Instruments Incorporated

Fan-out per gate is 2mA. This semi-custom low-power Schottky beam-lead circuit requires the preparation of only one mask—the metal interconnect.

## Beam-lead chips off-the-shelf

In addition to their use in custom assemblies, TI's new low-power Schottky MSI beam-lead circuits are available as individual chips. Delivery of production quantities is 6 weeks ARO. Sample quantities of these functions are now in stock:

BEAM-LEAD CHIPS		Typical Speed/Power	100-piece Chip Price
BL54LS95A	4-bit right shift register	30MHz/52mW	\$15.50
BL54LS138	3-to-8 line decoder	20ns/30mW	13.20
BL54LS139	Dual 2-to-4 line decoder	20ns/35mW	13.20
BL54LS153	Dual 4-to-1 line data selector/multiplexer	15ns/35mW	9.90
BL54LS155	Dual 2-to-4 line decoder/demultiplexer	20ns/30mW	15.50
BL54LS181	Arithmetic logic unit (ALU)	30ns/105mW	37.00
BL54LS193	Synchronous up/down 4-bit binary counter		24.50
BL54LS194	4-bit bi-directional universal shift register	30MHz/60mW	15.65
BL54LS195	4-bit parallel-access shift register	30MHz/52mW	15.65
BL54LS196	50-MHz divide-by-5 presettable decade and binary counter/latch	30MHz/55mW	21.30
BL54LS197	50-MHz divide-by-2 presettable decade and binary counter/latch	30MHz/55mW	21.30
BL54LS253	Dual 4-to-1 line data selector/multiplexer with tri-state logic	20ns/45mW	11.90
BL54LS295	4-bit right/left shift register with tri-state logic	30MHz/60mW	18.55

## Beam-lead IC technologies

TI offers a broad beam-lead integrated circuit capability. In addition to the 13 new low-power Schottky MSI circuits, TI can now supply beam-lead versions of 7 low-power TTL SSI circuits, 7 standard TTL SSI circuits, a 256-bit ROM, and a 741 op amp. And more circuits are on the way, including SSI/MSI low-power Schottky and several linear functions.

## For more information

Call your local TI sales engineer for details on TI's custom beam-lead assembly capability. For product literature, including data sheets on standard catalog chips, circle 243 on Service Card. Or write Texas Instruments Incorporated, P.O. Box 5012, M/S 308, Dallas, Texas 75222.





## Computers

# *An 'amazing' top war secret is bared, and a new age in civilization results*

**T**he news item published at the bottom of the front page of The New York Times on Friday, Feb. 15, 1964, was, in retrospect, gee-whizzish. It began:

*Philadelphia, Feb. 14—One of the war's top secrets, an amazing machine which applies electronic speeds for the first time to mathematical tasks hitherto too difficult and cumbersome for solution, was announced here tonight by the War Department. Leaders who saw the device in action for the first time heralded it as a tool with which to begin to rebuild scientific affairs on new foundations. . . .*

It was the first public revelation of an event that was to have a profound effect on civilization and to usher in a new technological age—the age of the computer.

The news story referred to the dedication of the Eniac, known more formally as the "Electronic Numerical Integrator and Computer." Built at

the University of Pennsylvania by Prof. John Mauchly and Prof. J. Presper Eckert, Eniac was the first large-scale electronic computer. It was developed for the Ballistic Research Laboratories of the United States Army Ordnance Corps. Objective: the computation of firing and ballistic tables.

Physically, Eniac was impressive. It occupied 30 by 50 feet and contained no less than 18,000 vacuum tubes. It required 130 kW of power for operation. The computing elements consisted largely of decade rings, flip-flops and pentode gates. These were direct-coupled, requiring 18 power-supply voltages and consequent heater-cathode potential differences of over 100 V. The input-output system consisted of modified IBM card readers and punches.

The challenge of Eniac was that its operation depended upon the simultaneous functioning of almost all of the 18,000 vacuum tubes without failure.

Stories were told, some apocryphal, of how all the lights in West Philadelphia would dim when Eniac was turned on and how the starting tran-

---

Ralph Dobriner  
Managing Editor

## On seeing the light

During the early days of Eniac—the world's first electronic computer—the Swedish Government sent an official over to look at the huge machine. He was very impressed, but also somewhat chagrined at the prospect of having to prepare a report on the computer.

He remarked that he felt in the same situation as an old gentleman in Sweden who, years before, had been shown the electric light for the first time. The man was astonished and asked how it worked. He was given a complete explanation and then was asked whether he had any questions.

The old gentleman said: "Well, it's a brilliant explanation on your part, but I really have just one small question: How in the world does the oil float through those tiny wires?"

sient would always burn out three or more tubes. Yet Eniac was successful. It was a productive computer until it was turned off for the last time on Oct. 2, 1955.

Eniac was the first of a series of digital electronic computing systems that were more university projects than commercial ventures. As originally designed, Eniac was not a stored-program computer. Programs were installed and changed by engineers who changed the wiring among the machine's various components. The first stored-program digital machines as we know them today were the Edvac (Electronic Discrete Variable Automatic Computer) and the Edsac (Electronic Delay Storage Automatic Calculator).

Edvac was built at the Moore School of the University of Pennsylvania between 1947 and 1950. Instead of using vacuum-tube flip-flops as storage elements, the internal memory was composed of 128 thermostatically controlled acoustic delay lines, each storing 384 bits as sound waves in mercury. Each delay line accommodated eight words—a total of 1024—with an access time of 48 to 384  $\mu$ s. The information circulated constantly through the lines.

Edsac was completed before Edvac and went into operation at Cambridge University in England early in 1949, where it performed the first computations by a stored-program computer anywhere.

Other milestones in the early development of digital computers were the following:

- The Standards Electronic Automatic Computer (SEAC), built by the National Bureau of Standards and placed into operation in 1950. It was a serial, synchronous, binary, fixed-point machine operating at a 1-megapulse-per-second rate with a word length of 44 bits. It was the

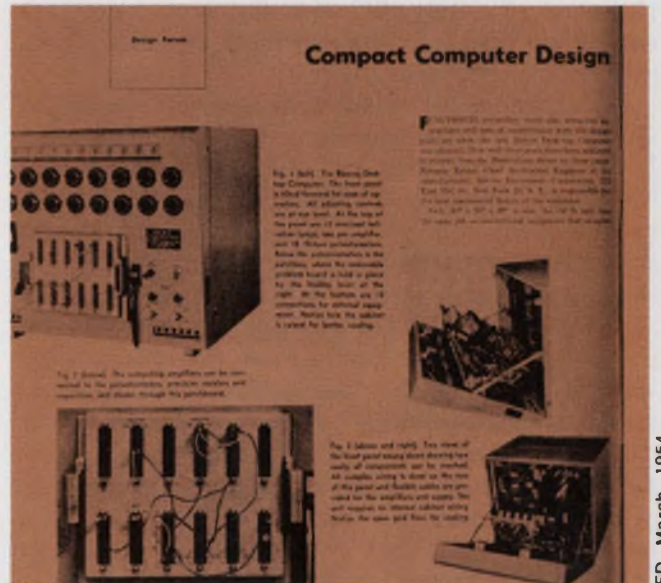

An early desk-top analog computer from Reeves Instrument Corp. weighed just 150 pounds.

first U.S. machine to use the CRT electrostatic storage system, the Williams tube memory, developed at the University of Manchester in England. It was perhaps to be the best memory device available until the invention of magnetic core.

- Whirlwind I, built at the Digital Computer Laboratory of the Massachusetts Institute of Technology and put into operation in 1951. It was probably the first computer designed with eventual real-time application in mind. It used 0.5- $\mu$ s circuitry and could multiply two 16-bit numbers in 16  $\mu$ s. Although the machine's memory consisted at first mainly of 16 specially designed electrostatic storage tubes, a coincident-current magnetic core memory was used later. The core-memory designs developed at MIT were made available to the computer industry and served as the basis for the core memories built by IBM and other computer manufacturers.

### The first commercial machines

By now first-generation commercial computer systems were on the scene, built by such companies as Remington-Rand, IBM, Raytheon, Honeywell and Burroughs. The first generation belonged essentially to vacuum-tube computers, and it flourished roughly from 1946 through 1959. All of the early transistorized computers after this period belong to the second generation.

The distinction between second-generation and third-generation commercial computers is not so clear-cut, however. New computers, and most of the computers that remained on the market after 1965, are called third generation by their manufacturers, with some companies contending that they are already in the fourth generation. The major new technological development has been in

the area of integrated circuits, and computers employing these circuits can truly be called third-generation machines.

The granddaddy of the first generation was the Univac (Universal Automatic Computer). Univac I was built by Eckert and Mauchly, who founded the Eckert-Mauchly Computer Corp. (which later became a subsidiary of Remington Rand and subsequently the Remington Rand Univac Div. of the Sperry Rand Corp.). Univac I was built for the Census Bureau and was put into operation in the spring of 1951. For almost five years after that, it was probably the best large-scale computer in use for data processing. Internally it was the most completely checked commercial computer ever built. Perhaps its most impressive achievement was its magnetic-tape system, a buffered system that could read forward and backward at speeds comparable to some quite-recent tape systems.

Univac I was a serial, synchronous, stored-program machine operating at 2.25 megapulses per second. It contained some 5000 vacuum tubes and several times as many semiconductor diodes in logic and clamp circuits. A hundred mercury delay lines provided a thousand 12-decimal-digit words of internal storage.

Not long after the machine was put into operation, "automatic programming" techniques were developed by its builders. These consisted essentially of ways to instruct the computer to prepare its own instructions to perform a given task. Sets of such instructions have become extensive programming languages that are important for the effective use of the modern digital computer. Univac I also introduced the concept of direct recording onto magnetic tape from a typewriter keyboard.

### IBM 650: The industry workhorse

Univac I was the only mercury delay-line storage computer that achieved the status of a commercial product. By 1953 it was apparent that computers with magnetic-core memories could be produced that would make Univac I obsolete. The IBM 650 intermediate-size, vacuum-tube machine, introduced in 1954, was considered the workhorse of the industry during the late 50s. It had a 1000 or 2000-word magnetic drum, 60 words of magnetic core memory, magnetic tapes, a basic clock rate of 125 kilopulses per second, an 800- $\mu$ s add time and a 24-to-200-ms multiply time. Over a thousand 650s were put into service. For the first time, a large group of machine users had more or less identical systems. This had a profound effect on programming. It was now desirable to have common programs and programming techniques.

Almost from the time of its public announce-

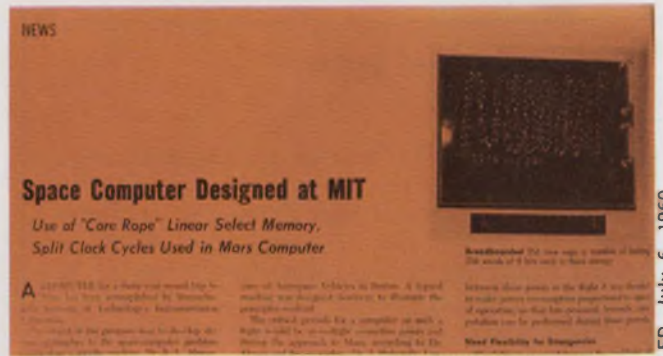

Space computer designed for a three-year round-trip mission to Mars was designed at MIT.

ED, July 6, 1960



Replacing the slide rule with compact calculators was a major objective as long as eight years ago.

ED, June 8, 1964

ment in 1948, the transistor was expected to become the key to revolutionary advances in computer technology.

The earliest transistorized computers were medium-speed, business-oriented systems. National Cash Register was one of the first major companies to withdraw from the vacuum-tube computer market with the announced intention of returning with a transistorized model. Its 304—the first all-transistorized computer in its class—was a joint effort, designed by National Cash Register and built by General Electric. The first installation was made in November, 1959. The central processor contained some 8000 diodes and 4000 transistors. With single-address instruction, addition required 60  $\mu$ s and multiplication 1260  $\mu$ s. A total of 2400 to 4800 words of magnetic-core storage, each word with a maximum of 10 characters, could be used.

About this time RCA tried to establish itself in the computer field with its transistorized 501—a general-purpose, data-processing system using "building block" construction and completely variable word length. It was quite slow. Typical additions required 0.24 to 0.42 ms, typical multiplication 1.9 to 9.6 ms. However, much of the success the machine achieved was due to its COBOL compiler—one of the earliest available. The compiler was also very slow, but for many



users, a slow COBOL was better than none at all.

A breakthrough in the use of transistors for very-high-speed computing appeared in 1954 with the development of the surface-barrier transistor by the Philco Corp. It was the first of a series of developments that produced transistors for the high-speed computers.

With the emergence of the surface-barrier transistor, which was incorporated in a number of small, specialized, high-speed machines, Philco felt that by 1957 it was a year or more ahead of most companies in the development of big transistorized computers. By the end of 1958 the company announced the Philco 2000, an all-purpose, data-processing system. The design was based upon direct-coupled, asynchronous logic circuits that used surface-barrier transistors.

A typical Philco 2000 system contained 450 tubes, 1200 diodes and 56,000 transistors. The computer utilized binary, binary-coded-decimal and alphanumeric internal-number systems with a 48-bit word length. Addition required 1.7  $\mu$ s and multiplication of 40.3  $\mu$ s. Although the computer was a considerable advance, the company, because of internal problems, never really penetrated the computer market.

About that time IBM announced its 7090 with a 2.18- $\mu$ s memory, compared with the 10- $\mu$ s memory of the 2000. And the 7090 had faster arithmetic speeds. After some of the early bugs were eliminated and engineering changes made—an air-cooled memory was designed to replace an earlier oil-cooled memory system—the 7090 became an extremely reliable computer and a tremendously successful one.

Another significant second-generation machine about this time was Control Data Corp.'s 1604, a basic 48-bit binary computer, not as powerful as the 7090 or 2000 but considerably lower priced. In 1963 the company introduced the 3600, a much faster, improved version of the 1604. It made Control Data a major factor in the large-scale computer market.

### The third generation arrives

Third-generation computing systems came into being about the time IBM announced its System 360 series. On April 7, 1964, IBM introduced six new computers: Models 30, 40, 50, 60, 65 and 75 of the System 360. These computers, along with other members of the same family, were intended to replace all existing IBM computer series. A major aim was to standardize within IBM such computer characteristics as instruction codes, character codes, units of information and modes of arithmetic. IBM developed a new technology for the System 360 that it called Solid Logic Technology. The new logic still used discrete transistors, but very small ones in a small ce-

## From doughnuts to electronics

Among the electronics companies of the 1950s were the Doughnut Corp. of America, United Shoe and General Mills.

The Doughnut Corp.? United Shoe? General Mills?

Correct. It came about this way: After World War II the most advanced manufacturing facilities in the nation were in the food and ready-wear industries. So it was not surprising that major electronics manufacturers of the time turned to these first for help in mass-producing circuitry.

When Project Tinkertoy established a system for mechanizing the construction of electronic circuits in 1951, the Doughnut Corp. of America was among the concerns that contributed fabrication expertise. In the mid-50s United Shoe built—for RCA, Emerson and others—assembly systems that inserted components, terminals and jumpers in wiring boards. And General Mills contributed a machine called Autofab that helped IBM assemble thousands of boards in about 100 designs for Air Force early-warning-radar computers.

Assistance like this eased the electronics industry into mass-production capabilities and the era of automation.

ramic package. The circuits were hybrid rather than monolithic ICs. Many features of the 360 have since been accepted as standard by other manufacturers.

Not long after the introduction of the 360, RCA (which subsequently dropped out of the computer business, as did General Electric) announced its Spectra 70 series—machines that were almost completely compatible with the IBM 360, except that they used monolithic ICs.

Other third-generation computer systems were developed from the middle to the end of the 1960s by Control Data (3000 series), General Electric (600 series), Honeywell (Model 200), Scientific Data Systems, now Xerox (940 series), National Cash Register (Century series) and Digital Equipment Corp. (PDP series). DEC also introduced its first minicomputer during the 1960s.

What distinguished most of these computing systems from the first and second-generation machines were that most were entirely solid-state so far as the processors were concerned. The systems were constructed with upward compatibility in mind. There were advances in memory size and speed, and magnetic discs were used.

*Parts of this account are from "Electronic Computers: A Historical Survey," by Saul Rosen, published by the Association for Computing Machinery, Inc., New York, N.Y. ■■*

# New from Amphenol's Spectrum

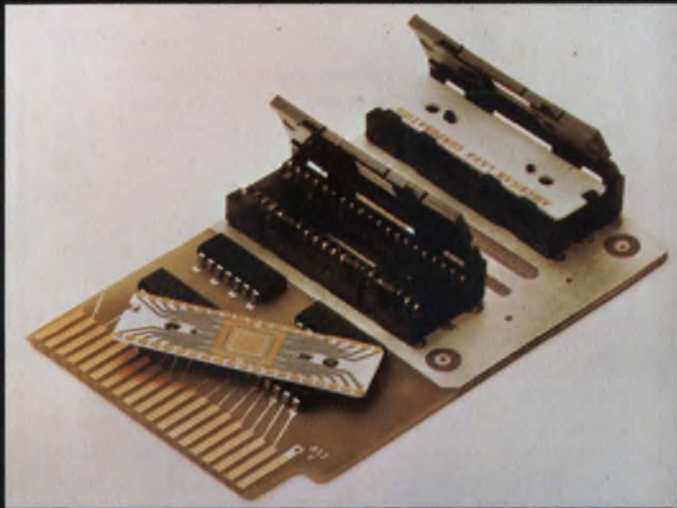

**level 1** MOS/LSI Planar Plug-In connectors (above) for leadless, flat mount ceramic substrates. Permits fast, easy replacement of IC package, no screws, has snap-down lid. ■ Free-standing terminal (below) terminates IC's to PC boards for lowest total systems cost.

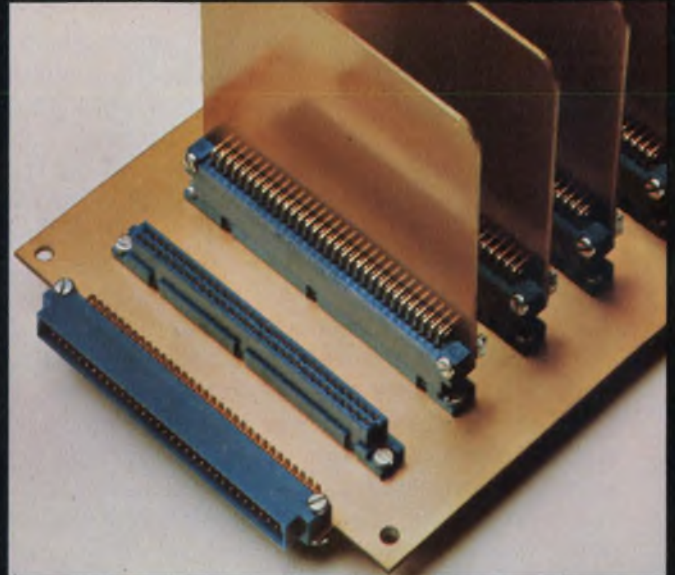
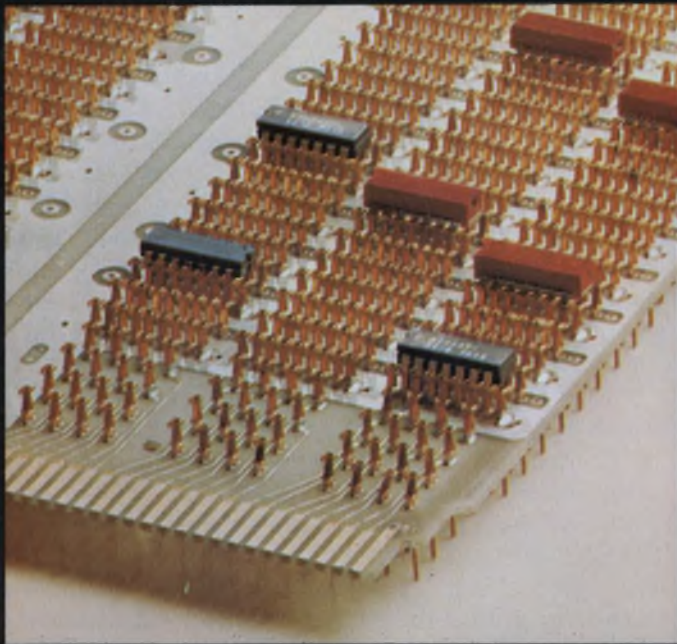

**level 2** Box contact connectors (above) intermate with .025" square or round contacts. Low insertion force. Terminations for crimp, wire wrapping or wave solder. ■ Zero insertion force connectors (below) improve PC board and connector life by eliminating strain and wear.

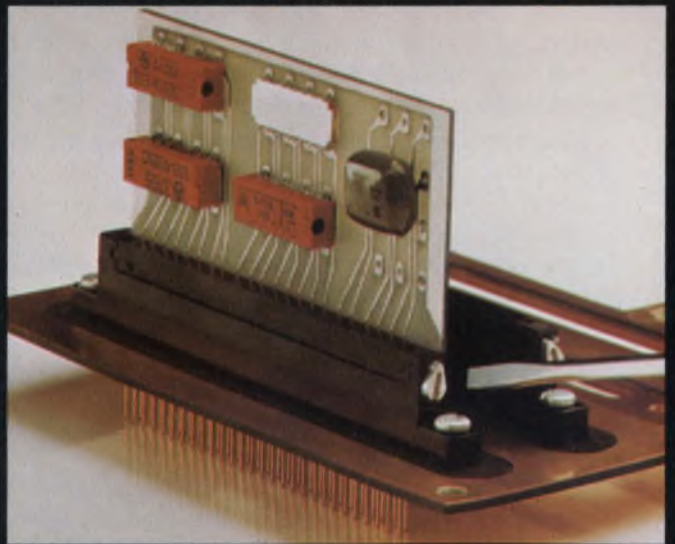

Above are seven new ideas from Amphenol Industrial Division's Spectrum of interconnection capability.

Amphenol's SPECTRUM offers you *all four* levels of interconnections from our unmatched breadth of product line:

**Level 1 . . . DEVICE TO BOARD OR CHASSIS.** We offer interconnections for components such as tubes, relays, transistors, IC packages, trimmers, resistors or capacitors to a PC board or chassis.

**Level 2 . . . BOARD TO MOTHERBOARD OR BACK PLANE.** We offer interconnections for PC boards or

other sub-circuit modules to a motherboard or to a back plane.

**Level 3 . . . MOTHERBOARD OR BACK PLANE WIRING.** We offer interconnections for levels to each other and to other sub-circuits with multi-layer circuit boards, wire wrapping, clip terminations, jumper techniques and dip-soldering.

**Level 4 . . . INPUT/OUTPUT CONNECTIONS.** We offer interconnections for power and signals to and from a system. This interface may be between sub-assemblies within the same enclosure or between individual units.

# of interconnections.

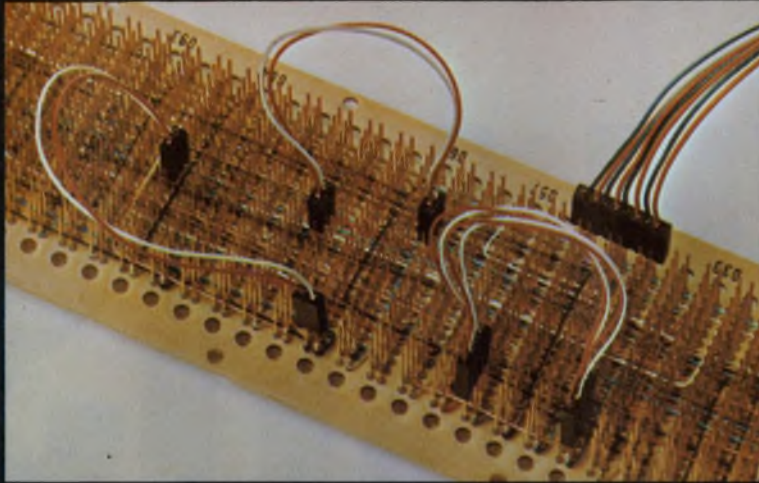

level **3**

Low cost strip connectors (above) are used as jumpers in back plane wiring. Intermates with .025" square or round posts. ■ Circuit Concentration Bay (below) consists of wire wrappable panels that are five times as compact as the telephone distribution frames they replace.

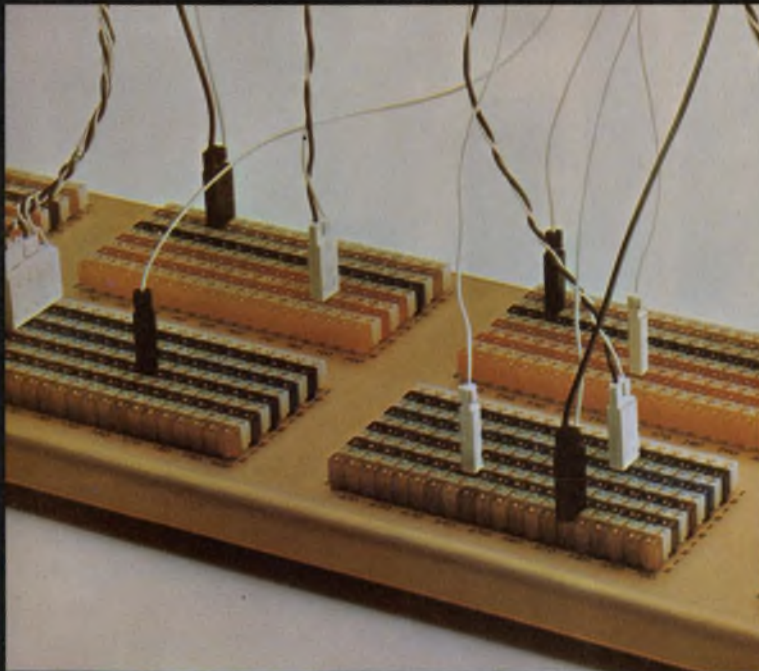

level **4**

Modular Integral Connector concept lets you make your own pin & socket connector to fit your needs. Five contact sizes, thousands of combinations. Sufficient components for six connectors in handy MIC-KIT. Design and assemble your own prototypes.

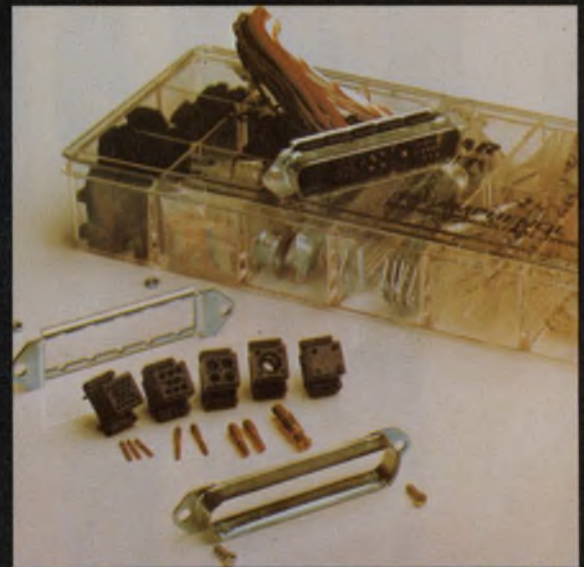

From the simple tube socket—to a myriad of electrical/electronic connectors—to complete and complex termination systems . . . SPECTRUM.

But SPECTRUM is far more than products. It is a depth of capability in engineering, manufacturing and quality control. Amphenol's SPECTRUM is a new height of service, availability and distribution backed by seven Amphenol interconnection-oriented divisions.

Amphenol can fulfill your total interconnection requirements because we are not limited to specifics such as one or two product lines, one or two levels.

Therefore we approach your interconnection needs with complete open-mindedness.

For more new ideas and specific information, write for your copy of "SPECTRUM." Amphenol Industrial Division, Bunker Ramo Corp., 1830 South 54th Ave., Chicago, Illinois 60650.

**BUNKER  
RAMO**

# AMPHENOL

# CDE

# 60 YEARS YOUNG . . .



It's nice to know that a company you do business with has been around a long time . . . it's more important to know that it will be around tomorrow to back up its products and reputation. CDE has been here for 60 years and is committed to the future with a list of new ideas in capacitors, relays and filters too involved to describe. If you'd like to know more about CDE components, just take a look at our COMPONENT SELECTOR GUIDE — yours for the asking.

**CDE** **CORNELL-DUBILIER**

150 Avenue L, Newark, N. J. 07101 • (201) 589-7500

INFORMATION RETRIEVAL NUMBER 46

# The 5-volt, N-channel MOS static RAM.

(Much more useful. Much easier to use.)



100% TTL compatibility—without clocks, without refresh. Interfacing's so simple you'll think you're working with bipolar parts. All the performance you've been itching to get your hands on. Backed by the smoothest specs ever put into MOS static RAMs. 1024 bits. 500ns access time. Single +5V supply.

N-channel technology developed by Signetics makes the difference. We designed out the kinks in competing devices, and came up with a new trouble-free line of ion-implanted N-channel MOS static RAMs.

And what a difference N-channel makes on your boards. Three times the circuit speed of P-channel RAMs. 50% lower power dissipation. Absolutely no fudging on bipolar compatibility—no clocks, no refreshing needed. So the parts are much easier to understand and put to use.

First super-RAM off the line: Signetics' new ion-implanted 2602 static RAM.

# 2602

N-channel delivers 1024x1 organization: four times the density of similar products. With extremely fast access time for a static RAM: 500ns. And we threw out the -12V power requirement that made terminal applications so sticky. 2602 operates from only +5 and ground.

In production now in a 16-pin package. For full details, write Signetics, or call your Signetics rep, salesman or distributor.

And ask about our breakthrough N-channel dynamic RAM, the 2601: non-overlapping clocks, 1024x1 in 18-pin packs, with 85ns access time, requiring under 300mW power.

High speed, high density, lower power, optimized convenience. Signetics make it in MOS. Of course.

Signetics-MOS  
811 East Arques Avenue  
Sunnyvale, California 94086  
(408) 739-7700

Please send complete specs and technical data on your new N-channel line of RAMs; including the 2602 5V static RAM and the 2601 dynamic RAM.

Name

Title

Company

Address

City

State

Zip

Telephone

Signetics Corporation—A subsidiary of Corning Glass Works.

## signetics

INFORMATION RETRIEVAL NUMBER 47



## Communications

# *A scholarly paper and technology join forces to start a revolution*

**T**echnological revolutions are seldom perceived by people as they unfold. It is usually in the perspective of history that the real significance of events can be safely assayed. So it was that in the late 1940s a minor upheaval in communications began to take shape almost imperceptibly.

The transistor had come along in 1947 to solve "unsolvable" problems in switching and to sow the seeds of automation in communications. But the transistor needed time to develop and make its mark. Meanwhile, in 1948, a new "magic" emerged—information theory. A dynamic concept, it laid the foundation upon which our current understanding of communications is built.

The impact of information theory—first described by a Bell Telephone Laboratories engineer, Dr. Claude E. Shannon, in a paper entitled "A Mathematical Theory of Communication"—was felt almost immediately. Shannon introduced the bit as a unit of measure for communications systems and found a means of predicting the ultimate communication capabilities of any particular system. In addition his theory helped stimulate work in pulse-code-modulation (PCM) systems, which had been developed 10 years before by Alec H. Reeves, a member of the International Telephone and Telegraph Laboratory in Paris,

but had never been widely used.

PCM began to get off the ground in the early 1950s, and it added a new dimension to communications. With the ability to transform the input signal into a series of pulses that could be regenerated when the signal became weak or noisy, PCM kept interference at a minimum. It also made it possible to multiplex a large number of signals over the same link.

The first commercial system to demonstrate the advantages of PCM was the T-1 carrier, introduced by American Telephone and Telegraph in the early 1960s. It could provide 24 channels on a single pair of wires. Since then PCM has been used in a growing number of applications, from microwave relay links and space communications to CATV systems.

Could PCM have succeeded without the transistor? Dr. Henri Busignies, senior vice president and chief scientist for International Telephone and Telegraph, doubts it today. Pulse-code modulation would not have been impossible without the transistor, he says, but it certainly would have been impractical. It would have required too many tubes and would have been too expensive to use.

By 1960 electronic switching had made its debut in the first electronic telephone exchange in Morris, Ill. Essentially a special-purpose digital computer, the system used a combination of transistors and reed relays to provide switching and isolation. It also contained a flying-spot store that

---

**Jules H. Gilder**  
Associate Editor

used photographic plates as a read-only memory. The switching function was under program control and could be altered simply by changing the photographic plates. Successful operation of this early electronic switching system cleared the way for today's computerized switching networks.

But the computer was also becoming popular as an information-processing tool, and in the 1960s the need to transmit data from one place to another became urgent. The telephone network was the logical way to do it. But to use it, some means of interfacing digital data with the analog telephone system had to be found. Thus the modem (modulator-demodulator) was born.

The early growth of modems was slow, because the number of private lines on which they could be used was relatively small and only telephone company equipment could be used with the telephone system. The Carterfone decision of June, 1968, changed the picture. The Federal Communications Commission ruled that certain privately owned communications equipment could be connected to the public telephone system.

### Microwaves expand phone system

But besides modems, microwave communications were being developed to expand the telephone system. In November, 1947, about a month before the introduction of the transistor, the first broadband microwave link had been opened between New York and Boston. Capable of carrying both telephone and television signals, the relay link was the forerunner of the sophisticated microwave relay system that spans the United States today.

Active interest in one of the most significant areas of microwave communication, tropospheric propagation, began in the early 1950s. At that time the National Bureau of Standards, the Lincoln Laboratory of the Massachusetts Institute of Technology and Bell Telephone Laboratories were conducting extensive theoretical and experimental investigations into this new means of transmitting beyond the horizon.

The decade of the 50s saw many developments in tropospheric scatter transmission. The technique was very attractive because of its high degree of reliability. DuMont Laboratories, Philco, Westinghouse and Bell Telephone were only a few of the companies that built experimental scatter systems. The early work in tropospheric scatter led ultimately to over-the-horizon radar for the Distant Early Warning line and to secure military communication systems.

But not only new methods of transmission followed the growth of microwaves in the 50s; new devices and subsystems were developed as well. The klystron, the traveling-wave tube, masers, parametric amplifiers and solid-state tech-

nology—all had a tremendous impact on the design of microwave systems.

The klystron started and ended the decade as the workhorse of microwave sources. Three developments made practical a power-handling capacity previously impossible. The first was the convergent electron beam, which allowed electrons from a large area cathode to be focused into a small, high-density electron beam. The second was the perfection of precision beam control, which prevented vaporization of the supporting tube structure by the beam itself. And the third was the development of practical ceramic windows that permitted the high-level energy to be coupled from the vacuum bottle to the pressurized transmission line.

The traveling-wave tube (TWT), conceived in England by Rudolph Kompfner in 1943, was transformed into a practical broadband, stable microwave amplifier by John R. Pierce, a member of Bell Telephone Laboratories, in 1945. Since that time it has progressed to become a leading contender among microwave sources and amplifiers because of its high gain, voltage tunability, low rf voltage, low impedance and very broad bandwidths.

The first maser, a gas type, was capable of amplifying weak signals with very low inherent

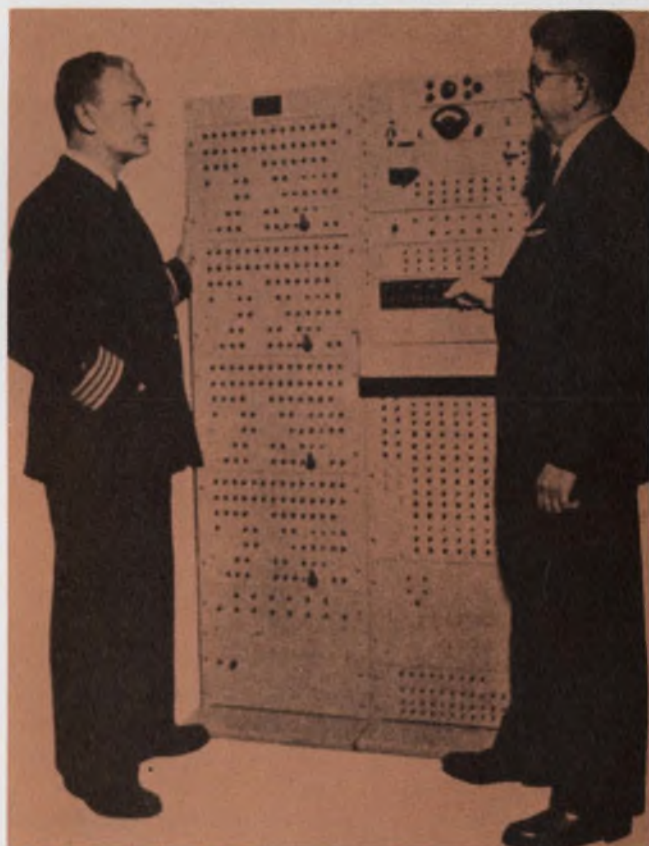

The first all-electronic transistorized switchboard was developed for the U. S. Navy by Stromberg-Carlson. Four years after its introduction, the first electronic telephone exchange appeared.

ED, May 5, 1956

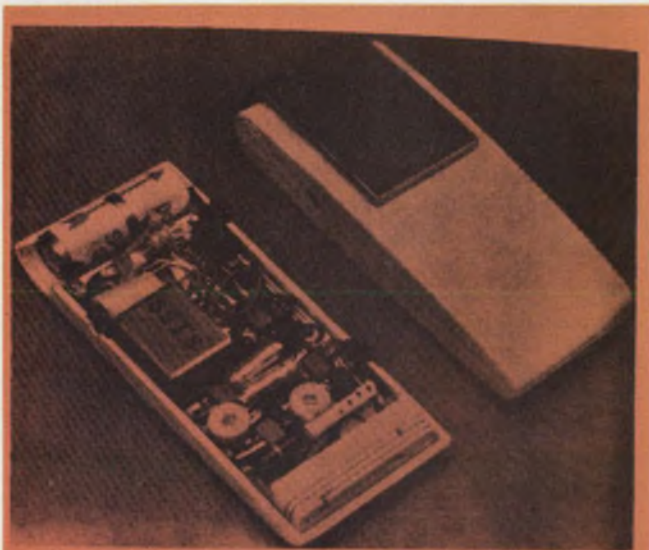

Pocket Receiver

## Pocket-Radio Signaling

A small, pocket-radio receiver under development at Bell Telephone Labs., 463 West St., N.Y.C. may result in city-wide personal radio signaling. Reported in the current issue of Bell

Pocket-paging systems got their start in the late 50s with the availability of small sensitive receivers.

ED, Feb. 19, 1958

ELECTRONIC DESIGN  
**NEWS**

### Steered Arrays Sought for Communications

Electronically Steered Arrays Held Useful for Communications; Beam-Switching and Phase-Shifting Systems Now in Design

**Beam Steering**

5 STEERING, the art of directing the energy of a radio wave, is a key to the development of a new type of communication system. The use of electronically steered arrays, which can be switched to any direction, is being studied by the Army Research Office-Durham, Durham, N.C., and the Air Force Office of Scientific Research, Dayton, Ohio. The use of such arrays is being studied by the Army Research Office-Durham, Durham, N.C., and the Air Force Office of Scientific Research, Dayton, Ohio. The use of such arrays is being studied by the Army Research Office-Durham, Durham, N.C., and the Air Force Office of Scientific Research, Dayton, Ohio.

**Beam Steering**

The use of electronically steered arrays, which can be switched to any direction, is being studied by the Army Research Office-Durham, Durham, N.C., and the Air Force Office of Scientific Research, Dayton, Ohio. The use of such arrays is being studied by the Army Research Office-Durham, Durham, N.C., and the Air Force Office of Scientific Research, Dayton, Ohio.

Electronically steered arrays that showed promise for use in communications, have yet to find wide application.

ED, Feb. 1, 1961

noise levels. Interest in this new device, developed in 1954 by Prof. C. H. Townes at Columbia University, was great and its use in a broad range of applications was widely predicted. But the enthusiasm was destined to be tempered. Because of its size, cost and complexity, the maser has found use only in applications where noise is the most important consideration, such as in ground stations for communication satellites, radio astronomy and radar.

The microwave parametric amplifier, developed in the mid-1950s, began to challenge the dominance of the TWT and masers in applications

where narrower bandwidths were acceptable. Parametric amplifiers magnify the signal by means of a variable reactance. It was the varactor diode, developed by Bell Laboratories, that enabled parametric amplifiers, starting in 1957, to extend their operating frequencies to higher ranges.

As remote computer processing became more popular in the 1960s, the telephone system became more crowded. High-speed data transmission often required as many as 12 regular voice channels. To help meet this demand, a dormant development came to life. For six years, Microwave Associates of America, Inc., had been battling telephone companies, trying to enter the common-carrier business. In August, 1969, the challenger succeeded. The FCC authorized the construction of custom communications channels on a common-carrier basis between Chicago and St. Louis.

The case laid the foundation for a later FCC ruling, known as Docket 18920, which allowed private companies to enter the common-carrier field in other parts of the country, not just between Chicago and St. Louis. Microwave Associates is presently operating the Chicago-St. Louis link and constructing three similar networks between St. Louis and Dallas, New York and Chicago, and Boston and Washington.

## Radio: SSB to the rescue

What of radio communications? The military and international companies with a need to communicate abroad leaned heavily on radio, and by the 1950s designers were hunting for ways to ease spectrum crowding. Single-sideband transmission appeared to hold great promise.

Like so many other radio techniques, it had been developed originally for use in telephone systems. In 1915, J. R. Carson of AT&T's Development and Research Dept. had proved that only one sideband was needed for transmitting intelligence. Three years later the first commercial application of single-sideband showed that it was possible to use this technique to increase channel capacity. By the mid-1930s single-sideband transmission at high radio frequencies had proved successful. In the late 50s, after its first major application in the Strategic Air Command became known, single-sideband really caught on.

Much of the early use of single-sideband was by amateur radio operators. It enabled them to put out a stronger signal with the same amount of power, and it eliminated selective fading, a problem in high-frequency communication. These advantages became of particular interest to two amateur operators: Gen. Curtis E. LeMay, commander, and Lieut. General Francis H. Griswold, vice commander, of the Strategic Air Command.

So intriguing were they by the apparently superior qualities of single-sideband transmission





sure it works,  
but can you work with it



Belden makes all kinds of wire and cable: Ultrafine magnet wire to the most complex multi-conductor cable designs. Cables that resist heat, cold, abrasion, moisture, chemical attack and fit many other environmental needs. Configurations that can help you cope with numerous codes, specs, industry standards plus nitty-gritty electrical/electronic design parameters.

We also make it as easy as possible to work with.

An important benefit if you consider that cable usually costs far less per foot than the time of the hands making the installation.

A more workable wire involves many things: type of termination; method of

stripping; insulating, jacketing and shielding materials; conductor design. Your Belden wire specialist can help you get the best buy. He can tell you if a standard or special is called for. The tradeoffs. Modifications that might be made, and the costs.

He might not be able to give you a cable as strippable as a banana, but can deliver a complete package tailored to meet your job requirements. The kind of cable that can save you time and money all down the line.

If you have a wire problem right now, call (317) 966-6681. If you don't have a copy of the Belden Electronic Wire and Cable Catalog, write: Belden Electronic Division, P.O. Box 1100, Richmond, Indiana 47374.

862

INFORMATION RETRIEVAL NUMBER 234

**BELDEN** 

We want your cable business  
and are out to prove...

Belden covers wire with performance,  
service and ingenuity



The transistor is twenty-five years old this year. Monsanto has been supplying ultra-pure silicon and compound semiconductors for half of that time. We weren't involved in the original work on this marvel of electronics, but not many of today's leading suppliers were.

The point is, Monsanto saw a growing need and was able to draw on its resources to meet it.

The same thing is happening now in the III-V area for LED's.

Monsanto was there when the transistor business needed a reliable source for high grade materials. And we're still here, supplying not only silicon for today's device markets, but exotic materials for tomorrow.

## Monsanto

*Advancements in Electronics through  
Materials Technology.*

P. O. BOX 8, ST. PETERS, MISSOURI 63376  
(314) 272-7676

**WE HELPED  
MAKE IT  
POSSIBLE!**

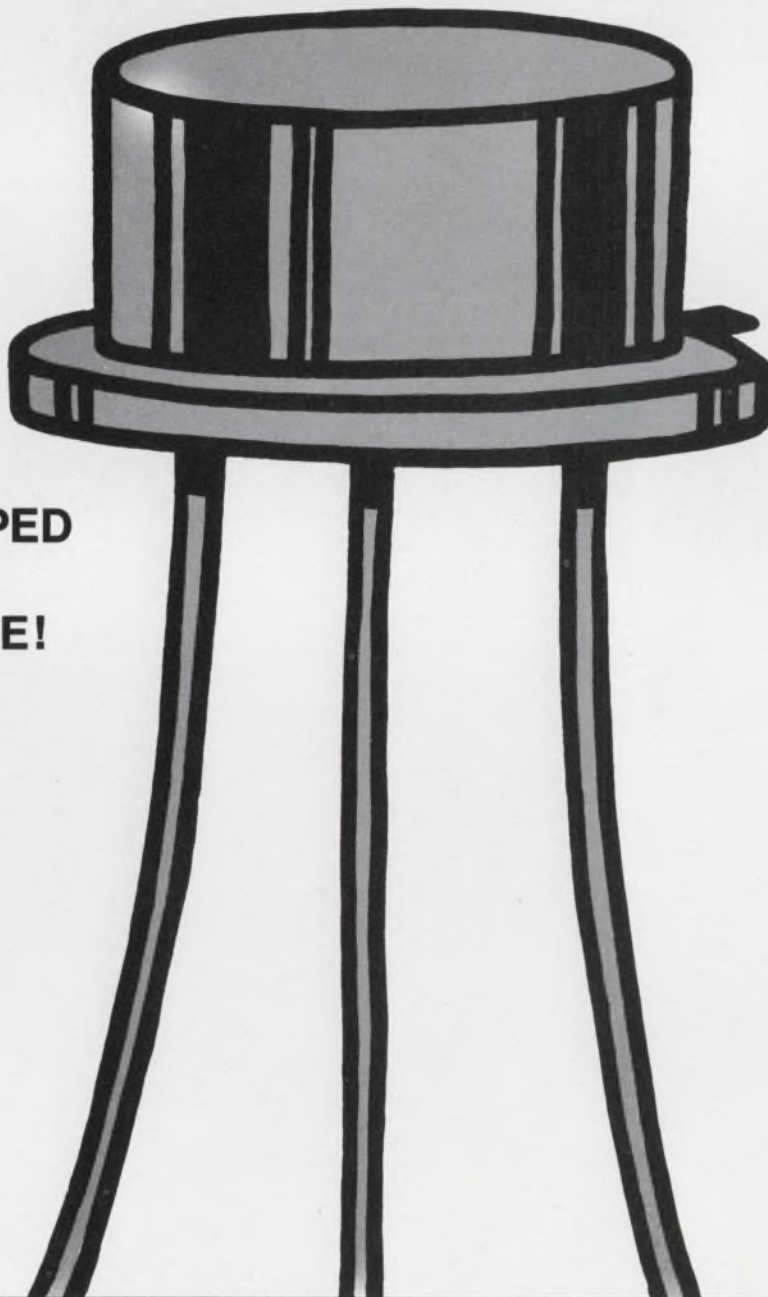





## Instruments

# *The touch of solid state miniaturizes equipment and enhances readability*

**R**emember the first oscilloscopes? It wasn't so long ago that two men were needed to carry one from bench to bench. Transistors changed that pretty fast. Today you can slip a three-pound scope into your briefcase.

And how about the first digital voltmeter? Who in the early 50s could have predicted the revolution that this crude, \$4000 instrument would create in the following two decades.

Yes, the transistor—and the host of solid-state circuits that followed it—have indelibly altered the design of electronic instruments. The resulting changes encompass every facet of instrument design, from the circuitry to the internal packaging to the case.

Starting in 1952, transistors invaded more and more instruments, until today virtually every major instrument is all-solid-state.

The small size and low power dissipation of the transistor brought drastic reductions in instrument size and weight, yet allowed increased circuit density within a steadily shrinking package. As a result, instrument performance has soared in practically every category. The kilocycle band-

widths of the 50s have yielded to the "hundreds of megahertz" so casually bandied about today. And the older accuracies of 1% are sniffed at in the light of today's commonly available .001%.

### The digital revolution

But while the transistor was applied to instrument design soon after its almost-unnoticed birth, it was its marriage to digital processing that brought about the greatest changes. In fact, it's doubtful that the trend from analog to the more complex digital process could have continued without the transistor.

The digital revolution started in 1952, when Andy Kay unveiled the first digital voltmeter. The Model 419 was crude, compared with today's DVMs. But both the idea and Non Linear Systems—the company formed around the idea—took off like a rocket. Today, almost every instrument from signal generators to multimeters to scopes is digitized, thanks to Andy Kay and to the commercial digital readout tube, introduced by Burroughs (then Haydu) just one year before. (Burroughs' familiar Nixie tube actually had a rival in its early days—the Inditron, which was developed by National Union Radio Corp. and which did not survive.)

---

**Stanley Runyon**  
Associate Editor

Digital ohmmeters and ratiometers appeared soon after the first DVM. But while these instruments achieved wide appeal with their high resolution, high accuracy, storage capabilities and automatic operation, they had one major shortcoming: their cost. The Model 419, for example, went for \$4000. It wasn't until the 60s that prices began to drop. But while a \$300 DVM (Electro Logic) appeared in 1961, it never sold. Apparently engineers didn't believe a reliable DVM could be produced for that price. It wasn't until 1967 that low-cost DVMs came into their own with the Fairchild 7050. At \$299, it had dual-slope integration, extensive ICs and five resistance and four dc V ranges.

The 7050 opened the floodgates. At least two dozen companies entered the market, including many of the leading analog meter companies. Since then, both performance and the number of convenience features have increased steadily, while prices and case sizes have continued to drop. Today \$295 buys a 4-1/2-digit DVM that weighs only 14 oz., yet can measure ac and dc volts/current and resistance. And paralleling the rapid growth of digital instruments is the boom in programmable instruments. Today practically every major instrument has functions that can be controlled by a computer.

Although the digitals now dominate the industry, analog meters—with their lower prices and ability to show direction of change—are still popular, and are even being improved. The present crop of analog meters trace their origins to just before World War I, when a peak-reading voltmeter was described in the AIEE Transactions. However, the first commercial VTVM—by General Radio—wasn't offered until 1928. Ten years later S. Ballantine used a negative-feedback amplifier to produce an averaging VTVM. Other VTVMs soon followed. In 1954 HP introduced its now-classic 400D, a 4-MHz VTVM that is still catalogued today.

### Analog meters: Alive and well

Evolving from the Weston and Jewell meters of the 1920s, the VOM remains the most popular of the analog meters. The granddaddy of all is, of course, the Simpson 260. Introduced in 1935, it still plays a leading role. FET VOMs entered the picture in the mid-60s when Amphenol—and then Triplett, Philips, Sencore and Simpson—introduced them. The FET combined the high input impedance, sensitivity and accuracy of the line-operated bench meter with the VOM's portability.

The VOMs of today provide such features as low-power ohms—which allows in-circuit measurements without biasing semiconductor junctions—breakproof cases and battery lives that ap-

proach shelf life even under continuous operation. These and other features indicate that VOMs will eventually replace the line-powered meter.

Surprisingly, the DVM and its digital cousins can be counted among the few "firsts" in the last two decades. Most of the major commercial instrument firsts occurred in the 1930s. The line-up includes the scope, the VOM, the impedance bridge (General Radio's 650A) and the first stable signal generator (HP).

However, the 50s and 60s brought many major developments. Scopes, for example, have come a long way since 1931, when General Radio offered a three-piece "instrument" that included a power supply, a sweep circuit and a CRT. Three years later, after it had added to and improved the basic unit, GR decided to drop oscilloscopes from its product line. This, it admits today, was a considerable error.

By 1933, however, GR had competition. DuMont Laboratories introduced its \$250 Model 130 in that year. This 3-inch scope had a 5-kHz sweep, an input amplifier with a bandwidth of 20 Hz to 10 kHz and sensitivity of 1 V full scale, and a power supply. The 130 launched DuMont—and

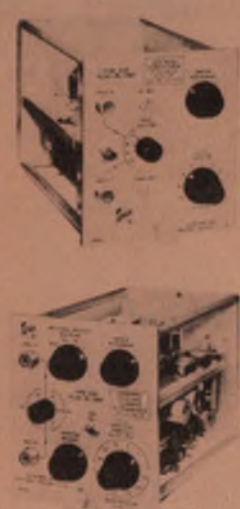

## Cathode-Ray Oscilloscope With Plug-In Preamplifiers

Fig. 1. Two of the plug-in preamplifiers which greatly increase the usefulness of the Type 535 Cathode-Ray Oscilloscope.



Fig. 2. This cathode-ray oscilloscope makes use of plug-in preamplifiers to adapt it for many types of precise measurements. One of the preamplifiers (a dual trace unit) is shown in plugged-in position. The other units include a differential high gain d-c unit and a wide-band d-c unit.

1953: The first plug-in scope. The concept, pioneered by Tektronix, influenced future instrument design.

ED, Oct., 1953

the scope market—into prominence.

Tektronix, the present leader in scope sales, appeared on the scene about 1947. The story is told about Dr. DuMont's visit to the Tek booth at the 1948 IRE show. Tek's young founder, C. Howard Volland, demonstrated the 10-MHz 511, the first scope with calibrated vertical and calibrated, triggered sweep. After congratulating Volland, Dr. DuMont offered some advice: A \$700 scope will never sell.

Scopes continued to improve in the 50s. DuMont contributed the first dual-beam type and the first scope with delaying and mixed sweeps. Then, in 1953, Tek unveiled the plug-in concept. The 535 CRO came with a choice of three preamps, allowing the user to change the characteristics of his scope. Three years later Hewlett-Packard entered the scope market with its 300-kHz Model 130A and its 10-MHz 150A. Today HP is second to Tek in scope sales. The year 1957 brought another major advance: Hughes Aircraft introduced the Memo-Scope, a direct-view storage scope that retained traces indefinitely until erased.

Early 1962 saw the birth of the sampling scope. Produced by the now-defunct Lumatron Electronics, the unit had a bandwidth of 1 GHz. But the remainder of the 60s brought no radically different scope. Instead, manufacturers concentrated on steadily increasing bandwidths, on improving performance and on adding new features. After bouncing back and forth between Tek, HP and Iwatsu, a Japanese concern, the speed crown finally went to Tek's 500-MHz 7904, where it rests today.

### Vacuum tubes linger on

The 60s also brought the first transistorized scopes. But it wasn't until the end of the decade that the last vacuum tube (the nuvistor) was finally edged out by FETs.

The vacuum tube also lingered until recently in another popular instrument—the signal generator. Developed by General Radio in 1928 to measure radio receiver characteristics, the first signal generator used two tubes and a tank circuit to produce a 400-Hz AM signal out to 1500 kHz. But audio oscillators didn't come into their own until 1939. In that year William Hewlett took the "idea" light bulb from the top of his head and stuck it in a Wien-Bridge oscillator.

The first sales of the resulting stable audio oscillator were made to Walt Disney, who used the units to provide sound effects for his 1940 classic, *Fantasia*. The movie was a hit—and so was the new company, Hewlett-Packard.

Improved and different types of signal sources made their appearance soon after. By 1939, both the sweep generator and the vhf generator were already being used, mostly by radio service men.

The first sweepers were standard oscillators whose dials were driven by motorized attachments. FM signal generators appeared in the early 40s with the establishment of the FM broadcasting industry. By the early 50s audio oscillators were available with outputs to 600 kHz, and vhf signal generators with outputs to 480 MHz.

In the mid-40s research on circuit behavior in the time domain led to a new class of signal sources—the pulse generator. It provided rectangular waves, ranging from square waves to brief pulses. HP's Model 212, probably the first commercial pulse generator (1946), managed to squeeze out pulses with a rise time of 20 ns and a "staggering" 5-kHz rep rate.

In 1949 Charles Rutherford founded Ruther-

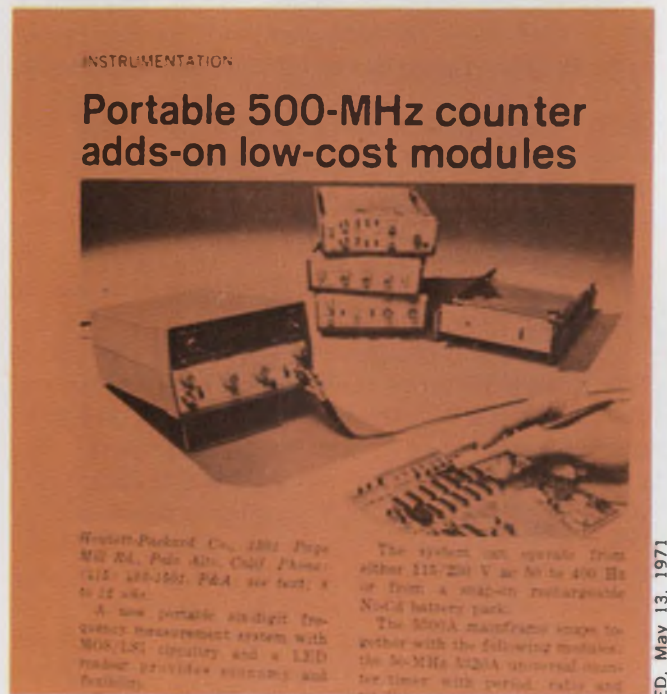

Instrumentation, 1971: MOS/LSI circuitry, a LED digital display, 500-MHz performance and portability.

ford Electronics, a company devoted to pulse sources. The company didn't last long, but the technology it generated found a home with the Data Pulse Div. of Systron-Donner. Then, in 1958, E-H Research Laboratories—today a leading company in pulse generators—was founded by Frank Evans and Jack Hubbs. Its first model, the 120A, delivered pulses with a rise time of 2.5 ns.

Today pulse generators remain one of the few instrument classes that still use vacuum tubes in some models—at least in the output stage. The reason? They still provide the fastest rise time per output volt (at low-duty cycle). But all-solid-state units are used today for high rep rates. E-H currently holds the rep-rate lead in the U.S. with its Model 129, which provides pulses with rise



## How to succeed in business by trying

It takes talent, luck, timing and one good order to get a new company off the ground, and these ingredients were present about a year after two young engineers, William Hewlett and David Packard, started an informal partnership and a part-time business in a one-car garage in Palo Alto.

The two had built and sold isolated equipment in the first year: a diathermy machine, a thyatron drive, an electronic device for tuning harmonicas, an air-conditioning control, a foul-indicator for bowling alleys and a reducing machine. About this time Hewlett was finishing an EE thesis on the resistance-tuned oscillator. It was a simple oscillator—relatively inexpensive and easily assembled from standard parts—but it looked as if it would maintain better stability, cover a greater frequency range and have less distortion than any other oscillator heretofore

marketed.

The first few HP oscillators were assembled in the garage, and the first HP gray paint job was baked onto the finish in Mrs. Packard's kitchen stove. The instruments were sold to friends, who gave it raves. Encouraged, Hewlett displayed the oscillator at the 1938 IRE meeting in Portland, Ore., and luck was with him. The chief sound engineer for Walt Disney Studios saw it, was impressed and ordered nine oscillators. They were used in the stereophonic-sound presentation of a film classic, "Fantasia."

That order did it. Hewlett-Packard was on its way. The new oscillator, called the 200A—because, the company says today, "the number sounded big"—began to pay off immediately. By 1940 HP had outgrown the garage and moved into its first plant. And by 1942, expansion brought 60 people into the HP fold.

times of less than 0.5 ns and a rep rate to 500 MHz. (A Japanese company, Takeda Riken, offers a generator with a 1-GHz rep rate.)

In the late 1950s a new signal source, the function generator, was unveiled by Hewlett-Packard. This instrument was originally designed to provide the signal source for process-control systems and low-frequency mechanical vibrators and to test servo-mechanisms. As such, the early function generators covered a range of 0.008 Hz to 1.2 kHz. HP's 50-pound, vacuum-tube unit never caught on, and it wasn't until late 1961 that function generators came into their own. In that year a new company—Wavetek—unveiled the solid-state Model 101. The half-rack unit sold for \$395.

Today the function generator is sold as a universal, general-purpose signal source. Square waves, triangles, ramps and pulses—as well as sinusoids—are available over the enormous frequency range of 1  $\mu$ Hz to 20 MHz. And at least 15 companies produce them.

The assault on the standard signal generator continued in 1964 when HP unveiled its 5100A Frequency Synthesizer. The unit used over 2000 discrete semiconductors to provide frequencies to 50 MHz in 0.1-Hz increments.

Then, in 1968, the sig gen struck back. Logi-Metrics introduced the 900 series, a generator with a built-in counter. Like the synthesizer, the counter made exact frequency settings possible; the calibrated dial seemed doomed. Singer, and then HP, soon introduced similar generators.

Today the Cadillac of signal generators uses built-in counters plus phase-locking to deliver ultra-stable frequencies to beyond 500 MHz.

The coupling of a high-frequency counter with a signal generator illustrates how far the counter has come since its birth in 1950. Counters can

now be made small enough and cheap enough to allow such coupling, yet provide high performance. Two other counter-instrument marriages are worth noting: Tektronix offers a counter plug-in for its 7000-series scopes. The counter's eight-digit readout appears directly on the scope screen—right above the waveform display. And, in 1969, counter/DVM combinations were first offered by Heath, Calico and HP.

While pulse counters were first used in the 30s and 40s by nuclear physicists, it wasn't until 1950 that the first commercial instrument appeared. The Model 554 Events Per Unit Time Meter was offered by Berkeley Scientific (now the Electronic Instrument Div. of Beckman Instruments). The \$775 instrument had a five-digit columnar display, and it could count at a 100-kHz rate.

Less than a year later, in early 1951, HP boosted the counting rate by an order of magnitude in its 524A. The unit had another advantage: It could also measure period. Only three years later the 524A was replaced by the 524B, the first plug-in counter.

Other companies soon entered the counter business, and the great race toward higher and higher performance was on. The columnar readout gave way to the in-line Nixie display. More recently the light-emitting diode (LED) and other displays have begun to eat into the Nixie monopoly. More features—and more digits—were added. Then, in 1959, the first commercial solid-state counter made its debut, and package size began to shrink. The Model 5310 was introduced by the Berkeley Div. of Beckman, the company that fathered the first commercial counter.

The thrust of the 1950s and 1960s toward higher counter performance, plus solid state, have resulted in today's line of impressive instruments. ■■

# NEW TES



# TAMENT.

We've just succeeded in putting together the world's largest, most complete source book of Linear ICs. A 2½ pound, 468-page testament to our in-depth design capabilities. Nearly double the size of our last linear catalog.

It was only right that we should do this, since we've been building the best linear circuits for many years.

We're still building them. *In fact, since the last printing of our catalog in January 1971, we've added 53 new circuits, 13 of them proprietary devices such as the new LM119 Precision High Speed Comparator, the new LM3900 Quad Amp and the new LM380 Audio Power Amp.*

Even now, as we offer our new 468-page catalog to you, new linear devices are being designed by each of our three linear circuit design teams. Bright, eager groups headed by superstars like Bob Dobkin, Al Howard and Jim Solomon. (See if you can spot them in the picture to the left. Winners get a genuine imitation leather bookmark.)

Your nearest National sales rep will be glad to put our new linear catalog into your hands, as well as data sheets for all linear devices designed since the catalog was printed. At the same time, ask him for a copy of our 304-page Linear Applications Handbook — a perfect companion to our Linear Catalog.

So call your nearest sales rep today, or write on your letterhead to National Semiconductor Corporation, 2900 Semiconductor Drive, Santa Clara, California 95051.

## National

# Flats Fixed!

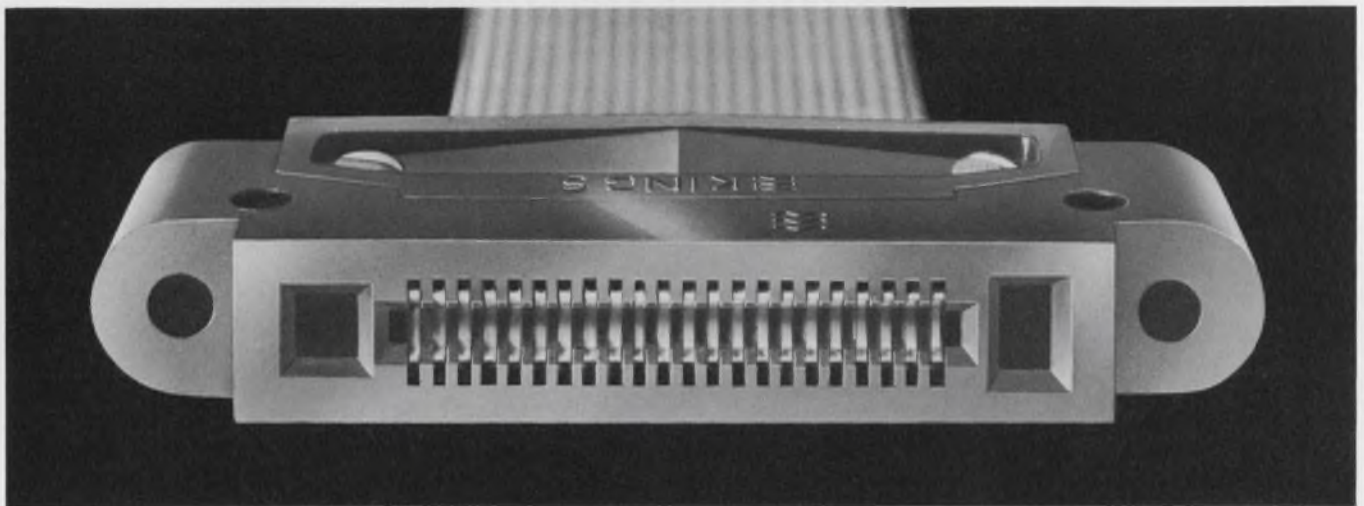

With more than a quarter century of specialization in the connector field, it was only natural for Kings to come up with a uniquely designed series of **FLAT CABLE CONNECTORS** offering the design engineer complete flexibility and reliability.

These connectors have been designed to satisfy the high density termination problems that are inherent in the areas of communication systems, computers, office equipment, aircraft, home entertainment systems and control systems.

There are plugs, jacks, receptacles and printed circuit receptacles de-

signed to couple flat conductor or ribbon cables on 50 mil. centers.

Assembly time and labor costs are held to a minimum. No stripping of the cable is required. The entire assembly operation takes but a few seconds and requires no special tools nor training.

These connectors meet the applicable requirements of specifications IPC-FC-218A and MIL-C-55544. They are field serviceable and reusable.

Further information on *FIXING THOSE FLATS* may be obtained by contacting your Kings Representative or contacting us directly.

 **KINGS**

ELECTRONICS COMPANY, INC.  
40 MARBLEDALE ROAD, TUCKAHOE, NEW YORK 10707  
(914) SW 3-5000  
TWX 710-562-0110 / TELEX 13-7449

Fluke problem solvers

# A new AC calibration system with wide range, superb stability, high accuracy and complete programmability.



**Here's the best ac calibration system you've ever seen. It's designed to give you state-of-the-art performance in the cal lab, in the factory or in automatic test systems.**

The new system consists of the Model 5200A AC Calibrator and the Model 5205A Precision Power Amplifier.

Covering a frequency range of 10 Hz. to 1.2 MHz, the Model 5200A output is from 100 microvolts to 120 volts at current levels up to 50 milliamperes. Mid-band accuracy is  $\pm 0.02$  percent. Short term amplitude stability is  $\pm 10$  ppm. Six month stability,  $\pm 0.01$  percent. Working with the 5200A, the Model 5205A provides output voltages from 100 volts to 1200 volts at current levels up to 200 milliamperes. Combined 5200A/5205A amplitude accuracy is  $\pm 0.03$  percent.

The 5205A can also be used as a stand-alone amplifier providing programmable gains of X10 and X100 for frequencies from dc to 120 kHz. Output amplitudes from 1 millivolt to 1700 volts peak are offered for a wide variety of waveforms including pulses, sawtooths and triangles. All functions are remotely programmable with standard TTL logic levels. Uniquely, the 5205A can be programmed by both the 5200A and another control source so that it can be time-shared in an automatic system to perform a multitude of functions.

Price of the Model 5200A AC Calibrator is \$3,995. The Model 5205A sells for \$2,495.

To arrange a demonstration or get more details just dial 800-426-0361 for the location of your nearest Fluke sales office. Call it free anywhere in the contiguous United States.

Fluke, P.O. Box 7428, Seattle, Washington 98133. Phone (206) 774-2211.  
TWX: 910-449-2850 / In Europe, address Fluke Nederland (N.V.), P.O. Box 5053, Tilburg,  
Holland. Phone (04250) 70130. Telex: 884-55237. In the U.K., address Fluke  
International Corp. Gargett Close, Watford, WD2. 4TT. Phone, Watford, 33066. Telex: 934583.



# Man on the moon

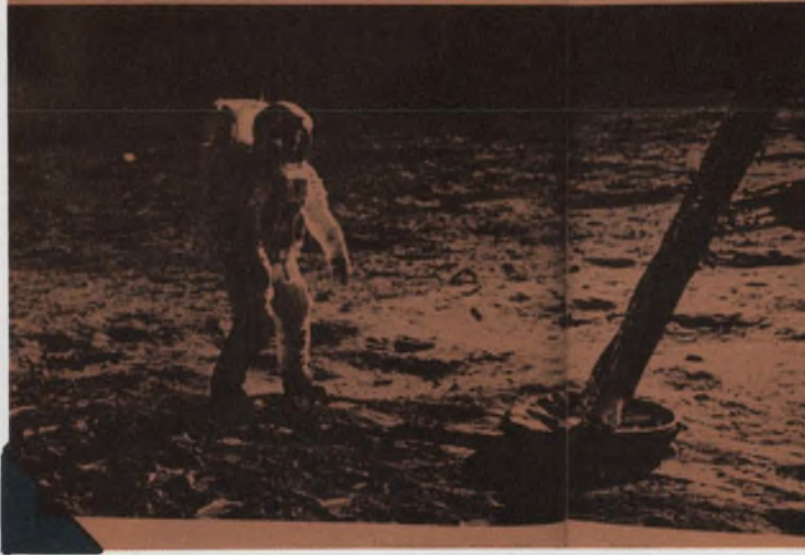

Apollo 11 overcomes close calls as mission nears lunar surface and proves that humans and electronics can team up successfully to achieve an 'unbelievable' goal!

Charles D. Leland, Staff, Washington News Service

When man first placed foot and hand upon the moon, July 20, 1969, it was the greatest feat in all man's history. It was the engineering miracle of the century. It was the triumph of the human spirit. It was the triumph of the American people. It was the triumph of the American way of life. It was the triumph of the American dream. It was the triumph of the American people. It was the triumph of the American way of life. It was the triumph of the American dream.

ED, Aug. 16, 1969

## Military and Space

# A big nonsecret in Washington alters U.S. defense capability and history

Many improvements in American military equipment have flowed from R&D stamped secret. But some of the most rapid and dramatic improvements yet made—not only in military gear but also space and consumer equipment—followed a Defense Dept. decision early in the game to develop semiconductor technology in the open.

"The military saw very quickly the value of Bell Labs' transistor, awarded contracts for its continued development, but did not classify it," says Edwin N. Myers, staff specialist in electronics sciences for the Director of Defense Research and Engineering in the Pentagon.

As a result, everyone was able to jump in without restrictions and explore how it could be used—the National Aeronautics and Space Administration, all the military services and all kinds of consumer manufacturers. Without transistors, the first U.S. satellite, Explorer I, could never have been built and certainly man would not have been able to walk on the moon. Without the semiconductor industry, there would have been no

proliferation of miniature radios, portable tape recorders or improved hearing aids.

One of the first significant military uses of the transistor, Myers recalls, was in an airborne IFF (Identification, Friend or Foe) beacon. "We could never have reduced the size of the IFF's Mark 12 computer sufficiently for airborne use without transistors," the defense specialist says.

A sophisticated proximity fuze for antiaircraft artillery shells, and later for missiles, also became possible with transistors and ICs. Proximity fuzes made with tiny vacuum tubes were used in World War II, but they were crude. "Semiconductors permitted tremendous advances," Myers says.

For a while, only a small segment of military and space equipment could be transistorized. The germanium transistor—the only kind available until the mid-50s—worked only in the low, audio-frequency range. Then Texas Instruments' silicon transistor appeared. It permitted greater design flexibility and use in higher temperatures. A little later Fairchild's planar process emerged, and it opened the door to equipment operating at higher frequencies—such as radar, sonar, communications networks—and to signal processing at high speeds. The planar process also led to ICs.

John F. Mason  
Associate Editor

The germanium transistor arrived at a critical time in the design of NASA's early workhorse, the Redstone missile, recalls James Taylor, Chief of the Technology Div. of the Astronautics Laboratory at the Marshall Space Flight Center in Huntsville, Ala.

"In the later 1940s," he recalls, "we were trying to develop a guidance and control system for the Redstone without using vacuum tubes, when the germanium transistor became available. We were then able to use the magnetic amplifier as a power amplifier and the transistor as a preamplifier."

The Redstone did use some vacuum tubes but not in a critical loop, Taylor notes.

The Navajo surface-to-surface "pilotless bomber" marked a transitional stage that made use of both germanium silicon transistors and vacuum tubes, recalls Robert Gardiner, now assistant director for electrical systems at NASA's Manned Space Flight Center in Houston.

"We were designing the fuel-control system with germanium transistors," he says, "and we could see they wouldn't work out. Fortunately silicon became available and solved the problem. The ground test equipment for the inertial unit was built entirely with vacuum tubes."

Dan Mazur, associate deputy director for engineering at the Goddard Space Flight Center Greenbelt, Md., cites a number of firsts.

"The first silicon transistor that NASA used in space was in a University of Iowa experiment that flew in the Explorer I satellite," he recalls. "Germanium transistors were still used after that in the circuitry of satellites themselves at Goddard for a couple of years.

"In 1961 we used the first silicon controlled rectifiers. These went into Explorer 12. In 1963, ICs and tunnel diodes flew for the first time in a satellite. They were designed into circuits used to trigger flip-flops in Explorer 18. In 1966, Explorer 33 flew the first p-channel MOSFETs.

"The following year we began using tunnel diodes in counter circuits. And in Explorer 43, in 1971, we used RCA's Cosmos series CMOS."

The first big, significant use of ICs in missiles came with Minuteman II. But in 1964 dark clouds appeared in the otherwise sunny progress of military transistors. Sen. Barry Goldwater told Congress, much to the annoyance of Defense Secretary Robert McNamara, that electromagnetic pulses from nuclear detonations could cause "catastrophic electrical and electronic failures" in American missiles before they could leave their launching pads, as well as in other electronic equipment. McNamara, who was basing the nation's strategic defense on missiles instead of bombers, rebutted Goldwater's statement, defending the reliability of missiles. But work—mostly classified—continues to this day to harden components against the effects of radiation.

The giant strides made with each successive manned spacecraft are cited by Robert Gardiner.

"Mercury, which flew in 1961, was designed in the late 1950s and had no computer," he points out. "Gemini had a computer with a 4-k word memory. Apollo had a 32-k memory in the command module, 32-k in the lunar module and a 4-k memory in a backup computer in the LM. The shuttle is being designed with two 65-k memory computers, two 16-k computers and one 16-k backup computer." ■■



## EMP: Can It Short-Circuit Our Defenses?

*Electromagnetic Pulses From Nuclear Detonations Worry Government, Industry; Incompletely Understood Effects Cause Variety of Damage; Most Data Classified*

Sen. Barry Goldwater shook up a number of people when he described to Congress in 1964 the effects of a nu-

clear detonation on semiconductors and other electronic equipment, even though stored in silos.



## Too often, wet tantalums live up to their name.

They leak.

Which is a pretty good reason to switch to a tantalum that won't.

Our KEMET® T242 tantalum.

It's a true hermetic sealed, extended range, solid state tantalum capacitor. Which means it contains no electrolyte to freeze, dry, drip or ooze.

Now recognized by the military as CSR23, it's available in L, M, and P failure rates. In standard MIL A, B, C and D case sizes. And with a capacitance range of 1.8—1000uF—6 to 50 volts.

What's more, the T242 has much better low temperature electrical characteristics than wets. For example,  $\Delta C$  and D.F. for a 560uF T242 at  $-55^{\circ}\text{C}$  is  $\pm 10\%$  and 10% respectively,

versus -64% and 128% for the CLR65.

If DC leakage is bothering you, ask us. We can beat the CSR23 specs by a large margin, and often beat the wets too. At a price less than half that of a hermetic sealed wet.

So if you're using wet tantalums, you now have a choice. Ask your KEMET representative about switching. Or contact us direct. Union Carbide Components Department, Box 5928, Greenville, S.C. 29606. Phone: (803) 963-7421. TWX: 810-287-2536.

After all, you need a capacitor that won't run out on you.

**UNION CARBIDE** COMPONENTS DEPARTMENT

Available through your KEMET distributor.



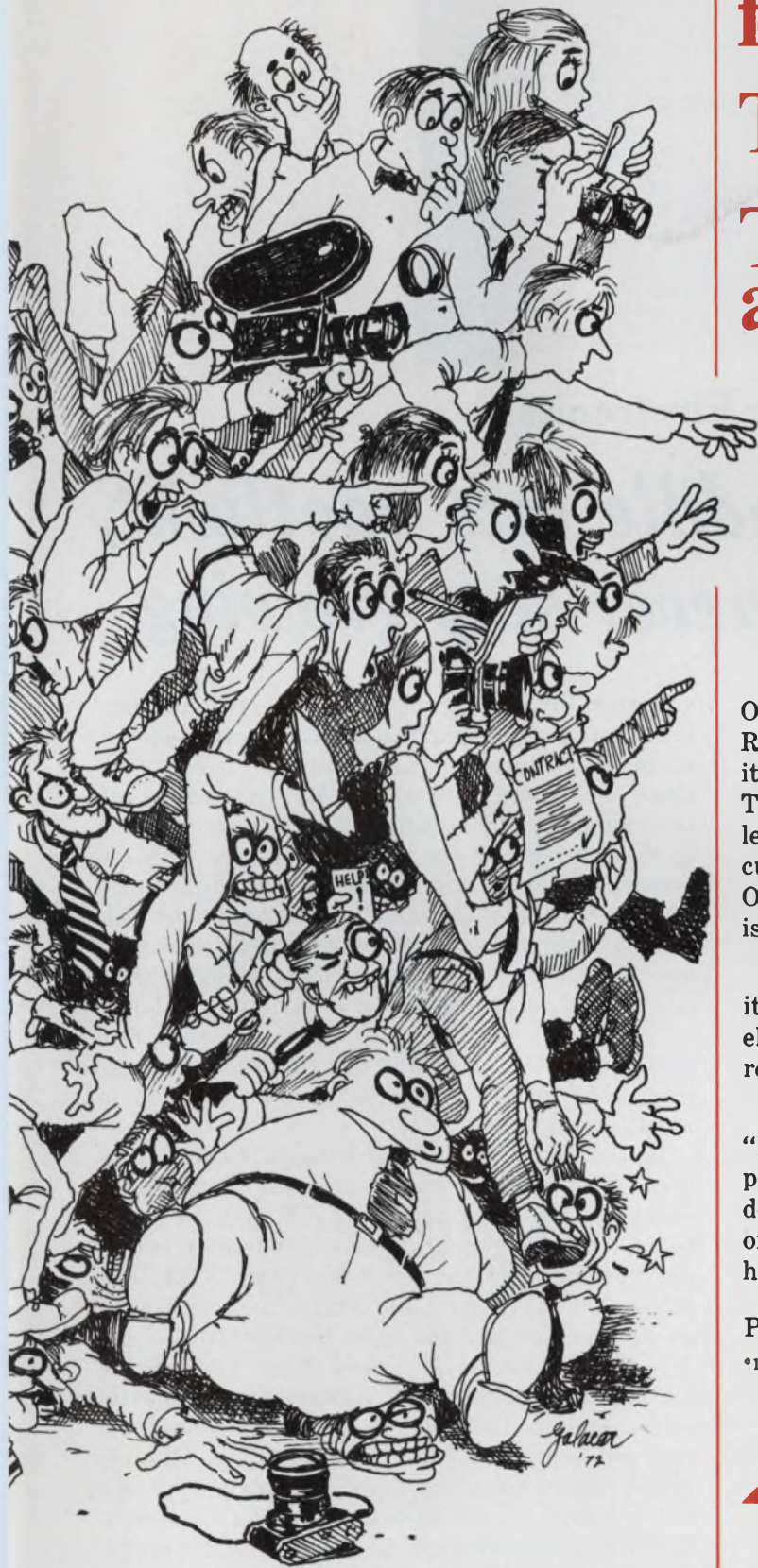

**Crystalonics  
has a 4-ohm FET  
with a 1-volt threshold  
for \$3.69?\***

**That's almost right.**

**The best doesn't cost  
any more anymore.**



Our 2N5066 has a 4-ohm typical (8-ohm maximum)  $R_{ON}$ . We have to admit, it does have an offset voltage, but it's only 300 microvolts typical (1 millivolt maximum). The off-current is still 1 nano-amp maximum, and it takes less than 1 volt to turn it on. The device does draw some current in the on state (less than 1 milliamp), but that's OK in most cases, because the signal source impedance is usually less than 1 ohm.

If you're getting suspicious, you're right. We lied . . . it's an NPN transistor, not a FET . . . but everything else we've said about it is the truth. Besides, do you really care?

If you're not miffed and are still interested, we have a "P-channel" equivalent (the 2N3677) at an even lower price. Both really warrant your investigation if you are designing analog switching circuits. We'll send you one of each to try if you'll drop us a note. If more data would help, circle the reader service number.

P.S. We also make the real McCoy.

\*100-piece price

**TELEDYNE  
CRYSTALONICS**

147 Sherman St. • Cambridge, Mass. 02140 • TEL: 617-491-1670  
1800 N. Highland Ave. • Suite 616 • Hollywood, Calif. 90028 • TEL: 213-469-5871



## Consumer Electronics

# Radio and TV waddle into spotlight, steal show and never stop growing

**O**f all the technological achievements in consumer electronics in the last 25 years, which stands out above all others?

How about television—first black and white and then color? Many engineers would give it the nod.

Actually the introduction of TV receivers with cathode-ray tubes to display the picture goes back 33 years to 1939. In April of that year, at the New York World's Fair—after seven years of research, development and field-testing—RCA started the first full-time public telecasts. Programs transmitted from a National Broadcasting Co. transmitter atop the Empire State Building were viewed in the New York area on a small number of nine-inch direct-view and 12-inch reflection RCA receivers.

Four months later Hitler's assault on Poland and declarations of war by France and Britain opened World War II, and all progress on commercial television halted for the duration. In addition production of civilian radios and phonographs was suspended as factories turned to the job of providing the Allies with radio and radar equipment.

Though the war years were a temporary setback for civilian electronics, they provided major

advances in high-frequency techniques, in complex system developments and in electron-optics, all of which were to make substantial contributions to civilian technology. By the war's end television was to benefit by such developments as a sensitive camera tube—the image orthicon—more powerful wideband vhf and uhf transmitters, effective vhf and microwave-relay network techniques, and improved cathode-ray tubes and phosphors that gave substantially higher resolution and brightness in a variety of colors.

Peace came in August of 1945 and with it a consumer rush to replace old radios. Sales rose from 250,000 sets in the latter part of 1945 to 16,541,000 in 1947.

In the fall of 1945, the Federal Communications Commission had approved commercial standards for black-and-white TV, and factories began converting to peace-time production of TV receivers. Among the producers were RCA, DuMont, General Electric and Philco. Telecasts were quietly revived in 1946 with the opening of the first NBC network. It linked New York, Schenectady, Philadelphia and Washington by coaxial cable. And in 1947 the first mass-produced set emerged—the RCA 630 TS. It had a 10-inch, round picture tube that displayed images 6-3/8 inches high by 8-1/2 inches wide. The set weighed 85 pounds and used 30 tubes. The tuner received only the 13 vhf channels.

Jim McDermott  
Eastern Editor

In contrast, today's transistorized black-and-white sets weigh as little as 14 pounds and have one tube—the picture tube. And they receive both vhf and uhf channels.

Meanwhile the FCC's TV standards were causing industry debate and indecision. Both the Columbia Broadcasting System and Zenith felt that higher TV standards should be in effect. They wanted a broader bandwidth than the 6 MHz in use, to provide pictures of higher resolution, and they were concerned about a development that seemed inevitable—color TV.

While CBS hesitated, the public did not and production zoomed from 6000 television sets in 1946 to over 7 million in 1950. Zenith began TV production in 1948. Its models all had provision for uhf in turret tuners, a development that was several years ahead of its time.

However, a new factor entered the picture. By the end of 1948 some 127 black-and-white TV stations were broadcasting, and many listeners complained of "venetian blind" and other distorted picture effects caused by adjacent and co-channel interference.

The FCC declared a six-month freeze on TV permits—a freeze that lasted for four years before the technical bugs were worked out. The situation made it obvious that TV channel space was definitely limited in the radio spectrum. Because of this, the 12-MHz requirement for color TV was reduced to 6 MHz. CBS met this with a modified 405-line image, scanned sequentially at the rate of 144 fields per second. In August of 1950 CBS demonstrated this system to the FCC.

RCA countered by demonstrating a newer system that used a single-color subcarrier modulated by the three colors in three-phase form.

### CBS has better color pictures

But the CBS system produced better color tones and better registration of the colors. Also, CBS pointed out that existing black-and-white sets could be converted to receive the CBS color broadcasts by making modifications to their sweep rates and sweep circuits—characteristics that could be controlled by an external switch. A color-wheel adapter was also needed.

After 62 days of testimony, the FCC decided on Oct. 10, 1950, to give the CBS system official sanction. One factor in the decision was the fact that CBS had a working system, while RCA's needed development to reduce the size of the experimental equipment to a consumer cabinet. In addition interference between the RCA carrier and subcarriers appeared as a dot structure—this due to the as yet imperfect frequency interleaving of the early system.

RCA and others challenged the FCC decision, which was finally upheld by the Supreme Court.

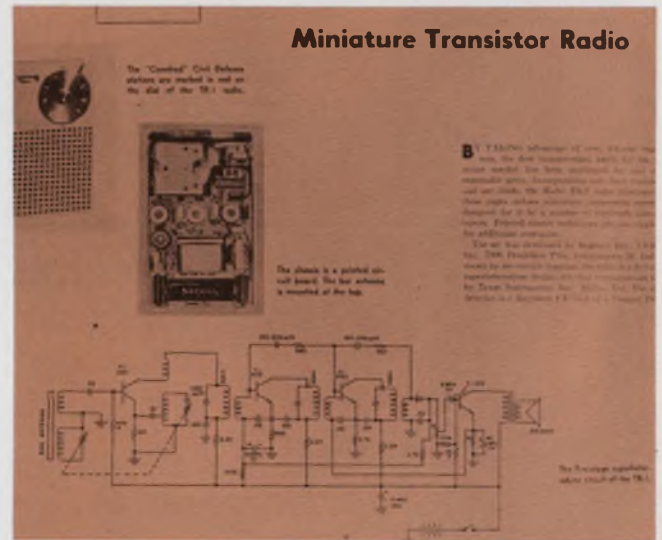

The world's first all-transistor radio appeared on the market in 1954. By Regency, it had four transistors.

Public color broadcasts by CBS began in New York on June 25, 1951. But none of the black-and-white television sets could receive these broadcasts, and it was this factor that ultimately caused the FCC to reverse itself.

RCA's dot-sequential system had several advantages. It was compatible with black-and-white sets; it was free from flicker, which was noticeable with the CBS system at high brightness levels; the resolution of the picture was potentially high, and the system used the radio spectrum efficiently.

Noting these advantages, a number of companies—including Hazeltine, Philco, General Electric and RCA—continued their own research. By 1953 an industrywide committee led by RCA had developed new color standards that were compatible with black-and-white TV.

In the meantime a vital link in the all-electronic TV color system, the tricolor "mask-and-dot" kinescope tube, was invented by Alfred N. Goldsmith and developed in the RCA laboratories. Further demonstrations by RCA showed that a color-TV system that could operate within the bandwidth of the standard black-and-white system was indeed practical. On Dec. 17, 1953, the FCC approved the new compatible technical standards for color transmission.

By 1954 commercial color telecasting began on a regular, but limited, basis in 35 cities. Westinghouse was the first to ship color TV receivers. In March, 1957, RCA introduced its first 15-inch-screen set: It carried a price of \$1000, and a production run of 5000 was planned. By May the company announced that 4000 sets had been delivered.

The same year Zenith demonstrated a 21-inch rectangular color TV—the largest tube yet—to its dealers, but stated that it had no intention of marketing it until color TV was more highly

## Motorola Unveils 19-In. Battery TV Set

WHILE anxious eyes looked to the Far East for the promised flow of direct-view, transistorized battery TV receivers, Motorola, Inc. of Chicago, Ill., unveiled its large-screen, 19-in. set in New York City.

The 22-transistor, 12-diode receiver, resulting from an intensive research program, materially alters the import threat and its potential impact on the American market. With production deliveries scheduled within a month, the U. S. consumer may link transistor TV with "19-in. screen" before the first Japanese midget sets appear on dealers' shelves. The 40-lb. American-made 19-in. set is priced at \$275 (less battery, which is expected to cost about \$100) compared to the \$270 tag (battery included) originally scheduled for the Sony Sony portable, due within the next few months. The Sony is expected to

porters had merely added and said sales figures would upset the market-research predictions.

### 15-Kv High-Voltage Supply

To achieve the high brightness and small spot size necessary for comfortable viewing in open areas such as patios or beaches, 15-kv sec anode voltage is applied to the picture tube; voltage regulation is within several hundred volts when changing from a bright to a dark scene. To minimize battery drain, the specially designed picture-tube heater operates from 12.6 v at 150 ma, a 50-percent power reduction over conventional tubes. The accelerating anode is supplied with 100 v tapped from the flyback transformer and rectified by a silicon diode. The picture tube is a type 19AEP, a standard modified 19XP4.

is possible before recharging is necessary. A minimum of 500 recharge cycles is claimed. Other benefits include almost constant voltage delivery until end of discharge, automatically long life and no damage due to complete discharge (possible, for example, if a set is inadvertently turned off).

The set may be operated from 110 v ac or dc energy cell. A relay-controlled battery dump circuit permits the energy cells to be recharged while the receiver is on. Overcharge is prevented by the relay control provision.

### Video Response 3.5 Mc

A three-stage video section, at a video rate frequency of 11.73 mc, contains a triode filter to achieve greater than 70 db gain at the 47.25 mc lower subcarrier and



Available operating controls on the 22-transistor receiver include eye volume, tone, brightness and picture advance.

allows a wide range of equal-level eye volume being the signal propagation delay that explains an amplified key tone is supplied. A three-position

ED, May, 1960

A 22-transistor, 12-diode TV receiver was produced by Motorola in 1960 to combat the flow of Japanese sets.

perfected and color programming was much better.

DuMont produced a prototype model of a Duo-scope, a TV set that allowed two viewers to watch separate stations. And in 1954 another event occurred that quietly signaled the end of the era of tubes. It was the forerunner of the application of semiconductor technology to consumer products.

The first all-transistor radio—incorporating four Texas Instrument transistors and one diode detector—was developed and marketed in 1954 by Regency of Indianapolis. The circuit, powered by a 22.5-V hearing-aid battery, was a superhet with three i-f stages of 262 kHz. The chassis was a printed-circuit board.

The use of semiconductors in consumer products had started, and in May of 1955 an experimental auto radio incorporating nine transistors and operating from 6 V was demonstrated at RCA Laboratories. The same year Sony introduced a transistor radio and General Electric developed a transistor clock.

The magic of electronics was extending to other consumer products, and microwave technology was introduced by Tappan in 1955 in an electronic oven marketed at \$1000.

The first fully automatic home-movie camera using a semiconductor photocell to control the lens iris was produced by Bell & Howell for a 16-mm camera in 1956.

A Bureau of Census survey showed that by now three out of four households had one or more television sets.

By this time the TV manufacturers were busy refining their sets as competition stiffened. Zenith had produced the first ultrasonic wireless remote control to turn the set on and off and to operate the controls. This had been preceded by a photocell and hand-flashlight remote-control system that had a feature desirable even today. Flashing

the light properly would turn off the sound during commercials. The system had a fatal flaw, however. Since it operated on light, daylight in a room turned the set on, and the system was abandoned in favor of ultrasonics.

During this period radio designers were busy converting tube sets to transistors, and in 1957 Zenith announced the result of a three-year development program—the world's first eight-band, shortwave, nine-transistor radio. A strong interest among hi-fi buffs was developing for stereophonic sound. In the same year a three-speed transistorized record player was introduced from Germany. The three-speed unit, now a standard, was an offshoot of an older RCA-CBS battle back in 1948 and 1949, when CBS produced the 33-1/3-long-play phonograph and RCA the 45-rpm player. Neither was compatible with the thousands of 78-rpm players then in use.

### RCA produces CBS records

RCA claimed the fastest record changer with its system, but CBS prevailed. In 1950, RCA began to produce 33-1/3 records as well as the 45s and 78s.

By 1958 stereophonic sound continued to draw more interest, with several systems simultaneously developed for the transmission of twin channels over the air. By November of 1959, 22 stereo broadcasting systems were competing for FCC approval, including FM systems with FM subcarriers, FM systems with AM subcarriers, TV sound stereo systems and AM stereo systems.

In 1961 the FCC chose the GE-Zenith system—an FM stereo system with AM subcarriers, the system in use today.

One of the first consumer products to use discrete transistors and miniaturized components successfully was the hearing aid, beginning

# Coming: Everyman's TV-Tape Recorder

New York

Economical home video-tape recording moved a significant step closer with demonstration by Fairchild Camera and Instrument Corp. of a model designed to sell for about \$500.

The demonstration model records and plays back for one hour. The recorder's single-track tape is 1/4-inch-wide, 1/2-mil-thick Mylar of instrumentation grade. It makes four passes on 11-inch reels.

With its flat-to-2-Mc bandwidth, the demonstrator's playback quality is comparable to reception on most home TV sets.

The recorder attains its bandwidth by means of the same techniques used for years, in wideband instrumentation amplifiers.



**Home video-tape recorder**, shown in prototype by Fairchild, uses 11-inch reels and photoelectric reversal so that four tracks, at 15 minutes each, provide an hour's recording time. The mechanical focusing knob is an azimuth adjustment for the tape head.

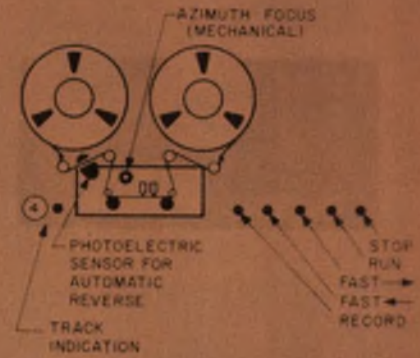

and is being refined by Cinerama, Inc. Those who saw both the Fairchild and Telefunken demonstrations

shown by IIT Research Institute, Chicago. Marvin Camras, an institute professor, says the recorder

**A number of video-recorders/players for home use have appeared and then vanished as the price remained too high.**

in the latter 1950s. In August of 1958, Zenith produced the Solaris, a hearing aid powered by silicon solar cells mounted on the temple bar of eyeglasses.

But integrated circuits were a natural for this application and in March of 1964 Zenith introduced the first hearing-aid IC containing six transistors and 16 resistors. Ten of these circuits could be stacked inside the head of a safety match.

Added applications of semiconductor technology continued to appear. In 1959, Whirlpool and Westinghouse demonstrated thermoelectric refrigeration. This type of cooling underwent a resurgence in 1962, with five more firms introducing these refrigerators—the Wright Manufacturing Co., Norge, Warner, Whirlpool, the York Corp. and Sanyo Electric. But the high cost and low efficiency killed consumer acceptance.

By this time watch manufacturers were looking at the new microminiature techniques developed by the electronics industry. The first to adopt electronic technology was Bulova, which introduced its Accutron tuning-fork watch in October, 1960. The discrete-component watch was a forerunner of today's electronic quartz-crystal watches that have integrated circuits and solid-state displays. But the Accutron established that electronic accuracies in timekeeping were possible.

Home-appliance and home-workshop tool manufacturers were taking a look at new capabilities, and in 1961 GE introduced a cordless electric toothbrush while Black & Decker marketed a cordless electric drill.

A potential multimillion-dollar market for home video tape recorders and playback systems

stirred development efforts in 1964. The common projected price of these devices was \$300 to \$400, but these objectives were never met. As of last June, only one company, Cartridge Television, Inc., had produced a low-cost home TV recorder/reproducer for about \$700.

In 1971 a new era in sound entered the picture—quadrasonics. At the years' end over 50 concerns were producing multichannel encoders and decoders or sound systems.

And as we near the end of 1972, hand calculators using LSI and LEDs are here. Sophisticated digital techniques for tuning and for other receiver functions are appearing in new receivers. The use of linear ICs, particular in the i-f detector and audio stages are widespread.

All-transistor black-and-white and color TVs are being produced by several manufacturers. The use of integrated circuits for color video signal amplification and processing, originated by Zenith in 1970, has been widely adopted.

The status of quadrasonics is similar to that of the stereo field in 1961. Petitions are up before the FCC for adoption of an FM system that can transmit four sound channels instead of two, with the Quadracast system invented by Lou Dorren, vice president and research director at Quadracast Systems, Inc., leading the contenders.

Both CBS and Electro-Voice, leading proponents of competing quadrasonic matrix coding and decoding systems, are exchanging technical data in a compromise. The system that presently seems to have the best long-run potential is one developed by JVC-America—a discrete four-channel recording and playback system that is compatible with the Quadracast system. ■■

ED, April 27, 1964

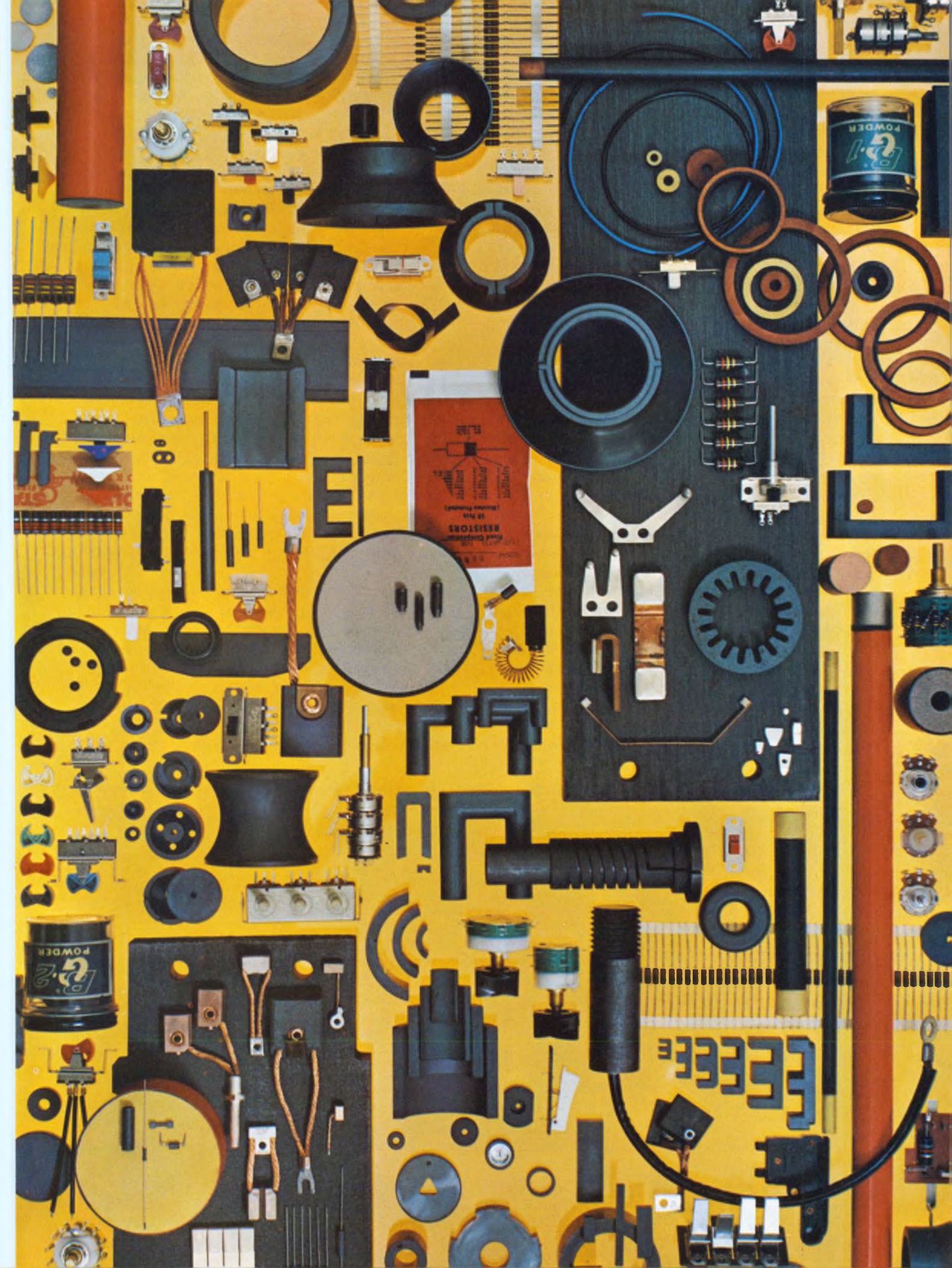

# Our part in your product is value



**Carbon and  
Graphite  
Products**



**Electro-  
Mechanical  
Components**



**Hard and Soft  
Ferrites**

*The items shown are produced by Stackpole's  
Carbon Division, Electronic Components Division,  
Magnet Division and Stackpole Components Company.*

We make a lot of things at Stackpole. Components by the millions. Materials by the ton. But what really makes us different is our philosophy.

Stackpole believes in producing the best possible product, for the lowest practical price, delivered on time and backed by service. Simple? Sure. Perhaps even old-fashioned. But true. And certainly no small task.

Ours is a manufacturing technology. A capability to produce. In volume. To your specific needs.

For sixty-five years, Stackpole has served virtually every industry. To many, we are the known, respected leader. Others in emerging technologies are coming to know the special skills, imagination, experience and quality uniquely Stackpole.

Value. It's determined in performance. For products and companies alike. Let us be a part of your production team.

Stackpole Carbon Company,  
St. Marys, Pennsylvania 15857.



# STACKPOLE

# New and recent Spartan Books . . .

## Introduction to Defense Radar Systems Engineering

JAMES N. CONSTANT, *President, RCS Associates, Inc.*

*Just Published!* The first book to bring together all aspects of radar systems and integrate them in a systematic and logical pattern offers all the background needed to specify a system for a given application. Each chapter presents analyses and equations in engineering terms. Among this comprehensive volume's many unique features are: the most extensive treatment of the effects of Electronic Counter Measures (ECM); coverage of the theory of trajectory predictions and array theory; and an in-depth treatment of data processing in radar systems. 260 pp., 6 x 9, *illus.*, #9194, cloth, \$20.00

## Checklists for Management, Engineering, Manufacturing, and Product Assurance

W. B. ROSSNAGEL, *Rossnagel and Associates*

Technically accurate and ready to be applied, these checklists are an excellent means to ensure that a given specification, contract, design, etc., is complete in every respect.

### Volume I, Management Checklists

22 checklists cover computers, engineering, finance, labor relations, manufacturing, marketing, personnel, product assurance, proposals, publications, small business, and other subjects. 192 pp., 6 x 9, *illus.*, #9178, cloth, \$14.00

### Volume II, Electrical and Electronic Checklists

22 detailed lists encompass cables and connectors, communication radios, multi-coders, lasers, microelectronics, integrated circuits, and much more. 192 pp., 6 x 9, *illus.*, #9181, cloth, \$14.00

## Vibration and Acoustic Measurement Handbook

MICHAEL P. BLAKE, *Development Engineer, and*  
WILLIAM S. MITCHELL, *Vibration and Acoustical Consultant, both of Lovejoy, Inc.*

This original 700-page illustrated guide closes the great technological gap between theory and operations in the field. Developed through years of practical testing, it demonstrates the value of vibration and acoustic measurement in terms of actual situations and machine problems. It clearly shows how these measurements can give warning months in advance of 90 percent of equipment problems, allowing time to take corrective action before trouble starts. The net-result: less production stoppage, fewer lost man-hours, better quality control, and lower maintenance costs. 656 pp., 6 x 9, *illus.*, #9195, cloth, \$30.00

## Analysis of Plates

D. E. McFARLAND, B. L. SMITH, *and*  
W. D. BERNHART, *Wichita State University*

This comprehensive text presents both classical and computer-oriented solutions for the analysis of thin plates for stresses, strains, and lateral deflections. The coverage includes orthotropic plates, continuous plates, various shapes, plates on elastic foundations, large deflections, and laminated plates. The authors add new insight to the variational approach to plate theory, including many illustrative examples. Although intended as a text in mechanical engineering, the book should be of great interest to engineers in industry. 296 pp., 6 x 9, *illus.*, #9191, cloth, \$18.50

## Control Theory, Volume 1

### Elements of Modern Control Theory

ARTHUR L. GREENSITE, *Convair Division of General Dynamics*

The first of these two volumes on flight control provides the practicing engineer and advanced student with a comprehensive, modern, and up-to-date exposition of all facets of modern control theory. Based on a series of monographs written for NASA, it is recommended as a primary or supplementary reference text. Extensive sample problems and exercises included. 896 pp., 6 x 9, *illus.*, #9154, \$29.95

## Control Theory, Volume 2

### Analysis and Design of Space Flight Vehicle Control Systems

The companion volume treats applications to aerospace vehicles in detail. It examines techniques and methods for the design of launch vehicle control systems, and presents an analytical framework for the study of the performance of satellite attitude control systems. 752 pp., 6 x 9, *illus.*, #9163, cloth, \$29.95

## Modeling of Thinking and the Mind

N. M. AMOSOV, *Academy of Medical Science, U.S.S.R.*

An exciting work on the theory and techniques of simulating the functions of the human intellect by one of the Soviet Union's leading cyberneticists and Lenin Prize winner. Presenting his original hypothesis concerning programs of man's psychic functions, the author outlines methods for modeling these on the computer. 208 pp., 6 x 9, *illus.*, #9147, cloth, \$12.00

SPARTAN BOOKS / HAYDEN BOOK COMPANY, Inc., New York



# ... now available from Hayden

## Pattern Recognition

M. BONGARD, *Translated from the Russian by T. Cheron;*  
*Edited by J. K. Hawkins, Robot Research*

Although primarily directed toward specialists in computers and artificial intelligence, this volume is of importance to engineers and others attempting to understand such brain functions as the ability to "find similarity," "create abstract ideas," and "act by intuition." The Soviet scientist clarifies the meaning of pattern recognition and problem solving. 256 pp., 6 x 9, illus., #9195, cloth, \$12.95

## The Future of Science

MORRIS GORAN, *Roosevelt University*

A provocative, well documented investigation of the scientists' relationships with society, government, and money. It examines three current problems of the scientists: communication, education, and financing. Throughout, discussions are supported by facts rather than moralistic statements. 168 pp., 6 x 9, #9190, cloth, \$8.50

## Technology Gap in Perspective

### Strategy of International Technology Transfer

DANIEL LLOYD SPENCER, *Morgan State College*

An original strategy for visualizing and coping with the technological variants of the modern world. Presenting a novel systems vision, the author deals with the problems of incessant waves of technological impact, and holds that we must view them as a world technology system. 192 pp., 6 x 9, illus., #9180, cloth, \$10.00

## Character Readers and Pattern Recognition

Edited by V. A. KOVALEVSKY, *Institute of Cybernetics, Kiev, U.S.S.R.*

This collection of articles focuses on problems of pattern recognition and computer simulation of various algorithms

and recognition systems. All methods discussed and all work examined are based on procedures used in the development of actual equipment at the Institute of Cybernetics. 280 pp., 6 x 9, illus., #9150, cloth, \$12.00

## Durability and Reliability in Engineering Design

GILBERT KIVENSON

This thought-provoking work places at your disposal highly relevant findings from a variety of technical areas. It examines materials properties, breakdown mechanisms and phenomena, and failure modes along with steps to counter them; provides a capsule course in reliability theory; relates design considerations to the user's needs. 200 pp., 6 x 9, illus., #5851-9, cloth, \$9.95

## Materials Science and Technology for Design Engineers

Edited by ALEX E. JAVITZ

The fundamentals of materials integrated with the hard facts of day-to-day engineering practice. The coverage offered you ranges from basic structure and behavior through new materials and applications, to environmental effects, reliability concepts, and cost effectiveness. 560 pp., 6 x 9, illus., #5640-0, cloth, \$23.95

## The Successful Engineer-Manager

### A Practical Guide to Management Skills for Engineers and Scientists

Edited by ROBERT C. HAAVIND and RICHARD L. TURMAIL

A well-organized, realistic guide to the critical areas of technical management — career, decisions, people, projects, finances, and communications. Articles carefully chosen from *Electronic Design* offer you valuable pointers on financial analysis, person-to-person dealings, project scheduling, promoting new ideas, and much more. 176 pp., 7 1/8 x 9 3/4, illus., #5879-9, cloth, \$8.95

## 15-DAY FREE EXAMINATION

Please send the book(s) circled on 15-day free examination. At the end of that time, I will remit payment, plus postage, or return the book(s) with no further obligation.

9194	9195	9163	9150	5851-9
9178	9191	9147	9190	5640-0
9181	9154	9195	9180	5879-9

### Save Money!

**Payment Enclosed.** Publisher will pay all shipping and handling charges — same 15-day guarantee.

Name \_\_\_\_\_

Firm \_\_\_\_\_

Address \_\_\_\_\_

City/State \_\_\_\_\_ Zip \_\_\_\_\_

**\$10.00 minimum for free exam orders.** Because of higher billing and collection costs, we must ask for payment in full with any order for less than \$10.00. Same 15-day guarantee.



**HAYDEN BOOK COMPANY, INC., 116 W. 14th Street. New York, N.Y. 10011**  
ISBN Prefix 0-8104

72-87

## Capacitor designs aim for IC compatibility

High-temperature and beam-lead tantalum devices in chip form developed for wide semiconductor use

Lucinda Mattera  
New Products Editor

On the theory that if you can't lick 'em, join 'em, capacitor manufacturers are emphasizing compatibility rather than competition with the snowballing semiconductor industry.

At the 1969 Electronic Components Conference in Washington, D.C., the capacitor industry, with an eye on the blossoming use of hybrid circuit modules, unfolded a manufacturing program aimed at substrate compatibility for integrated circuits. At the

▪ New alumina ceramic capacitors that can be used in rf transmission applications.

### Fall-sale tantalum chip capacitors

Boasting as much immunity to high-temperature exposure as monolithic ceramic capacitors, a new family of solid tantalum chip capacitors was described in a paper by David Maguire, group product manager, Electronics Div., Union Carbide Corp. Previous limitations, caused by the breakdown or outgassing of the silver paint used to

Since carbon cannot be added, silver paint is normally used to contact the counter-contacts. But this painted silver layer is destroyed at processing temperatures of about 600 C.

Another temperature problem often occurred in assembling film circuit modules because the gages within the sealed packages must be prevented from oxidizing the semiconductor die. During the baking of these packages for purification, the silver paint layer could be destroyed if the packages were not sealed. On the other hand, the silver paint could outgas if the packages were sealed.

Union Carbide Corp.

ED, June 7, 1969

## Components

# Devices shrink and their reliability expands to keep up with transistor

The development of the transistor may have been a boon to electronic technology, but to component manufacturers it presented a difficult challenge. What good was it to save space by using transistors if all the other components remained large and bulky? Component manufacturers were forced to reduce the size of their devices.

Reliability was another challenge: Shouldn't the components be as reliable as the transistors they're working with?

With these goals in mind, component manufacturers set out in the early 1950s to meet the challenge. The following were highlights of developments in the next 20 years.

▪ Tube manufacturers, anxious to retain their lion's share of the electronic components market, demonstrated some impressive advances in tube design.

▪ Resistor manufacturers produced smaller, more stable devices. New concepts—such as trimming potentiometers, tape resistors, printed-circuit boards with built-in resistors and the selectable fixed resistor—emerged.

▪ The lower operating voltages of transistor circuits gave rise to miniature, large-value capacitors. Solid-state technology also gave the designer a new device—the voltage variable capacitor—and new materials with high dielectric constants.

▪ Inductor manufacturers developed new core materials to reduce the size and increase the operating temperatures of their devices. Inductors began to lose ground, however, to active circuits in low power applications.

▪ Reduced component size paved the way for the increased use of function modules—complex circuits in small packages.

▪ Relay manufacturers developed hybrid devices that used both transistors and mechanical relays for switching. They also reduced the size and changed the packaging of their devices so they would be compatible with solid-state devices.

### Better tubes are built

With the commercial availability of transistors, pundits predicted the demise of the tube industry—a forecast that quickly proved exaggerated and premature. It was not until the early 60s that the trend reversed and transistors took over most of the market. In the interim tube manufacturers provided stiff competition for transistor makers.

In 1954 Sylvania introduced an extremely rugged, stacked vacuum tube. Considerable size reduction, with temperature operation ranging from -195 to 540 C, were claimed for the device. It used ceramic rather than mica spacers for improved shock and vibration characteristics, and it was packaged in a ceramic envelope to protect against environmental failure.

The next year General Electric announced a

Jules H. Gilder  
Associate Editor

microminiature tube that was only three-eighths of an inch long and five-sixteenths of an inch in diameter. Operating in the uhf region, the tube was capable of withstanding temperatures in excess of 500 C.

In 1959 cold-cathode and Nuvistor tubes were introduced. Tung-Sol developed the cold-cathode to eliminate the major cause of failure in vacuum tubes—the heater. A dramatic increase in tube reliability resulted, as well as improvement in the tube's ability to withstand nuclear radiation and temperature extremes. RCA meanwhile placed its hopes on the radically new Nuvistor. Smaller than a thimble, its shape and low mass offered a high degree of freedom from shock and vibration.

But despite efforts like these, the early 60s saw the transistor proved far superior to the tube in most applications; it became the dominant force in electronic components.

### Passive components improve

As the transistor gained ground, other components—resistors, capacitors and inductors—kept pace. In 1952 the need for an easy method of adjusting the value of a resistor during the final stages of circuit assembly led to the trimming potentiometer. Introduced by Bourns, the Trim-pot was a small, self-locking adjustment poten-

tiometer with good setability. It eliminated the need for filing fixed resistors to a desired value or for using bulky rheostats.

In the mid-50s a new approach to resistors appeared—tape resistors. With these it was possible to cut individual elements into any size and shape. The elements could then be pasted onto a printed-circuit board, where they made connections with the printed conductor lines. This early use of resistor elements on printed-circuit boards led eventually to the deposition of thick-film resistors onto the boards and to boards with built-in resistors in 1971.

Capacitor advances were equally pronounced. In the 30s almost all high-performance devices were made of mica. The silvered mica capacitor was introduced by Bell Telephone Laboratories and hailed as a major step in minimizing capacitance change with the time and temperature.

But with the advent of World War II, U.S. manufacturers found themselves cut off from their main sources of mica in the Far East. A substitute was sought, and before long glass was being widely used in capacitors.

In the early 50s a new trend in capacitors began to emerge. With the increased use of transistors, it was no longer necessary for capacitors to have high breakdown voltages. Miniature high-capacity tantalum capacitors began to appear. One of the early ones was the Micro-Miniature tantalum capacitor, introduced by General Electric in 1953.

In 1954 the Mucon Corp. of Newark, N.J., presented a new device to the electronic designer—the voltage-variable capacitor. By varying the voltage applied to this new device, the engineer could change its capacitance by as much as 70%.

By the early 1960s ceramic capacitors were becoming popular because of their high dielectric constants, which resulted in smaller devices. Early developments in this field were carried out by the Aerovox Corp. and Packard Bell Electronics Corp. At about the same time new film capacitors were using plastic, ceramic and cellulose acetate. The film capacitors offered more capacitance per volume. They also led to higher reliability devices.

Then, in the late 60s, integrated circuits arrived, and capacitor manufacturers joined the snowballing semiconductor industry by offering chip capacitors.

The availability of chip devices led in the 1960s to a whole new concept in components—function modules. While systems had been built on a modular basis for a long time, it was the ability to put complex circuits into small packages at low cost that transformed entire subsystems into components. Examples of this are d/a and a/d converters. Very few manufacturers build their own today. They usually specify a module. ■■

## BEHIND THE NEWS

**Latest Threat to the Transistor**

**.... Nuvistor Tube Design ....**

**T**ube manufacturers have succeeded in recent years in developing new concepts and techniques aimed to keep them in the race with the transistor industry.

Tung-Sol's cold-cathode development opens the way for low-power consumption, high-reliability tubes (ED, March 4, 1960, pp. 35; Science, "New cold-cathode construction" (ED, March 4, 1960, pp. 32-33) also have unusual characteristics, lower noise, and greater freedom from breakdown than possible with previous processes.

**RCA Contribution**

Smaller than a thimble, more rugged and efficient than previous tube designs, and particularly suited for unattended production, the "Nuvistor" represents a radical departure in the electron tube concept developed by the RCA Electron Tube Division.

Thinning, bending and intricate weaving have already been demonstrated in TV tubes, followed by use of the volume of conventional tubes. Final development in miniature is a beam power tube for radio and TV deflection circuit applications.

**Construction Features**

Construction of the Nuvistor starts with a strong ceramic base, made serving as a platform for an array of tube electrode assemblies (see Fig. 1). Each assembly is held rigidly in place by a tripod-like structure (see Fig. 2).

The electrodes are strongly supported from the end as a cantilever tubing, eliminating the need for inner support discs or spacers. All electrodes are small, high cylinders capable of withstanding a high degree of shock and vibration due to their shape and low mass.

All the parts in the complete tube are processed at white heat temperature of approximately 2100 F in a brazing furnace and then in a vacuum-annealing furnace. As a result, the parts are joined in their original strain-free positions. Since the tube elements are accurately secured in this manner, the possibility of shorts developing in the tube during operation is greatly reduced.

**Advantages of Construction**

- Cylindrical symmetry and cantilever support of the electrodes provide high cathode efficiency and permit the use of accurate pip for parts assembly.
- By the use of brazing, rather than spot welding for the joining of materials, a potential source of failure is removed and residual strain in assembly is diminished.
- There are no areas to fray under vibration or to interfere with high-temperature brazing and the exhaust processing of the tube.
- High-temperature processing eliminates many of the gases and impurities that are difficult to remove during manufacture of tubes of conventional design in which glass and metal limit the processing temperatures.
- Inhibiting legs on the base of the Nuvistor

Fig. 2. Internal construction of Nuvistor Tube.

The Nuvistor tube represented a vigorous attempt to meet the competition of the transistor.

ED, April 15, 1959

**GENERAL  
AUTOMATION  
SAYS  
BUY DEC**

If you're shopping the minicomputer market for raw hardware at rock bottom cost, it's hard to know where to stop. With more than two dozen price lists to choose from, it can get confusing. And time consuming.

We're here to make it easy for you. Buy DEC.

When you cut through all the claims, DEC's priced as low as anyone else. And they have built a business fulfilling the needs of the low-end iron buyer.

We make low cost hardware too. And if you're price shopping, you'll find us competitive. But raw iron is not our primary business.

### **The cheapest machine vs. the cheapest solution:**

Sure, our goal is to save you money too. But our long suit is squeezing these savings out of your total systems cost rather than off of our price list. So if you need more from the machine or the company that sells it to you, we recommend us. General Automation.

Take *the world's most powerful minicomputer*, for instance.

The General Automation SPC-16.

The SPC-16 possesses the most powerful instruction set you can buy in a minicomputer today. Think about that. The *most* powerful. As a result, the SPC-16 does more things in less time. It will actually reduce the total cost of your system.

Depending on your specific needs, you can choose from six different models in the SPC-16 family. Each backed by the best software and peripheral capability in the business. There's another very important reason why you should buy from us.

### **It's called involvement.**

All the other big mini manufacturers

today are touting the fact that they're "end-user oriented" or that they're now "in the systems business."

We've been doing exactly that for more than five years now. And it's nice to see that others have begun to recognize our leadership.

We learned a long time ago that the only way to really help our customers in solving their systems problems was to fully understand those problems.

So we got involved with our customers. Both end-users and OEMs. Listened attentively. Learned a lot. Got answers. And wound up building systems to solve some very tough, very complex problems.

Emissions analysis and electrical test systems for the nation's largest automobile manufacturers.

Production machine control systems for some of the biggest companies in the machine tool business.

Telecommunications and message switching systems for the world's leading communications companies, to name just a few.

In short, we've built our company and our reputation by offering answers, not just iron.

### **Who's it gonna be?**

Actually, we've made your choice fairly simple.

If all you need is raw minicomputer hardware at a "rock bottom" price, we recommend DEC.

If you'd like something more—from a mini with more oomph to the total solution of a complex systems problem—we recommend us.

General Automation.

Our phone number is (714) 778-4800.

Or write:

1055 South East St., Anaheim, Calif. 92805

# **General Automation**



ED, Oct., 1953



ED, Feb. 18, 1959

## Packaging and Materials

# *In the nick of time, automation comes and with it miniature modules*

For years, design engineers had thought of electronic circuits as aggregates of wire-connected parts. Integrated circuitry changed that. The advent of LSI stressed packaging and interconnection techniques, with small size as the main consideration. And while miniaturization has always been a prime concern in the fabrication of most electronic circuitry, small packages were actually an offshoot of automated assembly.

When Danko and Abramson of the Army Signal Corps invented dip soldering in 1949, a new era of automation came into being. It came in the nick of time. Spurred by new developments, like television, manufacturers of consumer products were increasing their demands for electronics. And by June, 1950, the military was to find itself embroiled in the Korean War.

In 1950 the Navy Bureau of Aeronautics asked the National Bureau of Standards to study further automation of circuit assembly. The process that followed in 1951—developed by Robert Henry of the Bureau of Standards—was dubbed Project Tinkertoy. It provided for the automatic assembly and inspection of circuit components, and it led to the first modular package.

The system started with individual components mounted on steatite ceramic wafers 7/8-inch square by 1/16-inch thick. The components were machine-printed or mounted over printed wiring. Four to six wafers were then automatically selected, stacked and mechanically and electrically joined by machine-soldered riser wires, which were attached at notches along the sides of each wafer. The resulting module generally had a tube socket on the top wafer (see photo top left).

Though this modular approach to packaging was used for production items, it faded in the late 50s as the transistor began to replace the vacuum tube. But Project Tinkertoy had an effect on packaging shapes that were to come.

By 1957 the goal for packaging had shifted from automation to miniaturization. Working with the Army Signal Corps, RCA suggested an approach that was similar to Tinkertoy's but with smaller wafers. Using wafers 310 mils square, spaced 10 mils apart, RCA encapsulated the assembled module with an epoxy resin to increase mechanical strength and provide environmental protection. Micromodule had arrived.

With RCA as the prime contractor for an \$18-million contract, the Signal Corps promoted micromodule as a standard package. A Signal Corps team headed by Daniel Elders, Stan Danko and

Richard Lee Goldberg  
Associate Editor

Weldon Lane established a continuing development program for micromodule.

The micromodule approach combined high packaging density, machine assembly and modular design. It was the first attempt at functional modular replacement, where the entire module was treated as a single component. The program established a compact universal packaging system using standard-shaped parts. But just as micromodule was gaining popularity in the early 60s, the IC deflated its chances of achieving sufficient volume for a competitive price.

Nevertheless, offshoots of the micromodule program changed the direction of the electronics industry at the time. The modular system inspired thick films and ceramics, TO transistor cans and multilayer substrates. Miniature components were developed on subcontracts of the \$18-million Signal Corps program, and ceramic-chip and tantalum-slug capacitors, miniature crystals and trimmers, and low-profile transistor packages emerged.

Cordwood modules, another approach to packaging, appeared in the same period. Based on an idea by R. J. Roman of the Eastman Kodak Co. in 1956, the technique suspended components between two etched circuit boards. The module was then encapsulated with a potting compound. The components were held in place either by soldered joints or welded terminations.

Cordwood construction gained rapid acceptance during the early 60s for aerospace applications, and it is still in use today. It allowed the building of smaller modules and stimulated the development of the multilayer PC board for module interconnection.

Although patents for printed wiring date to the 1860s, it wasn't until the early 1920s that photoetching techniques and multilayer circuit boards appeared. During World War II the Centralab Div. of Globe-Union, Inc., developed a ceramic-based circuit for the National Bureau of Standards. This "printed circuit" used screen-de-

posited resistor inks and silver pastes to support the miniature circuits in an Army proximity fuse. The PC board that followed stimulated manufacturers to develop components with radial leads and tubular shapes.

When circuit complexity outgrew the capacity of single-sided PC boards in the late 1950s, multilayer PCs were built as an alternative. The Photocircuits Corp. developed the first flush multilayer board. The idea was based on a technique used for switch commutator plates, but problems of interconnecting the layers prevented attainment of 50-mil terminal spacing until 1965.

### Multilayer boards and Minuteman

The use of multilayer boards in the Minuteman missile in 1962 was a shot in the arm for the multilayer technique. It paved the way for today's high-speed logic to apply the controlled impedances and predictable electrical characteristics of multilayer boards. But though multilayers lend themselves to automation, they're difficult to repair. Something else was needed.

Gardner-Denver's Wire-Wrap system grew from an idea by H.A. Miloche at Bell Telephone Laboratories in the late 1940s. It combined the automation of multilayer with the ability to modify the circuit.

After the interconnection problem for multilayer boards, suitable materials proved to be a second major stumbling block. Early glass-epoxy laminates represented a shotgun wedding of two materials that caused compatibility problems during thermal cycling. With homogeneous insulations—such as Mylar, Teflon and Kapton—multilayer boards were able to accommodate automatically printed artwork approaching the same line widths as that used in the manufacture of the ICs themselves.

With the emergence of the IC as the modern circuit element of the early '60s, transistor packages were found to lack sufficient heat sinking and adequate interconnections. To dissipate heat and provide a standard package size, Yung Tao created the flatpack in 1962 while at Texas Instruments. It was 1/4 by 1/8 inch and originally had 10 leads. Intersil's Pico Pak, introduced last September, is 0.14 by 0.21 inch—the smallest size yet.

Bryant (Buck) Rogers fostered the invention of the DIP while at Fairchild Semiconductor in 1964. It originally had 14 leads and looked just as it does today.

In 1964, Martin Lepselter of Bell Telephone Laboratories invented the beam lead as a mechanical and electrical interconnection between the IC and its case. This and other flip-chip techniques allowed the IC to revolutionize the world of electronics. ■■

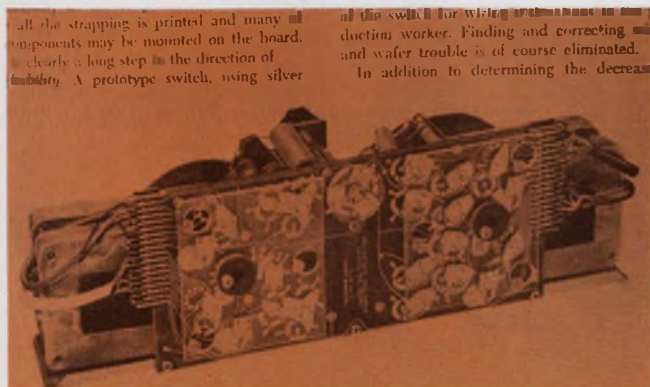

The Hartsack Etched Plate switch of Allison Laboratories, shown in an octave band filter assembly, was an early application of etched multilayer circuitry.

ED, Dec. 15, 1957

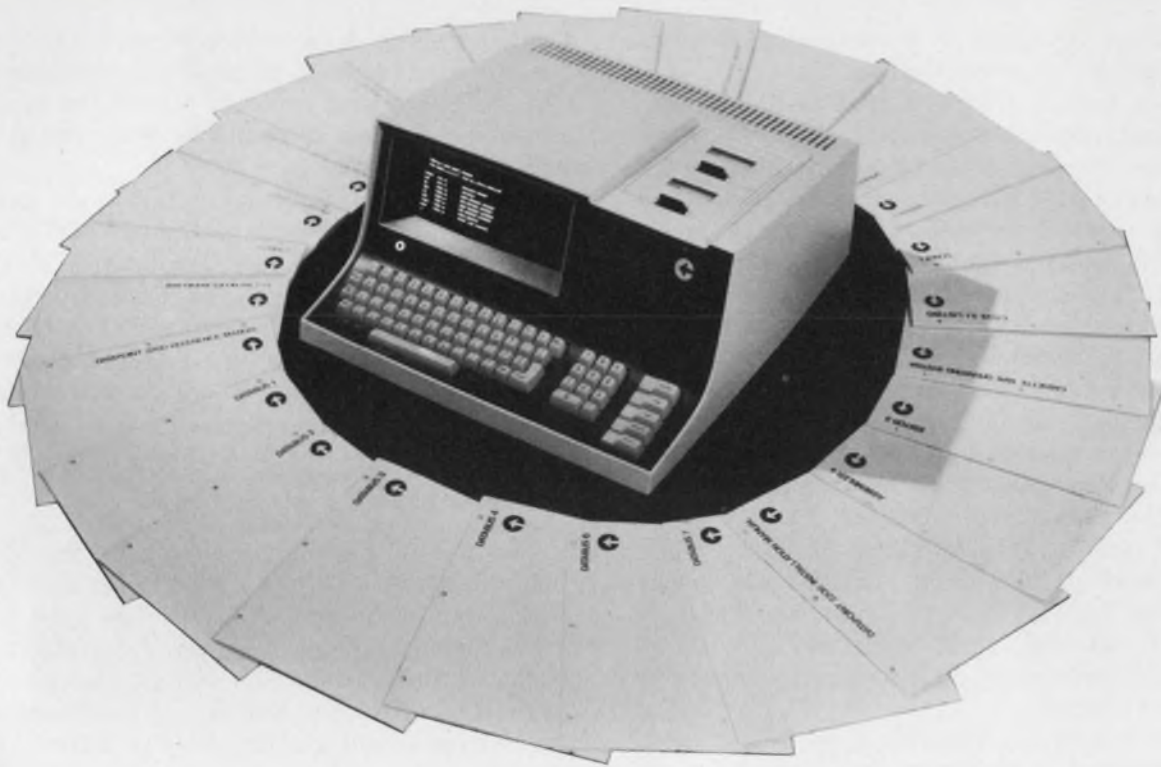

## Other mini computer manufacturers talk about their software: Datapoint delivers

The Datapoint 2200, a unique combination of powerful computer display, and dual cassette drives, has established an enviable record as an all-purpose computer and communications system. Its success, however, is not based on hardware capabilities alone.

Many computer professionals have been pleasantly surprised to discover that the Datapoint software catalog makes available more comprehensive offerings of program-generation software than most other mini computer makers. And all the programs are created and run on the Datapoint itself — no other computer is required.

Here's a selection of available Datapoint software:

### OPERATING SYSTEMS

- DOS A powerful Disc Operating System based on the 2.4 megabyte cartridge disc.
- MTOS An operating system based on the Industry-compatible magnetic tape.
- CTOS For stand-alone operation, a powerful cassette-tape operating system.

**DATABUS, A HI-LEVEL LANGUAGE** — Databus, the Cobol-like Datapoint Business Language, was written especially for the Datapoint. The language contains comprehensive character and arithmetic capabilities. While programs may be written quickly in English-language statements, its real power lies in its ease of I/O operation. Tapes, disc, and printers are handled in Databus as well as communications peripherals.

**SCRIBE, A TEXT PROCESSING LANGUAGE** — The combination of a Datapoint 2200 plus an upper and lower case printer can form the heart of a text-processing system. The SCRIBE program, actually a high-level language, allows text to be entered via the 2200's keyboard, visually edited and stored on a cassette tape. Upon command, this stored text may then be printed on a Selectric typewriter or on any Datapoint printer. Users having heavy text handling

chores such as reports or manuals will find the SCRIBE system extremely cost/effective.

**ASSEMBLY LANGUAGE PROGRAM GENERATION** — Machine Language Programs are quickly constructed by use of the Editor, Assembler, and a selection of Debuggers.

**TERMINAL EMULATORS** — Datapoints can simulate many well-known terminals and offer a multi purpose alternative to a user. A variety of Terminal Emulator programs are available with many of the packages offering more flexibility than the original, yet maintaining the required discipline. Recent terminal packages include an IBM 2780, CDC 200 User Terminal, UNIVAC DCT-2000 and UNITERM, a flexible teletype-format emulator.

**UTILITIES** — Many sub routines and other useful software items are available for the applications programmer. I/O drivers, communications, fixed and floating point arithmetic and a variety of other routines are available as well as a complete set of diagnostics.

This proven-in-use software capability is a big reason for the success of the Datapoint 2200 as a versatile computer or data terminal system in more than 1000 installations. Prices for the Datapoint 2200 begin at \$6040 with a variety of lease and purchase plans, with worldwide maintenance available.

To learn more, ask for our hardware and software catalogs from the sales representative nearest you or the home office.



# Datapoint 2200

THE COMPLETE MINI COMPUTER SYSTEM

Computer Terminal Corporation

**Home Office:** 9725 Datapoint Drive/San Antonio, Texas 78284/(512) 696-4520 • **Sales Offices:** Beverly Hills, Calif./ (213) 553-0811 • Boston/(617) 891-9220 • Chicago/(312) 671-5310 • Cleveland/(216) 831-1777 • Dallas/(817) 265-7745 • Darien, Conn./ (203) 655-4800 • Denver/(303) 771-0140 • Detroit/(313) 557-6092 • Los Angeles/(213) 645-5400 • Minneapolis/(612) 854-4054 • New York/(212) 759-4656 • Orlando, Fla./ (305) 671-4500 • Philadelphia/(215) 272-1444 • Phoenix/(602) 265-3909 • Portland/(503) 289-9655 • San Francisco/(408) 732-9953 • Washington, D.C./ (301) 587-3910  
**International Representatives:** TRW Communications/Toronto, Ontario, Canada/(416) 481-7288 • TRW Communications/Lyss/Berne, Switzerland/Telex: 34446 • TRW Electronics-International/Los Angeles, California/Telex: 674593



# Amphenol sets your contacts straight



## for 30% faster terminations.

With Amphenol 97 Series connectors, the contacts *don't rotate* within the insert. They're pre-aligned—to stay aligned—so the solder cups are uniformly positioned for quick, easy soldering.

Test ours against the competition's. You'll find the soldering 30% faster, with less wasted motion, giving you lower termination costs. Our inserts are thicker, too. For extra strength and reliability. These benefits mean fewer scrapped parts during assembly, longer product life.

The 97 Series is basically the same connector as our original "Old Vet" AN (MIL-C-5015). In com-

mercial applications such as computers, traffic controls, dynamometers and welding controls, 97 Series connectors are lowering costs.

On-the-shelf inventory at your Amphenol distributor's means fast delivery, less for you to stock. Of all the orders we ship, 90% are straight from stock. Another good reason to specify Amphenol "97 Series" right on your drawings.

Get the "straight" story from our salesman or your Amphenol Industrial Distributor (AID). Amphenol Connector Division, 2801 South 25th Avenue, Broadview, Illinois 60153.

**BUNKER  
RAMO**

**AMPHENOL**

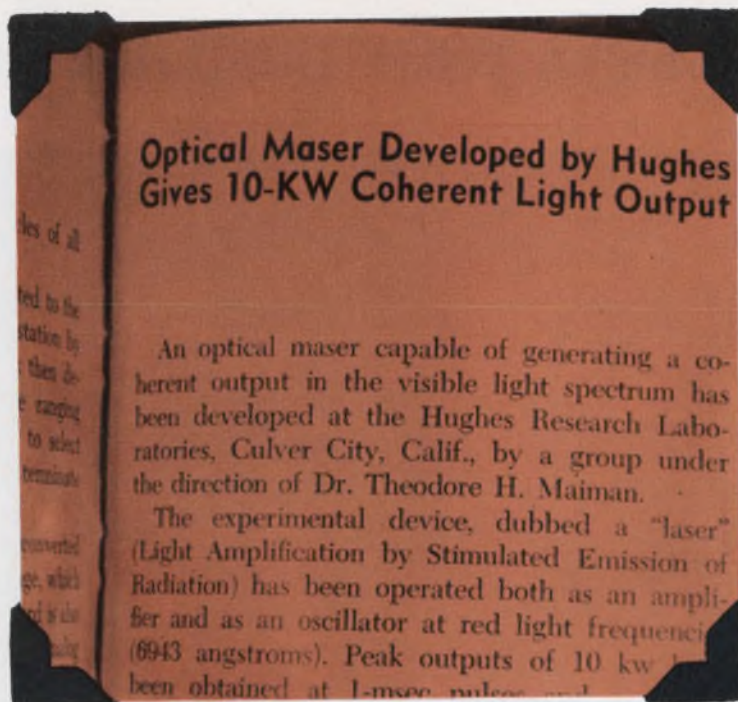

## Electro-Optics

# *A physicist with a mind of his own helps usher in the world of lasers*

The year was 1960, the start of a fresh decade, and at Hughes Research Laboratories in Malibu, Calif., Dr. Theodore H. Maiman was nearing the end of tenacious research. A physicist who refused to follow a path that most of his contemporaries were following, he obtained in July, at long last, emission from an "optical maser" made of a ruby crystal. The emission was obtained by pumping the ruby with a pulsed mercury arc. It signaled the invention of the most spectacular electro-optic device to emerge in the last quarter century—the laser. And it touched off a laser-development race that was to unfold frantically over the next two to three years.

The rapidly growing knowledge of the physics of semiconductors and other materials—triggered by the invention of the transistor—had produced two other new electro-optical components before the laser: solid-state photosensors and fiber optics. And in time another milestone was reached: solid-state lamps.

Research programs on the laser were under way in 1960 not only at Hughes but also at Bell

Telephone Laboratories, the American Optical Co., RCA Laboratories, General Electric, Electronic Laboratories, Varian Associates and in four programs supported by the Air Force.

By March of 1961 six different types of lasers were in use. At this time ruby lasers were operating at Hughes, Bell Laboratories, Raytheon and other plants. IBM had developed samarium-doped and uranium-doped calcium fluoride lasers. Bell had also produced the first cw helium-neon gas discharge laser, pumped by 28 MHz rf.

The original optical modulators used for lasers were Kerr cells, but they were not efficient. Losses could range up to 80%. As a result, an active search began for better modulators, and in October of 1961 the Sperry Gyroscope Co., of Great Neck, N.Y., revealed that it had built several microwave Pockels-cell modulators—a more efficient solid-state equivalent of the Kerr cell.

Both germanium and gallium-arsenide materials were found to be transparent to infrared. By applying a voltage to these semiconductor crystals, infrared laser beams could be modulated. These modulators were used in low-power communications systems with limited bandwidths.

A principal limitation of the basic laser-communication system was a lack of detectors for

---

**Jim McDermott**  
Eastern Editor

microwave-modulated laser signals. But devices were being developed to fit this need. By 1962 Philco unveiled a solid-state silicon planar epitaxial photodiode—the L4500—suitable for use up to 5 GHz.

A second new device—a microwave traveling-wave phototube—was developed this same time by Sylvania's Microwave Device Div. Dr. Burton J. McMurtry at Sylvania, together with Prof. A. E. Siegman of the Stanford University Electronics Laboratory, developed a photosensitive thermionic cathode surface. The tube had a broadband helix configured like that of a standard traveling-wave tube. When microwave-modulated light was projected on the photocathode, a microwave-modulated photocurrent was produced. Amplified in the helix section it came out as microwave signal output that could be demodulated with standard techniques.

### Semiconductor lasers appear

While the advent of the laser stimulated intensive research that ultimately resulted in many types—gas and crystal lasers, cw and pulsed, low-power and super-power, and Q-switched—semiconductor scientists were busy producing a true solid-state laser—one that would work by simply passing current through it.

By the end of September, 1962, R. N. Hall and co-workers at General Electric Research Laboratories succeeded in making the first semiconductor laser. Some 10 days later a rival team, led by M. I. Nathan at the IBM Research Laboratory, were also successful.

The laser properties of gallium arsenide were verified by RCA scientists and others in 1962. These diodes were immersed in liquid nitrogen or liquid neon for cooling. Over the next several years the efficiency of injection lasers was slowly improved at RCA. A new RCA semiconductor laser design, using a heterojunction, sharply reduced internal losses and permitted relatively high-power room-temperature operation.

A byproduct of semiconductor laser studies has been the development of light-emitting devices (LEDs)—true solid-state lamps, which are now beginning to be produced in yellow and green as well as the familiar red. The first commercial LED display was introduced in 1968.

Steady progress in semiconductor technology throughout the 50s and 60s produced a wide variety of photosensors, including silicon photodiodes and phototransistors.

Back in 1963 computer designers were looking for ways to speed the operation of their logic from submicroseconds to subnanoseconds. The semiconductors then available were too slow, and the Air Force funded programs by American Optical and RCA to look into computers that

## NEWS

# Fiber Optics Pointed Toward Bright Future

*4 Companies Exhibit at SPIE Show,  
But Concede Production Problems*

**F**IBER optics held an important place in the Aug. 7-11 symposium of the Society of Photographic Instrumentation Engineers. Four companies had samples of fiber-optic technology on exhibit in Los Angeles.

Mosaic Fabrications, Inc., and American Optical Co., both of Southbridge, Mass.; Chicago Aerial Industries, Inc., Barrington, Ill.; and Bausch & Lomb, Rochester, N. Y.; showed fused-fiber image conduits. American Optical also exhibited flexible cable.

J. W. Hicks, president of Mosaic Fabrica-

As a means of piping optical signals around communication and computer circuits, fiber optics was proposed.

would be a marriage of lasers and fiber optics.

RCA's Walter Kosonocky proposed a computer built with optical lasers as the active elements. The transmission lines were to be of optical fibers containing active-emissive ions and saturable-absorptive ions. He estimated that with a 1- $\mu$ m fiber and a laser pulse duration of 100 ps at a frequency of 1 GHz, a logic device requiring only 10 mW could be obtained. But two problems were apparent: The optical fiber material was not yet developed, and pumping power sufficient for GHz rates was unavailable.

Before these basic problems could be solved, semiconductor computer technology advanced rapidly in speed at reduced costs. Laser projects were quietly dropped.

But within the last two years optical memories, comprised of LEDs driving photosensors through fiber optics, have appeared. And much work has been done on large-store holographic memories, with lasers used to put the data into the memory and to remove it.

And a new technology of optical integrated circuits for communication and data-transmission systems, borrowing fabrication techniques from the semiconductor industry, has only recently appeared. In these optical ICs the energy is carried by optical fibers. ■■

Additional copies of this special anniversary issue are available for \$2.00. Send check or money order to: William H. Smith, ELECTRONIC DESIGN Magazine, 50 Essex St., Rochelle Park, N.J. 07662.

ED, Aug. 30, 1961

# ENOUGH! ENOUGH!

## *Our cup runneth over!*

When we advertised our "coffee cup" survey a few months ago and gave you the opportunity to sound off about function generators, pulse generators, and test instruments in general, we anticipated a large response. But we didn't expect to be **deluged!** Your completed questionnaires poured in from IEEE and WESCON, and through the mail, and IEC responded with "Nobody Asked You" coffee cups by the thousands.

You had a lot to say, and true to our word, we read every single questionnaire. Your comments were frank and specific as you criticized, analyzed, accused... and complimented. Many of you told us you agreed with IEC's price-capabilities position, and you liked the performance ideas that were designed into our 3 MHz and 11 MHz function generator series. Thanks.

On the facing page is just a tiny sample from the tremendous number of replies we received — real statements from real engineering professionals — maybe even **you!** However, if you believe in forming your own opinion, we'll send you straight technical information, along with a free copy of our "Nobody Asked You" report. You can order it with the product information number given below. **Like our coffee cup, it's quite an eye-opener!**



"Two engineers spent an entire afternoon looking over the specs of all the leading function generators. We came to the conclusion that several cheaper function generators can be a better deal than one super-deluxe job. Basically, they decided that your F34 looked good from a price/performance standpoint . . ."

J.E., President — Gainesville, Fla.

"Humbug." J.F., Senior Project Engineer — Eatontown, N.J.

"Your F55 is the best in the business. I just bought one."  
D.L., Elect. Tech. — China Lake, Cal.

"More suggestions for test applications should accompany the goods."  
T.B., Test Engineer — Newport News, Va.

"Unique applications that have developed in my use of test instruments include . . . detection of corona discharge by ultrasonics."  
W.F., General Electronics Supv. — Cumberland, Md.

" . . . Precision-shift position displays for astrological telescopes."  
R.A.C., President — Claremont, Cal.

" . . . Trouble-shooting my kids' electrical toys."  
L.V., Chief Engineer — Wheaton, Md.

"It would be helpful to get a composite function."  
R.D.B., Sr. Logistics Engineer, Phoenix, Ariz.

"Some models cannot be pulsed from an external source."  
H.D., Field Engineer — Jolon, Cal.

"They (function generators) must be capable of AM and FM modulation."  
F.D.C., SMTS — Sunnyvale, Cal.

"Like your function generators with AM/FM."  
S.J.O., Senior Engineer — Baltimore, Md.

"Glad a variable width pulse is included in your instruments."  
W.K., Assoc. Prof. — Klamath Falls, Ore.

"I like the F34. Versatility is important — otherwise one would stick to RC oscillators."  
C.S., Tech. Specialist — Buffalo, N.Y.

"OK, now send me my coffee cup so it doesn't break!"  
J.K., Project Engineer — Oberlin, Ohio

"My gripe about test instrument products is . . . \$, \$ and more \$."  
D.T., Project Officer — Edgewood, Md.

"Improve performance and lower prices for bottom-of-the-line equipment for people who don't need all the bells and whistles."  
J.S., Engineer — Irvington, N.J.

"Like the price and features of your Series 50."  
H.A., Project Engineer — Indianapolis, Ind.

"Many function generators lack output indicator or calibrated attenuator."  
A.W., Senior Engineer — Philadelphia, Pa.

"I appreciate IEC's function generators that have output attenuators and go to 11 MHz."  
S.H.S., Physicist — Dahlgren, Va.

"Forget about claims of 'fastest,' 'most,' 'best' . . . give us the numbers and we'll decide if it's 'best.'"  
G.V., Senior Specialist — Dallas, Tex.

"Your F31 — GREAT."  
W.F., S.A.E. — San Jose, Cal.

"My biggest gripe about test instrument manufacturers is . . . bidding on items that are out of range, spec-wise — and not delivering on time!"  
M.R., Research Assoc. — Stillwater, Okla.

" . . . New equipment that has to be sent back for repair when it comes in the door."  
W.D., Assoc. Engineer — Niles, Ill.

"I hate banana jacks."  
R.L.G., Chief Engineer — Hayward, Cal.

"Special parts are often available only after a long wait."  
N.M., Electronic Engineer — Washington, D.C.

"You try hard!" R.H., Research Assistant — Little Rock, Ark.

"Thanks for giving away coffee mugs to help steady our nerves."  
F.W., Project Engineer — White Plains, N.Y.

"If you send two cups, my partner will speak to me again."  
T.R.L., Medical Electronic Tech. — Beaverton, Ore.

"Don't like poor manuals, missing schematics, not enough calibration data."  
N.M., Electronic Engineer — Washington, D.C.

"Not sufficient data in catalogs or service manuals."  
B.S., E.E. — Ft. Wayne, Ind.

"The instruction book that came with our F53 . . . Wow!"  
F.M., Research Engineer — Livingston, Mass.

"Can't stand ultra-miniaturization on control knobs (my fingers are still the same size)."  
J.G., Senior Staff Engineer — Los Angeles, Cal.

" . . . In-human engineering."  
R.K., Design Engineer — Athens, Ga.

"Like IEC's ease of setting end points of the sweep function."  
J.R.L., Senior Engineer — Goleta, Cal.

" . . . Asking engineers in the field before designing equipment — Good show, IEC!"  
H.S., E.E. Tech. — Danville, Ill.

"Testing TTL with a standard pulser is like trying to tighten screws with a chisel . . . Both may have good characteristics, but not for the job at hand."  
J.A.C., E.E. — Cambridge, Mass.

"Why not put a 5 v d-c output on a pulse generator?"  
B.A., Research Asst. — Middletown, Conn.

"Too many Rolls-Royce pulse generator types — not enough VW's. We can build what we need at less cost than buying."  
L.G., Ph.D., Director — Silver Springs, Md.

"I would like a pulse generator with dependable frequency stability of 0.1%."  
R.C., Chief Elect. Engineer — Reno, Nev.

"Once in a while you guys do something right . . . like this feedback, for instance!"  
L.C.McE., Chief of R&D — Ogden, Utah



Subsidiary of A-T-O Inc.

Dept. 7000, Box 3117, Anaheim, Calif. 92803  
Phone: (714) 772-2811 • TWX (714) 776-0280  
TELEX 655443 & 655419

# The promise and the reality

A glimpse of the significant and (ultimately) not so significant events of the past, as covered in the pages of Electronic Design

## The Vanishing Hearing Aid

ONE of the major electronic industries in which credit must go for handsome improvements is the hearing aid industry. (Travel on by a glance at the hearing aid case to appreciate why.) Heavy batteries, tangled "hook-ups," etc., the hearing aid engineers have pushed us toward the front of a "single," "weightless," low-cost aid.

Other designers are now developing aids that satisfy the military requirements for size and range rather than "standard."

Here is an example of how things got better, more reliable, for the hard of hearing.



ED, JULY 1, 1957

## NEWS BULLETINS

### Space, electronic firms eye \$1.5 billion MOL plans

Aerospace and electronic firms are eyeing a \$1.5 billion MOL (Major Operating Lease) program, recently announced by President Johnson. Possibly one of the largest private-public contracts in the history of the United States, the program will provide for the development and operation of a fleet of 100-150 space shuttles for the Department of Defense.

The program is being developed by the General Electric Co. and the Lockheed Aircraft Corp. The program will provide for the development and operation of a fleet of 100-150 space shuttles for the Department of Defense.

ED, SEPT. 13, 1965

## Cw Infrared Maser Developed; Gas Unit Uses Helium and Neon

Development of a continuously operating infrared maser has been announced by the Bell Telephone Laboratories. The device is a gas maser of the helium-neon type, with a continuous output of several hundredths of a watt at one wavelength.

ED, FEB. 1, 1961

## First Automotive Radios Using Transistors . . .

A major advance in the automotive radio field took place recently with the introduction of an automobile radio which now includes transistors.

Developed by the Deleo Radio Div.

ED, FEB. 15, 1956

## Advances Spur Thin-Film Computer Hopes

Hughes Testing Complete DDA Using Films  
RCA Claims Field-Effect Deposited Transistor

SEVERAL recent developments indicate that thin-film computers are approaching the stage of practicality.

ED, JULY 19, 1961

## WASHINGTON REPORT



### WORK ON NASA'S HOUSTON CENTER TO BEGIN SOON

After surveying some 150 possible sites in the greater Houston area, the choice for the National Aeronautics and Space Administration's electronics center is now down to 22—with the split about 50-50 as between urban and rural locations. Which way the decision goes will determine if the center will be a "high-rise" or a "campus" type of facility. NASA is expected to pick the site before the end of the month.

Meanwhile, a task force for the center of about 25 persons now stationed in Washington will move into the Cambridge-Houston area about Sept. 1. This group will include the recently hired director of the center, Dr. Winston E. Koek (pronounced "cok"), former vice president in charge of research for the Bendix Corp. in Detroit.

Initially, this group will undoubtedly be more concerned with problems of plant layout and architecture and engineering, than with the placing of contracts for electronics R&D. NASA's budget for the center in Fiscal Year 1965 is \$10 million—for facility design and initial construction—compared with \$5 million in Fiscal Year 1964 (carried over to FY-65) for the search for and purchase of real estate.

ED, AUG. 3, 1964

## Using Magnetic Cores in Computers

Robert D. Koils

Head, Research and Development Section, Computer Dept.,  
Eastman Manufacturing Co., Waltham, Mass.

MAGNETIC core circuits can be used for...  
The use of magnetic cores in computers...  
...the use of magnetic cores in computers...  
...the use of magnetic cores in computers...

ED, APRIL, 1955

## Industry's First Solid Circuits Now Available to Designers

The first solid circuits are now commercially available, marking the beginning of a new era for the electronics industry.

Texas Instruments, Inc., which developed the monolithic devices, has produced evaluation quantities of a binary multivibrator operating at a 200-ke repetition rate.

According to the company, the solid circuits are produced by extensions of mesa-transistor production techniques. Diffusion, oxide-masking, evaporation and chemical forming are used to make a single-crystal semiconductor wafer behave as a complete circuit. Thus "most reliability-decreasing interconnections are eliminated," the company says.

Orders are being accepted for solid-circuit logic blocks, gates, oscillators, NOR circuits and flip-flops. The multivibrator available for evaluation measures 0.250 x 0.125 x 0.131 in.

More details on this landmark development will be described in a forthcoming issue of *Electronic Design*.



Solid-circuit added package developed by Texas Instruments for American Bosch Arms is a combination of seven individual semiconductor elements.

ED, MARCH 30, 1960

## Portable Radio Transistors May Last Forever

Replacement of transistors in portable radios and other electronic equipment may never be necessary if they are used within the limits set by the manufacturer, a General Electric Engineer suggested recently in New York.

In addition he said...

ED, OCT. 15, 1956

Transistors in Commercial Product... Just before going to press, *ELECTRONIC DESIGN* learned of the first application of junction transistors to a commercial product available to the general public. This application is in the power output stage of a hearing aid. The unit employed is an n-p-n transistor, and its use makes possible a life of over six months for the tiny "B" battery. The circuit incorporates a "micro-miniature" (sub-sub miniature) tubes and transistor. Weight of the hearing aid complete with batteries is only 3 oz, it is 25% to 30% smaller than the company's previous model... is twice as great...

ED, JAN. 1953

## Publications Show Determined Soviet Push Toward Moon

Soviet plans for sending a manned space vehicle to the moon are being discussed with increasing vigor in the Russian scientific community, recent Soviet publications indicate. The following tentative timetable emerges from a study of these publications:

- Artificial earth satellites and a spacecraft will continue to be launched from the Soviet main-

ED, DEC., 1954

ED, AUG. 2, 1962

## Miniature Transistor Radio

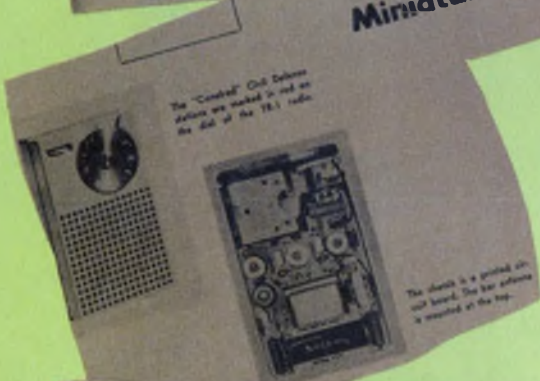

The "Control" Out Deluxe station are marked in red on the dial of the TR-1 radio.

The circuit is a printed on self board. The top antenna is mounted on the top.

## Color TV Still A Question

Two conflicting statements by the leading receiver manufacturers have made the color TV receiver picture cloudier than ever.

It all began with GE President Ralph Cordiner's statement that color TV was not yet ready for the market (*ELECTRONIC WEEK*; Oct. 22). The statement brought a prompt and heated response from RCA Chairman David Sarnoff.

ED, DEC. 1, 1956

## BEHIND THE NEWS

## New Field Effect Semiconductor Tetrode Is Almost "Universal" Component

FUNCTIONS of a transformer, gyrator, isolator, non-distorting modulator, or short-circuit stable negative resistance can be duplicated by a new four-terminal semiconductor device developed by Bell Telephone Laboratories. Labeled a "field-effect tetrode," the device has no analog either in electron tubes or previous transistors.

or decreases the resistance of each "channel" between the bottom of the trench and the junction.

### Unusual Applications

Depending on the polarity of the biasing voltage, the tetrode will function either as a transformer or a gyrator. As a transformer, it has a very decided...

**ELECTRONIC DESIGN  
NEWS**

ED, APRIL 29, 1959

## FCC Acts on Pay-TV; Hopes For UHF-VHF Sets

Commission Approves Hartford RKO-Zenith Pay-Television Tests. Again Asks Congress For Expanded Power Over Set Standards

ED, MARCH 15, 1961



We're the power  
semiconductor  
specialists.  
Good for us.

SCRs ■ SILICON RECTIFIERS ■ ZENER DIODES ■ SEMICONDUCTOR FUSES  
POWER CIRCUITS / ASSEMBLIES ■ OPTOELECTRONICS ■ HEAT EXCHANGERS



# Better for you.

That's right, better for you. And for more reasons than one.

When a company has specialized for 25 years in rectifiers and thyristors, it can come up with better new products to answer almost any design requirement.

**New products. Better design alternatives.** One good example is our Schottky Power Rectifier, which makes great increases in power conversion efficiency. Another is the PACE/pak™ molded assembled circuits, which reduce costs many ways.

Now, we are far along in the development of some exciting new products. Like new series of faster recovery rectifiers, low-cost, high performance SCRs, and high-frequency SCRs, including what we believe is the best 125 Amp device ever built.

But the present and future products are just one of the reasons you'll do better with IR.

**100% testing. Quality assurance programs.** Since rectifiers and thyristors are our only business, we've grown by solving problems for our customers. Our products have to be tops. Our service has to be exceptional. We can't afford anything less, because you can't.

That's why we maintain a highly effective QC program, and do extensive testing... still 100% on both high and low power devices. Some companies may have abandoned this practice in the face of today's high costs. But for us, abandonment is too high a price to pay.

**25 years of applications know-how.** We also know it takes more than a good data sheet to help equipment designers arrive at the best circuit design with the best device. That's why we've continued to expand our Applications Engineering group.

When you need an applications

engineer with a strong background in your product field, that's what we send.

**Leadership. International strength.** When you consider a source, it is always good to know its standing in the field. And in the field of power semiconductors, IR builds and sells more devices world-wide than any other company.

However, as good as specialization has been for us, it can be even better for you.

If our better design alternatives improve your product, you win new customers.

If we can help you lower costs, your profit grows.

And if we provide higher reliability, it helps you keep your customers.

We've done these things for other companies. We'd like to do the same for you. Write International Rectifier, 233 Kansas Street, El Segundo, CA, 90245.

# International Rectifier

...the innovative power people





P-Channel  
JFET



N-Channel  
JFET

Since 1962, Siliconix has evolved FET technology and applied it to a complete line of singles, duals, arrays, and ICs. So what's new?

# Economy Epoxy FETs

Siliconix, the world's leading supplier of FETs, now brings you a full line of plastic encapsulated field-effect transistors—at economy prices as low as 32c each in 1000-unit quantities. Why be concerned over alternate sources? Call on the FET leader for quality devices at rock-bottom cost.

The Siliconix line of epoxy products includes

- FETs for general purpose amplifiers
- FETs for VHF/UHF amplifiers and mixers
- FETs for switches, choppers, and commutators
- FET pairs for differential amplifiers
- FET diodes for current limiters and regulators

Use these new epoxy FETs with the same confidence you have placed in Siliconix products in the past—they are typed, manufactured, and tested specifically for the industrial and commercial markets.

A copy of our new epoxy FET cross-reference guide and full line catalog is yours for the asking. Just circle the bingo card number or call your nearest Siliconix distributor.

## Write for Data



**Siliconix incorporated**

2201 Laurelwood Road. Santa Clara, California 95054

INFORMATION RETRIEVAL NUMBER 62

## editorial

# Thanks for 20 grand years —and here's to the next 20!

It was 20 years ago that readers saw their first issue of *ELECTRONIC DESIGN*. That issue was the first recognition of the importance of design engineers and their special needs and interests.

From the start, subscribers have been extraordinarily involved, responsive and cooperative. There were 20,000 subscribers to the first issue, and over 5000 asked for more information about products described in it. Today we have in excess of 78,000 subscribers. Combined with pass-along readers, the magazine's audience regularly numbers more than 300,000. We have processed over 16-million of your inquiries in these two decades; the current level is 1.3-million a year.



You are a wonderful audience to work for, and you provide your applause in many ways. In nine out of 10 readership studies conducted by manufacturers of their customers and prospect lists, *ELECTRONIC DESIGN* is rated No. 1 as the magazine read regularly. You have always cooperated with our circulation requirements, which call on you to renew once a year your request for the magazine and your engineering qualifications to receive it. And you have cooperated with the abundant research we conduct. We've prospered, and this has enabled us to assemble and develop engineer-journalists recognized as the best in the industry.

Our magazine is not a baby any more. It's a young adult. It has grown because the electronics industry has grown—from about \$5-billion then to \$25-billion today. Our industry has grown—and I hope this doesn't sound corny—because of you. With your design of products that directly or indirectly help man, you have reduced drudgery and increased the possibilities for pleasure. You have designed telephone systems; radio, television and high-fidelity systems; computers; systems to help doctors diagnose, care for and heal the sick; systems that have allowed men to tour the moon. The moon! We've become so blasé about your achievements that no one raises an eyebrow about them anymore. But when *ELECTRONIC DESIGN* started in 1952, the moon was explored only in the pages of science fiction and even computers were only a vacuum-tube novelty.

It's difficult for us to describe the pleasure and pride we feel in knowing that our magazine has played a role in helping you to do your job. It's been a privilege to have served you for 20 years, and we look forward to serving you even better in the next 20.

A handwritten signature in cursive script that reads "James S. Mulholland, Jr.".

JAMES S. MULHOLLAND, JR.  
President  
Hayden Publishing Co., Inc.



# WOULD YOU LIKE A CAREFREE WEEK FOR TWO IN THE BLUE CARIBBEAN?

Relax or lend a hand, swim, scuba dive, or just put your feet on the rail. Visit exotic tropical islands and foreign ports. It's the vacation for thinking people with a spirit of adventure. Sail in air conditioned comfort on big, safe windjammers. Choice of Bahamas, Virgin Islands, Windward or Leeward islands cruises. Pick your own departure dates. It's a trip you'll always remember. AND it's only part of the big first prize offered this year.

## PLUS: \$1,000 IN CASH!

Everyone can use some extra money—especially on a cruise. Use it for babysitters, tropical clothes, shop the free ports, bank it or spend it. It goes along as an extra bonus to the lucky first prize winner who picks the Top Ten ads in the January 4 issue.



### LAST YEAR'S TOP PRIZE WINNERS TELL HOW TO DO IT



**Ronald S. Newbower**  
*Bio Engineering Division  
Harvard Anesthesia Center  
Massachusetts General Hospital*

Dr. Newbower looked through the contest issue with particular attention to general interest advertisements. He assumed that those ads with appeal to a large fraction of readers would place in the Top Ten. He also tended to choose ads for products that were (a) new (and of general interest), or (b) had their logos emphasized. The result: Dr. Newbower sailed off with first prize. He and his wife enjoyed their windjammer cruise; sent *Electronic Design* an enthusiastic note from the Caribbean island of Saint Lucia.



**William R. Austin**  
*Senior Engineer  
Singer, Simulated Products Division  
Binghamton, New York*

Mr. Austin selected 37 ads which he considered potential winners. Then he made a chart, assigning points to each ad for esthetic appeal, copy approach, usefulness, etc — six rating categories in all. The final results were then modified using a purely subjective approach. His system must be a good one. Two or three hours of work paid off with second prize.



**Arthur L. Moorcroft**  
*E.E.  
Naval Underwater Systems Center  
New London, Connecticut*

Mr. Moorcroft first selected the 15 to 20 ads that he considered exceptional. Then culled them to pick the Top Ten. He leaned heavily toward new advertisements, new products, or new features in making his choices. The system worked well enough to make him one of the three big reader winners in last year's contest.

# Electronic

# 1973 SUPER TOP

LOOK FOR COMPLETE INFORMATION — LIST OF PRIZES —

## AND: FREE JET TRANSPORTATION

This really makes the 1st prize complete. Think about it! The cruise . . . the \$1,000 in cash, AND free round-trip tickets for two on



regularly scheduled jets to the cruise's point of departure. It all adds up to the vacation of a lifetime. AND, you can be the lucky winner!

## AND: YOU CAN WIN VALUES UP TO \$4,500—OR MORE— FOR YOUR COMPANY

Another big feature of the Top Ten Contest is the free advertising you can win for your company. Here's what your company can win if it has an ad in the January 4 issue:

**A FREE RERUN . . .** for each of the ads that are voted in the Top Ten by *Electronic Design's* readers.

**A FREE RERUN . . .** if one of your company's engineers wins any one of the first 3 prizes — whether or not your ad placed in the top ten.

**A FREE RERUN . . .** if one of your company's advertising or marketing people, or your advertising agency, wins any of the first 3 prizes.

Suppose you are one of the first three prize winners. If your company has a full page, 2-color ad in the January 4 issue, your company will receive a free rerun worth \$2,165. But suppose it is a 4-color spread. You've just racked up space worth \$4,500 for your top brass.

Be sure to alert your advertising or marketing manager to these possibilities. Urge him to schedule your company's ad in the January 4 issue . . . It's an opportunity no company can afford to miss.

## PLUS 99 OTHER VALUABLE PRIZES

There are two separate Top Ten Contests, one for *Electronic Design's* engineer-readers, and one for advertisers and their advertising agencies.

### PRIZES (Reader Contest)

- 1st Prize: Windjammer cruise for two.  
Jet transportation for two.  
\$1,000 cash.  
Free ad rerun.
- 2nd Prize: Portable color TV.  
Free ad rerun.
- 3rd, 4th & 5th Prizes: Bulova timepieces.  
Free ad rerun (3rd Prize only).
- 6th thru 100th Prizes: Technical books.  
(Title to be announced.)

### PRIZES (Advertiser Contest)

- 1st Prize: Windjammer cruise for two.  
Jet transportation for two.  
\$1,000 cash.  
Free ad rerun.
- 2nd Prize: Portable color TV.  
Free ad rerun.
- 3rd Prize: Bulova timepiece.  
Free ad rerun.

## NO STRINGS, NO GIMMICKS ... HERE'S ALL YOU HAVE TO DO TO ENTER

- (1) Read the January 4th issue of *Electronic Design* with extra care.
- (2) Select the ten advertisements that you think will be best remembered by your 78,300 fellow engineer readers.
- (3) Identify the advertisements by company name and *Information Retrieval Number* (Reader Service Number) on the entry blanks bound in the issue. Mail before midnight February 15.



## MARK JANUARY 4 ON YOUR CALENDAR NOW

Try for the Top Ten. Contest judges will compare your selections with "Percent Recall Seen" scores on Reader Recall—*Electronic Design's* method of rating readership. Complete information, rules, and entry blanks will appear in the January 4 issue.

# Design

# TEN CONTEST

RULES — ENTRY BLANKS IN THE JANUARY 4 ISSUE

# Speed active multipole filter design

with a flexible computer program that calculates the component values for optimum performance.

With IC op-amp costs down to those of passive components, high-performance, active multipole filters are economically feasible. But calculating the component values—a procedure that may take several iterations to come up with the desired circuit—is extremely tedious and difficult to do manually. To solve this problem, a flexible computer program has been developed for designing filter stages that can be cascaded to build multipole filters, either Butterworth or Chebyshev. A multiple-feedback realization is used for low pass, while either twin-T single-feedback or dual-op-amp multiple-feedback networks are used for the bandpass realization.

The program can be run on a minicomputer with only 8 k memory—a PDP-8I, say. In addition to calculating component values, the program plots and tabulates the filter's transfer function. Options allowed by the program include specification of the number of poles (limited only by the symbol-table memory allocation of the computer), Chebyshev ripple factor, center frequency, bandwidth, gain and standard or exact component values. Although component values are derived with approximation techniques, the transfer function is calculated using exact values.

The program is also written to allow the designer to re-enter actual component values or to modify any or all values and obtain the corresponding updated transfer function. This feature is extremely useful for demonstrating filter sensitivity to component-value changes for worst-case analysis.

A program listing in either FOCAL or FORTRAN is available from the author.

## Using the program is easy

The program is an interactive routine for use with machines that have a minimum memory of 8 k (Fig. 1). In operation, the operator is seated at a teletypewriter terminal. After typing GO, the dialogue begins with a sequence of questions

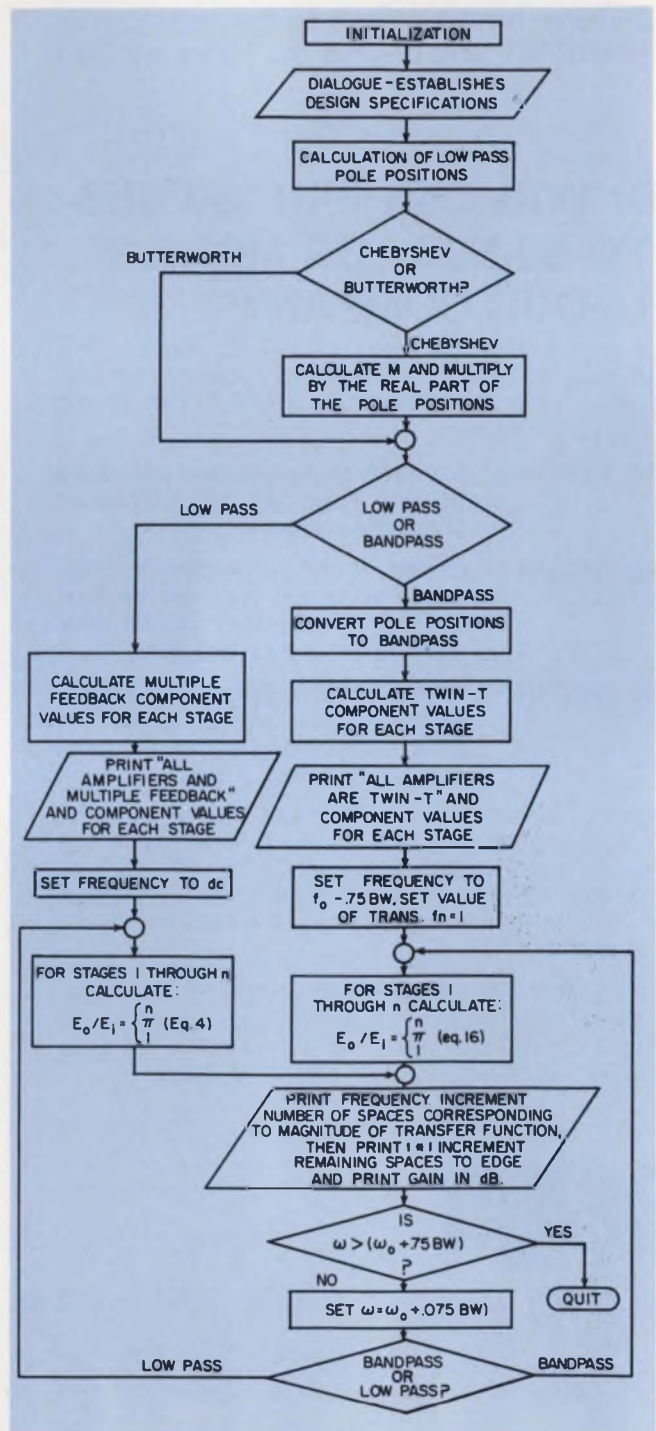

1. Active multipole filters are designed with a flexible program that runs as shown above.

David E. Olsen, Senior Development Engineer, Center for the Health Sciences, UCLA, Los Angeles, Calif. 90024.

that depend on previous answers (Table 1). These include filter type, number of poles, voltage gain, exact or nearest standard component values, bandwidth and scaling factor. Filter options are low pass or bandpass—Butterworth or Chebyshev. If Chebyshev is chosen, the amount of ripple must be specified. For bandpass, center frequency is required. Such questions must be answered before the next is generated.

After completion of the dialogue, the type of circuit is printed along with the component values for each stage. Next a plot and corresponding tabulations of the transfer function are printed.

To modify component values, the operator simply types in the desired changes and then the appropriate GO TO command. The altered transfer function is then plotted and tabulated.

It is important to note, especially in the case of the rather complicated pole-zero configuration for the twin-T circuit, that an exact expression, rather than the normally used approximate solution, is employed for plotting and tabulating the transfer ratio. This aids in understanding subtle

differences in the bandpass characteristics of low-Q, low-frequency, twin-T realizations that significantly deviate from their corresponding approximations.

### Choosing Butterworth or Chebyshev

Figure 2 depicts plots of transfer functions and pole configurations for the two most popular approximations to the "square" or "brickwall" transfer functions—Butterworth and Chebyshev filters. The transfer function for the Butterworth filter is flat within the passband, since the poles are arranged symmetrically along the circumference of a circle in the complex plane (Fig. 2b). For bandpass applications, the radius of the circle is  $BW/2$  and the center is at  $f_0$ , where  $BW$  is the bandwidth and  $f_0$  is the center frequency of the filter. In the case of a low-pass filter, the radius equals  $BW$ , and the center is at the origin of the complex plane.

In applications requiring sharper rolloff, a Chebyshev filter can be used. The sharper rolloff is obtained at the expense of a nonflat or rippling transfer ratio over the passband. The imaginary coordinate values for the Chebyshev filter are the same as for a corresponding Butterworth filter, but its real-axis coordinates are reduced by a multiplication factor  $m$  that is less than unity and that is given by:

$$m = \tanh a, \quad (1)$$

where

$$a = (1/n) [\sinh^{-1}(1/x)], \quad (2)$$

$$n = \text{number of poles (including conjugate)}$$

$$x = [1/(1 - R_1/100)^2 - 1] \quad (3)$$

$$R_1 = [E_{o/pk} - (E_{o/low}/E_{o/pk})] 100. \quad (4)$$

The definition of  $R_1$ , the ripple factor, is indicated in Fig. 2a. It is the percent of peak gain attained by the troughs of the transfer function. The higher the ripple factor, the more pronounced the peak-to-valley transitions of the transfer function and the steeper the rolloff. In Eq. 4,  $E_{o/pk}$  is the peak output voltage and  $E_{o/low}$  is the valley output voltage.

Thus the program first determines the Butterworth pole locations and then, if Chebyshev is specified, factor  $m$  is computed and is used to multiply the real pole coordinates. Next, the real and imaginary coordinates are multiplied by  $BW$  (if low pass) or by  $BW/2$  (if bandpass). Finally, in the case of a bandpass filter, the imaginary values are increased by  $2\pi f_0$ .

### Why twin-T and multiple-feedback filters?

A summary of the tradeoffs among five commonly used active filter circuits is presented in Table 2. As explained in Reference 2, circuit selection depends on the ease of tuning, stability,

**Table 1. Program dialogue**

<p>Note: Numerical designations do not appear in the program and are included here to provide clarity only. Operator response follows the colons. Double entries are shown to include the options. The parenthetical comments are those of the author.</p>	
1.	SPECIFY TYPE OF FILTER. TYPE 1 FOR LOWPASS OR 2 FOR BANDPASS. :1 :2
2.	SPECIFY CHOICE OF BUTTERWORTH OR CHEBYSHEV. TYPE 1 FOR BUTTERWORTH, 2 FOR CHEBYSHEV. :1 :2
3.	WHAT IS THE MAXIMUM ALLOWABLE RIPPLE? TYPE THE DESIRED PERCENTAGE I.E., 5 FOR 5%, ETC. :10
4.	HOW MANY POLES SHOULD THE FILTER HAVE? INCLUDE COMPLEX CONJUGATE POLES IN YOUR COUNT. :8
5.	WHAT IS THE DESIRED PEAK VOLTAGE GAIN? :50
6.	SPECIFY EITHER EXACT OR CLOSEST STANDARD COMPONENT VALUES. TYPE 1 FOR EXACT OR 0 FOR CLOSEST STANDARD. :1 :0 (Computer reads standard list of values into memory. To conserve memory, the values are not read in unless standard values are specified. This allows a choice of more poles with exact component values.)
7.	WHAT IS THE DESIRED BANDWIDTH? :10
8.	(Bandpass only.) WHAT IS THE DESIRED CENTER FREQUENCY? :200
9.	(Bandpass only.) SPECIFY THE SCALING FACTOR K1. IF CONFUSED, SEE THE DISCUSSION IN THE PROGRAM DOCUMENTATION. A GOOD INITIAL VALUE IS .0001. :.0001

# Table 2. Performance comparison of active filters.

	Single feedback	Multiple feedback	VCVS (Voltage-controlled voltage source)	INIC (Current negative immittance converter)	State variable
1. Realizable Q's	High (twin-T).	Low (<10 single op amp, <50 dual op amp).	Low for low pass and high pass. High for bandpass.	High	High
2. Ease of tuning	Difficult because of component interaction in locating poles.	Moderate. Independent tuning of $\omega_0$ with some configurations.	Good. Q and $\omega_0$ independent and usable over wide range.	Good	Good
3. Component value spread	Moderate	Large	Low	Low	Moderate
4. Achievable gain	High. Independent of op amp gain.	Low. Independent of op amp gain.	Moderate. Varies with op amp open-loop gain. Independent of passive element values.	High	High
5. Input/output impedance restrictions	Fair. $Z_{in} \cdot Z_{out}$ varies inversely with loop gain. Permits cascading in most applications.	Same as single feedback.	Low $Z_{out}$ . Can be cascaded.	Poor. Cannot be cascaded without buffers.	Good
6. Stability (Sensitivity to changes in op amp parameters)	P-Z locations determined by passive components. Therefore not subject to small changes in op amp parameters.	Good	Poor	Poor	Good
7. Number of required components (Passive)	7-8	5-8	6-7	6-7	8 (3 op amps)
8. Can be used as summing junction with individual transfer functions?	Yes	No	No	No	No

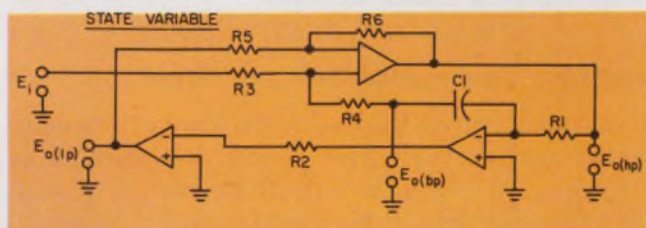
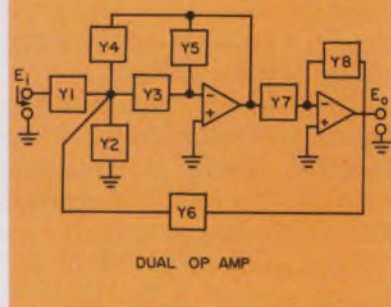
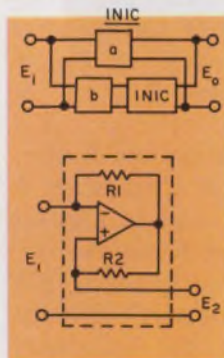
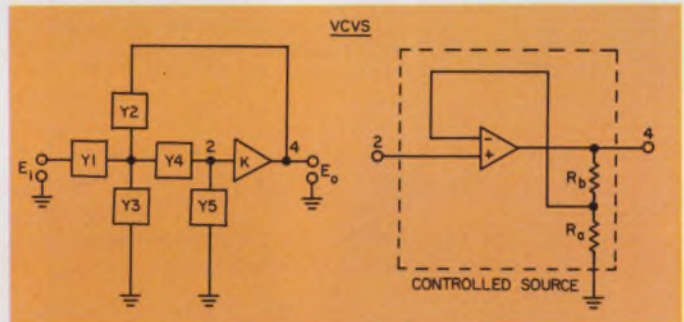
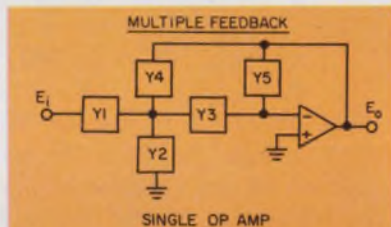
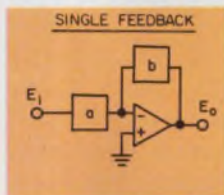

maximum achievable Q, spread of component values and output impedance. Thus, after comparing these circuits in the light of these criteria, we choose the twin-T circuit for the bandpass realization and the multiple-feedback network for the low-pass circuit.

The state-variable circuit is rejected because it uses three op amps for each pole; the controlled source because of the difficulty of achieving high Q; and the INIC because of input and output impedances that require the use of buffering when several stages are cascaded.

The multiple-feedback configuration is selected for the low-pass circuit because the twin-T net-



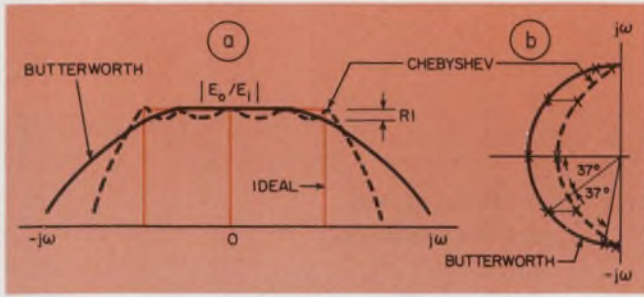

2. Rolloff sharpness or flatness of the transfer function largely determines the choice between a Butterworth or a Chebyshev filter (a). Note that the five poles of the Chebyshev have the same imaginary coordinates as those for the Butterworth filter.

work has a zero at the origin and poles and zeros along the real axis, which makes it unsuitable for a low-pass filter. At the same time the multiple-feedback network cannot be used for bandpass circuits, because it is difficult to achieve a high Q (this requirement is not as critical in low-pass applications).

For stages requiring a Q of up to 50, a second bandpass network is incorporated into an alternate version of the program to circumvent the high component-tolerance sensitivity of the twin-T network and the consequent fine-tuning difficulties. This multiple-feedback network uses two op amps for each pair of complex poles, but its center frequency and Q fine-tuning adjustments are practically independent of each other.

### Calculating component values for low-pass filters

Figure 3 depicts a low-pass (multiple-feedback) circuit with the following transfer function:

$$E_o/E_i = -(G_1 G_2 / C_1 C_2) / \{s^2 + [s(G_1 + G_2 + G_3) / C_1] + (G_2 G_3 / C_1 C_2)\}. \quad (5)$$

This equation is of the form

$$E_o/E_i = K / (s^2 + 2RPs + RP^2 + IP^2), \quad (6)$$

where RP and IP are the real and imaginary pole coordinates, respectively. Since the desired pole positions are known from the computations described earlier (see flow chart), we derive component values in terms of RP, IP and K. This could normally be done by equating the coefficients of Eqs. 5 and 6. The resulting simultaneous equations, however, would be nonlinear and would have no unique solution.

By assigning arbitrary values either to individual components or to a common scaling factor, we can reduce the number of remaining variables to the number of constraining equations, and the remaining unknowns can then be calculated. In this way an infinite number of solutions are possible.

A workable set of equations has been derived<sup>2</sup> by first picking capacitor values and then assign-

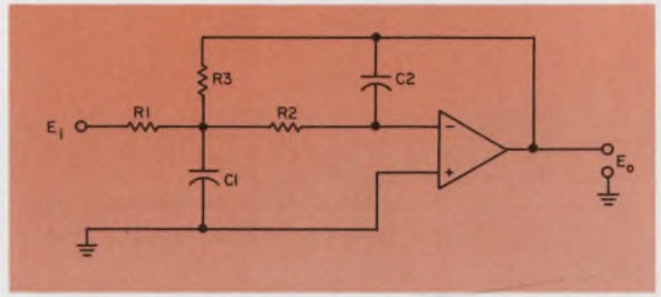

3. Multiple-feedback low-pass filter is designed by the program, which starts with an assumed value for  $C_2$  and then calculates all other values. The component values can be then changed, if the desired transfer function is not obtained during the first run.

ing such values to the remaining unknowns that would minimize the spread of component values and the sensitivities of pole position to component changes.

The reason for picking capacitor values rather than resistor values is that they usually have wider tolerances and fewer standard values. Thus the computation of the low-pass component values begins with the arbitrary selection of  $C_2$ , which has the assumed value of  $0.01 \mu F$  in the program. The remaining values are computed from the following equations:

$$K = 2\pi C_2 \sqrt{RP^2 + IP^2} \quad (7)$$

$$C_1 = [4C_2 (H + 1) / RP^2] \sqrt{RP^2 + IP^2} \quad (8)$$

$$R_1 = RP / [HK \sqrt{RP^2 + IP^2}] \quad (9)$$

$$R_2 = RP / [K (H + 1) \sqrt{RP^2 + IP^2}] \quad (10)$$

$$R_3 = HR_1 \quad (11)$$

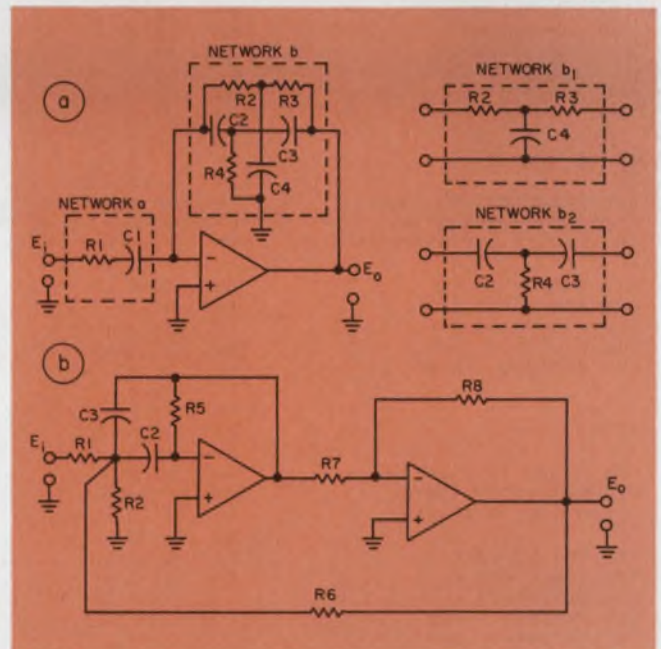

4. In bandpass applications two networks are used—either a twin-T (a) or a multiple-feedback circuit (b). While the latter uses two op amps, it permits virtually independent tuning of center frequency and Q.

```

GO
OLSEN LIBRARY PROGRAM NO. 001: COMPUTER AIDED FILTER DESIGN
SPECIFY TYPE OF FILTER. TYPE 1 FOR LOW PASS, OR 2 FOR BANDPASS.
:1

SPECIFY CHOICE OF BUTTERWORTH OR CHEBYSHEV. TYPE 1 FOR BUTTER-
WORTH, 2 FOR CHEBYSHEV.
:1

HOW MANY POLES SHOULD THE FILTER HAVE? INCLUDE COMPLEX CONJUGATE
POLES IN YOUR COUNT.
:8

WHAT IS THE DESIRED PEAK VOLTAGE GAIN?
:50

SPECIFY EITHER EXACT OR CLOSEST STANDARD COMPONENT VALUES. TYPE 1
FOR EXACT OR 0 FOR CLOSEST STANDARD.
:0

WHAT IS THE DESIRED BANDWIDTH?
:25

```

-----

ALL AMPLIFIER STAGES ARE THE MULTIPLE FEEDBACK CONFIGURATION

STAGE NO.= 1

```

RP= 0.3064466468E+02
IP= 0.1540610380E+03
AO= 0.2659147999E+01

```

```

R1= 47.000000 K
R2= 33.000000 K
R3= 120.00000 K
C1= 1.00000 UFD
C2= 0.01000 UFD

```

STAGE NO.= 2

```

RP= 0.8726862946E+02
IP= 0.1306068631E+03
AO= 0.2659147999E+01

```

```

R1= 130.00000 K
R2= 100.00000 K
R3= 360.00000 K
C1= 0.12000 UFD
C2= 0.01000 UFD

```

STAGE NO.= 3

```

RP= 0.1306067453E+03
IP= 0.8726880577E+02
AO= 0.2659147999E+01

```

```

R1= 200.00000 K
R2= 150.00000 K
R3= 510.00000 K
C1= 0.05100 UFD
C2= 0.01000 UFD

```

STAGE NO.= 4

```

RP= 0.1540609966E+03
IP= 0.3064487265E+02
AO= 0.2659147999E+01

```

```

R1= 240.00000 K
R2= 180.00000 K
R3= 620.00000 K
C1= 0.03900 UFD
C2= 0.01000 UFD

```

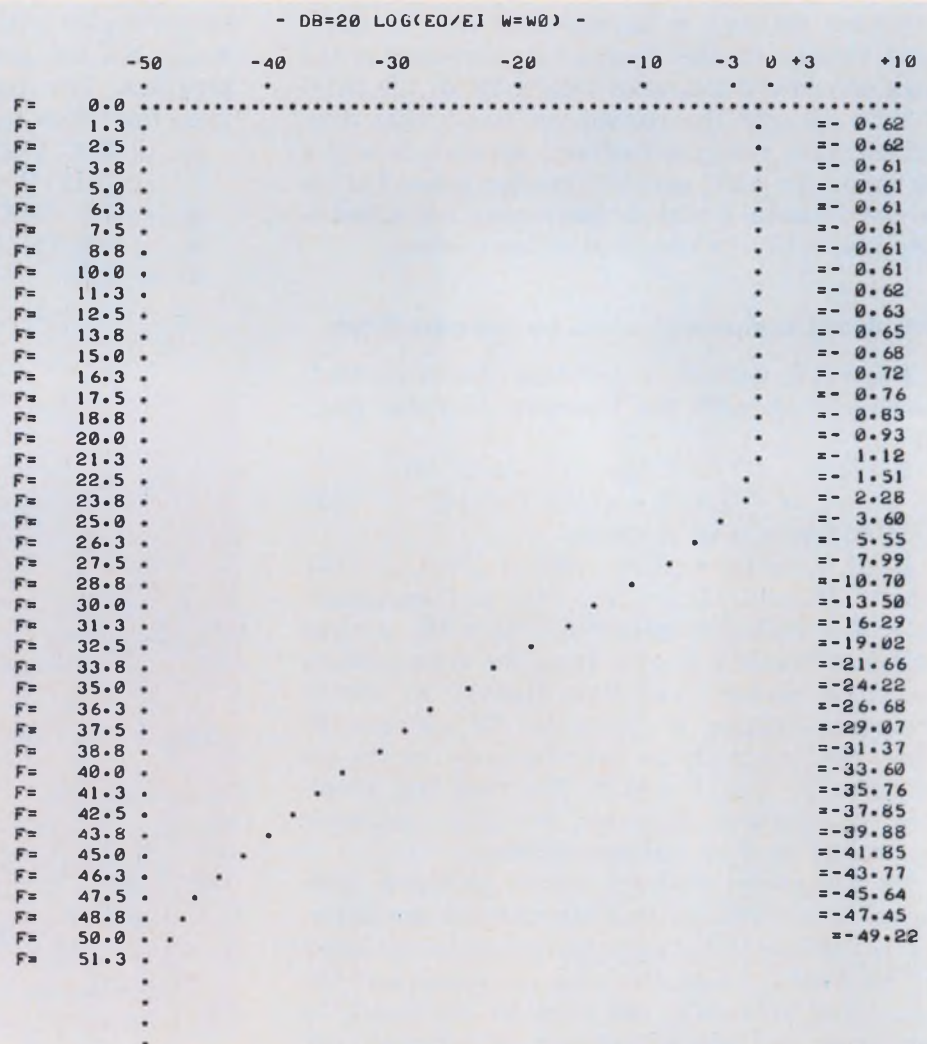

5. A four-stage Butterworth low-pass filter is designed as shown in this computer run. Note that the transfer

function is both plotted and tabulated. Exact component values are used to plot/tabulate the transfer function.

The general expression for the transfer function of the twin-T network (Fig. 4) is

$$E_o/E_i = - (y_{12a}/y_{12b}), \quad (12)$$

where a and b designate the input and feedback networks, respectively, and  $y_{12}$  is the reverse transfer ratio in terms of the small-signal, two-port parameters. An expression for  $y_{12a}$  can be written<sup>3</sup> as

$$y_{12a} = G_1 s / [s + (G_1/C_1)]. \quad (13)$$

To obtain  $y_{12b}$ , the b network (Fig. 4) is split into two parallel T networks with reverse transfer ratios that are

$$y_{12b1} = -G_1 G_2 / (G_2 + G_3 + C_4 s), \quad (14)$$

$$y_{12b2} = -C_2 C_3 s^2 / [G_4 + (C_2 + C_3) s]. \quad (15)$$

Since  $y_{12b}$  equals the sum of Eqs. 14 and 15, the final transfer function can now be written by combining Eqs. 12, 13, 14 and 15 as

$$E_o/E_i = s [G_1 (C_2 + C_3) / C_2 C_3] [s + (G_2 + G_3) / C_4] [s + G_4 / (C_2 + C_3)] / \{ (s + G_1 / C_1) \{ s^3 + (G_2 G_3 / C_4) s^2 + [(G_2 G_3 / C_3 C_4) + (G_2 G_3 / C_2 C_4)] s + (G_2 G_3 G_4 / C_2 C_3 C_4) \} \}. \quad (16)$$

This transfer function has one pair of complex conjugate poles, a zero at the origin and two poles and two zeros on the real axis. Very high values of Q can be obtained by moving the complex pair of poles along the real line.

The effect of the singularities lying on the real axis is small for poles that are near the imaginary axis, and it diminishes with increasing frequency. Again, a unique solution for the component values in terms of singularity positions cannot be obtained, unless the real-axis poles and zeros are canceled. The program accomplishes this by equating the following parameters to one another<sup>2</sup>:

$$C_2 = G_2 = (2.5 - a) [(1 + a) / (2 + a)], \quad (17)$$

$$C_3 = G_3 = C_2 / (C_2 - 1), \quad (18)$$

$$C_4 = G_4 = C_2 C_3 / (1 + a), \quad (19)$$

where

$$a = 2RP / \sqrt{RP^2 + IP^2}. \quad (20)$$

This technique results in cancellation of the real-axis zeros and poles for  $RP = 0$  (complex pair) and near-cancellation for values of RP that are small in comparison with IP (high Q). The approximation is generally acceptable, except for low values of Q at low frequencies. For this reason, the transfer function is plotted and tabulated with the use of Eq. 16.

As mentioned previously, in addition to the twin-T bandpass filter, a two-op-amp, multiple-feedback network configuration was incorporated into the program. Such a network appears in Fig. 4b, and its transfer function is

$$E_o/E_i = (sR_8 / R_1 R_7 R_4) / \{ s^2 + s [1 + (C_4 / C_3) - (R_5 R_8 / R_6 R_7)] / R_5 C_4 + [(R_2 R_6 + R_1 R_6 + R_1 R_2) / R_1 R_2 R_5 R_6 C_3 C_4] \}. \quad (21)$$

To select the component values for this circuit,

the same arbitrary value is assigned to both  $C_2$  and  $C_3$ . The remaining component values are computed from the following equations:

$$R_1 = R_5 = R_7 = IP / 2RP \omega_o C, \quad (22)$$

$$R_6 = R_8 = GR_1, \quad (23)$$

$$R_2 = 1 / \{ \omega_o C [(IP / 2RP) - (2RP / IP) - (2RP / IPG)] \}. \quad (24)$$

Independent frequency and Q adjustments are now readily apparent from these equations, since the center frequency is tuned by varying  $R_2$  and Q is tuned by varying  $R_6$ .

### Selecting an op amp

The choice of op amps for these circuits is generally not critical, provided that some degree of fine tuning is acceptable. For instance, both  $\mu A 741$  and  $\mu A 747$  have performed quite well. Some fine tuning is needed to compensate for the assumptions that the op amp has an infinite open-loop gain and an infinite input impedance. Even in filters with high Q and high component values, where these assumptions become more critical, the discrepancies between the theoretical predictions and practical realization can easily be tuned out.

### Running the program

The length and complexity of program listings prohibit its publication here, but a good idea of the program sequence can be obtained from Fig. 1 and Table 1. Because of the large number of I/O steps required in the dialogue and the low-speed printer used when running the program, the run time was as long as 15 minutes. The majority of the time is used up during the plot, so that optional termination of the run after component values have been printed out may substantially reduce this time.

A typical run for a four-stage Butterworth low-pass filter is shown in Fig. 5. Filters built on the basis of these calculations show excellent agreement between the predicted and test performances. As expected, the circuit is relatively insensitive to component changes within the specified tolerances; so it is easy to tune. ■■

### References

1. Stewart, J., "Circuit Theory and Design," J. Wiley, 1960.
2. Burr-Brown Research Corp., "Handbook of Operational Amplifier Active RC Networks," Burr-Brown, 1966.
3. Kopp, E., "Matrices for Basic Two-Port Networks," *Electro-Technology*, March, 1964, pp. 34-39.

### Acknowledgment

This work was supported in part by: NASA Grant NGL 05-007-195, NASA Contract NAS 22503, U. S. Public Health Service Grant USPHS-GM 16058

# Harris

Here are the first eight of our new growing DI/CMOS family—the fastest low-power devices of their kind available today.

If you're joining the big move to CMOS, we've got your device. Or soon will have. Because we've committed ourselves to dielectrically isolated CMOS (DI/CMOS) development on a major scale. The first eight are available now. These devices offer speeds twice as fast as any comparable ICs, typically 10ns with 10-volt power supplies. They also offer a wide power supply range (3 VDC to 18 VDC), while providing large noise immunity, typically 45% of supply voltage. In terms of chip reliability, our engineers currently report more than 230,000 device hours at +125°C without failure.

All of the new devices are available in 14-pin dual in-line packages except the HD-4009 and HD-4010, which come in 16-pin packages. Because of their compatible pin-out configurations these circuits will replace or interface with the CD 4000A series. For details see your Harris distributor or representative.

## 1

HD-4000 Dual 3 NOR Gate

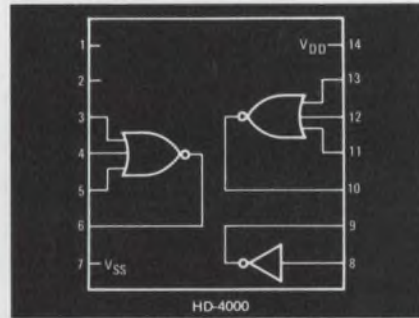

Pin for pin compatible with CD 4000A.

High speed 10ns  
Low power 1nW

–40°C to +85°C 100-999 units \$1.00  
–55°C to +125°C \$3.10

## 3

HD-4009 HEX Inverter

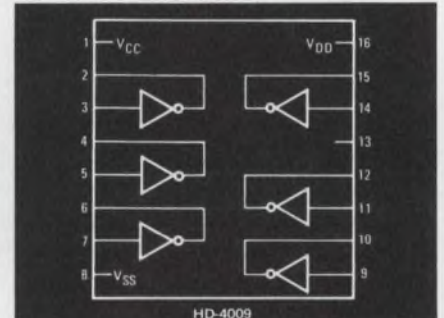

Pin for pin compatible with CD 4009A.

High speed 10ns  
Low power 50nW

–40°C to +85°C 100-999 units \$2.20  
–55°C to +125°C \$5.25

## 2

HD-4001 Quad 2 NOR Gate

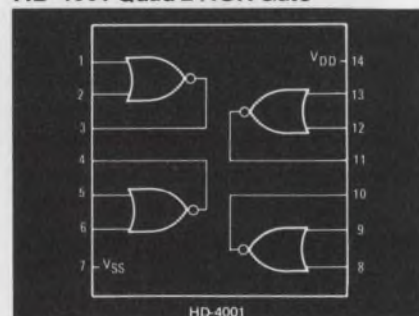

Pin for pin compatible with CD 4001A.

High speed 10ns  
Low power 1nW

–40°C to +85°C 100-999 units \$1.00  
–55°C to +125°C \$3.30

## 4

HD-4010 HEX Buffer

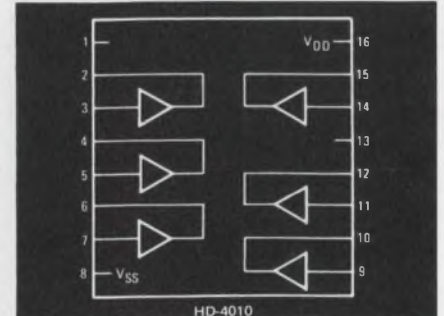

Pin for pin compatible with CD 4010A.

High speed 10ns  
Low power 50nW

–40°C to +85°C 100-999 units \$2.20  
–55°C to +125°C \$5.25

# CMOS:

## 5

**HD-4011 Quad 2 NAND Gate**

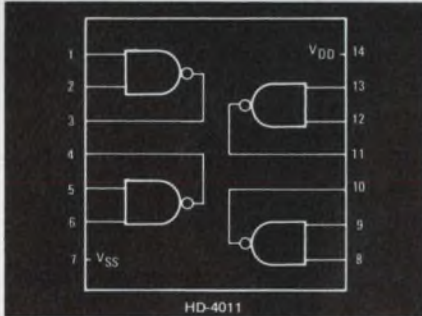

Pin for pin compatible with CD 4011A.

High speed 10ns  
Low power 1nW

100-999 units  
-40°C to +85°C \$1.00  
-55°C to +125°C \$3.30

## 7

**HD-4013 Dual "D" Flip Flop**

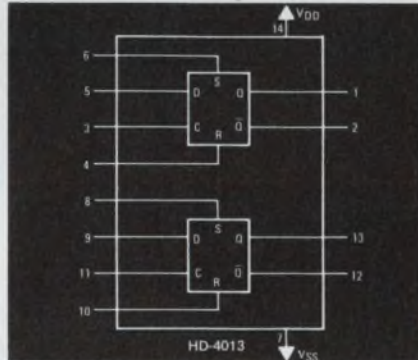

Pin for pin compatible with CD 4013A.

High speed 18MHz typical toggle rate  
Low power 50nW

100-999 units  
-40°C to +85°C \$2.10  
-55°C to +125°C \$4.75

## 6

**HD-4012 Dual 4 NAND Gate**

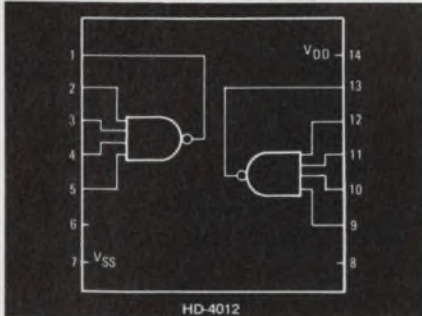

Pin for pin compatible with CD 4012A.

High speed 10ns  
Low power 1nW

100-999 units  
-40°C to +85°C \$1.00  
-55°C to +125°C \$3.45

## 8

**HD-4809 Triple/True Complement Buffer**

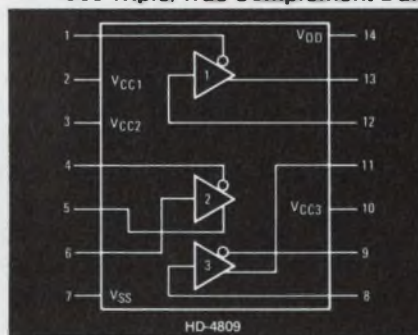

A Harris proprietary device.

High speed 10ns  
Low power 50nW

100-999 units  
-40°C to +85°C \$2.25  
-55°C to +125°C \$5.30



**HARRIS**  
**SEMICONDUCTOR**

A DIVISION OF HARRIS-INTERTYPE CORPORATION

P.O. Box 883, Melbourne, Fla. 32901  
(305) 727-5430

**WHERE TO BUY THEM:** ARIZONA: Phoenix—Liberty, Weatherford, Scottsdale—HAR (602) 946-3556  
CALIFORNIA: Anaheim—Weatherford; El Segundo—Liberty; Glendale—Weatherford; Long Beach—HAR (213) 426-7687; Mountain View—Elmar; Palo Alto—Weatherford; HAR (415) 321-2280; Pomona—Weatherford; San Diego—Weatherford; Western  
COLORADO: Denver—Elmar; Weatherford  
WASHINGTON, D.C.: HAR (202) 337-3170  
FLORIDA: Hollywood—Schweber; Melbourne—HAR (305) 727-5430  
GEORGIA: Atlanta—Schweber  
ILLINOIS: Chicago—Semi-Specs; Schweber; Palos Heights—HAR (312) 597-7510  
INDIANA: Indianapolis—Semi-Specs  
MARYLAND: Rockville—Schweber  
MASSACHUSETTS: Lexington—R&D; Waltham—Schweber; Wellesley—HAR (617) 237-5430  
MICHIGAN: Detroit—Semi-Specs  
MINNESOTA: Minneapolis—Semi-Specs  
MISSOURI: Kansas City—Semi-Specs; St. Louis—Semi-Specs  
NEW MEXICO: Albuquerque—Weatherford  
NEW YORK: Melville—HAR (516) 249-4500; Syracuse—HAR (315) 463-3373; Rochester—Schweber; Westbury—Schweber  
OHIO: Beachwood—Schweber; Dayton—Semi-Specs  
PENNSYLVANIA: Pittsburgh—Semi-Specs; Wayne—HAR (215) 687-6680  
TEXAS: Dallas—Weatherford; Semi-Specs; HAR (214) 231-9031  
WASHINGTON: Seattle—Liberty; Weatherford  
WISCONSIN: Wauwatosa—Semi-Specs  
**LEGEND FOR HARRIS SALES OFFICES & DISTRIBUTORS:** Harris Semiconductor (HAR); Elmar Electronics (Elmar); Harvey/R&D Electronics (R&D); Liberty Electronics (Liberty); Schweber Electronics (Schweber); Semiconductor Specialists, Inc. (Semi-Specs); R. V. Weatherford Co. (Weatherford); Western Radio (Western).

INFORMATION RETRIEVAL NUMBER 64

# Digital data systems work faster when a storage buffer is used. It lets the slow peripheral digest the information while the data source zips ahead.

You have a fast data source—like a computer, a calculator, a digital voltmeter—but what good is its speed when the system can be bogged down by a slow printer. A buffer can solve this problem. An eight-bit, 99-character storage buffer, developed originally to link a data terminal to a serial printer, can interface almost any asynchronous data equipments.

It can receive a block of data from a disc memory and hold it ready for the computer. Or it can receive and hold data from the computer while the disc is being accessed. Or it can receive and accumulate data from a keyboard, DVM or other source for transfer upon demand to a display, magnetic tape, computer, printer or other device. In general, almost any data-flow delay between two units that takes more than one character period can be handled without holding up the faster data unit.

For example, calculators and computers can keep going after dumping a block of data, while the slower printer plods along. This buffer requires only about 5 ms at a 2 MHz clock rate to load to its full capacity of 99 eight-bit characters. But a typical 30 char/sec serial printer requires 3.3 sec to print 99 characters, from 200 to 300 ms to return the carriage, as much as 500 ms to advance sprocket-fed paper and usually more than one-character time for tabbing.

Thus a buffer provides considerable over-all time savings. Programming of the computer or calculator becomes more flexible. And where more than a 99-character data batch can be used, the buffer storage can be easily expanded to handle it.

The cost of a buffer does not increase proportionately with its storage capacity. The 100-stage (99-character) buffer of Fig. 1 could easily be modified to use a 200-bit register, which would allow it to store 199 characters. The Signetics 2510 MOS, dual 100-stage shift registers used in the buffer would then be replaced with larger units. If the exact requirements are uncertain, you can use longer shift registers without un-

duly increasing cost. Also, the buffer can easily be modified to handle more than eight-bits per character through the addition of more registers. And any character code can be used.

## Clocking the buffer

In the original application, the buffer register of Fig. 1 was shifted with a 50-kHz clock (not shown). Thus the time required for one complete register recirculation (100 steps) was about 2 ms. However, trials were run at the register's maximum clock-rate capability of 2 MHz. This reduced the recirculation period to 50  $\mu$ s. The recirculation time is, of course, the worst-case access time for reading a particular character when the register is already loaded. The quad latches (SN7475) act as a pre-buffer so that input data need remain on the input terminals only long enough to be loaded into the latches. The required time is determined by the Load One-Shot, and it is about 5  $\mu$ s. However a complete recirculation must occur before the next character can be entered.

Though the specified registers need only a single-phase clock, two phases ( $\phi 1$  and  $\phi 2$ ) are used for the external logic to help avoid race problems. The clock generator (Fig. 2) accepts a square wave of twice the frequency of the register shifting rate and generates the required two phases.

The second phase ( $\phi 2$ ) shifts the registers via a driver gate. Data in the register shift on the rising pulse edge. A 10-k- $\Omega$  pull-up resistor is used on this and all other register inputs, as recommended by Signetics.

The registers are clocked continuously and are normally recirculating with pin 1 held low. For this reason these static registers could have been dynamic types; however, none was found that interfaced with TTL as readily as the static type selected. Further, the built-in recirculating path and single-clock requirement of the 2510 help simplify the wiring.

When one character is written or read, pin 1 is raised high for one clock period. Data are written character-by-character in parallel and recirculate until they are read out character-by-

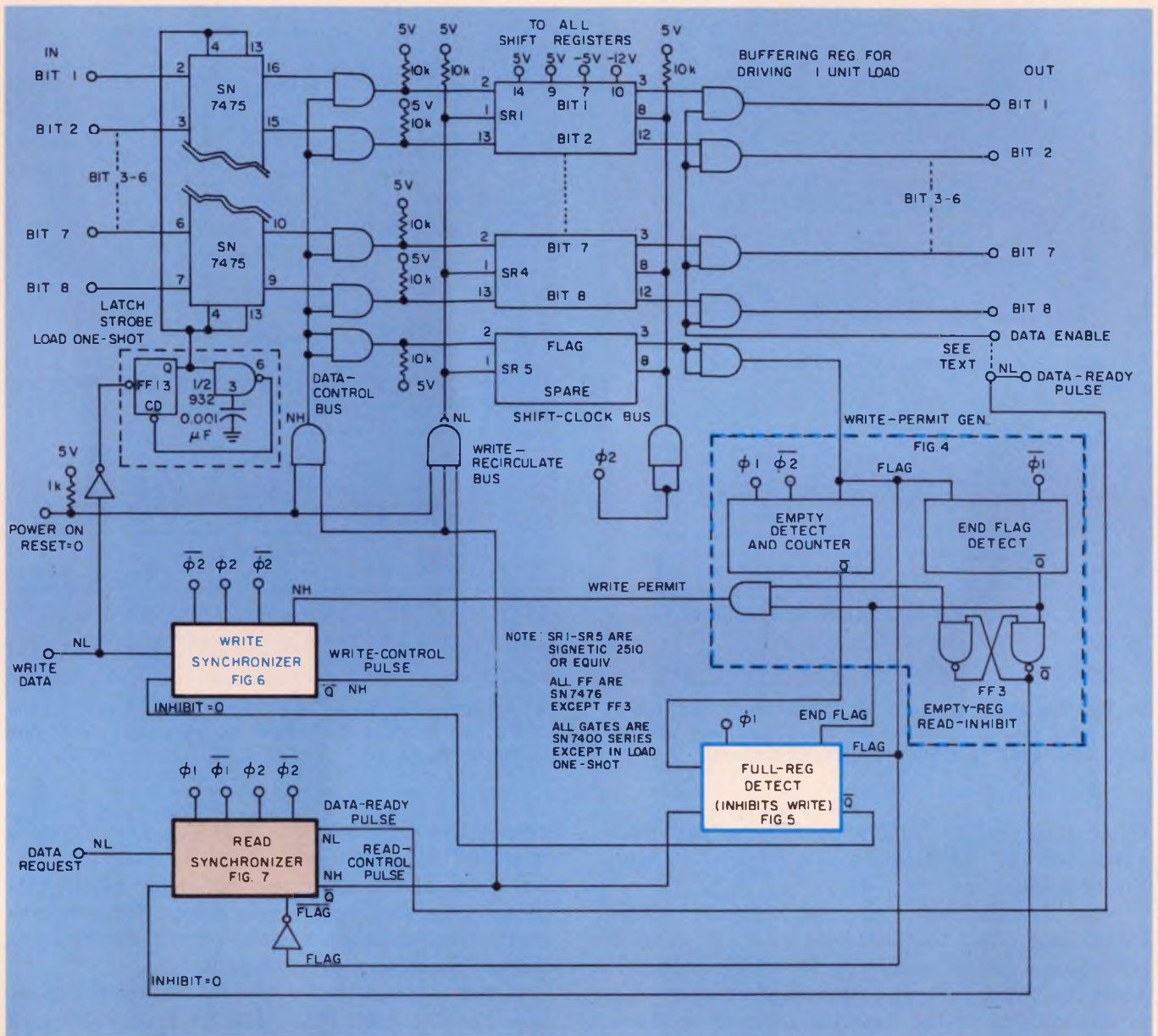

1. Buffer storage length can be increased by replacing the 100-stage shift registers, SR<sub>1</sub> through SR<sub>5</sub>, with

larger units. Buffer word size can be increased by adding shift registers. Any character code can be used.

character. Buffer systems of this type are called first-in, first-out (FIFO).

### The flag track controls read and write

Besides the four dual registers that handle the eight bits for each character, half of a fifth unit—called the flag track—controls the reading and writing functions. Whenever a character is written, a ONE is entered into the flag track. If the character registers are empty, the flag track contains all ZEROS. If the register is half full, the flat output looks like a 50% duty-cycle square wave (Fig. 3). New characters are written on the falling edge of the flag output signal. Stored characters are read on the rising edge. This sequence gives the design its first-in, first-out feature.

To make it possible to write into an empty buffer, an artificial flag must be generated to provide the needed falling edge. This function is provided by the Empty-Register Detect circuit (Fig. 4). The circuit includes two cascaded decade counters that count to 100 shift pulses (for a 200-stage register the counters should count to 200). The flag signal, when present (high), resets the counter. Thus one or more characters in the buffer keep the count to less than 100. And when the buffer is empty, the flag remains low, enabling the counter to reach 100. At the count of 99, the next clock will reset the counter to ZERO to produce a falling edge at pin 11 of the second decade stage. This edge causes the  $\bar{Q}$  output of the Empty-Detect flip-flop (FF<sub>1</sub>) to go low until the next rising  $\phi_1$ -clock edge. The result is a short pulse on the Write-Permit line. For

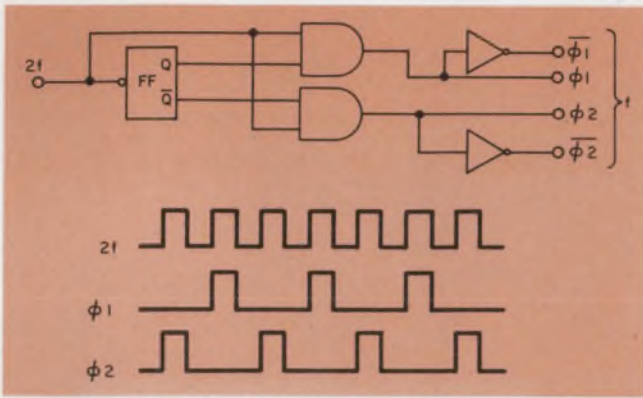

2. Logic race conditions are avoided by use of a two-phase clock.

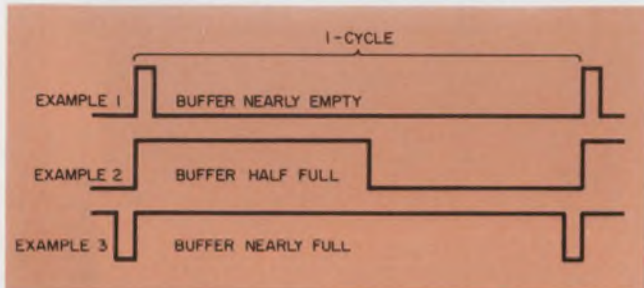

3. The flag signal keeps track of how much data are in the buffer registers and which characters were entered first. The result is a first-in, first-out system.

other than empty buffer conditions, the End-Flag detector ( $FF_2$ ) produces a pulse every time the flag goes low.

Note that the flag is also fed to the FF, Clear Input. This direct-terminal (cd) on a J-K flip-flop overrides a pulsed signal on its toggle input, T. Thus the buffer is truly empty only when the flag is already low at the time the counter produces a falling-edge output. Such a false counter output is obtained when the counter has gone beyond 80 and is reset by a rising-flag signal. The high condition of the flag thus prevents a false Write-Permit signal.

### Detecting a full register

The buffer cannot be allowed to fill completely to 100 characters because the control logic depends upon an active flag. One code on the tracks must always be all ZEROS; otherwise the flag is always high. This lack of a signal edge in the flag would result in a locked-up buffer.

The Full-Register Detect ( $FF_6$  in Fig. 5) determines if 99 characters are circulating in the register. Whenever a stream of characters ends, an End-Flag signal is generated by  $FF_2$  in Fig. 4. The timing diagram of Fig. 5 shows how this produces a sampling window that occurs one  $\phi_1$ -clock pulse after the End-Flag Detect pulse. If the flag signal is high at this time, 99 characters

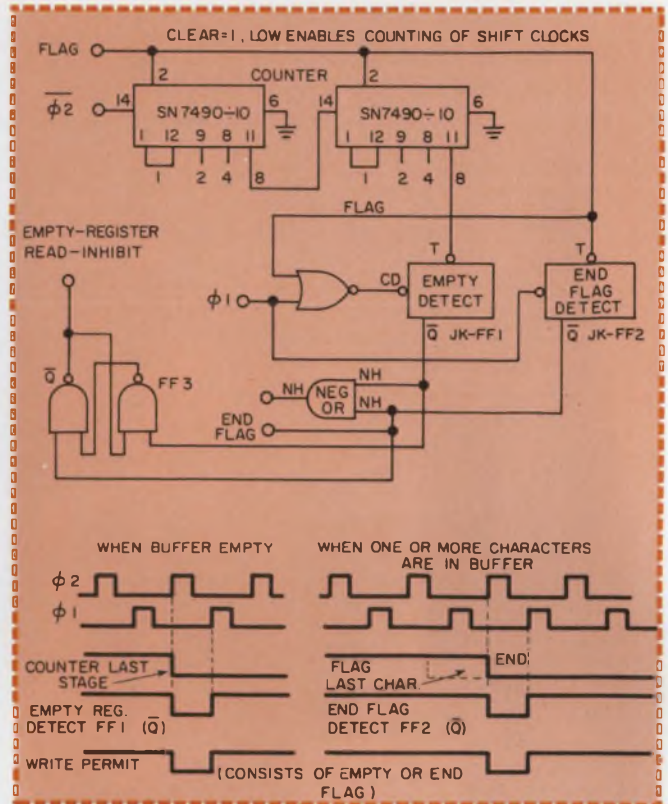

4. An active flag signal is a primary requirement of the buffer. An artificial flag must be generated when the buffer is empty.

occupy the registers. The Full-Register sequence is started by a falling-flag signal. If the flag signal rises again after one  $\phi_2$  clock pulse, this means that a character was absent for only one shift pulse and that, for the rest of the 99 shift pulses, characters were present.

A full register then sets  $FF_6$  and its  $\bar{Q}$  output goes low to inhibit  $FF_{10}$  (Fig. 6) from setting in the Write-Synchronizer circuit. Thus the buffer can no longer write characters. This Write-Inhibit signal may also be used externally to indicate a full-buffer state. As soon as one or more characters are read out of the buffer, or when an Empty-Detect signal occurs (as after power is shut off), the Full-Register, Write-Inhibit flip-flop,  $FF_6$ , is reset.

### Writing into the buffer

Pulsing the normally low Write-Data input line (Fig. 6) with a 5- $\mu$ s (minimum) positive-going pulse starts a character-entering sequence. With an eight-bit character on the eight input lines, the leading edge of the Write-Data pulse triggers the Load One-Shot ( $FF_{13}$ ), which strobes the data into the buffer quad-latches (Fig. 1). This one-shot has a period of about 5  $\mu$ s, as determined by the 1000-pF capacitor. The input data bits should remain stable for at least this period. When the character bits are in the quad latches,



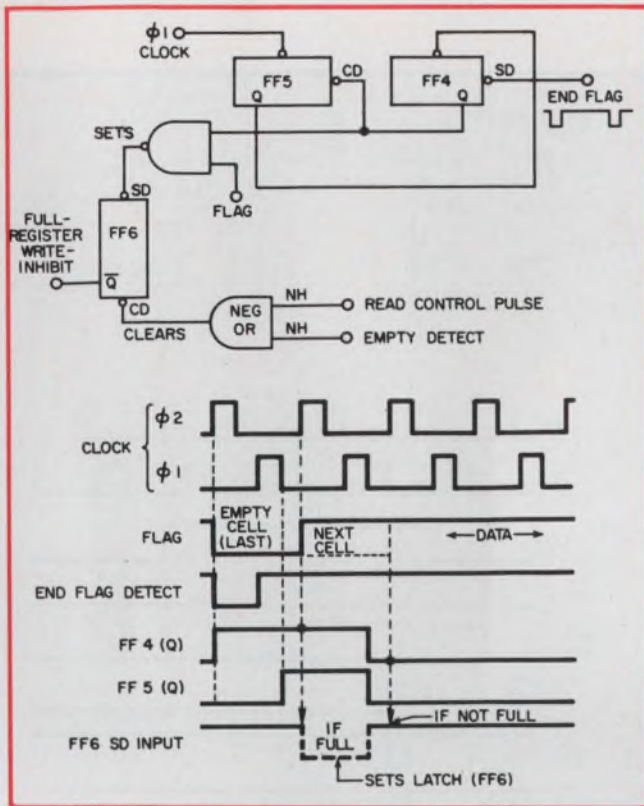

5. A completely full register of 100 characters would result in no flag transitions. Therefore at least one stage is always empty to insure an active flag signal.

they are ready for entry into the shift registers.

The Wait flip-flop, FF<sub>10</sub>, is triggered on the falling edge of the Write-Data pulse. The Acknowledge flip-flop, FF<sub>11</sub>, is then enabled to receive the next available Write-Permit falling edge. When FF<sub>11</sub> sets the previous stage, FF<sub>10</sub> is reset. Also, the next available  $\phi_2$  pulse sets Write-Control flip-flop, FF<sub>12</sub>. The FF<sub>12</sub> output, Write-Control, feeds into the Write/Recirculate gate (Fig. 1) to force its output high for the one clock period that FF<sub>12</sub> stays set. This changes the internal mode of each shift register from recirculate to write. Since FF<sub>12</sub> is set for a period that brackets one  $\phi_2$ -clock pulse, a  $\phi_2$  pulse can now clock the eight-character bits in parallel into the corresponding eight registers. When FF<sub>12</sub> resets, the Write/Recirculate control line returns to the recirculate mode, with the newly entered character available for reading. The next character can be entered into the registers on the next recirculate cycle.

### Reading from the buffer

A falling edge into the Data-Request input line (Fig. 7) starts the read sequence. The quiescent state of the Data-Request line can be either low or high. The Read-Synchronizer circuit (Fig. 7) is identical to the Write-Synchronizer circuit (Fig. 6), except that the reading sequence waits for a rising-flag edge instead of a falling edge. Reading can start with writing in progress.

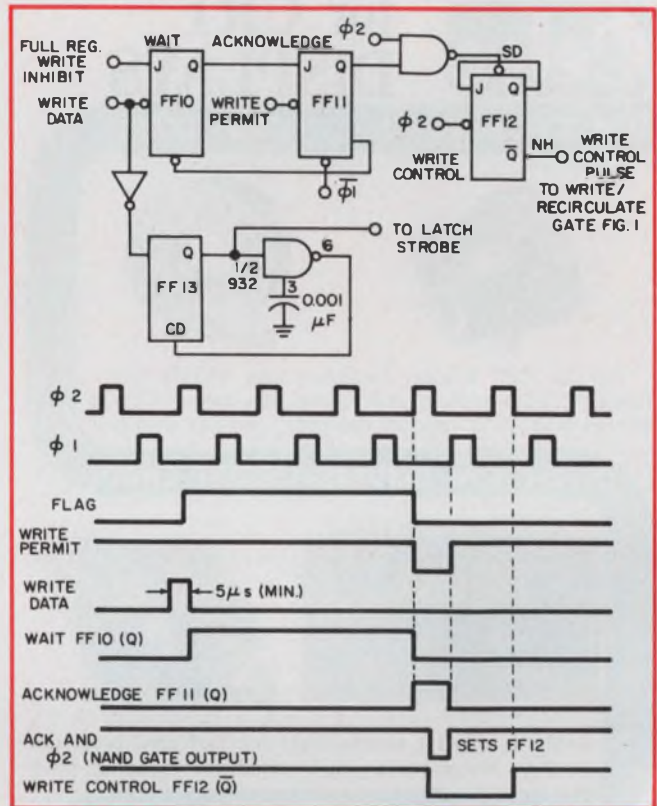

6. A character is written into the buffer when a positive-going pulse actuates the Write-Data line. One character is entered per register circulation cycle.

The resulting Read-Control output pulse straddles the  $\phi_1$  clock to strobe out a Data-Ready pulse. The Data-Ready pulse then strobes out a single character from the buffer. At the same time the character is erased when the circuit simultaneously forces the Write/Recirculate bus line high and the Data-Control bus low. This writes ZEROs in place of the character readout. Thus each data-request pulse delivers just one character to the output, and then automatically the character is erased from the buffer. When requests are repeated rapidly, the flag signal when viewed on an oscilloscope, appears as if something is nibbling away at its front edge. The single  $\phi_1$ -clock pulse that serves as a Data-Ready signal provides a delay with respect to the shift-clock,  $\phi_2$ , so that the shift-register outputs have settled by the time a Data-Ready signal is given.

### Output drivers and Empty-Registers

The outputs of the registers themselves are capable of driving only a single-gate load. They are therefore buffered with driver gates. A common strobe line for these driver gates, the Data-Enable line, can be used at the designer's option to control selectively WIRE-ORed drivers from another buffer system. Also, this strobe line, when tied to the Data-Ready line, can mask the register outputs during the register-recirculating mode.

# Celco

# for CRT DISPLAYS

DEFLECTION YOKES

FOCUS COILS



For the CRT Display Designer who NEEDS everything, CELCO makes everything you need. CELCO serves you in a unique capacity; we are the only

DEFLECTION DRIVERS • CIRCUIT CARDS



single source for all the most sophisticated precision display components you'll need for building your

RAMP GENERATORS



entire display system. All CELCO components are designed to perform exactly according to the requirements of your particular display, are fully compatible

POSITIONERS CRT SPOT ANALYZER

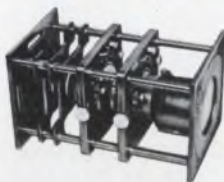

with each other, and create a harmoniously performing system.

COMPLETE DISPLAY SYSTEMS



.0006" SPOT

# Celco

CONSTANTINE ENGINEERING LABORATORIES COMPANY  
UPLAND, CAL. 91786 MAHWAH, N. J. 07430

INFORMATION RETRIEVAL NUMBER 65

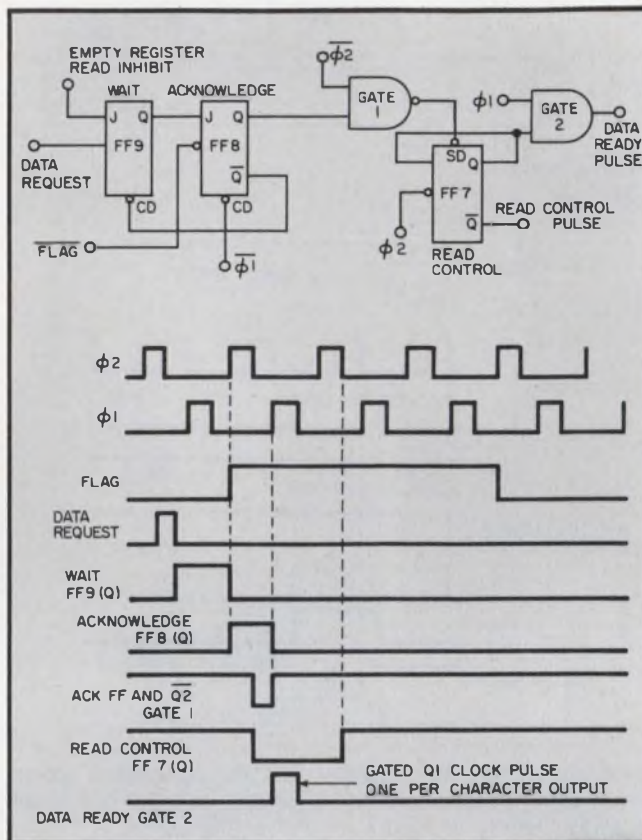

7. A character is read out of the buffer when a negative-going edge actuates the Data-Request line.

If the buffer is empty and a data request is received, the Read-Synchronizer-Wait flip-flop, FF<sub>9</sub>, in Fig. 7, would set and wait indefinitely for a flag-signal transition. Thereafter any character written into the buffer would be erased as soon as it recirculated once. To prevent such a system lock-up, an Empty-Register Read-Inhibit signal supplied by flip-flop FF<sub>3</sub> is set directly by the FF<sub>1</sub>, Empty-Detect pulse to inhibit the Read Synchronizer (Fig. 7) from starting a sequence. Flip-flop FF<sub>3</sub> is reset as soon as an End-Flag signal appears, indicating that a character is available.

### Clearing the registers

There is no way to predict what is in the registers when power is turned on. It's necessary to clear them once the power is on. The Power-On reset signal, when it goes low, forces the Data-Control bus low, thereby making the registers ignore the quad latches' contents. Also, the signal forces the Write/Recirculate control bus high, so that ZEROs are written into all cells of every register. The Power-On reset pulse should be longer than one recirculation period to insure complete erasure. This reset can be implemented by a manual pushbutton or even derived automatically. ■■

# We made it because there wasn't a high performance digital panel meter at this price. Now there is.

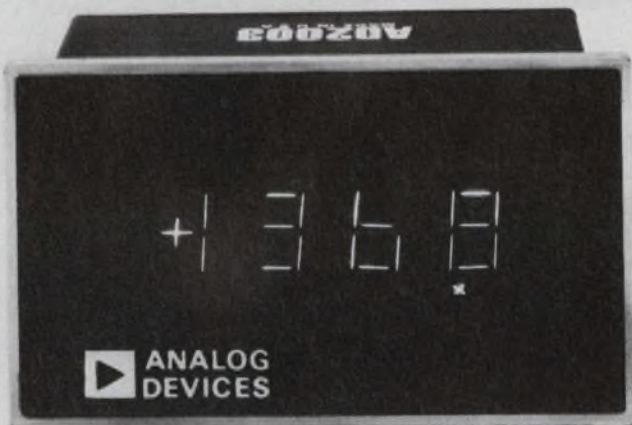

## Our AD2003 3½-digit DPM. Only \$93 in 100's.

When we introduced our first 3½-digit panel meter it was the world's smallest and least expensive DPM.

We made it primarily for high accuracy display applications.

And it cost only \$89 in 100's.

Now for only \$4 more, our 5VDC powered AD2003 has the kind of performance you need for complex system interfacing and data processing.

That's because we designed it with a true differential instrumentation input amplifier and fully latched DTL/TTL compatible BCD outputs.

You can count on high common mode rejection of 80dB minimum at  $\pm 2.5V$ . Good normal mode rejection of 40dB. And you'll get a conversion

time of 60ms max.

A few other things that make our panel meter a lot better are green filtered RCA Numitron display tubes with optional color filters you can choose for color-coding.

Polarity and overload indicators.

A seven segment filament test.

And all this performance comes neatly and reliably packaged in a 1.8" H x 3" W x 2"D rugged aluminum case which easily snaps into your panel from the front.

Think of it as a component.

We burn-in each AD2003 for 7 days before shipping.

Something we do with all our panel meters.

Like our first 3½-digit meter — perfect for display.

Our second meter — an economical 2½-digit snap-in replacement for analog meters.

And now this new high performance 3½-digit DPM.

And a soon-to-be high performance 4½-digit model.

You can get evaluation samples of our AD2003 right now. As well as our Product Guide which shows all the other things we make to solve more of your problems better than anyone else.

Analog Devices, Inc., Norwood, Mass. 02062  
(617) 329-4700.



# Linearize analog signals continuously

with high accuracy. The circuits are simple and can be built with inexpensive op amps and resistors.

In the design of many automatic control systems, process or machine variables are first translated into suitable electrical signals. More often than not, the available transducers for converting such physical variables—temperature, pressure, flow, velocity, force, color and others,—generate nonlinear analog signals. Most existing techniques for linearizing these signals—piecewise linearization or the use of an on-line computer—lead to errors or result in expensive system configurations. But the availability of good, inexpensive IC op amps permit the *continuous* linearization of most analog signals with any desired accuracy—say,  $\pm 0.1\%$ —and with simple circuits.

Let's examine the design considerations and procedures and then detail a complete design of the key parts of a circuit for linearizing a thermocouple output.

## Nonlinear function linearizes itself

Figure 1a depicts the functional block diagram of the CAL (continuous analog linearization) circuit. In operation, the nonlinear input function is first amplified. The amplified signal generates a *mirror image* of itself within a "nonlinear function generator." After summing the two functions, the circuit produces a linear output that can be used to represent the original function (Fig. 1b).

The nonlinear function generator is preprogrammed so that a predictable input will be mirrored by the generator's output. The accuracy of the generator depends on the number of op-amp circuits used. For increased accuracy, more op-amp circuits, each with appropriate gain range, can be added.

## Linearizing wide-range nonlinear functions

To understand the operation of a nonlinear function generator with several op amp circuits, consider Fig. 2a. The function generator is broken down into three functional modules—the

Martin Weiner, Group Leader, and David Schneider, Supervisor, Thermo Electric, Saddle Brook, N.J. 07662.

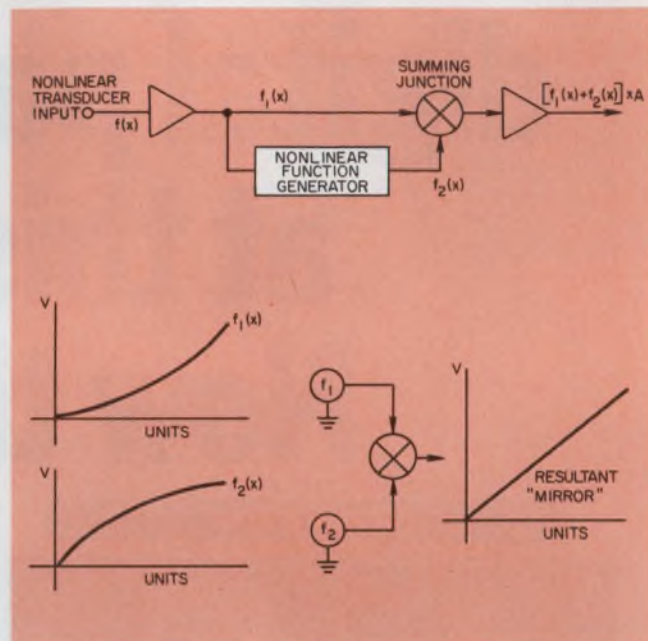

1. Analog functions are linearized with a simple circuit (a) that uses the original input functions to generate its mirror image,  $f_2(x)$ , shown in (b). After the original amplified function,  $f_1(x)$ , is added to  $f_2(x)$ , the desired linear output is obtained and it is called "mirror." Functions  $f(x)$  are voltages generated in response to some physical variable "x," which might be temperature, pressure, velocity, etc.

breakpoint detector, segment amplifier and the positive/negative deflection circuit. Each breakpoint refers to the  $f_1$  amplitude at which the required nonlinear function generator begins to operate.

The number and location of breakpoints (Fig. 2b) depends on the required accuracy of the linearization process and is determined as follows: Referring to the exaggerated portion of the input curve (inset, Fig. 2a), we see that the breakpoint 2 is found at the intersection of the straight line connecting breakpoints 1 and 2. The maximum deviation between this line and the input function,  $f_1$ , denoted as  $V_e$ , represents the maximum tolerable error.

Breakpoint-detection circuits for the first three breakpoints are shown in Fig. 2c. The input-signal amplitude at which each circuit begins to conduct is determined by the reference voltage,

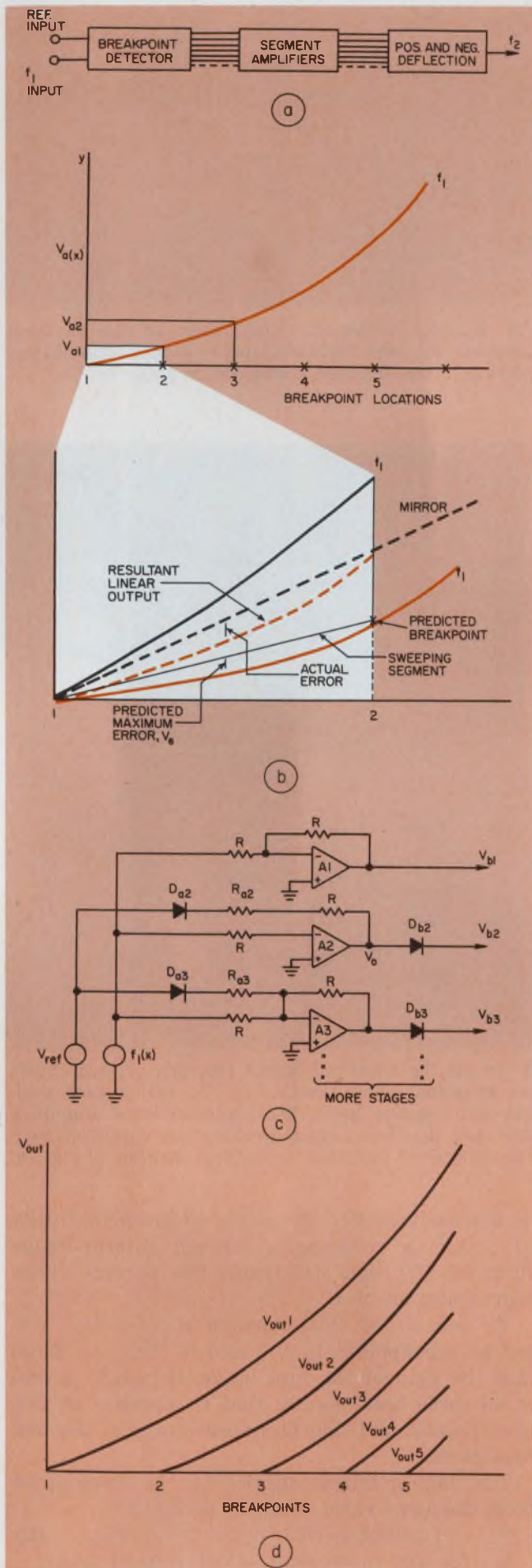

2. The heart of the CAL is its nonlinear function generator, which consists of three major blocks (a). The function of the first block, the breakpoint detector, is shown in "b" and the meaning of each breakpoint is indicated in the accompanying inset. Breakpoint amplifiers (c) come into action as determined by the reference input, the  $D_{an}$  diodes and values of the  $R_a$  resistors to produce outputs as shown in "d."

$V_{ref}$ , the value of breakpoint resistors,  $R_a$ , and the diode IV (current-voltage) characteristics.

The amplifier  $A_1$  requires neither a reference voltage nor diodes. It begins to conduct as soon as the input signal is applied. Breakpoint amplifier  $A_2$  generates a positive output starting at breakpoint 2. The  $D_b$  diodes prevent any negative outputs, permitting positive output signals only after a certain input level has been exceeded.

### Designing breakpoint amplifiers

For a given reference voltage (typically 5 V dc), the breakpoint amplitude will be determined by the exponential diode characteristics and values of  $R_a$ . Diode characteristics can be determined by measuring voltage drops across the diode and the corresponding currents. After making a few measurements, we can obtain a close fitting curve using the exponential expression

$$I = Ae^{BV}, \quad (1)$$

where

$I$  is the diode current,

$V$  is the diode voltage drop,

and  $A$  and  $B$  are constants that can be readily determined on the basis of a few measurements.

From the diode characteristic, we can find the maximum positive voltage,  $V_o$ , that will not cause appreciable diode conduction. The  $V_o$  is the voltage that will appear at the output of each breakpoint amplifier at its breakpoint. (Approximately 0.3 V for silicon diodes.)

The  $R_a$  resistors can now be found from

$$R_{an} = R(V_{ref} - V_{Dan}) / (f_{in} - V_o), \quad (2)$$

where

$R$  is the feedback resistor,

$f_{in}$  is the amplified input function at the breakpoint stage  $n$ ,

$V_{Dan}$  is the voltage drop across the  $D_a$  diode of stage  $n$ ,

$V_o$  is the voltage previously determined.

More specifically,  $R_{an}$  must be chosen so that  $V_o$  will be produced at the desired breakpoints. Each selection of an  $R_a$ , however, produces a different value of  $V_{Da}$ , thus giving different values of  $V_o$ . Thus the  $R_a$  evaluations and the resulting values of the  $V_{Da}$ 's should be repeated with an iterative scheme, such as the Newton Raphson method, until each  $R_a$  produces a tolerable value of  $V_o$ .

Once all the  $R_a$  resistors are chosen, the com-

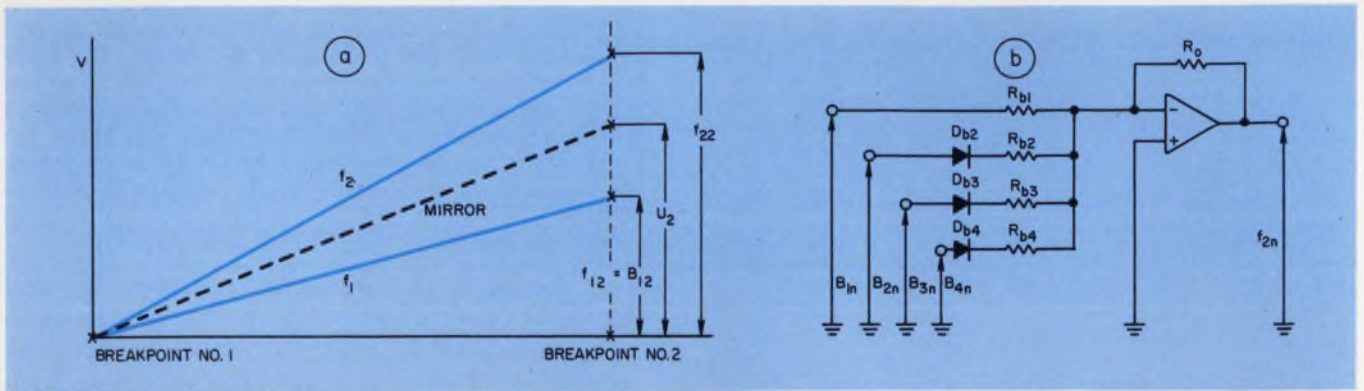

3. To determine the gain of each segment amplifier required to combine outputs of the breakpoint amplifiers (see Fig. 2d), graphs for each segment can be prepared

(a). Resistor values for each stage of the segment amplifier,  $R_{bn}$ , are then calculated to produce the desired gains with the amplifier configuration shown in "b."

posite outputs of all the breakpoint amplifiers will be as in Fig. 2d.

Each output of a breakpoint amplifier is next fed into the corresponding segment amplifier, so that each output curve is fitted to produce the correct  $f_2$  function, which is the properly amplified mirror image of  $f_1$ . The gain of each segment amplifier is calculated at the subsequent segment breakpoint—that is, the gain of segment amplifier 2 is computed at breakpoint 3. The amplification of the final stage is calculated at the end point of the function.

Figure 3a demonstrates the determination of the gain at breakpoint 2. There are three voltages at breakpoint 2:  $B_{12}$  is the voltage applied to segment 1, and it is equal to  $f_{12}$  (using the notation of Fig. 2);  $U_2$  is the theoretical mirror (linearized output) reference, and  $f_{22}$  is the desired resultant output from segment amplifier 1. This output must be equidistant from the mirror and opposite to  $f_{12}$ . The value of  $f_{22}$  can be determined either graphically or from

$$f_{22} = 2U_2 - f_{12}. \quad (3)$$

Knowing the input voltage to the segment amplifier and the desired output, we see that the gain is

$$G_1 = f_{22}/B_{12}. \quad (4)$$

A simplified schematic of the segment amplifier stages is shown in Fig 3b.  $B_{an}$  refers to the breakpoint-amplifier output at breakpoint n. Any  $B_{an}$  voltage of less than  $V_o$  can be omitted in the calculation of the segment resistors,  $R_{bn}$ , which are obtained as follows:

$$R_{bn} \text{ is calculated from } R_{bn} = R_o/G_n, \quad (5)$$

where  $R_o$  is the feedback resistor.

In calculating the values of  $R_{b2}$ ,  $R_{b3}$ , etc., we must take into account the over-all contributions of the previous stages. At each breakpoint, voltage outputs of the previous stages will differ. In addition voltage drops across each segment diode,  $D_{bn}$ , will change with these various inputs. Thus all the theoretical  $R_{bn}$  values can serve only as first-degree approximations and must be trim-

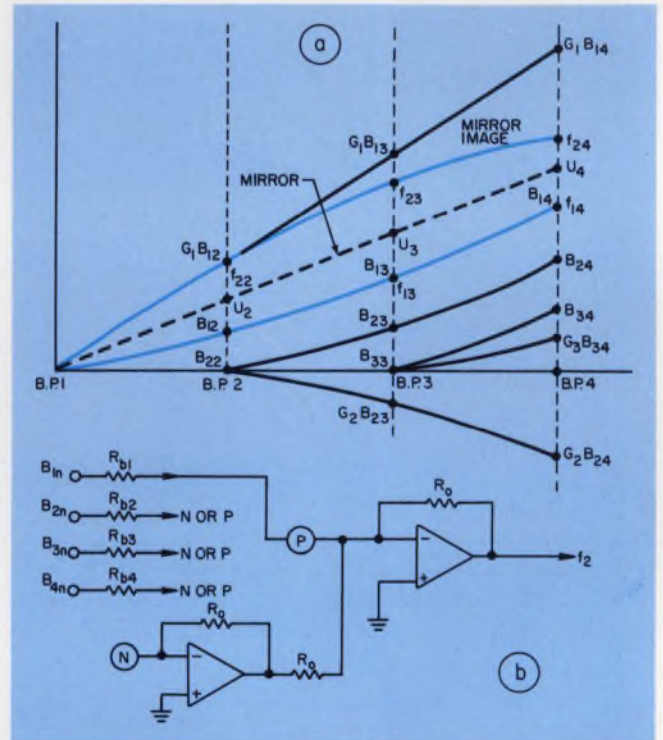

4. To get the linearized output (mirror), various curves are generated within the CAL (a). To realize both positive and negative gains, two complementary amplifiers are used (b). This circuit provides the "positive/negative deflection" indicated in the block diagram of Fig. 2a.

med experimentally or calculated mathematically to obtain a continuous, smooth mirror-image function ( $f_2$ ) that will insure the correct linear representation of  $f_1$ .

To understand this, consider a composite output at breakpoints 1, 2, 3 and 4 (Fig. 4). Note that the gain of the first stage,  $G_1$ , plays a role at all three breakpoints; that  $G_2$  appears at two breakpoints; and that  $G_3$  appears only at the last breakpoint.

The mirror-image curve,  $f_{2n}$ , is determined from the same basic equation as Eq. 3:

$$f_{2n} = 2U_n - f_{1n}. \quad (6)$$

$B_{an}$  for any breakpoint is determined from

$$B_{an} = f_{1n} - [R(V_{ref} - V_{Dan})/R_{an}]. \quad (7)$$

The points  $G_1B_{1n}$  can now be determined, since the value of  $G_1$  is already known (Eq. 4):

$$G_1B_{1n} = f_{1n}(R_o/R_{b1}). \quad (8)$$

We can now determine  $G_2B_{23}$  at breakpoint 3, knowing that its amplitude and the  $G_1B_{13}$  cause the mirror-image curve,  $f_{2n}$ , to pass through point  $f_{23}$ , or

$$f_{23} = G_2B_{23} + G_1B_{13}, \quad (9)$$

so that

$$G_2 = (f_{23} - G_1B_{13})/B_{23}. \quad (10)$$

But  $G_2$  is also given by

$$G_2 = R_o/(R_{Db2} + R_{b2}), \quad (11)$$

where  $R_{Db2}$  is the forward resistance of the diode.

$G_2B_{23}$  is also given by

$$G_2B_{23} = (B_{23} - V_{Db2})R_o/R_{b2}, \quad (12)$$

so that solving for  $R_{b2}$ , we get

$$R_{b2} = (B_{23} - V_{Db2})R_o/G_2B_{23}. \quad (13)$$

In calculating  $R_{b2}$ , we must recalculate the voltage drop across diode  $D_{b2}$ , as in the case of the  $R_a$  resistors.

The remaining  $G_2B_{2n}$  points along the composite curve can now be calculated from

$$G_2B_{2n} = (B_{2n} - V_{Db2n})R_o/R_{b2}. \quad (14)$$

$R_{b3}$  is calculated in the same way as  $R_{b2}$ , except that at breakpoint 4 the contributions of both  $G_1B_{14}$  and  $G_2B_{24}$  must be taken into account in the calculation of  $G_3$ . Thus

$$f_{24} = G_3B_{34} + G_2B_{24} + G_1B_{14}. \quad (15)$$

With omission of the arithmetic,  $R_{b3}$  is given by

$$R_{b3} = (B_{34} - V_{Db3})R_o/G_3B_{34}. \quad (16)$$

Note that in some resistance calculations it is possible to obtain negative values.

To satisfy both the negative and positive ( $R_b$  values), we use two complementary amplifiers (Fig. 4). One has a positive gain, and the other has a negative gain. The sign of each  $R_b$  resistor determines which amplifier is used.

The  $f_2$  function obtained at the output of the segment amplifier shown in Fig. 4b is then added to the original input function,  $f_1$  (Fig. 5). The output of this summing circuit is

$$f_o = (f_1 + f_2)R_f/R, \quad (17)$$

which is the desired linearized representation of  $f_1$ .

### Building a CAL circuit

A complete general schematic of a CAL circuit is shown in Fig. 6. In designing it, we can prepare a simple computer program and solve the appropriate equations. Whether or not a computer is used, the following step-by-step procedure should be followed.

1. Compile sufficient data to generate the  $f_1$  (input) function. In the case of a thermocouple, voltage vs temperature points are determined.

2. Determine the range of  $f_1$  to set the gain of the input amplifier.

3. Determine the number and location of the

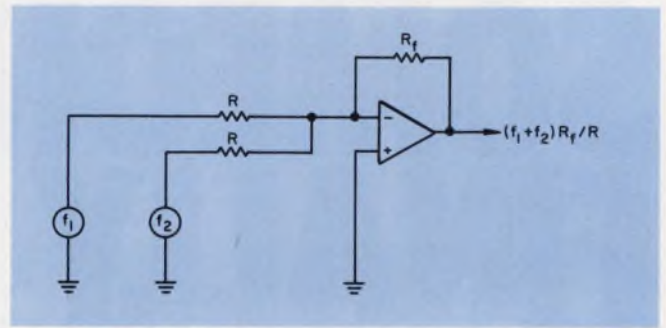

5. Final linear output is obtained after  $f_1$  and  $f_2$  are summed by a simple circuit.

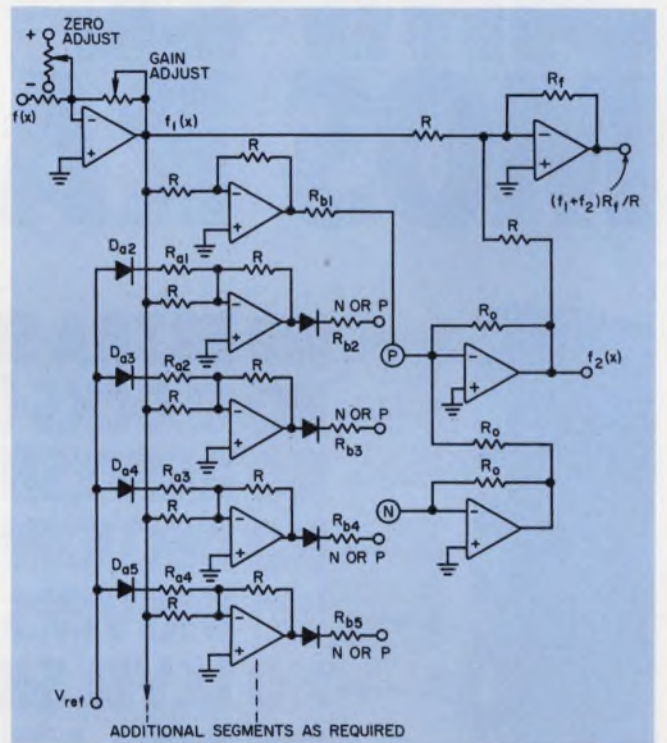

6. A complete CAL with five breakpoints can be built inexpensively. Except for the input amplifier, which should be  $\mu A727$  or equivalent,  $\mu A741$  op amps can be used throughout. Silicon diodes, such as 1N4004, can be used throughout. The  $R_a$  and  $R_b$  resistors can be 1% and all others 5%. Using seven breakpoint amplifiers, the authors linearized the output of an ISA type K (chrome/alumel) thermocouple with a temperature range of  $-310$  to  $2500$  F with  $\pm 0.1\%$  accuracy.

breakpoints on the basis of the desired accuracy, either mathematically or graphically (Fig. 2b).

4. Determine the slope of the linearized function. This can be the slope of a line connecting the end points of the input function, modified by the gain of the input amplifier.

5. Determine all  $U_n$  and  $f_{1n}$  values at the breakpoints.

6. Using experimental data, determine the constants in Eq. 1.

7. Using Eq. 2, find the breakpoint-amplifier resistors,  $R_n$ .

8. Compute the values of all  $R_o$  resistors by using Eqs. 4 through 16. ■

# SOMEONE FINALLY MADE A SIMPLE-TO-USE MOS RAM.

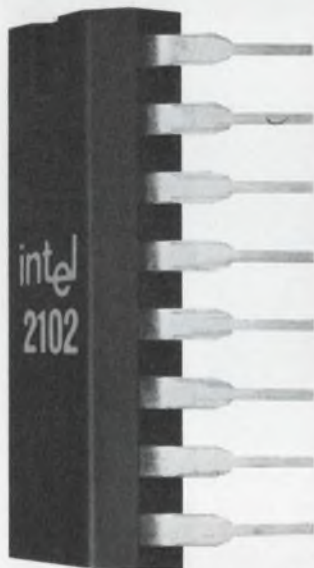

- NO** EXTRA SUPPLIES (+5V ONLY)
- NO** CLOCKS (IT'S STATIC!)
- NO** REFRESH CIRCUITS
- NO** DECODING CIRCUITS
- NO** DRIVERS
- NO** LEVEL SHIFTERS
- NO** PULL-UP RESISTORS
- NO** TTL INTERFACE CIRCUITS WHATEVER

**YES** it's in distributor stock now.

Ask for Intel 2102, the static 1024-bit N-channel MOS RAM with one microsecond access.

intel<sup>®</sup>  
delivers n-channel



If you find our new,  
**low cost 600 MHz wide sweeper**  
 a little hard to believe...



meet our new,  
**low cost 1000 MHz wide sweeper.**  
 You better believe it.

Both 600 and 1000 MHz Models Feature:

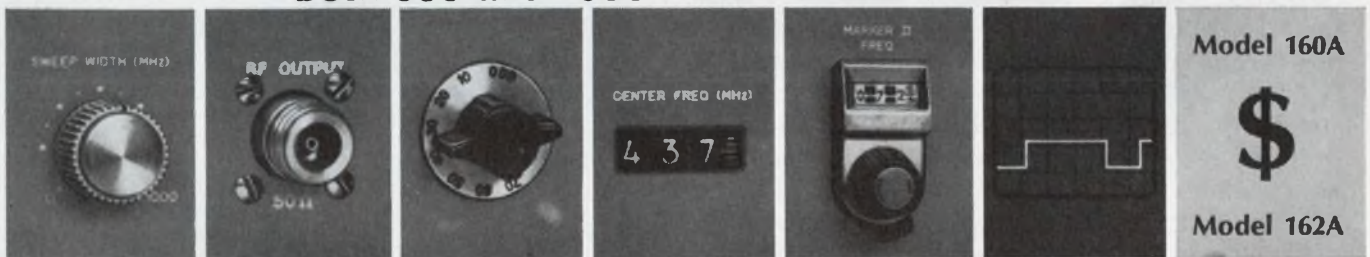

- Wide Sweep Widths**
  - High, Flat RF Output**
  - Precision Attenuator**
  - Digital Readout**
  - Marker Options**
  - Summation Sweep Trigger**
  - Big Savings**
- The 160KE -.5-500 MHz **\$1095.00** ·  
 The 160A-.5-600 MHz **\$1295.00** ·  
 The 162A-1.0-1000 MHz **\$1495.00** ·

**Half Rack Size Units  
 Also Available.**

**KAY**  
**Elemetrics Corp**  
 Maple Avenue Pine Brook, N. J. 07058

INFORMATION RETRIEVAL NUMBER 68

• U.S.

# Can't decide which instrument to buy?

Flow charts can help you make your decision, or at least limit the number of candidates.

You've decided you need a signal source. But what exactly should you buy? You've got a choice of function generators, RC or LC oscillators, pulse generators and frequency synthesizers. Each has its virtues. None can handle all situations.

You can evaluate the competing sources in light of your own requirements by using flow charts such as those shown in the figures. The charts will pinpoint the viable candidates for further consideration. If parameters other than frequency and waveform are important, additional charts can be drawn.

After you crank your problem through the charts, suppose you discover that both pulse and function generators will meet your requirements. To eliminate one, look at the cost effectiveness of both candidates. You can do this by compiling a figure-of-merit chart. The output of the chart is a purely subjective effectiveness factor (E) for each instrument. Since each unit cost (C) is known, the effectiveness per dollar (E/C) is immediately visible.

To compile the effectiveness chart, list the important parameters of the two units side by side under major categories. For example, under "performance," you can list frequency range, resolution, stability, amplitude range, waveforms, modes and programmability. Under "operability," you can list number of outputs, control simplicity, control size and spacing, rear-panel controls, etc. Under "serviceability," you can have instruction manual, maintainability, reliability and warranty. Finally, under "flexibility," you can list physical size, handles, battery operation, stacking ease, etc.

Each parameter is then assigned a subjective rating—on a scale of 1 to 5, say—and a weighting factor (1 to 10) based on the parameter's value to the intended application. The product of the sum of the ratings and the feature values are then formed for each major category. Since performance may be a more important category than flexibility, etc., you may also wish to multiply

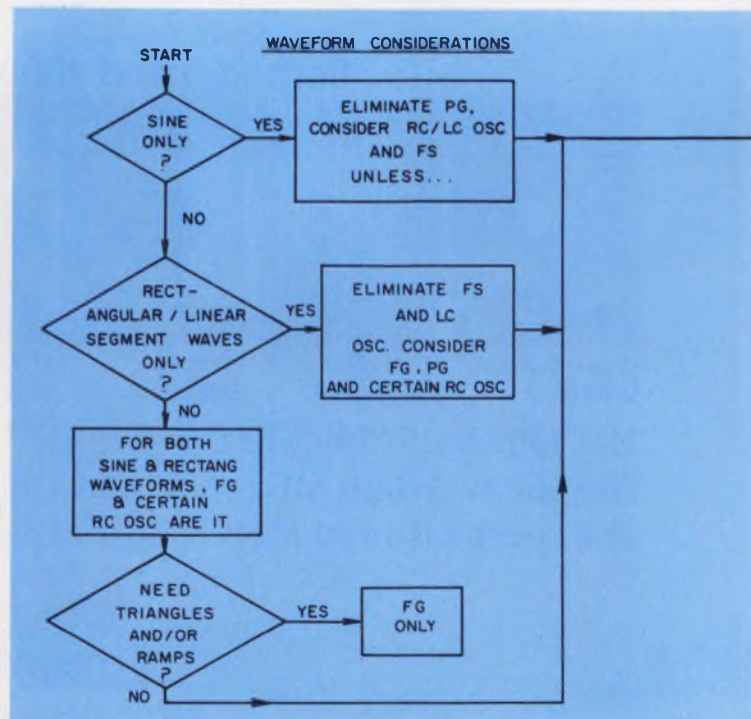
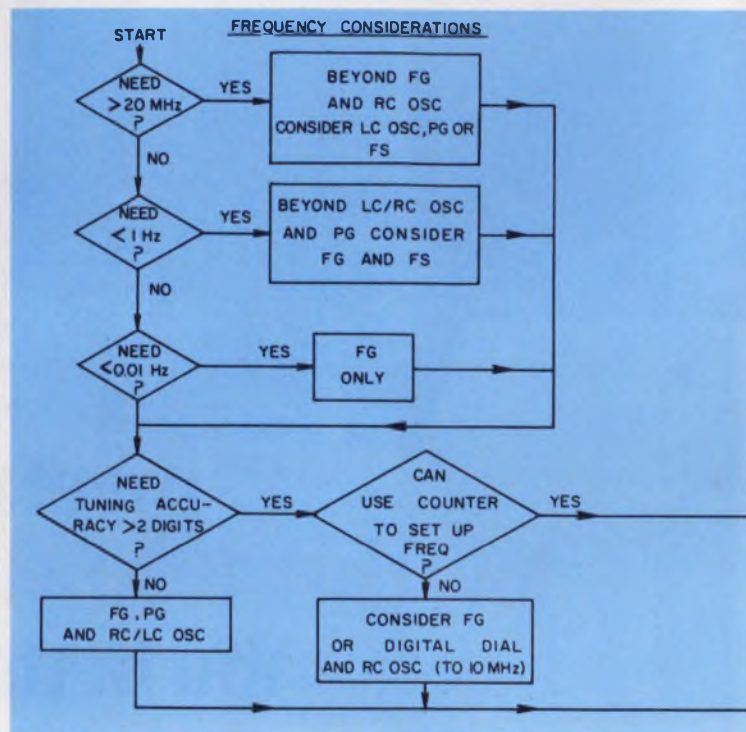

Ed Reamer, Chief Engineer, Interstate Electronics, Anaheim, Calif. 92803.



**BOONTON**  **ELECTRONICS** congratulates **ELECTRONIC DESIGN** on its 20th anniversary, and celebrates its own 25th birthday with the new Model 93AD True RMS Voltmeter-latest in a long line of **BOONTON** voltmeters.



**Model 93 AD**  
**\$1135**

## True RMS Voltmeter

Outstanding for its superb sensitivity, the Model 93AD includes in its basic price many features ordinarily supplied only as extra cost options:

- 300  $\mu\text{V}$  sensitivity usable over the full 20 MHz bandwidth.
- Fully programmable.
- BCD and analog outputs.
- Auxiliary analog meter.
- Selectable bandwidths.

Several options and accessories are available for special requirements:

- Digital dBm readout (600  $\Omega$ ).
- Automatic ranging.
- High impedance probe.

**BOONTON**   
**ELECTRONICS**  
CORPORATION

TEL: 201-887-5110 ■ TWX: 710-986-8241  
ROUTE 287 AT SMITH ROAD  
PARSIPPANY, N. J., U. S. A. — 07054

INFORMATION RETRIEVAL NUMBER 69

# DIGITEC'S NEW DATA LOGGERS



## HAVE ALL THIS VERSATILITY

- Models to measure Voltage, Current, Resistance, Temperature & other transduced parameters.
- 20 selectable scan points standard, expandable to 200.
- Real-time digital clock with program interval for unattended operation, standard.
- Digital printout arranged for quick, easy reading.
- BCD and system interlocks brought out to interface peripherals such as: comparators, tape punch, and mini-computer.
- Loss of power indication.
- All LED long-life displays.

## WITH PRICES UNDER \$1900

To see the DigiTec 1200 or 1500 series Data Loggers, simply contact your DigiTec representative. Or, you can call or write; **United Systems Corporation**, 918 Woodley Rd., Dayton, Ohio 45403 Phone (513) 254-6251.

All DigiTec instruments are available for rental or lease through Rental Electronics, Inc.

**DIGITEC**  
UNITED SYSTEMS CORPORATION  
subsidiary of **Monsanto**

## Pick a filter from this chart.

Here are practical low and high-pass filters selected from several hundred computer-designed circuits.

Designing a filter is time-consuming and requires specialized knowledge. And the designs frequently yield circuits with nonstandard component values. Where the requirements are not stringent, a relatively small number of pre-designed filters can meet the bulk of everyday needs. Here is a chart based on selections from computer-calculated filter designs<sup>1</sup>. They will work at frequencies from 1 kHz to 100 MHz, and they use standard capacitor values.

Thirty-six designs (18 low-pass and 18 high-pass) of five-element circuits were chosen for tabulation, and they were normalized for 50- $\Omega$  terminations and a 0.1-to-1-MHz frequency range. To select a filter, simply choose a frequency nearest the desired 3-dB cutoff frequency ( $f_{co}$ ). Read the L and C component values from the table, and assemble the components in accordance with the appropriate diagram. Although the filter tabulation covers directly only a 0.1-to-1-MHz frequency range and 50- $\Omega$  terminations, filter parameters for other cutoff frequencies and termination impedances can easily be determined by a simple scaling operation.

Termination of input and output with equal impedances makes possible equal values for the inductors ( $L_2 = L_4$ ) and capacitors ( $C_1 = C_5$ ). This simplifies component selection. Also a  $\pi$  configuration for the low-pass filter, and T for the high-pass, minimizes the number of inductors.

### Standard capacitors are used

The tabulated filter cutoff frequencies ( $f_{co}$  in megahertz at -3 dB) have been selected to provide values to within about 15% of any value in the 0.1-to-1-MHz range. The designs are keyed to indicate three levels of standard capacitor use. For example, those with the symbol "0" have all capacitors of the more common standard sizes. Where the choice of cutoff frequency is flexible, selection of designs with a greater number of the more common standard capacitance values makes component procurement easier. Inductor

values are nonstandard, but this should present no problem, since inductors are often hand-wound or available with a slug adjustment.

Filter attenuation slope, VSWR, and passband ripple are interrelated. In the first octave after cutoff, the tabulated designs have a minimum and maximum attenuation slope that lies between 30 and 40 dB/octave. The minimum and maximum values of VSWR and passband ripple are 1.00 to 1.29 and zero to 0.079 dB, respectively. The attenuation slope increases as the filter VSWR and passband ripple increase. Beyond 3  $f_{co}$  the attenuation slope becomes 30 dB/octave and is independent of the VSWR. Because the VSWR and passband ripple of these designs are low, they should prove adequate for most ordinary filter requirements. Attenuation curves plotted for the filters are normalized in terms of  $f/f_{co}$  for low-pass filters or  $f_{co}/f$  for high-pass.

For termination resistances other than 50  $\Omega$  and cutoff frequencies outside the 0.1-to-1-MHz range, use the scaling equations shown with the tabulations. However, to retain the new capacitor values in standard sizes, the resistance or frequency multipliers, F or R, must each be an integral power of 10. For example, if a 500- $\Omega$ , 2-kHz low-pass filter is required, the resistance and frequency multipliers are  $R = 10$  and  $F = 10^{-2}$ . The tabulated 0.20-MHz low-pass filter design would be selected. The corresponding capacitances and inductances—.01  $\mu$ F, .033  $\mu$ F and 65.5  $\mu$ H—then become 0.1  $\mu$ F, 0.33  $\mu$ F and 65.5 mH, respectively.

To match a 500- $\Omega$  filter to a 600- $\Omega$  line, two minimum-loss, 500/600- $\Omega$  L-pads can be installed, one at each end of the filter. For instance, each pad could consist of a series-connected, 240- $\Omega$  resistor and a shunt-connected, 1200- $\Omega$  resistor. The insertion loss of these two pads is approximately 7.5 dB.

Though capacitors and inductors with tolerances of 5 or 10% can be used, the actual cutoff frequency obtained will vary accordingly from the tabulated  $f_{co}$  values. ■■

### Reference

1. Wetherhold, E. E., and Lee Jr., H. A., "Design your Own Filter by Computer," *Electronic Design*, Jan. 20, 1972, pp. 48-50.

---

Edward E. Wetherhold, Senior Engineer, Honeywell, Inc., Test Instruments Div., Annapolis, Md. 21404.

# Filter Chart

## Scaling Equations

For cutoff frequencies outside the 0.1 to 1 MHz range and termination other than 50 Ω, use the following scaling equations:

$$L' = L \left( \frac{R}{F} \right), \quad C' = \frac{C}{(R \cdot F)}$$

L' & C' = New Component Values

L & C = Tabulated Values

$$\text{Multiplier } R = \frac{R'}{50}$$

Where R' is a new termination resistance chosen to make R an integral power of ten.

$$\text{Multiplier } F = \frac{f'_{co}}{f_{co}}$$

Where f'\_{co} is a new cutoff frequency and f\_{co} is a tabulated cutoff frequency, both chosen to make F an integral power of ten.

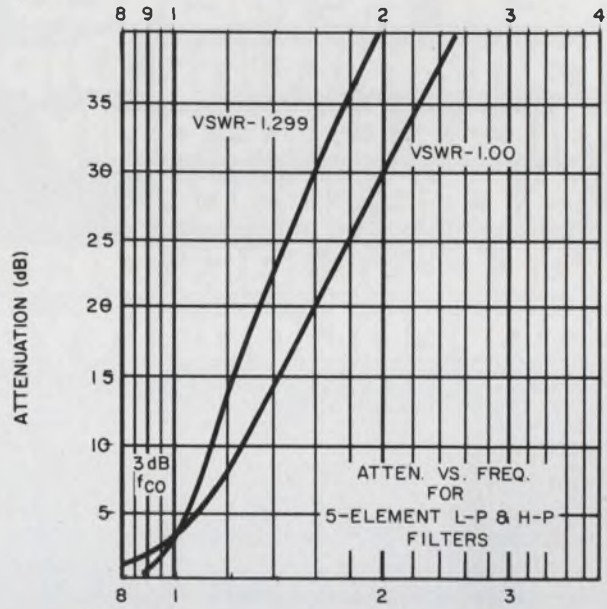

## Low-pass Filters

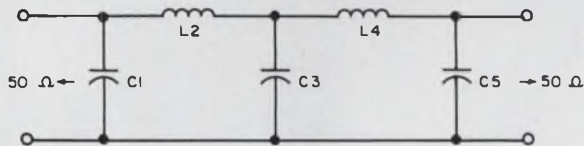

## High-pass Filters

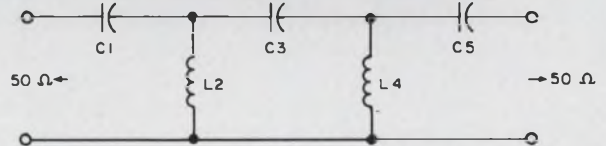

* Key	f <sub>co</sub> 3dB (MHz)	VSWR	C <sub>1,5</sub>	C <sub>3</sub>	L <sub>2,4</sub>
			μF		μH
Δ	0.10	1.299	0.039	0.068	125.0
x	0.11	1.020	0.022	0.056	119.0
o	0.14	1.083	0.022	0.047	98.5
x	0.17	1.260	0.022	0.039	73.7
o	0.19	1.062	0.015	0.033	70.7
o	0.20	1.000	0.010	0.033	65.5
x	0.24	1.010	0.010	0.027	56.8
o	0.29	1.000	0.0068	0.022	44.5
x	0.35	1.010	0.0068	0.018	38.6
o	0.42	1.000	0.0047	0.015	30.8
Δ	0.47	1.273	0.0082	0.015	27.0
x	0.53	1.020	0.0047	0.012	25.3
x	0.57	1.273	0.0068	0.012	22.4
o	0.64	1.083	0.0047	0.010	21.0
x	0.71	1.151	0.0047	0.0091	18.5
x	0.76	1.020	0.0033	0.0082	17.8
x	0.85	1.051	0.0033	0.0075	16.0
o	0.95	1.105	0.0033	0.0068	14.1

* Key	f <sub>co</sub> 3dB (MHz)	VSWR	C <sub>1,5</sub>	C <sub>3</sub>	L <sub>2,4</sub>
			μF		μH
o	0.10	1.073	0.033	0.015	45.0
x	0.13	1.210	0.022	0.012	38.3
Δ	0.14	1.286	0.018	0.010	34.7
o	0.16	1.000	0.033	0.010	31.5
x	0.18	1.235	0.015	0.0082	27.1
x	0.20	1.151	0.015	0.0075	23.8
o	0.23	1.000	0.022	0.0068	21.0
x	0.26	1.030	0.015	0.0062	18.1
x	0.30	1.151	0.010	0.0050	15.9
o	0.34	1.000	0.015	0.0047	14.3
x	0.41	1.020	0.010	0.0039	11.6
o	0.48	1.105	0.0068	0.0033	10.0
x	0.53	1.051	0.0068	0.0030	8.77
x	0.60	1.020	0.0068	0.0027	7.88
x	0.65	1.139	0.0047	0.0024	7.32
o	0.72	1.083	0.0047	0.0022	6.56
x	0.85	1.210	0.0033	0.0018	5.75
x	0.96	1.116	0.0033	0.0016	4.93

### \*Key

o — C<sub>1</sub>, C<sub>3</sub>, and C<sub>5</sub> are common standard values.

x — C<sub>1</sub> & C<sub>5</sub> are common standard values; C<sub>3</sub> is a less-common standard value.

Δ — C<sub>1</sub> & C<sub>5</sub> are less-common standard values; C<sub>3</sub> is a common standard value.

# NEW EL-MENCO Transmitting Dipped Micas take only 1/6 the space, yet cost less than conventional types.

*NEW in the industry*—El-Menco TDM43 Transmitting Dipped Mica Capacitors are unequalled in small size and low cost for their ratings. Compared to conventional types with similar characteristics, they require only one-sixth as much space ... save you 83% of the volume previously required. The superior coating transmits heat more efficiently, so you can use a smaller size for a given rating.

Specify these high-quality TDM43 Capacitors wherever better performance and long, reliable life are critically important ... and where space and weight are at a premium. For medium power, moderate-to-high voltage service, TDM43's can be used in tuned amplifier tank circuits, for DC blocking in high frequency amplifiers, in high frequency filter networks needing high Q and RF current capabilities, and in timing circuits requiring a high degree of stability.

Check the table below for representative values among the many standard TDM43 units available ... or call or write Electro Motive if you have a special application or one in which pulse conditions are present. Technical literature available on request.



Typical TDM43 Capacitor, actual size

Ideal for high frequency circuits, in military, communication, and industrial portable and airborne equipment... equivalent to RTM 63 in EIA spec. TR-109.

Typical Values Available—TDM43 Transmitting Dipped Mica Capacitors

Capacitance Value in pF	60 Hz Peak W.V.	Characteristic	Rated Current in amps. at Freq. of				Max. Dimens. in Inches		
			3.0 MHz	1.0 MHz	0.3 MHz	0.1 MHz	L	W	T
47	1500	C	0.50	0.10	0.07	0.03	2.010	.850	.220
1200		F	4.90	3.80	1.20	0.42	2.010	.850	.230
2700		F	5.90	5.80	2.20	0.90	2.010	.850	.230
3300	1000	F	6.10	6.20	2.60	1.10	2.010	.850	.230
5600		F	6.50	7.30	4.10	1.80	2.010	.850	.240
9100		F	6.80	8.10	5.50	2.40	2.020	.860	.260
10,000	750	F	6.90	8.40	6.40	2.70	2.020	.860	.260
15,000		F	7.00	8.90	7.80	3.30	2.030	.870	.280
20,000		F	7.10	9.20	8.30	3.50	2.040	.880	.310
22,000	500	F	7.20	9.40	8.80	3.70	2.030	.870	.300
30,000		F	7.20	9.60	9.30	3.90	2.040	.880	.320
36,000		F	7.30	9.80	9.70	4.10	2.040	.890	.340
39,000	250	F	7.30	9.90	10.0	4.20	2.050	.890	.350
68,000		F	7.40	10.3	10.9	4.50	2.050	.900	.370
100,000		F	7.40	10.5	11.5	4.70	2.070	.910	.440



## The Electro Motive Mfg. Co., Inc.

WILLIMANTIC, CONNECTICUT 06226

Dipped Mica • Molded Mica • Silvered Mica Films • Mica Trimmers & Padders  
Mylar-Paper Dipped • Paper Dipped • Mylar Dipped • Tubular Paper

West Coast Manufacturers contact:

COLLINS & HYDE CO., 900 N. San Antonio Rd., Los Altos, California 94022  
5380 Whittier Blvd., Los Angeles, California 90022

ALSO SOLD NATIONALLY THROUGH ARCO ELECTRONIC DISTRIBUTORS

INFORMATION RETRIEVAL NUMBER 71



If you need  
 a high quality **3½-digit**  
 V-O-M at your price . . .  
 buy **Triplett's** new **8035**

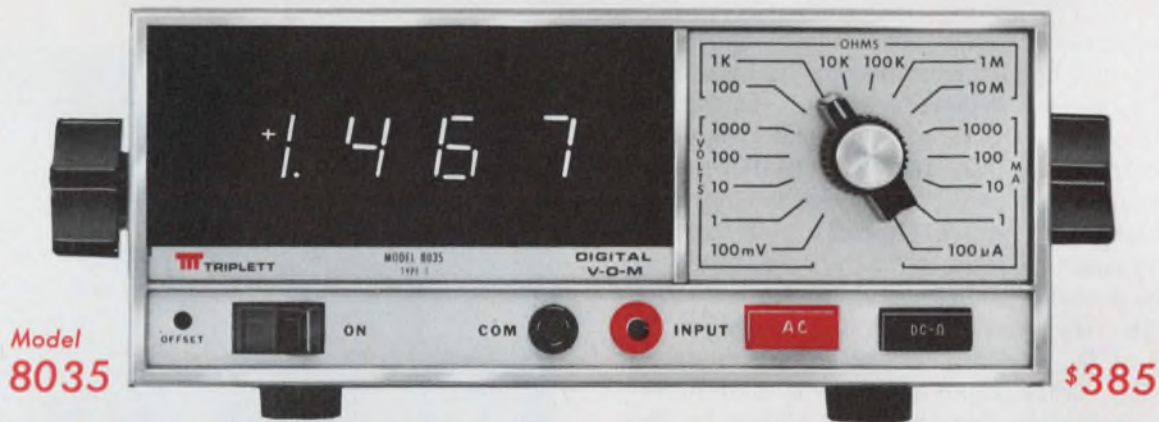

1. **EASY OPERATION** — Single polarized plug for test leads eliminates switching leads when changing functions.
2. **LOW POWER CONSUMPTION** — Less internal heating for greater stability and reliability.
3. **LOW CIRCUIT LOADING** — Greater measurement accuracy with 10 megohm input resistance for all AC and DC voltage ranges.

Designed for R&D, production, quality control, maintenance and classroom use, Triplett's new Model 8035 Digital V-O-M features an automatic polarity display, 100% overrange capability, out-of-range display blanking and high input resistance to make it nearly fool-proof.

With 26 ranges, the Model 8035 boasts accuracies from  $\pm 0.1\%$  to  $\pm 0.7\%$  of reading  $\pm 1$  digit . . . ranking it among the best on the market. Its green, polarized window and its single-plane, seven-bar, fluorescent display combine to insure bright, reflection-free readability from virtually any viewing angle.

Hardware for rack mounting is available.

See the **Model 8035**, priced at **\$385**, at your local distributor. For more information, or for a free demonstration of the convenience and accuracy of the 8035, call him or your Triplett representative. Triplett Corporation, Bluffton, Ohio 45817.

**TTT TRIPLETT**

The World's most complete line of V-O-M's  
 choose the one that's just right for you

# ideas for design

## Sensing amplifier stabilizes VCO frequency for temperature and supply variations

A voltage-controlled oscillator's sensitivity to temperature and supply-voltage variations can be reduced significantly if the oscillator is linked to a differential sensing amplifier. This technique does not increase circuit complexity or cost nearly as much as other stabilization techniques, such as zener diodes or compensating networks.

The sensing amplifier (Fig. 1) reduces the temperature coefficient of the VCO to as little as 0.01%/°C. A power-supply voltage variation of 10% causes an oscillator free-running frequency shift of 1.5%.

The voltage-controlled oscillator consists of two interlocked halves, each having its own positive feedback. One regenerative half is formed by transistors Q<sub>1</sub>, Q<sub>3</sub>, Q<sub>7</sub> and Q<sub>9</sub>; the other half is formed by Q<sub>2</sub>, Q<sub>4</sub>, Q<sub>8</sub> and Q<sub>10</sub>. Oscillation results when transistors Q<sub>7</sub> and Q<sub>8</sub> switch between their ON and OFF states (Fig. 2).

The frequency of oscillation is determined by the charging and discharging of timing capacitor C<sub>x</sub> through two sets of current sources at the collectors of Q<sub>11</sub> and Q<sub>12</sub>. These current sources, I<sub>Q11</sub> and I<sub>Q12</sub>, track input current I<sub>N</sub> and determine the oscillation frequency, as shown by the following equations:

For symmetrical operation,  $I_{Q11} = I_{Q12} = I_N$

and the frequency of oscillation can be expressed as:

$$f_o = \frac{I_N}{4 C_x \Delta V} \quad (1)$$

where  $\Delta V$  is the change in the collector voltage of Q<sub>1</sub> and Q<sub>2</sub>, and I<sub>N</sub> is the input current through Q<sub>13</sub>, as shown. In addition

$$I_N = (V_E - V_{BE(Q13)})/R_C \text{ when } V_N = 0, \text{ and}$$

$$\Delta V = \frac{(V_E - V_{BE(Q6)})}{R_B} R_L.$$

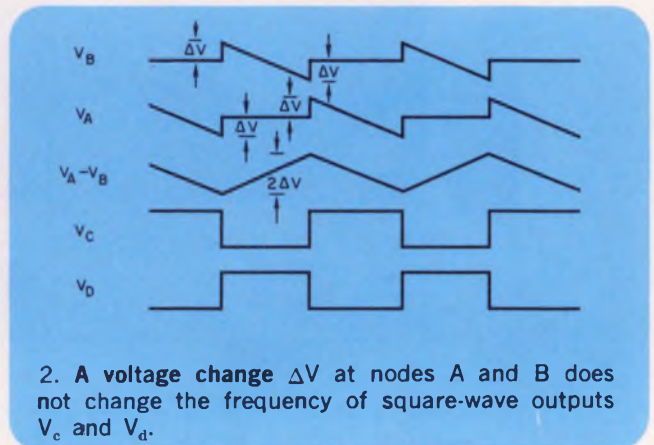

2. A voltage change  $\Delta V$  at nodes A and B does not change the frequency of square-wave outputs V<sub>c</sub> and V<sub>d</sub>.

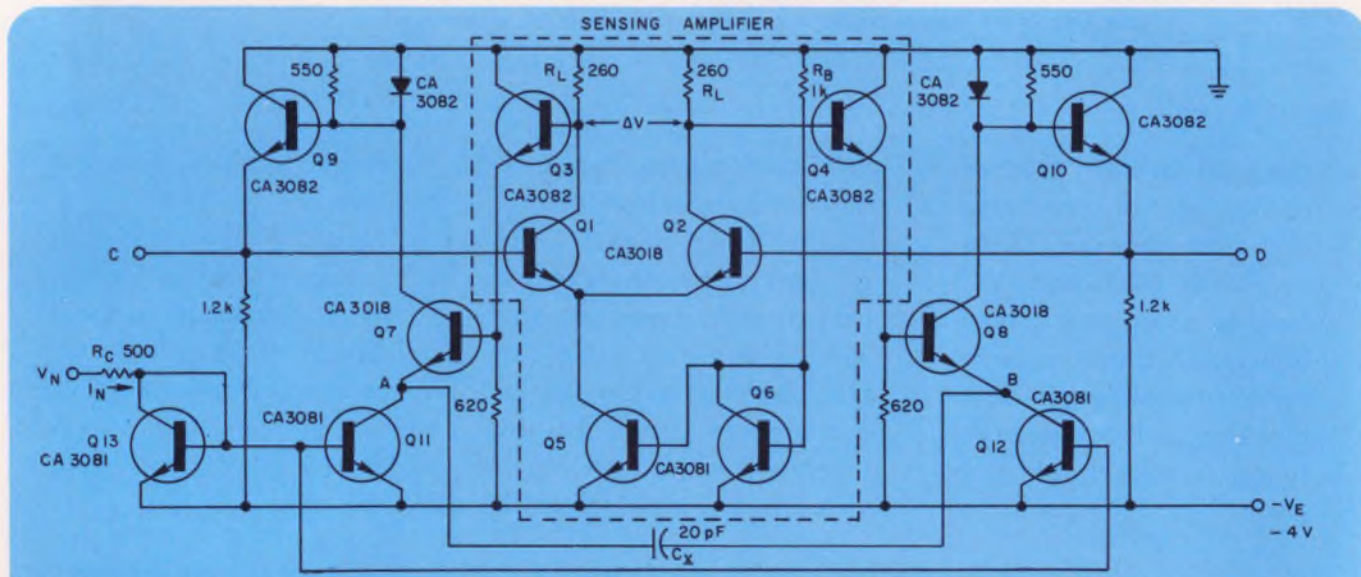

1. Sensing amplifier stabilizes free-running VCO frequency with variations in temperature and sup-

ply voltage. The transistor V<sub>BE</sub> and β characteristics must be matched for optimum performance.

# New from Helipot: the lowest trimmer profile in the business.

SHOWN ACTUAL SIZE

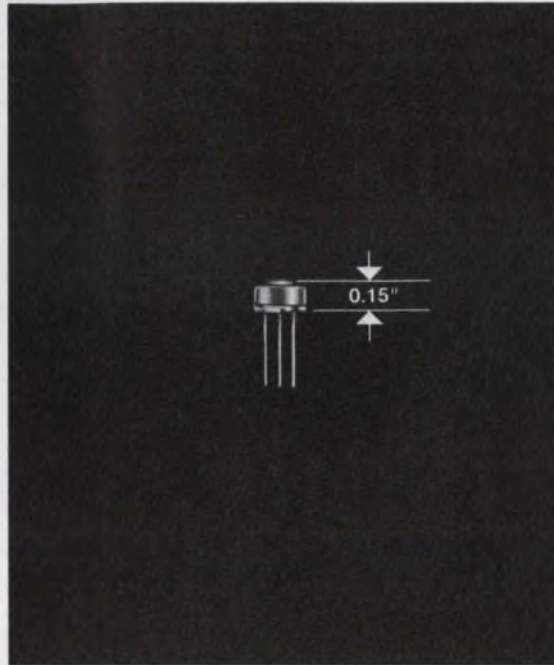

You can't do better than our Series 82 Trimmers for small size and low cost . . . and, of course, Helipot dependability. These  $\frac{1}{4}$ " single-turn, general-purpose cermet models have the lowest profile in the industry with a proven cermet resistance element that can be set to any voltage ratio within 0.05% of full scale. Sealed metal housings, solid stops, and essentially infinite resolution. They'll save you space—they'll save you money. (Our prices start at \$1.40 list.) Two good reasons to write for specs and prices today.

**Beckman**® INSTRUMENTS, INC.

**HELIPOT DIVISION**

2500 Harbor Blvd., Fullerton, Calif. 92634

HELPING SCIENCE AND INDUSTRY IMPROVE THE QUALITY OF LIFE

INFORMATION RETRIEVAL NUMBER 73

If we substitute these equations into Eq. 1, we get

$$f_o = \frac{1}{4 C_x R_c} \frac{R_B}{R_L} \frac{(V_E - V_{BE(Q13)})}{(V_E - V_{BE(Q6)})}$$

$$f_o \cong \frac{1}{4 C_x R_c} \frac{R_B}{R_L}, \quad (2)$$

where  $R_c$  is the gain resistor in the input control circuit and  $V_{BE13}$  and  $V_{BE6}$  are the nearly equal

diode voltages of  $Q_{13}$  and  $Q_6$ , respectively.

As shown by Eq. 2, the oscillation frequency is independent of the power-supply voltage,  $-V_E$ , and temperature variations, since it depends only on the ratio of resistors  $R_B$  and  $R_L$ .

*C. C. Liu and D. F. Cox, IBM General Products Div. Monterey and Cottle Rds. San Jose, Calif. 95114.*  
CIRCLE No. 311

## State of CPU determined at remote card reader

A transistor in saturation provides an indication of the state of a central processing unit at a remote location. The condition of the interconnection is also verified.

When a card reader or input terminal is connected to a CPU at a remote location, the condition of the CPU is not readily known. The problem is complicated by the necessity of distinguishing between three states of the CPU: OFF, ON-NOT READY, and ON-READY. In addition the long interconnecting wires can cause an appreciable resistance between the reader and the CPU.

In the circuit shown, resistors  $R_1$  and  $R_2$  have values selected to saturate transistor  $Q_1$  in the absence of a ground at the input. Any condition other than a ground at the input, such as during OFF or ON NOT-READY states, maintains  $Q_1$  in saturation. Since the base of  $Q_1$  is connected to the input, only a small current flows through the interconnecting cable. Diode  $CR_1$ , which

should be germanium, prevents a high input from causing damage. Inverter state  $Q_2$  turns on lamp  $L_1$  when  $Q_1$  goes out of saturation.

*Gordon Albert, Seaelectro Corp., Mamaroneck, N.Y. 10543.*  
CIRCLE No. 312

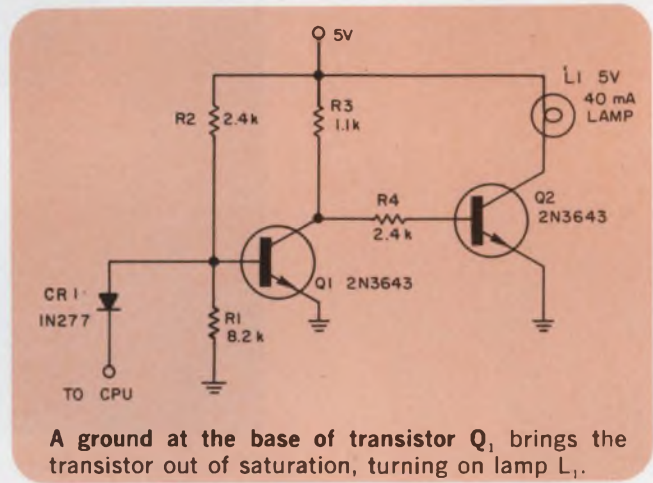

## Dc amp has automatic offset recovery

By occasionally sampling the offset voltage and subtracting it from the input, you can build a dc amplifier that will have a gain of 1000 and an over-all voltage drift of  $\pm 2$  mV over  $-55$  to  $125$  C. On a full-scale output voltage of  $\pm 10$  V, this is a drift error of  $\pm 0.2\%$  of full-scale.

Differential amplifier  $A_1$  acts as a square-wave oscillator, driving FET switches  $Q_1$  through  $Q_6$ . Since switches  $Q_1$ ,  $Q_2$ ,  $Q_3$  are on when switches  $Q_4$ ,  $Q_5$ ,  $Q_6$  are off, and vice versa, the input of the circuit either receives the input or is grounded.

When the input is grounded, the offset voltage of amplifier  $A_2$  is sampled. When switch  $Q_4$  is turned off, capacitor  $C_1$  maintains the voltage at output amplifier  $A_3$ . When switch  $Q_1$  turns on, removing the input ground, switch  $Q_2$  turns on. Thus the offset error is eliminated.

*Dr. Alberto Mezzogori, S.E.B., Via Savona, 97, 20144 Milan, Italy.*  
CIRCLE No. 313

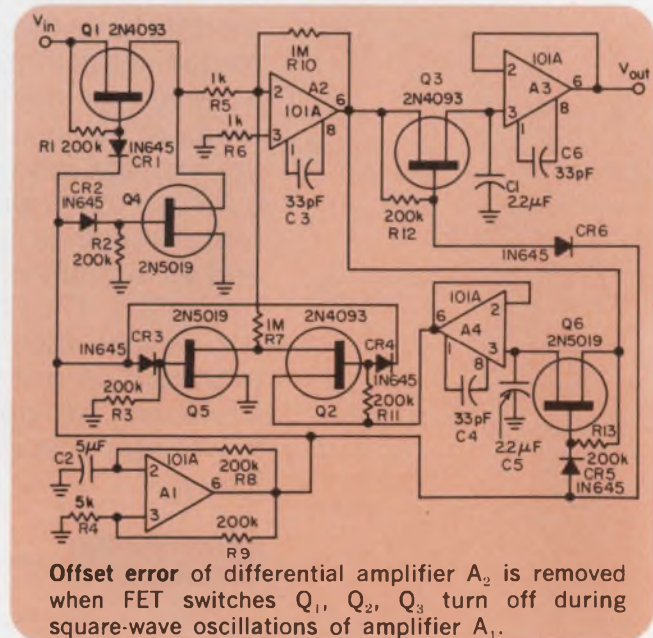

# OUR ANGLE: Low Cost D/S and S/D Modules



TYPICAL S/D MODULE SETS		
FUNCTION	LINE-LINE	FREQUENCY
S/D or R/D	11.8V	400Hz
R/D	26V	400Hz
S/D or R/D	90V	400Hz
S/D	90V	60Hz

TYPICAL D/S MODULE SETS		
FUNCTION	LINE-LINE	FREQUENCY
D/S or D/R	11.8V	400Hz
D/R	26V	400Hz
D/S or D/R	90V	400Hz
D/S	90V	60Hz

How does a choice of 14-bit resolution, 60 or 400 Hz data frequency, high accuracy, 11.8V to 90V line-line voltages and all kinds of self-protection circuitry look from your angle?

North Atlantic's Series 780 is available now. Only 5 modules make up a complete S/D or D/S converter, and any set nests in an area less than 21 square inches.

S/D specifications include 3 minutes  $\pm$  0.9LSB accuracy, and continuous tracking with low velocity errors. D/S specifications include 4 minute accuracy, 1.25 VA output and 25  $\mu$ sec settling time.

Key performance specifications for both converters include 14-bit (0.22°) resolution over 360°, 0-70°C operation and 4000°/sec data rates. Both units are DTL and TTL compatible.

To shrink your prototype schedule, we offer an interconnecting PC board. Or, if you plan to integrate a converter directly onto your own PC cards, we can supply proven mylar artwork.

Any set of modules — \$650. Order a set today. North Atlantic sales engineering representatives are located throughout the free world.



**NORTH ATLANTIC** industries, inc.

200 Terminal Drive, Plainview, New York 11803 Phone (516) 681-8600  
California District Office: 13418 Wyandotte Street, N. Hollywood, CA 91605; Phone (213) 982-0442

INFORMATION RETRIEVAL NUMBER 74

# Missing-pulse detector reacts to 100-ns pulse widths

An IC timer circuit detects missing pulses with widths as short as 100 ns. The input pulse train must have a frequency below 1 MHz.

To use the circuit of Fig. 1, first set its time delay to be slightly longer than the time between successive pulses of the input. This is done by deriving a value for capacitor  $C_1$  from the formula for the line delay:

$$t_1 = 1.1 R_A C_1$$

Transistor  $Q_1$  discharges capacitor  $C_1$  each time an input pulse occurs within an interval  $t_1$  of a previous pulse. If an input pulse fails to appear within  $t_1$  of a previous one—that is, when there is a missing pulse—the SE/NE 555 timer is allowed to complete its timing cycle. The output then switches to the negative state, indicating the missing pulse (Fig. 2).

A standard one-shot could be used instead of the SE/NE 555 timer. Suitable types include the 9601 or 74122/3.

The IC timer, however, has several key advantages over standard digital one-shots. The SE/NE 555 operates over a 5-to-15-V supply-voltage range, compared with 4.75 to 5.25 for the 74122/3. Also, the IC timer has an output drive of up to 200 mA—more than 10 times greater than for the 9601. The time-delay variation with supply-voltage and temperature changes is also improved by at least an order of magnitude with the SE/NE 555.

*Jack Mattis, Linear Product Marketing, Signetics, 811 E. Arques Ave., Sunnyvale, Calif. 94086.*

CIRCLE NO. 314

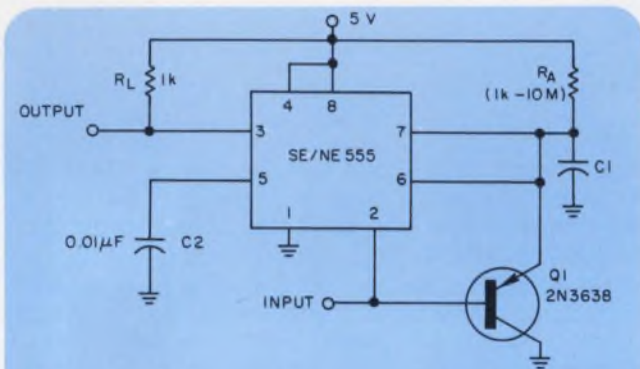

1. IC timer SE/NE 555 produces an output when an input pulse fails to occur within the delay of the timer. The time delay may be set by the value capacitor  $C_1$  to as little as 1 ms.

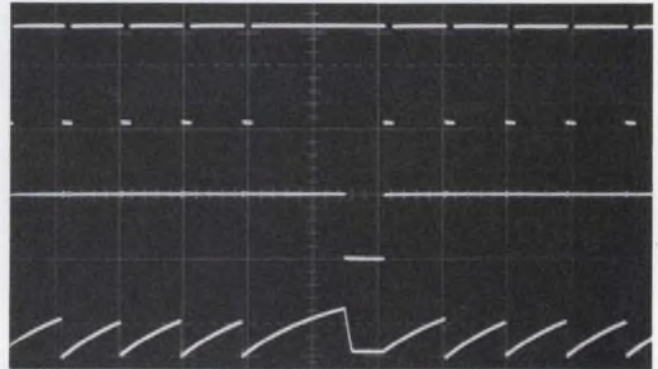

2. When the input signal (top) has a missing pulse, the output voltage (middle trace) changes state as the timing cycle is completed. This results from  $C_1$  charging (bottom). The voltage scale is 2 V/cm for the input and 5 V/cm for the output and capacitor voltages.

## IFD Winner of July 20, 1972

**L. Boiucaner**, Electrical Engineering Dept., University of the Negev, P.O. Box 2053, Beer Sheva, Israel. His idea "Use an IC voltage regulator in simple lab power supply" has been voted the Most Valuable of Issue Award.

**Vote for the Best Idea in this Issue**

**SEND US YOUR IDEAS FOR DESIGN.** You may win a grand total of \$1050 (cash)! Here's how. Submit your IFD describing a new or important circuit or design technique, the clever use of a new component or test equipment, packaging tips, cost-saving ideas to our Ideas for Design editor. Ideas can only be considered for publication if they are submitted exclusively to ELECTRONIC DESIGN. You will receive \$20 for each published idea, \$30 more if it is voted best of issue by our readers. The best-of-issue winners become eligible for the Idea of the Year award of \$1000.

ELECTRONIC DESIGN cannot assume responsibility for circuits shown nor represent freedom from patent infringement.

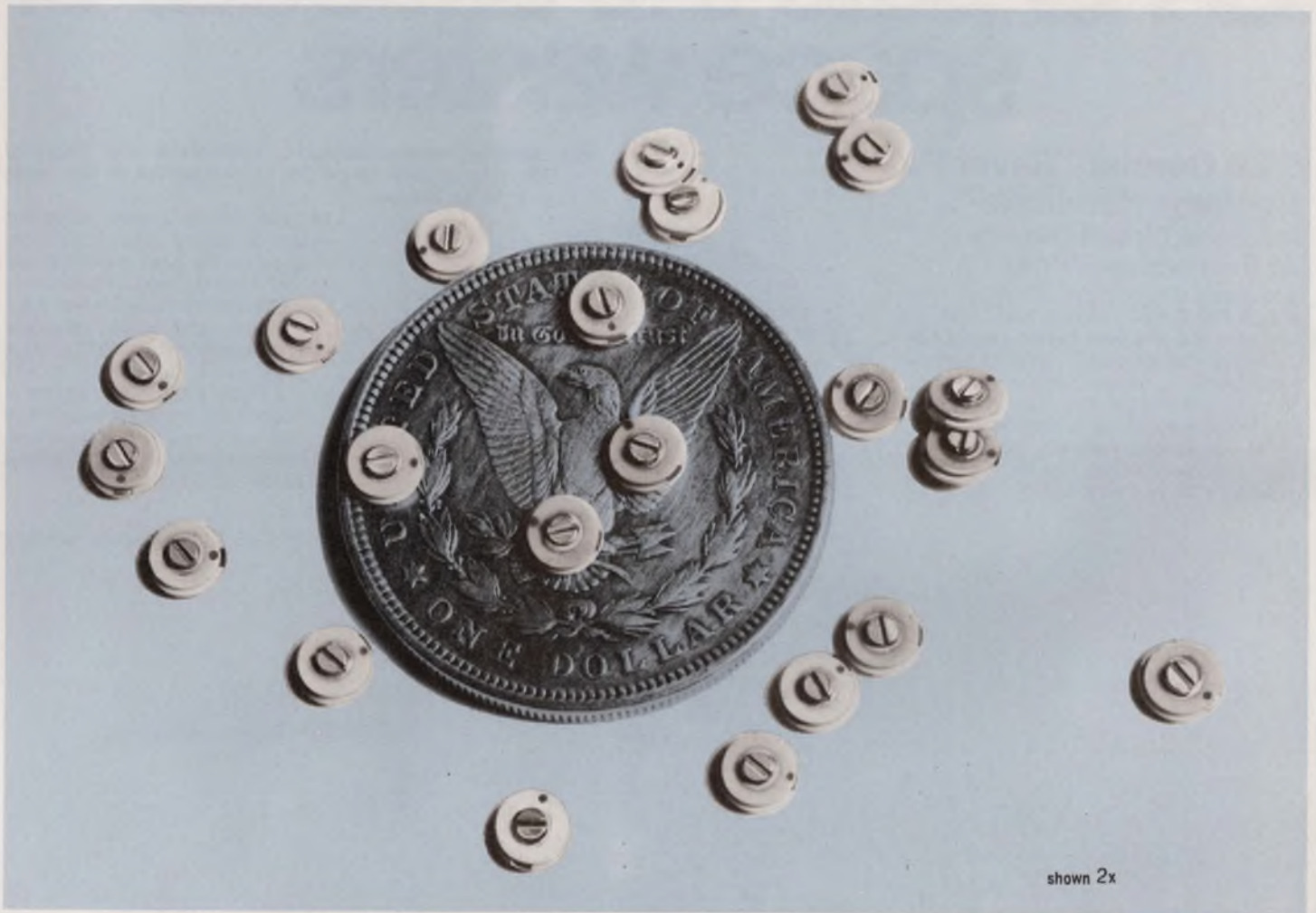

## Introducing the littler trimmer.

### Meet our new microminiature ceramic variable capacitor.

It provides maximum adjustable capacity for a given size—plus high reliability at low cost.

The DVJ5014 trimmer, with a height of .070 inches above the mounting surface, is only .245 inches in diameter yet matches the electrical performance of other capacitors many times its size. This trimmer features a slotted adjustment head.

Also available is the DVJ5009 series (with a height of only .045 inches above the mounting surface) featuring a flush adjustment head. In applications where cost rather than height is the prime consideration, use of the DVJ5014 is recommended.

Rotors for both models are constructed with a monolithic embedded electrode in a special pro-

prietary ceramic material and a stator body made from high alumina ceramic. These features provide a larger  $\Delta C$ , and higher reliability than previously available, as well as complete environmental stability.

The new JFD microminiature ceramic variable capacitors are well suited for printed or hybrid circuit mounting as well as other applications involving ceramic substrates, microminiature crystal oscillators, stripline assemblies, multiplex transceivers, telemetry oscillators and transmitters, frequency multipliers, and other subminiature electronic circuits.

That's quite a lot for a little trimmer.

Why trade off performance to get lower prices? For full details write or call us or your local JFD field engineer.

DVJ5009	ACTUAL SIZE	DVJ5014
Model		Capacitance Picofarads Min.-Max.
DVJ5009/10		3-10
DVJ5014/10		
DVJ5009/15		3.5-15
DVJ5014/15		
DVJ5009/20		4-20
DVJ5014/20		
DVJ5009/30		5-30
DVJ5014/30		

# JFD

A Riker-Maxson Subsidiary  
**JFD Electronics Corporation**  
 15th Ave. at 62nd Street  
 Brooklyn, N.Y. 11219

# CTS puts the squeeze on space wasters

## CTS Cermet "Saver Pac" Resistor Networks Increase Circuit Density ... At Economical Prices

Space comes *high!* So you'll like how much a CTS 750 Series "SAVER PAC" network can save you, and your circuit. Less space ... fewer components ... greater system reliability ... quicker, easier installation ... reduced handling costs ... and faster inspection. Consolidate up to 13 discrete resistors into one compact in-line resistor module. CTS can do it easily

with twenty standard packages ... available in .100", .125", or .150" lead centers. High power capabilities to 4.3 watts @ 70°C per module.

CTS 750 series cermet thick-film resistors assure proven performance—ultra high stability and reliability—backed by over 700,000,000 hours of test data. Hand install or use automatic assembly equipment...they're designed for either. Pick a SAVER PAC today. Large or small orders welcome. CTS of Berne, Inc., 406 Parr Road, Berne, Indiana 46711. Phone: (219) 589-3111.

INFORMATION RETRIEVAL NUMBER 76



**CTS CORPORATION**

A world leader in cermet resistor technology.

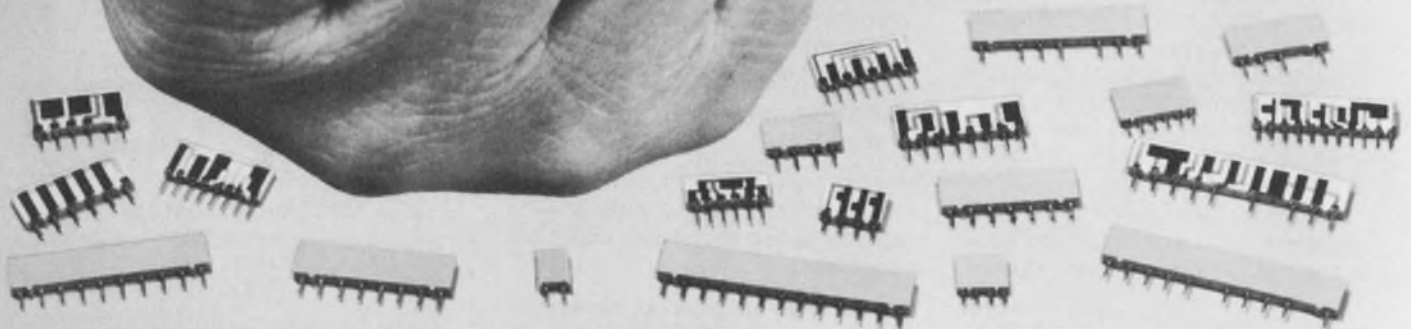



## new products

# Staggered two-level contacts give rugged, high-density connector

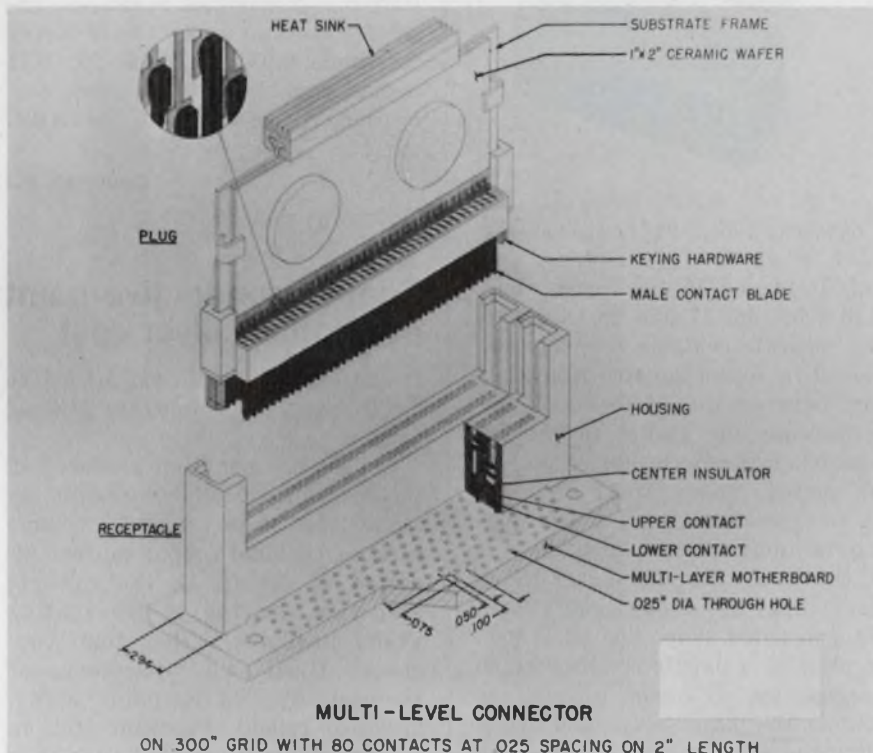

ON 300" GRID WITH 80 CONTACTS AT 0.25 SPACING ON 2" LENGTH

Elco Corp., Maryland Rd. and Computer Ave., Willow Grove, Pa. 19090. (215) 659-7000. \$12 (100 up); 60 days.

By using two levels of contacts mounted in different planes, an Elco substrate connector combines the ruggedness of a "tuning-fork" contact with the high density of costly miniature connectors.

The substrate attaches to a plug that has 80 contacts spaced 25 mils apart along one side of its two-inch length. The receptacle, which mounts on the mother board, comes with tails for either soldering to the PC board or for a solderless-wrap termination.

The contact design provides the high ruggedness. The male contacts, which are in the plug, have tines that connect to the contact pads on the substrate by thermo-compression bonding or reflow soldering. Each male contact has an upper and a lower tine to connect to either the upper or lower row of pads on the module substrate.

The male contact protrudes from the bottom of the plug as a blade, with a nose beveled for ease of entry into the receptacle. The male blade is 18 by 40 mils, which compares with the 20 by 50 mils of a tuning-fork connector blade. The ruggedness of the Elco connector is thus similar to that of the tuning-fork connector.

The female contacts, located in the receptacle, have noses basically of the tuning-fork type but with the two tines at different levels. The connecting link between the tines of the female contacts and their tails is slightly longer if the contact connects to an upper pad instead of a lower one. The upper level contacts are thus higher than the lower level ones within the receptacle.

The tail of the female contact may be 12 by 22 mils for soldering to a 25-mil-diameter plated-through hole of a multilayer PC board. Or it may be a 12-by-17-mil solderless-wrap extension. Though

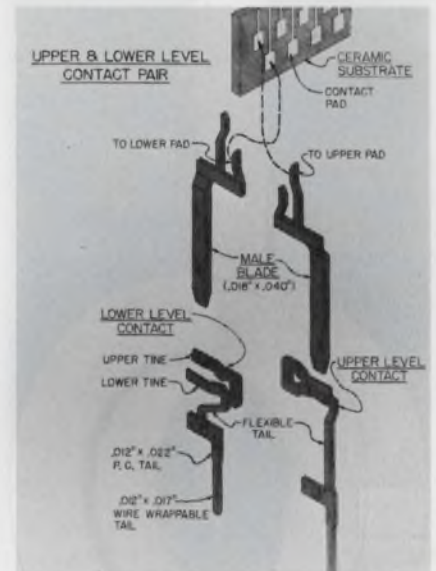

Male contacts, located in the plug, connect to either upper or lower pads on the substrate depending on their orientation. The female contacts below them reside in the receptacle.

a standard wrapped-wire tail is 25 mils square, Elco reports that its connectors can be used with automated wrapped-wire equipment.

The plug has a glass-filled nylon insulator that houses the male contacts in two rows, 50 mils between adjacent contacts of each row.

The substrate has contact pads in two rows, with 40 pads in each row, each pad 50 mils apart. Since the rows are offset, the spacing of the pads is actually 25 mils.

The receptacle is 294 mils wide to permit its mounting on a 300-mil grid. The 80 female contacts in the receptacle terminate in four rows of 20 contacts, with 100 mils between contacts and 75 mils between rows. The rows are offset by 50 mils.

Each row contains both upper and lower-level female contacts. This contact density is presently found in other commercial connectors, but they lack the ruggedness of Elco's tuning-fork contact construction.

CIRCLE NO. 251



# temp·r·tape

of teflon\*

Because Teflon has one of the slipperiest surfaces known, everything slides off Temp-R-Tape. Temp-R-Tape withstands severe environmental conditions. The electrical characteristics are excellent and remain constant through a temperature range of -100 F. to +500 F. It has excellent conformability and the silicone polymer pressure-sensitive adhesive makes it easy to apply and remove.

CHR's Temp-R-Tape line offers the industry's widest variety of types and sizes of pressure-sensitive Teflon tape.

Stocked by a national network of CHR distributors capable of technical assistance and fast delivery. Look in Yellow Pages under "Tapes Industrial" or in major industrial directories under CHR. Or write for a free sample to The Connecticut Hard Rubber Co., New Haven, Connecticut 06509.

\*TM of DuPont

# CHR

a HITCO company

INFORMATION RETRIEVAL NUMBER 77

## PACKAGING & MATERIALS

### DIP sockets work with no separate contacts



Jermyn, 712 Montgomery St., San Francisco, Calif. 94111. (415) 362-7431. \$0.45 (100 up); stock.

DIP 14 and 16-pin sockets, Nos. A23-2055, 56, 57 and 58, eliminate the separate contacts normally employed in socket construction. Contact between the IC legs and pins connecting the socket to the PC board is made by means of gold or tin plated copper areas deposited on the plastic body by a new plating technique. The plated body is in the form of a saddle over which the IC legs are slipped and located in open sided slots. The IC is held in place by a plastic retainer which presses the IC legs inwards to contact the plated areas and firmly locks the IC in place. No insertion force is required.

CIRCLE NO. 252

### Silver epoxy features 10:1 ratio mix

Epoxy Technology, Inc., 65 Grove St., Watertown, Mass. 02172. (617) 926-0136. \$18/oz.; stock.

Epo-Tek H21D is a silver epoxy claimed to be the first to have silver powder dispersed in both the epoxy itself and the hardener. This results in a convenient 10:1 ratio mix that is much less critical than in other two-part silver epoxies. Another important feature of Epo-Tek H21D is that it can be stored at room temperature, thus eliminating the need for special low temperature storage facilities. The 100% solids system contains no solvents or thinners and can be screen printed even after eight hours without the need of adding solvents or thinners.

CIRCLE NO. 253

### Relay socket panel has solderless-wrap pins

Midtex Inc., 10 State St., Mankato, Minn. 56001. (507) 388-6286.

The Series 203 19-inch NEMA standard panel assembly accepts Type 157, 3PDT, 5 or 10 A relay or Type 113 solid state time delay relay. Up to nine sockets can be mounted per row, with from one to four row assemblies available. The solderless-wrap sockets have eleven terminals  $0.031 \times 0.062 \times 0.75$  inches, capable of up to three connections of No. 20 to 26 AWG wire.

CIRCLE NO. 254

### Copper conductive paint overcomes silver cost

Paso Chemicals s.r.l., via Michelino da Besozzo, 16 - I.20155, Milano, Italy.

Copper has not been produced in the form of a conductive paint because the high surface volume ratio of colloidal copper causes oxidation to set in as the solvents evaporate, leaving a dry coating which insulates rather than conducts. Until the discovery of Pasoram. Applied like paint (spray, brush or roller), Pasoram dries to a conductivity 10 times better than graphite, at a cost which is a mere fraction of silver paint.

CIRCLE NO. 255

### Rack, panel connector withstands 15 kV, 10 A

Capitron, Div. of AMP Inc., 1595 S. Mount Joy, Elizabethtown, Pa. 17022. (717) 367-1105.

Designed for the "blind mating" encountered in drawer-type packaging, a high-voltage rack and panel connector features a tapered lead-in that makes exact alignment unnecessary. Internal design is such that bottoming of the plug is not required for proper mating and there is no need for a stop to accurately control the closed position of the rack. Rated at 15 kV dc up to 70,000 ft., the gold-plated 10-A pin and receptacle contacts are recessed in deep insulating shrouds for maximum safety.

CIRCLE NO. 256

# This is no time for popcorn noise...

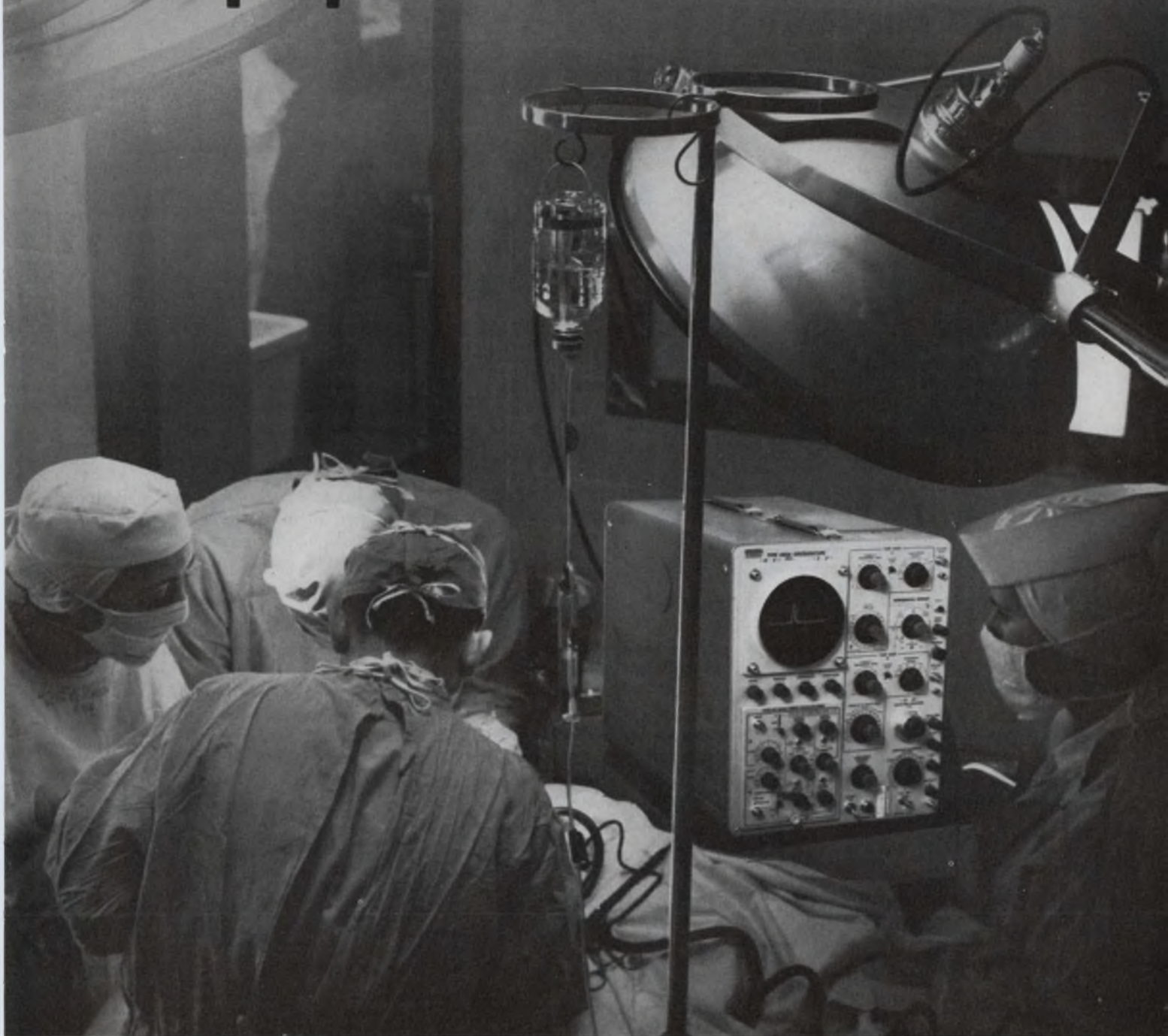

In fact, no time is acceptable for Popcorn (burst) noise, if you're designing a system to handle extremely small signals.

So RCA is announcing a new micropower, low noise operational amplifier. It's a designer's dream.

Our unique process gives you a monolithic silicon op amp that not only exhibits low burst noise but operates from a single 1.5-volt cell with a power consumption of 1.5 microwatts.

How low is the noise? Every CA6078AT op amp that leaves RCA must operate with equivalent

input burst noise less than 20 $\mu$ V (peak) at  $R_s = 200,000$  ohms.

That's not all, the CA6078AT features output short-circuit protection through built-in output resistors, input voltage range ( $\pm 15$ V max. for  $\pm 15$ V supply) wide dif-mode range ( $\pm 6$ V), and low offset-voltage nulling capability.

So go ahead! Design the CA6078AT into your system... and relax. Because you can be certain that with the new RCA micropower op amp, no time is acceptable for popcorn (burst) noise.

Want more data on the

CA6078AT or CA3078AT (the low cost version of the CA6078AT for less critical applications) or the CA6741T, RCA's low-burst-noise 741? See your RCA Representative or Distributor and ask for Technical Bulletins, File No. 530 and 592 and Application Note ICAN-6732. Or write RCA Solid State, Box 3200, Somerville, N.J. 08876. Phone (201) 722-3200.

**RCA** Solid State  
products that make products pay off

# Terminal combines clip action with wrapped-wire termination

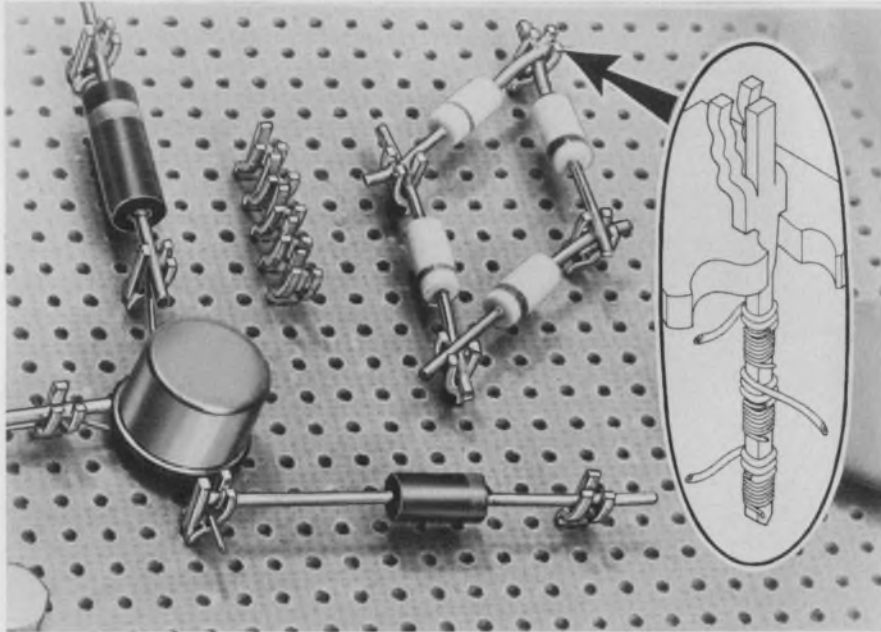

Vector Electronic Co., 12460 Gladstone Ave., Sylmar, Calif. 91342. (213) 365-9661. See text; stock.

A new breadboarding terminal combines the advantages of a 0.025-inch-per-side-square wrapping post with a clip-action upper

end that will hold component leads having diameters from 0.010 to 0.040 in.

Called the T-49 Trifurcated Terminal by Vector Electronic, the device, at its upper end, provides solid three-point contact to hold component leads for testing and

checkout. The three-pronged clip allows wires and component leads to be held in the terminal prior to soldering. The clip will accept wires from three different directions.

T49 terminals are available with either tin and gold plating on spring-tempered phosphor bronze.

The terminals are intended for use with 0.042-in.-diameter circuit-board holes. The holes may be placed on centers as close as 0.2 in. A \$2.50 hand tool, called the P156, installs the terminals so they can withstand the torque of an automatic wire-wrapping machine. When installed in a 1/16 in.-thick circuit board, a full 1/2-in. post is available for connection of up to three wires.

A strip form of the terminal for semiautomatic machine installation will be available in three to six months.

Prices of the terminals are \$20 a thousand tin-plated and \$27 a thousand gold-plated.

Free samples of the terminal are available.

CIRCLE NO. 250

## Casting resin features nonabrasive properties

Hysol Div., The Dexter Corp., 211 Franklin St., Olean, N.Y. 14760. (716) 372-6300.

Soft filled EE1029 epoxy casting system is designed for use in mixing and metering equipment and other applications requiring nonabrasive properties. The system resists jet fuel, gasoline and other solvents when cured with hardener H2-3404. It has a compressive strength of 17,000 psi and a flexure strength of 15,000 psi. The coefficient of linear thermal expansion, in/in/C (30 C to 90 C) is  $42 \times 10^{-6}$  as tested with method ASTM D 696.

CIRCLE NO. 257

## Zinc paint prevents rust without galvanizing

Force Chemicals Div., American Solder & Flux Co., Inc., Industrial Blvd., Paoli, Pa. 19301. (215) 647-3575.

Almost pure zinc protection can be applied to metal surfaces, without hot-dip galvanizing, either by aerosol or brush. DryGalv deposits a dense, zinc-rich coating that acts as a sacrificial cathode to protect metals from corrosion. One gallon covers 400 square feet with a 95% zinc-rich coating 2.5-mils thick. DryGalv dries to a mat gray color in 15 to 30 minutes and will withstand temperatures up to 250 F. A 2.5-mil coating has 95% zinc.

CIRCLE NO. 258

## Polycarbonate resin offers foam economy

General Electric Co., Plastics Dept., One Plastics Ave., Pittsfield, Mass. 01201. (413) 494-4803. \$0.80/lb.; stock.

Lexan FL-900, a polycarbonate resin family, combines the engineering properties of standard injection molded Lexan resin with the inherent advantages and economies of structural foam. At -40 F its impact strength is still 90% of its value at room temperature. An inherently high flexural modulus of about 300,000 psi allows parts to be designed thinner, lighter and less expensively without sacrificing product performance.

CIRCLE NO. 259

# *The things we can do with small lamps should interest you.*

*One reason to buy Tung-Sol lamps is because you can get all the miniature and subminiature types you need from one source. More importantly, the quality will be the highest that 75 years of experience can produce. And as a major supplier for original equipment, we have learned how to produce large volume without sacrifice of quality.*

*But, if you really want value in your application of Tung-Sol lamps, let our engineers help you while your product is in the prototype stage.*

*Tung-Sol lamps that are specially encapsulated to eliminate the conventional base and socket, might simplify your production, improve your product reliability,*

*or even just plain save you money. For more specific information, write, describing your requirements.*

**Lamp Sales**  
**WAGNER ELECTRIC CORPORATION**  
630 W. Mt. Pleasant Avenue  
Livingston, N.J. 07039  
TWX: 710-944-4865  
Phone: (201) 992-1100  
(212) 732-5426

® TRADEMARKS WAGNER AND TUNG-SOL, REG. U.S. PAT. OFF. AND MARCAS REGISTRADAS



# **WAGNER**

### Wrapped-wire board has lowest socket profile

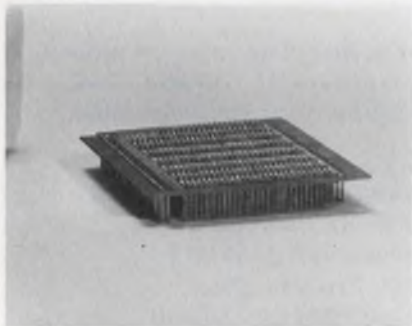

Robinson-Nugent, Inc., 800 E. 8th St., New Albany, Ind. 47150. (812) 945-0211.

Allochiral, a solderless-wrap interconnect board, features an above board profile height of 25 mils—the lowest in the industry. Competing boards have profile heights as low as 30 mils. The tradeoff is short IC lead lengths of 35 mils or longer. Allochiral is designed for high-volume automated component insertion.

CIRCLE NO. 260

### Terminal blocks are wrapped-to-wrapped wire

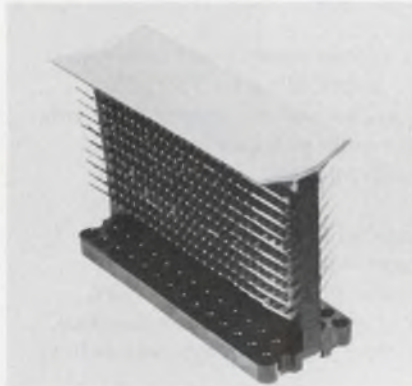

ADC Products, Inc., 4900 W. 78th St., Minneapolis, Minn. 55435. (612) 835-6800.

ADC 20-pin "Christmas Tree" terminal blocks offer up to 12 rows of 26 solder-to-solder or wrapped-to-wrapped wire terminals. Molded of thermo-set plastic, the terminal blocks meet MIL Spec MIL-F-14F. Terminals are brass, electroplated with tin alloy.

CIRCLE NO. 261

### Wrapped-wire IC sockets have replaceable pins

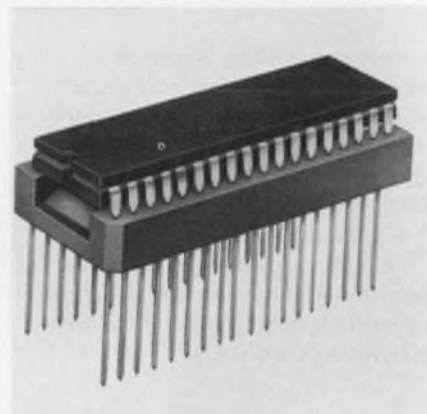

Cambridge Thermionic Corp., 445 Concord Ave., Cambridge, Mass. 02138. (617) 491-5400.

Replaceable pin IC sockets are available for two-wrap and three-wrap or standard pins to fit sockets which accept 14, 16, 18, 24, 28, 36 and 40-pin dual-in-line packages. Terminal size is the standard 25-mil square.

CIRCLE NO. 262



### FREE YOKE SELECTION KIT

Information you need to know about selecting and specifying a precision yoke for your CRT display. Indicates the interaction between circuitry, CRT and yoke. Includes an application checklist to simplify your work. Send for your kit.

SYNTRONIC INSTRUMENTS, INC.  
100 Industrial Road Addison, Ill. 60101 (312) 543-6444

**syntronic**



INFORMATION RETRIEVAL NUMBER 80

### INTRODUCING THE EA 1502 BIPOLAR COMPATIBLE 1024-BIT RAM

The EA 1502 is another new addition to the growing line of N-Channel silicon gate products from EA. The EA 1502 accepts TTL inputs without external level shifting and sinks 1.6 mA on the output. It has an access time of typically 130 nanoseconds and dissipates only 115 mW (typical). In fact, in a systems configuration the EA 1502 outperforms the so-called high performance versions of the 1103, with lower power, bipolar compatibility, automatic refresh and low cost to boot! Oh yes, there's no address cycling requirements either. A single write pulse refreshes all data independent of the state of the address and chip enable inputs. Place your order early, everyone else is. \$27.50 in 100 quantities.

To make it easier for you to evaluate our EA 1500 series RAM's, we have an evaluation P.C. board available which contains all of the necessary interconnections for building a 2K by 4 memory. Ask about it!



501 ELLIS STREET  
MOUNTAIN VIEW, CALIFORNIA 94040  
(415) 964-4321 TWX 910-379-6985

Stocking distributors: Burstein-Applebee Company, Computer Components, Cramer



# MORE FROM THE VERY SAME FOLKS WHO BROUGHT YOU N-CHANNEL SILICON GATE.

INFORMATION RETRIEVAL NUMBER 81

ELECTRONIC DESIGN 24, November 23, 1972

## Coax switching jacks span 10 W to 500 W

*Kings Electronics Co., Inc., 40 Marbledale Rd., Tuckahoe, N.Y. 10707. (914) 793-5000. \$100; 6 to 8 wks.*

A line of coaxial switching jacks ranges from 10 W to 500 W power handling into a 50  $\Omega$  impedance and provides excellent rf characteristics through 1 GHz. Inputs can be "K-Loc," or types "N," "BNC" or "TNC." Typical specifications through uhf range are: insertion loss—0.2 dB max.; VSWR—1.1 to 1; and cross talk—40 dB min.

CIRCLE NO. 263

## PC-flat cable connector uses cable for contacts

*Teledyne Kinetics, 410 S. Cedros Ave., Solana Beach, Calif. 92075. (714) 755-1181.*

In the TKC Series "K" PC connector, the connector body and flat multiconductor cable are a single unit. Solder joints are eliminated, since each conductor in the cable serves as its own contact. Electrical and mechanical connections are made simultaneously. Contact spacing may be as close as 10 mils.

CIRCLE NO. 264

## Connector has crimp contacts, moisture seal

*Hughes Connecting Devices, 500 Superior Ave., Newport Beach, Calif. 92663. (714) 548-0671.*

An electrical connector provides moisture-sealing capability not previously attainable with crimp-removable contacts. The C-21 series connectors feature a sealing technique to provide environmental performance greater than the most stringent military specifications. The C-21 connector uses individual pressure-sensitive seals attached to each contact—one at the rear where the wire is attached to the contact, and the other at the interface between the pin and the socket. Both seals are designed so that a pressure differential between the inside and outside of the connector—normally a cause of sealing failure—serves to improve the seal.

CIRCLE NO. 265

Reliability. Our patented Grand Prix sleeve bearing design is rated at 12 years operating life (at 54°C). It's cool running and quiet. A unique capillary seal eliminates lubricant seepage. Rugged all-metal construction won't warp, resists breakage and acts as an effective heatsink.

Cooling power. PeWee delivers more air at higher back pressures — 22 cfm at .10 inches of water, 30.5 at .06 inches, 36 cfm in free air.

Whatever the equipment — rack panel, tape deck, power supply, counter, or memory stack, where space is at a premium and cooling critical, PeWee Boxer performs.

Other airmovers? Of course! Send for our full-line catalog No. ND4r. It's free, and contains performance data, electrical and mechanical specifications on more than 100 units. Valuable application information too.

For immediate service, contact us at **IMC Magnetics Corp., New Hampshire Division**, Route 16B, Rochester, N.H. 03867, tel. 603-332-5300. Or the IMC stocking distributor in your area. There are more than 50 nationwide and overseas. **IMC. We're reliable.**

**The Tiny Giant. It's 3 $\frac{1}{8}$  inches square by  $\frac{1.655}{1.635}$  inches slim. The only fan its size delivering 36 cfm. IMC's PeWee Boxer.**

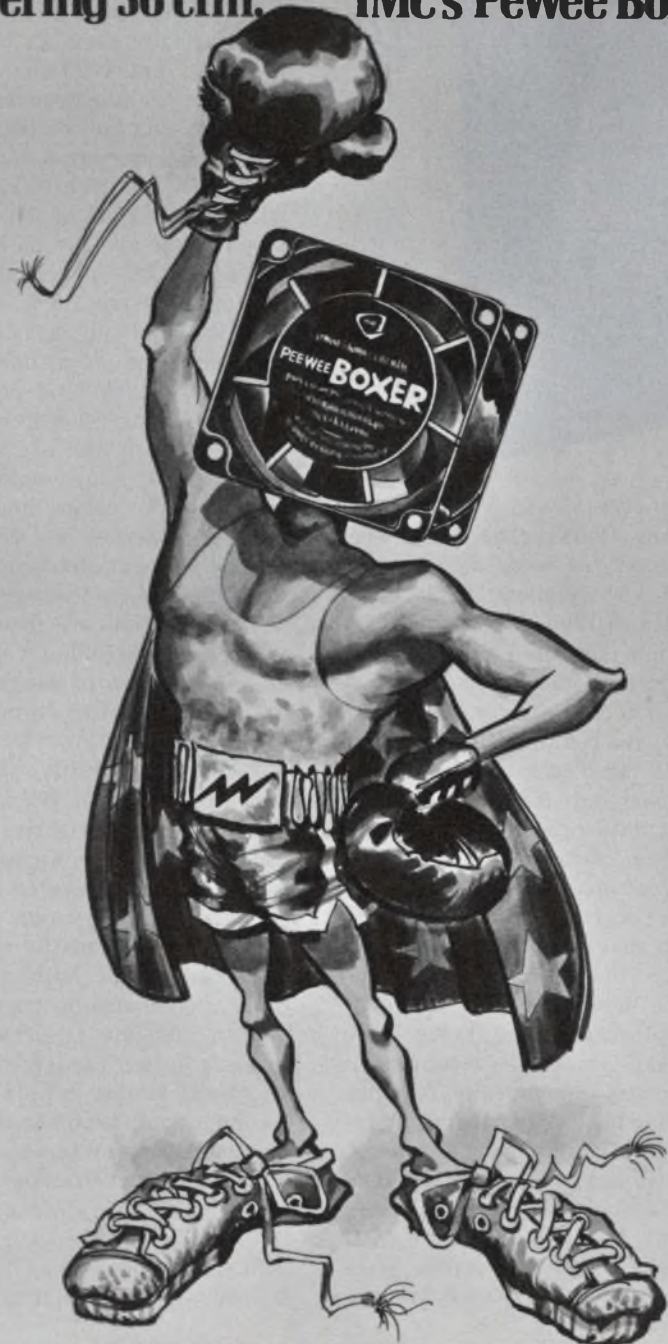

# Dual-processor mini performs many communications tasks



Microdata Corp., 644 E. Young St., Santa Ana, Calif. 92705. (714) 540-6730. \$8500 for basic system, less common core memory; 60-90 days.

The Micro 1600/60 processor can do the job of a data concentrator, front-end processor, store and forward switcher and many other communication subsystems. Its dual-CPU architecture permits the separation and independent handling of data processing and communication control tasks, while retaining complete interaction between them. Its high data capacity (40,000 char/sec) permits it to serve up to 256 communications channels, which is sufficient for most applications. And its low basic cost makes a small communications system economically feasible, while allowing for expansion as requirements increase.

The two independent Micro 1600 CPU elements share a common main core memory. The first CPU serves as a general-purpose data processor. Its Model 1600/30 micro-

program control causes the processor to fetch and execute macro-level instructions previously written by the user and stored in the core memory.

The second CPU serves a more dedicated function. Its operation is directed by firmware. This replaceable firmware is called the Communications Operations Module (COM), Model 1600/70, and automatically services the communications links. These data channels can be synchronous or asynchronous and full or half duplex.

The microprogram controller for each CPU is a high-speed ROM with a cycle time of 200 ns. Microinstructions are 16-bits long. While the first CPU is directed by programmed instructions, the second CPU is completely self-directed and references the main core only when looking-up tables or commanding the storage or reading of data for other parts of the system. An interrupt link allows each CPU to interrupt the other, and the common core serves as the transfer channel for data and control information between the two CPUs.

The common-core memory has a 1- $\mu$ s cycle time, 400-ns access time, an eight-bit word length and the basic size is 8192 words, expandable to 65,536.

Each CPU has its own I/O data and control lines. Because of the specialized nature of the COM firmware, only communications interfaces may be connected to the second CPU I/O system. The first CPU is more versatile and its I/O lines can accept both communications and general-purpose peripherals. In addition it permits direct memory access for transfer of data at speeds to one-million bytes per second from peripherals such as disc memories or tapes.

Dial-up asynchronous modems, Model 2613 (eight-channel) and 2613-1 (four channel), are available as options. They provide independently programmable charac-

teristics for each channel with rates from 110 to 9600 baud in ten standard values. Other programmable selections are one or two stop bits, and five to eight character bits with odd or even parity.

Asynchronous terminals, such as teletypewriters that use current-loop transmission or dedicated lines of the RS-232C type, should use the Model 2614 (eight-channel) or 2614-1 (four-channel) option. Baud rates and formats are selectable by jumper-wires.

And for synchronous terminals the company offers the Model 2600 modem, also adjustable for speed and format (to 9600 baud and with five to eight-bit characters) by jumpers.

Automatic dialing of both synchronous and asynchronous channels is accommodated through the Model 2630 interface and a Bell 801 automatic call unit.

CIRCLE NO. 266

## Incremental plotter has 36-inch width

Houston Instrument, Div. of Bausch & Lomb, 4950 Terminal Ave., Bellaire, Tex. 77401. (713) 667-7403. 45 days ARO.

Model DP-7 is a 36-inch incremental plotter which can slew continuously at 1800 increments/sec. Each increment is 0.0025 inch wide. One to three automatically selectable colored or plain pens can be used. The pens provide a rectangular trace. For off-line use, there is the Model MTR-4 nine-track 800 bit/in. buffered magnetic-tape reader. Its features include forward and reverse block search and a hardware vector generator. Both units will be available shortly after the first of the year on a 45-day ARO basis.

CIRCLE NO. 267





It takes a very smart bird to make an electronic package design fly. The kind of searching, sharp-eyed bird who beats his wings hard. Who soars high with new ideas. And lands on a nest of problems with sharp solutions.

If you're that kind of electronic packaging design engineer, we want you to know about Winchester Electronics 42 Series Input/Output Connectors. What's so special about them? They're not just advanced and reliable. They're the surest, most convenient, most adaptable way to interconnect busy, multi-wired cables. Even in tight places. With 42 Series Connectors, you can plug in to a back panel. To a printed circuit board. To an instrument panel. Or to another cable. And you'll plug in 50 or 74 high density input/output interconnects at one time. Anywhere, we repeat, in the package you want. It all happens neatly. Compactly. With minimum weight. In line with MIL-E-5400 airborne requirements.

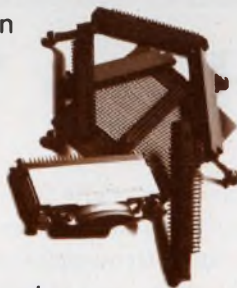

Another point, now. In a sense, you're really the designer of your own 42 Series Connectors. Because just about any variation you want, to suit your package design, is possible.

Beginning with moldings of diallyl phthalate offering 50 or 74 .100 centers high density

positions for pin and socket contacts. With 24 center row positions to use for polarizing pins, if you want them. With polarizing guides. With fixed, short turning or long turning jack-screws. And with anodized aluminum hoods.

You specify whatever kind of pin and socket contacts your particular design, prototype, production and field servicing require, too. Dip solder contacts for printed circuit board interconnections. Solder cup for wire. Or crimp removable contacts.

For extra design freedom. Greater choice in circuitry. Ease in modification. And simple, lower cost field servicing.

The 42 Series Input/Output Connectors from Winchester Electronics. Great to help your design fly. Compute. Count. Control. Remember. Or do any job you want it to do.

Great to help you complete your design in one fell swoop. Without getting into a flap.

For complete data and specifications, contact: Winchester Electronics Group, Main Street & Hillside Ave., Oakville, Conn. 06779. (203) 274-8891



**WINCHESTER ELECTRONICS**

# Centralab Ultra-Kap™ capacitors... in line with your design requirements



Write  
Centralab  
for  
Bulletin  
No. 1106CA3

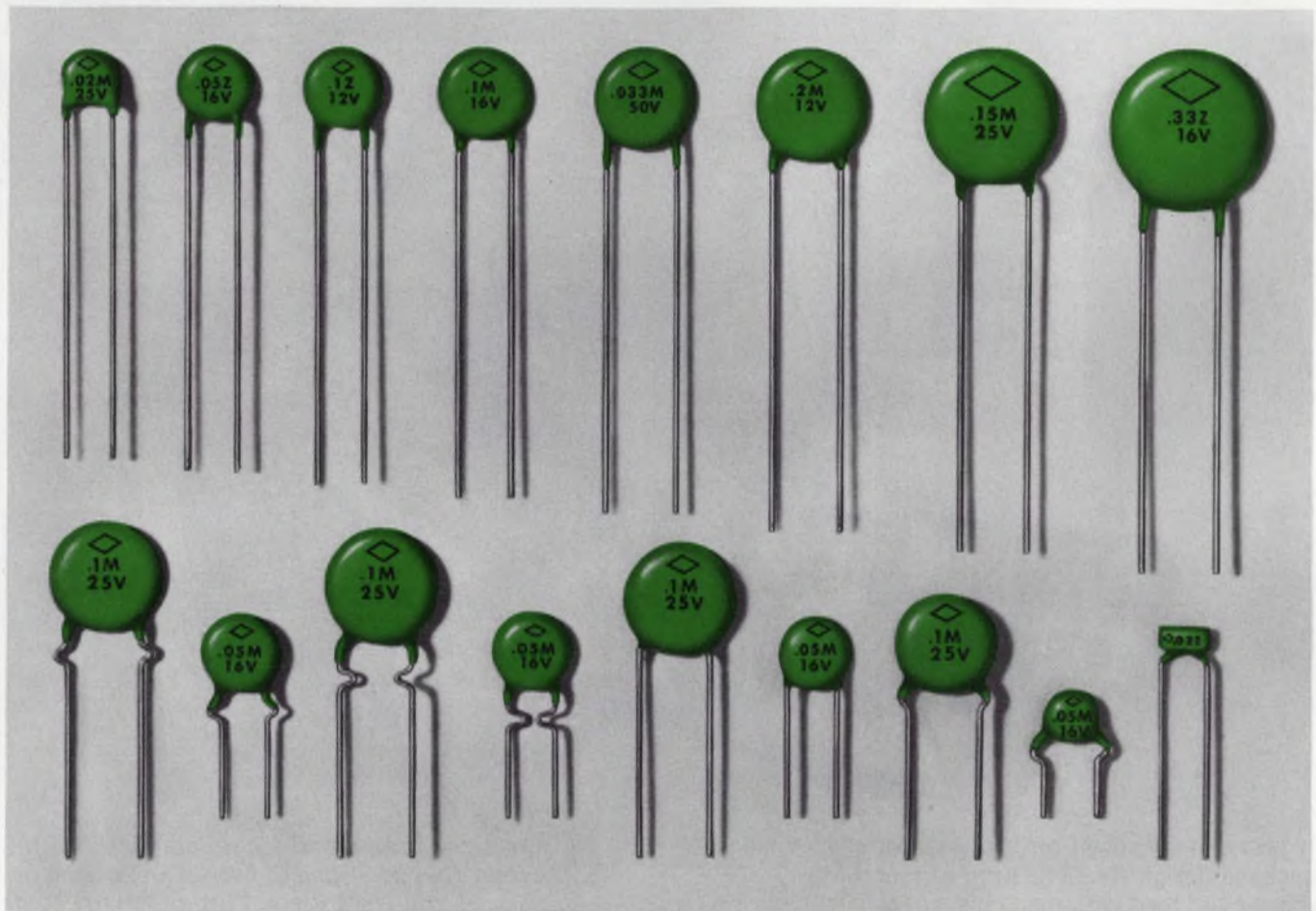

## The standard for Y5F stability

Y5F stability: a maximum capacitance change of  $\pm 7.5\%$  from  $+25^\circ\text{C}$  over a temperature range of  $-30^\circ\text{C}$  to  $+85^\circ\text{C}$ . It's standard performance with Centralab Ultra-Kap™ capacitors.

Ultra-Kap provides an economical alternative to more expensive Mylar® and multi-layer monolithic types. With the Ultra-Kap you get all the function at lower cost. Our recent improvements in design and process assure you of the smallest size for the rating.

So if you're looking to save space, Ultra-Kap 12, 16, 25 and 50 volt types should be the first capacitors you specify.

They meet such important design

parameters as low dissipation factor and high insulation resistance. Ultra-Kap operating frequencies of up to 1 MHz make them ideal for use in power, audio, IF and other low voltage circuits. They're available with a choice of lead size and configuration, and in a selection of coating controls. For special ratings, sizes and shapes, ask about our in-depth design capability.

The standard Ultra-Kap is the stability standard of the industry. Make it yours too! For specifications and performance curves on the complete line, including the 3 volt types, write Capacitor Sales Manager, Centralab.

### GET CENTRALAB THE "IN" LINE FOR YOUR DESIGN

Hybrid Microcircuits  
Pushbutton & Rotary Switches  
Capacitors  
Potentiometers  
Technical Ceramics  
Ceramic Packages  
Semiconductor Devices



**CENTRALAB**

Electronics Division  
GLOBE-UNION INC.

5757 NORTH GREEN BAY AVENUE  
MILWAUKEE, WISCONSIN 53201

# Centralab Distributors set the standard for immediate delivery



Centralab Distributors set the standard for immediate delivery of the complete line of standard ceramic capacitors. Call your Centralab Distributor for just one or thousands. It's the fastest way to get from design to finished product.

Choose from low voltage, transistor circuit, general purpose, high voltage, Gap-Kap<sup>TM</sup>, and Ultra-Kap<sup>TM</sup> ceramic disc capacitors. Available with voltage ratings from 3 V to 6000 V, in values from .75 pF to 2.2 mF.

Your Centralab Distributor also stocks other highly reliable, special purpose ceramic capacitors including feed-thru, variable trimmer and transmitting types. And, he's your source for a wide range of polystyrene capacitors and miniature electrolytics in both axial and PC lead styles.

So when you look for immediate delivery, look to your Centralab Distributor first. For a complete catalog of Standard Centralab Ceramic Capacitors, see your Distributor or write Centralab Distributor Products, Dept. CC-1.

DISTRIBUTOR PRODUCTS



**CENTRALAB**  
Electronics Division  
GLOBE-UNION INC.

INFORMATION RETRIEVAL NUMBER 85  
ELECTRONIC DESIGN 24, November 23, 1972

## DATA PROCESSING

Graphics terminal  
features ASCII keyboard



*Tektronix, Inc., P.O. Box 500,  
Beaverton, Ore. 97005. (503) 644-  
0161. \$4950 (software extra).*

Tektronix Model 4012, with a RS-232-C compatible interface, provides a full complement of ASCII upper and lower case alphanumeric. Features include a TTY-style keyboard, a bright graphic cursor and PLOT-10 software compatibility. This software provides graphic displays for most mini-computers as well as the IBM 360/370 lines. All peripheral accessories of the Tektronix 4010 family, such as the hard copy unit, are compatible with the 4012.

CIRCLE NO. 268

## Controller interfaces eight disc drives

*Telefile Computer Products, Inc.,  
17785 Sky Park Circle, Irvine,  
Calif. 92664. (714) 557-6660.  
\$17,500; 60 days.*

Telefile's Model DC-32 disc controller can interface up to eight IBM 2311 or 2314 compatible drives with Xerox's Sigma 5 or 7 computers. Features include 32 bytes of buffering, verification of track location, error checking and a single command for multiple-record read or write. The programming language requires a repertoire of ten commands. The controller provides all power needed by the discs.

CIRCLE NO. 269

# HIGH LEVEL DOUBLE- BALANCED MIXERS

Great Value at

# \$15<sup>95</sup>

in 5-piece quantities.

DC-500MHz  
6dB conversion loss  
40dB isolation  
up to +10 dBm  
signal input  
EMI shielded case



A breakthrough in technology and high production volume enables Mini-Circuits Laboratory to offer these new products at an unprecedented low price.

In today's tough competitive market can you afford not to use these remarkably low priced and high performance units?

Ruggedness and durability are built in the SRA-1H. These new units are packaged within an EMI shielded metal enclosure and hermetically sealed header. They use well matched hot-carrier diodes and uniquely designed transmission line transformers.

We invite you to convince yourself. Place your order now and check our delivery, product performance and reliability.

## Mini-Circuits Laboratory

2913 Quentin Rd., Brooklyn, N.Y. 11229  
(212) 252-5252, Int'l Telex 620156  
A Division Scientific Components Corp.

FRANCE: S.C.I.E., \*31, rue George-Sand, Palaiseau  
91, France. GERMANY, AUSTRIA, SWITZERLAND:  
Industrial Electronics GmbH, \*Klüberstrasse 14,  
6000 Frankfurt/Main, Germany \*UNITS IN STOCK

INFORMATION RETRIEVAL NUMBER 86

**Decision:** Assume you need an alterable, non-volatile memory in your system, what choices do you have *right now*? And at what *true* and *complete* cost-per-bit?

Cores and plated wire—patchboards—diode arrays? Fine. Providing you need lots of memory—and you're not concerned about size, bulk and speed. Or power consumption. Or compatibility with existing and future logic forms. Or the additional cost of power-fail detection circuitry, or retrieval software and reload hardware—and the like.

*Let's talk*

**Cost-per-Bit**

Semiconductor memories? If you go with RAMs your bit cost per se may be lower. But you'll have to consider the extra cost of providing an uninterruptable power source. Or power-fail detection circuitry and battery back-up. Or retrieval software and reload hardware. Just to compensate for their inherent volatility.

If you consider ROMs—either the fixed or one-shot programmable variety—your cost-per-bit for memory alone could be even lower. Until you start adding up all the extra peripheral costs involved in trying to overcome their inherent unalterability. Simulation systems. Special masks and programmers. Surplus capacity for unused future options. Not to mention multiple spare parts inventories, field retrofits, obsolete stock, and spoilage due to errors.

So where do you go from there? *Take a good look at RMMs!*

**AMORPHOUS RMM**  
**ALTERABLE / NON-VOLATILE SEMICONDUCTOR MEMORIES**

They're the only *inherently* non-volatile, *fully* electrically alterable semiconductor memories in production—*now!* You can use them just like any other hard-wired memory elements—but without having to buy and build a bunch of superfluous circuitry into your system just to protect stored data or correct program errors.

In fact, you can take Ovonic RMMs completely out of your system—for days, weeks, years at a time—without loss of data. And you can also change, up-date and re-alter stored information at will. Quickly, selectively and *repeatedly*—by simple electrical means.

Easy to apply, too. Standard packages. TTL/DTL compatible. Compatible with each other. Which means you can mix or intermix them any way you like to create flexible, expandable memory systems to meet present and future needs—*exactly!*

Cost-per-bit? Still a bit more than RAMs or ROMs on a straight device comparison basis.

But considering the fact that bit cost is the *only* cost with RMMs, you'll find they're worth it! Important, too: RMM costs have dropped dramatically in the past 18 months and haven't reached bottom yet. So if you start using them now, your true bit costs will be a lot less by the time you hit volume production.

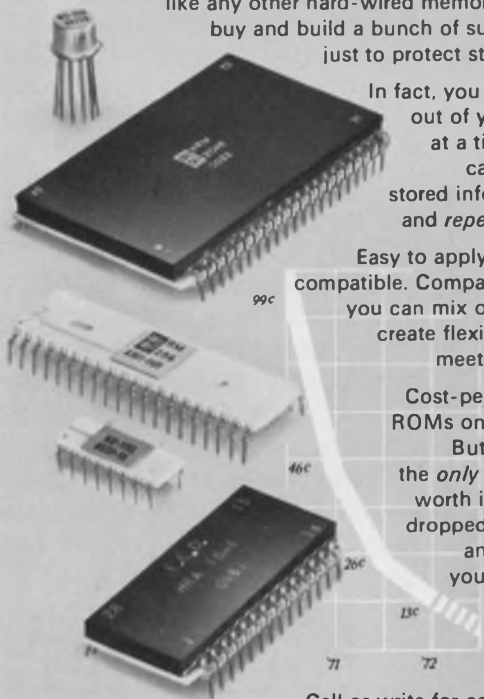

Call or write for complete information today!

**Energy Conversion Devices, Inc.**  
1675 WEST MAPLE ROAD • TROY, MICHIGAN 48084  
TELEPHONE 313/549-7300



**New line printer spews out 8000 lines/minute**



*Electro Print Inc., 10061 Bubb Rd., Cupertino, Calif. 95014. (408) 255-6100.*

Electro Print's Model EPI-100 uses electrostatic ink deposition in a dot matrix to attain a quiet 8000 line-per-minute printing speed. A maximum of 136 characters can be printed on one line with a spacing of 10 per in. Lines are spaced at 10 per in., while the print width can be varied between 3.5 and 16 in. Model EPI-100 prints on ordinary fanfold paper, in a number of upper and lower case fonts, graphics or foreign languages. It can be used off-line or on-line. Controllers for interfacing with major computer manufacturers' equipment will be available later.

CIRCLE NO. 270

**New tape heads reduce circuit requirements**

*Nortronics Co., Inc., 8101 Tenth Ave. N., Minneapolis, Minn. 55427. (612) 545-0401.*

Nortronics LTC and NFG digital heads operate at speeds up to 300 ips with densities of 6400 bits FRCI, or 3200 bit/in. phase-encoded. The maximum bit transfer rate is 960 kHz. A unique head profile maintains head-to-tape contact and therefore eliminates the need for electronics to compensate for forward/reverse output-signal changes. In addition, the 1/2-in. heads are suitable for self-threading systems and are IBM compatible.

CIRCLE NO. 271

## Card units for minis come with interface

Media III, 2454 E. Fender Ave., Fullerton, Calif. 92631. (714) 870-7660. \$2595; stock to 30 days.

Model 251X card input systems consist of a 600 or 1000 cards/min industry-compatible card reader and a complete interface with all connecting cables. Documentation and software are supplied with each system. Standard models are offered for the following minicomputers: Nova (Data General), PDP11 and 8/E/L/I (Digital Equipment Corp.), Models 316 and 516 (Honeywell), Models 2100, 2114, 2115 and 2116 (Hewlett-Packard) and Models D112 and D116 (Digital Computer Controls).

CIRCLE NO. 272

## Minicomputer performs hardware multiply-divide



Electronic Processors, Inc., 5050 S. Federal Blvd., Englewood, Colo. 80110. (303) 798-9305. \$4490 (unit qty.).

The number of standard instructions has been increased to 92 in the Model EPI-218 minicomputer. Memory size is  $4096 \times 18$  bits. The mini features items such as two 18-bit accumulators, a three-bit accumulator, 24 register manipulation instructions and instructions for 3-bit digits and half words. Addressing can be direct, indirect, or relative. A high speed direct memory access channel (optional) operates at a 16.4 Mbit/s burst rate. The core memory, with a cycle time of 960 ns, can be expanded to 32 k. LEDs are used for all panel displays.

CIRCLE NO. 273



ALL THIS  
IN THE SERIES BX

# BOX SWITCH

- **UP TO 4 POLES OF SWITCHING**  
1-A, 1-C, 2-C & 2-A in this MOMENTARY ACTION pushbutton Switch (or D, F or G contact forms on special order).
- **INTEGRAL SLIDE CONTACTS**  
Silver-plated spring-tempered phosphor bronze contacts rated 250 ma., 30 watts max., A.C. non-inductive load.
- **ADJUSTO-CLIP\* PUSH-IN MOUNTING**  
Instantly adjustable clips for front-of-panel "snap-lock" mounting; for panels  $3/64"$  to  $17/64"$  thick.
- **BEST LOOKING BEZEL IN THE BUSINESS**  
Low silhouette bezel pleasingly frames switch button; acts as an attractive escutcheon plate.
- **SUPER SPACE SAVING SIZE**  
Mounts in matrixes on  $11/16"$  centers in either of two planes. Takes only  $1\frac{1}{8}"$  behind panel depth.
- **CYBERNETICALLY DESIGNED BUTTONS**  
Handsome finger-fitted concave design: choice of white, black, red, green — other colors and/or identifying legends on special order.  $7/64"$  button stroke.
- **MOLDED BODY ENCLOSES CONTACTS**  
Protects against dust and dirt . . . prevents bending or disfiguring contacts caused by excessive handling. Terminal identification molded into case.
- **AND INCOMPARABLE QUALITY, TOO!**  
Built with the very finest materials manufactured in perfectly matched molds . . . with the "solid" feeling action you expect only from the most precisely engineered switches! Ideal for computers, data processors, telephones and telephone equipment, etc.

U. S. Patent No's  
3,446,467 & 3,419,696

WRITE FOR BULLETIN 169

## SWITCHCRAFT®

5529 N. Elston Avenue Chicago, Illinois 60630

INFORMATION RETRIEVAL NUMBER 88

### Modem operates at 4800 bit/s over dial-up lines

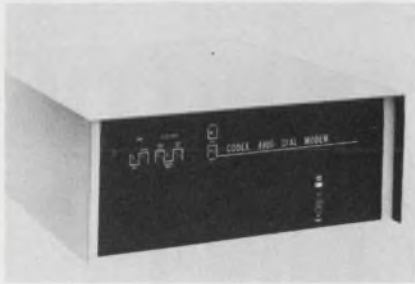

Codex Corp., 15 Riverdale Ave., Newton, Mass. 02195. (617) 969-0600.

The modem Codex 4800 operates at 4800 bit/s over ordinary switched telephone lines. Two separate simplex versions provide transmit-only (Model 4820) and receive-only (Model 4821) service. A half-duplex version (Model 4830) has a turnaround time of 40 ms. A reverse channel option on the 4830 provides full-duplex, asymmetrical single-line operation. Other features include automatic equalization and provisions for eye-pattern monitoring.

CIRCLE NO. 274

### X-Y recorder plots two traces at one time

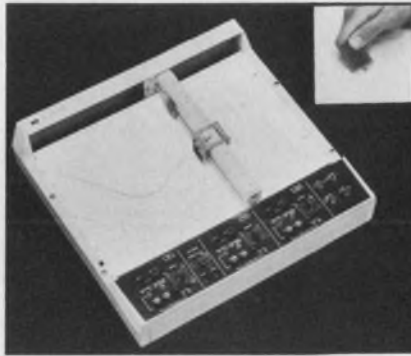

Hewlett-Packard Co., 1501 Page Mill Rd., Palo Alto, Calif. 94304. (415) 493-1501. \$2650; 11 wks.

The Model 7046A X-Y plotter can plot two signals at one time. The two pens can come as close as 0.05 in. The Y-axis acceleration exceeds 2500 in./sec<sup>2</sup> and the X-axis is 1500 in./sec<sup>2</sup>. Slew speed is 30 in./sec with less than 1% of full scale overshoot. A cast-aluminum main-frame protects against rough handling. Other features include: input ranges from 0.5 mV/in. to 10 V/in. at 1 MΩ, peak input to 500 V dc, and a writing area 10 × 15 in.

CIRCLE NO. 275

### Voice-response system uses synthetic speech



Master Specialties Co., 1640 Monrovia, Costa Mesa, Calif. 92627. (714) 642-2427.

Designed especially for the telecommunication industry, the ANA provides an audible voice message containing a series of up to seven digits. The synthesized voice is permanently stored in MOS read-only memories. The ANA can be interfaced with computers and other digital or analog equipment. The audio output is 250 mW into a balanced 600 Ω line. Digital or analog inputs are accepted. The unit consumes 15 W at 45 V dc and measures 10 in. by 10 in. by 11-1/2 inches high.

CIRCLE NO. 276

## It's Got Power!



Servo-Tek's engineers developed this permanent magnet D-SERVOMOTOR for high torque and wide speed range with minimum cogging.

- 12.7 watts @ 8600 rpm
- 0-10,000 rpm Range
- Torque Peaks @ 20 Oz-in., 2 Oz-in., Continuous
- Small, Lightweight
- Various Models Available

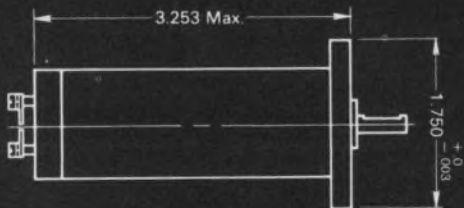

Ask for a copy of our NEW catalog.

## SERVO-TEK® PRODUCTS COMPANY

1086 Goffle Road, Hawthorne, N. J. 07506 • 201 — 427-3100  
 Servo-Tek of California, Inc.  
 8155 Van Nuys Blvd., Van Nuys, California 91402 • 213 — 786-0690  
 INFORMATION RETRIEVAL NUMBER 89

# SCR TRIGGER

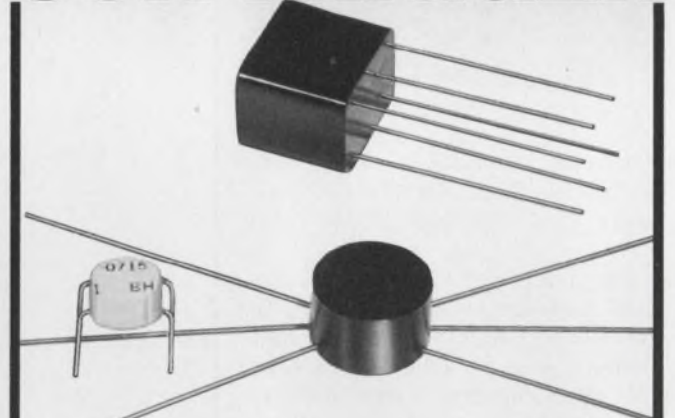

Three case styles: open, enclosed or encapsulated.  
 Insulation resistance: 1600 or 2500 VRMS, 60 Hz.  
 Primary Inductance: 250 uH to 20 mH.  
 Leakage Inductance: 5 uH to 200 uH.  
 Interwinding capacitance: 20 pF to 50 pF.

Call or write for more information on standard or custom trigger transformers, and some good news about fast delivery.

**BH Electronics, Inc.** A SUBSIDIARY OF **bmc**  
 245 EAST 6TH STREET • ST. PAUL, MINNESOTA 55101  
 612/228-4443 BUCKBEE-MEARS COMPANY

## Remote terminal performs many tasks

Pertec Corp., Dept. 1000, 9600 Irondale Ave., Chatsworth, Calif. 91311. (213) 475-8464. See below.

The DT1000 can be used as a remote job entry or batch terminal, a data entry key station or for media conversion. In its simplest form, the terminal is comprised of a data-entry keyboard, mode-selection control panel, display panel, IBM 2770-compatible communications electronics and a magnetic tape drive. Other input/output peripherals include a card reader, paper tape reader, a line printer and a serial printer. The binary synchronous method of communication is used with a maximum rate of 19,200 b/s. Unattended answer-back is also included. The conversion capabilities include paper-to-magnetic tape, card-to-tape, tape-to-tape and off-line printing. OEM prices for the basic configuration range from \$4000 to \$6000.

CIRCLE NO. 277

## New calculator uses BASIC language



Wang Laboratories, Inc., 836 North St., Tewksbury, Mass. 01876. (617) 851-7311.

Wang Model 2200 uses BASIC as the language for programming and operation. It displays 16 lines of 64 characters on its cathode ray tube. The keyboard provides single stroke keys for all BASIC commands, 32 user-function keys and standard mathematical-function keys. Functions are computed to 13 digit accuracy with a range of  $10^{-99}$  to  $10^{99}$ . The calculator has a 4096-step storage capacity, expandable to 32-k instruction steps, in 4096-step increments. Diagnostic and debugging features are included. A cassette driver for program and data storage, and an electric typewriter for hard copy are optional.

CIRCLE NO. 278

# Which of these General Electric lamps can help you most?

## New Green Glow Lamp!



Finally, a broad spectrum bright green glow lamp from General Electric, that gives you greater design flexibility than ever before. It emits green and blue light with suitable color filters. It is called G2B.

What's more, the G2B is directly interchangeable electrically and physically with our high-brightness C2A red/orange/yellow glow lamp.

So you can use the G2B alone for 120 volt green indicator service. Or together with the C2A to emphasize multiple functions with color. For example: for safe/unsafe functions, dual state indications and to show multiple operations in up to 5 colors.

And remember. Both the G2B and C2A save you money because of their low cost, small size and rugged construction.

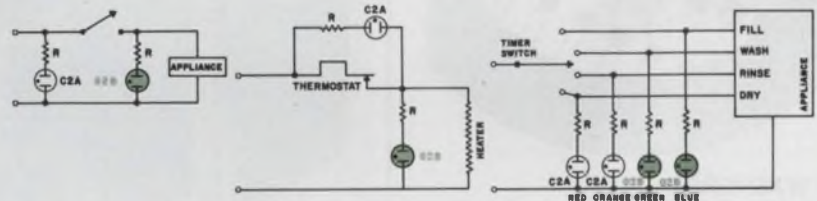

## New Sub-Miniature Wedge Base Lamp.

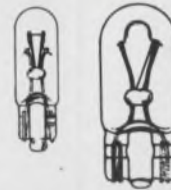

If space for indicator lights is your problem, this new GE T-1 1/4 size all-glass wedge-base lamp is your solution. It measures less than 1/4" in diameter.

The filament is always positioned

in the same relation to the base. It won't freeze in the socket, which virtually ends corrosion problems. And like its big brother — the T-3 1/4 wedge base lamp — it features a simplified socket design.

## Three Potent Infrared Solid State Lamps (LEDs).

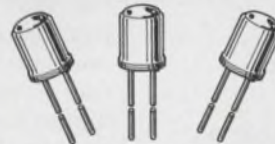

Get more than twice the useful output of other GE solid state lamps with GE SSL-54, SSL-55B and SSL-55C.

The increased energy concentrated in a narrow 20° cone allows you to use less sensitive detectors. Or to operate the lamps at lower current. Or to space lamps and detectors

farther apart.

All are excellent matches for GE photodetectors and can be used in many photoelectric applications. They're also particularly useful in applications demanding an infrared source capable of withstanding severe shock and vibration.

To get free technical information on any or all of these lamps, just write: General Electric Company, Miniature Lamp Products Department, Inquiry Bureau, Nela Park, Cleveland, Ohio 44112.

**GENERAL ELECTRIC**

INFORMATION RETRIEVAL NUMBER 91

# HIGH QUALITY LOW-COST THERMISTORS

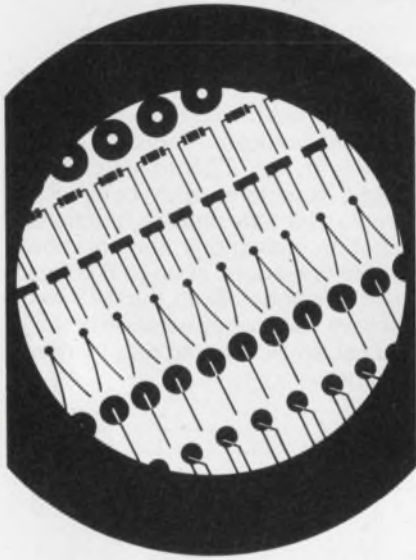

## WASHERS

To handle large amount of power

## RODS

Low/medium and high temperature coefficients

## LOW-COEFFICIENT

Discs or rectangular rods

## CRYOGENIC

For operation in liquid oxygen, nitrogen, hydrogen and helium

## DISCS

With radial, opposite or crossed leads

## MOLDED-IN-LEAD BEADS and RODS

Small size... low price

## GLASS BEADS

Protection from hostile environments—fast response

## PROBES AND ASSEMBLIES



Special design for temperature measurement and liquid level sensing

Write for 8-page Thermistor data bulletin T-501

**Keystone**  
CARBON COMPANY

Thermistor Division  
St. Marys, Pa. 15857  
Phone: 814/781-1591

INFORMATION RETRIEVAL NUMBER 92

## INSTRUMENTATION

# 4-1/2-digit DPM uses 5 V and has floating input

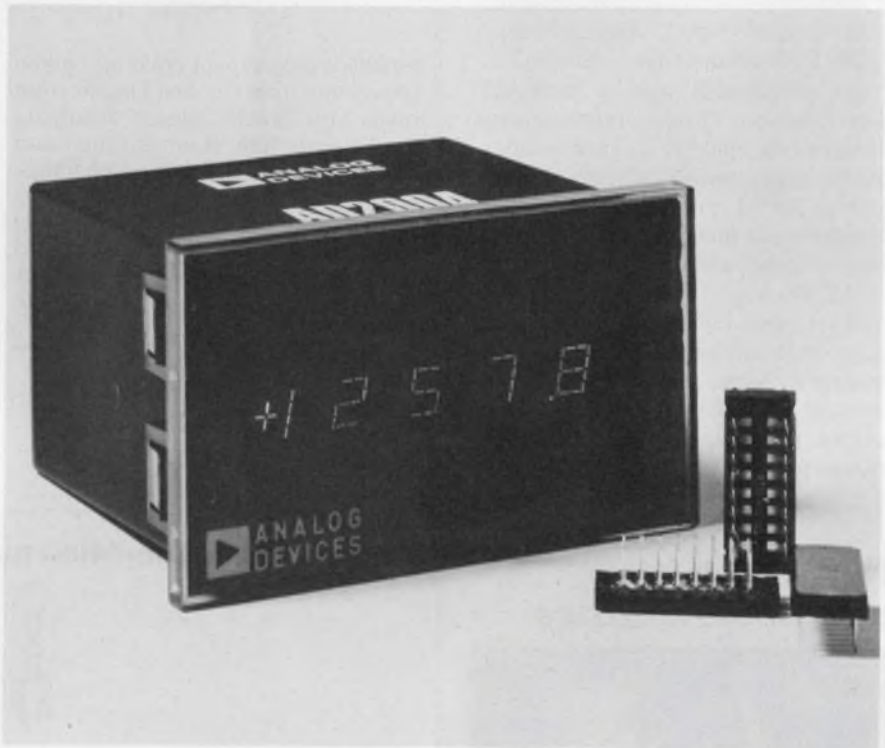

Analog Devices, Route 1 Industrial Park, Norwood, Mass. 02062. (617) 329-4700. Under \$200 (100s); 30 days.

Analog Devices continues to round out its DPM line. The company's latest entry is the AD2004, the first 4-1/2-digit DPM to be powered by 5 V dc. The unit has an additional asset: the analog section is optically isolated from the digital circuitry. The floating input permits the unit to withstand up to  $\pm 300$  V of common mode, and provides a CMR—from dc to 1 kHz—of 120 dB. Unfiltered normal-mode rejection at 60 Hz is also high—60 dB.

By using LEDs combined with decoder circuitry on one IC, the company has been able to squeeze the AD2004 into the same snap-in housing that's used for the AD2002 and AD2003 (3 × 1.8-in.). Only the behind-the-panel depth has increased slightly to 2.5 inches.

Full scale range of the AD2004 is  $\pm 1.9999$  V, with a maximum

reading error of 0.01%  $\pm 1$  digit. Input impedance is greater than 100 M $\Omega$ , and input bias current is 40 nA, maximum. Normal reading rate is 4 conversions per second, but this can be doubled by using an external trigger.

The unit can be operated over the temperature range of 0 to 60 C. Drift, over this range, is a maximum of 15 ppm/ $^{\circ}$ C.

A number of features make the AD2004 easy to use: The decimal point is programmable by the user; both polarity and zero are established automatically; the LED display indicates an overload by flashing all four zeros; and readings may be held indefinitely upon external command.

DTL/TTL-compatible outputs include latched BCD digits, with overrange digit; polarity and overload signals; and a status, or end of conversion, signal. Required input power is 5 V dc at 1.4 A. Case size is 3 × 1.8 × 2.5 in.

CIRCLE NO. 279



# START YOUR OWN BUG COLLECTION ...

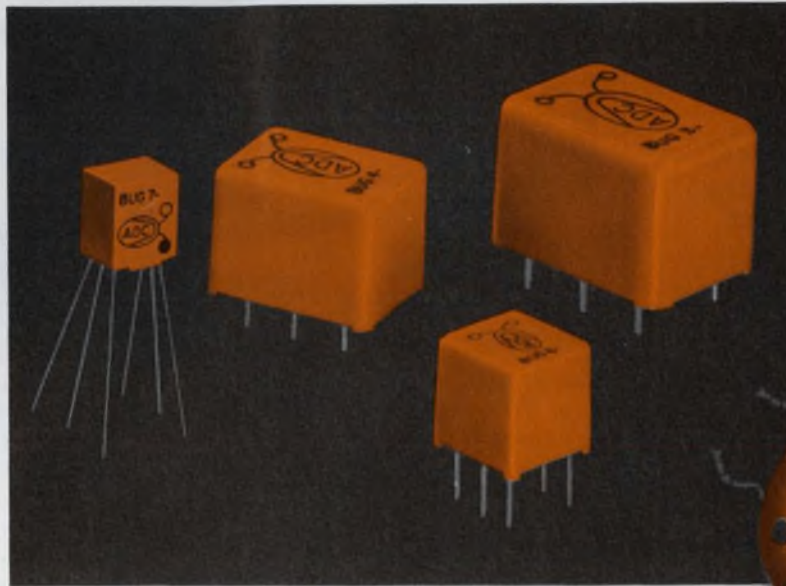

## WITH A FREE LADY BUG FROM ADC!

If you've been thinking that most commercial transformers are pretty much alike, these new ADC Lady Bugs will change your mind.

We've engineered Lady Bugs to provide the kind of reliability you've come to associate only with transformers meeting military specifications. More than that, we've made sure these ADC Transformers offer something you haven't seen in a while: economy. So, beginning now, you can have the transformer performance you've always wanted, and still keep costs in line.

ADC Lady Bugs come in 46 different electrical configurations with power ratings from 50 mw to 2 watts. There are four different case sizes, with the smallest being approximately one-third cubic inch.

We don't want to bug you, but if you have a real need for miniature transformers, we will send you an evaluation sample free — no strings attached. Just tell us what your requirements are on the coupon and send it back to us. Or, if you just want more information, please circle the number on the Reader Service card.

### ADC PRODUCTS, INC.

Division of Magnetic Controls Company  
4900 West 78th Street  
Minneapolis, Minnesota 55435  
TEL: (612) 835-6800 TWX: 910-576-2832 TELEX: 29-0321

4900 West 78th Street  
Minneapolis, Minnesota 55435

Yes, I would like an evaluation sample of the new Lady Bug transformer. Here's my application: \_\_\_\_\_

We anticipate using \_\_\_\_\_ units/year.

My needs are for \_\_\_\_\_ 30 days

\_\_\_\_\_ 60-120 days \_\_\_\_\_ Future

NAME \_\_\_\_\_

COMPANY \_\_\_\_\_

ADDRESS \_\_\_\_\_

CITY \_\_\_\_\_ STATE \_\_\_\_\_ ZIP \_\_\_\_\_

TELEPHONE \_\_\_\_\_



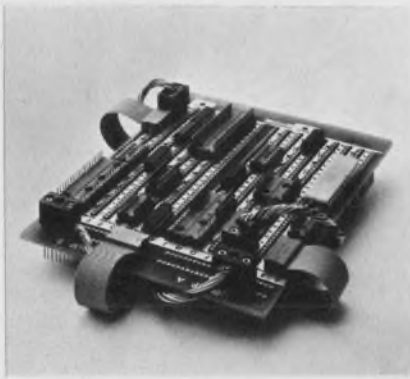

## Augat accessories give you more to plug in.

Wouldn't you know that Augat, the leader in wire-wrap panels, would come up with the most complete line of plug accessories around?

Like Augat interfacing plug assemblies for I-O connections. Or Augat adapter plugs to interpose discrete components or to let you build working modules on-the-spot. Or flat cable plugs with a unique "U" contact design for easy assembly without crimping, stripping or soldering. Plus header and jumper assemblies, too.

We'll also give you single-source supply for all panel interconnecting needs, including panels, sockets and enclosures. For quick information on price and delivery, call us at (617) 222-2202. Or write for our catalog. Augat Inc., 33 Perry Ave., Attleboro, Mass. 02703. Our representation and distribution is nationwide and international.



**Plug into Augat®**

## Waveform generator offers variable-phase outputs

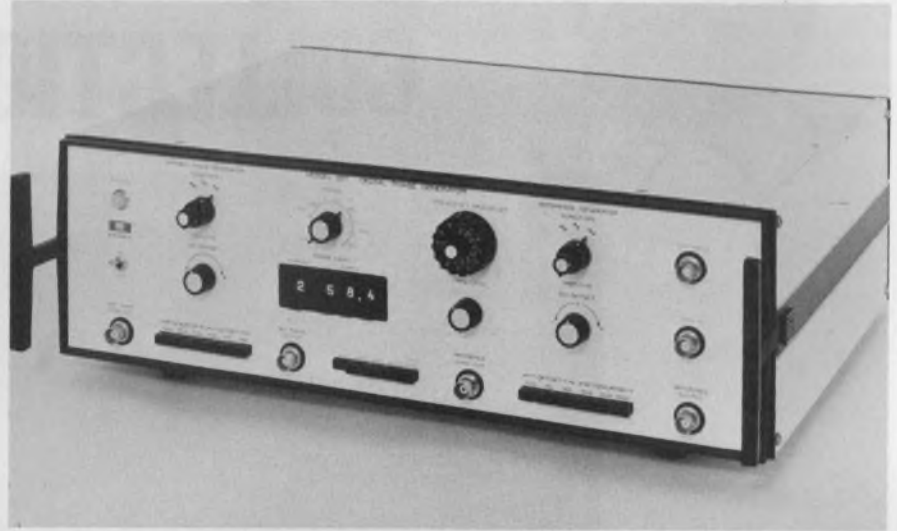

*Exact Electronics, 455 S.E. 2nd Ave., Hillsboro, Ore. 97123. (503) 648-6661. \$2495; 2 wks. ARO.*

Exact's new Model 337 Variable Phase Generator is actually a function generator with a twist. A choice of sinusoids, triangles or square-waves is provided by two outputs—a reference output and a variable-phase output. The phase lead between the reference and the variable-phase output can be set from 0 to 360 degrees in 0.2-degree increments with a thumbwheel switch. Pulses and ramps can also be generated.

The phase lead accuracy is specified at 0.2 degrees. However, because the waveforms are digitally synthesized, accuracy improves at the lower frequencies by approximately a factor of 10 per decade decrease in frequency. With its internal clock, the Model 337's frequency range is 0.00001 Hz to 55 kHz, and its frequency stability is 0.05% for 10 minutes. By using an external clock, the frequency range can be extended on the low end, and the stability can be improved. Amplitude stability is 0.05%, and sine distortion is less than 0.5%. The unit delivers 10 V pk-pk into 50  $\Omega$ .

The instrument can be triggered and gated either manually or by an external signal. Also, all waveforms

can be caught and held without disturbing the phase relationship. Controls include vernier amplitude and dc offset, plus step attenuation and fixed dc-offset pushbuttons.

Digital synthesis of the triangle waveform is accomplished by using three programmable up/down BCD counters to count through three decades. The output of the counters is fed to d/a converters whose outputs are then summed to produce a ramp. The counters are set to switch counting direction at counts of zero and 900, thus forming the triangular waveshape.

At a count of 449, the reference generator produces a pulse that is used to momentarily load the variable-phase counters to the count set at their programming inputs. This insures that the phase remains constant for each cycle, and allows the phase to be varied while the instrument is operating. Since both the reference and variable-phase outputs use the same clock, once the phase lead is set they will track precisely.

Typical applications include antenna positioning; phase calibration for phase meters, network analyzers and radar systems; servo systems testing; and use as a general-purpose source of sines, squares, triangles, pulses and ramps.

CIRCLE NO. 280



# MOSTEK's new digital clock circuit... A CLOCK FOR ALL REASONS

Designing clock systems? Say, alarm clocks? Clock radios? Calculator clocks? Calendar clocks? Stop watches? Industrial timers?

Then meet our MK 5017 P digital clock circuit. It's microprogrammable so we can tailor it to your exact application. Three standard versions are already available: the MK 5017—AA alarm clock; MK 5017—AN alarm clock/clock radio; and MK 5017—BB calendar clock. Look at these key features:

- 4 or 6-digit 7-segment display plus AM/PM indication (all versions)
- Clock radio features including sleep delay (AN)
- 12 or 24-hour operation and display (all versions)
- Snooze feature (AA, AN)
- Quick, convenient time and alarm setting (all versions)
- 50 or 60 Hz input—standard line or

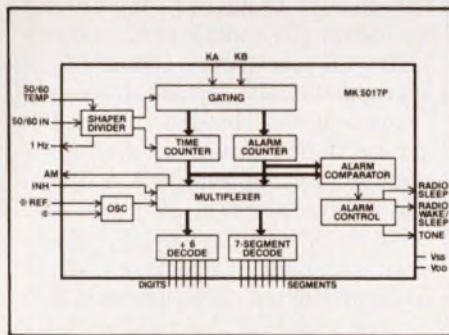

from our MK 5009 P time base circuit (all versions)

- Alarm tone generated on-chip; no external oscillator required (all versions)

Interfacing with your display is easy. If you're using luminescent anode tubes, our 5017 will drive your display *directly* (no driver transistors necessary). Or, you

can interface with LED, incandescent, gas discharge tube or light emitting film displays with minimal additional circuitry. And if you're using some other type, check our latest applications literature to shed some light on your problem.

It's easy to make time work for you. Just contact your nearest MOSTEK sales office, distributor or representative... today!

## MOSTEK<sup>®</sup>

**MOSTEK Corporation**  
1215 West Crosby Road  
Carrollton, Texas 75006  
(214) 242 0444

© Copyright 1972 by MOSTEK Corporation

**REGIONAL SALES OFFICES:** Western: 11222 La Cienega Blvd., Inglewood, Calif. 90304 (213) 649-2888; Eastern: 60 Turner Street, Waltham, Mass. 02154 (617) 899-9107; Central: 8180 Brecksville Rd., Brecksville, Ohio 44141 (216) 526-6747.

**INTERNATIONAL:** Europe: Mostek GmbH, 7 Stuttgart 80, Breitwiesenstrasse 19, West-Germany 0711-731305; Japan: System Marketing Inc., Center News Bldg., 1-3-11 Sotokanda, Chiyoda-ku, Tokyo, Japan; Far East: Imai Marketing Assoc., Inc., 525 W Remington Dr., # 108, Sunnyvale, Calif. 94087 (408) 245-3511; Hong Kong: Astec Components Ltd., Golden Crown Court, Flat "C," 5th Floor, 70 Nathan Rd., Kowloon, Hong Kong; Mid East: Racom Electronics, 60 Pinkas St., Tel Aviv, Israel.

INFORMATION RETRIEVAL NUMBER 95

# NEW SHORTER CASE! SCHAUER 1-WATT ZENERS

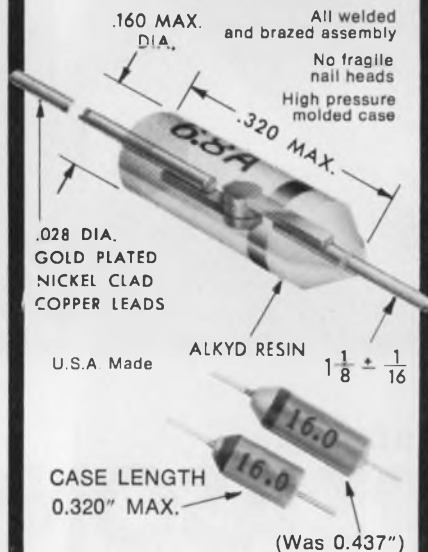

**SAME LOW PRICES FOR  
1% TOLERANCE ZENERS  
ANY VOLTAGE  
FROM 2.0 TO 18.0**

Quantity	Price Each
1-99	\$1.07
100-499	.97
500-999	.91
1000-4999	.86
5000 up	.82

## IMMEDIATE SHIPMENT

Send for rating data and 20%, 10%, 5% and 2% tolerance prices.

Semiconductor Division

# SCHAUER

MANUFACTURING CORP.

4511 Alpine Ave., Cincinnati, Ohio 45242  
Telephone 513/791-3030

## INSTRUMENTATION

### Digital delay generator has only 100-ps jitter



Berkeley Nucleonics Corp., 1198 Tenth St., Berkeley, Calif. 94710. (415) 527-1121. \$1800.

For those applications requiring precision time delays with ultra-low jitter, Berkeley Nucleonics offers its Model 7030, a programmable Digital Delay Generator.

This new instrument provides delays from 0 to 99.999  $\mu$ s in 1-ns increments, with less than 100-ps jitter between the external trigger and the succeeding initial and delayed pulses.

Berkeley avoids the double-pulse generator approach, with its inherent jitter, and instead uses an accurate, stable oscillator—synchronously triggered—to provide the delays. The clock used is a 100-MHz LC oscillator contained in a proportionally-controlled oven.

Accuracy of the delay—which is set by thumbwheel switches or by remote programming—is  $\pm 0.1$  ns for delays from 1 to 9 ns, and  $\pm 0.5$  ns or 0.01% of delay (whichever is greater) for delays from 10 ns to 99.999  $\mu$ s (delays from 1 to 9 ns are provided by passive delay lines). Stability is  $1 \times 10^{-5}/^{\circ}\text{C} \times$  delay over the temp range of 0 to 50 C.

Output pulses are +5 V or -1.5 V (50  $\Omega$ ), with transition times of 3 ns, max. Width of the output pulse is continuously adjustable from 15 ns to 1  $\mu$ s. Minimum external trigger required is 250 mV (0 to 10 MHz).

CIRCLE NO. 281

### Semiconductor tester comes in kit form

Heath Co., Hilltop Rd., St. Joseph, Mich. 49085. (616) 983-3961. \$49.95.

The Heathkit IT-121 checks transistors, diodes, FETs, SCRs, triacs and unijunction transistors in or out of the circuit. Five current ranges measure leakage as low as 1  $\mu$ A, and collector currents as high as 1 A. Gain (dc beta), transconductance (gm), and leakage values are read directly on the large meter face. The unit has color-coded pushbutton range selection, battery testing circuit and handy three-foot leads.

CIRCLE NO. 301

### 5-1/2-digit DMM costs \$1000

Non Linear Systems, Inc., P.O. Box N, Del Mar, Calif. 92014. (714) 755-1134. \$1000.

Non Linear Systems, Inc., announces a 5-1/2-digit multimeter—the MX-1. Based on its MIL-Spec counterpart the MX-1 has five ranges of dc from 0.1 V to 1000 V FS, auto/manual ranging, wide range ratio, fast active filter, sixth digit for 20% overrange and rugged construction. MX-1 options include 10 kHz and 100 kHz ac in four ranges from 1 V to 1000 V, FS, resistance in six ranges from 100  $\Omega$  to 10 M $\Omega$  FS, isolated data outputs, and  $\pm 100$  V external reference capability.

CIRCLE NO. 302

### 100/500-MHz scopes join 7000-Series

Tektronix, Inc., P.O. Box 500, Beaverton, Ore. 97005. (503) 644-0161. 7603: \$1200; R7903: \$2500 (mainframes only).

Two new scopes are offered by Tektronix. The 7603 is a 5-1/4-inch, 100-MHz mainframe with three plug-in compartments, two vertical channels and five operating modes. A CRT readout gives an alphanumeric display of test parameters. The R7903 is a 5-1/4-inch, 500-MHz rack-mount mainframe having three compartments, plus CRT readout. Pulsed graticle operation is optional with the R7903.

CIRCLE NO. 303

# Measure exact frequency in the field

With lab standard digital accuracy

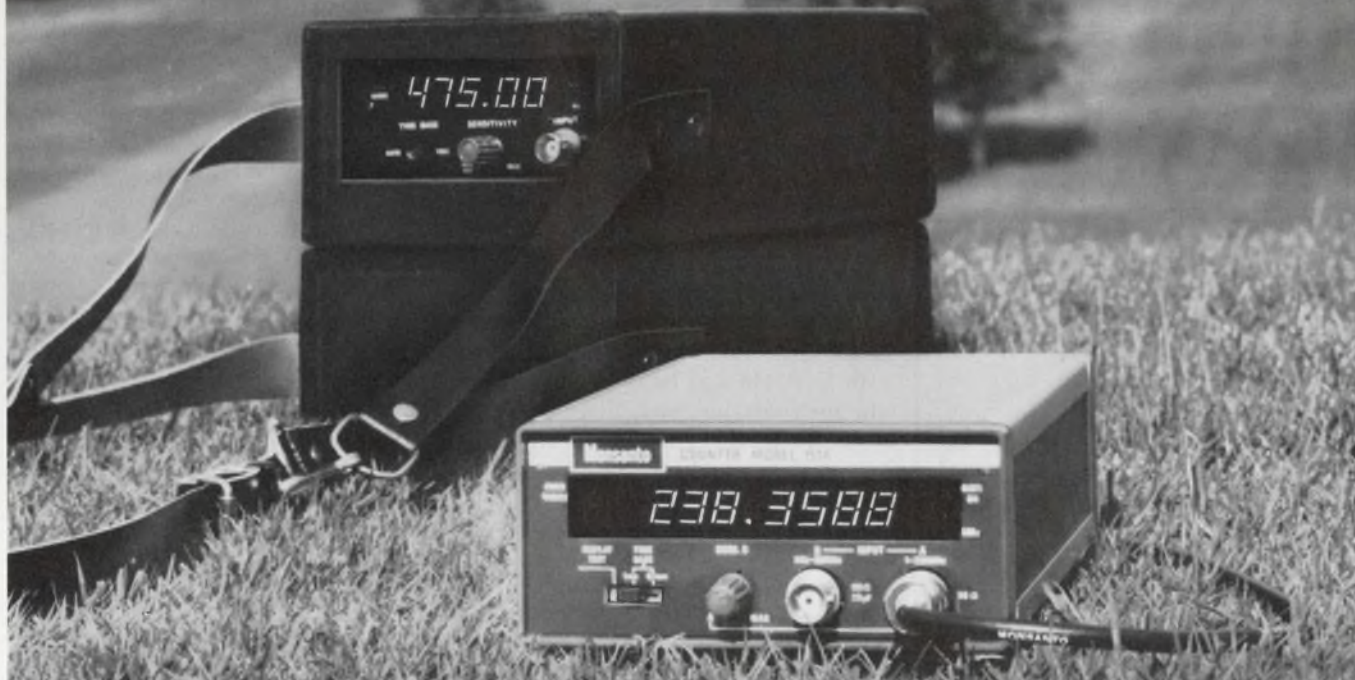

## Model 150A Automatic Counter

- 5Hz to 32MHz frequency range
- Auto-ranging, including automatic decimal point positioning
- 5 digit display with Hz, KHz and MHz indicators
- Only 3½ lbs. and 2"H x 4½"W x 8½"D
- \$475

## Model 151A 220MHz Counter

- 5Hz to 220MHz frequency range
- Resolution to 10Hz at 220MHz and 1Hz up to 20MHz
- 7 digit display
- Only 3½ lbs. and 2"H x 4½"W x 8½"D
- \$795

Monitor frequency with a Monsanto digital counter faster and more accurately than by analog methods. Crystal controlled clocks and all solid state components insure reliable, long-term stability. These instruments are operable from the AC line, 12V to 32VDC mobile sources and optional battery pack. The Model 155A battery pack allows for completely portable operation at only \$200. For a demonstration contact your local Monsanto representative.

# Monsanto

Precision measurements to count on.

United Systems Corp.

918 Woodley Road • Dayton, Ohio 45403 • (513) 254-6251 • a subsidiary of Monsanto  
All Monsanto instruments are available for rental or lease through Rental Electronics, Inc.

# Dit-Mco's Gone Computer!

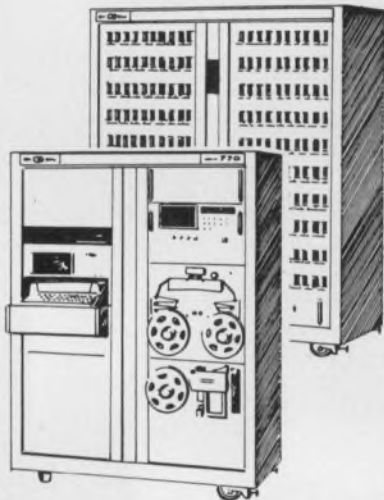

## The New 770 Series

### FEATURING:

- Computer or punched tape control
- Pluggable integrated circuit logic
- A wide choice of program controlled instrumentation
- Switching — including a choice of pluggable reed relay, WQB relay and solid state
- Simplicity of programming
- Extensive software and documentation

In fact, Dit-Mco's new 770 Series of tape-programmed random-access automatic wire-circuit analyzers has the speed, reliability, and capacity to meet almost any conceivable connection-testing need.

Give us a problem, and we'll put one to the test.

**Dit-Mco:**  
**The Difference In Testing!**



**DIT-MCO INTERNATIONAL**  
5612 Brighton Terrace  
Kansas City, Missouri 64130  
Phone (816) 363-6288

A Division of Xebec Corporation

## INSTRUMENTATION

### Resistance bridge reads percent limit



*Leeds & Northrup Co., Sumneytown Pike, North Wales, Pa. 19454. (215) 643-2000.*

The 4271 percent limit bridge makes high-accuracy four-terminal resistance measurements from 1  $\Omega$  to 100 M $\Omega$ . The bridge is equipped with Low, Go and High limit lights and provides ten switch-selectable, percent-limit ranges:  $\pm(0.001, 0.01, 0.1, 1$  and  $10)\%$  and  $\pm(0.0003, 0.003, 0.03, 0.3$  and  $3)\%$  of FS on the meter. The Low and High limit lights on the bridge can be set to respond anywhere from 0 to 110% of the meter range. The Go indicator lights up when the measurement is within selected limits. Bridge accuracy is  $\pm(0.005\%$  of reading  $+20 \mu\Omega$ ) from 1 to 100  $\Omega$ ;  $\pm(0.002\%$  of reading) from 100  $\Omega$  to 10 M $\Omega$ ;  $\pm(0.005\%$  of reading) from 10 to 100 M $\Omega$ .

CIRCLE NO. 304

### Digital temp indicator gives 0.1% accuracy

*Thermo Electric, 109 5th St., Saddle Brook, N.J. 07662. (201) 843-5800.*

The DTI/611 digital temperature indicator uses a linearization technique that's said to yield accuracies 10 times better than thermocouples. Various models of the four-digit unit measure over a wide temperature range to 0.1% accuracy, and to 0.1-degree resolution. Isolated inputs are standard. Operation is between one and four samples per second, and response time is 2 s. Input impedance is 5 M $\Omega$ .

CIRCLE NO. 305

### Synthesizer offers multiple waveforms

*Rohde & Schwarz, 111 Lexington Ave., Passaic, N.J. 07055. (201) 773-8010. \$3900.*

The SSN programmable synthesizer strikes a compromise between low accuracy waveform generators and high-precision synthesizers. Specs include: stability better than  $2 \times 10^{-5}$  per day; square waves, triangles and sinusoids from 0.01 Hz to 120 kHz, square wave up to 1.2 MHz; three separate paralleled outputs with fixed phase relationship for square wave, triangular and sinusoidal signals; square wave level suitable for DTL and TTL; sine wave output level, programmable in dB; electronic frequency programming (BCD neg. code) with response time  $< 100 \mu\text{s}$  (after switchover) with no overshoot.

CIRCLE NO. 306

### Automatic crystal saw cuts 0.005-in. slices



*Image Analysing Computers, Inc., 40 Robert Pitt Dr., Monsey, N.Y. 10952. (914) 356-3331.*

The Microslice 3 is a fully automatic and pre-programmable saw for slicing semiconductor materials. The unit can be programmed for both the number and thickness of each cut and can be left to run unattended. It is capable of cutting crystals of up to 3 in. diameter into slices as thin as 0.005 in. Its major applications are in the cutting of expensive or delicate materials where high yields and low surface damage is required. Typical materials that can be cut on a production basis include gallium phosphide, indium phosphide, cadmium telluride, cadmium sulfide and indium antimonide.

CIRCLE NO. 307

*New  
from HP...  
Modular  
Power Supplies*

# today

*for those who  
think about  
tomorrow!*



HEWLETT  PACKARD

POWER SUPPLIES

21201

Value has always been synonymous with HP power supplies, and these new 62000-series modular power supplies are no exception. They're competitively priced (with quantity and OEM discounts), reliable, systems compatible, and available now. Coverage is from 3 to 48 volts, at up to 200 watts, with performance assured to specifications. Best of all, HP offers applications assistance and service support before and after the sale. It's all backed up with an international network of 220 offices to serve you. For detailed information, contact your local HP field engineer. Or, write: Hewlett-Packard, Palo Alto, California 94304. In Europe: 1217 Meyrin-Geneva, Switzerland.

High resolution,  
low cost

# SCAN CONVERTERS

display any  
electronic  
information

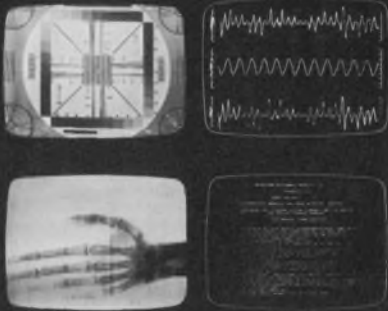

Any electronic information—from computers, lasers, TV cameras, scanners, X-ray, electron microscopes or whatever—can be displayed sharper, brighter, faster and at lower cost with PEP scan converters. Regardless of its format or speed. Even if it's only transient information. The reason: only PEP scan converters offer this combination of advantages:

- RESOLUTION to 3000 lines
- GRAY SCALE: 10 Logarithmic levels
- NON-DESTRUCTIVE readout
- WIDE RANGE of reading and writing speeds: video to DC
- WIDE system bandwidth: 30 MHz
- READ, write, selective erase, zoom, other functions
- LONG, trouble-free life

We're the people who developed high resolution, low cost scan conversion and image storage technology. Our Lithocon® silicon storage tube is the heart of all PEP scan converters, and makes them feasible for a whole new world of applications. Like microfilm/microfiche. Industrial process control. Facsimile. CATV systems. And X-ray, ECG and low light level detection systems. And hundreds more. We'll be happy to tell you about them. Write or call today for details. Princeton Electronic Products, Inc., P.O. Box 101, North Brunswick, New Jersey 08902; (201) 297-4448.



**PRINCETON  
ELECTRONIC  
PRODUCTS, INC.**

INFORMATION RETRIEVAL NUMBER 100

## Hybrid pulser and injection laser has fast narrow pulses

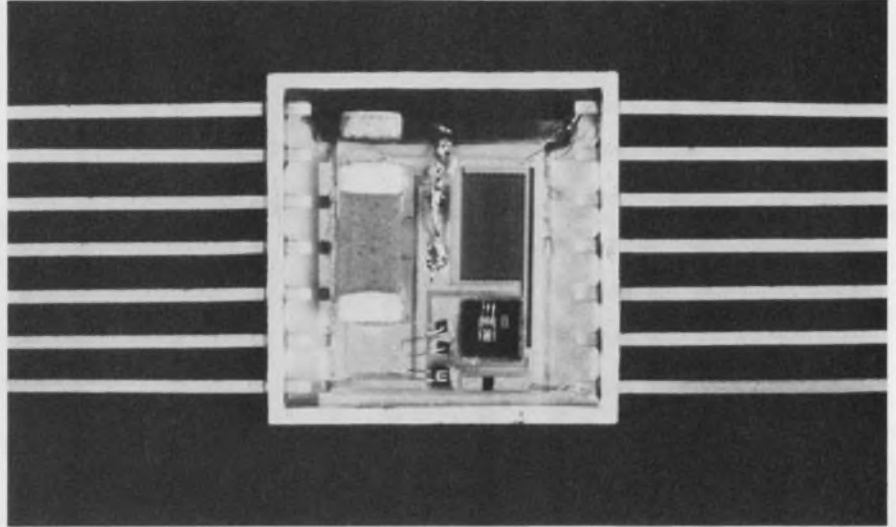

Meret Inc., 1815 - 25th St., Santa Monica, Calif. 90404. (213) 828-7496. P&A: \$289 (1-4 qty.); stock to 4 weeks.

Rise times of less than 15 ns and pulse widths of less than 30 ns are now possible with the introduction of the first hybrid laser-pulsar combination to be offered commercially. The GaAs laser puts out more than 10 W at a wavelength of 905 nm.

Produced by Meret Inc., and called the FIP327, the circuit is packaged in a 3/8-in square integrated-circuit flat-pack. Compared to other discrete laser-pulsar combinations available commercially, the unit is less than half the cost and has a five-fold reduction in rise time and pulse width.

Reduction of the rise time and pulse width results from minimization of the series resistance, inductance and stray capacitance inherent in the hybrid design, as compared to a discrete design.

Mounted next to an internal mirror at the edge of the package, the laser diode is efficiently heat-sunk. The mirror converts the output radiation into a fan-shaped beam.

A 67-V battery will drive the unit at a current drain of less than 2 mA.

Pulse repetition rates of up to 20 kHz with duty cycles of up to  $10^{-3}$  are within the capacity of the FIP327.

As with any laser diode, the wavelength and power output will shift as the temperature changes till it becomes unusable above about 70 C. Meret expects to introduce at a later date, a thermoelectric cooler that will fit on the flat-pack and allow it to operate up to 90 C. The additional cost for this option in small quantities will be in the range of \$150 to \$200. Also soon to be introduced will be the FIP-307 laser-pulsar with a 2-W output and a 10-ns rise time. This unit will sell for \$195 in small quantities. When the FIP327 is matched with the FDA427 hybrid laser detector/amplifier (first described in the April 27 issue of *ELECTRONIC DESIGN*) the combination provides the first high performance injection-laser transmitter/receiver at a cost of under \$500.

Applications of the transmitter/receiver combination include: ranging and surveying; audio communications; intrusion alarms; automotive collision avoidance devices; and smog, fog and haze detection.

Built-in lenses directly on the flat-pack surface are among the various options available.

CIRCLE NO. 308



# SUPER BOWL



...and what a line-up—depth in every position! A rugged team of general purpose relays from 1 to 20 amps, AC and DC, 1 to 6PDT, with ratings to 110 VDC and 250 VAC. At the corners, dry reed and mercury-wetted DIP; on the line, open frame and covered units, plug-in and axial lead, Forms A, B and C, with ratings to 2 amps, 50 watts and 500 VDC. And in line backer slots, a new series of electromechanical and solid state industrial timers and sensors with delays of 0.01 to 360 seconds, voltages to 220 VDC and 400 VAC, and frequencies to 440 Hz.

Whatever signals you call, you're the coach with the Babcock team. Call your own "audibles" with our general purpose units; they're completely interchangeable with other models. They'll plug right into your PC board or socket with no time out. And there's never a fumble on delivery—the entire Babcock team is available "off the bench". If you have a design problem, huddle with us on it,

too; our applications engineering staff is ready to join your team.

Send for your FREE program today—our new short form lists all the players...with some very interesting numbers. Write or call Babcock Electronics Corp., Unit of Esterline Corp., 3501 No. Harbor Blvd., Costa Mesa, Calif. 92626; Tel: (714) 540-1234.



**BABCOCK**

A UNIT OF ESTERLINE CORPORATION

INFORMATION RETRIEVAL NUMBER 101



if it's  
a matter  
of speed

## ROYTRON

Speed, in I/O devices, is directly related to price.

That's why we offer you over 60 ROYTRON Models. Paper Tape and Edge Punched Card Punches rated at 50, 60 and 75 cps. Readers rated from 1 to 1000 cps.

The lower the speed, the lower the price.

So, why buy more speed than you really need?

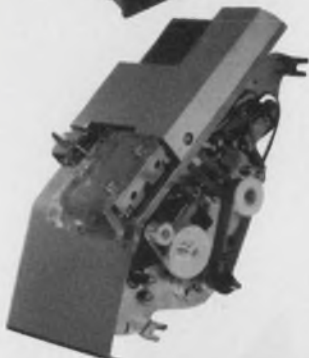
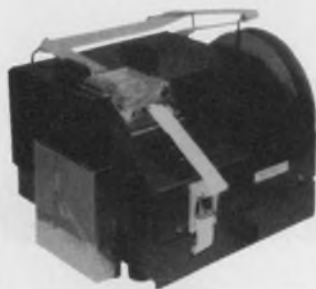

For more information  
call Frank Misiewicz  
OEM Products  
(201) 935-2200



OEM PRODUCTS DIVISION  
**LITTON ABS**  
Automated Business Systems  
600 Washington Avenue, Carlstadt, N. J. 07072

INFORMATION RETRIEVAL NUMBER 102

# Need connections?

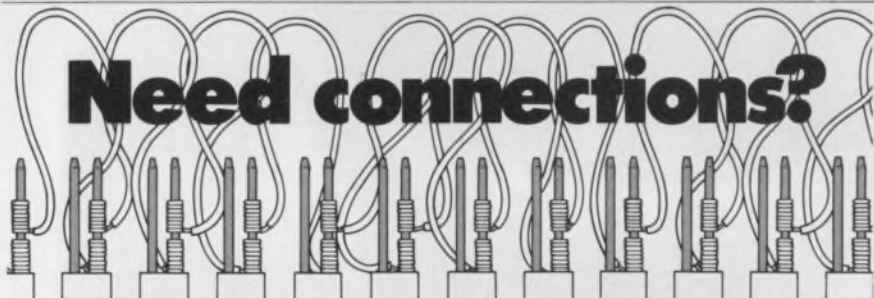

# Don't "daisy chain,"

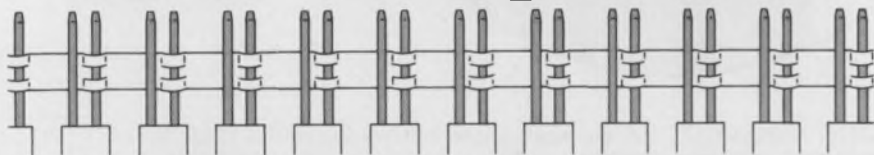

# Pin 'em down!

Don't wrap or solder terminal connections when you can do the job for 2 or 3 cents per pin. Pin Bars® are the ideal way to connect adjacent or alternate pins where common connection is desired. Available in configurations to fit square or rectangular pins, Pin Bars come in any size, any length, and provide a fast, positive method of making connections on a production basis.

FREE SAMPLE Pin Bar and brochure on request.



LEAR SIEGLER, INC.

ELECTRONIC INSTRUMENTATION DIVISION  
714 N. Brookhurst St., Anaheim, Calif. 92803, (714) 774-1010  
INFORMATION RETRIEVAL NUMBER 103

## MICROWAVES & LASERS

### Waveguide, coaxial detector line offered



Sivers Lab, Box 420 18, S-126 12, Stockholm 42, Sweden.

A range of waveguide and coaxial measuring detectors are introduced by the company. The PM 7520 coaxial detector has a frequency range of 10 MHz to 18 GHz, while the waveguide series, called PM 7297, covers the 5.85 to 18 GHz range in three bands. The measuring detectors PM 7520 and PM 7297 feature flat response, high sensitivity and low VSWR. The diode used is a point-contact diode that is field replaceable.

CIRCLE NO. 309

### Cyclic phase shifter uses less power



American Nucleonics Corp., 6036 Variel Ave., Woodland Hills, Calif. 91364. (213) 347-4500.

A solid-state cyclic fixed phase shifter, with adjustable switching rate, uses only two diodes to achieve a 180-degree ( $\pm 6\%$ ) phase shift. Because of the reduced number of diodes, input power needs are reduced: The input rating is 28 V dc, and 300 mA max, with insertion loss listed at 1.7 dB max. Termed the S-109, the new unit operates over the 2700-to-3000 MHz range and has a switching rate nominally at  $75 \pm 3$  Hz that is adjustable over the range of 30 to 1000 Hz. Power handling capacity is 1 kW peak, 1 W average.

CIRCLE NO. 310

Who ever heard of Plug-in delay/interval Timers that are reliable, economical and interchangeable for as low as \$27.90?

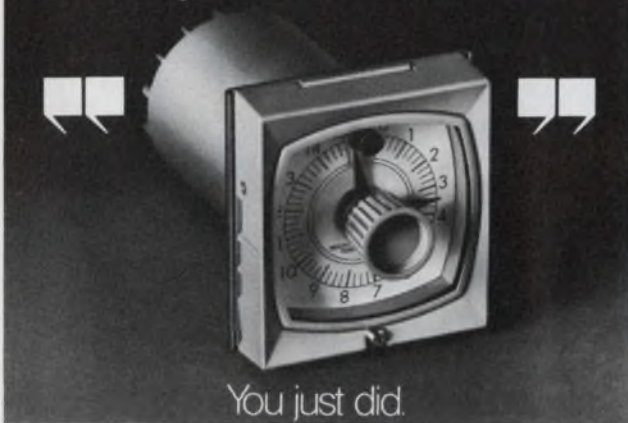

You just did.

It's our new Series GP which is completely interchangeable with over 80% of today's most widely used plug-in delay/interval timers. The GP is designed for easy installation in standard 3-inch diameter

panel holes.

Delivery is stock to 6 weeks, depending upon quantity. Consult us for further information and the GP Bulletin 310. Call 201-887-2200.



Industrial Timer Corporation, U.S. Highway 287, Parsippany, N.J. 07054  
INFORMATION RETRIEVAL NUMBER 104

## Your choice package for easier, less expensive circuit design



### CORDIP™ COMPONENT NETWORKS

CORNING Electronics offers combinations of resistors, capacitors and diodes in standard dual in-line packages. With these CORDIP networks you can design circuit combinations of up to 20 components in a 14-pin DIP and up to 23 in a 16-pin DIP. They offer higher component densities, less complex circuit boards, reduced inventory of discrettes, and significant savings in handling costs. Prototypes available in three weeks, production quantities in approximately eight weeks.

Send for our new brochure containing complete information on CORDIP component networks. Or call us. Corning Glass Works, Electronic Products Division, Corning, New York 14830. (607) 962-4444, Ext. 8684.

**CORNING**  
ELECTRONICS

INFORMATION RETRIEVAL NUMBER 105

ELECTRONIC DESIGN 24, November 23, 1972

need precision resistors with 1ppm/°C TC? ... 10ppm? ... ±0.001% tolerance .. ±1%? .. 5ppm/yr. stability? .. what-ever ... VISHAY HAS A RESISTOR THAT MEETS YOUR REQUIREMENTS

## TEMPCO

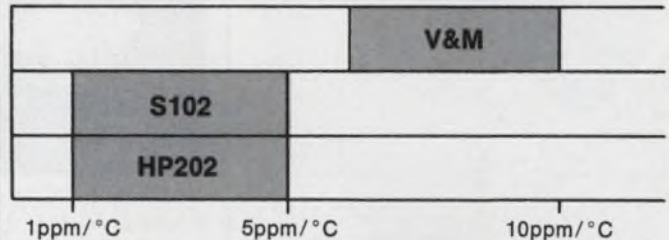

## TOLERANCE

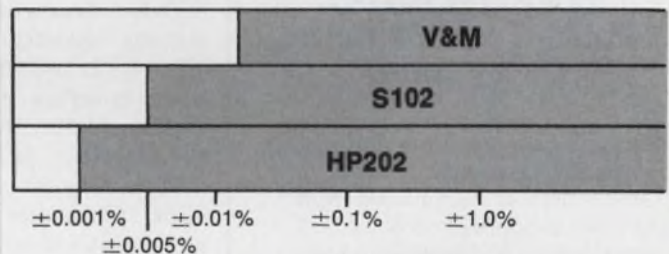

## PRICE

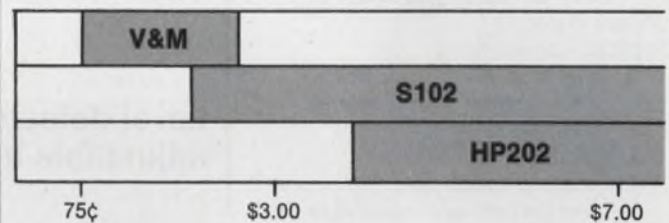

TYPICAL PRICES. OEM QUANTITIES EVEN LOWER!

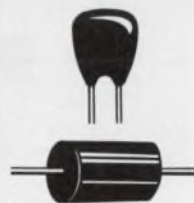

Actual Size V&M Series Direct replacement for precision wirewounds.

Circle (38)



Actual Size S102 Ultra-precise resistor

Circle (39)



Actual Size HP202 Hermetically sealed ultra-precise resistor

Circle (40)

All Vishay S102 & HP202 resistors are virtually non-inductive with 0.08 μh inductance max, and capacitance less than 1/2 pf! Additionally their TC tracking is within 3ppm/°C standard! Send for technical information and descriptive literature now. Circle reader service number above.



## VISHAY RESISTOR PRODUCTS

A DIVISION OF VISHAY INTERTECHNOLOGY INC

63 LINCOLN HIGHWAY ■ MALVERN, PENNA. 19355  
TELEPHONE: (215) 644-1300 ■ TWX: 510-668-8944

INFORMATION RETRIEVAL NUMBER 106



## Immediately available Pulse Transformers Delay Lines

Now you can save time and money by specifying standard Pulse transformers or delay lines from our wide range of in-stock components. We have the most commonly used designs—complete and reliable. And Pulse engineers are ready to assist you with unique designs.

### Typical Applications

1. SCR and TRIAC control
2. Small signal coupling and isolation
3. Baluns
4. Floating switches
5. Line drivers and receivers
6. DC isolation
7. Timing delays

For the broadest selection of in-stock components, available for immediate delivery in any quantity, call our catalog sales department.

### DIGITAL DELAY MODULE

(not shown)

• DTL and TTL COMPATIBLE • 50ns, 100ns, 250ns DELAYS • 5 TAPPED DELAYS • FAST RISE TIME—INDEPENDENT OF DELAY • HIGH FAN OUT CAPABILITY • 16 PIN DIP PATTERN • IN STOCK

PE No.	Delay Time	Delay/Tap	No Taps	Rise Time
20330	50ns	10ns	5	4ns
20331	100ns	20ns	5	4ns
20332	250ns	50ns	5	4ns

Send for bulletin no. 56

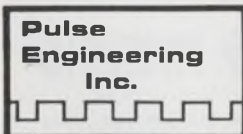

A Varian Subsidiary  
P. O. Box 12235  
San Diego, Calif.  
92112  
(714) 279-5900  
TWX 910 335-1527

INFORMATION RETRIEVAL NUMBER 107

## ICs & SEMICONDUCTORS

### 90-key encoder is interface system

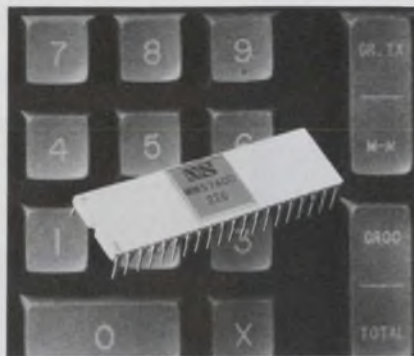

National Semiconductor Corp., 2900 Semiconductor Dr., Santa Clara, Calif. 95051. (408) 732-5000. MM-5740N; \$15.00 (100 up).

The MM5740 90-key keyboard encoder, featuring Tri-State data outputs directly compatible with TTL/DTL or MOS logic, is a complete interface system capable of encoding 90 single-pole, single-throw-switch enclosures into a usable nine-bit code. Fabricated with silicon-gate MOS technology and organized as a bit-paired system capable of either N-key or two-key rollover, it operates in either a pulse or level-data strobe mode.

CIRCLE NO. 320

### Level detector IC has adjustable hysteresis

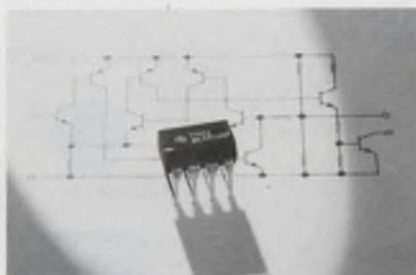

Texas Instruments Inc., P.O. Box 5012, M/S 308, Dallas, Tex. 75222. (214) 238-3741. DIP, \$1.86 (100 up); stock.

A precision level detector IC, the SN72560, features adjustable threshold level, allowing designers to adjust the trip point to the most appropriate level for particular applications. The device operates off typical logic supplies or popular battery voltages ranging from 2 to 6 V. Output voltages are as high as 25 V.

CIRCLE NO. 321

## McMOS line expands

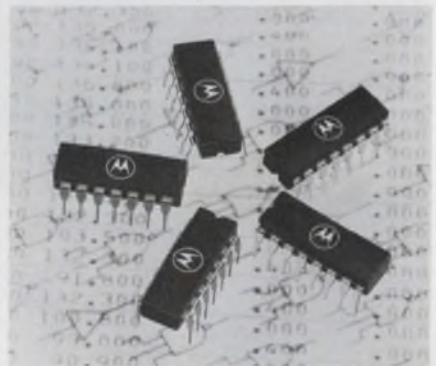

Motorola Semiconductor Products Inc., P.O. Box 20912, Phoenix, Ariz. 85036. (602) 273-3466. MC-14007CL, MC14023CL and MC-14025CL: \$0.78; MC14009CL and MC14010CL: \$1.69 (100-up).

Five CMOS logic ICs are pin-for-pin replacements for like-numbered RCA types. These consist of the MC14007 dual CMOS pair and inverter—for functional gating, pulse shaping and linear amplifier applications; the MC14009 (inverting) and MC14010 (noninverting) hex buffers—for CMOS-to-bipolar logic level conversion, sourcing or sinking outputs, and one-to-six multiplexing; and the MC14023 (NAND) and MC14025 (NOR) triple three-input gates—for a wide range of NAND and NOR CMOS building-block logic applications.

CIRCLE NO. 322

## Power SCRs list high I<sup>2</sup>t, surge specs

International Rectifier Corp., Semiconductor Div., 233 Kansas St., El Segundo, Calif. 90245. (213) 678-6281. 325RA5: \$53.20 (10-99); 375RA5: \$56.00 (10-99); 30 days (sample qty.).

Two lines of stud-package power SCRs have high I<sup>2</sup>t ratings and superior surge ratings. The 375RA has maximum I<sup>2</sup>t of 340,000 A<sup>2</sup> sec. and maximum RMS ON current of 590 A. The 325RA has corresponding values of 265,000 A<sup>2</sup> sec. and 510 A. Both types are available with maximum repetitive peak reverse voltage ratings from 50 to 600 V. Maximum peak one cycle, nonrepetitive surge current is 9000 A for the 375RA and 8000 A for the 325RA.

CIRCLE NO. 323

**now...you  
can test  
digital  
IC's...  
economically...  
to manufacturer's specs**



New Kurz-Kasch Model IC-590 is the first economically priced digital IC analyzer for accurate testing in the lab, shop, inspection, production, field or any other location.

The Model IC-590 is a completely portable, battery powered digital IC tester for use in conjunction with published IC specification sheets for static and dynamic testing of all 14 and 16 pin dual in-line IC modules of the DTL and TTL, 5 and 15 volt families. Flat pack and TO-5 modules may also be tested by using appropriate adapters. Price \$169.95.

A unique sister Model IC-591 is also available. It comes complete, as IC-590 above, internal power supply for highly regulated 5 volt, 1 amp operation and adapter cable for firing-up complete card units containing as many as 15 or more mounted IC's. Price \$295.00.

For complete technical data, write or call now: Tom Barth, Marketing Manager



**ELECTRONICS DIVISION  
Kurz-Kasch, Inc.**

1421 S. Broadway,  
Dayton, Ohio 45401

(513) 223-8161

INFORMATION RETRIEVAL NUMBER 108

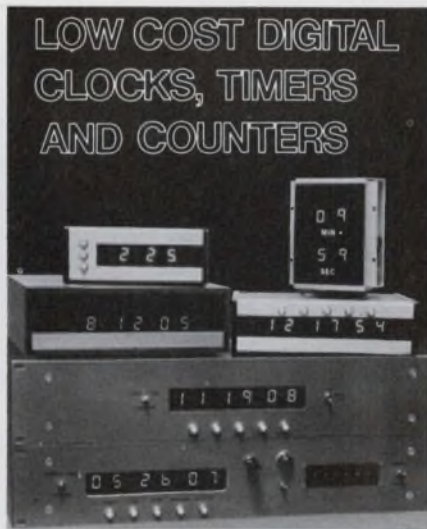

Dependable, solid state components and circuitry. Design efficiency makes these digitals the most economical available. Rugged and reliable. No moving parts.

Custom capabilities: Video tape counter/editor, monitoring systems, clock/timers 3, 4, or 6 digits. Record seconds in 10ths, 100ths or 1000ths. Thumbwheel or patchboard programming. BCD, Relay Closure, Solid State outputs.

ES 112/124: 12 or 24 hr. clock . . . \$100.00  
ES 300: 100 min. up/down counter . . . 125.00  
ES 400: 10 min. timer . . . . . 68.50  
ES 500: 12 hr. clock/timer . . . . . 110.00  
ES 510: 60 min. timer . . . . . 95.00

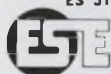

Inquire about our new thumbwheel or patchboard programmers.

506 Main St., El Segundo, Ca. 90245 772-6176

INFORMATION RETRIEVAL NUMBER 109

**Is your problem  
knowing what caused  
your problem  
after  
your problem occurred?**



**then you need the  
QuantaLatch**

A major factor in pinpointing the causes of a problem is having an accurate record of signal history(s) readily available to determine specifically what did occur.

With the QuantaLatch you can continuously monitor an electrical signal, until a predetermined trigger freezes the signal history surrounding the trigger instant. With this memory capability, you can now analyze the data to determine causes of machine malfunction or failures, quality defects or any transient deviation from normal.

QuantaLatch memory data is presented on a simple front-panel LED, 3 digit display; as well as a single or repetitive scan analog signal for use by an ordinary oscilloscope or chart recorder; or in parallel or serial (ASCII) digital form for use with a tape punch or directly into a computer.

We'd like to tell the complete story about how our new QuantaLatch can save you time and money in problem solving. For your copy of our latest specification sheet, simply fill out the coupon below and drop it in the mail to us.



**QuantaLog, Inc.**

Box 1523, Ann Arbor, Michigan 48106

THE DATA TRANSFORMERS

Yes, I want more information about the QuantaLatch

Name: \_\_\_\_\_

Company Name: \_\_\_\_\_

Street Address: \_\_\_\_\_

City: \_\_\_\_\_ State: \_\_\_\_\_ Zip: \_\_\_\_\_

Mail to: QuantaLog, Inc.

Dept. ED1, Box 1523, Ann Arbor, Michigan 48106

Phone: (313) 769-4936

INFORMATION RETRIEVAL NUMBER 110

## MECL flip-flop exceeds 500 MHz

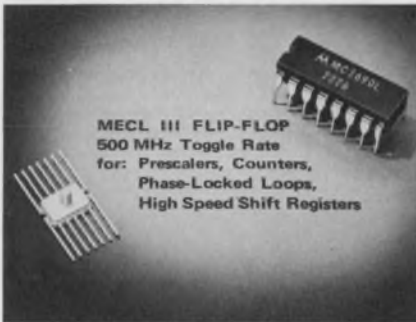

Motorola Semiconductor Products Inc., P.O. Box 20924, Phoenix, Ariz. 85036. (602) 273-3466. MC-1690L: \$45 (100 up).

The MC1690, an ECL master-slave D flip-flop, is capable of achieving toggle rates over 500 MHz. Typical units toggle at about 550 MHz. Other features of the MECL III unit include set-up time of 0.3 ns (typ), clock-to-output delay of typically 1.5 ns and power dissipation at 200 mW/package (excluding load power dissipation).

CIRCLE NO. 324

## Power transistors show gain at 5 A

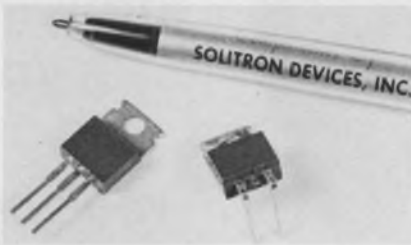

Solitron Devices, Inc., 1177 Blue Heron Blvd., Riviera Beach, Fla. 33404. (305) 848-4311. \$0.70 per pair (100 up).

A series of low-cost complementary npn/pnp plastic power transistors called SDT 5101-03 (nnp) and SDT 5111-13 (pnp) have gain capabilities with currents up to 5 A. They are packaged in TO-220AA and TO-220AB cases. These transistors feature triple-diffused planar construction resulting in low-leakage characteristics and fast switching times with  $f_t$  typically 8 MHz. Other features include typical gain of 100 at 1 A and typical  $V_{CE(sat)}$  at 2 A less than 0.5 V. The npn and pnp units have complementary specs.

CIRCLE NO. 325

## Dual line driver eases data-bus operation

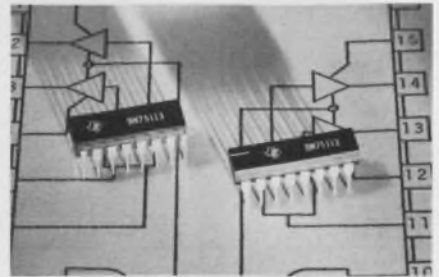

Texas Instruments Inc., P.O. Box 5012, M/S 308, Dallas, Tex. 75222. (214) 238-3741. SN55113J: \$5.77; SN75113N: \$3.10 (100 up).

A dual tri-state line driver IC, called the SN55/75113, has a high output impedance inhibit state that makes it possible to connect many drivers together on the same transmission line for data bus operation. The device has individual inhibit control inputs for each output pair, as well as a common inhibit control input for both output pairs. The output stages are similar to TTL totem-pole outputs, but with the sink outputs and the corresponding active pull-up outputs available on adjacent package pins.

CIRCLE NO. 326



## All you ever wanted to know about switches (But were afraid to ask)

Grayhill's new Engineering Catalog will save you the trouble of having to ask a lot of questions about meeting your switch needs. Many of our customers order directly from its pages.

The 104 pages cover our complete line of miniature rotary and pushbutton switches...plus specifications on Grayhill Solid State Relays...and all the essential information on a variety of termination hardware.

Why not write for your copy today?  
Grayhill, Inc., 565 Hillgrove Ave.,  
La Grange, Illinois 60525.  
(312) 354-1040.



INFORMATION RETRIEVAL NUMBER 111

BITE  
SIZE  
INDICATORS\*

ACTUAL SIZE

MINELCO® Bite Indicators are extensively utilized in Military Avionic equipment (Per Mil-I-83287 and Mil-E 5400) and in a wide range of Industrial and Commercial applications.

Write for our full line catalog including MINELCO® Indicators, Switches and Trimmer Potentiometers.

*\*Built-In Test Equipment*

## MINELCO

DIVISION  
GENERAL TIME  
A Tally Industries Company

135 SOUTH MAIN STREET • THOMASTON, CONN. 06787  
PHONE: 203/283-8261 • TWX: 710/475-1091

INFORMATION RETRIEVAL NUMBER 112

## 2-phase MOS clock driver replacement

Fairchild Camera & Instrument Corp., Analog Products Div., 464 Ellis St., Mountain View, Calif. 94040. (415) 962-3816. SH0013C9: \$12.50; (100-999).

The SH0013—a dual, high-voltage driver—can drive large capacitive loads at computer speeds. It is a pin-for-pin replacement for the NH0013 and MH0013 (currently supplied by National Semiconductor). The device has a 30-V output voltage swing and can drive two-phase MOS clock lines in such applications as MOS RAMs and shift registers.

CIRCLE NO. 327

## Grounded load driver monitors logic systems

N. V. Philips, P.O. Box 523, Eindhoven, The Netherlands.

The 60-series Norbit range is extended to include a grounded load driver, the GLD60, that drives loads up to 400 mA with one side grounded. The main application of the GLD60 is for monitoring and display of twin channel logic systems on automated logic-controlled production lines. It can also be used as a driver for power transistors to achieve higher power output (4 A).

CIRCLE NO. 328

## Radio transmitter on a chip

Lithic Systems, Inc., P.O. Box 869, Cupertino, Calif. 95014. (408) 257-2004. \$12.50 (100 up).

Designated the LP2000 Micro-transmitter, the monolithic IC is said to be the first radio transmitter on a chip. The device produces 100 mW PM, or 50 mW AM at 27 MHz from a high stability, regulated monolithic oscillator using external crystal control. Rf output power and power drain are externally controlled. The IC also includes a low-level modulation pre-amp/tone coding generator, internal power-supply regulation, and a latching power supply switch which draws zero power from batteries in the OFF condition. The circuit operates from 15 to 3 V supplies.

CIRCLE NO. 329

# NEW COOL-PAX MODULAR COOLING SYSTEMS FOR PowerSemiconductors

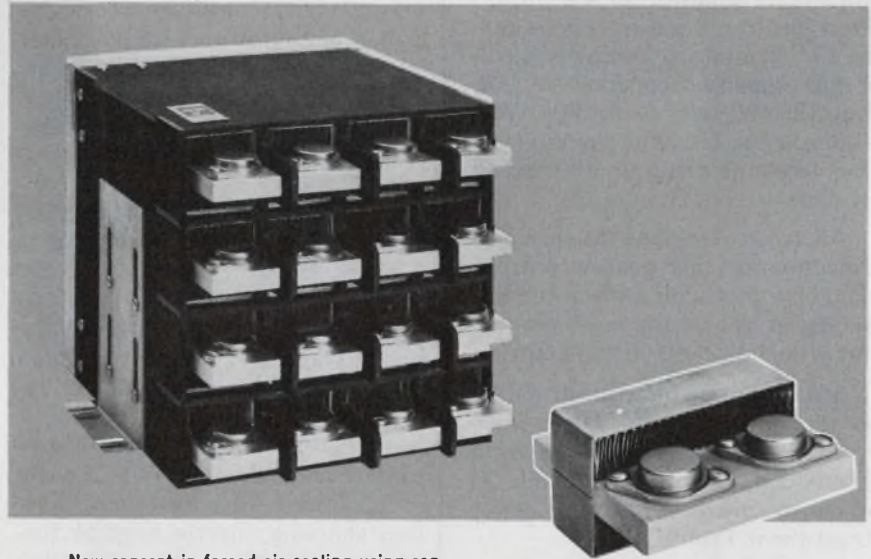

New concept in forced-air cooling using convoluted fin stock in modular assemblies accommodates any number of devices in case-common or single, isolated modules.

Modules are easily removed from system via a simple latching mechanism. Shown, a two-unit module.

### Brazed aluminum compact cooling packages:

- Provide .65°C/W cooling for each transistor at 8 CFM
- Provide parallel air flow to all devices
- Greatly reduce volume and weight

The COOL-PAX Modular System is a new generation in electronic cooling. Its superior performance and greatly reduced volume and weight make the heavy extrusion obsolete. COOL-PAX systems improve packaging versatility and lower overall systems costs. Devices are easily accessible and wiring complexity is reduced.

COOL-PAX Systems are simple to specify, to analyze, and to predict performance. For technical applications data to analyze your own system, write for our new COOL-PAX Catalog 72-CP-7.

WRITE FOR FREE CATALOG



## Thermalloy

P.O. BOX 34829  
2021 W. VALLEY VIEW LANE  
DALLAS, TEXAS 75234  
(214) 243-4321 TWX 910-860-5542

INFORMATION RETRIEVAL NUMBER 113

# PROTOTYPES

We'll ship them immediately—toroids and oscillators\* right out of stock—at far below competitive prices.

At Allen Electronics Division, we manufacture these, and other components, in quantity for the world's finest electronic organs. So we constantly maintain a complete stock of high quality frequency sources, and over 150 sizes of toroids. We'll send you the few you need to start your idea; the many you'll need to produce it.

All Allen components are made under the most rigid quality controls, including thorough inspection and testing, at one of the most modern and efficient plants in the country.

Send for complete information on the "Prototypes". Then, when you have an application that requires quality components immediately, at no-penalty prices, you'll know where to get them. Pronto.

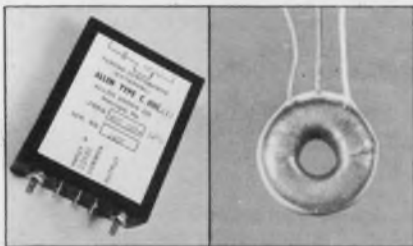

**Type C Oscillator**  
Range: 15 Hz to 10 kHz  
Use: Designed for applications having moderate requirements for stability in respect to temperature and frequency drift.

**Toroids**  
Over 150 sizes available from stock include Permalloy, Ferrite and Powdered iron types. Some no-center-tap. Inductance tolerance  $\pm 2\%$ .

\*Allow several extra days for packaging.

## ALLEN electronics division

Allan ORGAN COMPANY Dept. 1172  
Macungie, Pa. 18062

INFORMATION RETRIEVAL NUMBER 114

## MODULES & SUBASSEMBLIES

### Personality modules test 2048-bit pROMs

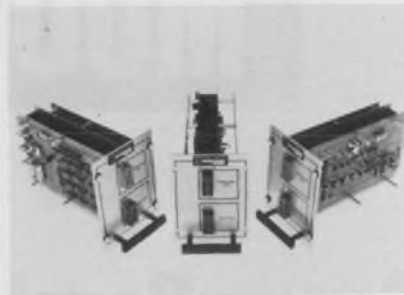

*Spectrum Dynamics, Inc., 2300 E. Oakland Park Blvd., Fort Lauderdale, Fla. 33306. (305) 566-4467.*

Personality modules for the Model 550 universal programmer set the timing and voltages for pROMs from Intel, Intersil, Monolithic Memories, Motorola, National Semiconductor, Texas Instruments, Signetics, Microsystems International and Harris Semiconductor. Memory sizes include  $32 \times 8$ ,  $64 \times 8$ ,  $256 \times 1$ ,  $256 \times 4$ ,  $256 \times 8$ , and  $512 \times 4$ . The Model 550 is a self-contained keyboard entry programmer/verifier with both manual and automatic capability. Automatic programming from a master pROM can be performed rapidly with the 550. It is capable of handling fusible link, diode junction shorting, electrochemical fusing, and floating gate avalanche-injection pROMs.

CIRCLE NO. 330

### Hybrid divider is accurate to 0.5%

*GPS Corp., 14 Burr St., Framingham, Mass. 01701. (617) 875-0607. \$160.*

GPS Corp. announces the Model D-5040, an encapsulated, hybrid linear circuit divider requiring no external amplifiers. The one-ounce D5040 is  $1.12 \times 1.12 \times 0.4$ -in. Specs include: an FS accuracy of 0.5%; X input equal to  $\pm 10$  V; Y input equal to 0 to  $-10$  V; X input impedance of 10 M $\Omega$ ; Y input impedance of 100 K $\Omega$ ; 10 X/Y output of  $\pm 10$  V at  $\pm 10$  mA; output impedance of 1 $\Omega$ ; 3-db bw of 1 MHz; full power bw of 150 kHz; offset of 3 mV/ $^{\circ}$ C; and scale factor tempo of 0.02%/ $^{\circ}$ C.

CIRCLE NO. 331

### Readouts and decoders mount back-to-back

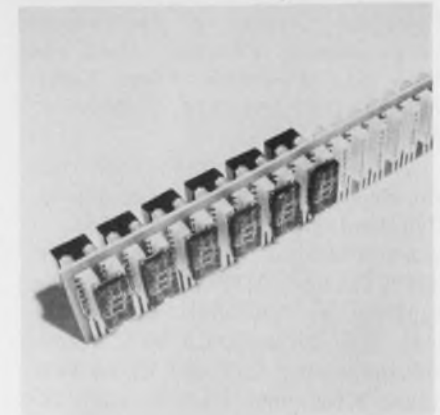

*Luminetics Corp., 1150 N.W. 70th St., Fort Lauderdale, Fla. 33309. (305) 974-5403. Stock to 4 wks.*

The L-100 series of readouts (incandescent or LED) and decoder/drivers are plugged into DIP sockets, allowing rapid interchange or repair. The entire PC-board assembly simply plugs into an edge connector, providing both mounting base and electrical interface. "Back-to-back" placement of the readouts and decoder/drivers permits a very compact configuration. Readouts are mounted on 0.6-in. centers, while decoder/drivers occupy the same amount of space on the rear of the PC board. Front-to-back dimension (including readout, decoder, two connectors and PC board) is less than one inch. Maximum height (including PC-board edge connector fingers) is less than 1-5/8 inches. Up to 18 digits are available in a continuous length.

CIRCLE NO. 332

### A/d converters offer \$1000 price cut

*Computer Labs, 1109 S. Chapman St., Greensboro, N.C. 27403. (919) 292-6427. 4-6 wks. ARO.*

Computer Labs has announced the CLB "Bare Bones" Series a/ds that offer the advantages of high-speed conversion in a small-sized, economical package. The units are  $7 \times 8 \times 9$ -inches and include track-and-hold circuits. Designed to operate on system dc power, the new converters resolve six to 10 bits at word rates from dc to 10 MHz. The absence of a power supply enabled a \$1000 price cut over earlier models.

CIRCLE NO. 333





# Stick with a winner!

Still the best low cost, 10-turn, precision wirewound pot on the market for commercial and industrial applications.

- Only 7/8" diameter, 3/4" length
- 500,000 shaft revolutions
- Linearity tol.  $\pm 0.25\%$
- Resistance tol.  $\pm 5\%$
- Gold plated terminals, welded terminations



Another Duncan first choice . . .

## MINIATURE TURNS-COUNTING DIALS



SERIES 60



SERIES 70



SERIES 80

Enable accurate positioning of multi-turn devices. All dials feature optimum readability, positive-action lock, excellent readings from any angle and precision compact design. **Call or write for complete specifications today!**

**DUNCAN ELECTRONICS**  
SUBSIDIARY

SYSTRON  DONNER

2865 Fairview Road Costa Mesa, California 92626  
Phone: (714) 545-8261 TWX 910-595-1128

### Projection readout displays any image

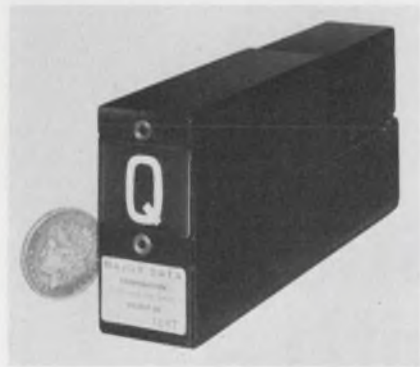

Major Data Corp., 1796 Monrovia Ave., Costa Mesa, Calif. 92627. (714) 646-2455. From \$49; stock to 4 wks.

The Major 16/32/64 modules are random access rear projection readouts, performing like mini slide projectors. They can display any graphic image, or up to 7680 separate characters in 16, 32 or 64 message versions for black and white or color displays. (Standard 64 message is ASCII code with capability of up to 120 characters per image frame.) Projected front panel image size ranges from 1.10-in. to 5-in., which can be viewed at cone angles up to 150° at distances up to 20-feet. Access time to messages is 70 ms. Readout is self-decoding and requires a six-bit input. The units have a built-in memory to retain the last selected message without need for signal power. Life expectancy is over 20 × 10<sup>6</sup> operations, or five years of normal use. Size is 3.6 × 1.65 × 8.8-in.

CIRCLE NO. 334

### A/d converter uses only 40 mW

Datel Systems, Inc., 1020 Turnpike St., Canton, Mass. 02021. (617) 828-6395. \$249 to \$349.

The most unique feature of the ADC-CM series a/d converters is the low-power consumption. Maximum power consumption is 40 mW at 12 V dc. Conventional a/d converters using TTL consume about 2.5 W and acquire three power supply voltages: +5 and ±15 V dc. Another unique feature of the series is its ability to normally rest in a standby state (12 V dc power disconnected), turn on upon receipt of a convert command signal, stabilize in a few microseconds, make a complete conversion and return to standby.

CIRCLE NO. 335

### Dc voltage standard costs just \$47

Traco Inc., 509 Rolling Hills Rd., Somerville, N.J. 08876. (201) 725-5333. \$47.

This lightweight, 1-V dc standard permits simple checking and correcting of DVMs, high-precision analog meters and scopes. Two flat 9-V batteries power a constant current source which remains constant regardless of the state of the batteries. The standard voltage source is activated by means of a push-button, which may also be arrested. An indicator displays the state of the batteries. Specs include: an output voltage of 1 V ±0.05%; an internal resistance of approximately 250 Ω; a tempo of ±1 × 10<sup>-5</sup>/° F; and noise ≤ 10 μV.

CIRCLE NO. 336

### 140-W power supply is uninterruptible

Pioneer Magnetics, Inc., 1745 Berkeley St., Santa Monica, Calif. 90404. (213) 829-3305.

Pioneer Magnetics, Inc., announces the addition of an uninterruptible power supply for volatile semiconductor memory systems to its PM2400 line of OEM multiple output computer power supplies. Designated the Model PM2412, the 140 W convection-cooled converter can provide power for up to 32 k × 18 or 65 k × 9 MOS RAMs at worst case temperatures. Operating from a 115 V ac source, this unit furnishes no-break power over power outages of 20 ms or longer and has a battery back-up with automatic switchover in the event of total ac power failure. A recharge circuit is included as part of the standard package. The converter is 7.0 × 5.25 × 11.0-in. (not including battery) and weighs approximately nine pounds.

CIRCLE NO. 337

### 5-V clock oscillators good to 25 MHz

Barber & Drullar, Div. of Barlow/Johnson Inc., 633 Delaware Ave., Buffalo, N.Y. 14202. (716) 886-3585.

Miniature crystal clock oscillators feature DIP-like size with DTL/TTL compatible output in 1 to 25-MHz range. The unit maintains frequency within ±50 ppm over 0 to 50 C, and operates on +5 V dc supply. Type CMO-8 case is 0.350 × 0.460 × 0.800-in. with six pins spaced to plug into standard 14-pin sockets.

CIRCLE NO. 338



ANALOGY  
TWO DOZEN OF INTECH'S BEST PRICE/ PERFORMANCE OP AMPS HAVE BEEN ASSEMBLED INTO ONE GREAT WINNING COLLECTION. EACH IS TESTED 100% ALL HAVE GUARANTEED MIN. AND MAX. SPECS INSTEAD OF THE USUAL TYPICALS. SEND THIS COUPON FOR OUR FREE OF CHARGE COLORFUL BROCHURE



DEAR ANA, PLEASE SEND ME YOUR FREE OF CHARGE, COLORFUL BROCHURE.

NAME \_\_\_\_\_ TITLE \_\_\_\_\_

COMPANY \_\_\_\_\_

ADDRESS \_\_\_\_\_

CITY \_\_\_\_\_ STATE \_\_\_\_\_ ZIP \_\_\_\_\_

**intech** INCORPORATED  
(408)244-0500  
1220 COLEMAN, SANTA CLARA, CALIF. 95050

## Custom hybrids offered in several packages



Airpax Electronics, Controls Div.,  
6801 W. Sunrise Blvd., Fort Lauderdale, Fla. 33313. (305) 587-1100. 6 wks.

Starting from a circuit diagram, Airpax can manufacture complete hybrid circuits in a wide variety of package configurations. Starting from screen manufacturing and photography, circuits are printed on ceramic substrates. Either chip and wire or discrete components can be used. Packages available include several DIP configurations, hermetic-sealed TO8s, conformally coated modules, etc. Resistor tolerances of under 1% with TCRs of 50 ppm are available. Many popular digital or linear semiconductor chips can be specified. Circuits are tested 100% electrically, and are subjected to environmental tests.

CIRCLE NO. 339

## Module holds peak voltage for DVM

Victory Engineering Corp., Victory Rd., Springfield, N.J. 07081. (201) 379-5900. \$99.50.

The MDL2 is a new peak holding lock for exact peak reading of a process via digital voltmeter (DVM). The automatic device will hold such a reading for an adjustable time period after occurrence. Designed to operate with any DVM that has terminals to "lock on" a reading (which practically all DVMs have), the MDL2 comes in two styles; one for OEM use and another as a separate modular adjunct to DVM equipment. Five ranges from 10 mV to 100 V are present on each unit. Input impedance is 10 M $\Omega$  min (all ranges) and response time is 1 ms. Operating temperature is 50 C max and holding time is variable to 10 seconds/infinite hold. Reset is automatic or manual.

CIRCLE NO. 340

# Need Opto Components & Assemblies?



### Optoelectronic Components

Spectronics components range from solid-state gallium arsenide emitters to photodarlington, photodiodes and phototransistors. Our broad line makes ordering easy; we'll also customize our components and systems to suit your exact needs. A wide selection of standard and custom opto chips is also available. Circle RS #167.

## Spectronics offers industry's broadest line of components, plus complete assemblies and IR emitters and detectors for immediate delivery!

### Complete Functional Assemblies

We offer a wide variety of complete assemblies and arrays using discrete, hybrid or monolithic techniques, including: read heads, card and tape readers, BOT/EOT sensors and linear encoders. Circle RS #168.



### IR Sensors and Emitters

InSb and InAs detector arrays typify Spectronics IR products available as catalog or custom items; these units have responses from 2 to 5 microns, are available in flatpack, glass dewar and metal dewars. Circle RS #169.

For complete information, circle the RS numbers indicated or call today.



**Spectronics**  
INCORPORATED

541 Sterling Drive  
Richardson, Texas 75080  
(214) 231-9381

COMPONENTS

**Small motor is priced at \$1.60 to \$2.00**



Barber Colman Co., 1300 Rock St., Rockford, Ill. 61101. (815) 968-6833. \$1.60 to \$2.00 (10,000 up); stock (small qty).

The type FYQM dc motor has low cost, is 1-1/4 in. diam., less than 2 in. long and weighs 5 oz. Typical torque output is 1.5 oz-in. at 3600 rpm. It operates on 6 to 32 V dc, has a seven-pole armature, a 1/8-in. shaft, pre-lubricated sintered bronze bearings and a sturdy motor enclosure. It is designed for use in battery-powered equipment.

CIRCLE NO. 341

**Toroidal inductors cover 50  $\mu$ H to 20 H range**



Dale Electronics, Inc., P.O. Box 180, Yankton, S. D. 57078. (605) 665-9301. \$1.90 for 100 mH, TD-4 (OEM qty.).

Dale's TD line of toroidal filter inductors are protected by a flame-retardant, abrasion-resistant vinyl coating. Four models are currently being produced. The TD-2 style covers 0.050 to 250 mH; TD-3, 50  $\mu$ H to 4 H; TD-4, 150  $\mu$ H to 7.5 H; and TD-5, 1 mH to 20 H. The standard tolerances are  $\pm 1\%$  for values above 2 mH and  $\pm 2\%$  for lower values. All models are available with temperature coefficients ranging from  $\pm 0.25/C$  to  $\pm 1\%/C$ .

CIRCLE NO. 342

**Magnetic clutch offered for computer peripherals**



Simplatrol Products, Div. of Form-sprag Co., 133 Southbridge St., Auburn, Mass. 01501. (617) 852-1107.

This Size 44, magnetic-particle electric clutch is designed for computer peripheral equipment. The design features a hollow-shaft, bearing-mounted construction ready to install on the customer's shaft. The unit is 2 D  $\times$  2-1/4 L in. and includes a drive and mounting hub. The unit can also be supplied as a brake. The rated torque for the clutch unit is 9 in-lb. and it has maximum torque of 14 in-lb.

CIRCLE NO. 343



**Photo-Electric Components**

**MUCH MORE THAN MEETS THE EYE!**



SHARP offers an entire new spectrum for applications in Computers and Peripheral Equipment, Industrial or Medical Instrumentation, Communications, and Controls.

- Silicon Photo-Detecting Diodes • Silicon Blue Cells
- Silicon Readout Cells • NPN-Type Silicon Photo Transistors • Photo-Coupling Diodes—GaAs Electro-Luminescent • Full Range of LED's including GaAs Infrared, GaAsP Visible & GaAs Negative Resistance Types

Write or call. Technical Literature available.  
**MARKETED EXCLUSIVELY IN THE U.S.A. BY SHIGOTO...**  
 one of the world's largest Manufacturing Importers.

**Shigoto Industries Ltd.**  
 350 Fifth Avenue, Empire State Bldg., N.Y., N.Y. 10001  
 (212) 695-0200/TELEX 224219

INFORMATION RETRIEVAL NUMBER 118

**WANTED**

THE NEWEST  
 MEMBER OF THE

**SUMMIT GANG**

**H.F. Mixer** alias: Double Balanced



**757**

**REWARD!**

**PRODUCTION \$\$\$ SAVINGS!!**

IF YOU DON'T KNOW HIS WHEREABOUTS:

CONTACT **SUMMIT engineering corporation**  
 Box 938 Bozeman, Montana 59715 Ph.(406)587-0838 fax(910)975-1950

H.F. MIXER (757) IS KNOWN TO CONSISTENTLY DISPLAY OVER 50db ISOLATION, AND IS LESS THAN A 6db LOSER. HE FREQUENTS THE DC-300 MHz RANGE. HIS ABILITY TO OPERATE WHIEST UNDER EXTREME CONDITIONS HAS MADE HIM A MOST WANTED MEMBER IN RF APPEACTIONS. MODEL 757 IS ONLY ONE OF THE MANY MIXERS IN THE SUMMIT GANG.

INFORMATION RETRIEVAL NUMBER 119

## Trimmer potentiometer mounts on PC boards

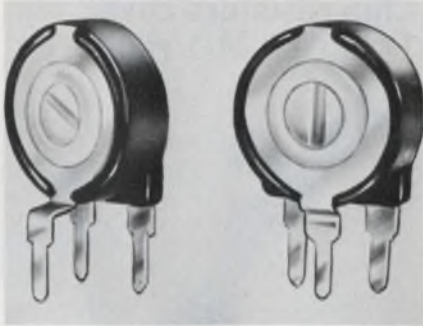

Piher International Corp., 1239 Rand Rd., Des Plaines, Ill. 60016. (312) 297-1560.

Piher PT10 Series, 3/8 in. D, trimmer pots feature fully-enclosed, carbon-composition elements. They have a snap-in, self-supported mounting for either a horizontal or vertical configuration that is particularly suitable for PC boards. They are available in resistances from 100  $\Omega$  to 10 M $\Omega$ , and they are rated at 0.20 W.

CIRCLE NO. 344

## Bleepers sound off in 13 different tones



C. A. Briggs Co., Inc., Cybersonic Div., P.O. Box 151, Glenside, Pa. 19038. (215) 885-2244. \$29.95 (per kit).

A sample kit of annunciators provides the design engineer with the opportunity to select the sound and audibility characteristics that he needs. Each kit includes one of the following: a 1-kHz Bleeptone unit, a 2.5-kHz Bleeptone unit, a two-tone Bleeptone unit, a Cyber-tone unit, a mounting ring and a mounting horn. All operate from 12 V dc. Thirteen different sounds are available from the four signaling devices. They produce sound pressure levels from 79 to 90 dB A, at one meter. Current drain is from 6.6 to 24 mA.

CIRCLE NO. 345

few major companies can give you this type of recorder.



Our Recorder is the one with greater accuracy and efficiency.

- With a larger memory bank . . . 41% larger . . . for more on-line processing before the memory has to be cleared again.
  - Greater accuracy in system stability and recording.
  - With these pluses and more, our Pulse and Transient Recorder costs less.
- Add to this an unheard of ease of operation, a compatibility with all types of recording devices and a flexibility that makes its applications seem endless, and you've got the one that fulfills your recording needs best. Ask for the whole story, ask for the literature on the \*ICE Pulse and Transient Recorder. The better one.

\*INTER-COMPUTER  ELECTRONICS INC.  
A subsidiary of AMERICAN ELECTRONIC LABORATORIES, INC.

P.O. Box 507, Lansdale, Pa. 19446 • (215) 855-0922 • TWX: 510-661-4976 • Cable: AMERLAB

INFORMATION RETRIEVAL NUMBER 120

**ELECTRONIC ENGINEERS:**

**CAREER OPPORTUNITIES  
WITH A FLORIDA COMPANY  
SPECIALIZING IN  
ADVANCED COMMUNICATIONS SYSTEMS  
AND HIGH TECHNOLOGY  
UHF RADIO EQUIPMENT**

Electronic Communications, Inc., a subsidiary of NCR, has openings at all levels for electronic engineers experienced in the design and development of communication systems, RF, digital and audio equipment. You will be working with major UHF command and control systems, satellite relay and telemetry systems, and a variety of other challenging long-term programs. At ECI, you (like all of our pros) will function with a minimum of supervision and a maximum of opportunity for advancement. ECI is small enough to give your accomplishments high visibility, yet big enough to provide the facilities and benefits of the largest companies. ECI is on Florida's West Coast — the BEST COAST — in comfortable, sunny cosmopolitan St. Petersburg.

If you are tops in your field, and if you are interested in a career opportunity on long-term programs in an intriguing location, write in confidence today to Paul D. Jordan, Supervisor of Professional Placement, Electronic Communications, Inc., Box 12248, St. Petersburg, Fla. 33733.

A Subsidiary of NCR  
An Equal Opportunity Employer — Male and Female

INFORMATION RETRIEVAL NUMBER 900

# ENGINEERS WHO KNOW ZENER DIODES SPEC DICKSON

That's because Dickson has earned a reputation for excellence in voltage regulating (Zener) and reference (TC) diodes. Since Dickson has always been a specialist in Zeners, engineers expect the best and they get it . . . from a hi-rel military unit to low-cost industrial devices. Give us a try! Write, today, for our 6-page Zener Selection Guide.

"The  
Specialists"



"Where Quality Makes The Difference"



**DICKSON**

ELECTRONICS CORPORATION

PHONE (602) 947-2231 TWX 910-950-1292 TELEX 667-406  
P.O. BOX 1390 • SCOTTSDALE, ARIZONA 85252

INFORMATION RETRIEVAL NUMBER 122

## COMPONENTS

### Chip resistors cover 1 $\Omega$ to 10 M $\Omega$ range

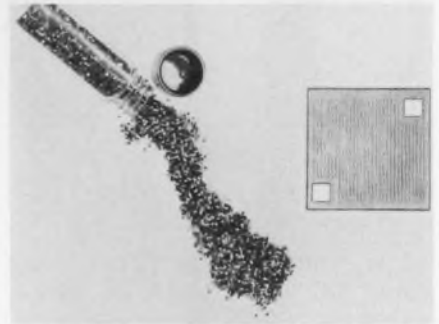

*Semi-Films Technology Corp., P.O. Box 188, W. Hurley, N.Y. 12491. (914) 338-7714.*

Tantalum-nitride chip resistors in a conventional 30-mil square configuration are now available in all standard RETMA resistance values from 1  $\Omega$  to 10 M $\Omega$ . Resistance values to 10 M $\Omega$  on such a chip size are said to be a significant advance in thin-film resistor technology. These resistors are deposited on silicon substrates and have aluminum bonding pads and gold backing for eutectic mounting.

CIRCLE NO. 346

### Triac device protects relay contacts

*Findlay Irvine Ltd., Bog Rd., Penicuik, Midlothian, Scotland.*

Suitable for all loads and voltages up to 70 A at 110 V ac, the ZERAC is claimed to be a solution to the problem of arcing at contacts of circuit breakers and relays. The device uses a triac circuit. With the contacts open or closed the circuit remains in an off condition. If the contacts change from closed to open while carrying current, the unit automatically switches to a conducting state. Thus the load current is supplied through the ZERAC. The unit's low-potential drop insures that no arc develops. At the end of the half-cycle (at almost zero current), the unit switches off automatically, achieving a virtually arc-free contact opening. Dimensions of the unit are 1.77 L by 0.86 D in. Models are available for resistive and inductive loads. A dc model will be available shortly.

CIRCLE NO. 347

## design aids

### Rectifier stack selector

A handy silicon rectifier stack and bridge selector enables power-supply designers to determine at a glance the correct high-voltage stacks and one-phase or three-phase full-wave bridges to best meet their voltage and current specifications. In the form of a 4-in. by 9-1/4-in. plastic slide-chart, the selector saves the designer the tedious job of searching through data sheets and experimenting with separate components in different hookups in order to create a stack or bridge close to his specs. With the selector, the user merely sets his desired voltage rating in an index window, looks at the appropriate output-current column, and reads directly the type number and package illustration code letter of the correct Unitrode stack or bridge for his application. He also sees at a glance the variety of Unitrode stacks or bridges available within each voltage range. Unitrode Corp.

CIRCLE NO. 348

### Industrial laminates

A brochure on popular industrial laminates includes a bound-in wall chart to aid engineers and industrial buyers in ordering sheets, tubes and rods for use in electrical and electronic equipment. Throughout the 14-page, two-color brochure each laminated plastic base is described in terms of its mechanical and electrical applications. Paper, canvas, linen and asbestos fabric laminations, as well as glass and nylon fabric base laminated plastics are listed, complete with data on their proper machining and finishing. Extraordinary properties of the laminated plastics, such as their high impact and dielectric strength, their effective moisture, heat, oil, chemical and abrasion resistance, etc., are illustrated, as well as ease of fabrication using standard machines and procedures. Commercial Plastics & Supply Corp.

CIRCLE NO. 349

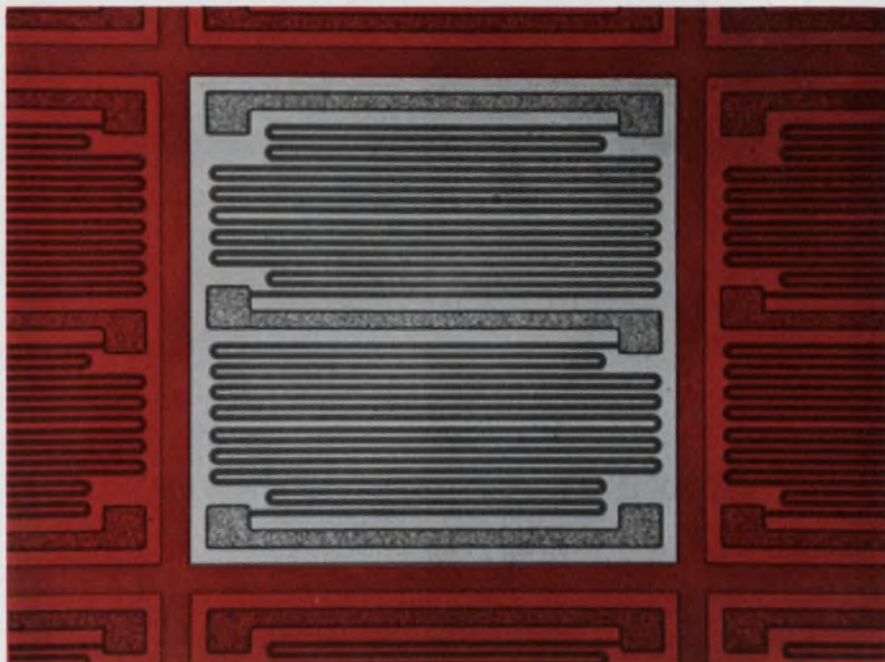

## New passivated thin-film resistor chips and wafers

from HYBEX a new division of Burr-Brown

Here's a new series of glass passivated thin-film resistors from a new, dependable source — Hybex. The unique "S" configuration, originated by Hybex personnel, greatly simplifies hybrid assembly. Since these center-tap resistors contain three pairs of large surface aluminum bond pads, the operator can accomplish straight line wire bonding without reorientation of the 30 mil chip. Gold silicon backing also allows the use of all conventional die bonding techniques including eutectic and epoxy.

### HYBEX "S" SERIES RESISTORS

- Temperature Coefficients: Standard  $\pm 50\text{ppm}/^\circ\text{C}$   
Custom  $\pm 10\text{ppm}/^\circ\text{C}$   
tracking to  $\pm 5\text{ppm}/^\circ\text{C}$
- Standard Resistance Value Range:  
1% tolerance, 10 ohms to 510 kohms  
5% tolerance, 10 ohms to 510 kohms  
10% tolerance, 10 ohms to 470 kohms
- Available as wafers or chips.
- Power Dissipation: 250 mw.
- All units 100% probe tested and visually inspected.

### FOR COMPLETE TECHNICAL INFORMATION

use this publication's reader service card or contact Hybex.



### HYBEX CUSTOM CIRCUITS, TOO!

Let Hybex assist you with your unique thin and thick film hybrid and monolithic circuit requirements. For details on our custom circuit capability, contact Mr. Dennis Haynes, your Hybex man in Tucson.

# HYBEX

INTERNATIONAL AIRPORT INDUSTRIAL PARK  
Tucson, Arizona 85706  
TEL.: 602-294-1431 • TWX: 910-952-1111

A division of Burr-Brown

INFORMATION RETRIEVAL NUMBER 123

# NEW Low Cost, 12-Bit D/A Converter



- Bipolar — 2's Complement Coding
- Pretrimmed — Ready to Use
- Full Range — 10V Output
- TTL, DTL Compatible
- All Hermetic Components
- 2" x 2" x 0.4"

**\$45**  
in hundreds

Now at a remarkably low OEM price . . . The DAC372-12 is a fine performance, general purpose 12-bit D/A converter featuring 30PPM/°C temperature coefficient, 0-70°C operation, and 5µSec settling. The unit incorporates thin film precision resistors and is complete and ready to use. Price for 1-9 — \$75.

Need ultra fast settling? The DAC372-WB-12, using an extremely fast internal amplifier, settles in under 950nSec for a full 10V output range . . . a remarkable unit at only \$120 (1-9). Contact us for full details.



## HYBRID SYSTEMS CORPORATION

87 Second Ave., Northwest Industrial Park, Burlington, Mass. 01803  
Telephone: 617-272-1522 TWX: 710-332-7584

INFORMATION RETRIEVAL NUMBER 121

## POWER SOURCES for

# A/D and D/A CONVERTERS FUNCTION MODULES, OP AMPS LOGIC DEVICES & LINE RECEIVERS

Single and Dual Regulated  
Outputs as low as **\$19.95**  
(1-9)

### LCD POWER SUPPLIES

	PRICE (1-9)
• ± 15V @ 25mA	\$19.95
• ± 15V @ 50mA	35.00
• ± 15V @ 100mA	45.00
<b>NEW</b> • ± 15V @ 200mA	59.95
<b>NEW</b> • ± 5V @ 250mA	59.00
<b>NEW</b> • 5V @ 500mA	37.95
<b>NEW</b> • 5V @ 1000mA	49.95

**REGULATION:** 0.20% max.  
**RIPPLE & NOISE:** 1 mV rms  
**SHORT CIRCUIT PROTECTED**

Plus 9 other standard models

See our ad in EEM, pages 948 and 949



## SEMICONDUCTOR CIRCUITS, INC.

306 RIVER STREET ■ HAVERHILL, MASSACHUSETTS 01830  
(617) 373-9104

INFORMATION RETRIEVAL NUMBER 124

## evaluation samples

### IC breadboard

An IC breadboard features perforated laminate and terminal pins. A universal wiring panel follows a set pattern or straight parallel copper strips bonded to a piece of phenolic or glass laminate. Assembly and soldering techniques, similar to those used in PC wiring, can be adopted without the need for detailed planning and etching. The sample (1-1/8 × 2-7/16 inches) has a set pattern of holes provided to make up a matrix with a pitch of 0.1 × 0.1 in between adjacent centers. The copper strips are 0.075 wide, 0.0015 thick and spaced 0.025 in. apart. Vero Electronics Inc.

CIRCLE NO. 350

### PC card guides

The type CG-108-3 PC card guide is for use with 1/16-inch PC boards. The guide can be used as a panel-mounted card guide or as a free-standing card guide in a mother-daughter board application. Card slots are provided front and rear for maximum space utilization. The guide will support short and tall PC boards and is unaffected by any of the cleaning agents normally used in removing solder flux. Material is Type 6/S nylon and natural color is standard. Other colors are available on request for OEM quantities. JOLO Industries.

CIRCLE NO. 351

### Drafting aids

A complete family of sequential reference designation letters and numbers, in addition to alphabetical and numerical symbols, are available in opaque black and transparent red or blue, and in a variety of sizes from 0.125 in. to 0.400 in. These symbols are printed on pressure-sensitive matte acetate film, are individually pre-cut for easy removal and positioning on master artwork drawings, and can be ordered in reverse reading for two-sided circuit board artwork. Centron Engineering, Inc.

CIRCLE NO. 352



## Compare Mox to whatever resistor you're using now.

Our Metal Oxide Resistors offer you:

- Small Size ■ Maximum Reliability
- 100 ppm TCR ■ High Stability
- High Voltage Capability

Set a comparable MOX Resistor beside the wire wound or metal film resistor you're using now. Chances are you'll find ours smaller, giving you greater design possibilities for ultra-critical applications.

We offer you a complete MOX Series to choose from, and we keep them stocked for prompt delivery.



**Mini-Mox**—Miniature high voltage resistors with ratings as high as 5 KV and dissipations to 1 watt.

**Maxi-Mox**—Rated at 2.5 watts and 7.5 Kv per lineal inch. Available in 1-5" lengths in 1" increments.

**Divider-Mox**—Single units with one or more taps. Ratios as high as 10,000:1. Input voltages to 37.5 Kv; .5% output voltage stability.

**Power-Mox** — High voltage, high power resistors. Voltages to 45 Kv. 45 watts in 70°C air ambient.

MOX FACTS and Technical Data Sheets are available from: Victoreen Instrument Div. of VLN Corp. 10101 Woodland Avenue, Cleveland, Ohio 44104. Telephone: 216/795-8200.

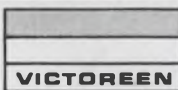

DMA 682

Expertise in high voltage.

INFORMATION RETRIEVAL NUMBER 139

Now you can get this  
OEM Ultra High-Speed  
solid state  
Printer direct from us.



We private-branded them for other people in the past. You might even have some. Now you can buy the Century Model 615, and get spares and service, for existing units, from the people that know them inside and out.

Ask for a copy of the 4-page Model 615  
Videoprint Bulletin. See it at the FJCC, Booth 3564

# HATHAWAY

i n d u s t r i e s

A HATHAWAY INSTRUMENTS INC. COMPANY

P. O. BOX 45381 • SOUTHEAST STATION • TULSA, OKLAHOMA 74145

PHONE: (918) 663-0110 TWX 910-845-2129

Formerly Century Electronics & Instruments, Inc.

INFORMATION RETRIEVAL NUMBER 140

ELECTRONIC DESIGN 24, November 23, 1972

## COUNTER REVOLUTION!

If you're on the verge of open insurrection  
over frequency counters that deliver too  
much price and not enough performance...

JOIN THE HEATH/SCHLUMBERGER  
COUNTER REVOLUTION!



We've got a new series of high frequency counters that combines exceptional performance and features with low cost. Standard features on all three models include 7-digit LED readout plus overrange...high stability time base...automatic decimal point switching...very high input sensitivity...combination carrying handle/tilt stand.

**Revolutionary Idea #1:** our new SM-110A...Direct counting 1 Hz to 200 MHz range...input sensitivity: 10 mV @ 35 MHz, 15 mV @ 200 MHz...one megohm/15 pF and 50 ohm inputs...4 time-base ranges...1 MHz crystal time base with 7.5 ppm/yr stability...all for only \$495.00\*.

**Revolutionary Idea #2:** the SM-110B...features the same range, input sensitivity and separate inputs as the SM-110A above...plus 1 MHz TCXO time base stable to 1 ppm/yr...complete programmability for Range, Reset, Input Select, Count Inhibit, all standard TTL-level. Outputs: 7 digits of BCD, Overrange Flag, Decimal Points, Print Command, 5 V reference and ground...just \$625.00.\*

**Revolutionary Idea #3:** the new SM-110C...with all the features of both the A and B models above...plus a 600 MHz range (prescaled by 10) for the high frequency input. Imagine...measurement capability into the UHF region for only \$795.00!\*

Use the coupon below to send for the free SM-110 series brochure...and join the Heath/Schlumberger Counter Revolution!

P.S.: We've also got a complete line of counters, pre-scalers and timers starting at \$350...send for our free catalog for complete information.

HEATH  
Schlumberger

Heath/Schlumberger Scientific Instruments

Dept. 531-261  
Benton Harbor, Michigan 49022

I'm ready to join the Counter Revolution... please send the SM-110 series brochure.

Send complete instrumentation catalog... including addresses and telephone numbers of the 36 company-owned distribution centers that provide sales and service.

Name \_\_\_\_\_

Company/Institution \_\_\_\_\_

Address \_\_\_\_\_

City \_\_\_\_\_ State \_\_\_\_\_ Zip \_\_\_\_\_

Prices and specifications subject to change without notice.

\*Mail order prices; F.O.B. Benton Harbor, Michigan

EK-350

INFORMATION RETRIEVAL NUMBER 141

# If you buy our DPM's because of low price, expect some pleasant surprises.

Newport builds low-cost DPM's loaded with standard features not even possible on competitive models.

Take our new Series 2000B — 4½ digits for \$280. Reads a full 20,000-counts at 30 readings per second without sacrificing 0.01% accuracy. And only Newport gives you \*BIG-BCD outputs (\*Buffered, Isolated, Gated) to reliably drive long cables or to form a multiplexing data buss.

Plan to significantly reduce checkout time. With the Series 2000B you can ignore ground loops.

True differential inputs compensate for common-mode noise voltage and guarantees immunity up to 6 volts. All this plus so much more are protectively packaged in an extruded-aluminum shield-case.

See for yourself! Ask for some pleasant surprises with details on the Series 2000B DPM, or any of Newport's 150 matching meters. The panel instruments you install and forget.

Newport Laboratories Inc., 630 East Young Street, Santa Ana, California 92705 (714) 540-4914.



SERIES 2000B DPM: ±19,999 counts • DC voltage and current models  
30 rdgs/sec • 2½"H x 4½"W x 5"D. • 0.01% accuracy • BIG-BCD output

## Newport Digital Panel Instruments

INFORMATION RETRIEVAL NUMBER 126

### Revolutionary New!!

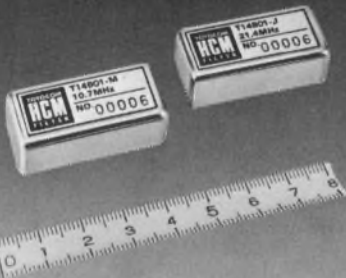

#### TOYO HCM FILTER T-1 SERIES

**FEATURES:**

- These filters provide guaranteed rejection of 90dB. Their volume is 46.3% that of widely used 8-element conventional filters. Their height is only 12mm.
- Terminating conditions are uniform, allowing these filters to be used in a wide range of applications. These filters are fully compatible with other filters in terms of electrical characteristics. Ample consideration has been given to mechanical compatibility.
- Stringent environmental tests (shock and vibration tests) assure adequate quality control levels.

**TOYOCOM**  
TOYO COMMUNICATION  
EQUIPMENT CO., LTD.

EXPORT DEPARTMENT  
TOYO BUILDING, 20-8-12, JINSHU-MAE,  
SHIBUYA-KU, TOKYO, JAPAN  
CABLE: EXPORTTOYOCOM-TOKYO  
TEL: (03) 406-3359  
TELEX: 09423001

INFORMATION RETRIEVAL NUMBER 127

### MORIRICA HIGH RELIABILITY! QUALITY OF THE FIRST ORDER CdS PHOTOCELLS

What is your application? Analogue? Digital?

The high power MPY series is suited to digital applications. The high-sensitivity MKY series is suited to analogue applications.

Type	Light resistance (At 10 Lux)	Dark resistance (after 10 sec)	Power dissipation (At 25° C)
MPY 7H59	20 - 50 KΩ	20 MΩ	200 mW
MPY 7H69	50 - 100	30	200
MKY 7H26	2 - 5	0.1	80
MKY 7H38	5 - 10	0.5	80

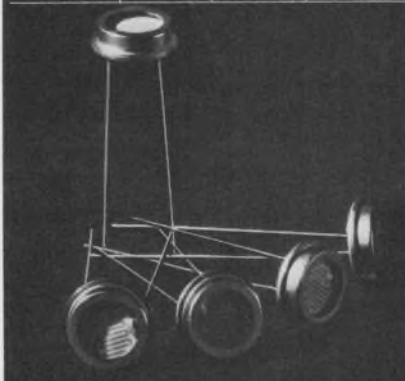

\*Main Items: CdS/CdSe Cell · Se Photovoltaic Cell · Photocell-Lamp  
**MORIRICA ELECTRONICS, LTD.**  
205, Tozuka-machi, Tozuka-ku, Yokohama, Japan  
Cable: "MORIRICA YOKOHAMA" Telephone: 045 881 2331

INFORMATION RETRIEVAL NUMBER 128

## EVALUATION SAMPLES

### Relay connector

A molded nylon connector for standard 11-circuit relays permits easy slip-in panel assembly, and has integrally designed panel and relay locking tabs. A flexible mounting ear snap-locks into a panel 0.035/0.050 inches thick to hold the Model 2177-1 Series 06-02 connector. Spring-action nylon tabs grip the base of the relay, making a hooking lock on two sides. Molex Inc.

CIRCLE NO. 353

### Strike-and-latch set

A strike-and-latch set, molded in tough plastic and including a tempered steel spring, snaps in from the front of any surface. There is no need for screws, bolts or other fasteners and only a rectangular hole in sheet steel is needed for each half. There is a special bracket for use with wood. Variations include a range in dimensions, various thicknesses of steel springs to vary the holding power of the female half and an unlimited range of colors. Fastex, Div. Illinois Tool Works, Inc.

CIRCLE NO. 354

### Polyurethane tubing

An extruded polyurethane tubing for miniature circuitry shows surprisingly flexible and elongation capabilities. This tubing makes possible miniature fluid power systems where applications demanding flow of gases or liquids without leakage at critical points of joining barbed fittings to tubing. The tubing needs no special tools, gaskets or chemical bonding, and creates its own positive seal. The tubing is odorless, nontoxic and has a clear plastic hygienic appearance, can be pinched or clamped to control flow, or can be stretched 350% and still retain pressure and sealing capabilities. Available I.D. sizes from 1/16 in. to 1/2 in. in clear and 10 different colors for circuit tracing. Industrial Specialties, Inc.

CIRCLE NO. 355

## Contact springs

A catalog lists off-the-shelf gold-plated bellows contact springs. The contacts, suitable for use in computers, instruments and high-quality electronic equipment, may be soldered into place. The nickel bellows which form the body of the contacts retains its spring characteristics indefinitely in most applications. Outside diameters of the available contacts range from 0.037 to 0.125 inch. Smaller or larger diameters or lengths can be custom made in approximately five weeks. Servometer Corp.

CIRCLE NO. 356

## Safety decals

If you've ever bumped into a glass panel door and wondered why someone didn't stick a label on it telling which way the door swings — here's something to help. These colorful, easy-sticking labels are two-sided. Labels can be attached to either side of glass panel doors, depending on the direction of the swing. Weather won't hurt them. Equipto.

CIRCLE NO. 357

## Adhesives

A line of adhesives feature cost-cutting, safety and reliability-boosting abilities. A color-coded application selector chart explains the uses and properties of nine adhesives. It also describes automatic application systems for use of the adhesives on assembly lines. Loctite Corp.

CIRCLE NO. 358

## Serrated grommet

An S-Series serrated continuous grommet is an addition to the company's solid-plastic line. The grommet is serrated for easier contouring around openings of any shape — square, round or oval. It provides a safe, smooth, fray-free finish or any potentially critical rough edging and protects wires, cables and cords from abrasion. The grommet comes in natural color polyethylene or nylon for five panel thicknesses from 0.036 to 0.250 inch and is packaged in 50 and 100 ft. rolls. Special colors are available. Richco Plastic Co.

CIRCLE NO. 359

# Waveform recording doesn't have to be all that complicated.

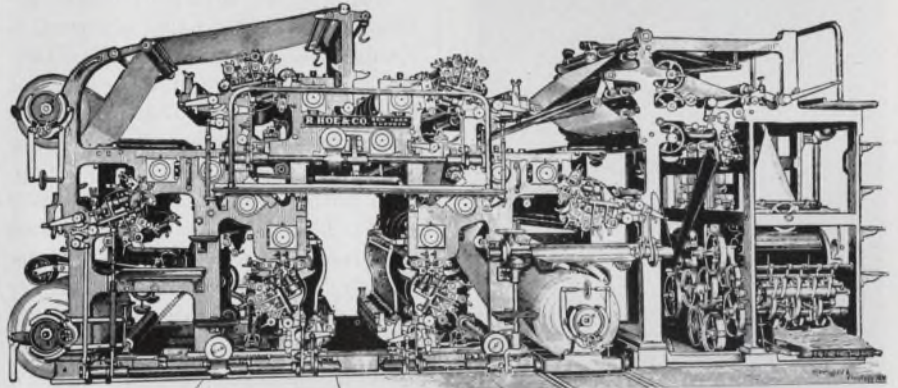

Tape deck, strip chart, conventional scope and camera — the old ways die hard.

But why make transient waveform recording all that complicated? Now you can easily stop, record, observe, and process fast, single-shot (or repetitive) signals or pulses without all the old-fashioned, time-consuming apparatus.

For example, you can stop any non-recurring signal — like a nuclear pulse, sonic boom, or power line transient — and store it digitally at analog-to-digital conversion rates up to 100 MHz per sample with 8 bit resolution.

You can even record the data preceding your trigger signal so that you can study conditions leading up to the trigger point.

Then you can transfer recorded data digitally to a computer or to other digital processors or peripherals; whatever is most convenient for you. Or, you can present the analog equivalent on a CRT display. Or make a permanent record on a strip chart or Y-T recorder.

This kind of data acquisition is priceless — especially in such convenient, easy-to-use form. You can measure explosion shock waves, for example. Shock tube studies, T-jump, stop-flow and other reaction kinetic chemistry, Plasma physics, Fluorescent decay studies, Automatic test systems for component testing, Lidar and other optics systems. Pulsed NMR work. Biomedical signal analysis — you name it.

We have the broadest line of waveform recorders in the world. Choose one that fits your application, regardless of A/D speed, A/D resolution, memory length, or price. For full information, write or call Biomation, 1070 East Meadow Circle, Palo Alto, California 94303. (415) 321-9710.



**biomation**  
Always a trace ahead.



## Double duty Double metals

H. A. Wilson Thermometals® are thermostatic bimetals that (1) change shape with temperature and (2) build up force with change of temperature when constrained.

They can be used for Temperature Indication, Temperature Control, Temperature Compensation or Sequence Control.

The many varieties of Thermometal available offer a choice of properties for an unlimited number of applications.

Thermometals can be rolled to any thickness, formed into almost any shape . . . plated, brazed or welded.

We have more engineering know-how and manufacturing facilities than anyone in this field. For information and/or technical assistance, call or write the H. A. Wilson Application Engineering Department (201) 464-7000.

**ENGELHARD**

ENGELHARD INDUSTRIES DIVISION  
ENGELHARD MINERALS & CHEMICALS CORPORATION  
2855 U. S. ROUTE 22, UNION, NEW JERSEY 07083

An Equal Opportunity Employer

38A

## application notes

### COS/MOS-bipolar DACs

Application Note ICAN-6080 details "Digital-to-Analog Conversion Using the RCA-CD4007A COS/MOS IC." The note demonstrates the use of a CD4007A COS/MOS dual complementary pair plus inverter as the d/a switch and op-amp output stage for a low-power DAC. This nine-bit DAC system combines the concepts of multiple-switch COS/MOS ICs, a ladder network of discrete metal-oxide film resistors, a COS/MOS-bipolar op-amp voltage follower and a monolithic regulator in a simple single-supply system. RCA Solid State Div., Somerville, N.J.

CIRCLE NO. 360

### Spanish assembly handbook

A Spanish edition of the company's 42-page, pocket-sized "Handbook for Electronic Assembly and Fabrication" contains valuable and practical information for the many phases of electronic assembly and fabrication. The manual is illustrated and contains seven chapters covering care and use of tools, wire preparation, assembly components, the use of PC boards, soldering and a list of reference charts and tables. Hexacon Electric Co., Roselle Park, N.J.

CIRCLE NO. 361

### Data indexing

"Time Code Data Indexing Handbook" presents a technical dissertation on the theory of data indexing and retrieval on different recording mediums such as magnetic tape, oscillographs, strip-chart recorders and camera film. In addition, it presents a summary of available time code formats and their application. This handbook is a guide for time data indexing, precision range timing, synchronized communication and remote time synchronization. Datametrics, Watertown, Mass.

CIRCLE NO. 362

### Liquid crystals

The "Bibliography of Liquid Crystals in Nuclear Magnetic Resonance (NMR)," Kodak Publication No. JJ-15, lists 45 journal papers about the application of liquid crystals to NMR studies. It also covers a wide range of studies including: NMR spectroscopy in liquid crystals, NMR of molecules oriented by liquid crystals, recent results in the field of liquid crystals, and others. Eastman Kodak Co., Rochester, N.Y.

CIRCLE NO. 363

### Optical surface cleaning

Optical surface cleaning with plasma chemistry is described in Plasma Applications Note No. 1. The note describes how organic impurities and films can be removed from optical surfaces without disturbing the reflectance coatings. The plasma chemistry technique provides removal by passing a stream of reactive oxygen plasma over the optical surface. The plasma causes a low-temperature combustion of the organic material. It carries away the combustion products in the gas stream. The plasma is a highly reactive mixture of ions, radicals and atoms. Tegal Corp., Richmond, Calif.

CIRCLE NO. 364

### Fused quartz

A 16-page technical guide on transparent pure fused quartz contains full chemical and physical properties as well as optical qualities. Setting forth definitions and nomenclature, the literature presents a table of mechanical, physical, electrical, thermal, optical and chemical characteristics. Data on softening under load, high-temperature properties, and devitrification are included. The brochure devotes five pages to detailing the six manufactured grades of quartz available and the variations in properties within each grade. In addition to the tables, graphs and charts, the guide includes many photographs of quartz fabrication for quick and easy reading. Quartz Products Corp., Watchung, N.J.

CIRCLE NO. 365

## Photodetector uses

An application note, entitled "The Use of RCA Solid-State Photodetectors in Small-Signal Detection Systems," develops the basic equation for noise equivalent power (NEP) and provides two nomographs that will be useful to all users of RCA solid-state photodetectors. The detection of small signals using silicon p-i-n photodiodes requires minimum NEP so that the lowest possible level of incident radiant flux can be detected. The note, AN-4849, develops the basic formula for NEP and provides nomographs to allow the rapid determination of optimum NEP as well as rise time and frequency cutoff for a given system. RCA Electronic Components, Harrison, N.J.

CIRCLE NO. 366

## Semiconductor coatings

A four-page selector guide aids in choosing from a line of eight ion-free semiconductor junction coatings. A highlight is a detailed table that presents specification and typical property data. In addition, application information, including recommended cure schedules and mixing instructions, is presented. Dow Corning Corp., Midland, Mich.

CIRCLE NO. 367

## Phase jitter measurements

A supplement to Application Note No. 109 "Phase Jitter Measurements Using the W&G 443 or 463 Level Meters" includes additional experience obtained using these models in the field. W&G Instruments, Inc., Hanover, N.J.

CIRCLE NO. 368

## PC coating procedure

Conformal coating problems and solutions are described in a bulletin. The bulletin covers areas of initial inspection, cleaning, application methods, coverage, solvent use, air sources and handling. Thoroughly field tested experiences are described by cause, effect and remedy. The Dexter Corp., Hysol Div., Olean, N.Y.

CIRCLE NO. 369

## Beta variation method

The relation between the gain of a transistor and its collector current may be simulated following the method described in a 27-page AEDCAP Application Note. The method is presented as an augmentation of the Ebers and Moll transistor model commonly used in computer simulation of electronic circuits. Where the variation in transistor gain at various collector current values is important, the augmented model gives more accurate simulation results. SofTech, Waltham, Mass.

CIRCLE NO. 370

## Polymer surface treatment

A technical bulletin features polymer surface treatment. The plasma surface treatment of polymers is finding increased use in industrial applications where polymers must be rendered bondable, printable, wettable, paintable or plateable at low cost. The company has developed surface treatment methods for polymers such as polypropylene, nylon and Teflon in numerous formulations with different fillers, molecular weights and degrees of plasticizer added. International Plasma Corp., Hayward, Calif.

CIRCLE NO. 371

## Using thermal instruments

A Tip Sheet covers the use and maintenance of scientific controlled-temperature equipment. Safety in the laboratory, setting of proper temperature conditions and the repairing of mercury thermometer columns are some of the items covered in the tip sheet. Hotpack Corp., Philadelphia, Pa.

CIRCLE NO. 372

## Film resistors

An authoritative design guide to film resistors provides design data and criteria for the selection and application of film resistors. Included are detailed definitions and interpretations of resistor parameters, designation codes, and a special section on temperature derating. Mepco/Electra, Inc., Morris-town, N.J.

CIRCLE NO. 373



## 1750 ways to keep in touch

At H. A. Wilson we have over 1750 precious and sintered metals and alloys available for electrical contact applications. Yes! Even more than any other company. This wide variety enables us to produce every conceivable form of contact in sizes ranging from the micro-miniature forms used on Apollo spacecraft to up to 1 $\frac{1}{4}$  in. square (NEMA  $\pm 6$  and  $\pm 7$ ) motor starters. Combine this wide selection of materials with our engineering and production capabilities, and it's obvious there are few, if any, contact problems we can't solve. Even yours.

For information and/or technical assistance, call or write the H. A. Wilson Application Engineering Department (201) 464-7000.

**ENGELHARD**

ENGELHARD INDUSTRIES DIVISION  
ENGELHARD MINERALS & CHEMICALS CORPORATION  
2655 U. S. ROUTE 22 UNION, NEW JERSEY 07083  
An Equal Opportunity Employer

34A

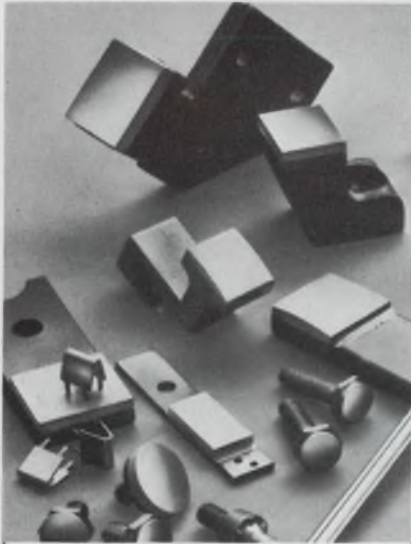

## For us, the truth comes easy.

When we recommend a contact material for your switch, thermostat, relay, elevator control, or any other contact application, it's because it's the proper material for you to use.

... Not because it happens to be the one we manufacture.

When you produce the broadest line of contact materials you can afford to be objective. No one else can.

While this objectivity is good for our business, it's even better for yours because we'll only recommend a metal because it's best suited for your application ... not to make a sale.

Our engineering background, manufacturing facilities and broad experience in applications surpass those of any one in the field. So does our product line of contact metals. For information and/or technical assistance, call or write the H. A. Wilson Application Engineering Department (201) 464-7000.

**ENGELHARD**

ENGELHARD INDUSTRIES DIVISION  
ENGELHARD MINERALS & CHEMICALS CORPORATION  
2656 U. S. ROUTE 22, UNION, NEW JERSEY 07083  
An Equal Opportunity Employer

1930

## APPLICATION NOTES

### Power transistors

The ability of a power transistor to withstand thermal cycling over a wide range of operating conditions is determined by a testing program. "Thermal-Cycling Ratings of Power Transistors" describes tests performed to verify a rating chart showing thermal cycling capability. The chart can be applied to practical operating conditions. The seven-page note also discusses thermal fatigue and includes the test results and the transistor predicted-capability chart. RCA Solid State Div., Somerville, N.J.

CIRCLE NO. 374

### Reed and Hg-wetted relays

The "Technical Application Reference for Mercury-Wetted Contact Relays, Dry Reed Relays and Mercury-Wetted Reed Relays" is probably the most useful, down-to-earth reference available on the subject. Though it leaves the impression that only C.P. Clare offers such relays, its 54 pages provide a wealth of information that can be used with anybody's dry-reed, mercury-wetted-reed and mercury-wetted-contact relays. Though an occasional redundancy may signal a certain lack of economy in the presentation (pages 31 and 46, for example, are identical), the over-all forthrightness is refreshing. The authors show the limitations of different relay types as well as their advantages, and clearly warn readers away from using certain relays in certain applications. In addition to discussing the theory of operation and applications of the different types, they give useful circuits for overcoming less-obvious switching problems. They add circuits for protecting driving semis and reducing  $dV/dt$  transients but they show the drawbacks of these circuits and suggest useful compromises. And they include useful measurement circuits, equations, charts and nomograms. With this brochure, Clare offers a 12-page guide, "Six Tough Interface Designs." C. P. Clare & Co., Chicago, Ill.

CIRCLE NO. 375

### Ac power supplies

"Programmable AC Power Systems . . . Wyes and Wherefores" is the title of a six-page article which deals with the problem of testing instruments and systems for their ability to function properly while under the influence of erratic ac power line conditions. Attention is focused on the application, implementation, programming, system characteristics and system performance. Block diagrams and scope traces are provided to support the technical discussion. California Instruments Co., a div. of Aiken Industries, Inc., San Diego, Calif.

CIRCLE NO. 376

### Relays and timers

A 100-page reference book features an extensive selection of timing, counting and switching devices and controls. The book covers a wide range of magnetic relays, including general purpose, power, control, mechanical, stepping, solid-state, PC board and mechanical latch types; solid-state and thermal time-delay relays; motor-driven, pneumatic and spring-driven timers; solid-state temperature controls; photo electric controls; counting devices; buzzers; foot switches, micro-switches and instrument cabinets. Relay Specialties, Inc., Fair Lawn, N.J.

CIRCLE NO. 377

### Twelve-bit DAC

An eight-page application note describes how to build a 12-bit digital-to-analog converter using the Intersil 8018A family of high speed IC current switches. These are TTL-compatible circuits designed for high speed (40 ns) precision (up to 0.01% absolute error) switching. Each device includes four logic-controlled current switches on a single monolithic chip. The bulletin, "Application Bulletin A010—Digital to Analog Converter Circuits Using the 8018A," by Bill O'Neil, provides circuit diagrams and a detailed discussion of circuit operation, paying special attention to such considerations as references, settling times and resistor networks. Intersil Inc., Cupertino, Calif.

CIRCLE NO. 378

## Screen printing inks

A ten-page, two-color illustrated brochure features information on etching and plating applications, screen printing inks, epoxy inks, screenmaking supplies and new through-hole plated board production systems. The brochure details the advantages of alkali removable etch resist inks and removal techniques, production of plated through-hole boards and hole plugging procedures, and plating resists and plating procedures including precleaning and avoiding common problems. Naz-Dar Co., Chicago, Ill.

CIRCLE NO. 379

## Cooling fan handbook

"The Fan Catalog" describes a wide range of propeller and tubaxial airmovers. The illustrated 64-page catalog features more than 100 standard designs, among them 60 Hz, 400 Hz, multi-Hz, and dc types, compact Boxer and slim-profile IMCool models. Air deliveries range from just 13 cubic feet per minute to 1600 cfm. Complete electrical and mechanical specifications, dimensional data, performance curves and accessory equipment information is presented for each airmover. Of special interest to the systems designer and specifier, a comprehensive technical notes section details selection factors, electrical and mechanical design options. IMC Magnetism Corp., Marketing Div., Westbury, N.Y.

CIRCLE NO. 380

## Magnesium extrusions

A 34-page handbook "Whitelight Magnesium Extrusions" details 21 separate topics relating to magnesium, which is the lightest structural metal for practical commercial use and has the highest strength-to-weight ratio of all the common low-cost industrial metals. The guide gives data on the machining, welding, joining, forming and finishing Whitelight magnesium alloys. A wealth of mechanical and physical property tables, as well as specification cross-reference tables, is included. White Metal Rolling and Stamping Corp., Brooklyn, N.Y.

CIRCLE NO. 381

## A/d converters

Getting high-speed data in the 1 MHz to 10 MHz region into digital form for on-line storage or processing is a problem which is becoming increasingly prevalent. Care must be taken to use analog-to-digital converters which will not degrade the data beyond the tolerances required. A pamphlet titled "How to Make a Thousand Words as Good as a Picture" discusses the types of error which can degrade a signal in the a/d process and even turn an eight-bit a/d converter into a four-bit one. It also describes two simple experiments which can be carried out on any a/d converter to determine its true ability to convert high-speed analog signals accurately. Computer Labs, Greensboro, N.C.

CIRCLE NO. 382

## Lock-in amplifier

An illustrated 16-page application note describes the use of a lock-in amplifier and current sensitive preamplifier for accurate measurement of semiconductor admittance. The note, AN-110, is entitled "The Lock-In Amplifier—A Capacitance/Conductance Meter" and discusses several advantages of the lock-in technique over ordinary bridge balancing methods. In addition, discussion of the measurement theory, including the required mathematics, calibration procedures and measurement methods are provided. Princeton Applied Research Corp., Princeton, N.J.

CIRCLE NO. 383

## Contact retention systems

An engineering test report answers the question "How Reliable is Polymer Vs Metal?" in medium-density connector contact retention systems. The test, administered under cognizance of USAF Development Center, compares ultimate contact strength capabilities of MIL-C-83723 (polymer retention) connectors with MIL-C-26500 and NAS-1599 (metal clip retention) types. The report presents ultimate contact pushout forces measured per MIL-C-83723; results have been plotted in terms of reliability to meet 20 lbs. retention. Amphe-nol Connector Div., Broadview, Ill.

CIRCLE NO. 384

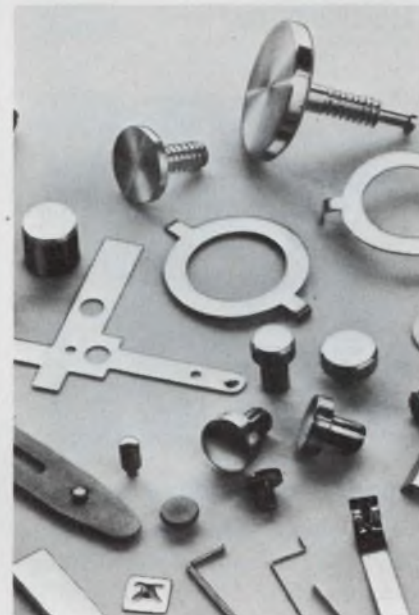

## Mini contacts, maxi line.

The smaller the contact material you need, the greater the chance is that you'll need H. A. Wilson to supply it. Our wide capability, engineering expertise and vast manufacturing facilities combine to let us recommend what is best for you... not just what we can supply.

When you have an application that calls for microminiature contact materials, such as MIL spec relays, telemetering equipment, conventional relays, potentiometers, telephone communications equipment, flashers, contact Engelhard.

Chances are it's not new to us.

Our engineering background, manufacturing facilities and broad experience in applications surpass those of any one in the field. For information and/or technical assistance, call or write the H. A. Wilson Application Engineering Department (201) 464-7000.

**ENGELHARD**  
ENGELHARD INDUSTRIES DIVISION  
ENGELHARD MINERALS & CHEMICALS CORPORATION  
2655 U. S. ROUTE 22 UNION NEW JERSEY 07083  
An Equal Opportunity Employer

1925

## new literature

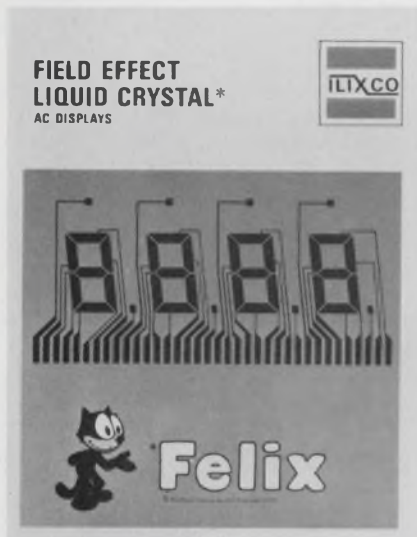

### Liquid crystal displays

A four-page technical bulletin on field effect liquid crystal displays describes their bilevel characteristics and operation in display systems. Data are provided for two specific ac displays—BLM 7041 available in 3, 3-1/2 and 4-digit configurations, and BLM 7080 available in either 3-1/2 or 4 characters. Diagrams and performance data are provided for electrical and optical properties. Dimensions and pin connections for all five ac modes are also included. International Liquid Crystal Co., Cleveland, Ohio.

CIRCLE NO. 385

### Industrial lasers

An eight-page catalog introduces a line of completely redesigned lasers the company has developed for industrial, research and OEM applications. Highlighted in the catalog are two helium-cadmium lasers that produce deep blue or ultraviolet beams, ten aluminum cathode helium-neon laser tubes, eight complete helium-neon red light lasers, two infrared lasers, eight cylindrical lasers and a variety of collimators, detectors, a spatial filter and mounting accessories. A table gives full specs on all the lasers and tubes described in the catalog. Metrologic Instruments, Inc., Bellmawr, N.J.

CIRCLE NO. 386

### Resistor handbook

The Resistor Engineering Handbook updates many technical specifications on the selection of precision and power wirewound resistors. Included is information about "sophisticated" high-reliability resistors, which satisfy the exacting demands of the aerospace industry, and chip resistors, for use in computer and peripheral equipment applications. Millimeter conversions, as well as MIL-Spec reference guide, are also included. RCL Electronics, Inc., Irvington, N.J.

CIRCLE NO. 387

### Dual monolithic transistors

A four-page summary of four families of dual monolithic FET and bipolar transistors includes general descriptions, specifications, performance curves, packaging outlines and pricing. Analog Devices, Inc., Norwood, Mass.

CIRCLE NO. 388

### Digital readout systems

A 50-page handbook covers the DMS 500 digital readout system. Dynamics Research Corp., Wilmington, Mass.

CIRCLE NO. 389

### DIP resistors

Results of a comprehensive study of the specific dollar and percentage savings available by using DIP resistors instead of discretes are presented in an eight-page publication. Tables show the number of resistors in each DIP network necessary to be used to effect a cost savings over discretes at different price levels. Additional tables indicate dollar and percent savings when using all resistors in each DIP network. A separate table can be generated for each quantity of resistors to be used in a DIP package. Beckman Instruments, Inc., Helipot Div., Fullerton, Calif.

CIRCLE NO. 390

### Gas laser guide

Gas Laser Product Guide, PWR-551D, provides, at a glance, revised and updated data and prices on the company's line of gas laser helium-neon tubes, heads, excitors and high-voltage connector kits. RCA Commercial Engineering, Harrison, N.J.

CIRCLE NO. 391

### Power supplies

Catalog 72-1 presents six distinct series of power supplies for systems applications. Outputs up to 120 A and 250 V are available. All pricing data are presented. Also, the 24-page catalog features a complete line of compensated voltage references with long-term stabilities. Dynage, Inc., Bloomfield, Conn.

CIRCLE NO. 392

### Uhf/microwave capacitors

A miniature chip and leaded capacitor catalog is a uhf/microwave designer's guide in disguise. Graphs of Q, insertion loss, VSWR, reflected power loss, equivalent series resistance and reactance vs capacitance value and frequency are presented on the ATC 100 low-loss microwave porcelain series. Also covered are the capacitors' high-power capability, low-noise figure contribution, stability, ruggedness, hermeticity and self-encapsulation, along with the cost advantages experienced and environmental characteristics. Lead styles, ordering code and a listing of kits for which the purchaser will receive an rf capacitor handbook are also shown. American Technical Ceramics, Huntington Station, N.Y.

CIRCLE NO. 393

### Optical instruments

Optical Catalog No. 86 contains 90 pages of illustrated listings of the latest developments in triangular optical benches and accessories, light sources, He-Ne laser, viewing telescopes, cathetometers, micro optical bench, optical components, demonstration and teaching apparatus for optics and includes many items not listed before. Klinger Scientific Apparatus Corp., Jamaica, N.Y.

CIRCLE NO. 394



# “ Spring contacts from Instrument Specialties eliminate extra test and inspection costs, loss of product in house, and losses due to product field fatigue!”



-reports Mr. J. B. Lambert, Exec. V.P. of T-Bar, Inc. in addressing Design Engineering Conference

Precision beryllium copper springs, made and heat-treated after forming by Instrument Specialties, are still making news. Mr. J. B. Lambert, Executive Vice President of T-Bar Inc., Wilton, Conn., referred to them again in his paper delivered before the Design Engineering Conference, terming them "essential" to his product.

T-Bar is a leading manufacturer of highly reliable switching devices for critical low level applications. The heart of each switch is one or more wafers, each consisting of 4 to 12 spring contacts, capable of switching up to 144 circuits. An assembly can consist of as many as 12 wafers.

Spring action is vital and springs must be uniform, because positive switching action must occur in a confined space. And since a completed T-Bar® package cannot be adjusted, spring dimensions and properties must be consistent at the time of assembly.

Instrument Specialties produces T-Bar's spring contacts by forming the springs of beryllium copper, placing them in fixtures, and then heat-treating them. This treatment, for all practical purposes, erases most variables that might be found in the same or different batches of beryllium copper, and produces an "accurate, stable, and highly reliable spring."

As Mr. Lambert reported to the ASME, "We need good conductivity, strength, stability and accuracy in a relatively small package." Springs furnished by Instrument Specialties "resulted in the best products. And we are not faced with hidden costs from excessive testing, inspection, or variations, or losses that might result from spring fatigue."

Instrument Specialties manufactures a wide variety of beryllium copper compression, flat, and strip springs, heat-treated after forming. They are available with or without precious metal contacts or platings, in stock sizes and shapes, or designed to your specific requirements. Write today for more information. Address: Dept. ED-71.

Specialists in beryllium copper springs since 1938



INSTRUMENT SPECIALTIES CO., INC.  
Little Falls, New Jersey  
Phone 201-256-3500

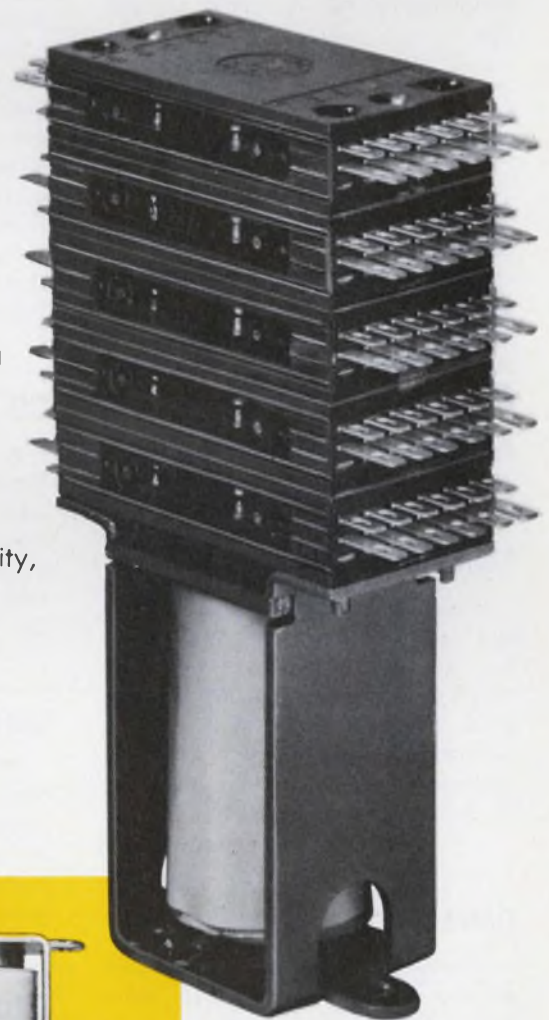

INFORMATION RETRIEVAL NUMBER 134

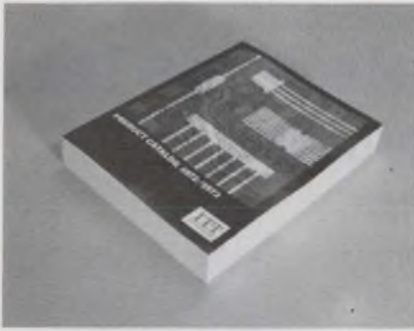

## ITT semiconductors

The Product Catalog contains over 700 pages of IC, transistor and diode data. Detailed electrical characteristics, circuit diagrams, packaging dimensions and other pertinent data are given. ITT Semiconductors, W. Palm Beach, Fla.

CIRCLE NO. 395

## Used computer prices

"Blue Book of Used Computer Prices," a 26-page quarterly, quotes current selling prices for all used computers available from the company. In addition, an entire section is devoted to the procedures used in negotiating a used computer purchase from first analysis of the problem to final installation. TBI Equipment Div., Elmsford, N.Y.

CIRCLE NO. 396

## Tantalum capacitors

Standard ratings, typical curves and performance characteristics for Tantalex capacitors are featured in a 20-page engineering bulletin. Also included are a catalog numbering system and a guide to application. Sprague Electric Co., N. Adams, Mass.

CIRCLE NO. 397

## DMM

Operation, features and specifications of the Model 8310 automatic DMM are discussed in a four-page, two-color brochure. The brochure includes a block diagram, explaining circuit design, and prices for the basic model with and without accessories. California Instruments Co., a div. of Aiken Industries, San Diego, Calif.

CIRCLE NO. 398

## Computer design

"Designing Computer and Digital Systems" shows how register-transfer components have matured to the status of a full-fledged system. The book was written in conjunction with the Carnegie-Mellon University and is aimed primarily at people who wish to design specific small digital systems. Copies of the handbook are available at \$3.95. Digital Equipment Corp., 146 Main St., Maynard, Mass. 01754.

## Analog instruments

"Sensitive Research Instruments," a short form catalog and price list, provides price and specification information on a line of analog instruments. Included in the 30-page catalog is information on laboratory standards, ac-dc and dc polyrangers and reference standards, ac-dc wattmeters, power factor meters, electrostatic voltmeters, thermocouple instruments, magnetic testing equipment, differential instruments and panel mounted instruments. Electrical Instrument Service, Inc., Mount Vernon, N.Y.

CIRCLE NO. 399

## CO<sub>2</sub> lasers

A data sheet on the Model XF Series of low-cost, flowing-gas CO<sub>2</sub> laser systems provides specifications and describes applications for these flexible industrial and scientific lasers. Apollo Lasers, Inc., Los Angeles, Calif.

CIRCLE NO. 400

## Danish trade directory

The Association of Electronics' Manufacturers in Denmark has prepared an Official Trade Directory for the Danish electronics industry. Consulate General of Denmark, New York, N.Y.

CIRCLE NO. 401

## FCC license courses

A catalog describes a home study program, which prepares students for the first, second or third class FCC radiotelephone license. The program is VA approved. International Correspondence School, Scranton, Pa.

CIRCLE NO. 402

## Oscilloscope monitor

The MMS-1A oscilloscope monitor, designed for display of physiological waveforms, is described in a two-page publication. Bulletin 5044 includes full description and operating specifications of the instrument which can be used at a patient's bedside or in the central nursing station. Beckman Instruments, Inc., Electronic Instruments Div., Schiller Park, Ill.

CIRCLE NO. 403

## Digital tape unit

Operation and specifications of the Model TMZ digital tape unit are described in a two-page brochure. Ampex Computer Products Corp., Marina del Rey, Calif.

CIRCLE NO. 404

## Crystal oscillators

Six styles of crystal oscillators for miniaturized communications equipment are described in a six-page selection guide. Included are temperature compensated and voltage controlled units. General specifications and dimensions are shown for each style. A special chart compares the variation in stability of oscillators with and without temperature compensation. Arvin Frequency Devices, Columbus, Ind.

CIRCLE NO. 405

## IPC specs

"End Product Description in Numerical Form" lays out the formats for transmitting data in digital form via punched cards and magnetic tape. "Performance Specification for Flexible Multilayer Wiring" establishes qualification and acceptance requirements for multilayered flexible wiring, consisting of three or more conductive layers on flexible insulating bases bonded to form a monolithic or solid mass. Both of these standards are available at \$1 each. "Results of Three Round Robin Tests of the Reliability of Multilayer Boards" provides data on the performance and reliability of plated through holes in multilayer boards. This report is available at \$5 per copy. Institute of Printed Circuits, 1717 Howard St., Evanston, Ill. 60202.

The News is

# Major!



## A 6" tubeaxial fan that moves more air . . . at higher pressures . . . and costs less!

It's the kind of news you expect from Rotron. An air mover with the extras built in. The Major<sup>®</sup> fan will deliver 150 cfm at a static pressure of .35 inches of water. That's 12% more air than the closest competitor.

The Major stays cooler, too. Its multi-slot permanent split capacitor motor draws less power than a shaded pole, and withstands line voltage variations better. An aluminum venturi and motor housing dissipate heat. And ball bearings add still further to long motor life.

The Major fan mounts interchangeably with other 6" fans. It can also be mounted on less than 6" centers.

Price? About 10% less than you used to have to pay for less performance! Get all the facts on Rotron's new Major tubeaxial fan today by sending for Catalog E2855.

*Why settle for less when the best costs no more.*



**ROTRON INC.**, Woodstock, N. Y. 12498 ☐ 914 • 679-2401 ☐ TWX 510-247-9033  
Pacific Div., Burbank, Cal. 91506, 213 • 849-7871 • Rotron B.V., Breda, Netherlands. Tel.: 49550, Telex: 844-54074

INFORMATION RETRIEVAL NUMBER 135

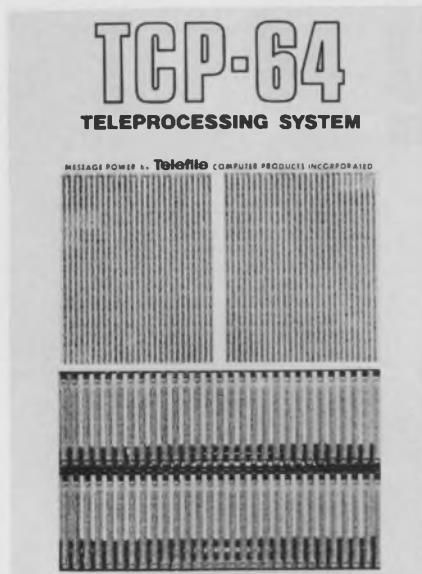

### Data communication system

The TCP-64 teleprocessing system is described in a six-page brochure. Complete details of the system components and block diagrams of several major configurations are included in the brochure. Telefile Computer Products, Inc., Irvine, Calif.

CIRCLE NO. 406

### Magnetic tape terminal

A complete line of Teletype 4210 magnetic tape data terminals is described in a four-page brochure. Of particular interest in this brochure is the description of the new unattended automatic rewind and local print-out option. Teletype Corp., Skokie, Ill.

CIRCLE NO. 407

### DMM evaluation kit

A 25-page evaluation kit is designed to help provide an objective and comprehensive analysis of digital multimeters. Called "Evaluating Digital Multimeters," the kit allows the user to match requirements and criteria against various manufacturer specifications, design, supporting data and instructions in seven different areas: functional performance, quality and completeness of specifications, technological superiority, software, QA standards, calibration effort and longevity, upkeep and economy. Data Precision Corp., Wakefield, Mass.

CIRCLE NO. 408

### Power supply selection

A six-page selection guide provides a convenient method of selecting standard Cirkitblock modules allowing the user to build his own custom power supply. Simple tables give information for forming complete power supply systems. The guide also shows photographs of typical applications. Powercube Corp., Waltham, Mass.

CIRCLE NO. 409

### Solid state relays

A specification and ordering guide sheet covers the company's 700 series solid state relays. Included is information on dimensions, mounting and application along with detailed specifications and curves on performance. A comparison of solid state design vs electromechanical devices is presented. Hamlin, Inc., Lake Mills, Wis.

CIRCLE NO. 410

### Potentiometers

Capabilities of 56 types of cermet, carbon and wirewound trimmers, potentiometers, cermet DIP resistor networks and Series 212 rotary selector switches are described in a two-color, eight-page catalog. The catalog contains complete electrical and mechanical specifications. Distributor quantity prices are also included. CTS Corp., Elkhart, Ind.

CIRCLE NO. 411

### NASA patent abstracts

Abstracts for 1892 NASA-owned inventions available for licensing are published in the first semi-annual edition of "NASA Patent Abstracts Bibliography" (NASA PAB), SP-7039. The 880-page publication features an index section of more than 300 pages, cross-referencing the patent abstracts. Included in the patent section are brief descriptions and illustrations of each device. Thirty-three specific technical categories, plus one general category, are listed. The bibliography is priced at \$6 for each section (\$12 for Sections 1 and 2 together). National Technical Information Service, Springfield, Va. 22151.

### Substrate connectors

A line of ceramic substrate terminations and the company's capabilities in custom designing such connectors is described in a bulletin. Dimensions and specifications of typical termination types are given; various application tools and a semi-automatic insertion machine are described and illustrated. Berg Electronics, Inc., New Cumberland, Pa.

CIRCLE NO. 429

### Communication filters

Fixed-tuned piezoelectric ceramic communications filters are described in a four-page short form catalog. Filter-design tables are offered. Units are pictured with typical performance curves and suggested applications for each. Vernitron Piezoelectric Div., Bedford, Ohio.

CIRCLE NO. 430

### Dual processor

A general description, application information and a complete list of specifications for the Micro 1600D are covered in a four-page bulletin. Photographs and diagrams illustrate functional characteristics, data flow and the physical packaging of the system. Microdata Corp., Santa Ana, Calif.

CIRCLE NO. 431

### Silicon rectifiers

A series of low-cost stud-mounted diodes is described in a data sheet. Included in the literature are five graphs, a dimensioned outline drawing and a photograph of the diode. Complete specifications and ratings are provided. International Rectifier Corp., El Segundo, Calif.

CIRCLE NO. 432

### Fuses and circuit breakers

Exact replacement fuse and circuit breaker caddy assortments designed for domestic and foreign electronic equipment service requirements in the field, shop or laboratory are featured in an illustrated four-color brochure. Liltelfuse, Inc., Des Plaines, Ill.

CIRCLE NO. 433

**Your choice of time display and mounting style!**

**\$9.80 ea.**

**NAPCC 6-digit Elapsed Time Indicators combine design flexibility with low initial cost!**

Keep track of operating time in your electrical and electronic equipment with NAPCC time meters. These low-cost indicators combine economy and accuracy with long, troublefree operation. You can specify the meters in "hours and tenths"; "minutes and tenths"; or "seconds". And you can choose a square or round bezel for front panel mounting, or a rectangular configuration for behind-the-panel or free-standing applications. It's your choice. Any 115V 60Hz model for only \$9.80 — more attractive pricing in quantity. Other voltages and frequencies are also available.

Send for information now!

A. W. HAYDON CO. PRODUCTS

**NORTH AMERICAN PHILIPS CONTROLS CORP.**

A NORTH AMERICAN PHILIPS COMPANY  
Cheshire, Conn. 06410 • (203) 272-0301

INFORMATION RETRIEVAL NUMBER 136

**HALEX, INC.**

**Second-sourcing HX0032 FET Operational Amplifier**

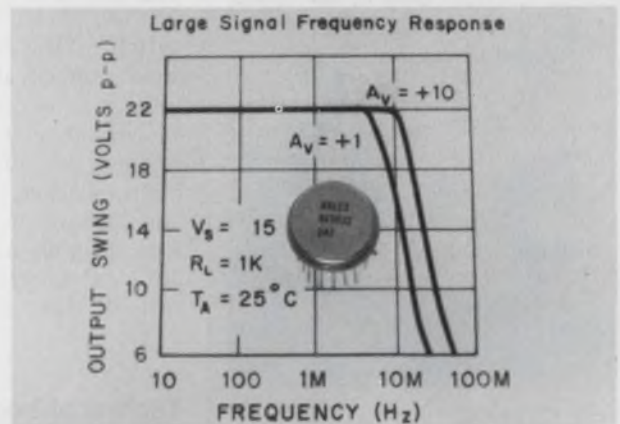

Halex Model HX0032 FET Operational Amplifier is a high speed, high impedance differential amplifier. This FET input op-amp features high slew rates of 500 v/ $\mu$ sec and low input bias currents of 10 pA, typical. HX0032 is priced at \$40 each and HX0032C at \$18 each in 100-price lots.

For more information on this product and other custom hybrids and precision thin-film networks, please write or call

**HALEX, INC.**  
Box 2940  
Torrance, California 90509  
(213) 772-4461, 542-3555

INFORMATION RETRIEVAL NUMBER 137



**It's time to order your 1973 RCA Solid State Databooks**

Complete, up-to-the-minute data for RCA's IC's and discrete devices.

Get off to a fast start in 1973 with timely, comprehensive data from RCA, the company that specializes in complete, accurate data on all of its solid state devices. The 1972 DATABOOKS have been used in thousands of plants in the United States and around the world. And even more plants will be reached in 1973. This is your chance to be one of the new recipients. The new DATABOOKS cover a great range of your requirements because RCA has some of the broadest lines in the industry: linear and COS/MOS ICs, MOS-FETs, power transistors, power hybrids, RF and microwave devices, thyristors, rectifiers, and diacs. 25% new or revised material. Complete commercial product data. Complete, current application notes. Easier-to-use quick-reference guides. New, comprehensive subject index. Cross-reference index of developmental to commercial type numbers. Six 1973 DATABOOKS for only \$10 (optional list price: \$12), with monthly new products newsletter. See coupon for details. Send the coupon along with your check or money order (payable to RCA Corporation) or your company purchase order. Or call your RCA distributor. If the coupon is missing, write RCA, Solid State Division, Section 57K-23 Box 3200, Somerville, N. J. 08876.

RCA Corporation  
Solid State Division  
Section 57K-23 Box 3200  
Somerville, New Jersey 08876

57K 23

- Rush me the six 1973 DATABOOKS and put my name on newsletter mailing list. My cost, only \$10. Offer good only until December 31, 1972.
- Rush me prices for individual DATABOOKS and updating service.

NAME/TITLE \_\_\_\_\_

COMPANY \_\_\_\_\_

ADDRESS \_\_\_\_\_

CITY/STATE/ZIP \_\_\_\_\_

I enclose payment by:  Check  Money Order  Purchase Order  
Offer good only in U.S. and Canada. Direct other inquiries to RCA sales offices or distributors.

INFORMATION RETRIEVAL NUMBER 138



### Allied catalog

A comprehensive buying guide for everything in industrial electronic parts and supplies has been compiled. The catalog lists over 50,000 separate stock items from more than 400 manufacturers. Detailed specifications, descriptions and illustrations cover semiconductors, ICs, LEDs, tubes, relays, timers, transformers, resistors, capacitors, connectors, etc. Other major sections include test equipment, intercoms, power supplies, electronic counters, sound equipment, hardware, technical books, tools and solder equipment. Catalog No. 730 sells for \$5 or is free with a \$10 minimum order. Allied Electronics, 2400 W. Washington Blvd., Chicago, Ill. 60612.

### Electro-optics

A solid-state electro-optics catalog combines infrared emitting diodes, injection lasers and silicon photodetectors. This 20-page catalog contains dimensional outlines as well as new applications selection guide sections which recommends devices, for example, for use in transit time measurements, data transmission, spectrometry, laser-detection, target designation, optical demodulation, ranging, star tracking, scintillation counting, optical communications and many others. RCA Commercial Engineering, Harrison, N.J.

CIRCLE NO. 412

### IC multiplier

Operation and application of precision IC four-quadrant multipliers are described in a five-page bulletin. The bulletin discusses in detail the uses of the 8013, a  $\pm 0.5\%$ -accuracy general-purpose analog multiplier fabricated on a single monolithic IC chip. Included in the bulletin is a tutorial explanation of the analog transconductance multiplication and a comprehensive circuit description. Discussions and block diagrams depicting use of the multiplier in multiplication, division, squaring and square-root applications follow, as well as a section on the 8013 as a variable-gain amplifier. Intersil, Inc., Cupertino, Calif.

CIRCLE NO. 413

### Technical book catalog

Electronics, electricity, amateur radio, audio and hi-fi, mathematics, and other do-it-yourself topics are among the categories featured in over 400 hardbound and paperback books. The titles, which range from ABC's of Electronics and Tape Recording for the Hobbyist to Modern Dictionary of Electronics, are listed in an 80-page catalog. Howard W. Sams & Co., Inc., Indianapolis, Ind.

CIRCLE NO. 414

### Tektronix products

A new product summary starts off the company's 330-page catalog. Reference information—glossary of terms, data charts, specifications—follow. Detailed descriptions of oscilloscopes, spectrum analyzers, curve tracers, cameras, test and measurement systems, TV products, automated test systems, display products, probes and accessories are included as well as purchasing, service and general information. Tektronix, Inc., Beaverton, Ore.

CIRCLE NO. 415

### Philips technical journal

"Test and Measuring Notes," a quarterly magazine, presents information on applications of Philips' electronic instruments and microwave devices. Test & Measuring Instruments Inc., Hicksville, N.Y.

CIRCLE NO. 416

### Testing digital ICs

Troubleshooting digital ICs while they're operating in-circuit is the subject of a 20-page brochure, "The IC Troubleshooters." It describes the whole family of logic probes, logic pulsers, logic clips, logic comparators and accessories which the company has developed over the last couple of years and gives specifics on how to cut downtime by fast, on-the-spot, in-circuit troubleshooting. Options, accessories and typical operation are detailed. Hewlett-Packard Co., Palo Alto, Calif.

CIRCLE NO. 417

### Semi memory test system

A six-page brochure announces the Venture II semiconductor memory test system. A dedicated system, the Venture II provides 10 MHz real-time functional testing of MOS, TTL and ECL RAMs ROMs and shift-registers. The brochure outlines highlights of the unit and includes a system description, block diagram and performance summary. Computest Corp., Cherry Hill, N.J.

CIRCLE NO. 418

### Dynamic MOS RAM

"Memory System Design with the 3534/1103 Dynamic MOS RAM," a 24-page catalog, contains chapters on functional characteristics, system implications of the 3534, basic storage board design and system logic design. Schematic and block diagrams are included. Fairchild Semiconductor, Mountain View, Calif.

CIRCLE NO. 419

### Semiconductor rectifiers

A 24-page catalog lists 131 different series of silicon devices, including SCRs, fast-recovery, standard-recovery and high-voltage rectifiers, bridge rectifier assemblies and zeners. In addition, representative listings of ratings of Klipvoltage suppressors, selenium rectifiers and tube replacement assemblies are included. Basic specifications and performance data are given for all devices. Sarkes-Tarzian, Inc., Semiconductor Div., Bloomington, Ind.

CIRCLE NO. 420

# Send for our brushup course on Brushless Synchros and Resolvers.

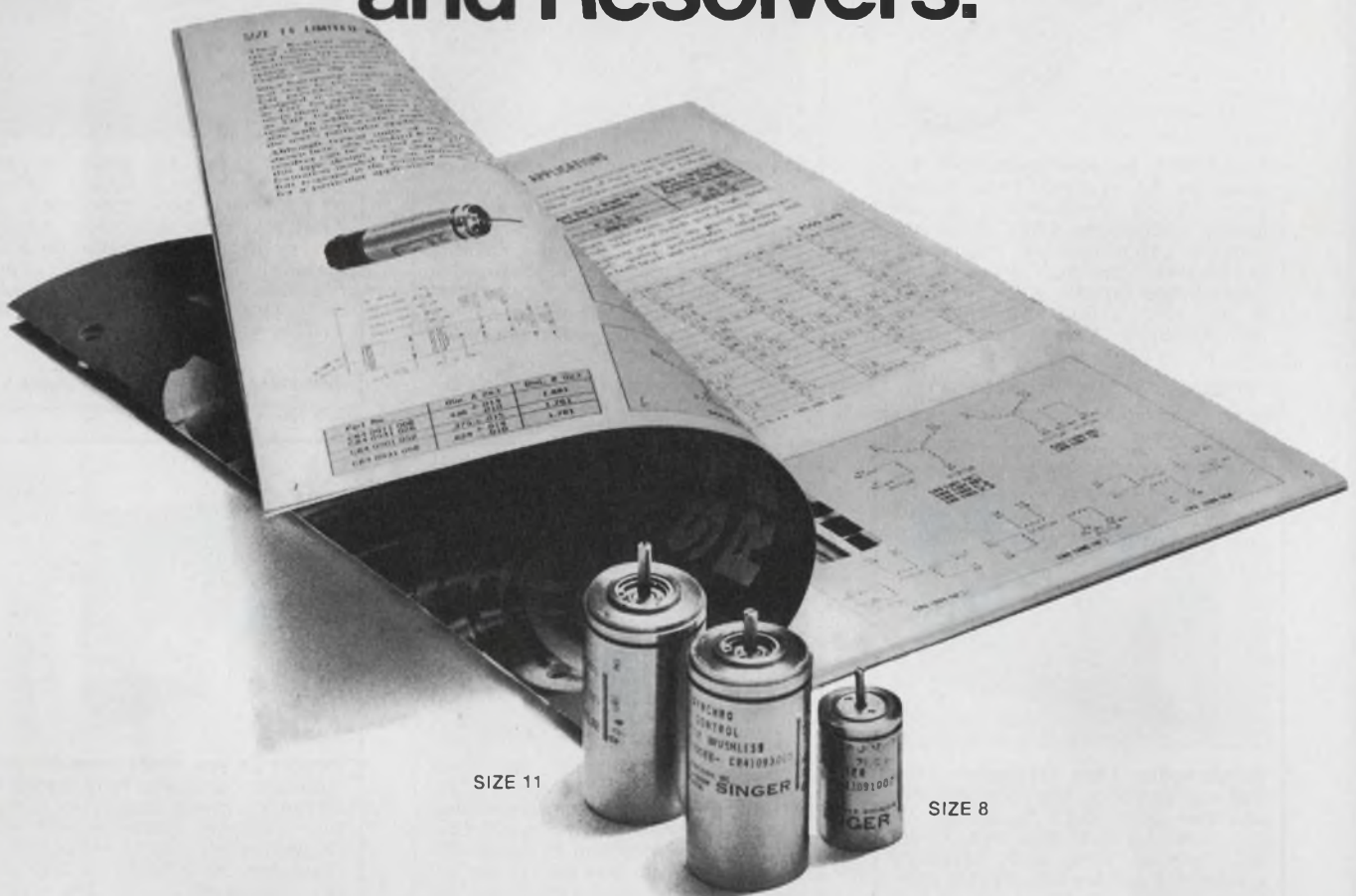

Faced with applications where synchros and resolvers have to be driven at extremely high speeds? Or where brush wiping contact can't be permitted?

Kearfott Brushless Components provide system performance advantages. (Instead of standard brushes and slip rings, rotary transformers couple power into the synchro motor.) And extra-wide bearings give you increased reliability and load-carrying capacity.

Our Brushless Synchros offer you a number of other benefits, too. Longer life, since there's nothing to wear but the bearings. No spurious signals from high-speed brush bounce which Digital Computers can interpret as a command input. Elimination of brush friction for Indicators that require the ultimate in minimum loading. And an end to RFI noise.

Kearfott Brushless Synchros and Resolvers also serve as excellent low cost Brushless Encoders when used in combination with Kearfott TRIGAC I S/D converter cards.

Like to know more? Write for our 36-page brochure on Synchros and Resolvers. It's packed with facts and figures on Brushless Synchros for

limited and continuous rotation applications—plus our full line of Synchros and Resolvers. The Singer Company, Kearfott Division, 1150 McBride Avenue, Little Falls, New Jersey 07424.

## SINGER

AEROSPACE & MARINE SYSTEMS

The Singer Company, Kearfott Division  
1150 McBride Avenue  
Little Falls, New Jersey 07424

Gentlemen:

- I want to know more about Brushless Synchros. Rush me your 36-page booklet on Synchros and Resolvers.
- I have an application for Brushless Synchros. Have a company representative call.

Name \_\_\_\_\_

Title \_\_\_\_\_

Company \_\_\_\_\_

Address \_\_\_\_\_

City \_\_\_\_\_ State \_\_\_\_\_ Zip \_\_\_\_\_

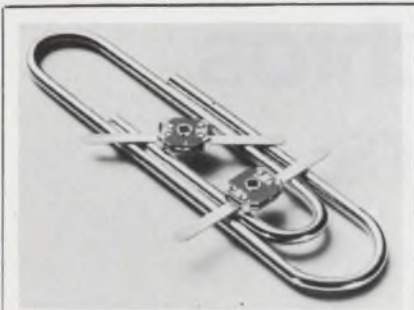

**Thin-Trim®** variable capacitors are designed to replace fixed tuning techniques. Applications include crystal oscillators, CATV amplifiers, communication and test equipment. Series 9410 has high Q's with five capacitance ranges from 1.0 - 4.5 pf to 10.0 - 50.0 pf. Johanson Manufacturing Corporation, Boonton, N. J. (201) 223-2676

INFORMATION RETRIEVAL NUMBER 181

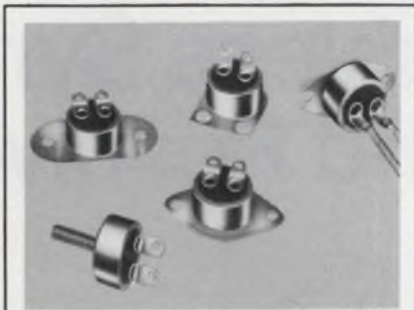

Prototypes of precision snap-action thermostats from Elmwood, widely specified for quick, reliable response; proven industrial and military performance record. Environ. expos.  $-65^{\circ}$  to  $550^{\circ}$ F; narrow or wide diff.; rated to 15 amps. Wide choice of brackets, terminals. Elmwood Sensors, Inc. (401) 781-6500. TWX 710-381-6413.

INFORMATION RETRIEVAL NUMBER 182

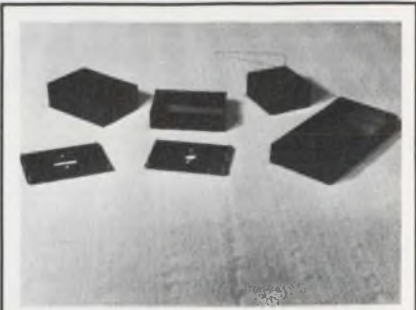

Module cases for power supplies, D/A converters, hybrid circuits, transformers, semi-conductors, etc. Available with matching headers, with or without molded-in terminals. Materials: Phenolic, DAP, Epoxy. Prescott Module Co. Ltd., Hawkesbury, Ontario, Canada. (613) 632-7102.

INFORMATION RETRIEVAL NUMBER 183



**Synchronous Tape Transports** offer IBM compatibility, high performance and low price. 6.25 to 45 ips. 7,  $8\frac{1}{2}$ , and 10 inch reel size. Power fail braking and edit capability standard. Available with PDP-8, PDP-11 and NOVA interfaces or dual buffers for asynchronous operation. DIGI-DATA CORPORATION, Bladensburg, Maryland (301) 277-9378

INFORMATION RETRIEVAL NUMBER 185



**Practical Relay Circuits**, by Frank J. Oliver. Time-saving guide classifies relays by function, presenting a rapid overview of the circuits that can solve the problem at hand. 384 pp., illus., cloth, \$14.95. Circle below for 15-day examination copies. Hayden Book Co., New York, N.Y. 10011.

INFORMATION RETRIEVAL NUMBER 186



Design as you order modular power supplies. Complete, fully tested high efficiency power supply in a miniature package. Available with AC or DC inputs with up to 6 isolated and regulated DC outputs to 150 watts. No engineering charges! Arnold Magnetics, 11520 W. Jefferson Blvd., Culver City, Ca. 90230. Phone (213) 870-7014.

INFORMATION RETRIEVAL NUMBER 187



**Snap-in card guides** increase PCB stacking or rack mounting options. Rigid reinforced nylon. Available in lengths  $2\frac{1}{2}$ " through 14" in  $\frac{1}{2}$ " increments. 24 standard lengths in stock. BIVAR, INC. 1500 S. Lyon St., Santa Ana, Calif. 92705 (714) 547-5832.

INFORMATION RETRIEVAL NUMBER 189

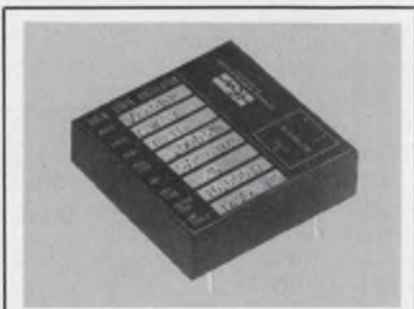

**VCXO** at freqs. from .00005 Hz to 50 MHz, freq. tol.  $\pm .0005\%$   $0^{\circ}$ C to  $+50^{\circ}$ C, control voltage range  $+10$ V to  $-10$ V changing freq. 20 ppm/V, linearity  $\pm .002\%$ ,  $1.75$ " sq. x  $0.5$ ". Supply 5 to 15Vdc  $\pm 1\%$ , Sq. wave 24V into  $200\Omega$  at Vdd = 5V, 9.5V into  $10K\Omega$  at Vdd = 10 V; stock to 3 weeks; Connor-Winfield Corp., Winfield, Ill. 60190, Tel. 312-231-5270.

INFORMATION RETRIEVAL NUMBER 190

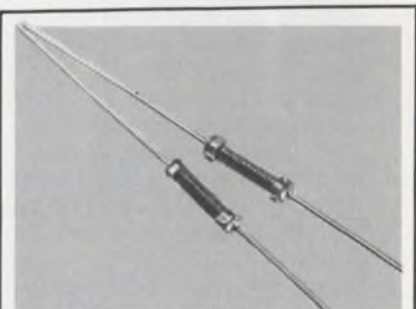

**Low cost wirebound resistors** provide extra reliability. High quality wire on impregnated woven fiberglass core. Axial and radial leads. Power to 5 watts per inch. Resistance: .1 to 7K ohms. Available with special abrasion resistant, smokeproof coating. Dale Electronics, Dept. 860, Box 609, Columbus, Nebr. 68601, (402) 564-3131.

INFORMATION RETRIEVAL NUMBER 191



# bulletin board



**Bristol Interval/Delay and Percentage Timers.** Front panel and chassis mount models. Manual, push button and remote start. Simple, durable, low-cost design. Available in time ranges from seconds to days. The Bristol Saybrook Company, Old Saybrook, Conn. 06475. (203) 388-3414.

INFORMATION RETRIEVAL NUMBER 184

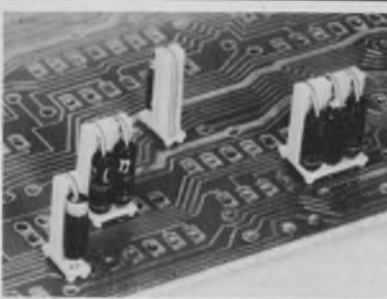

**Verti-Mount Insulators** permit vertical mounting of DO-7, DO-34, and DO-35 diodes and 1/8-, 1/4-, and 1/2-watt resistors on printed circuit boards. Verti-Mounts increase packaging density by 200%. Robison Electronics, Inc., 2134 W. Rosecrans Avenue, Gardena, Calif. 90249. Phone: (213) 321-0080.

INFORMATION RETRIEVAL NUMBER 188

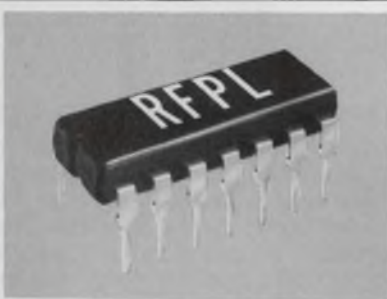

**DIP packaged signal processing components.** Now available complete line of double-balanced mixers, power dividers, frequency doublers, directional couplers, and impedance matching transformers in 14 pin DIP's — designed to match other low profile components. R. F. Power Labs, Inc., Bellevue, Washington. 206-454-3886.

INFORMATION RETRIEVAL NUMBER 192

Interdata, Inc., has announced a trade-in program, which expires on Dec. 31, 1972, for customers with Model 3 and 4 minicomputer systems. A 25% trade-in allowance against the single unit list price of a new series Model 70 processor is offered. One old-model processor or processor option must be returned in order to receive credit on one new-model processor or option. A further stipulation is that all CPU and option modules offered for trade must be in serviceable condition. And a final stipulation limits the offer to one trade-in per customer. With 8-KB of core memory, the Model 70 has a single unit list price of \$6800 but with the trade-in, the price would dip to \$5100.

CIRCLE NO. 421

A new price structure on selective increases in various circuit protector product categories has been announced by General Switch Co., a div. of Eastern Air Devices, Inc. The increases were applied to certain product lines and catalog items. The raises, averaging 10%, have the effect of establishing a 2% over-all increase in prices.

CIRCLE NO. 422

A 3% price increase for all its wire and cable products has been announced by Brand-Rex Co. The increase is in keeping with the guidelines of the Economic Stabilization Act of 1971.

CIRCLE NO. 423

New England Laminates Co., Inc., has announced a price increase by product line of from 3.6% to 9.2%.

CIRCLE NO. 424

## Price reductions

Computer Transceiver Systems, Inc., has reduced lease prices 22% on its line of Execuport Series 300 portable computer terminals. Ultra-lightweight models 302, 310 and 311, formerly \$199 a month including mainte-

nance, are now \$155 a month. Standard-weight models 302, 310 and 311, formerly \$181 a month including maintenance, are now \$135. Under the new lease plan, a terminal user also has the option to apply 50% of lease payments toward the outright purchase of any unit up to a maximum of 50% of the list price of the specified terminal.

CIRCLE NO. 425

Interdesign Inc. has reduced prices 40% for the integration of custom integrated circuits. Using the company's Monochip concept, the tooling cost to integrate a custom IC is now \$1800—down from \$2800. Concurrent with the integration charge, the company has reduced the price of its Monochip design kit from \$85 to \$39. This kit allows the entire design to be done by the user, even if he has no prior experience in IC design.

CIRCLE NO. 426

A 20% price reduction on standard seven and nine-track digital tape heads has been announced by Systematics/Magne-Head Div., General Instrument Corp. The seven-track is now \$189 and the nine-track is now \$196. The division also quotes to individual customer specifications and requirements.

CIRCLE NO. 427

Chicago Miniature Lamp Works has announced price reductions for three LED product lines. Reductions of approximately 35% have been posted for T-1 3/4 sub-miniature LED indicators in Series CM4-7 bi-pin and Series CM4-8 midget flange. Price reductions of approximately 15% were listed for Series CM44 LED cartridge indicators. The reductions were established due to improvements in the company's manufacturing techniques coupled with increased demand for these products.

CIRCLE NO. 428

ELECTRONIC DESIGN's function is:

- To aid progress in the electronics manufacturing industry by promoting good design.
- To give the electronic design engineer concepts and ideas that make his job easier and more productive.
- To provide a central source of timely electronics information.
- To promote communication among members of the electronics engineering community.

**Want a subscription?** ELECTRONIC DESIGN is sent free to qualified engineers and engineering managers doing design work, supervising design or setting standards in the United States and Western Europe. For a free subscription, use the application form bound in the magazine. If none is included, write to us direct for an application form.

If you do not qualify, you may take out a paid subscription for \$30 a year in the U.S.A., \$40 a year elsewhere. Single copies are \$1.50 each.

**If you change your address,** send us an old mailing label and your new address; there is generally a postcard for this bound in the magazine. You will have to requalify to continue receiving ELECTRONIC DESIGN free.

**The accuracy policy** of ELECTRONIC DESIGN is:

- To make diligent efforts to ensure the accuracy of editorial matter.
- To publish prompt corrections whenever inaccuracies are brought to our attention. Corrections appear in "Across the Desk."
- To encourage our readers as responsible members of our business community to report to us misleading or fraudulent advertising.
- To refuse any advertisement deemed to be misleading or fraudulent.

Microfilm copies are available of complete volumes of ELECTRONIC DESIGN at \$19.00 per volume, beginning with Volume 9, 1961. Work is now in process to complete the microfilm edition of Volumes 1-8. Reprints of individual articles may be obtained for \$2.00 each, prepaid (\$.50 for each additional copy of the same article) no matter how long the article. For further details and to place orders, contact the Customer Services Department, University Microfilms, 300 North Zeeb Road, Ann Arbor, Michigan 48106 telephone (313) 761-4700.

**Want to contact us?** If you have any comments or wish to submit a manuscript or article outline, address your correspondence to:

Editor  
ELECTRONIC DESIGN  
50 Essex Street  
Rochelle Park, N.J. 07662

## Catching Noisy Products in Production by Automatic Testing



Free new 12-pg. "Application Note 5" reports a continuing program by Ford Motor Co. to integrate a Ubiquitous® Real-Time Spectrum Analyzer into small motor production for high-speed automatic noise-testing. Based on the frequency spectrum of motor under test, an automatic analyzer/computer system makes accept-reject decisions on-line in 4 sec. Defects in small DC blower motors are pinpointed by analysis of freq. peaks or signatures. Automatic evaluation of signatures & computer-generated statistics of reject-causes. Increases product quality, lowers reject rates. Defects identified: shaft out-of-round, loose bearing retainers, bad brushes, roto unbalance. Production-line test results were obtained by a Mini-Ubiq™ UA 14A 400-line Analyzer interfaced with a Nova-1200 Mini-computer. Operable by non-technical personnel. Accept-reject test results appear on green & red lights.

**Federal Scientific Corp.**

615 West 131st St.  
New York, N.Y. 10027 (212) 286-4400

CIRCLE NO. 171

## Add Digital Control To Your Equipment

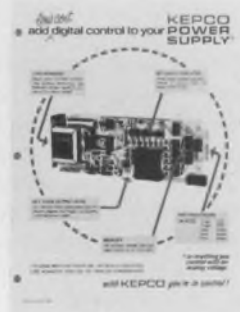

The Kepco SN programmers are a uniquely simple and low-cost way of adding digital compatibility to your product. A 0 to 10V or  $\pm 10V$  analog signal is produced with 2- or 3-digit BCD or 8-, 10-, 12-bit binary resolution. The digital input instructions are optically coupled and stored in a register "memory" so that the analog output can be floated up to 1000 volts from the digital common. After data transfer, the output slews to its new value at  $1V/\mu\text{sec}$ . All the power is, of course, built-in. All you need is 115/230V a-c, 50-60 Hz.

For details on the various SN converters and their housing accessories, request Kepco Brochure No. 146-1266.

**Kepco, Inc.**

131-38 Sanford Avenue  
Flushing, New York 11352 (212) 461-7000

CIRCLE NO. 172

## PC Drafting Aids Catalog

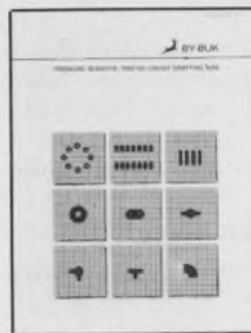

Thousands of time saving, cost saving artwork ideas are found in the By-Buk P-50 catalog of pressure sensitive printed circuit drafting aids. With the most practical artwork patterns for: TO cans, multi-pads, dual-inlines and flat packs featured. Donuts, connector strips, teardrops, ovals, tapes, tees, elbows, etc., by the hundreds are included in the most comprehensive list of sizes. Opaque black, transparent red and transparent blue materials for one and two-sided board designs. For a free copy and samples, write today.

CIRCLE NO. 173

**By-Buk Company**

Subsidiary of Webtek Corp., 4326 W. Pico Blvd.  
Los Angeles, California 90019 (213) 937-3511

# Manufacturers

Advertisements of booklets, brochures, catalogs and data sheets. To order use Reader-Service Card.  
(Advertisement)

## Circuit Zaps® for Instant PC Boards



Circuit Zaps® are 1 ounce copper circuit component patterns, pads, and conductor paths, precision-etched on 5 mil (.005") glass epoxy base material, backed by a special pressure-sensitive adhesive. Circuit Zaps® completely eliminate the artwork, photography, photoprinting, touch up, etching, stripping, and other time-consuming steps in PC board development.

Write today for the FREE TECHNICAL BULLETIN 1003 with FREE SAMPLE.

CIRCLE NO. 174

**Bishop Graphics, Inc.**  
7300 Radford Avenue (ED)  
North Hollywood, California 91605  
(213) 982-2000 Telex 674672

## CUSTOM DESIGN YOUR OWN PROGRAMMING WAVEFORM

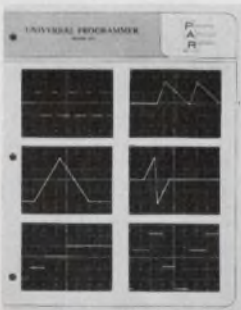

The PAR™ Model 175 Universal Programmer generates single or repetitive multi-segment ramp and step program functions. With it you can design a ramp program with up to four independent segments and two independent sweep rates ranging from 1 mV/s to 10,000 V/s. Or, you can design a step program with up to four independent levels and two independent level durations ranging from 1  $\mu$ s to 1,000 s. This versatility makes the Model 175 ideal for any application involving the programming of voltage controlled instrumentation. A complete description of the Programmer is contained in Bulletin T-317, available on request.

CIRCLE NO. 175

## Princeton Applied Research Corporation

P.O. Box 2565  
Princeton, New Jersey 08540

## NEW SMALL-SIGNAL TRANSISTOR CATALOG



A new catalog gives design engineers up-to-the-minute information on the broad line of silicon and germanium transistors available now from Sprague Electric. Performance characteristics, package sizes, and outline drawings are included. Catalog CN-210B covers low-cost Econoline® plastic-molded silicon transistors, miniature and dual silicon transistors, silicon transistor chips, as well as "electrochemical" germanium types. Send for yours now.

CIRCLE NO. 176

## Sprague Electric Company

347 Marshall St., North Adams, Mass. 01247

# Electronic Design

## Advertising Sales Staff

Bryce Gray  
Sales Manager

### Rochelle Park, N.J. 07662

Robert W. Gascoigne  
Daniel J. Rowland  
50 Essex Street  
(201) 843-0550  
TWX: 710-990-5071

### Philadelphia

Thomas P. Barth  
50 Essex Street  
Rochelle Park, N. J. 07662  
(201) 843-0550

### Boston 02116

Richard L. Green  
20 Columbus Avenue  
Boston, Mass.  
(617) 482-7989

### Chicago 60611

Thomas P. Kavooras  
Berry Conner, Jr.  
200 East Ontario  
(312) 337-0588

### Cleveland

Thomas P. Kavooras  
(Chicago)  
(312) 337-0588  
(call collect)

### Los Angeles 90303

Stanley I. Ehrenclou  
Burt Underwood  
2930 Imperial Highway  
Inglewood, Calif  
(213) 757-0183

### San Francisco 94022

Jerry D. Latta  
P.O. Box 1248  
Los Altos, Calif.  
(415) 965-2636

### London W. 1

For United Kingdom and Holland  
Brayton C. Nichols

For Eastern Europe  
Peter Kehr

The American Magazine Group

9 Warwick Street  
London, W. 1, England  
Phone: 437 5462

Cable: Ammagnic, London

### 4800 Verviers, Belgium

For Continental Europe

Andre Jamar  
Rue Mallar, 1

(087) 253.85 Telex 41563

### Tokyo

Haruki Hirayama  
Electronic Media Service  
5th Floor, Lila Bldg.,  
4-9-8 Roppongi  
Minato-ku

Phone: 402-4556

Cable: Electronicmedia, Tokyo



**AMERICAN BUSINESS PRESS, INC.**

# advertiser's index

Advertiser	Page	Advertiser	Page	Advertiser	Page
ACDC Electronics, Inc.	63	Fairchild Microwave and Optoelectronics	36, 37	Motorola Semiconductor Products, Inc.	34, 35, 55
ADC Products, Inc.	193	Federal Scientific Corporation	234	National Semiconductor Corporation	106, 107
Acopian Corporation	48A	Fluke Mfg. Co., Inc., John	109	Newport Laboratories, Inc.	218
Allen Organ Company	208	GTE Automatic Electric	48B, 48C, 48G	North American Philips Controls Corp.	229
Amplex Computer Products Division	38	General Automation, Inc.	124, 125	North Atlantic Industries, Inc.	173
Amphenol Connector Division, Bunker Ramo Corporation	129	General Electric Company, Miniature Lamp Products Dept.	191	Oak Industries, Inc.	52
Amphenol Industrial Division, Bunker Ramo Corporation	90, 91	General Electric Company, Semiconductor Products Department	41	Power/Mate Corp.	6
Amphenol RF Division, Bunker Ramo Corporation	1	General Instrument Corporation	51	Prescott Module Co. Ltd.	232
Analog Devices, Inc.	155	General Radio Company	64	Princeton Applied Research Corp.	235
Arnold Magnetics Corp.	232	Grayhill, Inc.	206	Princeton Electronic Products, Inc.	200
Augat, Inc.	194	Guardian Electric Manufacturing Company	48D, 48E	Pulse Engineering, Inc.	204
Avantek, Inc.	50	Halex, Inc.	229	QuantaLog, Inc.	205
BH Electronics, Inc.	190	Harris Semiconductor, A Division of Harris Intertype Corporation	148, 149	RCA Solid State Division	65, 179, 229 Cover IV
Babcock, A Unit of Esterline Corporation	201	Hathaway Instruments, Inc.	217	RCA Electronic Components	16D
Beckman Instruments, Inc.	171	Hayden Book Company, Inc.	120, 121	R. F. Power Labs, Inc.	233
Belden Corporation	98, 99	Heath Schlumberger Scientific Instruments	217	Radio Frequency Laboratories, Inc.	178
Bendix Corporation, The Electrical Components Division	15	Hewlett-Packard	2, 8, 9, 78, 79, 199	Rotron, Inc.	227
Biomation	219	Hickok Instrumentation & Controls Division	62	Robison Electronics, Inc.	233
Bishop Graphics, Inc.	235	Hybrex, A Division of Burr-Brown	215	Scanbe Manufacturing Corp.	49
Bivar, Inc.	232	Hybrid Systems Corp.	216	Schauer Manufacturing Corp.	196
Boonton Electronics Corporation	164	ILC Data Device Corp.	10	Semiconductor Circuits, Inc.	216
Bourns, Inc., Trimpot Products Division	44	IMC Magnetics Corporation	183	Servo-Tek Products Company	190
Bristol Saybrook Company, The	233	Industrial Timer, A Unit of Esterline Corporation	203	Shigoto Industries, Ltd.	212
Burdny Corporation	16A	Information Handling Services	12, 13	Signetics Corporation	93
By-Buk Company	234	Information Terminals	239	Siliconix Incorporated	138
CTS Corporation	176	Instrument Specialties Company, Inc.	225	Singer Company, The, Kearfott Division	231
Cambridge Thermionic Corporation	101	Intech, Incorporated	210	Sprague Electric Company	14, 235
CELCO (Constantine Engineering Laboratories Co.)	154	Intel Corporation	160	Spectronics Incorporated	211
Centralab, the Electronics Division of Globe-Union, Inc.	186, 187	Inter-Computer Electronics Inc.	213	Sperry Information Displays Division	43
Clare & Co., C. P.	59	International Rectifier	136, 137	Stackpole Carbon Company	118, 119
Collins Radio Company	60	Interstate Electronics Corporation	132, 133	Summit Engineering Corporation	212
Computer Terminal Corporation	128	JFD Electronics Corporation	175	Switchcraft, Inc.	189
Conner-Winfield Corp.	232	Johanson Manufacturing Corp.	7, 232	Syntronic Instruments, Inc.	182
Connecticut Hard Rubber Co., The	178	Johnson Company, E. F.	16	Tektronix, Inc.	47
Constantine Engineering Labs. Co. (CELCO)	154	Kay Elemetrics	161	Teledyne Crystalonics	113
Continental Connector Corporation	58	Kepeco, Inc.	234	Teledyne Semiconductors	16B, 16C
Cornell-Dubilier Electronics	92	Keystone Carbon Company	192	Texas Instruments, Incorporated	61
Corning Glass Works, Electronic Products Division	203	Kings Electronics Company, Inc.	108	Texas Instruments Incorporated, Components Group	84, 85
Cutler-Hammer	81	Kurz-Kasch, Inc.	205	Texas Instruments Incorporated, Digital Systems Division	4, 5
DIT MCO	198	Lambda Electronics Corp.	Cover II	Thermalloy Company	207
Dale Electronics, Inc.	232	Lear Siegler, Inc., Electronic Instrumentation Division	202	ThermoMetrics, Inc.	239
Data Precision, Inc.	64 A-B	Litton OEM Products Division	202	Times Wire & Cable Company	237
Dickson Electronics Corporation	214	M 3M Company	56	Toyo Communication Equipment Co. Ltd.	218
Digi-Data Corporation	232	MCL, Inc.	54	Triplet Corporation	169
Dow Corning Corporation	17 thru 33	Magnecraft Electric Company	240	Union Carbide, Components Dept.	112
Duncan Electronics	209	Meguro Denpa Sokki K. K.	237	United Systems Corporation	165, 197
ECC Corporation	42	Mepco/Electra, Inc.	70, 71	USCC/Centralab	239
ERA Transpac Corporation	80	Minelco Division General Time	206	Vernitron Electrical Components	239
E. S. Enterprises	205	Mini-Circuits Laboratory, A Division of Scientific Components Co.	187	Victoreen Instrument, Div. of VLN Corp.	217
Eastman Kodak Company	53	Molex, Incorporated	Cover III	Vishay Resistor Products, A Division of Vishay Intertechnology, Inc.	203
Edmund Scientific Company	237	Monsanto Company	100	Wagner Electric Company	181
Elco Corporation	11	Moririca Electronics, Ltd.	218	Weston Instruments, Inc.	57
Electro-Motive Mfg. Co., Inc., The	168	Mostek Corporation	195	Winchester Electronics Group	185
Electronic Arrays, Inc.	182	Motorola Component Products Dept.	48	Windjammer Cruises	48H
Electronic Communications, Inc.	214				
Electronic Design	48F, 140, 141, 237				
Elmwood Sensors, Inc.	232				
Energy Conversion Devices Inc.	188				
Engelhard Industries Division, Engelhard Minerals & Chemicals Corporation	220, 221, 222, 223				

**Test record not required!  
Designed for CD-4  
demodulator measurements**



**MSG-321**  
CD-4 System Record Signal Generator  
The MSG-321 is a record signal generator of the discrete four-channel system type. It generates a signal corresponding to left and right components of one side of the groove of a CD-4 record, thereby eliminating the need for a test record. Applications include research, adjustment, and inspection for demodulator isolation, distortion, and signal-to-noise ratio.

Please see our catalog for details.



**MEGURO DENPA SOKKI K.K.**

No. 5, 1, 2-chome, Chuo-cho, Meguro-ku, Tokyo, Japan  
TEL: 715-1211 Cables: MEGURODENPA TOKYO

INFORMATION RETRIEVAL NUMBER 143

**Attention Advertisers:**

Could you use copies of your ad exactly as it appeared in ELECTRONIC DESIGN? Then order your reprints directly from us; the minimum unit order is 500 copies.

Please specify if you would like the reprint line omitted on your copies and mail your/written order to:

**Production Dept.  
ELECTRONIC DESIGN  
50 Essex St.  
Rochelle Park, N.J. 07662**

	500	1,000	Add'l M
<b>8x10 or smaller</b>			
1 color, 1 side	\$74.70	82.95	18.15
2 color, 1 side	95.47	108.00	25.28
4 color, 1 side	311.03	342.00	44.33
<b>Spreads</b>			
1 color	113.66	126.65	25.98
2 color	191.19	205.98	29.58
4 color	354.17	380.76	53.19

Prices FOB Waseca, Minn.

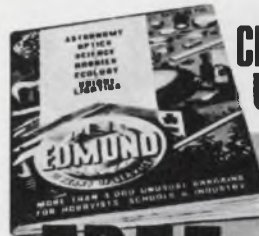

**CHOOSE FROM OVER 4,000!  
UNUSUAL BARGAINS!**

**OPTICS • SCIENCE  
ELECTRONICS**

**FREE CATALOG!**



**1,000's OF HARD-TO-FIND  
BUYS FOR INDUSTRY**

Brand new 164-page easy-to-read edition packed with new products, charts, diagrams, illustrations. On-the-job helps; quality control aids, unique, exclusive items to speed your work, improve quality, cut development and production costs! Loaded with optical, scientific and electronic equipment available from stock for industry, research labs, design engineers, experimenters, hobbyists.

**ONE SOURCE FOR ALL YOUR NEEDS**

Tremendous variety. Terrific savings. Countless hard-to-get surplus bargains. Many "one-of-a-kinds" nowhere else. Ingenious scientific tools. Thousands of components: lenses, prisms, wedges, mirrors, mounts, all types of accessories. Hundreds of instruments: pollution testing equipment, lasers, comparators, magnifiers, microscopes, projectors, telescopes, binoculars, photo attachments, ecological items, black light equipment and America's largest collection of unique lighting products.

**BUY DIRECT WITH MONEY-BACK GUARANTEE**

Edmund ships over 5,000 orders monthly to America's largest industrial — every item guaranteed! You must be satisfied, or return your purchase in 30 days for your money back. Shop the catalog of America's largest Science-Optics-Electronics Mart with confidence! Get your FREE copy without obligation. No salesman will call. Write now for free catalog "PA"



**EDMUND SCIENTIFIC CO.**  
300 EDSCORP BUILDING  
BARRINGTON, NEW JERSEY 08007  
TELEPHONE: 609-547-3488



INFORMATION RETRIEVAL NUMBER 144

**MICROWAVE  
ENGINEERS**

**Design-Project**

Our O.E.M. sales programs offer attractive assignments with lots of future. Degree, with up to 1-3 years of microwave experience preferred.

OTHER OPENINGS INCLUDE:

**Technical Jr.&Sr.**

Microwave experience preferred. Will work with test procedures and microwave passive devices.

**Technical Writer**

Technical writing experience required. Microwave experience preferred. Must be capable of writing test plans.

You'll join a thriving division for a strong, diversified company, attuned to today's opportunities. New England location offers advantageous living year round. Salaries open, based on qualifications; plus outstanding company paid benefits.

Please send confidential resume including salary history and requirements to Personnel Dept.

**TIMES WIRE & CABLE COMPANY**

*A Subsidiary of Insilco Corporation*

**358 Hall Avenue  
Wallingford, Conn. 06492**

*An Equal Opportunity Employer M/F*

INFORMATION RETRIEVAL NUMBER 901

# product index

**Information Retrieval Service.** New Products, Evaluation Samples (ES), Design Aids (DA), Application Notes (AN), and New Literature (NL) in this issue are listed here with page and Information Retrieval numbers. Reader requests will be promptly processed by computer and mailed to the manufacturer within three days.

Category	Page	IRN	Category	Page	IRN	Category	Page	IRN
<b>Components</b>			a/d converters	210	<b>335</b>	resistors	224	<b>387</b>
annunciators	213	<b>345</b>	crystal oscillators (NL)	226	<b>405</b>	resistors, DIP	224	<b>390</b>
arc suppressor, triac	214	<b>347</b>	displays	208	<b>332</b>	semi memory tester	230	<b>418</b>
clutch, magnetic	212	<b>343</b>	displays	210	<b>334</b>	semiconductors	226	<b>395</b>
inductors, toroidal	212	<b>342</b>	divider	208	<b>331</b>	solid-state relays	228	<b>410</b>
motor, miniature	212	<b>341</b>	hybrid circuits	211	<b>339</b>	technical catalog	230	<b>414</b>
potentiometers (NL)	228	<b>411</b>	memory tester	208	<b>330</b>	technical journal	230	<b>416</b>
pots, trimmer	213	<b>344</b>	oscillator	210	<b>338</b>	transistors	224	<b>388</b>
resistors, chip	214	<b>346</b>	peak reading module	211	<b>340</b>			
resistors, DIP (NL)	224	<b>390</b>	power supplies	210	<b>337</b>			
			power supplies (NL)	228	<b>409</b>			
			voltage standard	210	<b>336</b>			
<b>Data Processing</b>						<b>application notes</b>		
calculator, BASIC	191	<b>278</b>	<b>Packaging &amp; Materials</b>			ac power systems	222	<b>376</b>
card readers	189	<b>272</b>	board, socket	182	<b>260</b>	cleaning, optical	220	<b>364</b>
comm system (NL)	228	<b>406</b>	connector	177	<b>251</b>	coating, PC	221	<b>369</b>
controller, disc	187	<b>269</b>	connector	178	<b>256</b>	contact retention	223	<b>384</b>
data terminal key	191	<b>277</b>	connector	183	<b>264</b>	converters, a/d	223	<b>382</b>
magnetic heads	188	<b>271</b>	connector	183	<b>265</b>	converters, d/a	222	<b>378</b>
minicomputer	184	<b>266</b>	epoxy	178	<b>253</b>	DACs	220	<b>360</b>
minicomputer, 18-bit	189	<b>273</b>	paint, copper	178	<b>255</b>	data indexing	220	<b>362</b>
modem, dial-up	190	<b>274</b>	paint, zinc	180	<b>258</b>	fans	223	<b>380</b>
plotter incremental	184	<b>267</b>	resin	180	<b>259</b>	film resistors	221	<b>373</b>
plotter, two-pen	190	<b>275</b>	resin, casting	180	<b>257</b>	fused quartz	220	<b>365</b>
printer, line	188	<b>270</b>	socket panels	178	<b>254</b>	handbook, Spanish	220	<b>361</b>
terminal, CRT-graphic	187	<b>268</b>	sockets, DIP	178	<b>252</b>	liquid crystals	220	<b>363</b>
voice response system	190	<b>276</b>	sockets, IC	183	<b>262</b>	lock-in amplifier	223	<b>383</b>
			switching jacks	183	<b>263</b>	magnesium extrusions	223	<b>381</b>
<b>ICs &amp; Semiconductors</b>			terminal	180	<b>250</b>	phase jitter	221	<b>368</b>
CMOS logic ICs	204	<b>322</b>	terminal blocks	182	<b>261</b>	photodetectors	221	<b>366</b>
encoder, 90-key	204	<b>320</b>				power transistors	222	<b>374</b>
level detector IC	204	<b>321</b>				relays, reed & HG-wetted	222	<b>375</b>
line driver	206	<b>326</b>				relays and timers	222	<b>377</b>
load driver	207	<b>328</b>				screen printing ink	223	<b>379</b>
MECL flip-flop	206	<b>324</b>				semiconductor coatings	221	<b>367</b>
MOS clock-driver	207	<b>327</b>				software	221	<b>370</b>
power transistors	206	<b>325</b>				surface treatment	221	<b>371</b>
radio transmitter	207	<b>329</b>				temperature equipment	221	<b>372</b>
rectifiers (NL)	230	<b>420</b>						
SCRs	204	<b>323</b>						
transistors (NL)	224	<b>388</b>						
			<b>new literature</b>					
<b>Instrumentation</b>			CO <sub>2</sub> lasers	226	<b>400</b>			
bridge	198	<b>304</b>	capacitors, tantalum	226	<b>397</b>			
crystal slicer	198	<b>307</b>	capacitors, uhf	224	<b>393</b>			
delay generator	196	<b>280</b>	comm system	228	<b>406</b>			
digital panel meter	192	<b>279</b>	computers	226	<b>396</b>			
function generator	198	<b>306</b>	courses, FCC license	226	<b>402</b>			
instrumentation (NL)	230	<b>415</b>	crystal oscillators	226	<b>405</b>			
multimeter, digital	196	<b>302</b>	DMM	226	<b>398</b>			
oscilloscopes	196	<b>303</b>	Danish trade directory	226	<b>401</b>			
technical journal (NL)	230	<b>416</b>	data terminal	228	<b>407</b>			
temperature indicator	198	<b>305</b>	digital ICs	230	<b>417</b>			
transistor tester	196	<b>301</b>	digital multimeters	228	<b>408</b>			
variable phase generator	194	<b>280</b>	digital tape unit	226	<b>404</b>			
			dynamic MOS RAM	230	<b>419</b>			
<b>Microwaves &amp; Lasers</b>			electro-optics	230	<b>412</b>			
CO <sub>2</sub> lasers (NL)	226	<b>400</b>	gas laser guide	224	<b>391</b>			
electro-optics (NL)	230	<b>412</b>	IC multiplier	230	<b>413</b>			
laser	200	<b>308</b>	industrial lasers	224	<b>386</b>			
microwave detectors	202	<b>309</b>	instrumentation	230	<b>415</b>			
phase shifter	202	<b>310</b>	instruments, analog	226	<b>399</b>			
			liquid crystals	224	<b>385</b>			
<b>Modules &amp; Subassemblies</b>			optical instruments	224	<b>394</b>			
a/d converters	208	<b>333</b>	oscilloscope monitor	226	<b>403</b>			
			potentiometers	228	<b>411</b>			
			power supplies	224	<b>392</b>			
			power supplies	228	<b>409</b>			
			readouts, digital	224	<b>389</b>			
			rectifiers	230	<b>420</b>			
						<b>design aids</b>		
						rectifier stacks	215	<b>348</b>
						laminates, industrial	215	<b>349</b>
						<b>evaluation samples</b>		
						adhesives	219	<b>358</b>
						connector, relay	218	<b>353</b>
						contact springs	219	<b>356</b>
						drafting aids	216	<b>352</b>
						IC breadboard	216	<b>350</b>
						PC card guide	216	<b>351</b>
						polyurethane tubing	218	<b>355</b>
						safety decals	219	<b>357</b>
						serrated grommet	219	<b>359</b>
						strike and latch set	218	<b>354</b>

## T300: the cassette designed for data



Fully complies with **ANSI** and **ECMA** standards for digital data recording. It's the ultimate in cassettes — the only one with *performance* specifications:

- Zero dropouts — certified *after final assembly* to ANSI and ECMA specifications
- Off-center slot for use in drives built to ANSI and ECMA specifications
- Hinged record-lockout tabs can't be removed . . . and misplaced
- Fiberglass-reinforced screwed case dissipates static charges — doesn't attract dust

Stocked worldwide in key cities for fast delivery. For brochure with performance specifications, write or call:



**INFORMATION TERMINALS**  
1160 Terra Bella Ave., Mountain View, CA 94040  
(415) 964-3600

INFORMATION RETRIEVAL NUMBER 145

# 12¢\* THERMISTORS FOR MICROCIRCUITS

TEMP. COMPENSATION  
CURRENT SENSING  
TEMP. SENSING  
FLOW SENSING  
IR DETECTORS

0.012"

New Thermoflakes  
(Fast Response, Low Noise Thermistors)  
Designed Specifically For  
Substrate Mounting.  
Large Selection of Resistances, Sizes  
and Configurations.

\*Quantity Pricing For One Million Units  
**SPECIAL APPLICATIONS INVITED**  
Send For Details On Experimenters Flake Kits

## THERMOMETRICS INC.

15 JEAN PLACE, EDISON NEW JERSEY, 08817  
201-548-2299

M

INFORMATION RETRIEVAL NUMBER 146

ELECTRONIC DESIGN 24, November 23, 1972

# MONO-KAPS™

## Unique in Availability, Price and Quality



\* **FREE  
Samples**

USCC/Centralab Mono-Kap Ceramic Capacitors have availability, price and quality inherent in every part.

**AVAILABILITY.** Immediately available from over 150 distributors are stock units in six sizes from .100 x .100 x .500 x .500. Our four dielectrics are NPO, W5R, Z5U and Y5V, with capacitance values from 4.7 pF to 10 Mfd in 50, 100 and 200 VDC ratings.

**PRICE.** \$.09 average in production quantities. This low price is due to USCC's development of highly automated assembly techniques resulting in large volume production of Mono-Kaps.

**QUALITY.** USCC is currently under contract to produce chip capacitors (the heart of Mono-Kaps) at the rate of 25,000 per hour, with a failure rate level of only .001% per 1000 hrs.



\*Want FREE evaluation samples?  
Write on company letterhead to  
USCC/Centralab. For complete  
technical data on MONO-KAPS and  
other quality USCC components,  
circle the information retrieval  
number below.

USCC

**USCC/Centralab**

Electronics Division • Globe-Union, Inc.



2151 North Lincoln Street • Burbank, California 91504  
(213) 843-4222 • TWX: 910-498-2222

INFORMATION RETRIEVAL NUMBER 147

# GP

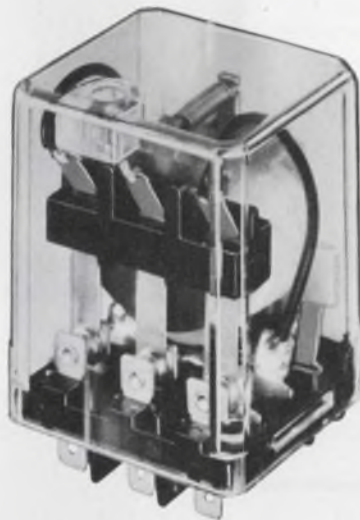

## MAGNECRAFT'S NEW CLASS 388 GENERAL PURPOSE RELAY

Magnecraft is pleased to introduce the new Class 388 General Purpose Relay. This inexpensive, high performance line of stock relays offers many quality features found only in custom built versions. Available in either a covered plug-in or open style with a wide choice of AC or DC coil voltages and SPDT, DPDT, or 3PDT 10 amp contacts.

All Class 388 relays have 3-way pierced terminals. While spaced for standard plug-in mounting, the flat terminals (0.187" x 0.020") also accept quick-connect receptacles or direct soldering. For plug-in use, three types of chassis mounted sockets are available; quick-connect, solder, or printed circuit terminals. Covered plug-in version has a tough clear polycarbonate plastic cover.

In a highly competitive business, delivery can be a deciding factor. If delivery is important to you, be aware that Magnecraft ships better than 90% of all incoming orders for stock relays, received before noon, THE SAME DAY (substantiated by an independent auditing firm). In addition to our shipping record, most stock items are available off-the-shelf from our local distributor.

# FREE!



## DESIGNER'S CATALOG

The purpose of this 36-page catalog is to assist the design engineer in specifying the proper relay for a given application. The book completely describes General Purpose, Sensitive General Purpose, and Mechanical Power Relays. New products include the complete line of Class 388 General Purpose Relays.

**Magnecraft** ELECTRIC COMPANY

5575 NORTH LYNCH AVENUE • CHICAGO, ILLINOIS 60630 • 312 • 282-5500 • TWX 910 221 5221

INFORMATION RETRIEVAL NUMBER 148



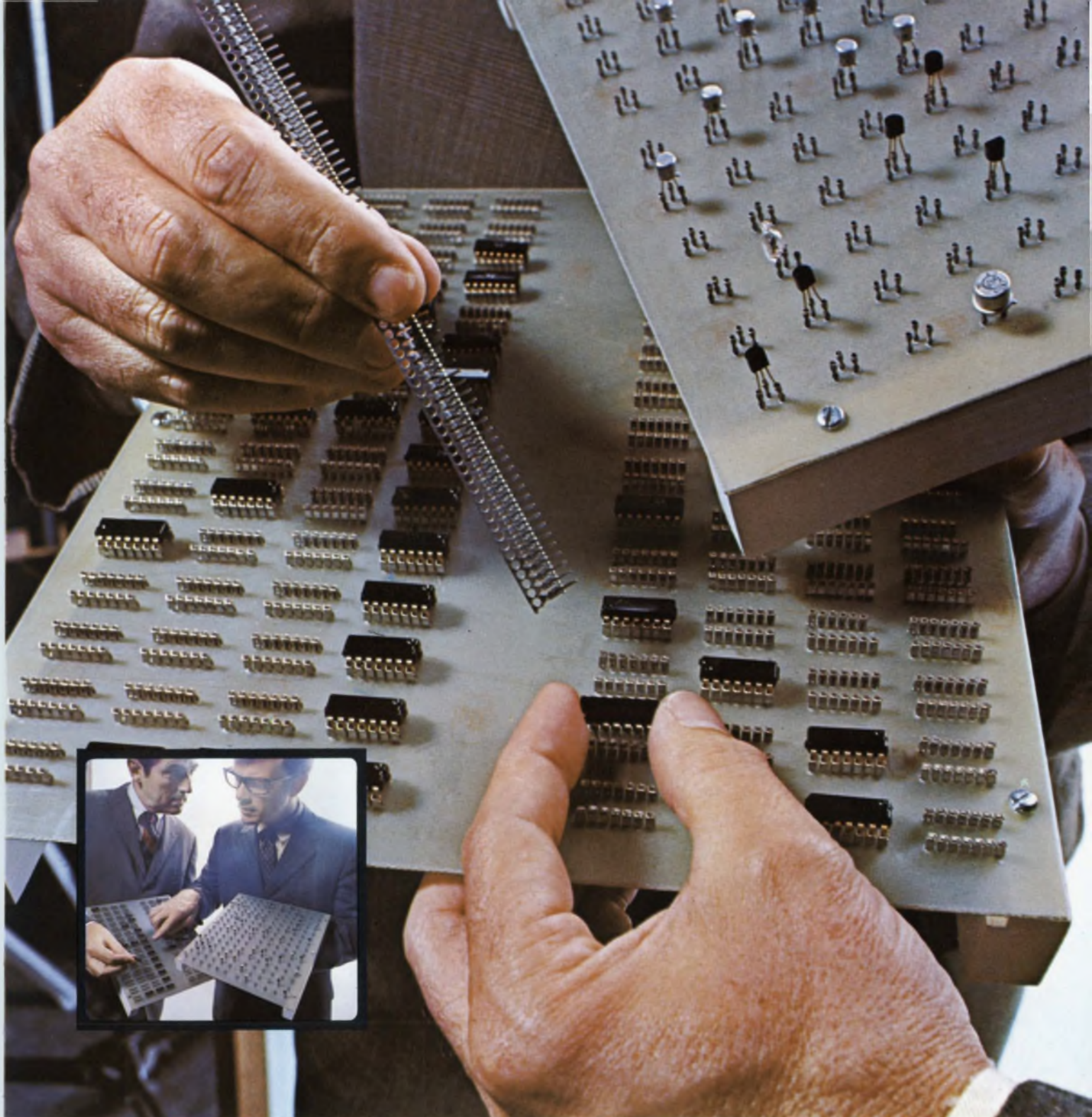

**HERE'S A NEW AND BETTER WAY:** To make printed circuit board connections. Reliably. At low, low cost. They're Molex Soldercon<sup>®</sup> terminals. Integrated circuit and transistor terminals. Offering the convenience of plug-in I.C.'s and transistors *without* the cost of insulators. They fit directly on the board. And there is equipment available to do the job *automatically*. Fast! Soldercon terminals save time. Money. Speed installation. Make

testing easier, too. And simplify service problems. It's another example of Molex ingenuity . . . in creating components that simplify circuitry. Molex has the know-how and facilities to provide the interconnecting system you need. You can make connections by calling (312) 969-4550. Or write . . . Molex Incorporated, Lisle, Illinois 60532.

*...creating components that  
simplify circuitry*

# Chip

off the old breadboard.



## RCA put 1,238 devices on a 150 mil COS/MOS chip. What are your LSI requirements ?

The move is toward LSI. And RCA is ready now to develop custom COS/MOS circuits to your most demanding requirements.

For example, the 149 x 150 mil timing circuit above was integrated from a breadboard containing 1,238 discrete devices. Just one of many custom chips designed with RCA's unique silicon interconnect process to provide high packaging density.

RCA maintains a staff of systems engineers who are experienced in the

development of complex micropower arrays. They are backed by extensive facilities to speed the process of IC design and development.

These facilities consist of computers for logic simulation, artwork digitizer-plotter systems that can cut turn-around time by 33% in typical circuits, Mann Pattern Generator facilities to speed mask preparation, and Teradyne Model J-283 digital IC systems which functionally evaluate complex arrays.

Put RCA's COS/MOS team to

work to help reduce package count, cut assembly costs, and achieve excellent cost effectiveness in your systems.

When it comes to COS/MOS LSI, come to RCA.

Contact your local RCA Representative or RCA Distributor, or write RCA Solid State Division, Section 57K-23, Box 3200, Somerville, New Jersey 08876.

**RCA** Solid State  
products that make products pay off