

Electronic Design 6

VOL. 20 NO.

FOR ENGINEERS AND ENGINEERING MANAGERS

MARCH 16, 1972

What's 'in' at the IEEE show?
Cool tech sessions that combine the practical and the futuristic. Hot products — tubeless scopes, dollar-a-digit LEDs, economy

minicomputers. Science exhibits. Special applications seminars. It all adds up to 'New Horizons for Engineering.' And you can preview it now. Turn to p. 68.

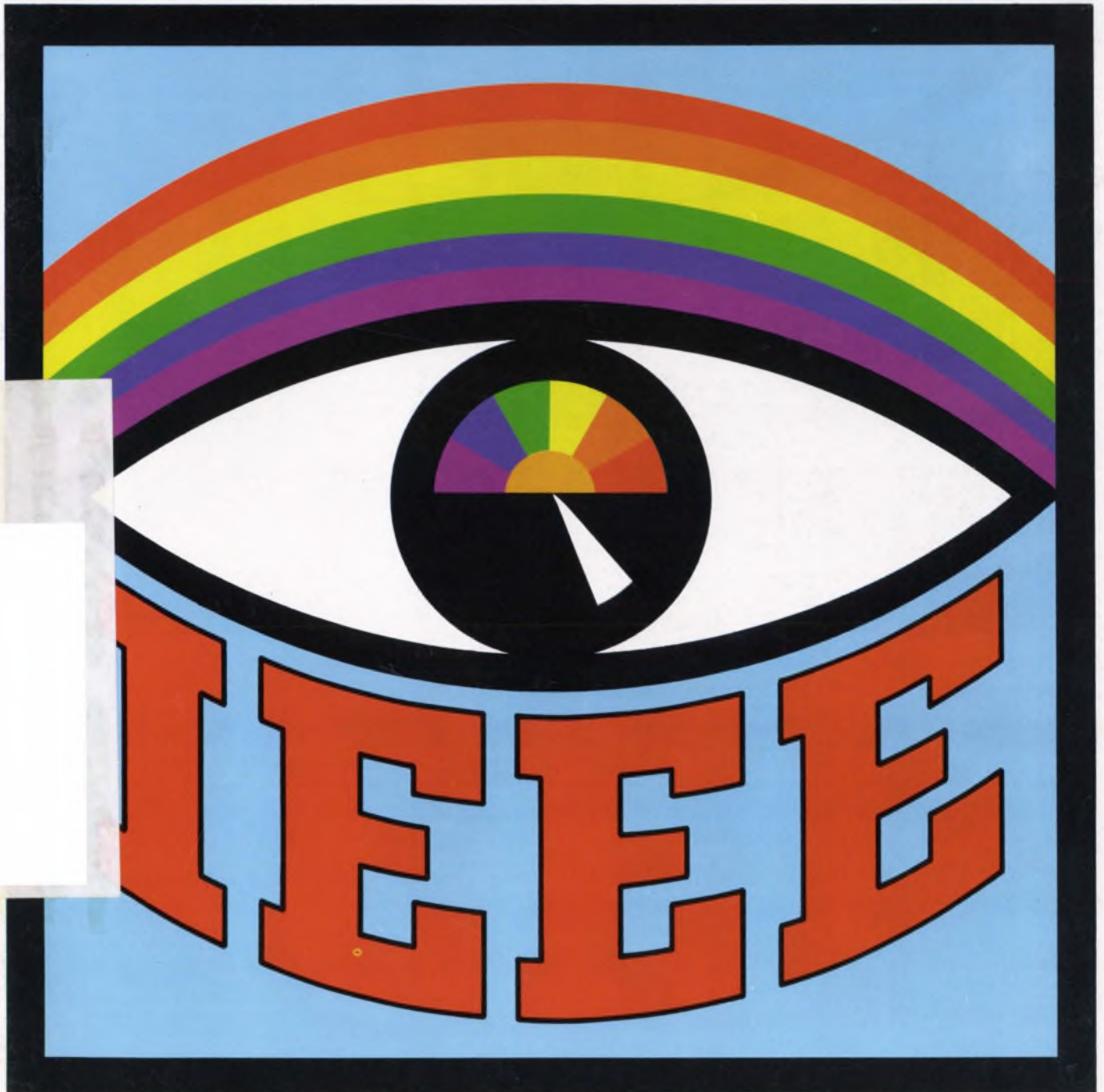

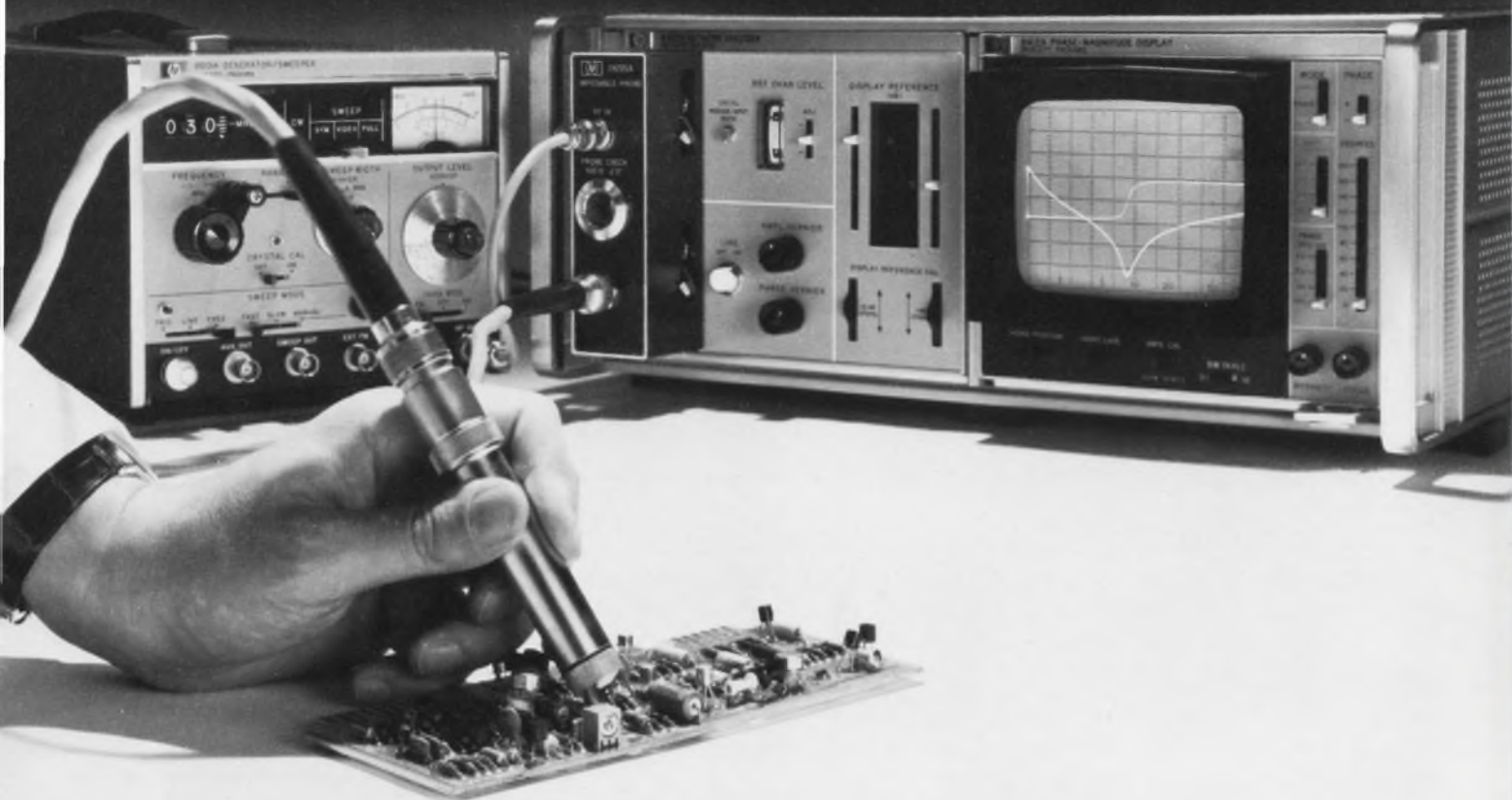

Introducing “touch & see” swept impedance measurement. Now the “do-everything” RF test system does even more.

Just add our new impedance probe to the HP 8407A Network Analyzer, and you can measure complex impedance of circuits, coax systems, discrete components. View impedance excursions over the wide range from 0.1Ω to $10K\Omega$ as you sweep between 500 kHz and 110 MHz.

The HP 8407A Network Analyzer itself makes comprehensive swept RF measurements quickly, and with high accuracy. You see important characteristics like gain/loss, phase shift, voltage and current transfer functions, group delay, impedance, return loss and S-parameters. Dynamic range is greater than 100 dB, yet you can resolve 0.05 dB. It has 360° phase range with 0.2° resolution.

The 8407A Network Analyzer with the 8412A Phase-Magnitude Display costs \$4650. The new impedance probe (Model 11655A) costs \$750. Other accessory kits for circuit probing and for general measurements in coaxial systems are also available, priced from \$325 to \$500.

To learn more about how our “do-everything” network analyzer can help you in design and production test applications, call your field engineer or write Hewlett-Packard, Palo Alto, California 94304; Europe: 1217 Meyrin-Geneva, Switzerland.

HEWLETT  PACKARD

NETWORK ANALYZERS

04112 A



Turn ON to Beauty and Protection, too. Airpax Type 203 Circuit Protectors

Why use a lighted on-off switch *and* a circuit breaker on your consumer, commercial, or industrial products? That's expensive. Fuses cost less, but then you're faced with a service problem.

The Airpax 203 offers the benefits of all these functions in one neat, attractive, easy-to-install package. Illuminated rocker handles in a variety of colors *plus* the usual Airpax

positive electromagnetic circuit protection. And just a single rocker arm for one, two, and three-pole models. Quick, easy snap-in front panel mounting, too. Or, if you prefer, you can have optional flush rear mounting.

Accurate current ratings from 0.020 to 20 amperes, with voltage ratings to 50V DC and 250V AC (50/60 or 400 Hz). All with choice of

inverse time delay or instant trip characteristics. Series, shunt, and relay trip internal circuits are available and can be combined in single, two, and three-pole versions.

Interested? Write for Bulletin 2009. Airpax Electronics, Cambridge Division, Cambridge, Maryland 21613.

AIRPAX™

Protection comes in many colors



INFORMATION RETRIEVAL NUMBER 2

Siemens

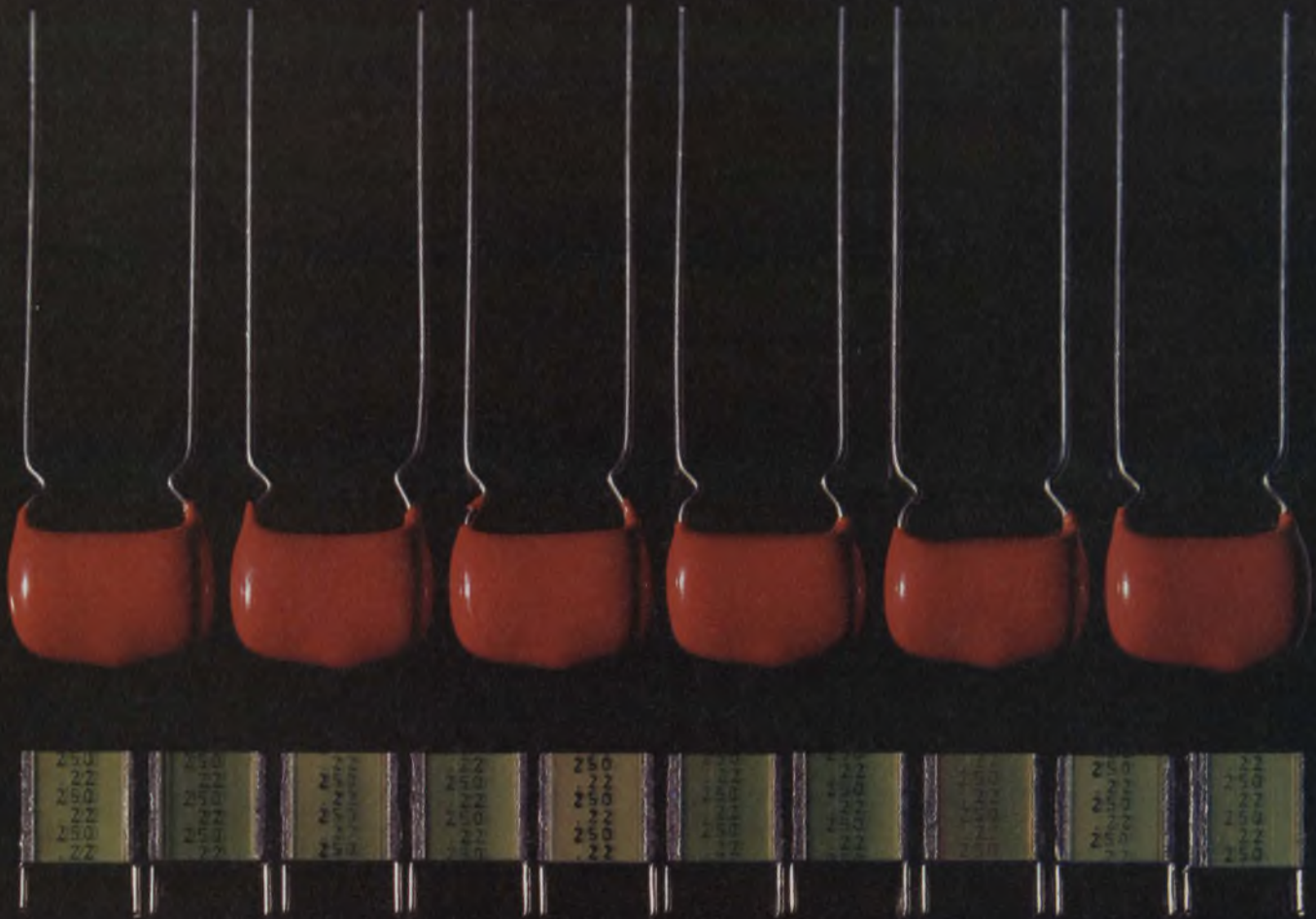

The square vs. the bulbous. The story of the shrinking film capacitor.

As you can see, ten Siemens .22 μ F \pm 5%/250V metallized stacked foil polycarbonate capacitors fit in the same space as six competitive .22 μ F \pm 10%/200V units.

The Siemens capacitors are designed for automatic PC board insertion. Their \pm 5% tolerance is standard. And they cost less.

All of this is possible because of Siemens unique stacked foil construction.

We can show you equally impressive advantages in our other capacitor lines.

Join the growing number of engineers who specify Siemens capacitors. Call us for film and

metallized film with dielectrics of paper, lacquer, polyester, polycarbonate, polypropylene, and polystyrene; tantalum and aluminum electrolytics. Contact Ken Liddane, Siemens Corporation, 186 Wood Avenue, So., Iselin, N.J. 08830. Call 201-494-1000.



SIEMENS

Electronic Design

FOR ENGINEERS AND ENGINEERING MANAGERS

VOL. 20 NO.

6

MARCH 16, 1972

NEWS

- 23 **News Scope**
- 26 **At the Solid-State Circuits Conference**—N-channel technology invading semiconductor memory field.
- 27 **Charge-coupled devices** await mass application by industry.
- 28 **Bipolar logic forges ahead:** More speed, less dissipation.
- 32 **New communication possibilities** flowing from IC optoelectronics.
- 34 **IC manufacturers** have yet to tap a vast consumer-goods market.
- 38 **Far-IR sensor detects objects by noting 0.5 C variations.**
- 42 **Technology Abroad**
- 45 **Washington Report**

-
- 68 **IEEE '72**—A special section devoted to this year's big show
-

TECHNOLOGY

- 134 **Implement digital transfer functions**, either simple or complex, with only two off-the-shelf MOS/LSI building-block chips.
- 140 **Use op amps with greater confidence** by understanding the subtleties of their parameters and how they are measured.
- 146 **Let a computer design your i-f amplifier.** You can do it simply and speedily by using FORTRAN subroutines to modify the standard RFAMP program.
- 152 **Solve filter parameter problems** with variable resistors and design curves. You select the cutoff frequency and damping ratio by adjusting resistance values.
- 156 **Ideas for Design**

PRODUCTS

- 169 **Instrumentation:** Waveform generators offer low cost, high performance
- 182 ICs & Semiconductors
- 190 Data Processing
- 198 Microwaves & Lasers
- 205 Modules & Subassemblies
- 212 Packaging & Materials
- 217 Components

Departments

- 67 **Editorial:** When was the last time you created something?
- 7 Across the Desk
- 223 Design Aids
- 224 Application Notes
- 226 New Literature
- 234 Bulletin Board
- 238 Advertisers' Index
- 240 Information Retrieval Card

Cover: Designed by Art Director Bill Kelly

ELECTRONIC DESIGN is published biweekly by Hayden Publishing Company, Inc., 50 Essex St., Rochelle Park, N.J. 07662. James S. Mulholland, Jr., President. Printed at Brown Printing Co., Inc., Waseca, Minn. Controlled circulation postage paid at Waseca, Minn., and New York, N. Y., postage pending Rochelle Park, N. J. Copy-right © 1972. Hayden Publishing Company, Inc. 82501 copies this issue.



Think Twice:

How will you choose your next portable scope ...on faith, or on fact?

Forget everything you ever knew about portable scopes; today's portables are something else entirely. In the last year, both major scope manufacturers have brought out completely new lines. So, choosing a new portable on "blind faith" in your old make is about as sensible as marrying a girl you've never met, just because her second cousin was Miss America in 1967.

The only rational way to choose a new portable today is to make a head-on comparison between our scopes and our competitor's. And this means more than just a quick look at price tags and specs. It means a thorough investigation of total acquisition cost. Be sure you check these specific points:

Initial purchase price. Are you getting the best price available? HP's Portables are priced as much as \$200 below the competition, with special purchase agreements available.

Ease of Use. Are the controls simple and logical? Or are they a jungle of tightly packed knobs. Ten minutes a day, spent in needless tinkering, can add up to hundreds of

dollars a year in wasted man-hours.

Fieldworthiness. Some scopes have such high power requirements that battery operation is impossible. HP feels that a portable scope should have "go-anywhere" capabilities, so our Portables all use low-power-requirement designs which permit battery operation. Low power requirements also mean lower heat, which prolongs component life. As a result, only HP's Portables eliminate the need for fans, or dust-admitting vent holes.

Calibration and Service. Have you considered how much your scope will cost you *after* you've purchased it? For example, HP Portables are quickly calibrated — requiring approximately half the time required to calibrate our competitor's portable scope. This could save you hundreds of dollars over the life of your scope. And are you going to have to deal with one manufacturer for scope service, and another for your voltmeters, signal sources, etc.? Or can you save time and money by limiting your dealings to one company? And don't forget training aids; HP offers live

demonstrations, video tapes and literature to simplify conversion problems.

Look into all these points, and we think you'll find that you'll save a lot of time, effort, and money — and avoid a lot of frustration — by choosing HP's Portables. But don't take our word for it; make the comparisons yourself.

For a revealing package of information on HP's new Portables, send for a free copy of our "No-Nonsense Guide to Oscilloscope Selection." Or contact your local HP field engineer for a demonstration. Check before you choose. Hewlett-Packard, Palo Alto, California 94304. In Europe: 1217 Meyrin-Genève, Switzerland.

**Scopes Are Changing;
Think Twice.**

082/2

HEWLETT  PACKARD
OSCILLOSCOPES

When your machine has more to say...



IEE Readouts provide the vocabulary.

When your machine has more to say, IEE rear projection readouts let it speak out with an eloquence that make other display systems seem taciturn.

For instance, just one IEE rear projection readout will improve the vocabulary of your machine with up to 64 new phrases expressed in any combination of alphanumeric, in any language, accompanied by the symbols of any discipline, all displayed in a variety of colors and in the type styles that go best with your panel decor.

No gas discharge tube, or LED or what have you, can make that statement.

IEE units communicate — loud and clear!

Our big Series 80 rear projection readout lets your machine shout in huge 3¾-inch characters. Or we can say things discretely

with our fit-anywhere ½ x ¾-inch Series 345 model.

All with single-plane viewing, variable brilliance, and the capability to change vocabularies right in the field. To assist, we have a powerful new low-cost hybrid driver/decoder for any of the readouts. Plus a host of other driver/decoders... all, competitively priced... purchased separately or customer mounted.

Rear projection readouts give you an order of display versatility a world apart from other techniques, and IEE builds more of them than anybody. Send today for our Short-Form Catalog on units that are long on talk. Industrial Electronic Engineers, Inc., 7740 Lemona Ave., Van Nuys, California 91405. Telephone: (213) 787-0311 • TWX 910-495-1707

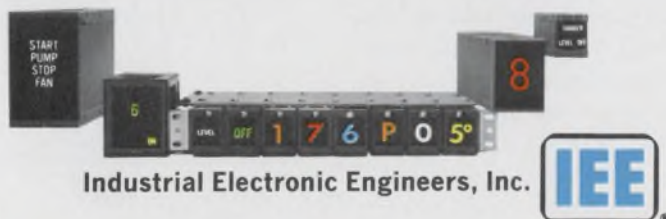

Industrial Electronic Engineers, Inc.



Publisher

Peter Coley

Editors

Editorial Offices
50 Essex St.
Rochelle Park, N.J. 07662
(201) 843-0550
TWX: 710-990 5071
Cable: Haydenpubs Rochellepark

Editor: George Rostky

Managing Editors:

Ralph Dobriner
Michael Elphick

Associate Editors:

Jules H. Gilder
Richard Lee Goldberg
Morris Grossman
John F. Mason
Stanley Runyon
Edward A. Torrero
Richard L. Turmail

Contributing Editor:

Peter N. Budzilovich

Editorial Field Offices

East

Jim McDermott, Eastern Editor
P.O. Box 272
Easthampton, Mass. 01027
(413) 527-3632

West

David N. Kaye, Senior Western Editor
2930 West Imperial Highway
Inglewood, Calif 90303
(213) 757-0183
Les Brock, Western Editor
95 Main St.
Los Altos, Calif. 94022
(415) 941-3084

Washington

Don Byrne, Washington Editor
1111 S. Army Navy Drive
Arlington, Va. 22202
(202) 296-8982

Editorial Production

Dollie S. Viebig

Art

Art Director, William Kelly
Richard Luce
Anthony J. Fischetto

Production

Manager, Thomas V. Sedita
Helen De Polo
Maxine Correal
Anne Molfetas

Circulation

Manager, Nancy L. Merritt
Joan Licari

Information Retrieval

Peggy Long

across the desk

A strong labor group urged for engineers

About your editorial: "Wanted 20 years' experience. Older men need not apply" (ED 23, Nov. 11, 1971, p. 41), I meant to write two months ago, but lots of unpaid overtime postponed my effort. The title was a winner. The editorial led very logically to the question: "What do we do with our 20 years of experience?" Then it fell on its face with the advice of Chairman Mao: "We've got to work harder." You don't have to tell us to work harder. We engineers are being ground into the dust by our efforts to stay employed.

After that advice, you continue with the thought that we should go after the tough, challenging new technologies. Picture a 45-year-old, unemployed semiconductor engineer applying for a job in the tough challenging new technology of laser engineering. He'd never even get a reply. Now picture the same engineer employed and taking a course in laser engineering. He applies for the same job, and he still doesn't get a reply. Now picture him employed and going to his boss with a request to enter the company effort in laser engineering. His boss answers, predictably, that he's needed where he is. But when the semiconductor assignment runs out, he's laid off.

Your editorial leads readers to think that they have significant control over their careers. If we have any control at all, it simply amounts to this: we must stay constantly alert for the end of the contract. When the end approaches, we send our 20 resumes. If we're lucky, we get one answer, and it's from a company in Biloxi that ran a blind ad. But at least we have someone interested. The only way we'll get more control over our jobs

is to form a strong professional association. If we fail to do that, we'll just run in and out with the tide.

Robert Bruce, MSEE
15 Johnstone Rd.
Great Neck, N. Y. 11021

Featured a/d converter available off the shelf

We were delighted to read Jim McDermott's article "Power Needs Cut Dramatically for Ocean-Floor Monitor System" (ED 2, Jan. 20, 1972, p. 28). Delighted, that is, until we discovered that while credit had been given to the designers of the unique ultra-low-power-drain converter, there was no indication in the article that it is being manufactured by Analog Devices, Inc., and is available as the ADC-12QL, a standard product.

If any of your readers liked the idea of an a/d converter that works from a single +12 V battery, needs less than 600 μ W of quiescent battery drain, 15 mW at a conversion rate of 200 Hz, and has 12-bit resolution, they'll love the idea that they can buy it off-the-shelf.

D. H. Sheingold,
Technical Marketing Manager
Analog Devices, Inc.
Route 1, Industrial Park
P.O. Box 280
Norwood, Mass. 02062

Wrong price given

In the new product announcement of Fairchild's doppler radar module, the DM (X)100 (ED 1, January 6, 1972, p. 142), the price was mistakenly given as \$13. The correct price is \$130.

(continued on p. 10)

Electronic Design welcomes the opinions of its readers on the issues raised in the magazine's editorial columns. Address letters to Managing Editor, Electronic Design, 50 Essex St. Rochelle Park, N. J. 07662. Try to keep letters under 200 words. Letters must be signed. Names will be withheld on request.

giga-trim capacitors for microcircuit designers



Actual size

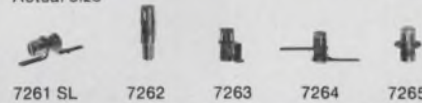

Giga-Trim[®] (gigahertz-trimmers) are tiny variable capacitors which provide a beautifully straight forward technique to fine tune RF hybrid circuits and MIC's into proper behavior. They replace time consuming cut-and-try adjustment techniques and trimming by interchange of fixed capacitors.

Applications include impedance matching of GHz transistor circuits, series or shunt "gap-trimming" of microstrips, external tweaking of cavities, and fine tuning of crystal oscillators.

Johanson

MANUFACTURING CORPORATION

ROCKAWAY VALLEY ROAD
BOONTON, NEW JERSEY 07005

(201) 334-2676

**Reliability is 756 little dents
and one big one.**





The big squeeze.

The heelpiece and frame are the backbone of our Class H relay. The slightest squiggle or shimmy out of either and the whole relay is out of whack.

756 tiny dents on the heelpiece, plus one big one on the frame, make sure this'll never happen.

They're the result of planishing, a big squeeze. Planishing is an extra step we go through in forming the pieces to add strength and stability by relieving surface strain. It also makes the parts extra flat.

This takes the biggest press in the industry and the biggest squeeze. Both exclusively ours.

A different kind of coil.

The heart of a relay is the coil. If ours looks different, it's because we build it around a glass-filled nylon bobbin. It costs us more, but you know how most plastic tends to chip and crack.

Also, moisture and humidity have no effect on glass-filled nylon. No effect means no malfunctions for you to worry about. No current leakage, either.

The coil is wound on the bobbin automatically. No chance of human error here.

We didn't forget the solder.

We use a solderless splice. That's because solderless splice connections are sure-fire protection against the coil going open under temperature changes, stress, or electrolysis.

A solderless splice is more expensive to produce, so it's usually found only on the most reliable relays. AE is the only manufacturer to use this method on all of its relays.

Finally, we wrap the whole assembly with extra-tough, mylar-laminated material. A cover is not really necessary here; but why take chances?



Springs and other things.

We don't take any chances with our contact assembly, either. Even things like the pileup insulators (those little black rectangles) get special attention. We precision mold them. Other manufacturers just punch them out.

It makes a lot of difference. They're stronger, for one thing; and because they're molded, there's no chance of the insulators absorbing even a droplet of harmful moisture. Finally, they'll withstand the high temperatures that knock out punched insulators.



Then there are the contact springs. Ours are phosphor-bronze. Others use nickel-silver. Our lab gave this stuff a thorough check, but found nickel-silver too prone to stress-corrosion. Atmospheric conditions which cause tarnish and ultimately stress corrosion have almost no effect on phosphor-bronze.



Two are better than one.

Our next step was to make sure our contacts give a completed circuit every time. So we bifurcate both the make and break springs.

Each contact works independently to give you a completed circuit every time.

Edge-tinned contact springs save you the job of solder tinning them later. Also, edge-tinning enables you to safely use the same relay with sockets or mounted directly to a printed circuit board. A simple thing, but it takes a big chunk out of the inventory you have to stock.

Etc. Etc. Etc.

There's a lot more to tell about what makes our Class H relay reliable. Now we're waiting to hear from you. GTE Automatic Electric, Industrial Sales Division, Northlake, Illinois 60164.

GTE AUTOMATIC ELECTRIC

INFORMATION RETRIEVAL NUMBER 7

RANGE CHANGE



Extralytic® Aluminum 'Lytic Capacitors give you extended temperature range without sacrifice in life or leakage current.

| Type 601D Tubular Case | Type 602D Cylindrical Case |
|--|--|
| -55C to +105C | -55C to +85C |
| Superior performance over entire temperature range, unlike conventional 'lytics that do not operate satisfactorily at low temperatures. High volumetric efficiency, long shelf life, low leakage current. Withstand high ripple current. Write for Engineering Bulletin 3456A or; CIRCLE 882 ON READER SERVICE CARD. | Power supply filter capacitors specifically designed for maximum efficiency. Offer the power supply design engineer the lowest ESR and the highest ripple current capability per case size available today for long, trouble-free life. Write for Engineering Bulletin 3457 or; CIRCLE 883 ON READER SERVICE CARD. |

MORE FROM SPRAGUE... THE BROAD-LINE PRODUCER OF ELECTRONIC PARTS

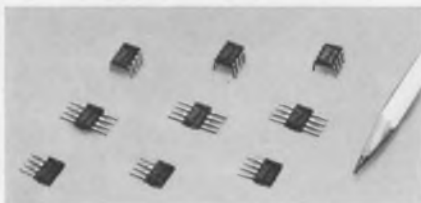

HALL EFFECT SWITCH ICs. Actuated magnetically, not mechanically or optically. Hall generator trigger circuit and signal amplification circuit on single silicon chip. Reliable (no moving parts). Easy interfacing with DTL/TTL/MOS logic. High speed. Low cost. Write for Engineering Bulletin 27,402A or;
CIRCLE 884 ON READER SERVICE CARD.



U.L. LISTED FILTERS. Series JX5000 for EDP equipment and general-purpose use. Rated 125/250 VAC, 0-60 Hz, 1 thru 50 amps. 60 db @ 150 kHz, 80 db from .5 MHz thru 1 GHz. Special designs and rectangular multi-circuit units also available. Write for Engineering Bulletin 8210 or;
CIRCLE 885 ON READER SERVICE CARD.

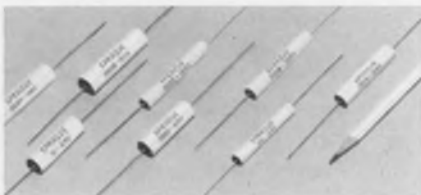

TYPE 430P METFILM® 'E' CAPACITORS. High-voltage metallized polyester-film capacitors designed for voltage multiplier circuits used in electrostatic copiers, TV power supplies, etc. Working voltages from 4,000 to 15,000 V. Capacitance is stable with time, temperature, voltage. Write for Engineering Bulletin 2445.1 or;
CIRCLE 886 ON READER SERVICE CARD.



BLUE JACKET® RESISTORS. Vitreous-enamel power wirewound. Unique all-welded end-cap construction eliminates moisture paths along leads, anchors leads securely to resistor body. Expansion coefficients of vitreous enamel, ceramic body, and end caps are closely matched. Write for Engineering Bulletin 7410E or;
CIRCLE 887 ON READER SERVICE CARD.



TECHNICAL LITERATURE SERVICE, SPRAGUE ELECTRIC CO., 347 MARSHALL ST., NORTH ADAMS, MASS. 01247

ACROSS THE DESK

(continued from p. 7)

A view

... of product development, as seen through the pen of an engineer at a test-equipment company.

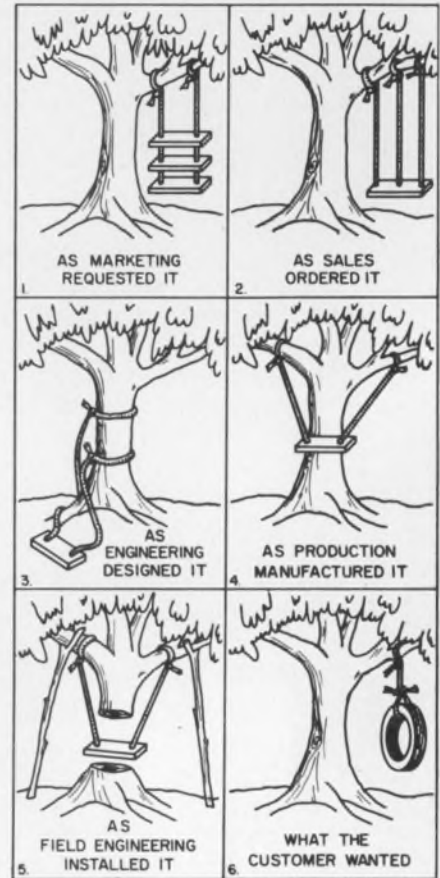

One design idea leads to another

While Horace Jones' Idea for Design ("Build a Dual-Voltage Regulator for \$11," ED 26, Dec. 23, 1971, p. 70) does point out the versatility of a dual op amp, I couldn't let this issue go by without pointing out that a Silicon General SG3501 dual regulator IC will do his job for \$7.50 (single-piece price). In addition to replacing 14 components with one, the SG3501 will provide more input voltage capability, better line and load regulation, and short-circuit protection.

I don't mean to detract from Mr. Jones' idea, because I know it is tough to keep up with all new

(continued on p. 14)



Coil Cords

for products that move

There's more to coil cord design than snapping back in place. Lots more. Like human, electronic, and environmental requirements. Color matching. Reliability. And cost.

Belden has the experience. Hundreds of retractile cord designs that are solving problems in communications, power and control applications. Coil cords in a wide variety of strain and stress relief configurations, special connectors, custom wire assemblies . . .

We've got a new booklet covering coil cord design parameters. It will help you determine important trade-offs between shielding, tensile strength, environmental protection, elasticity, and cost. We'll show you how Beldfoil® can eliminate noise problems that can originate in the shield itself. The advantages of thermoplastic and thermosetting jacket materials. And how to get the right elasticity for your equipment application. Just contact Electronic Sales Service Dept., Belden Corporation, Richmond, Indiana 47374. Phone (317) 966-6681.

Electronic Sales Service Dept.
Belden Corporation
Richmond, Indiana 47374
Phone (317) 966-6681



- I have an immediate coil cord design problem; please contact me.
- Please send me the new Retractable Cord Design Guide.



Name _____
Company _____
Title _____
Address _____
City _____ State _____ Zip _____
Application _____



PDP-8. PDP-11. For OEM's

A few months ago, we came out with new low cost versions of our PDP-8 and PDP-11 families for the OEM.

With prices as low as \$2436. In quantities of 50.

We made sure they'd have the features, architecture and compatibility that make PDP-11 and PDP-8 the most popular, most imitated minis ever.

We must have hit on the right combination. We've been mixing it up with some of the toughest OEM's around. And coming away with their business.

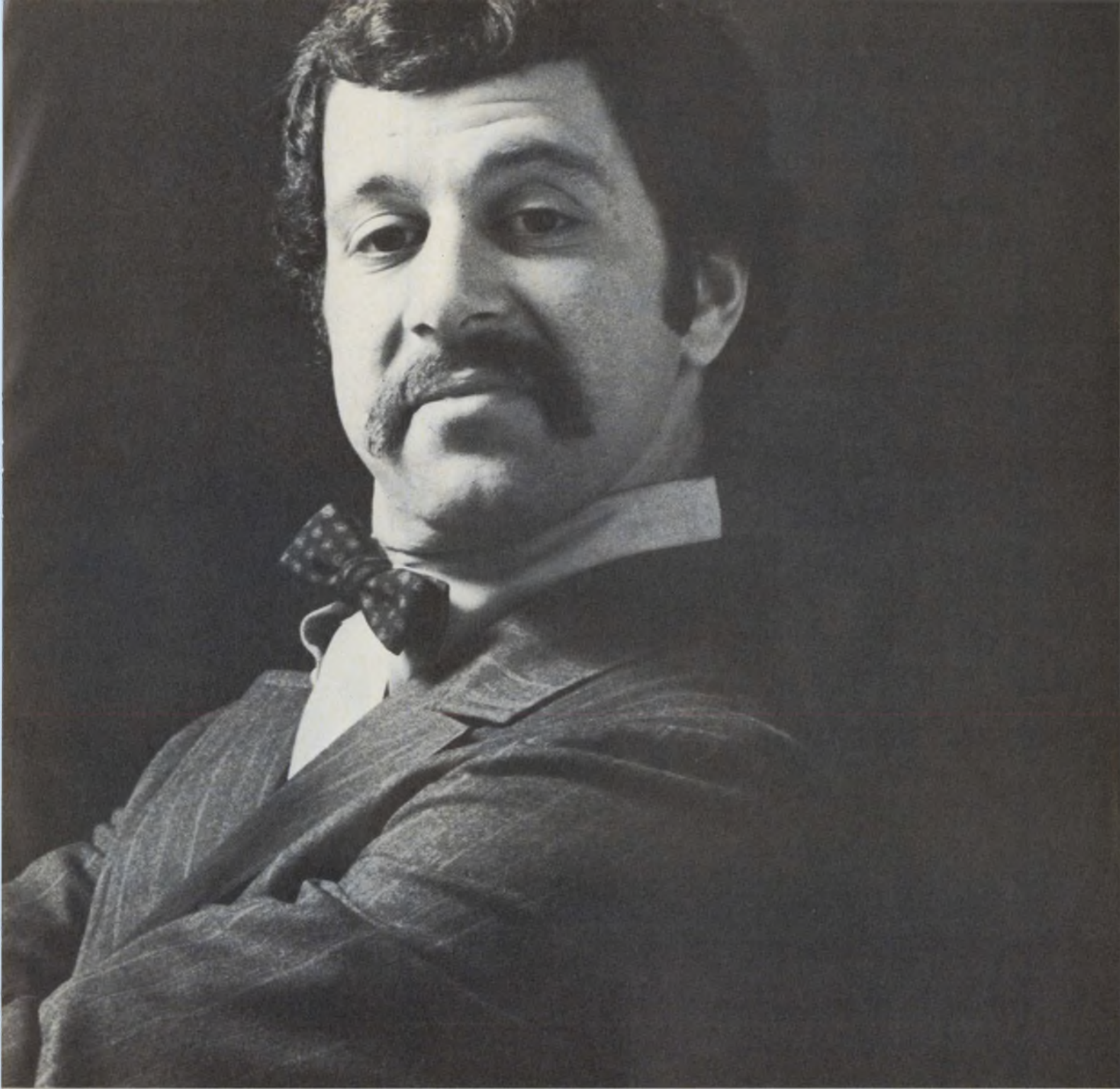

who hate to spend money.

We're after your business, too.
Because now we have the right
computers. At the right prices.
From the right company.
Come and get 'em.

Digital Equipment Corporation,
146 Main Street, Maynard, Mass.
01754. (617) 897-5111.

European Headquarters: Geneva.

digital

INDUSTRIAL GRADE WIREWOUND TRIMMERS

for
less
than

90¢*

Interchangeable with other wirewounds, carbons, cermet & films.

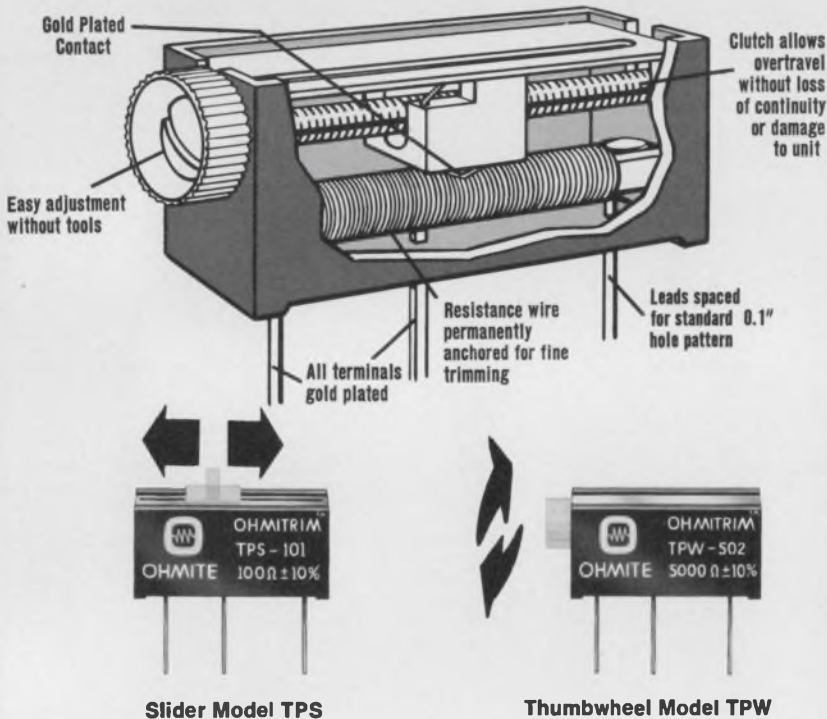

This is no me-too rectilinear trimmer. Ohmite's new design concept yields a quality 1-watt, 35-turn (or slider) resistance trimmer for less cost than non-wire-wound element devices. Moisture, noise, stability, T.C. and other problems associated with carbons, cermet and films are eliminated. Bonus: Fast and fine adjustment without tools; choice of thumbwheel or slider actuator. Available in quantities right now from your local Ohmite Stocking Distributor and Ohmite.

For Bulletin 250, write or phone Ohmite Manufacturing Company, a North American Philips Company, 3643 Howard St., Skokie, Illinois 60076. TEL: (312) 675-2600. TWX: 910-223-0805.

CHARACTERISTICS

- Resistance Range 10 to 20K Ω , $\pm 10\%$.
- Power Rating 1 watt @ 40°C max. ambient.
- Temp. co-efficient 0 \pm .010% per degree C.
- Dielectric Strength . . . 500 Volts rms.
- Insulation Resistance . . 100 megohms.
- Torque 0.1 to 8.0 oz.-in.
- End Resistance 2% maximum.
- Size . . . TPW—1.3" lg. x 0.3 w. x .495 h.
TPS—1.01 lg. x 0.3 w. x .495 h.

*88¢ in 5000 pcs. 10 through 5000 ohms

MARK OF QUALITY



OHMITE



Circle No for action required

Immediate Application
91

Probable Application
92

General Reference
93

ACROSS THE DESK

(continued from p. 10)

developments in this industry, but I feel that your readers should be aware of all the alternatives open to them.

Robert A. Mammano
Vice President, Engineering
Silicon General, Inc.
7382 Bolsa Ave.
Westminster, Calif. 92683

New use found for water



In the Feb. 17 issue we described a Hewlett-Packard 9100 calculator that was retrieved from a local mud-hole where it had been resting for a number of months. After a single transistor was replaced the calculator worked beautifully (See ED 4, "Crabby calculator," Feb. 17, 1972, p. 10).

Now in line with this trend to instrument immersion, HP has developed an oscilloscope that operates underwater. It's HP's Model 1700E, which the company says can be used on shipboard, in dusty environments or any place there is a corrosive atmosphere—or, as the photo shows, even underwater. Actually, if dropped in water, the scope would float since the amount of water it displaces is greater than the 35 pounds it weighs.

Yes. The mermaid is an HP employee. Interested?

CIRCLE NO. 319



Leave my power supply system alone! You can get your own in only 9 days from Acopian.

"I tried struggling through that old power supply system catalog. It was like a jigsaw puzzle, hunting for the pieces I needed for my new power system. There had to be a better way.

"Then I remembered the Acopian hotline. I called it. I told them the DC voltages and currents I wanted. Discussed panel size. Meters. Switches. And other accessories.

"They gave me a firm price. Right on the phone. It was a lot less than I expected. I had our buyer phone in the P.O. And Acopian designed,

built, tested and shipped it in nine days. Completely wired.

"So go order your own Acopian power system . . . It's easy!"

HOW TO ORDER ACOPIAN POWER SYSTEMS

- Call Acopian collect
- Tell us the outputs and accessories you need
- Get a firm price
- Shipment of completely wired system will be made in 9 days.

For immediate service, call the Acopian hotline: (215) 258-5441. For literature, write Acopian Corp., Easton, Pa. 18042. And remember, Acopian also offers 82,000 different DC power modules, every one shipped with this tag . . .





TEKTRONIX® 7900 FAMILY

1 GHz Direct-Access Oscilloscope

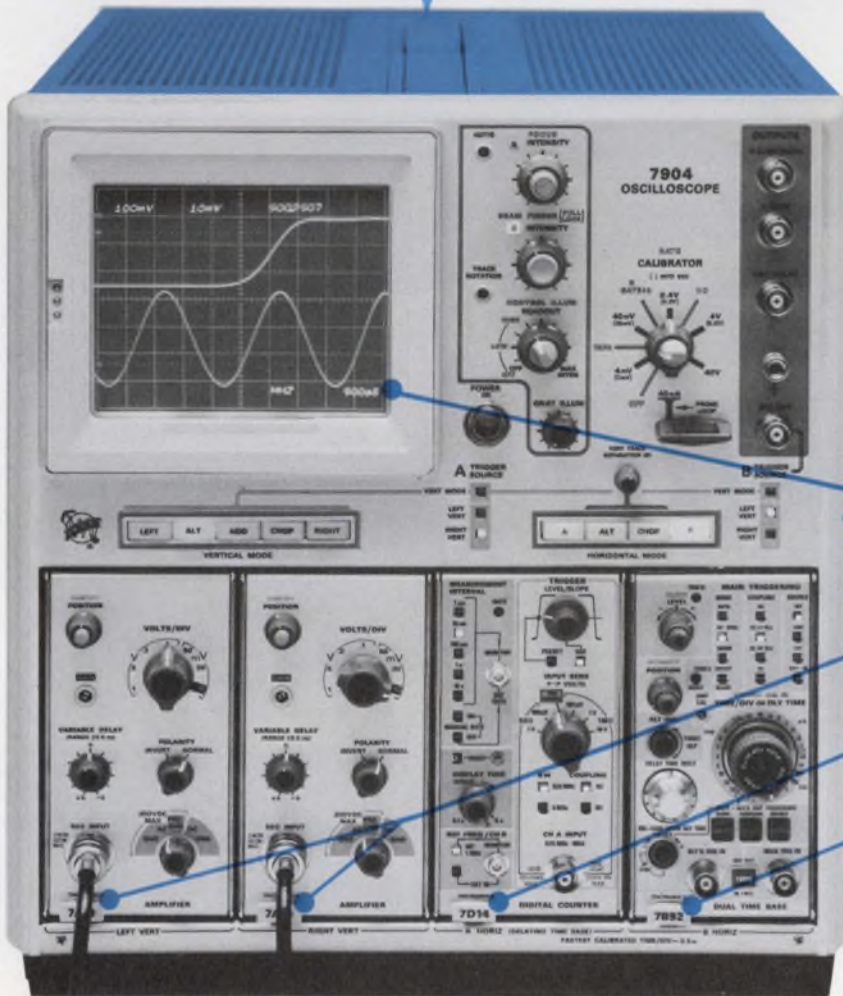

TEKTRONIX 7904

featuring extended performance or general purpose use, from one mainframe and a family of plug-ins.

Extended Performance — 20 kHz to 1 GHz

Plug in the 7A21N and install a simple vertical amplifier bypass to directly access the CRT. The bandwidth — 1 GHz, and risetime — 350 ps. Less than 4 V/div driving signal required — single ended or differential. Sorry — no CRT READOUT — vertical amplifier bypassed.

General Purpose — DC to 500 MHz

Plug in the 7A19 — 500 MHz bandwidth at 10 mV/div, 7B92 — delaying sweep rates to 500 ps/div, 7D14 — direct counting to 525 MHz. As your applications and measurement requirements change, choose from 24 plug-ins for: • sampling • TDR • spectrum analysis • curve tracing • digital multimeter • etc., etc. TEKTRONIX 7904 . . . A product of technical excellence.

For further information or a demonstration call your nearby TEKTRONIX Field Engineer or write: Tektronix, Inc., P.O. Box 500, Beaverton, Oregon 97005.



OR . . .

500 MHz real-time Oscilloscope System

- 8 x 10 cm display CRT READOUT
- 8 cm/ns writing speed
- 7A19 Amplifier 500 MHz @ 10 mV/div
- 7D14 Digital Counter 525 MHz direct counting
- 7B92 Dual Time Base 500 ps/div

OR . . .

choose from 24 compatible 7000-Series plug-ins for virtually any measurement

| | |
|-------------------------------------|--------|
| 7904 Oscilloscope | \$2900 |
| 7904 Oscilloscope, without readout | \$2500 |
| 7A19 Amplifier | \$500 |
| 7A19 Amplifier, with variable delay | \$700 |
| 7D14 Digital Counter | \$1400 |
| 7B92 Dual Time Base | \$1400 |
| 7A21N Direct Access | \$350 |

U.S. Sales Prices FOB Beaverton, Oregon

INFORMATION RETRIEVAL NUMBER 12

SEMICONDUCTOR NEWSBRIEFS

PUBLISHED BY MOTOROLA SEMICONDUCTOR PRODUCTS INC.

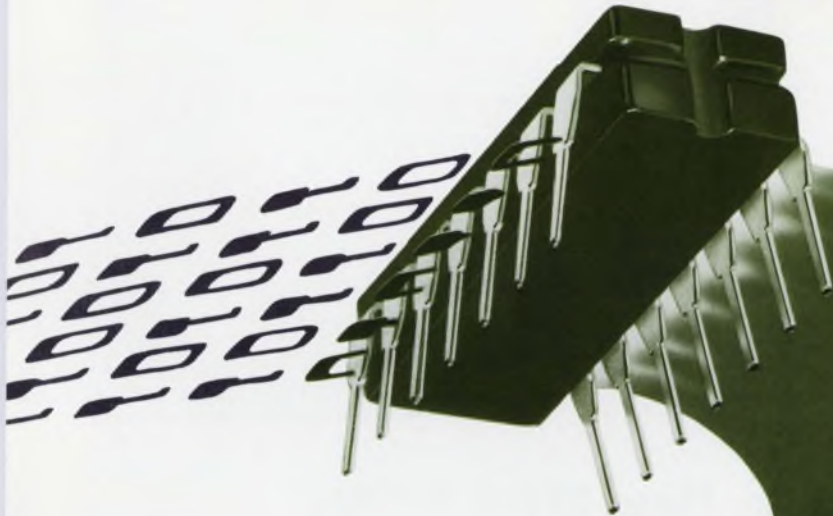

Get Flexibility, Economy With Monolithic Six-Bit Multiplying D/A Converter

In the MC1406L, Motorola is bringing you the guts of an ideal six-bit digital-to-analog converter — at a very gutty price.

For a 100-up cost of \$3.95, you get the basic unit you need for your converter application including a diffused resistor ladder network and all the switching circuitry necessary for six bits. Add only the regulating and amplifying components you need to achieve your design requirements. Why pay for performance you can't use?

For operation at room temperature, provide a simple reference by using a zener diode. Or choose the exact IC you need for a regulated reference over the 0 to 75° range.

To provide a voltage mode output, pay for only as much sophistication in an op

amp as the speed, accuracy, and output range your particular application requires.

Hang any components on this D/A that the performance of your system dictates and you'll still pay less — much less than for any comparably performing hybrid or monolithic converter now available.

The accuracy of this inexpensive unit is 0.78% of full-scale current, typical power dissipation is low at 95 mW, the settling time is a fast 200 ns (typical), and its six digital inputs are TTL and DTL compatible.

Applications possibilities abound for the MC1406L. Use it as a feedback element in an A/D converter, as the digital to analog decoder in a high speed data

modem, in digital transducers, and in display applications like CRT character generation, meters, and wave-form analyzers.

This D/A converter is also appropriate for some digital-analog multiplying applications since it will accept a varying reference. The magnitude of its output is directly proportional to the product of the reference voltage and the digital input.

MC1406L is packaged in the black ceramic 14-lead dual-in-line TO-116. Ample quantities are available now from distributors and Motorola sales offices. Use it anywhere you need an output current that's a linear product of an analog input voltage and a six-bit digital word — but use it!

For details, circle 211



McMOS Quietly Masters Voice Of Other Types

If you've heard but one voice in CMOS land — listen carefully now — Motorola McMOS outperforms RCA complementary MOS!

Motorola's noise-immune MC14000 series McMOS logic family has been expanded and given a new look . . . including direct pin-for-pin replacement for RCA CMOS and providing several unique Motorola features that makes McMOS more useful.

Several original designs have also been added to increase the system design utility of the line.

V_{DD} power supply upper limits are 18 V for the AL and 16 V for the CL types compared to just 15 V for all RCA units. A uniform output drive specification assures maximum simplicity of the design job. All devices in the mil-grade, AL series are directly compatible with low power TTL.

Improved system level speed and simpler system design is also possible

with the MC14000 AL and CL series, thanks to a uniform propagation delay specification for all gates. The complete McMOS supply voltage range is now 3.0 V to 18 V or 16 V, compared to the former spread of 4.5 to 18 V.

Check the benefits provided by these outstanding McMOS logic family features:

- Lowest quiescent power dissipation of any logic form — 10 nW/per gate
- Excellent noise immunity — 45% of V_{DD} (typ)
- Low output impedance — 750 ohms (typ)
- 25 ns basic gate delay
- High fanout — > 50
- Diode protection on all inputs
- Single supply operation — positive or negative
- Virtual immunity to any power supply variation from 3 to 18 V.
- Full power supply output voltage swing

- Choice of operating temperature ranges —
 - 55°C to +125°C
 - 40°C to +85°C

All McMOS types are available now from your Motorola distributor. Let him hear from you!

| Motorola Device # | Function | Pin-For-Pin Replaces | Price (100-Up) |
|-------------------|--|----------------------|----------------|
| MC14001AL | Quad 2-Input NOR gate | CD4001AD | \$ 4.15 |
| MC14001CL | NOR gate | CD4001AE | 1.18 |
| MC14002AL | Dual 4-Input NOR gate | CD4002AD | 4.30 |
| MC14002CL | NOR gate | CD4002AE | 1.22 |
| MC14011AL | Quad 2-Input NAND gate | CD4011AD | 4.15 |
| MC14011CL | NAND gate | CD4011AE | 1.18 |
| MC14012AL | Dual 4-Input NAND gate | CD4012AD | 4.30 |
| MC14012CL | NAND gate | CD4012AE | 1.22 |
| MC14013AL | Dual type D Flip-Flop | CD4013AD | 5.95 |
| MC14013CL | Flip-Flop | CD4013AE | 2.40 |
| MC14015AL | Dual 4-bit shift register serial in/parallel out | CD4015AD | 12.65 |
| MC14015CL | Serial in/parallel out | CD4015AE | 5.60 |
| MC14507AL | Quad Exclusive-OR gate | CD4030AD | 4.74 |
| MC14507CL | Exclusive-OR gate | CD4030AE | 1.86 |
| MC14021AL | 8-bit P/S shift register | CD4021AD | 12.24 |
| MC14021CL | Shift register | CD4021AE | 5.20 |
| MC14501AL | Triple Gate | — | 4.30 |
| MC14501CL | Triple Gate | — | 1.99 |
| MC14508AL | Dual 4-bit latch | — | 24.70 |
| MC14508CL | 4-bit latch | — | 13.75 |
| MC14519AL | 4-bit AND/OR Select | — | 4.75 |
| MC14519CL | 4-bit AND/OR Select | — | 2.10 |
| MC14027AL | Dual J/K Flip-Flop | CD4027AD | 6.60 |
| MC14027CL | Flip-Flop | CD4027AE | 3.18 |

For details, circle 212

Store Large Tables In New MOS ROMs

A 4096-bit static MOS ROM for large table or small increment continuous function storage heads a sizable list of additions to Motorola's standard high threshold memory complement. Five basic mask programmable ROMs have been announced, with standard options programmed for look-up table, code conversion, and character generation. Maximum access times for the family range from 500 ns (MCM1130L) to 800 ns (MCM1140L.) All use the 24-pin dual in-line ceramic package.

The MCM1140L is the mask programmable version of the 4096-bit memory, offering a choice of either 512 words of 8 bits or 1024 4-bit words. It offers two output buffer options for easy interfacing with either TTL or MOS external circuitry. A single mask change at the gate oxide stage of manufacturing provides the memory program, output buffer configuration, and programmable

chip selects. The MCM1141L is an 1140 pre-programmed as a 512 x 8 sine look-up table.

Medium-sized table and conversion applications are the tour de force of the 2048-bit MCM1110L and its pre-programmed 256 by 8 Hollerith to ASCII code converters, the MCM1111L and MCM1112L. Bipolar systems require the MCM1112 version, while the MCM-



A 4096-bit capacity enhances the mask-programmable versatility.

1111 is MOS compatible.

A choice of 256 x 10 or 512 x 5 organizations is available with the MCM1150L, a mask programmable 2056-bit ROM which like the others

For details, circle 213

offers a choice of output logic levels. The MCM1151L is a 256 x 10 ASCII to Selectric converter.

MCM1120L and MCM1130L are the mask programmable 2240-bit memories on which the familiar MCM1121-1122 and MCM1131-1132 USASCII character generators are based. Both series are organized with 64 characters of 35 (5 x 7) bits, but the MCM1130 types are also available in a 32 x 70 (5 x 14) organization. The TTL or MOS compatibility choice is offered by both series, as is a 28-pin package option.

Prices in 100-999 quantity range from \$14.60 to \$20.00. The MCM1110L series, MCM1120L series, and MCM1130L series are all at the \$14.60 level. The MCM1140L and MCM1141L are \$20.00, and the MCM1150L and MCM1151L are \$15.50. A one-time mask charge applies to all mask programmable types.



In the eight chips of the MCBH-7601 Crosspoint Switch, the frequency characteristics of lateral PNP transistors provide a good match for those of dielectrically isolated SCRs.



Swinging SCRs Successfully Serve Space Shrinking Solid State Silicon Switch

Some applications demand a combination of the best features of several technologies. And that's just what Motorola achieved in the MCBH7601 — a hybrid, two-wire, four-by-four crosspoint switch that successfully integrates multiple SCRs and lateral PNPs on its

eight chips.

An inspired meld of dielectric isolation with beam lead and silicon nitride techniques has produced this wide-band switch that can be employed for many uses beyond that of voice grade communications. Try it in your critical

For details, circle 214

digital switching applications, or as a current switch.

Conceived as a solid-state replacement for the reed relays normally used in voice switching, the MCBH7601 can really compress the space required by your switching system. And provide a quantum jump in reliability.

Each chip in the hybrid represents two of the 16 crosspoints in the 4 x 4 matrix, containing four PNP transistors, four silicon controlled rectifiers, four diodes and four diffused resistors. Although two crosspoints exist on each device, potential crosstalk is prevented through the use of dielectric isolation and, in the bargain, intercomponent capacitance reduced and efficiency improved over conventional transistor types.

For long system life, silicon nitride hermetically seals the MCBH7601's eight chips making them impervious to moisture and handling contamination. Beam leads make possible an array of crosspoints with closely matched characteristics and — a bonus — the chips can be replaced after beam bonding.

Give your system technology's best. Let the MCBH7601 make your connection.

Control Systems And Costs With Versatile, New MHTL Functions

More low-cost ways to control numerical, supervisory and computer-peripheral systems with noise-immune, high-threshold logic are yours with 4 new Motorola MHTL series.

The latest entries — a decade counter, dual J-K flip-flop and 2 hex inverters — combine high input threshold voltages with slower response time, enabling them to excel in both internal and external electrical noise rejection, compared with other logic families. MHTL also provides better noise immunity at the power supply and ground leads, in addition to the signal leads.

MC684, the decade counter, consists of four J-K flip-flops plus additional gating to accomplish the counter function. The flip-flops change state on the negative transition of the clock pulse. An asynchronous master reset clears all flip-flops, regardless of the state of the clock. Each flip-flop is provided with an individual set input which enables it to be set regardless of the state of the clock.

The MC688 dual J-K flip-flop is based on the master-slave principle and is triggered on the negative edge of the clock

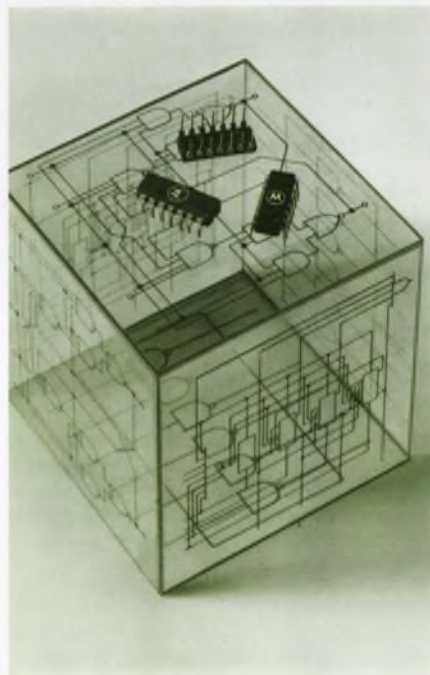

For systems operating in high noise environments, Motorola's High Threshold Logic provides the highest noise immunity of any bipolar family.

For details, circle 215

pulse. Each flip-flop is provided with a separate direct set input and a separate direct reset input. Each flip-flop may be set or reset by applying a low level to that particular input. The J and K inputs are inhibited when the clock is low and enabled when the clock is high.

The hex inverter MC689, featuring open collector outputs, is designed to drive low current lamps, interface with discrete components, and interface high-level logic to any logic level from 4.0 V to 20 volts.

MC690 is the other MHTL hex inverter and utilizes an active pull-up to minimize output impedance. As with the MC689, the input diode has been eliminated to allow the circuit to be expanded to any number of additional inputs.

The high 15-volt power supply voltage of MHTL allows easy interface with discrete components.

1k-up pricing, in either the plastic (P) or ceramic (L) TO-116 14-pin package is:

| | |
|-----------------|-----------------|
| MC684P — \$3.25 | MC689P — \$0.90 |
| MC684L — 4.20 | MC689L — 1.15 |
| MC688P — 1.70 | MC690P — 0.90 |
| MC688L — 2.25 | MC690L — 1.15 |



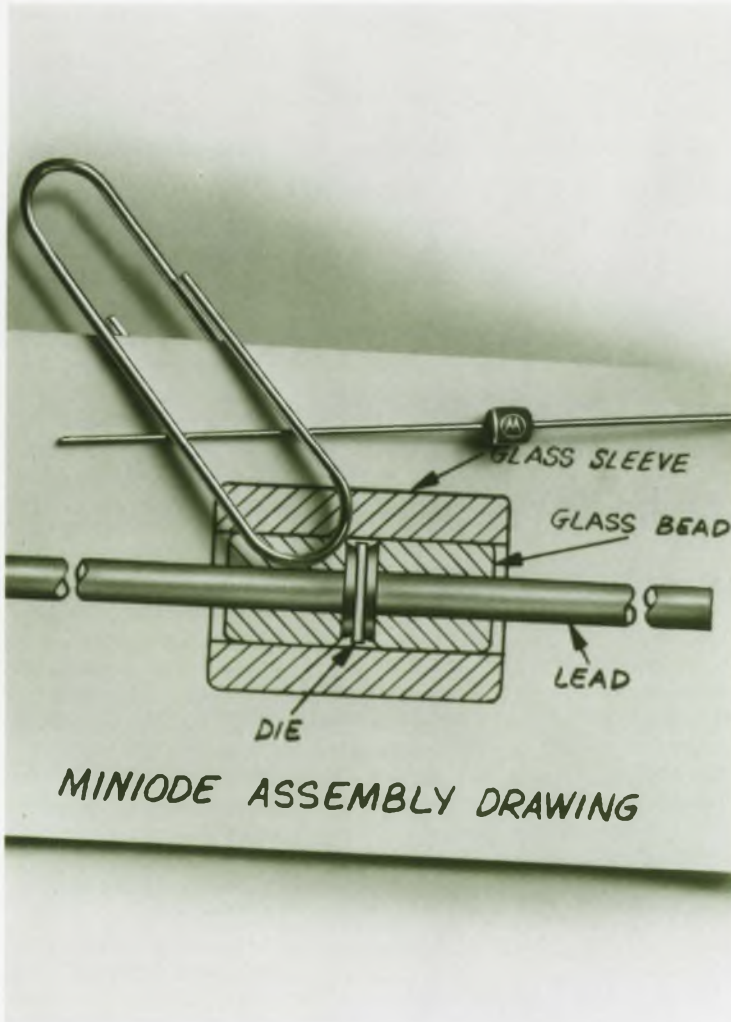

The 60 zener diodes in the MINIODE series use oxide-passivated, RamRod construction in a new, half DO-7 size package.

New MINIODE Zeners Deliver Maxi-Performance/Reliability

If you're a designer using miniature glass zeners, you can now get 400 mW Surmetic 20 performance at low cost in an improved, smaller, cavityless glass package. The MZ70 MINIODE series devices use the same, dependable, oxide-passivated chips encapsulated in a new, hermetic, axial-lead package half the size of the DO-7.

You can obtain these mini-zeners in the hard-to-get 2.4 to 6.8 voltage ratings as well as in the higher 7.5 to 200 V range. Prices range from 38¢ to 93¢, 1000-up. All 60 MINIODES are supplied in both standard tolerances of 5% and 10% corresponding to suffix A and B, respectively, on the type number. Thus, MZ70-2.4 A designates a 2.4 V diode of $\pm 5\%$ tolerance. With excellent capability and maximum limits specified

on six electrical parameters, the MZ70 MINIODES meet MIL-S-19500 specifications. And, because no solders are used in their construction, they are able to withstand high storage temperatures.

Laser Beams Now Scribe Motorola MINIODE Chips

MZ70 MINIODE zener diode chips are all scribed by laser.

Chips scribed by the laser method have smooth, straight, perpendicular edges. Cracked or crumbled edges are virtually eliminated.

Laser scribing is performed at a rate four times faster than by conventional methods. Chip yield has also been substantially improved.

A free evaluation sample and a Designers data sheet on the MZ70 MINIODES will be sent at your request.

For details, circle 216

300 Volt Powerhouse Leads Case 199 Takeover Of Metal-Device Sockets

Line-operated power supplies were never easier — or more economical — to design than now with the MJE2160 Thermopad silicon power transistor doing all the high-voltage work!

Priced at just \$1.35, 100-up, the device provides $V_{CE(O)(SAT)}$ of 300 V and can readily replace two comparable types handling less than its 1.5 A maximum IC rating.

Ready replacements for metal-device sockets, you say? Glad you asked!

The MJE2160 now leads the case 199 parade of more than 2 dozen individual metal-device replacements from 3 to 10 A, 30 to 350 V!

Case 199 plastic power devices are available in just about any size, power rating and lead configuration for immediate drop-in into TO-66 or TO-5 sockets, or PCB for flat or flag-mounting, with or without heat sinks. And some use complementary EpiBase and Darlington technology . . . authored by Motorola — echoed by others.

Besides providing more than 10 W greater power-handling capability over comparable plastic types, case 199:

- mounts easier . . . only 1 machine screw, 2 washers and a locknut are needed for all metal-to-metal mounting arrangements
- offers more chip sizes . . . choose the exact chip size you need to get the job done, from 60 x 60 to 120 x 140 mils, each one matched to its package
- always lies flat . . . the hole-in-the-middle means equal thermal/electrical contact all-around — the only device with a ± 1 mil flatness spec.
- provides the narrowest profile . . . 20% less body thickness than other plastic packages means denser mounting in hammer drivers where standup mounting is required
- lets you standardize . . . same package style as the case 77 and case 90 types you're familiar with . . . same chips . . . optimized price to fit your needs.

Send for the MJE2160 data sheet and a copy of our LEADFORMS brochure. All about plastic power!

For details, circle 217



In the MOC1000 Optoelectronic Coupler, die spacing is carefully controlled to provide a minimum of 1500 volts of dielectric isolation for your critical, man-rated applications.

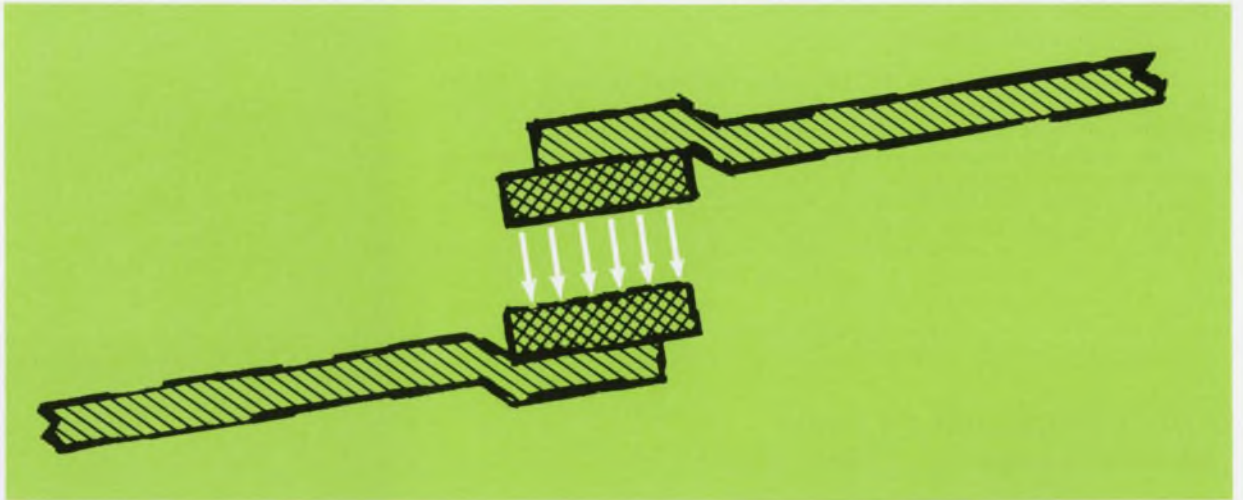

Lightly Switch On With Optoelectronic Couplers

Lights On: switch on. Lights off: switch off. Quickly. Simply. Reliably.

Consisting of a gallium-arsenide infrared LED optically coupled to a silicon phototransistor, the new MOC1000 coupler offers an impressive array of switching advantages: nearly perfect input/output isolation . . . 100 billion ohms; 1,500 V minimum dielectric isolation; 300 kHz typical frequency response; 60% typical input-output current transfer ratio and low 1.3 pF typical

coupling capacitance.

They don't wear out, they use minimum power and they're immune to bouncing, shock and vibration. They're light, compact and have closed construction. They're IC-compatible and cost as little as \$3.35. 100-999.

They can be used as replacements for mechanical relays, in interface and coupling systems, phase and feedback controls, amplifiers and general-purpose switching.

For example, in bipolar logic-to-MOS interfacing, coupling between logic forms without regard to differences in logic swings can easily be accomplished. In computer/peripheral interconnections, couplers can detect differential signals on twisted pair lines and translate them to single-ended outputs, providing complete ground-loop isolation.

Complete specs and applications information are available on the data sheet. Write for it.

For details, circle 218

Take 9 Steps Closer To The Ideal Diode – In Nanoseconds!

In no time at all, reduced power losses, increased switching speeds and savings in space and weight are yours . . . with 9 new, fast-recovery rectifier series!

Complementing the most comprehensive line of fast-recovery devices in the industry – now totaling 73 – Motorola's newest introductions include 3 A plastic types, 5 A "buttons," 6, 12, 20, 30, 40 and 50 A metal stud series.

All feature Designers data sheets. The industry's most complete, including new derating information.

All are rated from 50 to 600 V! – 1 A diodes are available to 1,000 V!

All feature nimble, 100 ns typical recovery times!

And with a 100 ns recovery, all Motorola fast-recovery types are maximum-efficient!

Because of agile switching which results in less power loss at high frequencies, these devices are ideally suited for use in power supplies requiring high-

frequency inverters and in switching regulators permitting significant reduction in the size, weight and cost of power conversion and filter components.

Additional applications include use as free-wheeling diodes in high-frequency

servo amplifiers and high-speed hammer drivers.

Use them in computer, industrial and military equipment.

Now's the time to go with them – faster!

| Type | PLASTIC | | | | METAL | | | | | | | |
|---------------------------|------------------------|------------------------|-------------------------|--------------------------|-------------------------|-------------------------|--------------------------|--------------------------|--------------------------|--------------------------|---------------------------|---------------------------|
| | AXIAL LEAD | | | | AXIAL LEAD | | | | STUD MOUNTED | | | |
| Package | 1A (DO-41) | 1A (DO-41) | 3A (Case 26) (D1) | 5A (Case 154) (D2) | 3A (Case 60) | 3A (Case 60) | 6A (DO-4) | 12A (DO-4) | 20A (DO-5) | 30A (DO-5) | 40A (DO-5) | 50A (DO-5) |
| 50V | 1N4933 | MR810 | MR850 | MR820 | MR830 | MR840 | 1N3879 | 1N3889 | 1N3899 | 1N3909 | MR860 | MR870 |
| 100V | 1N4934 | MR811 | MR851 | MR821 | MR831 | MR841 | 1N3880 | 1N3890 | 1N3900 | 1N3910 | MR861 | MR871 |
| 200V | 1N4935 | MR812 | MR852 | MR822 | MR832 | MR842 | 1N3881 | 1N3891 | 1N3901 | 1N3911 | MR862 | MR872 |
| 300V | MR2271 | MR813 | — | — | — | — | 1N3882 | 1N3892 | 1N3902 | 1N3912 | — | — |
| 400V | 1N4936 | MR814 | MR854 | MR824 | MR834 | MR844 | 1N3883 | 1N3893 | 1N3903 | 1N3913 | MR864 | MR874 |
| 600V | 1N4937 | MR816 | MR856 | MR826 | MR836 | MR846 | MR1366 | MR1376 | MR1386 | MR1396 | MR866 | MR876 |
| 800V | — | MR817 | — | — | — | — | — | — | — | — | — | — |
| 1000V | — | MR818 | — | — | — | — | — | — | — | — | — | — |
| *100-up Price Range | \$.40 to \$.79 | \$.30 to \$.94 | \$.85 to \$ 1.30 | \$ 1.20 to \$ 3.10 | \$.99 to \$ 2.58 | \$.85 to \$ 2.31 | \$ 1.50 to \$ 3.75 | \$ 2.00 to \$ 5.25 | \$ 2.80 to \$ 7.20 | \$ 3.25 to \$ 8.45 | \$ 3.90 to \$ 10.10 | \$ 4.30 to \$ 11.20 |
| f t _r (max) | 250kHz 0.2μsec | 50kHz 1.0μsec | 250kHz 0.2μsec | 250kHz 0.2μsec | 250kHz 0.2μsec | 50kHz 1.0μsec | 250kHz 0.2μsec | 250kHz 0.2μsec | 250kHz 0.2μsec | 250kHz 0.2μsec | 250kHz 0.2μsec | 250kHz 0.2μsec |

For details, circle 219



NEW PRODUCTS BRIEFS

DIGITAL/LINEAR BEAM LEAD ADDITIONS

— *Fast, Off-The-Shelf Reliability*

With the addition of the MCBC 5473 Dual J-K Flip-Flop and the MCBC-1748 Uncompensated Operational Amplifier, Motorola offers a choice of seventeen digital and three linear beam lead devices, with more on the way.

These beam lead versions of popular ICs offer the designer the ultimate in reliability. Their unique processing offers higher bond reliability. Nitride passivation protects the chips from contamination, and in hybrid applications, they provide the repairability needed for high system yields.

Both devices are available in chip (MCBC designation) and packaged flat pack (F) versions. 100-up prices are \$5.40 (MCBC5473); \$8.30 (MCB5473F); \$2.75 (MCBC1748); \$4.25 (MCB1748F).

For details circle 220

35 AMP ISOLATED STUD SCR SERIES

— *Offers Registered Specs For "Floating" Systems*

Here are the very first 35 A isolated stud SCRs to be 2N-registered . . . the new 2N6171-74 series providing electrical isolation for non-grounded, or "floating" systems. It's designed for use in power supplies, battery chargers, temperature, motor, light and welder controls in heavy-duty industrial/commercial systems. The units feature 350 A surge current protection; practical, 10 mA typical trigger and hold currents; and 100 to 600 V blocking voltage ratings.

Economical as well as versatile, the studs also offer pressfit and "hot" stud versions on the same data sheet . . . you have a broad package choice for your mechanical requirements.

Prices on the 2N6171 series start at \$4.15, 100-up.

For details, circle 221

MOTOROLA NOW SECOND SOURCE

— *For Popular Op Amps And Voltage Regulators*

The MLM107G, MLM207G, and MLM307G offer functional, electrical, and pin-for-pin compatibility with the similarly-numbered LM series of internally compensated op amps. The series is supplied in the 8-pin TO-99 can and features low input offset current (10 nA max.) and low offset voltage (2.0 mV max.). Prices in 100-999 quantities are \$15.00, \$12.00, and \$1.35 respectively.

Other new second-source devices are the MLM105G, MLM205G, and MLM305G positive voltage regulators and the MLM109K series fixed 5.0 V regulators. Output voltage of the MLM105 series is adjustable from 4.5 to 40 V. In the TO-99 package, these devices are \$6.00 (105), \$4.00 (205), and \$2.00 (305) in 100 to 999 quantities.

For those applications where a fixed 5.0 V output is needed, the MLM109K, 209K, and 309K are priced at \$19.00, \$7.95, and \$2.50 in 100-up quantities. The package is TO-3.

All of these units are available off-the-shelf.

For details, circle 222

2N3055 NOW PNP-MATCHED

— *MJ2955 Complements Industry Favorite*

The long-popular NPN 2N3055 now has an EpiBase PNP mate — the MJ2955 — forming an ideal, low-cost partnership for your complementary amplifier designs. Rated at 15 A, 60 V the MJ2955 offers 150 W power dissipation capability and excellent, 1.1 V maximum saturation voltage at 4 A. Current gain measures out at 20-70 at this I_c level. Good frequency response completes the picture.

Prices for both are equal — \$1.05 — an industry first!

For those needing a bit less power — up to 75 W and 4 A — you can design in the new 2N6049/2N3054A complements utilizing the space-saving TO-66 package and offering dc safe operating area of 1.5 A/30 V. They're priced economically to fit most pocketbooks . . . 82¢ each, 100-999. Gain on this pair is spec'd at 0.5 and 3 A.

For a copy, circle 223

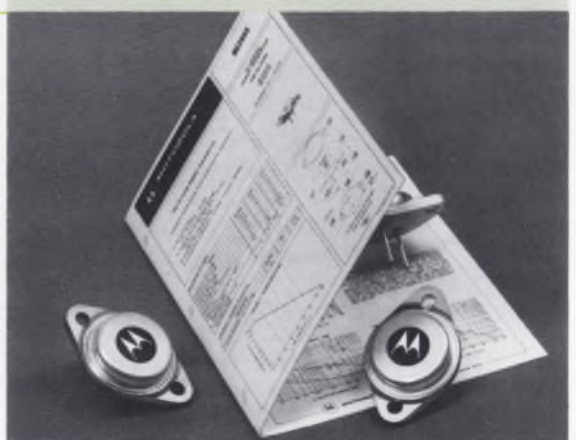
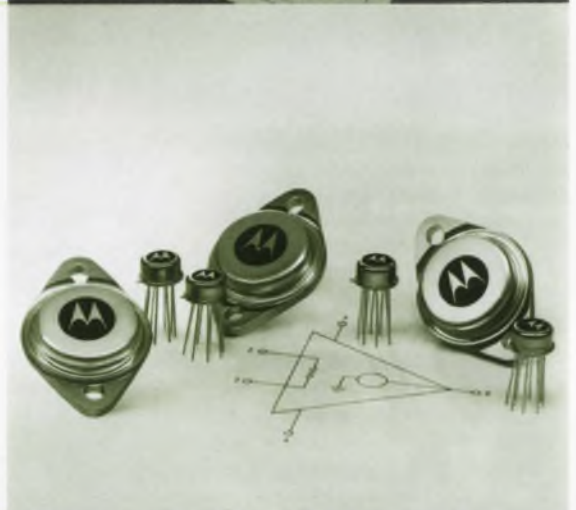
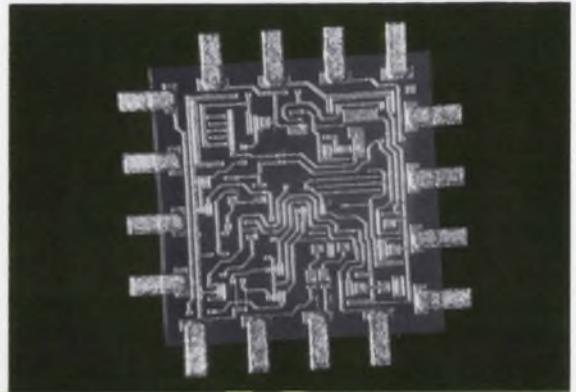

NEW LITERATURE

Please PRINT clearly (To expedite your literature we may have to use this as return mailing address)



New Master Selection Guide Now Ready

The January/February/March edition of Motorola's Master Selection Guide has been published for your reference. In its 117 pages you get all the information you need to make the best selection of Motorola semiconductors for your applications.

Within the Selection Guide's pages you'll find: selection guides, of course — 56 of them. They range from diodes up through microcircuit components through all 20 digital integrated circuit series through seven types of linear circuits.

You get much more helpful information also, including a glossary of microelectronic terms, a listing of devices for military applications and the titles and numbers of current application notes.

In short, this Guide provides just what you need to make the optimum choice. Send for your copy today.

For a copy, circle 224



NAME _____

TITLE _____

COMPANY NAME _____

DIVISION _____

DEPARTMENT _____

COMPANY ADDRESS (Street or P. O. Box) _____

CITY _____

STATE _____ ZIP CODE _____

Please circle the Reader Service number of item(s) you are interested in receiving.

| E. D. | | | | |
|-------|-----|-----|-----|-----|
| 211 | 212 | 213 | 214 | 215 |
| 216 | 217 | 218 | 219 | 220 |
| 221 | 222 | 223 | 224 | |

Do you wish a Motorola Representative to contact you?

VISIT PHONE

Phone No. _____ Area Code _____

NOTICE: Requests for literature on items described in this publication cannot be honored after July 1, 1972.

DATA BOOKS ORDERING COUPON

| LINEAR DATA BOOK | |
|------------------------------|-----------|
| Single Copy @ \$2.50 ea. | \$ |
| 2-24 copies @ \$2.00 ea. | \$ |
| 25-up copies @ \$1.75 ea. | \$ |
| MECL SYSTEMS DESIGN HANDBOOK | |
| 1-9 copies @ \$2.00 ea. | \$ |
| 10-up copies @ \$1.25 ea. | \$ |
| Total | \$ |

Fill in your name and address on the other side of this coupon. Tear along perforated lines and enclose in envelope with proper remittance.

FOLD HERE

FIRST CLASS
Permit No. 2565
PHOENIX
ARIZONA

BUSINESS REPLY MAIL
NO POSTAGE NECESSARY IF MAILED IN UNITED STATES

POSTAGE WILL BE PAID BY

Semiconductor NEWSBRIEFS No. 14-72
Motorola Semiconductor Products Inc.
P. O. Box 20924
Phoenix, Arizona 85036

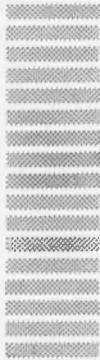

FOLD HERE

Study Compares Performance/Cost Of Minicomputer Designs

How would your minicomputer measure up against a comparable design using MECL 10,000? Would performance be improved? More ICs needed? How about board area? Power? Cost?

If any of these questions arouse your itch to know, here's how to scratch it. Send for the New Technologies In Mini-computer Design brochure. This new Motorola booklet answers these and many other questions by studying separate TTL and MECL10,000 implementations of a 16-bit word machine. For ease of comparison, architecture is minimized; instruction overlap, instruction lookahead and memory interleaving are not used. The designs are conservative, using semiconductor memory, 16 general purpose registers and ROM control.

We think the results of the study will give you valuable insight into the advantages new technologies can provide in minicomputers. But don't take our word for it, write for a copy and judge for yourself.

SEAL HERE

(Please use tape — do not staple)

ORDER COUPON

Be sure to fill out both sides of this coupon, tear along perforated edge, and mail in envelope with check, money-order, or purchase-order (*) to:

Motorola Semiconductor Products Inc.
P. O. Box 20924
Phoenix, Arizona 85036

Note: (*)P.O.'s for less than \$20.00 cannot be accepted. Make checks or money-orders payable to: Motorola Inc.

NAME _____

TITLE _____

COMPANY _____

ADDRESS _____

CITY _____

STATE _____ ZIP CODE _____

NEW LITERATURE

Industry's Most Comprehensive High Speed Logic Design Book Here



The knowledge gained from a decade of designing high speed logic and helping users apply it is yours — in the new MECL Systems Design Handbook!

In its 8 chapters, the Handbook presents nearly 200 illustrations providing circuit and waveform diagrams and numerical data. Of particular interest is Chapter 8. It covers high performance

applications and circuits and includes methods for interfacing various logic families with MECL. It also provides 53 circuit ideas — many being published for the first time.

Other chapters are concerned with design rules, PC board connections, system interconnections, power distribution, thermal management and transmission line theory for MECL II, III and the new, low-power MECL 10,000 series.

Use the handy order form at the left to obtain your copy of this comprehensive design guide. Its price is \$2.00 per copy.



New Linear IC Data Book Stands Alone

The first Motorola Linear Integrated Circuits Data Book is now available, and it's a beaut. In its more than 500 pages, you'll find data sheet specifications for over 140 types plus 28 devices now available as chips. And for maximum usefulness, you're given a master device index, an interchangeability guide, a guide to applications and packaging information. For quick access, all sections are edge-reference.

Motorola's broad linear line includes operational amplifiers, voltage regulators, high frequency circuits, multipliers, modulators, detectors, radio-TV types, linear-digital interface circuits, and a variety of special purpose circuits. Use the coupon to order your copy. Single copy price \$2.50.

CUTLER-HAMMER HAS THE RIGHT ILLUMINATED SWITCH FOR EVERY DESIGN.

Does your new product design call for an illuminated switch? Or would it be a better, more saleable product if it did?

Then Cutler-Hammer is ready to help with the broadest selection of illuminated switches you'll find anywhere.

We've got lighted toggles and rockers and paddles and pushbuttons. Standard sizes and miniatures. With lots of color choices and decorative hardware.

They come in a broad array of configurations—like double rockers and maintained or momentary action. With a range of electrical ratings that's sure to meet your specs. Including replaceable and non-replaceable lamps in several lamp types and many operating voltages.

Your Cutler-Hammer Sales Engineer or Stocking Distributor is ready to show you these switches in operation and to supply prototypes to match your designs. Contact him today and get the full story.

CUTLER-HAMMER

SPECIALTY PRODUCTS DIVISION, Milwaukee WI 53201



Switch
to No. 1

More than just switches,
prompt availability,
field help, innovation,
quality assurance, too.

INFORMATION RETRIEVAL NUMBER 891

Get it out of your system:

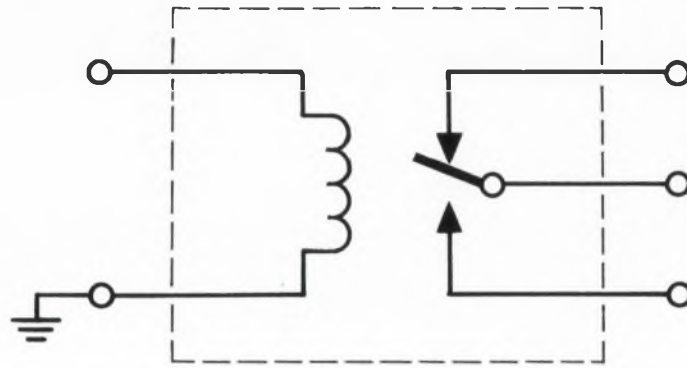

Replace it with a solid-state relay built around a Monsanto opto-isolator.

An all-semiconductor relay has a lot of sex appeal. No contact bounce, because there are no contacts. No coil. No reed. No transformer, either. Turn-on and turn-off times of less than 50 μ sec are easily achieved. It will take the severest Mil-Spec mechanical shock and vibration tests without blinking. It will operate in ambient temperatures from -55°C to $+100^{\circ}\text{C}$. Best of all, it gets a component with a built-in failure mechanism out of your system.

New Application Notes

It's easy and inexpensive to find out how the Monsanto line of opto-

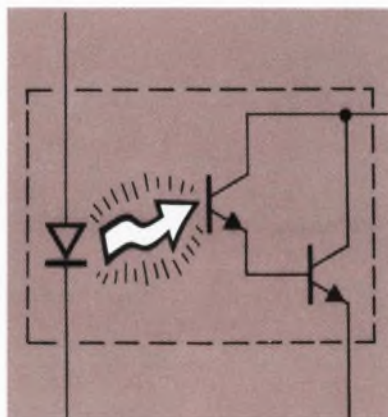

The MCA-2 photo-Darlington does the switching.

isolators (alias photo-coupled pairs) can help you build an all-solid-state relay into your system.

Send for our new application notes AN501 and AN502. The first shows you a DPDT 125 mA semiconductor relay, the second how to build a low cost (\$7.06) solid state AC relay that will switch a wide range of voltage and current levels. Very interesting reading. Use the bingo card or call us at (408) 257-2140. Monsanto Commercial Products Co., Electronic Special Products, 10131 Bubb Road, Cupertino, California 95014.

Monsanto

INFORMATION RETRIEVAL NUMBER 892

WHY USE A MISFET WHEN YOU CAN USE A MOSFET?

| TYPE | DEVICE | R _{D(ON)} OHMS | C _{rss} pF | R _D x C _{rss} pico sec. |
|----------------|---------------|----------------------------|------------------------|--|
| 2N5457 | J-FET | 100 | 2.0 | 200 |
| 2N5433 | J-FET | 5 | 12.0 | 60 |
| MEM 660 | MOSFET | 20 | 0.3 | 6 |
| 2N4392 | J-FET | 40 | 2.0 | 80 |
| 2N4979 | J-FET | 30 | 5.0 | 150 |

FOR SWITCHING

- APPLICATIONS:**
- Plated Wire Memory
 - Core Memory
 - Driver and Sense Amplifier Switches
 - High Speed Multiplexers and Buffer Amplifiers
 - Video Signal Switches
 - Balanced Mixers

- FEATURES:**
- Low Drive Voltage +4V
 - High I_{D(ON)} 70mA
 - R_{D(ON)} Match ±10%
 - High 'OFF' Impedance 5x10⁹ ohms

MEM 660 N-channel MOSFETS and its QUAD MEM 780 version are in stock and immediately available from your authorized General Instrument distributor. For complete information call 516-733-3084 or write:



GENERAL INSTRUMENT CORPORATION • 600 WEST JOHN STREET, HICKSVILLE, L. I., NEW YORK

INFORMATION RETRIEVAL NUMBER 893

Harris' Family of Op Amps. They're a different breed. By design.

Harris op amps have always been a little bit different ever since we introduced the industry's first internally compensated op amp back in 1966. Today, we still make our op amps a little different. For example, our PNP's, or better put, our β —are vertical instead of lateral to give you superior AC performance without sacrificing DC characteristics.

Then take our designs. We employ a single gain stage to provide better behaved frequency response. Our bias networks are a bit more complex for uniform performance over a wide range of supply voltages and temperature ranges, and our output stages have better output current capabilities. In testing we're different too—more thorough. In fact, we were guaranteeing slew rates and rise times long before other manufacturers did. Consider just two examples:

Harris wide band general purpose op amps offer:

- Close loop bandwidth up to 100 times greater at the same gain or 100 times greater gain capability for the same bandwidth than the common 741 types.
- Much lower closed loop phase shift, lower gain error, and lower distortion at all frequencies.

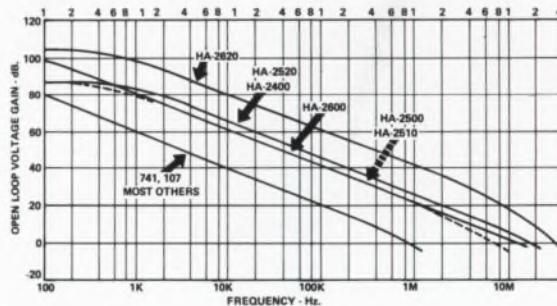
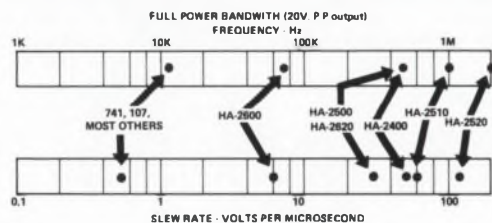

- Superior response at higher gains.
- Hundreds of times better DC performance (for example, the HA-2600/2620 has a 5nA bias current, 300M Ω input resistance, and 100K minimum open loop gain).

Harris high slew rate series offer:

- The only monolithic high slew rate amplifiers that are true operational amplifiers. They can be operated inverting, non-inverting, or balanced with fast settling times. In fact, they provide

improved performance in virtually any standard hookup. The fastest settling time of any monolithic op amp. (For example, the HA-2520 settles in 250 ns to 0.1%). Higher output voltage swing at high frequencies. (If you have ever tried to put a 10V peak 1MHz sine wave through a 741 type, you know what we mean.)

In summary, Harris makes a difference...our family of proprietary devices and popular alternate source devices can offer you the best price/performance op amp package for your system.

Full military temperature range (-55°C to +125°C):

| | | | | | |
|-----------|---------|---------|---------|---------|---------|
| HA-2101A | HA-2600 | HA-2620 | HA-2500 | HA-2520 | HA-2909 |
| HA-2101 | HA-2602 | HA-2622 | HA-2502 | HA-2522 | HA-2700 |
| HA-2107 | | | HA-2510 | | HA-2400 |
| HA-2107-3 | | | HA-2512 | | |

Commercial/Industrial (0°C to +70°C):

| | | | | | |
|----------|---------|---------|---------|---------|---------|
| HA-2301A | HA-2207 | HA-2505 | HA-2525 | HA-2704 | HA-2404 |
| HA-2201A | HA-2605 | HA-2515 | HA-2911 | HA-2705 | HA-2405 |
| HA-2307 | | | | | |

All in standard 741 pin-compatible configuration. (Except HA-2400/2404/2405 4-channel op amp.) For details see your Harris distributor, representative, or contact us direct.



HARRIS
SEMICONDUCTOR
A DIVISION OF HARRIS-INTERTYPE CORPORATION

P.O. Box 883, Melbourne, Florida 32901
(305) 727-5430

DISTRIBUTORS: Schwaber Electronics; Westbury, New York (516) 334-7474; Rockville, Maryland (301) 881-2970; Hollywood, Florida (305) 927-0511 / Harvey/R & D Electronics; Lexington, Massachusetts (617) 861-9200 / Semiconductor Specialists, Inc.; Chicago (312) 279-1000; Detroit (313) 255-0300; Minneapolis (612) 884-8132; Kansas City (816) 452-3900; St. Louis (314) 428-6100; Dallas (214) 358-5211; Indianapolis (317) 243-8271; Pittsburgh (412) 781-8120; Dayton (513) 278-9455 / R.V. Weatherford Co.; Albuquerque (505) 265-5671; Anaheim (714) 547-0891; Austin (512) Enterprise 1443; Dallas (214) 231-6051; Denver (303) 427-3736; Glendale (213) 849-3451; Houston (713) Enterprise 1443; Palo Alto (415) 321-5373; Phoenix (602) 272-7144; Pomona (714) 623-1261; San Diego (714) 278-7400; Seattle (206) 762-4200. **HARRIS SALES OFFICES:** Wellesley, Massachusetts (617) 237-5430; Wayne, Pennsylvania (215) 687-6680; Palos Heights, Illinois (312) 597-7510; Melbourne, Florida (305) 727-5430; Palo Alto, California (415) 321-2280; Melville, New York (516) 249-4500; Syracuse, New York (315) 463-3373; Washington, D.C. (202) 337-4914; Dallas, Texas (214) 231-9031; Scottsdale, Arizona (602) 946-3556; Long Beach, California (213) 426-7687.

\$2450



Model 5100

FREQUENCY SYNTHESIZER

- **Full Programmability** BINARY OR BCD
- **0.001 Hz to 2 MHz Range**
- **No Switching Transients**
- **0.001 Hz Resolution**
- **Direct Digital Technique**
NO MIXING OR PHASE LOCKING
- **High Spectral Purity** —70db SPURIOUS
—60db HARMONIC
- **High Stability** $\pm 2 \times 10^{-8}/^{\circ}\text{C}$ STANDARD
 $\pm 2 \times 10^{-10}/^{\circ}\text{C}$ OPTIONAL
- **Precision Attenuator**
0 TO 85db IN 1db STEPS PLUS CONTINUOUS CONTROL
(PROGRAMMABLE ATTENUATION OPTIONAL)
- **High Output Voltage**
10 VOLTS P-P, 50-OHM SOURCE IMPEDANCE

ROCKLAND SYSTEMS CORPORATION

131 Erie Street E., Blauvelt, N. Y. 10913 • (914) 359-1818

ROCKLAND

INFORMATION RETRIEVAL NUMBER 13

The difference and Alpha™ is only

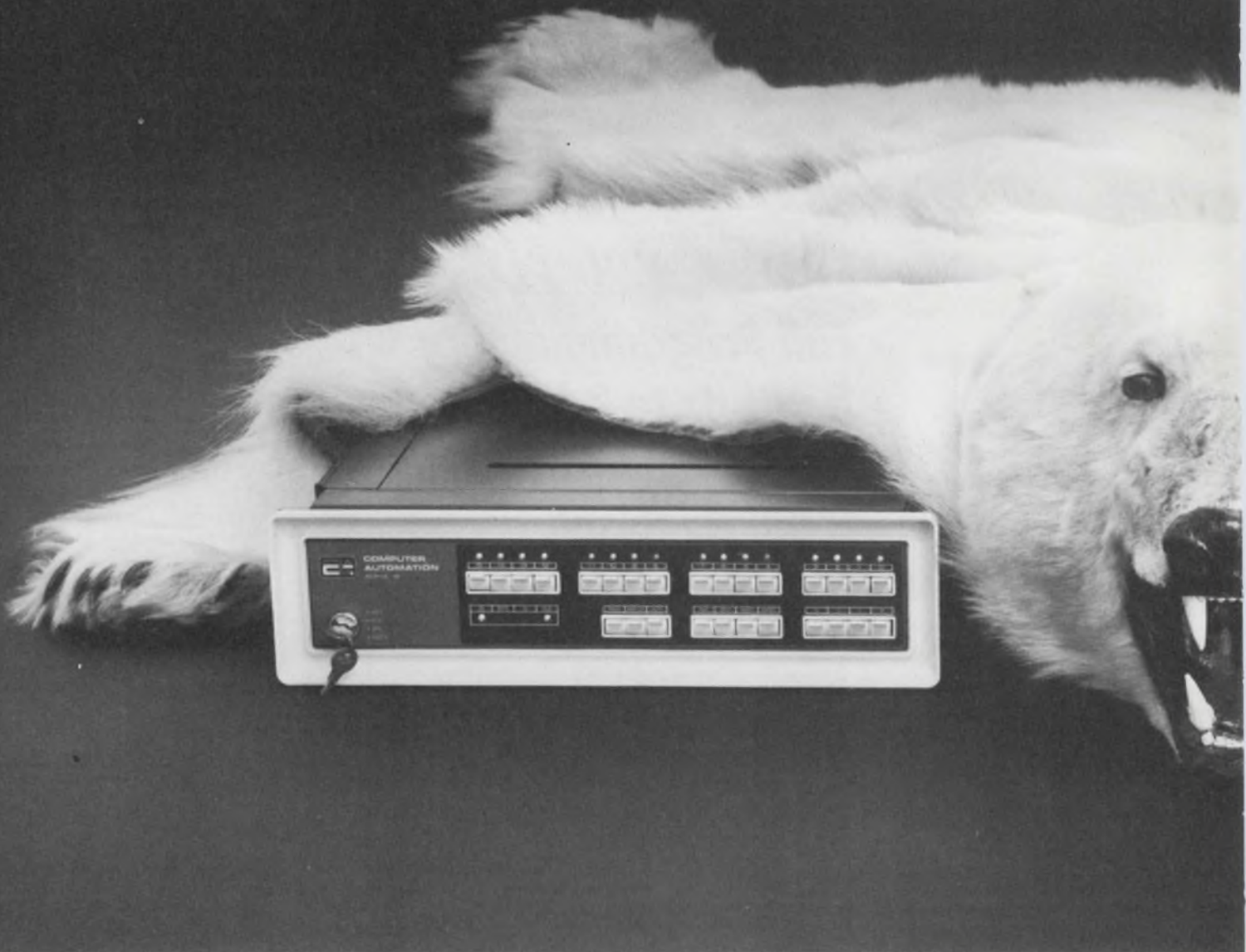

Actually the NAKED MINI is the ALPHA with its clothes off. We designed both with the same specifications for the same high performance. In fact, both are backed by the same one year unconditional warranty. The only difference is that the NAKED MINI is a computer that's really a component.

At first blush, you may think that the NAKED MINI is stripped. But it's not. It is just designed so that you can integrate a powerful mini-computer into your product and increase your profit margin.

How?

Because you don't get skinned by the NAKED MINI'S prices. In OEM quantities you get the NAKED MINI 8 for only

\$1450, and the NAKED MINI 16 for \$1995. And that includes 4K words of memory.

If you already have power and controls in your system, you may not need a control console, power supply and fancy enclosure with your computer. You may simply want to bury the computer in your product as another component. Yet you do want a complete and powerful general purpose computer that will add performance and reliability to your product.

That is exactly what you get from the NAKED MINI. Full computer power at drastically reduced prices. Fully parallel byte and word processing, direct memory I/O channels, hardware multiply/divide, vectored priority interrupts, 4 K

between the **NAKED MINI™** skin deep.

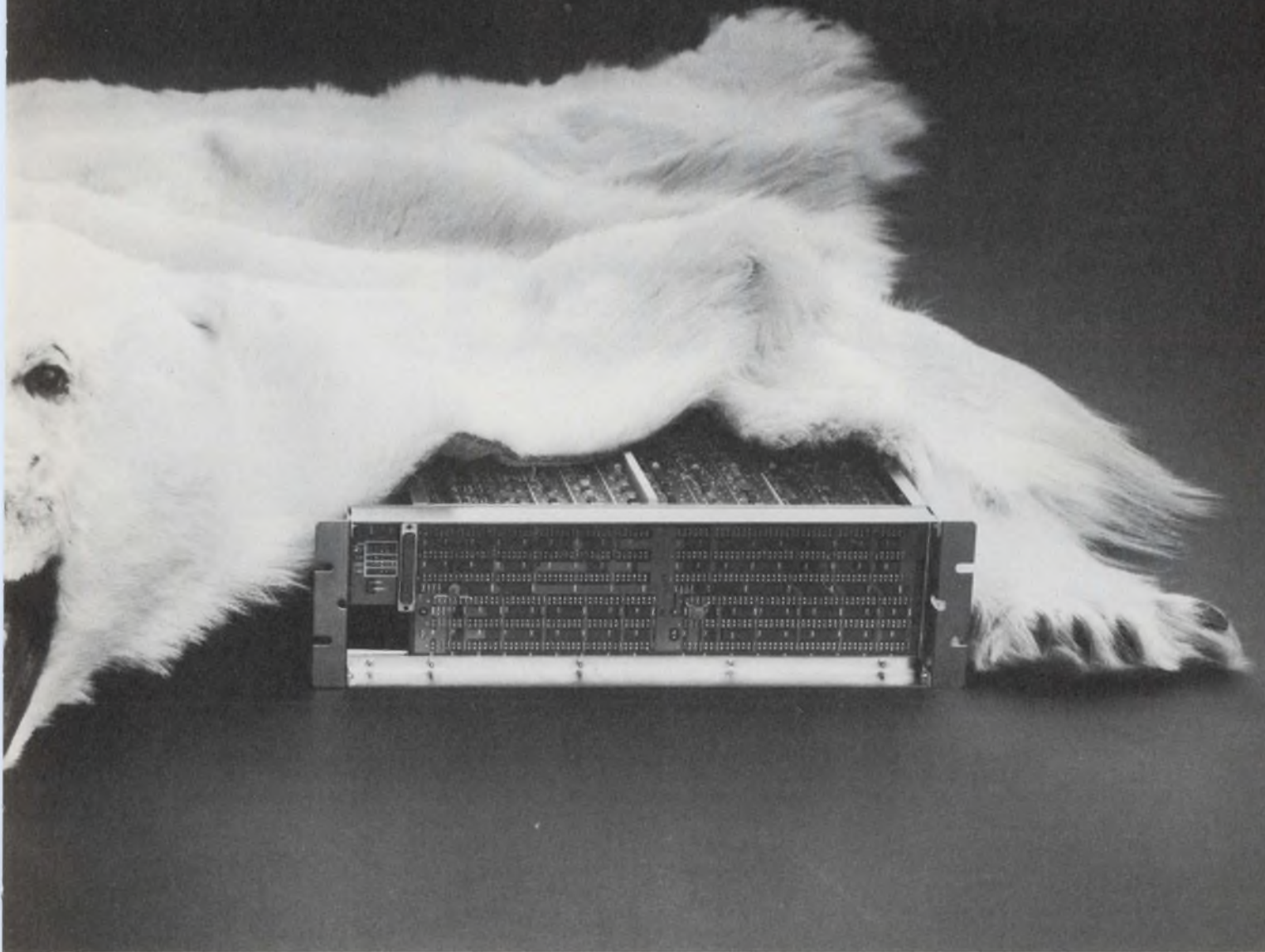

plug-in memory expandable to 32 K words. All this plus the industry's most powerful and straightforward instruction set, 156 basic instructions with many multi-function instructions.

What this means is simplified programming for producing shorter programs that take less core and run faster. And this saves you money in many ways. The NAKED MINI'S full broadside I/O and priority interrupt structure make it the easiest of all mini-computers to interface



with your equipment — and this saves you money also.

We offer a complete line of standard software and options including power fail restart, real time clock, parity, memory protect, buffered I/O cards, communication controllers, and multiplexers as well as all types of peripherals.

The bare fact is, you'll be impressed by all of THE NAKED MINI'S vital statistics. To get better acquainted call or write the NAKED MINI Company today.

COMPUTER AUTOMATION, INC.

895 West 16th Street • Newport Beach, California
92660 • Phone (714) 642-9630 • TWX 910-596-1377



inverter- ratedTM

ferramic[®]
components
instead of
guessing a lot

■ *Inverter-Rated* components end guesswork in your inverter designs. They're tested under actual inverter conditions to give you guaranteed, relevant electrical parameters, not just routine magnetic material data.

Inverter-Rated Ferramic components not only make your design and selection more precise—they work. Developed, tested and specified for inverter applications. So the reliability you design in—stays in.

For applications with unipolar or bipolar switching of direct currents, *Inverter-Rated* Ferramic components deliver. No trial and error selection. No rejects due to cores that only meet a material spec.

Ferrites for inverters are the latest in our growing family of application-rated components. And they're available now in Pot Cores, U Cores, Cross Cores, E Cores and Toroids.

We'd like to send you samples of our new Ferramic components that work in inverter applications. And specs that make sense. Or to consult with you about your design problems. Just contact Indiana General, Electronic Products, Keasbey, N. J. 08832. Or call (201) 826-5100.

National distribution through seven Permag locations.

indiana general 

a division of Electronic Memories & Magnetics Corp.



SUBSTRATES

Many advanced ceramic substrate materials for thick film, thin film and microwave applications are available to suit your exacting requirements. Many sizes are stocked for immediate delivery. Custom prototypes can be quickly manufactured. High volume production fulfills your needs. New Bulletin 712 on request or phone 803/682-3215.

CIRCLE NO. 201

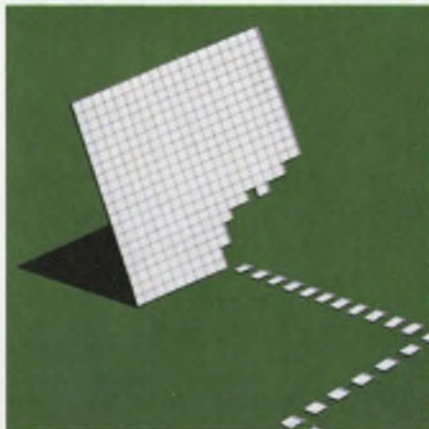

SNAP-STRATES

Originated by American Lava, these monolithic parts can be snapped into individual substrates after circuit work is completed. Tooled Snap-Strates permit odd shapes, holes, slots, etc. Laser Snap-Strates permit very small or thin parts of great accuracy. Phone 803/682-3215.

CIRCLE NO. 202

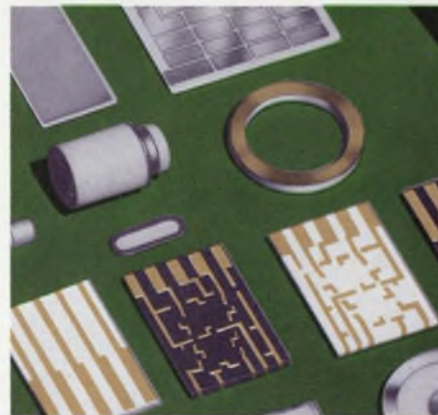

CUSTOM METALLIZING

Tailored for maximum bond strength on wide choice of our own ceramic compositions including Black Alumina, White Alumina and Beryllia. All popular metallizations are offered applied by both precision generation and photo-etching. Phone 615/265-3411.

CIRCLE NO. 203



BERYLLIA SUBSTRATES

Heat dissipation your major problem? Investigate beryllia substrates. We are in volume production on BeO substrates and heat sinks and can meet "fast turn-around" requirements. Stock items for immediate shipment let you make quick and economical tests. Phone 615/265-3411.

CIRCLE NO. 204

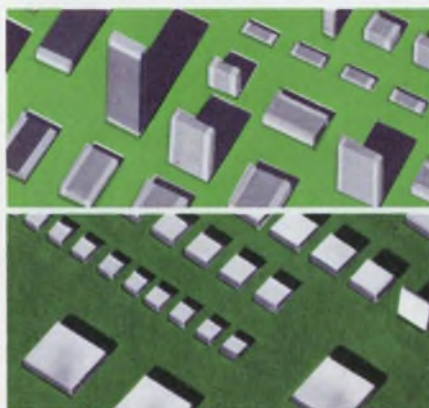

CAPACITOR CHIPS

Single or multilayer, custom made or stock. Diced chips from 1 pf to .05 mfd. Sizes .020" square and up. Multi-Cap® capacitors in all EIA preferred sizes, .080" x .050" and up. Available in TC compositions from P120 to N5600 and in all high dielectric constant materials. Bulletins 689 and 694 on request. Phone 803/682-3215.

CIRCLE NO. 205



APPROX. ACTUAL SIZE

MULTILAYER COMPOSITE SUBSTRATES

Monolithic multilayered structures with buried conductors permit a customized top layer for complex, custom designed, high reliability thick or thin film circuits. The conductive patterns are separated and insulated by planes of high alumina ceramic . . . NO glass. Also used for high quality hybrid packages and bases for complex Multi-Chip circuits. Phone 615/265-3411.

CIRCLE NO. 206

CODE IDENT. NO. 70371

LAURENS, S. C. 29360, U.S.A. • PHONE 803/682-3215 • TELEX 570449
CHATTANOOGA, TENN. 37405, U.S.A. • PHONE 615/265-3411 • TELEX 558432

For service, contact American Lava representatives in Offices of Minnesota Mining and Manufacturing Company in these cities (see your local telephone directory): Boston: Needham Heights, Mass. • Chagrin Falls, Ohio • Chicago: Elmhurst, Ill. • Dallas, Texas • Indianapolis, Ind. • Laurens, S. C. • Los Angeles, Calif. • Minneapolis, Minn. • Metropolitan New York: West Caldwell, N. J. • Up-State New York and Canada: Phoenix, N. Y. • Orange, Conn. • Philadelphia, Penn. • Salem, Va. • S. San Francisco, Calif. • Tempe, Arizona. • International: c/o American Lava Corporation, Chattanooga, Tenn. 37405, U.S.A., TELEX 558432

American Lava Corporation

A SUBSIDIARY OF



70th
YEAR
OF
CERAMIC
LEADERSHIP

PERFECTION IN CONFIGURATION



TO-5 Relay

Nothing man has made approaches the sheer perfection of shape and contour found in

nature's egg. In the industrial world, the TO-5 Transistor Case Relay comes close . . . Perfect? About as close as you can come! It was eight years ago when Teledyne Relays developed the miniature TO-5 . . . And since then, with continued breakthroughs in the state-of-the-art, the broad family of TO-5 Relays remain the most advanced and reliable general purpose relays available.

3155 West El Segundo
Boulevard, Hawthorne,
California 90250 • Telephone
(213) 679-2205

**TELEDYNE
RELAYS**

MARCH 16, 1972

FCC's proposed EMI rules stir anxiety in industry

New rules on rf emission proposed by the Federal Communications Commission have raised fears in the electronics industry of increased costs and delays in the manufacture of equipment.

The EIA, EIA-Japan, IEEE and manufacturers such as AT&T, Sylvania and Collins have filed objections to the FCC regulations, covered in Docket 19356. The FCC is studying all of the comments, and expects to decide by the end of the year on a final version of the new rule.

Herman Garlan, chief of the FCC's Radio Emergency Devices Branch, says the changes are needed to control spurious emissions by electronic equipment and subsequent interference with communications. The proposed rules affect two parts of the FCC's statutes. These are Part 15 covering incidental and restricted radiation devices, such as walkie-talkies, wireless microphones and radio-controlled garage door openers—and Part 18, which covers industrial, scientific and medical equipment, such as rf welders and heaters and diathermy machines. The new rules, Garlan says, would limit the manufacture, shipment and sale of devices that emit unwanted electromagnetic interference.

Manufacturers are objecting to the following:

- Elimination of a self-certification procedure by users and, in its place, a rule requiring FCC certification before the equipment is marketed.

- On-site certification requirements.

- Lack of maximum time delay provision which would allow manufacturers to assume that the device had been accepted if the FCC did not reply within 14 days.

- FCC inspection of sales and marketing records.

- A rule allowing public disclosure of all technical information about a product once the FCC has approved it. Manufacturers say this could give competitors an unfair advantage in cases where the marketing of a product did not immediately follow with its certification by the federal agency.

In the past the FCC has provided for a self-certification procedure for most equipment operated without individual license under Parts 15 and 18. Self-certification merely required the user to perform certain engineering tests on the device and to attach a label to it certifying that it had been tested and had been found to comply with FCC regulations.

This system, Garlan asserts, has not proved satisfactory from the standpoint of controlling electromagnetic interference (EMI). The FCC proposes that equipment be certified by it prior to marketing.

Florida paper to set up electronic newsroom

Video typewriters for newsmen will soon be available, thereby completing the development of the so-called "all-electronic newsroom." And the first such setup has already been sold to a daily in Florida.

While typewriters will cost around \$5000 each, the entire system, which can include as many as 32 typewriters, will cost from \$200,000 to \$600,000, depending on size, says its developer, the Harris-Intertype Corp. in Cleveland.

The rest of the system, which is already operational, consists of a disc storage, an electronic editing terminal and a computerized phototypesetter that turns out photographic galley proofs.

The Gannett Co., publisher of 53

dailies, has bought Harris-Intertype's first complete system for its 50,000-circulation daily *Today* in Cocoa, Fla. Costing \$250,000, it will be installed by the end of this year.

Other potential customers, says Harris-Intertype's president, Richard B. Tullis, include 300 to 400 of the nation's 1750 daily newspapers, with circulations ranging from 40,000 to 250,000.

These initial candidates alone, Tullis says, represent a market that may hit \$100-million over the next five to 10 years.

The Harris 1500 Editorial Input Terminal, about the size of a standard electric typewriter, is equipped with a typewriter keyboard and a 5-by-10-inch CRT display. No paper is required, and there is no carriage return or noise. Striking over an incorrect letter or word erases it. Paragraphs can be moved to a new sequence. And words can be inserted, deleted and changed. The finished copy goes to a disc storage, and from there to an electronic editing terminal.

RCA kicks off sale of electronics to China

The first large sale of American electronic equipment to the People's Republic of China—a satellite communications earth station—has been made by RCA Global Communications, Inc.

Under a \$2.9-million contract with China National Machinery Import and Export Corporation, RCA has installed the station near the Shanghai Airport in cooperation with the Chinese Telecommunications Administration.

During President Nixon's visit to China the station relayed pictures of the Presidential party and its activities to the United States. In addition to television, the facility can handle telephone, leased-channel, telegram and facsimile traffic, according to Howard R. Hawkins, president of RCA Globcom.

The earth station is transmitting to and receiving from the new Intelsat IV satellite, which is in a geostationary orbit 22,300 miles above the Pacific. The normal operating path is between Shanghai and an earth station in Jamesburg,

Calif., one of eight such stations in the U.S. and its territories.

Under the agreement signed by the Chinese, the Shanghai earth station—which consists of two transportable vans and a 33-foot parabolic antenna—was flown in from Thailand in four sections. A power generator station and test equipment were also delivered with the station.

Installed in 30 days by RCA and Chinese technical personnel, the station is currently in commercial operation, handling TV and other communications services between China and the United States.

In addition to the earth station, the contract calls for RCA to supply a microwave link and 20 Video-voice units. The microwave link will tie the ground station in with a downtown Shanghai studio.

Sales of electronic equipment to China will probably be limited to direct contacts between large U.S. corporations and the Chinese Government for some time to come, comments Melville Morris, vice president of International Media and Exhibits, promoters of electronics exhibitions for medium and small U.S. manufacturers in the Eastern European countries.

No wholesale rush to do electronics business with the Chinese is as yet evident, says Eric Fine, chief of the Electronic Equipment Branch, Office of Export Control of the Dept. of Commerce. Only a few requests for export licenses are pending, he notes, despite the fact that anything that can be sold to the Soviet Union can now be sold to China.

Special site now checks accuracy of ship sonar

Checking the accuracy of sonar has always been a tedious, time-consuming and not terribly accurate chore. Bearing and range accuracies have been checked with some success on known targets in the open sea, but this has not been possible for the receiving sensitivity and source-level. Now, an electronic setup has been devised to check all four factors in port, under controlled conditions, in about two days.

The solution appears obvious

But it was not tried before because skeptics felt that nearby objects in a port would cause specious returns. A group at the Naval Electronics Laboratory Center in San Diego has disproved this notion. The group built a facility, called the Sensory Accuracy Check Site, at Long Beach, Calif. Other facilities are planned for a number of ports that the Navy uses throughout the world.

"We are already working on a site for Charleston, South Carolina," says Allen G. Menke, operations manager of the facility at San Diego.

The electronics equipment in each site costs approximately \$200,000, much of it off-the-shelf. A minicomputer with a variety of peripherals, television equipment, frequency generators, counters, digital voltmeters, oscilloscopes and some interfacing electronics make up the bulk of the electronics package.

All data are processed in a control room at the site with a Varian 620-1 minicomputer, which prints out the sonar's performance record in real time.

Cruise vessels getting computerized radar

A computerized, anticollision radar plotting system, already successfully operating on cargo ships, has been installed on its first cruise ship.

Built by Iotron Corp. of Bedford, Mass., the system, called Digiplot, helped guide the new Norwegian cruise ship M/S Island Venture on her maiden voyage from New York to the Caribbean and back last month.

Using a Lockheed MAC-16 central processing unit, Digiplot analyzes data from three radars. It monitors continuously 200 targets, and it displays, tracks and plots the 40 most threatening within a 17-mile radius.

Although the cruise market looks good, James Coolbaugh, Iotron vice-president, says that the cargo market is bigger. There are more than 4000 tankers and freighters in the world, with 300 more joining the fleet every year.

Laser communications to be tested by NASA

NASA has asked the aerospace industry to submit proposals for a space-ground laser communications system that could pave the way for an earth communication system that would use low-orbiting satellites to relay line-of-sight links.

The plan is to develop a visible laser communication experiment to fly on the ATS-G (Applications Technology Satellite) in mid-1975. More than two dozen companies have been invited to submit their ideas.

Proposals are due at the Marshall Space Center in Huntsville, Ala., by March 24, and work is expected to begin in July. The winner will design, build and test the laser experiment and operate a mobile ground station over two years.

The laser system will consist of one laser source aboard the 22,000-mile-high satellite and another at a ground station, with each aimed at the other.

The satellite will carry a helium-neon laser with a wavelength of 0.6238- μ . The ground station will be equipped with a doubled neodymium YAG laser with a wavelength of 0.53 μ .

The satellite's laser will illuminate a 1000 foot-diameter circle on earth, although information will be collected from only six feet within this circle. The output power of the satellite laser will be 5 mW.

The ground-station laser will have 1 W of output power.

NASA has several objectives. It wants to:

- Determine the effects of the earth's atmosphere on laser propagation.

- Prove the feasibility of wide-angle acquisition, precision pointing and tracking between optical terminals.

- Establish an optical communication link with a capacity of 30 million bits of information a second, which would ultimately result in a communication network that used low earth-orbiting relay satellites.

The experiment is being sponsored by NASA's Office of Aeronautics and Space Technology. The ATS-G satellite and all of its experiments are under the direction of the NASA Office of Applications.

IMPROVED TRIAC RELIABILITY WITH GE **POWER-GLAS™** PASSIVATION



Press-Pac

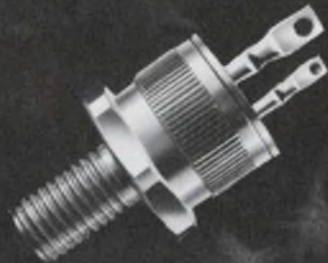

Stud

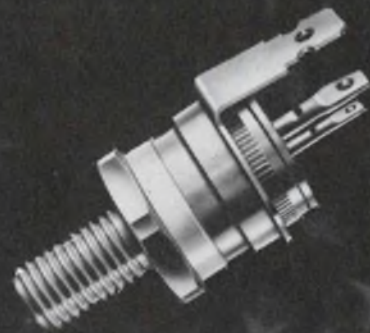

Isolated Stud

General Electric 6, 10, 15 and 25 amp triacs now incorporate **POWER-GLAS™** passivation... a proprietary glass formulation and deposition process that creates an intimate void-free bond between the silicon chip and the matched glass.

For the user this means significant reductions in "off-state" current (typically less than $100\mu\text{A}$) and new reliability standards for stability under conditions of AC blocking life. Additionally all General Electric triacs are transient voltage immune.

POWER-GLAS™ passivation available now in the SC240, SC245, SC250 and SC260 series, 6, 10, 15 and 25 amps respectively up to 500 volts, and in three package configurations... press fit, stud, and isolated stud.

Interested... contact any authorized General Electric Electronic Component Sales Office, authorized General Electric Distributor, or write for a copy of "Improved Triac Reliability thru **POWER-GLAS™**."

GENERAL  **ELECTRIC**

Semiconductor Products Department
Electronics Park, Syracuse, New York
13201

INFORMATION RETRIEVAL NUMBER 18

AT THE SOLID-STATE CIRCUITS CONFERENCE

N-channel technology invading semiconductor memory field

The use of n-channel technology to obtain an increase in speed in semiconductor memories has been talked about for some time, but the realization of the technique has always been put off till next year. From the papers presented at the 1972 IEEE International Solid-State Circuits Conference, held in Philadelphia, it appears that "next year" has finally arrived.

In a paper on "A 4096-Bit Dynamic MOS RAM," Joel Karp, a member of the MOS Engineering Dept. of Intel Corp., Santa Clara, Calif., described a semiconductor memory that uses n-channel silicon-gate technology to achieve smaller cell size and lower threshold voltages and power consumption.

At the same session Michael McCoy, manager of advanced product development for Electronic Arrays, Inc., Mountain View, Calif., described a 1024-bit, n-channel, silicon-gate RAM that uses a novel gated capacitor to provide self-refreshing of stored data.

The 4-k memory is constructed on a 137×167 -mil chip and, according to design engineers at the conference, will become another industry standard, like the 1-k bit 1103.

According to Karp, the new memory was designed for easy use. Unlike the 1103, however—which uses three clocks whose signals must overlap in a precise manner—the new RAM requires only a single 12-V clock, from which all other timing signals are internally derived. In addition all other in-

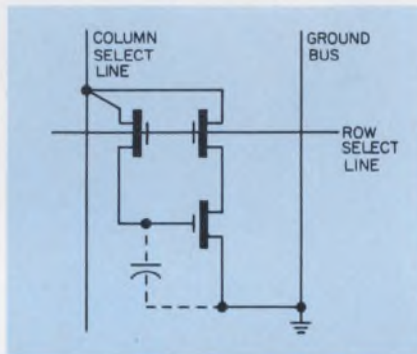

A novel configuration of the three-transistor cell in Intel's 4-k memory needs only 2-1/2 interconnect lines.

puts to the memory are TTL-compatible, a feature that is missing in the 1103.

The memory cell of the 4-k array is composed of three minimum-geometry transistors and occupies less than 2 square mils of area. One reason for the small cell size is its novel configuration, which results in a cell that requires only 2-1/2 interconnect lines—row select, column select and a ground line that is shared by two adjacent columns of cells.

In operation, a row selection line activates a row of cells for both reading and writing. The row voltage is a tristate signal gated onto the row select line by the row decoder. Reading of the cell is accomplished during the intermediate level of this signal, and writing or refreshing the cell is done during the high level of the signal. To conserve power, the high level is terminated as soon as proper information is gated to the cell.

The column-select line allows transfer of information into or out of the cell. This line is connected to the column amplifier, which is

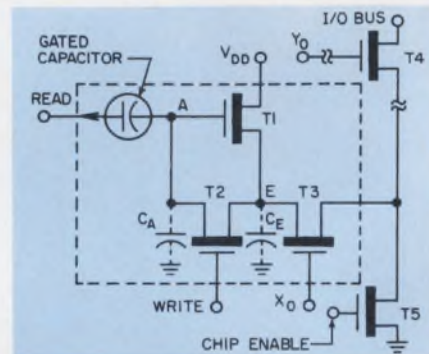

A gated capacitor is used in the self-refreshing cell of Electronic Array's new 1-k memory.

used to sense the information in the cell or write new information into the cell.

Data are stored as charge on the parasitic capacitance associated with each cell. Since the information is stored dynamically in the cell, it must be refreshed periodically by cycling through each of the 64 row addresses.

The Intel device is targeted for introduction sometime between September and November, with a price per bit about 1/3 that of the 1103, says a company spokesman. However, target dates and initial estimated prices are not always met, he cautioned.

As for the future, Karp predicted he would be back in two years with a 16-k chip. Engineers at the conference tended to believe him.

The 1-k bit memory described by McCoy integrates refresh circuitry into the basic cell, eliminating the need to cycle through addresses to achieve refresh. The memory is fabricated on a 116×128 -mil chip, and, like the new 4-k Intel memory, it uses n-channel, silicon-gate technology. But unlike

The following editors contributed to this report: Jules H. Gilder, Michael Elphick and Jim McDermott.

the 4-k memory and the 1103, which both have access times of about 300 ns, the Electronic Arrays EA 1500 memory has an access time of less than 75 ns.

This, says McCoy, along with the price advantages of MOS, should give us a big advantage in competing with bipolar memories.

The self-refreshing cell in the EA 1500 memory eliminates the need for excess control logic and is one reason why the new memory has such a low access time.

The self-refreshing of data is accomplished by making use of the two parasitic capacitances C_E and C_A (see figure). Capacitor C_E is the source of the refresh current. In the read mode, all the cells in the memory that contain a logic ONE have charged capacitor C_E to a voltage that is very close to V_{DD} . When the read line returns to ground and the write line goes to a ONE level, transistor T_2 is turned on and charge is transferred from node E to node A.

The EA 1500, unlike Intel's 4-k chip, is now available and its price ranges from \$37.50 for a single unit to \$15 a unit in lots of 1,000.

McCoy reported that Electronic Arrays planned to introduce by the third quarter of this year a self-refreshed 2-k memory, and, by next year, a 4-k self-refreshed chip.

Random-access memories are not the only ones using n-channel technology. Three other papers, all presented by representatives of Japanese companies described n-channel technology in electrically reprogrammable ROMs.

Two approaches were taken in the design of these nonvolatile ROMs. In the first, the electrically reprogrammable memory was constructed with an avalanche injection mechanism. To program, electrons are injected by avalanche breakdown of the drain p-n junction. This causes a floating gate to become negatively charged. To erase, holes are injected by avalanche breakdown of the n-p junction near the source. This discharges the floating gate.

The second method used to design the reprogrammable ROMs is characterized by a shift in the initial gate threshold voltage. The device is programmed by applying a positive pulse that is above a certain critical voltage. This changes the threshold voltage. To erase, a

negative voltage is applied to the gate to return it to the initial threshold voltage.

An electrically reprogrammable 256-bit ROM is available from the Nippon Electric Co., Ltd., Kawasaki, Japan for about 3 to 5 cents a bit. Sony is also working on these ROMs for in-house use and plans to incorporate them in automatic dialing telephones to replace the magnetic cards that are presently used, in desk calculators to provide a nonvolatile memory to store calculations and in television receivers that will have a digital clock to allow the consumer to program all of his TV viewing for a week. Once programmed, the TV will automatically turn on, tune in the desired program and then shut off when the program is completed.

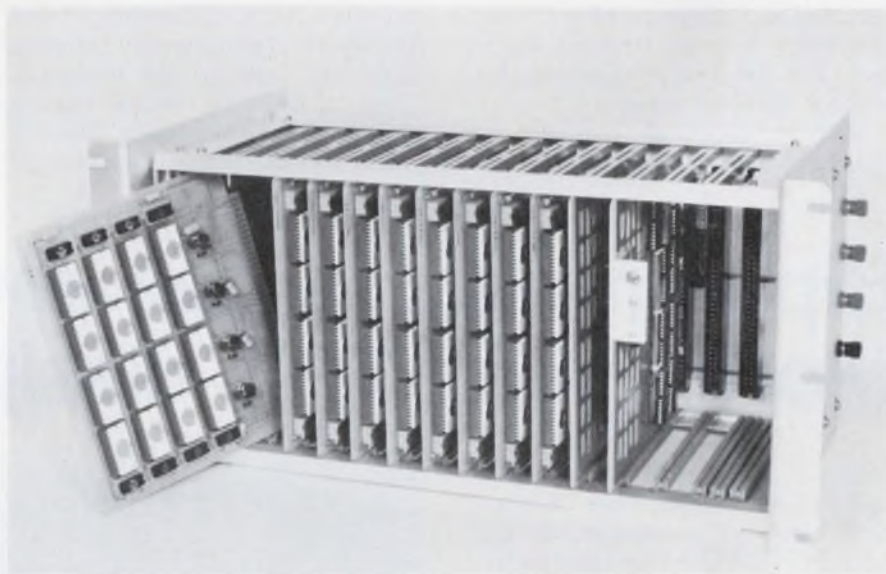

Nippon's electrically reprogrammable 256-bit ROM was assembled into a prototype of a microprogrammed memory for small computers.

Charge-coupled devices await mass application by industry

What are the prospects for off-the-shelf charge-coupled devices? For the long range, they'll probably be in ample supply, a panel at the Solid-State Circuits Conference indicated. But for the immediate future, they'll be scarce, the panelists went on.

Manufacturers simply aren't interested in making them unless they can get large orders, the panel—"The Impact of Charge-Control

Technology"—reported.

Only one company—Amperex—is offering a charge-coupled device at present: the M31, a 32-stage bucket brigade.

The economic problem was outlined by Dean Collins of Texas Instruments, Dallas. While it is true that, with the right masks, bucket-brigade devices can be fabricated on standard MOS production lines, manufacturers are not interested

in producing these devices unless they can offset the cost of the masks with, say, a \$100,000 order, Collins reported.

Another panelist, G. F. Amelio of Fairchild Semiconductor, Palo Alto, Calif., noted that over the last three years the efficiency of charge-coupled devices had increased from 99% to 99.99%.

Other advances mentioned by Amelio include increases in the fre-

(Solid-State, continued)

quency at which they operate, the number of elements strung together and the density on chips.

Typical areas of application for charge-coupled devices discussed by the panel included memories, variable audio and video delay lines, imaging and filters.

Collins maintained that memories were a tough area for invasion by charge-coupled devices because there are so many competing technologies. But William Engeler of General Electric, Schenectady, N.Y., disagreed. Engeler pointed out that with charge-coupled, random-access memories, manufacturers don't have to dig down and make contact with the silicon—a process that eats up a lot of chip real estate. Charge-coupled devices also offer first-in, first-out registers and can easily perform bit sorting, Engeler noted.

In the technical sessions on charge-coupled devices, several de-

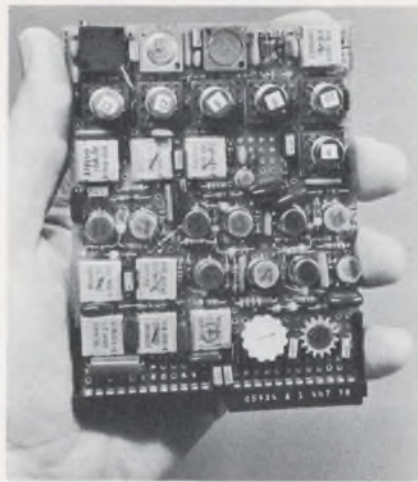

Charged-coupled-devices were assembled by IBM to test their feasibility in memory applications.

vices and their applications were described. Michael Tompsett of Bell Telephone Laboratories, Murray Hill, N.J., told of an n-channel, linear three-phase device that is used as an analog delay line for video signals. F.L.J. Sangster of

Philips Research Laboratories, Eindhoven, The Netherlands, described a bucket-brigade device that uses a new tetrode structure to improve signal-to-noise ratio and high-frequency response.

At a session on memories, Norbert G. Vogl of IBM's Components Div., Essex Junction, Vt. presented a paper on an experimental charge-coupled-device buffer memory.

The basic building block of the buffer memory is a silicon chip that contains two 480-bit shift registers. Six of these chips in individual cans, together with support circuit modules, were mounted on a card to provide a total memory capacity of 5,760 bits. The card was designed for an existing small machine and was used as a direct replacement for an existing card.

The whole purpose of this exercise, Vogl said, was to prove what people have been saying for years—that charge-coupled devices can be used in computer memories.

Bipolar logic forges ahead: More speed, less dissipation

The IC logic race between MOS and bipolar technologies aroused new levels of excitement at this year's Solid-State Circuits Conference. While n-channel MOS threatened to close the speed gap (see "N-Channel Technology Invading Semiconductor Memory Field," p. 26 in this issue) a bipolar circuit described at the conference was way out front into the subnanosecond region. Other papers described bipolar logic circuits with speed-power products of less than a picjoule, thus proving that fast circuits don't have to be power-hungry.

In addition to mentioning the speed and dissipation improvements, most of the bipolar logic papers reflected a trend toward simpler cell structures that occupy less real estate and require fewer processing steps. This may help bipolar circuits combat the traditional MOS advantages of low cost and high circuit density.

The front runner in subnanosec-

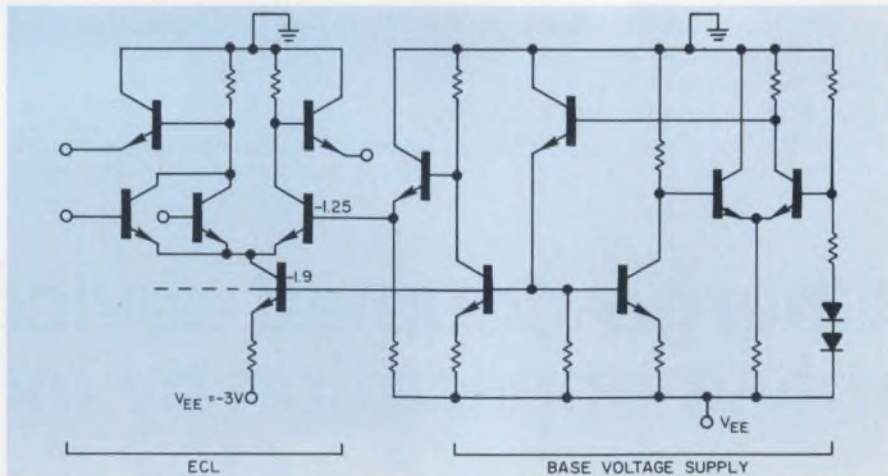

Hitachi's modified ECL circuit has a differential base-voltage circuit that supplies current-source transistors. A self-aligned etching technique produces high-speed switching transistors with small base areas. The special base-drive circuit insures reliable operation and relatively low power dissipation.

ond logic was described in a paper co-authored by Kenji Taniguchi and four other engineers from Hitachi's Central Research Laboratory in Tokyo. The modified ECL circuit has yielded cascaded-gate

propagation delays of 400 ps and typical raw-circuit gate delays as low as 300 us, the authors said. The power-speed product was 16 pJ. While much lower than for other subnanosecond circuits, this power-

NEW OP AMP CHAMP.

The new LM118 may well be the ultimate true differential operational amplifier. It not only has the fastest slew rate ever offered (a minimum of 50 volts per microsecond at $A_v=+1$), but *guarantees* it for every single device. In writing.

As if that weren't enough, the highly versatile LM118 is pin for pin compatible with general purpose op amps, has a 1MHz full power bandwidth, a unity gain crossover frequency of 15MHz, is internally compensated, can be offset nulled to zero with a single potentiometer, doesn't sacrifice dc performance for speed, comes in a TO-5 package and will soon be second sourced. (Once again giving testimony to the now-famous National

Linear Circuit Motto: "*In order to be followed you have to lead.*")

Naturally, the entire LM118 series is available for immediate delivery at the following (100 up) prices: LM318H, \$9.95; LM218H, \$19.95; LM118H, \$29.95.

For more information, contact your nearest National distributor. Or write, phone, TWX or cable us direct.

National Semiconductor Corporation, 2900 Semiconductor Drive, Santa Clara, California 95051. Phone (408) 732-5000. TWX: (910) 339-9240. Cable: NATSEMICON.

National

speed product is higher than those for some of the slower circuits described at the conference.

The Japanese engineers achieved the high speed by using a self-aligned etching technique to reduce significantly the base area of the transistors. (A similar technique has been developed independently by engineers at Hewlett-Packard). The Hitachi team also employed a differential type of base-voltage supply circuit for the current-source transistors in the ECL cell. This approach avoids the problems of temperature drift and supply-voltage dependence that occur with ECL circuits that have resistor current sources. The Hitachi cir-

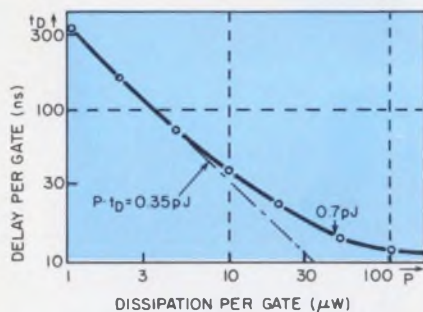

A new bipolar circuit called "merged-transistor logic," developed by IBM in West Germany, allows power-delay products as low as 0.35 pJ for propagation delays above 100 ns.

cuit allows the transistors to be operated at low supply voltages, thus offering lowered dissipation and increased yield.

To demonstrate the feasibility of the new circuit in practical logic arrays, the Hitachi engineers built a nine-bit parity checker circuit. The MSI circuit contained 29 of the new ECL gates. The total input-output delay (five cascaded gates) was reported typically as 2 ns. The output rise and fall time was less than 0.5 ns, and the total power dissipation 1.2 W.

Lowering the dissipation

Two other papers described circuits with low power-speed products. An IBM circuit was reported to have achieved a tangential slope of around 0.35 pJ, while a Philips circuit yielded a slope of 1 pJ.

The IBM circuit was developed at the company's laboratories in Boeblingen, West Germany, and was described in a paper by Horst H. Berger and Siegfried K. Wiedeman. Using a technique called merged-transistor logic (MTL), the IBM engineers produced compact circuits that should be reproducible at low cost. A half adder occupies a chip area of only 11 square mils, while a shift register occupies only 6.3 square mils per bit. The technique uses fewer process steps than the usual buried-collector circuits. Power-speed product is externally adjustable and ranges from 0.35 pJ (for delays over 100 ns) to 0.7 pJ (for a 16-ns delay).

In the MTL approach, minority carriers are injected directly into switching transistors that are operated in the inverted mode. The name MTL stems from the fact that complementary transistors are merged into a single structure. This approach avoids the usual device-isolation problem and reduces the process complexity to that of single planar transistors. Further chip-area savings result from the complete elimination of diffused resistors.

The second paper emphasizing low power-delay product was by Kees Hart and Aram Slob of Philips Research Laboratories in The Netherlands. They described a technique called integrated injection logic, in which multi-collector transistors are fed by carrier injection. The technique allows simple direct coupling and avoids the need for load resistors. Carrier injection also eliminates a large number of interconnections for power-supply rails, and thus maximizes chip utilization by the active devices.

The Philips paper described one version of the circuit that requires no power-supply connections at all—carrier injection is achieved by irradiating the chip with light. This technique may not prove very practical, however; to achieve constant and uniform operating speed, the light source must provide constant and uniform chip illumination.

A second version of the circuit includes a central p zone in the structure to provide carrier injection from an electrical source. This

version requires one power-supply rail on the chip. The speed vs power tradeoff can be externally adjusted by controlling carrier injection. The delay-versus-dissipation curve yields a power-speed product of 1 pJ over the straight-line portion.

But you can't buy it

Though conference papers described some impressive bipolar-IC laboratory developments, it's still impossible to buy production quantities of fast low-dissipation logic circuits. The fastest ICs on the market are still the rather power-hungry MECL III series from Motorola. These have data

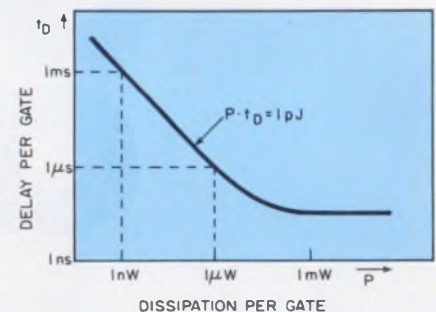

An "integrated injection logic" circuit, developed by Philips in The Netherlands, has a constant power-delay product of 1 pJ in its normal operating range.

propagation delays of around 1 ns. Michael Callahan of Motorola Semiconductor Products, Phoenix, Ariz., pointed out in a panel discussion, it is unlikely that manufacturers will invest in production capacity for subnanosecond logic until they see a larger potential demand and until a consensus on packaging requirements emerges. Potential manufacturers and users are now locked in a classic chicken-and-egg standoff, where nobody will make the first move. There are no large orders, and there is no quantity production. Callahan did predict, however, that one or two sample subnanosecond arrays would be in pilot production before the end of the year. This will allow engineers to experiment with high-speed logic to see whether they really want it in volume.

The major stumbling block for subnanosecond logic appears to be

Fluke problem solvers

The New .005% 8300A DVM: Bare Bones, \$1195; 5 Ranges DC, \$1295; 5 Ranges DC & 5 Ranges of Ohms, \$1445



Remember the original great Fluke 8300A... the first reasonably priced 5½ digit high accuracy DVM ever offered.

Now, after two years' high production and plenty of time on the learning curve, we've come up with a whole new family of 8300A's with lower prices overall and package deal prices on the most popular configurations.

There's the basic 0.005% unit with three ranges of dc (10, 100, & 1000 volts). It's the 8300A-00. It sells for a miserly \$1195. If you need millivolt dc ranges (0.1 & 1.0 v) added, we'll give you the 8300A-10 for just \$1295. For a few dollars more we'll give you the 8300A-20 with five ranges of dc volts and five ranges of ohms for \$1445.

So here's your chance to get famous Fluke quality at new low prices. And because we use single mainframe

construction throughout, you can add all the other options to make a full bench multimeter or systems box in the field an option at a time, anytime.

And remember, only Fluke can use the patented recirculating remainder A-to-D conversion technique with up to five times fewer parts than comparable DVM's for greater reliability and the best MTBF in the industry.

So, if you're looking for a very fine 5 digit DVM with 0.005% accuracy, plenty of low cost options, including ac voltage, external reference (ratio), fully isolated outputs, remote programming and complete systems compatibility including timing signals and ready indicator at package deal prices, take advantage of Fluke's great new DVM deal right away. For details, call your nearest Fluke sales engineer today or contact us directly.

Fluke, Box 7428, Seattle, Washington 98133. Phone: (206) 774-2211. TWX: 910-449-2850/In Europe, address Fluke Nederland (N.V.), P.O. Box 5053, Tilburg, Holland. Phone: (04250) 70130. Telex: 884-52337/In the U.K., address Fluke International Corp., Garnett Close, Watford, WD2, 4TT. Phone: Watford, 33066. Telex: 934583.



the choice of a suitable low-cost package. Though participants in the panel discussion were able to define the problems, they could not agree on a common solution.

Hitachi's Taniguchi favored packages similar in appearance to existing MSI packages, but with smaller dimensions so they could be mounted on PC boards with suitably fine grid spacing. This approach seemed to offer potentially lower cost than other methods that were suggested, but it offered no solution to the cooling problem for complex systems.

David Dewitt of IBM, East Fishkill, N.Y., pointed out that his company had a large investment in automated assembly and test systems for ceramic-substrate hybrid modules, and therefore was not likely to accept a completely incompatible packaging scheme for sub-

nanosecond logic arrays.

Richard Robrock of Bell Telephone Laboratories, Holmdel, N.J., favored beam-led circuits mounted on multilayer ceramic substrates, with finned heat sinks for convection cooling where necessary. He admitted that this approach was probably more expensive than the simple scheme proposed by Taniguchi. He pointed out, however, that though telephone companies were starting to manufacture large numbers of data terminals that require high-speed logic circuits, the actual proportion of subnanosecond logic would be a fairly small part of the total system. Therefore, Robrock said, it would not make sense to sacrifice reliability for the tiny cost savings yielded by less satisfactory packaging schemes.

Several panelists and audience members pointed out during the discussion that there are important applications right now that require

moderately high quantities of subnanosecond arrays. Some particular areas mentioned included telephone systems (for data and Picture-phone transmission), radar-signal processing, large switching computers, satellite communications and optical-character recognition equipment. Therefore, the speakers reasoned, some standard packages for subnanosecond logic should soon evolve.

Those companies that require special packages will probably roll their own, as they have in the past. One company that couldn't wait for commercial subnanosecond logic is Hewlett-Packard. Merrill Brooksby of HP, a panel member, said that his company processed about 24 wafers of logic each year for use in high-performance test equipment. As one wit suggested during the panel discussion, perhaps the only way you can get really fast logic today is to buy a \$2,000 counter and tear out the parts.

New communication possibilities flowing from IC optoelectronics

The application of solid-state integrated-circuit technology to the design of optical and optoelectronic components and devices is creating a new generation of optoelectronic elements—some with new capabilities, others with their performances substantially improved over those of existing devices.

Chief among the new elements reported at the Solid-State Circuits Conference are integrated optical circuits that have a potential for manipulating laser light as though it were a current in an electronic circuit. E. G. H. Lean, manager of the acoustical physics group at the IBM research center in Yorktown Heights, N.Y., sees widespread application of these circuits in high-capacity communication systems, as well as in computers.

The usefulness of the optical IC's, which has been demonstrated in the laboratory, results from the ability of thin, optical films to guide optical radiation, much like optical fibers do, says Lean, who was the author of a Session II pa-

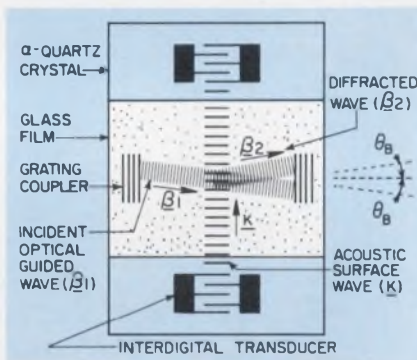

A laser beam can be coupled into and out of an optical thin-film circuit through grating couplers.

per, "Integrated Optical Circuitry."

The guided optical waves, Lean explained at the conference, are trapped inside a thin film that has a higher index of refraction than either the substrate, air or other medium on its outer surface. Most of the optical energy coupled into the thin-film layer is confined within the film, and consequently its intensity can be 30 or 40 times as great as the original beam.

For single-mode operation, the optical film thickness is about one wavelength of the optical radiation piped into it. The phase velocity of the guided waves is controllable by varying the thickness of the film or the propagation mode.

Interest in integrated optics has been high recently because efficient methods of coupling the laser beam into a thin-film optical guide have been devised, including a prism-film coupler, tapered-film coupler and a grating coupler. A portion of the incident beam is diverted by the grating on the thin-film surface to enter the optical guided wave area.

One application of the grating coupler is as an acousto-optic switch (see figure). In this device the optical wave is deflected by acoustic surface waves.

The acoustic source is the interdigital transducer. The acoustic surface waves are radiated through the glass film to an alpha quartz crystal, which acts as a sink.

(continued on p. 34)

Sperry displays are available in 3 digit, 2 digit, and 1½ (7 segment character and a 1 with + and -) digit models in both ½" and ¼" sizes.

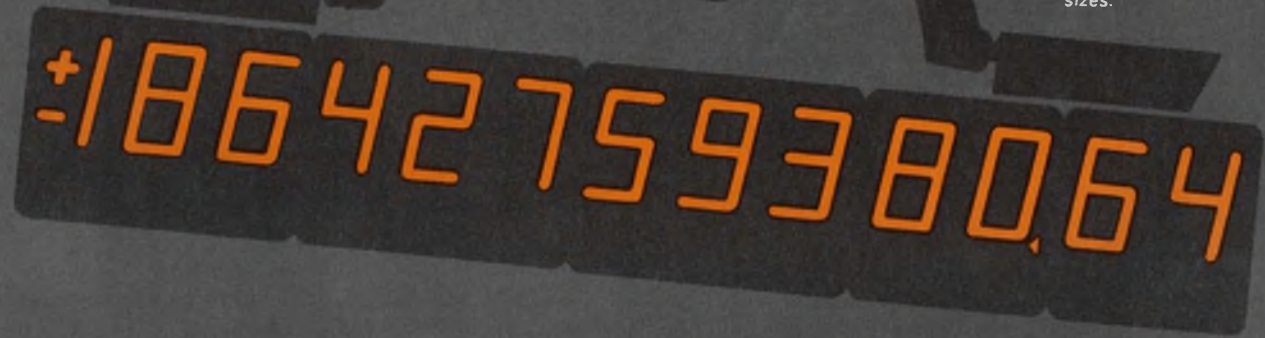

Compare portable displays

If you think that LED's or phosphor/fluorescent displays are the only one's you can logically use in your portable equipment, you better take a close comparison look at Sperry. The facts speak for themselves:

COMPARE READABILITY . . . a must requirement. Sperry displays† can be read in direct sunlight. Try the others.



85mW 100mW 500mW

COMPARE POWER . . . a very important factor. ¼ inch LED's normally require over 500mW. ½" phosphor/fluorescent devices normally require over 100mW. Because Sperry displays are so bright to begin with, they can go all the way down to 85mW without affecting readability. What about voltage? A simple, inexpensive DC/DC converter takes the battery voltage up to the 170 volts required to operate Sperry displays.

COMPARE RELIABILITY . . . simplicity is the key. Sperry displays have no wirebonds or filaments. They are so ruggedly built and reliable that they are used aboard the Boeing 747. Need we say more.

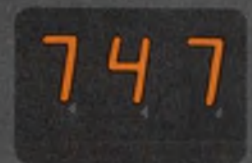

COMPARE SIZE . . . it's the housing to character size ratio that counts. Which display do you want in your portable equipment?



Add these Sperry advantages to continuous unbroken figures and a low cost of \$2.30* per digit for either the ½" and ¼" device and you can end the comparison and specify Sperry — the right displays for your portable equipment or any gear. Get the whole story on Sperry displays by requesting complete technical information using this publication's reader service card or phone or write: Sperry Information Displays Division, Post Office Box 3579, Scottsdale, Arizona 85257, Telephone (602) 947-8371

SPERRY
INFORMATION DISPLAYS

It's a whole new ball game in display devices!

†Patent Pending *Based on 5,000 digit quantity.

(Solid-State, *continued*)

Using the technology involved in microwave integrated circuits, some laboratories have fabricated such integrated optics elements as waveguides, filters, directional couplers, and beam splitters.

It is also possible, Lean said, to apply thin-film laser sources, as well as detectors and other elements, to the same substrate to produce a complete functional optical IC system on one chip.

Optoelectronics helps the blind

Another new development in optoelectronic ICs is a 3-by-8-element MOS image-sensing array for an optical-to-tactile converter—a portable device that gives a blind reader touch images of the printed characters being scanned. The MOS array was developed at Stanford University to reduce the battery drain of a lamp that illuminates the character being scanned and of the circuitry itself.

The new array has several advantages over its bipolar counterpart, said James D. Plummer, research associate at Stanford and co-author of a Session II paper, "A Low-Light-Level Self-Scanned MOS Image Sensor." The MOS array is substantially more sensitive. Blackbody radiation levels below $1\text{-}\mu\text{W}/\text{cm}^2$ at room temperature have been reliably detected, Plummer said. Photodiode currents at these

radiation levels are 10 to 20 pA.

The MOS array is self-scanning, whereas the bipolar array requires external scan circuitry, Plummer points out. This reduces both device size and circuit power drain.

A new array-scanning technique eliminates switching transients, one of the principal contributors to "fixed pattern noise," which Plummer described as the peak-to-peak variation in array-element outputs under uniform light.

The photodetector elements in the array are operated in the charge-storage mode, Plummer said, in which each element integrates the light falling on it over a single frame time.

The array, as he describes it, is fabricated on a 1.8-by-2.5-mm chip, the cell size being 150 by 200 μm . The scanning shift registers on the chip are two-phase dynamic circuits that take less than 0.1 mW per stage.

The row switching transients are removed by a new scanning technique in which the row scanning timing is modified. Photodiode information is temporarily stored in a parasitic column capacitance. The charge on the first row of diodes is then transferred to the column capacitance.

The switches in Row 1 are then turned off, removing the transient switching charge from the column capacitance before the bit switches are energized.

The bit-switching transients are removed by strobing the output of

a charge integrator.

A new gallium-arsenide-phosphide optical IC isolator for digital circuit applications was reported by Richard H. Maitz, R & D section manager for the Hewlett-Packard Co., Palo Alto, Calif. The new TTL-compatible device has a response of 5 MHz, compared with 40 kHz for a typical gallium-arsenide isolator, Haitz pointed out. In addition the new unit has an isolation of 6.5 kV, compared with 1.5 kV for gallium arsenide units.

Optically coupled isolators with gallium-arsenide emitters and conventional phototransistors have a low gain-bandwidth product, Haitz explains, because of the long penetration depth of the infrared radiation into silicon—namely 45 and 70 μm for 90% absorption of the radiation of gallium arsenide.

The deep photon penetration prevents separation of the large photodetector capacitance from the feedback, or collector-to-base capacitance, of the gain transistor.

The feedback capacitance was reduced from 20 pf to less than 1 by separating the photodiode from the gain transistor with monolithic epitaxial isolation techniques. The detector was processed to provide an 8- μm detection depth, which drops the efficiency to less than 33% when the detection is used with the gallium-arsenide emitter.

For better response, a gallium-arsenide phosphide emitter radiating at 0.7 μm was used as the emitter for the new combination.

IC manufacturers have yet to tap a vast consumer-goods market

New markets for solid-state circuitry, such as automotive electronics, await penetration and development. And established markets, such as radios, TVs and hi-fis, remain to be converted from discrete-component circuitry to integrated circuitry.

In outlining the potential for IC expansion in consumer electronics, speakers at the Solid-State Circuits Conference noted that excessive circuit costs were still the major barrier. In general, the speakers

agreed that IC costs could be lowered by better circuit design with smaller chips, as well as by the production of standardized circuit building blocks.

The outlook for electronics in the automotive industry was appraised by Giovanna Villa, director of the Electronics Div. of Fiat in Turin, Italy. He predicted that by 1980, about 10% of the value of the average car would consist of electronics systems.

Villa believes that solid-state

electronics will make possible the introduction of new and complex electronic systems on automobiles in the coming years.

System approach for autos

System integration will be a major consideration in future automotive electronics design, Villa said. A principle job of the input interface circuitry will be to match the incoming signal to the system using it. For example, he explain-

Silicone breakthrough: Flame-retardant pourable elastomer at general-purpose prices.

New Sylgard® 170 A & B silicone elastomer now offers silicone security at prices competitive with organics! This flame-retardant, low-price, two-part silicone cures, when catalyzed, to a rubber with excellent electrical insulating properties. Developed for general potting, encapsulating and conformal coating, Sylgard 170 does more. It now permits designers to utilize the superior resistive advantages of silicones on lower cost, high-volume products.

If this new material stimulates your thinking about silicones in applications where greater safety and improved flame retardance is important, we'd like to help. For a free sample of Sylgard 170, write us on your company letterhead describing your application. Dow Corning, Dept. A-2317, Midland, Michigan 48640.

Encapsulants and sealants from

DOW CORNING

DOW CORNING

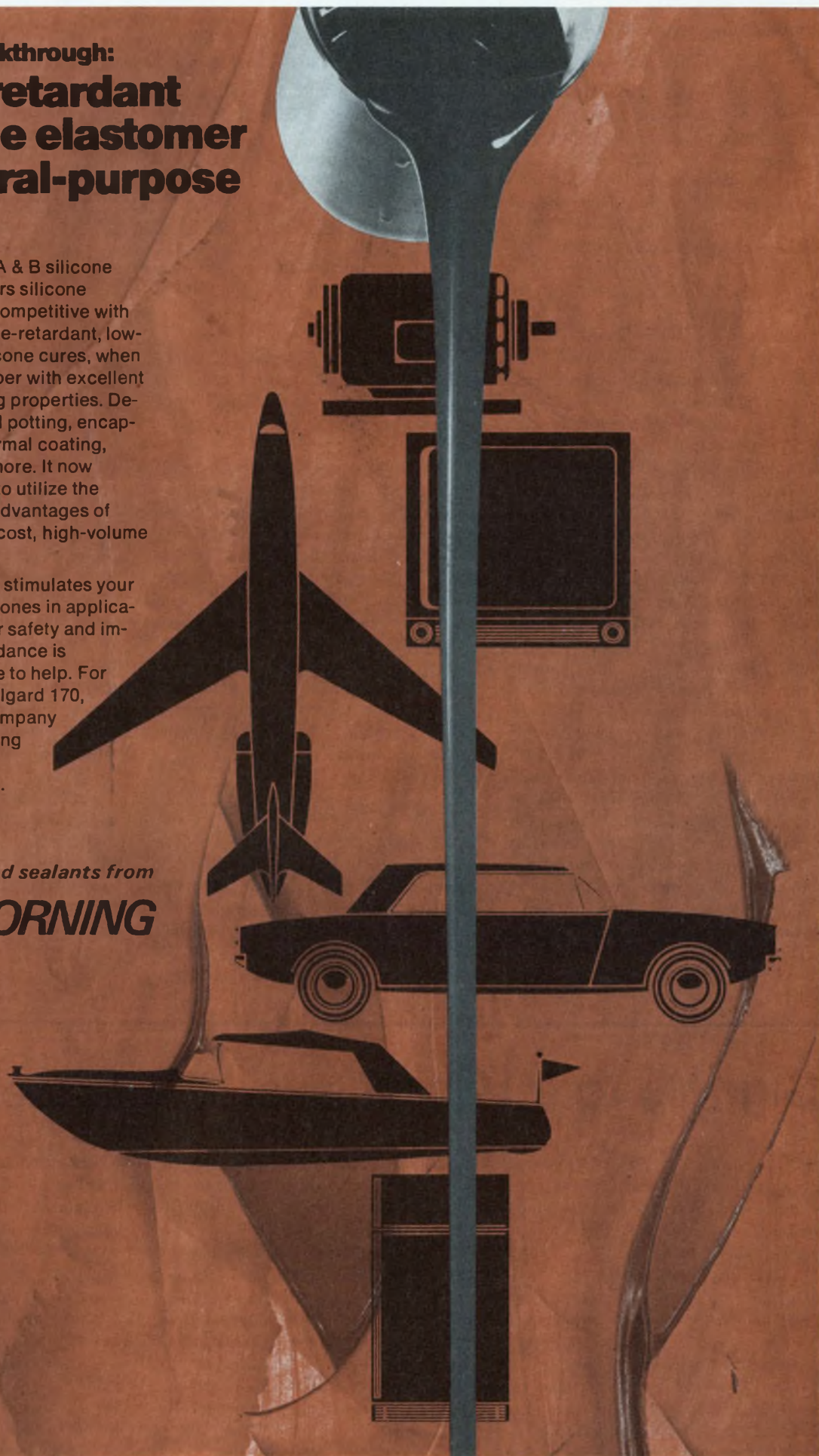

ed, a wheel-speed pickup can supply signals to several systems, such as a tachometer an antiskid system or a speed control.

While analog devices and circuits are used today, because they cost less than their digital equivalents, Villa said that digital devices will be ultimate ones for integrated systems. He also predicted the expanded use of LSI and MSI. Single-ended MOS circuits are a favorite, he said because of their relative immunity to voltage supply variations.

Villa strongly believes in the building-block approach to automotive electronic systems. He pointed to a circuit—a combination timer and trigger circuit—that could have broad general application (see figure).

The IC building-blocks were also favored by Roland W. Russell, a linear consumer circuit designer for Motorola Semiconductor Products, Phoenix, Ariz. A new generation of ICs must be designed, Russell pointed out, because the circuits available today are generally not suitable for use with the 12-V battery supply used in cars or are too sensitive to the transients in the automobile battery line. Also, today's typical ICs are generally overdesigned and too expensive for the automotive field, he noted.

In car systems, Russell said, ground is the essential reference.

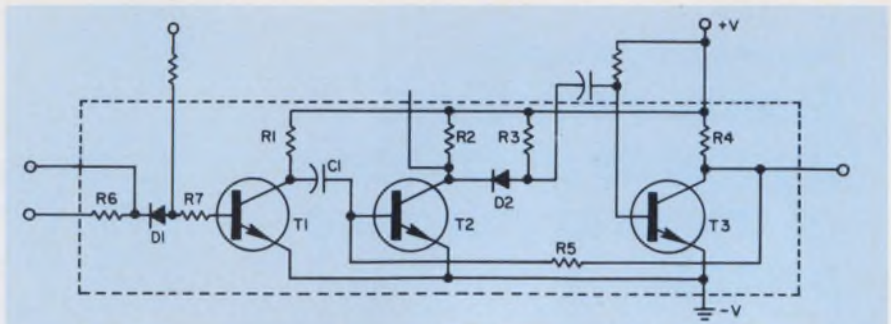

The trigger monostable circuit (above) is a needed building block for automotive electronics, says Giovanni Villa of Fiat.

Consequently the operational amplifiers or comparators used as building blocks require an input common-mode voltage that includes ground level.

An automotive electronics building block recently developed by Motorola—a precision monolithic time-delay generator—was described by William F. Davis. The 14-pin, dual in-line device was designed for control of fuel injection in the engine. The basic function of the new circuit, Davis explained, is to sense a reference spot on the distributor shaft and to produce a time delay with an accuracy of 1% over a -40 C to 125 C temperature range.

TV IC rejects intercoupling

Graham G. Baskerville, senior designer with the Plessey Co., Ltd., Swindon, Wilts, England, reported on the conversion of a complete TV i-f system from three chips to one.

A major problem, he said, was control of the spurious feedback caused by common coupling of amplifier elements to the substrate.

To isolate the video i-f amplifier, the amplifier input connections and resistors were screened by a buried diffusion connected to the decoupled agc line. This technique reduced capacitive coupling with the substrate by 30 dB.

Interference in the video channel from harmonics of the sound i-f was reduced, Baskerville said, by deposition between the sound and video sections of a large substrate conductor across the entire chip. The conductor provided a shunt path of 10 Ω from substrate to ground.

Independent bonds connecting the sound and video supply pads to the main supply voltage pin reduced the common impedance by one-half at 40 MHz, thereby further reducing interaction between the amplifiers. ■■

Signals to let deaf 'hear' TV tested

A National Bureau of Standards development—the encoding of time signals on TV transmissions—may revolutionize the way deaf people watch television.

The signal system was designed originally to give a precision time readout to TV viewers whose receivers were equipped with decoding circuits (see "What Time Is It? Your TV Set May Tell," ED 19, Sept. 16, 1971, p. 24). But the same system, transmitting at 60 characters per second, can send up to 600

words a minute, according to Richard Davis, electronics engineer in the National Bureau of Standards Time and Frequency Div.

In a recent test, subtitles for the ABC-TV production "Mod Squad" were transmitted in the Washington, D.C., area to a hundred deaf students at Gallaudet College. Millions of other TV viewers in the area were unaware of the special transmission because their sets did not have decoding circuits.

The signals are encoded in a

22-bit format, with each line containing two ASCII (American Standard Code for Information Interchange) characters. The decoder converts the incoming data from serial to parallel, and the parallel data are fed to a character generator and applied to the video channel of the receiver.

The national bureau estimates that the time-decoding module would cost less than \$20 factory-installed in TVs. Subtitle modules would be in the \$50 range. ■■

**Silicone breakthrough:
Noncorrosive
adhesive/sealant
at general-purpose
prices.**

The protective advantages of bonding and sealing with a noncorrosive silicone can now be extended to a wider variety of products. New Silastic® 738 RTV adhesive/sealant is offered at prices competitive to conventional silicone sealants and even to many organic materials. It will not corrode sensitive metals because it has a curing system different from that of regular silicone sealants. Also, there is no objectionable odor during cure.

Silastic 738 is a ready-to-use, durable sealant that will guard your products with all the superior resistive properties inherent in silicones.

For a free trial sample, fill out coupon:

Encapsulants and sealants from
DOW CORNING

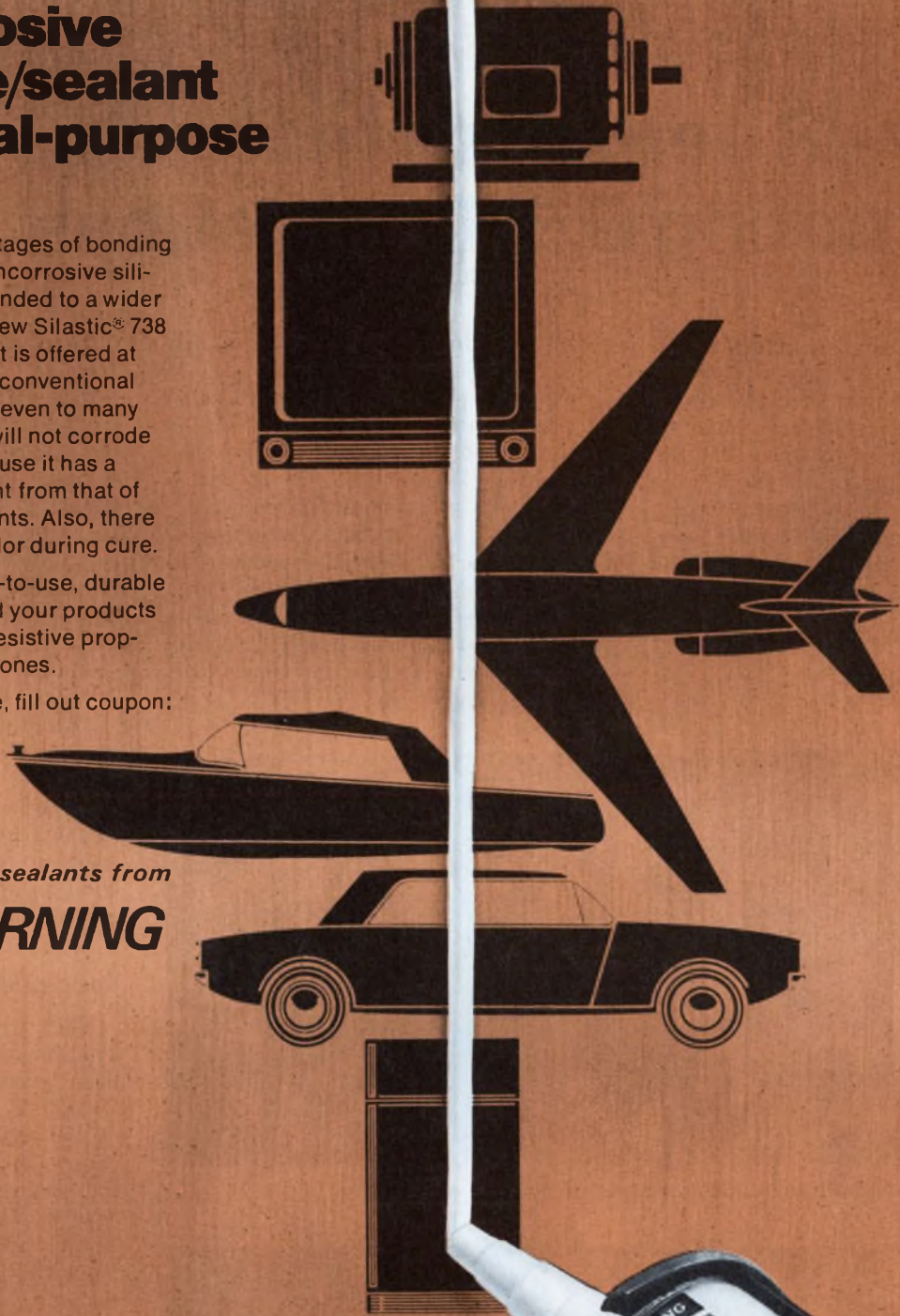

Dow Corning Corporation
Dept. A-2318, Midland, Michigan 48640
Send me a free trial sample of
Silastic 738.

Name _____
Title _____
Company _____
Address _____
City _____ State _____
Zip _____ Phone _____

offer expires Sept. 30, 1972

Far-IR sensor detects objects by noting 0.5-C variations

The Army has added to its new line of far-infrared surveillance devices a sensor for detecting personnel and vehicles and small enough to be carried by hand. The services are shifting to the far-infrared region of the spectrum because it permits the use of more versatile, passive systems than those in the near-infrared.

John F. Mason
Associate Editor

Weighing six pounds, the new Thermoviewer is handled like a pair of binoculars. It is powered by a 6-V, rechargeable battery that is mounted on the operator's belt. The battery weighs five pounds and is capable of 12 hours of operation.

Like its larger counterparts—and unlike near-IR systems—the Thermoviewer operates in total darkness or in daylight. It presents images of people or objects that are shielded by foliage and camouflage, light fog or haze.

The Army's far-infrared devices, operating in the 3-to-15-micron range, see in the dark because they respond solely to heat emitted by the target. Unlike near-infrared devices, in the 0.8-to-1.2-micron range, they do not depend on auxiliary illumination. The near-infrared Sniperscope, for example, requires an infrared light source to bathe a target with invisible light before the target can be viewed. The Thermoviewer detects heat differences as slight as 0.5 C.

The far-infrared device is able to see through fog, haze and foliage because it detects wavelengths that are long enough to flow past particles in the air and through holes between leaves—enough in many cases to reveal an outline of a man or vehicle concealed behind brush.

Basic principle not new

The principle on which the Thermoviewer was designed has been known for some time, says Donald J. Looft, deputy director of the Army's Night Vision Laboratory in Alexandria, Va., where the device was developed. "But earlier thermal sensors," he explains, "were large, extremely complex and sometimes required as much as 20 minutes to create a visible image. Also, for good sensitivity, the devices had to be cooled to an extremely low temperature."

The cooling was done, he says, by surrounding the detector elements with liquid nitrogen, contained in a vacuum bottle built around the detector assembly. The thermal detectors of the Thermoviewer also require cooling, but this is done by a thermoelectric cooling system.

The system's 56 small detector elements, made of lead selenide, are mounted on a thin sandwich of dis-



Can you find the man in this picture? If not, see photo below.



The Army's far-infrared Thermoviewer reveals the heat of tree trunks and a man concealed behind the foliage at right.



There's more to ESP rectifiers than you might think.

Customers have already perceived at least two additional features that provide more reasons to go ESP — low leakage, especially at high temperatures and operation over the full military range of -65°C to $+175^{\circ}\text{C}$.

Now Unitrode has added three more reasons. The voltage range has been increased to 150V. The three UES series are now available as 1N5802 through 1N5816. And you can get them in high efficiency assemblies as center tap rectifiers, bridges, and higher current modules.

Of course, you already know about the 15nsec typical recovery time in any circuit — forward voltage drop as low as 0.8V at 20A — continuous ratings of 2.5A to 20A — very low diode losses and low cost — and off-the-shelf delivery from local Unitrode distributors. These features alone added up to the best in Efficiency, Speed and Power.

And now there are five additional features that make very good sense. Maybe there's even a sixth one.

Unitrode Corporation, 580 Pleasant Street,
Watertown, Mass. 02172 (617) 926-0404.

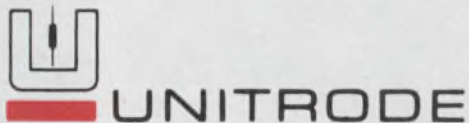

Call your local franchised Kierulff or Schweber distributor
for your ESP Rectifier "free sample card."

Introducing Souped-up TWTAs.

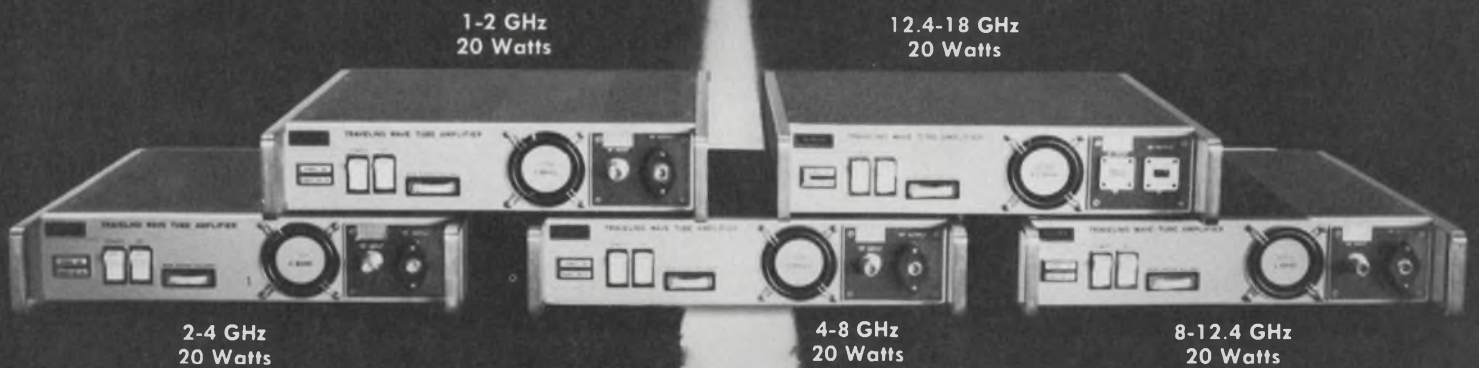

They're our new high performance models, Series 1277H.

20-watts minimum power, complete band coverage from 1-18 GHz.

And we didn't sacrifice reliability for the sake of power.

Every one of the 1277H series is built to the same standards as our 10-watt, 1-18 GHz 1177H series of TWTAs.

They have the same solid state design, compact lightweight size, self-contained construction and durability.

The same full one-year no hour limit war-

ranty. The same kind of traveling-wave tubes designed from the Hughes tubes used in Surveyor, Mariner, Early Bird, Pioneer, ATS, Syncom, Intel-Sat, TACSAT, Lunar Orbiter and Apollo. (Which is over a million operating hours in space.)

Souped-up Hughes TWTAs.

The first *grand prix* TWTAs made.

We'll send you a free brochure about them if you'll write us at Electron Dynamics Division, 3100 West Lomita Boulevard, Torrance, California 90509.

Or call: (213)

534-2121.

HUGHES

HUGHES AIRCRAFT COMPANY
ELECTRON DYNAMICS DIVISION

Hughes Industrial Electronic Products

similar metals. When an electric current is passed through these metals, the junction cools to 195 K.

"This detector-cooler module was the key to making the hand-held viewer," Looft says. "Except for increasing the sensitivity of the detector materials, there was no single breakthrough that enabled us to build the Thermoviewer; there were a number of factors.

"We increased the sensitivity of the detector by learning how to process the lead selenide material better; how to lay it down without getting cross-talk between the detectors and yet still maintain sensitivity; how to avoid surface defects which increase noise and reduce signal, and how to avoid having the material migrate from one state to another. Then, instead of using a single detector, we used an array of 56."

Other factors that made the small device possible, Looft says, "were simply good engineering, good packaging and miniaturizing the mechanical and optical parts."

Besides the Thermoviewer's obvious military applications, it is also being tested by the Bureau of Mines for detecting loose rocks behind apparently solid mine walls and in supporting pillars. The air around loose rocks is often 2 degrees different from rocks not surrounded by air.

The Federal Aviation Administration is interested in testing the device to enable pilots to see run-

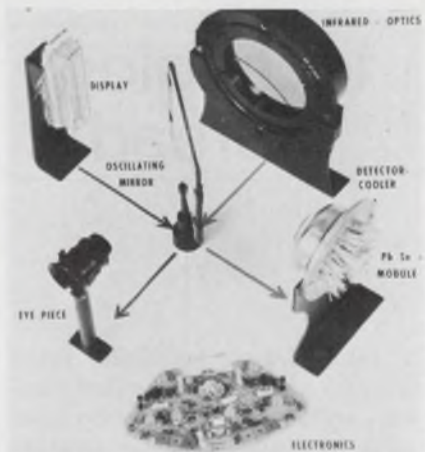

The Army's Thermoviewer is composed of an infrared optical system, infrared detector, a ray assembly with a cooling device, electronics, a scanning mechanism and a CRT display.

ways concealed by fog.

Thermal sensors may also help highway engineers and engineering geologists define wet zones of potential mud slides in excavations during highway construction. And it may help doctors locate potentially malignant tissue beneath the skin, or may detect thermal pollution in lakes and streams and determine the level of liquid in oil and water tanks.

The Phillips Broadcast Equipment Co. of Mahwah, N.J., is building 20 models for the Army and civilian agencies to test. In volume production, the thermal viewers could be built for \$8000 to \$10,000 each, Looft says. ■■

Coming: Atom pacemaker

A nuclear-powered pacemaker has moved one step nearer to reality with the completion of the first batch of electronic circuitry modules that will go into the device. Raytheon's Co.'s Industrial Components Operation at Quincy, Mass., built the modules, which consist of transistors, diodes, resistors and capacitors "chosen for reliability to meet the stringent testing and packaging requirements of Mil Standard 883, normally used for aerospace work."

The modules now go to Arco Nuclear of Apollo, Pa., a subsidiary of Atlantic Richfield, which is building the experimental pacemakers for the Atomic Energy

Commission.

Because conventional pacemakers with mercury power sources fail in less than two years and have to be removed surgically and replaced, the AEC decided to develop a pacemaker that would last at least 10 years. Already tested in animals, the nuclear-powered device is to be implanted in humans early next year.

A pacemaker using a battery that can be recharged by induction of rf energy from outside the body will be tested in humans before May. Developed by the Weizmann Institute of Science in Israel, this device is being built by Electro-Catheter Corp., Rahway, N.J. ■■

Hughes is more than electronic equipment and systems.

It's components, too.



Microwave diodes (RS 282)



Bipolar and hybrid circuits (RS 284) and MOS integrated circuits (RS 283)



Electrical connectors (RS 287)



Flat flexible cable and circuit assemblies (RS 288)



Special assemblies (RS 286)



Direct view and scan converter storage tubes (RS 290)

For complete information, write Bldg. 100, Mail Station C-512, Culver City, CA 90230. Or request by Reader Service (RS) numbers.



Industrial Electronic Products



**the safe
operating area
required for
TRUE
reliability!**

2N3055 SINGLE-DIFFUSED 15-AMPERE NPN POWER TRANSISTORS

Hermetically sealed, passivated surface devices designed for industrial and military switching and amplifier applications. Extremely low saturation resistance, uniformly high gain across collector current spectrum, low leakage currents. You can plug it in anywhere Brand 'R' is specified without secondary breakdown problems.

For complete technical data, write today for Engineering Bulletin 31,631 to Pirgo Electronics Inc., Pembroke Road, Concord, N.H. 03301

PIRGO
ELECTRONICS INC.

A Sprague Electric Co. Subsidiary
INFORMATION RETRIEVAL NUMBER 27

technology abroad

A solid-backed thermopile for a satellite-borne, earth-horizon sensing system is to be developed under a \$78,000 contract awarded to the British Aircraft Corporation and Space Systems Group by ESRO, the European Space Research Organization. The contract follows the successful completion of a previous 15-month contract to develop basic thermopile manufacturing technology.

CIRCLE NO. 570

Satisfactory transmission in the large, information-carrying 3 to 3.3 mm band may yet be possible, tests at the Radio Research Station in Slough, Berkshire, England, indicate. So far the band has remained unexploited because of severe attenuation of signals in rainstorms. Improved performance was obtained by providing several alternate radio links between two transmission points and by automatically switching from one to the other. Under the evaluation study, a network of microwave links was set up to transmit in the 11, 22 and 37-GHz bands. A number of fast-response rain meters monitored the rainfall along the transmission routes. A 3-to-10-cm radar measured the scattering properties of the rain. An on-line computer controlled the experiment.

CIRCLE NO. 571

A nationwide mobile telephone service is being completed in Sweden. When finished, it will be possible for a motorist to be connected to any subscriber in the country—at a fixed land point or in another vehicle. By dialing one of four special exchanges—the first has just been opened in Orebro—a subscriber can be put through to motorists. Subscribers to the new system will fit either

16 or 21-channel radio systems in their car. The scheme has been drawn up by the National Swedish Telecommunications Administration Government Buildings, Stockholm, Sweden.

CIRCLE NO. 572

A new type of data-transmission link, operating in the as-yet unexploited 20-GHz microwave band, is being developed by the British Post Office, in collaboration with industry. The data link will be comprised of small transmitter-receiver units mounted on poles no higher than conventional roadway lighting and spaced 5 to 10 km apart. The compact, solid-state transmitter-receiver links will have a 500 Mbit/s data rate. The data will be transmitted by advanced pulse-code-modulation techniques. The Post Office also is to develop an 11-GHz, 11 Mbit system suitable for 30-km hops.

CIRCLE NO. 573

A photodiode and integrated-circuit combination for regulating camera exposure time has been developed by Philips Research Laboratories at Eindhoven, The Netherlands. The integrated circuit measures the short-circuit current in the photodiode. This current is virtually independent of fluctuations in supply voltage and temperature. A novel feature of the circuitry is a memory element that retains the setting just prior to exposure. This is particularly useful in a through-the-lens reflex camera. During the moment of exposure—when the shutter exposes the film and simultaneously obscures the viewing lens and light meter—the iris is automatically held at the correct setting. The current drawn from a 4-to-6-V supply is 10 mA. The circuit is sensitive down to 0.01 lux.

CIRCLE NO. 574

McMOS

**TOP NOISE IMMUNITY,
WIDE SUPPLY VOLTAGE RANGE**

SIMPLIFY LOW POWER DESIGNS

McMOS* is Motorola's growing complementary MOS family. It's designed to provide a combination of benefits other digital technologies can't. McMOS is expanding in a manner designed to create a system-optimized family of functions, combining the most popular and useful second-sourced units with original devices to fill the gaps. McMOS can simplify your designs, and reduce system costs.

McMOS has the lowest quiescent power dissipation of any logic form — only 10 nW per gate, and the best available noise immunity — 45% of V_{DD} . That's mighty good when you consider the 3 to 18 V power supply range (3-18 V for the AL series and 3-16 V for the CL series).

No wonder this Select-Compare Data Register for industrial control systems or computers has a total quiescent power dissipation of just 25 μ W at 5 V_{DD} and operates virtually regulation free over a 3 to 18 V range.

It's also worth noting that McMOS is available in an unusually wide -40° to $+85^{\circ}$ C commercial temperature range, and the standard -55° to $+125^{\circ}$ C mil temperature range. A McMOS system requires only a single-phase clock and a single positive or negative power supply. It's logic level compatible with TTL, too.

Reduced system costs? Save on power (no cooling requirements) and save on voltage regulation. MSI practicality with McMOS means save on package count. As more and more designers start using it, even the purchase price will be a saver.

Find out more about McMOS by writing to Motorola Semiconductor Products Inc., P.O. Box 20912, Phoenix, AZ 85036, or circle the reader service number. Buy McMOS from the nearest Motorola Semiconductor Sales Office or distributor.

*TRADEMARK OF MOTOROLA INC.

Select-Compare Data Register
Total Quiescent Power Dissipation 25 μ W @ 5 V (V_{DD})

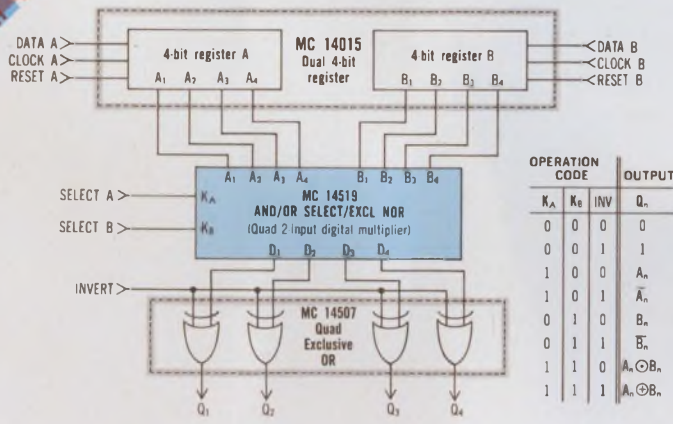

| OPERATION CODE | | | OUTPUT |
|----------------|-------|-----|------------------|
| K_A | K_B | INV | Q_n |
| 0 | 0 | 0 | 0 |
| 0 | 0 | 1 | 1 |
| 1 | 0 | 0 | A_n |
| 1 | 0 | 1 | \bar{A}_n |
| 0 | 1 | 0 | B_n |
| 0 | 1 | 1 | \bar{B}_n |
| 1 | 1 | 0 | $A_n \odot B_n$ |
| 1 | 1 | 1 | $A_n \oplus B_n$ |

McMOS FAMILY

| Motorola Device # | Function | Replaces Pin for Pin | Price (100-999) |
|-------------------|--|----------------------|-----------------|
| MC14001AL | Quad 2-Input NOR gate | CD4001AD | \$ 4.15 |
| MC14001CL | NOR gate | CD4001AE | 1.18 |
| MC14002AL | Dual 4-Input NOR gate | CD4002AD | 4.30 |
| MC14002CL | NOR gate | CD4002AE | 1.22 |
| MC14011AL | Quad 2-Input NAND gate | CD4011AD | 4.15 |
| MC14011CL | NAND gate | CD4011AE | 1.18 |
| MC14012AL | Dual 4-Input NAND gate | CD4012AD | 4.30 |
| MC14012CL | NAND gate | CD4012AE | 1.22 |
| MC14013AL | Dual type D Flip-Flop | CD4013AD | 5.95 |
| MC14013CL | Flip-Flop | CD4013AE | 2.40 |
| MC14015AL | Dual 4-bit shift register serial in/parallel out | CD4015AD | 12.65 |
| MC14015CL | serial in/parallel out | CD4015AE | 5.60 |
| MC14507AL | Quad Exclusive-OR gate | CD4030AD | 4.74 |
| MC14507CL | gate | CD4030AE | 1.86 |
| MCM14505L | 64-bit RAM | — | 25.00 |
| MC14501AL | Triple Gate | — | 4.30 |
| MC14501CL | — | — | 1.99 |
| MC14508AL | Dual 4-bit latch | — | 24.70 |
| MC14508CL | — | — | 13.75 |
| MC14519AL | 4-bit AND/OR Select | — | 4.75 |
| MC14519CL | — | — | 2.10 |
| MC14021AL | 8-bit P/S shift register | CD4021AD | 12.24 |
| MC14021CL | — | CD4021AE | 5.20 |
| MC14027AL | Dual J-K Flip-Flop | CD4027AD | 6.60 |
| MC14027CL | — | CD4027AE | 3.18 |

Recent Introductions



TRW capacitor technology...always on the grow.



You're looking at the smallest wound capacitor on the market — the TRW X440 metallized polycarbonate film capacitor. The X440 is typical of TRW's leadership in the development of high technology electronic components.

X440 capacitors are ideal for high density packaging requirements. Their electrical characteristics are excellent, with voltage ratings to 50 volts, in capacitances from .001 mfd to .01 mfd. Tolerances are to $\pm 1\%$. Dimensions and lead placement are equally precise, and don't vary a millimeter from one production run to another.

It took a constantly growing technology to produce the X440. And it takes a high degree of manufacturing expertise to turn them out by the thousands. And consistent quality control to insure reliability. All of these things are part and parcel of TRW's capability. TRW—where technology is always on the grow.

For samples of the X440 capacitor and applications assistance, write TRW Electronic Components, Capacitor Division, Box 1000, Ogallala, Nebraska 69153. Phone (308) 284-3611. TWX 910-620-0321. X440's are available off the shelf at all TRW stocking distributors.

TRW[®]
CAPACITORS

washington report



Don Byrne
Washington Bureau

Dulles Airport testing British landing system

The latest improvement in all-weather landing systems has been installed at Dulles International Airport near Washington, D.C. The new system—for what the Federal Aviation Administration calls Category 3A landings—will enable pilots to descend to 100 feet in bad weather to make a landing decision. The new equipment also decreases the requirement for forward visibility along the runway from 1200 feet to 700 feet. Called Stan 37/38, the system was built by Standard Telephone and Cables Ltd. of England. It is on two-year loan for evaluation, with an option to buy. All components are solid state and have triple redundancy. The localizer, which provides horizontal guidance, uses a 24-element antenna array with a 165-foot reflector, assuring excellent course structure, the FAA says. The glide slope is created by highly directional antennas in a null-reference configuration. Centerline illumination has been upgraded to 2000 candlepower, and a third transmissometer has been added to the mid-runway position. The FAA plans to install an identical system at its test center in Atlantic City, N.J.

FCC gears up for continued AT&T investigation

Dean Burch, chairman of the Federal Communications Commission, has told a Senate Government Operations subcommittee that his agency will scrounge up some \$1.2-million to kick off the second phase of its investigation of AT&T. Burch said that about 20 new positions would be added to the commission staff. Among other things, the FCC plans to look at the profits and prices of the Western Electric Co.

Congressional committee checking OTP role

Congressional investigators are looking into the makeup and role of the Office of Telecommunications Policy. The House Post Office and Civil Service Committee, headed by Rep. Thadeous Dulski (D-N.Y.), has assigned staff investigators to a two-month study of the new White House office. Hearings may be scheduled if there is sufficient evidence to support the fears of some Congressmen that the OTP is moving into the realm of the Federal Communications Commission.

Last month FCC Commissioner Nicholas Johnson decried the influence of the OTP on his agency's decision on cable television. The decision allowed CATV operators to "import" a limited number of broadcast

signals from out of town in competition with local broadcasters. The FCC originally wanted more liberal importation of signals, but the OTP successfully opposed this. Also of concern to the House investigators is the size of the new federal office—69 employees with an average salary of \$20,000 a year.

Two-continent aeronautical satellite plan held up

An ambitious, two-ocean aeronautical communications and surveillance satellite program, under study by the Federal Aviation Administration and NASA since 1966, has been sent back to the drawing board by the Office of Telecommunications Policy. After three months of study the OTP called the plan unworkable and told the FAA to start renegotiations with the European countries involved.

Basically the plan would have let the FAA own and operate half of the system, with the European Space Research Organization owning and operating the other half. The OTP, however, wants the FAA to lease the system from private industry—something the Europeans do not want. The federal office also feels that the entire system must be leased—that is, that the European half, as well as the U.S. half, must be furnished by private industry. U.S. airlines have continually opposed the FAA plan as being too much too soon.

Supreme Court to rule on software patents

The United States Supreme Court has decided to rule on whether computer software is patentable. Lawyers for the Justice Dept. and the U.S. Patent Office asked for review of a case that involves programming devised by Bell Telephone Laboratories to help make dial telephones. Computer manufacturers have long held that programming is nonpatentable and that to issue patents constitutes restraint of trade.

Capital Capsules: Defense Secretary Melvin Laird, in his "posture" statement to Congress, reveals that **the Defense Dept. telecommunications operation involves about \$5.6-billion in capital investment and \$2.6-billion in annual appropriations. . . .** The FAA is expected to issue in the next month or so an industry RFP for **something new in the way of bomb and weapon detectors.** It will ask for brand new ideas, not just improvements on magnetometers, X-rays, sniffers and dogs. . . . The long-haired, bicycle riding FCC Commissioner, Nicholas Johnson, is not expecting his term to be renewed when it runs out next year and is making noises like he wants to be a **U.S. Senate candidate from his home state of Iowa.** Throughout his term Johnson has been an outspoken foe of the Establishment. . . . Rohr Industries has received a \$5-million contract from the Dept. of Transportation to **build a 60-passenger tracked air cushion vehicle.** The vehicle would operate on an air cushion over a concrete guideway at speeds up to 150 mph. It would be powered by a linear-induction motor. Delivery is scheduled for early next year, with tests to be conducted at the Dept. of Transportation facility near Pueblo, Colo. . . . Control Data Corp. is now in process of installing a **computerized electronic voting system in the House of Representatives.** The \$950,000 system will store voting records, as well as statistical data, to help Congressmen make decisions on complex measures. The system has been under study for five years.

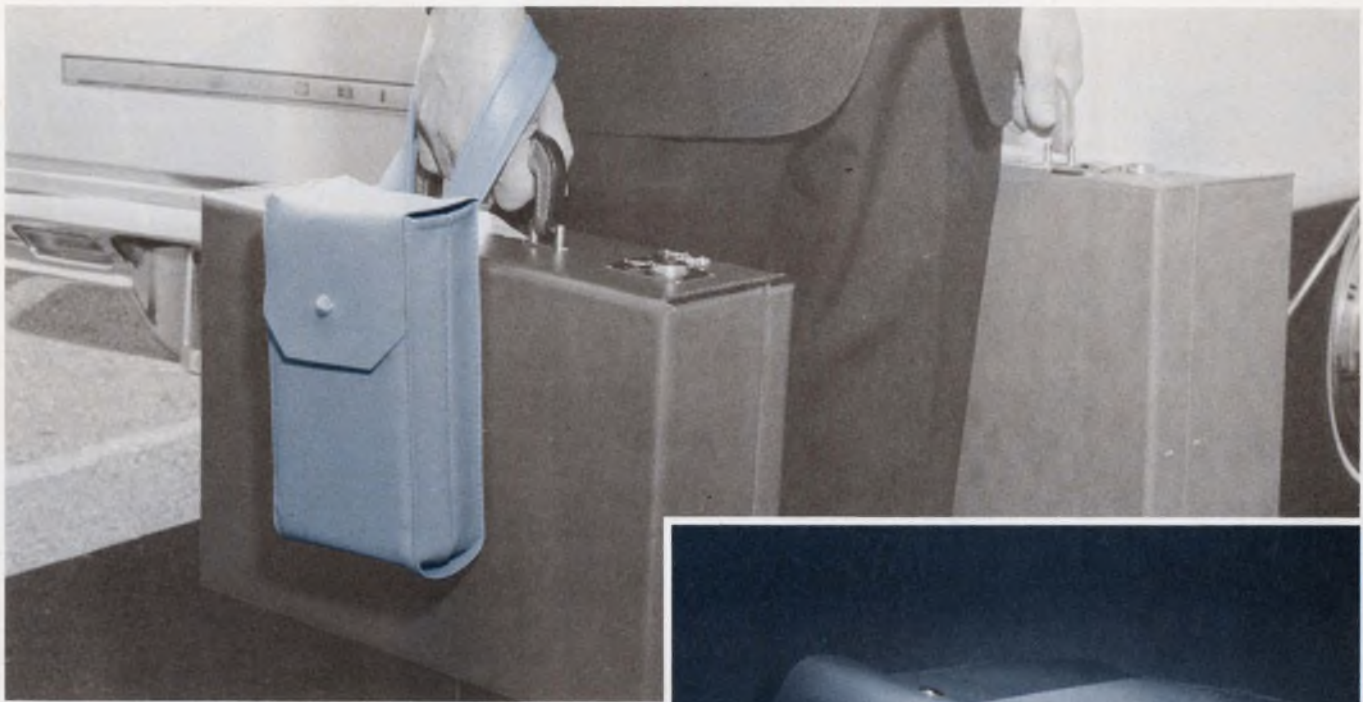

***See how easy
it is to carry
a suitcase,
a tool kit ...***

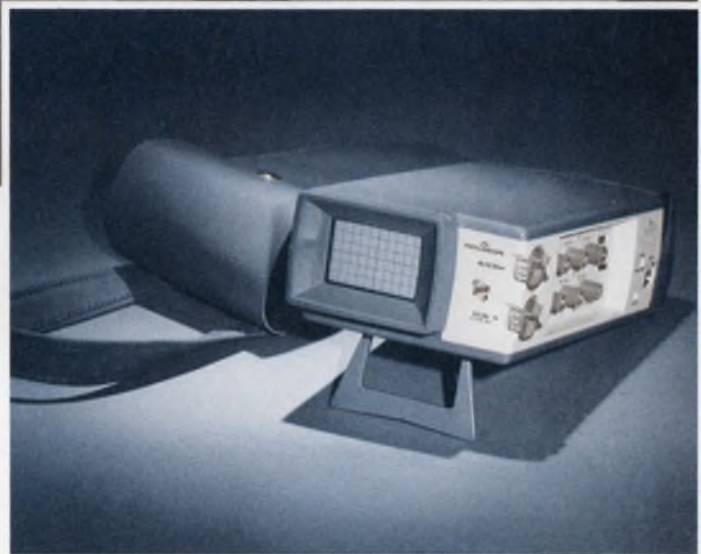

... and a scope!

Now there's a 3-pound scope that can be carried in your tool kit, suitcase, briefcase, glove compartment . . . almost anywhere.

It's the **211**, our first laboratory-quality miniscope. Size is only 3 x 5¼ x 9 inches. Bandwidth is 500 kHz. A lot of scope in a small package.

The **211** is easy to use. You spend your time solving measurement problems, not studying scope operation. Deflection factors from 1 mV/div and sweep rates from 5 μ s/div are read out from controls easily related directly to the CRT. One rotary control does all the triggering.

Ever wanted to float a scope? Here's one that floats to 500 volts RMS when operated from its internal batteries.

How many times have you misplaced a probe or power cord? There's no chance of that with the **211**. The probe and cord are attached and stored in a convenient, recessed area of the case. When you arrive on the job, both are right there, where you can find them.

And the **211** is built to take rugged trips. The double insulated high-impact plastic case takes tool kit knocks and bangs. Knobs are recessed for added protection. It's packaged in a real survival kit.

Need battery operation? The **211** operates from internal rechargeable batteries for up to 5 hours, and from AC.

Price? It's lower than many other 500-kHz scopes. Only \$545, FOB Beaverton, Oregon.

For a demo, just contact your local TEKTRONIX Field Engineer. He probably has a **211** in his briefcase. Ask him for complete information or write Tektronix, Inc., P.O. Box 500, Beaverton, Oregon 97005.



INFORMATION RETRIEVAL NUMBER 30

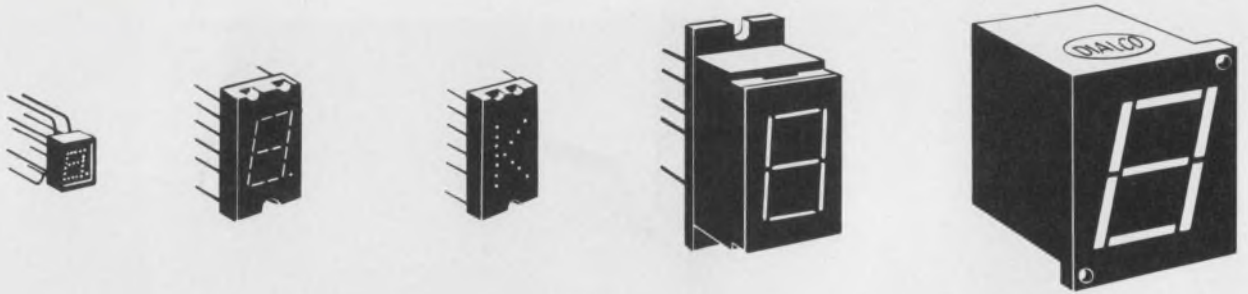

Readout modules in character heights from .125" to 1"

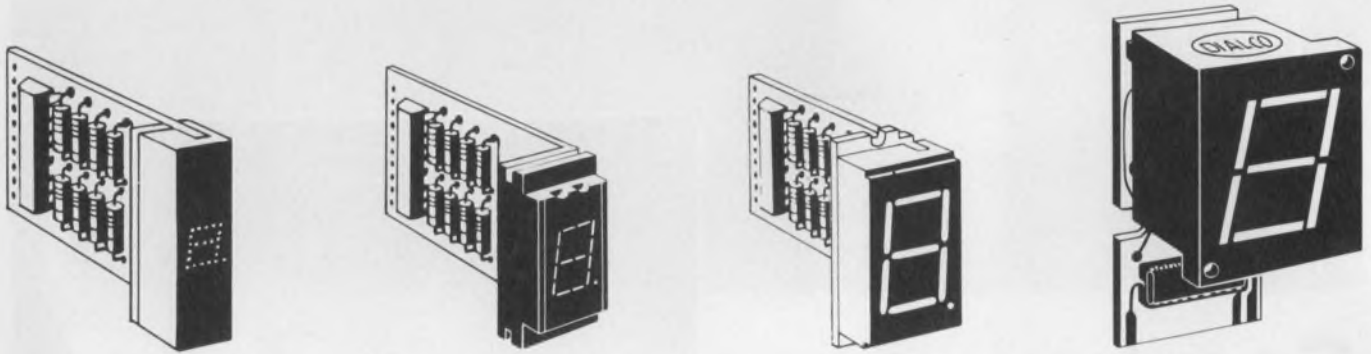

Readout packages (modules with decoder/drivers)

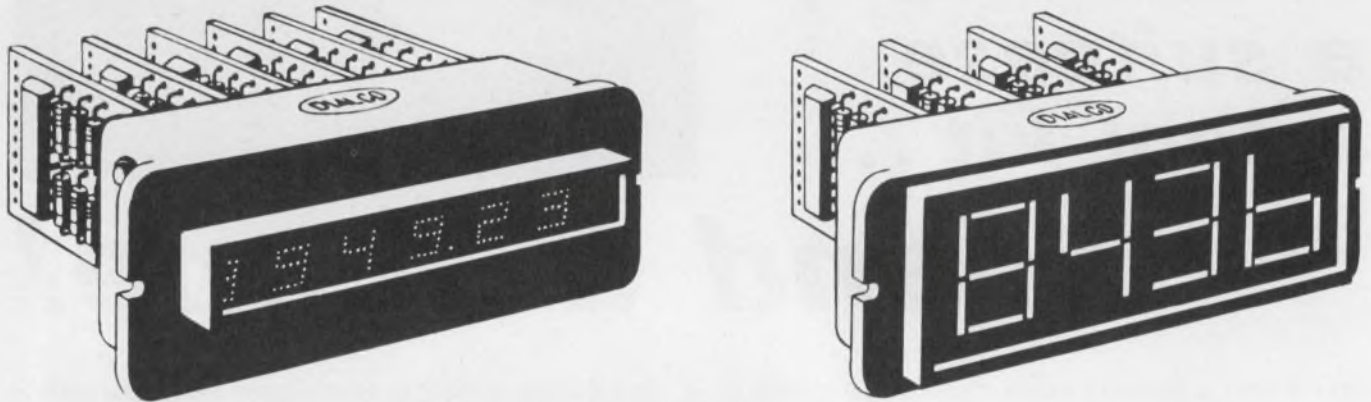

Complete readout assemblies (1-10 packages in bezel for instant mounting)

Readouts? Talk to the specialists at Dialight first. You won't have to talk to anyone else.

For one thing, Dialight offers you a wider range of sizes than anyone else—character heights from .125" to 1". Only Dialight can give you LED, incandescent or neon light sources. Important, too, Dialight gives you complete design flexibility—you can buy a digital module or that module packaged with a decoder/driver

or a complete assembly of packages ready to mount. And the cost per digit may well be less than you'd pay for the decoder/driver alone. Finally, you get Dialight's expertise in visual indicators. That doesn't cost you anything. Neither does the readout data we'll send you upon request. Write for it today!



DIALIGHT CORPORATION, A NORTH AMERICAN PHILIPS COMPANY • 60 STEWART AVENUE, BROOKLYN, N. Y. 11237 • (212) 497-7600
INFORMATION RETRIEVAL NUMBER 31

Kurz-Kasch Digital Logic Instruments*



... complete logic systems analysis through the Logic-Probe concept

Rugged, all solid-state, Kurz-Kasch logic probes are designed for fast, accurate testing of logic levels in all types of integrated circuit systems. A simple readout system indicates "true", "zero", or "pulse" readings precisely through color-coded visual electronic readouts in the probe tip. Absence of logic levels is indicated by all readouts remaining OFF.

Applications Logic levels can be accurately tested in virtually any (DTL, TTL, RTL) IC system including desk calculators, business machines, N/C devices, computers or telephone systems. Power is derived from the unit under test allowing use in the field or in the lab.

| | |
|-------------------------------|--|
| Specifications | High input impedance prevents loading of circuit under test. |
| Readout Light Red=Logic "1" | Size 5/16" dia., 6" long, 26 3/4" leads with pin terminals |
| Readout Light White=Logic "0" | |
| No Readout Light="infinity" | |

A pulse detection feature is available on most models of logic probe. A third readout is provided to display high speed pulse trains or a single cycle pulse of less than 50 nanoseconds on the standard Model LP-520. Overload protection to +50, -20 volts DC is also available.

Standard Probes Logic probes are presently available in five standard models. MODEL LP-500 for use in testing 4.75-5.0 V DC logic systems. MODEL LP-510 for testing 4.75-5.0 V DC systems . . . includes overload protection to +50, -20 V DC. MODEL LP-520 . . . for 4.75-5.0 V DC logic systems . . . includes overload protection and pulse detection features. MODEL LP-530 for testing of 12-15 V DC logic systems . . . includes overload protection to +50, -20 V DC. MODEL LP-540 . . . for 12-15 V DC systems . . . includes overload protection and pulse detection features.

Add these options: G-S-M: Gating Feature (-G)— 3 Channel input for timing. Pulse indicator displays only when probe tip and gate/gates are in coincidence. **Memory & Stretch (-M)**— Push-pull switch for selecting stretch or latch mode. Stretch mode detects high speed pulse and displays blue "P" lamp for 200 mS. Latch mode captures high speed pulse/trains and latches blue "P" on until reset. **5 Nano-second capability (-S)**— Allows detection of pulses up to 10 x faster than standard probes. Each option \$10.00.

Special Probes As a routine service, Kurz-Kasch will custom design logic probes to user specifications. Custom designs can include: both positive and negative logic levels from 50 to 30 volts . . . special pulse detection characteristics . . . floating or grounded cases . . . custom power supply requirements . . . power lead reversal protection . . . and your choice of logic crossover parameters.

Kurz-Kasch logic probes provide all the information you need to quickly and accurately evaluate all logic systems . . . and they are the most economical logic testing instruments available. Standard Models range in price from \$39.95 to \$69.95. Write today for complete details on all standard and special logic probes.

*Patent #3,525,939 applies, others pending.



Kurz-Kasch, Inc.

Electronics Division
1421 S. Broadway
Dayton, Ohio 45401
Telephone(513)223-8161

INFORMATION RETRIEVAL NUMBER 32

CTS *has the answer in*

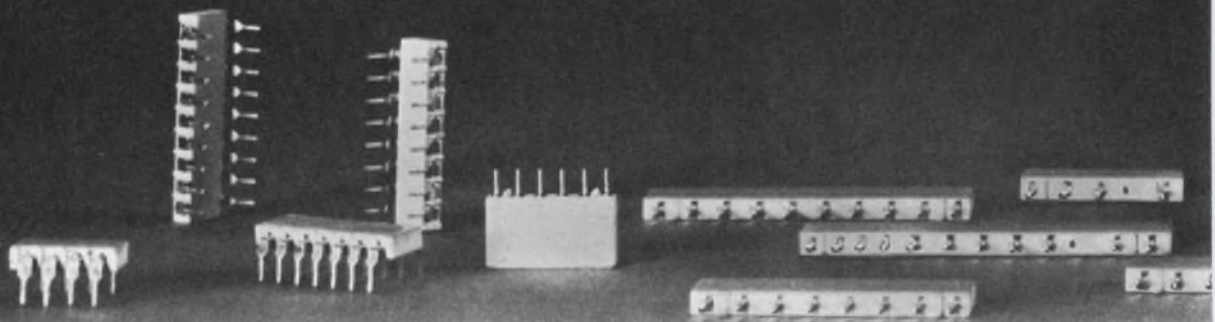

You name it—we have the exact cermet resistor network size and characteristics you need. Here's the choice you get right now: our 750 line includes: .100" centers with 4, 6 & 8 pins; .125" centers with 2, 4, 6 & 8 pins; and .150" centers with 4 through 13 pins. And we're working on new designs right now!

All compact, extremely stable and highly reliable. Recently we packed even more circuitry into our 760 series, giving you a choice of four popular space-saver packages: 8, 14, 16 and 18 flat lead styles. Packed with up to 17 resistors per module with flat leads standard (round leads on request).

cermet resistor networks. So ask us!

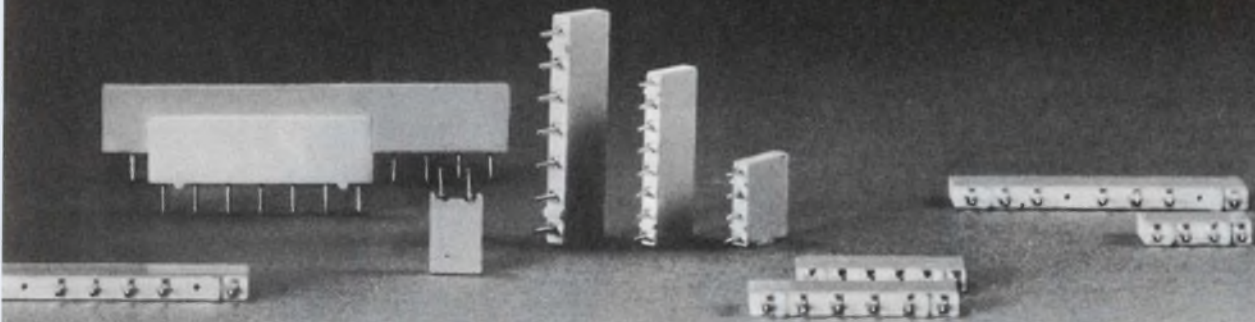

Our broad line provides an infinite number of circuit combinations, all with excellent TC, load and temperature characteristics supported by millions of hours of reliability testing. Ask your CTS sales engineer for data. Or write CTS of Berne, Inc., Berne, Indiana 46711. Phone (219) 589-3111.



ACTUAL SIZE



CTS CORPORATION *Elkhart, Indiana*

A world leader in cermet and variable resistor technology.

FLOW SOLDER PROBLEM?

YOU NEED THE

Double Plus

PC BOARD CONNECTOR WITH "BELLOWFORM" CONTACTS*

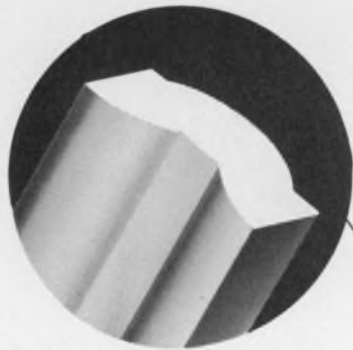

Plus One

SECTION THROUGH
CONTACT TERMINATION
DEVELOPED
ESPECIALLY FOR FLOW
SOLDER APPLICATIONS.
(ENLARGED APPROX. 40X)

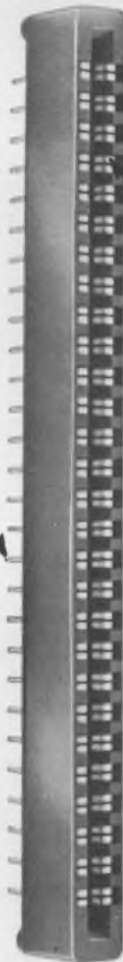

ACTUAL SIZE

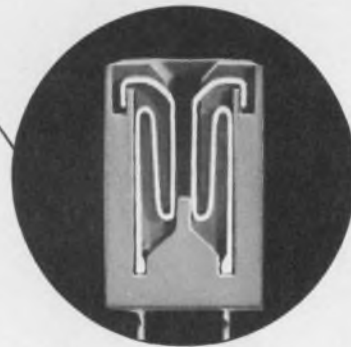

Plus Two*

CROSS-SECTION SHOWS
CONTINENTAL'S
"BELLOWFORM" FULL SURFACE
CONTACT ON
PRINTED CIRCUIT BOARD.
PAT. NO. 2,875,425

Series 6156 printed circuit connectors are available with 36, 44, 56, 64, or 72 contact sizes on .156" x 200" centers, and for 1/16" board. Write for free data sheet and assistance with your special requirements.



See EEM and VSMF Directories for Distributor or Sales Representative Nearest You

CONTINENTAL CONNECTORS

Continental Connector Corporation / Woodside, New York 11377 / 212-899-4422

INFORMATION RETRIEVAL NUMBER 34

We designed these instruments for people who count.

Here are three of Monsanto's counter/timers which span a wide spectrum of measurement needs. At top is Model 113A with a frequency range from DC to 80 MHz, 8 operating modes and Monsanto LED display. Price: \$895 with 5 digits; with 7 digits, \$995.

Model 110B (center) is a DC-150 MHz workhorse. Its companion, Model 120A, with 512 MHz capability, is a racehorse. Both are thoroughbreds with such features as TTL compatible

BCD output and programmability. Model 120A, in addition, gives you time-base autoranging, "Burst Mode" for radar and telemetry applications, plus a Monsanto solid state display.

Price of the 150 MHz Model 110B with 8 digits, \$1435; of the 512 MHz 120A, \$1795. And these—all—Monsanto instruments carry a 2-year guarantee. Ask for data. United Systems Corp., a subsidiary of Monsanto Co., 918 Woodley Road, Dayton, Ohio 45403.

All Monsanto instruments are available for rental or lease through Rental Electronics, Inc.



Monsanto

INFORMATION RETRIEVAL NUMBER 35

Before you start designing your next minicomputer, phototypesetter, automatic test equipment, numerical control or other system, give us a ring. If a genius answers, hang on.

We've got a shopful of the brightest heads in the peripheral equipment business. Who, at a moment's notice, will tackle your design problems. They'll show you how to save time, money and effort by designing a piece of our equipment into your next job.

It could be a digital magnetic tape cassette system that will cut

down errors to less than 1 in 100,000,000 bits (computer verified). And you've got the broadest modular line in the industry to pick from.

Or it could be one of the many compact perforator/reader combinations with 75 cps punching and 300 cps reading capability for the price of some perforators alone.

Or select from a wide range of tape readers or reader/spooler combinations that have made us number one in this field.

Whatever you need, we've got what it takes to make it work. That's

how we've built our reputation as a peripheral innovator over the past decade. Our price/performance has helped, too.

Just give us a ring (714) 557-6860. Remex, 1733 Alton St., Santa Ana, California 92705. In Europe and the U.K., contact S.p.A. Microtecnica, Torino, Italy.

REMEX

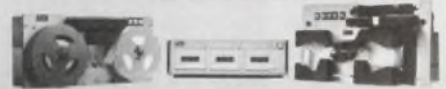

If a genius answers, hang on.



A UNIT OF
XLO
EX-CELL-O CORPORATION

**Unbeatable
portability
and range
coverage!**



the
new *Simpson* **460** DIGITAL
VOM



- Completely portable . . . no separate battery pack or power supply needed. Self-contained battery or line operation.
- Non-blinking 3½-digit display of 26 most used ranges . . . 5 each AC/DC voltages and AC/DC currents . . . 6 resistances . . . with "plus" and "minus" and overrange . . . analog meter readout . . . analog to digital converter uses the dual slope technique.
- A compact, lightweight, multi-use Digital VOM for lab, in-field or general testing only \$395.00 (less batteries)

NOW IN STOCK AT YOUR LOCAL ELECTRONICS DISTRIBUTOR • WRITE FOR BULLETIN T-811



SIMPSON ELECTRIC COMPANY

GENERAL OFFICES AND EXPORT:

5200 West Kinzie Street, Chicago, Illinois 60644 • (312) 379-1121 • CABLE: SIMELCO

IN CANADA: Bach-Simpson, Ltd., London, Ontario

IN INDIA: Ruttonsha-Simpson Private, Ltd., International House, Bombay-Agra Road, Vikhroli, Bombay

INFORMATION RETRIEVAL NUMBER 37



A CAMBION® Double "QQ" Product Line

Coils with high "Q" values have always been available from CAMBION. You've probably come to expect them as a matter of course.

What you may not have known, is that they are available, off-the-shelf, in substantial quantities, with identical performance characteristics to the prototype units you may have purchased for design development. Making quality coils available in quantity is the CAMBION Double "Q" approach.

You can be choosy, too. Large families with overlapping inductance ranges or EIA nominal values can satisfy your individual circuit needs. Shielded or unshielded units for chassis or printed circuit mounting. Variable inductances,

fixed chokes, L-C filters, balun transformers, toroids, micro-miniature types as small as .075" x .170" (1/10th the size of a TO-5 transistor). All come with fully guaranteed ratings.

We've got a catalog full of 'em. It's yours for the asking. And if, by chance, you can't find just the right one, we'll custom design one for you and guarantee to deliver additional identical units **in quantity**. That's just one more way CAMBION shows that the quality stands up as the quantity goes on. Cambridge Thermionic Corporation, 445 Concord Avenue, Cambridge, Massachusetts 02138. Phone: 617-491-5400. In Los Angeles: 8703 La Tijera Boulevard. Phone: 213-776-0472.

At Cambion, coils have a Double "QQ"



If you need
more accuracy
 and **resolution**
 than a
 2½-digit
 V-O-M, but
 don't want to
 pay the price
 of 3½-digits...

Buy **Triplett's**
 new **6028**

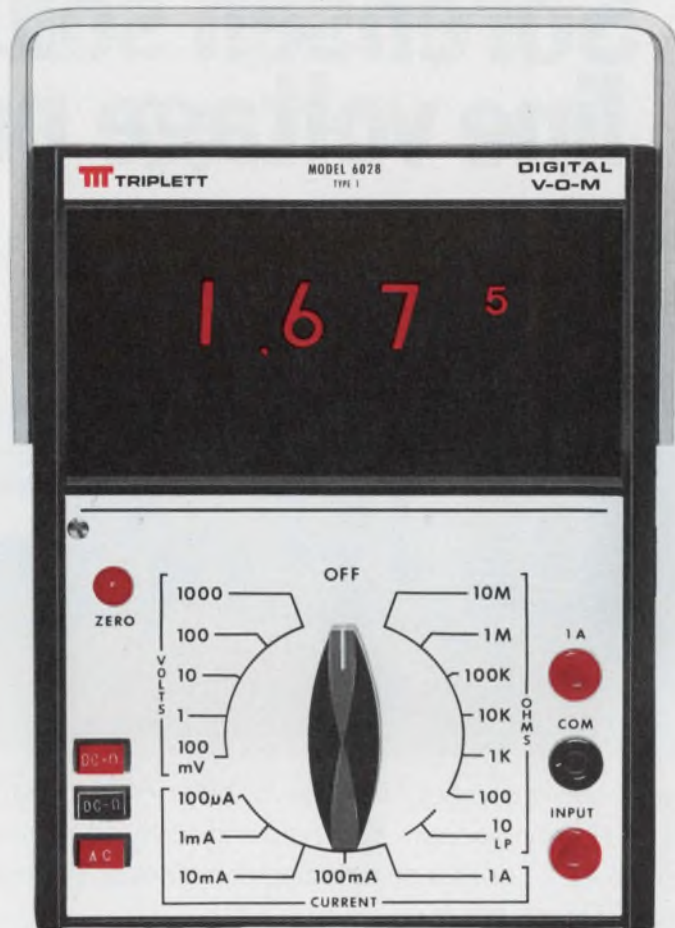

Model
6028
\$275

1. 2¾ DIGITS—Provides high accuracy with resolution to 500 Microvolts.
2. 10 OHMS TO 10 MEGOHMS — 7 Ohms ranges with zero adjust to null lead resistance.
3. LOW CIRCUIT LOADING — Greater measurement accuracy with 10 megohm input resistance for all AC and DC voltage ranges.

Its exclusive 2¾ digit readout lets you read to the nearest "0" or "5" one decimal place beyond the capability of 2½ digit instruments. And at accuracies of $\pm 0.35\%$ of reading $\pm \frac{1}{2}$ digit on DC voltage ($\pm 0.50\%$ of reading $\pm \frac{1}{2}$ digit, DC current), AC voltage $\pm 0.50\%$ (current 1.0%) of reading $\pm \frac{1}{2}$ digit, and resistance to $\pm 0.5\%$ of reading $\pm \frac{1}{2}$ digit. It also offers (among its 27 ranges) a 10

Ohm range and a front-panel zero adjust to zero out the test-lead resistance. Add to those advantages 100% overrange capability, positive out-of-range and reverse polarity indication, and the familiar single range-switch feature of Triplett's famous analog V-O-M'S... so that no retraining is necessary to switch to digital accuracy and readability... and you have just a few of the many reasons for

buying Triplett's new Model 6028 Digital V-O-M.

Designed for R&D, production, quality control, maintenance and classroom use, the **Model 6028** is priced at **\$275**. See it at your local Triplett distributor or, for more information or for a free demonstration of all of its great features, call him or your Triplett representative. Triplett Corporation, Bluffton, Ohio 45817.

TRIPLETT

The World's most complete line of V-O-M's
 choose the one that's just right for you

INFORMATION RETRIEVAL NUMBER 39

Sorensen solutions to line voltage problems.



Whether you have brownout, line noise, or other AC problems, Sorensen has the solutions... ACR regulators and FR conditioners. Both help end costly equipment downtime, or even catastrophic failure. □ The ACR Series is an amazing combination of price, power, performance, packaging, and ruggedness. Eight models cover the field. With 0.5 to 15 kVA, remote sensing and programming, and full load efficiency to 95%. □ FR's are something else.

Fast! Response and impulse settling time: 50 microseconds or less. 100 decibels of common mode rejection. Harmonic distortion of 0.2%. Regulation to 0.05%. Peak amplitude instability of less than 0.01%. 2.5 crest factor. With FR, you get just what you want — pure AC power. □ Sorensen offers more. Solid state circuitry, conservative thermal design, compact packaging. See the table below. For more complete data, write Sorensen Power Supplies, Raytheon Company, 676 Island Pond Road, Manchester, N.H. 03103. Telephone (603) 668-1600.

| ACR Series | | | | | | | |
|------------|-----------------------------------|-------|---------------|-----------|--------------------|--------|--------|
| Model | Output | | Input | | Voltage Regulation | | Price* |
| | Voltage (Vac) (Settable Range) | VA | Voltage (Vac) | Freq (Hz) | Line | Load | |
| ACR500 | | 500 | | | ±0.1% | ±0.1% | \$ 380 |
| ACR1000 | | 1000 | | | ±0.1% | ±0.1% | \$ 450 |
| ACR2000 | | 2000 | | | ±0.1% | ±0.1% | \$ 575 |
| ACR3000 | 110 | 3000 | 95 | 47-53 | ±0.1% | ±0.1% | \$ 700 |
| ACR5000 | to | 5000 | to | or | ±0.15% | ±0.15% | \$ 850 |
| ACR7500 | 120 | 7500 | 130 | 57-63 | ±0.15% | ±0.15% | \$1025 |
| ACR10000 | | 10000 | | | ±0.15% | ±0.15% | \$1450 |
| ACR15000 | | 15000 | | | ±0.15% | ±0.15% | \$1775 |

| FR Series | | | | | | |
|-----------|----------------|------|--------------------------------------|-----------|---------------------|--------|
| Model | Output | | Input | | Combined Regulation | Price* |
| | Voltage (Vac) | VA | Voltage (Vac) (Switch Selectable) | Freq (Hz) | | |
| FR516A ** | 115 | 500 | 95-115/105-125/115-135 | 59-61 | ±0.05% | \$ 925 |
| FR1016A | 115 | 1000 | 95-115/105-125/115-135 | 57-63 | ±0.05% | \$1500 |
| FR1015A | 115 | 1000 | 95-115/105-125/115-135 | 47-53 | ±0.05% | \$1500 |
| FR1026A | 230 (115 opt.) | 1000 | 190-230/210-250/230-270 | 57-63 | ±0.05% | \$1650 |
| FR1025A | 230 (115 opt.) | 1000 | 190-230/210-250/230-270 | 47-53 | ±0.05% | \$1650 |
| FR2516A | 115 | 2500 | 95-115/105-125/115-135 | 57-63 | ±0.05% | \$3425 |
| FR2515A | 115 | 2500 | 95-115/105-125/115-135 | 47-53 | ±0.05% | \$3425 |
| FR2526A | 230 (115 opt.) | 2500 | 190-230/210-250/230-270 | 57-63 | ±0.05% | \$3650 |
| FR2525A | 230 (115 opt.) | 2500 | 190-230/210-250/230-270 | 47-53 | ±0.05% | \$3650 |
| FR5016A | 115 | 5000 | 95-115/105-125/115-135 | 57-63 | ±0.05% | \$6800 |
| FR5015A | 115 | 5000 | 95-115/105-125/115-135 | 47-53 | ±0.05% | \$6800 |

**No CM Rejection

*USA List

Sorensen
POWER SUPPLIES

World's longest monolithic shift register

Now Intel introduces a dual 1024-bit shift register on one MOS chip, with a single 1024-bit alternative for those who can't use all the capacity.

Both shift registers are fully specified under worst case operating conditions from 0° to 70°C and over power supply variations of $\pm 5\%$. Speed is guaranteed to 1 MHz with a 100 pF load. Power dissipation averages only 120 μ W per bit at top speed.

Low clock capacitance of 7 pF eliminates need for clock drivers. And to eliminate other external circuitry, write/recirculate controls and chip-select logic have been incorporated on the chip.

Runs on one +5v supply

This N-channel MOS shift register accepts standard TTL inputs, generates standard TTL outputs, runs on a TTL clock, and operates on one TTL power supply, +5v $\pm 5\%$. You don't need level shifters, clock drivers, pull-up resistors, or any other interfacing circuitry.

The key to this unprecedented compatibility is Intel's N-channel silicon-gate process, a process that combines the interfacing ease of bipolar with the economy of MOS. This shift register is the first of a family of 5-volt N-channel devices that Intel will introduce in 1972.

Price in 100-piece quantities is \$24.00 for the dual 1024-bit Type 2401 and \$11.00 for the single 1024-bit Type 2405.

For immediate delivery phone your local Intel distributor: Cramer Electronics, Hamilton Electro Sales, Industrial Components, or Electronic Marketing. In Europe contact Intel at Avenue Louise 216, B 1050 Bruxelles, Belgium. Phone 492003. In Japan contact Intel Japan, Han-ei 2nd Bldg., No. 1-1, Shinjuku, Shinjuku-ku, Tokyo 160. Phone 03-354-8251.

Intel produces memory systems as well as memory devices at 3065 Bowers Avenue, Santa Clara, Calif. 95051. Phone (408) 246-7501.

intel[®]
delivers.



Clock Us!



Frequency-Response Recordings Up to 3 Times Faster

GR's new 1523 sweep oscillator/recorder can give you accurate frequency-response plots in 1/2 to 1/3 the time you've been accustomed to. And it gives you 1 Hz-to-500 kHz wide-range capability for only \$3800. You can sweep the full range, or selected portions of it, at output levels continuously adjustable from 500 μ V to 5 V behind 600 Ω .

Speed

The 1523 features a "Constant-Q" mode that sweeps slowly at low frequencies and increases the sweep speed automatically as frequency increases. Many devices require slow sweep speed at low frequencies; Constant-Q lets you take advantage of the fact that, as the exciting frequency increases, the sweep speed can be increased without sacrificing measurement accuracy.

Only GR offers Constant-Q to increase sweep speed automatically for accurate answers in minimum time. An example of time savings is a three-decade analysis starting at a rate of 100 seconds/decade. Measurement time is 300 seconds with constant sweep speed but only 115 seconds with the Constant-Q mode.

Stability

The 1523 output frequency is stable within 0.05% stability (short term) over the entire measurement range through use of the frequency-synthesizer technique. With this method of signal generation, stability is always a constant percentage of output frequency, a considerable improvement over the older beat-frequency-oscillator technique.

Recorder Reliability

A stepper motor drives the chart (no gears or clutches to fail or jam) and the disposable cartridge pens deliver easy-to-read, skip-free traces at all writing speeds.

And for \$400 more . . . Our 1523-P1 Preamplifier plug-in converts the instrument to a 1 Hz-to-500 kHz high-performance level recorder with 100- μ V sensitivity and chart speeds from 20 hours/inch to 0.5 second/inch. The -P1 plug-in module includes a continuously adjustable 0-to-70 dB attenuator for maximum resolution.

Write or Call Today

Do it now! Request complete specifications on GR's 1523 sweep oscillator/recorder from your nearest GR office or from GR at 300 Baker Avenue, Concord, Mass. 01742; in Europe write Postfach 124, CH 8034, Zurich, Switzerland.

Prices net, FOB Concord, Mass.

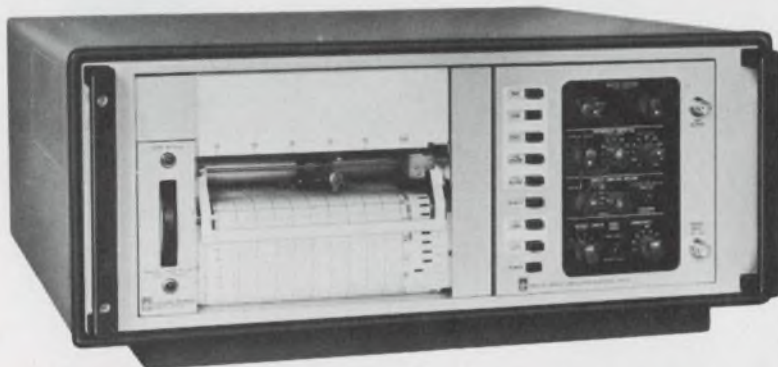

General Radio

NEW YORK (N.Y.) 212 984-2722 (N.J.) 201 791-8990 • BOSTON 617 646-0550
CHICAGO 312 952-0800 • WASHINGTON, D.C. 301 881-5333
LOS ANGELES 714 540-9830
TORONTO 416 252-3395 • ZURICH (01) 55 24 20
GRASON-STADLER 617 369-3787 • TIME/DATA 415 327-8322

We took everything they could throw at us

and came back for more.



We've written enough of the "book" on shielding to know there's no substitute for experience when solving tough EMI problems. That's why it took us practically twenty years to build our comprehensive line of shielding products... one solution at a time.

Perfection Mica offers bulk shielding materials for high or low density fields that are stress annealed for ease in punching, forming, spinning or drawing. These same quality materials are used in our line of portable or cabinet style mag-

netic tape preservers that prevent the degradation of vital taped information.

On the specialty side, there's our multi-cellular magnetic shield that permits sensitive instruments to operate in extreme magnetic field environments, or unique inter-8 weave cable for applications where either radiation or magnetic interference is a problem. We can furnish rooms that have lower spectrum magnetic shielding capability.

The tougher the shielding problem, the better we like it. Throw it at Perfection Mica.



PERFECTION MICA COMPANY / Magnetic Shield Division

740 Thomas Drive □ Bensenville, Illinois 60106 □ (312) 766-7800 □ TWX (910) 341-7277

The Heavy-Duty DMM

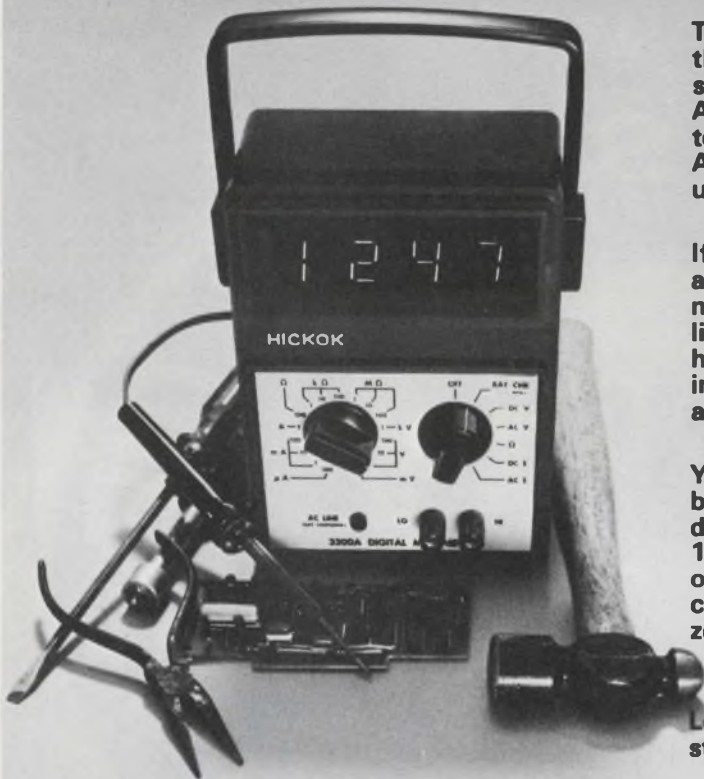

Take a look at the digital multimeter you can really knock around—and still get 0.1% accuracy for a year. The Hickok 3300A in its tough Cycalac case and with its shock-mounted circuits has enough built-in versatility to take the place of a stack of instruments.

The 3300A measures:

- DC/AC voltage from 100 microvolts to 1.5 kilovolts;
- DC/AC current from 100 nanoamperes to 2 amperes;
- resistance from 100 milliohms to 200 megohms.

To add to your value, the rugged 3300A is truly portable at no extra cost. It operates continuously for 24 hours off its internal rechargeable battery—no other DMM can hold a candle to that performance. You can make measurements while recharging the battery. And the battery's good for 1000 recharges.

This versatility is standard; you get it all in the \$435 price. If you add options and accessories, then the 3300A goes to 30 kilovolts AC/DC. It has a clamp-on current probe good to 100 amperes, DC as well as AC. With an Adapter, the Multimeter becomes a counter up to 20 MHz.

If you want a sweet multimeter, take a look at the Hickok 3301. It has the same measurement capabilities as the portable 3300A in a line-operated bench-top configuration. And it has a sweet price—\$385. Options for the 3301 include a BCD output or an internal rechargeable battery.

You'll like the other features standard with both Hickok models: automatic polarity and decimal point position, out-of-range indication, 1500 volts off ground operation, outstanding overload protection, easy operation with color-coded front panels, and continuous automatic zeroing.

Look for yourself. Call Hickok for a demonstration or complete specifications.



HICKOK

the value innovator

Instrumentation and Controls Division
10514 Dupont Avenue • Cleveland, Ohio 44108
(216) 541-8060

HICKOK

75 MFD/30 VOLT DC CAPACITORS

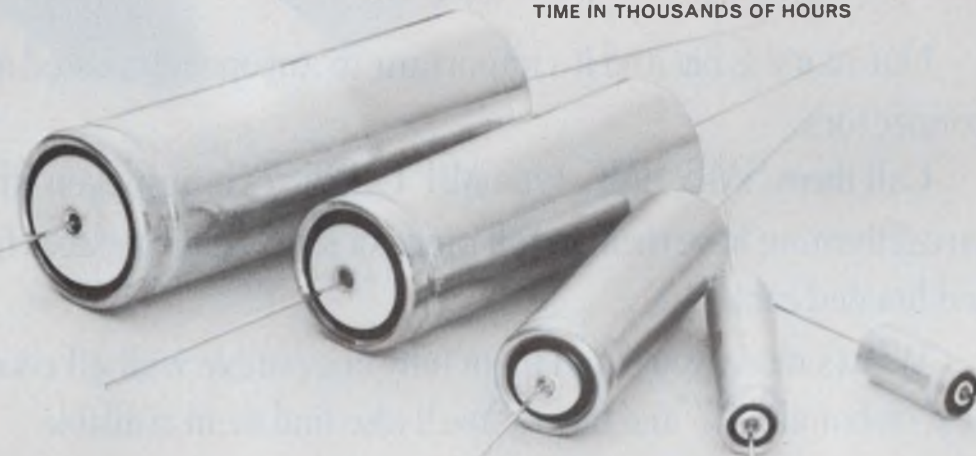
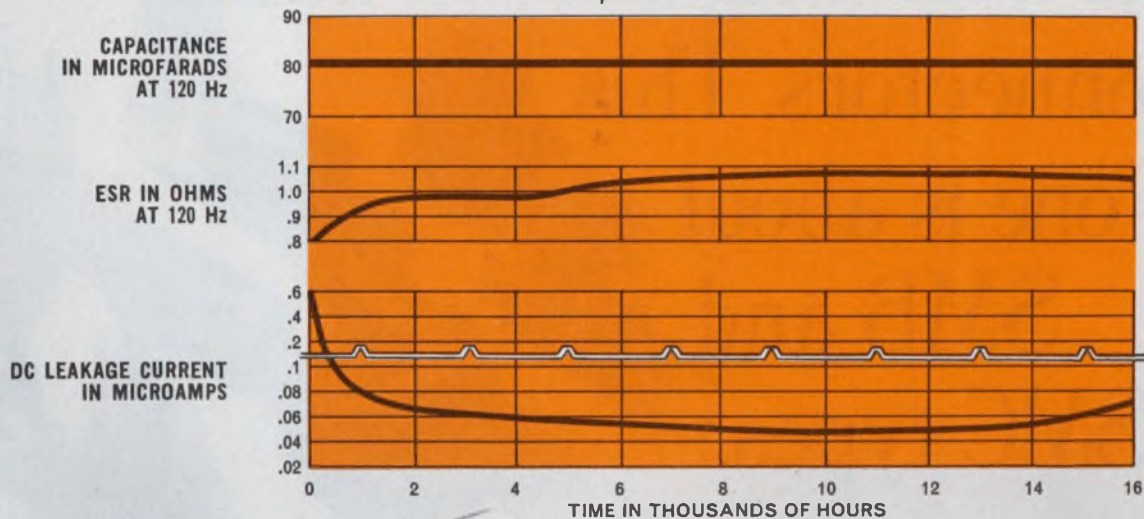

Our new TCG capacitor has curves you can't resist.

The curves tell at a glance the typical life story of one of our new TCG aluminum electrolytic capacitors. But there's more to a TCG than life curves. There are 45 case sizes, with safety vent protection where required; capacitances from 2 to 22,000 mfd; voltages from 3 to 450 VDC; and a -40 to $+85^{\circ}\text{C}$ temperature range.

Add to these a high C/V in a small package. Plus outstanding electrical and physical characteristics. And you've got our new TCG. Find out more by writing for Bulletin 4-307. Eighteen pages of data . . . and some curves that will open your eyes. Popular ratings available from authorized Mallory distributors.

MALLORY

MALLORY CAPACITOR COMPANY
 a division of P. R. MALLORY & CO. INC.
 Box 372, Indianapolis, Indiana 46206; Telephone: 317-636-5353

Electrical and electronic components • sequence timers • metallurgical products • batteries

INFORMATION RETRIEVAL NUMBER 45

We have a big story on little connectors. This one is about SMB and SMC types.

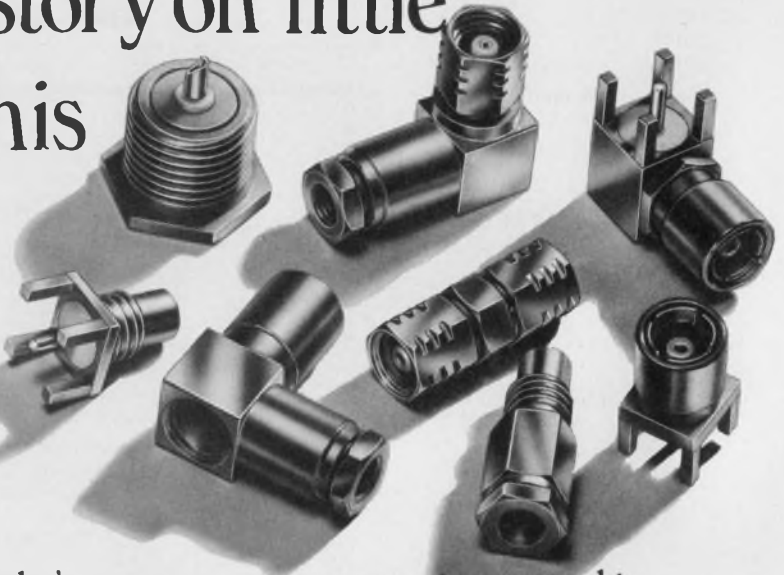

Our story is big and it's important to anyone interested in miniature connectors.

Call them SMB, SMC, type MIL C 22557's or just plain RF type, whatever you call them, we have them, in full range of sizes and interfaces for both semi-rigid and braided cable.

What's more, you'll find them fully compatible with all competitive types; Conhex*, Subminax-27* and others. You'll also find them available from in-depth inventories in Boston, North Haven, New York, Philadelphia, Washington, Orlando, Chicago, Dallas, Los Angeles and San Francisco.

And, don't forget our special edge. We give you the choice of conventional crimp type or proprietary Emlock® compression type connectors.

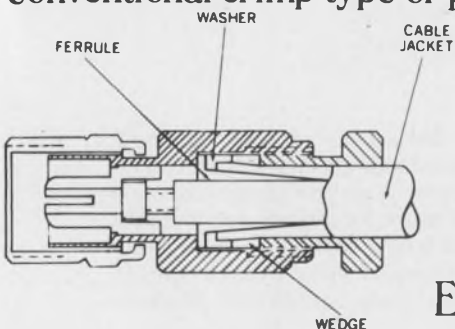

This Emlock® cable grip of ours is all metal and offers the advantages of compression back ends with assembly time equal to crimp. As a clincher, it's impossible to pull the cable out of an Emlock® connector. Disengagement will be caused only by failure of the braid, not pull-out of the compression.

Interesting? Let us tell you more. Write: Miniature Connectors, Phelps Dodge Communications Company, 60 Dodge Avenue, North Haven, Connecticut 06473.

*Trademark of others

**phelps
dodge**
Communications Company

INFORMATION RETRIEVAL NUMBER 46

The second edition of our microprogramming handbook is more revealing than the first

The original edition made many microprogramming concepts public for the first time. Now we have an expanded 450-page version with information on the Micro 1600, the mini that makes microprogramming irresistible. Our new paperback covers microprogramming from the most elementary stages all the way up to descriptions of complex computer architecture and special purpose applications.

Everything you need to know is there. Tutorial primer. Glossary of computer technology. Application information. Computer users' reference material. Complete details on hardware, software, and firmware for the Micro 800 and Micro 1600. Even if you already have the first edition, you'll value the second. Send for a copy today. It's free.



™ Trademark Microdata Corporation

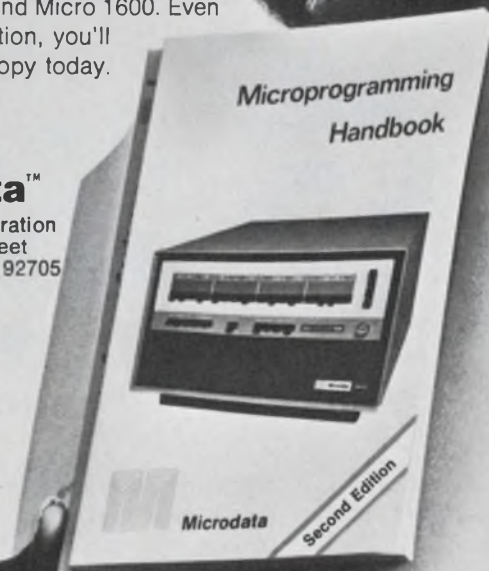

Gentlemen:
Send me a
free copy of
the 450-page
Microdata Micropro-
gramming Handbook.

NAME _____

TITLE _____

COMPANY _____

ADDRESS _____

CITY _____

STATE _____ ZIP _____

PHONE _____

announcing an FM-AM generator with direct digital readout

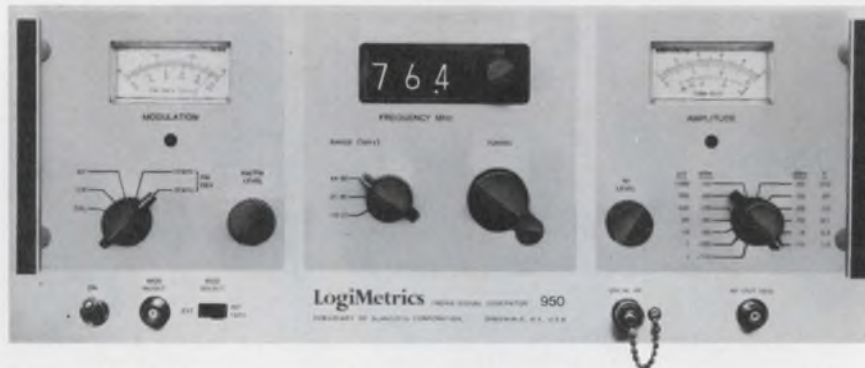

But that's not all.

LogiMetrics Model 950 represents a significant improvement over present FM generators in both ease of operation and performance.

The Model 950 — a solid state/IC design — provides directly calibrated frequency modulation with a full 1-volt output leveled to within ± 0.5 db. It has exceptional stability and reliability, low incidental FM and AM, and good spectral purity.

The 950 is ideal for aligning, calibrating, and testing narrow-band fixed and mobile FM receivers and transceivers. It is also perfect for alignment and measurement of limiters, ratio detectors/discriminators, signal-to-noise ratios, and for many other critical FM-AM applications.

The 950 has a clean, uncluttered front panel with controls functionally grouped to simplify equipment operation. FM deviation can be accurately set with a calibrated meter, and once set, it remains constant with frequency.

Frequency accuracy to $\pm 0.0012\%$ is provided by a patented built-in electronic frequency counter with a 3-digit "Nixie" display and X100 expander switch that enables increased resolution of a 5-digit display.

All internal circuit modules are individually shielded to virtually eliminate RFI, thereby enabling the 950 to be used at all signal levels without any interaction.

Without a doubt, the Model 950 is the easiest-to-use FM-AM generator available today. And in its frequency range (10 to 80 MHz), its performance is unmatched. For a fact-proving demo in the U.S.A. call collect: George Arzt, (516) 484-2222. Elsewhere: Telex 96-1371.

For more information, call or write for catalog data describing LogiMetrics Model 950. Or use the reader service card number.

The 950 FM-AM Signal Generator by **LogiMetrics** INC.

100 Forest Drive, Greenvale, New York 11548 ■ Phone: (516) 484-2222

See Logimetrics at Booth 2645 at IEEE

INFORMATION RETRIEVAL NUMBER 48



When was the last time you created something?

We live in an age of specialization. Job functions are defined, categorized, compartmentalized and automated. Which is great when machines are the workers. But is it the best way to get creativity from an engineer? American corporations that appear to operate on this theory might ponder the case of the fledgling Israeli electronics industry.

Like many small nations, Israel has limited natural resources. Unlike most countries of comparable size, she is determined to create a sophisticated electronics industry—fast and practically from scratch. She has one big thing going for her: brainpower. Can she make it? Not with conventional, specialized engineering techniques.

Israeli electronics companies know that if their industry is to take a great leap forward, they must encourage engineers to create. And creativity recognizes few boundaries.

In most respects, the Israeli engineer is like his American counterpart (see "Profile of the Israeli Engineer," ED 4, Feb. 17, 1972, p. 67). He is well-educated, tends to favor the pragmatic approach, keeps up with the latest technology and is proud of his profession and achievements. But he has something else, too. He appears to possess qualities of resourcefulness, a spirit of independent inquiry, a healthy skepticism and an informality to adapt to changing situations.

These qualities are often stifled in American designers. As a result, their capabilities aren't used to the fullest, and they never reach their full potential. They lack the flexibility to tackle design projects in allied engineering areas. Even their authority on specialized design projects is sometimes not clearly defined.

In Israel, where the designer may be called upon to work above his educational and skill levels, specialization is an engineering luxury. The engineer is assigned a project and left alone to come up with the answer. He adapts. He innovates.

And isn't that what engineering is all about? Innovation?
Or is it in this land of plenty?



Ralph Dobriner

RALPH DOBRINER
Managing Editor

IEEE '72: A leaner show, but a lively one

Today's engineer, more than ever, needs to learn about developments outside of his particular sphere of interest. This proposition is reflected in the theme of the 1972 IEEE International Convention and Exposition in New York City—"New Horizons for Engineering."

Despite optimism implied in the show's theme, all is not well with the annual affair, to be held March 20-23 at the Coliseum and New York Hilton. Only 30,000 visitors are expected to view the 250 exhibitors' booths. This compares with 48,000 visitors and 589 exhibits in 1970.

In an effort to boost the sagging attendance, this year's show has a new Science/Technology Center, which occupies the entire fourth floor of the Coliseum. It has exhibits of research and development projects by such companies as United Aircraft, General Telephone and Electronics, General Electric, Ford Motor Co.,

Grumman Aerospace and Magnavox.

A total of 55 regular technical sessions are being offered at the Hilton. These cover such subjects as trends in logic design, miniaturized filters, micro-programming and minicomputers, and 3D displays. In addition 24 special applications sessions at the Coliseum are zeroing in on everyday problems. The subjects being covered include industrial applications of lasers, the economics of automatic testing, and problems in testing digital modules.

This year the IEEE exhibits are dominated by instrument manufacturers. Particularly evident is a continuing trend to automated test equipment and the growing use of LED readouts in instruments. Major semiconductor manufacturers have dropped out of the show, as have practically all of the major computer hardware concerns.



| | |
|--|----|
| Design trends in key engineering areas as reflected in the technical papers | 70 |
| Components | 70 |
| Microelectronics | 72 |
| Computers | 74 |
| Electro-Optics | 76 |
| Medical Electronics | 77 |
| Microwaves | 79 |
| Civionics | 80 |
| Communications | 82 |

| | |
|--|-----|
| Engineers suggest changes to reverse attendance drop | 86 |
| Complete guide to technical papers by engineering subject | 92 |
| Outstanding new products | 108 |
| Instrumentation | 108 |
| Modules & Subassemblies | 122 |
| ICs & Semiconductors | 126 |
| Packaging & Materials | 128 |
| Components | 130 |

Components: Tiny filters and ferrites dominate

What's significant in components? Miniaturized filters. And ferrite components for the microwave region, IEEE is devoting a session to each.

Interest in miniaturized filters for frequency-selective networks runs high at this time because voice and data communications are among the fastest growing areas in electronics. And since microcircuits are being used in communications so extensively, filters must also be compatible in size.

Intended for the engineer who designs filters and the engineer who uses them, Session 2B brings both up to date on the status of three filter types that can be successfully produced in high volume. Two of the miniaturized filters are of the noninductive type—the active RC

and the digital—while a third, a crystal filter is inductive.

Miniaturized active RC filters are discussed by G. S. Moschytz and C. F. Kurth, both of Bell Telephone Laboratories in North Andover, Mass., although at present Moschytz is on leave of absence from Bell to the Swiss Federal Institute of Technology in Zurich. Crystal filters are described by D. F. Sheahan of the GTE Lenkurt Electric Co., San Carlos, Calif., and miniaturized digital filters by S. A. White of North American Rockwell Microelectronics Co., Anaheim, Calif.

"The speakers are not going to tell you exactly how they build their filters," says the session chairman, S. K. Mitra, professor of electrical engineering at the University of California.

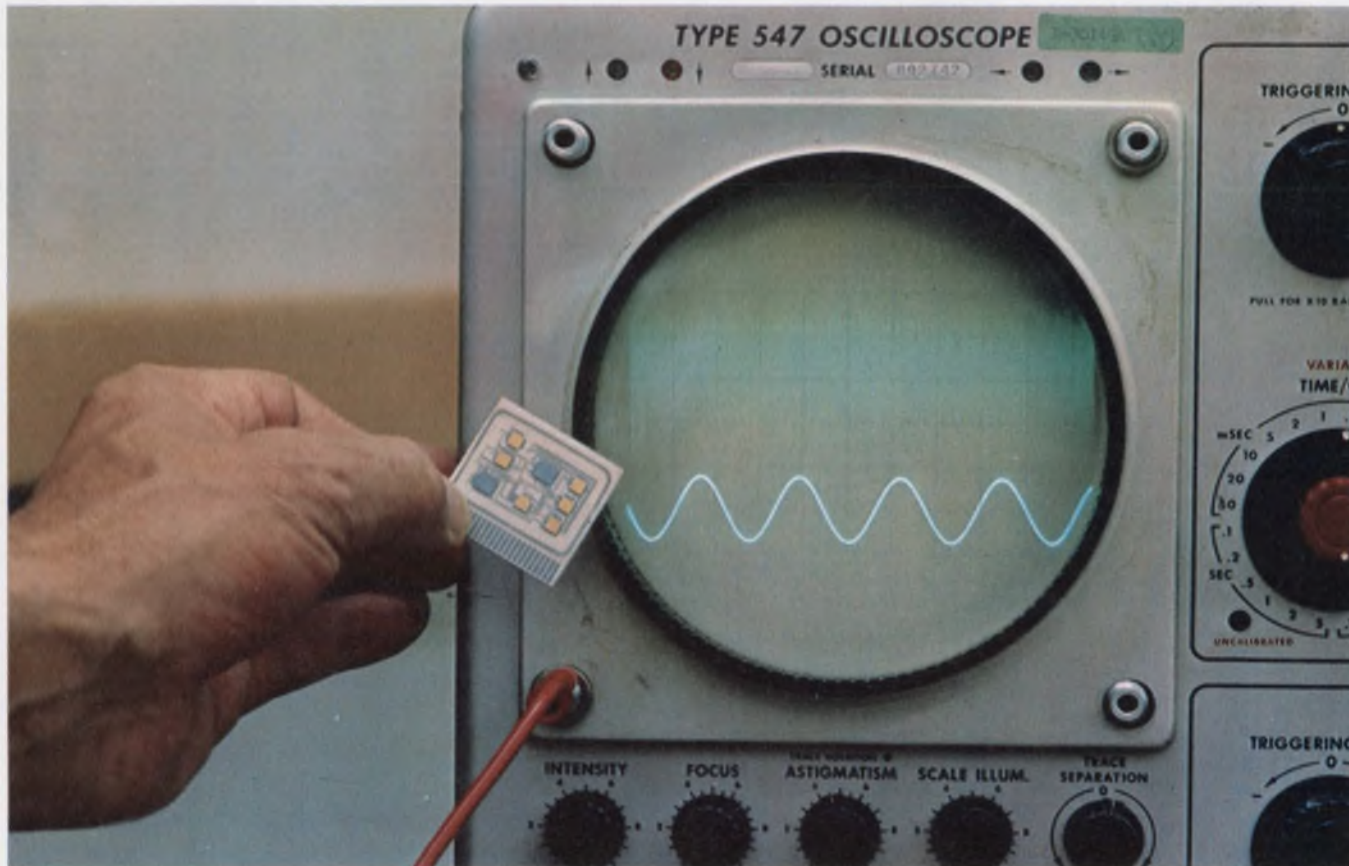

Digital filter from North American Rockwell Microelectronics consists of five serial/parallel multipliers and two

shift-register/adders mounted on a PC board. The scope simulates the filter output (session 2B.3)

Kurth and Moschytz give some design details of their active RC filter and also explain how to use it in a system. Monolithic filters, Moschytz says, are still not a reality and won't be in the near future. The alternative for small filters with stability has been to combine thin-film passive components, such as tantalum resistors and capacitors, in monolithic silicon integrated op amps in a hybrid integrated circuit form that has the necessary temperature stability. That stability, Moschytz says, "is much higher than that of the passive inductor-capacitor LC network."

Enumerating the advantages of active filters, Kurth says "that whether they are built with thin or thick film, they are smaller than passive filters and, in large-volume production, cost less. Another advantage, Kurth points out, is that active filters offer gain—"it's like a gift"—whereas passive filters do not.

Active filters should find ready application, Kurth says, in data transmission below 30 kHz—because of the size and cost advantages they provide—and in voice communication systems using frequencies of 3.4 kHz or below.

Miniaturized crystal filters for telephone systems have been sold and shipped out for the last six months from GTE Lenkurt Electric Co.'s plant in San Carlos, Calif., Sheahan reports. The filters are used in telephone multiplex systems, which are the backbone of long-distance networks. They operate in the 60-kHz-to-108-kHz region.

GTE's design differs from that of Bell Laboratories in that Bell uses a monolithic approach, while GTE's technique is polyolithic. "We use more than one piece of quartz," Sheahan says. "By using four pieces of quartz, we realize the same frequency response characteristics that Bell does with one piece of quartz."

The polyolithic form has an advantage of flexibility over the monolithic form, because it allows other elements, such as single resonators, to provide finite frequency attenuation poles. A further advantage is the fact that smaller pieces of quartz can be used, and the technology for cutting and lapping such pieces has been well developed.

Still another advantage, Sheahan says, is cost: "The crystal filter is cheaper than either the active RC or the digital. And the crystal requires no power, whereas both the active RC and the digital filters do."

Miniaturized digital filters are now being offered for on-line hardware by North American Rockwell Microelectronics. The company is not offering complete laboratory systems, White explains, "but little chips that you can hook up to your system."

"The user supplies the power supply and the

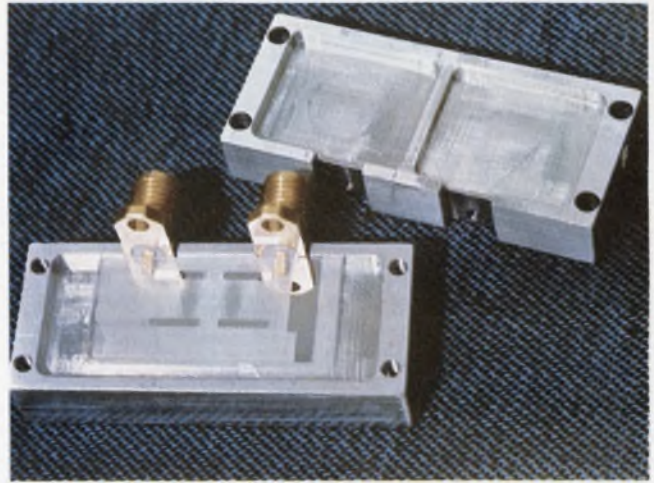

Acoustic surface wave filters are mounted in a metal holder. Transducers are interdigital patterns of aluminum deposited on lithium niobate (Session 5D.2)

box," White continues.

"He has to know what he wants it to do, and I provide him with design information for taking his transfer function and making a filter out of it with these chips."

The multiplier costs \$50. "With fairly large orders the price can come down to about \$10," White says.

The devices are used in voice and data communications, in digital-control systems and in servos. "We've even made little special computers out of them," White says. "Because they can do a wide variety of arithmetic functions. They can be used for many applications."

The advantages of a digital filter, White says, include stability and the ability to time-share, change the coefficient of the filter and even the configuration. The filter is small and uses little power.

Mitra says the main obstacle to more widespread use of digital filters is a lack of training. "People must be trained to think digitally," he says. "Digital filters are more accurate than analog filters, and they give the operator more control."

New devices for microwave radar

"Advanced Ferrite Components for Reliable Microwave Systems" are described in three papers at Session 6B. Intended strictly for the design or systems engineer working in the microwave region, particularly radar, the session considers the present status of microwave ferrite devices.

It focuses on latching ferrite devices and ferrite limiters—both relatively new and the materials that are used to make microwave ferrite components. Latching devices require a signal pulse of energy to change the operating func-

tion. Nonlatching devices, on the other hand, require continuous energy to maintain the device in a given state. Latching ferrite phase shifters and circulators are important because they are providing a new measure of system flexibility and adaptability in radar systems.

These advances are described by J. Pippin of Electromagnetic Sciences, Inc., Atlanta.

The evolution of ferrite limiters, which are replacing the gas TR tube for alternately switching a radar transmitter and receiver to a common antenna, is outlined by R. A. Kalvaitis and H. S. Maddix, designers with Varian Associates, Inc., Beverly, Mass. Several devices developed by the two engineers have already been sold, one of which is used in the Hughes Aircraft airborne radar designed for the Awacs airborne warning and control system.

The Varian system is a perpendicularly pumped subsidiary resonance limiter that consists of a series of polycrystalline YIG rods mounted on the side wall of a waveguide and magnetically biased but not magnetically separated.

The rod design, the developers believe, provides a structure in which critical physical parameters can be readily varied to obtain optimum coupling between the rf field and the ferrite. With improved coupling, the length of the device can be minimized for a given degree of limiting. Thus a complete ferrite-diode limiter, able to withstand 10 kW of peak power and operating over a 10% bandwidth at X-band, is only three inches long. An 80-kW, X-band device has been constructed with a total insertion length of 5-1/2 inches. Previous devices of this kind were approximately 12 inches long.

Ferrite diode limiters, using the ferrite rod approach, have also been developed for Ku and S bands by scaling down the rod diameters.

The advantages, Maddix says, are a limiter with longer life—the 2000 hours of previous limiters has been increased to 10,000 hours—and shorter recovery time—reduced from 1 μ s to 0.1 μ s.

The session ends with a paper by R. G. West

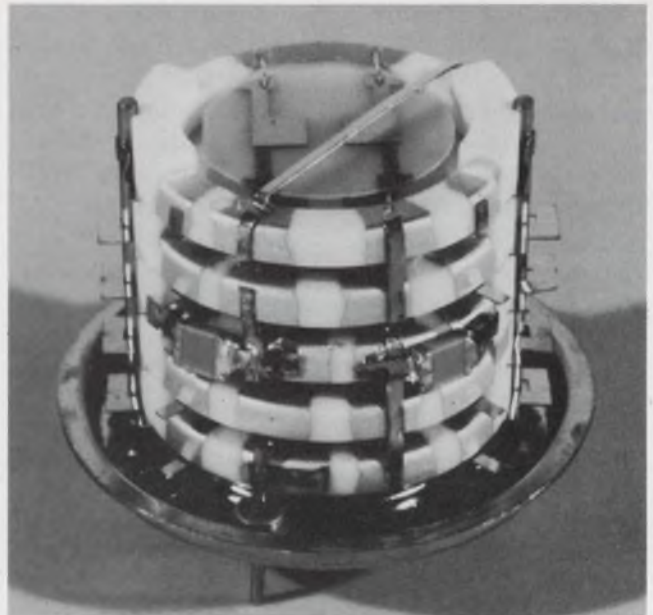

Miniaturized crystal filter, produced by GTE Lenkurt, is used in telephone networks. It has a passband of 3.25 kHz in the 8-MHz range (Session 2B.2).

and A. C. Blankenship of Trans Tech Inc., Gaithersburg, Md., describing how the materials in ferrite devices can be tailored for specific applications. The paper deals mainly with the electrical properties that are of interest to the engineer. "We tell how, within a given system, you can tune up a ferrite device for a certain bandwidth, a certain power-handling capacity and insertion loss," West says.

Tradeoffs between major tailoring methods are also described. If temperature stability is of the utmost importance, for example, a penalty must be paid in higher insertion loss. Also, the processing costs of applying the various methods depend on the degree of control sought.

"Given reasonable time and support," West says, "the material scientist can generally alter or tailor commercial materials so that a much superior microwave device can be realized. Much of the success depends on a close and coordinated joint effort between the material scientist and the device designer." ■■

Microelectronics: Circuitry at a significant power saving

Microelectronics sessions at this year's IEEE meeting are focusing on a significant trend: the design and development of micropower circuits, which use orders of magnitude less power than other circuits that perform the same functions. The trend is widespread, says Dr. P. H. Hudson,

electronic engineer at the Army Electronics Command, Fort Monmouth, N.J., and chairman of Session 1G on micropower integrated circuits.

As proof, he points to the variety of applications being presented in the session papers. One is an unusual application of CMOS in the linear

circuits of a micropower phase-locked loop. Another is the use of triple-diffused, vertical pnp transistors in complementary micropower circuits for high-performance operational amplifiers. A third is the use of micropower logic as the building block in an associative memory processor, while yet another is an implanted monolithic micropower receiver for turning power to implanted biomedical telemetry systems on and off.

G. W. Steudel, a designer of micropower circuits at RCA, Somerville, N.J., and author of a paper on the CMOS phase-locked loop circuitry, agrees that the trend to micropower design is here. The higher-powered, emitter-coupled logic circuits are less in favor today, he says, and device manufacturers are now featuring low-power versions of TTL logic.

There are several reasons for the swing to micropower. Many applications naturally require the lowest power drain, including portable instrumentation, communication and biomedical equipment and computers for aircraft.

Even with more conventional earthbound computers, the trend is to reduce power sharply and to lower the cost of the power supply. Also, for high current drains, the supply lines to the various circuits must be decoupled in the power supply—an expensive and bulky proposition because of the large filter elements needed.

With the substantially reduced currents of micropower circuits, the power supply is much smaller and less expensive. In addition decoupling problems are almost negligible.

A phase-locked loop design

A microwave phase-locked loop circuit designed by Steudel uses RCA's CMOS in linear operation, instead of the digital operation for which the CMOS was originally created. Steudel contrasts the 10 to 15 mA required by off-the-shelf phase-locked ICs, when they are used as a demodulator, with the 100 μ A at 6 V of the CMOS circuit—a power reduction of 160 times, he says.

More and more systems are being designed with phase-locked loops for low-frequency synchronization, Steudel points out, and it is here that the CMOS micropower version has advantages.

The loop's voltage-controlled oscillator, unlike that of conventional phase-locked IC counterparts, is a square-wave oscillator with a 50% duty cycle over its range of 100 Hz to 1000 kHz. As a result, it is admirably suited for a digital phase comparator, such as for comparing a sine-wave input against the square wave of the voltage-controlled oscillator.

A prime advantage of the RCA digital phase converter is that it locks only on the fundamental, whereas the conventional phase-locked ICs can

lock onto harmonics. In this respect, the CMOS phase reference with respect to the input signal is always zero degrees. If this phase relationship is disturbed by strong noise, Steudel says, the circuit locks again on the input signal when the noise vanishes.

This characteristic makes it ideally suited for applications like the digital communications pocket pager. In this case the CMOS phase loop locks onto the incoming clock signal and synchronizes an internal pager clock with it.

The CMOS phase-locked circuit has the lowest dissipation of any phase-locked circuit today, yet it provides the highest possible demodulation gain, Steudel says.

Op amp has high performance

Micropower operational amplifiers for battery-operated systems have been available. But with conventional IC fabrication techniques, the low power drain is obtained at the cost of undesirable low slew rate and narrow bandwidths. Consequently this approach is unsatisfactory for many instrumentation systems.

W. R. Harden, design engineer at the Westinghouse Defense and Electronic Systems Center, Baltimore, describes a Westinghouse process that has produced a micropower operational amplifier with fast slew rates and high bandwidths.

In this process the use of added diffusion steps creates high-frequency npn and pnp transistors on the same monolithic block. In contrast to conventional diffusion methods, these transistors have a high frequency response and a high beta at microampere levels.

Harden points out that the typical F_t at collector currents of 100 μ A is 180 MHz for the npn transistors and 120 MHz for the pnps.

An operational amplifier with externally adjustable parameters was the first application of the Westinghouse technique, says Harden. Positive slew rates of plus or minus 5 V/ μ s have been measured at a power dissipation of 1 mW. The bandwidth is commensurately wide. Slew rates of these orders at low power are possible, Harden says, only because the base transit time of the vertical diffusion pnps far exceeds that of conventional lateral-diffusion pnp transistors.

Micropower computer uses CMOS

To minimize the power requirements of a general-purpose associative processor memory for avionics applications, RCA, under a contract from the Naval Research Laboratory, Washington, has developed a basic CMOS building block for the memory. Described in a paper, "A Micropower Associative Processor Building Block"—authored jointly by H. W. Kaiser, engineering

leader of RCA's signal processing group at Camden, N.J., and T. L. Collins, electronic engineer at the Naval Research Laboratory—the basic block is a four-bit array.

It contains, says Kaiser, 63 standard cells and a total of 608 MOS transistors. The array—115 by 161 mils—is mounted in a 40-lead DIP package. Operating from a single 10-V supply and a single-phase, 10-V clock, the four-bit array has static power dissipation that is less than $500 \mu\text{W}$.

The associative logic and memory machine, now being developed at the Naval Research Laboratory, may use up to 2000 of these CMOS building blocks, says Collins. And in the final version, he adds, it may be possible to reduce the power dissipation further by a factor of 10.

A way to extend battery life

The use of battery-operated, implanted telemetry systems for experimental biomedical instrumentation is growing rapidly, says session chairman Hudson. But operating life is severely limited by the total battery energy. One answer to the problem is described by Hudson in a paper, "A Monolithic Micropower Command Receiver." It is a novel micropower receiver that can be implanted along with a telemetry package. The receiver, upon external radio command, disconnects the telemetry battery when the system is not in use.

The command receiver, says Hudson, consists of an rf amplifier, an AM detector and an audio amplifier. It has a sensitivity of better than $100 \mu\text{V}$ at 500 kHz, and total power dissipation is less than $15 \mu\text{W}$. Operating from a 1.35-V mercury cell, the receiver is fabricated on a single silicon chip. The only off-the-chip components are a small antenna and the battery.

For low power drain, Hudson points out, it was necessary that both the operating frequency and voltage gain of the receiver be low. The operating frequency of 500 kHz was chosen as a compromise between minimum power requirements and

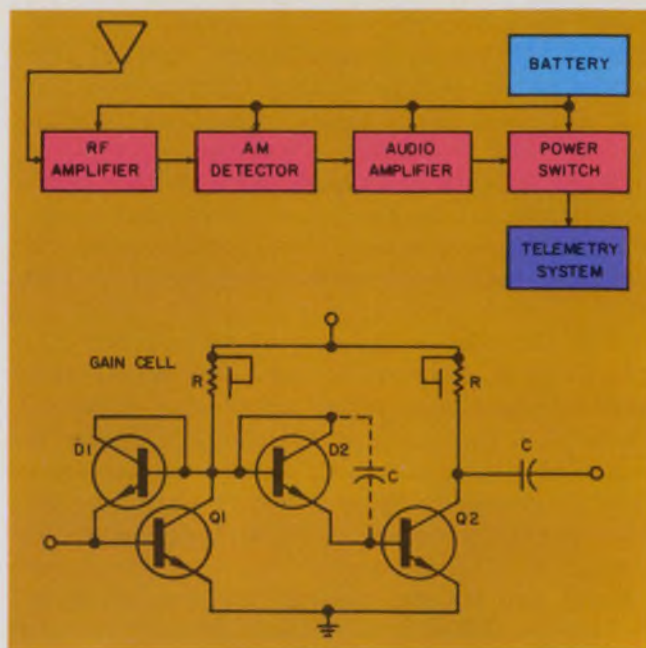

The micropower implanted receiver, top, turns power to an implanted telemetry receiver on or off on command. A basic two-stage amplifier is shown below (Session 1G.4).

a small, efficient antenna.

With an rf voltage gain of 10, the receiver sensitivity was $100 \mu\text{V}$ at a signal-to-noise ratio of 12 dB.

A two-stage amplifier, or "gain cell," was used as the basic building block of the receiver, Hudson explains. By selecting appropriate load resistor and coupling capacitors, it functions as a 500-kHz amplifier, an AM detector and the audio amplifier.

Special features were designed into the gain cell, Hudson notes. The cell employs a diode biasing technique that avoids the need for high-value resistors. It uses low-value monolithic capacitors because of the high circuit impedance levels. Its midband gain is relatively insensitive to resistor variation. Essentially no power is wasted in the biasing networks. And two stages of amplification are obtained with the use of only three isolation wells. ■■

Computers: Large-scale ICs rising in use, falling in cost

The expanding role of large-scale integrated circuits in computer memories and other functional computer elements is reflected in the papers at the computer sessions of the IEEE convention.

J. C. Logue, a fellow at IBM, Poughkeepsie, N.Y., and chairman of Session 5F—"Trends in

Computer Hardware"—says that IC devices with new capabilities are appearing, along with reduced costs. As an example, he points to a new microprocessor on one chip—a MOS device that has all the processing capability of a small general computer of the 1960s.

Dr. Robert Noyce, president of Intel Corp.,

Santa Clara, Calif, the company that developed the microprocessor, describes the potential of the device. He says it is a complete central-processing unit, requiring only an added memory to become a full-fledged microcomputer that can do the job of a minicomputer.

The principal limitation of the microprocessor is its slow speed, since it is a MOS device, Noyce says. But this is not a serious drawback, he argues, because minicomputers are typically too fast for 90% of their applications.

Noyce sees the microprocessor being used in a range of mass applications where a slow processor is adequate. These include data terminals, mechanical equipment controllers, medical applications and navigational computers for light aircraft. The processor is particularly adaptable for converting analog control and computation systems to their digital counterpart.

Two versions of the microprocessor have been developed, Noyce says. The first, which has been available for a short time, has 900 gates and processes four-bit words. Special RAMs and a programmable control ROM have been developed to provide a complete microcomputer.

The second version, an eight-bit microprocessor now in the sampling stage, has 1200 gates on the chip. With the addition of TTL interfacing circuits, this processor can tie in with any of the standard semiconductor memories.

Sharp price cuts foreseen

For the four-bit processor, the price is now \$100 for one, and for the eight-bit processor, \$200. Quantity prices are 25% of these. However, Noyce points out that the potential for cost reduction of these devices is so great that he sees microprocessor ICs selling for a dollar or two before 1980.

A direct comparison between the microcomputer and existing computers is hard to make, Noyce says, because the microprocessor uses microprogramming for its complete operation. To execute the same amount of data manipulation that a single instruction produces in a minicomputer may take two or three microprogrammed steps, he explains.

One microinstruction takes about 10 ms, and consequently it may take from 10 to 50 times as long to do the same job as it would with a fast minicomputer.

In comparing the new microprocessors with competing technology, Noyce feels that the bipolar equivalent of this system is lagging by only two years. But he makes an important point: Both the MOS and bipolar devices can be expected to double in capability every year to the end of this decade.

It has been over a year since the first large-

capacity, dynamic MOS storage arrays were introduced, notes J. R. Brown Jr., semiconductor memory product manager for Burroughs Electronic Memory Systems, Piscataway, N.J., and chairman of Session 5A, "Main Memory Technologies Through the 70s." While MOS memories are now firmly established, he points out, high-capacity bipolar devices for large memory systems are now appearing in sample quantities.

However, he feels that bipolar memories will never be as cheap as MOS. Bipolar will always cost more in this game of "catch up," he says, but will deliver a higher performance with a lower capacity.

While the rapid growth of semiconductor memories has placed core memories in the background, cores will not be outmoded by their semiconductor counterparts, says Arthur L. Friedman, R&D manager of the Electronic Memories and Magnetics Corp., Hawthorne, Calif. The author of a paper, "Core Memories in the 70s," he says LSI will help core memories to become faster.

Advanced techniques in the sharing of circuitry and the multiplexing of functions will be provided by the use of LSI with cores, he insists. And this, he says, coupled with lower costs and other benefits of the LSI technology will provide the lowest over-all cost for the electronics portion of the core memory in large systems.

As an example, Friedman points to his company's Micromemory 6000, an advanced sharing concept in large card memories. The cost of the electronics portion of the memory is reduced 40 per cent in comparison with a system without sharing.

MOS memory revolution predicted

On the other hand, Dr. G. E. Moore, executive vice president of the Intel Corp. and the author of "MOS Storage—a Revolution in Main Memory," is convinced that even though present dynamic MOS storage elements have made significant inroads as main memory devices, the next MOS generation will displace other technologies.

Second-generation MOS main-memory storage circuits—the standard 1024-bit array—are now being developed, Moore notes. But they will, in general, be tailored for particular applications, he says. Some designs will emphasize speed, others low power, still others ease of use and some lowest cost per bit.

For speed, n-channel circuits of 1024 bits, operating at less than 100-ns access time, have been fabricated, Moore points out. These devices can be produced at MOS-bit costs, he says, but they give performance at speeds heretofore attainable only with bipolar circuits.

Requirements for low power are emerging in

many application areas. For high operating speed with negligible standby power, Moore points to the use of CMOS. However, the relatively high cost may inhibit its use in mainframes.

Easy-to-use, newer-generation circuits will find their way into small memories and distributed mainframe storage, Moore believes. He sees the development of static 1024-bit, n-channel circuits that look like TTL building blocks. They will use 5 V only, he says, and all input and output levels will be compatible with TTL.

A higher functional density and more bits per chip will be a feature of the second-generation devices designed for lowest bit cost. A 4096-bit chip with less than 2 square mils per chip—more than three times as dense as present MOS—has already been fabricated by Intel. With this approach, Moore predicts that costs of 0.1 cent per bit by 1975 can be conservatively predicted.

Bipolar future uncertain

Henry Bloom, manager of digital circuit design at the Intersil Corp., Cupertino, Calif., and

the author of a paper on "Bipolar Memory—the Technology for the Future," sees MOS circuits being more widely used than bipolars in main memories for some time to come.

MOS manufacturers are concentrating on two processes, he says—metal gate and silicon gate—whereas bipolar memory manufacturers are diluting the impact of their product with a wide diversity of fabrication. For example, he notes that the bipolar field is using diffused resistors, epitaxial resistors and film resistors, as well as diffused bases and epitaxial bases for dielectrically isolated structures. As a result, he feels that it's not possible to predict at this time which process will dominate by, say, 1975.

However, he points out that two standard cell sizes will be attempted in both bipolar and MOS structures. One will be less than 2 mil² per bit, with an access time of less than 300 or 400 ns. The other will be a larger cell, of 7-to-10-mil² area, with an access time in the region of 50 ns per chip.

Bloom predicts that by 1975 both bipolar and MOS technologies will have developed these cell sizes. But which will cost less is not certain. ■■

Electro-Optics: Memories and displays with a future

Imaging and nonimaging displays, optical memories and solid-state imaging devices are highlighted in five IEEE sessions on optoelectronic components, devices and systems.

A look at the problems and possibilities of three-dimensional displays of the future is taken in Session 3A. One system is a true three-dimensional display in which the excitation of fluorescence, either in a solid material or a volume of gas, is achieved by crossing two high-power laser beams. The beams are oriented at right angles to each other, and wherever they cross, a spot is produced.

The solid fluorescent material has very limited resolution, and use of a fluorescent gas is seen as the preferred medium. However, such a gas has not yet been developed, although its composition has been proved theoretically feasible.

A three-dimension holograph information display that is generated by a computer is also discussed in Session 3A. Much work on this type of display has been done, and its use in air traffic control is considered a major application. But previous approaches have been limited by the need to compute complicated holographic diffraction patterns, requiring substantial computing

time and thus limiting display changes.

The new approach to holographic data display projects line drawings of two or three-dimensional objects. It constructs the holograms by deflecting a moving pair of collimated, mutually coherent light beams to selected spots on the source and reference planes. There they are converted, by optical elements, to expanding spherical waves. By deflection of the object beam in an X and Y dimension and the reference beam in a Z direction, holograms of arbitrarily located points are constructed.

For this system, the display computer generates only the deflection control signals corresponding to the data points. With this system, holograms of complex objects can be generated in less than one second with a minicomputer.

Electro-optics stores a trillion bits

Electro-optical memories can be built with large-capacity storage systems, approaching the terrabit level. In Session 3C two optoelectronic mass memory systems, each with a different approach, are described. One is a disc memory that uses the reversible changes in the optical proper-

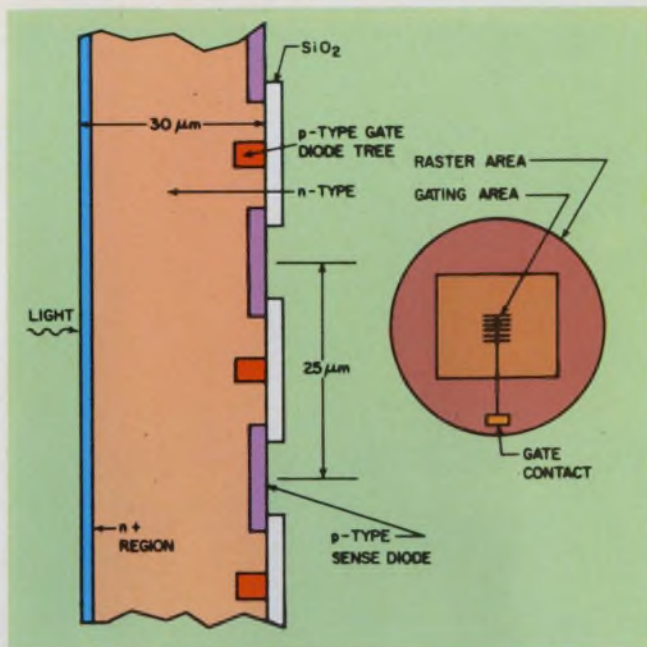

The geometry of Philips' gated silicon vidicon tube, at left, shows the gate elements imbedded under the silicon dioxide insulating barrier (Session 5H.3).

ties of amorphous semiconductors under excitation from laser light; the other is a holographic memory that uses lasers and a thermoplastic/photoconductor hologram storage medium.

The optical disc memory, says J. A. Aseltine, president of Ovonic Memories, Inc., has glass or metal discs coated with a thin layer of an amorphous semiconductor. The semiconductor is a thin-film layer a few microns thick.

When a laser beam is focused to an intense 2- μm spot, the optical transmission characteristic of the amorphous layer changes. This change is detected by passing a low-level light spot directly through the film on the glass discs, or by reflection from the metal disc.

With this system, Aseltine says, the number of tracks that can be recorded and played back is 10

times that of magnetic-disc machines. Characteristics of 4000 bits per inch and 2000 tracks per inch are realistic, he says.

The limitation of the present system is its slow access time, Aseltine points out. This is because the development model has electro-mechanical readout elements. But faster access, he says, is possible through the use of electro-optical laser-beam deflection systems, although this is still several years away.

Imaging tube controlled electronically

Solid-state imaging devices have great potential for future mass markets—Picturephones and other consumer applications. The present costs for available devices are high, and the performance of developmental designs is still on a laboratory basis. But the potential looks good, says Dr. Edward H. Stupp, senior program leader at Philips Laboratories, Briarcliff Manor, N.Y.

A problem with present silicon-diode array camera tubes is that their sensitivity cannot be varied electronically. Stupp reports that scientists at the Philips laboratory have developed a new tube that incorporates an auxiliary gate structure (see figure) with which the tube can be gated on or off. The development is discussed in Session 5H.

The preliminary design, Stupp says, demonstrates that gating on and off takes less than 100 μs . During the time it is on, it can receive information with maximum sensitivity, and when it is off, insensitive to unwanted signals.

"This, for example," Stupp says, "allows us to detect laser pulses that arrive during certain periods of time, and to reject other information arriving before or after."

In the development model, signal-handling capabilities and dynamic range are not good, he notes. "However, with what we've learned on this design, improvements are certain." ■■

Medical Electronics: Devices for tomorrow's hospital ward

One of the most ingenious electronic switches to be developed in recent times can be operated by a fully paralyzed person with the motion of his eyes. The device incorporates two switches, each with a small infrared source and sensor, mounted on a pair of eyeglass frames. The sensors detect the difference in reflectivity between the iris and the white of the eye when the eye is rotated upwards and outwards. This difference generates a pulse, which can be used to activate any other device.

The switch, and other medical electronic equipment, is being considered in Session 2G and in a special four-day seminar, "Engineering in the Hospital," that the IEEE is conducting at the Americana in conjunction with the annual show. For the electronics engineer interested in entering the medical instrumental field, the seminar may be just what the doctor ordered. It covers such topics as these:

- Engineers in the hospital.
- Computers in the hospital.

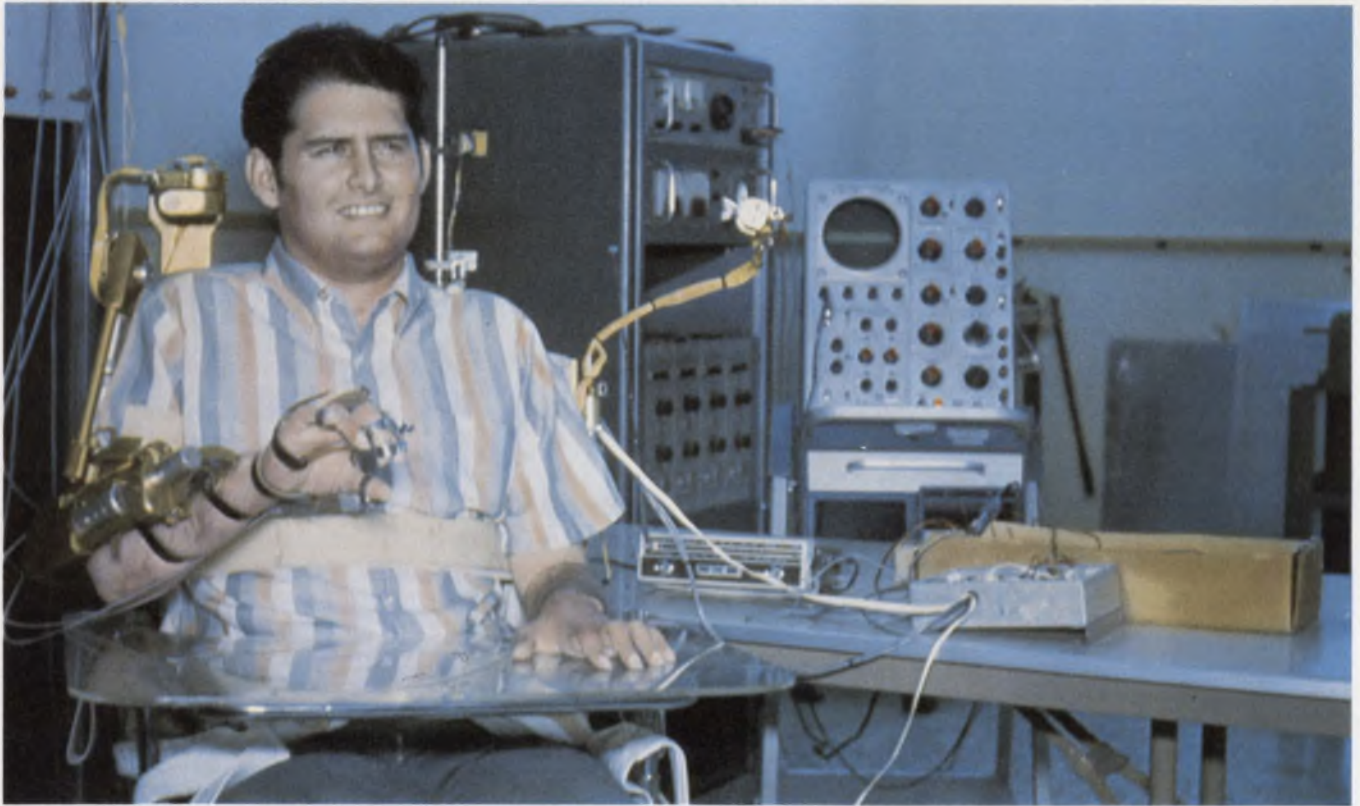

Severely paralyzed patients can be partially rehabilitated through the use of electronic control systems for ex-

ternally powered limbs. These complex devices are discussed at Session 2G.

■ The problem of manufacturing instruments for hospitals.

The unusual eye switch is discussed in Session 2G, "The Challenge of Applying Aerospace Innovations to Health Care." Developed originally by NASA for the Apollo program but never used, the switch was intended for use by an astronaut in the event he suddenly became paralyzed. Now it is being incorporated in various control systems for handicapped people. Once the switches are set for a particular individual, they are not operated by blinking or other normal eye movements.

Another paper in Session 2G discusses "The Oximeter—An Instrument to Detect the Onset of Shock in Leukemia Patients." And there are papers on a breath-operated switch and portable visual instrumentation.

Hospital problems outlined

To attend the special seminar, visitors must pay a \$45 fee, which includes two lunches and admission to the Coliseum show.

The seminar's first session is on "The Engineer in the Hospital." Of particular interest is a paper by Dr. Seymour Ben Zvi and Wallace Gottlieb, both of the Downstate Medical Center, Brooklyn, New York City. In discussing how the scientific and medical instrumentation department at Downstate works, they point out that all equip-

ment is given an initial checkout as soon as it enters the hospital, because from statistics gathered on checked equipment, they have found that about 40% of the equipment is defective on arrival.

Dr. Ben Zvi and Gottlieb also discuss preventive maintenance, in which equipment is checked periodically, even if there is nothing wrong with it.

The seminar session on "Computers in the Hospital" covers present and future uses. Jerry Courtier, product manager at Digital Equipment Corp., Maynard Mass., describes some of the small, dedicated computer systems available—for cardiac catheterization, medical history-taking, patient-monitoring and the like. Present systems monitor a patient on-line and recognize limits for patient parameters. If the limits are exceeded, an alarm sounds. This is an open loop system. The ideal system of the future, Courtier says, will be a closed loop, in which the computer senses an out-of-limit condition and then administers a therapeutic agent to correct the problem.

The seminar session on "Manufacturing for the Hospital Environment" examines problems that are peculiar to medical instrumentation. Among them, says Dr. Herbert Goldberg, engineering manager for American Optical in Bedford, Mass., is the fact that the medical profession requires equipment that must be reliable

over long periods of time—up to 10 years, in some cases.

“It is impossible to test equipment for such long periods,” he continues, “and we thus must take chances. Lawyers don’t like to hear this, but it’s a fact of life.”

The large number of deaths by electrocution caused by faulty medical equipment in hospitals has emphasized the necessity for developing isolated input devices.

The design of such a device, an isolated input electrocardiograph amplifier, is discussed in detail in a special session on “Recent Developments in Medical Instrumentation.”

In his paper, “An isolated Input EKG Amplifier,” William Jordan, product safety officer for Electrodyne Corp., Sharon, Mass., points out that while the problem of amplifying the low voltage differential EKG signal may appear to be easily overcome, the design problem becomes more difficult when the safety requirements of the medical profession must be met.

The most stringent of these requirements is the elimination of shock hazard from medical equipment, says Jordan. A leakage current of even a few microamperes in an electrode connected directly to the heart, is enough to electrocute a patient, he continues. There are several ways of isolating the patient from this danger, explains Jordan. One way is to use a signal chopper and



The sight switch, developed originally for the U.S. space program, is being incorporated in control systems for fully paralyzed patients. (Session 2G.3).

and an isolation transformer at the input. Another is to use optical isolation. He compares the methods used by three different manufacturers.

Other design innovations to be presented at this special session include a paper on memory refreshed waveform displays, another on the design of an automatic densitometer and also a paper on long-term electronic monitoring of respiration. ■■

Microwaves: Aids for cars, aviation and data-sending

The microwave invasion of the civilian market—with instrument aids for aviation, auto safety and high-speed data communications—is under scrutiny in two of the technical applications sessions being held in the Coliseum.

Session 6CK considers “Microwave Technology in Transportation Systems.” Session 7CJ is discussing “Applications of Microwave Technology to Today’s Communication Systems.”

Air traffic control, aircraft instrument landing systems and clear-air turbulence detection are among the applications spotlighted in Session 6CK. P. W. Hannan, J. H. Gutman and R. J. Giannini of the Hazeltine Corp., Green Lawn, N.Y., describe a new stationary beacon antenna for interrogating aircraft. It is 8 feet high, 40 feet in diameter and contains 224 columns of dipoles. Incorporated into an air-traffic-control system, the antenna provides many benefits over presently used beacon or radar systems, the authors report in their paper, “A Cylindrical Electronic-Scan Antenna for Air Traffic Control.”

The benefits, they say, include fewer aircraft

“missed” because of weak signals, fewer false targets because of spurious reflections and greater traffic-handling capability, the latter attributable in part to the electronic scan capability of the antenna.

Turbulence detector a critical need

The hunt for an instrument to detect clear-air turbulence has been particularly arduous, because the turbulence occurs without warning at high altitudes and has jolted several jetliners severely in the last couple years. The Federal Aviation Administration has been pressing for development of a detection device, and three engineers at the Dept. of Transportation Center in Cambridge, Mass., describe a solution in a paper on “A Millimeter-Wave Sensor and Detector for Clear-Air Turbulence.”

The authors—G. G. Haroules, W. E. Brown and G. W. Wagner—report that their method will give a pilot enough time to avoid, or at least to minimize, the damaging effects of the turbu-

lence. They note that a temperature gradient is associated with the severe critical vertical wind shear that accompanies the turbulence. A physical property of oxygen makes it possible to detect these temperature gradients.

At high altitudes, oxygen emits electromagnetic radiation, and the intensity of the emitted flux is temperature-dependent. By measurement of the emitted signal, it is thus possible to determine the temperature of the atmosphere and hence the presence of clear-air turbulence.

Temperature gradients are located by use of simultaneous, multi-frequency radiometric measurements—at 52 and 58 GHz. The use of two frequencies provides a ranging capability, making it possible to determine the distance of the gradient from the aircraft. The sensor is presently being used in aircraft tests at altitudes of up to 40,000 feet.

Microwaves for motoring safety

In other transportation areas, a paper by J. B. Hopkins and F. R. Holmstrom, also of the Dept. of Transportation, discusses "Cost-Effective Microwave Systems for Railroad and Automobile Safety Applications." Two applications are given for low-power, Gunn-diode oscillator systems.

The first offers protection for motorists at railroad-highway grade crossings. A 10-GHz, 100-mW Gunn-diode transmitter is placed about 1000 meters from the crossing. The transmitter is pulse-modulated at a repetition rate of 1 kHz and a duty factor of 1%. An approaching train changes the modulation of the transmitted signal, and this change is detected by a receiver at the grade crossing. The receiver then activates a warning device.

The second application is an inflatable-airbag automobile safety system. Most present systems under test detect a crash by the rate of vehicle deceleration. Since airbags require a deployment time of 25 ms, there is insufficient time to deploy them in high-speed crashes, the authors contend. What's needed, they say, is a system that can detect impending collisions a moment before im-

pact. Microwave radar was picked as a solution.

The microwave system uses a bistatic, 10-GHz, cw homodyne doppler radar and achieves the required position discrimination by overlap of the transmitted and received antenna patterns. The doppler shift at 10 GHz is 30 Hz/mph. Field tests showed that this approach may prove viable in terms of cost, reliability and effectiveness, the authors report.

A novel communications advance

An advance in communications—a novel 1-W cw Gunn oscillator for use in X-band systems—is described by A. L. Reynolds of ITT, Nutley, N.J. In his paper, "High-Power CW Gunn Oscillator for Communication Applications," Reynolds explains that while the highest X-band power levels presently available are limited to 500 mW, it is possible to combine two or more Gunn diodes in parallel in a single resonant structure to obtain higher levels.

Reynolds goes on to caution, however, that while the idea is conceptually simple, its implementation is subject to a variety of instabilities, generally referred to as "moding" problems. He says that a simple dual diode design has overcome these problems and that an oscillator output as high as 1.2 W, with efficiencies between 1.3 and 3.2%, has been achieved.

In another paper, the investigation of atmospheric wideband digital transmission systems is described by W. H. Schwarz, R. W. Kordos and R. W. Judkins. They tell in "An 18-GHz Transmitter and Receiver for Experimental High-Speed Digital Transmission" of a transmitter that uses a 10-GHz, 200-mW Impatt diode oscillator to generate a four-phase signal. It is externally modulated by two path-length switches at a 141-MHz rate.

The four-phase receiver uses an unbalanced Schottky-barrier diode down converter and four differential phase detectors. One transmitter-receiver pair has already been installed outdoors in pole-mounted cannisters and is operating over a 2.7-mile link. ■■

Civionics: Ways to revive the nation's drooping cities

Can electronics help save the nation's decaying cities? Electronics and society are examined as a package in two IEEE sessions.

In Session 4H the role of telecommunications in upgrading the quality of city life is discussed—more from a futuristic systems approach than

a technical one. Session 6E considers automation, engineering aids to education and the social responsibilities of engineers.

Session 4H, "Telecommunications—an aid to solving urban problems," follows relatively closely a report prepared by the Committee of Telecom-

munications of the National Academy of Engineering. Completed in June, 1971, the report is entitled, "Communications Technology for Urban Improvement."

Electronics can improve radically the city's education, medicine, nursing homes, traffic control and law enforcement, says the session's organizer, Alan Siegel of the Dept. of Housing and Urban Development in Washington, D.C. He refers to such equipment as cable television and wideband transmitter and receivers, with teleprinter and facsimile displays in homes and offices.

Greater use of phone urged

"A Systems Approach to City Communications" is described by Richard P. Gifford, vice president and general manager of the Communication Systems Business Div. of General Electric, Lynchburg, Va. He suggests making greater use of the home telephone to handle facsimile at high speeds and even interpersonal video.

"Ultimately this network [the telephone system] can handle all interpersonal mail via either teleprinter or facsimile," he says.

A second network would permit central facilities to transmit to the home and businesses. "With home terminals," Gifford says, "the system could be the substitute for newspapers, magazines and books and third-class mail." It could even provide for group entertainment, including participation games, he continues.

Coaxial cable systems could be used at first—such as those now used for CATV but with more bandwidth. "With time," says Gifford, "we may see hundreds of channels on elliptical waveguides, if we can figure out the human engineering aspect of the selection process—that is, how to cope with an almost infinite choice." Feedback capability from the home would let customers place orders for goods without leaving the house.

Gifford also suggests two-way broadband communication between public service centers—schools, hospitals, libraries, police stations, airports, railroad and bus terminals, city halls and nursing homes.

A fourth network would consist of "sensing nerves," all running to a central terminal. These sensors would monitor such conditions as weather, pollution, traffic, fire warning and vehicle location.

One answer to the increasing difficulties and cost in obtaining medical care is "Telemedicine for Improved Medical Care," according to Roger G. Mark, assistant professor of electrical engineering at the Massachusetts Institute of Technology.

Establishing a system that permits a physician to provide medical care at a distance is not pri-



An automatic system for moving passengers and baggage at airports has been proposed in a paper by General Railway Signal Co. (Session 7E.3)

marily a technological problem, Mark says. "In general," he explains, "modern bio-instrumentation, computer technology, communications technology and transportation systems are more than adequate. The problem really is how best to tie them all together." Some of the practical problems that will have to be worked out, Mark points out, are optimum bandwidth compression schemes, how to store patient histories in computers, system configuration and operating policies.

The evils of engineering

Session 6E, "The Technological Effects on Society—an Open Forum," is organized by a University of Oklahoma professor, L. W. Zelby, and there are papers by five other professors. In a discussion of automation, Edward L. Katzenbach of the New York Institute of Technology, Nova University, Fort Lauderdale, Fla., focuses on the misuse of the computer and its ability to "dehumanize" and invade privacy. He suggests that youth should be prepared for the world of tomorrow with "courses in computers and systems thinking."

An activist approach to engineering is recommended by Stephen H. Unger of the Dept. of Electrical Engineering and Computer Science at Columbia University, New York City—and his suggestions are likely to be controversial. In his paper, "Personal Responsibility of Engineers for Their Work," Unger suggests engineers evaluate the social impact of what they design and refuse to do the work if it conflicts with their consciences. He says:

"For example, if an engineer believes that American intervention in Indochina is wrong, then he cannot escape the conclusion that designing an air-to-ground missile for the American Air Force is also wrong. That he might have difficulty in deciding whether it is also wrong to

develop a radar navigation technique, possibly useful to the Air Force as well as to commercial airlines, does not justify evading the issue in the unambiguous case. In the real world, hard cases, though not rare, are also not in the majority. After establishing procedures for identifying and copying with the obvious cases, one can begin reducing the ambiguous class."

Unger concedes that an engineer may be fired for refusing to do his assigned work. He offers these alternatives: The engineer can appeal to higher authority within the company. If this

fails, he might try carrying his case outside the company.

"This might be done openly," Unger counsels, "by publicly calling attention to the situation, or surreptitiously by leaking the information to a Congressional committee or perhaps to a Ralph Nader group. Where the open route is chosen, the announcement might well be accompanied by a resignation, since severance from the company is likely in any event."

Comments anyone? An open forum concludes Session 6E. ■■

Communications: A high-level look at the future of CATV

The electronics industry has been flooded with predictions of a new multibillion-dollar utility in the United States—cable television. Will the forecasts come true? "CATV—What's Happening" a panel discussion in Session 2A gives the views of high-ranking experts.

For example, Paul Klein, president of the Computer Television Corp., New York City, says that the future of home entertainment lies not in video cartridges and cassettes, as some people think, but in a dial-access TV system in which the user has access to prerecorded video tapes stored in a remote library. These tapes could be of movies, Broadway shows, museum tours and educational courses, he says.

The technology for such a system is already available, Klein continues, and several hard-wire versions of this type of system have been installed experimentally in motels. By next year, Klein predicts, computer television will begin appearing in CATV systems.

Other panelists include Dr. Peter C. Goldmark, president of Goldmark Communications Corp., Norwalk, Conn.; Dr. Joseph V. Charyk, president of Comsat Corp., Washington, D.C.; Hubert Schlafly, president of TelePrompter Corp., New York City, and Dean Burch, chairman of the Federal Communications Commission.

The panel looks with favor on new FCC rules allowing CATV operators to carry a limited number of out-of-town broadcast signals in competition with local broadcasters. The regulations offer extensive program protection to local broadcasters in the top 50 markets. They also specify that cable operators in the largest 100 TV markets must provide, for each broadcast signal carried,

an equivalent channel that can be used for non-broadcast purposes.

"After all of these years of pulling itself up by its own bootstraps, the cable-television industry finally is getting some encouragement from the Federal Communications Commission," says Schlafly.

In a talk entitled "CATV—Subscriber, Supply and Demand," Schlafly reports on two-way, interactive home terminals. In particular he discusses a subscriber response system that TelePrompter will be testing this summer in El Segundo, Calif. The system, manufactured by Hughes Aircraft Co., Culver City, Calif., is a two-way, computer-controlled, data-transmission system that uses the home TV receiver with a subscriber console and interface electronics as a home terminal. This system is capable of providing such services as these: channel polling, opinion polling, remote reading of utility meters and emergency alarms.

The interaction between domestic satellite systems and CATV is discussed by Charyk in "CATV Network Via Satellite." He envisions a cable TV network in which signals are received by satellites and relayed economically to 5000 cities across the nation.

An FCC decision on domestic satellite systems is pending. At present eight companies have indicated that they want to launch communications satellites and many more have requested permission to build earth-receiving stations. Comsat wants to launch the satellites and own the associated ground stations, which it will lease to those that want to use them. CATV operators, such as TelePrompter, want to build their receiving stations. ■■

HOW TO READ A CONNECTOR

Specifically, Elco's brand new, Series 8219 two-piece miniature connector. A state-of-the-art, high contact density connector for your printed circuit and input/output rack and panel applications. Sophisticated. Highly reliable

The new Varicon™ low withdrawal force contact (1-6 ounces per contact pair) that makes it easy to assemble the connector into your board. And provides MIL-SPEC reliability as well (MIL-C-55302 Type)

Variations are provided for single-sided and double-sided p.c. cards, and for parallel or perpendicular p.c. card mounting

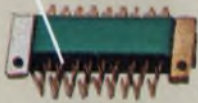

Contacts on .050" staggered spacing to help you cope with the packaging squeeze imposed by MSI and LSI circuitry

Coming soon!
Matable connectors with crimp-type contacts for a variety of wire sizes for your total system requirements.

Color-coded, rugged metal guides to help you properly orient mating connectors

Series 8219 connectors are available right off the shelf in six discrete, most popular sizes: 18, 30, 36, 42, 54 and 72 contacts. Also immediately available: the Series 8129 two-piece connector on .100" centers in four sizes—6, 9, 12 and 15 contacts. And the Series 8300 subminiature connector with the Bi/Con™ contact, miniature version of the high reliability Varicon contact

High dielectric strength, glass-filled diallyl phthalate insulators, ideal for critical electronic applications under the most severe environmental conditions

If these, or any others of our thousands of standard connectors don't fit your circuit, we can tool up for your special in a wink. Another service in keeping with CONNECTRONICS, Elco's Total Connector Capability

For full details on Elco's two-piece connectors, contact:

Elco, Willow Grove Division,
Willow Grove, Pa. 19090
(215) 659-7000

Elco, Pacific Division,
2200 Park Place,
El Segundo, Calif. 90245
(213) 675-3311

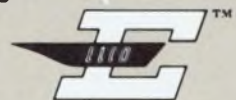

**Our R-10 series
offers more design
options than any other
single industrial
relay.**

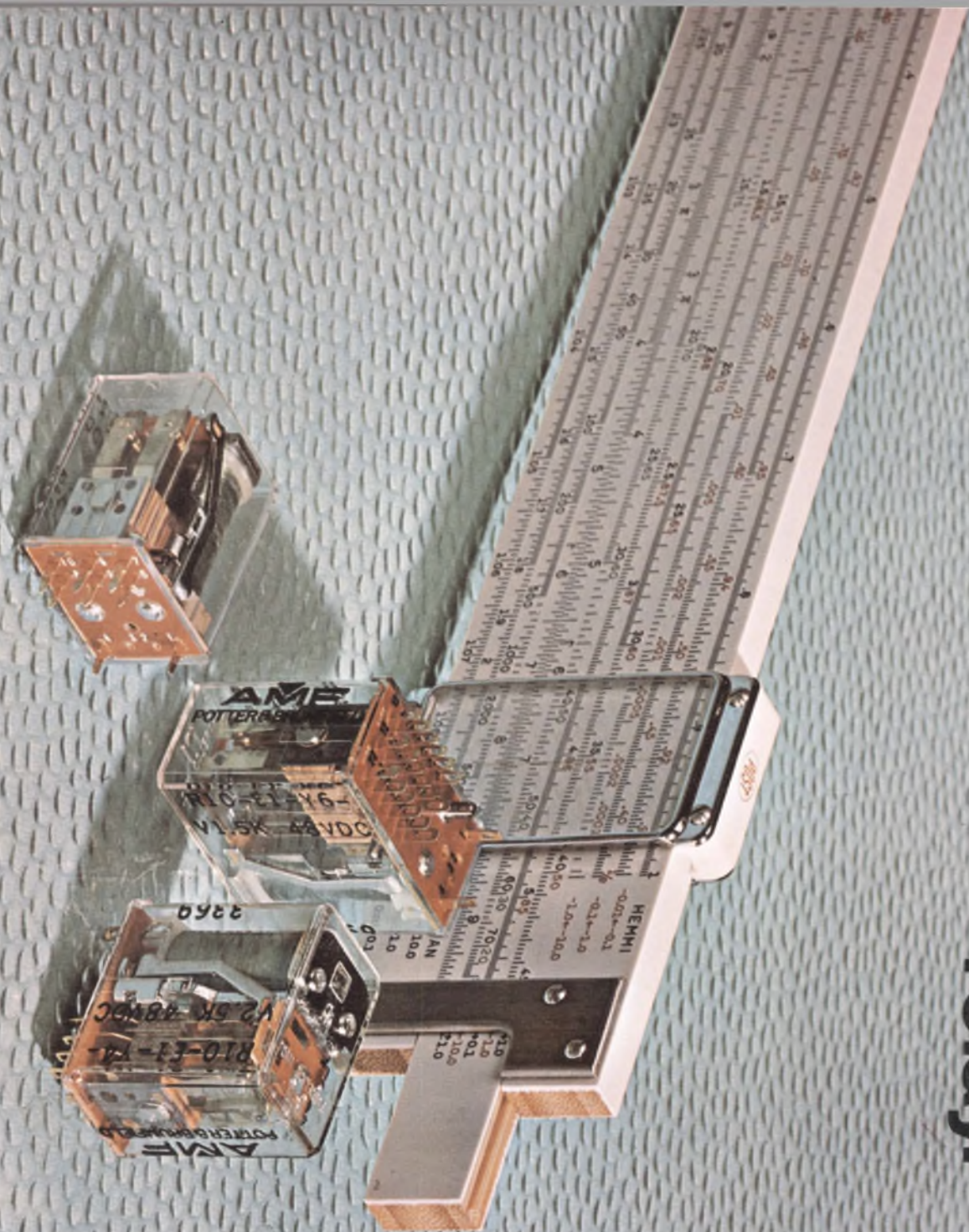

The P&B R-10 Series offers designers a whole family of AC and DC industrial relays that combine extraordinary versatility in application, the reliability of telephone-type relays, and small size (less than a cubic inch). They are widely used in copiers, computer peripherals, business machines and precision instruments.

So versatile is this series that each model is literally designed by you, to meet your special needs. You use a single family of

relays, with common mechanical dimensions and common mounting techniques, to cover the whole range of switching loads you may desire, from dry circuit to 10 amps, 28 V DC, 120 V AC. There are several terminal styles for solder or pc board mounting. Special octal plug mounting is available, and sockets multiply design options even more.

R-10's can now be ordered with Form A, B and D contacts as well as Form C, with arrangements up

to 8 Form C. Underwriters' Laboratories, Component Recognition, File 42810. DC relays have a continuous power dissipation of 2.2 watts maximum. Standard sensitivity is 125 milliwatts per pole. Mechanical life is up to 100 million operations, electrical life ranges from 100,000 to 100 million operations. Special light emitting diode (LED) indicator, a convenient check when troubleshooting a circuit is available as an option on R-10 relays.

Take just four easy steps to "design" the R-10 relay that fits your requirements perfectly.

1 Decide on the type of terminal mounting you want:

Solder terminals. Stud or plug-in mounting







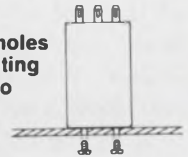

Printed circuit terminals. No stud mounting



Tapped holes for mounting directly to surface



2 Select desired rating and contact form:

| Rating | 10 amp† | | 5 amp (Bifurcated) | | 5 amp | | 2 amp | | Low Level (Bifurcated) | | Dry Circuit (Cross Bar) | |
|--|--|---------------------------|---|--------------------------------------|--|--------------------------------------|---|--|--|--|--|--|
| | Poles | Forms | Poles | Forms | Poles | Forms | Poles | Forms | Poles | Forms | Poles | Forms |
| Contact form | 2 4 6 | A,B,C,D A,B,C,D A,B | 2 4 6 8 | A,B,C,D A,B,C,D A,B,C A,B,C | 2 4 6 8 | A,B,C,D A,B,C,D A,B,C A,B,C | 2 4 6 8 | A,B,C,D A,B,C,D A,B,C,D A,B,C | 2 4 6 8 | A,B,C,D A,B,C,D A,B,C,D A,B,C | 2 4 6 8 | A,B,C,D A,B,C,D A,B,C,D A,B,C |
| Contact data | .125 DIA.  | | 100 DIA.  | | .100 DIA.  | | .078 DIA.  | | .062 DIA.  | | .017 DIA.  | |
| Resistive load* @ 28 VDC or 115 VAC | Typ. 7.5 Amps Max. 10 Amps Min. .200 Amps | | Typ. 5 Amps Max. 7.5 Amps Min. .200 Amps | | Typ. 5 Amps Max. 7.5 Amps Min. .050 Amps | | Typ. 2.0 Amps Max. 3.0 Amps Min. 0.01 Amps | | Typ. 0.1 Amp Max. 2.0 Amps Min. 0.001 Amp | | Typ. 500 mA Max. 250 mA Min. Dry Circuit | |

*Total load not to exceed 30 amperes per relay. †Use ungrounded frame for loads over 5 amperes.

3 Choose the proper coil resistance:

- Standard and sensitive DC voltage coils available from 3.0 to 115 volts @ 25°C.
- AC voltage coils from 12 to 115 V @ 25°C.
- DC sensitivity as high as 20 milliwatts per pole.
- Bifilar coils to protect relay drive transistors available to 48 V nominal.

4 Pick the socket that fits.



R-10 Relay Socket

Retains floating terminals of either solder or P/C pin configurations.



Printed Circuit Right Angle Socket

Allows relay to mount flat on P/C board, reduces height from 1.720" to .860" max.



Bracket Mount Socket

Allows solder terminal relay to mount flat on a chassis.

Versatile R-10 industrial relays, with their almost limitless design options and application capabilities, are available nationwide from leading electronic parts distributors. Or call your P&B representative. For a free 214 page relay catalog, write Potter & Brumfield Division AMF Incorporated, Princeton, Indiana 47670. Telephone 812 385-5251.



P&B makes more of more kinds of relays than anybody in the business.

Anybody.

What's wrong with the IEEE show?

Engineers suggest changes to reverse attendance drop

Richard L. Turmail, Management Editor

A record 64,000 engineers attended the annual IEEE International Convention and Exposition at the Coliseum in New York City in 1968. This year, the show's sponsors expect only about 30,000. Why is attendance at the industry's largest showcase falling?

A random sampling of typical showgoers turns up a variety of complaints, including these:

- There aren't enough new products to justify a visit to the show.
- Fewer components are being shown. Instead, exhibitors are relying on blinking lights and other gadgetry to pull in the curious.
- There are few company engineers in the booth to explain the products. Too many companies rely on hostesses or salesmen to do the job, and they're obviously unqualified technically.
- Technical sessions are frequently boring and poorly organized.

Spotlight on the technical

In brief, an *ELECTRONIC DESIGN* random sampling shows, engineers look at the IEEE show as a solid technical production, a chance to keep abreast of trends that will help them on the job. To the extent that the show fulfills these goals, it's a hit with engineers. But to the extent that it digresses into a commercial carnival—and some engineers fear this has been the recent direction—it's a flop.

Could the decline in attendance be reversed? Possibly. If the shortcomings were remedied and the IEEE show management took steps to introduce new attractions—such as this year's Science/Technology Center on the fourth floor of the Coliseum—more engineers might attend, engineers suggest.

From eight engineers who were interviewed, the following emerges as a composite profile of the technical-minded IEEE showgoer: He is an engineer with over 11 years experience in the electronics industry. He attends the show every two years and spends about eight hours visiting 20 booths (those in his field of interest mainly). He also attends about one technical session per



Lajoie—He builds systems, and he'd like to see more components displayed at the show.

show. Half of those interviewed were IEEE members, two were former IEEE members and two were never members.

Here are their comments on the show:

Peter H. Lajoie, an engineering manager at Trump/Ross Controls, Inc., Billerica, Mass., has gone to the show every two years for the past 10 years. "They're showing fewer and fewer components each year I go," he says. "I know it's easier to display instruments, because they blink and move, but I need components to build systems."

Kenneth Wong, senior engineer at Loral Corp., Electronics System Div., in the Bronx, New York City, who also has averaged a visit every other year for 10 years, agrees with Lajoie. "There just aren't enough new products each year to warrant an annual visit," he says.

Jerry Pessah, a design engineer at New York Telephone in the Bronx, who visited the show two years ago, comments: "The show doesn't seem to be well organized—it seemed more like a fair than an exposition."

Jack Heaviside, R&D engineer at North Atlantic Industries, Inc., Plainview, N.Y., has visited the show faithfully every year for the past 10 years. He says: "The show is a good place to see new products and the competition, but the sponsors should come up with a better way to classify the exhibits in the guide book to help reduce the time I waste. I can find a company I'm aware of in the visitor's guide, but if I want to see all the people who make counters, for example, there's no way to find out who the new ones are unless I take the time to tour the entire exposition."

Jimmy Loy, a chief engineer at the Bogen Div.

of Lear Siegler, Inc., Paramus, N.J., has attended every show for the past 10 years. "When the vendors stopped giving engineers free passes to the show," he says, "our company limited the number of engineers who could go. Often, too, you can get better product news from the sales reps that visit the company during the year."

Rick Spofford, an engineering manager at Analog Devices, Inc., Norwood, Mass., who has gone to the show every other year for the past 10 years, noted: "I want to see semiconductors, test equipment and passive components. Since there are fewer displays of those products each year, nothing has motivated me to go to the show on a regular basis."

Dick Tuhro, a project engineer from Computer Identics Corp. in Westwood, Mass., questions whether it's necessary to go to the show. "I must have something specific in mind to cover the show properly," he says. "When I attended the show four years ago, I found everything I needed to see in the electronic trade magazines before I went. Why go to the show?"

Morris Robison, an engineer at Tecstar, Worthington, Ohio, who has visited the show for the last 16 years, adds still another thought: "It's difficult for some engineers to see this show," he says, "especially if they have to travel a long

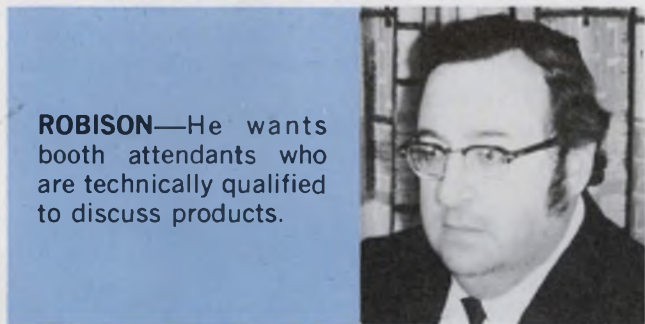

ROBISON—He wants booth attendants who are technically qualified to discuss products.

distance to attend. Often they get a bad taste of the whole trip because of heavier and heavier expenses each year, and because of other growing travel problems that aren't really related to the show itself."

Changes in the show noted

How has the show changed over the years?

"The show grew from a few booths to over 700 and back down again to 300 or 400," Robison says, "At 700-plus booths, the show was too big to cover properly."

And some visitors didn't always come to see just the exhibits. "At one time," Robison notes, "the show was identified as an employment agency—it became a quasi-social employee-stealing affair, but that's tailed off the past few years."



Some attendees say that there aren't enough new products to warrant an annual visit to the show.

Wong says: "I've changed more than the show. When I first attended the show, it helped me greatly because I was inexperienced. I saw new products I hadn't seen before. But the higher I get in job position, the less useful the show is to me. I think it's geared more to the young engineer."

Loy comments: "Recently engineers have come to town and skipped the show altogether. Rather than spend time looking at a lot of booths that are outside their interests, they go only to the hospitality suites to learn about specific product introductions and applications."

As for show improvements, some of the engi-



HEAVISIDE—He wants the visitor's guide book to tell him who the new producers are.

neers believe that the show's mission of spreading information would stand a better chance for success if the exhibitors manned their booths properly, if the papers and themes at the technical sessions were reassessed and if the exhibitors would organize the handling of their product literature better.

According to Robison, the quality of booth personnel is poor.

"Three of five attendants are not qualified to discuss the details of the product," he says. "And if only one qualified engineer has been assigned to a booth, he may well be off duty at just the time you visit his booth for information."

Lajoie says that salesmen are often assigned to the booth. "They've been primed with technical information for the show," he observes. "Many are helpful, but an engineer would be more helpful."

Four of the engineers interviewed have never attended a technical session at the IEEE show. Two report they've never had the time to attend, and one said he never actually knew that the sessions were being held. Two others say that too many of the sessions are over their heads or unrelated to their work.

Spofford says that he has found that the papers are not always related to one another, nor to the theme of the session in which they are presented.

Wong says that often the sessions are uninteresting and a waste of his time.

Robison notes: "I think that sometimes the



One complaint is that some speakers fail to relate their paper to the theme of the session.

guy giving the paper is trying too hard to impress a potential employer with his technical knowledge when he should be trying to communicate with his audience."

Robison also asserts that exhibitors sometimes fail to have the proper product literature at their booths. "Sometimes they promise to mail the information to me, but by the time I get it, if I get it at all, it's too old to use," he says.

Lajoie adds: "I think it would be a good idea if the IEEE polled its membership on needed show improvements."

Suppose the IEEE show management intro-

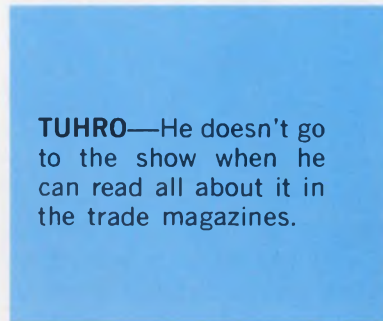

TUHRO—He doesn't go to the show when he can read all about it in the trade magazines.

duced improvements? Would they stimulate attendance?

Half of the eight engineers in the sampling said at first that they didn't think they'd be going to the show this year. And then they were told that the show would have a Science/Technology Center this year with innovative features. The engineers' reaction was positive to a man: "Fantastic! Sounds very interesting. Great idea!" With comments like these most said that now they would probably attend the show. ■■

Discover the value of power...



and how it saves you money on your mini.

Discover the all-new SPC-16 family of minicomputers. The first minis to save you substantial money in system implementation. They're from General Automation... the fast-growing, pace-setting mini maker.

In overall performance, SPC-16's run circles around those other two brands of minis you've heard so much about. With features like the industry's most powerful addressing scheme, including base relative addressing. Exclusive pre- and post-indexing. And eight (16 optional) true general purpose registers that can save you up to 4K (about \$2500 worth) of core. Another plus is a unique one word Load All Registers/Store All Registers capability. And much more.

Including the right price, the best quantity discounts in the industry and the easiest OEM buying policy of all.

SPC-16's are available as I/O and memory-integrated models for dedicated in-house applications. Or as unbundled versions for OEM users or large system applications requiring up to 65K of memory. Six models in all, in three speeds.

No other minis come close to SPC-16's in giving you so much performance for your money. Give us a benchmark, we'll prove it. Meantime, send today for a detailed brochure.



GENERAL AUTOMATION, INC. 1055 So. East Street, Anaheim, Ca. 92805 (714) 778-4800 TWX 910-591-1695
'Discover The Value Of Power'

NOBODY ASKED YOU.

Are you going to put up with that??

There has always been a tendency for the test industry to design products, give them the "bally-hoo" treatment, then find someone to sell them to. We intend to reverse this trend by finding out what your needs are **before** we start designing. Instead of talking about our own function generators and pulsers, we're going to sit back and listen to you. We'll be at IEEE and other industry conventions, and we'll listen. You can phone in your gripes, and we'll listen. You know what you want, and we'll listen to what you have to say. The essential thing is to set us straight about what's really important to you.

The questionnaire on the facing page was designed to let you be frank, specific, and critical. By taking time to help us build a dialog that's **going somewhere for a change**, you will be benefitting not only yourself and IEC, but the entire industry. We'll stand by our promise to get back to you with a report on the results of this communication, and what we plan to do about it.

Now it's your move — if you want what's coming to you.

TAKE A COFFEE BREAK AND FILL US IN.

It will take you 1 cup of coffee to fill out the "sound-off" sheet on the following page, and for doing so IEC will send you this **FREE COFFEE MUG.*** Or see IEC at IEEE, Booth 2633, and have your say. (We'll let you have the coffee mug, either way.)

*Quantities are limited! Forms will be acknowledged in the order they are received, and must be submitted by May 15, 1972. Offer limited to U.S.A.



You bet I've got something to say...

... about Function Generators

- Who needs a function generator? My RC oscillator does everything that I need to do.
- I'm content with the function generators available today. Models that I like best are _____

Wide Frequency range is extremely critical important not significant for my needs. The narrowest frequency range that I would consider for my requirements is _____ Hz to _____ MHz.

Output Voltage is extremely critical important not significant for my needs. The narrowest voltage range I would consider for my requirements is _____ mv to _____ v into a _____ ohm load.

The Function Generator waveforms that are important to me (order of importance) are:

- Square wave Triangular wave Sine wave
- Pulses Ramps _____

I'm not sold on function generators. What bugs me most is _____

... about Pulse Generators

Pulse repetition frequency range is extremely critical important not significant for my needs. The narrowest PRF range that I would consider for my requirements is _____ Hz to _____ MHz.

Rise/Fall Time is extremely critical important not significant for my needs. The slowest rise/fall time that I would consider for my requirement is _____ ns.

Pulse amplitude is extremely critical important not significant for my needs. The narrowest amplitude range that I would consider for my applications is _____ mv to _____ v into a _____ ohm load.

The other Pulse Generator capabilities that are important to me (in order of importance) are:

- External Trigger Baseline Offset Adjustable Pulse delay
- Adjustable Rise/Fall Time Gated Output _____
- I'm not sold on Pulse generators. What bugs me most is _____

... about Test Instruments in general

Unique applications that have developed in my use of test instruments include: _____

My biggest gripe about test instrument manufacturers and their products are: _____

But once in a while, you guys **do** do something right: like _____

NAME: _____

JOB TITLE: _____

COMPANY NAME: _____

ADDRESS: _____

CITY, STATE: _____



Mail to: "IEC SOUND-OFF,"
P.O. Box 3117, Anaheim, California 92803
(714) 772-2811

OK. NOW SEND ME MY COFFEE CUP!

What, who, when and where: A timetable to tech sessions

Avionics and Aerospace

- An Overview of Other Problems Waiting for Aerospace Solutions—R.J. Miner, NASA, Washington, D.C. (2G.6/Mon./p.m./R)
- Plans for the Japanese Domestic System—F. Ikegami, S. Morimoto, Nippon T&T Public Corp., Tokyo, Japan (4G.1/Tues./p.m./R)
- Canadian Domestic Satellite Communication System—J. Almond, Telesat Canada, Ottawa, Ont., Canada, (4G.2/Tues./p.m./R)
- Regional Communication Services via Intelsat Satellites—J.L. Dicks, Comsat Corp., Washington, D.C. (4G.3/Tues./p.m./R)
- Data Processing for Earth-Resource Sensors—P. Wintz, Purdue University, Lafayette, Ind. (5E.3/Wed./a.m./MS)
- Possible Roles of Satellite Communications for Educational Development—A.M.G. Andrus, NASA, Washington, D.C. (7H.4/Thurs./a.m./N)
- The Application of Cylindrical Arrays to Microwave Landing Guidance Systems—R. Kalafus, U.S. Dept. of Transportation, Cambridge, Mass. (6CK.1/Wed./p.m./C-K)
- A New Cylindrical Electronic Scan Antenna for Air Traffic Control—P. W. Hannan, J. H. Gutman, R. J. Giannini, Hazeltine Corp., Green Lawn, N.Y. (6CK.2/Wed./p.m./C-K)
- Application of the Doppler Scanning Beam Concept to Microwave Landing Systems—H. W. Redlien, Hazeltine Corp., Green Lawn, N.Y. (6CK.3/Wed./p.m./C-K)
- A Millimeter-Wave Sensor and Detector for Clear-Air Turbulence—G. G. Haroules, W. E. Brown, G. W. Wagner, U.S. Dept. of Transportation, Cambridge, Mass. (6CK.5/Wed./p.m./C-K)



The IEEE showgoer will have a choice of 79 technical sessions

Civionics

- Health-Testing Facilities and the Use of Computers for Processing Medical Signals—C. A. Caceres, Clinical Systems Associates, Inc., Washington, D.C. (1D.1/Mon./a.m./SN)
- Law, Aeronautical and Computer Technology—C. W. Swonger, Cornell Aeronautical Lab., Buffalo, N.Y. (1D.2/Mon./a.m./SN)

- Urban Systems Analysis—An Application—F. DiCesare, H. Stern, R.P.I., Troy, N.Y.; P. Van Buskirk, City Planning and Development Agency, Cohoes, N.Y. (1D.3/Mon./a.m./SN)
- Applications of Defense Research to Societal Problems—R. B. Ives, AFOSR/NM, Arlington, Va. (1D.4/Mon./a.m./SN)
- Panel Discussion: Philosophy of Electrical and Electronic Technology (Considering Social Impact Foremost in the Minds of Young Engineers)—J. E. Brittain, Georgia Institute of Technology, Atlanta, Ga.; A. B. Bronwell, University of Connecticut, Storrs, Conn.; P. Durbin, University of Delaware, Newark, Del.; D. Gabor, CBS Labs., Stamford, Conn.; M. L. Minsky, M.I.T., Cambridge, Mass.; C. Susskind, University of California, Berkeley, Calif.; E. Weber, National Research Council, Washington, D.C. (2C Mon./p.m./RG)
- Robots, Jobs and Rush-Hour Traffic—J. S. Albus, NASA, Washington, D.C. (2D.1/Mon./p.m./SS)
- Portable Visual Performance Instrumentation—P. W. Davis, Dept. of Transportation, Cambridge, Mass. (2G.1/Mon./p.m./R)
- Catheter-Tip Pre-amplifier—C. Laenger, Southwest Research Institute, San Antonio, Tex. (2G.2/Mon./p.m./R)
- Orthotic Control Systems—J. R. Allen, Communication, Power and Control Engineering, Downey, Calif. (2G.3/Mon./p.m./R)
- Design and Construction of a Sight-Switch-and-Breath-Switch-Operated Environmental Control System for Handicapped Persons—S. Sancar, Huntsville Hospital, Huntsville, Ala. (2G.4/Mon./p.m./R)
- The Oximeter—An Instrument Used To Detect Changes of Relative Blood Pressure To Detect the Onset of Shock in Leukemia Patients—F. T. Wooten, Research Triangle Institute, Research Triangle Park, N.C.; W. J. Penland, National Cancer Institute, Bethesda, Md. (2G.5/Mon./p.m./R)
- An Overview of Other Problems Waiting for Aerospace Solutions—R. J. Miner, NASA, Washington, D.C. (2G.6/Mon./p.m./R)
- Capsule History of BART—K. Bernard, BART, San Francisco, Calif. (3G.1/Tues./a.m./R)
- Transit Design; Functional, Esthetic and Environmental Considerations—T. B. Maule, Parsons-Brinckerhoff-Tudor-Bechtel, San Francisco, Calif. (3G.2/Tues./a.m./R)
- Engineering/Legal/Political Interfaces—W. A. Bugge, Parsons-Brincker-

Technical papers are grouped in these categories

- | | |
|-------------------------------------|---|
| Avionics and aerospace | Electro-optical |
| Civionics | Industrial |
| Communications | Materials, interconnections and packaging |
| Components | Microelectronics |
| Computers and Computer-aided design | Microwaves |
| Education and Marketing | |

hoff-Tudor-Bechtel, San Francisco, Calif. (3G.3/Tues./a.m./R)

A Systems Approach to Automotive Control Electronics—H. B. Tyson, F. P. Caiati, General Motors Technical Center, Warren, Mich. (4E.1/Tues./p.m./MS)

Development of Electronics for British Automobiles—M. M. Bertoli, Joseph Lucas Group Research, Warwickshire, England. (4E.2/Tues./p.m./MS)

On the OK-Meter Fault-Detection System for Automobiles—T. Kitano, O. Ito, H. Wakamatsu, Nippondenso Co., Ltd., Kariya, Japan (4E.3/Tues./p.m./MS)

Electronic Device Development for the Automobile—W. Harrison, Texas Instruments Inc., Dallas, Tex. (4E.4/Tues./p.m./MS)

A Systems Approach to City Communications—R. P. Gifford, General Electric, Lynchburg, Va. (4H.1/Tues./p.m./N)

Telemedicine for Improved Medical Care—R. Mark, M.I.T., Cambridge, Mass. (4H.2/Tues./p.m./N)

Community Reaction to Communications Technology—G. Heningburg, Newark Urban Coalition, Newark, N.J. (4H.3/Tues./p.m./N)

World Dynamics—D. L. Meadows, M.I.T., Cambridge, Mass. (5C.1/Wed./a.m./SN)

Industrialized Ecosystem Design and Management—H. E. Koenig, Michigan State University, East Lansing, Mich. (5C.2/Wed./a.m./SN)

Balance of Environmental Quality and Industrial Productivity—W. K. Linvill, Stanford University, Stanford, Calif. (5C.3/Wed./a.m./SN)

Biological Effects of Magnetic and Electrostatic Fields and Electric Current from DC to 1 Hz—R. O. Becker, Veterans Hospital, Syracuse, N.Y. (6C.1/Wed./p.m./SN)

EM Effects on Man—Sonic to Infrared Frequencies—C. L. Frederick, Southwest Research Institute, San Antonio, Tex. (6C.2/Wed./p.m./SN)

Survival and the Sea-Level Solar Electromagnetic Spectrum—H. L. Logan, Consultant, Bronxville, N.Y. (6C.3/Wed./p.m./SN)

Electronics in the Courtroom—R. Penn, NBS, Washington, D.C. (6D.1/Wed./p.m./SS)

Computer Model of the Felony Delay Problem—J. J. Uhran, Jr., M. K. Sain, E. W. Henry, D. Sharpe, University of Notre Dame, Ind. (6D.2/Wed./p.m./SS)

Systems Analysis of Juror Waiting—W. R. Pabst, Jr., Consultant, Washington, D.C. (6D.3/Wed./p.m./SS)

The Real Bottleneck—Our Obsolete Decision-Making Process—M. Altman, University of Pennsylvania, Philadelphia, Pa. (6E.1/Wed./p.m./MS)

Electronic Technology: A Panacea or Placebo for Education?—R. C. Dorf, Ohio University, Athens, Ohio (6E.2/Wed./p.m./MS)

Effects of Computers and Automation—E. Katzenbach, Nova University, Fort Lauderdale, Fla. (6E.3/Wed./p.m./MS)

Personal Responsibility of Engineers for Their Work—S. H. Unger, Columbia University, New York, N.Y. (6E.4/Wed./p.m./MS)

Code to abbreviations

Session locations in the New York Hilton are:

E—East Ballroom
G—Gramercy Suite
MH—Murray Hill Suite
N—Nassau Suite
R—Regent Room
RG—Rhineland Gallery South
RN—Rhineland Gallery North
SN—Sutton Ballroom North
SS—Sutton Ballroom South

All technical application sessions
C—Coliseum

Numerals refer to sessions and to papers in a session—for example, 3G.5 is paper 5 of session 3 G.

The hours for the regular sessions, Monday through Thursday are: 9:30 a.m. to 4:30 p.m. The hours for the technical applications sessions are: 10:30 a.m. to 5:00 p.m.

Technology and International Politics—I. L. White, University of Oklahoma, Norman, Okla. (6E.5/Wed./p.m./MS)

Centralized Traffic Management of the Paris Underground Railway—L. Gillon, Compagnie General de Constructions Telephoniques, Paris, France (7E.1/Thurs./a.m./MS)

Technical Achievements of the New Tokaido Line and Electronic Techniques Contemplated for New High-Speed Railways—T. Matsuo, Japanese National Railways, Tokyo, Japan (7E.2/Thurs./a.m./MS)

Modern Trends in the Command and Control of Mass and Personalized Transportation in the U.S.—J. E. Freehafer, General Railway Signal Co., Rochester, N.Y. (7E.3/Thurs./a.m./MS)

Cost-Effective Microwave Systems for Railroad and Automobile Safety Applications—J. B. Hopkins, F. R. Holmstrom, U.S. Dept. of Transportation, Cambridge, Mass. (6CK.4/Wed./p.m./C-K)

Communications

The New Rural Society—P. C. Goldmark, CBS Labs., Stamford, Conn. (2A.1/Mon./p.m./RG)

Computer Television—What Works and What Doesn't Work—P. Klein, Computer Television Corp., New York, N.Y. (2A.2/Mon./p.m./RG)

CATV Network via Satellite—J. V. Charyk, Comsat Corp., Washington, D.C. (2A.3/Mon./p.m./RG)

CATV—Subscriber, Supply and Demand—H. Schlafly, TelePrompTer Corp., New York, N.Y. (2A.4/Mon./p.m./RG)

CATV and Regulation—D. Burch, FCC, Washington, D.C. (2A.5/Mon./p.m./RG)

Robots, Jobs and Rush-Hour Traffic—

J. S. Albus, NASA, Washington, D.C. (2D.1/Mon./p.m./SS)

Potential Substitutions of Telecommunications for Face-to-Face Meetings; The Results of a Contact Record-Sheet Survey—A Reid, Joint Institute for Planning Research, London, England (2D.2/Mon./p.m./SS)

Video Conferencing—A. W. Williams, J. Duncanson, BTL, Holmdel, N.J. (2D.3/Mon./p.m./SS)

New Techniques in Connection with the Use of Cable and Home TV to Revolutionize Communications—W. F. Mason, Mitre Corp., McLean, Va. (2D.4/Mon./p.m./SS)

Transmission of a Holomicrogram Over a Limited Telemetry Channel—R. F. van Ligten, J. A. Levitt, J. T. Winthrop, American Optical Corp., Framingham, Mass. (2E.3/Mon./p.m./MS)

Panel Discussion: Telecommunications Policy and Society—A Case Study, Data Networks of the Future—S. Lasher, Office of Telecommunications Policy, Executive Office of the President, Washington, D.C. H. M. Boettinger, AT&T, New York, N.Y.; D. H. Foster, Datran, Vienna, Va.; R. Fano, M.I.T., Cambridge, Mass. (3F/Tues./a.m./G)

Hybrid-Circuit Applications in Portable Communications Equipment—M. L. Topfer, Motorola Inc., Fort Lauderdale, Fla. (3H.3/Tues./a.m./N)

Precision Tantalum-Film RC Circuits for Communication Systems—W. H. Orr, J. J. Degan, Jr., BTL, Indianapolis, Ind. (3H.4/Tues./a.m./N)

Canadian Data Communications—W. J. Inkster, Bell Northern Research, Ottawa, Ont., Canada (4F.1/Tues./p.m./G)

Bell System Data Transmission Plans in the U.S.—P. E. Muench, AT&T, New York, N.Y. (4F.2/Tues./p.m./G)

Serendipity of Digital Communications—C. R. Fisher, Datran, Vienna, Va. (4F.3/Tues./p.m./G)

Western Union Data Transmission Planning—J. E. Cox, Western Union Telegraph Co., Mahwah, N.J. (4F.4/Tues./p.m./G)

Plans for the Japanese Domestic Satellite System—F. Ikegami, S. Morimoto, Nippon T&T Public Corp., Tokyo, Japan (4G.1/Tues./p.m./R)

Canadian Domestic Satellite Communication System—J. Almond, Telesat Canada, Ottawa, Ont., Canada (4G.2/Tues./p.m./R)

Regional Communication Services via Intelsat Satellites—J. L. Dicks, Comsat Corp., Washington, D.C. (4G.3/Tues./p.m./R)

A Systems Approach to City Communications—R. P. Gifford, General Electric, Lynchburg, Va. (4H.1/Tues./p.m./N)

Telemedicine for Improved Medical Care—R. Mark, M.I.T., Cambridge, Mass. (4H.2/Tues./p.m./N)

Community Reaction to Communications Technology—G. Heningburg, Newark Urban Coalition, Newark, N.J. (4H.3/Tues./p.m./N)

Surface Acoustic-Wave Binary Phase Encoders and Decoders—L. T. Claiborne, Texas Instruments Inc., Dallas, Tex. (5D.1/Wed./a.m./SS)

- Surface Acoustic-Wave UHF and VHF Bandpass Filters—R. H. Tancrell, Raytheon Research Labs., Waltham, Mass. (5D.2/Wed./a.m./SS)
- A Surface Acoustic-Wave Digital Recirculating Memory—H. Matthews, Sperry Rand, Sudbury, Mass. (5D.3/Wed./a.m./SS)
- Digital Data Networks—M. Schwartz, Polytechnic Institute of Brooklyn, N.Y. (5E.1/Wed./a.m./MS)
- Mobile Communications for Urban and Interurban Use—J. Engel, BTL, Holmdel, N.J. (5E.2/Wed./a.m./MS)
- Data Processing for Earth-Resource Sensors—P. Wintz, Purdue University, Lafayette, Ind. (5E.3/Wed./a.m./MS)
- Processing of Scientific Biomedical Images—D. Chesler, Massachusetts General Hospital, Boston, Mass. (5E.4/Wed./a.m./MS)
- Panel Discussion: 900 MHz—A New Horizon in Land Mobile Communications—M. Cooper, Motorola Inc., Fort Lauderdale, Fla.; H. A. Jones, RCA, Meadowlands, Pa.; G. R. Peterson, General Electric, Lynchburg, Va.; R. E. Spence, FCC, Washington, D.C.; J. B. Keane, AT&T, New York, N.Y. (6A/Wed./p.m./RG)
- Biological Effects of Magnetic and Electrostatic Fields and Electric Current from DC to 1 Hz—R. O. Becker, Veterans Hospital, Syracuse, N.Y. (6C.1/Wed./p.m./SN)
- EM Effects on Man—Sonic to Infrared Frequencies—C. L. Frederick, Southwest Research Institute, San Antonio, Tex. (6C.2/Wed./p.m./SN)
- Survival and the Sea-Level Solar Electromagnetic Spectrum—H. L. Logan, Consultant, Bronxville, N.Y. (6C.3/Wed./p.m./SN)
- Some Developments in the Digital Processing of Images and Sound—T. G. Stockham, Jr., University of Utah, Salt Lake City, Utah (6H.1/Wed./p.m./N)
- Linear Programming Methods in the Design of Digital Filters—L. Rabiner, BTL, Holmdel, N.J. (6H.2/Wed./p.m./N)
- Algorithmic Formulation of Communication Problems—M. Schwartz, Polytechnic Institute of Brooklyn, N.Y. (6H.3/Wed./p.m./N)
- Detection with Finite-State Machines—R. Boorstyn, Polytechnic Institute of Brooklyn, N.Y. (6H.4/Wed./p.m./N)
- Audio-Visual Teaching Techniques in the Industrial Environment—J. T. LaMacchia, BTL, Holmdel, N.J. (7H.1/Thurs./a.m./N)
- Taped Television Instruction—P. R. Karmel, D. Eitzer, City College, New York, N.Y. (7H.2/Thurs./a.m./N)
- Individualized Learning with Cassette, Video Tape and Consultant—W. H. Hayt, Jr., W. L. Weeks, Purdue University, Lafayette, Ind. (7H.3/Thurs./a.m./N)
- Possible Roles of Satellite Communications for Educational Development—A. M. G. Andrus, NASA, Washington, D.C. (7H.4/Thurs./a.m./N)
- Communications Applications of Minicomputers—T. C. Stockebrand, Digital Equipment Corp., Maynard, Mass. (4CH.1/Tues./p.m./C-H)
- Applications of Minicomputers in Signal Processing—T. Storer, Time Data Corp., Palo Alto, Calif. (4CH.3/Tues./p.m./C-H)
- High-Power CW Gunn Oscillator for Communication Applications—A. L. Reynolds, ITT, Nutley, N.J. (7CJ.1/Thurs./a.m./C-J)
- Microwave Technology in Gigabit PSK Modulation and Demodulation for Digital Communication—C. L. Cuccia, Philco-Ford, Palo Alto, Calif. (7CJ.2/Thurs./a.m./C-J)
- A 19-GHz Transmitter and Receiver for Experimental High-Speed Digital Transmission—W. J. Schwarz, R. W. Kordos, R. W. Judkins, BTL, North Andover, Mass. (7CJ.3/Thurs./a.m./C-J)
- Technological Considerations for High-Speed Digital Radio Repeater—R. D. Silverthorn, Bell-Northern Research, Ottawa, Ont., Canada (7CJ.4/Thurs./a.m./C-J)
- Design of a Data Compression Vocoder—D. T. C. Dechaux, Thomson-CSF/DCT, Gennevilliers, France (7CK.4/Thurs./a.m./C-K)
- Perspectives of a Component Manufacturer—R. T. Rasmussen, Sigma Instruments, Inc., Braintree, Mass. (4CJ.4/Tues./p.m./C-J)
- Solid Aluminum Capacitors—F. R. Kunnen, N. V. Philips, Eindhoven, Netherlands (7CK.1/Thurs./a.m./C-K)
- Fault Diagnosis to Component Level—D. R. Perkins, Marconi Instruments Ltd., St. Albans, England (7CK.2/Thurs./a.m./C-K)

Computers and Computer-Aided Design

- Memory Hierarchies—Fact and Fiction—R. L. Mattson, IBM, San Jose, Calif. (1C.1/Mon./a.m./SN)
- Applications of Program Modeling to Hierarchies—P. J. Denning, Princeton University, Princeton, N.J. (1C.2/Mon./a.m./SN)
- Memory Hierarchies: Economic Considerations and Future Prospects—W. R. Beam, Consultant, Chappaqua, N.Y. (1C.3/Mon./a.m./SN)
- Health-Testing Facilities and the Use of Computers for Processing Medical Signals—C. A. Caceres, Clinical Systems Associates, Inc., Washington, D.C. (1D.1/Mon./a.m./SS)
- Hardware/Software Interfaces—J. Mekota, B. Rosebaum, Honeywell, Billerica, Mass. (1F.1/Mon./a.m./G)
- A User's View of Logic Simulation—R. Walker, Fairchild Semiconductor Mountain View, Calif. (1F.2/Mon./a.m./G)
- Logic Design Guidelines for Fault Isolation—P. Scola, Honeywell, Phoenix, Ariz. (1F.3/Mon./a.m./G)
- Logic Design Verification, Fault Detection and Resolution—G. W. Smith, Jr., BTL, Naperville, Ill. (1H.1/Mon./a.m./N)
- Automated Placement Wiring and Artwork Generation—A. Carrol, Automation Technology Inc., Champaign, Ill. (1H.2/Mon./a.m./G)
- Computer-Aided Design of Digital Integrated Circuits—R. Rohrer, Sof Tech Inc., Waltham, Mass. (1H.3/Mon./a.m./N)
- Microprogram Control For Minicomputers—W. H. Roberts, Consultant, Corona del Mar, Calif. (2F.1/Mon./p.m./G)
- The Wide Range of I/O Capabilities in a Microprogrammed Minicomputer—T. Mulder, D. Savitt, Microdata Corp., Santa Ana, Calif. (2F.2/Mon./p.m./G)
- Microprogramming—Real Applications in Minicomputers—D. Archdale, Interdata, Inc., Oceanport, N.J. (2F.3/Mon./p.m./G)
- A Survey of 3D Displays—J. F. Butterfield, Stereotronics Television, Sherman Oaks, Calif. (3A.1/Tues./a.m./RG)
- Three-Dimensional Displays Based upon the Sequential Excitation of Fluorescence—C. M. Verber, Battelle Columbus Labs., Columbus, Ohio; J. D. Lewis, Battelle Development Corp., Columbus, Ohio; R. B. McGhee, Ohio State University, Columbus, Ohio (3A.2/Tues./a.m./RG)

Components

- Miniaturized Active RC Filters—G. S. Moschytz, Swiss Federal Institute of Technology, Zurich, Switzerland; C. F. Kurth, BTL, North Andover, Mass. (2B.1/Mon./p.m./RN)
- Miniaturized Crystal Filters—D. F. Sheahan, GTE Lenkurt Electric Co., San Carlos, Calif. (2B.2/Mon./p.m./RN)
- Miniaturized Digital Filters—S. A. White, North American Rockwell Microelectronics Co., Anaheim, Calif. (2B.3/Mon./p.m./RN)
- Precision Thick-Film Resistors for High-Voltage Dividers—J. E. Turnbaugh, Tektronix, Inc., Beaverton, Ore. (3H.1/Tues./a.m./N)
- Light-Emitting Diodes—M. R. Lorenz, IBM, Yorktown Heights, N.Y. (4C.3/Tues./p.m./SN)
- Surface Acoustic-Wave Binary Phase Encoders and Decoders—L. T. Claiborne, Texas Instruments Inc., Dallas, Tex. (5D.1/Wed./a.m./SS)
- Surface Acoustic-Wave UHF and VHF Bandpass Filters—R. H. Tancrell, Raytheon Research Labs, Waltham, Mass. (5D.2/Wed./a.m./SS)
- A Surface Acoustic-Wave Digital Recirculating Memory—H. Matthews, Sperry Rand, Sudbury, Mass. (5D.3/Wed./a.m./SS)
- Latching Ferrite Technology—J. Pippin, Electromagnetic Sciences, Atlanta, Ga. (6B.1/Wed./p.m./RN)
- Recent Advances in Ferrite Limiters—R. Kalvaitis, H. S. Maddix, Varian Associates, Beverly, Mass. (6B.2/Wed./p.m./RN)
- Tailoring Ferrites for Microwave Devices—R. G. West, A. C. Blankenship, Trans Tech Inc., Gaithersburg, Md. (6B.3/Wed./p.m./RN)
- Radiation Effects on Electronic Components—J. P. Raymond, Northrop Corporate Labs, Hawthorne, Calif. (3K.2/Tues./a.m./C-K)

Pretend you never heard of Panasonic.

Imagine a different company. One of the world's largest battery manufacturers, selling batteries in more than 120 countries. A company whose research is revolutionizing the battery industry.

Now imagine another company. One that produces the world's most complete line of VTR/CCTV equipment. One whose diplomacy led to the first real standardization in video. Whose engineering skill is paving the way for pre-programmed cartridge video in the home.

Both of those companies are Panasonic.

Sometimes our reputation in consumer electronics makes people overlook our achievements in other fields. That means they

overlook a lot of our achievements.

Take video. Panasonic's new $\frac{1}{2}$ " Cartridge Video Recorder is a practical solution to the problem of home video. It conforms to both the EIAJ black and white recording standard and the new recommended color standard.



And standardization will make pre-programmed cartridge video in the home a reality rather than a dream.

On top of that, there's our VTP SYSTEM. The quickest,

most reliable, most economical system available for duplicating $\frac{1}{2}$ " video tapes.

Now take batteries. Panasonic has the latest. A new lithium High Energy Battery, with an energy density four to five times (in some cases ten times) greater than conventional batteries. And we've also got "Panaquick," our new device for rapid charging of batteries without the dangers of over-charge, gas generation or other damaging side effects.

Achievements like these shouldn't be overlooked. For a memorable experience, come visit us at this year's IEEE Show, booths 2814-2815. And when you do, pretend you never heard of Panasonic. You'll get to know us all over again.



Panasonic
just slightly ahead of our time

- A Computer-Generated Holographic 3D Display—J. D. Lewis, Battelle Development Corp., Columbus, Ohio; R. B. McGhee, Ohio State University, Columbus, Ohio; J. R. Shewell, Battelle Columbus Labs, Columbus, Ohio (3A.3/Tues./a.m./RG)
- User Requirements for Large-Capacity Memories—J. Jaffe, IBM, Yorktown Heights, N.Y. (3C.1/Tues./a.m./SN)
- Optical/Mechanical Design Parameters for a Laser Recorder Mass Memory—B. French, Precision Instruments Co., Palo Alto, Calif. (3C.2/Tues./a.m./SN)
- Holographic Optical Memory—R. D. Lohman, RCA Labs, Princeton, N.J. (3C.3/Tues./a.m./SN)
- Design of an Optical Disk Memory—J. Aseltine, Ovonic Memories, Inc., Los Angeles, Calif. (3C.4/Tues./a.m./SN)
- Masstape—A Systems Approach to Mass Storage—D. G. Ronkin, J. Haines, Grumman Data Systems, Garden City, N.Y.—(3C.5/Tues./a.m./SN)
- Panel Discussion: Making Quality Software—T. R. Parkin, Software Control Data Corp., Edina, Minn.; H. D. Mills, IBM, Gaithersburg, Md.; R. Pennington, Systems Development Corp., Hendersonville, N.C.; V. A. Vyssotsky, BTL, Whippany, N.J. (3E/Tues./a.m./MS)
- Panel Discussion: The Cost of Developing Software—R. W. Wolverton, TRW, Redondo Beach, Calif.; V. La Bolle, Dept. of Water and Power, Los Angeles, Calif.; T. E. Climis, IBM, Poughkeepsie, N.Y.; R. E. Merwin, Safeguard Systems Office, Arlington, Va. (4A/Tues./p.m./RG)
- Core Memories in the '70s—A. L. Friedman, Electronic Memories and Magnetics, Hawthorne, Calif. (5A.1/Wed./a.m./RG)
- MOS Storage—A Revolution in Main Memory—G. Moore, Intel Corp., Santa Clara, Calif. (5A.2/Wed./a.m./RG)
- Bipolar Memory—The Technology for the Future—J. Ricci, Intersil Corp., Cupertino, Calif. (5A.3/Wed./a.m./RG)
- Data Processing for Earth-Resource Sensors—P. Wintz, Purdue University, Lafayette, Ind. (5E.3/Wed./a.m./MS)
- Processing of Scientigraphic Biomedical Images—D. Chesler, Massachusetts General Hospital, Boston, Mass. (5E.4/Wed./a.m./MS)
- Trends in Semiconductors—R. Noyce, Intel Corp., Santa Clara, Calif. (5F.1/Wed./a.m./G)
- Trends for Small Systems—K. H. Olsen, Digital Equipment Corp., Maynard, Mass. (5F.2/Wed./a.m./G)
- Trends in Large Systems—J. Bertram, IBM, Armonk, N.Y. (5F.3/Wed./a.m./G)
- Computer Model of the Felony Delay Problem—J. J. Uhran, Jr., M. K. Sain, E. W. Henry, D. Sharpe, University of Notre Dame, Ind. (6D.2/Wed./p.m./SS)
- Effects of Computers and Automation—E. Katzenbach, Nova University, Fort Lauderdale, Fla. (6E.3/Wed./p.m./MS)
- Panel Discussion: Problem-Oriented Computer Languages—J. Sams, IBM, Atlanta, Ga.; S. Fenves, J. Moline, University of Illinois, Champaign-Urbana; D. Roos, M.I.T., Cambridge, Mass. (6F/Wed./p.m./G)
- Linear Programming Methods in the Design of Digital Filters—L. Rabiner, BTL, Holmdel, N.J. (6H.2/Wed./p.m./N)
- Throughput Analysis in Serial Processing—G. Amdahl, Amdahl Associates, Sunnyvale, Calif. (7C.1/Thurs./a.m./SN)
- Multiprocessors with Shared Resources—M. J. Flynn, Johns Hopkins University, Baltimore, Md. (7C.2/Thurs./a.m./SN)
- Second Thoughts on Parallel Processors—J. Shore, Naval Research Lab., Washington, D.C. (7C.3/Thurs./a.m./SN)
- Multistream Processors—An Example and Some Further Thoughts—W. J. Watson, Texas Instruments Inc., Austin, Tex. (7C.4/Thurs./a.m./SN)
- Computer Aids in the Layout of Large-Scale Integrated Circuits—I. Schischa, B. Wilner, IBM, Yorktown Heights, N.Y. (7F.1/Thurs./a.m./G)
- Benefits and Problems of CAD in IC Layout—M. M. Goldman, Motorola Inc., Phoenix, Ariz. (7F.2/Thurs./a.m./G)
- Interactively Aided IC Layout with a Minicomputer System—F. K. Richardson, Applicon, Inc., Burlington, Mass. (7F.3/Thurs./a.m./G)
- The Minicomputer as a Subsystem Component—L. Seligman, Data General Corp., Southboro, Mass. (3CH.1/Tues./a.m./C:H)
- Simple Processors: The Interface Link—S. Mintz, Hewlett-Packard, Cupertino, Calif. (3H.2/Tues./a.m./C:H)
- Interfacing the Minicomputer in Dedicated Industrial Applications—P. Secoolish, D.E.W. Archdale, Interdata, Inc., Oceanport, N.J. (3CH.3/Tues./a.m./C:H)
- Communications Applications of Minicomputers—T. C. Stockebrand, Digital Equipment Corp., Maynard, Mass. (4CH.1/Tues./p.m./C:H)
- Evaluation of Software for Industrial Minicomputer Applications—M. Mensh, Foxboro Co., Foxboro, Mass. (4CH.2/Tues./p.m./C:H)
- Applications of Minicomputers in Signal Processing—T. Storer, Time Data Corp., Palo Alto, Calif. (4CH.3/Tues./p.m./C:H)
- Minicomputers Applied to Computer-Aided Design—G. D. Hornbuckle, Applicon, Inc., Burlington, Mass. (4CH.4/Tues./p.m./C:H)
- The Computer in the Environmental Test Lab—C. L. Heizman, Time/Data Corp., Palo Alto, Calif. (5CK.1/Wed./a.m./C:K)
- Plug-in Measurements Come to the Computer—R. P. Anderson, General Radio Co., Concord, Mass. (5CK.2/Wed./a.m./C:K)
- Measuring Transfer Functions Using Noise—P. Roth, Hewlett-Packard, Santa Clara, Calif. (5CK.3/Wed./a.m./C:K)
- Computers in Instrumentation—Measuring the Unmeasurable—L. A. O'Neill, BTL, Holmdel, N.J. (5CK.4/Wed./a.m./C:K)
- Building High-Performance Memory Systems with Dynamic MOS Memory Components—G. Larkin, Advanced Memory Systems, Inc., Sunnyvale, Calif. (6Cl.1/Wed./p.m./C:I)
- Applications for COS/MOS Memories—J. R. Oberman, RCA, Somerville, N.J. (6Cl.2/Wed./p.m./C:I)
- Static and Dynamic Control Memory in Microprogrammed Minicomputers—R. Genke, Interdata, Inc., Oceanport, N.J. (6Cl.3/Wed./p.m./C:I)
- A Case for Intelligent Memories—W. Bruma, D. Duckman, Electronic Memories, Inc., Hawthorne, Calif. (6Cl.4/Wed./p.m./C:I)

Education and Marketing

- The Newman Committee Report: The Need for Reform in Higher Education—J. F. Gibbons, Stanford University, Stanford, Calif. (5B.1/Wed./a.m./RG)
- The Engineering of Engineering Education—R. E. Levien, Rand Corp., Washington, D.C. (5B.2/Wed./a.m./RG)
- Challenging the Minority Student—J. G. Easley, University of Michigan, Ann Arbor, Mich. (5B.3/Wed./a.m./RG)
- Continuing Education as a Job Requirement—H. W. Farris, University of Michigan, Ann Arbor, Mich. (6G.1/Wed./p.m./R)
- An Industry Viewpoint of Education for Engineers Beyond the Baccalaureate Degree—L. E. Saline, General Electric, Ossining, N.Y. (6G.2/p.m./R)
- Electrical Engineering Education Beyond the Baccalaureate Degree—A. M. Hopkin, University of California, Berkeley, Calif. (6G.3/Wed./p.m./R)
- Status of Current Federal Legislation That Will Be of Interest or Affect Engineers, Including Comments Regarding Portable Pension Legislation—R. Doyle, National Society of Professional Engineers, Washington, D.C. (7A.1/Thurs./a.m./RG)
- Recent NLRB Decisions That Will Be of Interest or Affect Engineers—L. Joseph, Western Electric, New York, N.Y. (7A.2/Thurs./a.m./RG)
- Comments Regarding Patent Law and Proprietary Information—J. C. Squillaro, General Electric, Schenectady, N.Y. (7A.3/Thurs./a.m./RG)
- Writing To Sell Yourself—T. Greene, RCA, Moorestown, N.J. (7D.1/Thurs./a.m./SS)
- Writing To Establish a Reputation—M. P. Southworth, IBM, White Plains, N.Y. (7D.2/Thurs./a.m./SS)
- Writing To Overcome the Wage Freeze—G. Rinehart, Famous Frieres School, Westport, Conn. (7D.3/Thurs./a.m./SS)
- Audio-Visual Teaching Techniques in the Industrial Environment—J. T. LaMacchia, BTL, Holmdel, N.J. (7H.1/Thurs./a.m./N)

Dip into Cinch D.I.P. socketry

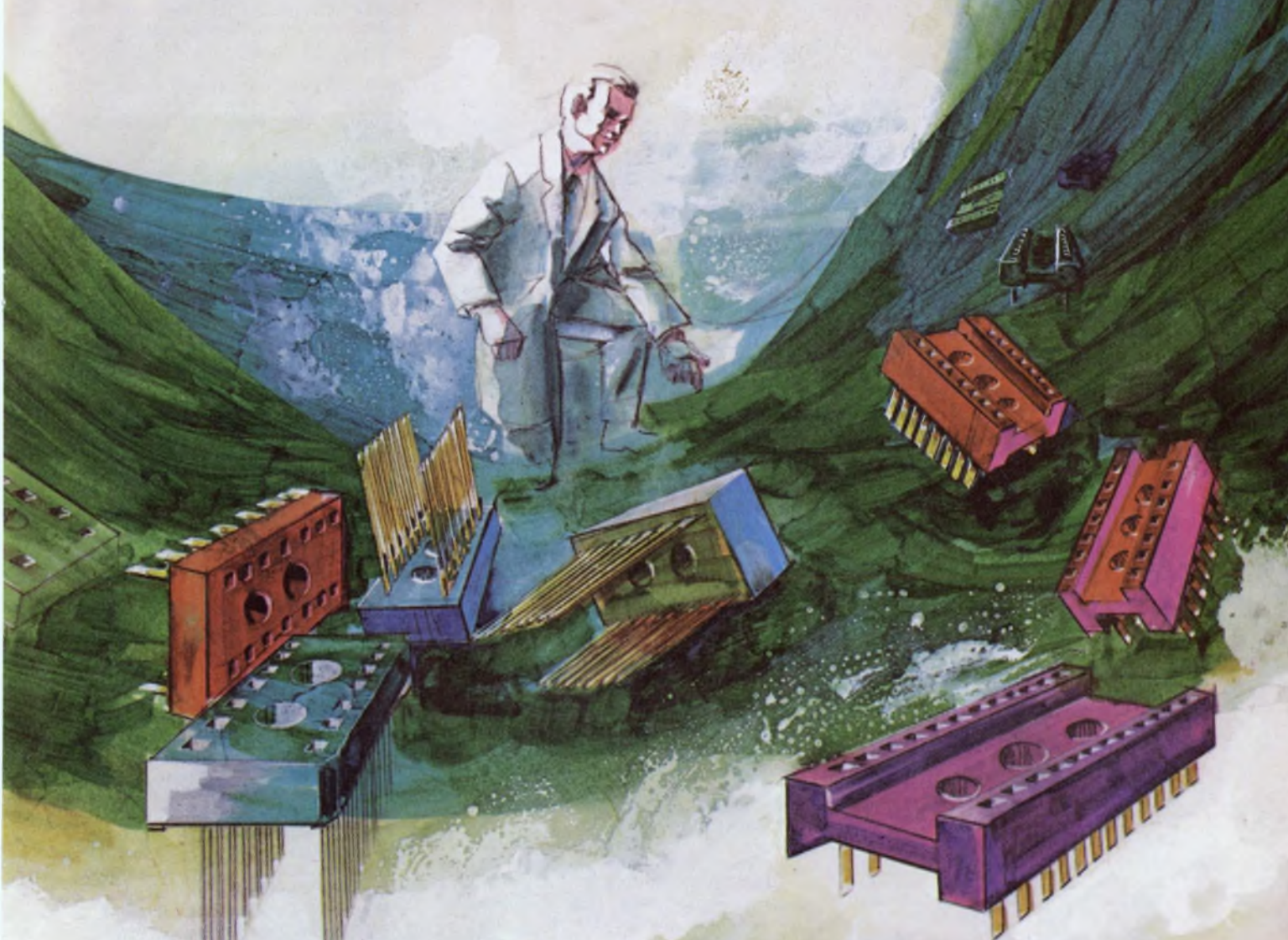

You'll find the 14, 16 or 24 pin DIP socket you need in the Cinch line. Try it . . . you'll like it!

Cinch sockets have a unique bowed pin contact that provides high contact forces but permits easy insertion and removal of the DIP. Broad contact surfaces give you maximum wiping action on two sides of the DIP terminal, be it flat, round or square.

You can choose from high performance diallyl phthalate or economical GP black phenolic mono-block insulators. The contacts are of beryllium copper for the best temperature stability, either gold or electro-tin plated.

Sockets with Wire Wrap* terminals and closed entry, one-piece insulators are also available in a variety of insulations and terminal materials . . . in addition to our DIP sockets with dip solder terminals.

Many styles are available off-the-shelf from Cinch distributors nationwide.

You can find out all about these sockets from your Cinch Distributor, Cinch Sales Office or by writing to Cinch Connectors, an Operation of TRW Electronic Components, 1501 Morse Avenue, Elk Grove Village, Illinois 60007, (312) 439-8800.

*Trade name Gardner-Denver

C-7202

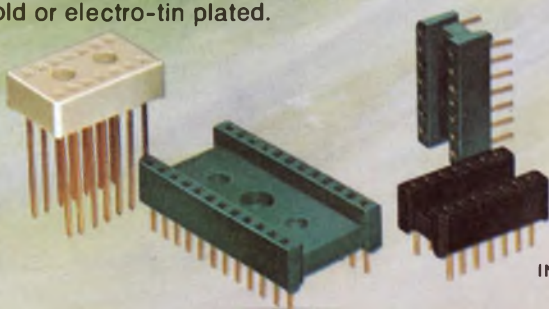

TRW[®]
CINCH CONNECTORS

- Taped Television Instruction—P. R. Karmel, D. Eitzer, City College, New York, N.Y. (7H.2/Thurs./a.m./N)
- Individualized Learning with Cassette, Video Tape and Consultant—W. H. Hayt, Jr., W. L. Weeks, Purdue University, Lafayette, Ind. (7H.3/Thurs./a.m./N)
- Possible Roles of Satellite Communications for Educational Development—A.M.G. Andrus, NASA, Washington, D.C. (7H.4/Thurs./a.m./N)
- Creating New Product Opportunities—J. D. Lewis, Battelle Development Corp., Columbus, Ohio. (2CK.1/Mon./p.m./C-K)
- Marketing Strategy During the New Product Cycle—F. H. McCarty, Raytheon Co., Lexington, Mass. (2CK.2/Mon./p.m./C-K)
- Producibility—The Key to Profitable Manufacture—A. Levy, RCA, Van Nuys, Calif. (2CK.3/Mon./p.m./C-K)
- Building a Marketing Organization in the Systems Business—J. A. Prestridge, Teradyne, Inc., Boston, Mass. (3CJ.1/Tues./a.m./C-J)
- Building a Marketing Organization in the Instruments Business—P. Macalka, General Radio, Concord, Mass. (3CJ.2/Tues./a.m./C-J)
- Building a Marketing Organization in the Components Business—F. Kvamme, National Semiconductor, Santa Clara, Calif. (3CJ.3/Tues./a.m./C-J)
- Building a Marketing Organization in the Computer Business—R. Underwood, Honeywell Information Systems, New York, N.Y. (3CJ.4/Tues./a.m./C-J)
- Pricing Techniques—D. F. McGuinness, Sprague Electric Co., Worcester, Mass. (4CJ.1/Tues./p.m./C-J)
- Building a Sound Representative Network—R. C. McColloch, Bourns Inc., Riverside, Calif. (4CJ.2/Tues./p.m./C-J)
- Marketing Through Distribution—Perspectives of a Distributor—J. Darcy, Arrow Electronics, Farmingdale, N.Y. (4CJ.3/Tues./p.m./C-J)
- Perspectives of a Component Manufacturer—R. T. Rasmussen, Sigma Instruments, Inc., Braintree, Mass. (4CJ.4/Tues./p.m./C-J)
- Finding and Evaluating Marketing Opportunities—J. Wasserman, Arthur D. Little Inc., Cambridge, Mass. (5CJ.1/Wed./a.m./C-J)
- The Black-Magic Engineering of an Ad Campaign—A. Heller, Fairchild Semiconductor, Mountain View, Calif. (5CJ.2/Wed./a.m./C-J)
- Public Relations and Publicity—The Neglected Tools—M. Snyder, Burson-Marsteller, New York, N.Y. (5CJ.3/Wed./a.m./C-J)
- How To Get International Marketing Started Profitably—L. E. Scriben, World Trade Center, New York, N.Y. (6CJ.1/Wed./p.m./C-J)
- International Market Growth Through Licensing—E. M. Lang, Resources and Facilities Corp., New York, N.Y. (6CJ.2/Wed./p.m./C-J)
- Defining Marketing Opportunities Overseas—F. H. Meyers, Cresap, McCormick and Paget, New York, N.Y. (6CJ.3/Wed./p.m./C-J)
- Panel Discussion: Financing Young Companies—J. Doede, Heizer Corp., Chicago, Ill.; C. P. Lecht, Advanced Computer Techniques Corp., New York, N.Y.; W. D. Witter, William D. Witter Inc., New York, N.Y. (7CH/Thurs./a.m./C-H)

Electro-optical

- Hybrid Optical Processing—A. Vander Lugt, Radiation, Inc., Ann Arbor, Mich. (2E.1/Mon./p.m./MS)
- Time-Lapse Interferometry and Counting Using Television Systems—A. Macovski, S. D. Ramsey, L. F. Schaefer, Stanford Research Institute, Menlo Park, Calif. (2E.2/Mon./p.m./MS)
- Transmission of a Holomicrogram Over a Limited Telemetry Channel—R. F. van Ligten, J. A. Levitt, J. T. Winthrop, American Optical Corp., Framingham, Mass. (2E.3/Mon./p.m./MS)
- A Survey of 3D Displays—J. F. Butterfield, Stereotronics Television, Sherman Oaks, Calif. (3A.1/Tues./a.m./RG)
- Three-Dimensional Displays Based upon the Sequential Excitation of Fluorescence—C. M. Verber, Battelle Columbus Labs, Columbus, Ohio; J. D. Lewis, Battelle Development Corp., Columbus, Ohio; R. B. McGhee, Ohio State University, Columbus, Ohio. (3A.2/Tues./a.m./RG)
- A Computer-Generated Holographic 3-D Display—J. D. Lewis, Battelle Development Corp., Columbus, Ohio; R. B. McGhee, Ohio State University, Columbus, Ohio; J. R. Shewell, Battelle Columbus Labs., Columbus, Ohio. (3A.3/a.m./RG)
- Optical/Mechanical Design Parameters for a Laser Recorder Mass Memory—B. French, Precision Instrument Co., Palo Alto, Calif. (3C.2/Tues./a.m./SN)
- Holographic Optical Memory—R. D. Lohman, RCA Labs, Princeton, N.J. (3C.3/Tues./a.m./SN)
- Design of an Optical Disk Memory—J. Aseltine, Ovonic Memories, Inc., Los Angeles, Calif. (3C.4/Tues./a.m./SN)
- Photochromics for Information Display—G. K. Megla, Corning Glass Research Labs., Corning, N.Y. (4C.5/Tues./p.m./SN)
- Low-Loss Optical Glasses for Optical Fiber Waveguides—A. D. Pearson, BTL, Murray Hill, N.J. (4C.6/Tues./p.m./SN)
- Silicon Imaging Devices—R. W. Redington, General Electric, N.Y. (5H.1/Wed./a.m./N)
- Negative Electron Affinity Imaging Tubes—E. D. Savoye, F. R. Hughes, R. E. Simon, RCA, Lancaster, Pa. (5H.2/Wed./a.m./N)
- A Silicon-Diode-Array Camera Tube with Electronically Controllable Responsivity—E. H. Stupp, B. Singer, J. Kostelec, M. H. Crowell, North American Philips Corp., Briarcliff Manor, N.Y. (5H.3/Wed./a.m./N)
- Recent Advances in Charge-Coupled Imaging Devices—W. J. Bertram, D. A. Sealer, C. H. Sequin, M. F.

Tompsett, BTL, Murray Hill, N.J. (5H.4/Wed./a.m./N)

- Characterization and Application of Photoconductors—A Practical View—J. G. Rabinowitz, Clairex Electronics, Mount Vernon, N.Y. (3CI.1/Tues./a.m./C-I)
- New Light-Emitting Devices—K. Lawley, Monsanto Co., Cupertino, Calif. (3CI.2/Tues./a.m./C-I)
- Display Circuits That Reduce User Cost—L. Pond, Sperry Rand Corp., Scottsdale, Ariz. (3CI.3/Tues./a.m./C-I)
- Liquid Crystal Displays Can't Be THAT Good!—G. Leffer, Optel Corp., Princeton, N.J. (3CI.4/Tues./a.m./C-I)

Industrial

- Multilevel Control of Interconnected Power Systems—H. H. Happ, General Electric, Schenectady, N.Y. (1E.1/Mon. a.m./MS)
- Control of Large Power Systems in the U.S.S.R.—V. A. Semyonov, S. A. Sovalov, G. A. Tchernya, (1E.2/Mon./a.m./MS)
- The Pertinent Design Features and 1-1/2 Years' Experience in the Operation of the PJM Control Center—W. S. Kleinbach, PJM Interconnection, Norristown, Pa. (1E.3/Mon./a.m./MS)
- Modern Concepts and Techniques for Interconnected Power Systems Operation and Control—T. W. Hissey, R. E. Godfrey, W. O. Stadlin, Leeds & Northrop Corp., North Wales, Pa. (1E.4/Mon./a.m./MS)
- The Role of Cycloconverters in Solid-State Power Conditioning for AC Drives—W. S. Chow, J. D. Duckworth, G. Hausen, J. A. I. Young, Canadian General Electric, Peterborough, Ont., Canada (2H.1/Mon./p.m./N)
- Direct Logic Controllers—Evolution in Process—G. A. Seyfert, General Electric, Schenectady, N.Y. (2H.2/Mon./p.m./N)
- On-Line Discrete Manufacturing Process Analyzers—R. H. Sherman, Reliance Electric Co., Cleveland, Ohio (2H.3/Mon./p.m./N)
- A Study of Coordination Applied to Control in Steel Processing—J. P. Matuszewski, Wright-Patterson Air Force Base, Ohio; I. Lefkowitz, Case-Western Reserve University, Cleveland, Ohio (2H.4/Mon./p.m./N)
- Control and Communication Systems for Personal Rapid Transit Vehicles—T. Trexler, Bendix Systems Div., Ann Arbor, Mich. (3B.1/Tues./a.m./RN)
- Automatic Controls for Railroad Classification Yards—P. J. De Ivernois, Westinghouse Air Brake Co., Pittsburgh, Pa. (3B.2/Tues./a.m./RN)
- Computer Control of Urban Vehicular Traffic—A. Cimento, Sperry Rand, Great Neck, N.Y. (3B.3/Tues./a.m./RN)
- Automatic Aircraft Landing Systems—J. Hall, Collins Radio Co., Cedar Rapids, Iowa (3B.4/Tues./a.m./RN)
- Status and Outlook of Controlled Thermonuclear Power—R. G. Mills, Princeton, N.J. (3D.1/Tues./a.m./SS)



Rogan
*The control knob
and custom dial company.*

Please send for our catalog.

Rogan

8025 North Monticello Avenue Skokie, Illinois 60076
(312) 675-1234 TWX: 910-223-4547



- The Coalplex: Clean Energy and Clean Fuel from Coal—A. Squires, City College, New York, N.Y. (3D.2/Tues./a.m./SS)
- Solar Energy—An Option for Power Generation—P. E. Glaser, Arthur D. Little Inc., Cambridge, Mass. (3D.3/Tues./a.m./SS)
- Batteries and Fuel Cells in Future Energy Handling—R. P. Hamlen, General Electric, Schenectady, N.Y. (3D.4/Tues./a.m./SS)
- AC Superconducting Power Transmission—R. W. Meyerhoff, Union Carbide Corp., Tarrytown, N.Y. (4D.1/Tues./p.m./SS)
- The Brookhaven Study on Superconducting Transmission Lines—E. B. Forsyth, Brookhaven National Lab., Upton, N.Y. (4D.2/Tues./p.m./SS)
- Superconducting Electrical Machinery—C. J. Mole, Westinghouse, Pittsburgh, Pa. (4D.3/Tues./p.m./SS)
- Homopolar Machines with Superconductive Fields—S. H. Minnich, General Electric, Schenectady, N.Y. (4D.4/Tues./p.m./SS)
- High-Speed Laser Trimming of Film Resistors—T. Chandler, Teradyne, Inc., Chicago, Ill; R. Lawler, Boeing, Seattle, Wash. (2CH.1/Mon./p.m./C-H)
- Laserscribing—The Modern Way To Separate Semiconductor Die—H. P. Manley, Quantronix Corp., Smithtown, N.Y. (2CH.2/Mon./p.m./C-H)
- Perforating Rubber with a CO₂ Laser—R. Scherer, Photon Sources, West Plymouth, Mich. (2CH.3/Mon./p.m./C-H)
- Microelectronics Environmental Control—L. C. Rogers, Motorola Semiconductor, Phoenix, Ariz. (2CI.1/Mon./p.m./C-I)
- Your Clean Room—Seven Keys to a Successful Facility—D. E. Bishop, American Filter Co., Louisville, Ky. (2CI.2/Mon./p.m./C-I)
- Clean Water for Clean Room Manufacturing—R. Martin, Culligan USA, San Jose, Calif. (2CI.3/Mon./p.m./C-I)
- Interfacing the Minicomputer in Dedicated Industrial Applications—P. Secoolish, D.E.W. Archdale, Interdata, Inc., Oceanport, N.J. (3CH.3/Tues./a.m./C-H)
- Evaluation of Software for Industrial Minicomputer Applications—M. Mensh, Foxboro Co., Foxboro, Mass. (4CH.2/Tues./p.m./C-H)
- Integrated Control Circuits for Power Conditioning—H. Fickenscher, K. R. Gardner, W. C. Gibson, R. H. Hock, J. Plany, BTL, Whippany, N.J. (4CK.1/Tues./p.m./C-K)
- Monolithic Gating-Circuit Techniques for Power Control—A. P. Ferro, J. D. Harnden, J. R. Mullaly, D. L. Watrous, General Electric, Schenectady, N.Y. (4CK.2/Tues./p.m./C-K)
- Power Hybrid Circuit Technology and Applications—S. W. Lefcourt, J. C. Pilecki, RCA, Somerville, N.J. (4CK.3/Tues./p.m./C-K)
- High-Power Hybrid Control Circuits—B. J. Bixby, L. R. Carver, D. Cooper, International Rectifier Corp., El Segundo, Calif. (4CK.4/Tues./p.m./C-K)
- Economic Analysis of Computer-Controlled Test Systems, or Items the Supplier Failed to Mention—R. G. Rogers, General Radio Co., Concord, Mass. (5CH.1/Wed./a.m./C-H)
- Economics of Dedicated vs. General Digital Test Systems—C. R. Trimble, Hewlett-Packard, Santa Clara, Calif. (5CH.2/Wed./a.m./C-H)
- Software Considerations in Automatic Test System Integration—R. E. Colgan, RCA Electromagnetic, Van Nuys, Calif. (5CH.3/Wed./a.m./C-H)
- Automatic Production Testing of Avionic Systems, M. Hustin, Thomson-CSF, Malakoff, France (7CK.3/Thurs./a.m./C-K)

Materials, Interconnections and Packaging

- Liquid Crystals—An Overview—G. H. Heilmeier, Office of the Director of Defense, Washington, D.C., A. Sussman, RCA Labs., Princeton, N.J. (4C.1/Tues./p.m./SN)
- Display Applications of PLZT Ferroelectric Ceramics—J. R. Maldonado, BTL, Murray Hill, N.J. (4C.2/Tues./p.m./SN)
- Light-Emitting Diodes—M. R. Lorenz, IBM, Yorktown Heights, N.Y. (4C.3/Tues./p.m./SN)
- Phosphors for Display Applications—J. D. Kingsley, General Electric, Schenectady, N.Y. (4C.4/Tues./p.m./SN)
- Photochromics for Information Display—G. K. Megla, Corning Glass Research Labs., Corning, N.Y. (4C.5/Tues./p.m./SN)
- Low-Loss Optical Glasses for Optical Fiber Waveguides—A. D. Pearson, BTL, Murray Hill, N.J. (4C.6/Tues./p.m./SN)

Medical electronics

- Portable Visual Performance Instrumentation—P. W. Davis, Dept. of Transportation, Cambridge, Mass. (2G.1/Mon./p.m./R)
- Catheter-Tip Preamplifier—C. Laenger, Southwest Research Institute, San Antonio, Tex. (2G.2/Mon./p.m./R)
- Orthotic Control Systems—J. R. Allen, Communication, Power and Control Engineering, Downey, Calif. (2G.3/Mon./p.m./R)
- Design and Construction of a Sight-Switch-and-Breath-Switch-Operated Environmental Control System for Handicapped Persons—S. Sancar, Huntsville Hospital, Huntsville, Ala. (2G.4/Mon./p.m./R)
- The Oximeter—An Instrument Used To Detect Changes of Relative Blood Pressure To Detect the Onset of Shock in Leukemia Patients—F. T. Wooten, Research Triangle Institute, Research Triangle Park, N. C., W. J. Penland, National Cancer Institute, Bethesda, Md. (2G.5/Mon./p.m./R)
- An Overview of Other Problems Waiting for Aerospace Solutions—R. J.

- Miner, NASA, Washington, D.C. (2G.6/Mon./p.m./R)
- Telemedicine for Improved Medical Care—R. Mark, M.I.T., Cambridge, Mass. (4H.2/Tues./p.m./N)
- Processing of Scientigraphic Biomedical Images—D. Chesler, Massachusetts General Hospital, Boston, Mass. (5E.4/Wed./a.m./MS)
- Biological Effects of Magnetic and Electrostatic Fields and Electric Current from DC to 1 Hz—R. O. Becker, Veterans Hospital, Syracuse, N.Y. (6C.1/Wed./p.m./SN)
- EM Effects on Man—Sonic to Infrared Frequencies—C. L. Frederick, Southwest Research Institute, San Antonio, Tex. (6C.2/Wed./p.m./SN)
- Survival and the Sea-Level Solar Electromagnetic Spectrum—H. L. Logan, Consultant, Bronxville, N.Y. (6C.3/Wed./p.m./SN)
- Changing Priorities in the Health-Care System—D. D. Rutstein, Harvard Medical School, Roxbury, Mass. (7G.1/Thurs./a.m./R)
- Engineering in the Design of Hospitals—P. S. Pierson, American Hospital Association, Chicago, Ill. (7G.2/Thurs./a.m./R)
- Trends in Medical Instrumentation—P. R. Brooks, American Optical Co., Framingham, Mass. (7G.3/Thurs./a.m./R)

Microelectronics

- Hardware/Software Interfaces—J. Mekota, B. Rosenbaum, Honeywell, Billerica, Mass. (1F.1/Mon./a.m./G)
- A User's View of Logic Simulation—R. Walker, Fairchild Semiconductor, Mountain View, Calif. (1F.2/Mon./a.m./G)
- Logic Design Guidelines for Fault Isolation—P. Scola, Honeywell, Phoenix, Ariz. (1F.3/Mon./a.m./G)
- A Micropower Phase-Locked Loop—G. W. Steudel, RCA, Somerville, N.J. (1G.1/Mon./a.m./R)
- Triple-Diffused Vertical p-n-p Adds a New Dimension to Complementary Micropower Integrated Circuits—W. R. Harden, R. C. Gallagher, D. W. Williams, Westinghouse, Baltimore, Md. (1G.2/Mon./a.m./R)
- A Micropower Associative Processor Building Block—H. W. Kaiser, RCA, Camden, N.J. (1G.3/Mon./a.m./R)
- A Monolithic Micropower Command Receiver—P. H. Hudson, J. D. Meindl, U.S. Army Electronics Command, Fort Monmouth, N.J. (1G.4/Mon./a.m./R)
- Precision Thick-Film Resistors for High-Voltage Dividers—J. E. Turnbaugh, Tektronix, Inc., Beaverton, Ore. (3H.1/Tues./a.m./N)
- A High-Performance, Thick-Film Attenuator—T. Zamborelli, A. Antes, Hewlett-Packard, Colorado Springs, Colo. (3H.2/Tues./a.m./N)
- Hybrid-Circuit Applications in Portable Communications Equipment—M. L. Topfer, Motorola Inc., Fort Lauderdale, Fla. (3H.3/Tues./a.m./N)
- Precision Tantalum-Film RC Circuits for Communication Systems—W. H. Orr, J. J. Degan, Jr., BTL, Indianapolis, Ind. (3H.4/Tues./a.m./N)

For built-in reliability, design with "Scotchflex" Flat Cable/Connector Systems.

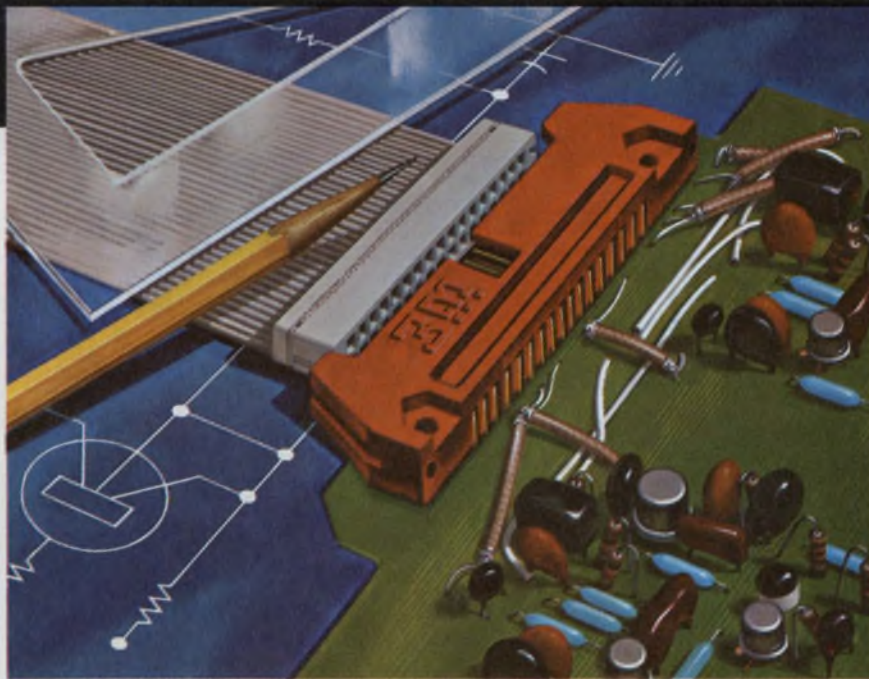

"SCOTCHFLEX" IS A REGISTERED TRADEMARK OF 3M CO.

"Scotchflex" Flat Cable and Connectors can offer you trouble-free packaging for your next generation equipment.

There's built-in reliability for your circuit inter-connects. Our flat, flexible PVC Cable has up to 50 precisely spaced conductors. The gold plated U-contacts are set into a plastic body to provide positive alignment. They strip through the insulation, capture the conductor, and provide a gas-tight pressure connection.

Assembly cost reductions are built-in, too. "Scotchflex" Connectors make up to 50 simultaneous connections without stripping or soldering. No special training or

costly assembly equipment is needed.

Off-the-shelf stock offers you flat cable in a choice of lengths and number of conductors from 14 to 50. Connector models interface with standard DIP sockets, wrap posts on .100 x .100 in. grid, or printed circuit boards. Headers are available to provide a de-pluggable inter-connection between cable jumpers and printed circuit boards (as shown). Custom assemblies are also available on request.

For full information on the "Scotchflex" systems approach to circuitry, write to Dept. EAH-1, 3M Center, St. Paul, Minn. 55101.

3M
COMPANY

INFORMATION RETRIEVAL NUMBER 56

- Ion Implantation Equipment for Semiconductor Processing—S. Harrison, KEV Electronics Corp., Wilmington, Mass. (4B.1/Tues./p.m./RN).
- Ion Implantation and Radiation-Enhanced Diffusion in Semiconductors—J. F. Gibbons, Stanford University, Stanford, Calif. (4B.2/Tues./p.m./RN).
- Applications of Ion Implantation to Semiconductor Manufacturing—R. J. Palack, Mostek Corp., Carrollton, Tex. (4B.3/Tues./p.m./RN).
- MOS Storage—A Revolution in Main Memory—G. Moore, Intel Corp., Santa Clara, Calif. (5A.2/Wed./a.m./RG).
- Bipolar Memory—The Technology for the Future—J. Ricci, Intersil Corp., Cupertino, Calif. (5A.3/Wed./a.m./RG).
- Trends in Semiconductors—R. Noyce, Intel Corp., Santa Clara, Calif. (5F.1/Wed./a.m./G).
- Historical Development of D/A Conversion Techniques—B. Gordon, Analogic, Wakefield, Mass. (5G.1/Wed./a.m./R).
- Partitioning D/A Converter Circuits for Implementation in Monolithics—R. Stata, Analog Devices, Inc., Norwood, Mass. (5G.2/Wed./a.m./R).
- The Impact of Precision Large-Scale D/A ICs on A/D/A Converter Design—M. B. Rudin, Precision Monolithics, Inc., Santa Clara, Calif. (5G.3/Wed./a.m./R).
- Microelectronics Environmental Control—L. C. Rogers, Motorola Semiconductor, Phoenix, Ariz. (2C1.1/Mon./p.m./C-I).
- Your Clean Room—Seven Keys to a Successful Facility—D. E. Bishop, American Air Filter Co., Louisville, Ky. (2C1.2/Mon./p.m./C-I).
- Clean Water for Clean Room Manufacturing—R. Martin, Culligan USA, San Jose, Calif. (2C1.3/Mon./p.m./C-I).
- How to Jump into MOS Without Drowning—E. Berezin, Redactron, Hauppauge, N.Y. (4C1.1/Tues./p.m./C-I).
- A Test System for Detecting and Isolating Faults on Four-Phase MOS/LSI Printed-Circuit Boards—D. Parker, National Cash Register Co., Dayton, Ohio. (4C1.2/Tues./p.m./C-I).
- MOS IC Reliability Considerations—G. L. Schnable, RCA, Princeton, N.J. (4C1.3/Tues./p.m./C-I).
- Integrated Control Circuits for Power Conditioning—H. Fickenscher, K. R. Gardner, W. C. Gibson, R. H. Hock, J. Plany, BTL, Whippany, N.J. (4CK.1/Tues./p.m./C-K).
- Monolithic Gating—Circuit Techniques for Power Control—A. P. Ferro, J. D. Harnden, J. R. Mullaly, D. L. Watrous, General Electric, Schenectady, N.Y. (4CK.2/Tues./p.m./C-K).
- Power Hybrid Circuit Technology and Applications—S. W. Lefeouri, J. C. Pilecki, RCA, Somerville, N.J. (4CK.3/Tues./p.m./C-K).
- High-Power Control Circuits—B. J. Bixby, L. R. Carver, D. Cooper, International Rectifier Corp., El Segundo, Calif. (4CK.4/Tues./p.m./C-K).
- Microwave Integrated Circuits—An Overview—F. Sterzer, RCA, Princeton, N.J. (5C1.1/Wed./a.m./C-I).
- Why Not Stripline?—H. Howe, Jr., Microwave Associates Inc., Burlington, Mass. (5C1.2/Wed./a.m./C-I).
- A Perspective on Lumped vs. Distributed Microwave Integrated Circuits—O. Pitzalis, Jr., U.S. Army Electronics Command, Fort Monmouth, N.J. (5C1.3/Wed./a.m./C-I).
- Application of Bulk Semiconductor Control Components to Microwave Integrated Circuits—A. Armstrong, P. E. Bakeman, W. C. Taft, R. P. I., Troy, N.Y. (5C1.4/Wed./a.m./C-I).
- Packaging of Microwave Integrated Circuits for Systems Applications—R. J. Bauer, Westinghouse, Baltimore, Md. (5C1.5/Wed./a.m./C-I).
- Digital Testers: What's Available? At What Cost? Who Needs Them?—S. Sampson, BTL, Naperville, Ill. (6CH.1/Wed./p.m./C-H).
- How to Talk to a Digital Tester: Is There a Universal Language?—S. D. Sadtler, Jr., Hewlett-Packard, Palo Alto, Calif. (6CH.2/Wed./p.m./C-H).
- Automatic Test-Program Generation: What It Is; Where To Get It; How To Use It—R. McClure, C. Oualline, Telpar Corp., Dallas, Tex. (6CH.3/Wed./p.m./C-H).
- Building High-Performance Memory Systems with Dynamic MOS Memory Components—G. Larkin, Advanced Memory Systems, Inc., Sunnyvale, Calif. (6C1.1/Wed./p.m./C-I).
- Applications for COS/MOS Memories—J. R. Oberman, RCA, Somerville, N.J. (6C1.2/Wed./p.m./C-I).
- A Comparison of Various Functional Trimming Techniques—G. J. Gross, General Radio Co., Concord, Mass. (7C1.1/Thurs./a.m./C-I).
- Comparison of Techniques for Testing Hybrid Electronics Circuits—P. Jackson, Instrumentation Engineering, Franklin Lakes, N.J. (7C1.2/Thurs./a.m./C-I).
- Techniques for Single- and Multiple-Fault Analysis of MSI Digital Logic Arrays—R. Wooster, Western Electric, North Andover, Mass. (7C1.3/Thurs./a.m./C-I).

Microwaves

- The New Rural Society—P. C. Goldmark, CBS Labs., Stamford, Conn. (2A.1/Mon./p.m./RG).
- Computer Television—What Works and What Doesn't Work—P. Klein, Computer Television Corp., New York, N.Y. (2A.2/Mon./p.m./RG).
- CATV Network via Satellite—J. V. Charyk, Comsat Corp., Washington, D.C. (2A.3/Mon./p.m./RG).
- CATV—Subscriber, Supply and Demand—H. J. Schlafly, TelePromPTer Corp., New York, N.Y. (2A.4/Mon./p.m./RG).
- Canadian Data Communications—W. J. Inkster, Bell Northern Research, Ottawa, Ont., Canada. (4F.1/Tues./p.m./G).
- Bell System Data Transmission Plans in the U.S.—P. E. Muench, AT&T, New York, N.Y. (4F.2/Tues./p.m./G).
- Serendipity of Digital Communications—C. R. Fisher, Datran, Vienna, Va. (4F.3/Tues./p.m./G).
- Western Union Data Transmission Planning—J. E. Cox, Western Union Telegraph Co., Mahwah, N.J. (4F.4/Tues./p.m./G).
- Plans for the Japanese Domestic Satellite System—F. Ikegami, S. Morimoto, Nippon T&T Public Corp., Tokyo, Japan. (4G.1/Tues./p.m./R).
- Canadian Domestic Satellite Communication System—J. Almond, Telesat Canada, Ottawa, Ont., Canada. (4G.2/Tues./p.m./R).
- Regional Communication Services via Intelsat Satellites—J. L. Dicks, Comsat Corp., Washington, D.C. (4G.3/Tues./p.m./R).
- A Systems Approach to City Communications—R. P. Gifford, General Electric, Lynchburg, Va. (4H.1/Tues./p.m./N).
- Telemedicine for Improved Medical Care—R. Mark, M.I.T., Cambridge, Mass. (4H.2/Tues./p.m./N).
- Community Reaction to Communications Technology—G. Heningburg, Newark Urban Coalition, Newark, N.J. (4H.3/Tues./p.m./N).
- Surface Acoustic-Wave Binary Phase Encoders and Decoders—L. T. Claiborne, Texas Instruments Inc., Dallas, Tex. (5D.1/Wed./a.m./SS).
- Surface Acoustic-Wave UHF and VHF Bandpass Filters—R. H. Tancrill, Raytheon Research Labs., Waltham, Mass. (5D.2/Wed./a.m./SS).
- A Surface Acoustic-Wave Digital Recirculating Memory—H. Matthews, Sperry Rand, Sudbury, Mass. (5D.3/Wed./a.m./SS).
- Digital Data Networks—M. Schwartz, Polytechnic Institute of Brooklyn, N.Y. (5E.1/Wed./a.m./MS).
- Mobile Communications for Urban and Interurban Use—J. Engel, BTL, Holmdel, N.J. (5E.2/Wed./a.m./MS).
- Panel Discussion: 900 MHz—A New Horizon in Land Mobile Communications—M. Cooper, Motorola Inc., Fort Lauderdale, Fla.; H. A. Jones, RCA, Meadowlands, Pa.; G. R. Peterson, General Electric, Lynchburg, Va.; R. E. Spence, FCC, Washington, D.C.; J. B. Keane, AT&T, New York, N.Y. (6A/Wed./p.m./RG).
- Latching Ferrite Technology—J. Pippen, Electromagnetic Sciences, Inc., Atlanta, Ga. (6B.1/Wed./p.m./RN).
- Recent Advances in Ferrite Limiters—R. Kalvaitis, H. S. Maddix, Varian Associates, Beverly, Mass. (6B.2/Wed./p.m./RN).
- Tailoring Ferrites for Microwave Devices—R. G. West, A. C. Blankenship, Trans Tech Inc., Gaithersburg, Md. (6B.3/Wed./p.m./RN).
- Biological Effects of Magnetic and Electrostatic Fields and Electric Current from DC to 1 Hz—R. O. Becker, Veterans Hospital, Syracuse, N.Y. (6C.1/Wed./p.m./SN).
- EM Effects on Man—Sonic to Infrared Frequencies—C. L. Frederick, Southwest Research Institute, San Antonio, Tex. (6C.2/Wed./p.m./SN).
- Survival and the Sea-Level Solar Electromagnetic Spectrum—H. L. Logan, Consultant, Bronxville, N.Y. (6C.3/Wed./p.m./SN).



c



b



a



d

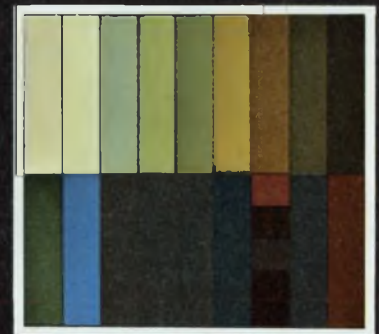

e

b Ensemble No. 33
Amco Colors Silver with Black Vinyl Inlay.

c Ensemble No. 6
Amco Colors Red and Dark Blue with Black Vinyl Inlay.

d Ensemble No. 31
Amco Colors Chutney and Russet with Walnut Vinyl Inlay.

e Represents a close reproduction of Amco's basic standard colors. There are over 125 professionally developed combinations in Catalog 310-A to assist you in your selection . . . presented in true color reproduction.

a This Semi-Custom frame is shown utilizing Interface 33 Ensemble 22. Captions B, C & D picture 3 additional variations of Interface 33. Amco Colors Gold and Earth Brown with Brown Leather Vinyl Trim Inlay.

Unprecedented Styling & Versatility

Interface 33—A system of professionally coordinated styling, developed around Amco's basic Modular Frames. These frames being structurally independent of exterior surfaces permitted the accomplishment of this unique and practical Styling System.

Utilizing selections of horizontal aluminum cowlings trims with vertical aluminum trims, combined with Vinyl Inlays and virtually unlimited color combinations, one can visualize the infinite possibilities of Interface 33.

To assist in your selections, but certainly not limited to, over 50 professionally developed combinations are presented and may be ordered by Ensemble numbers.

To add to the depth of selection, Amco's two Modular Semi-Custom



and Custom systems (offering choice of frame structure) are integrated with Interface 33.

Frame Panel Widths of 19", 24" and 30" and Frame Depths of 18 1/2", 22", 25 1/2" and 30" are all Standard.

Save Time—Save Money—Shipment made 3-4 weeks from receipt of order. Circle the number below for your copy of Amco New General Catalog 310 and Amco Color Guide Catalog 310-A.



AMCO ENGINEERING CO.

7333 W. AINSLIE STREET
CHICAGO, ILLINOIS 60656
312-867-8500

A year ago we introduced 7 new JCM miniature RF coaxial connectors that "do the job for a fraction of SMA prices."

Here, by popular demand, are 8 more.

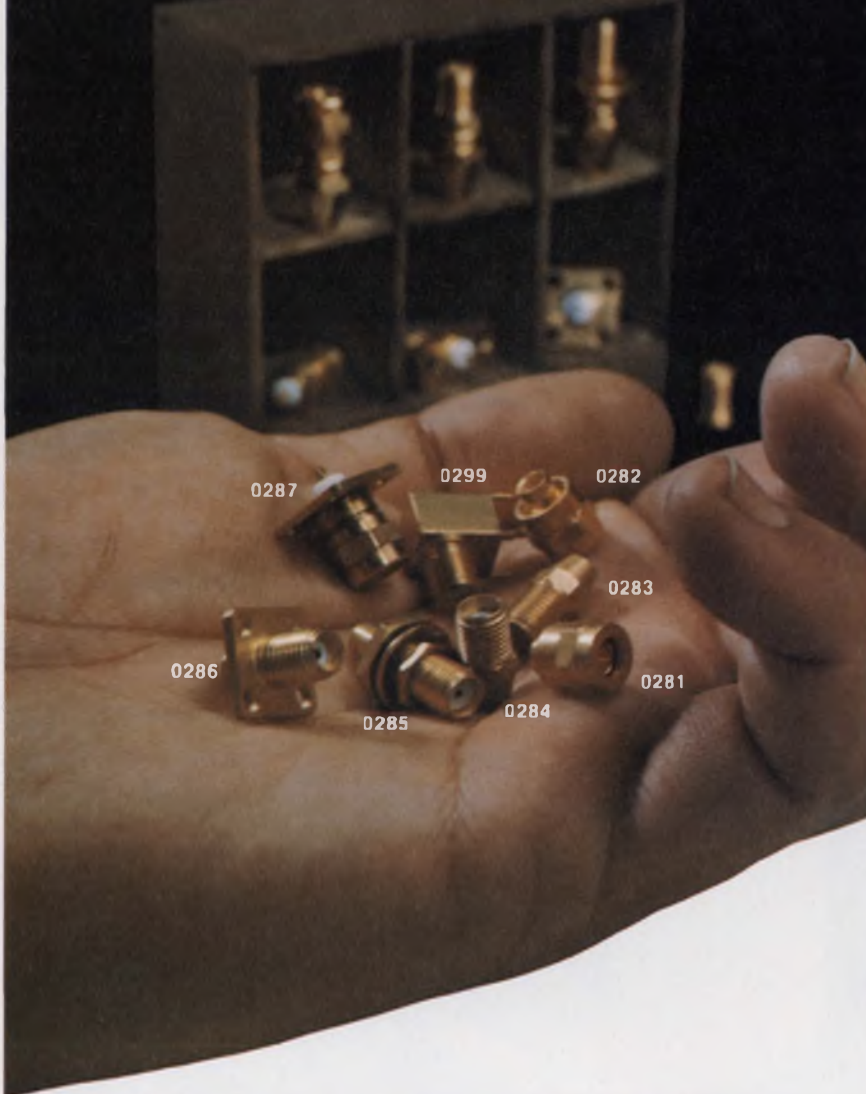

If you don't require all the electrical performance built into SMA type connectors, why pay for it? Up to 3 GHz for flexible cable assembly and even beyond 6 GHz for semi-rigid assembly, our new JCM series gives you the same electrical performance as the far more expensive SMA types. The series includes connectors for both panel and PC mounting. All are interchangeable and intermateable with the standard, expensive SMA connectors. So you can use them without making any changes . . . and without compromising required performance. There are JCM connectors to accept virtually any miniature size cable, so you don't have to stock a big variety. It's worth looking into, isn't it? All it costs is a stamp.

E. F. JOHNSON COMPANY / Waseca, Minnesota 56093
Please check for technical information or test samples of our new low-cost series 142-0200-001 JCM connectors.

Dept. ED-3

- Please send technical information.
 I desire test samples. Please call me at _____

NAME _____

FIRM _____ TITLE _____

ADDRESS _____

CITY _____ STATE _____ ZIP _____



E. F. JOHNSON COMPANY

INFORMATION RETRIEVAL NUMBER 58

IEEE '72

Linear Wide-Band Amplifiers Using Transferred Electron Devices—B. S. Perlman, D. L. Upadhyayula, RCA, Princeton, N.J. (7B.1/Thurs./a.m./RN).

Transmission-Type ADAs—T. A. Midford, H. C. Bowers, Hughes, Torrance, Calif. (7B.2/Thurs./a.m. RN).

Tunable Locked ADOs—S. F. Paik, C. W. Lee, Raytheon Co., Waltham, Mass. (7B.3/Thurs./a.m./RN).

Microwave Integrated Circuits—An Overview—F. Sterzer, RCA, Princeton, N.J. (5C1.1/Wed./a.m./C-I).

Why Not Stripline—H. Howe, Jr., Microwave Associates Inc., Burlington, Mass. (5C1.2/Wed./a.m./C-I).

A Perspective on Lumped vs. Distributed Microwave Integrated Circuits—O. Pitzalis, Jr., U.S. Army Electronics Command, Fort Monmouth, N.J. (5C1.3/Wed./a.m./C-I).

Application of Bulk Semiconductor Control Components to Microwave Integrated Circuits—A. Armstrong, P. E. Bakeman, W. C. Taft, R.P.I., Troy, N.Y. (5C1.4/Wed./a.m./C-I).

Packaging of Microwave Integrated Circuits for Systems Applications—R. J. Bauer, Westinghouse, Baltimore, Md. (5C1.5/Wed./a.m./C-I).

The Application of Cylindrical Arrays to Microwave Landing Guidance Systems—R. Kalafus, U.S. Dept. of Transportation, Cambridge, Mass. (6CK.1/Wed./p.m./C-K).

A New Cylindrical Electronic Scan Antenna for Air Traffic Control—P. W. Hannan, J. H. Gutman, R. J. Giannini, Hazaltine Corp., Green Lawn, N.Y. (6CK.2/Wed./p.m./C-K).

Application of the Doppler Scanning Beam Concept to Microwave Landing Systems—H. W. Redlien, Hazeltine Corp., Green Lawn, N.Y. (6CK.3/Wed./p.m./C-K).

Cost-Effective Microwave Systems for Railroad and Automobile Safety Applications—J. B. Hopkins, F. R. Holmstrom, U.S. Dept. of Transportation, Cambridge, Mass. (6CK.4/Wed./p.m./C-K).

A Millimeter-Wave Sensor and Detector for Clean-Air Turbulence—G. G. Haroules, W. E. Brown, G. W. Wagner, U.S. Dept. of Transportation, Cambridge, Mass. (6CK.5/Wed./p.m./C-K).

High-Power CW Gunn Oscillator for Communication Applications—A. L. Reynolds, ITT, Nutley, N.J. (7CJ.1/Thurs./a.m./C-J).

Microwave Technology in Gigabit PSK Modulation and Demodulation for Digital Communication—C. L. Cuccia, Philo-Ford; Palo Alto, Calif. (7CJ.2/Thurs./a.m./C-J).

A 19-GHz Transmitter and Receiver for Experimental High-Speed Digital Transmission—W. J. Schwarz, R. W. Kordos, R. W. Judkins, BTL, North Andover, Mass. (7CJ.3/Thurs./a.m./C-J).

Technological Considerations for High-Speed Digital Radio Repeater—R. D. Silverthorn, Bell-Northern Research, Ottawa, Ont., Canada. (7CJ.4/Thurs./a.m./C-J).

Increase Your Surveillance Capability With a Watkins-Johnson **PULSE SORTER**

The new WJ-1248 Pulse Sorter qualifies incoming pulse trains quickly and accurately, but that's only the beginning.

When a qualified pulse train is threatened by intermittent pulses or by the presence of various other frequency pulse trains, the WJ-1248 indicates lock-on to the desired waveform by means of an audio/visual feature. A light on the front panel is illuminated and an audio tone is initiated, alerting the operator. Matching the digitized input video against the internally tuned PRF keeps the pulse sorter on target.

The WJ-1248 is also capable of functioning as a PRF spectrum analyzer using an external X-Y scope display. The X (horizontal) axis represents the logarithmically decreasing PRF, and the Y (vertical) axis represents the output video qualified by the sorter. The Z (intensity) axis is modulated for brightness, allowing the baseline intensity to be reduced to a more pleasing level.

Using a new technique, the WJ-1248 does not fall victim to the usual sorter problems. No synchronization to the incoming signals or AFC circuitry is utilized. Qualification is accomplished digitally, thereby removing signal dependence for operation. For more details contact our Representative in your area or call Watkins-Johnson Applications Engineering at (415) 493-4141.

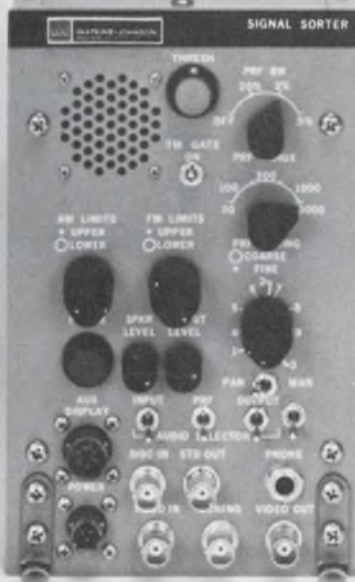

See Us During INTERCON
at the Barbizon-Plaza Hotel, Studio G.

UNITED KINGDOM: Shirley Ave., Windsor, Berkshire, England
Tel: Windsor 69241 • Cable: WJUKW-WINDSOR • Telex: 84578
WEST GERMANY: 8 Muenchen 2, Maximiliansplatz 12A
Tel: (0811) 29 33 30 • Cable: WJDBM-MUENCHEN • Telex: 528401
ITALY: Piazza G. Marconi, 25
00144 Roma-EUR
Tel: 59 45 54 • Cable: WJROM-ROMA • Telex: 60117



3333 HILLVIEW AVE., STANFORD INDUSTRIAL PARK, PALO ALTO, CALIF. 94304 (415) 493-4141

INFORMATION RETRIEVAL NUMBER 59

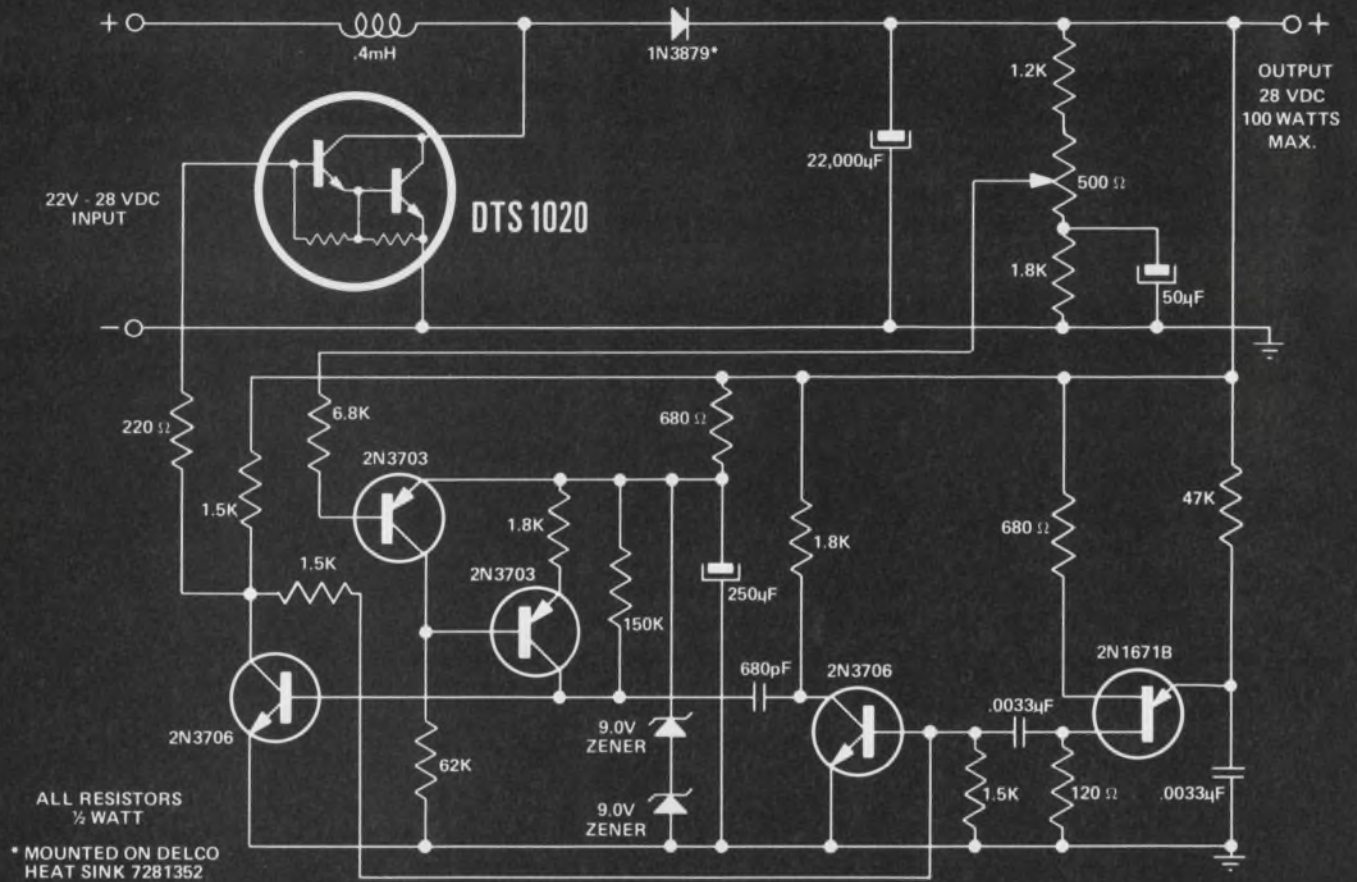

SWITCHING REGULATOR

| | V_{CE0} @ 0.1 mA | V_{EBO} @ 50 mA | $V_{CE(SUS)}$ @ 500 mA | h_{fe} @ 1 MHz ($V_{CE} = 10V,$ $I_C = 200 mA$) | h_{FE} ($V_{CE} = 5V,$ $I_C = 10A$) | $V_{CE(SAT)}$ @ 5.0 A | I_C | P_T @ 75°C |
|-----------------|-----------------------|----------------------|---------------------------|--|---|--------------------------|------------|-----------------|
| DTS-1010 | 120V | 7V | 80V | 12 | 200 | 1.8V | 10A | 100W* |
| DTS-1020 | 120V | 7V | 80V | 12 | 500 | 1.5V | 10A | 100W* |

*100 percent tested at 2.5A, 40V.

The Kokomoans now give you Darlington Switching Power.



Use a Darlington in place of an ordinary transistor, and you'll realize an additional magnitude of gain plus increased switching power. Use a Delco silicon power Darlington (DTS-1010 or DTS-1020) and you'll also realize a gain in dependability.

Delco's Darlington's are triple diffused mesa units housed in copper TO204MA cases and built for ruggedness. The design gives them high energy capability—the ability to handle surges of current and voltage simultaneously. They are ideal for switching inductive loads in circuits subject to transients or fault conditions.

Design a switching regulator circuit around a Delco Darlington or use it in any 60-100 volt

application to reduce circuit size, weight, and cost. In addition, the Darlington space saving feature allows you more design flexibility. Unlike an ordinary transistor, it's only energy-limited, not beta-limited. You can exploit its full energy capability in your circuit.

Call your nearest Delco distributor. He has them in stock and he's got the data on high energy switching for small spaces.

For details on the switching regulator circuit, ask for Application Note 49.



Delco Electronics

DIVISION OF GENERAL MOTORS CORPORATION.
KOKOMO, INDIANA

Now available from these distributors in production quantities.

ALA., BIRMINGHAM • Forbes Distributing Co., Inc. (205)-251-4104

ARIZ., PHOENIX • Cramer/Arizona (602)-263-1112 • Sterling Electronics (602)-258-4531

CAL., LOS ANGELES • Kierulff Electronics, Inc. (213)-685-5511 • Radio Products Sales, Inc. (213)-748-1271

CAL., PALO ALTO • Kierulff Electronics, Inc. (415)-968-6292

CAL., REDWOOD CITY • Cramer/San Francisco, (415)-365-4000

CAL., SAN DIEGO • Milo of California, Inc. (714)-232-8951

CAL., SAN DIEGO • Radio Products Sales, Inc. (714)-292-5611

COLO., DENVER • Cramer/Denver (303)-758-2100 • Denver Walker Electronics (303)-935-2401

ILL., ROSEMONT (Chicago) • Kierulff Electronics (312)-678-8560

ILL., SKOKIE (Chicago) • Merquip Electronics (312)-282-5400

IND., INDIANAPOLIS • Graham Electronics Supply, Inc. (317)-634-8202

MD., BALTIMORE • Radio Electric Service Co. (301)-823-0070

MASS., NEEDHAM HEIGHTS • Kierulff Electronics, Inc. (617)-449-3600

MASS., NEWTON • The Greene-Shaw Co., Inc. (617)-969-8900

MICH., ROMULUS • Harvey/Detroit (313)-729-5500

MINN., MINNEAPOLIS • Stark Electronics Supply Co. (612)-332-1325

MO., KANSAS CITY • Walters Radio Supply, Inc. (816)-531-7015

MO., NO. KANSAS CITY • LCOMP-Kansas City, Inc. (816)-221-2400

MO., ST. LOUIS • LCOMP-St. Louis, Inc. (314)-647-5505

N.J., CLIFTON • Eastern Radio Corporation (201)-471-6600, (212)-244-8930

N.M., ALBUQUERQUE • Cramer/New Mexico (505)-265-5767 • Sterling Electronics (505)-247-2486

N.Y., BINGHAMTON • Harvey/Federal (607)-748-8211

N.Y., EAST SYRACUSE • Cramer/Eastern (315)-437-6671

N.Y., ROCHESTER • Cramer/Rochester (716)-275-0300

N.Y., WOODBURY • Harvey/New York (516)-921-8700, (212)-582-2590

OHIO, CINCINNATI • United Radio, Inc. (513)-761-4030

OHIO, CLEVELAND • Pattison Supply (216)-441-3000

OHIO, DAYTON • Kierulff Electronics (513)-278-9411

OKLA., TULSA • Radio, Inc. (918)-587-9123

PENN., PHILADELPHIA • Almo Electronics (215)-676-6000

PENN., PITTSBURGH • RPC Electronics (412)-782-3770

S.C., COLUMBIA • Dixie Radio Supply Co., Inc. (803)-253-5333

TEXAS, DALLAS • Adleta Electronics Co. (214)-741-3151

TEXAS, FORT WORTH • Adleta Electronics Co. (817)-336-7446

TEXAS, GARLAND • Kierulff Electronics, Inc. (214)-271-2471

TEXAS, HOUSTON • Harrison Equipment Co., Inc. (713)-224-9131

UTAH, SALT LAKE CITY • Cramer/Utah (801)-487-3681

VA., RICHMOND • Meridian Electronics, Inc., a Sterling Electronics Company (703)-353-6648

WASH., SEATTLE • Kierulff Electronics, Inc. (206)-763-1550

WASH., TACOMA • C & G Electronics Co. (206)-272-3181

CANADA, ONT., SCARBOROUGH • Lake Engineering Co., Ltd. (416)-751-5980

ALL OVERSEAS INQUIRIES:
General Motors Overseas Operations
Power and Industrial Products Dept.,
767 Fifth Avenue, New York, N.Y.
10022. Phone: (212)-486-3723.

Kokomoans' Regional Headquarters.

Union, New Jersey 07083,
Box 1018, Chestnut Station,
(201) 687-3770.

El Segundo, Calif. 90245,
354 Coral Circle, (213)
640-0443.

Kokomo, Ind. 46901, 700 E.
Firmin, (317) 459-2175
(Home Office).



IEEE '72 products

LED readout in DMM probe cuts language pollution



Keithley Instruments, 28775 Aurora Rd., Cleveland, Ohio 44139. (216) 248-0400. \$325. Stock.

If you've ever poked a probe into a dense circuit board, then blurted out the kind of language that comes from shorting out a power bus while you turn to look at a meter reading, you'll appreciate a new digital multimeter from Keithley. The readout's in the probe. And the probe can be stored in the main frame or used there as the readout.

The readout uses multiplexed light-emitting diodes to show three full digits, an overrange "1," an automatically positioned decimal point, polarity and the function—dc or ac voltage or resistance (which is selected by pushbuttons on the Model 167's main frame).

To take a reading, one merely



squeezes the top of the probe, since ranging and polarity selection are fully automatic. From a cold start, it takes less than two seconds for the meter to turn on, range and settle to a reading within rated (0.2% rdg \pm 1 digit on dc volts) accuracy.

The battery-powered instrument can read 1 mV ac or dc (on the 1-V range) to 1000 V dc or 500 V ac and 1 Ω to 20 M Ω . All voltage ranges can withstand 1200 V dc and even the resistance ranges can take line voltage.

Input impedance is 55 M Ω (on dc-voltage ranges), 50 M Ω (on ac), each shunted by 220 pF. At 10 kHz, where ac voltages to 200 V are read with an accuracy of 1% rdg \pm 2 digits, the reactance, 73 k Ω , of that rather large capacitance makes 50 M Ω vanish.

For \$325 the 167 comes equipped with six alkaline D-cells, which should last about 20 hours with continuous operation, about three months with typical on/off operation. An additional \$65 buys nickel cads and a recharger that permits powering the instrument from line voltage. A five-decade, switched, current shunt, for 1 μ A per digit to 2 A full scale, costs \$35.

Booth No. 2307 Circle No. 257

Calculator kit cuts device costs to \$130



Heath Co., Benton Harbor, Mich. (616) 983-3961. \$129.95; April, 1972.

The Heathkit IC-2008 calculator, sold in kit form for \$129.95, performs addition, subtraction, multiplication and division electronically, and shows up to eight-figure totals on extra-bright 1/2-in. seven-segment display tubes. Punch-up the problem the same way it would be written ($7 \times 8 =$) and you have the result. The unit can perform constant or chain operation. The K (constant) key allows multiplication or division of a series of figures by one preselected number, or multiplication of the constant by itself for squaring or taking it to a power. Releasing the constant key permits performing any function or series of functions ($9 + 3 - 2 \times 8$) with the calculator memory holding all data until the total key is pushed.

Booth No. 2214 Circle No. 269

3-digit panel meter with fast conversion



Electronic Research Co., 10,000 W. 75th St., Overland Park, Kan. (913) 631-6700. \$198-225.

The 3000A series are general purpose digital voltmeters. Special features include a high conversion rate—100 complete conversions per sec and LED displays. The accuracy of the device is 0.1% of FS over the range 0 to 50 C. Applications include use in high-speed computer-controlled systems.

Booth No. 2447 Circle No. 326

Take a **GOOD LOOK**
 at **ERIE'S LOW COST**
SUBMINIATURE
CERAMIC TRIMMER
CAPACITOR...

Series 511

- OFF THE SHELF DELIVERY
- LOW COST
- SPACE SAVER ... OCCUPIES ONLY 007³ IN
- DESIGNED TO ASSURE RIGID MOUNTING STABILITY

Plus, you get a wide capacitance range in either of two low-profile mounting arrangements ... for top or side adjustment. When you consider the low cost, excellent reliability, tiny size and fast delivery, Erie's 511 is the perfect trimmer for your current circuit applications. Erie 511 ... take a good look, then try it. Write for Bulletin 511 — ask for samples too.

APPLICATIONS

Typical applications include crystal filters and oscillators, CATV amplifiers, attenuators ... and equipment such as avionics, telemetry and color TV cameras where high component density is vital.

SPECIFICATIONS

Working Voltage 100 WVdc @ 85°C
 50 WVdc @ 125°C

Dielectric Strength 200 WVdc for 1.5 sec

Operating Temperature Range — 55°C to 125°C

Q Factor @ 1 MHz 500 min. (values 5pF and above)

CAPACITANCE RANGES

1-3 pF 3-9 pF 6-22 pF
 2-5 pF 3-15 pF

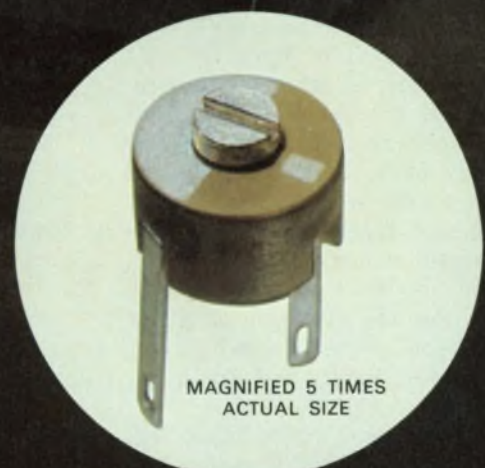

Digitally swept synthesizers have built-in keyboards



Hewlett-Packard, 1601 California Ave., Palo Alto, Calif. (415) 493-1501. P&A: see text; 60 to 90 days.

A highlight of Hewlett-Packard's booth at the IEEE show is an impressive line of new synthesizers. The various synthesizers in the line all have built-in keyboards for manual control and are fully programmable (using TTL logic) to perform an intricate variety of functions. Thus the new instruments combine the advantages of synthesizers and conventional signal generators—they offer a precision that can be achieved only by synthesis, yet they are flexible and convenient to use.

One new rf synthesizer, Model 8660B, covers a frequency range from 0.01 to 110 MHz in 1-Hz steps and has an extremely low residual FM of less than 1 Hz. Other important specifications include stability of 3×10^8 per day and spurious level of -80 dB.

The new synthesizer allows several useful modes of operation that are not possible with other synthesizers. For the first time, a single instrument allows digital sweep, synthesized search and frequency stepping.

In the digital sweep mode, the user first programs a center fre-

quency and sweep width. The rf output then sweeps half the selected width above and half below the chosen frequency. In the synthesized search mode, the synthesizer can be tuned quasi-continuously—actually a succession of discrete frequencies—by use of a manual tuning knob, as with a conventional signal generator. In the frequency stepping mode, a fixed increment of frequency is preselected on the keyboard, and then each push of either a “step-up” or “step-down” button moves the output frequency by the predetermined amount.

A 10-digit LED display normally shows output frequency, but, at the touch of a pushbutton, it can show selected sweep width, frequency step size or a newly entered command.

The HP8660 synthesizer series consists of basic mainframes with spaces for two plug-in units. The 8660B mainframe, with keyboard control, costs \$6000. It must have an rf section, which costs an additional \$1975 for the 86601A (0.01 to 110 MHz). For the second plug-in, if the \$900 FM/AM modulation section is not chosen, an auxiliary \$90 section is needed.

Booth No. 2400 Circle No. 322

Programmable IC tester for -55 to 180 C range



Temptronix Inc., 591 Hillside Ave., Needham, Mass. (617) 449-3710.

An IC tester, the TP20 Thermo-spot, is used to test and characterize components in the -55 to 180 C temperature range. Measurement on the remotely programmable device can be obtained in seconds, according to the company. It can be programmed to stabilize and test oscillation prone components, such as a 709 op amp, at 10 different temperatures in 10 minutes. The operator also has a choice of 3 temperatures quickly. These are obtained manually with a multiposition switch. Temperature stability is ± 0.3 C and the accuracy is 1 C at the probe tip.

Booth No. 2735 Circle No. 276

Solid-state modulator for 1 to 21 GHz range

Polarad Electronic Instrument Div., 5 Delaware Dr., Lake Success, N.Y. (516) 328-1100. \$475; March, 1972.

The Model 1020, a versatile solid-state modulator, provides pulses, square waves, and ramp waveforms. It can be used as a modular accessory for modulation of the Polarad microwave signal generators series in the frequency range 0.95 - 21 GHz. The Model 1020 requires only 1-3/4-in. of panel height vs 5-1/4-in. for earlier models. Adjustable pulses, square wave, AM, and sawtooth FM are provided from 10 to 10,000 Hz. Pulse widths range from 0.2 to 20 μ s. Sync pulses delay is up to 2000 μ s. Adjustable FM deviation and rates are also provided. The Model 1020 sells for \$475; as an accessory to a Polarad microwave signal generator, the price is \$240. Delivery begins in March, 1972.

Booth No. 2215 Circle No. 266

Do you have this No. 1 reference in the Solenoid Industry?

This free book lists more kinds of solenoids... with more spec info than any other solenoid reference file.

It's all you'd expect from No. 1 in the industry: Everything you need to know to spec a solenoid. Packaged in an easy-to-use 44-page manual/catalog covering the most complete line of solenoids available *anywhere*. Plus, "How to Select a Solenoid" section, pull/stroke graphs and schematic drawings of Guardian Solenoids in every imaginable shape and size to meet virtually any electro-mechanical requirement.

And it's yours for the asking from your Guardian Angel



Box-Frame Solenoids



Tubular Solenoids



U-Frame Solenoids



Laminated Solenoids

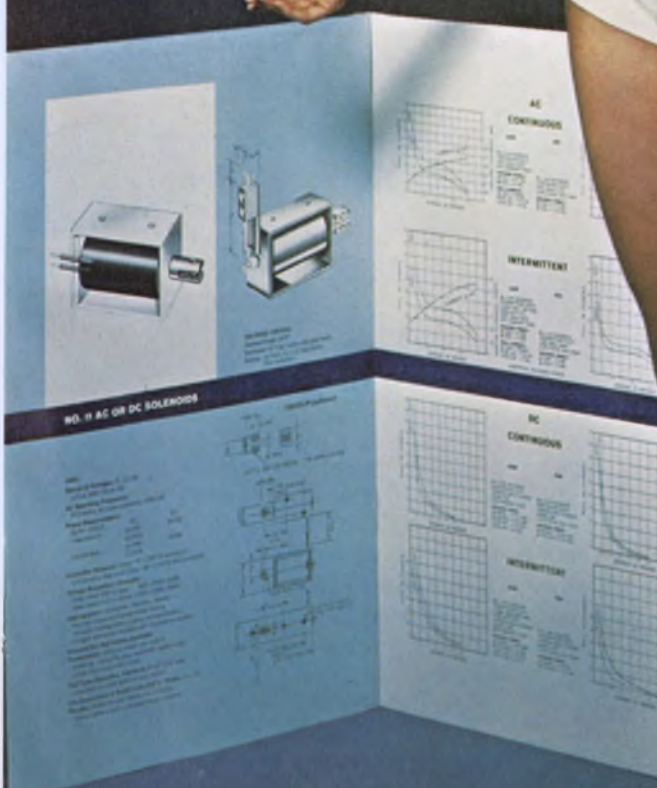

GUARDIAN®

GUARDIAN ELECTRIC MANUFACTURING CO. • 1550 W. Carroll Ave., Chicago, Illinois 60607
In a hurry? Call your Guardian Distributor.

Fast DMM provides 1-ppm accuracy



Julie Research Laboratories, 211 W. 61st St., New York, N.Y. 10023. (212) CI-5-2727. Price: see text. Delivery: 6 wks.

A pair of instruments, generously labeled a digital multimeter, offers standards-lab accuracy—1-ppm of full scale—in rather fast measurements of dc-voltage ratio. Extra-cost add-ons to the \$5995 digital ratiometer can extend its capabilities to those associated with a full multimeter—measuring dc voltage, current and resistance.

The basic pair includes a new automatic balance detector, labeled "Digital Multimeter Model DM-1000," and a two-year-old relay voltage divider, the "RVD 126J." Together the units take the name of the detector, DM1000, and constitute a ratiometer with superb accuracy and linearity of six full digits plus a seventh for 20% overrange. The 1-ppm (0.0001%) accuracy, given in relation to full scale, is said to be conservative enough to encompass percent-of-reading errors. Errors in down-scale readings are negligible in relation to the percent-of-full-scale spec. Full accuracy is obtained in about 1.5 seconds.

A \$490 digital-voltmeter add-on

provides full scales of 1.2 and 12 V. Another, for 120 mV f.s., costs \$990 and a third, with impressive sensitivity of 12 mV f.s., costs \$1440. A combination of the 1.2/12-V voltmeter with a four-range (1.2 k Ω to 1.2 M Ω) ohmmeter costs \$990. In each case, front-panel controls permit standardization to 1 ppm, traceable to NBS.

Current shunts for full scales from an astonishing 1.2 μ A f.s. (noise limits accuracy at the bottom of this scale) to 1200 A f.s. offer a range of accuracies from 0.04% to 0.001% at a range of prices from \$35 to \$1000. A high-voltage extender, to 120 kV, has accuracies from 0.1% to 0.005% at prices from \$900 to \$3000.

Though the DM1000 system doesn't provide automatic ranging and automatic polarity selection, which are common in other digital multimeters, it does permit remote programming in addition to automatic balancing. And it permits manual balancing, with the controls of the divider, as a potentiometer/voltage source, resistance bridge or ratiometer. The instrument also delivers BCD outputs compatible with TTL.

Booth No. 2313 Circle No. 250

Function generators expand line

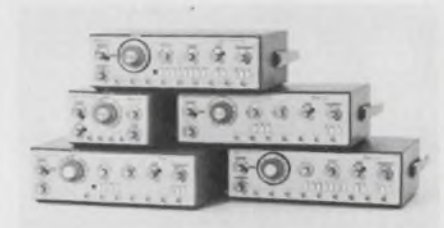

Interstate Electronics Corp., 707 E. Vermont Ave., Anaheim, Calif. (714) 772-2811. F51A: \$645; F55A: \$1350.

The 50A function generators, "next generation" of the firm's earlier models, permits coverage of the 10.6 to 10.8 MHz FM i-f range with operating frequencies of 0.0005 Hz to 11 MHz. They are designed to include full 15-volt peak-to-peak output into a 50-ohm load, 1000:1 VCG range, plug-in ICs; variable width pulse with improved 30-ns rise time and standard waveforms.

Booth No. 2633 Circle No. 331

Soldering machine is completely equipped



Technical Devices Co., 11242 Playa Court, Culver City, Calif. (213) 870-3751. \$2865; stock.

The Esson Mark I is a fully equipped bench model soldering machine. It comes ready to connect to the customer's electrical and air supply, according to the company, with no extras to purchase. The MARK I solders cords up to 10 inches in width. Some of the features include an adjustable wave depth and conveyor height, continuously variable conveyor speed and variable infrared preheat.

Booth No. 1612 Circle No. 262

Lost!

Time, man hours, dollars . . . precious commodities that could have been saved with a Honeywell Modu-Mount Cabinetry application.

If your Company uses these words about their present cabinets . . . Over designing, under engineering, not quite, almost, just about, adequate, or they'll do . . . If you are just 60% pleased with your present cabinetry, chances are it doesn't have the flexibility, strength, or beauty you require. If you want to push your pleased percentage nearer the 100 mark, call your Honeywell Modu-Mount Cabinetry man. He has solutions to problems you didn't realize you had.



CASE IN POINT . . .

Honeywell



A large national manufacturer called in the Honeywell Task Team and detailed the problem:

1. We want a savings
2. Contemporary styling
3. Each bay to hold approximately 1,000 lbs.
4. Cabinets completely assembled and mounting rails positioned to special dimensions

The Honeywell Task Team Solution:

1. A program savings of \$20,000
2. Heavy duty cabinets styled and matched to customer colors
3. Design concept for each bay tested internally to 3,007 lbs.
4. Cabinets completely assembled and mounting rails positioned to special dimensions . . . NATURALLY!

For more than just a catalog, for a study of how Honeywell solved this case in point, send your card or company letterhead to:

Honeywell

Honeywell Inc., 200 Bond Street, Wabash, Indiana 46992

Relieves design headaches 16 ways.

CONTACT MATERIAL is often the critical difference in relay performance. So Clare gives you 16 choices to relieve headaches caused by trying to fit a compromise relay into an uncompromising application. While Clare GP relays can be tightly "spec'd" to your needs, most are available off-the-shelf from a Clare distributor near you. For complete specifications on Clare UL recognized GP relays, circle the reader service number or write C. P. Clare & Co., 3101 Pratt Blvd., Chicago, Illinois 60645.



a GENERAL INSTRUMENT company

Space-saving VP relays from 2-5 Amps AC-DC, up to 6PDT and with Lexan® cases are available with **1.** bifurcated silver contacts or **2.** bifurcated gold contacts if redundancy is important, **3.** silver button contacts, **4.** silver cadmium oxide contacts, and **5.** WE #1 gold contacts.

Ideal for telecommunications, vending machines, appliances, etc.

Miniature GP1 4PDT relays up to 5 Amps AC-DC with Lexan® dust covers come with **6.** silver button contacts for intermediate loads, **7.** silver cadmium oxide button contacts for difficult loads, high currents, inductive loads, motor loads, lamp loads, **8.** Western Electric #1 gold button or **9.** crossbar contacts for low level loads, **10.** palladium button or **11.** crossbar contacts for switching both high and low level loads with the same relay, and **12.** Clareloy button contacts for either high or low level loads. (It's less expensive, but less flexible than palladium.)

Great for appliances, peripherals, office copiers, inc.

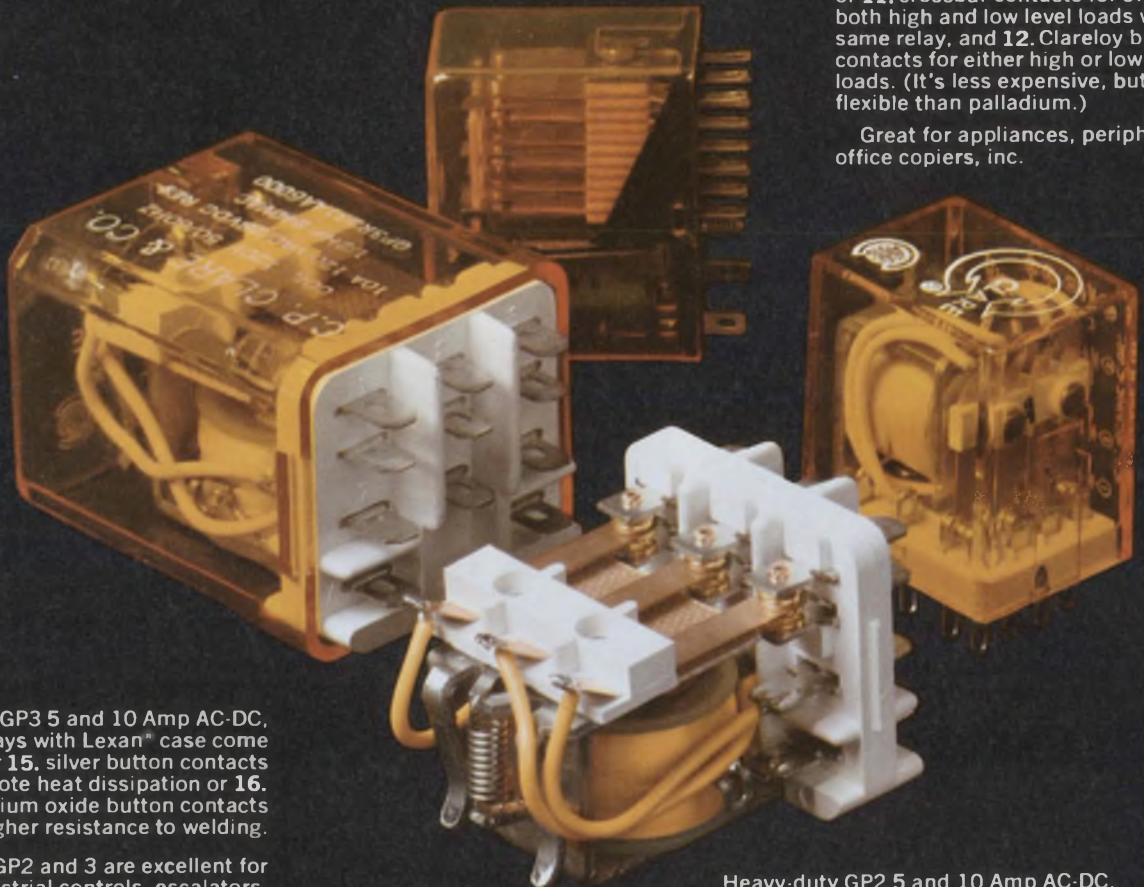

Rugged GP3 5 and 10 Amp AC-DC, 3PDT relays with Lexan® case come with either **15.** silver button contacts that promote heat dissipation or **16.** silver cadmium oxide button contacts with higher resistance to welding.

Both the GP2 and 3 are excellent for elevators, industrial controls, escalators, business machines, etc.

Heavy-duty GP2 5 and 10 Amp AC-DC, 3PDT relays are available with **13.** silver button contacts that provide low contact resistance and high electrical conductivity and **14.** silver cadmium oxide button contacts offering a low rate of electrical erosion under arcing conditions.

FREE CLARE GP sample!

Mail this coupon today to the Clare Distributor of your choice from the list below. Be sure to specify voltage.

O.K., send me one of the relays I've checked.

GP1, 3AMP, 4PDT } 24VAC 120VAC 24VDC
 GP3, 10AMP, 3PDT }
 (BE SURE TO CHECK VOLTAGE)

NAME _____

COMPANY _____

POSITION _____

APPLICATION _____

DO YOU SPECIFY? _____ ANNUAL REQUIREMENTS? _____

ADDRESS _____

CITY _____ STATE _____ ZIP _____

(This offer ends June 30th, 1972)

Allied Electronics Corporation
2400 W. Lake Street
Chicago, Illinois 60612

Almac/Stroum Electronics
5811 Sixth Avenue South
Seattle, Washington 98108

Angus, Inc.
10739 Tucker St.
Beltsville, Maryland 20705

Angus, Inc.
126 Pleasant Valley Avenue
Moorestown, New Jersey 08057

Bell Electronics
1070 O'Brien Dr.
Menlo Park, California 94205

Cameradio Co.
2801 Liberty Ave.
Pittsburgh, Pennsylvania 15222

Cramer/EW
2310 Bob Wallace Ave., S. W.
Huntsville, Alabama 35805

Cramer/EW
4035 North 29th Ave., P.O. Box WW
Hollywood, Florida 33022

Cramer/EW
345 N. Graham Ave., P.O. Box 20214
Orlando, Florida 32803

Cramer Electronics
85 Wells Avenue
Newton Center, Massachusetts 02159

Cramer/EW
938 Burke St.
Winston-Salem, North Carolina 27102

Dixie Radio Supply Co.
1900 Barnwell St.
Columbia, South Carolina 29202

Eastern Radio Corp.
312 Clifton Avenue
Clifton, New Jersey 07015

Electra Distributing Co.
1914 West End Avenue
Nashville, Tennessee 37203

Electrical Supply Corp.
205 Alewife Brook Parkway
Cambridge, Massachusetts 02138

Ft. Wayne Electronics Supply
3606 Maumee Avenue
Ft. Wayne, Indiana 46803

Genesee Radio & Parts Co., Inc.
2550 Delaware Avenue
Buffalo, New York 14216

Graham Electronics Supply, Inc.
133 South Pennsylvania Street
Indianapolis, Indiana 46204

Harrison Equipment Co.
1616 McGowan
Houston, Texas 77004

Harvey-Michigan, Inc.
36312 Ecorse Road, P.O. Box 444
Romulus, Michigan 48174

Harvey Radio Co., Inc.
60 Crossways Park West
Woodbury, L. I., N. Y. 11590

Kierulff Electronics Corp.
2633 East Buckeye Rd.
Phoenix, Arizona 85034

Kierulff Electronics Corp.
2585 Commerce Way
Los Angeles, California 90022

Kierulff Electronics Corp.
3969 E. Bayshore Rd.
Palo Alto, California 94303

Kierulff Electronics Corp.
8797 Balboa Avenue
San Diego, California 92123

Kierulff Electronics Corp.
10890 E. 47th Ave.
Denver, Colorado 80239

Kierulff Electronics Corp.
2524 Baylor Dr., S. E.
Albuquerque, New Mexico 87119

Kierulff Electronics Corp.
5940 Sixth Avenue, South
Seattle, Washington 98108

Klaus Radio & Electric Co.
8400 N. Pioneer Parkway
Peoria, Illinois 61614

M.G. Electronics & Equipment Co.
3112 6th Avenue, South
Birmingham, Alabama 35233

Marsh Radio Supply Co.
6047 W. Beloit Rd.
Milwaukee, Wisconsin 53219

Milo Electronic Corp.
170 Eileen Way
Syosset, New York 11791

Ohmtronics, Inc.
649 Vermont Ave.
Palatine, Illinois 60067

Olive Industrial Electronics, Inc.
6662 Olive Blvd.
St. Louis, Missouri 63130

Pioneer/Washington Electronics, Inc.
1037 Taft Street
Rockville, Maryland 20850

Pioneer/Cleveland Electronics, Inc.
4800 E. 131st St.
Cleveland, Ohio 44105

Pioneer/Dayton Electronics, Inc.
1900 Troy Street
Dayton, Ohio 45404

RS Electronics
12775 Lyndon
Detroit, Michigan 48227

Ralph's of LaFayette
3004 Cameron, P.O. Drawer "R"
LaFayette, La. 70504

Scott Electronics Supply Corp.
4040 Adams Street, P.O. Box 4467
Lincoln, Nebraska 68504

Simcona Electronics
275 Mt. Read Blvd.
Rochester, New York 14603

Specialty Distributing Co.
763 Juniper St., N. E.
Atlanta, Georgia 30308

Texas Instruments Supply Co.
7743 Troost Avenue
Kansas City, Missouri 64131

Texas Instruments Supply Co.
12151 E. Skelly Drive
Tulsa, Oklahoma 74128

Texas Instruments Supply Co.
6000 Denton Drive
Dallas, Texas 75235

Wise Radio & TV Supply, Inc.
1001 Towson Avenue
Fort Smith, Arkansas 72901

INSTRUMENTATION

More DVM for less \$



John Fluke Mfg. Co., P.O. Box 7428, Seattle, Wash. 98133. (206) 774-2211. Price: see text. Availability: 45 days.

If you're going to buy the very popular Model 8300A, which John Fluke introduced about 2-1/2 years ago (see "Economy voltmeter and multimeter uphold performance with fewer parts," ED 16, Aug. 2, 1969), make sure you get the new 8300A—not the old one with the same number.

For the new one, with the same three dc-voltage ranges (10 V to 1000 V) costs \$1195. That's \$100 less than the original price and \$200 less than the recent price. Addition of the low-voltage option (100-mV and 1-V ranges) costs only \$100. With the old 8300A, it was available only with an ohms option at \$295.

Addition of five 4-wire resistance ranges (1 k Ω to 10 M Ω) raises the total price to \$1445. That's \$245 less than the recent price.

Despite the reshuffling of options, the 8300A remains the same. It has five full digits plus a "1" for 20% overrange on the four lower ranges and 10% overrange on the 1000-V range. It includes automatic ranging, automatic polarity selection and box-in-a-box construction for full guarding as well as a switchable three-pole active filter.

Other options remain the same. For \$495, one can still obtain four ac ranges, 1 V to 1 kV, with accuracy of \pm (0.1% rdg + 0.005% f.s.) at 50 Hz to 20 kHz. A data-output option costs \$500 and a remote-control unit costs \$200.

Booth No. 2201 Circle No. 258



Two-in-one function generator calipers FM and AM



Wavetek, 9045 Balboa Ave., San Diego, Calif. 92123. (714) 279-2200. \$1495. Stock.

Amplitude and frequency of the three basic waveforms—sine, square and triangle—of a dramatically versatile function generator, Wavetek's Model 146, can be modulated by sines, squares, triangles or ramps from an auxiliary generator in the same box.

The auxiliary generator, which can be operated independently, has a frequency range from 4 mHz (for ramps) or 40 mHz (for all waveforms) to 10 kHz (or 100 kHz for only sines, squares and triangles). The main unit covers 500 μ Hz to 10 MHz.

The modulating waveforms, direct or inverted, can be applied to the main signal, whose trigger point can be moved and whose dc baseline can be offset from zero, to provide a breathtaking variety of waveshapes. Some can be extremely useful while others are useless but beautiful.

Unique caliper dials, for both amplitude and frequency, quickly show limits. Thus a user can set the main frequency dial to 500 kHz, for example, and turn the "FM Limits" knob. This moves a pair of caliper pointers away from the main pointer to show a deviation of, say, 400 kHz to 600 kHz or 300 kHz to 700 kHz. He can

similarly adjust "AM Limits" and corresponding calipers on the amplitude dial will show an excursion from, say, 3 to 7 V around a 5-V, offset (positive or negative).

But a man can't go too far. If one of the caliper pointers is at the end of a dial and a user tries to move it further, the dial itself rotates to bring the calipers within its range.

Booth No. 2523 Circle No. 256

100-MHz scope plug-in extends applications

Hewlett-Packard, 1501 Page Mill Rd., Palo Alto, Calif. (415) 493-1501. \$1400.

A 100-MHz vertical amplifier plug-in, the HP Model 1805A, for HP 180-series oscilloscopes, packs more measurement capability into one plug-in than any previous unit, according to the company. Chief among the plug-in's several capabilities is the switchable input impedance: a matched 50 or low-capacitance 1 M Ω . The VSWR is a maximum of 1.35. The 1-M Ω input impedance has a shunt capacitance of only 13 pF, about half that of the usual oscilloscope. Another capability is the provision for offset voltages on either or both channels. The offset voltage bucks out dc in the input signal so small deviations can be greatly magnified and brought on screen for examination. Yet another capability lies in the Vertical Output connector on the front panel. This provides an amplified version of low-level input signals for use by counters or other ancillary equipment. It also permits one channel to be cascaded into the other channel for increased sensitivity while maintaining a 50-MHz bandwidth.

Booth No. 2403-2404, 2504

Circle No. 274



DMM uses two logics, gets 20 readings/sec



Lear Siegler, Inc., Cimron Instruments EID Div., 714 N. Brookhurst, Anaheim, Calif. (714) 774-1010. \$1200; 30 days.

A five-digit multimeter, Model DMM 50, employs two logics: successive approximation (SA) logic is used for speed, and integrating (INT) logic supplies the needed noise rejection. The combination is called Saint logic. The four operations of the Saint technique are: (1) automatic zero set where the most significant of the five decades is examined; (2) subtractive digit where selection of the most significant decade is accomplished by (SA) logic; (3) integrate compare one; (4) integrate compare two. This means the DMM 50 can operate at greater than 20 readings per second with a rejection rate of 60 dB at 60 Hz.

Booth No. 2101 Circle No. 328

Frequency meter and tachometer has LEDs



Electronic Research Co., 10,000 W. 75 St., Overland Park, Kan. (913) 631-6700. \$360 to \$400.

A 20-MHz frequency meter/tachometer features a light-emitting-diode display in an all-aluminum case. Designated the 2700 series, the standard features include automatic triggering with a sensitivity of 100 mV rms and a front panel sensitivity control; stored display; buffered and latched BCD output; and a 1-ppm crystal time base. Eight ranges are selectable providing time bases from 1 ms to 60 s for reading MHz, kHz, Hz or rpm.

Booth No. 2447 Circle No. 264

GENTLEMEN, THESE DDC A-SERIES MODULES CAN MAKE EVERYTHING!

WOW! S/D, D/S, R/D, D/R...IT CAN BE A 2-SPEED EVEN A 3-SPEED CUSTOMIZED TO OUR NEEDS!

RIGHT ON! OVER 37 CONFIGURATIONS... OFF THE SHELF...AND IT'S MIL SPEC QUALITY. ALL SOLID STATE.

DOESN'T PAY TO MAKE OUR OWN ANY MORE

FLATTERY WILL GET YOU EVERYWHERE.

Everybody's talking about DDC's new A-Series synchro or resolver converters. And no wonder: You can assemble *your own* converter in your own way, to your own specifications, using low-cost off-the-shelf modules! And when it's all assembled, you get a lot more:

- Errorless tracking. To 4 RPS as a result of a Type II servo loop.
- Wide range of synchro or resolver conversion. A/D, D/A 60 Hz, 400 Hz, single speed, multispeed, binary, BCD, etc., etc., etc.
- Available for either commercial or military operating temperatures. Each module measures only 1.5 x 2.2 x .61.
- High reliability. Built-in test circuitry. All MIL grade parts, hermetic components. Qualified for airborne applications.
- Immediate availability. The 10 basic modules are available *now*, off the shelf. And they're fully interchangeable: no trimming or adjustment necessary.

When you can assemble your own custom converter at so little cost it doesn't pay to design, breadboard test, de-bug and build, does it? Please let us tell you more about it. And about the rest of our data conversion and signal conditioning devices. Write us. Or phone direct to either Steve Muth or Jim Sheahan. (516) 433-5330.

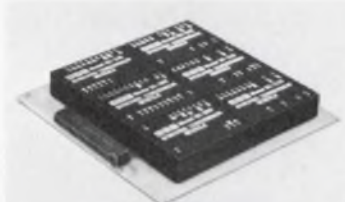

One of 37 possible assemblies of our multi-module conversion system.

SYNCHRO CONVERTERS



ILC DATA DEVICE CORPORATION
100 TEC STREET, HICKSVILLE, N.Y. 11801 Dept. ED3-16

INFORMATION RETRIEVAL NUMBER 65

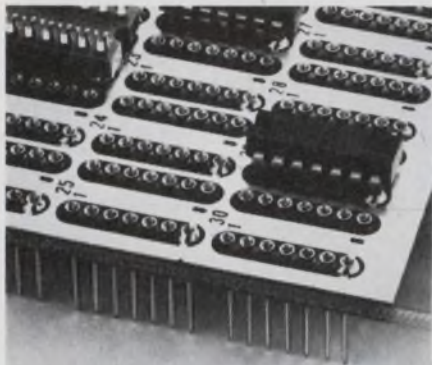

All plug-in panels are not the same.

It's one thing to want plug-in flexibility in your circuit. It's another to get flexibility plus all the other things you'd like in a dependable point-to-point system.

Like easier IC insertion. Precision-machined contacts. Tighter contact retention. Greater reliability (we'll prove it). Unique tapered entry sockets (patent pending). Lower profile. Plus the versatility to accept 14, 16, 18, 24, 28, 36 or 40 pin IC's in a choice of panel sizes.

And we offer virtually any panel you'll need, in any number of patterns, plane-mounted or edge-connected, off the shelf or custom.

We'll also give you single-source supply for sockets, enclosures and accessories—even automatic wire wrapping whenever you need it.

The Augat way? It's a better way. Call us at (617) 222-2202. Or write for our catalog. Augat Inc., 30 Perry Ave., Attleboro, Mass. 02703. Our representation and distribution is nationwide and international.

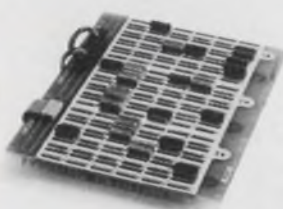

Plug into Augat* instead.

INFORMATION RETRIEVAL NUMBER 44

INSTRUMENTATION

Pulse generator has rep rates to 200 MHz

Hewlett-Packard, 1501 Page Mill Rd., Palo Alto, Calif. (415) 493-1501.



The HP Model 8008A pulse generator has repetition rates variable from 10 Hz up to 200 MHz, a speed that is needed for testing the new generation computer circuits. The new generator has two simultaneous and complementary outputs. Each output has separate amplitude controls and a separate offset control, useful for setting logic levels. Maximum output is 4 V into 50 Ω . Pulse transition times are fixed at less than 1 ns. Pulse width is selectable from 2.5 ns to 0.5 ms and delay between outputs and trigger is selectable from 25 ns to 0.5 ms. The generator can also work in a gated mode supplying pulse bursts under control of an external gate. It also works in a double pulse mode (triggered at rates up to 100 MHz) in which each trigger generates two pulses, with the time interval between each pair of pulses selected by the generator's delay control.

Booth No. 2403-2404, 2504

Circle No. 267

Photo artwork generator can be programmed

Superior Electric Co., 383 Middle St., Bristol, Conn. (203) 582-9561. \$30,000.

The Slo-Syn photo artwork generator is an automatic, tape controlled system for the generation of printed circuit board artwork designed to eliminate manual drafting and photo reduction. Working from a grid paper sketch, the tape can be programmed manually, by a digitizer or by computer. It produces, on film, an accurate circuit pattern to finished board size without the need for photographic reduction.

Booth No. 1102 Circle No. 309

1 and 2-channel Brush recorders introduced

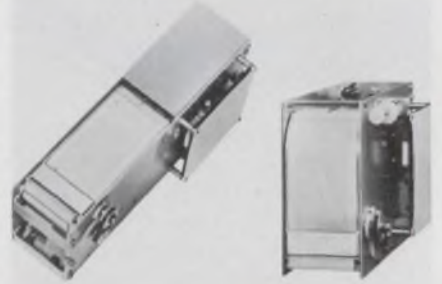

Gould Inc., Instrument Systems Div., 3631 Perkins Ave., Cleveland, Ohio. (216) 361-3315.

A new line of single-channel and two-channel direct writing recorders, available in both low profile and vertical models are ready to install in biomedical or industrial systems. Designated the 1101 series, the models are specified by the company as meeting American Heart Association requirements for electrocardiography. This is the first application of the exclusive Brush pressurized ink writing system to recorders for the OEM field. Pressurized ink writing at speeds up to 300 in./s is possible. Standard models include a chart speed of 25 mm/s and sensitivity of 100 mV/mm. Other single speeds and two-speed, three-speed and four-speed combinations are available as are sensitivities of 1, 10, 50 and 200 mV/division.

Booth No. 2509

Circle No. 272

Thermistor offered in smaller version

Yellow Springs Instrument Co., Box 279, Yellow Springs, Ohio. (513) 767-7242.

The Model YSI 44018 Thermilinear thermistor composite, consisting of two YSI precision thermistors packaged together in a single sensor, measures only 0.08 x 0.15 inches max. The small size represents a 27% reduction in size of the the unit offered previously. Linearities of 2 parts in 1000 over ranges as wide as 100 C are available. The composites have an accuracy and interchangeability of ± 0.15 C and are useable over a span of -50 to 100 C.

Booth No. 3102 Circle No. 327

Signetics chooses 10,000

Two years from now you'll wonder why you waited.

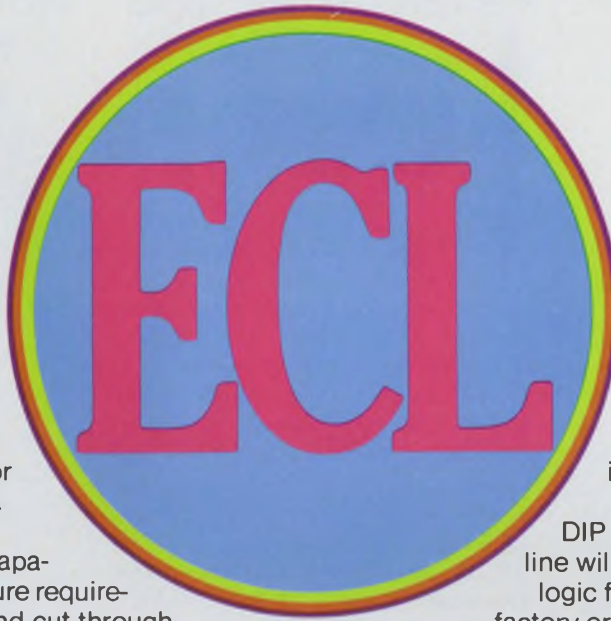

Take the time for a good hard look into ECL 10,000's high speed/performance advantages. And engineer your own head-start into tomorrow's optimized logic. Available today—and tomorrow—from the major new source for ECL series 10,000. Signetics.

Because Signetics never settles for less than total IC capability, we researched your future requirements in high speed logic. And cut through the claims of existing ECL alternatives without mercy. All the know-how, the back-up, the all-out commitment you expect in Signetics linear, digital and MOS, stands behind our development and production of proven, line-ready ECL 10,000 devices.

What's in it for you? A constant reliable supply of the best high speed/low power trade-off yet. Typical speed level: 2.0 ns propagation delay per gate. Low power dissipation of 25mW—with no special cooling required in any environment, still

air or forced. Switching rise and fall times compatible with conventional system layouts (3.0 ns edge speed).

ECL 10,000 delivers outstanding design/function flexibility. Multi-

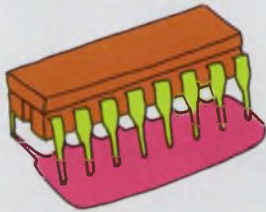

level gating on a single chip, through open emitter outputs and high impedance inputs, means a significant savings in gate and package count. Plus a free choice of terminating schemes and logic interconnects.

Packaged in plastic Silicone DIP or Cerdip, Signetics ECL 10,000 line will provide a complete high speed logic family—some already on-shelf in factory or distributor stock, the remainder due by summer.

signetics DUAL 3-INPUT 1 OR/2 NOR OUTPUT GATE 10112

DIGITAL 10,000 SERIES ECL

DESCRIPTION
The 10112 is a dual in-line gate with 1 OR and 2 NOR outputs. It is fabricated in silicon using the 10,000 series ECL technology. The typical delay of the gate is 2.0 ns. The gate is available in plastic DIP and Cerdip packages.

PACKAGE TYPES
14 Pin Plastic DIP
14 Pin Cerdip

TEMPERATURE RANGE
0°C to 70°C (Commercial)

RECOMMENDED OPERATING VOLTAGE
V_{CC} = 5.0V ± 0.2V

CIRCUIT DIAGRAM

Contact your Signetics salesman, rep or distributor for availability information. He will also rush you our informative ECL 10,000 booklet, free upon request. Or write Signetics/ECL directly, 811 E. Arques Avenue, Sunnyvale, California 94086.

SIGNETICS ECL 10,000 SERIES

- | | | |
|--|---|---|
| 10101 Quad 1-Input OR/NOR Gate | 10112 Dual 3-Input 1-OR/2-NOR Gate | 10130 Dual D-Type Clocked Latch |
| 10102 Quad 2-Input NOR Gate | 10113* Quad Exclusive -OR Gate/Comparator | 10131* Dual D-Type Master-Slave Flip-Flop |
| 10105* Triple 2,3,2-Input OR/NOR Gate | 10115* Quad Differential Line Receiver | 10161 1 of 8 Demultiplexer/Decoder (Low) |
| 10106* Triple 4,3,3-Input NOR Gate | 10116 Triple Differential OR/NOR Line Receiver | 10162 1 of 8 Demultiplexer/Decoder (High) |
| 10107 Triple 2-Input Exclusive OR/NOR Gate | 10117 Dual 2-wide 2,3-Input OR-AND/OA Invert Gate | 10170* 9 + 2-Input Parity Circuit |
| 10109 Dual 4,5-Input OR/NOR Gate | 10118 Dual 2-wide 3,3-Input OR-AND Gate | 10171* Dual 1 of 4 Demultiplexer/Decoder (Low) |
| 10110 Dual 3-Input 3-Output OR Gate | 10119* 4-wide 4,3,3,3-Input OR-AND Gate | 10172* Dual 1 of 4 Demultiplexer/Decoder (High) |
| 10111 Dual 3-Input 3-Output NOR Gate | 10121* 4-wide 3,3,3,3-Input OR-AND/OA Invert Gate | |

*Coming soon

signetics

A subsidiary of Corning Glass Works

INFORMATION RETRIEVAL NUMBER 66

Lab power supply spans 0 to 50 V dc, 0 to 1 A



Systron-Donner Corp., 1200 Shames Dr., Westbury, L.I., N.Y. (516) 997-6200. \$315.

Designated the PLS50-1, the SD/Trygon power supply spans the output range from 0 to 50 V dc, 0 to 1 A, which is five times the power range of comparable units. Output is selected by five 10-position rotary switches to within 1 mV. A vernier control permits resolution of less than 10 μ V. The PLS50-1 can also be remotely programmed.

Booth No. 2532 Circle No. 330

Dc voltage standard for digital systems



Traco Inc., 509 Rolling Hills Rd., Somerville, N.J. (201) 725-5333. \$47.

Two flat 9-V batteries supply the current for a constant current source in this dc voltage standard. The applications include checking and correcting of DVMs and high precision analog meters and oscilloscopes. The output voltage is 1 V \pm 0.05% and the internal resistance is about 250 Ω . The temperature coefficient is $\pm 1 \times 10^{-5}/^{\circ}$ F; noise is held to 10 μ V.

Booth No. 2003 Circle No. 263

Impedance comparator has accuracy and speed



Industrial Test Equipment Co., Inc., 369 Lexington Ave., Clifton, N.J. (201) 546-2130. \$595.

An impedance comparator, the Model 1100, features an accuracy of 0.05% with a fast time response. It's possible to measure 3 Ω to 10 M Ω of resistance, 30 pF to 50 μ F of capacitance, and 10 μ H to 100 H of inductance. The frequency range is 1 kHz, 10 kHz or 100 kHz. Bridge supply voltage is 0.8 V, while the component voltage at balance is 0.4 V. As an option, the Model 1100 can be supplied with provisions for automatic component selection.

Booth No. 2109 Circle No. 268

Sweep generator spans 50 kHz to 12.4 GHz



Wiltron Co., 930 E. Meadow Dr., Palo Alto, Calif. (415) 321-7428.

Reflection and transmission measurements are simplified with the Model 610C sweep generator. A 4 by 5-inch oscilloscope displays with a maximum resolution of 0.5 dB/div. (0.5 in.). A logarithmic level meter provides 60 dB of dynamic range with a digitally set loss offset control and accommodates i-f detector characteristics of from -40 to +20 dBm. The sweep generator is externally programmable. A reflection bridge set is available with better than 1 dB accuracy at 45 dB.

Booth No. 2115 Circle No. 329

Ac volt-amp recorder for \$159



Gulton Industries, Inc., Municipal Airport, Manchester, N.H. (603) 623-3591. \$159; 2 wks.

A recorder to measure both ac voltage and current—the Model 230—can be purchased for only \$159. The model records voltages in the ranges 0 to 150 V, 0 to 300 V and 0 to 600 V with an accuracy of 3% FS. Currents in the ranges 0 to 25 A, 0 to 100 A and 0 to 300 A are recorded to an accuracy of 4% FS. Conductors up to 1 inch in diameter can be handled. Clean, inkless writing on rectilinear paper is featured. A roll of chart paper lasts a month for continuous operation at 1 inch per hour. Other speeds from 1/8 inch to 60 inches per hour are available at no additional cost.

Booth No. 2130 Circle No. 265

Testers speed reed switch checking



Arvin Automatic, Inc., 1384 Pompton Ave., Cedar Grove, N.J. (201) 256-5300.

The Models RST-310 and RST-320 reed-switch testers check the three parameters most commonly of interest during incoming inspection: operate (pull-in), release (drop-out) and contact resistance.

Booth No. 1418 Circle No. 325

8-channel recorder has 1 mV/div sensitivity

Gould Inc., Instrument Systems Div., 3631 Perkins Ave., Cleveland, Ohio. (216) 361-3315. \$7900; May 1972.

The 8-channel general purpose recorder has built-in preamplifiers for a measurement range of 1 mV/division to 500 V full scale. There are 50 divisions across each 40 mm-wide channel. The unit, with carrying case, can be used in portable or bench applications; with a special kit it can be rack mounted. The preamplifiers have differential, floating, balanced-to-guard inputs that are isolated from each other, from chassis, and from the output. Thus, they accept signal sources of any configuration without affecting accuracy or creating system noise. Special features of the Brush 481 include pressurized ink writing for clear, crisp, dry and smudge-proof traces; rectilinear trace presentation; 99.5% linearity enforced by a servo pen positioning system; 40-Hz response at 50 divisions; and electronic signal limiters to protect pens from off-scale overloads.

Booth No. 2509 Circle No. 273

Waveform processor is fully programmable

Hewlett-Packard Co., 1501 Page Mill Rd., Palo Alto, Calif. (415) 493-1501.

A programmable waveform processor, the Model 1150A, is a dual-channel, 1-GHz sampling oscilloscope-like instrument for use in automatic test systems that characterize waveforms. Only six, 16-bit, bit-parallel, TTL-compatible words are required to program all ranges. Interfacing to any 16-bit computer needs only 32 data lines (16 in, 16 out) plus a flag and encode signal. Each programmable function has local storage, thus freeing the CPU from refreshing the settings.

Booth No. 2403-2404, 2504

Circle No. 323

New Miniature Open Frame DRY REED BABCOCK RELAYS... Greater Sensitivity, Low Cost, Fast Delivery!

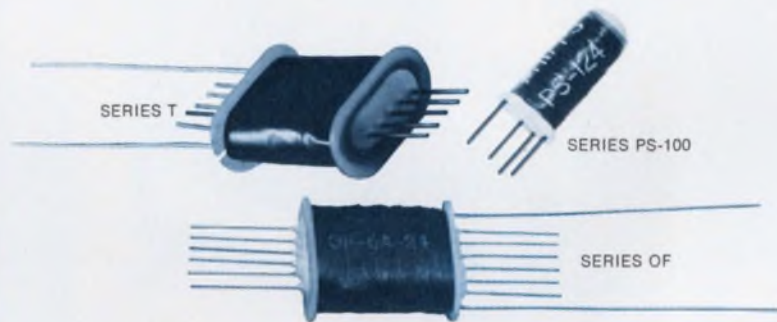

These new, miniature Babcock open frame dry reed relay series offer the engineer a wide variety of configurations to meet virtually any design requirement. High sensitivity, low-cost, extremely fast switching speeds to 0.5 ms., low power consumption, high density packaging, and a reliable long life to 100,000,000 operations are among the many features. From 1 to 6 contacts, in forms A, B and C — or combinations —

provide greater in-system versatility. These models are rated from 3 to 10 watts, for switching 28 to 250 VDC, at 0.25 and 0.50 amp. Other configurations — mercury-wetted, R.F., high voltage — are available. Magnetic and/or electrostatic shielding are optional on axial-lead versions.

**About Delivery —
off-the-shelf for
standard units, and
only 2 weeks for
specials.**

Get complete technical data on these miniature Babcock reed relays today from Babcock Control Products, Babcock Electronics Corp., Subs. of Esterline Corp., 3501 No. Harbor Blvd., Costa Mesa, Calif. 92626 — or better still, call (714) 540-1234.

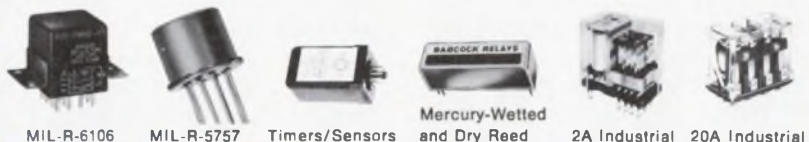

BABCOCK

A UNIT OF ESTERLINE CORPORATION

INFORMATION RETRIEVAL NUMBER 67

Compact analog-to-digital circuit performs 8-bit conversion in 100 ns



Datel Systems, Inc., 1020 Turnpike St., Canton, Mass. (617) 828-6395. \$2495 (1-9); 6 wks.

Datel Systems is well known as one of the front runners in the fiercely competitive market for low-cost data-conversion modules. What is less widely known, however, is that Datel also manufactures some impressive high-performance units. For example, the company's newest module, the ADC-uH, is a 10-MHz analog-to-digital converter. The circuit can complete an 8-bit conversion in under 100 ns. Yet the plastic-cased module measures only 2 by 4 by 1 in. But this performance doesn't come cheaply; in quantities of 1-9 the new a/d converter costs \$2495.

At first glance, it seems absurd to pay such a high price for so little hardware. After all, a solid-gold block with the same dimensions would cost less. When the ADC-uH is compared with other converters of comparable performance, however, its price starts to look more attractive.

Most a/d converters intended for operation at 10 MHz or higher, are housed in bulky metal boxes which are usually intended to be

rack mounted. Companies manufacturing these high-performance types include Computer Labs, American Astrionics and Inter Computer. But 10-MHz a/d converters from these competing companies range in price from \$6000 up to \$9000 or more. Admittedly the higher-priced converters include power supplies and front-panel controls, but Datel argues that \$4000 is a lot of money to pay for a power supply.

In addition to its lower cost and smaller size, the ADC-uH has much lower power dissipation than the larger types. Power consumption is only 5 W compared with upwards of 25 W for most other 10-MHz a/d converters.

In brief, Datel claims that the new converter is one-twentieth the size, one-half the cost, and has one-tenth the power dissipation of competing units. Like the larger converters, Datel's module is repairable.

For the ADC-uH, Datel's design engineers employed a parallel/serial conversion scheme to achieve high-speed performance with relatively compact circuitry. In a sense, the chosen circuit approach yields

a favorable compromise between the performance of a parallel converter and the simplicity of a serial (successive-approximation) converter.

A straight parallel converter would need a total of 256 voltage comparators plus an elaborate decoder, for 8-bit resolution. A serial converter, on the other hand, would minimize the number of components needed; but this type of converter has a limited conversion speed (usually no greater than 1 MHz).

The Datel circuit accomplishes the a/d conversion in two stages. First, the four most-significant bits are determined by a 4-bit parallel converter. These four bits, in turn, control a very fast d/a converter whose output is subtracted from the input signal. Finally, the remainder from the subtraction is fed to a second 4-bit parallel converter which determines the four least-significant bits.

According to Datel, the serial/parallel scheme needs only 30 comparators. Yet the total of the propagation delays and settling times amounts to less than 100 ns, thus allowing 10-MHz conversion rates.

The standard version of the ADC-uH has an input impedance of 50 Ω , but other versions are available to accommodate a customer's specific requirements. The input voltage range is zero to 5 V, with special ranges available to order.

The eight-line digital outputs are delivered by TTL registers which can drive up to eight TTL loads. Specified performance is maintained over the unit's operating temperature range of 0 to +70 C. The temperature coefficient is ± 30 ppm/ $^{\circ}$ C and long-term stability is $\pm 0.25\%$ /yr. The circuit requires externally supplied power of ± 15 V dc at 20 mA and ± 5 V dc at 0.5 A.

Booth No. 2108 Circle No. 310

The bright new ideas are also inexpensive.



This is one of the least expensive precision lighted pushbuttons in existence. We call it our Series 4.

Precision—because our reliable SM snap-action basic does the switching. Inexpensive—because our standard price includes assembled product with lamp. In short . . . low installed cost.

You just snap the Series 4 into the front of your panel. Quick-connect terminals make wiring a snap, as well. Relamping? Just pull out the display screen and the lamp is automatically extracted from its socket.

There's a choice of low energy (1 amp, 125 vac max.) and power load (5 amps, 250 vac max.) switching—both UL listed. Bezel and barrier housings plus matching indicators are also available.

So, depending on the business you're in, you can use this new pushbutton on things like business machines, computer peripheral, instrumentation and commercial equipment.

Make it your business to call your MICRO SWITCH Branch Office or Authorized Distributor (Yellow Pages, "Switches, Electric"). Or write for Product Sheet Series 4.

In either case, we guarantee to make your life a little brighter.

**MICRO SWITCH
makes your ideas work.**

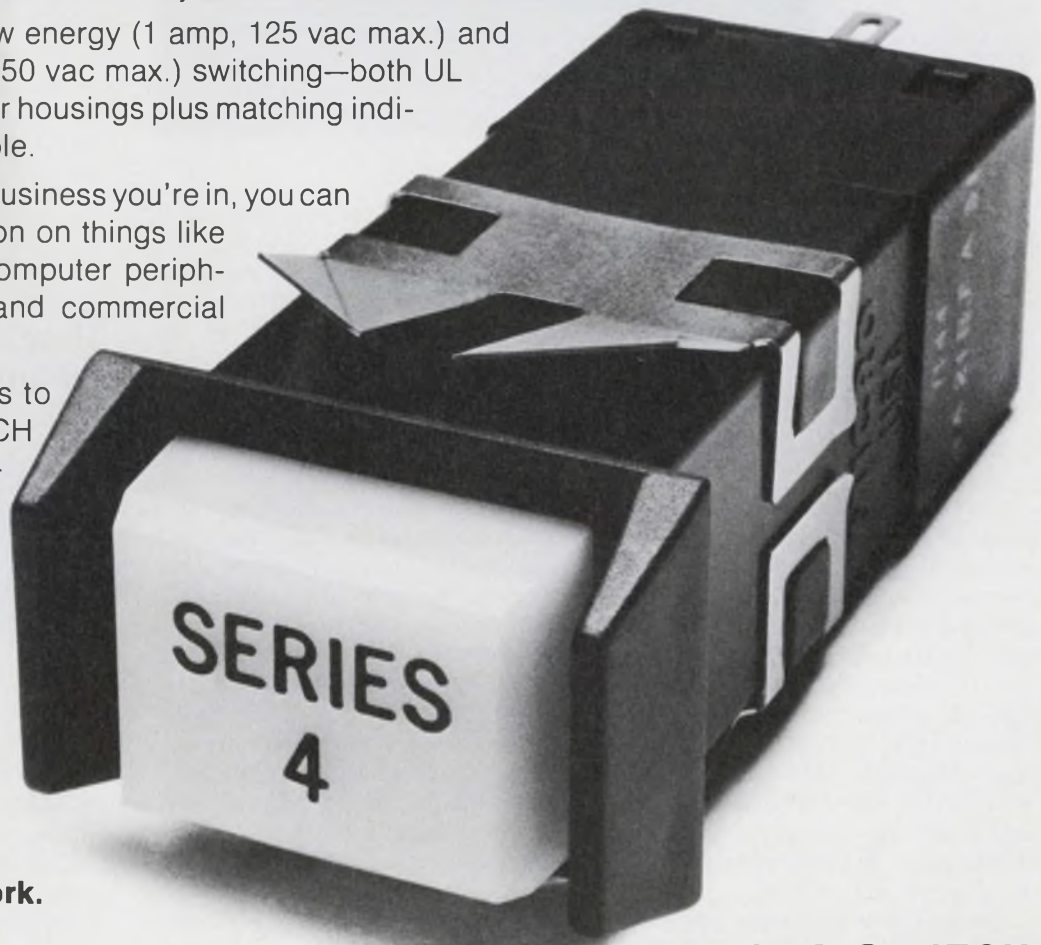

MICRO SWITCH

FREEPORT, ILLINOIS 61032

A DIVISION OF HONEYWELL

MICRO SWITCH products are available worldwide through Honeywell International.

INFORMATION RETRIEVAL NUMBER 68

Crowbar option protects slot supplies and systems

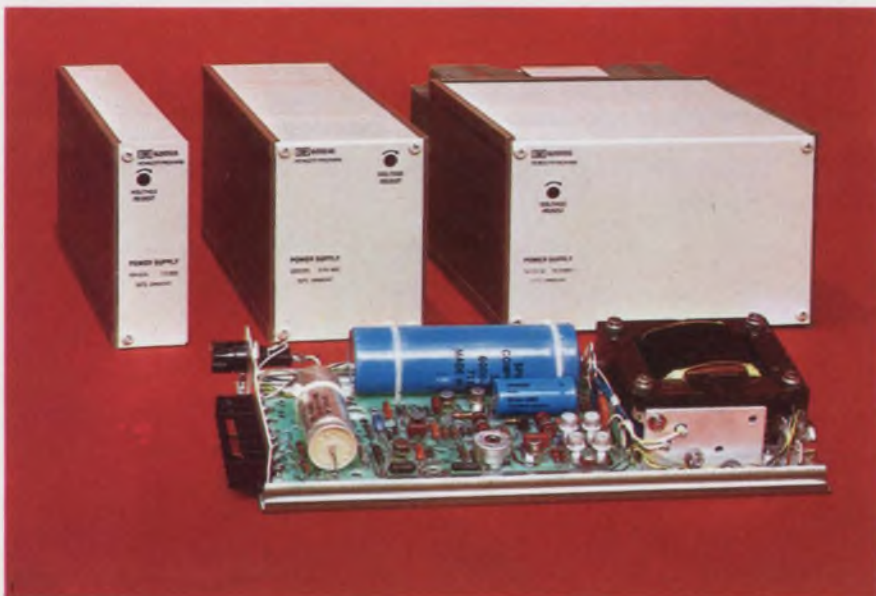

Hewlett-Packard, 1501 Page Mill Rd., Palo Alto, Calif. 94304. (415) 493-1501. Price: see text. Availability: 2 wks.

A line of 44 "fixed-voltage" power supplies, with an unusual crowbar option, marks Hewlett-Packard's serious entry into the slot-supply market, now dominated by Lambda.

HP's Series 62000 supplies, with screwdriver adjustment over a range of 0.5 V or 5% (whichever is greater) around nominal output, are available in three case sizes—with widths of 1/8, 1/4 and 1/2 of a standard 19-inch relay rack. Though custom voltages are available down to 1/2 V (with the rotten efficiency one might expect of a silicon series regulator at that level) and up to 200 V, standard voltages are available from 3 V to 48 V at 17 A to 0.45 A.

Current ratings apply for 0 to 50 C ambients and lower currents are available to 71 C.

In most respects, performance of the new line is typical of fine supplies: Line and load regulation are each 0.01% or 1 mV. Ripple

and noise are 1 mV rms and 3 mV pk-pk. In this case, however, the pk-pk rating is an actual measurement from dc to 20 MHz—not a misleading multiplication of an rms rating. Temperature coefficient is 0.01%/°C. Transient recovery, to within 15 mV of nominal output after a half-load swing, requires only 50 μ s.

Many of the standard features of the 62000 series would be extra-cost options in lines from other vendors. There's adjustable, fold-back current limiting. There's reverse-voltage protection. There's a thermostatic overtemperature protector. There's full output isolation, allowing either output terminal to be grounded. And there's remote sensing, with load protection against opened sense lines.

A most unusual \$40 option, Option 104, involves an adjustable overvoltage crowbar that generates 2 to 10 V into a 1-k Ω load for 2 to 20 μ s for status indication or for triggering other crowbars. The internal crowbar, activated within 10 μ s after overvoltage, can also be tripped by an 8 to 15-V pulse

that can deliver 1 A for 5 to 10 μ s.

Option 104 provides access to the summing point of the voltage-regulator loop. When that point is shorted—really shorted with a metallic contact—to the negative sensing line, the supply can be programmed to within 15 mV of zero. The delay can be long, however, ranging from hundreds of milliseconds to many seconds, depending on the model, load and line voltage. So this procedure should be used only for normal, on/off sequencing—not emergencies.

In small quantities, 1/8-rack modules for 0.45 to 2 A cost \$89; 1/4 racks for 1 to 4.25 A cost \$125; 1/4 racks for 2 to 8.5 A cost \$145; and 1/2 racks for 4 to 17 A cost \$195.

Booth Nos. 2403, 2504

Circle No. 251

Time delay relay features calibrated dial

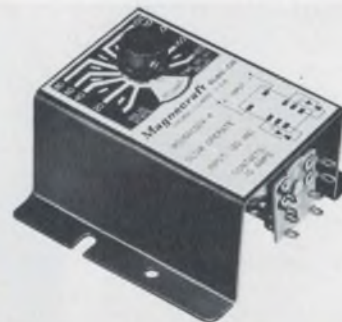

Magnecraft Electric Co., 5575 N. Lynch Ave., Chicago, Ill. (312) 282-5500. \$16.97 (1-9 quantities); Stock.

A panel-mounted industrial time delay relay features an adjustable calibrated dial and a solid state timing circuit. The Class 218 boasts repeatability accuracy of +2% under fixed conditions, and 10 A at 120 V ac 60 Hz may be switched.

Booth No. 1408

Circle No. 303

OPCOA sells LED displays and lamps...

lots of them.



SLA-1



SLA-1R



SLA-2



SLA-3



OSL-3,-3L



OSL-4,-4S

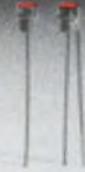

OSL-2,-2S

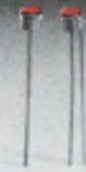

OSL-1,-1S

Lots of displays. All use gallium phosphide, the most efficient visible light emitting semiconductor with 200,000 hours typical half life. All are operable from standard low-voltage IC's. Numerals are red on an opaque black background. Choose from:

SLA-1: A seven-segment numeric display with decimal point featuring a large $\frac{1}{2}$ -in. character in a standard 14-pin dual-in-line package. Total power is less than $\frac{1}{4}$ watt. Operates directly from standard TTL decoder/drivers.

SLA-1R: Similar to SLA-1 but with right-hand decimal point.

SLA-2: For use with SLA-1 or -1R seven-segment displays to indicate the overflow numeral one and polarity.

SLA-3: The largest available solid state numeric display with an 0.8-in. character height—readable at distances of over 40 feet. It features a 0.17-in. thin package with 0.100-in. spaced leads for convenient socket mounting or soldering to a p-c board.

Lots of lamps. All use gallium phosphide LED's which emit light in all directions to provide an area light source rather than a pinpoint. All provide typical optical power output of 225 μ watts (4.5 millilumens) at 15 mA. Choose from:

OSL-1 and -1S: Full 0.100-in. sources of light in 0.100-in. diameter packages with good visibility over 180° viewing angle. For coaxial or two-wire hookup.

OSL-2 and -2S: Provide 2.0 millicandelas at 15 mA in 0.100-in. diameter reflector packages. Recommended where high luminosity with more directional viewing is desired. For coaxial or two-wire hookup.

OSL-3 and -3L: Large indicator lamps with 0.200-in. lens diameters offer exceptionally wide viewing angle. Convenient socket or soldered mounting with 0.100-in. lead spacing. Available with short (OSL-3) or long (OSL-3L) dome in either red or clear plastic.

OSL-4 and -4S: Directional 0.175-in. diameter "head-light" type lamps provide 2.7 millicandelas. Particularly useful for panel backlighting. For coaxial or two-wire hookup.

And lots of the model you've chosen. When your design moves from prototype into production, you can count on OPCOA to meet your requirements.

For technical literature or applications assistance, contact OPCOA, Inc., 330 Talmadge Road, Edison, New Jersey 08817; call (201) 287-0355; TWX 710-998-0555.

OPCOA

SOLID-LITE

SOS diode arrays may oust MOS ROMs with high-speed logic in digital systems

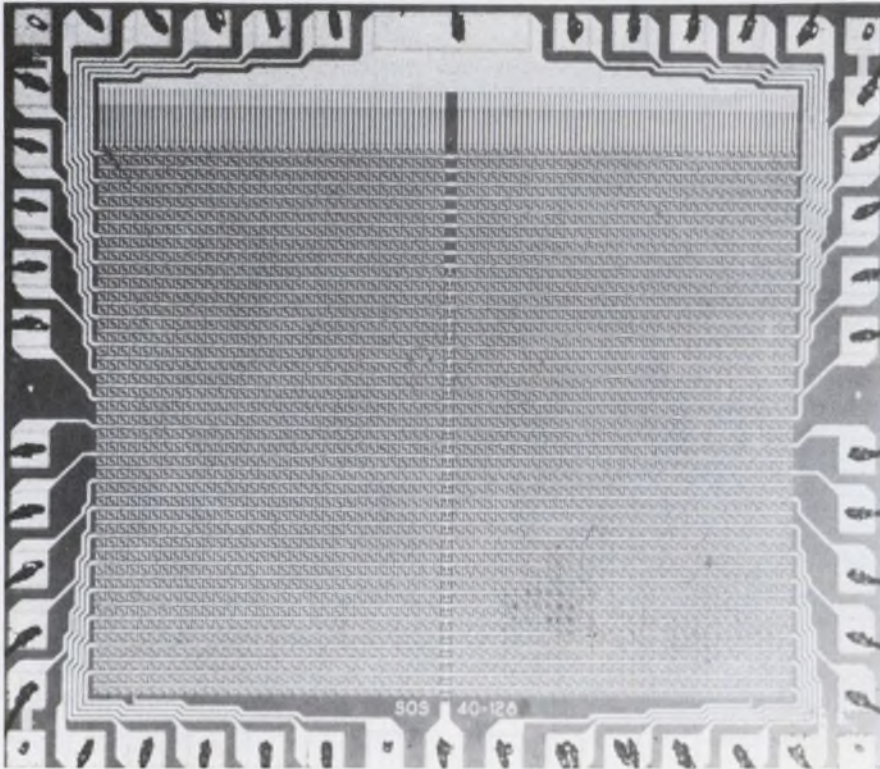

North American Rockwell Microelectronics Co., P.O. Box 3669, 3430 Miraloma Ave., Anaheim, Calif. (714) 632-2231. P&A: \$64, 2-3 day turn-around.

At the show, North American Rockwell Microelectronics (NRMEC) demonstrates the use of silicon-on-sapphire (SOS) 128 × 40 diode arrays in a high-quality character generation system for CRT display. In the system ROMs are used for character storage and combinatorial logic.

SOS diode arrays offer important advantages in this application. Compared with MOS ROMs, the NRMEC P/N 15900NA ROMs allow greater storage capacity and higher speeds.

The SOS diode ROMs have a maximum access time of 20 ns, with a power dissipation of 0.06 mW per diode. The fast switching allows the 5120-diode device to be used for high-speed logic in addition to traditional ROM storage applications.

As a general logic network, one

SOS diode array can compute the value of a function of 19 variables expressed as the sum of as many as 128 products. The equivalent TTL IC implementation would require 342 ICs (assuming use of 3-input AND gates per package). Implementation with a conventional ROM would require 524,288 bits.

The increase in bit capacity—by a factor exceeding 100—comes about this way: In a ROM, all possible combinations of the 19 variables must be stored. But in the diode array, ZEROs require no storage space. Each row function is an independent AND gate. A row can compute any function of the 19 variables.

The diode array is a versatile device. In the complete character-generator system, diode arrays are used in three subsystems: character logic, message store and control (see diagram). Five arrays, connected in parallel, form the basis of the character logic. Stored in the arrays are the ASCII character set, plus a few special sym-

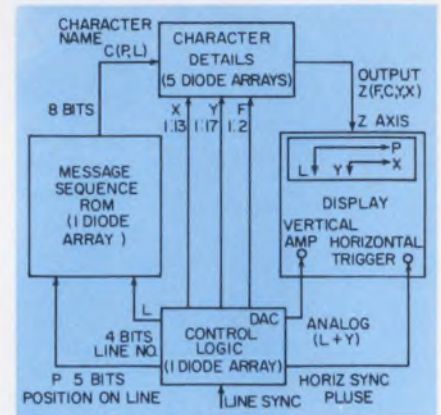

Direct serial readout simplified the circuitry for a character-generator system. The high speed of the SOS arrays makes this possible.

bols, for an average of 20 characters per device.

An SOS ROM stores the sequence of character code-names in the message store. The code-names define the message that appears on the display screen. In the control subsystem, another array is used to microprogram the system operation.

The same chip that serves as a high-speed ROM doubles as a general logic device. The procedure for the storing of logic equations begins with the writing of the logic equations in sum-of-products form. Minimization of the equations is not necessary but is desirable for an efficient array use.

Next, a group of rows are assigned. Each row mechanizes a product term. OR-gate connections are made to sum the products.

One constraint is that the total number of variables and functions should not exceed the number of columns (40). Similarly, the total number of rows required cannot exceed 128. Here's where minimization helps.

Finally, the data is transferred to software, which tells the manufacturer how to program the array.

Booth No. 2603, 2703

Circle No. 333

Data Conversion Modules

Performance...



General Purpose, High Reliability D/A Converters Series 372

- 8 thru 12 bits
 - All hermetically sealed active components
 - High stability, thin film resistors
 - 72 hr. min. factory burn-in
- Information Retrieval No. 191

\$9.90
in singles

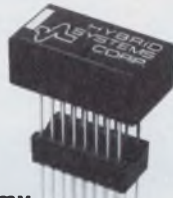

8-Bit, Economy D/A Converter Model 371-8

- Plugs into single IC socket
 - 950nSec settling time
 - All hermetically sealed active components
- Information Retrieval No. 192



High Speed, Multiplying D/A Converters Series 390

- Settles in 50nSec
 - Optional built-in reference
 - All hermetically sealed active components
- Information Retrieval No. 193



High Speed A/D Converter Model 540

- 8 Bits
 - 5 μ Sec conversion
 - Compact — 2" x 2" x 0.4"
 - \$95 (in singles)
- Information Retrieval No. 194

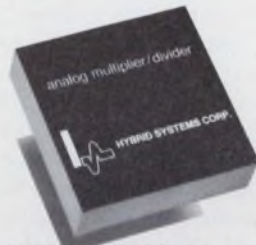

Multiplier/Dividers Series 100

- Accuracies to 0.1%
 - Multiply/divide/square/square root
 - From \$39
- Information Retrieval No. 195



General Purpose A/D Converters Series 550

- 20 μ Sec conversion
 - To 12 bits
 - From \$99
- Information Retrieval No. 196

Plus...

3 yr. warranty on these & other Hybrid Systems' modules

Hybrid Systems offers a full line of function modules, as well as applications assistance, including our free "Data Conversion Handbook." For more complete information, evaluation units, etc., contact us.



HYBRID SYSTEMS CORP. 87 Second Avenue, Burlington, Massachusetts 01803
Telephone: 617-272-1522 • TWX: 710-332-7584

Blind riveting system is magazine loaded

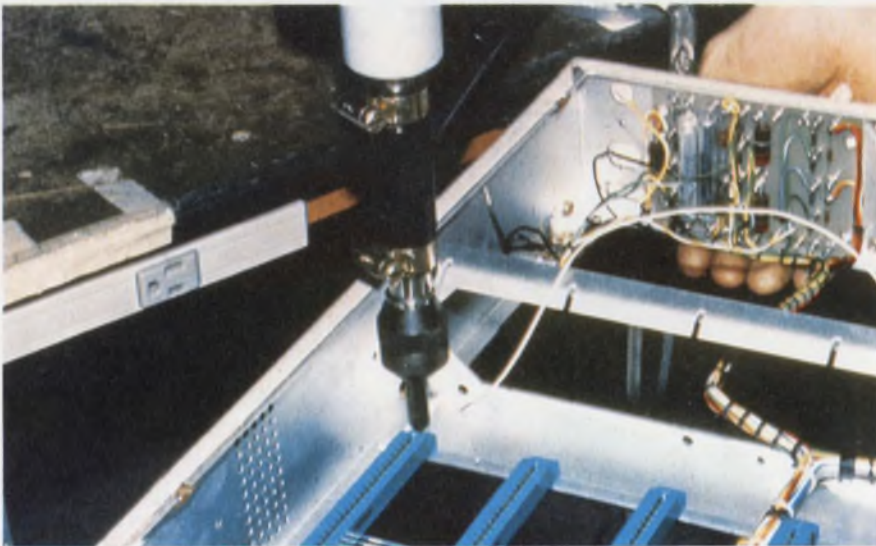

Avdel Corp., 10 Henry St., Teterboro, N.J. (201) 288-0500. \$75-\$100/year; stock.

The Chobert riveting system claims to be the only automatic feed blind riveting system for fastening PC board end card connectors to panels and chassis. The rivets are packaged in cartridges containing between 20 and 90 rivets, depending on their length. The cartridge is loaded onto a reusable mandrel, the wrapper removed, and the mandrel loaded into the tool in under 20 seconds.

The 1¢ rivet cost compares with that of a screw, lock-washer and

nut, but the installation time of 3 seconds is at least an order of magnitude faster. The resulting saving in labor costs amounts to 5¢ per hole or 10¢ per connector.

The installation time of the Chobert system is comparable with that of pop rivets, eyeletting, or semi-tubular riveting. But the chance of cracking expensive plastic connectors is negligible because the expansion of the fastener can be varied. This places the Avdel scheme above the other systems which compete favorably in fastener cost and installation time.

Booth No. 1204 Circle No. 332

Adhesive-backed mount attaches cable ties

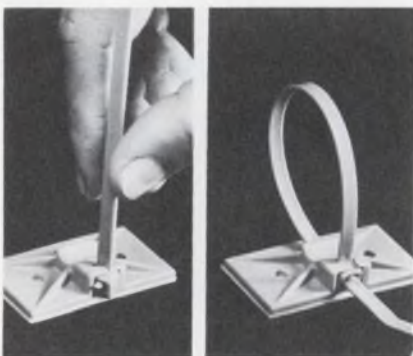

Panduit Corp., 17301 Ridgewood Ave., Tinley Park, Ill. (312) 532-1800. Stock.

A snap-in adhesive-backed mount secures harnesses to smooth surfaces in light duty applications. The unique mount has a pressure sensitive adhesive backing with a peel-off paper cover and can be used with either locking or releasable cable ties. Mounted to virtually any clean, dry, smooth, surface, the new SMS-A mount is designed to support one-half pound when used without screws or rivets.

Booth No. 1523 Circle No. 302

Heat pipes interface heat source to heat sink

Isothermics Inc., 291 River Rd., Clifton, N.J. (201) 473-3555. \$20-\$138.

The CWA series heat pipes provide a conduction-to-convection system, eliminating heat source-heat sink interface problems. The copper-water pipes operate over 32 F to 400 F, and are available in diameters from 3/16 to 1-inch, in lengths of 3 to 72 inches. The axial power rating of heat energy moving axially down the pipe varies from 60 (in the CW series) to 1400 (in the CWS series) watts/inch.

Booth No. 2740 Circle No. 334

Switch/relays plug into wire wrap back planes

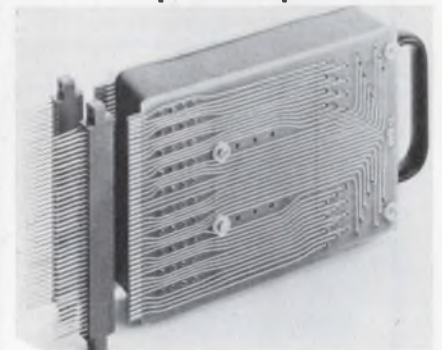

T-Bar, Inc., 141 Danbury Rd., Wilton, Conn. (203) 762-8351.

The 6800 Series offers T-Bar switch/relays mounted on or between PC boards for direct plug into card-edge connectors in a standard card frame. This allows for common wiring by wire wrap or dip solder backplane, and adds to the high density switching capability the same mounting ease encouraged by solid-state module packaging. As many as 21,600 switch points can be packaged into a 19-in. rack, 7 feet high. These T-Bar pluggables are offered with from 35 poles to 72 poles. In gang or matrix switching, 6800 Series units are ideal to interface switch computer-to-computer, computer-to-peripheral, or computer-to-modem. These units can pass data pulses with up to 100 ns rise times.

Booth No. 3301 Circle No. 278

Prototype panels accept ICs with 50 contacts

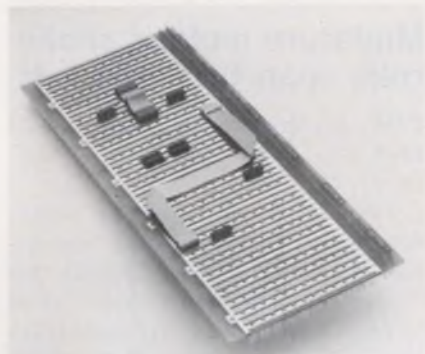

IFE, 25 Tripps Lane, E. Providence, R.I. (401) 438-3315.

Incorporating IFE's new socket/terminals, the complete 600 series of high density packaging panels offers the ultimate in low profile design and the maximum in flexibility for both prototyping and production through its new universal models. Closed-entry beryllium copper contacts housed in machined wire-wrap terminals guarantee excellent retention of IC leads, positive solderless connections, and minimum overall height. Designed to accept 14 and 16-lead ICs, with or without uncommitted pins at each position, and larger devices of up to 50 contacts, the panels are large enough for hundreds of devices.

Booth No. 3300 Circle No. 260

Shielded control cable is miniature

Daburn Electronics & Cable Corp., 2360 Hoffman St., Bronx, N.Y. (212) 295-0050.

A series of miniaturized shielded vinyl control and instrumentation cable conforms to MIL-W-16878D Type B-28 600V. Standard configurations from two cond #28AWG 7/36. C., braided TC shield with 0.120-in. nom O.D. to 20 cond B-28, shield with and O.D. of 0.260-in. These cables resist acid, alkalis, flame, moisture, oil, solvents and fungus, and can be used as interconnecting cable for electronic equipment, control and instrumentation cable and telemetry and remote control with sensitive recording instruments.

Booth No. 1208 Circle No. 277

POWERTEC'S WINNING OEM MULTIPLES

DUALS AND TRIPLES FOR ANALOG AND DIGITAL POWER

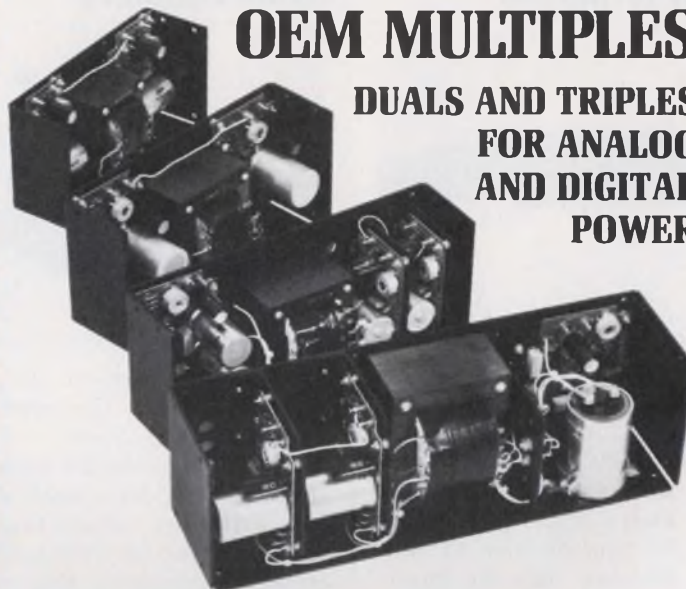

■ EXCEPTIONAL VERSATILITY ■ BEST POWER/COST RATIOS ■ PROVEN, RELIABLE DESIGN

Powertec, the fastest growing Powerhouse in the industry, introduces its new multiple output OEM line, with dual output models for analog circuits and the triple output models for digital and analog. Offering maximum versatility, the fully isolated outputs may be interconnected for any positive/negative requirement, including MOSFET and CCD.

This new design is an extension of our highly successful single output OEM series, has the same quality components and features the same low prices. Don't take second place — Win with the Power People from the Powerhouse — Powertec. Request free application data and catalog.

ALL MODELS DELIVERABLE FROM STOCK IN 24 HOURS.

| Model Number | Output Power | | | Unit Price |
|--------------|--------------|------|-------|------------|
| | ±12V or ±15V | 5V | | |
| 2K15D-1.3 | 1.5A | 1.3A | NA | \$ 46.00 |
| 2L15D-2.8 | 3.0A | 2.8A | NA | \$ 81.00 |
| 2R-70T | 1.5A | 1.3A | 6.0A | \$ 86.00 |
| 2S-140T | 3.0A | 2.8A | 12.0A | \$149.00 |

• REGULATION: Line ±.25%, Load ±.25% • INPUT: 115 VAC ± 10V 47-63Hz • RIPPLE: 1mv RMS 5 & 15V
 • RESPONSE: 50µsec typical • TEMPERATURE: 0°C to 40°C derated to 71°C • O.L. PROTECTION: Current limit/foldback • Optional OVP available

POWERTEC INC.

an Airtronics subsidiary

9168 De Soto Ave., Chatsworth, California 91311 (213) 882-0004 TWX 910-494-2092

12-digit plasma display with 24 terminals



NEC America, Inc., Pan Am Bldg., Ste. 4321, 200 Park Ave., N.Y., N.Y. (212) 661-3420.

The panel display, designated Model LD8026, is a 7-segment 12-digit panel that can indicate numerals 0 to 9 and has a decimal point for each digit. The LD8026, designed for time-division driving methods, features only 24 terminals. The width and thickness of the device are 30 mm and 5 mm. The indicator exhibits a neon-orange color and is rated 0 C to about 55 C (display ON).

Booth No. 3112 Circle No. 335

Rechargeable battery performs like dry cell



Eagle-Picher Industries, Inc., P.O. Box 130, Seneca, Mo. (417) 776-2256.

The Carefree battery system is an economical lead acid rechargeable battery featuring immobilized electrolyte for spill-proof service, high purity grid metal that greatly extends retention-of-charge characteristics on storage, plus the advantages of requiring no maintenance. The advanced performance characteristics of the Carefree system provide a rechargeable energy source with the convenience of dry cell batteries.

Booth No. 3322 Circle No. 306

Miniature metal oxide resistors



Victoreen Instrument Div., 10101 Woodland Ave., Cleveland, Ohio. (216) 795-8200. Stock.

A line of miniature metal oxide resistors provides a small size coupled with high voltage capabilities far in excess of wire wound and metal film resistors. Four types of resistors are included in the line: The Mini-MOX, with ratings as high as 5 kV and current dissipation capabilities of 1 W (available with 100 ppm TCR); the Maxi-MOX, rated at 2.5 W and 7.5 kV per lineal inch available in lengths from 1 to 5-in. in increments of one inch; Power-MOX, capable of handling voltages of 45 kV and up to 45 W in 70 C ambient; and Divider-MOX, a miniature resistor equipped with one or more taps with output ratios as high as 10,000-to-one and capable of input voltages up to 37.5 kV.

Booth No. 3506 Circle No. 307

Film capacitors useful for long time constants

Jermyn, 712 Montgomery St., San Francisco, Calif. (415) 362-7431. \$0.08-\$0.12 (1000 quantities); stock.

A range of tubular capacitors with polyester film dielectric and aluminum foil electrodes are ideally suited for high voltage applications where a long time constant is required. Capacitance ranges from 1000 pF to 0.47 μ F in 5% and 10% tolerances with dc voltages up to 1000 V. Pulse rise time is 100 V/ μ s maximum.

Booth No. 3323 Circle No. 308

Miniature molded choke coils span 0.15-100 μ H

TDK Electronics Co., Ltd., 23-73 48th St., Long Island City, N.Y. (212) 721-6881.

Transfer molded choke coils, designated Type TP0206L are designed to meet MIL-C-15305D. Although the inductors have axial leads, a special lead wire construction eliminates many deficiencies of the conventional axial type and prevents open-circuit failures. Size can be as small as 0.85-in. dia. by 0.24-in. length.

Booth No. 3527 Circle No. 281

Pushbutton switch/relay has a memory



Alco Electronic Products, Inc., 1551 Osgood St., North Andover, Mass. (617) 686-3887.

A new switch relay safeguards combustion devices, sequence circuits, etc., with a memory. To operate, simply push the button to activate the load and re-push the button when you want to deactivate it—just as you would manipulate an ordinary ON-OFF pushbutton switch. However, if the power source is accidentally interrupted, the switch-relay is so designed that current will not flow to the load even after the power source is restored, until the button is reset. In order to perform the same function with ordinary components, one would need several switches and relays, but the FRL-201 relay combines these functions in one compact, light-weight and simple-to-install unit. A dust cover is provided to protect the contacts from dust. The contacts are rated at 5 A dc, the coil at 15 mA for 115 V ac, 150 mA for 6 V ac.

Booth No. 3509 Circle No. 279

Miniature thumbwheel switches snap together



Dialight Corp., 60 Stewart Ave., Brooklyn, N.Y. (212) 497-7600. \$2.57/digit (1000 quantity); stock.

The series 545 miniature thumbwheel switches snap together side by side on 5/16-in. centers to provide any number of desired decades. Large 3/16-in. numerals make it easy for an operator to read the digits from a distance and the assembly has a modern low profile design—recessed on the face of the panel to eliminate accidental activation. Each switch has a gold-plated track on glass epoxy base to insure long life. Gold-to-gold contacts between wipers and tracks obviates electrolytic action and long wipers insure constant pressure. Switching functions include decimal—10 position, 1 or 2 pole, and binary—1.2.4.8 and 1.2.4.8 with complements.

Booth No. 3401 Circle No. 321

Clamps molded of flame-retardant nylon

Weckesser Co., Inc., 4444 W. Irving Park Road, Chicago, Ill. (312) 282-8626. Stock.

A new unreinforced modified nylon 6/6 is used for molding the only "flame-retardant" nylon with top Underwriters Laboratories, Inc., rating of Type I, in addition to U/L's SE-0 classification. The nylon is also flame-retardant under ASTM D-635-68. Clamps, screws, nuts, and cable ties molded of this nylon, are available in ANSI thread specifications and standard sizes.

Booth No. 1319 Circle No. 259

Compare Mini-Mox to whatever film resistor you're using now.

Our Miniature Metal Oxide Resistors Can Give You up to 10,000 Megs and 5000 Volts in 1/10th the Space.

Compared to metal film resistors our tiny Mini-Mox can give you greater power handling capability and substantially better resistance to size or voltage to size ratios. Mini-Mox reliability is unmatched under high voltage conditions.

Mini-Mox outstrips conventional carbon film in every category: 100 ppm TCR; voltage to size ratio; stability; power handling capability; initial tolerance and reliability, particularly under extreme environmental conditions.

Mini-Mox resistors offer a new degree of design freedom in stable and dependable high voltage circuitry. They are available in a range of sizes and we stock them for prompt delivery.

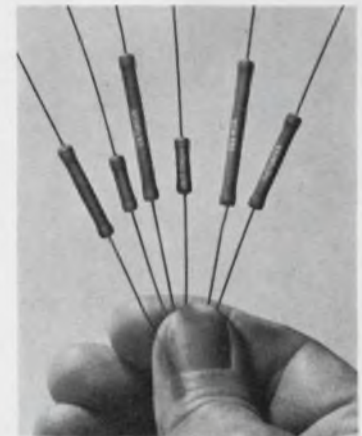
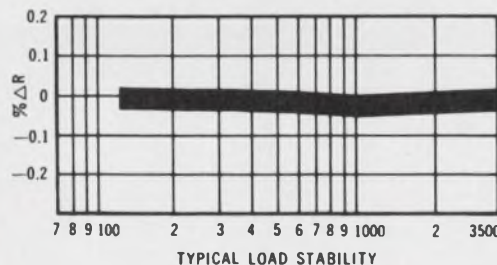
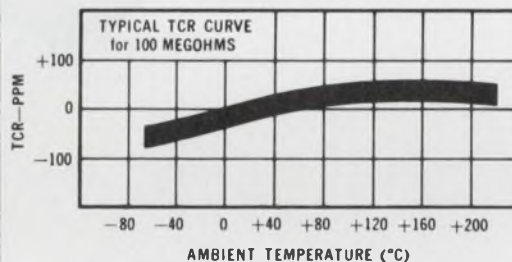

| Model | Resistance | Rating @ 70°C | *Max. Oper. Volts | Length Inches | Diameter Inches |
|----------|---------------|---------------|-------------------|---------------|-----------------|
| MOX-400 | 1-2500 megs | .25W | 1000V | .420 | .130 |
| MOX-750 | 1-5000 megs | .50W | 2000V | .790 | .130 |
| MOX-1125 | 1-10,000 megs | 1.00W | 5000V | 1.175 | .130 |



For detailed specifications on Mini-Mox send for this technical bulletin. Victoreen Instrument Div. of VLN Corp., 10101 Woodland Avenue, Cleveland, Ohio 44104. Telephone: 216/795-8200

DMA 683

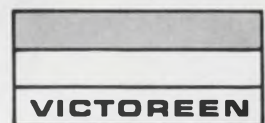

Expertise in high voltage.

NPE/New Product Engineering, Inc.

wabash

RELIABLE

Right Now



DIP REED RELAY

Our new 814 series 14-pin dual-in-line relay for high density packaging. It is an epoxy molded unit that is automatically insertable and fits IC sockets. Comes as standard product in 1A with nominal coil voltage of 5, 6, 12 or 24 volts. Options available in 2A, 1B and 1C (true form) packages.

SPECIFICATIONS

| | |
|------------------|---------------------------------------|
| Current (switch) | 0.110 amps |
| Voltage | 28v D.C. |
| Power (D.C.) | 3 watts |
| Life | up to 50 x 10 ⁴ Operations |
| Configuration | .100 x .300 pin centers |

INFORMATION RETRIEVAL NUMBER 237



MERCURY WETTED CONTACT RELAYS

Our expanded 5100 and 5500 series offer a greater variety of P.C. mount and plug-in types. They range from miniature to large 2-switch versions (3-switch version in plug-in) available in sensitive C and D or neutral D contact forms, single-sided or bi-stable coils. Typical applications: isolated power supplies driven from DTL and TTL logic; switching microvolt analog signals; 250 VA equipment requiring speeds up to 100 Hz; and digital circuits needing bounce-free operation.

SPECIFICATIONS

| | |
|--------------------|---|
| Contact Resistance | 50 milliohms max. |
| Contact Rating | 2 amps peak max. 500v peak max. 100 VA peak w/proper contact protection (up to 5A peak max. & 250 VA peak in neutral Form D switches) |
| Bounce | None |
| Life | Up to 1 x 10 ⁹ Operations |

INFORMATION RETRIEVAL NUMBER 238

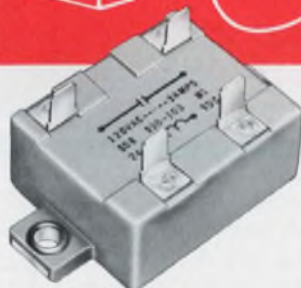
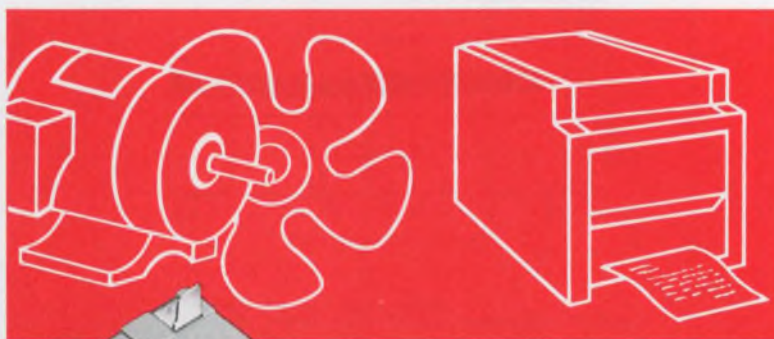

SSR MODULE

The 930 series semi-solid state, standard on-off relay module comes in this low profile package. Provides complete isolation between a low control power input and a high power load. The unit has exceptional switching reliability and is compatible with TTL logic. It can be used to switch inductive, capacitive, tungsten or resistive loads, as in lamps and transformers of office copiers and duplicators; motors, blowers, fans of heating and air conditioning systems; and in valves, solenoids and actuators.

SPECIFICATIONS

| | |
|---------------------------|--|
| Control Voltage (nominal) | 5 — 48v D.C. |
| Load Voltage (maximum) | 200 or 400v (peak) |
| Load Current (maximum) | 10 amps A.C. |
| Life | up to 500 x 10 ⁴ Operations |
| Size | 2.63"L x 1.52"W x .850"H |

INFORMATION RETRIEVAL NUMBER 239



EXPANDING

... and Right Soon

NOW, OR SOON... ALWAYS RIGHT

Reliability, here and now, is our continuing pledge as we expand to meet new markets. Check the new products we've engineered for delivery **right now**. And look over the ones coming **right soon**. Be certain that because they're from Wabash they come with assurance of best pricing, quality and delivery.

You'll be ordering not from an assembler, but a manufacturer with complete control of **all** components and performing over **3 billion daily** reliability test cycles.

Combined purchases of key materials by all Wabash operating divisions, and proprietary manufacturing efficiencies achieved by NPE during our 10 years of business have resulted in our providing quality products at substantial savings, which we share with you.

We recognize that high quality and competitive pricing have little merit unless you get parts when you need them. We have a reputation for fast delivery — typically 3 weeks lead time.

Call us for **PDQ** service: **Price, Delivery and Quality** — now.

RF REED SWITCHES

The 69-2721 switch is one of the latest additions to our growing family of dry reed switches. Its special switching capability is packaged in the .100" x .750" miniature size capsule. Capable of switching RF signals in multiplexing and video applications, it is used extensively in radio, TV and mobile communications equipment.

SPECIFICATIONS

| | |
|------------------------|---------------|
| Current (switch) | 0.010 amps |
| Voltage | 28v D.C. |
| Peak breakdown voltage | 300 volts |
| Power (D.C.) | 0.3 watts |
| Resistance (initial) | 200 milliohms |

INFORMATION RETRIEVAL NUMBER 240

ALSO READY NOW



SUBMINIATURE REED SWITCHES

The 69-2821 space saver miniature (SSM) is another addition to our family of switches. The .070" x .500" capsule makes it ideal for switching functions where space is at a premium, such as in DIP reed relays, keyboard switches or any other high-density control or switching package.



RF SWITCHING RELAYS

A miniature size package with .100" or .150" x 1.00" pin configuration for switching of RF signals, such as antenna switching where it is necessary to keep talk and receive transmission separated. Applications for this relay include: multiplex, base station, mobile or portable communications equipment.



COMMERCIAL MINIATURE REED RELAY

This miniature size package with .100" x 1.00" pin configuration is tailored to meet commercial requirements at lowest cost.

COMING SOON



ECONOMY REED RELAY

A miniature size relay package specifically designed for consumer goods and commercial OEM users who require low cost electrical switching devices.



HIGH VOLTAGE RELAY

A relay capable of switching loads thru 15 KV. May be used to reverse the polarity of the high voltage source in D.C. power supplies used in office copiers or duplicators, CRT displays and electrostatic air cleaners.



MULTIPLEX REED RELAY

An intermediate size open-frame package with .150" x 1.35" pin configuration for use in multiple switching sequencing operations. Typically used in telephone PBX or intercommunications equipment or video switching in security systems.

wabash

NPE/New Product Engineering, Inc.
a subsidiary of Wabash Magnetics, Inc.

First and Webster Streets, Wabash, Indiana 46992
telephone (219) 563-2191 TWX 810-290-2722

Implement digital transfer functions, either simple or complex, with only two off-the-shelf MOS/LSI building-block chips.

Digital filters and digital resolvers—so-called “pipeline” arithmetic units—of almost any complexity can be designed around only two basic MOS/LSI chips: a serial/parallel multiplier (SPM) and a shift register/adder (SRA).

While SPM and SRA chips lend themselves to a wide variety of applications (Table 1), they are particularly suitable for digital filters because they make for a simple design.

Any order of filter structure with any reasonable (and many seemingly unreasonable) lengths of coefficients and data-word lengths can be quickly breadboarded. Then the final design can be fabricated with the same components. Word lengths and scaling coefficients can be altered, if required, simply by changing connections to the chips.

Offhand it would appear that with only two kinds of chips for the design, it would take thousands of chips to build a filter of average complexity. It turns out that a typical filter can be built with about a dozen chips. A rule of thumb is that given a digital transfer function, the total number of chips required is approximately equal to one-half of the transfer-function order plus the number of coefficients that are other than zero or unity.¹ A fourth-order Bessel filter, for instance, can be built with only eight chips on a single ceramic substrate (replacing five printed-circuit cards, each about 7 by 7 inches, packed with bipolar ICs).

Filter coefficients can be either hard-wired or programmed and obtained sequentially from a ROM.^{2,3,4} More versatile time-varying and tracking filters can be easily realized by setting the filter coefficients by adaptive-element computation.⁵ The adaptive element can be a special shift-register chip and an SPM.

Control logic is included and fabricated on the chips along with the arithmetic operators. There are only two required central controls: the clock (bit time) and word-timing signals. The analog-to-digital converters (ADCs), clock and word-

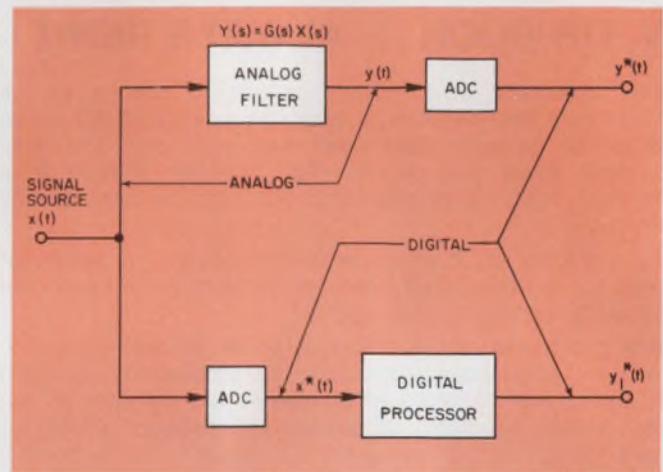

1. A digital filter is a special digital processor that can perform a function practically identical to that of an analog filter.

timing generator are often combined into an integrated unit.

Let's define a digital filter

A digital filter is a specialized digital processor. Consider Fig. 1, which depicts an analog filter, two ADCs and a digital processor of some kind. Now if $y^*(t)$ looks exactly like $y^*(t)$, the upper and lower channels in the figure must be equivalent. Or the digital processor must be doing the equivalent of the analog filter, but to a digital signal.

Although this is a rather limited definition, it illustrates the point. For our purposes, we define a digital filter as a digital processor whose output is a linear combination of past and present output and input samples. Regardless of the filter configuration, its derivation method⁶ and the order and accuracy requirements, the transfer function of the filter always can be expressed as a ratio of polynomials rational in z^{-1} , the unit delay operator. The discrete transfer function is thus:

$$G(z) = \left(\sum_{i=0}^M a_i z^{-i} \right) / \left(\sum_{j=0}^N b_j z^{-j} \right). \quad (1)$$

This expression can be factored to yield

Dr. Stanley A. White, Member of Technical Staff, North American Rockwell Microelectronics Co., Anaheim, Calif. 92803

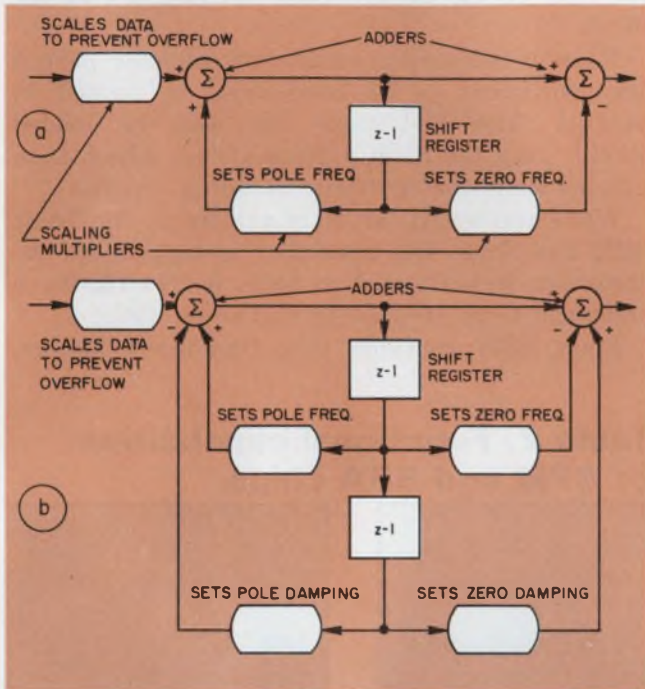

2. A filter of any order can be assembled by cascading the required number of basic sections. A first-order filter for real pole and zero is shown in "a", while a second-order filter for complex poles and zeros is in "b".

$$G(z) = \left[\prod_{i=1}^M (1 - A_i z^{-1}) \right] / \left[\prod_{j=1}^N (1 - B_j z^{-1}) \right]. \quad (2)$$

Each real pole can be implemented (Fig. 2a). Each complex pair of poles can be implemented (Fig. 2b). Thus the entire digital filter can be built cascading these sections.

The transfer function of Eq. 2 can also be partial-fraction-expanded into:

$$G(z) = \sum_{j=1}^N [K_j / (1 - B_j z^{-1})]. \quad (3)$$

This leads to a direct parallel realization of the filter.

Assembling the digital filter

A MOS/LSI digital filter is made up of SPM, SRA and ADC/DAC chips. The SPM and the

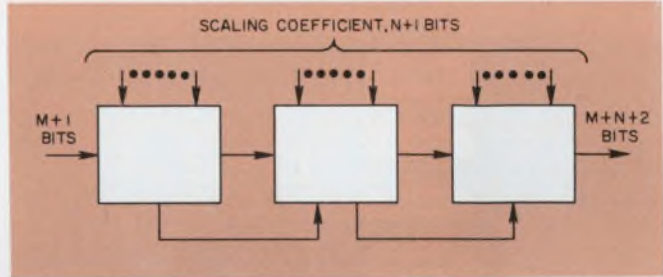

3. Any number of multipliers can be connected in tandem to accommodate a scaling coefficient of any length (N = 8 per multiplier).

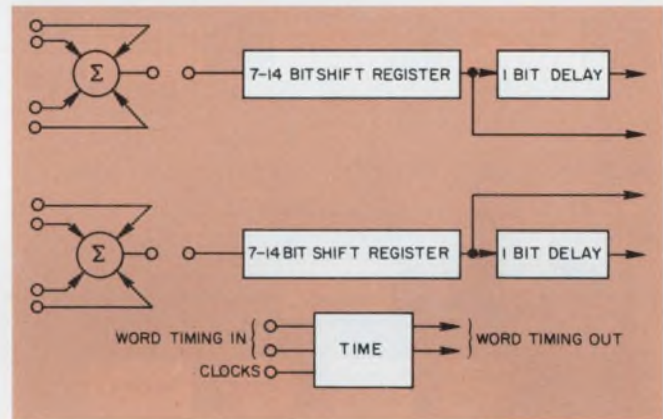

4. Each shift register/adder (SRA) chip contains the elements shown here.

Table 1. Applications for SPM and SRA chips.

| |
|--|
| Solve difference equations (digital filtering) |
| Bandpass filters |
| Weighting-function generation |
| Transversal equalizers |
| Clutter filters – Doppler MTI |
| Feedback-control-system equalization |
| Interpolation filters |
| Digital smoothing |
| Inverse function generation |
| Coordinate transformation |

SRA are highly versatile, multifunctional devices that can be used in many applications, (Table 2). These devices are just as basic to digital systems as resistors, capacitors and operational amplifiers are to analog systems. They were developed to optimize the tradeoff between chip versatility and capability on one hand and cost and yield problems on the other.^{7,8}

The SPM and the SRA chips are often called "digital-filter building blocks," not because this is their sole purpose but because they perform exceptionally well in filters.

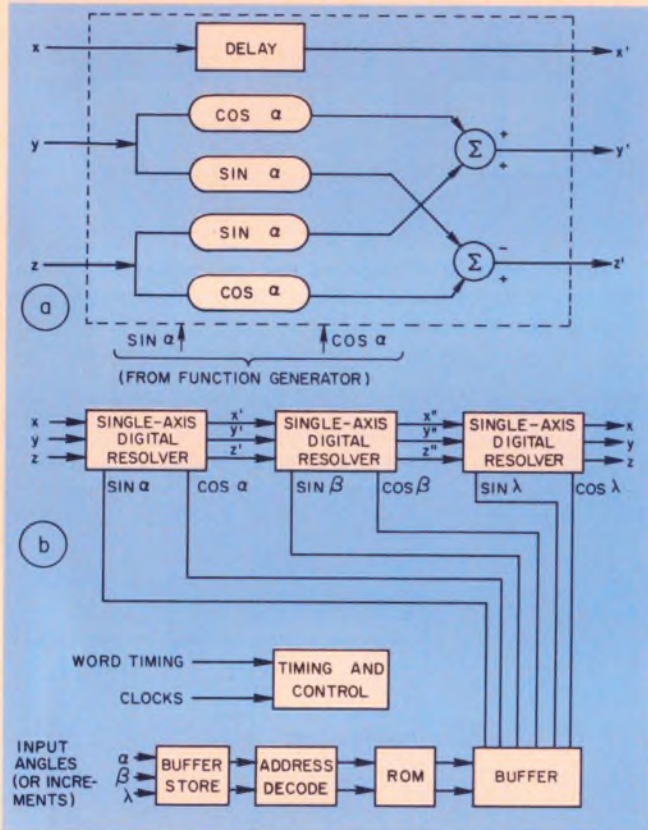

5. Combining three single-axis resolvers (a) into an integrated system results in a complete three-axis digital resolver (b).

An SPM multiplies a data word by a scaling coefficient. The data word is run in serially, least significant bit (LSB) first, in two's-complement format. This data word can be of any arbitrary length, say $M+1$ bits, where M is the number of bits without the sign and one bit is added for the sign.

If the scaling coefficient (stored in a holding register) were $N+1$, the sign-corrected output word length would be $M+N+2$ bits, including a redundant sign bit. The latter is discarded, and this bit-time is used for reset. The LSB of the product appears at the output one bit-time after the LSB of the input data-word appears at the input.

Taps to the scaling-coefficient register permit the coefficient to be hard-wired or loaded in parallel. The coefficient can also be loaded serially into the SPM shift register, which then parallel-loads the coefficient-holding register.

While the length of M is arbitrary, the basic SPM has $N=8$. The multiplier is tapped, so two chips can be connected to form $8 < N \leq 16$, three chips can form $16 < N \leq 24$ and so on (Fig. 3).

Each SRA contains two four-input adders,

Table 2. Functional capabilities of SPM and SRA chips.

| SPM | SRA |
|-------------------------|--------------------------------|
| Multiply signed numbers | Add |
| Add | Subtract |
| Delay | Delay |
| Sign spreader | Variable-length shift register |
| | Integrate (accumulate) |
| | Differentiate |
| | Up-down counter |

Table 3. Hardware for a single-axis digital resolver.

| No. of bits $\sin a, \cos a$ | No. of chips required* | | | Power diss. (mW) |
|---------------------------------|------------------------|-----|-------|---------------------|
| | SPM | SRA | Total | |
| 8 | 4 | 1 | 5 | 150 |
| 12 | 8 | 1 | 9 | 250 |
| 16 | 8 | 1 | 9 | 250 |
| 24 | 12 | 2 | 13 | 400 |

*Independent of word lengths of x, y, z .

two variable-length shift registers (0-7 bits in tandem with 7 bits, in tandem with one bit) and all the timing and control logic necessary to make that section of the filter self-sufficient (Fig. 4). The SRA requires word-timing pulses synchronized with the input data and, of course, the system clock.

SPM and SRA chips good for other jobs

Some of the jobs that can be done with SPM and SRA chips are listed in Table 1. The linear arithmetic operations are obvious applications. Here are two nonlinear applications:

A collection of one or more chips, which may include a ROM, may operate on an input signal, x , to provide some function of x . By adding the SRA chip, you can usually obtain the inverse function. For example, an SPM chip may be used to multiply one number by another, or to raise a number to a power. Adding an SRA chip, you can invert the function—that is, divide one number by another or extract the root of a number.

A programmable digital resolver can also be built with these chips. It is based upon a table-look-up, digital, sine/cosine generator (such as can be made with the ROM 2206). Data transformations from one coordinate system to another, through resolvers, are required in most guidance and control systems. If the data to be resolved are all digital, then a digital resolver is required—in the form of special-purpose hardware or a program within a general-purpose processor.

The basic functional block of a digital resolver (Fig. 5a) performs a single Euler-angle rotation. Three such blocks are required for three degrees of angular freedom. A block diagram of a three-axis digital resolver is in Fig. 5b, and the hardware requirements for a single-axis digital resolver are given in Table 3. ■■

References:

1. White, S.A., "Practical Digital Filter Structures," Wescon, Session 8, No. 5, 1971.
2. Luisi, J.A., "Silicon on Sapphire Read-Only Memories," *Electronics*, Vol. 42, No. 4, Feb. 17, 1969, pp. 114-119.
3. Sypherd, A.D., and Salman, N.D., "Automatic Laser Encoding of Semiconductor Read-Only Memories," *Proc. NEC*, Vol 24, December, 1968, pp. 206-209.
4. Sypherd, A.D., "Design of Digital Filters Using Read-Only Memories," *Proc. NEC*, Vol. 25, December, 1969, pp. 691-693.
5. White, S.A., "Digital Adaptive Element Building Blocks for MOS Large-Scale Integration" *IEEE Trans*, Vol C-18, No. 7, July, 1969, pp. 699-706.
6. Golden, R.M., "Digital Filter Synthesis by Sampled-Data Transformation," *IEEE Trans*, Vol AU-16, No. 3, September, 1968.
7. White, S.A., "Minimizing Word Lengths for Recursive Digital Filters," *Proc. IEEE Comp. and Comm. Conf.*, Rome, N.Y., October 1969, pp. 175-187.
8. White, S.A., "A Gain Limit and Computational Word-Length Criterion for Fixed-Point Digital Filters," *Proc. 1970 IEEE International Symposium on Circuit Theory*, Atlanta, Ga., December, 1970, pp. 131-133.

Two Top Choices

Frequency Synthesizer



- 1 kHz to 80 MHz in 1 kHz Steps
- 1 Hz Resolution Optional
- Fully Programmable

Model RF-828 is offered with 1 kHz phase-locked steps. An optional vernier provides 1 Hz resolution. The RF-828 is fully programmable with contact closures, RTL, DTL or TTL logic.

Or

Synthesized Signal Generator



- AM/FM/Pulse Modulation
- Manual and Automatic Sweep
- 160 db Output Level Range

Model RF-808 is three instruments in one: signal generator and frequency synthesizer and sweeper. Frequency range is 0.05 to 80 MHz in 1 kHz phase-locked steps with a vernier for 1 Hz resolution. Frequency, modulation and attenuation are programmable.

Applications

Automated Test Systems • General Lab Use • Computer-Controlled Signal Sources • Semi-Automatic Test Systems • Receiver and Transmitter Systems • Nuclear Magnetic Resonance • Crystal Calibration and Resonance



RF COMMUNICATIONS, INC.
Electronic Instrumentation Sales
1680 University Avenue
Rochester, New York 14610
Telephone: 716-244-5830; TWX: 510-253-7469
A subsidiary of Harris-Intertype Corporation

INFORMATION RETRIEVAL NUMBER 74

A simultaneous, rather than a sequential, reading and writing capability makes our new second-generation miniature storage tubes outstanding. Now you can have greatly increased flexibility in design. Now you can enjoy continuously up-dated data—and ease of handling high data bits. Now your designs can be more flexible than ever before, whatever your application (zooming, selective erasure, write and read stored data at the same time).

The new tubes are an extension of our RST family, retaining all the features previously demonstrated. They can store a full TV gray-scale image for half an hour. With power off, the storage capability is at least a month. And one TV frame is enough to erase a complete image thanks to a unique, patented, gun design.



THOMSON-CSF

THOMSON-CSF ELECTRON TUBES, INC.
50 ROCKEFELLER PLAZA / NEW YORK, N.Y. 10020
(212) 489-0400

Their flexibility, capability, and the low cost of associated electronics make these tubes ideal for a wide variety of applications. For complete information concerning them and our entire line of storage and display tubes, please circle the appropriate number on the Reader Service Card, or contact us direct.

| Model | Type No. | TV Lines at 50 % MF | Voltage (Mesh) |
|------------------|----------|---------------------|----------------|
| 1.5" EM | TME 1239 | 1200 | 750 |
| 1.0" EM | TME 1238 | 800 | 650 |
| 1.5" ES | TME 1348 | 600 | 1100 |
| Dual Gun 1.0" EM | TME 1496 | 800 | 650 |

France - THOMSON-CSF Groupement Tubes Electroniques / 8, rue Chasseloup-Laubat 75 PARIS 15^e / Tel. 566 70 04
Germany - THOMSON-CSF Elektronenröhren GmbH / Am Leonhardsbrunn 10 6 FRANKFURT/Main / Tel. 70 20 99
Italy - THOMSON-CSF Tubi Elettronici SRL / Viale degli Ammiragli 69/ROMA Tel. 63 80 143
Sweden - THOMSON-CSF Elektronrör AB / Box 27080/S 10 251 STOCKHOLM 27 Tel. 08/22 58 15
United Kingdom - THOMSON-CSF Electronic Tubes Ltd / Bilton House, Uxbridge Road, Ealing / LONDON W5 2TT / Tel. 01-579 1857

Our family of miniature storage tubes
can hold an image for one month
Now we have tubes
that read and write
at the same time.



OUR ANGLE: angle position indicators that do more and cost less

SHOULDN'T YOU TAKE A NEW READING ON THIS COST-PERFORMANCE ANGLE?

For better ways to measure synchro and resolver data, North Atlantic offers the best of both worlds: budget prices for the popular API-8025; superior performance and increased capability of the new 8525. • Both are interchangeable without any mechanical or wiring modifications. North Atlantic's solid-state 8525 offers an accuracy of 0.05° (3 minutes). Following a 180° step input, it synchronizes a five-digit NIXIE readout in $\frac{1}{2}$ second flat. And it tracks at up to 1000° per second. Where cost can be traded against performance, the proven electromechanical API-8025 . . . a recognized indus-

MODEL 8525



MODEL 8025

try workhorse . . . is available with its 6 minute accuracy, 25° /second slew speed, and many options. • Input of the 8525 is any 60 or 400Hz resolver/synchro data from control instrumentation. The patented servo design eliminates all inertia and improves dynamic performance many times over. Its digital outputs are especially suited to the computer-oriented requirements of today's automatic test systems. The 8525 . . . priced at \$1885 . . . and the API-8025 priced at \$995 actually cost less because they perform more functions per dollar. And with greater reliability.

For complete information on the cost-performance angle, please write or phone now.

"See us at IEEE-Booth #2123"

NORTH ATLANTIC
industries, inc.

200 TERMINAL DRIVE, PLAINVIEW, NEW YORK 11803
cable: noatlantic / twx: 510-221-1879 / phone: (516) 681-8600

INFORMATION RETRIEVAL NUMBER 76

Use op amps with greater confidence

by understanding the subtleties of their parameters and how they are measured.

As the IC op amp—one of the most powerful tools in the analog designer's basket—improves in performance, it's becoming more essential than ever for designers to understand the subtleties of op-amp parameters. How does the manufacturer measure them? And in the case of lower-cost IC op amps, when the manufacturer doesn't test all the parameters, what tests should you perform? Let's find out.

As a well-informed designer, you'll be able to choose the best cost/performance tradeoff. You'll design better circuits as a result.

While op-amp parameter definitions vary from manufacturer to manufacturer, the definitions for major parameters are the same for most makers. They include:

- Input offset voltage, V_{OS}
- Input offset current, I_{OS}
- Input bias current, I_B
- Input resistance, R_{IN}
- Supply current, I_s
- Large-signal voltage gain, A_V
- Output voltage swing, V_O
- Common-mode rejection ratio, CMRR
- Power-supply rejection ratio, PSRR

With the exception of a few special applications, these parameters provide sufficient dc operational data for the design engineer.

The circuit for measuring V_{OS}

Op-amp parameters are not measured directly. Rather, they are measured by connecting the amplifier under test (AUT) in series with a buffer op amp in a closed-loop configuration that has a certain gain (Fig. 1). The AUT parameters, multiplied by the loop gain, are reflected to the output of the buffer op amp.

Referring to Fig. 1, we have

$$V_{BUF} = A_{CL} V_{OS}, \quad (1)$$

where

$$A_{CL} = (R1 + R2)/R1. \quad (2)$$

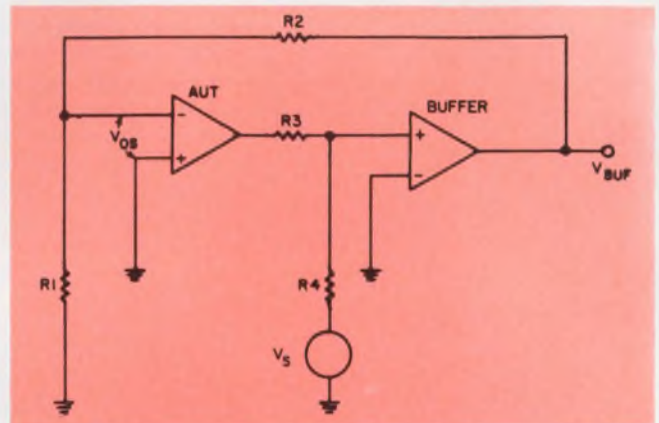

1. Input offset voltage, V_{OS} , is measured with the output of the op amp under test (AUT) set to zero (by setting $V_S = 0$).

Thus the desired value of the input offset voltage, V_{OS} , is given by Eq. 1. Two things must be considered in measuring V_{OS} , however.

First, V_{OS} is defined as the input offset voltage with the AUT output set at zero volts. This condition is achieved by setting the source voltage, V_S , to zero volts, since the V_S together with its resistor divider network will force the AUT output voltage to the same value as that of V_S but of opposite polarity. To understand this point better, suppose that $V_S = -1$ V dc. Since the noninverting input of the buffer op amp is at virtual ground, the current flowing through $R4$ will be, for all practical purposes, $-1/R4$ (the source of possible error here is the input offset voltage of the buffer op amp, but it can be nulled out).

This current must be supplied by the AUT, thus forcing the AUT output voltage to be $(+1/R4)(R3)$, or $+1$ V dc, since $R3$ is equal to $R4$. Thus the V_{OS} measuring circuit in Fig. 1 provides the means for setting the AUT output voltage to any desired value.

The second item of importance in the V_{OS} measurement involves the values of $R1$ and $R2$. These should be such that the loop current is much greater than the AUT bias current summed at their junction. Furthermore their ratio must

Charles F. Wojslaw, Section Leader, National Semiconductor, Santa Clara, Calif. 95051

be such as to provide sufficient closed-loop voltage gain (Eq. 2). The large voltage gain, A_{CL} , insures the accuracy of the V_{OS} measurement and, since the sensed value of V_{OS} is used in determining most other parameters, it is also important in other tests.

Measuring the input offset current

The circuit for measuring most of the other parameters requires the addition of AUT source

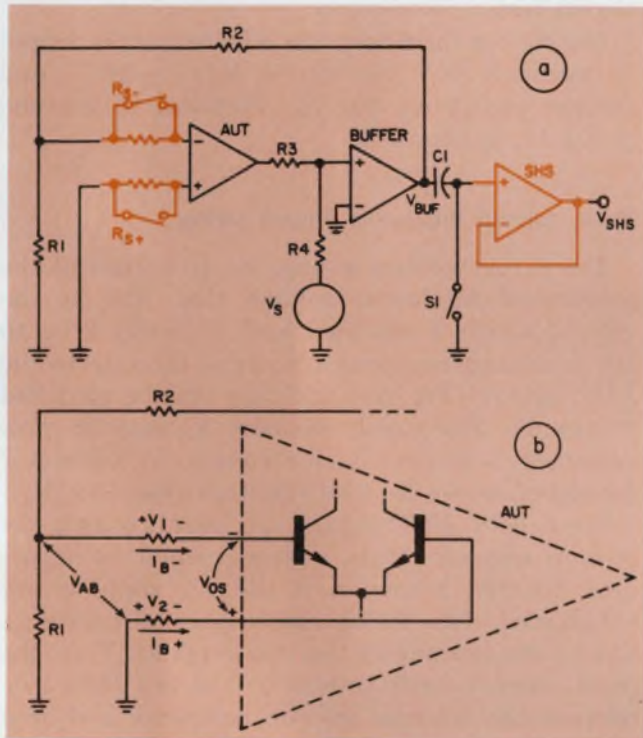

2. Adding source resistors and memory to the basic circuit of Fig. 1 permits measurement of the input offset current, I_{OS} . (a). The meaning of the offset current is explained by considering the two input bias currents (b).

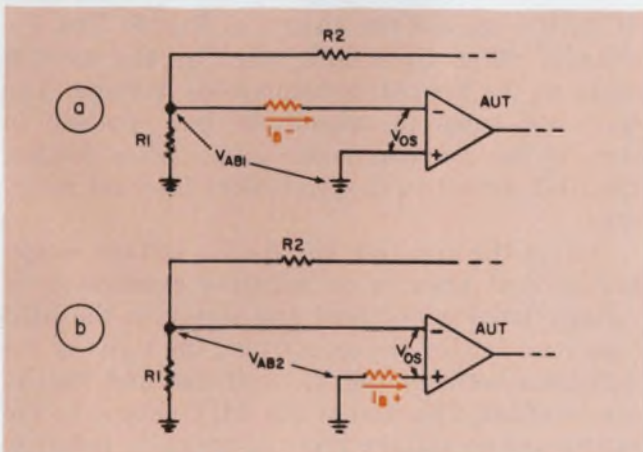

3. The input bias current, I_{B} , is the average of two currents: the bias current flowing into the negative op amp terminal (a) and the current flowing into the positive terminal (b).

resistors and a sample-hold-and-subtract (SHS) amplifier (Fig. 2a). The source resistors convert the AUT input currents to a voltage. The SHS subtracts the V_{OS} voltage in those cases where it interferes with the measurement.

To measure the input offset current, I_{OS} , source resistors (R_{S-} and R_{S+} denote the source resistors connected to the AUT negative and positive terminal, respectively), convert the amplifier bias currents to a voltage that is subsequently reflected into the output of the buffer

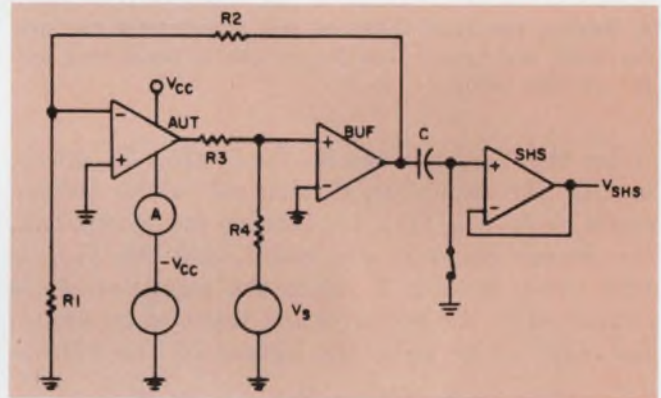

4. Supply current, I_S , and large-signal voltage gain, A_V , are measured with the basic test circuit and a sample-hold-and-subtract (SHS) circuit.

amplifier. For a clearer picture, let's examine the term "bias current" and what it means.

Referring to Fig. 2b, note that positive and negative op-amp inputs are connected to the bases of an npn differential pair of transistors. Thus by examining this figure, we can write

$$V_{AB} = V_1 + V_{OS} - V_2 = I_{B-}R_{S-} + V_{OS} - I_{B+}R_{S+} \quad (3)$$

If $R_{S-} = R_{S+} = R_S$, then

$$V_{AB} = V_{OS} + R_S(I_{B-} - I_{B+}), \quad (4)$$

and, since $I_{OS} = \Delta I_B = (I_{B-} - I_{B+})$,

$$V_{AB} = V_{OS} + R_S I_{OS}. \quad (5)$$

From Eq. 5 and Figs. 2a and 2b, we can finally write the expression that gives us the I_{OS} in terms of known and measurable voltages:

$$V_{BUF} = A_{CL} (V_{OS} + R_S I_{OS}). \quad (6)$$

The I_{OS} is measured with the circuit shown in Fig. 2a, with the AUT output forced to be zero. The V_{OS} appearing across the AUT input under these conditions is considered an error voltage during the I_{OS} measurement. The effects of the V_{OS} are eliminated, with use of the SHS amplifier, by performing two tests, one after another.

During the first test, switch S1 is closed and both source resistors are shorted out (we are back to the circuit for measuring V_{OS} , see Fig. 1).

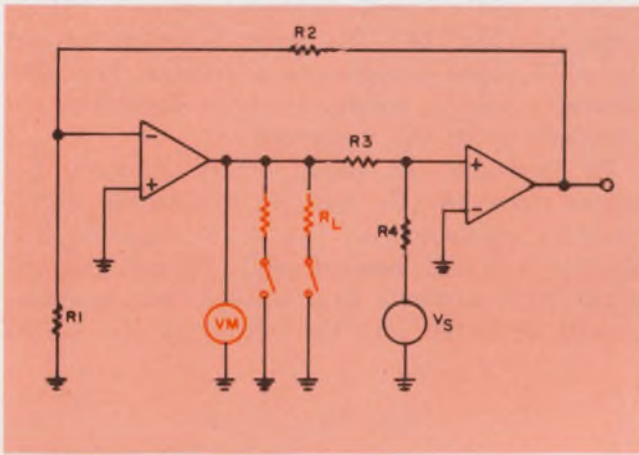

5. Adding two load resistors and a voltmeter converts the basic test circuit into the circuit for measuring output voltage swing.

After the V_{BUF} reaches its final value, S1 opens, leaving the capacitor, C, charged to the voltage equal to $A_{CL}V_{OS}$ (Eq. 1). During the second test, the source resistors are added, and the V_{BUF} is now given by Eq. 6. Since the capacitor, C, is connected to the noninverting input of an amplifier with unity gain, the output of the SHS is

$$\begin{aligned} V_{SHS} &= A_{CL}(V_{OS} + R_S I_{OS}) - A_{CL}V_{OS} \\ &= A_{CL}R_S I_{OS}. \end{aligned} \quad (7)$$

Both A_{CL} and R_S are known; therefore, the I_{OS} can be easily computed.

I_B is the average value

The specified op-amp input bias current, I_B , is defined as the average of two individual measurements. Once again, two tests and the use of the SHS are required for the measurement. During the first test (Fig. 3a), one source resistor, R_{S-} , is inserted and the resultant voltage, V_{AB1} , is stored in the capacitor C. The value of V_{AB1} is given by

$$V_{AB1} = I_{B-}R_{S-} + V_{OS}. \quad (8)$$

During the second test (Fig. 3b), the other source resistor is inserted, so that

$$V_{AB2} = V_{OS} - I_{B+}R_{S+}. \quad (9)$$

The SHS circuit subtracts V_{AB1} from V_{AB2} , yielding

$$V_{SHS} = -R_S(I_{B+} + I_{B-})A_{CL}. \quad (10)$$

The factor of 1/2 required to convert $I_{B+} + I_{B-}$ into an average value can, of course, be included in the constant.

Determining I_S and voltage gain

The measurement of supply current, I_S , is carried out by measuring the current drain of one

of the two V_{CC} supplies (Fig. 4), with the AUT output set to zero either by $V_S = 0$ or by grounding R4.

The large-signal voltage gain, A_V , is measured in the following three steps. Initially the V_S is set to zero, and the resultant $V_{BUF} = A_{CL}V_{OS}$ is stored in the SHS capacitor. During the second test, the V_S is set to +10 V, forcing the AUT output to -10 V, and the resultant $V_{BUF} = A_{CL}(V_{OS1} + V_{OS})$ is subtracted from the stored value, so that

$$A_V = 10(A_{CL}) / (A_{CL})\Delta V_{OS} \quad (11)$$

where $A_{CL}\Delta V_{OS}$ is the SHS output during the second test.

During the third test, the AUT output is forced to become +10 V (by setting $V_S = -10V$), and another expression for A_V , identical to the one in Eq. 11, is obtained.

Basic current measures output swing

The output voltage swing, V_o , is defined as the guaranteed minimum voltage that will be developed across a specified load, typically 2 or 10 k Ω . Such load resistors are added directly to the AUT output (Fig. 5), and they can be switched to ground. The supply voltage, V_S may be programmed to control device voltage. A voltmeter connected across the load resistors reads the V_o .

Since both AUT inputs are near ground, the op-amp common mode voltage cannot be measured directly. However, if the V_{CC} supplies are unbalanced, then the op amp's internal reference will be the average of the two supplies. Thus the input common-mode voltage will be the difference between the internal op-amp reference and zero volts.

Measuring CMRR and PSRR

In measuring the common-mode rejection ratio (CMRR), we use the circuit in Fig. 6. The V_{CC} voltages differ from each other by the amount equal to the desired common-mode voltage. The V_S is set equal in magnitude, but opposite in sign, to the common-mode voltage, thus forcing the AUT output to the equivalent internal reference.

During the first test, the $A_{CL}V_{OS}$ voltage representative of positive or negative common-mode voltage limits is obtained and stored in the SHS capacitor. During the second test, the signs of the difference between the V_{CC} voltages and the V_S are reversed. This forces the AUT output to the common-mode voltage limit of opposite polarity. The output of the SHS thus becomes

$$V_{SHS} = A_{CL}\Delta V_{OS},$$

so that

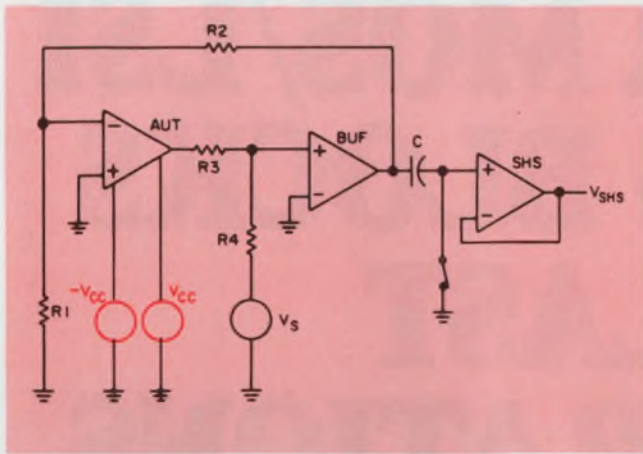

6. Common-mode rejection ratio (CMRR) and the power-supply rejection ratio (PSRR) are measured by manipulating V_{CC} and V_s values and polarities.

$$CMRR = (\text{common-mode voltage range}) / \Delta V_{OS} \quad (12)$$

measured in a similar way, except that equal V_{CC} voltages are used. During the first test, low V_{CC} values are used and the corresponding $A_{CL} V_{OS}$ value is stored in the SHS capacitor. During the second test, high V_{CC} values are used, and the SHS output becomes

$$V_{SHS} = A_{CL} \Delta V_{OS}$$

so that

$$PSRR = (\text{power supply voltage range}) / \Delta V_{OS} \quad (13)$$

During the PSRR tests, the AUT output is kept at zero. Also, care should be taken in using Eqs. 12 and 13, since the V_{OS} values are different in these equations.

Some practical tips

Finally, some practical advice: When using or designing automated test equipment for checking op amps, you can cut testing time considerably with sensible programming. Several tests, for instance, can be carried out simultaneously. Thus if the V_{CC} voltages during the PSRR test are minimum and maximum, then you automatically verify the V_{CC} operational limits. During the CMRR test, you can also verify the common-mode or input-voltage, V_{IN} , limits.

The test configurations themselves suggest several op-amp uses. The basic configuration in Fig. 1, for example, is very similar to an op amp in the inverting mode with gain. The only difference is that the input resistor of the inverting amplifier is grounded, instead of being connected to a voltage source. Source resistors, load resistors and even a second closed-loop gain position can be controlled by solid-state switches. ■■

The AN/PRC-25

(Army Back Pack Radio Case)

had to be:

Deep drawn, Spot welded,
Heat treated, Embossed,
Pierced, Assembled
and Finished.

The AN/PRC 25 is a portable military field radio tough enough to withstand the roughest battlefield conditions. It has two sections . . . transceiver case and a watertight battery box.

AMALCO produced both cases from 6061-T6 aluminum to the precise MIL-SPECS. Complete facilities handle the job from the starting blank to finishing. For the AN/PRC 25 this also included a waterproof seal and mating extrusion. (Delivery was on time.)

AMALCO supplied **all** the prime contractors for the AN/PRC 25 - AN/PRC 77.

We also:

- Engineer and Design • Stamp • Test
- Brake Fabricate • Hydroform • Heliarc Weld
- Spin • Anodize

But this is all just **part** of the AMALCO story. Get the rest from Charles W. Hunter collect (201) 233-3500 . . . today.



Manufacturers of Aluminum Products
for Industry Since 1910.

AMALCO
AMERICAN ALUMINUM COMPANY

230 SHEFFIELD ST., MOUNTAINSIDE, N. J. 07092

NOW YOUR MOS/LSI BUILDING BLOCKS CAN LAST FOR GENERATIONS.

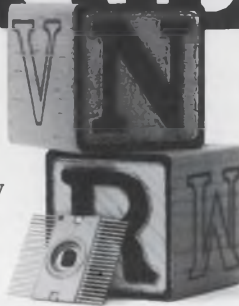

When you know about our advances in the state of the art, you're able to get a continuing return on your design investment in our MOS/LSI electronics.

Over and over again.

Since MOS/LSI circuits embrace so many functions, it's just good business to think of using them in different systems. And, with our unique custom-layout computer-aided design, we give those circuits versatile building-block capabilities.

In a single basic design, for instance, we provide MOS/LSI building blocks for several model generations of calculators, accounting machines, cash registers, appliance timers, automotive controls, or for modem and multiplexing subsystems of data transmission and telecommunication equipment.

MOS/LSI beats the high cost of product development.

Our MOS/LSI building-block circuits can be adapted quickly and inexpensively for use in a succession of different models. You can produce a new model before your salesmen can say "competition"—and go to Petty Cash instead of your Board of Directors to finance the changes.

We can even make it possible to produce a number of different

models of a machine from exactly the same circuits.

Wiring changes, that's all.

And, of course, circuit costs drop. Because you buy in quantity for a number of models, instead of buying a few circuits for each model.

Lower costs elsewhere, too.

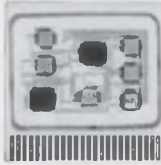

Mastery of MOS/LSI design and of high-volume production has enabled us to produce commercial electronic systems at an all-time low cost. As much as 50% the cost of conventional systems—electromechanical or electronic.

And, our MOS/LSI systems can be packaged so that non-electronic manufacturers can assemble them into their equipment without teaching employees new trades.

For many of the functions performed today by little black boxes selling for around \$20,000, you can buy our MOS/LSI digital filter circuits (in



small quantities) and fabricate a plug-in digital filter for less than \$1,000. Or, you can buy our MOS/LSI modem circuits and save substantially.

We've MOS/LSI memory systems and circuits that cost less per bit than conventional devices—and we're ready with other processes, too. For example, silicon-on-sapphire (SOS) diode arrays that make beautiful ROMS (3,000-plus bits) with 20 ns maximum access times. Within 24 hours we'll custom encode them with our special laser and sell them to you one by one for \$64. Less, much less, in quantity of course.

Collaboration made easy.

As part of NR's Electronics Group, we're ready to share with you the long-term commitment required for new product design, testing and development.

Even more.

We'll join you in product planning, so that you may share in the progress of current research.

Drop us a line on your company letterhead for a copy of our new brochure, "The Economics of Change!"

Write C.D. Chambers, P.O. Box 3669, Anaheim, California 92803.



**North American Rockwell
Microelectronics Company**

75-Ω Coaxial Components

General Radio's 75-Ω equivalents to the long popular and thoroughly refined 50-Ω GR874® and GR900® series of coaxial components bring new confidence and flexibility to your 75-Ω work.

The general-purpose GR874 (75-Ω) Known 75-Ω characteristic impedance and low SWR to 2000 MHz assure repeatable results. Unique hermaphroditic design and a broad selection of adaptors permit easy interconnection among a variety of connector types. Reliable quick-connect/disconnect simplifies use. Nominal cost and generous quantity discounts provide the utmost in value, especially for OEM applications.

The basic connector is only \$3.60 in lots of 100 (net FOB Concord, Mass.). Also available: • Panel and cable connectors • Adaptors to BNC, N, F, Western Electric large and small, and GR900 connectors • Matched, open-circuit, and short-circuit terminations • 6- and 10-dB attenuators • Air lines • Inner-conductor rod • 50-Ω to 75-Ω matching pad.

The precision GR900 (75-Ω) SWR of less than $1.0015 \pm 0.0015 f_{GHz}$ and repeatability of better than ± 0.002 dB and $\pm 0.01^\circ$ ensure the precision necessary for standards work at 75 ohms.

The series includes • Precision connectors • Precision adaptors to F, Western Electric large and small, and GR900 (50-Ω) connectors • Precision terminations • Precision 50-Ω to 75-Ω matching pad.

Detailed answers to your 75-Ω or 50-Ω problems are available from your GR sales engineer; from GR, Concord, Mass. 01742 or, in Europe, from Pqstfach CH 8034, Zurich, Switzerland.



General Radio

NEW YORK (N.Y.) 212 964-2722 (N.J.) 201 791-8990 • BOSTON 617 648-0550
CHICAGO 312 892-0800 • WASHINGTON, D.C. 301 681-5333
LOS ANGELES 714 540-9830
TORONTO 416 252-3395 • ZURICH (01) 55 24 20
GRASON-STADLER 617 369-3787 • TIME/DATA 415 327-8322



Let a computer design your i-f amplifier.

You can do it simply and speedily by using FORTRAN subroutines to modify the standard RFAMP program.

By modifying a FORTRAN program called RFAMP, you can simplify and speed the design of i-f amplifiers that use transistors and ICs. With the modifications, the program can do the following:

- Accept either s or y parameters.
- Generate design curves for a fixed source and variable load specified by the designer.
- Compute and print out power gain.
- Design matching networks for matched or mismatched applications.

Subroutines modify RFAMP

The new program capabilities can be installed by adding program statements to the original RFAMP¹ and by adding subprograms after RFAMP's END statement. The subprograms can be debugged separately, thereby saving time, since it's easier to debug several subprograms individually, rather than collectively, within a large program.

The subprograms are of the FORTRAN SUBROUTINE type, and each consists of a name, a list of arguments, program statements—such as computation, printing—a RETURN statement and an END statement (see SUBROUTINE STY, program steps 51700-56700). All required outputs are defined in the subroutine list of arguments. The subprogram is brought into operation with a CALL statement, which has the name of the subroutine and a list of arguments that serve as input and output variables. For example, subprogram STY is listed: SUBROUTINE STY (PI, G11, B11, G12, B12, G21, B21, G22, B22, ZO, XK, FREQ. The corresponding call is CALL STY (PI, G11, B11, G12, B12, G21, B21, G22, B22, ZO, XK, FREQ), where PI is the input variable and G11 through FREQ are output variables.

Although the names of the arguments are the same for SUBROUTINE STY and its CALL statement, this is not essential. Each argument, how-

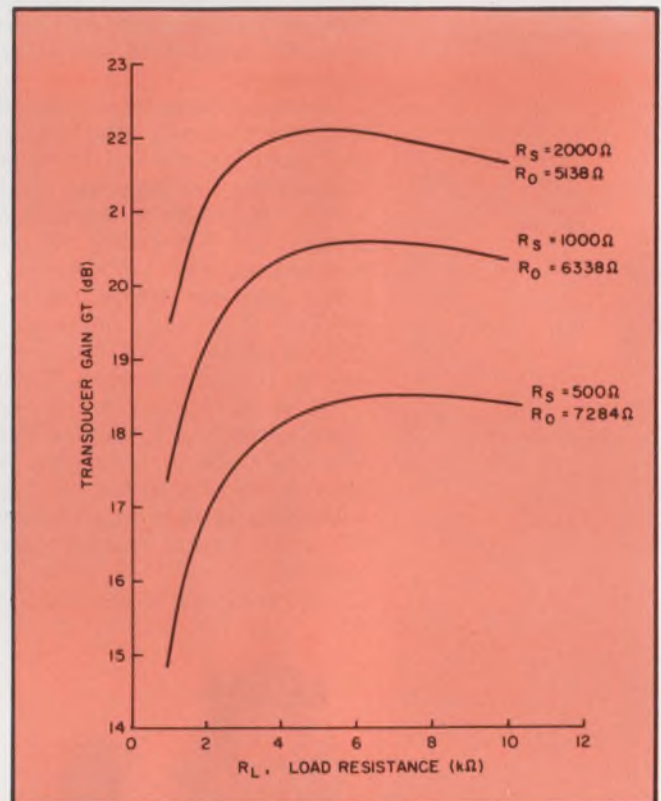

1. Tradeoffs can be made at a glance after plotting a few curves with computer-derived data. This set of curves is for a 2N4416 JFET, neutralized at $f_0 = 40.884$ MHz.

ever, must have a one-to-one correspondence with the other. This is essential because the arguments are used to transfer data back and forth between the main program and subprogram and for storing desired results.

The RETURN statement transfers control back to the main program from which the subprogram was called.

Convert s parameters to y for analysis

The ability to convert s parameters to y is very handy, since devices often are characterized by s parameters only. This feature is added by creating a FORTRAN SUBROUTINE STY

Randolph A. Reitmeyer Jr., Engineer, Electronic Technology and Devices Laboratory, Army Electronics Command, Fort Monmouth, N.J. 07703.

The modified RFAMP program

```
C= PROGRAM RFAMP
C= ANALYSIS OF A DEVICE BY ITS SCATTERING PARAMETERS OR
C= ITS ADMITTANCE PARAMETERS
C= MATCHING NETWORK DESIGN MATCH & ZMATCH
C= ITERATIVE DESIGN BY LOAD VARIATION
C=
C=
      J=0
      INTEGER AC=INCR
      AC=0
      PI=3.1416
      PRINT 1
1    FORMAT('IF YOU WANT TO ENTER 5 PARAMETERS TYPE 1//
      *OTHERWISE TYPE A 2 TO ENTER 5 PARAMETERS*//
      *TYPE A 3 TO GO TO OPTION CONTROL FROM TYPE A 0 TO STOP*//')
86   PRINT 85
85   FORMAT('ENTER N ')
      READ 86,N
84   FORMAT('I ')
      GO TO(73,82,100,140,140)N
73   CALL STYPI(G1,811,G17,812,G21,821,G22,822,Z0,AK,FREQ)
      GO TO 111
82   CONTINUE
      PRINT 3
3    FORMAT('4YM ENTER G11,811,G12,812,G21,821,G22,822,(MMMS) )
      PRINT 14
14   FORMAT('4YM DESIRED STABL FACT (STERNS) FREQ (IN MHZ), NAMP1)
112  CONTINUE
      READ /G11,811,G12,812,G21,821,G22,822,AK,PREQ
      GO TO 111
101  READ /G11
      GO TO 100
102  READ /811
      GO TO 100
103  READ /G12
      GO TO 100
104  READ /812
      GO TO 100
105  READ /G21
      GO TO 100
106  READ /821
      GO TO 100
107  READ /G22
      GO TO 100
108  READ /822
      GO TO 100
109  READ /AK
      GO TO 100
110  READ /FREQ
      GO TO 100
170  PRINT 171
171  FORMAT('//3M ENTER GS,GL1,GL2,INCR J
      READ /GS,GL1,GL2,INCR
      RL=(1./GL1)*1000.
      RL2=(1./GL2)*1000.
      RL3=(1./GL1)*1000.
      RL4=(1./GL2)*1000.
910  IF(AC=INCR)900,900,900
900  AC=AC+1

      MLC=RL1+MLC*(AC-1)
      GL=(1./MLC)*1000.
      GO TO 162

111  YR=G12*821*811*812*821
      YMG=12*821*811*812*821
      YMG2=821*811*812*821
      YMG3=821*811*812*821
      YMG4=821*811*812*821
      YMG5=821*811*812*821
      CRTHAG=5/(2*(G11+G22+YR))
      IF(C=1,30,20,20)
10   DS=(2*(Y11+Y22+YR))*2*(YMG)++5
      GS=DS/2./G22
      RS=811*YMG2./G22
      GL=NS/2./G11
      BL=822*YMG2./G11
      PRINT 44
4    FORMAT('LINVILLS STABILITY FACTOR =',F6.3)
      *'JUSTICE IS UNCONDITIONALLY STABLE'
      GO TO 30
20   PRINT 54
5    FORMAT('4YM LINVILLS STABILITY FACTOR =',F6.3)
      *'3M DEVICE IS POTENTIALLY UNSTABLE'
      GO TO 72
21   M=1
      RK2=-(G11+GS)*(G22+GL1)*(YMG+5*YR)
      A=(YMG+5*YR)*YK
      E=4*2*YMG
      F=(2*(YMG+5*YR)*YK)
      H=F+2*(YMG+5*YR)*YK
      IF(H=0)30,80
40   Q=(E/3.)**4
      PH1=ARCSIN(F/2./L*3./Q)**3
      Z1=2*(YMG+5*YR)*YK
      Z2=(2*(YMG+5*YR)*YK)
      Z3=(2*(YMG+5*YR)*YK)
      D1=2*(YMG+5*YR)*YK
      D2=2*(YMG+5*YR)*YK
      D3=2*(YMG+5*YR)*YK
      IF(D2=0)41,42,42
41   IF(D3=0)43,44,44
42   IF(D1=0)43,44,44
43   Z=Z2
      GO TO 90
44   Z=Z3
      GO TO 90
45   Z=Z1
      GO TO 90
50   Z1=(F/2.)**4./3.
      Z2=(2*(YMG+5*YR)*YK)
      D1=2*(YMG+5*YR)*YK
      D2=2*(YMG+5*YR)*YK
      IF(D2=0)51,52,52
51   Z=Z2
      GO TO 90
52   Z=Z1
      GO TO 90
60   P=(F/2.)**4./5
      Q=(F/2.)**4./5
      IF(P=0)82,82
61   P=(P+Q)**4./3.
      GO TO 63
62   P=P*(1./3.)

63   IF(Q=0)85,85
64   Q=(Q+Q)**4./3.
      GO TO 66
65   Q=Q*(1./3.)
66   Z=PP+Q
67   Q=YK*(YMG+5*YR)
      IF(N=1)41,41
91   GS=(GK*G11/2./G22)**5-G11
      GL=(GK*G22/2./G11)**5-G22
      GO TO 180
151  READ /G3
      GO TO 100
152  READ /G4
      GO TO 100
162  IF(C=1)30,21,21

0000100  0000700
0000200  0000800
0000300  0000900
0000400  0001000
0000500  0001100
0000600  0001200
0000700  0001300
0000800  0001400
0000900  0001500
0001000  0001600
0001100  0001700
0001200  0001800
0001300  0001900
0001400  0002000
0001500  0002100
0001600  0002200
0001700  0002300
0001800  0002400
0001900  0002500
0002000  0002600
0002100  0002700
0002200  0002800
0002300  0002900
0002400  0003000
0002500  0003100
0002600  0003200
0002700  0003300
0002800  0003400
0002900  0003500
0003000  0003600
0003100  0003700
0003200  0003800
0003300  0003900
0003400  0004000
0003500  0004100
0003600  0004200
0003700  0004300
0003800  0004400
0003900  0004500
0004000  0004600
0004100  0004700
0004200  0004800
0004300  0004900
0004400  0005000
0004500  0005100
0004600  0005200
0004700  0005300
0004800  0005400
0004900  0005500
0005000  0005600
0005100  0005700
0005200  0005800
0005300  0005900
0005400  0006000
0005500  0006100
0005600  0006200
0005700  0006300
0005800  0006400
0005900  0006500
0006000  0006600
0006100  0006700
0006200  0006800
0006300  0006900
0006400  0007000
0006500  0007100
0006600  0007200
0006700  0007300
0006800  0007400
0006900  0007500
0007000  0007600
0007100  0007700
0007200  0007800
0007300  0007900
0007400  0008000
0007500  0008100
0007600  0008200
0007700  0008300
0007800  0008400
0007900  0008500
0008000  0008600
0008100  0008700
0008200  0008800
0008300  0008900
0008400  0009000
0008500  0009100
0008600  0009200
0008700  0009300
0008800  0009400
0008900  0009500
0009000  0009600
0009100  0009700
0009200  0009800
0009300  0009900
0009400  0010000
0009500  0010100
0009600  0010200
0009700  0010300
0009800  0010400
0009900  0010500
0010000  0010600
0010100  0010700
0010200  0010800
0010300  0010900
0010400  0011000
0010500  0011100
0010600  0011200
0010700  0011300
0010800  0011400
0010900  0011500
0011000  0011600
0011100  0011700
0011200  0011800
0011300  0011900
0011400  0012000
0011500  0012100
0011600  0012200
0011700  0012300
0011800  0012400
0011900  0012500
0012000  0012600
0012100  0012700
0012200  0012800
0012300  0012900
0012400  0013000
0012500  0013100
0012600  0013200
0012700  0013300
0012800  0013400
0012900  0013500
0013000  0013600
0013100  0013700
0013200  0013800
0013300  0013900
0013400  0014000
0013500  0014100
0013600  0014200
0013700  0014300
0013800  0014400
0013900  0014500
0014000  0014600
0014100  0014700
0014200  0014800
0014300  0014900
0014400  0015000
0014500  0015100
0014600  0015200
0014700  0015300
0014800  0015400
0014900  0015500
0015000  0015600
0015100  0015700
0015200  0015800
0015300  0015900
0015400  0016000
0015500  0016100
0015600  0016200
0015700  0016300
0015800  0016400
0015900  0016500
0016000  0016600
0016100  0016700
0016200  0016800
0016300  0016900
0016400  0017000
0016500  0017100
0016600  0017200
0016700  0017300
0016800  0017400
0016900  0017500
0017000  0017600
0017100  0017700
0017200  0017800
0017300  0017900
0017400  0018000
0017500  0018100
0017600  0018200
0017700  0018300
0017800  0018400
0017900  0018500
0018000  0018600
0018100  0018700
0018200  0018800
0018300  0018900
0018400  0019000
0018500  0019100
0018600  0019200
0018700  0019300
0018800  0019400
0018900  0019500
0019000  0019600
0019100  0019700
0019200  0019800
0019300  0019900
0019400  0020000
0019500  0020100
0019600  0020200
0019700  0020300
0019800  0020400
0019900  0020500
0020000  0020600
0020100  0020700
0020200  0020800
0020300  0020900
0020400  0021000
0020500  0021100
0020600  0021200
0020700  0021300
0020800  0021400
0020900  0021500
0021000  0021600
0021100  0021700
0021200  0021800
0021300  0021900
0021400  0022000
0021500  0022100
0021600  0022200
0021700  0022300
0021800  0022400
0021900  0022500
0022000  0022600
0022100  0022700
0022200  0022800
0022300  0022900
0022400  0023000
0022500  0023100
0022600  0023200
0022700  0023300
0022800  0023400
0022900  0023500
0023000  0023600
0023100  0023700
0023200  0023800
0023300  0023900
0023400  0024000
0023500  0024100
0023600  0024200
0023700  0024300
0023800  0024400
0023900  0024500
0024000  0024600
0024100  0024700
0024200  0024800
0024300  0024900
0024400  0025000
0024500  0025100
0024600  0025200
0024700  0025300
0024800  0025400
0024900  0025500
0025000  0025600
0025100  0025700
0025200  0025800
0025300  0025900
0025400  0026000
0025500  0026100
0025600  0026200
0025700  0026300
0025800  0026400
0025900  0026500
0026000  0026600
0026100  0026700
0026200  0026800
0026300  0026900
0026400  0027000
0026500  0027100
0026600  0027200
0026700  0027300
0026800  0027400
0026900  0027500
0027000  0027600
0027100  0027700
0027200  0027800
0027300  0027900
0027400  0028000
0027500  0028100
0027600  0028200
0027700  0028300
0027800  0028400
0027900  0028500
0028000  0028600
0028100  0028700
0028200  0028800
0028300  0028900
0028400  0029000
0028500  0029100
0028600  0029200
0028700  0029300
0028800  0029400
0028900  0029500
0029000  0029600
0029100  0029700
0029200  0029800
0029300  0029900
0029400  0030000
0029500  0030100
0029600  0030200
0029700  0030300
0029800  0030400
0029900  0030500
0030000  0030600
0030100  0030700
0030200  0030800
0030300  0030900
0030400  0031000
0030500  0031100
0030600  0031200
0030700  0031300
0030800  0031400
0030900  0031500
0031000  0031600
0031100  0031700
0031200  0031800
0031300  0031900
0031400  0032000
0031500  0032100
0031600  0032200
0031700  0032300
0031800  0032400
0031900  0032500
0032000  0032600
0032100  0032700
0032200  0032800
0032300  0032900
0032400  0033000
0032500  0033100
0032600  0033200
0032700  0033300
0032800  0033400
0032900  0033500
0033000  0033600
0033100  0033700
0033200  0033800
0033300  0033900
0033400  0034000
0033500  0034100
0033600  0034200
0033700  0034300
0033800  0034400
0033900  0034500
0034000  0034600
0034100  0034700
0034200  0034800
0034300  0034900
0034400  0035000
0034500  0035100
0034600  0035200
0034700  0035300
0034800  0035400
0034900  0035500
0035000  0035600
0035100  0035700
0035200  0035800
0035300  0035900
0035400  0036000
0035500  0036100
0035600  0036200
0035700  0036300
0035800  0036400
0035900  0036500
0036000  0036600
0036100  0036700
0036200  0036800
0036300  0036900
0036400  0037000
0036500  0037100
0036600  0037200
0036700  0037300
0036800  0037400
0036900  0037500
0037000  0037600
0037100  0037700
0037200  0037800
0037300  0037900
0037400  0038000
0037500  0038100
0037600  0038200
0037700  0038300
0037800  0038400
0037900  0038500
0038000  0038600
0038100  0038700
0038200  0038800
0038300  0038900
0038400  0039000
0038500  0039100
0038600  0039200
0038700  0039300
0038800  0039400
0038900  0039500
0039000  0039600
0039100  0039700
0039200  0039800
0039300  0039900
0039400  0040000
0039500  0040100
0039600  0040200
0039700  0040300
0039800  0040400
0039900  0040500
0040000  0040600
0040100  0040700
0040200  0040800
0040300  0040900
0040400  0041000
0040500  0041100
0040600  0041200
0040700  0041300
0040800  0041400
0040900  0041500
0041000  0041600
0041100  0041700
0041200  0041800
0041300  0041900
0041400  0042000
0041500  0042100
0041600  0042200
0041700  0042300
0041800  0042400
0041900  0042500
0042000  0042600
0042100  0042700
0042200  0042800
0042300  0042900
0042400  0043000
0042500  0043100
0042600  0043200
0042700  0043300
0042800  0043400
0042900  0043500
0043000  0043600
0043100  0043700
0043200  0043800
0043300  0043900
0043400  0044000
0043500  0044100
0043600  0044200
0043700  0044300
0043800  0044400
0043900  0044500
0044000  0044600
0044100  0044700
0044200  0044800
0044300  0044900
0044400  0045000
0044500  0045100
0044600  0045200
0044700  0045300
0044800  0045400
0044900  0045500
0045000  0045600
0045100  0045700
0045200  0045800
0045300  0045900
0045400  0046000
0045500  0046100
0045600  0046200
0045700  0046300
0045800  0046400
0045900  0046500
0046000  0046600
0046100  0046700
0046200  0046800
0046300  0046900
0046400  0047000
0046500  0047100
0046600  0047200
0046700  0047300
0046800  0047400
0046900  0047500
0047000  0047600
0047100  0047700
0047200  0047800
0047300  0047900
0047400  0048000
0047500  0048100
0047600  0048200
0047700  0048300
0047800  0048400
0047900  0048500
0048000  0048600
0048100  0048700
0048200  0048800
0048300  0048900
0048400  0049000
0048500  0049100
0048600  0049200
0048700  0049300
0048800  0049400
0048900  0049500
0049000  0049600
0049100  0049700
0049200  0049800
0049300  0049900
0049400  0050000
0049500  0050100
0049600  0050200
0049700  0050300
0049800  0050400
0049900  0050500
0050000  0050600
0050100  0050700
0050200  0050800
0050300  0050900
0050400  0051000
0050500  0051100
0050600  0051200
0050700  0051300
0050800  0051400
0050900  0051500
0051000  0051600
0051100  0051700
0051200  0051800
0051300  0051900
0051400  0052000
0051500  0052100
0051600  0052200
0051700  0052300
0051800  0052400
0051900  0052500
0052000  0052600
0052100  0052700
0052200  0052800
0052300  0052900
0052400  0053000
0052500  0053100
0052600  0053200
0052700  0053300
0052800  0053400
0052900  0053500
0053000  0053600
0053100  0053700
0053200  0053800
0053300  0053900
0053400  0054000
0053500  0054100
0053600  0054200
0053700  0054300
0053800  0054400
0053900  0054500
0054000  0054600
0054100  0054700
0054200  0054800
0054300  0054900
0054400  0055000
0054500  0055100
0054600  0055200
0054700  0055300
0054800  0055400
0054900  0055500
0055000  0055600
0055100  0055700
0055200  0055800
0055300  0055900
0055400  0056000
0055500  0056100
0055600  0056200
0055700  0056300
0055800  0056400
0055900  0056500
0056000  0056600
0056100  0056700
0056200  0056800
0056300  0056900
0056400  0057000
0056500  0057100
0056600  0057200
0056700  0057300
0056800  0057400
0056900  0057500
0057000  0057600
0057100  0057700
0057200  0057800
0057300  0057900
0057400  0058000
0057500  0058100
0057600  0058200
0057700  0058300
0057800  0058400
0057900  0058500
0058000  0058600
0058100  0058700
0058200  0058800
0058300  0058900
0058400  0059000
0058500  0059100
0058600  0059200
0058700  0059300
0058800  0059400
0058900  0059500
0059000  0059600
0059100  0059700
0059200  0059800
0059300  0059900
0059400  0060000
0059500  0060100
0059600  0060200
0059700  0060300
0059800  0060400
0059900  0060500
0060000  0060600
0060100  0060700
0060200  0060800
0060300  0060900
0060400  0061000
0060500  0061100
0060600  0061200
0060700  0061300
0060800  0061400
0060900  0061500
0061000  0061600
0061100  0061700
0061200  0061800
0061300  0061900
0061400  0062000
0061500  0062100
0061600  0062200
0061700  0062300
0061800  0062400
0061900  00625
```

| | | | | | |
|-----|--|----------|----------|----------|----------|
| 13 | W=44 | 0002A00C | 75 | GO TO 47 | 00040000 |
| 14 | N=N+1 | 00027000 | K=320 | | 00040900 |
| 15 | GO TO 12, 14, 16, 18, 20, 22, 25, 11, 10, 12, 28, 29, 30, 31, 32, 33, 34, 37, 39, 42 | 00027100 | GO TO 50 | 00041100 | |
| 16 | W=44+80+90+31+53+54+58+60+61+65+67+71+11+10+88+74+75+76+77+78 | 00027200 | K=124 | 00041300 | |
| 17 | W=80+81+82+83+84+85+86+89+92+95+120+1 | 00027300 | GO TO 52 | 00041500 | |
| 18 | I=(C)110+110+1 | 00027400 | K=320 | 00041700 | |
| 19 | I=(C)115+115+1 | 00027500 | GO TO 50 | 00041900 | |
| 20 | K=120 | 00027600 | K=240 | 00042100 | |
| 21 | G=(PS-5)*0.5 | 00027700 | GO TO 55 | 00042300 | |
| 22 | H=PS/G | 00027800 | K=240 | 00042500 | |
| 23 | D=Z+H/(Z*H) | 00027900 | GO TO 57 | 00042700 | |
| 24 | H=Q*5 | 00028000 | K=240 | 00042900 | |
| 25 | C=U*H*G | 00028100 | GO TO 59 | 00043100 | |
| 26 | GO TO 2 | 00028200 | K=240 | 00043300 | |
| 27 | K=149 | 00028300 | GO TO 57 | 00043500 | |
| 28 | F=C*H | 00028400 | K=240 | 00043700 | |
| 29 | W=(0.5+5*(U+G)*2/S)/Q | 00028500 | GO TO 62 | 00043900 | |
| 30 | C=H*F/(H*F) | 00028600 | K=240 | 00044100 | |
| 31 | GO TO 2 | 00028700 | K=240 | 00044300 | |
| 32 | K=189 | 00028800 | K=182 | 00044500 | |
| 33 | H=PS/U | 00028900 | GO TO 88 | 00044700 | |
| 34 | C=G*U | 00029000 | K=182 | 00044900 | |
| 35 | D=(1.)/(1./H+1./H+1./Z) | 00029100 | GO TO 72 | 00045100 | |
| 36 | GO TO 2 | 00029200 | | 00045300 | |
| 37 | K=169 | 00029300 | | 00045500 | |
| 38 | F=H*H/(H*0) | 00029400 | | 00045700 | |
| 39 | H=2*H/(H.+(H+Z)/H)**2 | 00029500 | | 00045900 | |
| 40 | D=H*H | 00029600 | | 00046100 | |
| 41 | GO TO 2 | 00029700 | | 00046300 | |
| 42 | K=149 | 00029800 | | 00046500 | |
| 43 | H=H/Q | 00029900 | | 00046700 | |
| 44 | F=H/(1.+4*(H*H)/H)**2 | 00030000 | | 00046900 | |
| 45 | I=(H-F)/1+24 | 00030100 | | 00047100 | |
| 46 | G=((F*(H-F))/0.5) | 00030200 | | 00047300 | |
| 47 | C=G*F/(H*G) | 00030300 | | 00047500 | |
| 48 | D=H*F/(H*G) | 00030400 | | 00047700 | |
| 49 | GO TO 2 | 00030500 | | 00047900 | |
| 50 | K=102 | 00030600 | | 00048100 | |
| 51 | H=GT | 00030700 | | 00048300 | |
| 52 | F=T*(U+1)**2/1 | 00030800 | | 00048500 | |
| 53 | I=(F*5)/1+27 | 00030900 | | 00048700 | |
| 54 | C=((5*(I*5)+5)-U | 00031000 | | 00048900 | |
| 55 | U=(F*5)/(U+(C*5+QV)) | 00031100 | | 00049100 | |
| 56 | GO TO 2 | 00031200 | | 00049300 | |
| 57 | K=921 | 00031300 | | 00049500 | |
| 58 | GO TO 15 | 00031400 | | 00049700 | |
| 59 | K=911 | 00031500 | | 00049900 | |
| 60 | GO TO 17 | 00031600 | | 00050100 | |
| 61 | K=901 | 00031700 | | 00050300 | |
| 62 | GO TO 19 | 00031800 | | 00050500 | |
| 63 | K=901 | 00031900 | | 00050700 | |
| 64 | GO TO 21 | 00032000 | | 00050900 | |
| 65 | K=918 | 00032100 | | 00051100 | |
| 66 | GO TO 23 | 00032200 | | 00051300 | |
| 67 | K=291 | 00032300 | | 00051500 | |
| 68 | GO TO 26 | 00032400 | | 00051700 | |
| 69 | K=183 | 00032500 | | 00051900 | |
| 70 | G=5*(2.+U**2)-55*1**2 | 00032600 | | 00052100 | |
| 71 | I=(G)/1+33+35 | 00032700 | | 00052300 | |
| 72 | O=5*(O1+U**5)/(S-T)=U | 00032800 | | 00052500 | |
| 73 | C=U*V*W*(U+U*5) | 00032900 | | 00052700 | |
| 74 | H=(5*(U*U)**2/S)/U | 00033000 | | 00052900 | |
| 75 | GO TO 2 | 00033100 | | 00053100 | |
| 76 | K=183 | 00033200 | | 00053300 | |
| 77 | X=1/3 | 00033300 | | 00053500 | |
| 78 | I=(G)/1+33+30 | 00033400 | | 00053700 | |
| 79 | D=5*(O1+U**5)/(S-T)=U | 00033500 | | 00053900 | |
| 80 | GO TO 36 | 00033600 | | 00054100 | |
| 81 | K=720 | 00033700 | | 00054300 | |
| 82 | G=H*P*U**2*(R-P)**2 | 00033800 | | 00054500 | |
| 83 | I=(G)/1+4L+0 | 00033900 | | 00054700 | |
| 84 | H=(H*P)/(U*P*H*W) | 00034000 | | 00054900 | |
| 85 | D=H*H/(X*H) | 00034100 | | 00055100 | |
| 86 | C=(P)/(H*P/H*0) | 00034200 | | 00055300 | |
| 87 | H=0*H/(1.+(R/H)**2) | 00034300 | | 00055500 | |
| 88 | GO TO 2 | 00034400 | | 00055700 | |
| 89 | K=729 | 00034500 | | 00055900 | |
| 90 | I=(G)/1+43+43 | 00034600 | | 00056100 | |
| 91 | H=(P=Q)/1+6+5/R+Q | 00034700 | | 00056300 | |
| 92 | GO TO 41 | 00034800 | | 00056500 | |
| 93 | K=84 | 00034900 | | 00056700 | |
| 94 | I=(H*5)/10+5 | 00035000 | | 00056900 | |
| 95 | G=(PS-5)**0.5 | 00035100 | | 00057100 | |
| 96 | E=PS/2 | 00035200 | | 00057300 | |
| 97 | H=5*5 | 00035300 | | 00057500 | |
| 98 | Y=PS/(G*5) | 00035400 | | 00057700 | |
| 99 | H=Q*5*U+2 | 00035500 | | 00057900 | |
| 100 | C=U*H*G | 00035600 | | 00058100 | |
| 101 | GO TO 3 | 00035700 | | 00058300 | |
| 102 | K=23 | 00035800 | | 00058500 | |
| 103 | F=C*H | 00035900 | | 00058700 | |
| 104 | C=((1./U)/(PS+1./T+1./Z)) | 00036000 | | 00058900 | |
| 105 | GO TO 3 | 00036100 | | 00059100 | |
| 106 | K=782 | 00036200 | | 00059300 | |
| 107 | H=PS/(5+U) | 00036300 | | 00059500 | |
| 108 | GO TO 3 | 00036400 | | 00059700 | |
| 109 | K=782 | 00036500 | | 00059900 | |
| 110 | F=C*H | 00036600 | | 00060100 | |
| 111 | C=((1./U)/(PS+1./T+1./Z)) | 00036700 | | 00060300 | |
| 112 | GO TO 3 | 00036800 | | 00060500 | |
| 113 | K=782 | 00036900 | | 00060700 | |
| 114 | F=C*H | 00037000 | | 00060900 | |
| 115 | C=((1./U)/(PS+1./T+1./Z)) | 00037100 | | 00061100 | |
| 116 | GO TO 3 | 00037200 | | 00061300 | |
| 117 | K=782 | 00037300 | | 00061500 | |
| 118 | F=C*H | 00037400 | | 00061700 | |
| 119 | C=((1./U)/(PS+1./T+1./Z)) | 00037500 | | 00061900 | |
| 120 | GO TO 3 | 00037600 | | 00062100 | |
| 121 | K=782 | 00037700 | | 00062300 | |
| 122 | F=C*H | 00037800 | | 00062500 | |
| 123 | C=((1./U)/(PS+1./T+1./Z)) | 00037900 | | 00062700 | |
| 124 | GO TO 3 | 00038000 | | 00062900 | |
| 125 | K=782 | 00038100 | | 00063100 | |
| 126 | F=C*H | 00038200 | | 00063300 | |
| 127 | C=((1./U)/(PS+1./T+1./Z)) | 00038300 | | 00063500 | |
| 128 | GO TO 3 | 00038400 | | 00063700 | |
| 129 | K=782 | 00038500 | | 00063900 | |
| 130 | F=C*H | 00038600 | | 00064100 | |
| 131 | C=((1./U)/(PS+1./T+1./Z)) | 00038700 | | 00064300 | |
| 132 | GO TO 3 | 00038800 | | 00064500 | |
| 133 | K=782 | 00038900 | | 00064700 | |
| 134 | F=C*H | 00039000 | | 00064900 | |
| 135 | C=((1./U)/(PS+1./T+1./Z)) | 00039100 | | 00065100 | |
| 136 | GO TO 3 | 00039200 | | 00065300 | |
| 137 | K=782 | 00039300 | | 00065500 | |
| 138 | F=C*H | 00039400 | | 00065700 | |
| 139 | C=((1./U)/(PS+1./T+1./Z)) | 00039500 | | 00065900 | |
| 140 | GO TO 3 | 00039600 | | 00066100 | |
| 141 | K=782 | 00039700 | | 00066300 | |
| 142 | F=C*H | 00039800 | | 00066500 | |
| 143 | C=((1./U)/(PS+1./T+1./Z)) | 00039900 | | 00066700 | |
| 144 | GO TO 3 | 00040000 | | 00066900 | |
| 145 | K=782 | 00040100 | | 00067100 | |
| 146 | F=C*H | 00040200 | | 00067300 | |
| 147 | C=((1./U)/(PS+1./T+1./Z)) | 00040300 | | 00067500 | |
| 148 | GO TO 3 | 00040400 | | 00067700 | |
| 149 | K=782 | 00040500 | | 00067900 | |
| 150 | F=C*H | 00040600 | | 00068100 | |
| 151 | C=((1./U)/(PS+1./T+1./Z)) | 00040700 | | 00068300 | |
| 152 | GO TO 3 | 00040800 | | 00068500 | |
| 153 | K=782 | 00040900 | | 00068700 | |
| 154 | F=C*H | 00041000 | | 00068900 | |
| 155 | C=((1./U)/(PS+1./T+1./Z)) | 00041100 | | 00069100 | |
| 156 | GO TO 3 | 00041200 | | 00069300 | |
| 157 | K=782 | 00041300 | | 00069500 | |
| 158 | F=C*H | 00041400 | | 00069700 | |
| 159 | C=((1./U)/(PS+1./T+1./Z)) | 00041500 | | 00069900 | |
| 160 | GO TO 3 | 00041600 | | 00070100 | |
| 161 | K=782 | 00041700 | | 00070300 | |
| 162 | F=C*H | 00041800 | | 00070500 | |
| 163 | C=((1./U)/(PS+1./T+1./Z)) | 00041900 | | 00070700 | |
| 164 | GO TO 3 | 00042000 | | 00070900 | |
| 165 | K=782 | 00042100 | | 00071100 | |
| 166 | F=C*H | 00042200 | | 00071300 | |
| 167 | C=((1./U)/(PS+1./T+1./Z)) | 00042300 | | 00071500 | |
| 168 | GO TO 3 | 00042400 | | 00071700 | |
| 169 | K=782 | 00042500 | | 00071900 | |
| 170 | F=C*H | 00042600 | | 00072100 | |
| 171 | C=((1./U)/(PS+1./T+1./Z)) | 00042700 | | 00072300 | |
| 172 | GO TO 3 | 00042800 | | 00072500 | |
| 173 | K=782 | 00042900 | | 00072700 | |
| 174 | F=C*H | 00043000 | | 00072900 | |
| 175 | C=((1./U)/(PS+1./T+1./Z)) | 00043100 | | 00073100 | |
| 176 | GO TO 3 | 00043200 | | 00073300 | |
| 177 | K=782 | 00043300 | | 00073500 | |
| 178 | F=C*H | 00043400 | | 00073700 | |
| 179 | C=((1./U)/(PS+1./T+1./Z)) | 00043500 | | 00073900 | |
| 180 | GO TO 3 | 00043600 | | 00074100 | |
| 181 | K=782 | 00043700 | | 00074300 | |
| 182 | F=C*H | 00043800 | | 00074500 | |
| 183 | C=((1./U)/(PS+1./T+1./Z)) | 00043900 | | 00074700 | |
| 184 | GO TO 3 | 00044000 | | 00074900 | |
| 185 | K=782 | 00044100 | | 00075100 | |
| 186 | F=C*H | 00044200 | | 00075300 | |
| 187 | C=((1./U)/(PS+1./T+1./Z)) | 00044300 | | 00075500 | |
| 188 | GO TO 3 | 00044400 | | 00075700 | |
| 189 | K=782 | 00044500 | | 00075900 | |
| 190 | F=C*H | 00044600 | | 00076100 | |
| 191 | C=((1./U)/(PS+1./T+1./Z)) | 00044700 | | 00076300 | |
| 192 | GO TO 3 | 00044800 | | 00076500 | |
| 193 | K=782 | 00044900 | | 00076700 | |
| 194 | F=C*H | 00045000 | | 00076900 | |
| 195 | C=((1./U)/(PS+1./T+1./Z)) | 00045100 | | 00077100 | |
| 196 | GO TO 3 | 00045200 | | 00077300 | |
| 197 | K=782 | 00045300 | | 00077500 | |
| 198 | F=C*H | 00045400 | | 00077700 | |
| 199 | C=((1./U)/(PS+1./T+1./Z)) | 00045500 | | 00077900 | |
| 200 | GO TO 3 | 00045600 | | 00078100 | |

```

111=1000.*((1.+S22)*(1.-S11)+S12+S21)/D3/Z0
Y12=1000.*(-2.+S12/D3)/Z0
Y21=1000.*(-2.+S21/D3)/Z0
Y22=1000.*((1.+S11)*(1.-S22)+S12+S21)/D3/Z0
G11=REAL(Y11)
G11=AIMAG(Y11)
G12=REAL(Y12)
G12=AIMAG(Y12)

G21=REAL(Y21)
G21=AIMAG(Y21)
G22=REAL(Y22)
G22=AIMAG(Y22)

*****
77 FORMAT(/20X+23H Y PARAMS (CRS IN MMMS //)
PRINT 78,Y11,Y12,Y21,Y22
78 FORMAT(15X+4HG11=,1PE12.4,5X+4HG12=,E12.4//
,15X+4HG21=,1PE12.4,5X+4HG22=,E12.4//
,15X+4HG21=,1PE12.4,5X+4HG22=,E12.4//
,15X+4HG22=,1PE12.4,5X+4HG22=,E12.4//)

RETURN
END
C= MATCHING NETWORK DESIGN
C=
SUBROUTINE DMATCH(FREQ,P1,NG=0)
REAL LP
PRINT 141
141 FORMAT(/30H DESIGN MATCHING NETWORK BY ENTERING 1 )
GO TO(10,10+20)*NG
PRINT 150
150 FORMAT(/27H RL(S),RP,RO,CO(PF),W,FREQ )
READ /,RL,RP,RO,CO,W,FREQ
GO TO 151
10 PRINT 142
142 FORMAT(/23H RL(S),RP,RO,CO(PF), G. )
READ /,RL,RP,RO,CO,G
151 F=FREQ*.1E6
N=2,P=1
KC=RL*(RP/RL-.1)**.5
C=1,E12/(W*KC)
LP=1./G*(RP*RN)/(RP*RO)/(W*G)
CT=1.E18/(N**2*LP)
XCP=KC*(1.+(RL/KC)**2)
CP=1.E12/(N*XCP)
CA=C*(CP*CO)
PRINT 143,C,CA,LP
143 FORMAT(5X,7M C(PF)=,F7.3,5X,BH CA(PF)=,F7.3,5X,BH LP(UH)=,
*F7.3)
IF(N=3)1,2;1
1 RETURN
2 RETURN 1
END

```

```

00054700
00054800
00054900
00055000
00055100
00055200
00055300
00055400
00055500
00055600
00055700
00055800
00055900
00056000
00056100
00056200
00056300
00056400
00056500
00056600
00056700
00056800
00056900
00057000
00057100
00057200
00057300
00057400
00057500
00057600
00057700
00057800
00057900
00058000
00058100
00058200
00058300
00058400
00058500
00058600
00058700
00058800
00058900
00059000
00059100
00059200
00059300
00059400
00059500
00059600
00059700

```

gain is easily computed (steps 16900-18200) in terms of standard RFAMP parameters.

Design the matching network

A matching network design capability is particularly important for these two classes of designs:

1. Maximum power transfer (input matched to the source, output matched to the load).
2. Less than maximum power transfer (mismatched load or source terminations, or both).

For the maximum-power transfer case, ZMATCH is added to RFAMP as a subroutine. For designs involving less than maximum power transfer, another subroutine, DMATCH, is written for the circuit configurations in Fig. 3. The required inputs for the DMATCH are actual load (or source) resistance, $R_L(s)$, output (or input) impedance of the device to be matched— R_o, C_o or R_{in}, C_{in} —desired transformed load (or source) resistance, R_p , loaded Q and the operating frequency, FREQ. The program computes L, C and CA for the network. With these built-in matching-network subprograms, you can match stages previously analyzed in RFAMP without loading or running another program.

(program steps 51700-56700) that accepts the following data:

- Magnitude and phase angles for the s parameters.
- ZO, the normalizing impedance (also the impedance of the s-parameter measuring setup).
- XK, the required Stern's stability factor.
- FREQ, the frequency of interest.

When the SUBROUTINE is CALLED, it converts the s into y parameters by means of conversion formulas,² prints out the real and imaginary parts of the y's and then returns to RFAMP with these new y parameters, XK and FREQ for analysis.

Generate the design-curve data

Several curves are extremely useful for mismatched designs where tradeoffs such as noise figure, power gain, stability and ease of alignment must be made for different source and load terminations. Such curves include power gain (dB), Stern's stability factor, sensitivity and others as functions of a given source conductance and a range of loads (Figs. 1 and 2). The data for these curves are generated in the modified RFAMP by entering source conductance, GS, initial and final load conductances, GLI and GLF, and the number of desired points (increments). The program steps for this modification are 900-1000, 5100-6100 and 19200-19300.

The ability to compute and print out power gain is particularly important in multistage designs, where the first stage is designed for transducer gain and all others for power gain.³ Power

Expand option control

The addition of new capabilities to RFAMP calls for an expanded option control. First, a new option list is added at the beginning of the program (steps 1200-2100). The list allows selection of the following options by typing a number, 1 to 4, when requested ENTER N by the computer:

- If a 1 is typed, s parameters enter for analysis.
- If a 2 is typed, y parameters enter for analysis.
- If a 3 is typed, the program goes to the option for matching network designs by DMATCH or ZMATCH. At this level of option control, DMATCH and ZMATCH are selected by typing 17 or 19, respectively.
- If a 4 is entered, the program STOPS.

Another expansion of the option selection is the addition of choices—17 for DMATCH, 18 for ITERATIVE DESIGN, and 19 for ZMATCH—to the original 16 options in RFAMP (steps 21400, 21500).

With this option-control flexibility, the designer can design matching networks after the two-port analysis or without such an analysis. The designer can also add new features to the program, because of the modular construction, by adding subroutines and appropriately expanding the option selection lists.

To demonstrate how modified RFAMP can be

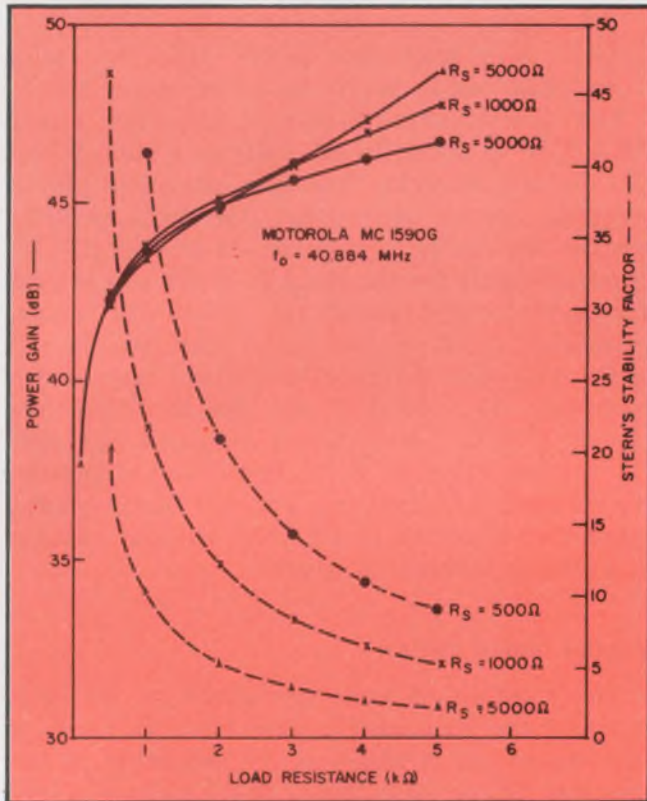

2. Another set of curves for easier tradeoff is also plotted with the computer-derived data. Power-gain curves (solid lines) are different for different source conductances, because susceptances are computed by a method for maximizing transducer gain.

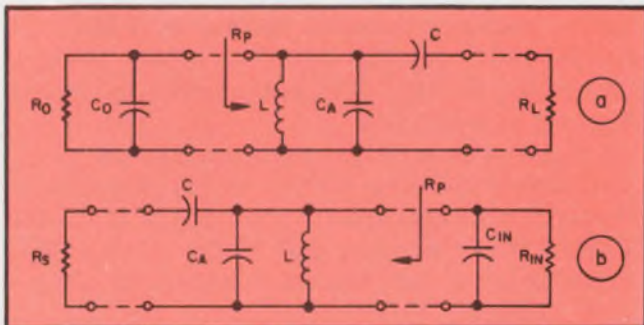

3. Design these networks with modified RFAMP. The network in "a" is for matching output impedance to load, while the circuit in "b" is for matching source to input impedance.

used, let's design a two-stage i-f amplifier with an over-all transducer gain of 68.3 dB, an operating frequency of 40.884 MHz, and source and load terminal conductances of 2000 ohms.

Designing an i-f amplifier

Step 1. The first stage is designed by using the y parameters of a 2N4416 JFET in RFAMP. The program indicates that the FET is potentially unstable at 40.884 MHz. The stage is stabilized by neutralizing the FET feedback and socket capacitances (if a socket is used). By combining the neutralization and tuning-coil losses and stray capacitances with the JFET y parameters to form a new set of y parameters, and by using RFAMP's iterative design option, we generate the data for the design curves of transducer gain in decibels (Fig. 1). For source and load terminal conductances of 2000 ohms, the measured gain is within 2 dB of the calculated value.

Step 2. The second i-f stage is designed using the y parameters (s parameters are also available) for the MC1590G amplifier, an IC unit suitable for high-gain i-f applications. The program indicates that the MC1590G is potentially unstable but that high power gains with good stability can be achieved by mismatching (Fig. 2).

Step 3. By considering various factors, such as noise figure, stability and ease of alignment, and by knowing the device input and output terminal properties, we can design matching networks in RFAMP by using DMATCH. The amplifier design requires that a 50-ohm generator be transformed to a 2000-ohm source to match the input impedance of the 2N4416 (6542 ohms in parallel with 2.76 pF) and to provide a Q of 10. The circuit configuration of Fig. 3b is chosen, the DMATCH selection is made (for less than maximum power transfer), and, upon request, all the necessary inputs to calculate the matching network components are provided.

The measured 68.3-dB gain compares very closely with the computed value of 66.7 for the selected terminal conductances. ■■

References

1. Richwell, G., "Design and Match Rf Amplifiers," *Electronic Design* 10, May 10, 1969, p. 106.
2. "S Parameter Techniques for Faster, More Accurate Network Design," *HP Application Note 95*.
3. Ghauri, M. S., "Principles and Design of Linear Active Circuits," McGraw-Hill, New York, 1961, p. 474.
4. Stern, A. P., "Stability and Power Gain of Tuned Transistor Amplifiers," *Proc. IRE*, March, 1957, pp. 335-343.

Why more people are buying DVM's from S-D:

Jerry Hartman, DVM Sales Manager

3½ digit, 17,000 units sold. High performance at lowest cost. Unequaled customer acceptance. Good noise rejection and long-term stability resulting from Dual-Slope integration design. Ideal for production, test and design areas. (Model 7050, \$279 and up)

4½ digit, AC, DC, volts, amps, ohms. 25 ranges of dc and ac volts, dc and ac current, and resistance. Full 4-digit display with 10 microvolt resolution. Dual-Slope design and a fully guarded input assure highest noise rejection. Lightweight, with optional battery pack and protective cover, for operate-anywhere convenience. (Model 7004, \$650)

5½ digit bench. Best price/performance. Full 5-digit accuracy and resolution at lowest cost. Use in any area where critical measurements must be made. Fast response readings. High input impedance; lowest 'kickback' noise. Plug-in card expandability-dc volts, dc millivolts, current, ac volts, resistance, auto-range, digital outputs. (Model 7005A, \$1295)

5½ digit systems. Fast and Accurate. 30 readings/second and high noise rejection. Fully isolated programming and digital outputs in a variety of optional formats. DC volts and ratio standard. Plug-in card options for ac volts, 4-wire ohms, system interface. (Model 7110, \$1695)

For full details, contact your Scientific Devices office or Concord Instruments Division, 888 Galindo Street, Concord, CA 94520. Phone (415) 682-6161. In Europe: 8 München 60, Haidelweg 20, Germany. Telex: 841-529-615.



SYSTRON  DONNER

The Systron-Donner Instruments Group:

Alpha Scientific □ Computer Systems □ Concord Instruments □ Dataprise □ Kruse Electronics □ Microwave □ Trygon Electronics

Solve filter parameter problems with variable resistors and design curves. You select the cutoff frequency and damping ratio by adjusting resistance values.

In the design of active filters for a system, the optimum filter parameters are generally not known until the full circuit is completed. The designer can, of course, estimate parameters and design to these, or he can wait until the parameters are known and build the filter then. A faster method is to use tuneable active filters.

These filters consist of the usual active and passive components in a specific configuration, but the resistance values are variable. As a result, the cutoff frequency, f_c , and damping ratio, ξ —both simple functions of the resistance values—can be selected to meet design requirements. An added feature of tuneable filters is that one filter configuration can be used to obtain Butterworth, Bessel or other functional characteristics.

Use of the noninverting circuit is suggested

Peter Zicko, Analog Devices, Inc., Route 1 Industrial Park, Norwood, Mass. 02062.

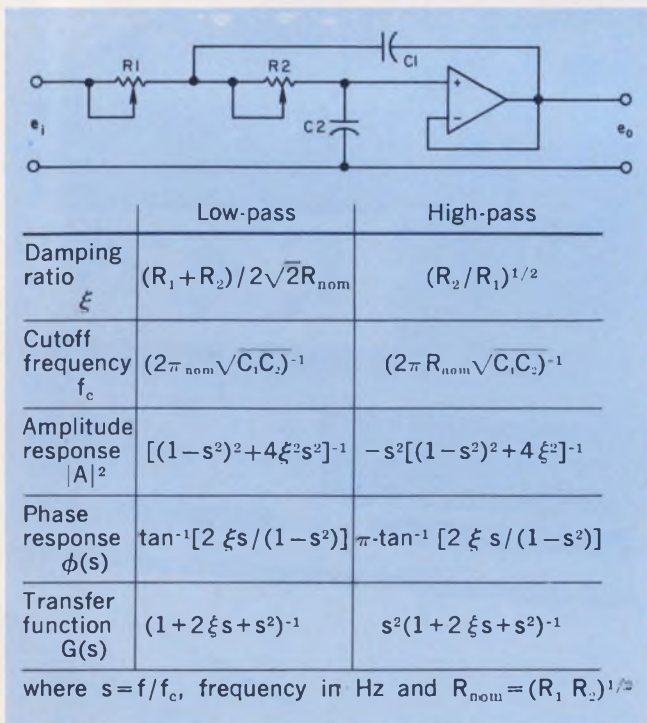

1. A noninverting configuration with variable resistances can be used as a tuneable active filter (top). In high-pass or low-pass applications, f_c and ξ are independently adjustable (bottom).

(Fig. 1—top). This filter features the minimum of active elements, the minimum of passive elements, the minimum offset voltage with temperature and the best passband gain accuracy of all configurations. And the filter can be used for high-pass or low-pass applications.

The two resistors in the circuit can be varied to obtain, independently, a design cutoff frequency damping ratio (Fig. 1—bottom). The amplitude response, phase response and transfer function are then determined by the formulas shown. These formulas are plotted in Figs. 2 to 4 as functions of f_c and ξ .

The sharpest attenuation (Fig. 2) is obtained with the Butterworth characteristic and $\xi = (1/2)\sqrt{2}$. The Butterworth characteristic is convenient to implement, since R_1 equals R_2 in the low-pass case and $2R_2$ in the high-pass case. Other curves shown are the Bessel curve ($\xi = 1/2\sqrt{3}$) and the RC curve ($\xi = 1$). The at-

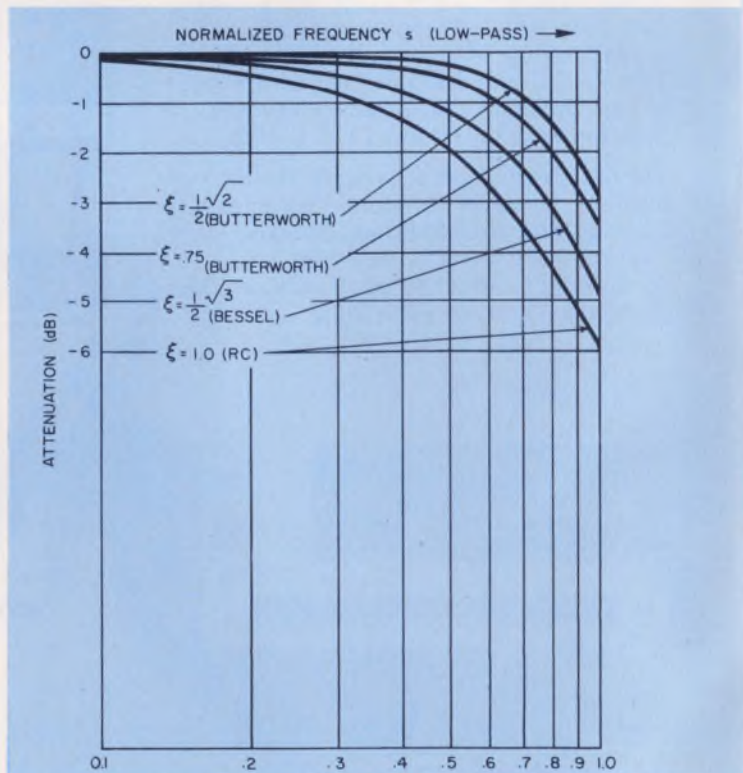

2. For high-pass as well as low-pass applications, the normalized curves cover the range of damping ratios

tenuation at the cutoff is relatively insensitive to both R_{nom} and $(R1/R2)$. An error of only 0.1 dB occurs with variations of $\pm 1\%$ in R_{nom} and $\pm 2\%$ in $R1$ and $R2$, and both tolerances are easily obtained with 1% metal film resistors.

The ideal phase characteristic (Fig. 3) is obtained with the Bessel curve: phase delay vs frequency is linear in the range $0 < f < 0.6 f_c$. The ultimate phase delay becomes π radians, or 180° , for all values of ξ as $f \rightarrow \infty$ (low-pass) and $f \rightarrow 0$ (high-pass).

The step response of the Butterworth characteristic displays 4.3% peak overshoot (Fig. 4). The RC filter has zero overshoot but a relatively long response time. The best compromise, when response time and overshoot are both critical, is usually the Bessel.

A tuning range factor of 200 for the cutoff frequency and damping ratio can be readily achieved. One of the practical limitations on the range of tuning is the increase of the offset voltage with temperature because of the increase in R_{nom} .

An appropriate upper limit of the tuning resistance is $R_{nom} = 10 \text{ M}\Omega$ (Fig. 5). This limit is set by the initial offset, which cannot be trimmed to zero over a range of greater than $\pm 10 \text{ C}$ at this value.

A lower limit of $R_{nom} \approx 3 \text{ k}\Omega$ for full input voltage range is set by the current capacity of the internal op amp. The two frequency ranges corresponding to the limits in R_{nom} are 0.1 to 330 Hz and 10 to 33 kHz. ■■

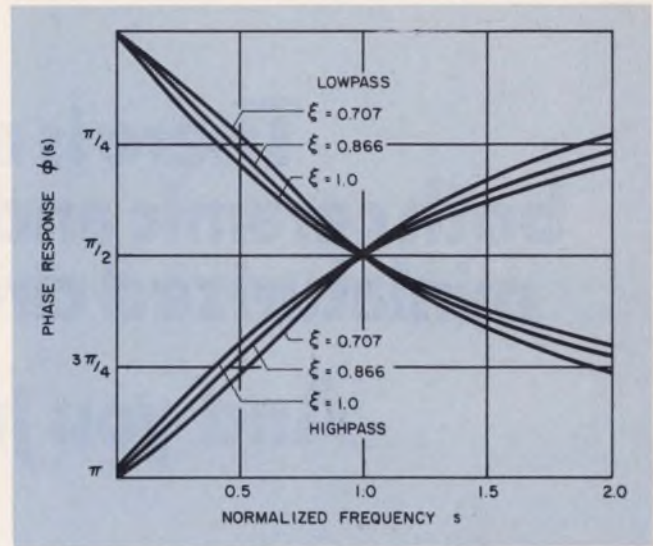

3. The output-to-input phase response is determined once the cutoff frequency and damping ratio are selected. For both high-pass and low-pass filters, the insertion phase shift at $f=f_c$ is $\pi/2$.

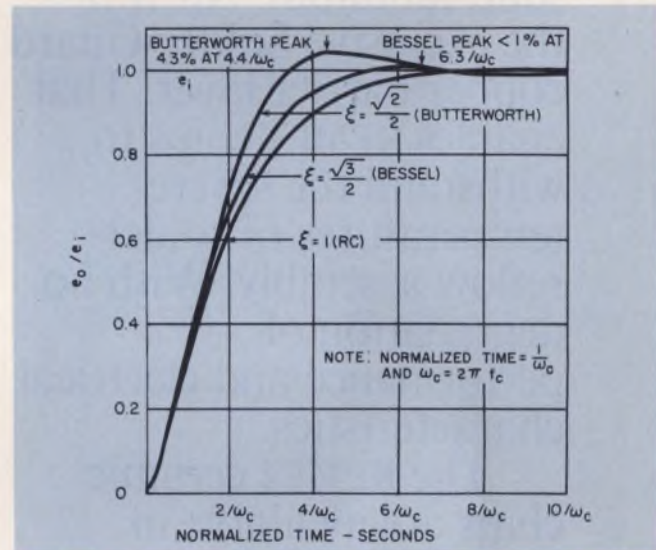

4. The output response time and overshoot are indicated for a low-pass, second-order step input.

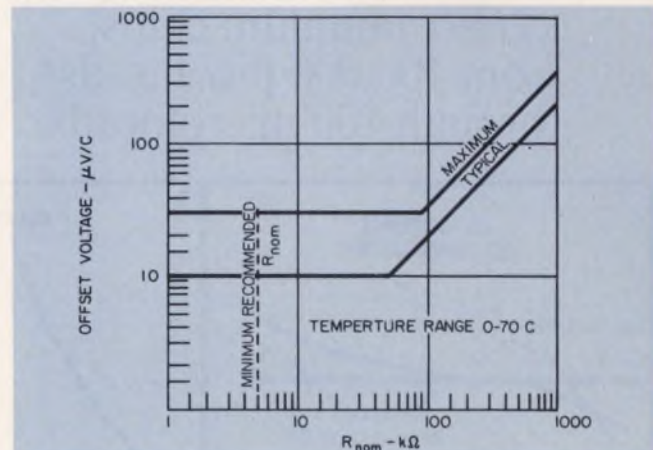

5. The range of R_{nom} that can be realized is dependent on the variation of the offset voltage with temperature. A practical range is 10 k Ω to about 10 M Ω . With these limits, a tuning range factor of 200 can be achieved.

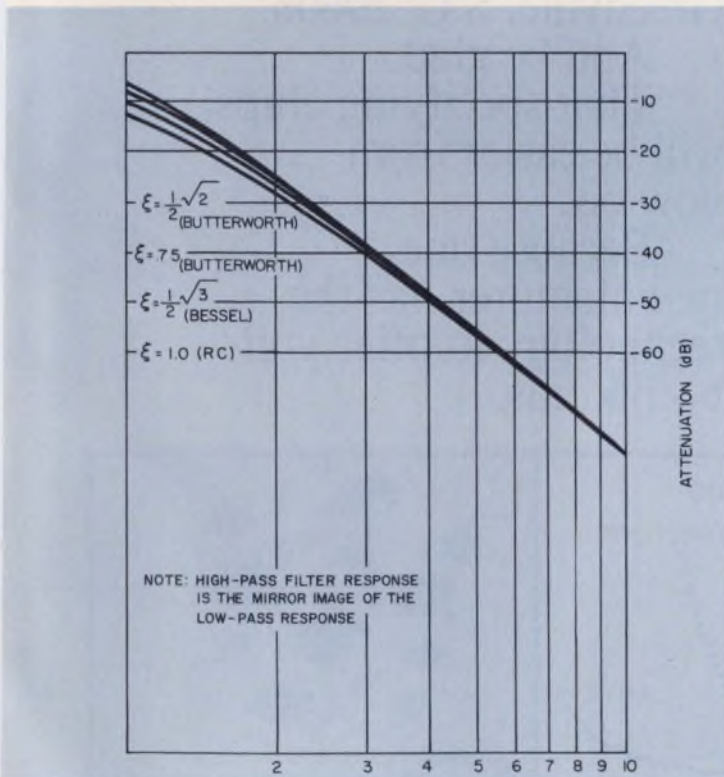

most often required. At $s=1$, the frequency is the design cutoff frequency for both high-pass and low-pass.

There is a place for both ceramic and tantalum chips in miniaturized circuit applications.

And you just found it.

Union Carbide.

Who makes KEMET® chips in both ceramic and solid tantalum. All with the exclusive Solder-Guard copper barrier layer. That enables KEMET chips to withstand the severe temperatures of solder-reflow assembly. With no degradation of performance and electrical characteristics.

The KEMET ceramic chips are available in ratings from 10 through 330,000 picofarads. The KEMET tantalum chips, from 100,000 picofarads through 100 microfarads.

The ceramics will withstand 260° C. for 20 minutes; the tantalums will withstand 300° C. for 3 minutes.

Check the tables below for stability and cost comparisons. Then write for free engineering samples and technical data. At Box 5928, Greenville, S.C. 29606.

And be glad.

That specifying chips will be easier from now on.

Because one manufacturer has the technology to offer you both kinds.

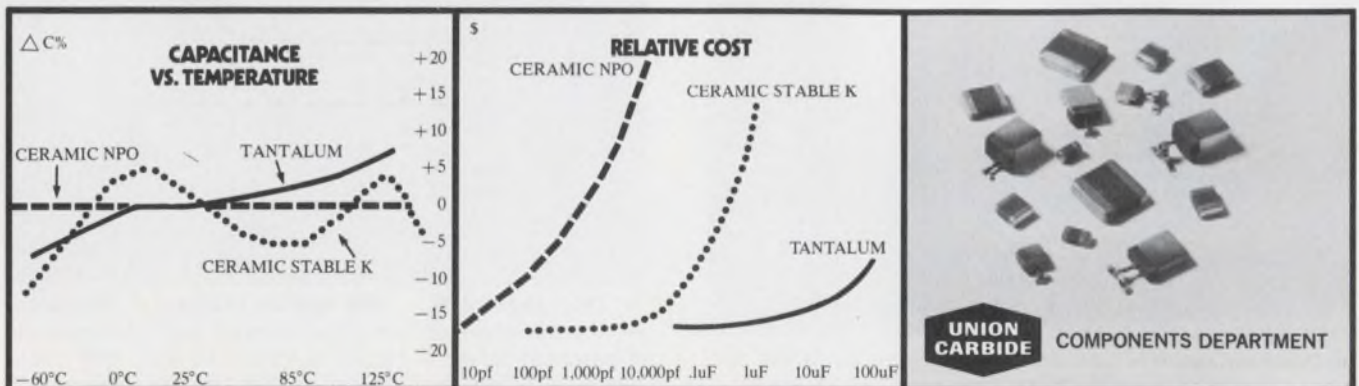

Variable compression mica capacitors:

Small, Inexpensive, Wide-range, Go-anywhere Capacitance Packages

(Try 'em . . . you'll like 'em!)

Do you need a capacitor you can adjust from 1400 to 3055 pF (or almost any other range down to 0.9 to 7.0 pF)? As small as $\frac{3}{8}$ " x $\frac{1}{32}$ "? That mounts by any method, in any location, including PC applications? That has a high Q, smooth adjustment, low inductance, excellent thermal stability and resistance to shock, vibration and humidity?

And that you can buy in quantity, off the shelf, typically for 15¢ each?

It will pay you to look into EI-Menco variable compression mica trimmers and padders—the "old reliables" whose highly developed characteristics and extremely wide line today make them the capacitors of choice in hundreds of state-of-the-art communications, instrumentation, audio and military electronics equipment. For example: in RF, oscillator and FM antenna circuits . . . HF bias (tape) from 85 to 95 kHz . . . phase control circuits . . . compensation for other components . . .

SSB 2.0 MHz channel strips. And perhaps one of these possibilities gives you an idea: coax cable line termination, pulse transmission, an equalizing/matching network, a low-Q tone generator, or padding in a TV circuit, power supply or home appliance.

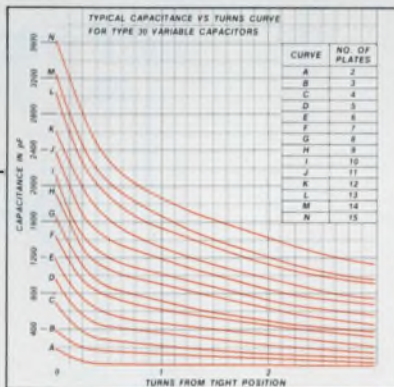

WRITE FOR COMPREHENSIVE TECHNICAL DATA:

a recent technical article reprint and a 29-page set of data sheets are yours for the asking. Send request directly to:



EI-Menco

THE ELECTRO MOTIVE MFG. CO., INC.

Willimantic, Conn. 06226

West Coast: Collins and Hyde Co.

Nationwide: Arco Electronic Distributors

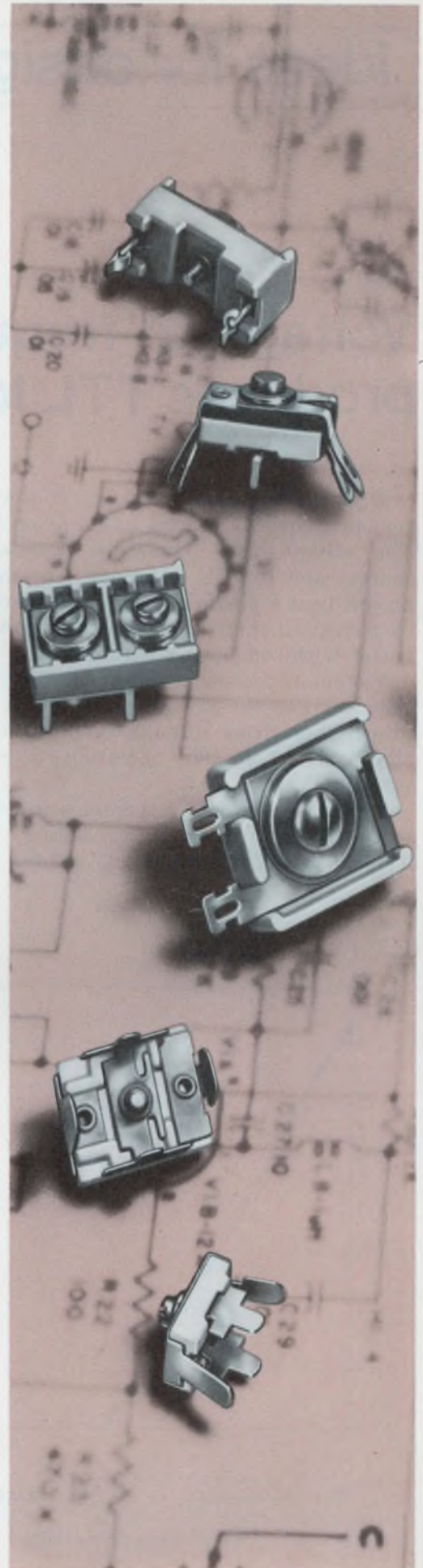

INFORMATION RETRIEVAL NUMBER 82

Voltage-to-frequency converter produces TTL logic output

A stable voltage-to-frequency converter allows remote frequency control by an ac or dc voltage. The circuit uses transistor constant-current sources and two IC one-shots. An alternate approach uses a single one-shot and current source connected to form a voltage-to-pulse-width converter with comparable stability.

Voltage-to-frequency linearity (Fig. 1) is excellent up to the frequency at which the 40-ns propagation delay through the one-shot becomes significant. Tolerable operation to 8 MHz is possible.

Two 2N2412s act as current sources (Fig. 2) to charge the two timing capacitors C1 and C2. The charging current, I_E , is related to the V_s

control voltage by the equation:

$$I_E = \frac{V_{cc} - 0.7 - V_s}{R_e}$$

Experimental results show the frequency of operation, f , to be given by the approximation:

$$f \approx \frac{I_E}{8C}$$

The two SN54121 one-shots produce the required TTL output.

Mike Black, Design Engineer, Texas Instruments, Inc., M.S. 257, 13500 North Central Expressway, Dallas, Tex. 75222.

CIRCLE No. 311

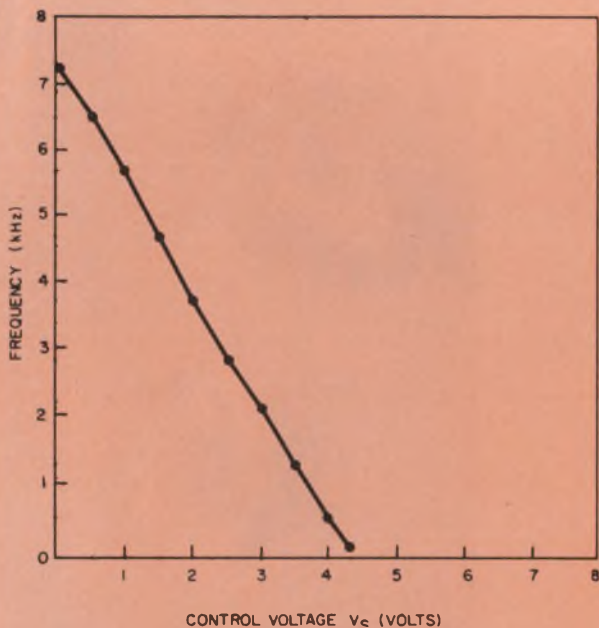

1. Plot of frequency vs control voltage for the component values shown in Fig. 2. Linearity is affected by the 40-ns propagation delay.

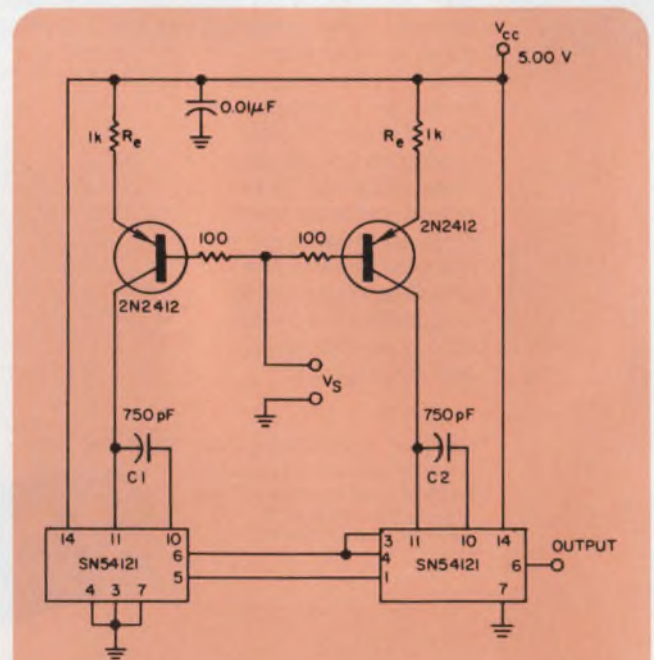

2. Voltage-to-frequency converter uses SN54121 one-shots controlled by 2N2412 transistors connected as current sources.



Now, Helipot offers covered cermet trimmers for low-budget projects.

There's not much sense in using cheap wirewound or carbon trimmers anymore. Not when the new Helipot Series 91 Cermet Trimmers are available *off-the-shelf* for a few cents more.

These single-turn, $\frac{3}{8}$ " , covered trimmers come in 10 different mounting styles and 19 standard resistance values from 10 ohms to 2 megohms. Covered construction helps protect against moisture, corrosive atmospheres, dust, oil and other

contamination. Which means, in addition to cermet stability and better resolution, you get long-term dependable performance.

The breakthrough price is just 35¢ each in the 50,000 piece quantity, and they're equally well-priced in other quantities.

Send now for complete data on the Series 91 Trimmers... the finest of their class. We've made them for your projects where the budget may be tight, but you don't want to compromise performance.

Beckman®

INSTRUMENTS, INC.
HELIPOT DIVISION
Fullerton, California

HELPING SCIENCE AND INDUSTRY IMPROVE THE QUALITY OF LIFE

INTERNATIONAL SUBSIDIARIES: AMSTERDAM, CAPE TOWN, GENEVA, GLENROTHES, SCOTLAND, MEXICO CITY, MUNICH, PARIS, STOCKHOLM, TOKYO, VIENNA

INFORMATION RETRIEVAL NUMBER 83

Diodes insure multivibrator start-up

In the conventional cross-coupled multivibrator, start-up cannot be guaranteed when the base current is generated from a different supply than the collectors. If the base current is applied first, both transistors saturate and the circuit will not start. This can be averted by the inclusion of four diodes, as shown in the diagram.

No other departures from normal design are required, but to maintain loop gain, the collector current must be greater than five times the base current.

A stable saturated state cannot occur now; the feedback diodes will insure that the transistors do not bottom but will be held in a linear state until oscillations occur. For the circuit to work, the $(V_{ce})_{sat}$ of the transistors must be less than 0.6 V. If the $(V_{ce})_{sat}$ is guaranteed at less than 0.3 V, then the base diode may be omitted, so long as the feedback diode is a germanium gold-bonded type or, in general, if

$$V_{be} - V_D > (V_{ce})_{sat}$$

As a secondary advantage, base-emitter breakdown of the transistor cannot occur either, because it is protected by series diodes.

If the capacitor is connected directly to the base, then the constriction on base and collector currents no longer applies. Each transistor now saturates on switching but subsequently returns

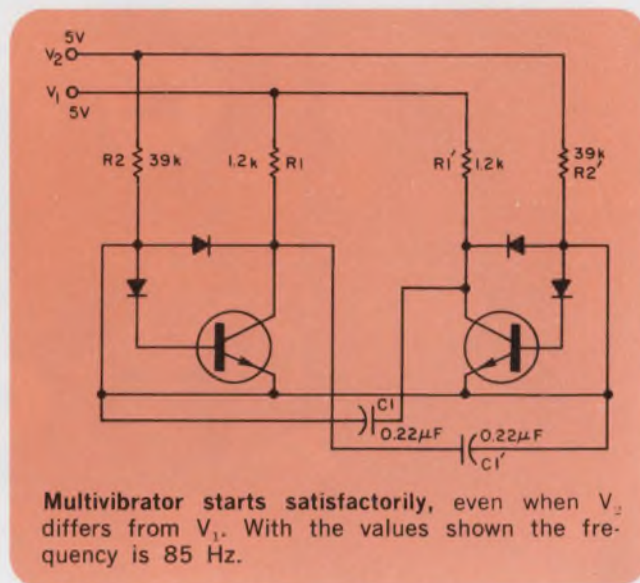

to the linear state. This change of voltage in one transistor is transmitted to the base of the other, which is prematurely triggered. This causes a discontinuity in the base current-frequency relationship.

W. Saich, *Research and Development, Solartron Electronic Group Ltd., Farnborough, Hampshire, England.*
CIRCLE NO. 312

Circuit eliminates input offset in a common-base amplifier

Here is a circuit for maintaining the input of a common-base amplifier at ground potential. An op amp in the circuit automatically adjusts the bias of a diode (see diagram). If used in place of the usual potentiometer, the op amp guarantees that the voltage drop across diode CR1 will track the base-emitter voltage of transistor Q1 with changes in temperature or power-supply voltage. The base-emitter offset in Q1 (and hence the input offset) is cancelled. This allows the common-base amplifier to be used without introducing an offset voltage at the signal input.

Resistors R4 and R6 and the forward-biased base-emitter junction of Q1 act as a feedback path for op amp A1, forcing the voltages at the amplifier's positive and negative inputs to be within 6 mV of each other. The input voltages are nearly identical, because R4 and R5 are equal in value and because the op amp bias currents are nearly equal. For the S5556 op amp, the 6 mV offset results from the offset voltage of the op amp input. The op-amp offset can be corrected by a nulling circuit.

The input capacitance of op amp A1 is pre-

Complete RF Network Analysis

0.005 dB

400 kHz to 500 MHz with 115-dB dynamic range and 0.005-dB resolution. Precise measurements of transmission and reflection properties — magnitude, phase, group delay, and S-parameters — all direct reading and neatly displayed on a built-in scope. Complete characterization of filters, amplifiers, cables, antennas, delay lines, transistors, or most anything else that comes to mind — all at the push of a button.

0.005 dB! 10, 2.5, 1, 0.25, 0.1, or 0.025 dB per major division displayed (0.005 dB per minor division resolution) and continuous calibrated offset — at the twist of a knob. There's more, of course, including computer-controlled systems or other versions tailored to your needs. Look into it. Better yet, see it — in action — in your application.

For a demonstration of this remarkable system, call your local GR center. The price for the basic 1710 RF Network Analyzer? Only \$6850 (*truly remarkable*).

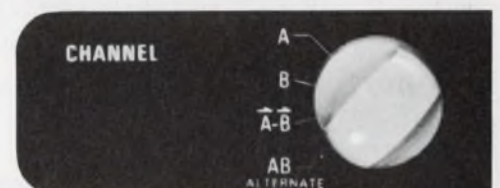
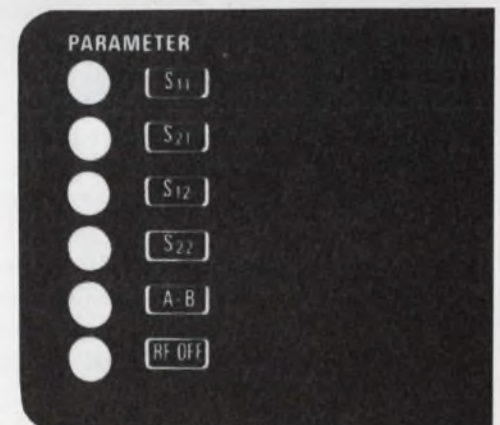
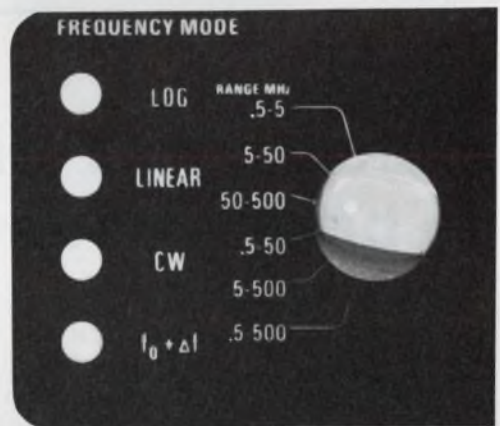
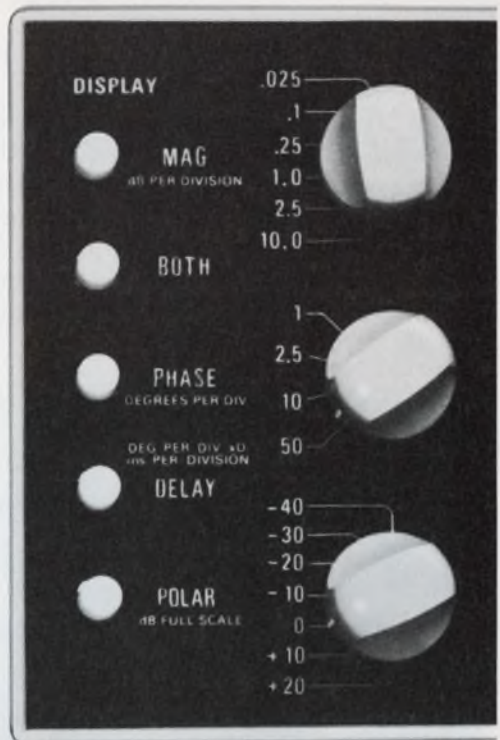

For High-Frequency Measurements



General Radio

300 BAKER AVENUE, CONCORD, MASSACHUSETTS 01742
 NEW YORK (N.Y.) 212 964-2722 (N.J.) 201 781-8990 • BOSTON 617 846-0550
 CHICAGO 312 992-0800 • WASHINGTON, D.C. 301 881-5333 • LOS ANGELES 714 540-9830
 TORONTO 416 252-3395 • ZURICH (01) 55 24 20
 GRASON-STADLER 617 368-3787 • TIME/DATA 415 327-8322

INFORMATION RETRIEVAL NUMBER 84

vented from affecting the high-frequency response of Q1 by resistor R4. Since the 3-MΩ input impedance of A1 compares with less than 15 Ω for Q1, the op amp has no appreciable effect on the gain of Q1 at any frequency. Resistor R7 biases CR1. This allows A1 to supply sufficient current for the voltage drop of diode CR1 to

cancel the base-emitter voltage drop of Q1. Resistor R6 limits the output current of A1 to its rated value. Diode CR1 prevents oscillations in Q1.

William Farnbach, Hewlett-Packard Co., 1900 Garden of the Gods Rd., Colorado Springs, Colo. 80907

CIRCLE NO. 313

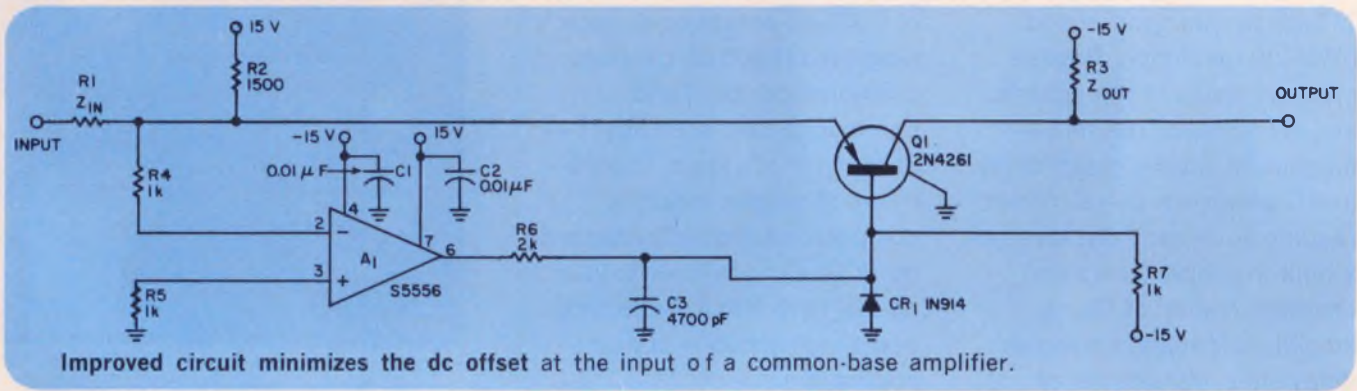

Convert four-bit-binary to binary-coded decimal

Although the sixteen states of a four-bit binary signal can be displayed using four indicators and may be read with a little practice, a decimal display is much more convenient. Gating circuitry can be used to convert the four-line binary signal to a four-line binary-coded-decimal (BCD) signal, with BCD-ten signals on a fifth line. Applications exist primarily where the binary signal is already available, since four additional integrated-circuit packages are required for the conversion, as opposed to one extra package if a BCD counter is to be used.

The circuitry is implemented by using one triple three-input NAND gate and three quad two-input NAND gates. The quad two-input NAND gates, however, are used as four two-input NAND gates, four inverters and three two-input negative-true NOR gates. The logic diagram is shown in the figure.

This circuitry will also decode a divide-by-twelve counter signal if the counter is configured in a ÷2, ÷2, ÷3 sequence (e.g., S8288A), so that it counts in normal binary fashion.

Ernest F. Wilson, Senior Scientific Specialist, EG&G, 2801 Old Crow Canyon Rd., San Ramon, Calif. 94583

CIRCLE NO. 314

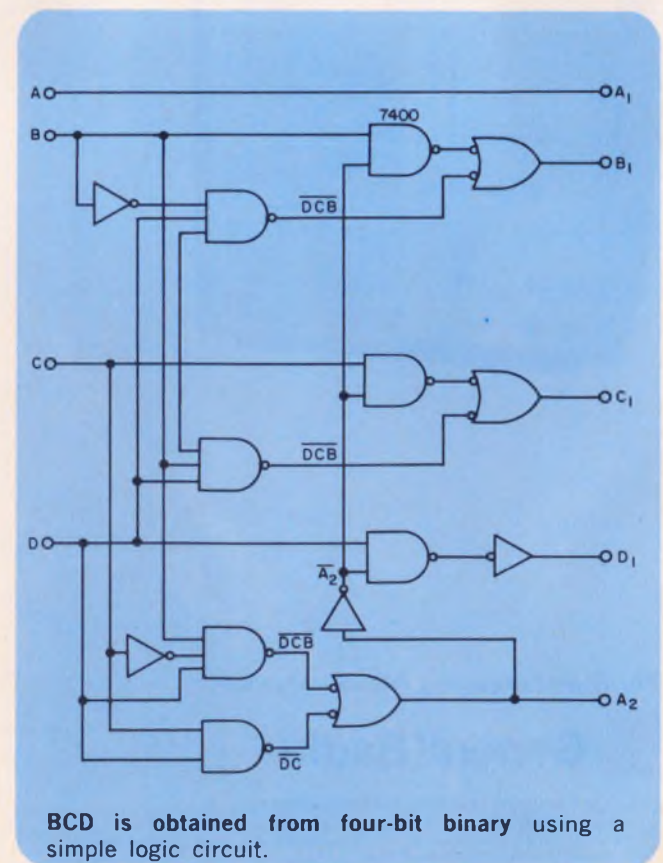

When it's **POWER** switching you need...



**our relays
come on STRONG!**

Now Magnecraft offers a complete line of Mercury Displacement Power Relays with liquid mercury-to-mercury contacts. These new Power Relays are available from stock with coil voltage of 120 VAC, however, all other coil voltages are available. In addition to the HI-POWER steel encapsulated version a complete line of glass tube relays are offered. These low cost, tempered glass relays are frictionless, non-corrosive and non-conducting. Contact configurations are SPST, DPST, and 3PST; NO or NC units rated at 20, 25, 35, 50, 60, and 100 amperes @ 115 VAC are on the shelf awaiting your order. Temperature control, sensitive, and time delay solid state hybrid units are also offered.

① The MR-11 miniature type is a glass tube DPST relay with 20 ampere switching capability. CSA listed. Also available SPST and 3PST.

② The EM-1 standard type is a glass tube SPST relay with 35 ampere switching capability. UL and CSA listed. Also available DPST and 3PST.

The HD heavy duty type is a glass tube relay similar to the EM type but features 60 ampere switching capability. UL and CSA listed.

③ The "100" relay is an encapsulated glass tube relay with 100 ampere switching capability. CSA listed.

④ The A-11 HI-POWER is an armored steel-encapsulated DPST relay with 25 ampere switching capability. Also available SPST and 3PST.

The "B" series HI-POWER relays are similar to "A" type but feature 50 ampere switching capability.

⑤ The H-1 HI-POWER is an armored steel-encapsulated SPST relay with 100 ampere switching capability. Also available in DPST and 3PST.

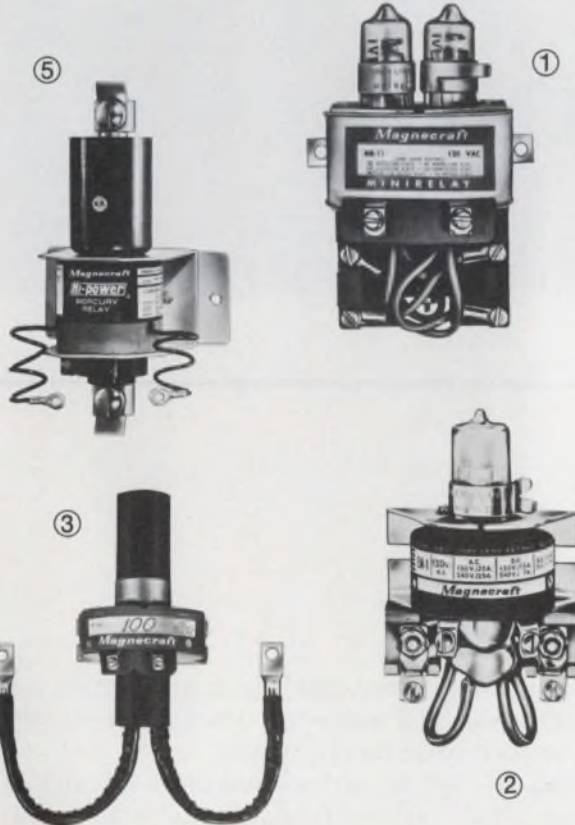

Magnecraft ELECTRIC COMPANY

5575 NORTH LYNCH AVENUE • CHICAGO, ILLINOIS 60630 • 312 • 282-5500 • TWX 910 221 5271

" See You at IEEE Booth 1408 "

FREE CATALOG

Send for our complete catalog of Mercury Displacement Power Relays describing how they operate, the many features available and giving complete specifications on over 60 types. Prices are also included.

Stop ac motors with triac control

A triac motor control used to drive an ac motor can also bring the motor to a dead stop in less than one revolution. The braking technique employs a timed dc pulse train to the motor field at the conclusion of the drive cycle. Since the generated locking torque adjusts to the horsepower rating, the technique will work with any size motor.

Let Q_1 be any triac sized in accordance with the load and specified for third quadrant triggering (MT-2 negative, gate positive), with resistors R_2 and R_3 calculated to satisfy the trigger requirements. The values shown in the figure will reliably trigger triacs needing trigger currents of 15 mA or less. Resistor R_1 prevents collector breakdown of transistor Q_2 , but it can be removed if a 50-V transistor is used for Q_2 .

Diodes CR_1 and CR_2 form a poor man's OR gate and also prevent circuit damage in the event

that MT-2 shorts to the gate. The M_D and \overline{M}_D drive signals are supplied from a TTL logic system. A positive M_D signal causes Q_2 to switch a steady dc bias into Q_1 's gate. Q_1 fires over an angular range of 360° , placing an ac voltage across the motor. When M_D is removed, its complement, \overline{M}_D , triggers the one-shot to place a 0.1 s dc pulse on Q_2 's base. Q_2 then switches its half-wave supply into Q_1 's gate. Since this gate signal is in phase with the motor supply, it causes Q_1 to force a similar half-wave pulse train through the motor field which instantly locks the rotor.

Since the iron takes a finite time to saturate, the instantaneous locking force generated will be far in excess of the motor's normal running torque.

Barry David Brown, Datak West, P.O. Box 192, Sparks, Nev. 89431

CIRCLE NO. 315

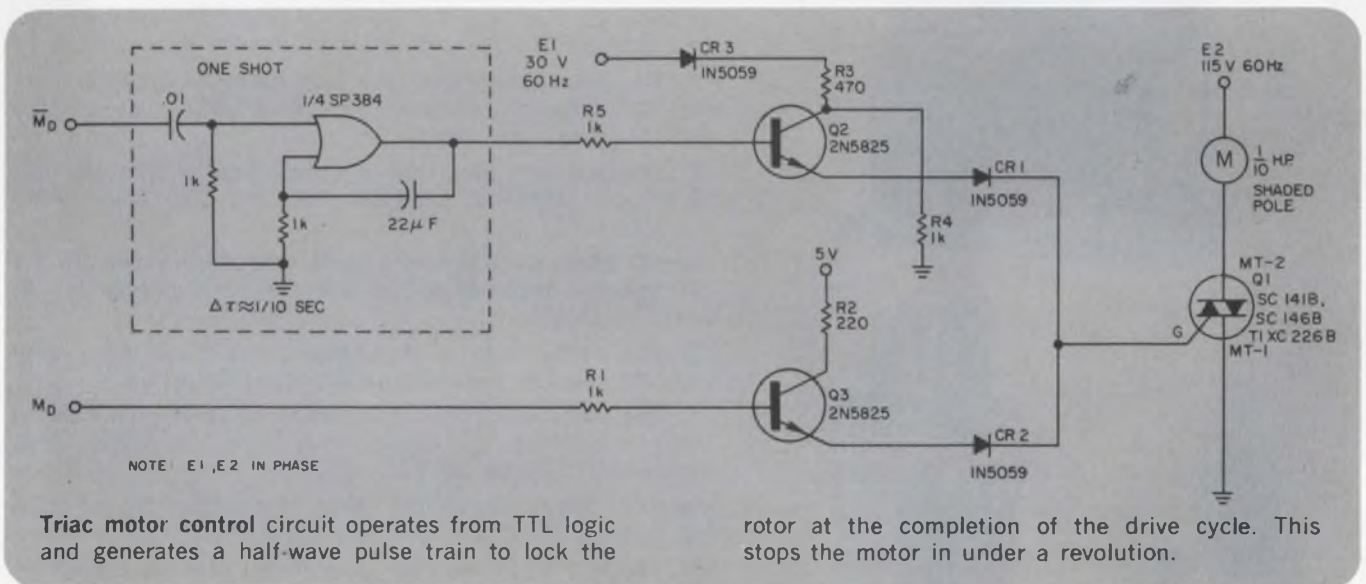

SUPER BASIC designs unbalanced-T or pi attenuator

A SUPER BASIC program computes resistance values in unbalanced-T or pi attenuators for any desired attenuation, and it also gives cross-checking with available resistance values. The control functions allow selection of the type

of attenuator desired, the input and output impedances and the value of attenuation—which may be any positive real value.

Using 5%, 1/8-W carbon-composition resistors, we can obtain attenuation accuracies to within

CANNON CENTRISIBLE CONNECTORS.

The performance you need, at a price you can afford.

ADAPTA-CON

ITT Cannon answers the demand for low insertion force post and receptacle interconnections that cost less—with ADAPTA-CON connectors, connector

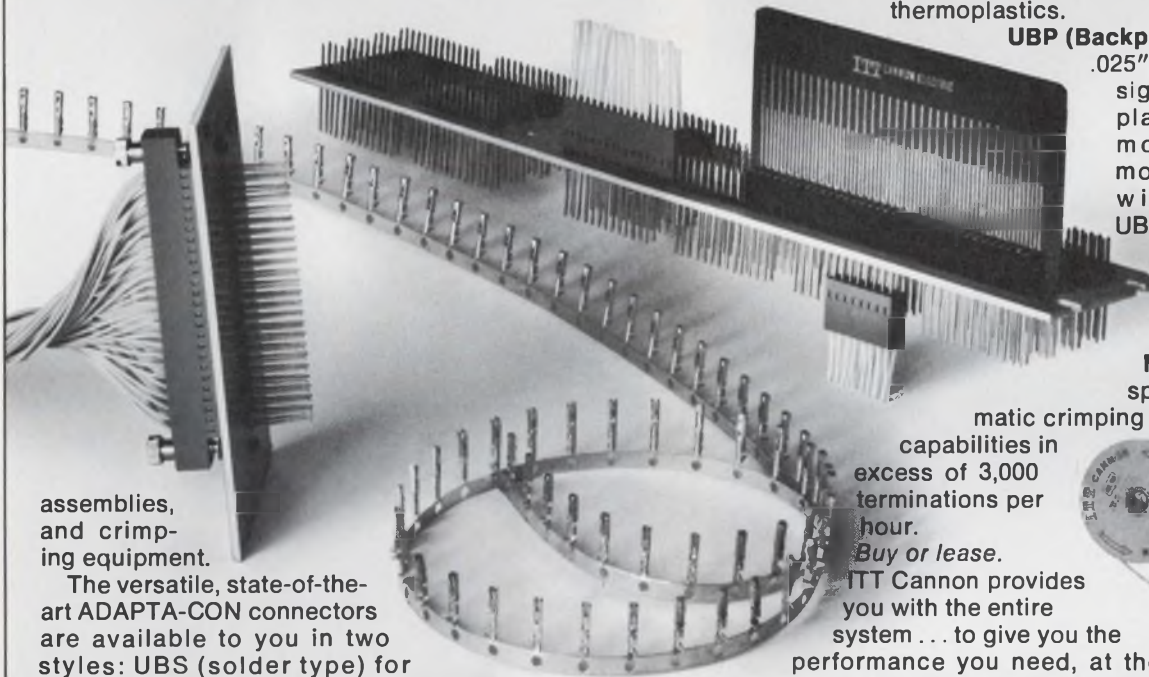

assemblies, and crimping equipment.

The versatile, state-of-the-art ADAPTA-CON connectors are available to you in two styles: UBS (solder type) for printed circuit applications, and UBC (crimp type, with machine and hand tools available) for system interconnection applications. Both offer you important advantages: 1) closed entry design that prevents contact damage and corrects misalignment; 2) tang lock contact retention; 3) "pin-stop" that provides positive location; 4) redundant, cantilever beam type contacts; 5) low insertion forces; 6) easy contact removal and replacement in the field.

UBS (Solder) — Receptacles mounted to P.C. board by standard flow-solder techniques. Mates

with .025" sq. posts mounted in epoxy mother board and metal backplanes. Single or double row. Up to 130 contacts on .100" or .150" grid spacings. Ideal for mother-daughter board applications.

UBC (Crimp) — Receptacles utilize insertable and removable crimp contacts that accommodate #22-30 AWG solid or stranded wire. Single or double row. Up to 86 contacts on .100", .125", .150" grid spacings. Choice of materials: U. L. approved thermoset or thermoplastics.

UBP (Backplane Assembly)

.025" sq. posts designed for metal plate and epoxy mother board mounting. Mates with UBS and UBC. Can be automatically wire wrapped.

ABT 500 (Crimping Machine)

High speed, semi-automatic crimping equipment with

capabilities in excess of 3,000 terminations per hour.

Buy or lease.

ITT Cannon provides you with the entire system... to give you the performance you need, at the price you can afford.

For further information, contact ITT Cannon Electric, International Telephone and Telegraph Corporation, 666 East Dyer

Road, Santa Ana, California 92702. Telephone (714) 557-4700.

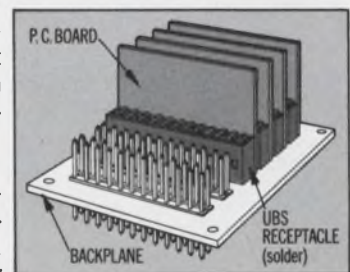
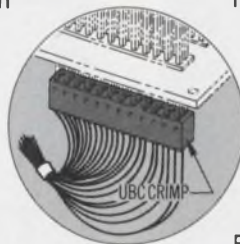

CANNON **ITT**

0.1 dB up to 500 MHz, varying to 0.4 dB at 2 GHz. Attenuation accuracy of 0.1 dB can easily be achieved with thick-film chip resistors in a microstrip transmission line pi structure below 6 dB attenuation out to 2 GHz. Accuracy of 0.2

to 0.4 dB can be attained out to 4.5 GHz.

W. Dale Harpster, Solid State Div., Watkins-Johnson Co., Stanford Industrial Park, Palo Alto, Calif.

CIRCLE No. 316

Unbalanced "T"

$$R_3 = \frac{2\sqrt{Z_1 Z_2}}{N-1}$$

$$R_2 = Z_2 \left(\frac{N+1}{N-1} \right) - R_3$$

$$R_1 = Z_1 \left(\frac{N+1}{N-1} \right) - R_3$$

Unbalanced "PI"

$$R_3 = \frac{N-1}{2} \sqrt{\frac{Z_1 Z_2}{N}}$$

$$\frac{1}{R_2} = \frac{1}{Z_2} \left(\frac{N+1}{N-1} \right) - \frac{1}{R_3}$$

$$\frac{1}{R_1} = \frac{1}{Z_1} \left(\frac{N+1}{N-1} \right) - \frac{1}{R_3}$$

Where N is equal to the ratio of the power absorbed by the attenuator from the source, to the power delivered to the load; and attenuation in dB equals $10 \log_{10} N$ so that $N = (10)^{A/10}$.

1. The resistance values of constant-impedance unbalanced-T or pi networks can be computed and cross-checked for a given attenuation with the program of Fig. 3.

```

RUN
UNSYMMETRICAL T OR PI PAD CALCULATION
WHICH TYPE PAD T OR PI ?
? T
WHAT IS THE DESIRED ATTENUATION IN DB ?
? 3
WHAT IS INPUT AND OUTPUT Z ?
? 50,50
R SERIES IN= 8.5498679 R SERIES OUT= 8.5498679 R SHUNT= 141.92616

DO YOU WANT TO CHECK? (Y OR N)
? Y
INPUT 5% TOL VALUES FOR R1,R2,R3
? 9.1,9.1,150
ATTEN= 3.0142325DB
INPUT VSWR= 1.0299197:1
OUTPUT VSWR= 1.0299197:1

DO YOU WANT TO CHECK? (Y OR N)
? N
ANOTHER PAD ?
? Y
WHICH TYPE PAD T OR PI ?
? PI
WHAT IS THE DESIRED ATTENUATION IN DB ?
? 3
WHAT IS INPUT AND OUTPUT Z ?
? 50,50
R SHUNT IN= 292.40218 R SHUNT OUT= 292.40218 R SERIES= 17.614799

DO YOU WANT TO CHECK? (Y OR N)
? Y
INPUT 5% TOL VALUES FOR R1,R2,R3
? 300,300,18
ATTENUATION= 2.9946432DB
INPUT VSWR= 1.0118765:1
OUTPUT VSWR= 1.0118765:1

DO YOU WANT TO CHECK? (Y OR N)
? N
ANOTHER PAD ?
? N
    
```

2. Sample run illustrates the effects of different component values and attenuator types on attenuation and VSWR.

```

10 PRINT"UNSYMMETRICAL T OR PI PAD CALCULATION"
20 PRINT"WHICH TYPE PAD T OR PI ?"
30 INPUT U
40 PRINT"WHAT IS THE DESIRED ATTENUATION IN DB ?"
50 INPUT A
60 PRINT"WHAT IS INPUT AND OUTPUT Z ?"
70 INPUT B,C
80 N=10^(A/10)
90 IF U="PI" THEN 100 ELSE 420
100 R3=((N-1)/2)*((B*C)/N)+.5)
110 R2=1/(((1/C)*((N+1)/(N-1)))-(1/R3))
120 R1=1/(((1/B)*((N+1)/(N-1)))-(1/R3))
130 PRINT"R SHUNT IN=":R1;"R SHUNT OUT=":R2;"R SERIES=":R3
140 PRINT
150 PRINT"DO YOU WANT TO CHECK ? (Y OR N)"
160 INPUT Q
170 IF Q="Y" THEN 180 ELSE 720
180 PRINT"INPUT 5% TOL VALUES FOR R1,R2,R3"
190 INPUT R1,R2,R3
200 Z1=(R1*((R2*C)/(R2+C))+R3)/(R1+((R2*C)/(R2+C))+R3)
210 Z2=(R2*((R1*B)/(R1+B))+R3)/(R2+((R1*B)/(R1+B))+R3)
220 P1=1/B
230 X5=(R2*C)/(R2+C)
240 Y5=(R1*(R3+X5))/(R1+(R3+X5))
250 E1=2*((Y5)/(B+Y5))
260 E2=E1*(X5)/(R3+X5)
270 P2=(E2+2)/C
280 A=P2/P1
290 A=ABS(10*LG(A))
300 PRINT"ATTENUATION=":A"DB"
310 IF Z1>B THEN 320 ELSE 340
320 V1=Z1/B
330 GO TO 350
340 V1=B/Z1
350 PRINT"INPUT VSWR=":V1":1"
360 IF Z2>C THEN 370 ELSE 390
370 V2=Z2/C
380 GO TO 400
390 V2=C/Z2
400 PRINT"OUTPUT VSWR=":V2":1"
410 GO TO 140
420 R3=(2*((N*B*C)+.5))/(N-1)
430 R2=(C*((N+1)/(N-1)))-R3
440 R1=(B*((N+1)/(N-1)))-R3
450 PRINT"R SERIES IN=":R1;"R SERIES OUT=":R2;"R SHUNT=":R3
460 PRINT
470 PRINT"DO YOU WANT TO CHECK? (Y OR N)"
480 INPUT Q
490 IF Q="Y" THEN 500 ELSE 720
500 PRINT"INPUT 5% TOL VALUES FOR R1,R2,R3"
510 INPUT R1,R2,R3
520 Z1=((R2+C)*R3)/(C+R2+R3)+R1
530 Z2=((R1+B)*R3)/(B+R1+R3)+R2
540 P1=1/B
550 E2=2*((R3*(R2+C))/(R3+(R2+C)))/(B+R1+((R3*(R2+C))/(R2+C))))
560 E3=(E2*C)/(C+R2)
570 P2=(E3+2)/C
580 A=P2/P1
590 A=ABS(10*LG(A))
600 PRINT"ATTEN=":A"DB"
610 IF Z1>B THEN 620 ELSE 640
620 V1=Z1/B
630 GO TO 650
640 V1=B/Z1
650 PRINT"INPUT VSWR=":V1":1"
660 IF Z2>C THEN 670 ELSE 690
670 V2=Z2/C
680 GO TO 700
690 V2=C/Z2
700 PRINT"OUTPUT VSWR=":V2":1"
710 GO TO 460
720 PRINT"ANOTHER PAD ?"
730 INPUT Q5
740 IF Q5="Y" THEN 20 ELSE 750
750 STOP
    
```

3. Resistance calculations in SUPER BASIC appear in lines 80, 100 to 120, and 420 to 440. Attenuation calculations take place in lines 540 to 600 for T and in lines 220 to 300 for pi networks. VSWR calculations occur in lines 520, 530 and 610 to 700 for T and lines 200, 210 and 310 to 400 for pi networks.

"RETRACING OLD DRAWINGS IS SUCH A DRAG."

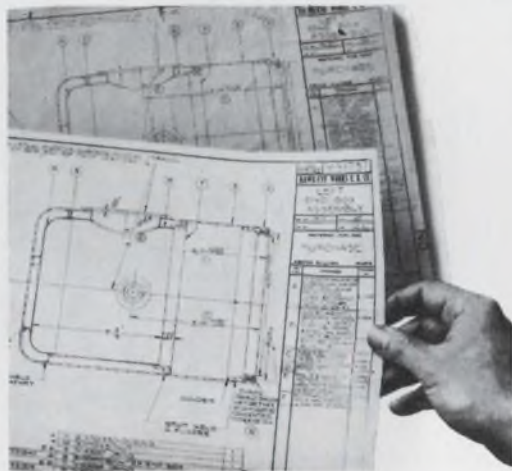

**Save hours of drafting time
with KODAGRAPH Films.**

There's really no reason to waste time retracing those old, battered drawings. A much better way is to rejuvenate them by making sharp, clear photographic restorations on Kodagraph film.

You'll be amazed at the results. Weak lines come back strong and clear. Stains virtually disappear. And instead of gray on yellow, you've got sparkling, contrasty, black-on-white prints. Best of all, you not only eliminate drafting time, you save money, too.

For a full, clear picture of all the ways Kodagraph films can offer creative solutions to your drawing problems, send in the coupon.

Please send me full details on the drawing shortcuts made possible by using Kodagraph films.

Name _____

Position _____

Company _____

Address _____

City _____ State _____ Zip _____

Eastman Kodak Company
Business Systems Markets Division
Dept. DP818, Rochester, N.Y. 14650

**ENGINEERING DATA
SYSTEMS**



Micropower switching regulator has a low standby current

A micropower switching regulator can extend battery life considerably when used in a battery-powered system where multiple regulated voltages are required. The circuit shown has a standby current of only 90 μA . Because of its low current drain, it uses miniature, low-power components, including micropower IC op amps.

With an input of 25 to 30 V, the regulator produces an output of $\pm 8.2\text{ V}$ referenced to the output ground point ($+8.2\text{ V}$ with respect to the input common line) for the component values shown. A maximum load current of 5 mA can be obtained from any output terminal. The output voltage drops 2 mV at this load current, and the measured efficiency is 70%.

The $\mu\text{A}735\text{C}$ micropower op amp (A1) has no external speed-retarding compensation circuitry. Also, a somewhat unorthodox capacitor connec-

tion between pins 5 and 8 further increases switching speed and reduces power consumption. The UC4250 op amp (A2) is connected as a voltage splitter to provide positive and negative voltages with respect to the output reference point. This arrangement assures perfect tracking.

The reverse-biased emitter junction of Q1 forms a stable, low-current zener diode for the constant-current source Q2. When input voltages down to 6 V are used, a low-voltage zener should be substituted for Q1, and R2 should be adjusted to give an I_o of 10 μA .

The output voltage is determined by varying resistor R1. Inductor L1 is a 10-mH subminiature unit with a dc resistance of 90 Ω .

John P. Cater, 7964 Ridge Mills Rd., Rome, N.Y. 13440

CIRCLE NO. 317

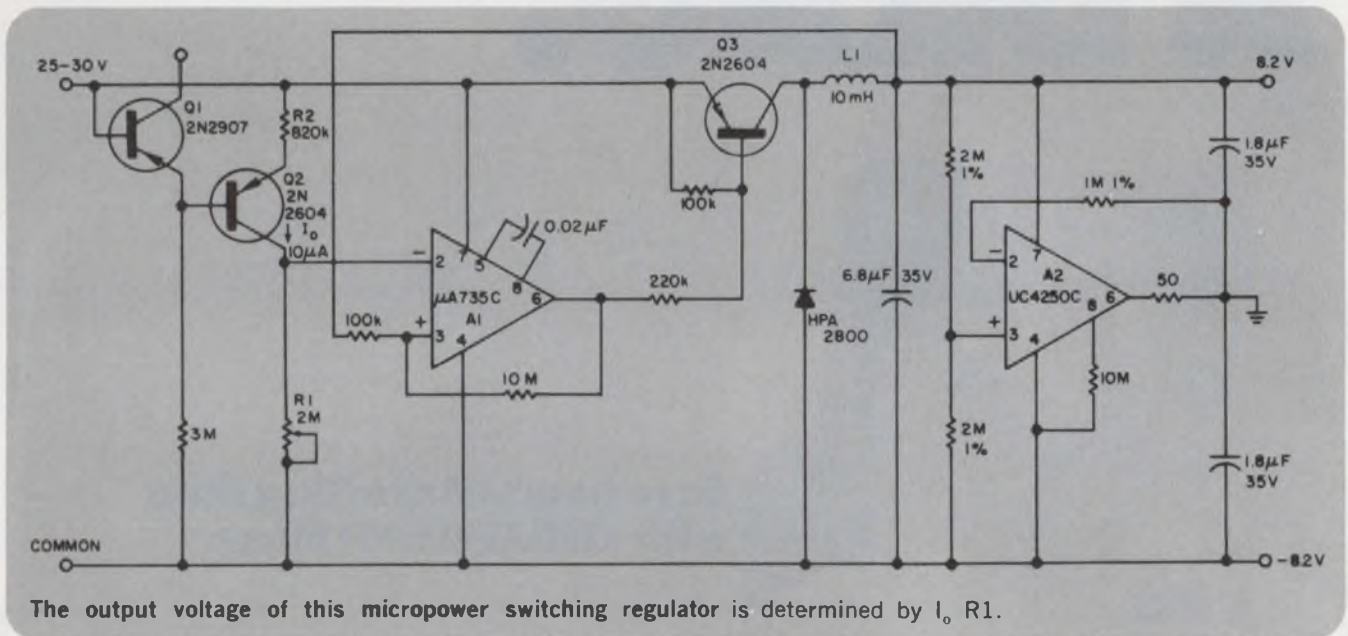

IFD Winner for November 11, 1971
Wayne Sefcik, Pinson Associates, Inc., P.O. Box 9648, Austin, Tex. His idea, "Digital filter design can be simplified if binary rate multipliers are used," has been voted the Most Valuable of Issue Award.
Vote for the Best Idea in this Issue.

SEND US YOUR IDEAS FOR DESIGN. You may win a grand total of \$1050 (cash)! Here's how. Submit your IFD describing a new or important circuit or design technique, the clever use of a new component or test equipment, packaging tips, cost-saving ideas to our Ideas for Design editor. Ideas can only be considered for publication if they are submitted exclusively to ELECTRONIC DESIGN. You will receive \$20 for each published idea, \$30 more if it is voted best of issue by our readers. The best-of-issue winners become eligible for the Idea of the Year award of \$1000.

THIS IS ALL WE ASK:

COMPARE OUR NEW OSCILLOSCOPES WITH SCOPES YOU'RE USING NOW.

| | Our 3100 | Your Comparable Scope | Our 4100 | Your Comparable Scope |
|-------------------------|--------------------|-----------------------|--------------------|-----------------------|
| Bandwidth & sensitivity | DC-35MHz @ 5mV/div | ? | DC-75MHz @ 5mV/div | ? |
| CRT Size | 8 x 10 Cm | ? | 8 x 10 Cm | ? |
| Fastest Sweep | 20ns/div | ? | 5ns/div | ? |
| Calibrated Sweep delay | Standard | ? | Standard | ? |
| List Price | \$1675.00 | ? | \$1825.00 | ? |

WE LET THE FACTS DO THE TALKING

For more of the facts behind these superior designs, write Raytheon Company, Instruments Operation, 175 Middlesex Turnpike, Bedford, Mass. 01730.

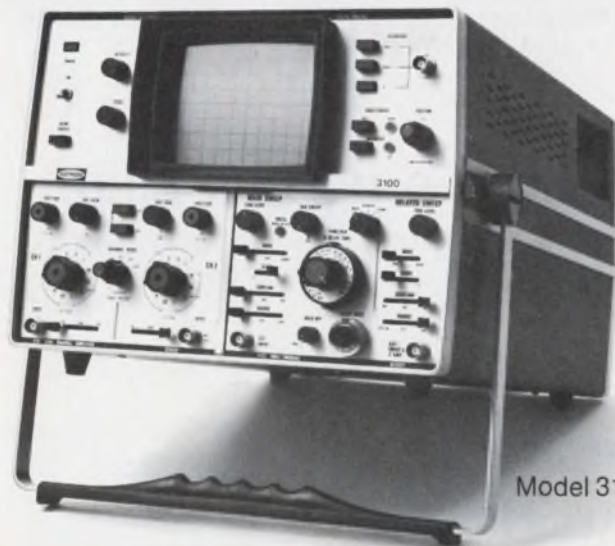

Model 3100

72
EXX Booth 2602

INFORMATION RETRIEVAL NUMBER 88

In Answer To Your Gripes About Every Other Portable Recorder

The no jazz CPR 4010. A 7 speed, 1/2" or 1" tape, 10 1/2" reel portable recorder/reproducer.

Old Clichés Revisited

What's so great about it? Mainly, it's the easiest machine around to use, maintain and service. (We know you've heard that before, but bear with us for a minute.)

Operation

We've got a single knob for transport speed and electronics equalization. Automatic. Other transport functions are push-button controlled including our proprietary AUTOLOAD automatic, mistake proof tape loader that works precisely. Every time. All the electronics are in one housing. Even monitor meters, voice logger, 7 speed servo card, and all 14 record and reproduce modules. It's easy to add options because it's pre-wired. All you do is plug in.

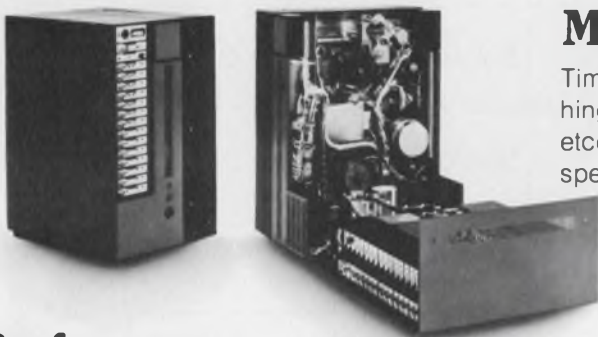
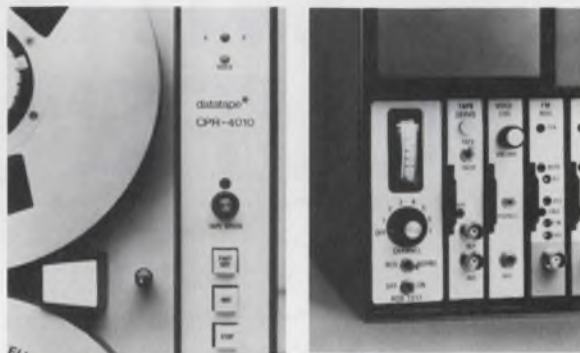

Maintenance and Servicing

Time for the annual P.M.? It's no big deal. The back panel's hinged. Just flip it down. All motors, power supplies, electronics, etcetera, are right there. (It even runs in this position.) Nothing special needed. How's that for simplicity?

Performance

Briefly, from the top: 7 speed transport, 15/16 to 60 ips; 7 speed direct, all automatically switched, 300 kHz at 60 ips; 7 speed FM record; 40/20 kHz, automatically switched. Any 2 speeds of FM reproduce; low tape flutter and TBE; isolation from reel perturbation via dual capstans and tension sensors. Low mass, closed loop IRIG servo system. (The same electronics design as our top-of-the-line VR-3700B.

Bell & Howell & the CPR 4010

Get all the specs. Just ask Bell & Howell, CEC/Instruments Division, 360 Sierra Madre Villa, Pasadena, California 91109.



CEC/INSTRUMENTS DIVISION



BELL & HOWELL

© Copyright 1972 Bell & Howell

INFORMATION RETRIEVAL NUMBER 89

new products

Waveform generators offer low cost, high performance



Microdot, Inc., Instrumentation Div., 19535 E. Walnut Dr., City of Industry, Calif. (213) 965-4911. P&A: see text, stock to 2 weeks.

A well-rounded package of features and a price 10% to 25% below that of major competitors give Microdot a solid new entry in the 10-MHz, high-performance waveform generator field.

Since the introduction several months ago of a 20-MHz waveform generator by Exact Electronics of Hillsboro, Ore., many in the field have said that all new high-performance waveform generators would achieve 20-MHz or higher. In fact, this hasn't been the case. Most of the action has been at the 10-MHz level.

In fact, Exact's Model 7060 and a Model 144 put out by Wavetek of San Diego have shared the bulk of the high-performance, 10-MHz market to date. Interstate Electronics of Anaheim, Calif., has also been a factor with its Model F52. While the Wavetek 144 is quoted at \$845, the Exact 7060 at \$845 and the Interstate F52 at \$795, the Microdot 511 costs only \$695.

It's only fair to note, though, that the Wavetek and Exact instruments have internal sweep and the Interstate and Microdot units

don't. However, Microdot is the only one to offer an output amplifier with a square wave risetime of less than 10 ns, as opposed to 20 ns for competitors. This amplifier can be used by itself through the application of a signal to the EXT IN jack on the front of the instrument. It is linear up to 50 MHz.

Other features that only Microdot offers include a complementary pulse output and a special audio mode. In the audio mode the frequency dial selects only from the band of 20 Hz to 20 kHz.

Functions provided by the 511 include sine, square and triangular wave, pulse and inverted pulse. In addition ± 10 V peak into an open circuit or ± 5 V peak into 50 Ω of offset voltage are available. If only a dc level is desired, with no function overlaid upon it, a pushbutton is provided to call dc alone.

All waveform generators in this class also provide a triggered gate input. This allows for tone burst generation, or for the calling of one or more cycles of any particular waveform.

In addition to the 511, Microdot is also introducing a lower-performance, 10-MHz waveform generator called the 510 and a 5-MHz waveform generator called the 501.

They are priced at \$495 and \$395, respectively. When lined up against their respective competitors, these generators also come in at a lower price with competitive features. All three of the new Microdot waveform generators use a similar package design.

| | |
|-----------------|----------------|
| FOR MICRODOT: | CIRCLE NO. 252 |
| FOR WAVETEK: | CIRCLE NO. 253 |
| FOR EXACT: | CIRCLE NO. 254 |
| FOR INTERSTATE: | CIRCLE NO. 255 |

Desk calculator features 8-digits 2x5x9-in. size



Eldorado Electrodata Corp., 601 Chalomar Rd., Concord, Calif. (415) 686-4200. \$180; stock.

The Models 8K and 8M electronic calculators combine a standard sized keyboard with a large, bright display to give a full time desk calculator that will fit in a briefcase. The Model 8K features: four functions with floating and fixed decimal point selection; constant multiply/divide key and true credit balance. The display is an easy to read 8-digit display with overflow indicator, automatic leading zero suppression and 100,000 hour life expectancy. The unit uses single multi-function LSI chip. The Model 8M which is aimed at the mass consumer market, has the same features as the Model 8K with exceptions of having floating decimal only and no constant multiply/divide capability.

CIRCLE NO. 336

Dual-trace 10 MHz scope is portable



Tektronix, Inc., P.O. Box 500, Beaverton, Ore. (503) 644-0161. \$1650.

Model 326 oscilloscope combines dual-trace convenience and portability in a small, rugged battery-operated package measuring 3.9 in. by 8.6 in. by 13.6 in. and weighing less than 12 lbs. Bandwidth is 10 MHz at 10 mV/div, dropping to 5 MHz at 1 mV/div. Sweep rate extends to 0.1 μ s/div. Signal delay allows viewing the display leading edge. Internal batteries provide up to 4 hours operation, but external dc source of 7.2 V to 32 V may be used. The 326 is manufactured by Sony/Tektronix Corp., Tokyo.

CIRCLE NO. 337

Digital panel meter has Numitron display



Electro-Numerics Corp., 2961 Corvin Dr., Santa Clara, Calif. (408) 738-1840. \$200-\$400; stock.

A full 4-1/2-digit panel meter, the Model 375, has a single plane display that is brighter, can be viewed at wider angles and is useful in higher ambient light levels. Its color can be changed with light filters. Both dual-slope integration and true digital storage are provided in the Model 375. The display can be tested to see that all segments are working by simply removing the bezel and shorting two traces together at the front of the printed circuit card.

CIRCLE NO. 338

Single input microwave counter handles 18 GHz



Hewlett-Packard, 1501 Page Mill Rd., Palo Alto, Calif. (415) 493-1501. \$5300; May 1972.

The 5340A automatically measures frequencies from dc to 18 GHz through a 50 Ω input connector. The instrument triggers on signals as low as -35 dBm to 12.4 GHz and -25 dBm to 18 GHz. The display shows eight digits with automatically positioned decimal point in units of kHz, MHz or GHz. A front-panel switch selects display resolution from 1 Hz to 1 MHz. Finer resolution at the higher frequencies is obtained by overflowing the most significant digit of the display. The counter handles signals from -35 dBm to +7 dBm. Damage level is high: typically +30 dBm \pm 7 V dc.

CIRCLE NO. 339

Checker tests junctions of solid-state devices



Kurz-Kasch, Inc., 1421 S. Broadway, Dayton, Ohio. (513) 223-8161. \$44.95.

The JV-1505 checks the operating condition of any junction on most solid-state devices in use. The JV-1505 tests for: junction open; junction shorted; junction conducting; and direction of current flow. The tester can be directly connected in circuits of 10 μ F shunt capacitance or less and 1500 Ω shunt resistance or more. The tester uses a unique digital technique that samples both forward and reverse current. Results are displayed on illuminated-diode symbols on the front panel.

CIRCLE NO. 340

Data test set measures transmission errors

Computing Devices of Canada Ltd., sub. of Control Data Corp., P.O. Box 8508, Ottawa, Canada. (613) 829-1800.

Data test set DTS-101 measures bit and block error-counts and turn-around time on data transmission facilities. A choice of 16 baud rates are selected from the front panel control. Error counts and turn-around time are indicated on a three-LED display indicating from 0 to 999 plus overflow. The unit features a selection of four pseudo-random word lengths, reversals, continuous spacing and continuous marking.

CIRCLE NO. 341

DPM has floating differential inputs

Analogic, Audubon Rd., Wakefield, Mass. Phone: (617) 246-0300. P&A: \$95 (100 quantities); stock to 3 wks.

Analogic's new 3-1/2 digit DPM features 0.1% accuracy at low-cost. Typical stability is 55 ppm/C over 0 to 50 C. The true instrumentation-type floating differential input is available for both unipolar and bipolar inputs. Full scale including overrange is 1.999 V or 199.9 mV. The unit operates from 100 to 240 V ac and, occupying only 19.7 in.³ behind the panel, is fully serviceable from the front.

CIRCLE NO. 342

Impulse 100 ps wide has a broad spectrum

Ikor, Inc., Northwest Industrial Park, Burlington, Mass. (617) 272-4400.

Ikor's pulse generator has kilovolt impulse output of 100 ps width, providing a flat instantaneous spectrum to beyond 1 GHz. Output level is 120 dB above 1 μ V/MHz. The impulse generator is used in RFI/EMC testing and transient response studies. Repetition rate is 1 kHz. An ultra-wideband antenna available, when used with the generator, provides radiation levels over a nearly flat spectrum from 100 MHz to 7 GHz.

CIRCLE NO. 343

If you've been looking for a miniature crystal-controlled clock oscillator in a 14 pin DIP package to fit standard PC board sockets, stop looking and start ordering. Get details on model K1091A from Motorola Component Products Dept. 4545 W. Augusta Blvd. Chicago, Ill. 60651.  *MOTOROLA*

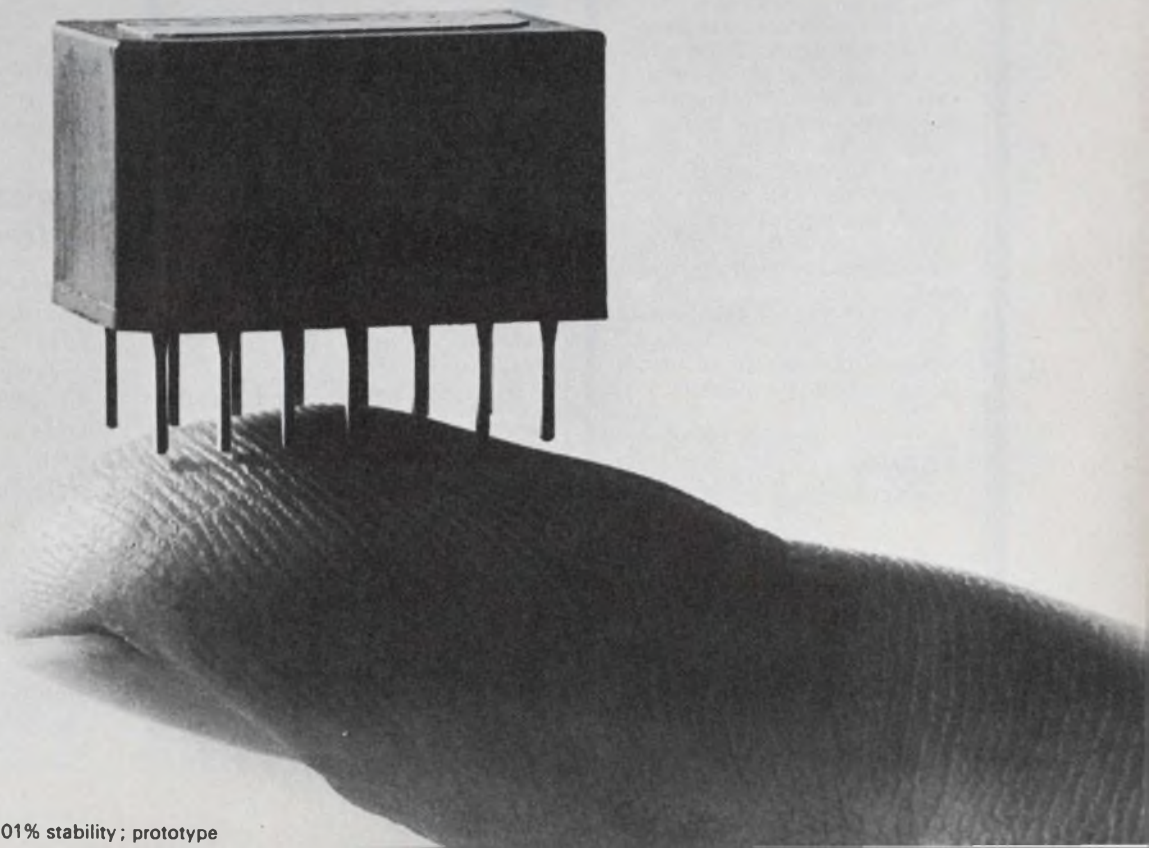

Specifications: 4 to 20 MHz range; 0.01% stability; prototype

Digital Guardmate™

the Secret's
in the
Third Lead!



In addition to the conventional red and black test leads, our Digital GUARDMATE has a third lead which offers an exclusive In-Circuit testing capability.

The third lead puts a patented Guard Circuit to work, electronically isolating the component under test from all unwanted parallel circuit paths. This is the same Guard Circuit that has been proven by years of operation in Systemation's \$40,000 production PC board testing systems.

The Digital GUARDMATE not only tests capacitors, resistors, diodes, transistors, SCRs and ICs with extreme $\pm 0.2\%$ accuracy, but it is the only inexpensive, digital instrument that can make in-circuit tests of such components on PC boards. You may save half your testing and troubleshooting costs simply by using the Digital GUARDMATE, the test instrument with the third lead.

IN-CIRCUIT-TESTING is as simple as A,B,C! To test R_1 , connect test leads to A and B, and Guard lead to C. Read the meter.

ONLY
\$985.00
COMPLETE

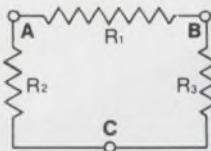

A-105 **Systemation Inc.**

Clifton Park, Elora, New York 12065
Telephone: 518-877-7424

INSTRUMENTATION

Mini calculator weighs just over a pound



Singer Co., Friden Div., 2350 Washington Ave., San Leandro, Calif. (415) 375-6800. \$325.

The 1008 is Singer's entry in the mini calculator field. Five by seven inches in size and weighing just over a pound, the calculator has an eight-digit fluorescent display, positive and negative multiplication and true credit balance. When the circuit's capacity is exceeded, the most significant first eight digits are protected by shifting excess digits to the right. A rechargeable self-contained battery gives cordless power. Alternately, the device plugs into a standard power outlet.

CIRCLE NO. 344

Rf network analyzer has range of 0.4 to 500 MHz



General Radio, 300 Baker Ave., Concord, Mass. (617) 369-4400. \$6850.

The 1710 RF Network Analyzer provides precise measurements of transmission and reflection properties, including magnitude, phase, group delay, and S parameters. It features a 115-dB dynamic range, 0.005-dB resolution, and the ability to operate into 50 or 75 ohms without performance degradation. A tracking detector, processor, and display scope are integrated into the analyzer.

CIRCLE NO. 345

10-MHz oscilloscopes are low-priced

Thornton Associates, 87 Beaver St., Waltham, Mass. (617) 899-1400. \$425, \$495; 60 days.

Series 300 low price oscilloscopes have dc to 10-MHz bandwidth, functionally grouped and color coded push button switching, and linear slide controls for easy trace positioning. Input resistance is 1 M Ω with vertical sensitivity from 5 mV/div to 50 V/div in 2% accurate calibrated decade steps. Sweep speed ranges from 100 ms/div to 1.0 μ s/div. The viewing area is divided into 8 \times 10 divisions. Type 310 is single trace, type 320 is a dual-trace model.

CIRCLE NO. 346

Meter reads currents as low as 1 pA

RCA, Test Equipment and Accessories, 415 S. 5th St., Harrison, N.J. (201) 485-3900. \$250.

A new sensitive meter, RCA WV-511A measures currents as low as one pA. Eighteen overlapping ranges from 0.1 nA to 30 mA have $\pm 3\%$ FS accuracy, and zero drift less than $\pm 2\%$ FS over 24 hrs. Other features include a zero-center scale and a recorder output connector. The chassis-isolated input terminals permit measurements in circuits up to 1000 V above ground. Where an electrometer-type voltmeter is required, the instrument will do the job, measuring 10 mV FS with an input resistance of 100 M Ω on the 0.1 nA scale.

CIRCLE NO. 347

Digital multimeter is frequency counter

California Instruments Co., 5150 Convoy St., San Diego, Calif. (714) 279-8620.

Frequency measurements up to 10 MHz in addition to ac volts, dc volts and resistance can be made with the Model 8421 digital multimeter. A 100% overrange capability is provided on all scales. Resolution of the 4-digit instrument is 1 part in 20,000 at 100% overrange or the equivalent of a 5-digit meter. Accuracies are 0.01% on dc, 0.1% on ac, 0.02% on resistance and frequency. Measurements are indicated by a 5-digit LED display.

CIRCLE NO. 348

If you add one of our 10 Amp Darlingtons to your application design...

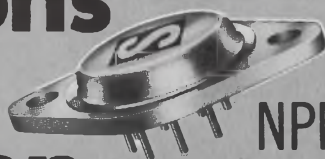

NPN/PNP

Available in an eight-lead TO-3 case, the SDM 3000 features:

- V_{CE0} from 40V to 120V
- Multiple Gain Selections @ 1.0A and 5.0A
- Typical 5.0A H_{FE} 5000 minimum
- Low Leakage Planar Construction (less than 100 μ A @ 80% of V_{CE0})
- High Speed ($f_t = 40$ MHz typical, rise and fall times 200 ns typical)
- θ_{JC} less than 2.5° C/W

TYPICAL SDM 3000 CIRCUIT DIAGRAMS

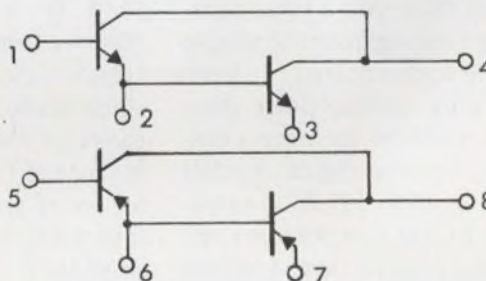

More performance for the money.* Solitron's new SDM 3000 Series of complementary 10 Amp NPN/PNP Silicon Power Darlingtons is the ultimate in state-of-the-art design. They're dual monolithics that represent a unique combination of power transistor capability and performance. Just one of these multi-purpose devices replaces four transistors with improved reliability.

* \$22.00 each in 1-99 quantities

you can subtract four transistors!

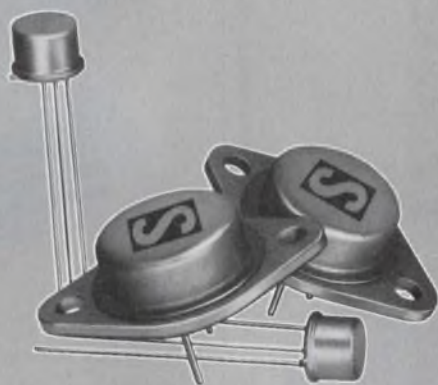

For complete information, prices and engineering application assistance, dial toll-free 1-800-327-3243. Or write:

Solitron

DEVICES, INC.

1177 BLUE HERON BLVD. / RIVIERA BEACH, FLORIDA / (305) 848-4311
TWX: (510) 952-7610

SAN DIEGO, CAL
8808 Balboa Avenue
FET & Dual FET
Transistors
MOS/FET Devices
MOS Memory Arrays
Shift Registers
Monolithic IC's
Small Signal
Transistors

RIVIERA BEACH, FLA
1177 Blue Heron Blvd
Hi-Rel Power Transistors
Si & Ge Power
Transistors
Hi-Rel Power Hybrids
PNP-NPN Industrial
Transistors

PORT SALERNO, FLA
Cove Road
Microwave Connectors
Plaxial (R) Cable
Precision RF Coaxial

JUPITER, FLA
1440 W. Indiantown Rd
Microwave Stripline
Components
Microwave Diodes
RF and Microwave
Transistors
Hi-Rel Power
Transistors

TAPPAN, N. Y.
256 Oak Tree Road
Diodes & Rectifiers
Zeners
High Voltage
Assemblies
Power Rectifiers
Thick Film Hybrid
Circuits
Ferrite & Ferrite Devices
Film Resistors

KENT, ENGLAND
Tubbs Hill House
London Road,
Sevenoaks
Solidev, Ltd
Full line of
Solitron devices

BEN BARAQ, ISRAEL
51 Hayarkon Street
AEL Israel, Ltd.
Full line of
Solitron devices

TOKYO 105, JAPAN
No. 5, 3-Chome
Shibahamamatsu-Cho
Minato-Ku
Matsushita Electric
Trading
Full line of
Solitron devices

INFORMATION RETRIEVAL NUMBER 95

Name your stepper motor needs. Chances are we can meet them. Off-the-shelf.

Whatever your design requirements . . . step angle, stepping speed, torque, direction of rotation . . . yes, even price . . . you can save time and money by talking to THE Stepper Motor People first. The A. W. Haydon stepper motor line is one of the most complete, most versatile and most economical available.

We offer you a total capability ranging from the simple to the sophisticated . . . from low-cost 2-phase pulse steppers at \$5.94 to more complex, 8-phase digital models costing up to \$67.75 in quantities of 100. Inexpensive logic cards, variable speed drives

or specially designed systems engineered to your requirements are also available.

Step angles? Name them. With our pulse steppers, you have an unlimited selection. As for our digital models, you can specify angles of $3\frac{3}{4}^\circ$, 7° , 15° , 30° , 45° , or 90° , pull-in rates to 1200 steps/sec and torque to 22 oz-in.

Mind you, this is all off the shelf. So, why shop around? Write For Stepper Motor Handbook Here's a clear, concise exposition of the why's and wherefore's of PM stepper motors. It's a MUST for every system designer. Send for it.

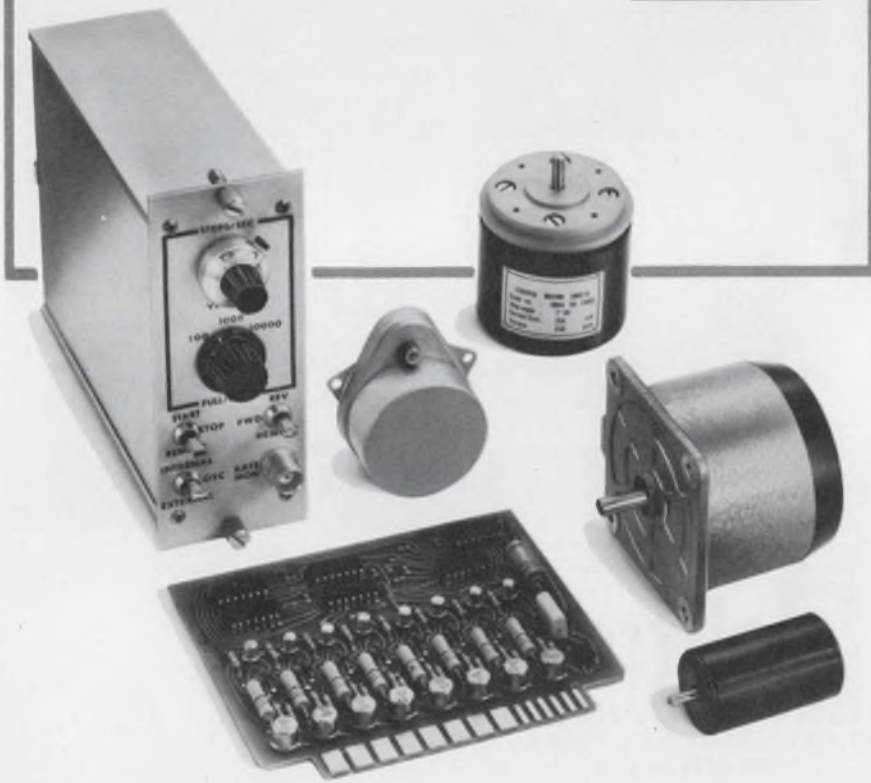

A.W. HAYDON PRODUCTS

NORTH AMERICAN PHILIPS CONTROLS CORP.

A NORTH AMERICAN PHILIPS COMPANY
232 North Elm St. · Waterbury, Conn. 06720 · (203) 756-4481

INFORMATION RETRIEVAL NUMBER 96

INSTRUMENTATION

Bridge measures from 1 milliohm to 1 gigaohm



Hickok Electrical Instrument Co.,
10514 Dupont Ave., Cleveland,
Ohio. (216) 541-8060. \$780; Stock.

The DP170/3202P resistance bridge provides 3-digit resolution over its 10 decade ranges from $1\ \Omega$ to 1000 M Ω . Overranging is 100% on the eight most sensitive ranges $1\ \Omega$ to 10 M Ω . Accuracy is nominally 0.1% of reading $\pm 0.1\%$ of range. Maximum power to the device under test ranges from 100 nW on the 1000-M Ω range to 2.5 mW on the $1\text{-}\Omega$ range.

CIRCLE NO. 349

Logic card tester makes field checks



Data Test Corp., 822 Challenge Dr.,
Concord, Calif. (415) 689-3583.
\$3750; 30 days.

The Model 2000, a portable digital logic-card tester, features a hand-held, high-temperature probe for inspection and diagnostic analysis. Boards are tested by plugging them into universal connector mounting hardware. Overlay templates for the matrix switch permit rapid set-up of internal test circuitry. The Model 2000 tests each output or intermediate point in a digital circuit by displaying, on the probe, the number of truth table transitions occurring between the inputs and the connection probed.

CIRCLE NO. 350

If you're not a statistician or a market researcher, don't read this page.

Model 1766. The Statistician. Available everywhere in the USA and Canada. Call (800) 631-1971 free for the Monroe office nearest you. In New Jersey call (800) 962-2804.

Single key summation of x , x^2 and n .



Two-key automatic summation of grouped data.



Two-key automatic summation of paired data accumulates xy , n , x , x^2 , y , and y^2 factors.



10 completely separate storage registers with complete entry, recall, transfer and accumulation flexibility.



Up to 256 steps of decision-making learn-mode programming. Accessory card reader available for automatic entry of programs.



Special keyboard functions for:

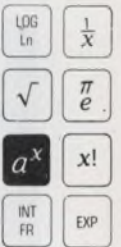

Single-key computation of mean and standard deviation from automatically accumulated data.



Selective printout of entries and answers.

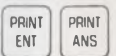

 **Monroe. The Calculator Company.**

550 Central Avenue, Orange, New Jersey 07051
81 Advance Road, Toronto 18, Ontario, Canada

INFORMATION RETRIEVAL NUMBER 97



not
for
everybody

UL Recognized RFI/EMI Filters for Data Processing Equipment

RtroN has developed 14 stock filter types (U.L. specification 478), for the RFI/EMI suppression requirements of data processing equipment. Terminal and bracket variations cover virtually every mounting need.

Custom designed multi-circuit RFI/EMI Filters in square, rectangular, bathtub and other enclosures are available.

Whatever your filtering needs may be, RtroN can design, produce, and deliver high reliability filters on time.

Phone or write for complete details.

RtroN

P.O. Box 743, Skokie, Ill. 60076

312 • 327-4020

INSTRUMENTATION

Frequency meter spans 100 kHz to 105 MHz



Rohde & Schwartz Sales Co.
(U.S.A.) Inc., 111 Lexington Ave.,
Passaic, N.J. (201) 773-8010.

The new synthesizer-type FD 100 frequency meter has a fundamental range of 100 kHz to 105 MHz with harmonics to 1000 MHz. The meter can be locked in 1 kHz steps with crystal accuracy and can be finely tuned to ± 20 Hz. Available as an accessory is a counter which sets the frequency to ± 1 Hz. The beat frequency is monitored using a loudspeaker or headphones, applied to a broadband output, or is indicated on a panel meter with six ranges 30 Hz to 30 kHz. A 3-V analog output is available for recording.

CIRCLE NO. 351

Recorder has 18 ranges and 0.25% accuracy



Siemens Corp., 186 Wood Ave. S.,
Iselin, N.J. (201) 494-1000.

A potentiometric recorder, the Kompensograph III, features a linearity of 0.1%. Forward and reverse recording have also been incorporated into the continuous line recorder. The unit is available as a single or double channel recorder for the indication of small measured values. Its high accuracy and sensitivity, combined with response times of 0.25 or 0.5 s together with in-built interference suppression, permit use in laboratories, test departments and control rooms. The Kompensograph III has 11 voltage ranges and 7 current ranges. Paper feed, both forward and backward, is selectable from 0.02 in./min to 47 in./min.

CIRCLE NO. 352

Stable pulse generator operates at 250 kHz



Berkeley Nucleonics Corp., 1198
Tenth St., Berkeley, Calif. (415)
527-1121. \$1450; stock.

A solid-state, precision pulse generator, the P4-B, has a pulse temperature stability better than ± 5 ppm/ $^{\circ}$ C and a linearity of ± 5 ppm. The generator can be connected to a 50- Ω load without degrading these characteristics. The PB-4 has independently adjustable rise and fall times, as well as a maximum rep rate of 250 kHz.

CIRCLE NO. 353

Digital multimeter has 10 μ V resolution



Data Precision Co., Audubon Rd.,
Wakefield, Mass. (617) 246-1600.
\$680-\$775; stock to 30 days.

The Series 2400 4-1/2 digit multimeter has a range of 0.10000 V full scale extending to 0.12000 V on a 20% overrange. An optional feature provides ultra-stable operation, including a six months stability of $\pm 0.01\%$ reading ± 1 LSD, and a temperature coefficient of $\pm 0.001\%$ of reading $\pm 0.001\%$ of full scale per degree, from 0 to 50 C. The Series 2400 instruments have Tri-Phasic data conversion, Iso-Polar referencing circuitry, high common-mode and normal-mode rejection ratios, auto-ranging, external trigger and range capabilities, and isolated BCD output.

CIRCLE NO. 354

V CXOs

Get 'em straight from Damon!

Whether you're in a sweat on a VCXO prototype for a tough application – or need a production run in a hurry, you can get 'em straight from Damon. Speedy proficiency in design and production of VCXOs allows Damon to deliver all-silicon solid state devices with linearity to within 1% of best straight line and frequency deviation to $\pm 0.25\%$.

Just glance at the specification guide below for more good news on available characteristics. Computer-assisted designs are available, too. Ask Damon today for a quote on VCXOs tailored to your specifications – and deadlines. Call or write: Damon/Electronics Division, 115 Fourth Ave., Needham, Mass. 02194. Phone: (617) 449-0800.



Shown approximately 3/4 size

SPECIFICATION GUIDE*

| Parameter | Basic and Multiplier VCXOs | Mixer and Mixer-Multiplier VCXOs |
|--------------------------------------|--------------------------------------|------------------------------------|
| Center Frequency | 1 KHz to 300 MHz | 100 Hz to 300 MHz |
| Frequency Deviation | $\pm 0.01\%$ to $\pm 0.25\%$ of C.F. | ± 10 Hz to ± 1 MHz |
| Frequency Stability 24 hr. @ 25°C | ± 1 to ± 10 ppm | $\pm 0.5\%$ of peak deviation |
| 0 to 65°C (no oven) | ± 10 to ± 50 ppm | $\pm 2\%$ of peak deviation |
| Linearity | to within 1% of best straight line | to within 1% of best straight line |
| Minimum Deviation Rate | 0 (dc) | 0 (dc) |
| Maximum Deviation Rate | 0.2% of C.F. (100 KHz max.) | 10 KHz to 100 KHz |
| Mod. Voltage (Typical) | ± 5 V peak | ± 5 V peak |
| Mod. Input Impedance | >50 K ohms | >50 K ohms |
| Output Power Available | 0.5 mw to 20 mw | 0.5 mw to 20 mw |
| Load Impedance | 50 ohms to 10 K ohms | 50 ohms to 10 K ohms |
| Power Requirements (Typical) | -25 V ± 1 V @ 30 ma | -25 V ± 1 V @ 40-50 ma |
| C.F. Manual Adjustment Range | $\pm 0.01\%$ | $\pm 5\%$ of peak deviation |

* Obviously, the limits are not absolute. The interrelationship of parameters for VCXOs are of such a nature as to permit optimization of any one or more characteristics to satisfy customer requirements.



Signal generator covers 10 to 512 MHz



Hewlett-Packard Co., 1601 California Ave., Palo Alto, Calif. (415) 493-1501. \$1135.

With calibrated and automatically leveled output, model 8654A signal generator covers the range from 10 to 512 MHz. Extensive rf shielding allows receiver sensitivity measurements at the 1- μ V level. Calibrated power levels between +3 dBm and -120 dBm into a 50 Ω load are automatically held constant to ± 1 dB over the entire frequency range. Internal oscillators provide AM or FM at 400 and 1000 Hz.

CIRCLE NO. 355

Temperature-humidity chamber on a bench



Tenney Engineering, Inc., 1090 Springfield Rd., Union, N.J. (201) 686-7870.

A temperature-humidity chamber has been added to the company's existing line of bench-top environmental test cabinets. It offers work space dimensions of five cubic feet and has a temperature range of -100 to +350 F. The chamber is furnished complete, ready for the buyer to plug into ordinary 208/230 volt single phase power. Also, no external vapor hook-up is required.

Booth No. 2009 Circle No. 324

Capacitances measured with a digital display



Spearhead, Inc., 1401 Cedar Post Lane, Houston, Tex. (713) 464-4882. \$1150; 6 wks.

Series 2350 digital capacitance meter measures capacitance continuously and automatically with readout on a 3-1/2 digit display. The device has both analog and optional BCD outputs. Readings are unaffected by cable capacitance or stray coupling to ground. Difference or deviation measurements can be made to 0.001 pF. Series 2350 measures capacitors from 0.1 to 200 pF. With the 2351 unit, range is extended to 2000 pF.

CIRCLE NO. 356

"MOON STUFF"

ONEIDA PERMABOND Instant Weld cyanoacrylate adhesive is a new generation of space-age miracle adhesives.

If you have used cyanoacrylate adhesives before, you will find that ONEIDA PERMABOND Instant Weld is a genuine improvement—if you haven't used them, you are in for a real experience.

ONEIDA PERMABOND Instant Weld will replace just about all mechanical fasteners—saving time, cutting costs, and resulting in a greatly improved product.

It works with plastics, phenolics, ceramics, glass and metal. It sets-up in seconds with only finger pressure and no heat.

It is used in trains, planes, ships and has been to the moon in our Apollo Program; it has been to the depths of the ocean in our Polaris Program.

ONEIDA PERMABOND Instant Weld is used by Grumman Aircraft, Bulova Watch, Ford Motor and most of Americas' best known industries.

Mr. Hecht of the Hecht Rubber Corporation, Jacksonville, Florida uses ONEIDA PERMABOND to bond rubber into elaborate fabricated assemblies. ONEIDA PERMABOND was chosen over all other adhesives for this exacting work.



ONEIDA PERMABOND Instant Weld can help you as well! Check it out yourself by ordering our Engineering Evaluation Kit of five assorted two-gram tubes for only \$7.50.

The unsurpassed performance of ONEIDA PERMABOND as a rubber bonding agent makes possible our fabulous ORK-1 Drive Belt and "O" Ring Kit. This Kit is a "must" in all laboratories and engineering design facilities. With this Kit, replacement belts and "O" rings can be made on the spot. New ideas and new designs can be checked out without delay and expense of a prototype mold.

ONEIDA Electronic Mfg. Inc.

843 Cottage Street
Meadville, Pa. 16335
Telephone (814) 336-2125

MORE SWITCH FOR LESS MONEY

NEW

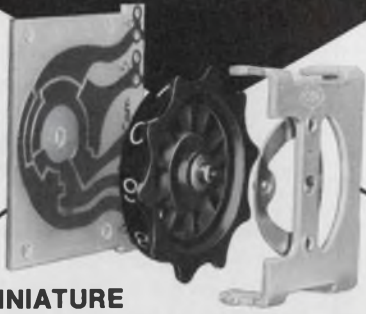

MINIATURE PRECISION THUMBWHEEL SWITCH

1,000,000 Detents (for quality)
Low Cost (for savings)

9 TOP QUALITY FEATURES

1. .05 ohms max. contact resistance.
2. 200 megohms min. insulation.
3. 1,000 volts min. dielectric strength.
4. 2 amps @ 115VAC current carrying capability.
5. 125 ma @ 115VAC current breaking capability.
6. Mounts on 1/2" centers only 1 1/2" behind panel.
7. Glass laminate with precious metal contacts & plating.
8. Multi-applications—you name it.
9. Over 1,000,000 detents.

IMMEDIATE DELIVERY . . . ASK THE PRICE—
BE PLEASANTLY SURPRISED.

CDI Covers The Spectrum of Switches Saves You Space • Effort • Time • Money

THUMBWHEEL SWITCHES



Completely sealed against hostile environments.



Mounts on 1/2" centers, retrofits most panel openings for miniature thumbwheel switches.

ROTARY SWITCHES

Snap-in, snap-out modules in seconds, eliminating downtime.

Tabet Pat.
2841660,
2971066,
3015000,
2856131,
2988607.



PUSHBUTTON SWITCHES



Miniature add/subtract units retrofit most minithumbwheel switch panel openings.

CDI earns its reputation every day for Consistently High Quality, Consistently Good Delivery.



CHICAGO DYNAMIC INDUSTRIES, INC.

PRECISION PRODUCTS DIVISION
1725 Diversey Blvd., Chicago, Illinois 60614
Phone: 312, 935-4600

**PROVEN RELIABILITY—
SOLID-STATE POWER INVERTERS,
over 260,000 logged operational hours—
voltage-regulated, frequency-controlled,
for missile, telemeter, ground support,
135°C all-silicon units available now—**

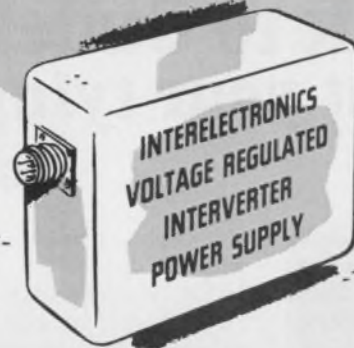

Interelectronics all-silicon thyatron-like gating elements and cubic-grain toroidal magnetic components convert DC to any desired number of AC or DC outputs from 1 to 10,000 watts.

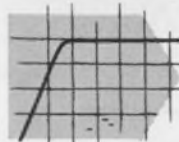

Ultra-reliable in operation (over 260,000 logged hours), no moving parts, unharmed by shorting output or reversing input polarity. High conversion efficiency (to 92%, including voltage regulation by Interelectronics patented reflex high-efficiency magnetic amplifier circuitry.)



Light weight (to 6 watts/oz.), compact (to 8 watts/cu. in.), low ripple (to 0.01 mv. p-p), excellent voltage regulation (to 0.1%), precise frequency control (to 0.2% with Interelectronics extreme environment magnetostrictive standards or to 0.0001% with fork or piezoelectric standards.)



Complies with MIL specs. for shock (100G 11 msec.), acceleration (100G 15 min.), vibration (100G 5 to 5,000 cps.), temperature (to 150 degrees C), RF noise (I-26600).



AC single and polyphase units supply sine waveform output (to 2% harmonics), will deliver up to ten times rated line current into a short circuit or actuate MIL type magnetic circuit breakers or fuses, will start gyros and motors with starting current surges up to ten times normal operating line current.



Now in use in major missiles, powering telemeter transmitters, radar beacons, electronic equipment. Single and polyphase units now power airborne and marine missile gyros, synchros, servos, magnetic amplifiers.

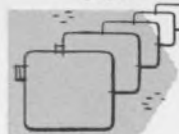

Interelectronics—first and most experienced in the solid-state power supply field produces its own all-silicon solid-state gating elements, all high flux density magnetic components, high temperature ultra-reliable film capacitors and components, has complete facilities and know how—has designed and delivered more working KVA than any other firm!

**INTERELECTRONICS CORPORATION
550 U. S. Route 303, Congers, N. Y.
Telephone: 914 ELmwood 8-8000**

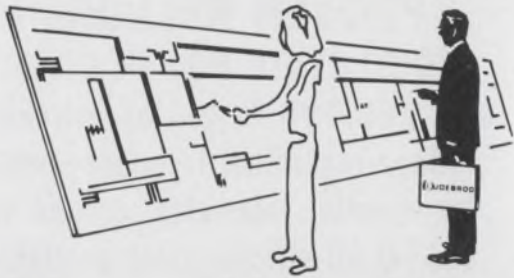

Talk to Gudebrod about your tying operation this month...

And about Lacing Tapes, harness rooms and systems. About temperature and vibration . . . speed and rejects! About Nylon, Dacron, Teflon, Nomex, Glass tapes and cords—treated and untreated . . . that meet or exceed military and industrial specifications, about cost comparisons with other methods . . . and all backed up with one hundred years of manufacturing knowledge.

Dacron, Teflon, Nomex—Du Pont Registered Trade Marks

Talk to Gudebrod this month!

Write to this address for prompt return of our
Product Data Catalog.

Electronics Division
Dept. 433

Gudebrod Bros. Silk Co., Inc. 12 South 12th Street, Philadelphia, Pa. 19107

INFORMATION RETRIEVAL NUMBER 103

Optima Enclosures on display · IEEE · booth 1302 Floor 1

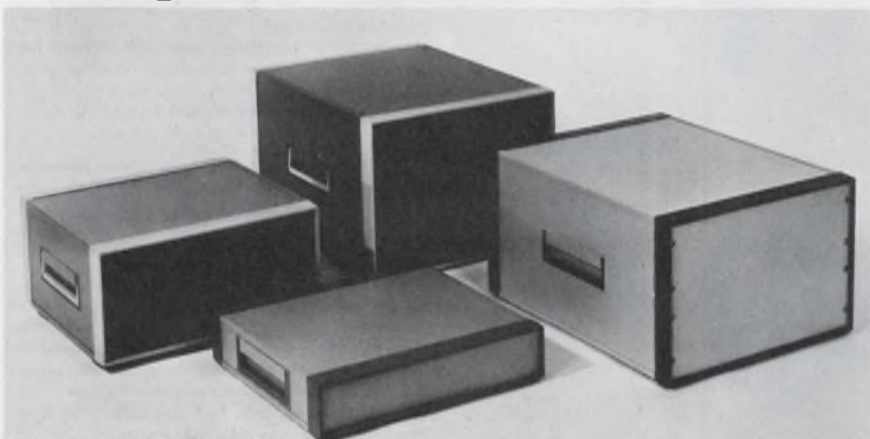

Write or call for a free catalog

optima enclosures
a division of Scientific-Atlanta, Inc.



2166 Mountain Industrial Blvd. Tucker, Georgia 30084 Telephone 404-939-6340

INFORMATION RETRIEVAL NUMBER 104

INSTRUMENTATION

Meter measures phase and amplitude to 13 MHz



Hewlett-Packard, 1501 Page Mill Rd., Palo Alto, Calif. (415) 493-1501. \$2450; 6 weeks.

The Model 3575A gain and phase meter has an 80-dB dynamic range from 1 Hz to 13 MHz. Input signal levels from 0.2 mV to 20 V are handled. Phase and amplitude accuracies depend upon frequency and signal level. At signal levels less than 10 kHz and 20 mV, phase accuracy is ± 0.5 degrees. Amplitude accuracy, above about 2 mV and below 1 MHz is ± 1 dB. Resolution of the digital readout is 0.1 degree for phase, and 0.1 dB for amplitude. Reading rate is 4 per second. With a 10:1 divider probe, signals up to 200 volts can be measured.

CIRCLE NO. 357

14-digit calculator has two memories



Singer Co., Business Machines Div., 2350 Washington Ave., San Leandro, Calif. (415) 357-6800. \$595; stock.

A 14-digit calculator with two memories and two operating registers, the Friden 118 electronic calculator measures 4-inches high, 10-1/2-inches wide and 12-1/8-inches deep. A self-contained, fold-away carrying handle makes the machine portable in an instant. The 14-digit nixie display features a algebraic sign and decimal point, as well as the "underflow" principle. When the display can handle no more numbers in a calculation it eliminates excess digits from the right.

CIRCLE NO. 358

Harris 1024-bit PROMs™

Phone by 4:00.

We ship by 5:00.

Sitting on our shelves.

Weatherford has the new 1024-bit Programmable ROM (PROM) from Harris Semiconductor, in quantity NOW, just waiting for your order.

It offers all the features you need in a large-capacity ROM: 256 x 4 organization, 50 ns access time, DTL/TTL compatibility, fully decoded circuitry. Reliability is documented by 260 million fuse hours of life test data.

Two outputs are supplied, the open-collector HPROM-1024A and the tri-state HPROM-1024, in 0° to +75°C temperature range. All are electrically identical and pin compatible with other 1024-bit devices.

Priced right, delivered sudden.

Because we have them, we can offer you standard Weatherford delivery on these units: We'll ship your order on the same day you place it. And at the right prices, too.

| Harris Part No. | 100-999 Pieces | Equivalent MMI Part No. |
|-----------------|----------------|-------------------------|
| HPROM-1024A | \$55.00 | MM6300 |
| HPROM-1024 | 55.00 | — |

Programing, anyone?

If you need your 1024-bit PROM (or any Harris PROM, for that matter) programmed, Weatherford does that too. Send your truth table and our fast-reaction Custom Components Department will have your PROMs programmed and on their way within three days, normally. If you need them faster, we'll do them faster. That's why people say we're more than just a distributor. Call us.

Albuquerque: (505) 265-5671

Anaheim: (714) 547-0891

Austin: Enterprise 1443

Dallas: (214) 231-7141

Denver: (303) 427-3736

Glendale: (213) 849-3451

Houston: Enterprise 1443

Palo Alto: (415) 321-5373

Phoenix: (602) 272-7144

Pomona: (714) 623-1261

San Diego: (714) 278-7400

Seattle: (206) 762-4200

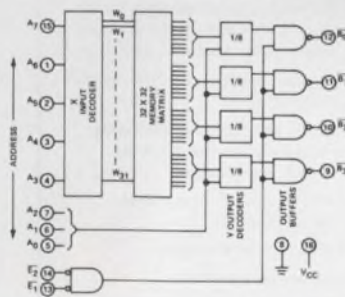

WEATHERFORD

Schottky TTL line boasts upgraded speed

Fairchild Semiconductor Components, 464 Ellis St., Mountain View, Calif. (416) 962-3816. \$1.47-\$3.26 (100-999).

Eight second-source SSI devices are the first Schottky TTL products to be announced by Fairchild. These super high-speed devices are designated as the 9S series and are

designed as pin-for-pin replacements for 54/74 and 9N series standard TTL/SSI units. The devices have typical gate propagation delays of only 3 ns and typical power dissipation of only 22 mW per gate. The new units also offer high noise margin and fanout (more than 10 TTL unit loads) and are completely compatible with other TTL products.

CIRCLE NO. 359

MOS shift registers are bipolar-compatible

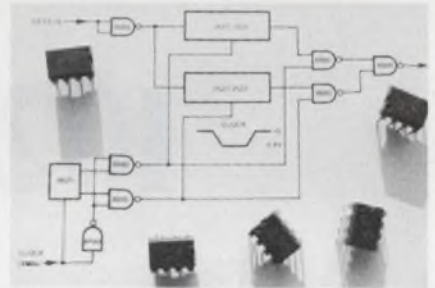

Signetics, 811 E. Arques Ave., Sunnyvale, Calif. (408) 739-7700. \$5.00 (250-999); stock.

Two MOS static shift registers—one a dual 128-bit device (2521 V) and the other a dual 132-bit register (2522 V)—are designed for use in low-cost sequential access memories, static buffer memories, line storage for CRT refresh memories, in-line printers and cassette recorders. Push-pull outputs are featured in these integrated circuits, and a recirculation path for logic is included on the chips of both ICs. Typical clock rate is 2 MHz. Typical input load and clock leakage currents are 10 nA and power supply current is 28 mA during continuous operation. The data input and clock capacitances are less than 5 pF.

CIRCLE NO. 360

WALL PLUG-IN POWER SUPPLY / CHARGER

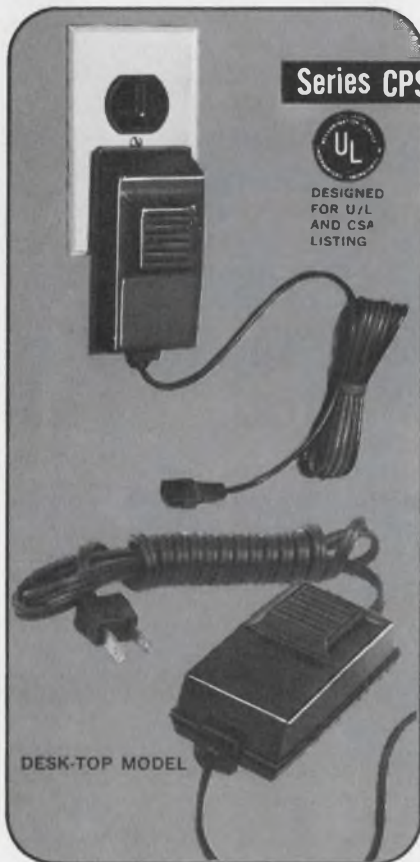

Series CPS-4.5

Ideally Suited to
PORTABLE BATTERY OPERATED:

- MINI-CALCULATORS . . .
- COMPUTERS . . .
- CRT TERMINALS . . .
- KEYBOARD LOGIC CIRCUITS . . .
- SOLID STATE PORTABLE INSTRUMENTATION . . .

The Series CPS-4.5 has been designed specifically for use with sophisticated portable battery operated electronic equipment and instrumentation, where a compact power supply with close regulation and filtering is required for proper operation of the device, and where recharging of the equipment's self-contained power source is also required. It provides charging at a fast (C/1)*, modified fast (C/3) or standard rate (C/10). The charging circuit can be tailored to the exact requirements of the individual cell-manufacturer to ensure compliance with his warranty terms. In certain equipments, this unit can be designed to provide charging simultaneous with operation.

Dynamic wall plug-in supplies offer the instrument/equipment designer:

- Reduction or elimination of the costly need to submit your equipment for U/L and CSA investigation.
- Elimination of a major heat source within the equipment.
- Reduction in size and weight.
- Increased design flexibility.
- Simpler installation at lower cost.
- Faster, easier maintenance of the low voltage power source of your equipment.

*C/1 = full charge within 1 hour
C/3 = full charge within 3-4 hours
C/10 = full charge within 14-16 hours

Contact local Dynamic representative or Power Conversion Products, Sales Department, Extension 27 at our Plainview facility.

Transistors switch 0.25 to 10 A in 200 ns



Kertron, Inc., 7516 Central Industrial Dr., Riviera Beach, Fla. (305) 848-9606. KS6128: \$18 (100 quantities); KS6130: \$22 (100 quantities); stock.

High-current, fast-switching transistors have been added to the KS6100 line. The new devices, designated KS6127-30, offer increased current capability but still switch in less than 200 ns. The KS6127-8 (80 V and 40 V) switch at 15 A and the KS6129-0 (80 V and 40 V) at 20 A.

CIRCLE NO. 361



DYNAMIC INSTRUMENT CORP.

MANUFACTURERS OF POWER CONVERSION AND BATTERY CHARGING SYSTEMS TO THE ORIGINAL EQUIPMENT MANUFACTURER

PLAINVIEW, N. Y. 11803

(516) 694-6000

TWX 510-224-6482

CRT

DISPLAY SYSTEMS DISPLAY DEVICES

CELCO

ALPHA-NUMERIC DISPLAYS

INFORMATION RETRIEVAL

DEFLECTION YOKES



Best resolution, speed, sensitivity.
Low residual and LI².

FOCUS COILS



Static and Dynamic for
sharp, round, small spots.

DEFLECTION DRIVERS



Up to 120 V p-p, 16 A.
Wide Bandwidth.

VIDICON CAMERAS

COMPUTERS

WRITING

READING

CORRECTIVE FIELDS



Coils for centering, correction of
astigmatism, pincushioning.

CIRCUIT CARDS



Plug-in cards provide primary and
secondary beam control circuits.

LOW COST POSITIONERS

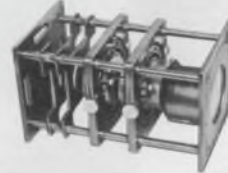

Low cost coil and tube positioners.
Positive spatial control.

ELECTROSTATIC PRINTING

SCAN CONVERTERS

BRIGHT DISPLAYS

MAGNETIC SHIELDS

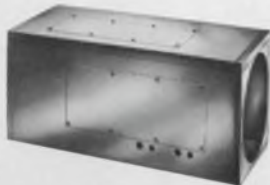

Positive exclusion of all stray magnetic fields.

RAMP GENERATORS



Dual X-Y ramps, 10 μ sec to 100 msec.
Variable rasters.

IMAGE ORTHICON CAMERAS

ELECTRON BEAM MACHINES

CRT SPOT ANALYZER

Determine CRT spot
characteristics,
phosphor noise, etc.,
on tube face.



COMPLETE DISPLAY SYSTEMS

Hi-Resolution X-Y monitor.
Linear to 0.1%,
fast, flexible.

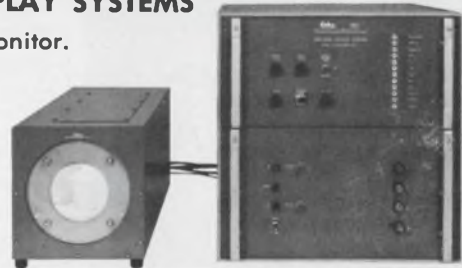

RASTER DISPLAYS

LINE SCANS

SPIRAL SCANS

MONITORS

CELCO

CONSTANTINE ENGINEERING LABORATORIES COMPANY

MAHWAH, N.J. 07430
201-327-1123
TWX 710-988-1018

UPLAND, CAL. 91786
714-982-0215
TWX 910-581-3401

INFORMATION RETRIEVAL NUMBER 107

If you can't stand
the heat ...

stay out
of the
kitchen!



Here are components that stand the heat ... and the cold (-55°C to $+125^{\circ}\text{C}$) without voltage de-rating. The dissipation curve is as flat as a pancake ... and the other specs are out of this world. Maybe your recipe calls for

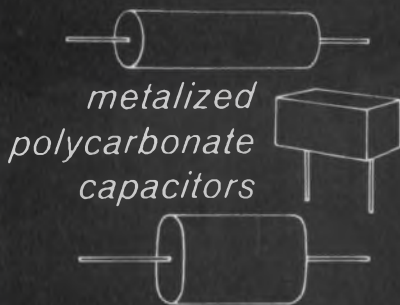

Try Standard's PC2-E (Rectangular Epoxy) and PC2-W (Wrap and Fill).

Send for Catalog and complete details.

Standard

CONDENSER CORPORATION

Dept. ED-8

1065 West Addison Street
Chicago, Illinois 60613 • (312) 327-5440

INFORMATION RETRIEVAL NUMBER 108

ICs & SEMICONDUCTORS

Planar diodes have
AuSi eutectic die-mounts



Solitron Devices, Inc., 1177 Blue Heron Blvd., Riviera Beach, Fla. (305) 848-4311. Stock.

A series of 5 A planar diodes feature fast recovery characteristics. The diodes, identified as the SDD500 Series and packaged in a DO-4 case, are the only ones of their type now available to the industry for hi-rel switching applications, including missiles, satellites and unmanned space flights. Features of these diodes are fast recovery (150 ns at 5 A); low leakage current (15 μA at 200 C); B_{VR} to 200 V.

CIRCLE NO. 362

SOS/MOS device
features 2 pA leakage

Inselek, University Park Plaza, 743 Alexander Rd., Princeton, N.J. (609) 452-2222. \$19.50 to \$36.73 (1-9 quantities).

The first MOS device with pico amp leakage and voltage matching of less than 10 mV uses silicon-on-sapphire technology. The L03 is a SOS/MOS multi-transistor featuring 2 pA leakage characteristics while at the same time offering a voltage matching capability on the order of 50 mV for the standard product. The excellent tracking between pairs of transistors in the L03 and L03M enable it to be used effectively as a high input impedance unity gain buffer in conventional op amps. The essential difference between conventional bulk silicon technology and SOS is the true dielectric isolation provided by the sapphire and the elimination of nonlinear capacitances at the input and output terminals.

CIRCLE NO. 363

Voltage comparator
has monolithic form

Intersil, 10900 N. Tantau Ave., Cupertino, Calif. (408) 257-5450. 8001C, \$3.00; 8001M, \$11.50; 100 quantities.

A monolithic IC voltage comparator, called the 8001 Precision Comparator, comes in two versions: the 8001M for operation over a temperature range from -55°C to $+125^{\circ}\text{C}$, and the 8001C for use between 0°C and $+70^{\circ}\text{C}$. Input bias current for the 8001M at $+25^{\circ}\text{C}$ is 40 nA typical, and 250 nA maximum over the entire military temperature range. Typical power consumption is 30 mW, typical response time is 250 ns. Offset voltage drift is 2 $\mu\text{V}/\text{C}$.

CIRCLE NO. 364

235-A SCR can
be used to 10 kHz



International Rectifier Corp., Semiconductor Div., 233 Kansas St., El Segundo, Calif. (213) 678-6281. \$63.10 (100-999 quantities); stock.

A 600 V, 235 A rms, SCR, the Type 151RF, features high speed and high dV/dt . The turn-off time is 20 μs , dV/dt is 200 V/ μs and dI/dt is 300 A/ μs . These characteristics, combined with low turn-on losses, make the SCRs suitable up to 10 kHz.

CIRCLE NO. 365

Part of a Complete Packaging Capability

CARD FRAME SYSTEM 3



Vero Card Frame System 3D now offers individual front panels on $\frac{1}{2}$ " and 1" pitch. Other features include:

- Individual card locking with one patented push-pull action
- 3U, 4U and 5U heights
- Maximum clear panel area
- Minimum number of component parts
- High quality finish
- Extraction tool for card removal
- Supplied fully assembled including guides at no extra cost
- Compatible - Veroboards, D.I.P. boards, D.I.Y. boards and Edge connectors also available
- stock delivery

VERO ELECTRONICS INC.

171 BRIDGE ROAD
HAUPPAUGE, N.Y. 11787
TEL: 516 234-0400
TWX: 510 227-8890

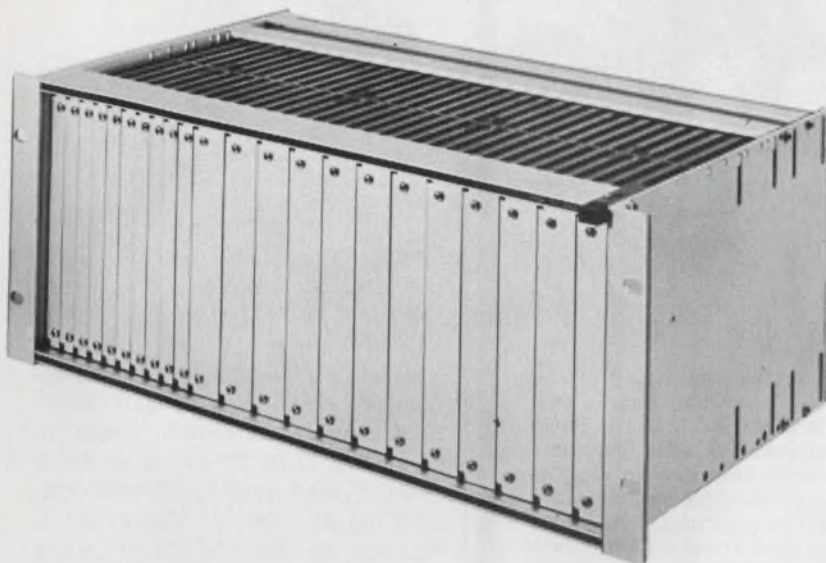

INQUIRE ABOUT OUR NEW DESIGN SERVICE

INFORMATION RETRIEVAL NUMBER 109



CONDUCTIVE SILVER/SILICONE ELASTOMER

TECKNIT CONDUCTIVE ELASTOMER ● Highly conductive pure silver/silicone ● Copper free ● Volume resistivity: 0.01 ohm-cm. ● Excellent Total Shielding Effectiveness ● Maintains electrical and physical properties over wide environmental conditions: -100°F. to +400°F. ● Wide range of compressibility: 30 to 80 durometer ● Uses include electrical contacts, grounding, static discharge and EMI/RFI shielding ● Available in sheets, strips, die cut, molded and extruded parts ● Patent pending ● Write for data #850.

TECKNIT® | *Technical Wire Products, Inc.*

Eastern Division • 129 Dermody St., Cranford, NJ 07016 (201) 272-5500
Western Division • 427 Olive St., Santa Barbara, CA 93101 (805) 963-1867

INFORMATION RETRIEVAL NUMBER 110

ELECTRONIC DESIGN 6, March 16, 1972

STRIP-BUS by Rogers

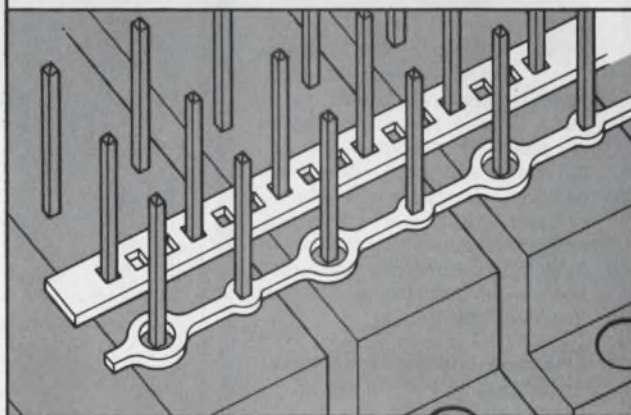

Low Cost Bussing Systems
Easy Installation
Reliable Solder Joints
Greater Pin Exposure



Write or call for details

Rogers Corporation / Rogers, Conn. 06263 (203) 774-9605

INFORMATION RETRIEVAL NUMBER 111

MONOLITHICS:

THE STATE OF THE ART

Specifying tips



The next time you order monolithics, here's a helpful hint. It's usually best to specify attenuation boundaries rather than bandwidth, since these are easily related to information transmission and selectivity requirements. We have a sheet filled with all the details that's yours for the asking. We'll also be glad to discuss design trade-offs.

Our new 21.4's



We've just come up with an off-the-shelf line of low cost monolithic and tandem monolithic crystal filters at 21.4 MHz. Here's the story — twenty-one standard models in 2, 4, 6 and 8 poles with 13, 15 and 30 kHz bandwidths. Available in flatpack or upright packages. We'll be happy to mail you our new data sheets with all the specs.

The Bare Essentials



A lot for a little — that's the idea behind the do-it-yourself approach to tandem monolithics. Take a set of our tandem monolithics. Mount them on your circuit board. Add two or three fixed capacitors and voila, you've got a 6- or 8-pole filter. Why bother? To save space, save money and gain layout flexibility. Whatever your filter problem, we can help reduce it to the bare essentials. Write us.

Like more information on monolithics? Drop us a line or call us.

Pi

Piezo Technology Inc.

2400 Diversified Way
Orlando, Florida 32804
305-425-1574

The standard in monolithic
crystal filters.

ICs & SEMICONDUCTORS

Line of 2-A transistors have gain up to 120



Kertron Inc., 7516 Central Industrial Dr., Riviera Beach, Fla. (305) 848-9606. \$2-\$15; stock.

A 2-A series is added to the company's planar power line. Designated KSP1300 through KSP1396, these transistors range in gain (h_{fe}) from 20 to 120 at 0.5 A and 5 V, and have breakdown voltages up to 300 V. There are 8 families in the KSP1300 series giving a cross-matrix of the above gain and voltage ratings along with a choice of TO-39, TO-66, or TO-3 package.

CIRCLE NO. 366

Registers contain command controls

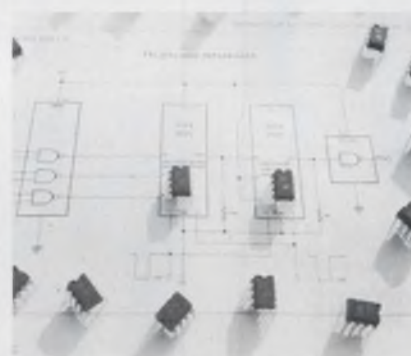

Signetics, 811 E. Arques Ave., Sunnyvale, Calif. (408) 739-7700. 2524 V—\$4, 2525 V—\$9.20 (250-999 quantities).

A 512-bit recirculating, dynamic shift register, the 2524 V, and a 1024-bit version, the 2525 V, are now available in quantity from Signetics. Both registers operate at a typical clock rate of 5 MHz. Power dissipation is 150 μ W per bit at 1 MHz, and clock capacitance is 80 pF in the 512-bit register, 160 pF in the 1024-bit version.

CIRCLE NO. 367

TTL shift registers operate to 30 MHz

Texas Instruments, Inc., 13500 N. Central Expressway, Dallas, Tex. (713) 494-5115. \$4.26-\$9.72 (100 quantities).

Two dc-coupled TTL IC 4-bit shift registers, designated the SN54/74178 and SN54/74179, are functional replacements for the 8270 and 8271 currently on the market. Closely controlled clock rise and fall times as well as external clamping of the clock input are eliminated since these two shift registers are dc coupled. Additionally, the registers provide fully buffered inputs and full 54/74 TTL fan-out of 10 compared to a fan-out of only 7 for the 8270 and 8271 when normalized to 54/74 loads.

CIRCLE NO. 368

KA-band p-i-n diode has 500 GHz cut-off

Hughes Aircraft Co., P.O. Box 90515, Los Angeles, Calif. (213) 670-1515. \$350-\$500; 45 days.

An ion-implanted silicon p-i-n diode, the model P3501U-H, is designed for phase shifter, switching and variable attenuation applications at frequencies through 42 GHz. The high cut-off frequency permits an insertion loss of less than 2 dB to be obtained in a 180° phase shifter circuit, and an even lower loss when used as a switch.

CIRCLE NO. 369

Isowatt package lessens triac heat problems

RCA Solid State Div., Route 202, Somerville, N.J. (201) 722-3200. 40900, 88¢; 40901, 98¢; 4092, \$1.14 (1000 quantities); stock.

Three 8-A triacs use an isolated-tab package to improve heat transfer. The Model 40900, 40901 and 40902 use a plastic case with three leads that are electrically isolated from the mounting flange. This internal isolation permits the triac to be attached directly to a heat sink. With the insulating layer eliminated the heat-sink size is reduced. The three triacs are designed for operation with a 24-V ac line, a 120-V ac line, or lower voltages.

CIRCLE NO. 370



Norden Encoders perform for you!

Look at these new 1971 additions to Norden's line. More are on the way.

| | Total Count | Revolutions for Full Count | Diameter" | Model Number |
|--|----------------------|----------------------------|-----------|----------------------|
| NEW! Optical Absolute | 10,000 | 50 | 2.25 | OADC-23/4/BCDQ-200L |
| NEW! Optical Absolute | 1,000 | 1 | 2.25 | OADC-23/3/BCD-1000L |
| NEW! Optical Incremental: Series now available with shaft seal—permits drenched operation. | | | | |
| NEW! Contact Size 11 | 8,192 | 32 or 64 | 1.06 | ADC-11/13/BNRY-256L |
| NEW! Contact Size 11 Altitude Reporting Encoder | 1,280 | 16 | 1.06 | ADC-11-ALT-1280 |
| NEW! Contact Size 11 | 10,000 | 100 | 1.06 | ADC-11/4/BCDX-100 |
| NEW! Contact Size 11 | 3,600 | 36 | 1.06 | ADC-11/4-36/BCDX-100 |
| NEW! Rugged Industrial Grade Optical Incremental Encoders | | | | |
| All available with quadrature and internal squaring circuit options | 2,000 Pulses | 1 | 3.500 | OADC-35/2000/INC |
| | 1,500 Pulses | 1 | 3.500 | OADC-35/1500/INC |
| | 1,250 Pulses | 1 | 3.500 | OADC-35/1250/INC |
| | 1,000 Pulses | 1 | 3.500 | OADC-35/1000/INC |
| | 600 Pulses | 1 | 3.500 | OADC-35/600/INC |
| | 500 Pulses | 1 | 3.500 | OADC-35/500/INC |
| | 300 Pulses | 1 | 3.500 | OADC-35/300/INC |
| | 200 Pulses | 1 | 3.500 | OADC-35/200/INC |
| | 100 Pulses | 1 | 3.500 | OADC-35/100/INC |
| Optical Incremental Encoders | | | | |
| All available with index marker, quadrature outputs and internal squaring circuit options. Other counts on special order | 100 Pulses | 1 | 2.250 | OADC-23/100/INC |
| | 250 Pulses | 1 | 2.250 | OADC-23/250/INC |
| | 256 Pulses | 1 | 2.250 | OADC-23/256/INC |
| | 336 Pulses | 1 | 2.250 | OADC-23/336/INC |
| | 500 Pulses | 1 | 2.250 | OADC-23/500/INC |
| | 512 Pulses | 1 | 2.250 | OADC-23/512/INC |
| | 1,000 Pulses | 1 | 2.250 | OADC-23/1,000/INC |
| | 1,024 Pulses | 1 | 2.250 | OADC-23/1,024/INC |
| IC-Compatible Encoders. For direct interface with TTL & DTL circuits | | | | |
| Binary | 128 | 1 | 1.750 | ADC-ST7-BNRY-E/L |
| | 8,192 | 64 | 1.750 | ADC-13-BNRY-E/L |
| | 524,288 | 4,096 | 1.750 | ADC-19-BNRY-E/L |
| Binary-Decimal Code | 100 | 1 | 2.250 | ADC-ST2-BCD/L |
| | 1,000 | 10 | 2.250 | ADC-3-BCD/L |
| | 10,000 | 100 | 2.250 | ADC-4-BCD/L |
| | 100,000 | 1,000 | 2.250 | ADC-5-BCD/L |
| | 1,000,000 | 10,000 | 2.250 | ADC-6-BCD/L |
| | 360 | 1 | 2.250 | ADC-3-36BCD-E-360L |
| | 3,600 | 10 | 2.250 | ADC-4-36BCD-E-360L |
| | 36,000 | 100 | 2.250 | ADC-5-36BCD-E-360L |
| | 360 | 1 | 3.250 | ADC-ST3-36-BCD/L |
| | 3,600 | 36 | 2.250 | ADC-4-36-BCD/L |
| | 36,000 | 360 | 2.250 | ADC-5-36-BCD/L |
| | 360,000 | 3,600 | 2.250 | ADC-6-36-BCD/L |
| External Logic V-Scan Binary Encoders | | | | |
| | 128 or 256 | 1 | 1.750 | ADC-7/8-BNRY-XB |
| | 8,192 or 16,384 | 64 | 1.750 | ADC-13/14-BNRY-XB |
| | 524,288 or 1,048,576 | 4,096 | 1.750 | ADC-19/20-BNRY-XB |
| Single Turn Gray Code Encoders | | | | |
| Available with various levels of RFI suppression | 256 | 1 | 1.066 | ADC/11/8/GRAY |
| | 256 | 1 | 1.750 | ADC-ST8-GRAY |
| | 512 | 1 | 2.250 | ADC-ST9-GRAY |
| | 1,024 | 1 | 3.062 | ADC-ST10-GRAY |
| Multiturn Gray Code Encoders | | | | |
| Available with various levels of RFI suppression | 1,024 | 4 | 1.062 | ADC-11/10GRAY256 |
| | 1,024 | 16 | 1.062 | ADC-11/10GRAY 64 |
| Low Cost Magnetic Noncontacting Encoders | | | | |
| Incremental | 128 | 1 | 1.750 | MADC-18/128/INC |
| Binary | 128(V scan) | 1 | 1.750 | MADC-18/7/BV |
| Binary | 8,192(V scan) | 64 | 1.750 | MADC-18/13/BV |
| Binary | 524,288(V scan) | 4,096 | 1.750 | MADC-18/19/BV |

For more information and detailed specs, write Norden, Att: Components Dept., Helen Street, Norwalk, Conn. 06856. Phone (203) 838-4471. TWX: 710-468-0788.

Norden DIVISION OF UNITED AIRCRAFT CORPORATION

NEW PRODUCTS FROM EDC

ELECTRONIC DEVELOPMENT CORP.
BOSTON, MASSACHUSETTS



The Low Impedance DC Millivolt Standard/Reference Model MV-105G (Series B), is designed for Thermocouple and Transducer applications. As a *Source*: for bridge excitation of load cells; as a *Calibrator*: to certify recording instrumentation and amplifier performance; as a *Potentiometric Volt Meter*: for production use to pre-set transducer power and to accurately calibrate transducer outputs directly (w/o amplifiers). *Output ranges*: ± 11 Vdc and ± 110 Millivolts with resolution of 1 ppm in each range. *Measurements*: from $1\mu\text{V}$ to 11 Vdc. The accuracy of the E_{in} and E_{out} modes is $\pm 0.005\%$ of setting. Low Z_{out} : V range = 30 milliohms; 100 mV range = 3 ohms (constant). High Z_{in} : ∞ at null; 10 Megohms off null. *Stability*: $\pm 0.0005\%/hr$. *Price*: \$820.00 w/o Galvanometer; w/Galv. add \$225.00.

Circle # 168



The model 2901 is a low cost DC DIFFERENTIAL VOLTMETER, GALVANOMETER, CALIBRATOR and SOURCE in one instrument. Voltage *measurements* from $\pm 1\mu\text{V}$ up to $\pm 1100\text{Vdc}$ with input impedances from 1 Megohm to infinity. The Model 2901 is also a D.C. Voltage *calibrator* with output voltages (selectable) from ± 100 nanovolts to ± 110 Vdc. Absolute Accuracy: $\pm(0.003\%$ of reading and 0.001% of range) using "Limit of Error" (Worst Case) "Concept" for both the measure mode and the output mode. The constant (selectable) DC Voltage *source* delivers up to 100 milliamperes via 4 terminal remote sensing with current limit control and overload indicator light.

Model 2901; Price \$1350; From stock. Instruments available for no-charge engineering evaluation.

Circle # 169

Instruments available for no-charge engineering evaluation.



Electronic Development Corporation
11 Hamlin Street • Boston, Mass. 02127
(617)268-9696.

ICs & SEMICONDUCTORS

Transistor gives 30 W cw at 400 MHz



RCA Solid State Div., Route 202, Somerville, N.J. (201) 722-3200. \$33 (1000 quantities). Stock.

A vhf/uhf power transistor, the 2N6104, delivers 30 W cw with 5-dB gain at 400 MHz. Designed for use in large-signal high-power cw and pulsed amplifiers at frequencies from 200 to 600 MHz, the transistor operates from a 28-V supply. It features the overlay multiple-emitter-site construction and emitter-ballasting resistors.

CIRCLE NO. 371

Optical switch offers 2 channels

HEI, Inc., Jonathan Industrial Center, Chaska, Minn. (612) 926-2721. \$7.10 ea. (1000 quantities). Stock to 4 wks.

A dual-channel version of the optical switch has a standard configuration with an LED/phototransistor pair. The dual channel optical switch is also available with photo-darlington transistors. The phototransistor models come with or without an amplifier and a Schmitt trigger.

CIRCLE NO. 372

Op amp features less than 1 $\mu\text{V}/\text{C}$ drift

Optical Electronics Inc., P.O. Box 11140, Tucson, Ariz. (602) 624-8358. \$68: (1-2); \$62: (3-9); \$56: (10-29); stock.

The Model 9815, a low-drift op amp, has less than $\pm 1.0 \mu\text{V}/\text{C}$ input offset drift, and an initial input offset voltage of less than $\pm 30 \mu\text{V}$ without external trimming. The 9815 approaches the ideal op amp in other respects as well, such as an input noise voltage of less than $10 \text{ mV}/\sqrt{\text{Hz}}$ and an open loop gain greater than 120 dB.

CIRCLE NO. 373

Computer memory first commercial SOS type

Inselek, University Park Plaza, 743 Alexander Rd., Princeton, N.J. (609) 452-2222.

A commercial silicon-on-sapphire (SOS) computer memory is introduced by Inselek. It is believed to be the first commercial type. The memory, a random-access type, has a capacity of 64 bits. It is organized into 16 words x 4 bits per word, and is fully compatible with TTL circuits at all inputs and outputs. Typical access time is less than 60 ns, with a read cycle of 85 ns. Power dissipation is less than 0.7 mW per bit.

CIRCLE NO. 374

Power transistor from combined processes

Solitron Devices, Inc., 1177 Blue Heron Blvd., Riviera Beach, Fla. (305) 848-4311. \$10 (100 quantities); stock.

A 20 A, 200 V npn silicon power transistor is produced by combining 3 semiconductor processes. Identified as the 2N6216 and 2N6217 series, it delivers the advantages of each process, according to the company. By combining these three processes into a single TO-3 unit, typical features include planar process for reliability, low f_T speed to eliminate unwanted oscillations and fast switching with low storage time.

CIRCLE NO. 375

EIA line driver has inhibit, slew control

Fairchild Semiconductor Corp., 464 Ellis St., Mountain View, Calif. (415) 962-3816. 9616-\$4.50; 9617-\$3.50 (100-999 quantities).

The 9616, an EIA line driver, is implemented by an AND/OR/Invert function instead of the positive NAND function used in conventional EIA drivers. This eliminates the need for external gating to perform the inhibit function. The 9616 also features internal slew rate control, which eliminates the need for an external capacitor for each driver. Slew rate is internally limited to a range of 4 to 30 $\text{V}/\mu\text{s}$.

CIRCLE NO. 376

BUZZERS & FOOTSWITCHES

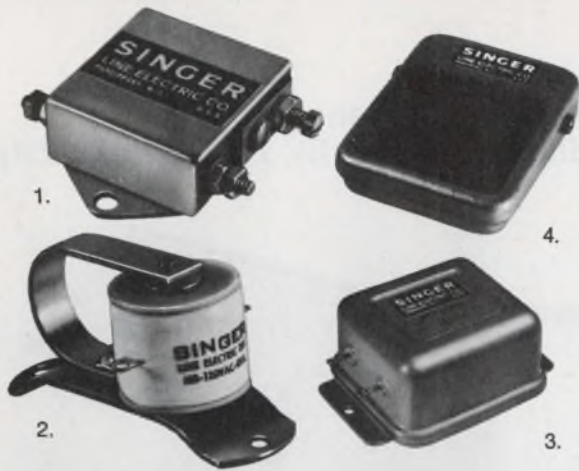

1. Series BD, variable sound and pitch D.C. — A.C. buzzers. Three sizes available, each adjustable in tone and volume. Supplied with dust-proof enclosure.

2. Series MA, MB, MC and MD buzzers for 6, 12, 24, 120, 240 and 440/60 Hz. A.C. operation. Non contact type suitable for continuous duty in paging, warning, starting and dismissal signals.

3. Hermetically sealed ver-

sion of the Series BD and MC buzzers for corrosive environments.

4. Pedaline, compact lightweight foot operated switch. Available with single pole snap action switch or 2 SPDT switches which operate in sequence. Contacts rated 5 amps. resistive 120/240/60 Hz.

Send for detailed information and prices.

SINGER
LINE ELECTRIC DIVISION

Line Electric Division, U.S. Highway 287, Parsippany, N.J. 07054 201/887-8200

INFORMATION RETRIEVAL NUMBER 115

OP AMP & LOGIC POWER

The PHU-30 CT-5 provides regulated ± 15 VDC @ 500 ma and 5 VDC @ 2 amps in one 21 cubic inch package ($1\frac{1}{8} \times 3\frac{3}{8} \times 3\frac{1}{2}$). Weight is only 27 oz. Input: 115 Vrms, 50-500 Hz

\$252.00 ea. (10 pc.)

ARNOLD MAGNETICS CORPORATION

11520 W. JEFFERSON BLVD. · CULVER CITY, CA 90230 · (213) 870-7014

INFORMATION RETRIEVAL NUMBER 116

DISPLAY AND LOGIC POWER CONVERTER

The PHU-180-5 provides regulated 180 VDC @ 100 ma for display tubes and 5 VDC @ 3 amps for logic power in a miniature $1\frac{1}{8} \times 3\frac{3}{8} \times 3\frac{1}{2}$ case with a weight of 21 oz. Ideal for small portable terminals.

Input: 115 Vrms, 50-500 Hz
\$212.00 ea. (10 pc.)

ARNOLD MAGNETICS CORPORATION

11520 W. JEFFERSON BLVD. · CULVER CITY, CA 90230 · (213) 870-7014

INFORMATION RETRIEVAL NUMBER 117

ELECTRONIC DESIGN 6, March 16, 1972

GO FAIL FREE

LOWEST PRICE
CO₂ CHAMBER... **\$395**



RW-1100

Now you can Go Fail Free without going broke! \$395 buys Associated's Model RW-1100 full range low/high temperature chamber, a compact bench unit lab-engineered specifically for small parts and assembly testing and quality control. Associated hasn't scrimped on quality at your expense either. Look at the full performance features you'll get: -100°F to $+350^{\circ}\text{F}$ range ($\frac{3}{4}^{\circ}$ stability)... half cubic foot work area... door-mounted temperature read-out... solid state temperature control... liquid CO₂ cooling.

LOWEST PRICE
MECHANICAL CHAMBER...

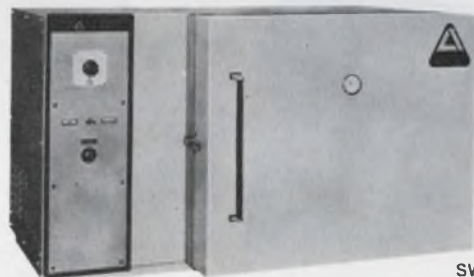

SW-5101

For a full range military testing capability, Associated's benchtop model SW-5101 extends from -100°F to $+350^{\circ}\text{F}$ at a phenomenally low cost. Add a host of other advantages such as single compressor design for simplified maintenance... all solid state control... high temperature failsafe. All for \$970!

Both units are fully presented in the all-new, complete Associated Environmental Equipment Catalog M-7-2. Why not get the whole story today?



ASSOCIATED/JADE HUNTINGDON VALLEY, PENNA. 15006 • (215) 947-3333

INFORMATION RETRIEVAL NUMBER 118

Best Buy

in 1% Tolerance
1-Watt Zeners

SCHAUER
Immediate Shipment

No fragile
nail heads

All welded and
brazed assembly

Gold plated
leads

Low Prices

ANY voltage from 2.0
to 18.0

| Quantity | Price each |
|-----------|------------|
| 1-99 | \$1.07 |
| 100-499 | .97 |
| 500-999 | .91 |
| 1000-4999 | .86 |
| 5000 up | .82 |

Write for complete rating data and other tolerance prices.

Buy The Kit!



A
\$54.57
value
for
only

\$24.50

Kit contains a 51-piece assortment of SCHAUER 1% 1-watt zeners covering the voltage range of 2.7 to 16.0. Three diodes of each voltage in reusable poly bags. Stored in a handy file box. Contact your distributor or order direct.

Semiconductor Division

SCHAUER

Manufacturing Corp.

4511 Alpine Ave. Cincinnati, Ohio 45242

Telephone: 513/791-3030

DATA PROCESSING

Terminals have input tablet and CRT display



Comptek, Inc., 143 Albany St., Cambridge, Mass. (617) 864-5140. 415GT: \$6950; 420GT: \$7450; 30 days.

The 415GT graphic station features an integral, high-accuracy graphic input tablet and generates vector graphics and alphanumerics on a storage CRT display. The accurate, high-speed graphical input tablet converts pen position into digital form while the pen is normally writing, drawing or pointing on the tablet surface. The 420GT curve generator paints a smooth curve with specified initial and final slopes between any two points on the screen.

CIRCLE NO. 377

Microprogramming used in display controller

Sanders Assoc. Inc., Daniel Webster Highway, S., Nashua, N.H. (603) 885-2817. \$35,900.

A low-cost graphic display system is designed for use in process control computer-aided design, simulation, and command and control applications. Designated the ADDS/900, Model L, the basic system includes a digital display controller with microprogramming and subroutine capability, a constant-velocity vector/position generator, a 22-stroke ASCII character generator dual display channel and a 21-inch high-speed graphic CRT display capable of being operated remotely. The expandable Sanders system features up to 128 displayable characters, 16 control characters, 12 display indicator stations, and 360° character and vector rotation.

CIRCLE NO. 378

Planar core module has 8k x 18 bit capacity

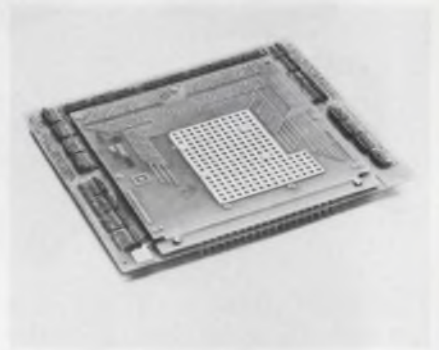

Electronic Memories Div. of Electronic Memories and Magnetics Corp., 12621 Chadron Ave., Hawthorne, Calif. (213) 644-9881.

A planar core memory module contained on a board 7.5 x 8-in. comes in capacities up to 8k x 18 bits. Designated the EM2230, this 3-wire, 3D stack has cycle times to 700 ns and utilizes EM 18 mil extended temperature core and 8192 words per sense line.

CIRCLE NO. 379

32-bit computer claimed industry's cheapest

Systems Engineering Labs, 6901 W. Sunrise Blvd., Ft. Lauderdale, Fla. (305) 587-2900. \$150,000 to \$400,000; July 1972.

The Systems 85 is as fast, or faster than the XDS Sigma 5 and DEC's PDP-10, but its price tag is anywhere from 20 to 40% below those systems. The Systems 85 is an 850-ns processor with core memory expandable from 8192 to 131,072 words. Memory byte parity and page protection are standard. Like its faster counterpart, the Systems 86 (600-ns), the 85 requires only one instruction to address any bit, byte, halfword, word or double-word in even the largest memory configuration.

I/O facilities for Systems 85 speed data to and from peripherals at up to 1.17 million words per second. As many as 16 device controller channels—capable of operating simultaneously—can be linked to the I/O bus and each of the channels can be interfaced to one or more peripherals.

CIRCLE NO. 380

Here are the first LED display Panel Meters priced

Under \$100.



Introducing from DigiTec — two all new DPM's — 3 digit unipolar and 3½ digit bipolar digital panel meters, priced under \$100 in production quantities. These instruments have many unique features such as solid-state LED displays, self-contained power supplies and optional BCD. The design reflects our many years of experience in providing OEM equipment. For example: range, scaling and decimal point are all programmable. In addition, the input filter is programmable to satisfy variable reading times and normal mode rejection.

See us at
IEEE
booth 2429

Let United Systems consult with you in selecting the most suitable DPM for your application. Contact the factory or your local representative for a demonstration or evaluation unit.

Call or write United Systems Corporation, 918 Woodley Road, P. O. Box 458, Dayton, Ohio 45401 (513) 254-6251, TWX (810) 459-1728.

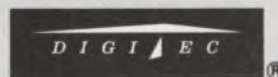

A SUBSIDIARY OF **Monsanto**

Keyboard entry memory programmer tests ROMs



Spectrum Dynamics Inc., 2300 E. Oakland Park Blvd., Fort Lauderdale, Fla. (305) 566-4467.

The only universal, keyboard entry memory programmer on the market today has a programming speed of 160 μ s plus the number of bits programmed per word times the specified time per bit. Words can be verified or blanks can be checked at a speed of 100 kHz per word. Data capacity is 9 bits per word but is expandable. Address capacity is 9999 words, but is expandable to 99,999 words. Address readout is a four-digit, seven-segment display. The Model 550 will program and verify fusible-link, diode junction-shorting, electrochemical fusing, and floating gate avalanche-injection ROMs both manually and automatically.

CIRCLE NO. 381

Two-chip calculator is first with memory

Mostek Corp., 1400 Upfield Dr., Carrollton, Tex. (214) 242-1494. Stock.

Two MOS chips contain all the operating and logic circuitry for a complex electronic calculator including memory. This compression of complex calculator logic and operating circuitry into a pair of chips is a major industry first, rivaling Mostek's development a year ago of the first single-chip calculator. The new chips contain the total of nearly 6000 transistors in a logic circuit of over 700 gates and 400 shift register bits. The new ion-implanted MOS calculator pair, designated the MK 5013/5014 P, incorporates 12-digits and four functions with memory.

CIRCLE NO. 382

Tailor instructions with writable control store

Hewlett-Packard, 1501 Page Mill Rd., Palo Alto, Calif. (415) 493-1501.

A writable control store (WCS) and a PROM writer allow the minicomputer user to tailor the instruction set of the HP 2100 general purpose computer to meet the unique needs of differing application areas. The control store makes possible easy expansion of HP's 2100 microprocessor-based minicomputer, allows a user to microprogram critical, time-consuming subroutines, or add custom, application-oriented instructions with a resulting increase in performance and savings of core storage. The primary advantage of writable control store is that a preliminary microprogram may be tested and debugged under actual run conditions.

A PROM writer allows a user to convert microprograms developed with writable control store to read-only memory which can then be added to the control section of the CPU. Programmable ROMs provide an economical way to reproduce debugged instruction extensions once the changeable feature of WCS is no longer required. Like WCS, the PROM writer is located on a single card which fits into an I/O slot.

CIRCLE NO. 383

Disc pack is compatible with IBM 3330 drives

Nashua Corp., 44 Franklin St., Nashua, N.H. (603) 883-7711.

The Nashua 4436 coated disc pack for external memory storage on IBM 3330 disc drives or the equivalent is designed to meet or exceed all known IBM specifications for disc packs. The 4436 contains 10 recording discs, 19 surfaces of which are available for data recording while the 20th surface is used for the control functions previously stated. There are 411 cylinders, including 7 alternates which provide 7676 data tracks and 133 alternate tracks per pack. Storage capacity of the Nashua 4436 disc pack is in excess of 100,000,000 bytes of data.

CIRCLE NO. 384

IF the
UniversalTM
RELAY CATALOG
facing this ad
IS MISSING
from this copy of
ELECTRONIC DESIGN
CIRCLE NO. 851
on the INFORMATION
RETRIEVAL CARD
for your personal copy

IF someone else in your
firm wants a copy of the
UNIVERSAL RELAY CATALOG
have him fill in and
CIRCLE NO. 852
on the INFORMATION
RETRIEVAL CARD

IF you need
FURTHER INFORMATION
Telephone—Write—TWX or
CIRCLE NO. 853
on the INFORMATION
RETRIEVAL CARD
and a **UNIVERSAL engineer**
will contact you

IF you want a
FREE RELAY SLIDE RULE

designed to find the missing factor
for relay operation—(voltage, cur-
rent, resistance or power); can also
be used for ohms-law calculations.
Standard "C" and "D" scales also
included...
CIRCLE NO. 854
on the INFORMATION
RETRIEVAL CARD
and the **FREE RELAY SLIDE RULE** will
be shipped promptly—no obligation.

If it's a relay or switch you need call

UniversalTM **RELAY CORP.**

42 White St., New York, N.Y. 10013
(212) 925-6900 • TWX 710-581-4461

3,500,000 RELAYS IN STOCK
LARGEST STOCK OF RELAYS IN THE WORLD



Attention Presidents, Vice Presidents, and Marketing Executives

All signs indicate we are now moving toward healthier business conditions in the electronics markets. The success or failure of your marketing program involves *your* livelihood as well as that of your company. To help re-examine the new opportunities for increasing sales and profitability that lie ahead, you are cordially invited to attend . . .

The 18th Semiannual Hayden Marketing Seminar Presented by Electronic Design During IEEE, New York. "MARKET PLANNING FOR A RESURGENT ELECTRONICS INDUSTRY"

Topics to be covered:

Subject: "The Secret to a Successful House Agency"
Mr. Chuck Granieri
Manager, Advertising &
Sales Promotion
MOTOROLA
Phoenix, Arizona

Subject: "Getting the Most from your Available Advertising Dollars"
Mr. T.A. Brown
Manager, Marketing
Communications
Electronic Products Division
CORNING
Corning, New York

Subject: "Product Planning for the 70's"
Mr. E. Floyd Kvamme
Vice President, Marketing
NATIONAL
SEMICONDUCTOR
CORPORATION
Santa Clara, California

Subject: "The Changing Needs of Marketing in a Growing Company"
Mr. James U. Dernehl
Vice President, Marketing
CHERRY ELECTRICAL
PRODUCTS
CORPORATION
Waukegan, Illinois

Subject: "Promoting Electronic Companies in Expanding Markets with Limited Budgets"
Mr. Eugene Wolfe, President, GENE WOLFE & CO., New York N.Y.

Time: 9:00 a.m. (coffee at 8:30) to 12:00 noon

Date: March 22, 1972

Place: South American Room, New York Coliseum

As always, this Hayden Seminar is open to all electronic marketers *free of charge*.

To insure your reservation, call Peter Coley, Publisher, at 201-843-0550 when you arrive in New York for the Show.



REED SWITCHES

RUGGED, RELIABLE...FOR ALL APPLICATIONS

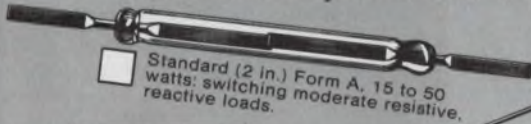

Standard (2 in.) Form A, 15 to 50 watts: switching moderate resistive, reactive loads.

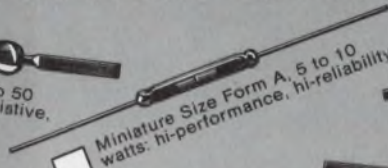

Miniature Size Form A, 5 to 10 watts: hi-performance, hi-reliability

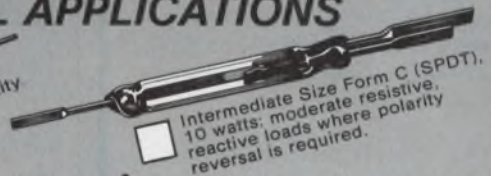

Intermediate Size Form C (SPDT), 10 watts: moderate resistive, reactive loads where polarity reversal is required.

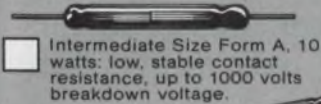

Intermediate Size Form A, 10 watts: low, stable contact resistance, up to 1000 volts breakdown voltage.

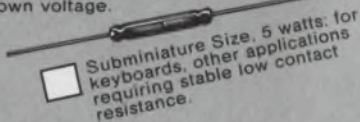

Subminiature Size, 5 watts: for keyboards, other applications requiring stable low contact resistance.

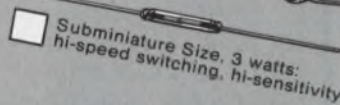

Subminiature Size, 3 watts: hi-speed switching, hi-sensitivity.

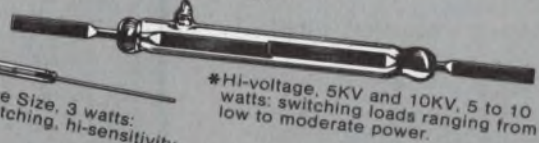

*Hi-voltage, 5KV and 10KV, 5 to 10 watts: switching loads ranging from low to moderate power.

FREE SAMPLES!

Check the box next to the GE Reed Switch that meets your requirements, fill out the coupon, and send it to ID², General Electric Co., 316 E. Ninth St., Owensboro, Ky. 42301

*Samples not available on this form. For literature on this, and the other types listed, use the reader service card.

NAME _____

COMPANY _____ STREET _____

CITY _____ STATE _____ ZIP _____

APPLICATION _____

GENERAL  ELECTRIC

send this coupon today

DC-DC CONVERTERS

SDS: SAME DAY SHIPMENT

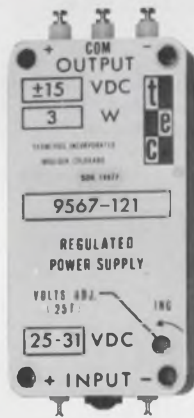

9500 SERIES DC-DC POWER SUPPLIES

Yes, we'll guarantee you shipment of most of our standard products the same day we receive your order.

That's because we're the DC-DC specialists. So, we can generally assure you of SDS. Take our 9500 Series of regulated 28V DC-DC power supplies. Whether you want 1,3,6 or 10 watts, they're ready to be shipped to you right off the shelf the same day your order reaches us.

And, to make sure you get the fastest service available, we've installed a new **HOT LINE**.

Just dial our regular phone number and ask our operator for the "**HOT LINE**." You'll get fast attention to your inquiry or order.

SDS and the HOT LINE.

Two more ways the specialists at tecnetics prove you're somebody special.

tecnetics inc.

P.O.Box 910, Boulder Industrial Park, Boulder, Colorado 80302
(303) 442-3837 TWX 910-940-3246

INFORMATION RETRIEVAL NUMBER 123

DATA PROCESSING

CRT terminal is fully buffered



Bendix Corp., Bendix Center, Southfield, Mass. (313) 352-6233.

The Model 4390 message-oriented communications terminal is compatible with teletypes and has on-site editing capability. Standard features include silent, stand-alone operation; a full, alphanumeric keyboard; numeric key pad; a non-glare, 40 or 80-character per line display; switch-selectable transmission control; tabbing and line and character insertion/deletion. The Model 4390 provides 10 or 20 lines per display, transmits at rates from 110 to 4800 baud, has a 9 x 7-in. display and a non-destructive, blinking underscore cursor. The character format is 5 x 7-inch dot matrix in upper case and there is a character set of 64 characters.

CIRCLE NO. 385

Medium-speed printers feature 132-column lines

Data Printer Corp., 225 Msgr. O'Brien Highway, Cambridge, Mass. (617) 492-7484. Model 246: \$5500; Model 306: \$6100. 30-60 days.

Two medium-speed impact printers feature variable-speed operation depending upon the number of print columns utilized. Model 246 prints full 132-column-lines at 200 lines per minute, and prints at speeds up to 400 and 600 lines per minute utilizing 96 and 48 columns, respectively. Model 306 prints full 132-column-lines at 300 lines per minute, and can operate at 600 lines per minute when utilizing 96 columns. Both models provide 64-character drums, 8-channel vertical formatting, and are housed in attractive sound deadening enclosures.

CIRCLE NO. 386

Hard copy recorders print 30 lines/s

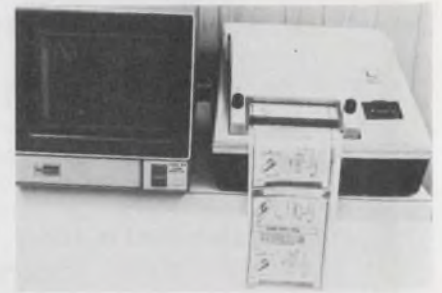

Alden Electronic & Impulse Recording Equipment Co., Inc., Alden Research Center, Westboro, Mass. (617) 366-8851.

The Alden 600 and 400 Push to Print recorders provide instant graphic hard-copy paper records from slow scan TV, data and CRT display terminals. Supplied with synchronous drive motor, sweep trigger output pulse and internal marking amplifier, the units are plug to plug compatible with current Tektronix Type 611 or Type 611 Mod 162C Storage Display Units and Robot Research, Inc.'s Model 80 voice band television cameras. Sufficient power and card file space are provided for addition of customer's circuitry within the recorder housing. Designed for OEM volume applications, the recorders utilize the Alden Flying Spot facsimile recording technique. Clean, crisp CRT recordings can be generated on Alfax electrosensitive paper at 30 lines/second or 20 seconds for a 600 line frame. Recordings are instantly visible and require no further processing. Cost of supplies is less than 1¢/frame.

Booth No. 2523 Circle No. 300

'Pacer' designed for end user applications

Electronic Associates, Inc., West Long Branch, N.J. (201) 229-1100. \$28,000.

Pacer, a digital computer for end user applications in dedicated and hybrid systems, utilizes the latest techniques in MSI and LSI technology. An 8192-word memory, 16-bits, expandable to 16K or 32K has a cycle time of 1 μ s, providing an execution time for a memory reference add of 2 μ s. Standard hardware multiply/divide instructions are performed at 5.6 μ s and 6.6 μ s, respectively.

CIRCLE NO. 387

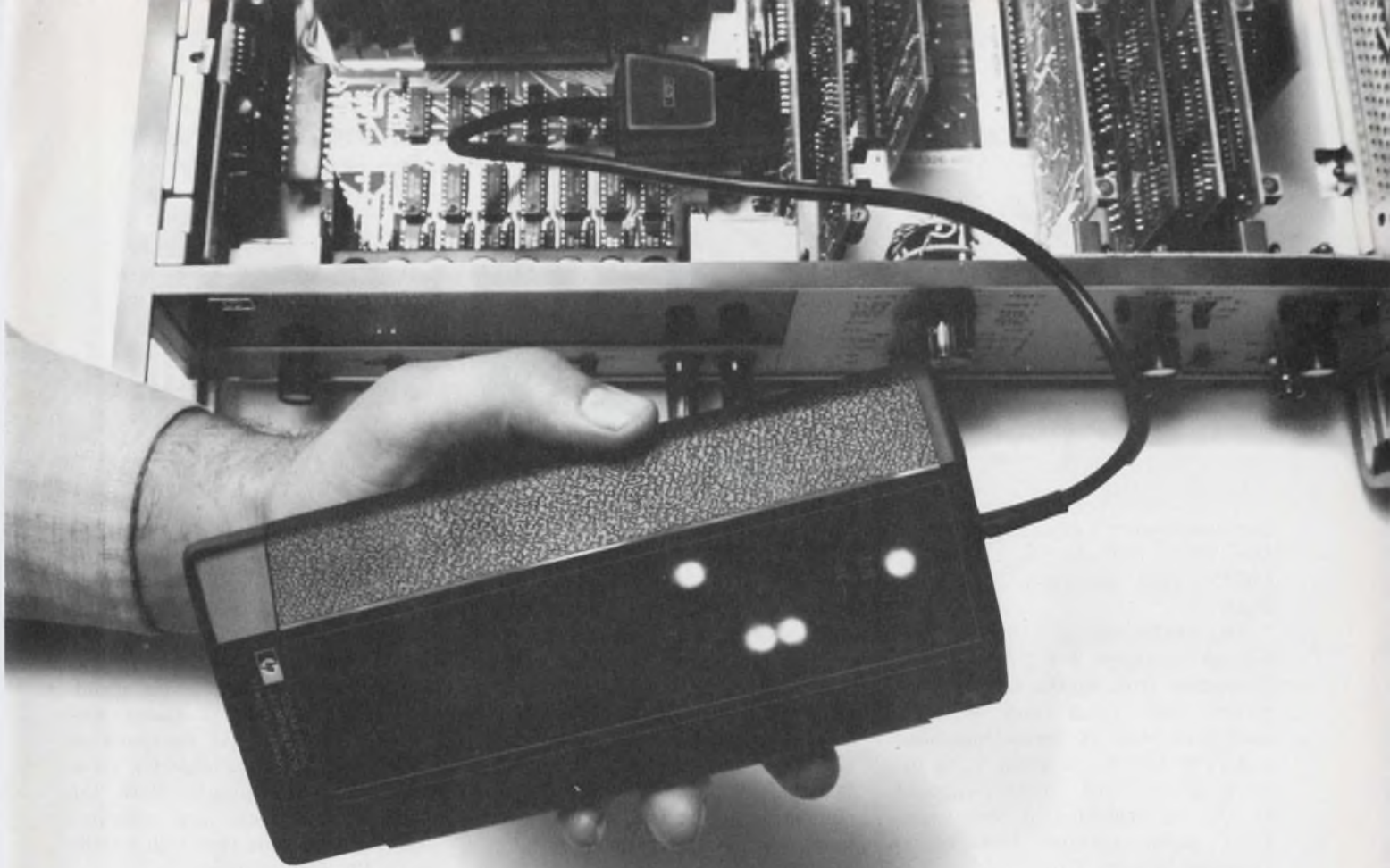

The IC troubleshooters march on.

This one spots a bad IC in 5 seconds or less.

Here comes the latest member of HP's Troubleshooters searching out faulty ICs. Just clip the HP 10529A Logic Comparator onto an in-circuit TTL or DTL IC. If the logic function isn't what it should be, bright red LEDs light up indicating which pins are at fault. A clever comparison scheme uses the circuit's power and input stimulus to do all this. Even dynamic errors as brief as 200 ns are stretched and displayed.

It comes complete with a self-test board, operating manual and all accessories packed in a handy case. It costs only \$295.

We're thinking ahead. Because the case is also designed



to hold our other two Troubleshooters — the HP 10525A Logic Probe and the HP 10528 Logic Clip.

The probe lets you trace pulses through integrated circuits simply by touching a pin. The probe's tip flashes a signal for pulses as narrow as 25 ns, and indicates pulse polarity, pulse trains and logic states. It's almost like having an oscilloscope squeezed into a ball-point pen. \$95.

The clip is a convenient state indicator. It slips over your DTL or TTL package and bright LEDs display the



Try them yourself at IEEE Booth 2400

static state of all 16 (or 14) pins at a glance. It operates like 16 binary voltmeters. \$125.

You can buy all three as the HP 5010A for \$495, saving you time, aggravation and \$20.

The IC Troubleshooters march on. Wait until you see what we're working on now! Just call your HP field engineer to get your hands on them right away. Or if you want to know more, write Hewlett-Packard, Palo Alto, California 94304; Europe: 1217 Meyrin-Geneva, Switzerland.

HEWLETT  PACKARD

Digital printer accepts BCD inputs



Systron-Donner Corp., Instruments Div., 888 Galindo St., Concord, Calif. (415) 682-6161. \$725; 30 days.

The 5103B digital printer is designed to accept 8-4-2-1 BCD information from digital test instruments and print out at the maximum rate of three lines/second. The 5103B can print 7, 14 or up to 21 columns. Column capacity can be expanded at any time. Data input storage features a transfer time of 4 μ s.

CIRCLE NO. 388

Micropositioners adjust CRT deflection yokes

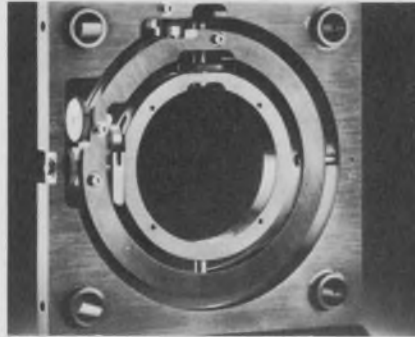

Syntronic Instruments, Inc., 100 Industrial Road, Addison, Ill. (312) 543-6444. \$250 to \$275; stock.

Low-cost micropositioners for CRT deflection yokes and focus coils are available for optical bench applications. The Model D7675 designs provide minimum backlash, fine adjustments for pitch, yaw, horizontal and vertical translation. Positive locks and all four independent adjustments make it easy to change one adjustment without disturbing others.

CIRCLE NO. 389

Punched-tape reader also is perforator

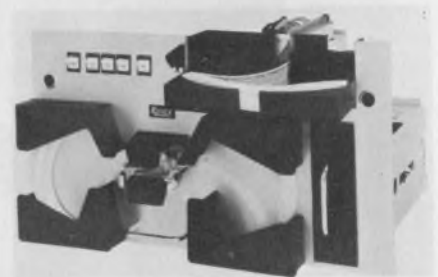

Remex, 1733 Alton St., Santa Ana, Calif. (714) 557-6860. \$2195; 60 days.

The Remex Model RAF3075 is a combination 300 char/sec photoelectric punched-tape reader and 75 char/sec tape perforator mounted on one panel 19 inches wide by 10-1/2 inches high. Each unit is supplied with a choice of standard RETMA chassis slides and mounts. The unit is equipped to supply fan-fold-tape directly from the box to the punch. Both the reader and punch are supplied with fan-fold bins that will handle up to 120 feet of tape.

CIRCLE NO. 390

RUBBERIZED ABRASIVES

DEBURR SM-O-O-T-H POLISH



COMPLETE KIT \$750

CONTENTS: 8 tapered edge wheels 3/8" dia. x 3/32"; 16 cylinder points 1/4" dia. x 7/8" long; 16 bullet points 5/32" dia. x 1" long; 8 bullet points 3/8" dia. x 3/4" long; 8 straight wheels 1/2" x 1/4" x 1/16" hole; 16 straight wheels 1/2" x 1/8" x 1/16" hole; 8 straight wheels 1" x 3/16" x 1/16" hole; 2 wheel mandrels 1/8" shank; 2 point mandrels 1/8" shank. For use at speeds up to 25,000 RPM.

\$7.50 BUYS IT ALL — 80 piece introductory Kit 777 equally assorted in 4 grit textures: coarse, medium, fine and extra fine. **TRY IT** — Cratex Rubberized Abrasives improve the surface while preserving critical workpiece dimensions by its unique cushioning action. **FINISH THE JOB** — to your most exacting specifications — often in a single operation. **SEND FOR KIT 777** — or your **FREE SAMPLE** and catalog illustrating the full Cratex product line and its applications.

CRATEX® RUBBERIZED ABRASIVES

1600 Rollins Road • Burlingame, Calif. 94010
Sold through leading industrial distributors

Cassette assures flat tape winding

Norelco, Div. of North American Philips Corp., 100 E. 42nd St., New York, N.Y. (212) 697-3600. \$3.49 to \$4.49.

A chromium dioxide tape cassette is designed in a special housing that incorporated Perma-Guides to assure perfectly flat tape winding. Known as the Norelco 400, the new cassette is available in 60 and 90 minute lengths. The new Perma-Guides mechanism consists of guiding arms on each spindle that move with the diameter of the tape to produce a perfectly flat tape pancake. By eliminating the telescoping of tape that can occur when switching from fast forward to fast rewind, the Perma-Guides provide a cassette which is virtually jam proof.

CIRCLE NO. 391

Punched tape reader spooler uses LEDs

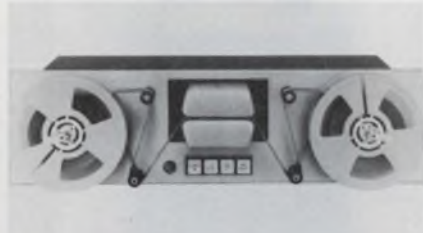

Electronic Engineering Co. of America, 1601 E. Chestnut Ave., Santa Ana, Calif. (714) 547-5501.

A fully proportional servo, stepping motor efficiency, a self cleaning read head and phototransistor sensing combine to give the TRS-9300BB Reader/Spooler fast and efficient, yet very gentle handling of punched tape. The Reader Spooler has a search/rewind speed of 700 char/sec and accurate stop-on-character reading at 300 char/sec. The 5-1/2-in. diameter reels handle up to 150 feet of tape. Tape can be any standard 5, 6, 7, or 8 level tape with as low as 40% opacity. LEDs are used as a light source for what is described as "infinite life without replacement." The reader is compatible with DTL, RTL and TTL logic.

CIRCLE NO. 392

at VISHAY we make more than just resistors and trimmers... we also make voltage dividers, BCD decade modules, attenuators, unitized resistor circuits, and resistor networks. that's why we call ourselves **VISHAY RESISTOR PRODUCTS!**

LADDER NETWORKS

Send now for our 16 page application engineering bulletin on resistor networks with all these specs:



| Model No. | No. Bits | L (Inches) |
|------------|------------|------------|
| Series 500 | 4 or 5 | 0.700 |
| | 6, 7, or 8 | 1.080 |
| | H=0.5" | 1.300 |
| | 9 or 10 | 1.500 |
| W=0.750" | 11 | 1.660 |
| | 12 or 13 | 1.900 |
| | 14 or 15 | 1.900 |
| | Series 375 | 4 |
| H=0.375" | 5 or 6 | 1.080 |
| | 7 or 8 | 1.380 |
| | 9 or 10 | 1.680 |
| W=1.230" | 11 or 12 | 1.980 |
| | 13 or 14 | 2.280 |
| | 15 | 2.590 |

| |
|---|
| RESOLUTION TO 16 BITS |
| FULL SCALE ACCURACY TO 0.005% |
| RISE TIME LESS THAN 1 NANOSECOND |
| SETTLING TIME LESS THAN 50 NANoseconds |
| TEMPCO LESS THAN 1 PPM / °C FOR ALL VALUES (0°C TO 60°C) |
| TRACKING TO 1/2 PPM / °C |
| STABILITY 25 PPM OVER 3 YRS. |

Write for bulletin URC-101 on our unitized resistor circuits for these unique resistor packaging concepts:

VOLTAGE DIVIDERS

VISHAY pre-packaged 2 resistor voltage divider. Other configurations available with up to 4 discrete resistors.

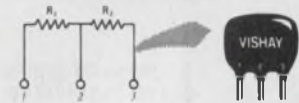

BCD DECADES

Available in any coding system: 1-2-3-4, 1-2-4-8, etc., up to 100K per resistor.

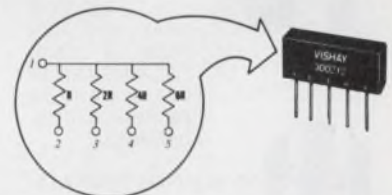

ATTENUATORS

Virtually noiseless with no cross coupling. Available in "L", "U", "Pi", "O", "J", Balanced "U", and bridged "T" configurations, with stability of 25ppm/yr. T.C. of +1ppm/°C and 10 nanoseconds rise time.

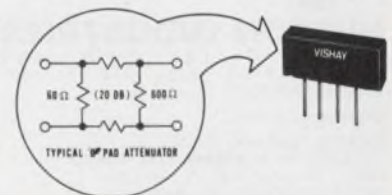

VISHAY RESISTOR PRODUCTS

a division of Vishay Intertechnology
63 Lincoln Hwy. ■ Malvern, Pa. 19355 ■ (215) 644-1300

WE MAKE MORE THAN JUST RESISTORS!

INFORMATION RETRIEVAL NUMBER 126



From Advanced
Thyristor Technology

HUTSON'S 30A & 40A TRIACS

with
**GLASS-PASSIVATED
CENTER-GATE CHIPS**

For motor, heating, cooling and lighting controls, the Hutson 30A and 40A triacs feature greatly improved dv/dt ratings and di/dt characteristics for faster turn-on and lower switching losses.

Improved thermal characteristics and current-carrying capabilities allow these triacs to withstand surges of up to 400A.

Di-Mesa* Construction

This patented construction eliminates operational cycling failures resulting from dicing-induced passivation fractures.

Immediate Delivery

Press-fit, stud, and TO-3 outline mounting. 30A & 40A [$I_{T(RMS)}$]; 50V to 600V (V_{DROM}).



3/4" PRESS-FIT SERIES. ELECTRICALLY ISOLATED. GLASS-PASSIVATED, CENTER-GATE



1/2" PRESS-FIT SERIES. GLASS-PASSIVATED, CENTER-GATE

OTHER HUTSON TRIAC'S AND SCR'S FROM 3A SENSITIVE GATE AND IN ALL POPULAR PACKAGE CONFIGURATIONS



*T.M. HUTSON INDUSTRIES

HUTSON INDUSTRIES

2019 W. VALLEY VIEW LANE
DALLAS, TEXAS 75234 (214) 241-3511
TWX 910-860-5537

Distributed by:

BODELLE COMPANY, Chicago, Ill.
312/468-1016 ■ **NEWARK ELECTRONICS CORP.**, Inglewood, Cal. 213/678-0441
THOR ELECTRONICS, Elizabeth, N.J.
201/354-2420

Canada: **WEBER-SEMAD ELECTRONICS**, Downsview, Ont.

European Marketing Director:

30 Rue Pierre Semard, Yerres, 91 France
Tel: Paris 925-8258 TELEX 21-311

Distributed in Europe by:

Switzerland: **D. LEITGEB**, Dubendorf
Sweden: **ELEKTROFLEX**, Sundbyberg
Spain: **BELPORT**, Madrid
Holland: **RODELCO**, Den Haag

INFORMATION RETRIEVAL NUMBER 127

MICROWAVES & LASERS

Modulated laser for low \$180

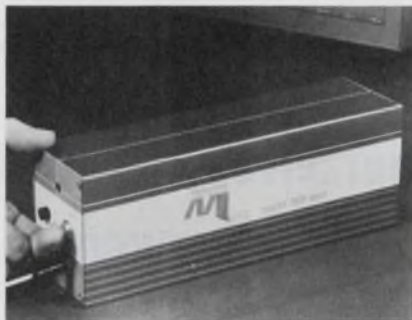

Metrologic Instruments, Inc., 143 Harding Ave., Bellmawr, N.J. (609) 933-0100.

The ML-369 modulated laser with a bandwidth of 1/2 MHz comes ready-to-use and sells for \$180. The laser starts automatically and generates a beam of red light at 6328 Å. Typical power output is 1.2 mW in the TEM₀₀ mode. The laser is capable of 15% modulation up to 500 kHz. Two to 5% modulation is obtained at frequencies above 750 kHz. The laser can be supplied for standard 115 V or 220 V operation.

CIRCLE NO. 393

MIC mixer preamp line offered

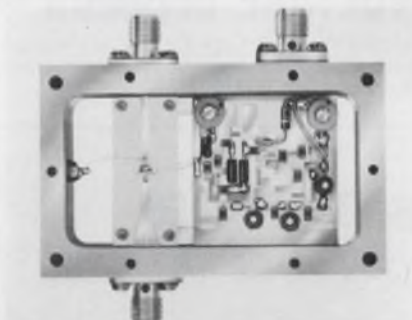

RHG Electronics Laboratory, Inc., 94 Milbar Blvd., Farmingdale, N.Y. (516) 694-3100.

A new line of microwave integrated circuit mixer preamplifiers is available. Known as the DM/14 series, the thin-film IC mixer preamplifiers feature multi-octave coverage in a single mixer, wide i-f bandwidths, and high i-f output capability. They are designed for use in ECM and surveillance systems. Model DM1-12 (shown) covers the rf range from 1-12 GHz.

CIRCLE NO. 394

Power transistor drives 400-MHz 16-W

RCA Solid-State Div., Box 3200, Somerville, N.J. Phone: (201) 722-3200. P&A: \$16 (1000 quantities); stock.

The RCA 2N5919A transistor for microstripline and lumped-constant circuits is unilaterally interchangeable with the 2N5919. Both are epitaxial silicon npn planar devices employing overlay emitter-electrode construction; however, the 2N5919A employs integral emitter ballasting to provide stabilization. The 2N5919A employs the same low-inductance, ceramic-metal, radial-lead stud-type hermetic package (recently assigned the JEDEC designation TO-216AA).

CIRCLE NO. 395

Tetrode generates 2 MW up to 30 MHz



EIMAC Div., Varian, 301 Industrial Way, San Carlos, Calif. (415) 326-4000.

The Eimac X-2159 tetrode develops 2 MW of cw power up to 30 MHz with 17 dB stage gain. Plate dissipation is 1-1/4 MW. For use in broadcast, communications and high power scientific applications, the X-2159 can also be used as a 60 kV, 1000 A switch tube or as an extremely high-power pulse modulator.

CIRCLE NO. 396

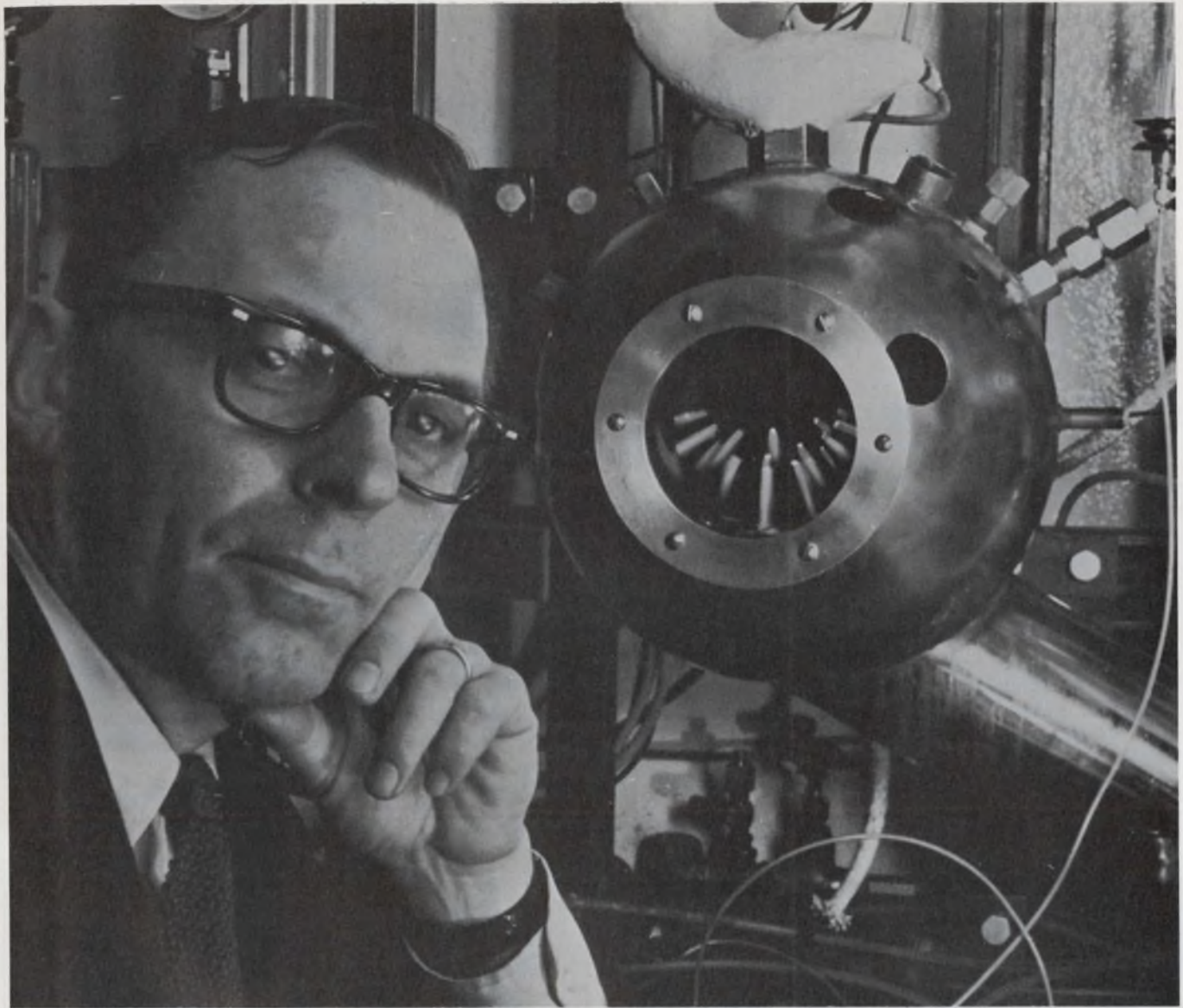

In New Jersey, nobody gets more burned up about pollution than Dr. Wright.

Dr. Frank Wright is a research associate at New Jersey's Esso Research and Engineering Company. That flaming gadget is an experimental device for the study of combustion. He and his associates use it to gain a deeper understanding of the undesirable by-products of burning in order to devise cleaner, more efficient ways to release the energy locked up in fuel. Their efforts are in the same spirit as all research and development in New Jersey: concern for man's destiny.

New Jersey, fifth smallest in land size, carries on about one-fourth of all private research and development in the United States. New Jersey has the greatest concentration of research workers in America, and more trained technicians are being

made available through New Jersey's new system of community colleges.

The environment is right for R&D in New Jersey. Its colleges and universities have a long record of successful research partnerships with private industry. Principal local airports put R&D people within hours of any place in America. And more than half of the state is still virgin forest, woodlands and farms that provide perfect campus-like settings for R&D facilities.

Your R&D operations belong

here too. Our new 40-page brochure, "Brainpower: New Jersey" shows you why. Mail the coupon for your free copy.



New 40-page report shows why R&D succeeds in New Jersey. Return coupon for free copy.



PSE&G

Public Service
Electric and Gas
Company

Mail This Coupon Now!

Please send my free copy of your new 40-page in-depth report "Brainpower: New Jersey."

Name _____
Company _____
Address _____
City _____ State _____ Zip _____

**Slotted line has
1.2 to 18 GHz range**

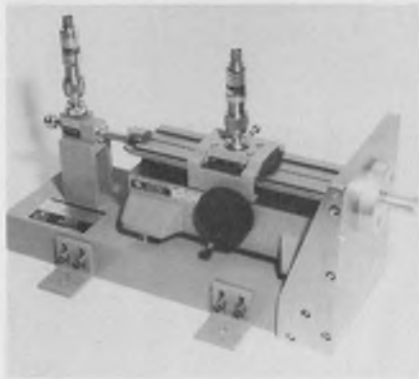

Alford Manufacturing Co., 120 Cross St., Winchester, Mass. (617) 279-8050. \$4000; 30-90 days.

The type 8843 slotted line with a 7-mm adapter attached has a residual SWR under 1.015 from 1.2 to 18 GHz. Both standard and custom-made units are available. Optional features include remote programming, electronically coupled sliding terminations, multiple function, and special packaging.

Booth No. 2443 Circle No. 270

**Ferrite absorber
spans 50 MHz to 15 GHz**

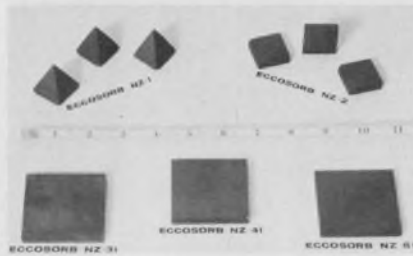

Emerson & Cuming, Inc., Microwave Products Div., Canton, Mass. (617) 828-3300. \$60-\$100/sq. ft.

Eccosorb NZ is a series of thin ferrite absorbers useful over a frequency range from below 50 MHz to above 15 GHz. They are offered in the form of small tiles, which can be bonded to both flat and curved surfaces as may be required in anechoic chambers, absorber caps, absorber baffles, etc. Since the absorber is completely inorganic, it is useful at high temperatures, high power levels, and in hard vacuum.

Booth No. 1210 Circle No. 304

**Compact wideband amp
gives 40 dB gain, 1 W**



Microwave Power Devices, Inc., 556 Peninsula Blvd., Hempstead, N.Y. (516) 538-7520. \$1450; 4-6 wks.

A wideband linear amplifier, the Model LWA 105-2, covers the frequency range of 100-500 MHz, delivering 1 W power output at 1 dB compression. The model operates in the Class A mode, making it ideal for many general purpose lab applications. Additional features include a gain of 80 dB, a maximum noise figure of 10 dB and a minimum harmonics level of -20 dB.

CIRCLE NO. 397



FREE

LAFAYETTE 1972 Catalog

Our 51st Year



468 PAGES

Your 1st Guide To Everything in Electronics

- Stereo/Hi-Fi Components
- Musical Instruments and Amplifiers
- Photography Equipment
- Ham and CB Gear
- Public Address Systems
- Tools and Test Equipment
- Educational and Optical Equipment
- Black and White/Color Televisions
- Police and Fire Monitor Receivers
- Books and Parts

Plus Thousands of Additional Items

Lafayette Radio Electronics, Dept. 45032
P.O. Box 10, Syosset, L.I., N.Y. 11791

Send me the FREE 1972 LAFAYETTE Catalog 45032

Name

Address

City State

Zip

(please include your Zip Code No.)

INFORMATION RETRIEVAL NUMBER 129

relays... general purpose, sensitive,
miniature, mechanical and magnetic latching





stepping switches...



NEW

RTM miniature
— 2 pole,
10 or 12
position



RT rotary
— 1, 2, &
4 pole

accessories...
plugs, sockets and dust covers





HIGH QUALITY • LOW COST • IMMEDIATE DELIVERY
SEND FOR FREE CATALOGS



ELECTRICAL SALES CORP.

1140 Broadway, New York, New York 10001 Tel: (212) 683-0790

INFORMATION RETRIEVAL NUMBER 130

Laser interferometer for speeds to 10-k ft/s

Systems Science and Software, Inc., La Jolla, Calif. (714) 453-0060.

The model 3SLVI-204, a laser velocity interferometer, provides velocity vs time information in the 0 to 10,000 ft/s range. Conventional interferometers, according to the company, are limited to 1000 ft/s because of frequency-response limitations. Velocity measurements with the 3SLVI-204 can be made to within 2% accuracies. The interferometer measures $26 \times 18 \times 5$ inches and weighs about 50 lbs. The system's optical package includes a 1-mW laser source, and two photo-multiplier detectors.

CIRCLE NO. 398

Dual polarized antenna for X-band

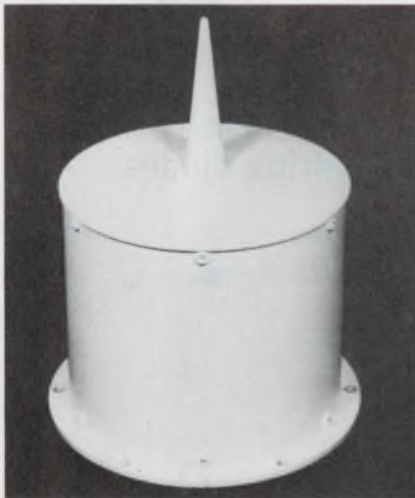

Vega Precision Laboratories, Inc., 239 Maple Ave., Vienna, Va. (703) 938-6300.

The Model 887X series and the Model 888X series of X-band antennas provide variations in azimuth coverage of the Vega RA-CON transponder. The antennas provide omnidirectional or fan shaped azimuth coverage with either horizontal polarization or combined linear polarizations. Birds are discouraged from landing on the antenna by a three-inch spike atop the radome. The weight varies from 2.0 to 4.25 lbs.

CIRCLE NO. 399

NEW AUTORANGING DIGITAL MULTIMETER... IN-PROBE DISPLAY, HIGH-SPEED READOUT, BATTERY OPERATION... \$325.



For AC or DC voltage, resistance and even current, our Model 167 with unique in-probe readout lets you make time-saving measurements directly at the point of measurement. With up to 3-month battery life. The Model 167's combination probe/readout, with $3\frac{1}{2}$ digit LED display, automatically indicates decimal point, polarity, range and function. Front panel terminals and probe receptacle allow alternative use as a bench instrument. The neat, sweet-to-hold 167 Auto-Probe DMM is only \$325 (less in quantity). Check it out and get our latest "How Sweet" button.

Measures easily ... 1 mV to 1000 VDC
• 1 mV to 500 VAC RMS • 1 ohm to 20 megohms

with the convenience of ... 55 megohms input resistance • 2-sec. reading time to rated accuracy • 1200 volts overload protection • Complete choice of accessories.



KEITHLEY INSTRUMENTS

U.S.A.: 2875 AURORA ROAD, CLEVELAND, OHIO 44139
EUROPE: 14, AVENUE VILLARDIN, 1009 PULLY, SUISSE



The Model 167... another how-sweet-it-is Keithley Multimeter

INFORMATION RETRIEVAL NUMBER 131

**step up
to greater
reliability...
at reduced cost**

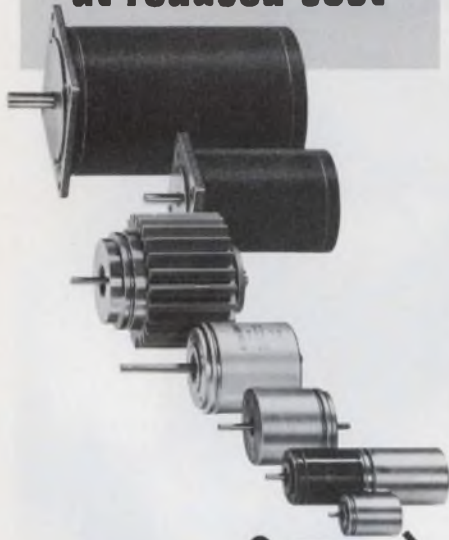

RAPID / SYN
**STEPPING AND
SYNCHRONOUS
MOTORS**

COMPUTER DEVICES deliberately set out to manufacture highest quality Steppers and Synchronous motors at lower costs — and our rapidly growing list of satisfied customers proves that we are accomplishing our objectives.

Standard RAPID-SYN Steppers include frame sizes of 3/4 inch diameter and up with stepping angles of 1.8°, 5°, 7.5°, 45°, and 90°—all designed to operate from solid state logics with DC input.

Heat sinks, dampers, gearheads, pulse sources, optical encoders, preset indexers and a wide range of solid state drivers, are also offered from stock.

RAPID-SYN Synchronous 72 and 200 RPM motors with torque of 25 oz-in and up are stock items and are rated for 110 VAC, 60 HZ. These high torque, low speed synchronous motors with permanent magnet rotors eliminate the need for gear reducers, clutches, and brakes used on conventional synchronous motors.

Computer Devices offers the greatest flexibility in modification of standard units and welcomes the challenge of developing new units for your special requirements.

Call or write for free Catalog!



COMPUTER DEVICES OF CALIFORNIA
11925 Burke St., Santa Fe Springs, Calif. 90670
(213) 698-2595 • TELEX: 65-7478

72-1

INFORMATION RETRIEVAL NUMBER 132

MICROWAVES & LASERS

**Sliding short
for dc to 18 GHz**

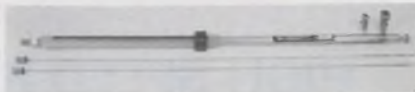

Alford Manufacturing Co., 120 Cross St., Winchester, Mass. (617) 279-8050. \$550; 60 days.

The type 8850 precision 7-mm sliding short-circuit has a frequency range of 0 to 18 GHz. Conductors and shorting contact are manufactured from silver alloys, resulting in a high-reflection coefficient of greater than 0.998 at 5 GHz while providing both long life and low noise. Interchangeable adapter sets allow conversion to several connector types such as 7-mm precision, N, TNC and SMA—while maintaining a low residual SWR. The short circuit has a 12-in. range of travel and can be coupled with the carriage of a slotted line.

Booth No. 2443 Circle No. 271

**Line of log-periodic
antennas introduced**

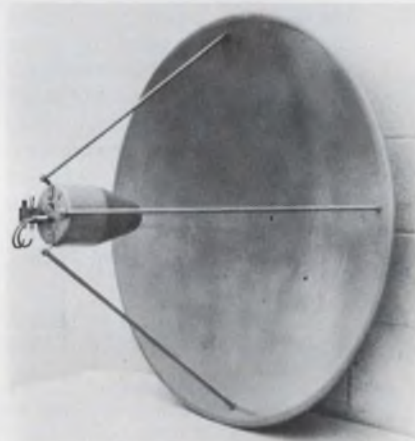

Watkins-Johnson Co., 3333 Hillview Ave., Stanford Industrial Park, Palo Alto, Calif. (415) 326-8830.

Three new dual-polarized log periodic antennas for operation to 18 GHz are being offered by the company. The 1 to 4 GHz frequency range is covered by the WJ-8508, 4 to 12 GHz is covered by the WJ-8517 and the WJ-8518 operates in the 12 to 18 GHz range. All three models are ideal for communications monitoring links and ECM surveillance applications.

CIRCLE NO. 400

**Rf relay for dc to 2 GHz
can handle up to 150 W**

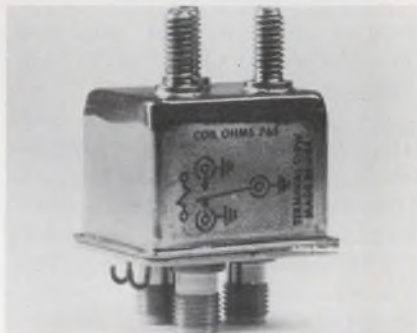

General Electric, 777 14th St., N.W., Washington, D.C. (202) 393-3600.

The type 3SBW hermetically sealed rf relay has spdt rf contacts designed for frequencies from 0-2 GHz. Power handling capacity is 150 W at 500 MHz. Auxiliary Form C contacts designed for up to 2 amps at 28 V dc are also available. Typical rf response characteristics of the 3SBW include an insertion loss of 0.08 dB at 1 GHz, an isolation of 30 dB at 1 GHz and a VSWR of 1.05 at 1 GHz.

CIRCLE NO. 401

**Reduced FM results
by pairing diodes**



MSI Electronics, Inc., 34-32 57th St., Woodside, N.Y. (212) 672-6500. \$40 (100-999 qty.); 2 wks. ARO.

Back-to-back varactors in a low inductance package are featured in the new BB Series microwave tuning diodes. Available in capacitance values from 1.2 pF through 12 pF at 4 V reverse, each diode section is individually tested prior to assembly to ensure that the tuning ratio from 0 to 30 V is the specified 3.4:1 capacitance ratio. The Q at 4 V and 50 MHz is a minimum of 1500 per section.

CIRCLE NO. 402

AC Voltage Control

VERSATILE — control up to 480 V, up to 300 A, 50 to 1200 Hz, single or three phase; and control it quietly without SCR-generated noise. Choose from hundreds of standard models or, as one out of five does, order a custom-tailored special.

RELIABLE — specify a device of uncompromising quality, so ruggedly built that only 1 out of 1000 is ever returned for repair during a two-year warranty period.

ECONOMICAL — compare; then use economical units, made even more attractive by generous quantity discounts.

FAST — receive prompt delivery on standard models off-the-shelf; wait only slightly longer for special units.

VARIAC® — of course! Great when introduced as the first commercial adjustable autotransformers, now they're 39 years better.

NEW! — A 2-amp unit for only \$13.00 — single-hole mountings, 140-volt output. Catalog and applications handbook for full line FREE on request.



for Line-Voltage Control



General Radio CONCORD, MASSACHUSETTS 01742

NEW YORK (N.Y.) 212 964-2722 (N.J.) 201 781-8990 BOSTON 617 846-0550 CHICAGO 312 992-0800
WASHINGTON, D.C. 301 881-5333 LOS ANGELES 714 540-8830 TORONTO 416 252-3395 ZURICH (01) 55 24 20

INFORMATION RETRIEVAL NUMBER 133

Downtime a problem?

Monitor your hardware continually and inexpensively!

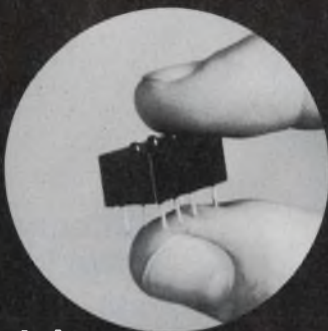

Plug in LD-4 logic status indicators among the ICs and you have a total design check as well as an individual circuit troubleshooter—the whole design is monitored at a glance. No need to rely on good luck and time-consuming oscilloscope tests to see you through a new design or to pick up a malfunction in an existing board. The LD-4 provides 4 bits of logic status in a DIL package. LEDs are mounted on 0.1 inch centers and require only 3 ma current. And their low \$3.99 price (5,000 units or more) makes them a terrific investment. Models available for a variety of applications. Fully guaranteed. Stocked for immediate delivery.

Call or write today for details.

Unique Devices Company

P.O. Box 70, Bountiful, Utah 84010 (801) 295-4252

INFORMATION RETRIEVAL NUMBER 134

ELECTRONIC DESIGN 6, March 16, 1972

TIME & SPACE PROBLEMS?

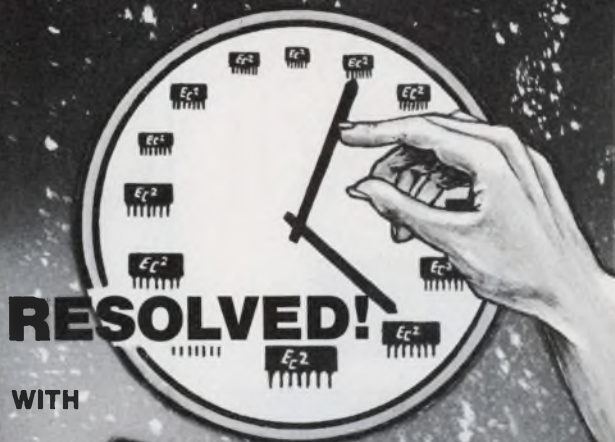

WITH



DIP

L.C. DELAY LINES

- LOW SILHOUETTE
- 4 - 150 NANOSECOND RANGE
- OVER 200 VARIATIONS

EC²'s "DIP Series" Lumped-Constant Delay Lines are packaged in an epoxy encapsulated 14-pin dual in-line configuration and can be supplied as either fixed or tapped lines. These lines are designed to permit series connection when extended delays are required.

"DIP Series" Delay Lines are available in impedances of 50-, 100-, and 200- ohms and exhibit high delay-to-rise-time ratios with minimum attenuation. These units are designed to meet the applicable portions of MIL-D-23859A, and are capable of meeting the environmental requirements of MIL-STD-202C for moisture resistance, vibration, shock, humidity and life.

EC²'s "DIP Series" Delay Lines find extensive use in radar, computer, communications and instrument applications. In addition to the "DIP Series", special configurations can be provided with short lead-times to satisfy specific customer requirements. For free brochure write:



engineered components company

2134 w. rosecrans ave. / gardena, calif. 90249
(213) 321-6565 · 321-8294

INFORMATION RETRIEVAL NUMBER 135

MEASURE COMPARE CONTROL



Hard working, versatile units compatible with data acquisition systems, automatic controllers, or computer controlled systems. Equipped with LED's, BCD outputs and many other standard features. Find out how hard ERC MEASURE-COMPARE-CONTROL components can work for you.

SEE AT IEEE BOOTH 2447

- A. DIGITAL COUNTERS**
SERIES 2300 ... \$216
Uni-directional and bi-directional
- B. CALENDAR CLOCK**
SERIES 2440 ... \$625
Full year time display
(24 hour model also available)
- C. DIGITAL COMPARATOR**
SERIES 2500 ... \$126
Single and dual limit models
- D. DIGITAL STOP WATCH**
SERIES 2600 ... \$214
3-6 digits of display,
resolutions from usecs to hours
- E. 4 1/2 DIGIT PANEL METER**
SERIES 4000 ... \$400
Full 4 digits with 100%
over-range
- 3 DIGIT PANEL METER**
SERIES 3000 ... \$198 (not shown)

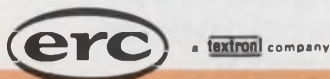

electronic research co.

Box 913 • Shawnee Mission, Kansas 66202

MICROWAVES & LASERS

Acoustic-wave delay line for 1 GHz

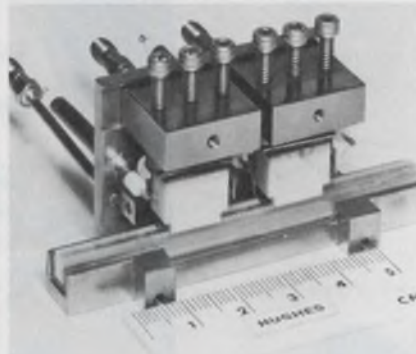

Hughes Aircraft Co., P.O. Box 90515, Los Angeles, Calif. (213) 670-1515.

A five-tap delay line, employing acoustic surface waves at microwave frequencies features a large time-bandwidth product. The tapped delay line uses 6 low-loss tuned interdigital transducers, and 4 adjacent semiconductor surface-wave amplifiers in 2 air-gap-coupled delay modules. The input and 5 tapping transducers each have 200 MHz bandwidth. The delay line provides a maximum delay of 30 μ s at a center frequency of 1.05 GHz.

CIRCLE NO. 403

BWO covers 8-18 GHz range

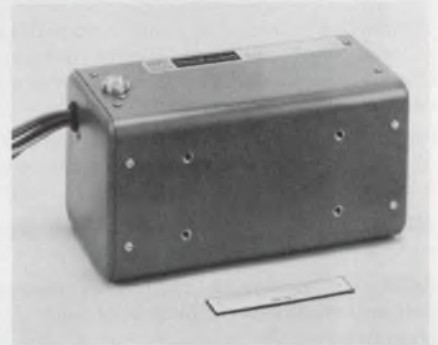

Watkins-Johnson Co., 3333 Hillview Ave., Palo Alto, Calif. (415) 326-8830.

A single backward-wave oscillator that covers the entire 8 to 18 GHz frequency range is being offered by the company. Designed for broadband countermeasure applications, the WJ-2068 BWO is also ideal for use in commercial test equipment. Special features include smooth power output coverage, reduced power variation across the band, and tube-to-tube tuning curve repeatability.

CIRCLE NO. 405

Solid-state signal source for TV, radar

Marconi Instrument Limited, St. Albans, Hertfordshire, England.

A third instrument to be added to the existing range of solid-state microwave signal sources is the Type 6070. The unit covers the frequency range 400 to 1200 MHz. Type 6070 weighs only 8 lbs. The instrument frequency stability is typically 0.001%. A transistor cavity-controlled oscillator gives a minimum power output over the whole frequency band in excess of 50 mW with a typical maximum power of 250 mW. Output power may be adjusted by at least 25 dB via an internal p-i-n diode modulator.

CIRCLE NO. 404

Antenna-feed cables have low VSWR at GHz

Phelps Dodge Communication Co., 60 Dodge Ave., North Haven, Conn. Phone: (203) 239-3311.

Low VSWR antenna-feed cable assemblies, factory prepared, are offered by Phelps Dodge Communication Co. Assemblies consist of cable pre-cut to length and terminated with connectors, usually type N or EIA. For frequencies between 1.7 and 2.3 GHz, peak VSWRs of 1.08 for 7/8 in. and 1.15 for 1 5/8 in. cables are guaranteed. After the connector is attached, each cable is pressurized to 5 psig with dry nitrogen. The air dielectric cable jacket is either corrugated copper or smooth aluminum.

CIRCLE NO. 406

Clock/timer tape options expand controller uses

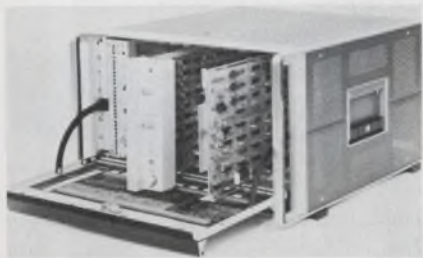

Hewlett-Packard, 1501 Page Mill Rd., Palo Alto, Calif. (415) 493-1501. 12811A: \$1250; 12812A: \$1400; stock.

Two new options—a clock/timer/pacer and an incremental magnetic tape interface—expand the capabilities of the HP Model 2570A Coupler/Controller to include stand-alone data acquisition and storage under timed, paced control. Both of the new options are printed-circuit cards that plug into the standard coupler/controller mainframe. The clock/timer/pacer, Model 12811A, has three principal functions. As a clock, it provides time-of-day output to any data-logging devices which are interfaced to the coupler/controller. As a timer, Model 12811A generates time delays which may be introduced into the coupler/controller program to delay the execution of selected program steps for a preset period of time. As a pacer, it controls the frequency of execution of the entire coupler/controller program. The incremental magnetic tape interface, Model 12812A, comes in two versions—read-write or write-only.

CIRCLE NO. 407

Power modules feature 5-28 V, 1.2-5 A outputs

TechniPower, Inc., Benrus Center, Ridgefield, Conn. (203) 438-0333. \$39.75 (10 or more); stock.

A line of regulated power modules, the "practicals" are available with one to four outputs in an 8-1/2 × 3-1/8 × 2-5/8-in. package. Combined line and load regulation is ±0.5% with 10 mV ripple. Short circuit protection is included, but overvoltage protection is an extra option. Dual output models are designed for op amp applications.

CIRCLE NO. 408

If your catalog data is over 7 months old, it's probably out of date. Send for the latest GE catalogs...they're free.



Solid State Lamps: 4 pages. Data covers 11 infrared and 4 visible Solid State Lamps, previously called Light Emitting Diodes, plus 2 SSL Numeric Readout displays. Diameter range, 0.080" to 0.230".

Circle Product Card #231



Sub-Miniature Lamps: 24 pages. Data covers over 200 sub-miniature lamps. Lamp life up to 60,000 hours. Diameters 1/4" and smaller.

Circle Product Card #232



Miniature Lamps: 40 pages of data covering over 500 miniature lamps ranging from 3 to 20,000 hours average rated life. With a design voltage range of from 1.2 to 125, and candle-power range from .02 to 250. Diameter range from 1/32" to 2 1/16".

Circle Product Card #233



Sealed Beam Lamps: 16 pages. Data covers over 180 Sealed Beam lamps, ranging from 4 1/2" to 8" in diameter, with a design voltage range of from 4.0 to 115 and initial candle-power of from 150 to 600,000.

Circle Product Card #234



Glow Lamp: 8 pages. Data covers 77 Neon Glow Indicator and Circuit Component lamps. Diameters ranging from 1/4" to 1 3/4".

Circle Product Card #235



Solid State Optoelectronics Selection Guide: 4 pages. Data covering SS Emitters, Photon Couplers, 18 Detectors, Photo Transistors Arrays, Programmable Unijunctions Transistors, Selecon Controlled Switches and Rectifiers (SCS's and SCR's).

Circle Product Card #236

All of the above catalogs have been revised or updated in the past 7 months. To get the catalog(s) you need, free of charge, circle the product card number shown under each catalog or write, General Electric Company, Miniature Lamp Department, Nela Park, Cleveland, Ohio 44112.



Your best choice in enclosures

- oil and dust tight
- EMI/RFI shielded
- rigid one-piece construction
- available from stock



Consoles in versatile stock design, 50" x 24" x 23", with gasketed front and rear doors. Options include rack angles, swing-out and stationary subpanels and writing desk. **Consolelets** are offered in eleven stock sizes for desktop mounting of remote controls. Floorstand optional.

All units are heavy gauge steel with all-welded seams, easily shielded.



NEMA 12 units in stock sizes up to 90" x 36" x 24". Rigid 12 gauge steel with all-welded seams, gasketed doors front and/or rear. Oil and dust tight. Options include several interior panel arrangements, rack angles and shielding.

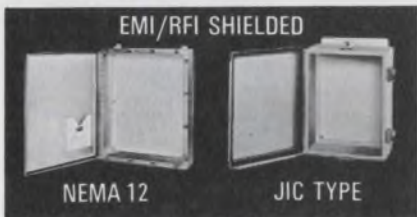

Heavy gauge steel boxes with hinged doors, all cadmium plated. Oil and dust tight, fully shielded. Interior mounting panels and terminal block kits optional. Shipment from stock, all sizes.



For mounting controls where oil, dust and water are not a problem. One-piece heavy gauge steel construction, finished in gray prime. Flush latches. Interior panels for mounting components. Wide size range in stock.

Hoffman

HOFFMAN ENGINEERING COMPANY
Division of Federal Cartridge Corporation
Anoka, Minnesota, Dept CE-439

ELECTRICAL ENCLOSURES

INFORMATION RETRIEVAL NUMBER 138

MODULES & SUBASSEMBLIES

Rms-to-dc converter takes inputs to 20 kHz

Function Modules Inc., 2441 Campus Dr., Irvine, Calif. (714) 833-8314. \$98 (1-9 quantities).

Rms converter module, Model 591, computes the rms level directly by squaring, averaging, and square-rooting. This approach has faster response time than thermal-type rms meters, and is less bulky. The complete module is only 1.5 inches square by 0.4 inch high, and the only requirement for operation is ± 15 V power. The averaging time-constant is 10 ms, and can be increased by adding an external capacitor. Accuracy is better than 0.05% of full-scale plus 0.2% of reading. This accuracy rating holds for ac inputs up to the full input range of ± 10 V and up to 20 kHz frequency.

CIRCLE NO. 409

Monolithic crystal filters have 6 poles

Piezo Technology, 2400 Diversified Way, Orlando, Fla. (305) 425-1574. \$28 (1-4 quantities); stock.

Comline tandem monolithic crystal filters of 21.4 MHz are available in flatpack and upright packages. Model 1627 features 15 kHz bandwidth and 6-pole performance. Other standard PTI models in the new 21.4 MHz line are offered with 13, 15 and 30 kHz bandwidths and 2-, 4-, 6- and 8-pole characteristics.

CIRCLE NO. 410

Clock oscillators span 1-25 MHz

Bulova Watch Co. Inc., Electronics Div., 61-20 Woodside Ave., Woodside, N.Y. (212) 335-6000.

A series of miniature dual in-line clock oscillators, designated XO-300, features outputs directly compatible with DTL and TTL digital integrated circuits through the use of IC circuits in the oscillator output stage. Frequency ranges run from 1 MHz to 4 MHz in some models; others go from 4 MHz to 25 MHz. Accuracy is ± 15 ppm throughout the series.

CIRCLE NO. 411

Driver/decoders mate with readout line



Industrial Electronic Engineering Inc., 7720-40 Lemona Ave., Van Nuys, Calif. (213) 787-0311. \$9.60 (large quantities); 6-8 wks.

An IC driver/decoder is designed specifically for mating to Series 0340/0345 and Series 0120/0220 readouts. Referred to as Display-mates, this line of decoders has a drive-capability of up to 80 mA at 30 V, allowing use of standard 5, 12, 14 and 28 V.

CIRCLE NO. 412

Modular power supplies offer design flexibility

ERA Transpac Corp., 67 Sand Park Rd., Cedar Grove, N.J. (201) 239-3000. RR51: \$10.95; PC2k: \$14.95; 30 days.

A system of modular remote regulators and power centers is intended to provide complete flexibility in solving power supply problems. A choice of 16 basic regulators and six matched unregulated power centers can be combined to provide an almost limitless variety of power systems. Remote regulators are available in voltages ranging from 5 through 24 V dc at current ratings from 150 mA to 40 A. Typical regulation is better than 0.05% for load or line variations; ripple reduction is better than 60 dB. Power centers provide the appropriate dc to operate specific regulators with a choice of voltages ranging from 10 through 32 V dc with individual current ratings from 50 mA through 50 A. Ripple for the power centers is less than 1.5 V rms, and when used in conjunction with the remote regulators results in a supply ripple of less than 0.01% or 1.5 mV. Regulator Model RR51 is 1-5/16 by 2-7/16 by 1/2 inches, and a two amp power center Model PC2k is 2-3/4 by 2-3/4 by 3-5/8 inches.

Booth No. 2610 Circle No. 320

TRIMLINE *by* PREMIER

for Distinctive Electronic Packaging... try TRIMLINE

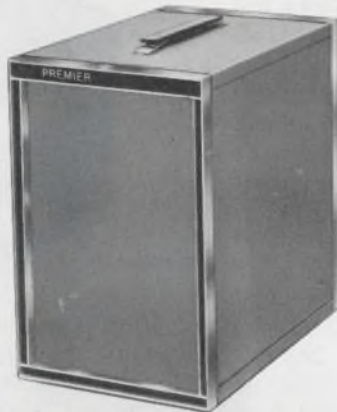

88 Standard Sizes • Trimmed front & rear • Decorative Vinyl Inlays • Welded Construction
 Special Sizes for Rack Mounting • Choice of Textured Vinyl or Semi Gloss Enamel Finishes
 11 Standard Colors • Modifications, Special Finishes & Accessories Available

For Detailed Literature, write to



PREMIER METAL PRODUCTS COMPANY

A Division of Sunshine Mining Company

337 MANIDA STREET, BRONX, NEW YORK 10474 (212) 991-6600

INFORMATION RETRIEVAL NUMBER 139

Attention Advertisers:

Could you use copies of your ad exactly as it appeared in ELECTRONIC DESIGN? Then order your reprints directly from us; the minimum unit order is 500 copies.

Please specify if you would like the reprint line omitted on your copies and mail your/written order to:

**Production Dept.
 ELECTRONIC DESIGN
 50 Essex St.
 Rochelle Park, N.J. 07662**

| | 500 | 1,000 | Add'l M |
|------------------------|---------|--------|---------|
| 8x10 or smaller | | | |
| 1 color, 1 side | \$74.70 | 82.95 | 18.15 |
| 2 color, 1 side | 95.47 | 108.00 | 25.28 |
| 4 color, 1 side | 311.03 | 342.00 | 44.33 |
| Spreads | | | |
| 1 color | 113.66 | 126.65 | 25.98 |
| 2 color | 191.19 | 205.98 | 29.58 |
| 4 color | 354.17 | 380.76 | 53.19 |

Prices FOB Waseca, Minn.

New Opto-Isolator...



has transfer ratio of 600% with 1mA input.

Clairex now offers a series of opto-isolators with a wide range of transfer ratios and speeds, and a minimum of 1500 volts isolation. Clairex opto-isolators, utilizing LED's to drive Clairex photo-transistors, offer minimum transfer ratios of 20% at speeds as fast as 2 μ sec and 600% minimum transfer ratios at slower speeds.

For more information or for special assistance with your isolation problems, call (914) 664-6602 or write Clairex, 560 South Third Avenue, Mount Vernon, New York 10550.

CLAIREX ELECTRONICS
 A DIVISION OF CLAIREX CORPORATION

INFORMATION RETRIEVAL NUMBER 140

12-bit DAC in a 16-pin DIP is industry's first



Micro Networks Corp., 5 Barbara Lane, Worcester, Mass. (617) 756-4635. \$45 (250 quantities); stock.

The industry's first 12-bit D-to-A converter in a 16-pin hermetic DIP package, the MN 312, incorporates monolithic amplifiers, planar chips and a precision 12-bit nichrome ladder network. The unit provides an output range of 0 to ± 1 V and settles to 0.01% of its final value in less than 0.5 μ s. The unit offers 12 bit linearity $\pm 1/2$ bit over the full operating range of 0 to 70 C. The unit is complete with internal reference and operation amplifier output.

CIRCLE NO. 413

400 Hz to dc converter has 0.05% regulation

Abbott Transistor Laboratories, Inc., 5200 W. Jefferson Blvd., Los Angeles, Calif. (213) 936-8185. \$395 (2-4 quantities).

The W15 series power modules convert 115 V ac, 400 Hz to any desired output voltage between 5 and 16 V dc at a full load output current of 15 A. The W15 series regulates line voltage to $\pm 0.05\%$ or 10 mV (whichever is greater) for input changes of 105 to 125 V rms at constant load. The load regulation is $\pm 0.05\%$ or 20 mV (whichever is greater) from no load to full load at constant line. Ripple has been reduced to 0.02% or 5 mV (whichever is greater), 25 mV peak-to-peak maximum. The series is protected against overloads or short-circuit of any duration, and will withstand input transients of up to 180 V ac for 0.1 s. The W15 is packaged in a case 5-1/2 \times 5-1/2 \times 3-5/8-in. and weighs only 8.9 pounds.

CIRCLE NO. 414

Analog comparator has 5 ns max response

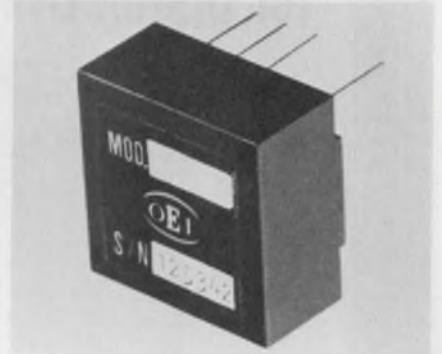

Optical Electronics Inc., P.O. Box 11140, Tucson, Ariz. (602) 624-8358. \$69 ea. 1-2, \$63 ea. 3-9, \$56 ea. 10-29; stock.

The unique feature of the 9050, an analog comparator, is its 5 ns maximum response time. The response is 3 ns when the device is used with TTL logic. The 9050 is TTL compatible and can also interface with MOS at 10 to 15 V logic. The minimum input and output slewing rate is 1000 V/ μ s, and the voltage gain exceeds 1000.

CIRCLE NO. 415



New, low-cost, enclosed miniature rotary switch

Another Grayhill innovation. New, low cost, enclosed miniature rotary switches—with 30°, 36°, 45°, 60° and 90° angles of throw!

Series 50A and 51A available with 1 to 4 poles per deck . . . 2 to 12 positions per pole (depending on number of poles) . . . solder lug or printed circuit terminals.

Available as-low-as \$3.10 per switch in one hundred quantity orders.

For our new Engineering Catalog G 308 write or phone: Grayhill, Inc., 565 Hillgrove Ave., La Grange, Illinois 60525. (312) 354-1040



INFORMATION RETRIEVAL NUMBER 142

The PC power supply that delivers years of service and costs

\$27 in single units

SPECIFICATIONS:

Size: 4.5 x 4.5 x 1.5

Input: 105-125V, 47-420 Hz

Output: Any DC voltage 3 to 30

Regulation: Line 0.005%
Load 0.05%

Ripple: Less than 250 microvolts

Recovery Time: 25 microseconds

Temperature:

Operating -20 to +71°C

Storage -65 to +85°C

Coefficient 0.01%/°C Max

Current Limiting:
Fixed- foldback type

Overvoltage: Optional

| MODEL | VOLTAGE | AMPS | MODEL | VOLTAGE | AMPS |
|-------|------------|------|---------|----------------|------|
| 10-5 | 4.5 to 5.5 | 1.2 | 10-28 | 26 to 30 | 0.35 |
| 10-12 | 11 to 13 | 0.8 | 10-1212 | ± 11 to 13 | 0.35 |
| 10-15 | 14 to 16 | 0.6 | 10-1515 | ± 14 to 16 | 0.35 |
| 10-24 | 23 to 25 | 0.4 | 10-1818 | ± 17 to 19 | 0.35 |

For Overvoltage Models, add -0 to Model number

| QUANTITY | PRICE | WITH OVERVOLTAGE | DUAL SUPPLIES |
|----------|-------|------------------|---------------|
| 1-9 | \$27 | \$32 | \$35 |
| 10-24 | \$24 | \$28 | \$32 |

DIRECT FROM STOCK
FREE — POWER SUPPLY CATALOG

Electrostatics, Inc.

7718 CLAIREMONT MESA BLVD. • SAN DIEGO, CA 92111 • (714) 279-1414

INFORMATION RETRIEVAL NUMBER 143

ELECTRONIC DESIGN 6, March 16, 1972

Power supply boasts $\pm 0.005\%$ line regulation

Unipower Div., Calif. Linear Circuits, 12741 Los Nietos Rd., Santa Fe Springs, Calif. (213) 698-7991. \$30 to \$80; stock to 4 wks.

A series of miniature ac to dc power supplies, the Series 400, measures just 1 x 2 x 3-in. and weighs only 9 oz. Accuracy is ± 0.01 V dc and zero to full load regulation is 0.02% maximum. Line regulation is $\pm 0.005\%$; ripple is 0.5 mV rms maximum. The power supplies feature overload and short circuit protection plus current limiting as standard.

CIRCLE NO. 416

Zero-volt switch isolates input from load power

Guardian Electric Manufacturing Co., 1550 W. Carroll Ave., Chicago, Ill. (312) 243-1100.

A zero crossover switch assures true zero-volt switching by forming an electrical cushion between the signal input and load power. In the Series 6500 module, the solid-state output switching circuit is isolated from the input signal through a longlife reed relay. The standard 120 V ac load is normally de-energized when load power is applied. Application of the 6, 12 or 24 V dc signal input causes 120 V ac load to become energized, with switching occurring at 0.0 V ac ± 10 V. Minimum operations life is 10⁷. Over-all size is 1-3/8 x 1-27/32-in.

CIRCLE NO. 417

Dpdt miniature relays are in DIP package

Potter & Brumfield, 1200 E. Broadway, Princeton, Ind. (812) 385-5251. \$8.35.

The HPD series is half-crystal case size. Terminals measure 0.02 x 0.02 x 0.21-inch long arranged on a 0.20 x 0.30-inch grid. Design advantages include a high torque motor structure, gold-plated silver alloy contacts rated 0.3 to 2 A at 28 V dc, resistive; 0.1 to 0.5 A at 120 V ac at 25 C. Coils are rated for continuous duty with an operate time of 5 ms maximum (both at nominal coil voltage and 25 C). Coil voltages of 6 V, 12 V, 24 V, 36 V, and 48 V are available.

CIRCLE NO. 418

NEW AT INTERCON BOOTH 2721

MODEL 102A SIGNAL GENERATOR



A frequency range of 5 to 520 MHz and low-distortion FM/AM feature the 102A. The FM bandwidth is 20 Hz to 200 kHz, with calibrated deviation to 200 kHz (uncalibrated to over 1 MHz). The AM bandwidth is 20 Hz to 20 kHz, with residual FM <0.25 ppm. Includes frequency-lock input for synchronizers, internal/external modulation, and digital LED frequency display.

MODEL 93AD TRUE RMS DIGITAL VOLTMETER



Sensibly-priced true rms measurements from 300 μ V to 300 V, 10 Hz to 20 MHz, at a basic 1% accuracy are features of this programmable meter. The LED digital display, plus small edge-meter scaled in dBm, insures error-free readings. Selectable bandwidth and response time. BCD and analog outputs are standard; dBm display and autoranging are optional. Price \$1100

MODEL 72AD DIGITAL CAPACITANCE METER



A wide-range, basic accuracy of 0.25% and a resolution of 0.001 pF distinguish this new programmable capacitance meter. Values from 0.01 to 2000 pF are quickly measured at a 1 MHz test level of 15 mV rms. BCD and analog outputs are standard; available as options are autoranging and logic-level programming. Price: \$1100. (An analog version is available at \$850)

MODEL 172A CAPACITANCE RATIO TESTER



High-speed, simultaneous, semi-automatic measurements of semiconductor capacitance ratio at selected upper/lower bias limits, and of capacitance at a chosen bias, are now possible with the new 1 MHz digital 172A. BCD outputs, remote control, and autoranging are standard features. Ranges are 2 to 2000 pF fs, 0-20 ratio and 0-200 V bias. Price: \$2700.

**BOONTON
ELECTRONICS**
CORPORATION

ROUTE 287 AT SMITH ROAD
PARSIPPANY, NEW JERSEY 07054
TEL: (201) 887-5110
TWX: 710-986-8241

INFORMATION RETRIEVAL NUMBER 144

Costs less than
60¢ in volume...

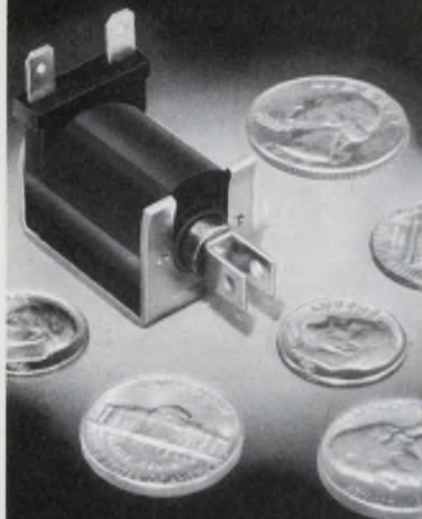

and what a
SOLENOID
for the money!

- NEW MODEL C-6
- More Force - @ .100" stroke force is:
AC CONT. - 7 ounces
AC INT. - 11 ounces
- Molded nylon coil for fungus and moisture resistance.
- Terminals molded into coil for extra strength, virtually eliminating open coils.
- Ideal for applications where cost and performance are important (are there any others?), such as appliances, vending machines, automobiles and trucks.
- Push and pull types. Plungers suited to your application.
- Available with optional buzz trimmer that eliminates AC hum - a patented exclusive (Patent No. 3,117,257).

1433

DELTROL
CONTROLS

2745 So. 19th St. Milwaukee, Wis. 53215
Phone (414) 671-6800 Telex 2-6871

MODULES & SUBASSEMBLIES

Binary-decimal decoders have built-in memory

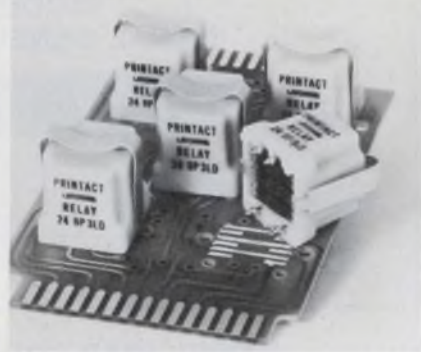

Executone, Inc., P.O. Box 1430, 47-37 Austell Place, Long Island City, N.Y. (212) 392-4800. \$25; 2 to 4 wks.

The PD-5LD series is a module which will translate binary coding to the more readily understood decimal system. This patented binary-to-decimal decoder, with built-in-memory, combines the simplicity of tough ceramic magnet latching relays with the foolproof reliability of PC boards. The relays are rated in excess of one hundred million cycles. However, in the event of a failure, it takes only seconds to replace them, since they plug directly into the printed circuit board without sockets or soldering, using plated conductors as the fixed contacts. Units take any 6, 12, 24-volt binary dc logic and output the corresponding decimal information. The memory feature enables them to be used as buffer registers; therefore multiplexing is easily accomplished.

CIRCLE NO. 419

Two cubic inch supply delivers -550 to -3 μ V

Capitron Div., AMP Inc., Elizabethtown, Pa. (717) 564-0101.

Measuring 0.75 \times 1.8-in. dia., a 3.5 ounce power supply delivers -550 to -3 kV linearly adjustable by varying the input voltage (14 V dc max). This unit is fully encapsulated in thermally conductive epoxy and can maintain rated current of 300 μ A at any temperature -55 to +75 C ambient.

CIRCLE NO. 421

Clock phase generator, driver used for TTL

Beckman Instruments, Inc., 2500 Harbor Blvd., Fullerton, Calif. (714) 871-4848.

The Model 835 clock phase generator and Model 836 MOS clock driver are thick film, hybrid units designed for use in digital systems. The Model 835 provides two inverted non-overlapping clock phases primarily intended for two-phase MOS clock systems. The Model 836 is designed to drive low threshold MOS circuitry and operate from supply voltages of +5 V, -15 V, and ground with TTL/DTL input drive. Additional features of the clock driver include: 50 ns t_r and t_f with 1000 pF capacitive load; 500 mA peak current capability; 5 MHz repetition rate.

CIRCLE NO. 422

Contacting keyboard can switch low current MOS

Colorado Instruments, Inc., 1 Park St., Broomfield, Colo. (303) 466-1881.

A contacting keyboard is designed for use in desk calculators and other devices. The assembled contacting keystation, including the printed circuit board, provides a price breakthrough with a high volume keystation cost of less than 25¢.

CIRCLE NO. 423

S&h module operates into video range

ILC Data Device Corp., 100 Tec St., Hicksville, N.Y. (516) 433-5330.

The Model VSSH, sample-and-hold module has an aperture time actually less than 300 ps even under worst-case conditions of voltage and temperature. Acquisition time is 20 or 50 ns. This combination of fast aperture and acquisition times, together with the unit's high input impedance (10 megohms) and low droop rate, yield a performance previously unattainable in so small a module. The unit operates over a wide dynamic range (± 5) and with a linearity of 0.1%.

CIRCLE NO. 424



DATAK's new DIRECT ETCH dry transfer RESIST

20X PHOTO OF
.015" LINE BETWEEN
DIP PADS

SIMPLE — patterns rub down directly on the copper and connect with rub-down lines or tapes supplied.

ACCURATE — patterns are printed to $\pm .002$ " tolerance. Measured undercut when etched is less than .0015".

ECONOMICAL — patterns are less than 1/50th the cost of copper foil circuit stickers.

COMPLETE ER-1 SET contains hundreds of dry transfer DIP, flatpack, TO-5, IC and transistor patterns; $\frac{1}{16}$ " and $\frac{1}{32}$ " etch resist tapes; 4 copper clad boards; $\frac{1}{4}$ lb. dry etch; tray and instructions. \$4.95

ER-2 REFILL SET — contains dry transfer patterns and tapes only. \$2.75

WRITE FOR FREE CATALOG listing this and many other dry transfer marking sets.

The DATAK Corporation

85 Highland Avenue • Passaic, New Jersey 07055
INFORMATION RETRIEVAL NUMBER 146

Environmental Control?

We've been doing it for 40 years with...



Environmental Rooms/
Temperature Humidity Chambers
Bench-top to walk-in.



TenneyZphere
For simulation of
temperature, humidity, vacuum.



Laminar-Flow
Clean Stations



Multi-Range Precision
Temperature Baths

Write or call for further information on any of these, or autoclaves, packaged refrigeration systems, thermal shrouds, low temperature storage chests, etc.

Tenney
ENGINEERING, INC.

1090 Springfield Rd., Union, N. J. 07083
(201) 686-7870 • (212) 962-0332

674A

"See us at Booth #209 at IEEE Show"
INFORMATION RETRIEVAL NUMBER 147

NEW!



A True-Thru shielded coaxial cable lets you pre-program removable patchboards.

Now you can plug in hundreds of pre-programmed coaxial cables simultaneously and instantly. The combination of a newly designed cable receptacle plus precise machining of rack camming action make it possible to program removable panels with as many coaxial cables as you need — at present, up to 2,448.

"True-through shielded" means that each cable has its own separate shield, isolated from other shields, carried through the system. It also means that cross-talk is down 120 to 150 db from ordinary commoned systems.

High frequencies present no problem. At 100 megacycles, VSWR is 1.02. And you don't destroy this by crimping the outer shield: the connection is held by a screw-on collar. This collar also lets you rewire the cable as often as needed—and rewire with maximum speed. VSWR has remained constant after more than 10,000 cycles.

A 50-ohm matched impedance and .002-ohm contact resistance are two more reasons why you may want to telephone in your order rather than just writing for our complete brochure on this new development. But the main reason is change-over speed. By using a panel programmed with these new through-shielded coaxial cables, you can switch a computer from one program to another in less than 30 seconds.

Let us tell you more—including how little all these advantages are going to cost you. Write to VPC in Waynesboro, Virginia, or telephone (703) 942-8376. We're looking forward to working with you.

That's why we developed the new True-Thru shielded coaxial cable programming system in the first place.



VIRGINIA PANEL CORPORATION WAYNESBORO, VA.

INFORMATION RETRIEVAL NUMBER 148

Adjustable cable tie fastens wire bundles

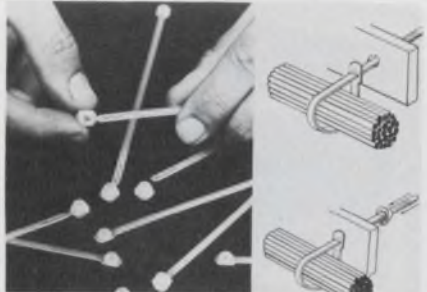

Thomas & Betts Co., 36 Butler St., Elizabeth, N.J. (201) 354-4321. Stock.

A new, convenient-size adjustable cable tie that fastens individual wires or wire bundles up to 1-in. in diameter to any small hole is the TYG-34M grommet type. A separate locking head fits a wide range of panel thicknesses without wobbling or slippage. A metal barb in the locking head creates a virtually permanent high-strength bond with the tie strip that withstands vibration and stressing environmental extremes without slipping.

CIRCLE NO. 425

Basic parts assemble Navy's SHP packages

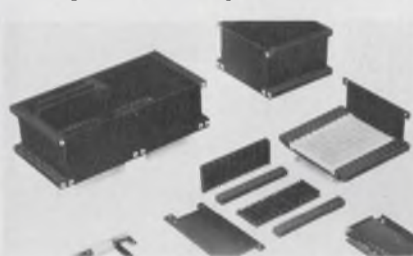

International Electronic Research Corp., 135 W. Magnolia Blvd., Burbank, Calif. (213) 849-2481.

Virtually any electronic equipment package for the Navy's Standard Hardware Program (SHP) can be easily assembled from an "Erector Set" of basic hardware pieces available from International Electronic Research Corp. IERC claims that the new system provides SHP packaging at a cost far less than that of custom-packaging by the contractor. It's designed to hold any circuit modules defined by the SHP in quantities ranging from a few up to very large.

CIRCLE NO. 426

Cable is molded onto DIP female connectors



Component Mfg. Service, Inc., 1 Component Park, West Bridgewater, Mass. (617) 588-0163.

DIP female connectors with molded-on cable are now available. The ribbon cable is #26AWG, PVC and color coded. Molding-on cable eliminates the need for contact housing, clamping arms, screws, covers and other vulnerable and expensive parts. These female connectors, in a black phenolic body with gold-plated contacts, come with or without mounting ears. Matching male connectors with molded-on cable are also available.

CIRCLE NO. 427

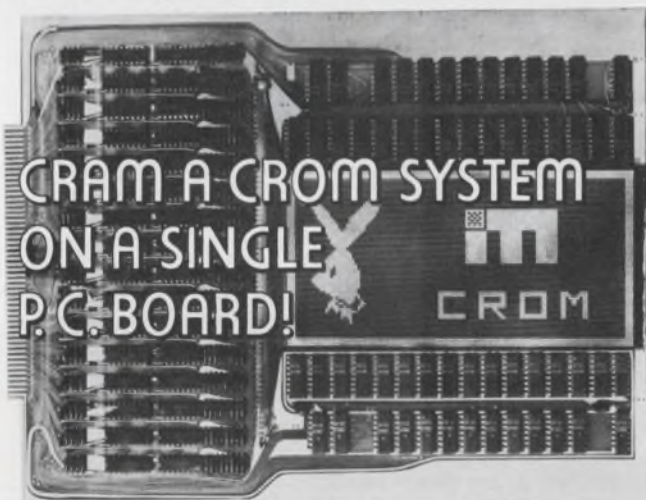

Access/cycle time 50ns or slower. MTBF 200,000 hours for 16K bits. OEM prices from 0.5 to 1.5 cents/bit.

Series 1001 Capacitive Read Only Memory (CROM) Systems on a SINGLE P.C. Board have capacities ranging from 2K to 36K (or more) bits per board. The size (4" x 6" to 12" x 15") and mechanical interface of the P.C. Board can be made compatible with the OEM's requirements.

Inherently non-volatile, the CROM System is a random access memory with non-destructive readout. It comes COMPLETE with storage array, input buffering, timing and control (synchronous or asynchronous), address decoding, output data registers and has TTL/DTL compatible interface.

OTHER IMI PRODUCTS Read/Write, DRO/NDRO memory planes and systems; Semiconductors MOS/Bipolar Read/Write memory systems; plated magnetic discs.

WRITE - we'll send you information on our factory programmable and field programmable systems.



INTEGRATED MEMORIES, INC.
260 FORDHAM STREET
WILMINGTON, MASSACHUSETTS 01887



EDITOR

Tired of your present job? Looking for new opportunities to meet people, travel, to attend conferences on the latest microwave technology?

MicroWaves is seeking a graduate electronics engineer to add to its editorial staff. If interested and have writing ability, send resume to:

Hayden Publishing Co./MicroWaves
50 Essex Street
Rochelle Park, New Jersey 07662
(201) 843-0550
Richard T. Davis, Managing Editor

One-part conductive epoxy bonds LED chips

Epoxy Technology, Inc., 65 Grove St., Watertown, Mass. (617) 926-0136. \$15 per oz.; stock.

Epo-Tek H31, a new silver, conductive epoxy, bonds both GaAsP and GaAs chips in light-emitting diodes. The epoxy cures in 45 minutes at 120 C. Its volume resistivity is 0.0001 to 0.0005 ohm-cm. Because it is a single-component system, Epo-Tek H31 can be applied directly to the substrate, without the necessity of weighing. It can be used with both commercial epoxy dispensing equipment and silk screening techniques.

CIRCLE NO. 428

Magnetic shielding has adhesive backing

Perfection Mica Co., 740 Thompson Dr., Bensenville, Ill. (312) 766-7800.

Shielding foil stock for both high and low intensity magnetic fields is available with adhesive backing for quick shielding applications on prototype or production runs. The stock is fully hydrogen annealed to obtain maximum magnetic shielding properties. It may also be used for special fabricated configurations if severe forming or drawing is not employed. The foil is stocked in 4-in. and 15-in. widths on 50 or 100-foot rolls. Nominal thicknesses are 0.002, 0.004, 0.006 and 0.010-in.

CIRCLE NO. 429

Heat sinking compound withstands 200 C

Jermyn, 712 Montgomery St., San Francisco, Calif. (415) 362-7431. \$4.50/5 oz. jar (25 quantities).

The Thermaflow 2001 heat conducting compound provides an efficient thermal conductor between SCRs, triacs, power transistors and their heatsinks. The compound applied as a thin film between the device and heatsink reduces thermal resistance up to 50%. Non-conductive, the compound will withstand a temperature of 200 C for 24 hours with a volatility of only 1%. Thermaflow 2001 is available in disposable syringes (A30/S) containing (14 g) or in jars (A30/J) containing (140 g).

CIRCLE NO. 430

Monolithic DAC

\$6.95*



complete!

MONO DAC-01HS

THIS MONOLITHIC D/A CONVERTER INCLUDES PRECISION REFERENCE AND HIGH SPEED OP-AMP!

Complete — nothing else to add!

Resolution — 6 bits

Linearity — .3%, 0°C to 70°C

Settling Time to $\pm 1/2$ LSB — 1.5 μ sec (10 V step)

Supply Range — ± 12 V to ± 18 V

Power Consumption — 200 mw.

—55°C to +125°C Models Available!

PRECISION MONOLITHICS

Delivering tomorrow's linear technology today, including...

- The only complete monolithic DAC — monoDAC-01
- The lowest noise, lowest drift op-amp — SSS725
- The fastest precision comparator — monoCMP-01
- The lowest input current, most precision comparator — monoCMP-02
- The lowest cost high speed op-amp — monoOP-01
- The highest performance 741 and 747 — SSS741 and SSS747
- The complete 10-bit fast current output DAC in a 16 pin DIP — aimDAC-100



**PRECISION
MONOLITHICS**
INCORPORATED

1500 SPACE PARK DRIVE, SANTA CLARA, CALIFORNIA 95050
TEL. (408) 246-9225 • TWX 910-338-0528 • CABLE MONO

The Prices Will Surprise You!
Call TODAY — 408-246-9225

*monoDAC 01HS (0°C to +70°C)
\$8.25 @ 100 pcs, \$6.95 @ 2500 pcs

INFORMATION RETRIEVAL NUMBER 151

Highest Speed A/D in Its Class!

(2 μ s for 12 bits)

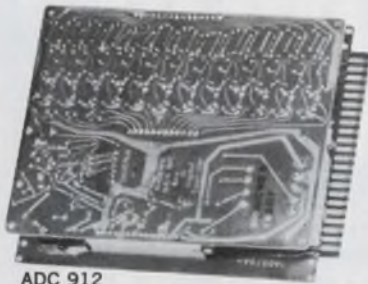

ADC 912

Designed to provide an exceptional speed/performance ratio, units in Phoenix Data's new ADC 900 Series offer fast, accurate, successive-approximation conversion with excellent repeatability, linearity, and monotonicity.

FEATURES:

High Speed Conversion

- 2 Microseconds for 12 Bits.
- 1 Microsecond for 10 Bits.
- 800 Nanoseconds for 8 Bits.

Accuracy

$\pm 0.025\%$ of Full Range — ADC912.

Versatility

Binary, pin-compatible with 700 and 70 series.

Self-Contained

Including precision reference voltage.

Repairable

No potted active circuitry.

Call or write today for the complete ADC 900 Series story.



PHOENIX DATA, INC.

3384 West Osborn Road
Phoenix, Arizona 85017
Ph. (602) 278-8528. TWX 910-951-1364

PACKAGING & MATERIALS

Prototype kits mount in-line packages

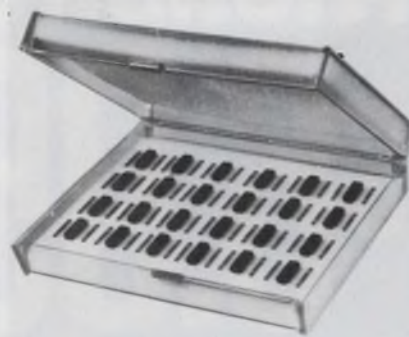

Aura Manufacturing Co., 50 McDermott Rd., North Haven, Conn. (203) 777-2541. \$26.

Three prototype kits provide pre-molded dual in line 14 and 16-lead packages for mounting miniature components, networks, hybrids and inductive devices. These packages have an interlocking case and header design which permits cementing for air tight seal. They are compatible with automatic insertion equipment. The headers which are molded of low-loss, glass-filled epoxy accept 0.160 wide substrates and 0.155 O.D. toroids. When cemented, the cover minimizes the possibility of magnetostriction or damage inherent in transfer molding.

CIRCLE NO. 431

Irradiate PVC insulates hook-up wire

Alpha Wire Corp., 711 Lidgerwood Ave., Elizabeth, N.J. (201) 925-8000.

A hook-up wire insulated with irradiated polyvinylchloride (PVC), RX-7000, is designed for electronic applications which require increased heat resistance and the outstanding flame-retardant characteristics of irradiated PVC. The radiation process rearranges the molecular structure of PVC, improving the basic properties of the material. This results in high-performance electrical and thermal characteristics for this insulation. RX-7000 can resist high temperatures, including contact with a hot soldering iron without melting, flowing, shrinking back, or deforming.

CIRCLE NO. 432

Flat ribbon cable boasts flexibility

Tri-Tech Electronic Corp., P.O. Box 20495, Orlando, Fla. (305) 277-2131.

Hyper-flex, multi conductor flat ribbon cable boasts extremely high flexibility. Hyper-Flex cables have withstood more than 100 million flexes at a rate of over 300 cycles per minute without damage. Hyper-Flex is specially molded with silicone or urethane insulation in almost unlimited varieties of wire gauge and pattern, including twisted pairs, triples, quads shielding and coaxial.

CIRCLE NO. 433

Platforms mount discrete components

Component Manufacturing Service Inc., 1 Component Park, W. Bridgewater, Mass. 02379 (617) 588-0163. \$0.37 (500 quantities); stock to 4 weeks.

Platforms for mounting discrete components and constructing electronic circuits are available in 14 and 16-pin DIP configurations and feature U shaped solder terminals with round or flat tails that plug into DIP sockets and packaging panels. Snap-on covers, available in five heights, protect components soldered to the platform terminals and are designed to permit encapsulation by potting if desired. The flat top is ideal for marking.

CIRCLE NO. 434

Door handles designed for industrial cabinetry

Southco, Inc., 200 Industrial Hwy., Lester, Pa. (215) 521-0800.

The Southco No. 25 extruded aluminum pulls are produced with an attractive brushed anodized finish in four distinctive styles; "C", 29 Angle, "L", and Offset. Each style is available in two envelope sizes plus several lengths ranging from 3-3/8 to 10-3/8 in. Standard lengths are graduated in 1-3/4-in. increments which allow vertical mounting on modular drawers of conventional electronic racks with a 1/8-in. clearance between adjacent pulls.

Booth No. 1613 Circle No. 301

photo
controls
for
every
need



51 sketches showing
photo controls for

- conveyors
- automation
- die-protection
- inspection
- measuring
- positioning
- packaging
- smoke detection
- sorting
- tension
- control
- weighing
- many, many others.
- cut-off
- counting
- jam-up
- limit
- orientation
- processing
- registration
- traffic
- winding

NEW Catalog 71

297 pre-engineered photo controls including retro-reflective, specular reflective, fiber optic and solid state; ON/OFF and Timing Controls; tremendous selection of photo sensors and light sources. Proximity Controls. Counting Eyes. Bin level, smoke, current surge and impact controls. All illustrated, described and priced.

See the AUTOTRON MAN in your
area or send for Catalog 71 NOW

AUTOTRON, INC.

3627 N. Vermilion, Danville, Ill. 61832
Ph 217-446-0650 TWX 910-244-1455

INFORMATION RETRIEVAL NUMBER 153

CAPITOL adds illuminated REED SWITCHES To their *QUALITY* line of Push Button Switches



See Them at Booth 3522 IEEE Show N. Y.
or send for Descriptive Literature
also available as non-illuminated

CAPITOL

WRITE FOR CATALOG
THE CAPITOL MACHINE AND SWITCH CO.
87 Newtown Road, Danbury, Conn. 06810

Representatives in principal cities Tel: 203-744-3300 TWX:710-456-0365

INFORMATION RETRIEVAL NUMBER 154

ELECTRONIC DESIGN 6, March 16, 1972

BOURNS VARIABLE NEW RESISTOR JACKPOT

CERMET OR COMPOSITION

MODEL
3359



MODEL
3353



MODEL
3351



3 WINNERS FROM THE
"QUALITY" PEOPLE

WIN 7 WAYS!

- 1 SUPERIOR MOISTURE RESISTANCE—Bourns actually calls out this important specification.
- 2 MULTIPLE TEMPERATURE RANGE — Why bear the cost of more operating temperature range than you need? Bourns offers you a choice of three.
- 3 TAILORED POWER—Again, Bourns gives you a chance to save. Select from three different power/temperature capabilities for the one closest to your specific application.
- 4 SOLVENT-RESISTANT—Bourns specifies less than 1% resistance change after normal circuit-board solvent cleaning processes; that's the best in the industry.
- 5 PIN AND MOUNTING VERSATILITY — Select from popular pin patterns in both vertical and horizontal mounting configurations.
- 6 PRICES YOU CAN'T IGNORE — Bourns has priced these new products very competitively; in 1000-1999 quantities \$.15 to .50, depending on the model you need.
- 7 FAST DELIVERY—That means fast, not next week. In-depth stocking is the key.

SPECIFICATIONS:

| | MODEL 3359 | MODEL 3353 | MODEL 3351 |
|----------------------------------|------------------|--------------------|-------------------|
| RESISTANCE RANGE | 100Ω-2 megohms | 500Ω-5 megohms | 500Ω-1 megohm |
| RESISTANCE MATERIAL | CERMET | COMPOSITION | COMPOSITION |
| POWER | ½ watt at 70°C | ½ watt at 60°C | ½ watt at 60°C |
| OP. TEMP. | -65 to +125°C | 0 to +100°C | 0 to +70°C |
| HUMIDITY | ±1% T.R. Change | ±12.5% T.R. Change | ±7.5% T.R. Change |
| LOAD-LIFE | 1000 hrs at 70°C | 500 hrs at 60°C | 100 hrs at 60°C |
| RESISTANCE CHANGE AFTER CLEANING | 1% | 1% | 1% |
| PRICES* | .50 | .20 | .15 |

*1000-1999 quantity prices, U.S. dollars, F.O.B., U.S.A.

KEEP OUR COMPETITION ON THEIR TOES . . . ENTER YOUR ORDER NOW AT A LOCAL BOURNS SALES OFFICE, REPRESENTATIVE, OR THE FACTORY-DIRECT.



TRIMPOT PRODUCTS DIVISION • 1200 COLUMBIA AVE., RIVERSIDE, CALIF. 92507

INFORMATION RETRIEVAL NUMBER 155

Panel mounts 450 DIPs in a single plane

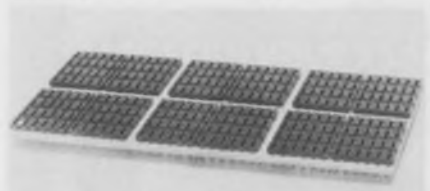

Electronic Engineering Co. of Calif. (714) 547-5501.

The AW Series panels hold up to 450 14 or 16-pin DIP packages in a single 19-in. by 12-in. plane. They're designed for large production use where high speed, fully automatic solderless wiring is advantageous. All socket pins are accurately located within a guaranteed 0.020 in. of true indicating position, thus eliminating the need for pin straightening prior to machine wrapping.

CIRCLE NO. 435

Package blanks give rapid programming

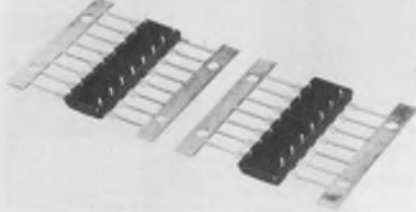

Aura Manufacturing Co., 50 McDermott Rd., North Haven, Conn. (203) 777-2541.

A line of DIP cases for mounting miniature components and crossover circuits is hard-wired. The cases provide a means for rapid front panel programming and reprogramming applications. Identical to standard IC packages, the DIP packages have various sized interlocking covers which can be cemented for air-tight circuit protection.

CIRCLE NO. 436

DIP socket has board-mating projections

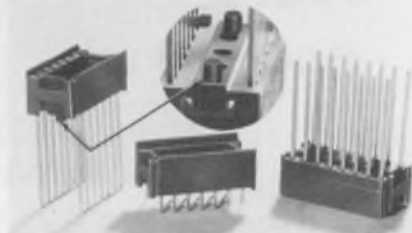

Aries Electronics Inc., P.O. Box 231, Frenchtown, N.J. (201) 996-6200. 29¢ to \$1.00; stock.

A new line of 14- and 16-pin solder and wire-wrap DIP sockets are molded with tapered, press-in buttons for rapid assembly. The socket is pushed into mating holes in the PC board. The buttons hold the socket in place prior to wave or dip soldering, thus eliminating screws, rivets or other attaching hardware.

CIRCLE NO. 437

Reliable Precise Measuring device



Servo-Tek's SPEED INDICATING SYSTEM, a complete package for measuring speed in all applications. Nothing else to buy, no other black boxes, it's self-contained, it's self-powered.

- Accurate, Less Than 1% Full Scale
- Direct Reading — RPM
- Bidirectional and Suppressed Indicators Available

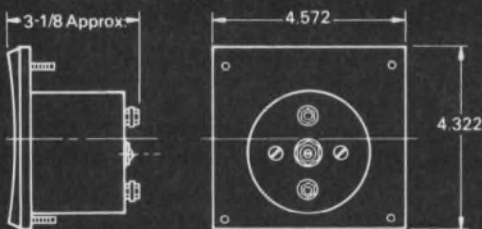

Ask for a copy of our NEW catalog.

SERVO-TEK[®] PRODUCTS COMPANY

1086 Goffle Road, Hawthorne, N. J. 07506 • 201 — 427-3100
Servo-Tek of California, Inc.
8155 Van Nuys Blvd., Van Nuys, California 91402 • 213 — 786-0690

INFORMATION RETRIEVAL NUMBER 156

Trouble-free service!

DORMEYER TUBULAR SOLENOIDS



used in computers, offer service in millions of cycles

Write for FREE BOOKLET

"SOLENOIDS, What they are—How to use them!"

DORMEYER INDUSTRIES, Inc.

3414 No. Milwaukee Ave., Chicago, Illinois 60641

WORLD'S LARGEST MANUFACTURER OF SOLENOIDS—COILS—TRANSFORMERS



DORMEYER
Dependability

INFORMATION RETRIEVAL NUMBER 157

ELECTRONIC DESIGN 6, March 16, 1972

COMPONENTS

Solderless, socketless LEDs are wire-wrapped

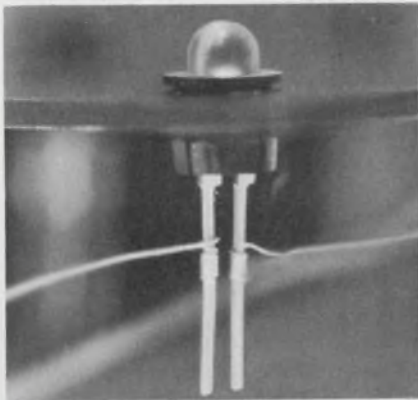

Hewlett-Packard, 1501 Page Mill Rd., Palo Alto, Calif. (415) 493-1501. Stock.

Designed to be wire wrapped, the Hewlett-Packard 5082-4880 series light-emitting diodes are the first offered for solderless, socketless assembly. The new series is designed with 0.7-in. long, 25 by 25 mil cross section leads which can be wire wrapped with Gardner-Denver Models 14R2, 14XL1, 14XA2 or equivalent. They can be panel or printed-circuit board mounted and the leads wire-wrapped directly without using a socket. Stiff leads are on 0.1-in. centers. A simple snap-in clip is available for panel mounting. The 5082-4880 series is available in three light levels, each with three different lenses. Light levels available are 0.5, 1.0 and 1.6 millicandles.

CIRCLE NO. 438

Photomultiplier claims highest sensitivity

RCA, *Electronic Components*, 415 S. Fifth St., Harrison, N.J. (201) 485-3900. \$975 (1-9 quantities); 90 days.

The Quantacon photomultiplier boasts the highest known photocathode sensitivity in the industry over the near ultraviolet to near infrared range. The RCA developmental type C81034A utilizes a GaAs photocathode, an ultraviolet transmitting glass window, and high stability copper-beryllium dynodes. The spectral response range is 200 to 930 nanometers. Luminous photocathode sensitivities of over 1000 μA per lumen have been obtained.

CIRCLE NO. 439

So you're looking for low frequency filters...

Like 10.2 kHz
11.3 kHz
13.6 kHz

Very Small

but High Performance

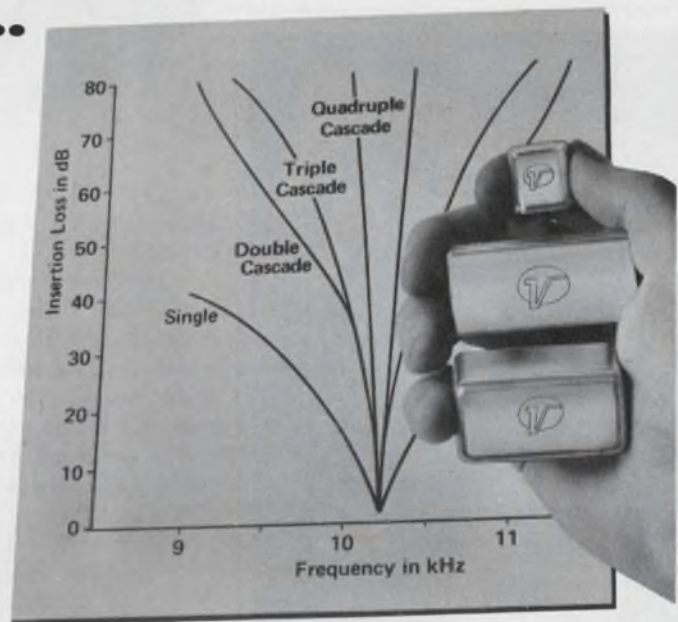

better check Vernitron... (the filters people)

For VLF receivers, Mil-Nav systems, Omega systems, command-destruct systems, underwater sound — these miniature ceramic LF filters are about one-tenth the size and weight of comparable low-frequency types, yet have narrower bandwidths, lower insertion loss and greater stability. This means you can pack more performance into one-tenth the space — and have no worries about shock, vibration, thermal drift. Available in any discrete operating frequency from 7.5 kHz to 50 kHz — including the Omega f_o 's of 10.2, 11.3 and 13.6 kHz. They're fixed-tuned, so you have no installation adjustments to make. Hermetically-sealed, immune to environments... and there's no need for shielding.

Performance? Just the single-resonator models have 20 dB/3 dB bandwidth ratios less than 13, stopband attenuation to beyond 30 dB from dc to above 100 kHz. Less than 5 dB insertion loss. And that's not all!

Cascaded Models for Higher Selectivity, Higher Rejections

Great thing about ceramic LF filters — they can be cascaded together in the same package, for quantum jumps in selectivity and rejection — with minimum sacrifice to volume and weight. Vernitron supplies them in 2-, 3- and 4-resonator models. Some examples:

- 2-resonator Models—40 dB/3 dB ratios of 10; stopbands to above 60 dB.
- 3-resonator Models—60 dB/3 dB ratios of 10; stopbands to above 80 dB.
- 4-resonator Models—80 dB/3 dB ratios of 13.5; stopbands to above 90 dB.

Both Mil-spec and commercial models. Prices will surprise you. They're at least competitive with conventional types, and often considerably less. If it's in the 7.5 kHz to 50 kHz range, it will pay you to check Vernitron. Send us your requirements. We'll send complete specs and technical data.



Vernitron Piezoelectric Division

232 Forbes Road / Bedford, Ohio 44146 / (216) 232-8600

INFORMATION RETRIEVAL NUMBER 158

Buying Power?



Here's the new, single source for all your power needs.

- Mil Spec DC Modules
- Wide Range DC Modules
- Slot Voltage DC Modules
- IC Logic Modules
- Full-Range Lab Supplies
- Inverters, Frequency Changers
- High-Voltage Supplies
- AC Regulators
- Full Technical Data
- Full Specifications
- Mechanical Data
- Model Types
- Prices & Availability

Ask for Your Free Catalog #157 Today!



ERA TRANSPAC CORPORATION

67 Sand Park Road, Cedar Grove, N. J. 07009
(201) 239-3000

A subsidiary of
Electronic Research Associates, Inc.

*See us at Booth No. 2610 IEEE Show

INFORMATION RETRIEVAL NUMBER 159

COMPONENTS

CRT tube handles bandwidths to 50 MHz



The Inter-Technical Group, Inc., P.O. Box 23, Irvington, N.Y. (914) 591-8822.

A high-performance mesh pda oscilloscope tube with a 5-1/2-in. diagonal is designed for high bandwidth oscilloscopes in the 30 to 50 MHz range. The all electrostatic tube has a pda ratio of up to 12:1 and is designed for deflection with transistor circuits. Deflection sensitivity at 12 kV is $-D_x$ —11 to 14.2 V/cm and D_y —4.3 to 5.4 V/cm. The D14-200 measures 405 mm (max) in length and features an ultrasquare rectangular face that offers a display area of 10 cm by 8 cm.

CIRCLE NO. 440

Miniature lamps are totally rubber encased



APM-Hexseal, 44 Honeck St., Englewood, N.J. (201) 569-5700. Stock.

Completely rubber encased T-3/4 and T-1 miniature lamps have their upper portion covered with a snug-fitting silicone rubber filter called Silikromes, which conforms to MIL-R-5847, Class III. The base is potted to prevent light leakage through the base and diluting the filter—a common problem with filtered miniature lamp assemblies. Lamp breakage problems are also reduced by the rubber jacket. These filter/lamp assemblies are in red, light blue, green, blue and yellow.

CIRCLE NO. 441

Color-illuminated rocker is protector and switch

Airpax Electronics, Cambridge Div., Woods Rd., Cambridge, Md., (301) 228-4600. \$4 each single pole (large quantities); 4-5 wks.

The Series 203 electromagnetic circuit protectors feature a wide selection of color-illuminated rocker arms and combine the function of circuit protection with that of an on/off switch in a small attractive panel-mounted device. Designed for equipment protection using hydraulic inverse time delay, they provide precise trip regardless of ambient temperatures. Features include illuminated single rocker actuator for 1, 2 or 3-pole assemblies, choice of illumination (filament, neon or light emitting diodes), snap-in front panel mounting for fast economical installation (optional flush rear mounting), voltage ratings of 32 V dc, 120 V ac and 250 V ac (50/60 or 400 Hz), current ratings from 0.020 to 20 A and choice of inverse time delay or instant trip.

Booth No. 3121 Circle No. 305

Miniature rocker switches rated at 5 A

JBT Instruments, P.O. Box 1818, 424 Chapel St., New Haven, Conn. (203) 772-2220. Stock.

Rocker switches in 1-, 2-, 3-, and 4-pole, double throw models, feature terminals for solder or for solderless wire-wrap, and for right angle or direct PC board insertion. Characteristics include UL rating of 5 A inductive load (0.75 pF) at 125 V ac for most models. Rockers, pinned with heavy-duty rivets, are nylon in three standard colors: red, white, and black, with other colors and custom hot-stamped markings on special order. Bodies are green either DAP or selected phenolic. Mounted with bezel or mounting bracket 0.275-in. wide by 1.156-in. long (scored for snip-off to 0.937-in.) Compact mounting—for instance, six switches mounted side-by-side with 0.03-in. separation between rockers take less than 2-in. panel width.

Booth No. 2223 Circle No. 280

Capacitors combine Ta performance, Al price

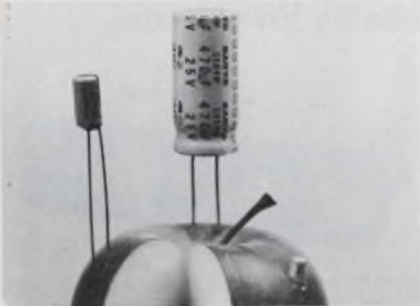

Sakata International, Inc., 208 S. LaSalle St., Chicago, Ill. (312) 372-1465. \$0.15 to \$0.23 (1000-10,000); 5 wks.

Two lines of capacitors combine the performance, tolerances and reliability of solid tantalum units with the price of aluminum electrolytic types. The Alsicon line of aluminum sintered capacitors covers a range of 0.1 to 22 μF ; the SP-CON line covers the 4.7 to 1000 μF range. SP-CON units are solid electrolytic capacitors which use an exclusive material and manufacturing process. Similar to tantalum types in their construction, Alsicon capacitors are composed of a sintered aluminum body, a dielectric layer covering the whole internal body surface, and electric contacts made of solid manganese dioxide semiconductor material. The dissipation factor, leakage current, and operating temperature range of the new units is identical with those of tantalum capacitors, yet they are cheaper, smaller and lighter than aluminum electrolytic units.

CIRCLE NO. 442

Endless cassettes run up to six minutes

TDK Electronics Corp., 23-73 48th St., Long Island City, N. Y. (212) 721-6881. \$4.75 - \$5.50.

Continuous-play, endless-loop tape cassettes are designed for repeat message applications. Like all endless cassettes, the EC series units are designed to play or record in the forward direction only. Standard EC cassettes are available in three basic message lengths. The EC-1 offers one minute of record/play time, the EC-3 runs for three minutes and the EC-6 for six minutes.

CIRCLE NO. 443

Multi-turn knob has multi-colored caps



European Electronic Products, Corp., 10150 W. Jefferson Blvd., Culver City, Calif. (213) 838-1912.

A multi-turn colored knob allows, for full turns, the coarse scale to have values 0-14. The graduated fine scale, lined with the knob, permits the precise adjustment of one turn into hundredths. The value set can be easily fixed by means of the large locking ring.

CIRCLE NO. 444

Snap-in pushbutton switches rated 3/4 A

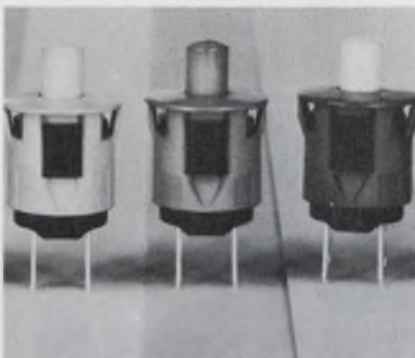

Cutler-Hammer Inc., 4201 N. 27th St., Milwaukee, Wis. (414) 442-7800. \$0.20 (100 quantities); 4 wks.

The 8423 and 8424 series single pole switches are rated 3.4 A, 125 V, and 1/4 A, 250 V, respectively. The 8419 series has dry circuit applications. Standard design features include Zytel nylon 101 buttons and shrouds; snap-in mounting, normally open or normally closed momentary circuits; screw, solder lug or 0.250-inch spade terminals; silver or gold plated contacts for dry circuit application. A myriad of colors are available, including orange, yellow, green, blue, purple, red, white and rose.

CIRCLE NO. 445

Now the famous 829 has a "G" for good measure!



Calibrate or Measure
with the

RFL Model 829G

RFL's famous 829, for 15 years the industry calibration standard, now gives way to the new 829G — still the industry calibration standard, but now it's twice as useful. The 829G provides a precision source of AC and DC volts, amps and ohms — plus precision measurements of these parameters from external sources. It offers four-terminal sensing in both source and measurement modes, and high accuracy, resolution and regulation, with 5-digit readout. 5 ranges of AC or DC, 0.1 to 1000V. 6 ranges of current, 100 μA to 10A. 50, 60, 400, 1000 Hz AC plus EXT. And many other features — all for just \$3,600. Write for complete data today. RFL Industries, Inc., Instrumentation Div., Boonton, New Jersey 07005. Tel: (201) 334-3100 / TWX: 710-987-8352 / CABLE RADAIRCO, N. J.



RFL Industries, Inc.

Dual-in-line Packaging BONANZA



Break through your present logic packaging limits with new versatility, new economy and new fast delivery. EECO's modular socket boards offer widest range of package sizes and shapes... help you eliminate unnecessary card connectors, connector wiring and power transient problems. Just 4-6 weeks from logic diagram to wired hardware.

NEW 1972 CATALOG

Very wide selection of socket boards, frames, drawers and accessory hardware offers new freedom for logic designers. 28 pages with 122 illustrations and 12 convenient product reference tables.



ELECTRONIC ENGINEERING COMPANY of Calif.
1441 East Chestnut Avenue, Santa Ana, California 92701
Phone: (714) 547-5651 • TWX 910-595-1550 • Telex 67-8420

INFORMATION RETRIEVAL NUMBER 161

ENGINEERS WHO KNOW ZENER DIODES SPEC DICKSON

That's because Dickson has earned a reputation for excellence in voltage regulating (Zener) and reference (TC) diodes. Since Dickson has always been a specialist in Zeners, engineers expect the best and they get it... from a hi-rel military unit to low-cost industrial devices. Give us a try! Write, today, for our 6-page Zener Selection Guide.

"The
Specialists"



"Where Quality Makes The Difference"



DICKSON
ELECTRONICS CORPORATION
PHONE (602) 947-2231 TWX 910-950-1292 TELEX 667-406
P.O. BOX 1390 • SCOTTSDALE, ARIZONA 85252

INFORMATION RETRIEVAL NUMBER 162

COMPONENTS

Miniature readout boasts lowest cost



Industrial Electronic Engineers, Inc., 7720-40 Leona Ave., Van Nuys, Calif. (213) 787-0311. \$14.70 (1000 quantities).

A tiny new rear-projection readout that takes advantage of a recently introduced driver/decoder to achieve sharply lower operational cost is priced in 1,000 quantities including the C58 lamps at \$14.70 each. The new Series 7800 Driver/Decoder (non-memory version) costs just \$9.63 for a total operational package cost of \$24.33 which compares to about \$85.00 for similar packages. Requiring only about as much panel space as a trading stamp, the readout packs 11 message positions, (with character height up to 0.37-in.) each complete with its own light source and optional projection system in a 2 inch long case. Designated the Series 0345, the unit employs a replaceable film mask containing all message intelligence in 11 discrete sections.

CIRCLE NO. 446

Subminiature reed switch handles lamps

Hamlin, Inc., Lake Mills, Wis. (414) 648-2361. \$0.15 (large quantities); Stock.

The form A switch, designated as the MAAC-2, was developed to switch lamp or other high-inrush loads. The subminiature size permits extremely close packaging in electrical control systems. Maximum recommended lamp loads are 12 V dc at 0.21 A or 120 V ac at 15 W. Maximum switching voltage is 12 V dc, 0.1 A dc current rating, with breakdown voltage 300 V dc, minimum. Physical dimensions: 1.775-in. nominal length; 0.8-in. maximum glass length; 0.105-in. maximum glass diameter.

CIRCLE NO. 447

Miniature pushbutton switches are oiltight

Micro Switch Div., Honeywell Inc.,
11 W. Spring St., Freeport, Ill.
(815) 232-1122.

The PW line of industrial miniature oiltight pushbuttons includes lighted and unlighted pushbuttons, indicators, selectors, selector-push devices and key-operated selectors. Elastomer panel seals assure long-term freedom from oil contamination. The industrial switches are designed for 7/8-in.-diameter panel mounting holes. The switches are claimed to be the first miniature oiltight industrial pushbuttons to have earned UL general listing.

CIRCLE NO. 448

All-plastic capacitor eliminates leakage



PYE TMC Ltd, Capacitor Div.,
Oldmeadow Rd., Hardwich Trading
Estate, King's Lynn, Norfolk, Eng-
land.

For the first time, an all-plastic capacitor introduces solid conductor insertion in capacitors. This permits connection of a stripped wire merely by pushing it into the terminal socket where a rat-trap device grips the wire securely in position. This feature provides quick, secure terminal fixing. It also conforms to modern light-fitting manufacturing techniques with savings in both assembly time and materials. The use of a special metalized polypropylene film construction eliminates the need for liquid impregnation and the potential problem of leakage. It also permits higher operating temperatures (85 C as against 70 C with impregnated types).

CIRCLE NO. 449

Trimmer resistor has T slider block design

Spectrol Electronics Corp., 17070
E. Gale Ave., City of Industry,
Calif. (213) 370-8551. Stock.

The 20-turn 3/4-in. Spectrol Model 43 is reported to have improved setability and stability because of a unique T slider block design and brush contacts, and it is said to have an improved CRV of 3% or 3 Ω and an RT tolerance of $\pm 10\%$. It has a low profile and stands only 1.4-in. above the board, is resistant to shock and vibration per MIL-R-22097, comes in a sealed case that permits board washing, and it is available in all 3 pin configurations.

CIRCLE NO. 450

Rechargeable battery believed to be cheaper

Gould Inc., Automotive Battery
Div., P.O. Box 3140, St. Paul,
Minn. (612) 452-1500.

The most economical, fully rechargeable batteries developed to date according to the manufacturer, are the Gelyte family. Incorporating a special gelled electrolyte, the three batteries in the series are priced as low as one-fifth that of nickel cadmium and up to 30% less than other domestic gelled electrolytes. The batteries are rechargeable from 100 to 300 or more full charge/discharge cycles, with up to 1000 cycles or more if not completely discharged during each cycle. The temperature rating is 68 F. Available Gelyte battery sizes include 6 V, 9 to 10 A; and 6 V, 4 to 6 A. Designated models Pb660 and PB690, each provides 6 V nominal voltage, operation over temperature ranges of -40 F to 150 F and have a charge time of 16 hours. Model Pb 660, weighing 2.3 lb, provides 5.55 amp-hour at a 20 hour rate with charging characteristics beginning at 0.4 A and tapering to 0.1 A for a total time of 16 hours. Charge characteristics for the 3.7 lb model PB690 begin at 1.0 tapering 0.5 A for a total time of 16 hours.

Booth No. 3521 Circle No. 275

The Elegant Capacitors



For elegant applications. Zero temperature coefficient ± 10 ppm/ C (-55 C to +85 C) with .01% accuracy - now 25% smaller.

Precise specs from precise craftsmanship. That's what you'll find in all components by EAI. Thick-film audio and servo amps. Active tone filters. Analog/digital converters plus other special function modules. Transformer kits. Molded plastic parts. Custom coils. Solenoids. And a growing list of other elegantly crafted etceteras.



Electronic Associates, Inc.
193 Monmouth Parkway
West Long Branch, New Jersey 07764
Tel. (201) 229-1100

INFORMATION RETRIEVAL NUMBER 163

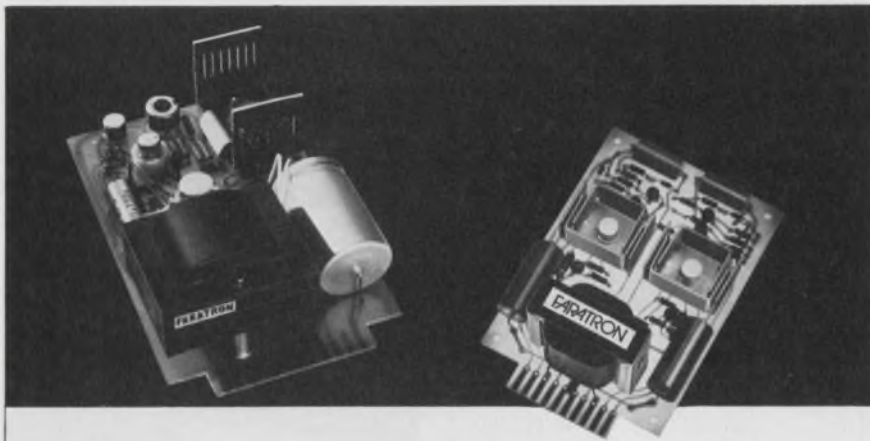

Cut costs 50% with this Basic Multiple Output power supply system

Companion Series for IC Logic

16 models offered in a voltage range of 5.0V (current 1.0A) to 48.0V (current 0.20A). An IC is the main source of regulation. Features: remote sensing, voltage adjustment, overload protection and a Crowbar option. Models from \$44 to \$49.

Regulated Dual Card Supplies for Op-Amp

Dual voltage outputs from 6.0V@50mA to 28 V DC @ 100mA. All silicon components. Remote sensing, overload and short protection, no derating of performance from -20°C. to +71°C. Prices from \$28. Large selection available from stock.

FARATRON

Write or call:
Faratron, 290 Lodi St.,
Hackensack, N.J. 07601
Phone (201) 488-1440.

INFORMATION RETRIEVAL NUMBER 164

NEW



Series MR1 (Rocker): 1-, 2-, 3-, and 4-pole
Nominal rating: 5 full amp./125 VAC



Series MP1 (Paddle): 1-, 2-, 3-, and 4-pole
Nominal rating: 5 full amp./125 VAC

NEW

WHAT MAKES OUR SWITCHES BETTER 'N THEIRS?

To begin with, let's get this straight — *we're biased*.

But we have reason to be, because we know about all the engineering that went into them. For instance, the unique, sturdy, rivet-pivot that pins the rockers or the paddles to the metal bushings so that they move freely but don't develop slop or work loose; the terminals that are anchored so firmly it practically takes an act of sabotage to yank them out; the "butt and shear" interior construction that gives smoother action and reduces arcing for longer life under load.

And materials: specially studied and selected from the mob of different ones available. Sifted out for their ability to do their thing better — such as the green-colored bodies (glass-filled DAP) in the 1- and 2-pole models. And let's not overlook the testing — here in our plant at our expense — not in your product at your expense.

You could say that these are all minor things, but the fact is, they all add up to an important total. All this goes for the whole line of J-B-T sub-miniature toggle switches that are definitely competitively priced in spite of definitely superior features. For the facts, get your copy of Catalog MT-40A.



J-B-T INSTRUMENTS INC.
NEW HAVEN, CONNECTICUT 06508
(203) 772-2220



See you at the IEEE Show — Booth 2223

INFORMATION RETRIEVAL NUMBER 165

COMPONENTS

Trimmer capacitors handle 5000 to 10,000V

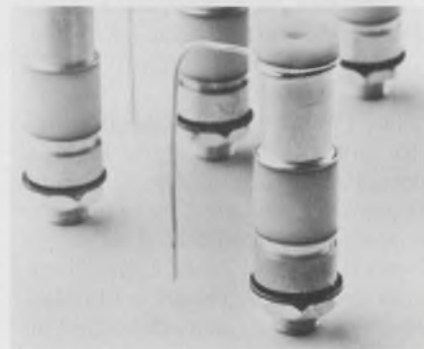

Polyflon Corp., New Rochelle, N.Y.
(914) 636-7222. \$10 (large quantities).

A family of trimmer capacitors is claimed to be more rugged than devices made with quartz or glass dielectrics and, additionally, has much lower losses. The capacitor is reported to be ideal for improving voltage ratings in communications and radar applications. The losses of the capacitors are as low as those of high-vacuum devices, while their size is comparable to that of glass and quartz units. The capacitors use electroplated Teflon and cover 0.8 to 25 pF.

CIRCLE NO. 451

Trimming pots are only 1/4-in. diameter

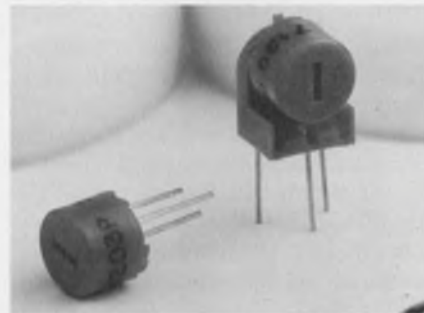

Amphenol Controls Div., 120 S. Main St., Janesville, Wis. (608) 754-2211.

A line of single-turn commercial trimming potentiometers offers infinite resolution. The 1/4-in. round style units feature multi-finger contact for excellent contact resistance variation. Designated 6203 Series, the trimming potentiometers are offered in either P (top adjust) or X (side adjust) PC pin termination styles.

CIRCLE NO. 452

PICTURE, PATTERN, OR PLOT



Alden recorder reproducing scanning electron microscope image of a 1 mil wire bond to an IC

Get sharp recordings displaying three dimensions and yielding greater detail and informational content than your present display with ALDEN COMPONENT FACSIMILE RECORDERS.

- Synchronizes easily with your scanning sensor or transducer
- Available in print-out widths from 2" to 48"
- Speeds range from 8 RPM to 3600 RPM
- Presentations, linear or non-linear . . . simply
- Used with a broad variety of systems such as ultrasonic/infrared flaw detectors, spectrum analyzers, computers, television, medical instrumentation and scanning radiometers, etc.

Call or write for free descriptive catalog.

ALDEN ELECTRONIC & IMPULSE RECORDING EQUIPMENT CO., INC.

Westboro, Mass. 01581 Tel.: (617) 366-8851

"See us at Booth 2523"

INFORMATION RETRIEVAL NUMBER 166

Apollo New Products!! Counting Display Unit DN-1130 Series

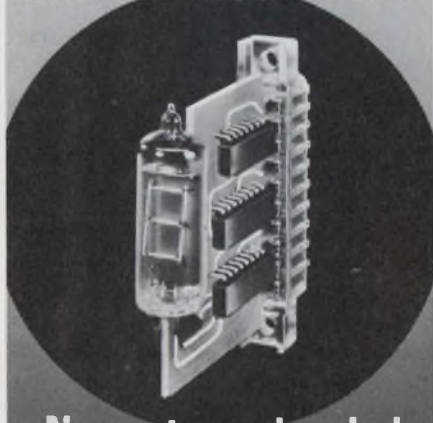

Now, Just plug-in!

- Digital display of counted pulses
- Consists of NEW-TRON DA-1300 (7 segment incandescent digital readout tube), decoder/driver, decade counter and quad latch
- BCD counter output and reset input may be connected externally
- Only 5V power supply required
- Compact size: 0.5" (W) x 2" (H) x 2.05" (D)
- Multiple digit and other circuit design available on special order

For further information, please contact:

Apollo CORPORATION
5-1, Togoshi 6 chome, Shinagawa-ku, Tokyo 141, Japan
Phone: (03) 786-2005

U.S. Distributor:
DAIMETRICS CORPORATION
1311 Post Ave., Torrance, Calif. 90501
Phone: (213) 328-2080

INFORMATION RETRIEVAL NUMBER 167

ELECTRONIC DESIGN 6, March 16, 1972

design aids

Capacitor substitutes

An interchangeability list covers designs of unique, solid-TFE capacitors with electroplated electrodes. The two-page bulletin describes the new TFE units and provides an easy cross-reference for applications presently employing vacuum capacitors and requiring full electrical and mechanical replaceability. Polyflon Corp.

CIRCLE NO. 453

Current conversions

The latest "Tech Tips" describes the peak, average or rms current conversions for half-sine and square wave forms. "Tech Tips" 1-2 provides formulas for the calculation of average and rms currents for a half-sine wave form at 60 Hz given the peak current and time or phase constants. A table gives the various conduction angle relationships for half-sine and square waves. Also included are charts which can be used to determine peak to rms, average rms, peak to average and reciprocals of the current relationships given the percent duty cycle or vice-versa. Westinghouse Electric Corp., Semiconductor Div.

CIRCLE NO. 454

Specialty tubing reprints

A comprehensive library of how-to-do-it article reprints of articles published by leading trade publications cover such areas as selecting, purchasing and ordering seamless steel specialty tubing; machining specialty tubing; fabricating and shaping; welding and joining; how to use small OD tubing; advantages of seamless specialty tubing over bar stock in making small parts; fabricating hydraulic cylinders; tubing for cryogenic application. Committee of Seamless Specialty Tubing Producers, American Iron and Steel Institute, New York, N.Y.

CIRCLE NO. 455

The Elegant Transformer Kits

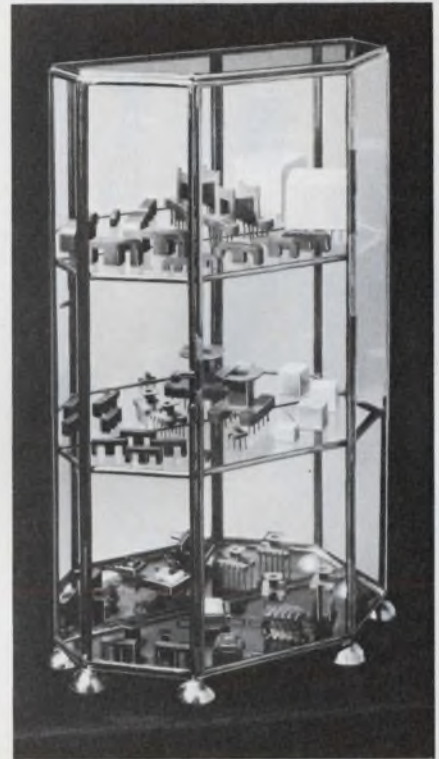

Select from 157 kits. To find the exact match for your needs. Plus ready-made economies. With ferrite cores. Steel frames. Cases. And bobbin/coil forms that pin precisely into standard printed-circuit grid patterns.

Six materials: fluorocarbon, nylon, glass-reinforced nylon, DAP, polyester and epoxy. For stability at temperature ranges from 105 to 200 C.

The complete collection expresses the craftsmanship you expect from EPC as an EAI component company. Look to EPC also for custom-molded parts. Or to EAI for thick-film audio amps. Capacitors. Custom coils. Solenoids. Active filters. Analog/digital converters and other special function modules. Plus a growing list of other elegantly crafted etceteras.



EPC

Electrical Plastics Corporation
500 Long Branch Avenue
Long Branch, New Jersey 07740
Tel. (201) 870-9500

A Subsidiary of Electronic Associates, Inc.

INFORMATION RETRIEVAL NUMBER 520

PICO transformers ... small size ... big specs

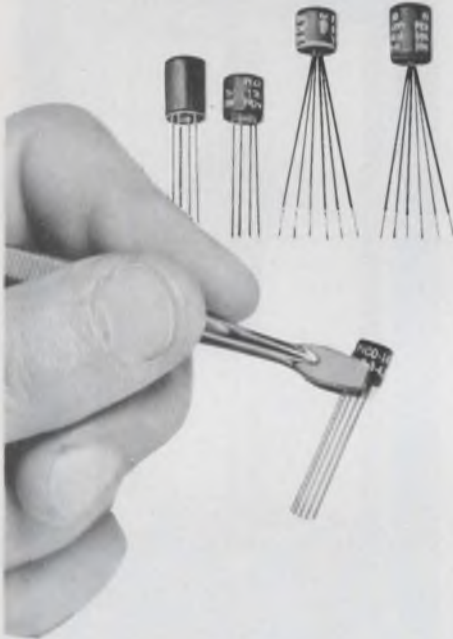

- size variations of .25" diam. x .25" ht. to .34" diam. x .49" ht.
- MIL-T-27C (PICO is QPL source)
- extreme resistance to thermal shock MIL-STD-202D, method 107(A-1)
- 300 Hz-250KHz
- pulse applications .05 μ s to 100 μ s
- prim. and sec. impedances 3 to 250 K ohms
- power to 600 milliwatts
- inductors to 80 henries
- flying leads or TO-5 plug-in construction (.1" grid available)

Send for 24 page Pico Catalog

PICO Electronics, Inc.

316 W. FIRST STREET
MOUNT VERNON, N. Y. 10550

Telephone 914-699-5514

(All PICO Products are patented)

INFORMATION RETRIEVAL NUMBER 521

224

application notes

Frequency synthesizers

ICAN-6716, "Low-Power Digital Frequency Synthesizers Utilizing COS/MOS IC's," briefly reviews digital phase-locked loop fundamentals and then discusses, in detail, practical digital phase-locked loops including the use of heterodyne down-conversion. Application of these principles to FM receiver synthesizers is discussed and implementation of the circuits using COS/MOS ICs is shown. Twenty-five figures include complete logic and circuit diagrams, as well as circuit and timing waveforms. RCA Solid State Div., Somerville, N.J.

CIRCLE NO. 456

Display storage tubes

A 52-page booklet includes background technical information on display storage tube (DST) operation and theory, applications data and a catalog of standard DST types and special tube design services. The catalog sections of the new booklet provide a listing of the standard DST phosphors available and include a DST reference chart in which the performance characteristics of all standard Westinghouse tube types are shown. Westinghouse Electric Corp., Electronic Tube Div., Elmira, N.Y.

CIRCLE NO. 457

PC terminal board design

A four-page booklet covers all pertinent technical data on four new series of terminal strips for use with printed circuit boards. These boards, designed specifically for wave-soldering, include a wide range of sizes, numbers of terminals, and other specifications so that they can be utilized for a broad variety of applications. The booklet contains complete specifications, application information and details covering electrical ratings, materials of construction, wire sizes accommodated, accessories and ordering codes. Kulka Electric Corp., Mount Vernon, N.Y.

CIRCLE NO. 458

Light emitter evaluation

A 14-page application note titled "How To Evaluate Light Emitters and Optical Systems for Light Sensitive Silicon Devices" describes design criteria for systems using photosensitive devices, such as the light-activated SCR (LASCR) the light-activated silicon-controlled switch (LASCS), the planar silicon photoswitch (PSPS), the photo-transistor, and the photo-darlington amplifier. The note describes a circuit for measuring effective irradiance, and explains how light measurements of calibrated devices can be transferred to other devices. General Electric Semiconductor Products Dept., Syracuse, N.Y.

CIRCLE NO. 459

Plastics testing

"Standard Tests on Plastics," a 40-page brochure contains 32 ASTM tests commonly used to describe the characteristics of plastics. The illustrated brochure separates tests into six categories: mechanical, thermal, optical, permanence, analytical and electrical. Also included are conditioning procedures and 11 conversion charts and reference tables. Celanese Plastics Co., Newark, N.J.

CIRCLE NO. 460

Tape wound core design

A 63-page Tape Wound Core Design Manual provides total tape wound core design data for square-loop and round-loop magnetic materials, as well as specific application instructions for signal transformers, coupling transformers, power transformers, current transformers, reactors, saturable reactors, saturable transformers, bi-stable magnetic amplifiers, magnetic amplifiers, magnetic inverter transformers, and others. Also provided is a Tape Wound Core Design Chart which gives the designer instant access to the most commonly used design formulae, core dimensions and constants. Magnetic Metals Co., Camden, N.J.

CIRCLE NO. 461

Electrochemical marking

A comprehensive 24-page illustrated manual describes the basic electrochemical process for stress-free marking metal parts and covers repetitive stencil-etched electrolytic marks; illustrates and describes various manual and automatic devices for production marking of tools, gauges, parts, cutlery, etc., with recommendations for use of each. Supplies, including different types of marking stencils and their applications, are covered. A two-page chart lists electrolytic current-carrying fluids recommended to mark specific metals with colors of marks produced. The Lectroetch Co., East Cleveland, Ohio.

CIRCLE NO. 462

Splicing power cable

Three instruction bulletins provide step-by-step procedures, illustrations and drawings for tape splicing, pennant termination and application of molded rubber adapters on the new UniShield power cable. In addition to cable preparation, the bulletins contain helpful information including a list of precautions, tool and material requirements, connector application, insulating, shielding and grounding procedures. A drawing provides all the basic dimensions. Anaconda Wire and Cable Co., New York, N.Y.

CIRCLE NO. 463

Serial time codes

A six-page application note entitled "Time Correlation for Instrumentation" describes serial time codes used for data correlation. A description is given of all the presently used serial time codes and the various code formats. Explanations of how time code generators, time code readers and tape search systems operate are also included. In addition, typical examples show how serial time codes and instrumentation are used in a weather data program and in studies of clear air turbulence. Chronolog Corp., Broomall, Pa.

CIRCLE NO. 464

Repairing assemblies

Application literature gives specialized techniques for the rework, repair, modification, and prototyping of microminiature electronic assemblies. The 21-page bulletin No. 700-005 gives comprehensive guide lines on how to assure the continued quality and reliability of the most advanced electronic assemblies. The rework and repair technology includes techniques for solder extraction, conformal coating removal, and component lead forming. Highlighted are applications and illustrated procedures for the removal of specific types of solder joints and conformal coatings. Pace Inc., Silver Spring, Md.

CIRCLE NO. 465

IC line drivers

Technical Note TRN-103, "The Differential Line Driver," describes the application of integrated circuit line drivers and receivers to the transmission of incremental encoder pulses down long lines and in noisy environments. Trump-Ross Industrial Controls, Inc., North Billerica, Mass.

CIRCLE NO. 466

Thermocouple calibrations

A four-page Engineering Data File 2 cross-references emf output values, at various temperatures, for five popular types of thermocouple wires as manufactured in the U.S. and five foreign countries. The so-called standard emf values can vary as much as 10% from one nation's manufacture to another. Besides the U.S., national standards are compared for the United Kingdom, Germany, France, Japan, and Russia. Emf values are cross-referenced for copper-constantan, iron-constantan, chromel-alumel, platinum 10% rhodium-platinum, and platinum 13% rhodium-platinum. Engineering Data File 1, also available, specifies U.S. temperature emf tables, and correction tables, for ISA types E, J, K, R, S and T. This file also includes standard temperature and accuracy limitations. Ari Industries, Inc., Franklin Park, Ill.

CIRCLE NO. 467

The Elegant Amplifiers



Incredibly small thick-film amps. For elegant audio and servo applications. At 15 watts, flat through 20 kHz. Through 100 kHz at 30 and up to 150 watts. Compatible with most pre-amps, they drive 3- to 8-ohm loads, use a 26-v. split/or single-ended supply. In lots of 100:

15 w. — \$ 9.05 each

30 w. — 29.00 each

Precise amplification from precise craftsmanship. Delivered economically through computer-aided design. That's the type of performance you'll find in all components by EAI. Capacitors. Active filters. Analog/digital converters plus other special function modules. Custom coils. Solenoids. Transformer kits. Molded plastic parts. And a growing list of other elegantly crafted etceteras. For details, write or call.



Electronic Associates, Inc.
193 Monmouth Parkway
West Long Branch, New Jersey 07764
Tel. (201) 229-1100

new literature



Data General catalog

A revised 20-page catalog includes the new Nova 1210, Nova 1220, and Nova 820 computers, and details new hardware options, including an 8 k, 16-bit core memory and a turnkey operator's console. Separate sections deal with software, peripheral equipment, customer support, and the Nova instruction set. Data General Corp., Southboro, Mass.

CIRCLE NO. 468

Multichannel analyzer

ND2400 brochure describes new system for pulse height analysis, multichannel scaling and list mode data acquisition. Several novel display features and data manipulation capabilities are discussed in detail. Nuclear Data, Palatine, Ill.

CIRCLE NO. 469

Microwave devices

A 24-page catalog includes data on the firm's full line of terminations, attenuators, launchers, resistors and dc blocks for microwave systems and general electronics applications. The brochure also includes more than 100 photographs, drawings and schematics. EMC Technology, Inc., Philadelphia, Pa.

CIRCLE NO. 470

Rent or buy guidelines

A 6-page brochure offers basic guidelines for use when making the rent or buy decision about expensive equipment. It outlines the benefits achieved through renting and details the firm's Master Rental Plan. Rental Electronics, Inc., Gaithersburg, Md.

CIRCLE NO. 471

Discrete component networks

Resistor-capacitor-diode networks are described in an illustrated eight-page brochure. Advantages in design flexibility, component density and reduced PC-board space requirements are cited and parameters for the components that can be used in component networks are listed in table form and six sample circuit diagrams are shown. Corning Glass Works, Corning, N.Y.

CIRCLE NO. 472

Miniature coax connectors

Details of 26 subminiature coaxial connectors for operation within the 5 kV working range are contained in a 22-page catalog. Details of cable outlets, insulated flyleads, solder spills, adaptors, "snap-on" and multi-pole connectors, including full dimensional drawings and panel cut-out details, are provided. Precision Electronic Terminations (EMI) Limited, Sevenoaks, Kent, England.

CIRCLE NO. 473

Connectors and cable

Microwave and rf connectors plus miniature semi-rigid cable and cable assemblies are covered in a new 72-page catalog. The literature covers PDM (SMA) connectors, SMB and SMC connectors, assembly and installation and miniature semirigid cable and cable assemblies with warranty data and full specifications and dimensional drawings. Phelps Dodge Communications Co. North Haven, Conn.

CIRCLE NO. 474

Power transistors

A 36-page catalog showing rf and microwave power transistors from 175 MHz to 2.3 GHz and power specifications to 50 W is now available. Each data sheet has typical power curves, package dimensions, amplifier schematic and a Smith Chart in addition to the product photograph and complete specifications. Power Hybrids, Inc., Torrance, Calif.

CIRCLE NO. 475



Semiconductor packaging

Catalog CC403, 71 pages, provides details on the company's packaging manufacturing, sealing, and finishing, as well as on the company's plating facility. Over half the catalog is devoted to the more than 50 different types of semiconductor packages TI offers. A basic description that includes specifications, package measurements, and recommended applications is given for each package type. Texas Instruments, Inc., Dallas, Tex.

CIRCLE NO. 476

Indicator lights

A full-color 4-page brochure, features a detailed description and ordering information for a complete line of microminiature indicators. Complete electrical and mechanical data on the incandescent BRITE-EYE, transistorized TRANS-EYE and neon GLO-EYE indicators that are available in standard or heat-resistant housings of black or white are provided. Shelly Associates, Santa Ana, Calif.

CIRCLE NO. 477

Solid-state LED readout

Bulletin R05051 details the series 745 solid-state light-emitting diode readout. Characteristic curves, operating specifications and applications data are included in the four-page bulletin. Dialight Corp., Brooklyn, N.Y.

CIRCLE NO. 478

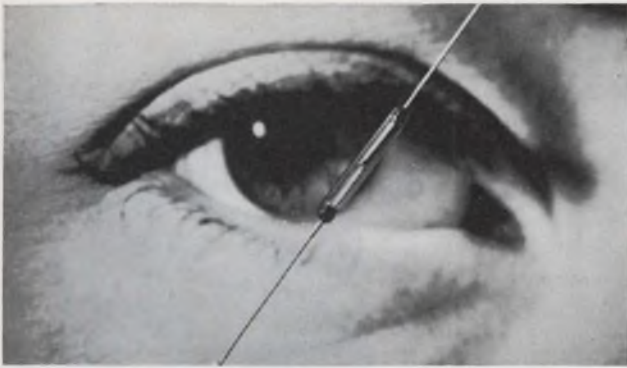

Take A Close Look at Hathaway Drireed Switches

Hathaway has them all, micro through standard, at the specifications you need. Testing, advanced production techniques and rigid quality control help assure that you get the high quality reed with the durability you asked for. Hathaway has off-the-shelf availability for Form A and Form C contact styles in Micro, Subminiature, Miniature, Intermediate and Standard sizes. Find out about the complete specifications in the new Hathaway Drireed Handbook showing 20 new switches. For your free copy and samples write to:



HATHAWAY
instruments, inc.

5250 EAST EVANS AVENUE, DENVER, COLORADO 80222
(303) 756-8301 TWX 910 931-0568

INFORMATION RETRIEVAL NUMBER 523

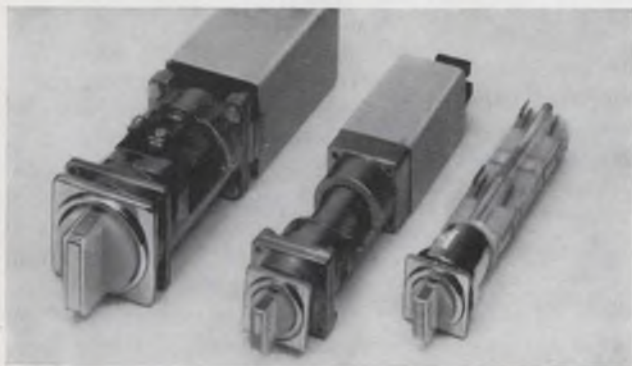

Turn On!

with Hathaway Rotary Control Switches

Simplify the most complex control problems. Where multiple switches are necessary, one Hathaway Rotary Control Switch can handle the chore. Built up from contact modules, one knob can control many contacts. A system of cams determine which of the contacts are closed or opened in each of the positions.

The simplicity of the cam design offers excellent reliability. The switches are rated at up to 380V ac and 10 amps continuous. Mechanical strength is 1,000,000 operations. Connections are easily accessible and numbered for fast reference. Control knobs come in nine varieties of styles and presentations including illuminated or key lock.

People in over 20 countries have turned on Hathaway Rotary Control Switches. Send for complete literature.

HATHAWAY
instruments, inc.

5250 EAST EVANS AVENUE, DENVER, COLORADO 80222
(303) 756-8301 TWX 910 931-0568

INFORMATION RETRIEVAL NUMBER 524

ELECTRONIC DESIGN 6, March 16, 1972

COUNTER REVOLUTIONARY



If you're on the verge of open insurrection over frequency counters that deliver too much price and not enough performance...

Join the Heath/Schlumberger Counter Revolution!

We believe counters should provide more performance at a lower price... and we've got the products to back up that radical philosophy... our SM-104A and SM-105A 80 MHz Frequency Counters:

Choice of time bases. If you want the best stability and time base accuracy you can buy at a modest price, choose our SM-104A with built-in TCXO that provides a 1 MHz ± 0.1 Hz time base and ± 1 ppm/year stability. It also provides 5 digits of BCD output, over-range and print command. If you don't need this much time base or BCD output, order the SM-105A which uses a 1 MHz crystal accurate to ± 2 Hz with overall time base accuracy of ± 10 ppm. Both counters share the following features.

80 MHz capability at a 15 MHz price... delivers instant, accurate counting from 10 Hz to over 80 MHz without prescaling. Time base switch and overrange indicator allow an 8-digit measurement with resolution down to the last Hz \pm clock accuracy.

High sensitivity... triggers up to 50 MHz with input levels as low as 100 mV... to 80 MHz with only 250 mV. And FET input completely eliminates input attenuators.

Other features include 5-digit LED readout... superspeed Schottky TTL... rugged aluminum chassis... handy gimbal mount... and quick switch-selection of 120 or 240 VAC operation.

Order your SM-104A or SM-105A now... and join the Heath/Schlumberger Counter Revolution!

Assembled SM-104A, 6 lbs., (less cables & connectors),
available **500.00**

Assembled SM-105A, 6 lbs., (less cables & connectors),
available **350.00**

SM-104A/SM-105A SPECIFICATIONS — Frequency range: 10 Hz to over 80 MHz. Sensitivity (after 5 minutes' warmup): 100 mV RMS, to 50 MHz; 250 mV RMS, 50 MHz to 80 MHz. Input Impedance: 1 megohm shunted by less than 15 pF. Maximum Input Voltage: 15 V RMS (max. DC input is ± 50 volts). Time Base: SM-104A: 1 MHz ± 0.1 Hz. 1 ppm maximum change from 0-40° C ambient. 0.25 sec stability $\pm 1 \times 10^{-9}$. 1-yr. stability, ± 1 ppm. SM-105A: 1 MHz ± 2 Hz; ± 10 ppm, 0° C ambient reference to 25° C. Readout: Five 7-segment light-emitting-diode displays plus one light-emitting-diode for overrange indication. Power Requirements: 120/240 V, 50/60 Hz, 12 watts. Dimensions: 9 $\frac{1}{8}$ " D x 6 $\frac{3}{4}$ " W x 2 $\frac{1}{4}$ " H.

| | |
|--|------------------------------|
| Heath/Schlumberger Scientific Instruments Department 501-263 Benton Harbor, Michigan 49022 | HEATH Schlumberger |
| <input type="checkbox"/> I want to join the counter revolution. Enclosed is \$_____ for _____ (model number) | |
| <input type="checkbox"/> I'm not a revolutionary yet, but try to convince me with your 1972 Instrumentation catalog. | |
| Name _____ | |
| Company/Institution _____ | |
| Address _____ | |
| City _____ State _____ Zip _____ | |
| EK-327 | |

INFORMATION RETRIEVAL NUMBER 525

227

Newer, Higher Quality

NDK

Products

CRYSTAL FILTERS

10.7MHz or 21.4MHz MCF
(Monolithic Crystal Filters)

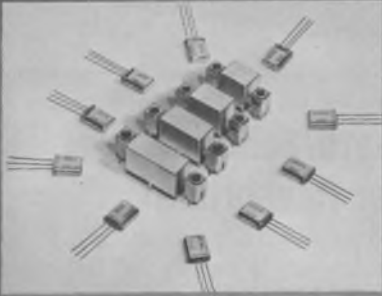

For FM Receivers
(10.7MHz-Series)



EF10.7BK

For SSB Transceivers



YF9000E

World's Leading
Manufacturer of:

- Synthetic Quartz Crystals
- Water Soluble Crystals (LH, ADP, KDP)
- Quartz Crystal Units
- Crystal Oscillators
- Crystal Filters
- Delay Lines
- Ultrasonic Instruments



**NIHON DEMP
KOGYO CO., LTD.**

Since 1948

1-21-2, Nishihara Shibuya-ku, Tokyo, Japan
Tel: (03) 460-2111
Cable: CRYSTALUNITS TOKYO TLX: 242-2291

NEW LITERATURE

Automatic test equipment

A 16-page brochure describes a variety of automatic testers custom-designed to check out such equipment as inertial systems and components, circuit cards and modules, assemblies, computers, and associated electronic elements. Brochure number R71-1171 describes and pictures a computer-aided test station, an automated strapdown package analyzer and controller, a computerized data acquisition system, an inertial measuring system test set, programmed automatic testers, a tape-controlled diagnostic tester, digital computer tester and computer-controlled automatic environmental screening and production reliability verification testing equipment and includes diagrams and characteristics tabulations. Kearfott Div., Singer Co., Little Falls, N.J.

CIRCLE NO. 479

SCR line

A 12-page catalog, listing seven series of SCR devices ranging from 3 to 35 A, gives detailed specifications and performance curves for each product group. High speed turn-on and high dv/dt characteristic units are available for all of the basic types listed and all devices are available from 25-800 V peak forward blocking voltage. Sarks Tarzian, Inc., Bloomington, Ind.

CIRCLE NO. 480

D/a converters

Twenty-five new d/a converters are described in a file folder brochure. All specifications, performance data and applications are listed. Hybrid Systems Corp., Burlington, Mass.

CIRCLE NO. 481

Unity-gain amplifier

A high-performance unity-gain follower amplifier featuring input resistance greater than 1 million M Ω , input capacitance less than 0.1 pF and rise time less than 30 ns is described in Bulletin AF2. Bioelectric Instruments, Farmingdale, N.Y.

CIRCLE NO. 482



Relay catalog

A 228-page catalog describes the company's full line of electromechanical, dry reed, mercury-wetted relays; custom assemblies; and precision snap-action switches. Catalog '72 contains product photos, detailed dimension drawings, suggested layouts for relay and socket mounting, socket descriptions, and designator numbers. Potter & Brumfield, Princeton, Ind.

CIRCLE NO. 483

Ferromagnetic components

A new "Minilog," a ready reference to the company's most frequently ordered ferromagnetic components, lists part numbers and specifications on a variety of data coils; pulse, wide band, toroidal and SCR transformers; high pass, band pass, band reject filters and a large number of variable and fixed inductors. Each product section includes charts, graphs and specification listings, which provide a complete performance profile for each model. Aladdin Electronics, Nashville, Tenn.

CIRCLE NO. 484

Function modules

A new capability type short-form catalog shows state-of-the-art performance in various product categories such as operational amplifiers, logarithmic function modules, analog multipliers, etc. The model number of the product having the indicated performance is also given. Optical Electronics, Inc., Tucson, Ariz.

CIRCLE NO. 485

Instrumentation catalog

The company's 33 products are described briefly in this 16-page brochure. They include EMI/field intensity meters, rf current probes, antennas, microwave components, FM/AM/ssb communications test instrumentation, frequency meters, signal generators, tone generators, synchro/resolver test instrumentation, angle-to-digital converters, phase-angle voltmeters, ratio transformers and electrostatic voltmeters. Singer Co., Los Angeles, Calif.

CIRCLE NO. 486

Nd:YAG laser rods

New literature describes Nd:YAG laser rods, lists standard sizes available (3 mm to 1/4 in. dia., 1 to 4 in. long) with standard end configurations and coatings. Specifications and prices are included. Allied Chemical Corp., Morristown, N. J.

CIRCLE NO. 487

Portable light beam recorder

A data sheet provides full details on the new TR-180 LB portable 18-channel light beam recorder. Information includes: full specifications on the recorder, chart of available galvanometers and their specifications, description of the controls and their operation, and a list of helpful accessories. Gulton/Techni-Rite, East Greenwich, R. I.

CIRCLE NO. 488

Single crystal silicon slices

A 4-page technical bulletin on polished Czochralski single crystal silicon slices lists those parameters required to specify polished slices on diameters from 1 in. to 3 in. or more. Information is given on type, orientation, resistivity, thickness, flats and taper with the polished surface and packaging also described as well as other Ventron silicon products such as silicon ingot, as-sliced wafers, and lapped wafers. Ventron Corp., Bradford, Pa.

CIRCLE NO. 489

if you're hearing comments like...



INFORMATION RETRIEVAL NUMBER 527



think woven

for connectability

Need a neat match for standard or specialized connectors? Woven Cable fits the picture with rollable, foldable, stackable adaptability. Woven connects!

WOVEN ELECTRONICS

A DIVISION OF SOUTHERN WEAVING COMPANY

P.O. Box 189, Mauldin, S.C. 29662, (803) 288-4411

INFORMATION RETRIEVAL NUMBER 528



our international interpreter (it reads and writes any language)

ASCII
BCDIC
EBCDIC
HOLLERITH

OEM 64, programmable card terminal, can read and write anything you can mark, punch or edge notch. In any code. Or many codes on the same card. You can change its internally stored program. In 5-10 seconds. Edit data before entry. And, It is designed for easy interface. Talk to us about OEM 64 in any language.

volare **日本**
parlez vous
buenas días

For more information
call Frank Milewicz
OEM Products
(201) 935-2200

LITTON ABS 
automated business systems
800 WASHINGTON AVENUE, CARLSTADT, NEW JERSEY 07072

INFORMATION RETRIEVAL NUMBER 529

broad-band, wide range and easy on the eyes: the **NEW** THRULINE® RF WATTMETER

spans 25-500 MHz,
measures
.02-500 watts

in eight ranges. All variable RF measurement parameters — frequency range, forward/reflected power and full scale values — are switched right on the front panel. Since it requires neither AC nor battery power, the model 4370 is equally at home in the lab or atop an antenna tower, at a remote base station or in a car, boat or plane.



SPECIFICATIONS:

Forward Power Ranges: 10, 25, 100, 500W; $\pm 5\%$ OFS
Reflected Power Ranges: 1, 2.5, 10, 50W; $\pm 5\%$ OFS
Insertion VSWR: below 1.1 with N Conn. (50 ohms)
Frequency Range: 25 — 500 MHz
Quick-Change Connectors: N, BNC, TNC, UHF, C, SC, HN, GR Type 874 or 7/8" EIA
Finish: Rich olive leather grain
Price incl. Line Section with N Conn: only \$475

Model 4370

 **BIRD** ELECTRONIC CORPORATION
Cleveland (Solon) Ohio 44139 • 30303 Aurora Road
Ph. 216-248-1200 • TWX 810-427-2687 • Cable BIRDELEC

See us at Booth 2243 IEEE Show
INFORMATION RETRIEVAL NUMBER 530

NEW LITERATURE



Light-emitting diodes

A new 100-page catalog provides detailed technical and design information on the company's complete line of light-emitting diode products. Included in the catalog are discrete light-emitting diodes, alphanumeric display units, coupled-pair (opto-isolator) products, and display module products. In addition, the catalog details information on specific circuit designs and applications information. Monsanto Commercial Products Co., Cupertino, Calif.

CIRCLE NO. 490

Boxcar integrators

Application of boxcar integrator signal averagers to investigations requiring resolution and recording of signals consisting of pulses as short as 10 ns is outlined in brochure T-227. A typical application of the technique described in detail is the measurement of second harmonics generated in laser excited gallium arsenide samples. Princeton Applied Research Corp., Princeton, N.J.

CIRCLE NO. 491

Packaging products

An eight-page brochure introduces a complete line of packaging systems and components including card files, logic panels, DIP sockets, DIP packaging drawers and a complete software/wiring service. Scanbe Manufacturing Corp., El Monte, Calif.

CIRCLE NO. 492

Digital readout

An eight-page catalog describes the company's line of completely packaged digital display assemblies. The catalog outlines decode displays with and without memory; counter displays with and without memory; bi-directional counters; preset counters and comparators; digital clocks; digital annunciators; compatible power supplies; and frequency counters/display stop watches and includes photographs of each model and available options. Instrument Displays, Inc., Waltham, Mass.

CIRCLE NO. 493

Miniature transformer

A 2-page data sheet describes the type NV-1 miniature variable inductor-transformer. Inductance ranges from 509 μ H to 438 mH are available with tuning ranges up to $\pm 10\%$ from the specified normal inductance. Up to 6 terminals are available for custom transformer designs as coupling or pulse transformers and multi-tapped inductors. Sangamo Electric Co., Springfield, Ill.

CIRCLE NO. 494

560 series plug-ins

A 20-page booklet contains updated specifications and lower prices on sampling and TDR plug-ins for the 560-series oscilloscopes. General purpose sampling with plug-in heads allows measurements from dc to 14 GHz with input characteristics from 50 Ω to 100 k Ω . Low-cost full-range TDR is available. Tektronix, Inc., Beaverton, Ore.

CIRCLE NO. 495

Keyboard encoding system

A system of keyboard electronics utilizing a scanning technique is described in a four-color brochure. A description of the scanning principle behind the system is accompanied by a diagram showing interaction between an 8 bit counter, two multiplexers and a 4 to 16 line decoder as well as a chart of basic electrical specifications, and listings of standard and optional features. Cherry Electrical Products Corp., Waukegan, Ill.

CIRCLE NO. 496

then it's time you looked into Visual Search Micro Film.

VSMF Design Engineering System:

- Arranges products by parameter.
- Allows rapid comparison of like products.
- Contains complete data sheets.
- Provides paper copies instantly.
- Is updated every 30 days.

"Hey, this is easy."

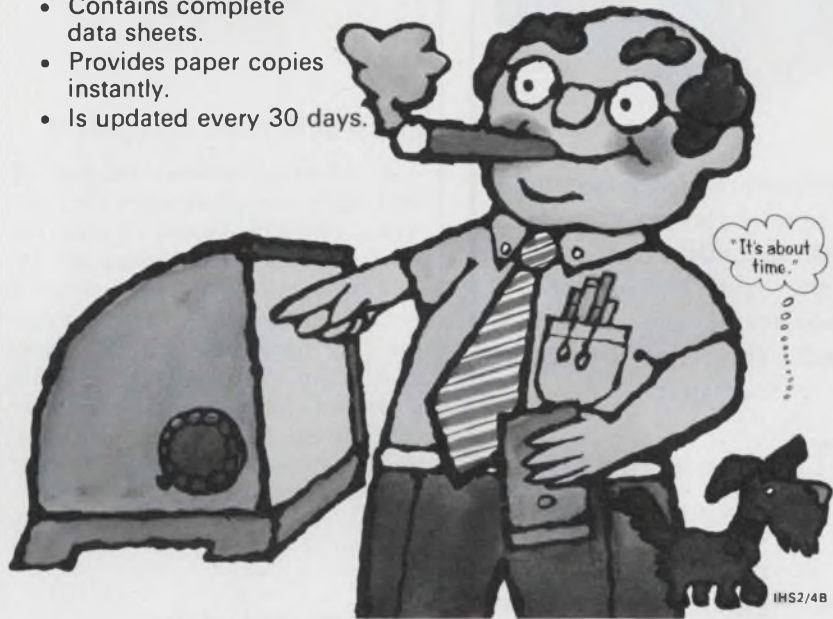

IHS2/48

INFORMATION RETRIEVAL NUMBER 531

VACTEC

Portable Photometer only \$295⁰⁰
includes probe



- High sensitivity, wide range .001 to 10,000 fc.
- Accuracy 5% full scale, linearity 3%.
- AC or battery operation.
- Recorder output (1 v. to 1 ma. output).
- Probes available with cosine correction and increased sensitivity to .0002 fc.
- Use a densitometer, reflectometer, edge sensor, counter.

New Vactec photometer performs functions normally found only in \$1,000 to \$5,000 research instruments. Calibrates illumination or brightness for inspection of photocells, phototransistors, etc. Not only measures illumination precisely for offices, factories, schools, or stadiums, but its low cost, versatility, high sensitivity, and recorder output also make it practical for use as a process control instrument for a variety of photometric operations. Call or write for new technical Bulletin P3100.

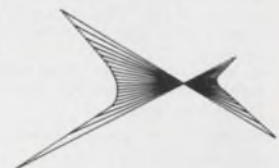

VACTEC, INC.

2423 Northline Ind. Blvd., Maryland Heights, Mo. 63043, Phone (314) 872-8300

INFORMATION RETRIEVAL NUMBER 532

4 DIGIT L.E.D. ELAPSED TIME INDICATOR



Measures and displays time in several ranges from 1 to 100 seconds. Two ranges in the same instrument are standard. Uses a 1MHZ crystal controlled time base for .01% accuracy.

d **Diversatron, Inc.**

A1 COUNTRY CLUB RD.
EAST ROCHESTER, N.Y. 14445
TEL. (716) 586-5600

INFORMATION RETRIEVAL NUMBER 533

THAT'S UP TO YOU!

LESS SPACE WITH
THE MINIPULSE MOTOR.
USING THE LSI DRIVING CIRCUIT!!
DIVERSIFY YOUR PRODUCTS RANGE
WITH THE MINIPULSE MOTOR.
THE GUARANTEED PERFORMANCE.
THE ECONOMICAL PRICE!!



MODEL PF1-20

Diameter 12 mm.
Max. Pull-out torque.... 0.5 gr.-cm.
Max. Pull-in rate..... 400 pps.
Step Angle 18°

Other six models for the higher torque are available. The diameter from 20 mm. to 51 mm. The maximum torque from 3.25 gr.-cm. to 150 gr.-cm. The stepping angle from 7.5°, 10° and up to 18°. You can use those models as well as the synchronous motors and the servomotors.

Please write your demand to us immediately.

NIPPON PULSE MOTOR CO., LTD.

International Department

No. 13-16, 2-chome, Hongo, Bunkyo-ku, Tokyo,
Japan. Cable: NIPULSEMOTOR TOKYO

INFORMATION RETRIEVAL NUMBER 534

NEW LITERATURE



Electronic heat dissipators

A 56-page general catalog of heat sinks and dissipators for electronic components and circuits describes many new dissipators including versions of the company's exclusive staggered finger design for DIP packages, GEL-246 packages, 1-in. square sealed metal packages, plus models specially configured for potting IC substrates directly to the dissipator. IERC, Burbank, Calif.

CIRCLE NO. 497

Analyzer/correlator

The best real-time analyzer/correlator choice in 9 areas of application: underwater acoustics, noise/vibration, speech, radar doppler, transients/shock, medical, machine diagnosis, geophysical/physical phenomena, and computer compatible use is indicated in the 8-page "Condensed Catalog of Real-Time Analysis Instruments." The catalog describes five easy steps to choosing the correct equipment. Federal Scientific Corp., New York, N.Y.

CIRCLE NO. 498

MOS static/dynamic RAM

Data sheets covering six 64 x 4 bit static and dynamic random access memories have been released. The RAMS of the UA2000 series operate over the full military temperature range of -50 C to +125 C while the UA3000 series operate over the full commercial range of -25 C to +70 C and come in either a 16 or 24 lead hermetically sealed dual in line package. Solitron Devices, Inc., San Diego, Calif.

CIRCLE NO. 499

Keyboard output codes

A new brochure includes illustrations of 7 bit output codes for each key, in each mode, for the company's standard 66-key ASCII Tri Mode and 53-key ASCII Quad Mode keyboards. Included are complete legend formats and panel cutout dimensions, plus printed circuit board size and terminal configuration for both of these stock, standard keyboards. Cherry Electrical Products, Inc., Waukegan, Ill.

CIRCLE NO. 500

Thick-film pastes

A 32-page brochure describes operating characteristics of thick-film conductors and resistors used in the manufacture of hybrid microcircuits. Complete technical data ranging from OHMPATH ruthenium resistive systems and compatible conductor materials, to multilayer capacitor materials and SILPAINT silver conductive coatings is included. Sel-Rex Co., Nutley, N.J.

CIRCLE NO. 501

Epoxy adhesives

A four-page brochure gives complete details on a line of epoxy adhesives for microelectronics and optoelectronics applications. Specifications on some 14 single and two-component electrically conductive gold and silver epoxies, as well as electrically insulating epoxies, are included. Epoxy Technology, Inc., Watertown, Mass.

CIRCLE NO. 502

Brazing alloys

A two-color technical bulletin (TBA) describes a new family of TiBelay brazing alloys for brazing titanium, beryllium, zirconium and dissimilar metal assemblies. The bulletin describes the chemistry, strength, ductility and corrosion resistant properties of the new alloys and the low brazing temperatures well below the transformation temperature of titanium. Alloy Metals, Inc., Troy, Mich.

CIRCLE NO. 503

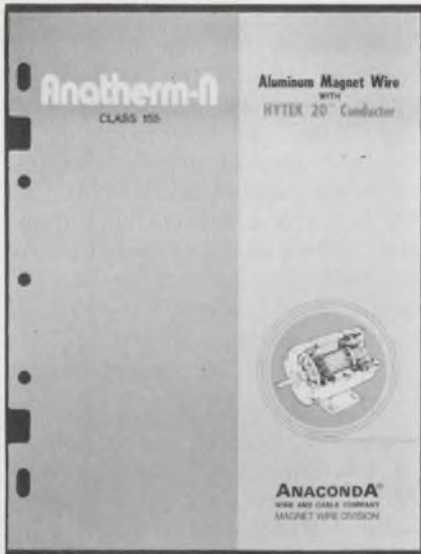

Aluminum magnet wire

New aluminum magnet wire, comprised of a Hytek 20 conductor and an Anatherm-N insulation system of polyamide-overcoated terephthalate polyester insulation, is described in a 4-page bulletin. Test data provided include typical thermal, physical, chemical and electrical properties and suggested winding tensions and procedures for termination. Anaconda Wire and Cable Co., New York, N. Y.

CIRCLE NO. 504

Beryllia products

A 20-page brochure describes composition and properties of beryllium oxide powder. Engineering and thermal conductivity properties are illustrated. Brush Wellman Inc., Elmore, Ohio.

CIRCLE NO. 505

Clean room bulletin

A bulletin describes AAF's complete line of gauge labs and clean room systems for the precise control of all environmental factors. AAF offers complete design and engineering assistance and furnishes the entire range of mechanical equipment required for gauge and clean room construction. AAF also provides single source responsibility for clean room systems and experienced field service. The new 16-page bulletin contains complete descriptions of all clean room components, design features and performance ranges. American Air Filter Co., Inc., Louisville, Kentucky.

CIRCLE NO. 506

VSMF keeps it simple, you find it fast

- Cuts search time up to 90%.
- Puts information where you need it . . . Data Centers and Satellite units.
- Reduces file maintenance.

VSMF costs less than a file clerk.

For a demonstration, write

Information Handling Services
An Indian Head Company

P. O. Box 1154, Dept. ED-3,
Englewood, Colorado 80110
Or, call
(303) 771-2600

"This could be the start of something big."



INFORMATION RETRIEVAL NUMBER 535



OUR CATALOG HAS A SWITCH TO MEET YOUR REQUIREMENTS.



Odds are...our catalog has a coaxial switch to meet your requirements—complete technical information, 16 data sheets, 31 switch types, many variations and options.

Transco Products, Inc., 4241 Glencoe Ave., Venice, Calif. 90291

INFORMATION RETRIEVAL NUMBER 536

RODAN

Built-in
Light Emitting Diode
Pilot lamps that
have been completely
restyled



A Small Device that Wins High Credit!

Another epochal page has been opened in the history of manufacturing of pilot lamps by Okaya, who has studied and rejected hundreds of drafts from the drawing board for a single pilot lamp which will withstand practically any environmental condition.

Complete range of pilot lamps are offered by Okaya at prices ranging from 60 cents to a dollar a piece.

Specialist manufacturers of pilot lamps



OKAYA ELECTRIC

INDUSTRIES CO., LTD.

Yasuda Bldg., 3-8, 1-chome, Shibuya, Shibuya-ku,

Tokyo, Japan TELEX(242)2469

bulletin board

The monoDAC-01HS of Precision Monolithics, the industry's first and only complete monolithic d/a converter incorporating internal reference and output op amp, is now available at \$6.95 in 2500 quantities. The 6-bit monolithic unit DAC includes a precision voltage reference, current switches, diffused R-2R ladder network and an internally-compensated high speed op amp on a single 70 × 106 mil silicon chip.

CIRCLE NO. 507

Solitron Devices, Inc., has announced the release of the first of the CMOS CM4000A series devices. These devices include: CMOS NOR gates, a CMOS 7-stage binary counter a CMOS 18-stage static shift register, a CMOS dual complementary pair plus inverter, a CMOS NAND gate-positive logic, a DUAL "D" type flip-flop, a CMOS 8-stage static shift register, and a CMOS quad bilateral switch. These devices are all in the 3-15 V operation range and are available in 14-pin dual-in-line packaging and in either hermetic or epoxy packages.

CIRCLE NO. 508

Armour Electronics Corp., leading manufacturer of standard and custom designed slot power supplies, has a new standardized pricing structure. Unlike traditional industrial policies, all individual unit prices will not vary according to quantity. State prices for each model in all the series manufactured by Armour will remain the same for all quantities—one or one hundred. The only additional cost will be a minimal handling charge for quantities under ten.

CIRCLE NO. 509

Price reductions

Electric Processors' 4K EPI-118 minicomputer, previously sold at \$5900, is now available to OEM customers at \$2790. This is the 18-

bit capacity, 900 ns cycle time machine with a full set of software, including the octal/binary loader, a 2-pass assembler, a tape editor, a tape butler, an interactive debug system, floating-point routines, diagnostic software, interactive BASIC, and a subroutine library. And, add-on-memory modules have also been reduced in price: the 4K module is now \$1300, while the 8K module is \$2400.

CIRCLE NO. 510

Monsanto Commercial Products Co. has announced a price reduction in its standard product opto-isolator MCS2. The new prices introduced are \$3.35 (10-99 quantity), \$2.80 (100-999 quantity), and \$2.50 (1000 quantity). Previous prices were \$6.25 (1-9), \$5.85 (10-99), \$4.95 (100-999), and \$4.50 (1000 quantity). In conjunction with new price announcement, Monsanto announced the availability of its new application note, AN502, entitled "Low Cost Solid-State AC Relay." This application note details the design of a solid-state ac relay, commercially costing as little as \$7.06, total cost. This circuit utilizes the MCS2 opto-isolator and standard off-the-shelf components.

CIRCLE NO. 511

Varian Data Machines has bundled a complete package of options within the mainframe price of its 620/f and 620/L minicomputers. In effect, it is an equivalent price reduction of about \$1500 per machine. According to the president of the firm, Varian is the first minicomputer manufacturer to make all options standard. Price of 620/L with 4096 words of core memory remains \$5400 in single quantity, but now includes: hardware multiply/divide; real time clock; power failure restart; and 8 levels of priority interrupts. Separately, these options were priced at approximately \$1900. As a total package, they had a price of \$1500.

CIRCLE NO. 512

Cost savings up to 50% were announced by Harris Semiconductor, a Division of Harris-Intertype Corporation, on its entire line of diode matrices. The new pricing

schedule resulted from improvements in production efficiency and a change-over to 14-lead ceramic dual in-line packages. Applications for the diode matrices included data encoding, decoding and code conversion. They have also been used as small read only memories.

CIRCLE NO. 513

Metrologic Instruments, Inc., is offering a 10% discount on the purchase price of any new Metrologic laser upon the trade-in of any used gas laser (working or not). The policy applies to companies or individuals currently using Metrologic lasers or those who wish to trade in a competitive laser.

CIRCLE NO. 514



Price reductions on Gold Crosspoint contact keyboard switches are announced by **Cherry Electrical Products Corp.** New list price is \$1.27 (was \$1.37). Net price at the 50 piece level is now \$0.90 (was \$1.00), at 1000 pieces is \$0.65 (was \$0.71), at 50,000 pieces is now \$0.40 (was \$0.44). In the 100,000 piece quantity the switches now cost \$0.34 (was \$0.43). Cherry's Gold Crosspoint switch innovation has been used in keyboards since 1967. The concept received its widest acceptance within the past year, as buyers of Cherry key modules and keyboards have changed over from reed switches to the less expensive, lower profile Gold Crosspoint contact key switch.

CIRCLE NO. 515

Design Data from Manufacturers

Advertisements of booklets, brochures, catalogs and data sheets. To order use Reader-Service Card (Advertisement)

FREE MONOGRAPH ON REAL-TIME CORRELATION

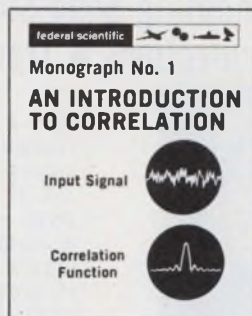

Monograph #1 explains how auto- and cross-correlation are as versatile & useful as Fourier transform. Correlation, a method for finding similarity between wave-forms & time delays, is made practical in REAL TIME through Federal's Ubiquitous® Correlation/Spectrum Analysis systems. For radar, geophysics, sonar, adaptive systems, communications, filter design, reactor control, etc. Detailed applications: reception of signals in noise, direction finding, decoding of magnetically recorded digital data, detection of a periodic signal immersed in noise.

CIRCLE NO. 177

Federal Scientific Corp.

A subsidiary of Elgin National Industries, Inc.
615 West 131st Street, New York, N. Y. 10027

DABURN'S NEW CATALOG III — FREE

"IEEE Booth #1208"



Just-off-the-press. Completely updated full line of wire, cable, tubing, electronic hardware and fastening devices.

Catalog III is 36 pages, highly detailed, with ordering numbers, Mil/comm spec listings and cross reference property charts.

Items include Flat Ribbon Cable per Mil-W-16879D Type B & C from 4 - 20 conductors individually color coded - Hi - Voltage Corona Resistant teflon, FEP & H-Film cables - Daflon & Dafx tubing and sleeving - STIK - KLIP fastening devices, component clips - ceramic/steatite insulators - retractile cords - power cords. Many specified-on-drawing hard-to-get items. For your free copy write direct to Dept. DDM-1 or check inquiry number.

CIRCLE NO. 178

Daburn Electronic & Cable Corp.

2360 Hoffman St.
Bronx, New York 10458

Techniques For Faster, More Accurate Circuit Design!



HANDBOOK OF SIMPLIFIED SOLID STATE CIRCUIT DESIGN, by John D. Lenk, provides you with techniques for quickly obtaining all component values of virtually any solid state circuit! Design examples for each circuit give you procedures for the complete design, allowing you to merely substitute your own conditions. You'll have procedures for assembling experimental circuits, troubleshooting and testing all factors in design and application. Pub. 1971, 320 pp., 189 illus., 6 x 9", \$12.00. Circle the reader service number for a 15 day FREE examination copy! If payment accompanies order, we pay postage and handling. Same return privilege, refund guaranteed.

CIRCLE NO. 179

Prentice-Hall, Inc.
Englewood Cliffs, N.J. 07632

ELECTRONIC DESIGN's function is:

- To aid progress in the electronics manufacturing industry by promoting good design.
- To give the electronic design engineer concepts and ideas that make his job easier and more productive.
- To provide a central source of timely electronics information.
- To promote communication among members of the electronics engineering community.

Want a subscription? ELECTRONIC DESIGN is sent free to qualified engineers and engineering managers doing design work, supervising design or setting standards in the United States and Western Europe. For a free subscription, use the application form bound in the magazine. If none is included, write to us direct for an application form.

If you do not qualify, you may take out a paid subscription for \$25 a year in the U.S.A., \$35 a year elsewhere. Single copies are \$1.50 each.

If you change your address, send us an old mailing label and your new address; there is generally a postcard for this bound in the magazine. You will have to requalify to continue receiving ELECTRONIC DESIGN free.

The accuracy policy of ELECTRONIC DESIGN is:

- To make diligent efforts to ensure the accuracy of editorial matter.
- To publish prompt corrections whenever inaccuracies are brought to our attention. Corrections appear in "Across the Desk."
- To encourage our readers as responsible members of our business community to report to us misleading or fraudulent advertising.
- To refuse any advertisement deemed to be misleading or fraudulent.

Microfilm copies are available of complete volumes of ELECTRONIC DESIGN at \$19.00 per volume, beginning with Volume 9, 1961. Work is now in process to complete the microfilm edition of Volumes 1-8. Reprints of individual articles may be obtained for \$2.00 each, prepaid (\$.50 for each additional copy of the same article) no matter how long the article. For further details and to place orders, contact the Customer Services Department, University Microfilms, 300 North Zeeb Road, Ann Arbor, Michigan 48106 telephone (313) 761-4700.

Want to contact us? If you have any comments or wish to submit a manuscript or article outline, address your correspondence to:

Editor
ELECTRONIC DESIGN
50 Essex Street
Rochelle Park, N.J. 07662

Trouble Shooting Solid-State Circuit Connections & Transistors



Here's an illustrated guide to troubleshooting and servicing all types of solid state TV, laboratory and industrial equipment. HANDBOOK OF PRACTICAL SOLID STATE TROUBLESHOOTING, by John D. Lenk, gives you quick on-the-job techniques for using test equipment and handtools. Here too are testing techniques for transistors, diodes, capacitors and scores of other solid state components all in ready to use form. Pub. Jan. 1972, 310 pp., 182 illus., 6 x 9", \$12.00. Circle the reader service number for a 15 day FREE examination copy! If payment accompanies order, we pay postage and handling. Same return privilege, refund guaranteed.

CIRCLE NO. 171

Prentice-Hall, Inc.
Englewood Cliffs, N.J. 07632

OVER 1,000,000 STANDARD FILTER TYPES

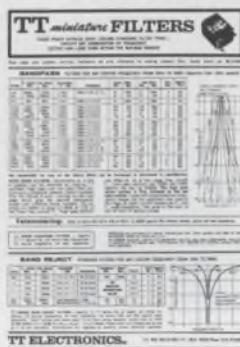

SELECT ANY FREQUENCY: DC-100MHZ

- BANDPASS • LOWPASS
- BANDSTOP • HIGHPASS

2 WEEK DELIVERY
L-C — CRYSTAL — VHF TYPES

This catalog describes signal conditioning Filters which have flat passbands and sharp cut-off slopes for selective circuits. Typical applications are in telemetry, sonar, seismic, modulator and modem, spectrum analysis, cue-tone, multiplexing and medical systems. All types are available in flat PC mounting cases.

CIRCLE NO. 172

TT ELECTRONICS, INC.
2214 S. BARRY AVE.
LOS ANGELES, CA. 90064 (213)478-8224

FUNDAMENTALS OF INTEGRATED CIRCUITS

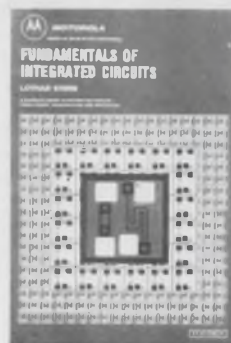

A practical guide to integrated circuits, their theory, manufacture, and applications. This new guide by Lothar Stern offers complete, highly readable coverage of the various techniques of circuit fabrication, and their effect on circuit design and performance. As to marketing considerations, it compares the characteristics of the numerous IC structures devised to date in terms of economics and logistics. A volume in the Motorola Series in Solid-State Electronics. 198 pages, 7 x 10, illustrated. \$8.95, clothbound. Circle the reader-service number below for 15-day examination copies.

CIRCLE NO. 173

Hayden Book Company, Inc.
116 West 14th Street
New York, N.Y. 10011

Manufacturers

Advertisements of booklets, brochures, catalogs and data sheets. To order use Reader-Service Card (Advertisement)

New 44 Page Engineering Data Guide & Catalog



Offers vital technical data plus complete specifications on Dearborn wire, cable, insulation and electronic accessory products for industry, military, aerospace, electronics and communications. This Guide and Catalog presents over 2,000 items, of which 404 are new additions to the Dearborn line. New items include: irradiated cross-linked hookup wire, insulated with either PVC or Polyethylene insulation; miniature control cables for computer usage; flame retardant U.L. hookup and high voltage anode wires; U.L. style, TGS 250° C hookup wire; retractile cord; and heat shrinkable tubing. Send for your Free copy by circling reader-service number below.

Dearborn Wire & Cable Co.

9299 Evenhouse Avenue, Rosemont, Illinois 60018
(312) 696-0090 and 775-8363

CIRCLE NO. 174

PC Drafting Aids Catalog

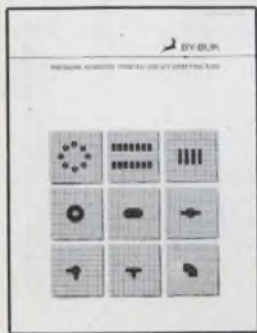

Thousands of time saving, cost saving artwork ideas are found in the By-Buk P-50 catalog of pressure sensitive printed circuit drafting aids. With the most practical artwork patterns for: TO cans, multi-pads, dual-inlines and flat packs featured. Donuts, connector strips, teardrops, ovals, tapes, tees, elbows, etc., by the hundreds are included in the most comprehensive list of sizes. Opaque black, transparent red and transparent blue materials for one and two-sided board designs. For a free copy and samples, write today.

By-Buk Company

Subsidiary of Webtek Corp., 4326 W. Pico Blvd.
Los Angeles, California 90019 (213) 937-3511

CIRCLE NO. 175

Over 200 Time-Tested Working Logic Circuits

HANDBOOK OF LOGIC CIRCUITS

JOHN D. LENK

OVER 200 TIME-TESTED
WORKING LOGIC CIRCUITS

Here's your one-source reference for techniques in any phase of logic equipment! Including miscellaneous combinational networks. HANDBOOK OF LOGIC CIRCUITS, by John D. Lenk, even provides you with separate chapters on the vital areas of flip-flops, counters, registers and shifting elements. Emphasizes "universal" circuits adaptable to a wide variety of logic applications. Circuits are supplemented with truth tables, equations, analysis of unused states, and so on, as well as explanations of how the circuits operate and how they can be used in overall logic systems. Pub. May 1972, 320 pp., 307 illus., 6 x 9", \$12.00. Circle the reader service number for a 15 day FREE examination copy! If payment accompanies order, we pay postage and handling. Same return privilege, refund guaranteed.

CIRCLE NO. 176

Prentice-Hall, Inc.
Englewood Cliffs, N.J. 07632

Electronic Design

Advertising Sales Staff

Bryce Gray
Sales Manager

Rochelle Park, N.J. 07662

Robert W. Gascoigne
Daniel J. Rowland
50 Essex Street
(201) 843-0550
TWX: 710-990-5071

Philadelphia

Thomas P. Barth
50 Essex Street
Rochelle Park, N. J. 07662
(201) 843-0550

Boston 02154

Joseph F. Palmer
1268 Main Street
Waltham, Mass.
(617) 894-2700

Chicago 60611

Thomas P. Kavooras
Berry Conner, Jr.
200 East Ontario
(312) 337-0588

Cleveland

Thomas P. Kavooras
(Chicago)
(312) 337-0588
(call collect)

Los Angeles 90303

Stanley I. Ehrenclou
Burt Underwood
2930 Imperial Highway
Inglewood, Calif
(213) 757-0183

San Francisco 94022

Jerry D. Latta
95 Main Street
Los Altos, Calif.
(415) 941-3084

London W. 1

For United Kingdom and Holland
Brayton C. Nichols
For Eastern Europe
Peter Kehr

The American Magazine Group
27 Maddox Street
London, W. 1, England
Phone: 499-0180
Cable: Ammagnic, London

Verviers, Belgium

For Continental Europe
Andre Jamar
1, Ru Mallar, 1
(087) 253.83 Telex 41563

Tokyo

Haruki Hirayama
Electronic Media Service
5th Floor, Lila Bldg.,
4-9-8 Roppongi
Minato-ku
Phone: 402-4556
Cable: Electronicmedia, Tokyo



advertiser's index

| Advertiser | Page |
|--|---------------|
| Acopian Corporation | 15 |
| Airpax Electronics, Cambridge Division | 1 |
| Alan Industries | 239 |
| Alden Electronic & Impulse Recording Equipment Co., Inc. | 223 |
| Amco Engineering Co. | 103 |
| American Aluminum Company | 143 |
| American Lava Corporation | 21 |
| Apollo Corporation | 223 |
| Arnold Magnetics Corp. | 189 |
| Associated/Jade | 189 |
| Augat, Inc. | 118 |
| Autotron, Inc. | 215 |
| Babcock Control Products Babcock Electronics Corporation .. | 121 |
| Beckman Instruments, Inc., Helipot Division | 157 |
| Belden Corporation | 11 |
| Bell & Howell CEC Instruments Division | 168 |
| Bird Electronic Corporation | 230 |
| Boonton Electronics Corporation .. | 209 |
| Bourns, Inc. | 215 |
| By-Buk Company | 236 |
| C & A Products, Inc. | 239 |
| CTS Corporation | 50, 51 |
| Cambridge Thermionic Corporation .. | 56 |
| Capitol Machine & Switch Co., The .. | 215 |
| CELCO (Constantine Engineering Laboratories Co.) | 183 |
| Chicago Dynamics Industries, Inc. | 179 |
| Cinch Connectors, An Operation of TRW Electronic Components | 97 |
| Clare & Co., C. P. | 114, 115 |
| Clairex Electronics, A Division of Clairex Corporation | 207 |
| Computer Automation, Inc. | 18, 19 |
| Computer Devices of California | 202 |
| Connor-Winfield Corp. | 239 |
| Constantine Engineering Labs. Co. (CELCO) | 183 |
| Continental Connector Corporation .. | 52 |
| Cratex | 196 |
| Cutler-Hammer | 16A |
| Daburn Corp. | 235 |
| Damon/Electronics Division | 177 |
| Datak Corporation, The | 211 |
| Dearborn Wire & Cable Co. | 237 |
| Delco Electronics, Division of General Motors Corporation | 106, 107 |
| Deltrol Controls | 210 |
| Dialight Corporation | 48 |
| Dickson Electronics Corporation | 220 |
| Digital Equipment Corporation | 12, 13 |
| Diversatron, Inc. | 232 |
| Dormeyer Industries, Inc. | 216 |
| Dow Corning Corporation | 35, 37 |
| Dynamic Instrument Corp. | 182 |
| ERA Transpac Corporation | 218 |
| Eastman Kodak Company | 165 |
| Elco Corporation | 83 |
| Electrical Plastics Corporation | 223 |
| Electro-Motive Mfg. Co., Inc., The .. | 155 |
| Electronic Associates, Inc. | 221, 223, 225 |
| Electronic Development Corporation | 188 |
| Electronic Design | 193 |
| Electronic Engineering Company of Calif. | 220 |
| Electronic Research Co. | 204 |
| Electrostatics, Inc. | 208 |
| Engineered Components Company | 203 |
| Erie Technological Products, Inc. | 109 |

| Advertiser | Page |
|---|---------------------|
| Faratron | 222 |
| Federal Scientific Corporation | 235 |
| Fluke Mfg. Co., Inc., John | 31 |
| GTE Automatic Electric | 8, 9 |
| General Automation, Inc. | 89 |
| General Electric Company | 25, 193, 205 |
| General Instrument Corporation | 16K |
| General Radio Company | 60, 145, 159, 203 |
| Grayhill, Inc. | 208 |
| Gudebrod Bros. Silk Co., Inc. | 180 |
| Guardian Electric Manufacturing Company | 111 |
| Harris Semiconductor, A Division of Harris Intertype Corporation | 16K |
| Hathaway Instruments, Inc. | 227 |
| Hayden Book Company, Inc. | 2, 195, 236 |
| Haydon Products, A. W. | 174 |
| Heath/Schlumberger | 227 |
| Hewlett-Packard | Cover II, 4, 5, 195 |
| Hickok Instrumentation and Controls Division | 62 |
| Hoffman Engineering Company | 206 |
| Honeywell, Inc. | 113 |
| Hughes Aircraft Company | 40, 41 |
| Hutson Industries | 198 |
| Hybrid Systems Corp. | 127 |
| ILC Data Device Corporation | 117 |
| ITT Cannon Electric, A division of International Telephone and Telegraph Corp. | 163 |
| Indiana General, A Division of Electronic Memories & Magnetics Corporation | 20 |
| Industrial Electronic Engineers, Inc. .. | 6 |
| Information Handling Services | 229, 231, 233 |
| Integrated Memories, Inc. | 212 |
| Intel Corporation | 59 |
| Interelectronics Corporation | 179 |
| Interstate Electronics Corporation | 90, 91 |
| J.B.T. Instruments, Inc. | 222 |
| Janise, Inc. | 239 |
| Johanson Manufacturing Corp. | 7 |
| Johnson Company, E. F. | 104 |
| Keithley Instruments, Inc. | 201 |
| Kurz-Kasch, Inc. | 49 |
| Lafayette Radio Electronics | 200 |
| Litton Automated Business Systems .. | 230 |
| LogiMetrics, Inc. | 66 |
| 3M Company | 101 |
| Magnecraft Electric Company | 161 |
| Mallory Capacitor Company | 63 |
| Microdata Corporation | 65 |
| MicroSwitch, A Division of Honeywell | 123 |
| Molex, Incorporated | Cover III |
| Monroe. The Calculator Company | 175 |
| Monsanto Company | 16L, 53 |
| Monroe Electronic Commercial Products | 16J |
| Motorola Component Products Dept. | 171 |
| Motorola Semiconductor Products, Inc. | 16A—H, 43 |
| National Semiconductor Corporation | 29 |
| New Products Engineering, Inc. | 132, 133 |
| Nihon Dempa Kogyo Co. Ltd. | 228 |
| Nippon Pulse Motor Co. Ltd. | 232 |
| Norden Division of United Aircraft Corporation | 187 |
| North American Rockwell Microelectronics Company | 144 |
| North Atlantic Industries, Inc. | 207 |
| Ohmite Manufacturing Company | 14 |

| Advertiser | Page |
|--|---------------|
| Okaya Electric Industries Co., Ltd. | 234 |
| Oneida Electronic Mfg. Inc. | 178 |
| OPCOA, Inc. | 125 |
| Optima Enclosures, A Division of Scientific Atlanta, Inc. | 180 |
| Panasonic | 95 |
| Perfection Mica Company | 61 |
| Phelps Dodge Communications Company | 64 |
| Phoenix Data, Inc. | 214 |
| Pico Electronics, Inc. | 224 |
| Piezo Technology, Inc. | 186 |
| Pirgo Electronics, Inc. | 42 |
| Potter & Brumfield Division of AMF Incorporated | 84, 85 |
| Power-Tec, Inc. | 129 |
| Premier Metal Products Company | 207 |
| Precision Monolithics, Incorporated .. | 213 |
| Prentice-Hall, Inc. | 235, 236, 237 |
| Public Service Electric and Gas Company | 199 |
| RCA Solid State Division | Cover IV |
| RF Communications, Inc. | 137 |
| RFL Industries, Inc. | 219 |
| RTRON | 176 |
| Raytheon Company, Instruments Operation | 167 |
| Raytheon Company, Sorensen Power Supplies | 58 |
| Remex Electronics Division of Ex-Cello Corporation | 54 |
| Rockand Systems Corporation | 17 |
| Rogan Brothers, Inc. | 99 |
| Rogers Corporation | 185 |
| Schauer Manufacturing Corp. | 190 |
| Schrack Electrical Sales Corp. | 200 |
| Servo-Tek Products Company | 216 |
| Siemens Corporation | 2 |
| Signetics Corporation | 119 |
| Simpson Electric Company | 55 |
| Singer, Line Electric Division | 189 |
| Soliton Devices, Inc. | 173 |
| Sprague Electric Company | 10 |
| Sperry Information Displays | 33 |
| Standard Condenser Corporation | 184 |
| Systomation, Inc. | 172 |
| Systron-Donner | 151 |
| TRW Electronic Components, Capacitor Division | 44 |
| TTElectronics, Inc. | 236 |
| Tecnetics, Inc. | 194 |
| Technitrol, Inc. | 239 |
| Technical Wire Products, Inc. | 185 |
| Tektronix, Inc. | 16, 47 |
| Teledyne Relays, A Teledyne Company | 22 |
| Tenney Engineering, Inc. | 211 |
| Thomson CSF | 138 |
| Tranco Products, Inc. | 233 |
| Triplet Corporation | 57 |
| Tucker Electronics Company | 239 |
| Tustin Electronics Company | 239 |
| Union Carbide, Components Dept. | 154 |
| Unique Devices Company | 203 |
| United Systems Corporation | 191 |
| Unitrode Corporation | 39 |
| Universal Relay Corp. | 192 A1—A36 |
| Vactec Inc. | 231 |
| Vernitron Piezoelectric Division | 217 |
| Vero Electronics, Inc. | 185 |
| Victoreen Instrument, Div. of VLN Corp. | 131 |
| Virginia Panel Corporation | 211 |
| Vishay Resistor Products, a Division of Vishay Intertechnology, Inc. | 197 |
| Watkins-Johnson | 105 |
| Weatherford | 181 |
| Webtek Corporation | 237 |
| Woven Electronics | 229 |



RF attenuators and RF components. Low cost and off-the-shelf Variable-Step Attenuators, Fixed Attenuators, Minimum Loss Matching Pads, RF Detectors, and Terminations covering the frequency range of DC-2GHz. All units are available with a wide choice of connectors in 50 and 75 ohm impedances. Alan Industries, Inc., Columbus, Ind. (812) 372-8860
INFORMATION RETRIEVAL NUMBER 181



Synchro to sine-cosine DC converter ± 3 min. of arc accuracy, 11.8 or 90 volts L/L 400 Hz synchro or resolver input. Output—10SIN θ and 10COS θ DC. Very low dynamic lag error < 5 arc sec./rpm. Hermetically sealed encapsulated. MIL-E-5400. 3 x 3 x 1.2-in. From \$190. C & A Products, Inc., 28-17 33rd St., Astoria, N.Y. 11102. (212) 796-2770.
INFORMATION RETRIEVAL NUMBER 182



Electronic Enclosures by Janise achieve that expensive look at low cost. The "VERSAPAC" Series with rich, colorful suede finishes offers flexibility in instrument design. Prices from \$24.00 in quantity. Janise, Inc., 3033 Jefferson Street, San Diego, California 92110. Telephone: 714-295-1320.

INFORMATION RETRIEVAL NUMBER 183



Treating materials according to their function, these design aids combine essential background with immediately workable data and techniques. Series in Materials for Electrical and Electronics Design, Edited by Alex. E. Javitz. Hayden Book Co., Inc., New York, N. Y. 10011.

INFORMATION RETRIEVAL NUMBER 184



Single event time interval and voltage measurements to 1.0 MHz in real time with Model 2152. Accuracy: $t_r = \pm 1$ ns, $v_r = \pm 1\%$ F.S. Range: 0-2V in 3 scales, 0-1 μ s. BCD output to LED display and for data logging. For automatic testing of semiconductor and magnetic devices. Technitrol, Inc., Phila., Pa. Phone: (215) 426-9105.

INFORMATION RETRIEVAL NUMBER 185

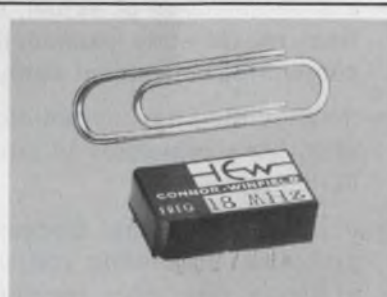

.3" high DIP TTL Crystal Oscillator measures .78" x .49" x .3" square wave at fixed freqs. 1 MHz to 30 MHz; $\pm .001\%$, to $+50^\circ\text{C}$, to $\pm .005\%$, -25 to $+75^\circ\text{C}$; fannout 10 TTL; logic 1 $> 2.4\text{V}$, logic 0 $< 0.4\text{V}$; supply 5Vdc $\pm 5\%$, 25 ma nominal; delivery stock to 2 weeks ARO. Connor-Winfield Corp., Winfield, Ill. 60190, (312) 231-5270.

INFORMATION RETRIEVAL NUMBER 186



L & N Type "W" 24 pt. recorders. Choice of paper speeds and t/c or MV range cards. Many features. Full warrantee. \$1295. ea. Send for '72 instrument catalog! Tucker Electronics Co. Box 435 Edison, N.J. (201) 225-2900

INFORMATION RETRIEVAL NUMBER 187



The Successful Engineer-Manager, Edited by R. C. Haavind and R. L. Turmail. Depth discussion and insights of the experts isolate the fine points of management: career, decisions, people, projects, finances, communications. Hayden Book Co., Inc., New York, N. Y. 10011.

INFORMATION RETRIEVAL NUMBER 188

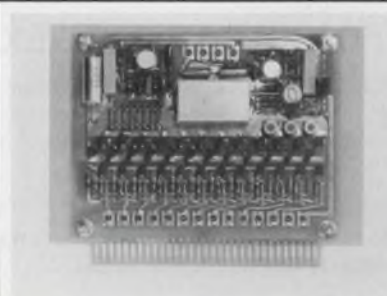

12 bit analog-to-digital converter, 8 μ sec conversion time. \$300. A converter with an accuracy of $\pm .0125\%$ of full scale $+1/2$ LSB. Size is 5.4" x 4.2" x 0.8". Other units available from 8 to 18 bits including a 15 bit (.01%) ADC with 1.0 microsecond throughput time. Tustin Electronics Company, 2103 S. Grand Ave., Santa Ana, California 92705

INFORMATION RETRIEVAL NUMBER 189

Candidate for the PE license this year?

Use these up-to-date guides...
specifically tailored for
your study campaign

HAYDEN PROFESSIONAL ENGINEERING EXAMINATION SERIES

LAWRENCE J. HOLLANDER, Editor-in-Chief,
Professional Engineer, New York State

Written with your needs kept foremost,
these study guides offer . . .

- a wide selection of actual, realistic problems from recent state examinations arranged by subject for convenient study
- detailed step-by-step solutions that bring out underlying principles to equip you to handle the unexpected
- concise background discussions precede the problems, presenting you with a mini-review of theory, principles, terminology
- separate tables of contents for subjects and problems quickly pinpoint the specifics for rapid review or "open book" examinations
- numerous schematic diagrams and detailed drawings to insure in-depth understanding

Review the books that concern you for
15 full days—FREE!

FOR 15-DAY FREE EXAMINATION

Please send the book(s) circled below on a 15-day examination basis. At the end of that time, I will remit payment, plus postage, or return the book(s) without further obligation.

5712-1 5715-6 5716-4

(For those ordering by ISBN, the Hayden Prefix is: 0-8104)

Save money! On all prepaid orders Hayden pays postage—
same 15-day return guarantee! 72-29 ED

Name _____

Firm _____

Address _____

City/State _____ Zip _____



HAYDEN BOOK COMPANY, INC.
116 West 14th St., New York, N.Y. 10011

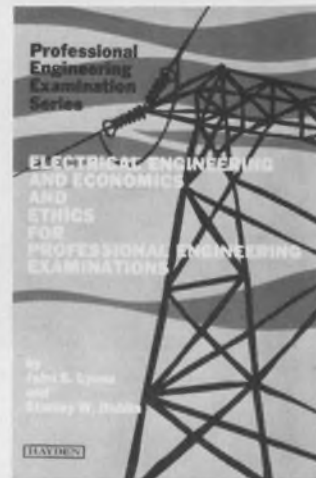
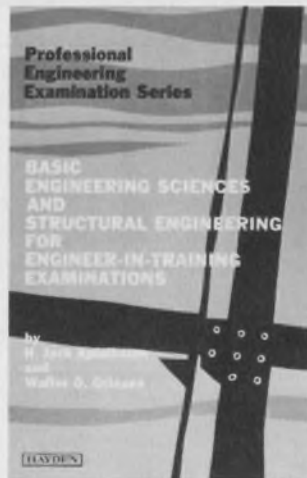

BASIC ENGINEERING SCIENCES AND STRUCTURAL ENGINEERING FOR ENGINEER-IN-TRAINING EXAMINATIONS

H. JACK APFELBAUM, P.E., Department of Mechanical Engineering, Lowell
Technological Institute; and WALTER O. OTTESEN, P.E., Patent Counsel

Nearly 200 solved problems selected from a nationwide survey of recent E-I-T examinations offer you a complete, well organized review of the concepts and techniques that must be understood to successfully pass the preliminary exam. Unlike other study guides that stress one aspect of the field while shortchanging others, this volume provides balanced coverage of the three broad engineering areas: *the basic sciences*: mathematics, physics, and chemistry; *the engineering sciences*: statics, dynamics, fluid mechanics, thermodynamics, electricity, and engineering economy; and *structural engineering*. More than 300 detailed illustrations pinpoint key concepts and problem-solving techniques.

408 pp., 6 x 9, illus., cloth, #5712-1, \$13.95

ELECTRICAL ENGINEERING AND ECONOMICS AND ETHICS FOR PROFESSIONAL ENGINEERING EXAMINATIONS

JOHN S. LYONS, P.E., and STANLEY W. DUBLIN, Institute of Environmental
Medicine, New York University Medical Center

Concentrating on the subjects and topics that form the foundation of this rapidly changing technology, this book analyzes and solves for you almost 100 problems from a nationwide sampling of recent PE examinations. Its comprehensive, up-to-date coverage includes materials and problems not found in other guides of this type, such as electrical-magnetic-thermal analogs, semiconductors, and power system short circuits. More than 170 detailed illustrations are included. The separate section devoted to economics and ethics features an unusual approach to such topics as interest, costs, valuation, and others—the summarized use of formulas in solving nearly 50 typical problems.

302 pp., 6 x 9, illus., cloth, #5715-6, \$12.95

also available

MECHANICAL ENGINEERING AND ECONOMICS AND ETHICS FOR PROFESSIONAL ENGINEERING EXAMINATIONS

EUGENE STAMPER, P.E., and STANLEY DUBLIN

Over 200 solved problems in mechanical engineering, along with the same thorough coverage of economics and ethics.

392 pp., 6 x 9, illus., cloth, #5716-4, \$14.95

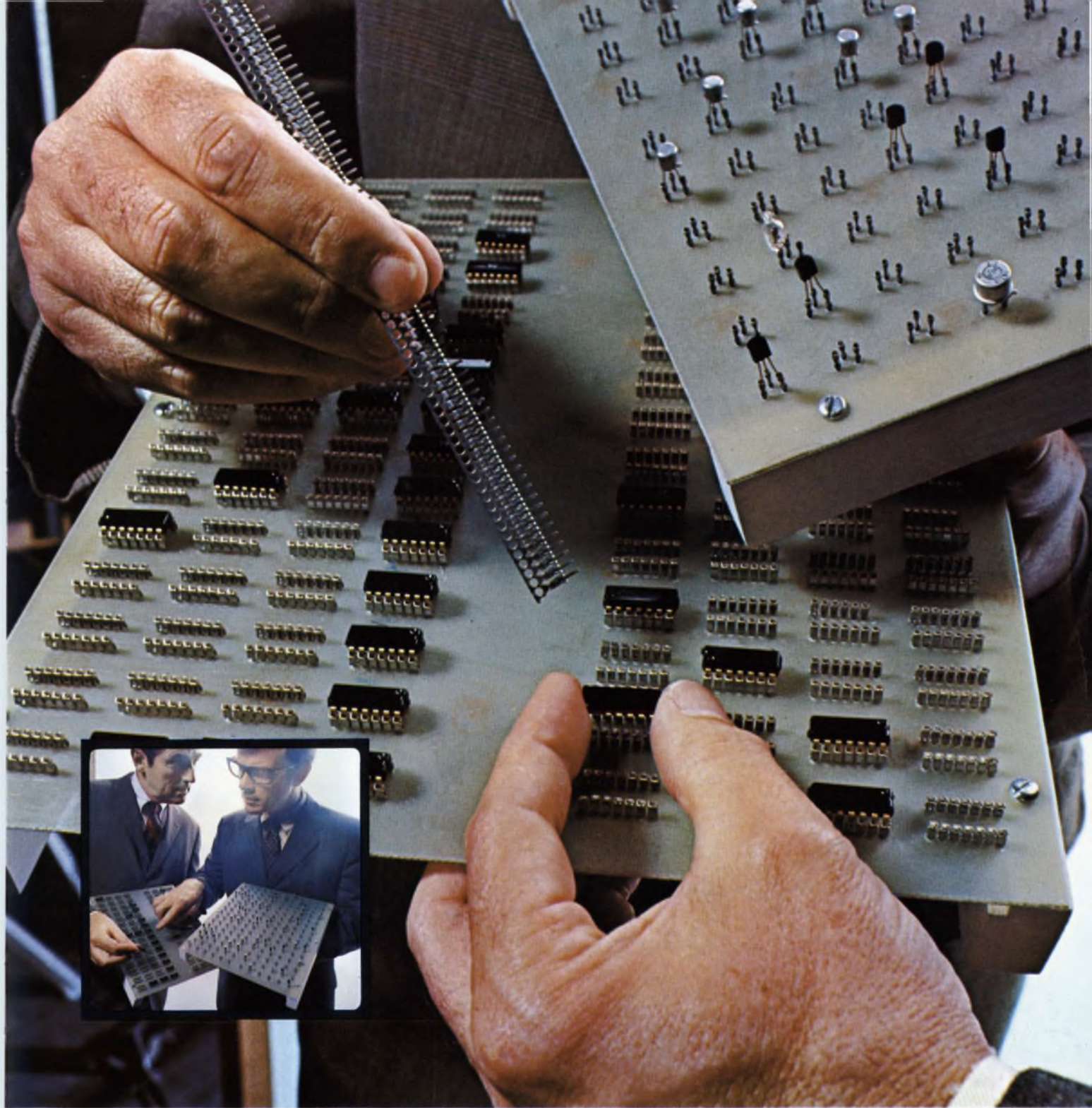

HERE'S A NEW AND BETTER WAY: To make printed circuit board connections. Reliably. At low, low cost. They're Molex Soldercon[®] terminals. Integrated circuit and transistor terminals. Offering the convenience of plug-in I.C.'s and transistors *without* the cost of insulators. They fit directly on the board. And there is equipment available to do the job *automatically*. Fast! Soldercon terminals save time. Money. Speed installation. Make

testing easier, too. And simplify service problems. It's another example of Molex ingenuity . . . in creating components that simplify circuitry. Molex has the know-how and facilities to provide the interconnecting system you need. You can make connections by calling (312) 969-4550. Or write . . . Molex Incorporated, Downers Grove, Illinois 60515. . . . *creating components that simplify circuitry*

RCA's glass-passivated/center-gate thyristor line continues to expand—in plastic.

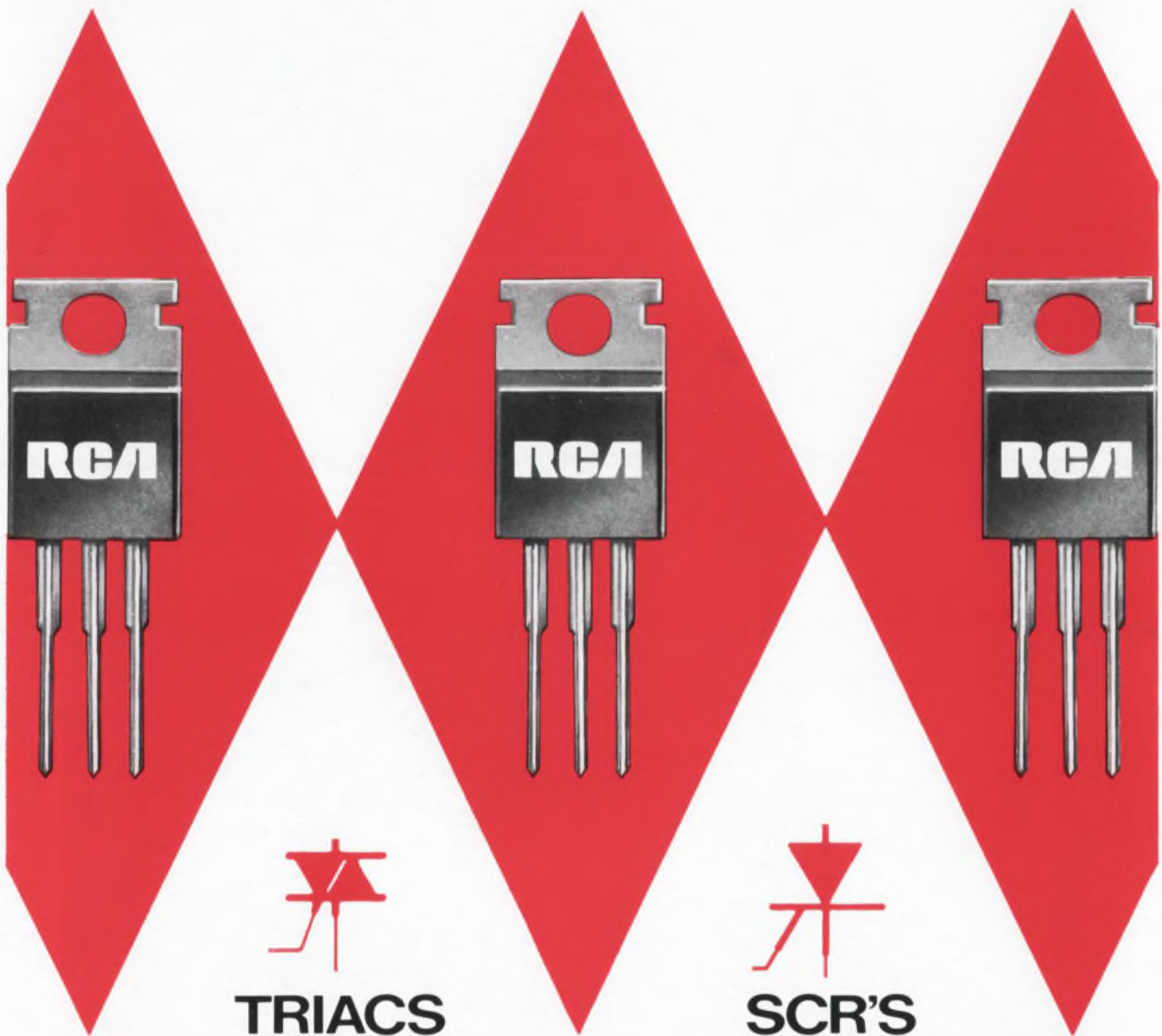

To its popular 40668/40669 triacs and 40868/40869 SCR's, RCA now adds 8 A ISOWATT triacs and 4 A SCR's—all available now—in the industry-accepted VERSAWATT package. Leads are custom-formed to your requirements, of course.

- ISOWATT triacs, 40900, 40901, 40902. These 8 A units are ceramic isolated versions of 40668/40669, providing great flexibility in chassis mounting.

- RCA-106 and 107. Here are 4 A SCR's that fill your needs for low-cost circuit areas that require triggering at 200 and 500 μ A. These RCA microamp gate SCR's

have extended voltage ratings to 500 V and 600 V (corner-gate design).

- 40668/40669. Use these 8 A triacs for control of AC loads for power control and industrial lighting applications.

- 40868/40869. Select these 8 A SCR's for applications in power switching and motor speed controls.

RCA triacs are gate-controlled in all four modes.

RCA VERSAWATT thyristors employ glass-passivated/center-gate chips for quality performance. With the RCA VERSAWATT thyristor, you get ease of mounting, low thermal impedance for operation

at elevated temperatures, and minimum heat sink requirements—all at excellent cost effective levels.

With RCA's full plastic capability, you can cover full- and half-wave applications with currents from 1 to 15 A and voltages from 15 to 600 V.

See your local RCA Representative for details. For technical data, write: RCA Solid State Division, Section /UR14, Box 3200, Somerville, N.J. 08876. International: RCA, Sunbury-on-Thames, U.K. or P.O. Box 112, Hong Kong. In Canada: RCA Limited, Ste. Anne de Bellevue 810, Quebec.

RCA Solid State
products that make products pay off