

Film-resistor trimming equipment: The choice is a laser system or an air-abrasive device. Both specify high production rates, but they can't always be reached.

Laser systems are hot items for functional trimming and small-film resistors, while air-abrasive units are lower in cost. Which one do you use? See report on page 44.

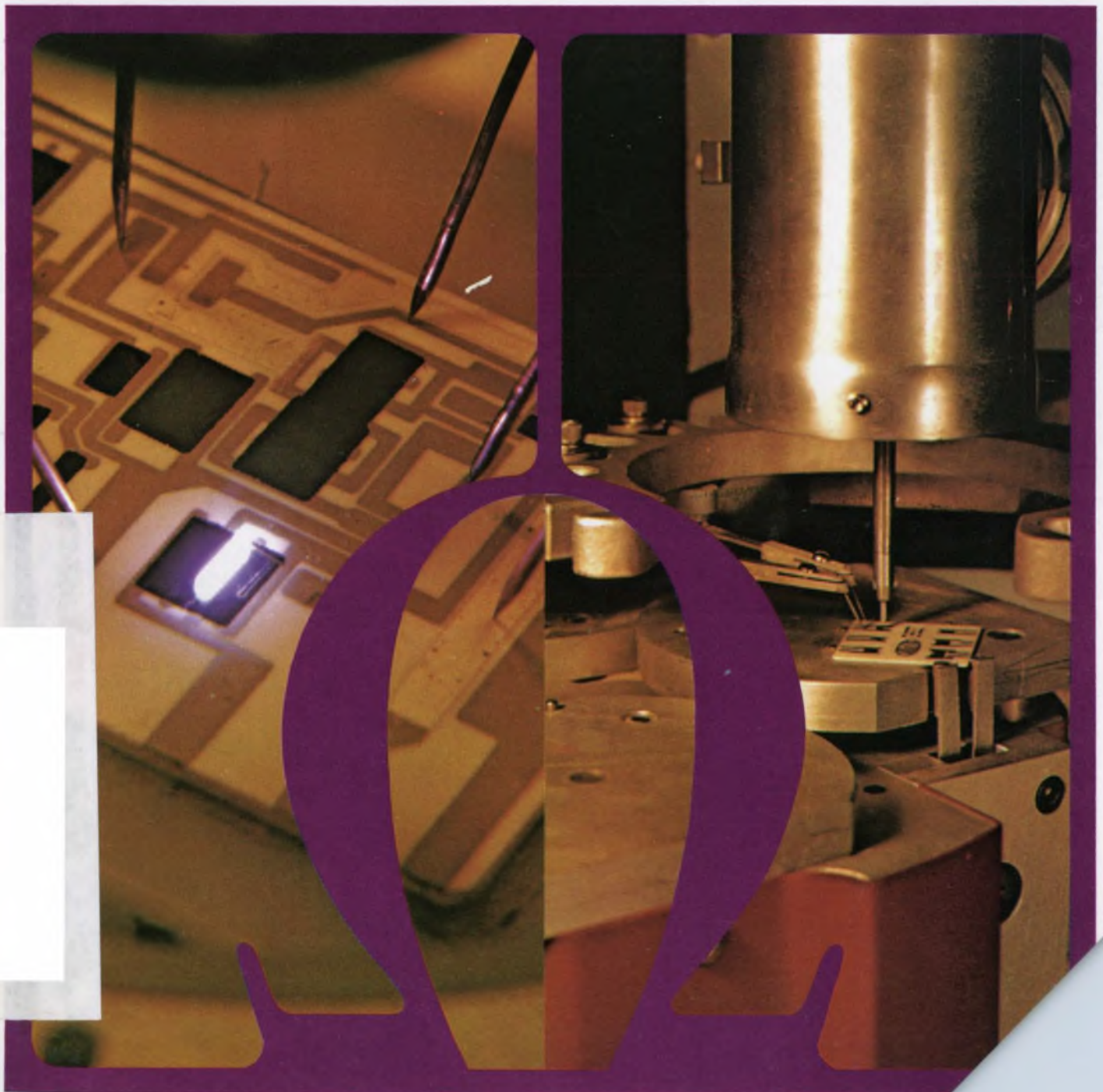

Circuit-Makers.

New DIP Tools from Dale.

DIP TRIMMERS

2600/8600 "Fastpacks". Wirewound model (2600) rated at 1 watt (40°C) over 10-50K ohm range $\pm 10\%$. T.C. 50 ppm/°C. Film model (8600) rated .75 watt (25°C) over 10 Ω -2 Meg. range $\pm 10\%$, $\pm 20\%$. T.C. 150 ppm/°C. Sealed cases, .75" long, machine or hand insertable.

85/87 "Fastpacks". Single or multi-turn models rated at .5 watt (25°C) over 10 Ω to 1 Meg. range $\pm 20\%$. T.C. 150 ppm/°. Sealed cases, .265" wide x .28" long. Machine or hand insertable.

DIP RESISTOR NETWORKS

TKR. Molded or coated networks with 14 (T.O. 116) 16, 18 pins. 1/8 watt max. per resistor, 3/4 watt max. at 125°C per package. 10 Ω to 1 Meg., $\pm 2.5\%$, 200 ppm/°C. Available with DIP or P.C. pins on .3" x .1" or .6" x .1" grid (coated only).

WDP/FDP. Film (FDP) networks in 14 and 16 pin packages. Up to 15 elements, .05 watt max. with .5 watt max. per package; 10 Ω to 1 Meg. per resistor, $\pm 1\%$, 10-200 ppm/°C. Wirewound (WDP) networks have up to 7 elements per 14-pin package, .5 watt per element, 3.5 watts max. per package. 1 to 800 Ω per resistor, .1%-5%, ± 20 , ± 50 ppm/°C.

DIP PULSE TRANSFORMERS

PT-14/PT-16 with 3 (14-pin) or 4 (16-pin) pulse transformers per package. Inductance 1 μ h to 2.0 mh over -55 to +125°C. range. Temperature stability $\pm 10\%$, tolerance $\pm 20\%$. Sealed cases with pins on .3" x .1" grid. Machine or hand insertable.

In addition to these standard DIP packages, we're ready to quote on custom RC networks and hybrids with active and passive devices to your specification. Fast turnaround on prototypes. Write for new DIP Brochure or phone our Application Engineering Department, 402-564-3131 today!

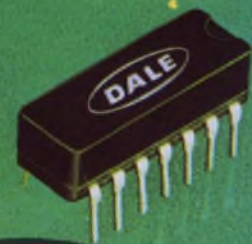
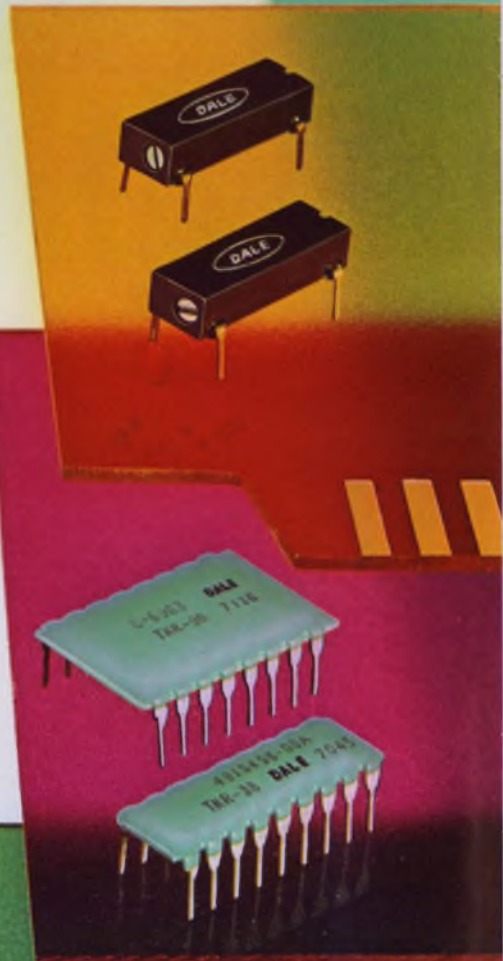

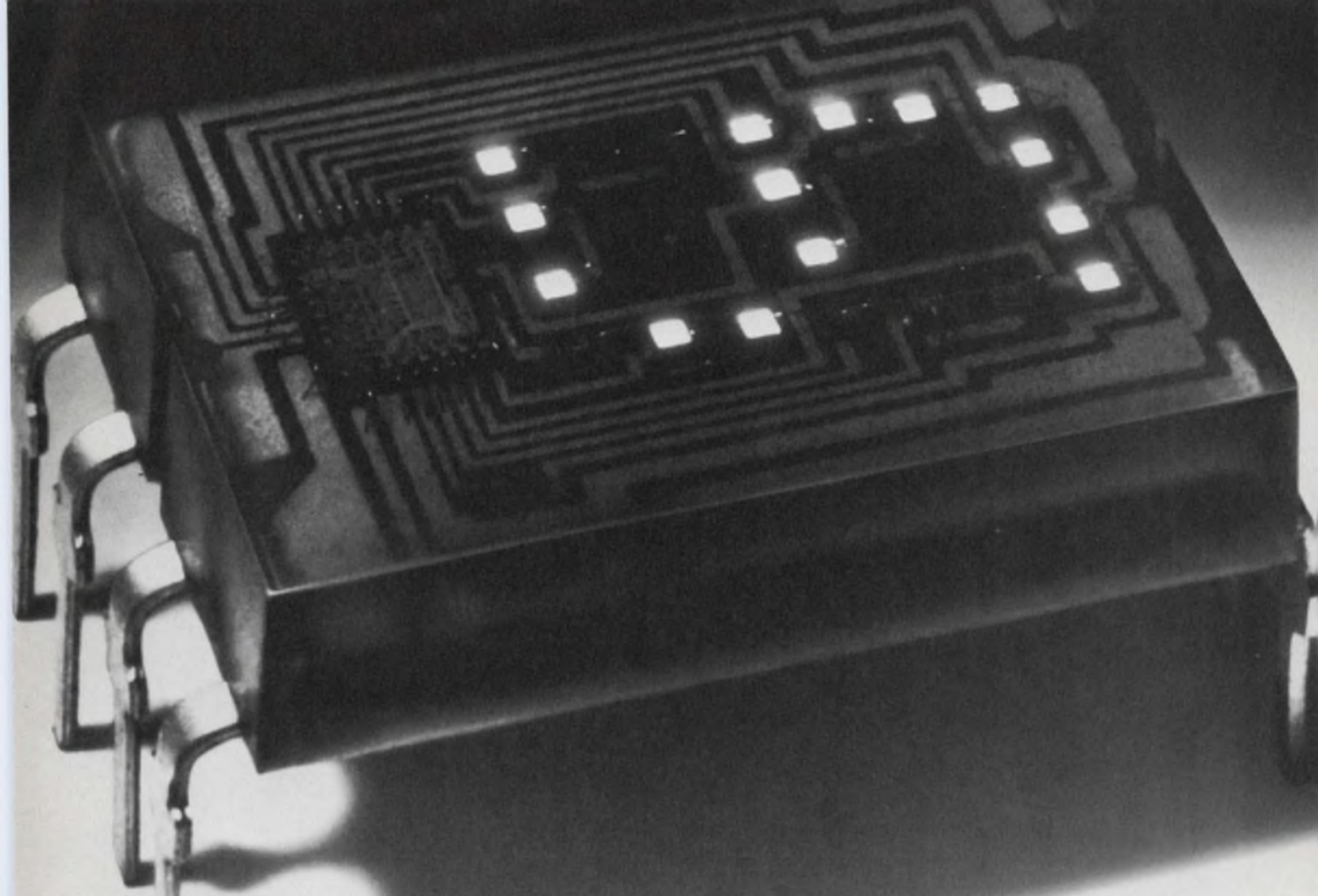

We built in the decoder/driver so you don't have to.

Not only the decoder/driver but the memory too! Now available for *immediate* delivery is the HP 5082-7300 series solid state display.

It's completely TTL compatible. All you do is address it directly with four-line BCD input. The on-board IC allows for either the storage of input data or real-time display. You save design time, space, and money, and get a completely reliable integrated display system.

A bright .290 inch high, shaped character gives

excellent readability over a wide viewing angle in a compact .600 inch by .400 inch package.

Best of all is the price: \$10.00 each in 1K quantities. So why wait? Order now! For *immediate* delivery on the HP 5082-7300 call your local HP sales office, or Hewlett-Packard, Palo Alto, Calif. 94304. In Europe: 1217 Meyrin-Geneva, Switzerland.

01202

HEWLETT  PACKARD

COMPONENTS

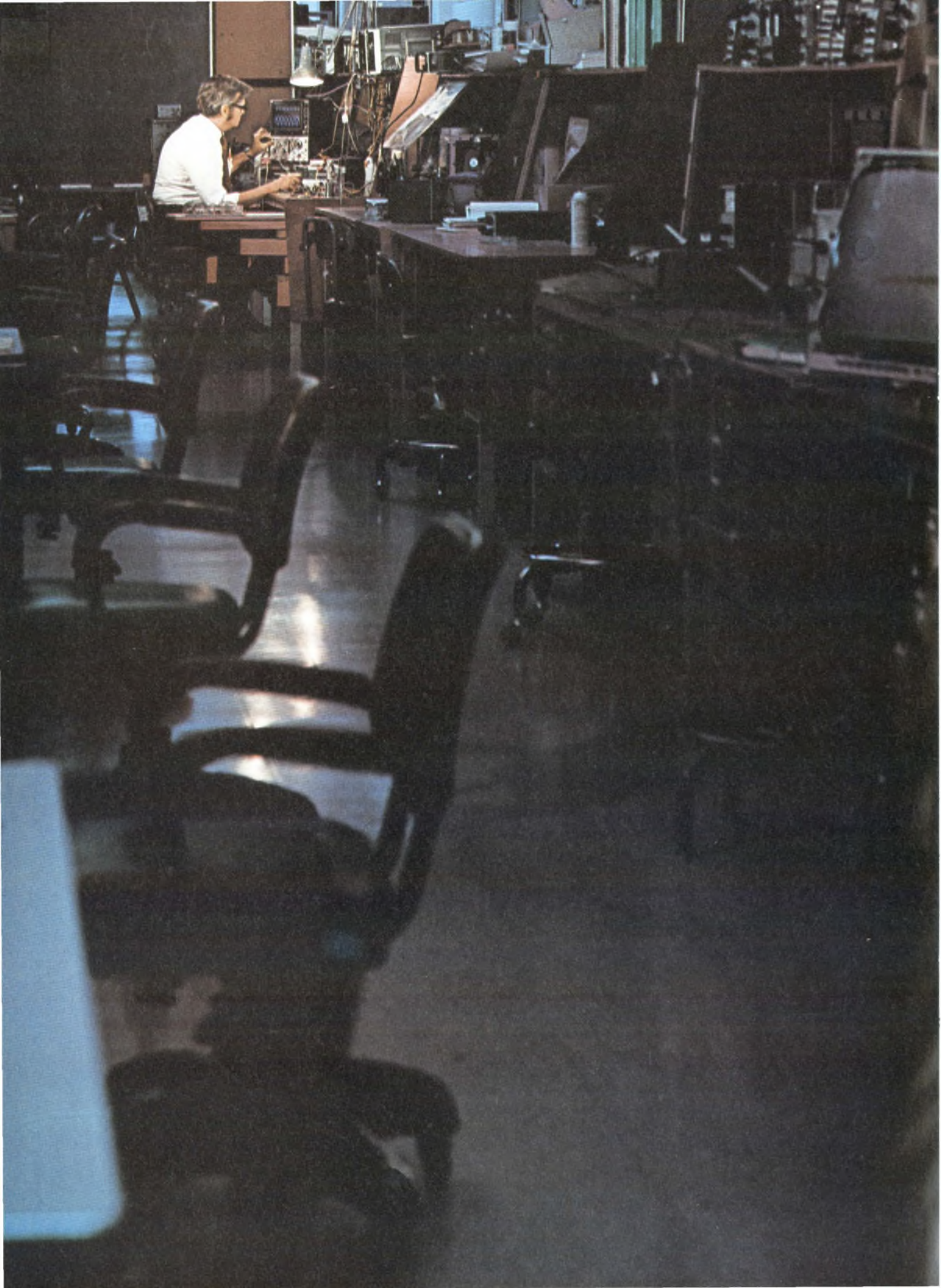

Think Twice:

If your job depends on your ability to make measurements... check out HP's new scopes.

You owe it to yourself. The days of the "gravy train" in the electronics industry are over. Today, you have to do a really outstanding job to get ahead—or even just to hold on to what you've already got.

That's why it's imperative that you *double-check* before making purchase decisions today — especially decisions on something as important as a new scope. Because, if you *do* make comparisons between the available alternatives, you'll be in an unassailable position to justify your choice — whatever it is — and in a pretty poor position, if you don't.

This is important because, today, as never before, you're going to be judged on your ability to do the best possible job at the lowest possible cost. Pinched for profits, management is now demanding hard-nosed justifications for every decision. They're examining *total acquisition costs*, as they've never done before.

As a result, doing things just because "you've always done them that way" can be deadly. Because now, it's a whole new ball game. The old reasons for "sticking with the tried and true" are out the window.

Take scopes, for instance. The cur-

rent generation is so different from the last generation that the decision to buy *any* new scope—whether ours or our competitor's—involves a whole battery of related changes. New test procedures. New calibration setups. New parts inventories.

Thus, to be sure that you're getting the best buy, in terms of performance vs. total acquisition cost, you should thoroughly check *both* manufacturers' offerings.

Check prices. Find out exactly how much it will cost to get the measurement capabilities you need, including all accessories. In many cases, you'll find that Hewlett-Packard can save you a significant amount.

Check Performance. Call us for a "hands-on" demonstration of the scopes or systems that are *most relevant to your particular needs*. Remember—what counts is the ability to meet *your* frequency, accuracy, and sensitivity requirements... not technological "fireworks displays" in areas far from your own concerns.

Check ease of use. Compare simplicity of controls, display size, error-prevention devices. Does the scope you're considering have *useful, time-saving* features, like selectable input

impedance, variable persistence storage, bandwidth to meet your current and near-future requirements, and simplified sampling...or just flashy "bells and whistles" that add little to usability, and a lot to the price?

When you make these comparisons, we think you'll choose Hewlett-Packard. We've found that once people get the facts, they usually do. For a revealing package of information on H-P's new scopes, send for a free copy of our "No-Nonsense Guide to Oscilloscope Selection." Or contact your local H-P field engineer for a demonstration. Check before you choose. Hewlett-Packard, Palo Alto, California 94304. In Europe: 1217 Meyrin-Geneva, Switzerland.

**Scopes Are Changing;
Think Twice.**

082/1

HEWLETT  PACKARD

O S C I L L O S C O P E S

TRW LVA diode... the sharpest knee below 10 Volts.

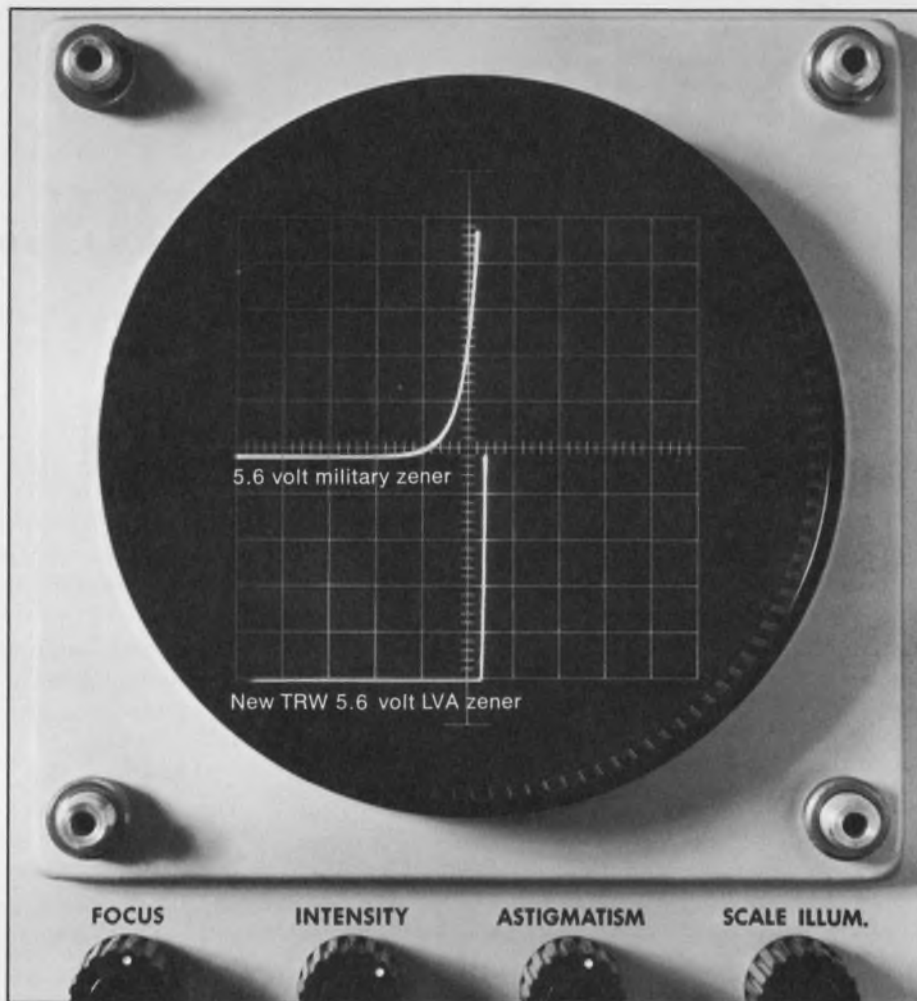

The current saver.

No other zener can approach TRW's LVA performance below 10 volts. Available for operation down to 4.3 volts, TRW LVA diodes minimize power consumption in portable-battery operated equipment. They're also ideal for instrumentation, where, as reference elements, they draw as little as 50 μ Amps. TRW LVA's are available in various package configurations, including passivated chip form for hybrid-

compatible packages. If you have a need for a low current voltage regulator or any other product that demands low current consumption, you should check out TRW LVA zeners. When it comes to current, they're really misers!

For product information and applications assistance write TRW Semiconductors, 14520 Aviation Blvd., Lawndale, California 90260. Phone (213) 679-4561. TWX 910-325-6206.

TRW
SEMICONDUCTORS

Electronic Design

FOR ENGINEERS AND ENGINEERING MANAGERS

VOL. 20 NO.

3

FEB. 3, 1972

NEWS

- 23 **News Scope**
- 26 **A new generation of highly sophisticated drones**, specifically designed for combat missions, is being designed by two teams.
- 30 **Laser can pinpoint one-foot object at a distance of 50 miles.**
- 32 **Time accuracy to within a minute a month** is being offered with a new electronic wristwatch—the first designed and developed in the U.S.
- 36 **Technology Abroad**
- 39 **Washington Report**

TECHNOLOGY

- 44 **Focus on Resistor Trimming Equipment: A special report on one of the biggest bottlenecks in hybrid circuit production.**
- 52 **Build reliable optoelectronic circuits** by knowing how to use data on photosensors and light sources, both incandescent and solid-state.
- 58 **Hybrid circuits are great** for high power designs. They simplify packaging, reduce equipment size and often decrease manufacturing costs.
- 62 **Build high-stability regulators** by combining ICs and discrete components and get reliable performance at low cost.
- 66 **Ideas for Design**

PRODUCTS

- 71 **Modules & Subassemblies:** Wideband multiplier reaches accuracy of averaging types.
- 73 **ICs & Semiconductors:** Comparator reduces uncertainty band to ± 1 mV.
- 76 **Instrumentation:** Digital-test logic probes detect pulses down to 5 ns.
- 75 Data Processing
- 78 Components
- 78 Microwaves & Lasers

Departments

- 43 **Editorial:** Let's not foul up the upturn
- 7 Letters
- 79 Design Aids
- 80 Application Notes
- 80 New Literature
- 83 Bulletin Board
- 86 Advertisers' Index
- 88 Information Retrieval Card

Cover: Resistor trimming equipment, from left to right, Electro Scientific Industries (laser system), S. S. White (air-abrasive system).

ELECTRONIC DESIGN is published biweekly by Hayden Publishing Company, Inc., 50 Essex St., Rochelle Park, N.J. 07662 James S. Mulholland, Jr., President. Printed at Brown Printing Co., Inc., Waseca, Minn. Controlled circulation postage paid at Waseca Minn., and New York, N. Y., postage pending Rochelle Park, N. J. Copy-right © 1972. Hayden Publishing Company, Inc. 82501 copies this issue.



How to Buy a Good Power Supply Without Spending a Bundle...

Take a long look at the Abbott line of over three thousand standard models **with their prices listed**. The unit shown above, for instance, is the Abbott Model R5S, a 60 Hz to DC converter which puts out 5 volts of regulated DC at 0.15 amps and sells for only \$83. Other power outputs from 2 to 240 watts are available with **any output voltage from 5 volts to 3,650 volts**, all listed as standard models in our catalog. These power supplies feature close regulation, short circuit protection, and the latest state of the art specifications for solid state modules.

If you really want to save money in buying your power supply, why spend many hours writing a complicated specification? And why order a special custom-built unit which will cost a bundle—and may

bring a bundle of headaches. As soon as your power requirements are firmed up, check the Abbott Catalog or EEM (see below) and you may be pleasantly surprised to find that Abbott already has standard power supplies to meet your requirements — **and the prices are listed**. Merely phone, wire, or write to Abbott for an immediate delivery quotation. Many units are carried in stock.

Abbott manufactures a wide variety of different types of power supply modules including:

- 60A to DC, Regulated
- 400A to DC, Regulated
- 28 VDC to DC, Regulated
- 28 VDC to 400A, 1 ϕ or 3 ϕ
- 24 VDC to 60A, 1 ϕ

Please see pages 618 to 632 of your 1971-72 EEM (ELECTRONIC ENGINEERS MASTER Catalog) for complete information on Abbott modules.

Send for our new 56 page FREE catalog.

abbott transistor

LABORATORIES, INCORPORATED

5200 W. Jefferson Blvd./Los Angeles 90016
(213) 936-8185 Cable ABTLABS

1224 Anderson Ave./Fort Lee, N.J. 07024
(201) 224-6900

INFORMATION RETRIEVAL NUMBER 5

Publisher

Peter Coley

Editors

Editorial Offices
50 Essex St.
Rochelle Park, N.J. 07662
(201) 843-0550
TWX: 710-990 5071
Cable: Haydenpubs Rochellepark

Editor: George Rostky

Managing Editors:

Ralph Dobriner
Michael Elphick

Associate Editors:

Jules H. Gilder
Richard Lee Goldberg
John F. Mason
Nathan Sussman
Edward A. Torrero
Richard L. Turmail

Contributing Editor:

Peter N. Budzilovich

Field Offices

East

Jim McDermott
P.O. Box 272
Easthampton, Mass. 01027
(413) 527-3632

West

David Kaye
2930 Imperial Highway
Inglewood, Calif. 90303
(213) 757-0183

Washington

Don Byrne
1111 S. Army Navy Drive
Arlington, Va. 22202
(202) 296-8982

Editorial Production

Dollie S. Viebig

Art

Art Director, William Kelly

Richard Luce
Anthony J. Fischetto

Production

Manager, Thomas V. Sedita
Helen De Polo
Maxine Correal
Anne Molfetas

Marketing Communications

Director, Al Porte

Circulation

Manager, Nancy L. Merritt
Joan Licari

Information Retrieval

Peggy Long

across the desk

Editorial draws reader dissent

In response to the editorial in the Dec. 23, 1971 issue ("Engineering Without Shame," p. 51), I am personally offended by your use of the word "guilt" in regard to the engineering profession to which I belong. My experience has been divided between military research, scientific research and commercial-social research, and in no instance do I recall seeing or talking to any "guilt"-ridden engineer or any who looked scornfully upon others in the profession. Perhaps your argument and its extrapolation of defense work to "directing bomb loads at a few snipers" is the best example of its very weakness. It is also doubtful that the national pride in our space achievement will be diminished by your diatribe.

It is too bad that you did not respond and direct your remarks to the topic of your article, because a positive program such as President Nixon's New Technology Opportunities Program should be actively supported in a positive manner. I certainly hope the program will succeed. But if it does, its success will be built on the solid foundation of engineering advancements and expertise of the 1960s, not upon the negative aspects you suggest in remorse, regret and shame.

*Ronald E. Timm
Electrical Engineer*

Argonne National Laboratory
9700 South Cass Ave.
Argonne, Ill. 60439

IEE takes exception to article on readouts

"Focus on Readouts" in the Nov. 25 issue (ED 24, pp 52-64) has caused considerable dismay and ire

from IEE management. It centers on your commentary regarding the 64-position nimo display.

First, there's a drastic typo. A one-time mask charge of \$200 to \$400 is required—"not \$400-\$5000," as stated. This misquote will cause us endless negative reception in the marketplace.

In addition we will have standard masks available for displaying alphanumeric and symbols, as required, to duplicate the typewriter keyboard from ASCII or EBCDIC codes or for any other application requiring letters and numbers, at no additional charge.

Second, I well realize your insight on the display market in general, but to state "Nimo 64 is not cheap" is a total contradiction to every customer inquiry to date from the ELECTRONIC DESIGN article of Oct. 14 ("64-Gun, Cathode-Ray Display Increases Readout Density," ED 21, p. 96).

It is extremely reasonably priced for the inherent capabilities of the device, which no one can match. What other display devices can:

- Display the complete typewriter keyboard in TRUE alphanumeric and symbolic style.
- Display five-line (eight characters per line) messages.
- Allow the end user to decode for less than \$4.
- Decode both ASCII and EBCDIC.
- Provide adjustable brightness.
- Time-share.

*Tom O'Gorman
Advertising Manager*

Industrial Electronic
Engineer, Inc.
7720-40 Lemona Ave.
Van Nuys, Calif. 91405

"Focus on Readouts" was, in general, objective and reasonably complete. However, I would like to

(continued on p. 10)

Electronic Design welcomes the opinions of its readers on the issues raised in the magazine's editorial columns. Address letters to Managing Editor, Electronic Design, 50 Essex St., Rochelle Park, N. J. 07662. Try to keep letters under 200 words. Letters must be signed. Names will be withheld on request.

ALL YOU NEED for LAB and MEDIUM PRODUCTION THICK FILM TRIMMING



the COMCO MICRO TRIMMER

from
\$2,900*

FAST — you can change from trimming one resistor pattern to another in minutes... and trim up to 600 resistors per hour.

ACCURATE — separate matched ratio arms provide precision null indication for ranges from 10 ohms to 10 meg ohms... higher and lower values too, with some loss of accuracy but without extra accessories.

AUTOMATIC SHUT OFF — abrasive flow stops automatically when resistor reaches programmed value.

AUTOMATIC RATIO TRIMMING — specific ratios of resistance between two resistors on a substrate can be obtained by trimming just one resistor... saves time and increases accuracy.

Micro Trimmer's modular construction allows complete flexibility of accessories... it operates with most abrasive supply systems, including COMCO's exceptional **Micro Blaster**.

*For Automatic Shut Off add \$300
For Automatic Ratio Trimming add \$700.

Write or call for complete technical data.



COMCO INC.

Phone (213) 849-5806
1222 W Olive Ave., Burbank, Calif. 91506

COMPLETE 3-TERMINAL IC VOLTAGE REGULATORS



New 7800 family: first with complete voltage regulation on a single chip.

Now you can virtually forget about your VR design problems and get on with the rest of your system. Our new 7800 series is the first high quality, sophisticated, versatile, yet simple way of regulating voltage. At a price low enough to inventory in quantity, so you can use them as you need them.

Here's why:

Simple to use: Complete and self-contained—one chip in one plastic package. Connect 3 terminals, bolt in place and add the normal line decoupling capacitor. Requires no other external components. You get optimum performance with no calculations.

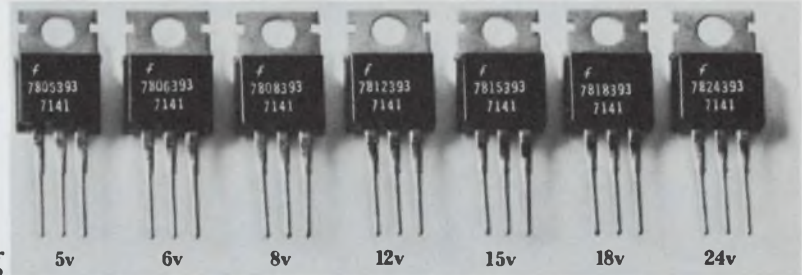

Superior Performance: Output voltage tolerance better than $\pm 5\%$; line regulation of 0.01%/volt; output impedance of 0.03Ω . Output current rated at 1 Amp (usable to 1.5 Amps depending on input voltage and heat sinking considerations).

Self-Protecting: Internal current limiting, thermal shut-down and safe area compensation protect device and circuit from current, power, temperature fluctuations. Resets automatically.

Versatile & Compact: Use locally...at the power source, on a remote chassis, on PC cards, wherever is most convenient and efficient. Compact; you can miniaturize your design. Result: simpler, smaller, cheaper, easier-to-use power supply and circuitry.

Low Cost: 1-24@\$2.20. 25-99@\$2.00. 100-999@\$1.75! (About 1/2 the cost of the elements required in a commonly accepted voltage regulator—and virtually no design cost.)

Available: In quantity, from distributor or factory stock. TO-220 package now; TO-3 in first quarter of 1972. There are 7 versions (last 2 digits indicate voltage): 7805, 7806, 7808, 7812, 7815, 7818, 7824.

Write for Data Sheets and application information.

**MADE IN
FAIRCHILD**

**You say all you need
is a delay relay
that times pretty well
and can carry
the load it switches?
And doesn't cost much?**



Then this is it.

For many applications, you don't need split-second timing accuracy in a delay relay. But you want something better than a thermal device.

Our Silic-O-Netic® relays time out like our circuit breakers. A solenoid core moving at a controlled speed through a fluid dashpot.

Within their timing range (¼ second to two minutes), we promise accuracy of $\pm 50\%$ of the selected delay. Doesn't seem like much, but it's plenty for most requirements. And you can depend on it.

Then the Silic-O-Netic has a continuous-duty coil and heavy gold-plated silver contacts with up to 5-amp capacity—a combination that lets the delay relay act as its own load relay. You don't pay for extra components, or extra design time.

Finally, there's the reassuring Heinemann five-year warranty.

So if you want a reliable low-price delay relay, you ought to try one of our five models. They're described in Bulletin 5006.

Heinemann Electric Company,
2616 Brunswick Pike, Trenton,
N.J. 08602.

 **HEINEMANN**

INFORMATION RETRIEVAL NUMBER 8

5038

ACROSS THE DESK

(continued from p. 7)

point out that Major Data Corp. recently introduced a new type of display that was not mentioned in your report. The display is a projection type, but the similarity to older types of projection systems ends at this point.

The Major 64 readout, for one thing, is self-decoding and can project any one of 64 images. The images may be essentially anything that can be photographed. Another feature is that the readout has only one optical projection system, so it is easy to provide image projections in a variety of sizes. Major 64 has inherent memory and will retain the last selected image without any input power.

One of the criteria used in your article was that of dollars per character or digit. It would be difficult to compare the Major 64 on this basis, since it can project up to 150 characters in each of the 64 positions. The price schedule shows that in large quantities, the Major 64 readout can be delivered for less than \$50.

*H. H. Sarkissian
Vice President*

Major Data Corp.
1796 Monrovia Ave.
Costa Mesa, Calif. 92627

In reading "Focus on Readouts" I noticed you omitted mention of Chicago Miniature Lamp Works, a significant factor in this business. It manufactures both LED and incandescent devices.

*Paul C. Mazzacano
Director of Public Relations*
Buti-Roberts Public Relations
505 North Lake Shore Drive
Chicago, Ill. 60611

"Focus on Readouts" presents the clearest, most balanced review of the industry to date.

*Stuart Harris
Marketing*

Monsanto Co.
10131 Bubb Road
Cupertino, Calif. 95014

Murphy strikes again

Murphy's Law, one of the most all-pervasive laws of nature, states that if anything can go wrong, it will. Well, it did—with a vengeance—in the January 6th issue.

(continued on p. 14)

INFORMATION RETRIEVAL NUMBER 9 ►



Our filter/capacitor family takes experimentation out of circuit design.

We provide the comprehensive data you need for every one of our filter and capacitor components. Attenuation curves (by current, voltage or in combination at room temperature and maximum). Test procedures. Application aids. Specs. Dimension drawings. That's why the Allen-Bradley family is easier to work with. We also give you high volumetric efficiency and

a wide variety of styles. Backed by our famous track record for quality and improved performance. Request your personal copies of our literature. Call our nearest appointed electronics distributor, or write: Allen-Bradley Electronics Division, 1201 South Second Street, Milwaukee, Wisconsin 53204. Export: Bloomfield, New Jersey 07003. Canada: Galt, Ontario.

Publication 5409: type FA, FB, FW, SB, SS ceramic disc capacitors for VHF/UHF.

Publication 5410: type FCS, SMFB, SMFO filters for the 50 MHz to 10 GHz range.

Publication 5411: type CL multi-layer, coaxial capacitors for connectors.

Publication 5414: type MT, MS by-passing capacitors for 50 KHz to 1 GHz.

Publication 5416, 5417: type BE, SF filters for RFI/EMI suppression.

Publication 5418: type AB broad band filters in Pi, T and L configurations.



NEW DIMENSION ELECTRONICS
ALLEN-BRADLEY



12 WAYS Electronic Design Leadership

CAN MAKE YOUR EOEM ADVERTISING MORE SALES-PRODUCTIVE

PINPOINT YOUR PRIME PROSPECTS

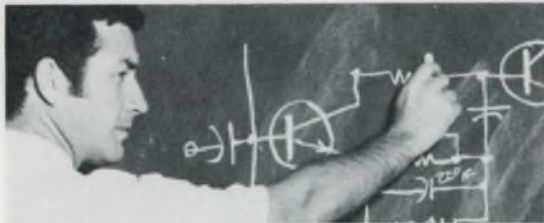

- 100% ENGINEERS AND ENGINEERING MANAGERS ● 100% DESIGN
- 100% QUALIFIED BY INDIVIDUAL REQUEST

Electronic Design goes only to your prime prospects — **engineers and engineering managers**. These are the "product specifiers", the men who start the life cycle of each new electronic product, device, or system; who need to know about components, devices, materials, hardware, subassemblies, test equipment, or systems. Study after study confirms their overwhelming importance in every step of the purchasing process, but most of all in **selection and specification by brand**.

GIVES YOU MORE OF THEM

Electronic Design delivers more than 74,000 known specifiers, without waste. The professionals that you value most are mostly to be found reading **Electronic Design**. Prove it for yourself — conduct a readership study over your own EOEM lists. We'll share the costs — we're that confident **Electronic Design** is best read!

A new 20 page booklet of special interest to electronics executives, sales, marketing, and advertising managers is just off press. Ask for the LEADERSHIP folder — it will help you to make better media decisions in '72.

INSURES THEY ARE LIVE AND SPECIFYING

Electronic Design makes sure that your advertising is being delivered to, and is being read by, active, on-the-job engineers and engineering managers — men who are in an immediate position to specify and buy products. In addition to one-year verification of the entire list, sampling checks are made 17 times each year. You know your audience is live in **Electronic Design!**

DELIVERS 99% IN-PLANT

Your prospects receive and read **Electronic Design** in the plant, where they work, where specifications are made. On the other hand, **Electronics** and **Electronic News** are only about 50% plant-delivered.

DEVELOPS HIGHEST READERSHIP

No. 97 1 DIGITAL EQUIPMENT CORP.	No. 96 1 E M RESEARCH LABORATORIES INC.	No. 95 1 KRONHYTE CORPORATION	No. 94 1 SIGNAL ANALYSIS INDUSTRIES CORP.
No. 87 1 KANE INTL. INC.	No. 86 1 PARKER INSTRUMENT CORPORATION	No. 85 1 DATATON INC.	No. 84 1 WELCH ELECTRONICS CORPORATION
No. 77 1 RFI INDUSTRIES INC.	No. 78 1 SYSTEMS DESIGN CORPORATION	No. 75 2 DAN MANUFACTURING CO.	No. 74 1 SCHWABER ELECTRONICS CORP.
No. 67 1 MASTER SPECIALTIES	No. 66 1 INTERNATIONAL ELECTRONIC RESEARCH CORPORATION	No. 65 1 INDIAN GENERAL CORPORATION	No. 64 1 CORU ELECTRONICS INC.
No. 57 1 NEALE RESEARCH LABORATORY INC.	No. 58 1 HELFERT DIV. TECHMAN INSTRUMENTS	No. 55 1 MECHTRONICS INC.	No. 54 1 ELECTRONIC FRAMEWORK CO. OF CAN.

No other electronics publication in the world offers you so many independent proofs of readership. We have 97 independent media readership studies to show you. **Electronic Design** is FIRST in "Read Regularly" in 89 of them!

COVERS EVERY EMERGING MARKET OPPORTUNITY



Keeping engineers knowledgeable is a mammoth task. Complexity is the norm; obsolescence a constant threat. **Electronic Design's** editors stay on the forefront of design; probe every emerging development in terms of its significance to the engineer, his company, and its competitors.

100% FOCUS ON DESIGN TECHNOLOGY

Electronic Design effectively bridges the gap between a constantly evolving technology and the needs of your customers — working engineers. They read **Electronic Design** because it is exciting . . . explores both sides . . . supplies their "total" needs. It gives them **BALANCED** coverage of **NEWS, TECHNOLOGY, and PRODUCTS** — all from the design point of view. Material is practical, immediate, solution-oriented; brought alive by color, typography and graphics. Our unique **FOCUS** series is typical of the extra technical emphasis in '72.

DATE	FOCUS ISSUE SUBJECT	CLOSING
Jan. 6	Digital Panel Meters	Nov. 29
Feb. 3	Resistor Trimming Equip.	Dec. 27
Mar. 2	Lighted Switches	Jan. 24
Apr. 1	Function Generators	Feb. 21
Apr. 13	ICs	Mar. 6
May 11	Disc & Drum Memories	Apr. 3
June 8	ICs	May 1
July 6	Reed Relays	May 30
Aug. 3	MSI/LSI Testers	June 26
Aug. 17	ICs	July 10
Sept. 2	Digital Cassette and Cartridge Recorders	July 24
Oct. 12	Time Delay Relays	Sept. 5
Oct. 26	ICs	Sept. 18
Nov. 9	Keyboards	Oct. 2
Dec. 7	Flat Flexible Cable & Flexible Printed Circuits	Oct. 30

PROVIDES MOST SALES LEADS

No other electronics or industrial magazine in the world can match the number of sales leads generated by **Electronic Design**! Over 1,500,000 per year! This massive influx of requests for further information is a basic proof that editorial and advertising in **Electronic Design** is seen, read, and **acted upon**. Ask to see copies of latest "Did You Buy?" studies.

HELPS YOU GET STARTED

Electronic Design is not just for the large advertiser . . . it's for the small company, too. Ask about our "Quick Ads". They're an easy way to get sales leads at low cost — only \$300 per insertion (and no production costs).

ACCELERATES RESULTS



Electronic Design readers not only react with requests for more information, if you give them the technical data they need, right away, in your ad, they can often be brought to the point of purchase quickly — sometimes immediately. Get the full story on our Purchase-Producing Advertising concept, then hear the cassette tape narrated by Triplett Corp.'s President. It tells how they received an avalanche of 12,000 responses from one Purchase-Producing Advertisement in **Electronic Design**. PPA insert discounts range as high as 75%!

OFFERS MORE MARKETING SERVICES

Be sure to take advantage of **Electronic Design's** arsenal of advertising and marketing aids. **FAST CLOSE FORM • AUDIT OF BRAND RECOGNITION • INQUIRY FOLLOW-UP STUDIES • READER RECALL STUDIES • BUYING AUTHORITY STUDIES • READER-SHIP STUDIES • MARKETING NEWSLETTER • MERCHANDISING PROGRAM.**

ENABLES PRECISION DIRECT MAIL FOLLOW-UP

Put the additional power of demographic direct mail behind your advertising program. **Electronic Design's** Precision Direct Mail Service offers 6 selections to zero-in on prospects; gives only current specifiers.

GET MOST SALES ACTION!

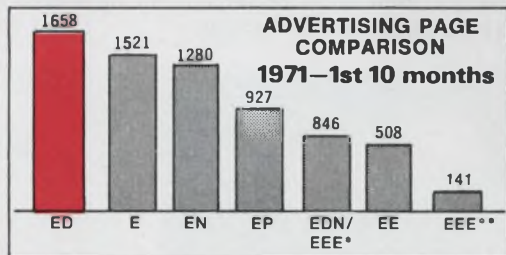

* EEE space after merger.

** EEE space prior to merger.

The industry clearly shows its preference for **Electronic Design**, places most advertising pages in this magazine.

Electronic Design

a Hayden publication • 50 Essex Street, Rochelle Park, New Jersey 07662 • Tel: 201-843-0550

VOICE YOUR CHOICE

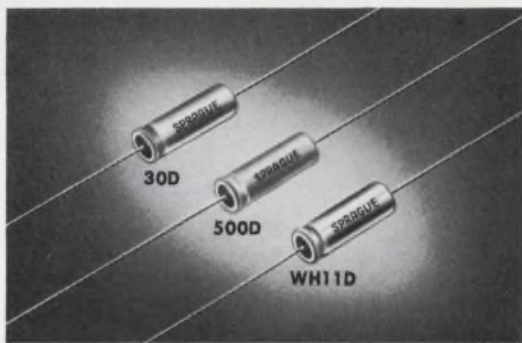

... Sprague makes three!

SMALL ALUMINUM 'LYTIC CAPACITORS

TYPE 30D FOR INDUSTRIAL APPLICATIONS

Will withstand 2000 hr. life test at 85C. Excellent stability, dissipation factor, leakage current. Designed for business machines, instrumentation equipment, etc. Write for Engineering Bulletin 3150A or:

CIRCLE 882 ON SERVICE CARD.

TYPE 500D FOR MODERATE-COST APPLICATIONS

Good operating life characteristics, including stability, ESR, leakage current. Will withstand 1000 hr. life test at 85 C. Ideal for radio, TV, and other entertainment applications. Write for Engineering Bulletin 3149 or:

CIRCLE 883 ON SERVICE CARD.

TYPE WH11D FOR ECONOMY APPLICATIONS

Welded construction, similar to higher-priced capacitors. Widely used in solid-state equipment where cost is of prime importance. Made by Sprague World Trade Corp. in Hong Kong. Write for Engineering Bulletin 3148C or:

CIRCLE 884 ON SERVICE CARD.

MORE FROM SPRAGUE ... THE BROAD-LINE PRODUCER OF ELECTRONIC PARTS

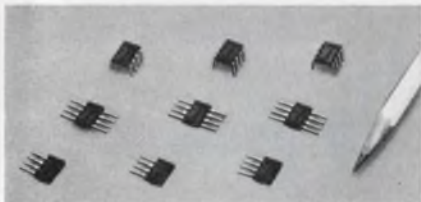

HALL EFFECT SWITCH ICs. Actuated magnetically, not mechanically or optically. Hall generator trigger circuit and signal amplification circuit on single silicon chip. Reliable (no moving parts). Easy interfacing with DTL/TTL/MOS logic. High speed. Low cost. Write for Engineering Bulletin 27,402A or:

CIRCLE 885 ON READER SERVICE CARD.



U.L. LISTED FILTERS. Series JX5000 for EDP equipment and general-purpose use. Rated 125/250 VAC, 0-60 Hz, 1 thru 50 amps. 60 db @ 150 kHz, 80 db from .5 MHz thru 1 GHz. Special designs and rectangular multi-circuit units also available. Write for Engineering Bulletin 8210 or:

CIRCLE 886 ON READER SERVICE CARD.



TYPE 36D POWERLYTIC® CAPACITORS. For use in computer power supplies, control equipment, energy storage, etc. Low impedance construction. Up to 650,000 μ F at 3 V. Ratings from 3 to 450 V. Can be operated at 85 C. Tapped 10-32 terminals simplify filter bank assembly. Write for Engineering Bulletin 3431D or:

CIRCLE 887 ON READER SERVICE CARD.



BLUE JACKET® RESISTORS. Vitreous-enamel power wirewound. Unique all-welded end-cap construction eliminates moisture paths along leads, anchors leads securely to resistor body. Expansion coefficients of vitreous enamel, ceramic body, and end caps are closely matched. Write for Engineering Bulletin 7410E or:

CIRCLE 888 ON READER SERVICE CARD.



TECHNICAL LITERATURE SERVICE, SPRAGUE ELECTRIC CO., 347 MARSHALL ST., NORTH ADAMS, MASS. 01247

45-1117R1

ACROSS THE DESK

(continued from p. 10)

The editorial pointed out that the Information Retrieval card had been expanded to include space for your feedback to the editors. But in that issue—and only that issue (we hope)—the extra space was chopped off.

Delete a word to keep the record straight

In your Oct. 28 issue you carried my response letter to Richard L. Turmail's article "Help Yourself to Jobs and Retraining," which appeared on pp. 54-57 in the Sept. 2 issue. Intentionally or unintentionally, in the process of publishing my letter you added the adjective "major" to my quotation of Dr. Merl Baker's quotation. The original quotation appeared on p. 56 of the Sept. 2 issue. The changed and inaccurate quotation reads: "There is no *major* job shortage for college-degree engineers if they have a positive attitude and have personalities to sell themselves."

The modified quotation allows for the possibility of interpreting the quotation to mean that some engineers might have difficulty finding employment even if they had a positive attitude and a good personality. I would not have responded to your Sept. 2nd article if the weasel word *major* had been used in your quotation of Dr. Baker's remark.

Please publish this letter, because my response to Dr. Baker's remark would only apply to his quoted remark that you provided in your Sept. 2 issue, where the word *major* is deleted.

Donald L. Huffman, Ph.D.
Wright-Patterson AFB,
Ohio 45433

Giving proper credit

In the Oct. 28 issue of ELECTRONIC DESIGN, the first item of the Washington Report ("B-1 Avionics Package Assembler to Be Named Soon," p. 37) incorrectly identified a competitor for the B-1 avionics package as the LTV Electronics Div. The correct designation is LTV Electrosystems, Inc. The Pentagon supplied the wrong information.

The No. 1 Interface Line is also the No. 1 problem solver.



Find a need and fill it. That's our orders. And now the one and only specifically designated, complete interface line in the field tackles two more stumbling blocks with:

The only bidirectional one-shot in existence, and the first IBM-compatible line driver and receiver. Applications and features below — along with the entire 8T series of exclusive interface devices. Your #1 problem solvers. Offering unique advantages unavailable in any

other ICs on the shelf. All production-proven, in stock now from your Signetics distributor, salesman or rep.

FREE complete handbook of applications for the #1 interface line is yours for the asking. Circle #246 on reader service card, or write Signetics-Interface, 811 E. Arques Avenue, Sunnyvale, California 94086. Or call (408) 739-7700.

Signetics

Find your need. We'll fill it.

APPLICATION	SOLUTION
Precision digitizer for disc, tape and drum systems. Digital communications receiver. Signal conditioner. Bidirectional transition detector. Frequency doubling.	8T20 New Bidirectional One-Shot. Combines linear comparator, one-shot and logic all-in-one. Functions as a zero-crossing detector with an input threshold of $\pm 4\text{mV}$ and positive or negative edge triggering, or both.
To meet compatibility requirements of IBM System 360 I/O interface specs, channel to control unit. When tying on any peripheral equipment such as core memory, discs, graphic terminals, etc.	8T23 Dual Line Driver. 8T24 Triple Line Receiver. The first and only interface driver/receiver pair proven totally compatible with IBM 360. Replaces discrete components.
To conform with EIA-Std-RS232, MIL-Std-188 and CC-ITT-V24 specs, when transmitting and receiving digital data.	8T15 Dual Line Driver. 8T16 Dual Line Receiver. EIA/MIL communications devices.
Digital data transmission and receiving, using coaxial cable, twisted-pair, or other low impedance lines. Party-line data transmission. Schmitt trigger. One-shot.	8T13 Dual Line Driver. High current driver with short-circuit protection and DOT-OR capability. 8T14 Triple Line Receiver. High input impedance receiver with Hysteresis.
Data transfer in bus-oriented systems. Modular systems design. Minicomputer design. Multiplexing.	8T09 Quad Bus Driver. Tri-state logic configuration to increase system performance. High speed (10ns) and high current (40mA) capability. 8T10 Quad D-Type Bus Flip-Flop Tri-state outputs with input and output disable. 50MHz typical toggle rate.
Driving seven-segment numerical displays, LEDs or incandescent lamps.	8T04, 8T05, 8T06 BCD-to-Seven Segment Decoder/Drivers. For driving almost any type of display — LEDs, Numitron, etc.
Low voltage (+5V) to high voltage (40V) level translation.	8T80 Quad 2-Input NAND Gate. 8T90 Hex Inverter. Low-to-high voltage interface gates.
High voltage (10V-50V) to TTL (+5V) level translation.	8T18 Dual 2-Input NAND Gate. High-to-low voltage interface gate.

SIGNETICS CORPORATION — A SUBSIDIARY OF CORNING GLASS WORKS

Where the answers are HAYDEN guides to computer equipment, languages, techniques, terminology

MODERN DATA COMMUNICATION: Concepts, Language and Media

William P. Davenport. This pioneering guide to a complex area of EDP provides an up-to-date working knowledge of how information is transmitted and received through electrical and electronic systems. Eliminating advanced mathematics, the book gets to the core of intricate theories and concepts, such as coding, channel capacity, and modulation and multiplexing. It describes limiting characteristics of transmission media, discusses efficiency and error control methods, and explores commercially available communications services. Both an in-depth introduction and a practical reference, this comprehensive source enables the data systems manager, engineer, student or technician to evaluate today's transmitting techniques and tomorrow's potential applications. 208 pp., 6 x 9, illus., cloth, #5810, \$7.95.

New and widely used programming texts

BEGINNING FORTRAN: Simplified 12-Statement Programming

J. Maniotes, H. B. Higley, and J. N. Haag. This new text teaches programming in Gotran, a subset of Fortran that can be mastered in only 10 to 15 classroom hours. From the outset portions of the Gotran language are applied in writing complete programs. Problems and end-of-chapter exercises reflect a wide range of practical applications. 260 pp., 7 1/8 x 9 3/4, illus., paper, #5869; cloth, #5870.

COMPREHENSIVE FORTRAN PROGRAMMING

James N. Haag. The highly successful course in Fortran II teaches the language as used by the IBM 1620 computer with an attached 1311 Disk Drive, with adaptations to suit other systems. 246 pp., 7 3/8 x 10 1/8, illus., paper, #5646, \$5.95.

BASICS OF DIGITAL COMPUTER PROGRAMMING

John S. Murphy. Providing a thorough introduction to business-data programming, this clearly written text uses general problems to illustrate practical computer applications. Discussion is clarified through continual reference to the organization of a typical computer. 118 pp., 6 x 9, illus., paper, #0405, \$3.95.

STANDARD DICTIONARY OF COMPUTERS AND INFORMATION PROCESSING

Martin H. Weik. Encompassing more than 10,000 hardware and software terms in general use throughout the field of computers and their applications, this authoritative reference has been widely praised for its detailed definitions, broad scope, and numerous illustrative examples. Thorough cross-referencing permits complete mastery of the vocabulary of hundreds of topics: programming and computer engineering to input-output devices and checking systems. The Computer Tree, reproduced on the end papers, traces the lineage of hundreds of computer models built to date. Up-to-date and thorough in every respect, this dictionary will prove indispensable to technical and non-technical personnel as well as trainees and students. 336 pp., 6 x 9, illus., cloth, #5677, \$10.95

BASIC BASIC: An Introduction to Com- puter Programming in Basic Language

James S. Coan. This text can be studied along with an existing math course or as a separate programming course. Progressing from short, complete programs to more sophisticated problems, it encourages the use of flowcharts as an aid in program-writing. 272 pp., 6 x 9, illus., paper, #5872, \$5.95; cloth, #5873, \$7.95.

COMPREHENSIVE STANDARD FORTRAN PROGRAMMING

James N. Haag. This well organized course uses sample problems from a variety of fields to teach how to program using the full version of Fortran IV as standardized by the U.S.A. Standards Institute. 312 pp., 7 3/8 x 10 1/8, illus., paper, #5811, \$6.95; cloth, #5812, \$8.95.

DISCOVERING BASIC: A Problem Solving Approach

Robert E. Smith. The reader begins programming on page three of this practical course, learning the vocabulary of Basic by working with it. The brief lessons and problems are reinforced by over forty pages of programs. 224 pp., 5 3/8 x 8 1/4, illus., paper, #5783, \$5.95; cloth, #5784, \$7.95.

BASICS OF DIGITAL COMPUTERS, Revised Second Edition

John S. Murphy. This profusely illustrated, three-volume work provides a thorough grounding in today's equipment and systems. It explains how data is programmed into the machine, discusses the function of individual components, and covers linkup and control of an overall system. 391 pp., 6 x 9, illus. 3 vol. set, paper, #0737, \$11.25; 3 vol. combined cloth, #0741, \$9.95; indiv. paper vols., #'s 0738-40, \$3.75.

BASICS OF DIGITAL COMPUTERS TRANSPARENCIES

Based on Murphy's widely acclaimed text, these two-color overhead transparencies illuminate the essential principles that underlie modern computers and systems. The series is available as a complete set of 125, or as ten separate subsets. Set, #6860, \$231.00. Write for complete brochure or 35mm film-strip preview.

UNDERSTANDING DIGITAL COMPUTERS

Ronald Benrey. Layman's guide describes computers in terms of building blocks that make up a system. Stressing the function of these elements, it explains programming, binary arithmetic, logical design, and other topics. 166 pp., 6 x 9, illus., paper, #0473, \$4.75.

DIGITAL MAGNETIC TAPE RECORDING: Principles and Computer Applications

Bernard B. Bycer. This unique design tool fully describes functions and operations. Data on specification, purchase, and use of the equipment is included. 328 pp., 6 x 9, illus., cloth, #5031, \$12.50.

COMPUTER ARITHMETIC

Henry Jacobowitz. A review of all positional number systems with applications in computers, this compact book explains binary, octal, hexadecimal, and ternary arithmetic, along with conversion methods. 128 pp., 5 1/2 x 8 1/2, illus., paper, #0297, \$3.75

COMPUTER NUMBERING SYSTEMS AND BINARY ARITHMETIC

Training Systems, Inc. and Stanley L. Levine. This programmed course proceeds gradually through all the required mathematical processes. No previous knowledge of binary or octal numbering systems, or computers, is needed. 232 pp., 6 x 9, paper, #0380, \$5.45.

FOR 15-DAY FREE EXAMINATION

Please send the book(s) circled on a 15-day examination basis. At the end of that time, I will remit payment, plus postage, or return the book(s) without further obligation.

5810 5869 5870 5646 0405 5677 5872 5873 5811 5812 5783
5784 0737 0741 0738 0739 0740 6860 0473 5031 0297 0380

\$10.00 minimum for free exam orders. Because of higher billing and collection costs, we must ask for payment in full with any order under \$10.00. Books will be shipped postpaid. Same 15-day return privilege for full refund if not satisfied.



Hayden Book Company, Inc., 116 West 14th St., New York, N.Y. 10011

NAME _____

FIRM _____

ADDRESS _____

CITY/STATE _____ ZIP _____

Save money! On all pre-paid orders Hayden pays postage—same return privilege!

72-91.

What's new in diodes?



PLANAR ZENERS

Whiskerless construction... DO-35 outline on bandoliers for mass production!

The good news has traveled quickly.

Not long ago electronic engineers learned we were producing 400 mW zener diodes by the silicon planar technique, in the 4.7 to 75V range ... putting them in a DO-35 package ... and bandolier-taping them for automatic cropping, forming and insertion.

Since then, the demand has forced our production rate up to more than 20 million per year!

One of the reasons for the quick acceptance of this BZX79 range (Jedec IN5729 series) is its remarkable combination of technical advantages.

- More reliable whiskerless construction
- Standard $\pm 5\%$ and $\pm 2\%$ tolerances with $\pm 1\%$ to order
- Very sharp "knee" voltage and low R_z (see diagram)
- Low diode capacitance
- High surge immunity
- Low leakage current.

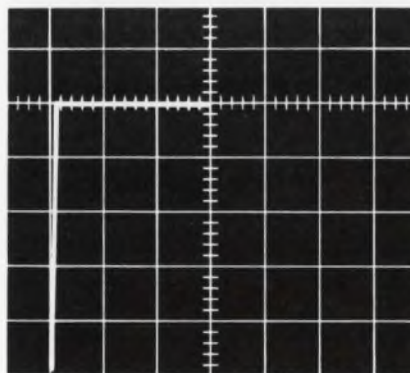

Another reason is its equally useful combination of packaging advantages.

DO-35 encapsulation saves space. Bandolier-taping saves money. Type branding and counting marks save time.

The result of this high production rate, of course, is that quantity orders are now deliverable quickly.

Send now for samples, documentation, and data on our total capability in voltage regulator and reference diodes.

N.V. Philips' Gloeilampenfabrieken
Electronic Components and
Materials Division
Eindhoven, the Netherlands.



electronic components
and materials

PHILIPS

Before ordering your next **connector**,

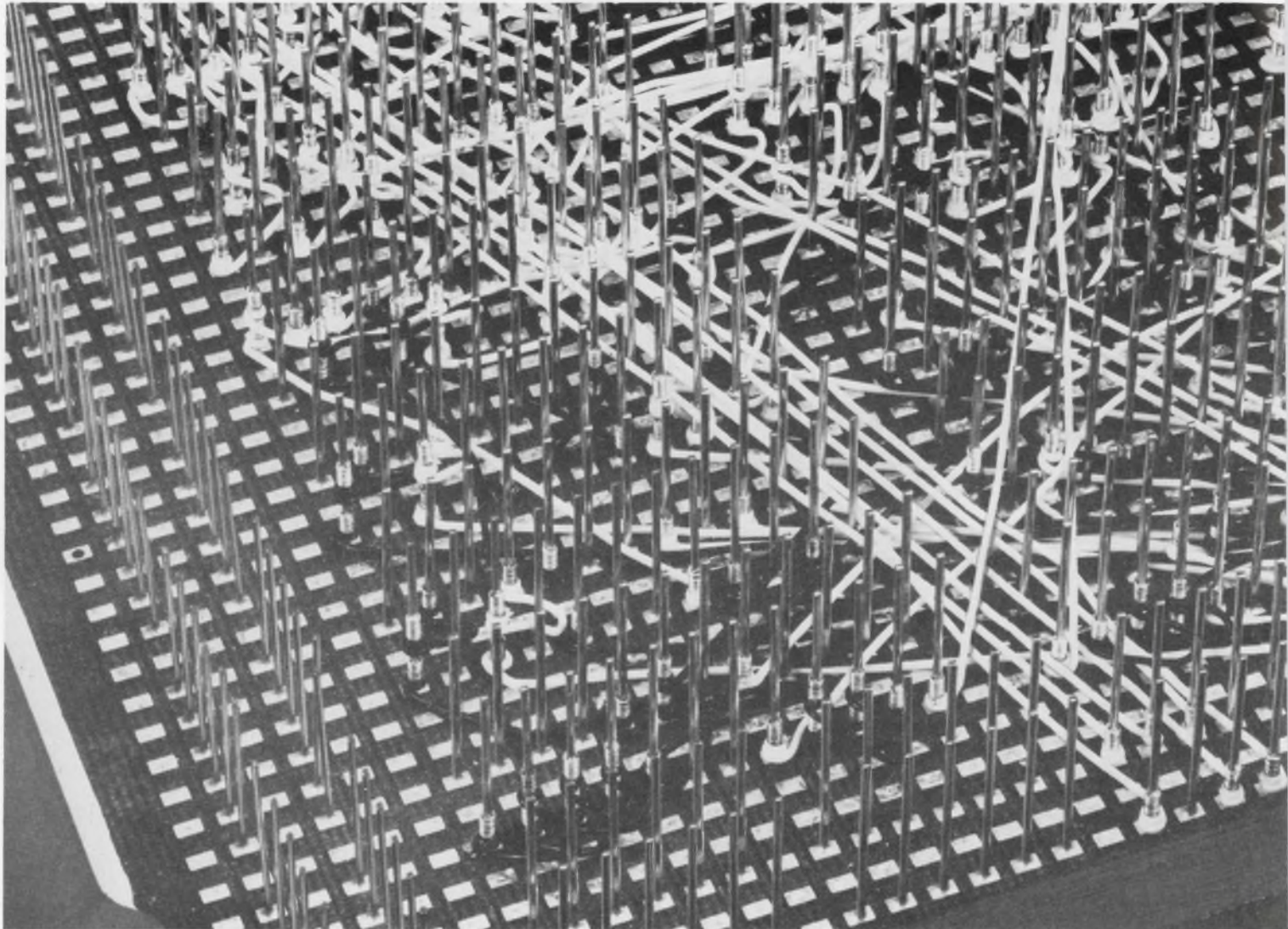

....ask your
supplier what
business
he's in.

And if he answers 'connectors'... or 'PCB's'... or 'back panels'... we suggest you think twice!

Think about the ever-growing complexity of the relationship between circuits, connectors, components, materials, modules and terminations. It's hard to make a clear separation, these days, between a connection and the circuitry it connects. It will get even harder.

Think about how embarrassing and costly the final result can be, if you wait too long before deciding on the interconnection

and termination method you will use on a piece of electronic equipment.

Think how much creativity you may be missing by relying too much on a 'connector specialist'.

There's a world of difference between the connector business, and the connecting business. The requirements are different... and so are the results.

To be in the connecting business, you first have to know all there is to know about the components and circuits you are connecting. And you have to know just as much about the equipment and systems for which the connections exist. Putting all this knowledge into a connector business is well nigh impossible... and certainly impractical.

PHILIPS

pcb or back panel....



Our solutions are usually made up of these elements.

Connectors. Full choice of termination types, materials, plating thicknesses, pitches and body types. Direct edge connectors... interconnectors... multi-pin units... even two-part composite connectors where high contact density and maximum reliability under extreme environmental conditions are overriding considerations. We have 25-mil pitch connectors... even before you've asked for them!

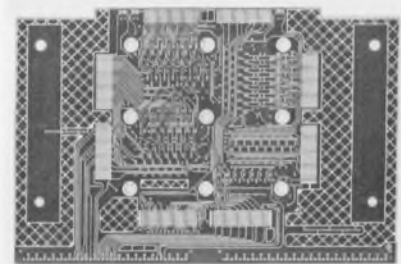
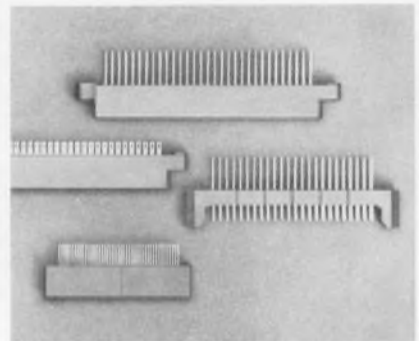

This is why there are so very few firms in the connecting business. Philips is one.

We know all there is to know about electronic components... because we make and sell them. The same goes for the end products. Sometimes we know the solution to your interconnection problem... before you know the problem. Try us and see!

N.V. Philips' Gloeilampenfabrieken
Electronic Components
and Materials Division
Eindhoven - The Netherlands

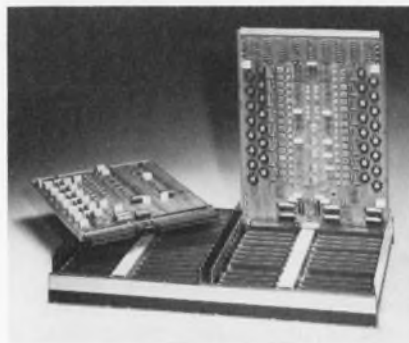

Back Panels and Contract Wiring. Computer-programmed layouts with wiring by automated equipment. Direct mounting of connectors... 100% wire-wrap... or almost any combination of wire-wrap and PCB. Double-sided or multilayer configurations... daughter panels of every type. And some other ideas... "dead-bug" mounting of DIL's, for example!

Printed Circuit Boards. Single or double sided... single or multi-layer... coarse or mini-track patterns... plated through holes as small as .4 mm in diameter... plating of copper, tin-lead, standard nickel, bright nickel, soft or hard gold. And you'll be surprised how far along we are with FLEXIBLE prints... wiring of the future!



electronic components
and materials

Sharpen your professional skills with these timely new engineering guides



THE SUCCESSFUL ENGINEER-MANAGER

A Practical Guide to Management Skills for Engineers and Scientists

Edited by Robert C. Haavind, Editor-in-Chief, Computer Decisions; and Richard L. Turmail, Management Editor, Electronic Design. Want to be on surer ground in directing your career? Need to sharpen your managerial skills? Use this well organized, realistic guide to tutor yourself in the critical areas of technical management: career, decisions, people, projects, finances, and communications. A carefully chosen selection of *Electronic*

Design articles, this book offers valuable pointers on financial analysis, person-to-person dealings, eluding the traps to sound decisions, project scheduling, promoting ideas, and much more. Techniques and the insights of top-flight managers to help you better manage yourself, others, a project, and even a company. 176 pp., 7 1/8 x 9 3/4, illus., #5879, cloth, \$8.95



400 IDEAS FOR DESIGN, Volume 2

Selected from Electronic Design

Edited by Frank Egan, Editor, Electronic Design. Borrow, modify, or adapt any of the more than 400 ideas placed at your disposal in this second collection of top, recent contributions to *Electronic Design's* popular "Ideas for Design" column. Whether highly ingenious or amazingly simple, all offer immediate on-the-job assistance either as parts of larger designs or as aids in measuring the

parameters or testing the effectiveness of other designs. This well-organized book provides rapid access to a wide range of subject areas, extending from amplifiers, through design and laboratory aids, to pulse, digital, and control circuits. Each idea is ready to go, or to touch off creative thinking. 288 pp., 7 1/8 x 9 3/4, illus., #5067, cloth, \$11.95

PROVE THEIR VALUE FOR TWO FULL WEEKS...FREE!

PRACTICAL INSTRUMENTATION TRANSDUCERS

Frank J. Oliver, Formerly Editor, Electro-Technology. The most comprehensive and authoritative source on physical-to-electrical transducers. Virtually every known device for industrial or aerospace application is described and illustrated. This well planned volume will bring you up to date on the state-of-the-art, clear up areas of confusion, offer pertinent data for specific applications. Hundreds of diagrams, charts, and tables are included. 340 pp., 7 1/8 x 9 3/4 illus., #5833, cloth, \$20.00

PRACTICAL DESIGN FOR ELECTROMAGNETIC COMPATIBILITY

Edited by Rocco F. Ficchi. An invaluable on-the-job reference, this book places at your disposal all the basic information needed to analyze, predict, control, and reduce unwanted signals in electronic equipment and systems. A team of EMC specialists fully explains measurement techniques and equipment, details recent advances in filtering, shielding, and bonding, and offers complete treatment of the specific problems encountered in computers, semiconductors, and solid-state devices. 272 pp., 7 1/8 x 9 3/4 illus., #5685, cloth, \$13.95

PRACTICAL RELAY CIRCUITS

Also by Frank J. Oliver. This time-saving guide classifies relays by function, providing you with a rapid overview of the circuits that can solve the problem at hand. Operating principles, reliability factors, standards, and specifications of the provisionally chosen circuits can then be checked from manufacturers' data or other sources such as the *Engineers' Relay Handbook*. Diagrams illustrating the discussion use the latest American National Standard graphical symbols. 384 pp., 6 x 9, illus., #5802, cloth, \$14.95

ENGINEERS' RELAY HANDBOOK

National Association of Relay Manufacturers. The Revised Second Edition of this authoritative reference provides a complete roundup of information on relay operating principles, properties, performance characteristics, application requirements, specification, and testing. New sections enlarge the scope of the book, including material on reed and mercury wetted relays, and solid-state devices. 355 pp., 7 3/8 x 10 1/8, illus. #5867, cloth, \$13.95

DURABILITY AND RELIABILITY IN ENGINEERING DESIGN

Gilbert Kivenson, Consulting Engineer. Practical and provocative, this path-breaking book surveys findings from all disciplines that have present or future engineering relevance. It discusses key concepts, provides a capsule course in reliability theory, and outlines design philosophies and techniques relating design factors to the requirements of the end user. 186 pp., 6 x 9, illus., #5851, cloth, \$9.95

ELECTRICAL ENGINEERING AND ECONOMICS AND ETHICS FOR PROFESSIONAL ENGINEERING EXAMINATIONS

John S. Lyons, P.E.; and Stanley W. Dublin, New York University. This concise, up-to-date review for the practicing engineer presents a wide range of typical problems from recent state exams, solved step-by-step. Permitting you to strengthen weak points, two separate tables of contents give rapid access to subject areas and sample problems. 320 pp., 6 x 9, illus., #5715, cloth, \$12.95

FOR 15-DAY FREE EXAMINATION

Please send the book(s) circled on a 15-day examination basis. At the end of that time, I will remit payment, plus postage, or return the book(s) without further obligation.

5879 5685 5802 5715
5067 5833 5867 5851

\$10.00 minimum for free exam orders. Because of higher billing and collection costs, we must ask for payment in full with any order under \$10.00. Books will be shipped postpaid. Same 15-day return privilege for full refund if not satisfied.



Hayden Book Company, Inc., 116 West 14th St., New York, N.Y. 10011

71-92

NAME _____

FIRM _____

ADDRESS _____

CITY/STATE _____ ZIP _____

Save money! On all pre-paid orders Hayden pays postage—same return privilege!

Why pay for features you can't use?

B & K INTRODUCES FOUR OSCILLOSCOPES! DC TO 10MHz, REMARKABLE PRICES!

If you use, design, test or service complex electronic equipment, B & K Precision has the oscilloscope for you at a remarkably low price. Four solid state scopes designed for production testing, incoming inspection, quality control, maintenance or engineering.

Their rugged construction, input protection and cool operation almost eliminate equipment down time. Simplified controls and built-in accuracy combine to minimize testing errors, reduce set-up and testing time. Ideal for untrained or semi-skilled operators, because they can now concentrate on the job, not the test equipment.

In fact, the 1440 and 1465 scopes can actually be used by semi-skilled people to read Peak-to-Peak voltages of waveforms. These two scopes incorporate CALI-BRAIN[®], the B & K patented system that automatically lights the correct meter scale and full scale voltage (with decimal point), collapses the horizontal sweep to a vertical line, and moves the vertical line to that meter scale! CALI-BRAIN simplifies test procedures, measures voltages of complex waveforms.

All of these scopes have FET input stages for drift-free operation with 10MHz wideband frequency response; 35 n sec risetime insures high fidelity resolution. For television work, there are special sync separator and integrator circuits and sweeps corresponding to TV horizontal and

vertical sync rates. Vectorscope operation is simplified with a removable CRT overlay.

B & K Precision scopes are built to test the performance of most types of electronic equipment. From the 1440 recurrent sweep scope, to the new 1470 dual trace triggered sweep scope, they cover the range of your oscilloscope requirements. But you no longer have to pay for features you can't use in order to get the durability and accuracy you need. Look again at the specifications and prices.

They're remarkable.

Sold by electronic distributors throughout the United States. For more technical data, and information on how to get a demonstration of these scopes, write Dynascan Corporation, or call your local B & K distributor.

B & K Precision Model 1440
Recurrent Sweep Oscilloscope



Vertical Amplifier: DC coupling, DC-10MHz (-3db), AC coupling, 2Hz-10MHz (-3db), Risetime 35 n sec., Sensitivity: .1, .3, 1, 3, 10, 30, 100, 300 volts full scale (16.6 mV/cm). Max. input 600 V (P-P) Horizontal Amplifier: DC-800KHz (-3db). Sweep System: AC-5Hz to 800KHz (-3db) recurrent sweep in 6 steps. Trace expansion 2 x screen diam. 6 cm x 10 cm CRT, with patented CALI-BRAIN[®] system.

Price **\$299.95**
(with Direct/10:1 probe)

B & K Precision Model 1465
Triggered Sweep Oscilloscope



Vertical Amplifier: DC coupling, DC-10MHz (-3db), AC coupling 2Hz-10MHz (-3db), Risetime 35 n sec., 0.1 volt full scale (16.6 mV/cm) to 200 volt full scale sensitivity range in 11 attenuator steps. Max. input 600 V (P-P) Horizontal Amplifier: DC-800KHz (-3db). Sweep System: 1µsec/cm to 20µsec/cm triggered sweep in 10 steps. Vernier adj. for continuous control. Trace expansion 5 x at all speeds, 0.2µsec/cm max. 6 cm x 10 cm CRT. With patented CALI-BRAIN[®] system.

Price **\$369.95**
(with Direct/10:1 probe)

B & K Precision Model 1460
Prof. Triggered Sweep



Vertical Amplifier: DC coupling, DC-10MHz (-3db), AC coupling 2Hz-10MHz (-3db), Risetime 35 n sec., 10mV/cm to 20V/cm sensitivity range in 11 attenuator steps. Max. input 600 V (P-P) Horizontal Amplifier: DC-800KHz (-3db). Sweep System: 0.5µsec/cm to 0.5 sec/cm triggered sweep in 19 steps plus TV-V and TV-H. Vernier adj. for continuous control. Trace expansion 5 x at all speeds. Max. 0.1µsec/cm. 8 cm x 10 cm CRT.

Price **\$399.95**
(with Direct/10:1 probe)

B & K Precision Model 1470
Dual Trace Oscilloscope



Vertical Amplifier: DC coupling two channels each, DC-10MHz (-3db), Risetime 35 n sec., 10mV/cm to 20V/cm sensitivity range in 11 attenuator steps. Max. input 600 V (P-P) Horizontal Amplifier: DC-800KHz (-3db). Sweep System: 0.5µsec/cm triggered or automatic sweep in 19 steps. Vernier adj. for continuous control. Trace expansions 5 x at all speeds, Max. 0.2µsec/cm. 8 cm x 10 cm CRT. Available in March 1972.

Price **\$499.95**
(less probes)



B & K Division
Dynascan Corporation
1801 W. Belle Plaine · Chicago, Illinois 60613

INFORMATION RETRIEVAL NUMBER 13

**Quality
Accuracy
Versatility
Reliability
1 yr. warranty
Low cost**

Heath/Schlumberger has them all!

80 MHz Frequency Counter:
10 Hz – 80 MHz range; 100 mV sensitivity; 5-digit LED readout; high stability. Assembled SM-105A, 6 lbs. . . . \$350*

1 MHz Function Generator:
Sine, square, triangle output; 7 decade ranges, 0.1 Hz – 1 MHz; Adjustable DC offset; VCO built-in. Assembled EU-81A, 8 lbs. . . . \$245*

15 MHz Dual Trace Scope:
Complete dual trace capability including X-Y; Triggered sweep; 18 time bases; 50 mV sensitivity. Assembled EU-70A, 35 lbs. . . . \$595*

1 mV 10" Chart Recorder:
23 speeds, 30 in/min to 0.2 in/hr; 18 spans, 1 mV – 500 V full scale; 15 full scales of offset; Fully programmable. Assembled EU-205B, 40 lbs. . . \$675*



HEATH
Schlumberger

Heath/Schlumberger Scientific Instruments
Dept. 520-26
Benton Harbor, Michigan 49022

Please send brochures on following models: _____

Please send 1972 Electronic Instrumentation Catalog (now in production, available soon).

Name _____

Title _____

Company _____

Address _____

City _____ State _____ Zip _____

*Mail order prices; FOB Benton Harbor, Michigan.
Prices & specifications subject to change without notice. EK-322

INFORMATION RETRIEVAL NUMBER 14

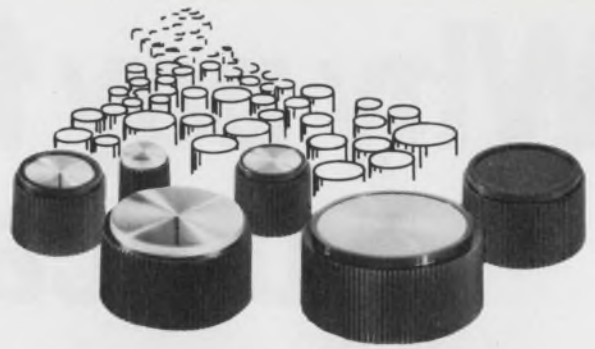

1,500,000

KNOBS TO CHOOSE FROM...
and they're "Warranted for Life"

Kurz-Kasch has over 1½ million low cost, high quality knobs in inventory, ready to ship to you. (You save . . . no tooling cost on stock knobs, specials 4 to 6 weeks delivery.) Your local distributor's stock is available at factory prices. Select instrument and control knobs from 24 families with 367 basic sizes and shapes in general purpose phenolics, melamines and ureas. All Kurz-Kasch knobs are warranted for the life of the product on which they're used. Send now for free 20 page catalog. (Also found in THOMAS REGISTER "THOMCAT."®)



Kurz-Kasch, Inc.

1421 S. Broadway
Dayton, Ohio 45401
513/223-8161

INFORMATION RETRIEVAL NUMBER 15

It's Got Power!



Servo-Tek's engineers developed this permanent magnet D-SERVOMOTOR for high torque and wide speed range with minimum cogging.

- 12.7 watts @ 8600 rpm
- 0-10,000 rpm Range
- Torque Peaks @ 20 Oz-in., 2 Oz-in., Continuous
- Small, Lightweight
- Various Models Available

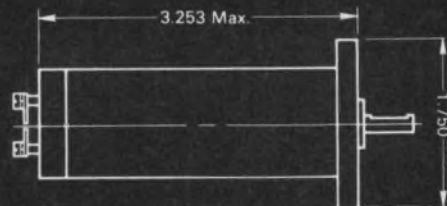

Ask for a copy of our NEW catalog.

SERVO-TEK®
PRODUCTS COMPANY

1086 Goffle Road, Hawthorne, N. J. 07506 • 201 - 427-3100

Servo-Tek of California, Inc.

8155 Van Nuys Blvd., Van Nuys, California 91402 • 213 - 786-0690

INFORMATION RETRIEVAL NUMBER 16

ELECTRONIC DESIGN 3, February 3, 1972



INSELEK

THE FIRST SOS/MOS MUX

COMPARE	P/MOS	SOS/MOS
On Resistance	250 Ω	250 Ω
Analog Input Range	$\pm 5V$	$\pm 5 V$
Off Leakage Current	2.0 nA	2.0 nA
Switching Time	1.0 μS	50 ns
Power Dissipation	150 mW	15 mW
DTL/TTL	Non-Compat-ible	Compat-ible

LO2

8 CHANNEL SWITCH

The LO2 is an 8 channel multiplex switch with output enable control and 1-out-of-eight decoder included on the chip. Vastly superior characteristics are obtained through the unique process of forming SOS/MOS transistors on an insulating sapphire substrate. The logic input lines of the LO2 can be used directly with TTL logic levels with no level shifting interface required. The channel switching time is typically 20 times faster, while power dissipation is only one-tenth that for conventional P/MOS multiplexers.

FEATURES

- TTL Compatible Input Logic Levels
- One-Out-Of-Eight Decoder on the Chip
- High On-Off Ratio
- Output Enable Control
- Fast Switching Time 50/ns
- Input Gate Protection
- Low Leakage Current
- Zero Offset Voltage
- $\pm 5 V$ Analog Signal Range
- Low Power Dissipation

APPLICATIONS

- A/D Converters .
- Multiplexing — Analog/Digital Systems
- Signal Selectors

AVAILABLE THRU YOUR COMPAR/INSELEK SALES OFFICE . . .

ALABAMA Huntsville (205) 539-8476	ILLINOIS—NORTHERN Des Plaines (312) 775-0170	MINNESOTA Minneapolis (612) 922-7011	NEW YORK (Cont'd) Rochester (716) 271-2230
ARIZONA Scottsdale (602) 947-4336	ILLINOIS—SOUTHERN See MISSOURI	MISSOURI St. Louis (314) 567-3399	NORTH CAROLINA Winston-Salem (919) 723-1002
CALIF.—NORTHERN Burlingame (415) 347-5411	INDIANA Fort Wayne (219) 747-0402	NEW JERSEY Haddonfield (609) 429-1526	OHIO Dayton (513) 890-9260 Cleveland (216) 333-4120
CALIF.—SOUTHERN Burbank (213) 843-1772	MARYLAND Baltimore (301) 484-5400	NEW MEXICO Albuquerque (505) 265-1020	TEXAS Dallas (214) 363-1526 Houston (713) 667-3420
COLORADO Denver (303) 757-7331	MASSACHUSETTS Newton Highlands (617) 969-7140	NEW YORK Clifton, N. J. (201) 546-3660 Albany (518) 489-7408 Endwell (607) 723-8743	WASHINGTON Kirkland (206) 822-4191
CONNECTICUT Hamden (203) 288-9276	MICHIGAN Garden City (313) 425-1235		



INSELEK

For further information, call or write:
Bert McCarthy - Dept 6
University Park
743 Alexander Road
Princeton, New Jersey 08540
Phone: (609) 452-2222

INFORMATION RETRIEVAL NUMBER 17

VERO CIRCUIT CARDS OFFER YOU...



AN ACE HAND!



For the real spade work D.I.Y. boards. Use our gold plated contacts but etch your own board. Another one of the club. Finger boards for discrete wiring but direct connectors.

The heart of the Vero system. Veroboard, over 100 sizes and types for all development and short run production work.

The gem of the pack. Vero D.I.P. boards provide ready bases for I.C.s. - Plug-in and breadboard styles available in Epoxy Glass and S.R.B.P.

- And the cards up your sleeve:-
- Largest range of standard boards available anywhere in the world.
- stock delivery.
- Many compatible accessories.
- Matching edge connectors.
- Card frames and Instrument cases to suit.
- Special configurations made to order.

Part of Vero's Complete packaging capability for Electronic Components.



VERO ELECTRONICS INC.

171 BRIDGE ROAD
HAUPPAUGE, N.Y. 11787
TEL: 516 234-0400
TWX: 510 227-8890

INQUIRE ABOUT OUR
NEW DESIGN SERVICE

INFORMATION RETRIEVAL NUMBER 18

ZIPBOND

New bonding liquid joins materials in 60 seconds. No mixing, heating, solvents or catalysts necessary!

One drop per square inch does it. Economical: One ounce equals a quart of epoxy or adhesive.

Perfect for production line—In case of equipment breakdown you can make emergency repairs on the spot in sixty seconds. Zipbond joins ferrous and non-ferrous metals, plastics, glass, rubber, wood, porcelain and "exotic" metals with a lasting, colorless and transparent bond.

Unaffected by weather or temperature.



one tiny
drop gives you
weld  like bond
in 60 seconds

TESCOM 2-N3
Instrument Division
2600 Niagara Lane
Mpls., Minn. 55441
Please rush more information on Zipbond.

Name _____
Firm _____
Address _____
City _____
State _____ Zip _____

INFORMATION RETRIEVAL NUMBER 19

Horse sense!



It's good business to do business with Permag. In stock and in service, Permag can solve your magnetic materials problems quickly, completely and economically. Look to Permag for all types of permanent magnets, assemblies, electrical alloys, flexible magnets, soft magnetic materials, ferrites and new, high-energy rare earth magnets. Also, special precision grinding and cutting. And full magnetizing and engineering facilities.

YOUR NO. 1 SOURCE
FOR ALL MAGNETIC MATERIALS

PERMAG

ALL ACROSS THE COUNTRY

SAN FRANCISCO • LOS ANGELES
• DALLAS • CHICAGO • TOLEDO •
BOSTON • NEW YORK

Consult your Yellow Pages for
address and telephone number of
Permag near you.

INFORMATION RETRIEVAL NUMBER 20

ELECTRONIC DESIGN 3, February 3, 1972

the environment, product safety, power, information, transportation... SO MUCH DEPENDS ON THE INFORMED USE OF BASIC MATERIALS

To draw upon the best resources in your design activities, you need an understanding of the fundamental physical principles upon which any particular device or instrument depends, and of the role these have in making that device reliable and workable. You'll find this essential information in a pioneering series of engineering references that combine background in basic theory with immediately useful data and techniques.

One volume in the series, *Materials Science and Technology for Design Engineers*, gives you a panoramic view of the entire spectrum of design considerations, ranging from fundamental structure to the latest materials and applications.

With each of the other four volumes, you have at your fingertips in-depth information on a major functional area — semiconductor, magnetic, structural and mechanical, conductive and resistive. Each clearly demonstrates how materials fulfill their intended design applications, taking into account fundamental properties, processing and fabrication variables, performance and operational parameters, cost criteria, and environmental considerations.

Throughout these books, you'll find discussion amplified by well drawn diagrams, graphs, charts, and tables. Comprehensive bibliographies are included.

Hayden Series in Materials for Electrical and Electronics Design ALEX. E. JAVITZ, Editor in Chief

Technical Consultant; Senior Member, Institute of Electrical and Electronics Engineers, American Chemical Society, Society of Plastics Engineers

Materials Science and Technology for Design Engineers

Edited by ALEX. E. JAVITZ

Just Published! In this comprehensive source Editor Javitz and 18 contributing specialists integrate a fundamental knowledge of all materials with the hard facts of day-to-day engineering practice.

CONTENTS: *Fundamental Structure and Behavior of Materials:* Engineering Significance of the Periodic Table of Elements. Structure of Metals and Inorganic Solids. Relationship of Structure to Dielectric Properties. Basic Magnetic Theory. Physics of Semiconductor Materials. Elements of Superconductivity. Fundamentals of Polymer Chemistry. *Critical Environments and Phenomena:* The Environmental System. Electromagnetic Radiation. Nuclear Radiation. Effects of Thermal Environments on Electrical Insulation. Effects of Thermal Environments on Electrical/Electronic Metals. Effects of Cryogenic Environments. Mechanical Environments: Vibration and Shock. Mechanical Environments: Wear. Combined Environments. *New Directions in Materials and Their Effects on Application Problems:* Importance of Pure and Ultra-pure Materials. Ultrahigh-Strength Materials. Basic Concepts of Composite Materials Systems. Film Materials and Techniques. *Failure Mechanisms in Electronic Materials and Devices:* The Systems Concept and Failures in Systems. Approaches to Achieving High Reliability. The Nature of Failure Mechanisms Investigations. Case Histories of Failure Mechanisms Investigations. Failure Mechanisms Techniques in the Manufacturing Process. *Scientific Approach to the Costs of Materials:* Cost — Basic Element in Application of Materials. Methods for Analysis of Cost Effectiveness. Appendices. Index. 560 pages, 6 x 9, illustrated, #5640, cloth, \$23.95

Materials for Magnetic Functions

FENNIMORE N. BRADLEY, Associate Professor, Metallurgical Engineering, Michigan Technological University

"... a valuable interdisciplinary reference book for the practicing engineer who requires a broad knowledge of design trade-offs and possible alternatives."— IEEE Spectrum

CONTENTS: The Nature of Magnetic Functions. The Physics of Magnetic Materials. Chemistry, Microstructure, and Processing of Ferrites. Chemistry, Microstructure, and Processing of Magnetic Metals. Permanent Magnet Devices. Electromagnetic Devices. Microwave Devices. Measurements. Environmental Influences. Appendices. Index. 360 pages, 6 x 9, illustrated, #5635, cloth, \$14.95

Materials for Conductive and Resistive Functions

G. W. A. DUMMER, Formerly Superintendent of Applied Physics, Royal Radar Establishment, British Ministry of Technology

"... much useful information and data in such diverse areas as hook-up wiring, transmission cabling, magnet wire, RF cables, printed wiring... the rapidly advancing area of integrated circuit microelectronics."— IEEE Electrical Insulation Group Newsletter

CONTENTS: Conductive Functions. Superconductive Functions. Contacting Functions. Resistive Functions. Index. 336 pages, 6 x 9, illustrated, #5636, cloth, \$13.95

Materials for Semiconductor Functions

E. G. BYLANDER, Texas Instruments, Inc.

Just Published! The first book to isolate the essentials of this critical design area covers the basic physical theory of semiconductor materials and also the diverse practical applications of materials preparation, purification, crystal growth, and fabrication.

CONTENTS: Elements of Semiconductor Functions. Structure of Solid Semiconductor Materials. Physics of Semiconductor Materials. Material Fabrication Techniques. Material Process Selection Criteria. Device Manufacturing. Materials for Diodes and Transistors. Materials for Energy Conversion. Materials for Electro-Optical Devices. Materials for Circuit Components and Transducers. Appendices. Index. 232 pages, 6 x 9, illustrated, #5638, cloth, \$13.50

Materials for Structural and Mechanical Functions

GABOR KOVES, Manager of Mechanical Technology, IBM General Systems Division

Answering the need of designers of hardware for electrical and electronic equipment, this volume deals with all classes of materials — metallic and nonmetallic, inorganic as well as organic. Essential data, screened for reliability, included throughout.

CONTENTS: Engineering Properties of Materials. Ferrous Metals and Alloys. Nonferrous Metals and Alloys. Nonmetallic Materials. Methods of Controlling Mechanical Properties. Fabrication Methods and Their Effects on Properties. Environmental Protection of Structural Materials. Materials for Static Load Applications. Materials for Dynamic Load Applications. Materials with High Wear Resistance. Materials for Special Applications. Index. 360 pages, 6 x 9, illustrated, #5637, cloth, \$13.95

Examine these important books for 15 full days — FREE!

ED-1

Please send the book(s) circled on 15-day free examination. At the end of that time I will remit payment plus postage or return the book(s) without further obligation.

5640 5636 5637 5635 5638

Save money! On pre-paid orders publisher pays postage. Same 15-day guarantee.

Name _____

Firm _____

Address _____

City _____ State _____ Zip _____

 HAYDEN BOOK COMPANY, INC.
116 W. 14 St., N.Y., N.Y. 10011

Subminiature tubular capacitors now offered in expanded ratings.

The latest revisions to our TT and TTX line of miniature aluminum electrolytic capacitors make expanded ratings available in $\frac{5}{8}$ " and $\frac{1}{2}$ " diameters, up to 5,000 mfd. All offer extra long life—on the job or off the shelf.

Both capacitors have the reliability of all-welded construction. They are cased in aluminum, with proven rubber end seals. PVC insulating sleeves are standard, but Mylar* insulating sleeves are available for high-temperature applications.

For more information on the expanded line write for TT Bulletin 4-104 or TTX Bulletin 4-105. Or see your authorized Mallory distributor. We'll show you how to get what you need, without paying more than you need to.

*Du Pont registered trademark.



MALLORY

MALLORY CAPACITOR COMPANY

a division of F. R. MALLORY & CO. INC.
Indianapolis, Indiana 46206

Electrical and Electronic Components • Sequence Timers • Metallurgical Products • Batteries

INFORMATION RETRIEVAL NUMBER 22

U.S. advised to rebuild a 'useless' air defense

Suppose the United States found itself engaged in a major war tomorrow. How vulnerable to air attack is the continental U.S.?

"The existing United States air defense is virtually useless—it is more of a concept than an actuality," says the House Armed Services Investigating Subcommittee, headed by Rep. Edward F. Hebert (D, La.). The subcommittee's conclusion is in a report based on testimony from the senior commanders of the North American Air Defense Command (Norad) and the Aerospace Defense Command, both headquartered in Colorado Springs, Colo.

If Congress decides to remedy the glaring defects in defense—and Hebert is determined that it should—there could be a sizable resurgence in Defense Dept. spending for R&D and production of electronic hardware.

The deterioration of the nation's defenses, the House panel says, began in 1963 as a result of Defense Secretary Robert S. McNamara's "series of economy moves." And in 1967 it was weakened further when much of the air-defense system was shut down. This was the year that McNamara promised to revitalize the system. A large portion of existing equipment would be phased out, he said, so the money saved in operating costs would be available to pay for new equipment. Phase I of the plan was carried out, but except for over-the-horizon radar, which already existed, new equipment was never built, the subcommittee notes.

Gen. Seth J. McKee, Norad's commander in chief, describes the result in the subcommittee report: There are 63 Nike/Hawk batteries instead of the original 270 in 1960; 14 regular Air Force fighter interceptor squadrons instead of

65; 15 Air National Guard fighter interceptor squadrons instead of 38; seven Bomarc missile squadrons instead of nine—with two of the remaining seven scheduled to go soon; 99 long-range radars instead of 187; and no gap-filler radars instead of 105.

The subcommittee report pays particular attention to a 1500-mile stretch along the southern coast of the United States that is virtually without defense. It was through this opening, the report notes, that a Cuban aircraft entered the country undetected last October on its approach to New Orleans.

Because of defense gaps like these and "the steadily increasing threat posed by submarine-launched missiles and newly developed Soviet long-range bombers," the subcommittee recommends immediate action by the Defense Secretary Melvin R. Laird to upgrade the nation's air defense with Awacs (Airborne Warning and Control System), over-the-horizon backscatter radar and an improved manned interceptor.

Meanwhile, to do something about the open door to the south, the subcommittee recommends that over-the-horizon backscatter systems presently available be installed to provide some warning for this approach. More work will undoubtedly go into this type of radar. Over-the-horizon radar now in use is of the forward-scatter type, which requires a receiver on the far side of the target to pick up the signals from a transmitter hundreds, or even thousands, of miles away—a configuration not always easy to arrange. The newer backscatter type permits placing a receiver alongside the transmitter.

In fiscal 1972 \$3.6-million was spent for developing a backscatter system. By this summer sufficient data should be available for the

Defense Dept. to decide whether to construct an operational system.

Awacs got \$145-million in fiscal 1972 to develop and test two downward-looking radars, which can detect and track low-flying as well as high-flying aircraft. When the tests are completed late this year, one of the two radars will be selected and a decision made whether to proceed.

An improved manned interceptor would have a "look-down/shoot down" capability, improved fire power and the ability to fly greater distances and stay on station longer than existing fighters can. Both the Navy F-14 and Air Force F-15, now under development, are capable of being modified to fulfill this mission, Secretary Laird says.

Development of other warning systems that could be speeded include a satellite early-warning system, designed to complement the aging Ballistic Missile Early Warning System (BMEWS) radars in detecting ICBMs, submarine-launched ballistic missiles and Fractional Orbit Bombardment System (Fobs) that the Russians have successfully tested.

\$395 LED calculator a 'slide rule'—and more

An electronic "slide rule" is on the market. It multiplies, divides, takes square roots, inverts, raises a number to a power, takes e^x and also sin, cos, tan, arc-sin, arc-cos and arc-tan. It also can add and subtract, and it has a memory for storing a constant. Several other machines on the market do all of these things, but none that you can slip into your shirt pocket.

Built by the Hewlett-Packard Data Products Group in Cupertino, Calif., the calculator, designated HP-35, costs \$395. According to Alexis Sozonoff, the company is manager of advanced products in Cupertino, "Competing calculators cost at least \$1500 and must be used on a table because of their size."

The HP machine presents the answers to problems on an array of LED numeric seven-segment displays to 10 significant decimal digits.

Sozonoff notes that the HP-35 contains most of its circuitry on

five MOS/LSI chips. The five chips were designed by Mostek of Carrolltown, Tex., and American Micro-systems, Inc. of Santa Clara, Calif. Three of the chips are ROMs that perform the special function key operations. One is for timing, synchronization and other control functions. And the fifth is the arithmetic chip that contains logic and registers. All five chips are made with an ion-implanted, p-channel, low-threshold process.

William R. Hewlett, president of Hewlett-Packard, points out: "One of the difficult problems was that of fitting the necessary 35 keys on a very small keyboard in such a



The HP-35 electronic calculator packs 35 keys and a 10-digit display, plus associated circuitry and power supply, into a 3 × 6 × 1-inch package. way that they would still be usable."

The unit measures only 3 × 6 × 1 inches and weighs a mere nine ounces. A unique keyboard designed by HP uses spring beryllium-copper to make contact when a keyboard switch is depressed.

Fifteen LEDs are used in the display. One is for the sign, ten are decimal digits, one is a decimal point and the three others are for the exponent. These LEDs have a built-in magnifying lens to make them appear quite large. They are made by HP in Palo Alto and are packaged five digits to a plastic package. HP plans to announce these LEDs as standard products shortly.

Three rechargeable Ni-Cd batteries give the unit about three hours of life between rechargings. However, while the batteries are recharging, the calculator can be

operated off conventional 115 or 230 V ac.

New Honeywell series vies with IBM computer

A new series of five medium-scale Honeywell computers—the 2000 series—is described as price and performance-competitive with machines of the IBM 370 series, such as the Models 140 and 145.

The smallest of the five new models (the 2040) leases for \$6125 a month, while the largest (the 2088) goes for \$36,800. The 2088 has a dual central-processor unit, while the other systems have a single one. All have a visual information control console, new operating systems and a data-communications front-end processor.

The next to the largest of the new Honeywell machines (the 2070) has a new type of memory that has a capacity of from 131-K 9-bit characters to 524-K 9-bit characters. This permits online trouble-shooting by allowing service personnel to shut down up to four 16-K-bit blocks without interfering with the operation of the rest of the memory. As a result, the user can continue running most of his programs while the machine is undergoing maintenance.

The new series, which is compatible with Honeywell's 200 series, was developed at the Waltham, Mass., plant of Honeywell Information Systems.

Duty-free importers get an X-ray assist

X-ray techniques can now be used to identify American-made components in semiconductor products that have been assembled abroad and returned to the U.S. for sale, according to a recent ruling by the U.S. Treasury Dept.

In the past, unless a product could be dismantled to prove that the components were U.S.-made, the American manufacturer could not take advantage of Item 807 of the tariff schedules, which allows such components to come back into the country duty-free.

In altering the dismantling rule, the Customs Bureau said that photographs made with X-ray ma-

chines "clearly and accurately make visible the components contained in the imported semiconductors at least as well, if not better, than the components would be if they were exposed by dismantling the semiconductors."

Suggested by the Electronic Industries Association, the X-ray method is expected to save the semiconductor industry approximately \$5-million a year in tariff duties, says James J. Conway, staff vice president of the EIA's Solid State Products Div. in Washington, D.C.

There is, however, still one problem, the EIA says. The components in semiconductors—such as wafers gold wires and lead frames—that lose their physical identity during assembly are not subject to duty, but those that are encapsulated in epoxy and similar resins are. The bureau contends that this encapsulation "advances the condition of those components beyond that in which they were exported," and thus makes them ineligible for Item 807 advantages. Changing this ruling, the EIA says, will be the next fight.

9.6%-a-year growth seen for electronics

The electronics market in the non-Communist world should grow an average of 9.6% annually in the next 10 years, reaching \$125-billion by 1980, according to a study released by the Stanford Research Institute, Menlo Park, Calif.

The \$125-billion total compares with \$55-billion last year, of which the U.S. accounted for 57%. By 1980, SRI says, the U.S. share will have dropped to 52% as a result of growth in Japan and Europe.

The findings were made public by Ken Taylor, senior industrial economist of the institute, in a speech in Los Angeles before the Western Electronic Manufacturers Association.

Commenting on the rapid spread of technology from the U.S. to other countries, Taylor noted that the technological "gap" between U.S. companies and the best non-U.S. firms is decreasing fast and may now be less than 18 months, for example, for the most advanced ICs.

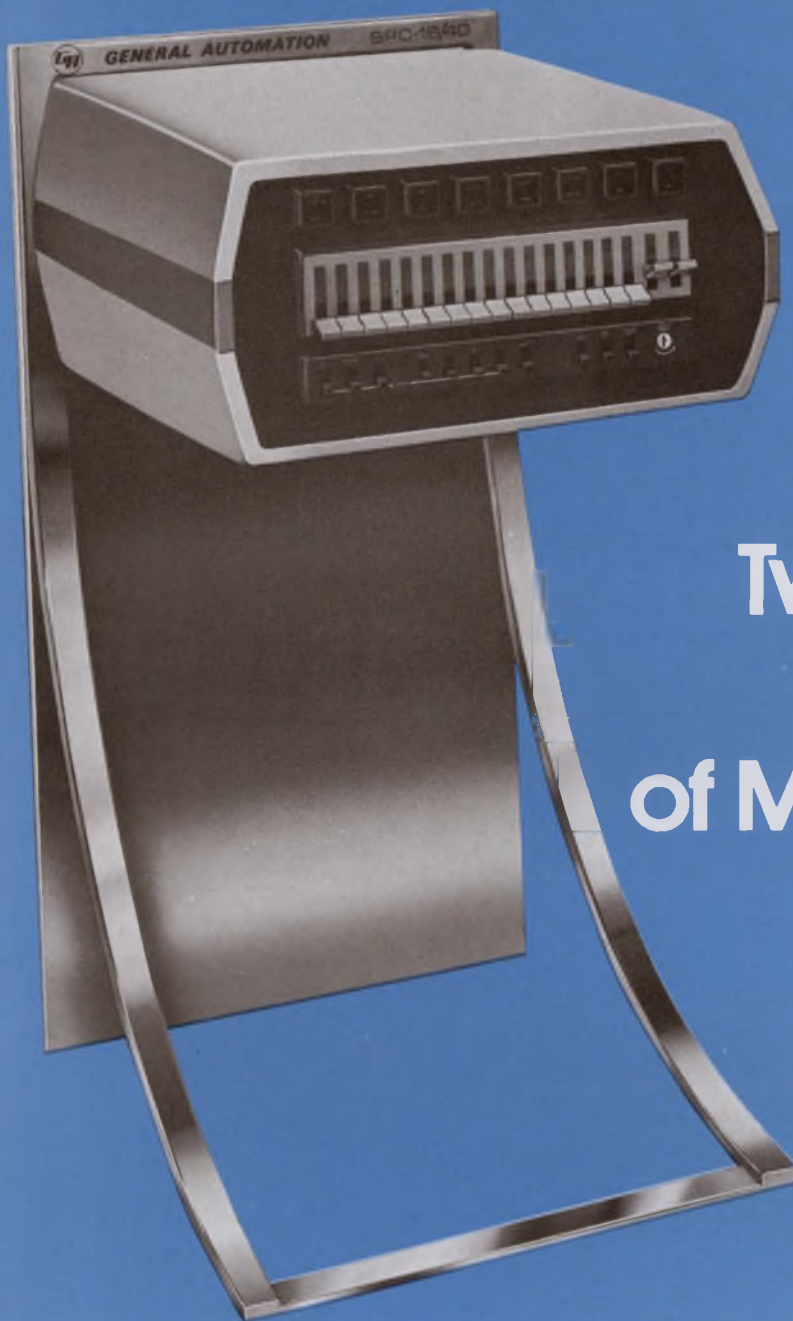

Introducing Two Great New Families of Minicomputers

GA introduces nine great new minicomputers in two related families. They work harder, act faster, learn quicker.

SPC-16 Family — The Power Leaders
(Quantity of 10 price \$2,923)*

The all-new SPC-16 family are the power leaders. These 16-bit minis feature four times the processing power of any other minis you can buy. They're available in an SPC-16/40, /60, /80 series that features integral input/output and memory expansion to 16K for most systems applications ... and in an SPC-16/45, /65, /85 series featuring external I/O and 4K memory expandable to 64K for the "bare bones" OEM buyer or for larger

systems requiring extra memory and I/O capacity. All six models are fully hardware and software compatible with each other and with existing SPC-16's.

SPC-12 Family — The Price Leaders
(Quantity of 10 price \$2,205)*

The all-new SPC-12 family are the price leaders. Three ultracompact models — the SPC-12/20, /15 and /10 — are available with standard 4K memory expandable to 16K and in I/O capacities to 19 minicontrollers. With fully compatible computer, I/O, interface and Real Time Executive modules, an SPC-12 system can be quickly and easily assembled to solve just about any industrial automation

problem. At a bedrock price.

Send today for descriptive literature on our two new families of "smart minis." We've tried to put our power/price story in plain English.



General Automation, Inc.



1055 South East Street
Anaheim, California 92805
(714) 778-4800 TWX 910-591-1695

'We Make The Smart Minis'

*Ask About Our Big New Discount and Easy-Buy OEM Policies.

A drone 'air force' for combat being designed by two teams

Will aerial combat missions of the future be flown by pilots from well-protected, concrete bunkers safely on the ground?

Because of advances in electronic sensors, data links, microelectronics, computers and display systems, a new generation of such highly sophisticated, remotely piloted vehicles (RPVs) is entirely feasible, according to two industry teams that have been studying the possibility. They say the proposal is technologically and economically sound.

Both teams have, in competition with each other, been assessing for the past three months the technologies needed for RPVs. Both are under eight-month contracts with the Air Force Systems Command's Aeronautical Systems Div., Wright-Patterson Air Force Base, Dayton, Ohio.

RPVs could be made fully capa-

ble of carrying out air-to-air attacks against piloted enemy planes, air-to-ground bomb and missile raids, and combined electronic warfare and sophisticated reconnaissance operations, both teams agree.

Without the pilot, the vehicle would be free to take more risks. Also, it could be put through maneuvers that a man could not survive. It could make quick turns that build up a 15-g positive force or a negative g force that would be unacceptable to human pilots.

Based on continuing assessments, each team, by June, 1972, will develop preliminary designs of three vehicles: one for air-to-air combat, another for air-to-ground attacks and the third for electronic warfare and reconnaissance. Each will also submit a preliminary design for a single vehicle that would accomplish all three missions.

The Ventura (Calif.) division of Northrop Corp. heads one team

with Cubic Corp. of San Diego supplying the data links and TRW Systems of Los Angeles, the command and control stations, the displays and shelters. The other team is headed by Ryan-Teledyne Aeronautical of San Diego, with the RCA Government Plans and Systems Development Div. in Camden, N.J., handling all the electronics in the vehicle, the remote ground stations, the data link and the checkout equipment.

New command approach sought

Although very few recommendations are yet considered frozen, a new approach is definitely needed for commanding the vehicle, says RCA's Frank Smead, program manager for RPV. Present drones are commanded by coded pulses transmitted by ground radar. The drones respond with information sent from their transponder, also via coded pulses.

"There are two problems with this technique," Smead says. "You can't go beyond line-of-sight without an airborne relay, which means you lose your chance to measure the azimuthal angle of the RPV—its bearing in relation to you. All you can measure is the bearing to the relay platform. Second, radar bandwidth is excessive and a waste."

To cut down on bandwidth RCA will abandon the radar approach and go to a communications technique that emphasizes high data content relative to bandwidth.

"By using a communication technique—frequency-shift keying or four-level encoding of the binary information—we can compress information even further," Smead says.

The reason spectrum economy is more important than usual is that

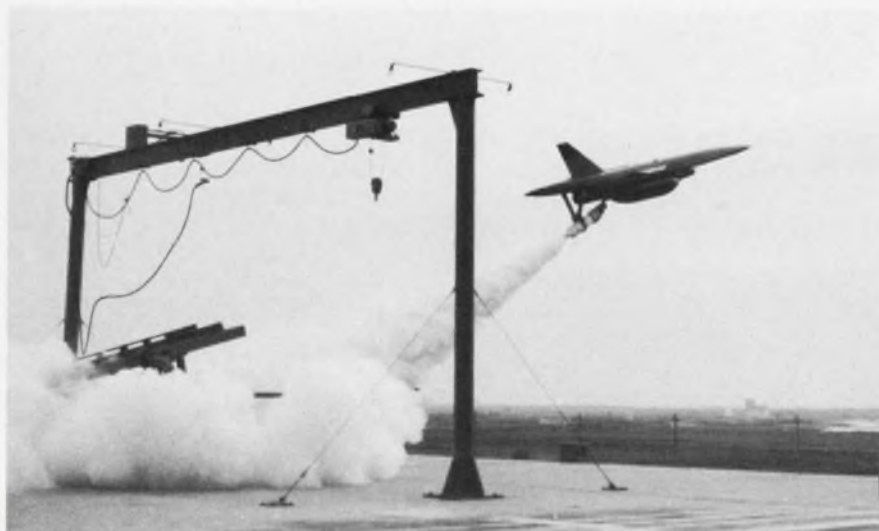

Supersonic drone built by Teledyne Ryan Aeronautical roars away from the launch pad. Pilotless aircraft similar to these may one day be capable of engaging in air-to air combat against piloted enemy planes.

SAVE // GAIN

\$\$\$ // performance

over any other 50-MHz, plug-in oscilloscope.

50-MHz oscilloscope with:

- 5-mV dual-trace amplifier and delaying sweep **\$2200**
- 5-mV dual-trace amplifier and single time base **1900**
- 5-mV single-trace amplifier and single time base **1670**

AND LOOK AT THESE BONUSES:

- 3 plug-in compartments and mainframe mode switching
- 6½-inch CRT — 50% larger than 8 x 10 cm CRT's
- time bases have 5 ns/div sweep rate
- amplifiers and time bases accurate within 2%
- high writing-rate CRT gives a brighter trace
- 5¼-inch rackmount version

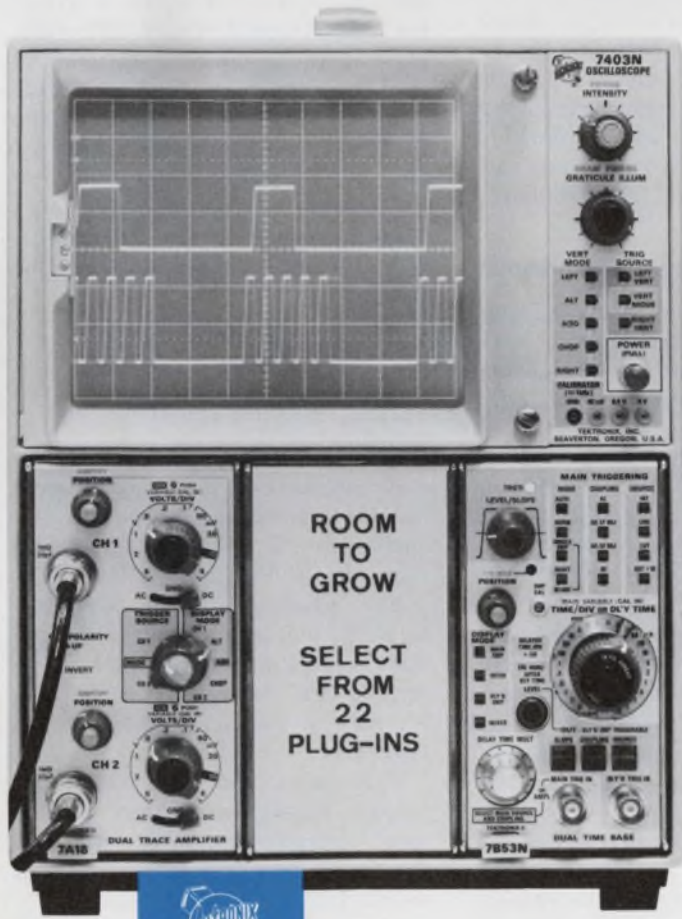

If you wish, select a plug-in for the second vertical compartment to give you 10 μ V/div at 1 MHz or 1 mV/div at 55 MHz or 1 mA/div at 55 MHz or another dual-trace unit for 4-trace capability, etc., etc. Plug-in prices start at a low \$270. Call your nearby TEKTRONIX Field Engineer today for a demonstration, or write: Tektronix, Inc., P.O. Box 500, Beaverton, Oregon 97005.

7403N Oscilloscope	\$950
R7403N Oscilloscope	\$1050
7A18 Dual-Trace Amplifier, Option 1	\$500
7A15 Single-Trace Amplifier	\$270
7B53N Dual Time Base	\$750
7B50 Time Base	\$450



U.S. Sales Prices FOB Beaverton, Oregon

TEKTRONIX lease and rental programs are available in U.S.

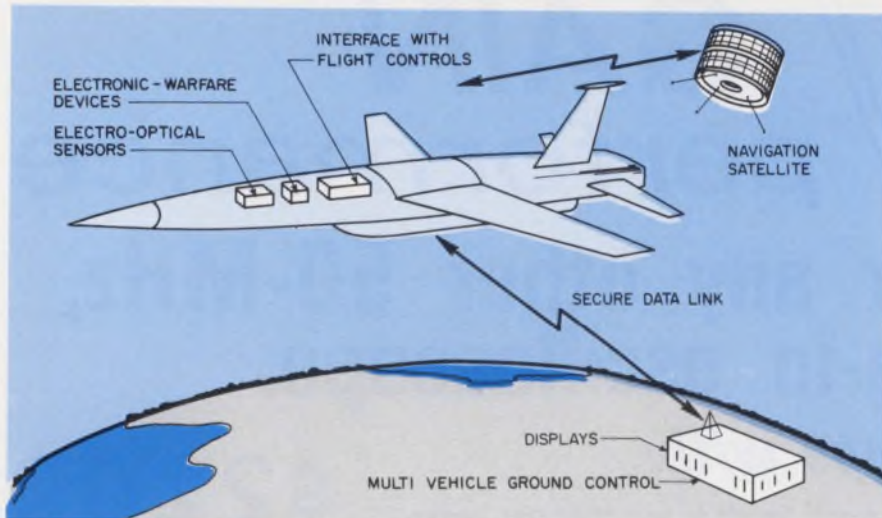

Remotely piloted aircraft of the future will carry a variety of electronic sensors and be aided by navigational satellites.

the Air Force wants to fly two dozen or more RPVs in the same air space at the same time—a problem it considers the most difficult in the RPV program. Providing a channel for each RPV with a safety margin in between would be prohibitively wasteful, Smead says.

RCA therefore plans to use one communication channel, time-division multiplexed, for all the vehicles in the area. Each RPV would have a different address to which it responded. RCA has already built such a system that could, if pushed, control as many as 24 vehicles with one channel.

TRW foresees using both radar and communications to command RPVs, according to the company's senior staff engineer, Naoji Morishita. "We're looking at frequency, time and space-multiplexing for multi-vehicle control," he says. "There's a tradeoff in how many one operator can control. Today it's one to one."

So far TRW favors the higher radar frequencies for both command and radar. "Rather than hf and vhf, we're looking to microwave frequencies," Morishita says.

Protecting the data link from enemy jamming is a big concern. "It's very cheap not to worry about jamming at all," Smead says, "and too expensive to make the system completely jam-free." RCA is studying various levels of protection and calculating the corresponding cost.

One choice is to reduce the data

rate enough to overcome certain threshold jamming. "You could put more power behind each pulse or you could spread the pulse across a greater part of the bandwidth," Smead says.

Another option is to spend money to make the data link secure while leaving the video link vulnerable. "In an emergency, the bird could fly blind for awhile, while still receiving commands and sending back data," Smead notes.

Airborne navigating units planned

For obtaining an RPV's bearing when it's over the horizon, both teams envision putting navigation receivers on the vehicle. This way the bird won't have to be tracked. It can tell you where it is.

It will do this in one of two ways: The receiver will either send raw information back to the ground station, where it will be converted into a geographical position, or computational capability will be installed on board the vehicle to solve the position problem there.

The tradeoff here is obviously cost. Bandwidth can be saved by solving the navigation problem on board the vehicle, but the cost of data-processing equipment that may be shot down must be considered. A self-contained system is becoming increasingly attractive, Smead says, because of the low cost of LSI technology.

"Within the next five years," he says, "an adequate airborne

computer for RPV requirements will cost one-fiftieth of what it costs now. Say that a sophisticated airborne computer costs \$500,000 today; it will cost \$10,000 in five years. And we can design now to equipment that will be available in five years."

Both teams are studying a wide range of navigational systems. According to Naoji Morishita, TRW is looking at Decca, Omega, Loran, the Air Force 621B navigation satellite, the Navy's Transit, doppler, inertial, image correlation (the correlation would be done at the ground station), DME plus time and DME plus angle.

RCA is considering a hybrid navigational system: a combination of an inexpensive inertial that could be periodically upgraded with Loran or a navigation satellite receiver.

Although a specific computer has not been chosen, the ground station will be equipped with third or fourth-generation mini or small computers, says Northrop's avionics head, Darrell Welch. "The display at the command station will be a multi-purpose-integrated CRT type," he says. The reason: "The CRT will be around for the next five or 10 years undergoing improvements all the time. We don't think the laser display will be sufficiently perfected within this time frame."

Putting eyes on the RPV

Sensors on the vehicles fall into two categories: those data-linked to the ground-based operator to enable him to "pilot" the bird and those for collecting intelligence.

For piloting during air-to-air combat, the ground operator will need some kind of eyeball capability, RCA's Smead says, adding: "It may be television, radar or infrared."

For air-to-ground missions, Smead continues, "video is the most desirable so you can see that the target is where you thought it would be."

"The exception," he notes, "is when an area target must be attacked. This could be done blind by navigational aids if there is a cloud cover."

For reconnaissance, Smead

Centralab hybrids... in line with your design requirements



Write
Centralab
for
Bulletin
No. 1492H3

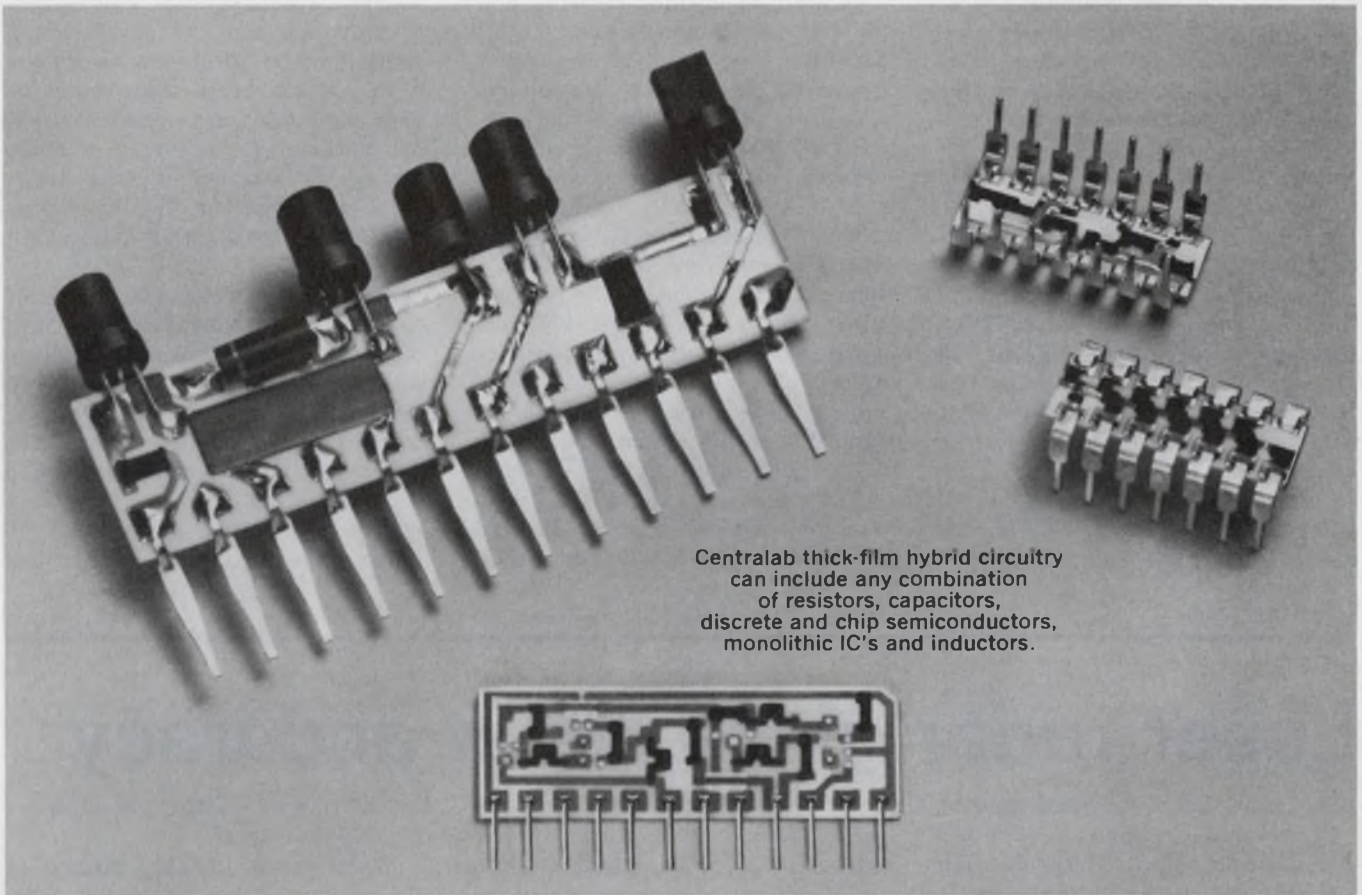

Centralab thick-film hybrid circuitry can include any combination of resistors, capacitors, discrete and chip semiconductors, monolithic IC's and inductors.

Come to us for thick-film capability

When you come to Centralab for custom thick-film hybrid circuits you have the assurance of over 27 years of experience in design and production. As the pioneer in hybrids we have developed over 50,000 custom designs. Today, no other manufacturer can offer you as much flexibility—in packaging, in circuit function and in reliability.

No other 300 mil. DIP, for example, can give you higher package power—up to 3 watts per package. Only Centralab offers you networks with as many resistors—28 in a 16 lead DIP, 24 in 14 lead configurations. Compare resistor tolerance, as low as .5% and TC of 0 ± 100 ppm and you'll see that our kind of customized circuitry is unmatched anywhere.

Chip hybrids that combine fired-on resistors, capacitors and interconnections with diodes, transistors and IC's

are small in size but big in reliability.

Discrete networks were our first hybrids—in 1945. Our expertise is your assurance you'll get circuits that save space and reduce costs of assembly and provide improved reliability as well.

Custom designs meet the most demanding specifications such as complex functions or power drivers.

Our specialized designs include resistor values to 1 gigohm, voltages to 50 kV and resistor value ranges from 10 ohms per square to 10 megohms per square.

If you've a special application for hybrids, call Centralab. We have the capability to give you the performance and reliability that meet your specs—with delivery that meets your requirements. Write or call, A. R. Wartchow, Marketing Manager, Electroceramic Products, Centralab.

GET CENTRALAB THE "IN" LINE FOR YOUR DESIGN

Hybrid Microcircuits
Pushbutton & Rotary Switches
Capacitors
Potentiometers
Technical Ceramics
Ceramic Packages
Semiconductor Devices



CENTRALAB

Electronics Division
GLOBE-UNION INC.

5757 NORTH GREEN BAY AVENUE
MILWAUKEE, WISCONSIN 53201

INFORMATION RETRIEVAL NUMBER 25

points out, "video is again needed, to help the operator line up the vehicle's sensors on the target."

Sensors proposed for helping the vehicle to carry out its mission run the gamut. For air-to-air missions they include radar; forward-looking infrared, infrared search and track devices, and TV trackers. For air-to-ground raids: low-light-level TV, radiometric sensors and target illuminators. And for electronic warfare and reconnaissance: sidelooking radar, multi-spectral sensors, photography and electro-optical devices.

"You can put as many sensors on board as the vehicle will hold," Smead says, "if you remember the limits of your wideband data link." Equipment providing up to 20 MHz is available now and systems with laser-modulated signals that offer up to 100 MHz are under development.

RCA is working on several TV tubes and cameras for RPVs. One candidate is the company's SIT

(silicon intensified target) tube, which can take an image and store it until the operator is ready to transmit it. Or it can be used in slow motion when the drone is flying at high altitude and fewer than the normal 30 pictures per second are required.

A high-resolution television now undergoing demonstration flights provides 6000 lines of resolution, compared with 525 on conventional TV. Called the Return Beam Vidicon, the 6000-line camera was developed under an Air Force contract.

For the future, RCA is developing a completely solid-state TV sensor that replaces the vidicon tube with a number of LSI mosaics coupled with photosensitive diodes, also laid down by LSI techniques. The entire system is arranged in a flat plane, except for a lens used to focus the picture.

The mosaics could be skin-mounted around the vehicle and read rapidly, one after the other.

For display, the readout from each mosaic could be fed directly to a matching mosaic with the same number of vertical and horizontal elements, or it could be converted to a conventional scan.

Lasers are also being studied. One of the more promising techniques, Smead says, is a laser designator. An aircraft or a ground spotter could illuminate a target with a laser beam that would be modulated with a unique coded on-off pattern. A sensor in a bomb or missile carried by the RPV, that is modulated the same way could then home on the coded illumination.

RCA feels it has solved one of the main problems that have plagued low-light-level TV: failure of a tube when it is pointed toward the sun. Called the High Dynamic Range Tube, a modification of the SIT tube, the device can be pointed directly at the sun and then to a poorly illuminated subject and operate normally. ■■

Laser radar gives super accuracy

A laser radar with accuracy of 14 inches at a range of 50 miles has been developed by the Lincoln Laboratories at the Massachusetts Institute of Technology under a grant from the Dept. of Defense.

According to Dr. Thomas J. Gilmartin, a staff member at Lincoln, the new radar is 10,000 times more accurate than the usual microwave radar systems.

The amount of information provided by a radar system is proportional to the frequency of operation, and since the frequency of the new laser radar is 10,000 times larger than that in the usual microwave radar systems, it is 10,000 times more accurate in angular and doppler resolution.

This accuracy, Gilmartin says, enables the system to determine the distance of an object to within 1 inch at 3-1/2 miles. In addition it can determine the velocity of a target to within 1/4 mm per second.

Gilmartin says the system uses a 10.6- μ carbon-dioxide laser with a mercury cadmium telluride diode

detector. It operates in the pulse mode, with a pulse repetition frequency of 10 kHz, a pulse width of 5 μ s and a peak power of 15 kW.

Range tracking employed

Additional features of the system include automatic frequency and range tracking and a transmitter and receiver that are temporally duplexed through a 20-inch optical aperture. The time duplexing is accomplished by a mechanical chopper with a rotating disc.

While the laser radar has the advantage of being much more accurate than microwave radar, it does have one serious drawback: Carbon-dioxide and water-vapor molecules in the air can attenuate its beam and thus reduce the range of the system. The attenuation ranges from 1/4 to 2 dB/km. In addition haze introduces an attenuation of typically 1/10 dB/km, while dense clouds reduce the signal by anywhere from 2 to 10 dB/km. The range of the system will

be cut in half, with 12-dB attenuation of the signal.

Where then lies the future of laser radar? When asked this question George Ammon of RCA's Advanced Technology Lab, Camden, N.J., said that they would probably be used to augment microwave radar systems. Ammon said that RCA was thinking of producing such a system whereby acquisition of the target would be made by the microwave radar. Once acquisition was established, the laser radar would take over. It would be capable of providing more accurate information than the microwave unit is capable of.

Perry Miles, of Raytheon, Waltham, Mass.,—the firm that built the laser for Lincoln Labs agrees. It will provide additional capability to present radar systems because laser back-scatter—the returning signal—depends on different properties than microwave back-scatter. Thus, an object might show up on the laser radar that is invisible to the microwave radar and vice versa. ■■

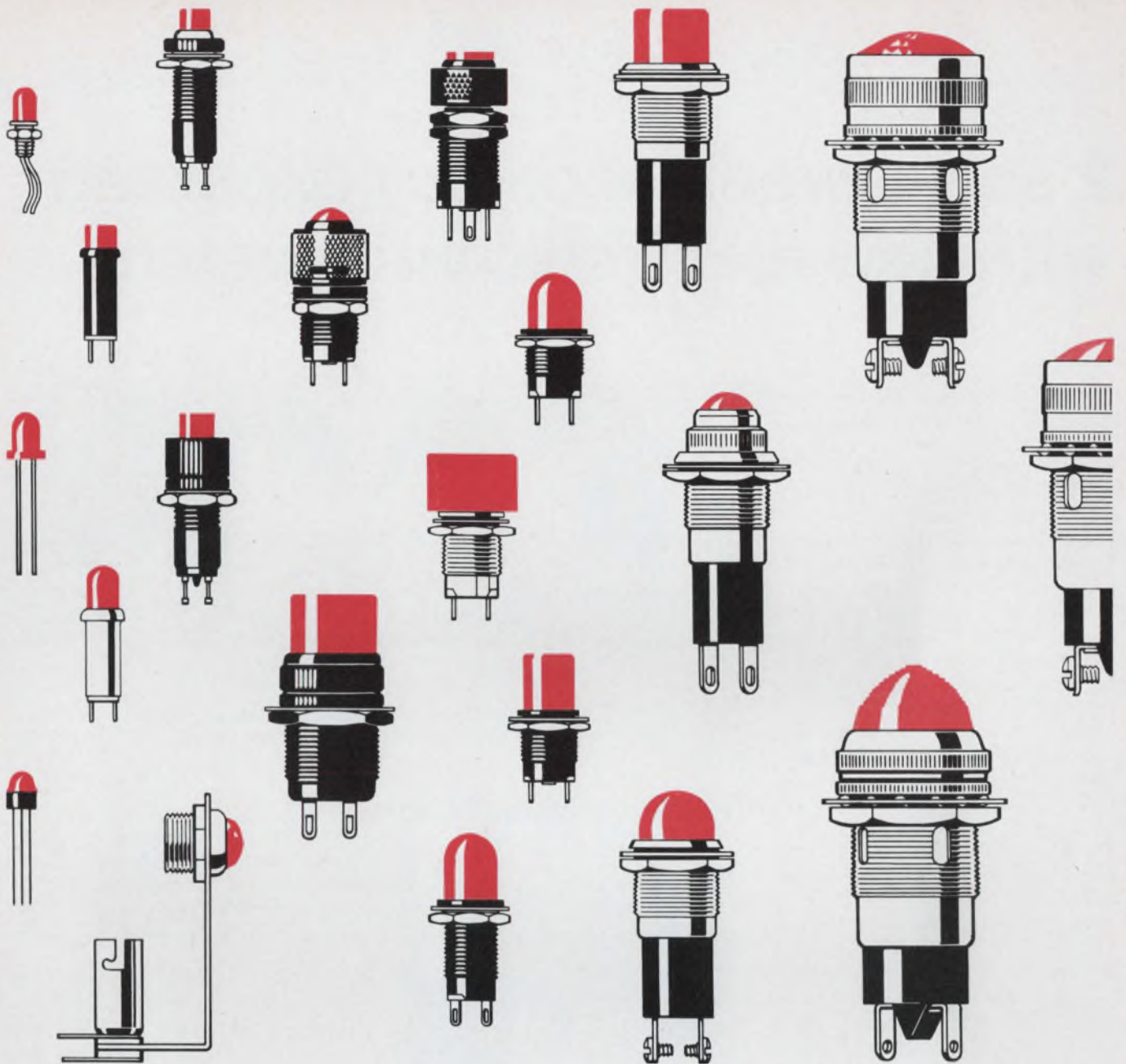

1,500,000 Indicator lights?

**Talk to the specialists at Dialight first.
You won't have to talk to anyone else.**

Permutations on the indicator lights shown here (and others not shown) give you 1,500,000 different ones to choose from. This is no mere mathematical exercise. Thousands are available from stock; any other can be quickly made up for you. Just specify the size, shape, color and type of illumination (incandescent, LED, neon) you want. If you need a specialty—oil-tight,

flashing, MIL spec . . . whatever—order it. You'll get what you asked for. Promptly. Because we and our distributors stock more varieties of indicator lights than anyone else. Our Selector Guide shows you how to find your way quickly to the indicator light you need. Send for your free copy and see how easy it is to find the one best suited to your needs.

DIALIGHT DIALCO

DIALIGHT CORPORATION, A NORTH AMERICAN PHILIPS COMPANY • 60 STEWART AVENUE, BROOKLYN, N. Y. 11237 • (212) 497-7600

INFORMATION RETRIEVAL NUMBER 26

2 sec-a-week accuracy expected with new electronic wristwatch

Time accuracy to within a minute a month, the guarantee made for the Accutron, isn't bad for a commercial wristwatch. But the Bulova Watch Co., maker of the Accutron, wasn't satisfied. A new wristwatch it has developed and put on the market, the Accuquartz, is offering expected accuracy to within two seconds a week.

The higher precision has been made possible, Bulova says, by combining a quartz-crystal oscillator with the well-known Accutron tuning-fork movement.

The new watch—the first electronic one to be completely designed, developed and produced in the United States, according to Bulova—retains the hands as a display and has been miniaturized enough to include a day and date movement.

Developed at Bulova's plant in Woodside, N.Y., the Accuquartz is powered by a 1.5-V, aspirin-sized cell that supplies $13 \mu\text{W}$ to complementary MOS circuits. These CMOS circuits, designed by Bulova and produced by Intersil, Inc., have a threshold of 0.75 V and make up the crystal oscillator-driver as well as frequency dividers. The battery life is one year.

The CMOS integrated-circuit package contains 126 transistors plus resistors and capacitors, all molded into a volume of 2/1000ths of a cubic inch.

The output of the quartz-crystal time base is counted down, from 32,786 Hz to 341.33 Hz—the frequency at which the modified tuning fork vibrates. This compares with 360 Hz for the Accutron tuning fork.

The modified fork is driven electromagnetically by—and is thus

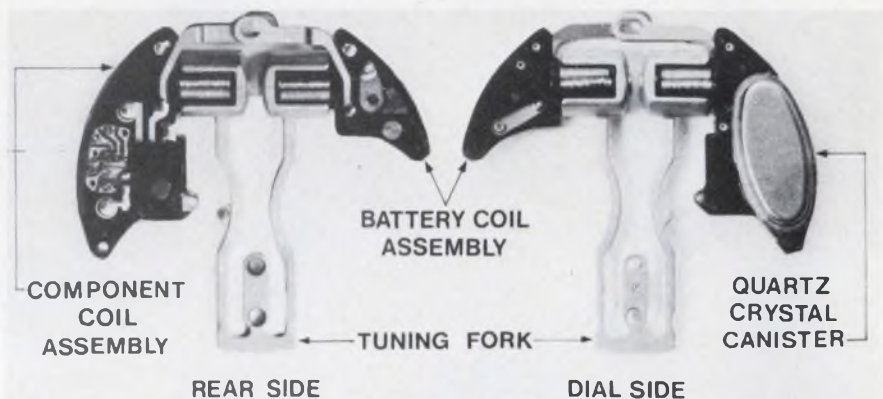

The output of one arm of the tuning fork is mechanically linked to an index wheel, which turns the hands of the new electronic watch.

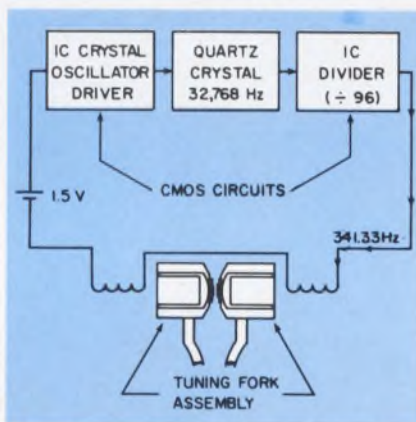

The electronic circuits of the new Bulova Accuquartz watch energize the tuning fork coils with 314.33 Hz.

slaved to—the counted-down output of the time base. In the Accutron watches the tuning fork is self-driven as an oscillating element.

Despite the reduction in resonant driving frequency with the Accuquartz fork, it is smaller. Its mechanical output, like that of the Accutron, drives the hour, minute and second hands, as well as the day and date calendars.

The new crystal is of the flexure, or bar, type—the same type

used by three competitors: Seiko, the CEH Swiss combine and Longines. But Bulova has increased the vibrating frequency to 32,768 Hz—four times that of the 8192-Hz crystals in the Seiko, CEH and Longines watches.

Several considerations, including miniaturization, entered into the choice of the crystal, says William O. Bennett, director of R & D for Bulova. The crystal was designed to provide high Q and good stability without the need for special temperature compensating circuits. A crystal of even higher frequency would be desirable, Bennett says, but power requirements increase with frequency, and the current drain would be prohibitive.

While the crystal has no temperature compensation, Bennett notes that the temperature-vs-frequency variation curve is a parabola that Bulova's designers have tailored to obtain a turnover point of 29 C—about halfway between standard room ambient and body temperature.

The Accuquartz sells for \$395 in a gold case and \$250 in stainless steel. More expensive models go to \$2500. ■■

Jim McDermott
East Coast Editor

MOSTEK MOS ion-implanted for high performance! easy to use...now easier than ever to buy!

RAMS

MK 4002 P

64 x 4 static TTL/DTL compatible RAM

MK 4006 P, MK 4008 P

1024 x 1 TTL/DTL compatible RAM; dynamic storage but no clocks required; 400 ns access times available; 16-pin package.

MK 4007 P

256 x 1, pin-for-pin replacement for 1101 but with less than 250 mW of power and wide -6.5 to -15 V negative supply range.

ROMS

MK 2002 P, MK 2101 P, MK 2302 P, MK 2408 P, MK 3101

Character generators; 64 characters, 5 x 7 dot matrix.

MK 2400 P

256 x 10 TTL/DTL compatible ROM with 550 ns cycle times.

CALCULATORS

MK 5010 P

Single IC, four function (+ x - +) 10-digit calculator with display decoder, multiplexing circuitry, leading-zero blanking.

MK 5012 P

12-digit version of MK 5010 P.

MK 5013/5014 P

IC pair; four function 12-digit calculator with display circuitry, 1 memory, automatic constant, selectable 5/4 roundoff or truncate, leading-zero blanking. Printer interface chip to be available.

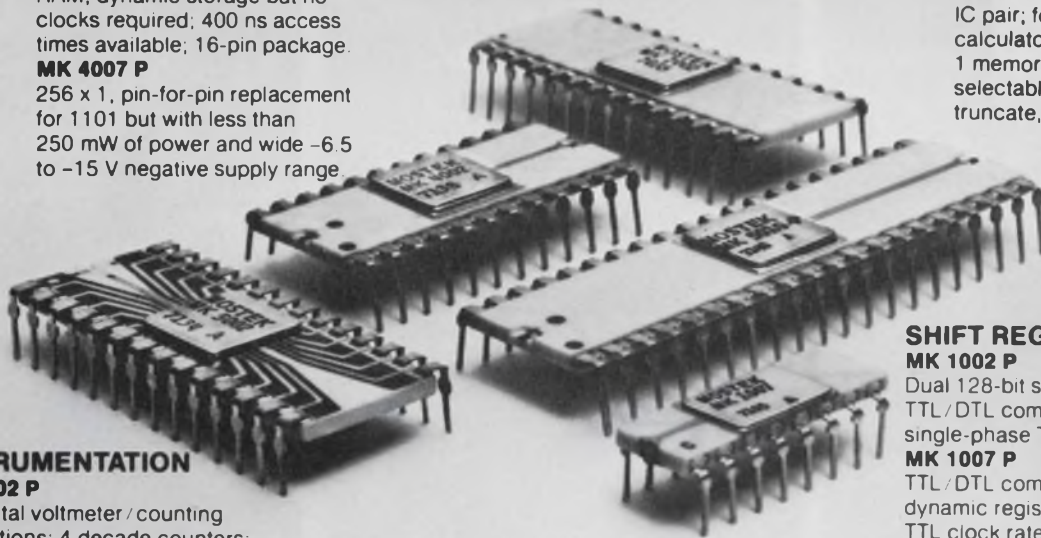

INSTRUMENTATION

MK 5002 P

For digital voltmeter / counting applications: 4 decade counters; storage; display; multiplexing; single +5 to 20 V supply; power under 25 mW.

SHIFT REGISTERS

MK 1002 P

Dual 128-bit static register; full TTL/DTL compatibility and single-phase TTL clocks.

MK 1007 P

TTL/DTL compatible quad 80-bit dynamic register; single-phase TTL clock rate to 2.5 MHz and built-in recirculate logic.

MOSTEK has made MOS easy to use and added unique MOS/LSI performance capabilities through its ion-implantation techniques. Now MOSTEK has made its standard

products more available than ever before thanks to a new network of distributors and representatives. Call the one nearest you *today* for information and off-the-shelf delivery.



1400 Upfield Drive
Carrollton, Texas 75006

Regional Sales Offices: West: 12870 Panama Street, Los Angeles, Calif. 90066 (213) 391-2746. East: 60 Turner Street, Waltham, Mass. 02154 (617) 899-9107. Midwest/Southeast: 515 S. W. Avenue, Jackson, Michigan 49203 (517) 787-0508.

Representatives: HMR Inc., Minneapolis, Minn. (612) 920-8200; W. J. Purdy Co., Burlingame, Calif. (415) 347-7701; Littleton, Colo. (303) 794-4225; KCE Corp., San Diego, Calif. (714) 278-7640; Los Angeles, Calif. (213) 391-0586; Sheridan Associates, Inc., Cincinnati, Ohio (513) 761-5432; Florissant, Missouri (314) 837-5200; Cleveland, Ohio (216) 524-8120; Dayton, Ohio (513) 277-8911; Lathrup Village, Mich. (313) 358-3333; Pittsburgh, Pa. (412) 243-6655; FM Associates Ltd., Greensboro, N. Carolina (919) 294-2754; Huntsville, Ala. (205) 536-9990; Orlando, Fla. (305) 851-5710; Sprague Electric Co., Wayne, New Jersey (201) 696-8200; Schiller Park, Ill. (312) 678-2262; Richardson, Texas (214) 235-1256; Tempe, Arizona (602) 966-7233; N. Seattle, Wash. (206) 632-7761; Precision Electronics, Inc., Glenside, Pa. (215) M16-8383.

Distributors: Cramer Electronics Inc.—Alabama: Huntsville (205) 539-5772; Arizona: Phoenix (602) 263-1112; California: San Diego (714) 279-6300; Colorado: Denver (303) 758-2100; Connecticut: North Haven (203) 239-5641; Florida: Hollywood (305) 923-8181; Orlando (305) 841-1550; Georgia: Atlanta (404) 451-5421; Illinois: MI Prospect (312) 593-0230; Maryland: Baltimore (301) 354-0100; Gaithersburg (301) 354-0100; Massachusetts: Newton (617) 969-7700; Minnesota: Bloomington (612) 881-8678; New Jersey: Union, (201) 687-7870; Pennsauken (215) 923-5950; New Mexico: Albuquerque (515) 265-5767; New York: Hauppauge, L.I. (516) 231-5600; Endwell (607) 754-6661; Rochester (716) 275-0300; East Syracuse (315) 437-6671; North Carolina: Raleigh (919) 876-2371; Winston-Salem (919) 725-8711; Ohio: Cleveland (216) 248-7740; Cincinnati (513) 771-6441; Oklahoma: Tulsa (918) 836-3371; Texas: Dallas (214) 350-1355; Utah: Salt Lake City (801) 487-3681; Wisconsin: Milwaukee (414) 462-8300; Canada: Ontario (416) 630-5023 Brill Electronics; Oakland, Calif. (415) 834-5888; Elmar Electronics, Mt. View, Calif. (415) 961-3611; Liberty Electronics, Inglewood, Calif. (213) 776-6252; Wesco Electronics, Los Angeles, Calif. (213) 685-9533; Merquip Electronics, Skokie, Ill. (312) 965-7500; Stark Electronics Supply, Minneapolis, Minn. (612) 333-3361; Sheridan Sales Co., Cincinnati, Ohio (513) 761-5432.

International: MOSTEK GmbH, 7 Stuttgart 80, Waldburgstrasse 79, West Germany 0711-731305; System Marketing Inc., Center News Bldg., 1-3-11 Sotokanda, Chiyoda-ku, Tokyo, Japan; W. G. Booth Pty. Ltd., 39 Church Street, Hawthorn, Victoria 3122, Australia.

CUSTOM, HIGH PERFORMANCE MOS

Low-voltage CMOS and high-speed PMOS. Built by the people who introduced ion implantation to MOS processing technology.

CMOS

- Low operating voltage—down to one volt.
- Complex, high density circuits—no channel stoppers, even at 1.5 volts.
- Low, matched and selectable threshold voltages—as low as 0.5 volts on both N and P channels.
- Tight threshold voltage control—within ± 0.2 volts.

PMOS

- High-speed at low power—low capacitance through zero gate overlap—example, 10 MHz shift register at 200 μ W per bit.
- Single power supply—operating voltage as low as 3 volts with ion implanted resistors.
- High circuit density—advanced photolithographic technology.

PLUS...

- Full silicon nitride passivation plus overglass protection.
- TTL/DTL compatibility.
- Full MIL STD temperature range.
- 100% screening to MIL STD 883.

If our custom capability appeals to your high performance requirements, write us. We're taking orders now.
Hughes Aircraft Company, Microelectronic Products Division, 500 Superior Avenue, Newport Beach, CA 92663
Telephone: (714) 548-0671

HUGHES

HUGHES AIRCRAFT COMPANY
MICROELECTRONIC
PRODUCTS DIVISION

Hughes Industrial Electronic Products

INFORMATION RETRIEVAL NUMBER 57

Hughes is more than electronic components and equipment.

It's systems, too.



Numerical control systems (RS 295)



Wire terminating and harness laying systems (RS 296)



N/C positioning tables and systems (RS 297)



Multiplex systems for remote communications/control (RS 292)



FACT automatic circuit testers (RS 298)

For complete information, write Bldg. 100, Mail Station C-512, Culver City, CA 90230. Or request by Reader Service (RS) numbers.



Industrial Electronic Products

Low-power beam leads hailed

Sharply increased reliability is promised by Texas Instruments to users of its low-power beam-lead integrated circuits, recently introduced.

Although conventional TTL beam-lead ICs have been available from Motorola and Raytheon for some time, TI is the first to offer a low-power version.

Formerly, says Larry A. Gast, senior project engineer for TI, designers who used low-power MOS/LSI integrated circuits were forced to make a tradeoff between reliability and power consumption. They could use either the less reliable low-power chip and wire-connected ICs or the more reliable, but higher-power, ICs. Now they

can get both features with TI's development, Gast says.

In addition, he notes, increased density can be achieved by bonding the beam-lead chips directly to multi-level conductor substrates. Chips can be placed in closer proximity, he says, because they are not restricted by bonding paths and the crossover requirements of bonding wires.

Increased reliability, Gast explains, is achieved by eliminating the fragile wire bonds and the resultant stress on the silicon wafer chips. Because of this, he believes that beam-lead ICs will soon replace other ICs in military specifications that call for higher reliability. ■■

A laser powered by sunlight

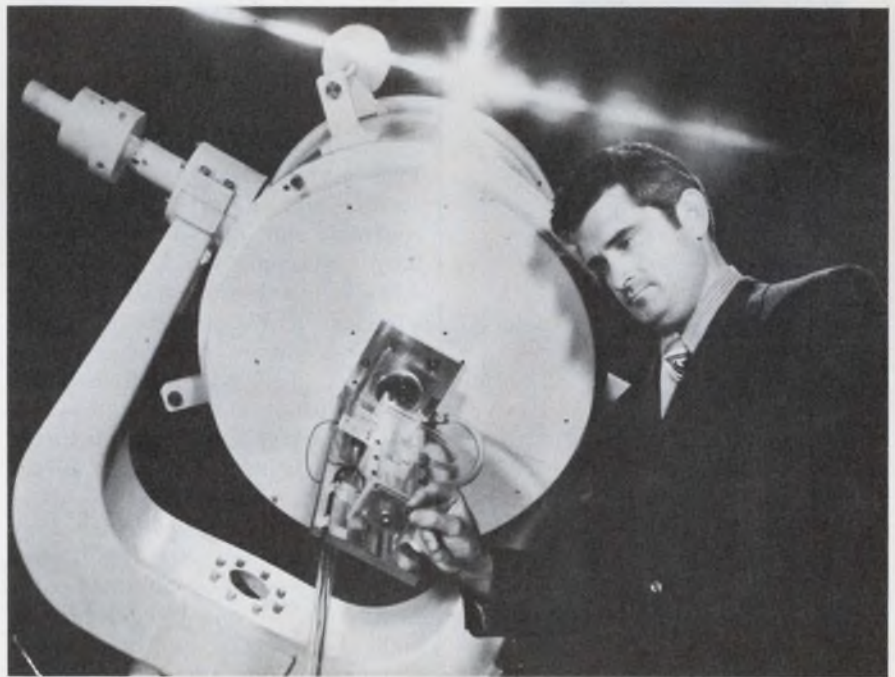

A working model of a sunlight powered laser—that may be used in future long-life space communications systems—is demonstrated by Dr. Lloyd Huff, scientist at GTE Sylvania, Mountain View, Calif. Present lasers powered by electrical discharges or lamps are not yet capable of operating the required five to seven years in a communications satellite. A 24-inch mirror in the background collects solar energy and directs it into a neodymium YAG laser by means of lenses and mirrors. A power output of 1.5 W has already been achieved, according to GTE. The power output and data transmission rate of the new laser is expected to equal those of present solid-state lasers.

NEW PRODUCTS FROM EDC

ELECTRONIC DEVELOPMENT CORP.
BOSTON, MASSACHUSETTS



The Low Impedance DC Millivolt Standard/Reference Model MV-105G (Series B), is designed for Thermocouple and Transducer applications. As a *Source*: for bridge excitation of load cells; as a *Calibrator*: to certify recording instrumentation and amplifier performance; as a *Potentiometric Volt Meter*: for production use to pre-set transducer power and to accurately calibrate transducer outputs directly (w/o amplifiers). *Output ranges*: ± 11 Vdc and ± 110 Millivolts with resolution of 1 ppm in each range. *Measurements*: from $1\mu\text{V}$ to 11 Vdc. The accuracy of the E_{in} and E_{out} modes is $\pm 0.005\%$ of setting. Low Z_{out} : V range = 30 milliohms; 100 mV range = 3 ohms (constant). High Z_{in} : ∞ at null; 10 Megohms off null. *Stability*: $\pm 0.0005\%/hr$. *Price*: \$820.00 w/o Galvanometer; w/Galv. add \$225.00.

Circle # 168



The model 2901 is a low cost DC DIFFERENTIAL VOLTMETER, GALVANOMETER, CALIBRATOR and SOURCE in one instrument. Voltage *measurements* from $\pm 1\mu\text{V}$ up to $\pm 1100\text{Vdc}$ with input impedances from 1 Megohm to infinity. The Model 2901 is also a D.C. Voltage *calibrator* with output voltages (selectable) from ± 100 nanovolts to ± 110 Vdc. Absolute Accuracy: $\pm(0.003\%$ of reading and 0.001% of range) using "Limit of Error" (Worst Case) "Concept" for both the measure mode and the output mode. The constant (selectable) DC Voltage *source* delivers up to 100 milliamperes via 4 terminal remote sensing with current limit control and overload indicator light.

Model 2901; Price \$1350; From stock. Instruments available for no-charge engineering evaluation.

Circle # 169

Instruments available for no-charge engineering evaluation.



Electronic Development Corporation
11 Hamlin Street • Boston, Mass. 02127
(617)268-9696.

technology abroad

A new black-and-white display from Thomson-CSF in France uses nematic crystals. The device consists of an addressing light source, a glass substrate, a transparent electrode, a photoconductive Cds layer, a $15\text{-}\mu$ liquid-crystal film and a second transparent electrode and glass substrate. Light forms an image on the device through a photo negative. Relatively light parts of this image activate the photoconductive layer, producing a field between the two electrodes and through the liquid crystals. This field induces light-scattering structural changes in the material. When the device is removed after addressing, and projected like a 35-mm film slide, the switched areas appear darker than the unswitched areas, producing an image of up to 20 line pairs/mm resolution.

CIRCLE NO. 441

Two major disadvantages of liquid-crystal displays—limited contrast and cross-talk—have been overcome by scientists at AEG-Telefunken's research laboratories in West Germany. Individual elements in such displays are X-Y addressed, but because the liquid-crystal effect has no threshold level, adjacent elements in the display are also partly turned on. Now, Kurt Fahrenschon and Manfred Schiekkel of AEG-Telefunken Special Tubes Div. at Ulm have obtained contrast ratios on the order of 1000 to 1 between illuminated elements and the surrounding area. This is a twenty-five-fold improvement over conventional liquid-crystal displays. Crosstalk is also eliminated by use of a liquid-crystal cell design that allows the crystals to align their axes vertical to the electrode when no voltage is applied to it. When

a voltage of sufficiently high frequency is applied to the electrode, the crystal axis begins to tilt. The crystals behave like minute prisms and move rapidly from cutoff to transmission. A very small voltage yields a large change in the transmitted light, and therefore a high contrast display.

CIRCLE NO. 442

A technique of producing acoustic holograms has been devised by researchers at Thomson-CSF in France. Their method is ideal for imaging large objects, and holograms thus produced could be used in medicine to view the inside cavities of the body. Alternately the technique offers a simple method of obtaining the Fourier transform of a signal. The object to be investigated is immersed in a liquid and subjected to 5-MHz ultrasonic waves. The emerging wave front interferes with that produced by a second piezoelectric transducer. The net interference pattern produces a wave pattern in the liquid surface. When this is illuminated by a laser beam and viewed through a suitable optical filter, the object can be observed.

CIRCLE NO. 443

An automatic mask-alignment system that reduces IC diffusion time by 50% has been developed by Britain's Rank Precision Industries. In less than 25 seconds, the machine moves a semiconductor chip from a 50-slice magazine, positions it automatically with photo-electric microscopes and makes the exposure. The slice and mask are separated by a $5\text{-}\mu\text{m}$ gap to eliminate abrasive damage. Rank says that alignment accuracy is better than 10 microinches, even with slightly warped slices.

CIRCLE NO. 444

The wave of the future lies within our newest basic switch.

Our new SV basic switch isn't very basic inside. In fact, it's downright revolutionary.

At the heart of it all is our "Rolling Wave" spring—an "S" shaped snap-action spring that produces a rolling action. This action, in conjunction with resilient, multi-point stationary gold contacts, provides maximum assurance for circuit closure.

This new spring concept allows us to offer features unique to a miniature, snap-action switch.

For example, we designed the SV to give millions of trouble-free operations under low-energy conditions. (The SV was tested thru 5,000,000

cycles at .006 ampere, 5VDC with each cycle electrically monitored. Not one fault was recorded; and switch resistance was found to be stable throughout.) Some people might call it over-designing. We call it reliability.

The SV has a high ratio of return force to operating force which makes it ideal for use with extended lever actuators. And the SV has a low operating force of only 18 grams.

For more information, call your MICRO SWITCH Branch Office or Authorized Distributor (Yellow Pages, "Switches, Electric"). Or write for Product Sheet SV.

MICRO SWITCH makes your ideas work.

MICRO SWITCH

FREEPORT, ILLINOIS 61032
A DIVISION OF HONEYWELL

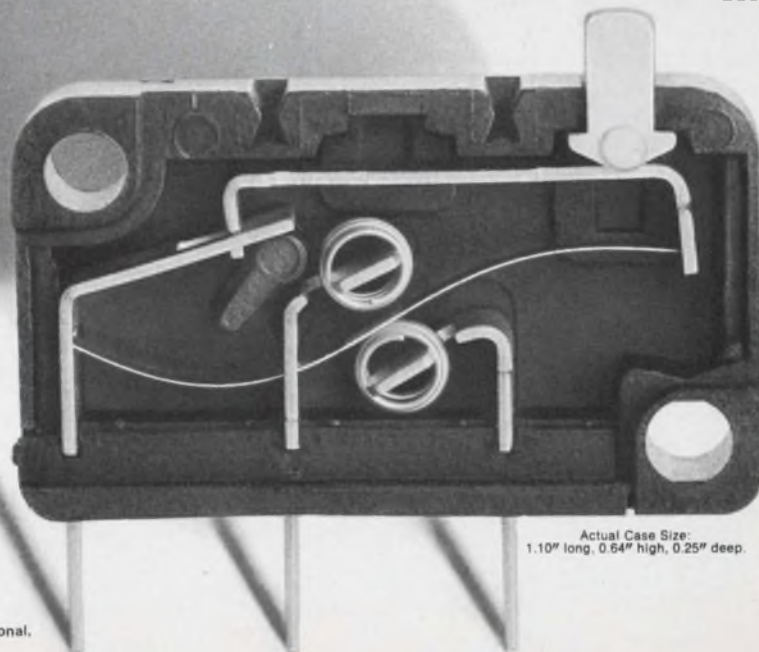

Actual Case Size:
1.10" long, 0.64" high, 0.25" deep.

MICRO SWITCH products are available worldwide through Honeywell International.

INFORMATION RETRIEVAL NUMBER 30

We packed even more circuitry into CTS cermet resistor networks.

*8,-14,-16 and -18 lead styles
Series 760 Dual In-Line Packages.*

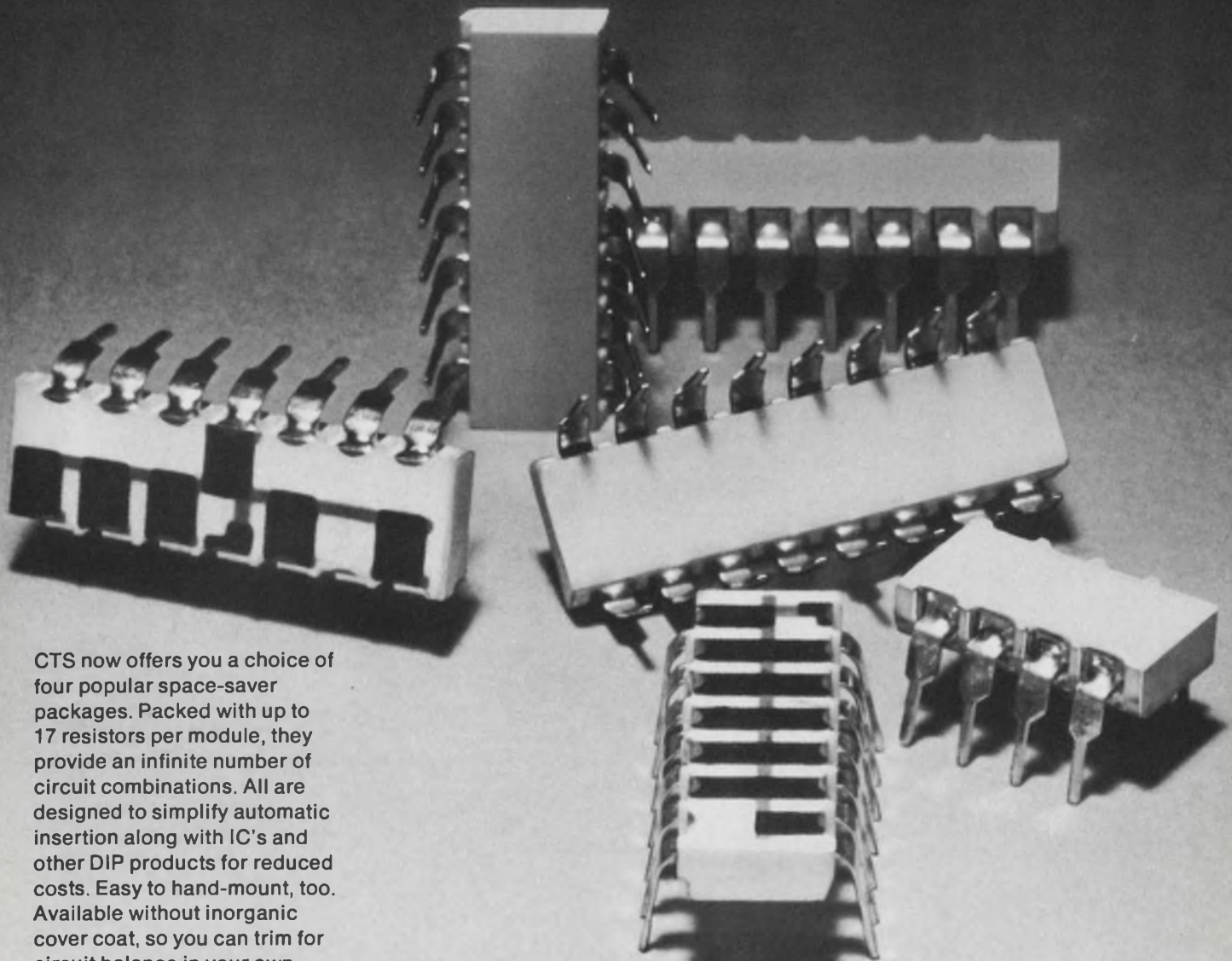

CTS now offers you a choice of four popular space-saver packages. Packed with up to 17 resistors per module, they provide an infinite number of circuit combinations. All are designed to simplify automatic insertion along with IC's and other DIP products for reduced costs. Easy to hand-mount, too. Available without inorganic cover coat, so you can trim for circuit balance in your own plant. 5 lbs. pull strength on all leads; .100" lead spacing; rated up to 2 watts on 18 lead style. Choose from standard circuit available for immediate delivery (see data sheet 3760... or custom design to specifications).

CTS of Berne, Inc., Berne, Indiana 46711. (219) 589-3111.

Series 750 edge mount cermet resistor packages available in infinite number of resistor patterns and wide selection of package configurations.

CTS CORPORATION

Elkhart, Indiana



A world leader in cermet and variable resistor technology

washington report



Don Byrne
Washington Bureau

Less-expensive shuttle better than none for 5000 engineers

The space shuttle program announced by President Nixon will probably mean about 5000 new jobs for engineers and 35,000 new jobs for technicians, NASA sources say, but it's a sharply curtailed program, compared with what NASA would like. NASA had sought a reusable booster; it will get a less-expensive one. About 10,000 of the 50,000 jobs predicted in the White House announcement will be filled by administrative and other white-collar personnel. The job figures are at best an estimate and are based upon experience in the Apollo program. The shuttle program is now three years old and its over-all predicted cost of anywhere from \$10-billion to \$14-billion has dropped to between \$5.5-billion to \$6.5-billion, with 1978 remaining as the target date for the first flight. NASA's budget for the coming fiscal year will carry about \$200-million for the shuttle, up \$100-million from last year. A fight is expected in the Senate over the money, but the measure is expected to pass. NASA hopes to issue bids next month for both the manned orbiter and the as-yet-undefined, but definitely unmanned, booster. North American, General Dynamics, McDonnell Douglas, Martin-Marietta, Grumman, Boeing and Lockheed are expected to be in the running.

U.S. policy body to study computer communications

The Office of Telecommunications Policy has announced that it plans a long-range study of the interaction between computers and communications, with an eye to setting national policy on the subject. The office plans to award a study contract to an independent research firm. Companies with experience in computer communications and systems analysis, and interested in the project, should get in touch with Michael J. McCruden, Room 755, Office of Telecommunications Policy, Executive Office of the President, Washington, D.C. 20504.

Army and Navy detail helicopter avionics

The Navy has revealed that its first Light Airborne Multipurpose System (Lamps) helicopters will carry the Canadian Marconi LN-66 anti-submarine warfare radar, but that the system will be replaced in later models by an AN/ATS-115 radar made originally by Texas Instruments for the Lockheed P-3C fixed-wing patrol aircraft. The helicopters, a conversion of the Kaman Sea Sprite helicopter, were beginning to be sent to fleet units at the end of last year. In addition the SH-2D, as it is officially known,

will have AN/SSQ-41 and SSQ-47 sonobuoys, the new AN/ALR-54 electronic warfare sensor and Mark-46 homing torpedoes for ASW work. The Army meanwhile has announced that it is seeking a lightweight, low-cost modular avionic system for the Utility Tactical Transport Aircraft System (Uttas) helicopter, a replacement for the present HU-1D helicopter. The Army listed as essential components a low-level, tactical navigation system; low-frequency automatic direction finder; vhf-FM homing capability; a tactical precision approach system; vhf-AM, uhf-AM and vhf-FM radios; a medium-high-frequency, single-side-band radio; provision for a heads-up cockpit display; and provisions for operation in the civil airways system. The Uttas will be the first helicopter, the Army says, capable of carrying a fully armed 11-man infantry squad. Requests for proposals for the helicopter are out, and bids are expected by April 6.

CATV center set to help localities

A cable-television clearinghouse has been set up here to help communities decide which should get CATV franchises in their areas. The Cable Television Information Center, headed by Lloyd N. Morrisett, president of the Markle Foundation, said the center hoped to offer technical, financial, legal and administrative expertise to cities and communities faced with the job of awarding CATV franchises.

MCI files first tariff as common carrier

Microwave Communications, Inc., the company that opened the specialized common-carrier field to competition, has finally filed its first tariff—eight years after its fight against American Telephone & Telegraph started. The tariffs cover the route between Chicago and St. Louis, the original application. MCI has plans to build a coast-to-coast microwave grid connecting most of the major population centers. The Federal Communications Commission's decision in the case opened the door for dozens of companies to service customers with point-to-point communications, previously the sole fief of the established telephone companies.

Capital Capsules: The Army, which lost the funding for its XM-803 Main battle tank in this year's budget, has lost the drive to come up with a replacement. The first step naturally was to appoint a study group. Some \$20-million is available to the Army for prototype development, expected to be completed in about three years. Congress balked at the Main tank when the cost went above \$1-million per tank. . . . NASA is reviewing over 250 proposals from groups **planning to use space-related technology to solve domestic problems.** Air and water pollution, solid-waste disposal and clinical medicine are the fields covered in the proposals. NASA will award \$75,000 to study contracts in those four fields. . . . The Pentagon has determined that **prime contractors must pay subcontractors before they can receive progress payments from the Government.** To offset the costs of primes, the Defense Dept. has directed its contracting officers to multiply total estimated contract cost by 0.07% and to multiply estimated costs of purchase parts, raw materials and subcontracted parts by 0.8%. The two sums are then added to the contract price. It was the latest step in a defense program to link profits eventually to capital investments by the contractor.

*all portable storage oscilloscopes
with 5000 cm/ms writing speed...*

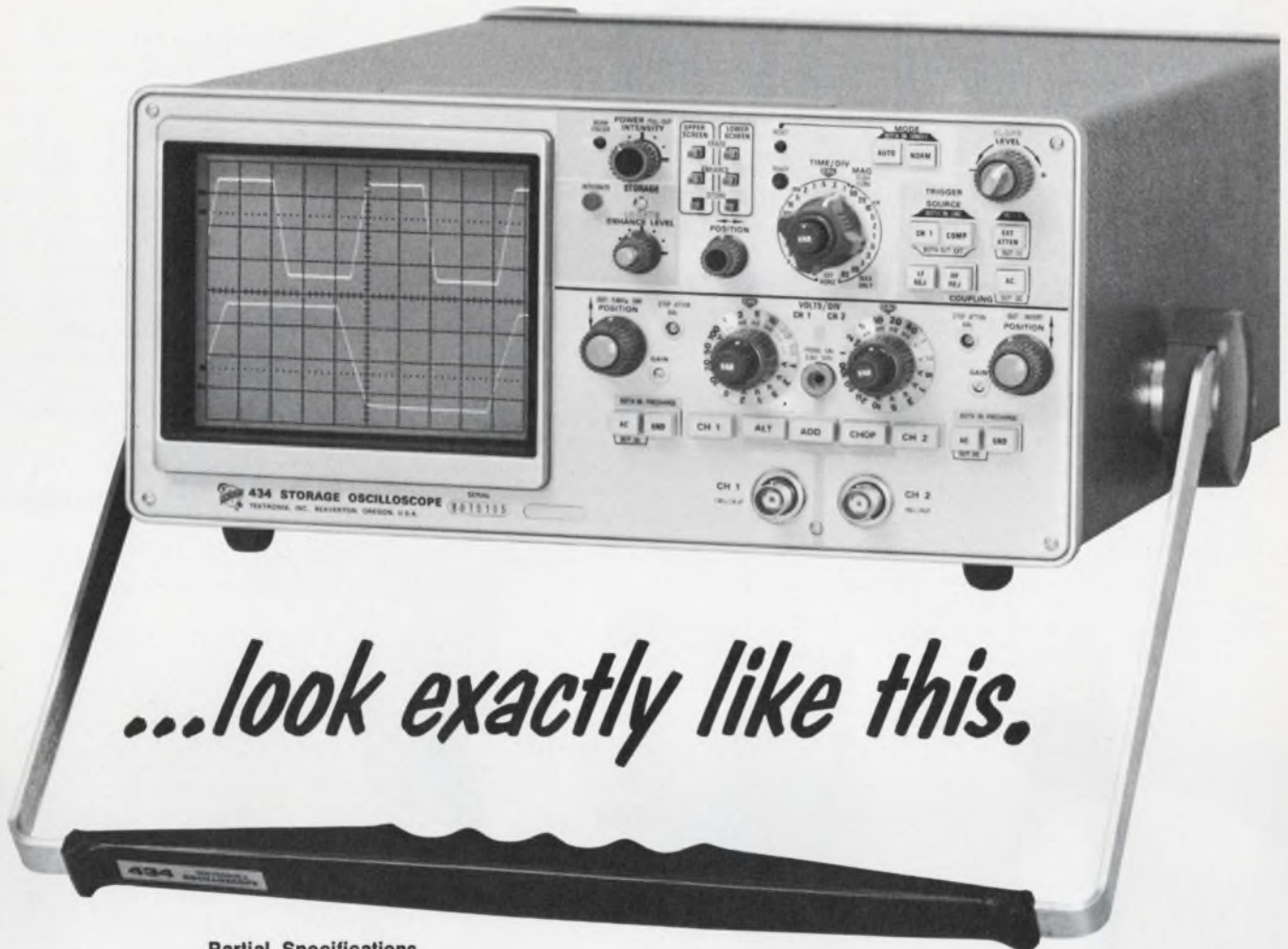

Partial Specifications

Storage Writing Speed— 434, up to 400 cm/ms.
434 Option 1, up to 5000 cm/ms.

View Time—Clearly discernible traces for as long as four hours.

Resistance to Burns—Requires same care as a conventional CRT.

Locate—Operates without disturbing stored display.

CRT— 5 inches.

Bandwidth— 25 MHz.

Volts/Div— 1 mV dual trace.

Time/Div—To 20 ns.

Height— 5¼ inches (cabinet), 5¼ inches (rack).

Weight— 20¾ lb.

AC Powered

The 432 is a conventional oscilloscope with all 434 performance characteristics except storage.

How often have you had difficulty measuring signals which are single event, low rep rate, aperiodic or random? 434 storage provides you with easy solutions to many of these measurements—434 portability solves the problem of getting storage to the measurement. And, 434 storage writing speed is the highest you can get.

Before selecting your next portable, you'll want to see what's really new. Your field engineer will arrange a demo of the 432 and 434 at your convenience. Prices are: 434 Storage Oscilloscope, \$2150 (add \$25 for Option 1); 432 Oscilloscope, \$1585.



U.S. Sales Prices FOB Beaverton, Oregon

TEKTRONIX®
committed to
technical excellence

UP-FRONT SIMPLICITY: LEVER-LITE III

Rugged modular construction gives you a reliable lighted lever switch that provides front-of-panel convenience on the assembly line or in the field.

Our new "Lever-Lite" III switches were designed to simplify installation and servicing of lighted lever switches on computers, telecommunications systems, industrial control equipment, intercoms, broadcast consoles and scientific or test instruments of all kinds.

SIMPLE to mount and terminate. "Lever-Lite" III switches are installed from the front. In a single hole. The lever assembly (lever-actuator, lamp and socket, and color filters) simply

slips into its housing. An escutcheon that "snaps-in" place secures the lever assembly and "trims" the mounted switch. Switching and lamp terminals are solder lug type but also accept standard quick connect-disconnect receptacles.

SIMPLE to relamp. Front-of-panel relamping or changing of color filters can be done easily by removing the escutcheon and lever assembly with your fingertips.

SIMPLE to find what you need. "Lever-Lite" III switches are available in 2- and 3-position types. With locking, non-locking and talk-listen functions. You can order multi-color (different colors in each position), mono-color (one color in all positions) or non-illuminated "Lever-Lite" III switches. And they can be specified with SPST to 8PDT switching.

SIMPLE to get. Contact your local Switchcraft distributor, sales representative, or write us direct. Switchcraft, Inc., 5529 N. Elston Avenue, Chicago, Illinois 60630.

SWITCHCRAFT
INC.

See us at Computer Systems Design Conference BOOTH 615

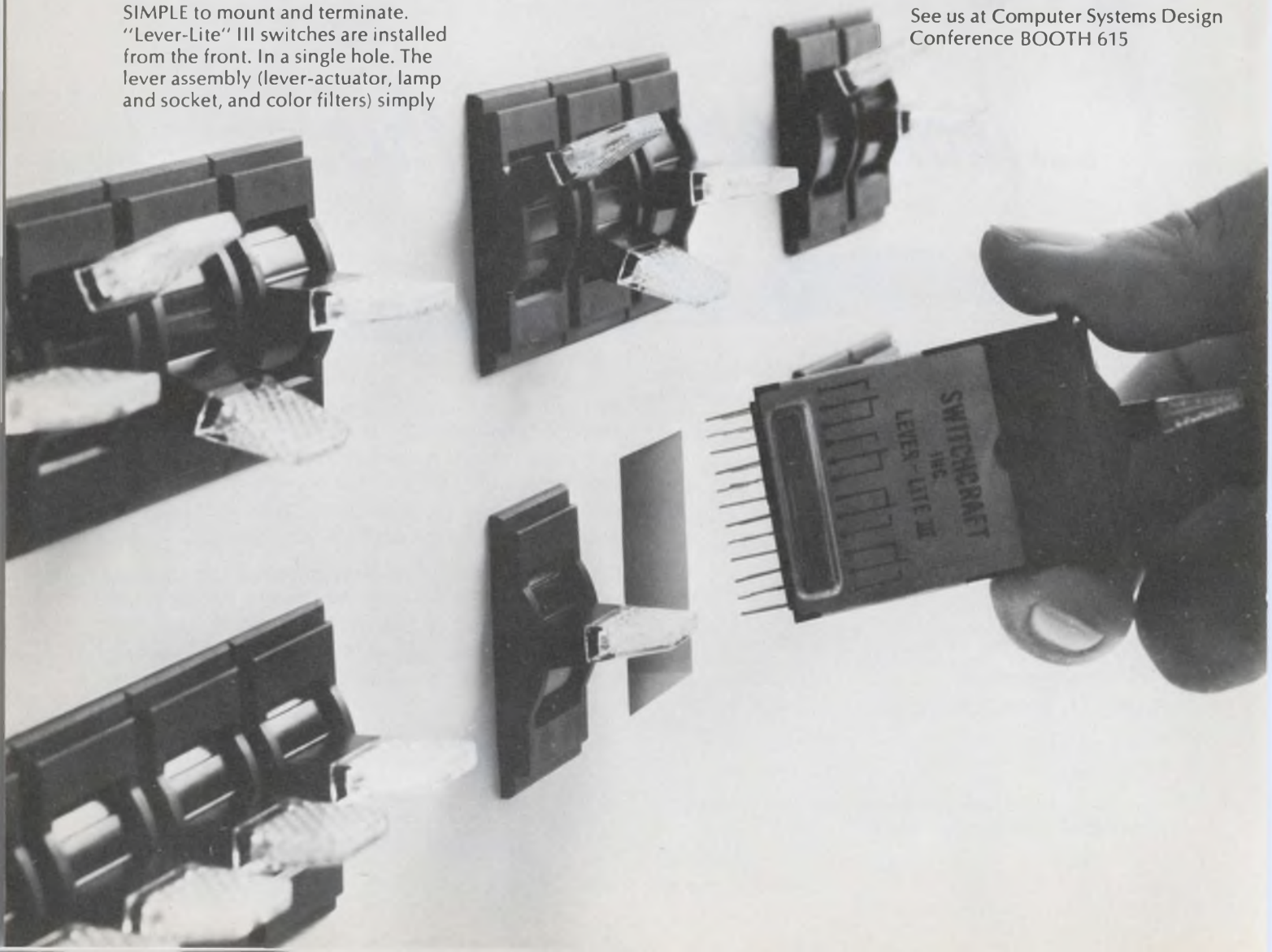

Let's not foul up the upturn

The awful bath our industry has been taking seems to be behind us. We're seeing many signs that we're in for an upturn.

That's great. But what shall we do this time? Overreact again? When business is bad, we seem hell-bent on making it rotten. And when it's good, we're miserable unless we can make it sensational.

Many of us have forgotten the good old boom years with their ever-rising salaries, frequent job-hopping for big pay jumps, invasions of engineering campuses by head-hunters trying to lure graduates to high salaries, intellectual challenge, rapid advancement and company-paid everything. We've forgotten the soaring stock prices and the Wall Streeters begging us to take their money to start new companies. We've forgotten the hectic excitement and the dream that we were all going to be rich and happy.

But many of us won't quickly forget the spirit-deadening layoffs of the recent past, nor the plummeting earnings or shocking losses of so many companies, nor the failures. In those dark days many corporate managements desperately tried to save pennies, often acting as if tomorrow would never come.

They laid off engineers, dropped experienced production workers, closed plants, stopped developing new products and tried to milk the last drop of value out of near-obsolete equipment. Diving deeper and deeper into the holes they dug, they made themselves less and less competitive.

In the good days they did the opposite. They hired wildly, invested heavily in front-office furnishings, blindly built new plant capacity and purchased equipment that nobody really needed. Scrambling for mountain peaks, blinded to what lay beyond, they created a sure base for a steep decline.

Will we do it again? More than any other industry, ours is dominated by engineers. And we supposedly make decisions based on fact and reason; we don't get caught up in a swirl of emotional reactions. Do we?



A handwritten signature in dark ink that reads "George Rostky". The signature is fluid and cursive, written in a professional style.

GEORGE ROSTKY
Editor

Focus

on Resistor trimming equipment

One of the biggest bottlenecks in hybrid-circuit production is the trimming of film resistors. To get around it, some manufacturers have built their own trimming units. But the trend now is to buy complete systems. And deciding which machine to get isn't easy.

First, the user has to choose between an air-abrasive and a laser system; the two are very different in operation and cost. Both remove film-resistor material to increase the resistance to a design value, but where the laser burns it away, the air-abrasive device grinds it away.

In cost, air-abrasive and laser units start at prices under \$20,000. The generally lower priced air-abrasive systems go up to around \$90,000. A large laser system featuring ac measurement capabilities can top \$100,000.

Second, the specs don't always tell you what you need to know. The important spec—production rate—is usually inflated. And the critical cost per trim is often omitted.

Thick and thin-film trimming

The competition between air-abrasive and laser systems is hottest in thick-film trimming. For medium to high production rates, moderately tight tolerances and reasonably sized, low-density resistors on substrates without active components, either approach will do—and at comparable prices.

It's a different story in thin-film trimming: Laser systems have virtually taken over. One significant exception is tantalum thin-film trimming. Where the film pattern becomes overly complex, an anodizing technique is used. But here the customers are few, and equipment suppliers are even scarcer.



Edward A. Torrero
Associate Editor

As a start to a choice of systems take a closer look at the two key specs: production rate and cost per trim.

Factors affecting production rate

Production rate, or throughput, is defined as the number of resistors trimmed to tolerance every hour. But what you see on the spec sheet is not necessarily what you get on the production line.

One factor that reduces production rate is the value of the untrimmed resistor. This can be around 50% of the required value. When it is, the trimming time is increased.

Another factor in production rate is the tolerance required. Again, trimming time increases as the tolerance is tightened. The actual throughput, for example, may be about 50% that of the listed spec when resistors, initially 30 to 40% under value, are trimmed to 0.5% tolerance.

Finally, the production rate can be very misleading if it is taken to be the trimming speed—the rate at which the machine can trim a resistor. What is omitted here is the loading/unloading time. If this time is not included, the published spec can be way off.

Factors involved in cost per trim

The second key spec—cost per trim—is often omitted on the manufacturer's sheet because the parameters that determine it vary widely from one application to another. In general, the factors that go into the calculation of a meaningful cost per trim include these: labor and maintenance costs, amortization of equipment, density and size of resistors, and expected yield. Expressed in percentages, yield is the number of successfully trimmed resistors divided by the total loaded



Trimming the S.S. White way means Airbrasive equipment (left). Available nozzle openings are as small as 5 mils, and the shape can be either round or rectangular. Functional trimming is also possible (above), but generally this requires a coating over the active components for protection. System prices start at \$6000.

into the machine. Published cost-per-trim values are normally under 1¢, with lower values associated with higher-priced machines.

In addition to the key specs, the choice of air-abrasive or laser equipment depends, of course, on the advantages and limitations of each process.

Air-abrasive advantages

The air-abrasive, or air-jet, technique—known also as sandblasting to detractors or rock throwing to hard-core opponents—uses an air jet with fine particles of abrasive powder to grind away portions of thick-film resistors. This has these advantages over laser trimming:

- The jet stream is safer for operating personnel than might be expected. Although the particles travel at high velocity, their inertia is low. The particles bounce harmlessly off human skin or other soft, flexible material.

- The accuracy of abrasive jet trimming is not affected by variations in resistor inks, whose glass content is related to the required sheet resistivity. Nor is it affected by film-resistor color, which can require retuning of power and rep rate in laser trimmers.

- Microscopic cracking of the resistive ink and substrate does not occur. When it does (as it can with laser trimming), the cracks can propagate. The electrical effects include an increase in noise and in the drift of the resistance value with time when compared with an untrimmed resistor.

- For medium-sized production runs—about 300 trims per hour—an air-abrasive machine is lower in cost than a laser system—by about a 4:1 ratio. The cost advantage continues for much higher production rates.

Laser advantages

Laser trimming, on the other hand, offers these advantages over the air-abrasive approach:

- Functional trimming—trimming of the resistor with the hybrid circuit activated—is simplified. The remainder of the circuit doesn't need protection against dust that results from the trimming process.

- The trimming of film resistors that are smaller than about 30 mil squares is possible, because the laser beam can be focused to an approximate spot size of a few mils.

- Production rates are higher for film-resistor densities of greater than around 10 per substrate. Further, the trim costs are less for very high production rates.

While there is a range of applications where either system will do, at the extremes one system is generally clearly superior to the other. For continuous production of the same hybrid, some

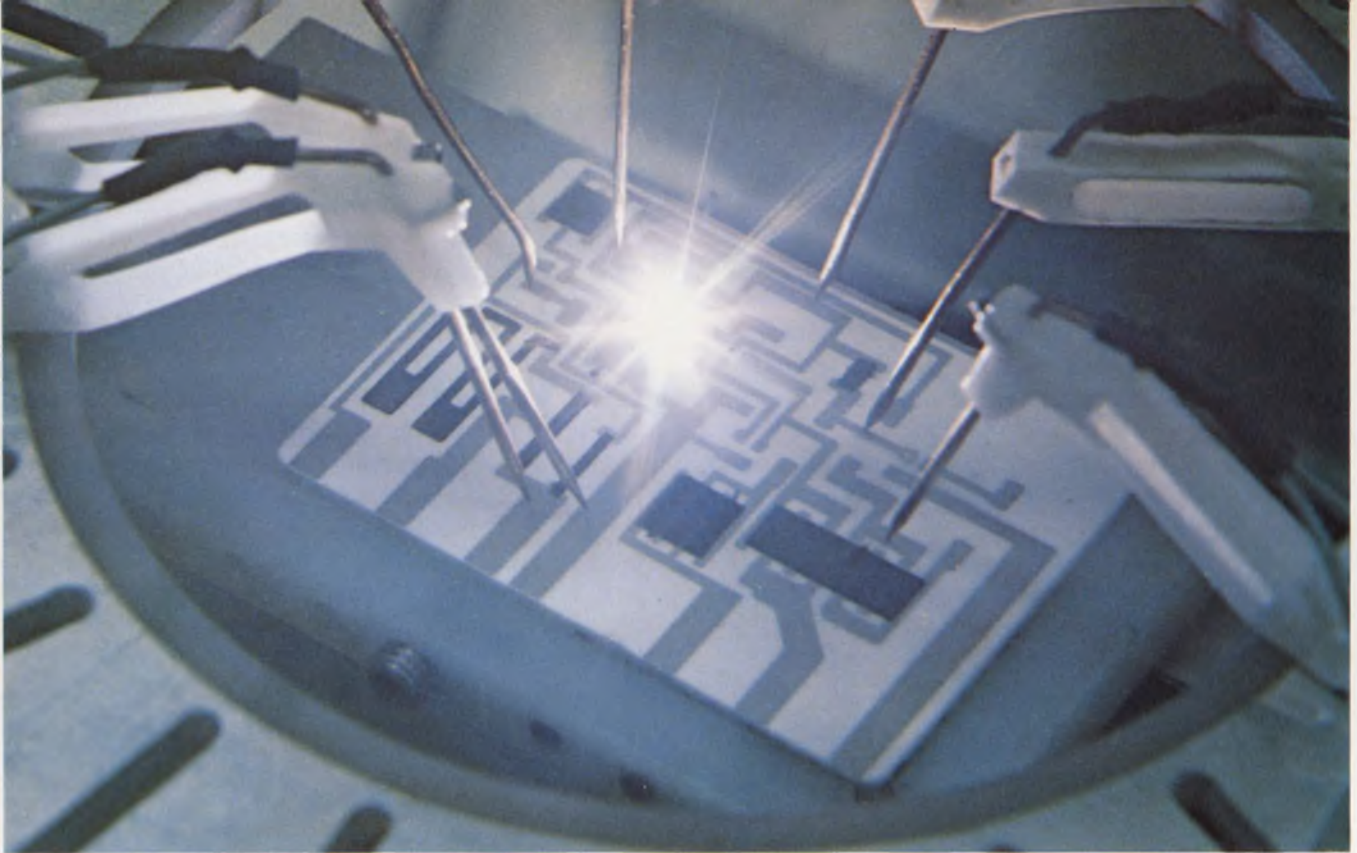

ESI's model 20 uses an acousto-optic Q-switched YAG laser. With it, turn-off times are reduced to a pulse

width. The model 20 can probe 24 unconnected resistors on a substrate—47 if they are connected.

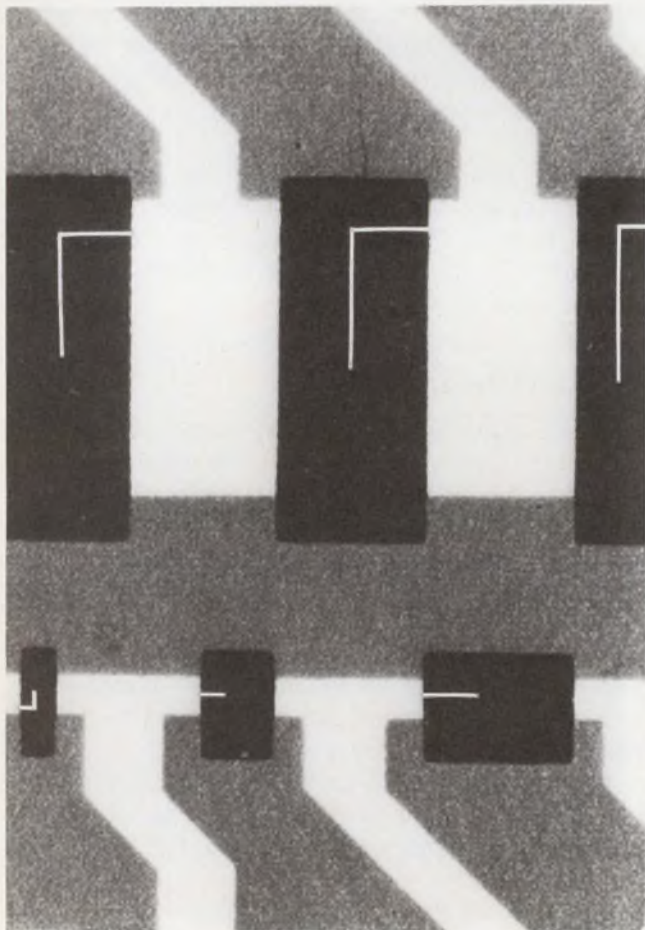

L cuts and straight-in cuts are no problem for ESI's 20. The L cut starts at one terminal and ends toward the other, for a maximum power-dissipation area.

manufacturers use the following rules of thumb: Use air-abrasive systems when the production rates are less than 30,000 trims per week, the resistor areas are larger than 30 mil squares and the required tolerance is above 3%. Otherwise use a laser system.

In some cases the decision is justified; in others it may not be. For a closer look at the case for each, let's see in detail how each system works and what's available.

In air-abrasive systems, the particles most often used to grind away portions of a thick-film resistor are 27- μ alumina grits. Air-abrasive machines have a dust collector to remove the abrasive powder and excess film-resistor material. Probes, in contact with the resistor during trimming, are connected to a Kelvin bridge for continuous monitoring of the resistance value.

Advanced air-abrasive machines include a secondary chamber that guarantees that the same powder-to-air ratio is always fed into the nozzle. This feature minimizes the problem of overshoot (the jet stream continues after the equipment is turned off). However, overspray—microscopic pitting of areas close to the cut—can be expected.

The major variables in air-abrasive trimming, with values provided by S. S. White of Piscataway, N.J. (which manufactures virtually all the components in contact with the abrasive powder), are these: nozzle-tip distance—should be a maximum of about 0.025 inch; air pressure—should be between 40 and 80 psi; abrasive flow—should

be from 1 to 5 grams per minute; and rate of cut—should be 25 ips for 0.5% tolerances.

Several types of cuts are possible, depending on the nozzle used. A rectangular nozzle can be used to make a wide shallow cut. In general, less noise is produced in making a wide, shallow cut than a thin, deep one. But a round nozzle is easier to set up, and it consumes less powder. High-hat film configurations are recommended for better power dissipation.

For functional trimming, semiplastic material is coated over the hybrid components that require protection from the abrasive powder. But the increased handling can result in damage to the hybrid circuit. And since the coating is left on, it's possible for wires to lift because of temperature cycling.

Available nozzles have openings as small as a few mils. But the smaller the opening, the greater the possibility of clogging, especially in a production-line environment.

The chief maintenance problem with air-abrasive machines, aside from powder refilling, is replacement of the nozzle tip. Typically this is required every one and a half weeks at a cost of \$5 to \$8. The cost of the powder runs about \$1 per hour in continuous operations.

Variety of air-abrasive equipment

What's available in air-abrasive equipment? S. S. White, the dominant supplier, offers the LAT-100 at \$6000. You can spend more—lots more. The larger AT-707 is available for \$88,200.

Far more LAT-100s have been sold than AT-707s. The listed production rate for the LAT-100 is 300 trims per hour at a cost of 0.015¢ per trim. This model can be operated automatically: With the electronics-measurement controls set, the operator loads a substrate, starts the trimming process and then removes a trimmed resistor. One resistor is trimmed per cycle.

The AT-707 has a listed speed of 12,000 trims per hour, and the cost per trim is 0.0017¢. The machine consists of seven trimming stations with an X-Y table for substrate positioning. Seven resistors are trimmed per cycle. The machine is automatic; parts handling involves only loading and unloading.

It's possible to obtain a complete air-abrasive unit for less than \$6000. Comco Supply, Inc., of Burbank, Calif., offers an MT-100A air-abrasive trimmer for \$3290. Listed speeds are 800 trims per hour for 3 to 5% tolerances. The quoted cost per trim is 1/4¢. This model features automatic trim shutoff.

The SART-5 from deHaart, Inc., Burlington, Mass., sells for about \$5700. Operation is semi-

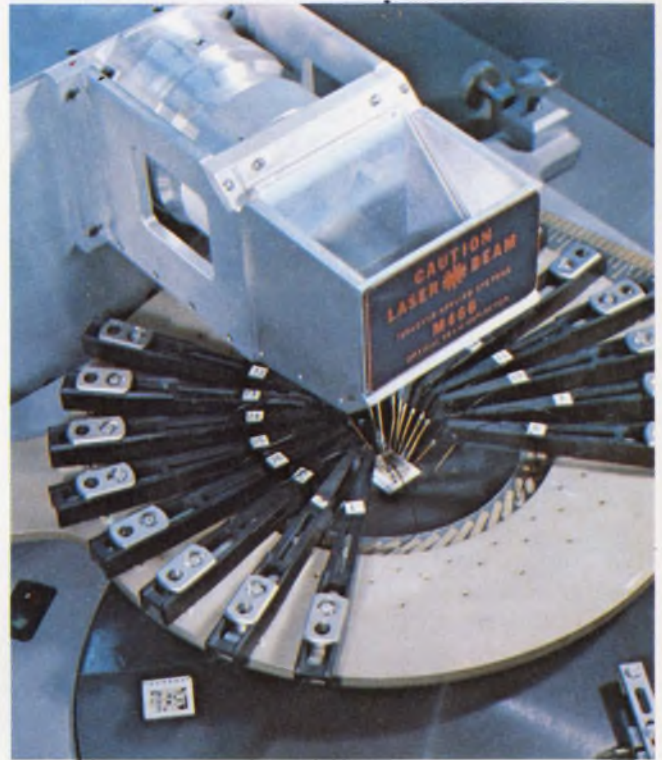

Safety devices, like optical shields and interlocks, provide protection to personnel—as in this Teradyne W301.

automatic. A feature of this model is rapid trimming initially and then slower trimming for the more critical stages. The average cycle time is 3 to 5 seconds per trim.

The Modern Printing Methods Corp. of Cambridge, Mass., sells semiautomatic trimmers in the \$5000-to-\$7000 price range. The company's RT-6SR features a step-and-repeat table, and listed rates for this model are 1500 trims per hour.

The laser side of the story

What about laser trimmers? Two kinds of lasers are used mainly in film-resistor trimming: a gaseous CO₂ or a solid-state YAG.

The wavelength of CO₂ laser light is 10.6 μ; for the YAG, it's 1.06 μ. Because of the wavelengths, film resistors tend to absorb more of the YAG's radiation and reflect more of the CO₂ light. But if the substrate is alumina—as is most often the case—the opposite is true.

Also, it's theoretically possible to focus YAG light to a smaller beam size than CO₂ light—0.5 mil vs 3 to 5 mils. From this point of view, a YAG laser would seem to be preferable to a CO₂ laser.

The operating modes for lasers are continuous wave, pulsed or Q-switched. The cw mode is what the name implies—once on, the laser radiates until it is turned off. Pulsed-mode operation re-

sults in a series of discrete bursts of radiated light, while Q-switching gives a series of spikes. The latter two modes are used most in lasers for trimming, because of the higher power available. For maximum power, the Q-switch mode is the way to go.

When Q-switching YAG and CO₂ lasers, the YAG again has the edge. The solid-state laser uses an acousto-optic Q-switch. The CO₂ laser is mechanically modulated with rotating prisms. The YAG features faster rep rates, faster turn-off times and higher peak power, with lower average power. The last feature allows faster removal of material with less substrate heating.

With a Q-switched YAG, peak power can reach 5 kW over a 200- μ s interval. And turn-off times are on the order of a pulse width, permitting higher accuracies. A common rep rate for laser trimming is about 7500 pps.

The case for CO₂ lasers includes simplicity, few parts, no required cooling and lower cost. Perhaps more important, the older CO₂ laser is respected for its reliability.

Regardless of which laser is used, though, it must be pumped. One of two basic pump types is used: tungsten-halogen lamps or krypton lamps. Pumping with a krypton lamp leads to higher power. In multimode operation, the cw figures possible with a laser are 40 W vs 10 to 15 W for tungsten-halogen lamps. For TEM₀₀ operation, the corresponding values are 3 W vs 1 W.

Computers control cuts

With microsecond times involved in operating lasers, minicomputer control seems natural. For laser systems priced above \$50,000, a minicomputer is included, and usually a Q-switched YAG or CO₂ laser is also part of the price.

The minicomputer controls both the laser beam and the electrical measurements. It controls the X-Y stage motors, commands the laser to begin or stop and programs the traverse speed of the head. This speed is not constant during a trim. At the start of a cut, trimming is usually faster.

In addition to the minicomputer, the larger systems feature either a galvanometer or stepping motors for beam positioning. Substrate feeding is often accomplished with rotary tables, to reduce handling time. A TV monitor aids in the initial setup.

Extras include closed-cycle laser-cooling, step-and-repeat probing and ac-parameter monitoring during the trim process. This last feature permits a resistor to be trimmed while a parameter other than the resistance is monitored. Up to 47 resistors in a connected circuit can be handled with adjustable probe rings.

Listed trim speeds are as high as 20 ips. Measurement modules allow decisions—like how much more to cut and how fast—to be made in 100 μ s. And production rates are specified at 15,000 trims per hour with accuracies of $\pm 0.1\%$.

The types of cuts most used are the following: an L-cut for resistors with length-to-width aspect ratios of greater than 1; a straight-cut when aspect ratios are 1 or less; multiple straight cuts for greater accuracy; and serpentine cuts for large changes in resistor value.

The problems associated with laser trimming often stem from incorrect repetition rates and power levels. If the rate is too low, you get no cut; if it's too high, the cut isn't clean and material bridging can occur, leading to drift in resistance values. If the power level is too high, the resistance value can drift upward because of micro cracks; if it's too low, the resistance value can drift either way—again, because of material bridging.

The problem of drift in resistance values is obviously a serious one. Studies indicate that the



At Motorola Semiconductor, a two-stage complementary symmetry line extender is trimmed on a laser system. The thin-film hybrid includes inductors (square loops).

stability of trimmed resistances does not really come into question until resistances of smaller than about 30 mil squares are trimmed and tolerances of less than 3% are required. Studies also show that whatever drift results from the trimming process probably occurs during the first five minutes.

While the whole story is not yet in, some points can be made about minimizing drift. First, the laser should be tuned to the correct power level and repetition rate for a clean cut. These parameters vary with the inks used. Second, the ink composition should be uniform and the screening and firing processes under reasonable controls. Finally, drift can be expected in high-value, long and skinny resistors. And abnormal drifts can result from trimming close to the resistor terminals.

Laser systems off the shelf

For the user who decides to buy a laser system, prices start at about \$10,000 for manual devices. Automated systems begin at about \$50,000.

In the higher-priced range four companies dominate the field: Electro Scientific Industries of Portland, Ore.; General Radio/Micronetics, Watertown, Mass.; Spacerays, Burlington, Mass., and Teradyne Applied Systems, Chicago.

Electro Scientific's model 20 can be used to adjust thick or thin-film resistors up to 16 M Ω . Trim accuracies are specified at $\pm 0.1\%$. The listed trim rate is one to four resistors per second, depending on the accuracy required and the chip geometry. The basic model can probe and scan multiple resistor circuits, trim resistors within a network and be expanded to permit functional trimming.

General Radio/Micronetics offers a model 80 laser trimming system, starting at \$59,000. The listed trim rate is 15,000 per hour to accuracies of $\pm 0.1\%$. A special feature is a resistance measurement module. In the tracking or trim mode, the response time is 50 μs for 0.01% changes in resistance values. Comparison times—when the resistance value is compared with a programmed value—are about 100 μs . For beam positioning, a 12-ips X-Y table is used.

Spacerays has the YT60C for \$100,000. It uses a pulsed YAG laser to obtain a listed production rate of 2000 to 3000 resistors per hour; the cost per trim is given as 0.02¢. Two programmable probes connect the hybrid circuit to a dc measurement system, and a multi-tray loading scheme permits 20 to 25 substrates to be loaded at one time.

Filling out the picture above \$50,000 is Teradyne's W301. This model can cost over \$100,000



Micronetic's model 80 lists 15,000 trims per hour to 0.1% accuracies. At a base price of \$59,000, the unit uses a Q-switched YAG with rep rates up to 10 pps.

when the test system is expanded to include ac as well as dc testing. The W301 uses a galvanometer beam positioner, permitting the fastest positioning time in the industry—0.03 s. The average time per cut is given as 0.05 s and the measurement time as 50 μs .

Laser trimming systems that cost less than \$50,000 are offered by several companies. Apollo Lasers of Los Angeles has a Lasertrim system for \$15,500 to \$28,000, depending on which laser is used. The listed trimming rate is 1000 resistors per hour and the cost per trim is 1¢.

From Arvin Systems, Dayton, Ohio, a laser system can be purchased for \$30,000 to \$39,000—again, depending on the laser. Designated ART, the model lists a table speed of 25 ips and trim rates of 1000 to 3600 per hour. Operation is tape-controlled.

A manual trimmer from Coherent Radiation, Palo Alto, Calif., employs a Q-switched YAG laser. Designated model 660, the trimmer features a 0.5-mil beam spot size and trim speeds of 1 to 4 ips. Accuracies of $\pm 0.01\%$ are obtainable because of the YAG's fast turn-off times, the company says.

Laser Nucleonics, Waltham, Mass., offers a laser trimming system for about \$8000. This price includes a cw or pulsed YAG, complete with cooling system and optics for manual operation. Dc measurements are performed with a Wheatstone bridge.

Raytheon, also in Waltham, has the model SS-328 for \$40,000 to \$45,000, depending on probe requirements. A Q-switched YAG laser is used. Up to 35 probes on a PC card can be used for trimming at a rate of 1.25 ips.

From TRW, El Segundo, Calif., comes the

emi/rfi filters...

**STOCK
TO
TWO
WEEKS**

...from USCC/Centralab

If you have an EMI/RFI problem—contact us first. That's because we've amassed an extensive distributor inventory on popular size EMI/RFI filters ready for immediate delivery. In addition, we've stocked our production shelves with all the components necessary to deliver other sizes in not more than two weeks. And if you have a custom requirement we have a staff of applications engineers whose business is solving your specific problem... and fast.

Before you buy, contact a reliable source for highest quality EMI/RFI filters—USCC/Centralab, 2151 N. Lincoln St., Burbank, California 91504 • (213) 843-4222.



Send for your free copy of our EMI/RFI Catalog containing complete technical data on: Miniature Ceramic 1000/2000 Series, Subminiature Ceramic 3000 Series, 8000 Series for Data Processing Equipment, and 9000 Series Ceramic Feed-thru Filter/Capacitors.

USCC

U. S. CAPACITOR
CORPORATION



CENTRALAB
Electronics Division • GLOBE-UNION INC.

model 110B, a \$14,500 laser system with a pulsed Xenon laser. Intended for prototype and low-volume production, the system features a laser peak power of 300 W and a beam spot size as small as 1/4 mil.

Union Carbide-Korad, Santa Monica, Calif., offers the model KRT for \$20,000 to \$50,000, covering manual to automatic operation. A Q-switched YAG laser is used. The listed cost per trim is 0.01¢, and production rates can reach 15,000 trims per hour. ■■

Need more information?

The products cited in this report don't represent the manufacturers' full lines. Readers may consult with the following for additional details by circling the appropriate information retrieval number:

Air-abrasive trimming systems

Comco Supply, Inc., 1222 W. Olive Ave., Burbank, Calif. 91506. (213) 849-5806. (H. W. Weightman, President.) **CIRCLE 401**

deHaart, Inc., 12 Wilmington Rd., Burlington, Mass. 01803. (617) 272-0794. (Dennis Hurder) **CIRCLE 402**

Modern Printing Methods, Corp., 9 Harvey St., Cambridge, Mass. 02140. (617) 876-7111. (Gunter Erdman, President) **CIRCLE 403**

S.S. White Div., Penwalt Corp., 151 Old New Brunswick Rd., Piscataway, N.J. 08854. (201) 752-8300. (Hal Skurnick, Sales Manager—Electronics Dept.) **CIRCLE 404**

Laser trimming systems

Apollo Lasers, Inc., 6365 Arizona Circle, Los Angeles, Calif. 90045. (213) 776-3343. (Bob M. Weiner, Marketing Manager) **CIRCLE 405**

Arvin Systems, Inc., 1771 Springfield St., Dayton, Ohio 45403. (513) 254-6177. (Al Schmidt) **CIRCLE 406**

Coherent Radiation, 932 E. Meadow Dr., Palo Alto, Calif. 94303. (415) 328-1840. (Murray Horton, Industrial Laser Marketing Manager) **CIRCLE 407**

Electro Scientific Industries, Inc., 13900 N.W. Science Park Dr., Portland, Ore. 97229. (503) 646-4141. (Edward J. Swenson, Manager, Technical Services) **CIRCLE 408**

Laser Nucleonics, Inc., 123 Moody St., Waltham, Mass. 02154. (617) 891-7880. (Harry E. Franks, President) **CIRCLE 409**

Micronetics, associate of General Radio, 60 Arsenal St., Watertown, Mass. 02172. (617) 926-2570. (Garret B. Stone, President) **CIRCLE 410**

Raytheon Co., Microwave and Power Tube Div., 130 Second Ave., Waltham, Mass. 02154. (617) 899-8080. (E.T. Maloney, Marketing) **CIRCLE 411**

Spacerays, Inc., Northwest Industrial Park, Burlington, Mass. 01803. (617) 272-6220. (Cal Callihan, Vice President—Marketing) **CIRCLE 412**

TRW Instruments, 139 Illinois St., El Segundo, Calif. 90245. (213) 535-0854. (Bob Wallstrom, Marketing Manager) **CIRCLE 413**

Teradyne Applied Systems, 4034 N. Nashville Ave., Chicago, Ill. 60634. (312) 725-2011. (Warren B. Cozzens) **CIRCLE 414**

Union Carbide, Korad Dept., 2520 Colorado Ave., Santa Monica, Calif. 90406. (213) 829-3377. (Rodney L. Waters, Applications Manager) **CIRCLE 415**



Coil Cords

for products that move

There's more to coil cord design than snapping back in place. Lots more. Like human, electronic, and environmental requirements. Color matching. Reliability. And cost.

Belden has the experience. Hundreds of retractile cord designs that are solving problems in communications, power and control applications. Coil cords in a wide variety of strain and stress relief configurations, special connectors, custom wire assemblies . . .

We've got a new booklet covering coil cord design parameters. It will help you determine important trade-offs between shielding, tensile strength, environmental protection, elasticity, and cost. We'll show you how Beldfoil® can eliminate noise problems that can originate in the shield itself. The advantages of thermoplastic and thermosetting jacket materials. And how to get the right elasticity for your equipment application. Just contact Electronic Sales Service Dept., Belden Corporation, Richmond, Indiana 47374. Phone (317) 966-6681.

Electronic Sales Service Dept.
Belden Corporation
Richmond, Indiana 47374
Phone (317) 966-6681



- I have an immediate coil cord design problem; please contact me.
- Please send me the new Retractable Cord Design Guide.

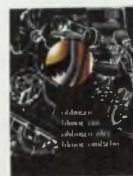

Name _____
Company _____
Title _____
Address _____
City _____ State _____ Zip _____
Application _____

Build reliable optoelectronic circuits

by knowing how to use data on photosensors and light sources, both incandescent and solid-state.

One way to build a light-sensing system is to fish a few components out of a junk box, throw them together and "fire up" the system. The minute it "works," the "design" is frozen and the prototype is ready.

While minimizing engineering, this approach is sure to maximize potential problems. You can expect field failures and the general tendency of the system to fail whenever the environment deviates from the laboratory conditions that existed during the design phase.

A reliable light-sensing system can be built without much more effort than the haphazard junk-box method. But it calls for step-by-step design. Let's examine the designs for two such systems, one for sensing incandescent light and the other for sensing light from a LED.

Sense incandescent light reliably

The trouble with most designs is that data sheets for phototransistors and photodiodes usually give photocurrent or sensitivity at some irradiance level from a source operating at a particular color temperature. This information is extremely meaningful if a designer uses a tungsten source at the specified color temperature and irradiance level. However, what if the source conditions are different? Or, for that matter, how does one determine source conditions?

With an optical pyrometer and a thermopile at hand, the designer can quickly determine the source conditions. But these instruments are generally not available in most laboratories. Thus most designers are faced with these problems:

- What are the source conditions?
- What are the effects of a nonstandard source on the light sensor?

It turns out that answers to both of these questions can be obtained with sufficient accuracy.

Suppose a type 47 lamp is to be used as a light source with an MRD450 silicon phototransistor as a product counter on an assembly line. The lamp is to be operated at rated voltage, 6.3 V at 0.15 A, so its optical output is 0.52 mean

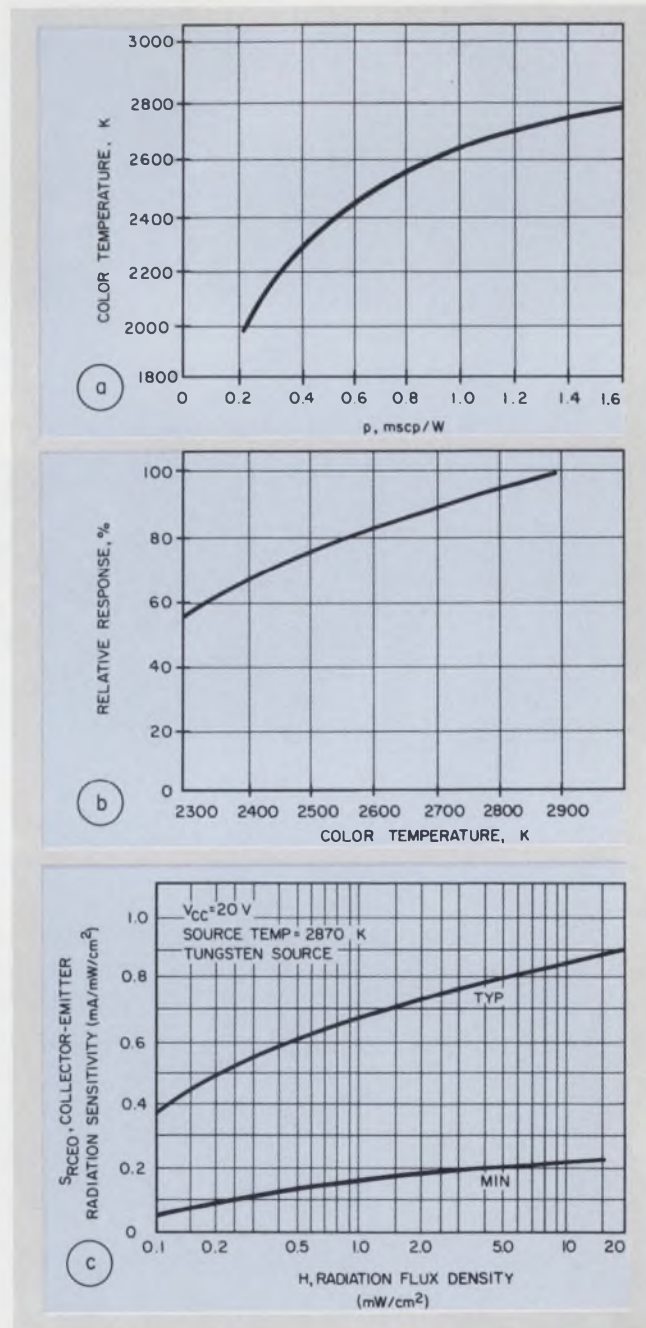

1. To predict light-sensing system performance, an incandescent source description is obtained from curve "a". Once this is done, the phototransistor relative response is obtained from "b". After calculating the radiation flux intensity, H, on the basis of data from "a" and "b", you can read the actual phototransistor radiation sensitivity from "c".

John Bliss, Applications Engineer, Motorola Semiconductor Products, Inc., Phoenix, Ariz. 85008

spherical candlepower (mscp). This yields the following mean spherical candlepower per watt:

$$p = 0.52 [(6.3) (0.15)] = 0.55 \text{ mscp/W. (1)}$$

From Fig. 1a, a plot of color temperature vs mscp/W for small incandescent sources, we see that the color temperature corresponding to this light output is 2400 K. This is several hundred degrees below the value at which the sensitivity of the MRD450 is specified. From Fig. 1b, a plot of relative response of MRD phototransistors vs color temperature, we note that the sensitivity is 68% of the value at 2870 K.

Next, the irradiance level must be determined. While the efficiency of incandescent lamps in terms of visible light is quite low—5 to 20%—the efficiency in terms of total radiated energy is high—about 90%. Since an MRD450 detects a large amount of this energy, the total radiated power for the 47 lamp is

$$P_r = (0.9) (6.3) (0.15) = 850 \text{ mW. (2)}$$

If the lamp is assumed to be a uniform point source, the source intensity is

$$I = P_r / 4\pi = 67.7 \text{ mW/steradian. (3)}$$

If we assume that the distance between the lamp and the transistor is 20 cm, the incident irradiance is

$$H = I/d^2 = 67.7 / (20)^2 = 0.17 \text{ mW/cm}^2. (4)$$

The radiation sensitivity of the MRD450 as a function of irradiance (or incident flux density) for a tungsten source at 2870 K is shown in Fig. 1c. Since our source color temperature is 2400 K—and thus the transistor sensitivity, from Fig. 1b, is reduced to 68%—the actual incident irradiance, H' , becomes

$$H' = (0.68)H = (0.68) (0.17) = 0.115 \text{ mW/cm}^2, (5)$$

so that, directly from Fig. 1c, the effective minimum radiation sensitivity is 0.06 mA/mW/cm².

Thus the expected photocurrent is given by

$$I_r = (0.115) (0.06) = 6.9 \mu\text{A. (6)}$$

If the calculated photocurrent is too low for reliable circuit performance, and if the lamp voltage and the source-to-transistor distance are

fixed, a pair of lenses can be added to increase the effective irradiance (Fig. 2). Here lens 1 collects the lamp light output, and lens 2 converts the light beam to parallel rays, since the built-in lens of the MRD450 works best on a beam of light comprised of parallel rays.

The light flux density at lens 2 is a function of the total light collected by lens 1 and the area of lens 2—that is, if H_1 is the irradiance at lens 1 (area = πr_1^2), then

$$P = H_1 \pi r_1^2, (7)$$

and the irradiance at lens 2, H_2 , becomes

$$H_2 = P / \pi r_2^2 = H_1 (r_1 / r_2)^2. (8)$$

If the radius of lens 2 is the same as that of the MRD450 lens, then the net increase in irradiance (neglecting a small lens loss) will be a function of the square of the ratio of the radius of lens 1 and the radius of the MRD450 lens—nominally 0.075 inch.

If $r_1 = 0.5$ inch, then the previously computed irradiance (Eq. 5) increases to

$$H' = (0.115) (0.5 / 0.075)^2 = 5.1 \text{ mW/cm}^2. (9)$$

Empirically losses caused by lens imperfections and misalignment average about 10% per lens. Thus the actual irradiance at the MRD450 is

$$H' = (5.1) (0.81) = 4.45 \text{ mW/cm}^2. (10)$$

From Fig. 1c, the radiation sensitivity, S_{RCFO} , is 0.2 mA/mW/cm², so that the photocurrent is

$$I_c = (0.2) (4.45) = 828 \mu\text{A, (11)}$$

indicating that the gain of the two-lens system is about 120.

For more current, add an amplifier

Since the system is intended for assembly-line operation, a high-noise-immunity logic counter is needed to count the phototransistor pulses (Fig. 3). The input termination of the MC672 that meets the noise requirements must sink up to 1.2 mA, or the output of the phototransistor given in Eq. 11 must be increased by about 50%. While such an increase can be obtained by raising the lamp voltage, the lamp life—inversely proportional to the cube of the lamp voltage—

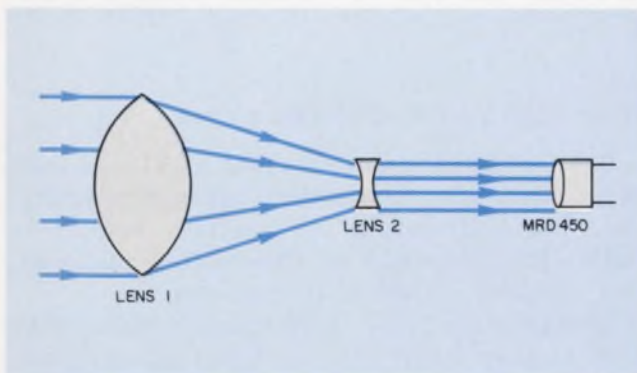

2. Photocurrent can be increased by collecting more light from the source. The radius of lens 2 is equal to the radius of the lens built into the phototransistor.

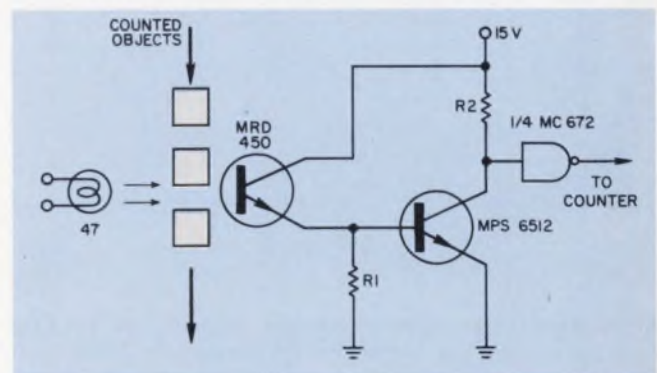

3. To meet the input-current requirements of an IC counter, a common-emitter amplifier is used to amplify the phototransistor current.

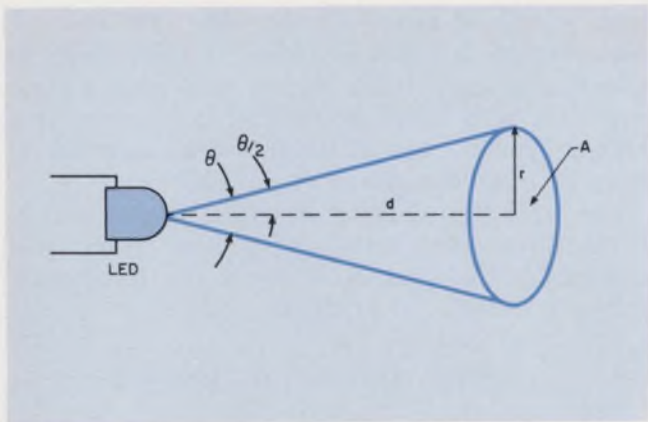

4. Area irradiated by a light-emitting diode (LED) can be computed from this sketch.

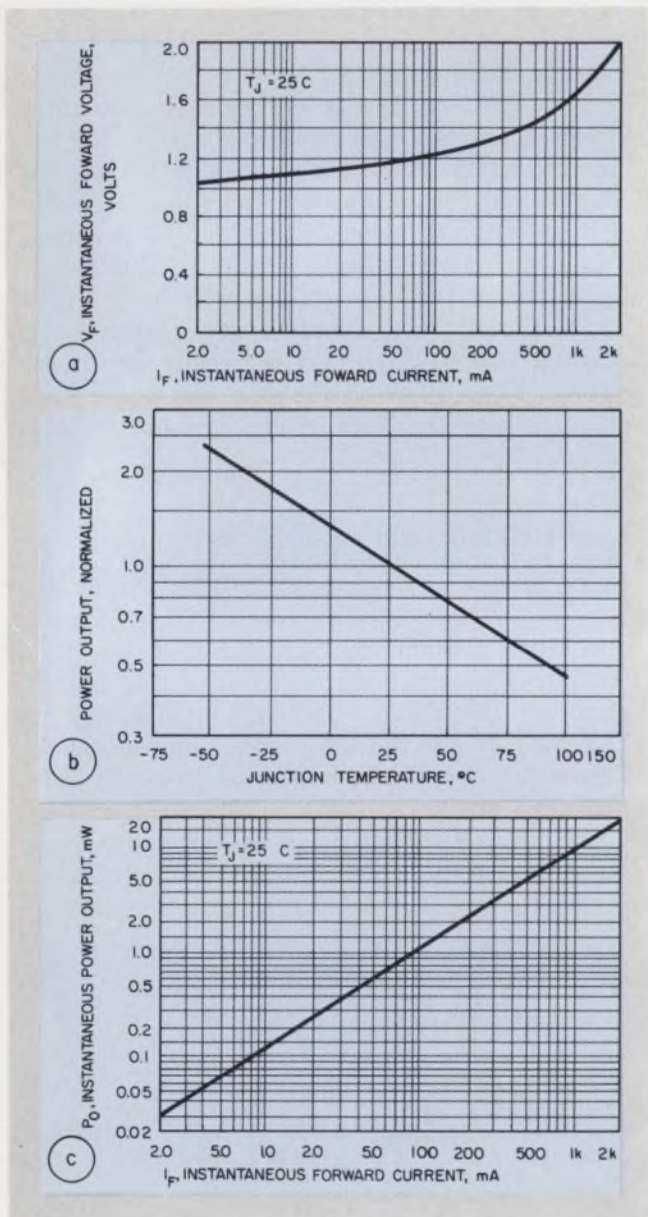

5. In predicting a phototransistor response to a LED, first determine the instantaneous power dissipation of the LED from "a", which is needed for calculating the corresponding junction temperature. With these data, you can determine the LED's power output by using curves "b" and "c" and a few simple calculations.

will be reduced. Thus a gain stage between the phototransistor and the counter should be added (Fig. 3).

With the gain stage in, a noise current, I_n , in the phototransistor due to background lighting must be inhibited from introducing wrong counts.

To this end, the voltage across R1 at the time an object blocks the light to the MRD450 is

$$V_{R1} = (R1) (I_n + I_{CBO}), \quad (12)$$

where I_{CBO} is the worst-case base leakage current for the MPS6512 ($0.05 \mu\text{A}$ at 25 C).

To keep the amplifier transistor safely OFF, the V_{R1} must be held below 0.2 V , and the value of R1 can be computed from

$$R1 = (0.2) / (I_n + I_{CBO}). \quad (13)$$

This R1 value is for 25 C operation. To provide for higher temperature environment, R1 might be reduced by a factor of 4. The noise current, I_n , required for determining R1 should be measured, since it depends on the system layout.

To determine the circuit ON requirements, consider the conditions when the light path is unblocked and the phototransistor current is 0.828 mA .

The base-emitter of the MPS6512 will clamp the voltage across R1 to about 0.7 V , so that

$$I_{R1} = (0.7) / (R1). \quad (14)$$

The MPS6512 base current will be

$$I_B = 0.828\text{ mA} - I_{R1}. \quad (15)$$

The collector current of the amplifier transistor will be the 1.2 mA required to drive the counter, plus the steady-state current through R2, chosen to be 1 mA . Since the total collector current is 2.2 mA maximum, the minimum h_{FE} of the amplifier transistor must be

$$h_{FE(\text{min})} = (2.2\text{ mA}) / I_B \quad (16)$$

$$= (2.2\text{ mA}) / (0.828\text{ mA} - I_{R1}) \quad (17)$$

$$= (2.2\text{ mA}) / [0.828\text{ mA} - (0.7/R1)]. \quad (18)$$

And since the minimum specified h_{FE} of the MPS6512 is 50, the h_{FE} in Eq. 16 must always be less than 50 for saturated switching of the MPS6512. Also, note that the maximum permissible value of the noise current, I_n , in Eq. 13 can be determined from Eq. 18, which expresses h_{FE} in terms of R1.

Sense light from a solid-state source

If a GaAs light-emitting diode (LED) is used as a source, color temperature becomes meaningless: The LED output is essentially monochromatic. Thus determining the induced photocurrent becomes a problem in geometry.

Assuming the LED to be a point source with a divergence angle θ , we find that the area irradiated by the LED at a distance d will be as in Fig. 4, and the divergence half angle is

$$\tan(\theta/2) = r/d, \quad (19)$$

so that

$$r = d \tan (\theta / 2), \quad (20)$$

or, since for small angles the tangent is approximately equal to the

$$r \cong d (\theta / 2). \quad (21)$$

The irradiated area thus becomes

$$A = \pi r^2 = \pi d^2 \theta^2 / 4. \quad (22)$$

If the total output power, P_T , of the LED is assumed to irradiate the area A , the surface irradiance is

$$H = P_T / A = 4P_T / \pi d^2 \theta^2. \quad (23)$$

Using Eq. 23 as an expression for irradiance, we can develop a procedure for determining photocurrent. Suppose a GaAs LED is used as the transmitter in an optically coupled switch, while an MRD450 is used as the receiver. The LED is driven by 500-mA, 5- μ s pulses, and it is one centimeter away from the detector.

To determine the incident irradiance at the phototransistor, the LED power output must be determined first. Since it is a function of the average LED junction temperature, the junction temperature must also be computed.

Referring to Fig. 5a, we see that the forward voltage V_F , across the LED at the current of 500 mA is about 1.45 V. If the worst-case duty cycle, D , is 10% and the ambient temperature, T_A , 25 C, the average junction temperature is

$$T_{J(av)} = T_A + \theta_{JA} V_F I_F D, \quad (24)$$

where the junction-to-ambient thermal resistance, θ_{JA} , is given in the data sheet as 500 C/W maximum. Thus the average junction temperature is

$$\begin{aligned} &= 25 + (500)(1.45)(0.5)(0.1) \\ &= 61.3 \text{ C.} \end{aligned} \quad (25)$$

As in Fig. 5b, the LED's output power is down at this junction temperature to about 65% of its value at 25 C, or 4.8 mW (Fig. 5c). Thus the actual power output is

$$P_T = (4.8)(0.65) = 3.12 \text{ mW.} \quad (26)$$

Since the values in Fig. 5c are typical, the minimum value (about 30% of typical) is a more realistic figure, so that

$$P_T = (3.12)(0.3) = 0.94 \text{ mW.} \quad (27)$$

From Fig. 6, the divergence angle for the MLED900 is about 30°, or 0.523 rad. Thus the incident irradiance at the phototransistor is, from Eq. 23,

$$\begin{aligned} H &= (4)(0.94) / [(\pi)(0.523)^2(1 \text{ cm})^2] \\ &= 4.4 \text{ mW/cm}^2. \end{aligned} \quad (28)$$

To determine the phototransistor response to the LED, consider Fig. 1c once more. Here the specified sensitivity of the transistor is given for a tungsten source at 2870 C. The radiation of this source is about 25% effective on the transistor, while the LED's 9000-Å output is 90% effective. Thus the transistor sensitivity to the LED, S'_{RCEO} , is

$$S'_{RCEO} = S_{RCEO}(0.9) / (0.25) = 3.6S_{RCEO}. \quad (29)$$

The minimum sensitivity of the MRD450 at the available irradiance (from a tungsten

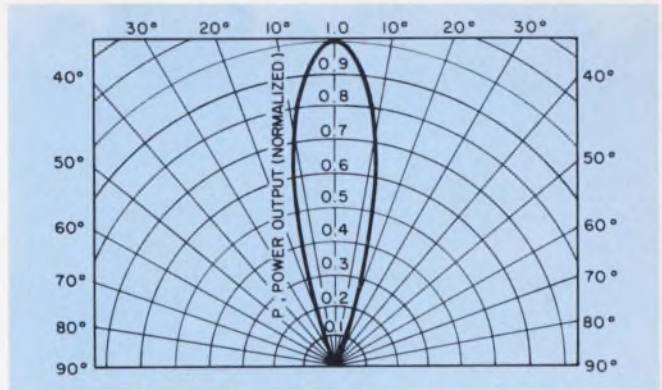

6. Divergence angle of a LED output is read directly from its radiation pattern, which is usually a part of manufacturers' data.

source) is about 0.2 mA/mW/cm². Thus the sensitivity to the LED is

$$\begin{aligned} S'_{RCEO} &= (3.6)(0.2) \\ &= 0.72 \text{ ma/mW/cm}^2, \end{aligned} \quad (30)$$

inducing the photocurrent of

$$I_C = (0.72)(4.4) = 3.17 \text{ mA.} \quad (31)$$

There are two sources of error in the calculation. One is due to the small-angle approximation (Eq. 21) that introduces an error of about 10%. The other is due to the small separation distance between the LED and the transistor (1 cm), resulting in the nonparallel rays at the transistor surface. Thus the photocurrent value calculated in Eq. 31 should be reduced by about 30%, or

$$I_C = 2.23 \text{ mA (minimum).} \quad (32)$$

Compensate for temperature changes

Phototransistor temperature problems, while similar to those of other semiconductors, are further aggravated by their typically low output currents. For example, consider the application of the accepted approximation of leakage current doubling for every 10 C rise in temperature to the MRD450.

At 25 C, maximum I_{CEO} is 100 nA. At 85 C, this becomes about 6.5 μ A. If the induced photocurrent is close to this value (as in the first example, Eq. 6), then the system might not be able to distinguish between the signal and no-signal conditions. Furthermore h_{FE} of the phototransistor also increases with temperature.

If the phototransistor is a three-lead device—that is it has an electrical connection to its base—the classical bias-stabilization circuit for a common-emitter transistor amplifier can be used, (Fig. 7a). Its performance characteristics are somewhat different in the case of a phototransistor.

The collector current is given by

$$\begin{aligned} I_C &= \{h_{FE}(E_i - E_0) / [R1 + (1 + h_{FE})R_c]\} \\ &+ \{I_{CEO}(R1 + R_c) / [R1 + (1 + h_{FE})R_c]\}, \end{aligned} \quad (33)$$

where $E_0 = V_{BE} = 0.7 \text{ V}$.

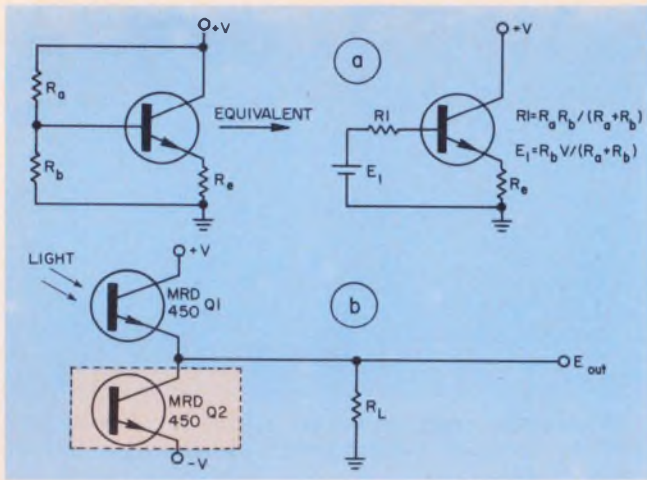

7. Temperature-compensation methods for a three-lead phototransistor are quite similar to a classical bias-stabilization approach (a). In the case of a two lead device, a matched pair of phototransistors can be used, one to receive the normal light input, while the other is masked (b).

Since $I_{CFO} = (1 + h_{FE}) I_{CO}$, Eq. 33 becomes

$$I_C = \left\{ h_{FE} (E_1 - 0.7) / [R_1 + (1 + h_{FE}) R_e] \right\} + \left\{ I_{CO} (R_1 + R_e) (1 + h_{FE}) / [R_1 + (1 + h_{FE}) R_e] \right\} \quad (34)$$

The two stability factors, S_1 and S_2 , are

$$S_1 = dI_C / dI_{CO}, S_2 = dI_C / dh_{FE} \quad (35)$$

Since the phototransistor cannot distinguish between I_{CO} and the collector-base photocurrent, S_1 should be maximized, but the h_{FE} variation should be reduced by minimizing S_2 . Thus the ratio S_1/S_2 should be maximized, or, omitting the arithmetic,

$$S_1/S_2 = (1 + h_{FE}) [R_1 + (1 + h_{FE}) R_e] / [(E_1 - 0.7) + I_{CO} R_1] \quad (36)$$

The examination of Eq. 36 suggests maximizing R_1 and R_e to maximize the ratio. Indeed, the effect of increasing R_1 will be more pronounced in the numerator, as desired. Furthermore larger R_1 results in better sensitivity. Maximizing R_e helps increase the output voltage.

In the case of a phototransistor without an electrical connection to the base (such as the MRD450), the circuit in Fig. 7b can be used to compensate for temperature variations. Here two matched phototransistors are used, one to do the normal light sensing, while the other is kept in the dark all the time. Under zero-signal conditions both transistors pass I_{CFO} and no current flows through the load resistor, R_L , so that the output remains at zero. When a light signal is applied, photocurrent flows through Q1 and R_L , thus developing the desired output. The two matched transistors can also be operated as a differential pair, and the thermal effects will be nulled as will all other common-mode signals.

Because of the large collector-base capacitance (which, in turn, is due to the large active area of the base), phototransistors generally have a

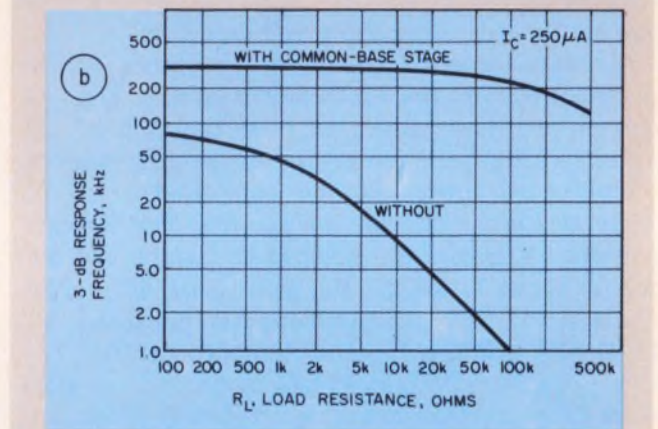
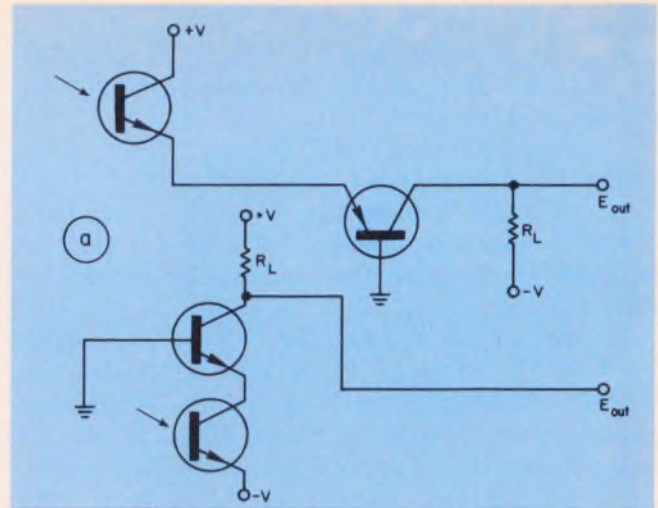

8. Improved frequency response of a phototransistor is obtained with a common-base load-impedance transforming network (a) in either the collector or emitter circuit. The degree of the improvement is shown in "b".

limited frequency response. Furthermore the response depends on the load resistance. If the load is in the emitter circuit, the R_L is reflected into the base circuit as $(1 + h_{FE}) R_L$. The time constant for this case is

$$\tau = (1 + h_{FE}) R_L C_{CB} \quad (37)$$

where C_{CB} is the collector-base capacitance.

As the load resistance is increased to raise the output voltage, the time constant also increases, and the frequency response falls off rapidly (Fig. 8).

If the load resistor is in the collector circuit, an equivalent voltage gain, A_V , becomes proportional to R_L . The Miller capacitance at the input is thus

$$C_{in} = C_{CB} A_V,$$

so that here again raising R_L results in decreased frequency response.

High-load resistance and an improved frequency response can be obtained with a simple impedance-transforming network (Fig. 8). Note that the frequency response for one of such networks in Fig. 8 remains flat for R_L to 50 kΩ ■■

Lean and mean!



Modular instrumentation amplifiers with rack-mount performance.

Burr-Brown offers over twenty modular instrumentation amplifiers, including programmable gain types, that provide a low-cost approach to systems instrumentation. Performance is equivalent to that of rack-mount units — we've simply removed the frills and packed them into compact, rugged, low-cost, modular packages. Of course, if you have to have rack-mounts, remember, we supply those too.

These versatile amplifiers all feature a wide range of gain, set by a single external resistor. Because of their small size, ruggedness, and low-cost, they lend themselves to a variety of instrumentation applications including amplification of signals from transducers — such as strain gage bridges, load cells, thermistor networks, thermocouples, and biological probes. Other applications include: recorder pre-amplifiers, multiplexer buffers, servo error amplifiers, current sensing, and the measurement of any small differential signal riding on common mode voltages.

A SAMPLE OF THE VARIETY OF PERFORMANCE FEATURES AVAILABLE	
FET INPUT - LOW DRIFT HIGH INPUT IMPEDANCE LOW COST	MODEL 3621 Input drifts as low as $5\mu\text{V}/^\circ\text{C}$, max. Input impedance to 10^{11} ohms. $2\mu\text{V}$ input noise, peak to peak. Single unit price from \$39.00
LOW NOISE - LOW DRIFT	MODEL 3620 Input noise only $1\mu\text{V}$, peak to peak. Gain nonlinearity, .01%. Both $1\mu\text{V}/^\circ\text{C}$ and $3\mu\text{V}/^\circ\text{C}$ max input drifts available. Single unit price from \$85.00
HIGH SPEED WIDE BANDWIDTH	MODEL 3622 $150\text{V}/\mu\text{sec}$ slew rate. Settles to $\pm 0.1\%$ of final value in less than $1\mu\text{sec}$. 3MHz bandwidth at gain of 100. Single unit price from \$79.00
DIGITALLY PROGRAMMABLE GAIN	MODEL 3600 Digitally programmable gain, 46 steps, 0 to 3840. Differential input. $\pm 1\mu\text{V}/^\circ\text{C}$ input voltage drift. Gain nonlinearity .01%. Single unit price: \$245.

PRICES FOB, TUCSON, ARIZONA, USA

For complete technical information and applications suggestions, use this publication's reader service card or contact your Burr-Brown Representative.

NEW BURR-BROWN BOOK

"Operational Amplifiers — Design and Applications", over 470 pages, 300 illustrations. Written by Burr-Brown application-engineering staff, published by McGraw-Hill. U.S. price, 15.00 dollars. Order from Burr-Brown.



BURR-BROWN
RESEARCH CORPORATION
International Airport Industrial Park • Tucson, Arizona 85706
TEL: 602-294-1431 • TWX: 910-952-1111 • CABLE: BBRCORP

Hybrid circuits are great for high-power designs. They simplify packaging, reduce equipment size and often decrease manufacturing costs.

While hybrid circuits offer a number of advantages in many low-level applications, they become particularly attractive when the outputs are between 25 and a few hundred watts. Here they can greatly simplify packaging, reduce size and weight, and improve performance and reliability.

And when produced in large numbers, hybrids will often cost less than circuits built with discrete components or a combination of discretely and ICs.

What hybrids can do for power circuits

Power circuits such as voltage regulators, servo drives and power amplifiers typically exhibit very poor form factor. The standard approach has been to place all low-level circuitry on a printed circuit board and to interface it in some manner with high-power components on a heat sink. The result is two separate, mechanically incompatible assemblies.

The incompatibility helps create a number of significant performance and reliability problems. For instance, excessive length in low-power leads reduces sensitivity, increases noise pickup and decreases closed-loop stability. Error-producing voltage drops result when long leads carry high currents. And complete tests cannot be performed until high and low-power assemblies are mated, usually in the final system.

The size and weight of the power section can be reduced dramatically with hybrids. Conventional power semiconductors, each in a large and heavy package, are usually bolted to an intermediate heat sink, which then is mounted on a system heat sink.

We can improve form factor by combining all semiconductors, high and low-power, in a single package. This also solves the long-lead problem, both low and high-power. And when it comes to size, a complete 100-W series regulator (Fig. 1)

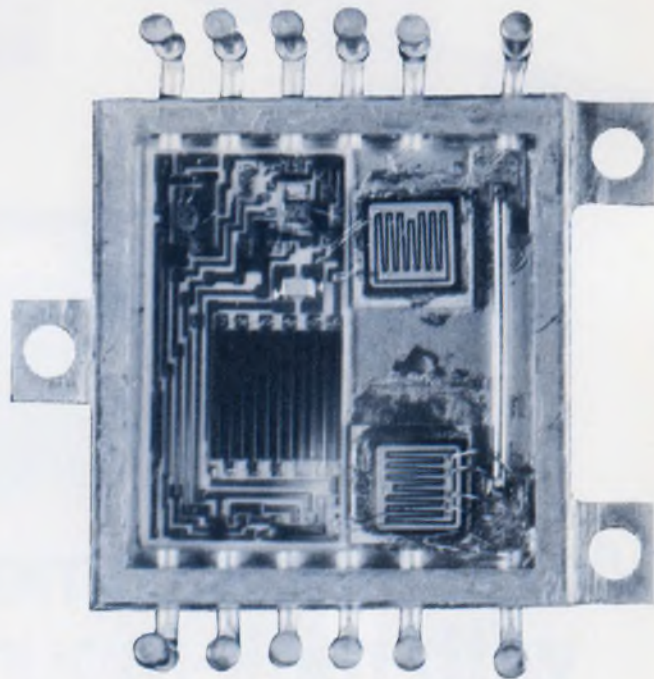

1. A complete 100-W series regulator fits into the "squared off" volume of one of the two TO-63 power-transistor packages required in the equivalent discrete design. (Several external resistors are shown in Fig. 3b.) The large dark area is a 2-W large-area film resistor, required in this positive regulator.

fits into the "squared off" volume of one of the two TO-63 power transistors in the discrete design.

The key to achieving high-power dissipation is a low-impedance thermal path from the junction of the dissipating devices to a heat sink. Junction-to-case thermal impedances must be in the same range as those in discrete power transistors to meet or exceed discrete-circuit performance. Furthermore the components must be electrically isolated from each other.

Since the alumina substrates in hybrid circuits are poor heat conductors, there are ways to solve the heat problem. One is the use of a more thermally conductive material, such as beryllia, for mounting power semiconductors. Another is the use of a heat-spreading copper tab between power semiconductors and the alumina. In this

case the dissipating junction sees the alumina through a larger area, thus reducing the thermal impedance. The effects of these techniques are summarized here for a 0.240 by 0.240 inch, 30-A power transistor:

Alumina substrate	2.4°C/W
0.45" by 0.45" heat spreader	1°C/W
Beryllia substrate	0.6°C/W
Discrete device	1°C/W

Choosing right resistors

Next in importance to power semiconductors are power resistors. In hybrid circuits, any resistor capable of dissipating more than 0.5 W is considered a power resistor. There are several types of power resistors, including large-area film resistors, film conductors, solid wire and external discrete resistors.

Large-area thick and thin-film resistors are used to make resistors that are larger than 1 ohm and rated less than 2 to 3 W. They can be made with 1% tolerances and with 50 ppm/°C temperature coefficients. While the area for a given power dissipation depends on a number of variables, an average for the resistor material itself is around 10^1 mils²/W. In some cases the area requirements, together with conductor terminations, can run as high as 10^5 mils²/W.

Film conductors are used for resistors ranging from a few milliohms to several ohms. They can be obtained with resistivities from 0.001 to 0.3 ohm/square. The accompanying table summarizes resistive and other properties of several widely used film conductors:

Conductor	Resistance (ohms/sq.)	Temp. coeff. (ppm/°C)	Power rating (W/in ²)
Thin-film gold	0.005 - 0.05	1600	500
Thick-film PtAu	0.02 - 0.15	4000	100 - 800
Thick-film PdAg	0.05 - 0.3	700	100 - 800

The main advantage of film conductors over thick and thin-film resistors is their considerably smaller size (for low-value resistors). For instance, a 0.025-ohm resistor will occupy 8000 mils² when made of thin-film resistor material, and only 500 mils² when made of thin-film gold conductor.

Tolerances for film-conductor resistors are more difficult to hold than for standard film resistors. Furthermore normal tolerances (2 to 20%) depend heavily on the manufacturing process. Better tolerances, for instance, can be maintained when laser-trimming is used than when more conventional air-abrasive trimming is used.

Solid wire, such as nichrome, is used to make resistors that carry high currents and have low values (below several hundred milliohms). Referring to Fig. 2, we see that a 0.43-inch, 18-gauge nichrome wire makes a 15-mΩ, 15-A resistor. The BeO substrates serve as resistor-to-package heat conductors, as well as mounting surfaces. The nichrome is welded to metal plates, which, in turn are soldered to beryllia, which is finally soldered to the package. Heavy—5-to-10-mil—"flying" wires, similar to those used in power transistors, connect the resistor to the rest of the circuit. This approach, while some-

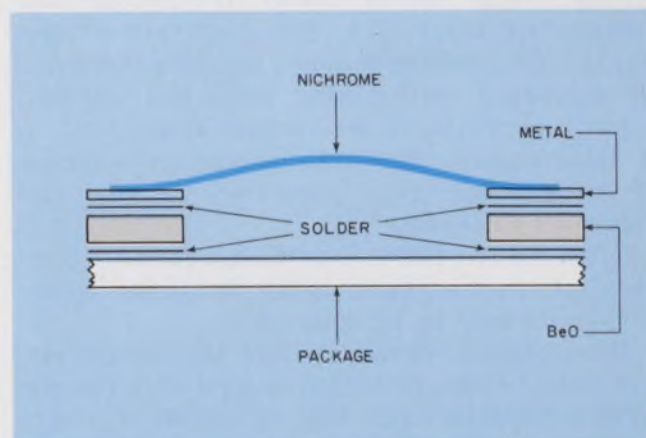

2. High-current, solid-wire resistors, rather than film conductors or film resistors, are used wherever surface area is scarce. Among their obvious disadvantages is manufacturing complexity.

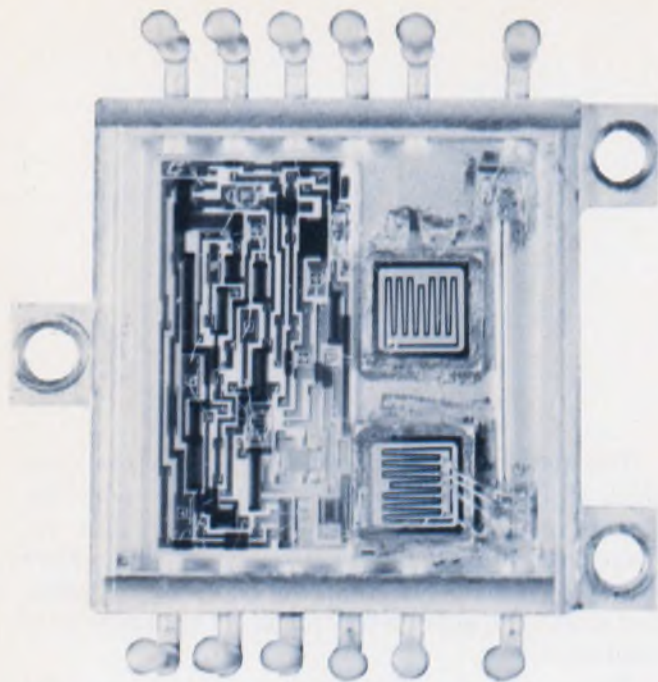

(a)

3. A complete 100-W negative regulator (a) is a good example of the possibilities that hybrids offer in power designs. Components that can't be made economically

what complex, results in resistors that can carry very high current and require the least amount of surface area.

For higher powers—5 W and more—external discrete resistors become increasingly more attractive from a power/volume point of view (Fig. 3b).

Conducting high currents

Standard thick and thin films can't carry currents over a few amperes, but there are several ways to do so. The most common is to use film conductors that are up to 10 times wider than normal. As a rule of thumb, 10-mil-wide conductors will carry 1 A. The resistance of film conductors should be watched carefully, however. As mentioned earlier, most thick and thin-film conductors will have resistivities from 0.001 to 0.1 ohm/square. The lower values are achieved by using a maximum percentage of gold and maximum thickness.

Often it's possible to isolate high currents completely from the film circuitry by wiring power devices directly to external pins.

Where power devices within the hybrid circuit must be interconnected, a solid-wire resistor technique can be used—that is, instead of a wire with the required resistive value, a highly conductive wire (copper, for instance) is used. A 100-mil copper wire will easily carry up to 30 A without appreciable voltage drop (a short length

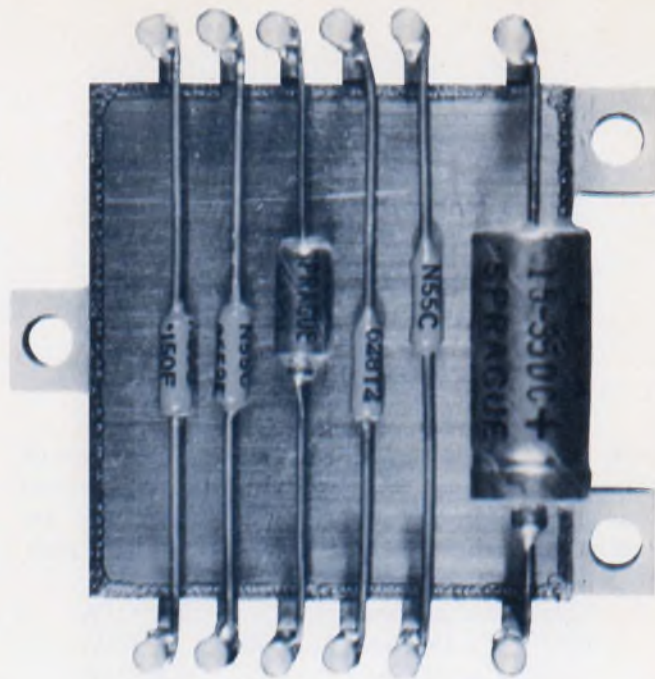

(b)

with hybrid techniques are added externally (b) and attached to the pins, which also serve as connections for the entire hybrid-regulator package.

of wire is assumed). This compares very favorably with the 10 A that could be carried in the same area with film conductors. The solid-wire approach is more costly, however.

Package hybrids with care

External components accompany most hybrid designs. Some are required to permit adjustments, such as setting the desired output voltage of a regulator. Others might be large capacitors that can't be made with hybrid techniques. And, finally, high-power resistors often must be external.

To avoid construction of two packages—one with the hybrid circuitry, the other with all the external components—the hybrid package can include all components. One way to do this is by providing a number of raised pins that bring out those points within the circuit that accept the external components (Fig. 3b).

Several other packaging points can be made (Figs. 1 and 3). The solid wire adjacent to the power transistors in Figs. 1 and 3a is a nichrome one, serving both as a 12-A connection and as a 3.5-W resistor. The power dissipation of each circuit is 100 W at 100 C heat-sink temperatures. Both regulators have 5 to 25-V outputs, 10-A output current, $\pm 1\%$ voltage stability and foldback overload protection. To isolate high currents from the hybrid circuitry, power transistors are wired directly to the pins. ■■



**A good bench DVM
is fast
and accurate...**

**A great bench DVM
is fast, accurate,
and easy to use!**

HP's 3480 is a great bench DVM. Simple, foolproof controls and full, five-decade autoranging reduce operating effort and errors. Fast response time and low noise make millivolt adjustments easy. And high noise rejection makes the last digit fully useable.

Low injected noise will not disturb the circuit under test. And constant $>10^{10}\Omega$ input resistance on the lower three voltage ranges reduces loading errors.

The digital readout display is presented in standard format for easy reading, easy understanding; i.e., +143.17 mV—not backwards, or inside out. Other convenience features include a sampling-rate indicator and a manual trigger for quick one-shot samples.

Options and plug-ins are available to give you combinations of five DC ranges, five true-RMS AC ranges, and six ohms ranges. And you pay for only the capabilities you want. Prices begin at \$1500 for five ranges of fully autoranging DC.

For further information, contact your local HP field engineer, or write to Hewlett-Packard, Palo Alto, California 94304. In Europe: 1217 Meyrin-Geneva, Switzerland.



HEWLETT  PACKARD

DIGITAL VOLTMETERS
090/45

Build high-stability regulators

by combining ICs and discrete components and get reliable performance at low cost

An order of magnitude improvement in regulator performance can now be achieved, thanks to the ready availability of higher complexity ICs at low cost. Thus instead of 0.1% regulation and 1% stability previously attained in a general-purpose power supply using ICs, 0.01% regulation and stability can now be realized. Schematics for two such precision regulators are shown in Figs. 1a and 1b.

Both regulators (one with positive, the other with negative output) use an IC op amp as the control amplifier and a zener diode as the reference. Both can provide better than 0.01% regulation for worst-case changes of line, load and temperature. Typically, the line rejection is 120 dB to 1 kHz and the load regulation is 10 μ V for a 1-A change. The worst errors are due to temperature variations. However, changes in the output voltage can be kept less than 0.01% over a -55 C to +125 C temperature range.

This performance is achieved while retaining the flexibility of a general-purpose power supply. Thus each regulator operates over an input-voltage range of 12 to 35 V for a 10-V output. The output voltage may be set between 7 to 30 V while using the 6.2-V zener diode. (If lower output voltages are needed, a lower voltage reference can be used.) And finally, unlike many precision regulator circuits, no preregulator nor separate power supplies are required.

Here is how they work

Both circuits use a stable zener diode (more on the zener selection later) to provide a voltage reference. The operational amplifier compares a fraction of the output voltage with the reference at terminals 2 and 3. The resulting op-amp output is level-shifted with a FET to operate the series-pass devices. Frequency compensation is provided by a roll-off capacitor at the op amp, and a capacitor across the regulator output. A high degree of line rejection is obtained by

powering both the op amp and the zener from the regulated output.

The use of an IC 5-V regulator as a series pass element in the positive regulator instead of a discrete power transistor has several advantages. Firstly, the IC contains all the biasing and current-limit circuitry necessary to supply a 1-A load, considerably reducing the discrete component count. Secondly, and perhaps even more important, the IC regulator shown in the schematic has built-in thermal overload protection, making the power supply virtually burn-out proof: Whenever the chip temperature reaches 175 C, it turns off, preventing overheating.

Since no suitable IC regulator is available for

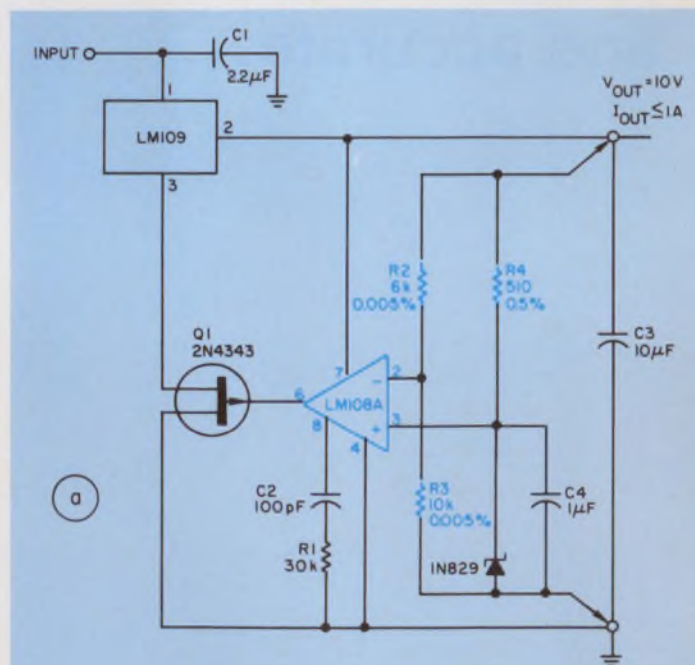

1. Regulation and stability under 0.01 percent are achieved in these precision regulators that combine high-performance ICs with a few discrete components. Circuit simplicity of the positive-output regulator, (a), is largely due to the use of an IC series-pass element, LM109. It takes three transistors and several passive components to perform its function in the negative-

Robert C. Dobkin, Manager of Advanced Circuit Development, National Semiconductor Corp., 2900 Semiconductor Dr., Santa Clara, Calif. 95051

the negative power supply, power transistors are used, Fig. 1b. To provide high current gain and to maintain a minimum input-output differential of under 2 V over a -55 C to $+125\text{ C}$ range, pnp and npn devices are used. Current limiting is provided by Q2 with C2 and R3 acting as a frequency-compensating network.

Select components with care

To meet the 0.01% regulation and stability goals, all components must be selected carefully. Equally important is a good circuit layout to eliminate the possibility of lead drops, magnetic or capacitive pickup, and thermal gradients.

The most important item is the zener diode. The 1N829 has a temperature coefficient of $0.0005\%/^{\circ}\text{C}$, or a maximum drift of 0.05 percent over the -55 C to 125 C temperature range. The drift of the zener is linear with temperature and may be varied by changing its operating current from the nominal value of 7.5 mA. The temperature coefficient changes by about $50\ \mu\text{V}/^{\circ}\text{C}$ for a 15% change in operating current. Therefore, by adjusting the zener current to suit a given operating temperature range, one can minimize the temperature drift.

Next important component is the op amp,

since it affects both regulation and temperature stability. Offset voltage drift and noise of the amplifier are multiplied by the same factor as the reference (1.6 in both circuits) and appear at the output. Offset current of the op amp can cause an additional error in conjunction with the source resistors. For good load regulation, high open-loop gain is needed. And finally, the op amp should lend itself to an easy frequency compensation.

The device used in both circuits meets these requirements. Its voltage drift is only $5\ \mu\text{V}/^{\circ}\text{C}$ and its input currents are so low that they can be neglected as an error term. (The low input-current requirement permits the use of a standard cell as a voltage reference instead of the zener diode. If standard cells are used, however, some means to disconnect them when the supply is off must be provided. They will quickly discharge through the protection diodes internal to the op amp.)

Note that a solid tantalum capacitor is used across the regulator output. Unlike other electrolytic capacitors, solid tantalum capacitors have low internal impedance at high frequencies. This low impedance is needed both for frequency compensation and also to eliminate possible minor-loop oscillations.

The power transistor, Q4, used in the negative regulator should be a single-diffused, wide-base device. This transistor type has fewer oscillation problems than double-diffused transistors. Furthermore, it has been found less prone to fail under overload conditions.

The resistors that provide voltage inputs for the op amp (terminals 2 and 3) must be low-temperature-coefficient wirewound or precision metal-film units. Ordinary 1-percent carbon film, tin oxide or metal film resistors are not acceptable since they might drift as much as 0.5% with temperature. While the resistors need not be 0.005% as shown in Fig. 1, they should be capable of tracking better than $1\ \text{ppm}/^{\circ}\text{C}$. Another point in favor of wirewound resistors is that they usually have lower thermoelectric effects than film types. The resistor determining the zener-diode current is not as critical, but it should change less than 0.2% over the temperature range.

Good construction techniques throughout are most important. It is necessary to use remote sensing at the load as is indicated in the schematics. Even an additional inch of wire may degrade the regulator performance. Shielding around the voltage-sensing resistors, zener diode and the op amp should be used. Printed-circuit board leakages or stray capacitance can easily introduce a $100\text{-}\mu\text{V}$ ripple or a dc error. Short wires and single-output grounding should be used to obtain the expected performance. ■■

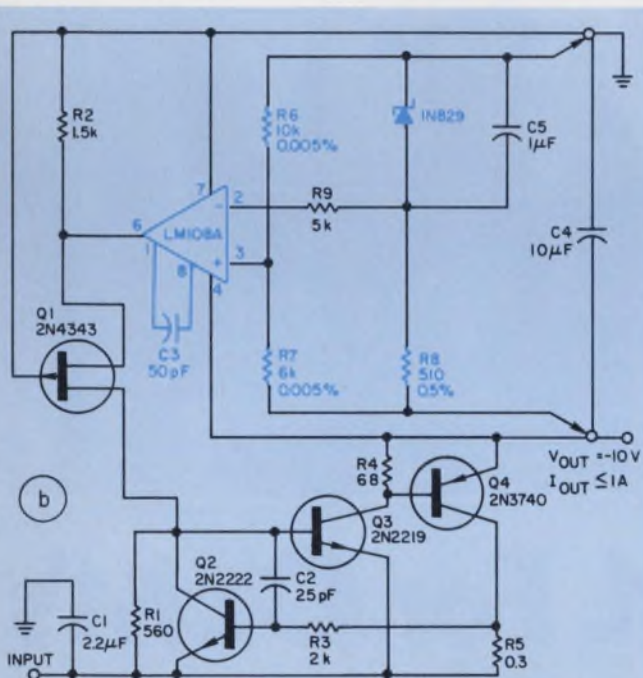

output supply (b). Basic regulation in both circuits is performed by the zener diode serving as a voltage reference and an op amp serving as the control amplifier. All capacitors $1\ \mu\text{F}$ and larger should be solid tantalum. The requirement for remote sensing at the load is indicated by arrow-head connections. See text for guides concerning circuit construction.



PDP-8. PDP-11. For OEM's

A few months ago, we came out with new low cost versions of our PDP-8 and PDP-11 families for the OEM.

With prices as low as \$2436. In quantities of 50.

We made sure they'd have the features, architecture and compatibility that make PDP-11 and PDP-8 the most popular, most imitated minis ever.

We must have hit on the right combination. We've been mixing it up with some of the toughest OEM's around. And coming away with their business.

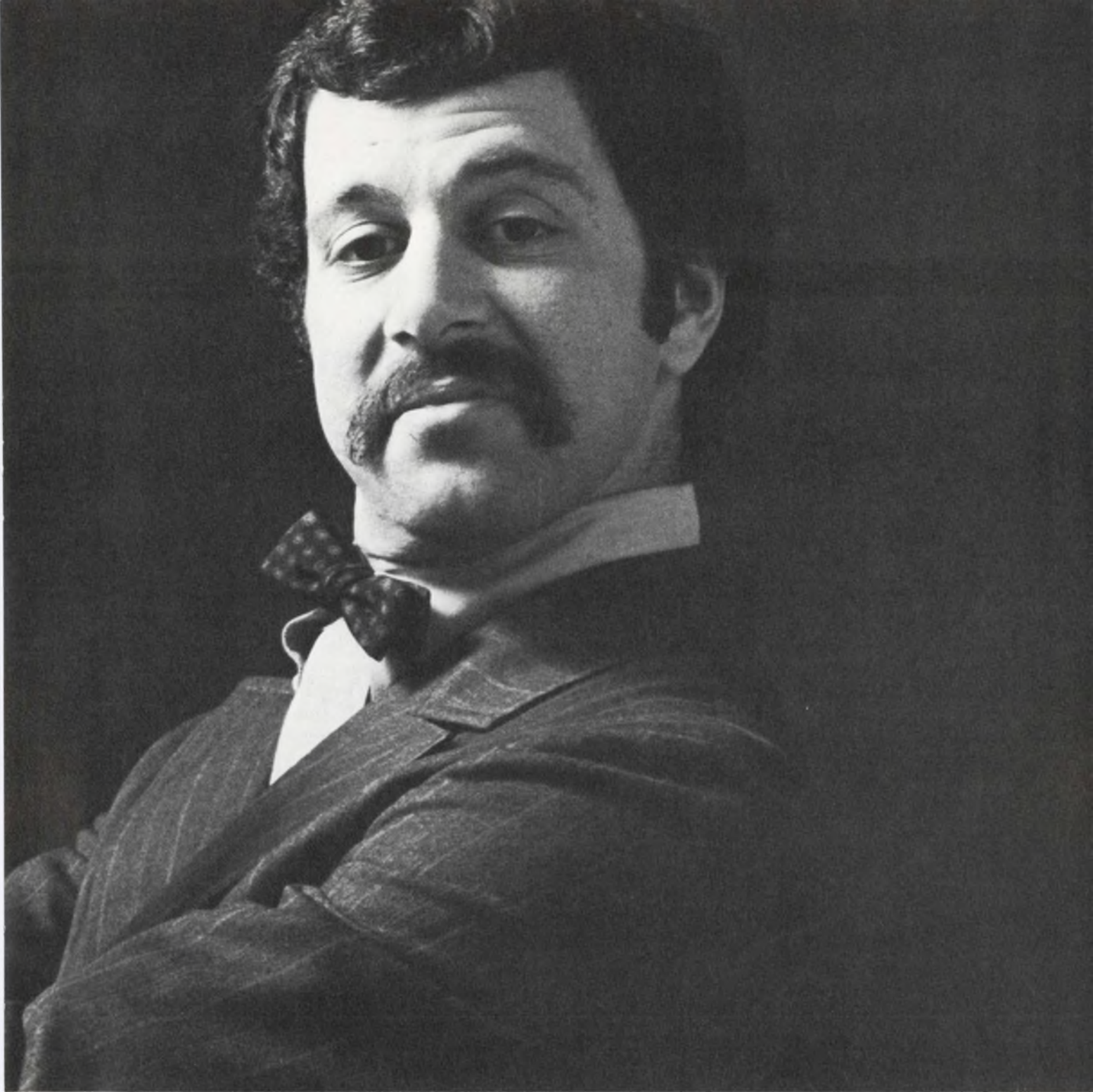

who hate to spend money.

We're after your business, too.
Because now we have the right
computers. At the right prices.
From the right company.
Come and get 'em.

Digital Equipment Corporation,
146 Main Street, Maynard, Mass.
01754. (617) 897-5111.

digital

Digitize analog curves with an integrator

Expensive and complex feedback-sensing techniques can be replaced with a simple electrical integrator to center a recording head on X-Y recorder traces for computer processing.

The feedback system is eliminated because a dc voltage applied to an integrator will cause its output to rise linearly. If the input is disconnected, however, the output will remain for a very long time at whatever voltage it had reached. Therefore if the integrator drives the Y input of an X-Y recorder, the pen or any system attached to it must simply detect the trace and disconnect the integrator. The integrator output will then retain the Y coordinate voltage long enough for it to be digitized, recorded, printed or otherwise processed.

The curve to be digitized is either pencil-drawn or recorded on a sheet of paper with electrically conducting ink or diluted colloidal graphite. The sheet is placed on an X-Y recorder. The trace and the pen are connected through a bat-

tery to a sense amplifier. On closure of the ON switch, a voltage is applied to the Y integrator and the Y voltage rises, causing the pen to move toward the trace. When the pen contacts the trace, the sense amplifier triggers relay A. Contact A-1 opens and the Y voltage remains constant, keeping the pen on the line. At the same time contact A-2 closes and signals the computer interface to read the X-Y coordinates.

After allowing the computer sufficient time to read, relay B is triggered. During this time contact B-1 closes and shorts out the Y integration capacitor. The Y voltage drops to zero, and the pen returns to the base line. Simultaneously a voltage pulse is applied to the X integrator through contact B-2, which causes the pen to move to the next X value. Upon release of relay B, the cycle starts anew.

H. H. Zappe & R. S. Warren, IBM, Thomas J. Watson Research Center, P.O. Box 218, Yorktown Heights, N.Y. 10598

CIRCLE No. 311

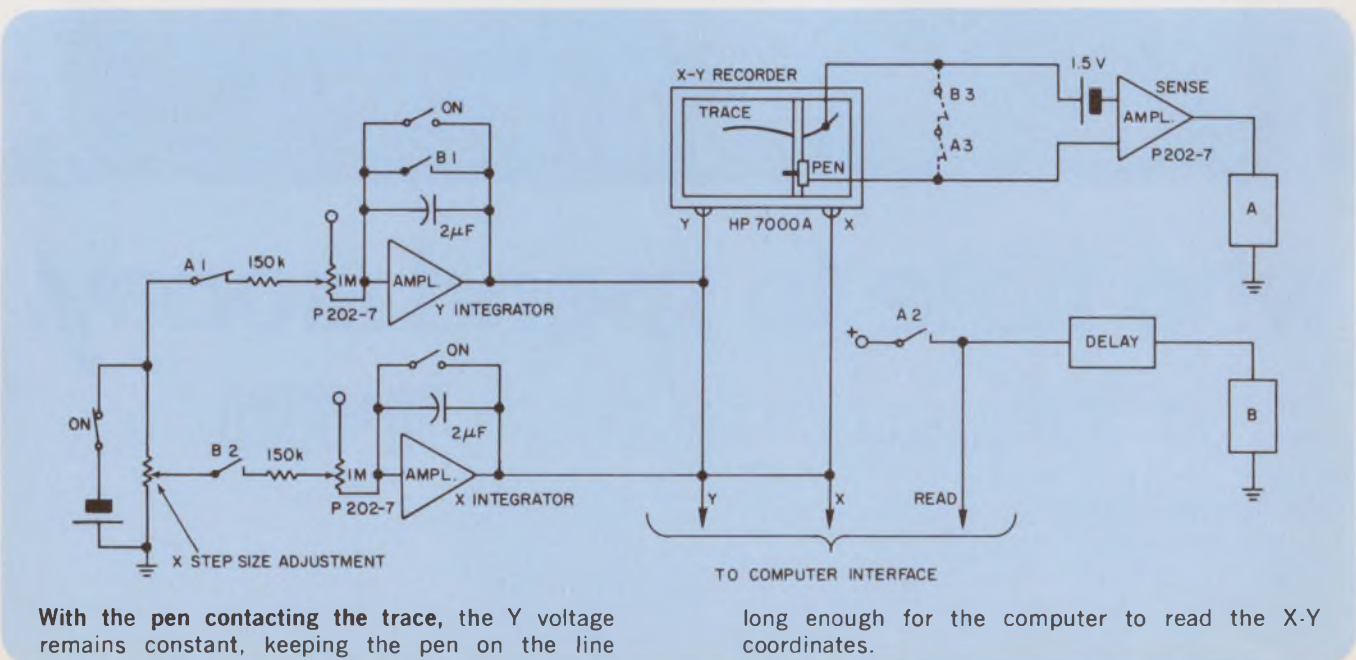

Sharpen your professional skills with these timely new engineering guides



THE SUCCESSFUL ENGINEER-MANAGER

A Practical Guide to Management Skills for Engineers and Scientists

Edited by Robert C. Haavind, Editor-in-Chief, Computer Decisions; and Richard L. Turmail, Management Editor, Electronic Design. Want to be on surer ground in directing your career? Need to sharpen your managerial skills? Use this well organized, realistic guide to tutor yourself in the critical areas of technical management: career, decisions, people, projects, finances, and communications. A carefully chosen selection of Electronic

Design articles, this book offers valuable pointers on financial analysis, person-to-person dealings, eluding the traps to sound decisions, project scheduling, promoting ideas, and much more. Techniques and the insights of top-flight managers to help you better manage yourself, others, a project, and even a company. 176 pp., 7 1/8 x 9 3/4, illus., #5879, cloth, \$8.95



400 IDEAS FOR DESIGN, Volume 2

Selected from Electronic Design

Edited by Frank Egan, Editor, Electronic Design. Borrow, modify, or adapt any of the more than 400 ideas placed at your disposal in this second collection of top, recent contributions to Electronic Design's popular "Ideas for Design" column. Whether highly ingenious or amazingly simple, all offer immediate on-the-job assistance either as parts of larger designs or as aids in measuring the

parameters or testing the effectiveness of other designs. This well-organized book provides rapid access to a wide range of subject areas, extending from amplifiers, through design and laboratory aids, to pulse, digital, and control circuits. Each idea is ready to go, or to touch off creative thinking. 288 pp., 7 1/8 x 9 3/4, illus., #5067, cloth, \$11.95

PROVE THEIR VALUE FOR TWO FULL WEEKS...FREE!

PRACTICAL INSTRUMENTATION TRANSDUCERS

Frank J. Oliver, Formerly Editor, Electro-Technology. The most comprehensive and authoritative source on physical-to-electrical transducers. Virtually every known device for industrial or aerospace application is described and illustrated. This well planned volume will bring you up to date on the state-of-the-art, clear up areas of confusion, offer pertinent data for specific applications. Hundreds of diagrams, charts, and tables are included. 340 pp., 7 1/8 x 9 3/4 illus., #5833, cloth, \$20.00

PRACTICAL DESIGN FOR ELECTROMAGNETIC COMPATIBILITY

Edited by Rocco F. Ficchi. An invaluable on-the-job reference, this book places at your disposal all the basic information needed to analyze, predict, control, and reduce unwanted signals in electronic equipment and systems. A team of EMC specialists fully explains measurement techniques and equipment, details recent advances in filtering, shielding, and bonding, and offers complete treatment of the specific problems encountered in computers, semiconductors, and solid-state devices. 272 pp., 7 1/8 x 9 3/4 illus., #5685, cloth, \$13.95

PRACTICAL RELAY CIRCUITS

Also by Frank J. Oliver. This time-saving guide classifies relays by function, providing you with a rapid overview of the circuits that can solve the problem at hand. Operating principles, reliability factors, standards, and specifications of the provisionally chosen circuits can then be checked from manufacturers' data or other sources such as the Engineers' Relay Handbook. Diagrams illustrating the discussion use the latest American National Standard graphical symbols. 384 pp., 6 x 9, illus., #5802, cloth, \$14.95

DURABILITY AND RELIABILITY IN ENGINEERING DESIGN

Gilbert Kivenson, Consulting Engineer. Practical and provocative, this path-breaking book surveys findings from all disciplines that have present or future engineering relevance. It discusses key concepts, provides a capsule course in reliability theory, and outlines design philosophies and techniques relating design factors to the requirements of the end user. 186 pp., 6 x 9, illus., #5851, cloth, \$9.95

ENGINEERS' RELAY HANDBOOK

National Association of Relay Manufacturers. The Revised Second Edition of this authoritative reference provides a complete roundup of information on relay operating principles, properties, performance characteristics, application requirements, specification, and testing. New sections enlarge the scope of the book, including material on reed and mercury wetted relays, and solid-state devices. 355 pp., 7 3/8 x 10 1/8, illus., #5867, cloth, \$13.95

ELECTRICAL ENGINEERING AND ECONOMICS AND ETHICS FOR PROFESSIONAL ENGINEERING EXAMINATIONS

John S. Lyons, P.E.; and Stanley W. Dublin, New York University. This concise, up-to-date review for the practicing engineer presents a wide range of typical problems from recent state exams, solved step-by-step. Permitting you to strengthen weak points, two separate tables of contents give rapid access to subject areas and sample problems. 320 pp., 6 x 9, illus., #5715, cloth, \$12.95

FOR 15-DAY FREE EXAMINATION

Please send the book(s) circled on a 15-day examination basis. At the end of that time, I will remit payment, plus postage, or return the book(s) without further obligation.

5879	5685	5802	5715
5067	5833	5867	5851

\$10.00 minimum for free exam orders. Because of higher billing and collection costs, we must ask for payment in full with any order under \$10.00. Books will be shipped postpaid. Same 15-day return privilege for full refund if not satisfied.



Hayden Book Company, Inc., 116 West 14th St., New York, N.Y. 10011

NAME _____

FIRM _____

ADDRESS _____

CITY/STATE _____ ZIP _____

Save money! On all pre-paid orders Hayden pays postage—same return privilege!

71-92

One-shot multivibrator uses single IC

A one-shot can be constructed from a single IC, and it will differ from all known monostables with set-reset latches, in that the timing of the output pulse will be fully independent of the width and rise time of the input pulse. The constraint is that the input pulse, S_1 , must be above the threshold level of the gate for longer than $2t_d$, where t_d is the propagation delay of the gates.

A single quad two-input gate can use TTL, DTL or other logic inputs. External capacitor C extends the time constant, t_r , of node Q_2 to several tens of nanoseconds.

The delay, t_{do} , of the output pulse is given by $t_{do} = 2t_d$. The width of the output pulse is $t_{wo} = 3t_d + k \times t_r$, where $k \times t_r$ is the time needed for the voltage at node Q_2 to fall below the threshold. The recovery time, given by $t_{ro} = 3t_d + t_r$, where t_r is the rise time at node Q_2 . Recovery is also independent of the relative length of the command pulse.

O. Anthony Horna, Communications Satellite Corp., Comsat Laboratories, Box 115 Clarksburg, Md. 20734

CIRCLE NO. 312

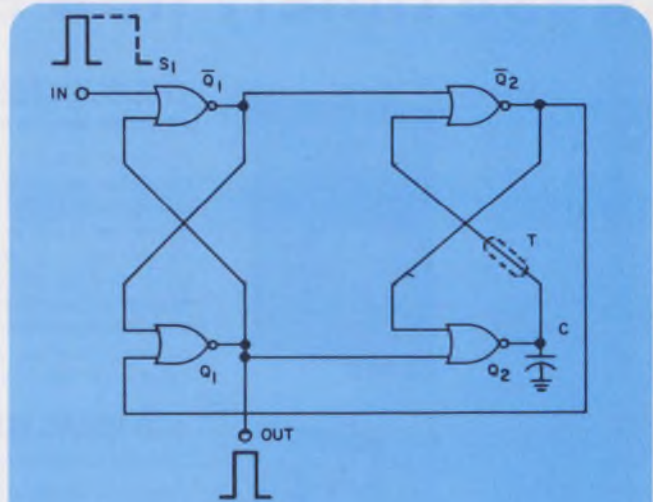

A constant-width pulse appears at the output, Q_1 , each time a command pulse appears at the input, S_1 . The width of the output pulse is determined only by the propagation delay, t_d , of the gates and by the time constant, t_r , of the node Q_2 , i.e., by the capacitor $C \leq 200$ pF which can also be replaced by a delay line T with a delay in the order of tens of nanoseconds.

Sequenced switching circuit cleans up encoder signals

Deriving properly phased, clean signals from a rotating machine is difficult when the direction of rotation changes or the speed is very slow. Here is a sequenced switching circuit that derives two clean, square-wave, phased-output signal trains from an encoder disc rotating at variable speeds in either direction. Its two output signals, which swing between 0 and +5 V, are displaced in phase by 90° and are virtually noise-free (Fig. 1).

The circuit may be used with a variety of magnetic, mechanical or optical sensors. It is particularly effective when the sensor outputs are unstable, as the disc either stops near or slowly passes through the sensor threshold.

The circuit automatically synchronizes itself at start-up and resynchronizes itself each time the disc changes its direction of rotation. Signals originating at the A and B sensors are stored in the A and B registers, respectively (Fig. 2). The circuit uses the phase displacement between the sensor output signals, so each channel acts as a

guard band for the other channel. When an active register changes state, the switching sequencer also changes state, inhibiting any further changes in the active register until after the inactive register changes state. The switching sequencer enables the registers to change state only in an alternating sequence of A, B, A, B, etc.

The inactive register provides a guard band

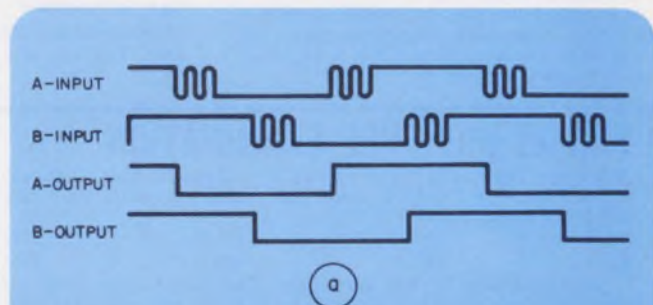

1. Typical waveforms for very slow disc rotation or unstable sensor outputs.

Bell & Howell & Heads You Win



"Wow! We've done it! A super headed recorder/reproducer like nothing nobody's ever seen!"

This from one of our brighter back room boys as he charged into our office.

"Take a look guys. 2MHz performance at 60 ips. Realize what that means? Perfect recording with half the tape. And at about \$200 a reel, that's a cash register full of saved bucks."

"Not bad."

"And it's so good we've given the record head a whompin' 5,000 hour warranty."

"Well, I think we got something to work with. Anything else?"

"Yeah, those are both industry firsts from Bell & Howell."

"And?"

"Well, it has the usual 14 channels. 15/16 to 240 ips and stuff like that, in the conventional format."

"Ummm, who uses the thing?"

"R&D types mostly. It's about as sophisticated as you can get. They use it for aircraft tests. Cars. To pull down whole libraries of data from field recorders. That sort of thing."

"Sounds like a heckuva machine."

"System."

"Okay, system. So what do you call the super headed system?"

"The VR3700B."

"Wow. That really tells it like it is. Okay, we'll do an ad. But first I'll flip you for coffee. Call it."

"Heads."

"You win."

"Hey, not a bad headline for the..."

"Are you kidding? Beat it. Sheez, can you imagine."

Read about it. Bell & Howell, CEC/Instruments Division, 360 Sierra Madre Villa, Pasadena, California 91109.

CEC/INSTRUMENTS DIVISION

 **BELL & HOWELL**

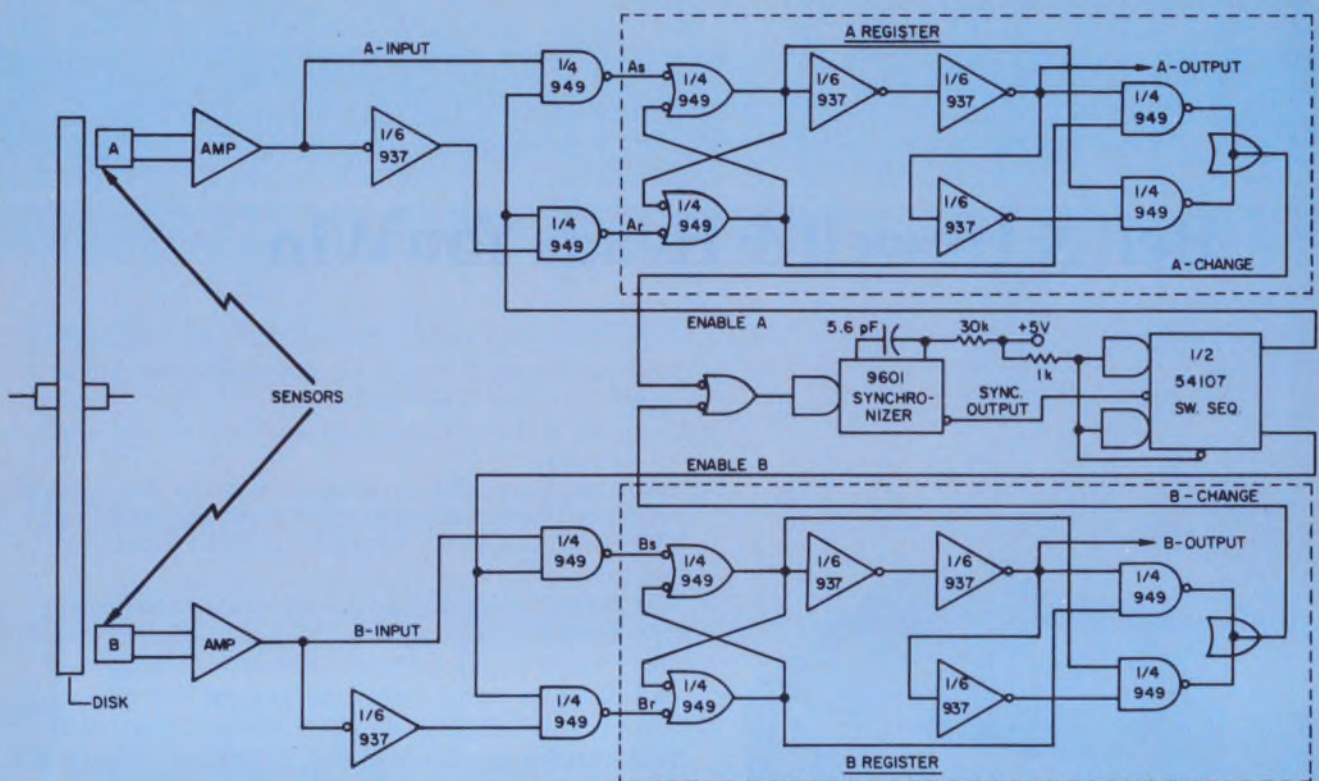

2. Circuit logic diagram indicates that the A register produces both a level (A output) and a pulse (A change) output signals. The A-output signal may

be directly interfaced with either TTL or DTL current-sinking logic. The switching sequencer's state changes with the register's contents.

for the active register, desensitizing it to the effects of switching transients and sensor instability. The A and B register flip-flops are isolated from noise on their input lines by the enable signals, and on their output lines by the two inverter isolation stages.

The synchronizer commutates the switching sequencer during continuous disc rotation and re-synchronizes the sequencer when the disc reverses direction and one sensor changes state twice in succession. The sequencer permits the associated register to store only the first change; hence this register's contents are temporarily incorrect. When the other register changes state, the incor-

rect register immediately corrects itself.

The synchronizer output duration is chosen to prevent the correction change from commutating the sequencer. Since two register changes produce only one sequencer change, the sequencer is re-synchronized.

The circuit exhibits good voltage and temperature stability over the specified operating range of the ICs — 4.5 to 5.5 V, 0 to 75 C.

Charles J. McBrearty, Valley Forge Div., Control Data Corp., 2621 Van Buren Ave., Norristown, Pa. 19401

CIRCLE NO. 313

IFD Winner for September 30, 1971

Larry Mellenbruch, University of Texas, P.O. Box 8029, 10000 FM Road 1325, Austin, Tex. 78712. His idea, "Voice-operated switch dissipates only 600 μ W," has been voted the Most Valuable of Issue Award.

Vote for the Best Idea in this Issue.

VOTE! Go through all Idea-for-Design entries, select the best, and circle the appropriate number on the Reader-Service-Card.

SEND US YOUR IDEAS FOR DESIGN. You may win a grand total of \$1050 (cash)! Here's how. Submit your IFD describing a new or important circuit or design technique, the clever use of a new component or test equipment, packaging tips, cost-saving ideas to our Ideas-for-Design editor. You will receive \$20 for each accepted idea, \$30 more if it is voted best-of-issue by our readers. The best-of-issue winners become eligible for the Idea Of the Year award of \$1000.

new products

Wideband multiplier reaches accuracy of averaging types

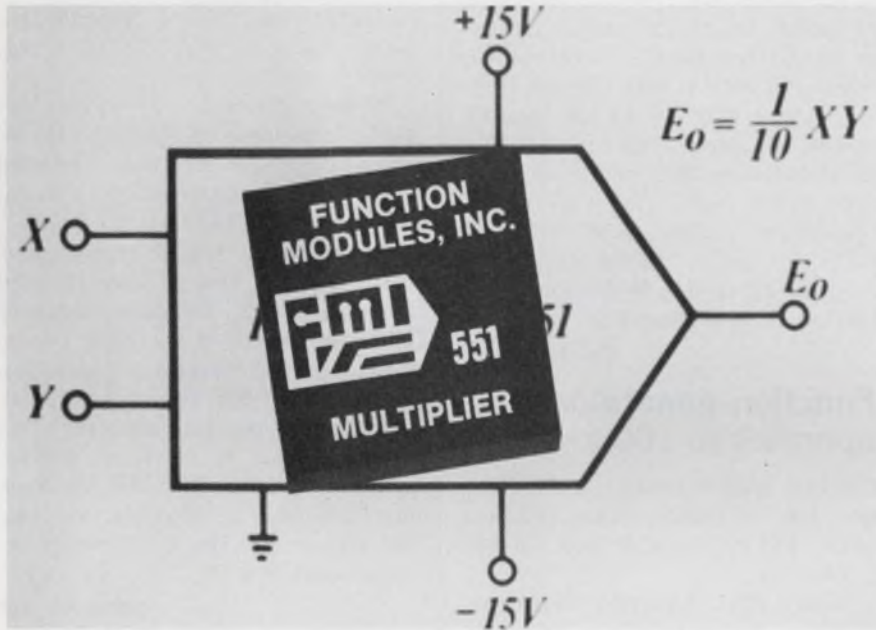

Function Modules, Inc., 2441 Campus Dr., Irvine, Calif. (714) 833-8314. \$98 (1-9).

With an accuracy at 25 C of 0.25% FS (without additional trimming by the user), a price of \$98, a small-signal bandwidth (to $\pm 1\%$ amplitude error) of 10 kHz and a volume of only 0.9 cubic inches, an analog multiplier module from Function Modules, Inc., the model 551, is the most accurate transconductance type, but not the cheapest, nor the smallest, nor the one with the greatest bandwidth.

But its bandwidth far exceeds the few hundred hertz available in averaging types; the unit is smaller (by a factor of 2 to 3) and it costs less. And while its accuracy matches that of some averaging types, there are some that beat it and some that are worse.

For example, the Analog Devices averaging-type 427J (at \$159) has equal accuracy (0.25%), the Burr-Brown 4031/25 (at \$125) has worse accuracy (0.5%) and the Intronic 311 (at \$145) has better accuracy (0.1%).

Compared to other transconductance types, the FMI module has at least twice the accuracy of modules

and eight or more times the accuracy of monolithics. In bandwidth, however, it doesn't fare so well. For example, the Intronic M416 (with 0.5% accuracy) has a bandwidth of 180 kHz—and it costs only \$59. That's also the price of the Burr-Brown 4096/15, which offers full-power response of 10 kHz. But the Burr-Brown unit has four times the error—1%. Intronic has another module, the M425C, that can be externally trimmed to 1% accuracy. It costs only \$29 and has the same 0.9 cubic-inch volume of the FMI module while offering 150-kHz small-signal bandwidth.

For very large bandwidth, Hybrid Systems has the Model 122, whose response is down 3 dB at 5 MHz. With 0.5% accuracy, the unit costs \$75. The Analog Devices 422 (\$109) and the Intronic M506 (\$130) have similar specs.

For more detailed information on these products, use the information-retrieval card and circle the following numbers.

Analog Devices	CIRCLE NO. 250
Burr-Brown	CIRCLE NO. 251
Function Modules	CIRCLE NO. 252
Hybrid Systems	CIRCLE NO. 253
Intronic	CIRCLE NO. 254

Triac solid-state relay is optically isolated

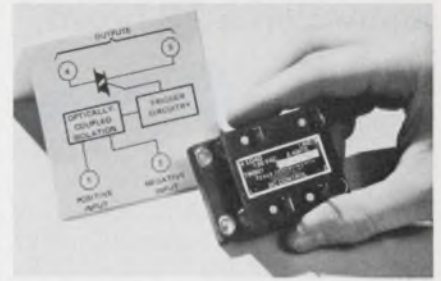

Texas Instruments, Inc., P.O. Box 5012, MS/308, Dallas, Tex. (214) 238-2011. \$6.50 (1000 up); 4 weeks.

Low cost solid-state relays, TIH501 and TIH502 feature bidirectional triode thyristor (triac) outputs with optically coupled isolation between input and output. The relays interface low-level logic inputs with 110 V ac motors, solenoids, power relays and displays. The devices turn on when the ac voltage crosses zero and off when the load current reaches zero, and operates with loads from 15 V ac at 10 mA up to rated 140 V ac and 8 A.

CIRCLE NO. 255

One power supply has ± 15 V and +5 V outputs



Shane Industries Div. of Q.C.I., 800 San Antonio Rd., Palo Alto, Calif. Phone: (415) 326-2121. P&A: \$69; stock.

To ease power supply problems for d/a and a/d designers, Shane offers three dc voltages from a single miniaturized package; plus and minus 15 V at 100 mA and an isolated 5 V at 250 mA. The ± 15 V supplies track. Model P1108 ac input is 115 V with 230 V ac for the P1208. Combining three outputs in one case reduces weight from 26 oz. to 18 oz. and price from \$88 to \$69. Size is 3.5 in. by 2.5 in. by 1.25 in.

CIRCLE NO. 256

Time delay relay mounts on a PC board



Guardian Electric Mfg. Co., 1550 W. Carroll Ave., Chicago, Ill. (312) 243-1100.

All-solid-state time delay relay Series 6400 features "flat-bottom" design for easy PC board mounting. Delay range is from 25 ms to 120 s with accuracy of $\pm 10\%$ and repeatability of $\pm 2\%$ of set point at constant voltage and temperature. Delay is furnished fixed or externally adjustable. Operating voltages available are 12, 24 or 110 V dc. Minimum operating life is 10^7 cycles. Units are available for either in-line or isolated loads.

CIRCLE NO. 257

Touch tone filters are used to transmit data

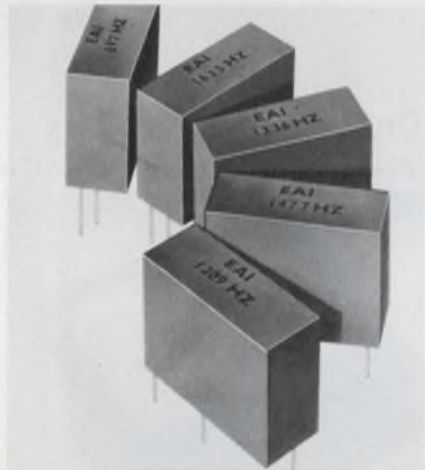

Electronic Associates, Inc., West Long Branch, N.J. (201) 229-1100.

Electronic Associates, Inc., has designed a new family of Band Pass Touch Tone Filters specifically for the data transmission industry. Standard center frequencies of 697 Hz, 770 Hz, 852 Hz, 941 Hz, 1209 Hz, 1336 Hz, 1477 Hz and 1633 Hz, located to $\pm 0.5\%$, conform to telephone industry standards and requirements. Each filter is supplied in a small potted module 1.4-in. by 1.625-in. by 0.625 in.

CIRCLE NO. 258

A FREE new Hayden Service for you—see card inside front cover.

New ac regulators replace magnetic types

ERA Transpac Corp., 67 Sand Park Rd., Cedar Grove, N.J. Phone: (201) 239-3000. P&A: \$175-\$290; stock-30 days.

ERA Transpac solid state sinusoidal ac line regulators replace the conventional magnetic types in applications with wide variations of input frequency and inductive or capacitive loads. Three models rated at 250 VA, 500 VA and 1000 VA output and 105 to 130 Vac, 47 to 440 Hz input are available. The units accommodate load power factors from -0.7 to $+0.7$. Line regulation varies from 0.1% to 0.2% for power factor variations from unity to 0.7. Wave form distortion is less than 5%.

CIRCLE NO. 259

Function generator operates to 100 kHz

Cal-Tek Engineering, 20 Pemberton Rd., Wayland, Mass. Phone: (617) 653-0355. P&A: \$89; stock-6 wks.

Model 7301 Function Generator module provides square and triangular wave outputs. The +3 V square wave with 20 ns rise and 40 ns fall times will drive a 50 Ω load. The triangular wave has less than 0.25% non-linearity. Operation over a decade of frequency between 1 Hz and 100 kHz is accomplished with an external capacitor and a potentiometer. The 2-in. by 2-in. x 0.375-in. module mounts on PC cards spaced 0.5 in. or more.

CIRCLE NO. 260

Latching relay requires no holding current

Frederick Controls Div., North American Philips Corp., E. Church and 2nd St., Frederick, Md. (301) 663-5141.

Latching reed relays have "magnetic memory" contacts which remain in a set open or closed position without holding current. The relays transfer from a 5.5 ms pulse and are set to operate at 5, 6 or 12 V dc nominal input. Contacts are six form A or three form C, hermetically sealed and encapsulated for environmental protection.

CIRCLE NO. 261

Card modules convert digital to synchro



Astrosystems, Inc., 6 Nevada Dr., Lake Success, N.Y. (516) 328-1600.

A new Digital-to-Synchro Converter composed of Standard Hardware Program modules, designed to NAFI requirements (Naval Avionics Facility, Indianapolis), consists of a single transformer card module and 7 circuit card modules. The modules measure 2-5/8 in. by 1-5/8 in. with 7.5 in. total width. Accuracy is 6 minutes, worst case, 1.5 minutes typical. Resolution is 1.2 minutes (14 bits). Output is 90 V ac 3-wire-synchro and drives a 6.8 k Ω load, one 18CT6a at 60 Hz, or one 18CT4a at 400 Hz. Total power requirement is 8 W.

CIRCLE NO. 262

D/S and S/D convert angles \leftrightarrow 14 bits

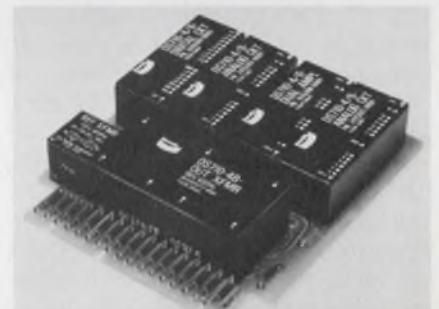

Environmental Science Div., Bendix Corp., 1400 Taylor Ave., Baltimore, Md. Phone: (301) 825-5200

Bendix has a new line of high resolution, modular synchro-to-digital and digital-to-synchro packages for both military and commercial applications. Synchro to digital converters provide a 14-bit angle output with a resolution of 1.32 and accuracy of ± 4 minutes of arc. The digital to synchro converter provides signals to control transformers or differential synchros within ± 0.07 degrees of the binary input data under the operating conditions specified.

CIRCLE NO. 263

Voltage comparator reduces uncertainty band to ± 1 mV

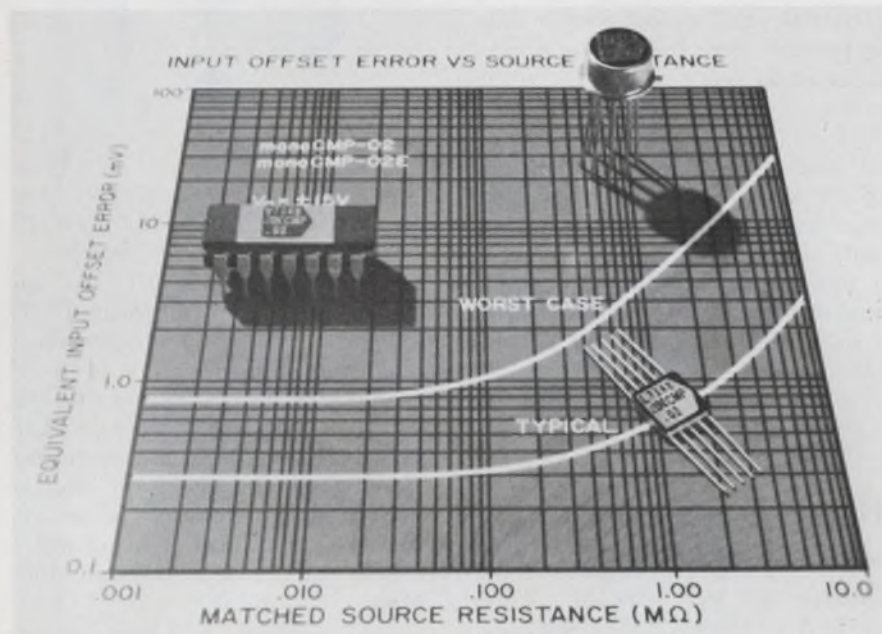

Precision Monolithics Inc., 1500 Space Park Dr., Santa Clara, Calif. (408) 246-9222. Stock.

A precision voltage comparator IC, the mono CMP-02, can compare input voltage levels to within a ± 1 mV band; source resistances can approach 2 M Ω in value, and no offset nulling is required. The uncertainty band is about 1/4 that presently obtainable with other IC comparators. According to Precision Monolithics, its improved performance results from circuit design, layout and processing control.

High-gain npn transistors arranged in a modified Darlington configuration are used for the input stage. The four input transistors of the configuration are geometrically arranged in a tight cross-connected quad centered on a line passing through the center of a large output transistor. This arrangement minimizes the effect of thermal gradients on the 69 by 42 mil chip, thereby reducing V_{os} and I_{os} offset drifts and minimizing hysteresis due to thermal feedback across the chip.

The input stage uses a balanced split-load nulling scheme. This significantly improves the offset

voltage drift when the comparator is nulled. An external 2-k Ω potentiometer can provide adequate null range.

Both the first and second stages are fully balanced and use current sources to provide maximum common-mode and power-supply rejection combined with minimum drift. Each stage has Schottky-barrier diode clamps to eliminate speed-robbing collector saturations.

The combined voltage gain of the first two stages allows the comparator to resolve signals of less than 10 μ V.

The circuit can operate from power supplies ranging from ± 5 V to ± 18 V, or from a single +5 V supply.

Three models are offered: mono CMP-02 (-55°C to $+125^{\circ}\text{C}$), mono CMP-02E premium performance (0° to $+70^{\circ}\text{C}$) and CMP-02C (0° to 70°C). Delivery in TO-99, hermetic dual-in-line and flat packs is from stock.

Prices for the "J" (TO-99) package are, in quantities of 100-999: mono CMP-02J, \$12.00; mono CMP-02EJ, \$7.50 and mono CMP-02CJ, \$3.25.

CIRCLE NO. 264

1024-bit pROM features 50 ns max access time

Fairchild Semiconductor, 464 Ellis St., Mountain View, Calif. (415) 962-3816. \$16.50 (100 up); 4-8 wks.

A 1024-bit mask programmable ROM, the 93406, has a maximum access time of 50 ns from 0° to 75°C . The TTL ROM is fully decoded on chip and is organized as a 256-bit by 4-word memory. The 93406, pin compatible with other currently available 1024-bit TTL ROMs, also offers a chip select feature which can be programmed as part of the truth table. A one-time mask preparation fee of \$500 is charged for each mask option desired.

CIRCLE NO. 265

High voltage pnp and npn transistors

Lectro Communications Corp., 98 Cutter Mill Rd., Great Neck, N.Y. (516) 466-6511. 400, \$3; 800, \$7 (1000 up).

A line of low-priced, high voltage pnp and npn transistors feature the highest voltages available in commercial models, according to the manufacturer. The units, designated the 400 to 800, have a $V_{(CEO)}$ range of 400 V to 800 V (sust.), respectively. The characteristics of the units include a V_{EB} of 6 V min, h_{FE} of 25 to 300, V_{CE} (sat) of 1.5 V max and V_{BE} (sat) of 1.0 max. These values are the same for both the pnp and npn transistors.

CIRCLE NO. 266

Micropower op amp boosts V, temp ranges

RCA Solid State Div., Route 202, Somerville, N.J. Phone: (201) 722-3200. Price: \$4.95 (1000 units).

A premium version of the year-old CA3078, the CA3078AT has more than double the voltage and temperature range of its predecessor— ± 0.75 to ± 15 V and -55 to $+125^{\circ}\text{C}$. At 25 C, input errors are reduced as follows. V_{os} from 5 to 3.5 mV, I_{os} from 32 to 2.5 nA. I_B from 170 to 12 nA. Open-loop voltage gain is boosted from 88 to 92 dB. The unit is packaged in an 8-pin TO-5.

CIRCLE NO. 267

Electrically erasable reprogrammable ROM

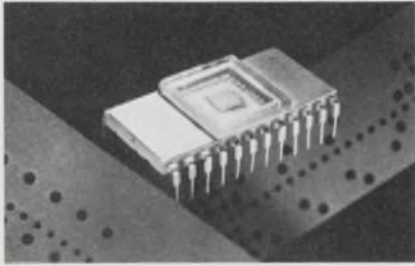

National Semiconductor Corp., 2900 Semiconductor Dr., Santa Clara, Calif. (408) 732-5000. \$100; stock.

A MOS read-only memory that is electrically programmable, and in one version erasable and reprogrammable, is the new MM5203 2048-bit static ROM. Made with silicon gate technology, it has a maximum access time of 1 μ s. Other characteristics include complete bipolar compatibility and static operation without clocks. A mode control allows organization of the 2048 bits as 512 4-bit words or 256 8-bit words.

CIRCLE NO. 268

IC op amps available in drift-matched pairs

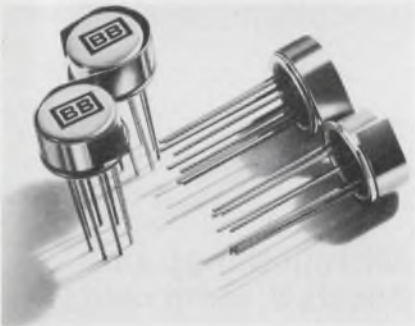

Burr-Brown Research Corp., International Airport Industrial Park, Tucson, Ariz. (602) 294-1431. \$16.-70 (100 up); stock.

The 3500MP is a pair of op amps whose initial offset voltage and drift are matched to 200 μ V max and 1.0 μ V/ $^{\circ}$ C max. The op amp pair provides ultra low drift in many two amplifier circuits at a cost far less than that of two individual low drift op amps, according to the manufacturer. The bias current is less than 50 nA, and the required power supply ranges from \pm 3 V to \pm 20 V dc.

CIRCLE NO. 269

Receiver converts serial data to parallel form

Motorola Semiconductor, P.O. Box 20912, Phoenix, Ariz. (602) 273-3466. \$18.60 (100 up).

The MC2259L terminal receiver accepts serial digital data from a MODEM, and provides this data in parallel form to peripheral communication equipment. The receiver operates over the range of dc to 10 k bits per second in a divide by 64 mode. An operating frequency of 200 k bits per second is possible in a divide by 1 mode of operation. Data are transferred according to a number of externally selectable modes. Character lengths of 5, 6, 7 or 8 bits are externally selectable.

CIRCLE NO. 270

High-V transistors drive gas-glow tubes

Dionics, 65 Rushmore St., Westbury, N.Y. Phone: (516) 997-7474. Price: Npn 65 ϕ , pnp 85 ϕ , dual \$2.25 (large quantities).

Discrete complementary npn (DTN 200) and pnp (DTP 200) transistors in TO-5 cans or complementary pairs (DTNP 200) in TO-78 cans are designed specifically for driving gas-discharge displays. They withstand up to 225 V with current gain typically greater than 100 at 10 mA. Leakage is 50 nA typically. Operating f_t is 50 MHz min. All units are also available as bare chips.

CIRCLE NO. 271

64-bit bipolar-RAM uses Schottky clamps

SGS Societa Generale Semiconduttori, Via C. Olivetti, 1, 20041-Agrate Br., Milan, Italy.

A 16 by 4-bit read/write random-access memory features a propagation delay less than 60 ns from the chip-select or address input to the output. Write recovery is less than 50 ns and the write pulse must be 40 ns wide. Open-collector outputs permit easy wired-OR expansion.

CIRCLE NO. 272

Cascadable amplifiers in miniature cans



Avantek, Inc., 2981 Copper Rd., Santa Clara, Calif. (408) 739-6170. Under \$30 in quantity; stock.

The models GPD 401, 402 and 403, packaged in miniature TO-12 transistor cans, are cascadable amplifiers for operation in the 5 to 400 MHz range. Across this six-octave bandwidth, the gain flatness is \pm 1 dB. The minimum gain for the 401 and 402 is 13 dB; the lowest typical noise figure—for the 401—is 4.5 dB. Additionally, a usable gain exists through 1000 MHz.

CIRCLE NO. 273

Si bridge rectifiers take up to 1000 V

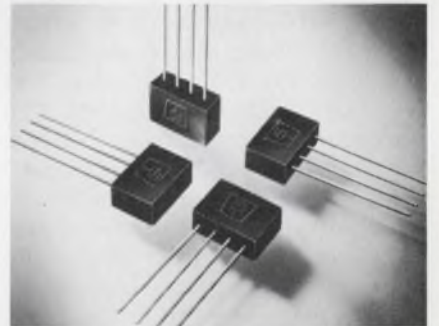

Sarkes Tarzian, Inc., 415 North College Ave., Bloomington, Ind. Phone: (812) 332-1435. P&A: 1 A, 80 ϕ -\$3.20; 1.5 A \$1.32-\$3.80 (under 100); depending on PRV.

Eight peak reverse voltage ratings from 50 to 1000 V are available for new bridge rectifiers rated to conduct 1 A and 1.5 A at 55 C. The bridges have a maximum drop of 1 V, maximum leakage of 10 μ A and maximum dissipation at rated current of 2.2 W for the 1-A unit, 3.3 W for the 1.5-A unit. One-cycle surge current is 25 A peak.

CIRCLE NO. 274

Kit converts Teletype ASR 33 to data terminal



Anderson Jacobson Inc., 1065 Morse Ave., Sunnyvale, Calif. Phone: (408) 734-4030. Price: \$400.

The DC 230, a kit for converting Teletype ASR 33 to a data terminal, comes complete with modem electronics packaged to mount with spring clips inside the Teletype stand, panel to be used with data access arrangement, hook-up cables, and easily installed acoustic adapter which receives the telephone handset. No drilling or modification to the Teletype is required.

CIRCLE NO. 275

CRT module corrects pin cushion errors

Intronics Inc., 57 Chapel St., Newton, Mass. Phone: (617) 332-7350. P&A: \$348; 2 wks.

The C101, a CRT geometry/focus correction module, synthesizes the correct mathematical functions with 1-MHz bandwidth to eliminate pin-cushion distortion errors in CRTs. Correction is made by processing the deflection signal ahead of the horizontal and vertical deflection amplifiers to subtract out a correction term which is dependent on the magnitude of the two deflection signals. A third output produces a correction for dynamic focus. Corrected position errors using the C101 are less than 0.1% for a 60° CRT and less than 0.01% for a 20° CRT.

CIRCLE NO. 276

Multiplexer accepts 16 computer terminals

Delta Data Systems Corp., Woodhaven Industrial Park, Cornwells Heights, Pa. Phone: (215) 639-9400. P&A: \$750; 30 to 60 days.

The MultiTerm 1 is a digital multiplexer which has the ability to use as many as 16 computer terminals on a single telephone or communications line. These terminals may be located up to 4000 feet from the MultiTerm 1 and are operational at speeds of up to 9600 baud. Basic multiplexers are compatible with any type of RS 232 serial device, such as teleprinters, cassette recorders and display terminals.

CIRCLE NO. 277

Dual 480-bit shift register uses 25 mW

Fairchild MOS Products Div., 464 Ellis St., Mountain View, Calif. Phone: (415) 962-3816. Price: \$8.50 (100 quantities).

The 3337 is a two-phase ratioless silicon gate dynamic shift register that features a 2-MHz clock frequency and 5- μ s pulse rise and fall time.

CIRCLE NO. 278

Time division multiplexer has built-in modem

Timeplex Inc., 65 Oak St., Norwood, N.J. Phone: (201) 767-1650. Availability: stock.

The Timeplexer is the first time division multiplexer to be price and feature competitive with frequency division multiplexers even in small capacity systems. Available in 4, 16 and 20-channel versions, the Timeplexer provides efficient character interleaved multiplexing of any number of asynchronous data channels from 50 to 1200 bps or synchronous data channels from 600 to 7200 bps.

CIRCLE NO. 279

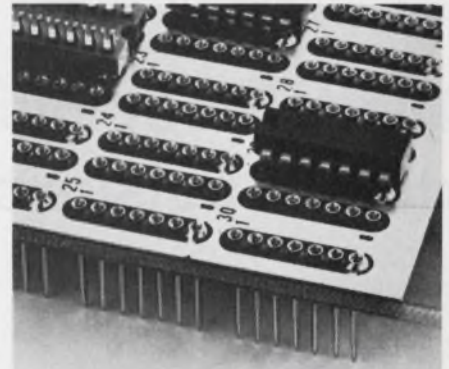

All plug-in panels are not the same.

It's one thing to want plug-in flexibility in your circuit. It's another to get flexibility plus all the other things you'd like in a dependable point-to-point system.

Like easier IC insertion. Precision-machined contacts. Tighter contact retention. Greater reliability (we'll prove it). Unique tapered entry sockets (patent pending). Lower profile. Plus the versatility to accept 14, 16, 18, 24, 28, 36 or 40 pin IC's in a choice of panel sizes.

And we offer virtually any panel you'll need, in any number of patterns, plane-mounted or edge-connected, off the shelf or custom.

We'll also give you single-source supply for sockets, enclosures and accessories—even automatic wire wrapping whenever you need it.

The Augat way? It's a better way. Call us at (617) 222-2202. Or write for our catalog. Augat Inc., 30 Perry Ave., Attleboro, Mass. 02703. Our representation and distribution is nationwide and international.

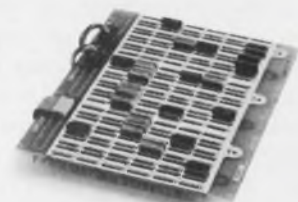

Plug into Augat' instead.

Have you filled our your free REQUESTED DATA DELIVERY enrollment form? See card inside front cover.

Digital-test logic probes detect pulses down to 5 ns



Kurz-Kasch Inc., 1421 S. Broadway, Dayton, Ohio. (513) 223-8161. P&A: See text; stock.

Five-nanosecond pulse detection capability, a memory mode, and three-channel gating-input options expand the use of Kurz-Kasch's LP-520 logic probes in 5 V digital testing.

These low cost probes replace oscilloscopes in trouble-shooting in the field or on the production line. Probes provide color coded (red, white and blue) readouts at the tip, indicating logic "1", "0" and "pulse."

Option S detects pulses as narrow as 5 ns. 50 ns was the previous lower limit. Option M adds a memory mode which latches on pulses and displays ON until reset.

The last option, G, simulates a three-input oscilloscope providing a "P" output only when the three inputs are in coincidence. In this mode, the probe connects to the four lead cable at the photograph

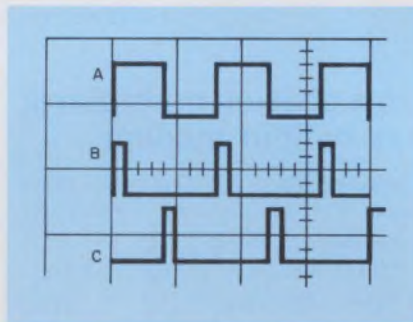

left. One lead is grounded, a second displays on an oscilloscope when desired, and the remaining two leads and the probe tip connect to the three pulse inputs. The diagram illustrates operation. With two inputs in coincidence, (gate input A, probe input B), the "P" indicator displays. If the probe tip moves to C, the indicator does not display. With three inputs, all must coincide for a display.

Each of options M, G or S adds \$10.00 to a base price of \$69.95.

CIRCLE NO. 300

Sweeping comparator evaluates networks

Hewlett-Packard, 1601 California Ave., Palo Alto, Calif. (415) 493-1501. \$2950; 12 to 14 weeks.

Model 8728A network comparator is the heart of a system measuring and displaying amplitude and phase characteristics with resolution to 0.01 dB and 0.2°. This swept system covers 100 kHz to 110 MHz with a dynamic range to 100 dB. The gain, loss or phase shift of the device in test is compared with the transmission of a precisely-known network, using the same signal input. A complete system costs approximately \$12,000.

CIRCLE NO. 301

Function generator delivers at 20 MHz

Exact Electronics Inc., 455 S.E. 2nd Ave., Hillsboro, Ore. (503) 648-6661. \$795; stock.

The first 20-MHz voltage-controlled function generator—that's Exact Electronics Inc.'s claim for model 7230. The unit delivers 30 V peak-to-peak square and pulse waveforms into 50 Ω with typical rise and fall time of 10 ns, and the frequency ranges down to 0.0001 Hz. A variable offset from -15 to +15 V positions sine, square, triangle, ramp or pulse waveforms off ground. The frequency can be swept over a 1000:1 ratio as controlled by an external voltage or internally.

CIRCLE NO. 302

Generator produces four laser pulses

Union Carbide Corp., Korad Dept., 2520 Colorado Ave., Santa Monica, Calif. (213) 829-3377. \$10,500; 45 days.

Four Q-switched laser pulses are produced during a single flash-lamp discharge in model KQS2M high-voltage generator. With Union Carbide's K1 laser system, energies of 5 mJ TEM₀₀ and coherence length of 25 cm in each pulse are achieved. Pulse width is less than 50 ns with interpulse separations of 50 to 200 μs.

CIRCLE NO. 303

DVM reads out from two thermocouple types



Leeds & Northrup Co., Sumneytown Pike, North Wales, Pa. Phone: (215) 643-2000.

Reading outputs from two different types of thermocouples is facilitated by a selector switch on a new Leeds & Northrup Numatron five-digit display. Outputs are linearized by variable-length approximating segments. Reference junction compensation for each thermocouple type is provided. Stability is $5 \mu\text{V}/6$ months over 0 to 45 C. The instrument also measures voltage on four additional ranges.

CIRCLE NO. 304

Phasemeter has five-digit direct readout



Dranetz Engineering Laboratories Inc., 1233 North Ave., Plainfield, N.J. Phone: (201) 755-7080. Price: \$2000 to \$3000.

Model 305C measures phase to an accuracy of 0.1 degree over a frequency range from 50 Hz to 50 kHz and displays on a 5-digit readout with 0.01-degree resolution. There are no operator controls. Drift stability is guaranteed under 0.1 degree for 30-day intervals. BCD and analog ($10 \text{ mV}/^\circ$) outputs are furnished.

CIRCLE NO. 305

Three-digit DPM features LED display



Electronic Research Co., P.O. Box 913, Shawnee Mission, Kan. Phone (913) 631-6700.

Model 3000 has a three-digit LED display. With 100 complete conversions per second, the DPM digital output is suitable for use with high speed computer controlled systems and fully compatible with TTL/DTL logic interface systems. Provision for remote control is provided. Accuracy is 0.1%. The unit is packaged in an all-aluminum case. Polarized lens make for easy reading.

CIRCLE NO. 309

Comparison tester checks ICs in-circuit



KAR Electronics, Inc., 4995 Telegraph Rd., S. Amherst, Ohio. (216) 986-8817. \$499; stock to 8 wks.

Model 113 is a portable in-circuit IC tester for TTL/DTL, operating on a comparison basis. Twelve ICs in the tester and known to be good, serve as the comparison reference. A different reference set can be set up in one minute. The hand-held probe makes connections to a suspect DIP on a PC board and operation is checked under normal circuit conditions by comparison.

CIRCLE NO. 310

\$ 86

BUYS THIS 12-BIT BINARY A/D CONVERTER



Model 53B12

WITH $\pm 0.01\%$ ACCURACY AND 50ppm/C° STABILITY

Here's more A/D converter for your money than ever before! Gralex integrating A/D converters are available in 8, 10 or 12-bit and 2 or 3-digit BCD—priced as low as \$59 in single quantities. Input voltages include $\pm 0.1\text{V}$, 1V , 10V —uni or bi-polar. Shielded or unshielded construction. Design and performance features include: high noise immunity; high input impedance; flexibility of output data formats; buffered analog output for recorder use; external and internal trigger.

Send for complete tech data today, and put your money where the value is!

GRALEX INDUSTRIES

155 MARINE ST., FARMINGDALE, N. Y.
516-694-3600

DIVISION OF GENERAL MICROWAVE CORP

INFORMATION RETRIEVAL NUMBER 55

Screen switch provides rear projection display



Industrial Electronic Engineers Inc., 7720-40 Lemona Ave., Van Nuys, Calif. (213) 787-0311. \$44.50 (1-49); 8 wks.

The Series 0123 Read-out incorporates a unique screen switch: a single pole momentary contact, consisting of two bonded, copper laminated mylar squares, separated by a plain mylar square with a built-in aperture. The outer face of the switch can be either a high contrast rear-projection screen, or used with a film strip when a single static display is required.

CIRCLE NO. 320

Photocells packaged for PC board design

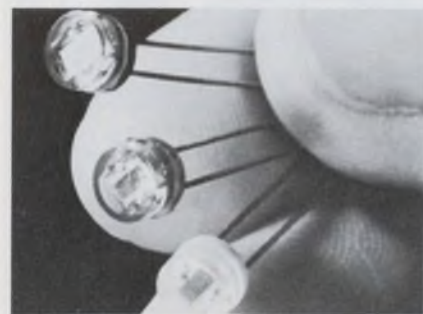

Allen-Bradley Co., Electronics Div., 1201 S. Second St., Milwaukee, Wis. (414) 671-2000. \$0.39 (2500 up); 3 to 6 wks.

CdS and cadmium sulfo-selenide photodetectors feature a new plastic packaging, with color-coded bases to correspond with three peak spectral response areas—green, orange, or red for 625, 575, and 515 nm. The packaging affords the benefits of relatively low cost with a high level of environmental protection against humidity. Voltage ratings of 80 and 100 V over a temperature range of -40 C to $+75\text{ C}$ for the PE photodetector are standard. Power dissipation is typically 75 mW.

CIRCLE NO. 321

Zener voltage regulators handle 50 W

International Rectifier Corp., Semiconductor Div., 233 Kansas St., El Segundo, Calif. (213) 678-6281. \$4.75 (1-99); stock.

A line of 50 W zener voltage regulators in the TO-3 package have nominal zener voltage ratings from 3.9 through 100 V. Types IN4549 to IN4564 have V_z ratings from 3.9 to 7.5 volts. The 3.9 volt IN4549 has a maximum zener current of 11.9 A dc, and a maximum reverse current of 150 mA; maximum zener impedance at 1 mA is 400 Ω . The 6.8 V IN3305 and IN2804 units have a maximum zener current of 6.6 A.

CIRCLE NO. 322

Volt sensor has 50 M Ω input

Calex, P.O. Box 555, Alamo, Calif. Phone: (415) 932-3911. P&A: \$58; stock.

Voltages as high as 20,000 V have been accurately monitored to 0.05% of absolute value using the Model 535 Volt sensor and a high impedance voltage divider string. Sensitivity is 1 mV out of a set point range of $+10\text{ V}$ to -10 V , hysteresis is 4 V, trip point stability is 1 mV/C, operating time is 10 μs , and output $+12\text{ V}$ at up to 50 mA.

CIRCLE NO. 323

Thick-film resistors use metanet elements

Sprague Electric Co., North Adams, Mass. Phone: (413) 664-4411.

A comprehensive series of standard thick-film dual and single in-line resistors include pull-up, interfacing, pull-down, and terminating resistor networks. The Sprague Type 914C and Type 916C networks are furnished in 14 and 16-pin molded dual-in-line cases respectively, and use Sprague's exclusive Metanet precision metal film resistance elements encased between protective glass frits.

CIRCLE NO. 324

Log spiral antennas span 0.05 to 12 GHz



GTE Sylvania, P.O. Box 188, Mountain View, Calif. Phone: (415) 966-2452.

A line of conical log spiral antennas, Model AN-15, can be used in principal radiators or reflector feeds. The log spirals are printed on dielectric cones to provide essentially constant radiation patterns with low polarization axial ratio over several bandwidth octaves. Right or left-hand circular polarization is available, with 7 to 8-dB gain over isotropic. VSWR is 2.5:1 maximum relative to 50 ohms.

CIRCLE NO. 325

Single-assembly mixer covers 1-12 GHz

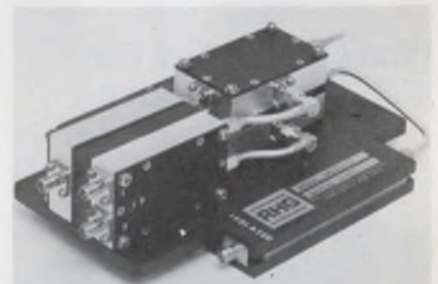

RHG Electronics Laboratory, Inc., 94 Milbar Blvd., Farmingdale, N.Y. Phone: (516) 694-3100. P&A: \$895 (for octave mixers); 60 days.

A double-balanced mixer, the series IRDM, with a wide dynamic range of 100 dB and an output of $+5\text{ dBm}$ maintains a typical noise level of 8 dB. VSWR is less than 1.5:1. Image rejection is nominally 20 dB. Intermediate frequency is as high as 160 MHz. Models are available for rf ranges of 1-2, 2-4, 4-8, 8-12, or 1-12 GHz.

CIRCLE NO. 326

Have you filled out your free REQUESTED DATA DELIVERY enrollment form? See card inside front cover.

design aids

PSD calibration nomograph

A nomograph provides a fast means of calibrating a real-time power spectral density system in terms of PSD level using a sine-wave calibration signal. It is intended to make it possible for the user of a Ubiquitous Spectrum Analysis system to easily scale the output data in terms of g^2/Hz or V^2/Hz . It allows a non-technical operator to take into account the bandwidth of analysis in gain settings of the system when performing calibration. Federal Scientific Corp., New York, N.Y.

CIRCLE NO. 327

Berlon properties chart

A comprehensive properties chart covers Berlon high thermal conductivity dielectric encapsulants, adhesives and fillers. Thermal, electrical and mechanical properties, as well as cure time, pot life and viscosity, are listed for four grades of flexible encapsulants, and three epoxy adhesives. Size, density and suggested applications are also listed for fifteen Berlon filters. National Beryllia Corp., Maskell, N.J.

CIRCLE NO. 328

Decimal/metric equivalents

A new chart of inch fractions with decimal and metric equivalents is available on request. Boker's Inc., Minneapolis, Mn.

CIRCLE NO. 329

Temperature conversion

A large, easy to read, temperature conversion chart, offers expanded fahrenheit-centigrade scales which highlight many refractory metals and ceramic materials for ready reference by design and operational engineers. The chart can be used as a wall chart or may be added to a loose leaf record. A.P. Keith Co., Inc. Pico Rivera, Calif.

CIRCLE NO. 330

Optima small cases

Boldly designed to meet contemporary market needs • 24 sizes with useable inside space ranging from 133.6 to 144.5 cubic inches + liftoff cover provides complete access + durable vinyl finish.

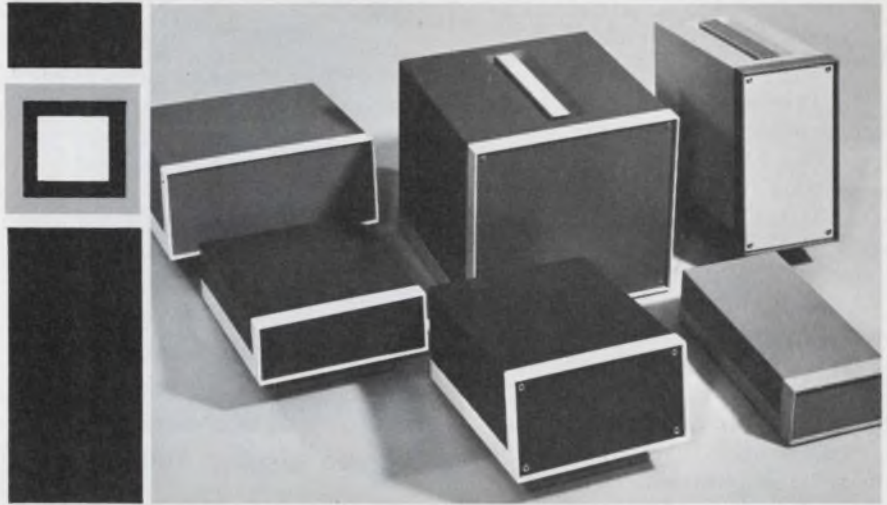

Write or call for a free catalog

optima enclosures
a division of Scientific-Atlanta, Inc.

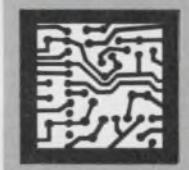

2166 Mountain Industrial Blvd. Tucker, Georgia 30084 Telephone 404-939-6340

INFORMATION RETRIEVAL NUMBER 42

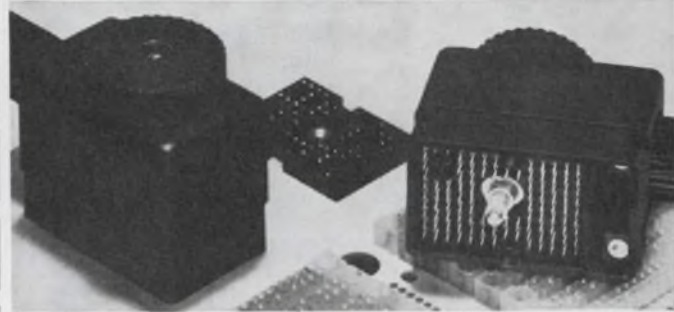

At last. An I/O connector designed exclusively for back panel assemblies.

Here it is. An input/output connector that features up to 120 crimp-removal contacts on a .100" grid which accepts #22 to #26 gage stranded wire.

The receptacle contacts, fixed to the panel half, can be supplied in numerous .025" wrap post lengths. The receptacle contacts are as precisely located as the rest of the back panel contacts, and automatic wiring presents no problem.

Get all the facts, write for free Bulletin No. I/O 100.

Gentlemen:
Please send me Bulletin No. I/O 100.

TERADYNE

Name _____
Company _____ Street _____
City _____ State _____ Zip _____

Teradyne Components, Inc. 900 Lawrence Street, Lowell, Mass. 01852

INFORMATION RETRIEVAL NUMBER 43

application notes

Analog multipliers

An 11-page application note describes analog multiplier principles and gives 14 circuits. The bulletin on Analog Devices AD530 monolithic MDSSR (multiplier, divider, squarer, square-rooter) combines insights into basic transconductance multiplier operating principles, details the circuit operation of the monolithic AD530, then presents 14 circuit applications. Key multiplier application groups discussed, beyond those of more obvious multiplication, division, squaring, and square rooting, include automatic level control, power series function generation, voltage control of frequency response in filters and oscillators, capacitor-free demodulation and peak detection, frequency discrimination, modulation and phase-locked loops. Twenty-five circuits and illustrations are used in the application note to present operation, error analysis, and applications. Analog Devices, Inc., Norwood, Mass.

CIRCLE NO. 331

Surge voltage protectors

Basic applications information on SVPs is outlined in a new 8-page brochure. Complete with charts and diagrams, the brochure instructs the design engineer how to design gas filled surge voltage protectors. The brochure outlines how to select and determine: dc striking voltage, response time, discharge capability, extinguishing behavior and the use of SVP tubes in series to obtain non-standard dc striking voltage. Siemens Corp., Iselin, N.J.

CIRCLE NO. 332

Low phase noise oscillators

An eight-page booklet, "Technical Considerations of Low Phase Noise Oscillators," defines and gives techniques for measuring phase noise. Accutronics, Geneva, Ill.

CIRCLE NO. 333.

new literature

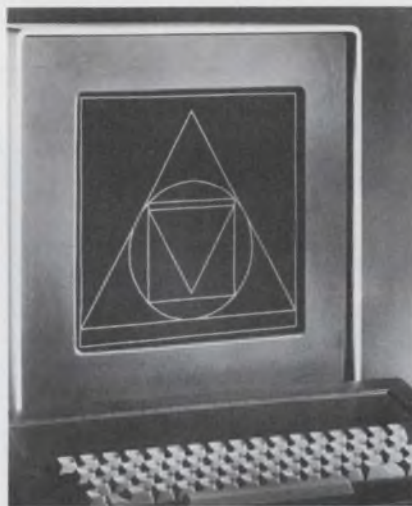

Digivue display memory

An illustrated brochure describes Owens-Illinois' line of Digivue display/memory units, which are now in production. The brochure discusses such features as inherent memory, selective write, rear projection, and hard copy potential. Also provided is a description of available size and resolution characteristics. The Digivue display/memory units are 1/2-inch thick and are capable of displaying the full range of alphanumeric characters and graphic symbols. Electro/Optical Display Business Operations, Owens-Illinois, Inc., Toledo, Ohio.

CIRCLE NO. 334

Plastic hardware parts

A 20-page catalog/price list features a wide variety of plastic hardware products, including tube and pipe fittings, valves, fasteners, balls and washers. Product Components Corp., Mount Vernon, N.Y.

CIRCLE NO. 335

Bit error rate tester

A four-page, two color bulletin, BERT-901, discusses typical applications and engineering features of a unit designed to test and evaluate modems, multiplexers, rf links, voice grade data circuits, T-carrier systems, disk memories and magnetic tape recorders. II Communications, Inc., Willow Grove, Pa.

CIRCLE NO. 336

Voltage control device

Precision dc voltage comparators, bistable trips with adjustable trip points, and voltage sensitive relay drivers all can be replaced with a Voltensor. A new eight-page paper entitled, "The Voltensor, A New Control Device," describes the various functions of this new, solid-state voltage detector. Graphs of operating characteristics of the Voltensor and of a competitive device, the op amp comparator circuit, are included for comparison. The use of a power supply adjustment of the set points, precautions necessary for optimum performance, hysteresis and response time are also discussed. California Electronics Mfg. Co., Inc., Alamo, Calif.

CIRCLE NO. 337

High-power op amp

The performance and use of the RCA HC2000 high-power op amp are described in a new six-page application note. "General Application Considerations for the RCA-HC2000 Hybrid Power Operational Amplifier," application note AN-4782, has been issued to help users to achieve the full performance potential of the new circuit component. The HC2000 is a general-purpose power hybrid operational amplifier that can deliver 100 watts rms to a 4-ohm load at a maximum peak current of 7 amperes. RCA Solid State Div., Somerville, N.J.

CIRCLE NO. 338

Power supplies

Standardized modular power supplies ranging from 3.7 to 150 V dc in output are described in a newly revised 16-page brochure. North Electric Co., Galion, Ohio.

CIRCLE NO. 339

Lacing tapes

Two eight-page catalogs describe a line of lacing tapes, dial cords, lacing systems and accessories. Gudebrod Bros. Silk Co., Inc., Philadelphia, Pa.

CIRCLE NO. 340

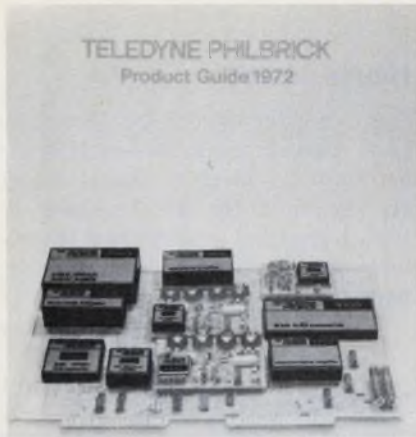

Philbrick product guide

A 48-page color-keyed product guide includes detailed information on the complete 1972 product line. The new product guide, which is coded with five different colors for convenience, includes photos, charts, schematics, pricing, and specifications on Philbrick's linear modules, nonlinear function modules, data conversion modules, power supplies and regulators, testers, and other technical information. Teledyne Philbrick, Dedham, Mass.

CIRCLE NO. 341

Microprogramming handbook

A 448-page second edition of the Microprogramming Handbook is a sequel to the shorter first edition. It tells how to microprogram, why the concept is effective, and when it is most appropriate. The handbook contains a primer with a glossary of data processing terms, application examples of microprogrammed computers, a Micro 800 user's manual, a Micro 1600 reference manual, a firmware manual showing the architecture of a general-purpose computer implemented by microprogramming, and a section of tutorial text on system design procedures. Microdata Corp., Santa Ana, Calif.

CIRCLE NO. 342

Ceramic disc capacitors

A 23-page catalog describes types of ceramic disc capacitors including Ultra Kap, temperature stable and general purpose. Centralab, Electronics Div. of Globe-Union Inc., Milwaukee, Wis.

CIRCLE NO. 343

NEW Low Cost, 8-Bit D/A Converters

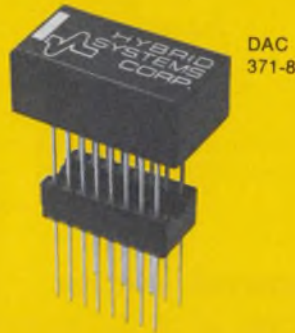

- Plugs into a Single 16 Pin IC Socket
- All Hermetically Sealed Active Components — No Plastic Devices
- Thin Film Precision Resistors for Extra Stability
- 8-Bit, Current Output

\$9.90 in singles

The DAC 371-8 D/A Converter is a new complete 8-bit, fine performance unit, economically priced at \$9.90 in singles. It incorporates all the standard features — built-in reference, DTL and TTL compatibility, and ready to use operation — plus several additional ones for high reliability and long term stability.



HYBRID SYSTEMS CORPORATION

87 Second Ave., Northwest Industrial Park, Burlington, Mass. 01803
Telephone: 617-272-1522 TWX: 710-332-7584

INFORMATION RETRIEVAL NUMBER 44

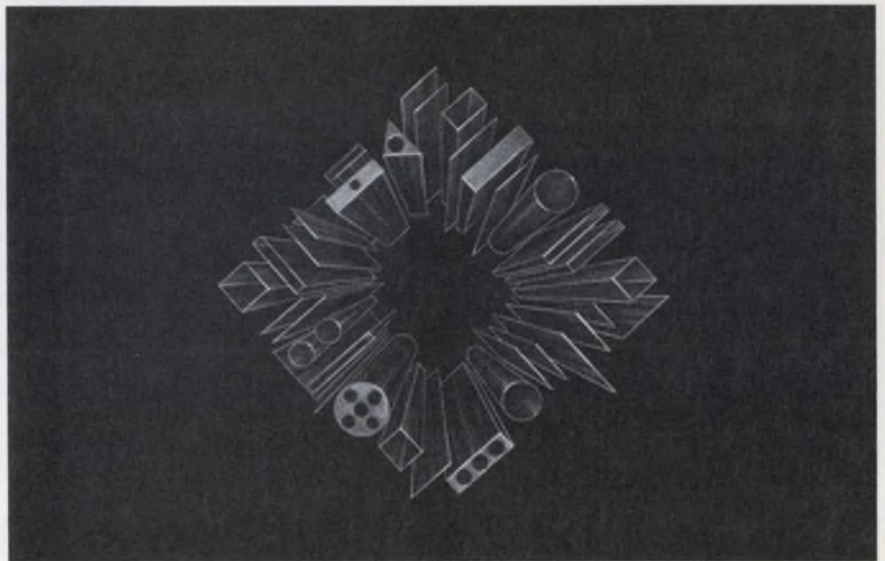

Look deep into our sapphire.

You're a designer. You call us on the phone to ask about our sapphire — and what can it do for your present design problem. It's a special problem, but you know our sapphire does special things. You know it comes in unusual shapes and sizes you can't get anywhere else in the world. And if we don't have the shape or size you want, chances are we

can grow it for you. Quickly. To your specifications. And because we grow it to shape without machining, we have the costs down to some unusual sizes, too.

You're a designer. You have a question about how we can help solve your design problem. Look deep into our sapphire by calling us collect. We probably have the answer you've been looking for.

LYCO saphikon division 16 Hickory Drive • Waltham, Mass. 02154 • (617) 890-2400

INFORMATION RETRIEVAL NUMBER 45

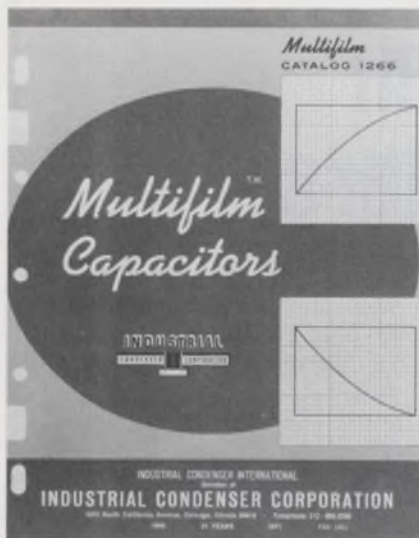

Multilayer capacitors

The Multifilm capacitor catalog 1266 describes in detail the performance characteristics and unique construction of multilayer dielectric capacitors. This special multilayer dielectric results in higher reliability and smaller size. Available in molded polypropylene case for PC mounting—in capacitance values from 0.2 μF to 7 μF . Industrial Condenser Corp., Chicago, Ill.

CIRCLE NO. 344

Guide to real time analysis

The unusual versatility of real time spectrum analysis—a technique that in less than five years has virtually revolutionized the observation and analysis of periodic, random and transient signals—is summed up in a new folder. Applications of real time analysis described in the guide range from display of acoustic and vibration spectra to performing near-instantaneous analysis of high-speed rotating machinery. Spectral Dynamics Corp., San Diego, Calif.

CIRCLE NO. 345

Function generators

A 90-page catalog describes a line of generation and measurement equipment. The publication covers theory, application, specifications and prices of function and sweep generators (from 10 Hz to 10 GHz), phase measurement equipment, and rf detectors and attenuators. Wavetek, San Diego, Calif.

CIRCLE NO. 346

PC repair manual

A printed wiring board repair manual has been assembled to offer the electronics industry suggested procedures for rectifying conditions which may occur to printed wiring boards during their manufacture or assembly. The manual may be used to modify, repair or rework printed wiring board assemblies which have been in field service and have been returned to a vendor for modification. Institute of Printed Circuits, Evanston, Ill.

CIRCLE NO. 347

Commercial switches

No. 43 of "Uses Unlimited," features application ideas for industrial, military and commercial switches. The eight-page publication offers application items, new products, "idea-exchange" features, and a special page describing the highly automated processing of Micro Switch orders worldwide. Micro Switch, Div. of Honeywell, Inc., Freeport, Ill.

CIRCLE NO. 348

FM-FM telemetering modules

A 52-page catalog describes FM-FM telemetering modules, including voltage controlled oscillators, dc amplifiers, dc signal isolators, frequency-to-dc converters, tone oscillators, mixers, phase detectors, analog to digital converters, discriminators, pressure transducers and a telemetering system. Solid-State Electronics Corp., Sepulveda, Calif.

CIRCLE NO. 349

Mechanical rubber products

A 16-page catalog describes facilities and capabilities in the manufacture of mechanical rubber products. Helpful information to both rubber buyers and engineers includes rubber compound design and properties of major elastomers, ordering information with checklist and synthetic rubber compound identification and conversion charts. The Williams-Bowman Rubber Co., Cicero, Ill.

CIRCLE NO. 350

He-Ne lasers

A six-page brochure describes one-, three-, and ten-milliwatt helium-neon laser products which are designed for use in construction, industrial and general laboratory work. Hughes Electron Dynamics Div., Torrance, Calif.

CIRCLE NO. 351

Industrial controls

Various industrial controls consisting of voltage, current and phase monitors, solid-state controls and time-delay relays are illustrated in a 14-page catalog. Diversified Electronics, Inc., Evansville, Ind.

CIRCLE NO. 352

Thin-film resistors

Thin-film precision resistor network catalog provides data on typical standard network and guidelines for custom networks. Standard networks illustrated range from 4-bit to 13-bit ladder networks in DIP and flat-pack packages. Micro Networks Corp., Worcester, Mass.

CIRCLE NO. 353

Coaxial instruments

Twelve valuable instruments for rf and microwave applications are described in a new 16-page booklet. Included are complete and highly detailed specifications for reflectometers, admittance and standing-wave meters, bridges and slotted lines, amplifiers, detectors, and programmable attenuators. General Radio, Concord, Mass.

CIRCLE NO. 354

Linear-IC testing

A 30-page illustrated brochure describes the application of a computer-operated linear-IC test system to the testing of a variety of commercial devices. Among the linear ICs whose testing is discussed are stereo demodulators, chroma demodulators, TV and FM sound systems, and voltage regulators. Teradyne, Inc., Boston, Mass.

CIRCLE NO. 355

bulletin board

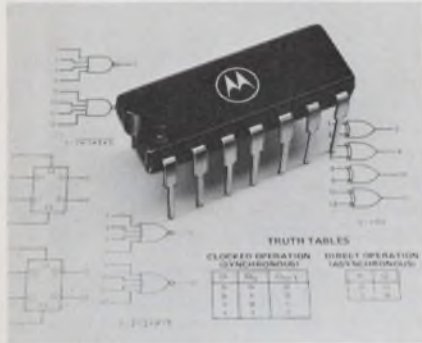

An improved family of low power CMOS logic elements, the Motorola MC14000AL/CL series directly interfaces with low power TTL. Previously known as the MC-14000L series, the seven logic devices currently being offered are: a quad 2-input NOR gate, a dual 4-input NOR gate, a quad 2-input NAND gate, a dual 4-input NAND gate, a dual type "D" flip-flop, a dual 4-bit static shift register, a quad exclusive OR gate. An input impedance of $10^{12} \Omega$ is typical. Prices range from \$1.18 to \$12.65 each in 100-up quantities.

CIRCLE NO. 356

Signetics has added two general purpose and one special purpose high performance op amps to its extensive list of linear ICs. The S5107 and the N5307 are general purpose, internally compensated op amps which directly replace the LM107 and LM307, respectively. Advanced processing techniques which are used in fabrication of these units permit input currents to be held an order of magnitude lower than those of the 5709 op amp. The S5107 and N5307 feature input currents that are no more than 100 nA, maximum input offset current of 20 nA, and offset voltage less than 3 mV. These offset figures are guaranteed over the full common mode and temperature ranges and input and output are both protected against short circuits. The Signetics N5740 is a special purpose, high performance op amp which utilizes a FET input stage for high input impedance and low input current. The device features internal compensation, standard

"pin-out." wide differential and common mode input voltage ranges, high slew rate, and high output drive capability. Input bias current in the N5740 is 0.1 nA, and the slew rate is $6 \text{ V}/\mu\text{s}$.

CIRCLE NO. 357

A family of 20 high-noise immunity logic ICs have been announced by Texas Instruments as alternate-source products to Series 300 circuits. Featuring an internal threshold-setting zener diode, Series 15300 circuits provide a ten-times dc noise immunity improvement over standard TTL. Typical threshold voltage is 6.5 V at 25 C. Offered in 16-pin plastic (N suffix) and ceramic (J suffix) dual-in-line packages, Series 15300 ICs are intended for industrial temperature applications and range in price from \$1.10 to \$4.00 each in 100-up quantities.

CIRCLE NO. 358

Price reductions

At prices less than half those previously common, Hewlett-Packard offers new low-noise microwave transistors. The small quantity price is \$60, and noise figures for the HP21As are 4.5 dB at 4 GHz and 3 dB at 2 GHz.

The reason why price can be so low is the same as the reason why performance can be fully specified: the new low-noise HP21As differ in only one way from HP21s, which have been in volume production for more than a year—the low-noise transistors have arsenic emitters. In all other respects they are HP21s, the 12 GHz small-signal transistor introduced in October, 1970, now in wide use in microwave amplifiers and oscillators.

CIRCLE NO. 359

Pirgo Electronics, power transistor subsidiary of the Sprague Electric Co., has reduced its prices on three key single diffused silicon power transistors. Prices on the 2N3055 have been lowered to \$0.99 each in quantities of 100-999 from \$1.80 each. Price reductions on the 2N3771 and 2N3772 are from \$3 each to \$2.10 each.

CIRCLE NO. 360

Relcom has reduced prices up to 62% on its line of high level mixers, which cover a frequency range of 50 kHz to 500 MHz. They are recommended for use where maximum third order two-tone and intermodulation product suppression is desired; a feature particularly important in wide-band receivers.

CIRCLE NO. 361

Design Data from Manufacturers

Advertisements of booklets, brochures, catalogs and data sheets. To order use Reader-Service Card. (Advertisement)

Low-Noise High-Gain Pre amplification



Complete specifications of a variable-bandwidth high-gain preamplifier are contained in the P.A.R. data sheet, T-224. Included are typical noise figure contours illustrating the amplifier's exceptionally low noise, which is as low as .05 dB at mid frequencies with a 1 megohm source. Other illustrations include typical plots of the equivalent input noise and common mode rejection, which exceeds 100 dB at 60 Hz at all gain settings. The data contained in the specification sheet will be of interest to all engineers and researchers looking for a preamplifier with calibrated gain and rolloffs from dc to 300 kHz. CIRCLE NO. 171

Princeton Applied Research Corporation
Box 2565, Princeton, New Jersey 08540 - (609) 452-2111

Design Data from Manufacturers

Advertisements of booklets, brochures, catalogs and data sheets. To order use Reader-Service Card.
(Advertisement)

FREE MONOGRAPH ON REAL-TIME CORRELATION

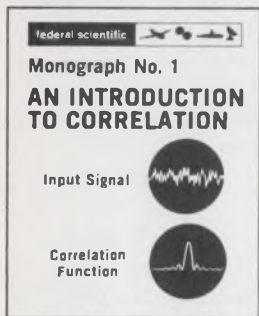

Monograph #1 explains how auto- and cross-correlation are as versatile & useful as Fourier transform. Correlation, a method for finding similarity between wave-forms & time delays, is made practical in REAL TIME through Federal's Ubiquitous® Correlation/Spectrum Analysis systems. For radar, geophysics, sonar, adaptive systems, communications, filter design, reactor control, etc. Detailed applications: reception of signals in noise, direction finding, decoding of magnetically recorded digital data, detection of a periodic signal immersed in noise.

CIRCLE NO. 172

Federal Scientific Corp.

A subsidiary of Elgin National Industries, Inc.
615 West 131st Street, New York, N. Y. 10027

Data Acquisition And Control Systems



New illustrated brochure explains step-by-step how engineering measurement problems can be easily solved by directly interfacing laboratory and production line instrumentation to a computer or programmable calculator. The data acquisition and control system described provides a two-way interface permitting the computer or calculator to automatically alter experiment or process parameters as a result of the measurement and computation. Modular construction of the system permits interface capabilities to be tailored to the individual application.

CIRCLE NO. 173

Princeton Applied Research Corporation

Box 2565, Princeton, New Jersey 08540 - (609) 452-2111

Giant Free Catalog! 4,000 Unusual Bargains



New 148-page catalog! Packed with 1,000's of hard-to-find buys in Optics, Science, Electronics. Loaded with optical, scientific, electronic equipment available from stock. Rare surplus buys. Many "one-of-a-kinds". Ingenious scientific tools. Components galore: lenses, prisms, wedges, mirrors, mounts, accessories. 100's of instruments: pollution test equipment, lasers, comparators, magnifiers, microscopes, projectors, telescopes, binoculars, photo attachments, unique lighting. Shop, save by mail! Request free Catalog "DA".

CIRCLE NO. 174

Edmund Scientific Co.

America's Largest Science-Optics-Electronics Mart
300 Edscorp Bldg., Barrington, New Jersey 08007 (609) 547-3488

Electronic Design

ELECTRONIC DESIGN's function is:

- To aid progress in the electronics manufacturing industry by promoting good design.
- To give the electronic design engineer concepts and ideas that make his job easier and more productive.
- To provide a central source of timely electronics information.
- To promote communication among members of the electronics engineering community.

Want a subscription? ELECTRONIC DESIGN is sent free to qualified engineers and engineering managers doing design work, supervising design or setting standards in the United States and Western Europe. For a free subscription, use the application form bound in the magazine. If none is included, write to us direct for an application form.

If you do not qualify, you may take out a paid subscription for \$25 a year in the U.S.A., \$35 a year elsewhere. Single copies are \$1.50 each.

If you change your address, send us an old mailing label and your new address; there is generally a postcard for this bound in the magazine. You will have to requalify to continue receiving ELECTRONIC DESIGN free.

The accuracy policy of ELECTRONIC DESIGN is:

- To make diligent efforts to ensure the accuracy of editorial matter.
- To publish prompt corrections whenever inaccuracies are brought to our attention. Corrections appear in "Across the Desk."
- To encourage our readers as responsible members of our business community to report to us misleading or fraudulent advertising.
- To refuse any advertisement deemed to be misleading or fraudulent.

Microfilm copies are available of complete volumes of ELECTRONIC DESIGN at \$19.00 per volume, beginning with Volume 9, 1961. Work is now in process to complete the microfilm edition of Volumes 1-8. Reprints of individual articles may be obtained for \$2.00 each, prepaid (\$.50 for each additional copy of the same article) no matter how long the article. For further details and to place orders, contact the Customer Services Department, University Microfilms, 300 North Zeeb Road, Ann Arbor, Michigan 48106 telephone (313) 761-4700.

Want to contact us? If you have any comments or wish to submit a manuscript or article outline, address your correspondence to:

Editor
ELECTRONIC DESIGN
50 Essex Street
Rochelle Park, N.J. 07662

Electronic Design

Advertising Sales Staff

Bryce Gray
Sales Manager

Rochelle Park, N.J. 07662

Robert W. Gascoigne
Daniel J. Rowland
50 Essex Street
(201) 843-0550
TWX: 710-990-5071

Philadelphia

Thomas P. Barth
50 Essex Street
Rochelle Park, N. J. 07662
(201) 843-0550

Boston 02154

Joseph F. Palmer
1268 Main Street
Waltham, Mass.
(617) 894-2700

Chicago 60611

Thomas P. Kavooras
Berry Conner, Jr.
200 East Ontario
(312) 337-0588

Cleveland

Thomas P. Kavooras
(Chicago)
(312) 337-0588
(call collect)

Los Angeles 90303

Stanley I. Ehrenclou
Burt Underwood
2930 Imperial Highway
Inglewood, Calif
(213) 757-0183

San Francisco 94022

Jerry D. Latta
95 Main Street
Los Altos, Calif.
(415) 941-3084

London W. 1

For United Kingdom and Holland
Brayton C. Nichols

For Eastern Europe

Peter Kehr

The American Magazine Group

27 Maddox Street
London, W. 1, England

Phone: 499-0180

Cable: Ammagnic, London

Verviers, Belgium

For Continental Europe

Andre Jamar

1, Ru Mallar, 1

087) 253.83 Telex 41563

Tokyo

Haruki Hirayama

Electronic Media Service

5th Floor, Lila Bldg.,

4-9-8 Roppongi

Minato-ku

Phone: 402-4556

Cable: Electronicmedia, Tokyo



AMERICAN BUSINESS PRESS, INC.



If you're using screw machined parts
as circuit board terminals,
we can save you money.

**ART WIRE
KNOWS
HOW!**

We manufacture a variety of circuit board wire terminals and clips. We fabricate them accurately . . . at far less cost than parts made on screw machines. We supply these parts made from round wire, square wire, flat stock and ribbon . . . plated or unplated.

We'll supply a head or upset to solve your "locating" problems, a knurl or

flat to prevent "rocking" and a radius or chamfer to facilitate insertion and wire attaching. We do this as a single operation and pass the savings on to you.

If you're using these terminals . . . especially if you're using screw machine parts . . . send us a sample or print. We may be able to save you a lot more money than you realize.

ART WIRE & STAMPING COMPANY

116 Wing Drive, Cedar Knolls, New Jersey 07927

INFORMATION RETRIEVAL NUMBER 46

MURA/HIOKI PANEL METERS

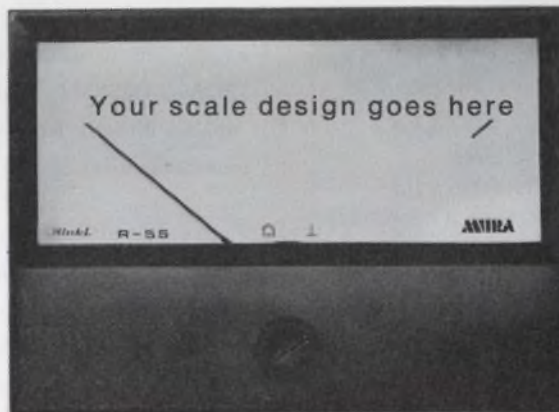

TOP QUALITY AND FULLY GUARANTEED

Made by Hioki, Japan's leading manufacturer of quality panel meters, these fine instruments can be used wherever precision measurement is an absolute requirement. They come in various sizes from 2" x 2½" to 6" x 4½" with either d'Arsonval or taut-band movements. Resistances and scale designs can be tailored to your special needs. Distributed in the United States only by Mura Corp., they are attractively priced and fully guaranteed. Sold only in O.E.M. quantities of 300 and up.

Write for detailed information on your letterhead.

MURA

50 SOUTH SERVICE ROAD, JERICHO, N.Y. 11753

Telephone: (516) 334-2700

Telex: 967-879

Mura is the world's largest supplier of miniature panel meters.

INFORMATION RETRIEVAL NUMBER 47



Information, room reservation forms, admission tickets:
 GERMAN AMERICAN CHAMBER OF COMMERCE
 666 5th Avenue, New York, N.Y. 10019
 77 E. Monroe Street, Chicago, Ill. 60603
 465 California St, San Francisco, Cal. 94104

INFORMATION RETRIEVAL NUMBER 48

advertiser's index

Advertiser	Page
Abbott Transistor Laboratories Incorporated	6
Allen-Bradley Co.	11
Art Wire & Stamping Co.	85
Augat, Inc.	75
Beckman Instruments, Inc., Helipot Division	67
Belden Corporation	51
Bell & Howell, CEC Instruments Division	69
Burr-Brown Research Corporation....	57
Burroughs Corporation	Cover IV
CTS Corporation	38
Centralab, the Electronics Division of Globe-Union, Inc.	29
Chicago Dynamics Industries, Inc....	88
Comco, Inc.	7
Condenser Products Corporation....	86
Dale Electronics, Inc.	Cover II
Dialight Corporation	31
Digital Equipment Corporation—64,	65
Dynascan Corporation	17
Edmund Scientific Company	84
Electronic Development Corporation	36
Electronic Design	12, 13
Fairchild Semiconductor, A Division Fairchild Camera and Instrument Corporation	8, 9
Federal Scientific Corporation	84
General Automation, Inc.	25
German American Chamber of Commerce	86
Gralex Industries	77
Hayden Book Company, Inc.	16, 21
Heath Company	88
Heath Schlumberger Scientific Instruments	18
Heinemann Electric Company	10
Hewlett-Packard	1, 2, 3, 61
Hughes Aircraft Company	34, 35
Hybrid Systems Corporation	81
Inselek	19
Kurz-Kasch, Inc.	18
Lambda Electronics Inc.	Cover III
Mallory Capacitor Company	22
MicroSwitch, A Division of Honeywell	37
MicroWaves	88
Minelco, A Subsidiary of General Time	88
Mostek Corporation	33
Mura Corporation, The	85
Optima, A Division of Scientific Atlanta, Inc.	79
Permag	20
Philips Electronic Components and Materials	16A,B,C
Princeton Applied Research Corp.	83, 84
Servo-Tek Products Company	18
Signetics Corporation	15
Sprague Electric Company	14
Switchcraft, Inc.	42
TRW Semiconductor Division of TRW, Inc.	4
Tektronix, Inc.	27, 41
Teradyne	79
Tescom Corporation	20
Tyco Saphikon Division	81
U. S. Capacitor Corporation	50
Vero Electronics, Inc.	20

WITH OUR CATALOG YOU MAY NOT NEED A CUSTOM

CAPACITOR

AND THE CATALOG IS YOURS FOR THE ASKING



Picture a complete concise composite catalog of over 800 off-the-shelf capacitors, over 1200 variations including some weird and unusual units.

If what you need isn't there, then drop us a line, or give us a call, we'll custom design a capacitor for your circuit, and in most cases there is no charge for customizing. But check the catalog first, what you need may be there and ready for immediate shipment.

TO GET YOUR CATALOG, JUST DROP US A LINE.

**condenser
products
corporation**

Box 997, Brooksville, Florida 33512
 Phone (904) 796-3562

Attention Advertisers:

Could you use copies of your ad exactly as it appeared in ELECTRONIC DESIGN? Then order your reprints directly from us; the minimum unit order is 500 copies.

Please specify if you would like the reprint line omitted on your copies and mail your written order to ELECTRONIC DESIGN, Production Dept., 50 Essex Street, Rochelle Park, New Jersey 07662.

500 1,000 Add'l M
 8x10 or smaller

1 color, 1 side	\$74.70	82.95	18.15
2 color, 1 side	95.47	108.00	25.28
4 color, 1 side	311.03	342.00	44.33

Spreads

1 color	113.66	126.65	25.98
2 color	191.19	205.98	29.58
4 color	354.17	380.76	53.19

Prices FOB Waseca, Minn.

INFORMATION RETRIEVAL NUMBER 49



Learn how to guard against heart attack

Ask your Heart Association for vital information on the early warning signs of heart attack and what you should do to reduce your risk.

You can also learn more about high blood pressure, stroke, inborn heart defects and other heart and blood vessel diseases in interesting booklets prepared by medical experts. They are free — an educational service made possible by your gifts to the Heart Fund.

GIVE... so more **HEART FUND**
will live



Contributed by the Publisher

BITE^{*} SIZE INDICATORS

MINELCO[®] Bite Indicators are extensively utilized in Military Avionic equipment (Per Mil-I-83287B and Mil-E 5400) and in a wide range of Industrial and Commercial applications.

Write for our full line catalog including MINELCO[®] Indicators, Switches and Trimmer Potentiometers.

**Built-In Test Equipment*



MINELCO

a subsidiary

GENERAL TIME

a Talley Industries Company

135 SOUTH MAIN STREET • THOMASTON, CONN. 06787
PHONE: 203/283-8261 • TWX: 710/475-1091

INFORMATION RETRIEVAL NUMBER 50

MINI-THUMBWHEEL SWITCH

FOR COMPUTERS.
NUMERIC CONTROLS.
IN-FLIGHT GEAR.
MANY OTHER SMALL-SPACE INPUT SWITCHING OPERATIONS.

RETROFITS MOST MINIATURE THUMBWHEEL SWITCH PANEL OPENINGS.

CDI Series TSM mini-thumbwheel switches mount on 1/2-inch centers . . . can be furnished with decimal, binary, or binary with complement output—or with specified code characters. Available with extended PC boards for mounting additional components if desired. Large, easily-read numerals . . . positive detent . . . 8, 10 and 12 positions. Completely O-ring sealed against hostile operating environments.



.900" x .980"
FRONT PANEL SIZE
FOR SINGLE
MODULE ASSEMBLY.



CHICAGO DYNAMIC INDUSTRIES, INC.

PRECISION PRODUCTS DIVISION
1725 Diversey Blvd., Chicago, Illinois 60614
Phone (312) 935-4600

INFORMATION RETRIEVAL NUMBER 51

FREE

'72 HEATHKIT CATALOG

- Now with more than 350 kits to save you money
- See the new Heathkit 3 1/2 digit multimeter for just 229.95*

A kit form multimeter that meets lab specs for about half the cost of comparable wired units . . . has 3 1/2 digits for 100 uV resolution on 200 mV range, 1V on 1000V . . . can be calibrated to 0.2% accuracy VDC with calibrator provided, or lab calibrated to 0.1%. There's also a new 5" triggered sweep scope at a price you can't afford to pass up . . . DC-10 MHz response, 50 ns sweep rate with magnification, AC-DC coupling, 50 mV sensitivity, all for only 229.95*. Not to mention over 350 other fun-to-build, money saving kits for every hobby and professional interest . . . from test instruments, marine and ham radio gear, to stereo-hi-fi and color TV. The Heathkit catalog is bigger & better than ever this year. Order yours now.



HEATHKIT
Schlumberger

HEATH COMPANY, Dept. 60-2
Benton Harbor, Michigan 49022

Please send FREE Heathkit Catalog.

Name _____

Address _____

City _____ State _____ Zip _____

Prices & specifications subject to change without notice.
*Mail order prices; F.O.B. factory.

TE-256

INFORMATION RETRIEVAL NUMBER 52

EDITOR

Tired of your present job? Looking for new opportunities to meet people, travel, to attend conferences on the latest microwave technology?

MicroWaves is seeking a graduate electronics engineer to add to its editorial staff. If interested and have writing ability, send resume to:

Hayden Publishing Co./MicroWaves
50 Essex Street
Rochelle Park, New Jersey 07662
(201) 843-0550
Richard T. Davis, Managing Editor

Do you face a make or buy decision on power supplies?

BUY THE NEW LAMBDA LY SERIES

**>50% efficient, 20 KHz switching,
50mV P-P ripple, 0.1% line or load regulation**

SINGLE OUTPUT

\$300

**5 VOLTS 30 AMPS
WITH OVERVOLTAGE
PROTECTION BUILT-IN**

DUAL OUTPUT

\$380

**±15 TO ±12 VOLTS
8.5 AMPS EACH OUTPUT**

TRIPLE OUTPUT

\$395

**5 VOLTS 18 AMPS
DUAL ±15 TO ±12 VOLTS
2 AMPS EACH OUTPUT**

QUADRUPLE OUTPUT

\$450

**5 VOLTS 16 AMPS
DUAL ±15 TO ±12 VOLTS
1.5 AMPS EACH OUTPUT
24 TO 28 VOLTS 1.0 AMPS**

AC input: 105-132 VAC, 47-440 Hz
DC input: 145 VDC ±10%

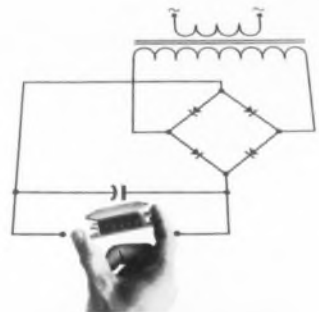
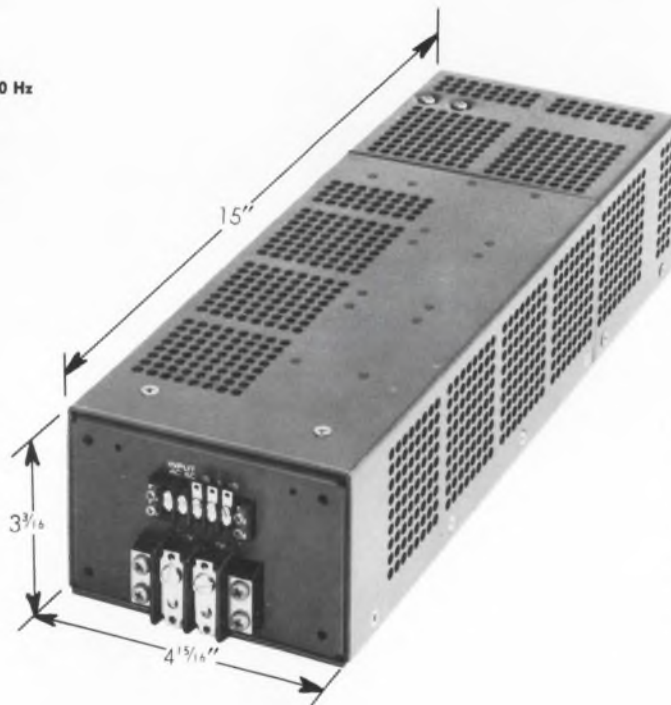

11 standard models in single, dual, triple or quadruple outputs in new "5" package. Triple and quadruple output models incorporate Lambda Power Hybrid Voltage Regulator.

**ALL CARRY LAMBDA'S 5-YEAR GUARANTEE.
ALL IN STOCK FOR 1-DAY DELIVERY.**

**WHETHER
YOU MAKE
OR BUY...**
LAMBDA
ELECTRONICS CORP.
A  Company

We've turned the world of displays upside down

NEW PANAPLEX II™ PANEL DISPLAY

lowest cost... lowest power MOS compatibility

- Lowest power—average power less than 5 milliwatts per segment
- Lowest cost—\$1.00 per digit*
- MOS compatibility—cathodes and anodes can be driven from MOS circuits

There is a lot of talk about displays—new technologies, new innovations, a lot of good new things just “over the horizon.” But the fact is that the PANAPLEX II panel display, representing a technology that grew from the NIXIE® tube, is the best numeric display available now.

Only PANAPLEX II panels switch on voltage and current low enough for direct MOS compatibility Cut power requirements to milliwatts And cut costs down to \$1.00 per digit.* Characters are bright and readable and can be custom-tailored for numerous applications . . . including annunciators requiring special fonts. We packed 8 to 16 digits into a 0.2”-thick (not including tubulation) in-plane display panel for calculators, cash registers, special instruments, you name it.

PANAPLEX II PANEL DISPLAY — More than another new readout, a whole new way of looking at numeric displays.

For additional information write:
Burroughs Corporation,
Electronic Components Division,
P.O. Box 1226, Plainfield, N.J. 07061;
or call our special applications
assistance number, (201) 757-3400.

*50,000 tube quantity.

Leader in the World of Displays

Burroughs



INFORMATION RETRIEVAL NUMBER 01