

Electronic Design 25

VOL. 19 NO.

FOR ENGINEERS AND ENGINEERING MANAGERS

DEC. 9, 1971

Industrial chart recorders can be used to monitor almost anything—from manufacturing processes to environmental pollution levels. The trick is to choose the right

recorder for the job. Should you use a galvanometric recorder or a potentiometric unit? Forced-fluid writing or a heated stylus? For help in deciding, turn to page 48.

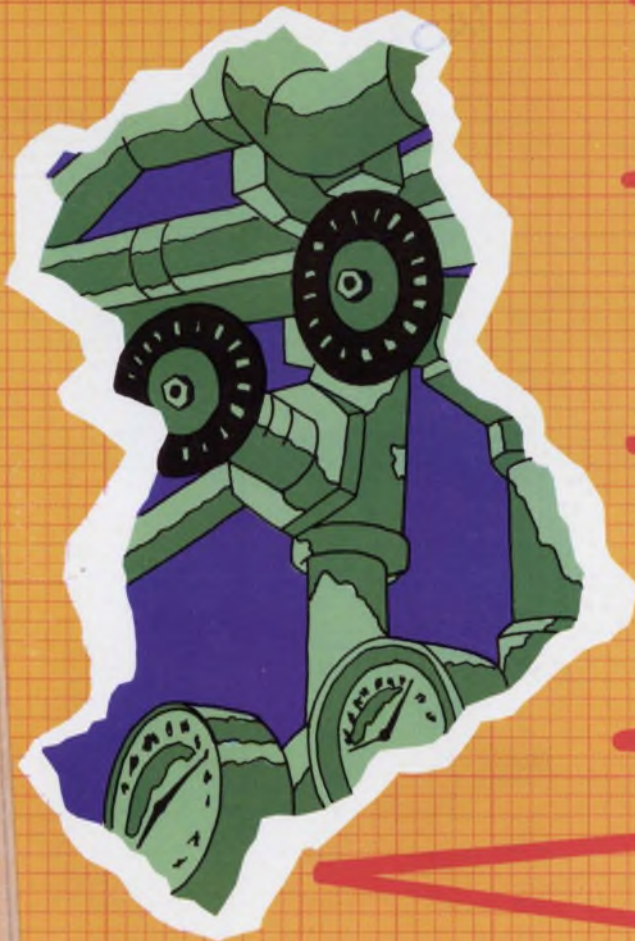

NEW FREE SERVICE!
Enroll Now
Use Card Inside
Front Cover



Custom Toroids



Custom Bobbin Coils



Variable Pitch Inductors



RF Transformers and Inductors



Series Resonant Traps

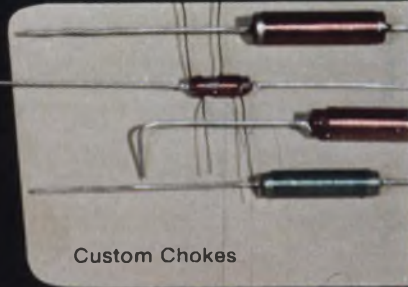

Custom Chokes



PC-Mount Toroids



DIP Pulse Transformers

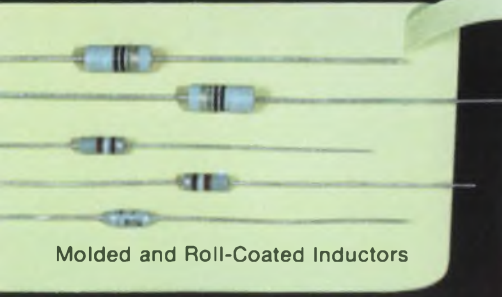

Molded and Roll-Coated Inductors

A good inductor source... just got better!

Dale is moving quickly to qualify as your preferred inductor source. In recent months we have:

DOUBLED our line of standard PC mount toroids (Mil-T-27C, Type TF5SX20ZZ). Standard inductances now available from $.05 \mu\text{h}$ to 20h, in a wide selection of Q vs frequency ranges.

ADDED Pulse Transformers in DIP configurations. Machine and hand insertable models (14,16 pins) are available containing up to four pulse transformers. Inductance range: $1 \mu\text{h}$ to 2 mh; Tolerance $\pm 20\%$; Leakage inductance: As low as .2% of total inductance; Interwinding capacitance: As low as 3 pf; ET product: Up to 10 volts- μsec .

EXTENDED the values and frequencies available in molded inductors (Mil-G-15305D, Grade 1, Class A,B) and roll-coated chokes. Inductance: $.10 \mu\text{h}$ to 1000 μh . Self-resonant frequency: 680 to 3.5 Mhz.

This increased ability to supply standard inductors (many direct from stock) balances well with our custom capabilities in bobbins, rf transformers, chokes and toroids. For a fast quote or immediate design help get in touch with Dale—**lots of people are!** Call today: 605-665-9301

INFORMATION RETRIEVAL NUMBER 241

Take the price you'd normally pay to measure one nanosecond and 550 MHz.

Now divide by two.

Now for less than half the price of alternative solutions you can measure frequencies up to 550 MHz and time intervals from 0.15 nanoseconds to 10⁹ seconds. You get the best resolution too, <50 picoseconds. Only HP's unique type of time interval averaging permits these measurements with such economy.

And you get all the other functions you expect in universal timer/counters. Features such as totalizing, period, ratio and conventional time interval measurements. They're the most programmable counters of their type as well.

This series also includes the only counters with built-in digital voltmeters.

So you can set trigger levels digitally and better than an oscilloscope can for accurate time interval measurements. Use the DVM to check out dc voltages too, or add an HP 11096 probe for ac.

For more accurate measurements you can option for a high stability time base of 5 parts in 10¹⁰/day. Or to measure low level signals, we can offer input sensitivities as high as 25 mV.

The HP 5327 Series is ideal for testing logic timing, cable delays, low-power circuits, and crystal oscillators—as well as calibrating frequency and pulse generators. Prices of the three models in the HP 5327 Series range from only \$1495 to \$2150. Or, if a 50 MHz will do your job, there's the companion 5326 Series from just \$950 to \$1595.

Sound too good to be true? Ask your local HP field engineer about these outstanding counter values. Or for more information, write to Hewlett-Packard, Palo Alto, California 94304; Europe: 1217 Meyrin-Geneva, Switzerland.

02117



HEWLETT  PACKARD

ELECTRONIC COUNTERS

INFORMATION RETRIEVAL NUMBER 2

Siemens

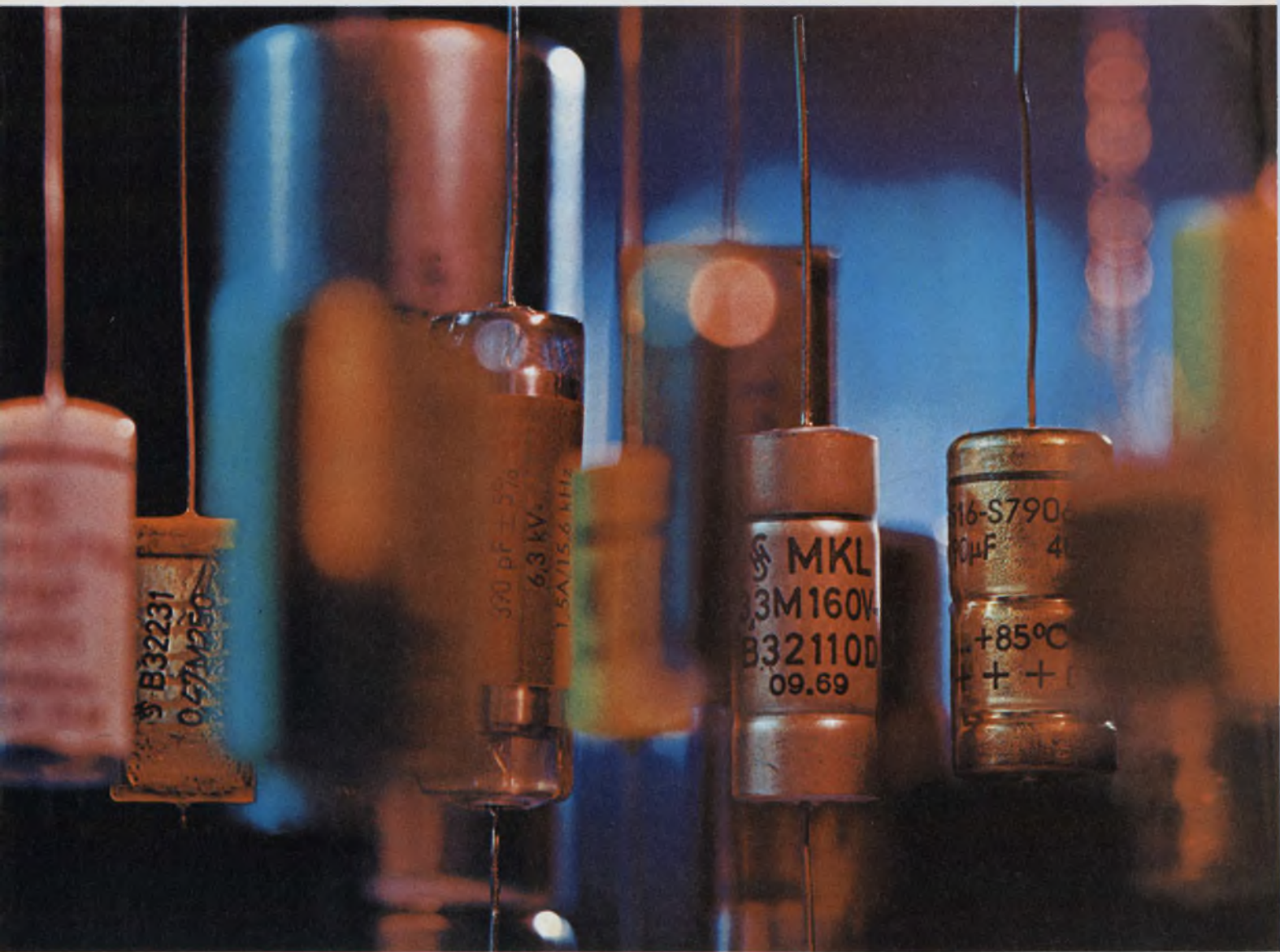

Our MKL metallized lacquer capacitors handle peak voltages four times their rated voltages.

And that means you can use a much smaller capacitor for any given application. This is just one of many Siemens innovations. Our double anodized foil aluminum electrolytics are 30% smaller than competitive units. And our unique MKM metallized polycarbonate construction makes possible a

dramatic reduction in the size of film capacitors.

Our capacitor line is one of the most extensive available. Film and metallized film dielectrics of paper, lacquer, polyester, polycarbonate, polypropylene and polystyrene. Tantalum and aluminum electrolytics. All for immediate delivery.

More and more engineers are designing in Siemens capacitors. You can benefit by doing the same.

Siemens Corporation, 186 Wood Avenue South, Iselin, N.J., 08830. (201) 494-1000. Siemens. A three billion dollar name in quality products.  **SIEMENS**

NEWS

- 19 **News Scope**
- 22 **Coming in computer memories** in the next decade: semiconductors plus moving-magnetic-domain types.
- 24 **How minicomputers can end communication bottlenecks.**
- 26 **A substitute has been proposed for vacuum deposition techniques.**
- 30 **'Instant' holograms** are made possible with new thin-film materials that do not require chemical development.
- 32 **Laser communicator** put in a 3-lb. binocular-type package.
- 38 **Technology Abroad**
- 41 **Washington Report**

TECHNOLOGY

- 48 **FOCUS on Industrial Chart Recorders:** A special report on the most important parameters to consider when shopping for these units.
- 56 **Start logic designs with flow diagrams.** A properly drawn diagram helps you eliminate repetition, simplifies implementation and corrects malfunctions.
- 62 **Constructing the primitive flow table,** the initial step in any sequential circuit synthesis, helps you avoid uneconomical, or even faulty designs.
- 66 **Start bridged-T equalizer design easily** with approximate formulas that avoid trial and error. You can estimate equalization fits and finite-Q effects.
- 70 **Ideas for Design**

PRODUCTS

- 77 **Instrumentation:** Smallest 3-1/2-digit DPM is also the lowest priced—\$89.
- 92 **Modules & Subassemblies:** First commercially available GaP green LED display.
- 96 **Data Processing:** Real-time software expands Varian 620 computer capabilities.
- 84 **ICs & Semiconductors** 106 **Microwaves & Lasers**
- 90 **Data Processing** 108 **Components**
- 102 **Packaging & Materials**

Departments

- 47 **Editorial:** Further confirmation of a changing industry.
- 7 **Letters** 112 **New Literature**
- 13 **Designer's Calendar** 115 **Bulletin Board**
- 110 **Evaluation Samples** 118 **Advertisers' Index**
- 111 **Application Notes** 120 **Information Retrieval Card**

Cover: Designed by Art Director, Bill Kelly

We Must Communicate

... on land!

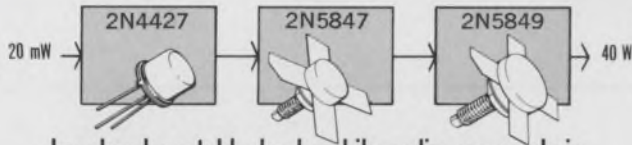

Low-band, portable land-mobile radio power chain.
25 to 50 MHz, 12.5 V.

Send for data sheets and AN282: "Systemizing RF Power Amplifier Design" and AN502: "A 40 W, 50 MHz Transmitter for 12.5 V Operation."

INFORMATION RETRIEVAL NUMBER 211

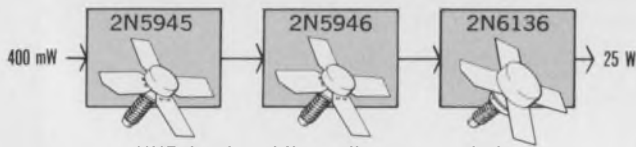

UHF land-mobile radio power chain.
470 to 512 MHz, 12.5 V.

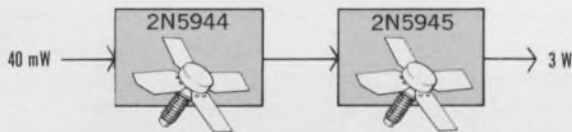

UHF portable land-mobile power chain.
470 to 512 MHz, 7.5 V.

Send for data sheets and AN548: "Microstrip Design Techniques for UHF Amplifiers."

INFORMATION RETRIEVAL NUMBER 212

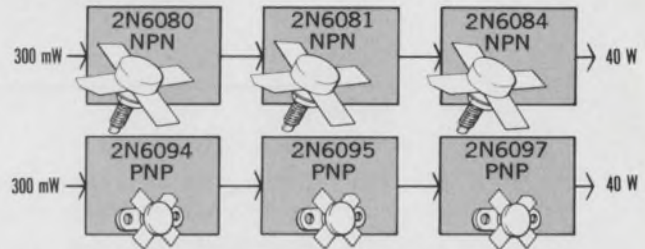

High-band, portable land-mobile radio power chain.
150 to 175 MHz, 12.5 V.

Send for data sheets and AN282: "Systemizing RF Power Amplifier Design" and AN495: "A 25 W, 175 MHz Transmitter for 12.5 V Operation."

INFORMATION RETRIEVAL NUMBER 214

Land-mobile radio, covering 3 distinct frequency ranges, requires significantly different devices in each band. Other design techniques are required for UHF devices than low or high-band. Data sheets and application notes examine these differences with UHF types even characterized at 7.5 V for portable operation. Motorola has them all!

... at sea!

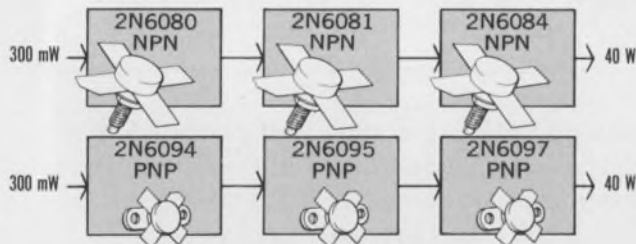

Marine radio power chain.
152 to 162 MHz, 12.5 V.

Send for data sheets and AN282: "Systemizing RF Power Amplifier Design" and AN495: "A 25 W, 175 MHz Transmitter for 12.5 V Operation."

INFORMATION RETRIEVAL NUMBER 215

Marine radio falls into the same frequency range as high-band land-mobile with the same type of modulation and voltage required. Both PNP and NPN chains are available from Motorola for your designs!

... in the air!

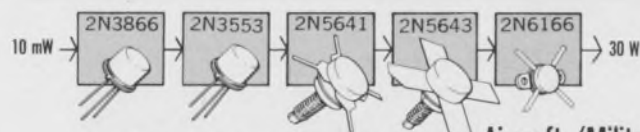

108 to 136 MHz, 13.5 V.

Aircraft/Military radio power chain.

225 to 400 MHz, 28 V.

Send for data sheets and AN481: "A broadband 4 W Aircraft Transmitter;" AN503: "A 25 W Broadband Aircraft Transmitter" and AN507: "A 13 W Broadband AM Aircraft Transmitter."

INFORMATION RETRIEVAL NUMBER 213

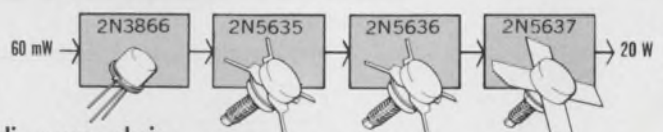

INFORMATION RETRIEVAL NUMBER 216

Typical AM systems are shown. Devices capable of 25 W and 50 W output for 225 to 400 MHz range are available on special request. And they're Isothermal-rugged!

With You At Once

... by cable TV!

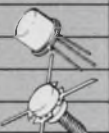
CATV Device	Gain (dB)	Cross Modulation Distortion	Noise Figure (dB)	Case
2N5109	11 Typ	-70 dB Typ ⁽¹⁾	3.0 Typ	
2N5943	11.4 Typ	-67 dB Typ ⁽²⁾	3.4 Typ	
2N5947	11	-60 dB Typ ⁽³⁾	3.8 Typ	
2N6135	11	-62 dB Typ ⁽³⁾	4.8 Typ	

⁽¹⁾ 2 channel with +54 dBmV output level
⁽²⁾ 12 channel with +40 dBmV output level
⁽³⁾ 12 channel with +50 dBmV output level

CATV. 5 to 300 MHz

... on single sideband!

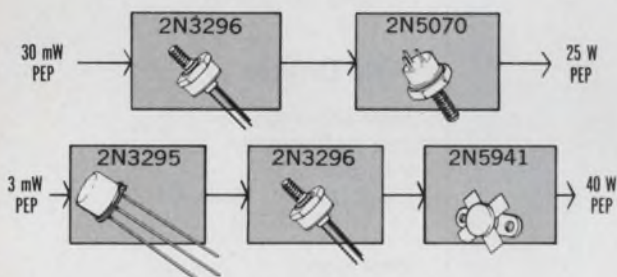

Single sideband power chain.
2 to 30 MHz, 28 V.

Send for data sheets with complete characterization for broadband CATV operation including distortion specs, noise figures and Y & S parameters . . . they're unique with Motorola!

INFORMATION RETRIEVAL NUMBER 217

Hybrid circuits offer important performance, reliability and space advantages. Both upstream and downstream hybrid designs are available from the factory.

Send for data sheets and AN546: "Solid-State Linear Power Amplifier Design."

INFORMATION RETRIEVAL NUMBER 218

The problem of linear amplifier design, including a technique for temperature compensation utilizing only passive devices can be solved. The block diagrams show output capability at two of the most popular power levels with 150 W PEP outputs easily obtainable with multiple devices.

... without noise!

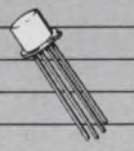
Low-Noise Device	Noise Figure (max)	Frequency	Case
2N5179	4.5 dB	200 MHz	
2N5031	2.5 dB	450 MHz	
2N2857	4.5 dB	450 MHz	
2N5829 (RNP)	2.5 dB	450 MHz	
2N4957 (RNP)	3.0 dB	450 MHz	

Low Noise Designs.

Send for data sheets and AN215: "RF Small Signal Design Using Admittance Parameters;" AN419: "UHF Amplifier Design Using Data Sheet Design Curves" and AN421: "Semiconductor Noise Figure Considerations."

INFORMATION RETRIEVAL NUMBER 219

These low-noise devices excel in receiver front-end designs and have excellent noise figures at frequencies other than those listed. Design in Motorola quietness!

... and a word about ruggedness in RF.

Few semiconductors are subject to as severe treatment as RF devices. Load mismatching — by far the largest single cause of transistor failure — has largely been curtailed with the introduction of Motorola balanced emitter technology . . . BET* . . . and most recently, Isothermal* fabrication techniques. The latter has furnished an important new level in RF device ruggedness on many Motorola types with heat buildup reduced 50% through use of an asymmetrical emitter-resistor path design

which apportions heat evenly over the entire chip surface.

Choose from more than 150 standard — and rugged — Motorola types . . . with frequency ranges to 2 GHz . . . power outputs to 100 W . . . in 18 optimized package styles. And you can customize device performance and testing merely by letting us know your particular needs. Write for data sheets and let's communicate.



MOTOROLA RF
— Get The Message.

Trademark of Motorola Inc.

A Smart Way to Beat Your Power Supply Size Problem



1½" thin, 2¾" narrow, 2¾" short

yet this converter produces 1000 volts DC, regulated, from a battery input of 28 VDC! It weighs less than 15 ounces. This is only one of our wide variety of many small light weight converters, inverters and power supplies — there are over 3000 models listed in our newest catalog, including size, weight and prices. If you have a size problem, why not send for an Abbott catalog?

MIL SPEC ENVIRONMENT — All of the power modules listed in our new catalog have been designed to meet the severe environmental conditions required by modern aerospace systems, including MIL-E-5272C and MIL-E-5400K. They are hermetically sealed and encapsulated in heavy steel containers. New all silicon units will operate at 100°C.

Please see pages 930 to 949 of your 1970-71 EEM (ELECTRONIC ENGINEERS MASTER Catalog) for complete information on Abbott modules.

Send for our new 68 page FREE catalog.

RELIABLE -- Highest quality components are used in Abbott power modules to yield the high MTBF (mean time between failure) as calculated in the MIL-HDBK-217 handbook. Typical power modules have over 100,000 hours MTBF — proving that the quality was built in from the beginning.

WIDE RANGE OF OUTPUTS — Any voltage from 5 volts DC to 3,650 VDC is available by selecting the correct model you need from our catalog with any of a variety of inputs including:

- 60 ∞ to DC, Regulated
- 400 ∞ to DC, Regulated
- 28 VDC to DC, Regulated
- 28 VDC to 400 ∞ , 1 ϕ or 3 ϕ
- 24 VDC to 60 ∞ , 1 ϕ

abbott

transistor

LABORATORIES, INCORPORATED

5200 W. Jefferson Blvd./Los Angeles 90016
(213) 936-8185
Cable ABTLABS

1224 Anderson Ave./Fort Lee, N.J. 07024
(201) 224-6900

INFORMATION RETRIEVAL NUMBER 4

Publisher

Peter Coley

Editors

Editorial Offices

50 Essex St.

Rochelle Park, N.J. 07662

(201) 843-0550

TWX: 710-990 5071

Cable: Haydenpubs Rochellepark

Editor: George Rostky

Managing Editor: Ralph Dobriner

Managing Editor: Raymond D. Speer

Associate Editors:

Roger Allan

Jules H. Gilder

Richard Lee Goldberg

John F. Mason

Michael J. Riezenman

Nathan Sussman

Edward A. Torrero

Richard L. Turmail

Field Offices

Massachusetts

Jim McDermott

P.O. Box 272

Easthampton, Mass. 01027

(413) 527-3632

West Coast

David Kaye

2930 Imperial Highway

Inglewood, Calif. 90303

(213) 757-0183

Washington

Don Byrne

1111 S. Army Navy Drive

Arlington, Va. 22202

(202) 296-8982

Editorial Production

Dollie S. Viebig

Art

Art Director, William Kelly

Richard Luce

Anthony J. Fischetto

Production

Manager, Thomas V. Sedita

Helen De Polo

Maxine Correal

Anne Molfetas

Circulation

Manager, Nancy L. Merritt

Joan Licari

Information Retrieval

Peggy Long

letters

Hospital engineer joins call for better devices

Your article in the Oct. 28 issue on "Defects in Medical Electronics Draw Heavy Fire From Hospitals" (ED 22, pp. 22-26) is timely, true and revealing.

The hospitals should be blamed for not giving much attention to the problem. This, however, is changing rapidly, as is the case in our facility. But, the major share of the problem lies with the manufacturers. It seems that some manufacturers do not understand, nor are they willing to accept, the hospital environment. When electronic equipment is built to fly to the moon, it is designed accordingly; there is no reason why electronic equipment designed for the hospital should not be made for the hospital environment.

Allan Belgard [president] of Electrodyne may be only partly correct in his statement. Some of

Electrodyne's equipment, which is only about one year old, lacks the most basic service considerations, and there is still a mess of wires in the new pressure monitor, Model PR-15. For example, PC boards do not show component references, workmanship is marginal and replacement of an indicator light on a monitor requires a major effort. These problems are not new to the electronics industry—I have been in this field for over 15 years. So what is Electrodyne's excuse? Or what is the excuse for not having a good instructional manual with accurate schematics?

The hospitals need to accept and learn about proper equipment care. But, more important, the manufacturers need to design and build quality instruments. The hospital, or anyone else, cannot inspect quality into an instrument; the quality must be built-in in the first place.

Mort Arditti

Senior Biomedical Engineer

Computer Sciences and
Bioengineering Facility
Department of Cardiology
Cedars-Sinai Medical Center
Los Angeles, Calif. 90054

A manufacturer's view

As the leading manufacturer of meter relays, I would like to comment on your Oct. 28 article "Defects in Medical Electronics Draw Heavy Fire From Hospitals."

First, let me express my sympathy for the plight of the doctors and other users of medical electronic equipment. I am sure that one of the world's most frustrating experiences must be the failure or malfunction of electronic-support equipment in the middle of a critical operation. Especially aggravating must be the discovery that the failure was in some simple (to them) low-cost component.

Since the article mentioned meter relays as high failure-rate components, I would like to say that the meter relay is a complex component. Our company (LFE's

recent acquisition, API Instruments) has devoted much money and effort to educate the prospective user to the advantages and design pitfalls of meter relays. Nevertheless there have been cases of misapplication. Whenever they have come to our attention, we have worked with the manufacturer, either in correcting this circuit or in making changes in the meter relay, until the misapplication problem was solved. As Electrodyne's president, Alan Belgard, points out, equipment that was built 10 and 15 years ago is often being used as a basis for present-day complaints, and this just isn't rational.

John D. Saint-Amour

Senior Vice President

LFE (AUI Instruments)

LFE Corp.
1601 Trapelo Rd.
Waltham, Mass. 02154

Electronic Design welcomes the opinions of its readers on the issues raised in the magazine's editorial columns. Address letters to Managing Editor, Electronic Design, 50 Essex St., Rochelle Park, N. J. 07662. Try to keep letters under 200 words. Letters must be signed. Names will be withheld on request.

PICO transformers ... small size ... big specs

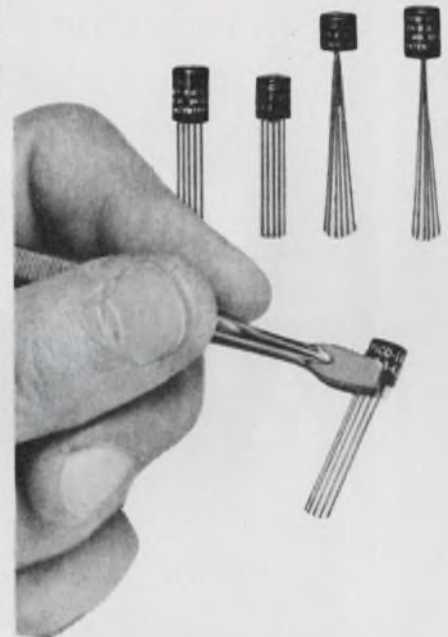

- size variations of .25" diam. x .25" ht. to .34" diam. x .49" ht.
- MIL-T-27C (PICO is QPL source)
- extreme resistance to thermal shock MIL-STD-202D, method 107(A-1)
- 300 Hz-250KHz
- pulse applications .05 μ s to 100 μ s
- prim. and sec. impedances 3 to 250 K ohms
- power to 600 milliwatts
- inductors to 80 henries
- flying leads or TO-5 plug-in construction (.1" grid available)

Send for 24 page Pico Catalog

PICO Electronics, Inc.

316 W. FIRST STREET
MOUNT VERNON, N. Y. 10550

Telephone 914-699-5514

(All PICO Products are patented)

INFORMATION RETRIEVAL NUMBER 5

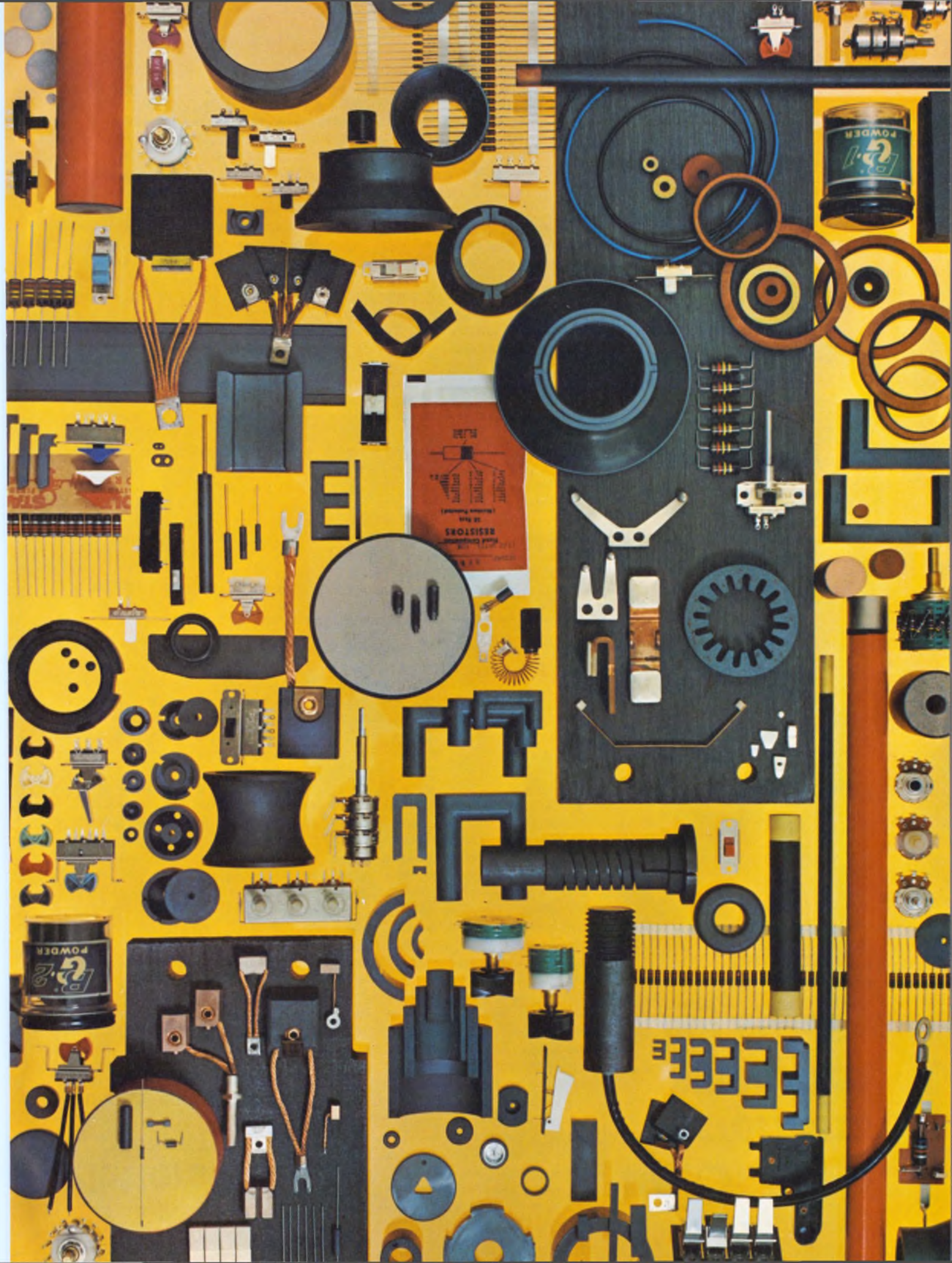

Our part in your product is value



**Carbon and
Graphite
Products**



**Electro-
Mechanical
Components**



**Hard and Soft
Ferrites**

*The items shown are produced by Stackpole's
Carbon Division, Electronic Components Division,
Magnet Division and Stackpole Components Company.*

We make a lot of things at Stackpole. Components by the millions. Materials by the ton. But what really makes us different is our philosophy.

Stackpole believes in producing the best possible product, for the lowest practical price, delivered on time and backed by service. Simple? Sure. Perhaps even old-fashioned. But true. And certainly no small task.

Ours is a manufacturing technology. A capability to produce. In volume. To your specific needs.

For sixty-five years, Stackpole has served virtually every industry. To many, we are the known, respected leader. Others in emerging technologies are coming to know the special skills, imagination, experience and quality uniquely Stackpole.

Value. It's determined in performance. For products and companies alike. Let us be a part of your production team.

Stackpole Carbon Company,
St. Marys, Pennsylvania 15857.



STACKPOLE

Dow Corning silicones seal, bond, insulate, cool, encapsulate...

and how's this for repairability?

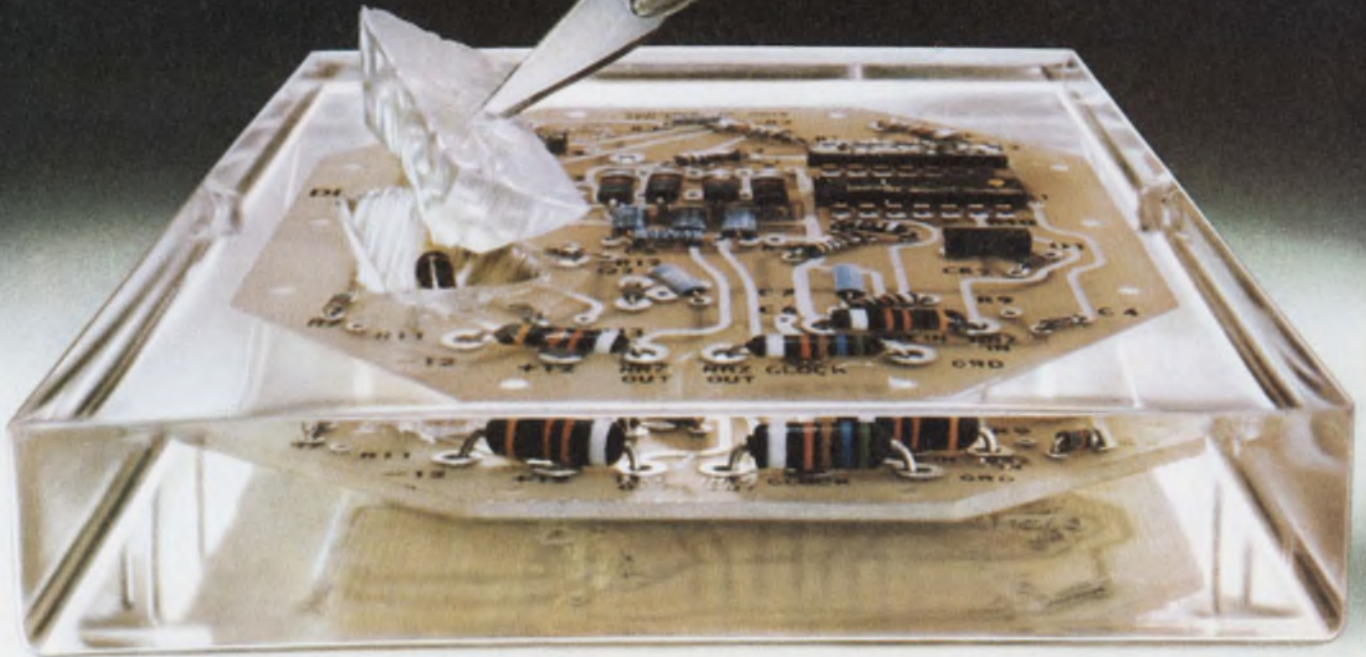

See-through silicone package speeds repair. Encapsulation of microcircuits with a clear resilient Sylgard® brand resin pays off with more than just protection. When circuits are under development, the encapsulant can be cut away to expose components for testing and modification. And, if fast field repair is a factor, defective components are more quickly located and replaced. Voids are merely filled with the silicone resin and protection is again intact. Sylgard resins also eliminate cure shrinkage associated with other encapsulants. They easily meet the most exacting shock, vibration, temperature and moisture resistant requirements. Circle Information Retrieval Number 821.

Silicone materials are unusually versatile. But whether they are used to seal, bond, insulate, impregnate, encapsulate or cool—their one basic function is to protect. And they protect better because of inherent silicone resistance to change—regardless of environment. When electronic equipment must function reliably in hostile atmospheres, look

to silicones from Dow Corning to shut out trouble. Described here are a few ways our materials can ensure the integrity of your designs. Many others are described in our Silicone Electronic Materials brochure available from your Dow Corning distributor. His name appears on the following page. Or write Dept. A-1220, Midland, Michigan 48640.

Electrical / electronic materials from

DOW CORNING

DOW CORNING

Noncorrosive silicone sealants.

For critical electronic insulating requirements on corrosion-sensitive materials. Four noncorrosive, acid-free curing silicone sealants are available from Dow Corning—two are pourable, self-leveling liquids for conformal coatings; the other two are nonslump materials for sealing, mounting and bonding. All are ready to use, cure at room temperature and are serviceable over a wide temperature range. Circle Information Retrieval Number 822.

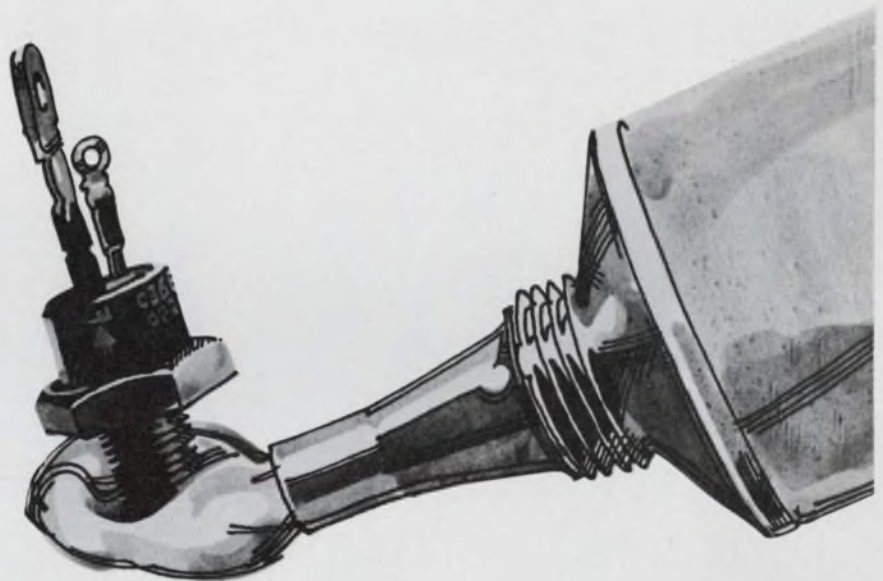

Dissipate heat fast with silicones.

You can use silicone materials to protect from heat, or to get rid of it. A Dow Corning® brand heat sink compound helps cool components such as transistors, diodes and rectifiers by transferring operating heat to heat sink or chassis. Thermal conductivity is effective as high as 200 C with this noncorrosive, metal-oxide filled silicone material. Ask about silicone fluid coolants also. Circle Information Retrieval Number 823.

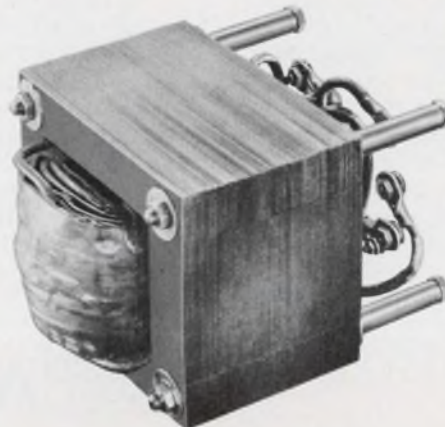

Silicone varnish aids miniaturization.

When operating temperatures of new spacesaving power supplies such as transformers hit the 200 C mark, protection with Dow Corning® brand silicone impregnating varnishes ensures performance. These materials are the most reliable insulating resins available. And they are easy to apply. Stators, chokes, coils, solenoids and other electronic equipment are protected by simply dipping, brushing, flooding or impregnating. Circle Information Retrieval Number 824.

The new Merlin 1[®] connector.

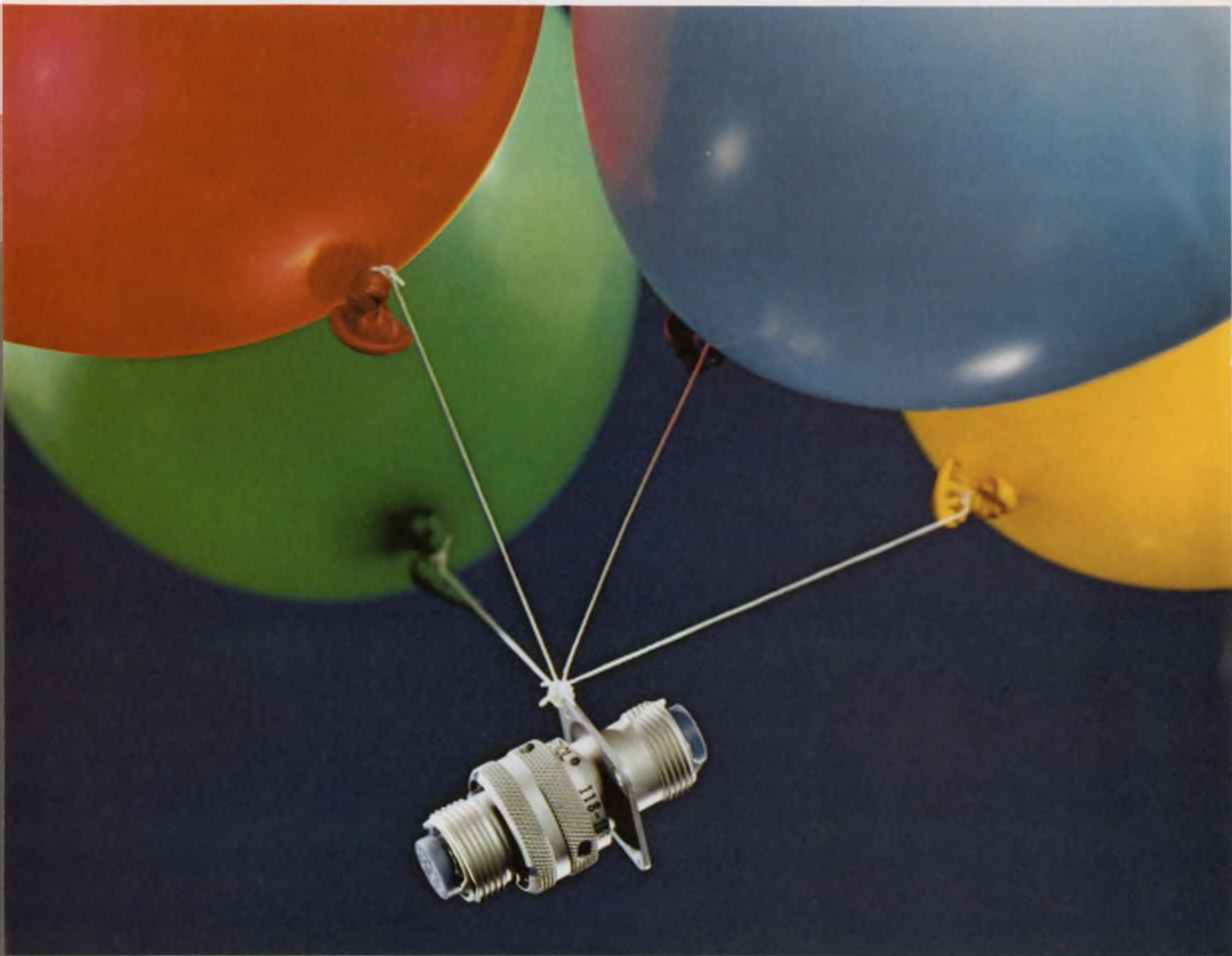

40% lighter than anybody else's.

Through the magic of Amphenol engineering we now bring you a rear-release, cylindrical, environmental connector that is not only 40% lighter than competition, but ½-inch shorter than most.

A one-piece thermoplastic retention disc, molded of tough Astrel 360* replaces the individual metal retention clips common in heavier connectors. Therefore, a 61-pin Merlin configuration has one retention disc instead of 61 individual metal clips. The result is a lot less useless weight. And, without all those parts, more reliability.

Adds a little magic to cost-cutting, too.

Our new Merlin exceeds all performance requirements of MIL-C-83723, MIL-C-26482 and NAS-1599 and is fully intermateable and intermountable with all three of these types.

Shell sizes are available in the eight most popular configurations with your choice of straight plug and both wall-mounted or jam-nut receptacles.

To get the full story on the new Merlin 1 connectors, just write or call Steve Kelleher, Amphenol Connector Division, Bunker Ramo Corporation, 2801 S. 25th Avenue, Broadview, Ill. 60153, (312) 261-2000.

*Registered Trade Mark 3M Company.



AMPHENOL

designer's calendar

JANUARY 1972

S	M	T	W	T	F	S
						1
2	3	4	5	6	7	8
9	10	11	12	13	14	15
16	17	18	19	20	21	22
23	24	25	26	27	28	29
30	31					

Jan. 25-27

Symposium on Reliability, (San Francisco), Sponsor: IEEE, J. H. Simm, Beckman Inst. Inc., 2200 Wright Ave., Richmond, Calif. 94804

CIRCLE NO. 422

Jan. 30-Feb. 4

Power Engineering Meeting, (New York City), Sponsor: IEEE, J. W. Bean, AEP Service Corp., 2 Broadway, New York, N. Y. 10004

CIRCLE NO. 423

FEBRUARY 1972

S	M	T	W	T	F	S
			1	2	3	4
5	6	7	8	9	10	11
12	13	14	15	16	17	18
19	20	21	22	23	24	25
26	27	28	29			

Feb. 8-10

Aerospace & Electronic Systems Winter Convention (WINCON), Los Angeles), Sponsor: IEEE, Gerry Goldenstern, L.A. Council Office, 3600 Wilshire Blvd., Los Angeles, 90010

CIRCLE NO. 424

Feb. 16-18

International Solid-State Circuits Conference (Philadelphia), Sponsor: IEEE, A. V. Brown, T. J. Watson Res. Ctr., Box 218, Yorktown Heights, N.Y. 10598

CIRCLE NO. 425

DOW CORNING SILICONE PROTECTORS

A full line of silicone encapsulating, insulating, sealing, coating and dielectric materials is available from Dow Corning Distributors at the following warehouse locations:

- ARIZONA**
Phoenix Essex International Inc.—I.W.I. Div. 602-278-8568
- CALIFORNIA**
Berkeley C. D. LaMoree 415-841-0601
Culver City E. V. Roberts & Associates, Inc. 213-870-9561
Los Angeles Essex International Inc.—I.W.I. Div. 213-264-7000
C. D. LaMoree 213-225-5666
Mountain View K. R. Anderson Company, Inc. 415-961-6007
San Diego A. E. Yale Enterprises 714-296-6148
San Francisco Essex International Inc.—I.W.I. Div. 415-626-5351
- COLORADO**
Denver Waco Electronics, Inc. 303-322-7708
- FLORIDA**
Fort Lauderdale Cramer/Florida Inc. 305-947-6517
Orlando Brownell, Inc. 305-424-5634
Electrical Insulation Suppliers, Inc. 305-855-7100
- GEORGIA**
Atlanta Electrical Insulation Suppliers, Inc. 404-355-1651
Hapeville Brownell, Inc. 404-767-9301
- ILLINOIS**
Chicago Prehler Electrical Insulation 312-384-6100
Magnuson Electronics, Inc. 312-956-0700
Niles Essex International Inc.* 312-647-0044
- INDIANA**
Fort Wayne Essex International Inc.—I.W.I. Div. 219-742-7441
Hammond Electric Supply Corp. 219-932-8840
- IOWA**
Marion Ensco Distributing Corporation 319-377-6313
- KENTUCKY**
Louisville E & H Electric Supply 502-587-0991
- LOUISIANA**
New Orleans Williamson Distributing Corp. 504-486-5584
Shreveport Williamson Distributing Corp. 318-424-6638
- MARYLAND**
Baltimore Essex International Inc.—I.W.I. Div. 301-644-0140
Pyttronic Industries, Inc. 301-539-6525
- MASSACHUSETTS**
Cambridge Brownell, Inc. 617-864-7500
Newton Cramer Electronic, Inc. 617-969-7700
Peabody Essex International Inc.—I.W.I. Div. 617-531-7100
- MICHIGAN**
Detroit Essex International Inc.* 313-921-6000
Madison Heights McNaughton-McKay Electric 313-399-7500
- MINNESOTA**
St. Paul Magnuson Electronics, Inc. 612-227-8495
- MISSOURI**
Kansas City Essex International Inc.—I.W.I. Div. 816-842-1613
St. Louis Ensco Distributing Corp. 314-542-3935
Essex International Inc.—I.W.I. Div. 314-371-2616

- NEW JERSEY**
Livingston Robert McKeown Co., Inc. 210-992-0700 or 212-267-9264 (NYC)
Moonachie Essex International Inc.—I.W.I. Div. 201-641-4400 or 212-695-7495 (NYC)
North Bergen Electrical Insulation Sales 201-864-2376 or 212-564-6273 (NYC)
- NEW MEXICO**
Albuquerque Waco Electronics, Inc. 505-268-2409
- NEW YORK**
Buffalo Summit Distributors, Inc. 716-884-3450
New York City Brownell, Inc. 212-691-7900 or 212-924-6000
- NORTH CAROLINA**
Charlotte Brownell, Inc. 704-399-9791
Electrical Insulation Suppliers, Inc. 704-392-2306
Essex International Inc.—I.W.I. Div. 704-394-1315
- OHIO**
Cincinnati Cramer/Tri States, Inc. 513-771-6441
Electrical Insulation Suppliers, Inc. 513-771-4073
Sheridan Sales Co. 513-761-5432
Essex International Inc.* 513-771-6500
Cleveland Essex International Inc.* 216-781-2310
Prehler Electrical Insulation 216-267-2650
Columbus McGraw-Edison Co. National Electric Coil Division 614-488-1151
- OKLAHOMA**
Oklahoma City Essex International Inc.—I.W.I. Div. 405-236-5411
- OREGON**
Portland Essex International Inc.—I.W.I. Div. 503-665-0138
C. E. Riggs, Inc. 503-226-3286
- PENNSYLVANIA**
Harrisburg Pyttronic Industries, Inc. 717-233-6591
Montgomeryville Pyttronic Industries, Inc. 215-643-2850
Philadelphia Brownell, Inc. 215-632-3030
Essex International Inc.—I.W.I. Div. 215-236-7100
Prehler Electrical Insulation 215-725-5914
Pittsburgh Essex International Inc.* 412-244-1145
- TENNESSEE**
Memphis Brownell, Inc. 901-323-7693
Electrical Insulation Suppliers, Inc. 901-947-4176
- TEXAS**
Dallas Essex International Inc.—I.W.I. Div. 214-339-8346
Specialized Products Company 214-358-4663
Williamson Distributing Corp. 214-741-5831
Houston Essex International Inc.—I.W.I. Div. 713-227-6358
Williamson Distributing Corp. 713-672-1715
- WASHINGTON**
Seattle Atlas Packing & Rubber Co. 206-623-4697
Essex International Inc.—I.W.I. Div. 206-763-8650
C. E. Riggs, Inc. 206-623-5707
- WISCONSIN**
Milwaukee Essex International Inc.* 414-342-3927
*IMC/I.W.I. Div.

Electrical/electronic materials
from

DOW CORNING

DOW CORNING



Motorola Holds The Trump In Thyristors

And we want to deal you in!

Into one of the broadest thyristor lines available in the 1/2 to 100 A range. Backed by the No. 1 discrete house in the industry. But besides these two factors we're introducing several new reasons for letting us do the dealing.

For one, device number standardization.

Anyone who's ever specified thyristors realizes the jumble of house numbers staring him in the face; sometimes as many as thirty for one single device. Yet no one's had the motivation to standardize the situation by bringing 2N numbers, in mass, to this segment of the semiconductor industry.

Until now.

Motorola has begun a program of standardizing its total thyristor line — SCR's, triacs, triggers, UJT's, and diacs — by introducing 2N numbers to replace the frequent occurrence of house numbers. This will result in more useful specifications for easier device comparison and fast ordering procedures for both you and your company along with the peace of mind that comes with a 2N number.

A 2N number means security. Security that specs will play a repeat performance; no alterations just to satisfy manufacturing purposes.

A second idea is our glass-passivated process assuring uncontaminated junctions to provide the reliability in thyristors you've learned to expect from Motorola.

And the third idea we're promoting is really just common sense, but isn't commonly practiced — customer satisfaction. Well, we'd like to make customer satisfaction a common rule.

We want to supply you with every quality, reliable thyristor you need, whether you want one or thousands, when you want them, and at a price we're sure you'll find very attractive. To do all these good things we've committed our widely known and respected "production house" capability.

So take advantage of the offer on the opposite page. We know you'll draw a trump in thyristors.

YOUR FRANCHISED MOTOROLA SEMICONDUCTOR DISTRIBUTORS

ALABAMA, Huntsville	Gulf Electronics Corp	(205) 539-2731	MICHIGAN, Detroit	RS Electronics	(313) 491-1012
ARIZONA, Phoenix	Hamilton/Avnet	(602) 269-1391	MINNESOTA, Edina	Low Bonn Co	(612) 941-4860
CALIFORNIA, El Segundo	Liberty Electronics Corp	(213) 322-8100	MINNESOTA, Minneapolis	Semiconductor Specialists, Inc.	(612) 854-8841
CALIFORNIA, Los Angeles	Hamilton Electro Sales	(213) 870-7171	MISSOURI, St. Louis	Semiconductor Specialists, Inc.	(314) 428-6100
CALIFORNIA, Los Angeles	K-Tronics/Wesco	(213) 685-9525	NEW JERSEY, Moorestown	Angus, Inc.	(609) 235-1900
CALIFORNIA, Mountain View	Elmar Electronics	(415) 961-3611	NEW JERSEY, Pennsauken	Radio Electric Service Co.	(609) 662-4000
CALIFORNIA, Mountain View	Hamilton/Avnet	(415) 961-7000	NEW MEXICO, Albuquerque	Kierulff Electronics Co., Inc.	(505) 247-1055
CALIFORNIA, Palo Alto	Kierulff Electronics, Inc.	(415) 968-6292	NEW YORK, Binghamton	Federal Electronics, Inc.	(607) 748-8211
CALIFORNIA, San Diego	Hamilton/Avnet	(714) 279-2421	NEW YORK, Hauppauge, L.I.	Cramer Electronics, Inc.	(516) 231-5600
CALIFORNIA, San Diego	Kierulff Electronics, Inc.	(714) 278-2112	NEW YORK, Rochester	Cramer Electronics, Inc.	(716) 275-0300
COLORADO, Denver	Hamilton/Avnet	(303) 433-8551	NEW YORK, East Syracuse	Cramer/Eastern	(315) 437-6671
COLORADO, Denver	Kierulff Electronics Co., Inc.	(303) 343-7090	NEW YORK, Westbury, L.I.	Schweber Electronics	(516) 334-7474
CONNECTICUT, North Haven	Cramer Electronics Inc.	(203) 239-5641	NEW YORK, Woodbury, L.I.	Harvey Radio Co., Inc.	(516) 921-8700
FLORIDA, Hollywood	Schweber Electronics	(305) 927-0511	OHIO, Cincinnati	Sheridan Sales Co.	(513) 761-5432
FLORIDA, Miami Springs	Gulf Electronics Corp.	(305) 885-8761	OHIO, Cleveland	Pioneer Standard Electronics, Inc.	(216) 587-3600
FLORIDA, Orlando	Hall Mark Electronics Corp.	(305) 855-4020	OHIO, Cleveland	Sheridan Sales Co.	(216) 524-8120
GEORGIA, Atlanta	Jackson Electronics Co.	(404) 355-2223	OKLAHOMA, Tulsa	Hall-Mark Electronics Corp.	(918) 835-8458
ILLINOIS, Chicago	Newark Electronics Corp.	(312) 638-4411	PENNSYLVANIA, Pittsburgh	Semiconductor Specialists, Inc.	(412) 781-8120
ILLINOIS, Chicago	Semiconductor Specialists, Inc.	(312) 279-1000	TEXAS, Dallas	Hall Mark Electronics Corp.	(214) 231-5101
ILLINOIS, Schiller Park	Hamilton/Avnet Electronics	(312) 678-6310	TEXAS, Dallas	Sterling Electronics	(214) 357-9131
KANSAS, Lenexa	Hall Mark Electronics Corp.	(913) 888-4747	TEXAS, El Paso	Midland Speciality Co.	(915) 533-9555
MARYLAND, Baltimore	Pyttronic Industries, Inc.	(301) 539-6525	TEXAS, Houston	Hall Mark Electronics Corp.	(713) 781-6100
MARYLAND, Rockville	Cramer/EW Washington	(301) 948-0110	TEXAS, Houston	Sterling Electronics, Inc.	(713) 623-6600
MARYLAND, Rockville	Schweber Electronics	(301) 881-2970	UTAH, Salt Lake City	Cramer Electronics, Inc.	(801) 487-3681
MASSACHUSETTS, Lexington	R & D Electronics, Inc.	(617) 861-9200	WASHINGTON, Seattle	Hamilton/Avnet	(206) 624-5930
MASSACHUSETTS, Newton Centre	Cramer Electronics, Inc.	(617) 969-7700	WASHINGTON, Seattle	Liberty Electronics	(206) 763-8200
MICHIGAN, Detroit	Semiconductor Specialists, Inc.	(313) 255-0300	WISCONSIN, Milwaukee	Hall Mark Electronics Corp.	(414) 476-1270



Pick A Card, Any Card- For A Free Thyristor From Motorola

To prove our commitment is no card player's bluff, we're inviting you to pick *one* of the following nine thyristors, all direct replacements* for those listed, to receive free.

Then just "Plug It In And Try It."

*Although these devices have comparable specifications, in some instances they may require slight modifications for the specific application before being considered "direct replacements."

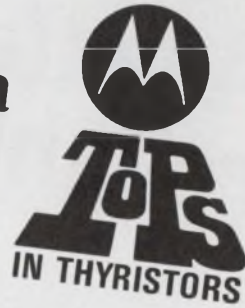

If You're Using

AA101 2N2689
AA108 2N3003
AA115 2N3007
B152 2N3029
BA152 2N3032
C103A 2N4097
CB202 2N4109
HR879A 2N4147
HR879B 2N4334
HR3029 2N5725
HR3032 2N5789
TSW22C 2N5720
TSW100C 3F100
TSW101S 3G100
TIC46 3J100
1D102 3K100
2N879 3L100
2N887 3L1100
2N950 3L2100
2N2681 4K100
2N2685 4L100

Pick Motorola's

FREE
2N5062

100 V 800 mA
TO-92 packaged
SCR

If You're Using

B01051 C122G
B01052 C122B
B01071 TA7404
B01072

Pick Motorola's
FREE
2N4442

200 V 8.0 A
Thermopad
Case 90 packaged SCR
GLASSIVATED!

If You're Using

A1001 2N5755
A1002 40430
A1021
A03001
A03002

Pick Motorola's
FREE
2N6071**

200 V 4 A
Thermopad
Case 77 packaged
Triac
GLASSIVATED!

If You're Using

B03041 2N685
B05042 2N6845
C30B 2N1845A
C31B 2N1845B
C35B 2N1846
C36B 2N1846A
C37B 2N1846B
C38B 2N4317
C135B 40742
TCR1520 40754
TI3039
TI152

Pick Motorola's
FREE
2N3897

200 V 35 A "STUD"
Case 175 packaged
SCR

If You're Using

SC50B
SC60B
TI6242B
TIC252B
TIC262B
2N5573
2N5806
2N5273
40662

Pick Motorola's
FREE
2N6160

200 V 30 A
"STUD" case 175
packaged Triac
GLASSIVATED!

If You're Using

D5E43
D5E44
2N4898
5E29

Pick Motorola's
FREE
2N4852

$I_p = 4.0$ mA (min)
TO-18 packaged UJT

If You're Using

A01061 SC141B
A61101 SC146B
A01141 40668

Pick Motorola's
FREE
2N6151**

200 V 10 A
Thermopad
Case 90 packaged
Triac
GLASSIVATED!

If You're Using

D137I 2N6119
U137I 2N6120

Pick Motorola's
FREE
2N6027

$I_p = 2\mu$ A (max)
TO-92 packaged
programmable UJT

And along with that winning card, we'll also provide you with an "ace-in-the-hole" in the form of our new, complete 35-page **Guide To Thyristors**. This comprehensive book includes a guide to devices; selector guides; package outline dimension drawings; thyristor application guide; a guide to definitions, symbols, and terminology; and a thyristor cross-reference guide. It's **THE** thyristor guide; handy, informative, and concise; an invaluable reference manual for designers.

So pick out the Motorola thyristor card that can win for you, fill in the coupon, and mail it to your nearest Motorola franchised distributor today.



You can see this player means business — our cards are on the table!



I've picked a card! Send me the circled thyristor card (one only, please) including device, data sheet and "Plug It In And Try it" button along with my "ace-in-the-hole"; Motorola's Guide To Thyristors.

- SCR'S 2N5062 2N4442 2N3897
- Triacs 2N6071 2N6151 2N6139 2N6160
- UJT's 2N6027 2N4852

Name _____ Title _____

Company _____

Division _____ Dept. _____

Address _____

City _____ State _____ Zip _____

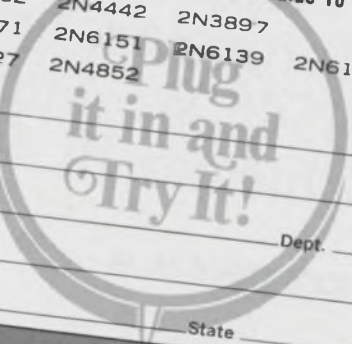

A better source for reliable reeds.

If you want the best source for reeds, go to the people who make them for their own equipment. Us. The "Vibrasponder" reeds that we use for thousands of remote control and signaling applications are now for sale.

Features include contactless design, narrow bandwidths, shock and vibration protection, and over 120 standard tones from 67Hz to 3225.8Hz. Specs available from Motorola Component Products Dept., 4545 W. Augusta Blvd., Chicago, Ill. 60651.



MOTOROLA



CUTLER-HAMMER HAS THE RIGHT ILLUMINATED SWITCH FOR EVERY DESIGN.

Does your new product design call for an illuminated switch? Or would it be a better, more saleable product if it did?

Then Cutler-Hammer is ready to help with the broadest selection of illuminated switches you'll find anywhere.

We've got lighted toggles and rockers and paddles and pushbuttons. Standard sizes and miniatures. With lots of color choices and decorative hardware.

They come in a broad array of configurations—like double rockers and maintained or momentary action. With a range of electrical ratings that's sure to meet your specs. Including replaceable and non-replaceable lamps in several lamp types and many operating voltages.

Your Cutler-Hammer Sales Engineer or Stocking Distributor is ready to show you these switches in operation and to supply prototypes to match your designs. Contact him today and get the full story.

CUTLER-HAMMER

SPECIALTY PRODUCTS DIVISION, MILWAUKEE, WI. 53201



Switch
to No.1

More than just switches.
prompt availability,
field help, innovation,
quality assurance, too.

DESIGN ENGINEERS—WE'VE GOT YOUR NUMBER

Whether It's Eye-easy Phosphorescent Display Tubes or Crt's and It'll Show You a Thing or Two in Quality, Performance, and Other Important Advantages That Constitute a Big Seeing-Is-Believing Difference

EXCITE
YOUR
CREATIVE
APPETITE

Variety is the spice of life — and here it is on a silver platter. Legi variety comes big so you can design big, and it comes small so you can design small. The choice is yours. But the latitude in physical size isn't all you get with Legi. You also get important quality and performance advantages. Legi phosphorescent display tubes meet portable and circuit-board mounting requirements, have a readout as bright as day, and a dynamic life of 100,000 hrs; 'Multi-Legi' is our special package deal for display electronics system designers; Legi compact decoders and drivers are more designer specials in separate, composite, and Bipolar MOS types; and Legi picture perfect picture tubes let you design from 9" to 5-1/2" down to pocket-size 3" spec. There's a lot more you should know about Legi, if you don't know already. Write today for full particulars, and we'll show you how it pays to think Legi when you're thinking new systems. The spice of life is yours. Now.

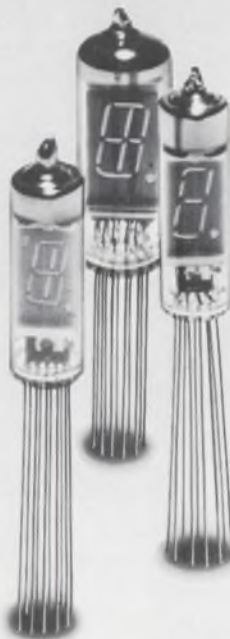

SPECIFICATIONS (pulse operation)

TYPE	Filament Current mA	Filament Voltage V _f	Phosphor Segment Voltage V _p	Control Grid Voltage V _g	Phosphor Segment Current mA _p
DG12M	85	±1 0.8 ± 10%	50	±2 50	4
DG12H	85	±1 0.8 ± 10%	50	±2 50	3
DG19E	95	±1 1.7 ± 10%	55	±2 55	4
Unit	mA	V _{a.c.}	V _{d.c.}	V _{p-p}	mAp-p

TYPE	Control Grid Current mA	Phosphor Segment Cut-off Voltage V _{ps} (MAX.)	Control Grid Cut-off Voltage V _{gc} (MIN.)	Brightness
DG12M	19	0	-4	150
DG12H	18	0	-4	150
DG19E	22	0	-4	150
Unit	mAp-p	V	V	Ft-L

±1 Effective Value at 50 or 60 Hz A.C.
±2 Pulse condition—Duty Factor 1/16 pulse width 80 μsec.

Legi Sole U.S. Agent

LEGI ELECTRONICS CORPORATION

3118A, West Jefferson Blvd. Los Angeles, California 90018, U.S.A.
Tel: (213) 733-9105

ISE The Brighter Side of Electronics

ISE ELECTRONICS CORPORATION

P.O. Box 46, Ise City, Mie Pref., Japan
Phone: Mie (05963) 2-4944, (05963) 5-2121

The No. 1 Interface Line is also the No. 1 problem solver.



Find a need and fill it. That's our orders. And now the one and only specifically designated, complete interface line in the field tackles two more stumbling blocks with:

The only bidirectional one-shot in existence, and the first IBM-compatible line driver and receiver. Applications and features below — along with the entire 8T series of exclusive interface devices. Your #1 problem solvers. Offering unique advantages unavailable in any

other ICs on the shelf. All production-proven, in stock now from your Signetics distributor, salesman or rep.

FREE complete handbook of applications for the #1 interface line is yours for the asking. Circle #246 on reader service card, or write Signetics-Interface, 811 E. Arques Avenue, Sunnyvale, California 94086. Or call (408) 739-7700.

Signetics

Find your need. We'll fill it.

APPLICATION	SOLUTION
Precision digitizer for disc, tape and drum systems. Digital communications receiver. Signal conditioner. Bidirectional transition detector. Frequency doubling.	8T20 New Bidirectional One-Shot. Combines linear comparator, one-shot and logic all-in-one. Functions as a zero-crossing detector with an input threshold of $15 \pm 4\text{mV}$ and positive or negative edge triggering, or both.
To meet compatibility requirements of IBM System 360 I/O interface specs, channel to control unit. When tying on any peripheral equipment such as core memory, discs, graphic terminals, etc.	8T23 Dual Line Driver. 8T24 Triple Line Receiver. The first and only interface driver/receiver pair proven totally compatible with IBM 360. Replaces discrete components.
To conform with EIA-Std-RS232, MIL-Std-188 and CC-ITT-V24 specs, when transmitting and receiving digital data.	8T15 Dual Line Driver. 8T16 Dual Line Receiver. EIA/MIL communications devices.
Digital data transmission and receiving, using coaxial cable, twisted-pair, or other low impedance lines. Party-line data transmission. Schmitt trigger. One-shot.	8T13 Dual Line Driver. High current driver with short-circuit protection and DOT-OR capability. 8T14 Triple Line Receiver. High input impedance receiver with Hysteresis.
Data transfer in bus-oriented systems. Modular systems design. Minicomputer design. Multiplexing.	8T09 Quad Bus Driver. Tri-state logic configuration to increase system performance. High speed (10ns) and high current (40mA) capability. 8T10 Quad D-Type Bus Flip-Flop Tri-state outputs with input and output disable. 50MHz typical toggle rate.
Driving seven-segment numerical displays, LEDs or incandescent lamps.	8T04, 8T05, 8T06 BCD-to-Seven Segment Decoder/Drivers. For driving almost any type of display — LEDs, Numitron, etc.
Low voltage (+5V) to high voltage (40V) level translation.	8T80 Quad 2-Input NAND Gate. 8T90 Hex Inverter. Low-to-high voltage interface gates.
High voltage (10V-50V) to TTL (+5V) level translation.	8T18 Dual 2-Input NAND Gate. High-to-low voltage interface gate.

SIGNETICS CORPORATION — A SUBSIDIARY OF CORNING GLASS WORKS

INFORMATION RETRIEVAL NUMBER 9

From Monsanto... something new for people who count.

We build counters for just about every requirement, but a lot of people who count asked for a mix of capabilities we hadn't yet packaged in a single unit. Now, here it is—the Model 113A Counter/Timer, newest addition to the Monsanto line.

Take a quick look at some of its outstanding features... **Frequency range: DC to 75 MHz... 8 operating modes: frequency, totalize, ratio, period, period average, time interval A to B, positive pulse width, negative pulse width... Monsanto LED display.**

The Model 113A gives you automatic selection of slope when measuring positive or negative pulse widths, so you have one less mental calculation to make, one less knob to turn. And you get Monsanto's two-year warranty. What other major instrument manufacturer offers you that? All this versatility, all this four-figure performance, sells for just \$895 for 5-digit display. For complete data or a demonstration, write Monsanto Company, Monsanto Electronic Instruments, West Caldwell, N. J. 07006.

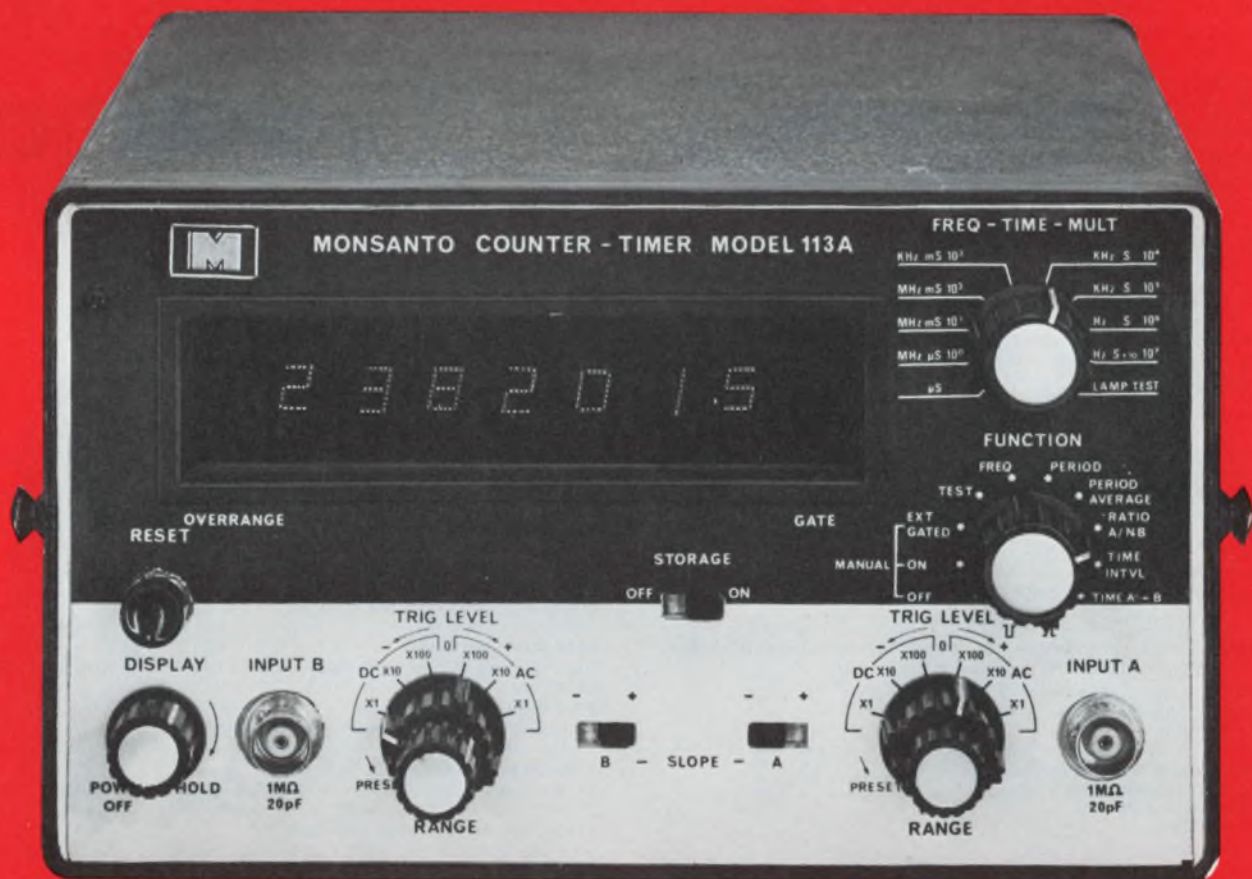

Monsanto

Cable TV pact expected to open up huge market

The recent compromise agreement between the cable and broadcast television industries is seen by cable TV system operators and hardware suppliers as opening the door to a market that may eventually run to several billions of dollars. Microwave and studio equipment are expected to be in heavy demand.

Formulated by the Office of Telecommunications Policy at the White House, the new agreement—which is more restrictive than the original Federal Communications' proposed rules on CATV earlier this year—is expected to be adopted by the FCC in March of 1972.

The agreement requires the cable TV operator to pick up and distribute all network and independent station programs within a 35-mile radius of his location. If this coverage does not provide the cable customers with at least the three major network programs plus those of two or three independent stations, the CATV operator can then supply the signals of stations beyond the 35-mile radius to fulfill minimum service requirements.

Another requirement that will affect future hardware demand is the need for cable TV operators to provide "two-way capacity" between the CATV station and the customer.

As a result, according to a spokesman from Jerrold of Philadelphia, the largest U.S. manufacturer of cable-TV distribution equipment, the principal cable-TV building block will be a distribution system with two-way capability. Along with this will be development of consumer-oriented terminals with data capabilities, as well as computer systems with the intelligence to implement the terminals.

A spokesman for TelePrompter Cable TV Corp. of New York City,

the nation's largest CATV system operator, said the new agreement would be good for the industry. But he emphasized that the pickup of distant signals is not too important in the long run since new services, other than TV station programs would be the eventual primary source of income.

Some of these services, he noted, would be local television pickups for merchandising, delivery of certain classes of government mail, burglar alarm systems, fire alarm systems, and remote meter reading.

As a result, he predicted there will be a large demand for studio equipment as well as for more sophisticated terminal-type equipment that would allow the subscriber to communicate with the CATV studio and perhaps print out pages of data.

But most important, he felt that the larger firms, such as Westinghouse and General Electric, would jump into the hardware market. As an example, he pointed out that Hughes Microwave Division is already in partnership with TelePrompter, owning 49% of the system in New York and 50% in Los Angeles.

Hughes principal contribution is in microwave systems that TelePrompter uses in both New York and Los Angeles. Originally run experimentally on the GHz band, their equipment is now operative in the 12.7 to 12.95 GHz band, set aside by the FCC for cable television.

A.M. Sereng, planning manager for Sylvania cable TV systems, Waltham, Mass., feels that the principal use of microwaves is primarily in the larger cities such as New York, Chicago, where it is too costly to run cables.

Ira Kamen, president of Laser Link Corp., Woodbury, N.Y., which has frequency-division multiplex-

ed FM microwave systems that put 18 TV channels on one carrier—in contrast to Hughes' amplitude modulated link—says that the rules open up wide new markets, particularly for local microwave distribution systems.

Laser Link, he says, has a backlog of \$10 million in letters of intent for 23 filings with 18 new ones coming in anticipation of the FCC approval of the new agreement.

Daniel Mezzalingua, president of Craftsman, a Magnavox cable TV subsidiary, says that the new agreement can only help the equipment manufacturer.

However, he notes that the immediate problem for the industry is to obtain the funding for system construction. They're going to need vast amounts of money to build some of the system franchises that have been held for the last few years, he argues. But he's confident that the chances of raising the money are now considerably better.

Conference will feature charge-coupled devices

The second anniversary of charge-coupled devices will be celebrated at the Solid-State Circuits Conference in Philadelphia from Feb. 16 to 18 in what appears sure to be two of the most popular sessions there, according to a conference spokesman.

In the first session, "Charge-Transfer Devices," several papers will be presented on recent developments in the field, including two that will describe the application of charge-coupled devices to analog delay lines (for more information, see "Bucket-Brigade Device Said to Cut Audio Delay-Line Costs Drastically," ED 24, Nov. 25, 1971, p. 34).

Perhaps of more interest, however, will be a panel discussion, "The Impact of Charge-Control Technology," which will evaluate progress to date, and future applications of charge-coupled devices.

Xerox copiers to get electronic logic

Xerox copying machines of the future will look much the same as today's, the company says, but a

revolution is under way inside.

"We're embarking on a very strong trend to replace mechanical logic with electronic logic," says James Donohue, electronics designer in Xerox Corp.'s Research and Engineering Div., Webster, N.Y. The changeover is going to be *painful*, as any big switch in procedure is, but it will be worth it, he says.

The reasons for the new trend: cost and performance requirements. "We're no longer able to meet the production performance requirements with relay mechanical logic, and we see that the low cost of integrated circuits makes electronic logic cheaper," Donohue says. The IC generation has arrived at Xerox, he adds, without the company's having to go through the transistor stage, except for power transistors.

The 4000 series is the first Xerox copier to use any significant electronics. "It's roughly halfway there," Donohue says. "ICs will be the key electronic component in the 4000. They will be zener offset DTLs, the HNIL (high noise immunity logic) IC made by the Amelco Div. of Teledyne. "In the future the IC most likely to be used," Donohue says "is the 5474 TTL series made by many companies."

Over the next five years Xerox will go very heavily into MOS LSI, he notes. "For the present, we'll use DTL-TTL. Later, more TTL, and eventually full MOS LSI."

Xerox will always remain a bipolar MOS house, Donohue says, because of the frequent need to bring its machines up to date. "The constraints on changing an MOS design are just too severe at this stage," he explains. "However, when someone builds a \$15 processor with a read-only memory, to fulfill the logic requirements of a particular machine, then that's a different ballgame." Donohue believes such a data processor will be available by 1976.

An electric commuter car passes all road tests

An electrically powered commuter car can be built today with available hardware at a cost of about \$3896 per car, according to Tom N. Thiele, electronic and con-

trol technology director of Allis-Chalmers Corporation's Advanced Technology Center, West Allis, Wis.

Addressing a session of the Electric Vehicle Council's symposium and exhibition held recently in Atlantic City, Thiele described his experience with an electric powered Karmann Ghia. Driving the car almost 10,000 miles in a 10 month period, Thiele said that the car demonstrated a number of important things. Among these were reliable transportation, no vehicle breakdowns, and a maximum range of 65 miles at a speed of 60 miles per hour. For city driving at lower speeds, Thiele continued, a considerably greater range is possible.

The car contains an efficient direct current drive configuration in which a 27-hp direct-current shunt wound motor with field control is coupled through a standard transmission and clutch to the differential and driving axle. Speed is controlled by a low power chopper.



This electric commuter car developed by Allis-Chalmers Corp. uses a standard clutch and transmission.

However, the day of the mass-produced commuter electric car is still off in the distant future. In a recent session on electric cars held at the Transportation Conference at Nerem '71 in Boston, R.D. Thornton of the Massachusetts Institute of Technology predicted that only a thousand electric cars will be on the road in this country by 1975. The reason for this relatively small number of vehicles can be attributed to the lack of interest in development exhibited by major U.S. automobile companies.

According to Thornton, the evolution of electric cars continues to follow a somewhat surprising path with the major automotive companies in the U.S. abandoning all

serious development efforts. Thus the only development being carried out here is by two or three battery companies and a few smaller non-automotive organizations.

In contrast to this, the Japanese have been quite active in this field. Major Japanese electronics and automotive companies such as Toyota, Nissan, Mitsubishi, Hitachi, and Sanyo to name a few, are presently collaborating in a government sponsored program to develop an electric car. In addition to being aimed at Japan's need for short range low emission vehicles, the Japanese are also considering the potential overseas market left to them due to lack of interest by U.S. manufacturers.

3-D image technique could replace X-rays

A new research project that will combine holography with ultrasonics to aid in the diagnosis of early cancer signs and heart disease was announced by Dr. George W. Stroke, head of the electro-optical sciences laboratory at Stony Brook University, N.Y.

The technique is known as sonoradiography and was first conceived of by Dr. Dennis Gabor of CBS. The technique described by Stroke will enable physicians to take three-dimensional pictures of internal body organs without the dangers normally associated with X-ray techniques presently used.

In actual operation, a broad wave of ultrasound would permeate the entire organ. A three-dimensional "map" would then be produced by the impression of the echoed sound wave onto a hair-thin mirror-like plastic membrane. Laser light and other optical and holographic techniques would then be used, continued Stroke, to convert these deformations of the membrane into a hologram.

Dr. Stroke said that a working model of the instrument could be ready within three years.

The project, a joint venture of Stony Brook University and CBS Laboratories is being funded by a \$200,000 National Science Foundation grant, and is part of the foundation's increasing emphasis on practical research to combat national problems.

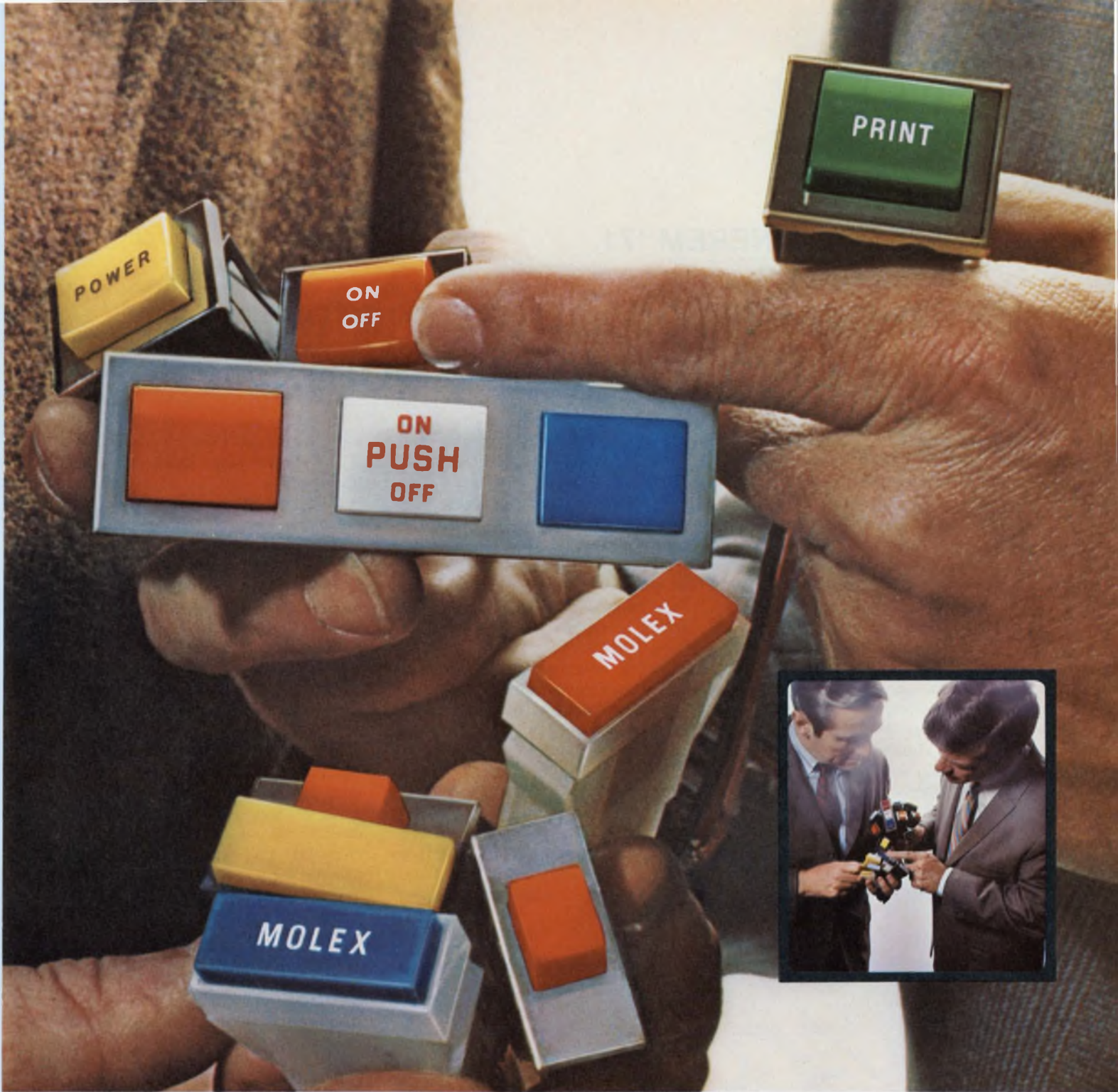

HERE ARE TWO EASY WAYS TO SOLVE LIGHTED PUSH BUTTON SWITCH PROBLEMS. Economically. Reliably. Fast. The Molex 1175 snap mounts. Offers spade or wire terminals for fast, easy assembly. A choice of nine colors, 500 variations. And look at the Molex 1820. You can use one, or a gang of them, for an infinite variety of applications. Lighted push button can be wired to light independently of the switch. And it's available in colors galore. Best of all . . . both switches are priced considerably under one

dollar in quantity. ■ These components are good examples of the Molex creative approach to design problems. And we have the ability to design reliability and ease of assembly into a product without letting costs run wild due to over-engineering. ■ If this makes sense, and you would like a *free sample* of either the 1175 or 1820 switch, write: Molex Incorporated, Downers Grove, Illinois 60515. Or phone (312) 969-4550.

...creating components that simplify circuitry



REPORT FROM NEREM '71

Coming in computer memories: semis plus magnetic domains

Semiconductor and moving-magnetic-domain technologies—one a mature and the other an infant technology—will team up and play a dominant role in computer system memories of the next decade, according to experts who gathered at the 1971 Northeast Electronics Research and Engineering Meeting (Nerem) in Boston.

They called at a technical session for a variety of storage technologies to increase the efficiency of future computer systems and said this could be achieved mainly through a higher degree of organization. The session was entitled "Future Memory Systems: Architecture and Technologies."

Mainframes, the experts said,

Roger S. Allan
New Products Editor

will use increasingly bipolar and MOS memories capable of sub-nanosecond speeds. The rest of the computer system, where bulk storage is important, will be using memory blocks of moving-magnetic-domain storage, capable of providing high-density storage with microsecond access times at prices competitive with current core, disc and drum memories. Two types of magnetic-domain storage will be employed, the session was told: domain-tip (DOT) and bubble (see figure for a cross-section of a DOT memory).

Growth in semiconductors seen

Despite the present maturity of semiconductor technology, further growth was predicted by Dr. Richard F. Elfant, manager of pack-

aging at IBM, East Fishkill, N.Y. By 1975, he said, most computer mainframes will be made almost exclusively of semiconductor bipolar and MOS storage elements.

At present IBM does use all-semiconductor mainframes on two of its systems—the 370/135 and 370/145. Two of its newest models—the 370/155 and 370/165—use a combination of core memories and semiconductors.

"The key factors in the realization of all-semiconductor computer mainframes will be future improvements in photolithographic and semiconductor-processing techniques," Elfant said.

As he saw it, future small and medium-capacity computer memories will use LSI ICs that will provide high operating speeds with gate delays in the picoseconds. They will take up less space, he said, because of small chip sizes, with typical chips housing all the supporting electronics—decoding and sense amplifiers. Costs in the range of 0.6¢ to 1¢ per bit are expected.

Elfant predicted a twofold to threefold shrinkage in the size of IC chips, resulting in bit/chip density increases of 10 to 50 times, by 1975.

"Without projecting too far out in time," he said, "by the early 1975s we can see densities on the chip level to 64k bits per chip on chips measuring no more than 200 mils to a side. Densities of one million bits per inch can certainly become a reality."

Despite these higher densities, the expected use of pulsed power, instead of steady power, and static, instead of dynamic memory cells will cause total chip power dissi-

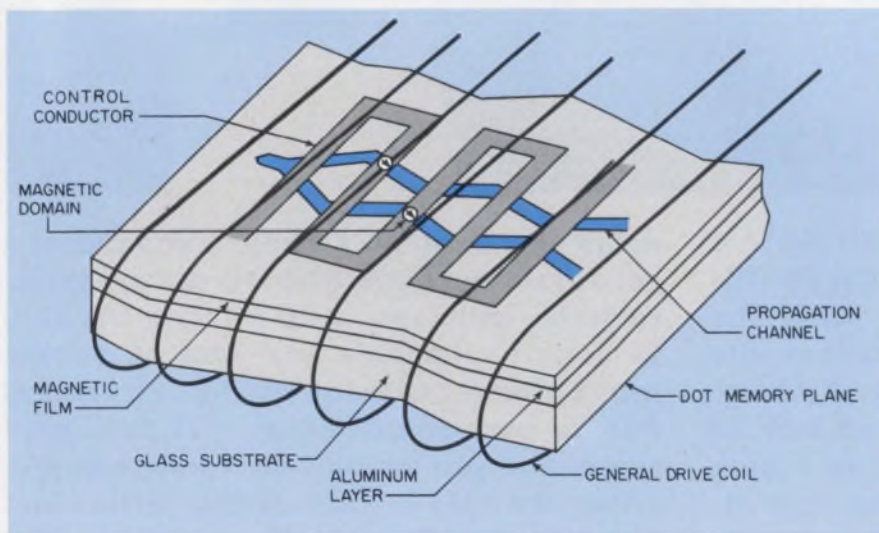

Cross-section of a DOT memory shows propagation channels etched into the storage plane. Overlaying conductors are excited to control the shifting of moving magnetic domains (arrows indicate direction of the motion). Data blocks are selected by applying a current to the drive coil.

Chances are you're paying up to 30% too much for this kind of breaker.



Unless you're already using Heinemann's new Series AM1.

It's our low-priced, direct replacement for AM12-type breakers that have been so popular everywhere.

But now you can save 17% on a single-pole model with auxiliary switch. Or 30% on a three-pole, 400-Hz model with auxiliary switch. Over comparable AM12s.

That ain't hay.

And AM1s are UL-recognized in any current rating up to 50 amp, at 240Vac or 65Vdc.

We offer you a bunch of options, too. Custom current ratings, choice of time-delay or non-time-delay response, special-function internal circuits. You can even get multipole

models with all poles identical or with different voltage and current ratings, time-delay curves, and internal

circuits for each pole.

If you've been using AM12-type breakers (incidentally, the most copied design in the world!), it's a cinch for you to work our AM1s right into your production. And you might even be able to lower your selling price. Or pocket some extra profits.

For all the details, write for Bulletin 3306. Heinemann Electric Company, 2616 Brunswick Pike, Trenton, N.J. 08602. Or Heinemann Electric (Europe) GmbH, 4 Düsseldorf, Jägerhofstrasse 29, Germany.



HEINEMANN

4975

INFORMATION RETRIEVAL NUMBER 12

pation to remain at least at the same levels, Elfant said.

The challenge of DOTs

"Magnetic-domain storage elements—particularly DOT types, which use polycrystalline magnetic-film mediums—will offer very fast mass-memory blocks at low cost and power dissipation and with high reliability," Joseph Kruey, president of Cambridge Memories, Newton, Mass., told ELECTRONIC DESIGN. He attributed the low costs to the excellent yields that DOT memories can provide—much better than semiconductor yields. However, he would not elaborate with any specific figures. Kruey was chairman of the session.

He did not see magnetic domain DOT and bubble memories competing with semiconductors, but rather complementing them in hierarchical computer structures. Semiconductors will be used in the computer's fast-memory section, he said, and DOT and bubble in the mass-storage section as backing-storage systems (see figure).

Dr. Robert J. Spain, director of research for Cambridge Memories, told the session of specific DOT advantages over current bulk disc, drum and core memories. He pointed out that DOT memories can have block access times of less than 1 μ s, compared with 10 to 20 ms for fixed-head disc and drum memory blocks. Speed of 1 μ s is competitive with cores. "The average DOT word access time is only 0.5 ms," he explained.

And because disc and drum memories use moving mechanisms, which are subject to mechanical wear, DOTs with nonmechanical operation offer more reliability, Spain pointed out. As for cost, less than 0.1¢ per bit within a year, compared with about 0.25¢ at present—at least an order of mag-

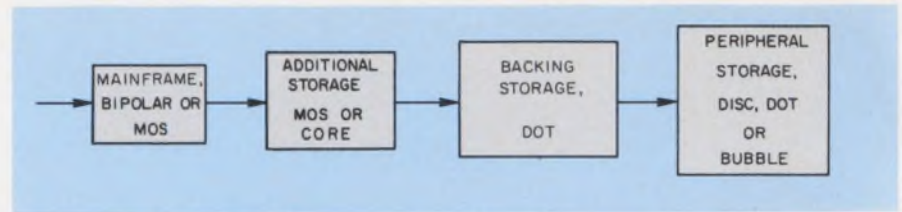

Semiconductors are expected to be used in the computer's fast memory section, while magnetic domain and DOT bubble memories will be used in the mass-storage section as backing storage systems.

nitude cheaper than semiconductor and core, and competitive with disc and drum memory prices.

Spain explained further that DOT memories offer low power consumption in the standby mode. A typical 1-megabyte memory block consumes only 10 W—less than 1 μ W per bit. And like core memories, DOTs are nonvolatile—a feature that is very important for mass-memory users.

Still another reported advantage of DOTs over disc and drum memories is that they can be synchronized to any frequency, which simplifies memory interfacing.

Spain said that present densities of 6000 bits per square inch are available in DOT technology, with densities of 50,000 bits per square inch achieved in the laboratory.

Cambridge Memories, Inc., is reported making a 2.5-megabit, 18-bit-word mass DOT memory that should be available by early next year.

Bubbles of the future

The outlook for bubble memories was outlined by Andrew H. Bobeck, supervisor of propagation-domain devices, Bell Telephone Laboratories, Murray Hill, N.J. Bubble memories are similar to DOT in operating principles; both use moving magnetic domains for storage. They differ, however, in that bubbles use single crystals for

storage mediums, whereas DOTs use polycrystalline magnetic films.

Although bubble memories are not yet commercially realizable, Bobeck believes they will be soon and will leave all other types of memories, including DOTs, far behind in density and cost advantages.

Present densities of 10 megabits per square inch can be designed easily and evaluated, Bobeck said. "Work is already going on," he noted, "to increase this density to 100 megabits per square inch—the highest density of any existing storage technology." As for cost, Bobeck saw prices as low as 0.001¢ per bit by the mid 1970s.

He reported on the design of a 15-megabit memory, now in progress. "Based on a 100-kHz, in-plane field rate," he said, "the average access time to any of the 1328 word blocks is 1.25 ms. This speed makes bubble very competitive with disc and drum type memories."

Large-capacity, high-density experimental shift registers that use bubble techniques have been designed and evaluated by Bobeck. Specifically, 10,000-step shift registers have been operated in memories that were only 100 mils square in area. He reported on even more recent experiments in which 100-step shift registers with densities of 10^7 bits per square inch were achieved. ■■

How minis can unknot communications

The use of minicomputers as digital controllers could increase the capacity of present communication systems by 100%, a session at Nerem '71 was told.

Jules H. Gilder
News Editor

The same session discussed new uses of the mini in health care.

In a presentation to the session—"Why a Minicomputer?"—Ed Rearick of Sanders Associates, Nashua, N.H., described a municipal communication network to show how minicomputers could im-

prove both communications capacity and functions.

Because present communication systems are heavily loaded with voice, the over-all efficiency is greatly reduced, he said. In an attempt to overcome this, he noted, municipalities are now looking to

And now, from the ROM capital of the world...

...4096 and 3072 bits.

With seven ROMs, we were already on top in the read-only-memory market.

Our two newest ROMs will keep us on top for a long time to come.

Each is worthy of special note.

The MM4232/MM5232 is a 4096 bit static ROM organized in either a 512 word x 8 bit or 1024 word x 4 bit configuration controlled by a mode control input. With an access time of 1 microsecond. It features two mask programmable chip enable lines (CE₁ and CE₂), a clever innovation which provides logic control up to 16K bits *without external logic*.

Our other new ROM is the MM4241/MM5241 Vertical Scan Character Generator. A 3072 bit static read-only-memory organized in a 64 x 6 x 8 format with an access time of 750nS. The MM4241AAN/MM5241AAN is a standard 5 x 7 font available off-the-shelf.

Both of our newest ROMs use standard supplies (+5, -12V) and are bipolar compatible at the inputs and outputs. In addition, both have been designed with Tri-State™ logic outputs. (Another innovation, and one which gives you wire OR'd capability without loading common

data lines or reducing the 750nS access time.)

Finally, both the MM4232/MM5232 and MM4241/MM5241 are mask programmable. Thereby allowing you to submit your own programs for processing in a paper tape or punched card format.

That's a look at our two newest ROMs. For more details on them, our other seven read-only-memories, our line of standard code converters and look-up tables, or a handsome picture postcard of the ROM capital of the world, contact us today.

National Semiconductor Corporation,
2900 Semiconductor Drive, Santa Clara,
California 95051. Phone (408) 732-5000.
TWX: (910) 339-9240. Cable: NATSEMICON.

Note: MM42xx refers to -55°C to +125°C temperature range devices; MM52xx to -25°C to +70°C



National

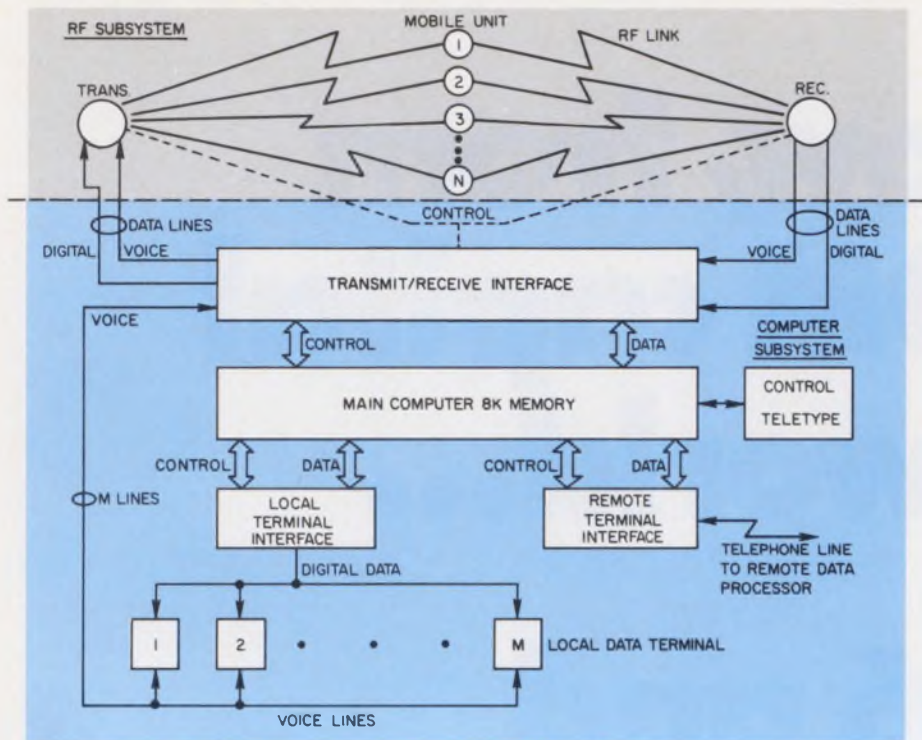

Multimode communication system uses a minicomputer to control the base station transmitter and receiver. Mobile units are automatically polled for status and location.

the installation of vehicle location systems, in-car teletypes and other techniques to reduce voice communications.

To implement these additional systems, it ordinarily would be necessary to use another communication channel, thus necessitating the purchasing of additional transceivers at about \$1000 apiece. For small systems, this may be the best solution Rearick said. However, for larger applications—40 or more mobile units—a minicomputer system that might cost less than \$20,000 to implement would be a much more practical approach, he contended (see figure).

The minicomputer, he explained, could improve the response of the system by using the “dead” time, which normally is present in voice systems, to interleave digital data that is automatically sent to and from vehicles to determine their status and location. According to Rearick, the status of 40 mobile units could be determined in 120 ms, while their location could be resolved to within 500 feet.

The proposed system would use existing communication equipment, with only minor changes in circuitry required. These changes would include a modification on the receiver to disable the transmitter

whenever the frequency was in use and to permit the mobile unit to respond only when the unit's digital identifier code was received. This would give the base station the ability to choose one or more mobile units.

With the minicomputer, voice transmission could be limited to “mission-oriented” information only, Rearick said, and even then only to selective mobile units.

Hospitals turning to minis

On the medical front, minicomputers are gaining a strong foothold in hospital systems, the Nerem session heard. Since hospital applications are easily grouped by function, dedicated minicomputer systems have been developed as a counter-trend to integrated systems, which require large-scale computers, Cody Webb of Arthur D. Little Co., Boston, told the conferees.

Webb grouped the mini's hospital functions into five categories:

1. Automated clinical laboratory.
2. Communications and admissions.
3. Scheduling and inventory.
4. Multiphasic testing.
5. Computer-aided diagnosis.

Because minis are relatively inexpensive, he said, it is feasible for each of these functions to have its own computer. In addition the use of minis eliminates the problems inherent in large computer installations, such as access time and down time of the entire system because of failure in a small part. Minis allow each department of the hospital to retain its autonomy, Webb said. ■■

A substitute proposed for vacuum deposition

For over a hundred years, manufacturers of glass and ceramic tableware have been using organic solutions of gold to apply decorative coatings to their products. Since the manufacture of modern microwave integrated circuits is largely concerned with the same activity—depositing thin films of

precious metal onto a ceramic substrate—why don't microwave engineers study this almost-ancient technology?

The question is raised by Ralph T. Hopper of the Hanovia Liquid Gold Div. of Engelhard Industries, Inc., East Newark, N.J. He told ELECTRONIC DESIGN in an inter-

view that metallo-organic compounds offer three big advantages over the commonly used vacuum-deposition approach: They're cheaper; they provide films with much better adhesion, and they're much more versatile.

One problem with such vacuum-deposition techniques as evapora-

Whiskers are out.

The new military standard for 1.5 watt power zeners is Unitrode's double pin bonded design.

The 1N4461-89 series from Unitrode is available off-the-shelf as JAN and JANTX zeners to MIL-S-19500/406 in most voltages from 6.8V to 100V. They offer greater reliability and improved electrical characteristics at no more cost than conventional 1 watt whisker-type metal can zeners.

The reliability of the double pin design is further increased by bonding the silicon chip directly between terminal pins and then fusing a hard glass sleeve to the exposed silicon surface and pins.

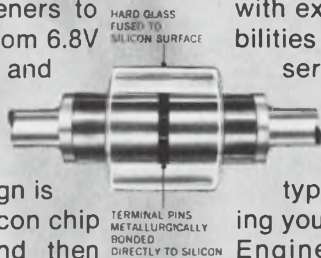

This results in a voidless, monolithic structure with exceptional zener stability. Surge capabilities are 5 times greater than the 1N3016B series. Zener impedances are improved and reverse currents are two orders of magnitude lower. The point is, now you can switch from whisker-type to double slug design without shaving your standards. For fast action, call Sales Engineering collect at (617) 926-0404, Unitrode Corporation, Dept. 11B, 580 Pleasant Street, Watertown, Mass. 02172.



UNITRODE

INFORMATION RETRIEVAL NUMBER 14

tion and sputtering. Hopper notes, is that they coat not only the object being treated but the inside of the entire vacuum chamber as well. This leaves you with the choice of wasting gold or going through the expense of recovering it.

Because the films in question are extremely thin (typically on the order of hundreds or thousands of angstroms) the waste of gold is probably of less economic significance than the cost of the capital equipment used in vacuum deposition.

When someone talks about setting up a vacuum-deposition facility, he is usually talking about spending more than \$100,000. By contrast, a four-ounce bottle of formulated metallo-organic solution containing about 25% gold costs about \$16 and need only be fired in air at about 800 C to produce a high-quality coating on a ceramic substrate. A production conveyor furnace costs approximately \$5000 more.

Briefly, a formulated metallo-organic compound is a mixture of metallo-organic resinates with small amounts of fluxes and other additives. The resinates are formed

by the reaction of noble-metal salts with organic acids or mercaptan and dissolution of the resulting compound in organic solvents, such as toluene.

These formulated compounds can be made in varying concentrations and typically have the appearance and consistency of varnish. When the compounds are applied to a glass or ceramic surface and fired slowly in air, all of the organic components are volatilized or burned away, leaving behind a metal film.

Because the formulated compounds contain special fluxes and other additives, they produce brilliant, conductive metallic films with excellent adhesion to the substrate, Hopper says. And since they are thermally deposited, the films are heat-stable and will not delaminate under the thermal stresses of, say, soldering operations—a major problem with vapor-deposited films.

Perhaps the most outstanding feature of these metallo-organic preparations, Hopper points out, is that they can be applied by any of the methods commonly employed in the graphic-arts and surface-

coatings industries. No special equipment is needed. Brushing, dipping, spin-coating, spraying, roller-coating and decalomania transfer are standard methods that can be used.

Spin-coating is particularly attractive in the electronics field, since it is already widely used as a method for applying photoresist solutions in the photolithographic manufacturing of integrated circuits. Thus the same spin-coating equipment that applies the photoresist could be used to apply the metal coating, if this method of manufacture is used.

One interesting possibility mentioned by Hopper is the development of photosensitive metallo-organic compounds. This is not feasible when the more common thick-film deposition methods are used, since they employ inks or pastes that are essentially suspensions of finely powdered metal. The metal particles would scatter the light used to expose the photosensitive material, and would make high-resolution etching impossible.

The metallo-organic preparations, are true solutions and present no such problems. ■■

Slotted coax breaks an rf barrier

A new slotted coaxial cable known as Radiax provides two-way "wireless" communication in buildings, tunnels, subways and other problem areas where propagation characteristics are severely limited.

Designed by the Andrew Corp. for Motorola, the cable can radiate and receive rf signals. The slots in the cable shield allow the cable to function as a continuous antenna, permitting a controlled portion of the transmitted rf signal to radiate along the entire length of the cable. Conversely, a signal transmitted near it will couple into these slots and be carried along the cable.

According to J. S. Brown, director of cable and rf component engineering at the Andrew Corp., the cable opens up possibilities for the manufacturers of pocket

paging systems. With Radiax, low-power transmitters of approximately 1 W could be added to pocket paging units to provide a talk-back capability. In addition, if Radiax is connected to a roof-mounted antenna, the pocket pager would also be able to communicate with mobile or other distant units.

Contrary to twin lead, which is commonly used in radiating applications, Radiax can be installed directly against any surface, including grounded surfaces, with conventional hardware and only a negligible effect on both radiation and attenuation. Insulators and standoffs are not required, and accumulated dirt, oil, and moisture have no appreciable effect on attenuation, the manufacturer says, as they do with twin lead. The reason for this is that while twin lead is a balanced line whose

attenuation increases enormously with the slightest imbalance, Radiax is designed as an unbalanced line and exhibits the qualities of a poor coaxial conductor.

In recent evaluation tests of Radiax in the Lincoln Tunnel at New York City, Art Schneider, staff services engineer of the Port of New York Authority said that it performed very well and that, pending final evaluation, it might be installed in the PATH subway tubes and the underground sections of the World Trade Center in lower Manhattan. Comparing the costs of twin lead and Radiax, Schneider said that the installed costs of Radiax were at least half those of twin lead.

Radiax is presently available in commercial quantities. It is designed for use in the 30, 150, and 450-MHz bands. ■■



Coil Cords

for products that move

There's more to coil cord design than snapping back in place. Lots more. Like human, electronic, and environmental requirements. Color matching. Reliability. And cost.

Belden has the experience. Hundreds of retractile cord designs that are solving problems in communications, power and control applications. Coil cords in a wide variety of strain and stress relief configurations, special connectors, custom wire assemblies . . .

We've got a new booklet covering coil cord design parameters. It will help you determine important trade-offs between shielding, tensile strength, environmental protection, elasticity, and cost. We'll show you how Beldfoil® can eliminate noise problems that can originate in the shield itself. The advantages of thermoplastic and thermosetting jacket materials. And how to get the right elasticity for your equipment application. Just contact Electronic Sales Service Dept., Belden Corporation, Richmond, Indiana 47374. Phone (317) 966-6681.

Electronic Sales Service Dept.
Belden Corporation
Richmond, Indiana 47374
Phone (317) 966-6681



- I have an immediate coil cord design problem; please contact me.
- Please send me the new Retractable Cord Design Guide.



Name _____
Company _____
Title _____
Address _____
City _____ State _____ Zip _____
Application _____

'Instant' holograms produced with a new thin-film material

A new, optically sensitive thin-film material—arsenic trisulfide—can produce holographic images in 10 seconds or so without any film processing.

In contrast with the conventional method of exposing special film and then developing it, the vacuum-deposited arsenic trisulfide film produces holograms directly when exposed to the green beam of a 15-mW argon laser. The images are

read out with the red beam of a helium-neon laser. The arsenic trisulfide film is insensitive to the radiation at this wavelength.

The technique was discovered by RCA Laboratories in Princeton, N.J., during research aimed at providing high-speed, large-capacity optical memories for data processing.

In operation, the arsenic film is exposed to the green beam, and while the holographer watches, the image develops. He then turns the beam off when the image reaches the desired intensity. At this point

the image is ready for use.

Initial tests have indicated that the hologram is permanent, provided it is not further exposed to read out beams of green or blue laser light.

The new technique was developed by Scott A. Keneman, a member of the RCA staff, under the direction of Dr. Jan A. Rajchman, vice president of information sciences. It uses standard evaporation methods for depositing the film. Consequently it is potentially a low-cost method for rapid holography.

When the new film is exposed in a standard holographic setup, the optical pattern created by the interference of the object and reference beams causes the atomic absorption edge of the arsenic trisulfide to shift. This, in turn, changes the index of refraction of the material. The intensity of the change is proportional to the exposure.

The holographic interference pattern is therefore recorded in variations of the refractive index of the material. Consequently the hologram can be read out with the red beam. There is, however, some image distortion with the red illumination, says Robert Lohman, head of information sciences and systems at RCA.

Diffraction efficiencies of several per cent—more than adequate to produce an excellent hologram—can be produced by exposing the arsenic film to the beam of a 15-mW argon laser for 10 seconds. Scattering of the readout beam is exceptionally low in the arsenic trisulfide. As a result, resolution in the hologram is unusually high.

Holograms with a resolution of 2860 lines per millimeter have been recorded in a 2- μ m film, with no signs of approaching the resolution limits of the arsenic trisulfide, Keneman says. ■■

Jim McDermott
East Coast Editor



Almost simultaneous exposure and readout of holographic images occurs with a technique that does not require chemical development. Here, Scott A. Keneman of RCA watches the image of a letter as it is projected from an arsenic trisulfide thin film that is exposed to an argon laser.

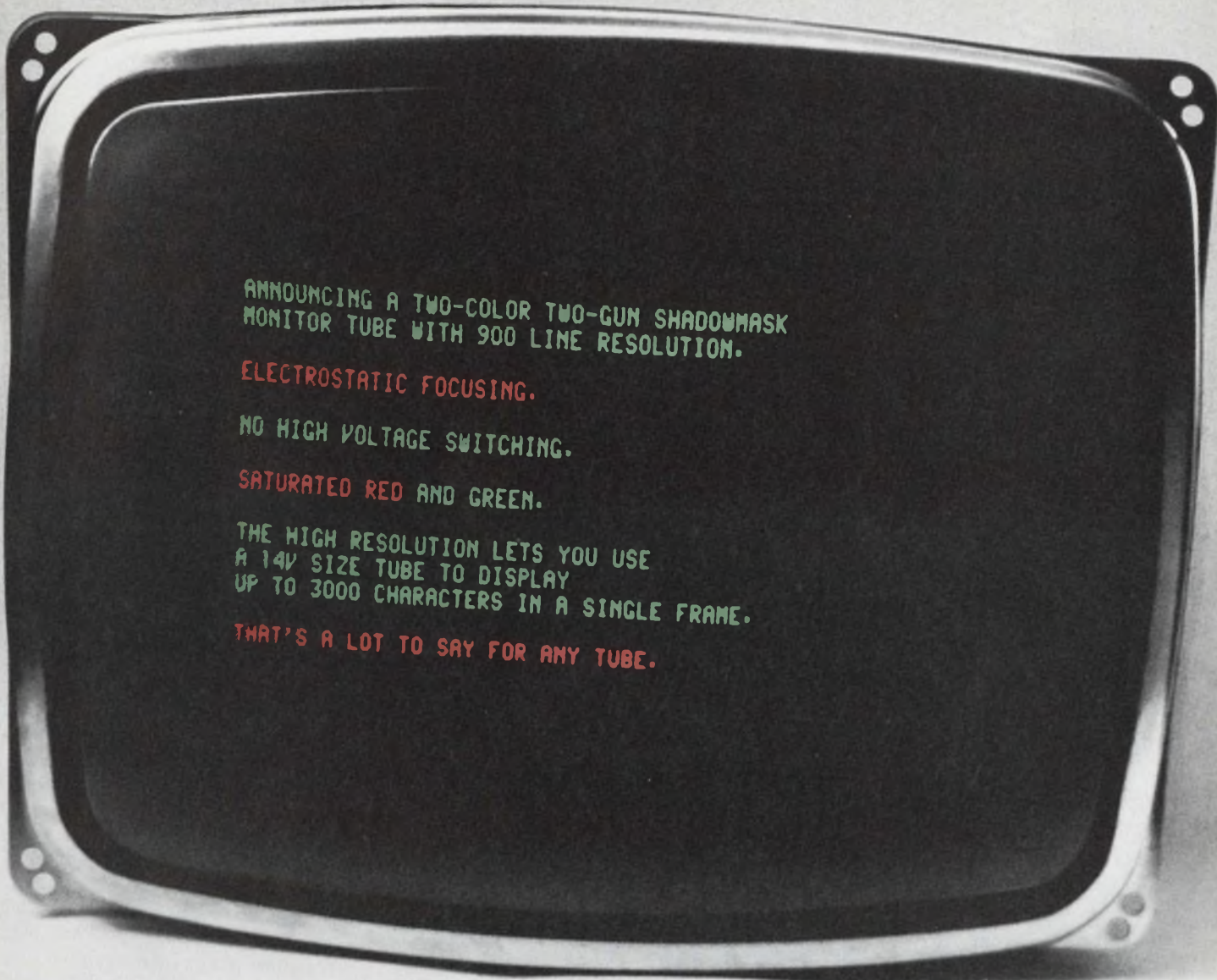

ANNOUNCING A TWO-COLOR TWO-GUN SHADOWMASK
MONITOR TUBE WITH 900 LINE RESOLUTION.

ELECTROSTATIC FOCUSING.

NO HIGH VOLTAGE SWITCHING.

SATURATED RED AND GREEN.

THE HIGH RESOLUTION LETS YOU USE
A 14V SIZE TUBE TO DISPLAY
UP TO 3000 CHARACTERS IN A SINGLE FRAME.

THAT'S A LOT TO SAY FOR ANY TUBE.

Sylvania Electronic Components, Seneca Falls, N.Y. 13148

GTE SYLVANIA

Powerful laser communicator put in 3-lb binocular package

A laser communications system has been put into a binocular-like package that weighs only three pounds, to make one of the most powerful, lightweight, compact laser communicators built (also see

"Laser Rangefinder Built in Binocular Form," ED 23, Nov. 11, 1971, p. 23).

Powered by one 500-mA-hour, 6-V nickel cadmium rechargeable battery, the transceiver uses a gallium-arsenide semiconductor laser. The wavelength of the laser output is 0.9163μ , and the peak power output is 10 W. Each light pulse

has a time duration of 100 ns.

Developed by the Santa Barbara Research Center, a subsidiary of the Hughes Aircraft Co. in Santa Barbara, Calif., the transceiver has a range up to four miles in clear weather (visibility of 10 miles or greater). The range is cut by haze and precipitation.

Norman Rigby, product manager for infrared special systems at the Santa Barbara Research Center, notes that signal transmission is accomplished by pulsing the laser and frequency-modulating the pulse repetition rate with the voice signal inputs.

Rigby points out: "A p-i-n silicon photodetector is used to receive the transmitted light pulses through a 2.5-inch receiver aperture. The infrared energy received is then processed, using current-mode preamplification to enhance the signal to noise ratio. The pulses are then amplified and the repetition rate demodulated to convert the received pulses into audio or data signals."

The transmitter current consumption is approximately 100 mA during transmission, and receiver consumption is less than 3 mA.

Rigby's group has made these transceivers with both two and three-degree beam divergences. He says that because of its wide-angle transmitter beam design, the communicator can be used under any conditions that allow the use of binoculars.

Under normal operation, the two people communicating would first view each other through the alignment telescopes contained within one ocular of the binocular. After alignment, communication is merely a question of pushing a button and talking into a microphone. Listening is done through a small earphone set that plugs into the binocular. ■■

David N. Kaye
West Coast Editor



Laser communicator, weighing three pounds and looking like a pair of binoculars, contains a gallium arsenide infrared laser and has a range of up to four miles in good visibility.



Hey, look at our modern mini now!

Take another look at our gal on the go. She now can be dedicated to time-sharing, real-time or batch.

We've teamed up our 2100 digital computer, 7900 Fast Access Disc, and a choice of powerful operating systems. Result: a new family of disc-based computer systems that can be easily dedicated to your processing problem. And all offer big system performance that your pocketbook will appreciate.

With time-sharing you can now run HP Extended BASIC. With the real-time and batch systems, FORTRAN IV, ALGOL, and Assembly language are

available. The batch system has features like program chaining and extended file management. For real-time applications, HP's Real-Time Executive puts you in business for powerful, on-line problem solving. And when it comes to time-sharing, presto — you have an efficient, dedicated system that can handle as many as 32 terminals.

And in any of these operating modes, our modular design lets you expand both capacity and capability, as you need it. For instance, when you want more disc memory, it's available. When you need a tape drive, line printer, card

reader, or other peripherals, add them. Plus as many as 47 HP instruments. And everything plugs right in.

That's our gal on the go. So why not take a look at her now. Just call your HP computer specialist. Or write for the system brochure. Hewlett-Packard, Palo Alto, California 94304; Europe: 1217 Meyrin-Geneva, Switzerland.

22129

HEWLETT  **PACKARD**
DIGITAL COMPUTERS

DIRECTIONS MOS

Many Faces of MOS

Display Mixed Performance, Cost, And Availability

MOS technology today includes varied approaches to structure and processing techniques. Some are converted to high volume production capabilities, others are in advanced development and offer great promise for improved performance and early implementation, and still others are experimental. All must be evaluated carefully for potential advantages.

P-Channel MOS Is Readily Produced

P-channel MOS isn't the most advanced, the fastest, the lowest power, nor the most versatile approach, but it is familiar and at several companies is in high-volume production. Hence, it is the prevalent MOS form for both standard and custom circuits. Achievable speeds are, conservatively, about 2 MHz — reconcilable with the requirements of many data-processing applications. Power dissipation, down to 0.5 mW/gate, presently is about the same as the lowest-power bipolar line, higher than other MOS forms, yet low enough for some really large-scale integration. The MCM1131L 2240-bit character generator, for example, has a maximum power dissipation of only 400 mW.

Representative PMOS circuits available now are MSI/LSI parts, with simple gates and flip-flops conspicuously absent. Why? Typical PMOS technology loses its price advantage as circuit complexity is reduced, giving way to the widely available, broad-line bipolar families. Since MOS generally is more appropriate for MSI/LSI, the more creative complex designs are usually in custom programs. Established PMOS process variations permit custom tailoring of circuits, even to the point of making them functionally compatible with bipolar logic. The two digital forms can be used together without extensive interface circuitry.

Two High Threshold PMOS Power Levels

Two power levels, medium ($P_D = < 1.7$ mW/gate) and low ($P_D = < 0.45$ mW/gate), are available with high threshold (V_T) PMOS. A 20% saving in active on-chip cell area is also achieved in the low power line, but the tradeoff is speed. It is some four times slower, at 300 ns typical propagation delay per logic level, than the medium power line. Nevertheless, where performance is adequate, this represents the quickest, least expensive, and least troublesome technology. High threshold logic offers the designer the advantage of high noise immunity, with turn-on voltages on the order of 3.5 volts making it relatively secure from noise spikes and spurious signals.

Low Threshold PMOS Has Advantages

Low-voltage MOS is faster and more economical in the system because of the lower power-supply voltage. It is compatible with the most popular bipolar logic forms such as TTL and DTL whereas the outputs of bipolar types are simply too low to turn on the high voltage PMOS devices. Of the methods used to lower the threshold, the $\langle 100 \rangle$ crystal orientation achieves good reduction of the threshold voltage and power supply requirements, but speed and packing density are not improved.

Another method, the Silicon Gate process, is preferred at Motorola. Not only is the threshold voltage reduced to an extremely low level, but circuit speed is increased, packing density can be increased, and manufacturing efficiency is greater. This technology has matured rapidly, and an impressive number of products is available off-the-shelf.

What About NMOS?

Everyone eagerly awaits the ready availability of NMOS for its speeds, potentially two/three times as fast as conventional high threshold PMOS. The Silicon Gate process is applicable too, and it considerably increases the packing density potential. NMOS yields generally aren't good enough yet to make this eagerly awaited technology available at viable prices.

CMOS — Developing Rapidly

Any MOS circuit exhibits significantly lower power dissipation than bipolar capability permits, but far and away the greatest power miser in sight is complementary MOS circuitry, known as CMOS at Motorola. In fact, with complementary MOS dc power dissipation can be

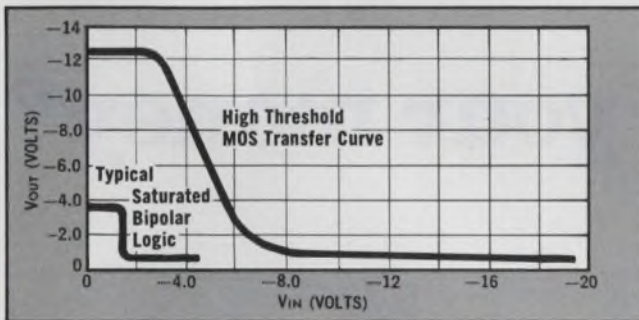

reduced virtually to zero — enviable where battery operation or battery backup is a requirement.

Matching comparable simple examples, a single-channel circuit draws current from the power supply during the entire "on" portion of the input signal. With the CMOS circuit, power dissipation occurs only during input signal transitions. Extreme low power designs are practical when frequency is less important, say for 100 kHz operation. Speeds in excess of 10 MHz also can be designed at the expense of some power dissipation increase due to the higher rate of signal transitions. Gen-

erally, the high speed and low power drain make CMOS a significant factor in the future of MOS technology, and by most indicators, a major logic form.

MOS PROCESS	THRESHOLD VOLTAGE	SUPPLY VOLTAGE V _{cc} (V _{cc})	PROP. DELAY (ns/gate)	FREQ. (min.)	POWER DISS PER GATE	RELATIVE CHIP COMPLEXITY	NOISE MARGIN	
							V _{OH}	V _{OL}
P-CHANNEL MOS High Threshold Medium Power Low Power	-3.5 TO -5	-17 TO -27	75 ns 300 ns	2 MHz 500 KHz	1.7 mW 0.45 mW	1 1.2	3	1.5
Low Threshold < 100 > Silicon Gate	-1.5 TO -2.5	-12 TO -17	70 ns 60 ns	2 MHz 5 MHz	1.0 mW 1.0 mW	1 1.3	2	0.7
Ion Implant, Depletion Loads	-1.5 TO -5	-12 TO -27	35 ns	5 MHz	1.5 mW	1.3	1.5	1
N-CHANNEL MOS Metal Gate / Silicon Gate	1 TO 2	5 TO 20		10 MHz	1.0 mW	1.3 1.6	1	1
COMPLEMENTARY Metal Gate / Silicon Gate	(±) 1.5 TO (±) 2.5 ±0.5 TO ±2.5	3 TO 18 1.2 TO 15	40 ns 25 ns	20 MHz 25 MHz	50 nW 50 nW	0.3 0.4	V _{cc} /2.2	
BIPOLAR LINES								
TTL		5.0 v +20% -10%	10 ns	60 MHz	15 mW*	40	1.2	1.2
ECL		5.2 v +20% -10%	< 1 ns	400 MHz	25 TO 35 mW	20	0.4	0.4
DTL		5.0 ± 10%	30 ns		8 mW	20		
RTL		3 ± 10% OR 3.6 ± 10%	24 ns		12 mW	10		

*A Special Low-Power Line (54/74L) Has Power Dissipation of ≈ 1 mW/Gate

COMPARISON OF MAJOR CHARACTERISTICS OF MOS PROCESS AND BIPOLAR LOGIC LINES

erally, the high speed and low power drain make CMOS a significant factor in the future of MOS technology, and by most indicators, a major logic form.

Numerous manufacturers have announced standard CMOS products, custom capability, or both, and Motorola has invested heavily in this area. Lower cost, because of the basically simpler process, greater circuit density, and lower power dissipation, suggest CMOS will prosper at the expense of TTL. Penetration of the consumer market is anticipated in areas such as watches, clocks, various automotive applications, appliance controls, and even toys. Features such as high noise immunity, operation from an unregulated power supply, microwatt power dissipation, and low noise-generation are expected to make the industrial market another big CMOS user.

Summarizing, Silicon Gate PMOS shapes up as a leading MOS form with CMOS maturing rapidly to take its place as the second dominant approach, essentially extending PMOS capability rather than replacing it. NMOS will be built, but for the near term probably will not be widely available. How to evaluate suppliers? Published specifications probably speak for themselves in respect to standard products. For custom designs, consider carefully the total MOS capabilities of a prospective supplier. Those with many faces are probably the best bet.

This is the second in a series designed to present a realistic, objective analysis of MOS technology in a dynamic, competitive industry. For an examination of this and other aspects of the MOS technology in greater depth than is permitted here, circle the reader service number or write to Motorola Semiconductor Products Inc., P. O. Box 20912, Phoenix, AZ 85036.

 **MOTOROLA MOS**
Directions in digital designs

Coming Next: "REFLECTIONS ON CUSTOM MOS"

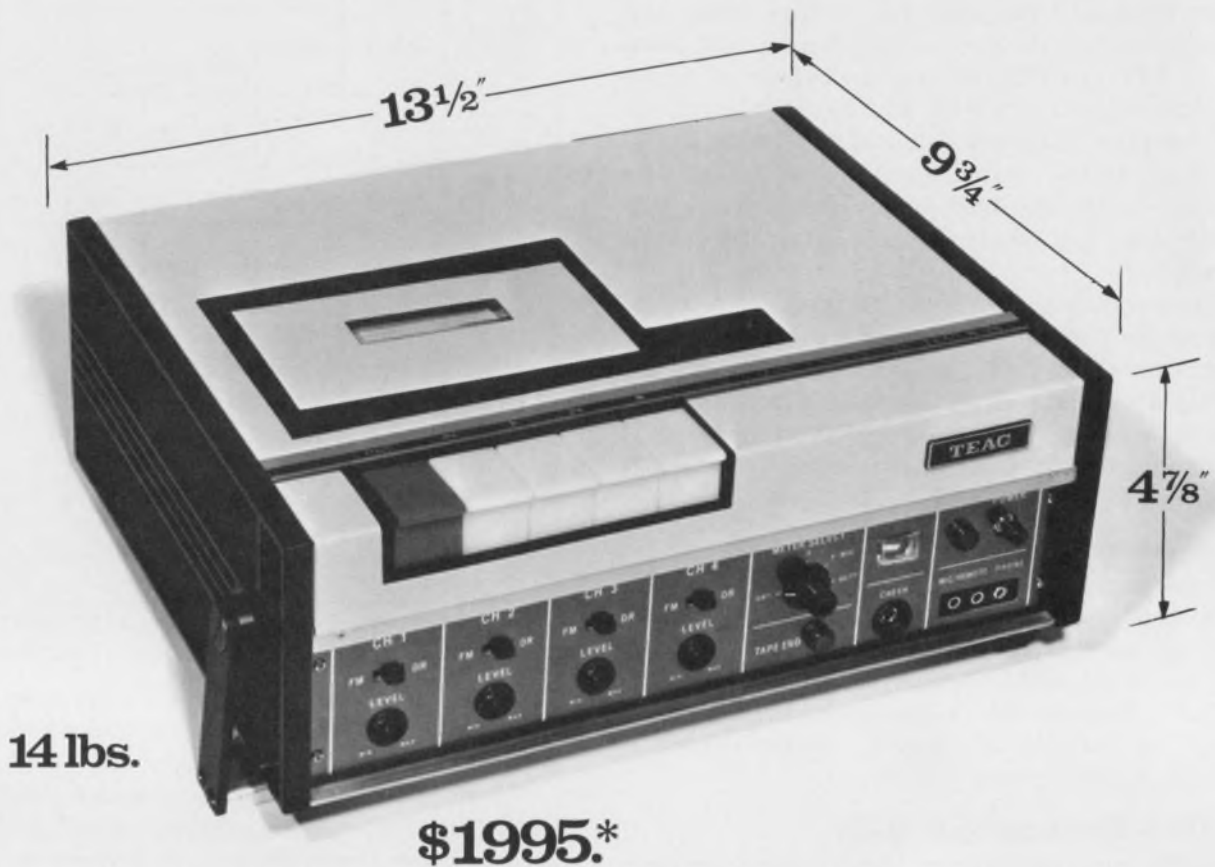

This is a lot for your money?

If you judge superiority by size and worth by weight, the looks of our R-70 cassette data recorder may be deceiving.

But for what it's worth, it's not just another pretty face with a slim figure and expensive taste.

It's a handful of fine features that no other data recorder its size can measure up to.

We make it that way because the R-70 has the family name to uphold.

Its housing is a strong case against dust, vibration and manhandling. And it's made to do the job lying down or standing up.

Since both FM and direct record

electronics are built in, you can choose either with a mere flip of a switch on any of its four channels. And even add voiced comments.

Each channel can be individually monitored, too, via a meter or a built-in output to a scope or VTVM to insure proper input level.

And a built-in tape counter tells you the exact spot of any recorded data.

For those who tend to be forgetful, we've even included a warning light that tells you when you're at the end of your tape.

Frequency response in the FM mode is DC to 625 Hz while the direct mode is 100 to 8,000 Hz.

The unit uses commercially available instrumentation grade Philips-type cassettes.

Made to travel in fast company, the R-70 can operate on its own self-contained batteries, or draw upon outside AC or DC power sources.

For more of the fine points on this or other data recorders in our line, write or call Ken Williamson, Director of Marketing, Technical Products, TEAC Corporation of America, 7733 Telegraph Rd., Montebello, CA 90640. Telephone (213) 726-0303.

He'll tell you why it pays to

go TEAC.

*Price includes these accessories: TEAC CT-60 tape cassette; memo announcement microphone; monitoring earphone; input-output cords; fuses and lamps; AC power cord; DC power cord; check terminal cord; cleaning kit; vinyl cover; adjustment screwdriver; operating manual.

For built-in reliability, design with "Scotchflex" Flat Cable/Connector Systems.

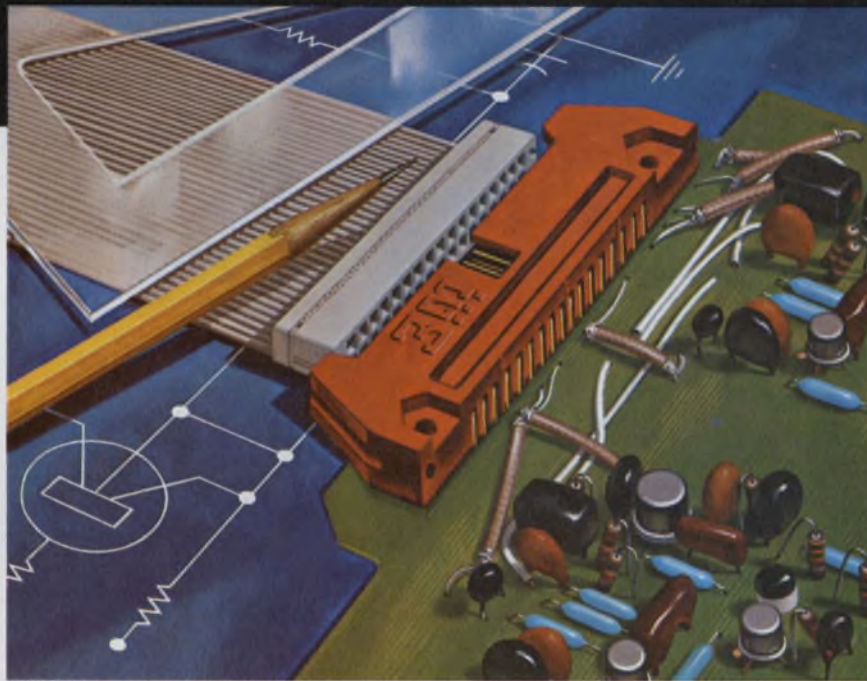

"SCOTCHFLEX" IS A REGISTERED TRADEMARK OF 3M CO.

"Scotchflex" Flat Cable and Connectors can offer you trouble-free packaging for your next generation equipment.

There's built-in reliability for your circuit inter-connects. Our flat, flexible PVC Cable has up to 50 precisely spaced conductors. The gold plated U-contacts are set into a plastic body to provide positive alignment. They strip through the insulation, capture the conductor, and provide a gas-tight pressure connection.

Assembly cost reductions are built-in, too. "Scotchflex" Connectors make up to 50 simultaneous connections without stripping or soldering. No special training or

costly assembly equipment is needed.

Off-the-shelf stock offers you flat cable in a choice of lengths and number of conductors from 14 to 50. Connector models interface with standard DIP sockets, wrap posts on .100 x .100 in. grid, or printed circuit boards. Headers are available to provide a de-pluggable inter-connection between cable jumpers and printed circuit boards (as shown). Custom assemblies are also available on request.

For full information on the "Scotchflex" systems approach to circuitry, write to Dept. EAH-1, 3M Center, St. Paul, Minn. 55101.



This
Sweet
MICROVOLT
MULTIMETER is
SENSITIVE to $1\mu\text{V}$,
STABLE within $2\mu\text{V}/\text{day}$
and easy on the budget at
\$545



Users call it "the-how-sweet-it-is-meter".
But it's really the Model 160 that . . .

- MEASURES WITH DIGITAL ACCURACY
 - Voltage** — $1\mu\text{V}$ to 1000V
 - Current** — 0.1 nA to 2A
 - Resistance** — 0.1Ω to 2000 M Ω
 - 100% OVERRANGING
 - ANALOG and OPTIONAL BCD OUTPUT
 - MANY MORE SWEET PERFORMANCE FEATURES
- SEND FOR FULL DETAILS AND YOUR FREE "HOW SWEET IT IS" BUTTON



**KEITHLEY
INSTRUMENTS**

U. S. A.: 28775 Aurora Road, Cleveland, Ohio 44139
Europe: 14, Ave. Villardin, 1009 Pully, Suisse

**technology
abroad**

An electro-optical light-beam deflection system being developed at the Central Research Laboratory of Thomson-CSF of France uses polarization commutation and a dual refractive system. Consisting of six cells assembled in series and successively crossed by a light beam, the prototype system is capable of deflecting the beam into 64 positions. The first application will be in an ultra-rapid optical printer able to feed one million characters per second into a computer optical memory core. The deflection system will also be used in numerically operated photocomposing machines. Another long-term application is in telephone switching.

CIRCLE NO. 440

Hybrid techniques are applied in a new 300-MHz frequency meter produced by Racal Instruments of Windsor, England. Thick-film circuits, designed in-house, provide a latched, eight-digit display with overspill and an automatically positioned decimal point. Resolution is 1 Hz up to 300 MHz with a one-second timing gate. Sensitivity is 10 mV. The internal frequency standard has a stability of better than one part in 10^9 per day.

CIRCLE NO. 441

An alternative to the air bags under investigation by auto safety experts in the United States is a new ultrasonic system being jointly developed in England by Mullard and the Ford Motor Co. The new system consists of seat belt interlocks that prevent the starting of the car until the belt has been fastened in place. When this happens, a fan-shaped ultrasonic beam from a transducer fitted to one of the diagonal shoulder straps strikes an ultrasonic sensor in the roof. In addition a

seat switch makes contact when the driver climbs in. When both the ultrasonic beam and the seat switch are operative, the ignition circuit is completed and the driver can start the car. If a driver unbuckles the belt, audible and visible alarms occur, and the ignition is cut off. Mullard believes that the equipment would add about \$25 to the price of seat belts.

CIRCLE NO. 442

An ultrasonically operated remote-control TV channel changer is being produced by Grundig of West Germany. In addition to channel selection, the viewer can adjust the color contrast and the brilliance. A microphone in the TV set picks up signals from this channel change unit, and conventional TTL circuitry then transforms each ultrasonic channel signal. These voltages control a voltage-variable capacitor that is part of the TV tuner circuit. The capacitor automatically selects the correct channel.

CIRCLE NO. 443

An ion laser with a 10-W output is being produced by use of a plasma jet instead of a conventional cathode. Developed by Laser Associates in England, the new laser is formed by striking an arc in the gas that is made to lase. The resulting conductive plasma then forms the cathode in the gas laser system. Other advantages claimed for this type of laser are its ruggedness and its maintainability. The system is open and a rotary vacuum pump maintains the necessary low pressure conditions for the plasma jet.

CIRCLE NO. 444

A simple magnetic switch that can signal the theft of documents or banknotes is being marketed by Siemens of West Germany. The device uses a thin, flat magnet that can be concealed within a bundle of paper. If the bundle is lifted from its normal resting place, a magnetic switch fitted under the drawer or compartment initiates an alarm. The alarm contact can actuate a concealed camera for filming the scene.

CIRCLE NO. 445

A year ago we introduced 7 new JCM miniature RF coaxial connectors that "do the job for a fraction of SMA prices."

Here, by popular demand, are 8 more.

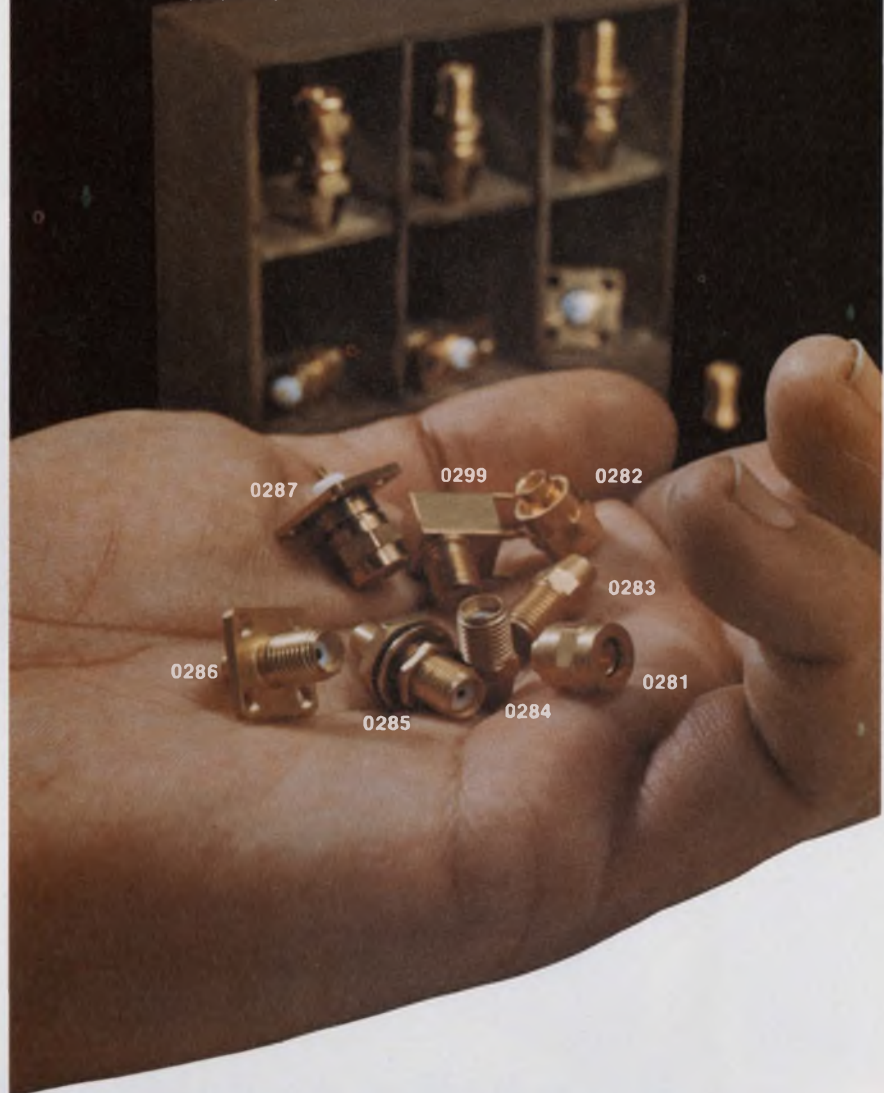

If you don't require all the electrical performance built into SMA type connectors, why pay for it? Up to 3 GHz for flexible cable assembly and even beyond 6 GHz for semi-rigid assembly, our new JCM series gives you the same electrical performance as the far more expensive SMA types. The series includes connectors for both panel and PC mounting. All are interchangeable and intermateable with the standard, expensive SMA connectors. So you can use them without making any changes . . . and without compromising required performance. There are JCM connectors to accept virtually any miniature size cable, so you don't have to stock a big variety. It's worth looking into, isn't it? All it costs is a stamp.

E. F. JOHNSON COMPANY / Waseca, Minnesota 56093

Dept. ED-12

Please check for technical information or test samples of our new low-cost series 142-0200-001 JCM connectors.

Please send technical information.

I desire test samples. Please call me at _____

NAME _____

FIRM _____

TITLE _____

ADDRESS _____

CITY _____

STATE _____

ZIP _____



E. F. JOHNSON COMPANY

INFORMATION RETRIEVAL NUMBER 22

GOODBYE SOLID STATE.



Hello better switching alternatives.

Until today, solid state was the only approach to logic or power switching you considered. But there's another way.

LOGIC

When you need a simple decision-making or interlocking circuit, why bother with a 5-volt supply, filter capacitor, ground plane pc board and logic packs? Clare general purpose relays can accomplish the same function at a fraction of your design time. You don't have to worry about line transients, overvoltages, lead capacitance, ambient temperature, etc.

Less expensive, too. Clare GP relays can provide logic circuitry at a fraction of the cost of solid state.

And you can switch indicating lamps, small motors and other output loads with the same relays used for the logic circuits. Try that with TTL!

Don't be oversold by solid state life

claims, you may be paying for operations you'll never use.

POWER

In multipole switching, Clare GP relays offer advantages over solid state, too. They're less expensive . . . by a substantial margin. They're easier to work with. You don't have to worry about heat sinking, dv/dt , di/dt , overvoltages or ambient temperature. And Clare GP relays provide you with as complete isolation from your control circuit to the power circuit as you're likely to find.

A WORD ABOUT QUALITY

Our thirty years of relay experience helped develop a general purpose relay line with all the features we know you want—a simplified design so there are fewer parts to go wrong, a combustion-proof, virtually unbreakable Lexan* cover, the highest UL motor control

recognition, and a wide choice of terminals and sockets.

SUPPORT SERVICES

While we offer a better switching alternative to solid state for logic or power switching, our prices are competitive with the low-priced general purpose relays. We also provide the complete support services you expect from a large, well-established relay manufacturer. For enough general purpose relay information to fill a coffee break, circle our reader service number or write C. P. Clare & Co., 3101 Pratt Ave., Chicago, Ill. 60645.

*Registered Trademark of General Electric.



a GENERAL INSTRUMENT company

washington report

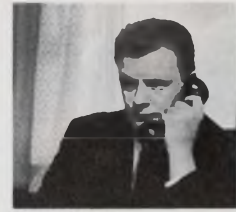

Don Byrne
Washington Bureau

Lockheed and Grumman lead defense contractors

The Lockheed Aircraft Corp. and Grumman Aerospace Corp. dominated Defense Dept. contracting in fiscal 1971, a new Pentagon report shows. For the third straight year, Lockheed led the top 100 companies in receiving prime contracts of \$10,000 or more. Grumman led the research and development contractors.

Lockheed received \$1.50-billion in Government work and was followed by General Dynamics, with \$1.49-billion; AT&T, \$1.2-billion; Grumman, \$1.1-billion, and General Electric, \$1.04-billion. In all, the top 100 companies accounted for \$21.5-billion in fiscal '71 awards, or 72.1 per cent of the \$29.8-billion awarded to U.S. concerns.

In R&D and test and evaluation, Grumman led all companies with \$569.1-million in awards. McDonnell Douglas was second with \$385.8-million and Lockheed third with \$333.7-million, followed by Hughes Aircraft Co., \$323.3-million, and Western Electric, \$318.8-million.

AT&T extends protection tariff a year as meetings continue

The American Telephone & Telegraph Co., acting on a Federal Communications Commission request, has agreed to put off for one year imposing fees on customer-owned equipment. Meetings between the commission staff, telephone company representatives and other manufacturers and users on what kind of standards should be set for the customer-owned PBXs—private branch exchanges—are continuing meanwhile.

In another PBX development, the FCC has responded to the National Association of Regulatory Utility Commissioners by saying that a federal-state board will indeed be set up to handle questions on customer-owned communications equipment, as suggested by the association.

With contract overruns rising, AIA asks guidelines

Sen. William Proxmire (D-Wis.) says a General Accounting Office survey of 45 major weapons systems shows overruns of \$35.2-billion in development costs—more than the overruns in the same programs last year. Last year the overrun figure was \$28-billion, he said. Meanwhile the Aerospace Industries Association has asked Congress to set broad guidelines for Government procurement.

The association said that many of the industry's problems were caused by a lack of guidance in procurement. An AIA study noted that "there

are 4000 statutory provisions, scores of executive orders and circulars, hundreds of court decisions, innumerable policies spread through various agencies and thousands of procurement regulations procedures, management systems and reporting requirements" affecting the Government's dealings with private industry. Among the association's recommendations to Congress were some calling for the Government to abide by the same business principles that govern others, to avoid the use of monopolistic leverage to exact unfair contracts and to offer a reasonable profit commensurate with the risks assumed.

Broadcasters and cable TV reach compromise

The boards of directors of the National Association of Broadcasters and the National Cable Television Association have reached a tentative accord on a plan to govern television operations. The plan, which hinges on rules for the importation of distant signals and copyrights, was worked out by Dean Burch, chairman of the Federal Communications Commission, and Clay T. Whitehead, director of the Office of Telecommunications Policy. The major impact will come in the smaller cities in which more channels will be permitted to be piped in via microwave from distant points. Copyright legislation will also be sought. The House Interstate and Foreign Commerce Committee says it is not planning any hearings on CATV at this session of Congress or the next, so presumably the new FCC regulations for expanding the CATV market will go into effect in March, as planned.

Capital Capsules: The House has rejected an effort to kill the F-14, the Navy fighter being developed by Grumman. The motion came as the House was debating the defense appropriations bill. **Rep. Jonathan Bingham (D-N.Y.) tried to cut the \$800-million for the F-14, saying the program was headed for disaster in overruns.** The Appropriations Committee chairman, George Mahon (D-Tex.), argued that removing the \$800-million would allow a new contract to be renegotiated, with Grumman adding \$1.4-billion to the program. The committee said the Navy would probably have to restructure the program. . . . NASA is seeking bids for proposals to use space-related technology to solve problems in air and water pollution, waste management and clinical medicine. . . . FCC Commissioner Charlotte Reid has been appointed Defense Commissioner of the FCC to replace Robert Wells, who resigned from the commission to run for Governor of Kansas. **She will handle emergency communication matters and represent the FCC on interagency defense matters.** . . . The Postal Service's facsimile mail transmission is now in operation between New York and Washington, and the service says it is aiming for a total delivery time of four hours between the two points. . . . A NASA computer program is being used by the Ford Motor Co. to help design light trucks and cars. **Ford reports a 60% improvement in predicting the behavior of components under stress and a two-thirds reduction in the time needed to arrive at such calculations.** The NASA program—Nastran—is one of several hundred developed for space use and now available to any U.S. company for the "nominal cost of evaluation, processing and distribution." Information is available from NASA's Computer Software Management and Information Center, Barrow Hill, University of Georgia, Athens, Ga. 30601. . . . House action has killed once and for all the Army's Main battle tank program. **The cost of the "economy" version of the elaborate and trouble-plagued XM-803 had soared to almost \$1-million per tank.**



TEKTRONIX® 7900 FAMILY

1 GHz Direct-Access Oscilloscope



OR...

500 MHz real-time Oscilloscope System

- 8 x 10 cm display CRT READOUT
- 9 cm/ns writing speed
- 7A19 Amplifier 500 MHz @ 10 mV/div
- 7D14 Digital Counter 525 MHz direct counting
- 7B92 Dual Time Base 500 ps/div

OR...

choose from 24 compatible 7000-Series plug-ins for virtually any measurement

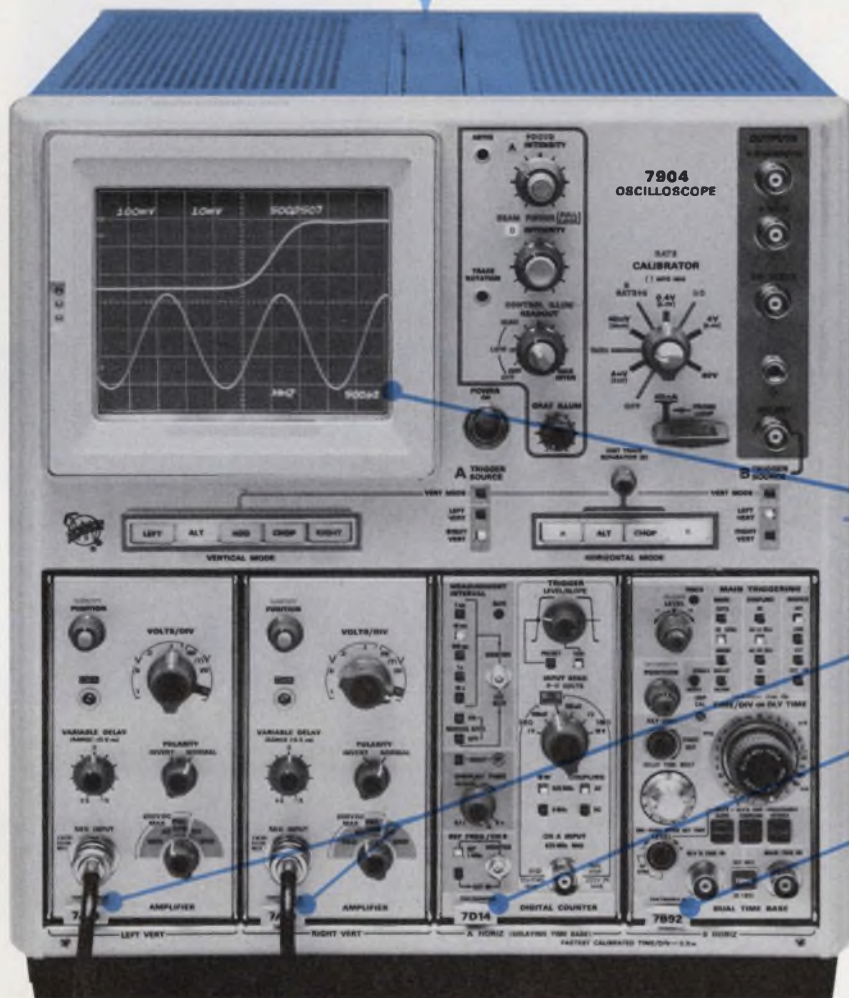

TEKTRONIX 7904

featuring extended performance or general purpose use, from one mainframe and a family of plug-ins.

Extended Performance — 20 kHz to 1 GHz

Plug in the 7A21N and install a simple vertical amplifier bypass to directly access the CRT. The bandwidth — 1 GHz, and risetime — 350 ps. Less than 4V/div driving signal required — single ended or differential. Sorry — no CRT READOUT — vertical amplifier bypassed.

General Purpose — DC to 500 MHz

Plug in the 7A19 — 500 MHz bandwidth at 10 mV/div, 7B92 — delaying sweep rates to 500 ps/div, 7D14 — direct counting to 525 MHz. As your applications and measurement requirements change, choose from 24 plug-ins for: • sampling • TDR • spectrum analysis • curve tracing • digital multimeter • etc., etc. TEKTRONIX 7904 . . . A product of technical excellence.

For further information or a demonstration call your nearby TEKTRONIX Field Engineer or write: Tektronix, Inc., P.O. Box 500, Beaverton, Oregon 97005.

7904 Oscilloscope	\$2900
7904 Oscilloscope, without readout	\$2500
7A19 Amplifier	\$500
7A19 Amplifier, with variable delay	\$700
7D14 Digital Counter	\$1400
7B92 Dual Time Base	\$1400
7A21N Direct Access	\$350

U.S. Sales Prices FOB Beaverton, Oregon

Cut costs...increase production... improve quality...just 90 minutes after your new Fluke ATE* comes through the door.



Terminal/10, Fluke's new series of automatic test, control and data acquisition equipment comes to you after a three year development program and more than a year of on-line testing.

Here's the ATE you can put right to work verifying and calibrating lab or production multimeters or ac and dc sources. Check out analog and combination analog-digital subassemblies. Collect, manipulate, reduce, store and report high accuracy data. Calibrate oscilloscopes, high frequency signal generators, meters and counters. Do it with ease and assurance because each of these ATE systems has been specifically designed with the user in mind by one of the world's outstanding precision electronic instrument firms.

The Fluke Terminal/10 uses a non-dedicated computer so you won't have to alter it in any way or take it away

***Automatic Test Equipment**

from other tasks. In many instances you can plug right into the computer you already have. Up to 16 Terminal/10 systems can be served by a single computer.

We use BASIC, a popular language compatible with a wide range of system requirements and standard industry-wide time-sharing packages. Other languages are also available.



Instruments and processes can be added to the system at any time without changes in CPU core size requirements.

All systems come with self-check routines to give you a fast way to verify

performance and establish system pre-cal, post-cal and so on. Systems are manually programmable from the Fluke interface processor and CRT terminal.

The CRT display interfaces with the operator to give him rapid instruction or provide a means of program development. For proportional systems control, an auxiliary keyboard is provided.

The EIA compatible interface gives you a broad range of CPU configurations using an initial computer utility meeting both cost and need parameters. At the same time, you can economically expand the system to meet new requirements.

The new Fluke Terminal/10 is on the air now and a touring demo unit will be in your area soon. To arrange a demonstration or get complete information call your local Fluke sales engineer or contact us directly.

Fluke, Box 7428, Seattle, Washington 98133. Phone: (206) 774-2211. TWX: 910-449-2850/ In Europe, address Fluke Nederland (N.V.), P.O. Box 5053, Tilburg, Holland. Phone: (04250) 70130. Telex: 884-52237/ In the U.K., address Fluke International Corp., Garnett Close, Watford, WD2, 4TT. Phone: Watford, 33066. Telex: 934583.



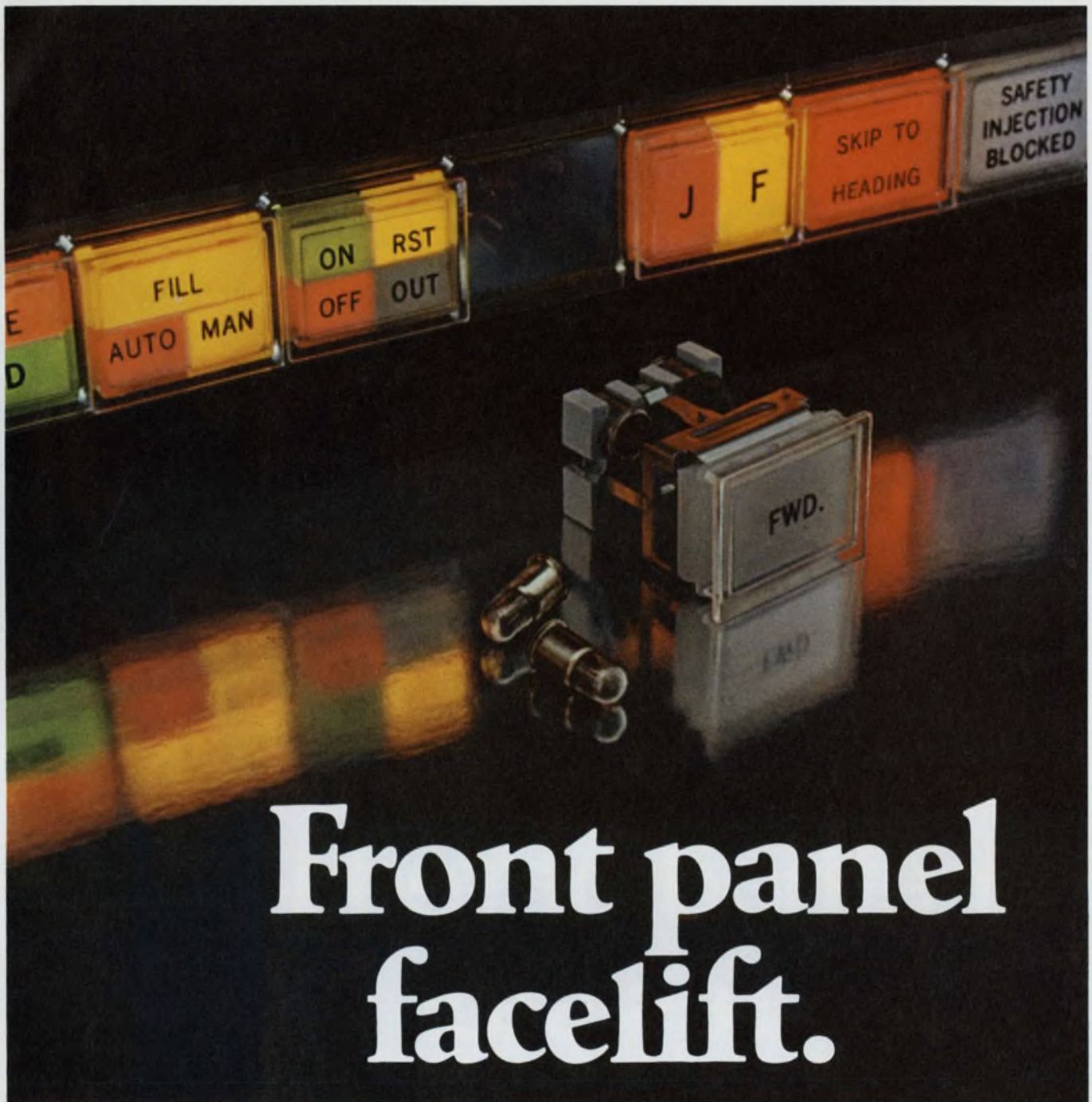

Front panel facelift.

When one of our Series 2 lighted pushbuttons needs a change of color filters, legends, or lamps—the change is simple. Because the switch stays mounted in the panel. Just one straight, gentle pull and the change is ready to be made.

Accessible . . . as well as available. The Series 2 can be had with a wide variety of display screens, color filters and switch modules.

So, more than likely, our switch is perfect for the

application you're now working on. Even if it's military/aerospace. Because we have Series 2 versions that meet the requirements of MIL-S-22885.

For more information, call your MICRO SWITCH Branch Office or Authorized Distributor (Yellow Pages under "Switches, Electric"). Or write for Catalog 51.

MICRO SWITCH

FREEPORT, ILLINOIS 61032

A DIVISION OF HONEYWELL

MICRO SWITCH products are manufactured, sold and serviced worldwide through Honeywell International.

INFORMATION RETRIEVAL NUMBER 26



Try our straightforward method of reducing fixed resistor costs.

Paying the lowest price for fixed resistors doesn't mean they're costing you less. Split an A-B resistor apart and discover the difference between Allen-Bradley and all the others. Our exclusive hot molding process forms the element into an integral structure. Physically strong. With a densely packed,

uniform resistance track. And note how the leads are firmly and thoroughly imbedded to reduce circuit noise. Hot molding is just one way we have engineered more quality into our resistors. Consistent A-B quality. You can lower your installed costs and put more reliability into your products. If you

think all resistors are the same, request our booklet "7 ways to tell the difference in fixed resistors." Available from your local A-B electronic distributor, or write Allen-Bradley Electronics Division, 1201 South Second Street, Milwaukee, WI 53204. Export: Bloomfield, N. J. 07003. Canada: Galt, Ontario.

ALLEN-BRADLEY



Further confirmation of a changing industry

The "10-year Forecast of Government Markets" presented by the Electronic Industries Association at last month's EIA Fall Conference in Los Angeles (see ED 23, Nov. 11, 1971, p. 28) may have put a final damper on any remaining speculation that the U.S. is about to embark on a new round of defense spending.

A consensus of predictions submitted to the association by 18 electronic companies, ranging from components manufacturers to large aerospace concerns, reveals even more pessimism about long-term defense spending than the 10-year outlook presented by the EIA last year.

Total Defense Dept. procurement is expected to hang around the \$20-billion level continuing to decline as a percentage of the total federal budget. The budget itself is expected to more than double in the next 15 years—to \$450-billion by 1985.

Despite rumors of huge increases in defense spending after the Vietnam war ends, despite claims of a growing Soviet military threat, despite the predictions of some Congressmen, aerospace executives, military "experts" and stock-market speculators, it appears the unlimited spending days of the mid-60s are gone—if not forever, at least for the foreseeable future.

The EIA survey confirms what this magazine has believed for some time—namely, that action will be in new markets and in the civionics sector. In fact, Government spending is expected to at least double in the next five years, with hundreds of millions to be spent on automatic train control systems, vehicular traffic control, justice communications and so on. Though still small when compared to total Defense Dept. and NASA figures, the relative growth of these markets *is* phenomenal.

As ELECTRONIC DESIGN has said so often in the past, times are changing, and particularly so in the electronics area. New markets call for new technology, and this will in turn create new opportunities for engineers.



Hayden has a new, free, personalized and self-selected information system. We call it our Requested Data Delivery Service, and as a qualified professional you're entitled to take advantage of it. Please take a moment now to fill out the enrollment form; you'll find it inside the front cover.

Ralph Dobriner

RALPH DOBRINER
Managing Editor



FOCUS

on
Industrial
chart
recorders

Speed. It's probably the most important parameter to consider when you shop for an industrial chart recorder. The

appropriate pen-drive mechanism, writing method, paper type and chart speed will all be determined primarily by the frequency of the signal you want to monitor. And these factors, in turn, will determine how much you're going to pay for the recorder and the paper it uses.

Industrial chart recorders differ from laboratory units; they're cheaper and less flexible. Typically they're purchased in large quantities, with each unit earmarked for a specific function. Lab recorders, on the other hand, are usually purchased singly, and they have the front-panel-selectable chart speeds and sensitivity ranges required by general-purpose instruments.

Because of the relative lack of flexibility of the industrial units, it's particularly important to be sure to specify all of the features you'll be needing when you place your order. The machine isn't likely to have any bells and whistles that you don't ask for.

First, decide how to drive the pen

By and large, there are two ways to move the thing that marks the paper: It can be attached to a galvanometer, or it can be driven by a motor that forms part of a potentiometer-feedback positioning system.

Galvanometers are the faster of the two. Writing instruments of this type can usually follow signals as high as 100 to 200 Hz.

In all other respects, however, the potentiometer-feedback approach is better. It allows larger chart widths, better resolution, better accuracy, less drift and lower price. Its speed, however, is

limited to signals on the order of 1 to 2 Hz.

The first rule of chart-recorder selection, therefore, is to stick to potentiometer types, unless your speed requirements make a galvanometer necessary. And if a standard galvanometer isn't fast enough, you'll have to go to the subminiature light-beam galvanometer types or even the fiber-optics CRT approach.

The light-beam galvanometer approach uses a tiny galvanometer to which a low-mass mirror is attached. Movements of the mirror are used to deflect a light beam, which then writes on photosensitive chart paper. Because of the low mass of its moving parts, a light-beam galvanometer can usually handle signals as high as 5 kHz; some high-performance units, in fact, boast 3-dB bandwidths of dc to 10 kHz, and even slightly higher.

For the ultimate in chart-recorder speed, mechanical schemes must be abandoned completely. One way to do this is to use a cathode-ray tube to generate a moving spot of light, which is transmitted to photosensitive chart paper by a bundle of fiber optics. Honeywell's Visicorder recording oscilloscope uses this approach to achieve a 3-dB bandwidth of 1 MHz. But at \$12,500 and 120 pounds, the instrument is much better suited to the laboratory than to industrial applications.

'Sensitivity' is a flexible word

Since most industrial applications will not need the speed of light-beam oscillographs, let's concentrate on the two basic mechanical systems.

An important advantage of potentiometric recorders over galvanometric types is in sensitivity. However, as John Deans, advertising manager of Hewlett-Packard's San Diego division points out, the difference is not immediately obvious from a

Michael J. Riezenman
Technical Editor



General Radio's GR1523 Level Recorder operates fully automatically here, recording a one-third octave analysis of the noise generated by the nearby compressor.

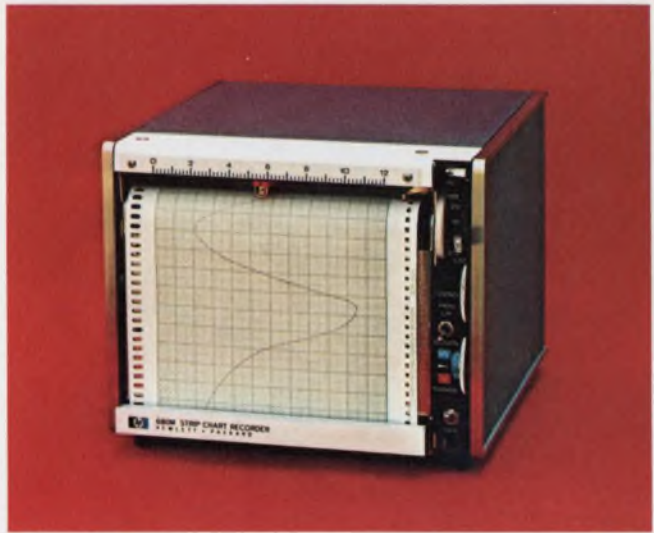

Hewlett Packard's Model 680 potentiometric recorder is available with either capillary-ink or electric writing. Response time is a maximum of 0.5 s full scale.

casual glance at the spec sheets.

"By some old, unknown convention," he explains, "the sensitivity of a galvanometric recorder is specified like a scope: so many volts per division. A potentiometric recorder, by contrast, is specified like a voltmeter: so many volts full-scale. You could have one of each type recorder with '1-mV sensitivity,' but a 1-mV signal would move the pen 25 cm on a potentiometric unit but only 0.1 cm on the other."

Another area in which specifications are not handled in the same way for both types of recorders is speed. Potentiometric recorders are so slow that their speed is usually described in response time rather than bandwidth.

This response time is the time required for the pen to traverse the full width of the chart when a full-scale step input is applied. It is customary for the response-time spec to include settling time, but it never hurts to check.

One thing to watch when you compare response-time specs is the width of the chart. For example, HP specifies a response time of less than $1/3$ s for its model 7123A/B and less than $1/4$ s for its 7143A/B. The latter unit isn't really faster than the former; it merely has a five-inch chart width instead of a 10-inch width.

Some companies avoid this problem by specifying a slew rate instead of a response time. Thus Precision Standards Corp. characterizes its Series GP702 recorders as having a slew rate of 20 inches/s, which corresponds to a response time of $1/4$ s for a five-inch chart.

Watch those bandwidth specs

Someone once said that a broadband isn't an all-girl orchestra. Sometimes it also isn't a frequency-response spec that looked pretty broad at

first. And this is not a minor consideration.

For example, one manufacturer's spec sheet states that the galvanometric recorder in question has "response to 100 Hz." Further down the sheet it says "Frequency Response: $\pm 1/2$ dB dc to 80 Hz. -3 dB to 100 Hz. 10 Hz reference."

The proper interpretation of this spec isn't obvious, but it can mean that the response at 100 Hz is 3 dB below the response at 10 Hz, while the dc response is 3 dB above 10 Hz. Thus, over-all, the output at 100 Hz may be 6 dB below dc, without the numeral 6 appearing on the spec sheet.

Another way you can go astray in interpreting frequency-response specs, according to C. H. Vaughan of General Scanning, Inc., Watertown, Mass., is to assume that the advertised frequency response of a recorder is for a large signal. It usually isn't.

The effect of this consideration can be profound. One particular recorder with a maximum output of 50 divisions peak-to-peak is 3 dB down at 80 Hz. However, if the dc signal is limited to 10 divisions, the 3-dB point moves out to 150 Hz.

Rectilinear doesn't mean linear

Galvanometer recorders all have at least one problem in common: The normal movement of their pointers is along a curve—not in a straight line. A common way to deal with this problem is to use chart paper with curved-grid construction, in which the radius of curvature of the grid lines is the same as the effective radius of the pointer.

A second approach is to employ a mechanical linkage between the galvanometer and the pen to translate the curved swing into a linear motion. Sometimes—in the case of thermal writing systems, for example—the stylus-paper contact is



Varian's series G-2500 recorders feature 0.5-s pen response across a 10-inch usable chart width. The series has an accuracy rating of $\pm 0.25\%$.

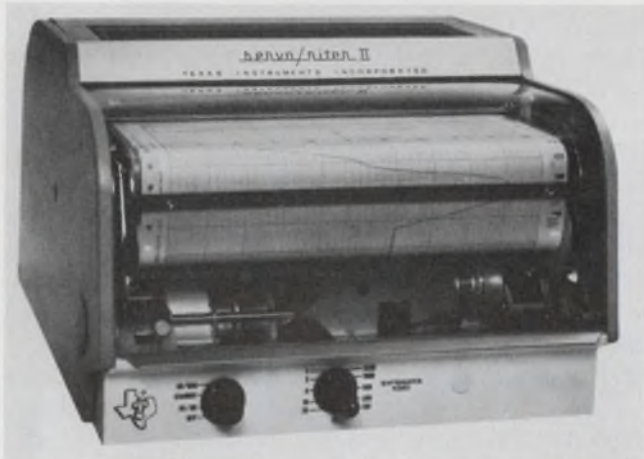

Texas Instruments' Servo Riter II series of potentiometric recorders feature an accuracy of $\pm 0.25\%$ of full scale or $\pm 5 \mu V$, whichever is greater.

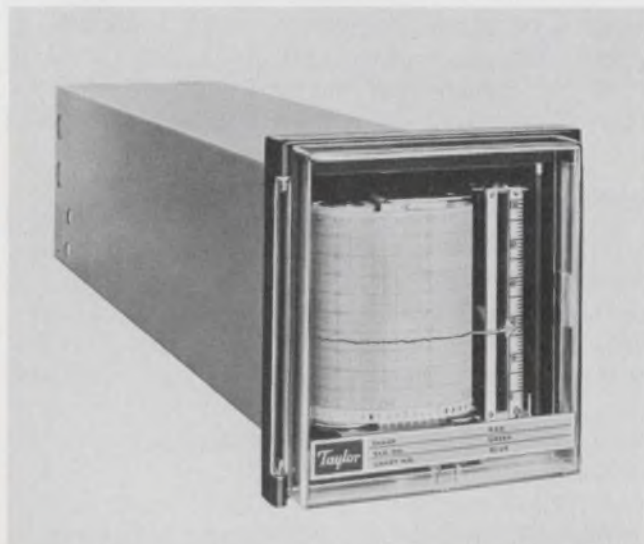

Taylor's 800 J transistorized servo recorder operates at a standard chart speed of 1 inch/hour; other speeds are available as options.

at a knife edge. This guarantees that the chart presentation will be perfectly rectilinear, but it does not say anything about the linearity of the presentation.

Generally speaking, to get really good linearity from a galvanometer movement, you've got to use the same trick that's used with potentiometric recorders—position feedback. Using this approach, several manufacturers combine small contactless transducers with mechanical linkages to reduce linearity errors to less than 0.5%.

Drawing the line

It's hard to believe the many ways man has devised for drawing lines on paper, until you examine the writing methods used in various chart recorders. The methods include capillary ink, felt-tipped pen, pressurized ink, heated stylus, pressure-sensitive paper and electrosensitive paper. Which should you choose?

The answer, of course, is pick the cheapest one, unless there's a good reason for doing otherwise.

Your first choice, therefore, may be capillary ink. This system consists of a metal pen tip connected to an ink reservoir by a piece of tubing. Ink is fed to the pen tip, on demand, by capillary action. As the paper moves relative to the pen tip, it pulls ink from it at a rate determined by the viscosity of the ink, the size of the orifice in the pen tip and the speed of the relative motion between the pen tip and the paper.

In addition to being simple and inexpensive, capillary ink has three other advantages: It works very well on cheap, ordinary chart paper; it produces a thin dark line that is easily reproduced by conventional copiers, and it works well over a fairly wide range of speeds.

The disadvantages of capillary ink become obvious when you go to high-speed writing. To prevent skipping at high writing rates, it's necessary to use a low-viscosity ink and a large-diameter pen tip. This combination is an open invitation to flooding if you attempt to use the pen at low speeds or, heaven help you, if you let the pen rest on one spot on the paper.

Furthermore, at high speeds, it's usually necessary to use a fast-drying ink, so the chart will not smudge when the user is ready to handle it. These inks, unfortunately, can dry almost as quickly in the pen tip as on the paper. In some cases if the pen is left inoperative for only a few minutes, it can get clogged enough to become inoperative until it is cleaned.

Felt-tipped pens provide many parallel passages for the ink, and thus they are less susceptible to clogging than capillary pens. They are also able to write without skipping at reasonably high speeds. Their big disadvantage is that they

tend to bleed on the paper at low speeds and will deposit a pool of ink if left standing in one spot.

As fiber tips wear, they tend to make broader lines and thus lose resolution. Worn-out pens, it should be noted, can be cheaply and easily replaced. And they make good reproducible records on low-cost paper.

Putting on the pressure

For really high-speed ink writing, pressurized-ink is the way to go. A pressurized-ink system is a completely enclosed miniature hydraulic system, containing a pump and a pressure-control system that modulates the pressure on the ink as the pen speed varies. Because the pressure is always optimized for the particular chart speed and pen speed in use, this method of writing produces very uniform lines over a wide range of speeds.

The main disadvantage of the pressurized-ink approach is economic—it costs more than the capillary-ink and felt-tipped-pen approaches, and it uses a more expensive type of chart paper. The paper must have a special coating on it that lets the pen make a liquid seal with the paper. The coating must also promote rapid drying of the ink once it is deposited.

An unusual type of pressurized-ink system—one that does away with the pen—is used in the



Siemens Oscillomink liquid-jet recorder. This recorder, with a 3-dB bandwidth of 1000 Hz, has a writing speed of 150 ft/s—claimed by Siemens to be the fastest ink writing system ever developed.

Instead of using a pen or stylus, the Oscillomink recorder directs a fine jet of ink onto the

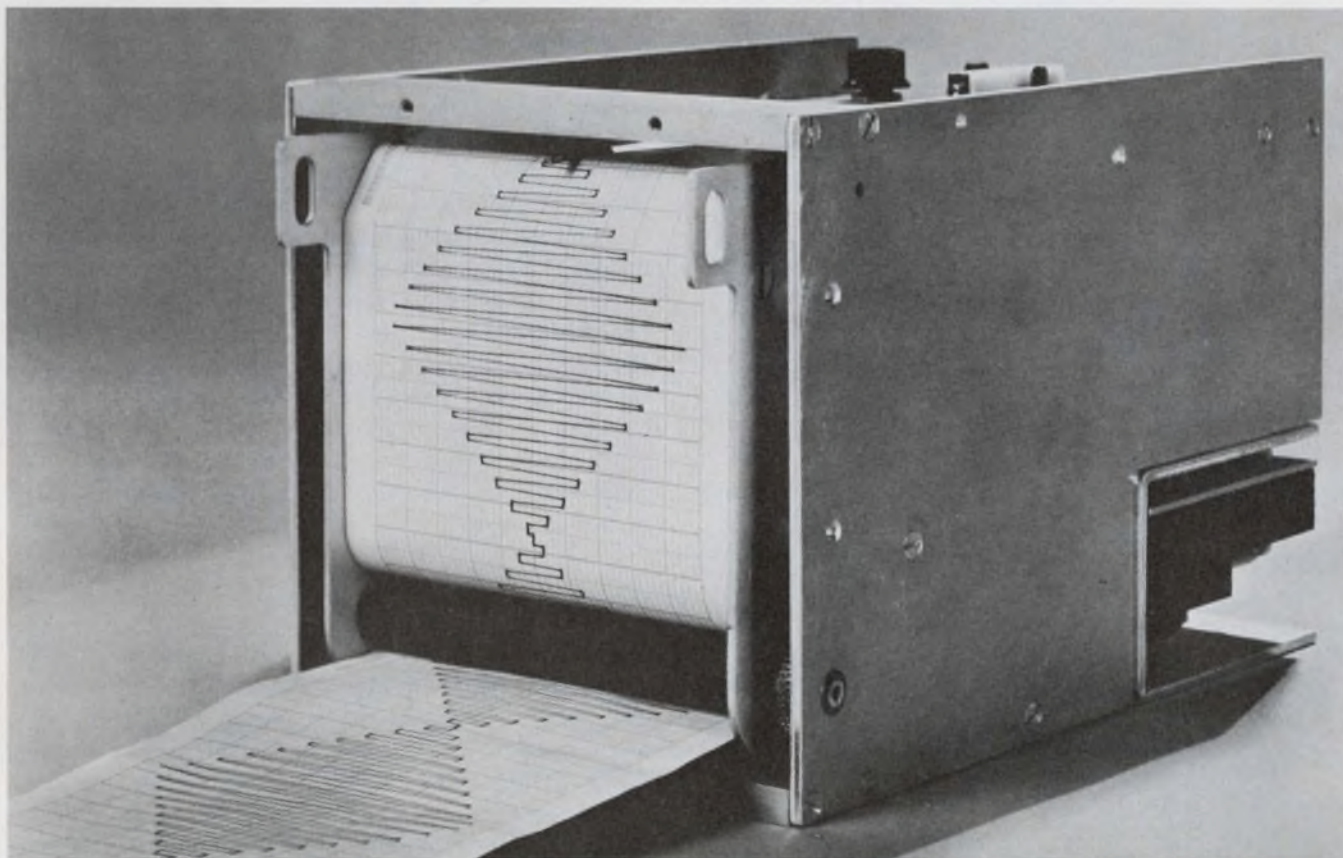

General Scanning's GR-1701 is claimed to be the fastest 100-mm strip chart recorder on the market. The

unit has a 3-dB full-scale response of 20 Hz and uses a heated stylus recording.

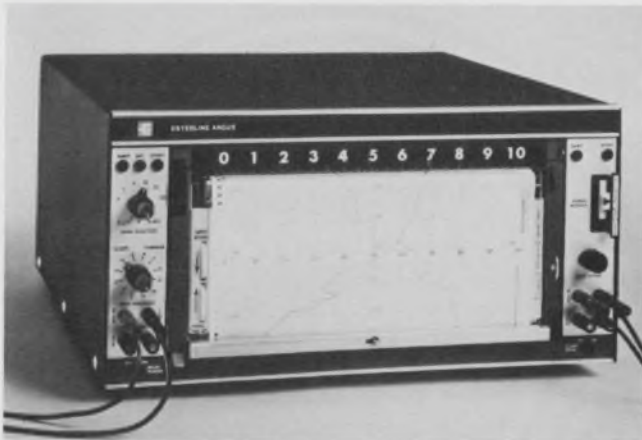

The latest from Esterline Angus is the Speed Servo II series of 10-inch recorders, featuring response time below 0.3 s and over 240 different models.

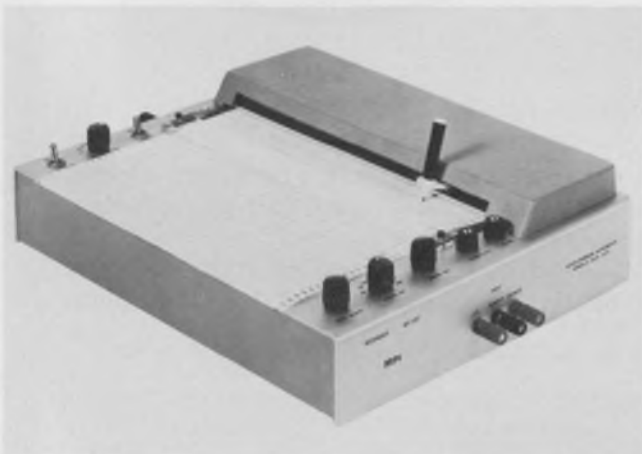

McKee-Pedersen Instruments' Model MP-1027 come in two standard models: a 1 to 100-mV model and a 10 to 1000-mV version. Both have eight ranges.



Rustrak's Model 3400 new miniature two-channel potentiometric recorder utilizes a pressure-sensitive strip chart. Chart width is 2-5/16 inches per channel.

chart paper. Among its other advantages, this permits high-speed ink recording of overlapping traces.

Writing without ink

If the thought of ink-stained fingers and clothes makes you shy away from an ink-writing system, you may want to consider one of the many dry-writing systems available. In general, these schemes use rather costly special papers on which a special stylus can make a mark by applying either heat, pressure or electricity.

The traces produced by these methods usually lack the contrast of a good ink record, and the chart papers are often easily marked in casual handling.

Two of the most common dry-writing systems in use today are the pressure-sensitive and heat-sensitive types. Both use chart paper that is made by coating a black paper base with tiny spherical wax beads. This gives the paper surface a white appearance.

In the pressure-sensitive approach, a stylus is pressed against the paper, causing the wax beads to flow and become transparent thereby exposing the black base.

Heat-sensitive papers are almost identical in construction, but they use a harder wax with a low melting point. With the thermal approach to writing, a heated stylus is employed. It melts the wax, causing it to flow, and thus produces a mark in the same way that a pressure stylus does.

Pressure-sensitive writing systems find their widest application in low-speed recording situations, where unattended operation is important. In this type of application the consumption of paper is usually low, so the materials cost is reasonable. And the high reliability of the method makes it preferable to a capillary-ink approach.

Heat-sensitive papers are not immune to mechanical pressure, but they are less likely to be marked accidentally in normal handling. Since the stylus does not have to press heavily against the paper, thermal-writing systems can be used with high-speed galvanometers to produce clean, high-contrast records of high-frequency phenomena.

How about electric writing?

Probably the oldest and most common type of electric writing involves the use of carbon-impregnated electrosensitive paper. These papers are marked by a high-voltage stylus that breaks down a light-colored coating material, thus uncovering the carbon-filled base material.

During the marking process, carbon is blown from the coating, leaving a residue on the paper and in the machine. RFI is also an important

problem; the machine can interfere with nearby equipment if the recorder is not properly shielded. In addition carbon-impregnated papers are susceptible to accidental marking in normal handling.

An improved form of electrosensitive paper is Hewlett-Packard's zinc oxide chart material. This low-voltage writing method is based on the reduction of zinc oxide to free zinc. The paper is covered with a thin sheet of aluminum foil, which is coated with conductive zinc oxide dispersed in an organic binder. Passing a current through the coating reduces the oxide, thereby leaving a mark.

Records made on this type of paper do not have quite as much contrast as a good ink record, but they are rugged and reliable, and the paper cannot be marked by heat, pressure, light or moisture.

Take care of your chart paper

Some accuracy specs aren't worth the chart paper they're printed on. And this isn't because the recorder manufacturer is trying to fool you, but because all chart papers expand and contract with changes in temperature and humidity. The papers are manufactured and tested under controlled conditions that will probably never be duplicated in the paper's future history. This is far from a trivial consideration. In fact, a spokesman for the Brush Instruments Div. of the Clevite Corp., Cleveland, estimates that temperature and humidity effects can introduce recording errors up to 2% because of their effect on the chart paper. This is pretty impressive in a 0.01% machine. ■■

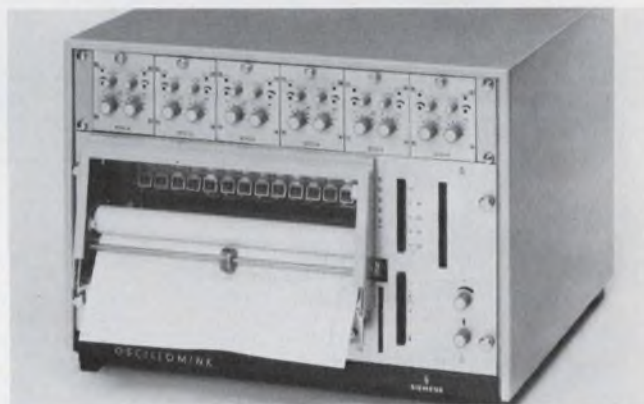

Siemens' Oscillomink liquid-jet recorder has a 3-dB bandwidth of 1000 Hz and a writing speed of 150 ft/s. This pressurized system is claimed to be the fastest ink-writing system ever developed.

Need more information?

Products cited in this report have, of necessity, received only cursory coverage. They've been selected for outstanding or unique qualities, though other specifications, not discussed, may limit or enhance their value in specific applications. Readers may wish to consult the manufacturers, listed here, for further details.

ELECTRONIC DESIGN is deeply grateful to many individuals who generously gave their time and patience to provide information for this report. To some of these men, listed here, we extend our special thanks for their very special help.

Amprobe Instrument Div., SOS Consolidated, Inc., 630 Merrick Road, Lynbrook, N.Y. 11563. (516) LY3-5600. (Joe Perz, Advertising Manager).
 Beckman Instruments, Inc., Process Instruments Div., Fullerton, Calif. 92634.
 Bell & Howell, Electronics and Instruments Group, 360 Sierra Madre Villa, Pasadena, Calif. 91109. (213) 796-9381. (James J. Kehoe, Manager of Public Relations).

Esterline Angus Div., Esterline Corp., Box 24000, Indianapolis, Ind. 46224. (317) 244-7611.
 Fischer and Porter Co., Warminster, Pa. 18974. (215) 675-6000. (Joseph H. Mayer, Sales Promotion Editor).
 General Radio, 300 Baker Ave., Concord, Mass. 01742. (617) 369-4400. (E. G. Rahaim, Sales Promotion).
 General Scanning, Inc., 80 Coolidge Hill Road, Watertown, Mass. 02172. (C. H. Vaughan).
 Hewlett-Packard Co., San Diego Div., 16399 W. Bernardo Drive, San Diego, Calif. 92127. (714) 487-4100. (John Deans, Advertising Manager).
 Honeywell, Inc., Industrial Div., 1100 Virginia Drive, Fort Washington, Pa. 19034. (215) 643-1300. (William W. O'Hara, Instrument Editor).
 McKee-Pedersen Instruments, P.O. Box 322, Danville, Calif. 94526. (415) 937-3630. (Richard G. McKee).
 Precision Standards Corp., 1701 Reynolds, Santa Ana, Calif. 92705. (714) 546-0431. (E. Zimmer).
 Rust Corporation, 168 Tremont St., Everett, Mass. 02149. (617) 389-3380. (Sal Fulchino, President).
 Rustrak Instrument Div., Gulton Industries, Inc., Municipal Airport, Manchester, N.H. 03103. (603) 623-3591.
 Siemens Corp., Measuring Instruments Div., 186 Wood Avenue South, Iselin, N.J. 08830. (201) 494-1000 (Martin Bauer).
 Taylor Instrument Process Control Div., Sybron Corp., 95 Ames St., Rochester, N.Y. 14601. (716) 235-5000. (Robert M. Waples, Advertising Dept.).
 Texas Instruments, Inc., Digital Systems Div., P.O. Box 1444, Houston, Tex. 77001. (713) 494-5115. (Charles D. Newman, Recorder Marketing Manager).
 Varian Associates, Aerograph Div., Box 313, Walnut Creek, Calif. (415) 939-2400.

Call on the power of the Kokomoans for your systems of the 70's.

The tough breed of High Voltage Silicon Power Transistors.

Transistor	V _{CEX} Voltage	Con- tinuous I _C	V _{CEO} (sus)	Maximum Power Dissipation	Typical Applications
DTS 401	400V	2A*	300V		*I _C Peak = 5A Vertical magnetic CRT deflection, has good gain linearity.
DTS 402	700V	3.5A*	325V		*I _C Peak = 10A Horizontal magnetic CRT deflection, features fast switching time, high reliability under horizontal sweep fault condition.
DTS 410	200V	3.5A	200V	80W	Voltage regulator, switching regulator, DC to DC converter, class A audio amplifiers.
DTS 411	300V	3.5A	300V	100W	
DTS 413	400V	2.0A	325V	75W	*I _C Peak = 10A High V _{CB0} and V _{CEO} ratings make it practical to operate directly from rectifier 117V or 220V AC line.
DTS 423	400V	3.5A*	325V	100W	
DTS 424	700V	3.5A*	350V	100W	*I _C Peak = 10A High V _{CB0} , V _{CEO} (sus) ratings make them ideal for use in deflection circuits, switching regulators and line operating amplifiers.
DTS 425	700V	3.5A	400V	100W	
DTS 430	400V	5A	300V	125W	Voltage regulators, power amplifiers, high voltage switching.
DTS 431	400V	5A	325V	125W	
DTS 701	800V	1A	600V	50W	Vertical magnetic CRT deflection circuits.
DTS 702	1200V	3A	750V	50W	Horizontal magnetic CRT deflection circuits operating off-line.
DTS 704	1400V	3A	800V	50W	
DTS 721	1000V	3A	800V	50W	High voltage DC regulators.
DTS 723	1200V	3A	750V	50W	Very high voltage industrial and commercial switching.
DTS 801	1000V	2A	700V	100W	Color vertical magnetic CRT deflection circuits.
DTS 802	1200V	5A	750V	100W	Color horizontal magnetic CRT deflection circuits.
DTS 804	1400V	5A	800V	100W	
2N3902†	700V	3.5A*	325V	100W	*I _C Peak = 10A Ideal for switching applications. Can be operated from rectified 117 or 220 volt AC line.
2N5157	700V	3.5A*	400V	100W	
2N5241	400V	5A	325V	125W	For general use in electrical and electronic circuits such as converters, inverters, regulators, etc.
2N2580	400V	10A	325V	150W	
2N2581	400V	10A	325V	150W	
2N2582	500V	10A	325V	150W	
2N2583	500V	10A	325V	150W	
2N3079	200V	10A	200V		
2N3080	300V	10A	300V		

†Mil. qualified units available.

Transistors are NPN triple diffused.



Delco Electronics

DIVISION OF GENERAL MOTORS CORPORATION,
KOKOMO, INDIANA



Now available from these distributors in production quantities.

ALA., BIRMINGHAM • Forbes Distributing Co., Inc. (205)-251-4104

ARIZ., PHOENIX • Cramer/Arizona (602)-263-1112 • Sterling Electronics (602)-258-4531

CAL., LOS ANGELES • Kierulff Electronics, Inc. (213)-685-5511 • Radio Products Sales, Inc. (213)-748-1271

CAL., PALO ALTO • Kierulff Electronics, Inc. (415)-968-6292

CAL., REDWOOD CITY • Cramer/San Francisco, (415)-365-4000

CAL., SAN DIEGO • Milo of California, Inc. (714)-232-8951

CAL., SAN DIEGO • Radio Products Sales, Inc. (714)-292-5611

COLO., COLORADO SPRINGS • Walker Electronics (303)-636-1661

COLO., DENVER • Cramer/Denver (303)-758-2100 • Denver Walker Electronics (303)-935-2406

ILL., ROSEMONT (Chicago) • Kierulff/F-J-R (312)-678-8560

ILL., SKOKIE (Chicago) • Merquip Electronics (312)-282-5400

IND., INDIANAPOLIS • Graham Electronics Supply, Inc. (317)-634-8202

MD., BALTIMORE • Radio Electric Service Co. (301)-823-0070

MASS., NEEDHAM HEIGHTS • Kierulff Electronics, Inc. (617)-449-3600

MASS., NEWTON • The Greene-Shaw Co., Inc. (617)-969-8900

MICH., ROMULUS • Harvey/Detroit (313)-729-5500

MINN., MINNEAPOLIS • Stark Electronics Supply Co. (612)-332-1325

MO., KANSAS CITY • Walters Radio Supply, Inc. (816)-531-7015

MO., NO. KANSAS CITY • LCOMP-Kansas City, Inc. (816)-221-2400

MO., ST. LOUIS • LCOMP-St. Louis, Inc. (314)-647-5505

N.J., CLIFTON • Eastern Radio Corporation (201)-471-6600

N.M., ALBUQUERQUE • Cramer/New Mexico (505)-265-5767 • Sterling Electronics (505)-247-2486

N.Y., BINGHAMTON • Harvey/Federal (607)-748-8211

N.Y., EAST SYRACUSE • Cramer/Eastern (315)-437-6671

N.Y., NEW YORK • Harvey/New York (212)-582-2590

N.Y., ROCHESTER • Cramer/Rochester (716)-275-0300

N.Y., WOODBURY • Harvey/New York (516)-921-8700

OHIO, CINCINNATI • United Radio, Inc. (513)-761-4030

OHIO, CLEVELAND • Pattison Supply (216)-441-3000

OHIO, DAYTON • Kierulff/F-J-R (513)-278-9411

OKLA., OKLAHOMA CITY • Radio, Inc. (405)-235-1551

OKLA., TULSA • Radio, Inc. (918)-587-9123

PENN., PHILADELPHIA • Almo Electronics (215)-676-6000

PENN., PITTSBURGH • RPC Electronics (412)-782-3770

S.C., COLUMBIA • Dixie Radio Supply Co., Inc. (803)-253-5333

TEXAS, DALLAS • Adleta Electronics Company (214)-741-3151

TEXAS, FORT WORTH • Adleta Electronics Co. (817)-336-7446

TEXAS, GARLAND • Kierulff Electronics, Inc. (214)-271-2471

TEXAS, HOUSTON • Harrison Equipment Co., Inc. (713)-224-9131

UTAH, SALT LAKE CITY • Cramer/Utah (801)-487-3681

VA., RICHMOND • Meridian Electronics, Inc., a Sterling Electronics Company (703)-353-6648

WASH., SEATTLE • Kierulff Electronics, Inc. (206)-763-1550

WASH., TACOMA • C & G Electronics Co. (206)-272-3181

CANADA, ONT., SCARBOROUGH • Lake Engineering Co., Ltd. (416)-751-5980

ALL OVERSEAS INQUIRIES:
General Motors Overseas Operations
Power and Industrial Products Dept.,
767 Fifth Avenue, New York, N.Y.
10022. Phone: (212)-486-3723.

Ready Now for Your Systems of the 70's: The Kokomoans' new breed of silicon power is ready to handle your high energy switching and amplification circuits. Our high voltage transistors permit the design of simplified circuits . . . without the extra weight, bulk and complexity you get with low voltage, higher current systems.

Delco silicon power transistors have earned a reputation for survival in the most rugged applications. Their proven performance in solid state deflection circuits in the new, large-screen color TVs is but one example.

It's because we design Delco transistors to have greater peak energy capability—to be able to withstand higher surges of voltage and current for a specified time. And we back it up with Peak Energy Testing to verify our safe operating curves.

Designing for your new systems of the 70's? The Kokomoans have the silicon power you need.

Kokomoans' Regional Headquarters.

Union, New Jersey 07083, Box 1018, Chestnut Station, (201) 687-3770.
El Segundo, Calif. 90245, 354 Coral Circle, (213) 772-5181.
Kokomo, Ind. 46901, 700 E. Firmin, (317) 459-2175 (Home Office).



Start logic designs with flow diagrams.

A properly drawn diagram helps you eliminate repetition, simplifies implementation and corrects malfunctions.

The design of logic systems can be torturous if the designer approaches the job circuit by circuit. The possible problems include circuit redundancy, overly complex logic and complicated debugging procedure. But all of these obstacles can be avoided if a complete logic flow diagram is used.

The diagram—a block-form representation of AND and OR circuits—is the blueprint from which the logic drawing is made. In the diagram, all passive circuits are left out.

The components omitted include inverters, driver blocks, counters and triggers. Although this is a tremendous simplification, every function of the machine is described graphically and specifically as to time, condition and execution. And that's all the information needed to draw control logic.

A flow diagram is developed from design specs. Let's see how.

Assume the specifications for a simple counter function are that the counter have these properties:

1. Is stepped by an oscillator with a basic frequency of 100 Hz and an output that is a symmetrical square wave.
2. Starts when a manual start switch is activated.
3. Steps from 0 to 5, then resets to a count of 3.
4. Resumes stepping from the count of 3 to a count of 4, then resets to 7.
5. Is then stepped from 7 to 5, backward.
6. Stops and signals that it is ready to start again.

The flow diagram based on these specs is shown in Figs. 1 and 2. In Fig. 1 the start counter sync control—essentially a sequence-oriented flow diagram—is shown. Beginning with a start block at the top, the first decision that is interrogated is the condition of the start switch.

In this application the common requirement for a no-bounce start switch is avoided for design simplicity. Instead, a bounce-suppression latch is specified. If the start switch is inactive, the bounce latch is cleared.

As soon as the start switch is activated, the bounce-suppression latch is set and a 1- μ s single shot is fired. Then the step-sync latch is set, the negative alternation of the oscillator is specified as NO and the step-counter trigger is set on the leading edge.

Control counter stepping

The flow diagram continues with the step-sequence control in Fig. 2. Let's assume that the logic has been reset before this circuit is started. Now, with the step-counter trigger set, the oscillator on its first positive alternation, the counter not equal to 4 or 5 and sequence 2 trigger clear, the counter is stepped +1 on the pulse trailing edge.

The flow diagram shows a line going down to the left and back up to the top. The step-counter trigger, oscillator and counter are interrogated

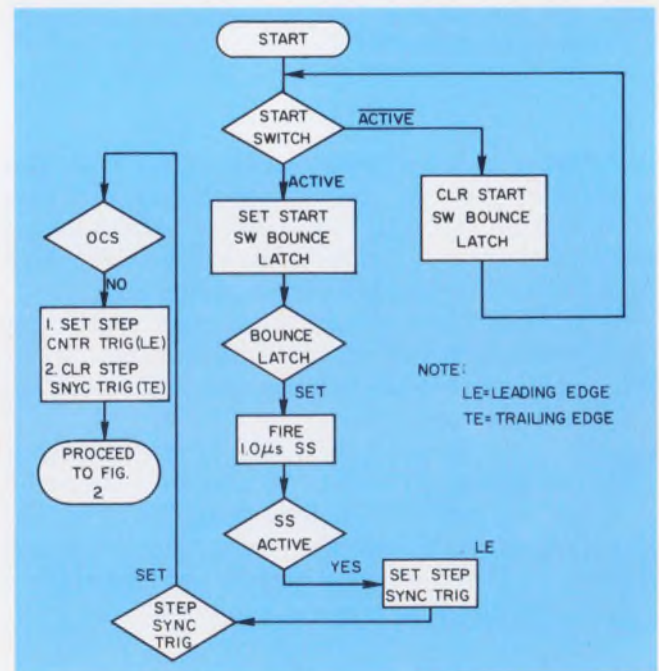

1. A start-counter sync control, as a flow diagram, shows all machine functions for this phase of the design, even though the passive circuits are left out. Initial and final blocks specify timing, rhombic blocks indicate conditions and rectangular boxes provide the executions.

again. Since the counter is still not equal to 4 or 5, and the sequence 2 trigger is still cleared, the counter is stepped up again to 2.

Consecutive oscillator pulses continue in this way, stepping the counter until it reaches 4. Now, with the step-counter trigger set, the oscillator on a positive alternation and the counter equal to 4, the sequence 1 trigger is interrogated and found to be clear. This returns the control path to a point where it is ORed with the counter not equal to 4 or 5, and since the sequence 2 trigger is still clear, the counter is stepped to 5. At this value and with the sequence 1 and 2 triggers clear, the 2^1 and 2^2 stages of the counter are switched, or complemented, and the sequence 1 trigger is set. Again, these functions are performed on the trailing edge of the oscillator pulse. Since the counter was at 5, complementing the 2^1 and the 2^2 counter stages switches it to 3, and control is returned to the top of the page.

The counter is stepped to 4 with the next positive alternation of the oscillator, since the counter is equal to 3 and the sequence 2 trigger is still cleared. Again, the control is returned to the top of the flow diagram. With the oscillator YES and the counter equal to 4, the sequence 1 trigger is again interrogated.

This time, however, it is found to be set. On the trailing edge of this pulse, the 2^0 and 2^1 counter stages are switched, or complemented, the sequence 2 trigger is set, and the sequence 1 trigger is cleared. Complementing the 2^0 and the 2^1 counter stages when the counter is equal to 4

switches the counter to 7. Again the control is returned to the top of the flow diagram.

In the next sequence of events—with the oscillator YES and the counter equal to 7—the sequence 2 trigger is interrogated and for the first time is found to be set. This time the counter is stepped backward to 6. The next time through, the counter is stepped to 5, with the step counter trigger set and the oscillator YES. The functions performed at this time are clearing the sequence 2 trigger, clearing the step-counter trigger and switching, or complementing, the counter stages 2^0 and 2^2 . Since the count was equal to 5, this switching returns the counter to a 0 state.

Clearing of the step-counter trigger stops the gated oscillator pulses from stepping the counter. Clearing the sequence 2 trigger clears the last control trigger in the logic, thus stopping the sequence. A ready light is illuminated when the step-counter trigger is cleared. All control triggers and counters have been reset, and the counter is ready to start again when the start switch is depressed.

Implement the flow diagram

From the complete flow diagram, a logic drawing can be detailed directly. This is shown in Fig. 3. Through normally closed contacts of the start switch, a signal is applied to gate $A1_2$ to keep the bounce latch clear. When the start switch is activated, a signal is applied to $A1_1$, setting the latch. As long as the start switch does not exhibit any cross-contact bounce, the bounce latch will remain set until the start switch is released.

The transition from a clear to a set state fires single-shot 1, a $1\text{-}\mu\text{s}$ negative pulse. This pulse, in turn, sets the step-sync trigger. Gate $A1_3$ is conditioned by the step-sync trigger being set and by negative alternations from the oscillator through inverter 1. Thus $A1_3$ generates a negative-going pulse to set the step-counter trigger on the leading edge of the pulse.

The purpose of the step-sync trigger is to set the step-counter trigger on a negative alternation of the counter. In this way the step-counter trigger is set in a synchronized fashion.

The logic drawing corresponding to the step-sequence control (Fig. 2) begins with $A1_1$ and N_3 , for the step-counter trigger set and the oscillator YES decision, respectively.

Follow a control path

Let's follow one of the control paths in Fig. 2 and show the logic implementation in Fig. 3. The first path activated is as follows: step-counter trigger set, oscillator YES, counter not equal to 4 or 5, and sequence 2 trigger clear. The execu-

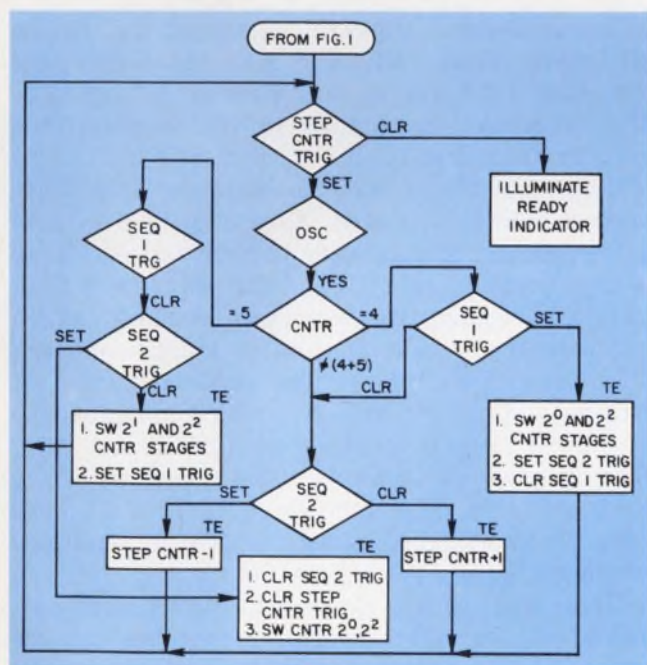

2. The step-sequence control diagram provides for stepping a counter. The sequence of events is as follows: the counter steps from 0 to 5, resets to 3, steps to 4 and then resets to 7. It's then stepped backward from 7 to 5, stops and signals it's ready to restart.

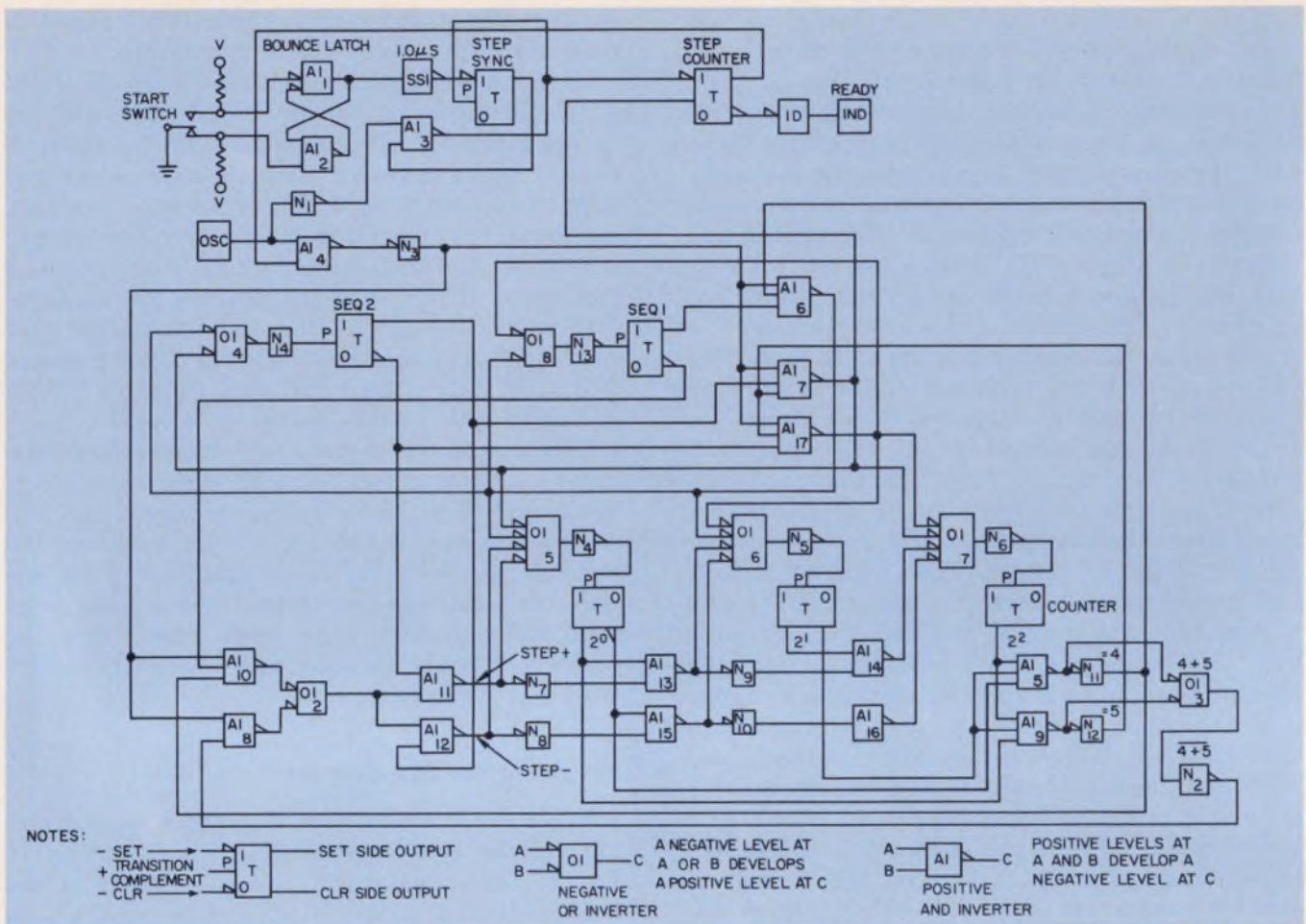

3. The implementation of the logic flow diagram can be simplified even further by taking into account such factors as the logic family selected and the packaging

tion for this path is to step the counter up by one count on the trailing edge of the pulse.

Gate A1₈ is conditioned from the output of N₂, which indicates when the counter is not 4 or 5. The other input to A1₈ comes from the output of N₃. The output here consists of gated positive alternations of the oscillator. The output of A1₈ drives O1₂, which in turn drives A1₁₁ and A1₁₂. Since the sequence 2 trigger is clear, A1₁₁ is conditioned, thus driving N₇ and the step-plus line.

New path for counter equals 4

Once the counter equals 4, the following path in Fig. 2 is activated: step-counter trigger set, oscillator YES, counter equal to 4, sequence 1 trigger clear and sequence 2 trigger clear. The final block steps the counter +1 on the trailing edge.

Gate A1₁₀ is the AND circuit for this leg. Its inputs are as follows: output N₁₁, which indicates the counter is equal to 4; the output of inverter 3, the output consisting of gated positive alternations of the oscillator; and the clear side

of the logic. Binary triggers with a ground level dc set and clear are used. The complementing input switches the trigger from the set to the clear, or vice versa.

of the sequence 1 trigger. The output A1₁₀ drives O1₃, which drives A1₁₁ and A1₁₂. As before, the sequence 2 trigger is still cleared, so it's A1₁₁ that generates an output to N₇, stepping the counter from 4 to 5.

Now that the counter is equal to 5, another control path is activated. As shown in Fig. 2, it is as follows: step-counter trigger set, oscillator YES, counter equal to 5 and the sequence 2 trigger clear, leading to the execution block, which switches the 2¹ and 2² counter stages and sets the sequence 1 trigger. The implementation of this path starts off with N₁₂, which indicates the counter is equal to 5. This output conditions A1₁₇. The other inputs to A1₁₇ are the clear side of the sequence 2 trigger and the output of N₃, the output consisting of gated positive alternations of the oscillator.

The output of A1₁₇ drives O1₇ and O1₁₁. The output of O1₇ through inverter 6 switches counter stage 2² and the output of O1₁₁ through N₅ switches counter stage 2¹. A1₁₇ also drives O1₁₄, which drives N₁₃ and switches the sequence 1 trigger to the set state. The complementing, or switching, of counter stages 2¹ and 2² switches the counter

from 5 to 3. At this point the control path is active for oscillator YES and the counter not equal to 4 or 5.

When the counter reaches 4, the operational control path is: step counter trigger set, oscillator YES, counter equal to 4 and sequence trigger 1 set.

This path is shown in logic in Fig. 3, as follows: The output from N_{11} , indicating counter equal to 4, conditions A_{16} . The output of N_3 also conditions A_{16} . The third input to A_{16} is the set side of the sequence 1 trigger. The output of A_{16} drives O_{16} , O_{15} , O_{18} and O_{17} . O_{16} through N_5 switches counter stage 2. And O_{15} through N_4 switches counter stage 2⁰. Gate O_{18} through N_{13} switches sequence 1 trigger to the clear state, and O_{17} through N_{14} switches the sequence 2 trigger to the set state. The switching of counter stages 2⁰ or 2¹, with the counter stepped to 4, sets the counter to 7.

Counter stepped backward

Now that the counter has been stepped to 7, the active control path in Fig. 2 is as follows: step-counter trigger set, oscillator YES, counter not equal to 4 or 5 and sequence 2 trigger set. This path steps the counter back one on the trailing edge of the pulse.

The implementation of this control path (Fig. 2) is as follows: The output of N_2 , indicating counter not equal to 4 or 5, conditions A_{13} . Gate A_{13} , also driven by inverter 3 or the positive alternations of the oscillator, drives O_{13} , and O_{12} drives A_{11} and A_{12} . This time, however, instead of A_{11} being conditioned by the clear side of the sequence 2 trigger, A_{12} is conditioned by the setting of the sequence 2 trigger.

With A_{12} fully conditioned, N_3 and the step line of the counter are driven. Ensuing oscillator pulses step the counter from 7 to 6, and then to 5, at which time a new control path takes over. This path is: step counter trigger set, oscillator YES, counter equal to 5 and sequence 2 trigger set. The execution for this path is to clear the sequence 2 trigger, clear the step counter trigger and switch stages 2⁰ and 2², thereby setting the counter to 0.

The implementation is as follows: N_{12} drives A_{17} . The output of N_{12} indicates the counter is equal to 5. Gate A_{17} is also driven by N_3 or the positive alternations of the oscillator, and by the setting of the sequence 2 trigger. The output of A_{17} drives O_{17} , O_{15} and O_{14} . Gate O_{17} switches the 2² stage of the counter. Gate O_{15} switches the 2⁰ stage of the counter, and O_{14} clears the sequence 2 trigger. A_{17} also clears the step-counter trigger.

The sequence is complete. The counter is reset, and all control triggers are clear. Since the step-counter is clear, the ready indicator lights. ■■

PUSH BUTTON SWITCH-RELAY

Another Alco First...
By combining a push on/off switch and a relay, we've created a very unusual safety switch. If power is accidentally interrupted it automatically cuts off the load. Specify, 115VAC, 6 or 14VDC. Rating 5A.



ALCOSWITCH®

ALCO ELECTRONIC PROD. INC., N. ANDOVER, MASS. 01845

INFORMATION RETRIEVAL NUMBER 231

MAGNET REED MINIATURES

Super miniature proximity switch & magnet assembly includes an encased Alnico-5 magnet that actuates the reed switch within .39".
Rating @ 50 VDC: 150ma break, 500-ma carry.

NORMALLY OPEN or



NORMALLY CLOSED

ALCOSWITCH®

DIV. OF ALCO ELECTRONIC PRODUCTS, INC., LAWRENCE, MASS.

INFORMATION RETRIEVAL NUMBER 232

ROTARY SWITCH MINIATURES

Two series: MRA Series with adjustable stop & in 1-2-3-4 poles on a single deck with max. of 10 or 12 positions. MSRE waterproof series meet high reliability standards; non-adj. 1 to 4 poles. 500 mA @ 125 VAC.

IMPROVED FEATURES



ALCOSWITCH®

DIV. OF ALCO ELECTRONIC PRODUCTS, INC., LAWRENCE, MASS.

INFORMATION RETRIEVAL NUMBER 233

WORLD'S NO. 1 MINIATURES

The original miniature switch is available with standard, flat, long and plastic toggles. Normally supplied with silver contacts. Gold-plating or P.C. terminals are available on request. Common 1/2" case size. Rate 5A @ 115VAC.



MST SERIES

ALCOSWITCH®

124 STYLES ON THE SHELF FOR IMMEDIATE DELIVERIES.
DIV. OF ALCO ELECTRONIC PRODUCTS, INC., LAWRENCE, MASS.

INFORMATION RETRIEVAL NUMBER 234

West Indies Isles. Bequia, Carriacou. Dutch St. Maarten. English Antigua. French Martinique. Beautiful schooner. White sails. White beaches. Pink beaches. Black beaches. Old forts. Native markets. Volcanoes. Beachcombing. Sailing. Sunbathing. Skindiving. Boasun's chair ride. Great grub. Great grog. Limbo. Goombay. Golden moons. Beach parties. Night watch. Iridescent sunrises. Intimate shipmates. Kaleidoscopic sunsets. Star spangled skies. Steel bands. Calypso. Exotic Caribbean. 10 adventurous days. From \$265. That's a Windjammer Cruise. Come on.



Cap'n Mike. Send me your color brochure.
 P.O. Box 120, Dept. 145
 Miami Beach, Florida 33139.

Name _____
 Address _____
 City _____
 State _____ Zip _____



Windjammer Cruises.

New D/A converters from Burr-Brown



just a little bit better!

Premium performance combined with Burr-Brown quality make the new DAC-40 and DAC-50 digital-to-analog converters just a bit better. The optimum performance comes from the use of Burr-Brown monolithic current switches designed for tight temperature tracking and Burr-Brown thin film resistor networks developed for tight ratio tracking.

Burr-Brown quality is evident in the comprehensive specifications which include test details. All critical specs are fully-tested over the standard 0 to +70°C specification temperature range — including gain, offset, and linearity.

A variety of optional features are available in these competitively priced series; Binary or BCD codes, optional input buffer register, +5V, +10V, $\pm 2.5V$, $\pm 5V$ and $\pm 10V$ output voltage ranges and current output options. The DAC-40 series offers 8-, 10-, and 12-bit resolutions and accuracies. The DAC-50 is available in 10- and 12-bit models.

NEW BURR-BROWN BOOK "Operational Amplifiers — Design and Applications", over 470 pages, 300 illustrations. Written by Burr-Brown application-engineering staff, published by McGraw-Hill. U.S. price, 15.00 dollars. Order from Burr-Brown.



GUARANTEED MAXIMUM SPECIFICATIONS

	DAC-40 Series	DAC-50 Series
Low Temperature Coefficient Linearity (8-, 10-bit) Gain 12-bit Gain 8-, 10-bit	± 3 ppm/°C ± 5 ppm/°C ± 7 ppm/°C	± 5 ppm/°C ± 10 ppm/°C ± 12 ppm/°C
Linearity (over 0-70°C range; 12-bit)	$\pm \frac{1}{2}$ LSB	± 1 LSB
Conversion speed	5 μ sec to .01%	5 μ sec to .01%
Power Supply Rejection	0.002%/%V _S	0.002%/%V _S
Resolution	8-10 or 12 bits	10 or 12 bits

Models available with Input Buffer Register.

For complete information on the DAC-40 and DAC-50 series digital-to-analog converters, use this publication's reader service card or contact your Burr-Brown Representative.

BURR-BROWN
RESEARCH CORPORATION
International Airport Industrial Park • Tucson, Arizona 85706
TEL: 602-294-1431 • TWX: 910-952-1111 • CABLE: BBRCORP

Constructing the primitive flow table, the initial step in any sequential circuit synthesis, helps you avoid uneconomical, or even faulty, designs.

In the synthesis of sequential circuits, the first step in the design is the construction of a primitive flow table from the word statement of the problem.¹ Knowledge of which circuit actions can occur and which cannot can be very important to the minimization of the circuit or even to the circuit's performance. Negligence in this regard can lead to an uneconomical or faulty design.

So let's study in detail the construction of the primitive flow table.

For our example, we'll design a sequential circuit with two inputs, C and S, and one output, Z. The C input is a periodic clock signal, and the S input is a switch. Each time S is closed, the circuit is to transmit the next complete positive clock pulse as the output, Z. Two possible timing sequences are shown in Fig. 1, and a partly completed primitive flow table is shown in Fig. 2.

Mitchell P. Marcus, Senior Engineer, Systems Development Div., IBM Corp., P.O. Box 6, Dept E52, Endicott, N. Y. 13760.

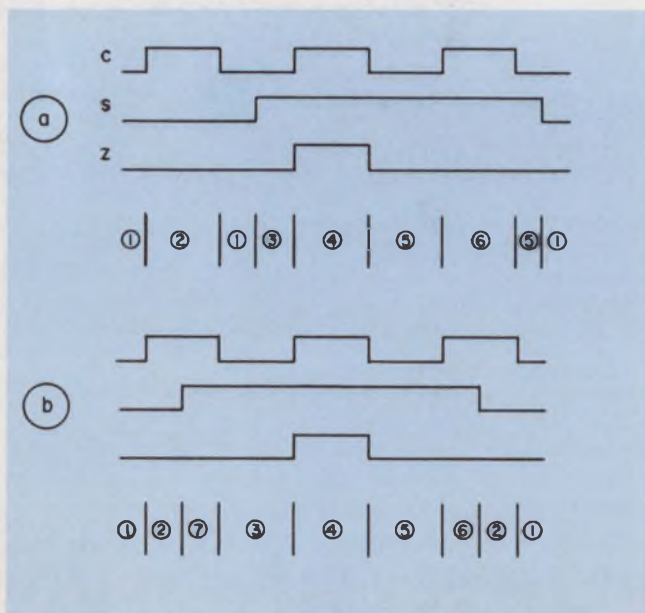

1. Timing sequences fall into two categories: those in which the switch closes while the clock is OFF (a) and those in which it closes while the clock is on (b).

Corresponding state numbers are used in these figures.

The table contains those states that can easily be written down by inspection. But states indicated by letters are not quite so simple.

Consider first the entries labeled h, i and j. If the circuit is in state (3) and S turns off, the circuit cannot return to state (1); since the output pulse has not yet occurred; another state, (8), is needed, and the h entry must be an 8.

If the circuit is in state (4) and S turns off, the circuit cannot return to state (2), since the output pulse has not been completed; another state, (9), is required, and the i entry must be a 9.

If the circuit is in state (7) and S turns off, the circuit cannot return to state (2), since the output pulse has not yet occurred; another state, (10), is needed, and the j entry must be a 10.

Blindly adding these three states would be unfortunate if they proved to be unnecessary. If the closure of the switch, S, is known to be of long duration relative to the clock signal, C—which, in fact, is very likely from a practical standpoint

SC	00	01	11	10	Z
①	2	k	3		0
i	②	7			0
h		4	③		0
		i	④	5	1
		6	⑤		0
	2	⑥	5		0
	j	⑦	3		0

2. To properly complete this primitive flow table, we must ask whether or not the switch closure is known to be of long duration relative to the clock signal, C.

—none of the preceding transitions would ever occur, and the three additional states would add nothing but cost to the circuit. Thus knowledge of the circuit action can result in optional entries in the flow table, rather than additional unnecessary states.

Simultaneous changes must be considered

The remaining entries all relate to both inputs changing state simultaneously. We cannot assume that simultaneous input changes are impossible; in fact, in this example such transitions are entirely possible, since the switch closure is random.

Blindly assuming that certain transitions are optional when, in fact, they may actually occur can lead to false circuit action. The most interesting case in this example relates to the entry labeled k. If the switch is turned ON simultaneously with the start of a clock pulse, the choice exists for making that clock pulse the output pulse, by a transition to state ④, or for making the following clock pulse the output pulse, by a

SC		00	01	11	10	Z
①	2	4 OR 7	3	3	0	
1	②	7	3	3	0	
-	-	4	③	3	0	
-	-	④	5	5	1	
1	2	6	⑤	5	0	
1	2	⑥	5	5	0	
-	-	⑦	3	3	0	

3. If the switch closure is of long duration compared with the clock signal, and if simultaneous changes in S and C are possible, this completed table results.

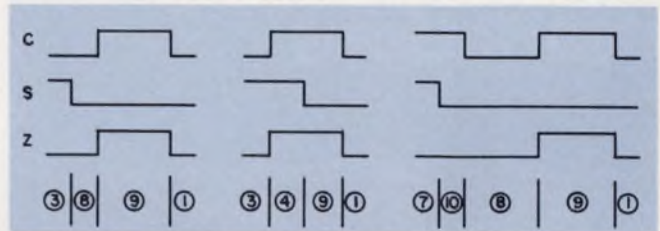

4. When the switch closure can be of short duration relative to the clock signal, these additional sequences become possible.

SC		00	01	11	10	Z
①	2	4 OR 7	3	3	0	
1	②	7	3	3	0	
8	9	4	③	3	0	
1	9	④	5	5	1	
1	2	6	⑤	5	0	
1	2	⑥	5	5	0	
8	10	⑦	3	3	0	
⑧	9				0	
1	⑨				1	
8	⑩				0	

5. Things get more complicated when we consider the possibility of a short-duration switch closure. This is the partly completed primitive flow table resulting from the additional sequences in Fig. 4.

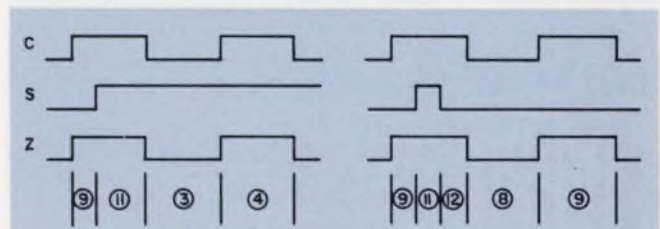

6. Things can get even more complicated, as shown by these additional sequences that arise when the time between closures is small relative to the clock period.

vero

MODULE RACK part of a complete packaging capability

provide electronic engineers with money-saving variations

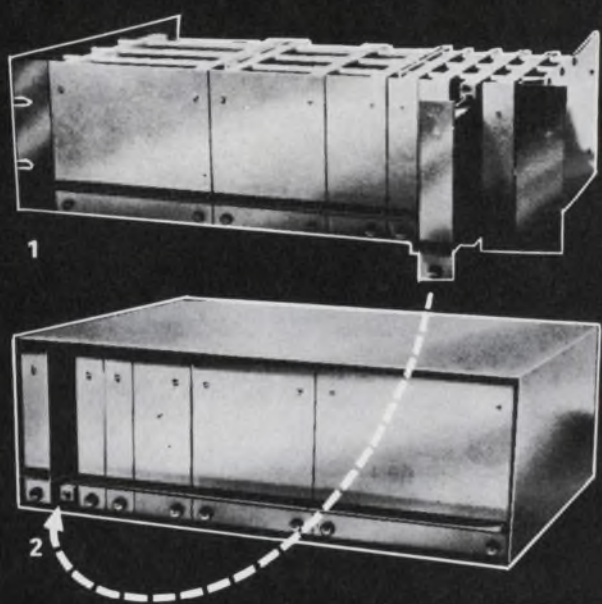

1. Vero Modular Rack Units 19" Mounting
Permitting 1,000's of variations using basic standard components. Module widths available are 1", 2", 4", 6", 8" and 16" in panel heights of 5 1/4", 7" and 8 3/4" with module depths of 7 1/4" and 10 1/4".

2. Vero 'C' Series Cases
Designed with an integral guide system to accept standard Vero Modules, case widths are 4", 6", 8" and 16", the latter housing the same module combinations as the 19" framework. Standard guide configuration suits one module or modules on 1" centres. Heights 5 1/4", 7" and 8 3/4".
These are only a small part of Vero's systemised products which are all compatible to each other. Send now for full details of our complete packaging systems.

vero **VERO ELECTRONICS INC.**
171 BRIDGE ROAD
HAUPPAUGE, N.Y. 11787
TEL: 516 234-0400
TWX: 510 227-8890
INQUIRE ABOUT OUR
NEW DESIGN SERVICE

SC	01	11	10	Z
00				
①	2	4 OR 7	3	0
1	②	7	3	0
8	9	4	③	0
1	9	④	5	1
1	2	6	⑤	0
1	2	⑥	5	0
8	10	⑦	3	0
⑧	9	4 OR 11	3	0
1	⑨	11	3	1
8	⑩	7	3	0
8	12	⑪	3	1
8	⑫	11	3	1

7. Here's the primitive flow table that results when the sequences shown in Fig. 6 can occur.

transition to state (7). If the k entry were made an optional entry, the danger could exist of the transition terminating in state (6), in which case the circuit design would be faulty, since no output pulse would then occur.

If it is known that the closure of the switch is of long duration relative to the clock signal, and if we assume that simultaneous input changes are possible, the completed primitive flow table shown in Fig. 3 results.

If the switch closure can be of short duration relative to the clock signal, some additional sequences are possible (Fig. 4), and the partly completed primitive flow table in Fig. 5 results.

A new parameter must now be considered: the repetition rate of switch closure. If the duration between successive closures is known to be long relative to the clock, none of the remaining transitions can ever occur, and the six remaining entries in the flow table in Fig. 5 can be optional.

If the duration between successive switch closures can be short relative to the clock, we have a condition in which the switch can close during a clock pulse that is being transmitted as an output pulse, which will, according to the specifications, call for the next clock pulse to generate an output pulse also. This leads to some additional possible sequences (Fig. 6) and to the completed primitive flow table in Fig. 7.

To summarize, full knowledge of possible circuit action should be utilized in constructing the primitive flow table. Failure to take advantage of possible optional transitions can lead to redundancy in the circuit and a more costly design. Capricious assumption of optional transitions when, in fact, they are not optional can lead to a faulty circuit design. ■■

Reference
1. Marcus, M.P., *Switching Circuits for Engineers*, Prentice-Hall, Inc., Englewood Cliffs, N.J., second edition, 1967.

there is a difference
between

MTBF

AND

MTTR

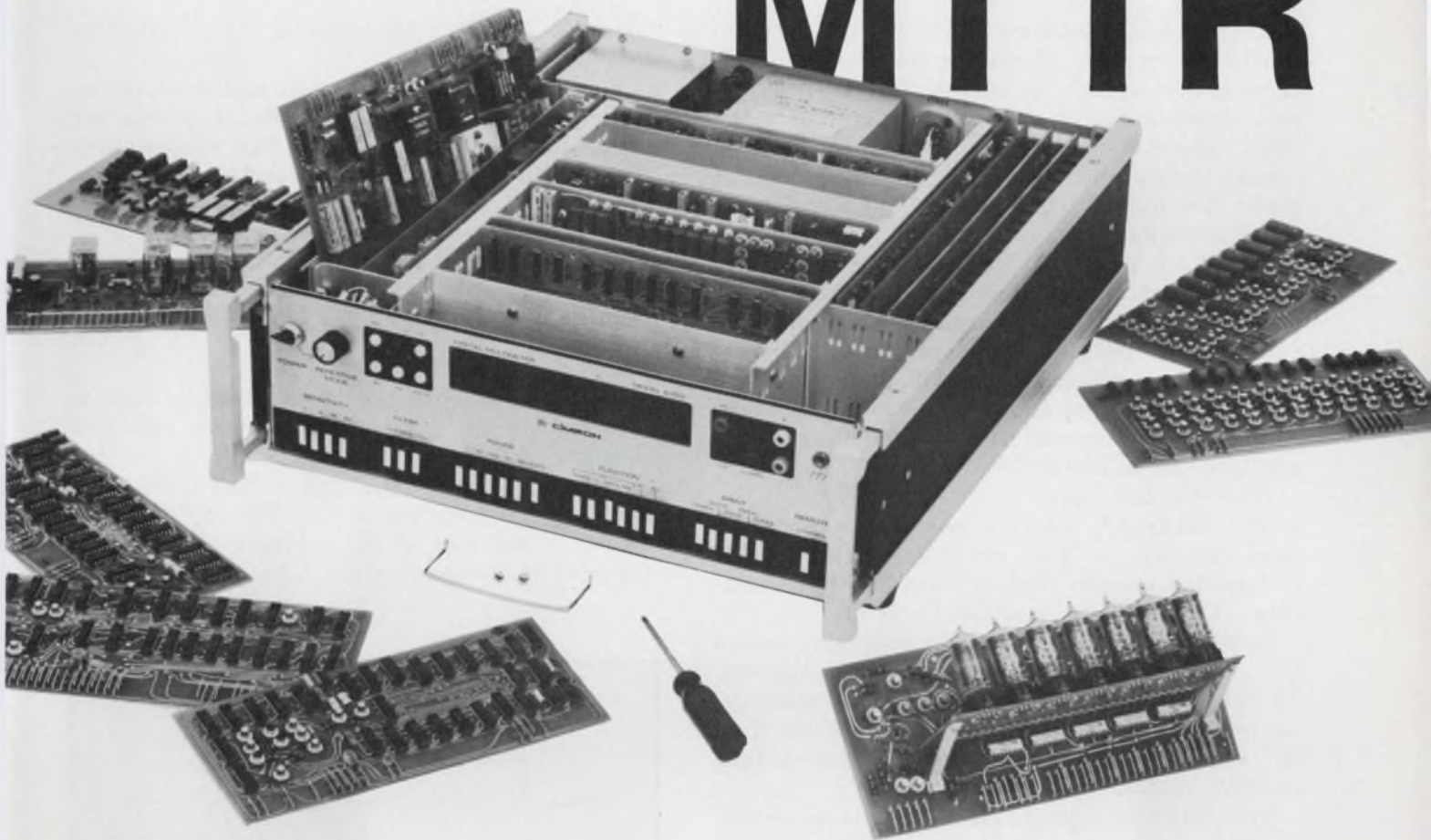

... and the difference is Cimron.

What we're talking about, of course, is the difference between "meantime before failure" and "meantime to repair." All four Cimron DMM'S are designed for the fastest possible service. All functions are on plug-in circuit boards... even the readout. You can replace all cards, button-up, and make an accurate measurement in less than two minutes.

What happens when you have a failure in an instrument that has a majority of its components anchored to the master board? You have the choice of replacement or logging downtime during lengthy and costly repair. "MTTR" now becomes more important than "MTBF."

A word about specsmanship — when looking at accuracy, remember that one least significant digit means 0.01% of range on a 4 digit DVM, and 0.001% of range on a 5 digit DVM; also, a 24 hour spec means calibrating every 24 hours. Cimron's short-term spec is 90 days.

We're proud to show the inside of our DMM — and you will be too.

Remember CIMRON when you need a high quality AC Power Source, Line Regulator, Pulse Generator, Two Phase Clock (MOS Driver), Data Acquisition System, and Digital Multimeter. Local Warranty service is now available. Write or call Lear Siegler, Inc./Cimron Instruments, 714 N. Brookhurst St., Anaheim, California 92803. Telephone 714-774-1010.

LEAR SIEGLER, INC.



CIMRON INSTRUMENTS

Start bridged-T equalizer designs easily

with approximate formulas that avoid trial and error.

You can estimate equalization fits and finite-Q effects.

The bridged-T network is widely used to equalize the group delay of other units in communications systems—such as bandpass filters. And circuit elements can be obtained readily with tabulated values of normalized components. But the circuit theory and design criteria on which the tables are based do not include quick estimates of equalization fit, nor the amplitude variations incurred by practical bridged-T networks that use inductors with finite-loaded Qs. This leaves the designer with the prospect of building an equalizer by trial and error—either with a computer or by making tedious lab tests. A better alternative is to use approximate formulas based on a frequency normalization technique that gets you into the ballpark.

Let's develop them.

The bridged-T network usually employed is shown in Fig. 1a. The transmission characteristics are more easily derived from a lattice prototype (Fig. 1b)—an equivalent circuit.

Bridged-T network analysis normally makes use of polar coordinates to simplify calculations. To build this bridged-T network, a minimum polar angle of 60° is required. Angles of less than 60° require a different bridged-T network that employs mutual inductance.

The insertion loss, L , of a prototype section working between a matched generator and matched load is given as

$$L = 10 \log \left[\frac{(1 + d_o)^2 + x^2}{(1 - d_o)^2 + x^2} \right] \text{ dB}, \quad (1)$$

where $x \cong 2(f - f_o)/\Delta f$ is the normalized frequency variable, f is the frequency, f_o is the center frequency, Δf is the normalizing bandwidth, $d_o = Q_{ii}/Q_{ii}$ is the normalized dissipation factor, $Q = f_o/\Delta f$ is the network Q and Q_{ii} is the unloaded Q of the lattice resonators. When $x = 0$, then $f = f_o$, and the bandwidth for $x = \pm 1.0$ is Δf .

It is assumed that both the series and shunt resonators of the equivalent lattice have the same

unloaded Qs. This condition is one of uniform dissipation.

For transmission phase shift and group delay responses, the effects of incidental dissipation can be neglected. Thus, $d_o = 0$. The transmission phase shift, θ , of an equalizer section is then

$$\theta = 2 \tan^{-1} x \text{ rad}, \quad (2)$$

and the group delay response is

$$\tau = \frac{2}{\pi \Delta f} \left[\frac{1}{1 + x^2} \right] \mu\text{s}, \quad (3)$$

where Δf is in MHz.

The bridged-T group delay equalizer is used to approximate the two most commonly specified equalizer fits—parabolic and linear.

The design center frequency is that of the resonators of the prototype lattice. The resonant frequency is not that of the bridging resonator in the equivalent circuit, since L_3C_3 is not equal to

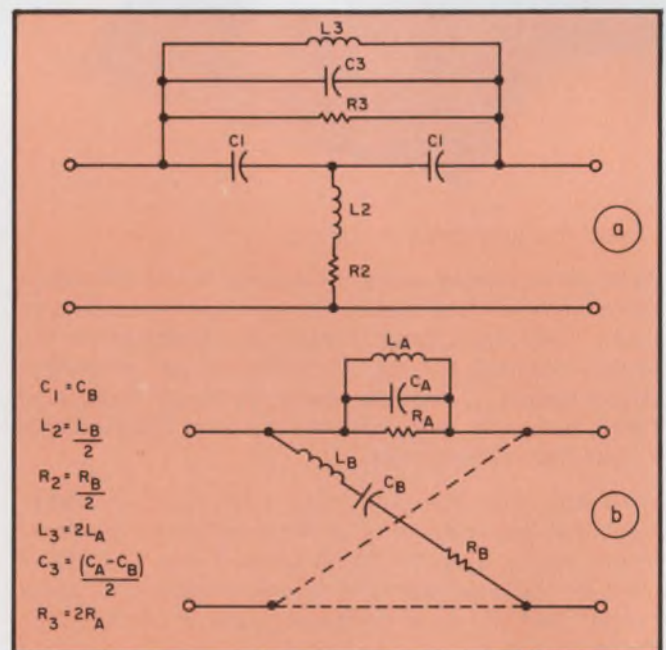

1. A popular network for the equalization of group delays of other networks, the bridged-T equalizer (a) is an all-pass network when pure reactive elements are used. For transmission analysis, it's more convenient to treat the equivalent circuit—a lattice prototype (b).

Richard M. Kurzrok, Consulting Engineer, 545 West End Ave., New York, N.Y. 10024

$L_A C_A$. Actually, $L_3 C_3 = L_A (C_A - C_B)$.

The equalizer, frequency-centered at $x = 0$, operates out to some limiting values, plus and minus of the normalized frequency.

Rewriting the group delay response from Eq. 3 as a relative response gives:

$$y = \frac{1}{1 + x^2} = \tau/\tau_0, \quad (4)$$

where y is the relative group delay and $\tau_0 = 2/\pi\Delta f$ is the group delay at $x = 0$. Equation 4 is plotted in Fig. 2.

If we now restrict the usable equalizer frequency range to $0 < |x| < |1.1|$, then the equalizer fit is approximated by the following parabola:

$$y = 1 - (1/2) x^2. \quad (5)$$

Equation 5 is also plotted in Fig. 2. The error in the parabolic fit is limited to 9.7%, which is adequate for many applications.

For linear group-delay fits, the closest approximation is found this way: The center frequency of the linear fit is offset, above or below lattice resonances, to normalized frequencies near the points of inflection of the bridged-T group delay response curve. By successively differentiating Eq. 4 and equating to zero, the points of inflection are found to be $x = \pm 0.577$. For practical linear group delay equalizers, the design center frequencies are offset to $x = \pm 0.6$.

By restriction of the usable equalizer frequency range to $-1.3 < x < -0.1$ (for positive linear slopes) or $+0.1 < x < +1.3$ (for negative slopes),

a good linear fit is achieved. The negative linear slope is approximated by the following straight line:

$$y = -0.502 x + 1.055. \quad (6)$$

Equation 6, also plotted in Fig. 2, gives a difference error limited to 3.2%. The bridged-T equalizer inherently provides a better linear fit than parabolic fit.

Practical equalizers, of course, do not realize idealized all-pass behavior. Because of finite Qs, some dissipation exists and amplitude variations result. To estimate the amount of the variation, let's take a closer look at Eq. 1.

For small values of the normalized dissipation factor d_0 , the equation simplifies to

$$L \cong 10 \log \left[\frac{(1 + 2 d_0 + x^2)}{(1 - 2 d_0 + x^2)} \right] \text{ dB}. \quad (7)$$

At $x = 0$,

$$L_0 \cong 10 \log \left[\frac{1 + 2 d_0}{1 - 2 d_0} \right] \cong 17.36 d_0 \text{ dB}. \quad (8)$$

Equation 8 provides the magnitude of the amplitude notch that occurs at $x = 0$ for an imperfect dissipative equalizer section. When $x = 1.0$, Eq. 7 reduces to:

$$L \cong 10 \log \left[\frac{2 + 2 d_0}{2 - 2 d_0} \right] \cong 8.68 d_0 \text{ dB}. \quad (9)$$

If the range of usable normalized frequency is restricted to $0 < |x| < |1.0|$, the amplitude variation, ΔL , due to incidental dissipation is

$$\Delta L = L_0 - L = 8.68 d_0 \text{ dB}. \quad (10)$$

Equation 10 can now be used to provide quick estimates of the amplitude variation in most bridged-T equalizers.

The discussion so far has been based on the assumption that equalizer bandwidths are narrow. When this is the case, arithmetic symmetry can be used for small percentage bandwidths—those of less than 10%. Of course, this normalization becomes invalid when larger percentage bandwidths are encountered; they require a normalization that produces geometric symmetry.

If geometric symmetry is assumed, Eqs. 1-6 can be used with certain modifications. These include a new normalized frequency variable,

$$x = Q (f/f_0 - f_0/f). \quad (11)$$

The Q is unchanged from the form given under Eq. 1.

The center frequency group delay now becomes

$$\tau_0 = \frac{1}{\pi \Delta f} [1 + (f_0/f)^2] \quad (12)$$

Eq. 12 introduces a skewing that superimposes a linear component on the bridged-T quasi-parabolic response shape. ■■

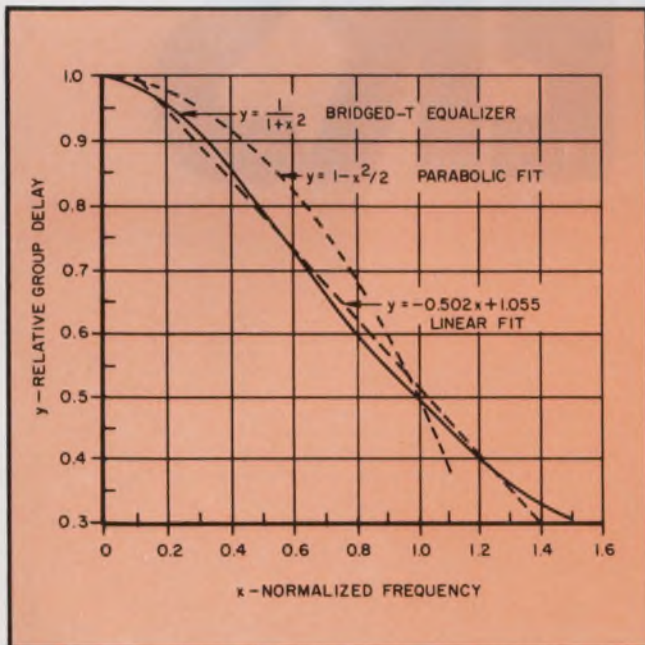

2. The bridged-T is used to approximate parabolic and linear equalization fits. As a parabolic approximation, the best fit occurs when both center frequencies are at $x = 0$. But for a linear fit, the straight line intersects the bridged-T curve at its inflection point.

**NEW
TTL/MSI
PROBLEM
SOLVERS**



From our TTL Family Tree, simple new solutions for A/D converters, minicomputers, high speed systems.



Four new high quality members have been added to the Fairchild family of 96 TTL/MSI circuits. Each can be used in a variety of designs—alone, or combined with other members of our TTL and/or MOS families—for simple solutions to complex systems problems: For example:

9334 8-Bit Addressable Latch for general purpose storage in high speed digital systems. Combined with other MSI devices, it can be easily expanded to form large storage arrays. By itself, the 9334 can serve as an 8-bit addressable latch memory, one-of-eight decoder or one-of-eight demultiplexer.

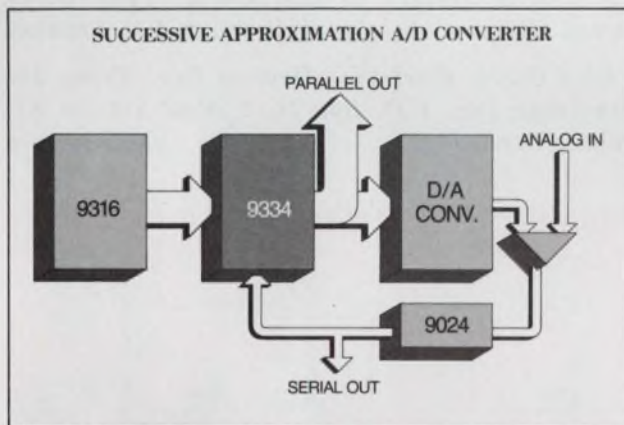

In an A/D Converter, the 9334, combined with a 9316 Binary Counter and standard linear devices, provides a successive approximation analog-to-digital conversion. Send for our Appl. Note 294.

9338 8-Bit Multiple Port Register for high speed storage in an arithmetic logic unit is probably the most significant new function yet designed for minicomputer memories. Uniquely, it eliminates any addressing restrictions by permitting simultaneous read/write without race problems and by allowing data to be written into any one of the 8 storage locations and read out of any two of the locations *simultaneously*.

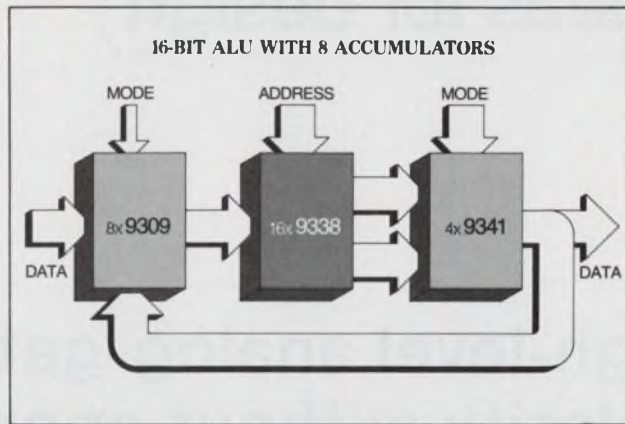

Used as a one-bit slice of eight registers/accumulators, it combines with either the 9340 or 9341/74181 ALU device to become the powerful heart of a minicomputer central processing unit. It's equivalent to a 9301 decoder, a 9308 latch, two 9312 multiplexers and a dual flip-flop. Send for our Appl. Note 220.

93H00 and 93H72 High Speed 4-Bit Shift Registers improve system performance up to 300% over a wide range of design applications that are based on the 9300 industry standard shift register.

The 93H00 has the same pin configuration as 9300 but has improved minimum shift rate by a factor of 3 (to 45MHz). This high-speed 4-bit shift register is a multi-functional sequential logic block, useful in a wide variety of register and counter applications.

The 93H72 has a minimum shift frequency of 45MHz and typical 58MHz. It uses the same basic 4-bit shift register configuration as the 9300 but with additional logic flexibility. 9300 J and K inputs are replaced by single D type input and a clock enable input E, providing a HOLD ("do-nothing") state. This eliminates the need for external clock gating.

These MSI devices are indicative of the problem-solving power of the Fairchild TTL Family Tree, most comprehensive TTL line in the industry. They are available, along with product and application information, from your friendly Fairchild Distributor.

**MADE IN
FAIRCHILD**

High-level analog-gate circuit reverses polarity without operational headaches

Controlling ac signals isn't easy; most devices are not bilateral, and they don't function properly when the polarity is reversed. The polarity problem can be overcome by using a relay, of course, but if no contact bounce and small current are required, a better solution is to use a 3N160 P-channel enhancement mode FET.

In the diagram the source is connected to the 5-V supply because the gate must be negative with respect to the source to turn the device ON. The substrate is connected through a 47-k Ω resistor to the gate. This keeps the substrate reversed biased when the device is OFF and allows the device to operate bilaterally—the key to the operation of the circuit.

When logic ZERO exists at the base of Q₁, the device turns OFF, allowing the gate of Q₂ to rise to the peak value of the ac signal. This is accomplished by charging C₁ through R₂ and D₁. For Q₂ to turn OFF, the gate must be ZERO, or positive with respect to the source and drain.

By holding the gate at the peak positive value of the ac signal, we turn the device OFF, and the signal passes through R₁ to the output.

When there is a logic ONE at the base of Q₁,

the device turns ON, and the collector goes to ground, discharging C₁ and placing the gate at -5 V with respect to the source. Thus Q₂ is turned ON, and the signal is shunted to ground.

Glen Coers, *Electronic Devices Div., Texas Instruments, Inc., P.O. Box 5012, Mail Station 84, Dallas, Tex. 75222*

CIRCLE NO. 310

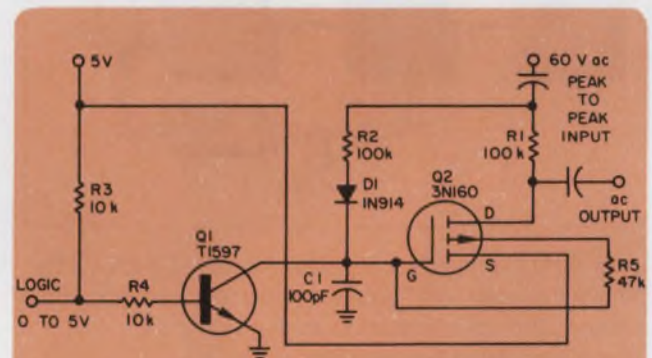

No contact bounce, low switching current and small size are the advantages of this high-level shunt, analog-gate circuit over a relay. The circuit can be used wherever ac signals need to be controlled.

Build a digital clock without BCD conversion in the design

Digital clocks—driven from a 60-pulse-per-second source—usually also require either one programmable ROM or a number of standard ICs to get the proper BCD coding for the hour count. But by manipulation of only a few standard counter sections and the addition of one quad NOR gate, a digital clock can be built with the

required BCD coding built in (see diagram).

The input of 60 pulses per second is divided by 3600 with three μ L9305 variable modulo counters (U, V and W) and a quad NAND gate (S) that provide $\div 16$, $\div 15$ and $\div 15$, respectively. The divide by 15 is accomplished by controlling the modulus of the three digit (D, C, B)



HELIPOT BREAKS THE HALF-BUCK BARRIER.

Here they are: the best buys. Our new Series 72 single-turn $\frac{3}{8}$ " cermet trimmers at an eye-opening 49¢ each in the 1,000 quantity. They're equally well-priced in other quantities, too. One alone costs just 70¢.

But there's also that dependable Helipot quality and performance, plus things you don't get elsewhere. Like our resistance and slider stability... change is less than 0.5% in the first 1,000 operation hours, progressively less thereafter. Impressive, when the life expectancy exceeds five years' continuous duty under full-rated power. And the Series 72 sealing — compatible with wave soldering, low-viscosity potting, and board washing even with chlorinated solvents.

Add the wide range of values, ± 100 ppm/ $^{\circ}$ C tempco, and off-the-shelf availability from 17 nationwide stocking points and what have you got? The best reasons in the world for requesting complete specs and data on this breakthrough line of Helipot cermet trimmers. Do it now — it won't cost you a cent.

Beckman®

INSTRUMENTS, INC.
HELIPOT DIVISION
FULLERTON, CALIFORNIA

HELPING SCIENCE AND INDUSTRY IMPROVE THE QUALITY OF LIFE.

INFORMATION RETRIEVAL NUMBER 33

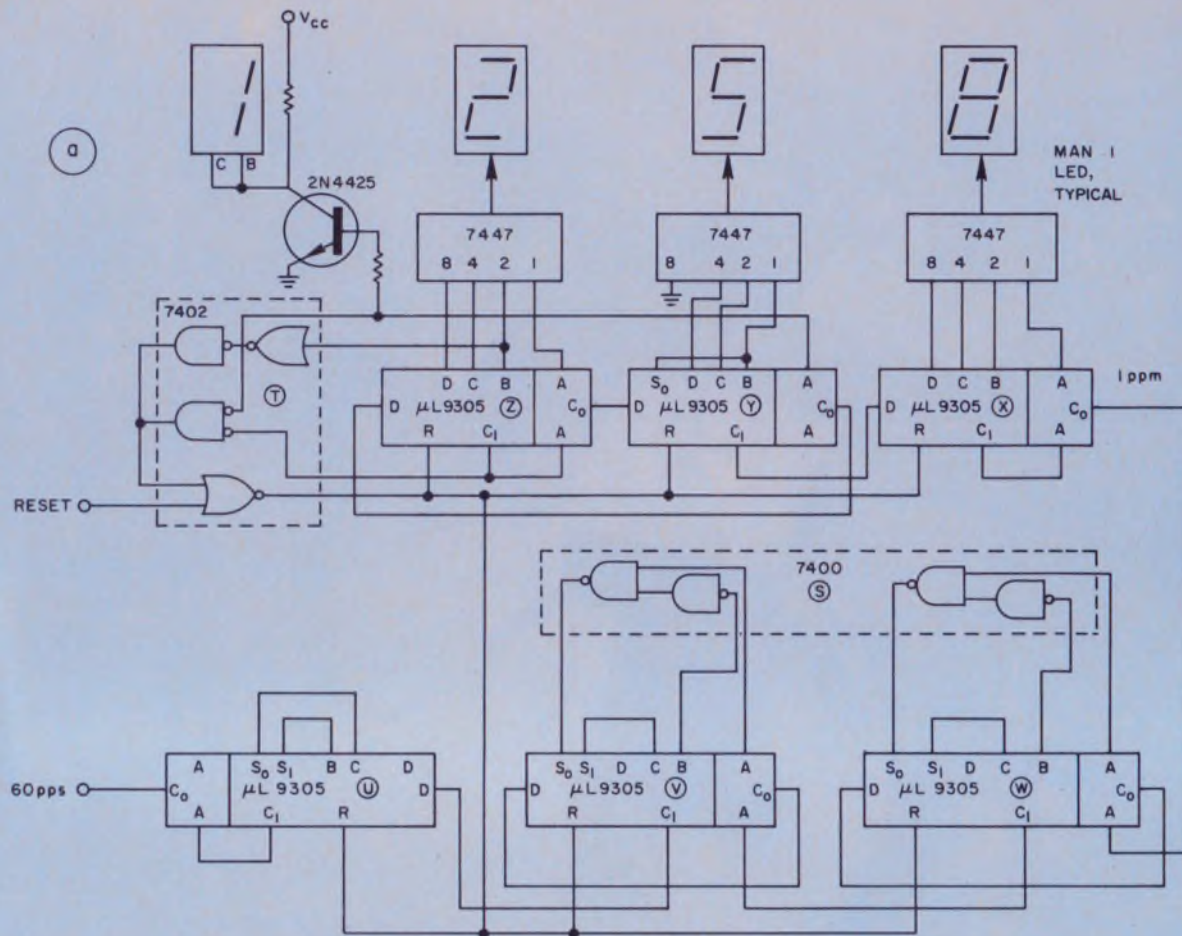

(b)

STATE =	0	1	2	3	4	5	6	7	8	9	10	11	X
BCD OUT =	1	2	3	4	5	6	7	8	9	10	11	12	
$2^2 = \bar{Z}A$	1	0	1	0	1	0	1	0	1	0	1	0	1
$2^1 = ZB$	0	1	1	0	0	1	1	0	0	0	0	1	1
$2^2 = ZC$	0	0	0	1	1	1	1	0	0	0	0	0	0
$2^3 = ZD$	0	0	0	0	0	0	0	1	1	0	0	0	0
$2^0 = YA$	0	0	0	0	0	0	0	0	0	1	1	1	1

RESET (MR) ←

MR = RESET $\vee \bar{Z}A$ A ZB A YA

The digital clock circuit is simplified with a rearrangement of standard modulus counters to give

directly the necessary BCD coding (a). An hour sequence table and the reset equation are given (b).

counter section, with the output of the succeeding digit (A).

With A = 0, the modulus is 8. On count 8, A is toggled, and the modulus is changed to 7. The μ L9305 counters toggle on the positive edge. Therefore succeeding stages are driven by the inverted outputs, which assure integrity of count after the reset is released.

The minutes and hours are counted and BCD is encoded by three additional μ L9305 counters (X, Y, Z). The minute LSD is a straight decade count. The minute MSD is a modulo 6 connection of the three-digit section of Y.

The hour LSD is a decade connection, except

that the first-stage (A) outputs are reversed. This provides the proper 1 thru 12 (zero skipped) code sequence, and a 1:00 code when reset. The hour MSD is obtained with the extra digit section of Y. The required modulo 12 count is attained by deriving a master reset pulse from the 13-code output that instantly resets the counters to 1:00.000.

Walter L. Rutchik, Associate Research Engineer, Corporate Development Dept., Cutler-Hammer, Inc., 4201 N. 27 St., Milwaukee, Wis.

Heath/Schlumberger?

That's right . . . Heath/Schlumberger. A new name in design-quality, factory assembled and calibrated instruments.

The "Heath" part of our name comes from being a division of that well known manufacturer of kits. But we don't make kits. In fact, Heath/Schlumberger is an entirely separate operation.

The "Schlumberger" (pronounced Shlum-bear-zhay) part of our name comes from being a member of that world-wide corporation devoted to measurements of many kinds. Schlumberger is one of the leading European manufacturers of electronic instrumentation.

With that background, you can see why we are producing state-of-the-art, ready-to-use, instrumentation . . . comparable to some of the best in performance . . . but with better performance/price ratios.

So when you are ready to buy electronic instruments, check the growing Heath/Schlumberger line.

We're the group to watch.

To order or receive additional information, write Dept. 520-26.

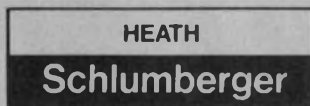

Heath/Schlumberger
Scientific Instruments
Benton Harbor,
Michigan 49022

A. SM-104A 80 MHz counter. BCD output. 1 MHz TCXO with 1 ppm/yr. stability. \$500.

B. EU-205B solid-state strip chart recorder. 23 speeds, 30 in/min. to 0.2 in/hr.; 18 calibrated ranges, 1 mV to 500 V full scale. 0.5 sec. pen response. 0.1% tracking accuracy and linearity. Completely programmable. \$675.

C. EU-70A solid-state dual trace scope. DC-15 MHz. Complete dual trace capability. Triggered sweep. 18 calibrated time bases. X-Y capability. \$595.

D. SM-105A 80 MHz counter. Same as SM-104A above but without BCD output and uses a 1 MHz crystal with ± 10 ppm/yr. stability. \$350.

E. EU-81A function generator. Sine, square and triangle wave output. 0.1 Hz to 1 MHz. Linear dial. External voltage control. \$245.

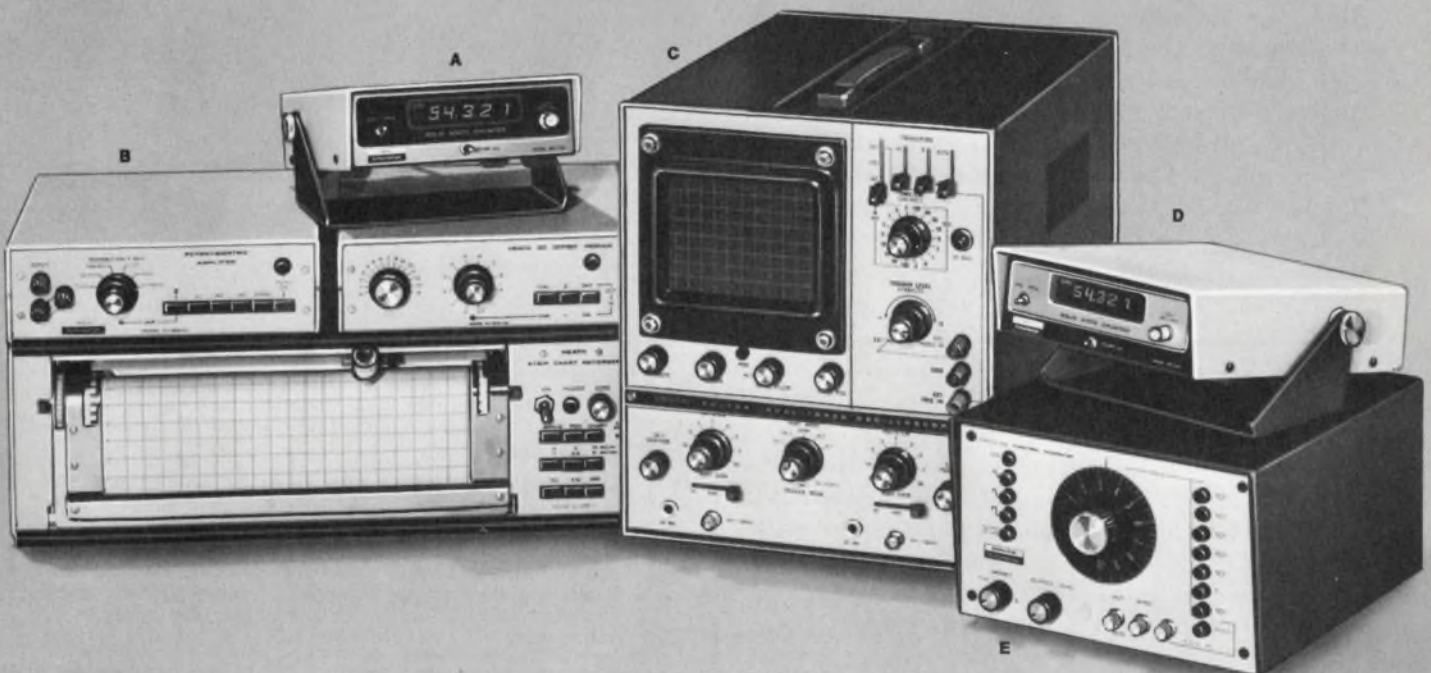

Replace UJT and SCR in a timing circuit with a programmable unijunction transistor

The timing and switching functions in a timing circuit are usually obtained with a UJT and SCR. But a simpler and less-expensive circuit with increased reliability results when the UJT and SCR are replaced by a programmable unijunction transistor (PUT).

With a PUT in the circuit, the timing and latching functions are independent, because the $R_T C_T$ timing network is connected to the gate and the V_S reference is applied to the anode (see diagram). The valley current, I_V , can be programmed between 25 μA and 150 mA without affecting the timing.

Delays from 0.05 to 60 seconds or longer are provided, and the reset time is less than 5 ms. While most UJT-SCR timing circuits are limited to not less than 5 to 10 mA load currents by the maximum holding current requirement I_H , the PUT-designed system will handle load currents from 25 μA to 150 mA.

It can operate from 20 to 40 V, with $\pm 2\%$ or better repeat accuracy, and it will operate between -30 to 170 F with less than $\pm 10\%$ change in timing and without compensation. Changing the ratio of R_1 to R_2 by a small amount provides a calibration of the timer.

When R_3 is replaced by a triac, the circuit operates as follows: Capacitor C_T charges to V_{CC} with the closing of the switch. The instantaneous charging current of C_T develops a voltage drop across R_T , reverse-biasing the gate to anode junction. As the current exponentially decays, V_{RT} is reduced at the same rate and at $(V_S - V_{AG})$ the pnp base-to-emitter junction of the PUT becomes forward-biased.

As C_T discharges, the PUT is driven through the negative resistance region, and the circuit latches on.

Ernie Foldzari, 1520 Plymouth Circle, Carpentersville, Ill. 60110

CIRCLE NO. 312

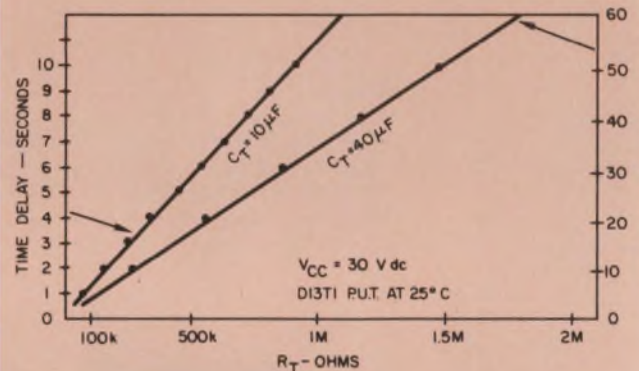
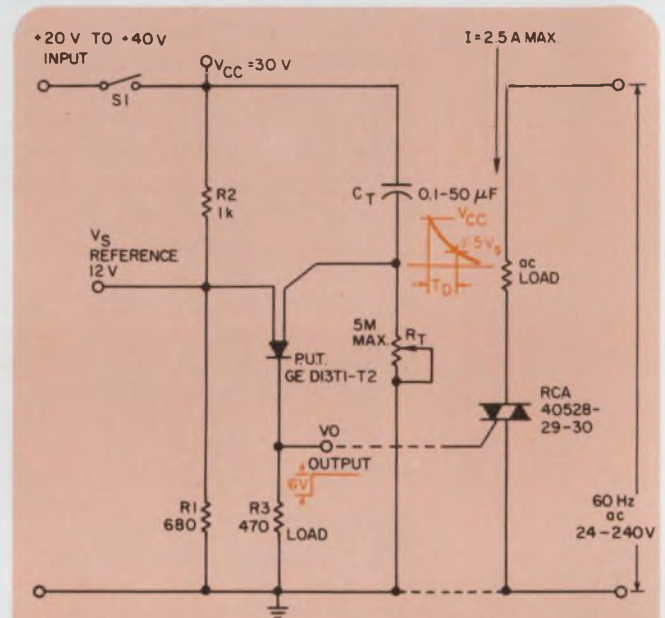

Cost savings and increased reliability are obtained with a programmable unijunction transistor in this timing circuit (a). The PUT replaces a UJT and SCR. Measured time delays are given as a function of timing resistance for two capacitance values (b).

IFD Winner for August 5, 1971

Doug Clifford, Design Engineer, Hewlett-Packard Co., 1501 Page Mill Rd., Palo Alto, Calif. His idea "Reset dividers faster with a single flip-flop" has been voted the Most Valuable of Issue award.

Vote for the Best Idea in this issue.

VOTE! Go through all Idea-for-Design entries, select the best, and circle the appropriate number on the Reader-Service-Card.

SEND US YOUR IDEAS FOR DESIGN. You may win a grand total of \$1050 (cash)! Here's how. Submit your IFD describing a new or important circuit or design technique, the clever use of a new component or test equipment, packaging tips, cost-saving ideas to our Ideas-for-Design editor. You will receive \$20 for each accepted idea, \$30 more if it is voted best-of-issue by our readers. The best-of-issue winners become eligible for the Idea Of the Year award of \$1000.

DESIGN

IDEAS

FROM
SYLVANIA

Let us mill.

Not all sheet-metal parts should be manufactured by force and violence. It's much more humane to dissolve away the unwanted metal. This process, called photo chemical machining, leaves the parts unstressed, unbent, unbroken, unbeaten. It's extremely accurate. And it may cost less than militant methods such as stamping and machining.

We became expert in photo chemical machining by running one of the largest chemical milling operations ever set up. It's a continuous process that turns out a couple of million color TV aperture masks per year. (Each mask is pierced by half-a-million tiny, round holes.)

If we can make masks, we can make almost anything by photo chemical machining: parts such as IC lead frames, display-tube numbers, grids, heaters, computer-card guides, electric-razor cutter heads. We do everything: artwork, milling, finish plating.

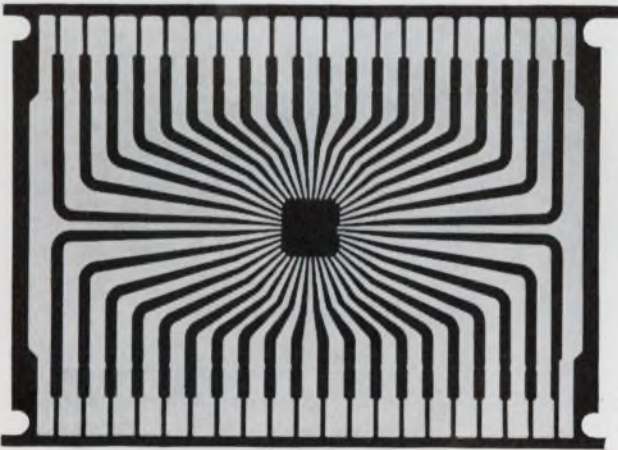

40-lead IC frame. (PCM part)

Naturally, we welcome run-of-the-mill chemical milling work. (It's our bread and butter.) But we're overjoyed when people give us a really tough PCM job. We have a whole crew of metallurgists, chemists and designers, and they can come up with sweet answers where others produced sour notes.

So if you're having any problem with PCM parts, come to us.

Instead of just milling around.

For more about PCM, call Bill Johnson at 717-265-2121. Or write him at GTE Sylvania, Chemical & Metallurgical Division, Towanda, Pa. 18848.

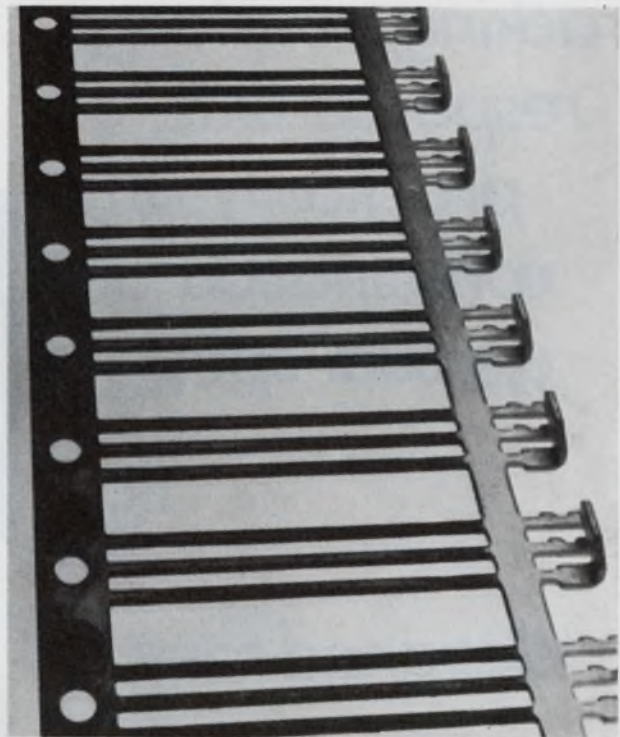

Gold-plated transistor lead frame. (Stamped part)

Stamp out everything.

One of our most creative areas is the stamping of electronic parts.

We can bang them out like a machine gun—about 10 million parts per day. From a wide range of materials. In all sorts of finishes and tempers. To extremely close tolerances.

We've got presses that will blank, cup, draw, pierce, bead, knurl and trim—all in one pass.

We'll take on the most intricate shapes you have, make our own dies for them and knock out beautiful parts by the barrelful.

And we'll do it at a reasonable cost. (After all, stamping is the most economical way to mass-produce metal parts.)

So give us your huddled contacts. Your teeming lamp bases. Your integrated circuit parts. Your cans and headers. Your anything and everything.

And we'll stamp 'em out for you.

Call our stamping people at 717-764-9853. Ask for Hal Martin. Or write to him at: GTE Sylvania, Parts Division, 1128 Roosevelt Ave., York, Pa. 17404.

GTE SYLVANIA

INFORMATION RETRIEVAL NUMBER 35

If you need panel instruments with **custom** dials, cases, accuracy, tracking, resistance, response time, or practically any combination of unusual specs...

Buy **Triplett's** designed-for-you **Panel Instruments**

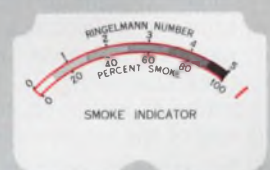
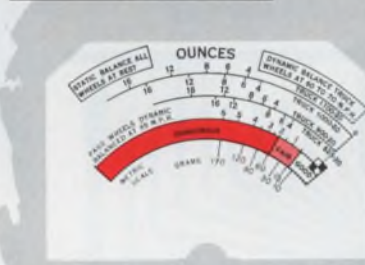
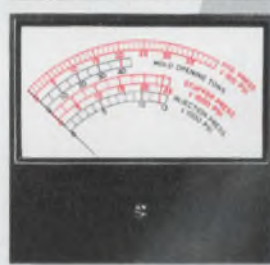
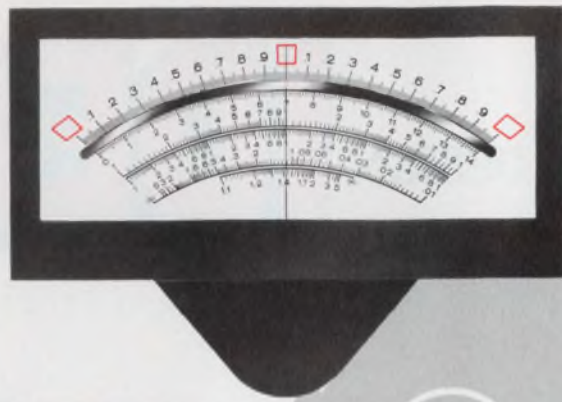

Although we stock some 1369 different styles, sizes and types of standard panel instruments, a very large proportion of our customers buy custom instruments.

Because they need:

custom dials

reading in such units as pH, roentgens, mm Hg, rpm, %, inches.

custom cases

square, round, rectangular, edge-wise (horizontal and vertical), wide, narrow, shallow.

custom accuracy

to within 1/2% with mirror scales and knife-edge pointers.

custom tracking

to match the specific needs of existing or new instrument designs.

custom resistance

for low circuit loading with tolerances as low as $\pm 1\%$.

custom damping

to meet stringent electrical and vibration requirements.

For instance, one of our customers had us design and manufacture a custom instrument to replace — in every detail of physical and electrical specifications — one which he was using on a delicate piece of medical instrumentation. Rejects from his previous source had risen to over 20%. He rejected only 3 of the first hundred we shipped — with almost negligible rejections from the many hundreds we've shipped since.

What custom panel instrument specifications do you need to make your

product more reliable, more accurate, more rugged and — in the long run — less expensive? For quick, dependable delivery of small quantities of Triplett's "designed-for-you" panel instruments, contact your Triplett Sales/Service/Modification Center. For prototypes or production quantities, contact your Triplett representative. He'll put you in touch with our Instrument Designers/Engineers who'll help you analyze the problem and suggest the optimum cost/result solution.

TRIPLETT
BLUFFTON, OHIO 46817
Manufacturers of the World's most complete line of V-O-M's

INFORMATION RETRIEVAL NUMBER 36

new products

Smallest-volume 3-1/2-digit DPM features the lowest price of \$89

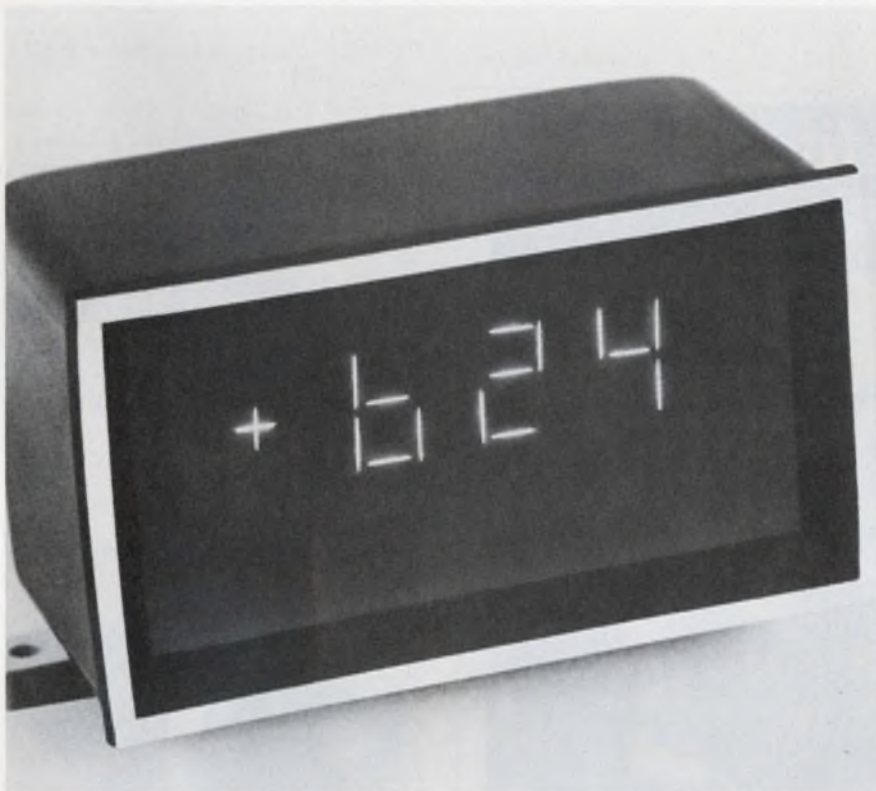

Just under 8 cubic in. in volume, this smallest 3-1/2-digit DPM is also the lowest priced—\$89 in quantities of 100.

Analog Devices, Inc., Norwood, Mass. Phone: (617) 329-4700. P&A: \$89 (100-up); stock.

The latest victory in the size and price battles in digital panel meters comes—not from one of the old-line DPM vendors—but from Analog Devices, a large manufacturer of analog and conversion modules, a small manufacturer of monolithic ICs and a brand new manufacturer of panel meters.

In quantities of 100, the company's bipolar 3-1/2-digit AD2001 costs \$89—just \$6 less than Analog's AN2532, the lowest-cost bipolar, cased DPM. Weston's unipolar 1291 costs \$99.75. Datascan's unipolar 610 costs \$95 and its bi-

polar 620 costs \$101, but case and bezel for either cost an extra \$5.

The AD2001's price advantage is small. Its size advantage is large. The aluminum case has dimensions of 3-in.-wide by 1-3/4-in.-high by 1-1/2-in.-deep for an over-all volume just under 8 cubic in. That's less than half the 18 cubic in. of Digilin's LED-readout 3330—the smallest DPM till now.

While most DPMs use gas-discharge readouts and a few use LEDs, the AD2001 uses RCA's Numitrons. The DR2110 for full digits and the DR2120 for the ± 1 have 0.4-in. characters.

Unlike most DPMs, the AD2001 does not operate from the ac line,

so it saves the price, size and weight of a line transformer, rectifier and filter. Further, thanks to new, "Analok" circuitry, which the company won't describe till its patent application has been acted on, the meter doesn't need the inverter required by other DPMs that operate from 5 V to allow bipolar operation or readings near 0 V. There are two 5-V terminals (which can be commoned). An unregulated source of 5 Vdc at 800 mA (or 5 Vac) can power the display while +5 V dc at 200 mA, with a modest regulation of 5%, can drive the rest of the circuitry.

Accuracy is 0.05% of reading ± 1 digit and tempco is 0.005% of reading per degree C. Noise rejection is 40 dB at 60 Hz, which is good, but hardly sensational. Full scale is 199.9 mV and the unit can take a 20-V input without damage. The meter can operate from 0 to +60°C.

The meter includes automatic zero correction; in effect, it shorts the input once every reading. Conversion rate is five per second with the internal trigger, up to 20 per second with an external trigger.

The unit has BCD output for the three full digits and outputs for the most-significant 1, polarity, the conversion gate and readings beyond 200 mV (which make the "1" flash). The meter can accept print commands and commands to hold a reading.

All the circuitry is contained on two small (about 1-1/2 by 2-7/8 inch) PC boards. They are held together, at right angles, by three DIP IC's along the corner—with half their leads in one board, half in the other.

For Analog Devices: **CIRCLE NO. 250**
For Analog: **CIRCLE NO. 251**
For Datascan: **CIRCLE NO. 252**
For Digilin: **CIRCLE NO. 253**
For Weston: **CIRCLE NO. 254**

INSTRUMENTATION

Palm-size 3-lb scope works to 0.5 MHz



Tektronix, Inc., Box 500, Beaverton, Ore. Phone: (503) 644-0161. P&A: \$545 (includes batteries); stock.

The tiny 211 solid-state mini-scope is a 0.5-MHz lab scope weighing just 3 lbs and measuring only 3 by 5-1/4 by 9 in. It has an integral 1-MΩ probe and operates from the ac line or up to 5 hours on internal batteries. Deflection factors are 1 mV/div. to 50 V/div. and sweep rates extend to 1 μs/div. Triggering is simplified to one rotary control.

CIRCLE NO. 255

\$595 4-1/2-digit DMM features 25 ranges



Weston Instruments, Inc., 614 Frelinghuysen Ave., Newark, N.J. Phone: (201) 243-4700. P&A: \$595; stock.

A new 4-1/2-digit portable multi-meter includes 25 ranges for measuring ac and dc voltage and current and resistance. The new model 1242 has a maximum ±19999 reading and is small enough to be carried in a standard attache case. It can be bench or rack mounted and weighs only 4.5 lb. Dc accuracy is 0.05% of reading ±1 digit and ac accuracy is ±0.2% of reading ±1 digit.

CIRCLE NO. 256

Let us help you fit together a custom switch ...

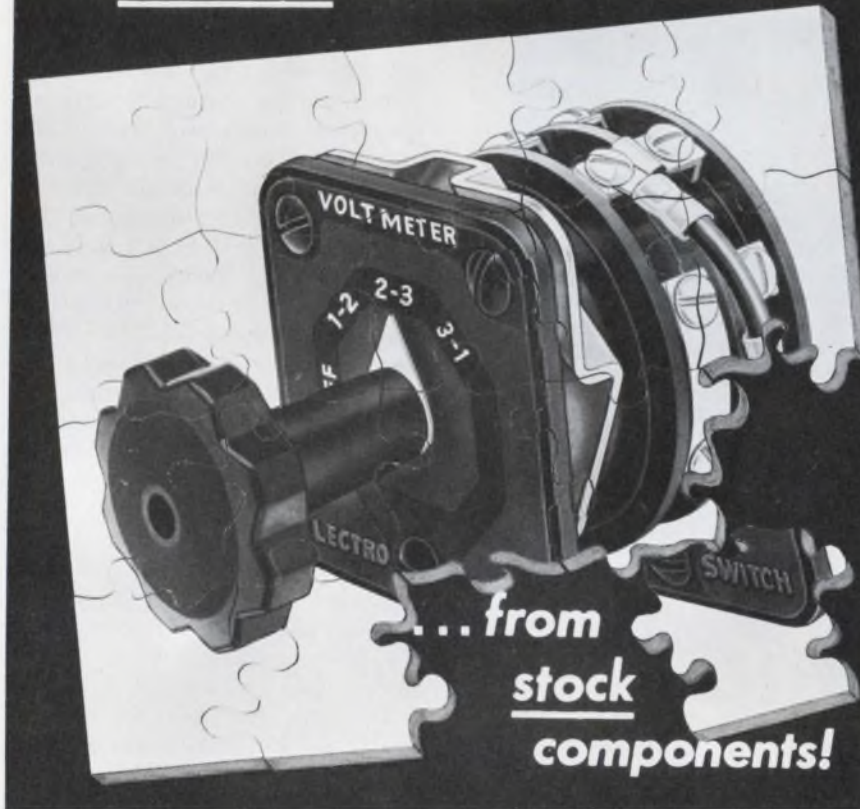

The overwhelming chances are that you'll find the *exact* power switch you need in one of our catalogs. Here's why: You'll find literally *hundreds* of types *in stock*. Or you can combine your own special configuration from *millions* of components off-the-shelf! Choose from Rotary, Cam, Detent & Snap-action, Pushbutton and other types. Standard specs range from 1/2 up to 200 Amps...from one to 75 poles per switch...plus combinations (tandem, gear train, etc.). And if you don't find your specific need, we'll find it (or build it) for you...usually at *standard* switch prices!

Send for Bulletin C-1 (our "Catalog of available catalogs") or tell us your specific interests for detailed information.



ELECTRO SWITCH
CORP

Weymouth, Massachusetts 02188

Telephone: 617/335/5200 TWX: 710/388/0377

INFORMATION RETRIEVAL NUMBER 37

Frequency counters mount in panels



Anadex Instruments, Inc., 7833 Haskell Ave., Van Nuys, Calif. Phone: (213) 782-9527. P&A: see text; 4 wks.

The CPM-600 series of digital panel meter counters feature 10-mV sensitivity, 5-digit displays, BCD output, remote programming, integral power supplies and small size. Four models are presently available: the CPM-600 counter-timer (\$425), the CPM-601 variable-time-base counter (\$595), the CPM-603 frequency counter (\$295) and the TPM-600 totalizer (\$250).

CIRCLE NO. 257

REQUESTED DATA DELIVERY SERVICE is here—see card inside front cover.

85-mil Centers

If you need a bright spot of light but don't want to give up much real estate on your PC board, note our new MV5080-series. They're T-1 bulb size, and have straight-down leads that let you array them on 85-mil centers. They give you all the good things you expect from GaAsLITEs — long life, reliability, low power (1.6 V @ $I_f=20\text{mA}$). Let your mind wander over applications for our clear or red-lens versions for on-board diagnostics, film annotation arrays, or . . . **59¢***



*All prices quoted are unit price in 1000 lot quantities.

Panel Light Package

If you're looking for a panel indicator lamp that's as easy to mount as it is to see, gaze on our new MV5025, the T-1 3/4 bulb size. It's fully-flooded for maximum visibility from any angle and comes with its own snap-in bezel mount. Fits standard panels ranging in thickness



from .062 to .125". It's quick, neat, and sexy as heck for dressing up your product. Also: when it comes time to cost out the panel light (a modest cost in your over-all part count anyhow) think what it costs to change a burned-out light bulb. Ours don't burn out. That's one reason so many smart engineers are doing the GaAsLITE thing in their new gear . . . **71¢** including mounting clip.

Axial leads, anyone?

Our MV50 GaAsLITEs feature axial leads that can mount on 100-mil centers. More MV50's are in use today than any other light-emitting diode in the world. And the new red-lens version looks like a winner, too. The MV50 has documented reliability: over 400,000 hours of testing at maximum current. Oh, yes: it's bright, long-lived, and (yawn! you know this already) very low cost: **49¢**



GaAsLITE Update

In September we shipped more than a quarter million discrete GaAsLITEs. The reason? Availability on our distributors' shelves, proven reliability, low prices that even include extensive testing and applications help, and products like these:

More Panel Lights

Everything we've said already about the MV5025 goes for the other panel light varieties we offer under the secret code names of MV5010, 5020, and 5030. They have leads and lenses of varying lengths and sizes, and come in clear, clear red, diffused, red diffused, and . . . Hell, why don't you get our data sheet and figure out which one is right for your application. We know that one is bound to be. And they're beautiful . . . As low as **69¢**



Distributors at your service

All the GaAsLITEs we've mentioned here — and a whole lot more — are in stock, in quantity, at our fine distributors. Call your P.O. numbers to them.

Elmar Electronics
Kierulff Electronics
K-T/Wesco

Liberty Electronics
Schweber Electronics
Semiconductor Specialists
Western Radio

ENGLAND
Semicomps Ltd.
Semiconductor Specialists

FRANCE
Radio Television Francais

GERMANY
Alfred Neye-Enatechnik

ITALY
Silverstar Ltd.

JAPAN
New Metals & Chemicals Ltd.

SWEDEN
Ingenjoersfirman
Gunnar Petterson

SWITZERLAND
Omni Ray A/G

Monsanto

For additional technical information write
Monsanto Electronic Special Products
10131 Bubb Road, Cupertino, California 95014
(408) 257-2140

UNIVERSAL

**GREATER FLEXIBILITY —
ACCEPTS ALL I. C.
PACKAGES**

**Point to point
wiring saves time,
space and money**

Available in multiples of 9 row sections up to 54 rows, as standard catalog item. Each 9 row section accepts 3 plugs for interfacing or input-output connections. Double sided board with power and ground planes connected to additional wire wrap terminations outside of contact row. Changes and replacements made at component level. Complete wire wrap service.

I C PACKAGING PANELS Request Catalog 266

AUGAT
INC.

TEL: 617-222-2202
31 PERRY AVE., ATTLEBORO, MASS. 02703

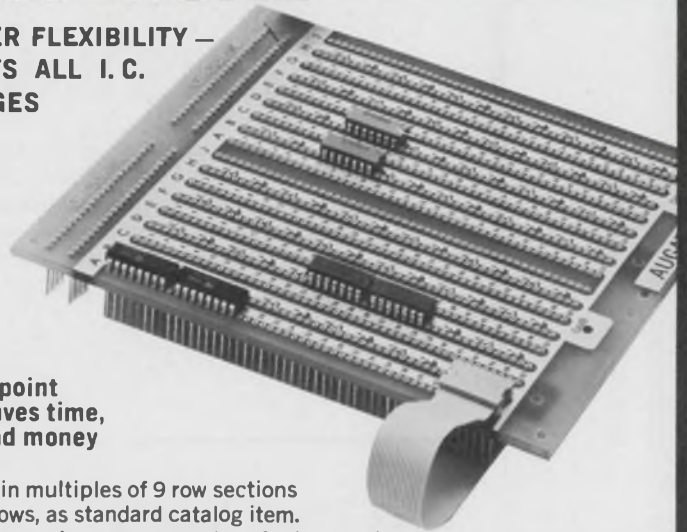

INFORMATION RETRIEVAL NUMBER 39

INSTRUMENTATION

4-1/2-digit DMM houses 25 ranges



John Fluke Mfg. Co., Inc., Box 7428, Seattle, Wash. Phone: (206) 774-2211. P&A: \$795; stock to 30 days.

A new 4-1/2-digit multimeter, the model 8120A, features 25 measurement ranges and modes. The instrument has ac and dc ranges from 100 mV to 1000 V, current ranges from 100 μ A to 1 A and resistance ranges from 1000 Ω to 10 M Ω . Overranging on all ranges is 20%. Other features are fully guarded circuits and field-installable options.

CIRCLE NO. 258

the grabber^{T.M.}

Our plunger action Mini-Test Clip is designed specifically for reaching into densely packaged miniaturized circuitry to make rapid, reliable tests.

- Gold plated copper contact hook makes positive connection, and won't damage lead wires.
- Specially designed tip slides down over square Wire-Wrap pins for solid contact.
- Integrally molded wire assures greater reliability and eliminates time-consuming assembly.
- Molded nylon probe provides complete insulation to point of connection.
- Four models offer widest selection of connecting plugs. Write for complete information and prices.



POMONA ELECTRONICS

1500 E. Ninth St., Pomona, Calif. 91766 • Telephone: (714) 623-3463

*Registered trade mark of Gardner Denver Co.

INFORMATION RETRIEVAL NUMBER 40

Spectrum analyzer spans 0.5 to 1300 MHz



Singer Co., Instrumentation Div., 3176 Porter Dr., Palo Alto, Calif. Phone: (415) 493-3231. P&A: \$5995 to \$6995; 30 to 60 days.

A general-purpose spectrum analyzer with normal and variable-persistence storage displays operates from 500 kHz to 1300 MHz. The Alfred model SA-70 has a dynamic range of 141 dB—from -121 to +20 dBm—and can resolve equal-amplitude signals as close as 300 Hz. It also features a crystal-controlled marker generator, with markers at every 100 MHz across the band.

CIRCLE NO. 259

These amplifiers make your test equipment—and your budget—look good.

Hewlett-Packard's new wideband RF amplifiers improve the sensitivity of your scopes, spectrum analyzers, counters, network analyzers — anywhere you need low-noise, high-gain amplification.

As a result of HP's hybrid thin-film microcircuit technology, these amplifiers bring you superior perform-

ance and high reliability at low cost.

The table below gives frequency ranges, prices and performance of the six basic configurations. Dual channel versions of the preamps can also be supplied to improve the performance of 2-channel instrumentation.

They're ready for delivery now. A call to your HP field engineer will

bring you the details of how these amplifiers can help enhance the test equipment you're using now. Or write to Hewlett-Packard, Palo Alto, California 94304; Europe: 1217 Meyrin-Geneva, Switzerland.



04021A

HEWLETT-PACKARD 8447 SERIES LAB AMPLIFIERS

	HP 8447A Preamp	HP 8447B Preamp	HP 8447C Pwr. Amp.	HP 8447D Preamp	HP 8447E Pwr. Amp.	HP 8447F Preamp/Pwr. Amp.
Frequency Range	0.1-400 MHz	0.4-1.3 GHz	30-300 MHz	0.1-1300 MHz	0.1-1300 MHz	0.1-1300 MHz
Nominal Gain	20 dB	22 dB	30 dB	26 dB	22 dB	48 dB
Gain Flatness	±0.5 dB	±1 dB	±1 dB	±1.5 dB	±1.5 dB	±3 dB
Noise Figure	<5 dB	<5 dB to 1.0 GHz <6 dB, 1.0-1.3 GHz	<11 dB	<8 dB	<11 dB	<8 dB
Output Power @ 1 dB Gain Compression	>+7 dBm	>-3 dBm	>+17 dBm	>+7 dBm	>+14 dBm	>+14 dBm
Price	\$550	\$600	\$450	\$650	\$700	\$1175



75-MHz counter/timer handles many functions



Monsanto Electronic Instruments, 620 Passaic Ave., W. Caldwell, N.J. Phone: (201) 228-3800. P&A: \$895; stock.

The new half-rack counter/timer model 113A is a 75-MHz universal dual-input counter that can count or measure the frequency of electrical events, can measure the period, the average period, the ratio of two events, elapsed time, the time between events and the time between the leading and trailing edges of a pulse.

CIRCLE NO. 260

High-speed scope writes 1500 cm/ μ s



Hewlett-Packard, 1501 Page Mill Rd., Palo Alto, Calif. Phone: (415) 493-1501. P&A: \$950 (180C cabinet version), \$1050 (180D rack version); 6 wks.

In the new model 180C/D version of its 180 series oscilloscopes, Hewlett-Packard has increased trace brightness by a factor of about 5 to give a writing speed of 1500 cm/ μ s (with P31 phosphor and 10,000 ASA film without film fogging). The new scope can use all existing plug-ins for the 180 series that give real-time frequency response to 100 MHz.

CIRCLE NO. 261

A FREE new Hayden Service for you—see card inside front cover.

Multi-channel source spans 50 to 300 MHz

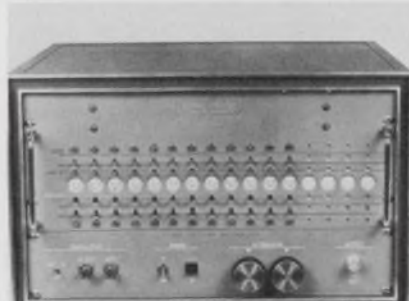

Dix Hills Electronics, Inc., 163 Dix Hills Rd., Huntington Station, N.Y. Phone: (516) 271-9800. P&A: \$6100; 6 wks.

A new multiple-frequency signal generator for CATV and broadband systems is useful in making cross-modulation, intermodulation and gain-flatness measurements. The SX-16 offers high-level, multiple-signal outputs over 50 to 300 MHz. Its front panel can accommodate up to 16 channels with +57 dBm V of output per channel (after combining).

CIRCLE NO. 262

Transistor tester provides fast checks



J & J Electronic Laboratories, Box 247, New City, N.Y. Phone: (914) 638-0776. P&A: \$169.50; stock.

A new instrument uses a visual display on the face of a small CRT to ascertain the type of and the quality of the transistor under test. Named the Q Check model 100A, it can be operated by unskilled personnel and will provide an instant result by displaying characteristic patterns. It can check npn and pnp transistors, diodes, SCRs, zeners and UJTs. Applications include quality control and incoming inspection.

CIRCLE NO. 263

Look for your nearest Raytheon Oscilloscope Representative:

Avionics Liaison, Inc.
6770 Perimeter Rd.
Seattle, Washington 98108
(206) 767-3870

Coherent Mktg. Associates, Inc.
1890 Embarcadero Rd.
Palo Alto, California 94303
(415) 327-2212

FLW, Inc.
10760 Burbank Blvd.
N. Hollywood, Ca. 90601
(213) 877-5518

Instrument Associates, Inc.
175 Middlesex Tpke.
Bedford, Mass. 01730
(617) 275-0700

Klein Aerospace
PO Box 1056
Englewood, Colorado 80110
(303) 781-4967

KLS Associates, Inc.
387 Passaic Avenue
Fairfield, N.J. 07006
(201) 227-2900

K-G Electronics, Inc.
11151 Veirs Mill Rd.
Wheaton, Md. 20902
(301) 946-4055

RJC Associates
26 Morningside Drive
Cortland, N.Y. 13045
(607) 753-3909

Scientific Devices-Midwest
3300 S. Dixie Drive, Suite 212
Dayton, Ohio 45439
(513) 298-9904

Scientific Devices-Philadelphia
PO Box 201
Plymouth Meeting, Pa. 19462
(215) 825-2841

Scientific Devices-Southeast
707 E. Colonial Dr. Suite 6
Orlando, Florida 32803
(405) 424-6792

Scientific Sales Company
777 S. Central Expressway
Richardson, Texas 75080
(214) 231-6541



Why buy the Star of India? When you really need a little gem.

Overbuying can be princely fun. If you're the Aga Kahn.

But now, with the current budget squeeze, common sense has entered the picture. So has Raytheon's CDU-150 scope.

A top quality, general-purpose oscilloscope with price/performance second to none. DC to 35MHz at 5 mV/cm. Dual channel. Big, bright 8x10 cm display. Stable triggering over the full bandwidth.

Time-base delay.

Plus light weight for honest portability. Ruggedness that can easily take hundreds of miles in the trunk of your car without a flutter. At a price of only \$1495.

Think about it. The uncompromising quality of the CDU-150. And the money you save by not buying more than you need. Send us the coupon. Or contact the nearest sales reps on the opposite page.

Raytheon Company
Instruments Operation
175 Middlesex Turnpike
Bedford, Mass. 01730

Gentlemen: Send information on the CDU-150.

Name _____

Company _____

Address _____

City _____

State _____ Zip _____

RAYTHEON



(Our little jewel.)

INFORMATION RETRIEVAL NUMBER 43

PRICE BREAKTHROUGH!

BOURNS® CERMET POTENTIOMETERS

for as low as...

35¢

Now you can buy Bourns quality at the lowest prices ever offered on cermet potentiometers.



SPECIFICATIONS

size (top adjust)
power
res. values
res. tol.
temp. coeff.

MODEL 3359

3/8" dia. x .228" high
1/2W at 70°C
100Ω to 1 meg.
±20% Std.; 10% avail.
to 1K, 0 to +300 ppm/°C
1K and up, 0 to +200 ppm/°C

MODEL 3389

.390" x .360" x .240" high
1/2W at 70°C
100Ω to 2 meg.
±20% Std.; 10% avail.
±150 ppm/°C

sealed

no

yes

Price (50,000 quantity)

35¢

42¢

Send for catalog sheets on these two new single-turn adjustment potentiometers. Or call your nearest Bourns sales office for details.



BOURNS, INC., TRIMPOT PRODUCTS DIVISION • 1200 COLUMBIA AVE., RIVERSIDE, CALIF. 92507

INFORMATION RETRIEVAL NUMBER 44

MURA/HIOKI PANEL METERS

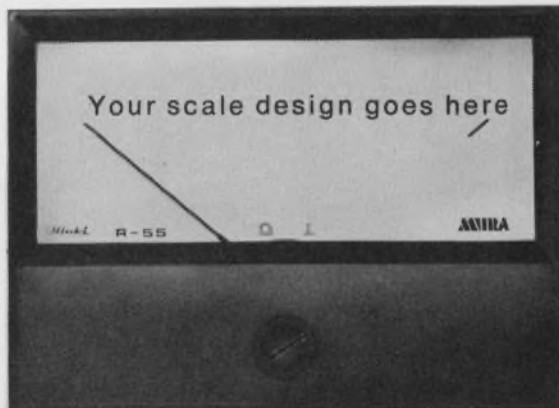

TOP QUALITY AND FULLY GUARANTEED

Made by Hioki, Japan's leading manufacturer of quality panel meters, these fine instruments can be used wherever precision measurement is an absolute requirement. They come in various sizes from 2" x 2 1/2" to 6" x 4 1/2" with either d'Arsonval or laut-band movements. Resistances and scale designs can be tailored to your special needs. Distributed in the United States only by Mura Corp., they are attractively priced and fully guaranteed. Sold only in O.E.M. quantities of 300 and up.

Write for detailed information on your letterhead.

MURA 50 SOUTH SERVICE ROAD, JERICHO, N.Y. 11753
Telephone: (516) 334-2700 Telex: 967-879

Mura is the world's largest supplier of miniature panel meters.

INFORMATION RETRIEVAL NUMBER 45

ICs & SEMICONDUCTORS

8-bit LSI multiplier comes on a single wafer

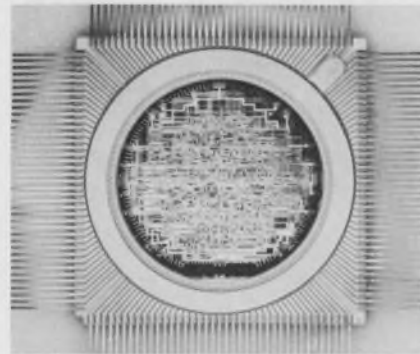

Hughes Aircraft Co., Microelectronics Div., 500 Superior Ave., Newport Beach, Calif. Phone: (714) 548-0671.

A new 8-bit full-wafer bipolar LSI multiplier is designed for high-speed signal processing and digital filtering applications. The new 8-bit plus sign multiplier designated H1002MC is comprised of 52 full adders and 96 gates for an equivalent 616 gates integrated on a single 1-1/2-in. silicon wafer. It will operate at a rate of 8 million multiplications of two 8-bit words plus sign per second. Its electrical characteristics conform to TTL logic levels. Typical speeds are 10 ns/gate.

CIRCLE NO. 264

Eight new linear ICs come with beam leads

RCA Solid State Div., Rte. 202, Somerville, N. J. Phone: (201) 722-3200. Price: see text.

Eight new linear ICs are available with beam leads and sealed junctions. These include Type CA3015L op amp (\$2.03), CA3018L general-purpose transistor array (\$1.53), CA3028AL differential/cascode amplifier (\$1.39) and CA3039L diode array (\$1.53). Also CA3045L general-purpose transistor array (\$1.53), CA3054L dual independent differential amplifiers (\$1.96), CA3084L general-purpose pnp transistor array (\$2.80) and CA3741L op amp (internally compensated) (\$2.70). All prices are for 100 quantities.

CIRCLE NO. 265

Announcing REQUESTED DATA DELIVERY, it's free—see card inside front cover.

NEW! THE PRAM.™

The first 4-channel programmable op amp. With more application possibilities than we could possibly list on this page.

HA-2400/2404/2405

Take a good look at this new linear building block. It's unique and so versatile we keep discovering more and more applications for it.

Each PRAM contains four preamplifier sections, one of which is selected through the DTL/TTL compatible inputs and connected to the output amplifier. The selected analog input terminals and the output terminal form a high performance operational amplifier for just about any use you can dream up. And we hope you'll dream up some. If you do, send them along to us and we'll see what we can dream up by way of a reward.

Features:

Offset current 5nA

Voltage gain 150K

Slew rate

$A_v = +1 \quad \pm 15V/\mu s$

$A_v = +10 \quad \pm 50V/\mu s$

Gain Bandwidth Product

$A_v = +1 \quad 8MHz$

$A_v = +10 \quad 40MHz$

DTL/TTL compatible

	100-999 units
0°C to +75°C	\$10.45
-25°C to +85°C	\$15.95
-55°C to +125°C	\$23.65

For more details on the PRAM contact your Harris representative or distributor.

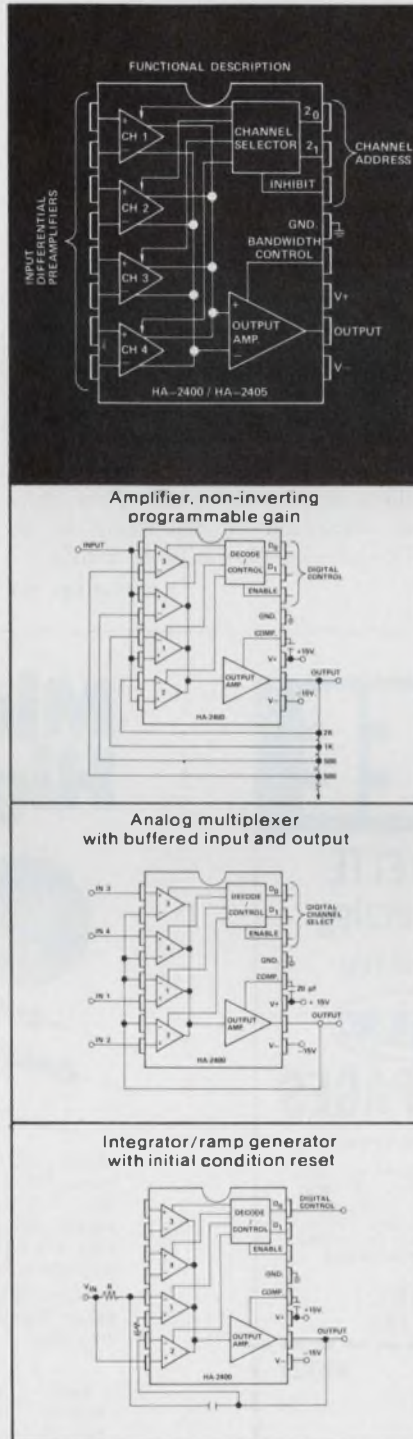

More challenges:

The foregoing diagrams show just three of many applications we've designed using the PRAM. The following lists other possibilities we haven't had time yet to prove out. Why don't you try your hand at designing them or any other ideas you come up with, and send them to:

E. Fernandez
P.O. Box 883
Melbourne, Florida 32901.

A to D converter, Dual Slope Integrating

Active Filter, State Variable Type with Programmable Frequency and/or Programmable "Q"

Amplifier with Programmable D.C. Level Shift

Chopper Amplifiers

Crossbar Switches

Current Source, Programmable

F.M. Stereo Modulator

F.S.K. Modem

Function Generators, Programmable

Gyrator, Programmable

Monostable Multivibrator, Programmable

Multiplier, Pulse Averaging

Peak Detector with Reset

Resistance Bridge Amplifier/Comparator with Programmable Range

Sense Amp/Line Receiver with Programmable Threshold

Spectrum Analyzer, Scanning Type



HARRIS
SEMICONDUCTOR

A DIVISION OF HARRIS-INTERTYPE CORPORATION

P.O. Box 883, Melbourne, Florida 32901
(305) 727-5430

DISTRIBUTORS: **Schweber Electronics:** Westbury, New York (516) 334-7474; Rockville, Maryland (301) 881-2970; Hollywood, Florida (305) 927-0511
Harvey/R & D Electronics: Lexington, Massachusetts (617) 861-9200/**Semiconductor Specialists, Inc.:** Chicago (312) 279-1000; Detroit (313) 255-0300; Minneapolis (612) 884-8132; Kansas City (816) 452-3900; St. Louis (314) 428-6100; Dallas (214) 358-5211; Indianapolis (317) 243-8271; Pittsburgh (412) 781-8120; Dayton (513) 278-9455/**R.V. Weatherford Co.:** Albuquerque (505) 265-5671; Anaheim (714) 547-0891; Austin (512) Enterprise 1443; Dallas (214) 231-6051; Denver (303) 427-3736; Glendale (213) 849-3451; Houston (713) Enterprise 1443; Palo Alto (415) 321-5373; Phoenix (602) 272-7144; Pomona (714) 623-1261; San Diego (714) 278-7400; Seattle (206) 762-4200.

Quad transistor array delivers 1-A pulses

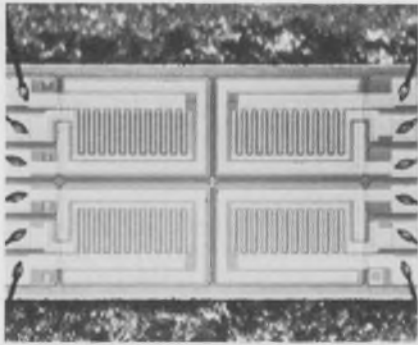

Harris Semiconductor, Melbourne, Fla. Phone: (305) 727-5412. P&A: \$5.85 (100 quantities); stock.

A new quad npn transistor array consists of four transistors on a common chip and delivers up to 1 A of pulsed current. The HT-6500 array is intended primarily for use as a memory core and relay driver, or in similar applications requiring pulsed currents of up to 1 A at up to 50 V. In operation, one of the four transistors on the chip functions at any one time.

CIRCLE NO. 266

2560-bit ROM family accesses in 400 ns



Texas Instruments, Inc., 13500 N. Central Expwy., Dallas, Tex. Phone: (214) 238-2011. P&A: from \$11.25 (100 quantities); stock.

A new family of static 2560-bit MOS/LSI ROMs features access times of 400 ns. Designated the TMS2500 series, the circuits in this family are architected for fast character generator and ROM applications in a variety of displays and peripherals. They may be organized as 256 words of 10 bits or as 512 words of 5 bits.

CIRCLE NO. 267

Miniature SCRs have 0.1-in. diameters

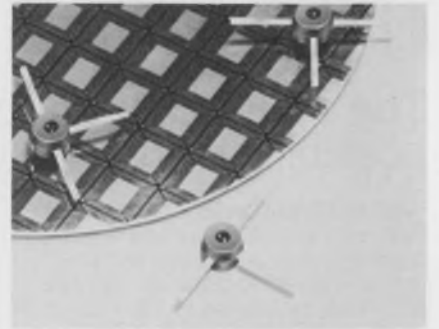

Motorola Semiconductor Products, Inc., Box 20924, Phoenix, Ariz. Phone: (602) 273-6900. P&A: from \$3.40 to \$4.95; stock.

Control in miniature-space applications can be maintained by using the new Micro-T MCR051 through MCR054 plastic SCRs. The miniature-package SCRs are less than 1/10th of an inch in body diameter. Their gate trigger currents of 200 μ A maximum provide triggering from low-level sources. Peak forward surge-current rating is 6 A.

CIRCLE NO. 268

FREE

LAFAYETTE 1972 Catalog

Our 51st Year

468 PAGES

Your 1st Guide To Everything in Electronics

- Stereo/Hi-Fi Components ● Musical Instruments and Amplifiers ● Photography Equipment ● Ham and CB Gear
- Public Address Systems ● Tools and Test Equipment
- Educational and Optical Equipment ● Black and White/Color Televisions ● Police and Fire Monitor Receivers
- Books and Parts Plus Thousands of Additional Items

Lafayette Radio Electronics, Dept. 45121
P.O. Box 10, Syosset, L.I., N.Y. 11791

Send me the FREE 1972 LAFAYETTE Catalog 4-5121

Name

Address

City State

Zip (please include your Zip Code No.)

INFORMATION RETRIEVAL NUMBER 47

Miniature High Voltage Resistors



new Mini-MOX resistors offer 100 ppm TCR plus low noise characteristics

Mini-MOX resistors have all the ingredients you need for new designs for ultra-critical applications. For instance, Mini-MOX resistors are a fraction the size of conventional types; they meet or exceed MIL-R-10509-F for environmental parameters . . . 100 ppm or less; T.C.R. stability better than $\pm 2\%$ for 2,000 hours at full load; low-voltage coefficient less than 5 ppm/volt, measured between 100 volts and full-rated voltage; in addition typical quantech noise at 20 megohms is less than 0.5 microvolt/volt.

Available off-the-shelf, Mini-MOX resistors are ideally-suited for high-voltage applications where long-term stability and power-to-size ratios are critical.

Model	Resistance	Rating @ 70°C	*Max. Oper. Volts	Length Inches	Diameter Inches
MOX-400	1-2500 megs	.25W	1000V	.420	.130
MOX-750	1-5000 megs	.50W	2000V	.790	.130
MOX-1125	1-10,000 megs	1.00W	5000V	1.175	.130

Write for complete Technical Data Sheet on Mini-MOX Resistors: Victoreen Instrument Div. of VLN Corp., 10101 Woodland Ave., Cleveland, Ohio 44104. Telephone: 216/795-8200. DMA 558



Expertise in high voltage

INFORMATION RETRIEVAL NUMBER 48

ELECTRONIC DESIGN 25, December 9, 1971

Don't repeat yourself.

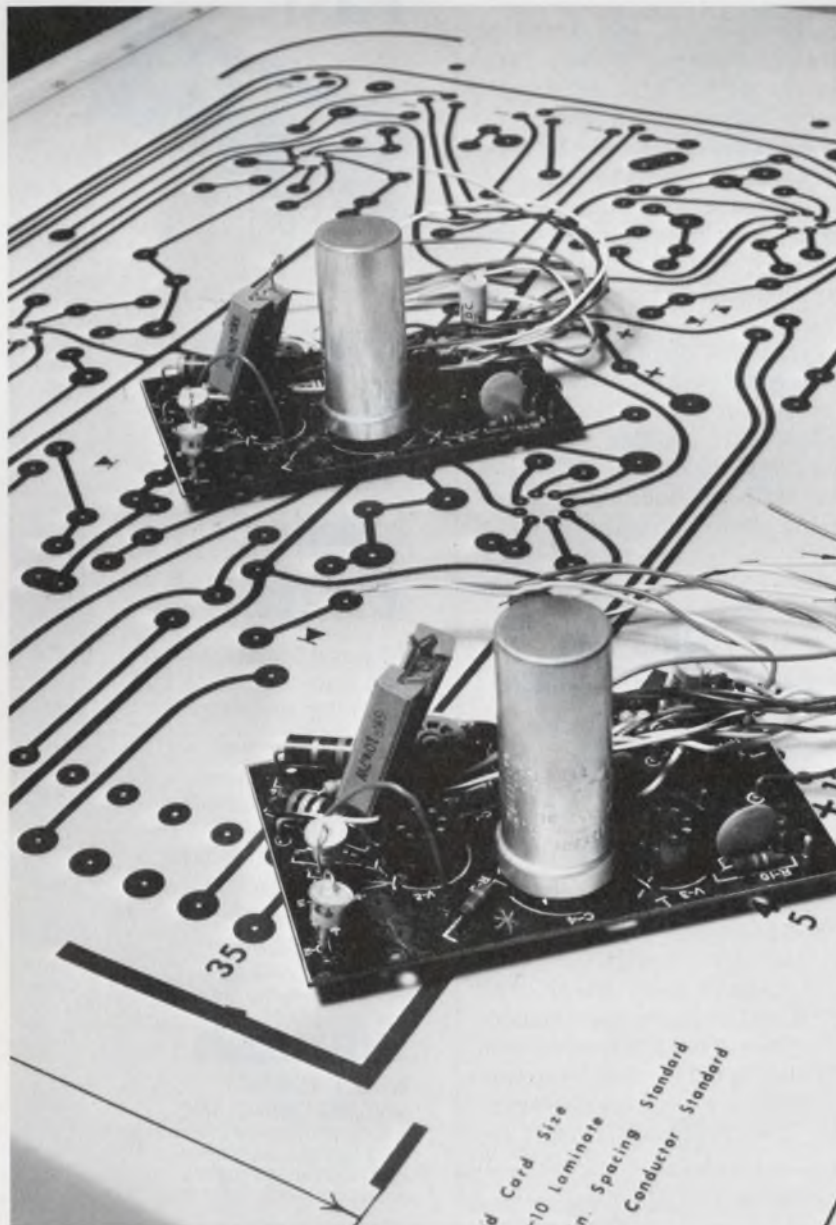

Use KODAGRAPH Films for repetitive design elements.

It's easy to bypass tedious retracing when the same design must be repeated in a drawing. Or when you want to transfer a design from one drawing to another. Let photography and Kodagraph films do the work for you.

We'd like to show your drafting/design department our new slide presentation, "Focus on Drafting." It will clue them in on the many shortcuts possible with Kodagraph films and papers. Whenever you're ready, just call your Kodak Technical Sales Representative.

Or write for literature to Eastman Kodak Company, Business Systems Markets Division, Dept. DP837, Rochester, N.Y. 14650.

DRAWING REPRODUCTION SYSTEMS BY KODAK

Kodak

The IC trouble-shooters march on.

Here comes the latest member of HP's Troubleshooters searching out faulty IC's. The HP 10529A Logic Comparator slips over the in-circuit IC you're testing and in 5 seconds or less tells you whether it is functioning properly.

A clever comparison scheme uses the circuit's power and input stimulus to do all this. Even dynamic errors as brief as 200 ns are stretched and displayed. Complete with accessories for only \$295.

We're thinking ahead. The comparator carrying case also holds our other two Troubleshooters.

The HP 10525A Logic Probe lights up for pulses as narrow as 25 ns and indicates pulse polarity, pulse trains and logic states. \$95.

The HP 10528A Logic Clip clamps over IC packages to show the state of all 16 (or 14) pins instantly. \$125.

You can buy all three as the 5010A for \$495, saving you time, aggravation and \$20.

The IC Troubleshooters march on. Wait until you see what we're working on now!

Call your HP field engineer to get your hands on them right away. Or if you want to know more, write Hewlett-Packard, Palo Alto, California 94304; Europe: 1217 Meyrin-Geneva, Switzerland.

02116

HEWLETT  PACKARD

INFORMATION RETRIEVAL NUMBER 50

ICs & SEMICONDUCTORS

Bi-directional one-shot IC has ± 4 -mV threshold

Signetics, 811 E. Arques Ave., Sunnyvale, Calif. Phone: (408) 739-7700. P&A: \$5 (100 quantities); stock.

A new bi-directional one-shot digital IC is available for use in disc file controllers and in applications that require high-speed low-level-signal processing. Designated as the N8T20B, the IC functions as a zero-crossing detector with thresholds of ± 4 mV over its dynamic range of -3.2 to $+4.2$ V. Typical propagation delay time is 30 ns.

CIRCLE NO. 269

256-bit TTL RAM accesses in 45 ns

Texas Instruments, Inc., 13500 N. Central Expwy., Dallas, Tex. Phone: (214) 238-2011. P&A: 10¢/bit (100 quantities); 8 wks.

A new TTL 256-bit RAM organized as 256 words by 1 bit is fully decoded and features typical 15-ns access times from memory-enable input and 45-ns access from binary address inputs. The SN-74200's triple-state outputs retain the desirable characteristics of totem-pole outputs yet may be bus-connected. Up to 256 outputs can be connected together to form memory systems up to 65k words of n bits without additional output buffering. Power dissipation is 1.8 mW/bit.

CIRCLE NO. 270

1024-bit ROMs offer two-way programming

Harris Semiconductor, Melbourne, Fla. Phone: (305) 727-5412. Price: \$55 for programmable devices and \$33 for custom-programmed devices (100 quantities).

A new series of 1024-bit ROMs includes both mask-programmed and field-programmed devices. The series includes the HROM-1024B mask-programmed ROM, the HPROM-1024 field-programmable ROM with a Tri-state output, and the HPROM-1024A field-programmable ROM with an open-collector output. The 1024A and 1024B are identical except for the method of programming.

CIRCLE NO. 271

Some of our customers said they needed a good D. I. P. Reed Relay for high density packaging that fits I.C. sockets and was automatically insertable and they needed it...

Fast!

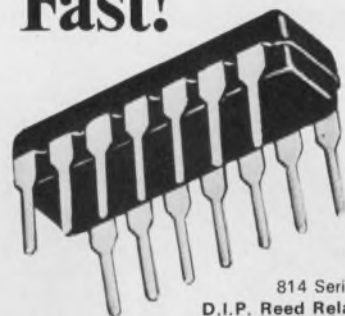

814 Series
D.I.P. Reed Relay

So we made it Fast!
And are ready to deliver Fast!

At our prices—and you can't beat that. Write for the data.

Also ask about our:

- Dry Reed Switches
- Proximity Detectors
- Dry Reed Relays
- Mercury Reed Relays
- Solid State Relays
- Electronic Module Boards

If you don't have our condensed catalog—TWX or write for one.

wabash

NEW PRODUCT ENGINEERING, INC.

A Subsidiary of Wabash Magnetics, Inc.

First and Webster Streets
Wabash, Indiana 46992
Telephone (219) 563-2191

TWX 810-290-2722

Agc IC amplifier works up to 2 MHz

Lithic Systems, Inc., Box 869, Cupertino, Calif. Phone: (408) 257-2004. P&A: \$11.70 (100 quantities); stock.

The LS170 agc IC is a dc-to-2-MHz monolithic amplifier whose gain may be continuously varied by an external dc voltage. It also has an independent input level detector which provides the high current, fast attack and slow release needed for squelch and VOX switching. The LS170 has input characteristics similar to those of an op amp. Operating voltage range is from 4.5 to 24 V. At 4.5 V, power dissipation is 18 mW.

CIRCLE NO. 272

MOS calculator sets provide low-cost logic

Electronic Arrays, Inc., 501 Ellis St., Mountain View, Calif. Phone: (415) 964-4321. P&A: \$40/set (100 quantities); stock.

Two new MOS calculator circuit sets are designed to provide low-cost logic with standard or custom programming. The S-101 and S-114 are 4-chip versions of the standard S-100 6-chip MOS calculator set. The S-101 handles 8-digit entries and the S-114 16-digit entries. Both provide keyboard input processing, add, subtract, multiply, divide, stored-constant operation, keyboard setting of decimal-point location and BCD outputs.

CIRCLE NO. 273

Linear IC trio form color TV chroma system

Signetics, 811 E. Arques Ave., Sunnyvale, Calif. Phone: (408) 739-7700.

Three monolithic ICs constitute a complete chroma system for color TV receivers. The system consists of the N5070B chroma signal processor, the N5071A chroma amplifier and the N5072A chroma demodulator. The N5071A features automatic color control, dc chroma gain control, a color killer and short-circuit protection. The N5070B features dc hue control and a shunt regulator. The N5072A achieves the R-Y, G-Y and B-Y color difference outputs.

CIRCLE NO. 274

For 25 years, Sage gave you the finest resistors possible.

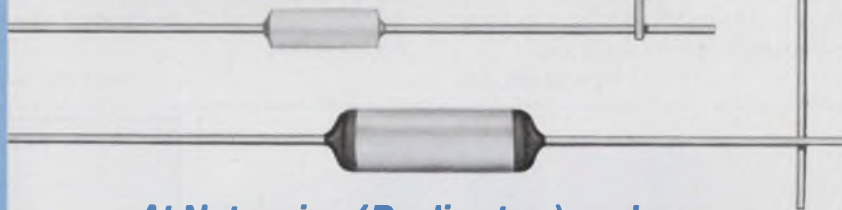

At Nytronics (Darlington), we're accomplishing the impossible.

For the past quarter-century, Sage precision and power resistors have been the accepted industry standard for quality and dependability.

Today, these fine quality components are being produced, along with famous precision-crafted Nytronics inductors and capacitors, in Nytronics' huge 250,000 square foot facility in Darlington, S.C. — with one important difference — we believe we're making them even better than before:

Tighter tolerances, more rigid quality control, in-

creased reliability, simplified specifying and immediate availability from an ever-expanding network of full-line Nytronics distributors.

Check the "impossible" new Sage precision, power wirewound and thin film microwave resistors yourself. And while you're at it, put Nytronics super-quality inductors and capacitors through their paces too. We'll be pleased to send you literature and off-the-shelf samples for your most critical applications. Simply write:



Nytronics, Inc.

Sage Electronics Corp.

Orange St., Darlington, S.C. 29532 (803) 393-5421 TWX-810-665-2182

Shirt-pocket calculator retails under \$100



Ragen Precision Industries, Inc., 9 Porete Ave., N. Arlington, N.J. Phone: (201) 997-1000. Price: see text.

A new shirt-pocket-sized electronic calculator features a tiny 2-3/8 by 7/8 by 3-1/2-in. size and retails under \$100. The new eight-digit (16-digit capacity) "micro" calculator can add, subtract, multiply and divide and uses a floating decimal point. It operates for more than a year on throw-away batteries that need no recharging.

CIRCLE NO. 275

Thermal printer-key unit has expandable memory



Electronic Communications, Inc., 1501 72 St., St. Petersburg, Fla. Phone: (813) 347-1121. Price: under \$8000.

A new thermal printer-keyboard with an expandable message memory is the ANGGC-46 Mini Comm-Terminal with an MTBF of 2000 h and a small size of 5 by 13 by 17 in. It can receive hard copy at 300 words/minute (30 characters/s) and transmit at unlimited speed. It has an optional incoming storage memory and 94 alphanumeric characters designed from a 35-element matrix font of 7 horizontal lines and 5 dots.

CIRCLE NO. 276

Selectric KSR terminal leases at \$52/month



Terminal Equipment Corp., 750 Hamburg Tpke., Pompton Lakes, N.J. Phone: (201) 839-3000. P&A: see text; 60 days.

The new Holmes Tycom model 38 KSR terminal can be leased at only \$52/month with the customer furnishing the Selectric typewriter. Maintenance service will be provided by Terminal Equipment or by the Raytheon Service Co. through its network of service centers across the country. The Tycom 38 replaces Teletype Corp. models 33, 35 and 38 terminals.

CIRCLE NO. 277

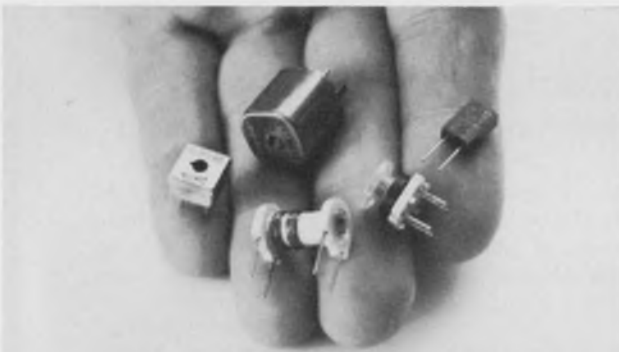

small wonders: big news

Denser PC packaging at low cost is now possible . . . thanks to CAMBION's low-profile standard variable inductors. They're wound on new, thin wall coil forms that allow higher Q's and inductance values.

Ultra-reliable as well as miniature, these high performance inductors are built for longer life . . . longer by a factor of ten in tuning torque. They have an operating temperature range of -55° to 125°C and a tuning range of ±20% from the mean inductance.

For total circuit reliability - at a small price - it pays to choose CAMBION inductors. They're available in a wide choice of values, sizes, styles and finishes for immediate delivery.

Cambridge Thermionic Corporation, 445 Concord Ave., Cambridge, Mass. 02138. Phone: (617) 491-5400. CAMBION Electronic Products, Ltd., Castleton, Near Sheffield, England. Phone: Hope 406/407.

Standardize on

CAMBION

The Guaranteed Electronic Components

INFORMATION RETRIEVAL NUMBER 53



CONDUCTIVE ELASTOMERS

- Highly to moderately, electrically conductive compounds to provide tailor-made electrical and mechanical properties
- Volume resistivity from .001 to 100,000 ohm-cm
- Molded parts
- Extruded shapes
- Standard sheets
- Heating
- Motion-sensing
- Static discharge
- Grounding
- Inter-Connecting
- Contacting
- Write for data #850.



Technical Wire Products, Inc.

Eastern Division • 129 Dermody St., Cranford, NJ 07016 (201) 272-5500
Western Division • 427 Olive St., Santa Barbara, CA 93101 (805) 963-1867

INFORMATION RETRIEVAL NUMBER 54

ELECTRONIC DESIGN 25, December 9, 1971

Face it.

In panel design, looks are everything.

But, you don't have to sacrifice good looks for the sake of function. Every Rogan control knob and dial is designed to enhance your front panel *and* perform flawlessly.

Rogan offers hundreds of different shapes and sizes and 17 handsome ABS standard colors—with custom colors readily available. So no matter what your application, Rogan control knobs will contribute both functionally *and* aesthetically.

See for yourself. Write for our new "R-71" catalog. Or outline your requirements for quotation. Free samples of particular items will be sent on request.

Rogan

8019 North Monticello Avenue, Skokie, Illinois 60076
Phone: (312) 675-1234 • TWX: 910-223-4547



INFORMATION RETRIEVAL NUMBER 55

Now divide and conquer your sensor's wildest curves.

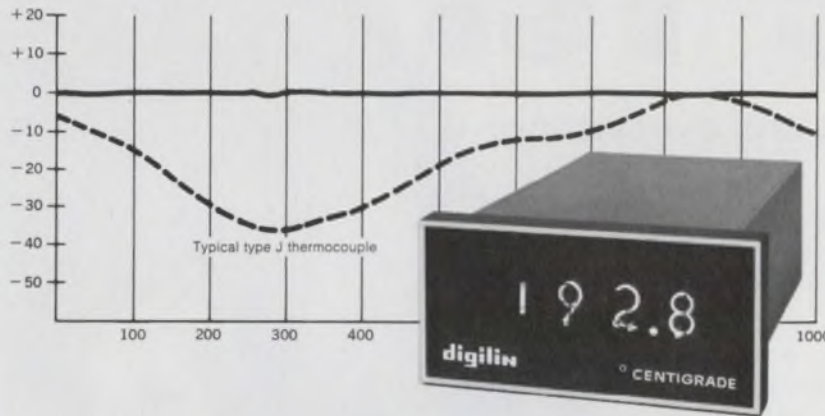

Digilin's linearizing readout breaks up your non-linear sensor information into ten straight-line segments that approximate the most capricious curve with all the accuracy you need for just about any transducer.

And our exclusive piecewise linear approximator works so well with our standard A/D conversion technique that you get the 3½-digit linearizing readout complete in one small panel meter package in

your choice of engineering units with BCD output for as low as \$195 in OEM quantities.

(Which means that now transducer manufacturers can expand their product line with an accurate digital readout and keep prices sharply competitive.)

Be first in your marketplace with Digilin linearizing digital readout. Call Stan Ericsson today. Digilin, Inc., 1007 Air Way, Glendale, Calif. 91201. (213) 240-1200.

digilin
DIGITAL INSTRUMENTS

INFORMATION RETRIEVAL NUMBER 56

"MINITRON"[®] SEGMENTED READOUT

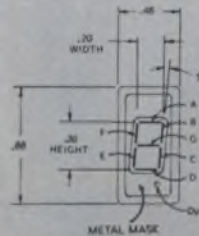

COM 16
A 15
B 14
COM 13
COM 12
C 11
COM 10
Dp 9

3015F

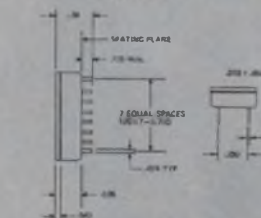

COM 16
C 15
C 14
COM 13
COM 12
D 11
Dp 10
COM 9

3015G

LONG LIFE.....

4 volt units 50,000 Hours (Over 5 years)
5 volt units 100,000 Hours (Over 10 years)

LOW POWER.....

Two ratings available
4 volts 0.010 Amps/Segment
5 volts 0.008 Amps/Segment

LOW COST.....

- Units may be multiplexed or driven direct by low cost decoder/drivers.
- Installation may be accomplished by soldering direct to printed circuit boards or use of low cost air insulated DIP sockets
- Unlimited color filter selection

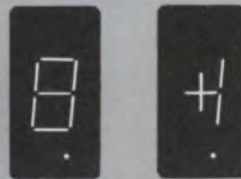

3015F SERIES • CN...5.0V, 0.008A/Segment, 100,000 Hours Life at 700 Foot Lamberts • CN4...4.0V, 0.010A/Segment, 50,000 Hours Life at 1700 Foot Lamberts • CN-OPEN MASK ...Same as CN Unit has no metal mask, providing a wider viewing angle. Also BN with metal mask and BN/BN4 OPEN MASK available which has no metal mask providing a wider viewing angle. **3015G PLUS, MINUS, ONE, DECIMAL, 5.0V, 0.008A/Segment, 100,000 Hours Life at 700 Foot Lamberts.**

• For more information, contact to:

Exclusive Distributor: MITSUI & CO. (U.S.A.) INC.

Head Office: (General Machinery Dept.)
Pan American Bldg, 200 Park Ave. New York, N.Y.
10017 Phone: 973-4600
Los Angeles Office: (Machinery Dept.)
611 West Sixth St. Los Angeles, Calif. 90017
Phone: (213) 680-1000

• Manufacturer:
FUJI ELECTRONICS CO., LTD.
Kawasaki, Japan

DATA PROCESSING

Real-time software for 620 computers

Varian Data Machines, 2722 Michelson Dr., Irvine, Calif. Phone: (714) 833-2400. P&A: \$48,000 for a complete package which includes installation, training and documentation.

Vortex (Varian Omnitask Real-Time EXecutive) operating system is a new software package that significantly increases the capability of a Varian 620 computer installation. It custom tailors computer hardware, rotating memories, and peripheral devices into a true real-time system.

With Vortex software controlling the system, the user is freed from such chores as I/O handling, interrupt servicing, and resource allocation. These operations are handled instead by a real-time executive task stored in the computer's main memory, which enables the user to assign priorities to real-time foreground duties, that may be loaded and run either immediately or in the future.

This can be in response to a real-time clock, an external interrupt, the operator or an inter-task command.

The real-time program performs the housekeeping functions that permit general-purpose background tasks to be run concurrently with the real-time foreground operations in multi-programming.

This multi-programming capability of the Vortex system takes advantage of normally wasted periods of idle time which are embedded in most programs. Since such periods often constitute a large percentage of the run time of a program, Vortex may actually double system hardware utilization by using these periods to run lower priority tasks.

The fact that all foreground tasks and the Vortex nucleus run in protected memory insures system integrity for the real-time application. At the same time, the background user has such advantages as easier software debugging (e.g. his program may blowup in the background without disturbing system operation or necessitating lengthy coldstarts and reload operations).

CIRCLE NO. 278

INFORMATION RETRIEVAL NUMBER 57

Clairex phototransistors give you higher sensitivity at extremely low illumination levels...and they cost no more.

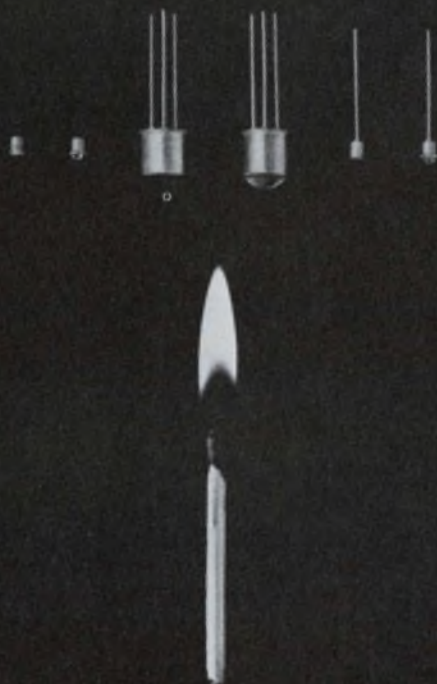
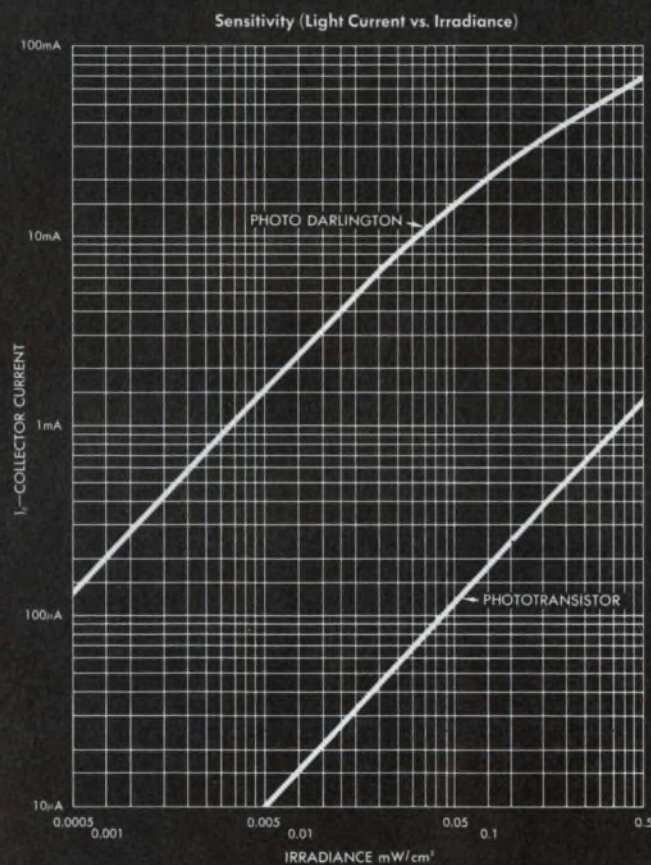

One of our customers is using our phototransistors to detect signals from an LED at distances up to 60 feet.

If you need phototransistors to give you more current at lower light levels, call (914) 664-6602, or write Clairex[®], 560 South Third Avenue, Mount Vernon, New York 10550.

CLAIREX ELECTRONICS

A DIVISION OF CLAIREX CORPORATION

Graphics digitizer simplifies CAD



Bendix Computer Graphics, 23850 Freeway Park Dr., Farmington, Mich. Phone: (313) 477-3700. Price: approx. \$100,000.

A new computerized system can be used by unskilled personnel to generate precise engineering drawings from rough sketches in a fraction of the time required by trained designers using conventional methods. Called the Interactive Graphic System 100, it allows the operator to communicate with the computer without knowing programming or data processing techniques.

CIRCLE NO. 279

Asynchronous terminal prints 30 characters/s



Synerdata, 133 Brimbal Ave., Beverly, Mass. Phone: (617) 927-3222. P&A: see text; 30 days.

TotalTerm, a new high-speed 30-character/s communications teleprinter, is an asynchronous system which prints on edge-sprocketed multi-part forms and is fully adjustable to 132 columns. It incorporates a proprietary incremental printing mechanism, solid-state circuitry and controls and a power source with a one-year warranty on all parts. Purchase prices are: \$4200 for RO models, \$4760 for KSR models and \$6490 for ASR models. Lease and maintenance terms are also available.

CIRCLE NO. 280

Space-saving core memory cycles in 650 ns

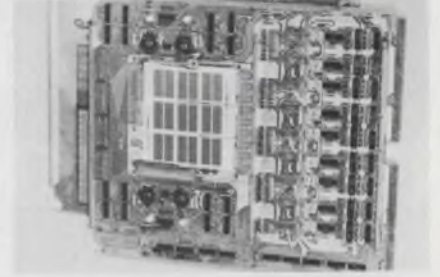

Lockheed Electronics Co., Inc., 6201 E. Randolph St., Los Angeles, Calif. Phone: (213) 722-6810.

A new core memory system offers users high-speed operation (650-ns cycle time) at space savings of 25 to 30% over conventional systems of equal performance and capacity. The CB-65 memory system uses 18-mil cores in 3-wire 3D arrays. A single logic board carries 4096 18-bit words of memory, the entire bit structure of the words and all the sensing electronics. A second timing and interface logic board completes the entire system.

CIRCLE NO. 281

SAVE TIME · CUT COSTS · UP QUALITY CONTROL

HARD-TO-FIND INDUSTRIAL BUYS

MANY U. S. GOVERNMENT SURPLUS BARGAINS IN SCIENCE, OPTICS, SPACE



FLEXIBLE IMAGE TRANSMITTER

Hi-resolution image-transmitter lets you see into remote, inaccessible illuminated areas; through pipes, tubes or any 3/8" + opening no matter how intricate. Provides clear, wide sighting. 7X magnifying eyepiece focuses from less than 1/2" from subject to infinity. Ideal for monitoring hazardous processes, surveillance instrument, demonstrate fiber optics. Over 4,000 coherent glass fibers (.002") 3/8" dia. semi-rigid gooseneck sheathing. Stock No. 60.857DA \$40.00 Ppd.



POWER HORN BLASTS A MILE

Frighten prowlers, muggers, vicious dogs with 118 decibels. Just press and this Freon powered pocket-sized metal horn can be heard a mile away to signal for help or fun. Great for boating (it floats), hiking, camping, hunting, seashore, rooting for your team. Can be heard over traffic and constant noises to sound fire drill, lunch break or emergency. Weighs only 3 oz. but contains up to 100 mile-piercing blasts. A real bargain. Stock No. 41.423DA \$3.25 Ppd. 2 Refill Cartrs. (P-41-424DA) \$2.75 Ppd.



25X TO 900X LABS MICROSCOPE

Sturdy, monocular-type 3 Coated Achromatic parfocal objectives — 5X (0.10 NA), 10X (0.25 NA), 60X (0.85 NA); triple revolving nose piece. Automatic focusing stop prevents damage to objectives and slides. Fixed 160mm tube. Rack & pinion coarse focusing & fine micrometer type slide adjustments. 3 Huygenian eyepieces: 5X, 10X, 15X. Bakelite stage 4-1/2" x 4-5/16". 2 stage clips accept Edmund graduated mech. stage No. 30.060 — Substage equipment: Fixed-condenser lens, iris diaphragm, 1-7/8" diam. plano-concave mirror, 11-3/4" H., 11 lbs. W. Stock No. 85.049DA \$99.75 F.O.B.



GIANT FREE CATALOG

Completely new 1972 edition — 148 pages. Bargains galore! New categories, items, illustrations, 1,000's of buys for industry—Optics, Ecological and Physical Sciences, Electronics. On-the-Job helps, quality control aids. Optics for research labs, design engineers, experimenters. Instruments for checking, measuring; improve quality, cut costs. Hard-to-get surplus bargains. Write for catalog "DA".

EDMUND SCIENTIFIC CO. 300 EDSCORP BLDG. BARRINGTON, NEW JERSEY 08007
ORDER BY STOCK NUMBER · OPEN ACCOUNT TO RATED FIRMS · MONEY-BACK GUARANTEE

INFORMATION RETRIEVAL NUMBER 59

SWITCH/INDICATORS

Super-compact 5 & 15 amp models.

Alternate or momentary action. Push-on, push-off power switch mounts in a 3/8" hole on centers as close as 1 1/2" (5 amp model) and 2 3/2" (15 amp). Minimum life: 100,000 cycles.

Independent, isolated incandescent lamp (neon optional). Match other TEC-LITE indicators for panel design harmony. Switch contact rating: 5 or 15 amps at 115 VAC, 60 Hz or 28 VDC resistive. Available in 14 lens colors. As low as \$3.40 in quantities of 100 - 499.

For more information on PBL-PBS switches — or our complete line of display/control products and systems — write: **TEC, Incorporated, 9800 N. Oracle Road, Tucson, Arizona 85704. (602) 297-1111.**



INFORMATION RETRIEVAL NUMBER 60

ELECTRONIC DESIGN 25, December 9, 1971

AIRPAX™ Type 203 Electromagnetic Circuit Protector

Now with Illuminated Rocker Arm

This exclusive combination of ON-OFF switch function, snap-in front panel mounting, and illuminated single-rocker actuator has made the Airpax Type 203 Circuit Protector ideal for use in computers, computer peripherals, copying machines, air conditioners, marine controls, and other high-quality industrial and military equipment where accurate, reliable protection is demanded.

FEATURES

- Illuminated single rocker actuator for 1, 2, or 3-pole assemblies
- Choice of illumination voltages
- Snap-in front panel mounting for fast, economical installation
- Optional flush rear mounting available
- 32V DC and 250V AC (50/60 or 400 Hz)
- Current ratings from 0.020 to 20 amperes
- Choice of inverse time delay or instant trip



Trip Time vs Percent Rated Current @ 25°C

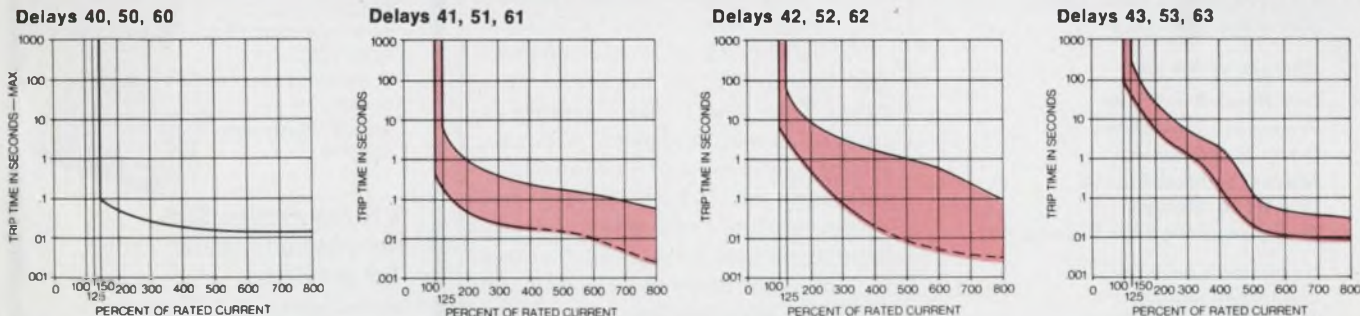

Delays 40, 41, 42 and 43 are for use in 400 Hz systems; delays 50, 51, 52 and 53 are for use in DC systems; and delays 60, 61, 62 and 63 are for use in 60 Hz systems.

For complete details, specifications and application examples, call or write:

AIRPAX™

AIRPAX ELECTRONICS / CAMBRIDGE DIVISION / Cambridge, Maryland 21613 / Phone (301) 228-4600 / TELEX 8-7715 / TWX 710 865-9655

INFORMATION RETRIEVAL NUMBER 61

The people that buy from us wondered why we didn't have a low-profile isolating Solid State Relay that was TTL compatible...

Right now!

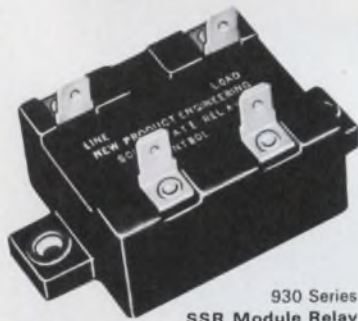

930 Series
SSR Module Relay

So we made it
Right now!
And are ready
to deliver
Right now!

At our prices—
and you can't beat that.
Write for the data.

Also ask about our:

Dry Reed Switches
Proximity Detectors
D.I.P. Reed Relays
Mercury Reed Relays
Dry Reed Relays
Electronic Module Boards

If you don't have our
condensed catalog—
TWX or write for one.

wabash

NEW PRODUCT
ENGINEERING, INC.

A Subsidiary of Wabash Magnetics, Inc.

First and Webster Streets
Wabash, Indiana 46992
Telephone (219) 563-2191

TWX 810-290-2722

INFORMATION RETRIEVAL NUMBER 62

MODULES & SUBASSEMBLIES

Green LED display is
available commercially

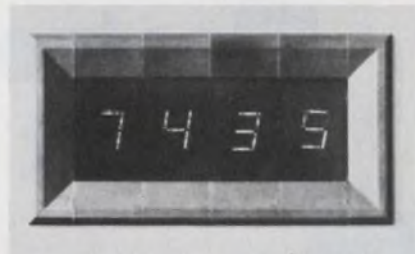

Monsanto Electronic Special Products, 10131 Bubb Rd., Cupertino, Calif. Phone: (408) 257-2140. P&A: under \$10/digit (1000 quantities); stock.

Monsanto has introduced the first commercially available green GaP LED display. The device peaks at 5600Å, very close to the average human eye's response which peaks from 5500 to 5600Å. Except for its thickness of 0.18 in. and 0.125-in. lead length, it has the same physical characteristics as those of the MAN-1A.

CIRCLE NO. 282

11-bit d/a converter
slews at 4 V/μs



Beckman Instruments, Inc., Helipot Div., 2500 Harbor Blvd., Fullerton, Calif. Phone: (714) 871-4848.

A binary 11-bit d/a converter features a 4-V/μs minimum slew rate. The model 848 includes a current-summing ladder network, analog switches, a precision voltage reference, an output op amp and preset scaling and offset adjustment resistors. Additional features include guaranteed monotonicity and electrical specifications from -55 to +125°C. It meets MIL-STD-883 environmental specifications.

CIRCLE NO. 283

Have you filled out your free REQUESTED DATA DELIVERY enrollment form? See card inside front cover.

The SPACE SAVERS from tecnetics .316 CUBIC INCH HYBRID CONVERTERS AND REGULATORS

As a team they're a miniature DC-DC regulated converter. Or, take them individually.



1.05" x .94" x .32"

HC hybrid converter:

- . converts voltages at the point of load
- . output isolated from input
- . 3W output maximum
- . less than 4W input typical
- . outputs to 300 volts

HC hybrid converters:
\$59 hermetically sealed;
\$49 non-hermetic.
1-9 quantity.

VR regulator:

- . maximum output current 250mA with 1W max. internal power dissipation
- . output voltage +3 to +36 or -3 to -36 VDC
- . continuous short circuit protection
- . power dissipation limited

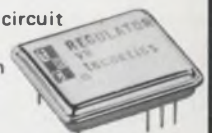

VR regulators: \$39
hermetically sealed only
1-9 quantity.

Hybrid converters and regulators—the space savers from Tecnetics. 2 x DIP mounting and off-shelf delivery.

(See EEM catalog vol.1 pp.880-885)

tecnetics inc.

P.O.Box 910, Boulder Industrial Park, Boulder, Colorado 80302
(303) 442-3837 TWX 910-940-3246

13 and 14-bit a/ds convert to 6 μ s/bit

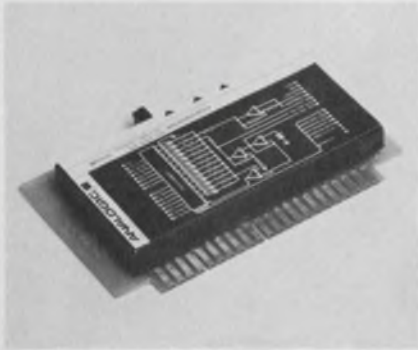

Analogic, Audubon Rd., Wakefield, Mass. Phone: (617) 246-0300. P&A: \$345, \$395; stock to 3 wks.

New series 2813 and 2814 13 and 14-bit monolithic hybrid a/d converter modules feature accuracy to $\pm 0.01\%$ of full scale, stability to 6 ppm and an adjustable clock of 2 to 6 μ s/bit. Their precision voltage switches track over the range of 0 to $+70^\circ\text{C}$. Input options of +5 V, +10 V, ± 5 V, ± 10 V and ± 10.24 V full scale may be specified. An optional input amplifier can be supplied in several gain ranges.

CIRCLE NO. 284

Tiny 0-to-32-V supply delivers up to 1.75 A



Faratron Corp., 290 Lodi St., Hackensack, N.J. Phone: (201) 488-1440. P&A: \$95; 3 days.

The model MR-95 is a 0-to-32-V dc supply with a 175 A output capability. A front-panel slide switch enables the user to select either 0-to-16 or 16-to-32-V dc ranges. The supply has a constant-current limiting feature and line and load regulation of $\pm 0.005\%$ for rated input changes and no load to full load respectively. Ripple is under 0.5 mV rms.

CIRCLE NO. 285

regulates to 150 watts...

New Ledex LMR-4
thick film voltage regulator

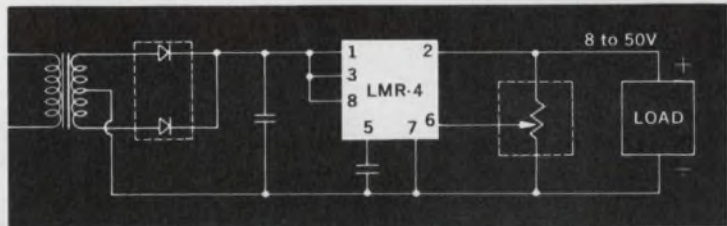

Typical application and connection diagram. Also available with built-in rectification and pre-set output voltage from 8 to 50 VDC.

Typical Specifications ($T_a = 25^\circ\text{C}$)

Parameter	Typical	Maximum
Input voltage	—	60V
Output voltage	8 to 50V	
Load current	1 amp	3 amp
Line regulation, basic mode	0.02%	0.2%
Load regulation, basic mode	0.2%	0.5%
Power dissipation	10 watts	25 watts

Here's a 1 ampere precision regulator with a 0.02% load regulation tolerance. You can go all the way up to 25 amperes with it by simply adding pass transistors... and still hold a respectable 2% variation.

The new LMR-4 comes with a built-in FET current source, so you get excellent ripple rejection (40 db minimum). And you can put your whole regulator circuit on one tiny board, because its design simplicity lets you get by with small and inexpensive capacitors.

Maybe you already know Ledex as the company with the positioning and switching technology people. We're also the people to see when it comes to blending microelectronic miniaturization and low logic levels with the higher current and voltage levels you need to drive electromechanical products.

For more information on Ledex standard and custom pulsers, drivers and regulators, ask for Catalog E-6000. Or, give us a call and let's talk about your application.

LEDEX the total technology people

LEDEX INC.
123 Webster Street
Dayton, Ohio 45401
(513) 224-9891

POSITIONING • SWITCHING • MICROELECTRONICS
INFORMATION RETRIEVAL NUMBER 64

*Come
Aboard The
Ad-Venture
of the Year!*



We'll send you on the vacation cruise of a lifetime if you can choose the ten ads appearing in the January 6th, 1972 issue that get highest reader recall "seen" scores in the same ranking as selected by readers. It only takes a little time and some marketing smarts to enter. And it's fun to see if you can outsmart the experts! It may be your ticket to winning these nifty prizes:

1st PRIZE—10 unforgettable days for 2, cruising the storied Caribbean aboard the coveted Windjammer schooners. Sunshine and blue water unlimited...enough out-of-the-way beaches and tropical lagoons to last a lifetime of memories. **AND** round-trip luxury flights for 2.



2nd PRIZE—Heathkit 25-inch Solid State Color TV. World's most unique color TV, ultra rectangular, largest picture in the industry.



3rd PRIZE—Brother miniaturized Desk-Top Digital Calculator—and 100 other prizes.



Nothing to write, no gimmicks—all you need do is check the ads carefully and pick those you think have the most memorable information and data and will be best read by your colleagues in engineering and management. It's the one contest that tests your marketing sense. It proves, once more, that computers can't do everything.

Electronic Design

1972 TOP TEN CONTEST

*More Prizes, More Excitement,
More Fun Than Ever Before!
It's All In The January 6th Issue.*

FOLLOW THESE EASY STEPS...IT
COULD BE YOUR FIRST STEP TOWARD
A CARIBBEAN CRUISE!

1. Look over the January 6, 1972 issue with extra care.
2. Pick the 10 ads that you think will be the best read in the Jan. 6 issue.
3. List your selections on the specially provided Top Ten entry blank available in the January 6, 1972 contest issue.
4. Mail to Electronic Design before midnight, March 15, 1972.

This year the Top Ten ads will again be selected on the basis of "Recall Seen" scores. This means that attractive, well-designed ads in smart form will be *on a par* with strong marketing ads... messages that offer dramatic news, give complete product data and features in compelling copy terms...ads that produce purchasing action for advertisers.

The judges will select winning entries based on the "seen" category of Reader Recall—Electronic Design's method of measuring readership in the contest issue. Remember, in selecting your Top Ten list of ads, be sure to watch for both the graphic form and appealing words that you think would stimulate a strong sales reaction from our 74,000 engineer subscribers.

READ THE RULES CAREFULLY, EXAMINE THE ADS, MAIL IN YOUR ENTRY BEFORE MARCH 15, 1972, AND THIS YEAR YOU MAY BE THE WINNER OF THE WINDJAMMER CRUISE OF A LIFETIME!

ENTRY FORMS IN THE JANUARY 6TH ISSUE

1972 TOP TEN READER CONTEST RULES

1. Enter your Top Ten selections on the entry blank provided, or on any reasonable facsimile. Be sure to indicate the names of the advertiser and page number for each of your choices. These choices should be placed in the order you think readers will rank them. (Ads placed by Hayden Publishing Company in Electronic Design should not be considered in this contest.)
2. No more than one entry may be submitted by any one individual. Entry blank must be filled in completely, or it will not be considered. The box on the entry blank marked "Reader Contest" must be checked. Electronic Design will pay postage for official entry blanks only.
3. To enter, readers must be engaged in electronic design engineering work, either by carrying out or supervising design engineering or by setting standards for design components and materials.
4. No cash payments, or other substitutes, will be made in lieu of any prize.
5. Contest void where prohibited or taxed by law. Liability for any taxes on prizes is the sole responsibility of the winners.
6. Entries will be compared with the "Recall Seen Most" category of Reader Recall (Electronic Design's method of measuring readership). That entry which in the opinion of the judges most closely matches the "Recall Seen Most" rank will be declared the winner.
7. In case of a tie, the earliest postmark will determine the winner. Decisions of Top Ten contest judges will be final.

THERE IS A SEPARATE CONTEST— SEPARATE PRIZES FOR ADVERTISERS

Each advertisement ranking in the Top Ten will receive a free rerun. In addition there is a separate contest, separate prizes for advertisers. The 3 winners can also receive free ad reruns. SEE THE LAST PAGE OF THE JAN. 6, 1972 ISSUE FOR RULES AND PRIZE INFORMATION.

Waiting
for
you...



Your copy
of the best
dc power supply
catalog
in the world.

- Forty-two informative pages
- Specifications
- Drawings
- Photos
- Selection guide
- Prices

To get your copy, write Acopian Corp., Easton, Pa. 18042, or call (215) 258-5441. And remember, every power module you order from it will be shipped with the best tag in the world...



INFORMATION RETRIEVAL NUMBER 65

MODULES & SUBASSEMBLIES

7-segment LED displays
come in 4-digit arrays

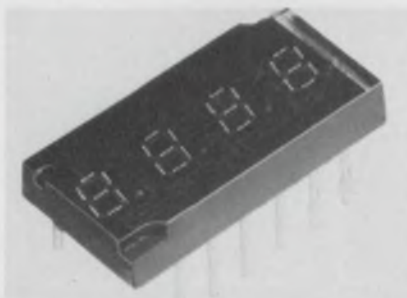

Litronix, 19000 Homestead Rd., Cupertino, Calif. Phone: (408) 257-7910. P&A: \$3.80/digit (1000 quantities); stock.

A new four-digit array of seven-segment LED displays is the Data-Lit 34 which has 0.125-in.-high characters and exhibits four times the light-emitting area as the MAN-3A, its nearest competitive device. It has brightness of 200 foot-lamberts at 5 mA. In pulsed operation, with average current as low as 2 mA, the device has a typical brightness of 100 foot-lamberts. The four digits are mounted in a standard 14-pin DIP on 0.187-in. centers and can be stacked end-to-end.

CIRCLE NO. 286

Reference amplifiers
start from 10-ppm TC



Centralab Semiconductor, 4501 N. Arden Dr., El Monte, Calif. Phone: (213) 686-0567. P&A: from \$4.25 (1000 quantities); 4 to 6 wks.

A new family of stable reference amplifiers for use in precision measuring applications includes the CH2001 through CH2004 which exhibit reference-voltage temperature coefficients of ± 10 , ± 25 , ± 50 and ± 100 ppm/ $^{\circ}\text{C}$, respectively. The new amplifiers consist of matched npn transistor and reference-diode chip combinations in TO-12 packages (4-pin TO-5s). Operating temperature range is from 0 to $+75^{\circ}\text{C}$.

CIRCLE NO. 287

Portable Guardmate™

the Secret's
in the
Third Lead!



In addition to the conventional red and black test leads, our Portable GUARDMATE has a third lead which offers an exclusive In-Circuit testing capability. The third lead puts a patented Guard Circuit to work, electronically isolating the component under test from all unwanted parallel circuit paths. This is the same Guard Circuit that has been proven by years of operation in Systomation's \$40,000 production PC board testing systems.

The Portable GUARDMATE not only tests capacitors, resistors, diodes, transistors, SCRs and ICs with $\pm 3\%$ accuracy, but it is the only inexpensive, portable instrument that can make in-circuit tests of such components on PC boards. You may save half your testing and troubleshooting costs simply by using the Portable GUARDMATE, the test instrument with the third lead. IN-CIRCUIT-TESTING is as simple as A,B,C! To test R_1 , connect test leads to A and B, and Guard lead to C. Read the meter.

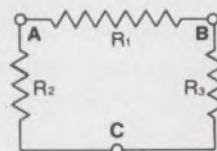

Systomation Inc.

Clifton Park, Elnora, New York 12065
Telephone: 518-877-7424

INFORMATION RETRIEVAL NUMBER 66

ELECTRONIC DESIGN 25, December 9, 1971

Limiter/dead-band units enhance analog designs

Optical Electronics, Inc., Box 11140 Tucson, Ariz. Phone: (602) 624-8358. P&A: \$65, \$32; stock.

Two new analog function modules are available. The model 9005 features independent negative and positive limiting levels and has 0.1% accuracy of input signal and limiting levels. Its gain changes from unity below limiting to less than 0.001 above limiting. Model 9006 is a precision analog dead-band unit. Its output is at zero until the input is above a given positive and negative threshold level. Gain below the threshold is less than 0.01 and unity above the threshold.

CIRCLE NO. 288

D/a converters settle in 20 μ s

Zeltex, 1000 Chalomar Rd., Concord, Calif. Phone: (415) 686-6660. P&A: \$19, \$39; stock.

New ZD429 and ZD433 d/a converters accept 2 and 3-digit BCD inputs and provide corresponding outputs of 0 to +9 V and 0 to +9.99 V. These completely self-contained units have a settling time of 20 μ s and $\pm 1/2$ -LSB linearity. Their temperature coefficient is ± 20 ppm/ $^{\circ}$ C. Additional features include pin-for-pin compatibility between models, adjustable full scale and zero offset, DIP socket compatibility and a 16-h burn-in at 85 $^{\circ}$ C to ferret out infant mortality.

CIRCLE NO. 289

Digital-to-sine/cosine converter uses 1.2 W

Progressive Technology, Inc., 1019 Westminister Ave., Dix Hills, N.Y. Phone: (516) 586-6382. P&A: \$385; stock.

A new low power digital-to-sine/cosine dc converter is the model DSC-1212 which features a total power consumption of only 1.2 W. Its accuracy is a full 12 bits $\pm 1/2$ LSB. The analog outputs are 10-sine θ and 10 cosine θ with a temperature dependence of 10 ppm/C maximum. The converter is a module 3.5-in. long by 2.5-in. wide by 1.25-in. in diameter.

CIRCLE NO. 290

NOW, A COMPLETE REFERENCE ON OP AMP THEORY, CIRCUIT DESIGN, APPLICATIONS AND TEST METHODS

OPERATIONAL AMPLIFIERS

DESIGN & APPLICATIONS

PUBLISHED BY McGRAW-HILL
WRITTEN BY BURR-BROWN

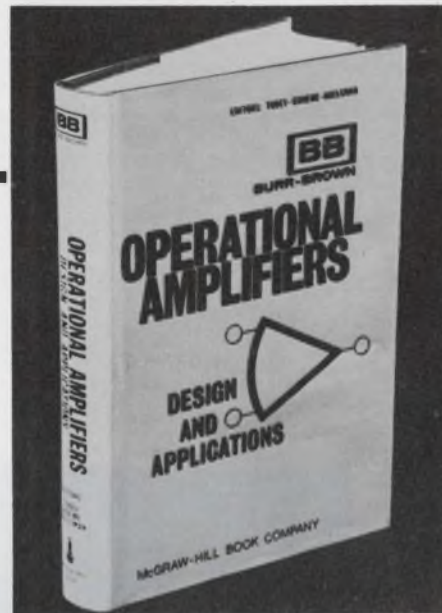

This is the first reference work to present **complete** information on operational amplifiers, both ICs and discretics. It's the result of over 2 $\frac{1}{2}$ years of effort by the applications and engineering staffs of Burr-Brown — the same team which authored two smaller op amp handbooks so popular that over a quarter of a million copies were distributed. Both the **design** of operational amplifiers and their **use** are covered in the more than 500 pages and 300 illustrations. Five chapters are devoted to the internal design of op amps. Six chapters deal with circuit applications. Another portion of the book covers basic op amp theory and test methods.

Performance parameters are thoroughly discussed and test circuits are explained. Truly a valuable reference of daily use to circuit and systems designers.

U.S. PRICE 15 DOLLARS. ORDER YOURS TODAY

Outside USA include the U.S. price of 15.00 dollars plus postage for each book (payable to Burr-Brown Research Corporation). Postage to countries outside the USA and Canada is as follows:

	<u>Air Mail</u>	<u>Surface Mail</u>
South America & Western Europe	\$5.30	\$1.80
Africa, Australia, India, Israel, Japan, New Zealand	\$7.80	\$1.80



BURR-BROWN
RESEARCH CORPORATION
International Airport Industrial Park • Tucson, Arizona 85706

(B-4)

Please send me () copies of "Operational Amplifiers-Design and Applications."
My payment is enclosed.

Name: _____

Company: _____

Mail Station or Dept.: _____

Address: _____

City: _____

State: _____

Country: _____

INFORMATION RETRIEVAL NUMBER 67

Easy reader.

Clearly the best 4 digit DVM around. Our new 351 combines a bright new L.E.D. display and function indicator with the time proven performance and reliability of dual slope integration. Autorange; 80% overrange capability; four ranges of DC. Set it manually for 1-10 readings per second (twice the readings you'd expect). All standard.

Easy reader features easy access, too. Slide the top back. It's all right there. In cards, plug and package

size, completely interchangeable with our popular 350.

And if you can use DC Millivolts, AC Volts, Ohms, BCD outputs with remote programming, and/or an external reference option, this is our DVM. Price? We made that easy, too. \$749 base cost, including the tightest warranty in the business.

Call collect for immediate requirements. Data Technology Corporation, 2700 S. Fairview St., Santa Ana, California 92704 (714) 546-7160.

Data Technology



INFORMATION RETRIEVAL NUMBER 68

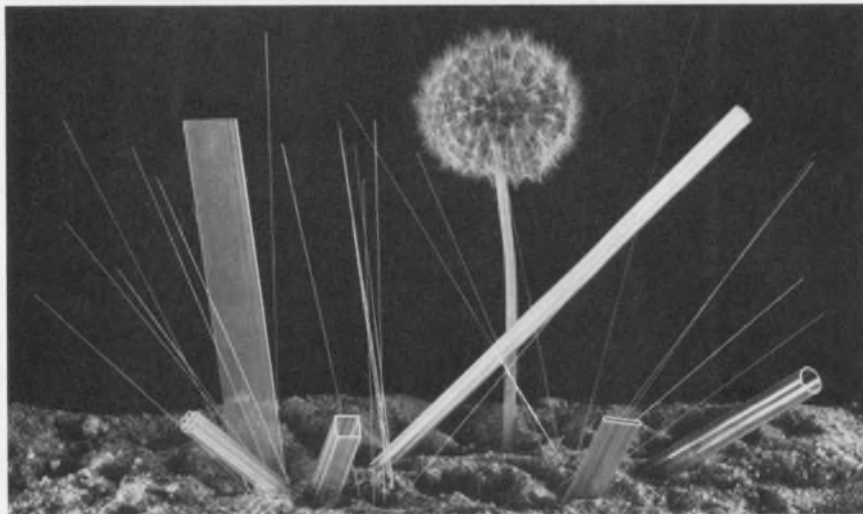

We grow sapphire... to spec

We grow sapphire in many shapes for many people. Flat sapphire ribbon for electronics. Capillary tubes for medicine. Lamp tubes for high intensity lighting. Nozzle tips for sand blasting. Special shapes for chemistry. Filament for almost anything. Pure sapphire every one.

We grow pure sapphire Saphikon™ to the shape that's specified. In the quantities needed. Grown-to-shape without machining of any type. No microcracks. surface

irregularities or sapphire waste from conventional techniques.

Sapphire shapes and lengths previously unattainable. With all the strength (350,000 psi tensile), hardness (9 on the MOHS scale), transparency, zero porosity, chemical inertness, and thermal, corrosion and abrasion resistance you get with sapphire. Write for our bulletin and see what we can grow for you.

NYCO saphikon division 16 Hickory Dr. • Waltham, Mass. 02154 (617) 890-2400

INFORMATION RETRIEVAL NUMBER 69

PACKAGING & MATERIALS

Beryllia ceramic cases enhance IC packaging

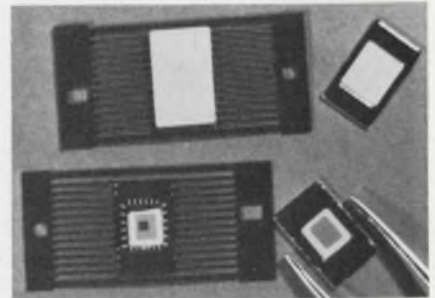

Brush Beryllium Co., Metal and Oxide Div., Elmore, Ohio. Phone: (419) 862-2715.

A full line of new beryllia ceramic flatpack and dual-in-line packages are available for integrated circuit designers. The packages offer substantially lower thermal resistance and superior heat dissipation than either alumina or plastic packages. They are designed for applications in packaging high-speed TTL and ECL integrated circuits.

CIRCLE NO. 291

Single-strip socket holds 25 contacts

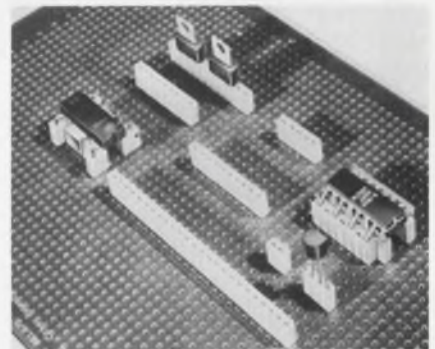

Jermyn, 712 Montgomery St., San Francisco, Calif. Phone: (415) 362-7431. Price: \$1.25.

The A23-2033TR 25-contact single-strip socket provides the ideal answer to most non-standard requirements. This new concept in socket design for IC and semiconductor devices is molded in transparent glass-filled nylon and can accept flat or round leads. It can be cut into any number of contacts and mounted in any configuration on a 0.1-in. matrix.

CIRCLE NO. 292

REQUESTED DATA DELIVERY SERVICE is here—see card inside front cover.

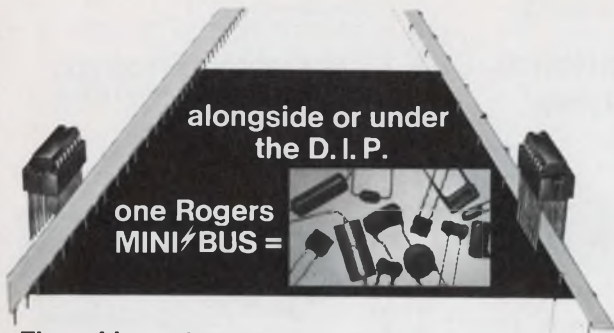

The evidence is accumulating. You may eliminate *all* discrete bypass capacitors — and get a lower-noise printed circuit board at frequencies where it counts — with a single Rogers Mini/Bus.

DELIVERY: Standard configurations are available on short notice. Telephone EAST: (203) 774-9605; WEST: (602) 963-4584 to know where we stand today on your requirements. Ask for our Mini/Bus brochure, showing standard parts.

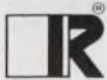
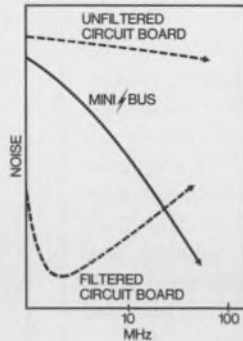

Rogers Corporation Rogers, Conn. 06263 (203) 774-9605

INFORMATION RETRIEVAL NUMBER 70

tran-tec

IMPROVED-DESIGN HEAT SINKS



COMPLETE LINE OF
FORCED AIR

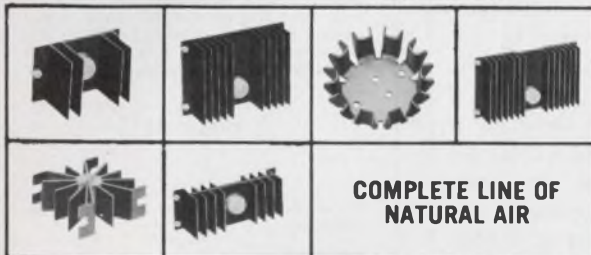

COMPLETE LINE OF
NATURAL AIR

We fabricate heat sinks to your specifications. Write for NEW CATALOG.

tran-tec
CORPORATION
P.O. Box 1022 — Columbus, Nebr. 68601

INFORMATION RETRIEVAL NUMBER 71

ELECTRONIC DESIGN 25, December 9, 1971

You say you want a

low-profile snap-in-mounting push button switch or matching indicator that is interchangeable with most 4-lamp displays ... available in a full range of cap colors ... with a choice of bezels with or without barriers in black, gray, dark gray or white.



and a

legend presentation that's positive (like this one) or negative (like the one below) or just plain (like the one above) ... one that's white when "off" and red, green, yellow (amber), blue or light yellow when "on" ... or colored both "on" and "off."



and a

highly reliable switch proven in thousands of installations ... available in momentary or alternate action ... N.O., N.C. or two circuit (one N.O., one N.C.) ... that accommodates a T-1 1/4 bulb with midget flanged base, incandescent, in a range of voltages from 6-28V.



etc.
etc.
etc.

Now, for the first time Dialight gives you custom panel designing with a standard line of push-button switches and matching indicators

Dialight offers a broader range of switch and indicator possibilities than you'll find anywhere in a standard single-lamp line. Sizes: 3/4" x 1", 5/8" and 3/4" square and round. Send today for our new catalog.

DIALIGHT

Dialight Corporation, 60 Stewart Ave., Brooklyn, N. Y. 11237

DT-125

INFORMATION RETRIEVAL NUMBER 72

103

**ONLY
TUNG-SOL
PERFORMANCE
IS
LARGER**

Tung-Sol single phase and three phase bridge rectifiers come in standard size packages. It's their current ratings and forward surge ratings that are larger. They give you added performance reliability — and at no additional cost!



B-10 series

DC rating — 30A @ 55°C. Forward surge rating—400A @ rated load. B-10 series replace similar bridges rated from 8 to 25A and from 50 to 1,000 PRV per leg.

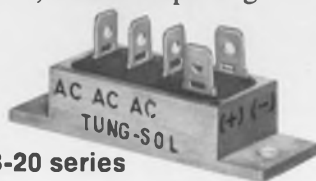

B-20 series

DC rating — 35A @ 55°C. Forward surge rating—400A @ rated load. B-20 series replace similar bridges rated up to 25A and from 50 to 1,000 PRV per leg.

SILICON POWER RECTIFIERS
Tung-Sol makes a complete line of high reliability silicon power rectifiers in the DO-4, 5, 8, 9 and 21 configurations.

WRITE FOR TECHNICAL INFORMATION
SPECIFY BRIDGES, OR POWER RECTIFIERS.

SILICON PRODUCTS SECTION
TUNG-SOL DIVISION
WAGNER ELECTRIC CORPORATION

630 West Mt Pleasant Ave. Livingston, N.J. 07039

TWX: 710-994-4865 PHONE: (201) 992-1100
(212) 732-5426

Trademark TUNG-SOL Reg. U.S. Pat. Off. and
Marcas Registradas

PACKAGING & MATERIALS

**Component platforms
come in DIP styles**

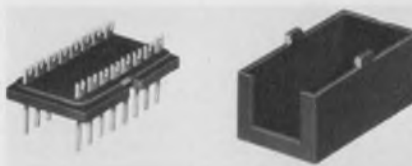

Component Mfg. Service, Inc., 1 Component Park, W. Bridgewater, Mass. Phone: (617) 588-0163. P&A: 62¢ for 14-pin platform with cover (500 quantities); stock to 4 wks.

Versatile low-cost platforms allow mounting of discrete components and constructing electronic circuits. The new units are available in 14 and 16-pin DIP configurations and feature U-shaped solder terminals with round or flat tails that plug into DIP sockets and packaging panels. Snap-on covers are available in five heights and permit encapsulation.

CIRCLE NO. 293

**Transition connector
interfaces backplanes**

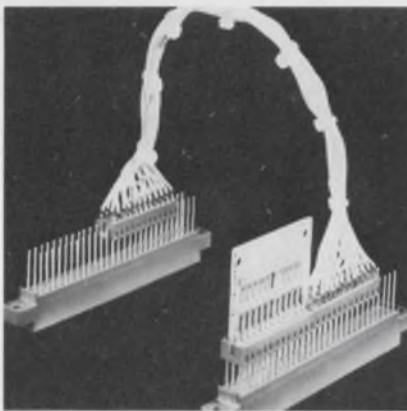

SAE Advanced Packaging, Inc., 2165 S. Grand Ave., Santa Ana, Calif. Phone: (714) 540-9256.

The 2501-24 series multi-purpose transition connector is designed to interface with backplanes. Pin-to-pin compatible with IBM equipment, it can be used as a board-mounting receptacle or as an input-output, cable-end or test-point connector. The connector engages on the third level of 0.025-in. Wire-Wrap pins with conventional 0.125 by 0.25-in. spacing.

CIRCLE NO. 294

A FREE new Hayden Service for you—see card inside front cover.

(Advertisement)

**NEW PRODUCTS FROM EDC
ELECTRONIC DEVELOPMENT CORP.
BOSTON, MASSACHUSETTS**



REFERENCE SOURCE FOR PROCESS CONTROL APPLICATIONS . . . LOW PRICE. A new DC Voltage calibrator, offered by EDC, is specifically optimized for process control. The E 100 C is a calibrator for A/D converters, a computer reference, and a simulator representing transducers such as strain gages, thermocouples, pressure transducers and other analog signal sources. The EDC model E 100 C is very lightweight and inexpensive so that other "on location" applications may include: production line, design lab, QC inspection, and field service. The model E 100 C provides two output voltage ranges: $\pm 10V$ and $\pm 100mV$, plus 10% over range. Resolution on the 10V range is 100 μV , and on the 100mV range the resolution is 1 μV . Output current on the 10V range, with an output impedance of 30 milliohms. The $\pm 0.01\%$ accuracy is defined by the "limit of error" method which is truly the "worst case" specification. The stability is better than $\pm 0.0025\%$. The company is offering instruments for customer evaluation. The weight just 8 pounds. The E 100 C is priced at \$525. Available from stock.

Circle # 238



DIGITALLY PROGRAMMABLE D.C. CALIBRATORS. This series is true digital programming. BCD 8421 or other codes. Programmed from TTL or DTL logic (1.5V logic level swing). Up to 28V logic level swing also available. Programmable constant DC current sources and DC Voltage sources. I_{out} from 1.0 μA to 100mA. E_{out} from 1.0 μV to 100V, plus over-ranging using "illegal codes". Output accuracies 0.01% to 0.02% (using the "Limit of Error" or "Worst Case" concept). Options available to conform to budget as well as engineering requirements. Options: current & voltage compliance, operation, remote sensing, added resolution, binary programming, parallel or serial input programming, and remote control console. Shown here: EDC Model MV 100 P5J with remote control RCM-2. Prices from \$1120 to \$1420. F.O.B. Boston. Delivery: Stock to 30 days.

Circle # 239

Instruments available for no-charge engineering evaluation.



Electronic Development Corporation
11 Hamlin Street • Boston, Mass. 02127
(617) 268-9696

Adapter plug assemblies use snap-open covers

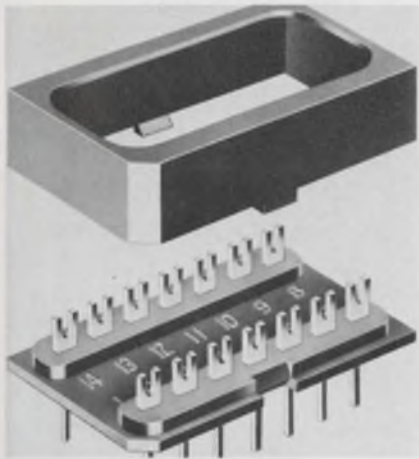

Augat, Inc., 33 Perry Ave., Attleboro, Mass. Phone: (617) 222-2202. P&A: 10¢ to 50¢; stock to 2 wks.

New inexpensive plugs may be used as module bases with open-top snap covers for potting. They are available in 14 and 16-contact configurations with polarization notch and numbers for identification and plug into standard 8136 series IC packaging panels. Plugs and covers are available separately in glass-filled nylon material and gold-over-nickel-plated slotted brass contacts.

CIRCLE NO. 295

Connector-cables stack on 0.1-in. centers

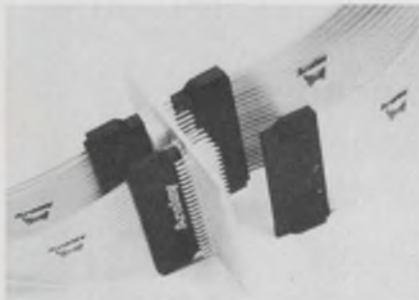

Ansley Electronics Corp., 4100 N. Figueroa St., Los Angeles, Calif. Phone: (213) 223-2333. Price: \$7.50 (100 quantities of 12-in. cable).

New flat Flex-Strip connector-cable assemblies can be stacked row-to-row on 0.1-in. centers. They can easily be plugged into either side of back-panel wiring systems, to pins mounted on circuit boards, to NAFI type hardware and to ends of other cables. Three types of contacts are available.

CIRCLE NO. 296

MECANORMA Symbols. Because thinner layouts print better circuits.

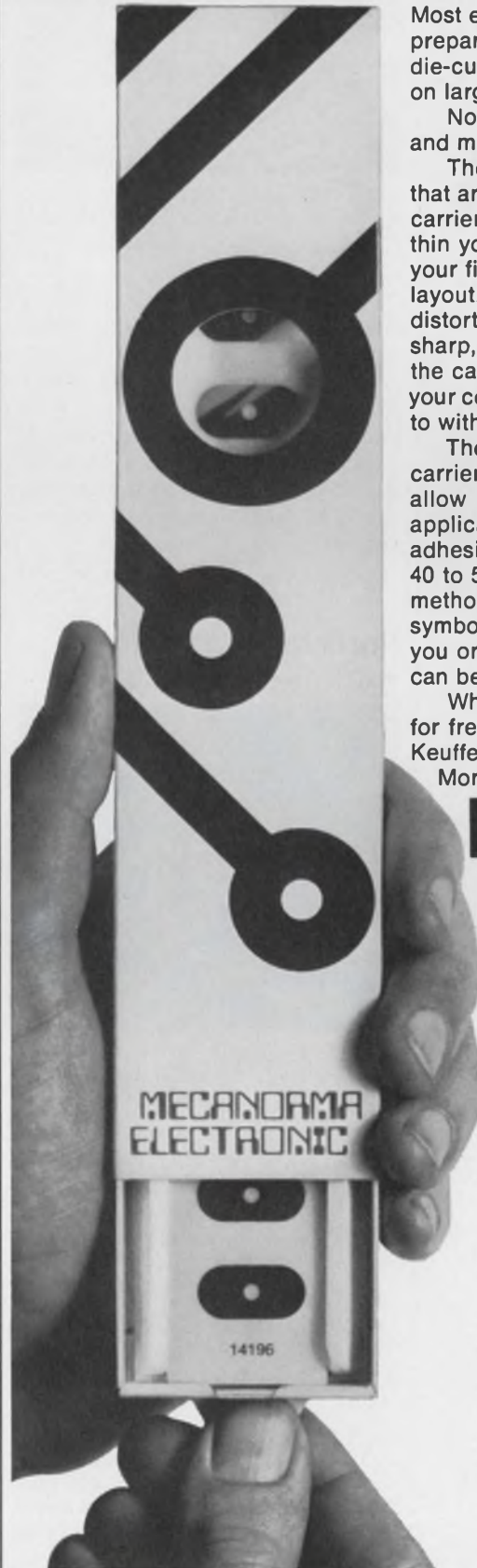

Most electronic symbols used in preparing printed circuit layouts are die-cut from crepe paper and mounted on large sheets or rolls.

Now K&E offers you something new and measurably better.

The MECANORMA System. Symbols that are *printed* on transparent strips of carrier film, only 20 microns thin. So thin you can barely feel the film with your finger, once you press it on the layout. So thin there's no parallax, no distortion, no rough edges—just a sharp, opaque symbol that's ready for the camera. Unaffected by the heat of your copying equipment. And accurate to within 1/1000 of an inch!

The convenient size of MECANORMA'S carrier strips, and their transparency, allow rapid, precise positioning, application and correction (with adhesive tape or blade)...a remarkable 40 to 50% more rapid than other methods! There are more than 800 symbols available, and packaged so you order only those you need. Others can be printed to your specifications.

Why not write us today for free samples and our catalog: Keuffel & Esser Co., 20 Whippany Road, Morristown, N.J. 07960.



KEUFFEL & ESSER CO.

Double Balanced Mixer

price slashed to . . .

\$ 7 95

**DC-500MHz
6dB conversion loss
40 dB isolation
EMI shielded case**



Mini-Circuits Laboratory now offers its model SRA-1 double balanced mixer at an unprecedented low price . . . \$7.95 each in 500 quantity and only \$9.95 each in 6-49 quantities.

Ruggedness and durability are built into the SRA-1. Packaged within an EMI shielded metal enclosure and hermetically sealed header. This new unit uses well matched hot-carrier diodes and uniquely designed transmission line transformers.

In today's tough competitive market can you afford not to use these remarkably low priced and high performance units?

For ordering and technical information call (212) 252-5253.

Mini-Circuits Laboratory

A Division Scientific
Components Corp.

2913 Quentin Rd.
Brooklyn, N. Y. 11229
(212) 252-5252

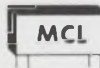

European Representative: S.C.I.E., 31,
rue George-Sand, Palaiseau-91, France

INFORMATION RETRIEVAL NUMBER 75

MICROWAVES & LASERS

Opto-hybrid devices contain sensors/amps

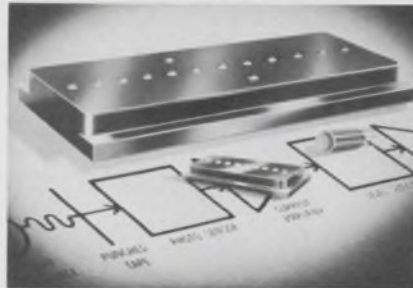

Centralab Semiconductor, 4501 N. Arden Dr., El Monte, Calif. Phone: (213) 686-0567. Availability: 4 to 6 wks.

A new series of standard 1, 9 and 12-position IC chip opto-hybrid devices utilize monolithic IC chip amplifier/digitizers with DTL/TTL-compatible outputs. With built-in light sensors, they provide a complete sub-system with plug-in-and-use convenience for applications of light sensing at precise levels.

CIRCLE NO. 297

Porcelain capacitors work up to 12 GHz



American Technical Ceramics, 1 Nordon Lane, Huntington Station, N.Y. Phone: (516) 271-9600. P&A: from 46¢ (1000 quantities); 2 wks.

The ATC150 series of porcelain microwave chip capacitors has low insertion loss to 12 GHz in capacitance values from 0.1 to 100 pF. The capacitors come in case sizes only 50 mils cube. Their termination material is palladium-silver. Features include power handling of 15 W, 50 WV dc, a TC of +90 ±20 ppm and operating temperature of -55 to +125°C.

CIRCLE NO. 298

Announcing REQUESTED DATA DELIVERY, it's free—see card inside front cover.

WILEY-INTERSCIENCE

3 Technical Tools



DIGITAL DESIGN

By R. K. Richards,
Engineering
Consultant

A practical aid in the design of real machines, **Digital Design** discusses the "logical" or "switching" design of electronic computers and other digital equipment. Including material not previously available in book form, the volume covers all aspects of the subject from basic Boolean notation and component minimization procedures to arithmetic implementation methods and complete digital system considerations.

1971 577 pages
134 illus. \$22.50

SEMICONDUCTOR MEMORIES

Edited by Jerry Eimbinder,
EEE Magazine

Compiled to help the system designer choose the optimum semiconductor approach for his application, this book describes every type of semiconductor memory in use as well as those currently being developed. In twenty articles, some of the outstanding experts in the field of electronics discuss the differences between semiconductor memories in terms of performance, economics, and ease of use.

1971 214 pages
154 illus. \$11.95

MICROPOWER CIRCUITS

By James D. Meindl,
Stanford University

A comprehensive introduction to micropower circuit design, this book deals with the problem of achieving a given electronic circuit function with the minimum possible expenditure of energy. The author shows that the power drain of virtually all basic types of transistor and integrated circuits can be reduced by an order of magnitude or more if appropriate novel micropower design techniques are employed.

1969 260 pages
illus. \$11.50

wiley

WILEY-INTERSCIENCE

a division of JOHN WILEY & SONS, Inc.
605 Third Avenue, New York, N. Y. 10016
In Canada:
22 Worcester Road, Rexdale, Ontario

INFORMATION RETRIEVAL NUMBER 76

ELECTRONIC DESIGN 25, December 9, 1971

V-band power sources deliver up to 75 mW

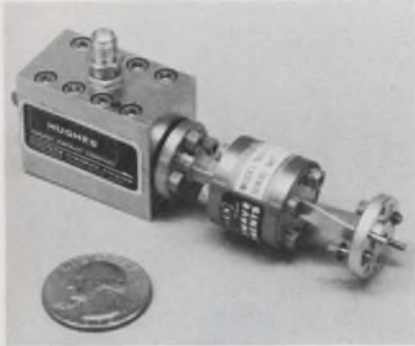

Hughes Aircraft Co., Electron Dynamics Div., 3100 W. Lomita Blvd., Torrance, Calif. Phone: (213) 534-2121. P&A: \$4750, \$4000, \$3000, \$2500; 60 days.

A series of V-band 50-to-75-GHz power sources feature up to 75-mW output power and both mechanical and electrical tuning capabilities. Model numbers 44050H, 44051H, 44052H, and 44053H have 75, 50, 25 and 10-mW outputs at 3%, 2%, 1% and 0.5% efficiencies, respectively. All models have 0.5-GHz minimum mechanical tuning, except for the model 44050H which has a fixed frequency.

CIRCLE NO. 299

Fast photo control unit has 3.5- μ s rise time

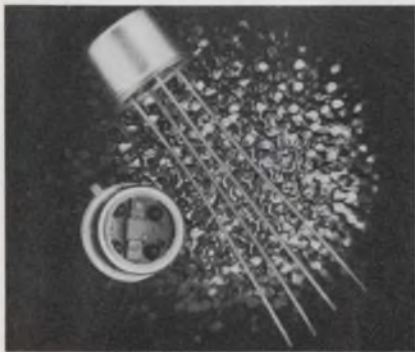

European Electronic Products Corp., 10150 W. Jefferson Blvd., Culver City, Calif. Phone: (213) 838-1912. Price: \$5.77 (100 quantities).

High sensitivity and large angle of opening are featured in a new silicon photo-electronic control unit which contains a silicon photo element, a silicon npn transistor and two silicon diodes. Suitable for direct relay driving, the EPX28 is fast—it has a rise time of 3.5 μ s. It operates from a collector-emitter voltage of 45 V.

CIRCLE NO. 300

New 8-Amp economy SCR makes false triggering passé!

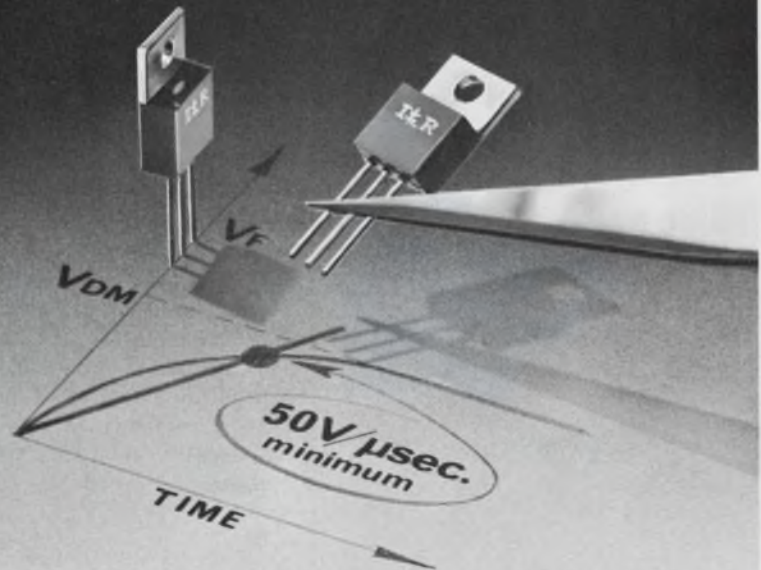

Only IR guarantees minimum dv/dt of 50V/ μ sec. at 110°C (10°C higher than others) that eliminates any chance of erratic "turn-on".

Now you don't have to trade-off reliable performance for price in your economy SCR applications. International Rectifier's new IR122 series gives you all the advantages you wouldn't expect at such low prices. For example, they have the highest minimum dv/dt available (nobody else even specs a minimum), at a full 10°C greater than competitive units. Their characteristics remain stable, even under severe long-term operating conditions, due to IR's advanced passivation techniques. They have round, easily bent leads to simplify mounting. And, you don't have to be concerned about die breakage so often encountered when using the center-mounting-hole packages offered by other suppliers.

They're available now—in 50V, 100V, 200V, 300V and 400V versions—from IR industrial distributors. Contact our local sales office or call factory for details.

INTERNATIONAL RECTIFIER 

Semiconductor Div., 233 Kansas St., El Segundo, CA 90245 • (213) 678-6281

TOROIDAL TRANSFORMERS

Perkin-Elmer guarantees

a response
within

1

week

That's right! Send us your specs for any one of these transformer types -

- Scott T
 - reference
 - isolation
 - resolver isolation
 - tapped autotransformer
- and we'll respond *within one week!* That's a promise - from Perkin-Elmer.

PERKIN-ELMER TRANSFORMERS

INFORMATION RETRIEVAL NUMBER 78

COMPONENTS

Ceramic capacitors come with radial leads

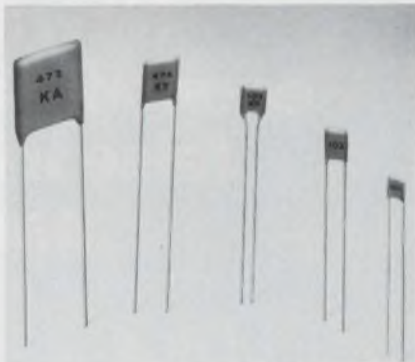

Vitramon, Inc., Box 544, Bridgeport, Conn. Phone: (203) 268-6261.

Two new series of low-cost VK dipped-ceramic capacitors feature radial-lead configurations and 0.1-in. lead spacing. The NPO type BA series is offered in five body sizes and capacitance values ranging from 1 pF to 0.047 μ F at TCs of 0 to \pm 30 ppm/ $^{\circ}$ C. Designers seeking higher volumetric efficiency can obtain the general-purpose type BY series which is offered in four body sizes and capacitance values ranging from 10 pF to 0.47 μ F at TCs of 15%.

CIRCLE NO. 301

Compact plug-in relays feature 5-A capacity

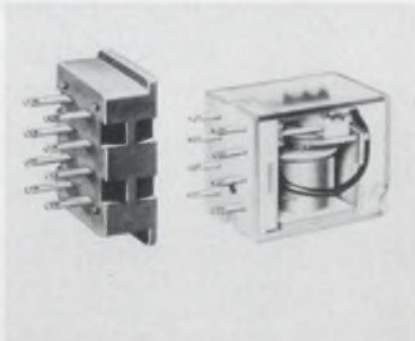

Guardian Electric Mfg. Co., 1550 W. Carroll Ave., Chicago, Ill. Phone: (312) 243-1100.

A space-saving new dpdt series of enclosed plug-in miniature relays feature 5-A control capacity. Series 1330 relays measure 1.1 by 0.744 by 0.894 in. and feature rugged construction with mechanical life of 100 million operations dc and 50 million ac. They are available with a choice of plug-in and printed-circuit terminations.

CIRCLE NO. 302

TOROIDAL TRANSFORMERS

Perkin-Elmer guarantees

a prototype
within

3

weeks

after receipt of order

That's a guarantee from one of the most experienced and respected names in electronics, a company that has been designing and building highly accurate toroidal transformers since 1954.

After you receive our quote, give us the go-ahead and we'll deliver a finished prototype within three weeks!

PERKIN-ELMER TRANSFORMERS

INFORMATION RETRIEVAL NUMBER 79

ELECTRONIC DESIGN 25, December 9, 1971

Thermal ribbon sensors sense -328 to $+500^{\circ}\text{F}$

MINCO Products, Inc., 7300 Commerce Lane, Minneapolis, Minn. Phone: (612) 786-3121. Availability: stock.

Thermal-ribbon temperature sensors are available to provide fast and accurate sensing of air, gas, liquid or solid surface temperatures from -328 to $+500^{\circ}\text{F}$. Two basic sensor types are available to match either new or existing instrumentation: Platinum or nickel-iron element resistance thermometers and thermocouples. Thermal-ribbon temperature sensors can be used in various industrial, commercial and aerospace applications.

CIRCLE NO. 303

High-speed TV camera tubes widen video band

ITT Electron Tube Div. of ITT Corp., 3700 E. Pontiac St., Fort Wayne, Ind. Phone: (219) 743-7571.

Two high-speed Vidisector TV camera tubes, the F4077 and F4087, are available for modulated-carrier laser tracking and high-information-rate scanning systems where wide video bandwidths (745 MHz) are required. Both have focused, high-speed electron multipliers. In addition, the F4087 has an evaporated image-section wall electrode that reduces high-scan-speed eddy current losses. Various input windows and photocathode spectral sensitivities can be provided to cover the UV, visible, and near-IR spectral regions.

CIRCLE NO. 304

Time-delay relay includes bezel mount

Potter & Brumfield, 1200 E. Broadway, Princeton, Ind. Phone: (812) 385-5251. Price: \$36 to \$50.

A new bezel-mount solid-state time-delay relay designated the PT series is available. The PT relay is an improved design over the usual motor-driven timers that require mechanical speed reduction. It is engineered for easy front-panel mounting and time-adjustment accessibility. A large knurled knob and an easy-to-read time selector dial allows convenient time-setting changes.

CIRCLE NO. 305

TOROIDAL TRANSFORMERS

Perkin-Elmer guarantees

a prototype at least

10%

more accurate

size for size, than any other prototype you have received from any other company.

If it's not, you pay *nothing*.

There's our offer: a response within *one* week, a prototype within *three* weeks. And a prototype that's 10% more accurate or *it's free*.

If you're working on a project right now, and want to take immediate advantage of this offer, phone Larry Kovarovic at (203) 762-4786. Or send us your specifications directly.

If you want more information, including technical data on Perkin-Elmer transformers, circle the reader inquiry number. Electronic Products Dept., Perkin-Elmer Corp., 131 Danbury Road, Wilton, Conn. 06897.

PERKIN-ELMER TRANSFORMERS

4-pole monolithic filter fits on a TO-5 holder



McCoy Electronics Co., Mount Holly Springs, Pa. Phone: (717) 486-3411.

Ideal for miniature receivers and paging systems, two two-pole monolithic units are contained within one TO-5 holder to yield a four-pole design. The resultant four-pole filter has a center frequency of 20 MHz, minimum 3-dB bandwidth of 16 kHz and insertion loss of 3-1/2 dB maximum. Its ripple is 0.5 dB.

CIRCLE NO. 306

14-mil lithium cores increase memory speeds

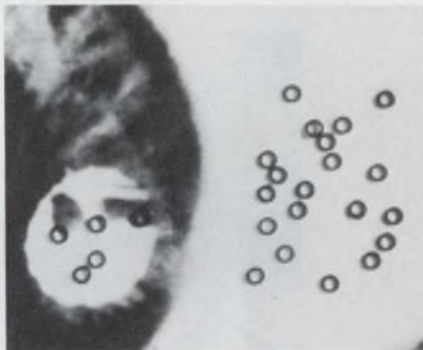

Data Products Corp., 6219 Desoto Ave., Woodland Hills, Calif. Phone: (213) 887-8246.

New 14-mil lithium memory cores are available to offer memory peaking speeds of 50 ns and switching times of 100 ns. The fast-switching cores, designated MT-1401, can make possible a 4K-word by 18-bit memory system with an access time under 235 ns and a cycle time of less than 500 ns. Such a system is also very compact—it can be readily fabricated on a 4-in.² circuit board.

CIRCLE NO. 307

Have you filled out your free REQUESTED DATA DELIVERY enrollment form? See card inside front cover.

LOW-COST

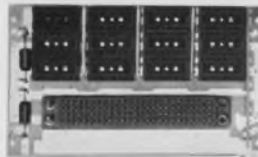
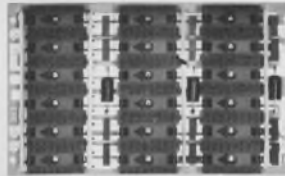
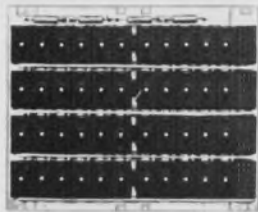

LOGIC PANELS

Now from EECO, logic hardware and low-cost come together, all you need is your design and you've got it made.

KITS ... Take advantage of new low-cost (S186 up) breadboard kits — everything you need including modular socket boards with more location flexibility from 14, 16, and 28 pin IC assemblies. We'll send you frames, boards, plugs, clips, terminals and enough wire to wrap up the job. Even a wire wrapping tool and power supply, if you like. And EECO provides an advanced power distribution system to knock out high speed switching transients, so you maintain full noise immunity.

PANELS ... World's largest selection of sockets, panels, drawers and special assemblies — everything to implement your IC logic design. Low-cost, high density, socket modularity and fast delivery, all combined to give the ultimate in design flexibility. If you want more help from us than that, ask about our computer-aided-design and wire wrap service — from logic diagram to wired hardware in 4 weeks. If you're thinking logic design, EECO's thinking of you.



Send for the latest kit information in the new hardware supplement.

ELECTRONIC ENGINEERING COMPANY of California

ELECTRONIC PRODUCTS DIVISION • 1441 E. Chestnut Avenue • Santa Ana, California • Phone: (714) 547-5651

TWX 910-595-1550

Telex 67-8420

INFORMATION RETRIEVAL NUMBER 81



There are holes in the type bar.

A phototransistor unit detects code holes in each type bar to provide photoelectric readout. This is a unique sensing method and enables you to make:

- Parity checking right from the source
- Type bar velocity check
- Echo check

There is further interesting information on the new Facit 3851 in this publication.

Facit 3851 — the conventional typewriter with input/output



For further information, contact in US: Facit-Odhner Inc., 501 Winsor Drive, SECAUCUS, New Jersey outside US: Facit AB, Albygatan 102, 171 84 Solna, Sweden

INFORMATION RETRIEVAL NUMBER 82

evaluation samples

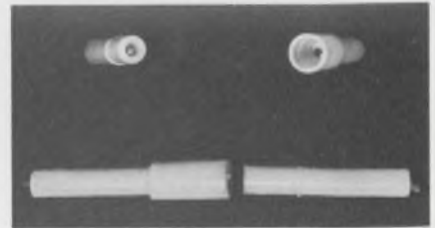

High-voltage connector

A new high-voltage single-circuit connector with 0.093 in.-dia. terminals is designed for 5000-V use. Plug and receptacle model 1951 in the 03-09 connector series was designed as a focus connector for solid-state color TV sets. It is also adaptable for any single-circuit high-voltage use within specifications. Standard 0.093-in. crimp-type terminals are housed in the connector. The female plug is designed with a 7/16-in.-dia collar that is 7/8-in. long over the terminal connecting length. Plug diameter is 15/16 in. for the balance of the connector's length of 2-1/4-in. The mating receptacle has a 5/16-in. outside dia and is 1-55/64-in. long. Detailed engineering specifications and a free sample are available. Molex Inc., Downers Grove, Ill.

CIRCLE NO. 340

Aluminum-foil nameplates

A new aluminum foil mylar-laminated nameplate is designed to substantially reduce the overall cost of making and attaching serial nameplates. The nameplate with Pres-a-ply self-adhesive backing offers several unique advantages over rigid stamped metal types. It eliminates die-setting and can be embossed on a standard Dennison dial-set printer—in-plant and on-line—at the rate of 165 plates/minute. The new nameplate adheres easily and permanently and eliminates the need for screws and rivets. This reduces the cost of preparation and the time-consuming labor involved in attaching metal nameplates. Free samples are available. Dennison Mfg. Co., Marking & Attaching Systems Div., Framingham, Mass.

CIRCLE NO. 341

application notes



The time-delay handbook

Magnecraft Electric has just come out with its revised fourth-edition of the "Designers' Handbook & Catalog of Time-Delay Relays." This handy 92-page reference is divided into two main sections—a handbook section and a catalog section. The handbook section offers a glossary on time-delay terms, discusses their styles, characteristics, principles of operation and application and design considerations. A comparison is made between electromechanical and solid-state time-delay relays. The booklet also shows designers how to specify time-delay relays and details various testing procedures. Magnecraft Electric Co., Chicago, Ill.

CIRCLE NO. 342

Logic design

An application note shows how the circuit designer, faced with solving logic noise problems, can quickly overcome these problems with a few simple design techniques. The note discusses industrial applications of high-noise-immunity logic to replace switches, latching and stepping relays and mechanical counters. Teledyne Semiconductor, Mountain View, Calif.

CIRCLE NO. 343

VACTEC

"PLASTIC" PHOTOCELLS

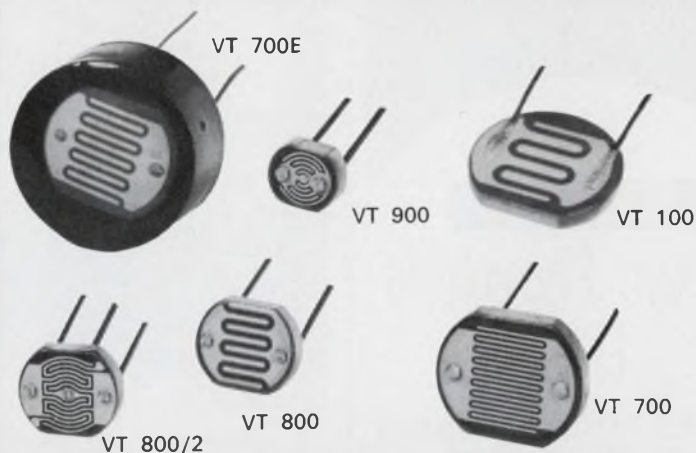

Twice actual size, priced as low as .25 each ($\pm 33\%$ tolerance) in 10,000 quantities.

EVEN LOWER FOR $\pm 50\%$ TOLERANCE

Low Cost Way to Meet Most Photocell Requirements

Here is a complete line made with the same quality characteristics and precise tolerances by the originator of the first **stable** plastic coated cell. Six different thin-film materials of CdS and CdSe deposited on ceramic substrates. A VACTEC development with almost 10 years of production experience. When others said it couldn't be done — we were doing it! NOW improved passivation processes make them better than ever. Why experiment — buy where the experience is. The proof — they have been used in **millions** of cameras all over the world!

The newest addition is the VT 800/2 series, a dual element cell with bifilar type electrode for two-cell controls from a single light source. The expanded line also includes the epoxy encapsulated VT 700E series for protection against humidity and salt spray.

Costing less than $\frac{1}{2}$ of hermetically sealed cells, they have excellent resistance to humidity, eliminating need for hermetic cells in **most** applications. VACTEC "plastic" photocells are conveniently controlled by ambient light or from closely coupled low voltage lamps. Industrial and commercial applications, like controlling relays in line voltage circuits; switching SCR's on or off; phase control and proportional circuits; audio controls; and feedback elements for motor speed controls in consumer appliances.

Series Type	Substitutes for hermetic type
VT 100	TO-8
VT 700 and VT 700E	TO-8
VT 800 and VT 800/2	TO-5
VT 900	TO-18

Write for Bulletin PCD-6, PCD-41, 57, 58, and 59. Ask about our new Photometer which measures light as low as .0002 fc. Priced less than \$300.00.



VACTEC, INC.

2423 Northline Ind. Blvd. • Maryland Heights, Missouri 63043
(314) 872-8300

Specializing in standard Cds, Cdse, and Se cells. Custom engineering for every photocell need. Listed in EBG under "Semi-Conductors" and EEM Sec. 3700.

OPCOA

lamps and displays

with

SOLID-LITE

Gallium Phosphide LED's..

THE HIGH-EFFICIENCY DIODES FOR BRIGHT LIGHT AT LOW CURRENT.

New SOLID-LITE SLA-3 Numeric Display with 0.8-in. character

- Largest available solid state numeric display
- Low voltage operation compatible with TTL and DTL IC's
- Single-plane wide viewing angle
- High reliability — 200,000-hr. half life
- Excellent shock and vibration resistance
- Thin package — 0.100-in. lead spacing

New SOLID-LITE OSL-3 and -3L Lamps with exceptionally wide viewing angle

- Large 0.200-in. diameter lens with long or short dome
- Red or clear lens available
- Low voltage, low power operation
- Area light source — not a pinpoint
- IC compatible
- Excellent shock and vibration resistance
- High reliability — 200,000-hr. half life
- Socket or soldered mounting — 0.100-in. lead spacing
- Low cost

For technical information or applications assistance, contact OPCOA, Inc., 330 Talmadge Road, Edison, New Jersey 08817; (201) 287-0355; TWX 710-998-0555.

OPCOA

INFORMATION RETRIEVAL NUMBER 84

new literature

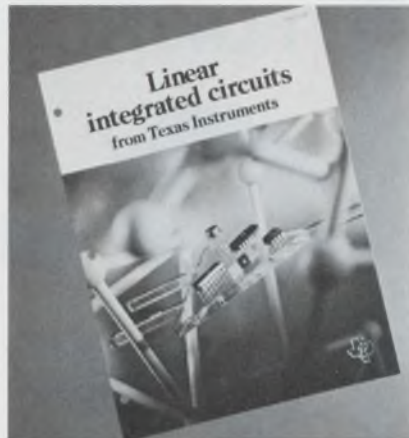

Linear ICs

A new linear IC brochure describes Texas Instruments' complete line of linear ICs. The six-page bulletin covers differential video amplifiers, op amps, communications circuits, voltage comparators, line drivers and receivers, peripheral drivers, sense amplifiers and memory drivers. A full page is devoted to 16 recently announced computer systems interface circuits. Texas Instruments Inc., Dallas, Tex.

CIRCLE NO. 344

Transistor sockets

A new eight-page catalog supplement introduces a broad line of standardized transistor sockets and allied mica insulators and mounting hardware for use with TO-3, TO-66, npn/pnp plastic silicon and hybrid power transistors. Keystone Electronics Corp., New York, N.Y.

CIRCLE NO. 345

NBS time standard

A brochure is available explaining the NBS's current experiment which utilizes a geostationary satellite to broadcast standard time and frequency information and encourages interested parties to participate in the experiment. Included in the brochure is a block diagram and explanation of a typical receiver system and its requirements. Previous experiments with other satellites are also described. U.S. Dept. of Commerce, National Bureau of Standards, Boulder, Colo.

CIRCLE NO. 346



Miniature HV supplies

Miniature high-voltage power supplies are comprehensively described in a 30-page catalog. The booklet contains complete specifications and descriptions of many high-voltage units designed for use with photomultiplier, CRT image-intensifier and night-vision gating systems. Background data and a capabilities index are included for ready reference. Venus Scientific Inc., Farmingdale, N. Y.

CIRCLE NO. 347

Stepper motors

A four-page bulletin describes a series of high-energy permanent-magnet stepper motors. A. W. Haydon Co., Waterbury, Conn.

CIRCLE NO. 348

Terminal boards

A booklet provides technical data on a wide variety of insulated feed-through terminal boards. Kulka Electric Corp., Mount Vernon, N.Y.

CIRCLE NO. 349

Motor starters

A handy guide simplifies selection of three-phase solid-state motor starters. Fractional 2, 5 and 10-hp motor ratings are included. Hamlin Electronics, Inc., Lake Mills, Wis.

CIRCLE NO. 350

Chip capacitors

A new four-page brochure describes and illustrates a series of monolithic ceramic chip capacitors. Gulton Industries, Inc., Metuchen, N.J.

CIRCLE NO. 351

Radio Shack catalog

Radio Shack's new 1972 electronic equipment catalog features four-channel quadraphonic stereo equipment as well as a complete line of conventional audio components. The 92-page full-color catalog includes Radio Shack's Allied and Realistic brand radios, phonos, shortwave receivers, police band monitors, home and auto tape players and intercoms. Radio Shack, a Tandy Corp., Fort Worth, Tex.

CIRCLE NO. 352

Adhesives selector

To make a designer's job a little easier, Emerson & Cuming, Inc., offers a newly revised Eccobond adhesive selector chart in the form of a folder suitable for notebook or wall mounting. The folder describes 17 non-conducting and 9 electrically conductive adhesives. Emerson & Cuming, Inc., Canton, Mass.

CIRCLE NO. 353

Power supplies

A 27-page catalog lists over 1000 models of dc-to-dc power supplies with single, dual, triple and quadruple outputs up to 20 W. Mil Electronics, Inc., Lowell, Mass.

CIRCLE NO. 354

Thick-film pastes

A four-page brochure contains information on thick-film pastes for hybrid ICs, ceramic packaging, digital displays and microcircuit applications. Electro-Science Laboratories, Inc., Philadelphia, Pa.

CIRCLE NO. 355

GaAs lasers/IR diodes

A catalog describes GaAs injection lasers and IR-emitting diodes. RCA Solid State Div., Somerville, N.J.

CIRCLE NO. 356

Potentiometers/trimmers

An easy-to-use short-form reference catalog features quick access to a diverse line of trimmers, potentiometers, pressure transducers and switches and turns-counting dials. Amphenol Controls Div. of Bunker Ramo Corp., Janesville, Wis.

CIRCLE NO. 357

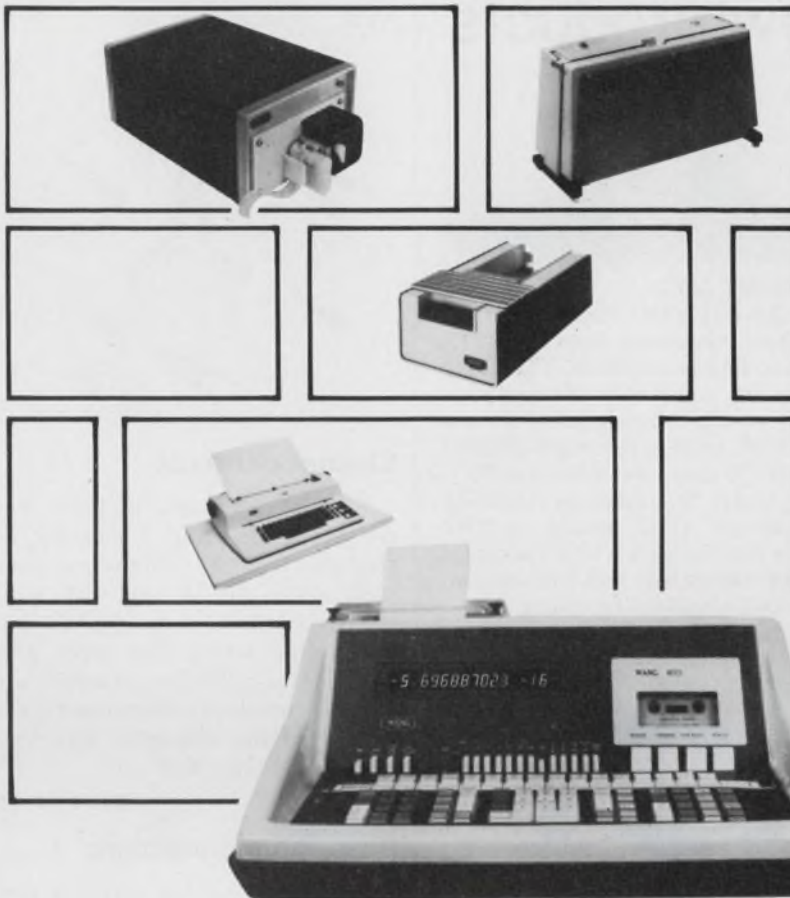

CORNERSTONE

Regardless of your specialty, you can build your own calculating system using the Wang 600 as the cornerstone.

When you start with the basic 600, you have a calculator with the best price/performance ratio in its class. It has sixteen special keys whose functions you determine. And you don't have to give up any functions: you always have trig keys, stat keys, and push-button programming with full decisions and five-level subroutines.

55 storage registers or 312 program steps are standard, but you can build your 600 all the way up to 247 registers or 1848 program steps. Because you can swap registers and steps, you can find the exact combination to solve your problems.

Now you can build on this foundation with an almost endless variety and combination of peripheral modules. You can select alphanumeric printers and plotters, on-line interfaces and off-line paper tape readers, and many more. And you can add on whenever you're ready, right in your office.

Custom-building your own calculating system is easy and inexpensive — when you start with the correct cornerstone. Call Mr. Courtney, collect, at 617-851-7211, for our complete list of building supplies.

WANG LABORATORIES, INC. Dept. ED-12
836 NORTH STREET, TEWKSBURY, MASSACHUSETTS 01876
TEL. (617) 851-7311, TWX 710 343-6769, TELEX 94-7421

INFORMATION RETRIEVAL NUMBER 85

new products



NEW 10-BIT ADC

Model ZD 471 offers 10-Bit resolution and 30 μ s conversion time with 0.1% accuracy. Features include: TTL/DTL; $\pm 10V$, $\pm 5V$, and 0 to +10V operation over 0° to 70°C; adjustable FSR and zero offset; built-in reference stability — 100 μ V/30 days; and bake-in at 85°C for 16 hours for optimum reliability and stability. Data output is NRZ serial or parallel binary bits. Package is only 0.4 inches high and fits standard dip sockets. Availability: Stock
Price (1-9) — \$99 CIRCLE NO. 111



1 μ V/°C FET AMPLIFIER

New model ZA903M2 features ultra-low voltage drift of 1 μ V/°C which is independent of zero offset adjustments. Other features include: 10pA input current, 4MHz frequency response and 100 KHz full power output. Package is low profile (1X1X0.4 high). Economy Model ZA903M1 features 3 μ V/°C. Availability: Stock
Price (OEM) — \$39 CIRCLE NO. 112



LOW COST INSTRUMENTATION AMPLIFIER

Model ZA703M1 offers FET input stage and gain range of 1-1000 selected with only one external resistor. Input current is 3pA with gain non-linearity of 0.02%. Package is only 0.4 inches high. Model ZA702M1 (bipolar input) also available. Availability: Stock
Price (1-9) — \$29 CIRCLE NO. 113

Call, TWX, or write today!

TEL: (415)686-6660

TWX: 910-481-9477

Zeltex INC.

A SUBSIDIARY OF REDCOR CORP.
1000 Chalmar Road Concord, California 94520

NEW LITERATURE



Clean-room tools

A 20-page catalog of hand tools for production and laboratory activities features ultra-clean-room tools which can be used with minimum contribution to over-all contamination levels. The stock tools are nickel-chromium plated and can be completely degreased prior to use. Atsing Assembly Materials, Inc., Big Flats, N.Y.

CIRCLE NO. 358

Buss interconnections

A 32-page catalog covers a complete product line of laminated buss bars, solderless clip-on busses for various types of terminals, circuit-board busses and special buss-interconnect devices. Bussco Engineering, Inc., El Segundo, Calif.

CIRCLE NO. 359

Portable digital VOM

A two-page data sheet describes a small new portable 2-3/4-digit VOM. Triplet Corp., Bluffton, Ohio.

CIRCLE NO. 360

Ac dielectric testers

A 16-page brochure is available on a line of ac dielectric/insulation test equipment. Hipotronics, Inc., Brewster, N.Y.

CIRCLE NO. 361

Hardware

Three new catalogs list complete lines of security hardware for industrial, institutional, transportation and marine fields. The hardware includes a wide range of cam and pawl locks and latches, padlocks, hasps, seal-type door latches, lock handles, truck safes, trailer king pin locks and many other items. AIMSCO Inc., Seattle, Wash.

CIRCLE NO. 362



Put quality on your panel for under \$5

Accuracy, readability, response and ruggedness need not be sacrificed for low cost: these International Instruments Series 3000 and 3100 meters will meet your design goals at costs as low as \$4.15 (in 100-piece quantities), for a 1½" square DC millimeter. Jeweled D'Arsonval movements, in ranges down to 50 μ A, provide response time to 2 sec. max. and initial accuracy to $\pm 2\%$ DC ($\pm 3\%$ AC), meet shock and vibration requirements of ANS C39.1. Repeatability is maintained over the life of the meter.

Both Series available in 1½, 2, 2½, 3½ and 4 inch sizes, in 61 standard ranges from 50 DC μ A to 5000 AC volts. Clear acrylic crystals, sweep scales and red bar-type pointers enhance readability and random-size compatibility. Custom dials carrying your trademark and special colored shrouds available at moderate additional cost. For data and quotes, send requirements to:



INTERNATIONAL INSTRUMENTS

DIVISION OF SIGMA INSTRUMENTS, INC.

88 MARSH HILL RD., ORANGE, CONN. 06477

INFORMATION RETRIEVAL NUMBER 87

ELECTRONIC DESIGN 25, December 9, 1971

bulletin board

Westinghouse Electric Corp. has announced a major advance in TV CRTs that increases both the brightness and contrast of the pictures displayed on home TV receivers. Westinghouse says that the improvement results from a new method of color tube manufacture developed at the company's Electronic Tube Div., in Pittsburgh, Pa.

CIRCLE NO. 363

General Computer Systems, Inc., Dallas, Tex., has announced several additional standard software features now available at no extra cost on its System 2100 key-disc-tape data entry systems. A new re-entry capability allows an operator to interrupt the entry of a data batch for any reason and continue that same batch from the point of interruption.

CIRCLE NO. 364

Prices of Hewlett-Packard's series 5082-7100 of alphanumeric GaAsP LED displays have been cut for the second time since they were introduced early in 1970. This latest price reduction cuts nearly 50% off recent prices. For example, in quantities of 1000, prices per character have been reduced from \$20 to \$11. Comparable price cuts were also announced for lesser quantities.

CIRCLE NO. 365

The Cyphernetics Corp. of Ann Arbor, Mich., has announced operational software support for the recently announced Textronix 4010 graphic terminal.

CIRCLE NO. 366

Fairchild Semiconductor has expanded its line of 9500 series temperature-compensated ECL ICs with the addition of 15 new devices. Four of the new circuits are MSI devices. Fairchild's latest additions include the 95L series of low-power and high-speed gates (2 ns at 20 mW).

CIRCLE NO. 367

Design Data from Manufacturers

Advertisements of booklets, brochures, catalogs and data sheets. To order use Reader-Service Card. (Advertisement)

Free Nomograph Simplifies PSD Calibration

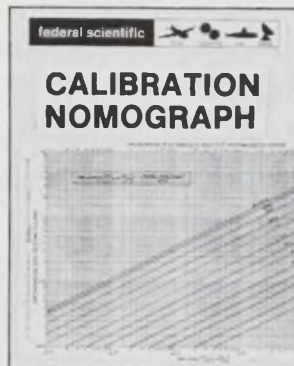

A new unique tool, Federal Scientific's Nomograph provides a fast means of calibrating a real-time power spectral density system in terms of PSD level using a sine wave calibration signal. It makes it possible for the user of a Ubiquitous® Spectrum Analysis System to easily scale the output data in terms of g^2/Hz and V^2/Hz . Printed on $8\frac{1}{2} \times 11$ heavy glossy stock for durability, it is useful for all those who analyze random data such as noise, vibration, or underwater acoustic signals. It applies expressly to Federal's Ubiquitous series of Real-Time Spectrum Analyzers with 200, 400, 500, 1000, or 2000-line resolution. It allows a non-technical operator to take into account the bandwidth of analyzers and gain settings of the system when performing calibration. Write to Federal for your copy.

CIRCLE NO. 171

Federal Scientific Corporation

a subsidiary of Elgin National Industries, Inc.
615 West 131st Street, New York, N. Y. 10027

PC Drafting Aids Catalog



Thousands of time saving, cost saving artwork ideas are found in the By-Buk P-50 catalog of pressure sensitive printed circuit drafting aids. With the most practical artwork patterns for: TO cans, multi-pads, dual-inlines and flat packs featured. Donuts, connector strips, teardrops, ovals, tapes, tees, elbows, etc., by the hundreds are included in the most comprehensive list of sizes. Opaque black, transparent red and transparent blue materials for one and two-sided board designs. For a free copy and samples, write today.

CIRCLE NO. 172

By-Buk Company

Subsidiary of Webtek Corp.
4326 W. Pico Blvd.
Los Angeles, California 90019
(213) 937-3511

1972 Electronic Components Drafting Aids Catalog



Free Catalog! Free Samples! Exciting innovations in pressure-sensitive electronic component drafting aids and methods are detailed in the new 1972 edition of the combined Bishop Technical Manual and Catalog 105.

84 illustrated pages of over 15,000 multi-pad configurations, symbols, tapes, sequential reference designations plus hundreds of time-and-money saving hints in making artwork for PC boards. Includes instructions for using the industry's only red and blue tape system for making two-sided boards in perfect registration. Send now for free Catalog 105 and free samples.

CIRCLE NO. 173

Bishop Graphics, Inc.

7300 Radford Avenue
North Hollywood, California 91605
(213) 982-2000 Telex: 674672

ELECTRONIC DESIGN's function is:

- To aid progress in the electronics manufacturing industry by promoting good design.
- To give the electronics design engineer concepts and ideas that make his job easier and more productive.
- To provide a central source of timely electronics information.
- To promote two-way communication between manufacturer and engineer.

Want a subscription? ELECTRONIC DESIGN is sent free to qualified engineers and engineering managers doing design work, supervising design or setting standards in the United States and Western Europe. For a free subscription, use the postfree application form inside the back cover. If none is included, write to us direct for an application form.

If you do not qualify, you may take out a paid subscription for \$25 a year in the U.S.A., \$35 a year elsewhere. Single copies are \$1.50 each.

If you change your address, send us an old mailing label and your new address; there is generally a prepaid postcard for this inside the back cover. You will have to requalify to continue receiving ELECTRONIC DESIGN free.

The accuracy policy of ELECTRONIC DESIGN is:

- To make reasonable efforts to ensure the accuracy of editorial matter.
- To publish prompt corrections whenever inaccuracies are brought to our attention. Corrections appear at the end of the Letters column.
- To encourage our readers as responsible members of our business community to report to us misleading or fraudulent advertising.
- To refuse any advertisement deemed to be misleading or fraudulent.

Microfilm copies are available of complete volumes of ELECTRONIC DESIGN at \$19.00 per volume, beginning with Volume 9, 1961. Work is now in process to complete the microfilm edition of Volumes 1-8. Reprints of individual articles may be obtained for \$2.00 each, prepaid (\$.50 for each additional copy of the same article) no matter how long the article. For further details and to place orders, contact the Customer Services Department, University Microfilms, 300 North Zeeb Road, Ann Arbor, Michigan 48106; telephone (313) 761-4700.

Want to contact us? If you have any comments or wish to submit a manuscript or article outline, address your correspondence to:

Editor
ELECTRONIC DESIGN
50 Essex Street
Rochelle Park, N.J. 07662

Plastic Parts



CUSTOM production to your specs from patented, low-cost tooling. Any size, any quantity in Nylon, Delrin, other thermoplastics. Let us quote. We have 20 years experience.

STANDARD gears, racks, bearings, sprockets, pulleys, washers, insulators, many other components available quickly from stock tools. Over 2,500 items described in our 48-page catalogue. Write today for a free copy.

CIRCLE NO. 174

Nylomatic

11 Nolan Ave., Morrisville, Pa. 19067
A DIVISION OF WEHCO PLASTICS INC.

D/A Converters – 25 New Models

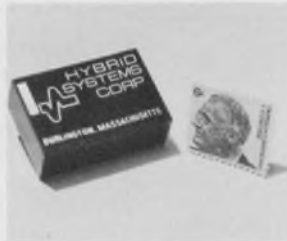

DAC 371-8
\$9.95

Twenty-five new D/A converters are described in the file folder brochure. All specifications, performance data, and applications are listed. Some of the new units are: DAC 371 low cost miniature converters; DAC 372 series, a family of low cost D/A converters featuring hermetically sealed active components, thin film resistors; and DAC 390-10, ultra-fast settling multiplying D/A converter.

CIRCLE NO. 175

Hybrid Systems Corporation

87 Second Ave., Northwest Industrial Park
Burlington, Massachusetts 01803
Tel: 617-272-1522

Revised Digital Computer Brochure



UniComp's 16-page fully illustrated brochure has been completely revised to describe UniComp's FAST FOURIER TRANSFORM PROCESSOR that reduces FFT Computation Time by more than 100 times over software, as well as the increased power of their COMP-16 and COMP-18 Minicomputers, and the expanded Command list.

The revised brochure contains a general description of UniComp's ruggedized Digital Minicomputers, as well as photographs, illustrations, specifications and engineering drawings. A full page is devoted to the COMP-18 and its interface modules available to augment the CPU for specific applications.

CIRCLE NO. 176

UniComp, Incorporated

subsidiary of Hoffman Electronics Corporation
18219 Parthenia Street, Northridge, California 91324
(213) 886-7722

Manufacturers

Advertisements of booklets, brochures, catalogs and data sheets. To order use Reader-Service Card (Advertisement)

Minimizing Capacitance Changes



Causes of capacitance value changes in wound dielectric capacitors are treated in an Electrocube technical bulletin to aid designers in selecting and using capacitors. Graphs and formulas are used to illustrate the straight-forward discussion and to compare performance of various dielectrics with changes in operating and environmental conditions. Also available are bulletins treating the sometimes confusing considerations of capacitor dissipation factor and insulation resistance, as part of a continuing series of two and four page technical discussions by Fred L. Johnson.

CIRCLE NO. 177

Electrocube, Inc.

1710 South Del Mar Avenue
San Gabriel, California 91776

Economical High Performance Electrometers



New P.A.R. electrometers offer superior performance at low cost. Model 134, with wide range and high stability, is priced at \$615; Model 135, with self-contained battery power supply, \$675; and Model 136 with digital display and BCD output, \$1125. Drift, offset and noise figures are lowest available in this price range. Other features include guarded input circuits and fast recovery from large overloads. Full line of accessories available. Request new brochure, demonstration or applications assistance.

CIRCLE NO. 178

Princeton Applied Research Corporation

Box 565, Princeton, New Jersey 08540 — (609) 452-2111

“Zoom In” on Any Portion of the Spectrum During Real-Time Analysis

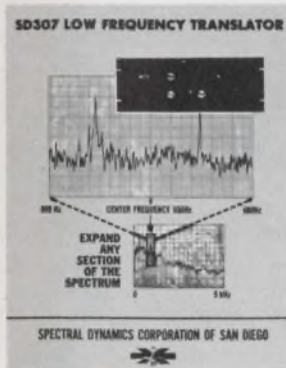

Closely spaced harmonics in a frequency spectrum can be clearly separated, analyzed and displayed in real time by combining the SD307 Low Frequency Translator with any SD301-series Real Time Analyzer. In effect, it expands a given spectrum band like a zoom lens, to enable detailed examination. Resolution can be increased by as much as 1000 to 1. The combination is especially valuable for detecting very low level periodic signals normally buried in noise. The SD307 selects any one of four “windows”: 50 Hz, 100 Hz, 500 Hz and 1 kHz, providing detailed narrowband analysis of 0.15 Hz, 0.3 Hz, 1.5 Hz and 3 Hz, respectively. Send for data.

CIRCLE NO. 179

Spectral Dynamics Corporation

P.O. Box 671, San Diego CA 92112

Electronic Design

Advertising Sales Staff

Bryce Gray
Sales Manager

Rochelle Park, N.J. 07662

Robert W. Gascoigne
Daniel J. Rowland
50 Essex Street
(201) 843-0550
TWX: 710-990-5071

Philadelphia

Thomas P. Barth
50 Essex Street
Rochelle Park, N. J. 07662
(201) 843-0550

Boston 02154

Joseph F. Palmer
1268 Main Street
Waltham, Mass.
(617) 894-2700

Chicago 60611

Thomas P. Kavooras
Berry Conner, Jr.
200 East Ontario
(312) 337-0588

Cleveland

Thomas P. Kavooras
(Chicago)
(312) 337-0588
(call collect)

Los Angeles 90303

Stanley I. Ehrenclou
Burt Underwood
2930 Imperial Highway
Inglewood, Calif
(213) 757-0183

San Francisco 94022

Jerry D. Latta
95 Main Street
Los Altos, Calif.
(415) 941-3084

London W. 1

For United Kingdom and Holland
Brayton C. Nichols

For Eastern Europe

Peter Kehr

The American Magazine Group

27 Maddox Street
London, W. 1, England
Phone: 499-0180

Cable: Ammagnic, London

Verviers, Belgium

For Continental Europe

Andre Jamar
1, Ru Mallar, 1

(087) 253.83 Telex 41563

Tokyo

Haruki Hirayama
Electronic Media Service
5th Floor, Lila Bldg.,
4-9-8 Roppongi
Minato-ku
Phone: 402-4556
Cable: Electronicmedia, Tokyo





The "no maintenance" PUNCHED TAPE READER

No edge guides
No capstans, pinch
rolls or brakes
No lenses
No lubrication
No adjustments

You may have to
replace this bulb
after 25,000 hours.



New DECITEK Punched Tape Readers give greater accuracy, freedom from maintenance and longer tape life. With 20% to 30% fewer parts than units of comparable performance, they start, stop and hold tape accurately through a stepping motor/dual sprocket bi-directional drive. Tests at 300 cps for more than a quarter-million cycles showed insignificant sprocket hole wear.

DECITEK Readers interchangeably read 5, 6, 7 or 8-level paper, paper-polyester or metallized polyester tapes at 60 to 600 cps. Fiber optic elements illuminated by a single, easily replaced bulb eliminate cross-talk and partial or bit failure. Photo-transistor sensing delivers high signal-to-noise ratio outputs. Input-outputs are TTL or DTL compatible. For technical brochure, write DECITEK, 16 Sagamore Rd., Worcester, Mass. 01605. Call (617) 757-4577.

DECITEK

A DIVISION OF JAMESBURY CORP.
INFORMATION RETRIEVAL NUMBER 88

advertiser's index

Advertiser	Page	Advertiser	Page
Abbott Transistor Laboratories Incorporated	6	Lafayette Radio Electronics	86
Acopian Corp.	100	Lambda Electronics Corp.	Cover III
Airpax Electronics, Cambridge Division	95	Lear Siegler, Inc., Cimron Division..	65
Alco Electronic Products, Inc.....	59	Ledex, Inc.	97
Allen-Bradley Co.	46	3M Company	37
Amphenol Components Group	12	Magnetico, Inc.	119
Augat, Inc.	80	MicroSwitch, A Division of Honeywell	45
Beckman Instruments, Inc., Helipot Division	71	Mini-Circuits Laboratory, A Division of Scientific Components Co.....	106
Belden Corporation	29	Mitsui & Co. (U.S.A.) Inc.	92
Bishop Graphics, Inc.	115	Molex, Incorporated	21
Bourns, Inc., Trimpot Division	84	Monsanto Company	18, 79, 119
Burr-Brown Research Corporation	61, 101	Motorola Component Products Dept.	16
By-Buk Company	115	Motorola Semiconductor Products, Inc.	4, 5, 10, 11, 34, 35
Cambridge Thermionic Corporation..	90	Mura Corporation, The	84
Clairex Electronics, A Division of Clairex Corporation	93	National Semiconductor Corporation	25
Clare & Co., C. P.	40	New Product Engineering, Inc.....	88, 96
Cutler-Hammer	16A	Nylomatic Corporation	116
Dale Electronics, Inc.	Cover II	Nytronics, Inc.	89
Data Technology Corporation	102	OPCOA, Inc.	112
Decitek, Division of Jamesbury Corp.	118	Perkin Elmer Corp.	108, 109
Delco Electronics, Division of General Motors Corporation....	54, 55	Philips Electronic Components and Materials	96CDE
Dialight Corporation	103	Pico Electronics, Inc.	7
Digilin, Inc.	92	Pomona Electronics Co., Inc.	80
Dow Corning Corporation.....	10, 11, 13	Princeton Applied Research Corp.....	117
Eastman Kodak Company	87	RCA Solid State Division.....	Cover IV
Edmund Scientific Company	94	Raytheon Company, Instruments Operation	82, 83
Electro Cube, Inc.	117	Requested Data Delivery Service	Cover II A-B
Electro Switch Corp.	78	Rogan Brothers, Inc.	91
Electronic Development Corporation	104	Rogers Corporation	103
Electronic Design	60, 98, 99	Siemens Corporation	2
Electronic Engineering Co. of California	110	Sigma Instruments, International Instruments Div.	114
Facit-Odhner, Inc.	110	Signetics Corporation	17
Fairchild Semiconductor, A Division Fairchild Camera and Instrument Corporation	68, 69	Spectral Dynamics Corporation	117
Federal Scientific Corporation	115	Spectrum Dynamics	119
Fluke	44	Stackpole Carbon Company	8, 9
GTE Sylvania Chemical & Metallurgical/Parts	75	Switchcraft, Inc.	120
GTE Sylvania Electronic Components	31	Systemation, Inc.	100
Harris Semiconductor, A Division of Harris Intertype Corporation...	85	TEAC Corporation of America	36
Hayden Book Company, Inc.	2, 96F, 119	TEC, Incorporated	94
Heath/Schlumberger Scientific Instruments	73	Tecnetics, Inc.	96
Heinemann Electric Company	23	Technical Wire Products, Inc.	90
Hewlett-Packard	1, 33, 81, 88	Tektronix, Inc.	43
Hybrid Systems Corporation	116	Trans-Tec Corporation	103
International Rectifier	107	Transistor Devices, Inc.	119
ISE Electronics Corporation	16B	Triplett Corporation	76
Johnson Company, E. F.....	39	Tyco Saphikon Division	102
Keithley Instruments, Inc.	38	Tung Sol Division, Wagner Electric Corporation	104
Keuffel Esser Co.	105	UniComp, Incorporated	116
		Unitrode Corporation	27
		Vactec Inc.	111
		Vero Electronics, Inc.	64
		Victoreen Instrument, Div. of VLN Corp.	86
		Wang Laboratories, Inc.	113
		Wiley Interscience	106
		Zeltex, Inc.	114



Program all fusible-link programmable ROMs manually with the Model 300. Designed with a 4096 bit (512 words x 8 bits) capacity. Both 115 VAC and 220 VAC versions available. Spectrum Dynamics, Inc., 2300 East Oakland Park Boulevard, Ft. Lauderdale, Florida. Phone (305) 566-4467 or 566-2547.

INFORMATION RETRIEVAL NUMBER 181



Create your own special power supplies with TDM & TDMD modules bolted to a single 5 1/4" panel. No costly cabling, racks or accessories. Outputs 0-305VDC, .06-60A. Modules feature front panel voltage & current limit adj., test points, ind. lamps. OV crowbar protection. Transistor Devices, Inc., Cedar Knolls, N. J. 07927.

INFORMATION RETRIEVAL NUMBER 182



Treating materials according to their function, these design aids combine essential background with immediately workable data and techniques. Series in Materials for Electrical and Electronics Design, Edited by Alex. E. Javitz. Hayden Book Co., Inc., New York, N. Y. 10011.

INFORMATION RETRIEVAL NUMBER 183



Scott-T-Transformers — 30 arc seconds accuracy, 90 volts or 11.8 line to line synchro inputs at 60 or 400 Hz sine & cosine outputs. Standard units resolver to synchro available. In quantity \$19.00 each. Magnetico Inc., East Northport, N. Y. (516) 261-4502.

INFORMATION RETRIEVAL NUMBER 184



The Successful Engineer-Manager, Edited By R. C. Haavind and R. L. Turmail. Depth discussion and insights of the experts isolate the fine points of management: career, decisions, people, projects, finances, communications. Hayden Book Co., Inc., New York, N. Y. 10011.

INFORMATION RETRIEVAL NUMBER 185



High performance pulse generator provides simultaneous positive and negative pulses with < 5 ns rise — fall times at rates from 10 Hz to 50 MHz. Front panel switches select external or manual trigger and double pulse operation. 2 outputs (50-ohm source impedance) are short-circuit protected. \$425. Monsanto Instruments, West Caldwell, N. J. 07006.

INFORMATION RETRIEVAL NUMBER 186

Advertisers wishing to reserve Quick Ad units should note the following mechanical requirements: Specs—Supply glossy photo of product and approximately 40 words which will set no more than 10 lines of 34 characters each. AFTER SUBMISSION NO COPY CHANGES CAN BE ACCEPTED. Quick Ads cost only \$300 per insertion, less for frequency advertisers.

RATES:

1x
\$300

7x
\$280

13x
\$255

19x
\$250

26x
\$245

39x
\$240

52x
\$235

104x
\$230

A NEW FIELD-OF-ONE IN LIGHTED PUSHBUTTON SWITCHES.

Switchcraft's "PUSH-LITE" switch offers reliable leafspring switching in a neat little package.

This whole new field of compact (1" x 1 1/8" x 1 3/4") pushbutton switches reduces the size of your control panels, consoles—and cost, too! Our new field-of-one consists of 6 series—including non-illuminated and illuminated single and twin-lamp units in two housing colors (black or grey). Up to 4PDT switching in momentary and push-lock/push-release functions. Ratings range from dry circuit switching, up to 3 amps., A.C., non-inductive load.

A rugged molded housing encloses the highly reliable leafspring switching and protects against dust, dirt and mishandling.

Pick from flange or barrier mounting—individually or in matrix configurations. Series PL "PUSH-LITE" switches mount from front of panel with clamp brackets, simply and quickly. No mounting screws show!

Design with up to two lamps and either full or split display screens—vertically or horizontally. Full display provides up to 3 lines of 6 characters each. Virtually unlimited lighting versatility

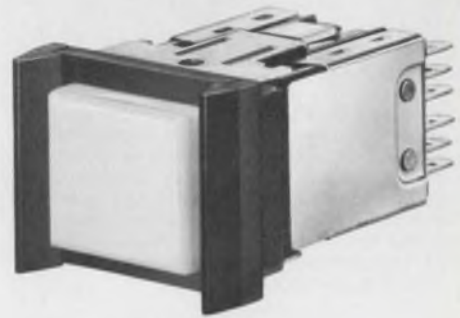

ACTUAL SIZE

provided by 7 different colors of pushbuttons, insert filters and silicone boots.

For additional information, contact a Switchcraft Representative or write for Catalog S-345. SWITCHCRAFT, INC. 5529 N. Elston Avenue Chicago, Illinois 60630

SWITCHCRAFT
INC.

INFORMATION RETRIEVAL NUMBER 89

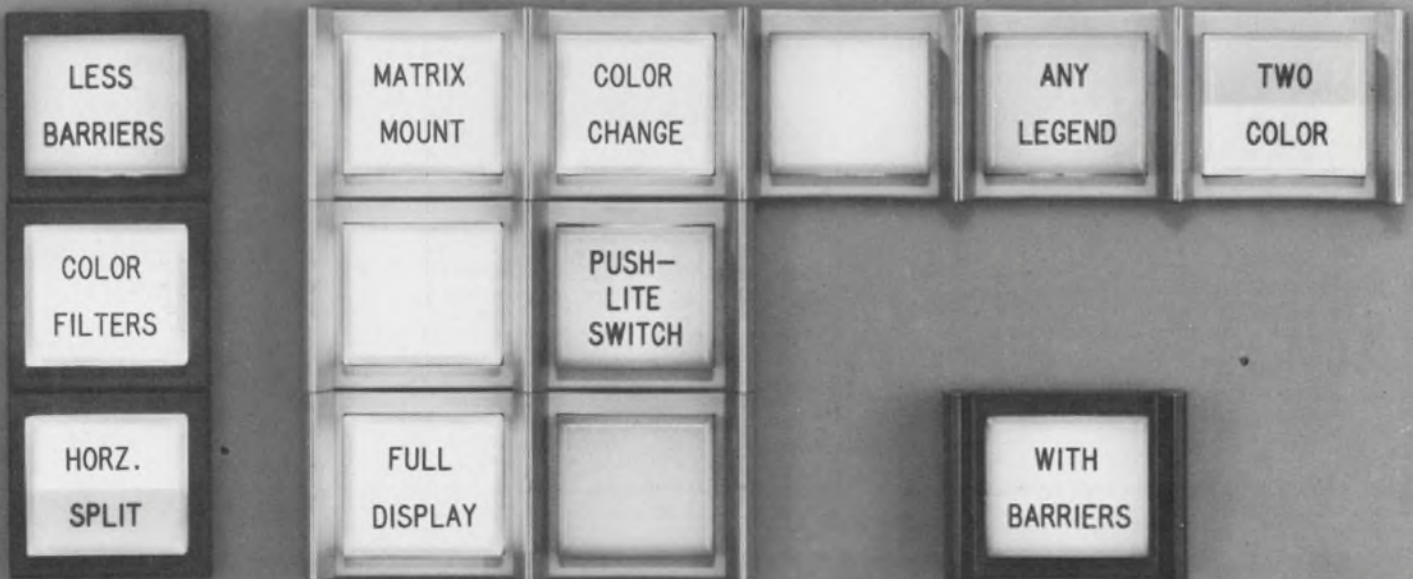

Do you face a make or buy decision on power supplies?

BUY THE NEW LAMBDA LY SERIES

**>50% efficient, 20 KHz switching,
50mV P-P ripple, 0.1% line or load regulation**

SINGLE OUTPUT

\$300

**5 VOLTS 30 AMPS
WITH OVERVOLTAGE
PROTECTION BUILT-IN**

DUAL OUTPUT

\$380

**±15 TO ±12 VOLTS
8.5 AMPS EACH OUTPUT**

TRIPLE OUTPUT

\$395

**5 VOLTS 18 AMPS
DUAL ±15 TO ±12 VOLTS
2 AMPS EACH OUTPUT**

QUADRUPLE OUTPUT

\$450

**5 VOLTS 16 AMPS
DUAL ±15 TO ±12 VOLTS
1.5 AMPS EACH OUTPUT
24 TO 28 VOLTS 1.0 AMPS**

AC input: 105-132 VAC, 47-440 Hz
DC input: 145 VDC ±10%

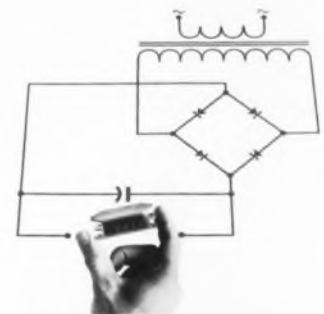
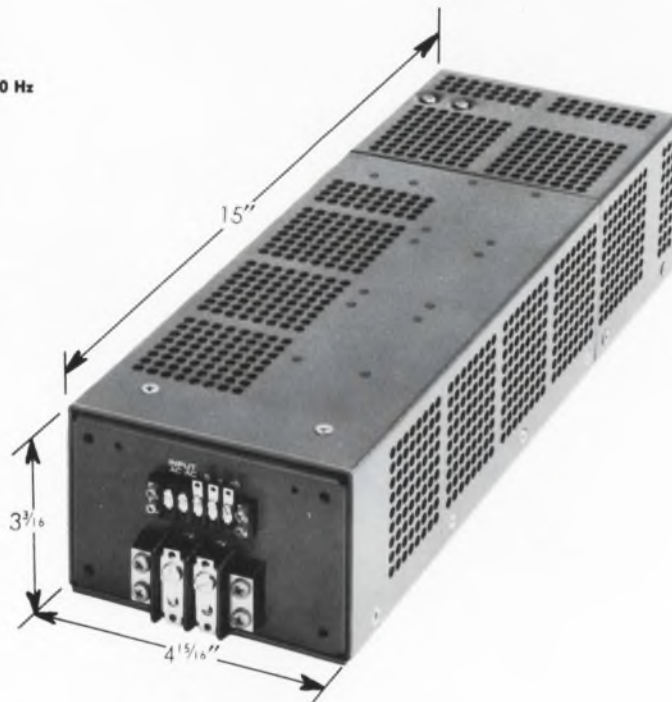

11 standard models in single, dual, triple or quadruple outputs in new "5" package. Triple and quadruple output models incorporate Lambda Power Hybrid Voltage Regulator.

**ALL CARRY LAMBDA'S 5-YEAR GUARANTEE.
ALL IN STOCK FOR 1-DAY DELIVERY.**

**WHETHER
YOU MAKE
OR BUY...**

LAMBDA
ELECTRONICS CORP.
A  Company

MELVILLE, NEW YORK 11746 515 Broad Hollow Road Tel. 516-694-4200 ARLINGTON HEIGHTS, (CHICAGO) ILL. 60005 2420 East Oakton St., Unit Q Tel. 312-593-2550
NORTH HOLLYWOOD, CALIF. 91605 7316 Varna Ave. Tel. 213-875-2744 MONTREAL, QUEBEC 100C Hymus Blvd., Pointe-Claire, Quebec-730 Tel. 514-697-6520

RCA extends triac capabilities again with this exclusive new 80-amp series.

You can hold down design costs for high power lighting and heating controls, welders, induction motors and other applications, because these new triacs simplify circuitry and heat sinking.

And you save on device costs because the triacs utilize the RCA low cost package with compression seal. Available in press-fit and stud pack-

ages. Four modes of gate control add design flexibility. All this means more amps per dollar.

That's why the new 80-amp triac is another example of cost effective simplification from RCA.

Unit prices are \$25 to \$45 in small quantities. Call your RCA Representative or RCA Distributor. For new RCA catalog write RCA Commercial Engineering, Section 57L9/UR12, Harrison, N.J. 07029. International: RCA, Sun-

bury-on-Thames, U.K., or P.O. Box 112, Hong Kong. RCA Limited, St. Anne deBellevue, 810 Quebec, Canada.

	Repetitive Peak Off-State Voltage ^V _{DROM}		
PACKAGE	200V	400V	600V
Press Fit	TA7752	TA7753	TA7754
Stud	TA7755	TA7756	TA7757
Isolated Stud	TA7937	TA7938	TA7939

All types are available with flexible lead attachments.

New RCA Triac controls 80 Amperes

You control design and system cost

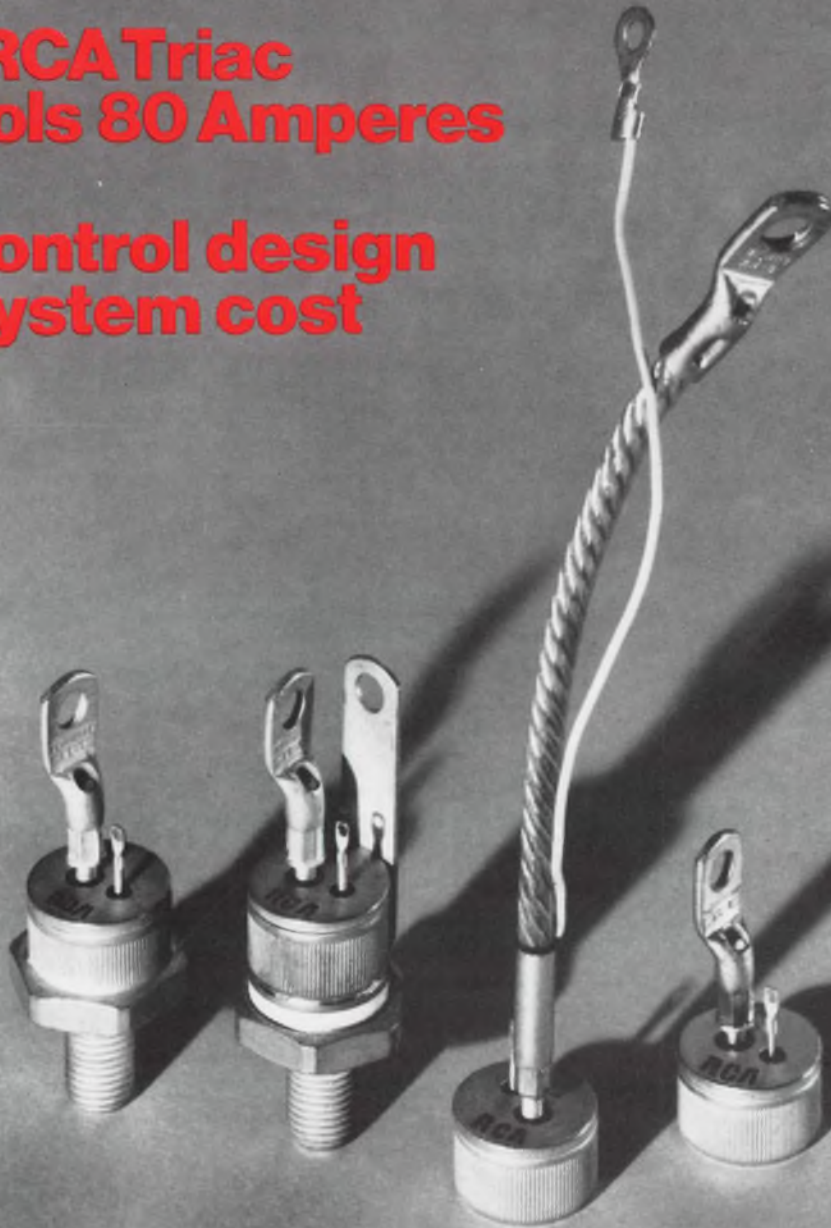

RCA Solid State