

Electronic Design 20

VOL. 19 NO.

FOR ENGINEERS AND ENGINEERING MANAGERS

SEPT. 30, 1971

Unusual electrostatic cooling uses kilovolts and microamperes to reduce surface temperatures hundreds of degrees in seconds. A high-voltage ionic discharge

from stationary probes removes the heat without fans or blowers. Applications? Possibly to cool semiconductors and high-power laser optical elements. Page 22.



Hewlett-Packard believes that design engineers doing digital IC work should have a scope that's **intended** for digital IC work. You shouldn't have to face a makeshift adaptation of a scope that doesn't really "have what it takes," or an "overkill" unit with lots of capabilities you don't need and can't afford.

That's why we've developed two new additions to the HP 180 Scope System.

The first is a new mainframe, the 180 C/D. Like our 180 A/AR, it's compatible with all 180-System plug-ins to 100 MHz real time, plus the easy-to-use 1 GHz sampling plug-in and the 12.4 GHz sampling/TDR plug-in.

In addition, the 180 C/D incorporates new circuitry advances that allow optimized CRT performance. A 15 kV accelerating potential now gives you greater brightness and higher writing speed. Thus, photographic writing speed is several times faster—1500 div/ μ s (1 cm/div) with the standard P31 phosphor. These advanced capabilities make the 180 C/D fully compatible in single-shot response with the 180 System's fastest plug-ins.

The second bright idea is a new 75-MHz vertical plug-in—the 1808A. This bandwidth capability makes the 1808A ideal for testing digital circuits using T²L or ECL, yet saves you a healthy amount in comparison with a 100-MHz system.

As you'd expect, the 1808A gives you the usual selection capabilities found in scopes of this class—deflection sensitivity (5mV/div to 5 V/div) and polarity. In addition, however, the 1808A also gives you a new first—selectable input impedance (50 Ω and 1 M Ω)!

And despite all these advantages, both 180 C/D and the 1808A are priced very competitively. The 180C is under \$1,000; the rack-version 180D is slightly higher. The 1808A is \$880—\$800 without probes. Compatible time bases range from \$450 to \$700.

For further information on either of these new additions to the "more-to-come" HP 180 System, contact your local HP field engineer. Write Hewlett-Packard, Palo Alto, California 94304, for data sheets. In Europe: 1217 Meyrin-Geneva, Switzerland.

Scopes are changing.
Are You?

081/17

HEWLETT  PACKARD

Two bright new ideas in digital IC testing

INFORMATION RETRIEVAL NUMBER 241





MAKE YOUR CONNECTIONS: FAST. With Molex standard and miniature connectors. They're easier to work with. Simplify wiring. Speed production. Save assembly steps. Make installation and servicing extra easy, too. This is why circuitry idea men everywhere are making connections with Molex. From one circuit to 104 or more. Production keyed and available in a variety of colors to meet design requirements. Molex has the

connector. Plus the design and engineering capability to solve the most complex wiring problems . . . fast. For a colorful free sample of the Molex connector write: Molex Incorporated, Downers Grove, Illinois 60515. Or you can make connections by calling (312) 969-4550.

*...creating components that
simplify circuitry*



700v. 10A. 200 nsec.

BREAK
THROUGH



A new dimension in power switching transistors.

Our new SVT7000 series power switching transistors (700 V, 10 A, 200 nsec switching transistors with a pulse energy rating of 4.5 KW for 100 μ sec.) make the impossible possible.

Now you can break through with weight, size and cost reductions in off-line 40 KHz power conversion units. High-speed deflection amplifiers. Power modulators. You name it.

And whatever you build will run

cooler, longer, more reliably than comparable units built around heavy transformers and old-fashioned circuitry.

Only your imagination limits the uses for these remarkable new transistors. To help you along, we've prepared an in-depth paper, "Application Notes for the TRW SVT7000 Series of Power Switching Transistors." Send for your copy today.

Or get the real thing right now.

SVT7000 transistors are on the shelf at TRW stocking distributors. Or call us at our toll-free number: 800-421-2061. (In California, call 213-679-4561, collect.) TRW Semiconductors, 14520 Aviation Blvd., Lawndale, Calif. 90260.

TRW
SEMICONDUCTORS

INFORMATION RETRIEVAL NUMBER 3

ELECTRONIC DESIGN 20, September 30, 1971

NEWS

- 19 **News Scope**
- 22 **Electrostatic cooling method uses high-voltage ionic discharges to provide silent, efficient heat transfer**
- 26 **All-solid-state TV set wins a rave for easy servicing**
- 28 **A robot worker being developed to assist space station crews transfer cargo, repair satellites and add to space base complexes**
- 31 **Technology Abroad**
- 35 **Washington Report**

TECHNOLOGY

- 44 **Use an N-bit detector for phase-locking.** You get 360×2^N electrical degrees of phase modulation and hold a range that is 2^N times that of a single-bit loop.
- 50 **Simplify sample-and-hold design** by making an orderly approach. using graphical aids and doing careful worst-case analysis.
- 56 **Improve vhf amps with an attenuator** to separate the main amp from the feedback path. You get less distortion and increased stability.
- 62 **Ideas for Design**

PRODUCTS

- 72 **Modules & Subassemblies:** High-reliability d/a converters start from \$39.
- 78 **Data Processing:** Circuit analysis is simplified with a new software program.
- 83 **ICs & Semiconductors:** CMOS multiplexers increase their speed and drops power dissipation.
- 73 Instrumentation
- 76 Microwaves & Lasers
- 82 Packaging & Materials
- 96 Product Index
- 84 Components

Departments

- 43 **Editorial:** Overseas trade shows, a powerful sales tool
- 7 Letters
- 13 Designer's Calendar
- 88 Evaluation Samples
- 88 Design Aids
- 88 Application Notes
- 90 New Literature
- 91 Bulletin Board
- 94 Advertiser's Index
- 96 Information Retrieval Card

Cover: Cover photo by Stephen Heiser, Chicago, for Inter-Probe, Inc., No. Chicago

**Reliability is a single-sided frame,
a ball and a cricket room.**

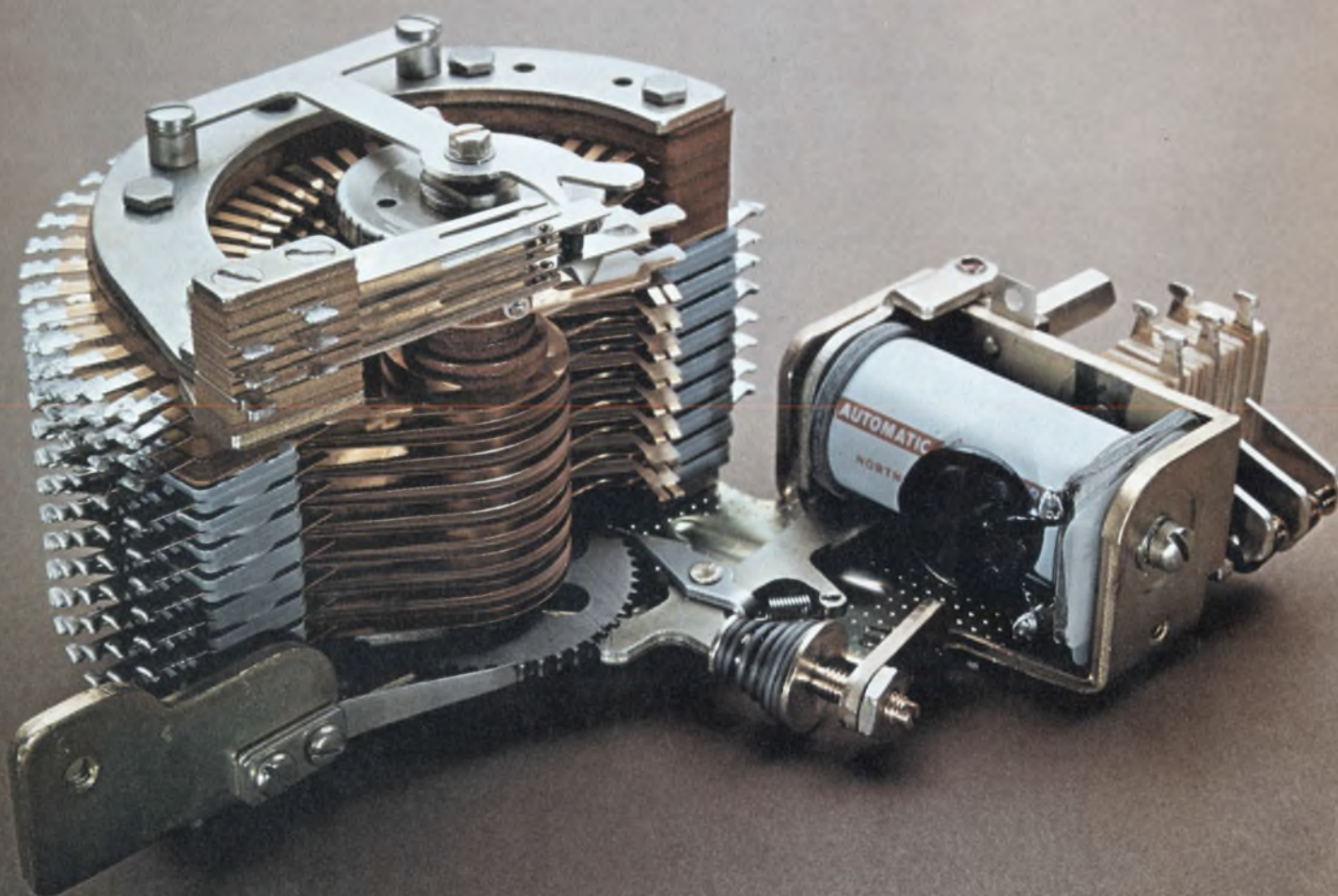

Our Type 45 rotary stepping switch is made to be forgotten. We build them to work hard, fast and long without constant fiddling or adjusting. They've got to be able to work in heat or cold, take bumps and grinds and still click-click along with close-spaced consecutive operations.

We start out really flat To keep everything on the level we start our assembly with an open-type, one-piece frame. Thick and really flat. Some manufacturers use two thinner frames. But we found that starting with a single thick frame eliminates problems of matching the switch parts. Everything stays in line. And a single-sided frame takes a lot less room—the switch is only as wide as need be.

A lube job that lasts a lifetime The entire wiper assembly rotates on a large-diameter stainless steel shaft around a full-length hub bearing. We lubricate this bearing and seal it during assembly. So throw away the oil can.

Then we supply a pinch that's just right Each pair of wipers is tension-adjusted during assembly. As they click around the bank levels on a flat plane, we want each pair to pinch the contact just the right amount. Too hard a pinch and the contacts will wear out quickly. Too soft a pinch will cause a poor connection. We teach our wipers to pinch just right.

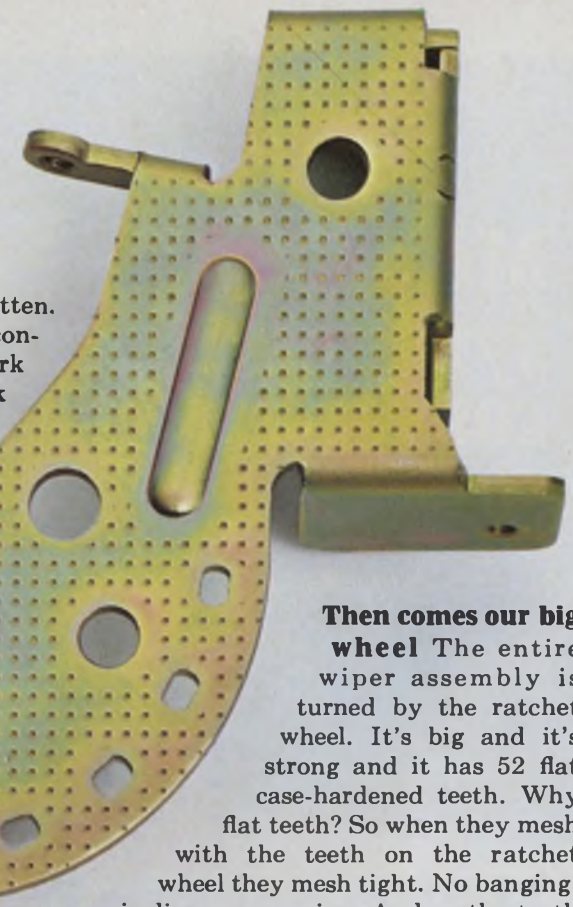
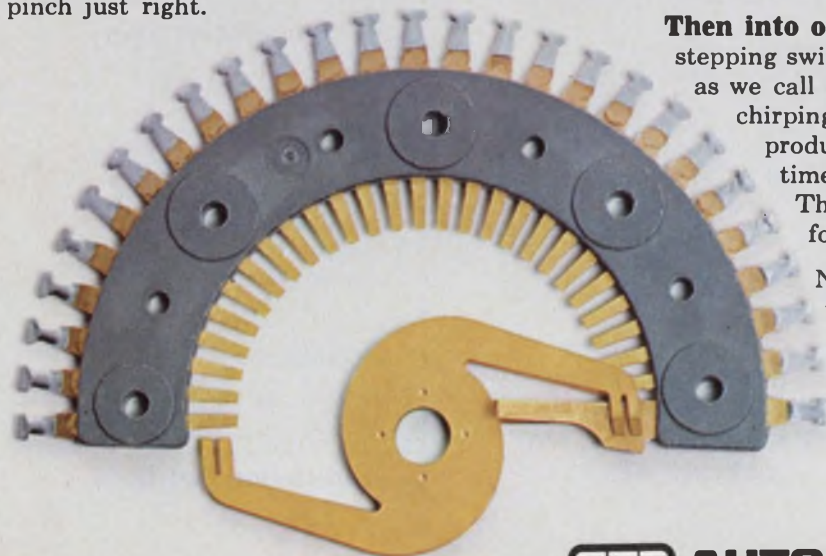

Then comes our big wheel The entire wiper assembly is turned by the ratchet wheel. It's big and it's strong and it has 52 flat case-hardened teeth. Why flat teeth? So when they mesh with the teeth on the ratchet wheel they mesh tight. No banging, wiggling, or scraping. And as the teeth wear, they just mesh deeper in the grooves.

Ball bearing anchor for good measure The armature assembly has to be securely fastened to keep it from wobbling up and down, or everything goes out of whack. So we choose a big stainless steel pin and secure it with wide bearings to the armature yoke. To make sure this pin never slips out of the yoke, we drill a hole in both ends. Then we force a steel ball bearing into these holes. This expands the walls of the pin into and against the walls of the armature and the whole assembly is anchored for life. We're the only ones that do it this way. So we're the only ones that offer a lifetime fit.

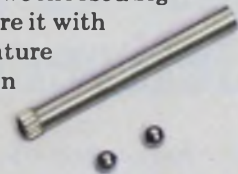

Then into our cricket room Every single AE stepping switch goes to the run-in test room. Or, as we call it, the cricket room, because of the chirping noise all the switches we're testing produce. Here, every switch is tested 50 times a second for 45,000 operations. Then, and only then, are they ready for delivery to our customers.

Now that we've explained all the little things we do to make our Type 45 reliable, put it through your own tests. GTE Automatic Electric, Industrial Sales Division, Northlake, Illinois 60164.

GTE AUTOMATIC ELECTRIC

Mil spec synchro/digital converters:

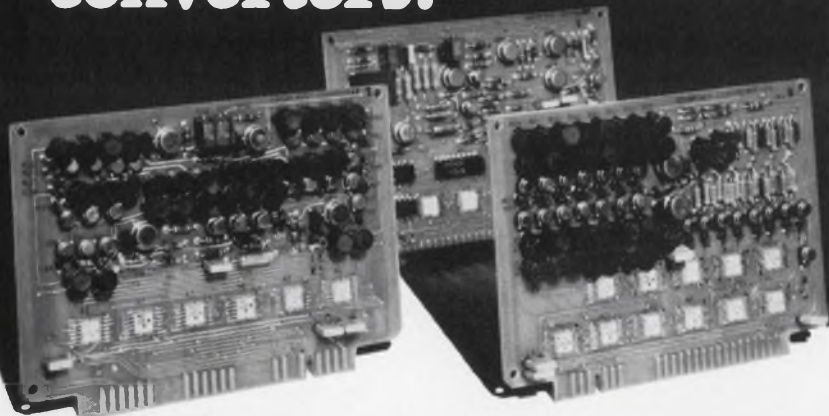

**We've got 'em in cards.
Or cased.
For off-the-shelf
delivery.**

Kearfott can solve your conversion problems with two production model solid state synchro/resolver digital converters. Both meet MIL-E-5400.

TRIGAC I—A low cost, successive approximation converter, accurate to 12 minutes.

TRIGAC III—Using demodulators, integrators, inverters and zero crossing detectors, this converter offers high accuracy at moderate cost.

	Typical Characteristics	
	TRIGAC I	TRIGAC III
Model Number	C70 4773 001	C70 4773 013
Input Signal	3 wire synchro	11.8 V line-to-line 400 Hz
Output	13 bit BCD code or 13 bit natural parallel	14 bit natural parallel
Resolution	6 minutes arc	LSB—1'9"
Accuracy	12 minutes arc	± 2 LSB
Logic Levels	Logic "1" = ± 5V ± 10% Logic "0" = 0—0.5 V	

We can supply either cards as shown, or in corrosion-resistant metal enclosures. Write today for new catalog. The Singer Company, Kearfott Division, 1150 McBride Avenue, Little Falls, New Jersey 07424.

SINGER
AEROSPACE & MARINE SYSTEMS

INFORMATION RETRIEVAL NUMBER 5

Publisher

Peter Coley

Editors

Editorial Offices
50 Essex St.
Rochelle Park, N.J. 07662
(201) 843-0550
TWX: 710-990 5071
Cable: Haydenpubs Rochellepark

Editor: George Rostky
Managing Editor: Ralph Dobriner
Managing Editor: Raymond D. Speer
Microelectronics, Steven A. Erenburg
Computers, Raymond D. Speer
Microwaves, Michael J. Riezenman
Circuits, Edward A. Torrero
Special Projects, George Rostky
Management, Richard L. Turmail
Military-Aerospace, John F. Mason
News, Michael P. London
New Products, Roger Allan

Field Offices

Massachusetts
Jim McDermott
P.O. Box 272
Easthampton, Mass. 01027
(413) 527-3632

West Coast
David Kaye
2930 Imperial Highway
Inglewood, Calif. 90303
(213) 757-0183

Washington
Don Byrne
1111 S. Army Navy Drive
Arlington, Va. 22202
(202) 296-8982

Editorial Production

Dollie S. Viebig

Art

Art Director, William Kelly
Richard Luce
Anthony J. Fischetto

Production

Manager, Thomas V. Sedita
Helen De Polo
Kathleen McConkey
Maxine Correal

Circulation

Manager, Nancy L. Merritt

Information Retrieval

Peggy Long

letters

A cheer for keeping you readers awake

Congratulations to your editorial staff for attempting to awaken the notoriously absent-minded engineer to public consciousness. In your June 10 issue editorial ("All You Train Drivers Better Start Talking") Mr. Egan briefly mentions the contribution of the engineering society in improving the engineer's "status, respect and security." That issue also makes brief mention of the September IEEE elections in an article regarding the impending candidacy of Irwin Feerst ("A Hot Race for a Change for IEEE Presidency?" News Scope).

The electrical engineering community needs an honest appraisal of the IEEE's efforts to promote engineering as a true profession, and of the alternatives offered in the upcoming IEEE elections.

Michael A. Allocca

Design Engineer
Data Trends, Ins.
Parsippany, N.J.

Subway power plan is a nice plan, but—

News Scope of June 10, 1971 ("Energy Storage Planned to Save Subway Power") quotes a plan to save power for the New York City Metropolitan Transit Authority by using a flywheel to convert kinetic energy of the train into electrical energy as it decelerates and vice versa.

This scheme was tried some years ago on the City of London bus system, and while it showed promise, the mechanics of keeping it working were well-nigh impossible. To reduce the friction of the high-speed flywheel in its cage with the surrounding air, a vacuum was tried, which showed excellent

promise except for the fact the seals on the shaft would not permit them to hold a vacuum.

To my knowledge, this scheme has now been discontinued by the City of London because of this impractical type of mechanical device.

Fred A. Kahl

P.O. Box 817
Goleta, Calif. 93017

A clarification on market data

In the article "Electronics at Mid-1971," ED 14, July 8, 1971, p. 23, I am misquoted three times.

I am erroneously quoted as stating that 198.8 million ICs were shipped in 1970. I stated that 298.8 million were shipped. Secondly, I stated that the average selling price of ICs drops approximately 30% for each doubling of the accumulative volume. In the article the key word "accumulative" was somehow deleted. I did not state that industry revenue in 1971 would jump 40% over 1970. At best, we can expect 8%.

Rolland F. Smith

Manager, Market Research
and Planning

Signetics
811 E. Arques Ave.
Sunnyvale, Calif. 94086

Accuracy is our policy

In the Aug. 5, 1971 issue (ED 19, p. 70), a mechanical counter for the Veeder-Root Co. of Hartford, Conn., was incorrectly described as an electrical counter. This mechanical counter, known as the Little Miracle, is used for electrical-equipment applications.

Electronic Design welcomes the opinions of its readers on the issues raised in the magazine's editorial columns. Address letters to Managing Editor, Electronic Design, 50 Essex St., Rochelle Park, N. J. 07662. Try to keep letters under 200 words. Letters must be signed. Names will be withheld on request.

WITH THIS: YOU CAN TROUBLE-SHOOT THIS

LOOK AT THESE NEW FEATURES ON THE KURZ-KASCH LOGIC PROBES*

Basic Model LP-520 — Provides the color coded (red, white & blue) visual readout system at the probe tip that indicates logic "1", "0" and "pulse" (50 nano-seconds or greater) conditions in any 5v digital logic system. Absence of logic levels is indicated by all readouts remaining off.

The Model LP-520 is priced at \$69.95. **ADD THESE FEATURES: G-S-M Gating Feature(-G)** — Pulse indicator displays only when probe tip and gate/gates inputs are in coincidence. (see diagram above.) Example: **A.** Gate 1 input **B.** Probe tip input; pulse indicator displays. Moving probe tip to **C.** pulse indicator does not display. Add \$10.00 and suffix G.

Memory & Stretch(-M) — Push-Pull switch for selecting stretch or latch mode. Stretch mode detects high speed pulse and displays blue "P" lamp for 200 mS. Latch mode captures high speed pulse/trains and latches blue "P" display on until reset. Add \$10.00 and suffix M.

5 Nano-Second Capability(-S) — This allows detection of pulses up to 10 x faster than standard probes. Add \$10.00 and suffix S.

Free Trial Offer — Keep abreast of the state of the art. Kurz-Kasch offers a 15 day free trial period. Select the Kurz-Kasch logic probe model above (or any combination of features) that fit your requirements. At the end of 15 days, you may return the probe, or, send us your check. *All the features you ever needed for testing digital logic now available in one economical probe unit; 3 input channels, 5 nano-second pulse width detection, pulse latching.*

Kurz-Kasch offers a complete line of digital logic testing instruments. Want to talk about your instrumentation requirements? Call Tom Barth, or Dick Pitner, now, at (513) 223-8161.

 **Kurz-Kasch, Inc.**
1421 S. Broadway, Dayton, Ohio 45401

*Patent #3,525,939 applies, others pending

INFORMATION RETRIEVAL NUMBER 6

A better way to maintain oscillator specifications.

A lot of oscillators can't meet their own specs once in operation. That's why we came up with a better way. A die cast zinc enclosure to keep specs what they should be. No other oscillator offers our kind of enclosure. Or our kind of performance:

Models in 1MHz, 3MHz, and 5MHz ranges. And when you write for our spec sheets, what you read is what you get. Write to Motorola Component Products Dept., 4545 W. Augusta Blvd., Chicago, Ill. 60651.





Introducing the best DC power supply catalog in the world.

Forty-two informative pages. Specifications. Drawings. Photos. Prices. Three-day shipping guarantee. Organized for quick selection of the best model for your application. Included are:

 **Mini-modules** with regulated single or dual outputs. Save space and improve reliability by mounting them directly on printed circuit boards. \$30 up.

 **Standard modules** with ratings to 32 amps. Choose from single and dual output regulated models and single output unregulated. \$60 up.



Low-profile modules to 4.0 amp from a package only 1.68" thick. \$75 up.



Plug-ins with single or dual outputs, for commercial or MIL-Spec. use, regulated or unregulated, high isolation, fixed or adjustable. \$45 up.

Acopian also offers rack mounting power systems, designed to meet specific multi-output power needs. Shipping time for these fully wired, fully tested systems is only 9 days from your order.  \$150 up.

For your copy of the world's best power module catalog, write or call Acopian Corp., Easton, Pa. 18042. Phone: (215) 258-5441. The power modules you order from it will be shipped with (you'll happily agree) the world's best tag...



There is a place for both ceramic and tantalum chips in miniaturized circuit applications.

And you just found it.

Union Carbide. Who makes KEMET® chips in both ceramic and solid tantalum. All with the exclusive Solder-Guard copper barrier layer. That enables KEMET chips to withstand the severe temperatures of solder-reflow assembly. With no degradation of performance and electrical characteristics.

The KEMET ceramic chips are available in ratings from 10 through 330,000 picofarads. The KEMET tantalum chips, from 100,000 picofarads through 100 microfarads.

The ceramics will withstand 260° C. for 20 minutes; the tantalums will withstand 300° C. for 3 minutes.

Check the tables below for stability and cost comparisons. Then write for free engineering samples and technical data. At Box 5928, Greenville, S.C. 29606.

And be glad.

That specifying chips will be easier from now on.

Because one manufacturer has the technology to offer you both kinds.

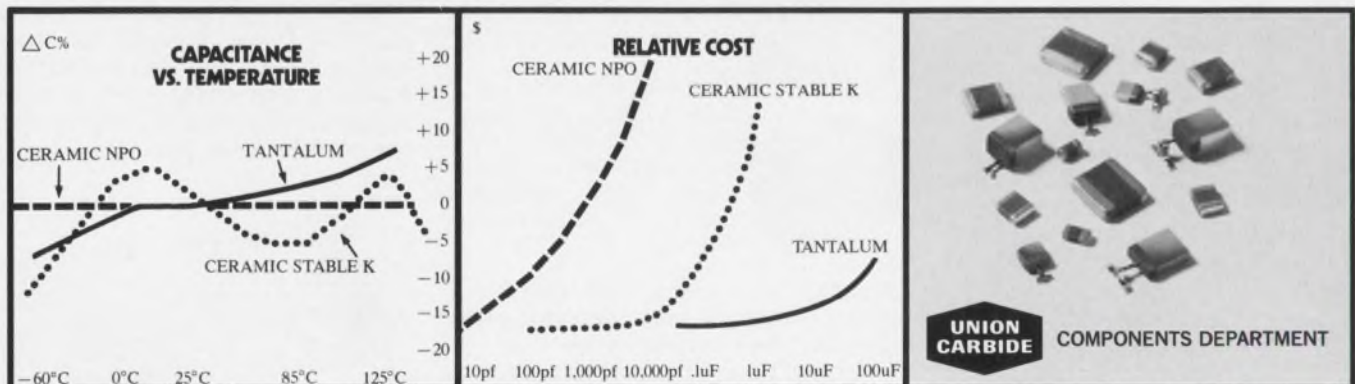

More "snaps" at less cost



The Licon® Basic Switch Line offers a full selection of sizes, actuators, ratings and price ranges. Switches actual size.

Today's constant demand in circuit design is "Make 'em smaller, cheaper and more reliable!" So you need better basic switches than ever before. And Licon builds them. With no sacrifice in size, rating or price. For example, the Type 10 series provides precise operation, hefty current rating, high vibration resistance and Mil Spec conformance. The Type 11 is a miniature, general purpose version of the incredibly reliable Licon Butterfly® double-break switch. The switch tested

up to 20 million mechanical cycles without failing. And only Licon has it. The Type 25 is an SPDT switch for broad use in narrow places. It's just 9/32" thick. But because it is similar to the Butterfly, it offers utmost reliability at low cost. And the newly designed Type 19 subminiature SPDT switch packs big reliability and load capacity into really tiny volume. There are a lot more types—from the sub-subminiature Type 18 to the rugged 20-Amp Type 14. Available in single

pole to triple pole designs at prices that you'll like. Send for the book, or have a Licon man bring in the demo kit so you can snap a few yourself. Call or write Licon, Division Illinois Tool Works Inc., 6615 W. Irving Park Road, Chicago, Ill. 60634. Phone (312) 282-4040.



itw LICON

The Innovating Electronic Group of ITW... LICON ■ ELECTRO MATERIALS ■ PAKTRON

INFORMATION RETRIEVAL NUMBER 10

For basic industrial connectors



think of us as your hardware store.

Plugs, sockets, connectors, hardware and accessories—for relays, tubes, cable connections, sound systems or whatever—a whole raft of things you'd never expect from us. They've been in our industrial product line for many years. In fact, it's the broadest line available anywhere. So next time you need something

in basic black, think of us as your connector hardware store. Drop us a line and we'll send you our latest 32-page II-1 Catalog along with the name of your closest Amphenol distributor. Write to Amphenol Industrial Division, The Bunker-Ramo Corporation, 1830 South 54th Avenue, Chicago, Illinois 60650.

**BUNKER
RAMO** **AMPHENOL**

designer's calendar

Oct. 31-Nov. 4

Engineering in Medicine & Biology Conference (Las Vegas) IEEE, John Hanley, Brain Research Inst., Univ. of Calif., Los Angeles, Calif. 90024

CIRCLE NO. 413

NOVEMBER 1971						
S	M	T	W	T	F	S
	1	2	3	4	5	6
7	8	9	10	11	12	13
14	15	16	17	18	19	20
21	22	23	24	25	26	27
28	29	30				

Nov. 2-3

Eastern Electronics Packaging Conference (Boston) Sponsors: IEEE, ASTM, S.M. Stuhlberg, Raytheon Co., Box 605, Hartwell Rd., Bedford, Mass. 01730

CIRCLE NO. 414

Nov. 3-5

Northeast Electronics Research & Engineering Meeting (NEREM), Boston, Sponsor: IEEE, IEEE Boston Office, 31 Channing St., Newton, Mass. 02158

CIRCLE NO. 415

Nov. 15-18

Fall Joint Computer Conference, (Las Vegas) Sponsors: IEEE, AFIPS, AFIPS Hdqs., 210 Summit Ave., Montvale, N.J. 07645

CIRCLE NO. 416

Nov. 16-19

Conference on Magnetism & Magnetic Materials (Chicago) Sponsors: IEEE, The American Institute of Physics, F.M. Mueller, Argonne National Laboratory, Argonne, Ill. 60439

CIRCLE NO. 417

Nytronics Chip Capacitors.



Nytronics Chip Inductors.



When a little has to do a lot

If you buy Nytronics leaded capacitors, you *know* the quality we must put in our chips.

Building quality and reliability into sub-miniature chip capacitors takes talent. And it takes the experience and unequalled precision that has made Nytronics the number one name in sub-miniature capacitors and inductors.

Our ultra high stability chip capacitors provide highest possible lump capacitance per unit area. Especially suited for micro and hybrid circuits, Nytronics chip capacitors are available in solid tantalum and ceramic in the following sizes.

Ceramic: 4.7pf to 220pf; 0.170" x 0.065" x 0.070", 270pf to 4700pf; 0.28" x 0.95" x 0.070". Tantalum: .120" x .065" x .035", 4700pf to 1,500,000pf (1.5 μ f); .220" x .180" x .070"; 1.5 million pf to 22 million pf, .470" x .370" x .145"; 22 million pf to 220 million pf.

If you buy Nytronics leaded inductors, you *know* the quality we must put in our chips.

Nytronics, one of the nation's largest suppliers of miniature precision-made RF inductors, is big in sub-miniature chip inductors too. Our little Wee-Chip, the highest quality magnetically shielded inductor available in the industry, is made especially for mounting on substrates. The inductor body is of high stability, low-loss ferrite combined with a coil cavity of optimum cross sectional area and mean radius, producing a unit with outstanding "W" factor. Wrap-around type copper terminations provide the highest degree of mounting flexibility. Available from stock in 23 standard values.

Whatever your capacitor or inductor requirements, it will be worth your while to check with Nytronics or your local distributor.



Nytronics, Inc.

Orange Street, Darlington, S.C. 29532 • (803) 393-5421 • TWX 810-665-2182

OUR ANGLE: High Speed Accurate and Automatic Angle Position Indicators

WHAT'S YOUR ANGLE?



MODEL 545/100

If you're converting synchro/resolver data to digital format, you need both speed *and* accuracy to keep pace with today's data explosion. Only one converter meets both these requirements without compromise. And for under \$4K. . . . North Atlantic's Model 545/100.

The solid-state Model 545/100 converts both resolver and synchro data with 0.01° accuracy and resolution. And continuously digitizes input angle data at $20,000^\circ$ per second in the face of real-life noise, harmonics and quadrature levels. BCD output is available at the rear connector. Conversion can be stopped by a data freeze command. If multiplexed signals are your bag, acquisition time is less than 30 ms.

Options? Other models offer many options, including 0.001° resolution with 10 arc-second accuracy; data frequencies from 60Hz to 2.4kHz, binary output, small size.

No matter what your conversion problem, if you require ultra-fast, ultra-accurate tracking, contact your North Atlantic sales engineering representative today. He'll show you a better angle.

NA

NORTH ATLANTIC
industries, inc.

200 TERMINAL DRIVE, PLAINVIEW, NEW YORK 11803
cable: noatlantic / twx: 510-221-1879 / phone: (516) 681-8600

75 MFD/30 VOLT DC CAPACITORS

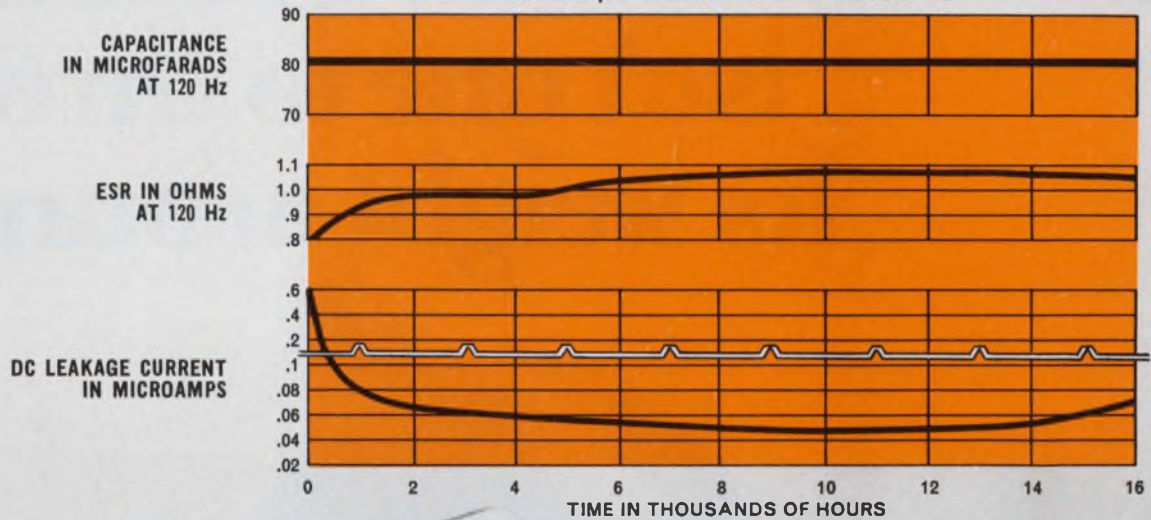

Our new TCG capacitor has curves you can't resist.

The curves tell at a glance the typical life story of one of our new TCG aluminum electrolytic capacitors. But there's more to a TCG than life curves. There are 45 case sizes, with safety vent protection where required; capacitances from 2 to 22,000 mfd; voltages from 3 to 450 VDC; and a -40 to $+85^{\circ}\text{C}$ temperature range.

Add to these a high C/V in a small package. Plus outstanding electrical and physical characteristics. And you've got our new TCG. Find out more by writing for Bulletin 4-307. Eighteen pages of data . . . and some curves that will open your eyes. Popular ratings available from authorized Mallory distributors.

MALLORY

MALLORY CAPACITOR COMPANY

a division of P. R. MALLORY & CO. INC.

Box 372, Indianapolis, Indiana 46206; Telephone: 317-636-5363

Electrical and electronic components • sequence timers • metallurgical products • batteries

INFORMATION RETRIEVAL NUMBER 14

Our low-inertia dc motor isn't one to throw its weight around.



The rotor of our motors is completely hollow.

So our motors have little weight to start with.

So it starts instantly. Or stops. Or positions. In fact, it can go from dead stop to 2,000 rpm in less than one millisecond.

The fastest response of any motor of similar size.

It can handle rate-step requirements (from 1 to 500 steps per second). Or be used stalled, as a torque motor, without damage.

Which makes our motor ideal for use in incremental tape capstan drives, line printer drives, machine tool positioning and industrial automation. Several models are available.

With capacities from 15 to 135 oz/in of torque and pulse torques of 10 times larger. Also, options such as special shafts and inertias, forced air cooling adaptations, and integral tachometers.

For additional information, call your MICRO SWITCH Branch Office (Yellow Pages under "Switches, Electric"). Or write for our Product Brochure VM.

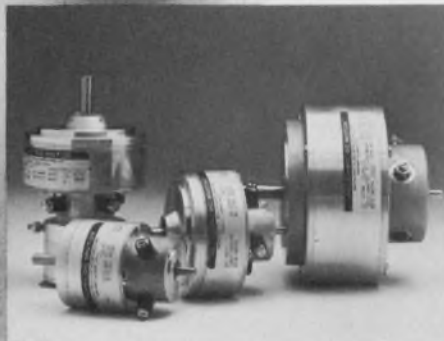

MICRO SWITCH

FREEPORT, ILLINOIS 61032

A DIVISION OF HONEYWELL

MICRO SWITCH products are available worldwide through Honeywell International.

INFORMATION RETRIEVAL NUMBER 15

ELECTRONIC DESIGN 20, September 30, 1971

Lean and mean!



Modular instrumentation amplifiers with rack-mount performance.

With the recent introduction of seven new units, Burr-Brown now offers over twenty modular instrumentation amplifiers, including programmable gain types, that provide a low-cost approach to systems instrumentation. Performance is equivalent to that of rack-mount units — we've simply removed the frills and packed them into compact, rugged, low-cost, modular packages. Of course, if you have to have rack-mounts, remember, we supply those too.

These versatile amplifiers all feature a wide range of gain, set by a single external resistor. Because of their small size, ruggedness, and low-cost, they lend themselves to a variety of instrumentation applications including amplification of signals from transducers — such as strain gage bridges, load cells, thermistor networks, thermocouples, and biological probes. Other applications include: recorder pre-amplifiers, multiplexer buffers, servo error amplifiers, current sensing, and the measurement of any small differential signal riding on common mode voltages.

NEW BURR-BROWN BOOK "Operational Amplifiers — Design and Applications", over 500 pages, 300 illustrations. Written by Burr-Brown application-engineering staff, published by McGraw-Hill. U.S. price, 15.00 dollars. Order from Burr-Brown, today.



A SAMPLE OF THE VARIETY OF PERFORMANCE FEATURES AVAILABLE

FET INPUT - LOW DRIFT HIGH INPUT IMPEDANCE LOW COST	MODEL 3621 Input drifts as low as $5\mu\text{V}/^\circ\text{C}$, max. Input impedance to 10^{11} ohms. $2\mu\text{V}$ input noise, peak to peak. Single unit price from \$39.00
LOW NOISE - LOW DRIFT	MODEL 3620 Input noise only $1\mu\text{V}$, peak to peak. Gain nonlinearity, .01%. Both $1\mu\text{V}/^\circ\text{C}$ and $3\mu\text{V}/^\circ\text{C}$ max input drifts available. Single unit price from \$85.00
HIGH SPEED WIDE BANDWIDTH	MODEL 3622 $150\text{V}/\mu\text{sec}$ slew rate. Settles to $\pm 0.1\%$ of final value in less than $1\mu\text{sec}$. 3MHz bandwidth at gain of 100. Single unit price from \$79.00

PRICES FOB, TUCSON, ARIZONA, USA

FOR COMPLETE TECHNICAL INFORMATION on Burr-Brown's complete line of modular and programmable gain instrumentation amplifiers, use this publication's reader service card or contact your Burr-Brown Representative.

BURR-BROWN
RESEARCH CORPORATION
International Airport Industrial Park • Tucson, Arizona 85706
TEL: 602-294-1431 • TWX: 910-952-1111 • CABLE: BBRCORP

256 TO 1 YOUR BEST BET IS BURROUGHS

LEADING TODAY'S DISPLAY REVOLUTION

NIXIE® INDICATOR TUBES

Burroughs NIXIE Tubes are available in a complete line of sizes, shapes and costs to satisfy all of your requirements for numeric displays requiring 1 to 8 digits of displayed readouts.

BURROUGHS NIXIE TUBE MODULES

Off-the-shelf, low-cost readout system flexibility for 3- to 15- digit numeric applications. Decoder drivers and counters are available in any number of configurations and for all applications.

PANAPLEX™ NUMERIC PANEL DISPLAYS

Lowest cost-per-digit, in-plane numeric readout for 8- to 16- digit applications provides a 150° viewing angle. Nine-segment format allows centered numeral "1". Less than 2 connections per digit. One-piece common-segment construction with no internal welds assures digit alignment and guarantees high shock/vibration resistance. Unitized packaging cuts display length by 25%. Available in 8-, 10-, 12- or 16-digit displays.

32-, 18-, 16-CHARACTER SELF-SCAN™ PANEL DISPLAYS

This family of SELF-SCAN panel displays is available in a variety of sizes and complexities for any application requiring 16 to 32 characters of alphanumeric information displayed on one line. Only power and ASCII code required for a 64-character format. Units can be supplied less the electronic board for graphic or special applications.

256-, 128-, 64-CHARACTER SELF-SCAN PANEL DISPLAYS

Alphanumeric displays equivalent to over 12,000 light-emitting diodes arranged in a matrix format. These lightweight, in-plane displays with dots on 0.040" centers are available in a variety of capacities including 256 characters (8 rows of 32 characters); 128 characters (4 rows of 32 characters); and 64 characters (2 rows of 32 characters).

For further information, write or call Burroughs Corporation, Electronic Components Division, Box 1226 Plainfield, N. J. 07061 (201) 757-3400

INFORMATION RETRIEVAL NUMBER 17

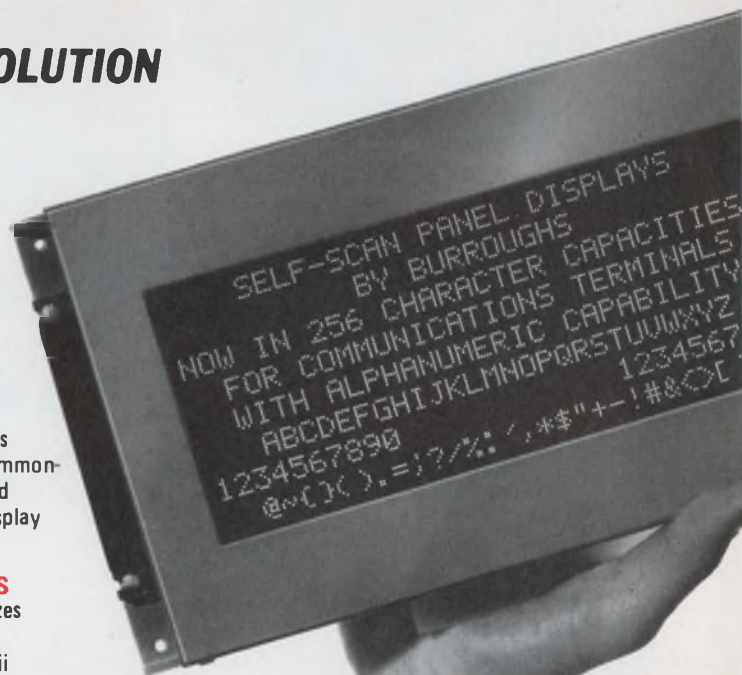

Burroughs 



Digital Equipment goes from minis to whoppers

Long the king of the minicomputer world, Digital Equipment Corp., has decided to take on the big boys in the big computer field as well.

The Maynard, Mass., company has built and is now accepting orders for five models of what it calls its DECsystem-10 family of machines. They range in performance from that offered by the IBM 370/135 to the IBM 370/165. Prices range from a little below \$400,000 to \$2-million.

Two of the five systems are dual processor systems—the first of this type that DEC has produced. The company also announced several new peripherals and communication devices for its large systems.

According to Winston R. Hindle Jr., DEC group vice president, the company believes that “the capabilities offered by this new product family will substantially increase our share of the large-computer systems market and expand Digital’s growth opportunities in the years ahead.”

The large systems business presently accounts for 20% of DEC’s sales and is expected to increase by at least 50% next year, Hindle predicts.

The DECsystem-1077, largest of the new systems, is a dual-processor system, with at least 131,072, 36-bit words of core memory shared by the two processors. The 1077 sells for about \$2-million and has throughput power exceeding that of the IBM 370/155, the Univac 1108 and the CDC 6400, Digital reports.

DEC has announced a new equity leasing policy for the large systems. This allows the purchaser to pay for the large systems over a five or six-year period. Although common to the large

computer market, this is a new policy for DEC.

One of the most significant features of the new system, says John Leng, DECsystem-10 group manager, is that they are the only systems in the industry that provide real-time, multi-program-batch, remote-batch and time-sharing capabilities with a single operating system and a single command language.

“Competitive systems typically cost 50% more and do not provide the equivalent capability.”

DEC has also introduced new peripheral equipment for the DECsystem-10 line, including a communication multiplexer built around the company’s PDP-11 minicomputer. Other new peripherals are two magnetic-tape units, a remote-batch terminal built around a PDP-8, a dual-track disc drive and three card readers.

Paris components show wide open to U.S. in '72

The 40-year-old Composants Electroniques, one of Europe’s outstanding electronics shows, is breaking with tradition this year by allowing United States manufacturers without French representatives to participate for the first time. In the past only companies with local offices or licenses, or those with French distributors or agents, have been permitted to exhibit.

The 1972 show of electronic components and instrumentation will be held in Paris April 7-13. American companies wishing to participate can write William A. Warnes, BIC-948, United States Department of Commerce, Washington, D. C. 20230.

Economist sees threat to electronics industry

A Stanford Research Institute economist, Kenneth W. Taylor, has warned that the U. S. electronics industry faces overpowering competition from foreign countries unless it can get its labor force to be more productive.

Speaking before the Hayden Marketing Seminar at Wescon in San Francisco, Taylor questioned “how effective Nixon’s policies will be in the long run for fighting inflation, exportation of jobs and the like, as long as people of other countries believe in working harder than workers in the U. S.—with the same or better capital equipment than we furnish them.”

He reminded the audience that “international trade is a two-way relationship” and asked: “If the United States puts restrictions on imports to reduce the outflow of jobs, where will foreign nations get the money to buy our exports?”

MW system increases transmissions to CATV

A new technique using microwaves has been developed for transmitting multiple television channels within cable television networks. Instead of amplitude-modulating each channel, as is now done, the new approach combines the multiple channels by multiplexing them at vhf frequencies. The multiplexed signal is then frequency-modulated on X-band, then amplified and transmitted to the receiving antenna.

The developer of the technique is the Laser Link Corp. in Woodbury, N. Y.—a name that could give the erroneous impression that the system uses a laser. It doesn’t; it operates at microwave frequencies.

The new technique has been used to build a system called Airlink that is expected to be much cheaper than other systems, says Ira Kamen, president of the company. “Airlink will cost a little more than \$80,000 for a 20-mile FM link, as opposed to approximately \$145,000 for a 10-mile conventional amplitude-modulated microwave link (AML). A 5-mile cable costs almost \$120,000, and if it is underground,

the cost doubles," says Kamen.

Using frequency-division multiplex/frequency modulation (FDM/FM), the system can transmit up to 18 TV channels on one rf carrier in the 12.7-to-12.95-GHz band, according to J. H. Vogelman, senior vice president of the Laser Link Corp. Given a wider bandwidth, it can transmit 32 channels on one rf carrier. The conventional amplitude-modulation link is limited to a single TV channel for each rf carrier.

Among other advantages, Vogelman says, the new system can transmit in as many as 21 directions simultaneously with ranges in excess of 10 miles. AML is limited to four directions of less than 10 miles, he says.

The new system is also reported capable of unrestricted line-of-sight transmission to a comfortable range of 20 to 25 miles. AML is limited to about nine miles, Vogelman says.

FDM/FM penetrates weather regardless of the conditions, because of its 20 W power reserve. If more power is needed, the new system can operate up to the FCC limit of 60 W by paralleling three traveling-wave tubes.

A new image enhancer, developed for TV

The first automatic image enhancer for use by the broadcast industry has been developed by CBS Laboratories in Stamford, Conn. The unit, called Mark 3, sharpens color television signals while they are being transmitted. It is being mass-produced by CBS and should be available in November.

Intended as a replacement for the more than 1500 manual image enhancement systems now used here and abroad, the new device was developed jointly by Renville H. McMann Jr., executive vice president of CBS Laboratories, and Clyde Smith, a senior broadcast engineer. The company has filed for patent protection.

According to CBS, solid-state technology has made it possible to reduce the size of the automatic image enhancer to less than half that of the manual system now in use.

The process of image enhancement was first introduced by CBS Laboratories in 1968 and has since become standard in the broadcast industry. Lack of sharpness is a common problem in color television broadcasting; it accounts for the difficulty in identifying the football or numerals on a player's jersey during fast-moving plays, for example.

The enhancer increases sharpness and detail by performing a process of vertical and horizontal equalization. Differences between the middle and outside lines of three successive lines on the television picture are added to the middle line. This provides a higher contrast image and permits the viewer to identify clearly both the ball and the player.

Balky antenna control knocks out ATS-3

A locked antenna control system on Applications Technology Satellite 3 has caused the four-year old experimental satellite to stop transmitting weather pictures and other data.

ATS-3 is in stationary orbit at 70° W Longitude, 22,300 miles above Colombia.

NASA officials believe the 805-pound spacecraft gets heated up when the sun is north of the equator in the summer. And, they add, because the antenna is on the top, or north side of the spacecraft, the drive or control system probably overheats, causing the antenna to stop spinning.

The spacecraft spins at 100 revolutions per minute and the antenna spins in the opposite direction at almost the same speed which keeps the antenna pointed toward earth.

If the ATS-3 situation is consistent with past problems of a similar nature, NASA scientists expect it will recover as the sun slowly moves south.

FCC adopts new rules for remote TV stations

Despite objections of the National Association of Broadcasters, the National Broadcasting Company and Columbia Broadcasting Sys-

tem, the Federal Communications Commission has adopted new rules developed by the Electronic Industries Association for monitoring the performance of remotely operated television stations. The rules, to be effective Oct. 5, give the users until next April 1 to equip their stations with the proper test equipment.

As Noel Luddy, chairman of the EIA's Broadcast Equipment Section, explains it: "The remote station is monitored by transmitting special test signals that are inserted on lines 18 and 19 in the vertical blanking area of the picture. These lines are not seen on home receivers."

With the problems of monitoring off-the-air signals in mind, the EIA proposed three different test signals to permit the station operator to evaluate the transmitter's performance.

The National Association of Broadcasters, NBC and CBS say that extensive field tests should be conducted prior to the adoption of the rules. In particular, CBS points out that in demodulating the TV signal off the air, distortion could be introduced that is not in the original signal.

The EIA says that the absolute and relative levels of its proposed signals have been designed to minimize the effect of interaction with one another. It contends its method permits accurate measurements through noise.

Ultrasonics explored as a cancer detector

Ultrasonic equipment may have found a new and highly important role as an early detector of lung cancer, according to findings by Prof. C. Hellmuth Hertz of the Institute of Technology in Lund, Sweden.

A few years ago Hertz, along with other Lund researchers, introduced a radar technique for three-dimensional heart diagnosis. Now he has developed an ultrasonic device that has a repetition frequency high enough to provide extremely well-defined oscillographical curves of the vocal cord movements. If the cycles are unsymmetrical, the prognosis may well be cancer.



Try our straightforward method of reducing fixed resistor costs.

You can't blame engineers or purchasing agents for trying to save every last penny on resistors these days. But lowest price doesn't necessarily mean lowest cost. For example, most manufacturer's color bands won't stand up to the cleaning methods used to remove excess flux. Or they darken and become illegible from the heat

produced in normal usage. This can mean costly identification errors on your production line. The unnecessary expense of rework. Our solution? A-B quality. Bright, crisp identification of Allen-Bradley's specially formulated paints. Baked on to stay on. Designed to resist aging. Discover the other ways to save money. Ask your nearest

A-B distributor for our free booklet "7 ways to tell the difference in fixed resistors." Or write Allen-Bradley Electronics Division, 1201 South Second Street, Milwaukee, Wisconsin 53204. Export: Bloomfield, New Jersey 07003. Canada: Galt, Ontario. United Kingdom: Bletchley, Bucks.

NEW DIMENSION ELECTRONICS
ALLEN-BRADLEY



High-voltage ionic discharges provide silent, efficient cooling

A 30-kV 200- μ A electrostatic discharge that reduces the red-hot 1675-F temperature of a 1000-W heating coil to a dark 975 F in a second or two (see cover photo) may compete with fans and blowers in electronic applications, according to the inventor of the technique.

It removes heat by the effect of a non-arcing ionic corona dis-

charge from the negative ends of high-voltage probes.

The cooling method, patented by Oscar Blomgren Jr., vice president of Inter-Probe, Inc., North Chicago, Ill., has been applied to welding and metallurgical processes, but its use for electrostatic cooling of optical elements in a high power CO₂ laser system was recently investigated by General Dynamics in Fort Worth, Tex., a licensee of Inter-Probe. According to Dr. K. G. Kibler, senior research scientist at General Dy-

namics, it shows considerable promise for the laser application as well as for other electronic uses.

The method may be used where vibration and the noise of motors and blowers cannot be tolerated and also where the object to be cooled has an unusual geometry that might restrict the use of blowers or duct work. Kibler points out that electrostatic cooling can also require less power than blowers and fans.

Jim McDermott
East Coast Editor

Cooling discovery accidental

The cooling effect of a high-voltage discharge was accidentally discovered by Blomgren when he tried to use an electric field to keep an acetylene flame from touching the inside of a pipe. He was attempting to solve a burner-nozzle deterioration problem.

Blomgren says there is still much to be learned about the precise mechanism that causes the increased rate of heat dissipation. Kibler describes the action as a corona discharge, or electric wind, that creates vortex columns in the air adjacent to the heated surface.

Normally a thin boundary layer of air clings to heated surfaces. The layer acts as an insulating barrier, inhibiting the rate at which adjacent, cooler air can carry away the heat. But with the action of the electric field, vortex columns are created, Kibler explains. These pull in cooler air from regions outside the normal boundary layer. It is this swirling action that apparently provides the transport mechanism by which the heat transfer rate is increased.

Just how this laminar boundary layer is distributed and heat transfer is improved by the application of the high-voltage discharge is shown in Schlieren

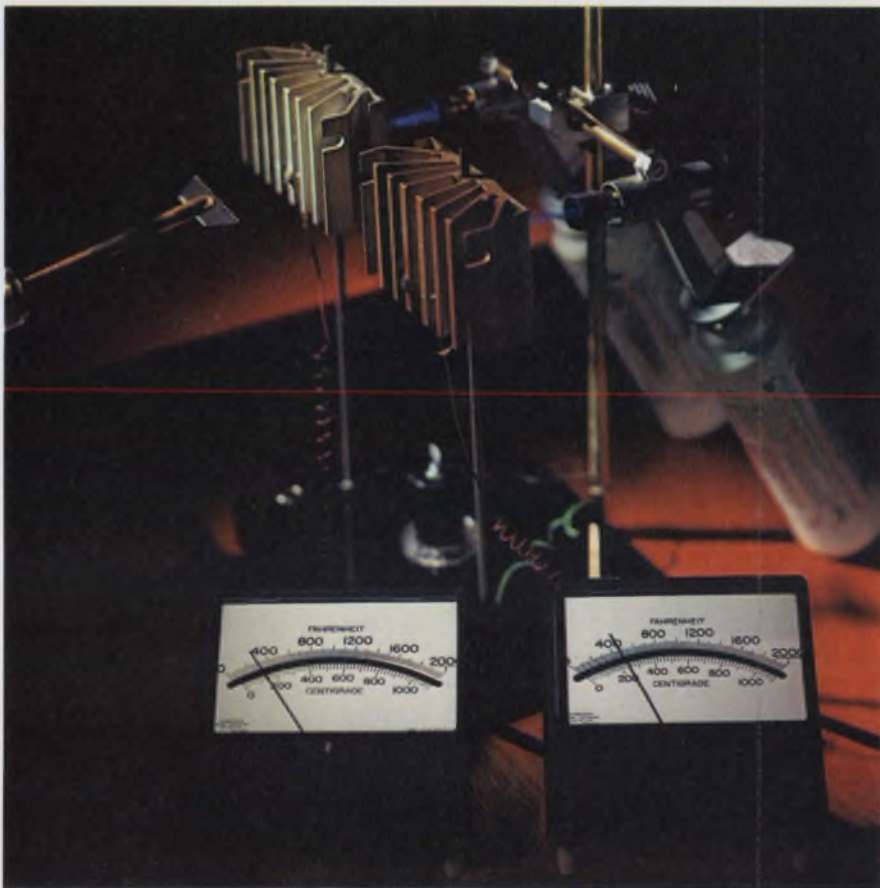

The effectiveness of the electrostatic method in cooling heat sinks is demonstrated in the setup shown above. Equal amounts of heat, from the two burners, are supplied to the identical heat-sink halves. The pyrometer readings show the 185-F temperature drop when the field is applied.

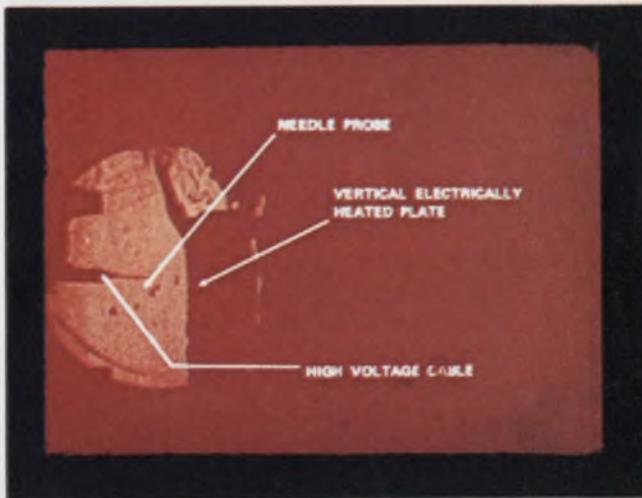

A high-voltage discharge cools a hot surface by producing a turbulence that disturbs the thin boundary layer. At the left, from a Schlieren movie by General Dy-



namics, a 1100-F copper plate has minimum heat transfer with no field. At the right, the turbulence of a 20-kV field lowers temperature 300 F.

movies—pictures that reveal normally invisible phenomena, like heat waves—taken by General Dynamics in its investigations (see accompanying photos).

In the Schlieren setup, high-voltage fields were applied to a vertical copper plate three inches in diameter and one-half inch thick. The plate covered a hole in a fire-brick wall containing a 900-W electrical heating element. The temperature of the plate was stabilized at 1100 F, with no field applied. When 20 kV was applied through a probe, the temperature of the plate fell 300 degrees.

A problem with high power lasers, such as CO₂ devices, is the generation of heat in the optical elements through which the beam passes. In the worst case, this heat can destroy the elements; in lesser cases, it can distort them.

Because of the configuration of optical systems, fan or blower cooling is frequently too bulky and not feasible. To seek a better method, General Dynamics conducted extensive experiments with electrostatic cooling of germanium and Irtran 2, a polycrystalline zinc-sulfide window produced by Eastman Kodak. Both elements, because of their long wavelength transmission characteristics, are widely used with infrared lasers.

General Dynamics' Dr. Kibler reports that the electrostatic cooling was "effective" for both materials. Irtran, which is used for high-power CO₂ laser systems, distorts at temperatures of only

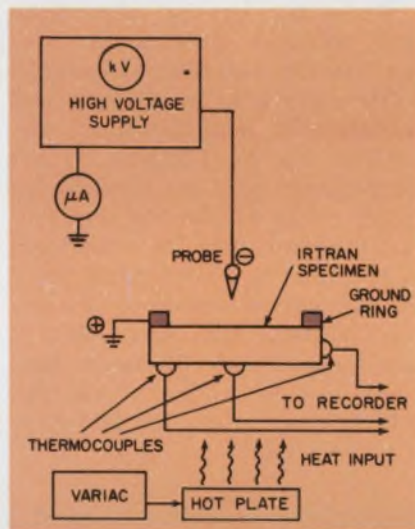

1. Data on electrostatic cooling of laser optical elements was provided by this basic test setup.

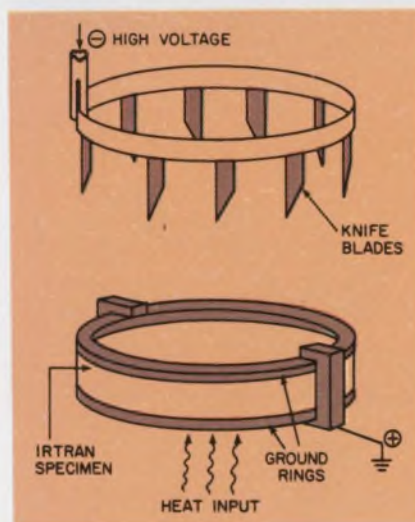

2. The best electrostatic cooling of the Irtran window was obtained with the setup shown above.

a few hundred degrees fahrenheit, Kibler notes.

In a typical experimental arrangement by Kibler (Fig. 1), flat cylindrical Irtran specimens were placed horizontally over an electric hot plate, surrounded by insulating bricks. By controlling the power input to the hot plate with a Variac, and by monitoring the temperature with thermocouples, the experimenter obtained a constant temperature.

Electrostatic probes used in the experiment included needles, discs of fine-mesh screen and rings of knife blades. The specimens were grounded with copper rings.

With a constant heat input that brought the Irtran to 270 F, application of 25 kV to the probe lowered the temperature by 140 F in a few minutes.

Kibler points out that an interesting feature of the electrostatic method of heat transfer is the possibility of shaping the electric field by shaping the probes or by using arrays of probes. This can permit the use of high-voltage cooling in inaccessible areas without interference with the functions of the object to be cooled. A good example is the use of this method to cool Irtran and germanium IR windows without obstruction of the window aperture.

All of the probes tried in the General Dynamics experiments lowered the temperature, but by different degrees. The maximum cooling was observed for a probe made up of eight knife blades in

a circle (see Fig. 2).

To simplify thermodynamic analysis, Kibler set up an experiment—a simple needle probe positioned vertically above the center of one of the windows, as shown in Fig. 1.

Reliable cooling results, Kibler reports, were obtained with needle probe spacings of two to six inches from the window. The results showed that the cooling depended largely on the ionic current flow, which ranged from 10 to 60 μA . Applied voltages ranged from 5 to 30 kV. The window temperature of 240 F was reduced 20 F at 5 kV and 100 F at 30 kV.

No cooling was noticeable until about 10 μA began to flow. At current values of 50 to 60 μA , a saturation effect began to appear, and the drop in temperature with an increase in current grew smaller (see Fig. 3).

To determine how electrostatic cooling compared with forced air cooling, Kibler ran trials using an aluminum block of 2 x 6 x 1 inches with thermocouples installed in holes drilled halfway through the block. From stabilized temperatures of 250 F, and with a constant heat input, the temperature decreased at the rate of 8 F per minute with the application of high voltage. It dropped 11 F per

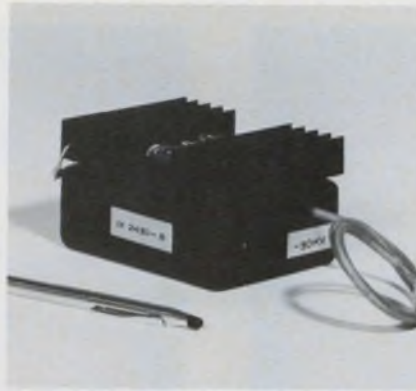

This 30-kV electrostatic cooling power supply was designed by Inter-Probe to provide up to 800 μA .

minute when a fan was used, but the power required for the electrostatic method was only 3 W compared with 14 W for the fan.

While the precise phenomena that produces electrostatic cooling has not yet been pinpointed, Kibler says it appears to be heat transfer by boundary-layer disruption. As he explains it, the temperature gradient between the object to be cooled and the surrounding air may be considered as confined to a very thin film of air that clings to the object's surface. Outside this film, most of the temperature difference vanishes, due to mixing of the air. Within the film, or boundary

layer, the heat transfer takes place by conduction. However, the electrostatic cooling effect apparently disrupts this boundary film to allow convection, as well as conduction, to occur closer to the surface of the object, and thus more effectively to cool it.

Kibler says that his best cooling result was obtained with an Irtran specimen at 280 F. The specimen was cooled to 130 F by applying 27.5 kV at 100 μA through the probe.

The heat dissipated without the electrostatic field in this particular experiment was calculated, in terms of the film heat-transfer coefficient, to be 9 BTU/hr/ft²/°F. With application of the field, the coefficient increased to 35. Improvement in this case was therefore roughly 4:1. In more typical cases the improvement factor was found to be about 2:1 (Fig. 3).

The cooling effect is one that is highly dependent on the geometry of the situation. Few generalities can be drawn, Kibler says, based on their own experience.

Semiconductor fins are cooled

To demonstrate the application of electrostatic cooling to high-power semiconductor radiators, Inter-Probe constructed a special setup. In it, individual blow torches heated two sections of radiator fins, each instrumented with a thermocouple and its own pyrometer.

The burners were adjusted to stabilize the temperatures of both heat sinks at 500 F. Then a 28 kV electrostatic field at 1000 μA was applied to one radiator to reduce its temperature by 185 F. The other heat sink remained at 500 F, with no field applied to it.

General Dynamics is exploring the possibilities of using the new cooling method for IC boards and other electronic components.

Dramatic effects, in addition to cooling, have been observed in the application of electrostatic fields to welding, says Inter-Probe's Blomgren. Metallurgical changes have been noted that cannot be ascribed to simply breaking down the boundary layer. These include control of grain size and hydrogen content, and elimination of inclusions and voids. ■■

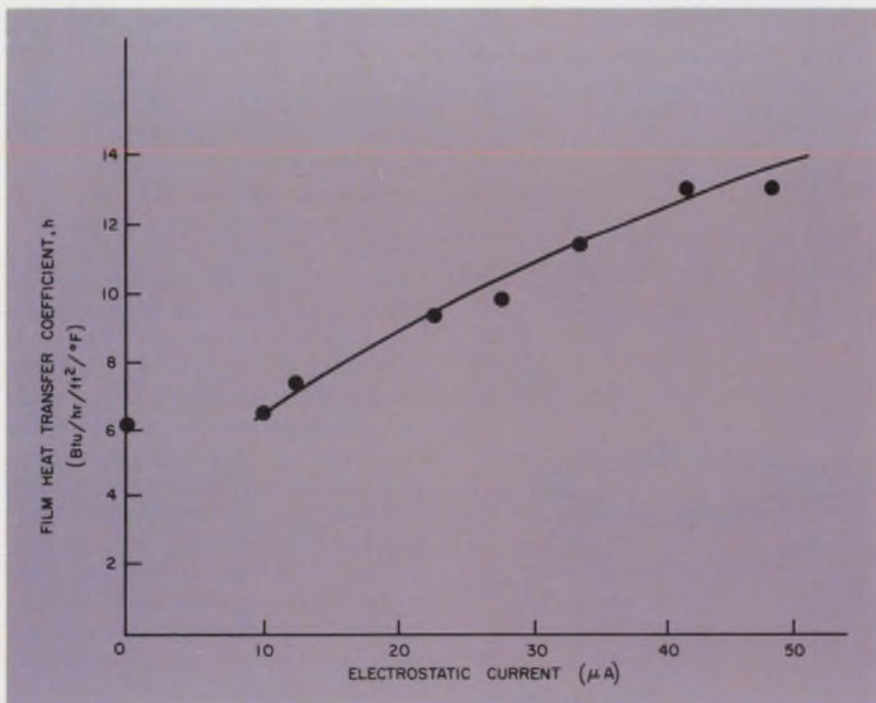

3. Electrostatic cooling depends strongly on the current flow. Here, cooling of an Irtran-2 element with a needle probe begins at 10 μA .

OUR NEWEST MOS CLOCK DRIVER IS QUITE A HUSTLER.

Speed's the name of the game in the MOS clock driver business these days. Whether you're driving a long shift register or one of the new MOS memories like the MM1103.

That's why the new two-phase MH0026 comes complete with a repetition rate of 5MHz and rise and falls times of 15ns (even while driving a 500pF load). Which makes the monolithic MH0026 as fast as the best hybrids and discrete modules on the market. (Which is even nicer when you consider the long term cost advantages of monolithic over hybrids or discrettes.)

The speedy new MH0026 has also been designed to be driven from standard DTL/TTL circuits.

All in all, the MH0026 is a welcome addition to a line of clock drivers which already includes the industry's only TTL compatible clock

driver (MH0007), one capable of dc operation (MH0009), a 10MHz clock driver (MH0012), a dual ac coupled driver (MH0013), the world's first monolithic (the low cost MH0025) and a TTL-to-MOS memory interface driver (MH0027).

Incidentally, our drivers are available in TO-5, TO-8 and one watt mini dip packages.

For clock drivers, it would behoove you to write, phone, TWX or cable us today. (Although orders more than a week old will also receive prompt attention.)

National Semiconductor Corporation,
2900 Semiconductor Drive, Santa Clara,
California 95051. Phone (408) 732-5000.
TWX: (910) 339-9240. Cable: NATSEMICON.

National

All-solid-state TV set wins a rave for easy servicing

An all-solid-state television receiver that can be serviced like a tube set was the goal that General Electric's Television Receiver Products Dept. in Portsmouth, Va., set in designing the company's first all-transistor TV chassis.

The final design of the 19-inch portable-TV chassis, designated U-1 by GE, not only achieves this goal; it incorporates a host of additional features that won for it the highest serviceability rating ever awarded by the National Electronic Association. The association, an organization of licensed TV service organizations and technicians, works with the TV manufacturers to simplify the servicing of television receivers.

A departure in design

"The high rating was the result of several departures from previous transistor-TV design," says W. J. Meyer, GE's manager of product service. Innovations include the following:

- The U-1 chassis has a single half-wave, high-impedance, unregulated 140-V power supply, with taps at 130 and 22 V—a type commonly found in tube sets. Some solid-state TV chassis have one or two low-voltage, highly regulated power supplies that are difficult to troubleshoot.

- The relatively high transistor voltages of +22, +130 and +140 permit the use of a 20 k Ω /V voltohmmeter, as with tube sets. With a 22-V source for transistors element voltages can more easily be read and interpreted than with 12 V transistor sets.

- Current measurements that usually require unsoldering a circuit are not necessary.

- Transistors are all npn, eliminating the need for a nega-

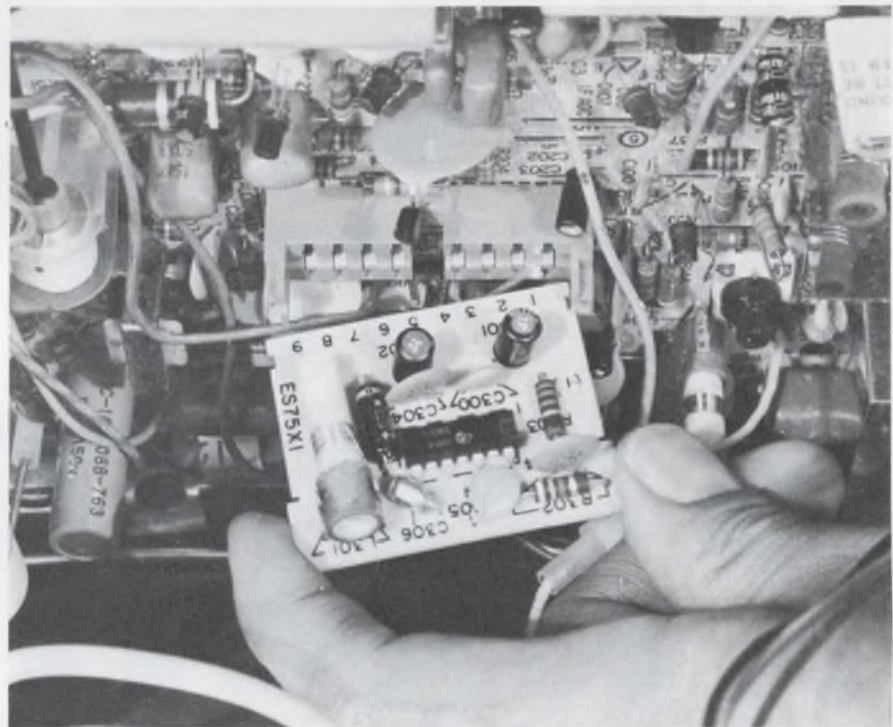

Seven transistors—power and signal—and an audio module plug into GE's new PC chassis. Power transistors can't be improperly plugged into their sockets. Signal transistors are protected against faulty insertion.

tive, regulated power supply.

- Plug-in transistors are provided for circuits in which the semiconductors are most likely to fail. The rest of the transistors in the main chassis are soldered in place, because their expected failure rate is very low. This also provides a clue for the technician to look elsewhere first for trouble.

- For ready accessibility, the receiver has three separate chassis. The main one is printed-circuit board on which components are grouped by function: i-fs, detectors, sync, video and sweep-generating circuits. The PC conductor pattern in the main chassis is designed so that any single component can be removed without unsoldering any other. The deflection

system is on a separate metal chassis, as are the power supply and output stage. GE's Meyer notes that sets have been designed that require removal of the chassis to replace a fuse—a task difficult to explain to the set owner.

Rapid removal of components is a part of GE's new design.

- The main PC circuit board is held in place by two spring clips that can be pried loose with a screwdriver.

- The high-voltage transformer assembly, the vertical output transformer and the picture-tube filament transformer are each secured with one screw.

- The loudspeaker is held with spring fasteners that can be quickly removed with pliers. ■■

How to live within your budget!

Money for new test equipment is tight. Every dollar has to stretch as far as possible without hurting performance.

If you're looking for a 15 to 50-MHz scope—like the 422, 453A or 1700—you owe it to your company to try Hickok. Because, with a Hickok scope, you get quality performance while saving money.

With Hickok, you receive:

- dual and single channel models
- 25-MHz bandwidth
- stable triggering beyond 50 MHz
- 10-mV sensitivity
- built-in delay line

The value-priced 5000A and 5002A are the results of Hickok's experience in producing more than 20,000 scopes for reliable operation in rugged military environments. These performance-packed scopes are ideal for lab applications: clean pulse response; 4 screen width horizontal and 3 screen height vertical deflection; sharp, bright trace. And for field use, lightweight, compact design.

These are features usually found on models costing up to \$2100. And this brings us back to economy—the 5000A single channel scope is \$595 and the 5002A dual channel is \$845. Call Hickok to take a look at these scopes in your lab.

HICKOK
the value leader

Instrumentation and Controls Division
10514 Dupont Ave. • Cleveland, Ohio 44108
(216) 541-8060

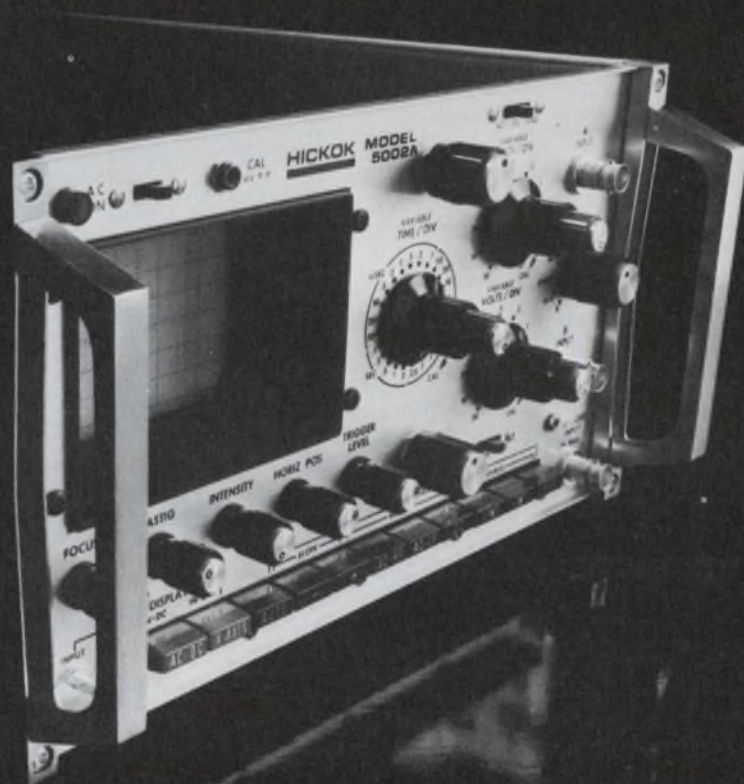

HICKOK

A robot worker being developed to assist space-station crews

When the space shuttle arrives at the orbiting space base, who is going to move all those heavy supplies from the shuttle to the base? There'll be big telescopes, hundreds of pounds of electronic experiments to be moved in and out, spare parts, food and even mail.

And who in the space base is going to get out of a warm bed after a hard day's work to step out into space so a loose solar cell can be checked?

Hopefully, a robot or teleoperator—now officially called “a remote manipulator system”—will do all this and a great deal more.

Working on the project is Bell Aerospace, a division of Textron in Buffalo, N. Y., under a contract with the National Aeronautics and Space Administration's Marshall Space Flight Center in Huntsville, Ala.

Feasibility under study

The immediate project is for Bell to determine the feasibility of using controllable arms on a spacecraft. Eventually arms might be fixed to the space shuttle itself or built on a special subsatellite that could be carried aloft by a mother craft and released in space or shot into space by its own booster.

Looking at future possibilities, Heinz Fornoff, chief engineer of Bell Aerospace's Space Systems Dept., says: “Fifty to 100-foot manipulators on the space shuttle might be used to hold onto a space station for docking; they could bring an ailing satellite back to earth, or they could help add a new compartment to an orbiting station.”

John F. Mason
Military-Aerospace Editor

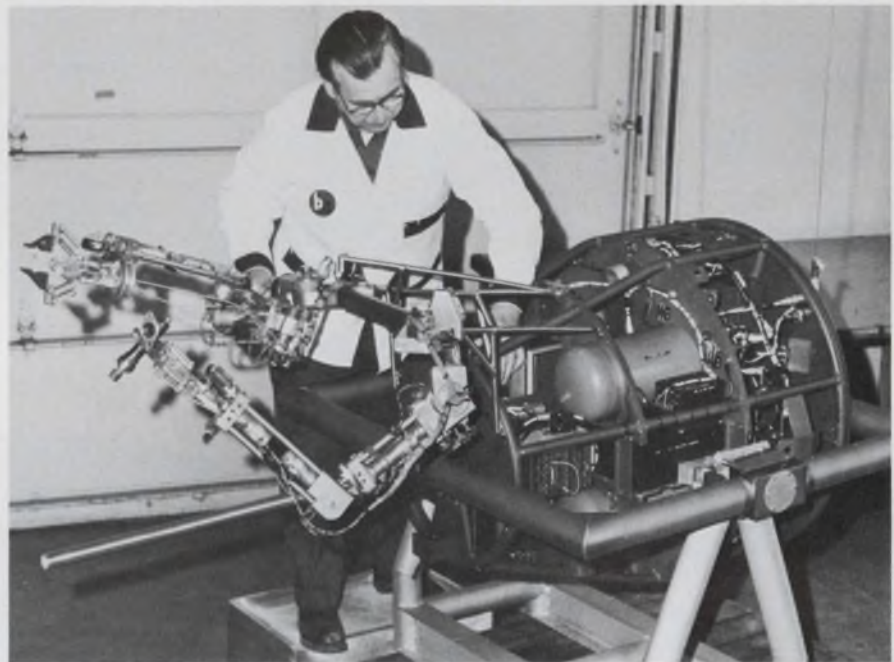

Arms on this flyable subsatellite can be controlled remotely by an operator in a nearby spacecraft or from the ground. Television cameras strategically placed on the robot show the operator the results of his maneuvers.

Built as a subsatellite, the unit would be equipped with several television cameras that would relay pictures to a human operator, either in a nearby spacecraft or on the ground, and the operator could command the manipulator by radio to do any number of chores. It could inspect alien satellites, remove and replace experimental packages, and assemble or erect space structures or large antenna arrays. And it could transfer cargo and even rescue an astronaut in distress.

“Another application,” Fornoff says, “would be as a rover for the moon or for Mars.”

Here is how the operation of the subsatellite manipulator is envisioned:

The operator sits at a console, about the size of a small desk, with

antennas. He maneuvers the robot remotely by manipulating two control handles, as he watches one or more television screens showing pictures from the robot. Digital and analog radio commands are sent over 40 channels. The subsatellite is propelled by thrusters. Solenoids provide precise control of the thrusters.

Integrated circuits are used throughout the unit. Two means of stabilizing the system under consideration are control-moment gyros and rate gyros.

NASA is considering proposals from industry for designing a manipulator system to be used on the first 10 flights of the space shuttle.

An experimental model, built in the form of a subsatellite with two manipulative arms, is being tested

at Bell's space-simulation facility. The facility consists of a room with a 20-by-24-foot floor, where two platforms float on virtually frictionless jets of pressurized gas 1/1000th of an inch thick.

The floor is flat to within 2/1000th of an inch accuracy. The platforms are remotely controlled from individual consoles, each equipped with a display from television cameras aboard the units.

With this facility, each attribute of the space environment needed to evaluate a robot concept, except



Operator watches the robot on several television screens and commands it by 40 radio channel links.

vertical motions, can be achieved on earth with a five-degree of freedom unit. It is installed in a low-friction gimbal ring (for pitch and roll motions) that operates on an extremely low-friction, air-bearing platform (for yaw, forward, reverse and lateral motions) within the one-g earth field.

When friction is reduced to extremely low levels, instability, control system requirements and docking difficulties associated with a flight robot can be simulated, Fornoff says.

"The results of the experiments," Fornoff says, "are expected to establish the performance capabilities and design criteria that we hope are first steps toward development of the operational remote manipulator systems that will play an increasing role during man's second decade in space." ■■

MORE digits PER DOLLAR



THE NEW NATIONAL[®] NUMERIC DISPLAY PANEL

Lowest cost per digit—initial cost is lower than all other types of numeric displays. Installation costs are lower, too, because panels simply plug into mating connector. No alignment of digits necessary.

More digits in smaller display area—higher character density packs 16 digits into approximately 7¾" of display length. On .375" centers, numerals are 0.4" high. All numerals on the one-piece module are centered for distinct legibility.

Packaging is exceptionally flexible—panels are available in 8 through 16 digit displays. Multiple digit module can be custom designed to meet almost any customer needs.

SEND FOR DATA FROM:

NATIONAL ELECTRONICS, INC.
a varian subsidiary

Geneva, Ill. 60134, phone 312-232-4300

Read Light Right

Read Light Closely!

Light emitted from concentrated, multiple, high density light sources calls for light sensors of comparable mechanical mounting capability. Motorola plastic Micro-T* and hermetic "pill" detectors can be mounted close as 85 mils in discrete applications using manual soldering and 100 mils with flow soldering. Perfect emitter-detector matching is ensured through use of identical array packaging. For extremely high resolution requirements, Motorola standard monolithic, 39-element diode/transistor arrays are on 0.005" center-to-center spacing. The active area is 0.005" x 0.0045" with 0.0005" space between elements. Use both in OCR, mark sensor and card/tape reading designs.

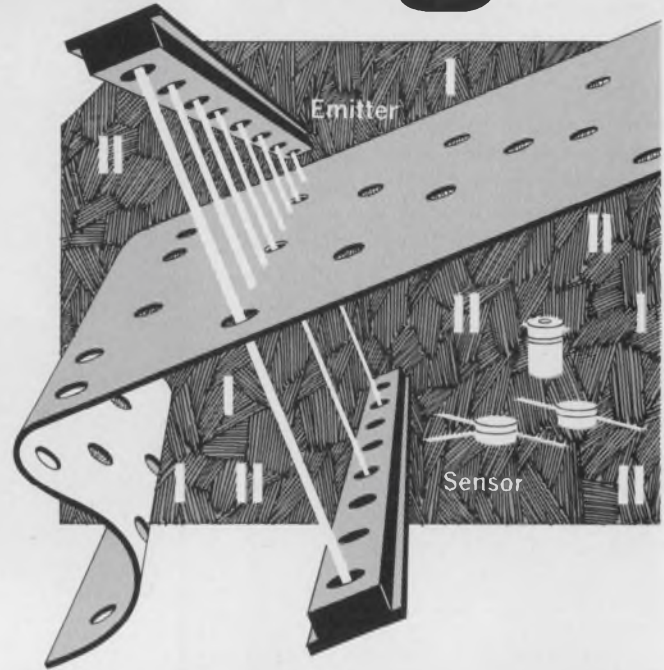

Read Light Quickly!



RELATIVE RESPONSE TIME

Light Sensor	Time
Motorola Pin Photodiode	1 ns
Photomultiplier Tube	4 ns
2N2369 Switching Transistor	6 ns
Motorola Phototransistor	4 μs
Motorola Photodarlington	300 μs
Cadmium Selenide Cell	0.5 ms
Cadmium Sulfide Cell	1 ms
Human Eye	16 ms

Ultra-fast recognition of red or IR wavelengths in laser detection, light demodulation, shaft/position encoders, switching and logic circuits in the nanosecond range demands ultra-fast devices. MRD500/510 PIN diodes typically respond in 1 ns; conventional, bulk-effect detectors need longer response times. Both units feature high sensitivity and are available with convex or flat glass lenses in standard, TO-18 cases. Exclusive Annular* passivation ensures long-term reliability and stability.

Read Light Reliably!

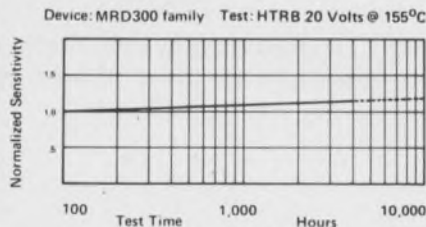

Critical to any application requiring stable characteristics over very-long-term operating life expectancy is detector sensitivity which must remain constant so system biasing is not thrown off spec. Similar to beta

measurement in a conventional transistor, phototransistor sensitivity = output current ÷ light input. Curve shows the sensitivity for a standard hermetic, MRD300 detector family having little or no change in documented or projected sensitivity beyond 4,000 hours of testing. Indications from this and other ongoing tests show Motorola's family of Annular passivated light detectors to have identical reliability as standard metal-can transistors which have shrugged off millions of hours of rugged, mil-type life testing without significant failures.

Read Light Economically!

TYPICAL PLASTIC DETECTOR PRICE TRENDS

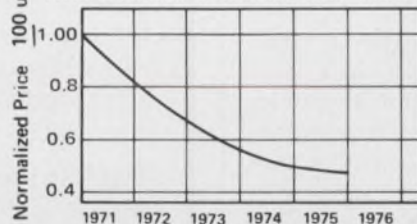

The trend in silicon photodetector pricing is *down!* And you can control light-generated current flow with 24 different Motorola PIN photodiodes, phototransistors and photo Darlington for optimized optical performance in dc to high frequency designs. For example, 100-up prices on the *metal*, MRD3050 series now start at only 80¢ — a level comparable to plastic! Select the right light detector for your design from the broadest light detector line available — Motorola's! Write Box 20912, Phoenix, AZ 85036 for complete detector data.

*TRADEMARK MOTOROLA INC.



MOTOROLA OPTO
Let There Be Light

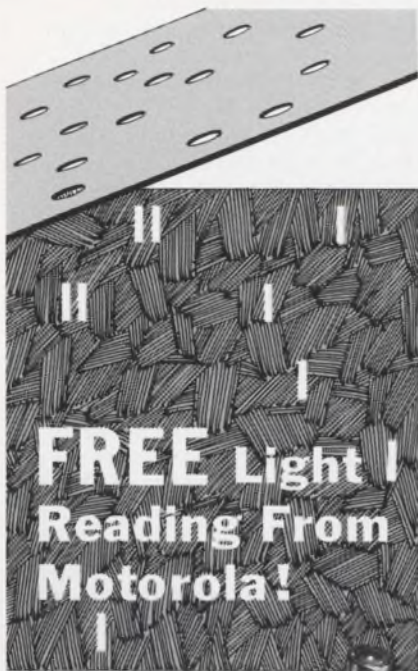

FREE Silicon Photodetectors
MRD450, MRD3051

FREE IR Led
MLED900



FREE Application Notes:

AN440—"Theory & Characteristics of Phototransistors"

AN508—"Application of Phototransistors in Electro-Optic Systems"

Lighten your prototype loads with free photodetectors and an IR emitter — just send this coupon to your Motorola distributor for one or all of these optoelectronic design aids for your new-design workbench!

To: _____
(Distributor)

I'd like these free opto design kits delivered to me immediately:

- MRD450, MRD3051 Photodetectors
- MLED900 IR LED
- AN440, AN508 Phototransistor Application Notes

Name _____

Title _____

Company _____

Address _____

City _____

State _____ Zip _____



technology abroad

Homopolar generators and motors — very-high-current, low voltage dc devices — with a built-in system for removing contaminants from their gallium-indium liquid-metal brush rings are being developed by the GEC Hirst Research Center in Wembley, England. An electrolytic cell, supplied by voltage from the machine itself, removes the contamination products. The company reports that an experimental 5-kW motor-generator/torque-converter and a generator that yields 6 kA at 1 V have been tested successfully with the new system. Homopolar generators, which work on the Faraday disc principle, are gaining increasing favor for the production of large direct currents.

CIRCLE NO. 451

Electrolytic capacitors with aluminum foil electrodes that are spaced with glass fiber instead of paper reduce failure in high capacitance, low-volume units, according to Philips of the Netherlands. Now in production by Philips, the new 121-series of capacitors is cheaper than solid tantalum counterparts. Capacities are in the 2.2-to-330- μ F range, with 20% tolerances and working voltages from 6.3 to 40 V dc. Philips reports a failure rate of 0.02% per 1000 hours at rated voltage and 2-C ambient temperature, increasing to 0.2% at 12 C.

CIRCLE NO. 452

Five to eight times better performance from a new zinc-air primary dry battery than is provided by an equivalent Leclanche cell is claimed by Crompton-Parkinson Ltd. of England. The battery is about 2 x 1 x 1/2 inches and weighs slightly more than an ounce. It has an open-circuit rating of 2.8 V. The voltage remains almost constant as 250 mA is drawn continuously over 10 hours. A design innovation is placement of the air-breathing cathode faces of the two series-connected cells

toward each other on each side of an air channel. This protects the faces from damage and gives the battery a smooth exterior.

CIRCLE NO. 453

Italy's first major computer project, the Selenia CDG 30/32—a real-time machine developed initially for military and air traffic control—is now under final evaluation. The machine makes extensive use of LSI technology and has a powerful set of 112 instructions. Since word lengths of 32, 30, 16 and 15 bits can be chosen by microprogramming, the computer can be used efficiently in real-time digital conversion. Production is expected to start next year.

CIRCLE NO. 454

An experimental "programmed driving" system in which urban drivers are told how to get to their destinations by computer is being tested by Siemens of West Germany. If the idea becomes a reality, drivers will install a transceiver in their cars to program their position and destination, using street names that are encoded into six-digit figures. A central computer tells the driver whether to turn left or right or to drive straight ahead, as well as at what speed he needs to travel to get through the green lights without stopping.

CIRCLE NO. 455

A \$588 digital counter using MSI-MOS circuits is being produced by Venner Electronics in England. The MOS circuits are found in both the counting and dividing chains. These circuits replace over 24 integrated circuits in the more conventional approach. The counting chain has a high-speed TTL circuit, followed by three MOS chips that provide the seven-digit count capability. In the divider chain, a 10-MHz crystal output is divided down to 1 MHz by one TTL decade and two MOS chips.

CIRCLE NO. 456

Etched or stamped parts?

Buckbee-Mears offers both to help you save money.

Many precision parts can be made by either photo etching or stamping. BMC offers both, which means you can be sure we will recommend the most economical method to produce your part. That's mighty important if you're concerned about costs.

There are other advantages. With our ability to etch parts in large volume, we have built-in second source protection for stamping. That means no expense for a second set of tools. We can get you in production fast by etching your prototypes. Then, when volume is sufficient, you can switch to stamping.

All with one supplier, Buckbee-Mears.

Most component manufacturers must take suppliers into their confidence. Since we are completely independent, you can be sure your proprietary designs are safe with us.

If you need precision parts, call or write our marketing department. Better still, see your regional BMC sales consultant. He's a real pro, specially trained to solve your production problems. And he can make an expert cost analysis on etching versus stamping for you.

Buckbee-Mears is the world's largest volume producer of precision etched, stamped and electroformed parts.

You can expect us to deliver, on time, what we say we can deliver. You'll save money with BMC, too, because we can choose from a wide range of capabilities to solve your particular needs. We have a large variety of etchable metals on inventory for fast prototype production.

Fast delivery, reasonable prices, in-depth capability, well trained sales force. Shouldn't you talk to us first?

Buckbee-Mears Company, 245 East 6th St., St. Paul, Mn 55101, Telephone (612) 228-6371, Telex 297080.

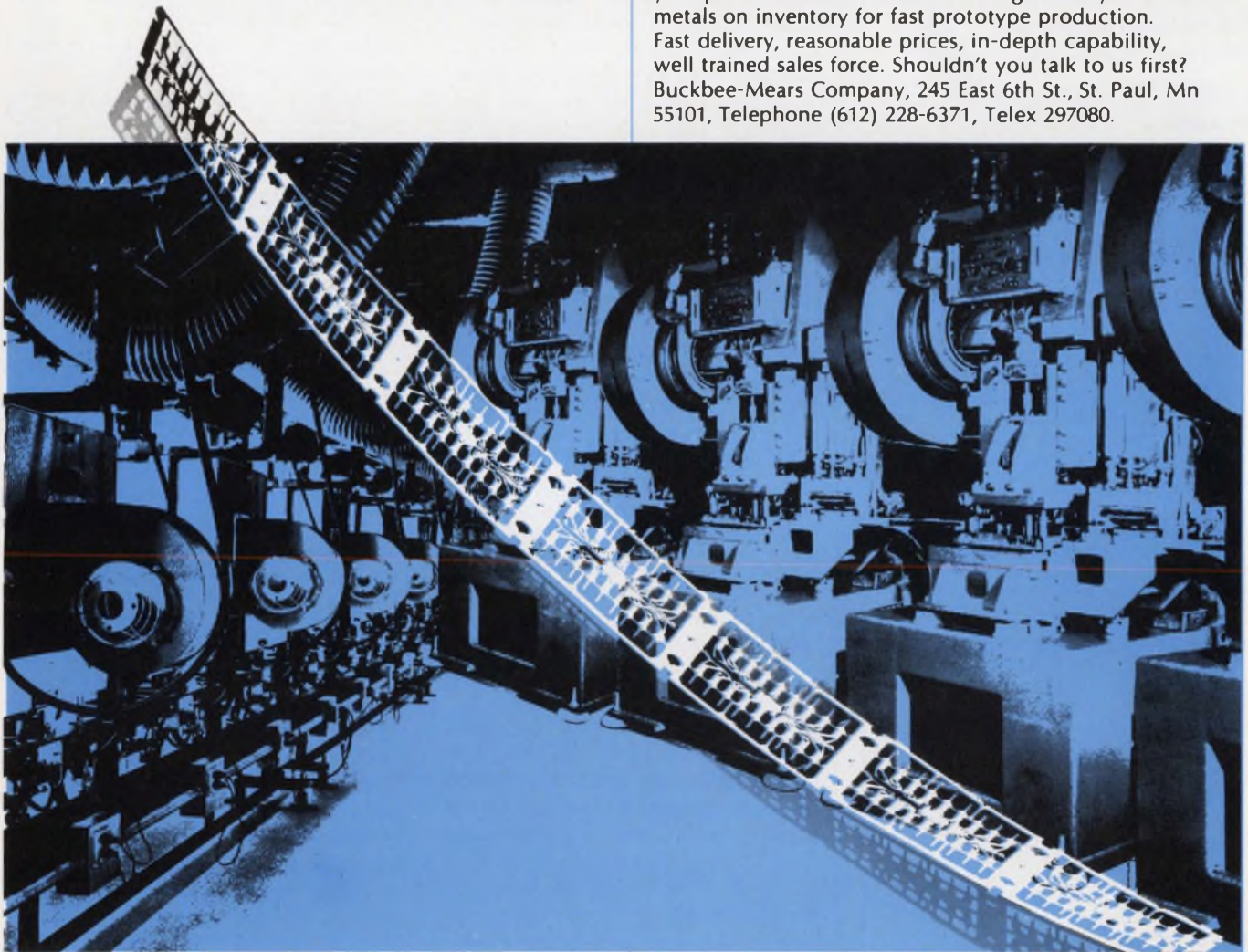

Buckbee-Mears offers immediate delivery of etched prototypes, and can, without interruption, shift to identical stamped parts to meet low per-piece cost, long run requirements.

BUCKBEE-MEARS COMPANY
bmc

At \$49.00 this 12-bit DAC will convert you, too.

Ready? 12-bit resolution, speed $5\mu\text{sec}$, linearity $\pm\frac{1}{2}\text{LSB}$, and temperature coefficient $\pm 30\text{ppm}/^\circ\text{C}$, plus the extras you expect in converters made by Analog Devices — like TTL/DTL-compatible inputs and monotonicity. All for \$49 in 100's.

The DAC-12QZ inherits its performance from our top-of-the-line converters, and it owes its low price to new production techniques we've developed. Result: there is nothing like it for the money.

There *is* a less expensive converter in our line — the \$29, 10-bit DAC-10Z we introduced last month. And there are some other nasty surprises for our competition coming up. For example, the ADC-8S to be announced next month. Its low price will doubtless change your buying habits — like using one ADC-8S per channel instead of multiplexing an expensive ADC.

Meanwhile send for detailed information. And if you want an evaluation sample of the DAC-12QZ or the DAC-10Z just call, or write us on your letterhead. Both are in full production and we have lots in stock. Analog Devices, Inc., Norwood, Mass. 02062, (617) 329-4700.



Take a turn for the better in rotary switches.

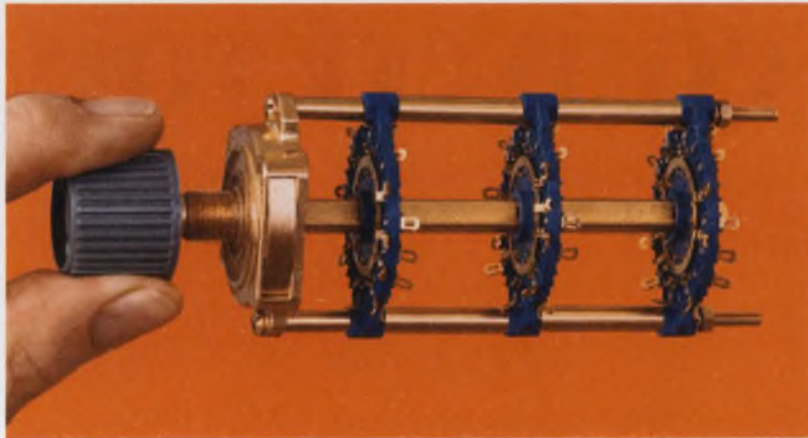

Oak continues to market the broadest line of rotary switches in sizes and configurations to fit your applications.

For example:



Our 1/2-inch subminiature rotary switch.

Ultra-compact, yet provides superior insulating qualities and dimensional stability in demanding environments at lowest competitive price.

A new 12-position Acorn rotary for printed circuits.



A size-saving design. Crisp, uniform detenting with Oak's patented Unidex™ indexing. Has glass epoxy wafer and tinned PC terminals ready for soldering.

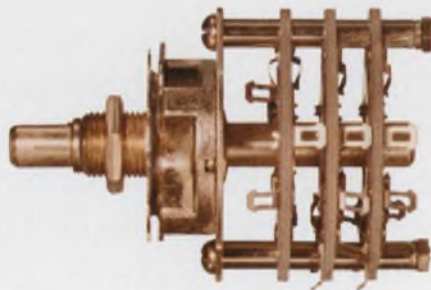

Rotary switches with Unidex indexing, too.

Our F and JKN series. Versatile, economical. And Unidex detent means uniform torque, crisp feel.



And our Multidex® rotary: the almost-universal switch.

Versatile enough to replace 7 old-style rotary designs. Thousands of variations available. With Unidex detent for sure switching time after time. Multidex cuts the cost of engineering design.

There's more.

Miniaturized lever switch: Type 184. Improved dielectric properties plus more clips per stator.



Miniature rotary trim switch. For SPDT trim switching in tight PC-board locations. Long life. Low cost.



Stepping switches: Compact, lightweight. Subminiature to extra-heavy-duty types. Fast response.

Now: order Moduline™ Switches from your distributor.

Choose from 2-million possible switch combinations. 72-hour delivery. Write for the Moduline Catalog.



OAK MANUFACTURING CO.

CRYSTAL LAKE, ILLINOIS 60014 · A DIVISION OF OAK ELECTRO/NETICS CORP

Telephone: 815-459-5000

TWX: 910-634-3353

TELEX: 722-447

INFORMATION RETRIEVAL NUMBER 26

washington report

DON BYRNE, WASHINGTON BUREAU

Air Force to select associate contractors for B-1

The Air Force expects to name associate contractors to develop the electronic countermeasures and infrared surveillance systems for the B-1 bomber. The countermeasures associates should be picked by the middle of next month, and the surveillance associates by November. They will work with the over-all avionics contractor, who will put the whole package together.

Meanwhile, the Air Force says the following companies will provide the Government-furnished avionics for the aircraft, navigation and weapons delivery: Northrop, the stellar inertial system; Delco Electronics, the Carousel inertial system; General Precision Laboratories, the Doppler radar; Stewart Warner, the radar altimeter; General Electric, the forward-looking radar; Texas Instruments, the terrain-following/avoidance radar; Hughes and Texas Instruments, a forward-looking infrared sensor; Westinghouse and RCA, a low-light-level TV, and Raytheon, the threat-associated electronic countermeasures system.

For mission and traffic control, Collins Radio will provide the radio, Avco, the AN/ARC-123 hf radio, Collins Radio, the ILS-70 instrument landing system, Hoffman Electronics, the AN/ARN-91 Tacan navigation aid, Motorola, the AN/APX tracking beacon, and Magnavox, the AN/URC-64 uhf air rescue beacon. Earlier estimates said that the off-the-shelf avionics would probably cost about \$4.8-million per aircraft and weigh about 3900 pounds. The Air Force says now that these estimates are high, but declined to come up with new figures.

Collins Radio gets emergency communications contract

A \$7.7-million contract between the Navy and Collins Radio, Inc., of Cedar Rapids, Iowa, has signaled the start of production of the Navy's Sect—Submarine Emergency Communications Transmitter—system. The contract is expected to be the first in a series over five years to outfit nuclear submarines with communications buoys that would go into action in any undersea emergency that the craft encountered.

Sect touched off an international alert a few years ago when a Navy laboratory working on the buoys allowed the prototype to start transmitting the "submarine down" message. Brass in the Pentagon and the Norfolk Atlantic Fleet Headquarters were rapidly heading for their panic buttons when triangulation established that the "underwater" broadcast was coming from a Washington, D. C., suburb.

Airlines push talks on Microwave System

The board of directors of Aeronautical Radio Inc. (ARINC), the communications arm of the nation's airlines, met in the first of a series of meetings this week to establish policy on the possible construction of a \$257-million microwave coaxial cable communications system to serve the airline industry. ARINC's chairman, John S. Anderson, says that

should the airlines go to their own system and forsake the present leasing arrangements with AT&T, they could save as much as \$50-million a year. They would also, he says, "eliminate the uncertainties of future tariff increases."

ARINC has told the Federal Communications Commission that two AT&T tariff changes less than a year and a half apart almost doubled airline communication costs to \$60-million a year, and projections of usage indicate that by 1980 the cost of leased facilities would reach almost \$140-million annually. The possibility of an airline-owned and operated communications system has been in the incubation stage for several years and, until recently, has been scoffed at by some segments of the communications industry as too costly for the airlines and as merely a ploy by ARINC in a rate case pending before the FCC.

But ARINC points out that the system would not, of course, be built in one swoop; that it would be financed as it was being constructed through user charges.

Navy seeks \$50-billion building program

The Navy has given Congress a guideline for a minimum rebuilding program that would cost approximately \$50-billion for shipbuilding over the next decade. Envisioned in the unofficial plan, sponsored by the Chief of Naval Operations, Admiral Elmo R. Zumwalt, is the construction of a nuclear carrier every three years, seven nuclear submarines every year, one nuclear-powered guided-missile frigate every year and introduction of the undersea long-range missile system ULMS subs by the mid-1980s.

Meanwhile, the General Accounting Office in a report to Sen. William Proxmire (D-Wis.) has charged that the Navy shipbuilding program, as it now exists, has had little competitive bidding for contracts and that the advantages of what little competition there has been has been largely negated by extensive design changes. The report says that changes in 1970 accounted for 22% of the over-all costs. This year's budget calls for \$3.3-billion in shipbuilding funds.

Capital Capsules: The Air Force has pushed up the selection date for its advanced Loran—Loran C/D program, designed to outfit 3000 tactical aircraft with precise navigation equipment over the next five years. It now expects to pick a contractor before the first of the year. The Navy has stepped up efforts to equip its tactical aircraft with better electronic countermeasures gear to combat improved Soviet missiles and early-warning radar. It shifted \$12.4-million from other programs to accelerate the Itek AN/ALR-45 threat-warning receiver and the Magnavox AN/APR-27 passive missile-warning receiver programs. Only \$900,000 had been allocated for the programs in the budget. . . . Lockheed has won a \$1.3-million contract from the Air Force for development work on the Malfunction, Detection, Analysis and Recording—Madar—subsystem for the C-5A aircraft. Madar is called an "aircraft cardiograph" because it continuously checks 1200 test points during flight. . . . NASA now expects to launch the first of its three orbiting solar satellites about this time next year. They will cost about \$80-million and be built by Hughes for examination of the sun—particularly its corona, which is 400 times the temperature of the sun itself. . . . The Commerce Dept. reports that U. S. exports of business machines totaled \$839-million in the first half of this year, up from \$770-million over the same period last year. Computers, peripherals and parts accounted for 68% of the exports or \$569-million. The biggest importers were West Germany, Japan, Britain, France and Canada.



When you need contact centers from .100" down to .025" you're in Cannon country.

The roundup of microminiature connectors in ITT Cannon's corral gives you the broadest selection in the industry — for any application where space and weight are critical.

When you need a rugged, moisture-sealed rectangular type, choose our MDM series. Metal shells in 7 sizes and up to 51 MICROPIN®/MICROSOCKET® contacts on .050" centers (equivalent to 420 contacts per sq. in.) Or take our original MICRO-D's, which give you a choice of 3 plastic insulator materials, clip or screw mounting, and from 9 to 51 contacts on .050" centers.

Need a circular connector with up to 55 contacts in a size 4 shell? The MICRO-K is found on all kinds of equipment, from bio-medical to ground support, and it meets the applicable requirements of MIL-C-26482.

Applications for our low profile, lightweight

50-MIL STRIPS are as unlimited as your imagination. Available in any length up to 6-inch strips with 120 contacts on the same density spacing. Or when you want a low cost commercial crimp type for EDP, instrumentation or communications applications, use our CENTI-LOC® rectangulars, or strips with up to 53 contacts on .075" centers or 60 on .100" centers. And the Double Density D gives you from 19 to 100 contacts on .075" centers, in 5 shell sizes.

If we don't have the exact one you need (and we produce more types, shapes and sizes than anyone), we'll be glad to discuss creating one for you.

Contact the most experienced house in microminiature country, ITT Cannon Electric, International Telephone and Telegraph Corporation, 666 East Dyer Road, Santa Ana, California 92702. (714) 557-4700.



How can Philips **guarantee** the performance of its RF power transistors for mobile transmitters?



Yes...the word is **guarantee.**

No more wondering "50 watt is 50 what?"

With Philips RF power transistors for mobile transmitters, you know precisely what you're ordering. You get precisely what you order. If used as specified, it will not fail... or your money back!

How is this possible? Not as difficult as it seems.

It starts, of course, with a product of superior reliability. But the real secret is in the specifying.

We provide you with a set of SOAR (Safe Operating Area) curves setting forth, in detail, at exactly what combination of VSWR, temperature and supply voltage variations the transistor will operate correctly. When we say "25 watt", we mean, for example, "25 watt performance, with a 70°C heat sink, withstanding a VSWR of 50, 20% overvoltage and an increase of 20% drive power". Rather than forcing you to build in your own safety margin... with the probability you will over-specify and over-spend to be on the safe side... we determine all the derating parameters for you. The specification is part of the product... and we stand behind it.

The full range of Philips RF power

transistors for mobile transmitting equipment... civil, military, aerospace or maritime... is shown in the accompanying table. Write for full specifications.



electronic components and materials

N.V. Philips' Gloeilampenfabrieken Electronic Components and Materials Division Eindhoven, The Netherlands.

Distributed and sold in the U.S. by: Amperex Electronic Corporation Semiconductor and Microcircuits division Providence Pike, SLATERSVILLE R.I. 02876

In Canada: Philips Electron Devices a division of Philips Electronics Industries Ltd. 116, Vanderhoof Avenue TORONTO 17 - Ontario

Pout (Watt)	SSB	VHF		UHF	
	30 MHz	175 MHz	FM	470 MHz	FM
	28 V	13.5 V	28 V	13.5 V	28 V
0.5				2N4427	
1.0		2N4427			
1.5			2N3866		
2.0				BLX65	
2.5			2N3553	BLX66	
3.0		2N3924		BLX67	BLX92
4.0		BFS22A	BFS23A		
6.0			2N3375		
7.0		2N3926		BLX68	BLX93
8.0	BLX13	BLY87A	BLY91A		
12.0		2N3927			
13.0			2N3632		
15.0		BLY88A	BLY92A		
20.0				BLX69	BLX94
25.0		BLY89A	BLY93A		
40.0					BLX95
50.0	BLX14	BLY90	BLY94		
100.0	BLX15				

PHILIPS

INFORMATION RETRIEVAL NUMBER 29

Centralab offers immediate delivery on functional modules

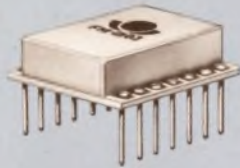

Centralab, the industry leader in thick film microcircuitry, now has combined its recent advances in packaging and chip hybrid technology to bring you five new functional modules available for immediate delivery from stock. These modules are sealed in ceramic packages with 14 swaged terminal pins universally spaced .600" row-to-row and .100" apart to facilitate printed circuit board mounting.

Module	Function	Rating	Suggested Applications
FM-1110	Power driver	1 amp @ 60v steady state	Interfacing with relay/solenoid coils, magnetic cores, lamps, etc. in computers, control consoles, test equipment, digital systems, etc.
FM-1203	Dual driver	300 ma @ 28v steady state	
FM-1403	Quad driver	300 ma @ 28v steady state	
FM-2100	MOS clock driver	200 ma with up to 30v shifts	To drive all popular MOS circuitry in calculators, computers and other digital systems.
FM-3110	Programmable multivibrator	Output pulse widths 200 ns to 12 μ s	Delay, timing and pulse shaping in computers, control circuits, test equipment and other digital systems.
*FM-4110	RC clock oscillator	500 kHz to 6 mHz	Time base, square wave generators and tone signalling controls for computers, test equipment, etc.
*FM-5110	Overvoltage crowbar	Trip voltage 4.5 to 12.5v, < 1 μ sec response	To protect voltage sensitive devices such as IC's, MOS devices, etc.
*FM-5111	Overvoltage crowbar	Trip voltage 12.5 to 20.5v, < 1 μ sec response	
*FM-5120	Electronic fuse	Trip current 1 amp @ 40v, < 1 μ sec response	DC electronic equipment and systems where precise, fast current disconnect is required.
*FM-6110	Power operational amplifier	250 ma peak output current with supply voltages \pm 15 vdc	Servo systems, test equipment, power supplies, etc.

DESCRIPTION

FM-1110, 1203, 1403: Single, dual and quad drivers
Designed to accept standard DTL and TTL logic levels and to drive loads which require high power. Consist of single or multiple NAND/NOR gates and high gain amplifiers.

FM-2100: MOS clock driver
Designed to accept standard DTL and TTL logic levels and universally drive MOS circuitry. Consists of a three input AND function followed by a power inverter.

FM-3110: Programmable monostable multivibrator
A flip-flop which, when triggered by an input pulse, generates an output pulse of prescribed width, with control through interconnection of appropriate package pins.

***FM-4110:** RC clock oscillator
An RC astable multivibrator and an output buffer stage capable of providing a square wave output at a predetermined fixed frequency. It can operate down to 5 Hz with the addition of external capacitors.

***FM-5110, 5111:** Overvoltage crowbar
A high speed electronic voltage sensing element and switch designed to protect voltage sensitive electronic devices by shunting out the supply voltage when high transients or other overvoltage conditions are experienced on the supply line.

***FM-5120:** Electronic fuse
The electronic equivalent of a fuse which features accurate threshold levels, high speed and reset capabilities. Available in a variety of current threshold levels.

***FM-6110:** Power operational amplifier
An operational amplifier designed to provide output capabilities far beyond those obtainable with equivalent monolithic IC's.

***These modules are scheduled for introduction in 1971.**

We welcome inquiries on any variation of the above modules and can provide rapid turnaround on samples and production quantities of custom modules. For design assistance or other information, write Sales Manager, Microcircuits, Centralab. Standard modules are also available through Centralab Distributors.



CENTRALAB

Electronics Division
GLOBE-UNION INC.

5757 NORTH GREEN BAY AVENUE
MILWAUKEE, WISCONSIN 53201

M-7115

First erasable MOS ROM!

Intel introduces the E-ROM, a 2048-bit Erasable Read Only Memory you can reprogram anywhere.

You program the E-ROM electrically, using a programmer actuated by tape cut on any teletypewriter or a simple manual programmer.

You can erase it in the field by shining ultraviolet light through the transparent quartz cap.

THEN YOU CAN REPROGRAM IT AGAIN—AND AGAIN—AND AGAIN.

Neither sunlight nor artificial illumination will affect the stored program, but 10 minutes of exposure to a commonly available ultraviolet lamp will erase the E-ROM for reprogramming.

Imagine the possibilities! Mistakes can be corrected easily. Programs can be modified quickly. Small quantities with special programs are practical to make—and unmake. Not least important, every E-ROM you get has been programmed, tested and erased, so you are 100% sure it works.

Two types of E-ROM are now in stock: Intel 1701, a dynamic/static MOS memory with 650 nsec dynamic access time and Intel 1702, a static-only MOS memory with 1 μ sec access. Either type can be replaced by a low-cost, pin-compatible, mask-programmed ROM, Intel 1301, anytime you have production requirements.

Programming services are available at Intel, at our major distributors or at our representatives in the U.S., Europe and Japan.

We will also supply schematics free of charge to customers who are interested in building inexpensive manual programmers.

For immediate delivery of 1701 or 1702 E-ROM's programmed for EBCDIC-8 to ASCII-8 call your local Intel distributor, Cramer Electronics, Hamilton Electro Sales, Industrial Components, or Electronic Marketing. In Europe contact Intel at Avenue Louise 215, B 1050 Bruxelles, Belgium. Phone 492003. In Japan contact Nippon IC, Inc., Parkside Flat Bldg. No. 4-2-2, Sendagaya, Shibuya-Ku, Tokyo 151. Phone 03-403-4747.

Intel Corporation is in a brand-new production facility at 3065 Bowers Avenue, Santa Clara, California 95051. Phone (408) 246-7501.

reprogram anywhere



**intel™
delivers.**

INFORMATION RETRIEVAL NUMBER 80

Here's enough to put you onto flat flexible cable.

Now you can have all the benefits of flat cable—weight, density and flexibility—to use it, everywhere. Our full line of connectors, specifically designed to take advantage of what flat flexible cable offers, will take you wherever you want to go—cable-to-cable, cable-to-wire, cable-to-post and cable-to-printed-circuit board. Now with the addition of our newest one-piece connector, we can also offer cable-to-printed-circuit board with a card-edge connector.

Once you decide on how to go, AMPECONOMATION, our unique automated termination technique, makes getting there fast, reliable and easy. No need to prepare the cable. Just cut to length and the machine terminates up to 3400 connections per hour . . . automatically. Four areas of contact, made with our exclusive insulation displacement crimp technique, assures the utmost in reliability.

We can supply connectors and application machine for flat cable assembly production in your plant, or provide finished assemblies to your specifications, ready for your equipment. For complete information write:
AMP Incorporated, Industrial Division, Harrisburg, Pa. 17105.

AMP
 INCORPORATED



Overseas trade shows— a powerful sales tool

The overseas trade picture for U.S. electronics firms is really beginning to brighten. There are two reasons for this. The first is the slow but steady upward revaluation of foreign currencies—particularly the yen—relative to the American dollar. This will enable U.S. exports to compete more favorably with products from abroad.

A second more subtle, but equally important, reason is the increasing number of trade fairs and exhibitions that will be held overseas aided by the efforts of independent U.S. overseas marketing organizations as well as the U. S. Department of Commerce. For example, in April of next year, 116 U. S. manufacturers of computers and computer-related data equipment will exhibit their products at a special exhibition in Moscow (see News Scope, "U. S. concerns step up sales pitch to Soviet," ED 18, September 2, 1971, p. 18).

Another Russian electronics exhibition in which U.S. firms will participate is scheduled to be held in Leningrad the following October. A show principally for the small computer manufacturer will be held in Munich November 30 to December 3 of next year. Other major trade shows are scheduled for London, Paris, Frankfurt, Milan and Tokyo.

According to the U.S. Department of Commerce there will be over 300 industrial-type trade fairs held outside of the United States in the next two years. U.S. participation in these shows is being pushed by the Dept. of Commerce's Export Licensing Division. As one spokesman told ELECTRONIC DESIGN: "We give top priority to processing the licenses of exhibitors at the overseas trade fairs. We know these exhibitions mean U.S. sales."

Another spokesman for International Media and Exhibits, Inc. of Newark, N. J., organizer of the Moscow exhibition, recently observed: "The countries of Eastern Europe place a great deal of importance on trade shows. These shows are considered so important a means of disseminating technical information that participation in them is almost tantamount to success in terms of potential sales."

The message is clear. The market outlook for U.S. electronic products in both communist and non-communist countries has never looked brighter than at this time. And what better way for U.S. firms to get in on the action than to participate in the numerous overseas trade shows that are being planned. For more information on these trade exhibitions write to Export Business Relations Div., U.S. Department of Commerce, Bureau of International Commerce, Washington, D.C. 20230.



Ralph Dobriner

RALPH DOBRINER

Use an N-bit detector for phase-locking.

You get 360×2^N electrical degrees of phase modulation and a hold range that is 2^N times that of a single-bit loop.

Single-bit digital phase-lock loops have two disadvantages that limit their use: narrow phase modulation and narrow hold-in ranges. But with a multi-bit phase detector in the loop, these disadvantages are greatly minimized.

With an N-bit phase detector, the phase modulation and hold-in range is 2^N times greater than that obtained from a single-bit loop. The improved performance results from the use of a subtractor in the phase detector that prevents the loss of phase tracking when the counters overflow.

The most common type of digital phase-lock loop is the single-bit loop (see Fig. 1). When the loop is locked, the following features are available:

- The loop's phase-modulation range is 360 electrical degrees.
- Its hold-in range is $K_\phi K_{VCO}$ Hz.
- Its resolution with respect to changes in phase modulation and input frequency f_1 is infinite.

If the loop is not locked, the low-pass filter output beats at a frequency equal to $|f_1 - f_2|$. This frequency difference must approach approximately $K_\phi K_{VCO} / 2\pi$ Hz before the loop will lock.

A multi-bit phase-lock loop having the same closed-loop bandwidth, response time and phase margin as the single-bit loop is shown in Fig. 3. The basic difference between this and the simple loop is the multi-bit digital phase detector. It consists of two N-bit counters, an N-bit subtractor and a digital-to-analog converter.

The counters are straight N-bit binary ripple or clocked types. Any modulus can be used, provided it is the same for both counters. The subtractor is an N-bit, two's-complement, full subtractor that contains the difference between the numbers in the counters at any time. When the loop is locked, but a phase difference that is not a multiple of 360° exists, the subtractor puts out a pulse width proportional to this phase shift. The amplitude of the pulse, before filtering, equals the amplitude of the least significant bit.

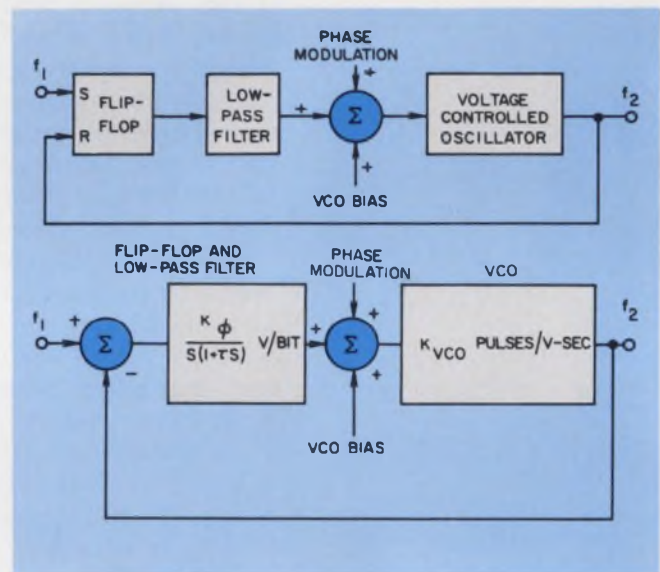

1. A single-bit digital phase-lock loop is the simplest phase-locking circuit (a), and the most often used. Input frequency f_1 is locked in phase to f_2 ; the magnitudes are equal. The loop transfer function is in terms of the Laplace variable and a time constant τ (b).

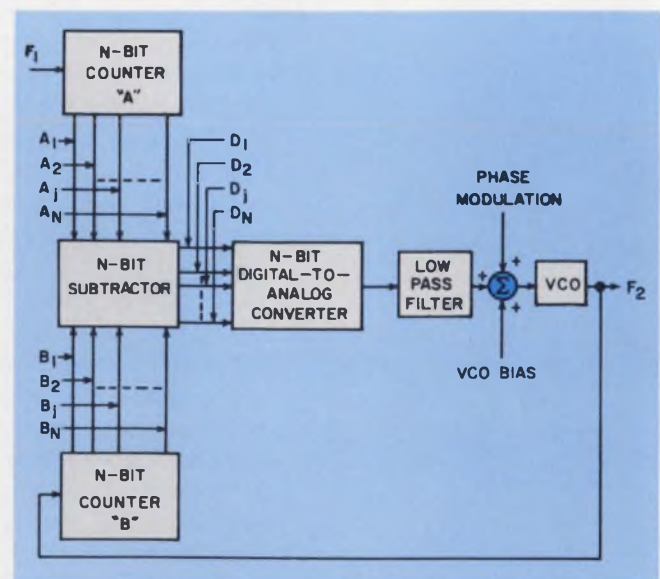

2. The N-bit digital phase-lock loop provides a 2^N improvement factor over the single-bit loop with respect to phase modulation, hold-in and capture ranges. The subtractor tracks phase differences continuously; phase tracking is unaffected by counter overflows.

Richard L. Labinger, Optical Technology Div., Perkin-Elmer Corp., Danbury, Conn. 06810.

Filtering yields the average value of this signal.

A timing diagram illustrates the operation of the phase detector (see Fig. 3). The phase difference between f_1 and f_2 is 2.5 bits. This corresponds to 900 electrical degrees if the distance between each pulse is considered to be 360 electrical degrees. The pulses in this circuit can slide past each other without losing phase tracking, unlike a single-bit phase-detector.

The locked multi-bit loop has the following:

- Phase-modulation range of 360×2^N electrical degrees, because there are 2^N unique states the subtractor can assume. The phase-modulation range for a three-bit device, for example, is zero degrees to 2880.

- Hold-in range of $K_\phi K_{vco} 2^N$ Hz, 2^N times that of the simple loop.

- Infinite resolution with respect to phase-modulation and input frequency changes, as in the single-bit loop.

When the loop is not locked, the two frequencies cause a beat frequency. Now, however, the beat frequency is $|f_1 - f_2|/2^N$ Hz. That's 2^N times the beat frequency of the single loop. The loop

can now capture and lock when the two frequencies differ by as much as $2^N K_\phi K_{vco}/2\pi$ Hz.

Another way of taking advantage of the multi-bit loop is to allow the phase-modulation range to remain 360° but to raise f_1 and, therefore, f_2 by 2^N . To keep the dynamic properties the same, K_ϕ has to be reduced by 2^N . The ripple frequency to be filtered is 2^N times the frequency it was before. The higher ripple frequency is easier to filter, and the capture range is still $2^N K_\phi K_{vco} 2\pi$ Hz.

The multi-bit phase detector is also insensitive to coincidence between input and feedback pulses. This is a problem that plagues up-down counter types of phase detectors.

The counters and subtractor can be built with IC logic. With the 930 DTL series, for example, each bit requires two RST or J-K flip-flops for the counters and two quad-two input gates for the subtractor. Bits can be added, therefore, at a cost of four packages per bit. Any standard digital-to-analog conversion scheme can be used for the d/a converter. The implementation of a five-bit phase detector is shown in Fig. 4.

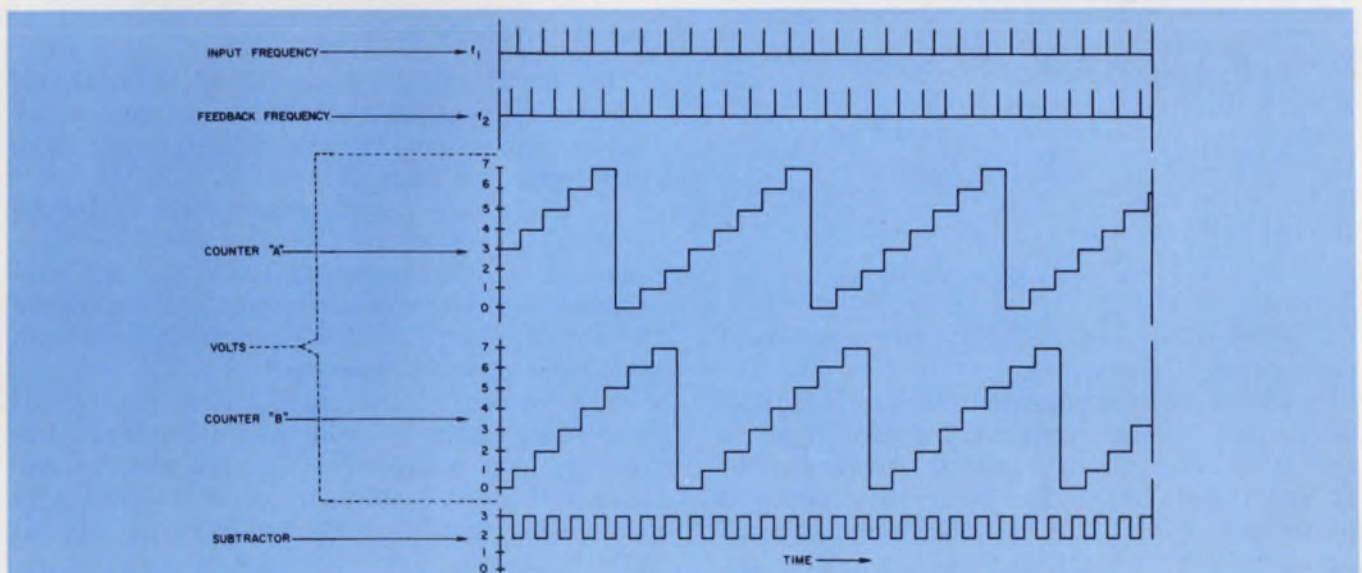

3. The outputs of a three-bit phase detector are shown as if all of the outputs were added with their proper binary weighting. The subtractor output maintains the

phase difference of f_1 with respect to f_2 through all counter-overflow transitions. The two pulse trains can slide past each other without loss of phase lock.

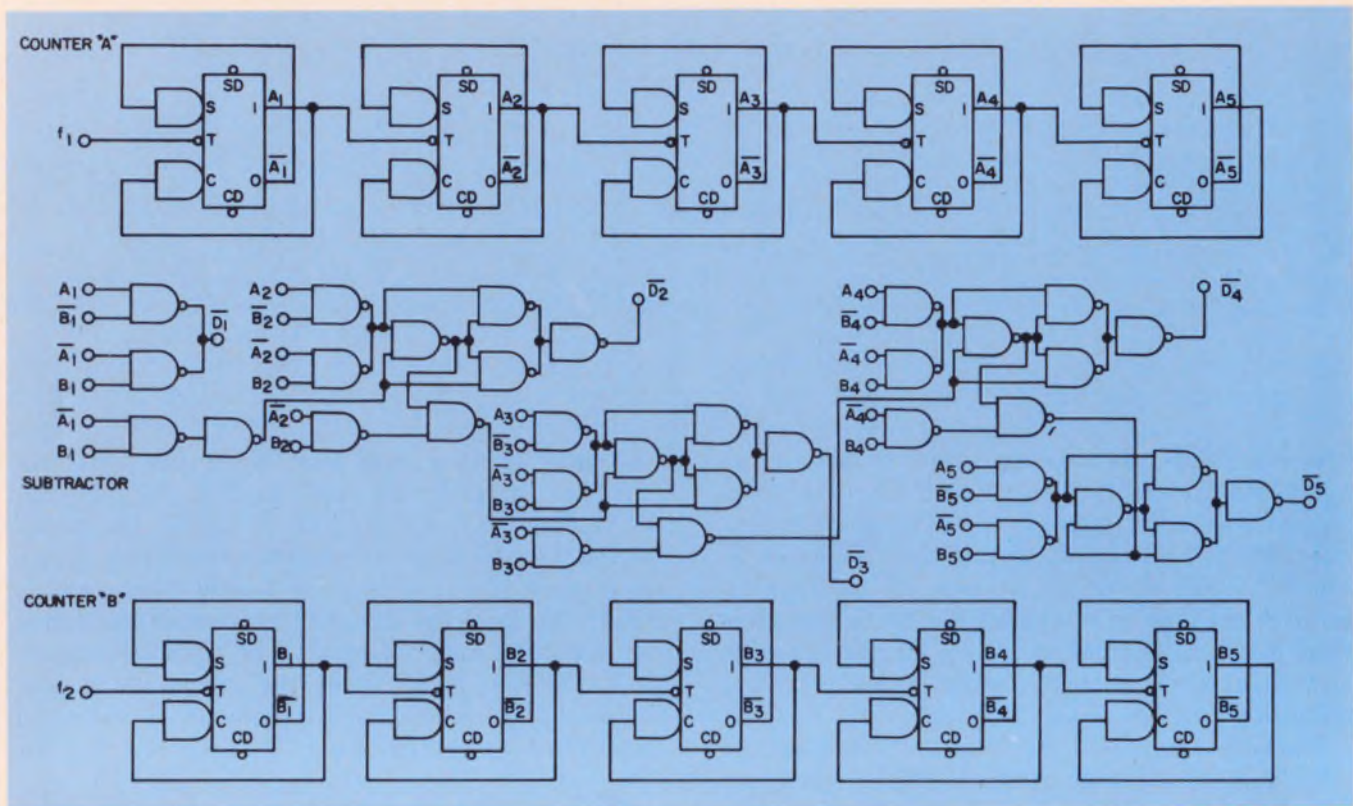

4. In this complete five-bit phase detector, the counters are connected to the subtractor at points labeled in

common. The D output provides a two's-complement subtraction of the B input from the A input.

The N-bit phase detector is by far the most important component in the multi-bit phase-lock loop. Let's take a closer look at it.

Track phase continuously

A typical interior bit circuit of the subtractor is shown in Fig. 5a. This circuit is used as the basic unit to obtain continuous phase tracking as the counters overflow.

When Boolean algebra is applied to the interior circuit,

$$X = \overline{A_j} \overline{B_j} + \overline{A_j} B_j = \overline{A_j} (B_j + \overline{B_j}) \text{ and}$$

$$Y = (A_j B_j + \overline{A_j} \overline{B_j}) C_{j-1}$$

The output difference is calculated as

$$D_j = \overline{X} \overline{Y} + \overline{X} C_{j-1} + \overline{Y} + \overline{Y} C_{j-1} =$$

$$A_j B_j C_{j-1} + \overline{A_j} \overline{B_j} C_{j-1} + A_j \overline{B_j} \overline{C_{j-1}} + \overline{A_j} B_j \overline{C_{j-1}},$$

and the borrow-out is

$$C_j = Y \overline{A_j} B_j = \overline{Y} + \overline{A_j} B_j = A_j B_j C_{j-1} +$$

$$A_j \overline{B_j} C_{j-1} + \overline{A_j} B_j$$

The equations verify that a two's-complement subtraction is performed.

Consider now the phase detection by a four-bit device as a counter overflows. Initially let $A=15$ and $B=8$. The relative phase is represented by D , and $D=(15-8)=7$. The binary subtraction is performed in a table (Fig. 5b), and the result agrees with that obtained from the analog subtraction. On the next pulse, $A=15$, $B=9$ and $D=6$. A binary subtraction of A and B gives the same result.

The following pulse causes counter "A" to overflow and results in $A=0$ and $B=9$ (Fig. 5c). The binary subtraction gives $D=7$, the correct value, and not -9 , the analog result. The disagreement occurs for negative differences because the last borrow-out is thrown away and end-around-borrow is not used. However, the example shows that the detector has tracked the phase difference continuously through a counter overflow.

Use for a velocity servo

The phase-tracking capability of the multi-bit loop makes possible its use for applications not normally considered for the single-bit loop. Take this design, for example:

A velocity servo, with steady-state variations of 0.025% maximum, is capable of following a constant input frequency (Fig. 6). The servo responds to periodic shaft-modulation commands by running faster or slower, in accordance with the input modulation command.

The required position modulation is $\pm 150^\circ$ of load shaft angle, and the maximum input frequency, f_1 , is 4 kHz. The required encoder frequency is about 64 kHz, which is obtained with an encoder that has 1000 line-pairs per revolution. To facilitate the phase detector mechanization, the encoder repetition rate is divided by 16. The selection of $N=6$ results from the observation that $1000/16$ cycles per 360° of shaft rota-

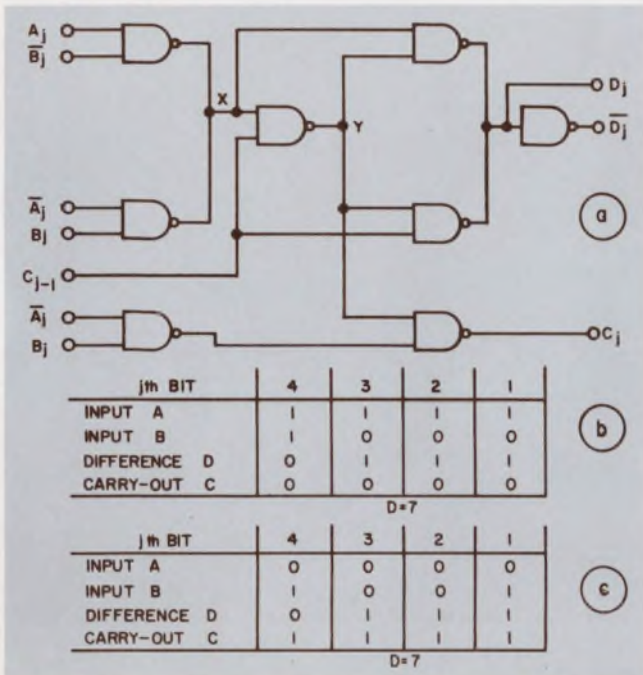

5. The basic unit of the subtractor is the *j*th-bit circuit (a). An example using a four-bit detector gives identical analog and binary results for $A=15$ and $B=8$. But for negative differences, as when $A=0$ and $B=9$, corresponding to a counter overflow, only the two's-complement subtraction gives the correct phase difference (b).

tion gives 5.7° per cycle. And since the required modulation is $\pm 150^\circ$, or 300° total, 2^N must be at least $300/5.7$.

It is impossible to mechanize this loop with a single-bit phase detector, because of the modulation range required. The phase-lock frequency has to be about $1/32 f_1$, thereby lowering the ripple frequency to be filtered. In addition the ripple amplitude to be filtered is 64 times the amplitude resulting from the multi-bit detector. With these limitations, a reasonable bandwidth position loop (300 rad/s , in this case) cannot be realized. ■■

Test your retention

Here are questions based on the main points of this article. Their purpose is to help you make sure you have not overlooked any important ideas. You'll find the answers in the article.

1. Why does the N -bit phase-lock loop give better performance over the single-bit loop?
2. How does the N -bit subtractor maintain phase lock when either counter overflows?

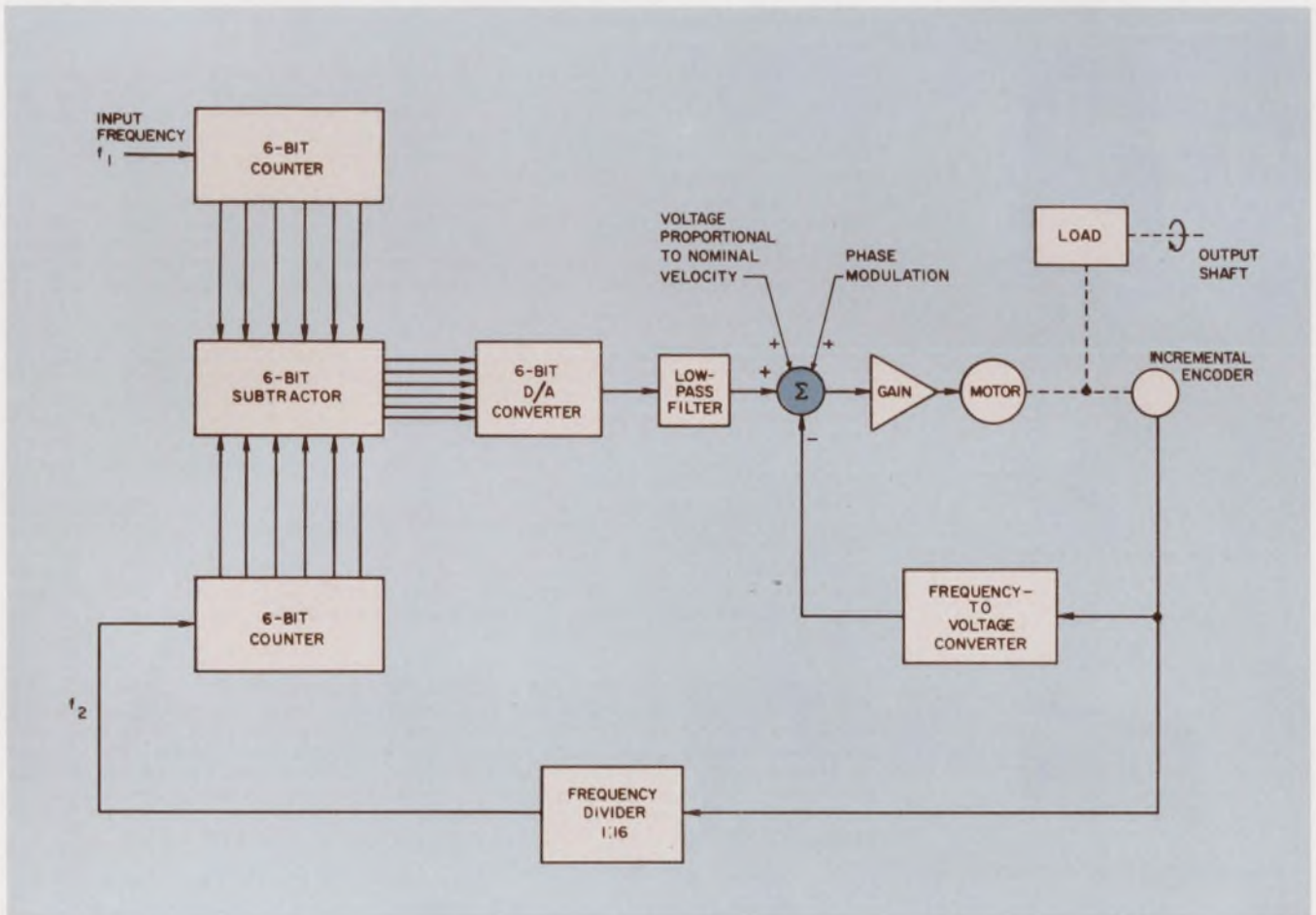

6. An application of a six-bit digital phase-locked loop is this precision velocity servo. This design minimizes the

inherent position or phase lag of a standard, single-integration servo. A single-bit loop cannot be used.

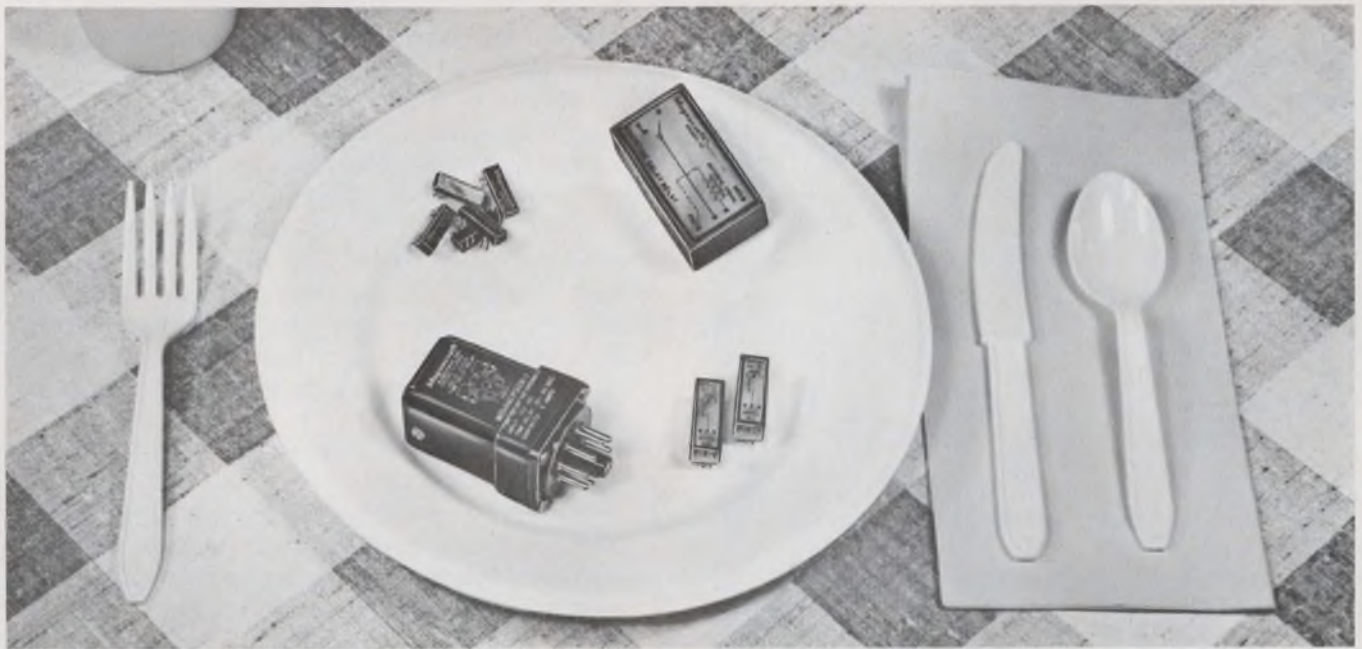

designers will have a **PICNIC** with these new relays



INFORMATION RETRIEVAL NUMBER 151



INFORMATION RETRIEVAL NUMBER 152



INFORMATION RETRIEVAL NUMBER 153



INFORMATION RETRIEVAL NUMBER 154

NON-POSITION SENSITIVE MINIATURE MERCURY WETTED REED RELAY CLASS 137MPC—This amazing new relay represents a significant state-of-the-art advancement in relay technology. The low-profile miniature PC-mounting mercury wetted reed relay offers bounce-free operation in any position. Now circuit designers will have new freedom of design. Further, the relay is only 1.12 x .40 x .375 inches, requiring minimal area on printed circuit boards. This relay features stable contact resistance of 100 milliohms over its long life of over 20 million bounce-free operations with diode suppressed coil.

SOLID STATE (HYBRID) TIME DELAY RELAY CLASS 214CP—Magnecraft takes great pride in announcing this new time delay relay. Proven hinge-pin reliability designed into the output relay driven by a solid state circuit used in thousands of our timers, gives you the best low cost small size timing relay on the market. Operate delay timing ranges are offered between 3 hundred milliseconds and 4 minutes with $\pm 5\%$ repeatability and input supply of 115VAC.

We are sure you will share our enthusiasm in this new product when you apply the small size and cost savings to your circuit designs. The body of the timer is only 1.4 x 1.4 x 2.1 inches, the size of our 88 general purpose relay case. The adjusting potentiometer gives full range timing control and the very popular octal socket pins extend just a bit beyond the body of the time delay relay to an overall height of 2.3 inches.

DUAL-INLINE-PACKAGED REED RELAYS CLASS 107DIP, 108DIP, 117DIP AND 118-DIP—Magnecraft is proud to announce its new DIP (dual-inline-package) line of 8-pin reed relays. These new relays are designed not only to be compatible with the standard packaging developed for integrated circuits, but to offer Magnecraft quality at a lost cost. This unique design gives further savings by offering the user the optimum in automated insertion and other economical installation techniques associated with printed circuit applications.

These fantastic new epoxy molded reed relays are ideal for use in circuits where high density packaging is essential. The 5VDC IC compatible versions of these relays will operate directly from TTL or DTL circuits.

Other standard coil voltages are available from stock in 6, 12, and 24 VDC as well as contact configurations in 1 form A, 2 form A, 1 form B, and 1 form C. Most versions are also offered with a choice of an internal clamping diode. The size of this device is a tiny .750 x .300 x .210 inches.

SOLID STATE (HYBRID) PRINTED CIRCUIT TIME DELAY RELAYS CLASS 502PCSR AND CLASS 503PCSR—These new time delay relays make use of hybrid circuitry combining a monolithic silicon structure in the control function with a dry reed relay performing isolated circuit switching. Two fully adjustable timing ranges are afforded by using a remote pot or fixed resistor giving 0.2 to 100 seconds or 1 to 300 seconds each with $\pm 2\%$ repeatability. Standard coil voltages are available from stock in 12 and 24VDC as well as contact configurations in 1 form A rated at 1 amp and 1 form C at 0.5 amp. The size of this time delay relay is a mere 2.25" x 1.25" x .75".

Magnecraft® ELECTRIC COMPANY

5575 NORTH LYNCH AVENUE • CHICAGO, ILLINOIS 60630 • 312 • 282-5500 • TWX-910-221-5221

See you at I. S. A. Booth 658

AIRPAX

TYPE 203

ELECTROMAGNETIC CIRCUIT PROTECTORS



Type 203 front panel mount electromagnetic circuit protectors are designed for use in computers, computer peripherals, copying machines, air conditioners, marine controls, and other high-quality industrial and military equipment where accurate, reliable protection is demanded.

FEATURES

- Snap-in front panel mounting for fast, economical installation
 - Optional flush mounting available
- Single rocker actuator for 1, 2 or 3-pole assemblies
 - Selection of color combinations
 - 50V DC and 250V AC (50/60 or 400 Hz)
 - Current ratings from 0.020 to 20 amperes
 - Choice of inverse time delay or instant trip

Trip Time vs Percent Rated Current @ 25°C

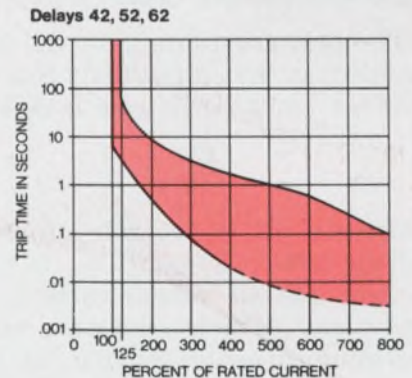
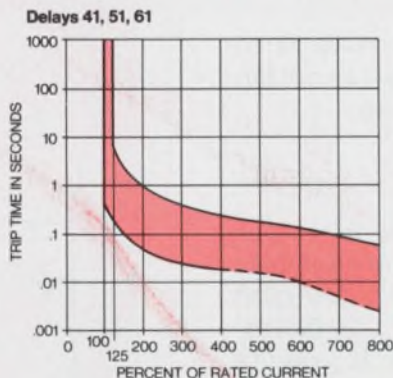
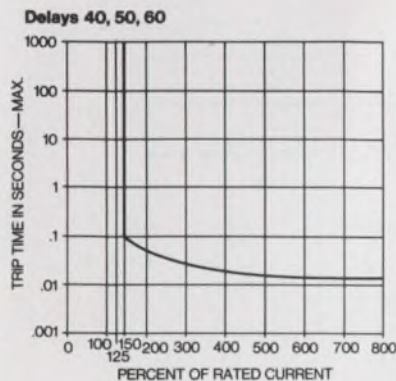

Delays 40, 41 and 42 are for use in 400 Hz systems; delays 50, 51 and 52 are for use in DC systems; and delays 60, 61 and 62 are for use in 60 Hz systems.

For complete details, specifications and application examples, call or write:

AIRPAX™

AIRPAX ELECTRONICS / CAMBRIDGE DIVISION / Cambridge, Maryland 21613 / Phone (301) 228-4600 / TELEX 8-7715 / TWX 710 865-9655
INFORMATION RETRIEVAL NUMBER 34

Simplify sample-and-hold design

by making an orderly approach, using graphical aids and doing careful worst-case analysis

Sample-and-hold circuit design involves a series of difficult compromises, and keeping all of the variables, and their effects sorted out can be troublesome. But a carefully tailored approach, and the use of graphical aids, can make the job a lot easier.

A sample-and-hold circuit (Fig. 1) senses and stores the average value, over a simple interval, of a variable input signal. Three modes of operation—sample, hold and reset—must be carefully analyzed in the design, and the characteristics of the switching circuitry are important too. Of these four separate design problems, the hold mode (Fig. 2) is the most critical. This is because circuit operation and performance is committed for the longest time interval.

Assume, for our design example, that the range of the input voltage V_i must be 0.5 to 8 V, sample time t_s must be 13.5 ms, and hold time t_h must be 140 ms. The circuit must operate from 0 to 100°C and have a maximum sample error ϵ_s of 0.5% and maximum hold error ϵ_h of 0.75%. The sample error is to be defined as

$$\epsilon_s = [-(V_i - V_o) / V_i] \times 100\%$$

and the hold error as

$$\epsilon_h = \{[(V_o)_{t=0} - (V_o)_{t=140 \text{ ms}}] / (V_o)_{t=0}\} \times 100\%$$

Begin with the hold circuit

The primary concern in the hold mode is to ensure that the output drift rate remains within specified limits. Drift rate is defined as

$$\frac{dV_o}{dt} = \frac{I_{LT}}{C_1} \quad (1)$$

where dV_o/dt is the rate of change in output voltage time, $I_{LT} = V_o/R_{eq}$ is the op-amp bias current plus all leakage current, R_{eq} is the total equivalent leakable resistance and C_1 is the integrating capacitor. Solving Eq. 1 for R_{eq} results in

$$R_{eq} = \frac{t_h}{C_1} \{ \ln [(V_o)_{t=t_s} / (V_o)_{t > t_s}] \}^{-1} \quad (2)$$

W. H. Williams, Fellow Engineer, Westinghouse Electric Corp., Defense and Space Center, Systems Development Div., P.O. Box 746, Baltimore, Md. 21203.

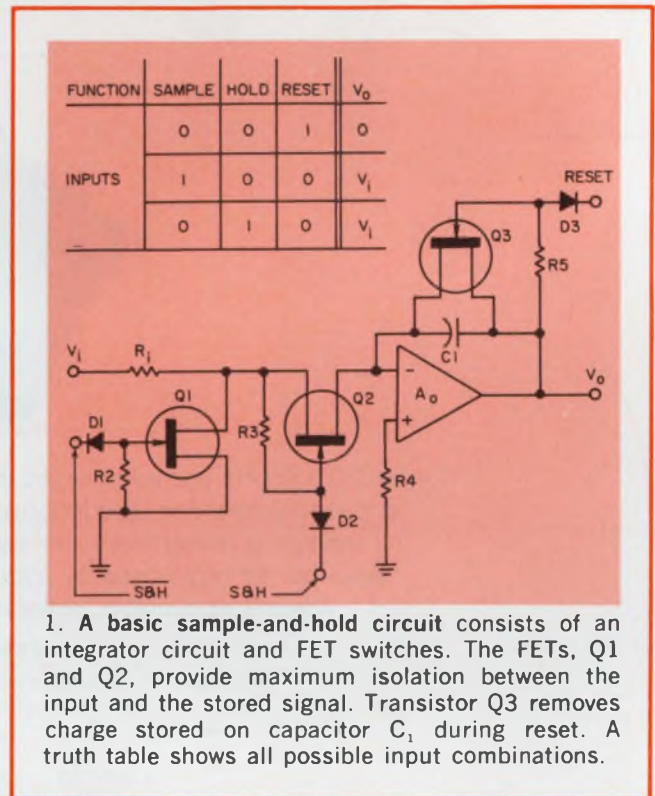

1. A basic sample-and-hold circuit consists of an integrator circuit and FET switches. The FETs, Q1 and Q2, provide maximum isolation between the input and the stored signal. Transistor Q3 removes charge stored on capacitor C_1 during reset. A truth table shows all possible input combinations.

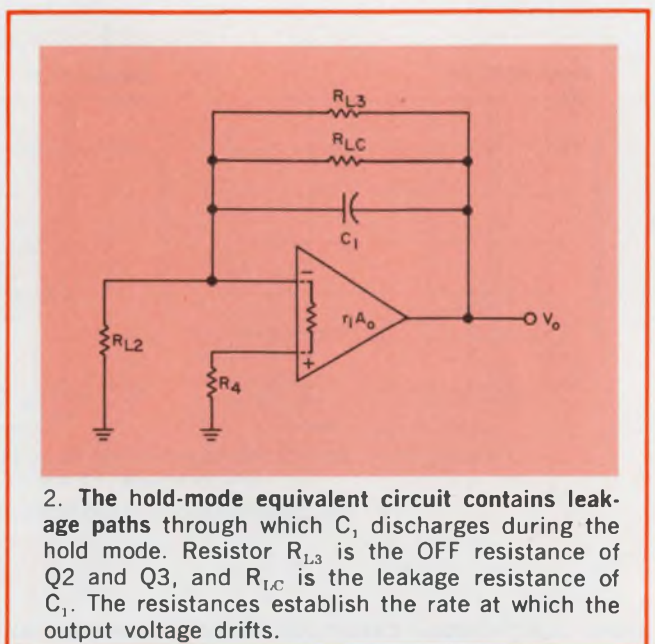

2. The hold-mode equivalent circuit contains leakage paths through which C_1 discharges during the hold mode. Resistor R_{L3} is the OFF resistance of Q2 and Q3, and R_{LC} is the leakage resistance of C_1 . The resistances establish the rate at which the output voltage drifts.

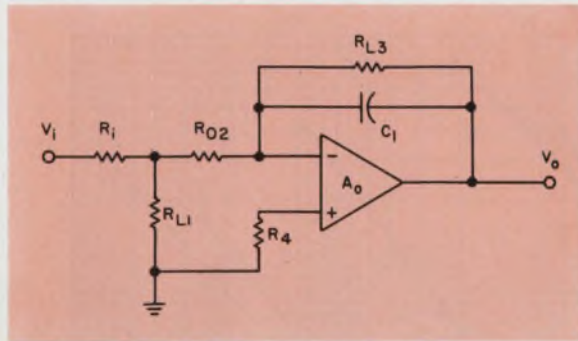

4. The sample-mode equivalent circuit design requires $R_{01} \ll R_i \ll R_{L1}$. This results in minimum attenuation of the input voltage and achieves a further reduction of the integration error.

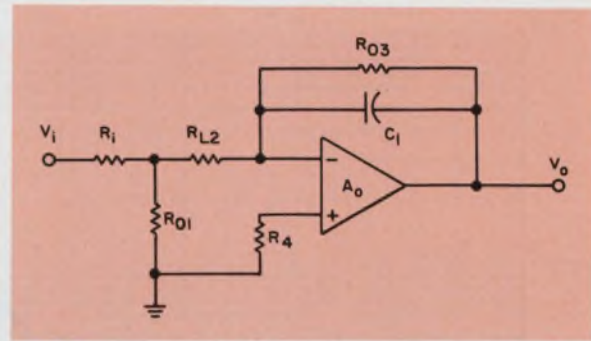

5. The reset-mode equivalent circuit applies during discharge of C_1 . The input voltage is attenuated by R_{01} , where $R_{01} \ll R_i$, and isolated by $R_{1,2}$. Unity gain compensation eliminates instability.

a function of the input offset voltage drifts and the input bias current drifts (curve b) is calculated as

$$\epsilon_{Td} = \frac{(t_s/RC_1)(I_b R + V_{od}) + V_{od}}{V_i} \% / ^\circ C \quad (5)$$

where V_{od} is the drift rate in $\mu V / ^\circ C$. Curve d is Eq. 5 projected to $100^\circ C$.

The change in output voltage due to changes in supply voltage (curve c) is calculated as

$$\epsilon_{ps} = \frac{PSRR}{(V_i)_{min.}} \left(1 + \frac{t_s}{RC_1}\right) \% \quad (6)$$

where PSRR is the power supply rejection ratio in $\mu V / V$.

Use a trial-and-error technique

A design value of $t_s/RC_1=1$ is selected from Fig. 3 on the basis of the following considerations:

- for the specified input voltage range, increasing gain to improve low-level accuracy causes the output to become saturated at the high-level inputs;
- signal attenuation causes system-performance degradation for all levels of input and may contribute to circuit instability;
- the error for this ratio is negligible and
- checking circuit performance is practical and easy.

The allowable drift rate is easily calculated. Summing the errors for $t_s/RC_1=1$ gives a total error of 0.37%. With a hold error of 0.65%, the allowable drift error $\epsilon_d = (0.65-0.37) = 0.28\%$. The worst-case error occurs for $V_i = 0.5$ V, and during a time interval of 140 ms. Thus, the allowable drift rate is $dV_o/dt = (0.28)(0.5)/140 = 10.0$ mV/s.

For the calculation of C_1 , current I_{LT} is determined for a worst-case temperature of $100^\circ C$. The FETs used are both 2N4092 types with a maximum leakage current of 20 nA (at $100^\circ C$). The maximum bias for the op amp is 10 nA, and

the capacitor leakage is 5 nA. The value of capacitor C_1 is calculated from Eq. 1: $C_1 = [2(20) + 10 + 5]/10 = 5.5 \mu F$. The closest standard capacitor is $5.6 \mu F$ with 1% tolerance and -0.2% change over the temperature range.

With the op amp and integrating capacitor selected from hold-mode considerations, let's turn now to the design decisions determined by the sample mode, the reset mode and the switching circuit.

Check the sample mode

An equivalent circuit representing the sample mode is shown in Fig. 4. From this equivalent the input resistance R_i —a fixed and variable resistance—is calculated. Since the error caused by the integrator is negligible, the integrator output

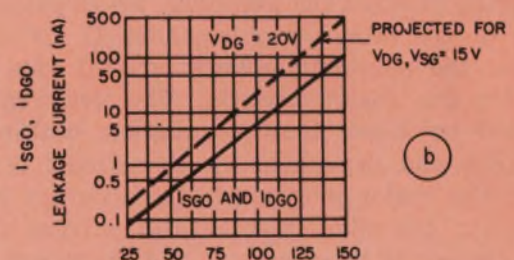
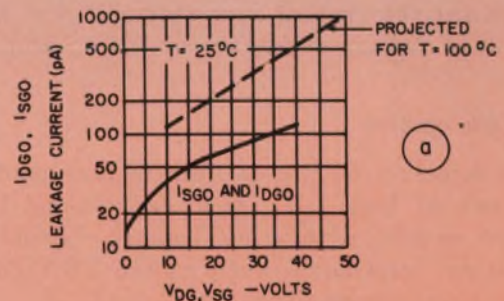

6. The FET leakage parameter I_{DGO} which has a marked dependence on voltage (a) and temperature (b) is used to determine $(R_{L1})_{min}$ or $(R_{L2})_{min}$.

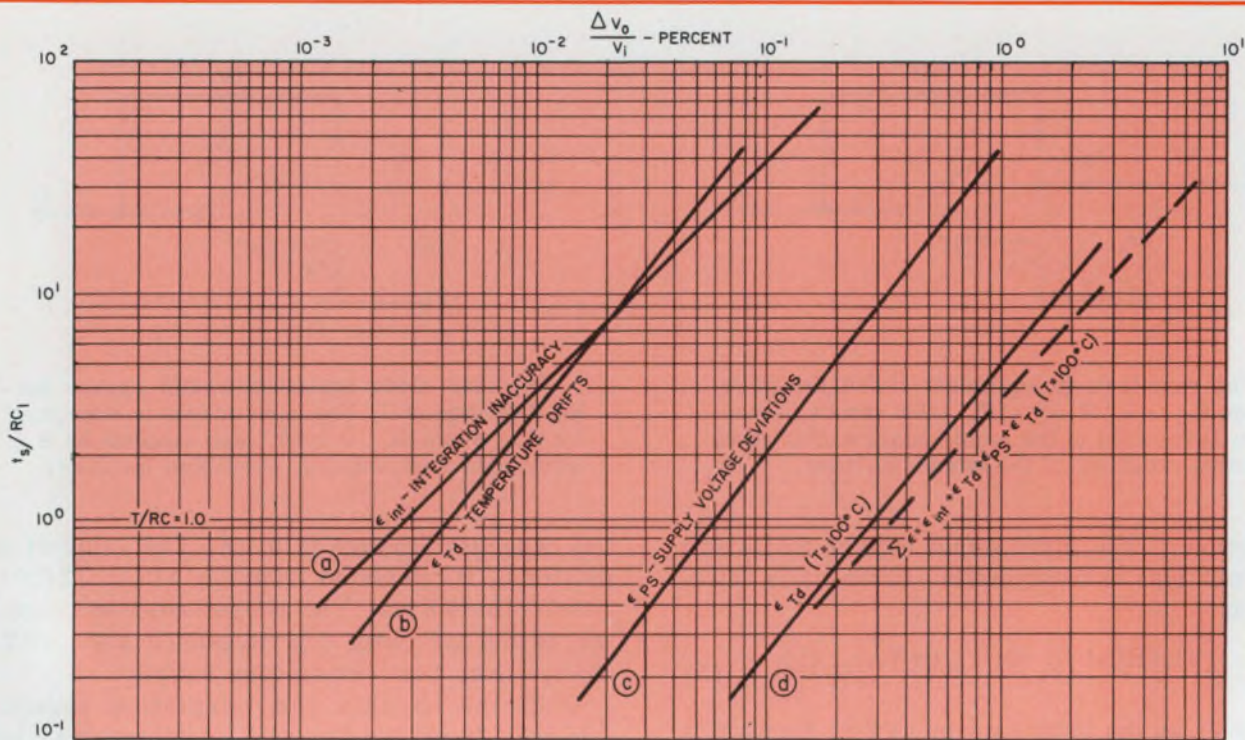

3. Plotting the calculable errors from the op-amp specs and its feedback components leads to an isolation of each error, highlighting troublesome

areas. The cumulative error is compared with the maximum allowable design error. A reasonable ratio of t_s/RC_1 is then selected.

where t represents an interval such that $t_s < t < t_n$. Resistance R_{vq} can also be expressed in terms of the components of Fig. 2:

$$R_{vq} = \frac{1}{\frac{2}{R_{L2}} + \frac{1}{R_{LC}} + \frac{1}{A_o r_i}} \quad (3)$$

where R_{L2} is the OFF resistance of each of two identical FET switches, R_{LC} is the leakage resistance of the integrating capacitor and $A_o r_i$ is the equivalent leakage resistance of the op amp.

Select the op amp

The selection of the op amp is now made on the basis of Eqs. 1-3. These expressions imply that an op amp with a low leakage current and high input impedance, such as the TOA7809, is needed to minimize drift rate.

Having selected the amplifier, we calculate the value of the integrating capacitor C_1 by determining the maximum allowable drift rate that satisfies the design criteria. The drift rate is affected by error sources inherent within the amplifier and dependent on the circuit parameters. The major sources are the accuracy of integration, the offset voltage and current drifts with respect to temperature, and the power-supply rejection ratio.

The effects of these errors can be calculated from the known characteristics of the op amp

and its feedback components. Other sources of error—such as the effects of drift vs time and system degradation as a function of component life—are not readily calculable. For these effects a worst-case condition of 15% over-design is assumed and ϵ_n is decreased from 0.75% to 0.65%.

Plot the error curves

A graph relating the calculable errors to a common normalized variable is shown in Fig. 3. The variable is the integration gain factor t_s/RC_1 , where RC_1 is the integrator time constant.

The curves are generated from component values and specifications obtained from the manufacturer on the components selected. All curves are plotted for an input integrating resistance in the range 1-10 k Ω .

The inaccuracy of integration (curve a) is approximated by the following expression:

$$\epsilon_{in} \approx \frac{50(P+1)}{A} \left(\frac{t_s}{RC_1} \right) \% \quad (4)$$

where $P = (R_o/R_i) + (R/R_{id}) + (R_o R/R_i R_{id})$, R_o is the amplifier output resistance, R_i is the load resistance, R is the integrating resistor, R_{id} is the amplifier differential input resistance and A is the open-loop gain of the op amp. The values for P and A are determined from the specification sheet on the particular amplifier chosen.

The percent change in the output voltage as

is described by the ideal case: $V_o = V_i (t_s/RC_1)$, where $R=R_1+R_{L1}$, and $R_{L1}=30 \Omega$, the leakage resistance of the FET. The integration gain constant $t_s/RC_1=1$ and $R_1=13.5/5.6=2.41 \text{ k}\Omega$. A convenient form for R_1 is a 2.32 k Ω fixed resistance and a 200- Ω potentiometer in series. Assuming initial adjustments within $\pm 0.05\%$, the deviations of output voltage from initial adjustments range from 0.3% to 0.6% over the temperature range.

The equivalent circuit for the reset mode is shown in Fig. 5. This mode of operation normally places the amplifier in a potentially unstable state, because the input resistance is very large and the resistance in the feedback path has been made very small. However, since the actual input signal is being attenuated, the circuit configuration becomes that of a voltage follower and, with unity gain compensation, it remains stable during reset.

The switching circuit is important, too

Another important factor in this design is the switching circuit, especially at the input. A design consideration is that semiconductor switches do not exhibit the ideal zero ON resistance nor infinite OFF resistance. And the bias voltage must be selected to ensure turn-on and turn-off at the correct times.

The finite resistances of the FETs cause voltage errors. However, with the components selected a typical value for this error is about 0.0005% in the initial amplitude of the output. For the hold mode this tends to aid rather than degrade

performance.

A more important consideration is ensuring the correct turn-on and turn-off times. The ON condition for a FET exists when $(V_i)_{\max} \geq V_{EE} - V_{RD}$, where V_{EE} is a positive gate voltage and V_{RD} is the voltage required to keep the gate diode reverse-biased—normally about 50 mV.

For the OFF condition, the relation to be satisfied is $(V_i)_{\min} \leq V_{CC} - V_{FD} - V_p$, where V_{CC} is a negative gate voltage, V_{FD} is the forward-voltage drop of the gate diode and V_p is the pinch-off voltage. For the FETs selected, $V_{RD}=0.05 \text{ V}$, $V_{FD}=0.6 \text{ V}$ and $V_p=7.0 \text{ V}$. The required gate voltages, with $0 \text{ V} \leq V_i \leq 8.0 \text{ V}$, are $V_{EE} \geq 8.05 \text{ V}$ and $V_{CC} \leq -7.6 \text{ V}$. The respective voltages selected are +15 V and -15 V.

The equivalent leakage resistance R_{eq} (see Eq. 3) is now calculated from the leakage parameters of the FETs. This calculation is important because it represents the leakage path for current while in the hold mode.

In the hold mode, the leakage path between the drain and gate is significant. To determine the minimum value of this resistance (R_{L1} or R_{L2}) consider the curve shown in Fig. 6a. The value of I_{DGO} , the drain-to-gate leakage with the source open, for V_{DG} equal to -15 V is approximately 50 pA or 0.5 nA. This value of I_{DGO} is projected to the 25°C point on the curve of Fig. 6b.

Since the gate leakage current vs temperature is linear, the value of I_{DGO} may be extrapolated to the 100°C point for the worst-case. Thus, I_{DGO} at 100°C is approximately 3.5 nA. However, the maximum value of I_{DGO} for $V_{DG} =$

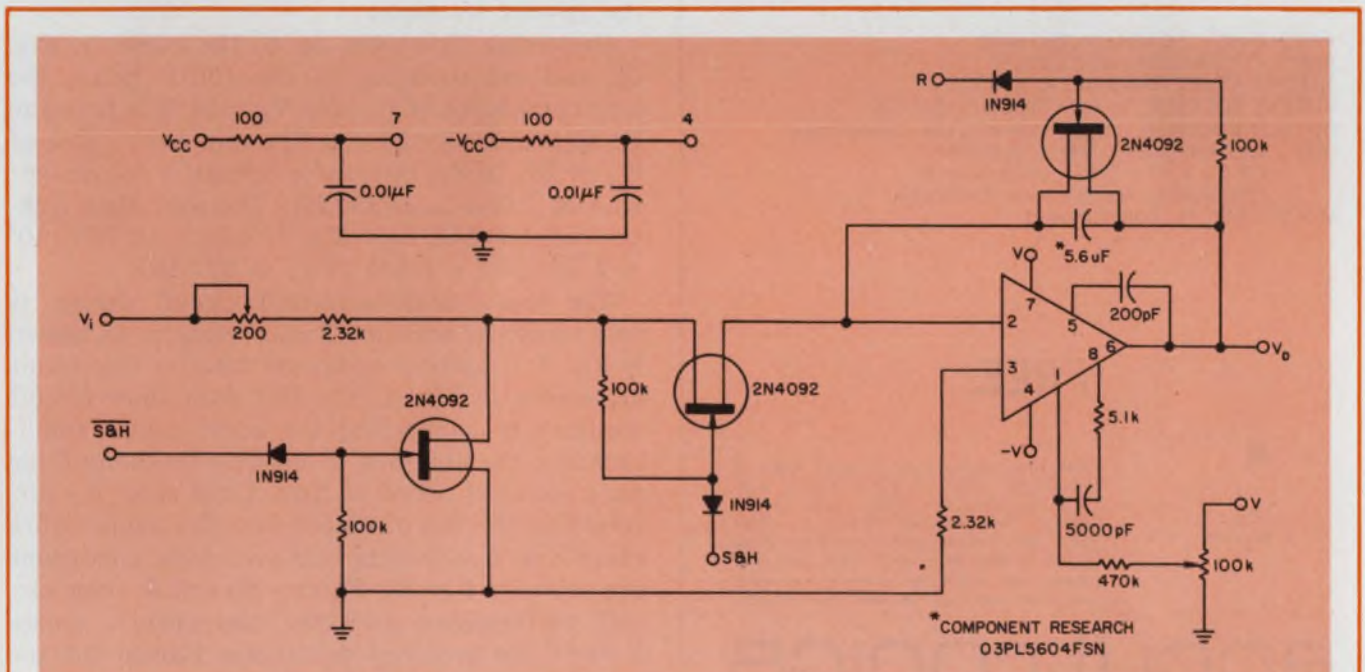

7. The final sample-and-hold circuit design includes all of the components selected, biasing for the FET switches, the compensation network and

the output of the op amp set adjustment. The adverse effects of worst cases are compensated for by an over-design technique.

OSCILLATORS

1 Hz to 250 MHz



ACCUTRONICS IS
NOW COMPATIBLE
WITH ULTRA-HIGH
SPEED LOGIC
MECL III,
SCHOTTKY

SURE, ANYONE CAN BUILD . . . their own oscillator between 1 MHz and 50 MHz and maybe even two, BUT TRY TO BUILD one at 250 MHz compatible with high-speed saturated logic, non-saturating Schottky or emitter coupled logic, then come to Accutronics and we'll save you on your prototype or production runs. Accutronics was the first to advertise oscillators compatible with RTL, DTL and TTL logic (Electronic Design October 1965), and we have continued our engineering capabilities to keep up with the latest IC logic.

NEED HELP? Call Wayne Benson (area) 312-232-2600, and he will be glad to fill you in on the details and send you our new catalog.



Series 110

FREQUENCY: 50 MHz to 250 MHz
FREQ. TOLERANCE: $\pm 0.001\%$
TEMPERATURE RANGE: 0°C to 60°C
SUPPLY VOLTAGE: + or -5Vdc or -5.2VDC
OUTPUT VOLTAGE: Compatible with the newest logic
SIZE: 38.1 MM x 38.1 MM x 15.8 MM
1.5" x 1.5" x 0.62" compliments
70th edition Machinery's Handbook
MOUNTING: PC board mount



FREE:

NEW 1972 CATALOG

Our new catalog covers various types of oscillators: VCXO, LCXCO, RCXCO, high stability, computer clocks, high output power, Navy standard hardware modules and low current drain oscillators from 1 Hz to 250 MHz. We'll even send you three neat conversion charts (3) to hang on your wall and impress your friends.

accutronics

A HAMMOND CORPORATION COMPANY

628 NORTH STREET • GENEVA, ILLINOIS 60134

INFORMATION RETRIEVAL NUMBER 35

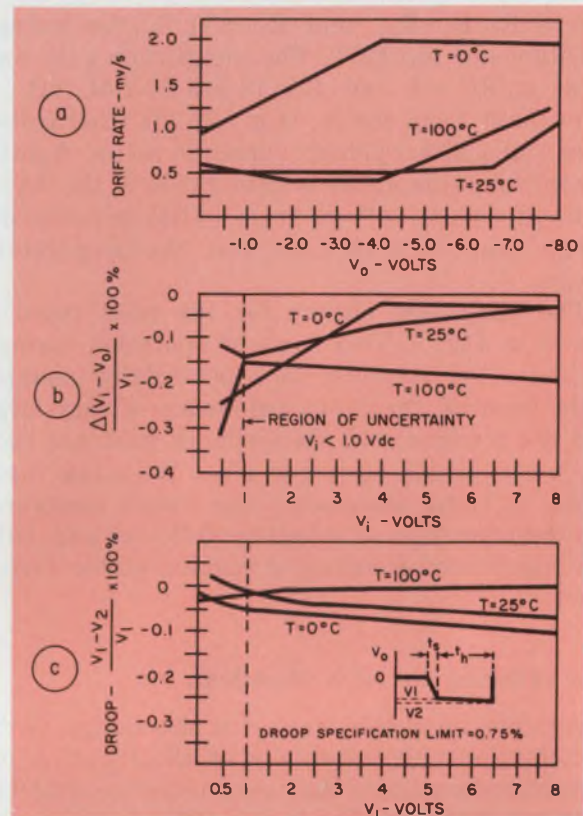

8. Measured data of the sample-and-hold design show the drift rate (a) plotted for one-second averages. Drift rates are significantly smaller for $t_b \ll 1s$. The accuracy with which a given input is reproduced at the output is shown in b. Plotted in c, the percent change in the output voltage.

20 V is 0.2 nA from the specification sheet for the 2N4092 transistor.

Projecting this point on to the curve in Fig. 6b, and extrapolating to the 100°C point, the maximum value of I_{DGO} for $V_{DG}=15\text{ V}$ is found to be approximately 20 nA. The minimum value of R_{L1} or R_{L2} in the integrator circuit is calculated: $R_{L1}=R_{L2}=V_{DG}/I_{DGO}=750\text{ M}\Omega$. The equivalent leakage resistance is, from Eq. 3, $R_{eq}=1/[2/750 \times 10^6 + 1/16 \times 10^{10} + 1/540 \times 10^6] = 221\text{ M}\Omega$.

The basic sample-and-hold circuit design is now complete, with the final schematic as shown in Fig. 7. Graphs of measured data for the circuit are shown in Fig. 8. The test data show circuit accuracy in duplicating the input signal amplitude and the accuracy in holding this amplitude for a specified period of time. Drift rates for different amplitudes of output over the temperature range for steady-state non-switching conditions are shown in Fig. 8a. Figures 8b and 8c show circuit performance over the temperature range $0\text{-}100^\circ\text{C}$ for switched conditions. Except for the region below 1.0 V, the amplitude is reproduced to an accuracy of 0.25% while the droop is held to 0.1%. ■■

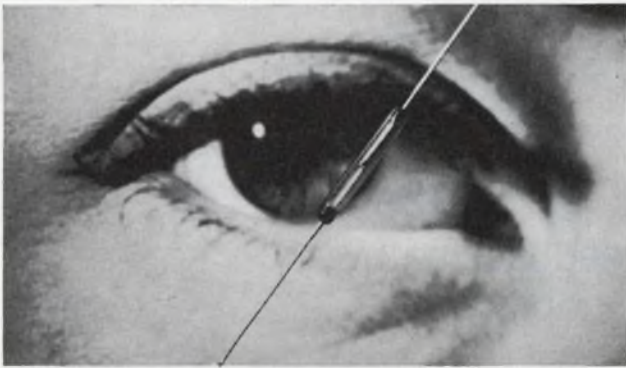

Take A Close Look at Hathaway Drireed Switches

Hathaway has them all, micro through standard, at the specifications you need. Testing, advanced production techniques and rigid quality control help assure that you get the high quality reed with the durability you asked for. Hathaway has off-the-shelf availability for Form A and Form C contact styles in Micro, Subminiature, Miniature, Intermediate and Standard sizes. Find out about the complete specifications in the new Hathaway Drireed Handbook showing 20 new switches. **For your free copy and samples write to:**



HATHAWAY
instruments, inc.

5250 EAST EVANS AVENUE DENVER COLORADO 80222
(303) 756-8301 TWR 910 931-0568

INFORMATION RETRIEVAL NUMBER 36

Togetherness!

Hathaway's Wire Termination System

Hathaway Modular Terminals are more compact than the wire terminals you are now using, possible 30% smaller at equivalent ratings. This saves you expensive cabinet space and reduces the total size of your electrical installation.

Hathaway Terminals are also installed faster and modified quicker, terminal by terminal, saving you labor cost. Hathaway's complete rail mounted termination system is rated from 24 AWG to 400 MCM, 125 to 1500 volts and 12 to 630 amps. Plug-in accessories include knife switches, fusible links, jumper bars, test plugs, insulated slide links, clear protective covers and isolating petitions.

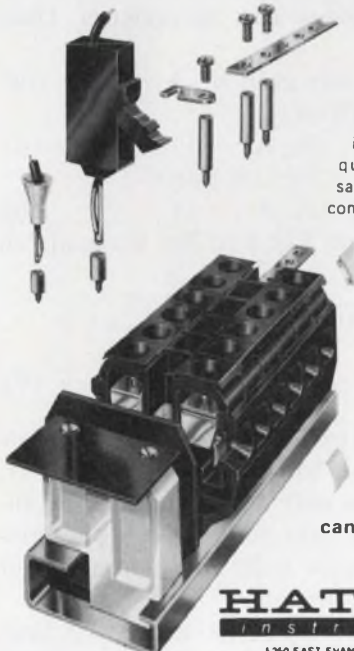

Let us show how you can save. Write to Hathaway for complete details.

HATHAWAY
instruments, inc.

5250 EAST EVANS AVENUE DENVER COLORADO 80222
(303) 756-8301 TWR 910 931-0568

INFORMATION RETRIEVAL NUMBER 37

ELECTRONIC DESIGN 20, September 30, 1971

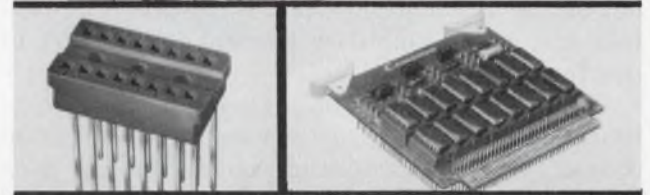
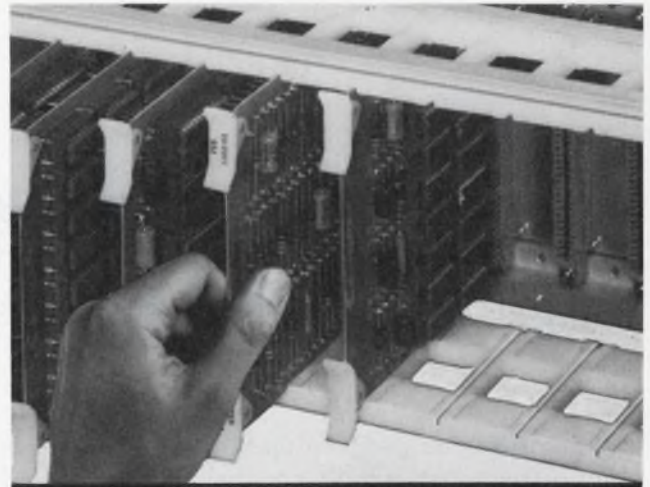

if you design with ic's Cambion has the "works" for your work

If your digital system is a packaging puzzle, CAMBION can provide the solution.

We have the high density sockets, wire-wrappable Cambi-Cards®, PC logic cards, general purpose and discrete component cards for your functional requirements.

And to complete the picture: card files, power planes, card connectors and extenders, plus a complete numerically controlled Wire-Wrap* service.

Result: Tightly integrated packaging systems. The "works" for your work.

For details, call us or write for the latest word on IC accessories and wire-wrapping. Cambridge Thermionic Corporation, 445ED Concord Avenue, Cambridge, Mass. 02138. Phone: (617) 491-5400. In Los Angeles, 8703 La Tijera Boulevard 90045. Phone: (213) 776-0472.

*Registered Trade Mark Gardner-Denver Co.

Standardize on

CAMBION®

The Guaranteed Electronic Components

INFORMATION RETRIEVAL NUMBER 38

Improve vhf amps with an attenuator

to separate the main amp from the feedback path. You get less distortion and increased stability.

When designers put automatic level control in a high-frequency amplifier, they normally feed back part of the output signal directly to an active amplifier transistor. This gives the proper control all right, but it also introduces such unwanted side effects as these: second-order and cross-modulation distortion, bandpass deviations, possible amplifier instability and mismatching. These conditions can be minimized by setting up a variable attenuator as the key feedback element.

The attenuator uses components that are non-linear at low frequencies but that exhibit low distortion at vhf frequencies. Input and output impedances are maintained constant, independent of the attenuation value. With this level control, the active amplifier element is not part of the feedback path.

In addition to the inter-stage attenuator, of course, the control loop consists of an output rf coupler, an rf preamplifier, a detector and a dc amplifier that drives the control elements (see Fig. 1). In the ideal case, the variable-attenuator transfer function is the inverse of an error-producing function.

To determine the over-all design requirements on the loop, let's define E_i as the nominal input voltage and Δ as any undesirable change from the nominal voltage. The ratio change E_R of the input voltage for a given Δ is

$$E_R = (E_i + \Delta) / E_i \quad (1)$$

The transfer function A_T of the attenuator to compensate for this change is

$$A_T = E_i / (E_i + e_r) \quad (2)$$

where e_r represents an equivalent feedback voltage applied to the attenuator. This feedback equivalent is, in turn, related to the change in output voltage from its nominal value by a factor b , so that

$$e_r = b \Delta e_o \quad (3)$$

where Δe_o is the change in output voltage for a given change in input voltage, and b is some conversion factor that proportionally relates the

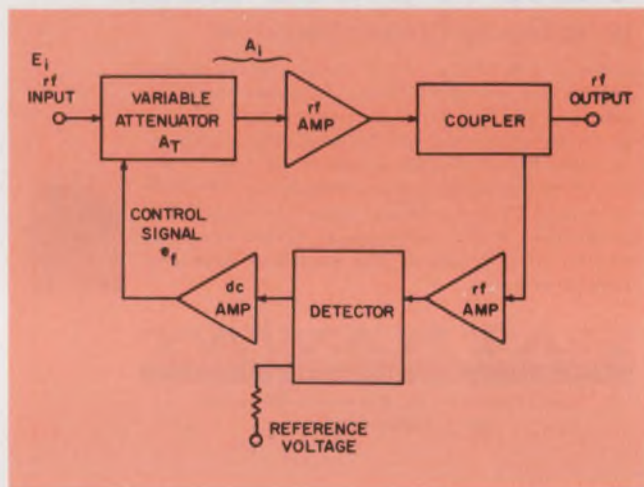

1. Automatic level control loop uses attenuator action apart from the active elements. An optimum design requires an appropriate gain distribution among the various blocks, as well as bias stability for each block.

feedback quantity e_r to the change in output voltage. The quantity b includes conversions of the rf signal to a voltage corresponding to an attenuation factor rather than to an equivalent rf feedback voltage, as in the usual feedback loop. Its value for these purposes can be greater than unity.

For a given open loop gain of A_i in the forward loop of the amplifier,

$$\Delta e_o = A_i E_i (E_R A_T - 1) \quad (4)$$

Substituting from Eq. 3 for Δe_o gives

$$e_r = b A_i E_i (E_R A_T - 1) \quad (5)$$

and substituting e_r from Eq. 3 in Eq. 2 results in

$$A_T = \frac{E_i}{E_i + b A_i E_i (E_R A_T - 1)} \\ = \frac{1}{1 + b A_i (E_R A_T - 1)} \quad (6)$$

Ideal control requires that $A_T = 1/E_R$, or $E_R A_T = 1$. But this leads to the trivial case $A_T = 1$, a condition that exists only when there is no input error. This means that for $A_T \neq 1$, the condition of $E_R A_T = 1$ cannot exist and some output error must always be present.

To minimize this error, it is necessary that $|E_R A_T - 1|$ be minimized. Equivalently, from

Dan Lieberman, Section Head, CATV Electrical Engineering, GTE Sylvania, Inc., Seneca Falls, N.Y. 13148

Table 1. Select your attenuator

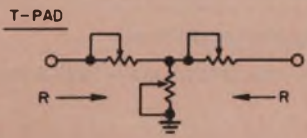
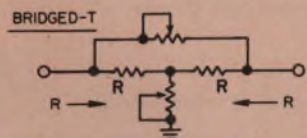
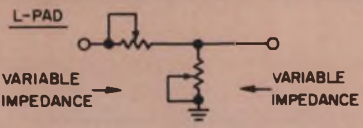
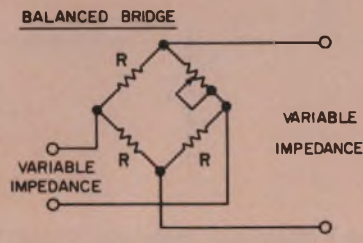
Configuration	Advantages	Disadvantages
 <p>T-PAD</p>	<p>Wide control range.</p> <p>Maintains impedances.</p>	<p>Expensive.</p>
 <p>BRIDGED-T</p>	<p>Moderate expense.</p> <p>Maintains impedances.</p>	<p>Moderate control range.</p>
 <p>L-PAD</p> <p>VARIABLE IMPEDANCE</p>	<p>Moderate expense.</p> <p>Fewest components.</p>	<p>Moderate control range.</p> <p>Does not maintain all impedances.</p>
 <p>BALANCED BRIDGE</p> <p>VARIABLE IMPEDANCE</p>	<p>Widest control range.</p> <p>Moderate expense.</p>	<p>Requires balun transformer.</p> <p>Does not maintain impedances.</p>

Eq. 6, this magnitude is expressed as follows:

$$\left| E_R A_T - 1 \right| = \left| \frac{1 - A_T}{b A_i A_T} \right|. \quad (7)$$

For any given A_T , the magnitude $|E_R A_T - 1|$ is minimized as the quantity $b A_i$ increases. Therefore the greater the open loop gain A_i and the greater the transfer ratio b , the greater the level stability. With the transfer ratio constant, an increase in input error results in increased attenuation and output error. Output error limit, as a function of expected input error, is therefore defined for maximum attenuation.

Select the attenuator

The design of the level control begins with the selection of a configuration and control element for the variable attenuator. Any of several configurations can be used. These are listed in Table 1, along with their main advantages and disadvantages. Not shown are the coupling capacitors needed for dc isolation between elements, and the isolation chokes and bypass capacitors needed for coupling to the dc amplifier.

The selection of a configuration requires a

tradeoff between complexity, cost, range of attenuation and ability to maintain input and output impedances over the attenuation range. The latter factor affects loading of the stages and is a determining one in maintaining passband shaping and in ensuring gain stability of the stages. Because of this factor, both the L-pad and balanced bridge arrangements, which don't maintain all impedances constant, are more limited in use. The bridged T-pad requires only two variable elements in comparison with the three elements required by the T-pad. It therefore is slightly cheaper and less complex than the T-pad and is more widely used.

Some commonly used control elements are described in Table 2, together with the advantages and disadvantages of each type. The ideal control element:

- Does not dissipate dc power.
- Does not introduce distortion to signals.
- Achieves a wide range of impedance values for low dc control voltages.
- Has a high-Q variable reactance element or a purely resistive variable resistance element for all frequencies in the amplifier passband.
- Is environmentally stable.

Table 2. Compare the control elements

Elements	Advantages	Disadvantages
P-i-n diode	Wide control range for small signal current.	Expensive.
Thermistor	Low shunt capacitance. Relatively inexpensive. Low distortion at vhf.	Temperature sensitive. Low impedances require large drive current.
Voltage-variable capacitive diode	Dissipates no power. High-Q element. High reliability.	Reactive device. Limited control range.
Photodiode	Isolates rf and dc control circuits.	Sensitive to environment. Low impedances require large drive current. Limited life.

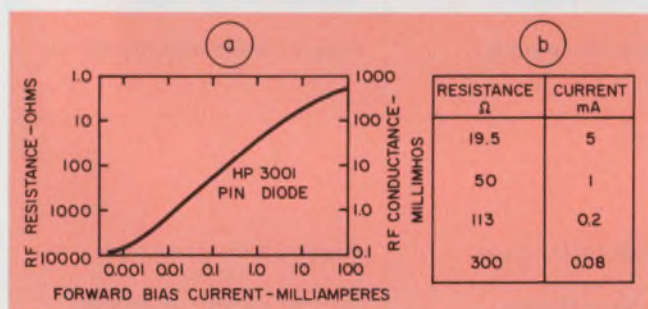

2. The control element determines the attenuator currents. Shown here is the characteristic curve of the control element selected (a). From the curve and the calculated attenuator-resistance values, the required range of currents is determined for the design specs. (b).

- Simplifies isolation between rf circuitry and dc control circuitry.
- Is small, light, and inexpensive.
- Is highly reliable.

From the entries in Table 2, it is obvious that no control device is perfect, and tradeoffs among characteristics are necessary to select a good device.

Once an attenuator is selected, the design of a feedback loop can proceed. Consider, for example, an automatic level control with the following specifications: attenuation range of 12 dB, allowing voltage control of +100% and -50% of the nominal input level; attenuator input and output impedances of 75 Ω ; initial attenuator insertion loss of 2 dB (maximum); loop tightness of ± 0.5 dB change in output level for ± 6 dB change in input level; nominal output level at reference output of 100 mV rms (for a single carrier or the rms composite of several carriers) and a response time (for output stabilization with a delta change at the input) of 10 ms.

For this example, the bridged-T configuration is used because it is the simplest configuration having constant input and output impedances. An

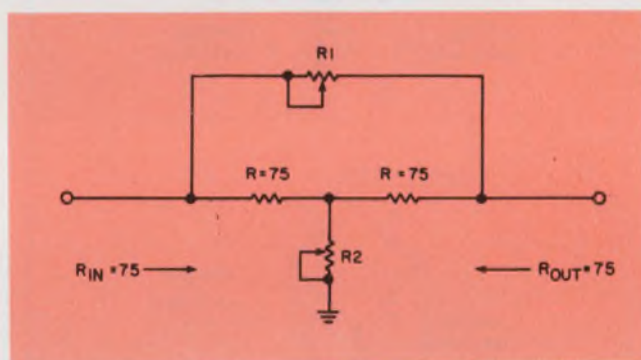

3. The bridged-T attenuator maintains constant input and output impedances as two elements, which can be varied by a single control, are varied simultaneously.

HP 3001 p-i-n diode is used as the control element because of its wide control range for small signal current. The diode characteristic curve is shown in Fig. 2a.

Seven steps to design

The design procedure is separated into seven parts, with each devoted to a critical component or parameter:

1. The attenuator currents are determined by first calculating the bridged-T component values. These are found from commonly known formulas¹: $R = \text{characteristic impedance} = 75 \Omega$, $R_1 = R(K-1)$, where $K = \sqrt{N}$ and N is the ratio of input to output power levels and $R_2 = R/(K-1)$. For an initial insertion loss of 2 dB, $N=1.56$ and thus, $R_1 = 19.5 \Omega$ and $R_2 = 290 \Omega$ (see Fig. 3).

Including the attenuation range with the initial insertion loss yields a total of 14 dB, for which $N = 25$, $R_1 = 300 \Omega$ and $R_2 = 19 \Omega$. And, finally, for a midway attenuation value of 8 dB, $R_1 = 113 \Omega$ and $R_2 = 50 \Omega$.

To achieve these resistance values, the current

values in Fig. 2b are required. This shows that a current swing of $(5 - 0.08) \approx 5\text{mA}$ is needed to achieve a 14-dB attenuation range. And a maximum current of only 5 mA is required at the minimum attenuation value of 2 dB. Since this is readily achieved, the requirement of maximum initial insertion loss of 2 dB is also easily achieved.

2. The feedback ratio is found from the design specifications. The maximum output variation is ± 0.5 dB for a ± 6 dB change in input. This corresponds to an output level change of ± 5 mV rms for a nominal output level of 100 mV rms. Therefore an output error range of 10 mV rms results in a current swing of 5 mA through the attenuator diodes for 12 dB of attenuation control. Calculating the feedback ratio: $b' = (5 \times 10^{-3}) / (10 \times 10^{-3}) = 0.5 \text{ mA/mV}$.

3. The output coupler is selected on the basis of three factors: minimal loading to the output signals, minimal insertion loss as voltage is transferred to the rf amplifier and stable transfer ratio with environmental changes.

The coupling device that best fulfills these objectives is a passive directional coupler. It isolates the feedback loop from the forward loop and transfers the voltage at a prescribed tap loss with minimal insertion loss. And being entirely passive, it can remain very stable with time and temperature.

A 10-dB tap loss is reflected as 0.5-dB loss in output level. A $100 \pm 5.0\text{-mV}$ rms output level is then sampled as a $33 \pm 1.6\text{-mV}$ rms signal level at the output of the coupler.

4. It's preferable to place most of the feedback gain in the rf amplifier because its output-level stability can be greater than that of the dc amplifier. But the total gain in the rf amplifier is limited by cost and space (much higher gain per stage can be achieved at dc than at the vhf frequencies), detector level and rf amplifier stability. The most significant factor is amplifier stability, since any change of level in the feedback path, before the comparator, is directly reflected as an error in output level. This is due to the fact that the output level must shift in an equal and opposite direction to the feedback change to maintain a signal level at the comparator equal to that of the reference.

With an rms input voltage to the rf amplifier of 35 mV, yielding a peak level of 50 mV, the voltage gain of the rf amplifier is limited to a value of 8:1 (19 dB in the matched case). This results in a peak voltage level of about 300 mV to the diode detector. With an input level of 33 ± 1.67 mV and a voltage gain of 8:1, the rf amplifier presents a signal of 264 ± 13.3 mV rms to the detector.

5. An efficient rf detector has the qualities of low shunt capacitance and fast inverse recovery time. The detector should also be charged from a low-impedance source in the interest of speed. And it should work into a high impedance load so the peak signal is maintained.

These characteristics determine the conversion efficiency of the detector—the ratio of detected dc level to peak level of the rf signal. The higher the efficiency, the greater the gain of the feedback loop for given rf amplifier and dc amplifier gains. In effect, high efficiency of the rf detector means, for a given loop tightness, less stringent gain requirements for the feedback amplifiers.

This is important because conversion efficiencies can range from almost nothing to a maximum of unity. A conversion efficiency of 0.75 is considered quite good. A loop with a detector of this efficiency, for a given loop tightness, needs only one-half the gain in its amplifiers compared with a loop that has a detector efficiency of only 0.375.

6. The problem of dc level instability exists because the diode detector usually has some forward bias, which also supplies bias current to the dc amplifier. Changes with temperature in forward voltage drop across the diode detector are usually reflected as changes in current through the dc amplifier—and therefore as changes in signal through the attenuator control element.

This type of change essentially results in a bias on the control element that is independent of the error signal and that thus serves to change the signal on the control element and the attenuation. Sensing of this change by the feedback loop results in a slight change in output level. The sensed error is $e_o = e_r/b$.

One arrangement to assure dc stability is shown in Fig. 4a. The dc amplifier is assumed to be fully stabilized by operational feedback and by internal compensation of the base-to-emitter junction of its first stage. The dc amplifier is also assumed to have a very high input impedance. The detector diode junction drop is then compensated for by the use of an additional diode of the same type, which tracks the change in detector diode voltage drop with temperature, so that the input voltage to the dc amp remains stable.

A much more accurate means—but also a more costly and complex one—of assuring dc stability is shown in Fig. 4b. A balanced diode pair (unbalanced by rf detection) feeds a balanced differential dc amplifier. One diode-amplifier pair balances the other, so that without a change in rf signal, a balanced output level is maintained independent of temperature changes.

The advantage of this scheme is that all parameters that are a function of temperature are compensated by the fully balanced arrangement.

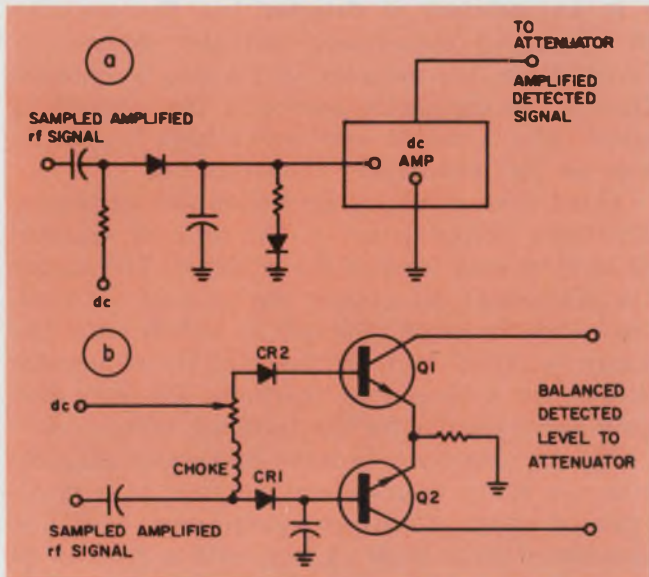

4. Compensation networks protect against dc level instabilities from the detector-dc-amp combination. A simple circuit compensates for the detector voltage drop (a). A more complex circuit provides a balanced scheme, compensating temperature-sensitive parameters (b).

The limitation in using this arrangement is that of securing inexpensive balanced detector diodes and transistors that can closely track each other's parameters as a function of temperature.

If the detector conversion efficiency is assumed to be about 0.707, then an rms level of 264 ± 13.3 mV from the output of the rf amplifier yields a peak detected dc level of 264 ± 13.3 mV at the input of the dc amplifier.

7. System considerations can determine part of the dc amplifier design. One factor is that response time is limited by the lowest frequency of modulation, when AM carriers are used as sam-

pled signals. A second factor is that tight loops that require high-gain dc amplifiers can be obtained with a tradeoff of fast response time for loop tightness. In this case, the option is not needed.

Achieving the required response time calls for the use of a dc amplifier with a 3-dB bandwidth of 35 Hz. If the sampled rf signal contains amplitude modulation, then the lowest modulating frequency should be about ten times greater, or 350 Hz.

The current gain of the dc amplifier is calculated from the amplifier input impedance βR_E , where β is the current gain in the first stage and R_E is the emitter resistance. For the design example, the current gain $A_I \approx 0.2\beta R_E$, where R_E is in ohms. The required loop tightness and response time are achieved with $\beta = 100$ and $R_E = 50 \Omega$: the required dc amplifier gain is about 1000.

With the dc amplifier gain calculated, the basic design procedure is formulated. The final block-diagram design is shown in Fig. 5. For the dc amp, only the input and output stages are indicated. The p-i-n-diode attenuator is shown with its coupling networks to the rf signal source and to its dc control source.

In the bridged-T configuration, the series diode and shunt diode resistances move in impedance directions opposite to each other as a function of attenuation. This lends the attenuator to a differential amplifier drive as the control. The use of this amplifier also increases the over-all level stability of the dc amplifier and reduces balanced interference, such as hum and noise, from the dc supply. ■■

Reference:

1. *Reference Data for Radio Engineers*, Fourth Edition, ITT Corp., pp. 250-253.

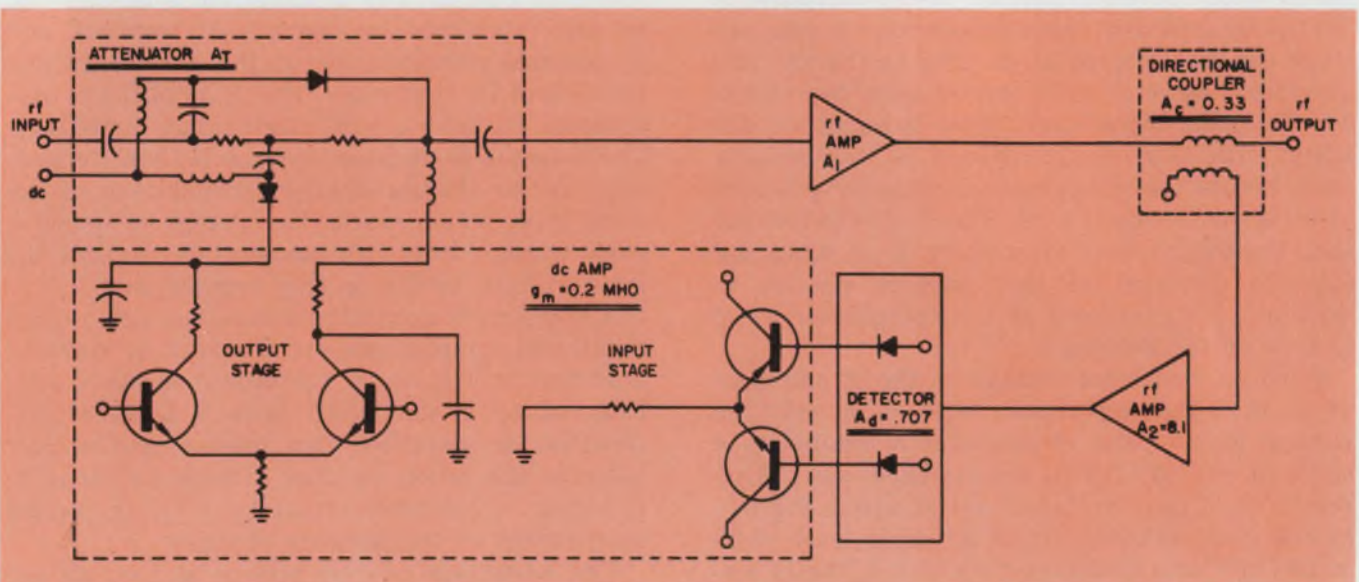

5. In a typical level-controlled amplifier, shown here in block form, proper decoupling of rf signals and coupling

of dc control signals are essential for the required frequency response over all attenuator values.

New line of solid-state devices will broaden your choice of microwave sources and amplifiers

Are you ready to make the design jump from tubes to solid-state in your low-power microwave applications? Sperry Electronic Tube Division is ready to help you.

We've recently acquired the microwave solid-state capability of a sister division, and we're melding that with our own field proved knowledge of microwave systems requirements. Working from that base, company-funded R&D will soon be bringing you a whole generation of solid-state devices.

In the very near future, you can expect both fixed frequency and voltage-controlled transferred electron (Gunn effect) oscillators and a new breed of IMPATT oscillators. A little later, you'll see transferred electron amplifiers, IMPATT amplifiers and a full line of TRAPATT devices. Our R&D efforts will continue in silicon and GaAs technology and other aspects of microwave solid-state.

We'd like to keep you abreast of what's happening in solid-state at Sperry. How about filling in the coupon above, so that we can add you to our mailing list. We'll update you regularly. While you're at it, jot down the details of your thorniest application problem. Maybe we can aim our R&D efforts directly at you. Sperry Electronic Tube Division, Gainesville, Florida 32601.

 SPERRY RAND

**SPERRY
CAN GET
YOU IN
SOLID**

Please help me get in solid.

- Add my name to your solid-state mailing list.
- I'm attaching the details of an application problem. Let me know what you think about a solution.

NAME _____ TITLE _____

COMPANY _____

ADDRESS _____

CITY _____ STATE _____ ZIP _____

 **SPERRY**
ELECTRONIC TUBE DIVISION

ideas for design

Long-period analog timer uses small capacitors

Analog timers using integration techniques generally require large, unwieldy integrating capacitors to obtain long time intervals.

But if a high-input impedance buffer amplifier is inserted into the integrator circuit, the effect of input impedance, offset, and bias current in the integration amplifier are minimized, allowing a high-quality capacitor of reasonable size and cost to be used in the timing circuit (see diagram).

Op amp A₁ serves as a high-input impedance buffer, isolating the timing network R₃C₁ from the integrating amplifier A₂. Op amp A₃ is connected as a Schmitt trigger, with D₂ and D₃

furnishing a stable reference voltage for the trigger trip point.

Transistor Q₁ and Q₂ serve as saturated switches sourcing the voltage divider R₁₈-to-R₂₈ for timing selections. The timer output is negative, but reversing D₁ produces a positive output pulse.

Resistor R₆ is adjusted to minimize drift measured at the output of A₂ and with the wiper of S₁ grounded. Resistor R₁₈ is adjusted to set 0.5 minutes timing-interval accuracy.

D. L. Ruhberg & F. R. Wuensche, Narco Bio-Systems, Inc., Houston, Tex. 77017.

VOTE FOR 311

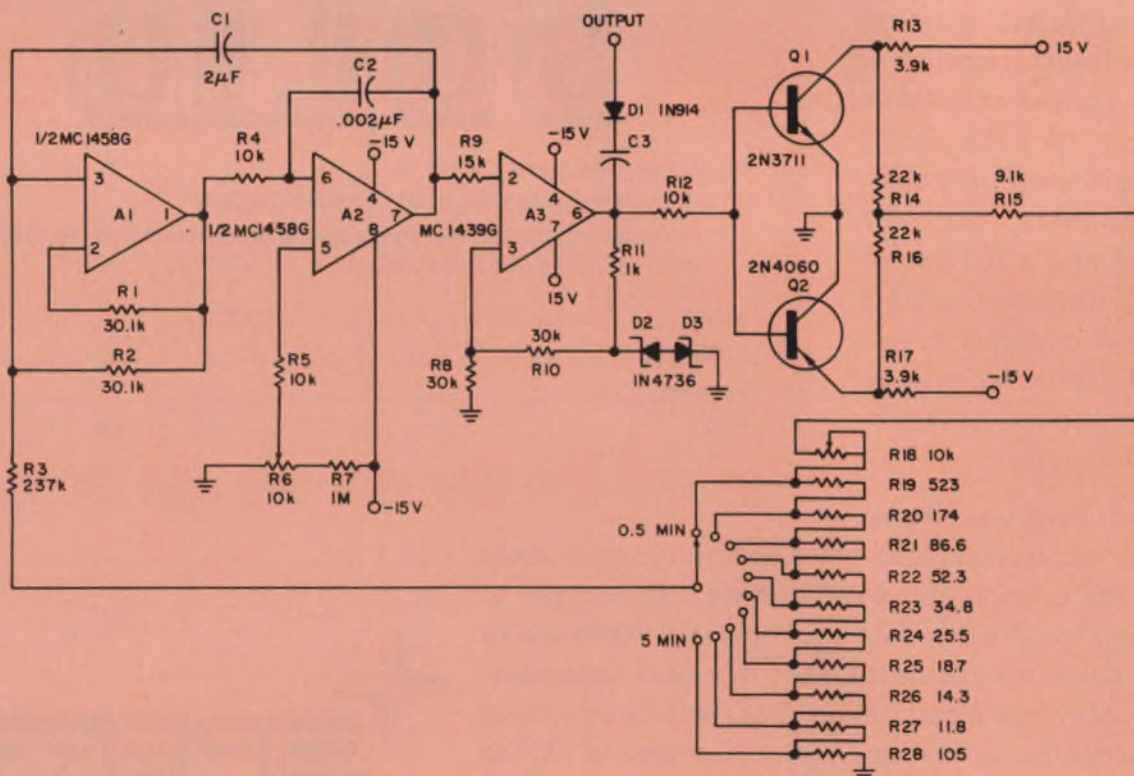

A self-resetting timer develops output pulses that are selected by S₁, at 30-s intervals, between 30 s

and 5 min. Accuracy is typically $\pm 2\%$. The use of buffer A₁ enables the use of small capacitors.

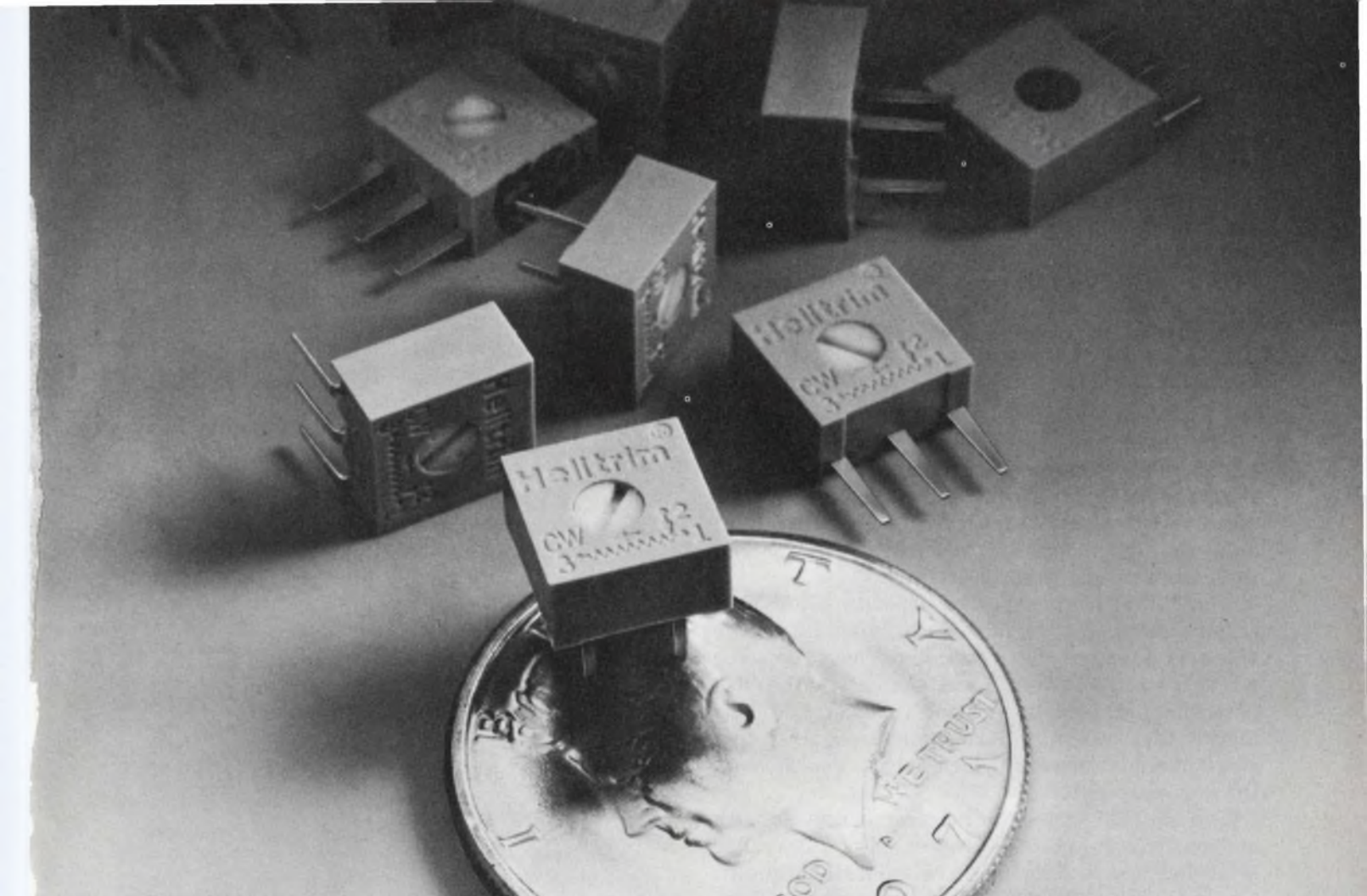

HELI POT BREAKS THE HALF-BUCK BARRIER.

Here they are: the best buys. Our new Series 72 single-turn $\frac{3}{8}$ " cermet trimmers at an eye-opening 49¢ each in the 1,000 quantity. They're equally well-priced in other quantities, too. One alone costs just 70¢.

But there's also that dependable Helipot quality and performance, plus things you don't get elsewhere. Like our resistance and slider stability ... change is less than 0.5% in the first 1,000 operation hours, progressively less thereafter. Impressive, when the life expectancy exceeds five years' continuous duty under full-rated power. And the Series 72 sealing — compatible with wave soldering, low-viscosity potting, and board washing even with chlorinated solvents.

Add the wide range of values, ± 100 ppm/ $^{\circ}$ C tempco, and off-the-shelf availability from 17 nationwide stocking points and what have you got? The best reasons in the world for requesting complete specs and data on this breakthrough line of Helipot cermet trimmers. Do it now — it won't cost you a cent.

Beckman®

INSTRUMENTS, INC.
HELI POT DIVISION
FULLERTON, CALIFORNIA

HELPING SCIENCE AND INDUSTRY IMPROVE THE QUALITY OF LIFE.

EKG detector improves heart-rate measurement

Standard EKG detectors employ Schmitt trigger circuits. But these detectors can fail to detect heart beats because of noise or a wildly varying EKG signal—as when unrestrained activity affects the EKG signal.

A circuit that reliably detects EKG signals is shown in Fig. 1. This circuit can also be used to detect an EKG signal that is being telemetered from a remote location.

The input amp (A1) differentiates the EKG signal coming from the preamp. The nonlinear characteristics of the following diode network improve the signal-to-noise ratio. For small signals the impedance of the diodes is large and these signals are greatly attenuated.

The signal is then passed through a low-pass filter, which has variable gain capability. The filter is followed by a standard level detector whose detection point is adjustable via the bias potential provided by emitter follower Q1. This allows the system to discriminate against any small residual signals which might get through the low-pass filter.

The output of the level detector is a pulse with an approximate peak-to-peak value of 1.5 V. The level detector is followed by a monostable multivibrator (Q2 and Q3), which produces an 80-ms

signal for each negative transition of the level detector.

Transistor Q4 is provided to inhibit the output of the monostable circuit during periods of heart-rate reinforcement, which can take the form of shock treatment to stimulate particular heart rates. Shock periods often lead to spurious counts.

Transistor Q5 provides an interface for the remainder of the system.

Typical output data are shown in Fig. 2 for a standard detector and the EKG detector described.

Gordon Silverman, Research Associate, Rockefeller University, New York, N. Y. 10021.

VOTE FOR 312

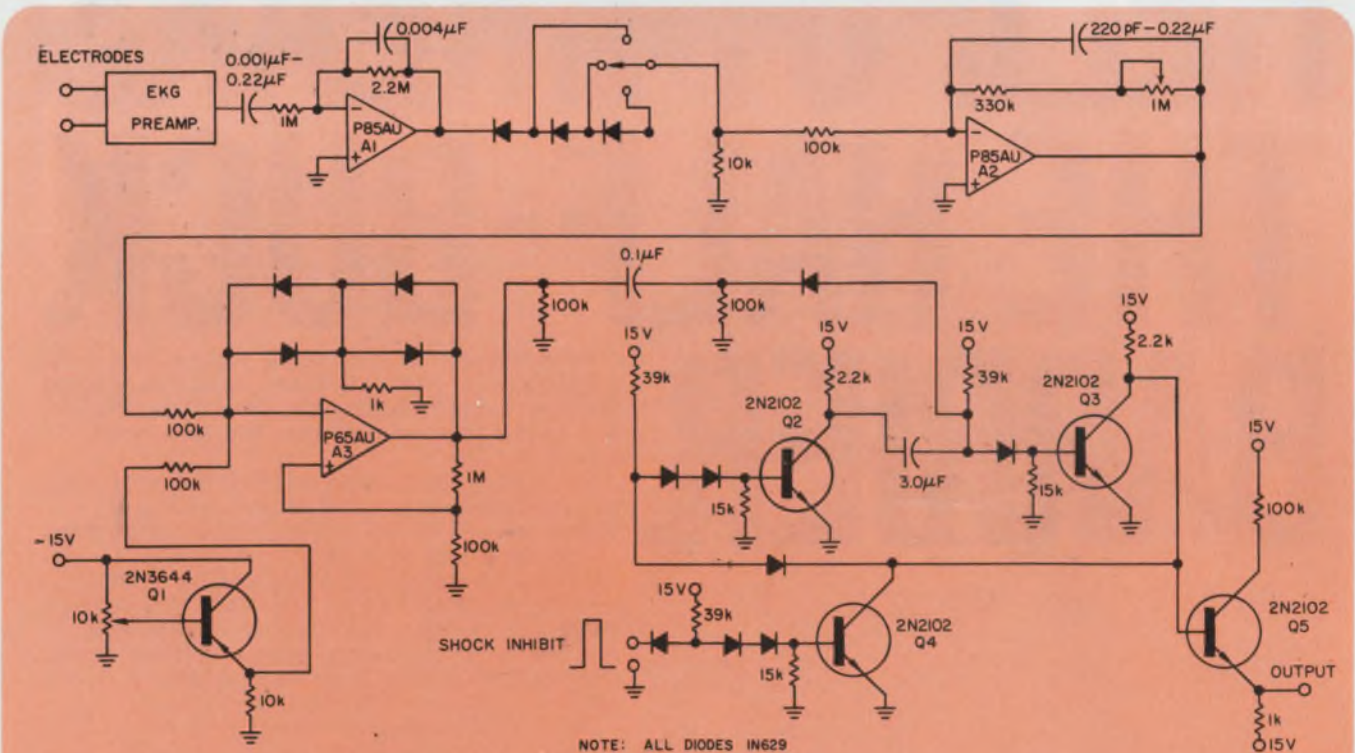
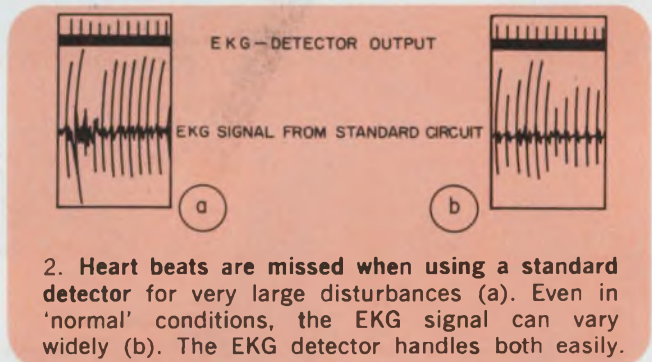

1. Nonlinear elements and filtering networks in the EKG detector provide an output pulse for each

heart beat. The output can be processed by logic circuits for heart-rate reinforcement.

Our New AC Source, \$495. With Rechargeable Battery Pack, \$595.

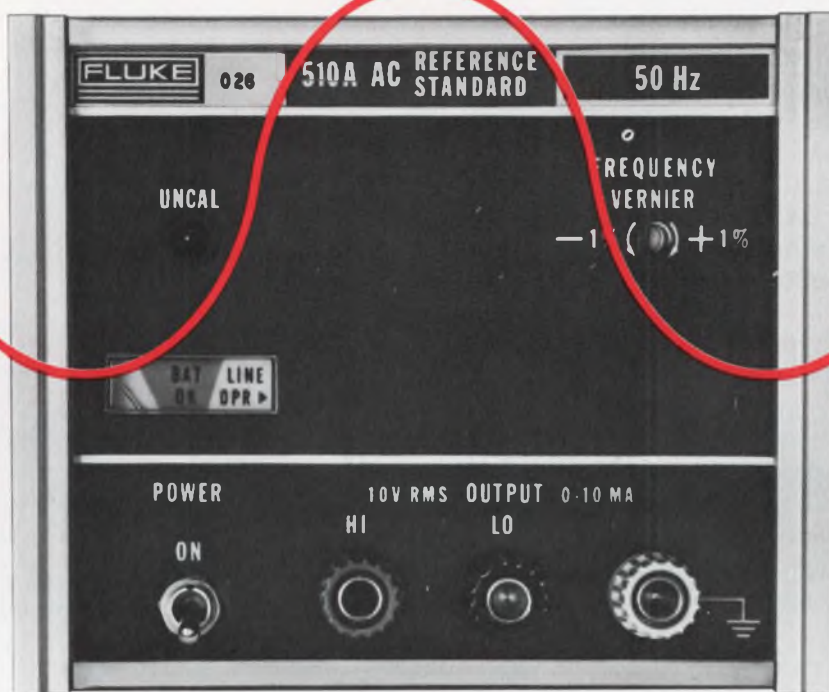

Actual Size

Our new AC Reference Standard, Model 510A gives you accuracy and a wide choice of frequencies with dollars to spare. You can use the new source as a calibration standard or a fixed frequency source for test applications. In the calibration laboratory, the 510A provides an accurate reference for calibrating both true rms and average reading ac voltmeters. On the production line, the 510A can be used to rapidly verify ac test instrumentation or to generate a precise ac stimulus for circuit testing.

Used in conjunction with the new Fluke 4200 Series Programmable Power Sources, the 510A contributes to a very accurate, very stable ac and dc system for automatic test and process control.

Output voltage of the Model 510A is 10 volts rms with an accuracy of $\pm 0.01\%$ for 30 days and $\pm 0.02\%$ for 90 days. Output current is 10 ma rms short circuit protected. Any single fixed frequency output is available from 50 Hz to 100 kHz. Total harmonic distortion is less than 0.005%.

Standard frequencies available at time of order are 50 Hz, 60 Hz, 400 Hz, 1 kHz, 2.4 kHz, 19.2 kHz, and 100 kHz. Other frequencies may be obtained on special order at a price of \$50.

An optional rechargeable battery pack provides up to 16 hours of operation without ac line power. Any accurate dc source can be used for calibration.

Up to four 510A's can be mounted side by side and installed in a standard 19" EIA rack.

**And you know,
you just can't
get a 0.01% source
for anything
like this
money elsewhere.
Anyway,
why would you
want to when
Fluke's got it?**



Fluke, Box 7428, Seattle, Washington 98133.
Phone: (206) 774-2211. TWX: 910-449-2850/In Europe,
address Fluke Nederland (N.V.), P. O. Box 5053, Tilburg,
Holland. Phone: (04250) 70130. Telex: 884-52237/In the
U. K., address Fluke International Corp., Garnett Close,
Watford, WD2, 4TT. Phone: Watford, 33066. Telex: 934583.



Model 510A shown in four-up configuration.

Digital multiplexing without a multiplexer

It's possible to multiplex four 4-bit words without using a multiplexer.

The standard approach (a) for reformatting a single 16-bit word into four 4-bit words is very straight forward. The system control inputs are LOAD—to load the 16-bit word into the 16-bit holding register—and INCREMENT—to format each 4-bit word. The 2-stage counter and decoder provide the four steer inputs needed by the 4-bit multiplexer, which performs the formatting operation.

But with reconnection (b) the multiplexer is eliminated. The four MSI devices shown are serial/parallel shift registers, with the numbers in the boxes showing how the 16-bit word is loaded into the 16-bit register. The increment signal is used as the serial/parallel shift clock, and the load signal is used as the parallel enable signal. Each 4-bit register shifts right one bit with each increment signal not accompanied by the load signal.

Edward G. Linde, Senior Engineer, Radiation Systems Div., Harris-Intertype Corp., Melbourne, Fla. 32901

VOTE FOR 313

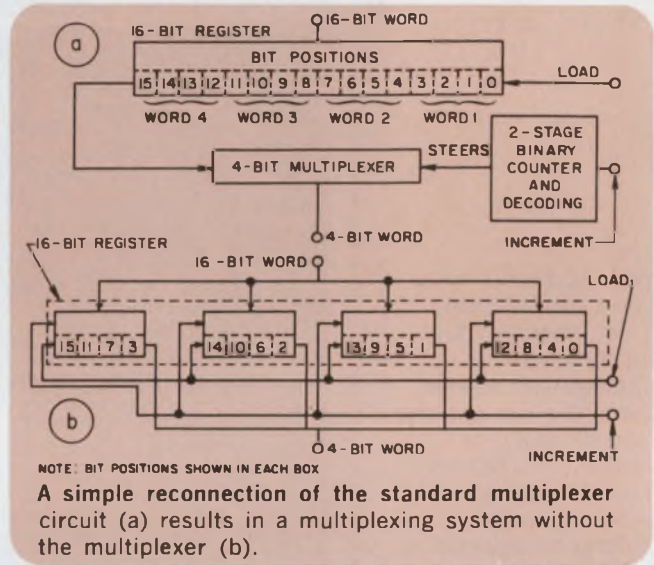

designing solid state inverters?

Fix lag/lead relation in digital 90° phase shifter

In an ordinary 90° phase shifter, two 180° out-of-phase signals are fed into two flip-flops and a quadrature output is obtained. The problem with this type of phase shifter is that the output signals can be either leading or lagging one another, depending on the state of the Q outputs prior to signal application. And you don't know which leads and which lags.

This problem is eliminated with a single transistor phase locking circuit (a). When the Q output of FF2 goes positive it produces a negative going pulse at the collector of Q1. This pulse is applied to the clear input of FF 1, setting its Q output to a logic ZERO before the positive edge of its input signal arrives. Thus the Q output of FF 1 always lags the Q output of FF 2 by 90° (b).

The time constant in the base circuit of Q1 is set to ensure that the clear pulse at FF 1 is not present when the leading edge of the input signal arrives.

William Lennox, Electronic Engineer, Microdyne Corp., Box 1527, Rockville, Md. 20850.

VOTE FOR 314

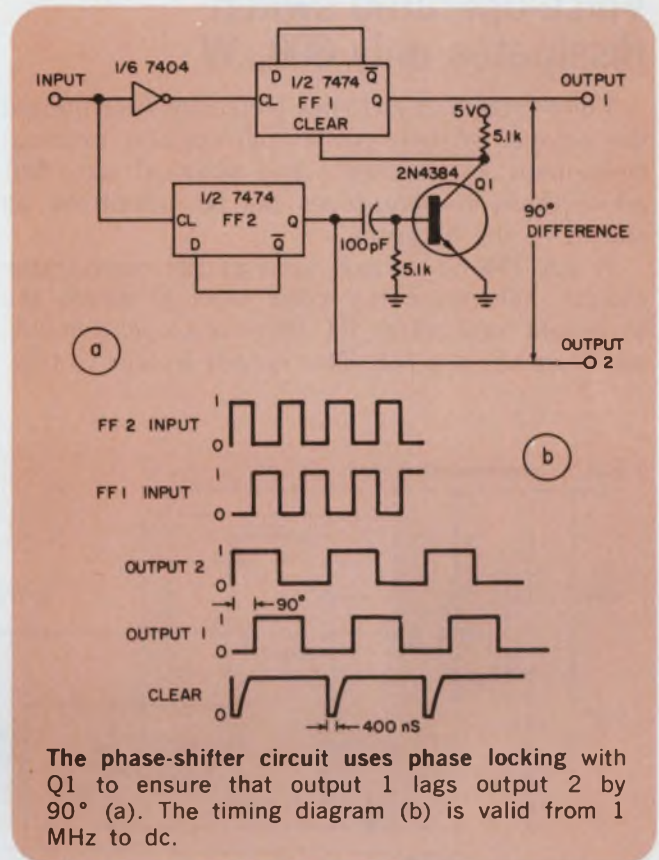

The phase-shifter circuit uses phase locking with Q1 to ensure that output 1 lags output 2 by 90° (a). The timing diagram (b) is valid from 1 MHz to dc.

General Electric's new 28F SCR capacitor bulletin can help you select the right capacitor for commutating or filtering applications involving high frequency sinusoidal waveforms and unidirectional or bidirectional square waveforms.



circle 28

reader service card
or write General Electric Company
Section 448-01, 1 River Rd.
Schenectady, N.Y. 12345

GENERAL  ELECTRIC

Voice-operated switch dissipates only $600\mu\text{W}$

Voice-triggered switches generally find limited use because of their power consumption, external component requirements and physical size. But all of these disadvantages can be minimized, as shown in the diagram.

A $\mu\text{A} 735$ op amp is used as the comparator circuit. Whenever the voice level is above the threshold level set by R_1 , there is a negative output from the $\mu\text{A} 735$. This output is used to trig-

ger the CD4007, which is connected as a low-power monostable multivibrator. The circuit has a total standby power drain of $600\mu\text{W}$.

Resistor R_2 and capacitor C_2 provide a 2-second time constant. The charge on C_2 is reset each time the CD4007 is triggered, and the output level trips when the first voice signal is detected. It does not reset until 2 seconds after the last voice signal.

Larry Mellenbruch, University of Texas P.O. Box 8029, 10000 FM Road 1325, Austin, Tex. 78712.

VOTE FOR 315

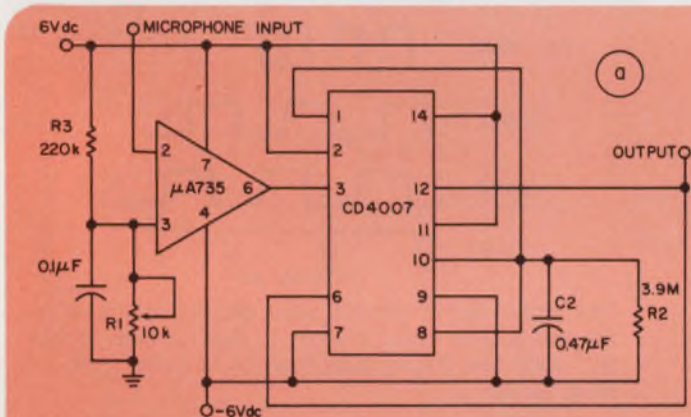

Low-power, minimum components and small size characterize this voice-operated switch (a). The

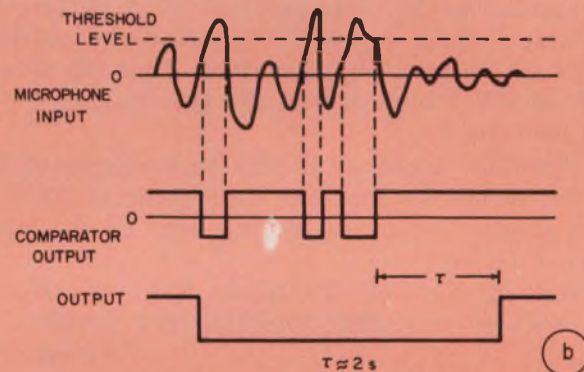

output level sets when the voice signal is above the threshold level (b).

Transistors in breakdown reveal negative resistance

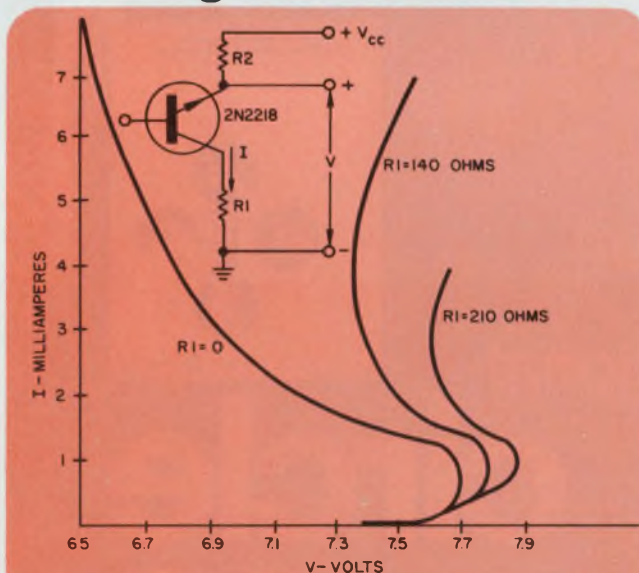

A reverse-biased 2N2218 transistor illustrates the negative-resistance characteristics possible with common devices. Similar curves result when other transistors are forward-biased to breakdown.

By forward-biasing or reverse-biasing common transistors to the breakdown point, a number can be made to exhibit negative-resistance characteristics. This allows transistors to be used in applications that normally require more sophisticated components.

An example of the reverse-breakdown case is shown in the diagram—an expanded dc point-to-point plot of the breakover point of the 2N2218.

To linearize a characteristic curve, the collector and base are connected together through a resistor, so that the base breaks down first, rounding off the sharp foldover in the curve. The collector starts conducting at the point corresponding to the intersection of the base-to-emitter and collector-to-emitter curves. The remainder of the characteristic is then a composite of the two, which, if properly proportioned, results in a linear curve.

A series resistor in the collector-to-emitter circuit enables the vertical slope to be changed from negative to positive without changing the shape of the curve.

Richard L. Phares and Robert N. Luther, Huntsville, Ala.

VOTE FOR 316

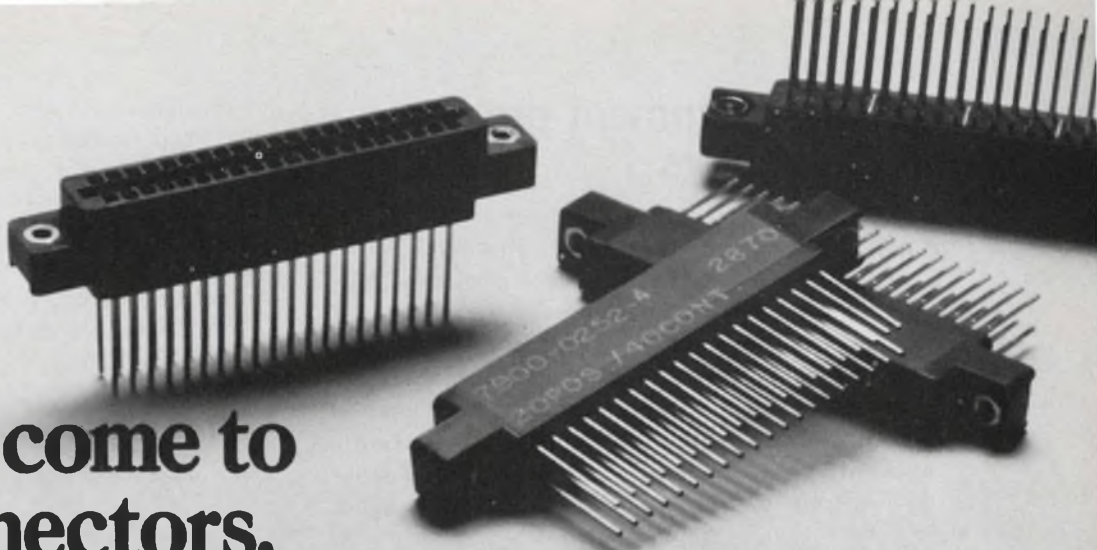

When you come to us for connectors, you could have your whole job wrapped up.

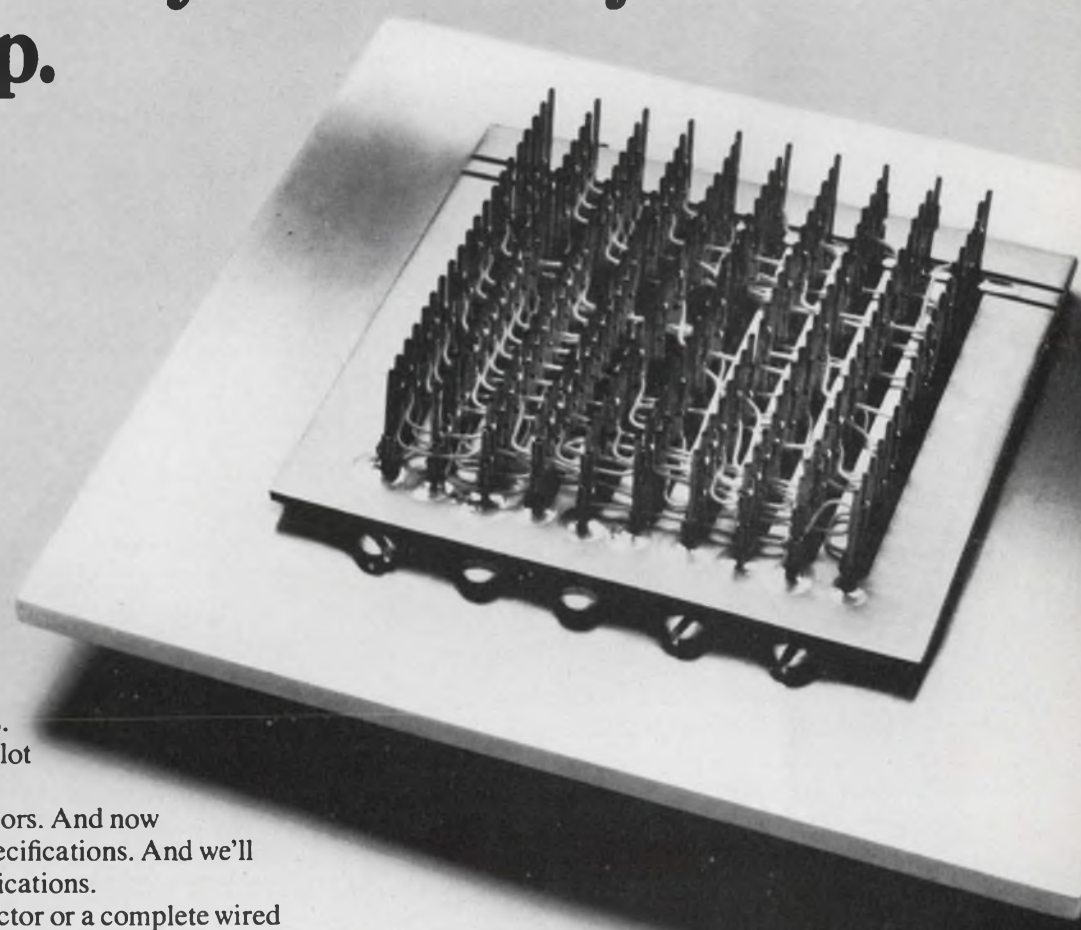

In the old days, we made connectors only to your specifications. We still do. But now we've gone a lot further.

We added off-the-shelf connectors. And now we'll mount either type to your specifications. And we'll have them wrapped to your specifications.

In short, we'll give you a connector or a complete wired backpanel assembly. Or anything else in between.

You save time, money and aggravation, because you don't have to set up an in-house operation.

And we can probably do it at lower cost because we make our own plastic bodies, form our own contacts, and assemble our own connectors. We even draw our own wire for wrapping.

It used to be you could only come to us for connectors.

Now you can throw the whole wrap at us.

To find out what we really can do, call Russ Sanders at 814-723-2000 or write him at GTE Sylvania, Precision Materials Group, Parts Division, Warren, Pennsylvania 16365.

GTE SYLVANIA

Eliminate alignment problems in FM detectors

Most FM detection circuits include an inductive coil that requires alignment. But with a circuit employing a $\mu A754$ IC and a ceramic filter, no circuit adjustment is necessary (a).

The $\mu A754$ consists of a high gain 4-stage limiting i-f amplifier, a doubly balanced quadrature detector and a driver amplifier. The normal quadrature coil has been replaced by a four-pole ceramic filter—which can be used because a separate i-f output terminal is available on the $\mu A754$.

Resistors R_1 and R_2 are added to provide the required source matching, and R_2 also provides a dc bias path for the detector (normally provided through the quad coil). Typical ceramic filter impedances are 1 k Ω or less. At these low impedance levels the internal 4-pF capacitor has little effect on performance and may be neglected.

Performance data (b) is given for a 4.5 MHz signal frequency.

Rodney Smith, Fairchild Semiconductor, Mountain View, Calif. 94040.

VOTE FOR 317

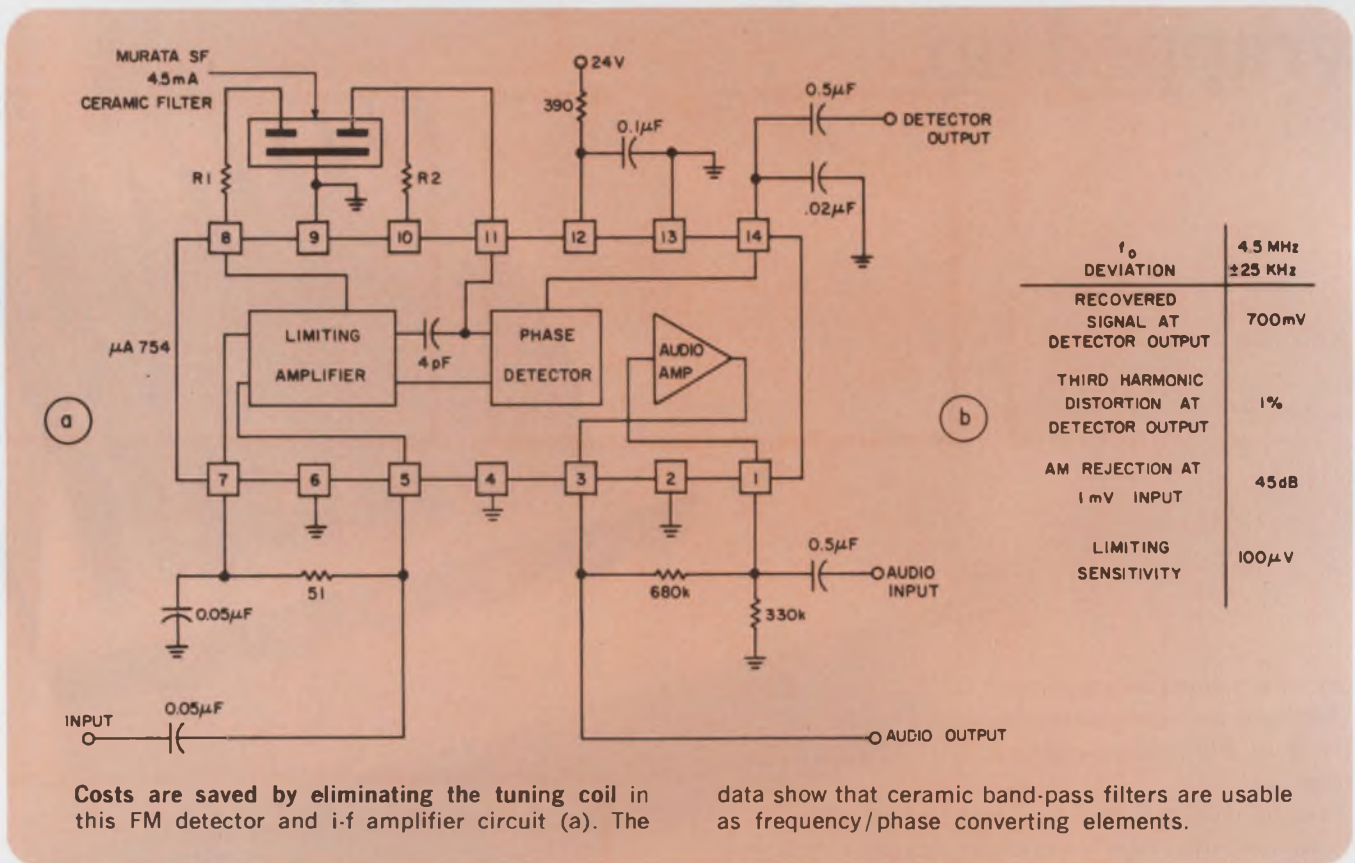

Costs are saved by eliminating the tuning coil in this FM detector and i-f amplifier circuit (a). The

data show that ceramic band-pass filters are usable as frequency/phase converting elements.

IFD Winner for June 10, 1971

Thomas L. Hershey, and G. A. Dunn, Electronics Engineers, Department of Defense. Their idea "Vary One-Shot's Pulse Width Over 1600:1 Controlled Range" has been voted the Most Valuable of Issue Award.

Vote for the Best Idea in this Issue.

VOTE! Go through all Idea-for-Design entries, select the best, and circle the appropriate number on the Reader-Service-Card.

SEND US YOUR IDEAS FOR DESIGN. You may win a grand total of \$1050 (cash)! Here's how. Submit your IFD describing a new or important circuit or design technique, the clever use of a new component or test equipment, packaging tips, cost-saving ideas to our Ideas-for-Design editor. You will receive \$20 for each accepted idea, \$30 more if it is voted best-of-issue by our readers. The best-of-issue winners become eligible for the Idea Of the Year award of \$1000.

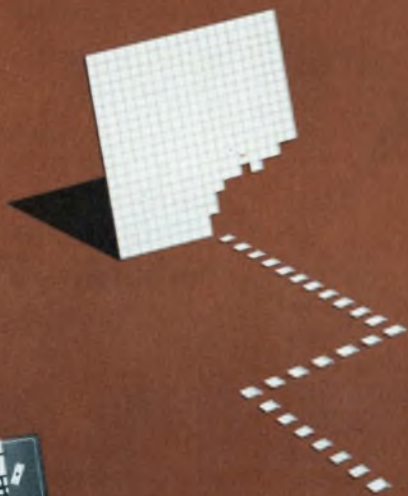
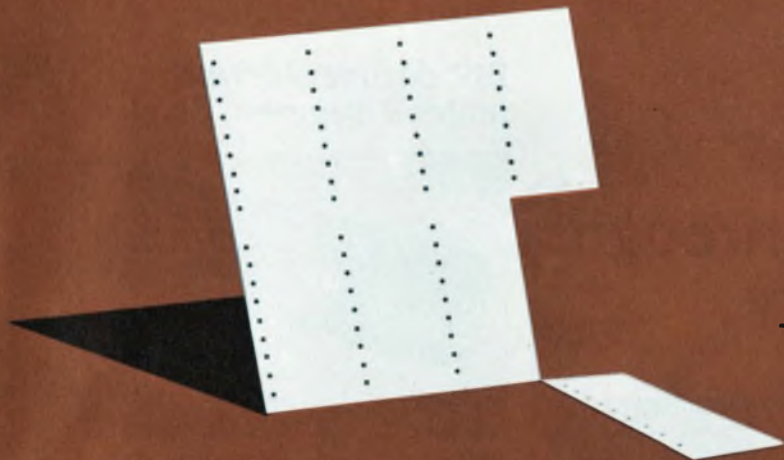

New BULLETIN No. 712
AISI Base® Substrates and
Snap-Strates sent on request.

TOOLED SNAP-STRATES

Snap-Strates made with this technology have been in existence for many years at American Lava with a history of excellent results.

A few of the advantages offered by this technique are:

- Economy.
- Accurate line placement in relation to slots or holes.
- Excellent breaking characteristics at any temperature used in normal processing.

LASER SNAP-STRATES

This new concept in precision Snap-Strates offers many advantages that were all but impossible previously.

Several of these are:

- More accurate line placement.
- No tool cost.
- Thin sections available with high snap yields.
- Working temperature range to 1000°C.
- Fast delivery.

AISI Base[®] CERAMIC SNAP-STRATES

CODE IDENT. NO. 70371

LAURENS, S. C. 29360. • PHONE 803/682-3215 • TELEX 570449
CHATANOOGA, TENN. 37405. • PHONE 615/265-3411 • TELEX 558432

For service, contact American Lava representatives in Offices of Minnesota Mining and Manufacturing Company in these cities (see your local telephone directory): Boston: Needham Heights, Mass. • Chagrin Falls, O. • Chicago: Elmhurst, Ill. • Dallas, Tex. • Indianapolis, Ind. • Laurens, S. C. • Los Angeles, Calif. • Metropolitan New York: West Caldwell, N. J. • Up-State New York and Canada: Phoenix, N. Y. • Orange, Conn. • Philadelphia, Penn. • St. Louis: Lee's Summit, Mo. • Salem, Va. • S. San Francisco, Calif. • Tempe, Ariz. • International: c/o American Lava Corporation, Chattanooga, Tenn. 37405, U.S.A., TELEX 558432

American Lava Corporation **3M**
A SUBSIDIARY OF COMPANY

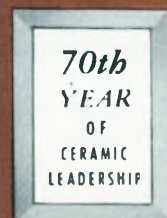

new products

D/a converters breakthrough with low-cost reliability

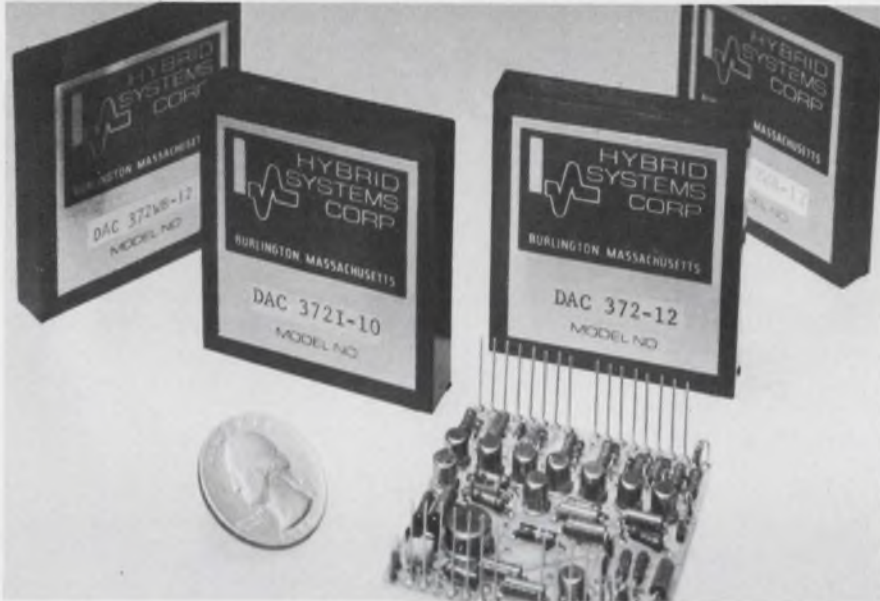

Hybrid Systems Corp., 95 Terrace Hall Ave., Burlington, Mass. Phone: (617) 272-1522. P&A: see text; stock.

A new family of d/a converters stresses critical standards of reliability and stability without sacrificing economy. This versatile family offers three classes of converters—high speed current-output, high-speed voltage-output and medium-speed voltage output.

Each converter in the DAC372 series has all its active components in hermetically sealed glass or metal-can packages. No plastic packaged transistors or ICs are used. This means a longer MTBF (mean-time between failure) for the converters, calculated at 30,000 hours or better.

Only thin-film resistor ladder networks are used to give a stability of 0.01% per year.

Every d/a converter is burned-in while under power for a minimum of 72 hours. This is done to eliminate early component failure.

The DAC372-8, -10, -11 and -12 are 8, 10, 11 and 12-bit medium-speed voltage-output units.

They feature a 10- μ s settling time.

The DAC372i-8, -10, -11 and -12 are 8, 10, 11 and 12-bit high-speed current-output units. They feature a fast 300-ns settling time.

The third class is the DAC372-WB. It consists of the DAC372-WB-8, -10, -11 and -12 which are 8, 10, 11 and 12-bit high-speed voltage-output units. They are extremely fast, settling in 950 ns.

All the DAC372 converters drift only 30 ppm/ $^{\circ}$ C (except 8-bit models which drift 50 ppm/ $^{\circ}$ C). All will operate from ± 5 or $+10$ V as standard. An option is available for operation from ± 10 V.

Each of the converters is pin-compatible with each other having dual-in-line spacing.

Prices are as follows: \$39, \$49, \$69 and \$75 for 8, 10, 11 and 12-bit units, respectively, of the medium-speed voltage-output and high-speed current-output converter classes. The high-speed WB class of voltage-output converters cost \$84, \$94, \$114 and \$120, for 8, 10, 11 and 12-bit models, respectively. All prices are for quantities of 1 to 9.

CIRCLE NO. 250

DIP decoder/driver mates 7-segment display



Sperry Information Displays Div., Box 3579, Scottsdale, Ariz. Phone: (602) 947-8371.

A new DIP decoder/driver is available for use with the Sperry seven-segment SP-730 and SP-750 series of information displays. The new monolithic device, model DD-700, will accept 8-4-2-1 BCD, which is TTL/DTL compatible, and decode it to provide seven outputs. Its hexadecimal output provides a numerical readout from 0 to 9 and letters A through F.

CIRCLE NO. 251

1-MHz vector module computes $\sqrt{X^2 + Y^2}$

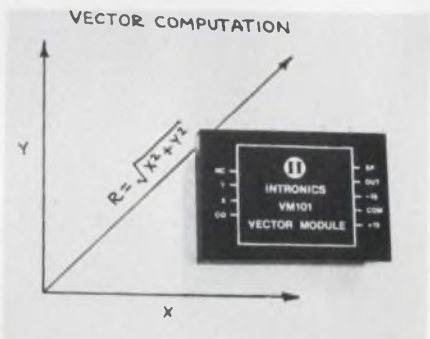

Intronics, Inc., 57 Chapel St., Newton, Mass. Phone: (617) 332-7350. P&A: \$95; stock.

Model VM101 vector operator module computes $\sqrt{X^2 + Y^2}$ to 1% accuracy with a 1-MHz bandwidth. This analog computation would normally require 3 analog multipliers connected together and the output bandwidth would vary with signal level. In the VM101 the bandwidth is independent of the signal level. The computation is made instantaneously, but can be averaged by the addition of an external capacitor.

CIRCLE NO. 252

Four-digit DVM uses LED display



Data Technology Corp., 1050 E. Meadow Circle, Palo Alto, Calif. Phone: (415) 321-0551. P&A: \$749; 2 wks.

A new 4-digit DVM displays its readings with LEDs. Model 351 is fully compatible with earlier model 350, accepting all plug-in card options interchangeably. The 351 incorporates dual-slope integration, is autoranging, has 80% overrange capability and four dc ranges. Readings of 1 to 10 per second are determined by manual setting.

CIRCLE NO. 253

Tiny 3-1/2-digit DPM dissipates but 4.2 W

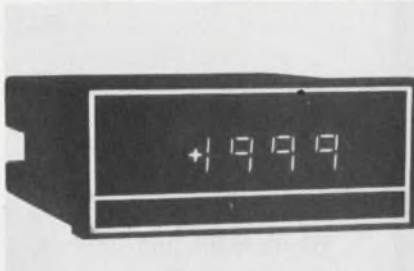

Electro-Numerics Corp., 2961 Corvin Dr., Santa Clara, Calif. Phone: (408) 738-1840. P&A: \$189; stock.

The model 300 DPM is a bipolar 3-1/2-digit meter featuring small size, low cost and only 4.2 W of power consumption. It zero-drifts $2 \mu\text{V}/^\circ\text{C}$, full-scale drifts 30 ppm $/^\circ\text{C}$ and needs zero warmup time. Standard BCD outputs and a high degree of noise immunity are available. The Model 300 has a resolution as low as $100 \mu\text{V}$.

CIRCLE NO. 255

Low-cost generators span 0.03 Hz to 3 MHz



Interstate Electronics Corp., Box 3117, Anaheim, Calif. Phone: (714) 772-2811. P&A: \$295 to \$495.

Four new low-cost function generators span 0.03 Hz to 3 MHz. Series 30 generators, designated F31 through F34, feature output amplitudes of 10 V pk-pk into 50Ω with voltage offset designed into each instrument. Output waveforms include sine, square and triangle with variable width pulse and sweep available.

CIRCLE NO. 257

60-MHz 5-mV/cm scope improves triggering



Dumont Oscilloscope Laboratories, Inc., 40 Fairfield Pl., West Caldwell, N.J. Phone: (201) 228-3665. P&A: \$2045 (rack-mount version); 45 days.

Model 1062 60-MHz scope features a unique triggering system which offers flat full-bandwidth trigger sensitivity, settable trigger levels on small signals and independence between position and triggering controls. The scope has 5-mV/cm sensitivity, calibrated delayed sweep, variable hold-off and an 8-by-10-cm screen.

CIRCLE NO. 254

AM/FM sweep generator has a digital synthesizer



Telonic Industries, Inc., 21282 Laguna Canyon Rd., Laguna Beach, Calif. Phone: (714) 494-9401. P&A: \$1250; Sept. 1971.

The model 1019 AM/FM 0.25-to-115-MHz sweep generator includes a digital frequency synthesizer. All functions are pre-programmed with front-panel pushbutton selectors, covering rf and i-f frequencies with less than 1% distortion. Automatic frequency tracking allows "hands off" alignment, with up to 30 frequency markers.

CIRCLE NO. 256

Battery powered scope is 3 instruments in 1



Hewlett-Packard Co., 1501 Page Mill Rd., Palo Alto, Calif. Phone: (415) 493-1501. P&A: \$2700 (plus \$200 for battery); March, 1972.

A new portable scope combines waveform storage, variable persistence and a 35-MHz lab scope into one instrument that operates on battery power. In the storage mode, the 1703A retains a waveform for more than an hour. In the variable-persistence mode, the trace can be made to fade out within 1/4 to 1 minute. In the normal mode, the CRT has the persistence of P31 phosphor ($40 \mu\text{s}$).

CIRCLE NO. 258

Dual CRT scope multiplexes input

Vu-Data Corp., 7595 Convoy Court, San Diego, Calif. Phone: (714) 279-6572. P&A: \$1695; stock to 30 days.

A new systems scope provides dual-CRT multiplexed displays in only 1-3/4 in. of panel height, each offering a dc-to-10-MHz bandwidth. Two rows of front-panel pushbuttons allow selective display of 14 rear-panel and 2 front-panel signals on the MS700A. Any of 8 channel A inputs can be displayed on one CRT while any one of 8 channel B inputs is displayed on the other.

CIRCLE NO. 259

Real-time analyzer spans 0.03 Hz to 50 kHz

Spectral Dynamics Corp., Box 671, San Diego, Calif. Phone: (714) 278-2501.

By adjusting a 3-digit positioner on the front panel of the new SD301C real-time analyzer, the operator can easily move a bright spot across the CRT screen until it rests exactly on that point of a spectrum whose frequency he wishes to determine. The component's frequency is within 1 part in 1000 of the total frequency range in which he is working. Range of the analyzer is from 0.03 to 50 kHz.

CIRCLE NO. 260

DMM with 27 ranges costs only \$385

Hickok Electrical Instrument Co., 10514 Dupont Ave., Cleveland, Ohio. Phone: (216) 541-8060. P&A: \$385; 60 days.

The low-cost 3301 digital multimeter features 27 measurement ranges. This includes 100 mV to 1 kV ac and dc, at 100- μ V resolutions and accuracies of 0.5% and 0.1%, respectively. Ac and dc currents are measured from 100 μ A to 1 A, at 100-nA resolutions and accuracies of 0.5% and 0.2%, respectively. Resistance ranges cover 100 Ω to 100 M Ω .

CIRCLE NO. 261

THE NEW *Princess* HEAT GUN IS AVAILABLE NOW FROM THESE UNGAR DISTRIBUTORS:

EAST COAST

Cramer Electronics, Inc.
Boston, Mass.

Rome Electronics
Rome, N.Y.

Henry Mann, Inc.
Feasterville, Pa.

Radio Electric Service Co.
Mount Holly, N.J.

Resco Electronics Div. of Astrex
Pennsauken, N.J.

SOUTHEAST

Grice Electronics, Inc.
Pensacola, Fla.

Hammond Electronics, Inc.
Orlando, Fla.

Sunset Electronics, Inc.
Cocoa Beach, Fla.

P. I. Burke Company
Louisville, Ky.

MIDWEST

Newark Electronics, Inc.
Chicago, Ill.

Klaus Radio, Inc.
Peoria, Ill.

Ra-Dis-Co, Inc.
Indianapolis, Ind.

Radio Supply Company, Inc.
Wichita, Ks.

Burnstein-Applebee
Kansas City, Mo.

Stotts-Friedman Company
Dayton, Ohio

ROCKY MOUNTAIN-WEST COAST

Scottsdale Tool & Supply
Phoenix, Ariz.

Orvac Electronics, Inc.
Anaheim, Calif.

Claude Michael, Inc.
El Monte, Calif.

Yale Radio Electric Co.
Hollywood, Calif.

Newark Electronics, Inc.
Inglewood, Calif.

Brill Electronics
Oakland, Calif.

Zack Electronics
Palo Alto, Calif.

Dunlap Electronics
Sacramento, Calif.

Quement Electronics, Inc.
San Jose, Calif.

Electronic Parts Company
Denver, Colo.

Soldering Supply Specialists
Denver, Colo.

Almac/Stroum Electronics
Seattle, Wash.



Division of Eldon Industries, Inc.

the one and only Heat Gun- made just for electronic assembly

Ungar's new, feather light, solid state Heat Gun #6955

Forget the old all-purpose hot-and-heavies. Ungar gives you the only flameless heat gun built to meet your special needs in electronics assembly and lab work. Now tackle shrink tubing, solder sleeves, shrink film packages, epoxy curing, parts drying/heating/cooling and numerous other jobs . . . all with this versatile new gun. And get greater accuracy, better handling, safer operation than ever before.

First, it's an ultra light *17 ounces* (literally *pounds* lighter than other guns). That's because it's all solid state and encased in a rugged polyester glass case. Your girls get all the fatigue-free handling accuracy you've always needed. For even more operator comfort and safety, heat is isolated at the nozzle area . . . the handle stays cool!

Next it's versatile. Works cold or hot (a high 850°F approx.) and includes a standard set of baffles. Also, it stands by itself for hands-free operation. But that's not all, in addition to a neoprene plug and cord, it's trigger actuated, U.L. listed and carries Ungar's guarantee of excellence. You can get the new Princess at a pretty lightweight price, too.

It's at your nearest electronic distributor or dealer now. Order the Ungar Princess Heat Gun today — prove to yourself that in the age of solid state Ungar really outguns the heavyweights.



A Division of Eldon Industries, Inc.



**ONLY
TUNG-SOL
PERFORMANCE
IS
LARGER**

Tung-Sol single phase and three phase bridge rectifiers come in standard size packages. It's their current ratings and forward surge ratings that are larger. They give you added performance reliability — and at no additional cost!



B-10 series

DC rating — 30A @ 55°C. Forward surge rating—400A @ rated load. B-10 series replace similar bridges rated from 8 to 25A and from 50 to 1,000 PRV per leg.



B-20 series

DC rating — 35A @ 55°C. Forward surge rating—400A @ rated load. B-20 series replace similar bridges rated up to 25A and from 50 to 1,000 PRV per leg.

SILICON POWER RECTIFIERS
Tung-Sol makes a complete line of high reliability silicon power rectifiers in the DO-4, 5, 8, 9 and 21 configurations.

WRITE FOR TECHNICAL INFORMATION. SPECIFY BRIDGES, OR POWER RECTIFIERS.

**SILICON PRODUCTS SECTION
TUNG-SOL DIVISION
WAGNER ELECTRIC CORPORATION**

630 West Mt. Pleasant Ave Livingston, N.J. 07039
TWX: 710-994-4865 PHONE: (201) 992-1100
(212) 732-5426

Trademark TUNG-SOL Reg. U.S. Pat Off. and
Marcas Registradas

MICROWAVES & LASERS

**Microstrip relays
have long life**

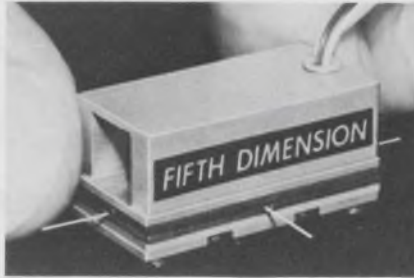

Fifth Dimension, Inc., Box 483, Princeton, N.J. Phone: (609) 924-5990. P&A: under \$20; stock to 5 wks.

Two new miniature relays provide lifetimes of 100-million operations in microstrip applications. They measure 1/2 by 1 by 7/16 in. The Logcell model SLR1103 rf relay has a 50-Ω impedance. Over dc to 1 GHz it exhibits a VSWR of only 1.2:1, an insertion loss of 0.3 dB and isolation of 37 dB. The Logcell SLH1104 high-speed-pulse relay switches pulses of 150-ps risetime with 10% distortion.

CIRCLE NO. 262

**High-Q ceramic caps
handle up to 50 W**

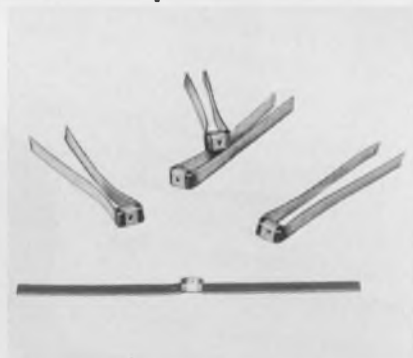

Aerovox Corp., New Bedford, Mass. Phone: (617) 994-9661.

A new line of high-Q monolithic microwave ceramic capacitors feature power capability to 50 W. Insertion loss is less than 0.03 dB at 10 W. Type HF-1 pellet and HF-11 silver-foil-lead pellet units are available at working-voltage ratings of 100, 200, 300 and 500 V dc from 0.1 through 1000 pF. Five tolerances range from ±1% to ±20%. VSWR rating is less than 1.05:1.

CIRCLE NO. 263

**70-W vhf transistor
has infinite VSWR**



TRW, Inc., Semiconductor Div., 14520 Aviation Blvd., Lawndale, Calif. Phone: (213) 679-4561. P&A: \$67.50 (100 quantities); stock.

A new hybrid transistor provides 70 W of cw broadband vhf power with infinite VSWR capability. The J01001 works in a fixed-tuned circuit over any 70-MHz increment from 30 to 200 MHz. It is guaranteed to deliver 70 W at 180 MHz, works from 28 V dc, has 6-dB gain and 70% efficiency and dissipates 146 W. VSWR is infinite at 60 W of output.

CIRCLE NO. 264

**100-W rf capacitor
operates at 1.5 GHz**

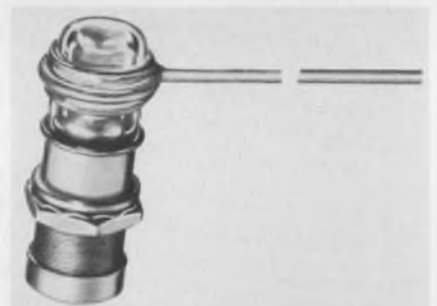

Johanson Manufacturing Corp., 400 Rockaway Valley Rd., Boonton, N. J. Phone: (201) 334-2676. P&A: \$9.50 to \$6.25; 6 to 8 wks.

A new high-power variable capacitor is designed to handle 100 W of cw power in a high-current-mode application and to operate at 1.5 GHz. This new quartz-dielectric capacitor, model 7558, has a unique slotted-piston design to improve thermal dissipation and power handling ability. It also features noise-free dynamic tuning and non-magnetic construction. Capacitance range is from 0.6 to 2.5 pF.

CIRCLE NO. 265

Thin-film resistors work up to 10 GHz

Sage Electronics Corp., 1212 Pittsford-Victor Rd., Pittsford, N.Y.
Phone: (716) 586-8010.

Thin-film microwave resistors are available with essentially flat response from dc to beyond 10 GHz. Their nonspiralized manufacture provides minimum inductance. The resistance materials are pyrolytically deposited carbon film on ceramic substrates. Standard TCs are 0 ± 70 ppm/ $^{\circ}$ C for metal-film types and -250 ± 100 ppm/ $^{\circ}$ C for carbon-film types.

CIRCLE NO. 266

Internal-mirror He-Ne lasers deliver 5 mW

Spectra Physics, 1250 W. Middlefield Rd., Mountain View, Calif.
Phone: (415) 961-2550. Price: from \$365 to \$625.

A series of internal-mirror He-Ne lasers are available with 3, 4 and 5-mW power outputs. They feature expected tube lifetimes over 10,000 h. Two models of the new lasers are available: the 134 with an integral power supply and the 135 where the laser head and power supply are separate. The new lasers feature cold aluminum cathodes, humidity resistant window seals and hard-dielectric-coated optics.

CIRCLE NO. 267

Photodetector/amplifier units come in TO-5's

The Meret Co., 1050 Kenter Ave., Los Angeles, Calif. Phone: (213) 826-5248. Price: from \$75 to \$375.

A new integral filter/detector preamplifier, MCA-9125, combines several new electro-optical features in one 4 or 8-pin TO-5 unit. The device is suited as a receiver front-end in ranging and communication systems using GaAs lasers or LEDs where detection of high modulation rates (20 MHz) or sharp pulses is important.

CIRCLE NO. 268

DO YOU USE 3000 TRANSISTORS / DIODES

per month?

NEW

FROM
LORLIN

Model T8BQ



FOR INCOMING INSPECTION

100% incoming inspection of discrete semiconductors is now economically feasible even if you use only 3000 devices a month. The new Lorlin Model T8BQ tester screens out defective transistors and diodes before assembly and substantially reduces the cost of trouble-shooting completed instruments both in the plant and in the field. In addition, inspection thruput is increased, and the quality of the finished product is enhanced. Write for Lorlin Application Note No. 38 to see how you can pay for a T8BQ with the first 33,700 devices you test.

\$7400 COMPLETE

Lorlin has responded to the industry's increased need to automate incoming inspection by streamlining a tester for this specific application and by refining production techniques to provide an economical instrument.

TESTS MOST DEVICES

Small signal through power devices are accommodated. Ranges include 0.1 nA-10 A, 10 mV-600V. Model T8BQ performs all common dc tests with 1% accuracy. An option is available for FET testing.

EASY TO USE - FAST - RELIABLE

Model T8BQ is an 8 test instrument, easily programmed by referring directly to the device data sheets. The operator simply inserts the device into the test socket, pushes the test button and instantly observes the test results on the fail indicators, one corresponding to each test. The tester is built and guaranteed for 10 years continuous service.

LORLIN MANUFACTURES A COMPLETE LINE OF DISCRETE COMPONENT TEST INSTRUMENTATION INCLUDING DIGIT SWITCH AND COMPUTER CONTROLLED SYSTEMS. SEND FOR DETAILED LITERATURE.



LORLIN industries inc.

Precision Road, Danbury, Conn. 06810 • (203) 744-0096

For Literature Circle 47 For Demonstration Circle 75

Software simulation program simplifies circuit analysis

Softech, 391 Totten Pond Rd., Waltham, Mass. Phone: (617) 899-6900. Price: see text.

A new software program known as AEDCAP (automated engineering design circuit analysis program) allows novice as well as expert engineers to easily perform a multitude of circuit analysis. The new program avails the designer of the following:

- Dc analysis for circuit operating point, input, and transfer characteristics.
- Ac analysis for driving-point and transfer responses.
- Transient analysis for determination of time responses to arbitrary inputs.
- Temperature and environmental changes.
- Built-in models for pn-junction and zener diodes; bipolar, MOS and junction FETs and linear circuit elements.

AEDCAP features convenient editing facilities, built-in circuit models, library files, functions and graphical output.

A single circuit-description language is sufficient with AEDCAP to allow the designer to create

models, sub-circuits and circuits for filing or for immediate analysis.

Any number of results can be saved from a single analysis and can then be printed or displayed, singly or together, with or without post-processing functions.

The program utilizes a uniform sparse matrix approach, taking full advantage of the fact that typical electronic networks do not contain complex interconnections. Because most entries in the nodal-admittance matrix are zero, all modes of analysis are very efficient, even for small as well as large circuits.

This new simulation program can accommodate circuits of unlimited size. An automatic node-renumbering algorithm and implicit integration techniques yield excellent performance at low cost.

AEDCAP is available as an in-house installation and as a time-sharing service. Inhouse versions of the program are available at an installation cost of \$15,000 plus a \$600-per-month leasing fee.

The program operates on IBM 360 to 370 computers under OS, TSO and CP-67/CMS systems.

CIRCLE NO. 269

Touch Tone terminal has alphanumeric keys



Wavetek Data Communications, 9045 Balboa Ave., San Diego, Calif. Phone: (714) 279-2200. P&A: \$700; 90 days.

Model T-500 is a desktop Touch Tone terminal with a 49-key alphanumeric keyboard containing letters, numerals, punctuation marks and special characters for inputting data to a computer via an audio-response system. The answer from the computer is in the form of a spoken audio message which can be easily heard on the T-500's built-in speaker.

CIRCLE NO. 270

Low-cost minicomputers are designed for OEMs



Digital Equipment Corp., Maynard, Mass. Phone: (617) 897-5111. Price: see text.

Two new low-cost minicomputers are designed for the OEM. Called the PDP-8/M and the PDP-11/05, they are priced as low as \$2362, and \$3069, respectively (quantities of 100). Base price of the PDP-8/M is \$3690 and the PDP-11/05 is \$4795. Each includes a central processor, 4096 words of core memory, power supply and an operator's console for the PDP-8/M and a programmer's console for the PDP-11/05.

CIRCLE NO. 271

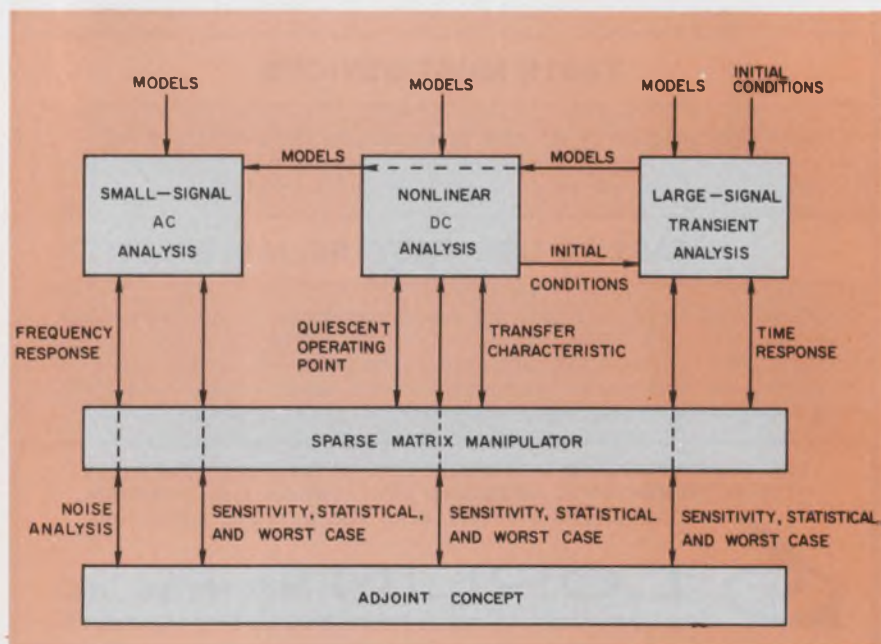

The flowchart of a new software program shows how circuit analysis is made simple. The program accommodates circuits of unlimited size.

7-in.-reel transport handles dual formats

Kennedy Co., 540 W. Woodbury Rd., Altadena, Calif. Phone: (213) 798-0953. Price: \$1900.

The model 8700 7-in.-reel synchronous tape transport is the first dual-format 800/1600-character/in. tape system. It reads and writes IBM-compatible tape in either 7-track 200, 556 or 800-bit/in. or 9-track 800-character/in. NRZI and 1600-character/in. phase-encoded formats. Tape speeds of 10 to 18-3/4 in./s allow for data transfer rates up to 30 kHz.

CIRCLE NO. 272

Magnetic-tape sensor balances tape output

Spectronics, Inc., 541 Sterling Dr., Richardson, Tex. Phone: (214) 231-9381. Availability: stock.

A new beginning-of-tape/end-of-tape sensor for use in magnetic tape drives provides a balanced tape-signal output eliminating detection errors. Each of its two channels utilizes an LED and a phototransistor pair. The SS403 is available with special configurations designed upon request.

CIRCLE NO. 273

Modem interface unit mates PDP8/E system

Scidata, Inc., 1250 Warren Dr., Norcross, Ga. Phone: (404) 448-5620. Price: \$795.

A new modem interface for the PDP8/E computer features RS232 standard data and control lines. Designed for use with 103 and 202 series data sets, the interface is also ideal for local CRTs and other bit serial terminals used as peripherals. Its crystal-controlled transmission rate is pin-selectable at 150, 300, 600, 1200, 4800, 9600 baud.

CIRCLE NO. 274

MECANORMA Symbols. Because thinner layouts print better circuits.

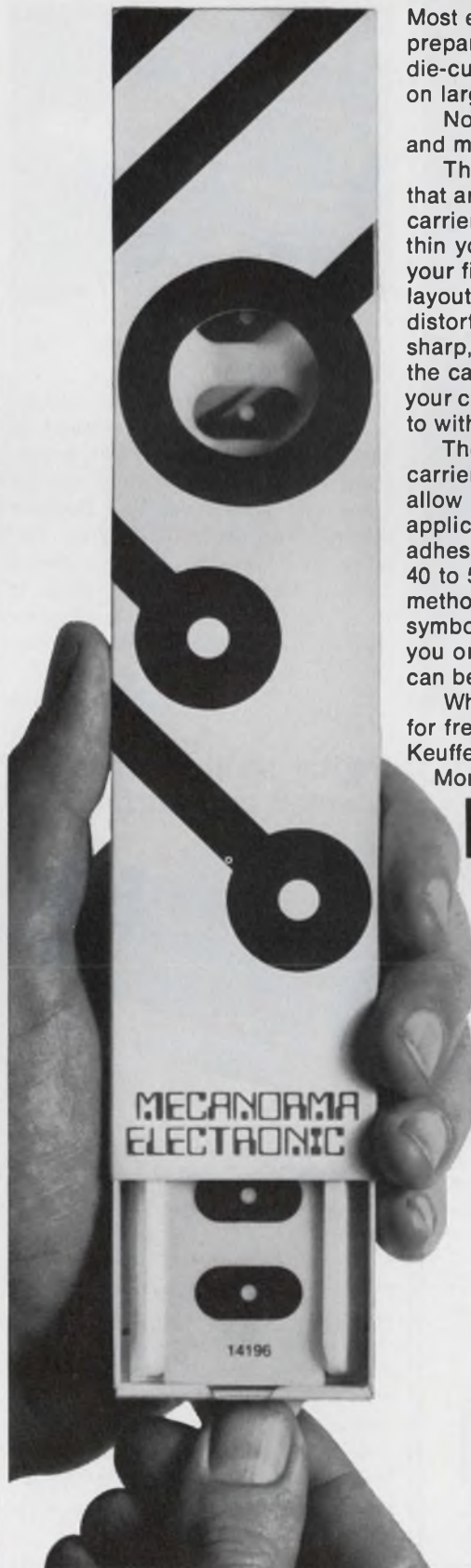

Most electronic symbols used in preparing printed circuit layouts are die-cut from crepe paper and mounted on large sheets or rolls.

Now K&E offers you something new and measurably better.

The MECANORMA System. Symbols that are *printed* on transparent strips of carrier film, only 20 microns thin. So thin you can barely feel the film with your finger, once you press it on the layout. So thin there's no parallax, no distortion, no rough edges—just a sharp, opaque symbol that's ready for the camera. Unaffected by the heat of your copying equipment. And accurate to within 1/1000 of an inch!

The convenient size of MECANORMA'S carrier strips, and their transparency, allow rapid, precise positioning, application and correction (with adhesive tape or blade)...a remarkable 40 to 50% more rapid than other methods! There are more than 800 symbols available, and packaged so you order only those you need. Others can be printed to your specifications.

Why not write us today for free samples and our catalog: Keuffel & Esser Co., 20 Whippany Road, Morristown, N.J. 07960.

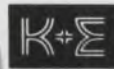

KEUFFEL & ESSER CO.

at prices from \$40
**Hipotronics offers you
 immediate delivery
 on over 800 standard
 models of**
**regulated &
 unregulated**
**hv dc
 power
 supplies**

... with output voltages
 from 1 to 1000 KV and
 current outputs from
 0.1 ma to 50 amperes



7.5 Kv, 130 ma,
 air-insulated unit,
 with HV section included in control box.

- Standard regulation ranges:**
 Unregulated 10-18%
 Regulated:
 Electromechanical
 (M Series) 0.5%
 Electronic (R Series) 0.01%
- HV components:** — transformers, capacitors, rectification assemblies, tanks, etc. — designed and manufactured under our roof.
- Custom design units:** for wide range of applications — electrostatics, accelerators, lasers, high power radars, high voltage testing, and more.

For more information call Keith Reed at (914) 279-8091, or send for our 24-page catalog, which lists complete specifications: "High Voltage DC Power Supplies and Components."

High Potential Technology ®



HIPOTRONICS, INC.
 Brewster, N. Y. 10509 / (914) 279-8091

DATA PROCESSING

**Electronic calculator
 is priced under \$200**



*Eldorado Electrodata Corp., 601
 Chalomar Rd., Concord, Calif.
 Phone: (415) 686-4200.*

The model 8C desk-size calculator with an eight-digit readout, a full four-function keyboard, a constant key, overflow and minus signs and both fixed and floating decimals retails under \$200. The machine's logic circuitry is based on LSI technology. This allows it to be pre-packaged on a single, tiny chip that is less than one square inch in size.

CIRCLE NO. 275

**Digital strip printer
 is small and portable**



*Heller Roberts Instruments Corp.,
 Dataline Div., 700 Jamaica Ave.,
 Brooklyn, N.Y. Phone: (212) MI7-
 4600.*

A compact digital impact strip printer provides recognizable hard-copy readout as an independent desktop or portable data terminal. The unit prints on pressure-sensitive paper tape at up to 30 characters/s and displays the 64-character ASCII subset (full alphanumeric plus symbols) spaced at 9 characters/in. It measures 7-5/8 by 4 by 2-1/2 in.

CIRCLE NO. 276

**125-ns plated-wire
 memory costs 4.9¢/bit**

*Toko, Inc., Memory Div., 1-17, 2-
 Chome, Higashi-Yukigaya, Ohta-
 Ku, Tokyo, Japan. P&A: 4.9¢/bit
 (50 quantities); 3 months.*

Model HS-150 is a direct competitor of bipolar semiconductor memories. The new memory of 2000 words of 72 bits each has 125-ns read access time, 150-ns read cycle time, and 300-ns write cycle time. Since the new memory operates in the non-destructive readout mode, part of it can be used as read-write memory and part as a random-access read-only memory.

CIRCLE NO. 277

**Disc-pack assembly
 records 200 tracks/in.**

*Applied Magnetics Corp., 75 Robin
 Hill Rd., Goleta, Calif. Phone:
 (805) 964-4881.*

A new flying-head assembly for use with disc-pack drives permits twice the storage capacity over standard IBM 2314 drives by recording 200 tracks/in. on the disc surface instead of the normal 100. Model ERW-306301 consists of a read/write section, a straddle erase section and a mounting arm. The assembly comes in a ramp-load or torsion-arm-load configuration.

CIRCLE NO. 278

**Alterable U-core ROMs
 price under 1.5¢/bit**

*Datapac Inc., 3180 Redhill Ave.,
 Costa Mesa, Calif. Phone: (714)
 546-7781. P&A: under 1.5¢/bit;
 stock.*

A complete line of low-cost standard off-the-shelf U-core alterable ROMs are available. The customer need only supply his desired data contents in either punched tape, cards or tabulated listing formats. Capacities range from 8 kbits to over 200 kbits per system. A variety of basic word/bit configurations are available.

CIRCLE NO. 279

Interactive terminals offer 2 display formats



Photophysics, Inc., 1601 Stierlin Rd., Mountain View, Calif. Phone: (415) 969-9500. P&A: \$3430, \$4650; 60 days.

Two new interactive display terminals are models 80 and 84, both stand-alone, fully buffered units with 12-in. screens and switch-selectable data rates of 1200 baud (asynchronous) or 2400 baud (synchronous). Model 80 displays 1000 characters in 25 lines of 40 characters/line and model 84 displays 960 characters in 12 lines of 80 characters/line.

CIRCLE NO. 280

Numeric keyboard complements terminals



Eastern Dynamics Corp., 1158 Suffolk Ave., Brentwood, N.Y. Phone: (516) 231-8800. P&A: \$295; 30 days.

A new 10-key numeric keyboard operates in line or local modes through any ASCII coded terminal while the terminal keyboard remains fully operational. The KBG-25 features a single-key carriage return line feed, rubout and X-off functions. Eight option keys are available for selecting a combination of any of 64 functions or symbols. The KBG-25 allows users to generate data via an adding-machine keyboard arrangement.

CIRCLE NO. 281

Now IR power technology shrinks both the size and cost of premium 20-Amp rectifiers!

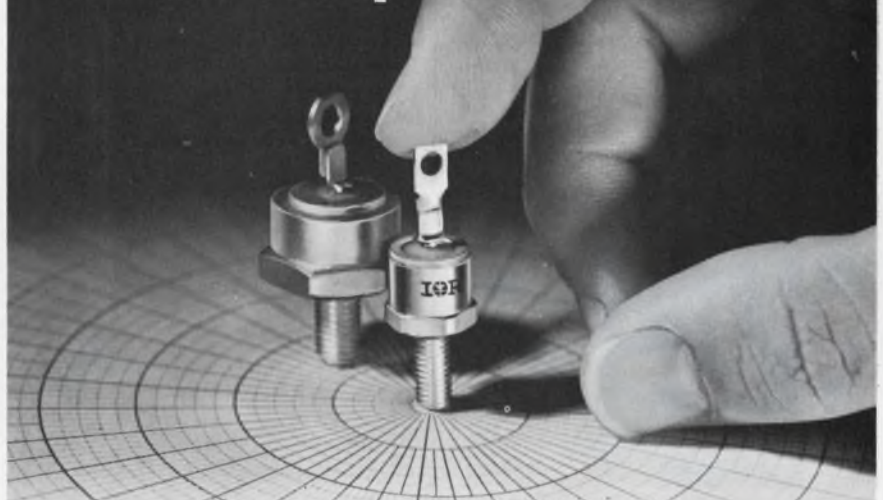

With its new 20F series that's priced and packaged like a DO-4, yet provides the peak performance and power you'd only expect from DO-5 case devices.

Another power semiconductor first from International Rectifier, the DO-4 sized and priced 20F silicon rectifier series now frees you from having to use bulky and expensive DO-5 packaged units to handle 20 Amps (avg.) requirements! They offer a great deal more than just their small-size-to-high-current handling capability and low cost. Highlighting just a few: They can handle peak one-cycle surges to 400 Amps and have an unusually high I^2t rating of 650 A²sec. They display low leakage currents (I_h) of only 2.0mA, average, at +150°C junction temperature.

Their economy and performance make them ideal for a broad range of commercial, consumer and industrial applications such as battery chargers, motor controls, power supplies, transmitters and transceivers.

They're available in a choice of forward or reverse polarity, in seven peak reverse voltage versions (50V, 100V, 200V, 300V, 400V, 500V and 600V), from your International Rectifier Industrial Distributor. For production requirements and/or applications aid, contact your local IR sales office or call the factory.

INTERNATIONAL RECTIFIER 

Semiconductor Div., 233 Kansas St., El Segundo, CA 90245 • (213) 678-6281



High-Speed Digital Power

Supplies. Unique Series 3530 offers 0 to $\pm 100V$ and 0 to 10A. Remotely programmed in BCD or binary (14-bit with sign) at speeds greater than 10kHz and accuracies of 0.1%. Digital input controls output with TTL logic levels. Isolation 10pf AC and 2,000 megohms DC. Repeatability 0.005%.

SRC/MOXON

CIRCLE NO. 131



\$84.00 Isolated Miniature Power Supplies.

Compact Model 3564 exceeds specifications of high priced supplies. Low 0.1pF AC and 10,000 megohms DC isolation (due to fiber glass front panel, precise component placement and multi-shielded XFMR). Ripple 75uV p-p. Front panel 10-turn pot. adjusts output 0-25VDC, 0 to 200mA.

SRC/MOXON

CIRCLE NO. 132

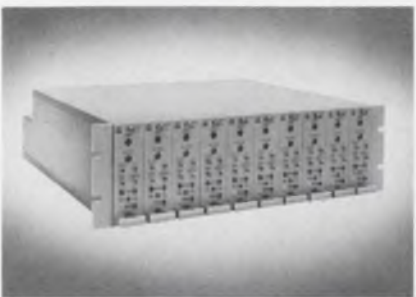

Universal Signal Conditioner.

Excite transducers, troubleshoot or calibrate complete systems with Model 2541 or 2545. Modular plug-in construction allows individual channels to be adapted for conditioning of strain gages, thermocouples, RTB's, potentiometers, etc. Highest performance in industry.

SRC/MOXON

CIRCLE NO. 133



SRC DIVISION/Moxon Inc.
2222 Michelson Drive
Newport Beach, Calif. 92664
Phone: (714) 833-2000

PACKAGING & MATERIALS

Heat exchangers cool up to 20 kW

Wakefield Engineering Inc., Audubon Rd., Wakefield, Mass. Phone: (617) 245-5700.

A new series of 12 standard liquid-to-air heat exchangers are available to cool high-power electronic components or for any cooling system requiring heat-transfer capability up to 20 kW. The series includes single and double-pass versions which use one or two of each of three standard fan sizes. Units range in sizes from 7 by 7 in. to 12 by 23 in.

CIRCLE NO. 282

Pin/socket connector has wire-wrap contacts

Amphenol Industrial Div. of Bunker Ramo Corp., 1830 S. 54th Ave., Chicago, Ill. Phone: (312) 242-1000.

A new, miniature pin-and-socket connector features fixed-pin wire-wrapped contacts. As an addition to the MinRac 17 series, the connector's locked-in wire-wrappable contacts eliminate the need to solder for termination. Suited for rack-and-panel, cable-to-panel or cable-to-cable applications, it is intermateable and intermountable with other D-shaped connectors.

CIRCLE NO. 283

Gold cermet paste allows hybrid rework

Bala Electronics Corp., Cermalloy Div., 14 Fayette St., Conshohocken, Pa. Phone: (215) 828-4650.

With S4300C high-purity gold cermet paste, hybrid-circuit processors can now rework circuits by removing a defective IC chip, then replacing it with a working device without deteriorating the integrity of the completed circuit. Specially formulated for chip and wire bonding operations, the paste is said to be excellent for beam-lead bonding in hybrid work.

CIRCLE NO. 284

Three ceramic packages enhance edge-mounting

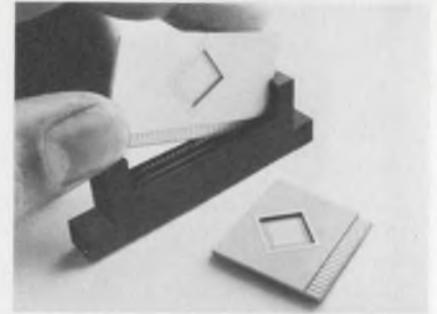

Metalized Ceramics Corp., West River Industrial Park, Providence, R.I. Phone: (401) 331-9800.

Called "InCert," a new ceramic edge-mount IC-package family consists of a 64-lead double-sided package with 32 contacts/side and a 40-lead miniature double-sided package that measures 1 by 0.75 in. In the latter package, the chip cavity has a plated seal ring. A third new InCert package is a 40-lead single-sided unit that is interchangeable with edge-mount packages already in use.

CIRCLE NO. 285

40-lead edge-mount package raises density

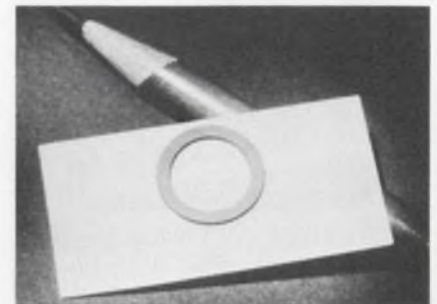

Owens-Illinois, Inc., Electronic Materials Group, Box 1035, Toledo, Ohio. Phone: (419) 242-6543.

A new 40-lead MOS/LSI edge-mount circuit package is designed for quick plug-in and interchangeability in high-density circuit applications. The new-generation alumina circuit package is built from a matched set of materials including ceramic, dielectric glasses and thick films. It features a thick-film die-attach area, which eliminates the need for gold preforms.

CIRCLE NO. 286

CMOS multiplexers upgrade performance

Harris Semiconductor, Melbourne, Fla. Phone: (305) 727-5407. P&A: \$39.95 (100 quantities); stock.

A new series of fully decoded, eight-channel CMOS analog multiplexers offers high switching speeds with low power dissipation. The HI-1818 and HI-1828 combine CMOS and dielectric isolation performance over -55 to +125°C. The merging of CMOS and dielectric isolation results in low leakage currents and fast switching speeds.

CIRCLE NO. 287

Tiny transistor chips mate thin/thick films

European Electronic Products Corp., 10150 W. Jefferson Blvd., Culver City, Calif. Phone: (213) 838-1912. P&A: 42¢ (1000 quantities); stock.

New miniature npn (ET60) and pnp (ET61) transistors are available for thin and thick-film applications in audio-frequency input stages and switching networks. They are rated for base-emitter voltages of 5 V, output capacitance of 8 pF, power dissipation of 150 mW and collector-emitter voltages of 32 V. The transistors handle 100-mA collector currents.

CIRCLE NO. 288

Low-noise, low-drift IC op amp costs \$15

Precision Monolithics, Inc., 1500 Space Park Dr., Santa Clara, Calif. Phone: (408) 246-9222. P&A: \$15 (250 quantities); stock.

The SSS725EJ is a low-cost monolithic op amp that competes with the more expensive modules in transducer amplifier and other instrumentation applications. It features drifts of 0.6 $\mu\text{V}/^\circ\text{C}$ and 40 pA/ $^\circ\text{C}$ maximum, offset of 0.5 mV and maximum input noise of 15 nV/ $\sqrt{\text{Hz}}$ at 10 Hz.

CIRCLE NO. 289

FET analog switches come in TO-5/TO-8 cans

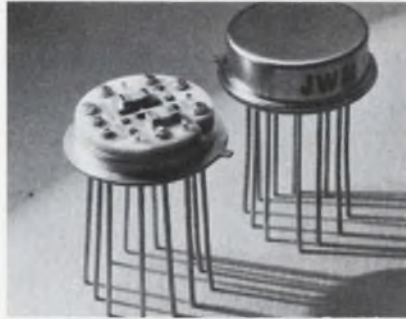

J. W. Microelectronics Corp., Philadelphia, Pa. Phone: (215) DA9-8681. Price: from \$10.40 to \$28.25.

Two new high-speed FET analog switches are the model HC1273, packaged in a 12-lead TO-8 can and the model HC1265, packaged in an 8-lead TO-5 can. Both use thick-film screening techniques and stacked wafers. Model 1273 can be used as a dpst or spdt switch. It is available to operate up to +125°C. Model 1265 is used as a dpst switch.

CIRCLE NO. 290

RF wins the synthesizer numbers game



with Model RF-828 Frequency Synthesizer Specs & Prices

PRICE \$2,676
 RANGE 1 kHz to 80 MHz
 RESOLUTION 1 kHz (1 Hz Optional)
 REMOTE PROGRAMMING
 MINIMUM SYSTEM INTERFACE



RF COMMUNICATIONS, INC.
 Electronic Instrumentation Operation
 1680 University Avenue, Rochester, N. Y. 14610
 Telephone: 716-244-5830; TWX: 510-253-7469
 A Subsidiary of Harris-Intertype Corporation

INFORMATION RETRIEVAL NUMBER 52

Programmable switch handles 1 A at 100 V



ITT Jennings, Div. of ITT Corp., 970 McLaughlin Ave., San Jose, Calif. Phone: (408) 292-4025.

A low-profile 4pdt switch, type JAEP, features contacts each of which can handle 1 A at 100 V. This tiny switch—only 1.2 by 1.02 by 0.32-in.—is suitable for sandwiching between closely spaced PC boards. It is available with either 4 on-off positions or 1-through-4 progressive positions. Its contacts come with a choice of silver or gold alloy.

CIRCLE NO. 291

Temperature sensors are self checking

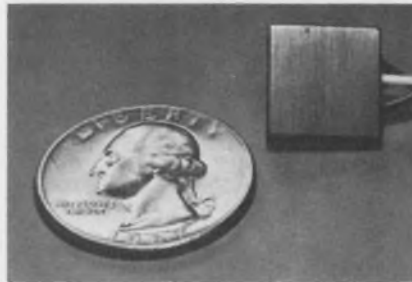

Sense, Inc., Box 280, Bethayres, Pa. Phone: (215) 659-4160. P&A: from \$125; 60 days.

The series IVSC sensors accurately measure temperature under varying input voltages and are self checking without calibrated temperature inputs. They use pre-selected elements whose outputs bear a pre-determined relationship to each other, and whose summed outputs represent the excitation voltage. The comparison of these outputs yields a unique indication of the sensor calibration.

CIRCLE NO. 292

Miniature capacitors are 30 ppm/°C stable

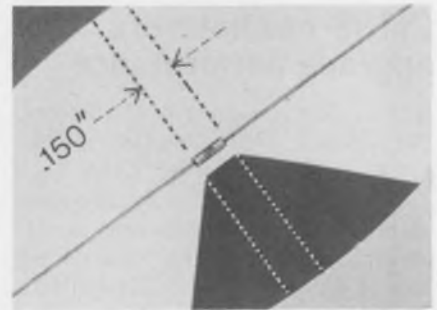

Republic Electronics Corp., 176 E. 7th St., Paterson, N.J. Phone: (201) 279-0300. Availability: stock to 4 wks.

A new line of miniature capacitors are available with ultra-stable features. Designated as Micro Mu-Caps, they feature temperature coefficients of ± 30 ppm/°C over -55 to $+125$ °C. Capacitance range is 1 through 390 pF. Micro Mu-Caps are rated at 50 V dc and are 0.15-in. long by 0.055-in. in dia. They are used at high frequencies.

CIRCLE NO. 293



Little Giant Rotary Switches 16, 20, 24 Positions, 1-12 Decks

New military style, sealed rotary switches offer optimum capacity-to-size ratio. Up to 24 positions per pole available. Diameters from 1.125" to 1.281"; behind-panel depths from .916" (1 deck) to 4.829" (12 decks).

Enclosed, with molded-in terminals. Fixed stop or continuous rotation. Raised contacts allow arc to make and break in the

air — prevent tracking across insulation material.

Like to know more? Write, or phone for more details on Series 53, 57, 59 or our latest general engineering catalog: Grayhill, Inc., 565 Hillgrove Ave., La Grange, Ill. 60525 (312) 354-1040.

Grayhill
pioneers in miniaturization

INFORMATION RETRIEVAL NUMBER 53

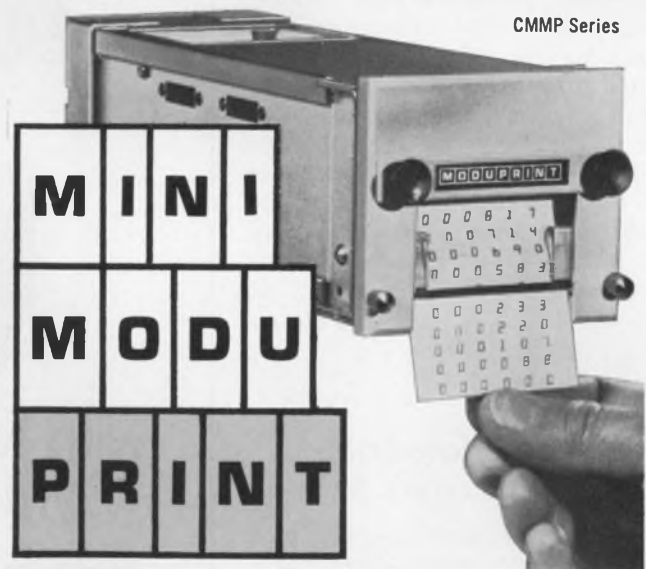

adds the necessary dimension to digital instruments

- 6 columns; 3 lines per second
- Full BCD T²L interface built-in, for IC instrument compatibility.
- Entire printer a plug-in
- Size: 3" x 3½" on panel
- Price: Only \$292.50* for full 6 columns

Send for catalog of the P. A. LINE of Printers, Counters and Digital Displays

*quantity 50

PRACTICAL AUTOMATION, INC.
Trap Falls Road, Shelton, Conn. 06484 • (203) 929-1495 • Telex 96-4217

INFORMATION RETRIEVAL NUMBER 54

Pt resistance elements come in many sizes

Hy-Cal Engineering, 12105 Los Nietos Rd., Santa Fe Springs, Calif. Phone: (213) 698-7785.

A complete line of platinum resistance elements is offered for industrial and laboratory applications for use as parts of systems and for use where a resistance probe design is not warranted. The line has 14 standard diameters and lengths in ceramic-covered elements and waterproof styles. Standard 100- Ω strain-free elements are provided with either copper or platinum leads.

CIRCLE NO. 294

Compensated oscillators drift but 1 ppm/year

Ampere Electronic Corp., Hicksville, N.Y. Phone: (516) 931-6200. Price: \$45 (1000 quantities).

A new line of temperature-compensated crystal oscillators is available in two frequency groups of 4.5 to 15 MHz and 20 to 60 MHz, all with long-term stability of ± 1 ppm per year. Output frequency is stable within ± 2 ppm over the entire operating range of -20 to $+70^\circ\text{C}$. Output wave shape is a distorted sine wave with the first harmonic approximately 15 dB down.

CIRCLE NO. 295

DIP resistor units use discretes/thick-films

Dale Electronics, Inc., Box 609, Columbus, Ga. Phone: (402) 564-3131.

A new series of DIP resistor networks feature a choice of thick-film or discrete-film resistive elements. Designated as type FDP, they offer power ratings to 0.05 W per resistor. Maximum dissipation is 1/2 W per package over -55 to $+150^\circ\text{C}$. Produced with up to 15 elements, the new networks range from 10 Ω to 1 M Ω per resistor.

CIRCLE NO. 296

Solid-state relay is housed in a DIP

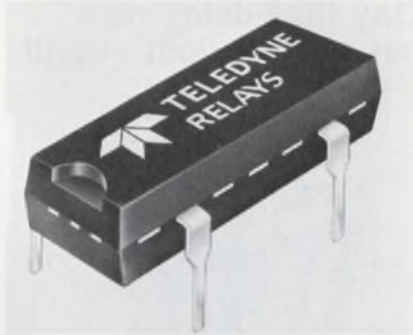

Teledyne Relays, 3155 W. El Segundo Blvd., Hawthorne, Calif. Phone: (213) 679-2205. Price: \$4.45 (1000 quantities).

A unique new concept in solid-state relays is the model 640-1 SerenDIP which is housed in a TO-116 DIP. The spst, four-terminal device is capable of bounceless switching up to 0.1 A at 50 V ac or dc, and at switching rates up to 100 kHz. The SerenDIP is fully TTL compatible and replaces most DIP reed relays (pin-for-pin basis) and FET analog switches.

CIRCLE NO. 297

Precision pots are priced from \$5



New England Instrument Co., 14 Kendall Lane, Natick, Mass. Phone: (617) 873-9711. P&A: from \$4.99 (100 quantities); stock.

The new Econopot model C is specially designed to meet low-cost applications. Standard models come in servo and bushing designs with a 7/8-in. dia and a choice of 1/8 or 1/4-in.-dia shafts. Bushing models have an optional bushing length of 3/8 or 1/4-in. All models feature infinite resolution, resistance from 1 k to 50 k Ω , and linearities from 1 to 0.25%. Power rating is 1 W.

CIRCLE NO. 298

all shapes and sizes

Standard CONDENSER

specialized capacitors

to your specifications
at stock prices

Standard Condenser has designed and produced thousands of specialized capacitors for industry. In fact, what you think of as "special" may be among the many designs already available from stock at Standard. However, if you require capacitors of unusual shape, size, value and material, our engineering department will help you design and produce them to your exact specifications at stock prices. For immediate action, send us a sketch and complete details.

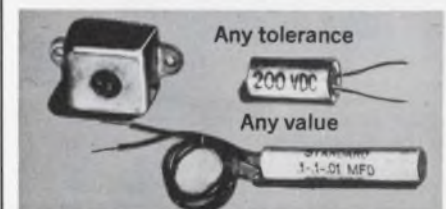

Send for Catalog and complete details.

Standard
CONDENSER CORPORATION
Dept. ED-9
1065 West Addison Street
Chicago, Illinois 60613 • (312) 327-5440

INFORMATION RETRIEVAL NUMBER 55

Best Buy

in 1% Tolerance
1-Watt Zeners
SCHAUER
Immediate Shipment



No fragile
nail heads

All welded and
brazed assembly

Gold plated
leads

Low Prices

ANY voltage from 2.0
to 18.0

Quantity	Price each
1-99	\$1.07
100-499	.97
500-999	.91
1000-4999	.86
5000 up	.82

Write for complete rating data and other tolerance prices.

Buy The Kit!



A
\$54.57
value
for
only

\$24⁵⁰

Kit contains a 51-piece assortment of SCHAUER 1% 1-watt zeners covering the voltage range of 2.7 to 16.0. Three diodes of each voltage in reusable poly bags. Stored in a handy file box. Contact your distributor or order direct.

Semiconductor Division

SCHAUER

Manufacturing Corp.

4511 Alpine Ave. Cincinnati, Ohio 45242

Telephone: 513/791-3030

COMPONENTS

Tiny time-delay relay has a 10-A dpdt output

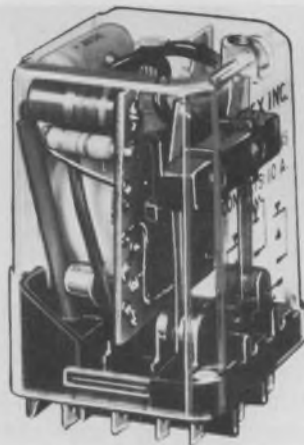

Midtex, Inc., 10 State St., Mankato, Minn. Phone: (507) 388-6286. Availability: 4 to 6 wks.

A compact time-delay relay designated type 613 is a delay-on-operate unit with either a 5 or 10-A dpdt contact output. Its input voltages are available as standard voltages—24 and 120 V ac, and 24, 48 and 100 V dc. Delay-on-operate time ranges from 1 to 100 s. Delay tolerance is 5% and repeatability is 3%.

CIRCLE NO. 299

Fixed active filters have up to 8 poles



A. P. Circuit Corp., 865 West End Ave., New York, N. Y. Phone: (212) 222-0876.

A line of fixed-frequency active filters are available in three versions: low, high or bandpass. Up to 8 poles and an attenuation slope as steep as 48 dB/octave can be provided for the low or highpass modules. These steep-rolloff filters have wide applications at low frequencies where they eliminate bulky and costly chokes.

CIRCLE NO. 300

Tantalum capacitors cost as low as 10¢

International Electronics Corp., Melville, N. Y. Phone: (516) 694-7700. P&A: see text; stock to 6 wks.

A new line of low-cost tantalum capacitors designed for industrial and commercial equipment features units with costs down to 10¢ each, in production quantities. Utilizing a high-grade tantalum pellet with an epoxy coating, the DIT series comes in straight or crimped-radial-lead models for insertion into PC boards. They are available with 0.1 to 100- μ F values.

CIRCLE NO. 301

Energy storage device has high capacitance

Gould Ionics, Inc., Box 1377, Canoga Park, Calif. Phone: (213) 341-1040.

Popularized for its very high capacitance density (160 farads/in.³), the ESD 3-in.-dia capacitor has a low resistance value (0.8 Ω for a 1-in.-dia rating). A primary application of these high-capacitance, low-resistance ESDs is for standby power of volatile semiconductor memories or other circuits where loss of power is inconvenient, expensive, or catastrophic.

CIRCLE NO. 302

Thin-film resistors span 0.5 to 10 Ω

Film Microelectronics, Inc., 17 A St., Burlington, Mass. Phone: (617) 272-5650. P&A: 37¢ to \$1.45 per chip; stock.

A new series of low-resistance-value thin-film chip resistors for hybrid circuitry and low-VSWR microwave terminations are available. Resistance values range from 0.5 to 10 Ω in three sizes: 0.025 by 0.025 in. with 50-mW power dissipation; 0.02 by 0.04 in. with 75-mW dissipation; and 0.05 by 0.05 in. with 100-mW dissipation.

CIRCLE NO. 303

Compact rocker switches decrease in cost to 24¢

Stackpole Components Co., Box 14466, Raleigh, N.C. Phone: (919) 828-6201. Price: see text.

New low-cost RJ-16 rocker switches feature flexibility of operation with positive, compact, snap-action mechanisms. They can be used with or without their rocker knobs and brackets. Price is approximately 38¢ per switch in quantity. Without a rocker knob and bracket, a switch costs about 24¢.

CIRCLE NO. 304

Silicon zener diodes drop dynamic impedance

Semtech Corp., 652 Mitchell Rd., Newbury Park, Calif. Phone: (805) 498-2111.

A new series of silicon zener diodes feature the lowest dynamic impedance of any such available devices—they can be operated at a lower bias current for a given dynamic impedance requirement than any zener currently available. They are presently being produced with a nominal voltage of 30 to 120 V for 1, 3 and 5-W applications.

CIRCLE NO. 305

Conductive-plastic pots increase service life

Markite Div. of GCA Corp., 155 Waverly Pl., New York, N.Y. Phone: (212) 675-1384.

Low-cost, conductive plastic infinite-resolution potentiometers built to withstand service life in the one-to-two-million-cycle range are available for all types of industrial applications. Types BT11 and BW11 are available in a resistance range of 100 to 200 k Ω . Linear or tapered outputs can be supplied over required electrical angles and linearity is available down to $\pm 0.2\%$. Dielectric strength is rated at 1000 V to ground.

CIRCLE NO. 306

Metalized capacitors are small in size



S&E I Mfg., 1800 Parthenia St., Northridge, Calif. Phone: (213) 349-4111.

Series 22 of Mini-Miniature metalized polycarbonate capacitors are available in standard case styles. Produced in a variety of encasements in 50 and 100-V dc ratings and space-saving sizes, they range from 0.001 through 50 μ F with tolerances to $\pm 1\%$. A typical size for a 10- μ F, 50-V capacitor is 0.58 in. in dia by 1.16 in. in length.

CIRCLE NO. 307

Time-delay circuit features flexibility



Nytronics, Inc., Orange St., Darlington, S.C. Phone: (803) 393-5420. Availability: stock.

A new high-stability, epoxy-molded delay element known as the Wee Bit module can be used alone or connected in series to provide a wide range of delays and delay-to-rise-time ratios. Standard delay times are from 10 to 200 ns with $\pm 5\%$ tolerances. Bandwidths, decreasing with increasing delay times, range from 25 down to 1.5 MHz. Standard impedance is 500 Ω $\pm 10\%$. Other delay times and impedances are available.

CIRCLE NO. 308

Four dual transistors with excellent matching characteristics, high current gain, and high voltage breakdown.

We got to making linear I.C. dual NPN transistors because we couldn't find good enough ones to put in our circuit modules. Now we're ready to share.

The AD-813 has outstanding input characteristics: 0.5mV max. V_{BE} differential, 2.5 μ V/ $^{\circ}$ C max. V_{BE} drift. The AD-812 has an extremely high and linear gain of 400 minimum at 10 μ A to 350 minimum at 5mA. The AD-811 has all around excellent input and gain performance and a minimum BV_{CEO} of 45V. And the AD-810 has a remarkably good performance combined with a remarkably low price.

All four are specified from -55° to 125° C. All are hermetically sealed. All are available in quantity now. Send for the full specifications. Analog Devices, Inc., Norwood, Mass. 02062



 **ANALOG
DEVICES**

evaluation samples

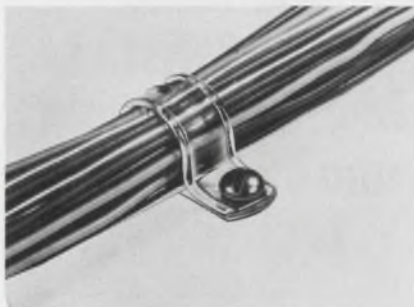

Cable clamps

A new line of plastic cable clamps known as Pro-Grip clamps are made from propionate cellulose to meet the needs for economy, dependable cable support and long life. Pro-Grip clamps are ultra-violet stabilized for extreme weather resistance and are ideally suited for outdoor applications. The line is available in 36 different sizes and types to fit wire and bundles from 1/8 to 3 in. in dia. Standard color is transparent brown. Samples are offered. Weckesser Co., Inc.

CIRCLE NO. 340

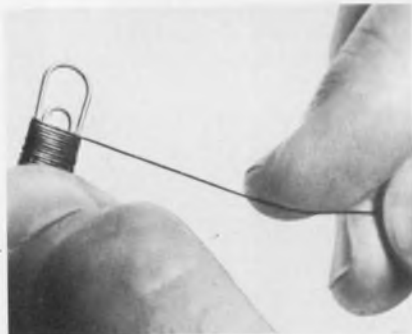

Insulated magnet wire

Samples are being offered of a new Kapton polyimide insulated magnet wire. Its construction consists of an AWG 32 silver-plated conductor that is insulated with three mils of Kapton. Kapton constructions can be used for long periods at temperatures up to 240°C, and short periods up to 400°C. The Kapton film insulation exhibits dielectric strength as high as 7000 V/mil. All wire gauges are available from AWG 34 to AWG 8. Berk-Tek, Inc.

CIRCLE NO. 341

design aids



Radii rule

When arcs of radii greater than can be conveniently handled by beam compasses are required, the new Arc Rule is the answer. Of precision construction, the Arc Rule is simple in application. The required radius is simply referred to on a calibration chart included with the unit. Opposite the radius is a micro setting. The adjustment of the rule's micro control to the indicated setting automatically forms the flexible edge of the Arc Rule into the desired arc. Alternatively, the rule can also be used where camber rather than radius is specified. The Arc Rule is priced at \$20.50 complete with case. Hunter Assoc.

CIRCLE NO. 342



Programmer's kit

Developed to assist programmers is a new kit of ten handy calculating tools. It contains a small machine known as the Hexadat which calculates hexadecimal values composed of numbers and letters, a universal decimal calculator and a conversion table. In addition, the kit contains a slide rule, a programmer's stencil and drawing pencils and refills. The entire set comes in a black leather briefcase. Addiator Rechenmaschinenfabrik.

CIRCLE NO. 343

application notes

IC voltage regulators

A new applications note on the 723/823 IC voltage regulators shows design engineers how to best apply the IC regulators for more efficient, trouble-free designs. The 16-page note includes a wealth of information on IC regulators, including basic theory of operation and parameters. A discussion of bias limitations and how to improve ripple rejection, external sensing, thermal effects, foldback current limiting, increasing output current capabilities and special applications are also included. Tele-dyne Semiconductor.

CIRCLE NO. 344

Temperature controls

A 10-page guide on temperature controls is especially valuable in explaining control theory, making competitive comparisons and evaluating the importance of various control features. It defines temperature repeatability, accuracy, resolution, sensitivity and stability. Succinct differentiation is made between such terms as two-position and two-mode control. Other portions of the guide cover thermistors, resistance bulbs and thermocouples, phase-angle firing and time, current and positioning-proportioning controls. The Apparatus Controls Div. of Honeywell.

CIRCLE NO. 345

Impatt diodes

The use of impatt diodes for microwave power generation and amplification is discussed in a 32-page application note. The note acquaints the reader with principles of operation and construction of impatt diodes and describes how the diodes are designed into oscillator and amplifier circuits. Several practical impatt-diode circuit designs are described. The note is liberally illustrated with electrical and mechanical diagrams, and with graphs that describe circuit performance. Hewlett-Packard Co.

CIRCLE NO. 346

**The heart of
our gaussmeter is
so good, even our
competitors use it.**

The Hall generators that we make for our own gaussmeters are so accurate and dependable, our competitors even use them. But that's where the similarity ends. We have other special features like internal calibration, temperature stable probes, and many more items that are covered in our gaussmeter brochure. Write to: 4949 Freeway Drive East, Columbus, Ohio 43229.

F.W. Bell Inc.

A subsidiary of The Arnold Engineering Co.

INFORMATION RETRIEVAL NUMBER 58

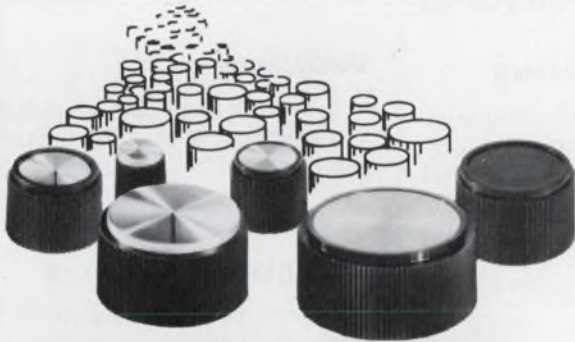

1,500,000

KNOBS TO CHOOSE FROM...

and they're "Warranted for Life"

Kurz-Kasch has over 1½ million low cost, high quality knobs in inventory, ready to ship to you. (You save . . . no tooling cost on stock knobs, specials 4 to 6 weeks delivery.) Your local distributor's stock is available at factory prices. Select instrument and control knobs from 24 families with 367 basic sizes and shapes in general purpose phenolics, melamines and ureas. All Kurz-Kasch knobs are warranted for the life of the product on which they're used. Send now for free 20 page catalog. (Also found in THOMAS REGISTER "THOMCAT."®)



Kurz-Kasch, Inc.

1421 S. Broadway
Dayton, Ohio 45401
513/223-8161

INFORMATION RETRIEVAL NUMBER 59

ELECTRONIC DESIGN 20, September 30, 1971

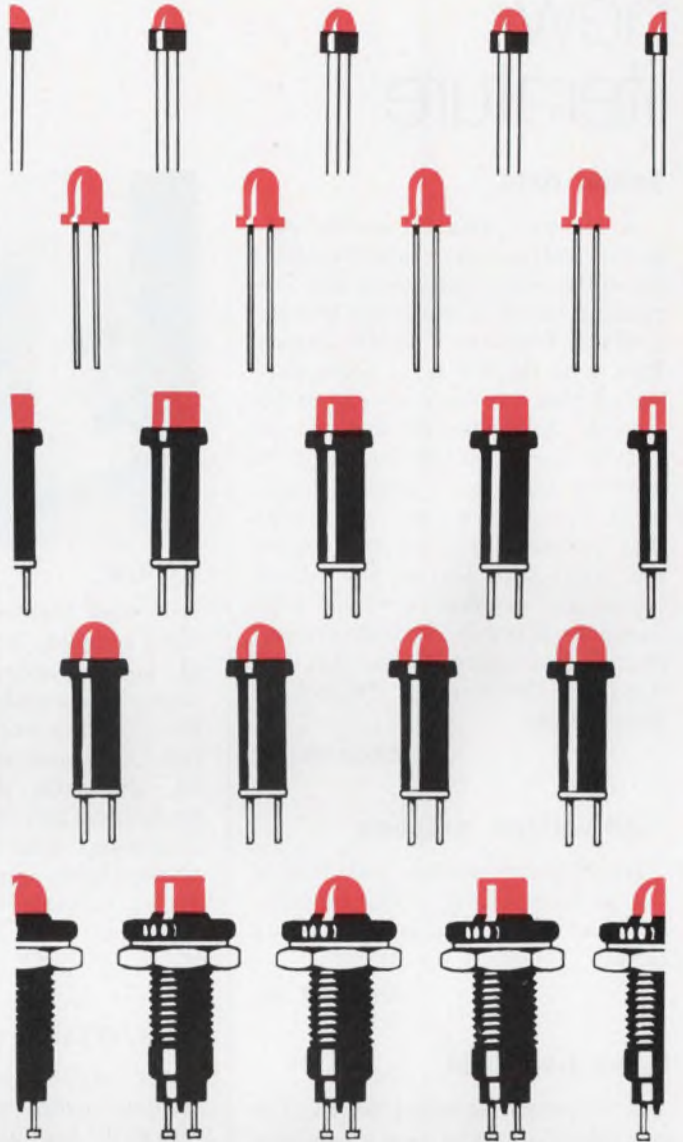

**Want one-stop
shopping
in solid-state
(LED) indicators?**

Dialight's DIODE-LITE™ visual indicator line offers you the industry's broadest choice. Dialco gives you complete design flexibility with a wide choice of LED solid state lamps and indicator lights (which can be retro-fitted to present incandescent units) . . . illuminated pushbutton switches . . . digital readouts. Supermarket pricing and availability too. Only Dialight "got it all together" in LED solid state displays. Write today for our Data File on DIODE-LITES.

DIALIGHT

DIALIGHT CORPORATION, A NORTH AMERICAN PHILIPS COMPANY
60 STEWART AVENUE, BROOKLYN, N.Y. 11237 • (212) 497-7600

INFORMATION RETRIEVAL NUMBER 60

new literature

Teflon data

A two-unit data kit on the subject of Teflon solves most problems encountered in machining and fabricating parts, components and assemblies from stock Teflon shapes. Part I of the kit is an eight-page leaflet that presents an all-out review of the properties and uses of Teflon stock shapes and how to machine them on standard equipment. Part II is a four-page leaflet that complements and expands on the eight-page leaflet and shows typical and atypical parts and components—many so intricate or complex as to require special jigs and fixtures. Commercial Plastics & Supply Corp.

CIRCLE NO. 347

High-voltage supplies

A six-page catalog describes a line of high-voltage power supplies. Spellman High Voltage Electronics Corp.

CIRCLE NO. 348

Capacitive ROM

A six-page technical description is available on the new capacitive read-only memory (CROM) system which features cycle times down to 125 ns, at less than 2¢ per bit. Integrated Memories, Inc.

CIRCLE NO. 349

Circuit breakers

Four optional and four prototype designs of hydraulic-magnetic circuit breakers for OEM front-panel applications are briefly described and illustrated in a six-page brochure. Heinemann Electric Co.

CIRCLE NO. 350

Resolver/synchros

An eight-page condensed catalog describes computer-interface, automatic-test, phase-sensitive, and resolver/synchro instruments, components and sub-systems. North Atlantic Industries, Inc.

CIRCLE NO. 351



Relays

A new eight-page catalog contains complete information on lines of general-purpose, multiple-arm, junior and tubular relays. Comprehensive data such as life and reliability characteristics are included, and with detailed electrical, mechanical and environmental specifications, dimensional drawings, photographs, applications and ordering information. Wheelock Signals, Inc.

CIRCLE NO. 352

Fork/crystal oscillators

An eight-page comprehensive catalog covers standard and custom-built tuning-fork and crystal oscillators. Fork Standards, Inc.

CIRCLE NO. 353

PC connectors

A 16-page handbook displays seven basic connector series designed for use with printed-circuit boards. Positronic Industries, Inc., Connector Div.

CIRCLE NO. 354

Metric hand tools

An illustrated 20-page catalog describes a complete line of quality metric hand tools and sets. Bevco.

CIRCLE NO. 355

Core memories

New literature introduces a full line of core memory systems with storage capacity from 4k by 9 bits to 65k by 36 bits. Fabri-Tek, Inc.

CIRCLE NO. 356

Laser trimming

A 25-page bound manual describes laser resistor trimming and ceramic scribing techniques and equipment. Apollo Lasers, Inc.

CIRCLE NO. 357

Optoelectronic products

A 12-page catalog describes new optoelectronic devices such as displays, LEDs, IR-emitting diodes and phototransistor opto-isolators. European Electronic Products Corp.

CIRCLE NO. 358

High-isolation amplifier

A four-page data sheet describes an isolation amplifier module that uses carrier techniques for transformer coupling to achieve extreme isolation between the FET-input circuitry and subsequent amplifier stages. Analog Devices, Inc.

CIRCLE NO. 359

Delay lines

A new 20-page catalog describes a complete line of electromagnetic delay lines. ESC Electronics Corp.

CIRCLE NO. 360

Back-plane connectors

A new 20-page illustrated brochure discusses the technology and design of back-plane connector systems. Cinch Mfg. Co.

CIRCLE NO. 361

High-density DIP panels

A new and revised 28-page catalog describes high-density packaging panels and related accessories for interconnecting dual-in-line ICs. Augat, Inc.

CIRCLE NO. 362

Thin-film materials

Literature on the use of thin-film etchants for microelectronic circuits is available. Transene Co., Inc.

CIRCLE NO. 363

bulletin board

of product news and development

Photodetectors

A four-page publication shows a new line of cadmium-sulfide and cadmium-sulfo-selenide photodetectors. The brochure provides information on performance characteristics of the new line, including three types of materials and five basic product configurations. Allen-Bradley Co., Electronics Div.

CIRCLE NO. 364

Selector switches

A complete line of selector switches is included in a new 16-page catalog. CTS Corp.

CIRCLE NO. 365

Instruments

A new short-form catalog covers digital multimeters and measuring systems, oscilloscopes, tube and transistor testers, data-collection terminals and card and industrial readers. Hickok Electrical Instrument Co.

CIRCLE NO. 366

Microwave instrumentation

A four-page catalog describes and illustrates a line of power, pulse, video, general-purpose, wide-band, laboratory and low-cost modular amplifiers for commercial and military use from dc to 1 GHz. C-COR Electronics, Inc.

CIRCLE NO. 367

Microelectronic packages

A 16-page illustrated catalog of microelectronic packages shows dimensional drawings of 45 standard package configurations with ceramic, glass or metal bases. National Beryllia Corp.

CIRCLE NO. 368

Touch-Tone receivers

A 12-page brochure details a complete line of Touch-Tone receivers ranging from small key systems and computer terminal receivers through PABX/EPABX to central office receivers. International Components Corp.

CIRCLE NO. 369

Hewlett-Packard has begun marketing instructional videotapes on electronic subjects for use by scientific and technical organizations, hospitals, medical schools, colleges and universities. The tapes cover three broad subject categories: tutorial, operational and maintenance. The subjects range from electronic measurement techniques to nurses' training to basic transistor theory. Hewlett-Packard will initially offer approximately 70 taped courses, ranging in length from 25 minutes to 9 hours. All tapes are available in Sony 1-in., Sony 1/2-in. (EIAJ-compatible) and Ampex 1-in. monochrome videotape formats, ranging in price from \$65 to \$150, depending on tape length.

CIRCLE NO. 370

Fabri-Tek, Inc., Minneapolis, Minn. has developed a new core memory unit that doubles the capacity of IBM 360/50 systems.

CIRCLE NO. 371

Mepco, Inc., Morristown, N. J. has expanded its CV series of ceramic capacitors to include new dielectric materials, styles, expanded capacitance values and new colors.

CIRCLE NO. 372

Codi Semiconductor, Fairlawn, N.J., has announced the formation of a diode design service known as the "Diode Clinic." Based on its ten years of experience in designing and manufacturing diodes, the company will be making available with each diode it sells ten self-addressed cards for the user to indicate his specific diode problems on. These cards, when mailed to Codi Semiconductor, will be followed up with either postal or telephone correspondence or field visits by Codi's applications engineers.

CIRCLE NO. 373

General Electric's new 69F 2000 tantalum wet-slug capacitors

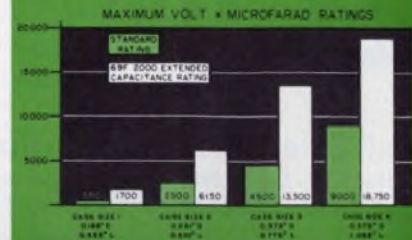

double...even triple the going capacitance ratings

The chart reflects it. Now you can design in one instead of two... in the same case size. Or, replace a standard MIL-type unit with a smaller case without losing capacitance or voltage.

Another plus is GE'S patented teflon/elastomer double O-ring seal that can withstand the environmental tests of MIL-C-39006.

Extended capacitance tubular tantalum wet-slug capacitors come in four sizes and are dual rated: 4 to 50 WVDC at 125 C or 6 to 75 WVDC at 85 C.

For more information, call your local GE Electronics Distributor, your GE Electronic Component Sales Office, or write Section 430-48, General Electric Company, 1 River Road, Schenectady, N. Y. 12305.

GENERAL ELECTRIC

Mini-Computer + Real-Time Analyzer for Automatic Testing



Complete Spectrum Processing System SP-6-1 automatically scales, equalizes, processes underwater acoustic data and noise/vibration signatures for production testing. Monitors on-line signals (nuclear reactor noise, heart sounds, machine tool vibration), recognizes aberrations, gives alarm. Setup conditions are entered via teletype unit as requested by computer. System prints out all spectral data or only frequency amplitude above preset levels. Data also pre-recordable on tape, played back often faster than real time. Analysis over frequency bands as wide as 40 kHz are possible. Many options.

CIRCLE NO. 174

Federal Scientific Corporation

a subsidiary of Elgin National Industries, Inc.
615 West 131st Street, New York, N. Y. 10027.

Ferroresonance is the Key to Simple Voltage Stabilization

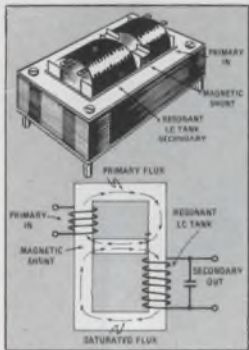

In a new 6-page brochure, Kepco outlines the flux-oscillating stabilizer technique, applied to modern power supplies with special emphasis on the requirements of integrated logic systems. High reliability, lack of overvoltage risk, exceptional line-noise isolation, inherent current limiting, these power supplies have what it takes at remarkably low cost.

The brochure describes the 58 different Kepco "PRM" stabilizers spanning the range from 4.5V to 240V d-c with ratings from 60W to 300W. There are charts and performance graphs plus complete mechanical installation data.

CIRCLE NO. 175

Kepco, Inc.

131-38 Sanford Avenue
Flushing, New York 11352
(212) 461-7000

World's Largest Line of Smallest Supplies



Now the world's smallest power supplies for microelectronics are available in the world's largest line of high power density, high efficiency supplies: 54 off-the-shelf models. From 100W to 500W; from 3VDC to 30VDC; single, dual, triple outputs; commercial, military, export models. Now in use by such leaders as Burroughs, Control Data, Honeywell, IBM, Litton, NCR, RCA, Univac, and many Government installations. Shown (left): Model SP631, 5VDC/100A, typical efficiency 70%, 8.50" x 6.81" x 8.85", 21.5 lbs., \$695. (Right): Model SP601, 5VDC/20A, typical efficiency 65%, 3.25" x 6.50" x 7.50", 6 lbs., \$400. Custom development and production also available.

CIRCLE NO. 176

Trio Laboratories, Inc.

80 Dupont Street,
Plainview, L. I., N. Y. 11803

ELECTRONIC DESIGN's function is:

- To aid progress in the electronics manufacturing industry by promoting good design.
- To give the electronic design engineer concepts and ideas that make his job easier and more productive.
- To provide a central source of timely electronics information.
- To promote two-way communication between manufacturer and engineer.

Want a subscription? ELECTRONIC DESIGN is sent free to qualified engineers and engineering managers doing design work, supervising design or setting standards in the United States and Western Europe. For a free subscription, use the postfree application form inside the back cover. If none is included, write to us direct for an application form.

If you do not qualify, you may take out a paid subscription for \$25 a year in the U.S.A., \$35 a year elsewhere. Single copies are \$1.50 each.

If you change your address, send us an old mailing label and your new address; there is generally a prepaid postcard for this inside the back cover. You will have to requalify to continue receiving ELECTRONIC DESIGN free.

The accuracy policy of ELECTRONIC DESIGN is:

- To make reasonable efforts to ensure the accuracy of editorial matter.
- To publish prompt corrections whenever inaccuracies are brought to our attention. Corrections appear at the end of the Letters column.
- To refuse any advertisement deemed to be misleading or fraudulent.

Microfilm copies are available of complete volumes of ELECTRONIC DESIGN at \$19.00 per volume, beginning with Volume 9, 1961. Work is now in process to complete the microfilm edition of Volumes 1-8. Reprints of individual articles may be obtained for \$2.00 each, prepaid (\$.50 for each additional copy of the same article) no matter how long the article. For further details and to place orders, contact the Customer Services Department, University Microfilms, 300 North Zeeb Road, Ann Arbor, Michigan 48106; telephone (313) 761-4700.

Want to contact us? If you have any comments or wish to submit a manuscript or article outline, address your correspondence to:

Editor
ELECTRONIC DESIGN,
50 Essex Street,
Rochelle Park, N.J. 07662

Electronic Design

Advertising Sales Staff

Bryce Gray
Sales Manager

Rochelle Park, N.J. 07662

Robert W. Gascoigne
Daniel J. Rowland
50 Essex Street
(201) 843-0550
TWX: 710-990-5071

Philadelphia

Thomas P. Barth
50 Essex Street
Rochelle Park, N. J. 07662
(201) 843-0550

Boston 02154

Joseph F. Palmer
1268 Main Street
Waltham, Mass.
(617) 894-2700

Chicago 60611

Thomas P. Kavooras
Berry Conner, Jr.
200 East Ontario
(312) 337-0588

Cleveland

Thomas P. Kavooras
(Chicago)
(312) 337-0588
(call collect)

Los Angeles 90303

Stanley I. Ehrenclou
Burt Underwood
2930 Imperial Highway
Inglewood, Calif
(213) 757-0183

San Francisco 94022

Jerry D. Latta
95 Main Street
Los Altos, Calif.
(415) 941-3084

London W. 1

For United Kingdom and Holland
Brayton C. Nichols

For Eastern Europe

Peter Kehr

The American Magazine Group

27 Maddox Street
London, W. 1, England
Phone: 499-0180

Cable: Ammagnic, London

Verviers, Belgium

For Continental Europe

Andre Jamar
1, Ru Mallar, 1
087) 253.83 Telex 41563

Tokyo

Haruki Hirayama
Electronic Media Service
5th Floor, Lila Bldg.,
4-9-8 Roppongi
Minato-ku
Phone: 402-4556
Cable: Electronicmedia, Tokyo



AMERICAN BUSINESS PRESS, INC.

Here's a Boxer with a stronger punch.

It delivers 88 cfm at .15" static pressure. About 1/3 more than the other contenders.

We call it, "The SuperBoxer."



It cools efficiently, economically, in tightly packed card racks, computer consoles, and similar space-critical systems enclosures. Slim profile styling (4-11/16" sq., 1 1/2" deep) adds to versatility.

Available with patented Grand Prix sleeve, or rugged ball bearings, both rated at 10 or more years operating life.

Other airmovers? Of course!

Send for our full-line catalog No. ND4r. It's free, and contains performance data, electrical and mechanical specifications on more than 100 units.

And valuable application information too.

For immediate service, contact us at **IMC Magnetics Corp., New Hampshire Division**, Route 16B, Rochester, N.H. 03867, tel. 603-332-5300. Or the IMC stocking distributor in your area. There are more than 50 nationwide and overseas.



INFORMATION RETRIEVAL NUMBER 61

New lab-quality instrumentation at famous HEATHKIT do-it-yourself savings!

(A) New Heathkit solid-state digital multimeter. A true lab-grade digital multimeter at about half the cost of comparable DMMs! 5 overlapping DC voltage ranges, 100 uV to 1000 V; AC ranges, 100 uV to 500 V; 10 ranges measure 100 nanoamperes to 2 amperes on AC or DC; 6 resistance ranges, 0.1 ohm to 20 megohms. Automatic polarity indicators. Automatic decimal point, over-range light. Precision DC calibrator furnished plus transfer method for AC calibration. Solid-state with cold cathode readout tubes & "memory" circuit for stable, non-blinking operation. Assembles in about 10 hours. Kit IM-102, 9 lbs. ... **229.95***

New Heathkit 175 MHz scaler & counter combo... for less than \$300! (B) The Heathkit IB-101 counts from 1 Hz to over 15 MHz. Hz/kHz ranges & over-range indicator let you make an 8-digit measurement down to the last Hz. 5-digit cold-cathode readout; extremely low input triggering... less than 30 mV at 100 MHz; all solid-state with 26 ICs, 8 transistors. (C) Heathkit IB-102 scaler extends capability well into the VHF range at a price far below a 175 MHz counter. Compatible with virtually any counter. 10:1 & 100:1 scaling ratios give resolution down to 10 Hz... 1:1 ratio provides straight-through counting. Solid-state, fully regulated supplies. Carrying handle/tilt stand. Kit IB-101, 7 lbs. **199.95*** Kit IB-102, 7 lbs. **99.95***

(D) New Heathkit DC-15 MHz dual trace solid-state oscilloscope ... \$399.95* Features rock-solid triggered sweep; full bandwidth in both automatic & normal modes; complete dual trace capability - Ch. 1, Ch. 2, chop, alternate; X-Y mode with 5% or less phase shift; 24 nsec rise time; 9-position 1, 2, 5 sequence vertical attenuator; 8 x 10 cm rectangular flat-face CRT with mu-metal shield. Kit IO-105, 35 lbs. ... **399.95***

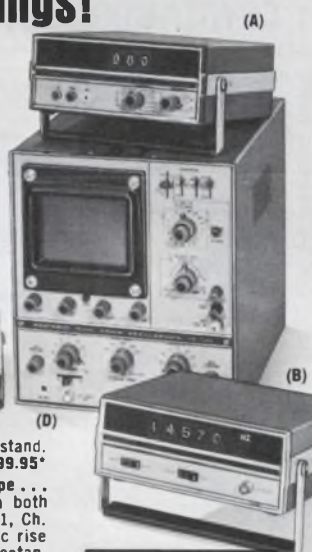

HEATHKIT
Schlumberger

HEATH COMPANY, Dept. 520-26
Benton Harbor, Michigan 49022

Rush my new Heathkit Catalog

Enclosed is \$ _____, plus shipping.

Please send model(s) _____

Name _____

Address _____

City _____

State _____

Zip _____

Prices & specifications subject to change without notice.
*Mail order prices; F.O.B. factory.

TE-249



Exciting '72
Catalog
Yours
FREE
for the
Asking

INFORMATION RETRIEVAL NUMBER 62

DESIGNERS and ENGINEERS BEFORE YOU START,

CONSIDER MANUAL PUSH BUTTON SWITCHES
CAPABLE OF REMOTE CONTROL

CHANCES ARE A CAPITOL
MECHANICALLY OPERATED SWITCH IS

BETTER* provides many more contacts and
circuits in less total space

CHEAPER* frequently eliminates auxiliary
equipment — transformers, relays,
their installation and space

MORE RELIABLE*

Simple, quality construction. Fewer components insures
greater reliability

ILLUMINATED SWITCHES CAN ELIMINATE PILOT LIGHTS

Mechanical actions: interlocking, no-two operate, ac-
cumulative lock-up, push to lock push to release,
momentary. Combinations of all these are available on
the same strip. Plus, many combinations of contact
assemblies.

* Proven by Vending machine, communication,
Computer, Recording and many other industries

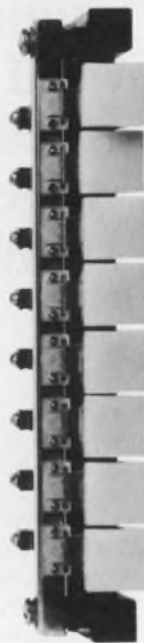

CAPITOL

WRITE FOR CATALOG

THE CAPITOL MACHINE AND SWITCH CO.

87 Newtown Road, Danbury, Conn. 06810

Representatives in principal cities Tel: 203-744-3300 TWX: 710-456-0365

In San Francisco 415 941-0660

In Los Angeles 213 879-0770

INFORMATION RETRIEVAL NUMBER 63

1MHz HIGH PRECISION PACKAGED CRYSTAL OSCILLATOR

- LOW PRICED
- READY SUPPLY



TYPE:
TCO-8D... 2 x 10⁻⁸
TCO-9E... 5 x 10⁻⁹

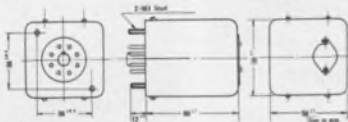

These oscillators feature a 4MHz, 3rd over-
tone cold-weld vacuum-sealed high-stability
crystal element having a Q above 1,500,000,
4:1 frequency division by means of IC, con-
tinuously controlled constant temperature
oven, new construction, and high reliability
components. Extremely fine frequency ad-
justment to the order of 10⁻⁶ - 10⁻⁹ is pos-
sible with a single trimmer.

TOYOCOM
TOYO COMMUNICATION
EQUIPMENT CO. LTD.

EXPORT DEPARTMENT
1000 BELLEVILLE
RD. S.E. AMSTERDAM, NETHERLANDS
TELE: 020-480000
TELE: 020-480000
TEL: 020-480000

INFORMATION RETRIEVAL NUMBER 64

Low Frequency MECHANICAL FILTERS

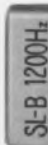

- Applications:
- Paging systems
- Remote control systems
- Remote supervisory systems

Mechanical filters distributed by Seiko
Instruments Inc. are derivatives of world
renowned SEIKO precision, the outcome
of exacting processes and production
technology. With almost a decade of ex-
perience in the manufacturer of mechan-
ical filters. DAINI SEIKOSHA is able to
offer miniature types exhibiting truly high
performance. Reliability?

Not questionable if you're talking about
one of our products.

Many types are available. On special order,
we can satisfy a wide range of specifications.



• Sole distributor in the United States:
SEIKO INSTRUMENTS, INC.
14333 South Figueroa Street, Gardena,
Calif. 90247 Phone: 213-770-0152
Telex: No 673686

INFORMATION RETRIEVAL NUMBER 65

advertiser's index

Advertiser	Page
AMP, Incorporated	42
Accutronics	54
Acopian Corp.	9
Airpax Electronics, Cambridge Division	49
Alco Electronic Products, Inc.	95
Allen-Bradley Co.	21
Ambient Systems	95
American Lava Corporation	71
Amphenol Components Group	12
Analog Devices, Inc.	33, 87
Beckman Instruments, Inc., Helipot Division	63
Bell, Inc., F. W.	89
Buckbee Mears Company	32
Burr-Brown Research Corporation	17
Burroughs Corporation	18
Cambridge Thermionic Corporation ..	55
Capitol Machine & Switch Co.	94
Centralab, the Electronics Division of Globe-Union, Inc.	39
Dale Electronics, Inc.	Cover III
Datak Corporation, The	95
Dialight Corporation	89
Electronic Design	40
Federal Scientific Corporation	92
Fifth Dimension, Inc.	96
Fluke Mfg. Co., Inc., John	65
GTE Automatic Electric	4, 5
GTE Sylvania, Parts Division	69
General Electric Company ...	66, 67, 91
Grayhill, Inc.	84
Hathaway Instruments, Inc.	55
Hayden Book Company, Inc.	48, 95
Heath Company	92
Hewlett-Packard	Cover II
Hickok Instrumentation and Controls Division	27
Hipotronics, Inc.	76
IMC Magnetics Corporation	93
ITT Cannon Electric, A division of International Telephone and Telegraph Corp.	37
International Rectifier	81
Janise, Inc.	95
Keeco, Inc.	92
Keuffel & Esser Co.	79
Kurz-Kasch, Inc.	7, 89
Licon, Division Illinois Tool Works, Inc.	11
Lorlin Industries, Inc.	77
Magnecraft Electric Company	41
Mallory Capacitor Company	15
MicroSwitch, A Division of Honeywell	16
Molex, Incorporated	1
Motorola Component Products Dept.	8
Motorola Semiconductor Products, Inc.	30, 31
National Electronics, Inc.	29
National Semiconductor Corporation	25
North Atlantic Industries, Inc.	14
Nytronics, Inc.	13
Oak Manufacturing Co.	34
Philips Electronic Components and Materials	38, 64A, 64B
Practical Automation, Inc.	84
RCA Solid State Division	Cover IV
RF Communications, Inc.	83
SRC Division, Moxon, Inc.	82
Schauer Manufacturing Corp.	86
Seiko Instruments, Inc.	94
Signal Analysis Industries Corp.	95
Singer Company, The	6
Sperry Electronic Tube Division, Sperry Rand Corporation	61
Standard Condenser Corporation	85
TRW Semiconductor Division of TRW, Inc.	2
Toyo Communication Equipment Co. Ltd.	94
Trio Laboratories, Inc.	92
Tung Sol Division, Wagner Electric Corporation	80
Union Carbide, Components Dept. ...	10
Ungar, A Division of Eldon Industries, Inc.	74, 75
Venus Scientific, Inc.	95



The Successful Engineer-Manager, Edited By R. C. Haavind and R. L. Turmail. Depth discussion and insights of the experts isolate the fine points of management: career, decisions, people, projects, finances, communications. Hayden Book Co., Inc., New York, N. Y. 10011.

INFORMATION RETRIEVAL NUMBER 181

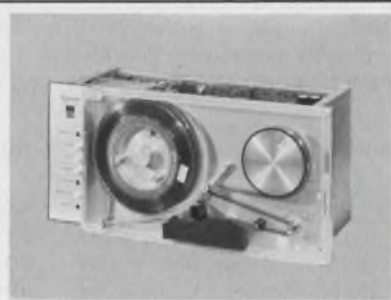

A minicomputer Interface, tape unit and formatter from \$4,650. Ultra high speed incrementals, 3000 characters/second and up from \$3,350. Continuous, incremental and low power tape units from \$1,950. Digi-Data Corporation, 4315 Baltimore Avenue, Bladensburg, Maryland 20710

INFORMATION RETRIEVAL NUMBER 182

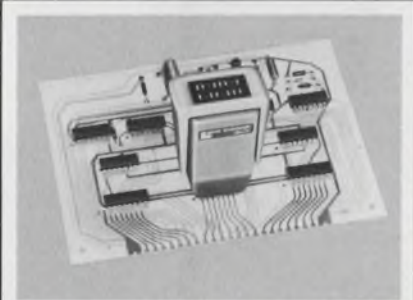

Displays IC logic state of all 14 or 16 pins. Clips over DIP pkg., uses the circuit's power. Lamps on top light for indication of a high logic state at the associated lead. Portable for shop, lab, field. 2.612" h. x 1.786" w. Has case, instructions. Send orders: Alco Elec. Prods. Inc., Dept. ED-1, Lawrence, Mass. 01842. \$89.95 prepaid.

INFORMATION RETRIEVAL NUMBER 183



Real time Spectrum Analyzers and Digital Integrators process signals from DC to 1 MHz in selectable bands. Both 200 and 400 line models are available. A must for analysis, identification and detection in vibration testing, machinery diagnostics, acoustics, radar and oceanography. Signal Analysis Industries Corp. Hauppauge, N.Y. 516-234-5700

INFORMATION RETRIEVAL NUMBER 184



400 Ideas for Design, Vol. 2, Edited by Frank Egan. Ready to borrow, modify, or adapt, the top recent contributions to Electronic Design's popular "Ideas for Design" column. Hayden Book Co., Inc., New York, N. Y. 10011.

INFORMATION RETRIEVAL NUMBER 185



MODEL H-20 MINIATURE HIGH VOLTAGE CRT POWER SUPPLY 10,000 to 20,000VDC @ 500ua. Ideal for airborne display applications. Just 30 cu. in., 2 1/2 lb. Regulation .05%, Ripple .05% @ F.L. Remotely adjustable, short circuit protected. Venus Scientific Inc., Farmingdale, N. Y. (516) 293-4100

INFORMATION RETRIEVAL NUMBER 186



Up-to-date, thorough, and economical study guides for licensing exams — the preliminary exam and PE exams in electrical and mechanical engineering. Professional Engineering Examination Series, Edited by Lawrence J. Hollander. Hayden Book Co., Inc., New York, N. Y. 10011.

INFORMATION RETRIEVAL NUMBER 187



JOTDRAFT — 128 PC pad arrays and component outlines, printed on see-through polyethylene for precise positioning. Transfer with ballpoint or burnisher in 3 to 5 seconds. Tough film transfers with each symbol assuring distortion-free transfer and protection from cuts and abrasions. The DATAK Corporation - 85 Highland Avenue - Passaic, N. J.

INFORMATION RETRIEVAL NUMBER 188



Dataspan 500 series Recorder/Coupler interfaces with laboratory and scientific instruments with digital outputs. Make code conversion and formats words into computer compatible paper tape with all control characters added. Model 505 Coupler drives Teletype or other incremental type recorders. Ambient Systems, Inc., Santa Clara, Ca.

INFORMATION RETRIEVAL NUMBER 189

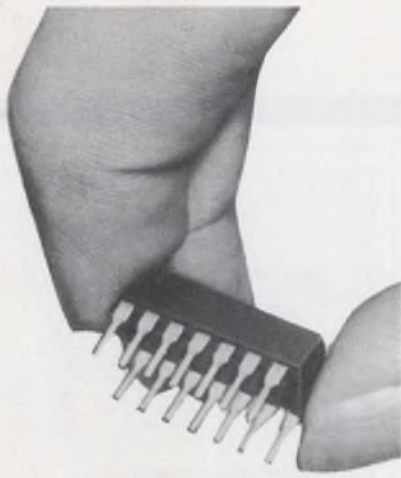

can one **LATCHING RELAY** offer all this?

- High Reliability
(100×10^6 operations)
- Inherent Contact Memory
- Bounce-Free Operation
- Self-Healing Contacts
- Operation in Any Mounting Position
- Miniature Size
- No Latching Current
- Virtually No Noise
- Shock and Vibration Resistance
- For Signals from DC to 120 MHz

Yes... if it's a **LOGCELL[®]** Mercury Film Relay

Both latching and nonlatching Logcell Relays are available. For more information about Logcell Relays, and Logcell Switches, too, write Fifth Dimension Inc., Box 483, Princeton, New Jersey 08540. Or call (609) 924-5990.



FIFTH DIMENSION INC.

INFORMATION RETRIEVAL NUMBER 66

product index

Information Retrieval Service. New Products, Evaluation Samples (ES), Design Aids (DA), Application Notes (AN), and New Literature (NL) in this issue are listed here with page and Information Retrieval numbers. Reader requests will be promptly processed by computer and mailed to the manufacturer within three days.

Category	Page	IRN
Components		
capacitors, polycarbonate	87	307
capacitors, stable	87	293
capacitors, tantalum	86	301
diodes, zener	87	305
energy storage device	86	302
filters, active	86	300
oscillators, crystal	85	295
potentiometer, plastic	87	306
potentiometers	85	298
relay, solid state	85	297
relay, time-delay	86	299
resistance elements, Pt	85	294
resistor networks, DIP	85	296
resistors, chip	86	303
sensors, temperature	84	292
switch, programmable	84	291
switches, rocker	87	304
time-delay module	87	308
Data Processing		
calculator, electronic	80	275
disc-pack assembly	80	278
keyboard, numeric	81	281
memory, plated-wire	80	277
minicomputers, OEM	78	271
modem interface	79	274
printer, strip	80	276
ROMs, alterable	80	279
sensor, tape	79	273
software program	78	269
terminal, alphanumeric	78	270
terminals, display	81	280
transport, tape	79	272
ICs & Semiconductors		
IC packages (NL)	91	368
multiplexers, CMOS	83	287
op amp, IC	83	289
regulators, voltage (AN)	88	344
switches, FET analog	83	290
thin-films (NL)	90	363
transistor chips	83	288
Instrumentation		
analyzer, real-time	74	260
DMM, low-cost	74	261
DPM, 3-1/2-digit	72	255
DVM, 4-digit	73	253
generators, function	73	257
scope, 35-MHz	73	258
scope, 60-MHz	72	254
scope, dual-CRT	74	259
synthesizer, frequency	93	256
Microwaves & Lasers		
capacitor, microwave	76	265
capacitors, microwave	76	263
lasers, He-Ne	77	267
photodetector/amplifier	77	268
relays, microstrip	76	262
resistors, thin-film	77	266
transistor, vhf power	76	264
Modules & Subassemblies		
amplifier, isolation (NL)	90	359
controls, temp. (NL)	88	345
converters, d/a	72	250

Category	Page	IRN
decoder/driver, display	72	251
power supplies (NL)	90	348
resolvers/synchros (NL)	90	351
vector module	72	252

Packaging & Materials		
connector, pin-and-socket	82	283
exchangers, heat	82	282
package, edge-mount	82	286
packages, edge-mount	82	285
paste, gold cermet	82	284

new literature

amplifier, isolation	90	359
circuit breakers	90	350
connectors, back-plane	90	361
connectors, PC	90	354
delay lines	90	360
hand tools, Metric	90	355
high-voltage supplies	90	348
instrumentation	91	367
instruments	91	366
laser trimming	90	357
materials, thin-film	90	363
memories, core	90	356
optoelectronic products	90	358
oscillators, crystal	90	353
packages, IC	91	368
panels, DIP	90	362
photodetectors	91	364
receivers, Touch-Tone	91	369
relays	90	352
resolvers/synchros	90	351
ROM, capacitive	90	349
switches	91	365
Teflon data	90	347

application notes

diodes, impatt	88	346
temperature controls	88	345
voltage regulators, IC	88	344

design aids

programming kit	88	343
radii rule	88	342

evaluation samples

clamps, cable	88	340
magnet wire, insulated	88	341

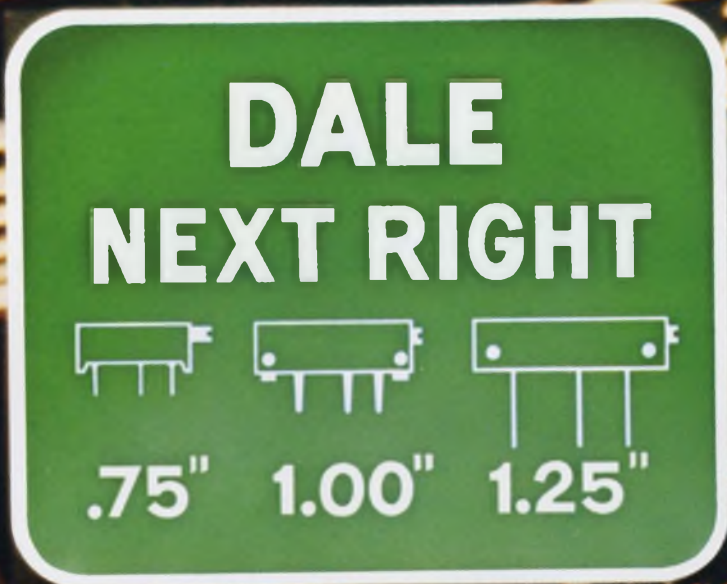

Take the Dale Interchange for a better deal in low-cost trimmers

Dale commercial and industrial trimmers interchange with scores of competitive models—including the ones you aren't totally satisfied with right now. Dale pricing is intensely competitive... and delivery is hard to beat. Quality is so high that we average less than 1% customer rejection for *all* causes. In three basic rectilinear sizes: 1.25", 1.00" and .75" Dale trimmers offer the versatility of wirewound or film elements—standard to handle normal production environments—sealed to approximate MIL-R-27208A standards. Consider all your circuit adjustment trade-offs—then call Dale for a better deal. Phone 402-564-3131.

Choice of element in 3 body styles

FILM ELEMENT

8400 SERIES Sealed/Unsealed; 10 Ω to 2 Meg., $\pm 10\%$ 100 Ω thru 500K, $\pm 20\%$ all other values; .75 watt at 25°C, derated to 0 at 125°C; T.C. 150 ppm/°C, 100 ppm available; .31 H x .16 W x .75 L.

8300 SERIES Sealed/Unsealed; 10 Ω to 2 Meg., $\pm 10\%$ 100 Ω thru 500K, $\pm 20\%$ all other values; .75 watt at 25°C, derated to 0 at 105°C; T.C. 150 ppm/°C, 100 ppm available; .36 H x .28 W x 1.00 L.

8100 SERIES Industrial counterpart RJ-11; 10 Ω to 2 Meg., $\pm 10\%$ 100 Ω to 500K, $\pm 20\%$ other values; .75 watt at 70°C, derated to 0 at 125°C; T.C. 150 ppm/°C, 100 ppm available; .28 H x .31 W x 1.25 L.

WIREWOUND ELEMENT

2400 SERIES Sealed/Unsealed; 10 Ω to 50K, $\pm 10\%$; 1 watt at 40°C, derated to 0 at 125°C; .31 H x .16 W x .75 L.

2300 SERIES Sealed/Unsealed; 10 Ω to 50K, $\pm 10\%$; 0.5 watt at 25°C, derated to 0 at 105°C; .36 H x .28 W x 1.00 L.

2100 SERIES Industrial counterpart RT-11; 10 Ω to 100K, $\pm 10\%$; 1 watt at 70°C, derated to 0 at 125°C; .28 H x .31 W x 1.25 L.

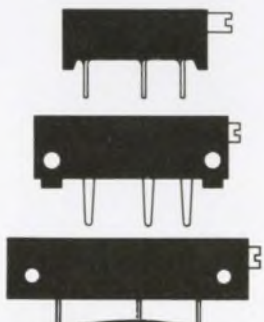

Write for Catalog B

DALE ELECTRONICS, INC.

1300 28th Ave., Columbus, Nebr. 68601
In Canada: Dale Electronics Canada Ltd.
A Subsidiary of The Lionel Corporation

RECEIVED
SEP 28 1971
CALMA CO.

Cut the Size of Your Power Supply in Half with Fast, High-Voltage Transistors from RCA.

TRANSISTOR TYPE	POWER SUPPLY OUTPUT (W)
40850	125
40851	250
40852	250
40853	500
40854	1000

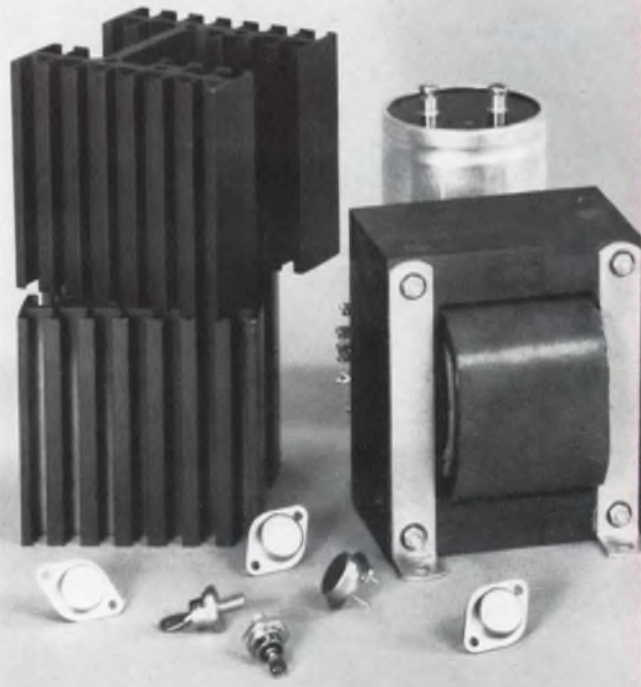

Conventional 5 V, 25 A Supply

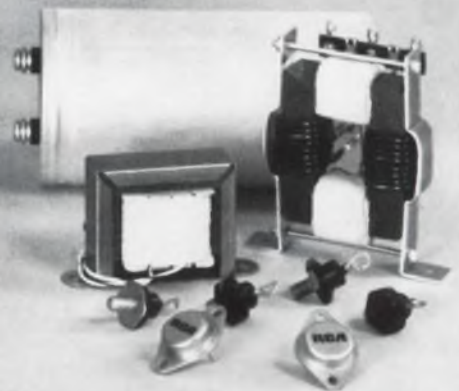

New 5 V, 50 A Supply



For details and application note, write: RCA, Commercial Engineering, Section 57130/UT23, Harrison, N.J. 07029