

Electronic Design

FOR ENGINEERS AND ENGINEERING MANAGERS

VOL. 19 NO.

8

APRIL 15, 1971

RECEIVED
APR 13 1971
CALIFORNIA

The minicomputer, a new tool for the engineer, will see rapidly widening application in the 70s. But to the designer it can mean problems. He must learn about

its capabilities and its limitations, specify it from a host of similar products, program and use it. For the first article of a series on using the mini, see p. 48.



Introducing: "The Portables" from HP



Shown: 1701A delayed-sweep version

They make your budget seem bigger.

HP's new dual-channel, portable scopes make slim budgets look fatter. At only \$1850, our delayed-sweep model, the 1701A, weighs in at \$200 less than the competition, which adds up to a 10% savings for you. (Our non-delayed-sweep model, the 1700A, is even lower—\$1680.)

The 1701A weighs less in pounds, too—24 as compared to 28—which makes it easy to carry around in the field. But the 1701A is no "light-weight" in its performance. It gives you all the necessary capabilities for digital field service work.

Its 10 ns/div sweep time and <10 ns rise time (35 MHz) let you measure T²L pulse timing and propagation delay.

And its simple-to-use delayed sweep allows expansion of complex waveforms, for easy observation on the large 6 x 10 cm screen.

Another advantage is the 1701A's low power requirement. This HP breakthrough eliminates the need for fans (or even vent-holes), which means that dust and moisture are kept out of the circuits. It also assures extreme reliability, as all components are operating at less than 20% of rated capability. And, this low power requirement allows battery operation in the field—a capability you get with no other scope in this class. (Internal battery pack, \$200 extra.)

For further information on "The INFORMATION RETRIEVAL NUMBER 242

Portables"—HP's new 1700 Series scopes—contact your local HP field engineer. Or write Hewlett-Packard, Palo Alto, California 94304. In Europe: 1217 Meyrin-Geneva, Switzerland.

Scopes are changing.
Are you?

081/7

HEWLETT **hp** PACKARD

Monolithic Memories bipolar 1024 bit field programmable ROM

Introducing the industry's first 1024 bit bipolar programmable Read Only Memory. Because you program it in your own facility, you save expensive masking charges and time delays for new bit patterns. With programming time cut to minutes, you won't be sitting there with an idle system waiting six weeks or more for parts. And, think how happy *your customer* will be if you replace a ROM in the field in minutes.

MMI field-programmable ROM's are easy to program. A low 20mA applied to the proper leads, using *any* test equipment, and your ROM is programmed. If you don't have test equipment, we'll sell you a portable field-programmer at nominal cost that can be plugged into any common electrical outlet. Or, have your *MMI* distributor program them for you the same day.

Sooner or later you'll need that programmed ROM in production quantities. That's where our MM6200 ROM comes in.

Only *MMI* offers pin for pin compatibility and interchangeability between our 1024 programmable ROM (MM6300) and a 1024 bit mask-programmable ROM (MM6200). Both are bipolar; both organized as 256 words by 4 bits, have an access

time of 50 nsec and low power dissipation of 0.35 mW/bit.

Both have full address decoding on the chip, are directly DTL/TTL compatible and have open collector outputs

for easy memory expansion. And they come in a standard 16 pin ceramic dual in line package.

The programmable ROM, MM6300, is available from stock at below 7¢ a bit in 100 unit quantity. The MM6200, with a four week turn around time, is priced at less than 2¢ a bit in 100 lots. Pick a winner, call, TWX, telex or write today.

Visit us at SJCC Booths 2643, 2644 and 2645.

Monolithic Memories

Monolithic Memories, Inc., 1165 East Arques Avenue, Sunnyvale, Ca 94086
(408) 739-3535 TWX: 910-339-9229 Telex: 356-301



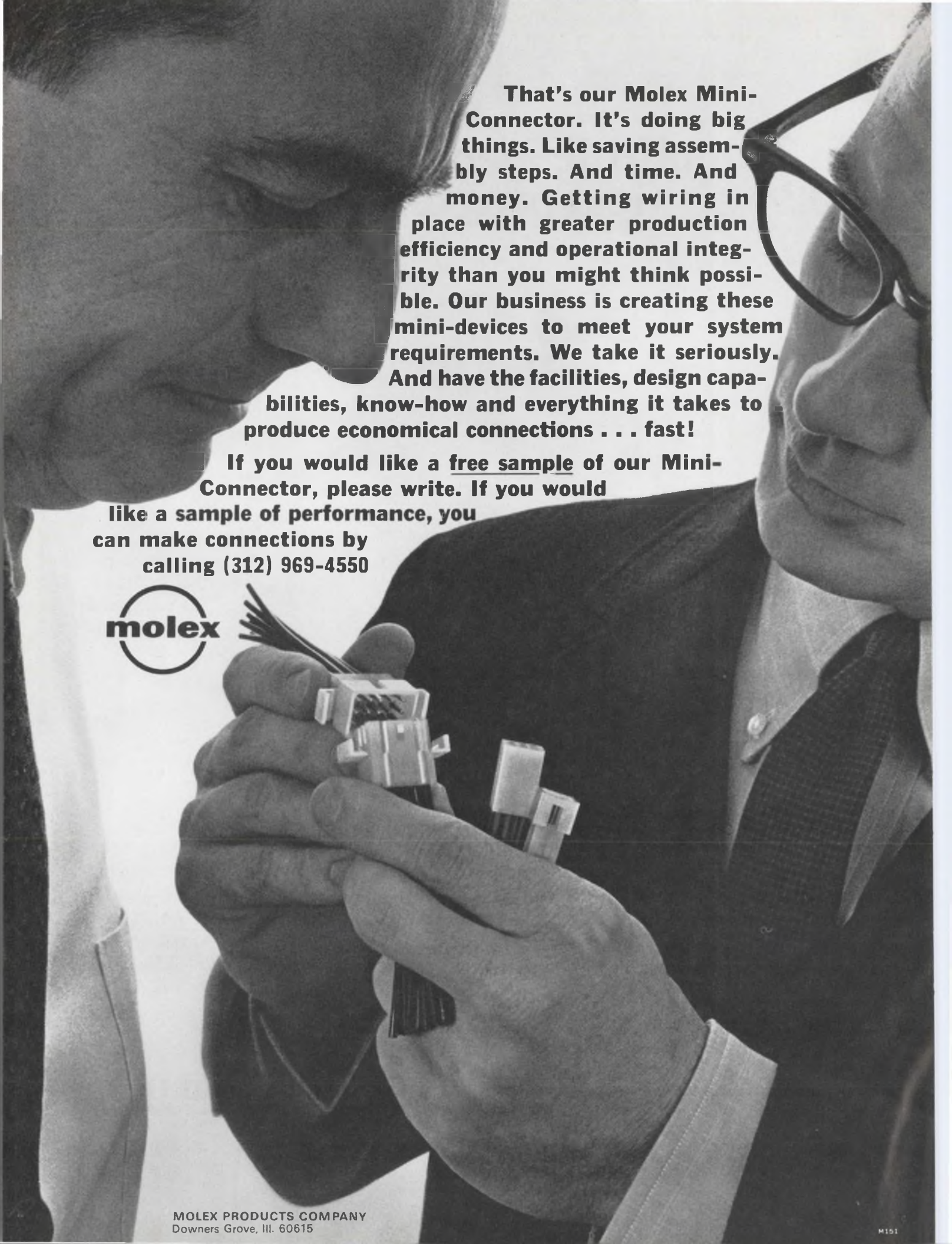

That's our Molex Mini-Connector. It's doing big things. Like saving assembly steps. And time. And money. Getting wiring in place with greater production efficiency and operational integrity than you might think possible. Our business is creating these mini-devices to meet your system requirements. We take it seriously. And have the facilities, design capabilities, know-how and everything it takes to produce economical connections . . . fast!

If you would like a free sample of our Mini-Connector, please write. If you would like a sample of performance, you can make connections by calling (312) 969-4550



NEWS

- 21 **News Scope**
- 25 **For pain and other suffering, new 'fast relief'** is provided by electronic implants in the human body.
- 30 **\$12 Army vibration transmitter** may end up on industrial duty.
- 32 **With the price right, complementary MOS integrated circuits** are headed for new industrial and consumer applications.
- 35 **New magnetic-oxide coating** boosts tape output and clarity.
- 39 **Technology Abroad**
- 43 **Washington Report**

TECHNOLOGY

- 47 **The Minicomputer and the Engineer.** An ELECTRONIC DESIGN special series on the minicomputer in the world of the engineer.
- 68 **Take a look inside the TTL IC.** If you understand its internal operation, you can take advantage of its capabilities and avoid misapplication.
- 74 **Linearize almost anything with multipliers.** Generate a power-series approximation of the function needed to cancel out the nonlinearity.
- 78 **What size company should you work for?** Robert Noyce, a small-company president with large-company experience, might help you decide.
- 82 **Ideas for Design**

PRODUCTS

- 91 **Instrumentation:** A new 80-MHz generator achieves ± 10 -Hz stabilities.
- 92 **Instrumentation:** Ac/dc 32-MHz LED palm-size counter costs only \$475.
- 102 **Microwaves & Lasers:** Low-cost optical scanner provides digital outputs.
- 96 ICs & Semiconductors
- 98 Modules & Subassemblies
- 104 Components
- 108 Data Processing
- 110 Packaging & Materials
- 124 Product Index

Departments

- 47 **Editorial:** The employment contract—a better way to work
- 7 Letters
- 13 Designer's Calendar
- 112 Evaluation Samples
- 112 Design Aids
- 114 Application Notes
- 116 New Literature
- 119 Bulletin Board
- 122 Advertisers' Index
- 124 Information Retrieval Card

Cover: Photo by Steve Grohe, courtesy of Data General Corp.

**Reliability is a single-sided frame,
a ball and a cricket room.**

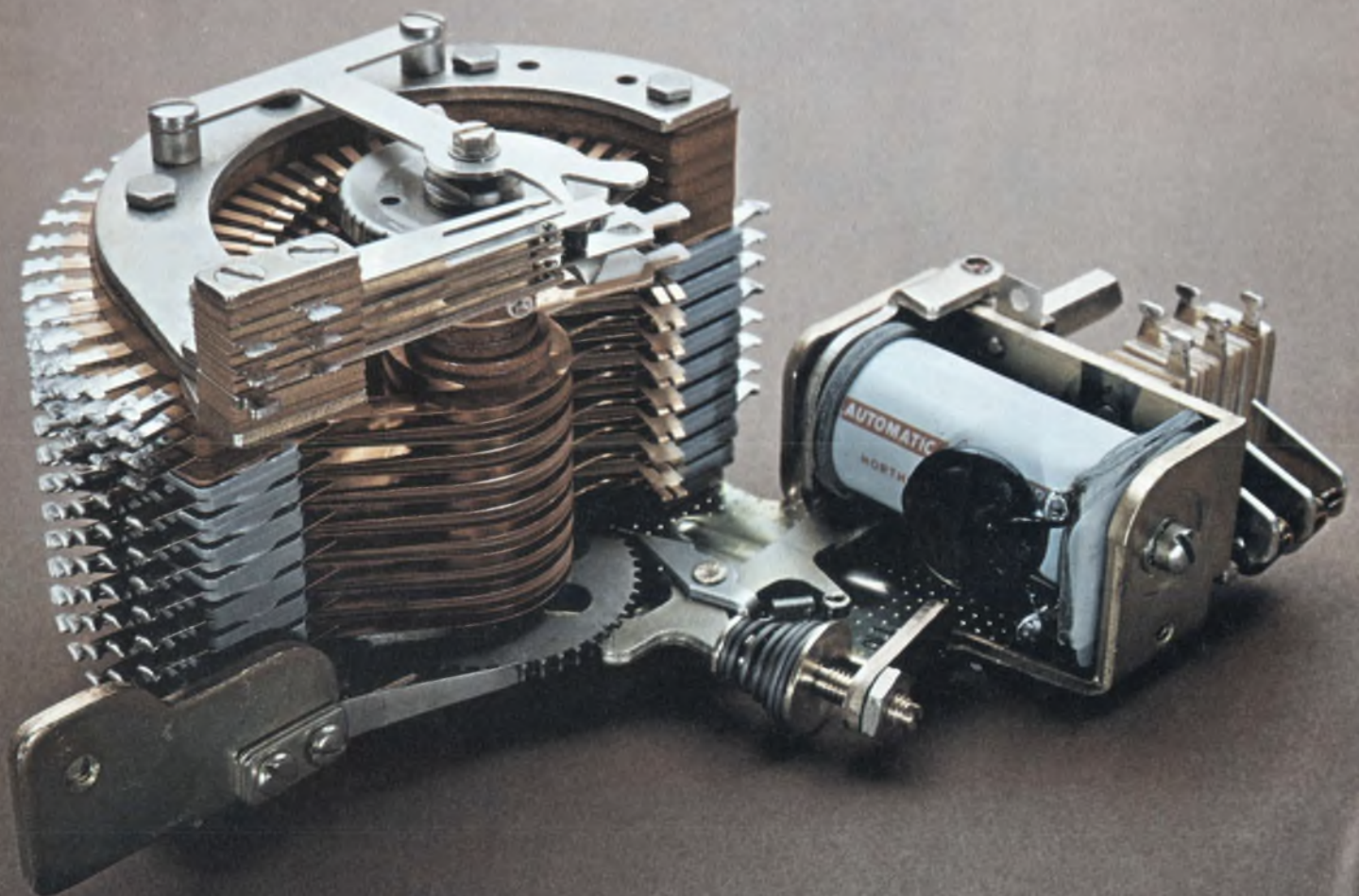

Our Type 45 rotary stepping switch is made to be forgotten. We build them to work hard, fast and long without constant fiddling or adjusting. They've got to be able to work in heat or cold, take bumps and grinds and still click-click along with close-spaced consecutive operations.

We start out really flat To keep everything on the level we start our assembly with an open-type, one-piece frame. Thick and really flat. Some manufacturers use two thinner frames. But we found that starting with a single thick frame eliminates problems of matching the switch parts. Everything stays in line. And a single-sided frame takes a lot less room—the switch is only as wide as need be.

A lube job that lasts a lifetime The entire wiper assembly rotates on a large-diameter stainless steel shaft around a full-length hub bearing. We lubricate this bearing and seal it during assembly. So throw away the oil can.

Then we supply a pinch that's just right Each pair of wipers is tension-adjusted during assembly. As they click around the bank levels on a flat plane, we want each pair to pinch the contact just the right amount. Too hard a pinch and the contacts will wear out quickly. Too soft a pinch will cause a poor connection. We teach our wipers to pinch just right.

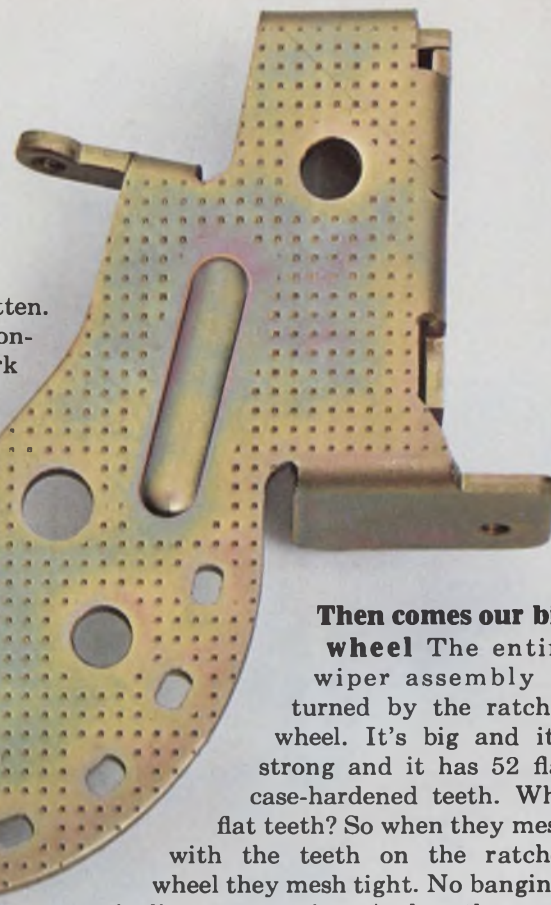
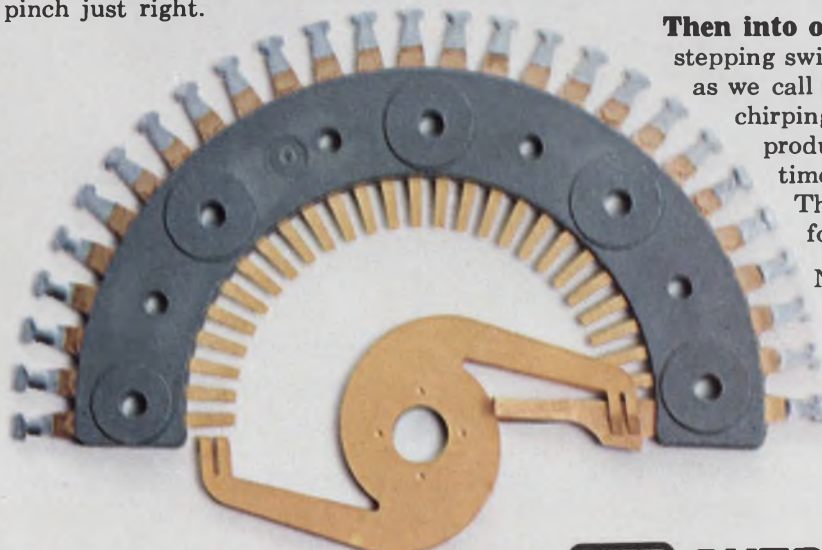

Then comes our big wheel The entire wiper assembly is turned by the ratchet wheel. It's big and it's strong and it has 52 flat case-hardened teeth. Why flat teeth? So when they mesh with the teeth on the ratchet wheel they mesh tight. No banging, wiggling, or scraping. And as the teeth wear, they just mesh deeper in the grooves.

Ball bearing anchor for good measure The armature assembly has to be securely fastened to keep it from wiggling up and down, or everything goes out of whack. So we choose a big stainless steel pin and secure it with wide bearings to the armature yoke. To make sure this pin never slips out of the yoke, we drill a hole in both ends. Then we force a steel ball bearing into these holes. This expands the walls of the pin into and against the walls of the armature and the whole assembly is anchored for life. We're the only ones that do it this way. So we're the only ones that offer a lifetime fit.

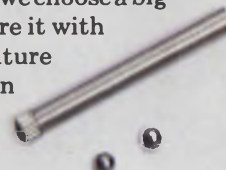

Then into our cricket room Every single AE stepping switch goes to the run-in test room. Or, as we call it, the cricket room, because of the chirping noise all the switches we're testing produce. Here, every switch is tested 50 times a second for 45,000 operations. Then, and only then, are they ready for delivery to our customers.

Now that we've explained all the little things we do to make our Type 45 reliable, put it through your own tests. GTE Automatic Electric, Industrial Sales Division, Northlake, Illinois 60164.

GTE AUTOMATIC ELECTRIC



NEW WAY TO GET A HANDLE ON CONSTANT CURRENT ... 0.1 AMPERE TO 1 NANOAMPERE

Now you can keep tight rein on low level currents for materials research, semiconductor testing and for other areas in science and industry where a reliable current source is needed. The Keithley 225 delivers from 0.1 A to 100 nA full scale with 0.02% resolution on most ranges. It keeps them on target with 0.02% stability and low 0.01% rms noise. Variably selectable compliance voltages from 10 to 100 volts and 0.005% load regulation wrap-up this neat source for really constant currents.

Consider convenience features

like bipolar output, the ability to float 500 volts off ground, an output filter to deal with inductive loads. And, protection from overloads with automatic recovery. Now—can you afford to pass up such capability when it's yours for only \$645?

For technical literature and demonstration, contact your Keithley Sales Engineer. Or, Keithley Instruments, Inc., 28775 Aurora Road, Cleveland, Ohio 44139. Telephone: (216) 248-0400. In Europe: 14 Ave. Villardin, 1009 Pully, Suisse. Prices slightly higher outside the U.S.A.



KEITHLEY

INFORMATION RETRIEVAL NUMBER 5

Publisher

Peter Coley

Editors

New York Office
850 Third Ave.
New York, N.Y. 10022
(212) 751-5530
TWX: 710-581-2874
Cable: Haydenpub

Editor: Frank Egan
Managing Editor: Ralph Dobriner
Managing Editor: Raymond D. Speer
Microelectronics, Steven A. Erenburg
Computers, Raymond D. Speer
Microwaves, Michael J. Riezenman
Management, Richard L. Turmail
Military-Aerospace, John F. Mason
New Products, Roger Allan

Field Offices

Massachusetts
Jim McDermott
P.O. Box 272
Easthampton, Mass. 01027
(413) 527-3632

West Coast
David Kaye
2930 Imperial Highway
Inglewood, Calif. 90303
(213) 757-0183

Washington
Don Byrne
1425 N St. NW
Washington, D.C. 20005
(202) 667-6568

Editorial Production

Dollie S. Viebig

Art

Art Director, William Kelly
Rita Jendrzewski
Richard Luce

Production

Manager, Thomas V. Sedita
Helen De Polo
Kathleen McConkey
Leslie Stein

Circulation

Manager, Nancy L. Merritt

Information Retrieval

Peggy Long

letters

How safe is a satellite solar-power system?

Sir:

Mr. Riezenman's description, in the Nov. 8, 1970, issue (ED 23, p. 43) of Dr. Glaser's proposal for a satellite system to supply solar-derived electric power to the earth via microwave links was read with interest in our laboratories. Our concern for the effects of long-term microwave exposure to humans leads us to examine the proposal from a different viewpoint.

The article states that the power density would be about 10 mW/cm² "in the beam" at the surface of the earth. This beam would cover an area of six square miles. Nothing is stated concerning the power density outside this area. Anyone planning to implement such a system must consider the following aspects:

- Over what area of the earth will there be an exposure of 1 mW/cm² or greater? And 0.1 mW/cm² or more?
- To what power densities would operating personnel be exposed?
- To what other microwave exposures would people occupying the fringe of the beam be exposed?
- What is the permissible level of continuous exposure to an uncontrolled human population?
- What effects will a continuous exposure of any level have upon an ecological system?
- Will air traffic (because of increased altitude) have to be directed around this area?

*Roger H. Schneider
Mays L. Swicord*

Radiation Measurements and
Calibration Branch
Division of Electronic Products
Bureau of Radiological Health
(HEW)
Rockville, Md.

Dr. Glaser's reply:

The remarks of Mr. Schneider and Mr. Swicord focus on a few of the problems that must be solved before a satellite solar-power system becomes a reality.

With regard to microwave radiation, we are presently unsure of the degree of hazard it represents. The exposure limits being considered range all the way from 10 mW/cm² now permissible in the United States to 1/1000th of that value as proposed by the Soviet Union. Until a consensus is reached no definite conclusion can be reached.

Regarding the microwave beam itself, 99.8% of the energy can be arranged to fall within the receiving area on earth. Because the beam can be formed to obey a Gaussian distribution, exposure outside these limits will be substantially below 10 mW/cm².

Operating personnel in the satellite would not be exposed to any microwave radiation. If repairs had to be undertaken in the receiving area, the personnel could work under a microwave shield that would screen out the radiation to permissible industrial limits.

Although it is unlikely that an airplane flying through the beam would suffer any consequences because of the low power density within the beam, air traffic could be arranged to avoid areas where the beam would be directed.

Interference with communication in the 10-cm wavelength range could occur if the line-of-sight communication equipment operating in this wavelength should be pointed toward the radiating antenna. As this antenna will be very accurately positioned, it should be possible to arrange the equipment to avoid interference.

Peter E. Glaser



The "no maintenance" PUNCHED TAPE READER

- No edge guides
- No capstans, pinch rolls or brakes
- No lenses
- No lubrication
- No adjustments

You may have to
replace this bulb
after 25,000 hours.



New DECITEK Punched Tape Readers give greater accuracy, freedom from maintenance and longer tape life. With 20% to 30% fewer parts than units of comparable performance, they start, stop and hold tape accurately through a stepping motor/dual sprocket bi-directional drive. Tests at 300 cps for more than a quarter-million cycles showed insignificant sprocket hole wear.

DECITEK Readers interchangeably read 5, 6, 7 or 8-level paper, paper-polyester or metallized polyester tapes at 60 to 600 cps. Fiber optic elements illuminated by a single, easily replaced bulb eliminate crosstalk and partial or bit failure. Photo-transistor sensing delivers high signal-to-noise ratio outputs. Input-outputs are TTL or DTL compatible. For technical brochure, write DECITEK, 16 Sagamore Rd., Worcester, Mass. 01605. Call (617) 757-4577.

Electronic Design welcomes the opinions of its readers on the issues raised in the magazine's editorial columns. Address letters to Managing Editor, Electronic Design, 850 Third Ave., New York, N.Y. 10022. Try to keep letters under 200 words. Letters must be signed. Names will be withheld on request.

DECITEK
A DIVISION OF JAMESBURY CORP.

INFORMATION RETRIEVAL NUMBER 6

Why call SIGMA for reed relays?

The acquisition of General Reed now gives us some unusual capabilities in the realm of reed relays. By manufacturing our own reed switches, we totally control the characteristics of this most important essential of any reed relay.



Form C Switch
Actual size

In fact, we have total control over the entire relay manufacturing process, starting with the selection of vacuum-melt nickel/iron wire used to form the reeds, all the way through 37 subsequent steps. This includes our ability to change performance characteristics by varying contact plating materials as well as pickup and dropout levels. Such complete control gives you considerably more assurance that the final product will meet your special requirements.

In seven years of making many million reed switches, we've learned from experience how to achieve desired performance. This can be particularly useful when you need a non-standard

type. For example, consider our spec. no. 63024: Form C; $250 \pm 50 \mu\text{sec}$ operate and release times; thermal drift less than $6 \mu\text{v}$ max.; electrostatic shielding for microamp signal levels. In the realm of specials like this, we consider ourselves experts.

Where a standard reed relay will do the job, we offer five series: up to 4 Form C and 6 Form A . . . 42 QPL types qualified to MIL-R-5757/29 . . . ultra-miniature and dual in-line types (DIP) for IC compatibility. Sigma Distributors across the country are stocked.

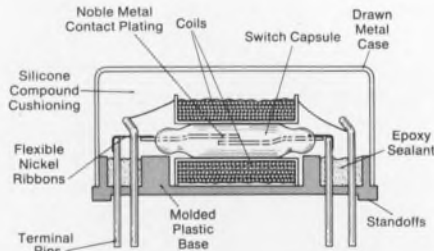

For application help, quotations on specials and technical bulletins, contact General Reed Division, 170 Pearl St., Braintree, Mass. 02185 / Tel. (617) 843-5000.



Series 191
Dual in-line (DIP)
for IC compatibility

Series 192
12 models,
3 case sizes

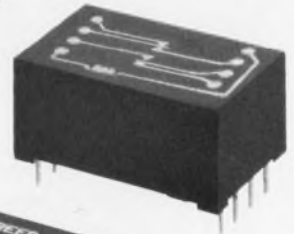

Series 193
10 models,
3 case sizes

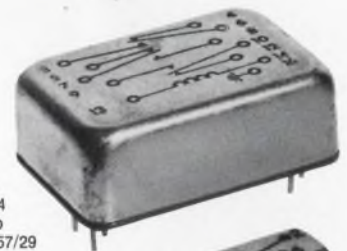

Series 194
Qualify to
MIL-R-5757/29

Series 195
Miniature:
1 Form A Case Size
.280" x .330" x .750"



SIGMA
GENERAL REED DIVISION
INFORMATION RETRIEVAL NUMBER 7



Look at Acopian's new mini-module dc power supplies

Look at their size. Single output models (there are duals, too) are as small as 2.32" x 1.82" x 1.00". And they can all be soldered directly into printed circuit boards.

Look at their performance. Load and line regulation is 0.02 to 0.1% depending on the model selected. Ripple is only 0.5 mv RMS. And Acopian's long experience in power supply technology assures high reliability.

Look at the choice of outputs. There are 58 different single output modules ranging from 1 to 28 volts, 40 ma to 500 ma. Duals are available in 406 different combinations

of voltages. And these are true dual power supplies, with like or different outputs in each section that are electrically independent of each other. Perfect for powering operational amplifiers. Or for unbalanced loads.

Acopian mini-module power supplies		
	Singles	Duals
Output Voltages (vdc):	1 to 28	1 to 28
Output Currents (ma):	40 to 500	40 to 250
Line and Load Regulation:	.02 to 0.1% depending on model	
Ripple:	0.5 mv RMS	
Ambient Temperature (without derating)	0 to 55°C	
Polarity:	outputs floating and isolated	

Look at their price. Single output models start at \$39, duals at \$58.

For a look at all the facts, write or call Acopian Corp., Easton, Pa. 18042. And just like Acopian's other 82,000 power supplies, every mini-module is shipped with a tag that looks like this . . .



Connector Problem? Call Our Fly Guy.

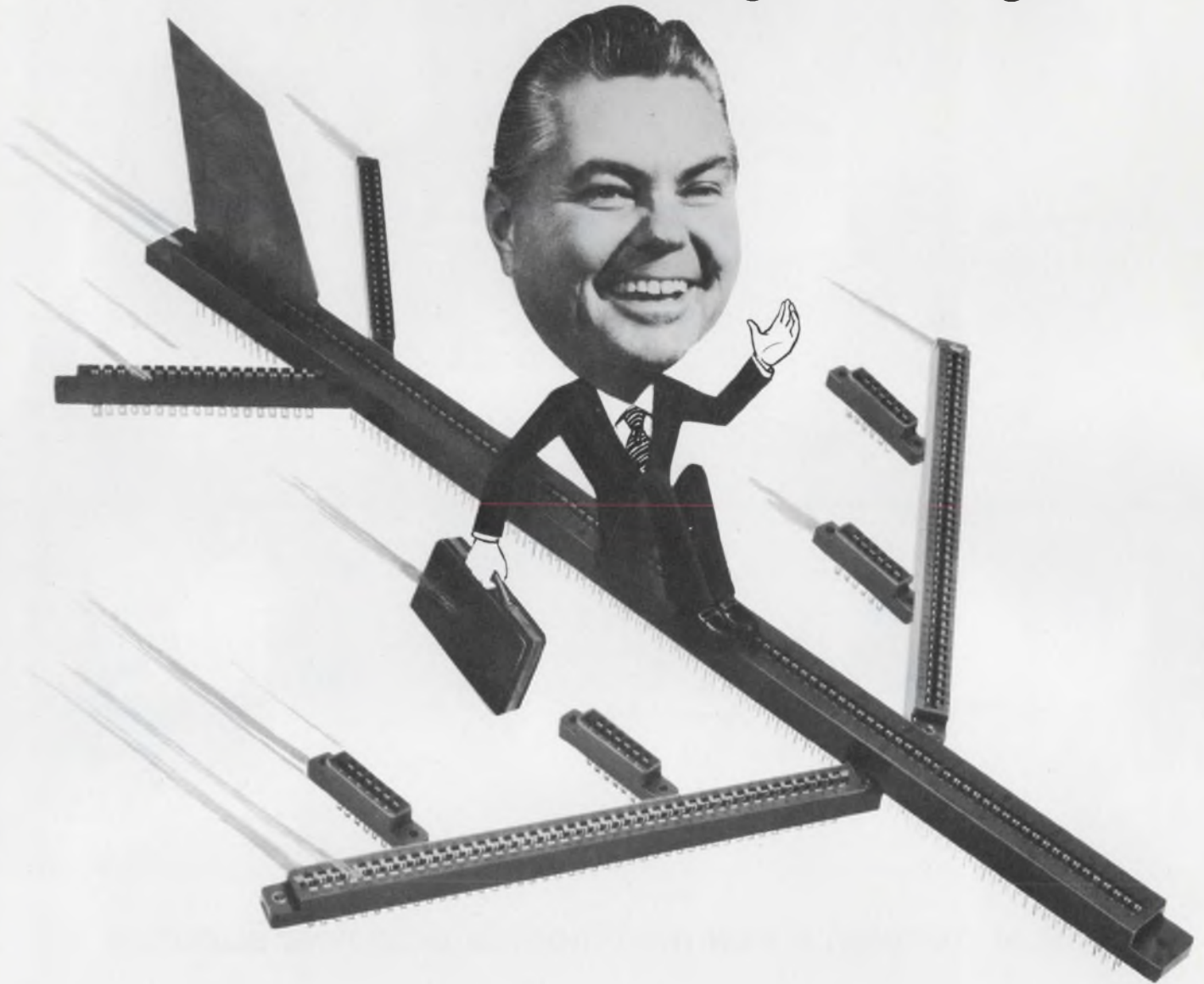

Guy Palmquist. When you need any special help or advice on connectors, get in touch with Guy. He's flown hundreds of thousands of miles working with people just like you to solve their connector problems. At a real competitive price. In back of Guy is a Continental team of design, manufacturing and molding specialists who can give you exactly the connector you require. So next time a connector bugs you – call our Mr. Palmquist. He's your kind of guy.



See *EEM* and *VSMF* Directories for Distributor or Sales Representative Nearest You.

CONTINENTAL CONNECTORS

Continental Connector Corporation / Woodside, New York 11377 / 212-899-4422

INFORMATION RETRIEVAL NUMBER 9

INFORMATION RETRIEVAL NUMBER 10 ►

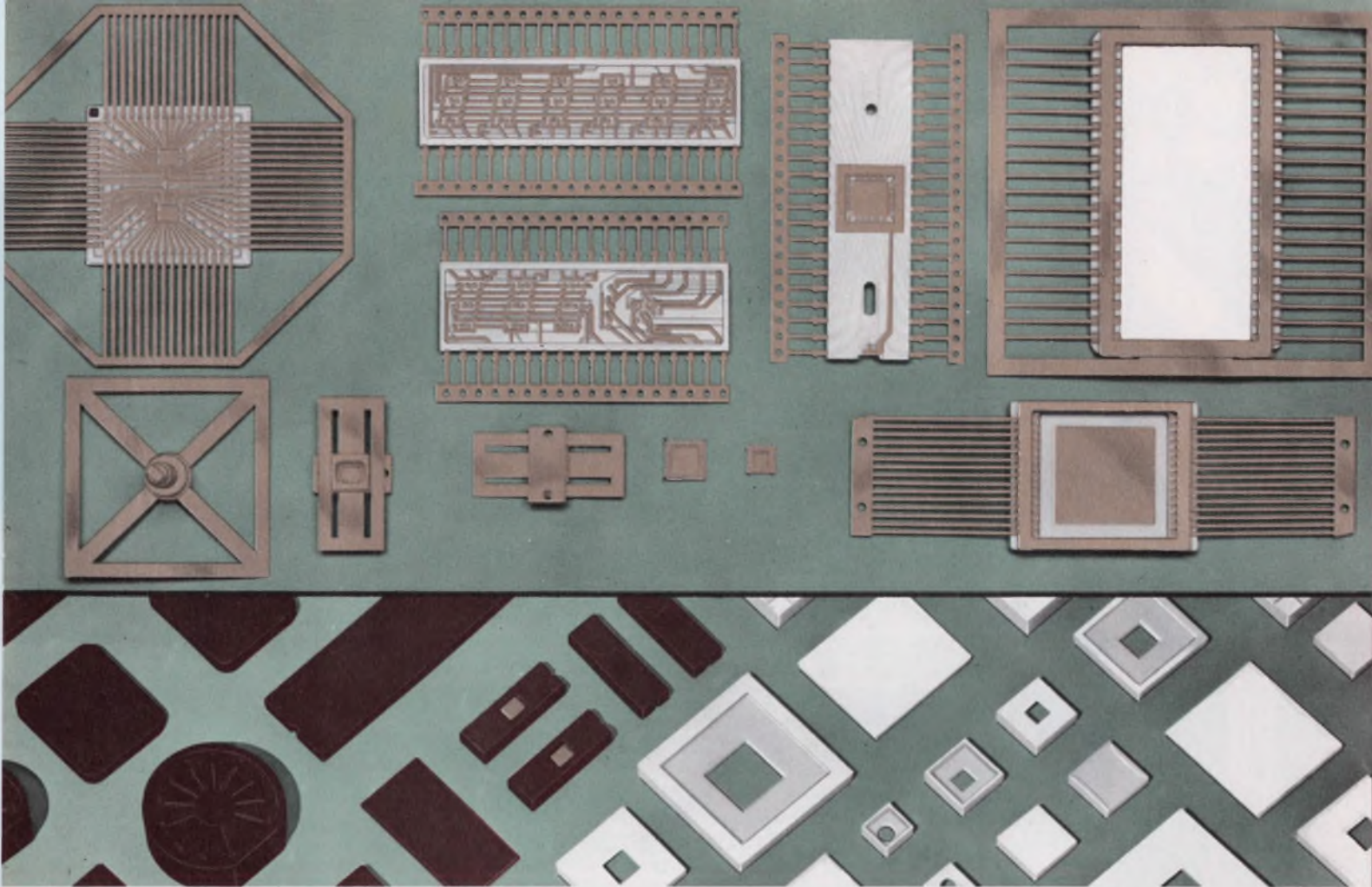

AlSiMag[®]
BRAND

CERAMICS

cover the broad spectrum of

RELIABLE

ELECTRONIC PACKAGING

Leadership in this field is well established with the major electronics firms. Head to head conferences and prompt production of prototypes have often proved to be the best stepping stones to progress.

COMPOSITE PACKAGES. All ceramic, standard and custom made. Includes hybrid, light emitting diode, MOS, high power transistor (both stud mounted and flange mounted), and high density leadless packages.

COMPOSITE SUBSTRATES. Custom made. All ceramic construction. Maximum circuit density and high reliability are attained by vertical stacking of planes. Single source responsibility on multi-layer components for multi-chip attachment.

BLACK CERAMICS. Widely used to protect light-sensitive semiconductors. American Lava offers a wide variety of custom made ceramic components in alumina and other materials. Bases and lids available with glass and gold.

RING FRAMES AND BASES. Pioneer in alumina ceramics of this type and construction. Many open designs may save you time and expense.

CHIP SUB-MOUNTS. Custom made in metallized alumina. Many open designs available for diode and transistor applications.

CODE IDENT. NO. 70371

PHONE 615/265-3411 • CHATTANOOGA, TENNESSEE 37405, U.S.A. A SUBSIDIARY OF

American Lava Corporation **3M**
COMPANY

For service, contact American Lava representatives in Offices of Minnesota Mining and Manufacturing Company in these cities (see your local telephone directory): Boston: Needham Heights, Mass. • Chagrin Falls, O. • Chicago: Elmhurst, Ill. • Dallas, Tex. • Indianapolis, Ind. • Laurens, S. C. • Los Angeles, Calif. • Metropolitan New York: West Caldwell, N. J. • Up-State New York and Canada: Phoenix, N. Y. • Orange, Conn. • Philadelphia, Penn. • St. Louis: Lee's Summit, Mo. • Salem, Va. • S. San Francisco, Calif. • Tempe, Ariz. • International: c/o American Lava Corporation, Chattanooga, Tenn. 37405, U.S.A., TELEX 558432

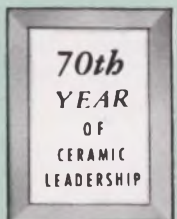

Count your savings.

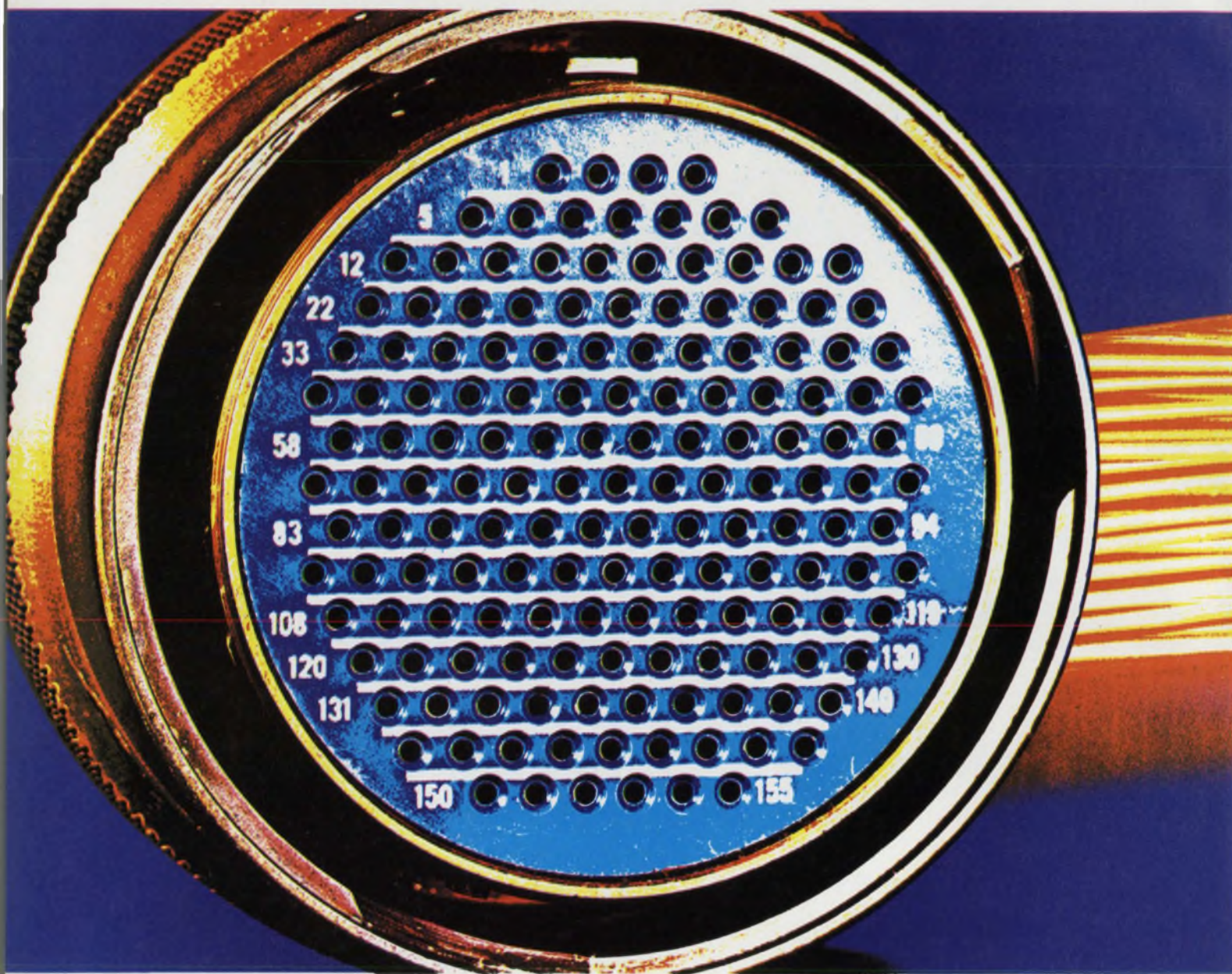

15¢ a hole.

ASTRO/348[®] Our MIL-C-81511 tri-service connector, the Astro/348[®], saves you 15¢ a hole because you get 20% more circuit contacts per square inch. For example, on our #23-22 high-density connector we have 155 circuit contacts instead of the usual 128.

So, with the Astro/348 connector you can engineer circuit cost reduction while demanding

aerospace construction.

For computers, for television cameras and for portable communications; solid-state modular electronics are perfect applications for the low-voltage Astro/348. We know you can add more.

Ask an Amphenol sales engineer or distributor to show you the complete family of Astro/348 connectors, or write Amphenol Connector Division, 2801 S. 25th Avenue, Broadview, Illinois 60153.



AMPHENOL
THE BUNKER-RAMO CORPORATION

designer's calendar

MAY 1971						
S	M	T	W	T	F	S
						1
2	3	4	5	6	7	8
9	10	11	12	13	14	15
16	17	18	19	20	21	22
23	24	25	26	27	28	29
30	31					

May 10-12

Electronic Components Conference (Washington, D. C.) Sponsors: IEEE, EIA. R. D. Allan, EIA, 2001 Eye St., Washington, D. C. 20006.

CIRCLE NO. 409

May 16-20

International Microwave Symposium (Washington, D. C.) Sponsor: IEEE. R. V. Garver, Harry Diamond Labs., Conn. Ave. and Van Ness St., Washington, D. C. 20438.

CIRCLE NO. 410

May 17-19

Aerospace Electronics Conference (NAECON), (Dayton, Ohio) Sponsor: IEEE. Dayton Office, IEEE, 124 E. Monument Ave., Dayton, Ohio 45402.

CIRCLE NO. 411

May 17-20

Spring Joint Computer Conference (Atlantic City, N. J.) Sponsors: IEEE, AFIPS. AFIPS Headquarters, 210 Summit Ave., Montvale, N. J. 07645.

CIRCLE NO. 412

June 2-4

Conference on Laser Engineering & Applications (Washington, D. C.) Sponsors: IEEE et al. D. E. Caddes, Sylvania Elec. Systems, Electro-Optics Div., Mountain View, Calif. 94040.

CIRCLE NO. 413

MORE POWER PER PENNY FROM POWER/MATE

A NEW SERIES OF POWER SUPPLIES FOR INTEGRATED CIRCUITS

ICX SERIES FROM
POWER/MATE CORP.
POWER SUPPLIES
FOR INTEGRATED CIRCUITS

\$75.

WITH LIBERAL OEM DISCOUNTS

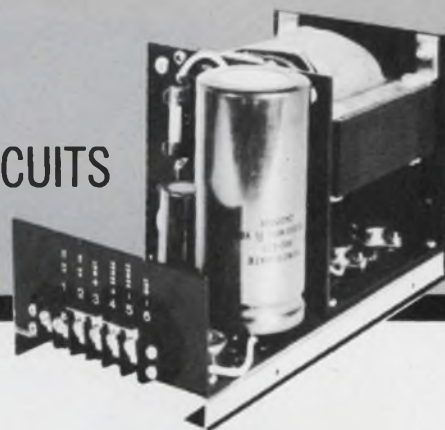

THE ICX SERIES GIVES YOU MAXIMUM ECONOMY WITH MAXIMUM RELIABILITY

Using an open chassis construction for economy and IC regulators, the **ICX SERIES** has been designed especially for integrated circuit applications.

Highly flexible... with optional features allow the user to purchase only those requirements needed for his particular application. Ideal for OEM needs.

Each power supply has built in overvoltage protection — and is completely short circuit and overload proof.

ICX SERIES FEATURE:

- * INTEGRATED CIRCUIT REGULATOR
- * BUILT-IN OVERVOLTAGE CROWBAR PROTECTION
- * BUILT-IN OVERLOAD AND SHORT-CIRCUIT PROTECTION
- * ADJUSTABLE VOLTAGE RANGES
- * REMOTE OR LOCAL SENSING REMOTELY PROGRAMMABLE
- * ±0.1% LINE AND LOAD REGULATION
- * 115 VOLT 47-420 CPS AC INPUT
- * TWO MOUNTING SURFACES
- * TOP QUALITY COMPONENTS
- * ALL SILICON SEMI-CONDUCTORS
- * FIVE-YEAR WARRANTY
- * SAME-DAY-SHIPMENT

SEND FOR
FREE CATALOG
giving specs
and prices



POWER/MATE CORP.

514 S. RIVER STREET, HACKENSACK, N. J. 07601
Phone (201) 343-6294 / TWX 710-990-5023

If you only see this

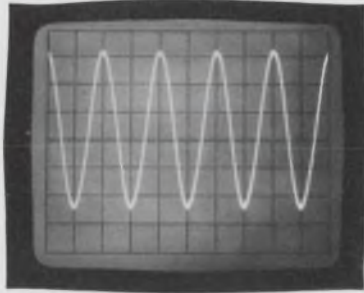

Conventional scope display of 5 MHz signal appears undistorted →

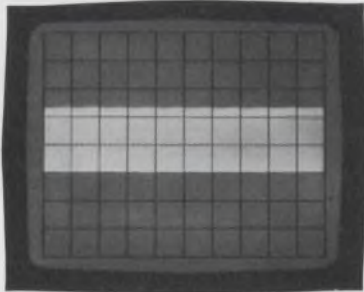

Conventional scope display barely shows 10 kHz AM of 30 MHz carrier →

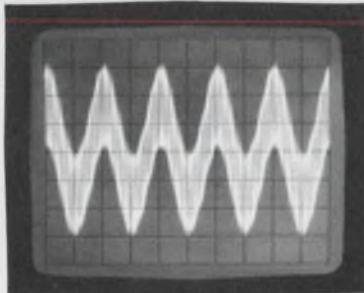

Conventional scope display merely shows "fuzzy" sine wave →

look what you're missing.

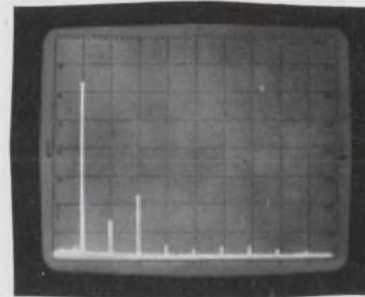

but spectrum analyzer display shows 2nd harmonic 50dB down and 3rd at -40 dB.

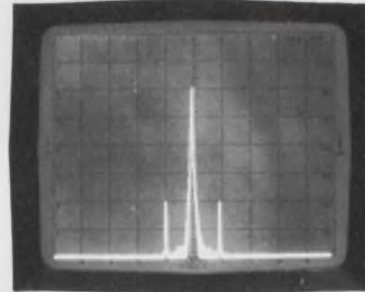

but spectrum analyzer shows sidebands 40 dB down; i.e., 2% AM.

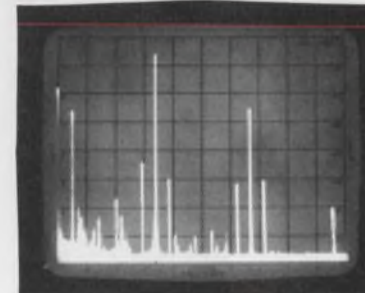

but spectrum analyzer identifies parasitic oscillations.



You're missing the wealth of information you need for *complete* signal analysis.

There's only one lab tool that fully characterizes oscillators, mixers, modulators, amplifiers, filters and systems, both in design and test stages. This tool is an HP spectrum analyzer, the oscilloscope that operates in the frequency domain.

One of the analyzers covers 1 kHz to 110 MHz, another goes from 500

kHz to 1250 MHz, and a third unit covers 10 MHz to 18 GHz (extendable to 40 GHz). Because frequency response is flat, each provides absolute amplitude calibration — and you can read out in dBm or volts (down to < -120 dBm or $0.1 \mu\text{V}$). The > 70 dB distortion-free dynamic range permits you to measure signals with very wide amplitude differences. You can sweep as wide as 2 GHz, then reduce the scan to zoom in for a closeup of any portion down to 0.001% of the initial sweep. Selectable bandwidths

04102 A

HEWLETT  PACKARD
SIGNAL ANALYZERS

INFORMATION RETRIEVAL NUMBER 13

provide resolution as high as 10 Hz at RF, 100 Hz at microwave frequencies.

So why struggle with half the picture when evaluating signal characteristics?

With one of these RF sections:

8553B (1 kHz-110 MHz), \$2200

8554L (500 kHz-1250 MHz), \$3500

8555A (10 MHz-18 GHz), \$5975

plus either of these IF sections:

8552B (highest resolution), \$2850

8552A \$2150

and a 141T Display Section:

with variable persistence CRT, \$1800

— you'll be all set for fast, accurate and thorough signal analysis.

For complete information on this universal measurement tool — or a demonstration — contact your HP field engineer. Or write to Hewlett-Packard, Palo Alto, California 94304; Europe: 1217 Meyrin-Geneva, Switzerland.

INFORMATION RETRIEVAL NUMBER 14 ►

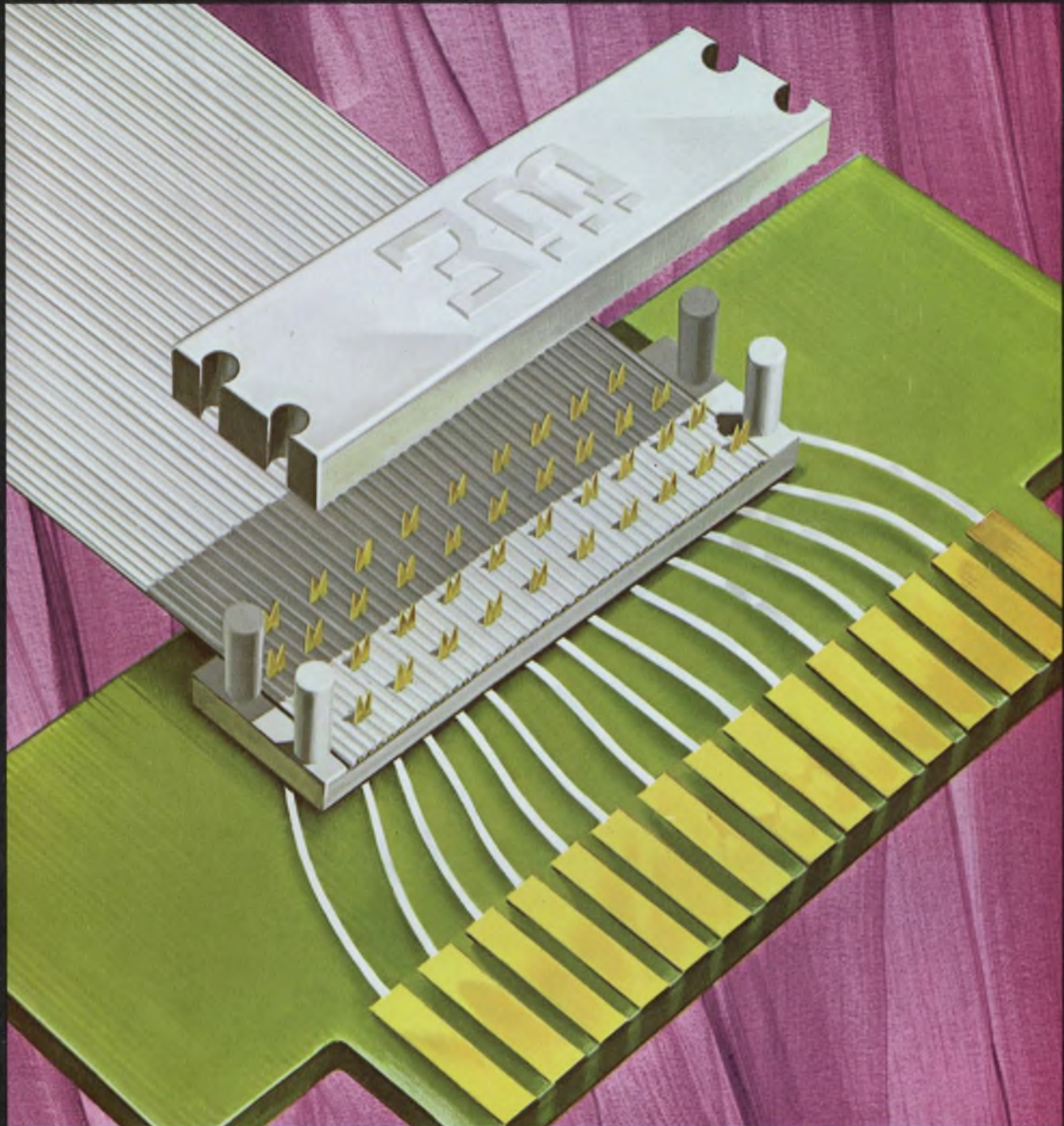

3M's Flat Cable and Connectors... your systems approach to circuitry.

Speed and dependability are yours for your circuitry system assemblies. 3M's "Scotchflex" Flat Cable and Connector Systems provide fast simultaneous circuitry transitions.

"Scotchflex" Flat Cable and Connector Systems win on every count • No stripping or soldering • Reduce wiring errors • Permit easy trouble-shooting •

Provide predictable electrical characteristics • Speed production. • Transitions available for printed circuit board, dual in-line plug, WWP and PCB edge card. For complete information, write: Dept. EAH-1, 3M Company, 3M Center, St. Paul, Minn. 55101.

"SCOTCHFLEX" IS A REGISTERED TRADEMARK OF 3M CO.

3M
COMPANY

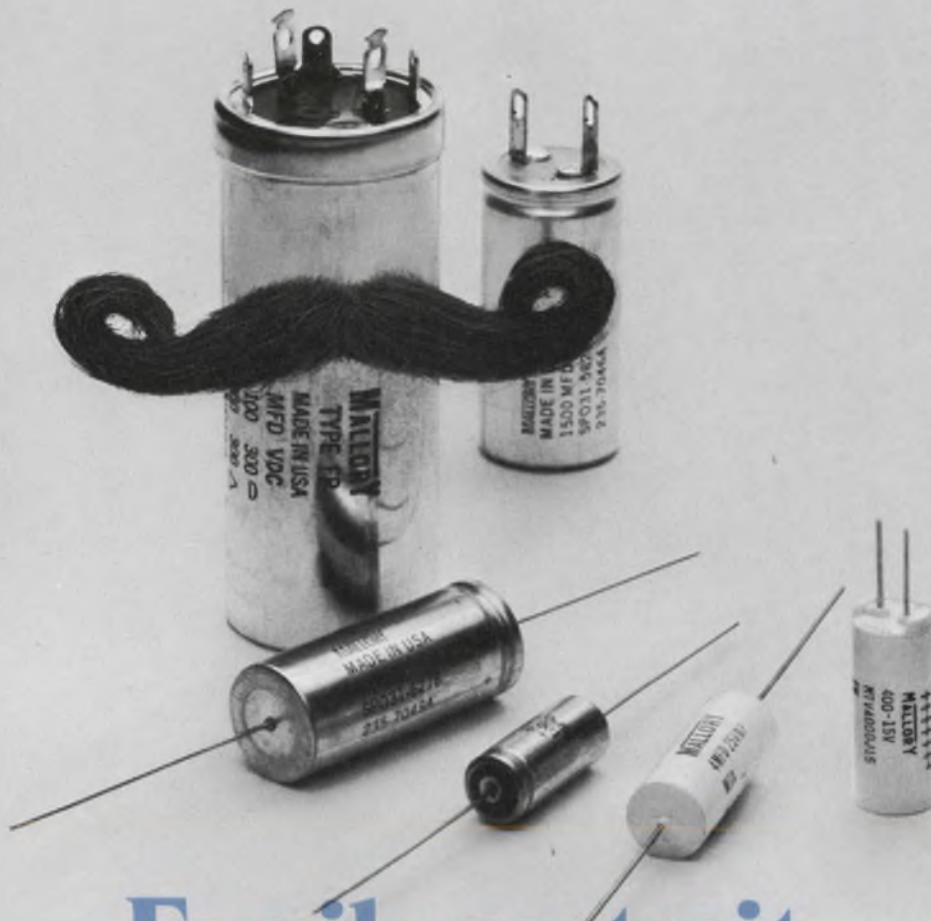

Family portrait.

Take a good look at one of America's first families—the Mallory family of aluminum electrolytic capacitors. And you'll see quality, experience and dependability.

THE FP. "Pop" has been around quite awhile and is still going strong. It's got a twist mount, solder lug terminals, -30 to $+85^{\circ}\text{C}$ temperature range, 80 to 60,000 mfd capacitances and voltages from 3 to 475 VDC.

THE TC. "Mom's" got temperature ranges of -40 to $+85^{\circ}\text{C}$, -30 to $+85^{\circ}\text{C}$ and -20 to $+65^{\circ}\text{C}$; capacitances of 5 to 3,000 mfd; and voltages from 50 to 500 VDC.

THE TCW has axial leads and all-welded construction. It operates from -40 to $+85^{\circ}\text{C}$, in capacitances from 2 to 20,000 mfd and voltages from 3 to 450 VDC.

THE TT is a miniature axial lead capacitor with beautiful performance from -40 to $+85^{\circ}\text{C}$. The TT goes from 1 to 4600 mfd, in voltages from 3 to 150 VDC.

THE MTA has axial leads and all-welded construction—in a good-looking molded plastic case. It operates in a range from -30 to $+85^{\circ}\text{C}$, with 3 to 4500 mfd capacitances and voltages from 3 to 100 VDC.

THE MTV is the latest addition to our aluminum electrolytic, molded-plastic-case family. It's all-welded, with a single-ended vertical mount. And has an operating range of -30 to $+85^{\circ}\text{C}$, capacitances from 5 to 1400 mfd and voltages from 3 to 100 VDC.

Take the time to meet a great family. Write for our Family Portrait Bulletin. Or see your authorized Mallory distributor.

MALLORY

MALLORY CAPACITOR COMPANY

a division of P. R. MALLORY & CO. INC.

3029 E. Washington St., Indianapolis, Indiana 46208; Telephone: 317-636-5353

Electrical and electronic components • sequence timers • metallurgical products • batteries

The *Thrust* in Digital Design

Plus news from Texas Instruments about

The fast-growing Schottky TTL family

Penny-a-bit bipolar ROM

Economy-plus MOS shift registers

MOS in plastic

Largest MOS/LSI ROM available

Linear ICs for MODEMs

Programmable diode matrices

Lowest-cost VLEDs

Economy power transistors

Higher-dissipation SILECT[®] transistors



Digital design: the thrust is ECL, TTL and MOS.

TI has the capability—across the board.

Digital design devours ideas very nearly as fast as men can express them. And its frontiers are extended daily. From switching speeds of well under one-millionth of a second to complexities of more than 300,000 transistors per square inch—that's today's designer's

choice. But broad (and sometimes bewildering) as it is, your choice now focuses on three major technologies. The thrust clearly is ECL, TTL, and MOS...and TI is at the forefront of all three.

You may not know that TI sells more ECL than anyone else. We do. TI's been producing ECL since 1964. Most circuits have been custom designed, but a big standard line of 28 functions is also available. We have experience in all speed ranges, with delays as low as 0.7 ns currently being achieved. And industry's most advanced standard line is coming soon—with single power supply operation, temperature compensation, and low sensitivity to power supply variations. These features will simplify all very-high-speed system applications, from the smallest to the largest.

TI's development of TTL has paced the industry. Currently, there are more than 200 different functions from which to choose—83 of them MSI. A constant high rate of development assures continued flexibility for this most versatile of all digital logics. Standard MSI functions were *doubled* during 1970 and already have increased *40% this year*. TTL's

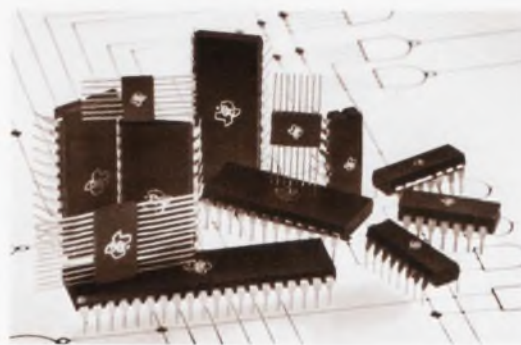

widespread boundaries are being pushed still farther with new low-power functions and with the TI-patented Schottky-clamped TTL line. It's now possible to build a system with devices as fast as 1.5 ns/gate and those with dissipations as low as 1 mW/gate—using the same,

perfectly compatible logic form.

MOS/LSI may be a bit younger than ECL and TTL, but TI has brought it to maturity fast. More than 40 standard functions are available. Six different MOS/LSI processes are now in production and a complete custom capability includes one of the most extensive computer-aided-design facilities in the industry. Complexity continues to soar. A newly announced 4096-bit read-only memory puts more than 5,000 transistors on a single chip of silicon. And new plastic packaging has reduced costs up to 25%.

This competent leadership in the thrust technologies—combined with such strengths as a complete facility for computer-designed controlled-impedance multilayer PC boards—provides a unique ability to help you solve your problems. But it's more than broadest digital product scope and technology...it's also the largest and most cost-efficient volume production in the industry. TI has always been committed to leadership, and the large dollars-and-men commitments necessary to maintain this leadership will continue to be made.

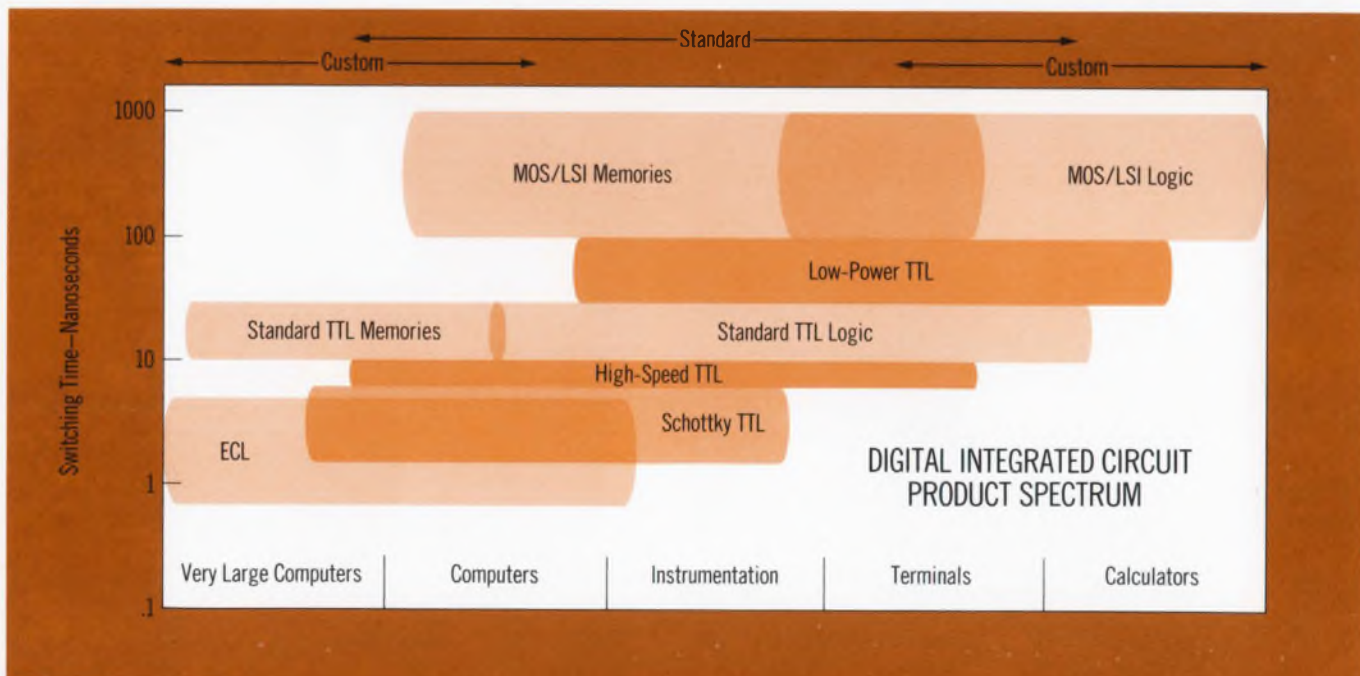

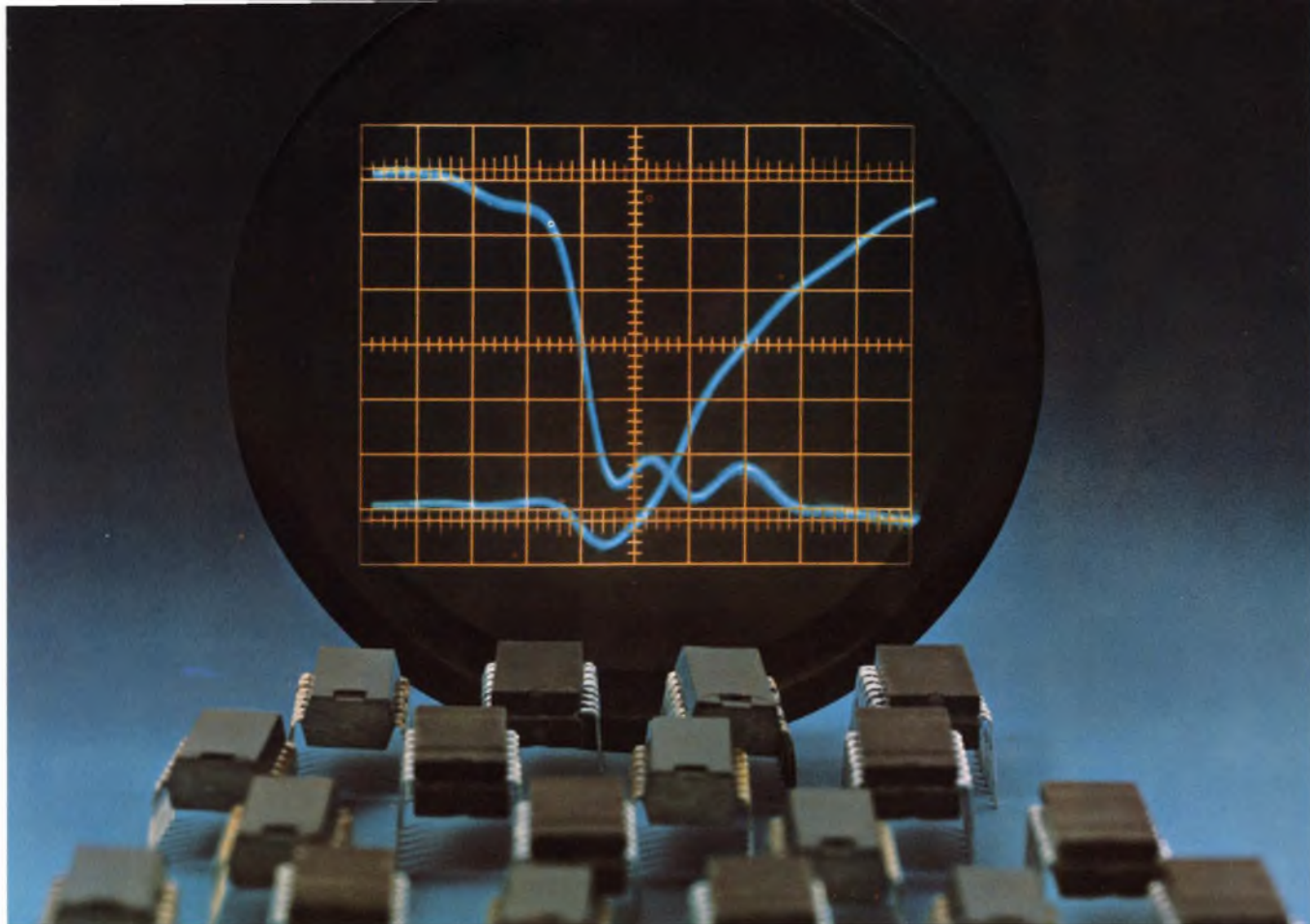

3 ns at 20 mW Schottky TTL

Fastest and fastest-growing TTL family.

Applying the unbeatable speed/power combination of TI's Schottky-clamped TTL family to your designs is getting easier and simpler. And at a cost below equivalent ECL families.

In little less than a year, this revolutionary thrust in TTL technology has grown to a choice of 18 functions and gained unprecedented acceptance.

Big SSI choice

Your 1971 choice includes: two quad 2-input NAND gates, a hex inverter, two triple 3-input AND gates, a triple 3-input NAND gate, two dual 4-input NAND gates, two 4-wide 4-2-3-2-input AND-OR-INVERT gates, a dual 4-input NAND buffer, a dual 4-input 50-ohm line driver/NAND buffer, a dual D-type flip-flop and three dual J-K flip-flops.

Even faster MSI functions

Two Schottky/MSI data selectors/multiplexers are the first MSI additions to this fast TTL family. Both are quadruple 2-line-to-1-line devices. The SN54S/74S157 features a true output and a data-to-output speed of 5.5 ns through three logic levels. The SN54S/74S158 has inverted output and a corresponding speed of 4 ns through two logic levels.

More MSI coming soon

Schottky growth continues with the 1971 expansion of the MSI portion of the line. Among 12 functions on the way is an MSI arithmetic logic unit, SN74S181. Consisting of 75 gates, it will perform 16-bit addition in 20 ns, making it about twice as fast as the industry's standard, TI's SN74181.

Speed... and full DTL/TTL compatibility

TI's Schottky-clamped circuits are faster than any other TTL family. Internal storage time is eliminated by the Schottky-diode clamping of all saturating transistors, while shallower diffusions and smaller device geometries reduce internal capacitance.

These circuits have all the traditional advantages of TTL, and more. For example, they are directly compatible with nearly all saturated digital devices including TTL MSI/LSI as well as most DTL circuits. Switching times are virtually insensitive to power supply and temperature variations. And very low output impedances suppress line ringing.

TI Schottky TTL circuits are available in plastic and ceramic DIP and ceramic flat pack. For data sheets on the 18 benefit-packed Schottky TTL circuits, circle 271.



choice—by far—at TI.



	Low-Power TTL	SUHL	DTL	MOS/LSI
<p>8-input NAND Dual 2-wide 2-input A-O-I 4-wide 2-input A-O-I Triple 3-input pos. NOR Quad 2-input pos. OR</p> <p>Buffers Quad 2-input NAND Dual 4-input NAND</p> <p>Interface/Open Collector Gates/Buffers/Inverters Quad 2-input NAND Quad 2-input NAND (54/7400 pin-out) Hex inverter Hex inverter driver (30 V) Hex driver (30 V) Quad 2-input AND Triple 3-input NAND Dual NAND Schmitt trigger Hex inverter driver (15 V) Hex driver (15 V) Quad 2-input HV (MOS) Interface NAND Quad 2-input NAND buffer</p> <p>Expandable Gates/Expanders Dual 4-input NOR Dual 2-wide 2-input A-O-I 4-wide 2-input A-O-I Dual 4-input</p> <p>Monostable Multivibrators Schmitt input, high stability Retriggerable with clear Dual retriggerable with clear</p> <p>Flip-Flops 35-MHz J-K pos. ET 25-MHz J-K neg. ET 20-MHz J-K AND-gated MS 20-MHz J-K AND-gated MS 20-MHz J-J/K-K AND-gated MS Dual 25-MHz J-K neg. ET Dual 25-MHz D-type ET Dual 20-MHz J-K MS, clear Dual 20-MHz J-K MS, clear, preset Dual 20-MHz J-K MS, clear</p>	<p>Gates Quad 2-input pos. NAND Quad 2-input pos. NAND (OC) Quad 2-input pos. NOR Quad 2-input pos. NAND (DC) Hex inverter Triple 3-input pos. NAND Dual 4-input pos. NAND 8-input pos. NAND Dual 2-wide A-O-I 4-wide 3-2-2-3-input A-O-I 2-wide 4-input A-O-I</p> <p>Flip-Flops 5-MHz R-S AND/OR-gated MS 5-MHz J-K AND-gated MS Dual 5-MHz J-K MS, clear Dual 5-MHz D-type ET Dual 5-MHz J-K MS, com. clear and clock</p> <p>Multivibrators Monostable</p> <p>MSI Latches Quad bistable</p> <p>MSI Data Selectors/Multiplexers 4-bit data selector/storage register Dual 4-line-to-1-line</p> <p>MSI Decoders 4-line-to-1-line BCD-to-7 segment decoder/driver</p> <p>MSI Counters Decade 4-bit binary BCD 4-bit up/down binary</p> <p>MSI Shift Registers 8-bit 4-bit universal parallel in, out 4-bit right-shift, J-K and D 8-bit serial-in, parallel-out</p> <p>MSI Arithmetic Elements 4-bit binary full adder 4-bit magnitude comparator Quad 2-input exclusive-OR</p>	<p>MSI Dependent carry fast adder Independent-carry fast adder Carry-decoder Quadruple latch (OC) Quadruple latch 16-bit scratch-pad memory cell</p> <p>Flip-Flops Set-reset Set-reset, clocked Single-phase S-R-T AND-input J-K OR-input J-K Dual J-K (sep. clocks) Dual J-K (com. clock)</p> <p>Gates Dual 4-input NAND Exp. 2-2-2-3-input A-O-I 8-input NAND/NOR Exp. dual 2-wide 2-input A-O-I Dual pulse shaper/delay AND 2-wide 3-input A-O-I Exp. 3-wide 3-input A-O-I Exp. 2-wide 4-input A-O-I Exp. 8-input NAND Dual 4-input line drivers Quad 2-input NAND 3-2-2-3-input exp. for A-O-I Triple 2-input NAND driver Dual 4-input exp. for A-O-I Dual 4-input exp. for NAND Triple 3-input NAND Exp. 8-input NAND Exp. 2-wide for input A-O-I Quad 2-input NAND 3-2-2-3-input AND/OR exp. for A-O-I Dual 4-input NAND 2-2-2-3-input A-O-I 8-input NAND Dual 4-input expander for A-O-I OR exp. dual 4-input AND Dual 2-wide 2-3-input exp. for OR exp. Exp. 3-wide, 2-input A-O-I Exp. dual 2-wide, 2-input A-O-I Triple 3-input NAND Quad 2-input NAND lamp driver</p>	<p>Gates, 6-KΩ Pull-Up Resistors Expandable dual 4-input NAND Quad 2-input NAND Triple 3-input NAND Dual 6-input NAND Expandable 8-input NAND 10-input NAND Quad 2-input AND Quad 2-input OR Quad 2-input NOR Quad 2-input exclusive-OR</p> <p>Gates, 2-KΩ Pull-Up Resistors Quad 2-input NAND Expandable dual 4-input NAND Triple 3-input NAND Dual 5-input NAND Expandable 8-input NAND 10-input NAND Quad 2-input AND Quad 2-input OR Quad 2-input NOR</p> <p>Power/Buffer Gates Exp. dual 4-input NAND buffer Exp. dual 4-input NAND power Quad 2-input NAND buffer Quad 2-input NAND power</p> <p>Hex Inverters With 6-KΩ pull-up resistors With exp. translator inputs With 6-KΩ pull-up resistors With 2-KΩ pull-up resistors With open-collector outputs</p> <p>Expanders Dual 4-input expanders</p> <p>Flip-Flops J-K/R-S (6-KΩ pull-up) J-K/R-S (6-KΩ pull-up) J-K/R-S (2-KΩ pull-up) Pulse-triggered binary (active pull-up) Dual J-K, sep. clocks, presets (6-KΩ pull-up) Dual J-K, sep. clocks, presets (2-KΩ pull-up) Dual J-K, com. clocks, clears (2-KΩ pull-up) Dual J-K, com. clocks, clears (6-KΩ pull-up)</p> <p>Monostable Multivibrators Gated, negative edge-triggered</p>	<p>Shift Registers Dual 25- and 32-bit static Dual 50- and 100-bit static Dual 128-bit accumulator Dual 16-bit static Dual 100-bit static Hex 32-bit static Dual 133- and 128-bit static accumulators Triple 66-bit dynamic Triple 64-bit dynamic Twin 512-bit dynamic shift register/accumulator Triple 60 + 4-bit dynamic 512-bit dynamic Dual 512-bit dynamic Dual 100-bit dynamic Quad 64-bit dynamic Quad 80-bit dynamic 4 \times 256-bit, 2-phase dynamic 2 \times 512-bit, 2-phase dynamic 1 \times 1024-bit, 2-phase dynamic</p> <p>Read-Only Memories 2560-bit dynamic ROM 2240-bit ROW output char. gen. 2560-bit static ROM 2048-bit static ROM USAC II to electric converter EBCDIC to USAC II converter USAC II to EBCDIC — electric to EBCDIC code converter Test code generator 3072-bit static ROM 1024-bit static ROM 8-level priority encoder 2240-bit series char. gen. 4096-bit static ROM</p> <p>Programmable Logic Arrays Random Access Memories 256-bit static RAM 1024-bit dynamic RAM High-speed content addressable memory 256-bit static RAM 2048-bit dynamic RAM 1024-bit dynamic RAM</p> <p>Special Purpose Devices 10 channel analog switch 6 channel analog switches Digital storage buffer</p>

MOS/LSI

Largest, most economical read-only memory.

Organized either as 512 words of 8 bits or as 1024 words of 4 bits, TI's new 4096-bit static ROM is one of the largest such MOS/LSI functions to date—and the most economical. The TMS 4400 is priced at less than 0.4¢ per bit in ceramic DIP, and even less in plastic. It is TTL compatible.

Memory organization and output buffer configuration may be programmed to customer specs. Three chip-select lines and single-ended buffers permit wire-ORing for large memory systems. Access time is well under one microsecond. For data sheet, circle 275 on the Reader Service Card.

Interface circuits

MODEM line driver and receiver meet EIA RS-232C spec—cold!

Using TI's new SN75150 dual line driver and new SN75154 quad line receiver permits MODEMs to receive and transmit with a minimum of IC packages, eliminates heat build-up problems. Both devices meet all EIA RS-232C requirements completely.

Available in TI's exclusive 8-pin plastic DIP, the SN75150 dissipates 200-300 mW, about half as much as similar ICs. The 16-pin SN75154 has a dual power supply for operation from +12 or +5 volts. For data sheets on both, circle 276 on the Reader Service Card.

Diode matrices

New programmable logic diode matrices.



Ten new monolithic diode matrices—programmable by selectively opening the fusible link in series with each diode—offer up to 48 diodes in flat pack or C-DIP. The ten come in two series: TIDM1 (10 nsec) and TIDM2 (25 nsec).

TI will perform programming at no extra cost, and the new matrices can be used as read-only memories, alphanumeric character generators, frequency generators and as encoders/decoders. Circle 277 on Service Card for data sheets.

Digital ICs: you'll find your broadest

ECL	Schottky TTL	High-Speed TTL	Standard TTL	
<p>Gates Dual 4-input OR/NOR 9-input OR/NOR Triple 2-input OR/NOR Quad 2-input NOR Quad delay inverter Triple 3-input NOR 4-wide 3-input NOR-OR 5-wide 2-input NOR-OR 6-wide 2-input NOR-OR 4-wide 2-input OR-AND/NOR-OR 4-wide 3-3-2 OR-AND/NOR-OR Quad 2-input OR Dual 3-wide 2-input NOR OR Dual 2-wide 2-input OR-AND/NOR-OR Four-bit group carry Full sum-carry adder Three-bit decoder with enable</p> <p>Multi-Output Gates (Drivers) Dual 2-input OR/NOR Dual 3-input OR Dual 4-input NOR Dual 3-input NOR</p> <p>Line Receivers/Drivers Dual diff-amp receiver Dual line driver</p> <p>Converters Dual HLL/ECL OR/NOR Dual ECL/HLL OR/NOR</p> <p>Storage Dual "D" latches Dual 1-input clocked latch Dual 2-input clocked latch</p>	<p>MSI Data Selector/Multiplexers Quad 2-line-to-1-line Quad 2-line-to-1-line (non-inverting)</p> <p>Gates, Inverters Quad 2-input NAND Hex inverter Triple 3-input NAND Triple 3-input AND Triple 3-input AND Dual 4-input NAND 4-2-3-2-input A-O-I</p> <p>Buffers/Line Drivers Dual 4-input NAND buffers Dual 4-input 50-ohm line drivers/NAND buffers</p> <p>Open-Collector Gates Quad 2-input NAND Triple 3-input AND Dual 4-input NAND 4-2-3-2-input A-O-I</p> <p>Dual Flip-Flops 125-MHz D-type ET 125-MHz J-K ET, clear, preset 125-MHz J-K ET, preset 125-MHz J-K ET, common clear, clock</p>	<p>MSI Arithmetic Elements 4-bit true/complement element Dual carry-save full adder</p> <p>Gates, Inverters Quad 2-input NAND Hex inverter Triple 3-input NAND Triple 3-input AND Dual 4-input NAND Dual 4-input AND 8-input NAND Dual 2-wide 2-input A-O-I 4-wide 2-input A-O-I</p> <p>Buffers Dual 4-input NAND buffers</p> <p>Open-Collector Gates, Inverters Quad 2-input NAND Hex inverter Dual 4-input NAND</p> <p>Expandable Gates/Expanders Dual 2-wide 2-input A-O-I 4-wide 2-2-2-3-input AND-OR 4-wide 2-2-2-3-input A-O-I 2-wide 4-input A-O-I Dual 4-input expander Triple 3-input expander 3-2-2-3-input AND-OR expander</p> <p>Flip-Flops 50-MHz J-K AND/OR gated ET 50-MHz J-K AND-gated ET 30-MHz J-K AND/OR-gated MS 30-MHz J-K AND-gated MS 50-MHz dual J-K ET, clear 50-MHz dual J-K ET, clear, preset 50-MHz dual J-K ET, com. clear, clock 43-MHz dual D-type ET 30-MHz dual J-K MS, clear 30-MHz dual J-K MS, clear, preset 30-MHz dual J-K MS, com. clear, clock</p>	<p>MSI Decoders/Demultiplexers BCD-to-decimal Excess-3-to-decimal Excess-3-gray-to-decimal 4-line-to-16-line (1 of 16) Dual 2-line-to-4-line Dual 2-line-to-4-line (OC)</p> <p>MSI Decoder Lamp Drivers/Buffers BCD-to-decimal decoder/driver (30 V) BCD-to-decimal decoder/driver (15 V) BCD-to-7-segment decoder/driver (30 V) BCD-to-7-segment decoder/driver (15 V) BCD-to-7-segment decoder (14-pin function) BCD-to-decimal tube driver</p> <p>MSI Code Converters BCD-to-binary Binary-to-BCD</p> <p>MSI Memories/Latches 16-bit RAM 16-bit RAM (GWI) 64-bit RAM, full decode 256-bit ROM, full decode 1024-bit ROM, full decode 4-by-4 buffer register file Quad bistable Quad bistable (14-pin) 8-bit bistable</p> <p>MSI Arithmetic Elements Gated full adder 2-bit binary full adder 4-bit binary full adder 4-bit magnitude comparator Quad 2-input exclusive-OR 8-bit odd/even parity generator/checker 4-bit arithmetic logic unit Look-ahead carry generator (for ALU)</p>	<p>MSI Asynchronous Counters Decade Divide-by-12 4-bit binary 50-MHz presettable decade 50-MHz presettable 4-bit binary</p> <p>MSI Synchronous Counters 6-bit binary rate multiplier Decade decimal rate multiplier Decade 4-bit binary Fully synch. decade Fully synch. 4-bit binary Up/down decade (1 clock) Up/down 4-bit binary (1 clock) Up/down decade (2 clocks) Up/down 4-bit binary (2 clocks)</p> <p>MSI Shift/Storage Registers 4-bit parallel-in, serial-out 4-bit universal parallel-in, out 5-bit dual-parallel-in, out Hex D-type FF/SR Quad D-type FF/SR 4-bit parallel-in, out bidirectional 4-bit parallel-in, out (J-K inputs) 8-bit serial 8-bit parallel-out Parallel-load 8-bit 8-bit parallel-in, bidirectional 8-bit parallel-in, out (J-K inputs)</p> <p>MSI Data Selector/Multiplexers 16-bit with strobe 8-bit with strobe 8-bit (14-pin) Dual 4-line-to-1-line with strobes</p> <p>NAND/NOR/AND/OR GATES INVERTERS Quad 2-input NAND Quad 2-input NOR Hex inverter Quad 2-input AND Triple 3-input NAND Dual 4-input NAND Dual 4-input NOR with strobes</p>

New TTL IC design book

Written by TI's IC applications staff and published by McGraw-Hill, *Designing with TTL Integrated Circuits* is 384 pages of valuable applications information. Send \$18.50 (check or money order only) to Texas Instruments Incorporated, P.O. Box 5012, M.S. 84, Dallas, Texas 75222.



TTL/LSI

New, custom-programmed 1024-bit TTL read-only memory costs a penny a bit.

For the first time, you can buy a custom-programmed TTL/LSI bipolar memory for as little as a penny a bit. It's TI's new SN54/74187 1024-bit random access memory – and you can get delivery 3 to 4 weeks after TI receives your custom pattern codes.

Typical access time of 40 ns makes the new ROM ideal for high-speed computer memories. Organized as 256 words by 4-bits, the memory is addressed in straight eight-bit binary with full on-chip decoding. Circle 272 on Reader Service Card for details.

MOS/LSI

New shift registers more economical than ever.

Economy is always a major benefit of MOS/LSI shift registers. Now, TI introduces three that are even more economical for use in calculators and terminals. They need no interface circuits or expensive clock drivers. TMS 3112 is a 6 x 32-bit static SR; TMS 3114 is a dual 128-bit device, and TMS 3409 is a quad 80-bit register.

Three other newly announced TI SRs provide long bit lengths for delay line applications. TMS 3412 is a 4 x 256-bit SR; TMS 3413 is a dual 512-bit circuit, and TMS 3414 is a single 1024-bit register. For data sheets, circle 273.

MOS/LSI

Now in time-tested, low-cost plastic.



All standard MOS/LSI devices supplied in ceramic DIP are now available in plastic, too – at typically 25% lower cost. Even shift registers normally in TO-100 packages are now available in plastic.

And reliability is excellent. More than 2.4-million device hours of MOS/LSI life testing have been completed on 16-, 18-, 24-, 28-, and 40-pin plastic packages. Circle 274 on the Reader Service Card for reliability bulletin.

New economy semiconductors expand your broad choice at TI.

Optoelectronics

Lowest-cost VLED:
TI's new 35¢ TIL209.



A new, highly-automated production line has made possible TI's breakthrough prices on visible light emitting diodes. The new VLED, TIL209, costs only 35¢ in quantities of 25,000 and 49¢ in small quantities of 100 to 4,999.

The TIL209 comes in a molded red filled plastic package, with an integral dome-shaped lens, 125 mils in diameter and 200 mils high. An epoxy filler in the VLED lens diffuses the emitted light creating a uniform light source throughout the dome structure.

The TIL209 features a radiated power output of 15 microwatts when forward biased at 20 milliamperes.

Because of its low cost, the TIL209 is ideal for use in home appliances, stereos and cameras; and as indicator lights in computer systems, data-processing equipment and communications systems. For your copy of TI's new optoelectronics brochure, including the full TI OPTO line of sensors, sources and coupled devices, circle 278 on the Reader Service Card.

Power transistors

TI reduces price, improves performance, doubles choice.

TI has turned on the power in plastic power transistors. Here's how:

Assembly time has been cut from 8 days to 4 hours to end delays and shortages. TI power transistors are there when you need them.

With industry-leading availability came industry-leading prices—down by an average of 20%. Plus, your ratings choice was doubled to 41 voltage/current combinations. Up to 100V and 25A, NPN and PNP complementary pairs, TO-3 and TO-66. Now industry's broadest line.

There's also a new high-performance plastic package. By far the most reliable you can buy, the new package design features an exclusive glass-passivated chip for lower leakage and better stability.

Also, all-soldered contacts boost resistance to thermal shock and vibration; solder-clad, copper leads facilitate solderability; nickel-plated copper heat sink improves thermal conductivity; pinned and soldered collector lead eliminates intermittent collector lead problems; plastic cap and epoxy fill solidly lock all elements inside the package.

High volume production, low prices, improved reliability, and broad choice: a whole new package of value built into TI's new plastic power transistor line.

Circle 279 on Reader Service Card for Brochure CB-124.



Small-signal transistors

Metal-can dissipation at low-cost plastic prices.

The highest power dissipation available in a plastic package—up to 800 mW—is yours with TI's SILECT® transistor line. You don't pay any more for this; in fact, you actually pay less. The reason is TI's lower-cost, lead-wire construction method as opposed to the conventional stamped lead frame.



And these transistors have been approved in practically all known sockets requiring power dissipation greater than 400 mW.

Your choice includes an NPN general purpose audio amplifier delivering three watts Class B power, TIS92, as well as a PNP version, TIS93. TIS92M and TIS93M are a complementary pair capable of three watts audio power. For video output stages, AFC amplifiers and Burst Amplifiers, there are the TIS100 and TIS101. Completing the line are the A5T5058 and A5T5059 high-voltage devices designed for operational amplifiers, high-voltage inverters and voltage regulators. For more details, circle 280.



TEXAS INSTRUMENTS
INCORPORATED

Here's a switch: A bright new idea that costs you 50% less.

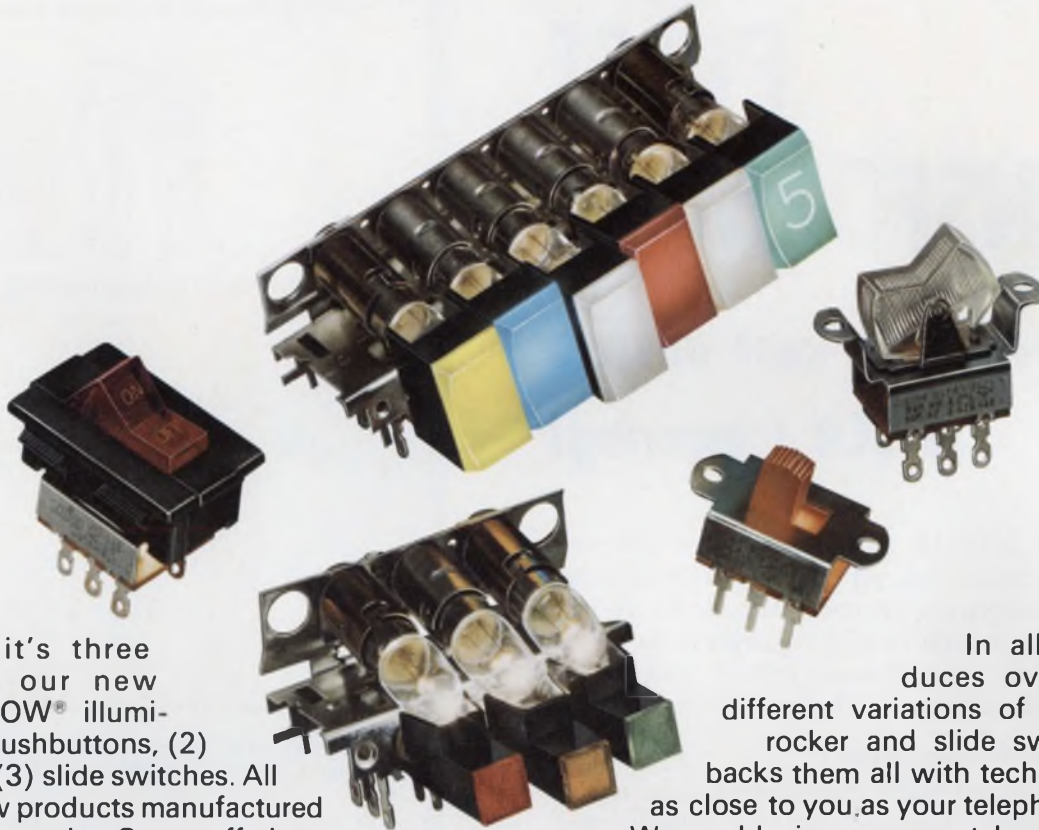

Actually, it's three switches: our new ULTRA-GLOW® illuminated (1) pushbuttons, (2) rocker and (3) slide switches. All brilliant new products manufactured by UID Electronics Corp., offering significant advantages over competition.

Not the least of which is the fact that ULTRA-GLOW products cost you up to 50% less than any others on the market.

Which means that now, for the first time, illuminated switches make cost and profit sense to companies other than just million-dollar computer manufacturers.

Now, your next question has to be, "How can UID give me a top-quality switch-and-light package—including the only illuminated push-button line whose basic switch is UL listed at 6 amps at 125v AC — for up to 50% less than competition?"

Well, the answer is that UID's high capacity, automated production and assembly techniques reduce unit costs to a minimum.

Not only that, UID does it with 4 week delivery, for companies in every conceivable industry, from toys to ultra-sophisticated computer manufacturers.

In all, UID produces over 500,000 different variations of pushbutton, rocker and slide switches, and backs them all with technical service as close to you as your telephone.

We could give you great long lists of all the other ULTRA-GLOW advantages. But we'd rather you send for and study our spec sheets depicting all three new ULTRA-GLOW switches.



UID Electronics Corp., Attn: Dept. ED
4105 Pembroke Road, Hollywood, Florida 33021
Phone: 305/981-1211 • TWX 510-954-9810

I've seen the light!

Please tell me more about your bright new ULTRA-GLOW illuminated push rocker slide snap-in switches.

Name _____

Title _____ Company _____

Address _____

City _____ State _____ Zip _____

Made to be used everywhere
 ...and priced so they can be

TRIGATE[®] PULSE TRANSFORMERS

... your lowest-cost answer
 to SCR triggering!

• Type 11Z TRIGATE Pulse Transformers are well qualified for industrial use, yet fully affordable for mass-produced commercial equipment. They can be used to both cut costs and improve SCR triggering in numerous applications such as: appliances, lighting controls, industrial controls, air conditioning and heating controls.

Unique features include:

1. Balanced pulse characteristics and energy transfer from primary to secondary and tertiary windings.
2. Minimum saturation effect to allow operation where increased pulse widths are required.
3. Fast pulse rise time and increased current capability to prevent SCR di/dt failure.
4. Increased energy transfer efficiency.

Operating temperature range, -10 C to $+105\text{ C}$. 2- and 3-winding designs for half- and full-wave applications. Turns ratios, 1:1, 1:1:1, 2:1, 2:1:1, 5:1. Available for use with line voltages up to 240 VAC or 550 VAC. Inductances to 1 mH at 550V, 5 mH at 240V.

For complete technical data, request Engineering Bulletin 40,003A. Write to: Sprague Electric Co., 347 Marshall St., North Adams, Mass. 01247

THE BROAD-LINE PRODUCER OF ELECTRONIC PARTS

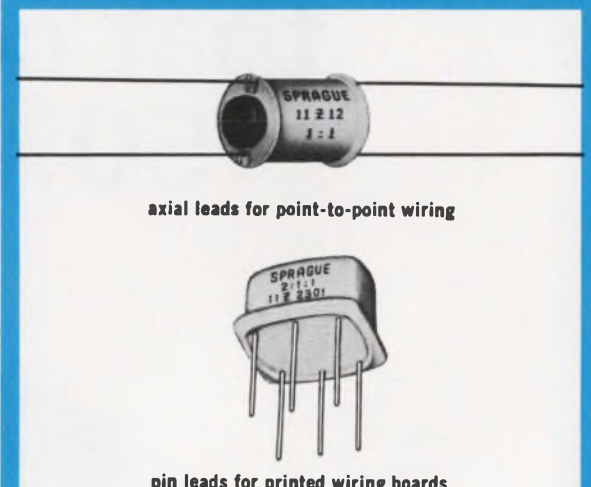

axial leads for point-to-point wiring

pin leads for printed wiring boards

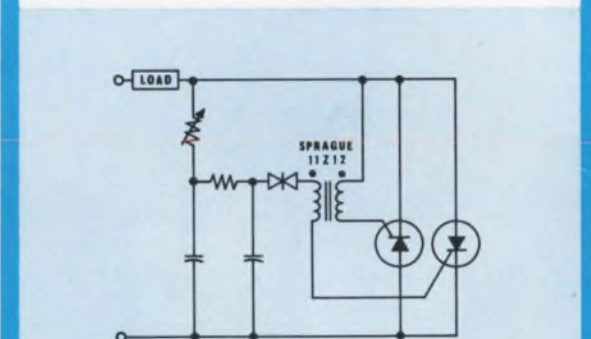

This breakdown-diode/transformer triggering circuit is a typical application for Type 11Z12 Trigate Pulse Transformers.

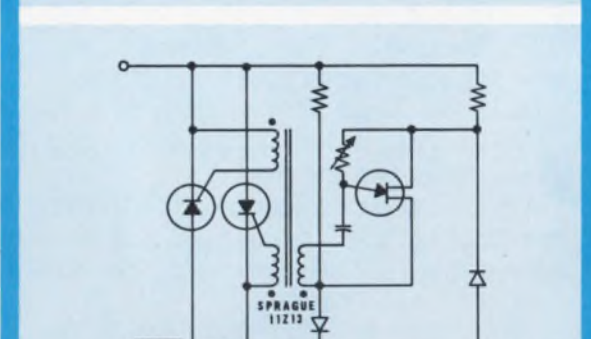

This unijunction-transistor/transformer triggering circuit is a typical application for Type 11Z13 Trigate Pulse Transformers.



'Sprague' and '®' are registered trademarks of the Sprague Electric Co.

highlighting

THE ISSUE



The use of the minicomputer is expanding at a rate nothing short of phenomenal. Mini suppliers are joyfully predicting an increase in worldwide systems sales and service to nearly \$1.6-billion in 1975—an annual growth rate of nearly 50% a year from the \$150-million of 1969.

The mini will be used in process-control and automation, data communications, medicine, education and traffic control, and it will be indispensable in scientific calculation, analytical instrumentation and business data-processing. The total of minicomputers shipped in 1969 was 30% of all computers shipped that year, and this figure is expected to grow to 90% by 1975.

Page 48



Continuously tunable over the frequency range of 50 kHz to 80 MHz in seven bands, a new rf signal generator uses a patented digital frequency lock circuit known as "Signalok" to achieve ultra-high stabilities of ± 10 Hz.

The model 925 generator, which is composed of a standard rf oscillator, a frequency counter and a synchronizer, provides high-stability signals by locking in the fundamental rf oscillator's output to the crystal time base of its built-in electronic counter. An external standard can also be used.

Page 91



The increasing use of electronic implants in the human body has begun to offer opportunities for engineers talented in designing precise tools for surgeons and physiologists.

While much of the work in implants is still performed at medical schools and government medical centers, some companies are providing doctors with this type of equipment. Avery Laboratories, Inc., of Farmingdale, N. Y., and Medtronics Inc., Minneapolis, have developed standards for implantable electronic prosthetics that have stemmed from continued association with leading research clinicians.

Page 25

PANEL DISPLAY IT

now it's possible

We've done the hard work— by making the first commercially available panel display subsystem for use in your application. Burroughs new SELF-SCAN panel display subsystem provides 256-character alphanumeric panel display capabilities and all necessary electronics — *drivers, memory, timing and character generation* — in a compact module.

And because SELF-SCAN panel display technology reduces electronics by 90% and cuts display thickness to less than 1½ inch, you get unprecedented flexibility and cost advantages for display applications.

The easily-read characters used in this unit are formed of dots on .040" centers, with eight 32-character rows in a 5 x 7 dot matrix format. Application versatility is designed-in with options including visual cursor, tab controls and expanded memory capability. The 256-character unit shown is available for off-the-shelf delivery; 64- and 128-character subsystems available soon. Units with only display and driver electronics are also available. Write or call for additional information: Burroughs Corporation, Electronic Components Division, Box 1226, Plainfield, N. J. 07061 (201) 757-3400.



256-Character **SELF-SCAN™** Panel Display Subsystems

Burroughs



Soviet reports advance in nuclear electricity

A system that converts nuclear energy directly into electricity, bypassing the laborious step of heating steam to drive a turbine generator, has been announced by the Soviet Union.

Tass, the official Soviet press agency, says in a statement that "comprehensive tests" have been completed on a thermionic converter with an electrical capacity of "several kilowatts."

Although details are insufficient to make a thorough appraisal, the Atomic Energy Commission says the Soviet development is at least "an important technical step."

In the United States thermionic power systems have been under development for some time, mainly for deep-space probes. A \$2-million contract from the Atomic Energy Commission for such a system is now in effect with the Gulf General Atomic Co. in San Diego. Specifications call for a system that will generate electricity in the 100-to-300-kilowatt range over a one-to-five-year period.

Other thermionic systems are under development by the General Electric Co. Laboratories at Vallejos, Calif., and at the General Atomic Div. of General Dynamics Corp in San Diego.

One problem in developing thermionic space power systems has been in finding nuclear materials capable of withstanding temperatures on the order of 1400 to 1900° C.

Other methods for direct conversion under development in the United States include the magneto-hydrodynamic (MHD) technique, in which an electrical conducting fluid is driven through a magnetic field; the thermoelectric method, in which the conversion is achieved by semiconductors, such as silicon and germanium alloys; and the use of electrochemical fuel cells that

can be regenerated by heat.

No system has been developed in the U. S. to date that will convert "several kilowatts," as the Soviet Union reports.

3 advanced satellites to study atmosphere

NASA has ordered three scientific satellites to study the atmosphere, and they will incorporate two highly advanced features for unmanned craft: They will descend to as low as 75 nautical miles above the earth without being pulled down to earth, and the spin rate of each satellite will be controlled by an on-board special-purpose computer.

When the low orbit begins to decay, a hydrazine propulsion system will be turned on in the craft, and it will be able to boost it to an apogee of 2500 miles. The on-board computer will command an electrically driven motor to control the satellite's spin rate. The rate at apogee will be 150 rpm; at perigee the computer will be programmed to slow the spin to from 0.5 to 10 rpm, to permit equipment aboard to conduct experiments at this altitude.

Called Atmosphere Explorers, the three satellites will be built by RCA's Astro-Electronics Div. in Princeton, N. J., for the Goddard Space Flight Center, Greenbelt, Md., under a \$12-million contract. The purpose of the missions is to acquire data in the thermosphere, where most of the sun's ultraviolet radiation is absorbed—a phenomenon that generates the energy actions and chemical processes that determine the composition of the upper atmosphere. The only information on this region to date has come from sounding rockets and smaller satellites.

The experiments, which Goddard will order from suppliers and give to RCA, will include an electron temperature probe, photometers and mass spectrometers. The instruments will gather data on such subjects as neutral particle and ion compositions, electron, ion and neutral gas temperatures; thermal electrons and photo-electrons; extreme ultraviolet radiation and air glow.

The satellites will be cylindrical, weigh 1000 pounds and be 54 inches in diameter and 36 inches high. They will be powered by solar cells mounted on the sides and top—paddles won't be used because aerodynamic drag is a consideration at the low altitudes at which the craft will fly. Their effective life is to be one year.

Telemetry will be transmitted at 2250 MHz, using pcm/pm modulation. It will be sent either real time or recorded and then transmitted when the satellite is passing over a ground station. An extra vhf transmitter (136 MHz) will also be used for real-time, down-link transmission. Uplink command signals will use 148 MHz.

At least one satellite will be put into polar orbit from the Western Test Range at Vandenberg Air Force Base, and one into an equatorial orbit from Cape Kennedy.

New group explores cure for unemployment

In an effort to deal with the related problems of engineering unemployment and what it calls "misguided national priorities," a new organization called the Committee for Social Responsibility in Engineering held a conference concurrent with the IEEE convention in New York.

Speakers included Rep. Edward I. Koch of New York City, Prof. Seymour Melman of Columbia University, Prof. Samuel Mason of the Massachusetts Institute of Technology, and the chairman of Ralph Nader's Clearinghouse for Professional Responsibility, Peter Petkas. Almost all of the speakers cited excessive dependence on military work as the cause of the current engineering crisis. Increased nonmilitary spending was suggested as the cure. As both

Congressman Koch and Professor Melman pointed out, this does not mean they are advocating an end to military work, but rather a better balance between military and civilian projects.

A Hofstra University professor, John Ullman, while agreeing wholeheartedly with this position, was not at all optimistic about achieving the desired balance.

"Nothing is being done," he asserted. "All sorts of bills are being dropped into all sorts of hoppers, but no results are forthcoming."

Ullmann, who is both an economist and an engineer, speculated that what he called the "Arab Refugee Approach" — keeping people in misery for political mileage — was being practiced on the nation's engineers by the Pentagon.

"Unemployed engineers," he explained, "may be a force in favor of increased defense spending."

The solution, according to Ullmann and many of the other speakers at the conference, is for engineers to take an active role in deciding where they should apply their skills. Unfortunately, he pointed out, "engineers tend to be very passive." Thus, getting them to come to help themselves was not regarded as an easy task.

Laser cuts men's suits —and cost too, by 25%

An automatic laser fabric cutter has been developed by Hughes Aircraft Co., of Culver City, Calif., for Genesco, Inc., of Nashville. According to Franklyn M. Jarman, chairman of Genesco, "This is the first major advance in the apparel industry since the sewing machine." The company expects the machines to save it as much as 25% in producing men's suits.

Fabric rolls off a bolt onto a conveyor, which pulls the fabric into position under the laser cutting head. A two-axis linear motor, developed by Xynetics, Inc., of Canoga Park, Calif., drives the cutting head over the fabric at an average speed of 20 inches per second, in accordance with the pattern. Instructions to the head are given by a Hewlett-Packard HP-2116B minicomputer. This is an 8-

K, 1.6 μ sec machine.

A fixed laser, developed by coherent Radiation Laboratories of Palo Alto, Calif., produces a 250-W beam of infrared energy. This is directed through an optical system to the moving head and then down onto the fabric. It produces a spot two thousandths of an inch in diameter, which does not burn the fabric away but sublimates it.

Two suits a minute can be cut by the machine. The development cost to Genesco was \$1.3-million. Three of the machines will be installed in Fredericksburg, Va., at the L. Greif & Bros. subsidiary of Genesco.

GaAs off-shelf wafers offered for first time

Gallium arsenide substrate material for light-emitting diodes has been in short supply because of large user demands and a shortage in production facilities. But the Bell & Howell Electronic Instruments Group, Pasadena, Calif., has just made available, for the first time, standard GaAs wafers from stock, with no turn-around time.

John Nickerson, marketing manager for Bell & Howell, explains that the company has increased its production facilities to handle large user demands and to eliminate long turn-around times.

"Formerly users have had to wait four to six weeks for small orders," he says. "Now they can get these orders off-the-shelf with no waiting."

Nickerson, who attributes the shortage of GaAs materials in part to non-uniform wafer specifications, adds: "We have developed a set of optimum mechanical and electrical GaAs wafer specifications and have standardized their production for faster deliveries."

AF to push studies in avionics program

Requests for proposals are expected to be invited soon on two avionics study contracts in an Air Force program that could result in a multimillion market.

The program would create an integrated avionics system for

military aircraft that would receive, through a single terminal, communications, navigation and identification information. This information would be transmitted from a network of satellites and ground facilities, all in the same frequency band, using compatible modulation techniques (see "Air Force Plans Integrated Avionics Network," ED 18, Sept. 1, 1968, p. 30). The Air Force Systems Command's Electronic Systems Div., will head up the program.

One of the two study contracts will be to determine the cost of the equipment and to highlight the most promising areas for potential cost reductions. The other contract is for an analysis of the projected message traffic, to determine the structure of the message flow and the characteristics and modes used for command and control of aircraft.

The frequency band and modulation techniques will be suggested by industry. The Air Force wants to steer clear of pushing any favorite bands or modulation techniques, in the hope that an improved system will result.

'Explosive' growth seen for hospital systems

"Health care will explode in the 70s to \$200-billion by 1980, from \$70-billion last year and \$27-billion 10 years ago. Hospital information systems sales will grow 17% annually during the next 10 years." So says Frost & Sullivan, Inc., the New York City research organization. It has just published a study, "The Hospital Information Systems Market," with prospects for hardware and software analyzed and forecast through 1980. In 1970, the study found, 90% of all installed systems were used for bookkeeping only. In the next decade, the findings continued, these systems will be expanded to include pharmacy control, patient monitoring, medical history, laboratory reporting, diagnosis, teaching, menu control and meal distribution. For information on obtaining the survey, contact Joseph Levy, Industrial Studies Div., Frost & Sullivan, 106 Fulton St., New York City 10038.

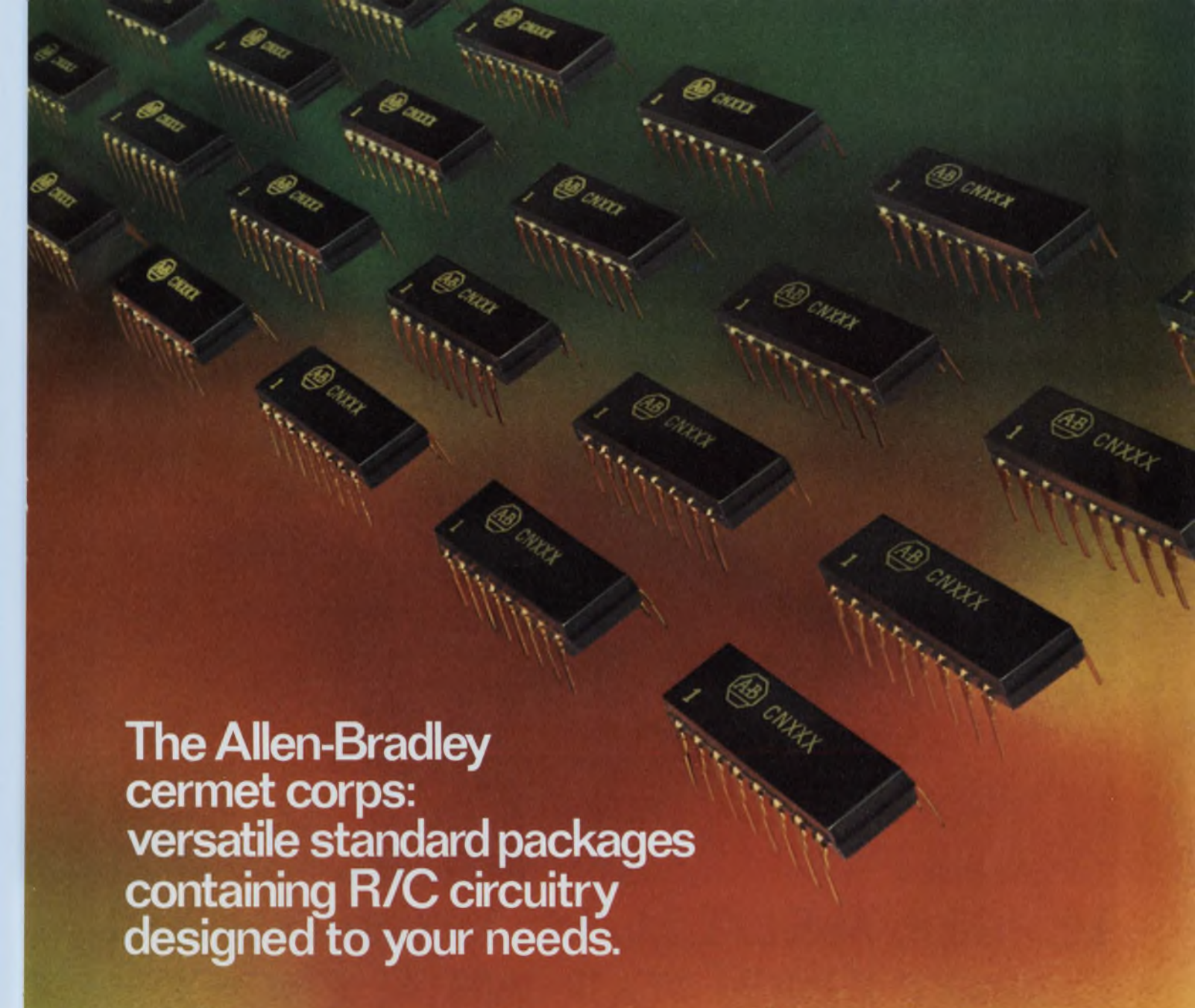

The Allen-Bradley cermet corps: versatile standard packages containing R/C circuitry designed to your needs.

The need: compact R/C networks in DIP's for terminator applications in new generation computer designs. To meet the circuit board space crunch, Allen-Bradley combines resistors and capacitors in a package compatible with automatic insertion equipment. These cermet networks save space and attachment costs. Packaged in dual in-line molded packs that lock out the environment and

match your IC's. Lead frames with built-in stand-offs are weldable or solderable. Volume production available.

SELECTED SPECIFICATIONS

TOLERANCES	Absolute to $\pm .5\%$
TRACKING	Excellent
RESISTANCE RANGE	10 ohms to 10 megs. standard; 1 ohm to 100 megs. special
CAPACITANCE RANGE	To 60,000 pF per cm ²
TCR	As low as ± 100 ppm/ ^o C
CALIBRATION	Abrasive or laser
LEAD SPACING	100 mil standard

Investigate the advantages of Allen-Bradley cermet R/C networks. For information write: Marketing Department, Electronics Division, Allen-Bradley Co., 1201 South Second Street, Milwaukee, Wisconsin 53204. Export office: 1293 Broad St., Bloomfield, N. J. 07003 U.S.A. In Canada: Allen-Bradley Canada Ltd., 135 Dundas Street, Galt, Ontario.



Actual Size



I.C./D.I.P./M.S.I./L.S.I./P.C.-For sockets with initials MAKE CINCH YOUR INITIAL CHOICE

For standard or custom multiple contact sockets, Cinch has — or will design — a high reliability device for your application.

P.C. sockets, with only .130" profile, use a new, unique miniature terminal, with wiping contacts, for 0.016"-0.019" diameter pins. Socket configurations, up to 100 contacts, for MSI, LSI, DIP or read-out tube use can be produced.

DIP sockets, for 14, 16 or 24 pin DIPs with pins as short as .100" in a variety of insulations and platings are available as standard units. Cinch industrial distributors stock many styles for immediate delivery.

C-7132

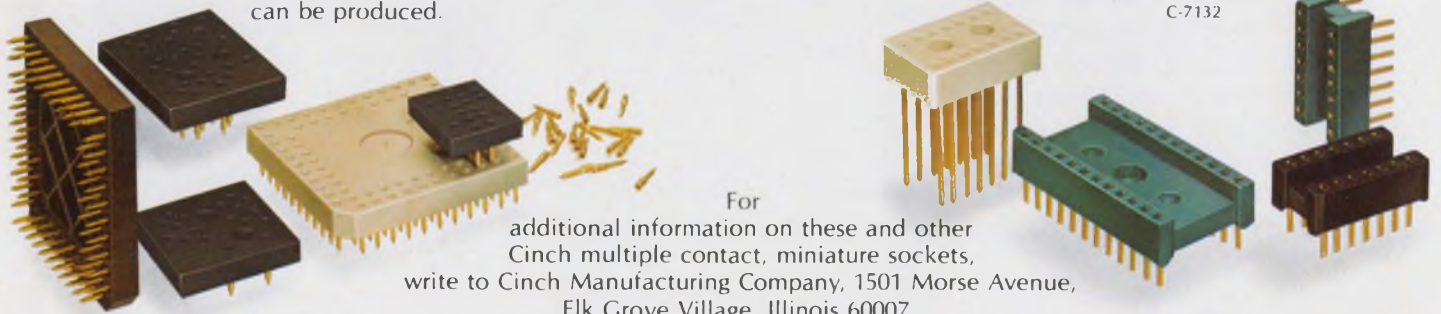

For additional information on these and other Cinch multiple contact, miniature sockets, write to Cinch Manufacturing Company, 1501 Morse Avenue, Elk Grove Village, Illinois 60007.

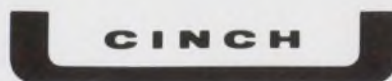

For pain and other suffering, new 'fast relief' is electronic

The increasing use of electronic implants in the human body has begun to offer opportunities for engineers talented in designing precise tools for surgeons and physiologists.

While much of the work in implants is still performed at medical schools and government medical centers, some companies are providing doctors with this type of equipment. Avery Laboratories, Inc., of Farmingdale, N. Y., and Medtronic, Inc., Minneapolis have developed standards for implantable electronic prosthetics that have stemmed from continued association with leading research clinicians.

In recent months surgeons have become more confident in the use of these devices, and the number of operations involving electronic implants—while not large in comparison with all operations—has increased greatly. While the types of devices are basically the same, the applications include:

- Suppressing intractable pain that cannot be eased by drugs, operations or other forms of

medical therapy.

- Inducing respiration in patients suffering from hypoventilation—a decrease in the muscular action of the lungs.

- Stimulating the bladder function in paraplegic patients to elimi-

minate a tiny receiver that could last a lifetime without being removed from the patient's head.

- Pacing the heart.

In each of these cases, batteries are not implanted in the patient. The devices operate by using an rf

transformer or transmitter to couple energy through the intact body wall to the transformer's secondary coil, or to a receiver that is implanted along with the electrodes, which stimulate specific body areas. Thus the implanted part of the equipment is designed to operate for the life of the patient without being replaced. This also permits complete control of the rate, amplitude and duration of the stimulus. Also, for those patients who display signs of recovery, the stimulus can be completely turned off.

But the materials problems are still not solved. At the Solid-State Circuits Conference last February, Robert Huber, director of the Solid State Electronics Laboratory at General Instrument, Salt Lake City, said that a material that is absolutely inert when placed inside

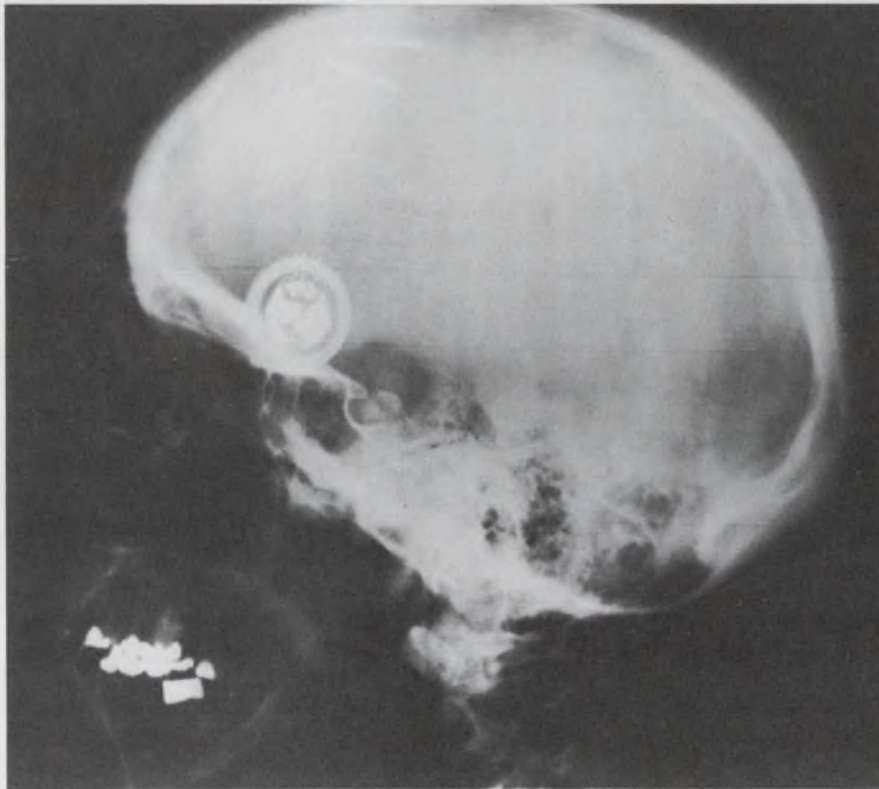

By stimulating the supraorbital branch of the trigeminal nerve, surgeons can alleviate severe facial pain. The receiver is above the eye, and the electrodes can be seen in the area of the forehead.

nate colostomy bags and catheters from the stomach and urinary tract.

- Alleviating paralysis caused by strokes, spinal-cord or head injuries and possibly permitting patients to walk.

- Facilitating hearing with a



Experimental neuro-stimulator consists of a transmitter with a coiled loop antenna. The antenna is placed over an implanted receiver.

the body had not been found. According to Huber, even Silastic—an epoxy-like covering—while a relatively good material for insulating implanted devices, is permeable to water and salt in the body.

The most common immediate problem with implants is the breakage of electrode wires. According to Dr. C. E. Anagnostopoulos and Dr. William W. L. Glenn, cardiovascular surgeons at the Yale University School of Medicine, "No unbreakable electrode wire has yet been developed for a bipolar system of stimulation." The factors that determine the ability of electrodes to resist breakage, they say, include the kind of metal used, the shape of the electrode, the type of waveform and the technique of placing the electrode in the body.

Electrical energy blocks pain

Although a number of theories have been formulated about the nature of pain, most pain-suppression techniques are based on empirical findings: They work.

In 1965, Dr. Ronald Melzack, professor of physiological psychology at McGill University in Montreal, and Dr. Patrick D. Wall, professor of psychology at Oxford University in England, set forth a new theory. Their "Gate Control Theory" of pain indicated that electrical energy could be used to perform a nerve-blocking function.

Roger Avery, then a consulting engineer, developed the electronics for the first neuro-stimulator for this application. The electronics consisted of a radio transmitter

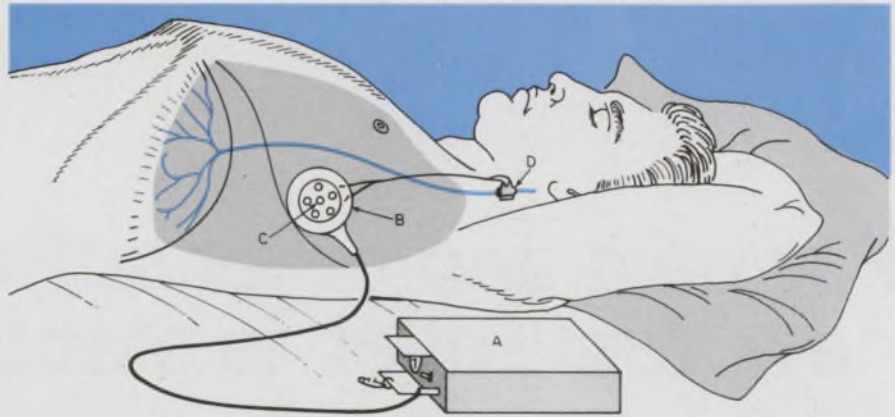

Electrophrenic respiration equipment includes a battery-run transmitter (A) which transmits signals through the antenna (B) to an implanted receiver (C) connected by subcutaneous wires to implanted electrodes (D) surrounding the phrenic nerve.

with a voltage and frequency control, an implantable receiver and platinum electrodes embedded in Silastic.

Dr. William H. Sweet, a neurosurgeon at Massachusetts General Hospital in Boston performed the first operation based on the "Gate Control Theory" of pain. The electronics implanted by Dr. Sweet in 1965 are still functioning, according to Karl Hallgren, marketing manager for Avery Laboratories. Hallgren says that the number of neuro-stimulators supplied by Avery in the last six years totals about 300, and that 150 such units have been sold in the last 12 months.

A critical factor in the design of the neuro-stimulator was in making the electrodes conform to the shape of the nerve. Avery accomplished this by reducing the size of the platinum electrode contacts to 1.5×1.75 mm. These were placed on Silastic pads 1-mm thick and 1 cm square.

Two Silastic pads, each with four platinum disks, are placed so that stimulation can be applied transversely across the nerve. This design varies, depending on the nerve to be stimulated. Each of the lead-wires is made of vacuum-deposited stainless steel filaments insulated with Silastic. They connect the electrodes to an rf receiver button, which is buried in the subcutaneous tissue adjacent to the nerve. "To fit the nerves more precisely," says Dr. James P. Wepsic, neurosurgeon at Massachusetts General Hospital, "the interelectrode distance has been varied 1, 2, 3, 4, 5, 7

and 10 mm." The rf receiver button is made of high-temperature components, which allow the entire assembly to be steam-autoclaved.

Patient controls transmitter

The radio transmitter operates at a carrier frequency of 2 MHz and puts out a bi-phasic square wave. Pulse width can be varied from 50 to 300 μ s and the voltage from 0 to 42 V. Pulse rate goes from 10 to 500 pulses per minute.

The patient can adjust both the pulse rate and the voltage. During stimulation, the transmitter's antenna is held or taped over the receiver button. This system is very similar to one being supplied by Medtronics.

While most of the operations in which neuro-stimulators are implanted are for pain in the leg or back, pain in the facial area has also been relieved with this technique.

In certain patients the breathing function can become so suppressed as to cause severe complications, such as an enlarged heart. This condition is referred to as "hypoventilation" and may be caused by central-nervous-system disorders, emphysema or bulbar polio. In such cases, iron lungs or respirators are used to assist respiration.

But more than 25 years ago it was found that an electric current applied to the phrenic nerve in the neck could stimulate the motor function involved in breathing.

The technique of electrophrenic respiration was advanced in the

C-LINE ONESHOT POWER PULSER



**more pulse stability
costs you less...**

and it's already designed to save you time.

This unique thick film hybrid circuit delivers a high power output pulse (up to 10 amps, 60 Volts) for a precisely-timed interval (500 μ sec. to 50msec.) initiated by the positive edge from a DTL, RTL, or TTL gate. It's optimized for pulse driving inductive loads in industrial applications such as print hammers, solenoids, servos and stepper motors. The Power Pulser is a complete, ready-to-use circuit in an 8 lead TO-3 package that will cost you less than building the complete function with discrete components. And, because a complete circuit can be treated as a single component, you can save P.C. board space, assembly costs and testing time. It's extremely versatile too. The load may be placed in the collector or emitter circuits of the output Darlington and driven from either plus or minus supply voltages. For optimum economy, the Unitrode PIC400 Series Power Pulser is stocked as a standard product. The built-in timing resistor is laser trimmed to user's requirements with a timing tolerance of $\pm 5\%$ over a temperature range of 0°C to 125°C. It's obviously a case in which being indiscrete has its advantages.

For fast action, call Sales Engineering collect at (617) 926-0404
Unitrode Corporation,
Dept 4B, 580 Pleasant St., Watertown, Mass. 02172

Application Notes and complete specs on request.



UNITRODE

quality takes the worry out of paying less.



Stimulation of the sciatic nerve can ease pain. X-ray shows shrapnel embedded in the body. The patient, a war victim, suffered phantom limb pain. Even though his leg had been amputated, the residual nerves transmitted pain signals to the brain. This was stopped by a neuro-stimulator, whose electrodes can be seen at the left of the body's midline. The four crimps for the electrodes are shown toward the top left of the X-ray.

mid-1960s when Dr. Glenn of the Yale School of Medicine and his associates used inductive coupling to eliminate the need for wires passing through the body wall to an external power supply.

After experiments with dogs, Dr. Glenn performed the first implant operation on a human in 1965. Nine patients have undergone such operations at Yale, five of them last year.

The instrument used is similar to the neuro-stimulator, but in this case the rf signals induce electrophrenic respiration.

When the phrenic nerve is stimulated, the diaphragm descends, pulling air into the lungs. This is achieved by implanting a receiver under the skin with wires leading to electrodes at the phrenic nerve.

The carrier frequency of the transmitter is 2 MHz; pulses are 1 to 2 ms wide. Inhaling can be varied from 5 to 25 breaths per minute, but it is set typically at 17. The power is about 2 W. As with the neuro-stimulator, the antenna is usually taped to the body.

The physiological advantage of this type of respiration, compared with that performed by a respirator, is that it creates a vacuum in the lungs, which fill with air—

much more in line with the actual breathing function. So far no patients with emphysema have received electrophrenic respiratory implants, but if the results continue to be positive, this technique could have far-reaching effects in aiding large numbers of such victims.

Electrical stimulation of the bladder and the bladder nerves, using rf coupling to an implanted device, has been achieved by Dr. Blaine Nashold at Duke University in Durham, N. C. While the basic technique is not new, the successful use of rf coupling with humans, after long experimental work with animals, may make this a means of eliminating catheters and colostomy bags in paraplegics.

Last year a group of doctors and engineers at Rancho Los Amigos Hospital in Downey, Calif., used a pacemaker-like device to enable partly paralyzed stroke victims to walk. The device is being built by Medtronics, with a team of Los Amigos doctors supplying medical expertise.

According to Dr. Vernon Nickel of Los Amigos Hospital, the patient wears the power pack on a belt. This is connected to a transmitter, which sends impulses to a tiny

receiver, which stimulates the peroneal nerve in the leg.

A key element in the design is the triggering of the transmitter with a tiny microswitch in the heel of one of the patient's shoes. Dr. Nickel says that this switch provides the proper timing interval to enable a patient to walk.

Tiny hearing aid sought

An implantable hearing aid that stimulates the inner ear directly without a power supply was invented in 1968 by a Medtronics engineer, Rollin Denniston.

The device consists of a crystal less than half an inch long and ten-thousandths of an inch in diameter. A Teflon-coated platinum wire leads from the crystal implanted in the middle ear into the cochlea, or inner ear. From the inner ear, acoustic signals are converted to a form that can be transmitted to the brain via the auditory nerve. It is the vibration of the inner ear that performs this conversion process.

According to Dr. Jack A. Vernon, professor of otolaryngology and director of the Kresge Hearing Research Laboratory at the University of Oregon Medical School, the development of a complete hearing aid will require a tiny implantable microphone, as well as a battery pack to power the device.

At the Yale School of Medicine Wade G. Holcomb, Genichi Sato and Dr. Glenn have designed, built and tested an rf pacemaker in experimental animals. The implanted capsule contains circuitry to transmit electric current to the heart and convert received rf pulses from an external transmitter to constant-stimulus pulses. The anode electrode is attached directly to the implanted receiver.

The implanted receiver includes an electrocardiogram transmitter circuit and a secondary coil to receive the rf magnetic field from the patient's antenna. The rf voltage is converted by a rectifier circuit to dc. This supplies voltage for the electrocardiogram transmitter. The second circuit, the stimulus receiver, transmits signals to the single electrode at the heart. With both of these circuits, the cardiogram can be monitored, and if the heart fails, the organ can be paced at the proper rate. ■■

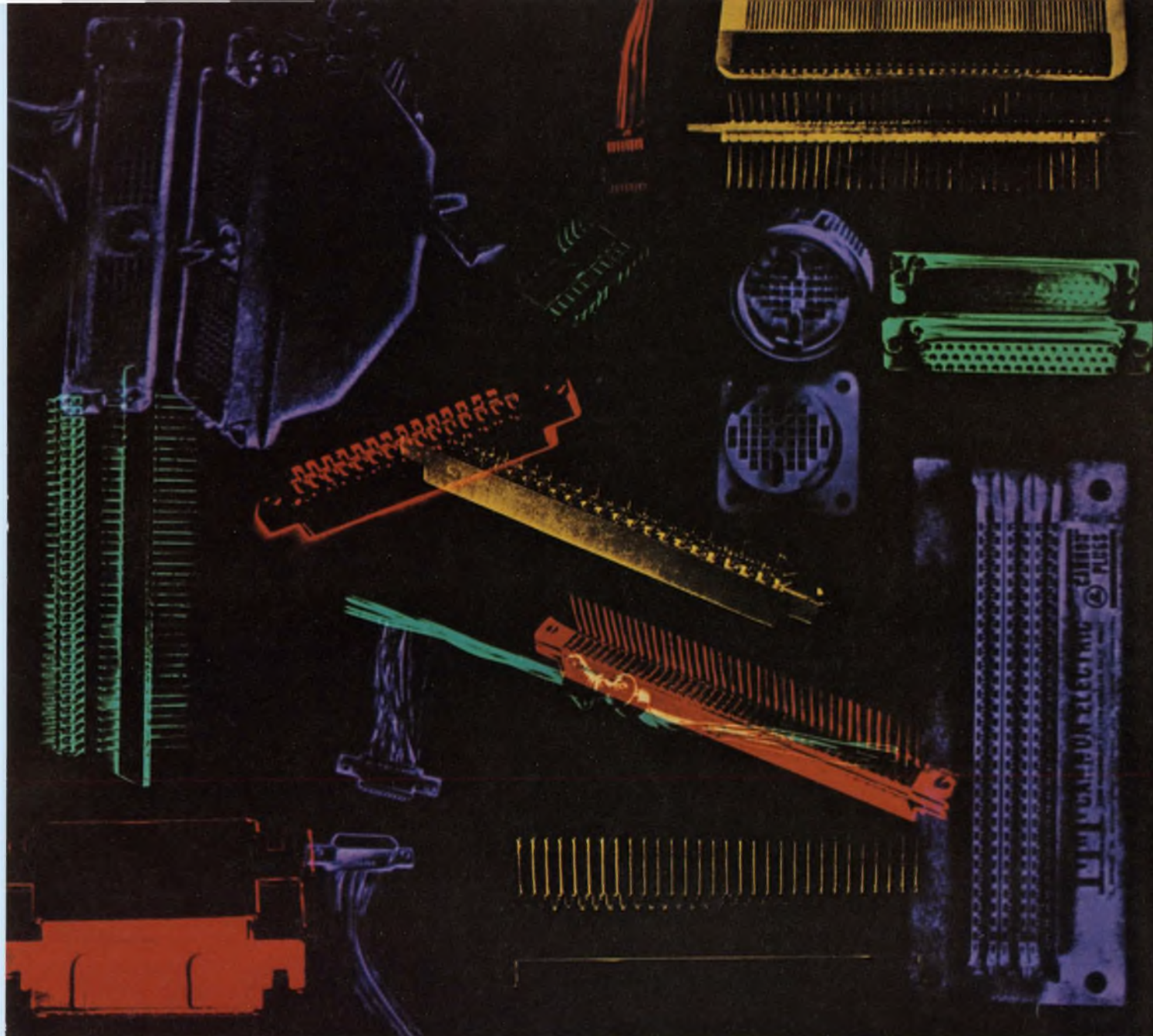

There are more reasons to buy Cannon than other EDP connectors. One is DL.

ITT Cannon now offers you a full line of EDP connectors. Printed circuit, input/output, flexible cable, microminiature—you'll find them all at Cannon. And some you won't find anywhere else. Like our exclusive DL's—multiple-wire rectangular connectors with cam-actuated spring contacts. They feature low cost, low mating force and low contact wear. Their crimp and wire-wrapping terminations make them ideal for I/O, cord-to-cord, and cord-to-panel applications.

Other input/output connectors you'll be interested in are our low cost Burgun-D subminiature rectangulars, and CL's (circulars combining low mating with high contact force).

Some of the other reasons why Cannon means

EDP are: low-cost, versatile backplane assemblies; bottom preloaded plate connectors; MIL-C-21097 edgecard connectors; low-cost circulars; FLEX-LOC cable connectors; and microminiature rectangulars, circulars and strip configurations, including the 50MIL for memory core applications.

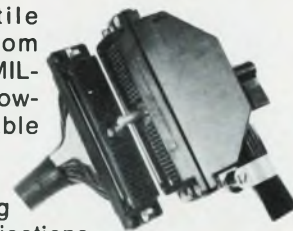

We've just shown you some of the reasons for connecting Cannon with all your EDP requirements. For others, contact ITT Cannon Electric, International Telephone and Telegraph Corporation, 3208 Humboldt Street, Los Angeles, California 90031 (213) 225-2151.

CANNON ITT

\$12 Army vibration transmitter may end up on industrial duty

An electro-optical transmitter, originally developed by the Picatinny Arsenal to collect vibration data from a rotating 105-mm rocket projectile, may prove valuable in industrial applications.

The device has an edge on conventional equipment. Mechanical commutators are noisy, have poor frequency response and don't adapt conveniently to all physical configurations under test. And while tele-

metry is effective, it is expensive.

"The electro-optical system is simple, rugged and cheap," says its developer, John Bera, an electronics engineer in the Army's Engineering Science Laboratory at Picatinny in Dover, N.J. "It has a good frequency response from 200 Hz to 100 kHz, and it doesn't require a skilled technician."

Besides transmitting vibration data, Bera says, his transmitter can also send measurements of temperature, pressure, resistance and noise. "It just depends on the

transducer you put on the rotating object. It would be very useful for testing motors and generators," the engineer says.

Hardware for the entire unit costs no more than \$10 or \$12, Bera says. It measures 1.5 by 1.5 by 2 inches.

The device operates by using a piezoid transducer to measure the vibration and convert it to an electrical signal. This signal is amplified and used to modulate the transmitting light-emitting diode.

The light sensitive diode in the receiver then converts the emitted lightwave back to an electrical signal. The signal is amplified and sent through impedance interfaces to the respective data-monitoring and readout equipment.

The range from transmitter to receiver is a little more than a half inch, "Just enough to keep the receiver away from the rotating body," Bera says. "With a better lens this could probably be increased to a foot."

The transmitter has an over-all voltage gain of 40, measured from the source-follower input to the receiving-amplifier output. Voltage gain is dependent on the circuit design and the optical characteristics and alignment of the two light-responsive diodes. Use of a 7-mm lens to focus the light from the emitting diode onto the receiving diode produces an output signal that is at least twice the magnitude of the voltage at the emitting diode terminals at the point of optimal alignment.

At present, the device is connected for single-channel operation. However, by electronic switching or multiplexing, multi-channel operation is possible, Bera says. On the present laboratory system, the over-all frequency response is limited by the transducer. ■■

John F. Mason
Military-Aerospace Editor



Electro-optical transmitter, examined here by its inventor, John Bera of Picatinny Arsenal, sends vibration data on 105-mm rotating projectile.

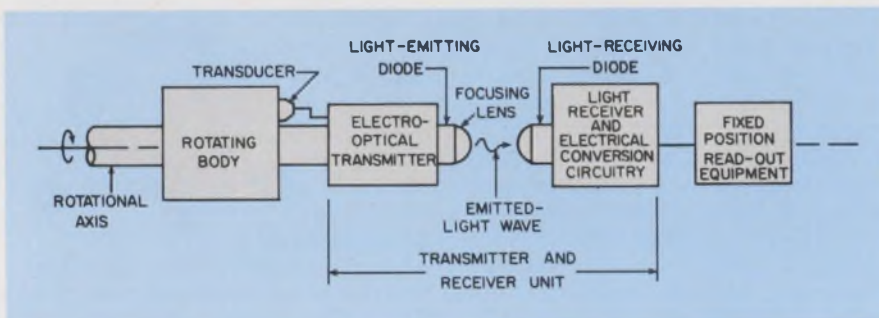

Transducer picks up vibration data from rotating object and feeds it into an electro-optical transmitter. The transmitter's modulated beam is received by diodes, converted back to the vibration rate and presented on a display.

Belden the Special "Specials" specialist

Here's what to do when cable catalog specs just won't do the job: Dial Area Code 317 ■
Then dial 966-6681 ■ You'll get action ■ From a man who devotes full time to solving
engineered cable problems ■ A Belden specialist that "lives"
with your design parameters from engineering through the
actual production run ■ Cables for underwater-under-
ground devices . . . extra-high voltage and pulse ap-
plications . . . medical instrumentation . . . low-level
signal interference problems . . . unusual environ-
mental conditions . . . he's tackled them all ■

Phone now.

8-5-0

DIAL (317) 966-6681

BELDEN



. . . new ideas for moving electrical energy

With the price right, CMOS is headed for new applications

For years, complementary symmetry metal-oxide semiconductor (CMOS) integrated circuits, because of their relatively high cost, have been used virtually exclusively in aerospace and military applications. But prices have been dropping, and the door is now open to industrial and consumer applications.

CMOS has these advantages over standard MOS logic: speed that is 10 or 20 times faster; high noise immunity (30 or 40% of the supply voltage); very low power drain (in microwatts); and the need for only one power supply instead of two or more.

And in the last month the price barrier has been all but shattered by RCA. The company's Solid State Div. in Somerville, N. J., has announced a new line of 23 low-voltage CMOS ICs. The price: half of

what it was six months ago, and one-tenth of what it was when these devices were first made available commercially in August, 1968.

Costs for RCA's new CD4000A line range, in quantities of 1000, from 96 cents for a dual, three-input NOR gate and inverter to \$5.70 for a 14-stage counter. Quad and/or select gates are now going for \$1.75 apiece. In 1968 the same gate cost \$17.50.

Packaged in plastic, instead of ceramic, the new RCA devices have also reduced the minimum operating voltage from 6 to 3 V, with the upper end remaining at 15 V. This has been made possible by using a cleaner oxide process, according to Elvet Moore, RCA's MOS product manager.

"This cleaner process does two things," Moore explains. "It lowers the threshold of both p- and n-devices, permitting us to characterize all of our circuits at the 3-V level. And it has also given us an improved yield. In addition we have three types—not a part of the new line—

that go down to 1.3 V."

The new line has been designed to operate at the 3-V level to double the speed at 5 V, Moore explains. Whereas the older devices operated at 5 MHz at 10 V, the newer line has speeds of 5 MHz at 5 V and 10 MHz at 10 V. The 3-V level also gives good performance at 5 V for TTL compatibility.

Moore sees a growing interest in such applications as digital voltmeters, portable calculators and electronic clocks and watches, where the low power drain is an advantage. He also notes that there is a use in automotive applications where the high noise immunity is useful.

Electronic wristwatches appear ideally suited for CMOS ICs, and RCA has a wristwatch circuit under development. Another manufacturer, Intersil, Inc., of Cupertino, Calif., has been making a 1.2-V silicon-gate CMOS and selling it to Seiko Watch-K, Hattori, Ltd., Japan's leading watchmaker, and also to a 19-company Swiss combine

Jim McDermott
East Coast Editor

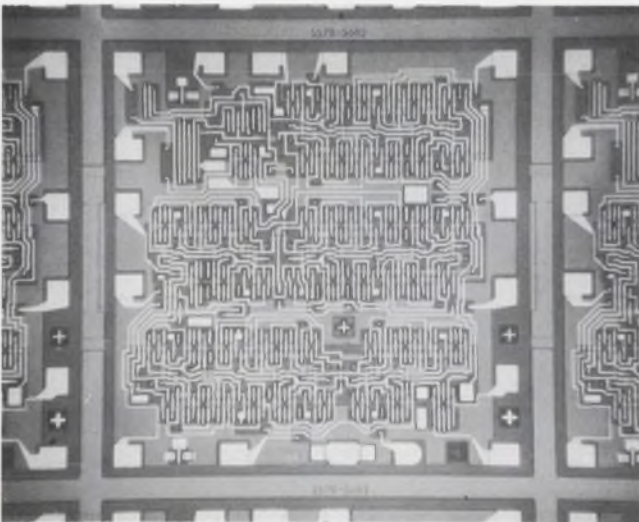

This CMOS eight-stage static shift register, selling for \$4.35, is one of RCA's new, low-cost series. Power dissipations for these MSI circuits are typically 10 μ W, while that for a gate package is 10 nW.

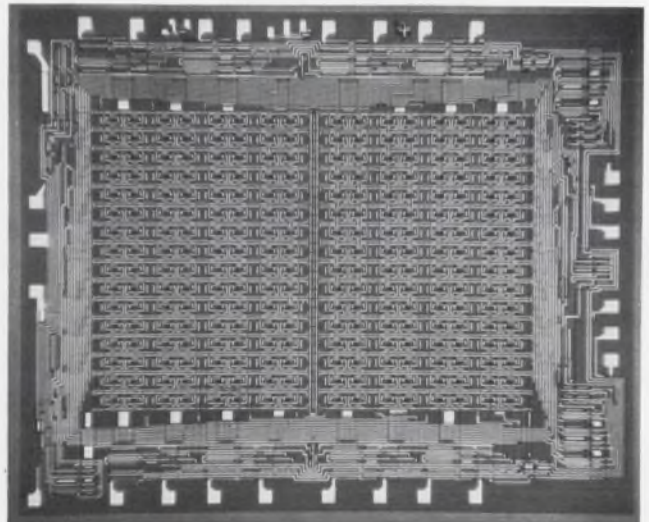

The CMOS chip, above, is a 256-bit RAM with decoding. Made by Ragen Semiconductor, it has 1900 devices on the chip, operates on 5 to 16 V, and has 32 eight-bit words. It is compatible with TTL logic.

called the Center of Electronic Horology.

Harry Neil, director of MOS marketing for Intersil, says that the ultimate CMOS market for watches will be about \$100-million a year.

Advantages of the silicon-gate process include a very low threshold voltage—almost at the theoretical lower limit of a few tenths of a volt—plus higher packing density of the devices on a chip.

RCA has been the leader in CMOS IC circuitry, but it has competition. Solid State Scientific of Montgomeryville, Pa., produces a series SCL 4000—a pin-for-pin replacement for the earlier RCA CD 4000 line—operating in the range of 6 to 15 V. But Oolep Indreko, manager of the circuits group at Solid State Scientific, points out that although the SCL 4000 series is his company's principal line right now, it will be developing silicon-gate CMOS devices with a low threshold voltage of 0.7 V for watch applications.

Large-scale arrays available

Another maker of CMOS ICs is Ragen Semiconductors, Inc., of Whippany, N. J., formed originally by men from RCA's CMOS operation. But its president, Albert H. Medin, says Ragen does not intend to compete with the RCA line.

"We specialize in large-scale arrays," he says.

He points out that Ragen's line includes custom items of 128-bit, and 64-bit static shift registers, as well as a 256-bit, random-access memory. These CMOS circuits range up to just under 2000 devices on a chip.

Motorola Semiconductor Products, Phoenix, also makes a basic line of CMOS gates and flip-flops.

Is MOS dead? Not by a long shot, says Berry Cash, vice president of marketing for Mostek, Inc., Dallas. He says MOS has the edge over CMOS in circuit complexity.

"Complimentary MOS is more the complexity level of TTL logic than conventional MOS," he asserts.

To hedge its bets, though, Mostek is planning to make CMOS. Cash says that he expects to market it by the end of this year. He sees the big market in low-power, low-voltage applications. ■■

new

From Veeder-Root... mini package predetermining and control that coincidentally gives maxi information



Our little 7702 Counter is only about 4 x 4 x 7 inches small, but it does a big job. It contains a predetermining counter which compares an input signal with a preset number. When coincidence is reached, the output circuit is activated to perform control functions. This solid state counter can replace — economically and efficiently — mechanical and electromechanical devices in machine tool, weaving, knitting, paper, chemical and pharmaceutical applications. For maxi information on our mini counter, write Veeder-Root, 70 Sargeant St., Hartford, Conn. 06102 (203-527-7201).

- Available with or without numerical display in 2, 3, or 4 decade models. (Without numerical display, a flashing light indicates every count.)
- Operates over DC to 10 kHz frequency range.
- State-of-the-art integrated circuits enable it to operate reliably over temperature range of 30 to 140°F.

V E E D E R - R O O T

INNOVATORS IN NUMERICS COUNTING/RECORDING/CONTROLLING

A VEEDER INDUSTRIES COMPANY



Cores on degaussing table being demagnetized.



The reason our core memories are in big demand is a small matter.



The small matter.

A core memory system is only as reliable as the cores that go into it. When you make 20-million-bit mass memories like our Large Core Store (LCS), you need the highest reliability. So we've invented an exclusive way of making cores uniform in quality, density and size. We have a way of testing every core for mechanical and electrical reliability before it's strung. Quality control all the way. All the way from cores to stacks, and from intermediate

systems to the LCS (20,000,000 cores worth of quality...that's no small matter). We'll make a compatible memory for any system you have, or any you have on the board. One with built-in economies. We specialize in specials, so buy only as much memory as you need. Just make your demands.

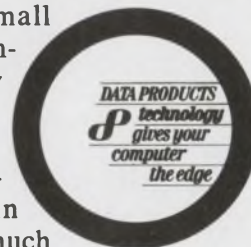

DATA PRODUCTS

OEM marketing 16055 Ventura Blvd., Suite 419, Encino, California 91316

Acton, Massachusetts (617) 263-3961; Bethesda, Maryland (301) 652-8120; Cherry Hill, New Jersey (609) 667-7555; Dallas, Texas (214) 231-2240; Detroit, Michigan (313) 354-5858; Los Altos, California (415) 941-5485; Los Angeles, California (213) 981-9600; Melbourne, Florida (305) 723-0720; Minneapolis, Minnesota (612) 827-8747; Amsterdam, The Netherlands 020-156-287; Tokyo, Japan 483-6451; London, England 01-578-2817; Vienna, Austria 34 53 61, 34 44 18

Our core memory systems...



CM 1700 Large Core Store — An advanced high-speed random access mass memory providing up to 20 million bits

in either 40 or 80 bit configurations. A 2-wire, 2½D system with 2.0 microsecond cycle time; 1.25 microsecond access time.

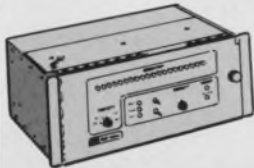

Store/33 — Buy only as much memory as you need: 4K x 6 to 16K x 24. A flexible

plug-in system with a full choice of cycle times. Built for easy maintenance and field expansion, with 2½D cycle times at 3D cost.

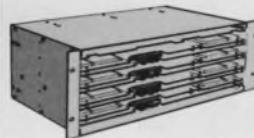

Store/233 — A planar core memory with modular design for ease of maintenance

and low spare parts inventory. The use of 3-wire 3-D organization provides access time of 275ns with a full cycle time of 650ns. Unit capacity is 4K x 18 to 16K x 18.

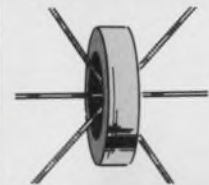

Ferrite Memory Cores — Our exclusive process gives you uniform quality at a greatly reduced price (as little as \$2.50/K).

Cores are cookie-cut from continuous ferro-plastic tape. A full range of diameters and electrical characteristics.

Remember them for speed and reliability. And for the matter of quality.



DATA PRODUCTS
OEM marketing

16055 Ventura Blvd., Suite 419
Encino, California 91316

New oxide boosts tape output and clarity

Development of a new magnetic oxide, termed a "major technological breakthrough" by the 3M Co. in St. Paul, Minn., makes possible an entirely new family of video tapes and sound cassettes, according to Daniel E. Denham, general manager of 3M's Magnetic Products Div.

The new proprietary formulation —ferric oxide modified with cobalt —"will have a tremendous impact on the future of video and sound cassette systems for the instructional and home entertainment markets," he says.

The tapes, backed with the new oxide material, operate at standard low-noise bias and equalization levels, making them compatible with current equipment as well as tailor-made, more sophisticated equipment of the future. Use of the tape for instrumentation applications will be announced the middle of May, 3M says.

The audio tapes have shown less distorted output at all frequencies as well as an improvement in dynamic range from 2 dB at low frequencies to 6 dB at the high end, according to 3M.

The video tapes already produced for test purposes show a 4-dB in-

crease in both rf output and signal-to-noise ratio. This means better color purity and a much crisper and cleaner picture, Denham says.

Backing the tape with a protective layer of micro-thin oxide has other advantages, the company says. It reduces flutter and wow, as well as unaligned tape, which is primarily responsible for cassette jamming.

The magnetic oxide tape will work well with a new high-speed video tape duplication system that 3M is developing, Denham says. The system will utilize three copy stations simultaneously duplicating at a tape speed of 150 inches per second. Conventional video tape duplication is accomplished at a speed of 15 inches per second for quadruplex broadcast tapes and at lesser speeds for helical tapes.

High Energy cassettes, as the new tapes are called, will first be introduced in 60 and 90-minute lengths. Extended Range cassettes in the full line of 30, 60, 90 and 120-minute lengths. Both lines are scheduled to be marketed early this summer. Prices will be 10 to 15% higher than those for conventional tapes. ■■

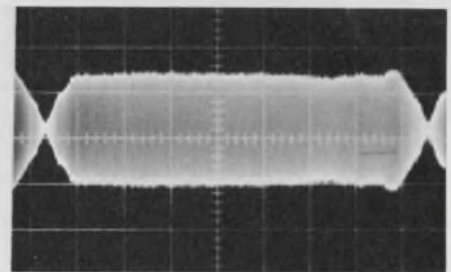
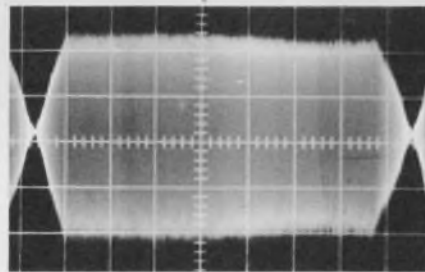

New "High Energy" tape being placed on video helical recorder is treated with a cobalt-modified ferric oxide formulation that creates a 4-dB increase in both rf output and signal-to-noise ratio. The 3M Co. will use the new material on video tapes, sound cassettes, and instrumentation and computer tapes. Above are the oscilloscope readings of rf output of standard tape (left) compared with almost double the output (right) of the tape backed with the new oxide.

The Magn

HP's got a great new idea in counters: buy one that just fits your specific application—without paying for extras you'll never use. Yet make your choice from a family of six counters with a wide range of unique features, at prices so low you'll wonder how we did it.

You'll get all the things you expect from our 5326 and 5327 family of counters: totalizing, frequency, ratio, period and time interval measurements, in a range of 50 MHz or 550 MHz.

In addition, they let you perform tasks no counters could handle before.

For instance, you can now do IC logic timing testing simply and economically with 15 picosecond resolution. HP's unique time interval averaging mode makes it possible! (Request HP Application Note 129 for the story.) Price is just \$1195 for a 50 MHz unit and \$1795 for the 550 MHz model with this powerful time interval capability.



ificent Six.

For just \$355 more you can get a counter with a DVM built in. So you can do things like measure rise times more rapidly, simply and accurately than with a scope. And you can check external dc voltages with it, too. Add a \$60 HP 11096A Probe if you need rf voltage measurements.

Want programming capability? Our options will permit remote control of all front panel functions, including trigger levels and attenuators.

Computer interface is easy and costs less than ever.

Suppose you just want the basics? Our frill-free models will supply them with trouble-free, simple operation. They'll cost you \$950 for 50 MHz, \$1495 for 550 MHz.

Your HP field engineer has the 5326/27 data sheet that tells the complete story about these precise new counters. Or write to Hewlett-Packard, Palo Alto, California 94304; Europe: 1217 Meyrin-Geneva, Switzerland.

INFORMATION RETRIEVAL NUMBER 27

02102



HEWLETT  PACKARD

Counters that promise a lot and deliver it all.

Trigger On A Free Triac Or Two.

... it'll handle up to 1,000 watts, full-wave!
... reliably and at low-cost!
... 25 to 600 volts!

The new, 4 A plastic Thermopad* Triac is destined to find its economy-minded way into more medium-current, power control designs than you can shake a price list at — and, you can get a 200-volt MAC77 Triac together with the MBS4991 trigger and 2 application notes from your Motorola distributor . . . right now . . . for your workbench prototype . . . FREE!

And, if you're into lamp and relay drivers, small motor controls, gate drivers for larger thyristors and sensing and detection circuits, tell your distributor you want a free 800 mA, 200 V Unibloc* SCR — optimized . . . and priced . . . for 3 different temperature requirements.

Big enough to handle 1,000 watts, yet inexpensive enough to be 100-up priced at only 86¢ at 200 V, the new MAC77/2N6068 series features reliable, fully glass-passivated (glassivated) construction. And high operating temperature capability is afforded by low forward voltage drop and low thermal resistance. θ_{JC} is, in fact, only 3.5°C/W making them naturals for demanding industrial/consumer motor controls, light dimmers and relay replacements, particularly where heat sinking problems occur.

Symmetrical gate and hold characteristics ensure consistent bidirectional switching. Both are low, 30 mA maximums.

Its nearest competitor costs over 10% more at 200 volts!

The MAC77/2N6068's hand-in-glove partner in phase-control, the MBS4991 bilateral switch, provides 0.2%/°C temperature coefficient, uniform conduction characteristics in both directions and built-in protection against premature firing. It turns on in 1 microsecond!

Contact your Motorola distributor today . . . put it all together with Motorola thyristor power control — FREE!

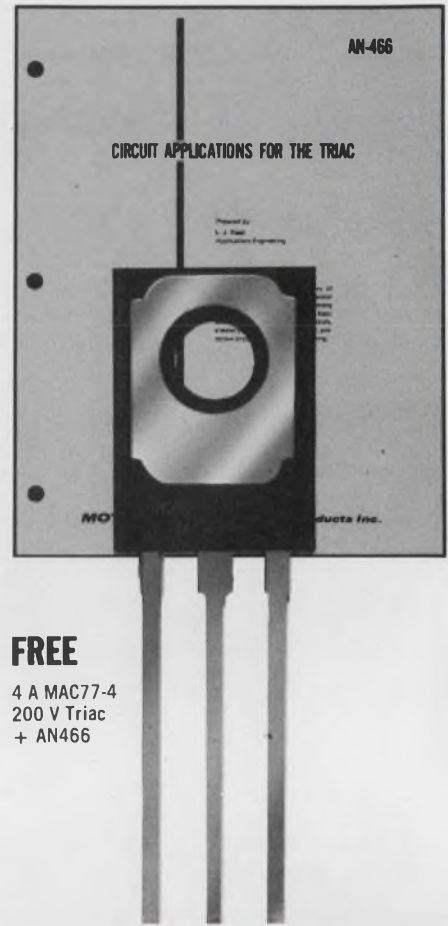

FREE
4 A MAC77-4
200 V Triac
+ AN466

...and the
broadest line of
plastic thyristors
available!

Circle the reader number and receive data sheets on them all. Or write Box 20912, Phoenix 85036 to trigger an immediate response to your immediate power control application needs.

Trigger Me On A Free Thyristor Or Two

TO: (Distributor) _____

Send me: MAC77-4 (2N6071)/MBS4991 200 V Triac Design Kit
 2N5064 200 V SCR Design Kit

NAME _____

TITLE _____

COMPANY _____

ADDRESS _____

CITY _____

STATE _____

ZIP _____

*TRADEMARK MOTOROLA INC.



MOTOROLA THYRISTORS
— 300 ways to get control

AN-526
Application Note

**THEORY, CHARACTERISTICS AND APPLICATIONS
OF SILICON UNILATERAL, AND BILATERAL SWITCHES**

Presented by
Lester J. Rosenberg
Microelectronics Engineering

The AN-526 is constructed to assist
engineers in the design of silicon
unilateral switches, bilateral switches,
and silicon diodes. It contains
theory and application information plus
circuit applications in the form of silicon
diode, unilateral switch and diode. Circuit
diagrams include the AN-526, AN-527 and
the AN-528.



MOTOROLA Semiconductor Products Inc.

FREE
Full-Wave MBS4991
Bilateral Switch
+ AN526

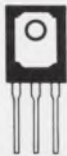

MAC10/11 Triacs — 10 A
glassivated ruggedness
in 2 or 4 quadrants
2N4441-44 — Glassivated
8 A plastic SCR
MCR406/407-Sensitive-
gate 4 A SCR



FREE
2N5060-68/MCR101-104,
MCR115-120 SCRs — 800 mA,
sensitive-gate, 85°,
110° or 125° application



MCR106 SCR —
True power rated,
sensitive-gate



MUS4987/MBS4991 —
Bilateral/Unilateral
triggers for
phase-control



2N4870's — Versatile,
economical unijunction
transistors
MU4891's — Wide-spec-choice-
at-low-cost unijunctions
MPU-131's — Programmable,
nanoampere leakage
unijunctions



MU851's — Compact,
1 MHz, color-coded,
computer unijunctions

INFORMATION RETRIEVAL NUMBER 29

ELECTRONIC DESIGN 8, April 15, 1971

technology abroad

A MOS transistor capable of 100-MHz operation has been developed by Hirst Research Laboratories of the British General Electric Co. To attain these speeds, the Hirst researchers used a combination of ion implantation and high-precision masks made with an electron microscope. In these transistor masks, made with a modified Cambridge Instruments stereoscan microscope, the channel is 1-micron long and the over-all pattern width is 12 microns.

A laser beam to measure the temperatures in an electrical arc has been used by Brown-Boveri's research group at Baden, Switzerland. Light is deflected when it passes through zones of differing temperatures. Consequently the temperature in a cross-section of the arc is obtained by photographing the magnitude of laser-beam deflection as the arc is scanned by the beam. This method can be used with temperatures up to several thousand degrees C. Above this the beam is luminous, and temperature is obtained by spectral analysis of the light.

A new method of mounting integrated-circuit chips directly onto inexpensive plastic tape has been developed by Philips Research Laboratories, Eindhoven, the Netherlands. The technique, while similar to that recently announced by General Electric in the U. S., has two significant differences. First, each flip-chip is directly bonded to a mating connection pattern on the film; GE uses a beam-lead technique. Second, each flip chip can be directly mounted on a specially designed header with conventional dual in-line pins; GE's IC chips have copper leads that are directly attached to the user's substrate. To demonstrate feasibility, a monolithic

audio amplifier with an output power of 3 W has been fabricated.

An attractive method of fabricating silicon-on-sapphire MOS microcircuits has been proved feasible by scientists at the Battelle Development Corp., Geneva, Switzerland. Instead of etching the thick silicon coating with conventional photolithographic techniques, Battelle engineers have selectively deposited silicon directly onto the sapphire substrate. This has been done by treating selected areas with a tantalum impurity. On these areas silicon can be deposited in a single process. The method overcomes such drawbacks as undercutting and bad pattern resolution, which can exist with other techniques.

A television set capable of receiving 12-GHz signals, was built by Mullard engineers in London to demonstrate how pictures might be directly received from a satellite without the intervention of an earth station. In the TV set, microstrip techniques are used throughout. The 12-GHz input is converted directly to vhf. Gunn devices are used for local oscillators while varactors provide local-oscillator automatic frequency control. Integrated circuits are used for FM-to-AM conversion as well as for the image rejection.

A 1500-W transmitter-receiver that handles all marine telephone, telegraph, telex and facsimile services has been produced by Askjeselskapet NERA of Oslo, Norway. Features include a digital frequency synthesizer that provides frequencies in 100-Hz increments from 10 kHz to 30 MHz. A special control permits tuning to the nearest 5 Hz in this range.

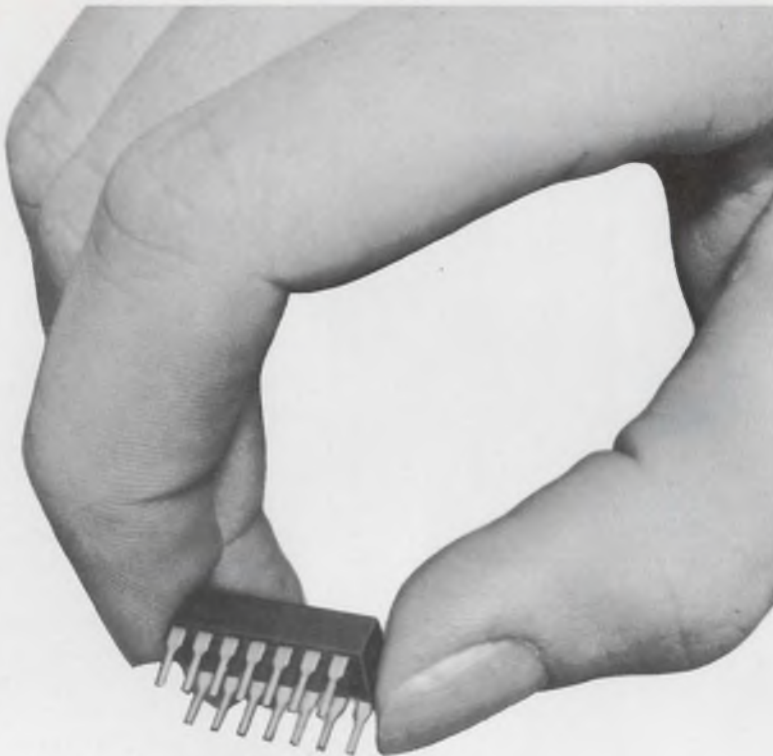

THIS LATCHING RELAY

**...HAS A LIFETIME OF 100 MILLION BOUNCE-FREE OPERATIONS
IN ANY MOUNTING POSITION**

It's a Logcell® Mercury Film Relay. It has an inherent contact memory. So no extra parts are needed to make it latch. It needs no holding current, either. The surface tension of a mercury film does it.

The same mercury film assures a bounce-free closure every time. Since it doesn't use a pool of mercury, a Logcell Relay can operate in any mounting position. Even under shock and vibration.

Logcell Latching Relays have been tested to billions

of operating cycles. That's why they can be rated at 100 million operations with a 90% confidence level.

The contacts of a Logcell Relay are self-healing. And produce virtually no contact noise. Contact resistance is constant within a four milliohm range.

For more information about latching and nonlatching Logcell Relays, and Logcell Switches, too, write Fifth Dimension Inc., Box 483, Princeton, New Jersey 08540. Or call (609) 924-5990.



FIFTH DIMENSION INC.



all fhp motors are alike?

Now that you're surprised at how different this Howard fhp motor looks on the *outside*, let's talk about *output*:

When Howard rates a motor 1/20 hp, we're not about to underpower your system with a 1/25 hp motor. We've always True Rated our fhp motors this way.

Now engineers and designers are finding that a carelessly overrated or underrated motor can cause system problems. And they want no part of either. That's why engineers look to Howard for True Rated fractional horsepower motors...

and they get them. Our computer guarantees it. And your products benefit.

Next time you look at the outside of a Howard motor, you won't find mod painting. You will find that if the label says 1/20 hp, we don't mean 1/25 hp. Or 1/15 hp, either.

Get the complete Howard True Rated story. Find out in detail why it makes no difference that all fhp motors *look* alike. It's the output that counts. Write or call Howard for Fractional Horsepower Motor Information Packet ED-471.



HOWARD

HOWARD INDUSTRIES
MSL INDUSTRIES, INC./MOTOR GROUP
2420 18th STREET, RACINE, WISCONSIN 53403
414-632-2731 TWX 910-271-2387

INFORMATION RETRIEVAL NUMBER 31

Siemens



Our MKL metallized lacquer capacitors handle peak voltages four times their rated voltages.

And that means you can use a much smaller capacitor for any given application. This is just one of many Siemens innovations. Our double anodized foil aluminum electrolytics are 30% smaller than competitive units. And our unique MKM metallized polycarbonate construction makes possible a

dramatic reduction in the size of film capacitors.

Our capacitor line is one of the most extensive available. Film and metallized film dielectrics of paper, lacquer, polyester, polycarbonate, polypropylene and polystyrene. Tantalum and aluminum electrolytics. All for immediate delivery.

More and more engineers are designing in Siemens capacitors. You can benefit by doing the same.

Siemens Corporation, 186 Wood Avenue South, Iselin, N.J., 08830. (201) 494-1000.

Siemens. A three billion dollar name in quality products.



SIEMENS

washington report

DON BYRNE, WASHINGTON BUREAU

AWARS contractor selection imminent

The Air Force is expected to announce shortly the winner in the competition to provide the Airborne Weather Reconnaissance System (AWARS) with improved equipment for the early detection and tracking of hurricanes. The General Dynamics Electronic Div. in San Diego, and Kaman Corp., Bloomfield, Conn., conducted four-month, \$300,000 studies last year as finalists in the competition. The winner is to produce a prototype system incorporating off-the-shelf and new equipment that will be flight-tested aboard WC-130 aircraft before the Air Force outfits 23 WC-130B/E and 10 WC-135B aircraft with the system. AWARS includes new weather-reconnaissance radar, a data-processing and display system, a data-transmission system and meteorological sensor systems to measure dewpoint, wind velocity, temperature, pressure, turbulence and other data.

Israeli visit triggers Defense Dept. missile program

A visit here last fall by Israeli Prime Minister Golda Meir and Defense Minister Moshe Dayan set off a Pentagon search for new defenses against late-model, Russian-made surface-to-air missiles. The U. S. Air Force has \$16.2-million in this year's budget for the project. Formed to work on the project is the Defense Suppression Group headed by Col. Gerald Hendricks of the Systems Command at Andrews Air Force Base.

The Israeli leaders had asked for help to combat the SAM missiles introduced around the Suez Canal by the Egyptians during the cease-fire. The U. S. Air Force is looking at several things, including the use of drones to detect the sites and to drop laser-guided bombs to destroy the missiles, or to be armed themselves with warheads and flown into the installations. A decision, says the Air Force, is expected late this spring.

Burial for the SST to cost \$275-million

Congress will soon get another chance to vote on the Supersonic Transport—this time for \$275-million needed to put the project out of business. The Department of Transportation says it will need that much to return deposits for the plane made by air carriers and to pay General Electric and Boeing contract termination money.

Meanwhile the pink slips fly. Boeing will lay off 7000, of which 2500 are management or "overhead" personnel. GE, the engine contractor, says 1500 people will be affected, although it hopes to move some of them to other slots within the company. SST subcontractors will fire 6000 employees, according to the Aerospace Industries Association. And DOT itself has started issuing layoff notices to the 177 people who make up its SST team including its director, William McGruder.

Representative Frank Bow (R-Ohio) has introduced legislation which

would allow the government to underwrite bonds to be sold to the public to finance the project, but little chance was seen for any success. DOT Undersecretary James Beggs says the project is "dead as a doornail."

Proxmire to hold hearings on defense industry

Sen. William Proxmire (D-Wis.) will open hearings this month before his Joint Economic Committee on defense contracting procedures and profits made by defense contractors. Proxmire's action follows release by the General Accounting Office of a study of procurement on 146 weapons systems. The GAO found cost overruns of \$33.4-billion and was highly critical of delays, unrealistic schedules, inadequate application of performance criteria and cost-effectiveness programs. It also recommended that the Defense Dept. change its procedures to figure allowable profits on a basis of percentage of contractor investment rather than on a percentage of costs.

Capital Capsules: Capt. Robert H. Smith, writing in the Navy-sanctioned Proceedings of the U. S. Naval Institute, calls the Navy's destroyer-escort construction program "**The greatest mistake in ship procurement the Navy has known.**" The captain was referring to the 46 ships of the DE 1052 and DE 1078 class, which cost about \$20-million each. He said that the ships' 8000-pound sonar domes make for severe handling problems; that the ships are too slow for ASW missions; and that they lack sufficient firepower. **The same is true, he charged, of new destroyers—the DD-963 class—being built by Litton Industries** NASA researchers at the Ames Research Center, near Palo Alto, Calif., **have been successful in tests to detect oil slicks via airborne sensors**, which can eventually be transferred to satellites for worldwide detection of oil spills. Tests showed that the airborne radiometer not only could detect the spills but could also pinpoint their size, makeup and volume The Federal Communications Commission, as expected, **has reaffirmed its stand, taken last year, that the data-processing field should be left unregulated.** The commission ruled that the companies were not common carriers and therefore should not be regulated, while the common carriers should be allowed to offer data-processing services as long as the operations were kept separate from the companies' other communications business. The case had been under study by the FCC for four years Sen. Edward M. Kennedy (D-Mass.) has introduced a bill that, he says, **will help unemployed scientists, engineers and technicians make** "the transition to civilian, socially oriented research and development." The bill would provide for low-cost, long-term loans of up to \$12,000 a year, or 60% of a person's previous salary, whichever is lower Representative Wilbur D. Mills (D-Ark.), Chairman of the House Ways and Means Committee, **has reintroduced a bill which would repeal the special tariff treatment accorded to articles assembled abroad with components produced in the U. S.** The protection is contained in section 807 of the U. S. Tariff Schedules Transportation Secretary John A. Volpe predicts a **big role for electronics in reducing automobile fatalities.** Tests are under way at his department's Transportation Systems Center in Cambridge, Mass., on a microwave system to inflate air bags to protect passengers before crashes, lasers to detect fog banks, microwave hardware to warn of railroad grade-crossings, and an oculometer to detect drug and alcohol users. Another device under test will measure alcohol molecules in a car near the driver.

Tektronix presents ... a totally different low-frequency oscilloscope

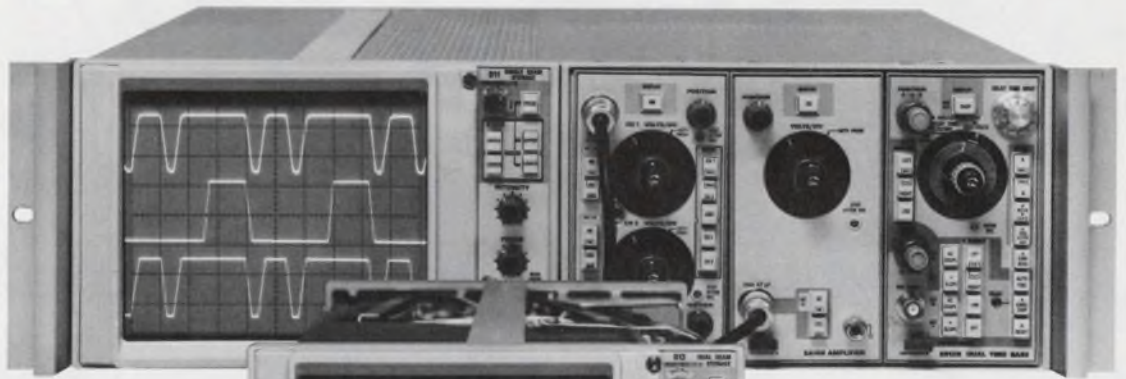

- unmatched low prices
- laboratory performance
- plug-ins
- 6-1/2-inch CRT's
- interchangeable display units
- cabinet-to-rackmount conversion
- solid state stability
- Y-T or X-Y operation
- new improved storage
- one to four trace displays
- lighted knob skirts for scale factor readout

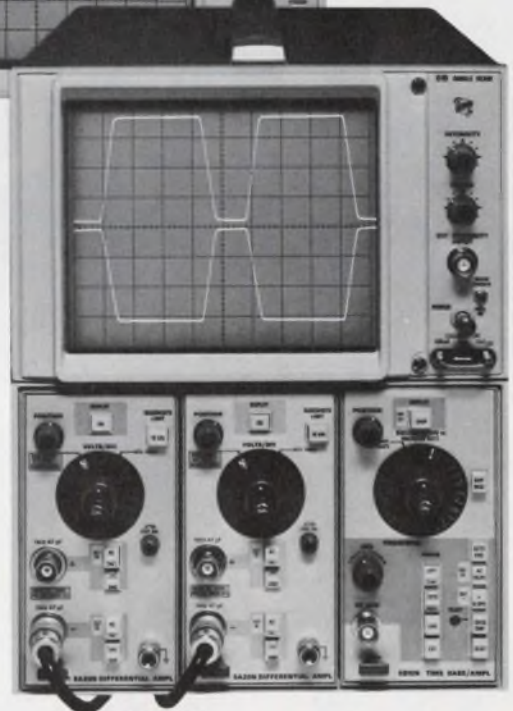
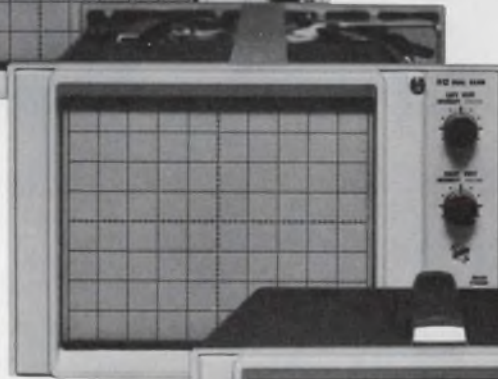

The low-priced 5103N Oscilloscope System offers cost-saving innovations never before available in any oscilloscope. Today, this series consists of six vertical amplifiers, three time bases and a three-plug-in mainframe compatible with four interchangeable display modules. Bandwidth is DC-to-2 MHz, depending upon the amplifier plug-ins.

Select a low-cost oscilloscope with a single-beam, dual-beam, single-beam storage or a dual-beam storage display module. When your applications change simply choose another low-cost display module and save the cost of buying a complete oscilloscope.

The unique modular design of the 5103N Oscilloscope System lets you convert between cabinet and 5 1/4-inch rackmount configurations at your convenience. It's easy. A few minutes of your time and a conversion kit (available for a few dollars) is all that's needed. When your application calls for a new configuration, convert! Save the cost of a new oscilloscope.

Here is just one example of the low-cost performance and unmatched versatility of the 5103N Oscilloscope System. Pictured at the right is a 5103N/D10 cabinet oscilloscope with a single-beam display module, two 5A20N 50- μ V/div DC-to-1 MHz high-gain differential amplifiers and a 5B10N 100-ns/div time base. The complete cost is only \$1045 in cabinet or 5 1/4-inch rackmount (includes slide assemblies). U.S. Sales Prices FOB Beaverton, Oregon.

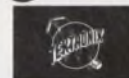

TEKTRONIX®

committed to
technical excellence

For complete information contact your field engineer or write Tektronix, Inc., P.O. Box 500, Beaverton, Oregon 97005.

INFORMATION RETRIEVAL NUMBER 33

Meet the cost cutter

New wire-wrap relay socket cuts costs up to 50% per connection

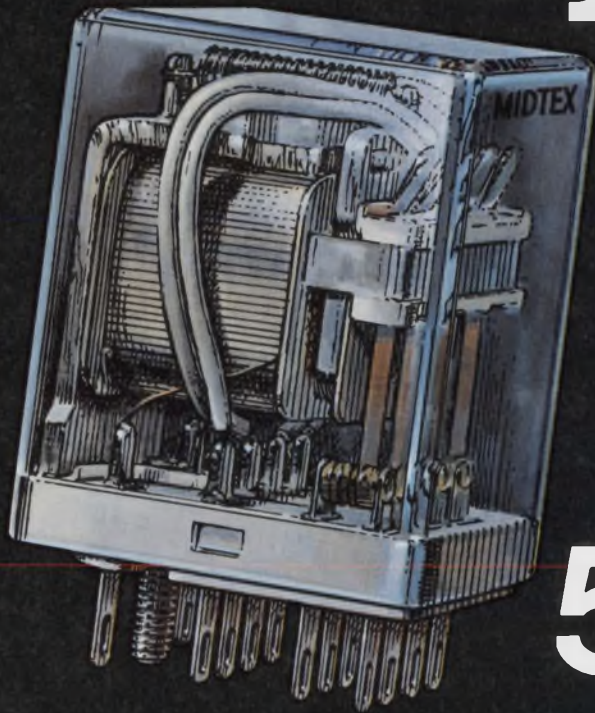

Here is the first wire-wrap[®] socket in the industry for a standard industrial relay. It can cut your connection costs in half because now you can wire-wrap industrial relays, too! It's another new idea from Midtex.

Wrapped wire connections cut costs because they're faster. Less than half the time it takes to solder.

Wrapped wire connections cut costs because they're cleaner. No solder splatter or wire clippings to short.

Wrapped wire connections cut costs through standardization. PCBs and relays *all* can be wire-wrapped . . . at once.

Designed for our Type 156 4PDT 3 amp relay, the Midtex wire-wrap socket provides 14 mating terminals, .031" x .062" x .75", and will accept solid wire wrapped or stranded Termi-point connections ranging in size from 20 AWG to 26 AWG. Terminals will provide for three separate connections. Socket dimensions: .75" x 1.55"; two .160" diameter mounting holes are 1.3" center-to-center. Socket body is U/L approved G.P. Phenolic.

Our job is to help you make your job more profitable through relays and relay assemblies. Midtex, The Total Relay Company.

® Trademark of Gardner-Denver Co.

MIDTEX 
INCORPORATED

10 STATE ST., MANKATO, MINN. 56001
507-388-2985

PROGRAMMERS / TIME DELAY RELAYS / MINIATURE COAXIAL RELAYS / INDUSTRIAL RELAYS / MERCURY-WETTED CONTACT RELAYS

The employment contract – a better way to work

Before the current recession became a reality, a surprising number of our readers were suggesting, in spite of themselves, that an engineering union might after all, be the only way they could expect to protect themselves from the inequities of bad management. Although the business slump greatly curtailed such union talk, the reasons for the talk still exist.

Unless corporate management upgrades its employment policies to avoid, for instance, laying off its engineers at the drop of a contract, they are going to find more and more highly qualified engineers going into business for themselves or using their abilities in areas other than industry, or just fewer engineers.

One solution to the problem—the employment contract—requires the efforts of management, the engineer and his society. The most positive step a company could take in the direction of improved employee relations could be to offer its engineers a contract. Such a contract could help the company as much as the engineer. It could:

- Give the company a competitive edge in the hiring of engineering talent.
- Neutralize any union-sponsored drives against the company.
- Force the company to plan its projects more carefully from their inception.
- Lessen random hiring, firing and re-training, all expensive operations.

The initial role of the engineer in this job betterment campaign could be to study the efforts of an umbrella organization for engineers that has been organized in England, and organize one in the U. S. English engineering organizations have recently organized a new group, called the Professional Engineers Association Ltd., to help bring about the preparation of a model employment contract. The group will also try to improve salary levels, urge pension portability, and provide job-counseling services and employment information.

Engineering societies in this country who feel they can't deal directly with the engineer's economic problem could do their part by helping to form an organization like the one in Britain to take on the responsibility.

The engineer's economic problem will not go away, and it may worsen. It behooves the engineer to help himself; the engineer's societies to help their membership. As for the company—it should remember that it has always had a tendency to overrate the loyalty of its employees. It should plan on ways to keep them.

RICHARD L. TURMAIL

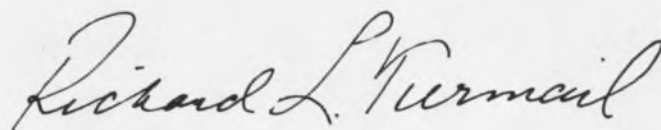

The Minicomputer and the Engineer

An **ELECTRONIC DESIGN**
special series on the
minicomputer in the
world of the engineer
—what it can do
—how to specify it
—problems of programming
—system applications
—interfacing techniques
—and adding peripherals to
expand its capabilities.



The use of the minicomputer is expanding at a rate nothing short of phenomenal. Mini suppliers are joyfully predicting an increase in worldwide systems sales and service to nearly \$1.6-billion in 1975—an annual growth rate of nearly 50% a year from the \$150-million of 1969.

The mini will be used in process-control and automation, data communications, medicine, education and traffic control, and it will be indispensable in scientific calculation, analytical instrumentation and business data-processing. The total of minicomputers shipped in 1969 was 30% of all computers shipped that year, and this figure is expected to grow to 90% by 1975.

Coupled with this growing market are plummeting prices. The average price for a minicomputer processor, estimated at \$15,000 in 1970, is expected to drop to \$5000 by 1975. The drop, due largely to expected cuts in memory and integrated-circuit prices, will make the mini an economic solution to a vast number of new calculation and control problems. (IC circuitry costs in 1975 are expected to be only 20% of what they are today.)

Of the total value of minicomputer units to be shipped in 1975—\$1320-million, according to Creative Strategies Inc., Los Altos, Calif.—fully 34% will go to process control applications. Rising labor costs, high process complexity, tighter tolerances and an increasing emphasis on quality control are forcing automation in a variety of industrial fields. The value of this market for minicomputers, placed by market analysts at \$76-million in 1970, is expected to boom to \$450-million by 1975.

Communications applications, such as in remote-batch terminal controllers, programmable message and line switchers and data concentrators, are expected to account for a market of about \$100-million, or 8% of the total, by 1975—up markedly from the \$11-million of 1970.

And new applications—medical, educational, auto traffic control, and others—will generate markets totaling \$205-million by 1975, or 16% over-all, according to industry estimates.

The application of minis to the analytical instrumentation and scientific market is expected to remain fairly stable, reaching only \$94-million, or 7% of the total, by 1975. And the growing demand for data-processing in small business will likely result in special-purpose systems and a 1975 market of about \$470-million.

The minicomputer world of tomorrow beckons to the engineer. Originally developed to replace control equipment in the process-control industry, the mini—expected, in stripped versions, to cost as little as \$1000 by the end of this year—is swiftly being applied to a multitude of jobs in engineering, science, business and industry. Photo courtesy of Hewlett Packard, Palo Alto, Calif.

For the designer of the 70s, the minicomputer marketplace promises to be complex and volatile. Here are a few of its characteristics:

- A growing tendency to regard the mini as “only” another system component.

- Increased emphasis by users on peripherals and software costs as the mini processors become cheaper (sale of the first \$1000 processor is expected in 1971), but a lagging development of miniaturized, low-cost peripherals for use with the mini. This may result in systems in which the Teletypewriter interface costs more than the minicomputer itself.

- Strong influence by minicomputers on the way in which systems and instruments are designed—the need to make the designs compatible with computer-controlled systems.

- The growing importance of small, highly specialized systems suppliers and software and



A minicomputer directs tests, classifies devices and logs data in the sophisticated J283 IC test system made by Teradyne of Boston. Here Norman Turner, software development engineer, works on a new job program which fixes pin and source assignments, source values and reject criteria.

consulting firms with applications expertise.

- Increased emphasis by the mini manufacturers on software, peripherals and systems work.

- The strong growth of dedicated minicomputer systems—both hardware systems, in which the manufacturer incorporates the processor in his own product, and software systems, in which the system supplier literally gives away a minicomputer with the software system.

Whatever the application—whether OEM use by a hardware system manufacturer, incorporation into a software and interfacing system by a system supplier or specific calculating and control tasks by an end user—the design engineer will be asked to select, specify, program and use the mini. His task will be fascinating, challenging—and possibly far from easy. ■■

The minicomputer and the engineer—Part 1

Here's what the mini can do for you

Now available in great number and variety, minicomputers offer the designer new possibilities in problem-solving, process and peripheral control, time-sharing and data-acquisition.

Whether they are stripped-down, inexpensive machines that can perform limited functions or powerful calculating tools with sophisticated input/output peripherals and expanded memory, minicomputers are destined to be so generally applied they'll be considered a basic tool by tomorrow's engineer.

Minis, which are simply smaller versions of large-scale, general-purpose computers, are organized the same way internally as the larger computers, are programmed the same way and use the same type of peripherals. Originally designed to be used with scientific instruments, their field of application has grown tremendously in the last two or three years to complement larger computers in all areas of use. And because of their size and low price they can be economically dedicated to single tasks.

Particularly interesting is the application gap that has been filled by the minicomputer between simple, hard-wired controllers and large-scale computers. In many process-control situations an off-the-shelf minicomputer now costs only slightly more than a specially designed logic module controller, and it can offer substantially increased performance. But designers often hesitate to use a mini, thinking perhaps that the application of a dedicated computer to their problem is unrealistic.

On the other hand, many engineers who are unfamiliar with minicomputer potential may consider and commit themselves to unjustifiably larger, more expensive systems to perform their control or analytical tasks.

The minicomputer should be used only if it saves time or money or performs new and valu-

able tasks. A mini can handle complex tasks economically, but there is no justification for using it where a cheap, hard-wired controller will do the job. Similarly there is no justification for using a large, expensive computer system where a minicomputer will do.

What is a mini really capable of? Let's take a look at its applications today, in the world of the design engineer:

The minicomputer is a personal computer

Using the mini as a free-standing computer, an engineer can have most of the computing power he will ever need available at his fingertips. And a time-share system can extend that power, through several terminals, to an entire design department. Carrying data to a large computer center—an obvious inconvenience—can be avoided, and minicomputer systems often offer a lower cost per user than that for sharing a large central computer.

The electrical engineering department at the University of Colorado, for example, recently installed a Nova time-sharing BASIC minicomputer system for use by students in laboratory applications. The system uses a 20,000-word, 16-bit core memory, a cassette recorder and seven Teletypes placed in several laboratories. The software consists of the BASIC language, originally developed at Dartmouth College.

One of the professors in charge of the systems operation says that the power laboratory was formerly highly unpopular in the curriculum. Now it is one of the most popular. He attributes this to the much more realistic problems that can be solved with the aid of the computer and to the elimination of arithmetic drudgery. A student trying to calculate the real power loss of electric motors, armed with only pencil and paper, finds the monotony of calculation a formidable barrier to his understanding of the parameters of the problem. The minicomputer has eliminated that barrier by eliminating a lot



A computer-controlled system for testing analog-to-digital converters at Analogic Corp., Wakefield, Mass., employs a Data General Nova computer and a Compu-Systems programmable voltage standard to automatical-

ly exercise analog/digital and digital/analog converters. The system permits Analogic engineers to test their products with a thoroughness and rapidity that is not possible if they use ordinary manual testing methods.

of the drudgery.

A typical minicomputer time-sharing system, capable of handling eight users, might be configured as follows:

- A 16-bit word, multi-accumulator minicomputer with 4000 words of core memory, direct-access channel, automatic priority interrupt and teletype interface—all in a jumbo chassis.

- 16,000, 16-bit words of core memory, 8 μ s access.

- A power monitor and auto restart.

- A complete system interface.

- Price: \$26,500.

Because Data General's time-sharing BASIC system uses a single, widely accepted computer language, it is less expensive than other multi-user computing systems. And a minicomputer time-sharing BASIC system can be more economical than sophisticated desk calculators.

Even expensive calculators have only a fraction of the power and flexibility of a fully programmable general-purpose computer with 16-bit word length, an easily expanded core memory and extensive input/output facilities.

Purchasing a minicomputer time-sharing BASIC system is also less expensive than leasing

the same number of terminals from a time-sharing utility. In a commercial time-sharing system a very large, expensive central computer is needed to satisfy the diversified requirements of many users, but most of them rarely, if ever, take advantage of the full capability of this large central processor.

The minicomputer is a testing device

Used in testing and experimentation, the minicomputer can provide a mobility that allows the engineer to get close to his problem area and interact with the variables in question. It's portable enough to be moved about the testing environment. Duplication of costly test systems can be avoided by replacing them with simple, inexpensive plug-in testing stations and one roving minicomputer.

In a particularly mobile, automated instrument application, LaCoste & Romberg, Inc., of Austin, Tex., reduced the cost and complexity of a design required to solve a complicated problem by taking full advantage of a minicomputer's potential. The company manufactures mobile gravity-measuring systems for use by oil-exploration firms,

government surveying agencies and research scientists. Their instruments gather data to help describe the geology of an area.

The principal difficulty involved in operating a gravity meter on a ship or in an aircraft is adjusting the output of the system to ignore the accelerations of the craft. In the LaCoste & Romberg systems, data from the gravity meter is output on a shaft encoder. Analog computers compute the effects of the external accelerations and other variables and correct the signal accordingly. The signal output from the analog computers is then processed by a minicomputer, which has two functions.

First, the minicomputer converts the signal back to real-time, correcting for the time lag caused by the analog computations. Then it performs averaging calculations, removing random disturbances and smoothing the signal.

It also performs cross-correlation calculations on the data after the latter has been stored on magnetic tape. If the system were not equipped with a minicomputer, the cross-correlation functions would have to be done on a remote, land-based computer—especially inconvenient for ocean-bottom surveys. With a computer built into the gravity meter, however, these calculations can be done quickly on the site, where they are of most use to the research.

The cost of specially designed logic modules for this system would be prohibitive, and their use would be limited. But an off-the-shelf minicomputer, used as a sophisticated component, decreased the over-all cost of the system and increased its capabilities.

A typical, simple data-acquisition system, based on a minicomputer, consists of the following:

- A 16-bit word, multi-accumulator minicomputer with 8000 words of memory, direct-access channel, automatic priority interrupt and Teletype interface.
- An ASR33 Teletype.
- An 8-channel, 10-bit a/d converter.
- 24-ips, IBM-compatible magnetic tape.
- The price: \$23,000 not including user data-acquisition programs.

Simple data-acquisition systems may contain simply a central processor, 8000 words of core memory, a Teletype, an a/d converter and a magnetic-tape unit. A real-time operating software system may be used to develop the data-acquisition programs.

The minicomputer is a system component

Using the minicomputer as a tool for testing and calculation is important, but to many design engineers the minicomputer's greatest potential

This is the minicomputer

The modern minicomputer is a sophisticated piece of equipment. Although there is some disagreement within the industry on the exact definition, a mini is generally agreed to have the following characteristics:

- It includes a central processor with general-purpose registers, magnetic core and a set of instructions.
- It will accept and store internally a program that can be altered at the option of the user.
- It incorporates a minimum of 4096 words of memory, in which programs and data can be stored and altered under control of operator's program. Word length varies from eight to 24 bits, depending on application.
- It is equipped with means for input/output to enable the operator to input commands to the system and receive results and instructions from it.
- It is small in size, perhaps approaching portability.
- The purchase price, including the basic processor and input/output capability, should be no more than \$25,000, and possibly less than \$6000.

Beyond these basic requirements, modern minis may have advanced, multiple-accumulator architecture and include such standard features as direct memory access and automatic priority interrupt.

The modern minicomputer takes advantage of the highest levels of integrated circuitry—MSI and LSI. An entire central-processing unit or a core memory of 4096 16-bit words with an 800-nanosecond cycle time can fit on one 15-inch square board.

An entire minicomputer can fit in about five inches of rack-mountable chassis and leave room for 16,000 words of memory and interface circuitry for several peripherals. A 10.5-inch chassis can contain up to 32,000, 16-bit words and interface circuitry for up to 64 peripherals.

The first minicomputers using all-semiconductor memories are to be delivered soon. These will be able to execute arithmetic instructions in 300 ns—two to three times faster than the fastest available core-memory computers.

Minicomputers built with a modular design are easy to maintain and modify. Individual components, including memory and central-processing boards, plug in and plug out in a few seconds, reducing maintenance costs and system down-time.

Modern minicomputers are available as families of fully compatible machines. The customer can run the same programs on any

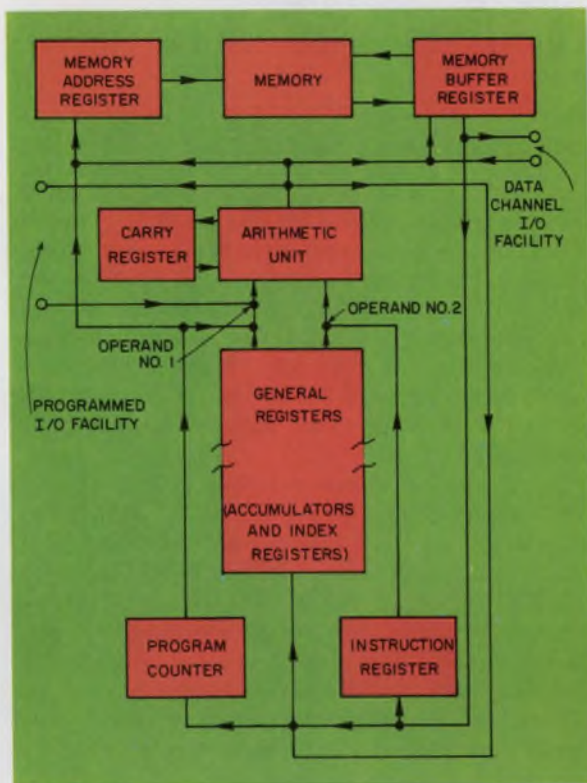

of the machines in the family and use the same peripherals with the same interfaces. Some of these families of machines are even mechanically interchangeable—the user can swap central processors or memories between machine models or change the processor in his machine.

Minicomputer software is now extensive. The small computers now have standard and relocatable assemblers, relocatable linking loaders, text editors and symbolic debuggers. They can use powerful compilers like BASIC, ALGOL and FORTRAN. Additional software, like disc operating systems to increase programming efficiency and floating point interpreters, are also available.

The modern minicomputer is supplied with a full line of peripherals. They are interfaced into systems with Teletype keyboards, high-speed tape readers and punches, discs, card readers and magnetic-tape units, line printers, incremental plotters, analog-to-digital converters and communications controllers. As many as 15 minicomputers may be connected via a communications adapter to form a multiprocessor system with up to 480,000 16-bit words of main memory.

A typical minicomputer structure is similar to that of a large, conventional stored program machine. The mini processor contains several registers; an arithmetic unit to do logic and arithmetic operations; a memory unit and one or more input/output

interface facilities. The memory address register contains the location of the word being written into or retrieved from the memory, and the memory buffer register contains the contents of the word that has been read from memory or the data to be written into memory. Data from the memory can be transferred to the registers where it is acted upon by the arithmetic unit.

Addresses are transferred to the memory address register from the arithmetic unit, or from the program counter, which always contains the address of the next instruction to be executed.

In a typical instruction fetching cycle, the contents of the program counter are placed in the memory address register. The memory is cycled, the instruction is placed in the memory buffer register and is then transmitted to the instruction register. The contents of the program counter are incremented one by one to point to the next instruction.

The instruction fetched in this cycle may be a memory reference instruction, such as load or store. If so, the address of the desired data word is computed from the instruction itself and one of the index registers (or from the program counter acting as an index register). These elements are transmitted to the arithmetic unit, which develops the required address and transfers it to the memory address register for retrieval later in the instruction execution cycle.

In the case of a branch instruction, the computed address is sent to the program counter, where it replaces the address of the next instruction to be executed and results in a branch in the program sequence transfer.

Minicomputers, like their large scale counterparts, contain "generalized" registers which can save both as accumulators and as index registers. A typical instruction, performing an arithmetic or logical operation, would combine the contents of two registers and return the result to one of them. Often the result is tested to determine a branch.

The carry register is one bit long, and is used to contain the carry bit developed during the arithmetic operation. The carry bit is important in the detection of arithmetic overflow and the programming of extended precision arithmetic operations, in which the length of the operand is greater than that of the A register.

Index registers augment the data-addressing facilities of the system. If the presence of a certain bit pattern in the instruction code specifies that indexing is to be performed, the contents of the specified index register is added to the address portion of the instruction word.

Here are some pointers on using the minicomputer

If you buy a basic minicomputer, with a Teletype or other input/output interface, all that will be required of you is the ability to program.

Minicomputers use the same basic hardware, peripherals, and software as the big computers. They are supplied with both core and semiconductor memories, and with word lengths of 8, 12, and 16 bits.

In machines with semiconductor memories, add times are now as fast as 0.3 microseconds. Generally, on otherwise equivalent machines, you will pay more for increased speed, but there are exceptions. There are comparably priced machines on the market with significantly different performance capabilities. Comparison shopping among manufacturers is bound to pay off.

For a bare machine with 4K of memory, sold as a component, you may expect to pay as little as \$5000 with substantial discounts available (40% or more) if you buy in volume. Packaged end-user systems run on the order of 2 to 5 times as much.

When you look at a manufacturer's hardware, be sure to consider the possibility of system expansion, as well as price. Machines built using a modular concept would be a logical choice where expandability is important—additional memory can be plugged in as needed without extensive changes in the mainframe configuration. If you think you might later need additional peripherals, a machine or a line of machines with peripherals common to the line should be considered.

The best guarantee of getting the machine you need is knowing the requirements of your application. Where this is difficult, and it can be, get some help. Let several manufacturers propose a system for you. You can check these pro-

posals with an independent consultant or systems house.

Look at peripherals carefully

All but the user with the simplest of needs should consider peripherals just as important as the "bare bones" computer itself. Teletypes, high-speed punches, and paper tape readers are commonly offered by most manufacturers and magnetic storage devices, such as discs and tape units, are becoming common. Some manufacturers offer a/d and d/a equipment, plotters, printers, CRT displays, and data communications hardware.

Interfacing of special peripherals, if performed as a service by the manufacturer, will be an additional cost. You might want to comparison shop among some independent systems designers for this service, as well as among manufacturers. Most major manufacturers offer extensive literature and guidelines for doing the interfacing yourself. Some manufacturers even offer plug-in circuit boards with the general interfacing hardware on them. In any case, special interfacing can be a major expense, and you should be aware of that fact.

Choose software critically

An evaluation of software is too often slighted in the purchase of minicomputers. Assemblers vary in quality. Some manufacturers offer BASIC, some ALGOL, some FORTRAN, and some all three. You can use BASIC, an easily learned language that allows the programmer to solve problems using a number of simple statements closely resembling algebra. If you wish,

is as part of the product he is designing. Mini applications range from intelligent controllers, a step above simple hard-wired controllers, to highly complex on-line/real-time processors capable of data collection, data analysis and process control. Because the minicomputer has become a mass-produced product, it is less expensive than all but the simple hard-wired controller—and certainly less expensive than the monthly rental on the larger computers.

While the cost of a mini is important, of equal importance to the sophisticated end-user is the question of reliability. The control outputs from time-sharing terminals are wholly dependent on the large computer to which they are connected. Should a failure occur in a large time-shared computer, all terminals, and the machines or processes to which they are connected, are disabled until repairs are made. But should a dedi-

cated minicomputer fail, only the one task to which it has been assigned is affected. It can often make good sense in this respect to apply several minis to a plant control problem than one, large time-shared computer.

Nor is a minicomputer subject to the time delays prevalent in many time-sharing systems—delays that cannot be tolerated in a variety of industrial applications. In real-time data-acquisition, the requirements for high data rates far exceed those currently possible for the available common-carrier facilities, which the time-shared systems use. The usage uncertainties of time-shared systems make them totally impractical in applications that demand control response at a specific time.

While minicomputers are ideal for in-process production applications, their use as components in design and research systems is equally precise.

you can proceed to learn other languages to write more complex programs, such as ALGOL and FORTRAN.

Manufacturers also offer, in varying degrees, loaders, text editors, debuggers, floating point and compilers. Some offer disc operating systems yielding input/output independence, expanded file capability, and program control by Teletype console. Manufacturers with large numbers of computers in use may additionally offer the advantages of users libraries, with documentation available for many special application areas.

When you shop for existing software, you will find that the major cost you'll face is for the additional hardware often necessary to run the programs that you can buy. The manufacturer who can provide additional memory easily and economically is especially appealing in this area. Software, like hardware, varies greatly in capability. One manufacturer's software may be only fractionally as powerful as another's.

Another software consideration is the ability to use your programs on different minicomputer models. By choosing a manufacturer whose software can be used on a line of increasingly powerful computers you will be able to expand hardware capability without extensive software changes.

The cost of maintenance is often overlooked. This cost is especially significant if you have many peripherals, because they are electro-mechanical devices and are inherently less reliable than the fully electronic central processing unit. Unless you want to make repairs and do preventative maintenance yourself, you should look at the service contracts available from established manufacturers. They usually range from time-and-materials agreements to the comprehensive on-call service contracts.

The on-line/real-time capacity of minicomputers means that results can be seen as they occur and progress can be evaluated on the spot instead of, say, weeks later. If the wrong approach is taken initially, the experiment can be redefined and rerun immediately, saving time that could have been lost in running unproductive tests or measurements.

The minicomputer is for the scientist

In one such research system the user takes advantage not only of the on-line/real-time capacity of the minicomputer component but also of the small computer's ability to function in a less than ideal environment.

Scientists at the Scripps Institute of Oceanography, University of California at San Diego,



The Designer II, an automated drafting system made by Computervision Corp., Burlington, Mass., enables engineers to sketch several complex electronic designs per day. Once a final design is selected the system, based on a Nova minicomputer, prints out final drawings to mil spec standards. Layouts, assembly drawings, bills of material and numerical-control manufacturing tapes are easily extracted from the new system.

use a minicomputer to process oceanographic data dealing with the nature of turbulence and heat flow in the ocean.

To collect their data, the researchers have a free-fall submersible device that contains a number of transducers, which sense standard oceanographic parameters: pressure, temperature, salinity, density and velocity and rotation of the sensor. The analog data collected by the transducers is tape-recorded. When the device surfaces, the magnetic tape is recovered and fed to the computer on board the research ship.

The minicomputer is programmed to sample the data channels. Incoming data is stored in two buffer memory areas. When the buffers are full, the data is read onto an IBM-compatible, magnetic-tape system. At the same time all of the data is fed to a three-channel galvanometer through a digital-to-analog converter. By reading



Shipboard analysis of the deep-sea data gathered by the Scripps Institute's free-fall instrumentation package is done by a SuperNova minicomputer. The mini samples analog data and performs storage, display and analysis.

the galvanometer, the researchers can make a qualitative evaluation of the data on the spot.

Significantly, an additional program for the minicomputer makes it possible to perform a preliminary spectral analysis on board ship. This feature is very attractive for oceanographers on extended research voyages. Although not as exhaustive as the more extensive analysis that is performed by a large computer after they reach port, it gives the researchers the opportunity to make a very accurate spectral analysis of data shortly after it is gathered.

On a three-month ocean voyage this means that they can have a very good idea of their progress during the voyage, and they can direct investigations toward promising areas. They can also abandon blind alleys before large amounts of money and time are expended.

The minicomputer is a process controller

In another example of minicomputer economy, a stand-alone process-control system does high-speed inspection and classification of sheet steel for tin-plating.

In the manufacture of tinplate, prior to the tinning procedure, the steel strip has to be inspected and classified, to eliminate any material

that is offgauge or defective due to pinholes or cracked edges. The inspection is done automatically by sensors. The minicomputer system was designed to log the locations of flaws in a coil or sheet tin stock, give the total footage of steel in five different grades, give the total footage of steel in each coil, stop the inspection line after a preset footage has been run, provide operating information, and provide a printed output of all inspected variables.

In this system the recording of flaws and gauges and the formatting of output data is relatively menial—it doesn't require the power of a minicomputer. But the capacity of the minicomputer is justified when the production line is reversed to scrap a section of steel. All recorded flaws must be retained and, if seen again by the computer system, they must be ignored until the mill has returned an equal footage forward.

If a portion of the coil is cut out and scrapped, the data related to the scrapped material is erased by the program, but all pertinent coil data is retained.

The initial step in the design of the system was to determine whether to use hard-wired logic or a minicomputer, and the answer was immediately obvious. The hard-wired system design included IC logic to perform the sequencing and control functions, a diode and matrix memory to store the operating program, and a core memory to provide storage for the accumulated values—essentially a custom hard-wired computer.

Minicomputer systems such as this can enhance product quality and reduce overhead in almost any process by lowering reject rates, isolating malfunctions and minimizing process down-time. They can often justify their cost in reduced scrap alone. And they can provide information as to the efficiency of the manufacturing operation, thereby permitting the user to maintain optimum production rates.

A typical process-control system is configured as follows:

- A 16-bit word, multi-accumulator minicomputer with 8000 words of memory, direct-access channel, automatic priority interrupt and two Teletype interfaces.
- Two ASR33 Teletypes.
- A/d converters.
- A low speed modem and control.
- Price: \$20,000.

This systems "looks at" five on-line process gas chromatographs. Low-frequency analog signals are digitized and waveforms are integrated. Areas under curves are analyzed to determine chemical composition.

The minicomputer gives commands to change the process. Commands are sent to the plant via the supervisory control system.

In the field of software development and tape

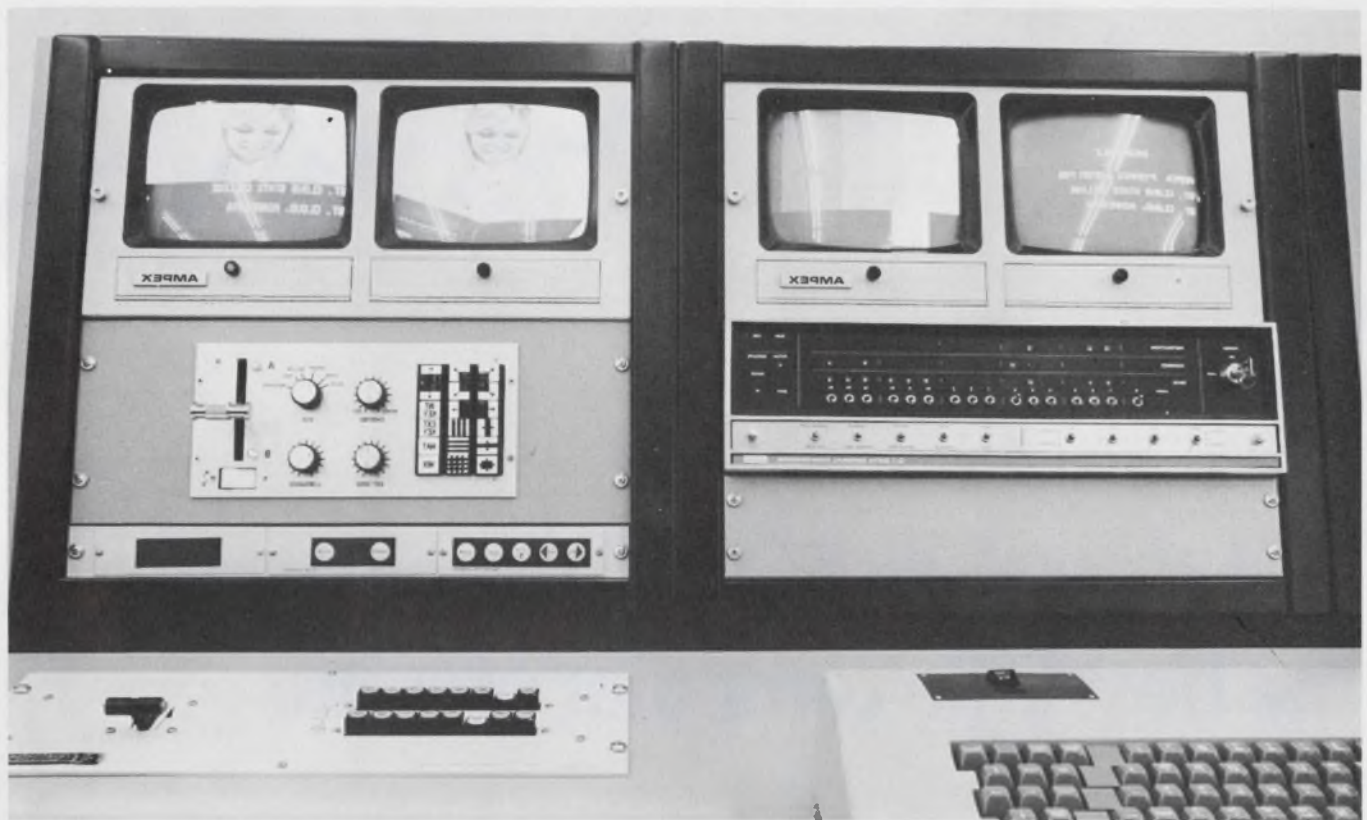

The heart of the Ampex PYRAMID educational system is the NOVA minicomputer. The system, a set of modular subsystems which function as peripherals, allows each student to start, stop, replay, hold, or discontinue his

instructional programs independently of other students. Fast enough to give the impression of instantaneous response to the students' commands, the NOVA handles automatic testing and scoring and logs usage rates.

preparation, a minicomputer can be especially valuable to today's engineer.

The minicomputer is for software generation

A disc operating system used in software development might consist of the following:

- A 16-bit word, multi-accumulator minicomputer with 16,000 words of core memory, direct-access channel, automatic priority interrupt and Teletype interface.
- An ASR33 Teletype.
- A high-speed paper-tape reader/punch combination.
- A 128-k, fixed-head disc.
- An 80-column line printer.
- Price: \$40,000.

Although program development for a given application can be accomplished on the same machine that will be used in the application, software is available for larger configurations to speed the program development process. The use of this software, such as the Nova Disc Operating System, can speed program development, save time and money, and justify the larger hardware configurations required. Where several machines will be required for a large application, or where the programming will often be changed, the use

of large configurations for program development is particularly desirable.

Using a fixed-head disc storage, the system provides the comprehensive file system capabilities of large systems. The file system allows the user to create and edit files, compile or assemble them, debug and execute them, and save and delete files. Other features allow the user to set and change access to protect his files and to obtain directory information about his files, such as length and access rights.

Files and devices are interchangeable in the operating system, since the system views devices as if they were files. All files and devices can be referenced by symbolic name. The operating system thus handles not only all storage and retrieval of files for the user but also all input/output, including interrupt-driven buffered service of all peripheral devices.

Note that substituting a 256k disc adds \$1500 to the system cost. A 132-column line printer adds \$4500.

Users can prepare parts programs that define a limited number of machine operations and then incorporate them into larger programs by using the "define pattern" statement. In this way, operations can be checked out easily, and large parts programs can be written. ■■

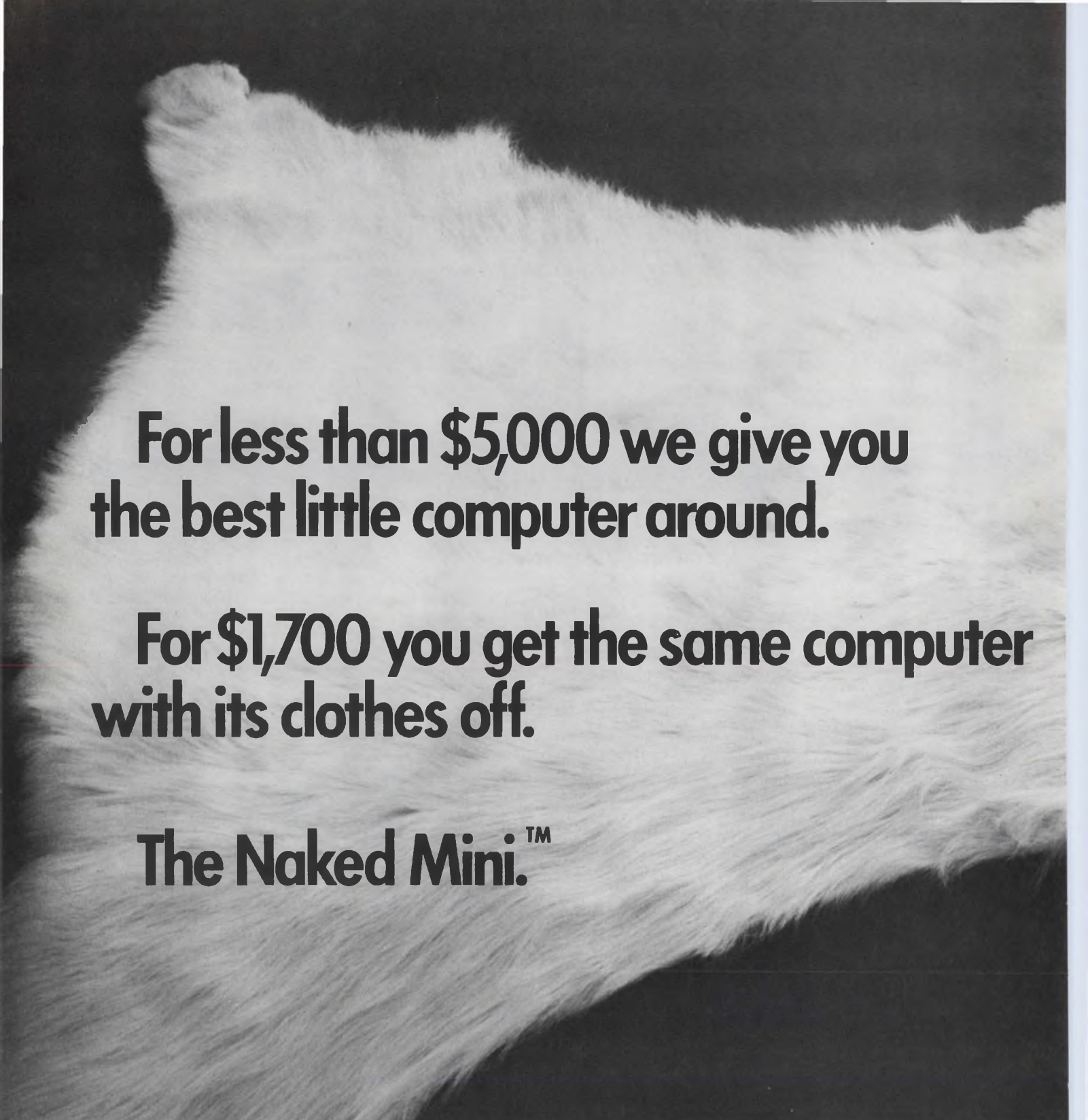

**For less than \$5,000 we give you
the best little computer around.**

**For \$1,700 you get the same computer
with its clothes off.**

The Naked Mini.TM

You're looking at the first official portrait of an entirely new minicomputer concept. The NAKED MINITM.

It represents a major breakthrough in minicomputer thinking. Specifically, it means that someone in the minicomputer industry has finally broken through the \$2000 barrier. With no sacrifice in computer power. It means that the computer has at last become a true component. To be buried inside your OEM product.

For the systems designer, it means an opportunity to get full computer power and greater design freedom at a drastically reduced price.

In all industries, the NAKED MINI opens up new application areas, with general purpose minicomputers replacing hard-wired circuitry.

The premise behind the NAKED MINI is actually rather simple: sometimes you need computer performance but not a whole computer system.

Let's say you need a large volume of minicomputers but in your product you already have the power, controls, and mounting hardware.

In the past, you could either buy a full-blown minicomputer or build your own scaled-down version. With the former choice, you obviously ended-up with redundant parts. And selecting the latter always cost you a lot more than you bargained for.

Well now you have a third option. Computer Automation's NAKED MINI. The computer with its clothes off. Everything that really counts — memory and processor — without the

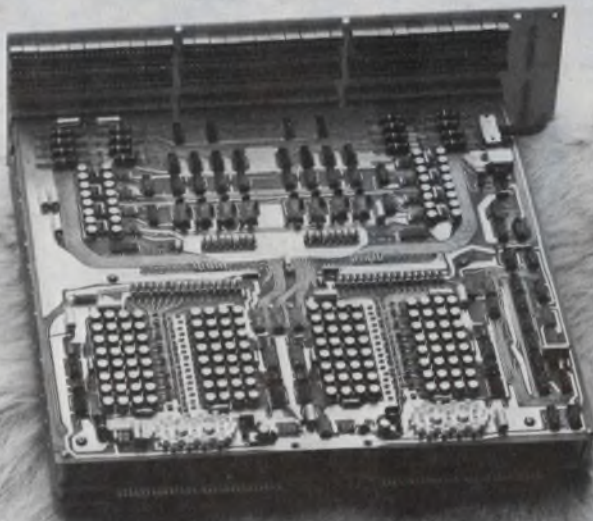

ancillary components that you already have in your system.

At this point you're probably skeptical. "I'm going to get a do-it-yourself kit . . . a processor only . . . a handful of cards and components without even a memory."

To the contrary, the NAKED MINI is a fully-operational computer. An integral unit designed for maximum useability and interfaceability. Fully tested and fully warranted. You get all the computer power of a stand-alone system. Without all the cost.

Functionally, the NAKED MINI is identical to our existing machines. Its low cost has been achieved without sacrificing any of the previous line's superb features.



INFORMATION RETRIEVAL NUMBER 35

The 16-bit NAKED MINI still gives you hardware multiply/divide as a standard item. Moreover, all machines offer direct memory channels, vectored interrupts, and 32K addressability. Because the software and I/O interface are compatible, all of the options and programs for our present machines are useable with the NAKED MINI.

The NAKED MINI with 4K of expandable memory is priced from \$1700 (\$2400 for the 16-bit unit) in 200-unit quantities. First deliveries are scheduled for this November.

In summary, the NAKED MINI gives you the same horsepower and computer flexibility as our packaged machines. But at the price of a component. For full details, write or call today.

COMPUTER AUTOMATION, INC.

895 West 16th Street • Newport Beach, California
92660 • Phone (714) 642-9630 • TWX 910-596-1377

S LEVEL CSRs. WE HAD TO TELL SOMEONE BEFORE WE BURST.

S level approved CSRs. KEMET® CSRs. CSR13. CSR09.

We know you knew tantalum capacitors were reliable. But S level? That's something else. No one has done it before.

0.001% failure rate level per 1000 hours. A full order of magnitude over any other manufacturer.

(And to top it all off, our

KEMET solid tantalums are the only ones approved to the new CSR23 extended range style of Mil-C-39003. Up to 1000uf at 6V.)

If you want to talk to some happy people, give us a call. (803) 963-7421. And watch us light up.

Union Carbide, Components Department, Box 5928, Greenville, South Carolina 29606.



COMPONENTS DEPARTMENT



Bodine helps data devices tell it like it is...

Bodine fractional horsepower drives. Small. Quiet. A complete line designed to power information-handling devices precisely, accurately, dependably. Motors built with all the integrity you've designed into your product—that deliver as specified with fewer callbacks and service problems. If this is the kind of power you're looking for, you'll find no better source.

Over 3,500 standard specifications to choose from. Bodine also builds custom fhp motors to meet design requirements. Our engineers will be happy to help you pinpoint the right one for your particular application need. Computers, business machines, instrumentation, copiers—whatever your product, specify Bodine fhp drives. We've been the power behind the leading products for some 63 years. Write for bulletin. Bodine Electric Company, 2500 W. Bradley Place, Chicago, Illinois 60618.

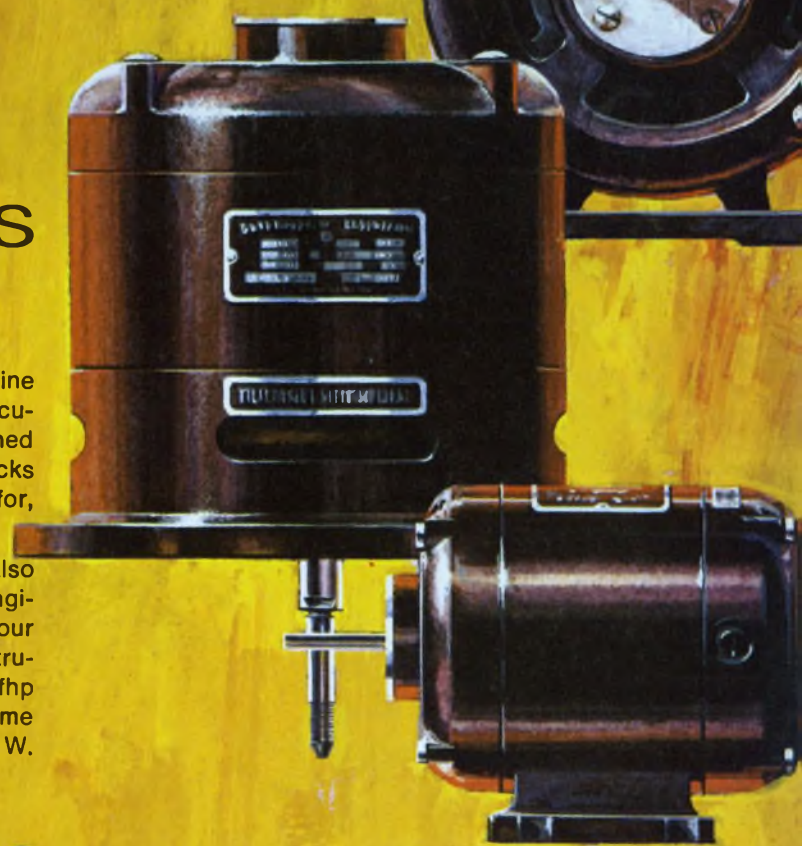

Bodine Motors Wear Out—It Just Takes Longer



BODINE MOTORS/CONTROLS

Ask about Bodine SCR motor speed controls



What happened to the model 19?

You're looking at some of the Teletype® basics used in building a data communications system. Printer, keyboard, tape sending and receiving combinations in a variety of speed capabilities. Teletype's modular design concept gives you the opportunity to extract the best terminal combination for system

needs today, and refine, add to, subtract and adapt as system modifications are called for. Just as important as the basics, are some of the things not obvious in the photos below. The logic devices, options and accessories that add almost limitless possibilities for making things happen exactly as

your system requires. We have some solid state logic devices that provide precise control of data traffic. That enable your computer to automatically poll data from a number of terminals and feed each terminal with processed data. There are error detection, correction and signal regeneration options to



model 33 series: An extremely economical 100 wpm terminal line. Has 4-row keyboard, uses 8-level ASCII code. The most widely used terminal in time-sharing systems today.



model 35 series: A rugged, heavy-duty line of 100 wpm terminals. Uses ASCII. Units in foreground are self-contained paper tape punch and paper tape reader.



Telespeed™ equipment: A line of high-speed tape-to-tape terminals capable of sending and receiving at speeds of 750, 1050 (shown above), or 1200 words per minute.

DATA COMMUNICATIONS

equipment for on-line, real-time processing

keep data flowing faultlessly. Options such as pin-feed platens and form feed controls that make it possible to fill multiple copy business forms on-line. And many, many more. What did happen to the model 19? Believe it or not, there are still some of these old, die-hard terminals around. And that's

another advantage your data communications dollar buys when you specify Teletype equipment. It lasts. Moves data reliably, economically, for a long time. On a price/performance basis, Teletype equipment is in a class by itself.

Teletype data communications equipment is available in send-receive capabilities of up to 2400 words per minute. If you would like specific information about any of the equipment described here, write: Teletype Corporation, Dept. 89-17, 5555 Touhy Ave., Skokie, Ill. 60076.



model 37 series: One of the most versatile heavy-duty terminal lines going. Generates all 128 characters of ASCII. Operates at 150 wpm. Prints in upper and lower case.

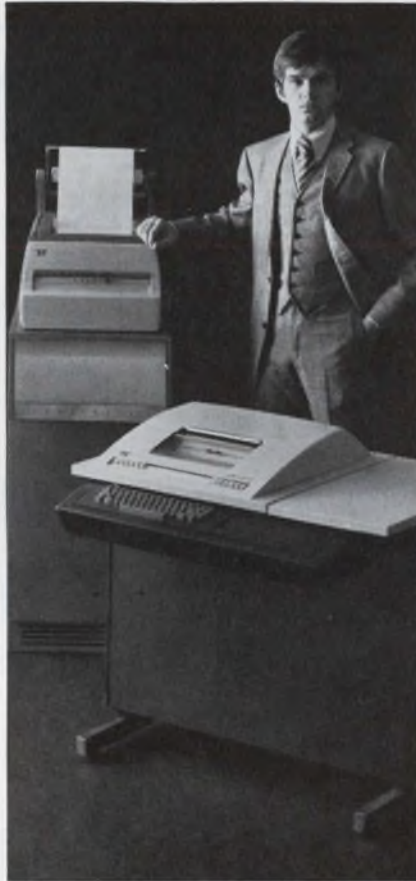

Inktronic® data terminals: A unique electronic, solid state terminal. Prints up to 1200 wpm. Forms characters through electrostatic deflection (no typebox). ASCII compatible.



magnetic tape data terminals: Use compact reusable tape cartridges. Operate on-line at up to 2400 wpm, and connect "locally" to lower speed Teletype terminals using ASCII code.

Teletype is a trademark registered in the U.S. Pat. Office

machines that make data move



INFORMATION RETRIEVAL NUMBER 38

Be an Engineering Editor - for ELECTRONIC DESIGN:

- attend state-of-the-art technical conferences;
- interview top design engineers, scientists and executives;
- find and edit technical articles on new design techniques;
- write by-lined special reports on new developments in electronics;
- visit high technology, up-to-the-minute electronics plants;
- build a future with the world-wide Number 1 electronics trade publication.

We are seeking a technical editor, preferably with a background in computers or circuit design. Some writing experience would be helpful.

Interested?

Send your resume to Raymond Daniel Speer, Managing Editor, ELECTRONIC DESIGN, 850 Third Ave., New York, N. Y. 10022



This is where you come in.

Right at the back of our 12-inch CRT monitor module.

You supply a composite video signal between 0.5 and 1.5 V, and we supply the rest—a complete CRT display package designed for alphanumerics that is suitable for rack, console or cabinet mounting.

Of course, you also have to provide a power source, but we've even made that easy. Your module comes off-the-shelf for either 120 V AC or 22 V DC operation.

Despite the fact that our 12-inch display module is an off-the-shelf design, you'll be surprised at the number of options available to you. Depending on lighting conditions you can have 92%, 70%, or 55% light-transmittance filter plates, with or without antireflection coating. You have a wide choice of phosphor types. All of our tube types meet UL requirements for implosion protection.

If our 12-inch monitor doesn't meet your needs, send us your specs and we'll come up with a custom design.

You take care of the system. We'll take care of the display module.

Because that's where we come in.

Sylvania Electronic Components,
Electronic Tube Division,
Seneca Falls, N.Y.

SYLVANIA
GENERAL TELEPHONE & ELECTRONICS



NEW 3V COS/MOS ICs

RCA gives you: a new solution to the problem of interfacing logic technologies... a 50% (av.) cut in plastic IC prices.

Now, gain maximum cost effectiveness and circuit reliability in your logic-circuit designs. Use RCA's COS/MOS Integrated Circuits exclusively in your new designs . . . or mix and match COS/MOS ICs with T²L and DTL devices in either new or existing circuit designs—they're compatible!

Look into it! You've always been able to save engineering and production expense by using COS/MOS ICs. Now, you have the new 3 to 15 V operating range in plastic-packaged devices at very substantial cost savings.

• New operating-voltage range makes COS/MOS ICs still easier to use over a much broader range of applications.

• One 5 V supply will provide power for both COS/MOS and T²L ICs (in some complex circuit functions, a T²L IC may drive a COS/MOS IC — or vice-versa).

• The 3 V operating level makes COS/MOS ICs suitable for portable (battery operated) digital systems.

Two added bonuses with COS/MOS ICs. They require less rigid voltage regulation than T²L ICs: COS/MOS, $5 \pm 1\frac{1}{2}$ V; T²L, 5 ± 0.5 V. RCA specifies ceramic packaged COS/MOS ICs' characteristic limits at -55°C and +125°C — the full military operating temperature range. (Plastic COS/MOS ICs' limits are specified from -40°C to +85°C.) Typical COS/MOS logic speeds are:

• Gate propagation delay— 35 ns @ 5 V
— 25 ns @ 10 V

• Flip-flop toggle rate } 4 MHz @ 5 V
and MSI clock rate } 10 MHz @ 10 V
For special applications, RCA will custom-tailor COS/MOS ICs to meet your needs. Ask your local RCA Representative about this service.

See your local RCA Representative or RCA Distributor for COS/MOS IC price and delivery information and a copy of RCA's new "Low-Voltage COS/MOS Product Guide" (COS-278) — which presents basic data on RCA's complete COS/MOS line. Copies of this product guide may also be obtained by writing to RCA, Commercial Engineering, Section 57D-16/CDC56, Harrison, N.J. 07029. International: RCA, Sunbury-on-Thames, U.K., or 2-4 rue du Lièvre, 1227 Geneva, Switzerland, or P.O. Box 112, Hong Kong.

RCA, Commercial Engineering
Section 57D-16/CDC56
Harrison, N.J. 07029

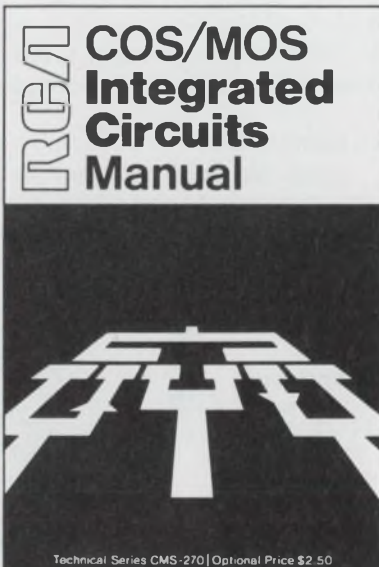

COS/MOS Manual CMS-270 may also be purchased at your RCA Distributor's.

Send me RCA's new COS/MOS IC manual CMS-270 that provides device fundamentals including characteristics, processing essentials, and layout procedures. This complete guide to existing RCA COS/MOS products contains an informative "how to use and design" section plus extensive applications data.

Name _____

Title _____

Company _____

Street _____

City _____

State _____ Zip _____

Enclosed please find my check or money order for \$2.50*

* Optional price

COS/MOS FEATURES

Ultra-low quiescent power dissipation

- Gates – 10 nW/pkg (typ) @ $V_{DD} = 10$ V
- Complex functions – 10 μ W (typ) @ $V_{DD} = 10$ V

Exceptionally high noise immunity

- Typically 45% of power supply voltage over the full operating temperature and voltage ranges

Wide operating voltage range

- 3 V – 15 V

Excellent temperature stability

- Typical $\pm 1.5\%$ shift in transfer characteristic over the full military temperature range

Single phase clock

Clock voltage equal to supply voltage

High input impedance

- $10^{12}\Omega$ (typ)

High dc fanout

- > 50 COS/MOS loads

The new "A"-Series COS/MOS ICs are produced in three package styles. (See Note.)

Plastic devices, listed below, are immediately available at an average 50% price reduction over previous plastic prices. Prices given are for each in 1000+ quantities.

Gates

CD4000AE	Dual 3-input NOR gate plus inverter	\$0.96
CD4001AE	Quad 2-input NOR gate	0.98
CD4002AE	Dual 4-input NOR gate	1.02
CD4007AE	Dual complementary pair plus inverter	0.98
CD4011AE	Quad 2-input NAND gate	0.98
CD4012AE	Dual 4-input NAND gate	1.02
CD4019AE	Quad AND-OR select gate	1.75
CD4023AE	Triple 3-input NAND gate	1.02
CD4025AE	Triple 3-input NOR gate	1.02

Flip-flops

CD4013AE	Dual "D" type with set/reset capability	\$1.98
----------	---	--------

Hex buffers/logic-level converters

CD4009AE	Inverting	\$2.15
CD4010AE	Non-inverting	2.15

Multiplexers

CD4016AE	Quad bilateral switch	\$1.98
----------	-----------------------	--------

Static-shift registers

CD4006AE	18-stage	\$4.65
CD4014AE	8-stage synchronous parallel-input/serial-output	4.65
CD4015AE	Dual 4-stage serial-input/parallel-output	4.65
CD4021AE	8-stage asynchronous parallel-or serial-input/serial-output	4.35

Counters, dividers, decoders

CD4004AE	7-stage ripple counter/frequency divider	\$3.35
CD4017AE	Decade counter/divider with 10 decoded outputs	4.80
CD4018AE	Presetable divide by "N" counter	4.20
CD4020AE	14-stage ripple-carry binary counter/divider	5.70
CD4022AE	Synchronous divide-by-8 counter/divider with 8 decoded outputs	4.25

Adder

CD4008AE	4-bit binary full-adder with parallel carry-out	\$4.50
----------	---	--------

New COS/MOS ICs to be announced soon

Decade counter with 7-segment decoder
 J-K master-slave flip-flop
 BCD-to-decimal decoder
 4-bit parallel/serial register
 8-bit parallel/serial, input/output bus
 Binary or BCD decade up/down counter
 Memory, word organized
 Quad exclusive OR gate
 Triple serial adder
 64-bit static register
 200-bit dynamic shift register

Note: Besides plastic devices listed above, COS/MOS ICs are also available in ceramic flat-pack, CD4000AK series, and ceramic dual-in-line, CD4000AD series. (The CD4004AT is furnished in a TO-5 style package.)

RCA Solid State

INFORMATION RETRIEVAL NUMBER 123

Take a look inside the TTL IC.

If you understand its internal operation, you can take advantage of its capabilities and avoid misapplication.

Transistor-transistor-logic (TTL) integrated circuits have been around for some time now, and most designers just regard them as little packages that get the job done, without ever knowing how. But a familiarity with the circuit designs of the chips can help you make better use of them.

You can improve over-all performance of your designs with simple outside-the-package modifications if you have a better understanding of the circuit configurations inside. And you can avoid demanding more performance from an IC than it can deliver if you are aware of circuit operating limitations.

The criteria in designing an IC are similar to those used for discrete-component circuits. Output gates, for example, have different design requirements than internal gates, and special circuit techniques, like clamping, make the gates work faster.

Three types of TTL output gates

There are a number of ways to build a TTL output gate without altering logic levels. A basic, popular output gate (see box) is one that uses a single transistor for active pull-up. A variation of this common gate employs a Darlington configuration (Fig. 1a) as the active pull-up. The Darlington set-up results in higher gain in the active region, thus lowering gate output impedance and increasing capacitive driving capability.

A variation of the Darlington pull-up itself ties resistor R_5 to the output node rather than to ground as indicated. This modification saves power at the expense of a larger current spike when the gate changes states.

A more recent modification of the Darlington pull-up (Fig. 1b) includes an active turn-off, which improves circuit transient characteristics and noise immunity by improving the gate's transfer characteristic. This type of turn-off serves

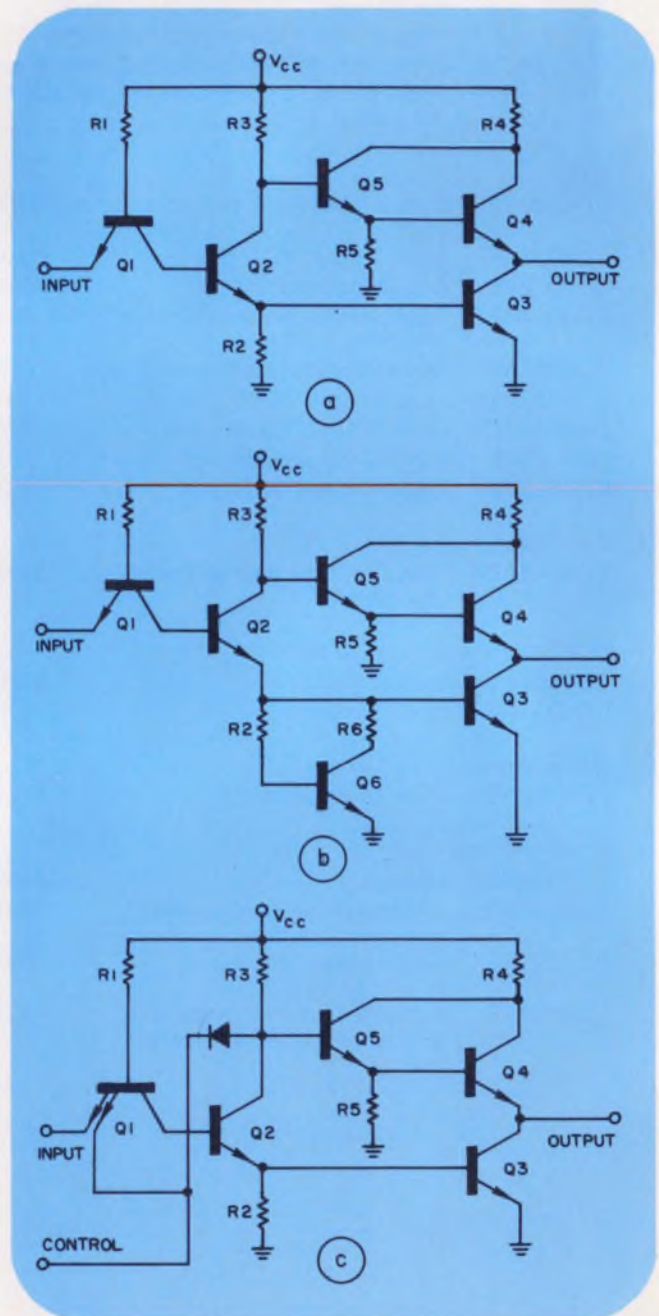

1. A Darlington pull-up on a TTL output gate boosts gain (a) to improve gate driving ability. Add an active pull-down (b) and turn-off time decreases. The tri-state TTL gate (c) can be wired-OR because it has a special, controlled high-impedance state in addition to the standard TTL ZERO and ONE states.

Ury Priel, Manager Digital Designs, National Semiconductor Corp., 2900 Semiconductor Drive, Santa Clara, Calif. 95051.

Here's how a widely used TTL output gate works

If you could look inside a TTL IC, it's likely that you would see the circuit configuration below in operation as the output gate. How it works is easy to understand. The plot of its transfer characteristic shows the current spike that occurs when both output transistors are ON at the same time.

When the input voltage is low (under 0.4 V), Q_1 is in saturation, Q_2 and Q_3 are OFF, and Q_4 is ON, supplying current to the load. The output level is at logic ONE, and $V_o = V_{cc} - [V_{be4} + V_d]$.

As the input voltage rises, so does the base voltage of Q_2 and $V_{be2} = V_i + V_{sat1}$. When the input voltage is 0.5 V, Q_2 turns ON, and its collector voltage drops as its emitter voltage rises.

Transistor Q_1 goes from saturation to inverse saturation to an inverse-active mode, as Q_2 goes from OFF to active. The output voltage drops, since the emitter of Q_4 follows its base voltage. The gate is now in the transition region of its transfer curve.

The emitter voltage of Q_2 increases with rising input voltage, until both Q_3 and Q_1 turn ON. When this happens, a current spike, I_r , occurs. A further increase in input voltage forces Q_2 and Q_3 into saturation, turning Q_4 OFF. The output is now at logic ZERO, or at V_{sat3} .

The current spike is mainly a transient phenomenon. When Q_2 turns OFF, its collector voltage rises quickly and turns Q_4 ON. The stored charge of Q_3 tends to keep it ON for a while, providing a low-impedance path for the emitter current of Q_4 , and contributing to the size of the current spike.

Each component of the gate establishes certain performance boundary conditions. For example, R_1 determines the speed at which the voltage at point A will rise, thus influencing gate turn-on time. R_3 affects gate power dissipation when the output is at logic ZERO. Both R_1 and R_3 influence the fan-in and fan-out properties of the gate and establish input and output load currents.

Resistor R_4 protects against short-circuits and affects the turn-off delay time when Q_4 is charging a load capacitor. The diode, D_1 , ensures that

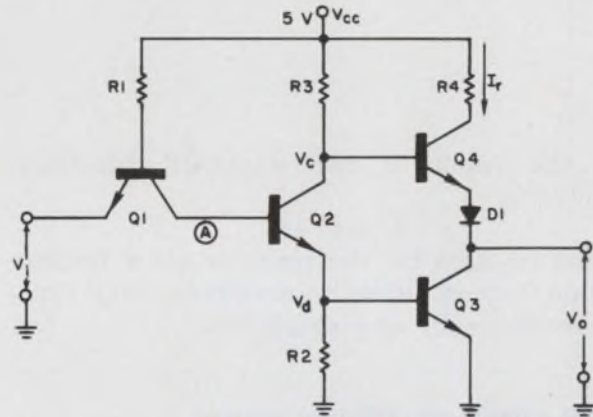

A popular TTL output gate employs an active pull-up. A current spike, I_r , occurs when the gate switches from logic ZERO to logic ONE, because a stored charge in Q_3 delays its true turn-off.

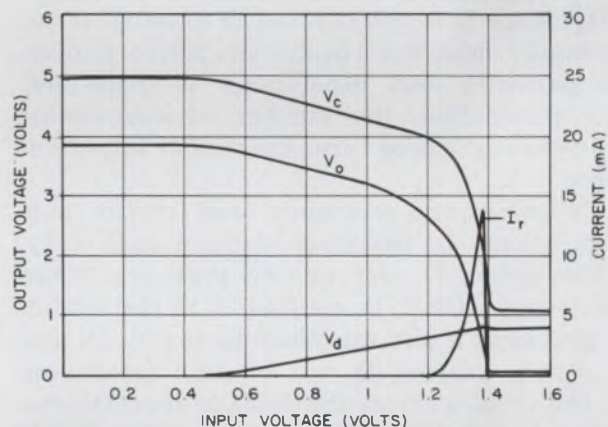

The transfer characteristic of an active-pull-up TTL output gate illustrates how the output voltage, V_o , behaves as the gate changes states. The resulting current spike is an ac/dc phenomenon.

Q_4 is OFF when Q_3 is saturated.

When the gate output switches to logic ONE, R_2 discharges the input capacitance of Q_3 . An important consideration is the ratio of R_1/R_2 . Its magnitude affects the size of the current spike as the gate switches from logic ZERO to logic ONE.

as a nonlinear load. Because it is high during the turn-on transient and low during the turn-off transient, it decreases both gate turn-on and turn-off times.

The tri-state gate of Fig. 1c is the latest development in TTL output gates. In addition to the low-impedance ONE and ZERO levels typical of TTL, this gate can be switched to a high-impedance state through its control line.

In its high-impedance state, the tri-state gate

will not supply or sink more than 40 μA when its output voltage is between 0.4 and 2.4 V—the guaranteed output levels of standard TTL. Because of this capability, the tri-state gate is very useful in bus-organized systems. It can be wired-OR like DTL or passive-pull-up TTL, but it offers the advantage of active pull-up for good driving performance.

There is a basic functional difference between wired-OR DTL and the tri-state tie. For the DTL

gate, the result of two wired-OR functions, f_1 and f_2 , is

$$\overline{f_3} = \overline{f_1} + \overline{f_2}.$$

For the tri-state tie, the result is not a Boolean function, but an ability to multiplex many functions economically on a single bus.

Internal gates need different designs

The design of an internal TTL gate is governed by different criteria than those of an output gate. For example, an internal gate may have different logic levels as well as a lower noise immunity, since it is not exposed to external noise. It normally does not require an active pull-up, since parasitic load capacitance is quite low. Power dissipation, the number of components and operating speed are the most important factors.

Let's look at two commonly used internal gate configurations. In the diode-clamped gate (Fig. 2a), the diode, D_1 , serves two purposes. When the gate turns OFF, D_1 couples R_3 to the output, thus providing a pull-up. When Q_3 is ON, D_1 acts as a clamp, keeping Q_3 out of deep saturation, since the voltage across the diode is approximately 100 mV less than the V_{be} of Q_3 . The diode's clamping action also enhances gate turn-off delay.

The gate of Fig. 2b is usually found in the input section of a complex IC. Its threshold is kept the same as that of a standard gate, but its ZERO level is higher. The main advantage of this configuration is the small number of components needed.

Clamping boosts gate switching speed

To increase the switching speed of a TTL gate, you try to keep the output transistor out of saturation as well as limit the voltage excursion between logic ZERO and logic ONE. There are a number of designs to do this.

A resistor-clamped internal gate (Fig. 3a) uses a low-value resistor ($R_4 \approx 100$ ohms) to prevent the output transistor, Q_3 , from saturating. The gate's ZERO level is therefore higher than the V_{sat} of Q_3 . In fact, it is possible to vary the ZERO level between V_{sat} for $R_4 = \infty$ and $V_{be} + V_{sat}$ for $R_4 = 0$.

Figure 3b shows a second clamping method for an internal gate, called a phase-splitter clamp.

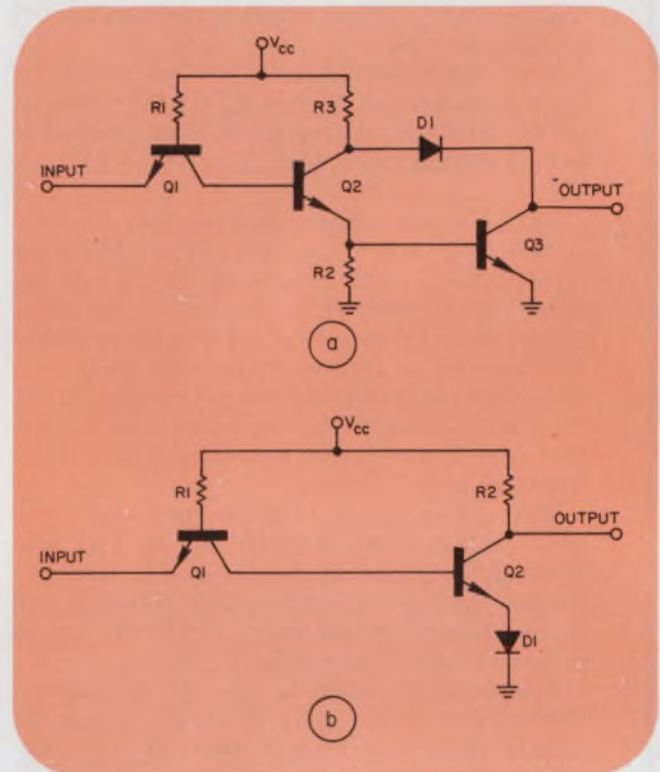

2. A TTL internal gate can be diode-clamped (a) to improve both turn-on and turn-off times. An input-type gate (b) with a higher-than-standard ZERO level reduces the number of components needed to a minimum.

Q_2 is the phase-splitter transistor because its emitter and collector voltages move in opposite directions. In this way Q_2 is clamped out of saturation to $2V_{be} - V_{offset}$ via the second emitter of Q_1 . The collector voltage of Q_3 is also raised, keeping it out of saturation as well.

Another way of clamping an internal gate's ZERO level is illustrated by Fig. 3c. The second emitter of Q_2 clamps the collector voltage of Q_3 to V_{be} . Pull-up can be provided by a diode (D_1) or by a resistor (R_4), which is indicated by the dashed lines.

The Schottky clamp aids TTL

A more recent advance in silicon technology has produced yet another clamped circuit—the Schottky-barrier-diode clamp. Figure 4a gives the circuit model for a Schottky-clamped transistor. Since the forward voltage drop of a hot-carrier or Schottky diode is approximately 0.3 V, the transistor cannot saturate.

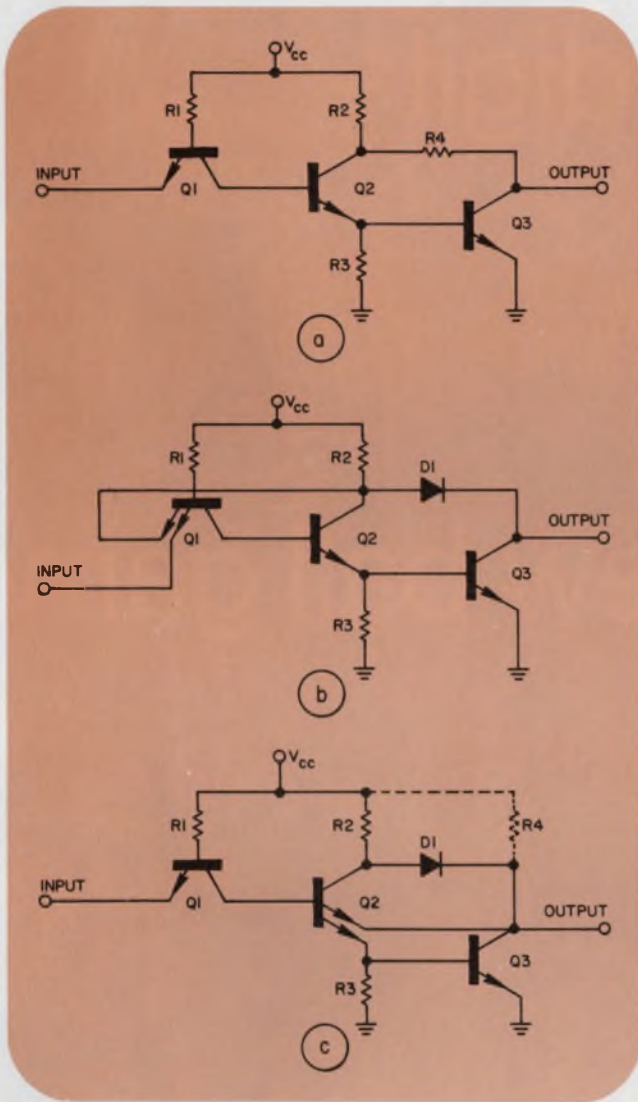

3. Clamping techniques enhance gate switching speed. Essentially the transistors are kept from saturating and the voltage excursions are reduced. A resistor clamp (a), a phase-splitter clamp (b) or an emitter clamp (c) can be used. The dashed lines in (c) show an alternate pull-up technique for the emitter clamp.

The Schottky diode is formed when a metal is used as the anode and the n-type silicon of the collector region of the transistor acts as the cathode. The interface between the metal and the semiconductor must form a non-ohmic rectifying contact.

An output gate using Schottky-clamped transistors (Fig. 4b) is efficient in terms of the number of components used to stop the transistors from saturating, but it is temperature dependent.

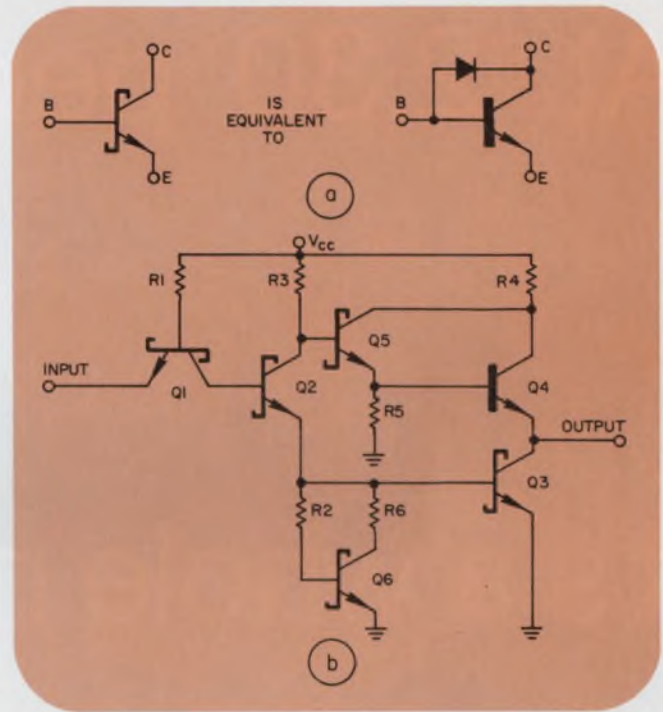

4. The Schottky-clamped transistor (a) is formed by shunting the base and collector terminals of a bipolar transistor with a Schottky-barrier diode. The Schottky-clamped gate (b) offers better speed performance than the standard TTL gate, but it lacks temperature stability because of material properties.

As temperature rises, the Schottky clamp becomes less effective and the transistors tend to saturate.

In addition the noise immunity of the Schottky-clamped gate is less than that of other clamped gates because the output ZERO level of the Schottky-clamped gate is higher. However, the superior speeds possible with Schottky-clamped gates usually outweigh the temperature and noise-immunity disadvantages they exhibit over other types of gates.

There's more to come

Future developments in TTL technology will result in more efficient use of silicon material and improved power dissipation. Specifically we can expect increased input impedances for larger fan-outs, higher noise immunity, better speed-power products, lower output impedances for bigger driving capabilities, and improved functional efficiency. ■■

Announcing new
Sperry display devices!
At \$2.30* per digit--

it's a whole new ball game

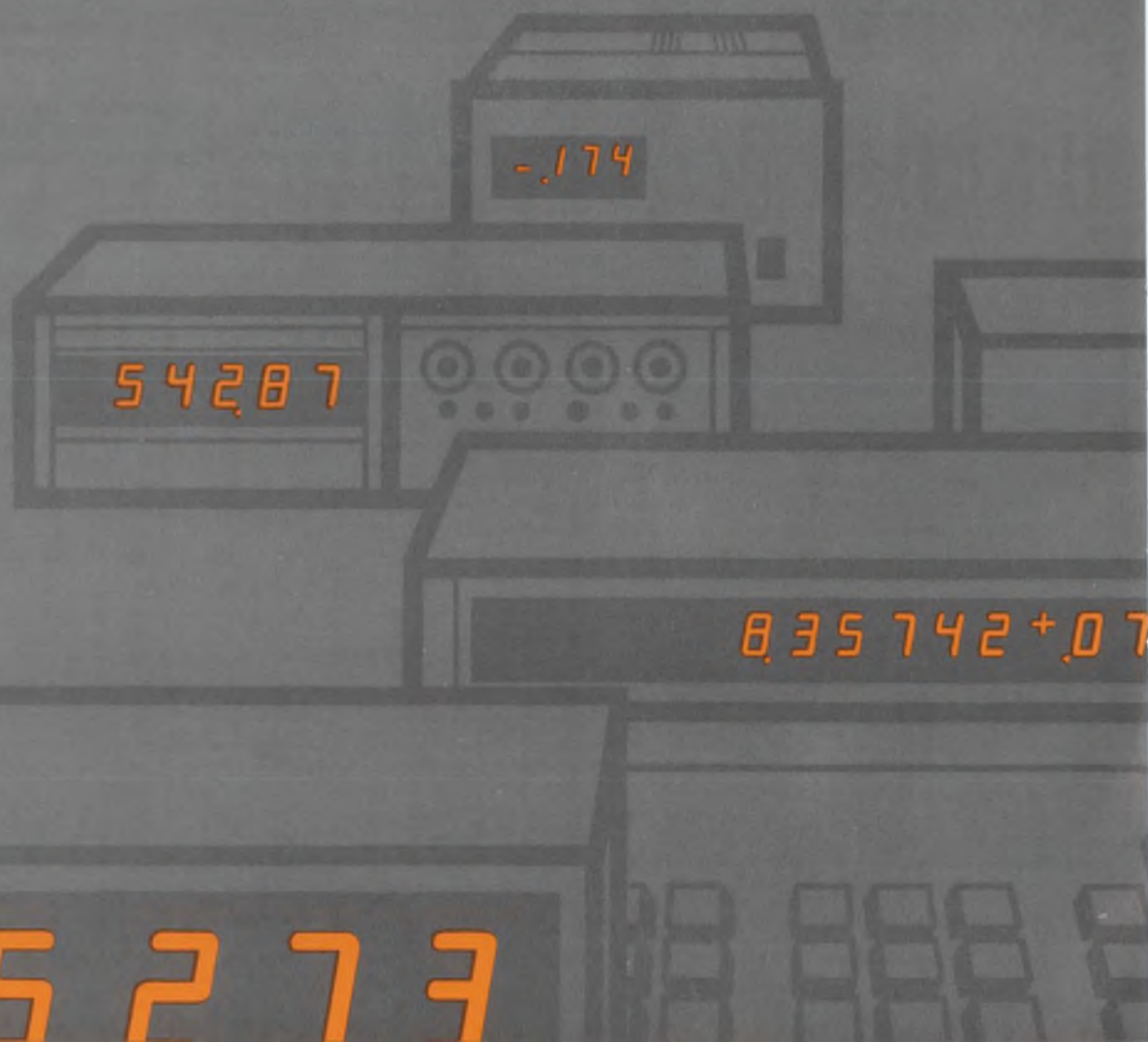

For starters, you pay less to get much more value — the result of design and fabrication breakthroughs. New Sperry seven-segment display devices† offer significant advantages over others on the market. High visibility and outstanding performance at a remarkably low cost make them especially suitable for use in calculators and other business machines, test and measurement instruments, process control equipment and many consumer products. Take a look at these major Sperry advantages.

Greater clarity and brightness —

Sperry displays are bright, crisp, and very easy to read. The pleasing orange glow provides excellent character definition and gives the segmented figures the appearance of continuous script. They're highly readable under all lighting conditions — not overpowering in soft light, yet clearly legible in direct sunlight.

Preferred character size and spacing —

Offering a character height of 0.33" with 0.375" centerline spacing, Sperry displays have the appearance of printed figures.

Even when they are stacked end-to-end, the uniform spacing is retained. The reduced size permits engineers to save critical housing space without loss of readability.

Wider viewing angle —

Advanced planar design permits Sperry displays to be read accurately within a 150° viewing angle. Characters are housed on a flat plane so all figures are displayed equally bright and clear regardless of combination.

Reduced current requirements —

Sperry devices rank among the lowest. Typical current drain is only 200 μ A per segment or 1.4 mA for a figure 8. Power dissipation is just 200 mW. Displays operate on 170 volts DC so they can be used in existing equipment without redesigning the power supply.

Multiplex capability —

A single decoder/driver may be used to multiplex several decades without impairing the appearance of the display. In standard applications, a decoder/driver can be used for each digit.

Proven reliability —

The cold cathode, gas discharge principle utilized in the new Sperry display devices has proven reliable in thousands of applications including a number of cockpit instruments aboard the Boeing 747. Sperry displays have a useful life expectancy in excess of 100,000 hours.

A full line of accessories is available, including connectors, decoder/drivers, and multiplex boards for horizontally stacking and multiplexing.

For complete technical information on the new Sperry display devices, use this publication's reader service card or phone or write:

Sperry Information Displays Division
P.O. Box 3579, Scottsdale, Arizona 85257
Telephone (602) 947-8371

SPERRY
INFORMATION DISPLAYS

in display devices!



The Sperry SP-733 (3-digit model), actual size. Also available are 2 and 1½ (a ± device with a figure 1 and a full 7-segment character) digit models.

*Price is based on 5,000 quantity.

†Patents Pending



Linearize almost anything with multipliers.

They can be used to generate a power-series approximation of the function needed to cancel out the nonlinearity.

Third of three articles

One of the fastest-growing applications of analog multipliers is in circuits used to straighten the response curves of nonlinear transducers, such as thermocouples and thermistors. These circuits are also good for eliminating pincushion distortion in CRT displays, and for generating arbitrary functions for a wide variety of applications—principally the simulation of physical phenomena.

The linearization technique is quite simple in concept: First the nonlinear characteristic of the transducer, or other device, is measured. Then a network whose transfer characteristic is equal to the negative of the nonlinear component of the transducer characteristic is cascaded with it, to cancel out the nonlinearity.

It is in the generation of the required transfer function that multiplier circuits demonstrate their superiority over more conventional methods.

The conventional method for synthesizing an arbitrary function—a square-law, for example—is to use an array of resistors and biased diodes (Fig. 1a). As the input signal level increases, it sequentially overcomes the ascending levels of bias voltage, thereby bringing new diodes into conduction and more resistors into the amplifier input path. As a result, the incremental gain of the circuit changes with the input signal.

The disadvantage of such a circuit lies in the large number of diodes and other components it requires for an accurate approximation of the desired function. For example, it needs a dozen diodes, resistors and bias-voltage sources to synthesize a simple dual-polarity square-law response, while the same job can be done by just one analog multiplier.

Other major disadvantages of the diode network are its poor temperature stability, uncertainties in the values of voltage and current at which successive diodes will begin to conduct, and errors stemming from the fact that diode

conduction voltages can be quite large, compared with the input signals.

Multipliers use a power-series approach

The multiplier-circuit approach (Fig. 1b) overcomes these disadvantages by abandoning the piecewise linear approximation in favor of direct algebraic synthesis. Each multiplier takes the output of the multiplier preceding it and multiplies it by the input signal, thus converting an input signal $x(t)$ into the power series $x(t) + x^2(t) + x^3(t) + \dots$. The summing resistors R_n, R_{n-1}, R_3, \dots , are selected to provide the proper coefficients for each term in the power series.

The output voltage, $V_o(t)$, is given by

$$V_o = (R/R_a)x + (R/R_b)x^2 + (R/R_c)x^3 + (R/R_d)x^4 \quad (1)$$

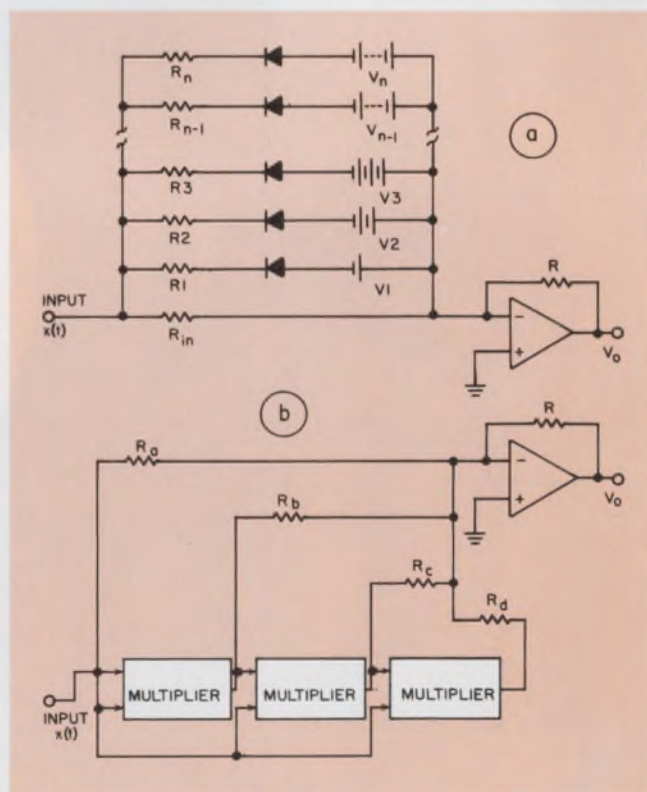

1. Don't use dozens of biased diodes (a) to generate arbitrary functions; multipliers are simpler to apply (b), and they give more accurate results.

Richard S. Burwen, Director of Advanced Development, Analog Devices, Inc., Route 1 Industrial Park, P. O. Box 280, Norwood, Mass. 02062.

The trouble with Eq. 1 is that all of its coefficients are ratios of positive resistances, and hence all are positive. To generate a more general polynomial, an additional op amp is required (Fig. 2). The extra op amp, A_2 , is added to the output, where it inverts the signal coming out of A_1 . Two sets of resistors are used: one on A_1 , the other on A_2 . For positive coefficients, the voltage is fed to A_1 ; for negative ones, A_2 is used.

Trigonometric manipulation made easy

The range of applications of this technique is enormous. In addition to linearization applications, many trigonometric manipulations are greatly facilitated when multipliers are used to exploit trigonometric identities.

To cite one simple example, a broadband frequency tripler can be made with only two multipliers if they are set up to generate the function

$$V_o(t) = -4x^3(t) + 3x(t). \quad (2)$$

If $x(t) = \sin \omega t$, then $V_o = \sin 3\omega t$ because of the trigonometric identity¹

$$\sin 3x = 3\sin x - 4\sin^3 x. \quad (3)$$

A more sophisticated example of trigonometric manipulation is the scheme outlined in Fig. 3 for developing a dc voltage proportional to the true power output developed by a three-phase generator.² Each multiplier is fed by two signals from each generator winding—one is proportional to the voltage, the other to the current.

It is interesting to note that the circuit produces a ripple-free dc output from ac inputs without the use of filters. In fact, the circuit has no energy-storage components whatever. Instead the circuit eliminates the ac components by manipulating them so they cancel each other out—an elegant scheme that needs no filters and hence provides very rapid response. ■■

References

1. Hodgman, Charles D., editor, *C.R.C. Standard Mathematical Tables*, Eleventh Edition, Chemical Rubber Publishing Co., Cleveland, 1957, p 379.
2. Smith, I. R. and Snider, L. A., "Detection and Measurement of Three-Phase Power, Reactive Power, and Power Factor, with Minimum Time Delays," *Proc IEEE*, November, 1970, p 1866.

There's a lot more to multipliers than just linearization. The first article in this series (ED 6, March 15, 1971) took up the subject of multiplier specifications—what they mean and what they don't mean. The second article (ED 7, April 1, 1971) presented a potpourri of applications, from phase-sensitive demodulation to rms measurement techniques. This article completes the series with a special class of applications based on the use of multipliers in arbitrary-function synthesis.

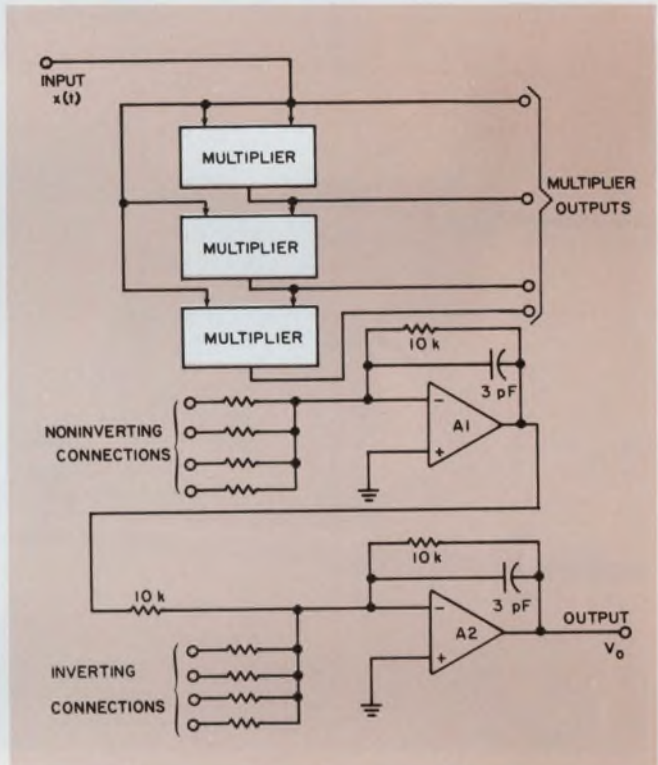

2. Polynomials with both positive and negative coefficients can be generated by this circuit because of its extra op amp. Just connect the multiplier output to one of the summing resistors on A_1 for a positive coefficient, or to A_2 for a negative coefficient.

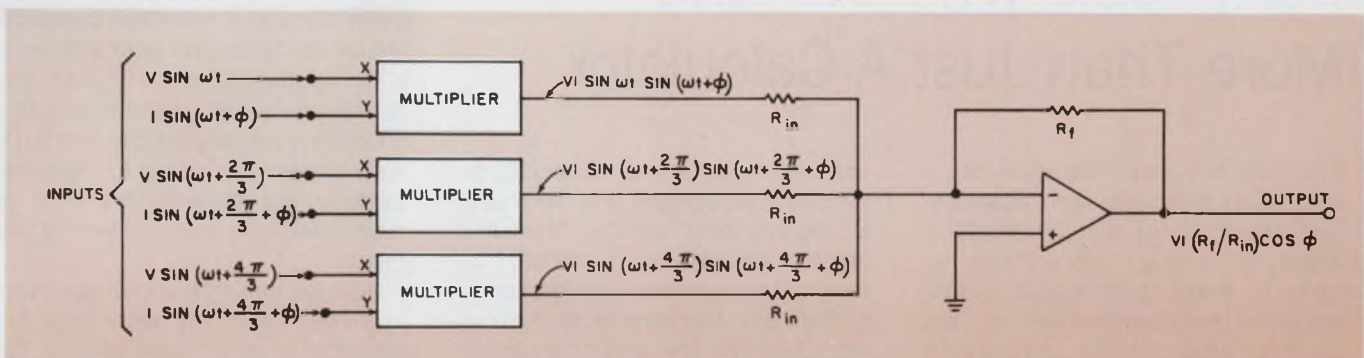

3. No filters are used in this power-measuring circuit, yet it provides a ripple-free dc output proportional to the

ac power in a three-phase system. The absence of filters greatly increases the circuit's response speed.

Bridge the Computing Gap

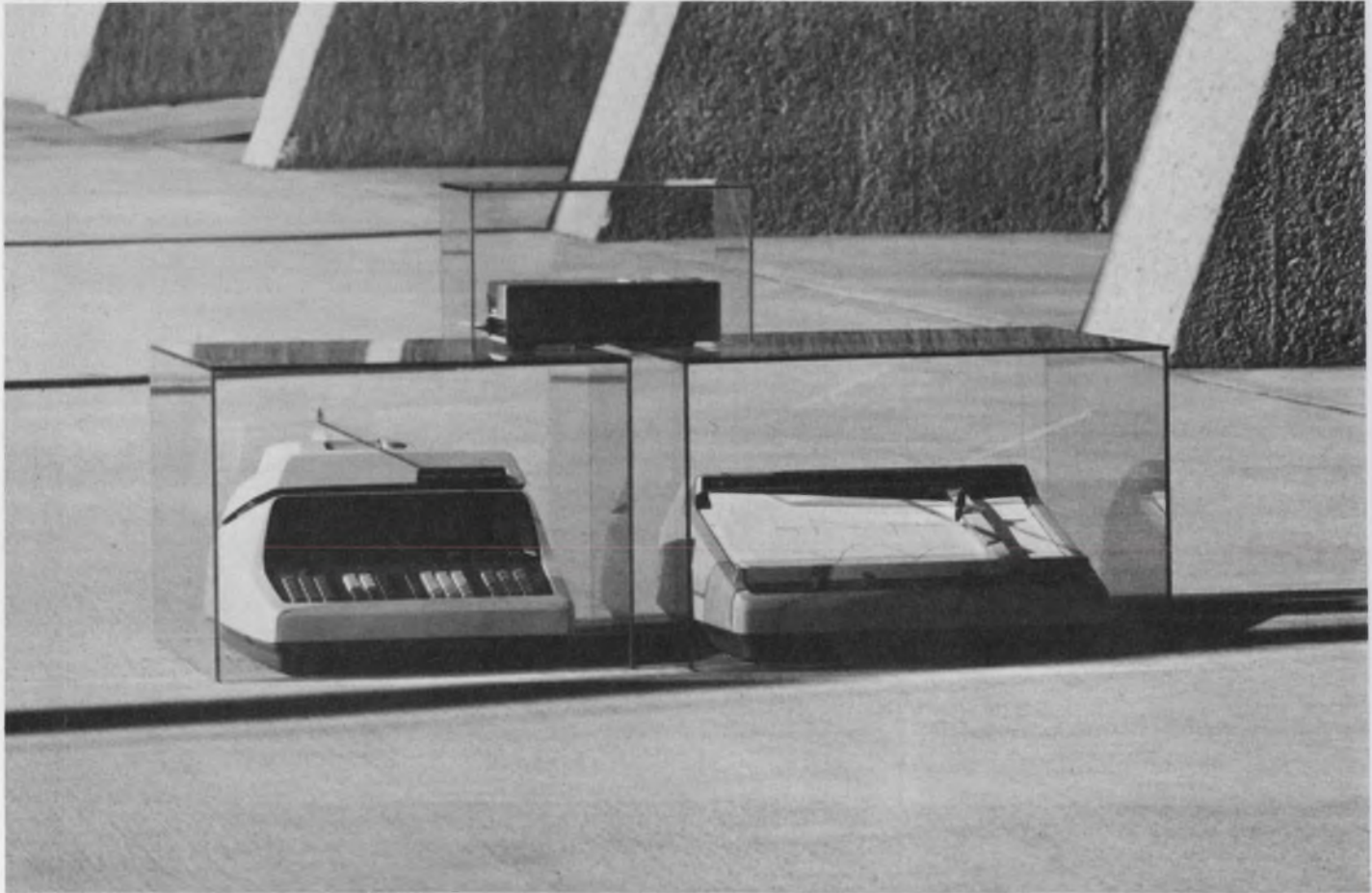

The HP Calculator System 9100. For People Who Demand More Than Just A Calculator

Chances are, you, like most other engineers, scientists, and businessmen, have found that a calculator alone isn't enough. Many times the tasks of entering data and putting solutions into useable form can eat up more time than the computation itself. That's why the HP Calculator System 9100 gives you more ways to

enter your data, more memory to perform the calculations, and more ways to receive your solution than any other calculator on the market. This true system approach allows you to fit the right machine to your needs yet retain the low cost and ease of operation of a calculator.

For instance, if graphs and charts

are important in your work, the System 9100 has the only X-Y Plotter on the market that can produce linear, log-log, and semi-log plots. Need a card reader? A large screen display? A strip printer? Formatted output? They're also available if you need them. Exclusive interface capability allows you to expand your system as your needs change—or add new peripherals as they become available. So, even if you bought the first 9100, you can take advantage of these new work-saving peripherals with no modification to your present equipment.

Now you can emancipate your time from big problems with long programs or large amounts of data. The **new 9101A Extended Memory** has the power you need to perform a 14 X 14

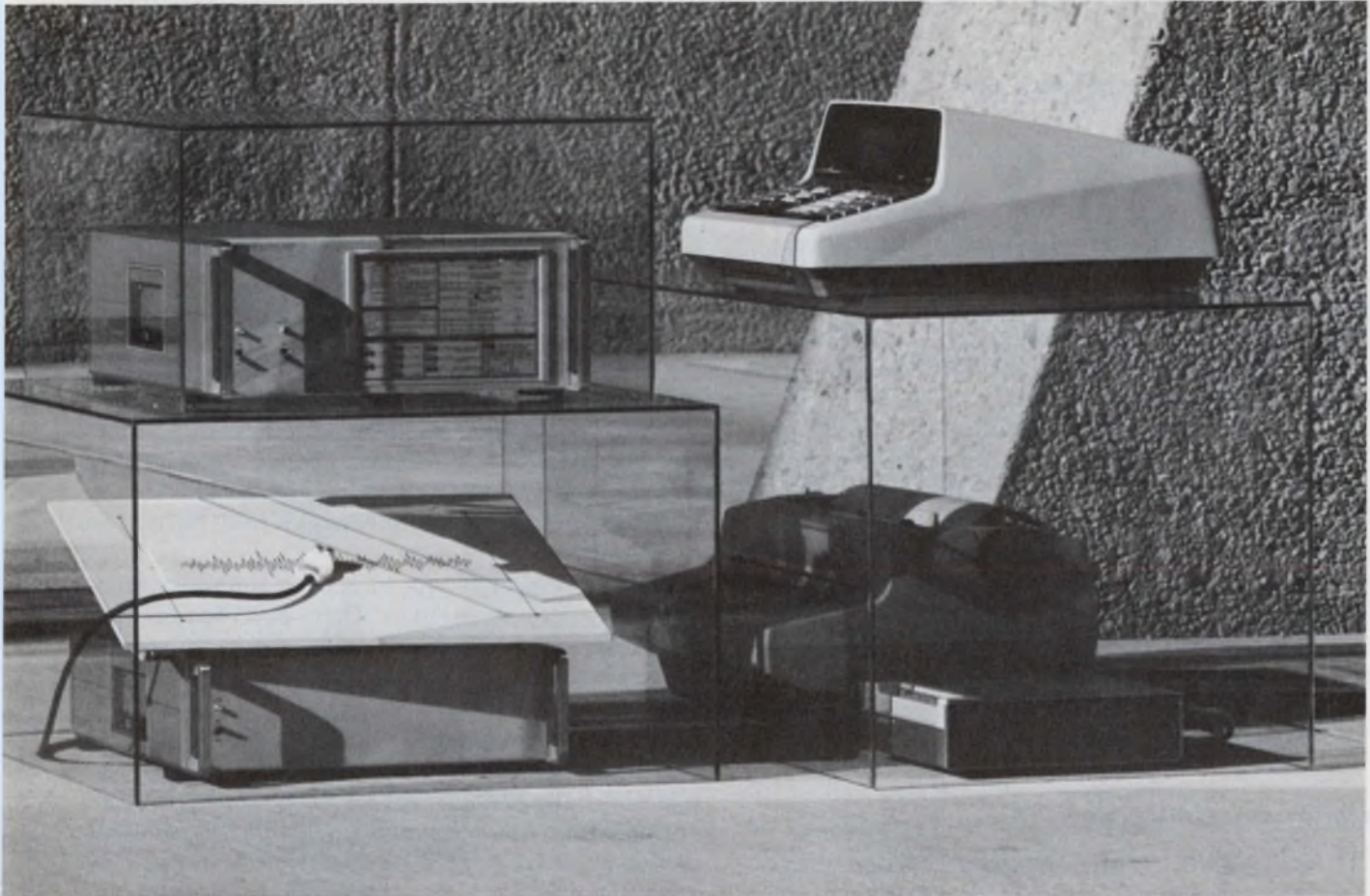

matrix inversion, or find real and complex roots of thirtieth degree polynomials. The Extended Memory is the biggest in the business. Its 248 storage registers will store up to 100 programs (3472 program steps), yet programming is quick and easy since you use indirect addressing.

And you can emancipate your time from tabulating data and solutions. The **new 9106A Typewriter Interface** will couple your 9100 Calculator with an IBM Model 73 Typewriter for fast, formatted numeric printout.

Or, you can couple the **new 9107A Digitizer** to your 9100 Calculator and have a fast, automatic means for checking mechanical drawings, profiles, maps—or analyzing strip chart data. The Digitizer automatically converts lines or points on charts or

drawings to digital data for instant analysis by your 9100 Calculator. Just enter the appropriate program in the Calculator, move the Digitizer's cursor over the data line, and the Calculator computes and prints out the solution you desire. Your imagination is the only limit to the application of this versatile data input device.

You can also couple your 9100 to a host of HP measurement instruments and automatic test systems. The new 9108A and 9108B Coupler/Controllers (not shown) will make your 9100 a true real-time, on-line data processing and control system.

All 9100 Calculators and Peripherals are backed by fully documented program packages—including a host of application Program PACs in many

disciplines of science, engineering, and business—so your System 9100 goes to work the moment you take it out of the box.

You can put the System 9100 to work for you for as little as \$1.11 per computing hour. Purchase, lease, and rental options are available for all System 9100 equipment. For further information, or to arrange a "hands-on" demonstration at your desk, write: Hewlett-Packard, P.O. Box 301, Loveland, Colorado 80537. In Europe: 1217 Meyrin-Geneva, Switzerland.

090/22

HEWLETT  PACKARD

HP CALCULATOR SYSTEM 9100

INFORMATION RETRIEVAL NUMBER 41

What size company should you work for?

Robert Noyce, a small-company president with large-company experience, draws a few comparisons that might help you decide.

Richard L. Turmail, Management Editor

There will be one or two occasions during your engineering career when you must choose between a large company and a small company. Which will fill your career needs and aspirations best? Your decision will be difficult if your employment experience has been limited.

Dr. Robert N. Noyce, inventor of the integrated circuit, has managed both large and small companies. Listen to him.

In 1968 Noyce co-founded Intel of Mountain View, Calif., as a producer of integrated semiconductor memories. Intel employs fewer than 200 people. Before that, Noyce managed 15,000 employees for nearly a decade at the Fairchild Semiconductor Div. in Mountain View. He advises engineers who are undecided whether to work for a large company or a small company to choose between these major career options:

- Security vs risk.
- Management vs engineering.

Security comes at a price

If an engineer rates security as the most important aspect of his job, says Noyce, he should work in such areas as government, public utilities and education, where there are few competitive pressures.

"But the engineer pays a price for security," Noyce notes. "If he's impatient, he'll just have to wait for the boss to die."

Marketing specialists will tell you that the larger the company, the more secure it is, because it sets the price in the marketplace. Small companies must compete with those prices, regardless of the size of their financial reserves. If the competitive pressures are severe, the engineer may find himself putting in a lot of unwanted overtime or looking for a job.

"Small companies in the electronics industry are a challenge to give birth to, rear and feed," Noyce says. "Often they're forced to lower the price of their product or increase its applications, just to keep it from getting stepped on by the giants in the competition."

Noyce's small company strategy has been to concentrate on a small segment of the memory market and turn out more specialized ICs than anybody else. Apparently the plan is working. At present Intel appears to have captured a sizable share of the computer memory market.

Management vs engineering

What about the choice between a management or engineering career?

Noyce notes that if the engineer wants to become a manager, he'll become one sooner at a small company—but at a higher risk. The risk is high because the company could fold before he has it made.

If the engineer wants to rise to senior or chief engineer, Noyce believes that his chances are better at a large company, where a cross-section of engineering disciplines offers more opportunities.

"But let management know your intentions early on," Noyce advises, "so it can help you plot the path of your career."

Engineers usually make up about 10 per cent of the work force at most electronics companies, regardless of size. If a company is working on product development, as Noyce's company is, the percentage of engineers employed will be higher. Intel, for example, employs 40 engineers out of 186 employees—22% of the total staff.

Business points that affect you

Other aspects of business that affect the engineer, whether he works for a large company or a small one, include finances, R&D policies, manufacturing operations and marketing. Here is how Noyce analyzes each from a management standpoint. Included is what this analysis implies for the individual engineer:

FINANCES. Most small companies are undercapitalized, especially when they're first starting. Investors don't realize that even when the company is going well, it needs capital to stockpile products for 90 days before the first sale. Large companies generally have a financial reserve to

fall back on. In an economic slump the small company has had it when the money's gone. However, in a recession, it's easier for the small firm to see what's essential to keep and to cut.

What this means to the engineer: Both large and small companies must offer the engineer comparable starting salaries. In large companies the top salaries are higher because the number of employees and responsibilities of top-level jobs are greater. An engineer might find himself working more overtime in a small company to get the product out. He might also find himself quickly out of a job if there's not enough capital.

One hazard for the large company engineer in a recession is that he might be buried in a non-productive project that is the first to be terminated, and he's out of work, regardless of his own ability.

R&D POLICIES. The small company usually concentrates on one or two products that are essential to its very existence. The large company can afford to experiment with bolder, wider R&D that need not always show an immediate profit.

What this means to the engineer: Small company engineers can seldom work on their own until they get down to basics. Although there isn't as much work freedom as in a large com-

consultant or refer to handbooks to acquire enough knowledge to solve the problem. He must be flexible and fast.

In a large company such diversity is not expected, and is often frowned upon since it may be interpreted as inefficiency or encroachment on another man's job. The large-company engineer rarely sees the manufacturing department. He has little knowledge of the over-all picture.

MARKETING. The fewer products the small company has, the less revenue it has to advertise. To compete, it must find a large-company market and upstage the opposition, and its salesmen must have intimate knowledge of the product.

Diversified companies like General Electric talk to the nation regularly on television, and they have hundreds of salesmen. Their weakness is that they have to advertise a broader product line and the salesmen usually cannot have an intimate knowledge of each product.



NOYCE: Let management know your intentions early on so it can help you plot the path of your career.

pany, there is identification with the product. The engineer will generally have more responsibility eventually and more recognition than he would in a large company.

Large company engineers often have time and opportunity to experiment on their own. Since they see only a small part of the product they're working on, however, they may find it difficult to identify with it. One danger for the ambitious large company engineer is that he may be wasted on a boring project requiring only half his time. Projects are usually so subdivided that accomplishment is the result of team effort rather than individual effort. In time, the engineer might lose his motivation.

MANUFACTURING. Planning, control and production in a small company calls for almost constant cross-reference between engineering and manufacturing departments. Such communication is more limited in large companies.

What this means to the engineer: The small-company engineer tends to be a generalist, concerned with not only his immediate design problems but aspects of manufacturing. For example, if there is no structural engineer in a small company and the product needs this skill, the engineer may use an outside supplier, hire a

What this means to the engineer: The benefits in a large company are obvious. The smaller the product line, the more limited are the engineers' chances for promotions, job opportunities and salary increases. In small companies engineers frequently work very closely with the salesmen to keep them informed.

The personal touch involved, too

There's one other consideration in choosing between big and small companies: the personal touch with the top bosses.

"One of the reasons I left Fairchild," Noyce says, "is because I'd lost the personal touch with employees. It got so bad that there were few of them I knew by their first names."

What about Intel—doesn't he expect it to grow? "By the time Intel gets that big," he counters, "maybe I'll be old enough to retire." ■

This RAM

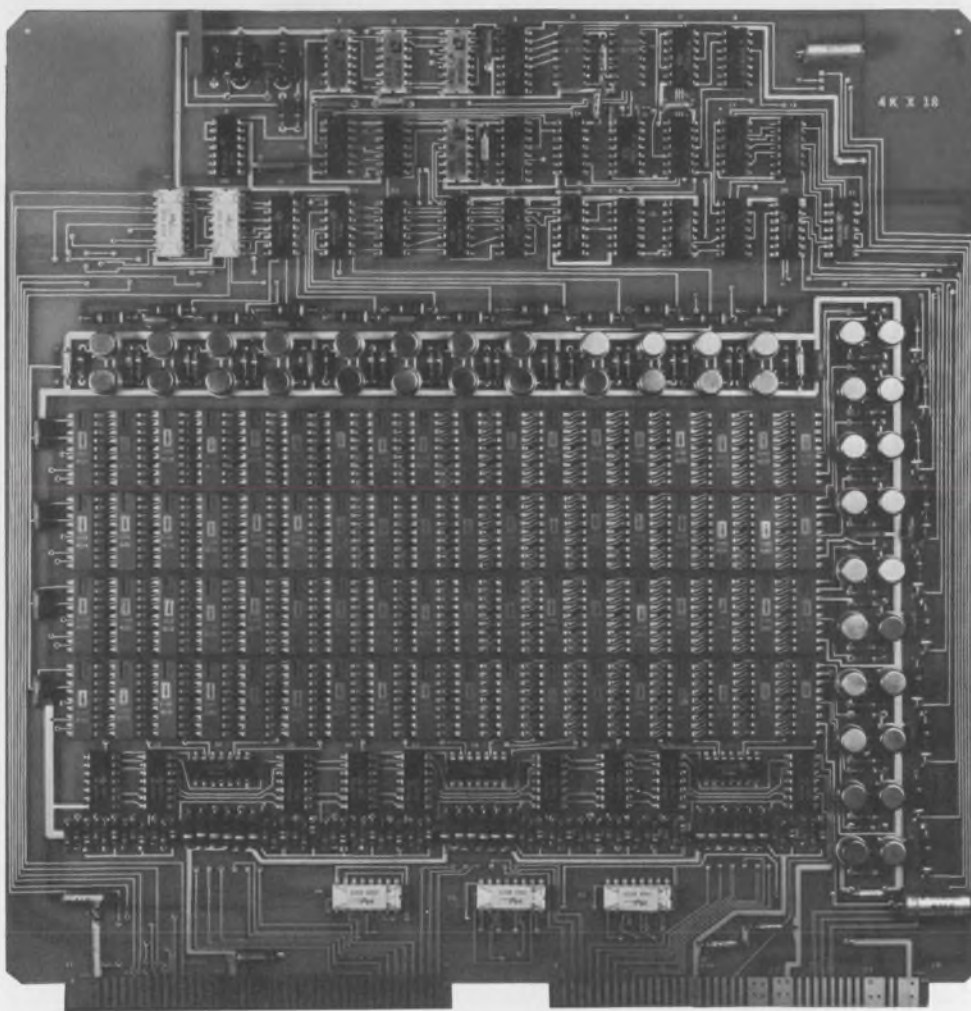

At left is a REAL 72,000-bit semiconductor memory built with Intel 1103's, the 1024-bit silicon-gate MOS RAM that's winning the price performance competition in main frame memories.

Intel's 1103 is a product, not a promise.

It's been in large-scale production since October 1970.

It's undergone 500,000 hours of life tests.

It makes complete operational memory systems that have 200 to 300 ns maximum access and 300 to 600 ns total cycle time.

"Just tell us what core memories cost you and we'll tell you how to build operational Type 1103 memories for less cost in any size from 50,000 bits to ten million bits."

We said that six months ago.

We say it again today.

For proof of this cost advantage, phone your Intel representative or call us collect at (415) 961-8080. For immediate delivery phone your local Intel distributor, Cramer Electronics, Hamilton Electro Sales, Industrial Components, or Electronic Marketing.

Intel Corporation is in high-volume production at 365 Middlefield Road, Mountain View, California 94040.

intelTM
delivers.

is no BULL

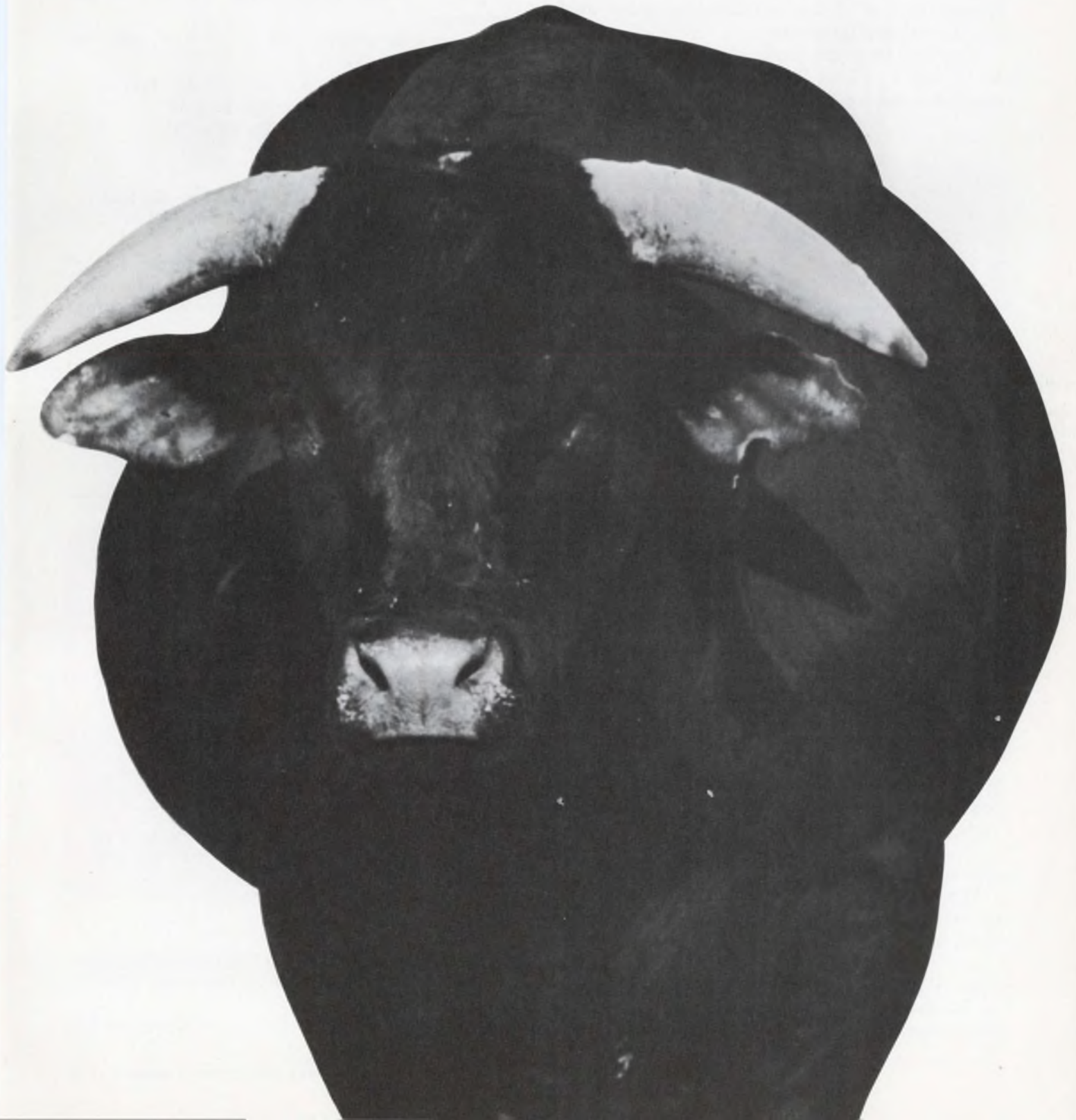

ideas for design

You need only one op amp to build a differential integrator

A differential integrator that provides the true integral of the difference between two input voltages requires only a single differential op amp. The circuit employs a capacitor (C_2) to ground, instead of the additional amplifier used in conventional integrators.

Provided that the time constants, T_1 ($T_1 = R_1 C_1$) and T_2 ($T_2 = R_2 C_1$), are equal, the circuit integrates the input difference voltage. If e_1 , the

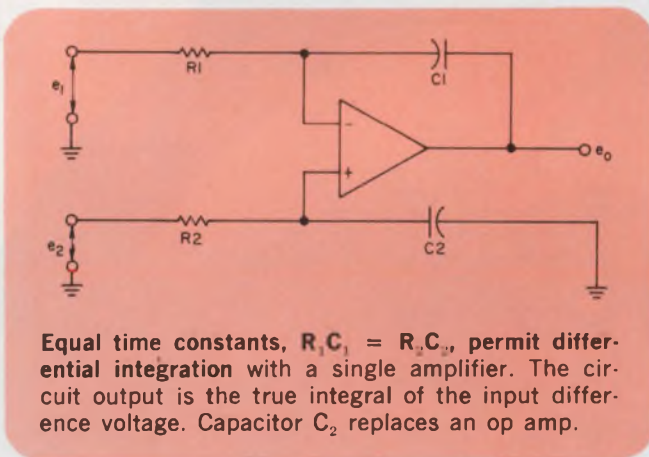

input voltage to the amplifier's inverting input, is 0 V, the circuit functions as a positive (non-inverting) integrator.

For the circuit to be a true differential integrator, the Laplace transform of its output should be

$$E_o = K(E_2 - E_1)/s,$$

where K is the inverse time constant of the integrator.

Using superposition, let $e_2 = 0$ V, and the output due to e_1 is

$$(E_o)_1 = (-E_1/R_1 C_1 s) = (-E_1/T_1 s).$$

with $e_1 = 0$ V, the output due to e_2 is

$$(E_o)_2 = (1 + 1/T_2 s) E_2 / (T_2 s + 1).$$

The total output becomes

$$E_o = (E_o)_1 + (E_o)_2$$

$$E_o = E_2 (1 + 1/T_2 s) / (T_2 s + 1) - E_1 / T_1 s.$$

Let $T_1 = T_2 = R_1 C_1 = R_2 C_2 = 1/K$, then

$$E_o = K(E_2 - E_1)/s, \text{ as required.}$$

If both inputs are true current sources, R_1 and R_2 can be eliminated, resulting in a differential current integrator. The transform of the output voltage becomes

$$E_o = (I_2/C_2 - I_1/C_1) / s.$$

If $C_1 = C_2 = C$, then

$$E_o = (I_2 - I_1) / s C.$$

Allan G. Lloyd, Holobeam, Inc., 560 Winters Ave., Paramus, N. J. 07652. VOTE FOR 311

PUT relaxation oscillator offers linear period control

A conventional unijunction-transistor relaxation oscillator does not have linear period variations with changes in the control resistance, because the network's capacitor is charged exponentially. But you can get linear period changes with a circuit that uses a linear potentiometer.

In the figure, Q_2 is a programmable unijunction transistor. D_1 , D_2 , R_1 , R_2 and Q_1 function as a constant-current source to charge C_1 . Capacitor voltage, V_a , is represented by

$$V_a = I_{E1} t / C_1 = kt,$$

where k is I_{E1}/C_1 .

When V_a equals the potentiometer voltage, V_s , Q_2 fires and sends out a pulse. The period of the train is

$$T = V_s / k.$$

Since V_s varies linearly with respect to a change in R_6 , the period of the output pulse train also varies linearly.

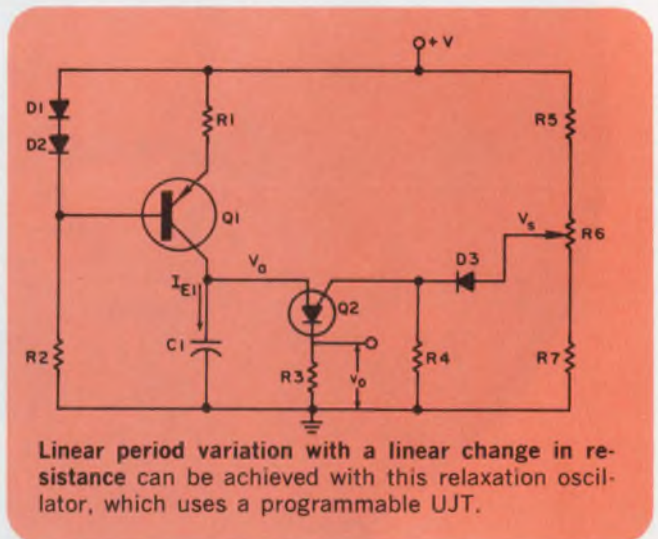

Vang Tou Cheong, Electrical Design Engineer, Beech Aircraft Corp., 1620 S. Pinecrest, Wichita, Kan. 67218.

VOTE FOR 312

**For you,
tailor made
control knobs at
off-the-shelf
prices**

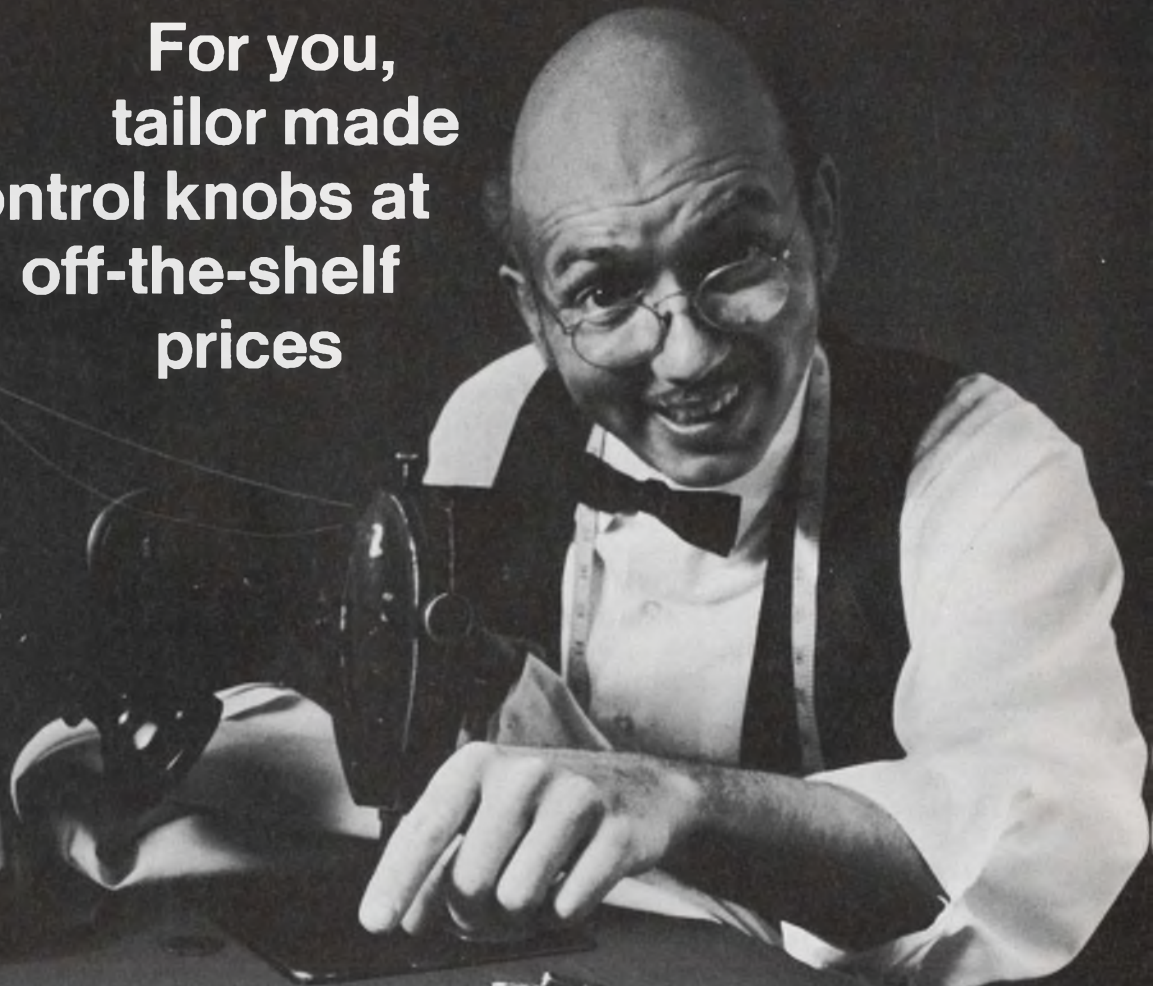

Now you can give your product a truly distinctive look, set it apart from the competition, without overextending your budget.

We'll work right from your blueprints or make adjustments in existing tooling to provide any custom modification you want. Special colors, unique, decorative inlays and custom markings; you'll get the perfect control knob or dial for your individual product needs.

Talk to the "custom tailors" at Rogan. You'll find they can set your product apart from the crowd, without setting you apart from your budget. And while you're at it, ask for our free new "R-71" catalog.

Rogan

8015 North Monticello Avenue, Skokie, Illinois 60076
Phone: (312) 675-1234 • TWX: 910-223-4547

Build a pulse generator that covers from 1 ms to 1000 s

Using an op amp as a balanced bridge comparator, a pulse generator provides a wide range of timing cycles—from 1 ms to 1000 s. During the capacitor charging time, the input of the op amp (National LM301-A) is back-biased, permitting the use of high charging-resistor values. Up to 50 M Ω can be used without any significant errors. The circuit is nearly independent of the source voltage, as long as supply voltage drift is much slower than the timing period and the bridge components are voltage-stable.

While the capacitor is charging, the op-amp output is low, keeping the thyristor OFF. As soon as the bridge, which is formed by R_1 , R_2 , R_3 and C_1 , is balanced (within the op-amp offset), the output becomes positive, turning the thyristor ON. This makes capacitor C_2 discharge through R_4 and R_5 , driving Q_1 into saturation and discharging C_1 very rapidly.

The measured reset time is 20 μ s when C_1 is 1 μ F. The cycle starts again as soon as C_2 makes Q_1 turn OFF. The choice of C_2 equaling $C_1/10$ makes a reasonable compromise between completely discharging C_1 and a short reset time.

Output pulses can be taken from the amplifier output or across R_5 . The latter gives 1- μ s-rise-time pulses with amplitudes of 5 to 25 V, depending on the supply voltage.

Pulse duration is determined mainly by the passive components in the bridge. And the period is given by:

$$T = C_1 R_3 \ln [(R_1 + R_2)/R_1]$$

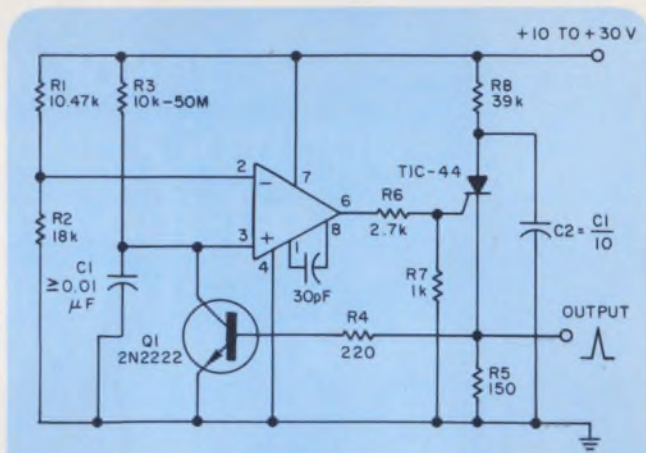

Vary the timing cycle of this pulse generator from 1 ms to 1000 s by simply tweaking some of the passive-component values. High accuracy and temperature stability are main features.

The op amp works with ratios of R_1/R_2 from 0.1 to 0.9.

Due to its high accuracy, the circuit is well suited for laboratory use. Using a precision 100-k Ω 10-turn potentiometer in place of R_3 and selecting different values for C_1 and C_2 allows the circuit to be used as a low-frequency master pulse generator.

To achieve the shortest possible reset time, R_5 must be matched to transistor Q_1 . Be sure to use a transistor that can withstand current pulses of 1 A or more.

Bjorn Dahl, Design Engineer, A/S Kongsberg Vapenfabrikk, Kongsberg, Norway.

VOTE FOR 313

A voltage-controlled delay lets you stretch pulse width

A wide-range voltage-controlled delay can be made using a field-effect transistor as a voltage-variable resistor and a quad dual-input TTL NAND gate (Motorola MC3000). Output pulse duration can be varied from 1.2 to 120 μ s with the components shown and is independent of input pulse width, as long as the input pulse is narrower than the output pulse.

The delay is not linear with control voltage, but in many control loop uses this is not important. Duty cycles of up to 80% are possible, and different output ranges may be achieved by changing the timing capacitor.

Gate G_1 is not necessary if negative-going pulses are used to trigger, and G_1 is used only to provide a complementary output. When triggered, G_2 's output goes high and is coupled to G_3 through the capacitor.

The output of G_3 then goes low, keeping G_2 's output high after the trigger has vanished. The high input to G_3 eventually decays to the low threshold through the FET, which causes the one-shot circuit to return to its stable state.

D. Eugene Hokanson, Physicist, Veterans Administration Hospital, 4435 Beacon Ave. S., Seattle, Wash. 98108.

VOTE FOR 314

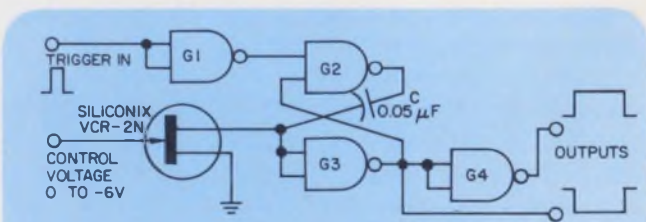

Output pulse duration can be varied from 1.2 to 120 μ s with this voltage-controlled one-shot. Although the delay is not linear with control voltage, duty cycles of up to 80% can be achieved.

Centralab DIPs have a secret...

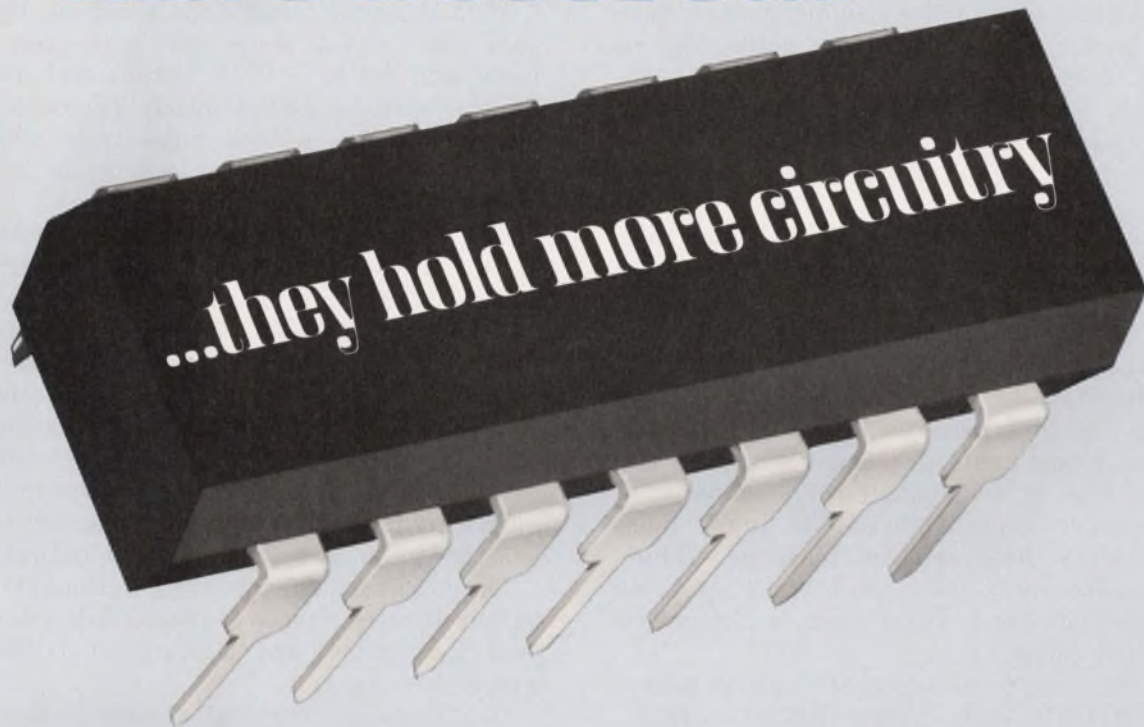
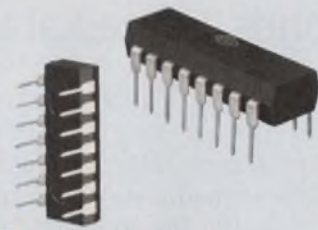

Every dual in-line package may look the same, but Centralab, through a unique manufacturing process, can now provide more circuitry per package. You can reduce the number of packages required for further miniaturization in design.

In resistor networks, including ladder networks, Centralab DIPs can accommodate a maximum of 24 resistors per package in 14 lead (TO-116) configurations. Our new 16 lead package provides up to 28 resistors.

A similar increase in elements is possible in two other general groups of networks:

- Resistor/Capacitor networks, including multi-layer ceramic chip capacitors.
- Active networks, including those with conventional semiconductor chips or beam-leaded devices.

The precision molded packages in either 14 or 16 lead configuration illustrated have a power rating of up to three watts and are designed to meet MIL Standards 883 and 202.

Centralab, the pioneer in thick-film technology, continues to lead with the introduction of these new packages. Laser adjusting techniques reduce resistor size, a special lead-frame material provides greater power handling capabilities, and automated final test equipment insures the reliability you demand. As producers of our own substrates, capacitors, resistor materials and semiconductors, we can provide customized circuitry that meets your standards of performance and reliability . . . with delivery in four weeks.

For complete information and specifications, write Sales Manager, MEC, Centralab.

SPECIFICATIONS*

Ohmic values	10 to 10 Meg.
Tolerance	to 0.5%
Ratio match	to 0.5%
TCR (-55°C to +150°C)	<100 PPM/°C
TC Tracking	10-25 PPM
Operating temperature range	-55°C to +125°C
Power density	up to 3 watts
High temperature stability (2000 hrs. @ 125°C)	$\Delta R < 0.5\%$
Operating load life (1000 hrs. @ 70°C & 2 watts)	$\Delta R < 0.5\%$
Short time overload (2.5 times power rating)	$\Delta R < 0.5\%$

*Typical

ALSO AVAILABLE THROUGH
GLOBE-UNION INC. - INTERNATIONAL DIV.



CENTRALAB

Electronics Division
GLOBE-UNION INC.

5757 NORTH GREEN BAY AVENUE
MILWAUKEE, WISCONSIN 53201

Digital IC tone detector responds immediately to inputs

The digital IC equivalent of a tone-activated relay can quickly discriminate or detect a signal whose frequency falls within its passband. The response is immediate—the output appears within one cycle of the input signal.

Applications range from opening garage doors through motor speed control to activating remote machine or telemetry stations.

A sharp, narrow, square-pulse output results when the input frequency is in the circuit's passband. The input signal should be a square wave with a 50% duty cycle.

The circuit can be tuned to detect pulse rates from less than 1 pulse per second to several megahertz. Since the upper and lower skirts are individually tunable, both the center frequency and passband are adjustable.

Each half of the detector can be used independently, as high-pass or low-pass frequency detectors. Adjustments are made with the two potentiometers or by changing RC values.

The positive-going edge of the input pulse signal triggers three one-shot pulse generators. Their outputs are a very short reset pulse, an upper-frequency-limit pulse and a lower-frequency-limit pulse.

First, the reset pulse forces the output latches into their OFF state (logic ZERO output), which causes the bandpass detector output to be in the untrue state (logic ONE output). The output can go true again only if the input pulse

period is within the bounds set by the RC timing components of the upper and lower-frequency-limit generators.

If the first half cycle of the input pulse is greater than the upper-frequency-limit pulse width, the upper-limit comparator sets the upper limit latch. Conversely, the lower-limit latch is set if the incoming pulse width is less than the lower-limit pulse width.

With these two conditions satisfied, the band-pass detector will sense that both limit latches have been set to a ONE output and switch to the true state—a ZERO output. The detector output will, therefore, be a pulse train within the bandpass frequency for as long as the input signal is at the selected frequency.

The integrator is added for applications requiring a continuous true output, rather than a pulsed output. The integrator is a retriggerable one-shot whose period is made 5% longer than the period of the bandpass center frequency.

As shown, the detector is set for a center frequency of 100 kHz, so the one-shot pulse width is set for 10.5 μ s. A retriggerable one-shot must be used, so that the dc logic level output is reinitiated with each new input pulse without any negative-going steps in the final output.

The circuit components are a National DMBDL-04 hex inverter, three National DM80L00 quad dual-input gates, and a National DM8850 retriggerable one-shot.

Don Fleming, National Semiconductor Corp., 2900 Semiconductor Dr., Santa Clara, Calif. 95051.

VOTE FOR 315

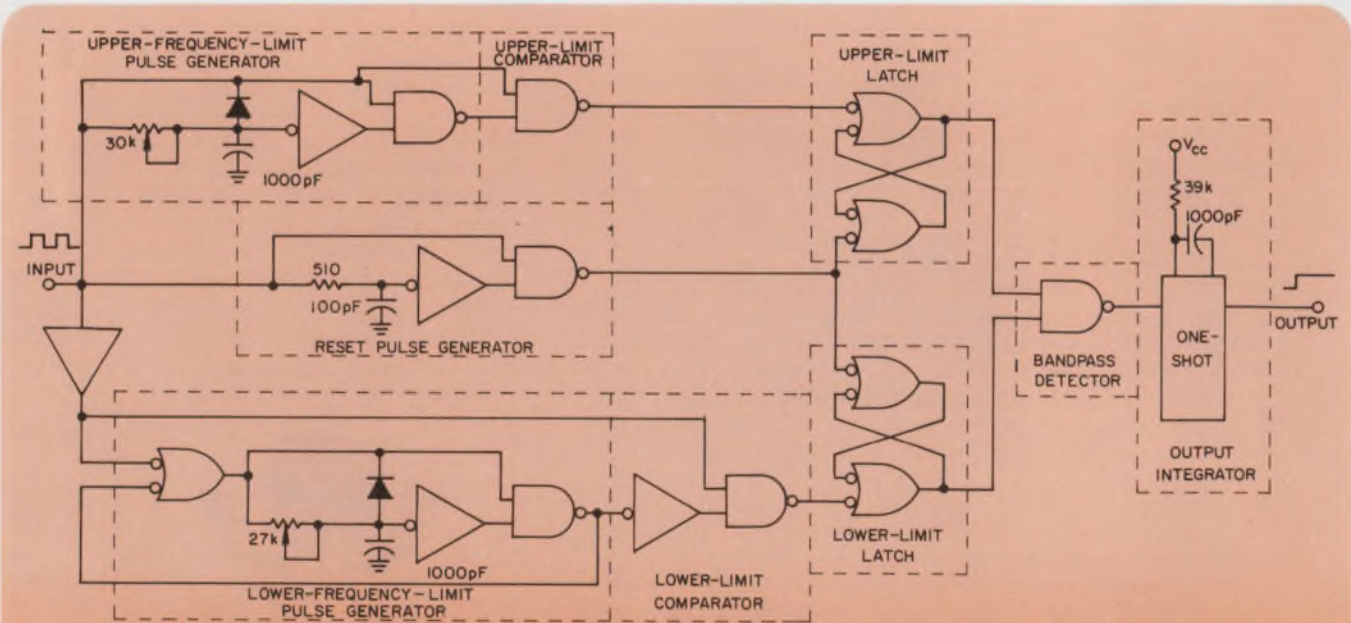

The output of this tone detector is a sharp, narrow, square pulse that is produced when the input frequency is within the preset passband. The upper and lower limits are individually tunable; thus both

the center frequency and passband are adjustable. An integrator, in the form of a retriggerable one-shot, can be added for applications requiring a continuous true output.

*If your problem is measuring μV ,
 μA and milliohms
 in transistorized
 and integrated
 circuits . . .
 Solve it with
 Triplet's 801*



Model 801
 \$ 210

1. Lower power ohms — 8 ranges with 35 mV power source and 1 ohm center scale.
2. High sensitivity — 5 mV AC full scale at 10 megohm input impedance; 50 mV DC at 11 megohm input resistance.
3. Simplified scale — 8" meter with only 4 arcs for all 73 ranges.

It offers 73 measurement ranges including 8 low-power resistance ranges that apply only 35 mV to the device under test . . . does not activate or damage solid-state components. With full-scale readings as low as 50 mV DC and 5 mV AC, 5 μA DC and 100 Ohms (1 Ohm center-scale) — plus a 10 megohm input impedance on the AC scales and 11 megohm input resistance

on DC — Triplet's Model 801 V-O-M is ideally suited to in-circuit testing. When you add 2% DC and 3% AC accuracy on the voltage ranges (current: 3% DC and 4% AC) and a 25 μA suspension-type meter with a nearly 7 1/2" scale length, there's no doubt that the Model 801 has no equal among analog V-O-M's in terms of sensitivity and versatility.

See the remarkable Model 801 V-O-M — priced at \$210 — at your Triplet distributor. For more information—or for a free demonstration—call him or your Triplet sales representative right away. Triplet Corporation, Bluffton, Ohio 45817.

TRIPLET

The World's most complete line of V-O-M's . . .
 choose the one that's just right for you

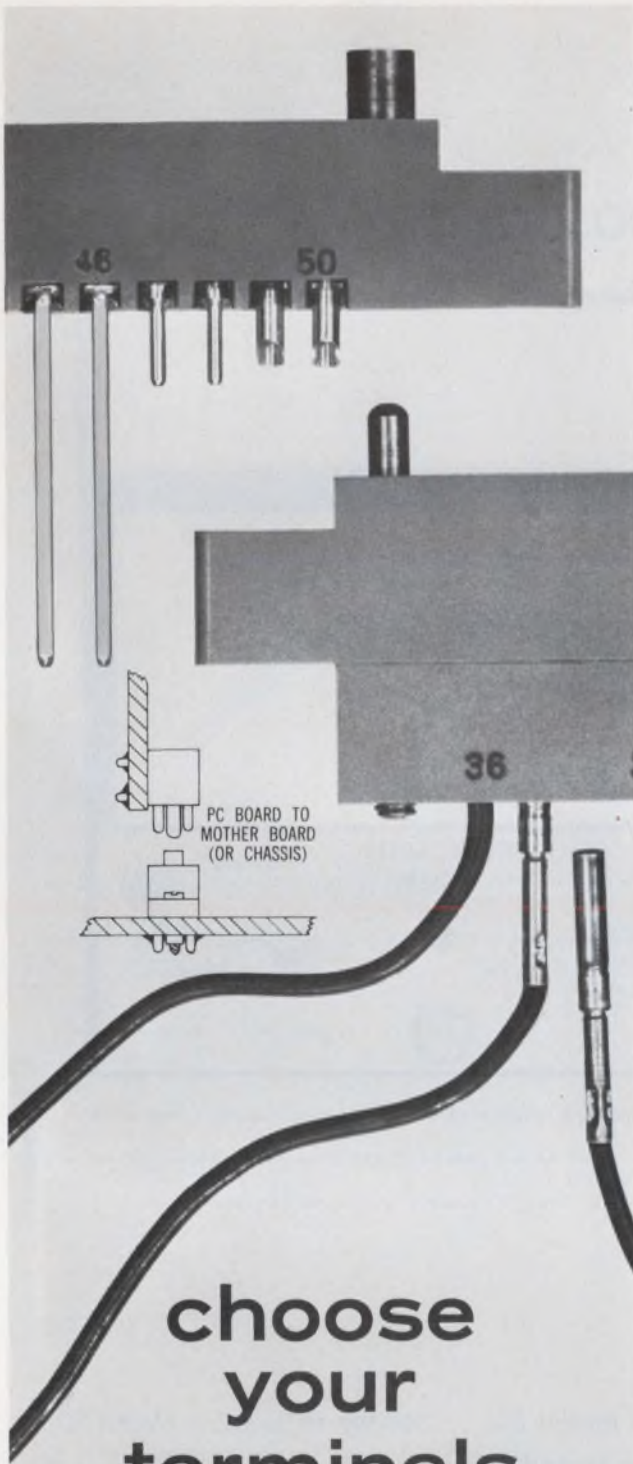

choose your terminals

On most all AirBorn subminiature connectors for printed circuit board or conventional interconnection applications, you can choose soldercup, dip terminal, wirewrap post, or crimp barrel terminations. For information on AirBorn's entire subminiature line, call 214-357-0274 or write 2618 Manana Drive, Dallas, Texas 75220.

AirBorn, Inc.

Halt noise spikes in IC logic gates

In integrated-circuit systems that have fast gates in cascade, noise spikes at the input of the first gate can cause trouble by rippling through and appearing as a false signal at a clocked element. Inserting a capacitor from the gate's input to ground can sometimes solve this problem, but it also creates others—like current spikes in the ground circuit.

A more effective solution is to use the built-in substrate diode of the IC and an RC feedback circuit to introduce a delay in the first gate's response to a noise spike. The appearance of a positive-going spike at the input to G_1 may cause it to turn ON, thus dropping the voltage at point A.

A portion of this voltage change will appear at point B if the voltage drop across R_1 is less than the drop at point A. Point B will then go negative, forward-biasing the substrate diode D_2 , and clamping the output of G_2 .

The noise spike has thus not propagated past the first gate. After the noise spike vanishes, the RC circuit charges up again, returning the circuit to normal conditions.

Two criteria govern the choice of R_1 and C_1 . R_1 must be small enough to insure that the negative-going voltage at point A will be transmitted to point B. The time constant must be large enough to trap the noise spike, yet not so large

Let your slide rule convert frequency to wavelength

In addition to its many well known uses, the slide rule can be used to directly convert frequency to wavelength or vice versa. All you need to remember is that 1000 MHz is equivalent to 30 cm of wavelength.

Simply set 3 for 30 cm on the C1 scale over the right-hand index. Now for any frequency

VOTE! Go through all Idea-for-Design entries, select the best, and circle the appropriate number on the Reader-Service-Card.

SEND US YOUR IDEAS FOR DESIGN. You may win a grand total of \$1050 (cash)! Here's how. Submit your IFD describing a new or important circuit or design technique, the clever use of a new component or test equipment, packaging tips, cost-saving ideas to our Ideas-for-Design editor. You will receive \$20 for each accepted idea, \$30 more if it is voted best-of-issue by our readers. The best-of-issue winners become eligible for the Idea Of the Year award of \$1000.

that it interferes with actual signals.

Simple circuit analysis shows that the maximum value of R_1 is given by:

$$(R_1)_{max} = R_{eq} (V_{CC} - V_A) / V_{eq}$$

where R_{eq} is the equivalent resistive load on G_2 , V_{eq} is the equivalent source voltage on G_2 , V_{CC} is the gate power supply voltage and V_A is the ON voltage of G_1 .

The value of C_1 that will clamp the output of G_2 for the duration of the noise spike is:

$$C_1 = -T / R_1 \log [V_{eq} R_1 / (V_{CC} - V_A)] R_{eq}$$

The period, T , to be used is the width of the noise spike to be stopped.

E. L. Smith, Westinghouse Electric Corp., Aerospace and Electronics Systems Div., Baltimore.

VOTE FOR 316

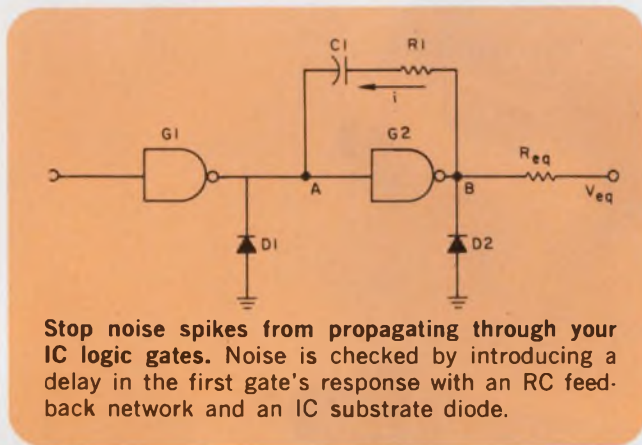

between 300 and 1000 MHz on the D scale, read its wavelength on the C1 scale in centimeters.

As an example, let us find the wavelength for 630 MHz. Set 3 on the C1 scale for 30 cm over right-hand index 1; then set the slider to 63 on the D scale. The C1 scale will show 47.6 cm as the wavelength for 630 MHz.

Ben R. Delgado, Senior Electronics Technician, Southwest Research Institute, P. O. Drawer 28510, San Antonio, Tex. 78228.

VOTE FOR 317

IFD Winner for December 20, 1970

James M. Loe, Engineering Specialist, Philco-Ford Corp., 1400 Union Meeting Road, Blue Bell, Pa. 19422. His idea "Get Two Voltages From One Bridge Rectifier" has been voted the Most Valuable of Issue Award.

Vote for the Best Idea in this Issue.

SLIDE SWITCHES

Miniature series offers multiple circuit switching in limited P. C. space. Choice of upright mounting or right-angle mounting. Compact size for P. C. cards. Economically priced.

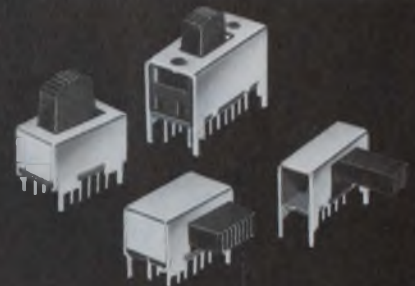

ALCOSWITCH®

DIV. OF ALCO ELECTRONIC PRODUCTS, INC., LAWRENCE, MASS.

IDEAL SIZE FOR PRINTED CIRCUITS

Telephone: TED LAMBERT (617) 686-3887

INFORMATION RETRIEVAL NUMBER 48

MAGNET REED MINIATURES

Super miniature proximity switch & magnet assembly includes an encased Alnico-5 magnet that actuates the reed switch within .39". Rating @ 50 VDC: 150ma break, 500-ma carry.

NORMALLY OPEN or



NORMALLY CLOSED

ALCOSWITCH®

DIV. OF ALCO ELECTRONIC PRODUCTS, INC., LAWRENCE, MASS.

INFORMATION RETRIEVAL NUMBER 49

DESIGN YOUR OWN KEYBOARD

A reliable reed switch is actuated by a permanent magnet. Close tolerance is maintained in operating pressure; and operating points are standard. Optional keytops similar to electric typewriters.

STEP-UP FORMATION



ALCOSWITCH®

DIV. OF ALCO ELECTRONIC PRODUCTS, INC., LAWRENCE, MASS.

Telephone: BOB LAFFEY (617) 686-3887

INFORMATION RETRIEVAL NUMBER 50

PUSH BUTTON MINIATURES

MSPN SERIES

Lighted snap-action DPDT models handle 6A @ 125 VAC & features separate connections to T-1 3/4 lamp. 1/2", 5/8", 3/4" round or square buttons; transparent or translucent colors. P.C. side terminals.



ALCOSWITCH®

DIV. OF ALCO ELECTRONIC PRODUCTS, INC., LAWRENCE, MASS.

ILLUMINATED

INFORMATION RETRIEVAL NUMBER 51

The key to size and weight problems in a broadband stepattenuator is our Model 9000 Series Mini Step.

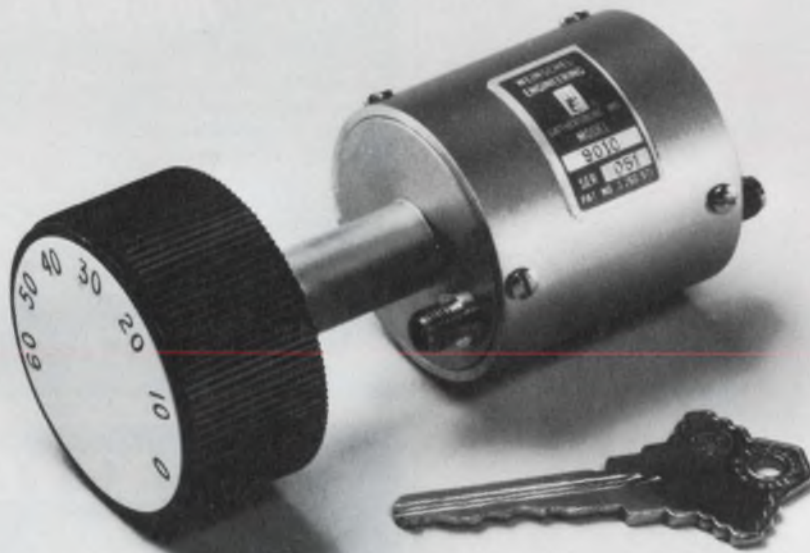

We're a step ahead again.

The Model 9000 series Mini Step Attenuators are broadband—dc to 18.0 GHz—and truly a step ahead in miniaturization: 1.62 inches body diameter and from 1.13 to 3.30 inches body length (varies with attenuation range). These stepattenuators are the smallest yet and provide better performance per volume than any other on the market.

Five standard models are available: single drum with 0 to 9 dB in 1 dB steps or 0 to 60 dB and 0 to 90 dB in 10 dB steps and double drum with 0 to 69 dB and 0 to 99 in 1 dB steps. All models handle 2 watts average power and come in a choice of five frequency ranges, including dc to 18.0 GHz. They are bidirectional and have WPM connectors which mate with SMA connectors. Repeatability is better than 0.05 dB to 18.0 GHz over 100,000 complete revolutions.

As an in-line design—where connector center conductors are parallel with the control shaft—they are most suitable for system and instrument applications when volume and weight are decisive factors. If performance counts, we're steps ahead again using only time proven and superior resistive film cartridges. These film resistors have a flat frequency response and thus, result in a small attenuation deviation over the frequency band.

If the Model 9000 series is the key to solving your stepattenuator problems, then get it now . . . one . . . ten . . . or more, they're on the shelf. If you need to get more details, then contact the Weinschel representative in your area, or call:



WEINSCHEL ENGINEERING
Gaithersburg, Md. 20760 Tel: (301) 948-3434 TWX: 710-828-9705

new products

50-kHz to 80-MHz generator locks-in output to ± 10 Hz

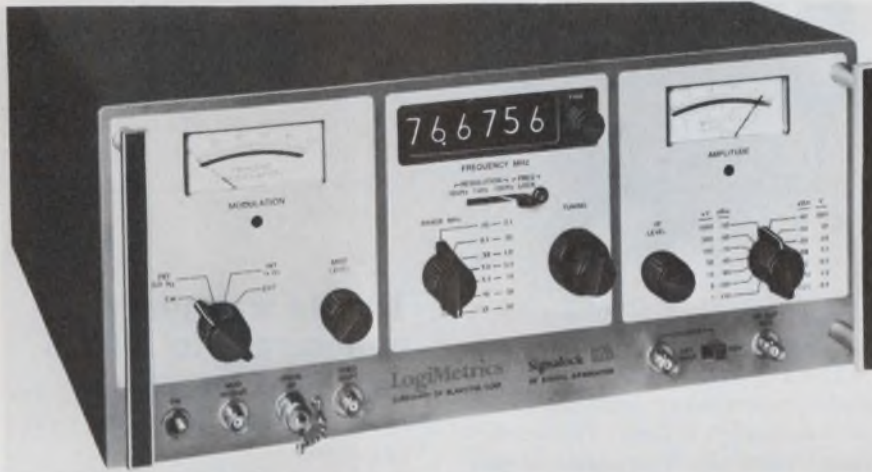

Logimetrics, Inc., 100 Forest Dr., Greenvale, N. Y. Phone: (516) 484-2222. P&A: \$2975; 90 to 120 days.

Continuously tunable over the frequency range of 50 kHz to 80 MHz in seven bands, a new rf signal generator uses a patented digital frequency lock circuit known as "Signalok" to achieve ultra-high stabilities of ± 10 Hz.

The model 925 generator, which is composed of a standard rf oscillator, a frequency counter and a synchronizer, provides high-stability signals by locking in the fundamental rf oscillator's output to the crystal time base of its built-in electronic counter. An external standard can also be used.

In use, the generator is first tuned to the desired output frequency. Then when the "Signalok" mode is switched in from the front panel, the digital frequency readout is fed to and stored in a memory bank where it is held indefinitely. The rf oscillator frequency is taken

from the counter and compared to the stored frequency. If the difference is 10 Hz or more, a correction voltage is fed back to the rf oscillator, causing frequency to return to the original setting.

An indicator light glows when the signal generator is put in the locked mode, after it is tuned to the desired frequency. If the "Signalok" circuit nears the limit of its holding range, the light will flash on and off. Once this happens, the user simply unlocks the generator, retunes it and relocks it.

The generator's built-in six-digit counter can be used independently to measure 50 kHz to 80 MHz. It has three resolutions of 100, 1000 and 10,000 Hz and its time base is accurate to 1×10^{-7} .

The 925 generator provides a continuously adjustable output from 0.1 μ V to 3 V rms into 50 Ω . Internal 400 and 1000-Hz amplitude modulation is provided.

CIRCLE NO. 250

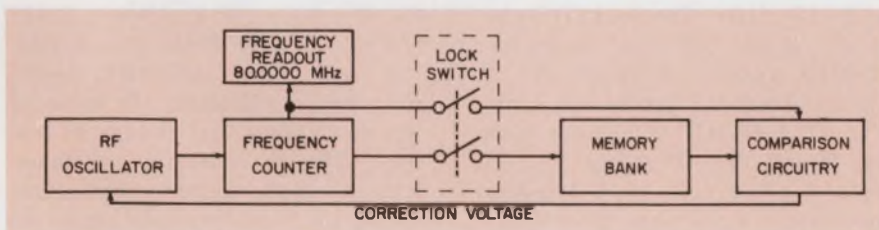

The 925 80-MHz generator locks its rf oscillator to a built-in counter for output signal stabilities of ± 10 Hz.

TDR scope plug-in enhances measurements

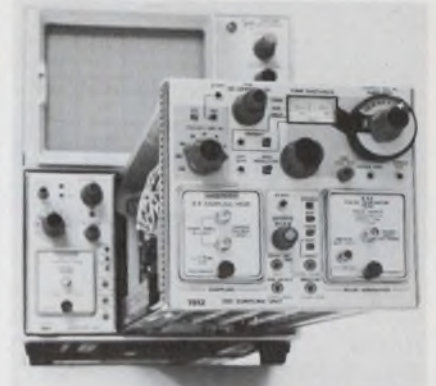

Tektronix, Inc., Box 500, Beaverton, Ore. Phone: (503) 644-0161. P&A: \$1200 (no heads); 2nd quarter, 1971.

The new 7S12 time-domain reflectometer scope plug-in fills three measurement needs: high resolution with 45-ps reflection risetime; long-line performance up to 9800 ft and general-purpose sampling with 35-ps system risetime. The 7S12 is a double-width plug-in designed for the 7000-series scopes. An interchangeable sampling-head is used.

CIRCLE NO. 251

20-kHz analyzer checks phase and amplitude



Weston Instruments, County Line Rd., Hatboro, Pa. Phone: (215) 672-1240. P&A: \$3950; April, 1971.

A precision frequency-response analyzer, model 1310, covers the frequency range from 0.02 Hz to 20 kHz to make possible the simultaneous measurement of phase and amplitude with 40 dB of noise and harmonic rejection. Amplitude and phase are measured to an accuracy of 1% of amplitude and 1 degree of phase.

CIRCLE NO. 252

Waveform generator has lin/log sweep

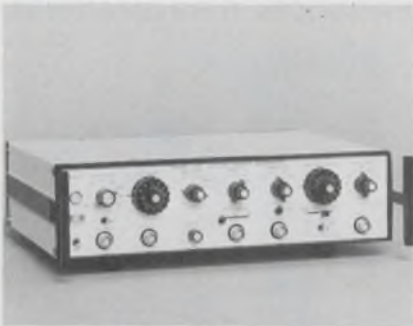

Exact Electronics, Inc., Box 160, Hillsboro, Ore. Phone: (503) 648-6661. P&A: \$695; stock to 3 wks.

A new two-in-one waveform generator features voltage-controlled frequency (VCF) and an internal 1000:1 sweeping source offering linear or logarithmic sweep. The model 128 has a frequency bandwidth of 0.1 Hz to 3 MHz (0.01 Hz to 5 MHz optional). It produces sine, square, triangle, ramp, pulse and sync waveforms and can operate in any one of 7 modes.

CIRCLE NO. 253

Ac/dc 32-MHz counter is a \$475 midget



Monsanto Electronic Instruments Inc., 620 Passaic Ave., W. Caldwell, N. J. Phone: (201) 228-3800. P&A: \$475; 3 wks.

Weighing less than 3 oz and measuring only 4-1/2 by 2 by 7-1/2 in., the \$475 150A automatic counter measures frequencies from 5 Hz to 32 MHz and operates from ac or dc battery sources. It features a five-digit LED display, auto-ranging, 6-W dc power consumption, 10 to 32-V dc operation and 50-mV sensitivity. The automatic mode can be disabled.

CIRCLE NO. 254

\$349 3-1/2-digit DMM ranges automatically

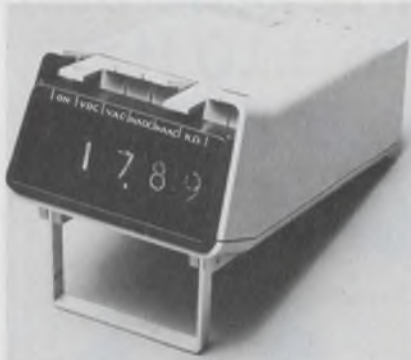

Dixson Instruments, Inc., Box 1449, Grand Junction, Colo. Phone: (303) 242-8863. P&A: \$349; stock.

The Digitest-750 is a \$349 3-1/2-digit autoranging multimeter. It automatically selects the correct range from the 5 available in each of the following functions: dc voltage from 100 μ V to 1000 V, ac voltage from 100 μ V to 500 V, dc and ac current from 100 nA to 2 A, and resistance from 0.1 Ω to 2 M Ω . It also features automatic polarity and zero.

CIRCLE NO. 255

Three portable scopes range up to 150 MHz

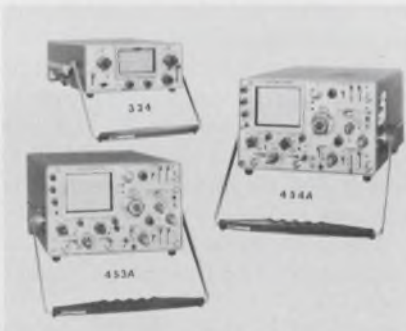

Tektronix, Inc., Box 500, Beaverton, Ore. Phone: (503) 644-0161. P&A: \$1225, \$2050, \$3050; 1st and to 2nd quarter, 1971.

Three new portable scopes reach up to 150 MHz. The Sony/Tektronix 324 is an 8-lb (with batteries) 10-MHz scope with 10-mV/div. It sweeps from 0.2 μ s to 0.2 s/div. The 453A 60-MHz dual-trace scope has 20-mV/div. It sweeps from 10 ns to 5 s/div. The 454A 150-MHz dual-trace scope has 20-mV/div. and sweeps from 2 ns to 5 s/div.

CIRCLE NO. 256

Multi-function generator can be set digitally

Clarke-Hess Communication Research Corp., 43 W. 16th St., New York, N. Y. Phone: (212) 255-2940. P&A: \$475; stock.

Model 745 function generator provides digitally settable, low-distortion sine, square and triangular outputs from 0.1 Hz to 1.099 MHz. All signals may be voltage-controlled over a 4000:1 range at rates up to 100 kHz.

CIRCLE NO. 257

10-kHz wattmeter is accurate to 0.02%

Yewtec Corp., 1995 Palmer Ave., Larchmont, N. Y. Phone: (914) 834-3550.

A new direct-reading digital wattmeter provides an accuracy of ± 0.02 to $\pm 0.5\%$ from dc to 10 kHz regardless of power factor. The new 2885 five-digit wattmeter is easily connected to the power to be measured through two current and two voltage leads.

CIRCLE NO. 258

Strip-chart recorders start from \$450

Yellow Springs Instrument Co., Inc., Box 279, Yellow Springs, Ohio. Phone: (513) 767-7242. P&A: \$450, \$625; stock.

Two new single and dual-channel strip-chart recorders are available for \$450 and \$625, respectively. Model 80A is the single-channel, model 81A is the dual-channel unit. The 81A can simultaneously record two independent variables.

CIRCLE NO. 259

Ratio computer uses one source

MSI Electronics Inc., 34-32 57th St., Woodside, N. Y. Phone: (212) 672-6500. P&A: \$995; 2 to 4 wks.

A new ratio computer, model 852, readily calculates the ratio of two dc voltages that change in real time. The dc voltages are taken from a single source, thus eliminating the need for resetting or recalibration.

CIRCLE NO. 260

Over 50-million SCR's from General Electric... one for every application

In 1957, General Electric introduced the first silicon controlled rectifier. The SCR has gone on to prove itself a real workhorse in power-control applications. And GE has gone on to manufacture 50-million SCR's for use in power supplies, appliances, automobiles, business machines, industrial process controls . . . its uses are limitless.

GE took the lead in SCR technology and manufacture and extended it over the years. Fifty million SCR's later, GE still offers a broader and more complete line of high quality, high reliability devices than anyone else. No one offers a wider selection of electrical ratings—from 800 ma. to 1300 amps, 25 volts to 2600 volts. No one offers more package types—stud mounts, lead mounts, Press Paks, plastic-encapsulated devices, press fits. No one offers greater reliability than that which comes from making 50 million SCR's. And no one offers greater application assistance—application engineers, published spec sheets, application notes, and GE's 500-page SCR Manual.

The result—there is no greater coverage of SCR applications than that offered by General Electric. When you use a GE SCR in your circuit, you benefit from all the skill that we've acquired in 14 years of SCR leadership.

For more information about these and other General Electric semiconductor products, call or write your GE sales engineer or distributor or write General Electric Company, Section 221-35, 1 River Road, Schenectady, New York 12305. In Canada: Canadian General Electric, 189 Dufferin Street, Toronto, Ont. Export: General Electric Co. International Sales Division, 159 Madison Avenue, New York, N. Y. 10016.

Over 50-million SCR's . . . practice makes perfect!

GENERAL  ELECTRIC

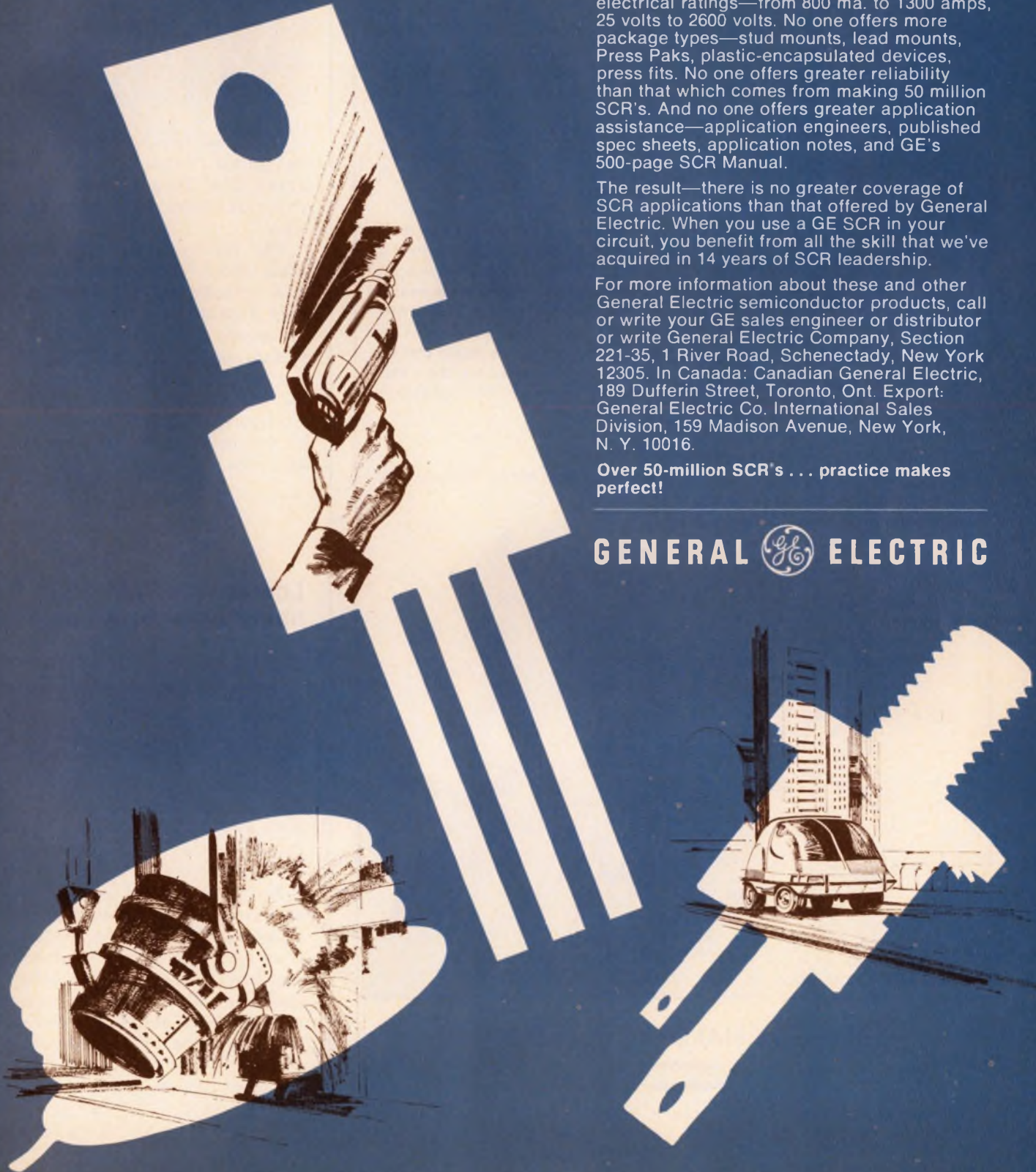

Size for size, pound for pound, you won't find a more efficient, more powerful, more durable NEMA gearhead motor than this!

Weighing only 1¼ pounds and measuring a scant 2½" in length, our new 86100 Series 115 VAC, 60 Hz, permanent magnet synchronous motor takes up to 12% less space and weighs about half as much as similar NEMA gearhead motors.

Sound great? That's only part of the story. The 86100 offers you a number of additional unique operating and performance advantages.

Power. for instance! The 86100 gives you 7 oz-in at 300 rpm directly from the rotor shaft or 120 oz-in at 15 rpm. Input required is only 8 watts nominal. Of course, your application may call for a different torque or different speed. In that case, we have a choice of eleven gear train ratios for speeds as low as 1 rpm and torques up to 200 oz-in.

Think about that. That's power to spare! And it means less wear on bearings, longer life, fewer operating problems. Maintenance is practically eliminated. The 86100 has permanent lubrication and will not require constant oiling, etc., as do other motors.

Two more important features are the 86100 motor's fast start/stop characteristics and its reversibility. You can start, stop or reverse this motor on a proverbial "dime." In many applications, this combination of features will eliminate the need for pre-starting and external clutching. These features will also allow you to simplify your design and achieve important savings in weight, space and cost.

Delivery? No problem. Standard motors are shipped from stock. You will also receive quick service on customized variations. As an example, unidirectional models with two output speeds, or models with speeds other than standard can be specified. We welcome the challenge of your special application problems.

Ask us.

Send for the 86100 bulletin. It's FREE.

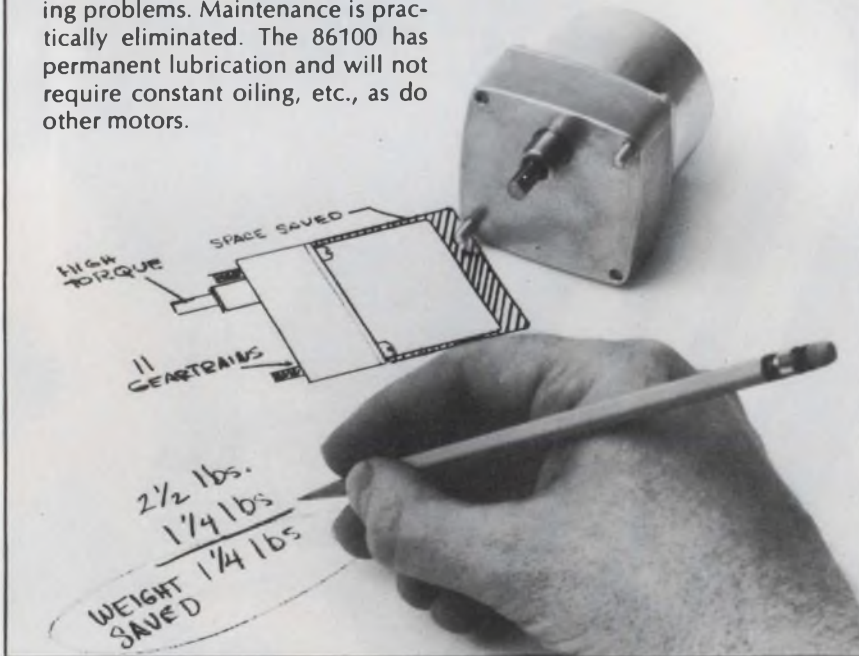

THE A. W. HAYDON COMPANY



232 North Elm Street, Waterbury, Conn. 06720 Tel. (203) 756-4481 TWX: 710-477-3141
In Europe: Polymotor International - Brussels 1, Belgium

INFORMATION RETRIEVAL NUMBER 54

INSTRUMENTATION

Thrifty scope camera costs only \$139.50



Integrated Controls, Inc., Box 17296, San Diego, Calif. Phone: (714) 453-5800. P&A: \$139.50; 2 wks.

The low-cost hand-held Scope-Mate model SC02 scope camera set fits virtually all scopes and costs only \$139.50. It fits either inside or outside 3, 4 and 5-in. round or rectangular CRTs and allows viewing and capturing of one-shot or recurring-trace data. A Polaroid Colorpack II or III camera is used to provide an object-to-image ratio of 1:0.85.

CIRCLE NO. 261

Low-cost lock-in amp has 2 operating modes



Keithley Instruments, Inc., 28775 Aurora Rd., Cleveland, Ohio. Phone: (216) 248-0400. P&A: \$1395; 60 days.

Model 840 low-cost lock-in amplifier with a differential or single-ended input and a center frequency from 0.5 Hz to 15 kHz features a choice of tuned-signal or wide-band operation. Its signal extraction ratio is 90 dB at 100 Hz, decreasing to 60 dB at 10 kHz. An optional filter card permits 140-dB of signal extraction. Input is 10 μ V to 1 V rms.

CIRCLE NO. 262

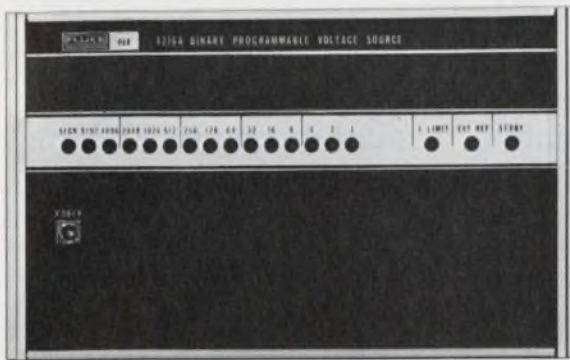

Instrument photos show Model 4216A Binary Programmable Voltage Source in half-rack version at top and Model 4250A BCD Programmable Power Source in full rack configuration.

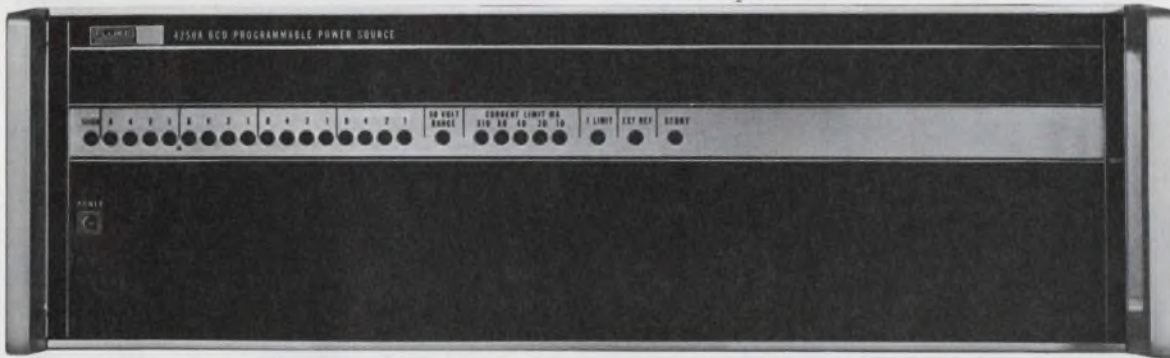

New Fluke programmable power sources put it all together. One instrument does the work of a whole rack of equipment.

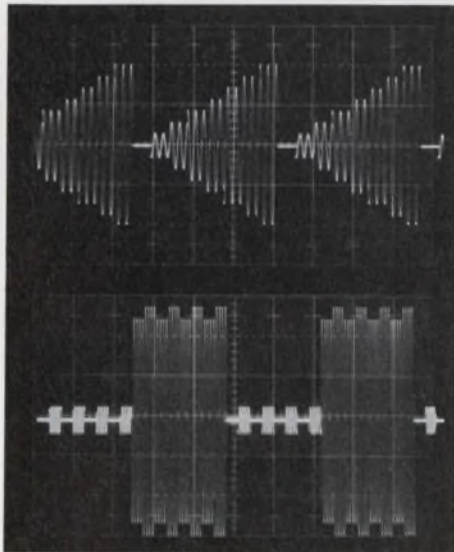

An indication of the powerful flexibility of the Series 4200 can be inferred from the scope photos.

This family of systems instrumentation represents an entirely new approach to automatic test and process control equipment. They serve as husky power supplies, fast digital-to-analog converters, programmable attenuators, power amplifiers, and even dynamic loads.

Either BCD or binary programming with internal memory is offered. Accuracy is 0.01% throughout. All models feature dc or ac external reference capability programmable in or out, 50mv peak programming noise, isolated control logic to eliminate digital noise, and complete digital display.

Brief specs of the first four models:

	4210A	4216A	4250A	4265A
V_o	10v	16v	65v	
I_o		100ma	1a	
Settling Time		30 μ s	100 μ s	
Basic Unit*		\$995	\$1295	

*Options extra

More data. Full data sheets and complete applications information are available from your Fluke Sales Engineer who will also be happy to arrange a demonstration at your convenience. Or you may address us directly if it's more convenient.



Fluke, Box 7428, Seattle, Washington 98133. Phone: (206) 774-2211. TWX: 910-449-2850/ In Europe, address Fluke Nederland (N.V.), P.O. Box 5053, Tilburg, Holland. Phone: (04250) 70130. Telex: 884-50237 / In the U.K. address Fluke International Corp., Garnett Close, Watford, WD2 4TT. Phone: Watford, 27769. Telex: 934583.

INFORMATION RETRIEVAL NUMBER 55

Static 256-bit RAM has 64 4-bit words

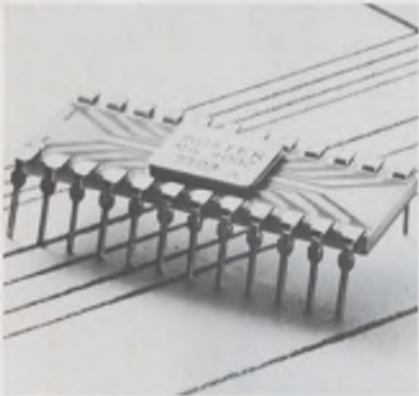

Mostek Corp., 1400 Upfield Dr., Carrollton, Tex. Phone: (214) 242-1494. P&A: \$26.50; stock.

A new static 256-bit RAM organized into 64 4-bit words is available. The new RAM, the MK4002P, is produced with low-threshold ion-implantation techniques and suited for use in buffer memory applications. Its access time is 1 μ s, and power dissipation is 200 mW. The RAM's chip includes pull-up resistors for driving from TTL gates.

CIRCLE NO. 263

Dual-output driver has twin circuits

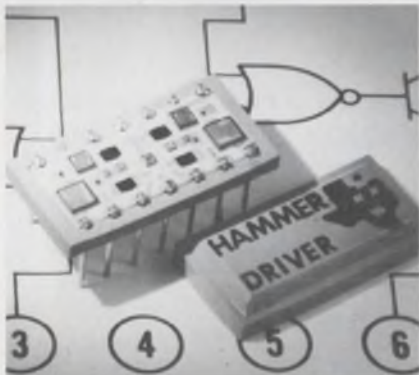

Texas Instruments, Inc., 13500 N. Central Expwy., Dallas, Tex. Phone: (214) 238-2011. P&A: \$8.46; 4 to 6 wks.

A new hybrid IC dual power logic module features two electrically independent circuits, each having drive and inhibit inputs for greater design flexibility. Commonly called a hammer driver, the TIH101 converts TTL/DTL inputs to high current outputs for use with high-speed printers. Each output can sink up to 6.4 A at a 5% duty cycle with pulse widths to 1.25 μ s.

CIRCLE NO. 264

Full line of TC zeners are 50 ppm/year stable

Codi Semiconductor, Pollitt Dr., Fair Lawn, N. J. Phone: (201) 797-3900. Availability: stock.

A full line of TC zeners stabilize 3 ppm/day, 20 ppm/month and 50 ppm/year. These are 1N821 through 1N829A, 1N935 through 1N946B, 1N3779 through 1N3784, 1N4069 through 1N4085A, 1N4565 through 1N4584A and 1N4611 through 1N4613C.

CIRCLE NO. 265

Five-bit comparator switches in just 10 ns

Advanced Micro Devices, Inc., 901 Thompson Pl., Sunnyvale, Calif. Phone: (408) 732-2400. P&A: from \$5.40; stock.

The new 5-bit Am9324 expandable comparator compares two 5-bit words and provides equal and unequal outputs in 11 and 10 ns, respectively. For over five bits, the comparator is connected in series or parallel.

CIRCLE NO. 266

Unity-gain op amps cover 10-MHz band

Silicon General Inc., 7382 Bolsa Ave., Westminster, Calif. Phone: (714) 839-6200. P&A: \$3 to \$10; stock to 30 days.

Featuring a bandwidth of greater than 10 MHz, three new voltage-follower op amps (models 102, 202 and 302) require input currents as low as 3 nA. The units include internal frequency compensation.

CIRCLE NO. 267

12-bit current switches switch in 100 ns

Intersil, 10900 N. Tantau Ave., Cupertino, Calif. Phone: (408) 257-5450. P&A: \$9.60 to \$36; stock.

A new series of 14-pin DIP quad current switches for d/a conversion feature 12-bit accuracy, 100-ns switching speed and a wide power supply range. ICL8018 units consist of 4 logically controlled current switches and a reference device on a single monolithic silicon chip.

CIRCLE NO. 268

Up/down IC counters count inputs to 32 MHz

Sprague Electric Co., N. Adams, Mass. Phone: (413) 644-4411.

Two new up/down IC counters feature synchronous operation at typical input count frequencies of 32 MHz. Type US74192A MSI decade and type US74193A 4-bit binary counters include parallel-entry capability, up and down input controls, independent clear input and borrow-and-carry outputs.

CIRCLE NO. 269

Power Darlington amps saturate 1.5 V at 5 A

Unitrode Corp., 63 Atlantic Ave., Boston, Mass. Phone: (617) 742-2850. P&A: \$2.75, \$2.95; stock.

A new series of planar 10-A power Darlington amps feature saturation of only 1.5 V at 5 A. This makes them ideal for high-gain switching applications. The U2T101 is in a 4-lead TO-5 can and the U2T201 in a 3-lead TO-66 package.

CIRCLE NO. 270

Small switch drivers operate in only 5 ns

Hytronics Corp., Newton Rd., Littleton, Mass. Phone: (617) 486-8911.

A new line of low-cost IC switch driver assemblies feature small sizes and switching speeds of 5 ns. One such unit is the model AS503P spst assembly which operates over the frequency range of 2 to 4 GHz and measures only 2 by 1.5 by 0.5 in., excluding connectors.

CIRCLE NO. 281

1024-bit bipolar ROM is field programmable

Monolithic Memories, Inc., 1165 E. Arques Ave., Sunnyvale, Calif. Phone: (408) 739-3535. P&A: \$150; stock.

The MM6300 is a new bipolar 1024-bit ROM that is field-programmable. It can be programmed to the desired bit-pattern by the customer in his own facility or in the field in a matter of minutes. It has an access time of 50 ns.

CIRCLE NO. 282



Great 'Standards' by the Power Professionals

We set out to engineer standardized power modules with some pretty high standards to meet. Yours. We had two things going for us. Nearly four decades of *custom* power experience . . . and, the determination to make an off-the-shelf line that was not merely good . . . but great! It paid off.

North's standard power units offer you real cost economy plus the utmost in reliability. May we suggest you look over our catalog . . . then take your *own measure* with a test unit.

Call 419/468-8244 or TWX 419/468-4860.

North Electric Company • Electronics Division / Galion, Ohio • A subsidiary of United Utilities, Incorporated



NORTH ELECTRIC

NSP-8

Self-Scan subsystem displays 256 characters



Burroughs Corp., Box 1226, Plainfield, N. J. Phone: (201) 757-5000. P&A: \$500; stock.

A new Self-Scan panel display subsystem features a 256-character format (8 rows by 32 characters/row). The characters are presented in a 5 by 7 dot matrix with dots on 40-mil centers. Custom subsystems, including 128 and 64-character position models, will become available in the near future. The new subsystem offers the user the advantages of a panel display less than 1-1/2-in. thick.

CIRCLE NO. 283

4-quadrant multiplier includes 4 op amps too



Optical Electronics, Inc., Box 11140, Tucson, Ariz. Phone: (602) 624-8358. P&A: \$260; stock.

The 5880 module contains four independent four-quadrant multipliers and four independent differential-input op amps plus a positive and negative voltage reference. It is designed to be a source of a wide variety of series functions. A large number of nonlinear functions can be generated with the 5880 using the series approximation approach.

CIRCLE NO. 284

Variable 32-kV supply works from 2 to 12 V dc



Venus Scientific, Inc., 399 Smith St., Farmingdale, N. Y. Phone: (516) 293-4100. P&A: \$168; stock.

The Q-30 is an all-silicon, variable dc-to-dc converter operating from 2 to 12 V dc to provide a variable 500 to 3 kV dc output. Its ripple is only 0.3% at 200 μ A at full load. Both input and output terminals are floating, and reverse-polarity and short-circuit protection are provided. The unit is fully encapsulated and measures 2-1/2-in. long by 1 in. in dia.

CIRCLE NO. 285

Thrifty driver/decoders start from \$11.65



Industrial Electronic Engineers, Inc., 7720-40 Leona Ave., Van Nuys, Calif. Phone: (213) 787-0311. P&A: from \$11.65; 6 wks.

Series 7800 driver/decoders mate with series 0340/0345 readouts at low cost starting from \$11.65. They use 5-V 72-mA #36 subminiature lamps designed to interface directly with MSI decoders. DTL/TTL input is 8-4-2-1 BCD. Both memory and non-memory models are available, all on single boards, requiring 2 in. of space behind the readout.

CIRCLE NO. 286

Position encoders operate from +5 V dc

Baldwin Electronics, Inc., 1101 McAlmont St., Little Rock, Ark. Phone: (501) 375-7351. P&A: from \$155 and \$279; 45 days.

Two new lines of optical absolute-position encoders feature integral electronics and operate from +5-V dc. The industrial type 5V80 is available with count ranges from 0 to 1023. The 5V200 high-performance line has up to 16,383 counts.

CIRCLE NO. 287

Improved sample-hold module costs \$150

Analog Devices, Rte 1 Industrial Park, Norwood, Mass. Phone: (617) 329-4700. P&A: \$150; stock.

The new improved SHA-1A sample-hold module for \$150 features 40-ns aperture delay, 5-ns peak aperture jitter, and 300-ns settling time to 1 mV. Voltage samples are preserved in accordance with a worst-case droop of 50 μ V/ms.

CIRCLE NO. 288

Module for CRTs corrects pincushioning

Intronics, Inc., 57 Chapel St., Newton, Mass. Phone: (617) 332-7350. Price: \$565.

Model C100 pincushion-correction module provides corrected vertical and horizontal-channel and dynamic-focus correction outputs in flat-face CRT systems. Bandwidth is 20 MHz, slew rate is 300 V/ μ s, and settling time to 0.1% is 100 ns.

CIRCLE NO. 289

12-kV CRT supply provides triple output

Del Electronics, 250 E. Sanford Blvd., Mt. Vernon, N. Y. Phone: (914) 0W9-2000. Price: \$90.

Model 12DRD-.25-1 multi-output CRT supply operates from 25 to 32 V dc to supply three outputs: 12 kV at 250 μ A with \pm 0.1% line and \pm 0.05% load regulation at 0.1% rms ripple; +500 V and -190 V at 1 mA regulated to \pm 0.25% for line and load.

CIRCLE NO. 290

Brazen Offer!

If you can come up with a PC fork and blade plate connector system that's more versatile than our 5420 system, we'll make your "special" for the price of our "standard".

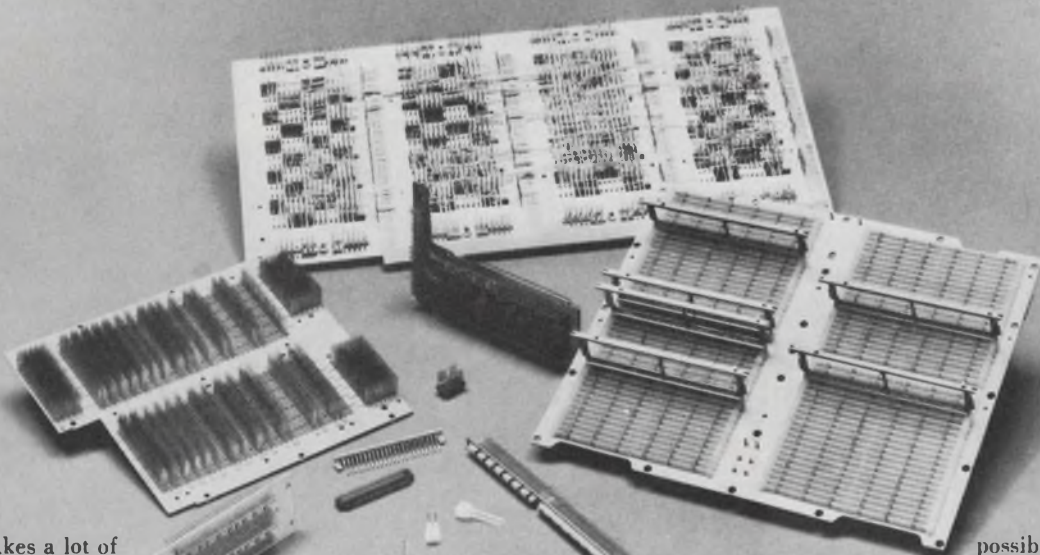

A bid like this takes a lot of guts and/or a miniature base plate connector system that's so versatile, we're fairly sure we've got ourselves covered.

Our 5420 system has that kind of universality.

First off, consider the 5420's base plate components. Singles. Doubles. Males. Females. .025 square post. All of which can be spaced on .100", .125", or .150" centers. Okay?

Then there're the header components: 5420 has 50 contact headers for IC packages; heat sunk 40 contact headers standardized for SHP's; and modular headers for any other size.

And all the 5420's components provide the metal-to-metal contact required by Mil-E-5400. (No relation.)

If that's still not enough, multiply by the added

possibilities of both squared and offset grid patterns.

Now you're beginning to see what makes us so sure that our 5420 system will do the job, even for the most cunning applications you can come up with.

They're very much in step with NAFI's standard packaging concept, and versatile enough to take hundreds (make that thousands) of non-standard jobs neatly in their stride.

What we haven't said here, we say in our catalog. Write for it. You'll find the 5420 specs on Page 14. For more information, write us at Elco, Willow Grove Division, Willow Grove, Pa. 19090. Elco, Huntingdon Division, Huntingdon, Pa. 16652. Elco, Pacific Division, 2200 Park Place, El Segundo, California 90245.

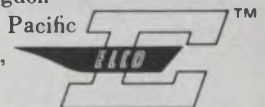

ELCO Plate Connectors

Send for your
1971 Design Handbook

monolithics: the facts

Monolithic crystal filters are becoming a popular topic of discussion these days. Since we've been making them longer (since 1967) and making more of them (over a quarter-million last year), we'd like to clear up a few misconceptions about the state-of-the-art.

1. Monolithics are expensive—Wrong. They cost less than conventional crystal filters. And, their low cost/high performance has brought reality to many "someday" applications.

2. There are no standard models—Wrong again. PTI has over 20 standards at the 10.7 MHz frequency alone. Plus a big selection of standards at other popular frequencies.

3. There isn't enough variety of packaging—PTI offers several models in flatpack, upright mount and P.C. assembly. We've got more on the drawing board.

If you're now using standard crystal filters, or if you've been holding off because of cost, size or performance, we'd like to show you how monolithics can do the job better for less. Drop us a line and we'll send our new fact sheet.

For off-the-shelf or custom models, if you have questions about monolithics, we've got the answers.



Piezo Technology Inc.

2400 Diversified Way
Orlando, Florida 32804
305-425-1574

The standard in monolithic crystal filters

MODULES & SUBASSEMBLIES

Compact d/a converters are 2 by 2 by 0.4 in.



Hybrid Systems Corp., 95 Terrace Hall Ave., Burlington, Mass. Phone: (617) 272-1522. P&A: \$99, \$115, \$125; stock to 2 wks.

Series 330 low-cost d/a converters feature compact dimensions of 2 by 2 by 0.4-in. They are available in 10, 11 and 12-bit models, each with switches, ladders, reference and output amp. They also feature 20-ppm/°C drift, operate from -55 to +125°C or 0 to +70°C and have 20:1 power supply rejection. Settling time to 0.5% is 10 μ s.

CIRCLE NO. 291

Voltage sensor responds in 25 μ s

California Electronic Manufacturing Co., Inc., P. O. Box 555, Alamo, Calif. Phone: (415) 932-3911. P&A: \$28; stock.

Labeled the 520 voltsensor, a new voltage sensor provides a full-scale accuracy of 0.5% and a response time of only 25 μ s. The unit offers continuous short-circuit protection, and has an input impedance of greater than 100 k Ω .

CIRCLE NO. 292

Transformer supplies come in kit form

Lambda Electronics Corp., 515 Broad Hollow Rd., Melville, N. Y. Phone: (516) 694-4200. Price \$42.50, \$97.50 (5-V 5-A models).

Two new ferroresonant transformer kits are the series 5000 and 6000 with 5% and 0.2% regulation, respectively. Each can be purchased in one of three versions with various combinations of a transformer, ac and dc capacitors and rectifiers.

CIRCLE NO. 293

Tiny resolver simulator works in 5-degree steps



North Atlantic Industries, Inc., Terminal Dr., Plainview, N. Y. Phone: (516) 681-8600. P&A: \$395; stock to 30 days.

Precision resolver simulator model 531 is a miniaturized panel-mounting source that produces electrical signals in 5-degree steps from 0 through 355 degrees with 30 arc-seconds accuracy. Internal circuitry consists of highly accurate transformers whose tapped windings are switched by thumbwheel switches.

CIRCLE NO. 294

Three-phase SCR drive has zero-volt switching

Vectrol, Inc., 1010 Westmore Ave., Rockville, Md. Phone: (301) 424-6900. P&A: \$62; stock.

A new three-phase SCR gate drive, series VTR4008, features proportional control through burst modulation on a 1-s time base and zero-voltage switching to minimize rfi/emi. The gate drive has terminals for the addition of two resistors for temperature controllers.

CIRCLE NO. 295

Data amplifier optimizes gain

Neff Instrument Corp., 1088 E. Hamilton Rd., Duarte, Calif. Phone: (213) 357-2281. P&A: \$1150 or \$1250; 30 days.

Automatic selection of optimum gain for a given input signal level is the unique feature of the model 127 automatic gain differential instrumentation amplifier. The unit is also available with programmable gain.

CIRCLE NO. 296

Cut yourself in.

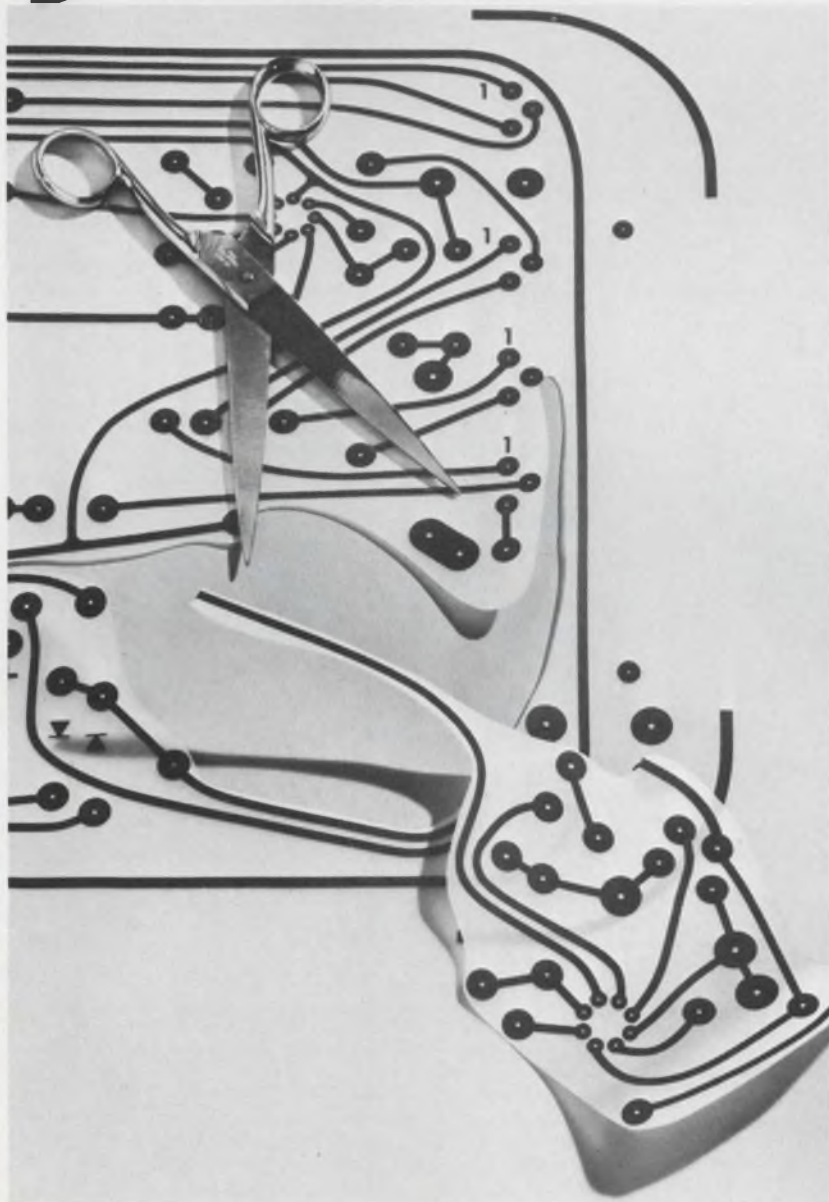

“Scissors draft” your way to increased production with KODAGRAPH Films and Papers.

Why retrace an entire drawing needing only revision? Instead, copy your original photographically on KODAGRAPH Film or Paper. Cut out the unchanged portions (often much of your drawing), mount them on a new drawing form, have a second original made on KODAGRAPH Film, and make your revisions on that.

For more on “scissors drafting” and other time-saving techniques, contact your Kodak Technical Sales Representative, or write Eastman Kodak Company, Business Systems Markets Division, Dept. DP782, Rochester, N.Y. 14650

DRAWING REPRODUCTION SYSTEMS BY KODAK

Kodak

Fiber-optic scanner detects 0.001-in. marks

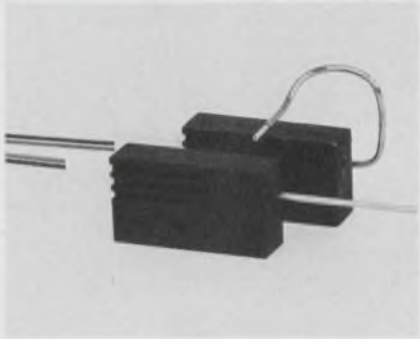

Skaneateles Corp., P. O. Drawer 68, Skaneateles, N. Y. Phone: (315) 685-3473.

A new fiber-optic scanner can detect a mark as small as 0.001 in. in dia. Designated the Nano-Skanner, the device has a minimum field of view of 0.005 in. in dia which enables it to read a ladder chart with 0.005-in.-wide lines and spaces. In field tests, repeatability of object position to 0.000005 in. has been obtained. A semi-rigid snout contains the fiber-optic bundle.

CIRCLE NO. 340

Thrifty optical scanner has digital outputs

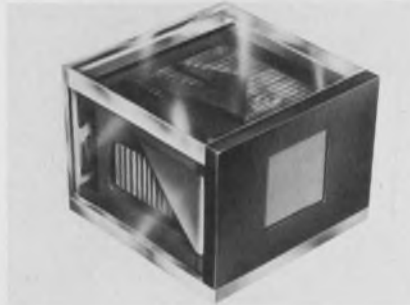

Optonetics, Inc., 32 Henry St., Teterboro, N. J. Phone: (201) 288-4900. P&A: \$100; 60 to 90 days.

Solidscan is a new solid-state optical scanning device that offers high-resolution conversion of optical images directly to digital outputs. It is composed of a polycrystalline electroluminescent phosphor layer within cross-grid wires laminated to a continuous layer of photosensitive semiconductor material. Linear resolution is 300 elements/in. Scan electronics are optional.

CIRCLE NO. 341

3- μ s photo arrays radiate 150 μ A/mW/cm²



Sensor Technology, Inc., 7118 Gerald Ave., Van Nuys, Calif. Phone: (213) 781-2154. Availability: stock.

A new 12-position photo array includes matched npn phototransistors with collector-emitter sensitivity of 150 μ A/mW/cm² and turn-off/turn-on time of 3 μ s each. The array's transistors are housed in standard drop-in packages. Each is electrically isolated and mounted on 250-mil centers. The array can be interfaced with DTL, RTL or TTL logic circuits.

CIRCLE NO. 342

**now...you
can test
digital
IC's...
economically...
to manufacturer's specs**



New Kurz-Kasch Model IC-590 is the first economically priced digital IC analyzer for accurate testing in the lab, shop, inspection, production, field or any other location.

The Model IC-590 is a completely portable, battery powered digital IC tester for use in conjunction with published IC specification sheets for static and dynamic testing of all 14 and 16 pin dual in-line IC modules of the DTL and TTL, 5 and 15 volt families. Flat pack and TO-5 modules may also be tested by using appropriate adapters. Price \$169.95.

A unique sister Model IC-591 is also available. It comes complete, as IC-590 above, internal power supply for highly regulated 5 volt, 1 amp operation and adapter cable for firing-up complete card units containing as many as 15 or more mounted IC's. Price \$295.00.

For complete technical data, write or call now: Tom Barth, Marketing Manager



**ELECTRONICS DIVISION
Kurz-Kasch, Inc.**
1421 S. Broadway,
Dayton, Ohio 45401

(513) 223-8161

THE INTERCHANGEABLE 1.

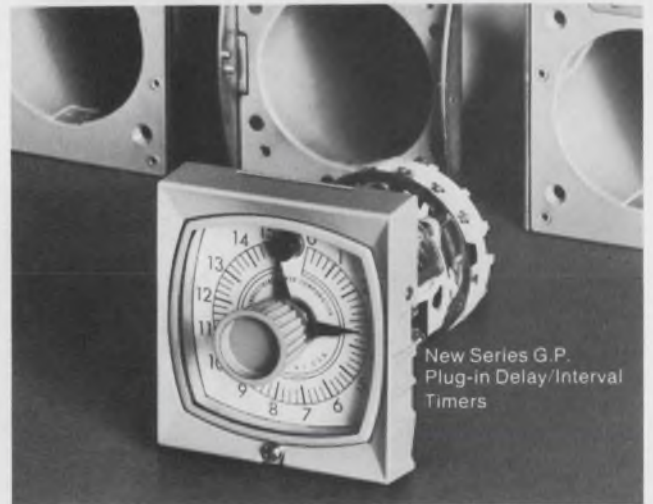

New Series G.P. Plug-in Delay/Interval Timers

Completely interchangeable with over 80% of the most widely used Plug-in Delay/Interval Timers

Who ever heard of a line of plug-in delay/interval Timers that is reliable, economical and interchangeable for as little as \$27.90? You just did.

Delivery is stock to 6 weeks, depending upon quantity. Consult us for further information and the G.P. Bulletin 310. Call 201-887-2200.

SINGER
INDUSTRIAL TIMER DIV.

Industrial Timer Division, U.S. Highway 287, Parsippany, N.J. 07054 201/887-2200

Neodymium laser system gives 1 joule of energy

American Optical Corp., Southbridge, Mass. Phone: (617) 764-3211. Price: \$795.

The new Mark 111 laser features a neodymium glass rod encased in a module containing a flashtube with cooling provisions. It develops more than 1 joule of output energy at the standard neodymium wavelength of 1.06 microns.

CIRCLE NO. 343

Air-cooled CO₂ laser delivers a 10-W output

Hadron, Inc., 800 Shames Dr., Westbury, N. Y. Phone: (516) 334-4402. P&A: \$1750; stock.

A new sealed air-cooled CO₂ laser, model 1010, has a minimum output power of 10 W. Since its tube is sealed, there is no requirement for an external gas supply or for gas monitoring or regulation. Resonant cavity reflectors are mounted on the laser tube.

CIRCLE NO. 344

Vhf 12.5-V transistors sock out up to 40 W

Solitron Devices, Inc., 1177 Blue Heron Blvd., Riviera Beach, Fla. Phone: (305) 848-4311.

A new series of 12.5-V vhf transistors deliver up to 40 W of output power at 175 MHz. The SRD-8B212 high-gain pre-driver delivers 3 W; the SRF-1B213 delivers 15 W; the SRF-5B215 supplies 25 W; and the SRD-5B216 handles 40 W. All are packaged in MT-75 cases.

CIRCLE NO. 345

5 to 12.4-GHz TWTs supply up to 100 W

English Electric Valve Co., Ltd., Chelmsford, Essex, England.

Three new high-power cw traveling-wave tubes for arduous-environment applications deliver up to 100-W outputs. The N1065 has a minimum output of 35 W over 10.5 to 12.4 GHz; the N1075 has a 100-W output from 8 to 12 GHz and the N1077 has 100 W from 5 to 10 GHz.

CIRCLE NO. 346

What You Should Know About...

Miniature High Voltage Resistors

new Mini-Mox resistors offer 100 ppm TCR plus low noise characteristics

If you are responsible for design of high-voltage, highly-stable miniaturized electronic networks and equipment, the new Mini-MOX resistor can be a life saver. Mini-MOX resistors have all the ingredients you need to cook-up new designs for ultra-critical applications. For instance, Mini-MOX resistors are a fraction the size of conventional types; they meet or exceed MIL-R-10509-F for environmental parameters . . . 100 ppm or less; stability

better than $\pm 2\%$ for 2,000 hours at full load; low-voltage coefficient less than 5 ppm/volt, measured between 100 volts and full-rated voltage; in addition, typical quantech noise at 20 megohms is less than 0.5 microvolt/volt.

All these characteristics combine to provide extremely-rugged and highly-stable resistor configurations that are virtually immune to environmental extremes. Available off-the-shelf in a wide range of resistance values, Mini-MOX resistors are ideally-suited for high-voltage applications where long-term stability and power-to-size ratios are critical.

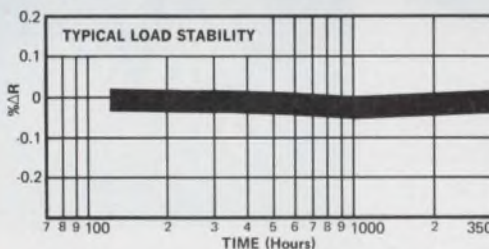
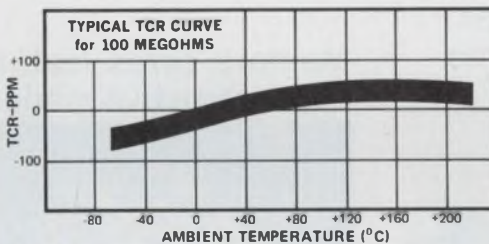

Model	Resistance	Rating @ 70°C	*Max. Oper. Volts	Length Inches	Diameter Inches
MOX-400	1-2500 megs	.25W	1000V	.420	.130
MOX-750	1-5000 megs	.50W	2000V	.790	.130
MOX-1125	1-10,000 megs	1.00W	5000V	1.175	.130

Write for complete Technical Data Sheet on Mini-MOX Resistors: Victoreen Instrument Div. of VLN Corp., 10101 Woodland Avenue, Cleveland, Ohio 44104. Telephone: 216/795-8200



Expertise in high voltage

DMA 657

Precise flat resistors dissipate up to 500 W

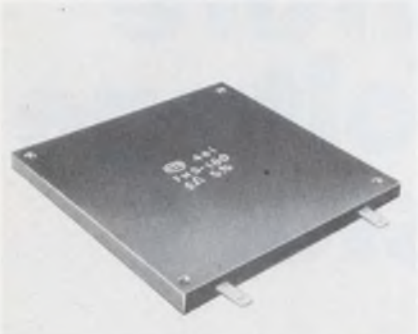

Charles T. Gamble Industries, Fairview St. & New Jersey Ave., Riverside, N. J. Phone: (609) 461-1900.

New flat heat-sink power resistors are available with temperature coefficients of ± 5 ppm and power ratings from 10 to 500 W. These noninductive low-tolerance (0.05, 0.5, 1, 5 and 10%) resistors are available within a resistance range of 0.003 to 1000 Ω . Kelvin-Varley four-wire construction is used. Lead position and resistor shape depend on resistance value.

CIRCLE NO. 347

Paddle-lever switches are the size of a dime



Cutler-Hammer, Inc., 4201 N. 27 St., Milwaukee, Wis. Phone: (414) 442-7800. P&A: \$2.92; 4 wks.

A new line of snap-in-mounted miniature paddle-lever rockette switches are only about the size of a dime. With a base less than 3/4-in. square, each new switch requires less than 7/8-in. behind-the-panel mounting space, and can be positioned horizontally or side-by-side. The switches are rated at 5 A 125 V ac and 28 V dc, resistive load. Single and double-pole models are available.

CIRCLE NO. 348

Fail-safe protector shorts permanently



Siemens Corp., 186 Wood Ave. South, Iselin, N. J. Phone: (201) 494-1000. P&A: \$2.40; stock.

A new fail-safe gas-filled surge-voltage-protector tube provides a permanent short when it is subjected to an extraneous current that exceeds its discharge capability. By shorting, the device prevents the transient from destroying valuable equipment. Type S8-C350 has a fast response time with a dc striking voltage of 200 to 400 V. Its insulation resistance is greater than 10,000 M Ω .

CIRCLE NO. 349

Memory cores feature nondestructive readout



Electronic Memories, 12621 Chadron Ave., Hawthorne, Calif. Phone: (213) 772-5201.

Model 31-105 30-mil toroidal ferrite memory cores are designed for nondestructive readout. These square-law devices produce 12-mV logic ONES or 5-mV logic ZEROS when interrogated with 116-mA read current pulses. Write and digit currents required to store initial data into the cores are approximately 105 mA each.

CIRCLE NO. 350

Stable chip resistors have low values of 1 Ω

Airco Speer Electronics, St. Marys, Pa. Phone: (814) 834-2801.

Metal-film chip resistors that feature 100 ppm/ $^{\circ}$ C TC span a resistance range down from 1 Ω up to 100 Ω . They measure 50 and 75-mils square, have thick gold termination suitable for wire bonding to thin or thick-film conductor patterns. Standard tolerances of ± 1 and $\pm 5\%$ are available.

CIRCLE NO. 351

Active transformer rejects signal noise

Burwen Laboratories, 12 Holmes Rd., Lexington, Mass. Phone: (617) 861-0242.

The model AT200 active transformer is a differential-input dc amp used to reject common-mode noise that occurs in transferring dc or audio signals from one chassis to another. It provides 100-k Ω input impedance and voltage gain from 0 to 30 dB.

CIRCLE NO. 352

Metal-film resistors are mil or industrial

Mepco, Inc., Morristown, N. J. Phone: (201) 539-2000.

Two new metal-film resistors that meet specification Mil-R-10509 are the 1/2% MR54 for military use and the 1% MR52 for industrial use. The MR54 is an RN65 style resistor, covers 10 Ω to 1 M Ω , has ratings of 1/4 and 1/2 W and TCs of 50 and 100 ppm. The MR52 has values from 10 Ω to 1 M Ω , a 3/4-W rating and TC of 100 ppm.

CIRCLE NO. 353

Time delay module holds for 10 ms to 20 s

B. H. Industries, 5794 Venice Blvd., Los Angeles, Calif. Phone: (213) 437-4763. Price: \$24.50.

Providing a fixed delay between 10 ms and 20 s, the model 3016 time delay module supplies an output current of 250 mA maximum for input voltages ranging from 14 to 32 V dc. The unit comes in a 0.557-in. square by 385-in. epoxy package.

CIRCLE NO. 354

We make 100 + different kinds of termination hardware but that's not the end

We are in termination hardware because our customers asked us. They had some definite ideas about miniature posts, sockets, plugs or test clips. Binding post caps that don't melt at soldering temperatures, for example.

Most of our termination products were developed for superior insulation, dielectric strength, contact resistance. (Transistor sockets with minimum insulation resistance of 500,000 megohms at 100 VDC.)

But despite the length of our line, it's not the

end. We will develop new hardware for new applications with the same commitment to quality in design, materials and workmanship that has fed the growing demand for our rotary and push button switch lines.

Like to know more? Write or phone for our latest general engineering catalog. Grayhill, Inc., 565 Hillgrove Ave., La Grange, Ill. 60525, (312) 354-1040.

Grayhill

pioneers in miniaturization

INFORMATION RETRIEVAL NUMBER 63

The power supply you plan to build is built!



\$125 each

It's on the shelf, ready for immediate delivery from Electrostatics. With specs proven in service. Low cost. Brief specs on our Model 503:

- 3 DC Voltages
- All in one DC power supply
- + or - 4.5 to 6.5 at 5A
- +12 to 20V at 0.5A
- -12 to 20V at 0.5A
- Input 105-125V, 47-420 Hz
- Regulation: Line 0.01% Load 0.1%
- Ripple: 500 μ V max.
- Temp: -20 to +71°C operating
- Foldback current limiting
- Size: 8" W x 4" H x 8" L

(\$150 with overvoltage protection)

For full information call Robert McCartney, Manager of Application Engineering, (714) 279-1414. Or circle the number below for our latest data sheet.

Electrostatics, inc.

7718 Clairemont Mesa Blvd., San Diego, California 92111

DEPT. 122

INFORMATION RETRIEVAL NUMBER 64

ELECTRONIC DESIGN 8, April 15, 1971

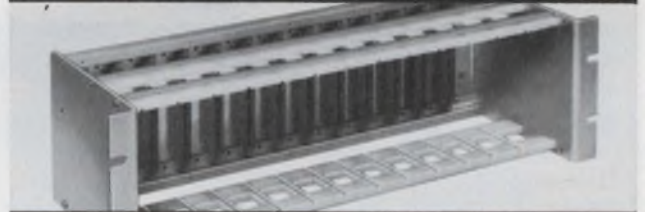
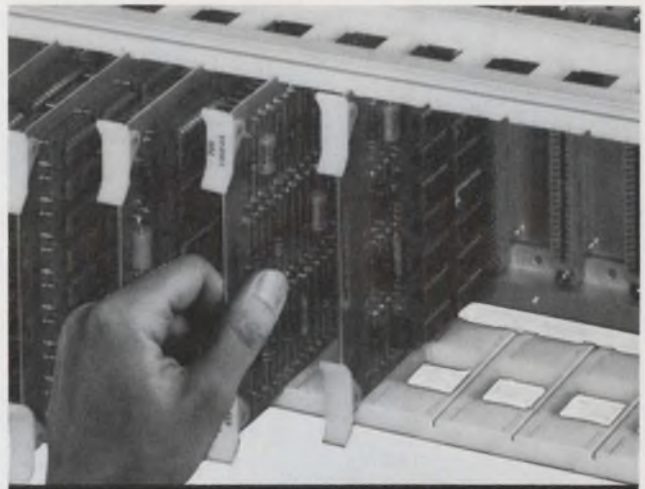

if you design with ic's Cambion has the "works" for your work

If your digital system is a packaging puzzle, CAMBION can provide the solution.

We have the high density sockets, wire-wrappable Cambi-Cards®, PC logic cards, general purpose and discrete component cards for your functional requirements.

And to complete the picture: card files, power planes, card connectors and extenders, plus a complete numerically controlled Wire-Wrap* service.

Result: Tightly integrated packaging systems. The "works" for your work.

For details, call us or write for the latest word on IC accessories and wire-wrapping. Cambridge Thermionic Corporation, 445ED Concord Avenue, Cambridge, Mass. 02138. Phone: (617) 491-5400. In Los Angeles, 8703 La Tijera Boulevard 90045. Phone: (213) 776-0472.

*Registered Trade Mark Gardner-Denver Co.

Standardize on

CAMBION®

The Guaranteed Electronic Components

INFORMATION RETRIEVAL NUMBER 65

EXAMINE THIS 50¢ BARGAIN

Bourns presents a quality built cermet commercial potentiometer for printed circuit board use. Try to match it at twice the price.

simple and rugged; only one moving part

10 terminal styles available

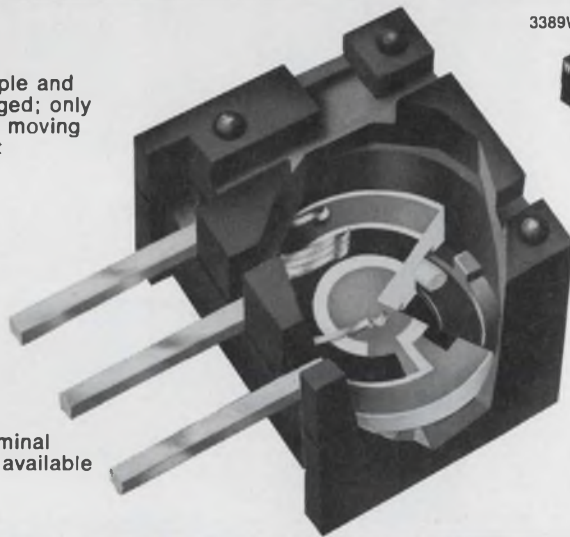

3389W

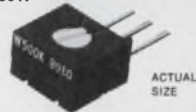

easy to spot white adjustment slot

multi-finger wiper for excellent CRV and setability

Only \$1.52 apiece, 50¢ in 50,000-piece quantity.

24-HOUR DELIVERY FROM DISTRIBUTORS NATIONWIDE.

Ask for full data on Model 3389 wherever Bourns potentiometers are sold.

BOURNS
INC.

TRIMPOT PRODUCTS DIVISION
1200 COLUMBIA AVE., RIVERSIDE, CALIF. 92507
TELEPHONE 714 684-1700 • TWX 910 332-1252

INFORMATION RETRIEVAL NUMBER 66

CORONA-FREE 30 kv High Voltage Connectors



Shielded Tri-Coupler
MODEL 3732

Shielded Coupler
MODEL 3731

Bulkhead Receptacle
MODEL 3730

Cable Plug
MODEL 3733

Ideal for use in X-ray, radar, laser, RF, pulse, power, and other military/industrial applications. ■ Rated 30 kv continuous unmated ■ up to 10,000 ft. and 90% humidity ■ molded of high dielectric epoxy resin ■ couplers are fully shielded for greater safety and reduction of electrostatic collection of dust ■ bulkhead receptacle includes corona ball, plus "O" ring for hermetic sealing.



POMONA ELECTRONICS CO., INC.
1500 East Ninth Street, Pomona, California 91766 • (714) 623-3463

INFORMATION RETRIEVAL NUMBER 67

COMPONENTS

Disc capacitors are 1/16-in. thick

Polyflon Corp., New Rochelle, N. Y. Phone: (914) 636-7222.

A series of small rf disc capacitors employing virgin TFE dielectrics and electroplated copper electrodes range in size from 11/16 to 1-3/8 in. in dia. and 1/16 to 1/8-in. thick. The discs range in capacitance from 1 to 10 pF and withstand continuous voltages in excess of 5 kV.

CIRCLE NO. 355

3-phase motor control suppresses rfi and emi

Hamlin Electronics, Inc., 3066 W. Clarendon Ave., Proenix, Ariz. P&A: \$37.70; 3 wks.

A Control-Pak three-phase controller for use with fractional-horsepower motors can operate adjacent to low-level logic circuits because of its reduced rfi/emi emissions. Load voltage rating is 208/240 V; maximum phase current is 2.5 A.

CIRCLE NO. 356

Variable-torque brake has constant tension

Machine Components Corp., 53 Werman Court, Plainview, N. Y. Phone: (516) 694-7203. Availability: stock.

A new variable-torque brake for spooling applications provides constant tension no matter what its load is. The brake is available in four sizes with a torque range from 1 to 200 oz.-in. Applications include tape and film spooling.

CIRCLE NO. 357

Encoded data switches come in keystrips

Maxi-Switch Co., 3121 Washington Ave., Minneapolis, Minn. Phone: (612) 529-7601.

A new line of encoded data-entry switches feature a modular keystrip construction technique. The switches are assembled in rows or strips, with double-shot buttons, dry-reed contacts, integral-contact bussing, plungers, magnets and PC terminals for each switch position.

CIRCLE NO. 358

Positive thermistors work over 40 to 180°C

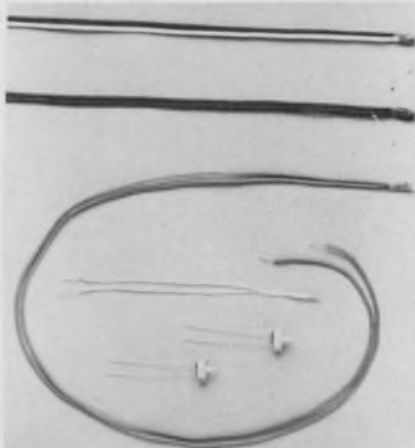

Siemens Corp., 186 Wood Ave. S., Iselin, N. J. Phone: (201) 494-1000. P&A: see text.

A new line of positive TC thermistors feature a wide range of unique resistance values over the temperature range of +40 to +180°C. They are available in many configurations that include threaded, welded and flange-type assemblies. Price and availability depend on the requirements. Applications include demagnetizing color CRTs and over-temperature protection for electric machines.

CIRCLE NO. 359

Cermet potentiometer has a 3/8-in. dia

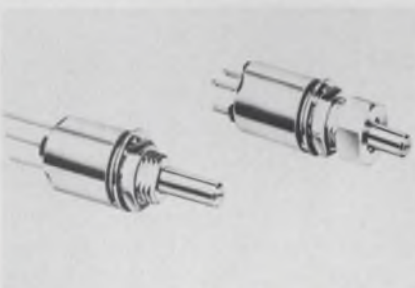

Allen-Bradley Co., 1201 S. Second St., Milwaukee, Wis. Phone: (414) 671-2000. Availability: stock.

A new miniature 3/8-in.-dia stable cermet variable resistor, designated type SP, is ideal for panel mounting where space is at a premium. It has power dissipation of 1 W at 70°C, a resistance range from 50 Ω to 1 MΩ and a temperature range from -65 to +150°C. It exhibits good stability under high-temperature and high-humidity conditions.

CIRCLE NO. 360

Neon indicator unit flashes when powered

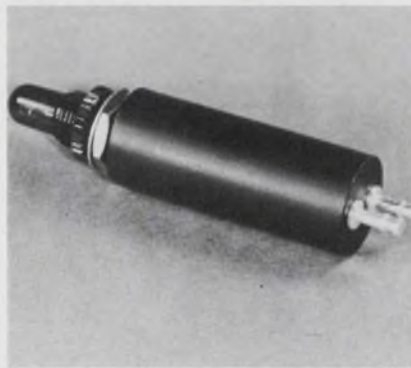

W-F Products, Inc., 1107 S. Pearl St., Denver, Colo. Phone: (303) 744-6097. P&A: \$12; stock.

A new panel indicator provides a flashing neon light at a nominal rate of 120 flashes/min, immediately upon application of power. Model 721 incorporates a totally encapsulated solid-state design without thermal elements or moving contacts. Power consumption is only 6 mW at 1.5 V dc. The indicator mounts in a 3/8-in.-dia hole from the rear of panels up to 1/4-in. thick.

CIRCLE NO. 361

Lighted rocker switch snaps into panels

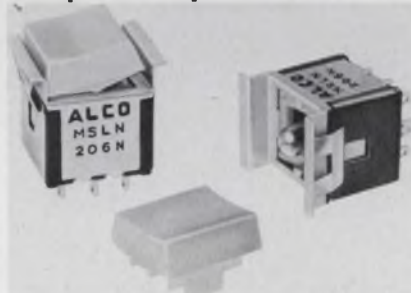

Alco Electronic Products, Inc., Box 1348, Lawrence, Mass. Phone: (617) 686-3887. P&A: \$4.75; stock.

The new 1/2-in. MSLN-206 illuminated rocker switch features simplified front-panel mounting by snap-fitting through a panel's opening. Metal mounting clips hold the housing firmly in place and no screws or tools are needed. Replacement is made easy by lamp removal from the front without disturbing the switch installation. Lens caps are in 4 colors.

CIRCLE NO. 362

Now the famous 829 has a "G" for good measure!



Calibrate or Measure with the

RFL Model 829G

RFL's famous 829, for 15 years the industry calibration standard, now gives way to the new 829G — still the industry calibration standard, but now it's twice as useful. The 829G provides a precision source of AC and DC volts, amps and ohms — plus precision measurements of these parameters from external sources. It offers four-terminal sensing in both source and measurement modes, and high accuracy, resolution and regulation, with 5-digit readout. 5 ranges of AC or DC, 0.1 to 1000V. 6 ranges of current, 100 μA to 10A. 50, 60, 400, 1000 Hz AC plus EXT. And many other features — all for just \$3,350. □ Write for complete data today. RFL Industries, Inc., Instrumentation Div., Boonton, New Jersey 07005. Tel: (201) 334-3100 / TWX: 710-987-8352 / CABLE RADAIRCO, N. J.



RFL Industries, Inc.

INFORMATION RETRIEVAL NUMBER 68

Core-memory stack prices down to 2.5¢/bit

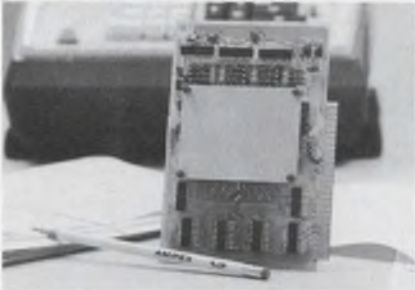

Ampex Corp., 9937 W. Jefferson Blvd., Culver City, Calif. Phone: (213) 836-5000. P&A: see text; 60 days.

A new digitized core-memory stack for small data systems is priced at 2.5¢/bit (large quantities). Configurations of the compact new stack may be 512, 1024, 2048 and 4096 words by 6 or 8 bits, on one planar pluggable board which measures 6 by 5 by 0.5 in. It has a full cycle time of 1.5 μ s with 18 and 22-mil cores or 2 μ s with 30-mil cores. Four-wire 3D design is used.

CIRCLE NO. 363

Solid-state keyboard shrinks parts count

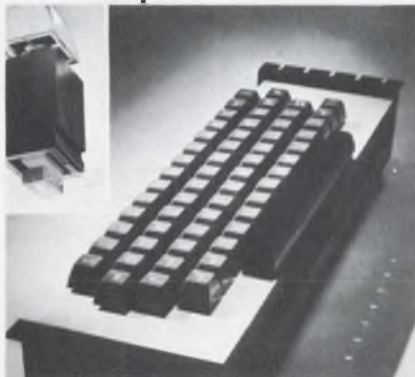

Fort Electronic Products, 133 Brimbal Ave., Beverly, Mass. Phone: (617) 927-3222.

A new modular solid-state keyboard eliminates all encoding electronics and electrical contacts and reduces the number of components normally needed in keyboards. The heart of the FS-300 is the Ferro-Snap ferrite key switch. Employing one moving part, it opens and closes a magnetic path, generating code at the key by transformer action. The FS-300 consumes 1/4 W for an 88-key model.

CIRCLE NO. 364

MOS-memory keyboard has N-key rollover

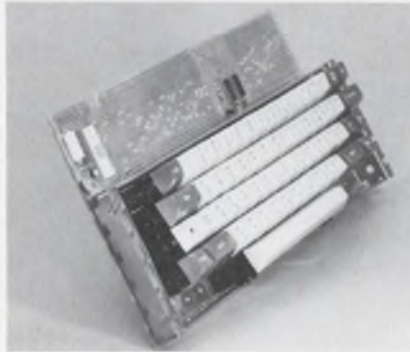

Micro Switch Div. of Honeywell, Inc., 11 W. Spring St., Freeport, Ill. Phone: (815) 232-1122. Availability: stock.

A new solid-state keyboard combines MOS encoding, N-key rollover and sculptured buttons. The 128-character Hall-effect keyboard, designated the 61SW12-1, is encoded with seven-bit USASCII code plus odd parity. Three operating modes (unshifted, shifted and control) are offered. An electronic lighted shift-lock is offered.

CIRCLE NO. 365

14-digit calculator weighs only 4 lb



Toshiba America, Inc., 477 Madison Ave., New York, N. Y. Phone: (212) 758-6161. P&A: \$395; March 15, 1971.

A new light-weight MOS office calculator, model BC1002, has 14-digit capacity and weighs only 4 lbs. The new calculator utilizes the popular floating/fixed decimal system, and adds, subtracts, multiplies and divides. The BC 1002 also has a clear indicator key to clear erroneous figures. Depression of this key shifts the figures in display one digit to the right.

CIRCLE NO. 366

Economy tape transports rewind at 125 in./s

Willard Laboratories, Inc., 4221 Redwood Ave., Los Angeles, Calif. Phone: (213) 390-3626. P&A: from \$2150; 60 days.

The new series 7/9 low-cost tape transports with 125-in./s rewind feature six 7-track and four 9-track IBM-compatible models with single-capstan drive and speeds of 12-1/2 in./s. Densities are 200, 556, 800 and 1600 bits/in.

CIRCLE NO. 367

Cassette transports employ direct drive

Computer Mate, Inc., 150 Calle de Los Molinos, San Clemente, Calif. Phone: (714) 492-6360. Price: \$800.

Designed for reliable digital recording, series CM-100 tape cassette transports use a direct-drive system that eliminates the need for a capstan and pinch roller. This design stops excessive tape wear and skewing and decreases error rate.

CIRCLE NO. 368

Cassette data system costs \$690 complete

GRI Computer Corp., 320 Needham St., Newton, Mass. Phone: (617) 969-0800. P&A: \$690; Jan., 1971.

A new inexpensive cassette recorder/reproducer system called the GRI-sette, includes interface controller, cassette unit and operating system software, all for only \$690. It operates at a read-write rate of 2.84 k-bits/s or 315 characters/s.

CIRCLE NO. 369

OEM PC-card modem sells for only \$95

RFL Industries, Inc., Boonton, N. J. Phone: (201) 334-3100. P&A: from \$95; 30 to 60 days.

Intended for OEM applications, a \$95 originate-only 103-type data modem occupies a compact printed circuit card. Model 5105 is capable of operating full-duplex at 300 bits per second, and is strappable for half-duplex.

CIRCLE NO. 370

relays... general purpose, sensitive,
miniature, mechanical and magnetic latching



stepping switches...



NEW

RTM miniature
— 2 pole,
10 or 12
position



RT rotary
— 1, 2, &
4 pole

accessories...

plugs, sockets and dust covers



**HIGH QUALITY • LOW COST • IMMEDIATE DELIVERY
SEND FOR FREE CATALOGS**



1140 Broadway, New York, New York 10001 Tel: (212) 683-0790

INFORMATION RETRIEVAL NUMBER 69

Celco Yokes for CRT DISPLAYS



CELCO makes YOKES. They make them good. In fact, CELCO has been making the best CRT deflection yokes and focus coils in the industry for the past twenty years. CELCO makes yokes for precision displays when you must have the highest performance available. And CELCO makes yokes for computer terminal displays when you need reliable repetitive scan yokes for commercial purposes, at low cost. Not only does CELCO make good yokes, but they make sure you get the right yoke for your particular CRT display requirements. Call CELCO on your present display problem. A CELCO yoke will solve it. (It might even be one of the standard CELCO yokes listed below.)

CELCO PRECISION DISPLAY YOKES:

- DNA702 "superfast" DYNAYOKE (2 +50C recovery time to 0.1%)
- HDA428 Low-Zero Approach
- HDA428 Mini-Spot (CRT Yoke matched)

CELCO COMPUTER TERMINAL DISPLAY YOKES:

- PW Position-Write Yokes
- PWM Position-Write with Pin-Point Correction
- YA Resonant Drive Hi-Q

CONSTANTINE ENGINEERING LABORATORIES COMPANY
MANHATTAN, N. J. 07840 TEL: 908-287-1100 FAX: 908-287-1019
UPLAND, CALIF. 91786 TEL: 916-888-0818 FAX: 916-881-3401

Go ahead and call CELCO. All you've got to lose are your yoke problems.



INFORMATION RETRIEVAL NUMBER 70

ELECTRONIC DESIGN 8, April 15, 1971

The newest, fastest and easiest way to specify indicator lights, push button switches and readouts.



**Dialco's new 56-page product
selector guide helps you select
from over 1,500,000 visual indicators**

This book is the result of an all-out effort to provide you with fingertip data on all Dialight components and to make it very easy for you to locate the detailed specs and information you desire. Designers and engineers will find the "Product Selector Guide" invaluable in their work. Send for your copy today. Dialight Corp. 60 Stewart Ave., Brooklyn, N.Y. 11237.



DIALIGHT
A North American Philips Company

INFORMATION RETRIEVAL NUMBER 71

Newer, Higher Quality

NDK

Products

ULTRASONIC FETAL PULSE DETECTOR

PULTONE

Ideally suited to fetal heart sound detection, operates on a doppler effect.



DELAY LINE

For Color TV

63.943µS
4.43MHz
TYPE DP-1C
NDK

CRYSTAL OSCILLATOR

High Stability 1 MHz
HS-Series



World's Leading
Manufacturer of:

- Synthetic Quartz Crystals
- Water Soluble Crystals (LH, ADP, KDP)
- Quartz Crystal Units
- Crystal Oscillators
- Delay Lines
- Ultrasonic Instruments



NIHON DEMPA KOGYO CO., LTD.

Since 1948

1-21 Nishihara, Shibuya-ku, Tokyo, Japan
Tel: 460-2111

Cable: CRYSTALUNITS TOKYO TLX: TK4893

PACKAGING & MATERIALS

Optical magnifier simplifies inspection



Vision Optical Instruments, Inc.,
34 Dumont Ave., Staten Island,
N. Y. Phone: (212) 979-2900.
Price: \$350.

Glare-free and shadow-free component illumination is assured by the new Vision NoGlare optical magnifier for inspection. Designed to eliminate eye strain, it has a 22-W circular fluorescent tube housed in a dome with a diffuser. At the dome's apex, a slotted chopping disc rotates faster than the persistence of the image's rate.

CIRCLE NO. 371

Handy terminal block accepts different leads

Modular Electronics, 4386 E. La
Palma Ave., Anaheim, Calif.
Phone: (714) 524-2663.

A new universal terminal block, the Uni-Block, accepts all common lead terminations—spade, ring or fork lug, test probe, straight pin and wirewrap. Exclusive top and side entry with optional feed-through pins make Uni-Block versatile. Insertion of a lug is all that is required.

CIRCLE NO. 372

PC-board headers interface flat cables

3M Co., Box 3686, St. Paul, Minn.
Phone: (612) 733-5755.

A new series of headers provide a method of depluggable interconnections between PC boards and Scotchflex flat cable-connector jumper assemblies. Headers 3428, 3429, 3431, 3432 and 3433 are offered in many pin lengths and styles for parallel or right-angle connection to PC board surfaces.

CIRCLE NO. 373

DIP IC socket accepts 14-pin units

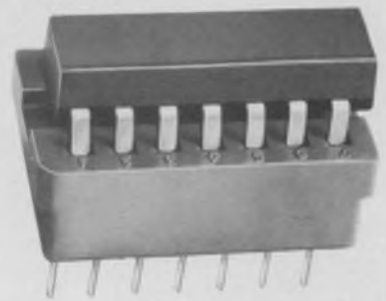

Cambridge Thermionic Corp., 445
Concord Ave., Cambridge, Mass.
Phone: (617) 491-5400.

A new DIP IC socket, series 703-3777, accepts all standard 14-lead IC packages. This one-piece glass-filled molded nylon socket will accept round or flat leads up to 0.024 in. Four bosses elevate the socket above a PC board slightly thereby facilitating flux removal and preventing moisture entrapment. Terminations are with solder tabs.

CIRCLE NO. 374

Customized connector costs no extra charge

Elfab, 762 Wiley Post Rd., Dallas,
Tex. Phone: (214) 239-7181.

A new edge card connector for 1/16-in. thick PC boards permits any number of dual-readout bifurcated contacts to be supplied without a charge for special tooling. Using the Edge-Pac connector, one can specify the actual number of contacts the circuit requires.

CIRCLE NO. 375

Compact package system uses epoxied extrusions

General Systems, Inc., I-Pac Div.,
4238 W. 12 St., Erie, Pa. Phone:
(814) 838-3564.

Inexpensive aluminum extrusions combined with an epoxy bonding system provide a new integrated package for electronic circuits. The package's PC cards slide into extruded guides. Heat-generating components are mounted to give electrical shielding with negligible thermal resistance.

CIRCLE NO. 376



There are holes in the type bar.

A phototransistor unit detects code holes in each type bar to provide photoelectric readout. This is a unique sensing method and enables you to make:

- Parity checking right from the source
- Type bar velocity check
- Echo check

There is further interesting information on the new Facit 3851 in this publication.

Facit 3851 - the conventional typewriter with input/output



For further information, contact
 in US: Facit-Odhner Inc., 501 Winsor Drive, SECAUCUS, New Jersey
 outside US: Facit AB, Albygatan 102, 171 84 Solna, Sweden

INFORMATION RETRIEVAL NUMBER 73

ANOTHER BPMC DYNAMIC DUO!

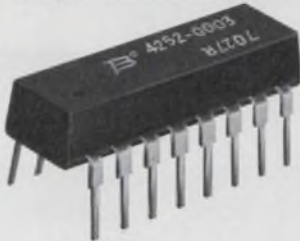

MODEL 4252
16-PIN DIL

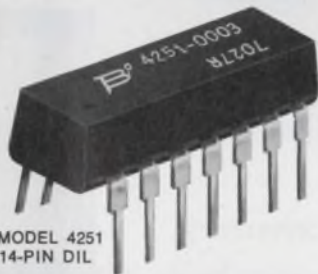

MODEL 4251
14-PIN DIL

Temperature range of
0° to 70°C

Pulse inductances
to 1 MH

Transfer molded construction

Maximum average power
to 250 Milliwatts

BPMC
BOURNS PACIFIC MAGNETICS CORP.

28151 HIGHWAY 74, ROMOLAND, CALIF. 92380 PH: 714 657-5195

INFORMATION RETRIEVAL NUMBER 74

ELECTRONIC DESIGN 8, April 15, 1971

instant move-in



just open your SE cabinet and move your equipment in...

It's "instant move-in" for your electronic equipment . . . SE cabinets have side panels, door, closed top and bottom panels in place. No further assembly needed. That's just one more "extra" you enjoy at no extra cost with SE. And, we have over 417 low-cost "customizing" options including blowers, air intake grilles, trims, and all finishes in colors and textures. Every option you order is in place . . . all you do is move your equipment right in. You get instant action on your order, too!

SYSTEMS ENCLOSURES

complete standard and custom series
 Division of Anetsberger Brothers, Inc.
 200 NORTH ANETS DRIVE • NORTHBROOK, ILL. 60062



INFORMATION RETRIEVAL NUMBER 75

IMPROVE axial lead component reliability

USE VERTI-MOUNTS
AND INCREASE BOARD
DENSITY BY
200%

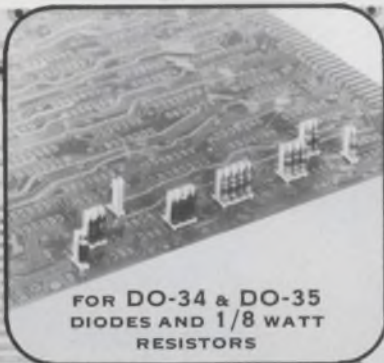

FOR DO-34 & DO-35
DIODES AND 1/8 WATT
RESISTORS



FOR DO-7 DIODES AND
1/4 WATT RESISTORS

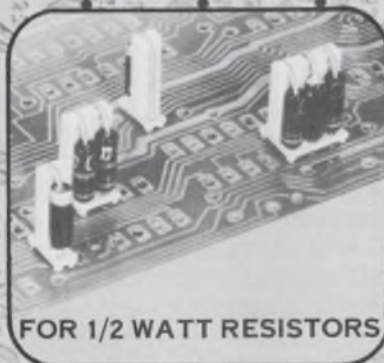

FOR 1/2 WATT RESISTORS

ROBISON ELECTRONICS, INC.
2134 W. Rosecrans Ave.
Gardena, Calif. 90249
(213) 321-0080, 327-5661

evaluation samples



Fiber optic cables

Standard foot-long flexible glass fiber optics are now offered at a price of 10¢ each in production quantities. The light pipes are completely ready for use and are cut to 12-in. lengths. Each has brass ferrules crimped on both ends and each end is epoxied and optically polished for maximum light transmission. These standard light pipes are 0.045-in. in dia. A free foot-long 0.045-in. dia sample is available with terminated ends. Corning Glass Works.

CIRCLE NO. 377

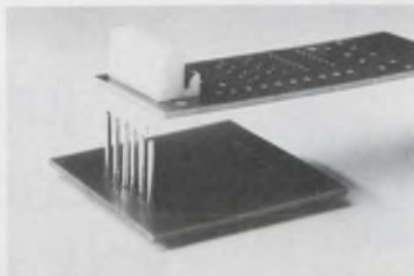

Board-to-board connectors

A new line of Conectcon connectors offer both perpendicular and parallel PC board interconnections. The perpendicular version is the model 2145A; the parallel one is the model 2145B. They are injection molded, presently of nylon, but can be supplied in several materials. The same connector housing is used for both types of interconnections. Included in the line are 3, 4, 6, 8 and 10-circuit models. Prices, specifications and a free sample are available. Molex, Inc.

CIRCLE NO. 378

design aids

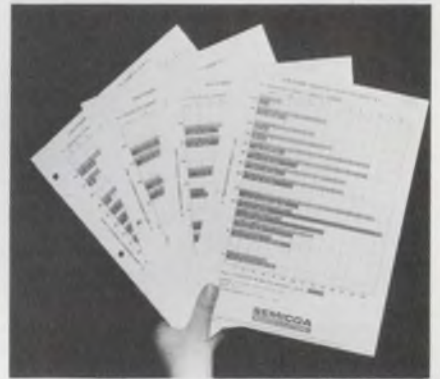

Semiconductor charts

A series of selector charts permits the user to specify virtually all mechanical and electronic characteristics of a required transistor. Four such charts are presently available. Two cover high-power transistors and two cover low-power transistors. To determine the proper chart for a certain requirement, the user first chooses the power level and as a second parameter, the power dissipation rating. Each chart consists of a 3-variable bar graph showing collector current, collector-emitter voltage and gain-bandwidth product. Semicoa.

CIRCLE NO. 379

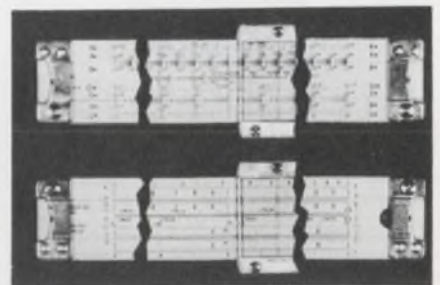

Decimal slide rule

A new slide rule is available for finding decimal points. It has special scales on one side to allow the user to find a decimal point without any scratch-pad calculations. This side also contains trigonometric, inverted, square and cube scales. The other side is a full conventional slide rule. Price of the new slide rule is \$7.50 which includes its case. Devonics, Inc.

CIRCLE NO. 380

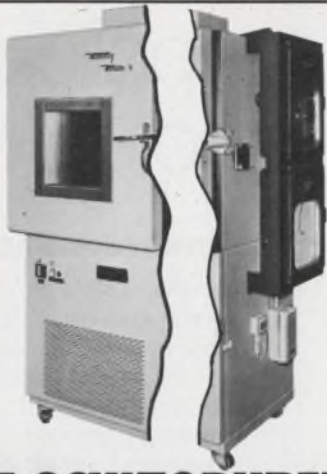

THE SCHIZOPHRENIC.

I'm a temperature test chamber. No, I'm a temperature-humidity test chamber. No, I'm both, in one compact unit. My Dr. Jekyll side has a dry bulb temperature testing range of -100°F to $+350^{\circ}\text{F}$. My Mr. Hyde personality combines temperature testing with a humidity range of 20% to 95%. I'm a five cubic foot automated test chamber with 2° control tolerances, but I have bigger brothers up to 64 cu. ft. (with other features) who can also help you. For full information write my keepers, Tenney Engineering, Inc.

Tenney
ENGINEERING, INC.

1090 Springfield Rd., Union, New Jersey 07083 • (201) 686-7870
Western Division: 15721 Texaco St., Paramount, Calif 90723



INFORMATION RETRIEVAL NUMBER 77



give...so more will live
HEART FUND

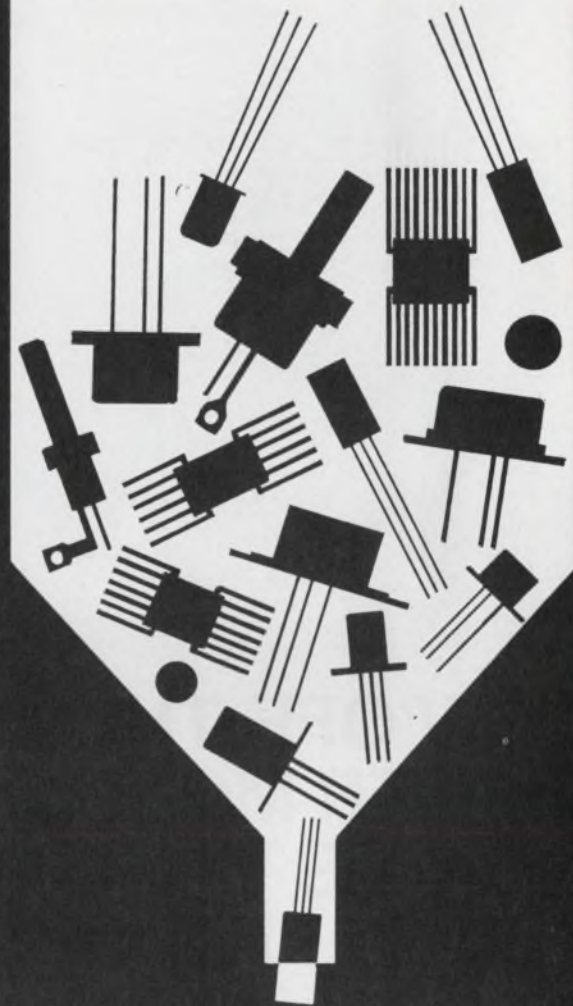

SEMICONDUCTOR SCREENING

Increase your yield and eliminate fallouts. Take advantage of ATL's semiconductor screening and testing capability, the best available insurance against field and production failure. Only Associated offers you a TOTAL CAPABILITY and is staffed to give you fast turn around, geared to the tightest production schedule—at a down-to-earth cost. Available services include: BURN-IN • HIGH-VOLUME MEASUREMENTS — DIGITAL AND LINEAR DEVICES • FAILURE ANALYSIS • QUALIFICATION TESTING • ACCELERATION TESTING TO 200,000 Gs • ELECTRONIC EVALUATION • TOTAL ENVIRONMENTAL TESTING • RELIABILITY PROGRAM DEVELOPMENT. Why not get the whole story today?



**ASSOCIATED
TESTING
LABORATORIES INC.**

200 ROUTE 46, WAYNE, N.J. 07470 • (201) 256-2800

INFORMATION RETRIEVAL NUMBER 78



NEW OFF-THE-SHELF POWER MONITOR SENSES VOLTAGE, FREQUENCY AND PHASE

Logitek's Type PMA power monitors, available as catalog items, monitor voltage, frequency, and phase sequence. The unit remains energized as long as line voltage and frequency are within 1% of the specified high and low limits and phase sequence is correct.

When frequency or voltage limits are exceeded, or if phase sequence is wrong, the monitor's output relay is de-energized. This can be used to trigger an alarm circuit, switch off the system, or both. When voltage, frequency and phase are corrected, the monitor automatically re-energizes.

A drop-out time delay allows for tolerable surges of frequency or voltage for a specified period. There's a pick-up time delay, too, which requires voltage and frequency to return to pre-set limits for a specified period before the unit re-energizes.

Logitek's Type PMA power monitors are designed for operation in single or three-phase systems, 60 or 400 Hz.

LOGITEK, INC.

42 Central Drive, Farmingdale, New York 11735 • (516) 694-3080

application notes

Signal processing

A monograph covers general and specific real-time signal processing techniques and theoretical constraints in the frequency domain. Material discussed includes random data processing and statistical certainty of power spectral density estimates, constraints in frequency analysis due to bandwidth, sampling and signal length and time-domain weighting with charts of theoretical performance using different weighting functions. Also discussed are theory of operation of time-compression analyzers, cross-property analysis and application in determining transmission, transfer functions by correlation and cross-power spectral density and processing of transient data. Federal Scientific Corp.

CIRCLE NO. 381

Semiconductor heat sinks

A 12-page application note comprehensively covers mounting high-power silicon semiconductors. It first simplifies working with heat flow problems by providing electrical analogs for thermal parameters. The application note then discusses surface requirements including flatness, finish and chemical treatment and cleaning of mounting surfaces. Additional theory sections cover thermal joining compounds and optimum mounting pressures. Westinghouse.

CIRCLE NO. 382

Wave analyzers

A 14-page application note discusses wave and spectrum analysis, and the differences in the methods used in the two techniques. Sections of the note include discussions of time domain vs frequency domain, definitions, and applications. The application note is intended to help those who must measure signals that range widely in level and frequency, and must be measured in the presence of other signals. Hewlett-Packard.

CIRCLE NO. 383

the Giant Killer strikes again...

Thermal shock analysis

A paper interpreting thermal shock specifications and describing accepted methods of meeting these specifications is available. "Let's Meet the Thermal Shock Specifications" is a paper that was presented at the Environmental Simulation and Test Equipment Show held in Stockholm, Sweden, in October, 1970. It analyzes the conditions which affect the thermal shock testing of electronic components and discusses conflicting interpretations of thermal testing specifications. Statham Instruments, Inc.

CIRCLE NO. 384

Automation

"Automation by Event Control" is a 20-page journal of practical solutions to automation problems, describing digital and analog techniques for industry. With 35 illustrations, it discusses practical industrial applications of digital arithmetic, describes the equivalent analog circuits, and compares equipment used in both disciplines. It also discusses stretch measurement, set-point switching, the human interface with instrumentation and the use of digital programmers as a computer interface. Airpax Controls Div. Airpax Electronics.

CIRCLE NO. 385

Programmable processors

"All About Programmable Communications Processors" is a report that covers 49 stored-program communications controllers from 28 manufacturers. The free 22-page report is an in-depth survey on the stored-program controllers that are being widely employed as front-end communications processors, message switching systems, and line concentrators. It tells how to select and apply this equipment. Detailed comparison charts summarize their characteristics. Datapro Research Corp.

CIRCLE NO. 386

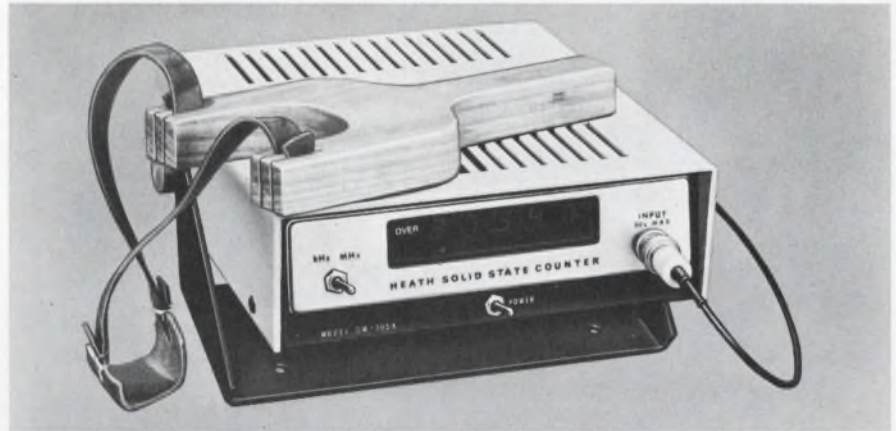

New Heath SM-105A

\$350.00*

**ASSEMBLED
& TESTED**

- 10 Hz to over 80 MHz range
 - Advanced design — new Texas Instruments 74S Series superspeed Schottky TTL
 - 5-digit LED readout
 - Wide range input without adjustment
 - 1 megohm input
 - Crystal clock
- *Send for free SM-105A spec sheet... and watch the giants fall!*

SM-105A SPECIFICATIONS — Sensitivity: 100 mV RMS to 50 MHz; 250 mV RMS, 50 MHz to 80 MHz. Frequency Range: 10 Hz to 80 MHz. Input Impedance: 1 Megohm shunted by less than 15 pF. Overload: 50 V RMS from 10 Hz to 40 MHz; from 40 MHz to 80 MHz derate linearly to 2.0 V RMS. Maximum DC input is ± 50 V. Time Base: 1 MHz ± 2 Hz, 0° C to 40° C ambient, ± 10 ppm. Readout: Five 7-segment light-emitting-diode displays. One single light-emitting-diode for overrange. Overrange: Flashing, 40 ms on, 60 ms off. Power Requirements: 120/240 VAC, 12 watts. Dimensions: 9 1/4" D x 6 3/4" W x 2 1/4" H. Net Weight: 3 1/2 lbs. Shipping Weight: 6 lbs.

FREE HEATH SCIENTIFIC INSTRUMENTATION CATALOG

Investigate these and other new ideas in Spectroscopy, Digital Instrumentation, Lab Equipment and Test Equipment. Send for your FREE catalog now.

HEATH COMPANY, Dept. 520-26
Benton Harbor, Michigan 49022



Please send free Heath Scientific Instrumentation Catalog

Name _____

Address _____

City _____ State _____ Zip _____

*Mail order prices; FOB factory.

Prices & specifications subject to change without notice. EK-296R

new literature



Digital panel meters

A two-color six-page catalog features a full line of new low-cost 2, 2-1/2, 2-3/4, 3 and 3-1/2-digit panel meters. The catalog gives complete electrical, physical and mounting specifications and provides a comprehensive specification selection guide with prices. Triplet Corp.

CIRCLE NO. 387

Emi selector guide

Those responsible for the design or manufacture of electronic products requiring emi shielding will want a copy of a new short-form catalog that describes a full line of shielding products and materials, as well as a handy reference to all applicable military material specifications. Qualified readers only. Tekshield Corp.

CIRCLE NO. 388

Instruments

A new instruments catalog contains photographs, specifications and prices for tube and transistor testers, oscilloscopes and signal generators. Hickok Electrical Instrument Co.

CIRCLE NO. 389

IC voltage regulators

Applications for two new dual-polarity tracking IC voltage regulators are described in detail in a six-page bulletin. Silicon General.

CIRCLE NO. 390

Hall-effect devices

Electronic designers will find an extensive review of Hall-effect solid state switching application procedures and possibilities in a new publication entitled "Magnetically-Operated Solid State Switches Application Notes." The 20-page document features a number of photographs, schematics, diagrams, graphs, tables and charts which review the ratings and characteristics of a series of Hall-effect switches. About half the booklet is devoted to a discussion of magnetic actuation. Honeywell Inc.

CIRCLE NO. 391

Vacuum tube handbook

A new 1971 edition abridged 96-page vacuum tube data booklet gives data for a range of 600 tubes and accessories. The booklet is divided into four main sections: the first three give details on power tubes, microwave tubes and light conversion devices; the fourth covers associated products including vacuum capacitors, lasers and flash tubes. Qualified readers may obtain a free copy. English Electric Valve Co. Ltd.

CIRCLE NO. 392

Power supplies

A new 40-page catalog covers a complete line of power supplies and related power control equipment. It includes modular, MIL-spec, inverter, frequency-changer, ac-regulator and high-current types. ERA Transpac Corp.

CIRCLE NO. 393

Drafting templates

A complete line of drafting templates is described in a 24-page catalog. RapiDesign, Inc.

CIRCLE NO. 394

Rectifiers/thyristors

A fully updated quick-reference guide is available with information on thyristors, triacs, rectifier and high-voltage stacks. Mullard Inc.

CIRCLE NO. 395

Precision tools

A new 176-page catalog describes tools and equipment for precision instrument and electronic work. It is fully illustrated and features such items as special non-magnetic tweezers for handling micro-miniature components and magnifiers and microscopes for use in in-process inspection. Krieger & Dranoff, Inc.

CIRCLE NO. 396

Medium-power rectifiers

A comprehensive new catalog cross-references more than 400 medium-power rectifiers by performance rating and by JEDEC and industrial-type number. The catalog covers a full line of 3 to 70-A stud-mount types. Westinghouse Electric Corp.

CIRCLE NO. 397

Pilot lights

A 16-page illustrated guide to indicator and pilot light selection includes a catalog with a line of pilot lights. Industrial Devices, Inc.

CIRCLE NO. 398

Indicator lights

A colorful 20-page brochure describes a variety of midsize indicator lights with specifications and suggested applications. Drake Manufacturing Co.

CIRCLE NO. 399

Panel potentiometers

Panel potentiometers are described in detail in a new 16-page brochure. Bourns, Inc.

CIRCLE NO. 400

Communications devices

A new brochure describes a line of communications devices covering the spectrum of 1 MHz to 3 GHz. It includes rf power and CATV transistors, ICs, amplifiers and linear broadband rf amplifiers. TRW Semiconductor Div.

CIRCLE NO. 401

The price of spacers comes tumbling



**Steel-
Aluminum**

Speedy shipment
from stock of over
1000 different sizes.

SEND FOR
LITERATURE AND
FREE SAMPLES!



CEM COMPANY, INC.

53 SCHOOL STREET, DANIELSON, CONN. 06239

INFORMATION RETRIEVAL NUMBER 81

3 OUTPUT MULTIPOWER

\$125 FROM
STOCK



MODEL MP 501	REGULATION
+ 5VDC 2.5A	1%
+15VDC 0.5A	0.5%
-15VDC 0.5A	0.5%
Voltage Adjustable \pm 10%	

Each Output Completely Isolated
Current Limiting Standard
Overvoltage Crowbar \$15. Per Voltage

Astro-Space Laboratories, Inc.



Research Park • Huntsville, Alabama 35806
Phone: 205/837-5830
TWX 810-726-2111

INFORMATION RETRIEVAL NUMBER 82

ELECTRONIC DESIGN 8, April 15, 1971

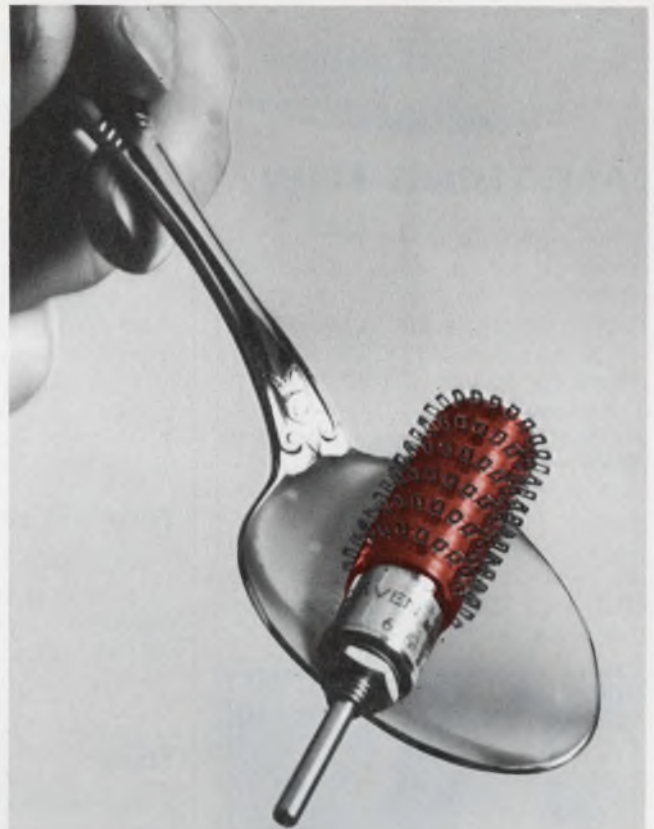

Try the Daven Reducing Plan for 30 days

Find out how the world's smallest
20 position rotary switch can trim
the fat off your equipment and
provide maximum programmability.

A tall order for a tiny switch less than a thin dime in diameter, yet the Daven Series "S" rotary switch thrives on challenges. For reliable, low-cost high density electronic packaging, it can be adapted to virtually any electrical configuration or function. Up to 20 positions and 8 poles per deck, ten decks in all, and spacing of 18°, 22½°, 30°, 36°, 45°, or 60°, shorting and non-shorting. 3 amps. current carrying capacity.

Enclosed dust-proof construction with sealed shaft and bushing meet requirements of MIL-S-3786. For a trial, write on your company letterhead to Edison Electronics Division, McGraw-Edison Company, Manchester, N.H. 03103. (603) 669-0940. TWX 710-220-1747.

Daven 'S' Switch,
9/16" diam., is
shown actual size.

**EDISON
ELECTRONICS
DIVISION**

McGraw-Edison Company

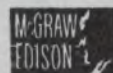

INFORMATION RETRIEVAL NUMBER 83

STABILITY & QUALITY

ANYTHING NEW?

Yes. The lead stoppers, not found in other capacitors, allow for ease of insertion along with the leads which are punch-cut by the same method as IC wire-leads to secure high dimensional accuracy. Wide operating temperatures, high insulating and moisture resistance, etc. . . . excellent in all respects.

See the specs. Operating temperature range: -55 to 85°C (125°C with derating voltage) Voltage rating: 6.3 10 16 20 35 VDC capacitance value: 0.1 to 100 MFD (E 6 series) Capacitance tolerance: ±20% (M).

DIPPED SOLID TANTALUM CAPACITOR "BLUE DT" TYPE DT

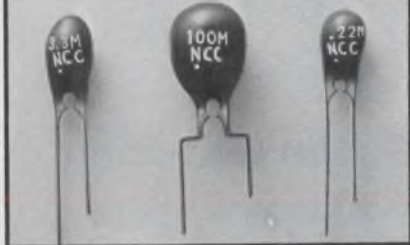

"TANCHIP", leadless and dimensionally accurate, is ideally used in hybrid ICs. It withstands the severe temperature conditions of solder reflow assembly (230°C, 2 minutes). Increases in leakage current, dissipation factor or impedance are avoided. Further, it is compatible with automatic assembly equipment and the resultant time and labour-saving.

Some of the features are—Temperature range: -55 to 85°C (125°C with derating voltage) Voltage rating: 6.3 10 16 20 35 VDC Capacitance value: 0.01 to 22 MFD (E 6 series) Capacitance tolerance: ±20% (M).

TANTALUM CHIP CAPACITOR "TANCHIP" TYPE TC

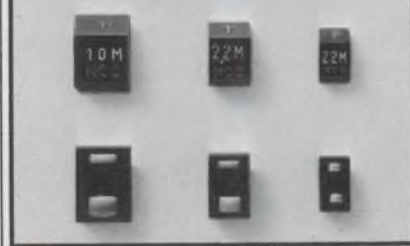

For further information, please contact:

MATSUO ELECTRIC CO., LTD.

3-5, 3-chome, Sennari-cho, Toyonaka-city, Osaka, Japan.
Cable: "NCCMATUO" OSAKA Telex: 523-4164 OSA

INFORMATION RETRIEVAL NUMBER 84

NEW LITERATURE

IR equipment

Applications and techniques useful to IR spectroscopists are included in a new 48-page authoritative handbook. The book gives performance characteristics, spectra, prices and ordering information for a complete line of IR spectrophotometer cells, crystals and accessories. Barnes Engineering Co.

CIRCLE NO. 421

Wire and cable

A comprehensive 72-page catalog lists several lines of wire, cable, connectors and cord sets. Victor Electric Wire & Cable Corp.

CIRCLE NO. 422

Tools

Time-saving tools for microelectronic and conventional electronic production are contained in a 54-page catalog. Starnetics Co.

CIRCLE NO. 423

16-bit computer

A new 16-page brochure describes a 16-bit real-time computer. Systems Engineering Laboratories, Inc.

CIRCLE NO. 424

Temperature instruments

A new informative brochure describes temperature instrumentation with considerable detail. The six-page booklet contains a variety of charts and diagrams. Simmonds Precision Products, Inc.

CIRCLE NO. 425

Encapsulants

Three two-part beryllia-filled thermally conductive rigid encapsulants are described in a bulletin. National Beryllia Corp.

CIRCLE NO. 426

Dc torque motors

A new 80-page catalog lists more than 300 standard dc torque motors with information on selection and application. Magnetic Technology.

CIRCLE NO. 427

Laser systems

A four-page brochure describes high-brightness laser systems. These include 11 ruby and seven Nd/glass systems. Union Carbide Corp., KORAD Dept.

CIRCLE NO. 428

Thermal/current limiters

A new 6-page illustrated brochure describes thermal and current-limiting protection devices. Micro Devices Corp.

CIRCLE NO. 429

DIP reed relays

A new catalog describes a line of dual-in-line reed relays. Allied Control Co.

CIRCLE NO. 430

Circuit breakers

Standard circuit breakers and time-delay relays, available as stock items, are covered in a new eight-page bulletin. Heinemann Electric Co.

CIRCLE NO. 431

Optical encoders

A line of 120 optical encoders which are used for the conversion of rotations to pulses are described in a brochure. Theta Instrument Corp.

CIRCLE NO. 432

Data equipment

Time-code indexing and data-retrieval equipment for rapid identification and location of data on magnetic tape, oscillographs, camera film and other recording mediums are in a handy instrumentation guide. CGS/Datametries.

CIRCLE NO. 433

Power supplies

A technical bulletin describes a new series of computer-grade power supplies with 3 outputs for powering both logic and linear circuitry. Trio Laboratories, Inc.

CIRCLE NO. 434

bulletin board

of product news
and development

A powerful **COBOL language processor** is among several new enhancements in Honeywell Information System's software package for series 400 computer systems. Called DAPS/70, the new software package is said to improve series 400 throughput.

CIRCLE NO. 435

Twenty-two new linear ICs have been added to GTE Sylvania's line of ECG replacement semiconductor devices.

CIRCLE NO. 436

Expanded production capabilities, according to CTS Corp., have enabled it to again **reduce prices** on its 190 series of 3/4-in. rectilinear **cermet trimmers**. A company spokesman states that prices have been reduced by as much as 19% for production quantities.

CIRCLE NO. 437

Energy Conversion Devices has announced **price reductions of approximately 50%** on its newly marketed 256-bit Ovonic read-mostly memory.

CIRCLE NO. 438

Computer Microtechnology has **reduced the price of four of its products**: the CM1101 256-bit MOS read/write memory from \$40 to \$20 each; the CM2100 64-bit TTL scratch-pad memory from \$40 to \$22.75 each; the CM2100P 64-bit TTL scratch-pad memory in a silicon package from \$20 to \$15.50 each; and the CM2900 bipolar character generator from \$102 to \$60 each.

CIRCLE NO. 439

Electronic Engineering Co. has **reduced prices on its D-4218 IC logic card** from \$180 to \$110 each.

CIRCLE NO. 440

RCA has reduced prices of its microwave transistors 2N5470, 2N5920, 2N5921 and TA7000 line by as much as 36%.

CIRCLE NO. 441

Design Data from Manufacturers

Advertisements of booklets, brochures, catalogs and data sheets. To order use Reader-Service Card.
(Advertisement)

Experi/Board: From Schematics to Electronics in Minutes



Circuit Accessories Co. has introduced a new method of breadboarding, "Experi/Board." CAC's "Experi/Board" is introduced and suddenly all other methods of breadboarding are obsolete. For integrated circuits or discrete components, the engineer can't find a faster way to bring his ideas from schematics to electronic realities than with "Experi/Boards." The new "Experi/Boards" are offered in 24 different sizes and models. The four page catalog covers complete specs, model numbers, mechanical dimensions and prices. "Experi/Boards" are shipped from stock. Write, call or TWX for your free catalog.

Circuit Accessories Co.

514 S. River Street
Hackensack, New Jersey 07601
(201) 343-6294 TWX: (710) 990-5023

CIRCLE NO. 171

No more Photography in PC Board Preparation



With Bishop's "B" Neg (Patent Pending) system, your board is ready to drill in minutes, not days. The most commonly used configurations of "TO" Cans, DIPS, Flat Packs, Connector Contacts, and other electronic component drafting aids are now available in negative form. Pressure-sensitive, absolutely opaque, "B" Neg patterns are made in 1X (1:1) scale (actual size), and are produced on 1.5 mil matte acetate. Write today for Technical Bulletin 1002: **complete information and free samples!**

Bishop Graphics, Inc.

7300 Radford Avenue
North Hollywood, California 91605
(213) 982-2000

CIRCLE NO. 172

Fight Fuzziness with New Real-Time 256-point Correlator

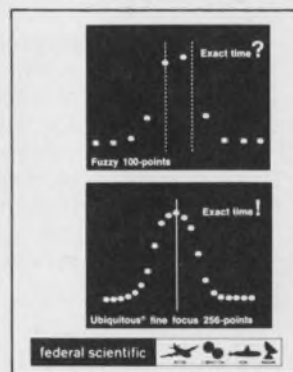

UC-201A Ubiquitous® Correlator is a complete time-domain measurement lab for real-time auto & cross-correlation, signal enhancement, & probability. For underwater acoustics, fluid dynamics, medical research, vibration analysis, noise source identification. Features: exact time measurements with digital dial; computes integral & differential of any stored function (converts probability density to cumulative distribution without rerunning data); pre-computational delay built-in (256 samples); sampling increments from 1/2 usec to 2 sec; complete ext. (computer) control plus digital outputs; built-in test signals for all modes; small, portable, easy to use; reasonably priced. Many options.

Federal Scientific Corporation

a subsidiary of Elgin National Industries, Inc.
615 West 131st Street, New York, N. Y. 10027

CIRCLE NO. 173

ELECTRONIC DESIGN's function is:

- To aid progress in the electronics manufacturing industry by promoting good design.
- To give the electronic design engineer concepts and ideas that make his job easier and more productive.
- To provide a central source of timely electronics information.
- To promote two-way communication between manufacturer and engineer.

Want a subscription? ELECTRONIC DESIGN is sent free to qualified engineers and engineering managers doing design work, supervising design or setting standards in the United States and Western Europe. For a free subscription, use the postfree application form inside the back cover. If none is included, write to us direct for an application form.

If you do not qualify, you may take out a paid subscription for \$25 a year in the U.S.A., \$35 a year elsewhere. Single copies are \$1.50 each.

If you change your address, send us an old mailing label and your new address; there is generally a prepaid postcard for this inside the back cover. You will have to requalify to continue receiving ELECTRONIC DESIGN free.

The accuracy policy of ELECTRONIC DESIGN is:

- To make reasonable efforts to ensure the accuracy of editorial matter.
- To publish prompt corrections whenever inaccuracies are brought to our attention. Corrections appear at the end of the Letters column.
- To refuse any advertisement deemed to be misleading or fraudulent.

Microfilm copies are available of complete volumes of ELECTRONIC DESIGN at \$19.00 per volume, beginning with Volume 9, 1961. Work is now in process to complete the microfilm edition of Volumes 1-8. Reprints of individual articles may be obtained for \$2.00 each, prepaid (\$.50 for each additional copy of the same article) no matter how long the article. For further details and to place orders, contact the Customer Services Department, University Microfilms, 300 North Zeeb Road, Ann Arbor, Michigan 48106; telephone (313) 761-4700.

Want to contact us? If you have any comments or wish to submit a manuscript or article outline, address your correspondence to:

Editor
ELECTRONIC DESIGN,
850 Third Avenue,
New York, N.Y. 10022.

Terminal Block Selector



A new 24-page, completely illustrated catalog contains photos, descriptions, ratings, engineering drawings, and prices of the complete line of Curtis terminal blocks. Included are printed circuit, insulated feed-thru, quick disconnect, track type, and high current terminal blocks. Handy selection chart quickly locates the perfect block for your particular requirements. Send today for your free copy.

CIRCLE NO. 174

Curtis Development & Mfg. Co.

3236 North 33rd Street
Milwaukee, Wisconsin 53216

SEE US AT BOOTH 4332, DESIGN ENGINEERING SHOW

Economical High Performance Electrometers



New P.A.R. electrometers offer superior performance at low cost. Model 134, with wide range and high stability, is priced at \$615; Model 135, with self-contained battery power supply, \$675; and Model 136 with digital display and BCD output, \$995. Drift, offset and noise figures are lowest available in this price range. Other features include guarded input circuits and fast recovery from large overloads. Full line of accessories available. Request new brochure, demonstration or applications assistance.

Princeton Applied Research Corporation

Box 565, Princeton, New Jersey 08540 — (609) 452-2111

CIRCLE NO. 175

Free Catalog of Technical Books



Hayden Book Company's 1971 Catalog describes a wide range of guidebooks, texts, and references of interest to engineers. Among areas covered are electrical and electronics engineering, professional engineering examinations, and computer technology and programming. Also included are texts, references, and guides for training and updating technical personnel. Circle the reader service number for a free copy.

CIRCLE NO. 176

Hayden Book Company, Inc.

116 West 14th Street
New York, N. Y. 10011

Manufacturers

Advertisements of booklets, brochures, catalogs and data sheets. To order use Reader-ServiceCard (Advertisement)

Plastic Parts



CUSTOM production to your specs from patented, low-cost tooling. Any size, any quantity in Nylon, Delrin, other thermoplastics. Let us quote. We have 20 years experience.

STANDARD gears, racks, bearings, sprockets, pulleys, washers, insulators, many other components available quickly from stock tools. Over 2,500 items described in our 48-page catalogue. Write today for a free copy.

CIRCLE NO. 177

Nylomatic

11 Nolan Ave., Morrisville, Pa. 19067
A DIVISION OF WEHCO PLASTICS INC.

New Tech-Data-Pak on Resistors



There's a Pyrofilm resistor to satisfy your most precise circuit designs . . . send for the free TECH-DATA-PAK which includes complete specifications on the entire Pyrofilm line including: CHIPS . . . MIL-R-55182 EXTENDED RESISTANCE RANGE . . . HIGH VOLTAGE . . . GLASS SEALED METAL FILM . . . EXTENDED RANGE METAL FILM . . . HIGH MEGOHM . . . NETWORKS . . . MICROWAVE RESISTORS.

CIRCLE NO. 178

Pyrofilm Corporation

60 S. Jefferson Rd.
Whippany, N. J. 07981
(201) 887-8100

How To Write Technical Articles



A guide for the engineer-author, "How to Write Articles for Electronic Design" shows how easy it is to write for publication—once the engineer knows what to write and how to write it. The Author's Guide includes a complete run-down of the types of articles published by Electronic Design—plus detailed instructions on how to prepare technical articles and short special features. A MUST for every "would-be-writer" in the electronics industry. Send for your complimentary copy by circling the number to the right.

CIRCLE NO. 179

Electronic Design

850 Third Avenue
New York, N.Y. 10022

Electronic Design

Advertising Sales Staff

Keith Aldrich
Sales Manager

New York 10022

Robert W. Gascoigne
Samuel M. Deitch
Daniel J. Rowland
850 Third Avenue
(212) Plaza 1-5530
TWX: 867-7866

Philadelphia 19025

Mort Sullivan
P.O. Box 126
Dresher, Pa.
(215) 884-6880

Boston 02154

Joseph F. Palmer
1268 Main Street
Waltham, Mass.
(617) 894-2700

Chicago 60611

Thomas P. Kavooras
Berry Conner, Jr.
200 East Ontario
(312) 337-0588

Cleveland

Thomas P. Kavooras
(Chicago)
(312) 337-0588
(call collect)

Los Angeles 90303

Stanley I. Ehrenclou
2930 Imperial Highway
Inglewood, Calif.
(213) 757-0183

San Francisco 94022

Jerry D. Latta
95 Main Street
Los Altos, Calif.
(415) 941-3084

London W. 1

For United Kingdom and Holland
Brayton C. Nichols

For Eastern Europe

Peterkehr
44 Conduit Street
Tel: REGent 4714

Verviers, Belgium

For Continental Europe

Andre Jamar
1, Ru Mallar, 1
087) 253.83 Telex 41563

Tokyo

Haruki Hirayama
Electronic Media Service
5th Floor, Lila Bldg.,
4-9-8 Roppongi
Minato-ku
Phone: 402-4556
Cable: Electronicmedia, Tokyo

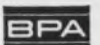

SPELLMAN HIGH VOLTAGE DC POWER SUPPLIES

1 KV to 500 KV

RHR/UHR SERIES: 0.01% regulation. 0.02% RMS ripple. All solid state. Rack mounted. Low cost. 115V AC input. Used for

- CRT displays
 - photomultipliers
 - linear accelerators
 - computer terminals
 - dielectric and tube testing
 - low power lasers
- Priced from \$325



HIGH POWER SERIES REGULATED to 0.002%. HP Series units up to 200 KV feature constant voltage / constant current modes with automatic crossover. 100 μ sec transient response. Used for

- gas lasers
- sputtering and radiation equipment
- capacitor chargers
- accelerators
- spectroscopy
- microwave tube sources

MINIATURE: Encapsulated, all solid state, high voltage, miniature DC power supplies. Used for

- CRT displays
- photomultipliers and quantity low cost precision applications. Available in regulated (RM Series) and unregulated (UM Series) models. DC input. Quantities of 100 priced from \$50.



Write or call for detailed technical literature

SPELLMAN
HIGH VOLTAGE
ELECTRONICS CORP.



1930 Adeo Avenue
Bronx, New York 10469
212/671-0300
Our third decade of leadership
in high voltage technology.

INFORMATION RETRIEVAL NUMBER 85

Perfect mate for Integrations- Micro-Vectorbord® Tenth-Tenth Pattern "P"

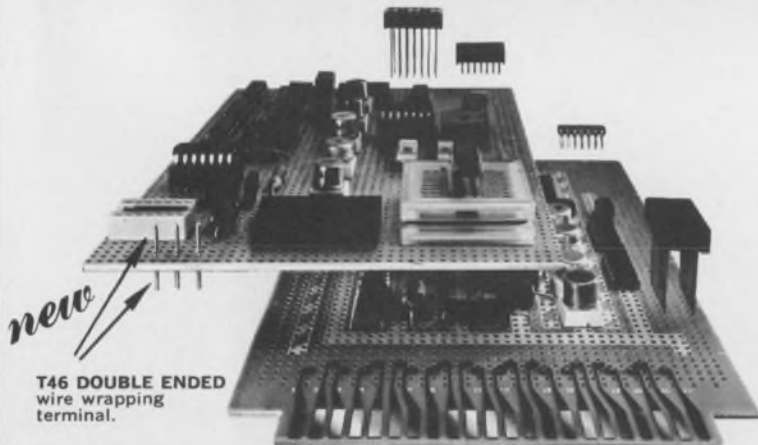

T46 DOUBLE ENDED
wire wrapping
terminal.

Precision punched .042" holes spaced .1" x .1" available in sheets of various sizes up to 8 1/2" wide by 35" long, 1/16" thick Epoxy Glass, Epoxy Paper, Phenolic. Now all flame retardant. Copper Clad and Non-Clad. Also available in Plugboards with etched or Elco Varicon contacts, buses, ground planes.

MINIATURE PUSH IN TERMINALS FOR .042" HOLES.



T44 MINIWRAP .025" Square, for wire-wrapping.



K27 .042" Diameter



T42-1 Micro-Klip

Send for complete literature

Vector

ELECTRONIC CO., INC.

12460 Gladstone Ave., Sylmar, California 91342

NEW Phone (213) 768-6080 • TWX (910) 496-1539

Earthquake? We resumed shipping Feb. 11 and production the 16 th.

INFORMATION RETRIEVAL NUMBER 86

advertiser's index

Advertiser	Page
Acopian Corp.	9
AirBorn, Inc.	88
Alco Electronic Products, Inc.	89
Allen-Bradley Co.	23
American Lava Corporation	11
Amphenol, The Bunker-Ramo Corporation	12
Associated Testing Laboratories, Inc.	113
Astro Space Laboratories, Inc.	117
Automatic Electric Company	4, 5
Belden Corporation	29
Bishop Graphics, Inc.	119
Bodine Electric Company	61
Bourns, Inc.	106
Bourns Pacific Magnetics Corp.	111
Burroughs Corporation	20
CEM Company, Inc.	117
Cambridge Thermionic Corporation ..	105
CELCO (Constantine Engineering Laboratories Co.)	109
Centralab, the Electronics Division of Globe-Union	85
Cinch Manufacturing Company	24
Circuit Accessories Co.	119
Cober Electronics, Inc.	123
Computer Automation, Inc.	58, 59
Constantine Engineering Labs. Co. (CELCO)	109
Continental Connector Corporation ..	10
Curtis Development & Mfg Co.	120
Dale Electronics, Inc.	Cover III
Data Products Corporation	34, 35
Decitek, Division of Jamesbury Corp.	7
Dialight Corporation	109
Eastman Kodak Company	101
Edison Electronics Division, McGraw-Edison Company	117
Elco Corporation	99
Electronic Design	64, 121
Electrostatics, Inc.	105
Facit-Ohdner, Inc.	111
Federal Scientific Corporation	119
Fifth Dimension, Inc.	40
Fluke Mfg. Co., Inc., John	95
General Electric Company	93
Grayhill, Inc.	105
Hayden Book Company, Inc.	42, 120
Haydon Company, A. W.	94
Heath Company	115
Hewlett-Packard	Cover II, 14, 36, 37, 76, 77
Howard Industries, MSL Industries, Inc./Motor Group	41

Advertiser	Page
ITT Cannon Electric, A division of International Telephone and Telegraph Corp.	31
Intel Corporation	80, 81
Jamesbury Corp., Decitek Division....	7
Keithley Instruments, Inc.....	6
Kurz-Kasch, Inc.	102
Logitek, Inc.	114
3M Company	15
Mallory Capacitor Company	16
Matsuo Electric Co., Ltd.	118
Midtex, Incorporated, Aemco Division	46
Molex Incorporated	2
Monolithic Memories, Inc.	1
Motorola Semiconductor Products, Inc	38, 39
Nihon Dempa Kogyo Co., Ltd.	110
North Electric Company	97
Nylomatic Corporation	121
Piezo Technology, Inc.	100
Pomona Electronics Co., Inc.	106
Power/Mate Corp.	13
Precision Monolithics, Incorporated	123
Princeton Applied Research Corp. ..	120
Pyrofilm Corporation	121
RCA Electronic Components and Devices	66, 67, Cover IV
RFL Industries, Inc.	107
Robison Electronics, Inc.	112
Rogan Brothers, Inc.	83
Schauer Manufacturing Corp.	124
Schneider Electronique	96B
Schrack Electrical Sales Corp.	109
Siemens Corporation	42
Sigma General Reed Division	8
Singer Industrial Timer Division	102
Sprague Electric Company	18
Spellman High Voltage Electronics Corp.	122
Sperry Information Displays	72, 73
Sylvania Electronic Components Electronic Tube Division	65
Systems Enclosures, Inc.	111
Tekelec Airtronic	96A
Tektronix Inc.	45
Teletype Corporation	62, 63
Tenney Engineering, Inc.	113
Texas Instruments Incorporated 16A—F	
Triplett Corporation	87
UID Electronics Corp.	17
Union Carbide, Components Department	60
Unitrode Corporation	27
Vector Electronic Co., Inc.....	122
Veeder-Root	33
Victoreen Instrument Division of VLN Corp.	103
Weinschel Engineering	90

FIRST TO BREAK THE PRICE BARRIER...

D/A CONVERTERS

as low as

\$9.95* each

2000 PIECE PRICE

THE BEST NOW COSTS LESS!

* monoDAC-01HS Monolithic D/A, 0-50°C, Silicone DIP

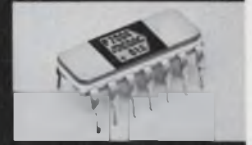

CHECK THE OUTSTANDING FEATURES:

- 6 Bits
- Settling Time 1-3µ Sec.
- Linearity 0.40% Max.
- TTL/DTL Compatible
- FS Tempco 160 ppm/°C Max.
- Completely self-contained
- Expandable to 7 bits with three low cost external parts

AT THIS PRICE, WHY BUILD YOUR OWN?

GET COMPLETE DATA ON THE
OUTSTANDING monoDAC-01 — FROM PMI
THE PACESETTER! WRITE OR CALL TODAY!



**PRECISION
MONOLITHICS
INCORPORATED**
1500 SPACE PARK DRIVE, SANTA CLARA, CALIFORNIA 95050

WEST COAST SALES OFFICE PHONE: (408) 246-9225
EAST COAST SALES OFFICE PHONE: (516) 582-4906

A BOURNS Affiliate

INFORMATION RETRIEVAL NUMBER 87

LESS THAN

\$2000

**FOR THIS ONE WATT TWT
CW LABORATORY
MICROWAVE AMPLIFIER**



SERIES LMA
19" RACK



SERIES LMA
HALF-RACK

... AND IT'S FROM COBER, TOO!

Uncompromised quality in your choice of ... 19" rack mount, 1/2 rack, 1/3 rack, and portable, too! Provides 30db gain at 1-2GHz, 2-4GHz, 4-8GHz or 7-12.4GHz.* Features include all solid state regulated power supply, full TWT protection including Helix overload, variable gain control and external modulation. Price is under \$2,000 for any of the above octave bands.

SERIES LMA SPECIFICATIONS: RF Power Output—1wCW Min.; Gain—30db min.; Noise Figure—30db max.; Residual AM—45db below carrier; Circuits—all solid state except TWT; Size—5 1/4" h X 17" w X 8" d.

* (12-18GHz or higher power units available on special order)

The High Power People

**COBER
ELECTRONICS, INC.**

7 Gleason Ave., Stamford, Conn. 06902
Tel: (203) 327-0003

For further details send for bulletin LMA.

INFORMATION RETRIEVAL NUMBER 88

Best Buy

in 1% Tolerance
1-Watt Zeners
SCHAUER
Immediate Shipment

No fragile
nail heads

All welded and
brazed assembly

Gold plated
leads

Low Prices

ANY voltage from 2.0
to 18.0

Quantity	Price each
1-99	\$1.07
100-499	.97
500-999	.91
1000-4999	.86
5000 up	.82

Write for complete rating data and
other tolerance prices.

Buy The Kit!



A
\$54.57
value
for
only

\$24⁵⁰

Kit contains a 51-piece assortment
of SCHAUER 1% 1-watt zeners
covering the voltage range of 2.7
to 16.0. Three diodes of each vol-
tage in reusable poly bags. Stored
in a handy file box. Contact your
distributor or order direct.

Semiconductor Division

SCHAUER

Manufacturing Corp.

4511 Alpine Ave. Cincinnati, Ohio 45242
Telephone: 513/791-3030

product index

Information Retrieval Service. New Products, Evaluation Samples (ES), Design Aids (DA), Application Notes (AN), and New Literature (NL) in this issue are listed here with page and Information Retrieval numbers. Reader requests will be promptly processed by computer and mailed to the manufacturer within three days

Category	Page	IRN	Category	Page	IRN
Components			CRT pincushion module	98	289
brake, variable-torque	106	357	display subsystem	98	283
capacitors, disc	106	355	driver/decoders	98	286
cores, memory	104	350	encoders, optical	98	287
indicator, flashing	107	361	kits, transformer	100	293
motor control	106	356	multiplier, 4-quadrant	98	284
potentiometer, cermet	107	360	power-supply, CRT	98	290
protector, surge	104	349	sample-hold module	98	288
resistors, chip	104	351	SCR gate drive	100	295
resistors, metal-film	104	353	simulator, resolver	100	294
resistors, power	104	347	voltage sensor	100	292
switch, rocker	107	362	Packaging & Materials		
switches, encoded	106	358	connector, edge card	110	375
switches, paddle-lever	104	348	headers, cable	110	373
thermistors, PTC	107	359	magnifier, optical	110	371
time delay module	104	354	package, integrated	110	376
transformer, active	104	352	socket, DIP	110	374
			terminal block	110	372
Data Processing			new literature		
calculator, 14-digit	108	366	breakers, circuit	118	431
core-memory stack	108	363	DPMs	116	387
keyboard, MOS	108	365	drafting templates	116	394
keyboard, solid-state	108	364	Hall-effect devices	116	391
modem, PC-card	108	370	indicator lights	116	399
recorder/reproducer	108	369	instruments	116	389
transports, tape	108	367	laser systems	118	428
transports, tape	108	368	pilot lights	116	398
			potentiometers	116	400
ICs & Semiconductors			tools	116	396
amps, Darlington	96	270	tools	118	423
comparator, 5-bit	96	266	vacuum-tube handbook	116	392
counters, up/down IC	96	269	voltage regulators, IC	116	390
hammer driver	96	264			
op amps	96	267			
RAM, 256-bit	96	263			
ROM, programmable	96	282			
switch driver	96	281			
switches, current	96	268			
zener diodes	96	265			
Instrumentation					
camera, scope	94	261			
counter, frequency	92	254			
DMM, 3-1/2-digit	92	255			
generator, function	92	257			
generator, rf	91	250			
generator, waveform	92	253			
lock-in amplifier	94	262			
ratio computer	92	260			
recorders, strip-chart	92	259			
scopes, portable	92	256			
TDR scope, plug-in	91	251			
wattmeter, digital	92	258			
Microwaves & Lasers					
laser, CO ₂	103	344			
laser system	103	343			
phototransistor arrays	102	342			
scanner, fiber-optic	102	340			
scanner, optical	102	341			
transistor, vhf	103	345			
TWTs, environmental	103	346			
Modules & Subassemblies					
amplifier, data	100	296			
converter, 12-to-32-kV	98	285			
converters, d/a	100	291			
			application notes		
			analyzers, wave	114	383
			automation	115	385
			heat sinks, semiconductor	114	382
			processors, programmable	115	386
			signal processing	114	381
			thermal shock analysis	115	384
			design aids		
			semiconductor charts	112	379
			slide rule, decimal	112	380
			evaluation samples		
			connectors, board	112	378
			fiber optics	112	377



Square trimmers go automatic with new Dale *Fastpack* styling

New from Dale: The first square, film-element trimmers really designed for your high-volume, high-density automatic packaging operations. Our new 87 and 85 **Fastpack** Series combine DIP pin spacing with ½-watt power dissipation and the tough, sealed construction it takes to function reliably after automatic insertion, washing and soldering. Setting stability is excellent—and you have your choice of adjustability. The multi-turn 85 **Fastpack** and the single-turn 87 **Fastpack** fit most industrial/commercial needs as well as many military applications.

SPECIFICATIONS

Power Rating: ½ watt at room temperature
Resistance Range: 10 ohms to 1 Megohm
Tolerance: ±20% standard,
closer tolerances available
Temp. Coefficient: ±150 PPM/° C standard
Operating Temp.: -55° C to +125° C
Resolution: Essentially infinite

Adjustment: 87 = 1 turn; 85 = 12 turns nominal

Construction: Sealed case permits cleaning in common solvents. Standoffs permit board washing.

Dimensions: .265" wide x .280" long x .190" high.
Pin spacing: .300" x .200" grid. Machine insertable models .355" x .200" prior to insertion.

*Gear up for faster production and lower costs with
Dale **Fastpack** trimmers—Phone 402-564-3131 today!*

DALE ELECTRONICS, INC.
1300 28th Ave., Columbus, Nebr. 68601
In Canada: Dale Electronics Canada, Ltd.
A subsidiary of The Lionel Corporation



DALE

RCA's five new IC arrays give you the design flexibility and cost-effectiveness of discrete devices

RCA linear IC arrays offer cost-conscious design engineers an ideal way to achieve new economies—they are priced as low as 10¢ per transistor (8¢ in high volume).

Here are five new monolithic, active-device arrays that combine the performance and versatility of discrete devices, with the inherent reliability and match of integrated circuits to provide a new approach to design problem solving.

Check into the:

- CA3081 and CA3082—for 7-segment incandescent and LED display drivers

and other current switching applications including relay control and thyristor triggering.

- CA3083—for high current signal processing, thyristor triggering, and driver applications from DC to 120 MHz.
- CA3084—p-n-p type for dynamic loads, level shifting, bias circuitry, and small-signal amplification (including complementary configurations).
- CA3086—5-transistor array for maximum economy and performance in signal processing systems operating in the DC to 120 MHz range.

For further information on these devices and RCA's complete line of linear IC arrays, see your local RCA Representative or RCA Distributor. For a copy of RCA's Integrated Circuit Product Guide (or a specific technical bulletin by File No.) write RCA, Commercial Engineering, Section 57D-15/CA61, Harrison, N.J. 07029. International: RCA, Sunbury-on-Thames, U. K., or 2-4 rue du Lièvre, 1227 Geneva, Switzerland, or P.O. Box 112, Hong Kong.

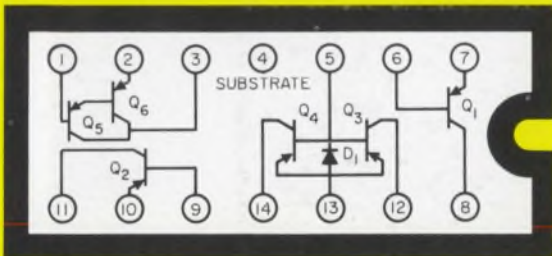

CA3084

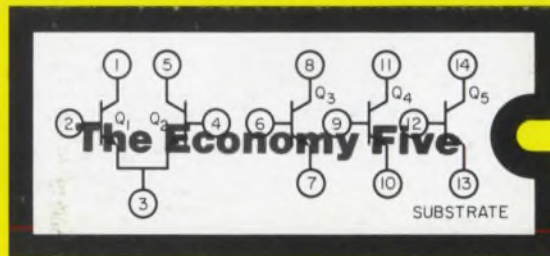

CA3086

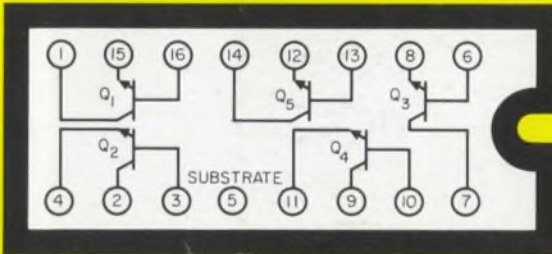

CA3083

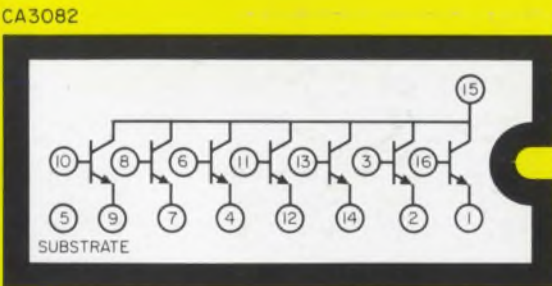

CA3082

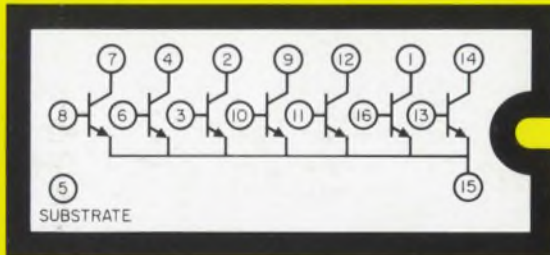

CA3081

Type	Package	Description	Technical Bulletin File No.	Price (1000-unit level)
CA3086	14-lead DIP	The economy five	483	.49
CA3084	14-lead DIP	P-n-p array	482	1.79
CA3083	16-lead DIP	Five independent 100-mA n-p-n transistors, with $V_{CE0} = 15$ V (Q_1 and Q_3 are matched at low currents, i.e. 1 mA)	481	1.69
CA3082	14-lead DIP	Seven 100-mA transistors with $V_{CE0} = 16$ V (common-collector array)	480	1.89
CA3081	16-lead DIP	Seven 100-mA transistors with $V_{CE0} = 16$ V (common-emitter array)	480	1.89

RCA Solid State