

# Electronic Design

FOR ENGINEERS AND ENGINEERING MANAGERS

VOL. 19 NO.

# 4

FEB. 18, 1971

**New electronic police devices** are coming into use to conduct a war on U.S. crime. The lineup of equipment includes improved walkie-talkies, telescopes that

'see' in darkness, teleprinters, speech scramblers, copter TV, and more. Police electronics, a \$100-million annual market, is headed upward fast. See p.55.





# Introducing: "The Portables" from HP

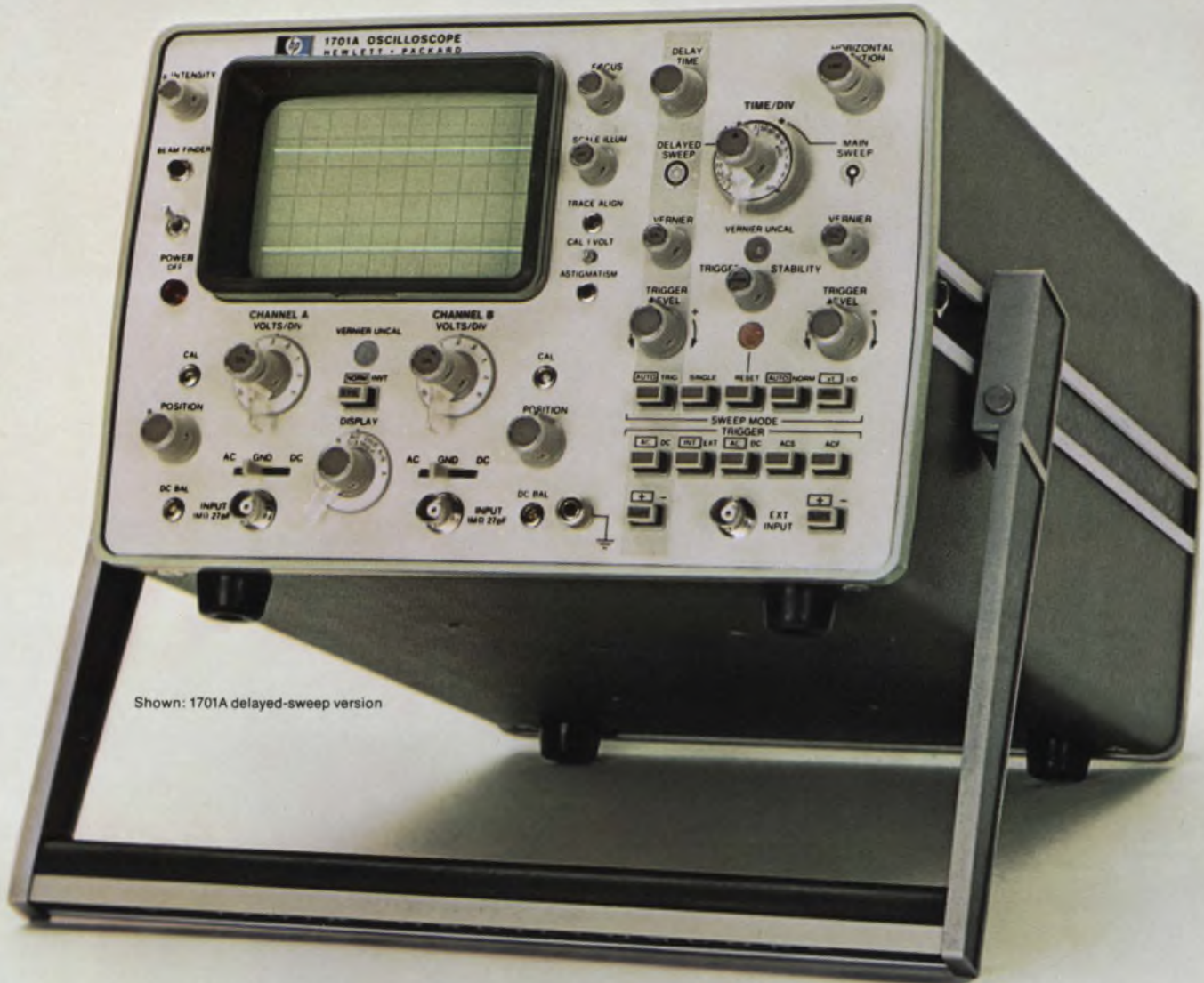

Shown: 1701A delayed-sweep version

## They make your budget seem bigger.

HP's new dual-channel, portable scopes make slim budgets look fatter. At only \$1850, our delayed-sweep model, the 1701A, weighs in at \$200 less than the competition, which adds up to a 10% savings for you. (Our non-delayed-sweep model, the 1700A, is even lower—\$1680.)

The 1701A weighs less in pounds, too—24 as compared to 28—which makes it easy to carry around in the field. But the 1701A is no "light-weight" in its performance. It gives you all the necessary capabilities for digital field service work.

Its 10 ns/div sweep time and <10 ns rise time (35 MHz) let you measure T<sup>2</sup>L pulse timing and propagation delay.

And its simple-to-use delayed sweep allows expansion of complex waveforms, for easy observation on the large 6 x 10 cm screen.

Another advantage is the 1701A's low power requirement. This HP breakthrough eliminates the need for fans (or even vent-holes), which means that dust and moisture are kept out of the circuits. It also assures extreme reliability, as all components are operating at less than 20% of rated capability. And, this low power requirement allows battery operation in the field—a capability you get with no other scope in this class. (Internal battery pack, \$200 extra.)

For further information on "The

Portables"—HP's new 1700 Series scopes—contact your local HP field engineer. Or write Hewlett-Packard, Palo Alto, California 94304. In Europe: 1217 Meyrin-Geneva, Switzerland.

Scopes are changing.  
Are you?

081/7

HEWLETT **hp** PACKARD





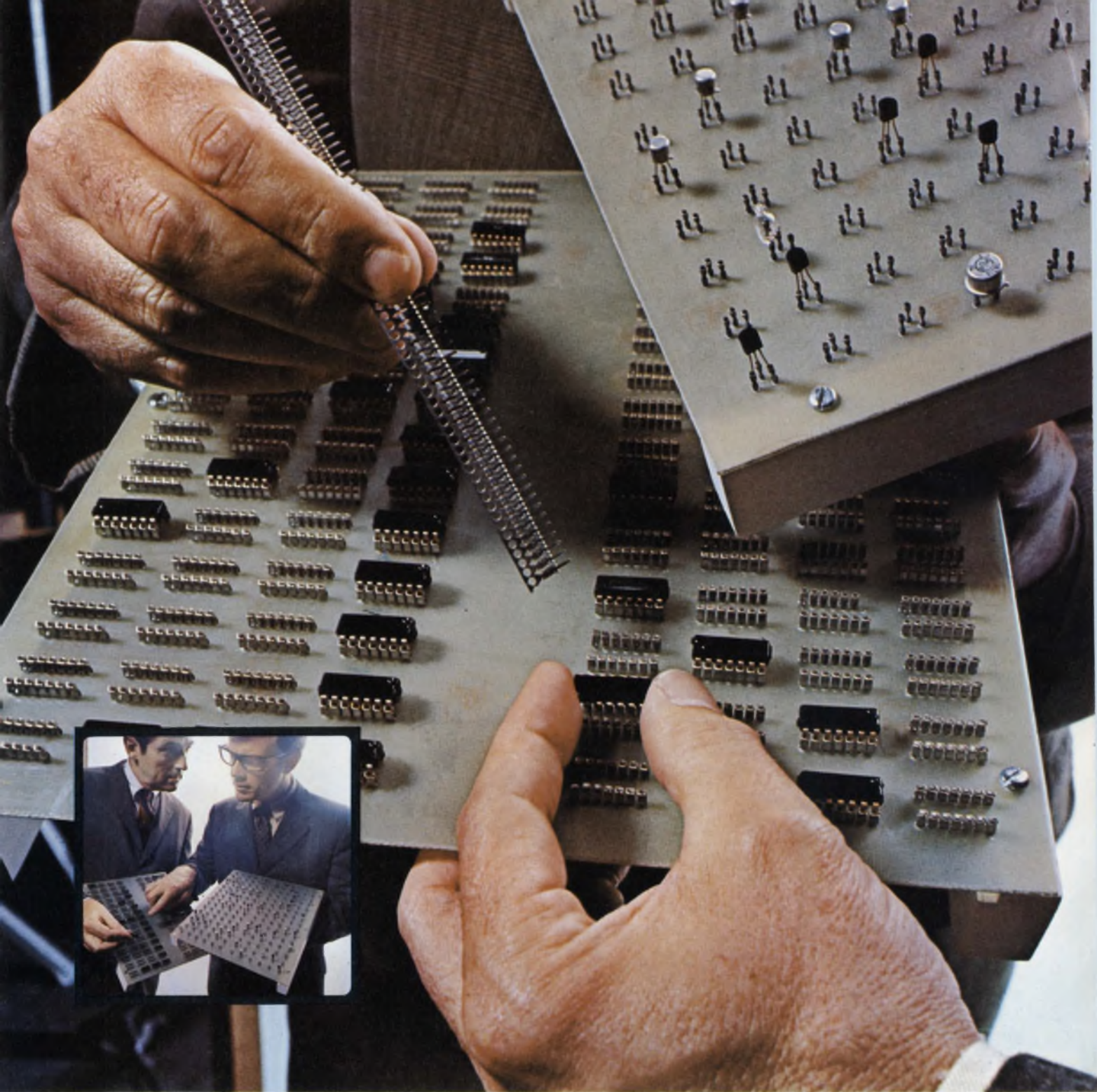

**HERE'S A NEW AND BETTER WAY:** To make printed circuit board connections. Reliably. At low, low cost. They're Molex Soldercon® terminals. Integrated circuit and transistor terminals. Offering the convenience of plug-in I.C.'s and transistors *without* the cost of insulators. They fit directly on the board. And there is equipment available to do the job *automatically*. Fast! Soldercon terminals save time. Money. Speed installation. Make

testing easier, too. And simplify service problems. It's another example of Molex ingenuity . . . in creating components that simplify circuitry. Molex has the know-how and facilities to provide the interconnecting system you need. You can make connections by calling (312) 969-4550. Or write . . . Molex Incorporated, Downers Grove, Illinois 60515.

*... creating components that simplify circuitry*





---

## NEWS

- 21 News Scope
- 25 **Semi output is entering the ion age**, where 'impossibles are possible.' The implantation method, instead of diffusion, offers better devices.
- 30 **Vlf system and geophones help rescue trapped miners**. For the first time, men can be located within minutes, and given instructions.
- 32 **New processor makes programming easy**
- 34 **The one-chip calculator is here, and it's only the beginning**
- 36 **Designers to mini makers: 'Please add improvements'**
- 40 Technology Abroad
- 45 Washington Report

---

## TECHNOLOGY

- 55 **Electronics joins the national war on crime**. A civionics report on the new hardware being developed for the police.
- 66 **Use RGB for color TV**. The red-green-blue circuit is cheaper than the color-difference type and, if well designed, can outperform it.
- 74 **Simplify high-speed counter design**. By combining the features of two types of counters, you can reduce parts and increase speed.
- 78 **Need a programmable word generator?** Don't go overboard on complexity—a few ICs are all you may need for your digital system.
- 82 **What price unionization?** This review indicates that a union cannot guarantee job security—but that management has much to learn.
- 88 Ideas for Design
- 96 **Semiannual Index of Articles: July through December, 1970**

---

## PRODUCTS

- 105 **Modules & Subassemblies: \$68** buys a complete alphanumeric display.
- 114 **Instrumentation: Four-digit systems multimeter** starts from \$1395.
- 122 **Data Processing: Plated-wire memory** cost drops down to 1.8¢/bit.
- 108 ICs & Semiconductors
- 118 Packaging & Materials
- 124 Components
- 128 Microwaves & Lasers
- 140 Product Index

---

## Departments

- 53 **Editorial: Our industry reels—while unions get 17%.**
- 7 Letters
- 13 Designer's Calendar
- 130 Evaluation Samples
- 131 Design Aids
- 131 Application Notes
- 132 New Literature
- 135 Bulletin Board
- 138 Advertisers' Index
- 140 Information Retrieval Card

**Cover:** Fighting crime with electronics. Illustration by Art Sudduth



**Reliability is a notched memory  
and a double-jointed thumb**

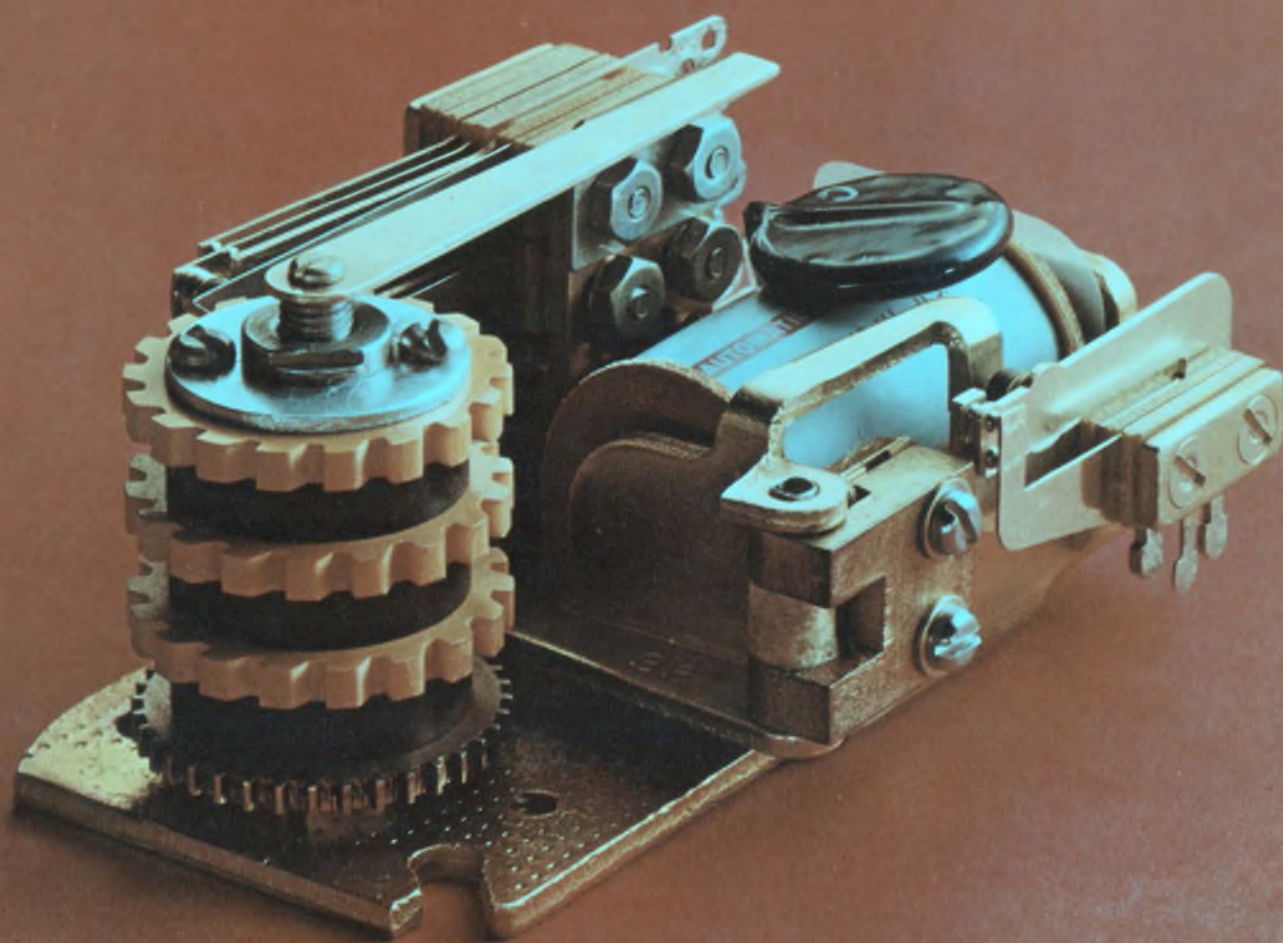



We combine the simplicity of a cam-operated relay with a tough, time-proven stepping switch to give you an uncomplicated and sturdy relay. The brains of our OCS relay are precisely notched cams that give it an unforgettable memory. Power blackouts won't change it.

### Faithfully redundant

There are no mysteries, no black boxes. First, phenolic cams are notched to your exact needs and every operation is faithfully repeated. The cams control the action. As the finger of the switch traces over the crests and the valleys of the cam, you get simple and precise "ons" and "offs" that you can use to control a variety of equipment. Pulse interval, pulse width—we'll let you make the decisions.

Now we anchor the stack of cams and a gear with two long bolts running exactly parallel with the camshaft axis. This keeps everything in line even under extreme vibrations or shock. You can't get this toughness in delicate latching relays.

### It clicks very carefully

A good brain deserves a rugged body. Ours is a time-proven stepping switch with our patented "free floating" pawl. The spring-loaded pawl swivels at

the midsection of a long, toothed, finger-like lever. Together they act like an index finger and a double-jointed thumb.

After it clicks and pushes the camshaft gear, the thumb floats over the teeth. Very carefully. Then the toothed finger locks the gear into place. You never have to worry about jamming and binding that are inherent with an old-style pawl stop and block. And you don't have to worry about wear on the gear teeth themselves.

That's because the gear is a little different. The way it's made, for one thing. First, we blank it, then shave it and finally caseharden it. Then it's super strong. Notice the big, square teeth that always provide a sure bite.

### A lot of attention to small details

Now we apply our finishing touch: a few drops of a highly refined mineral oil. Not any old oil will do. We figure that if we pay such close attention to details during the entire manufacturing process, why gum it all up trying to save a few pennies on oil. Right? Then every OCS relay is inspected after thousands of run-in cycles, and relubricated for shipment. We don't know of any other relay manufacturer that does this. It may be a small detail, but here at Automatic Electric we pay big attention to small details. It's just that we've always worked that way.

How about you? Do you want to know more about our OCS relay? Here's where we are: GTE Automatic Electric, Industrial Sales Division, Northlake, Illinois 60164.



# GTE AUTOMATIC ELECTRIC



**This  
Sweet  
MICROVOLT  
MULTIMETER** is  
**SENSITIVE to  $1\mu\text{V}$ ,  
STABLE within  $2\mu\text{V}/\text{day}$   
and easy on the budget at  
\$545**

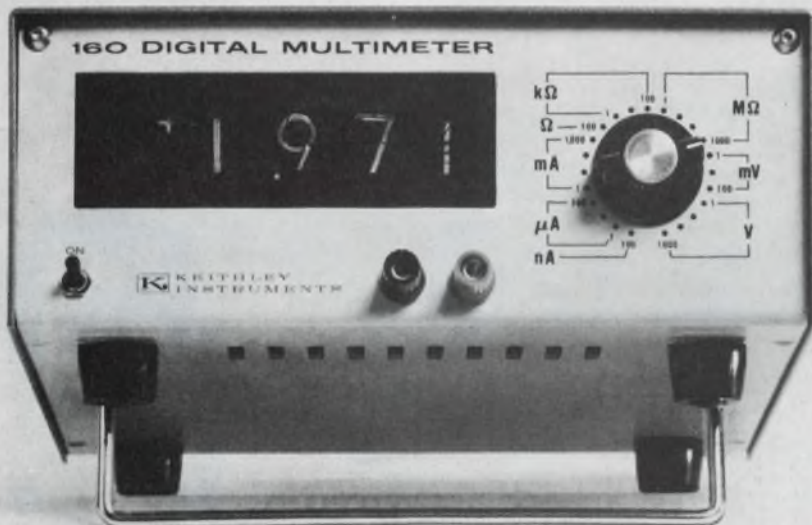

Users call it "the-how-sweet-it-is-meter".

But it's really the Model 160 that ...

- MEASURES WITH DIGITAL ACCURACY
  - Voltage** —  $1\mu\text{V}$  to 1000V
  - Current** — 0.1 nA to 2A
  - Resistance** —  $0.1\Omega$  to 2000 M $\Omega$
- 100% OVERRANGING
- ANALOG and OPTIONAL BCD OUTPUT
- MANY MORE SWEET PERFORMANCE FEATURES

SEND FOR FULL DETAILS AND YOUR FREE "HOW SWEET IT IS" BUTTON



**KEITHLEY  
INSTRUMENTS**

U. S. A.: 28775 Aurora Road, Cleveland, Ohio 44139  
Europe: 14, Ave. Villardin, 1009 Pully, Suisse

## Publisher

James S. Mulholland, Jr.

## Editors

New York Office  
850 Third Ave.  
New York, N.Y. 10022  
(212) 751-5530  
TWX: 710-581-2874  
Cable: Haydenpub

Editor: Frank Egan  
Managing Editor: Ralph Dobriner  
Managing Editor: Raymond D. Speer  
Microelectronics, Steven A. Erenburg  
Computers, Raymond D. Speer  
Microwaves, Michael J. Riezenman  
Circuits, Lucinda Mattera  
Management, Richard L. Turmail  
News, John N. Kessler  
Military-Aerospace, John F. Mason  
New Products, Roger Allan  
Copy, Marion Allen

## Field Offices

**Massachusetts**  
Jim McDermott  
P.O. Box 272  
Easthampton, Mass. 01027  
(413) 527-3632

**West Coast**  
David Kaye  
2930 Imperial Highway  
Inglewood, Calif. 90303  
(213) 757-0183

**Washington**  
Don Byrne  
1425 N St. NW  
Washington, D.C. 20005  
(202) 667-6568

## Editorial Production

Dollie S. Viebig

## Art

Art Director, Clifford M. Gardiner  
Assistant, William Kelly  
Rita Jendrzewski

## Production

Manager, Thomas V. Sedita  
Helen De Polo  
Kathleen McConkey  
Leslie Stein

## Circulation

Manager, Nancy L. Merritt

## Information Retrieval

Peggy Long



# letters

## More about a 'homing' device for heart cases

Sir:

I would like to offer the following comments concerning the very informative article, "The Patient Comes First in Telemetry," in the Nov. 22, 1970, issue (ED 24). One design parameter that is not available in any of the existing telemetry systems is a device to allow you to "home" in on a patient who may develop trouble in an area of the hospital away from his room or the monitoring station. It is quite possible that a patient wearing an EKG telemetry transmitter may, for example, develop an attack while in a telephone booth or in an elevator.

I must disagree with the concept that telemetry can save money as suggested in the article particularly with reference to the specific reason given—so that an existing hospital need not get involved with "expensive rewiring" to accommodate patient monitoring. If a hospital needs rewiring it should be done, regardless of the method of patient monitoring selected. Electrical hazards are a real problem in many of our existing hospitals, and we should not discourage them from taking corrective action by suggesting that a telemetry monitoring system will negate this requirement. This is what your statement implies, and it could be misused by some manufacturers and misinterpreted by hospitals.

With reference to the parameters listed in Table 1, the only one I can argue against is the temperature range. I am afraid that the upper limit of 40°C (104°F) falls dangerously close to a patient's normal temperature of 98.6°F and well within the range of temperatures occurring with patients hav-

ing a fever. Since the device is likely to be in constant contact with the patient, this temperature range should be extended to perhaps the 65°C recommended in Table 2 for receiver parameters.

Your point about the FCC regulations not accommodating the need of hospitals and the suggestion that the regulations need to be changed is well taken. There are serious restrictions in the present regulations, particularly with reference to continuous transmission and distance limitations.

*William S. Staewen*  
Chief, Div. of Electronics and Biological Engineering  
Sinai Hospital of Baltimore, Inc.  
Baltimore, Md. 21215

## What hospitals need is more 'heart' power

Sir:

Upon reading "The Patient Comes First in Telemetry" in the Nov. 22, 1970, issue (ED 24), the following idea occurred to me concerning the FCC allowable power levels. Since the individual transmitters are not designed for the consumer market, but rather a system of transmitters would be designed for a very specific "industrial" market, why could the FCC regulation not be interpreted as meaning that the maximum rated power would be measured at 50 feet from the system: i.e., at 50 feet from the hospital? This would allow the individual transmitting units, buried inside a steel and concrete structure, to have considerably higher power outputs, and thus reduce the effects of noise.

*Geoffrey W. Torrence*  
Research Associate  
The University of Texas  
Austin, Texas 78712

---

Electronic Design welcomes the opinions of its readers on the issues raised in the magazine's editorial columns. Address letters to Managing Editor, Electronic Design, 850 Third Ave., New York, N.Y. 10022. Try to keep letters under 200 words. Letters must be signed. Names will be withheld on request.

---

## There is a difference in Heath Dynamics' Quartz Crystal Filters!

Heath Dynamics specializes in the design and manufacture of the highest quality Quartz Crystal Filters and Discriminators for the Communications Industry

Our facility is completely new, inside and out, fully staffed and equipped with the most modern mechanical and electronic test measuring devices.

We employ the assistance of one of the largest time sharing computers available.

Heath Dynamics' area of specialization includes the manufacture of miniature and sub-miniature filters in the range of 10 thru 32 Mhz. Bandwidths may be from 0.25% thru 35% in the smallest packages and may range up to 2.0% in the larger ones.

*We manufacture direct replacement filters for all the current monolithic designs using our half lattice configuration which yield lower insertion loss, lower ripple and greater ultimate rejection. Yet our filters cost less and faster delivery is guaranteed!*

All Heath Dynamics' crystal filters designed and manufactured to your particular specifications meet Mil F. 18327.

In short, we want your business and we'll act like it. Do us both a favor and send us your print or specification for a quote. If you have any questions just write or call us... we're here to serve you.



**heath  
dynamics, inc.**

6050 n. 52nd avenue  
glendale, arizona 85301  
(602) 934-5234

subsidiary of  
Heath International, Inc., Richmond, Mich.



# It takes special data terminals to fill special data terminal requirements.

And special data terminals are our specialty.

Since we make most of the components that go into data terminals anyway, we can design and make the whole terminal, to meet your custom requirements.

And you'll be happy to hear that our typical turnaround for a prototype is normally less than four months.

If you prefer to put your terminal together yourself, we can supply you with do-it-yourself components such as card readers, switches, scanners, logic, indicator lights and all the connectors you'll ever need.

But you'll save time and money if you let us do the whole thing. And we'll treat it as special as you would.

For more data on our data terminals, write to **AMP Incorporated, Harrisburg, Pa. 17105**

**AMP**  
INCORPORATED

Manufacturing and Direct Sales Facilities in: Australia, Canada, France, Great Britain, Holland, Italy, Japan, Mexico, Puerto Rico, Spain, Sweden, United States and West Germany.

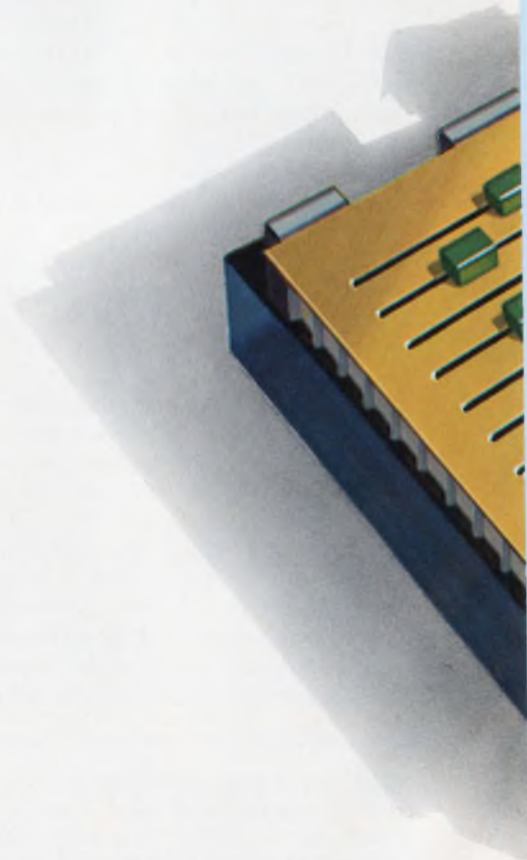



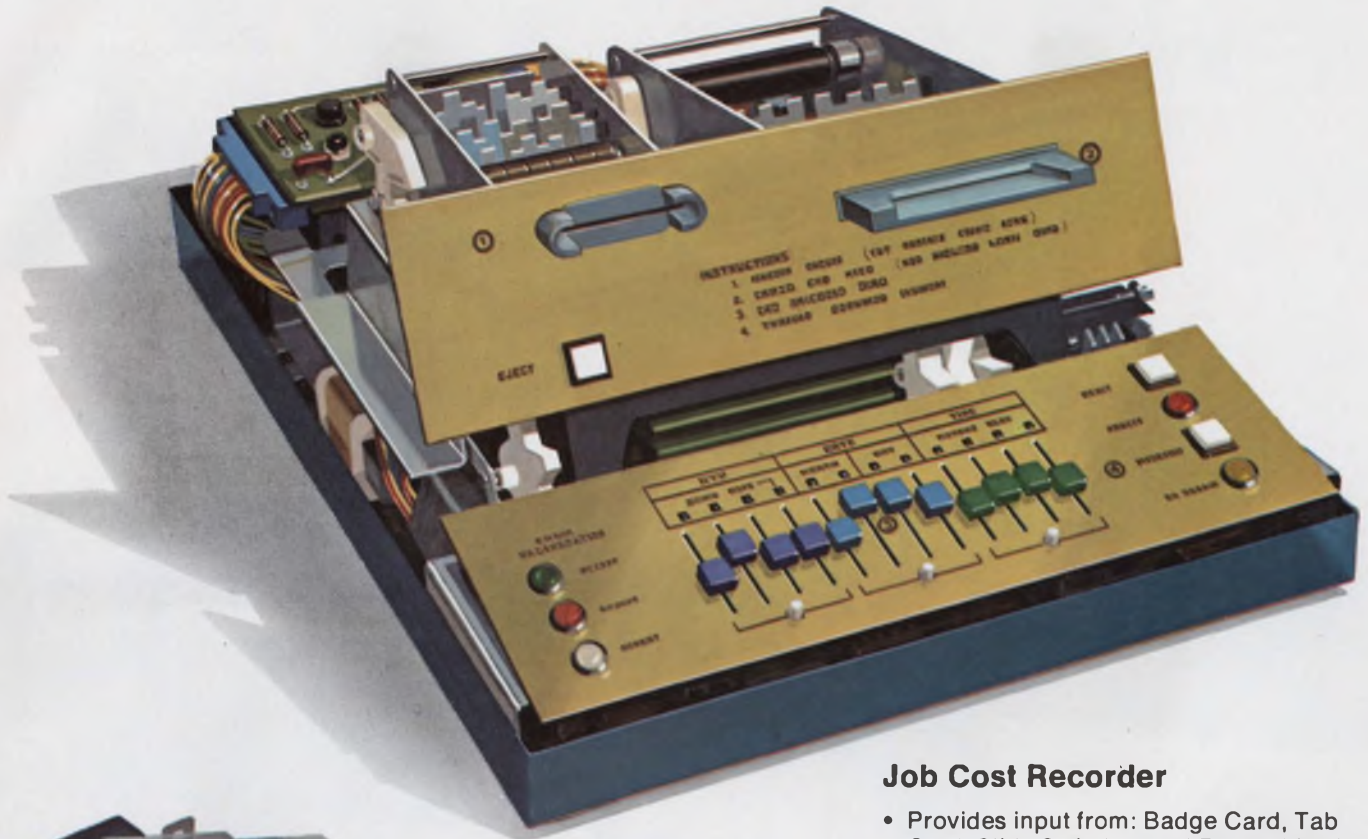

### Job Cost Recorder

- Provides input from: Badge Card, Tab Card, Slide Switches and Rotary Matrix Switches
- 10 or 11 level ASCII output +5 - 0 level
- ASR-33 compatible
- Output data rates from 10 characters per second to 500 CPS
- Lamps to indicate reject, repeat, error, standby
- Case designed to your specifications



### Dial-up Inquiry Terminal

- Useful for credit inquiry and data reporting
- Automatic dialing of computer telephone number
- Computer answer-back lamp
- Provides 12 digit inquiry number
- Three answer-back lamps can indicate valid credit, do not grant credit, repeat information
- Case designed to your specifications



# step up!





# to perfect performance

—with Bodine fhp motors and D.C. Motor Controls Now... precise control of speed, torque and power for every fractional horsepower need. Motor controls perfectly matched to characteristics of Bodine's NSH line of D.C. shunt-wound motors. Or, for just reliable fractional horsepower, Bodine motors available in over 3,500 standard catalogued specifications. Plus numerous specials. Virtually any type, size or rating: 1.45 milli-hp. to ¼ hp., torques from 0.18 oz.-in. to 350 lb.-in., speeds from 0.6 to 10,000 rpm. Also more than 330 stock types and sizes. Write for Bulletin. Bodine Electric Company, 2500 W. Bradley Place, Chicago, Illinois 60618.

Power/controls for office machines  
■ machine tools ■ electronic equipment  
■ electrical control devices  
■ medical apparatus ■ communications equipment  
■ data processing equipment ■ laboratory equipment  
■ recording instruments  
■ inspection and testing equipment  
■ musical instruments ■ scientific apparatus ■ many other applications.

*Bodine Motors Wear Out—It Just Takes Longer*



## BODINE MOTORS/CONTROLS

INFORMATION RETRIEVAL NUMBER 8

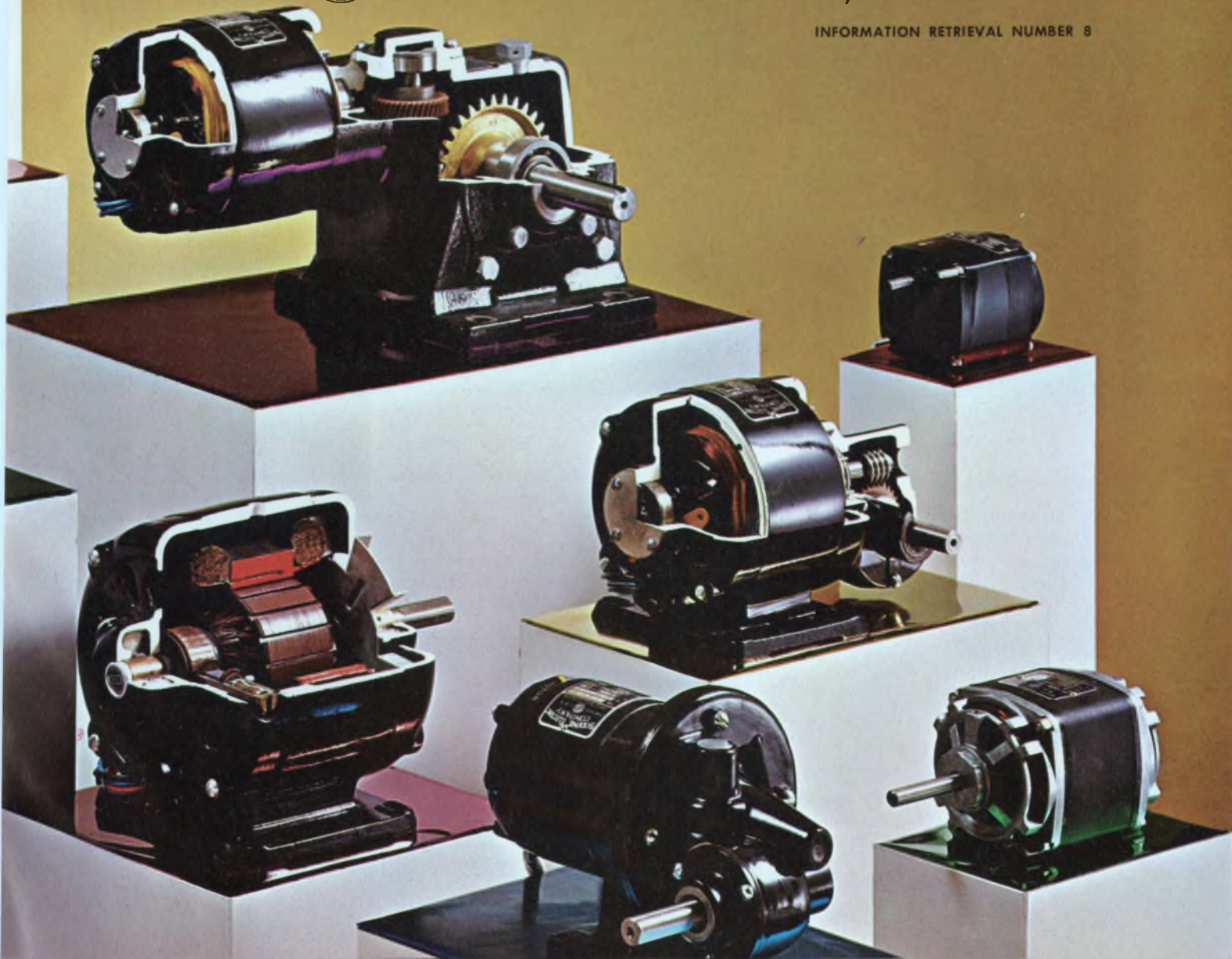





## an unfair comparison...

### The new Cyclohm Fan from Howard vs. "the other fan"

The new Howard tubeaxial fan delivers a larger volume of air over a wider range, runs up to 10 years without service or lubrication, has a rugged cast aluminum frame, yet costs about the same as "the other fan" you're now using. (See why we call the comparison "unfair"?)

In all fairness, we admit the new Howard Cyclohm fan is exactly the same size as "the other fan." They're interchangeable.

But then we come to comparisons like Howard Cyclohm's six-blade impeller (vs. three) which is computer-mated to the famous Howard Unit Bearing Motor with a 5-year warranty based on an engineered lifespan of 10 years (vs. a traditional bearing motor). Then, too, there's 115 CFM air delivery (vs. 100). And cost: The new Howard Cyclohm never costs more than "the other fan" . . . and Howard delivery is overnight!

**Be fair to yourself: Send for all the unfair facts.  
Ask for Information Packet ED27.**



# HOWARD

HOWARD INDUSTRIES  
A DIVISION OF MSL INDUSTRIES, INC.  
2420 18th STREET, RACINE, WISCONSIN 53403  
414-632-2731 TWX 910-271-2387



# designer's calendar

## MARCH 1971

S	M	T	W	T	F	S
	1	2	3	4	5	6
7	8	9	10	11	12	13
14	15	16	17	18	19	20
21	22	23	24	25	26	27
28	29	30	31			

March 22-25

IEEE International Convention and Exhibition (New York City). Sponsor: IEEE. J. M. Kinn, IEEE, 345 E. 47th St., New York, N. Y. 10017.

CIRCLE NO. 405

March 31-Apr. 2

Reliability Physics Symposium (Las Vegas). Sponsor: IEEE. O. D. Trapp, Fairchild Semiconductor, 464 Ellis St., Mountain View, Calif. 94040.

CIRCLE NO. 406

## APRIL 1971

S	M	T	W	T	F	S
				1	2	3
4	5	6	7	8	9	10
11	12	13	14	15	16	17
18	19	20	21	22	23	24
25	26	27	28	29	30	

April 12-15

National Telemetry Conference, (Washington, D. C.) Sponsor: IEEE. H. B. Riblet, Johns Hopkins Univ., 8621 Georgia Ave., Silver Spring, Md. 20910.

CIRCLE NO. 407

April 13-16

INTERMAG, International Magnetism Conference (Denver, Colo.) Sponsor: IEEE. Bernard F. DeSavage, U. S. Naval Ordnance Laboratory, Silver Spring, Md. 20910.

CIRCLE NO. 408

# MORE POWER PER PENNY FROM POWER/MATE

## A NEW SERIES OF POWER SUPPLIES FOR INTEGRATED CIRCUITS

ICX SERIES FROM  
POWER/MATE CORP.  
POWER SUPPLIES  
FOR INTEGRATED CIRCUITS

**\$75.**

WITH LIBERAL OEM DISCOUNTS

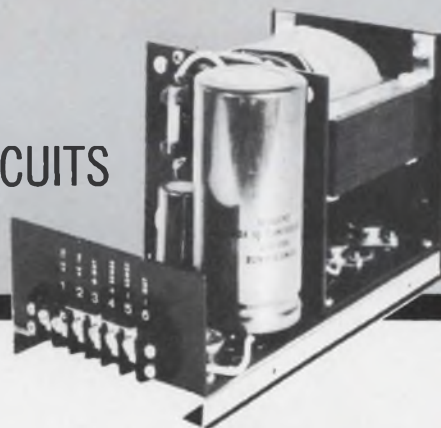

### THE ICX SERIES GIVES YOU MAXIMUM ECONOMY WITH MAXIMUM RELIABILITY

Using an open chassis construction for economy and IC regulators, the ICX SERIES has been designed especially for integrated circuit applications.

Highly flexible... with optional features allow the user to purchase only those requirements needed for his particular application. Ideal for OEM needs.

Each power supply has built in overvoltage protection — and is completely short circuit and overload proof.

### ICX SERIES FEATURE:

- \* INTEGRATED CIRCUIT REGULATOR
- \* BUILT-IN OVERVOLTAGE CROWBAR PROTECTION
- \* BUILT-IN OVERLOAD AND SHORT-CIRCUIT PROTECTION
- \* ADJUSTABLE VOLTAGE RANGES
- \* REMOTE OR LOCAL SENSING REMOTELY PROGRAMMABLE
- \* ±0.1% LINE AND LOAD REGULATION
- \* 115 VOLT 47-420 CPS AC INPUT
- \* TWO MOUNTING SURFACES
- \* TOP QUALITY COMPONENTS
- \* ALL SILICON SEMI-CONDUCTORS
- \* FIVE-YEAR WARRANTY
- \* SAME-DAY-SHIPMENT

SEND FOR  
FREE CATALOG  
giving specs  
and prices



# POWER/MATE CORP.

514 S. RIVER STREET, HACKENSACK, N. J. 07601  
Phone (201) 343-6294 / TWX 710-990-5023

INFORMATION RETRIEVAL NUMBER 11



# If a thousand solid-state low-level switches won't turn you on, how about \$80 a switch?

You may not have 1024 signals at 2.5 millivolts that you want to run at 15kHz, but you can control that many if you want to by hooking eight of our solid-state differential multiplexer units together.

What's probably more important to you is that, even if you need only 128 switch channels, it'll still cost you less than \$110 per channel, including a 12-bit A-to-D converter, power supply, all multiplexer control circuitry, 13 levels of programmed gain and interconnecting cabling — all ready to interface with your computer.

Actually, the incremental price per



switch is only \$50. The other goodies make up the difference.

You'll also be relieved to know that our low-level multiplexer works. Over 40 systems are operating in the field with high reliability. User testimonials furnished on request.

If you're interested in low cost, flexibility and reliability in proven units that are available now, you ought to call us at (213) 679-4511, ext. 1139 or 3392.

If you're not in a hurry, write Xerox Data Systems, Dept. A, 701 South Aviation Blvd., El Segundo, Calif. 90245





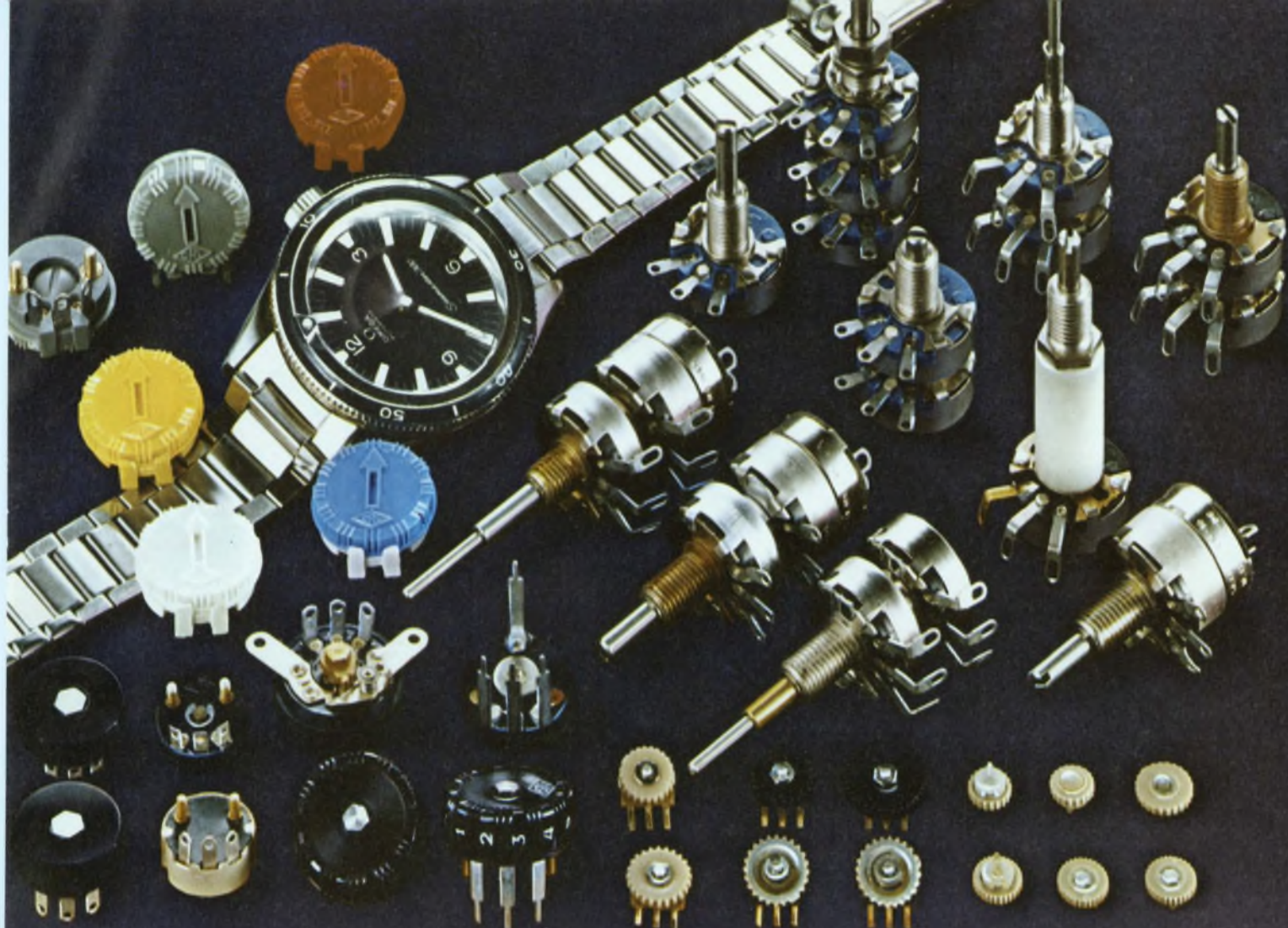

# a little something special for everybody

**Centralab designs miniature potentiometers to meet unique and exacting applications**

Throughout our more than 20 years of experience in the development of miniature industrial potentiometers, we've found that many special purpose designs soon establish an array of standard applications. Today, Centralab pots are relied upon for test and measurement instrumentation, communications, medical equipment and other exacting applications.

Many of your present requirements might be satisfied by our

standard models which meet the following design parameters:

- Wattage ratings: 1/10 to 2 watts
- Temperature range: -55°C to 120°C
- Resistance range: 4 ohms to 10 megohms
- Size: 5/32" to 5/8" diameter

Carbon composition resistance. Bushing mounted units also available with wirewound resistance.

Some models provide switching capability.

Our miniature potentiometers represent just a small share of our entire capability, which includes custom designs for a wide variety of unique applications.

Simply tell us what you need. We'll customize a potentiometer to your mechanical and electrical specifications with your economics in mind. For additional information, write: Centralab Electronics Division.

CENTRALAB PRODUCTS ARE MARKETING THROUGH CENTRALAB INDUSTRIAL DISTRIBUTORS AND INTERNATIONALLY THROUGH GLOBE-UNION INC. - INTERNATIONAL DIVISION.



**CENTRALAB**

Electronics Division  
GLOBE-UNION INC.

5757 NORTH GREEN BAY AVENUE  
MILWAUKEE, WISCONSIN 53201



# When you're known for Rolls-Royces,

# it's hard to get Volkswagen buyers to think of you.



Series 72 Pulse and  
Telegraph Polar Relay  
... pulse repetition to  
400/sec., life in hun-  
dreds of millions of  
operations



Series 67  
General purpose  
AC & DC, 4PDT, 5A

**SIGMA has 2000 good, different general-purpose relays— many for 50¢/pole.**

If you think of Sigma as a sensitive, close-differential relay house, you're partly correct. We're also a low-priced, general purpose relay house — as a substantial number of vending machine, alarm system, industrial control, copier and communications equipment manufacturers will attest.

For demanding applications such as computer peripherals, you can have one-cubic-inch 4PDT switching, on AC or DC coil signals, of low-level to 5-amp. loads at least 100,000 times with the Series 67. Fast wiring, mounting and interchangeability results from PC or solder terminals, or in sockets with PC or solder terminals.



Single-, two- or three-pole switching of loads up to 10 amps, for one million operations at 28 VDC or one-half million at 115VAC, is provided by the versatile and quickly-installed Series 68.

For up to 6PDT switching of low-level to 5 amp. loads by voltage adjustment, or 1-amp. loads on sensitive current adjustment, the Series 62 combines long life (up to 50 million operations with bifurcated contacts) with moderate cost.



For positive response to coil signals as low as 50 mw, at a cost of under 75¢/relay in quantity, the Series 65 is well-suited to TV channel selectors, slide projectors, vending machines and similar uses involving SPDT switching of 1-amp. loads.

Up to 3PDT switching of 5- or 10-amp. loads, on AC or DC voltages, is available in the compact and low-cost Series 50; wide application in automated equipment, switching small motors, solenoids and other relays.



We'll be glad to supply detailed technical data on any of the general-purpose relays mentioned, with complete price and delivery information on standards. Better yet, tell us your requirements (load, life, cost, driving signal, operating speed and environment) and let us recommend the relay best suited to the job. We can save you time, disappointment and perhaps some money as well. Sigma Instruments, Inc., 170 Pearl St., Braintree, Massachusetts 02185.

## SIGMA

INSTRUMENTS INC





**MOS**

**BY**

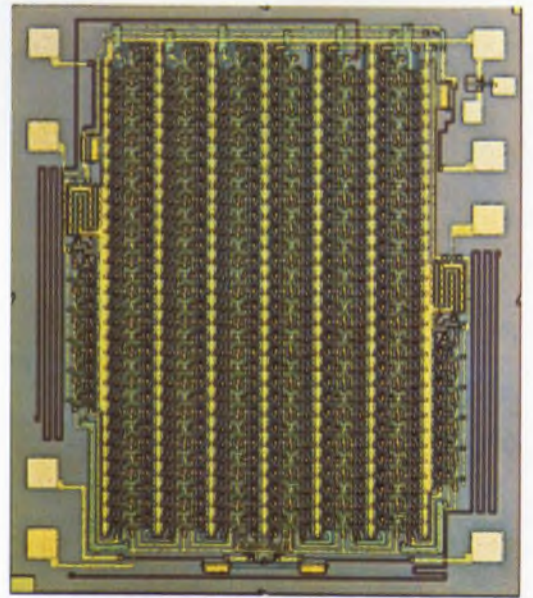

**MOTOROLA**





**Move Ahead with Motorola**

# MOS MEMORIES

## Beat core and plated wire size and costs

Systems designers' needs for good, fast, low-cost mini-computer and main-frame sequential bulk storage led directly to MOS memories.

The versatile MCM1173L heads Motorola's list of MOS types covering the broad range of memory applications. Highlights are:

- Low address-line capacitance of 2.5 pF (typ) improves system speeds
- Eliminates need for separate chip select clock signal to refresh stored information
- Low capacitance and high "on"-to-"off" current ratio of the output circuit for simplified bipolar interfacing
- Wired-OR capability for memory expansion
- Only 400 ns access time
- Low drive power required compared to other high-threshold MOS
- Monolithic fabrication with the proven P-MOS process
- Low Power Dissipation — 50  $\mu$ W/bit

## Motorola MOS memories available now

2240-bit read only memory — MCM1130  
64-bit read/write memory — MC1170  
1024-bit read/write memory — MCM1173L

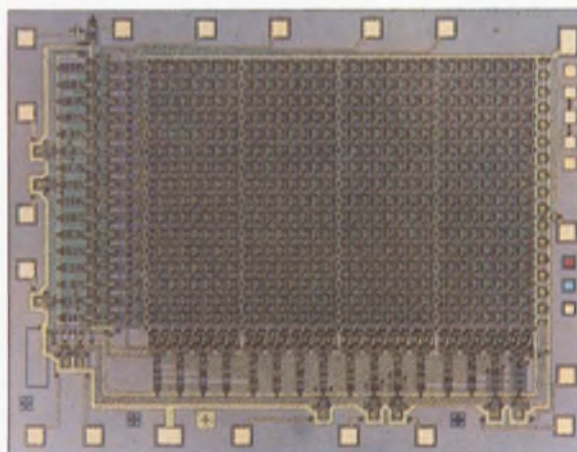

1024 word by 1-bit dynamic RAM — MCM1173L

## Available soon

Diversification and capability are the bywords for these scheduled MOS memory products:

2240-bit read only memory — MCM1120  
1024-bit (Si Gate) read/write memory — MCM2372L  
2048-bit read only memory (256 x 8) or (512 x 4) — MCM1110  
4096-bit (Si Gate) read only memory (512 x 8) — MCM2340  
2560-bit read only memory (256 x 10) or (512 x 5) — MCM1150

For details, circle 121





**Move Ahead with Motorola**

# MOS REGISTERS

**Reach for performance — get lowest prices, too**

Shift registers have been the most used device types in the early years of designing with MOS. For example, when the industry needed an elastic memory (low data rate in/high data rate out) for printer buffers, MOS shift registers were called on . . . move-ahead types . . . like Motorola's dual 100-bit static MC1160G shift register.

- DC to 2 MHz operation for a wide range of applications
- Specified for single or cascade operation for use as a 100-bit or a 200-bit shift register
- Non-inverting buffered outputs for greater drive capability
- Typical delay time is only 150 ns
- Common supply and clock lines
- Independent input/output lines

**Motorola MOS shift registers available now**

Triple 66-bit dynamic shift register — MC1141G

200-bit dynamic shift register — MC1142G

Dual 100-bit static shift register — MC1160G

Dual 50-bit static shift register — MC1161G

**Available soon**

The desirability of the Silicon Gate technology for many designs is evident in this great line-up of MOS shift registers scheduled for introduction soon.

Dual 100-bit dynamic shift register (Si Gate) — MC2380G (cover photo)

Dual 100-bit dynamic shift register (Si Gate) — MC2381G

Quad 64-bit dynamic shift register — MC2246G

Quad 256-bit dynamic shift register (Si Gate) — MC2384L

Dual 512-bit dynamic shift register (Si Gate) — MC2385G

1024-bit dynamic shift register (Si Gate) — MC2386G

Dual 256-bit static shift register (Si Gate) — MC2363G

Dual 100-bit static shift register (Si Gate) — MC2360G

Dual 250-bit static shift register (Si Gate) — MC2362G

500/512-bit dynamic shift register — MC2244G

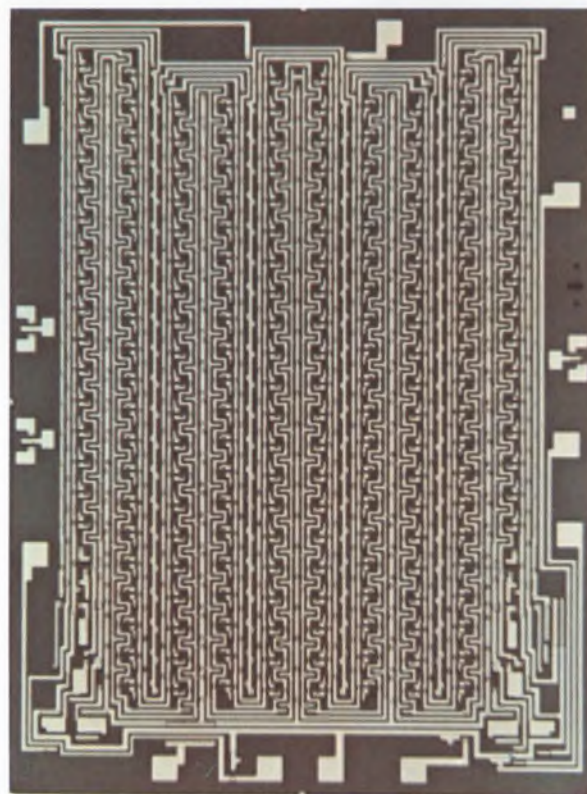

*Dual 100-bit static shift register — MC1160G*

NOTE: MC1100 series denotes high threshold, MC2200 series denotes low threshold, MC2300 series denotes Si Gate

*For details, circle 121*





**Move Ahead with Motorola**

# MOS LOGIC

## Greater component density encourages LSI now

MOS has set an altogether new pattern in standard development. In previous logic forms, single and

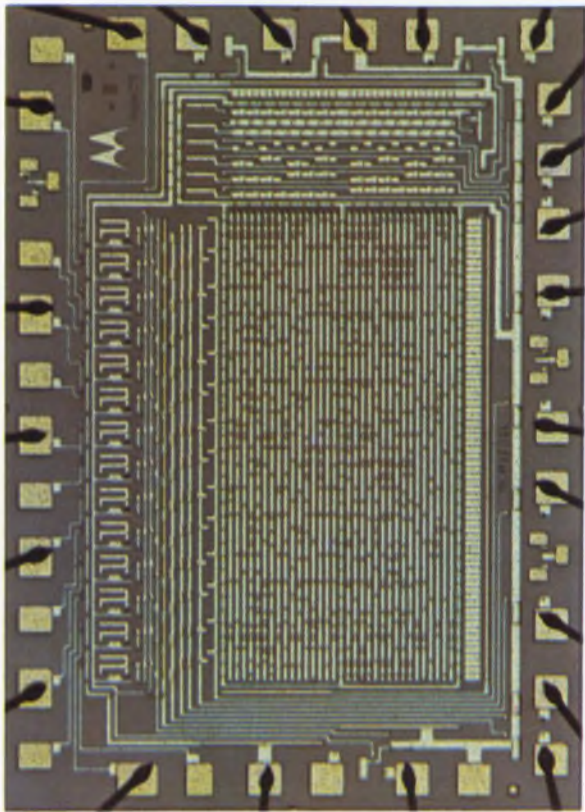

2240-bit column  
select character generator — MCM1131L

relatively simple logic functions were packaged in

many independent product types for years before complexity began developing. MOS benefits from greater chip component densities to make MSI and LSI feasible from the beginning. So when CRT people needed 5 x 7 character generation, an MOS2240-bit column select character generator like Motorola's MCM1131L was the logical solution. It features:

- Matrix options — 64 x 5 x 7 or 32 x 5 x 14
- Only 500 ns maximum access time
- Open drain output buffers sink 1.6 mA (min) for bipolar compatibility
- Wired-OR capability for memory expansion
- Programmed to standard USASCII Code
- Proven monolithic P-MOS process

## Motorola general purpose MOS available now

8-channel multiplex switch — MC1150L

2-of-8 channel multiplex switch — MC1151L

Versatile general purpose logic element — MC1155L

Versatile general purpose logic element — MC2255L

2240-bit column select character generator — MCM1131L

2240-bit column select character generator — MCM1132L

## Available soon

Representative of the complexity of coming Motorola logic introductions are these two additional character generators.

2240-bit character generator — MCM1121L

2240-bit character generator — MCM1122L

NOTE: MC1100 series denotes high threshold, MC2200 series denotes low threshold.

*For details, circle 121*





**Move Ahead with Motorola**

# MCMOS

## Works on next to no power — and ignores noise

Complementary MOS has its roots in the reliability conscious military and aerospace fields, and now spreads its branches and foliage over a widening range of commercial and industrial applications. Its low power requirements make it the mainstay for tiny, delicate, portable electronic watch systems, yet its high noise immunity makes it ideal for use in rugged applications like industrial controls. Complementary MOS offers operation with a wide range of supply voltages, and as the only logic to work directly from a car battery is a natural for automotive applications. MCMOS, Motorola complementary MOS, features:

- P and N-Channel devices in a single monolithic structure
- Real economy of operation with low quiescent power dissipation of only 50 nW/package (typ)
- Thrives in noisy environments — Noise immunity = 45% of  $V_{DD}$  (typ)
- Matches power supplies with any of them — 4.5 V to 18 V

## MCMOS available now

Quad 2-input NOR gate — MC14001L (MC2501L)  
Dual 4-input NOR gate — MC14002L (MC2502L)  
Dual type D flip-flop — MC14013L

## Available soon

This short term new product activity plus eighteen new MSI circuits planned from the ground up for system compatibility make MCMOS the premium low power logic family.

64-bit read/write memory — MCM14005L

Quad exclusive OR gate — MC14501L

Quad 2-input NAND gate — MC14011L

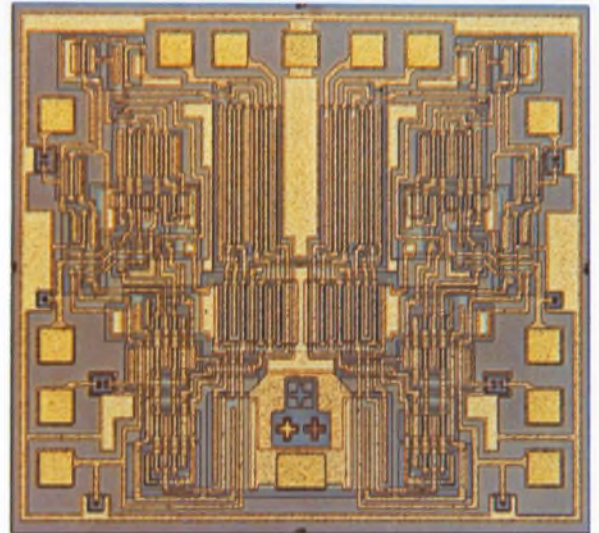

*Dual type D flip-flop — MC14013L*

Dual 4-input NAND gate — MC14012L

Dual 4-bit shift register — serial in/parallel out — MC14015L

MCMOS — Trademark of Motorola

*For details, circle 121*





**Move Ahead with Motorola**

# CUSTOM MOS

**Your designs or ours — Original from the ground up, or use our Polycell concept**

Let's start by assessing MOS circuitry.

- MOS processing is inexpensive permitting low-cost device manufacture.
- MOS component geometries are small permitting component densities and highly complex circuits on relatively small chips.
- MOS circuits are easy to design encouraging widespread design efforts.

Combined, these three MOS characteristics — inexpensive processing, high component densities, and simple circuit design — clearly point MOS technology in one specific direction; that is, *custom circuitry*.

## **New ground rules for user and manufacturer**

Users will be designing their own proprietary circuits and will implement systems with fewer building blocks. Each of these will be more complex and represent a larger portion of the complete system than is generally prevalent today.



*figure 1*

For the IC manufacturer, this demands quick-reaction time capabilities and versatile design techniques allowing the customer to interface at

any point in the design cycle. We emphasize this. We can and will enter the custom design process at any point in the cycle the customer desires.

This means we will work at either extreme or pick up the job anywhere in between. Give us your masks and we'll give you the product. Give us your system requirements, and we'll develop the design and deliver your product. We'll do it on the drawing board and with the computer.

## **Polycells and CAD**

Combining a library of standard MOS computer building blocks called polycells, an educated computer, and a variety of computer design and drafting aids, Motorola has developed a custom and customer oriented design capability. We're proud of our CAD capability but we recognize that



*figure 2*

it is only an aid to humans interfacing with humans. Here's how it works.

1. From the polycell library of logic building blocks, the designer selects the polycells to be used in his system.

2. He partitions the system to delineate a number of chips on which the system is finally implemented.

3. Armed with the appropriate preliminary logic diagrams, he transforms these into detailed topological chip layouts, either on a CRT console





(Figure 1), or in the form of a conventional drawing with a computer controlled digitizer (Figure 2).

4. With the exact geometries so displayed, the designer juggles the polycells for the most advantageous layout, and plots the required cell interconnection pattern (on the CRT console or on a coordinate digitizer). A conventional ink plot can be employed for layout verification.

5. Finally, a computer generated program that details the final design is used to control an auto-



figure 3

matic drafting machine (Figure 3) to prepare a complete set of masks for the MOS array.

Generic to the Motorola polycell program is a line of completely characterized circuits whose specifications, both electrical and physical, are stored in a computer memory. When a detailed layout is required, it is drawn automatically by the ink plotter in response to information stored in the memory. The amount of time saved through computer-aided design is one of the pivots around which a custom capability revolves. And so are the number and types of basic cells that define an engineer's design freedom. Motorola's initial line consisted of P-channel, high-threshold, static cells (51) with propagation delays of approximately 74 ns per logic level and a power dissipation of 1.7

mW or less per gate. A second series of 28 cells has a power dissipation of less than 0.45 mW per gate and a propagation delay of about 300 ns.

In addition, a series of 12 shift registers and a family of 172 dynamic (2-phase) logic cells have been put into the library. Corresponding sets of low threshold, silicon gate and CMOS cells are being rapidly expanded.

Emphatically, MOS technology is expected to be a dynamic growth area in the years ahead, and custom design capability represents a major challenge to all involved.

*Motorola is very much involved.*

If you have a custom MOS project, call Motorola Custom MOS, 602-273-3832. A 172-page Polycell MOS/LSI design brochure available for

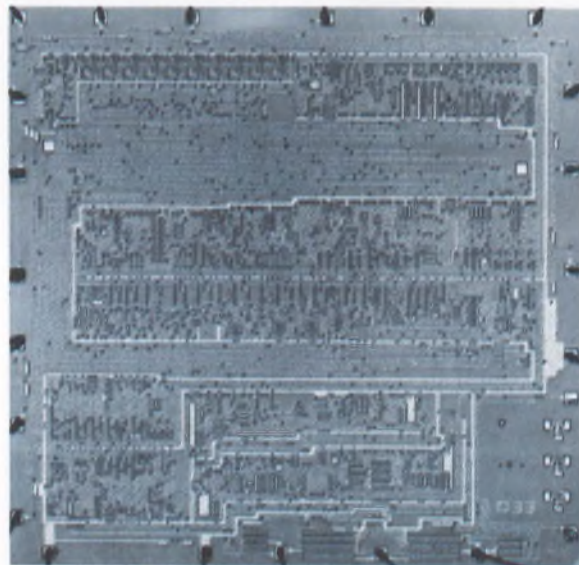

Custom MOS/LSI in Boeing 747 electronics.

the asking on your company letterhead, covers most of the cells in the library. The balance will be sent automatically as brochure supplements are published. Write to Custom MOS, Motorola Semiconductor Products Inc., P. O. Box 20912, Phoenix, Arizona 85036.



Move Ahead with Motorola

# SYSTEMS MOS

The thrust of Motorola's new MOS product activity, in 1971 and beyond, is orientation to the systems needs of the markets we serve. The final criterion for all future standard MOS product is service within the total needs of our customers.

This MOS product philosophy of serving systems is presently hard at work in such diverse fields as electronic timing and time keeping, desk-top calculators, memory systems for processors, CRT display systems and other data handling system requirements.

Complementary MOS, MCMOS, is ideally suited to reducing the costs of personal electronics timepieces capable of operating reliably with the extremely small power supplies necessary for this purpose. As a result of Motorola's systems development work, new products with extensive applications will evolve.

## MOS subsystems for terminal equipment

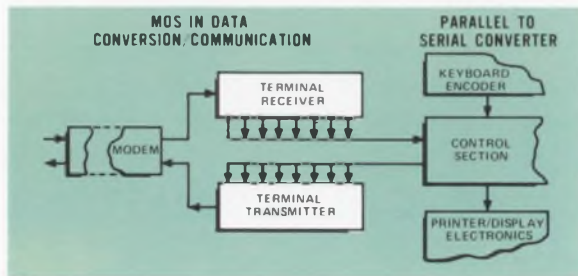

A good example of Motorola's systems approach

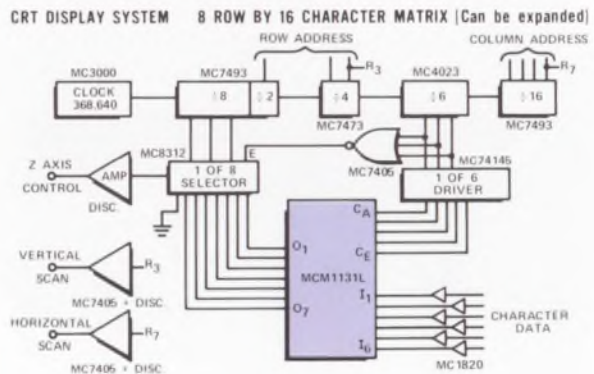

to terminal equipment requirements are new developments in products for terminal receivers and transmitters and for CRT display systems.

## Systems orientation vital

Another case of orienting new products to the systems needs is the Motorola memory system designed with multiple MCM1173L RAMs for use with a processor. And so it will go, into the future, whether the requirements are for standard or custom designed product, Motorola MOS will be oriented to fulfilling the system needs — all MOS where MOS delivers the best results or interfacing with other logic forms when that is the best solution.



**MOTOROLA MOS**

— the broad line is our specialty!



# Kurz-Kasch Digital Logic Instruments\*



... complete logic systems analysis through the Logic-Probe concept

Rugged, all solid-state, Kurz-Kasch logic probes are designed for fast, accurate testing of logic levels in all types of integrated circuit systems. A simple readout system indicates "true", "zero", or "pulse" readings precisely through color-coded visual electronic readouts in the probe tip. Absence of logic levels is indicated by all readouts remaining OFF.

**Applications** Logic levels can be accurately tested in virtually any (DTL, TTL, RTL) IC system including desk calculators, business machines, N/C devices, computers or telephone systems. Power is derived from the unit under test allowing use in the field or in the lab.

#### Specifications

Readout Light Red=Logic "1"  
Readout Light White=Logic "0"  
No Readout Light="infinity"

High input impedance prevents loading of circuit under test.  
Size  $\frac{5}{8}$ " dia., 6" long, 26 $\frac{3}{4}$ " leads with pin terminals

A pulse detection feature is available on most models of logic probe. A third readout is provided to display high speed pulse trains or a single cycle pulse of less than 50 nanoseconds on the standard Model LP-520. Overload protection to +50, -20 volts DC is also available.

**Standard Probes** Logic probes are presently available in five standard models. MODEL LP-500 for use in testing 4.75-5.0 V DC logic systems. MODEL LP-510 for testing 4.75-5.0 V DC systems... includes overload protection to +50, -20 V DC. MODEL LP-520... for 4.75-5.0 V DC logic systems... includes overload protection and pulse detection features. MODEL LP-530 for testing of 12-15 V DC logic systems... includes overload protection to +50, -20 V DC. MODEL LP-540... for 12-15 V DC systems... includes overload protection and pulse detection features.

**Kurz-Kasch shrinks square wave generator to logic probe size** Model LG-580 is a new shirt pocket size, all solid-state logic (square wave) generator for trouble-shooting, testing, or inspection of digital circuitry. Use it to... set flip-flops... run counters... perform clock functions. A unique one-shot mode plus 100 Hz, 1 K Hz, 100 K Hz, and 1 M Hz signals are injected through the probe tip. The Model LG-580 is power lead reversal protected and is priced at \$79.95. The Model LG-580 is for all 4.75-5 V DC systems. Also available is Model LG-581, same as Model LG-580 above, except for use with 12-15 V DC systems —\$89.95.

**Special Probes** As a routine service, Kurz-Kasch will custom design logic probes to user specifications. Custom designs can include: both positive and negative logic levels from 50 to 30 volts... special pulse detection characteristics... floating or grounded cases... custom power supply requirements... power lead reversal protection... and your choice of logic crossover parameters.

Kurz-Kasch logic probes provide all the information you need to quickly and accurately evaluate all logic systems... and they are the most economical logic testing instruments available. Standard Models range in price from \$39.95 to \$69.95. Write today for complete details on all standard and special logic probes.



## Kurz-Kasch, Inc.

Electronics Division,  
1421 S. Broadway, Dayton, Ohio 45401.

\*Patent #3,525,939 applies, others pending.

INFORMATION RETRIEVAL NUMBER 15



# SIZE & COST:

# NO BIG THING.

EASIER THAN EVER TO FIT  
YOUR BOARD & BUDGET.

BROAD LINE GETS BROADER.  
8 LOWER CAPACITANCE VALUES  
(100 pF thru 390 pF @ 200 V).

Type 192P Pacer<sup>®</sup> Polyester Film Capacitors are mass-produced to beat the space/cost squeeze in commercial and industrial applications. Extended-foil PETP film sections with metal end caps provide best possible non-inductive construction. End caps also act as moisture barriers. Ideal for automatic insertion on printed wiring boards. Expanded line includes capacitance values from 100 pF to .47  $\mu$ F. Voltage range, 80 to 600vdc. Write for Bulletin 2066C.

Technical Literature Service  
Sprague Electric Company  
347 Marshall Street  
North Adams, Mass. 01247

**SPRAGUE**<sup>®</sup>

THE MARK OF RELIABILITY

**THE BROAD-LINE PRODUCER OF ELECTRONIC PARTS**

48M-0143



# highlighting

THE ISSUE



This nation's crime rate has increased 120% in ten years, while population has increased 13%. If the number of policemen in the country increased at the same rate as crime, we would soon have a small army of police.

Part of the answer in combatting crime is to increase the effectiveness of each man on the police force. And this is why the anti-crime electronics market is growing. The hardware includes:

- See-in-the-dark devices.
- Voice scramblers.
- Helicopter-borne TV.
- Automatic vehicle monitors.
- Digital terminals for cars.
- Mobile teleprinters.

The market for electronic hardware and systems is estimated at \$100-million per year.

**Page 55**

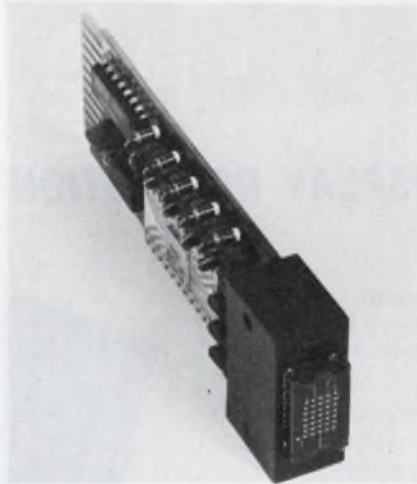

A complete alphanumeric LED display consisting of a 35-dot matrix readout and all the necessary driving circuitry in one package can now be purchased at \$68 in OEM quantities.

The display incorporates a 5-by-7 dot array in which each character height is 0.35 inch. It also contains a 2248-bit read-only memory, a shift register and buffers on one printed circuit board to generate and display 64 ASCII encoded characters.

**Page 105**

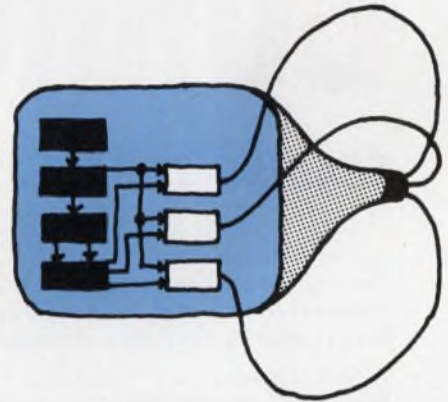

An important change is taking place in the design of color-television sets: The color-difference (CD) type of video output circuit is very likely to be replaced by the red-green-blue (RGB) type.

The primary advantage of the RGB circuit is that it eliminates the relatively expensive luminance-output stage of the CD circuit. The reason why the RGB circuit hasn't come into widespread use yet is that the earliest designs for solid-state color TVs were merely transistorized copies of tube-type receivers. It is only recently that designers have come to realize that the best design for a vacuum-tube receiver is not necessarily best when transistors are used.

**Page 66**

# 256 TO 1 YOUR BEST BET IS BURROUGHS

## LEADING TODAY'S DISPLAY REVOLUTION

### NIXIE® INDICATOR TUBES

Burroughs NIXIE Tubes are available in a complete line of sizes, shapes and costs to satisfy all of your requirements for numeric displays requiring 1 to 8 digits of displayed readouts.

### BURROUGHS NIXIE TUBE MODULES

Off-the-shelf, low-cost readout system flexibility for 3- to 15- digit numeric applications. Decoder drivers and counters are available in any number of configurations and for all applications.

### PANAPLEX™ NUMERIC PANEL DISPLAYS

Lowest cost-per-digit, in-plane numeric readout for 8- to 16- digit applications provides a 150° viewing angle. Nine-segment format allows centered numeral "1". Less than 2 connections per digit. One-piece common-segment construction with no internal welds assures digit alignment and guarantees high shock/vibration resistance. Unitized packaging cuts display length by 25%. Available in 8-, 10-, 12- or 16-digit displays.

### 32-, 18-, 16-CHARACTER SELF-SCAN™ PANEL DISPLAYS

This family of SELF-SCAN panel displays is available in a variety of sizes and complexities for any application requiring 16 to 32 characters of alphanumeric information displayed on one line. Only power and ASCII code required for a 64-character format. Units can be supplied less the electronic board for graphic or special applications.

### 256-, 128-, 64-CHARACTER SELF-SCAN PANEL DISPLAYS

Alphanumeric displays equivalent to over 12,000 light-emitting diodes arranged in a matrix format. These lightweight, in-plane displays with dots on 0.040" centers are available in a variety of capacities including 256 characters (8 rows of 32 characters); 128 characters (4 rows of 32 characters); and 64 characters (2 rows of 32 characters).

For further information, write or call Burroughs Corporation, Electronic Components Division, Box 1226 Plainfield, N. J. 07061 (201) 757-3400

Burroughs 





## Solid-state circuits parley turns to the medical field

PHILADELPHIA—For the first time in the 18-year history of the International Solid-State Circuits Conference, technical sessions on the impact of integrated circuits in biomedicine were presented here together with papers in another new field—optoelectronics.

In the biomedicine session, led by Dr. J. Stephen Brugler, research associate at Stanford University, implantable devices were emphasized.

One paper, "A Catheter-Type Semiconductor Radiation Detector for Medical Applications," was given by six representatives of Tokyo Shibaura Electric Co., Ltd., Kawasaki, Japan. It described the development of a semiconductor detector and associated electronics for beta-ray counting in tissue and body cavities during tracer investigations.

A problem in biomedical electronics is short battery life for implanted devices. One solution was described in "A Unique Hybrid Transformerless DC-to-DC Converter for Long-Term Nuclear Power." Presented by N. Poirier, B. L. Cochrun and M. J. Riccio of Northeastern University, Boston, the paper gave details on a miniaturized solid-state converter, built with hybrid techniques. The device steps up the output of a 0.4-V nuclear cell to 1.35 V, thus producing an equivalent mercury cell that is rated in mA years rather than mA hours.

The session on optoelectronics, dealing with the design and application of all-solid-state imaging systems, was led by R. D. Stewart, consultant to the General Electric Electronics Laboratory, Syracuse, N. Y. The basic problem with these solid-state imaging arrays, which have thousands of tiny sensors and scanning circuits on the same chip, lies in the development of low-

noise scanning and interrogating circuits that can select the sensitive areas and detect the signal at that point.

Papers discussing such circuit development included "New Solid-State Imaging Array with Reduced Switching Noise," presented by E. Arnold, M. H. Crowell, R. Geyer and D. P. Mathur of Phillips Laboratories, Briarcliff Manor, N. Y., and "Advanced Solid-State Light Detector Image Array," by H. B. Kurtz and M. B. Barron of General Electric Co., Schenectady, N. Y.

### Federal R&D budget up, with new fields to study

Across-the-board increases in the Federal budget for science and technology in fiscal 1971-72 indicate that there will be more marriages between engineering and other disciplines, such as the social sciences.

With the exception of the Dept. of Defense, new R&D will be aimed at solving society's problems—health, environmental pollution, power shortages, crime and transportation.

While federal support of the National Science Foundation is still the smallest segment of Government-sponsored R&D, that organization got a higher percentage increase than any other—up 22%, from \$507-million to \$622-million.

The total federal R&D budget is up 7.6%, from \$15.5-billion to \$16.7-billion.

### People transponders proposed to fight crime

A crime-deterrent system designed by a Defense Dept. engineer would require parolees and defend-

ants out on bail to wear radio transponders that would report the wearer's identification and whereabouts to a receiving center and computer. Consenting to wearing the transponder would be the condition on which the individual would be released.

The computer would update the position of each wearer and control the surveillance process. If a transponder should "disappear," the system would execute an intensive search. If the wearer were not located quickly, the police would automatically be notified.

Published in the January, 1971, issue of "IEEE Transactions on Aerospace and Electronics Systems," the report was prepared by J. A. Meyer.

### Calculators are in chips; Next: Minicomputers?

Two days after Mostek announced its development of a calculator on a chip (see p. 34), another Dallas-based company, Texas Instruments, said that it, too, was completing development of a one-chip calculator that would be available "off-the-shelf" by June.

And it was only last December that C. Lester Hogan, president of Fairchild Camera and Instrument Corp.—predicted that his company would be supplying the electronics for an entire desk-top calculator on a single chip to a Japanese company by the middle of this year (see "Super LSI predicted" News Scope, ED 25, Dec. 6, 1970, p. 21).

The Texas Instruments chip, containing "all the logic necessary to implement an eight-digit, full-floating (decimal point) calculator," will cost initially \$15 per unit in quantities of 25,000. TI says it has already received "large commitments" from several customers.

Cloyd E. Marvin, vice president of Four Phase Systems, Inc., Cupertino, Calif., reports that "our designers had single-chip calculators four or five years ago." But they were not developed because, according to Marvin, "there's more money to be made elsewhere."

Four Phase Systems will be marketing its all-LSI computer System IV/70 this spring. The IV/70, which the company says is equivalent to an IBM 360/30, has



all the circuitry for its central processor unit contained on 12 MOS/LSI chip (see "Central processor mode on single MOS chip" ED 20, Sept. 27, 1970, p. 24).

"One of our chips in the CPU has 12,000 transistors on it," Marvin says, "and with that kind of packing density we can put an entire minicomputer on just one single chip."

At Intel Corp., Mountain View, Calif., a single-chip central processor unit is being tested for a Basicom, USA, calculator. It will be used with custom ROMs and RAMs for programming and memory.

The circuitry supplied by Intel will enable the Basicom machine to perform logarithmic, square root, and other functions. If Intel's tests are successful, prototype units will be delivered by the end of this month and production units by the end of April. The cost of the CPU is about \$30 per unit.

Another company claiming to have had a "one-chip calculator through layout and partitioning for quite some time" is North American Rockwell Microelectronics Co., Anaheim, Calif. Charles V. Kovac, a vice president of the company, says that the over-all systems problem of interfacing the electronics between the keyboard, the display and the MOS device is a more important problem than manufacturing one-chip calculators.

Texas Instruments, which is now supplying Smith Corona Marchand, New York City, with the circuitry for a calculator on three chips, says its single-chip design "will dramatically reduce the cost of building calculators." TI is also offering low-cost keyboards and compatible light-emitting diode displays as building-block components for calculator equipment manufacturers.

The current price of calculators ranges from less than \$500 to upwards of \$3000. But James Imai, president of Imai Marketing Associates, Inc., Cupertino, Calif., says that calculator manufacturers are planning high production volumes and that there must be a drastic reduction in prices to attract new markets. He feels that prices under \$100 are likely within two years.

## New welder fuses metal without marring finish

A high-speed, low-temperature technique that welds painted metal without disturbing the paint has been developed, and it promises to find wide application on assembly lines for products ranging from transistor packages to automobiles.

Built jointly by Quanta Welding Co., in Troy, Mich., and the Linde Div. of Union Carbide Corp. in Moorestown, N. J., the system is described as an "ultrapulse," or short-duration pulse, welder. It applies 10 times more electrical current through the parts than conventional welders do, but only for several thousandths of a second. For this reason, the metal does not heat up. Besides the automobile industry, the biggest users, at first, are expected to be the aerospace and furniture industries.

The welding assembly process can be run at very high production rates—approximately one per second, says Quanta's president, John Parker. It can weld tubes up to an inch in diameter and solid parts from 3/8-inch to one inch in diameter, depending on the materials.

An SCR switching system is used to turn power on and off. The controls use medium-scale integration.

The welding process is sold as part of a machine that has standard modules that can be changed to fit the needs of the customer.

## Radiophone net growing in the 450-MHz band

Expansion of uhf-FM air-to-ground radiotelephone service in the 450-MHz common-carrier band—for private and corporate aircraft only—was made possible by the recent opening of a ground station at Wausau, Wisc. Installed by the General Telephone Co. of Wisconsin, it is the second such station to go on the air. The Federal Communications Commission has approved 95 sites to serve aircraft flying over the United States.

Three frequencies are used at the Wausau station, according to Michael Ladd, transmission engineer of General Telephone of Wisconsin: a 454.750-MHz transmit

channel, a 459.750-MHz receive channel and a 454.675-MHz signaling channel. Reliable coverage is reported within a radius of 225 miles from an aircraft flying at 10,000 feet.

## New gas laser from RCA generates many colors

A laser able to produce 24 separate color beams in the visible spectrum was demonstrated for the first time by RCA at the American Physical Society conference in New York City this month.

The helium-selenium laser was developed by RCA's Electronic Components Division in Harrison, N. J. It is expected that He-Se lasers of this type will become important laboratory tools in spectroscopy and studies of materials.

The new laser may also be used as an alignment device for surveying or pipe-laying.

According to the company, it can be more readily sighted "with the naked eye" since it operates in the green region of the spectrum.

## Effect of heated water on environment studied

An electronic system to monitor the effects of heated water on the marine environment has been installed in St. Petersburg, Fla. The system consists of buoys, each equipped with temperature-sensing devices, a telemetry unit and an antenna.

The equipment is being produced by Electronic Communications, Inc., of St. Petersburg, a subsidiary of the National Cash Register Co.

The buoys have been placed in the canal leading from Florida Power Corp.'s Crystal River generating station to the Gulf of Mexico. At regular intervals a shore radio station interrogates the buoys, which transmit the water temperature at various depths to a computer at the Marine Science Institute of the University of South Florida.

Marine biologists there will develop a mathematical model of the "thermal plume" to show the size and shape of heated water under different conditions of wind, tide and water temperature.



when  
it  
comes  
to  
power  
supplies

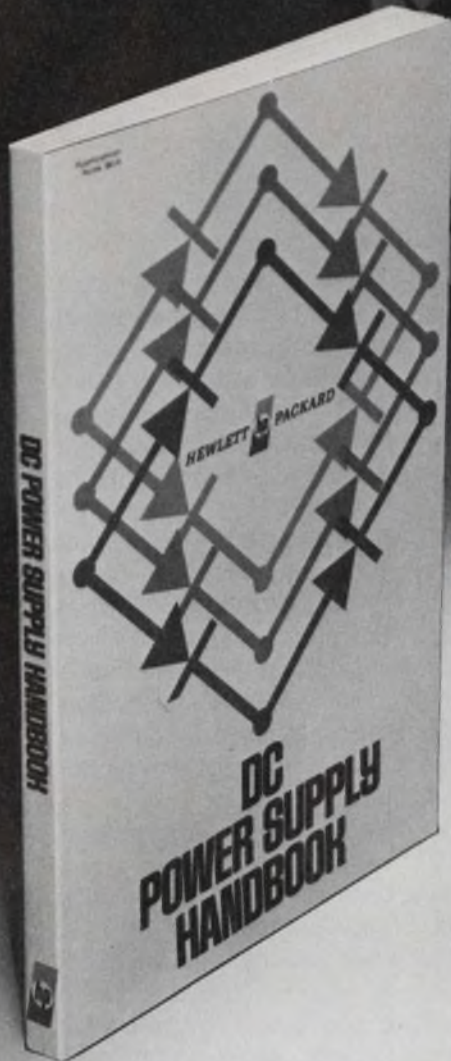

HEWLETT  PACKARD

wrote the books...

... Definitions, principles of operation, load connection, remote programming, performance measurements ... it's all here and more in this 140 page **Power Supply Handbook** ... yours for the asking. Write for your copy.

## PLUS...A NEW Power Supply Selection Guide...

This 36 page selection guide lists over 100 power supplies and makes it easy to find and select the right one for your specific application ... Includes ratings, performance, features, prices, options, etc. **For Your Copy Check Number 320.**



HEWLETT  PACKARD

POWER SUPPLIES

100 Locust Avenue, Berkeley Heights New Jersey 07922 • (201) 464-1234



# OUR ANGLE: High Speed Accurate and Automatic Angle Position Indicators

## WHAT'S YOUR ANGLE?



MODEL 545/100

If you're converting synchro/resolver data to digital format, you need both speed *and* accuracy to keep pace with today's data explosion. Only one converter meets both these requirements without compromise. And for under \$4K. . . . North Atlantic's Model 545/100.

The solid-state Model 545/100 converts both resolver and synchro data with  $0.01^\circ$  accuracy and resolution. And continuously digitizes input angle data at  $20,000^\circ$  per second in the face of real-life noise, harmonics and quadrature levels. BCD output is available at the rear connector. Conversion can be stopped by a data freeze command. If multiplexed signals are your bag, acquisition time is less than 30 ms.

Options? Other models offer many options, including  $0.001^\circ$  resolution with 10 arc-second accuracy; data frequencies from 60Hz to 2.4kHz, binary output, small size.

No matter what your conversion problem, if you require ultra-fast, ultra-accurate tracking, contact your North Atlantic sales engineering representative today. He'll show you a better angle.

NT  
A

**NORTH ATLANTIC**  
*industries, inc.*

200 TERMINAL DRIVE, PLAINVIEW, NEW YORK 11803  
cable: noatlantic / twx: 510-221-1879 / phone: (516) 681-8600

INFORMATION RETRIEVAL NUMBER 18

ELECTRONIC DESIGN 4, February 18, 1971



# Enter, the ion-implantation age, where 'impossibles' are possible

A new era in semiconductor performance is opening for designers as a result of ion-implantation techniques.

Semiconductors with performance characteristics that formerly were difficult or impossible to obtain in production models are beginning to reach market. The big advances right now are being made with silicon devices, because the material is well known and peculiarly adapted to ion implantation. But research is being pressed on other materials, too.

With ion implantation, the following is within reach for the first time:

- Large-scale integrated MOS structures with threshold voltages tailored to make their MOS memories compatible with external bipolar TTL logic operating at lower voltages.

- 20-MHz MOS registers (produced by eliminating the parasitic capacitances normally present between gate and the source and gate and the drain).

- Implanted resistors of 1 to 2% tolerance, with improved temperature stability and heretofore unattainable values of high resistance.

- Junctions that can be implanted internally in a substrate, making possible the realization of a long-sought three-dimensional semiconductor device.

## Ions improve devices

Improvements in performance that are being obtained with ion implantation include these:

- Increased operating speed and reduced chip size for large-scale complementary MOS—by

placing depletion FET load transistors alongside standard enhancement MOS devices on the same chip.

- Vhf and low-frequency tuning diodes with high-process repeatability and better reliability.

- Microwave diodes with increased power and efficiency.

- Photo emitters and photo

sensors capable of varying their spectral response.

Ion implantation is able to do all this because one of the prime bugaboos in diffusing semiconductors has been a lack of really precise control of doping, as well as the fact that diffusion must be carried out at temperatures of 1000° to 1100°C for silicon. Ion

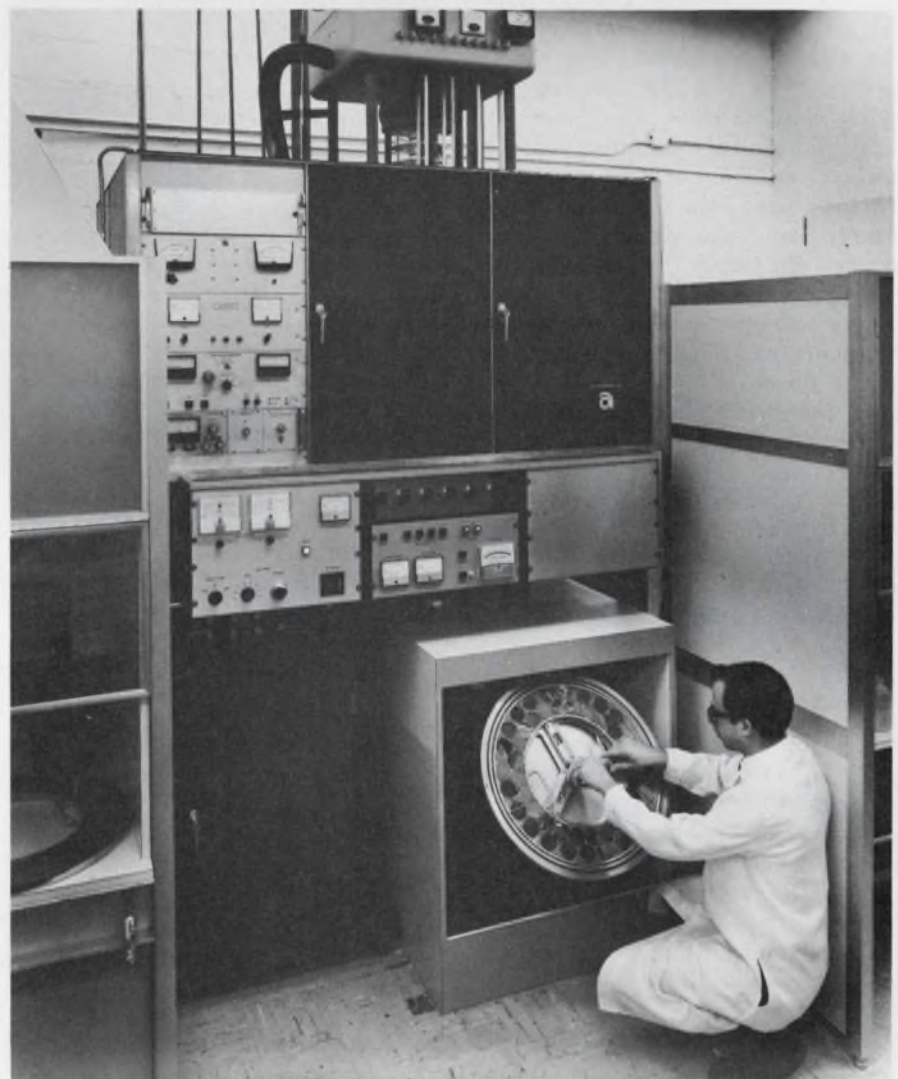

In one of Hughes Aircraft's newest ion-implantation systems for MOSFET ICs, a technician loads silicon wafers in the vacuum implantation chamber.

Jim McDermott  
East Coast Editor



implantation is a low-temperature process (400°C) that permits doping of materials that would normally be destroyed by diffusion.

But, most important, ion implantation provides very precise control of doping, because the number of ions striking the semiconductor targets can be accurately measured and monitored by electronic instrumentation that integrates the ion charges. This also provides precise control over the concentration of impurities that are implanted—control that can be orders of magnitude better than with diffusion.

For example, Dr. James A. Marley, manager of solid state chemistry for Signetics, Inc., Sunnyvale, Calif., points out that with diffusion the impurities can generally be altered between the limits of  $10^{10}$  to  $10^{20}$  atoms per cubic centimeter. But below that, reproducibility becomes difficult. With ion implantation, heavy doping can be achieved, and the doping can be accurately controlled down to  $10^{10}$  or  $10^{11}$  atoms per cubic centimeter.

By combining ion implantation's precise control of doping with control over the velocity with which the ions strike the substrate—the latter by varying the ionizing voltage on the accelerator, or ion gun—the device manufacturer can implant light or heavy doses of impurities on or near the surface of the chip. Or he can implant a layer of impurities inside the semiconductor substrate at some distance from the surface. Combining these options with low-temperature fabrication opens the door to a wide variety of device possibilities (Fig. 1).

### Implanters shoot ion bullets

Ion implanters are similar to mass spectrometers and isotope separators, in that a beam of ions is formed at the high voltage end of an accelerator that produces energies of several thousand to a few million electron volts. Since normally more than one type of ion is present, the accelerator is designed to permit only the desired doping ions, such as boron or phosphorus, to appear at the exit end. The beam is focused and usually deflected by an X-Y scan-

ner that produces a scanning raster on the targets to be implanted (see photo).

Until recently, ion-implantation equipment was essentially of laboratory design, and widespread use in semiconductor production was hampered by high equipment costs and complexity of operation. But the obstacles are vanishing fast. As Robert Palmer, director of research and development for Mostek, Inc., Carrollton, Tex., puts it:

"The equipment is getting down in the price range and is getting simple enough to operate where the industry can seriously consider ion implantation as production equipment. It's a complement to the diffusion process. You'll see a lot more firms doing ion implanta-

tion in 1971."

For more than a year Mostek and Hughes Aircraft Co., Newport Beach, Calif., have been fabricating large-scale, ion-implanted MOS ICs in production quantities.

Mostek has been producing random-access MOS memories and read-only MOS memories that are compatible with TTL logic. Compatibility has been achieved by lowering the usual 4-V MOS threshold to between 1 and 2 V by ion implantation. Changes in the threshold voltages can also be made by changing the gate metal or gate dielectric to give a different work function, but the threshold voltage then depends directly on this work function, as well as on the particular diffusion fabrication process used. But with ion implantation of the channel region, it's possible to adjust the threshold voltage to within an optimum range.

### Implantation is selective

Mostek recently started using ion implantation to make a single 1024-bit random-access memory chip that has the usual enhancement MOS devices as well as depletion devices on it. Palmer points out that this 1024-bit RAM, which is compatible with TTL and includes the buffer decoding and drive logic on the chip, was produced by selective implantation, with the depletion loads being used on the peripheral circuits.

A unique feature of ion implanting lies in the fact that the ions strike the substrates at right angles, and anything that masks the ion beam—such as a metal layer or heavy photoresist—will produce a sharp, doped contour of the masking area in the device. Hughes Aircraft uses this feature to produce 20-MHz registers. This speed is obtained by minimizing the parasitic gate-to-drain and gate-to-source capacitances as a result of the precise registration of the gate electrode between the doped drain and source areas (Fig. 2).

By using the aluminum gate as the implantation mask, Hughes eliminates the need for the gate to overlap the source and drain, as with conventional p-channel MOS devices. It is this overlap

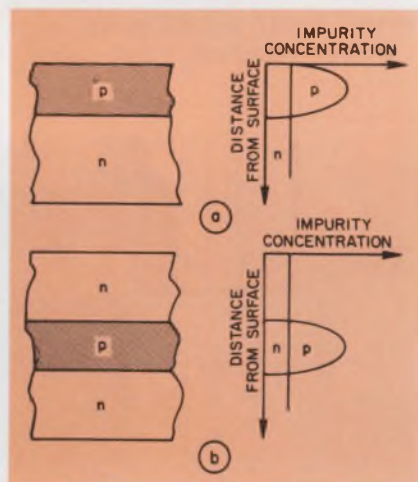

1. Layers of impurity concentrations can be implanted at the surface of a substrate (a) or buried inside (b).

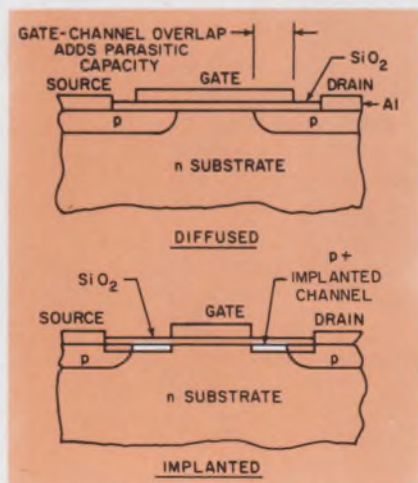

2. The parasitic capacities in diffused MOSFETs are eliminated by Hughes' ion-implanted structure.



# TRW X440 Metallized Polycarbonate Capacitors

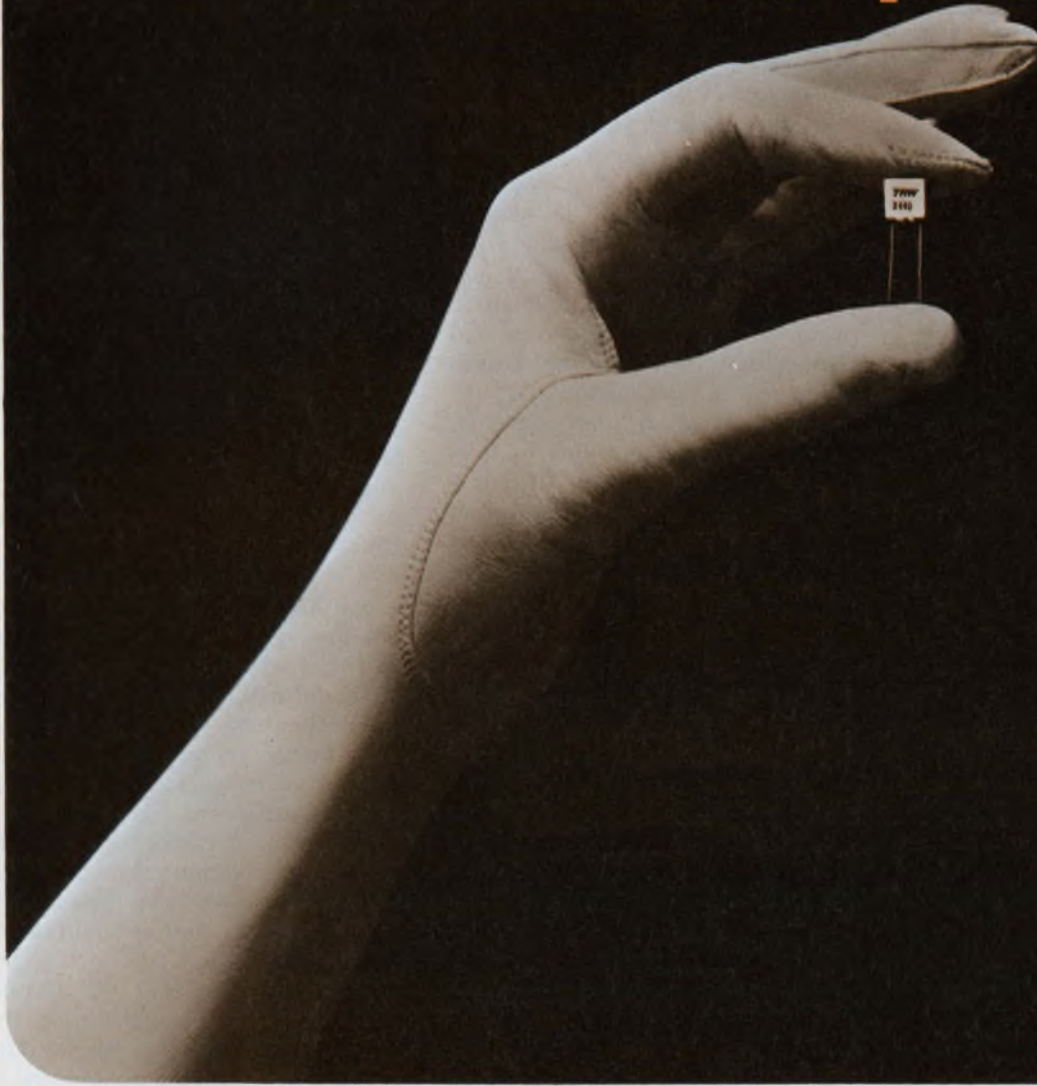

...fit like a glove!

14-75

Stand-out, premium quality in new capacitors that package so efficiently, so "tightly" that they always fit on your crowded printed circuit board!

Precision-dimensioned epoxy cases and precisely located leads take care of the "fit" problem. TRW know-how in metallized polycarbonate materials takes care of your rigid stability

and reliability requirements.

Environmental and electrical performance of the new TRW X440 metallized polycarbonate capacitors is even *better* than before. They're the smallest film capacitor on the market...and they fit like a glove!

Voltage...50VDC; Capacitance ...001 to .10 mfd; Tolerance to  $\pm 1\%$ .

For samples, detailed data and applications assistance, contact TRW Capacitor Division, Box 1000, Ogallala, Nebraska. Phone: (308) 284-3611. TWX: 910-620-0321.

## TRW®

INFORMATION RETRIEVAL NUMBER 19



that produces the speed-limiting parasitic capacitances. The implanted channel is exactly aligned.

Hughes is exploiting ion implantation in a number of areas. Dr. Hans G. Dill, manager of the company's Newport Beach Research Dept., told ELECTRONIC DESIGN that while ion-implanted designs constitute 30% of present production, new designs will raise this figure to 80%.

A rather mundane application of ion implantation, yet one that many feel will have a great impact on LSI chip designs, is the production of implanted resistors that require a substantially smaller chip area than diffused resistors do.

Dr. Dill says that while one can't get much more than 500 ohms per square with diffusion techniques, with ion implantation Hughes has been able to cover the range of 100 to 20 K ohms per square. While the practical resistor values used in Hughes' self-aligned circuits is about 2-to-3-K ohms, the company has produced implanted resistors of up to 10 megohms for special applications.

A principal application of these implanted resistors is found in Hughes' multiplexing entertainment system for the DC-10 jet liner. The system needs 10-MHz switching, which Hughes gets with its self-aligned gate.

In addition the multiplexing system requires resistor ladders for d/a converters. The implanted resistors provide ladders with 1 to 2% accuracy without requiring adjustment, according to Dr. Dill. This makes possible cost savings in the production of d/a converters.

Sprague Electric Co. of North Adams, Mass., is now in the early production stages with several linear monolithic ICs as well as low-power bi-polar digital circuits, all using ion-implanted resistors.

"Our interest," says Dr. John MacDougall, head of Sprague's Ion Implantation Dept., "lies in resistors from 20 K to several megohms. Most of that range has not been available with diffusion-formed resistors. The implanted resistors save us chip area and also extend the operating ranges of low-power linear circuits."

Important in Hughes' developmental program is a line of low-voltage complementary MOS circuits in which ion implantation is used for well doping, to put the complementary devices on the chip, and for threshold shifting. The principal outlet for this system is slated to be for electronic watches—although it can be used in a variety of other applications. The chip contains an oscillator, divider and a driver that can oper-

ate from a 1.4-to-5-V supply. At 5 V the switching speed can range from 5 to 10 MHz, but at 1.4 V it's lower. For watch applications, the threshold is adjusted to 0.7 V.

A new Hughes device that is scheduled to go into production soon is an IC MOS circuit with an ion-implanted 200-V breakdown, compared with the 60 to 80 V normally encountered. It is intended to be used as a Nixie tube driver, or possibly for liquid-crystal displays.

### Implantation is versatile

Ion-implanted, hyperabrupt tuning diodes for TV and FM tuners are being produced in quantities by Kev Electronics Corp., Wilmington, Mass., which also markets ion-implantation systems. Dr. Jerome Hartke, head of semiconductor R&D at Kev, reports that the ion doping improves signal-handling capability and provides the largest available variation of capacitance with voltage currently available. But there is some degradation in Q, compared with diffusion-formed tuning diodes.

Tailoring the doping curve of the tuning diode has improved the linearity of change in capacitance with voltage, with a capacitance approximately proportionate to  $1/V$  being centered around 8-V bias. Hartke says that minimum bias requirements of 3 to 4 V give lower temperature coefficients than comparable diffusion diodes, which must be tuned down to 1 to 2 V for an equivalent tuning ratio.

The power output of Impatt diodes has been doubled and the efficiency increased in the 50 GHz region for developmental units at Bell Telephone Laboratories, Murray Hill, N. J., through use of implanted complementary drift regions.

Tailoring the response of silicon light sensors by profiling the junction with ion implantation has been accomplished at Texas Instruments in Dallas, according to Dr. Werner Beyen, manager of the Semiconductor Research and Development Laboratory. The company has made samples and has demonstrated the feasibility of moving the peak spectral response toward the visible region. ■■

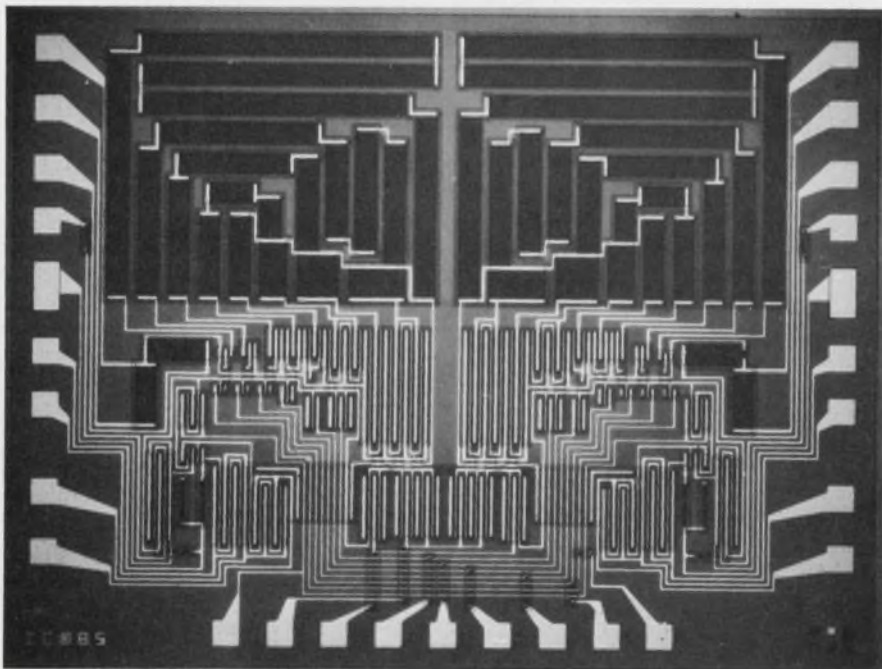

This digital-to-analog converter for Hughes' DC-10 jet entertainment system uses an implanted resistor ladder (top) for reliable performance and low cost.



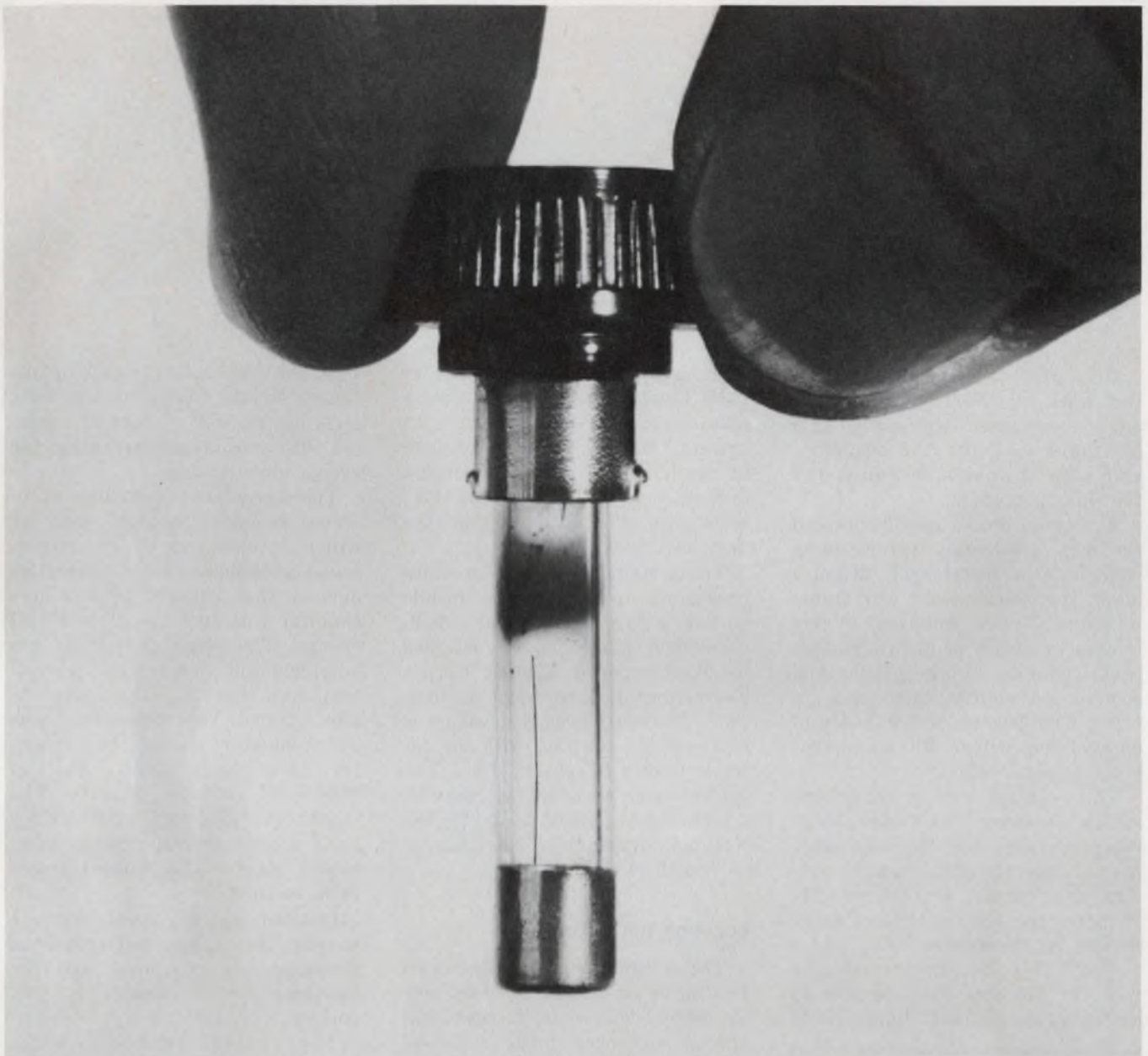

## This is a job for your service man?

When a fuse blows, does your customer know enough to change it?

Or does he head right for the phone?

That unnecessary service call costs you more than you'd like to admit.

For a fraction of that cost, you can put a Heinemann hydraulic-magnetic circuit breaker right on your front panel.

With multiple poles, precise ratings, job-matched time delays, and special function circuits inside.

And a nice-looking rocker handle or lighted pushbutton outside.

If the breaker clicks off, your customer simply clicks it back on.



If he tries to hold it on against a fault, it won't let him. (All Heinemann breaker mechanisms trip free of the handle.)

So he only calls for service when he needs it. Your service men aren't running around replacing fuses.

And you're saving a nice piece of change. How's that for a good idea?

Write us for a copy of Bulletin 3350; it's yours for the asking.

Heinemann Electric Company, 2616 Brunswick Pike, Trenton, N.J. 08602. Or Heinemann Electric (Europe) GmbH, 4 Düsseldorf, Jägerhofstrasse 29, Germany.



**HEINEMANN**

Does a Heinemann breaker really cost too much?

4599A

INFORMATION RETRIEVAL NUMBER 20

# Vlf system and geophones help rescue trapped miners

On a cold morning last month in the hills of West Virginia, an emergency system was rushed to a coal mine to locate and communicate with 14 miners deep in one of the mine's tunnels.

A seismic device quickly located the men, who were tapping on a wall with a metal tool. Minutes later, the rescue team was transmitting a voice message to the miners by means of a through-the-earth communications system. And soon coded signals came back in reply. The seismic device had pinpointed the men within 25 feet of their actual location.

The occasion was a happy one for two reasons. The "emergency" was simulated and the men were not actually trapped. And the system, still under development, promises to save the lives of many miners in the future.

With this equipment rescuers will, for the first time, be able to communicate almost immediately

with trapped miners and to pinpoint the location of men in a mine before rescue drilling is begun. At present, rescuers have to depend on the judgment of mine engineers and superintendents, based on their knowledge of the mine or where the men have been working.

The system, which also provides breathing apparatus, a mobile shelter, a fixed shelter, and a drilling-rescue subsystem, was designed by Westinghouse Electric Corp.'s Georesearch Laboratory at Boulder, Colo. The work was done under a \$3.44-million contract with the Interior Dept.'s Bureau of Mines. The project came about as the result of a nine-month study made by the National Academy of Engineering in Washington, D. C.

## Locating the victims

The seismic device that's rushed to a mine in trouble must be able to detect sounds in tunnels that spread out over many miles at depths to thousands of feet. Westinghouse's system, the company

says, can do this. It can pick up the "shock waves" caused by a miner's striking the wall or floor of a tunnel with a sledgehammer, a pick or even a mine timber.

The waves are detected by up to seven geophone arrays, each of which is made up of 19 conventional geophones—highly sensitive devices that convert seismic mechanical energy to electrical energy. The electrical signals are amplified and then fed into a small computer that is part of the on-site system. The computer, made by Computer Signal Processors, Inc., Lexington, Mass., has an 8000-word memory capacity. The signals are processed to determine their precise arrival time by techniques such as the Fourier transform method.

Once the signal arrival times are known, the times and geophone positions are compared and the location of the miners is pinpointed.

The survival chambers, which are located throughout the mine, are also equipped with a geophone to listen for miners who are stranded outside the chamber somewhere in the tunnel. Seismic waves are picked up by the geophone and transmitted by through-the-earth communications to the surface.

To augment the limited capacity of the on-site computer, a portable terminal is included with the system to enable the engineers to tie in with a bigger computer via telephone lines as soon as a line can be run out to the rescue site.

To communicate with the miners, very-low-frequency signals (200 to 3000 hertz) are transmitted by means of a surface antenna through the earth and rock. They are picked up by a small voice receiver mounted on the miner's lamp battery case, and also by a

John F. Mason  
News Editor

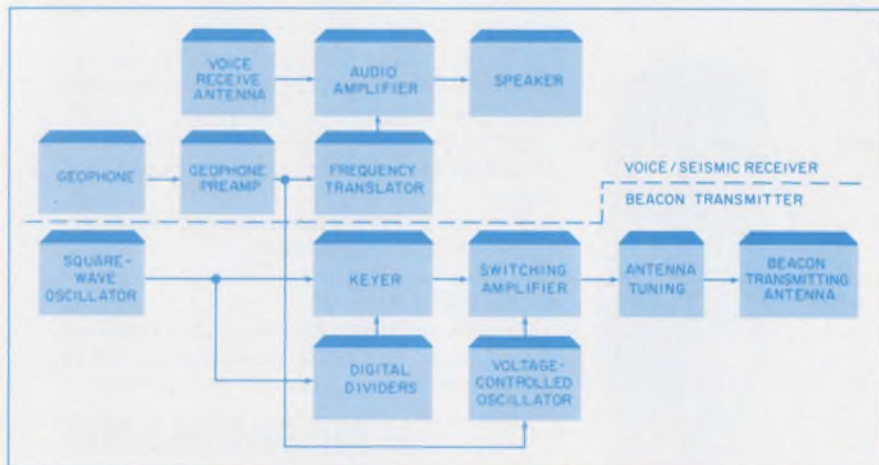

This subsurface system permits a trapped miner to receive instructions from a rescue team on the surface by through-the-earth voice communications. He replies with coded signals sent by a pushbutton square-wave oscillator.



UNITRODE  
580 PLEASANT STREET · WATERTOWN · MASS. 02172

# when you need high voltage switching transistors...

## we'll deliver more than promises.

We offer you faster, more efficient power switching at prices that won't make your temperature rise. And we can deliver off-the-shelf.

Our 2N5660-67 series high voltage switching transistors, operating to 2 and 5 amps, will sustain up to 400 volts with a saturation voltage of 0.4 volts maximum.

And they're fast enough to operate in 20kHz inverters. Standard packages are compact 15 watt Thermoslug TO-5's and TO-66's, or others such as TO-3, TO-59, and TO-61.

Use them for more efficient and simplified circuit design in power supplies, inverters, converters, switching regulators and motor drives. Wherever you need high reliability at reasonable cost.

We think they offer the best combination of specs and prices anywhere. (400 volt types are as low as \$15.00 in 100 lot quantities.)

With promises like these, shouldn't you make us prove it?

For fast action, call Sales Engineering collect at (617) 926-0404  
Unitrode Corporation, Dept. 2C, 580 Pleasant Street,  
Watertown, Mass. 02172, or contact your local Unitrode distributor.

**Data sheets and prices on request.**





receiver and transmitter in survival chambers.

The surface antenna is an insulated wire several thousand feet long that is grounded by long metal stakes at each end and then connected to the transmitter by a coupler.

When the system becomes operational, a miner would open his sealed receiver, following an accident, withdraw an earphone and listen for instructions. If he has been able to reach one of the mine's survival chambers he will reply

through an elaborate communications unit. It will have a voice receiver and a transmitter capable of producing coded or keyed pulses.

### Mine-to-surface communication

To reduce power requirements the miner will not reply by voice. Instead, his unit will transmit only a square-wave modulated carrier using an adjustable frequency (from 275 to 2750 hertz) to allow selection of an optimum frequency for the particular environment.

Five modulation frequencies and

the pure carrier frequency, keyed by pushbuttons, can be used to reply to questions from the surface. Coded responses will be simple, such as "yes," "no," "unknown," and "good." The coded pulses transmitted by the underground beacon will be received by the surface equipment, automatically decoded and displayed on a panel of lights.

Power for the transmitter is provided by a 24-V zinc and air battery that operates 48 hours on a set of renewable electrodes. ■■

---

## New processor makes programming easy

A unique programming concept, used in the design of a desktop data entry and processor system, has resulted in a highly flexible and programmable machine.

Built by the Cogar Corp.'s Information Systems Div. in Schuylers, N. Y., the system is called the Cogar 4. According to Jerry Randall, the company's director of engineering, the new machine can adapt to any mode or location of data preparation and can be taught new business applications by personnel with very little experience.

And by replacing the key-punch keyboard with a typewriter keyboard and loading different soft-

ware, the Cogar 4 is suitable for use in the departments where the source documents are, says George R. Cogar, the company's president. The placement of keys on the keyboard can be changed by reprogramming, and the characters of the alphabet can be changed, too.

"What we wanted to do was to design a machine that was not limited to one or two applications," says engineering director Randall. "With a 300-ns monolithic memory we are able to put in a powerful processor and use software programming to get the functions that we want. This gives the machine a much broader base on which to operate."

The system has a master program cartridge that contains pre-tested routines for data entry, verification, searching, editing, blocking and communications.

Routines can be selected at the touch of a key that tells the system what to do and how to do it. The user never has to prepare a program.

"The machine is not code-dependent," Randall says. "There is nothing in it that you could consider a code. The keyboard is really transparent. For example, the program takes a character it receives from the keyboard and, with a translate board, converts it to whatever function you want that character to represent. You can change the keytops to get special characters or special functions. Everything is totally under program control."

The CRT display, which measures 5 by 7 inches, does not contain a translate device such as most CRTs have, Randall says. "The dot pattern for the display resides in core. An 'A', for example, is generated by the programmer. An 'A' is an 'A' on the CRT only because there is a software programmed dot pattern in the memory that happens to represent that figure. An 'A' could just as easily look like a 'C' or an 'F' or anything else. By changing the program the key can be made to print out in a foreign language. Even the characters of one alphabet can be changed to another." ■■



Using a typewriter keyboard the Cogar 4 records data on tape cartridges.



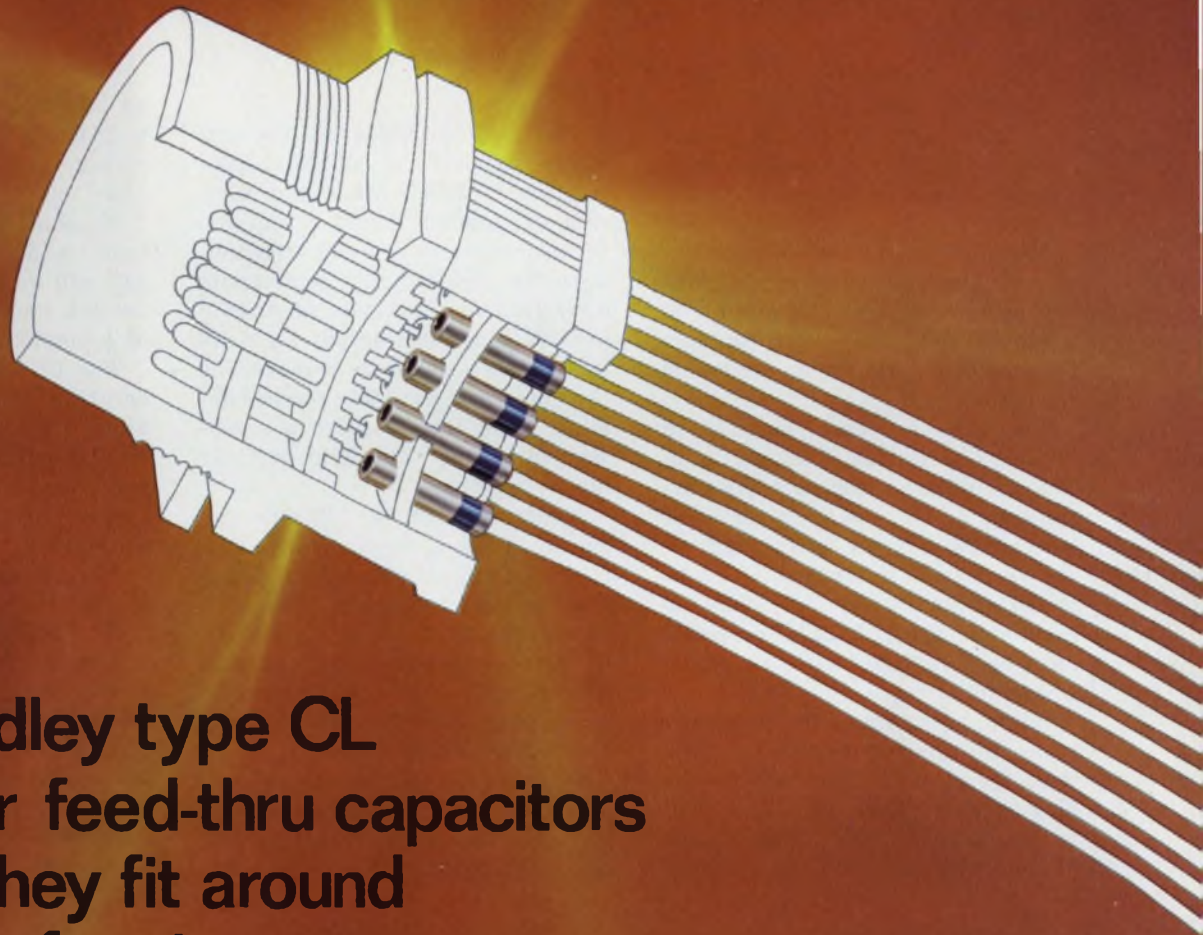

## Allen-Bradley type CL multi-layer feed-thru capacitors so small they fit around the head of a pin.

**VOLUMETRIC EFFICIENCY.** Big words that explain why Allen-Bradley type CL feed-thru capacitors are so small. Our unique multi-layer concept shaves size to a minimum, without affecting performance. It took Allen-Bradley to get filter capacitors down to their fighting weight. Now rolled capacitors are no longer a design alternative.

Concentric layers of proprietary Allen-Bradley ceramic and noble metal electrodes are fired together for unmatched protection against moisture and contamination. Rugged. Non-polar. With lower inductance and far less noise.

Voltages to 200 WVDC. Temperatures to 125°C. Capacities to 1.0  $\mu$ F. High dielectric strength and reliability.

Several styles and sizes are available through your appointed A-B industrial electronic distributors. For further information write: Marketing Department, Electronics Division, Allen-Bradley Co., 1201 South Second Street, Milwaukee,

Wisconsin 53204. Export office: 1293 Broad Street, Bloomfield, N.J. 07003 U.S.A. In Canada: Allen-Bradley Canada Ltd., 135 Dundas St., Galt, Ontario.

### **ALLEN-BRADLEY**





# The one-chip calculator is here, and it's only the beginning

Since the advent of ICs, prognosticators have envisioned a computer on a chip. Now, this dream appears one step closer to fulfillment.

Mostek Corp. of Dallas, an affiliate of Sprague Electric Co., has developed a custom LSI circuit on a single MOS chip that contains the complete logic for an electronic calculator.

The chip is being supplied to Nippon Calculating Machine Co. in Tokyo, under an exclusive sales arrangement, for use in a series of calculators. Nippon says it will begin production this month of a new model of its Basicom Jr. desk-top calculator, in which 22 MSI circuits have been replaced with the single LSI chip.

Later this year the company plans to produce two calculators, with the circuitry for each on the Mostek chip. Each calculator will be just a little larger than a pack of cigarettes and will be powered

by batteries.

The chip provides all the circuitry to perform addition, subtraction, multiplication and division of numbers up to 12 digits. It also contains the input/output decoders required to accept inputs directly from a keyboard and to provide a decoded output for driving a seven-segment display. The chip does not have the power-handling capability to drive a seven-segment tube or light-emitting diode directly.

Measuring 188 by 172 mils and packaged into a 40-pin-ceramic flat-pack, the chip contains the equivalent of approximately 700 gate functions. L. J. Sevin, president of Mostek, says he expects to have a chip with 1000-gate complexity in approximately the same size by the middle of this year.

A standard p-channel process was used to manufacture the chip. For the battery-operated, pocket-sized calculators, Mostek will use

an ion-implantation technique (see p. 25) to lower the chip's threshold voltage and reduce dissipation from 0.5 W to less than 50 mW.

Nippon's two pocket-sized calculator models, designated LE and LC, will measure 5 by 2-1/2 inches by 3/4 inch and weigh about 2/3 of a pound.

The LE model will have a light-emitting diode display and the LC unit a liquid-crystal version. The tiny calculators will feature left-zero blanking (extraneous zeros to the left of the displayed number are unlit).

The LE models will sell for \$395 in the U. S., and the LC models will be somewhat cheaper.

The one-chip calculators are just a beginning, according to Mostek's president. He predicts that within the next year or two the new calculators will include such features as floating decimal points, squaring, exponents and trigonometry functions. ■■

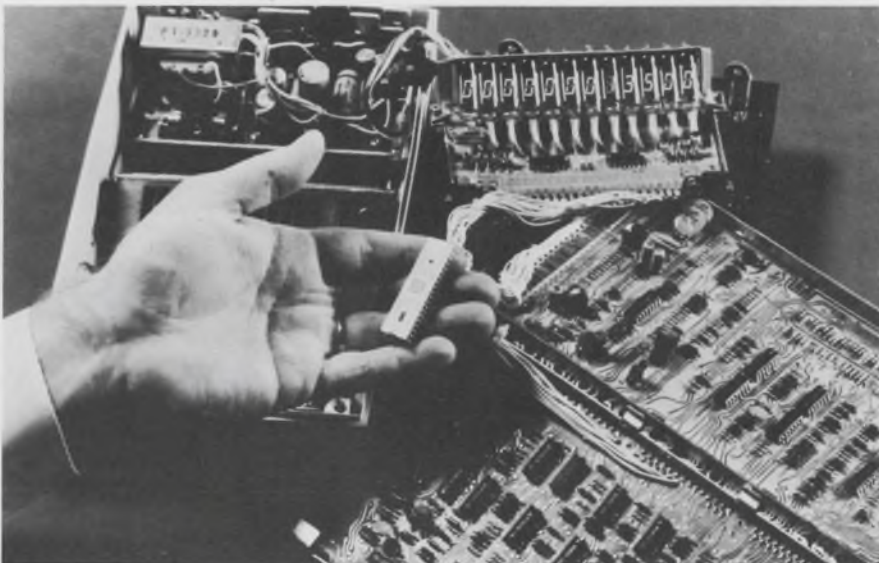

The single MOS-LSI chip (held in the hand) contains the complete logic for an electronic calculator. It replaces 22 MSI circuits and many discrete components contained on two circuit boards.



Battery operated pocket calculator will have a light-emitting diode display.



Programming: Choose either 128 or 256 step models for linear or conditional branching operations.

Dynamic range of  $10^{-99}$  to  $10^{+99}$   
Decimals printed in either preset or scientific notation.

Automatic special functions:  
 $a^x$ ,  $\log_{10}/\log_e$ , SIN/COS,  
 $\text{SIN}^{-1}/\text{COS}^{-1}$ ,  $x!$ ,  $\frac{1}{x}$ ,  
radians to degrees,  
single key  $\Sigma x$ ,  $\Sigma x^2$ , N,  
rectangular to polar conversion.  
Automatic entry  
of values for e and  $\pi$ .

Ten independent, directly addressable storage registers.

Special punch card system allows programming without tying up the calculator.

Accessory card reader for automatic entry of program data, special functions and decision-making capability not shown on keyboard.



Model 1665 shown.  
All MOS/LSI circuitry.  
Available with or  
without programming.

**The latest  
MOS/LSI technical  
calculators. As close  
to you as your telephone  
in over 350 cities. For  
the location nearest  
you call collect  
800 243-6000\***

\*In Connecticut: 800 942-0655

**Monroe. The  
Calculator  
Company**





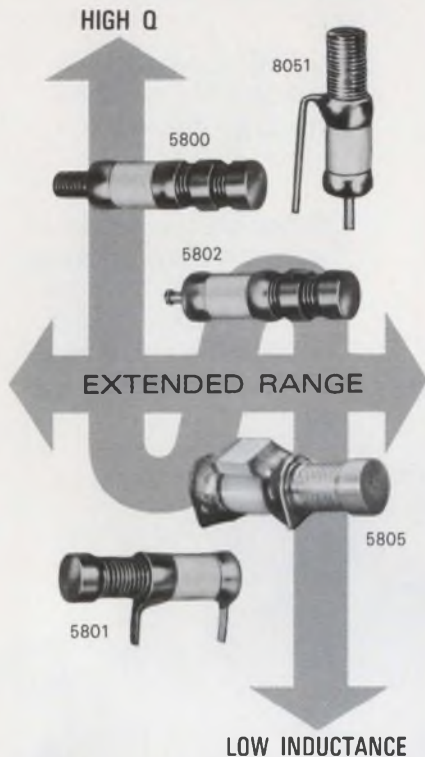

## SUB-MINIATURE LOW INDUCTANCE CAPACITORS

**$Q > 10,000 @ 100 \text{ MHz}$**

Now available with all these plus features: + 10:1 capacitance ratio in a micro-miniature size + Extra fine tuning < .35 pf per turn + Improved contact mechanism for noise-free tuning + Rugged construction.

### SPECIFICATIONS

**SIZE:** 1/8" diameter, 1/2" long

**CAPACITANCE RANGE:**

0.35 pf - 3.5 pf; .5 pf - 5.0 pf

**WORKING VOLTAGE:** 250 VDC (500 VDC Test)

**INSULATION RESISTANCE:**  $10^6$  Megohms

**TEMPERATURE RANGE:** -65°C to -125°C

**TEMPERATURE COEFFICIENT:**  $0 \pm 50 \text{ PPM}/^\circ\text{C}$

For immediate delivery and complete technical information call 201-334-2676.

**MANUFACTURING CORPORATION**

ROCKAWAY VALLEY ROAD  
BOONTON, NEW JERSEY 07005

**ELECTRONIC ACCURACY THROUGH  
MECHANICAL PRECISION**

INFORMATION RETRIEVAL NUMBER 24

## Designers to mini makers: 'Please add improvements'



More than 300 designers of systems that use minicomputers put their heads together in Anaheim, Calif., at the 1971 Computer Designers Conference and Exhibition to speak out on minicomputer problems they would like to see overcome. Their suggestions to manufacturers included these:

- Make the minicomputers more versatile. Memory should always be expandable in a single chassis. The need with most minis to add an external chassis to the basic unit for memory expansion is clumsy and takes up too much space.

- Offer different word lengths for different functions. A 16-bit computer that doesn't allow some calculations to be made with 8 bits, some with 12 bits and some with another arbitrary word length isn't flexible enough.

- Put in operator control functions to facilitate software debugging. At the very least, users should be able to call out memory locations and inspect their contents right on the control panel. This feature was designed into early minicomputer systems but is not available in most hardware today.

- Increase input/output data rates. Cycle times on the order of 400 to 500 ns are needed for some applications. Typical speeds today are about 1000 ns.

- Provide more applications assistance than is presently offered. Without this, the full capabilities

of the machines will never be realized.

- Make the peripherals cheaper. An inexpensive high-speed replacement for the teletype is essential. A line printer at less than \$2000 would be the way to go.

- Build more versatile, input/output drivers and code converters. It would be good if code conversion were a hardware function rather than a software function.

- Make low-cost mass storage available. At least 1 to 10 megabits of easily accessed peripheral memory are needed. Cassettes do not work well enough.

- Design d/a and a/d converters specifically to operate with the various transducers used in industrial control systems. High-accuracy, very-low-cost converters that are transducer-compatible are needed.

- Provide adequate software and software support. Present operational software is loaded with bugs. A standard language usable on any manufacturer's minicomputer is sorely needed.

The suggestions came from designers of test and measurement and industrial-control systems. The leader of the discussion—entitled, "What's Needed in Minicomputer Controlled-Hybrid Systems?"—was Joseph L. Massett, manager of test engineering at the RCA Data Processing Div., Palm Beach Gardens, Fla. ■■



# Meet Skinny Mini.

The first  
2 amp 2PDT relay  
skinny enough  
to mount on  
0.5 PCB centers.

Never has anything  
so flat caused so  
much excitement  
... since Twiggy.

Here she is, the skinniest,  
miniest 2 amp 2PDT relay  
in captivity. Only  
0.340 inches maximum  
off the board height.

Cheaper than a crystal  
can! Handles more power  
than a TO-5 relay! Has ver-  
satility of Form C compared  
to micro-reeds! And is smaller  
than all other 2 amp indus-  
trial relays!

Now Skinny Mini, or as she  
is sometimes affectionately  
called, Midtex/AEMCO Type  
181, with its maximum off-the-  
board height of 0.340, mounts  
neatly on printed circuit boards  
using 0.5 centers. The height  
is also compatible with semi-  
conductor component mount-  
ings.

Skinny as it is, the 181 pro-  
vides 1/16" clearance through air  
and 1/8" over surface. Terminals  
are 0.025" pins. The relay mounts  
on four raised pads to permit  
proper PCB cleaning and soldering.

Skinny Mini ... the skinniest news  
to hit the relay market this year. For  
more information about Mini, write or  
call Midtex/AEMCO, 507 388-6288, or  
see a Midtex/AEMCO representative.

Cheaper than  
crystal cans  
Handles more power  
than a TO-5  
More versatile  
than micro-reeds  
Smallest 2 amp  
industrial relay

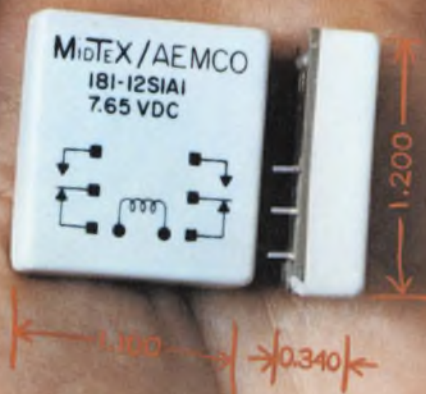

**MIDTEX**   
INCORPORATED  
AEMCO DIVISION

10 STATE STREET  
MANKATO, MINNESOTA 56001

PROGRAMMERS/TIME DELAY RELAYS  
MINIATURE COAXIAL RELAYS/INDUSTRIAL RELAYS  
MERCURY-WETTED CONTACT RELAYS



# In MOS/LSI, pharmaceutical water has too many bugs.

The water we use to make our MOS/LSI devices is 10 times purer than the water used to make penicillin. We make it with a special reverse osmosis purifier. So our water is completely deionized. So all possible contamination is eliminated.

One way we use this super clean water is to wash the acid off our wafers right after the etching stage, right before the sealing stage. Because wafers have to be absolutely clean to guarantee electrical conductivity in as many as 4000 circuits per single chip. And we know when ours are washed clean because we measure the impurities in the run-off water until there are no more impurities. (And just as a point of interest, the waste water from this process we put back into the environment is 3 times purer than ordinary tap water.)

This is just one of the extra contamination controls we've built into our new MOS/LSI manufacturing facility in San Diego. And it's one of the things that helps make it the only facility of its kind in the world — the finest in the world. We have a super clean manufacturing environment. A consistent and predictable one-of-a-kind environment for producing a consistent and predictable one-of-a-kind product. We have fewer rejections, higher yields and a lower cost passed on to the custom MOS/LSI user.

You're invited to see our new facility for yourself. Or you can write for our new brochure. Mr. David A. Beadling, Director of Marketing, Garrett Micro-Circuits Corporation, 16701 West Bernardo Drive, San Diego, California 92127.



# Garrett

## MICRO-CIRCUITS CORPORATION

*one-of-a-kind in MOS/LSI*



# THE ONLY ENVIRONMENTALLY SEALED SWITCH WITH A ONE-PIECE SEAL.

Check it out.  
Cutler-Hammer's new MIL-S-3950 switch line offers more designed-in reliability:

- A patented sealing process produces an exclusive-design seal of molded silicone rubber.
- Completely environmentally sealed. Tight enough to pass a mass spectrometer leak test.
- Improved dielectric capability because the one-piece seal is bonded to the lever, bushing, and the inside of the aluminum frame.
- Terminals that are molded into base without use of elastomers.
- No "O" rings to distort or age, and leak.
- A self-extinguishing Melamine base for increased arc resistance under contaminated conditions.
- Back-wired terminals with molded-in identification.
- A positive detent feel.
- A truly reliable momentary return action.
- Complete line including standard bat levers and lever-lock toggles in one, two, and four poles. Standard and special circuits.

- 25 MS configurations in stock for immediate delivery.
- Priced to meet many demanding commercial applications, too.

Cutler-Hammer's new MIL-S-3950 switches are a fitting companion line for our MIL-S-8834 positive-action switch line. For complete data and fast, helpful service, contact the Cutler-Hammer Sales Office or Stocking Distributor near you.

**CUTLER-HAMMER**  
SPECIALTY PRODUCTS DIVISION, Milwaukee, Wis. 53201



INFORMATION RETRIEVAL NUMBER 27

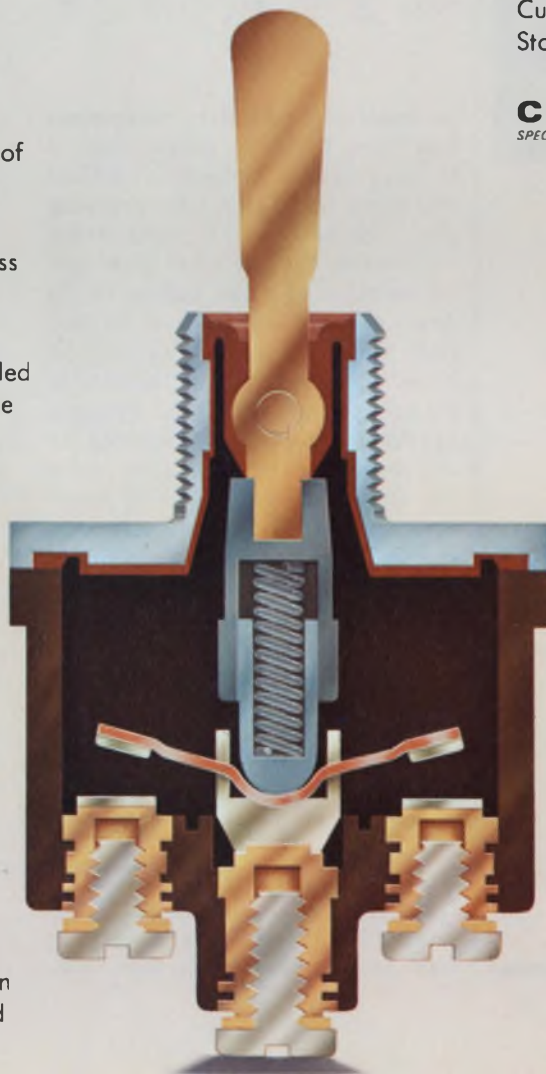

Switch  
to No.1

More than just switches;  
prompt availability,  
field help, innovation,  
quality assurance, too.

# Buying Power?



*Here's the new, single source for all your power needs.*

- Mil Spec DC Modules
- Wide Range DC Modules
- Slot Voltage DC Modules
- IC Logic Modules
- Full-Range Lab Supplies
- Inverters, Frequency Changers
- High-Voltage Supplies
- AC Regulators
- Full Technical Data
- Full Specifications
- Mechanical Data
- Model Types
- Prices & Availability

*Ask for Your Free Catalog #157 Today!*



## **ERA TRANSPAC CORPORATION**

67 Sand Park Road, Cedar Grove, N. J. 07009  
(201) 239-3000

*A subsidiary of  
Electronic Research Associates, Inc.*

## technology abroad

Three-dimensional radiographs that will allow inspection of any section of the human body at a glance are being developed into a system by researchers at the Philips Hamburg Laboratories in Germany. In this experimental technique a composite holographic image is built up from several radiograms, each taken at a different angle. Each radiograph is illuminated by a coherent light source and projected through a diffusing screen. A slit diaphragm, corresponding to the location of the X-ray source, positions the information from each individual plate on the hologram. The reference wave at the slit produces the holographic pattern. The composite hologram is read by illuminating the composite photographic plate with the reference plate.

Automatic car-locating equipment has been fitted to police cars of the Dorset and Bournemouth Constabulary in England. By pressing six buttons on the car's radio equipment, the car's call sign, and its location and the nature of its duty are transmitted in digital code to the central operations room. The equipment, which is manufactured by Digital Systems of Poole, Dorset, is expected to cut radio time by 90%, free police for other duties and prevent monitoring of police-car movements by criminals. Information passed to the central control room in this way is routed into a computer memory and displayed on a large wall chart. In October, 1969, the equipment won a joint first prize in the International Association of the Chiefs of Police—an American Express Co. award.

Long range radio control of a mining machine in a tunnel at Lanaye in the Winterslag, Bel-

gium, mines has been demonstrated by engineers from the Belgian Institute National des Industries Extractives. They hung a coaxial cable, with annular slots cut into it at regular intervals, along the wall. The tunnel became, in effect, a waveguide that was able to support radio waves up to 900 meters long. The Belgian engineers believe that, with careful design, transmissions up to 10 km or more will be possible.

The largest freely maneuverable radio telescope in the world is being built in northern Eifel in Germany by the Max Planck Institute for Radio Astronomy. It is now undergoing preliminary tests and adjustments. The 100-m aperture of its parabolic reflector will be capable of picking up extragalactic signals from sources that are  $5 \times 10^9$  to  $10^{10}$  light years away. It will also be used to receive signals from the German/U. S. Helios space probe.

A project for accelerated life tests on plastic encapsulated integrated circuits will be conducted by Ferranti, Ltd. for the British Post Office. At present, the Post Office uses only hermetically sealed ICs, but it is interested in gathering data on mean time between failures for plastic ICs. The reliability of the plastic units is good enough, however, to make such tests an unjustifiably long and expensive process. Ferranti has, therefore, developed an accelerated life test using extremes of temperature and humidity. The Ferranti engineers hope to establish a correlation between failure rates under these controlled conditions and rates for the same devices exposed to the extremes of environment defined by the Post Office specifications.





**Our KUP  
general purpose relays  
switch up to 10 amperes...reliably**

**KUP-type relays  
will sense 60 microwatts, latch,  
switch alternately or delay time.  
It's all in the family.**

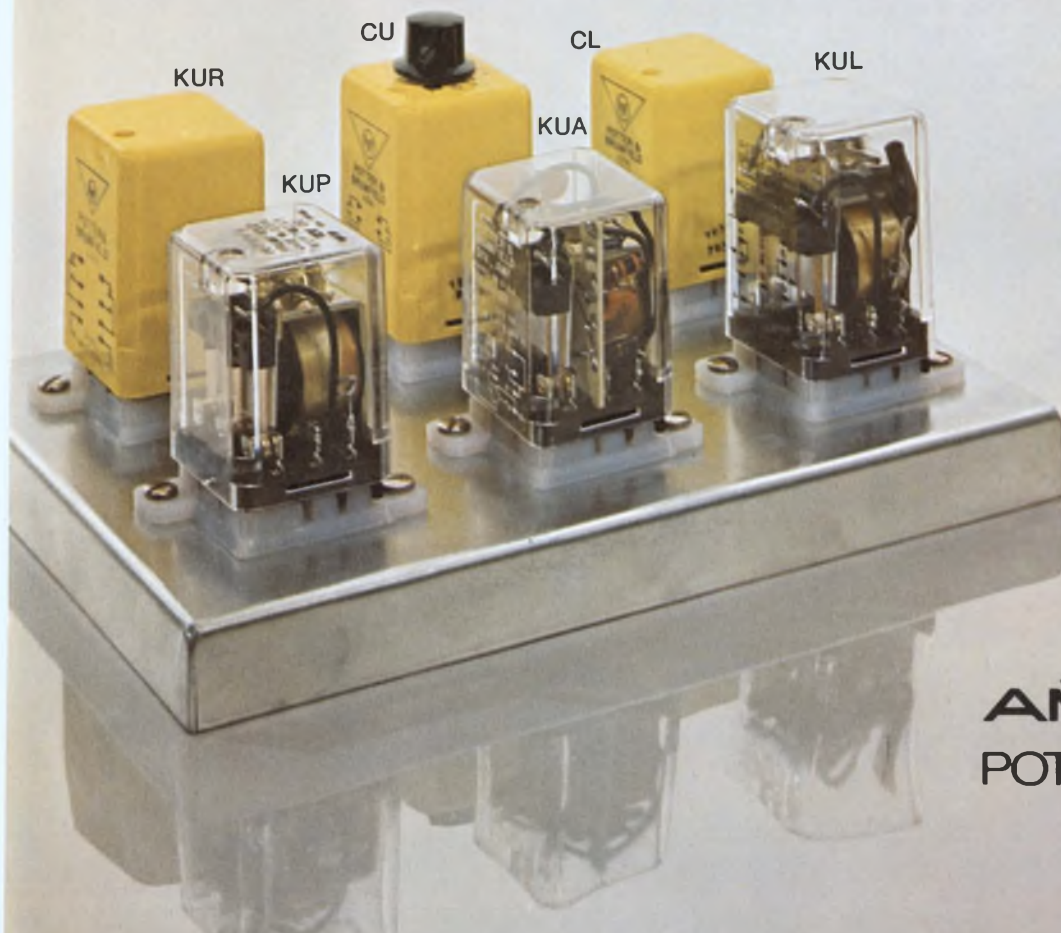

First off, our KUP relays save you money. More than \$2.00 each, compared with octal-type pin terminals. Then, to make your design job easier, the range of optional features includes a slotted case for direct-to-chassis mounting; sockets with solder, printed circuit, quick-connect or screw terminals; push-to test button; indicating lamp; choice of .187" or .205" terminals. U/L recognized. Contact arrangements to 3 Form C. Rated 5 or 10 amperes. Coil voltages to 120 VDC, 240 VAC. List \$4.10 to \$6.05. The KUP spawned a remarkable family of switching devices. They are housed in the same case (some 1/4" higher), use the same sockets, cover a wide variety of control functions:

**KUA Amplifier-Driven Relay.** Standard sensitivity: 60 microwatts. DPDT contacts switch 5 amperes at 28 VDC or 120 V 60 Hz., 80% PF. Features continuous operation, built-in polarity protection. Recommended for interfacing low-level logic circuits and work-performing loads such as motors, contactors, solenoids. As low as \$14.25 list.

**KUL Magnetic Latching Relay.** Takes half the space of mechanically-interlocking latches. Provides permanent memory, continuous duty operation. DPDT contacts switch 5 to 10 amperes. Contacts remain in last position without power. \$5.45 to \$7.10 list.

**KUR Alternate Action, Impulse Relay.** Features unique combination of KUL single coil magnetic latching relay with solid state flip-flop circuit drive. Pulse width of 25 milliseconds will effect switching. Contacts switch 5 or 10 ampere loads. List price, \$15.10 (DPDT).

**CU Time Delay Relay.** Low cost solid state relay for timing increments from 1 to 120 seconds. Switches 10 amperes and comes in 3 AC or DC versions: fixed time delay on operate; resistor-adjustable; knob adjustable. Priced as low as \$14.20 each, list.

**CL Time Delay Relay.** Provides a delay on operate. Won't false operate. Times as low as 0.1 second. Otherwise similar to CU. \$17.35 to \$21.15 list.

Standard versions of these relays are available now from your electronic parts distributor. For complete information, call your local P&B representative or Potter & Brumfield Division of AMF Incorporated, Princeton, Indiana 47570. Telephone: (812) 385-5251.

**AMF**

**POTTER & BRUMFIELD**

**P&B performance. Nothing else comes close.**



MEMO

Ed—  
Your latest factory costs are excellent. Note, I've modified our ad to show new prices.

Gene

4.75

The same pricing advantage holds true for RCA's 2N5038 — at ~~\$8.25~~. (Prices of 2N5039 and its companion type are based on 1000-unit purchases.) For the full story, call your local RCA Representative or your RCA Distributor. For technical data, write: RCA, Commercial Engineering, Section 57B-18/UT18, Harrison, New Jersey 07029. International: RCA 2-4 rue du Lièvre, 1227 Geneva, Switzerland, or P.O. Box 112, Hong Kong.

# 2N5039... switches off 15 A in less than 250 ns at ~~\$4.90~~

3.25

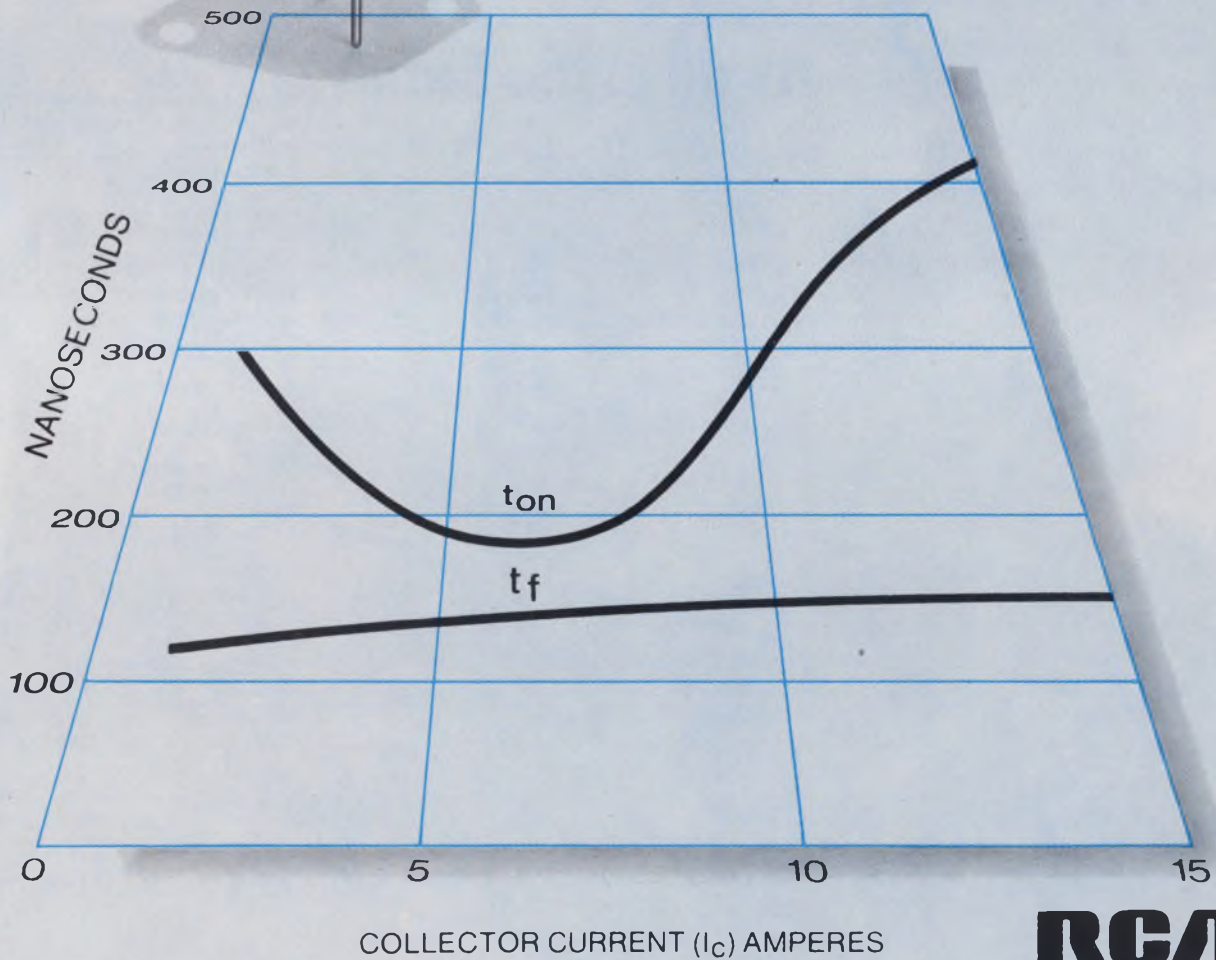

**RCA**





<p><b>TYPE: T</b>          Mtg. Area: 0.1 sq. in.          Q: &gt; 2000 @ 150 MHz          pF: 1.3-5.4 to 1.9-15.7          TC: plus 30 ± 15 ppm/°C</p>	<p><b>TYPE: U</b>          Mtg. Area: 0.2 sq. in.          Q: &gt; 2000 @ 150 MHz          pF: 1.2-4.2 to 2.4-24.5          TC: plus 45 ± 15 ppm/°C</p>	<p><b>TYPE: V</b>          Mtg. Area: 0.3 sq. in.          Q: &gt; 2000 @ 150 MHz          pF: 1.4-13 to 2.2-34          TC: plus 50 ± 20 ppm/°C</p>
---	---	--

## It takes brass to machine capacitors like these.

Johnson precision machines each rotor and stator for these compact capacitors from a single, solid brass extrusion. The benefits are outstanding mechanical stability and electrical uniformity. As a result, you get consistently high performance from every Johnson capacitor. You can rely on them for exceptionally high Q, low temperature coefficients and uniform minimum and maximum values. All at a cost probably lower than what you are now paying.

Return the coupon today for more complete information on the famous Johnson line of machined plate air variable capacitors. Or, perhaps you have a unique need. Our en-

gineers will be glad to work with you. Call (507) 835-2050.

-----  
**E. F. JOHNSON COMPANY / 3305 Tenth Ave. S.W. / Waseca, Minn. 56093**

- Please send new 1970 Capacitor Catalog (702-01)
- Specific interest: \_\_\_\_\_

NAME \_\_\_\_\_ TITLE \_\_\_\_\_

FIRM \_\_\_\_\_

ADDRESS \_\_\_\_\_

CITY \_\_\_\_\_ STATE \_\_\_\_\_ ZIP \_\_\_\_\_



**E. F. JOHNSON COMPANY**

INFORMATION RETRIEVAL NUMBER 31



# Siemens

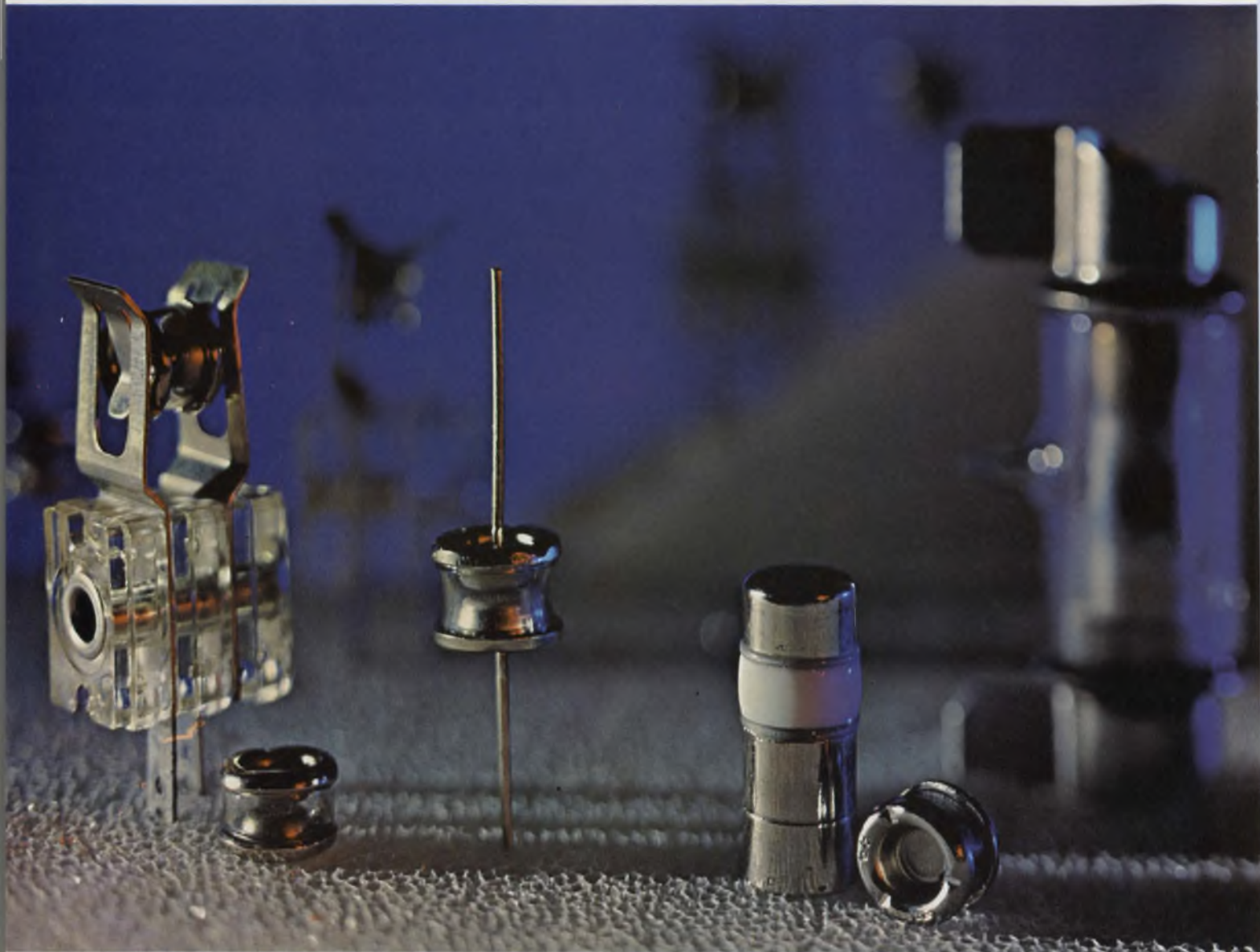

## Low-cost SVP™ devices can save your valuable equipment from destruction by voltage transients.

You can no longer overlook the need for protecting your circuits. New sources of transients are cropping up every day. And any one of them might cause operational failure of your equipment.

Now there is an easy low-cost way to protect your circuitry from these transients. It's a simple little

gas-filled surge voltage protector. We call it an SVP. Only this Siemens SVP offers high-current capability (up to 50 kiloamps) in such a small package and a high impedance when not conducting ( $10^{10}$  ohms, 1 to 6.8 pF depending on model).

Siemens is the world's largest manufacturer of surge voltage

protectors. More engineers are using them every day. You can benefit by doing the same.

Siemens Corporation, 186 Wood Avenue South, Iselin, N.J., 08830.

(201) 494-1000.

Siemens. A three billion dollar name in quality products.



**SIEMENS**



# washington report

DON BYRNE, WASHINGTON BUREAU

## **DOD gets biggest single budget hike**

The biggest increase in the President's \$229.2-billion fiscal year 1972 budget comes in the Defense Department where the new obligational authority will climb, Congress willing, to \$77.662-billion. This is an increase of \$6.2-billion over the amount presented last year. Defense R&D programming will increase \$874.9-million to a total of \$7.888-billion. Of the R&D increase, the B-1 bomber, Underwater Long-Range Missile System, Awacs and Safeguard missile improvement will account for almost \$500-million.

Defense procurement, meanwhile, will increase almost \$2-million to \$19.7-billion. Shipbuilding will hit its highest level since 1963 as the budget earmarks \$3.3-billion for the coming fiscal year—an increase of \$1.5-billion over the current fiscal year.

Five more high-speed nuclear-attack submarines, one additional guided missile frigate and seven more antisubmarine destroyers are covered. In addition, the Navy plans continuing research on fitting its carriers to a dual attack-and-antisubmarine capability, on high-speed patrol boats with surface-to-surface missile capacity and on a new class of smaller, faster escort ships.

The Air Force will spend \$2.897-billion on aircraft procurement—a drop of \$456-million from last year, and \$1.944-billion on missile procurement, an increase of \$567-million reflecting increasing Minuteman procurement.

## **FAA budget reflects more dependence on user taxes**

The Federal Aviation Administration budget for the first time is now split into two parts: \$436.8-million in federal funds and \$1.558-billion in Airport and Airways Trust Fund money. This adds up to a total budget authorization of \$1.997-billion—a very slight increase over last year. Automation of the en route and terminal parts of the air-traffic control system will require \$146-million. An additional \$104-million will be needed for electronic equipment for the towers, and for radars and electronic landing systems. The Airways Research request of \$81-million includes \$65-million for improvements in automated air-traffic control equipment. In addition, FAA will ask for \$235-million for supersonic transport funding.

## **NASA requests stay pretty much the same**

The Administration is requesting new budget authority of \$3.27-billion for NASA. This is close to the \$3.29-billion it asked last year. Cash expenditures are expected to run about \$3.2-billion or approximately \$217-million less than last year. NASA pegged its R&D needs at \$2.517-billion compared to \$2.555-billion in FY 1971. Of that total, Manned Space Flight will take \$1.286-billion, down \$144-million from last year, due, primarily, to the prior announced cancellations of Apollos 18 and 19.

Space Science Applications will increase \$185-million to \$749-million; Space Technology will get \$104-million—a drop of \$60-million; Aircraft Technology will increase \$8-million to \$110-million; and Supporting Space Activities will drop \$26-million to \$286-million.

Aside from the Apollo curtailment, other R&D reductions were made in the Nerva nuclear rocket program and other projects. But the reductions were somewhat offset by increases in Skylab experiments, the start of the engine development for the space shuttle and development of the Viking unmanned Mars lander.

## **NSF gets more money and changes direction**

The National Science Foundation got a good shot in the arm from the new budget—together with directions to change course. The Administration recommended a 23% increase in funding up to \$622-million, but it directed the agency to move away from programs expanding general training and research and go into specific research on problems concerning pollution, health, transportation and urban environment.

## **New Congress may be less favorable to SST**

The recent Congressional elections may well have been the straw that broke the supersonic transport's back. Last year the SST money squeaked through the House by a 16-vote margin, and then the Senate forced the money to be isolated from the Department of Transportation pending another vote on the funding scheduled for late March. But there are now 56 new members of the House. Independent polls by one pro and one anti-SST Congressman show that the project has a net loss of 20 votes from a year ago, meaning sure defeat barring some position changes.

## **FCC concludes microwave carrier hearings**

Nearly four years of filings, argument, application and hearings before the Federal Communications Commission on the microwave common-carrier case are now at an end. The commission must now decide how many companies should be in the business, who they will be and under what ground rule they will play. At stake is an estimated annual \$2-billion data-transmission business. The likely outcome? Anybody's guess, say most observers, noting that there are three unknown new members of the commission sitting in the case. During the recent 9-hour marathon hearings, 31 participants said exactly what everybody expected them to say, while observers tried to no avail to determine the commission's feeling. As Commissioner Nicholas Johnson, a strong advocate of a practically unregulated competition, put it, the question seems to hang on whether the specialized carrier proposals will be "economically viable for anyone."

**Capital Capsules:** Action by two telephone companies in Indiana is causing a bit of a murmur here. Seems the two companies borrowed money from the Rural Electrification Administration at a very nice 2% interest rate and used the money to purchase central-office electronic equipment in Japan. REA borrowers have traditionally bought American. . . . The Department of Commerce's Bureau of International Commerce is seeking queries from U. S. electronic data processing equipment manufacturers interested in making a presentation at the upcoming **EDP fair in Paris, June 7-11.**



# new tektronix 7514 with write thru...

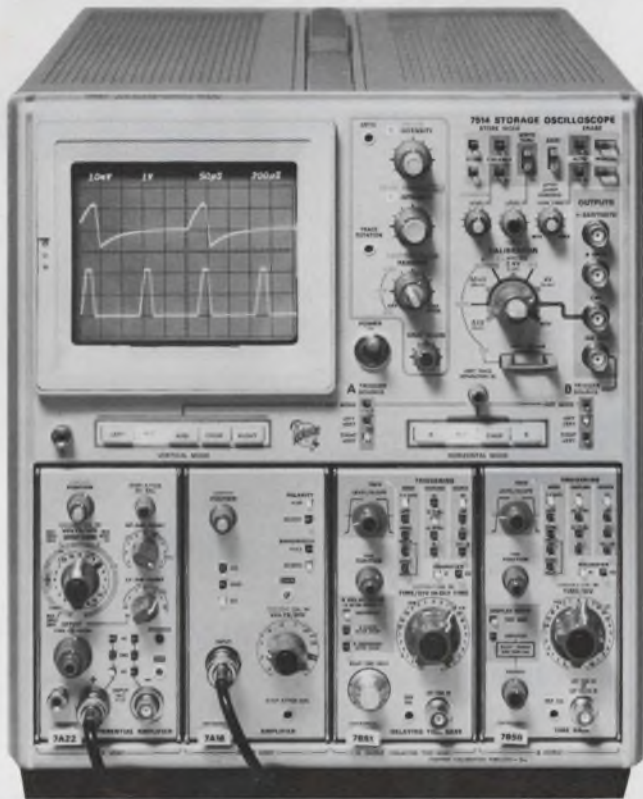

## a significant advance in storage oscilloscopes

**WRITE THRU** allows simultaneous stored and conventional displays in the same area of the CRT . . . ideal for precise comparison of waveforms. Store a waveform, switch to **WRITE THRU** and the stored waveform then becomes a reference for all subsequent ones. Storage oscilloscopes are frequently used in the non-store mode, but until now, their usefulness has been limited due to a lack of trace brightness. Not so with the 90-MHz 7514! The 7514 has a conventional writing speed of  $450 \text{ cm}/\mu\text{s}$ , faster than any other storage oscilloscope. Set the focus control only once, and a new **auto-focus** circuit will take over, so that additional manual focusing is not required with changes in intensity.

The NEW 7514 uses rugged, bistable, split-screen storage which has a **high-burn resistance**. An auto-erase system with variable viewing time allows automatic erasure of either half of the screen after pre-selected view time. The extensive use of push-button controls make the 7514 very **easy to use**.

Numerous plug-ins covering a wide performance spectrum are available, including the NEW 7D13 DIGITAL MULTIMETER, which measures voltage, current, resistance and temperature; and the NEW 7D14 500-MHz DIGITAL COUNTER. With vertical and horizontal mode switching in the mainframe, simultaneous measurements can be made by up to four plug-ins having widely different features.

For measurement ease, CRT Readout, which is exclusive to Tektronix, labels the CRT with time and frequency; volts, ohms, temperature (C), and amps; invert and uncal symbols.

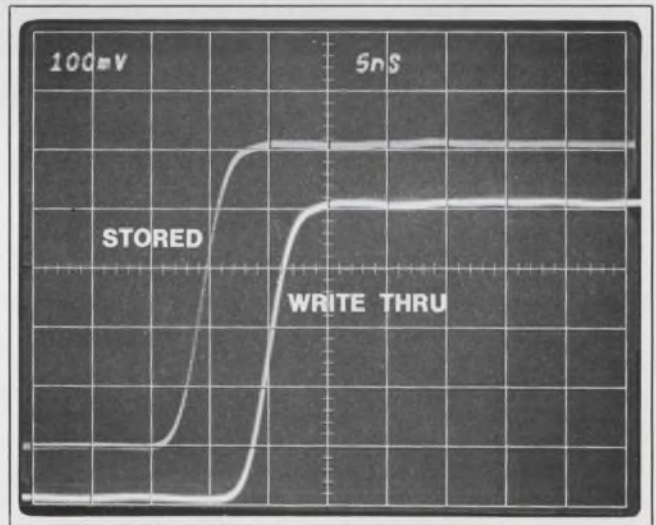

Call your nearby Tektronix field engineer for a demonstration. Prices of instruments shown: 7514 Storage Oscilloscope \$3200, 7A16 Amplifier \$600, 7A22 Differential \$500, 7B50 Time Base \$450, 7B51 Delaying Time Base \$510.

U.S. Sales Prices FOB Beaverton, Oregon

Available in U.S. through the Tektronix lease plan



### TEKTRONIX®

committed to  
technical excellence

INFORMATION RETRIEVAL NUMBER 33

# When it comes to regulator or a component made your choice

## LM 309.

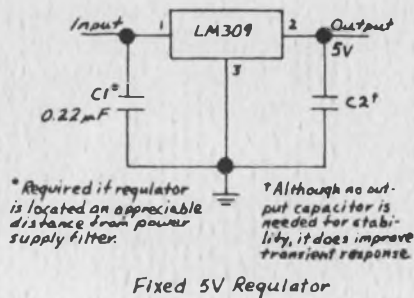

The easy-to-use LM 309 is a complete 5V regulator on a single silicon chip. Designed for local regulation on digital logic cards, the 309 neatly eliminates distribution problems caused by single-point regulation.

Significantly, no external components or adjustments are required.

But the real beauty of the LM 309 is the fact that you just plug it in and relax—knowing full well that it's *guaranteed* to limit incoming voltage transients so that the TTL (or DTL) circuits it drives will *always* work. (What comfort to know you've got a regulator that will—in the worst case—actually destroy itself to avoid damaging any of your more expensive digital circuits!)

Both the LM 309 and its military counterpart, the LM 109, are available off-the-shelf in two package configurations: a TO-5 which delivers output currents in excess of 200mA if adequate sinking is provided; and a TO-3, in which the available output current is greater than 1A.

Prices (100-999) are as follows: LM 109H \$20.00, LM 209H \$7.50, LM 309H \$5.50, LM 109K \$25.00, LM 209K \$8.95, LM 309K \$6.50.



# Selecting a voltage comparator, we've incredibly simple:

## LM 111.

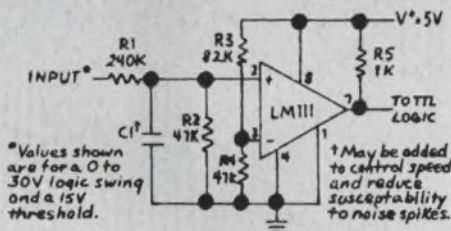

TTL Interface with High Level Logic

A plug-in replacement for both the LM 710 and LM 106, our new LM 111 voltage comparator has it all over its predecessors.

First of all, the LM 111 is very easy to use.

Then there's the "universal" voltage supply range. The LM 111 can operate from 5V and ground, or any combination of voltages from ground to  $\pm 15V$ .

Another big advantage is the 111's input impedance. It's so high, the resulting input current is a remarkable *one thousand times* lower than the 710's (250 nanoamps versus 25 microamps)!

Since we're dealing in superlatives, here's another: Gain with the LM 111 is 200,000, or *two hundred times better* than previously available.

Designed to drive RTL, DTL, TTL or MOS logic, the versatile LM 111 will also handle lamps or relays up to 50V at 50mA.

Finally, the entire LM 111 series (including the LM 211 and LM 311) is available off-the-shelf in TO-5, flat-pack or dual-in-line package configurations.

Prices (100-999) are very competitive.

For example: LM 111H \$12.00, LM 211H \$7.50, LM 311H \$3.25.

As usual, we've got all kinds of swell applications notes and other spec material on both these fine, easy to use devices. For your copies, write, phone, TWX or cable us today. National Semiconductor

Corporation, 2900 Semiconductor Drive, Santa Clara, California 95051. Phone (408) 732-5000. TWX: (910) 339-9240. Cable: NATSEMICON.

# National

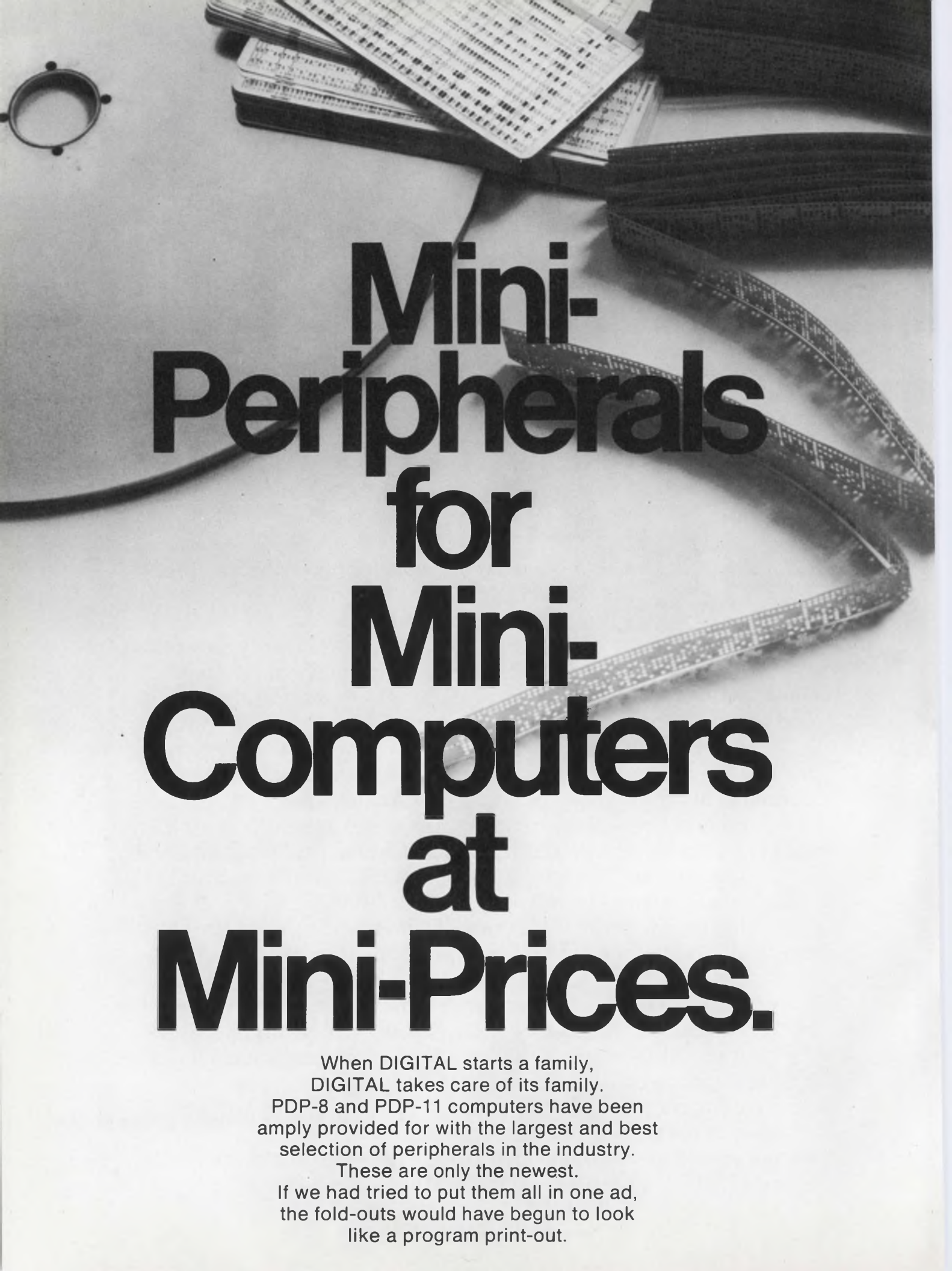

# Mini- Peripherals for Mini- Computers at Mini-Prices.

When DIGITAL starts a family,  
DIGITAL takes care of its family.  
PDP-8 and PDP-11 computers have been  
amply provided for with the largest and best  
selection of peripherals in the industry.

These are only the newest.  
If we had tried to put them all in one ad,  
the fold-outs would have begun to look  
like a program print-out.



Product

Specs

Processor

Typical Application

<b>DECwriter LA 30</b>	An impact printer that is faster, quieter, and more reliable than teleprinters. 30 cps printing speed. 64 character set, ASCII 1968. 96 or 128 character keyboard.	All PDPs	Any application where conventional teleprinters are used: local and remote data entry, interactive computation, data logging, etc.
<b>DECterminal VT 06</b>	A low-cost CRT and keyboard for direct computer input/output, telephone line transmit/receive. All interfaces built in. Full ASCII keyboard, 1800 character image area.	All PDPs	Interactive terminal applications where hard copy output is not needed: graphic display from mass storage files, text editing, on-line debugging.
<b>DECpack RK 02, 03</b>	A disk file with moving head under electronic control. Reliable and quiet operation. Capacity 10 million bits, with 80 ms average access. Compact and low cost. Interchangeable disk cartridge.	PDP-11, 8, 12	Convenient storage of programs and data files in installations where several people use same computer.
<b>DECprinter LP 08, 11, 12, 15</b>	A low-cost, high-speed line printer with 80 or 132 columns and 64 or 96 character sets. Basic speed of 356 lpm can be increased to 1100 lpm for a 20-column line. Up to six-part forms for multiple copies.	PDP-11, 8, 12, 15	High quality alphanumeric printout for business and scientific reports.
<b>DECmagtape TU 10</b>	This magnetic tape system is IBM-compatible at 45 ips speed, densities: 200, 556 and 800 BPI, and 7 or 9 channels. Vacuum columns and a simple mechanism make it extra reliable.	All PDPs	Low cost file and program storage, preparation of data for processing on other systems, backup for disk files.
<b>DECdisk RS 64</b>	A low-cost, fixed-head disk with nominal capacity of 64K 16-bit words, expandable to 256K words. Average access time 16 ms. Real-time look ahead capability and cyclic redundancy error check.	PDP-11	Monitor program residence. Data file storage.
<b>DECtape TU 56</b>	A simple, compact, highly reliable magnetic tape system of proprietary design. Pocket-sized reels contain $2 \times 10^6$ bits. Read, write, search, or update in forward or reverse direction at high speeds.	All PDPs	Reliable, high speed alternative to paper tape. Used for program & data file storage.
<b>DECscope VR 14</b>	A versatile, low-cost CRT display. Combines high speed and high resolution for graphic and alphanumeric display. Features easy-to-read 63 square inch screen.	All PDPs	Manuscript editing, source data entry, interactive computation, file scanning and updating.

More than 10,000 mini-computers delivered.

**digital**

Digital Equipment Corporation  
Maynard, Mass. 01754 (617) 897-5111

INFORMATION RETRIEVAL NUMBER 24

# The PDP-11 Family Grows On This month: COMTEX-11

## The greatest data communications software story ever told.

Start with this: the PDP-11 UNIBUS™ concept. UNIBUS is a natural system multiplexer with built-in hardware interrupt – ideal for multiple, asynchronous and synchronous communications lines, expandable by its very nature. Add the COMTEX-11 executive to schedule software interrupt service routines between or over hardware priorities. Already you have extraordinary communications handling power, but read on.

Next, the terminal applications packages – prepared and ready for many types of terminals, probably including the ones you're using. But COMTEX software is soft where it should be soft: you can add to the system by writing your own terminal applications packages, and when you do, you'll find that COMTEX-11 is transparent – no need to worry about timing problems, line protocol, and other such nuisances. Software and terminals can be mixed and matched, because all commands are device independent.

Which brings us to the interface controllers, choice of four. First is a 16-line, single speed multiplexer for low-cost data concentration. Second is a single-line, asynchronous interface with programmable character size and baud rate – ideal for service bureau-type systems. Third is a synchronous line interface for remote concentrating. Fourth is an automatic calling interface.

Combined with the unique and powerful architecture of the PDP-11, COMTEX-11 is ideal for store-and-forward message switching, source data collection, remote job entry, text editing, message concentrating, inventory control, and remote batching. In whatever application, its price/performance is unequalled.

Now that you've read the introduction, get the unabridged story. Next month still another member will join the PDP-11 family. Digital Equipment Corporation, Main Street, Maynard, Mass. 01754. (617) 897-5111.

**digital**

INFORMATION RETRIEVAL NUMBER 37





## Our industry reels – while unions get 17%

For over a year now we've been fighting inflation in the U. S. by controlling the money supply. The result, in the electronics industry and others, has been devastation, and we still have inflation. Isn't it time to consider what many feel is the overriding inflationary factor—the unreal demands of our trade unions?

The Federal Reserve Board last year shrank the money supply until the economy squeaked. The prime lending rate rose to 8-1/2%, and many companies were put through a terrible financial squeeze. Over the last year roughly 45,000 scientists and engineers lost their jobs, the electronics sales level in the U. S. dropped a full billion dollars from \$25.7-billion, 92 electronics firms went out of business and federal science support fell 25% from its 1965-68 level. Profit margins in the over-all economy dropped to an annual rate of 4.2%, the lowest since 1938. But the current rate of inflation is still at least 5% per year.

And while most of the corporations in the U. S. have faced some degree of liquidity crisis, the demands made by labor unions and the awards received by them have been nothing short of phenomenal. General Motors settled its dispute with the United Auto Workers by agreeing to wage increases totalling roughly 30% over three years, with an immediate 13% pay boost.

Gulf Oil Corp. recently agreed to pay its workers an 8.5% increase for the first year of their contract and 7.5% the second. And in the building trades, according to U. S. Labor Department figures, wage increases for the first year of a contract averaged 8% in 1968, 14% in 1969, and 17% in 1970. In many cases wages are expected to double within three years, and many skilled construction workers are expected to make \$20,000 per year by 1972. All of this during a time when the growth of productivity in the private economy has averaged only 1.6%/year—roughly one-half of its long-term trend.

Union wage rates are generally agreed to be a significant influence in settling wage scales for most of the workers in the U. S. If wage settlements go up at this rate, and productivity goes down, there is only one possible result: inflation.

The answer? Curb the power of the unions. Engineers in the electronics industry have suffered enough in this fight against the shrinking dollar. Let's insist to our Congressmen that our government fight inflation fairly, by attacking all of its significant sources—the excessive demands of organized labor included.

RAYMOND D. SPEER

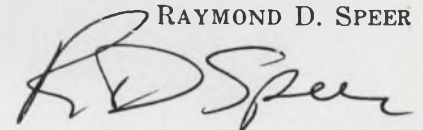

# We're putting our reputation on the line every time a Sorensen power supply goes into service.

## Maybe that's why we have such a great reputation.

Sorensen was the first commercial firm to manufacture and market precision electronic voltage regulators and power supplies.

Today we have the most extensive power supply line available from stock. Sixteen complete series, hundreds of individual models. Standard designs for almost any application. Custom designs for the rest. We have regulated and unregulated dc bench, rack, and modular supplies, dc high voltage and high power types, dc systems. DC isolated power supplies, dc/ac inverters, dc/dc and ac/ac converters. AC voltage regulators and line conditioners.

Our new plant is equipped to manufacture to any specification or standard. Everything is done in one plant, incoming material inspection to final equipment test, with rigidly controlled quality checking at each step.

Sorensen means built-in reliability assurance. Write for our complete catalog, with prices, today. Raytheon Company, Sorensen Power Supplies, 676 Island Pond Road, Manchester, N.H. 03103. Tel: (603) 668-1600.

**Sorensen**  
POWER SUPPLIES





## Electronics to curb a runaway crime rate

An Electronic Design Special Report

Crime in the United States is increasing faster today than ever before. The National Commission on the Causes and Prevention of Violence reports a 100% increase in violent crimes—homicide, forcible rape, robbery and aggravated assault—between 1958 and 1968. And the latest figures of the Federal Bureau of Investigation show that the trend is toward an even higher crime rate in the 70s.

# civionics

The nation's population increased 13% from 1960 to 1969, but the crime rate per 100,000 persons increased 120% in that time. Today, the average citizen's chance of being a victim of violence is double what it was 10 years ago.

If the number of policemen in the country were increased at the same rate as the current annual increase in crime rate (12%), the personnel needed for law enforcement would grow from 400,000 to an army of 1.2 million in 10 years.

Obviously part of the answer to combatting crime is to increase the effectiveness of police forces. The development of new electronic weapons for communication, identification and surveillance is a critical factor in achieving this end.

As the nation shifts its priorities from aerospace and defense to civionics—the area of electronics concerned with public needs—many companies have found that the technology once used to wage foreign wars can be applied to the national war on crime.

The main funnel for federal anticrime money is the Law Enforcement Assistance Administration, whose budget is expected to increase from \$480-million this year to \$1.75-billion in fiscal 1973. These funds will be supplemented by state and local law-enforcement agencies, which spent \$5.8-billion in 1970.

About one-third of this money will go for electronic equipment. And an even larger proportion of funds will be available for electronics once police personnel have been trained to use the hardware.

But money alone won't guarantee improved police efficiency. Better engineering of equipment is needed, too. And that's where design engineers enter the picture.



# New electronics joins national war on crime

by John N. Kessler, News Editor

Last summer in New York City the Police Dept.'s Safe, Loft and Truck Squad was nursing a bad case of frustration. A gang of thieves had committed 40 burglaries and netted \$1-million in a year; and many times, with apparent ease, they had escaped just as the police arrived.

The gang's method of operation was simple: They ignored the alarms they knew would be set off when they broke into an office or vault. Instead they worked extremely rapidly, carefully taking

into account the average time the police took to respond to an alarm. After cleaning out the portable valuables, they used the cover of darkness to escape by devious means, almost under the noses of panting police pursuers.

The police interrupted the sport one night by borrowing an electronic night-vision device called Owl Eye, manufactured by the Aerojet Delft Corp. of Azusa, Calif., and reported capable of intensifying light more than 24,000 times. Cruising the area favored

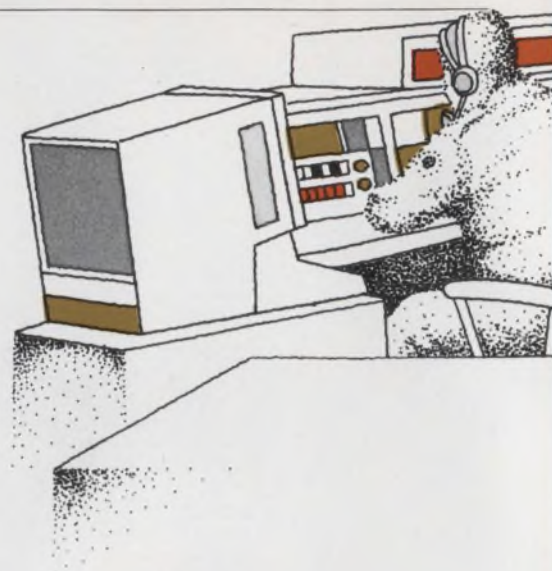

by the burglars, detectives of the Safe, Loft and Truck Squad responded faster than usual after the gang had triggered an alarm in a Manhattan jewelry office.

The thieves fled as detectives pounded up the stairs to the 18th-floor office, and they might have escaped without a hitch once more, but with the night-vision device, the police were able to observe their intricate escape maneuvers. Detectives seized one of the gang members as he dangled on a rope ladder over the side of a building, and they also recovered \$240,000 in loot.

Impressed with the effectiveness of the night-vision aid, the detectives asked the department to buy some at \$7500 apiece. About a dozen were ordered.

The market for police radios is about \$10-million a year and growing fast.

## Speech scramblers for security

Elsewhere in the United States comparable cases of police frustration and success are being enacted daily in the war between lawmen and criminals. In virtually every major city, for example, it's become common practice for many thieves to carry special radio receivers with them while they work; they monitor the police frequencies, and they get advance notice if they have been detected and radio patrol cars are on the way. More advanced police departments have begun to strike back with speech scramblers, so their radio messages are unintelligible to unauthorized listeners. But a major problem is getting a good electronic scrambler at relatively low cost.

Facts like these point to a grow-



SUDDUTH



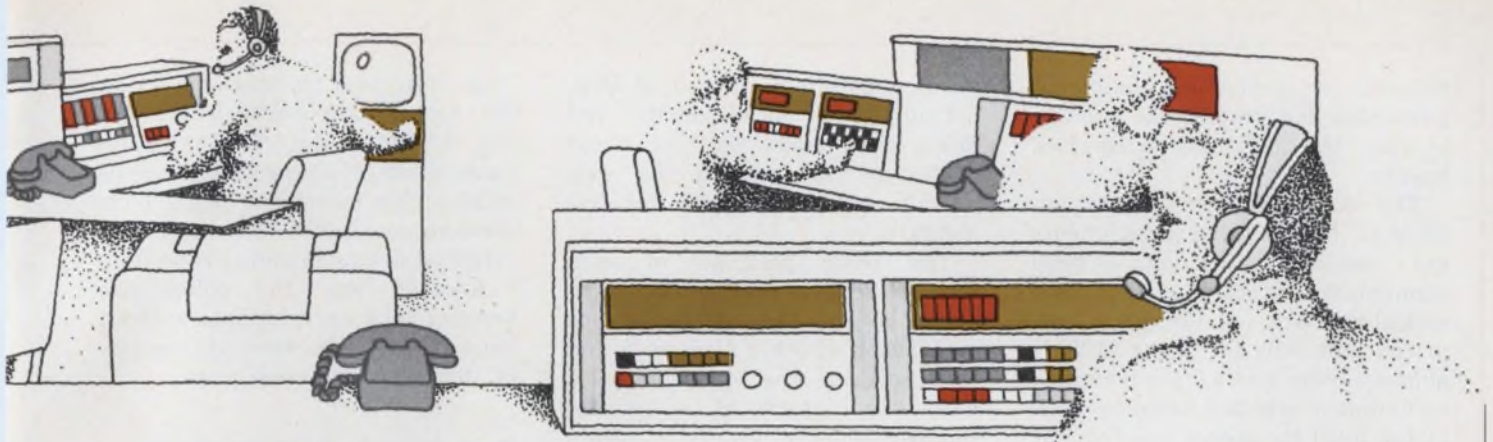

**Computer-based command and control centers** can link the cop on the beat to state and national data banks in seconds.

ing trend in crime-fighting in this country: The techniques of criminals are becoming more slick, and the police, like the military, are turning to improved electronic aids to outfox the enemy.

Robert F. Beebe, Director of GTE Sylvania's Sociosystems Laboratory, Mountain View, Calif., told *ELECTRONIC DESIGN* that law-enforcement agencies have created a \$100-million annual business in new electronic equipment and that demand "could increase fivefold in the next five years." Beebe's estimate is based on a study of planning criteria from federal, state and local sources.

In its first fiscal year, 1969, the Federal Law Enforcement Assistance Administration had a budget of \$63-million. Last year it received \$268-million; for fiscal 1971, the proposed authorization is \$480-million. By 1972 an LEAA spokesman said this figure will reach \$1.15 billion, rising again in 1973 to \$1.75 billion.

Nearly all of the agency's budget goes for action and planning grants to states. This is generally on a 75% (federal) 25% (state) basis.

Communications and information-retrieval hardware make up the biggest chunk of equipment in the anticrime electronics market. The hardware includes—besides such sophisticated devices as light intensifiers and voice scramblers—the following:

- Audio surveillance devices.
- Helicopter-borne TV.
- Automatic vehicle monitors.
- Miniature walkie-talkies.
- Improved two-way car radios.
- Digital terminals for cars.

#### ■ Mobile teleprinters.

To compete effectively in the law-enforcement market of the 1970s, electronics companies need new marketing approaches and new designs to meet the special requirements of the police. Basically this means advances in traditional areas: lighter, smaller, more reliable and cheaper designs. Compatibility, ruggedness and low power are also sought by the police.

#### War equipment declassified

In 1969 some of the components used in night surveillance in Vietnam were declassified by the military, and night-vision devices became available for police and commercial applications. The devices include infrared detectors and low-light-level TV.

Infrared systems, while less expensive, require IR illumination—often IR searchlights that, while invisible to the eye, require additional power and can be "seen" by anyone with a simple IR detector. For police work low-light-level TV seems more useful in the long run.

Sylvania's Electronic Systems Div. in Mountain View, Calif., has developed a low-light-level TV camera that, it reports, "can easily detect and record a man one-half mile away, even in extreme darkness." The camera is 20 by 7 by 9 inches and weighs 25 pounds. The low-light-level performance ranges from  $1 \times 10^{-4}$  foot candles in starlight to  $1 \times 10^4$  in daylight.

Motorola, Inc., Schaumburg, Ill., makes a low-light-level TV camera in which the image-intensifier tube

is bonded to the fiber optics faceplates of the vidicon tube. The company says this significantly improves camera reliability by providing protection of the vidicon in high-illumination situations. The camera is about the same size as Sylvania's and weighs about 36 pounds.

Aerojet Delft's Owl Eye consists of three image-intensifier tubes stacked horizontally. The unit looks like a megaphone, with telephoto lenses attached to the front. Images are viewed directly on a magnifying display tube.

According to the company's vice president, Peter F. LeFort, "You can use Owl Eye with a telephoto lens to read a license plate 10 city blocks away." Its resolution, he says, is equivalent to 10 times that of conventional TV raster scans. The unit is portable, weighing 12 pounds, and it uses only three flashlight batteries for power.

"When an officer shines a spotlight down an alley at night, he's a sitting duck," LeFort says. "With a unit like Owl Eye, he'll be able to watch a criminal without being observed."

In the next two or three years, the Aerojet Delft official predicts, night-vision devices will be used in nearly all of the country's 172,000 police cars.

The \$7500 price for Owl Eye, he says, "will come down as the volume increases and the technology improves."

Speech scramblers are being used increasingly in civilian applications, and law-enforcement agencies consider it essential that a manu-



facturer of scrambling equipment guarantee not to sell his product to any but officially authorized buyers.

The major problem with scramblers so far as police departments are concerned, is cost: Cheap scramblers are not good, and good scramblers are not cheap. A low-priced unit sells for about \$125. It almost always uses a voice-inversion technique in which a balanced modulator folds the speech spectrum at the center frequency and speech sounds are interchanged, so that the highest frequency components are transmitted as the lowest components and vice versa. Because the design is so simple, Charles F. Teacher, an engineer at Philco-Ford, Willow Grove, Pa., says, "It is doubtful whether such a device offers as much as one minute of privacy to a prospective user."

Scramblers that use digital techniques rather than voice inversion, insure relatively complete secrecy, but they cost close to \$3000 apiece. It is expected that production of such units in quantities of a hun-

dred or more, plus the use of MSI, hybrid-circuit developments and MOS, will reduce costs to about \$1000 as well as cut the size, weight and power-drain requirements.

The basic principle of such scramblers is to digitize the transmitted information with pulse-code modulation or other techniques and then combine the wanted signals with the output of a pseudo-random-sequence generator. Since pseudo-random signals have essentially the same frequency spectrum as Gaussian noise, the combined signals will be uninterpretable to any receiver that doesn't have a pseudo-random-generator decoding unit.

A serious problem with digital transmission of scrambled information is fading caused by multipath problems. Even if a few bits of information are lost in delays caused by multipath interference, signals can be readily lost. Philco-Ford's Teacher says it is "unlikely" that digital information can be transmitted at 10 kilobits/second

—the minimum transmission speed for speech data—without modifying vhf-FM radios. This is essentially a bandwidth problem, complicated by the movement of a vehicle through multipaths that cause differential delays in signal reception.

Another way the police are keeping tabs on criminals without being observed is through the use of improved electronic bugs.

### Bugs to pick up whispers

"A typical unsophisticated bug," says Ralph Herrlin, president of Microcomm Industries Corp., Clearwater, Fla., "might be a 2-by-1/2-by-3/10-inch package able to transmit a signal two or three blocks in a downtown area."

Herrlin, whose company makes listening devices and audio countermeasure devices for police and government agencies, says that such a device could pick-up "a whisper across a room." A voice-activated switch can be built into bugs so they turn on automatically when the voices in the room reach a certain level. This holds current drain to a minimum.

There are sophisticated, very-narrowband (1-kHz deviation) de-

**To get a message when he is away from his car, a patrolman needs devices like mobile teleprinters.**

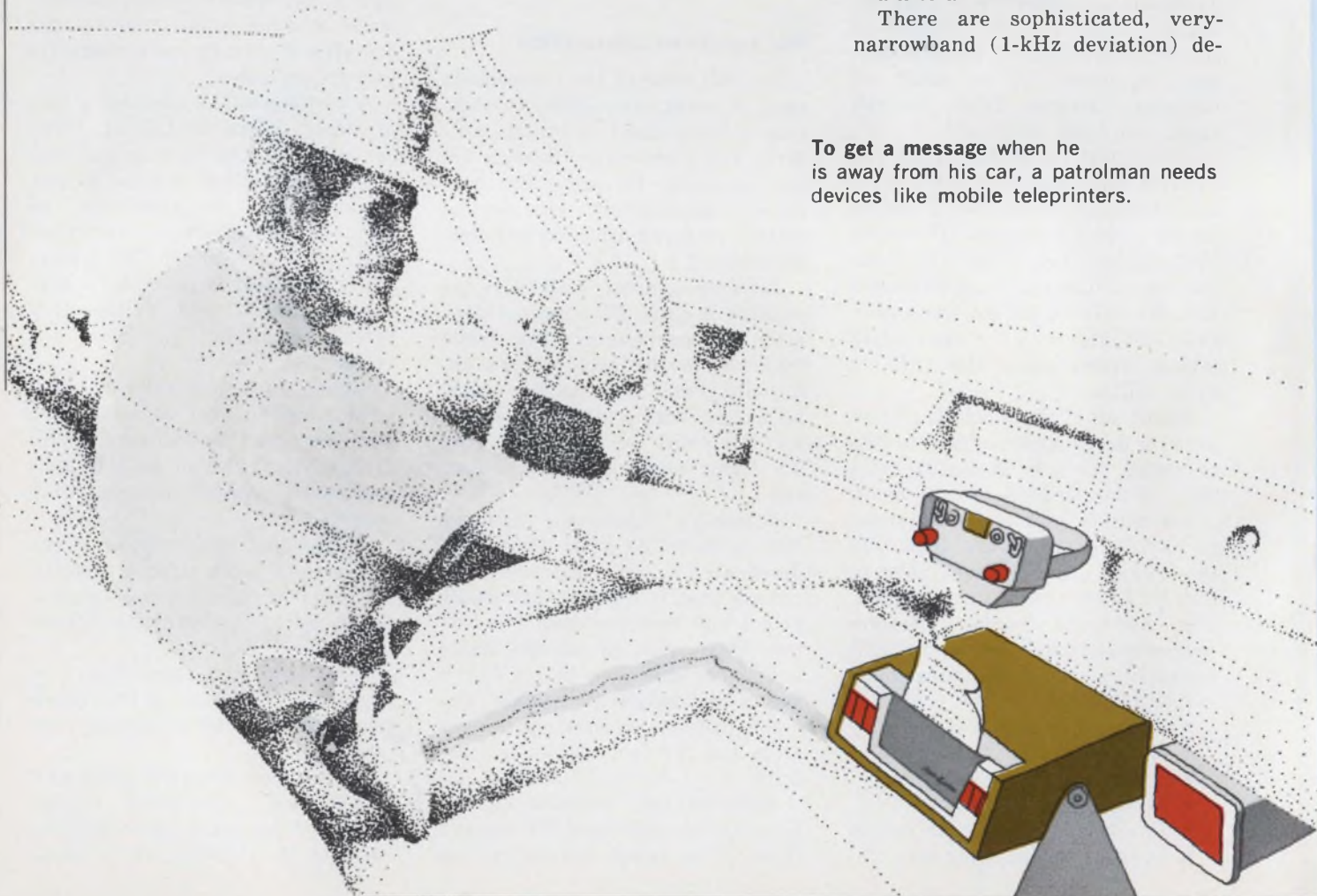



vices that require special receivers to detect. And there are devices that spread out their transmissions over many megacycles. Both types are difficult to detect because the signal tends to be lost in the surrounding noise.

Then there are frequency-hop devices that emit a tiny bit of intelligence at one frequency, then skip to another. Unless one had many receivers, all tuned sequentially to the proper frequency and able to recombine the information, it would be impossible to detect such a listening device without a decoder.

But Herrlin stresses that the big need in law-enforcement agencies is for simple, cheap, reliable devices that will do the job with the customer's receiving equipment.

The helicopter is hardly a new aircraft, but police departments in major cities are only now "discovering" the value of the chopper as a routine patrol vehicle. In civil riot situations, or even traffic jams, the helicopter can be used as an observation platform in the sky, but there is a big need for a good airborne TV system.

### Copter TV poses problems

"When the Los Angeles Police Dept. released specifications for an airborne closed-circuit TV system, only one company responded, and they suggested a tailor-made product that would only go in one aircraft," says Charles A. Holt, staff adviser for engineering with the Los Angeles Police.

"Prior to that, there were 15 companies saying that they were positive they understood our requirements and could solve our problems for much less money. The end result was they created chaos.

"One company, for instance, wanted to provide a planar triode [in the transmitter] with 50 W of output to go into a helicopter, not realizing we're flying a G-4A helicopter. Well, to put a planar triode in a helicopter together with the associated power supply to deliver 50 W of power would require a

helicopter to carry the power supply."

Holt arranged with the funding agency, the Law Enforcement Assistance Administration, to get permission to negotiate with the contractor to make the airborne TV system compatible with more than one aircraft. "Now we have a package that will snap into any one of our three aircraft," he says.

Microwave Associates of Burlington, Mass., developed this system. The Federal Communications Commission would not permit operation at more than 12-W transmitted power because of interference probability. This low-power requirement dictated the antenna design. Multipath was a problem, and an elaborate receiver had to be developed. Microwave Associates' airborne TV system operates at 2.475 GHz and 2.492 GHz.

According to Holt, "The lower the frequency on a helicopter, the better off you are." With higher frequencies, there is more multipath interference and greater free-space attenuation. Vibration can also be a problem. "When we tried 12 GHz," says Holt, "the rotor modulated the signal."

Omnidirectional antennas on the helicopter provide complete flight

flexibility. Holt recalls: "One of the manufacturers said, 'We'll put a vertical directional antenna on the helicopter.' But how do you transmit to two points simultaneously with a directional antenna?"

The over-all dimensions of the Microwave Associates transmitter are: 2.5 inches high, 5 inches wide, 8 inches deep. The system includes a telephoto zoom lens and a TV camera for swivel-mounted or hand-held operation. The cost of the system ranges from \$75,000 to \$200,000, depending on the complexity of the ground receiving stations.

Some of the most highly refined electronic equipment for police departments of tomorrow will be automatic techniques for locating patrol cars.

Hazeltine Corp. of Little Neck, N.Y., appears to be closest to actual development of an automatic vehicle-monitoring system. It says its system will be "the most accurate" available. In 274 location tests in New York City last year, only one error was greater than 500 feet, the company reports. About 95 per cent of the time a stationary vehicle was located within 300 feet. Hazeltine says the system will work equally

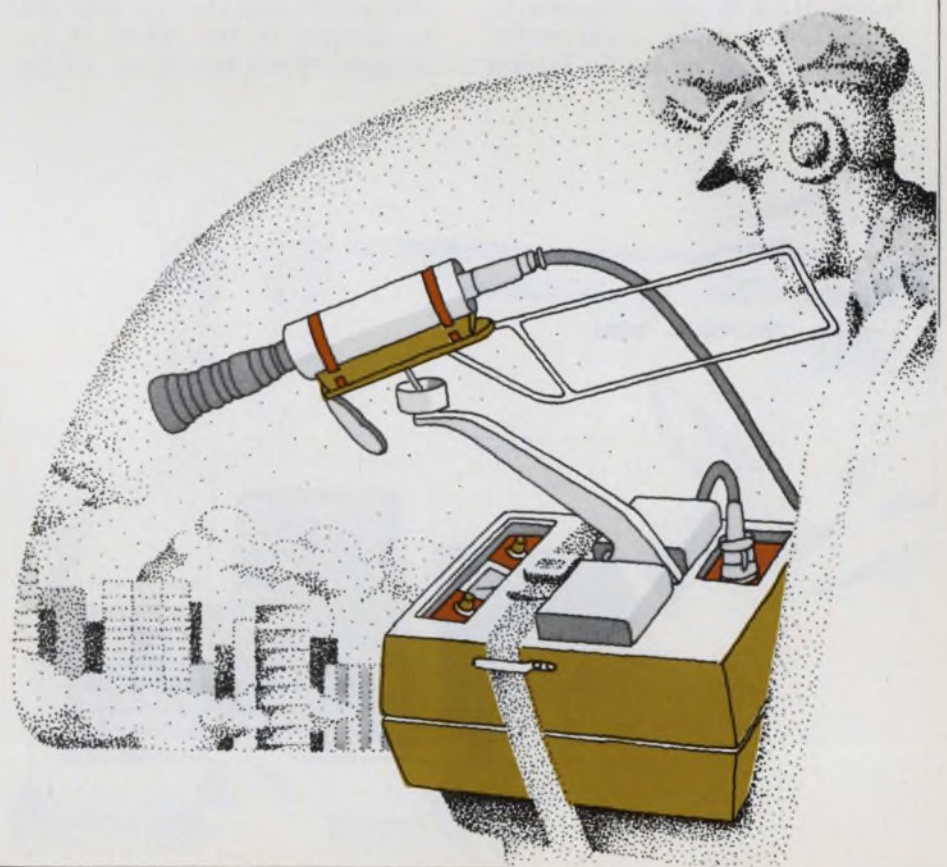

**Pictures transmitted** to a command center via a helicopter-borne TV can be used to direct field operations in case of riots.



accurately with moving vehicles.

The Hazeltine system uses a transponder in each vehicle. The transponders are arranged so that a received signal triggers a short signal pulse train. In conventional radar systems, the time it takes for the transponder to reply is a measure of distance from the interrogation point, with azimuth determined by the direction of the interrogator antenna.

But to deal with multipath problems, the Hazeltine system uses fixed receiving stations throughout the area being monitored. A vehicle's position is determined by the intersection of hyperbolas formed by signals from the car's transponder to two pairs of fixed stations. Information from these stations is sent to a central processor, where time-of-arrival differences are calculated and the car's position determined. A complete roll call of 5000 vehicles takes five seconds.

The reply of the vehicle transponder is a coded pulse train. Part of this signal is used to obtain a location fix; the rest can be varied by the patrolman in the car to indicate the operational status of the patrol or any need for emergency assistance. Thus the Hazeltine system incorporates both techniques for locating vehicles and transmitting routine messages by digital coding. With slight modifications, the system can be adapted

to two-way digital communication.

A problem with any pulse system is the need for a wide band of frequencies—5 to 10 MHz. Jerome Zauderer, Hazeltine's product line manager, points out, however, that the FCC has not yet made rules for automatic vehicle-monitoring systems. "When they do," he says, "we think the frequency allocations should be outside the voice bands."

The cost of Hazeltines' automatic vehicle locating system is estimated at \$1000 a vehicle, with about \$1-million needed for computer and peripheral equipment. "We will have hardware ready for production by the end of this month," Zauderer reports.

GTE Sylvania's Sociosystems Laboratory in Mountain View, Calif., has developed the Digimap 100 vehicle-location system, which operates directly from the company's Digicom terminal in a patrol car. The location unit consists of a pressure-sensitive map that transmits coordinate data from the patrol car to a dispatching center. To indicate his position, a policeman simply presses his finger at the point on the map where he happens to be, and in less than a second his position is displayed on a map at the command and control console.

Each vehicle carries a map of its own patrol area, but the map can be changed if the vehicle is re-assigned. While this is not a fully

automatic system, it is available immediately.

One of the most critical needs in routine police work is for a stationhouse to be in touch with every patrolman at all times.

"To do this," says Deputy Inspector Anthony Bouza of the New York City Police Dept., "the top priority is to equip all 4500 foot patrolmen in New York with walkie-talkies."

Size, weight and cost are the three chief design considerations. Better antennas are also needed.

"What we started out with," says Inspector Bouza, "was an electronic brick—it was a walkie-talkie that weighed more than two pounds."

To a foot patrolman, Bouza emphasizes, a 1/3 reduction in weight is important.

Motorola makes a range of "Handie-Talkie" FM radios that operate at 154 to 159 MHz and at uhf with multiple-frequency capability (up to six frequencies). These units weigh about 21 ounces and use integrated circuits and high-density design to cut weight and increase reliability.

### Power supply vs frequency

The major design tradeoffs in developing a satisfactory portable transceiver are power supply and frequency. To increase the range, the power supply must be bigger and heavier, and this is highly undesirable. Little test data is available on frequency propagation in areas of large buildings, but early studies by Bell Telephone Laboratories, Murray Hill, N.J., have shown much less interference at 960 MHz than in the traditional 450-MHz band when equipment is operated within buildings.

If you ask police agencies what can be done to improve walkie-talkies, they'll tell you the biggest need is to cut the cost to between \$100 and \$150. The average walkie-talkie made for police work today costs about \$700.

**Digital terminals linking police to computers can be used to obtain stolen-vehicle, gun-registration and fingerprint data.**

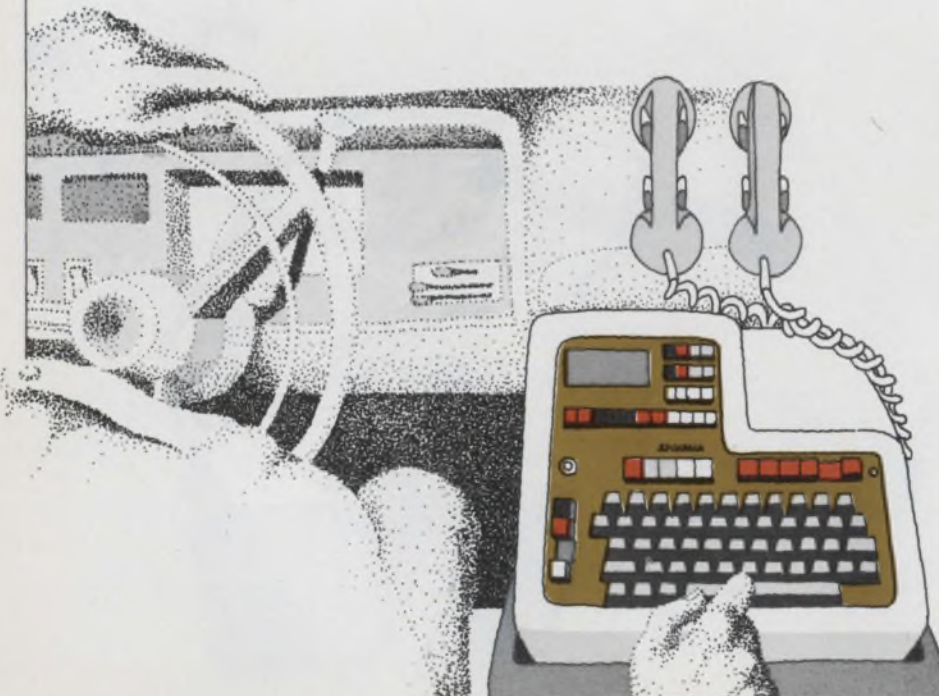



Most transceivers have collapsible whip antennas that must be pulled out, and the radio must be held away from the body when in use. This is awkward to do in emergencies, and while shirt-sleeve, trouser-leg and earphone-cord antennas have been designed, they tend to be inefficient because of rf loss resulting from the shadowing by the body. At higher frequencies (above 450 MHz) such losses are reduced.

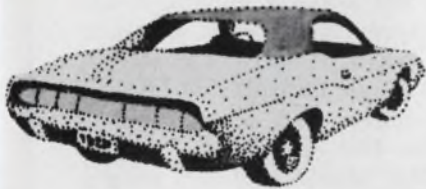

The National Institute of Law Enforcement and Criminal Justice is working with Air Force in the development of a new transceiver. It is expected that the Air Force will award contracts for the design, fabrication and testing of six prototypes early this year. The specifications are as follows:

Rf power output .....	2 W
Audio power output .....	75 mW
Transmitter efficiency of power consumption .....	50%
Battery weight .....	1/3 lb
Total weight .....	3/4 lb
Cost per unit (in quantity) .....	\$100-\$150

### Redesigning car radios

The car radio has been part of routine police work for so long that there's a tendency among designers to discount any opportunities to improve it. The cost of the average patrol-car transceiver varies from less than \$500 for Motorola's MOLOM 35 (which provides 8 W output at 154 to 159 MHz) to the \$700 to \$1000 price that is typical for most 100-W radios operating at 37 to 46 MHz. Most radios supplied by major manufacturers are completely solid-state, with increasing use of monolithic ICs. These units require no power supply other than the car battery. The radios are small, lightweight and rugged.

There have been proposals for detachable car radios that a patrolman can take with him when he leaves the car. But there are serious

disadvantages to this approach:

- Even a solid-state set would be cumbersome.
- Without the final amplifier to transmit to the dispatcher, the unit would have low power.
- The frequency for operation within buildings would not be optimum for car transceiver operation.
- A simple, short-range signal for distress calls could be developed to operate off a car radio, but a patrolman could not describe his situation or position or know that his call had been received.

Dual front-end receivers for car radios have not been designed for police agencies, but this approach could be helpful, especially in rural areas, where there is more of a need to maintain contact through the use of two channels. These would in effect, be two to four receivers in one housing, with the operator able to select one of two channels in each receiver. A search-lock mode could be helpful to listen in automatically on each frequency at a high repetition rate and to lock onto a frequency when a signal is transmitted.

As for designing a better radio network for the police, the limiting factor is not equipment but frequency congestion: too many cars, too many calls, not enough uninterrupted air time. This is why systems design can have a critical effect on whether or not a policeman in the field gets through to a dispatcher without delay.

Dr. Peter Kelly, president of Kelly Scientific, Inc., in Washing-

ton, D.C., which specializes in the design of command and control systems for law-enforcement agencies, says: "Twenty to 35 cars on a channel is an adequate load. The FCC allows 50 to 60. We keep it below that to allow for growth and for accommodating new devices, such as teletypewriters in the car."

Frequency problems vary with geography. In urban areas, the police don't need common channels with neighboring police agencies. This means that big cities could use vhf channels (TV channels 2 through 13), but only if they were not used for television. In most metropolitan areas, the available TV spectrum can provide about 300 additional channels.

But, as Kelly puts it: "In state police organizations that require large area coverage, the tendency is to stay in low band (30 to 40 MHz). (The tradeoffs are traditional: few lowband stations with wide ranges in rural areas vs many uhf stations with short range in urban areas.) There are a limited number of state police bands in lowband, and they can interfere with one another—all the way from Maine to Texas, says Kelly.

### Communications by the numbers

"Digital communication," says New York's Inspector Bouza, "is definitely the way to go."

While digital systems won't replace voice communications entirely, they will:

- Reduce rf congestion.

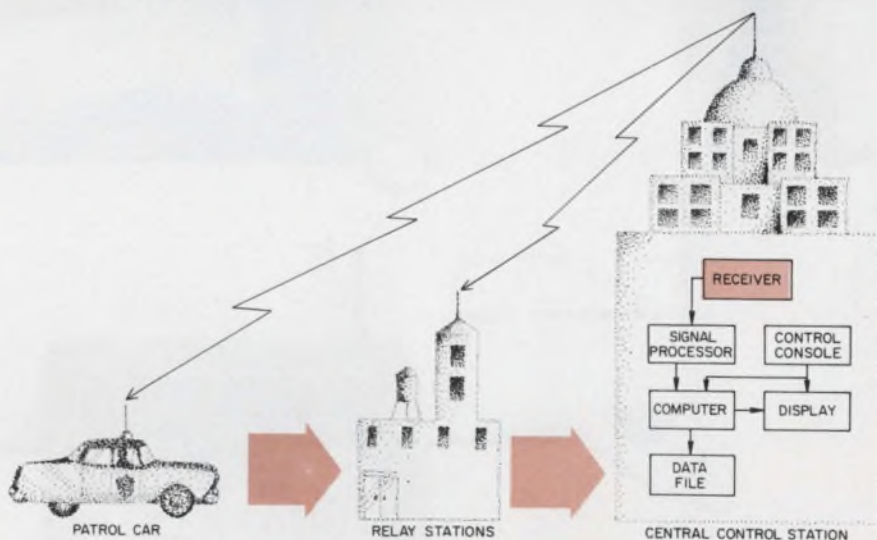

To locate a police car, signals from a central station trigger a pulse train from a transponder in each vehicle. This signal goes to relay stations and then to a computer that calculates time-of-arrival differences.



- Promote security.
- Create a written record.
- Eliminate phonetic errors.
- Permit reception at unattended vehicles (without special recording equipment).

Jona Cohn, director of research and engineering in Motorola's Communication Div., suggests that automatic vehicle identification with a digital system would enable a dispatcher to know as soon as he received a call who the caller was. This could be done by adding a signal at the beginning of a message, Cohn says.

Or a status-reporting system, Cohn says, could be operated by a patrolman throwing a switch in his car. A dispatcher would be able to check the status of all cars ("on assignment," "off duty," "out of vehicle") by a routine interrogation system. The cost of adding this to a car radio would be "modest," according to Cohn.

Sylvania's Digicom system is a two-way digital link that consists of a small alphanumeric keyboard in a patrol car that can access a computer directly. In this way a

patrolman can transmit his location, transmit and receive license plate and other information. (See "Stamping Out Crime by the Numbers," ED 8, April 12, 1970, p. 28). The cost of the car unit is about \$2300. Sylvania is also developing a small car-borne CRT display for its Digicom system.

RCA has also demonstrated a police digital data link that can be used for automatic identification, transmission of canned messages for typical functions, selective addressing from a dispatcher, disabling the ignition of stolen police cars by a dispatcher, computer pick-ups and other functions. The equipment operates off the patrol car radio channel and car battery.

There is no doubt about the desirability of receiving written messages, especially when a patrolman is away from his car.

"The problem with teleprinters," says Inspector Bouza, "is that most of them don't have 'send' capability, and when they do, the cost is very high."

For this reason, Bouza favors the Digicom type of unit.

Receive-only teleprinters cost \$1000 to \$2000, and, according to industry experts, two-way units would cost \$3000 to \$6000 a car. They all operate from the car's radio.

Motorola's VP-100 mobile teleprinter prints at the rate of 100 words per minute. It uses a 5 x 7 dot matrix to print characters, weighs 11 pounds and is about 4 inches high, 9 inches deep and 10 inches wide.

Xerox has also entered the market with its Mobile Printer that prints 280 words a minute. It fits conveniently in the front seat next to the driver; it operates unattended and can be incorporated into existing networks. A printed line is viewable 12.5 seconds after printing. The Mobile Printer weighs 16 pounds. It operates in the range of 1032 to 3032 Hz. The cost is about \$1100 for a mobile unit and \$6500 for a central translator at a command post. Equipment can also be rented for a six-month period. The car units rent for \$55 a month; the station console for \$250. ■■

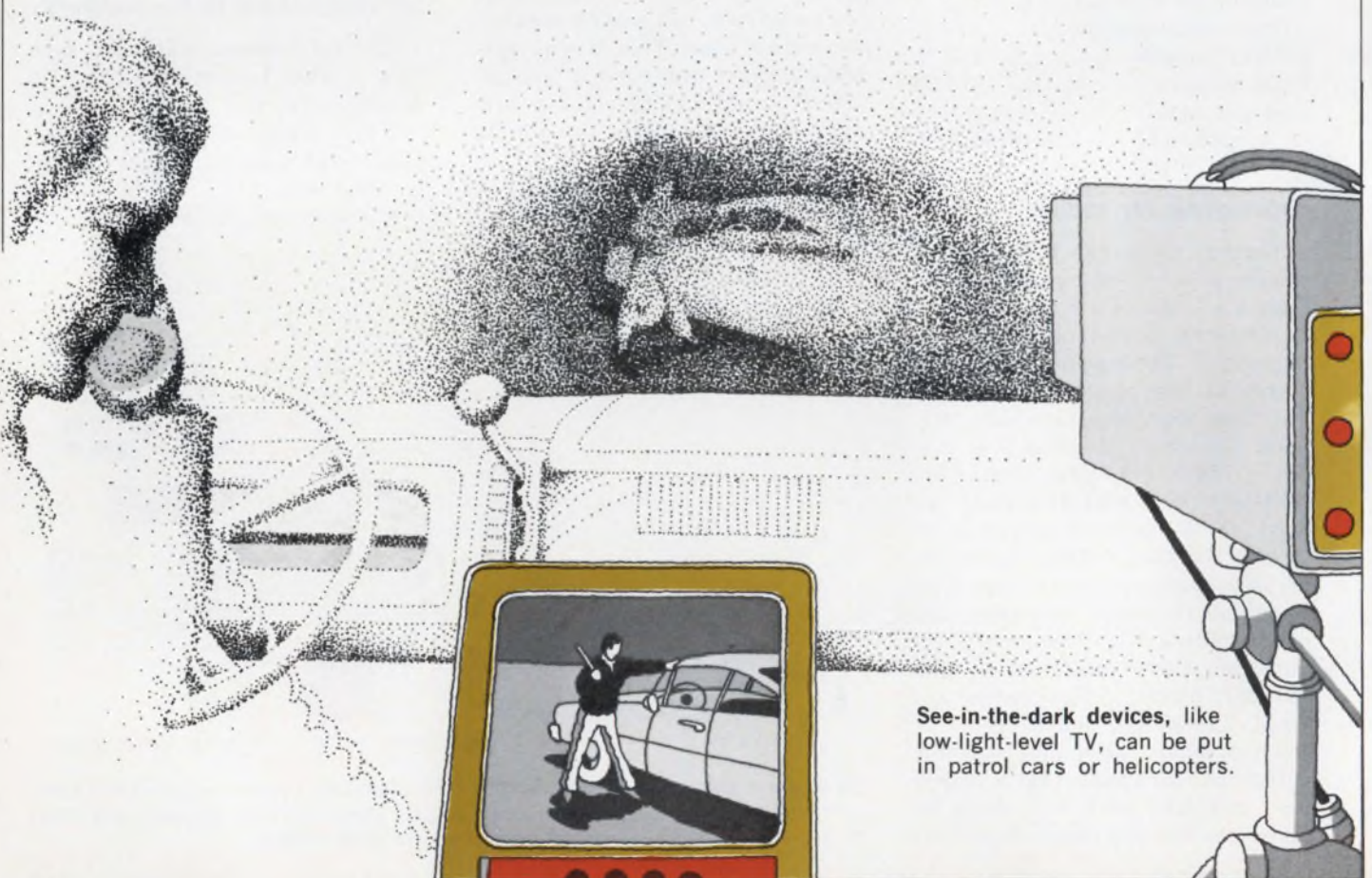

See-in-the-dark devices, like low-light-level TV, can be put in patrol cars or helicopters.



INDIANA GENERAL  
ELECTRONIC PRODUCTS

# Ferrite Components for Digital Circuits

Pulse Transformers  
Recording Head Ferrites  
Keyboards  
Read-Only Memories  
Modems  
Displays

## Get the inside free.

Ferrite components used in digital circuits often require specialized materials, shapes, and testing procedures. Indiana General engineers have pioneered the development of ferrites for digital applications and we have prepared this twelve page publication to assist you in applying ferrite technology to your digital circuit requirements.

If your design problems concern data in pulse form, this survey of the latest ferrite components and their application will give you a quick look at the state of the art in ferrite technology. And our engineers are always ready to work with you in finding solutions to your specific design needs.

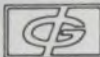
**indiana general** 

ELECTRONIC PRODUCTS • Crows Mill Road • Keasbey, N.J. 08832

Gentlemen: Please send me Ferrite Components for Digital Circuits

Name \_\_\_\_\_

Title \_\_\_\_\_

Company \_\_\_\_\_

Address \_\_\_\_\_

City \_\_\_\_\_

State \_\_\_\_\_

Zip \_\_\_\_\_



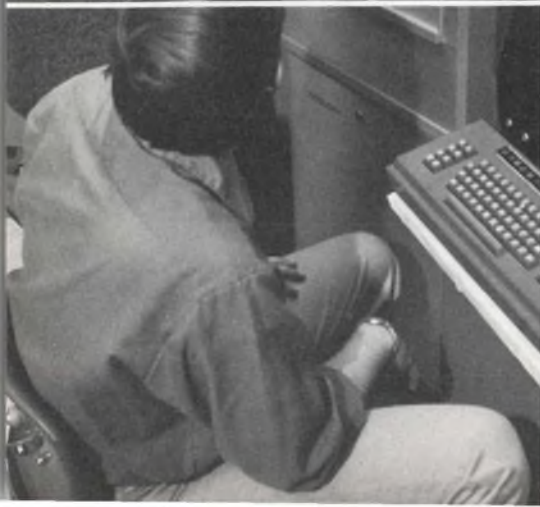
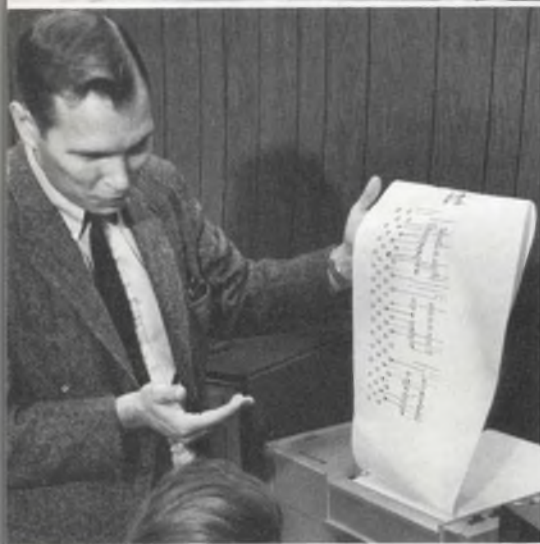
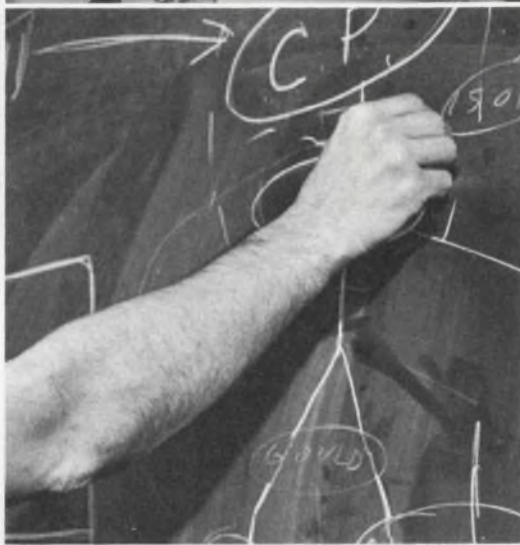
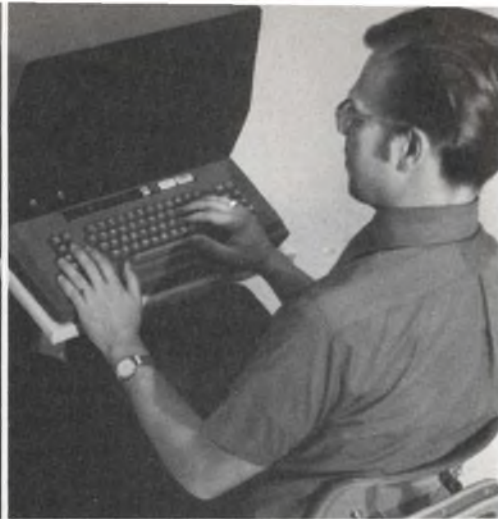



# Software systems firm slashes printout costs, compresses production schedules with Gould 4800.

Automation Technology Inc. is a specialty software systems house in Champaign, Illinois. One of their many capabilities is the design and production of the precision artwork used for making printed circuit boards. To help meet the rapidly growing demand for increasingly complex and compact circuitry, ATI uses a Gould 4800 electrostatic printer/plotter. Art Carroll, ATI's President, provides the details:

"One of the key steps in our operation is the validation of our circuitry designs. This is done with our design automation system and requires several iterations to arrive at the optimum combination of component placement, circuit paths, interconnections and drilling patterns. Before we had the Gould 4800, we had to go to our photoplotter for these iterations. This was both costly and slow as photoplotter time runs about \$75 an hour and one iteration may take hours to produce.

"The Gould 4800 gives us both alphanumerics and graphics for pennies per page. And lets us pinpoint defective inputs and make corrections as we go.

This way, we don't have to use the photoplotter until we're ready for the production master.

"As our circuit designs grow more complex, the Gould 4800 becomes even more valuable. At the rate of 100 sq. in. per sec., it furnishes a graphic printout that superimposes the wiring patterns for several layers of a multi-layer circuit. It also provides our alphanumeric "fail" list that gives us complete details on connections not successfully completed. This permits early manual intervention.

"This sort of speed, combined with its versatility, quietness and reliability, makes the Gould 4800 ideal for our operation. Without question, it's our key piece of peripheral equipment."

All kinds of companies with all kinds of hardcopy requirements have found the Gould 4800 to be an optimum solution. This smooth, quiet electrostatic printer delivers up to 4800 lines per minute on an 8½" or 11" format. It has an optional character generator. Software and interfaces for major computers are available. And while the Gould 4800 has relatively few moving parts and little need for maintenance, there are service facilities nationwide.

**Find out what the Gould 4800 can do for you.** Give us a call. Or write: Graphics Division, Gould Inc., 3631 Perkins Avenue, Cleveland, Ohio 44114.





# Use RGB for color TV.

The red-green-blue circuit is cheaper than the color-difference type, and care in design can prevent chroma cross-coupling and fringing.

An important change is taking place in the design of color-television sets: The color-difference (CD) type of video output circuit is very likely to be replaced by the red-green-blue (RGB) type.

What are the advantages of the RGB circuit? And why hasn't the change come sooner?

The primary advantage of the RGB circuit is that it eliminates the relatively expensive luminance-output stage of the CD circuit. The RGB circuit hasn't come into widespread use yet because the earliest designs for solid-state color TVs were merely transistorized copies of tube-type receivers. It is only recently that designers have come to realize that the best design for a vacuum-tube receiver is not necessarily best when transistors are used.

## How does the RGB circuit work?

To fully appreciate the advantages of RGB, it is helpful to briefly review the operation of the CD circuit.

In the CD approach (Fig. 1), a single wide-band (about 3 MHz) luminance (Y) amplifier drives all three cathodes of the three-gun aperture-mask picture tube. Color-difference signals—Y-R, Y-G and Y-B—are coupled to the three grids by the three color-difference amplifiers. These are much simpler than the luminance amplifier and have bandwidths of about 600 kHz.

Matrixing of the signal—that is, recombining the luminance signal with the color-difference signal to obtain the desired R, G and B modulation of electron-beam intensity—occurs within the individual electron guns.

In the RGB approach (Fig. 2), the matrixing is done in the three video-output stages. Thus each amplifier must handle both luminance and color information. A simple form of the RGB circuit (Fig. 3) has the color-difference signals applied to the transistor bases while the luminance signal is applied to the emitters.

With respect to the color-difference signals,

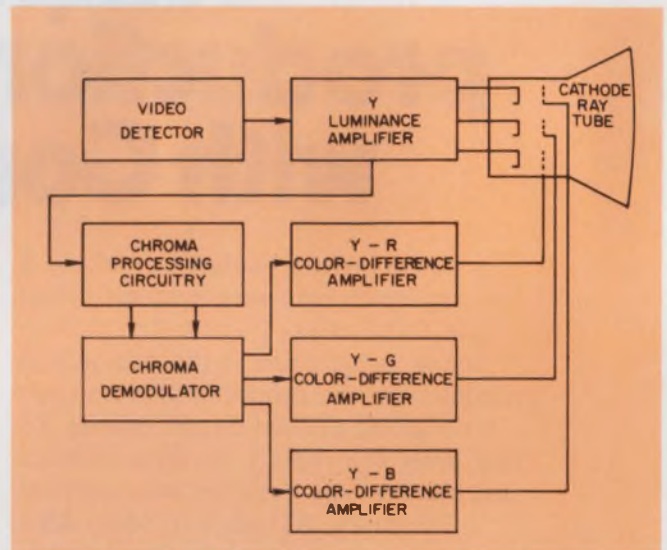

1. The color-difference circuit needs a powerful luminance amplifier that requires not only a high-power transistor but a large heat sink as well. It has the advantage of providing identical luminance transient responses for all three colors, thus eliminating a source of color fringing.

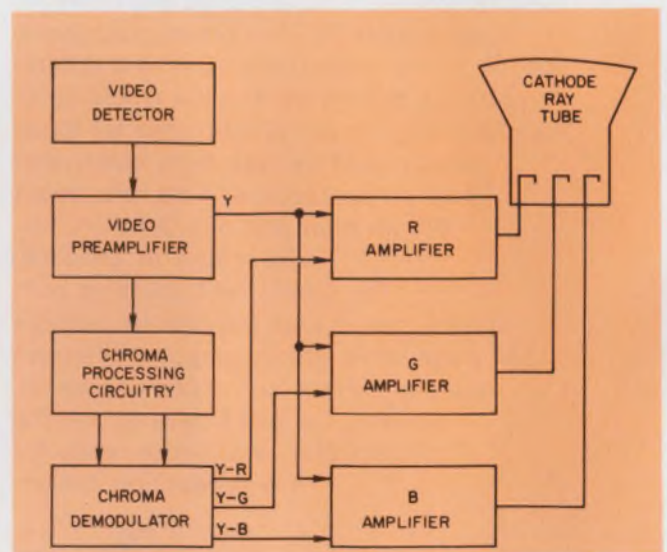

2. The red-green-blue circuit uses a separate amplifier for each cathode. Both luminance and color-difference signals are applied to these amplifiers. Therefore, individual amplifier gain adjustments will affect both chroma and luminance information, preserving their proper relationship at the CRT.

Roger Thielking, Applications Engineer, Semiconductor Products Dept., General Electric Co., Electronics Park, Bldg. 7, Rm. 330, Syracuse, N. Y. 13201.



## Red-green-blue vs color-difference: The trade-offs

The primary advantage of RGB is economic: It eliminates not only the luminance-amplifier transistor but its large heat sink as well.

Integrated-circuit chroma demodulators, which will probably come into general use, provide outputs that may be direct-coupled to RGB. This, and direct coupling of the outputs, eliminates not only coupling capacitors but also the chroma clamping circuitry, often required with color-difference amplifiers to restore the dc component.

In addition to its economic advantages, RGB also has a technical advantage. The individual amplifier gain adjustments affect both chroma and luminance information, preserving their proper relationship at the picture tube. In the color-difference system only the luminance information is changed, and so, to the degree that the luminance outputs differ, errors in the chroma-

aticity of the viewed picture result.

There is a performance disadvantage of RGB, however—the differences in luminance transient response between the outputs. In addition, frequency compensation and video peaking may be somewhat more difficult to effect. The full dc coupling may require an attenuation of the dc luminance component in the preceding low-level stages or some other means of preventing an excessively bright raster—which could damage the picture tube or overload its anode power supply. Also, an additional low-level luminance stage may be needed to provide a suitable dc level to the RGB circuitry.

However, these drawbacks appear to be outweighed by the advantages of RGB. Excellent performance can be achieved with proper design, and usually at a lower cost.

each transistor acts as a common-emitter amplifier. Voltage gain is controlled by emitter degeneration, and is approximately equal to the ratio of collector resistance to emitter resistance,  $-R_1/R_2$ , provided that the luminance (Y) signal source has a low output impedance.

For the Y signal, on the other hand, the transistor acts as a common-base amplifier with a gain of about  $+R_1/R_2$ . The color-difference waveform is inverted, but the luminance is not; therefore, the Y components cancel each other out, leaving the desired R, G and B signals at the output of the video circuitry.

That's how the RGB circuit works. To build one, six major design goals must be achieved:

- Adequate Y-signal bandwidth must be provided.
- Adequate chroma-signal bandwidth must be provided.
- Provision for adjusting the color temperature of the CRT screen at white level must be included in the design.
- Uniform transient responses must be maintained for the three color outputs to prevent color fringing.
- Cross-coupling of the chroma signals must be prevented.
- Temperature compensation must be included in designs where drifting of the direct-coupled amplifiers is a problem.

### Provide adequate frequency response

The luminance amplifier must have a bandwidth of about 3 MHz. The capacitive load of each CRT cathode and its associated circuitry is about 15 to 20 pF. Using conventional compensation techniques, this bandwidth can be achieved with a collector load resistor of 10 to 12 k $\Omega$ . Care

must be taken, however, that frequency response is not degraded elsewhere in the circuitry.

One possible source of trouble in maintaining a flat frequency response is the roll-off of current gain with increasing frequency. This effect is minimized by the emitter degeneration of the amplifiers and should be of little consequence with modern video transistors. Such transistors commonly have gain-bandwidth products in excess of 50 MHz.

The transistor collector-to-base capacitance  $C_{cb}$  can be very important when it combines with the source impedance of the color-difference signal at the base. High frequencies are coupled by  $C_{cb}$  from the output to the base, where voltages developed across impedance  $Z_s$  result in negative feedback (Fig. 4). The gain as a function of frequency, due to this effect alone, is given ap-

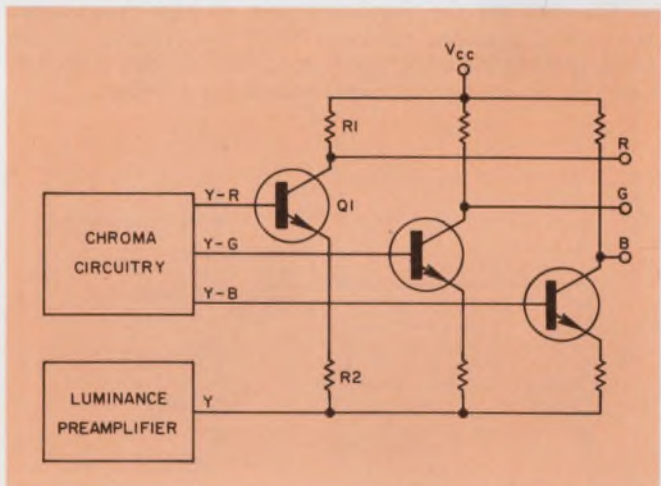

3. Each transistor acts as a common-emitter amplifier to the color-difference signal and as a common-base amplifier to the luminance signal. The gain of the former is  $-R_1/R_2$ , while that of the latter is  $+R_1/R_2$ .



proximately as follows:

$$\text{Luminance gain } (A_y) = R_1 / (R_2 + j\omega C_{cb} Z_s R_1).$$

To appreciate the practical significance of this function, let's try some typical values. The low-frequency gain,  $R_1/R_2$ , can easily be as much as 40 or more. The GE D40N video transistor has a very low  $C_{cb}$  of only 2 pF. With these values, a  $Z_s$  of only 300 ohms causes 3 dB of attenuation at 3 MHz, indicating that the impedance should be reduced to well under 100 ohms. This can easily be done by driving the base of the amplifier with an emitter follower.

The chroma signal is restricted in bandwidth to about 600 kHz. The factors that influence the response of the RGB amplifiers to this signal also, in general, influence the luminance frequency response. Thus, when the luminance response is satisfactory, it will usually be found that the frequency response to chroma content is more than adequate. In fact, there will probably be very little attenuation of the residual 3.58-MHz chroma carrier in the output stages. Attenuation is easily provided, however, by means of low-pass R-C filters in the coupling circuitry from the chroma demodulators.

In some designs these filters use large capacitances and low resistances, thus providing low impedances at high frequencies. The output transistors may then be driven directly from the filters, eliminating the need for emitter followers while maintaining adequate bandwidth for the luminance signal.

#### Include gray-scale adjustments

CRT electron-gun transconductances and phosphor efficiencies cannot be closely matched. To compensate for these variations, the gain of each RGB amplifier must be adjustable to provide proper color temperature of the CRT screen at

4.  $C_{cb}$  can cut the transistor gain at high frequencies because it provides feedback from the collector to the base. Driving the transistor from a low-impedance source, such as an emitter follower, solves the problem.

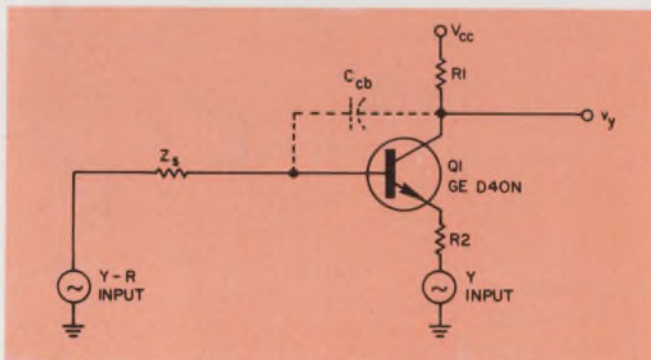

white level. The gain may be adjusted by changing either the collector resistance,  $R_1$ , or the emitter resistance,  $R_2$ , with a potentiometer. These potentiometers have an appreciable amount of stray capacitance that, in the collector circuitry, adds to the load capacitance. For this reason it is often preferable to place them in the emitter circuitry. There, the impedance is so low that the additional capacitance has no significant effect.

An arrangement that works well is shown in Fig. 5. Conditions corresponding to a black signal level are established by opening the service switch. The output dc voltage is then determined by  $R_1$  and the dc voltage at the chroma input (usually between +10 and +15 V). The electron beams are adjusted to cut-off with controls, usually at the CRT accelerating grids, not shown here. With approximately equal dc levels at the three chroma inputs, very little current flows through  $R_2$  and  $R_3$ . Consequently when  $R_1$  is later adjusted for proper white level, the black-level output will change very little so that interaction of adjustments is minimized.

#### Maintain uniform transient responses

In the design of color TV luminance amplifiers, video "peaking" is introduced by increasing the high-frequency gain. This produces considerable overshoot in the square-wave response and has the subjective effect of increasing the apparent resolution and enhancing picture detail.

Considerable variation in the over-all transient response can be tolerated. However, differential variations between the R, G, and B outputs must be minimized; otherwise, slight color fringing about objects in the picture might appear. If present, this will be especially objectionable when a monochrome transmission is viewed.

The key to maintaining uniform transient re-

5. Placing the gain controls in the emitter circuitry minimizes the effects of their stray capacitances. If put in the higher-impedance collector circuitry, the capacitances would add to the capacitance of the load.

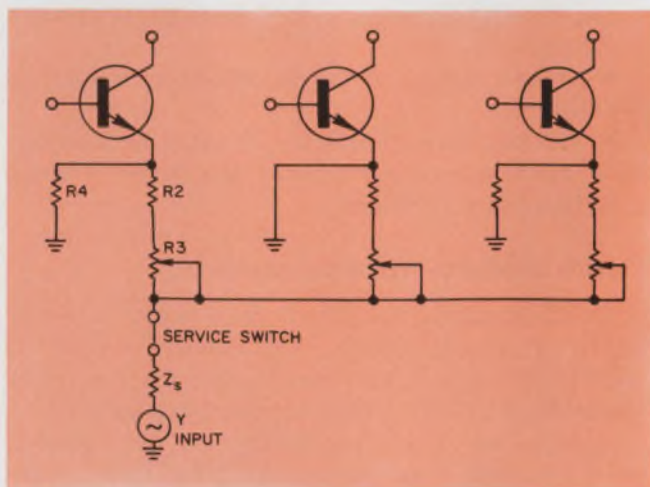



sponses is to keep the components that affect the frequency response out of the individual output stages, as far as possible. Video peaking, for instance, should be done in the luminance preamplifier ahead of the output stages. The inductors used for frequency compensation, however, are something of a problem.

The inductors can be placed in shunt, in series, or both (Fig. 6). It is unusual for the shunt-series combination to be used. Normally, either a single shunt inductor,  $L_1$ , or the three series inductors,  $L_2$ , will be used. If  $L_1$  is used, it produces uniform response only if all three stages are adjusted to equal gains with the gray-scale adjustments. When the gains differ, there will be some variations in the transient responses.

When individual inductors,  $L_2$ , are used, the response of each stage stays constant with gain changes; however, inductor differences will introduce some variation between stages. The choice between these alternatives is a difficult one. However, there are two factors that argue for the use of  $L_1$ . One is the economic advantage of using only one inductor, and the other is the industry trend toward closer control of CRT parameters, tending to require more nearly equal outputs from the RGB circuitry.

### Prevent chroma cross-coupling

Chroma cross-coupling is not usually a consideration in color-difference amplifiers, because completely separate circuitry is used for each chroma channel. But in RGB amplifiers, it's another story. Referring back to Fig. 5, note that the source impedance,  $Z_s$ , of the luminance input, is in series with all three emitter impedances. This will serve, like the common emitter resistor of an emitter-coupled amplifier, to couple the signal in each channel to both of the others.

**6. Inductors are used for frequency compensation.** Usually, either a single shunt inductor,  $L_1$ , or three series inductors,  $L_2$ , are employed. Neither approach has a really clear advantage over the other.

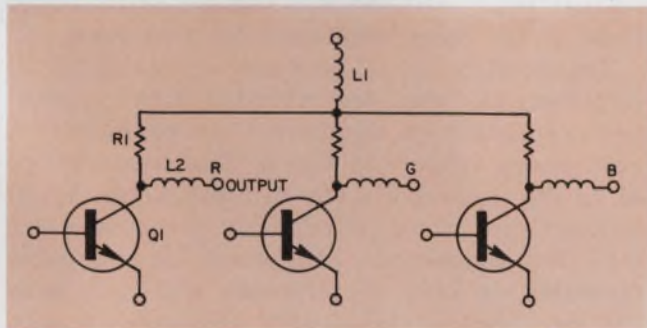

The amount of cross-coupling, expressed as the percentage of one chroma signal which appears in either of the other amplifiers, is approximately  $(100Z_s/R_2)\%$  for the worst case—where the gain adjustments are set to maximum.  $R_2$  is typically between 250 and 400 ohms. A source impedance of only 10 ohms, then, can cause as much as 4% of cross-coupling.

Another possible source of cross-coupling is the shunt frequency-compensation inductor,  $L_1$ , of Fig. 6. A small amount of chroma, at the high-frequency extreme of the passband, is developed across  $L_1$  and applied equally to all outputs. This effect is usually inconsequential and is avoided if individual inductors,  $L_2$ , are used instead.

The effect of small percentages of chroma cross-coupling is to introduce errors in the R, G, and B output signals. These errors cause slight chromaticity errors in the picture. The effect is difficult to discern when a single receiver is viewed by itself, but it may become apparent when compared with another receiver that is free of this form of distortion.

To keep the output impedance of the luminance input ( $Z_s$  in Fig. 5) as small as possible, a single pnp emitter follower is sometimes used. This is not always a satisfactory solution to the problem, however. The output impedance—approximately equal to the input impedance divided by the current gain,  $h_{fe}$ —may be 10 ohms or more with lower-beta units, which could be too high for satisfactory performance.

A Darlington circuit can be used to reduce the impedance further, but the circuit of Fig. 7 is preferred as an alternative. Negative voltage feedback from the collector of  $Q_2$  to the emitter of  $Q_1$ , reduces the output impedance to well under 1 ohm with most transistors, virtually eliminating cross-coupling. The closed-loop voltage gain is unity, as with an emitter follower.

**7. This circuit is highly recommended as a luminance preamplifier** because of its extremely low output impedance. The low impedance is desirable because it eliminates chroma cross-coupling in the RGB circuit.

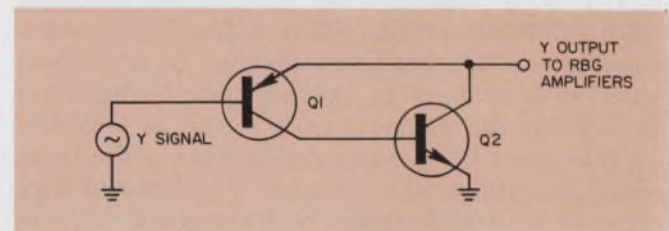



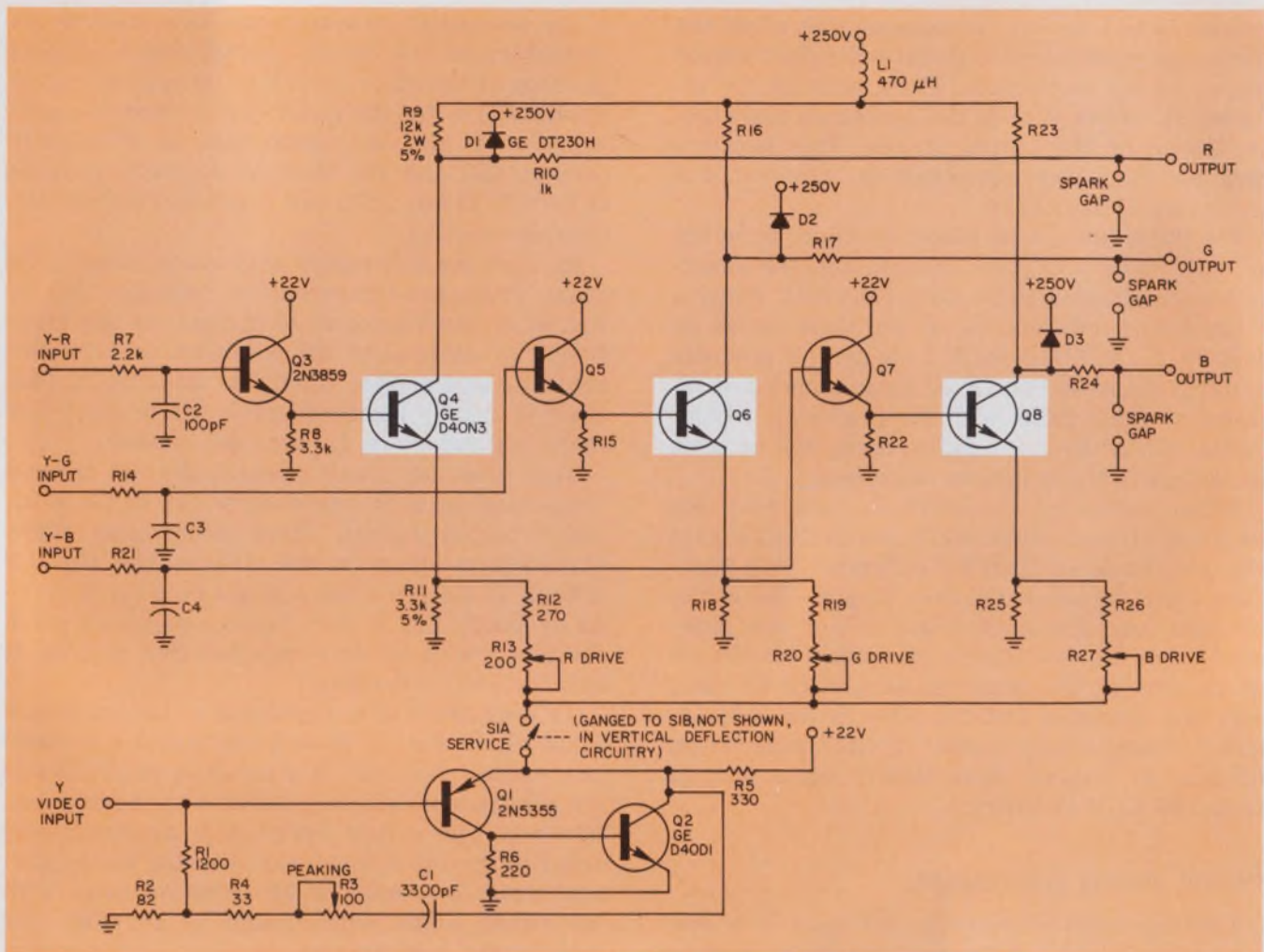

8. This complete RGB video amplifier uses a single shunt inductor for frequency compensation. Note how the low-impedance luminance preamplifier, Q<sub>1</sub> and Q<sub>2</sub>, of Fig. 7 is used to prevent chroma cross-coupling. The low-pass R-C filters on the three color-difference inputs are needed to attenuate the 3.58-MHz chroma carrier. And

the emitter followers, Q<sub>3</sub>, Q<sub>5</sub> and Q<sub>7</sub>, are employed because their low output impedances keep the collector-to-base capacitances of the power transistors from killing their high-frequency gains. The power transistors, Q<sub>4</sub>, Q<sub>6</sub>, and Q<sub>8</sub>, require small heat sinks; the Staver type F7-2, or its equivalent, is recommended.

This arrangement may be modified to provide greater than unity gain to high frequencies, to get a desired video-peaking characteristic.

#### Eliminate dc warm-up drift

The RGB amplifiers use full dc coupling and have relatively large voltage gains. When these conditions exist together, changes in dc output level with changes in the ambient temperature and during the warm-up period must be considered. The most likely source of trouble is the transistor base-to-emitter voltage,  $V_{be}$ . This voltage changes with temperature by about  $2 \text{ mV}/^\circ\text{C}$ , and thus acts as a dc signal source.

The greatest change occurs during the first moments after the circuitry is energized, while the transistor junctions are being heated from room temperature to their operating levels. The effect is most likely to show up with quick warm-up receivers, which maintain reduced picture-tube heater power when turned off. When such

sets are turned on, the picture appears within a very few seconds—before the transistor junctions are able to approach temperature stabilization.

If necessary, temperature compensation can be provided. This may be done by adding one or more diodes to the circuitry. These are arranged so that their own thermal voltage shifts offset those of the other semiconductor junctions.

The practicality of economical, quality RGB amplifiers has been demonstrated with commercial sets already on the market. An example of a good design appears in Fig. 8. This was developed, in the General Electric Semiconductor Applications Center, for demonstration purposes rather than for commercial production. It compares favorably, in both performance and cost, with CD circuitry in high-quality large-screen sets. Details of its performance are available.<sup>1</sup> ■■

#### Reference

1. Thielking, R. C., "RGB Video Amplifiers for Color TV Offer High Performance," *Application Note 90.88*, Semiconductor Products Dept., General Electric Co.





this



protects  
equipment  
against  
voltage  
surges

Electronic equipment is constantly running the risk of being "zapped" . . . by lightning, short circuits, switching of inductive components, etc. These ceramic gas filled arresters, from Signalite, offer maximum protection against voltage surges. They are low priced (under \$1.00) . . . reduce maintenance and down time . . . withstand shock and vibration. Some of the more vital statistics are listed, but for complete details, contact Signalite.

Guaranteed 50  
discharges . . .  
200 typical

Fast response . . .  
40 kv/ $\mu$ sec. wavefront

High temperature  
capability with true  
follow-on capability

Rugged ceramic  
construction . . .  
no glass

Low cost . . . under \$1

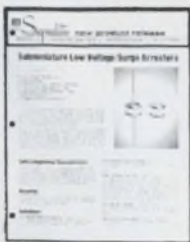

**AVAILABLE UPON  
REQUEST**

**Detailed Data Sheet . . .**  
on Signalite Subminiature  
Low Voltage Ceramic Gas  
Filled Surge Arresters.

**The Broadest Line of Spark Gaps In  
The World . . .** are described in the  
Signalite "300" Spark Gap brochure . . .  
including definition of terms,  
characteristics of gap operation and  
application information.

Signalite



DIVISION OF  
GENERAL INSTRUMENT

1933 HECK AVE., NEPTUNE, N.J. 07753  
(201) 775-2490



# High energy silicon for the 70's.

Switching Circuit

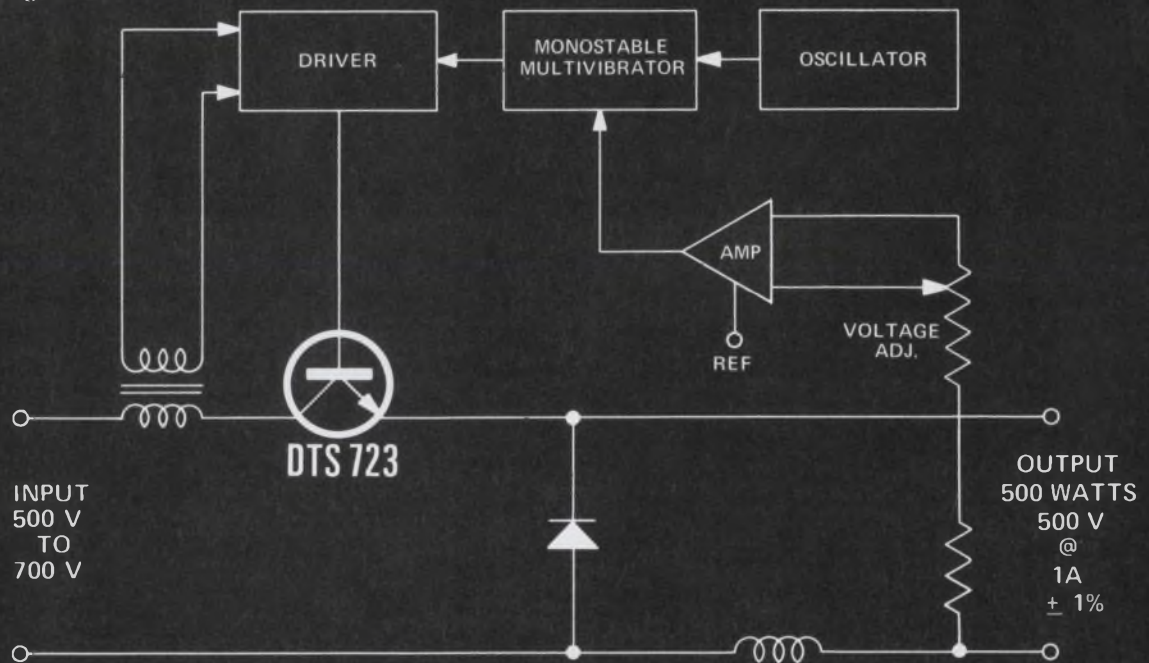

DC Regulator Circuit

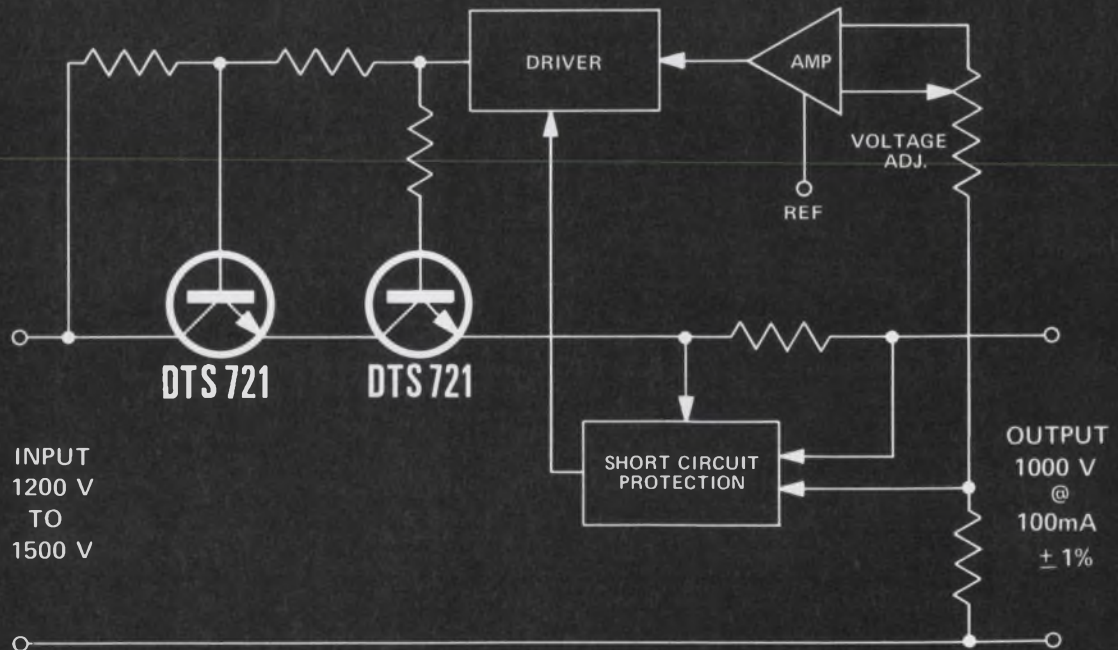

	V <sub>CEX</sub>	V <sub>CEO</sub>	V <sub>CEO</sub> (sus)	I <sub>C</sub> (cont)	h <sub>FE</sub> @ I <sub>C</sub> min/max V <sub>CE</sub> = 5.0V	P <sub>T</sub>
DTS-721	1000V	1000V	800	3A	20/60 @ 150 mA	50W
DTS-723	1200V	1000V	750	3A	2 min @ 2.5 A	50W



# Delco announces two new 1000-volt transistors for high power regulators in small packages.



Our new DTS-721 and DTS-723 1000-volt silicon transistors permit you to design solid state circuits for industrial applications with capabilities previously reserved for tubes. Now you can think small.

These two new silicon devices were developed specially for instrumentation and power supply builders, as well as for computer and military applications. They can operate from DC inputs of 1200 volts to 1500 volts. With 1% regulation at full load.

In a switching regulator, they can operate directly from a 220-volt line or from rectified 440-volt single or polyphase sources.

Both devices are NPN triple diffused, packaged in Delco's solid copper TO-3 cases. They are mounted to withstand mechanical and thermal shock because of special bonding of the emitter to base contacts.

The DTS-721 and DTS-723 have been proven by

application tests from production lots by prospective users with stringent reliability requirements.

And their energy handling capability is verified by Delco Pulse Energy Testing.

These new high voltage silicon transistors make it possible for you to take advantage of reduced size, weight and component costs in designing circuits—and get far greater reliability.

The circuits shown are explained in detail in our application notes nos. 45 and 46.

Call the Kokomoans or your Delco Distributor for more information.



## Delco Electronics

DIVISION OF GENERAL MOTORS CORPORATION, KOKOMO, INDIANA

### Available from these Delco distributors:

ALA., BIRMINGHAM • Forbes Distributing Co., Inc. (205)-251-4104  
ARIZ., PHOENIX • Cramer/Arizona (602)-263-1112 • Sterling Electronics (602)-258-4531  
CAL., LOS ANGELES • Kierulff Electronics, Inc. (213)-685-5511 • Radio Products Sales, Inc. (213)-748-1271  
CAL., PALO ALTO • Kierulff Electronics, Inc. (415)-968-6292  
CAL., SAN DIEGO • Milo of California, Inc. (714)-232-8951  
COLO., COLORADO SPRINGS • Walker Electronics (303)-636-1661  
COLO., DENVER • Cramer/Denver (303)-758-2100 • Denver Walker Electronics (305)-935-2406  
FLA., MIAMI • Mountain Electronics Subsidiary of Avnet, Inc. (305)-634-4556  
FLA., WEST PALM BEACH • Mountain Electronics, Subsidiary of Avnet, Inc. (305)-833-5701  
ILL., ROSEMONT (Chicago) • F-J-R/Kierulff (312)-678-8560  
ILL., SKOKIE (Chicago) • Merquip Electronics (312)-282-5400  
IND., INDIANAPOLIS • Graham Electronics Supply, Inc. (317)-634-8486  
MD., BALTIMORE • Radio Electric Service Co. (301)-823-0070  
MASS., NEWTON • The Greene-Shaw Co., Inc. (617)-969-8900  
MICH., ROMULUS • Harvey/Detroit (313)-729-5500

MINN., MINNEAPOLIS • Stark Electronics Supply Co. (612)-332-1325  
MO., KANSAS CITY • Walters Radio Supply, Inc. (816)-531-7015  
MO., NO. KANSAS CITY • ECI Semiconductors, Inc. (816)-221-2400  
MO., ST. LOUIS • Electronic Components for Industry Co. (314)-647-5505  
N.J., CLIFTON • Eastern Radio Corporation (201)-471-6600  
N.M., ALBUQUERQUE • Cramer/New Mexico (505)-265-5767 • Sterling Electronics (505)-247-2486  
N.Y., BINGHAMTON • Harvey/Federal (607)-748-8211  
N.Y., NEW YORK • Harvey/New York (212)-582-2590  
N.Y., WOODBURY • Harvey/New York (516)-921-8700  
OHIO, CINCINNATI • United Radio, Inc. (513)-761-4030  
OHIO, CLEVELAND • Pattison Supply (216)-441-3000  
OHIO, DAYTON • F-J-R/Kierulff (513)-278-9411  
OKLA., OKLAHOMA CITY • Radio, Inc. (405)-235-1551  
OKLA., TULSA • Radio, Inc. (918)-587-9123  
PENN., PHILADELPHIA • Almo Electronics (215)-676-6000  
PENN., PITTSBURGH • RPC Electronics (412)-782-3770  
S.C., COLUMBIA • Dixie Radio Supply Co., Inc. (803)-253-5333

TEXAS, DALLAS • Adleta Electronics Company (214)-742-8257  
TEXAS, FORT WORTH • Adleta Electronics Co. (817)-336-7446  
TEXAS, HOUSTON • Harrison Equipment Co., Inc. (713)-224-9131  
UTAH, SALT LAKE CITY • Cramer/Utah (801)-487-3681  
VA., RICHMOND • Meridian Electronics, Inc., a Sterling Electronics Company (703)-353-6648  
WASH., SEATTLE • Kierulff Electronics, Inc. (206)-763-1550  
WASH., TACOMA • C & G Electronics Co. (206)-272-3181  
CANADA, ONT., SCARBOROUGH • Lake Engineering Co., Ltd. (416)-751-5980  
ALL OVERSEAS INQUIRIES:  
General Motors Overseas Operations Power and Industrial Products Dept., 767 Fifth Avenue, New York, N.Y. 10022. Phone: (212)-486-3723.

Regional Headquarters, Union, New Jersey\* 07083, Box 1018 Chestnut Station, (201)-687-3770 ■ El Segundo, Calif. 90245, 354 Coral Circle, (213)-772-5181  
■ Chicago, Illinois\* 60656, 5151 N. Harlem Avenue, (312)-775-5411 ■ Kokomo, Ind. 46901, 700 E. Firmin, (317)-459-2175 Home Office  
■ Office includes field lab and resident engineer for application assistance.





# Simplify high-speed counter design.

By combining the features of two types of counters, you can reduce the number of parts and increase the speed.

How would you design a circuit to measure high-speed, random multiple events, such as radar returns from closely spaced multiple targets? Obviously, you would build a high-speed counter that measured time (clock pulses) in submicrosecond increments, referenced to the transmitted pulse, and read out the contents of the counter (calibrated in range) at each target return.

But suppose the targets are separated in range by only 10 feet (approximately 20 ns). Here you run into a snag because, although the counter may respond to the high-speed clock pulses, its contents normally cannot be read out unless all the flip-flops in the counter are in a static (non-transient) state during readout. This is difficult to achieve, even with high-speed synchronous counters.

Let's look at several counter techniques and discuss their speed limitations. Then we'll describe a method of implementing a counter to count and read out at a rate limited only by the inherent toggling speed of the flip-flops.

## How counters operate

Basically, all counters operate in a similar way. Input data, in the form of a continuous or random train of events, is fed to a series of flip-flops that change state with each event, according to the interconnecting logic. At some selected time the contents of the counter are read in parallel upon application of a "read" pulse. During readout the state of each flip-flop is simultaneously sampled and transferred to terminal equipment, which dictates that flip-flops must be in a static state during this time in order to prevent readout error.

In a ripple counter the input data signal is fed to the least significant bit of the counter, and each flip-flop is triggered by the one preceding it. The data propagates down the counter chain at a speed dependent upon the propagation delay of each element in the chain. The total time required

to travel from the least significant bit to the most significant bit is equal to  $nd$ , where  $n$  is the number of bits in the counter and  $d$  is the average propagation delay of each bit. The maximum count rate is limited to  $1/nd$ , in order to enable the read function to occur during the time when a data pulse is not propagating through the counter. In practice, the count rate is usually one-half of  $nd$  to allow the flip-flop outputs to settle and provide some safety margin.

As an example, let's see what happens when some high-speed logic circuits, such as the Schottky clamped TTL (54S/74S), are used. A typical 100-MHz flip-flop has a propagation delay of 6 ns, and gates of the same family have a nominal propagation delay of 3 ns. A simple 16-bit ripple counter would have a total propagation delay of  $16 \times 6$  or 96 ns, and be limited to a count rate of less than 10 MHz, even though the flip-flops have an inherent toggling speed of 100 MHz. Obviously this configuration is not desirable for high-speed readout.

A synchronous counter is much better suited to high-speed operation. But it, too, has its limitations. In this circuit the clock pulse is simultaneously fed to all flip-flops in the counter so that all bits change simultaneously. This allows sufficient time to read out the state of all flip-flops during their static state. The flip-flops are interconnected so that the only time a particular flip-flop can be toggled is when all those of lesser significance are in the ONE state. This requires a complex gating network. The outputs of all flip-flops must be "ANDed" before application to the input of any succeeding flip-flop (Fig. 1). The maximum number of inputs (fan-in) to any one gate is eight, so that at least two levels of gating are required in a 16-bit counter.

The speed of the synchronous counter is limited only by the delay of the first flip-flop, plus the delay of the gating network—in this case  $6 + (3 \times 2)$  or 12 ns. This limits the theoretical maximum speed to 80 MHz. However, practical considerations rule out the attainment of such speeds. New data must not be allowed to enter the counter during readout. If we assume a 5-ns readout pulse is applied 5 ns after the flip-flops

---

Albert Roth, Design Specialist, 6248 Rockhurst Dr., San Diego, Calif. 92120.



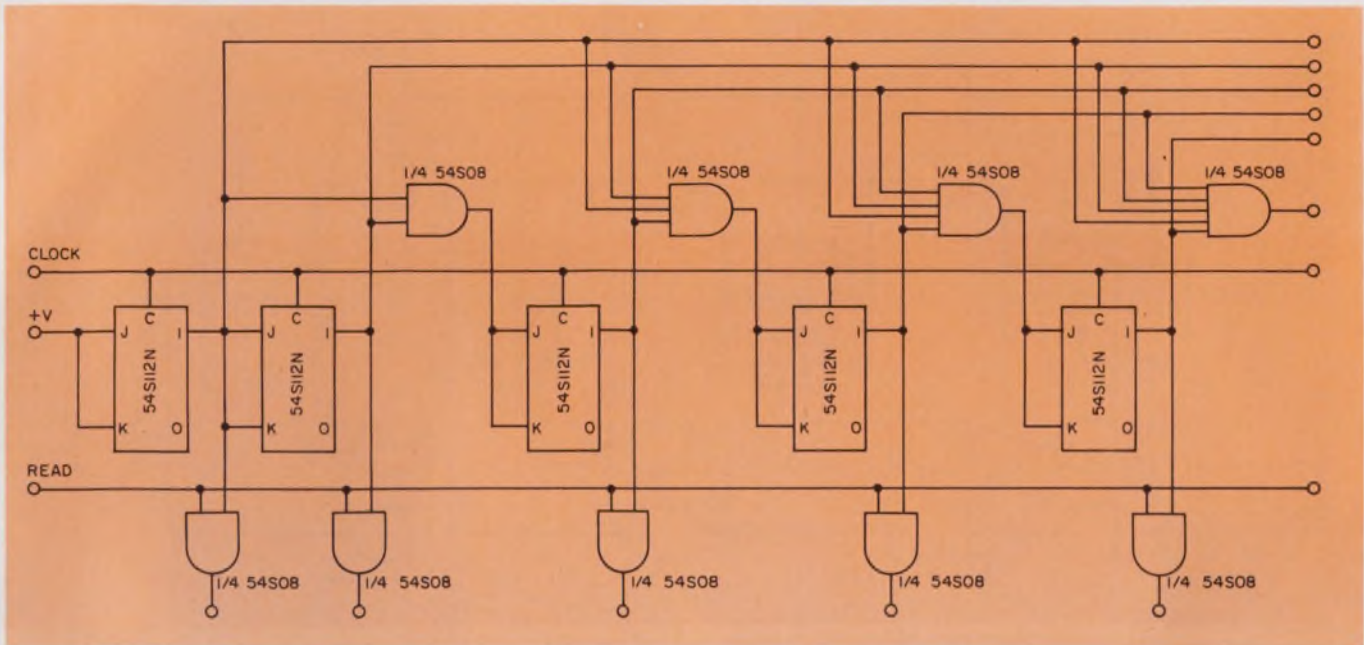

1. The complex gating network limits the speed of the synchronous counter. Before a flip-flop can be toggled,

have settled, this adds another 10 ns to the total delay. The best speed attainable is, then, about 40 MHz.

The clock must drive all the flip-flops. This places a severe load on the clock driver, limiting the fan-out and further reducing the speed capability of the counter.

With the ECL family, there is the added problem of increasing propagation delay with increased loading. A gate or flip-flop that has a delay of 4 ns with a unit load increases its delay to 14 ns with a fan-out of 15.

### Combine synchronous and ripple counters

A synchronous/ripple counter (Fig. 2) combines features of both. The name is derived from

the outputs of all the preceding flip-flops must be "ANDed." This counter is faster than a ripple counter.

the fact that the clock pulse is applied to all flip-flops simultaneously, whereas the carry pulse ripples down a chain of interconnecting gates. As with the synchronous counter, all flip-flops of lesser significance must be in the ONE state before the data pulse will trigger a given flip-flop. However, the implementation is different. Since a clock pulse may not occur while the carry pulse is rippling down the chain of gates, the counting speed is limited by the total propagation time of the first flip-flop, plus that of the gating network.

A 16-bit synchronous/ripple counter would have a delay of  $6 + 15 \times 3$  or 51 ns, plus readout time. The operating frequency will be about 16 MHz. The advantage of this configuration over a synchronous counter is a reduction in loading of the flip-flops and elimination of the need for large

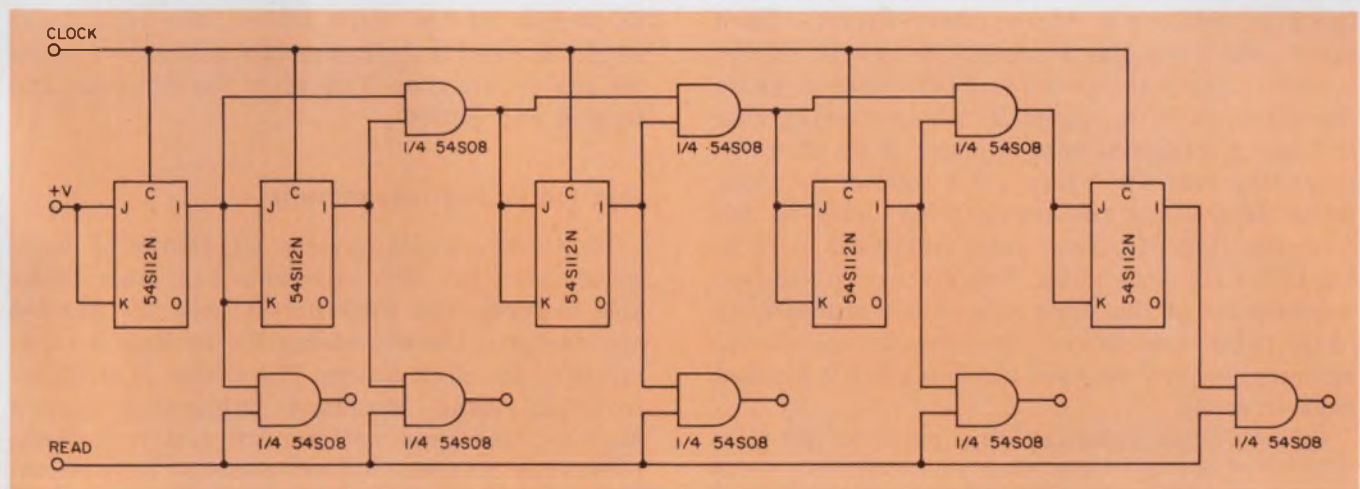

2. The features of both the synchronous and ripple counters are combined in a counter whose speed is limited

by the ripple time through the carry-pulse gates. This circuit is not as fast as a synchronous counter.



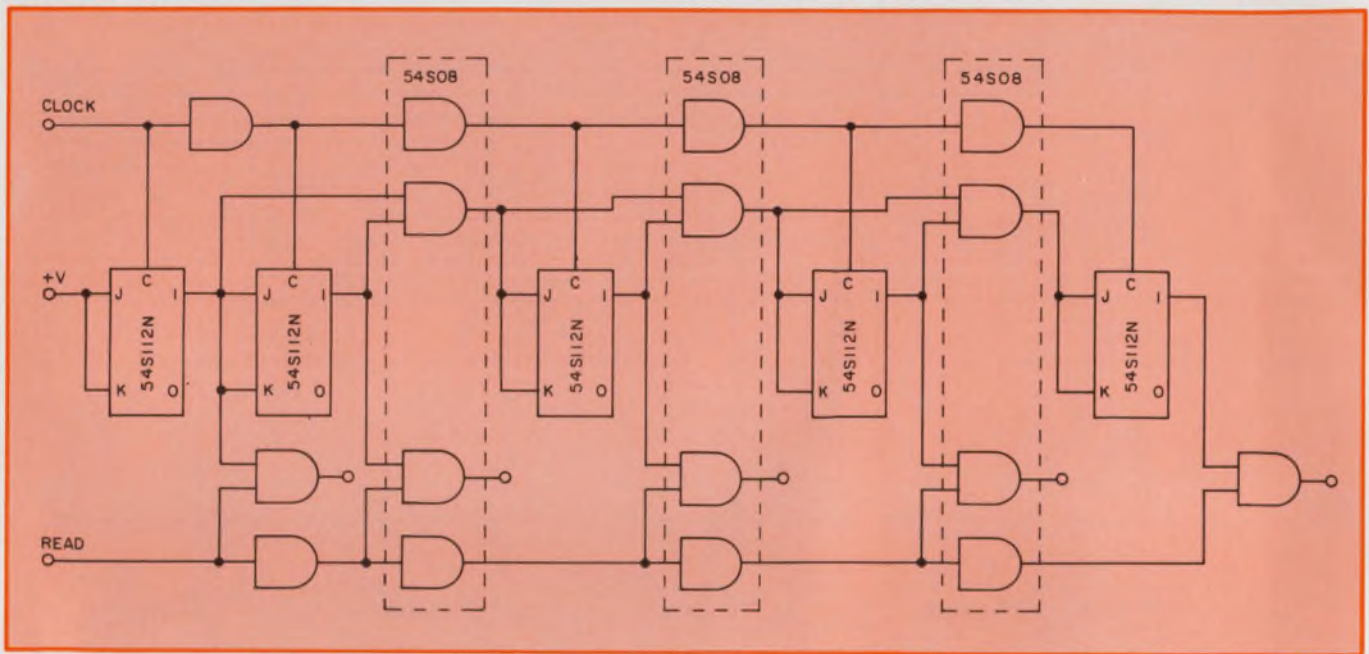

3. A simple modification of the synchronous/ripple counter of Fig. 2 can increase its speed beyond that of the synchronous counter. By applying both the clock and

read pulses to a set of series-connected gates, each flip-flop is read out sequentially at the same rate as the carry pulse is propagated in the counter.

fan-in gates. But the clock must still drive all 16 flip-flops. The disadvantage is a reduction in the operating speed.

### Improve the synchronous/ripple counter

A simple modification of the synchronous/ripple counter can increase the speed beyond that of the synchronous counter. The way to do this is to read out the state of each flip-flop sequentially, at a rate approximating that of the propagation velocity of the carry pulse rather than simultaneously as in the conventional configuration. This can be achieved by applying both the clock pulse and the read pulse to a set of tapped delay lines.

The delay lines consist of series-connected gates whose propagation delay is equal to that of the gate network in the counter (Fig. 3). Each tap in the delay line corresponds to a bit in the counter. Application of the clock pulse triggers the flip-flops in a sequential manner—each flip-flop being triggered approximately 3 ns after the preceding one. The carry pulse follows the clock pulse delayed by the propagation delay of the first flip-flop. If a read pulse is applied prior to the following clock pulse, it samples each flip-flop sequentially at the same rate as the propagating carry pulse. It is delayed, however, by an interval sufficient to read out each flip-flop after it has had time to settle.

A new clock pulse arriving prior to the time that all flip-flops have been read out will cause no interference or error as long as the clock pulse does not overtake a read pulse. This re-

quirement can be guaranteed by using all four gates of a quad 2-input gate package for each position. Thus all four gates associated with each flip-flop will have nearly identical propagation delays. Even though the delays may vary from package to package, it will not affect the operation since the time delay between the clock, carry, and read pulses will still remain relatively constant.

This technique allows the counter to be operated and read out at a rate determined only by the toggling speed of the counter, or 100 MHz for the assumed propagation delay. This circuit is tolerant of fairly large variations in the propagation delay of the flip-flops themselves, as long as the read pulse is applied after the clock pulse by a delay equal to or greater than the maximum anticipated delay of the first flip-flop. With a 10-ns period for the clock pulses, the read pulse would be applied approximately midway between the input pulses, or 3 ns after the flip-flops had toggled and settled.

### Ease the loading requirements

In addition to its obvious advantage of high-speed operation, this technique has other desirable features. The clock drives only one flip-flop and one gate, thereby easing the loading requirements of the clock driver. The design is straightforward, using standard integrated circuit modules, and does not require costly or time-consuming matching of components. This circuit may be used for any application requiring counting and readout of high-speed data. ■■



*If your problem is measuring  $\mu V$ ,  
 $\mu A$  and milliohms  
 in transistorized  
 and integrated  
 circuits . . .  
 Solve it with  
 Triplett's 801*



Model 801  
 \$ 210

1. Lower power ohms — 8 ranges with 35 mV power source and 1 ohm center scale.
2. High sensitivity — 5 mV AC full scale at 10 megohm input impedance; 50 mV DC at 11 megohm input resistance.
3. Simplified scale — 8" meter with only 4 arcs for all 73 ranges.

It offers 73 measurement ranges including 8 low-power resistance ranges that apply only 35 mV to the device under test . . . does not activate or damage solid-state components. With full-scale readings as low as 50 mV DC and 5 mV AC, 5  $\mu A$  DC and 100 Ohms (1 Ohm center-scale) — plus a 10 megohm input impedance on the AC scales and 11 megohm input resistance

on DC — Triplett's Model 801 V-O-M is ideally suited to in-circuit testing. When you add 2% DC and 3% AC accuracy on the voltage ranges (current: 3% DC and 4% AC) and a 25  $\mu A$  suspension-type meter with a nearly 7½" scale length, there's no doubt that the Model 801 has no equal among analog V-O-M's in terms of sensitivity and versatility.

See the remarkable Model 801 V-O-M — priced at \$210 — at your Triplett distributor. For more information—or for a free demonstration—call him or your Triplett sales representative right away. Triplett Corporation, Bluffton, Ohio 45817.

**TRIPLETT**

The World's most complete line of V-O-M's . . .  
 choose the one that's just right for you



# Need a programmable word generator?

Don't go overboard on complexity—  
a few ICs are all you may need for your digital system.

Almost every digital system requires a programmable word generator to test such equipment as modems, parity generators and checkers, or to test a digital message receiver. And commercially available units are often more complex and expensive than they need to be. Here are several types of easy-to-build programmable word generators and an application, using two word generators to form a bit-error detector.

## Flip-flops make simple word generators

The simplest form of programmable word generator is a shift generator with "jam-set" or presettable flip-flops (Fig. 1). Information is programmed via the data entry switches (either binary thumbwheels or toggle switches) and loaded by the start or "load-enable" switch.

A nondestructive readout (NDRO) feature is provided by tying the Q and  $\bar{Q}$  outputs of the last flip-flop to the J and K inputs of the first flip-flop. This allows the information to circulate until new information is loaded.

Transmission of data begins when the start switch is depressed and ends automatically after the last bit has been transmitted.

Since the data is hard-wired into the register, this word generator is nonvolatile—stored data is not lost when the power supply is turned off and then on. A load pulse is required each time power is restored, of course.

Another type of word generator uses a multiplexer as the basic storage unit (Fig. 2). The generator may easily be expanded to  $n \times 16$  by adding more multiplexers. Again, this type requires a data entry switch for each bit of data to be programmed and has the NDRO feature. As with the flip-flop, this is also nonvolatile. This word generator does not need a load pulse.

Both of the word generators discussed require one switch for every bit to be programmed. For message lengths above 32 bits, however, programming becomes a difficult and time-consuming

task. And for messages above 64 bits, the programmer is confronted by a maze of switches.

## Use a RAM for longer messages

A large NDRO programmable message generator may be built by using random-access memories (RAM). This type of generator, using a 256-by-4 RAM as a storage unit, is shown in Fig. 3. Programming it involves selecting the word address, presetting the address counter to this location, selecting the data to be loaded and writing it into the selected location in memory. The programmed message is transmitted each time the start button is pressed, but this circuit doesn't necessarily start at the zero location of memory. It starts at the location selected by the start switches and ends at the position selected by the stop switches. The start latch presets rather than resets the counter. Thus the RAM may be programmed, and either the entire memory, or portions of it, can be transmitted.

The advantage of the RAM is the ease it provides in programming a large message. The disadvantage is its volatility and the need to reprogram after each power interruption.

The programmable message generator of Fig. 3 can be especially handy in the measurement of error rate of a system. With RAMs used as the basic word generator, both memories (Fig. 4) have to be programmed with the same bit sequence. One memory, in the transmitter, has a hard-wired sync word (16 bits) that precedes the programmed message. The other, in the receiver, detects the sync, resets the address counter to zero, and then begins comparing the received data with its own memory. This comparison, made by using exclusive-OR logic, is gated with the received clock. Each time the received data differs from the stored data the clock is disabled, and the error counter is advanced.

Each time sync is received, the message counter is advanced. At the end of some interval, before the counters have exceeded their maximum count, the number of bit errors and message number (number of bits sent) is compared and the bit error rate is easily determined. ■■

---

C. D. (Mike) Talbert, Engineer, Avionics Div., Bendix Corp., 2100 N. W. 62nd St., Fort Lauderdale, Fla. 33310.



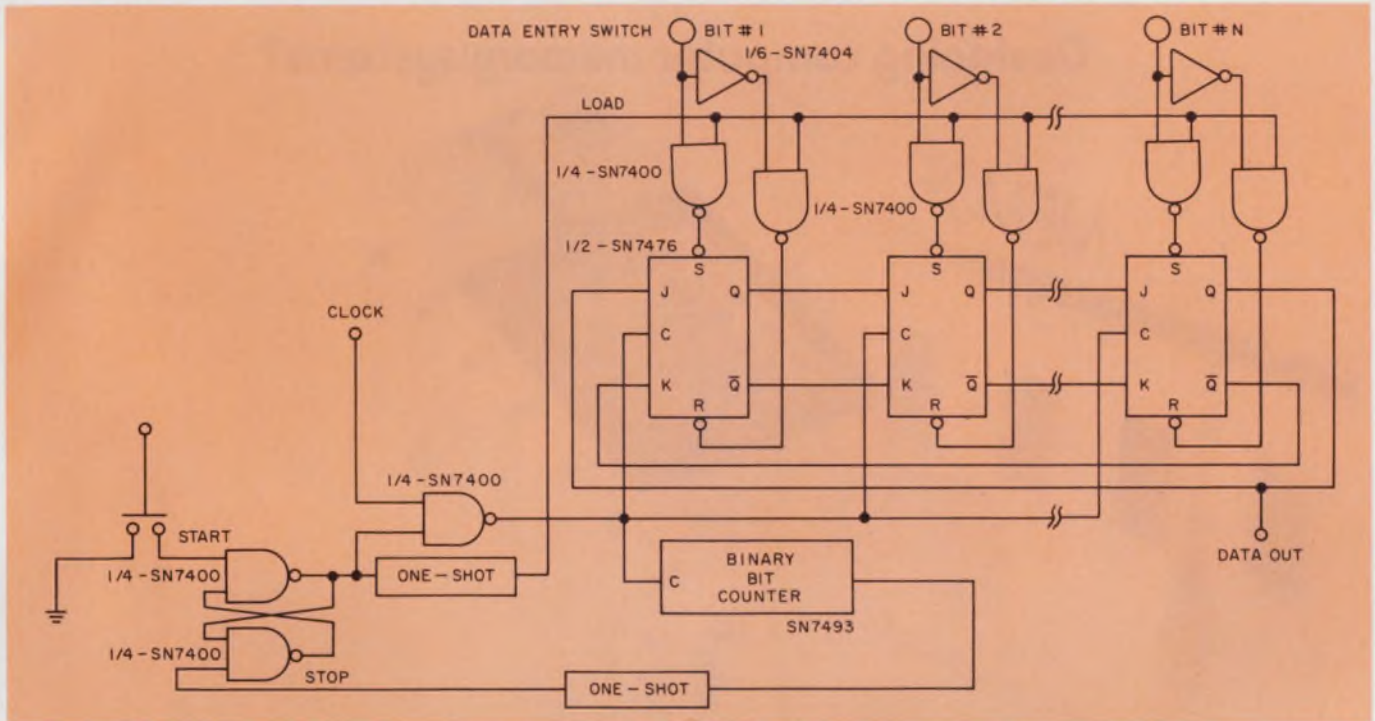

1. The simplest form of programmable word generator uses flip-flops to form a presettable shift register. This word generator is easy to build and is extremely useful

for small message lengths. The load pulse generated by the one-shot is required to set the initial conditions into the flip-flops.

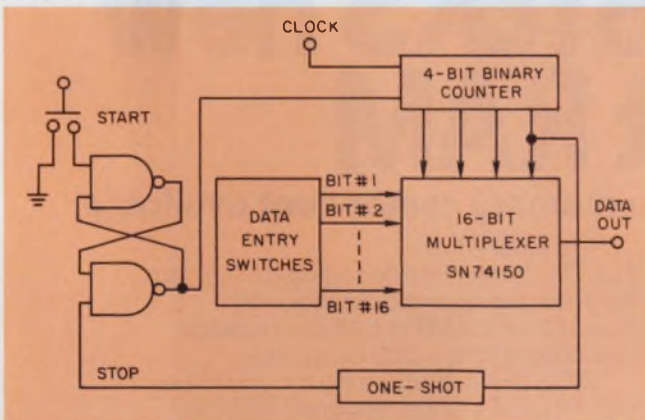

2. A multiplexer is used as the basic storage element in this 16-bit word generator. The outputs of the data entry switches are always available at the inputs to the multiplexer. Once the start button is depressed, the counter controls the sequencing of the multiplexer.

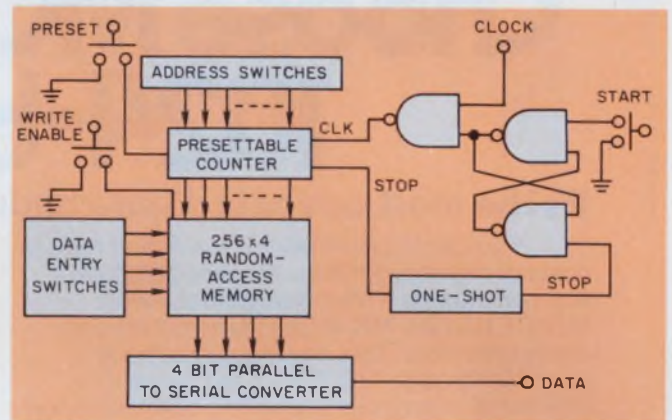

3. The random-access memory simplifies the programming when a large number of bits is to be stored. The presettable counter lets the operator select what information in the memory is to be transmitted. The RAM must be reprogrammed after each power interruption.

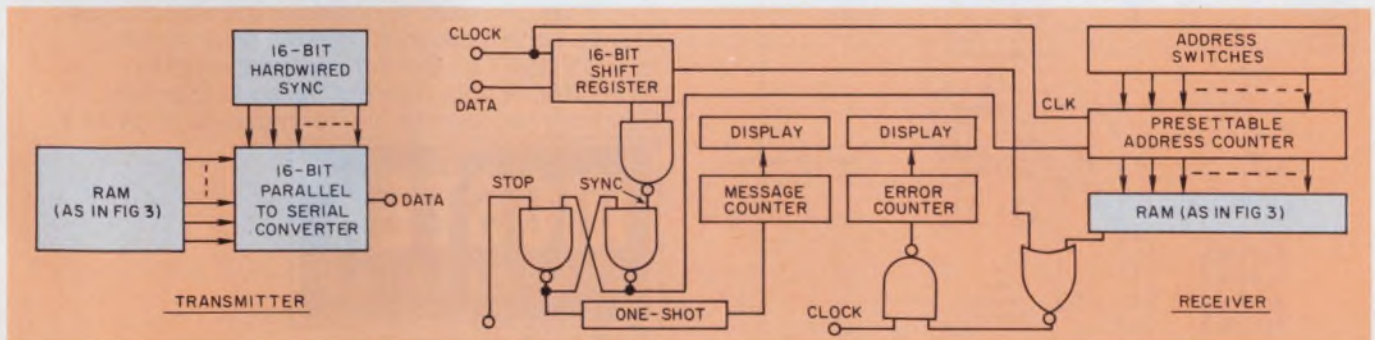

4. Two simple programmable word generators form a bit-error detector. The transmitter produces the test signal that is applied to the system under test. The sys-

tem output is applied to the receiver, which then compares it to the transmitted signal. The hard-wired sync signal resets the address counter in the receiver.



Designing computer memory systems?

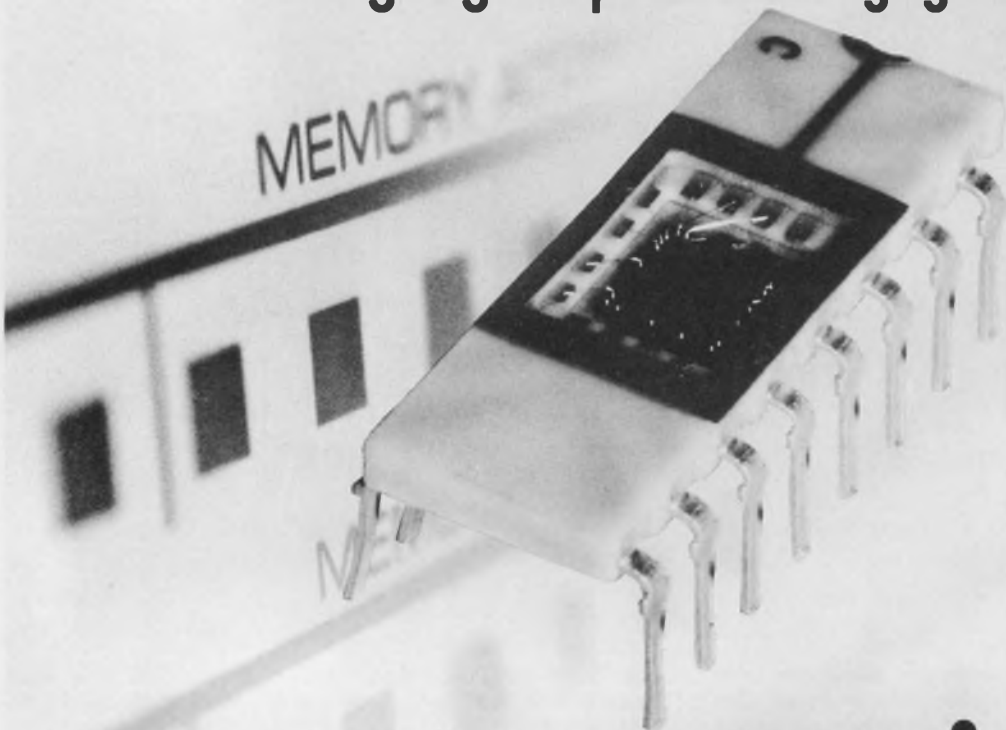

# Choose MOSTEK'S new 1024-bit RAM

It's the most advanced semiconductor memory component available.

You can improve performance and reduce costs of memory systems for mini-computers and peripherals — mainframes too! — with MOSTEK's new MK 4006 P dynamic random access memory. This new design is made possible through MOSTEK's exclusive ion-implantation process... *enabling both depletion and enhancement mode devices to be incorporated on the same silicon chip.* In the MK 4006 P MOSTEK has combined process leadership with creative design to bring you a whole bag of new features.

- Consider a few:
- Full TTL compatible decoding on the chip
  - No precharging or clocks required
  - First 1024-bit RAM in a 16-pin package
  - Fast access time — 300 ns typical

MOSTEK makes it easy for you to use MOS. All products are designed with the system designer's job in mind. Simple cycle timing: read, write, or read - modify - write. No need for interface circuitry like level shifters and clock drivers. (You don't even need pull-up resistors!) Result: you avoid noise problems and at the same time realize big savings in component costs and board space.

If you're ready to consider the advantages of solid state memories, make a smart move... to MOSTEK! Call Gordon Hoffman at (214) 242-1494, or your nearest Sprague Electric Company representative, for more reasons why.

MK 4006 P FUNCTIONAL DIAGRAM

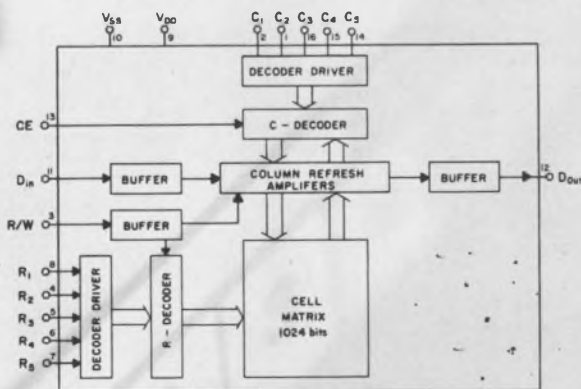

An affiliate of Sprague Electric Company.  
1400 Upfield Drive, Carrollton, Texas 75006



Pardon us...  
 while we  
 make a little noise  
 about our quiet  
**muffin<sup>®</sup> fan**



In this day and age, with all the talk about noise pollution and with everyone shouting that his product is best, we would like to tell you quietly, confidently and with documentation that the Muffin Fan is the quietest 100 cfm fan you can buy.

Side-by-side acoustical analysis tests of the Muffin Fan and comparable 100 cfm units of three other manufacturers were performed in our extensive Acoustic Test Facilities. The results are indicated in the octave band curve at the right. It proves conclusively that the Muffin Fan contributes less interfering noise than any of the other fans.

If you are faced with the task of designing and packaging electronic equipment to function to the critical low-noise standards required today, you're sure to want to learn more about our quiet Muffin Fan. And we have lots more to tell you about the "quiet one" — versus fans "I," "P" and "H" — just write to:

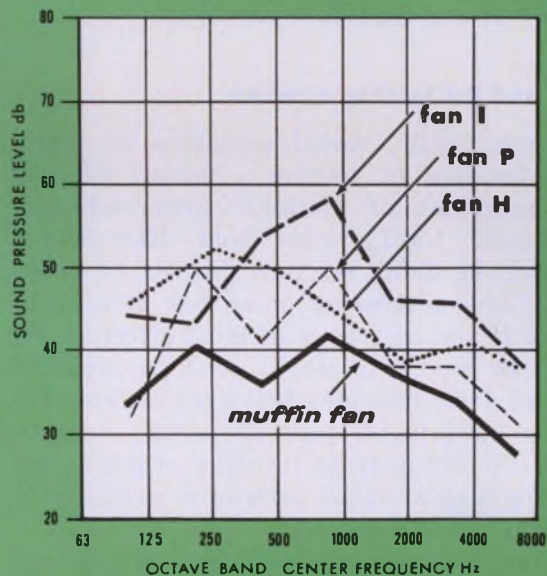

Results of acoustical analysis conducted under like conditions at 60 Hz and free air delivery Microphone 3 feet from specimens.



**WOODSTOCK,<sup>®</sup>**  
**NEW YORK 12498**



# What price unionization?

This review indicates that a union cannot guarantee job security or prevent layoffs, but that management has much to learn.

Richard L. Turmail, Management Editor

Among the issues that stimulated the most discussion in the engineering community during 1970 was unionization. Student and veteran engineers alike expressed more concern last year than ever before about job security—perhaps because more engineers than ever before were being laid off. The demand for engineers through October, 1970, was reported at a ten-year low, according to Deutsch, Shea and Evans, Inc., a technical recruiting agency in New York City.

Since many of our readers—engineers and management alike—have probably been weighing the issues of unionization, perhaps the best service we can provide them is to relay the information we've learned about unions. Our observations are based on our own surveys, a seminar, news sources, and the conversations we've had with many of our readers in the field.

## A survey and the leading question

Why, specifically, would engineers be interested in forming or joining a union? Charles Sporck, president of National Semiconductor, Santa Clara, Calif., once told *ELECTRONIC DESIGN* that he didn't see how they *could* be interested. "An engineering union has nothing to contribute to the objectives of most effective engineers," he said. "It would tend to separate engineering from management, when engineering has to be an integral part of management in order for the company to function properly. An engineering union would destroy a company in the semiconductor business."

While most engineers share Sporck's conclusion, an increasing number of them are voicing the difficulties they're having with management. And discontentment is the first step on the road to collective bargaining.

In answer to a questionnaire *ELECTRONIC DESIGN* ran in the article, "No Engineer Wants to Be a Crybaby!" (Sept. 13, 1969, issue), on the subject of whether engineers have legitimate gripes about their working conditions, 87% of the 250 readers who responded agreed that at

least one or more of the listed "sins" of management were valid. These included:

- Inconsideration.
- Indecision.
- Unnecessary paper work.
- Promotion bias.
- Poor judgment.
- Lack of support.

According to a survey article published in the May 24, 1970 (ED 11) issue one of every four engineers who responded to the question, "Do you favor a union for engineers?" indicated that a union would:

- Promote more benefits.
- Promote job security.
- Give engineers bargaining power with corporate management.

The remaining three out of four reported that union affiliation would:

- Stifle incentive.
- Degrade the engineering profession.
- Create a barrier between engineer and manager.
- Hinder recruitment of new employees.
- Foster promotion on a security basis rather than on merit.

## The two-sided company policy

Short of tying a bell around the neck of a white cat, putting the message in her mouth, and pushing her into the company president's office, there doesn't seem to be any way to convince most corporate managements that the best way to keep the company nonunion is to give their employees more than a union would.

Some firms have got the message. Instead of ordering mass layoffs during the current recession, some employers have shown concern for their engineers by variously calling for salary cuts, offering four-day workweeks, and, in one case, creating a two-week shutdown without pay around the first of the year to check inventory. The point of all these cutback measures is to avoid layoffs. When unable to avoid them, some plants have tried to help those laid off to find a job through company help programs.





## Student engineers study the unions

A new breed of engineering student is challenging industry. He's broad-minded, humanistic, socially oriented and has ideas that extend beyond his specialty. Most important, he's broadening the thinking both on campus and in industry.

For example, in mid-December, 1970, one of the new breed, Steve Waldorf, a New York University electronic engineering student, Class of '71, asked *ELECTRONIC DESIGN* to speak about unions to their Student Chapter of IEEE, along with the dean of engineering, and a union organizer.

Nurses, policemen, and especially teachers, have made the unions, organizers of 22% of the nation's labor force, legitimate in the eyes of many students. College professors who are now organized aren't apt to speak against unions as they once might have. Students are deciding for themselves whether or not a union is good or bad for an engineer.



Management Editor Turmail and Dean of the New York University School of Engineering and Sciences Ragazzini await their turn at the seminar rostrum.



Sanford Lentz, chairman of the Professional and Technical Conference Board of the International Union of Electrical Workers, makes a point at the NYU seminar.



A union, obviously, couldn't force those companies to do any more than they're doing without putting them out of business. The flip side of company policy, however, is the long-playing disregard many firms have for their engineers. As reported in "Pasture or Production, What'll It Be?", an article that appeared in the Oct. 25, 1970 (ED 22) issue: "While the severance of older engineers is accelerated by company mergers, company policy plays a leading role in keeping them unemployed. Many employers, for instance, have no intention of rehiring veteran engineers they've laid off. They'd rather invest in a recent college graduate who has boned up on the latest technology, and who can be hired at a lower salary than his older counterpart."

### A union seminar—for the employer

There's no doubt that engineers could use a few more assurances. In order to find out what a union could provide vs what a company could provide, we attended a two-day seminar that was sponsored by the Bureau of Industrial Relations of the University of Michigan at Ann Arbor. The seminar was titled, "Unionization of Professional, Technical, and Clerical Employees," and it was led by Cornelius P. Quinn and Thomas W. Hill, both associate directors of the Management Education Center in Ann Arbor. Between them, they have organized 60 assorted labor unions. Highlights of their discussion were why individuals join unions, how a company falls prey to a union, what it can do to maintain a nonunion status, and the reasons why employees should vote no to a union.

According to the seminar leaders, there are

three basic reasons why individuals join unions. They are:

1. *Poor supervision*: Unions don't just happen; companies organize themselves. Employees turn to a union to become their collective spokesman because of poorly trained and poorly informed first-line supervision. "Amateur" supervisors have organized far more employees than all the professional union organizers put together.

2. *Unfulfilling work*: If the individual's job fails to fulfill his drives and needs, he blames his supervisor and his company. He is convinced that he is being treated unfairly, and he turns to a union for help.

3. *Lack of job security*: The engineer's grievances are a lack of job opportunity and promotion, plus the fear of being fired. But the seminar leaders are not convinced that employees will join a union only for monetary gain. Too many companies with outstanding pay and benefit programs, they say, have fallen easy prey to the union organizer.

In such a case, this is generally what happens: Two or three employees form a committee and go to management armed with demands. If these demands are granted, they'll keep demanding until the demands are too unreasonable to honor. When that happens, the committee then invites a union steward to the plant, and, once that occurs, a union invariably results.

Quinn says: "Unions have won half of their elections in the last ten years." Hill adds: "Once a union gets in, it's impossible to get rid of it. People will never vote it out because of their investment in the pension and welfare plans."

What can companies do to protect themselves against this kind of unionization? Quinn and Hill

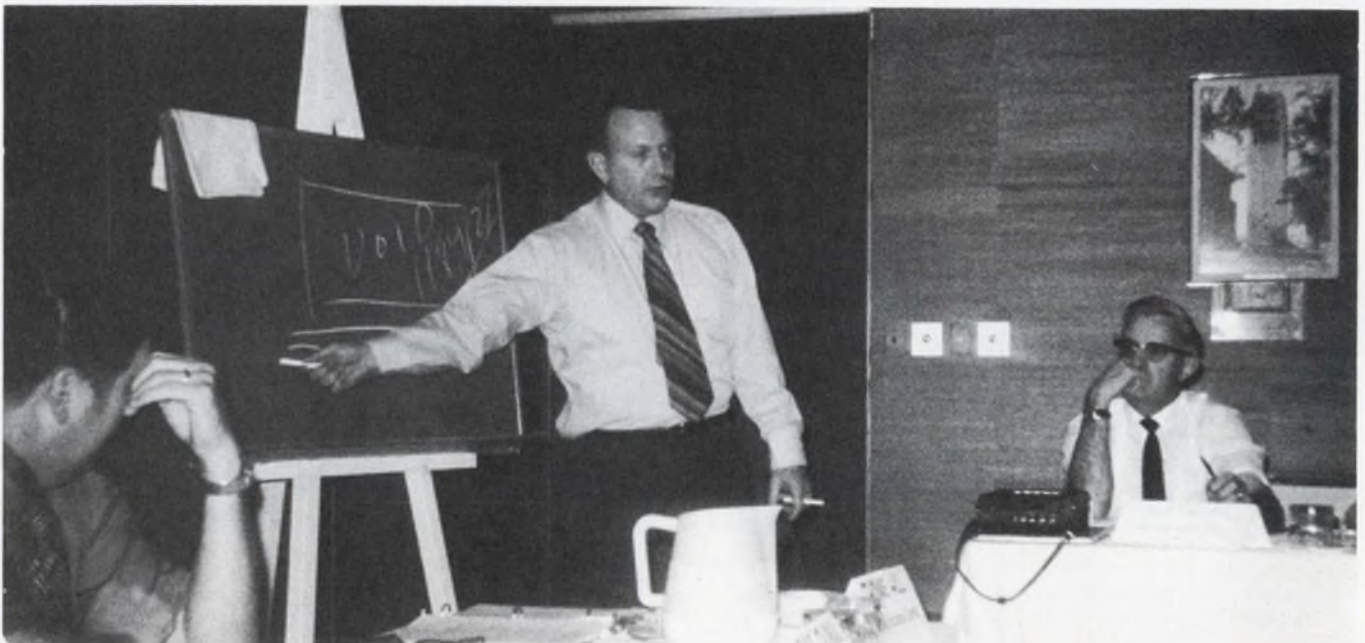

Seminar leader Tom Hill gives a chalk talk at the BIR conference on maintaining the nonunion status.



advise companies to meet the first demands of such a committee and then get rid of the committee members as soon as possible—especially if the demands aren't justified. Brutal? Perhaps. But Quinn and Hill claim that *a union is formed to protect only the mediocre worker*. Employees with incentive and ambition lose as well as a company when a union moves in.

And what does the company lose? Quinn says: "If I were to attempt to cost the price of a union's noneconomic demands, the following might be a close approximation. Assume the following:

1. Plant of 300 employees.	
2. Average wage: \$3 an hour (without burden).	
3. Time span—a 2-year contract.	
Two contract negotiations create the following situation:	
240 hours × 3 union = 720 hours × \$3...\$	2,160
720 hours lost in direct labor × \$3.....	2,160
Time lost in grievance procedure:	
6 stewards 1/2 time = 6,180 hours × \$3..	18,540
Direct labor hours lost .....	18,540
Arbitration cost (8 × \$500) .....	4,000
Management time total, 3 full-time .....	30,000
Estimated lost productivity due to bumping, posting, retraining and grievance procedure, 10% efficiency loss .....	180,000
TOTAL.....	\$255,400

"Hopefully", Quinn said, "You are now convinced it's a sound business decision to establish employee policies and keep your employees reasonably content to retain their nonunion status."

**What the employee should know**

One of the seminar participants, Greely Sanders, personnel manager of the Dayton Tire and Rubber Co., had also once been a union organizer. He said that his company is constantly fighting off the attempts of the union to organize employees there. The company has been successful, largely because Greely knows what a union can and can't give the employee. Among his long list of reasons why employees should vote no to a union, are the following four that we think apply specifically to engineers.

1. *What does it cost?* Union memberships are expensive. It will cost you a great deal of money to buy one. Union dues are payable every month—and they can be increased at any time. In addition, there are fines and dues supplement. There is no way to know the total cost.

2. *What about raises?* The union cannot guarantee to get you one cent more than you get now. Sometimes employees get less with a union than they get without it—and they have to pay union dues. (This happens when a union trades off some employee benefit for something the union wants, like dues checkoff or unionship.)

3. *What about job security?* The union does not give you real job security. Job security means

**R & D managerial systems**

The Bureau of Industrial Relations is a self-sustaining department within the Graduate School of Business at the University of Michigan. It is devoted to research and instruction in managerial systems and techniques. Founded in 1934, BIR serves the business community through 300 various seminars and conferences held each year on the Ann Arbor campus.

"We are concerned with the management of people," Director Albert W. Schrader told ELECTRONIC DESIGN, "and our major efforts are devoted to enabling those who attend our programs to do a better job of getting things done through others."

Of specific interest to engineers, Schrader says, is BIR's "Management of Managers" course. The engineer who attends this course has already been promoted to a responsible management position. Since his entire career has been spent in a technical/professional role, he needs this formal training for the job he now holds.

steady employment, and that depends upon whether the company's business is good. The union has nothing to do with this.

4. *What about layoffs?* Unions cannot prevent layoffs. In fact, they cause layoffs because they want to classify all employees for only one job, and refuse to let them do any other job. Under many union contracts, if there is no work in that one job you have to be laid off, because the union will not let you do anything else. That way the union hopes to have more members, so it can collect more dues.

**What the engineer wants**

From our talks with engineers in the field, we've found that, basically, they want only three major concessions from their employers:

1. The right to profit from their own inventions, and a safeguard against unreasonable work contracts or trade secret agreements.

2. A portable pension plan (employee-employer joint contribution).

3. Re-employment services for engineers laid off.

Ironically engineering employers could supply all of those needs for just a fraction of what a union would cost them.

The seminar leaders at the University of Michigan say that management underestimates the self-interest of employees and overestimates their loyalty. They suggested that management find ways to resolve the legitimate problems of employees at its next project meeting. ■■



THE  
WORLD FAMOUS  
**Simpson®**  
**260®**

**Constant improvement makes  
it consistently the world's  
largest selling VOM**

**SERIES 5 1964**

Varistor protection from movement overloads of 200,000%. New Taut Band suspension that can't develop error-causing friction.

**SERIES 4 1962**

DC accuracy increased to 2%. Plus self-shielding movement and shock-resistant spring-loaded suspension.

**SERIES 3 1959**

Low resistance banana jacks and improved full wave rectifier circuit for increased sensitivity (5000  $\Omega/v$ ) and 3% AC accuracy. Added 50  $\mu$ a and 250 millivolt ranges and new adjust-a-view handle. First VOM with printed circuitry. Fuse added for circuitry protection.

**SERIES 2 1947**

Molded front panel with integral indicating instrument plus DC current measurement extended to 10 amps.

**SERIES 1 1938**

Beginning of the revolution in tester design—an instant success. First commercially available VOM with 20,000  $\Omega/v$  sensitivity. Complete range coverage for industrial and radio servicing.

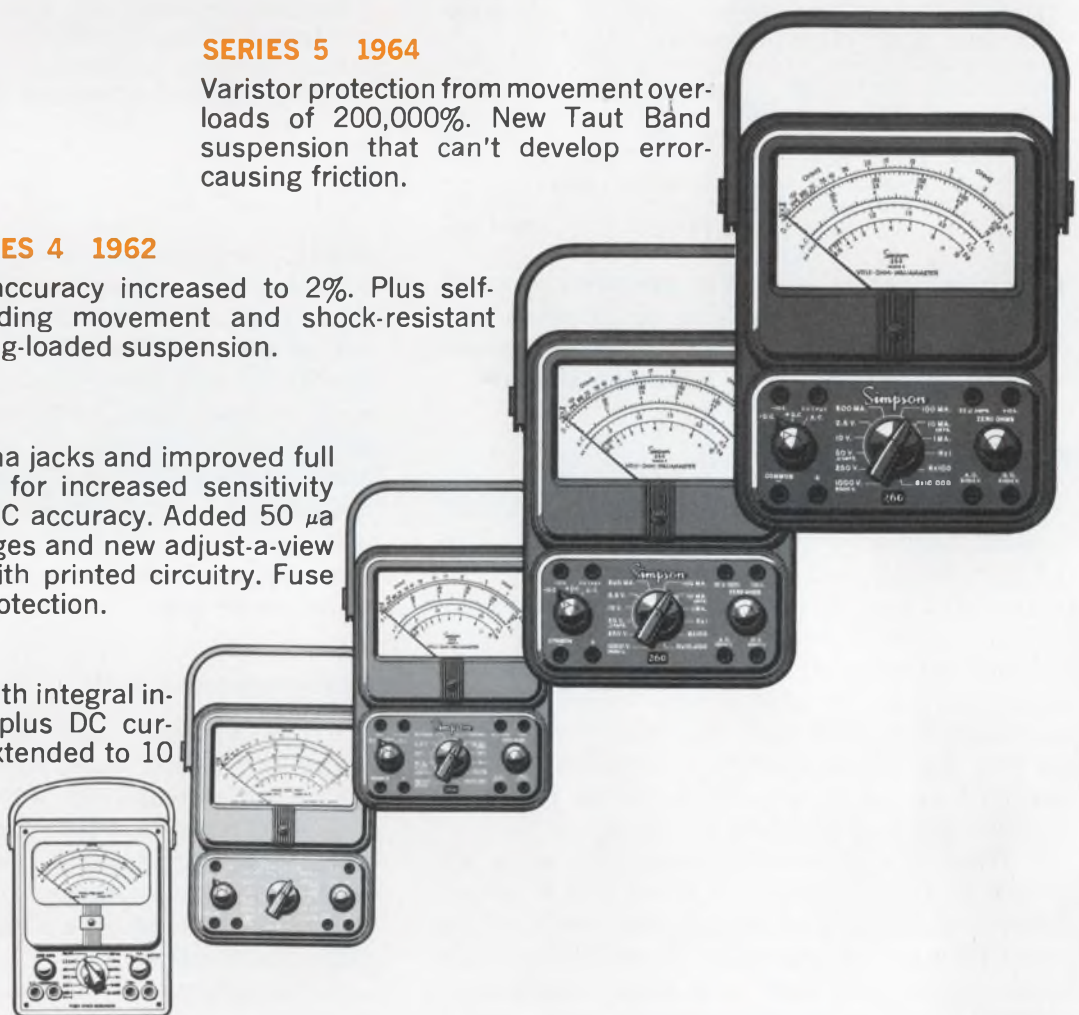

**Simpson®**  
INSTRUMENTS THAT STAY ACCURATE





**NOW...  
the new**

**Simpson**

**260<sup>®</sup>  
SERIES 6  
VOM**

THE NEW SERIES 6 HAS ALL THESE NEW FEATURES PLUS ALL THE ADVANCEMENTS IN THE SERIES 5:

- External access battery and fuse compartment.
- Clip-type fuse holder.
- 0-1 volt DC range.
- 0-500 volt AC and DC ranges.
- Available 5000 volt adapter-type DC safety probe.
- Multi-purpose, screw-on test leads with combination probe and alligator clips.
- Only 2 batteries . . . one 9-volt NEDA 1604 and one 1½-volt "D" cell.
- Rugged taut band movement.
- Varistor overload protection.

260-6 . . . . . \$65.00  
260-6M (Mirror scale) . . . . . \$67.00

EXTERNAL BATTERY AND FUSE COMPARTMENT

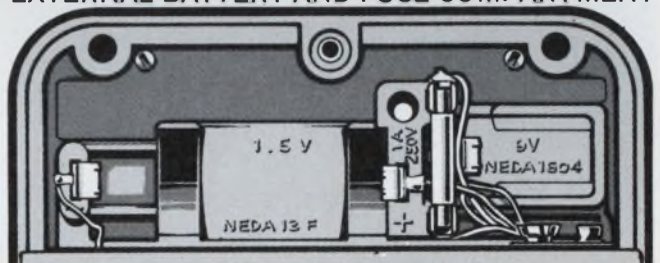

260-6RT (Roll-top protective case) . . . . . \$71.00  
260-6MRT (Mirror scale and roll-top case) \$73.00  
260-6P (Overload protected) . . . . . \$97.00  
260-6PRT (Overload protected and roll-top case) . . . . . \$103.00  
Safety Probe: 5000 volt DC adapter type #00506 . . . . . \$4.50

**GET "OFF THE SHELF" DELIVERY FROM YOUR LOCAL ELECTRONIC DISTRIBUTOR  
—OR WRITE TODAY FOR BULLETIN T-810.**

**SIMPSON ELECTRIC COMPANY**

5200 W. Kinzie St., Chicago, Ill. 60644, Phone: (312) 379-1121

Export Dept: 5200 W. Kinzie St., Chicago, Ill. 60644, Phone: (312) 379-1121, Cable SIMELCO  
IN CANADA: Bach-Simpson Ltd., London, Ontario

IN INDIA: Ruttonsha-Simpson Private, Ltd., International House, Bombay-Agra Road, Vikhroli, Bombay  
INFORMATION RETRIEVAL NUMBER 46



DIVISION



## Synchronize four digital signals using a crystal-controlled input

A digital frequency synchronizer develops pulse repetition rates of 100 kHz, 10 kHz, 1 kHz and 100 Hz, which are all synchronized with the crystal-controlled 100-Hz input. The circuit may be used where a phase-locked loop is normally employed to synchronize a signal with one of a lower frequency. Thus, synchronization can be accomplished using fewer components, since the analog devices for the phase detector, filter and voltage-controlled oscillators are not required.

With this circuit, the falling edge of the 100-Hz output will always lag the leading edge of the input by  $1 \pm 1 \mu\text{s}$  so that the phase angle between the two signals will not vary by more than one part in 10,000 or 0.036 degree. Since the 100-Hz output is developed from the 1-kHz signal, the two are also synchronized with each other; similarly, the 100-kHz and the 10-kHz outputs are synchronized with the lower frequencies.

Flip-flops FF<sub>1</sub> and FF<sub>2</sub> and gate G<sub>1</sub> are used

to form a 1- $\mu\text{s}$  pulse when the 100-Hz input makes the transition from the low to the high state. This pulse forces all four decade counters to be synchronously reset at the next leading edge of the clock. Between reset pulses the counters perform in the normal decade manner where the count of each of the last three decade stages is incremented by one whenever the driving decade stage makes the transition from 9 to 0.

If the 100-Hz input was exactly one ten-thousandth of the clock frequency, the 1- $\mu\text{s}$  reset pulse would always occur at the same time as the count 9999. However, the clock and the input are generated by two independent sources, therefore the phase angle between them is slowly shifting. If the input rate is too fast, the counter will occasionally be reset following the count of 9998, thus effectively speeding up the counter. Likewise, if the input is too slow, the counter will be reset following the count of 0000.

*Ken Erickson, Interstate Electronics Corp., Dept. 4750, P. O. Box 3117, Anaheim, Calif. 92803.*

VOTE FOR 311

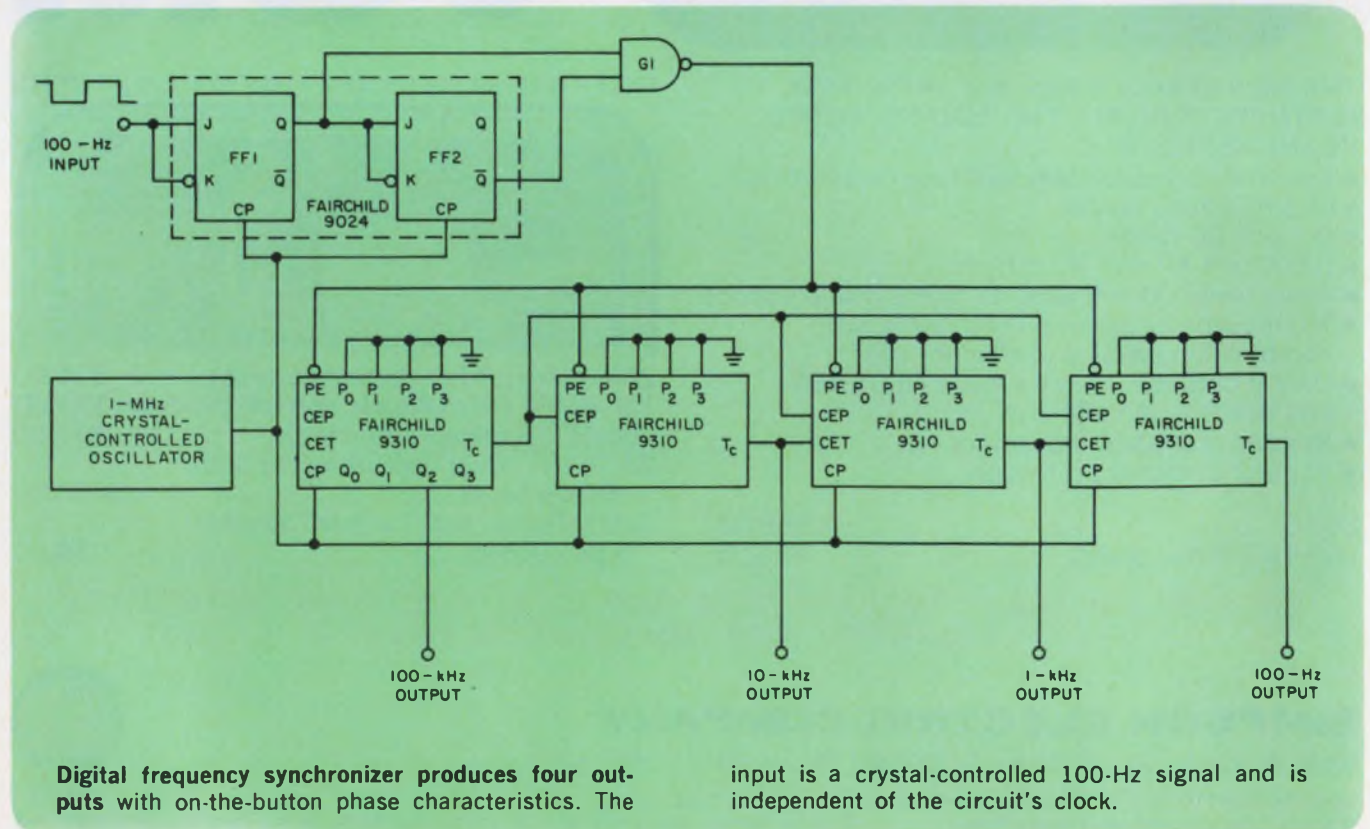



# New from Helipot... Standard Resistor Networks in dual in-line packages

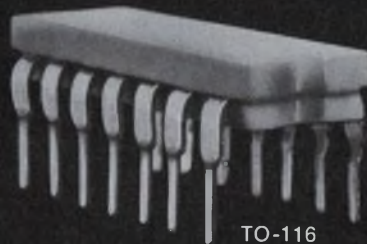

TO-116

## DIGITAL PULL-UP NETWORKS

**Model:** 899-1-R2K and 899-1-R6K  
**For:** unused gate pull-up, wired "OR" pull-up,  
 parallel high speed pull-up  
**Standard Tolerance:**  $\pm 2.0\%$   
**Pricing:** 1-99 \$1.45  
 1,000-4,999 0.81

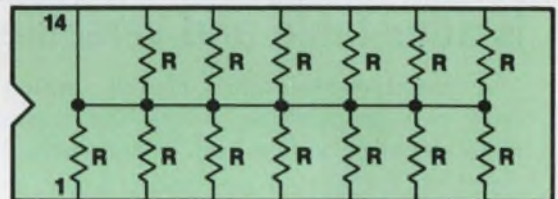

## ANALOG SCALING NETWORKS

**Model:** 899-2-R10K  
**For:** gain ranging, series attenuation,  
 voltage division  
**Standard Tolerance:**  $\pm 0.1\%$  voltage ratio  
**Tracking:**  $\pm 15$  ppm/ $^{\circ}\text{C}$   
**Pricing:** 1-99 \$2.75  
 1,000-4,999 1.55

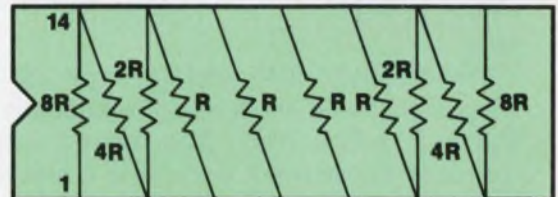

## DIGITAL LINE TERMINATOR ARRAYS

**Model:** 899-3-R110  
**For:** twisted pair termination,  
 coaxial line termination  
**Standard Tolerance:**  $\pm 2.0\%$   
**Pricing:** 1-99 \$1.25  
 1,000-4,999 0.72

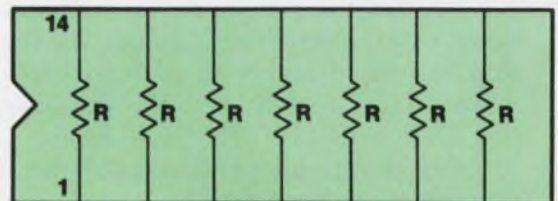

**Beckman** INSTRUMENTS, INC.

HELIPOT DIVISION  
 FULLERTON, CALIFORNIA

HELPING SCIENCE AND INDUSTRY IMPROVE THE QUALITY OF LIFE

Call your local Helipot Sales Engineering Representative  
 for additional information and application assistance.



## Controlled starting conditions overcome timing circuit errors

Timing errors of typical RC clock circuits are overcome by the circuit shown. Due to the starting conditions, the time between the first and second clock pulse in conventional designs is often different from the time between a pair of successive pulses that occur later.

This circuit produces an output pulse when the input pulse is received and simultaneously starts the relaxation oscillator. Since  $C_1$  is discharged in the quiescent state, the oscillator starts without bias. This is due to the input command, which causes the unijunction transistor to be held in conduction.

The first pulse in the output is derived directly from the input signal, and succeeding output pulses are generated by the oscillator, the timing of which is controlled by  $R_1$ ,  $C_1$ . A timing error can be exhibited at turnoff unless  $R_1$  is very small compared to  $R_1$ . If  $R_1$  is essentially zero, turnoff time will be controlled by the input command, which is typically a flip-flop output.

The transistor, a General Electric D13T2 programmable unijunction, is compatible with RTL logic if  $V_{cc} = 5$  V.

*R. T. Hart, Manager Development Section, Omega-T Systems Inc., 300 Terrace Village, Richardson, Tex. 75080.*

VOTE FOR 312

## Negative-resistance circuit is adjustable and versatile

A negative-resistance circuit, which employs only two transistors, offers the advantages of wide dynamic range and easily variable characteristics. Suggested applications for this simple configuration include its use as an oscillator, amplifier, power stabilizer, Q multiplier, or an active filter.

The transistors  $Q_1$  and  $Q_2$ , type 2SC182 from Nippon, have dc betas of approximately 50— $h_{FE1}$  and  $h_{FE2}$ , respectively. The input voltage to the circuit is  $V$ , the input current is  $I$ , and the supply voltage is  $V_{CC}$ .

Neglecting the base-emitter voltages and collector cutoff currents of  $Q_1$  and  $Q_2$ , the relationship between  $I$  and  $V$  is expressed by:

$$I = (h_{FE2} V_{CC}) / (R_2 + R_3) - [h_{FE1} h_{FE2} R_2 - (R_2 + R_3)] V / [R_1 (R_2 + R_3)]$$

Using the circuit parameters shown, this equation can be reduced to:

$$I = (h_{FE2} V_{CC} / R_3) - h_{FE1} h_{FE2} R_2 V / R_1 R_3$$

And finally:

$$I = (25 - 1.25 V) \times 10^{-3} \text{ amperes}$$

The ideal characteristics of  $I$  as a function of

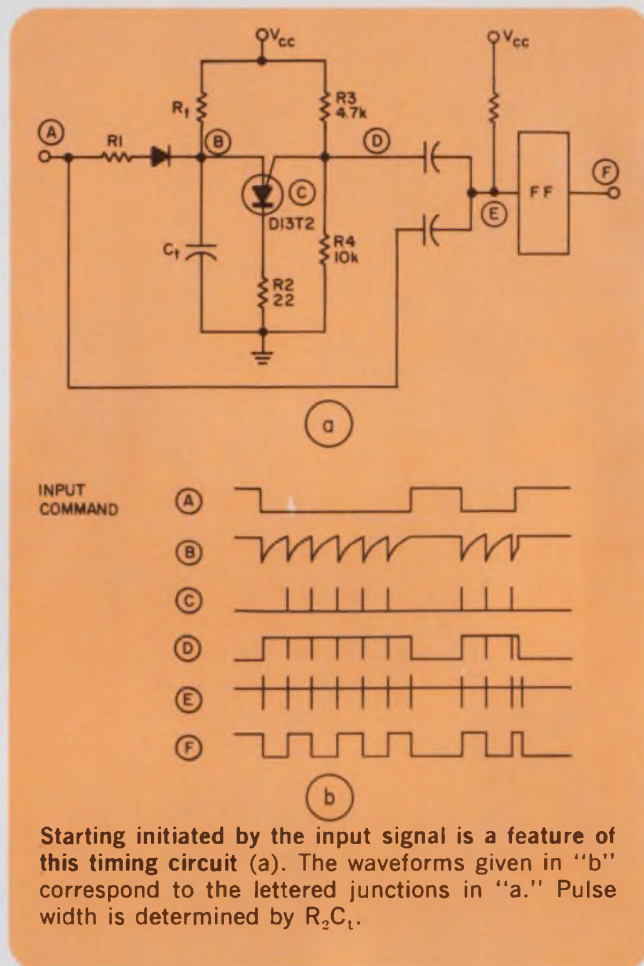

Starting initiated by the input signal is a feature of this timing circuit (a). The waveforms given in "b" correspond to the lettered junctions in "a." Pulse width is determined by  $R_2 C_1$ .

$V$  is represented by the solid line in the illustration. However, because the dc beta of real transistors varies with collector current, the actual current-voltage characteristic is shown by the dashed line.

Circuit performance can be easily altered by changing the supply voltage of  $V_{CC}$  and the value of the resistors  $R_1$ ,  $R_2$ ,  $R_3$  and  $R_4$ .

*Sadanori Nishikawa, Electrical Engineering Department, Oita Technical College, Oita City, Japan.*

VOTE FOR 313

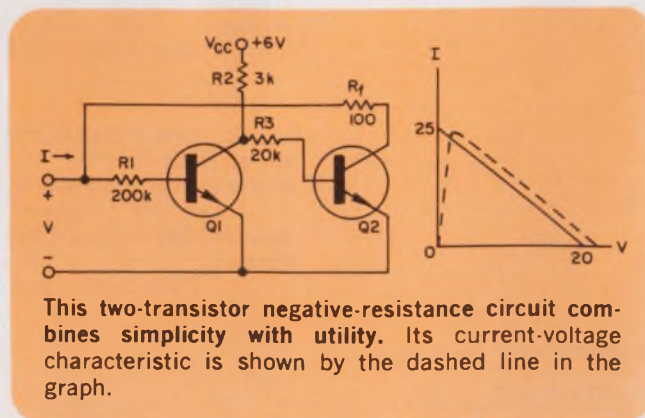

This two-transistor negative-resistance circuit combines simplicity with utility. Its current-voltage characteristic is shown by the dashed line in the graph.



# Buckbee-Mears research developed the absolute filter.

*Tasting our success  
was a great experience.*

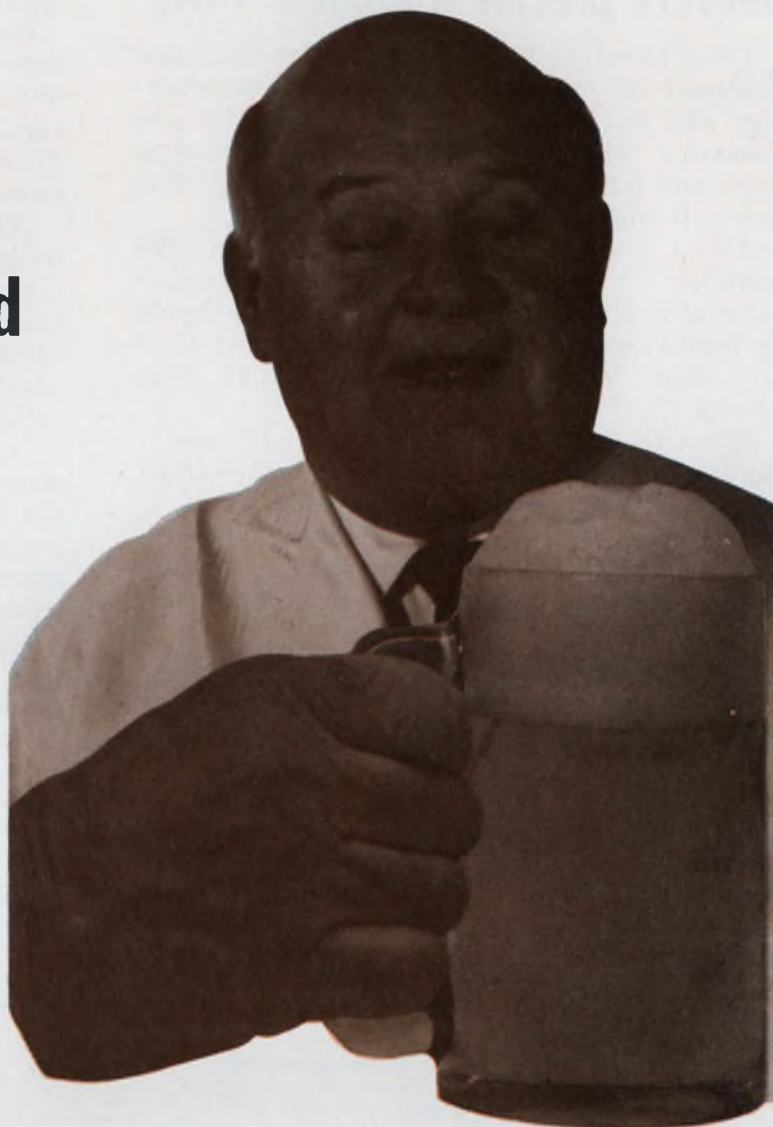

A key step in producing beer is pasteurization. Some of America's leading breweries have found they can produce a smoother beverage by using a precision-etched, Buckbee-Mears fine screen as a filter in the pasteurizing process.

It's no wonder. We make the only absolute filter available. With our process, we can hold the uniformity of holes in the filter screen constant. Our filter customers can choose just about any material they want, including stainless steel, molybdenum, nickel, monel and titanium — in any array.

Buckbee-Mears offers small or large holes in the array. Unlike die stamping, the on-centers can be adjusted close or far apart. Our absolute filters are self-cleaning because of planer construction. That's another exclusive advantage of our photomechanical reproduction process.

We etch absolute filter screens at a one-to-one ratio be-

tween metal thickness and hole size. Maximum hole size tolerance to  $\pm 10\%$  of metal thickness, minimum to  $\pm .0002''$ .

While we're delighted to help the nation's brewmasters upgrade their product, our absolute filters have many other uses. They include centrifuge, synthetic fiber filters, coffee brewer screens, particle size determination and back-up screens for sub-micron filters. Anyone with a filtering application where an absolute filter is required can use our capabilities.

Producing the only absolute filter screen on the market is another example of creative technology from Buckbee-Mears. We're in business to help you solve your problems. Call or write Bill Amundson, our industrial sales manager, about your absolute filter requirements. Phone 612-227-6371. Skoal!

PRECISION METAL AND GLASS ETCHING • ELECTRO FORMING • AUTOMATED DESIGN  
**bmc** BUCKBEE-MEARS COMPANY  
SAINT PAUL, MINNESOTA 55101

INFORMATION RETRIEVAL NUMBER 48



# Low-cost tri-function generator delivers precise triangular wave

Using only four ICs, four transistors and a few supporting components, a versatile function generator can be constructed for less than \$50. The generator, which can supply triangular, square-wave and pulse signals, can be tailored for frequency, frequency stability and linearity.

Fig. 1 shows a schematic of the circuit. The amplifier  $U_1$  (Motorola's MC1709CP) acts as an integrator and produces either a negative-going or positive-going ramp. If  $Q_2$  is OFF and  $Q_1$  is ON, point A is positive and a negative ramp results.

When the output of comparator  $U_3$  (Signetics' NE518A) goes to 0 V, the binary, which is formed by cross-connecting the NAND gates of  $U_4$  (Motorola's MC846P), changes states. This turns  $Q_1$  OFF and  $Q_2$  ON, bringing point A essentially to 0 V. When the binary switches again,  $Q_3$  turns ON and  $Q_1$  goes OFF.

Since point B is now negative,  $U_1$ 's output is a positive ramp. The integrator output goes to 0 V when it exceeds the positive reference voltage of

comparator  $U_2$  (Signetics' NE518A). The binary again changes states and reapplies a positive voltage to the integrator.

Fig. 2 shows the various circuit outputs and their locations. Short negative-going pulses, which are coincident with the peaks of the triangular wave, are available at points D and E. These are suitable for synchronizing other equipment to the function generator itself.

The frequency of the triangular wave is controlled by the integrator's resistance and capacitance, and the reference voltage. The network that consists of  $R_{10}$  through  $R_{13}$  allows fine zero adjustment. The lower or upper peaks of the triangular wave can be altered by changing the voltage at points H and I.

Coarse variable-frequency operation is also made possible by switch-selecting capacitor  $C_x$ ; fine frequency adjustment can be implemented by using ganged potentiometers for  $R_2$  and  $R_1$ . In addition, the positive and negative slopes of the triangular wave can be varied independently.

*Ivaras P. Breikss, Principal Engineer, Honeywell Inc., Test Instruments Div., 4800 E. Dry Creek Rd., Denver, Colo. 80217.*

VOTE FOR 314

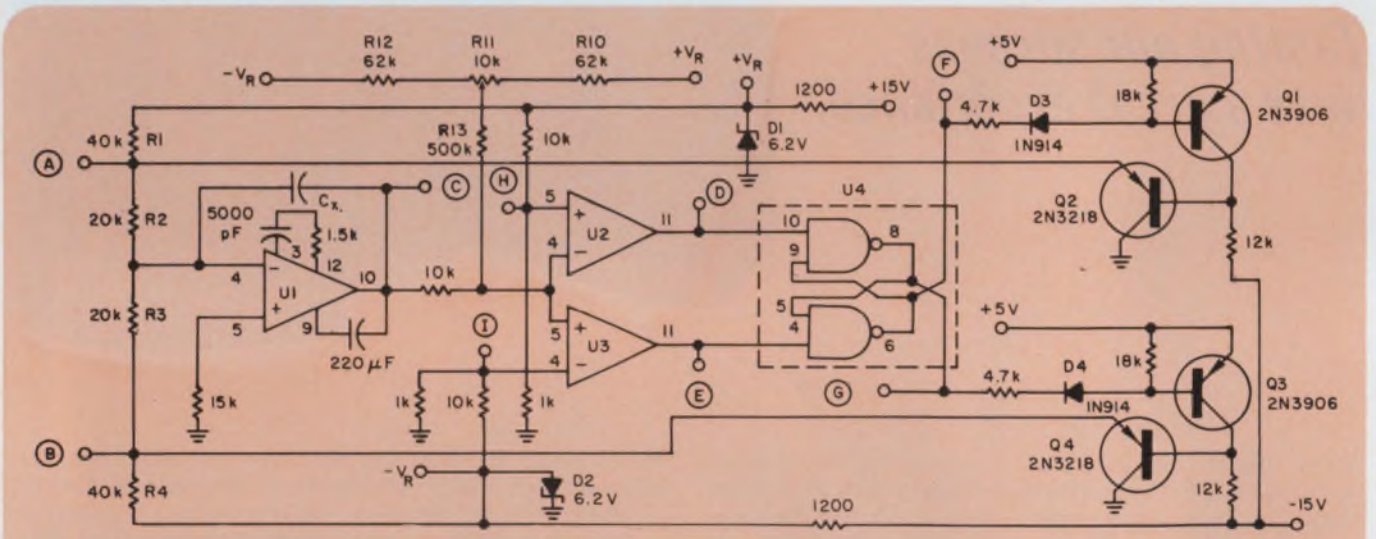

1. This versatile function generator provides triangular, square-wave and pulse outputs for less than \$50. The circuit employs only four ICs, four

transistors and a few other components. Its triangular output can be finely controlled with respect to frequency and slope.

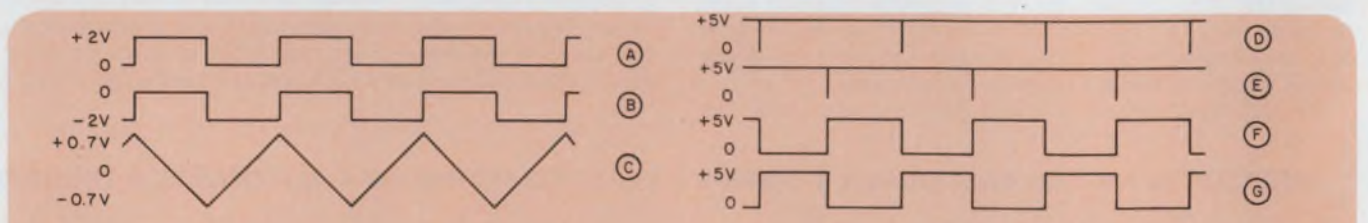

2. Available outputs include a fully adjustable triangular waveform, negative-going synchronization

pulses and square waves that are capable of directly driving logic circuits.



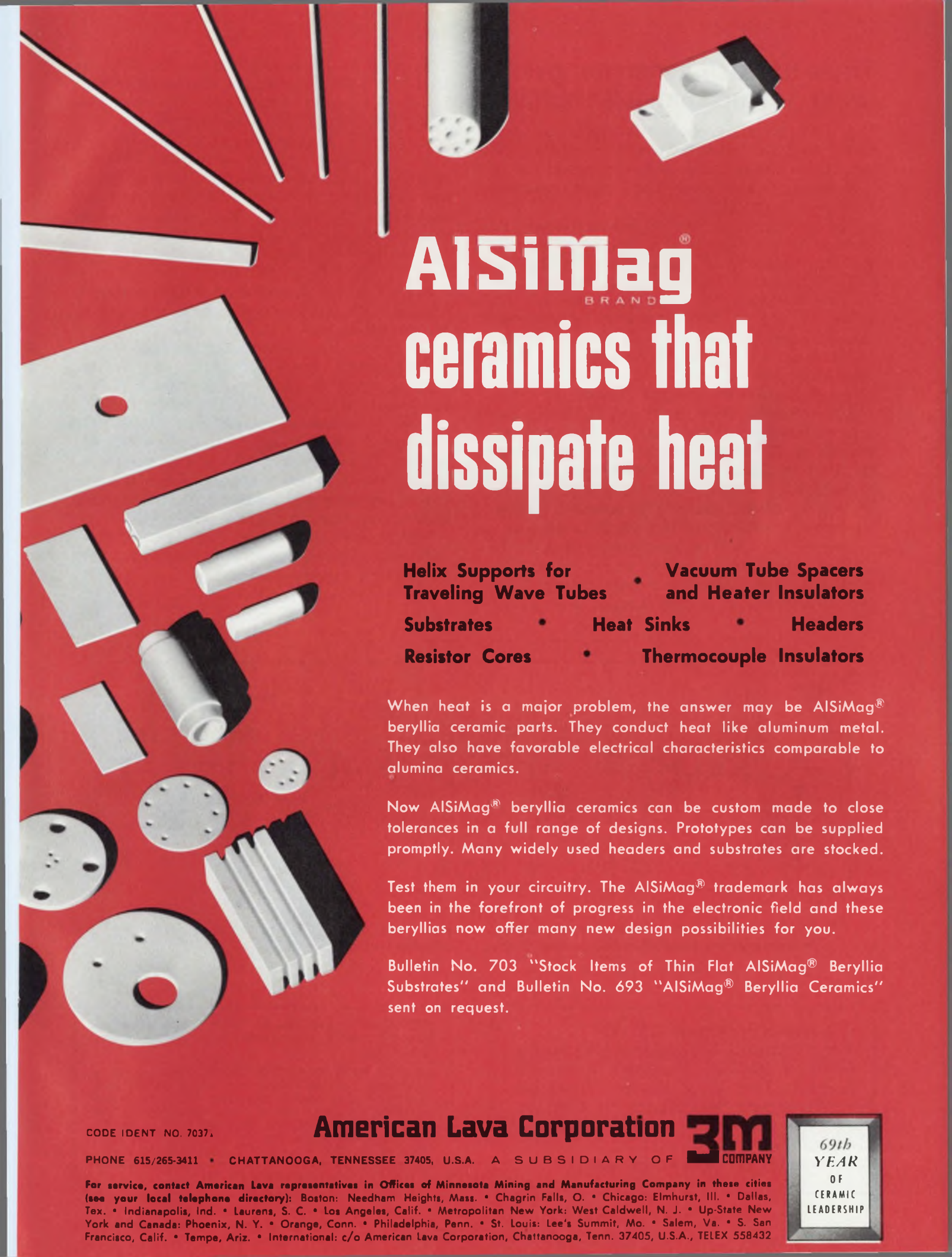

# **AlSiMag<sup>®</sup>** BRAND ceramics that dissipate heat

**Helix Supports for  
Traveling Wave Tubes**

**Vacuum Tube Spacers  
and Heater Insulators**

**Substrates**

**Heat Sinks**

**Headers**

**Resistor Cores**

**Thermocouple Insulators**

When heat is a major problem, the answer may be AlSiMag<sup>®</sup> beryllia ceramic parts. They conduct heat like aluminum metal. They also have favorable electrical characteristics comparable to alumina ceramics.

Now AlSiMag<sup>®</sup> beryllia ceramics can be custom made to close tolerances in a full range of designs. Prototypes can be supplied promptly. Many widely used headers and substrates are stocked.

Test them in your circuitry. The AlSiMag<sup>®</sup> trademark has always been in the forefront of progress in the electronic field and these beryllias now offer many new design possibilities for you.

Bulletin No. 703 "Stock Items of Thin Flat AlSiMag<sup>®</sup> Beryllia Substrates" and Bulletin No. 693 "AlSiMag<sup>®</sup> Beryllia Ceramics" sent on request.

CODE IDENT NO. 7037.

PHONE 615/265-3411 • CHATTANOOGA, TENNESSEE 37405, U.S.A. A SUBSIDIARY OF **3M** COMPANY

For service, contact American Lava representatives in Offices of Minnesota Mining and Manufacturing Company in these cities (see your local telephone directory): Boston: Needham Heights, Mass. • Chagrin Falls, O. • Chicago: Elmhurst, Ill. • Dallas, Tex. • Indianapolis, Ind. • Laurens, S. C. • Los Angeles, Calif. • Metropolitan New York: West Caldwell, N. J. • Up-State New York and Canada: Phoenix, N. Y. • Orange, Conn. • Philadelphia, Penn. • St. Louis: Lee's Summit, Mo. • Salem, Va. • S. San Francisco, Calif. • Tempe, Ariz. • International: c/o American Lava Corporation, Chattanooga, Tenn. 37405, U.S.A., TELEX 558432

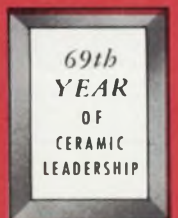



## Triple-function generator gives ramp, square, and pulse outputs

A relatively uncomplicated low-frequency generator provides three controllable simultaneous outputs—a linear ramp, a square wave, and a high-energy trigger pulse. The highest operating frequency is 100 kHz.

The driving circuit involves two time constants,  $T_1$  and  $T_2$ , and consists of a programmable unijunction transistor (General Electric's D13T1) and a high-speed comparator (National Semiconductor's LM306). The ramp generator is comprised of a FET constant-current source that charges capacitor  $C_3$ ; a zener diode,  $D_z$ , that sets the dc level,  $V_4$ ; and a super-Darlington output capable of driving loads as low as 50 ohms. A single emitter-follower output is used.

The voltage divider of  $R_5$  and  $R_6$  sets a 3-V reference voltage at the inverting input of comparator  $A_1$ .  $V_3$  establishes the firing voltage for the PUT of about 3 V. As power is turned on,  $V_R$  causes  $A_1$ 's output to go low, turning  $Q_3$  OFF so that  $C_1$  cannot charge. The positive voltage,  $V_3$ , keeps  $Q_1$  OFF;  $Q_2$  is OFF via  $R_7$  to ground.

The low output of  $A_1$  also enables diode  $D_1$  to be forward-biased through  $R_8$  to ground, and allows  $D_z$  to conduct because it draws current from the FET source.  $V_4$  is then clamped to a voltage

determined by  $D_z$ . It must be at least 4 V less than  $V_{CC}$  to allow a sufficient voltage differential for the Darlington output pair.  $Q_2$ , which has been OFF, allows  $C_2$  to charge within:

$$T_2 = R_2 C_2 \ln [V_{CC}/(1 - V_R)]$$

As  $V_2$  reaches  $V_R$ , the comparator switches states. Its output then goes high, turning ON  $Q_3$  and allowing  $C_1$  to charge.  $A_1$ 's high output also back-biases  $D_1$  and  $D_z$ . The constant-current source now charges  $C_3$  at a rate determined by  $R_3$ 's setting. The duration of the ramp is:

$$T_R = (\Delta V/\Delta I)C_3,$$

where  $\Delta V$  is the increment of voltage across  $C_3$  and  $\Delta I$  is the increment of current provided by the current source.

For this circuit,  $T_R$  had to be less than  $T_2$  and  $T_1$  (the period determined by  $C_1$ ).  $R_4$  sets the point at which the ramp starts. Without  $R_1$ , the ramp starts at a dc level determined by  $D_z$ .

When  $V_1$  reaches the potential of  $V_3$ , the PUT fires and dumps through  $C_1$  to its low ON impedance. This causes  $V_3$  to go negative, turning  $Q_1$  and  $Q_2$  ON.  $C_2$  is now dumped through  $Q_2$ 's low ( $V_{CE}$ )<sub>SAT</sub> impedance. Comparator  $A_1$  then switches back to a low state and a new cycle begins.

*Carl Brogado, Eng. Tech., University of Colorado, Medical Center, Bioengineering Dept., 4200 E. Ninth St., Denver, Colo. 80220.*

VOTE FOR 315

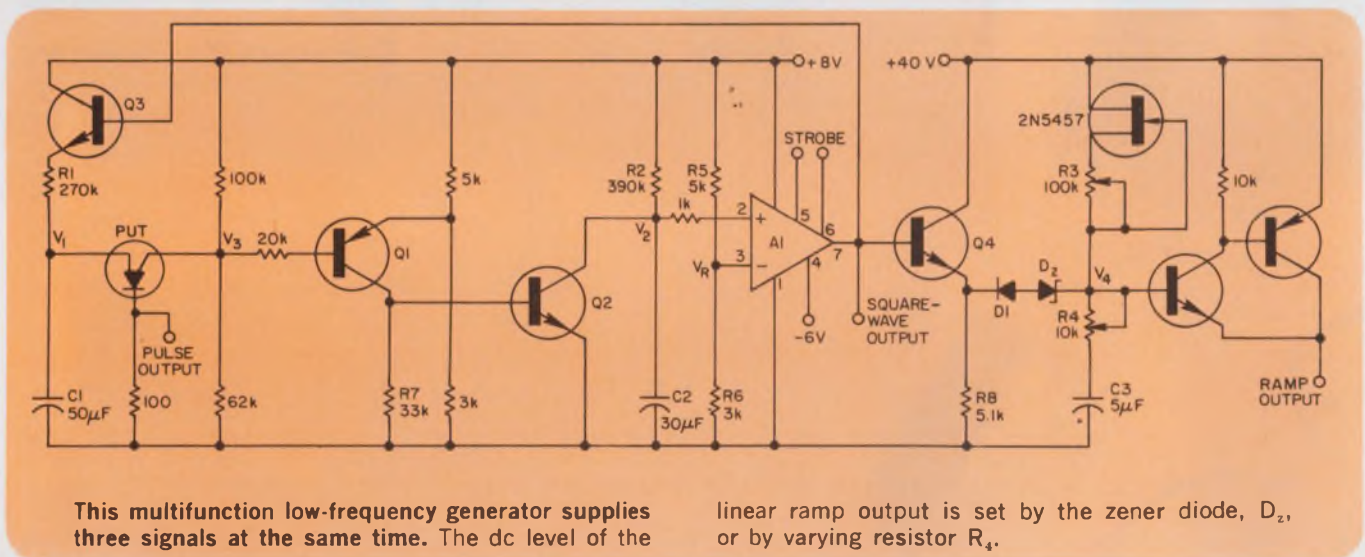

**IFD Winner for October 25, 1970**

**John D. Griffith, M. D.,** Dept. of Psychiatry, School of Medicine, Vanderbilt University, Nashville, Tenn. 37203. His idea, "Telemeter Sensor Outputs With Simple FM Transmitter," has been voted the Most Valuable of Issue award.

**Vote for the Best Idea in this Issue.**

**VOTE!** Go through all Idea-for-Design entries, select the best, and circle the appropriate number on the Reader-Service-Card.

**SEND US YOUR IDEAS FOR DESIGN.** You may win a grand total of \$1050 (cash)! Here's how. Submit your IFD describing a new or important circuit or design technique, the clever use of a new component or test equipment, packaging tips, cost-saving ideas to our Ideas-for-Design editor. You will receive \$20 for each accepted idea, \$30 more if it is voted best-of-issue by our readers. The best-of-issue winners become eligible for the Idea Of the Year award of \$1000.



# At last. A high-reliability capacitor you actually can rely on.

Our brand new TLW. It's the first-ever capacitor with a special glass-to-metal seal for positive hermetic sealing to prevent electrolyte leakage. There's just no better way to seal a capacitor.

And no harder way. Ask the guys who're still trying.

We used a solid tantalum wire through a glass-to-metal hermetic seal—no double seals, no internal dissimilar metal-weld joints. Very simple. And very effective.

But we didn't stop with great construction. We built in great performance, too.

The TLW meets environmental and electrical characteristics of MIL-C-39006/9A style CLR 65.

If you require nothing but the best, this is it. Available now in three sizes. For tech data, call or write for Bulletin 4-607.

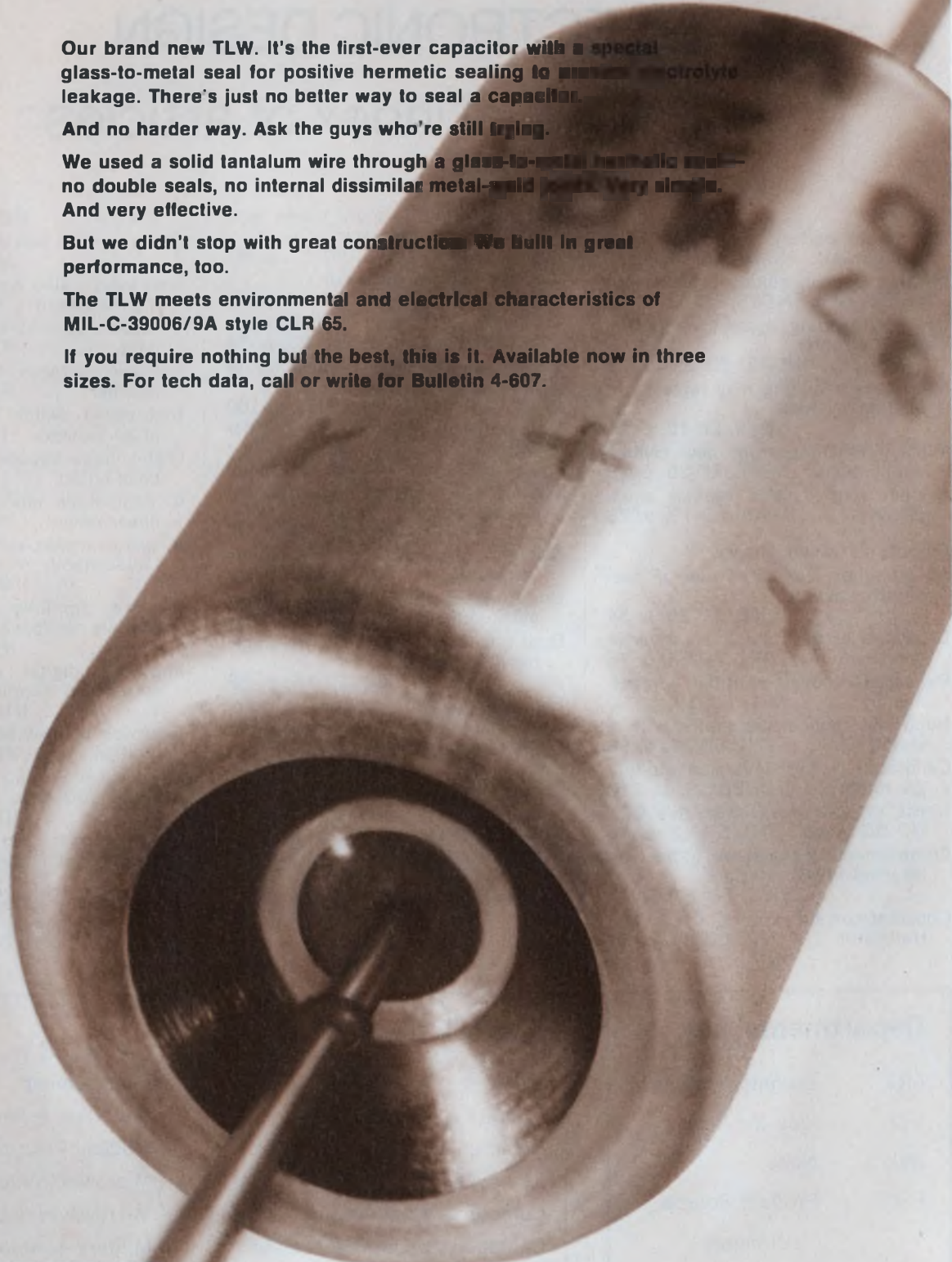

**MALLORY**

**MALLORY CAPACITOR COMPANY**

a division of P. R. MALLORY & CO. INC.

3029 E. Washington St., Indianapolis, Indiana 46206; Telephone: 317-636-5353

Electrical and electronic components • sequence timers • metallurgical products • batteries



# ELECTRONIC DESIGN

## semiannual index of articles

### Avionics

- Disposable battery slated for Army manpacks...NEWS, ED 14, p. 28
- Infrared beacon guides copters with precision...NEWS, ED 23, p. 40
- Low-cost landing system offered to small airports...NEWS, ED 22, p. 30
- Microwave scanning may replace vhf landing systems...NEWS, ED 18, p. 21
- Military R&D spurring new civilian applications...NEWS, ED 20, p. 23
- System warns pilots against aquaplaning...NEWS, ED 19, p. 23

### Circuits & Circuit Theory

- Ac amplifier eliminates use of coupling capacitor...IFD, ED 26, p. 54
- Be aware of a/d and d/a converter specifications...ART, ED 16, p. 76
- Be logical—consider unfamiliar gating...ART, ED 19, p. 90
- Build two monostable multis with a single IC...IFD, ED 24, p. 66
- Calibrated pulser covers one-to-ten- $\mu$ s range...IFD, ED 19, p. 110
- Check crystals easily with this GO/NO GO tester...IFD, ED 22, p. 86
- Complementary transistor buffer can be used for IC interface...IFD, ED 20, p. 67
- Constant-current source uses dual transistor...IFD, ED 26, p. 54

- Convert sine to square waves with no external dc source...IFD, ED 22, p. 82
- Cut down signal distortion...ART, ED 16, p. 56
- Designing sampling phaselock loops...ART, ED 23, p. 74
- Determine the series inductance of noninductive resistors...IFD, ED 21, p. 100
- Differentiator operates to 20 MHz without using discretes...IFD, ED 23, p. 90
- Digital tape channel converted for analog record/playback...IFD, ED 18, p. 82
- Divide-by-n counter uses unijunction transistor...IFD, ED 14, p. 72
- Don't neglect cable error in high loss measurements...IFD, ED 16, p. 66
- Dual tracking circuit added to single regulated supply...IFD, ED 16, p. 68
- Eliminate warm-up resistors in lamp-driver circuits...IFD, ED 25, p. 92
- Evaluate transistor bandwidths...ART, ED 26, p. 40
- Explore IC performance...ART, ED 21, p. 82
- Extra transistor speeds response of phototransistor...IFD, ED 19, p. 104
- Feedback analysis can be speeded...ART, ED 19, p. 84
- FET current source liberalizes multi-

- vibrator...IFD, ED 15, p. 108
- Find insertion loss at a glance...ART, ED 23, p. 78
- Frequency discriminator generates logical output...IFD, ED 18, p. 78
- Generate functions from discrete data...ART, ED 20, p. 42
- Get two voltages from one bridge rectifier...IFD, ED 26, p. 55
- High-speed switch reverses current in an inductor...IFD, ED 25, p. 96
- High-voltage decoder uses common-base buffer...IFD, ED 16, p. 72
- IC compatible monostable has wide linear range...IFD, ED 14, p. 72
- IC design makes stable ramp generator/sawtooth VCO...IFD, ED 17, p. 176
- Improve amplifier efficiency with positive feedback...IFD, ED 21, p. 96
- Improved digital converter offers speed and simplicity...IFD, ED 15, p. 104
- Improved IC fires SCRs used in auto ignition...IFD, ED 14, p. 68
- Inexpensive Schmitt trigger operates above 100 MHz...IFD, ED 15, p. 106
- Insure proper starting polarity of astable multivibrators...IFD, ED 25, p. 100
- Integrated current controls UJT-oscillator frequency...IFD, ED 19, p. 106

### Departments key

ART	Technical Article
IFD	Idea for Design
NEWS	News
PSD	Product Source
	Directory
SR	Special Report
WESCON	WESCON Section

### Subject Listing

Avionics	Management
Circuits & Circuit Theory	Materials & Packaging
Communications	Medical Electronics
Components	Microelectronics
Computer-Aided Design	Microwaves & Lasers
Computers & Data Processing	Military & Aerospace
Consumer Electronics	Semiconductors
Displays	Systems
General Industry	Test & Measuring
Industrial Electronics	



The SCR Power Supplies are high efficiency, high power units designed for a wide range of applications where both precise constant current and constant voltage operation are required. Competitive comparison shows E/M power supplies have lowest voltage ripple, more watts per cubic inch and per pound.



The EMX Power Supplies are specifically designed as constant current sources for Xenon and other high pressure lamps. The EMX series provides stable light output and features automatic starting, igniter pulse timing control, output current adjustment and provisions for certain remote functions. Low lamp current ripple insures maximum life.



The EM Power Supplies have the same advantages and the same applications where the precise regulation of the SCR Power Supply is not required. The EM Power Supplies are a low-cost 1% regulated voltage and current DC source in the medium power ranges up to 10 kw.



## GUARANTEED FOR FIVE YEARS

**Applications:**

Precision Welding	CW and Pulse Lasers
Semiconductor Aging	Focusing Coils for Accelerators
Diode Testing	Electroplating
Relay Testing	Battery Charging
IC and Transistor Testing	Electronic Memory Systems
Capacitor Forming	Cryogenic Magnet Applications
High Pressure Lamps	

# CALL TOLL FREE (800) 631-4298

Write today for your copy of our 1971 Power Supply Catalogs. Complete specifications, accessories and prices for your ready reference.



**ELECTRONIC MEASUREMENTS INC.**  
405 Essex Road, Neptune, New Jersey 07753

# WHEN THINKING PRECISE kw POWER SUPPLIES . . . it's E/M



# Annou Instant

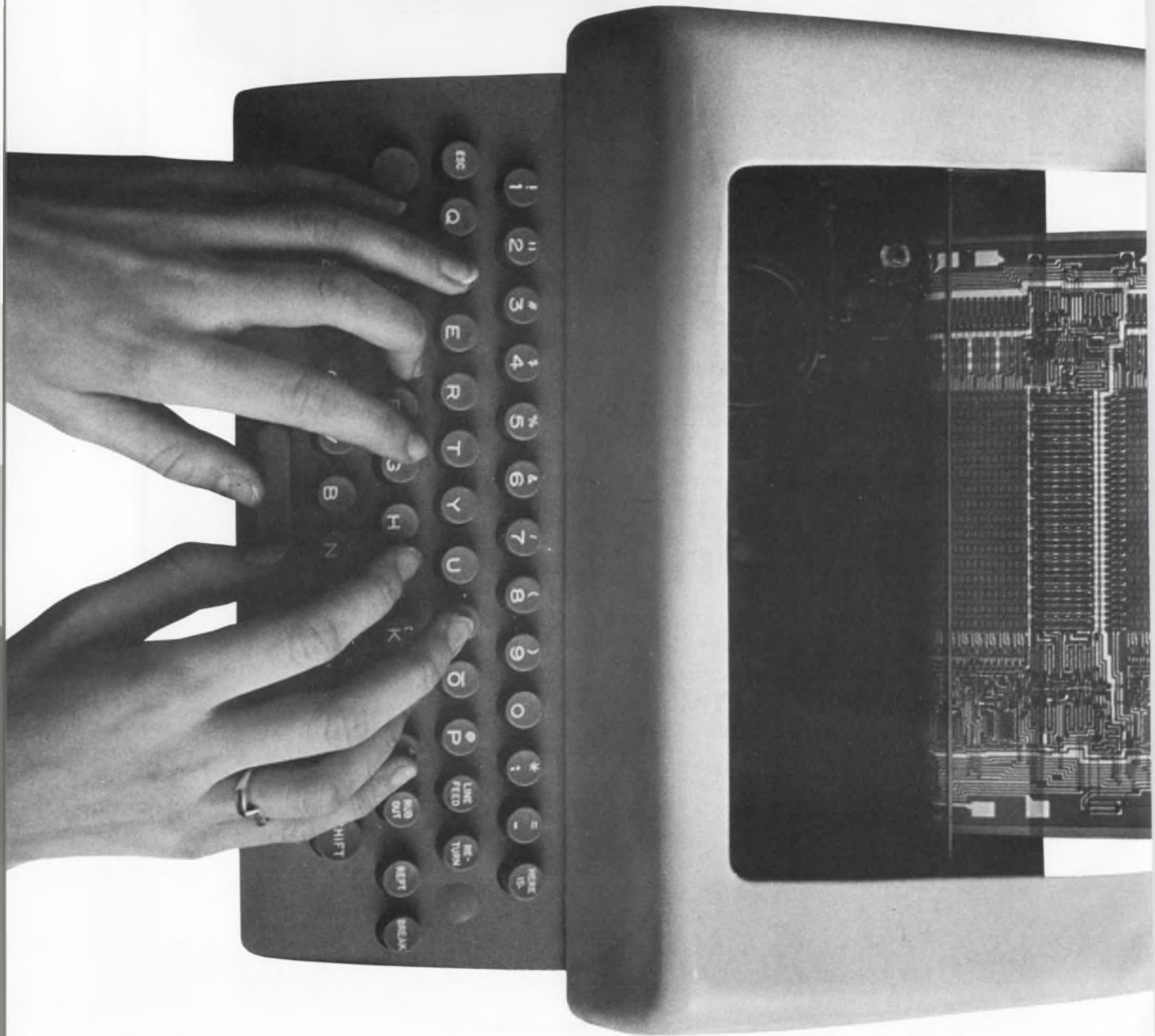



# ancing MOS ROM!

Introducing Type 1601, a 2048-bit monolithic MOS ROM that Intel will ship within 24 hours after receiving your custom programming instructions.

Only Intel can deliver MOS ROM's so quickly because only Intel has developed a MOS ROM that's programmed electrically instead of with a mask.

To get custom ROM's fast, you simply transmit to us a teletypewriter tape containing your program instructions. We load the tape in a simple programmer, insert finished 1601's from stock, and push a button to enter your program.

When you're ready for large quantities and want to cut costs, Intel will give you mask-made ROM's, Type 1301, that are operationally identical and plug compatible with your 1601's.

Programming is available at Intel and at many of our distributors and representatives in the U.S., Europe and Japan. Or you can do it yourself with an Intel programmer that costs about \$5,000.

Intel 1601's and 1301's are fully decoded, packaged in a 24-lead DIP and interface directly with DTL/TTL logic. Decoded dynamically, they have an access time of 750 nsecs and power dissipation of 0.1 mW/bit. With static decoding, access time is 1  $\mu$ sec and dissipation is  $\frac{1}{4}$  mW/bit.

Programmed 1601's cost about 3¢ per bit in small quantities. Fixed programmed 1301's cost about 1¢ per bit in quantities of 1000.

For immediate U.S. delivery of Type 1601 programmed for EBCDIC-8 to ASCII-8, phone your local Intel distributor, Cramer Electronics or Hamilton Electro Sales. If your distributor isn't stocked, just call us collect at (415) 961-8080 for same-day shipment.

In Europe contact Intel at Avenue Louise 216, B 1050 Bruxelles, Belgium. Phone 492003. In Japan contact Nippon IC, Inc., Parkside Flat Bldg., No. 4-2-2, Sendagaya, Shibuya Ku, Tokyo 151. Phone 03-403-4747.

Intel Corporation is in high-volume production at 365 Middlefield Rd., Mountain View, California 94040.

intel<sup>TM</sup>  
delivers.

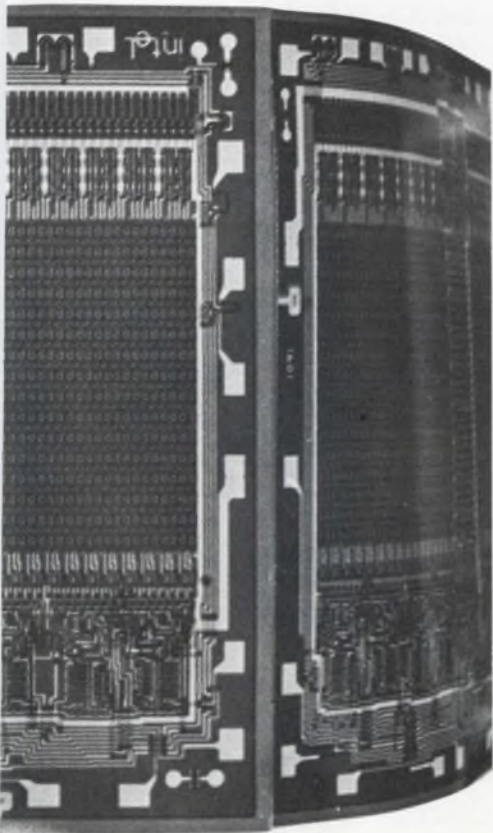



# Up-to-date and thorough PE Examination Guides

These two volumes offer the most convenient and economical coverage of the subject matter that must be mastered to successfully pass the preliminary examination (Engineer-in-Training) and the final examination for the professional license in electrical engineering.

Each concise, carefully organized volume presents problems from recent state examinations together with complete step-by-step solutions. Providing rapid access

to important topics, vital for "open book" examinations, each also includes numerous pertinent illustrations and lists of references for further study.

Prepared by practicing engineers, the books have been written on the premise that the reader is versed in engineering, and that he is approaching the time when his State Board of Examiners will consider him qualified for taking the examinations.

## BASIC ENGINEERING SCIENCES AND STRUCTURAL ENGINEERING FOR ENGINEER-IN-TRAINING EXAMINATIONS

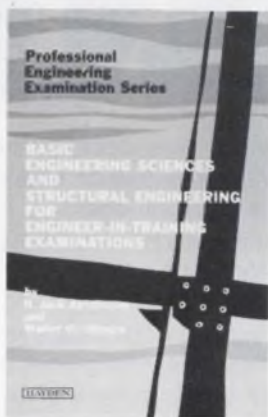

*H. JACK APFELBAUM, P.E., Department of Mechanical Engineering, Lowell Technological Institute; and WALTER O. OTTESEN, P.E., Patent Counsel*

Comprehensive and well balanced in its coverage of the concepts and techniques fundamental to all areas of engineering practice, this volume presents nearly two-hundred problems carefully chosen from recent examinations given by the individual states. Typical of the material the reader is likely to encounter in Engineer-in-Training Examinations, these are conveniently arranged by subject, and cover three broad areas: background material in mathematics, physics, and chemistry; the basic engineering sciences: statics, dynamics, fluid mechanics, thermodynamics, electricity, and engineering economy; and seven chapters detailing topics in structural engineering. Introductory sections precede each subject area and its fully worked-out problems, providing background in the specific concepts, principles, and terminology. More than three-hundred detailed illustrations insure a complete grasp of problem-solving techniques. #5712, 408 pages, illustrated, \$13.95

## ELECTRICAL ENGINEERING AND ECONOMICS AND ETHICS FOR PROFESSIONAL ENGINEERING EXAMINATIONS



*JOHN S. LYONS, P.E.; and STANLEY W. DUBLIN, Institute of Environmental Medicine, New York University Medical Center*

Presenting a wide range of problems in electrical engineering, this book concentrates on the subjects and topics that form the basis for an ever-changing technology. The portion of the book devoted to economics and legal and ethical considerations is equally complete, providing in-depth understanding that will prove valuable in future engineering assignments.

Almost one-hundred problems in electrical engineering range from basic circuitry to the uncategorizable "bonus" problems frequently encountered in examinations. More than one-hundred-seventy illustrations illustrate the text. The section on economics features an unusual approach to such topics as interest, costs, valuation, and the like — the summarized use of formulas in solving nearly fifty typical problems. #5715, 320 pages, illustrated, \$12.95.

**Hayden Professional Engineering Examination Series, LAWRENCE J. HOLLANDER, P.E., Editor-in-Chief. Subsequent volumes will focus on mechanical and civil engineering.**

*Send no money — clip or duplicate this coupon today!*

### 15-DAY FREE EXAMINATION

Please send the book(s) checked below on a 15-day free examination basis. At the end of that time, I will remit payment, plus postage, or return the book(s) without further obligation.

- #5712, Basic Engineering Sciences and Structural Engineering for Engineer-in-Training Examinations, \$13.95
- 5715, Electrical Engineering and Economics and Ethics for Professional Engineering Examinations, \$12.95
- Further information on the Hayden Professional Engineering Examinations Series



**HAYDEN BOOK COMPANY, INC.**  
116 W. 14 St., New York, N.Y. 10011

Name \_\_\_\_\_

Firm/Institution \_\_\_\_\_

Address \_\_\_\_\_

City/State \_\_\_\_\_

Payment enclosed (Hayden pays postage). Same return guarantee. On all overseas orders payment in U.S. dollars must be enclosed.

71-34 1



Laser diodes need high-current drivers . . . . . ART, ED 20, p. 50

LEDs find wider use in biomedical areas . . . . . NEWS, ED 26, p. 30

Linearize your CRT displays . . . . . ART, ED 17, p. 82

Low-cost 100-to-200-MHz doubler has 5-dB gain, 1% distortion . . . . . IFD, ED 18, p. 84

Low-cost one shot is capable of long delays . . . . . IFD, ED 21, p. 104

Low-pass filter has asymmetrical time constants . . . . . IFD, ED 26, p. 55

Make very wide-range log amps easily . . . . . ART, ED 21, p. 76

Measure low resistances with an inexpensive DVM . . . . . IFD, ED 19, p. 108

Microminiaturization is forcing inductors out . . . . . NEWS, ED 19, p. 27

NAND gate resets computer flip-flops . . . . . IFD, ED 23, p. 92

Op-amp follower has wide adjustable offset voltage . . . . . IFD, ED 22, p. 88

Operate remote relays with low control-line voltage . . . . . IFD, ED 24, p. 64

Phase locked loops plus ICs—and, presto, better circuitry! . . . . . NEWS, ED 25, p. 30

Pick the right op amp . . . . . ART, ED 18, p. 54

Precision op amps can be wasted . . . . . ART, ED 19, p. 94

Precision voltage comparator has low power-supply drain . . . . . IFD, ED 20, p. 65

Proportional oven control is low-cost and precise . . . . . IFD, ED 19, p. 106

Protect high-voltage supplies against load breakdown . . . . . IFD, ED 21, p. 102

Ramp generator has adjustable retrace . . . . . IFD, ED 20, p. 71

Random-data generator uses only two ICs . . . . . IFD, ED 20, p. 69

Reduce motor/tachometer coupling . . . . . ART, ED 22, p. 70

Remote control of a triac is made easy by using one IC . . . . . IFD, ED 20, p. 69

Resistors improve immunity of flip-flops to noise . . . . . IFD, ED 25, p. 92

SCR and programmable UJT make adjustable timer . . . . . IFD, ED 22, p. 86

SCR improves UJT oscillator circuit . . . . . IFD, ED 16, p. 66

Select the right oscilloscope . . . . . ART, ED 24, p. 70

Separate the signals from the noise . . . . . ART, ED 25, p. 66

Shift phase independent of frequency . . . . . ART, ED 18, p. 62

A simple astable multivibrator uses only two inverters . . . . . IFD, ED 23, p. 86

Simple control for sign of op-amp gain . . . . . IFD, ED 23, p. 86

Simplify function generator design . . . . . ART, ED 21, p. 86

Simplify random-access memory selection . . . . . ART, ED 17, p. 70

Simultaneously measure four av-

lanche characteristics . . . . . IFD, ED 26, p. 53

Solid-state circuit gives wide-range motor speed control . . . . . IFD, ED 24, p. 64

Solve interference problems painlessly . . . . . ART, ED 25, p. 78

Spectrum analyzers—let's look at the field . . . . . ART, ED 24, p. 74

Stable, low-cost dc restorer uses a single transistor . . . . . IFD, ED 18, p. 80

Stable voltage supply has programmable output . . . . . IFD, ED 14, p. 74

Standby power source uses diodes and battery . . . . . IFD, ED 18, p. 78

Surface-wave devices offer cheap signal processing . . . . . NEWS, ED 25, p. 25

Synchronize event detector to sampling time . . . . . IFD, ED 23, p. 90

Synthesize logic with exclusive-OR ICs . . . . . ART, ED 14, p. 52

Telemeter sensor outputs with simple FM transmitter . . . . . IFD, ED 22, p. 82

Temperature-controlled voltage regulator covers 0°C to 50°C . . . . . IFD, ED 23, p. 88

Three-level logic eliminates inverters . . . . . ART, ED 24, p. 56

Time or frequency? Convert from one domain to the other . . . . . ART, ED 14, p. 56

Tiny network employs novel thick-film design . . . . . NEWS, ED 14, p. 30

Transformer makes broadband phase shifter . . . . . IFD, ED 16, p. 70

Transformerless converter yields plus/minus voltages . . . . . IFD, ED 15, p. 106

Transformerless modulator operates from dc to 1 MHz . . . . . IFD, ED 17, p. 176

Transistor protects sensitive meter movements . . . . . IFD, ED 24, p. 62

Trimmer Potentiometers . . . . . PSD, ED 18, p. 88

Tristable latch makes multiple-input memory . . . . . IFD, ED 19, p. 104

Try 'back-door' circuit analysis . . . . . ART, ED 21, p. 70

Tunable low-cost LC oscillator has excellent stability . . . . . IFD, ED 20, p. 65

Two FETs make a sensitive suppressed-zero voltmeter . . . . . IFD, ED 21, p. 104

Two spst relays can work as one spdt unit . . . . . IFD, ED 26, p. 53

Unsnarl that logic-circuit testing! . . . . . ART, ED 16, p. 56

U. S.-Soviet space docking? Communications needed . . . . . NEWS, ED 22, p. 29

Use a self-adjusting method for forward-biasing diodes . . . . . IFD, ED 21, p. 96

Use a unijunction transistor as an integrator reset . . . . . IFD, ED 25, p. 96

Use squaring to multiply . . . . . ART, ED 17, p. 78

Use this pnpn latch to make a stable frequency divider . . . . . IFD, ED 21, p. 98

Use this tan-lock demodulator . . . . . ART, ED 25, p. 74

Variable clock source operates to 4 MHz . . . . . IFD, ED 25, p. 94

Vary op-amp gain by 2048:1 in steps of 2:1 . . . . . IFD, ED 24, p. 60

Versatile table simplifies convolution . . . . . ART, ED 22, p. 66

Voltage follower has separate limiting for each polarity . . . . . IFD, ED 22, p. 84

Voltage sensor serves as continuous monitor . . . . . IFD, ED 17, p. 180

Want a bandpass filter? . . . . . ART, ED 22, p. 76

What truth tables don't tell you . . . . . ART, ED 23, p. 68

Wideband sawtooth generator controlled by tunnel diode . . . . . IFD, ED 25, p. 98

Zener adds offset capability to active filter . . . . . IFD, ED 25, p. 94

## Communications

Automatic meter reading by microwaves seen . . . . . NEWS, ED 26, p. 19

Bell's goal: A telephone revolution in 1970s . . . . . NEWS, ED 20, p. 30

A communications center in every home . . . . . NEWS, ED 23, p. 48

Communications link based on mini-computer . . . . . NEWS, ED 16, p. 24

Device gives doctors speedy lab results . . . . . NEWS, ED 19, p. 34

Engineers make it easier for computer to talk . . . . . NEWS, ED 25, p. 21

Europe travels electronically . . . . . SR, ED 21, p. 26

FCC also OKs microwave links for CATV in cities . . . . . NEWS, ED 16, p. 23

FCC considers new plan for Microwave Licensing . . . . . NEWS, ED 16, p. 23

The 'impossible' communications system . . . . . NEWS, ED 15, p. 25

A laser that may change communications . . . . . NEWS, ED 20, p. 31

MCI petitions for use of intracity links . . . . . NEWS, ED 23, p. 39

Panel criticizes AT&T on data communications . . . . . NEWS, ED 24, p. 24

Microwave scanning may replace vhf landing systems . . . . . NEWS, ED 18, p. 21

New unit lets deaf see or feel phone messages . . . . . NEWS, ED 26, p. 19

The patient comes first in telemetry . . . . . ART, ED 24, p. 48

Peripherals: Cinderella of the Computer Industry . . . . . SR, ED 23, p. C4

Satellite communications seen facing competition . . . . . NEWS, ED 19, p. 24

Satellites would supply world's power needs . . . . . NEWS, ED 23, p. 43

Telemeter sensor outputs with simple FM transmitter . . . . . IFD, ED 22, p. 82

Tiny laser hailed as key to communications system . . . . . NEWS, ED 19, p. 23



Use this tan-lock demodulator...  
ART, ED 25, p. 74  
Voice print of threat is clue in oil  
blast... NEWS, ED 26, p. 19

### Components

A/D and D/A Converters...  
PSD, ED 16, p. 74  
Atomic battery built, with 10-to-20-  
year life... NEWS, ED 25, p. 22  
Be aware of a/d and d/a converter  
specifications... ART, ED 16, p. 76  
Cut production costs with this techni-  
que for ordering and bunching  
capacitors... ART, ED 22, p. 57  
Disposable battery slated for Army  
manpacks... NEWS, ED 14, p. 28  
Evaluate transistor bandwidths...  
ART, ED 26, p. 40  
For design flexibility, go hybrid!...  
ART, ED 15, p. 80  
Frictionless transducer uses Hall Ef-  
fect... NEWS, ED 14, p. 32  
Generate functions from discrete  
data... ART, ED 20, p. 42  
LEDs find wider use in biomedical  
areas... NEWS, ED 26, p. 30  
'Listening' to metal for telltale signs  
of wear... NEWS, ED 18, p. 30  
Most sensitive strain gauge develop-  
ed... NEWS, ED 24, p. 32  
Nomographs determine multiwire  
cable diameter. IFD, ED 17, p. 178  
Operational Amplifier Addendum...  
PSD, ED 17, p. 187  
PC-Board Connectors...  
PSD, ED 20, p. 57  
Phase locked loops plus ICs—and,  
presto, better circuitry!...  
NEWS, ED 25, p. 30  
Precision op amps can be wasted...  
ART, ED 19, p. 94  
Rack-and-Panel Connectors...  
PSD, ED 19, p. 113  
Satellite arrays could supply billions  
of watts... NEWS, ED 22, p. 29  
Satellites would supply world's power  
needs... NEWS, ED 23, p. 43  
Semiconductor Memories...  
PSD, ED 15, p. 113  
Simplify function generator design...  
ART, ED 21, p. 86  
Surface-wave devices offer cheap  
signal processing... NEWS, ED 25, p. 25  
Tiny network employs novel thick-  
film design... NEWS, ED 14, p. 30  
Watch your specs!...  
ART, ED 15, p. 92  
Word Generators...  
PSD, ED 17, p. 185  
0.1 $\mu$ -per-bit storage seen with new  
memory... NEWS, ED 21, p. 32

### Computer-Aided Design

Compute lead-lag network response...  
ART, ED 25, p. 70  
Generate normally distributed ran-  
dom numbers with BASIC...  
IFD, ED 24, p. 62  
IEEE alters handling of CAD informa-  
tion... NEWS, ED 15, p. 21

Mini-calculator rivalry intensifies in  
Japan... NEWS, ED 14, p. 22  
New aerospace computer features  
compatibility... NEWS, ED 17, p. 22  
Perform large-value factorial compu-  
tations on a computer...  
IFD, ED 14, p. 68  
Program your minicomputer in  
FOCAL... ART, ED 15, p. 86  
Shift phase independent of frequency...  
ART, ED 18, p. 62

### Computers & Data Processing

The big memory battle: semis take on  
cores... SR, ED 15, p. 70  
Burroughs computer an 'electronic  
grid'... NEWS, ED 22, p. 30  
Computer helps restore Caruso's fuz-  
zy voice... NEWS, ED 18, p. 21  
Computer troubleshoots as it auto-  
mates a process...  
NEWS, ED 14, p. 30  
Device gives doctors speedy lab re-  
sults... NEWS, ED 19, p. 34  
Electronic Desk Top Calculators...  
PSD, ED 15, p. 118  
Europe travels electronically...  
SR, ED 21, p. 26  
'Fastest minicomputer' heads for  
market... NEWS, ED 22, p. 30  
First all-LSI computer fits on a desk  
top... NEWS, ED 20, p. 24  
For off-track betting: a new computer  
system... NEWS, ED 20, p. 24  
GE plans big expansion of data-pro-  
cessing net... NEWS, ED 21, p. 24  
IBM's minicomputer worries competi-  
tors... NEWS, ED 24, p. 23  
IBM surprises industry with its new  
memory... NEWS, ED 21, p. 23  
IBM unveils System 370 with accent  
on speed... NEWS, ED 15, p. 21  
In Japan: A new computer line...  
NEWS, ED 23, p. 39  
In the U. S., drop in EDP growth is  
seen... NEWS, ED 23, p. 39  
Intermediate-speed printer fills gap...  
NEWS, ED 22, p. 30  
Keyboards... PSD, ED 23, p. C21  
'Magic wand' terminal to speed  
store sales... NEWS, ED 21, p. 46  
Magnetic domain memory going into  
production... NEWS, ED 14, p. 21  
Memory battle heightens at computer  
show... NEWS, ED 25, p. 21  
The mini-est computer is a house of  
cards... NEWS, ED 24, p. 27  
New company announces large-scale  
computers... NEWS, ED 15, p. 22  
New 'voiceprint' system uses a  
minicomputer...  
NEWS, ED 19, p. 24  
Peripherals: Cinderella of the Com-  
puter Industry... SR, ED 23, p. C4  
A rising market foreseen for U. S.  
computer exports...  
NEWS, ED 23, p. 39  
Riskless contract offered by RCA to  
computer user...  
NEWS, ED 20, p. 23  
Scanning for disease—a new diag-  
nostic tool... NEWS, ED 17, p. 32  
Terminals: the big future in computer

market... NEWS, ED 15, p. 28  
Univac posts new entry in large-  
computer derby...  
NEWS, ED 24, p. 24  
Voice print of threat is clue in oil  
blast... NEWS, ED 26, p. 19  
Westinghouse joins mini market, with  
high hopes... NEWS, ED 23, p. 40

### Consumer Electronics

Bell's goal: A telephone revolution in  
1970s... NEWS, ED 20, p. 30  
Cassette TV players face 'war' on 5  
fronts... NEWS, ED 22, p. 32  
CRTs being improved to counter  
competition... NEWS, ED 26, p. 19  
Improved IC fires SCRs used in auto  
ignition... IFD, ED 14, p. 68  
Riders must fasten seat belts—or  
else... NEWS, ED 20, p. 24  
Tricky circuitry for toys...  
SR, ED 25, p. 36

### Displays

Air Force to test EL for cockpit light-  
ing... NEWS, ED 18, p. 25  
Cassette TV players face 'war' on 5  
fronts... NEWS, ED 22, p. 32  
Color images copied in 3 seconds on  
any paper... NEWS, ED 20, p. 24  
Computer constructs 3-D castles in  
the air... NEWS, ED 19, p. 32  
CRTs being improved to counter  
competition... NEWS, ED 26, p. 19  
Display Devices... PSD, ED 14, p. 75  
Display Devices Addendum...  
PSD, ED 17, p. 186  
Displays to help CATV stand on its  
own feet... NEWS, ED 24, p. 30  
Gains are made in bubble-memory  
development... NEWS, ED 20, p. 28  
Intermediate-speed printer fills gap...  
NEWS, ED 22, p. 30  
Linearize your CRT displays...  
ART, ED 17, p. 82  
Liquid crystals: Material with a hot  
future... ART, ED 19, p. 76  
Peripherals: Cinderella of the Com-  
puter Industry... SR, ED 23, p. C4  
TV tube stops action and stores it in  
tube... NEWS, ED 22, p. 30

### General Industry

Color images copied in 3 seconds on  
any paper... NEWS, ED 20, p. 24  
Design the accidents out of your  
product!... NEWS, ED 20, p. 27  
Do R&D cuts peril U. S. lead in elec-  
tronics?... NEWS, ED 17, p. 24  
Educator sees growth in industrial  
R&D... NEWS, ED 25, p. 22  
Electronics at mid-1970: Beleaguer-  
ed industry battles economic slide...  
SR, ED 16, p. 27  
Electronics industry seen headed for  
a leveling-off... NEWS, ED 19, p. 23  
Foreigners seek U. S. market despite  
recession... NEWS, ED 20, p. 32  
How do we compete with 'Japan  
Inc.'?... ART, ED 19, p. 100  
In Japan: A new computer line...  
NEWS, ED 23, p. 39



Labor Dept. to bring job and engineer together. NEWS, ED 25, p. 22  
Outlook for European electronics: no slump. NEWS, ED 15, p. 30  
A rising market foreseen for U. S. computer exports. NEWS, ED 23, p. 39  
Tariff item 807 appears likely to remain intact. NEWS, ED 22, p. 29  
Technology expands on all fronts. WESCON '70, ED 17, p. W4  
The theme is solving real-world problems. WESCON '70, ED 17, p. W2

### Industrial Electronics

Automatic meter reading by microwaves seen. NEWS, ED 26, p. 19  
Automatic rain-making with computer aid? NEWS, ED 23, p. 50  
CRTs being improved to counter competition. NEWS, ED 26, p. 19  
Europe travels electronically. SR, ED 21, p. 26  
H-P in consumer market with tiny radar. NEWS, ED 26, p. 30  
The new postal service plans a rapid 'hands off' mail system. SR, ED 26, p. 22  
Precision scale uses electronic feedback. NEWS, ED 21, p. 34  
Sonar research put to work in urban sewage system. NEWS, ED 20, p. 32  
Voice print of threat is clue in oil blast. NEWS, ED 26, p. 19

### Management

Appraise with confidence. ART, ED 17, p. 86  
Can a production job be creative? ART, ED 20, p. 54  
Contraction puts a squeeze on managers. ART, ED 18, p. 74  
Contracts aren't won by accident! ART, ED 15, p. 98  
Give your patentable ideas a fair trial. ART, ED 23, p. 82  
How to succeed in spite of the slump. ART, ED 21, p. 92  
Job hunters, be prepared to scramble! ART, ED 16, p. 60  
Labor Dept. to bring job and engineer together. NEWS, ED 25, p. 22  
Pasture or production? What'll it be. ART, ED 22, p. 80  
Puzzled by management responsibilities. ART, ED 25, p. 86  
Seven engineers help design our laws. ART, ED 14, p. 60  
U. S. science post going to Bell Labs executive. NEWS, ED 19, p. 24  
Whet your data-gathering/sharing skill. ART, ED 26, p. 48

### Materials & Packaging

Back-panel interconnections go hybrid. NEWS, ED 15, p. 36  
Bell Labs simplifies magnetic-bubble device. NEWS, ED 26, p. 20  
CRTs being improved to counter competition. NEWS, ED 26, p. 19

Fluid dielectric cuts size and weight. ART, ED 26, p. 44  
For design flexibility, go hybrid. ART, ED 15, p. 80  
'Listening' to metal for telltale signs of wear. NEWS, ED 18, p. 30  
Major advances in interconnection promised. NEWS, ED 14, p. 25  
New wafer is expected to cut IC product costs. NEWS, ED 14, p. 22  
Nomographs determine multiwire cable diameter. IFD, ED 17, p. 178  
Redesign that military product for civilians. NEWS, ED 17, p. 38

### Medical Electronics

Artery disease study to use doppler method. NEWS, ED 18, p. 22  
Cancer fighter shoots subnuclear particles. NEWS, ED 21, p. 24  
Laboratory pacemaker doesn't need batteries. NEWS, ED 15, p. 22  
LEDs find wider use in biomedical areas. NEWS, ED 26, p. 30  
Minicomputer joins heart disease fight. NEWS, ED 24, p. 23  
New unit lets deaf see or feel phone messages. NEWS, ED 26, p. 19  
Pacemaker users warned of radiation hazards. NEWS, ED 14, p. 21  
The patient comes first in telemetry. ART, ED 24, p. 48  
Scanning for disease—a new diagnostic tool. NEWS, ED 17, p. 32

### Microelectronics

The big memory battle: semis take on cores. SR, ED 15, p. 70  
Boeing plans to sell electronic systems. NEWS, ED 21, p. 24  
Central processor made on single MOS chip. NEWS, ED 22, p. 30  
Custom LSI at low cost promised by Motorola. NEWS, ED 17, p. 22  
'Fastest minicomputer' heads for market. NEWS, ED 22, p. 30  
First all-LSI computer fits on a desk top. NEWS, ED 20, p. 24  
Generate functions from discrete data. ART, ED 20, p. 42  
IBM surprises industry with its new memory. NEWS, ED 21, p. 23  
IC and Semiconductor Testers. PSD, ED 22, p. 91  
Improved IC fires SCRs used in auto ignition. IFD, ED 14, p. 68  
Industry 'discovers' standard MOS/LSI chips. NEWS, ED 17, p. 34  
Laser heat offers a faster way to make photomasks. NEWS, ED 22, p. 36  
LEDs find wider use in biomedical areas. NEWS, ED 26, p. 30  
Measuring motion with 0.0001-inch accuracy. NEWS, ED 22, p. 36  
Memory battle heightens at computer show. NEWS, ED 25, p. 21  
Microminiaturization is forcing inductors out. NEWS, ED 19, p. 27

Mini-calculator rivalry intensifies in Japan. NEWS, ED 14, p. 22  
New wafer is expected to cut IC product costs. NEWS, ED 14, p. 22  
Semiconductor and TWT mated in new device. NEWS, ED 26, p. 20  
Semiconductor Memories. PSD, ED 15, p. 113  
Simplify function generator design. ART, ED 21, p. 86  
Simplify random-access memory selection. ART, ED 17, p. 70  
Super LSI predicted, along with 4-chip TV. NEWS, ED 25, p. 21  
Swift growth seen for interface ICs. NEWS, ED 21, p. 24  
Synthesize logic with exclusive-OR ICs. ART, ED 14, p. 52  
TI sees good prospects for standard hybrids. NEWS, ED 24, p. 24  
What truth tables don't tell you. ART, ED 23, p. 68  
Where to go in MOS debated in 'Silicon Valley'. NEWS, ED 25, p. 21

### Microwaves & Lasers

The applicator problem in microwave heating. NEWS, ED 23, p. 44  
Automatic meter reading by microwaves seen. NEWS, ED 26, p. 19  
Diode laser array offers 30-to-40-W power. NEWS, ED 22, p. 34  
Fast-scan radar used to detect small boats. NEWS, ED 16, p. 24  
H-P in consumer market with tiny radar. NEWS, ED 26, p. 30  
Laser diodes need high-current drivers. ART, ED 20, p. 50  
Laser heat—not light—makes holograms. NEWS, ED 18, p. 28  
Laser light amplifies acoustic signals. NEWS, ED 16, p. 24  
Laser makers are offering mass-production capability. NEWS, ED 21, p. 23  
Laser radar measures glide-path visibility. NEWS, ED 16, p. 24  
A laser that may change communications. NEWS, ED 20, p. 31  
Lasers help identify air-pollution gases. NEWS, ED 17, p. 22  
Lasers ray of hope as electronics slumps. NEWS, ED 25, p. 22  
Low-power microwave tube oscillators. PSD, ED 21, p. 107  
Measuring motion with 0.0001-inch accuracy. NEWS, ED 22, p. 36  
Military R&D spurring new civilian applications. NEWS, ED 20, p. 23  
New laser quadruples color-range emissions. NEWS, ED 19, p. 48  
100-billion-watt laser aids Battelle research. NEWS, ED 23, p. 40  
Power record set by GaAs Impatt diode. NEWS, ED 24, p. 28  
Semiconductor and TWT mated in new device. NEWS, ED 26, p. 20  
Solid-state Microwave Oscillators. PSD, ED 25, p. 104



# USING

# T<sup>2</sup>L?

High speed switching transients demand use of EECO's low impedance power bussing... laminated bus bar and hi-low frequency decoupling capacitors in...

## LOGICWARE

starts with your...  
 ...freehand logic diagram  
 or  
 ...pin and string lists  
 or  
 ...from-to pin list  
 or  
 ...(you name it)

## LOGICWARE

uses...  
 ...logic cards  
 or  
 ...wired IC sockets  
 or  
 ...planar PC boards  
 or  
 ...combinations  
 (whatever is best for your project)

## LOGICWARE

includes pre-tested power distribution systems to avoid false signals and modular concepts for economical changes or system additions.

Send for the latest LOGICWARE "literature kit"



# EECO

ELECTRONIC ENGINEERING COMPANY of Calif.  
 1441 East Chestnut Avenue, Santa Ana, California 92701  
 Phone: (714) 547-5651 • TWX 910-595-1550 • Telex 67-8420

INFORMATION RETRIEVAL NUMBER 51

Sonar research put to work in urban sewage system... NEWS, ED 20, p. 32  
 Tiny laser hailed as key to communications system... NEWS, ED 19, p. 23

### Military & Aerospace

Disposable battery slated for Army manpacks... NEWS, ED 14, p. 28  
 55-lb weather stations can be air-dropped... NEWS, ED 15, p. 21  
 Honeywell a 'partner' in Japan's space effort... NEWS, ED 14, p. 22  
 Improved electronics at weapons range puts Navy on target... SR, ED 17, p. 28  
 Luna 16 feat impresses Jet Propulsion Lab... NEWS, ED 21, p. 23  
 The mini-est computer is a house of cards... NEWS, ED 24, p. 27  
 NASA aims to increase solar-cell energy 100%... NEWS, ED 23, p. 40  
 NASA plans to monitor earth's carbon monoxide... NEWS, ED 19, p. 24  
 Navy simulates deep sea for man and sub... NEWS, ED 19, p. 46  
 New aerospace computer features compatibility... NEWS, ED 17, p. 22  
 New weather satellite to offer better coverage... NEWS, ED 24, p. 23  
 Satellite arrays could supply billions of watts... NEWS, ED 22, p. 29  
 Satellites would supply world's power needs... NEWS, ED 23, p. 43  
 21,000-W solar array being built for NASA... NEWS, ED 14, p. 21  
 Two-week space tour envisioned in 10 years... NEWS, ED 20, p. 24  
 U.S.-Soviet space docking? Communications needed... NEWS, ED 22, p. 29

### Semiconductors

Evaluate transistor bandwidths... ART, ED 26, p. 40  
 For design flexibility, go hybrid... ART, ED 15, p. 80  
 IC and Semiconductor Testers... PSD, ED 22, p. 91  
 New surface-charge transistor has high data storage potential... NEWS, ED 26, p. 28  
 New wafer is expected to cut IC product costs... NEWS, ED 14, p. 22  
 Riders must fasten seat belts—or else... NEWS, ED 20, p. 24  
 Semiconductor and TWT mated in new device... NEWS, ED 26, p. 20  
 Semiconductor Memories... PSD, ED 15, p. 113  
 Simultaneously measure four avalanche characteristics... IFD, ED 26, p. 53  
 TI sees good prospects for standard hybrids... NEWS, ED 24, p. 24  
 Tiny network employs novel thick-film design... NEWS, ED 14, p. 30

### Systems

DNC: The new assembly-line boss... NEWS, ED 22, p. 38  
 Europe travels electronically... SR, ED 21, p. 26  
 GE cuts costs 30% for control systems... NEWS, ED 23, p. 40  
 A 'magnetic' vehicle for transit studied... NEWS, ED 21, p. 34  
 Measuring motion with 0.0001-inch accuracy... NEWS, ED 22, p. 36  
 The new postal system plans a rapid, 'hands off' mail system... SR, ED 26, p. 22  
 Reduce motor/tachometer coupling... ART, ED 22, p. 70

### Test & Measuring

Check crystals easily with this GO/NO GO tester... IFD, ED 22, p. 86  
 Compare reliability at a glance... ART, ED 18, p. 69  
 Determine the series inductance of noninductive resistors... IFD, ED 21, p. 100  
 Digital Panel Meters... PSD, ED 26, p. 56  
 Electronic Desk Top Calculators... PSD, ED 15, p. 118  
 Evaluate transistor bandwidths... ART, ED 26, p. 40  
 IC and Semiconductor Testers... PSD, 22, p. 91  
 Infrared test system measures car exhaust... NEWS, ED 24, p. 24  
 Learn to evaluate IC tester performance... ART, ED 22, p. 92  
 'Listening' to metal telltale signs of wear... NEWS, ED 18, p. 30  
 Measure low resistances with an inexpensive DVM... IFD, ED 19, p. 108  
 Measuring motion with 0.0001-inch accuracy... NEWS, ED 22, p. 36  
 Most sensitive strain gauge developed... NEWS, ED 24, p. 32  
 NASA publications start using metric system... NEWS, ED 23, p. 39  
 New weather satellite to offer better coverage... NEWS, ED 24, p. 23  
 Select the right oscilloscope... ART, ED 24, p. 70  
 Simultaneously measure four avalanche characteristics... IFD, ED 26, p. 53  
 Spectrum analyzers—let's look at the field... ART, ED 24, p. 74  
 Telling component heat failures by color... NEWS, ED 18, p. 32  
 Test Instruments... PSD, ED 24 p. 68  
 Transistor protects sensitive meter movements... IFD, ED 24, p. 62  
 Quick-change simulator is easy to build... NEWS, ED 18, p. 32  
 Synchronize event detector to sampling time... IFD, ED 23, p. 90  
 Wheatstone bridge used to count and photograph fish... NEWS, ED 15, p. 33



# Face it.

In panel design, looks are everything.

But, you don't have to sacrifice good looks for the sake of function. Every Rogan control knob and dial is designed to enhance your front panel *and* perform flawlessly.

Rogan offers hundreds of different shapes and sizes and 17 handsome ABS standard colors—with custom colors readily available. So no matter what your application, Rogan control knobs will contribute both functionally *and* aesthetically.

See for yourself. Write for our new "R-71" catalog. Or outline your requirements for quotation. Free samples of particular items will be sent on request.

## Rogan

8919 North Monticello Avenue, Skokie, Illinois 60076  
Phone: (312) 675-1234 • FAX: 910-223-4547



INFORMATION RETRIEVAL NUMBER 52



# RCA Solid State Data for Designers



## 3N200—the last word in RF amplifiers up to 500 MHz

Looking for excellence in UHF performance? RCA's 3N200 dual-insulated gate MOSFET boasts a "pedigree" at 400 MHz that reads like a performance checklist for military and industrial communications, aircraft and marine mobile equipment, CATV, MATV, telemetry and multiplex equipment. 3N200 features:

- high unneutralized RF power gain

• 12.5 dB (typ.) at 400 MHz

### dual-insulated gates

- wide dynamic range
- low cross modulation
- simplified AGC circuitry
- operation at maximum gain WITHOUT NEUTRALIZATION

### integral back-to-back diodes

- bypass transients exceeding approximately  $\pm 10$  volts
- symmetrical diode characteristics preserve wide dynamic input range

### low noise figure

- 4.5 dB (typ.) at 400 MHz

For technical data, circle Reader Service No. 131

400 MHz high-gain, low-noise amplifier using the RCA-3N200.

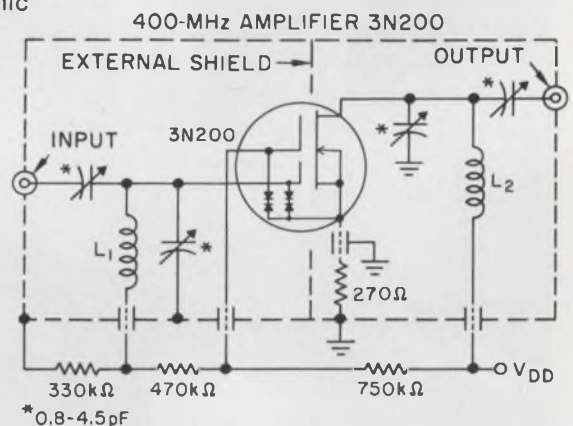

## Op amps rated for higher current output at no increase in price

Where output power up to 1/4 watt is a major consideration, look into RCA's

premium op amp types CA3033A and CA3047A. Now characterized for operation at  $\pm 15$  V, these high-gain op amps can handle up to 76 mA mini-

mum peak-to-peak output current and 255 mW typical sine-wave output power. And they still offer you outstanding economy! The RCA-CA3033A in 14-lead dual-in-line ceramic package still costs only \$4.90 at the 1,000-unit level; the CA3047A in 14-lead dual-in-line plastic package, only \$2.90 at the 1,000-unit level.

In response to many requests for information on how to use an op amp with a single power supply, the schematic at left shows a practical hookup for such an application.

Use either the CA3033A or CA3047A with a single 30-V supply. With  $R_L = 300$  ohms, this circuit provides 255 mW output and a swing of 25 V, with less than 5% distortion.

Want to know more? Circle Reader Service No. 132

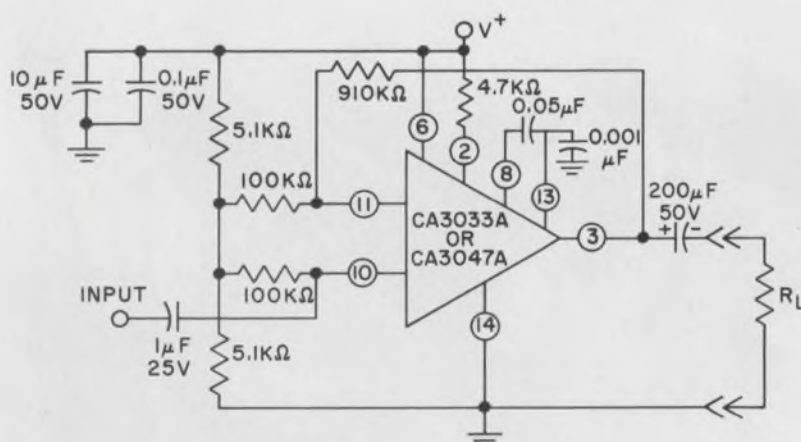

$R_L = 500\Omega @ V^+ = 24V$

$R_L = 300\Omega @ V^+ = 30V$

## RCA offers new modular approach to GaAs laser arrays

The RCA TA7789 and TA7790 arrays of gallium-arsenide laser diodes, connected in series, are designed for gated viewing, security illumination, target designation, and other high average power applications.

Smog? Fog? You can cut through

them with these laser modules that operate at cryogenic temperatures. The TA7789 and TA7790 can be used to make high average-power arrays

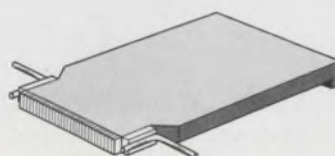

and custom arrays, because each module contains a keying tab to locate it in proper relationship to others, allowing them to be stacked side by side or on top of each other to meet increased power-output requirements.

For military, industrial, or commercial optoelectronic systems, the TA-7789 and TA7790 feature power outputs of 50 to 100 watts peak, or 1 to 4



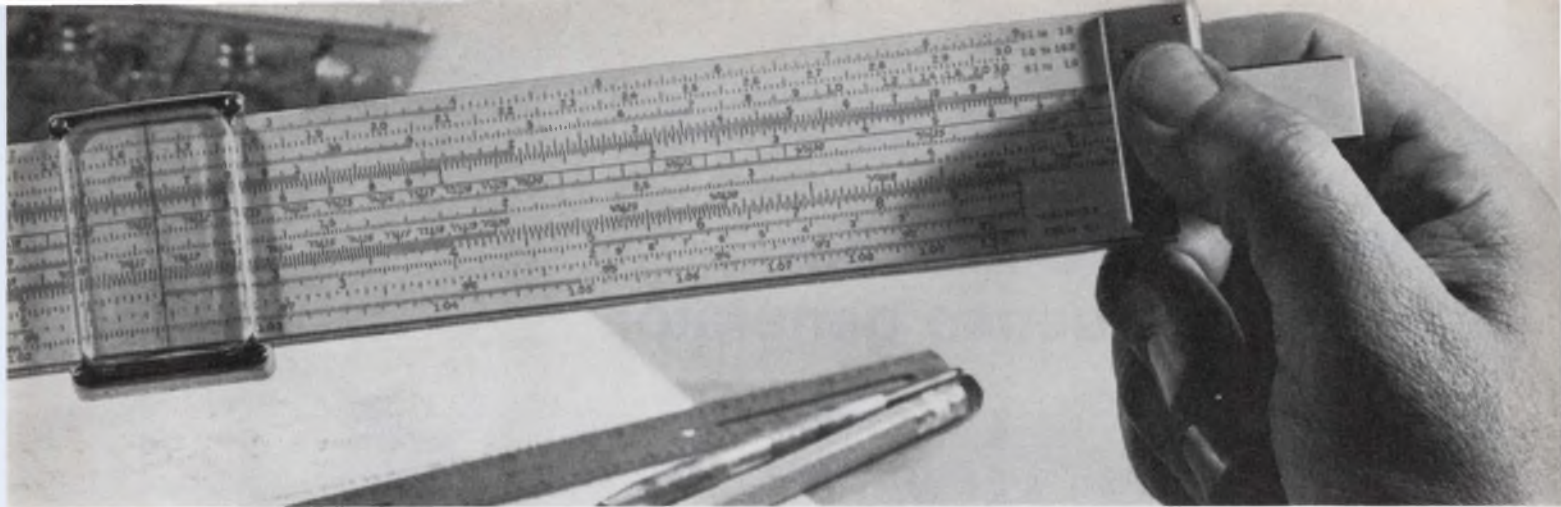

watts average, respectively; power efficiency of 20% minimum; a duty factor of 4%, and a peak emission wavelength of 8525 Å at 77°K.

Circle Reader Service No. 133 for further information.

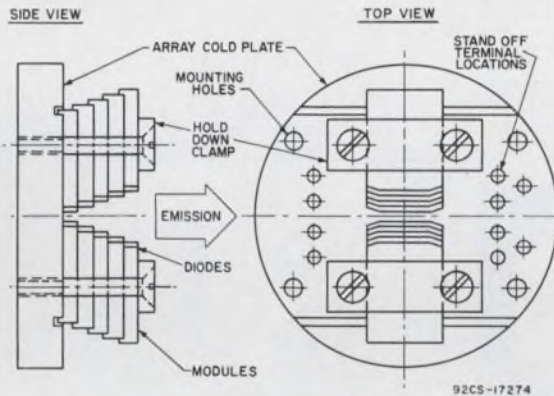

Typical stack of 10 RCA TA7789/TA7790 modules

### Available now! New RCA booklet features circuit module high-power arrays

Should your next generation of power circuits use hybrids? You should certainly consider this approach if your power circuits:

- cost more than a few dollars
- utilize power semiconductors
- are reasonably complex
- employ over 10 components

RCA's new brochure, "Solid-State Power Circuit Modules" (HPA-100), illustrates and explains an array and building block approach to power hybrids which is unique in the electronics industry. With standard products outlined in this new RCA brochure, you can obtain current capabilities to

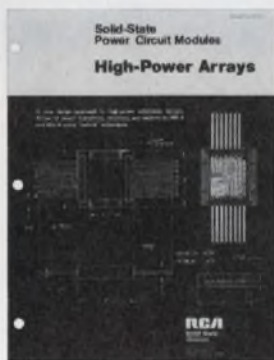

300 A and power handling to 800 W.

Following are listed some of the typical circuit categories which can be constructed using power hybrid technology to advantage:

- 40 A printer paper advance circuits
- 200 A servo motor controls
- battery operated vehicle controls
- 50 A variable speed induction motor controls
- 5 kW inverters

Thus, if you are considering next generation equipment and the best approach to it, ask your

RCA Representative how RCA power hybrids can provide you with the key to both price and performance!

To order your copy of the RCA Solid State Division's detailed brochure HPA-100, circle Reader Service No. 134.

### Fast-switching SCR's from RCA can revamp your power supply designs

RCA's 40555, 2N3650 and TA7395 fast-switching SCR's give you a performance range from 5 A to 40 A,

family	rms current	dI/dt	dv/dt (min.)	turn-off time (max.)
40555	5 A	200 A/μs	100 V/μs	6 μs
2N3650	35 A	400 A/μs	200 V/μs	15 μs
TA7395	40 A	400 A/μs	200 V/μs	15 μs

from 100 V to 600 V. The selection of one of these devices for your fast switching circuits can help you enter the "miniaturization race" by reducing size, weight, and system cost.



TA7395/2N3653 - actual size.

If you are designing high-speed switching circuits for power inverters, radar pulse modulators, switching regulators, or other high current pulse ap-

plications, this series of SCR's from RCA is made for you. They permit operation at frequencies as high as 25 kHz... with reduced-size magnetic components!

Let us know if your circuit demands *greater* limits of stress than listed in the preceding table:

For technical data on RCA's fast-switching SCR's, circle Reader Service No. 135

### These 400 V power transistors can become your standards for off-line conversion

Cut the size and weight of the power transformer, eliminate the heat sinks, get added savings on the chassis—and thereby reduce the size and cost of your power supply. The RCA 2N3585, 2N5240, 2N5840, 2N5805, 2N6078 (TA7673), and TA7007 families of power transistors are cost-saving leaders that can do a big job. They're all 400-volt devices, and they give you a current choice from 2 amperes to 20 A.

Family	Package	Power Output (W)	Ic Max. (A)	Ic (for beta of 10) (A)
2N3585	TO-66	125	3	2
2N6078 (TA7673)	TO-66	250	5	3
2N5240	TO-3	250	5	3
2N5840	TO-3	250	5	3
2N5805	TO-3	500	10	5
TA7007	TO-3	1000	20	10

The right combinations of these units for your particular applications can become your standards for off-line power conversion. And there's an added benefit: with RCA silicon power, you isolate from your power line for a new dimension in safety.

Circle Reader Service No. 136.

For price and availability information on all solid-state devices, see your local RCA Representative or your RCA Distributor. For specific technical data, write RCA, Commercial Engineering, Section 57B-18/UM7, Harrison, N. J. 07029. International: RCA, 2-4 rue du Lievre, 1227 Geneva, Switzerland, or P.O. Box 112, Hong Kong.

**RCA** Solid State Division



# The new way to measure bit error rate: HP's pseudo-random binary sequence generator

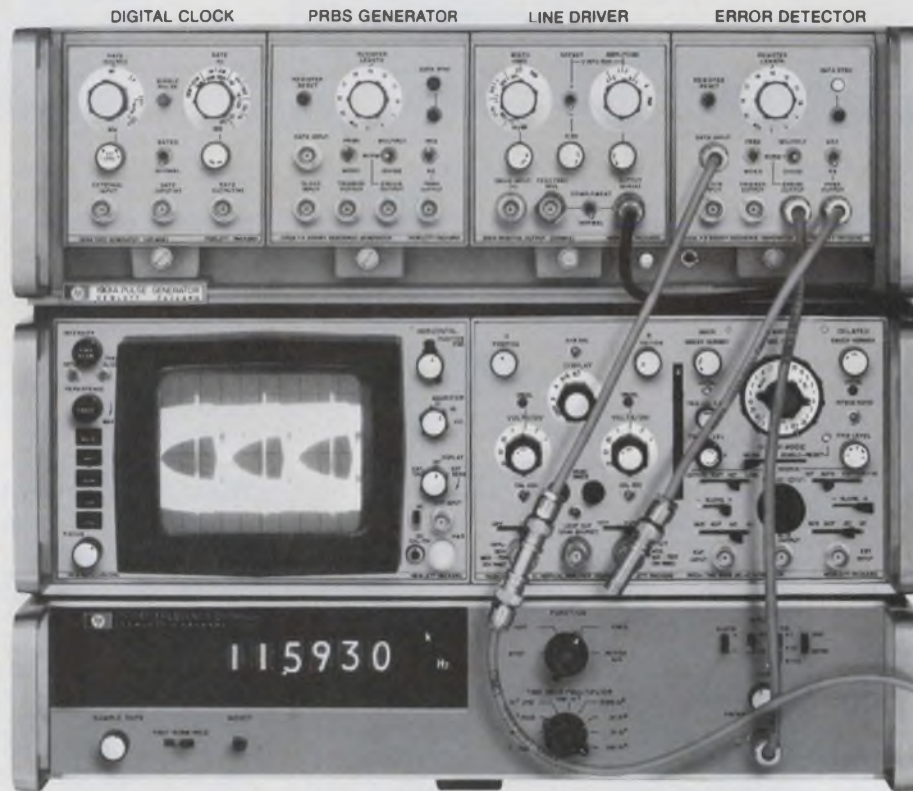

081/6

How do you test the quality of a digital transmission system? By feeding in data, and comparing what comes out with what you put in... right?

You can do this by hooking up a scope to the output, and looking at the "eye" pattern. The accuracy of your results depends on the randomness of your signal, however... and even at best, there's still an element of estimation involved.

That's why HP has developed the 1930A—a new plug-in for the 1900 Pulse Generator System. The 1930A is designed specifically to solve digital system testing problems. It enables the 1900 System to generate over 70,000 different apparently-random binary sequences ranging in length from 7 bits up to 1,048,575 bits... at any desired

rate up to 40 megabits/second. And this means a better "eye."

The 1930A's capabilities don't stop there, however. By using two synchronized 1930A's, one at each end of your transmission system, you can **directly** compare output with input. Every time there's a discrepancy between the pattern coming in over the transmission line and the pattern being generated by the 1930A at the receiving end, the "receiving" 1930A sends out an error pulse.

Add a counter, and you're measuring bit error rate **digitally**. No more guesses.

Another use for the 1930A's is to scramble and unscramble data where security is important. Data can be coded in over a million different ways and no complex synchronization

HEWLETT  PACKARD

SIGNAL SOURCES

is required to unscramble.

The 1930A is digitally programmable, as is the entire 1900 System. Price of the 1930A is only \$1200. For applications where a 16-bit word generator will suffice at the transmitting end, HP's 1925A may be substituted for the 1930A, at a savings of \$350.

For further information on the 1930A, or on any aspect of the 1900 Pulse Generator System, contact your local HP field engineer. Or Write Hewlett-Packard, Palo Alto, California 94304. In Europe: 1217 Meyrin-Geneva, Switzerland.

INFORMATION RETRIEVAL NUMBER 53



# new products

## LED alphanumeric display is a complete \$68 package

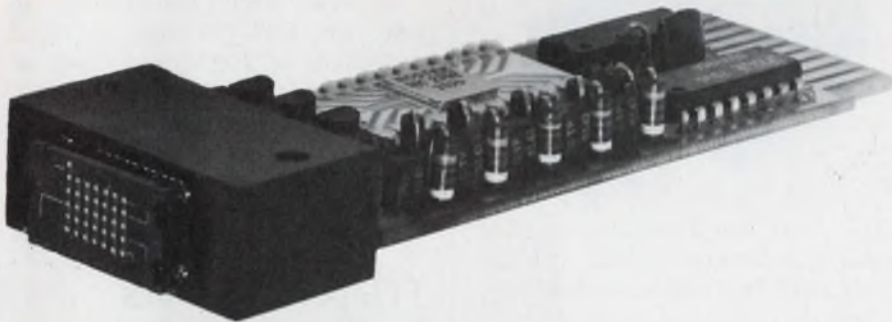

*Monsanto Electronics Special Products, 10131 Bubb Rd., Cupertino, Calif. Phone: (408) 257-2140. P&A: \$68 (500 to 1000 quantities); stock.*

A new complete alphanumeric LED display consisting of a 35-dot matrix readout and all the necessary driving circuitry in one package can now be purchased at \$68 (quantities of 500 to 1000).

The MDA111 uses a 5 by 7 dot array whose character heights are 0.35 in. It contains a 2248-bit read-only memory, a shift register and buffers on one printed circuit board to generate and display 64 ASCII encoded characters.

It incorporates six-line TTL/DTL compatible inputs and operates from +5 and -12 V. The display dissipates only 18 mA of current and has the capability for

convenient blanking.

Three main sections on the PC board make up the MDA111. These include a buffered memory display, a clock, a buffered scanner and a MAN-2 LED display.

The buffered memory display section is configured with an input character decoder, the read-only memory, column select switches followed by buffer circuits. It also includes a column select decoder and a counter.

The complete display is rated to operate over a temperature range of 0 to +70°C and radiates a brightness level of 300 foot-lamberts per diode.

Over-all dimensions (including the board) are a total length of 3.905 in., a width of 1.25 in. and depth of only 0.49 in.

CIRCLE NO. 250

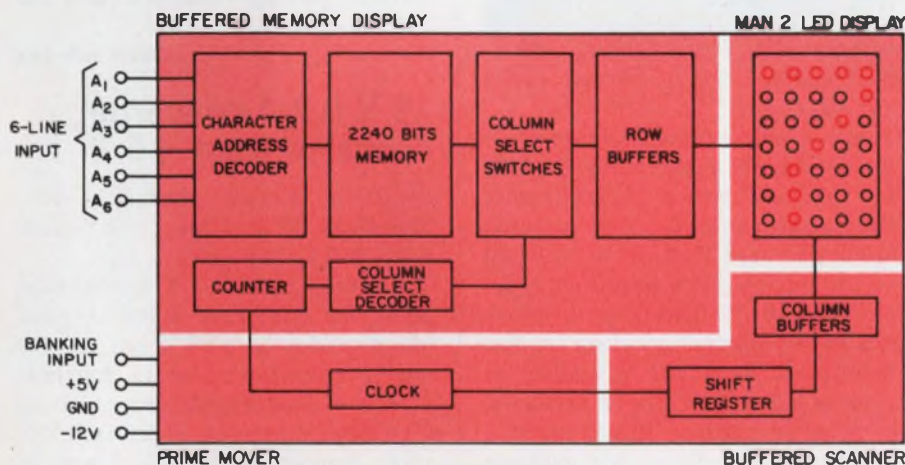

The MDA111 LED display package has four sections: a buffered memory display with a six-line input, a clock with a blanking input and power supply voltage lines and a MAN-2 35-dot LED display.

## Fast economy op amps trim setting to 1 $\mu$ s

*Dynamic Measurements Corp., 6 Lowell Ave., Winchester, Mass. Phone: (617) 729-7870. P&A: \$24, \$19; stock.*

Two low-cost op amps are the differential FET 155 with a 5-MHz gain-bandwidth product and a 1- $\mu$ s settling time to 0.01%, and the differential bipolar 104 with a 7-MHz gain-bandwidth product and a 3- $\mu$ s settling time to 0.01%.

CIRCLE NO. 251

## 4-MHz \$20 FET op amp has 10,000:1 CMRR

*Analog Devices, Inc., 221 Fifth St., Cambridge, Mass. Phone: (617) 492-6000. P&A: \$20; stock.*

With a 4-MHz bandwidth, the \$20 model 43 FET differential op amp has a 10,000:1 common-mode rejection ratio over its full  $\pm 10$ -V input range. Bias current is only 10 pA and drift is 30  $\mu$ V/°C. Full-power response is up to 100 kHz.

CIRCLE NO. 252

## 8-bit d/a converter costs only \$29

*Zeltex, Inc., 1000 Chalomar Rd., Concord, Calif. Phone: (415) 686-6660. P&A: \$29; stock.*

A new hybrid/monolithic 8-bit d/a converter in a 14-pin DIP features bipolar or two's-complement output coding, internal reference, a ladder network and an output amplifier for only \$29. The ZD430E1 is TTL/DTL compatible and has an accuracy of  $\pm 1/2$  LSB.

CIRCLE NO. 253

## Multiplier/divider needs no trimming

*Intronics, 57 Chapel St., Newton, Mass. Phone: (617) 332-7350. P&A: \$65; stock.*

The M416 multiplier/divider features 0.5% 4-quadrant accuracy and is internally adjusted at the factory, thereby requiring no external trimming potentiometers. It has a 750-kHz bandwidth, an output impedance of 1  $\Omega$  and drives 5-mA loads.

CIRCLE NO. 254



### 13-bit digitizer has 0.025% accuracy

Xerox Data Systems, 701 S. Aviation Blvd., El Segundo, Calif. Phone: (213) 772-4511. P&A: \$1800; March, 1971.

A new rack-mountable analog signal multiplexing digitizer offers an accuracy of 0.025% of full scale with 8 to 13-bit resolution and a throughput up to 100,000 samples/s. The MD40 is configured for rack mounting and is prewired.

CIRCLE NO. 255

### Accurate 0.1% multiplier needs no trimming

Analog Devices, Inc., 221 Fifth St., Cambridge, Mass. Phone: (617) 492-6000. P&A: \$189; stock.

Model 427 pulse height/width modulation analog multiplier is manually trimmed at the factory for 0.1% accuracy and requires no manual potentiometer adjustments. Its bandwidth is 100 kHz and output drift is 150  $\mu\text{V}/^\circ\text{C}$ . Output is  $\pm 10\text{ V}$  at  $\pm 7\text{ mA}$ .

CIRCLE NO. 256

### DIP 14-pin multiplexer handles four inputs

Zeltex, Inc., 1000 Chalomar Rd., Concord, Calif. Phone: (415) 686-6660. P&A: \$60; stock.

A new hybrid/monolithic analog multiplexer in a 14-pin DIP features four single-ended inputs with a common output. Model ZD410E1 is  $\pm 0.01\%$  accurate and has 10- $\mu\text{V}$  isolation from ground for each input channel. Crosstalk is  $\pm 0.01\%$  of full scale between all channels.

CIRCLE NO. 257

### 6/12-input audio mixers interface to outputs

Bell P/A Products Corp., 1200 N. 5th St., Columbus, Ohio. Phone: (614) 299-1487. Price: \$87.50, \$175.

Models MIX-6 and MIX-12 audio mixers permit the mixing of up to six or twelve inputs respectively, and feed these inputs to one or more outputs. In addition to their functions as interfaces, the mixers can be used as primary sources.

CIRCLE NO. 258

### Plug-in neon displays include decoder/drivers

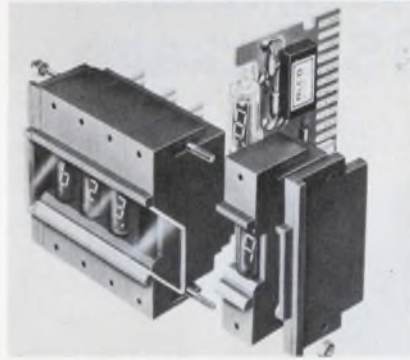

Alco Electronic Products, Inc., Box 1348, Lawrence, Mass. Phone: (617) 686-3887. P&A: from \$17.46; stock.

DM-17G series compact plug-in modules are factory-assembled ready-to-use devices featuring a miniature neon Elfin display and a decoder/driver. The neon Elfin is front-mounted on a PC board which contains the decoder/driver and the logic required to accept four-line BCD inputs. All input-output contacts appear on the PC connector.

CIRCLE NO. 259

### Switch module programs data

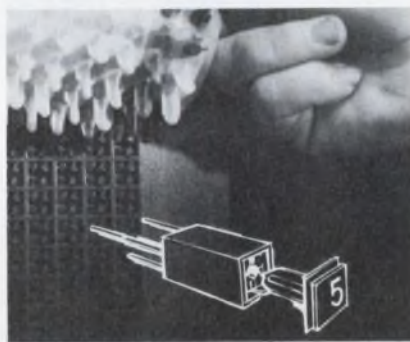

Interswitch, 770 Airport Blvd., Burlingame, Calif. Phone: (415) 347-8217.

A new data programming module consisting of a switch body with four silicon diodes provides binary-equivalent outputs for selected numbered keys that can be inserted in the module. The module may be mounted on PC boards or on standard or rectangular program boards. Numbered keys are available in various colors and can be arranged in rows or columns. Insertion of a numbered key closes the switch's contacts to provide the binary equivalent output.

CIRCLE NO. 260

### Fast-settling op amp reaches 0.01% in 0.15 $\mu\text{s}$

Dynamic Measurements Corp., 6 Lowell Ave., Winchester, Mass. Phone: (617) 729-7870. P&A: \$40; stock.

A new FET fast-setting op amp, the FST-157, has an input impedance of  $10^{12}\Omega$ , a dc gain of 300,000, a gain-bandwidth-product of 12 MHz and settles to 0.01% within 0.15  $\mu\text{s}$ . Overload recovery time is 1  $\mu\text{s}$  and frequency response is at 6-dB/octave rate.

CIRCLE NO. 261

### TTL power drivers handle up to 5 A

Solitron Devices, Inc., 256 Oak Tree Rd., Tappan, N. Y. Phone: (914) 359-5050. P&A: \$3 (100-unit lots); stock.

Compact BHB0007, 0008, 0007A and 0008A TTL-compatible power drivers with non-expandable four-terminal input gates have 5-A ratings with no duty cycle limitations. Operating voltages are as high as 6 V.

CIRCLE NO. 262

### 12-bit d/a converter is a 1.25-in. flatpack

Unisem Corp., Street Rd., Treviso, Pa. Phone: (215) 355-5000.

A new hybrid 12-bit d/a converter that operates over  $-55$  to  $125^\circ\text{C}$  is made up as a 7-layer 1.25-in. square flatpack. It contains a precision reference source, input storage, ladder switches, a tantalum nitride resistor network and an output op amp.

CIRCLE NO. 263

### 15-V 0.2-A converter operates from +5 V

Analogic Corp., Audobon Rd., Wakefield, Mass. Phone: (617) 246-0300. P&A: \$89; 2 to 4 wks.

Powered from +5-V digital supplies, the PWRPAC MP3015 module provides a  $\pm 15\text{-V}$  output for analog circuitry at up to 200 mA. Line and load regulation are both 0.1% and maximum noise is 1 mV rms. Remote sensing and output short-circuit protection are included.

CIRCLE NO. 264



# We've upped the line to 7 pin spacings without upping the price.

CTS cermet industrial trimmers  
still 50¢ each.\*



Stability of  $\pm .03\%$   
and environmental  
performance requirements  
of characteristic  
C of MIL-R-22097D plus:

- 1.5% average equivalent noise resistance
- 0.5% average CRV
- $\frac{1}{2}$  watt @ 70°C
- TC  $\pm 150$  ppm/°C

Now you can choose from an expanded line of compact CTS Series 360 single-turn cermet trimmers. Seven pin spacings: .150"-.125"-.100" in both top and side adjust, plus TO-5 arrangement in side adjust only. (TO-5 style at extra cost.) All available from your CTS Distributor, still at the lowest cost in the industry: **just 50¢ each**: CTS of Berne, Inc., Berne, Indiana 46711. Phone: (219) 589-3111.

\*in 50,000 quantity for  $\pm 20\%$  tolerance. Add 4¢ for 10% tolerance. Comparably low prices for smaller quantities.

CTS CORPORATION  
Elkhart, Indiana



Your CTS Answer Man stands ready to fit our expanded trimmer line into your application.





## HOW SYNCHRON® MOTORS control this specialized TIME-DELAY RELAY

In this special design timer a Hansen SYNCHRON Motor drives the cam-type sequence timer for an electronic time-delay relay. When power is applied, SYNCHRON runs through the first three sequences; starts the time-delay relay, then stops. Relay performs a panel-adjustable delay period of 180-240 seconds, then returns power to the motor to complete the sequence. Special applications are easy to design, using SYNCHRON Motors. How about yours? Call or write Hansen, or your SYNCHRON representative, for brochure and all the facts.

**SYNCHRON timing and control motors; 168 different speeds. Right, left or reversible rotations. 8, 20 or 30 oz.-in. torques; 220, 110 or 24 volts; 60, 50 or 25 cycles.**

# HANSEN

Manufacturing Co., Inc., Princeton, Ind. 47570

**HANSEN REPRESENTATIVES:** CAREY & ASSOCIATES, Houston and Dallas, Texas; R. S. HOPKINS CO., Sherman Oaks, Calif.; MELCHIOR ASSOCIATES, INC., San Carlos, Calif.; THE FROMM CO., River Forest, Ill.; JOHN ORR ASSOCIATES, Grand Rapids, Mich.; H. C. JOHNSON AGENCY, INC., Rochester, N. Y.; WINSLOW ELECTRIC CO., Essex, Conn.; Villanova, Pa., and Teaneck, N. J.

**EXPORT DEPARTMENT:** 2200 Shames Drive, Westbury, N. Y. 11590

INFORMATION RETRIEVAL NUMBER 55

## ICs & SEMICONDUCTORS

### Two op amps improve popular 108/741 types

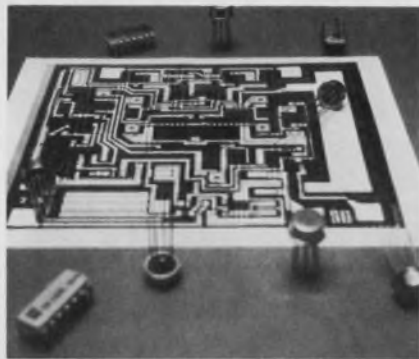

*Silicon General, Inc., 7382 Bolsa Ave., Westminster, Calif. Phone: (714) 839-6200. P&A: \$30/\$20/\$10, \$3.95/\$2.45/\$1.50 (100 pieces); stock to 30 days.*

Two new high-performance operational amplifiers, the SG118/208/308 and the SG1217/2217/3217, offer improved characteristics over two popular type operational amplifiers that are presently available.

The former is a pin-for-pin replacement of the popular 108/208/308 operational amplifier except that it has internal compensation. No external components are needed for frequency compensation since a 30-pF capacitor is built into the amplifier chip.

FET-input characteristics are achieved in the SG118/208/308 through the use of super-beta transistor processing techniques. But unlike FET-input amplifiers, the input bias current of less than 1 nA remains constant over the temperature range of  $-55$  to  $+125^{\circ}\text{C}$ .

"A" versions are also available to match the characteristics of the improved popular type 108A. Packaging is in either ceramic DIP or TO-5 cases.

The second new improved operational amplifier, the SG1217/2217/3217, is the same as the popular 741 operational amplifier except for a frequency response which is ten-times larger. This is accomplished by reducing the size of the input capacitor to the amplifier from 30 to 3 pF.

Unconditional stability is a characteristic of the SG1217/2217/3217 from open-loop to closed-loop gain of 20 dB from 0 to 1 MHz. Unity gain occurs at a frequency of 10 MHz.

CIRCLE NO. 265

### Binary/decade counters cost down to \$2.45

*Fairchild Semiconductor, 464 Ellis St., Mountain View, Calif. Phone: (415) 962-3563. P&A: \$3.05; stock.*

Two new TTL MSI 18-MHz decade and binary counters cost \$3.05 each (single-unit lots) and as low as \$2.45 (100-unit lots). The 9350 decade and the 9356 binary counter dissipate 160 mW each and are packaged in 14-pin DIPs with counter power pins.

CIRCLE NO. 266

### \$6 phase-locked loops encode and decode

*Signetics Corp., 811 E. Arques, Ave., Sunnyvale, Calif. Phone: (408) 739-7700.*

Two phase-locked loop ICs, the 566 encoder and the 567 decoder, can now be used for tone encoding/decoding and as a function generator (which would normally cost \$300) for a cost as low as \$6.35 each (100-unit lots).

CIRCLE NO. 267

### Static shift register is reversible

*General Instrument Corp., 600 W. John St., Hicksville, N. Y. Phone: (516) 733-3333. P&A: \$14.40; stock.*

The SS-6-2004 is a new dual 4-bit reversible static shift register. It is constructed on a monolithic chip and features reversible shift direction, parallel input and output, dc to 1 MHz operation and TTL/DTL clock interface.

CIRCLE NO. 268

### Transistor chips handle 1 A

*Dionics, Inc., 65 Rushmore St., Westbury, N. Y. Phone: (516) 997-7474. P&A: 17¢ to 19¢, 20¢ to 22¢; stock.*

A line of complementary npn and pnp transistor chips have collector currents to 1 A. Series 2N2222A through 2N2218A and 2N2222 through 2N2218 (nnp) and 2N2907A through 2N2904A and 2N2907 through 2N2904 (pnp) are goldbacked chips.

CIRCLE NO. 269



# isolators/ circulators



actual size

Once you needed 4 in.<sup>3</sup> for an isolator or circulator—the weight penalty you paid was nearly a pound.

No more! Amlabs isolators and circulators are only ½ inch square and weigh only 0.6 ounces. You won't have to re-design your system every time you find you need more isolation; the ½ inch "MINI-CUBE" will fit almost anywhere.

"MINI-CUBES" are available in the 700 MHz to 3.0 GHz frequency range. They have under 0.8 dB insertion loss, 20 dB minimum isolation, and 1.25 maximum VSWR over a 15% bandwidth. Standard units are supplied with OSM connectors, but stripline and other special packages are also available.

The price you pay for a "MINI-CUBE" is comparable to what you now pay for larger and heavier devices. Quantity prices are much less. And you can get a "MINI-CUBE" isolator or circulator when you need it—we have reduced delivery time as well as size and weight. Small quantities can be shipped in less than two weeks after we receive your order. You can get more information from our local rep.; or contact us directly at, ADVANCED MICROWAVE LABS, 450 North Wolfe Rd., Sunnyvale, California 94086. (408) 245-5770. TWX 910-339-9219.

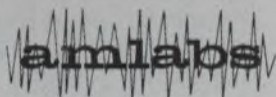

ADVANCED MICROWAVE LABS

# new 10-BIT LADDER NETWORK

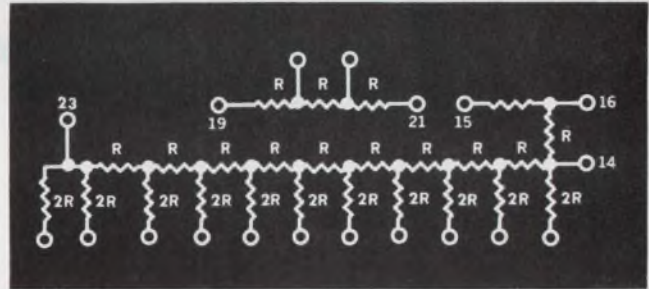

## OFF-THE-SHELF DELIVERY

Best ratio match and tracking provided by thin film nichrome resistors for D/A converter application.

- Accuracy — 0.05% and 0.1% over temperature
- R-2R Ladder —  $R = 5000\Omega$
- Includes R-2R Ladder plus auxiliary resistors for feedback or summing with external amplifiers or comparators.

**HI-1010** — \$15.60\*ea. — accuracy 0.05% — temp. range 0°C to +75°C  
 \$19.20\*ea. — accuracy 0.05% — temp. range -55°C to +125°C

**HI-0910** — \$10.80\*ea. — accuracy 0.1% — temp. range 0°C to +75°C  
 \$14.40\*ea. — accuracy 0.1% — temp. range -55°C to +125°C

\*100 to 999 unit price.



# HARRIS SEMICONDUCTOR

A DIVISION OF HARRIS-INTERTYPE CORPORATION

P. O. Box 883, Melbourne, Florida 32901 (305) 727-5430  
 DISTRIBUTORS: HARVEY / R & D ELECTRONICS — Lexington, Mass. (617) 861-9200 /  
 R. V. WEATHERFORD CO. — Albuquerque, (505) 265-6112, Anaheim (714) 547-0891,  
 Dallas (214) 231-6051, Denver (303) Enterprise 165, Glendale (213) 849-3451, Palo  
 Alto (415) 321-5373, Phoenix (602) 272-7144, Pomona (714) 623-1261, San Diego  
 (714) 278-7400, Seattle (206) 762-4200 / SEMICONDUCTOR SPECIALISTS INC. —  
 Chicago, (312) 279-1000.

INFORMATION RETRIEVAL NUMBER 57

INFORMATION RETRIEVAL NUMBER 56

ELECTRONIC DESIGN 4, February 18, 1971

109



What You Should Know About...

# Miniature High Voltage Resistors

new Mini-Mox resistors offer 100 ppm TCR plus low noise characteristics

If you are responsible for design of high-voltage, highly-stable miniaturized electronic networks and equipment, the new Mini-MOX resistor can be a life saver. Mini-MOX resistors have all the ingredients you need to cook-up new designs for ultra-critical applications. For instance, Mini-MOX resistors are a fraction the size of conventional types; they meet or exceed MIL-R-10509-F for environmental parameters . . . 100 ppm or less; stability better than  $\pm 2\%$  for 2,000 hours at full load; low-voltage coefficient less than 5 ppm/volt, measured between 100 volts and

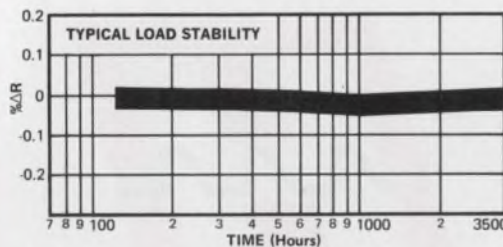
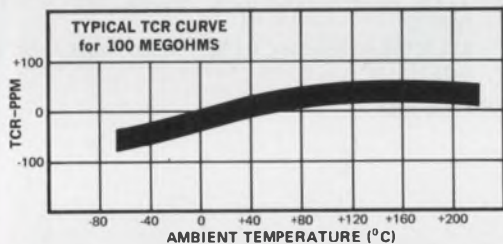

Model	Resistance	Rating @ 70°C	*Max. Oper. Volts	Length Inches	Diameter Inches
MOX-400	1-2500 megs	25W	1000V	.420	.130
MOX-750	1-5000 megs	50W	2000V	.790	.130
MOX-1125	1-10,000 megs	1.00W	5000V	1.175	.130

full-rated voltage; in addition, typical quantech noise at 20 megohms is less than 0.5 microvolt/volt.

All these characteristics combine to provide extremely-rugged and highly-stable resistor configurations that are virtually immune to environmental extremes. Available off-the-shelf in a wide range of resistance values, Mini-MOX resistors are ideally-suited for high-voltage applications where long-term stability and power-to-size ratios are critical.

Write for complete Technical Data Sheet on Mini-MOX Resistors: Victoreen Instrument Div. of VLN Corp., 10101 Woodland Avenue, Cleveland, Ohio 44104. Telephone: 216/795-8200



Expertise in high voltage

DMA 557

INFORMATION RETRIEVAL NUMBER 58

ICs & SEMICONDUCTORS

## 5-MHz 2-phase register accepts 233 to 512 bits

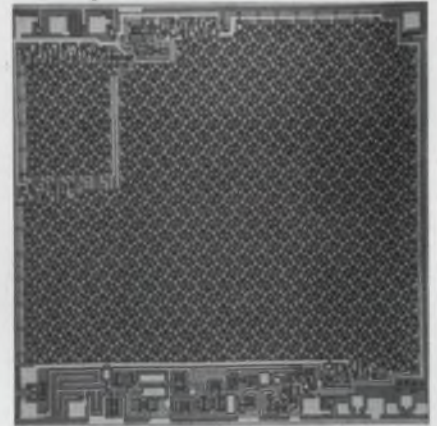

Texas Instruments Inc., 13500 N. Central Expressway, Dallas, Tex. Phone: (214) 238-2011. P&A: \$5; stock.

Designed for 5-MHz operation, a two-phase MOS/LSI dynamic shift register can be programmed to accommodate any bit length from 233 to 512 bits. Programming of the TMS3401LC's bit length is accomplished by changing a single photo-mask during the manufacturing process. The TMS3401LC interfaces with TTL circuitry and uses +5 and -12-V supplies. Power dissipation is 0.1 mW/bit.

CIRCLE NO. 270

## LSI 1120-bit ROM generates ASCII code

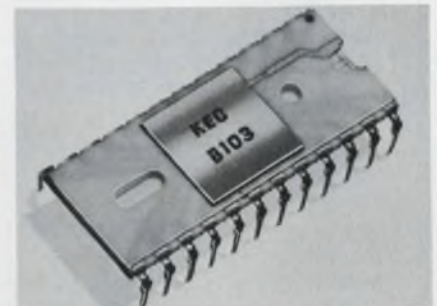

Kenics Electronics Corp., 125 Harvard St., Cambridge, Mass. Phone: (617) 868-5100. Price: 4¢/bit.

The B-103 1120-bit bipolar LSI read-only memory, with input-output decoding, memory matrix and buffers on one chip, generates 32 ASCII 5-by-7 dot-matrix characters. Its access and cycle times are 70 and 170 ns, respectively. Power dissipation is 225 mW and packaging is in a 24-pin DIP. Several units can be wire OR'd together if necessary.

CIRCLE NO. 271



## ALCO LITE OFFERS MORE

Large 3/8" dia. plastic lens removes for easy lamp replacement from the front. MCM-100 accepts T-1 base lamp. MCM-175 accepts T-1 3/4 based lamp. Choice of 5 lens colors. Supplied less lamp.

### FLANGED LAMP HOLDER T-1 T-1 3/4

MCM-100 USES  
T-1 LAMP

MCM-175 USES  
T-1 3/4 LAMP

**ALCO** ELECTRONIC PRODUCTS, LAWRENCE, MASS.  
INFORMATION RETRIEVAL NUMBER 59

## ALCO LITE OFFERS MORE

Has built-in NE-2H lamp & series resistor for 110V. Unique retainer allows front or rear panel mounting. 6" leads. 1 1/2" plastic housing. Wide choice of lens styles & colors. Details available.

### LOW COST 110V NEON INDICATORS

USES NE2H  
HIGH INTENSITY  
NEON LAMP

**ALCO** ELECTRONIC PRODUCTS, LAWRENCE, MASS.  
INFORMATION RETRIEVAL NUMBER 60

# NEW the mini six



Schrack's *MINI SIX*, designated type RE, is a building block for automation - designed to give maximum performance at minimum cost. Its reduced size makes it ideal for use wherever economy of space is important.

The RE, in standard design, is supplied with six Form C (change over) contacts with a maximum rated current of 2 amps. Five contact materials are available, with fine silver (gold flashed) in stock on the standard unit. Other types upon request.

The unit can be supplied as a plug-in, with solder lugs or in combination with our socket which meets standard printed circuit spacings. Unique hold-down spring enables mounting in any position. Write for free catalog today.

Schrack also manufactures all types of relays, stepping switches and accessories. Catalogs upon request.

**SCHRACK** ELECTRICAL SALES CORP.  
1140 Broadway, New York, New York 10001 Tel: (212) 683-0790

INFORMATION RETRIEVAL NUMBER 61

ELECTRONIC DESIGN 4, February 18, 1971

# new RS-232C DRIVER/RECEIVER

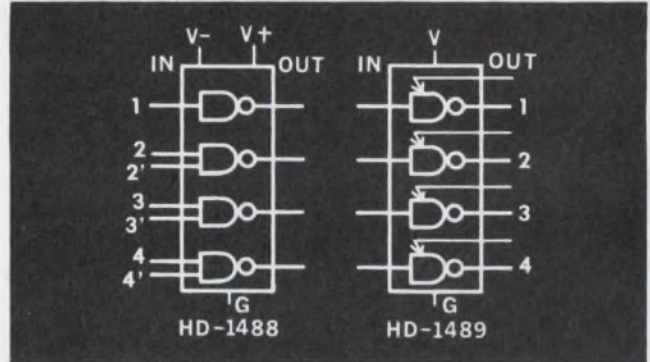

## OFF-THE-SHELF DELIVERY

Meets EIA RS-232C interface specifications. Input threshold levels are compatible with TTL and DTL logic. Four circuits facilitate transmission of single-ended binary data.

	HD-1488 Driver	HD-1489 Receiver
Impedance	300 $\Omega$ Min. (OUTPUT)	3000 to 7000 $\Omega$ (INPUT)
Voltage Swing	$\pm 6V$ Min. (OUTPUT)	$\pm 30V$ (INPUT)
Power Supply	$\pm 9V$	+5V
Propagation Delay	(tpd-) 30ns (tpd+) 250ns	(tpd+) 60ns (tpd-) 25ns
Temperature range	0°C to +75°C.	

Types available in 14-lead dual in-line package at:

HD-1488 \$6.80\*ea.

HD-1489 \$4.43\*ea.

\*100 to 999 unit price.

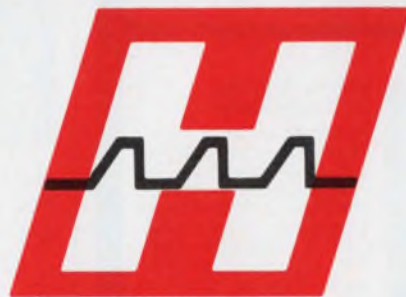

## HARRIS SEMICONDUCTOR

A DIVISION OF HARRIS-INTERTYPE CORPORATION

P. O. Box 883, Melbourne, Florida 32901 (305) 727-5430  
DISTRIBUTORS: HARVEY / R & D ELECTRONICS - Lexington, Mass. (617) 861-9200 /  
R. V. WEATHERFORD CO. - Albuquerque, (505) 265-6112, Anaheim (714) 547-0891,  
Dallas (214) 231-6051, Denver (303) Enterprise 165, Glendale (213) 849-3451, Palo  
Alto (415) 321-5373, Phoenix (602) 272-7144, Pomona (714) 623-1261, San Diego  
(714) 278-7400, Seattle (206) 762-4200 / SEMICONDUCTOR SPECIALISTS INC. -  
Chicago, (312) 279-1000

INFORMATION RETRIEVAL NUMBER 62



# TEC LITE

## INDICATORS/SWITCHES

### TTL/DTL Compatible

Integral transistorized circuitry uses low level IC outputs to control neon or incandescent lamps. Wide range of TEC-LITE models, lens colors, terminals, etc. available — many with integral switches. Price as low as \$1.75 in 100-499 quantities.



### Compact 5 & 15 Amp Switches — Isolated Indicator Optional

TEC-LITE alternate or momentary action SPDT power switch mounts in  $\frac{3}{16}$ " hole. Solid silver contacts reduce resistance — life exceeds 100,000 cycles. Priced from \$3.85 in 100-499 quantities.



## PACKAGED L.E.D.'s



### Solves your L.E.D./IC Packaging/Mounting Problems

TEC-LITE SSR Series L.E.D. readouts provide simple mounting and hook-up plus attractive bezel for L.E.D. readout and IC logic components.



### Bright, Infinite Life Indicators

Packaged L.E.D. Indicators/Switch-Indicators are shock resistant—no catastrophic failures. Operate from 5 VDC supply. Transistor controlled L.E.D.'s interface with RTL, DTL and TTL logic levels. Low as \$3.55 in 100-499 quantities.

See TEC-LITE for the complete line of readouts, indicators, switches, display panels, keyboards, CRT terminals.

TEC, Incorporated; 6700 South Washington Avenue; Eden Prairie, Minnesota 55343; or phone (612) 941-1100.

# TEC

INCORPORATED

INFORMATION RETRIEVAL NUMBER 63

## ICs & SEMICONDUCTORS

### Plastic transistors gain up to 5 A

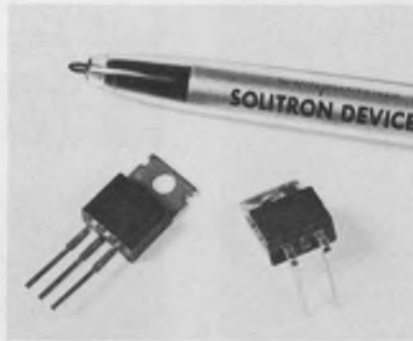

Solitron Devices, Inc., 1177 Blue Heron Blvd., Riviera Beach, Fla. Phone: (305) 848-4311.

A new series of plastic npn silicon power transistors feature gain capabilities up to 5 A in X-75 or TO-66-equivalent cases. They are the 2N5490 through 2N5497 and the 2N5293 through 2N5298 which have 150-mil<sup>2</sup> chips, tin-plated leads and a peak-current rating of 7 A. Specifications include 50-W dissipation at 25°C for the 2N5400 devices and 36 W for the 2N5200 devices.

CIRCLE NO. 272

### Low-power-drain op amp slews at 20 V/ $\mu$ s

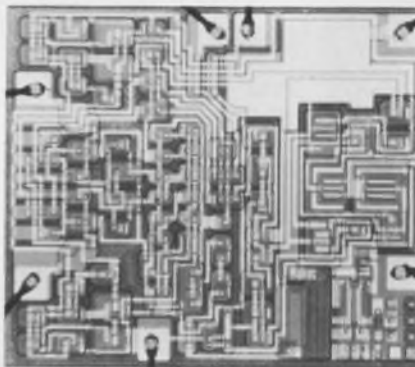

Harris Semiconductor, Melbourne, Fla. Phone: (305) 757-5412. P&A: \$10.20; stock.

Utilizing dielectric isolation, the HA-2700 monolithic operational amplifier with low power dissipation of 2.5 mW at  $\pm 15$  V slews at 20 V/ $\mu$ s. Open-loop gain is 2 million and input bias current is just 5 nA. Input offset voltage is 2 mV and common-mode rejection is 100 dB. Other features include offset nulling and output short-circuit protection. Power supply range is  $\pm 5.5$  to  $\pm 22$  V.

CIRCLE NO. 273

### Four DIP stereo ICs are for FM receivers

Sprague Electric Co., 551 Marshall, North Adams, Mass. Phone: (413) 664-4411.

Standard stereo processing ICs, including a 19-kHz amplifier, a frequency doubler, a stereo indicator lamp and a demodulator, are available for FM receivers. The four are: Type ULN-2120A, ULN-2121A, ULN-2122A and ULN-2128A.

CIRCLE NO. 274

### IC voltage regulator improves 723 specs

Teledyne Semiconductor, 1300 Terra Bella Ave., Mountain View, Calif. Phone: (415) 968-9241. P&A: \$2.30; stock.

A new superior version of the popular 723 IC voltage regulator, designated the 823, features a standard drain current of 1.5 mA and line and load regulation of 0.03% and 0.1%, respectively. Temperature drift is 0.0075%/°C.

CIRCLE NO. 275

### Parity generator has up to 12 inputs

Fairchild Semiconductor, 464 Ellis St., Mountain View, Calif. Phone: (415) 962-3563. P&A: \$3.95; stock.

A new parity checker/generator IC provides 12 inputs with separate odd and even parity outputs in a single TTL MSI package. The 9348 can generate a parity bit for up to 12 bits of input data, and check for parity on as many as 12 incoming bits (11 data, one parity).

CIRCLE NO. 276

### Plastic 0.8-A SCRs lower costs to 30¢

Motorola Semiconductor Products, Inc., Box 20912, Phoenix, Ariz. Phone: (602) 273-6900.

Three series of plastic 0.8-A SCRs have varied temperature ranges with prices to match. MCR101-104 units cost from 30¢ ( $-65$  to  $+85$ °C), MCR115-120 units cost from 55¢ ( $-65$  to  $+110$ °C) and 2N5060 through 2N4064 units cost from 46¢ ( $-65$  to  $+125$ °C).

CIRCLE NO. 277



LOWER YOUR COMPUTER  
BUILDING COSTS WITH  
MEPCO'S NEW

**D.I.P.**

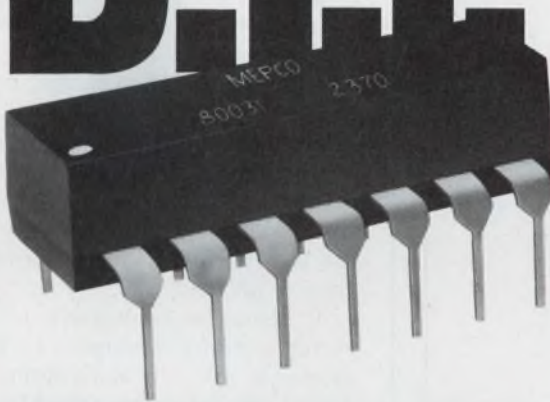

**RESISTOR NETWORK  
FOR AUTOMATIC INSERTION**

This new Dual-In-Line Resistor Network from Mepco is built to fit your standard specifications. Now Computer Manufacturers and other volume users of resistors and resistor networks can have the low-cost, ease of assembly and speed of delivery of a standardized component... plus Mepco's usual custom-built quality of performance.

**This exciting new package features:**

- Up to 13 Cermet Resistors in a 14 pin D.I.P.
- High temperature termination system.
- TO-116 Outline.
- Resistance Range 50Ω to 100KΩ standard — higher or lower on request.
- Tolerance to 1% standard and special matches on request.
- Size 0.750 x 0.300 x 0.200".

**Want to know more? Send for complete data to Dept. RN-1.**



MEPCO, INC., Columbia Road, Morristown, N. J. 07960

A NORTH AMERICAN PHILIPS COMPANY

INFORMATION RETRIEVAL NUMBER 64

ELECTRONIC DESIGN 4, February 18, 1971

**new**  
**4th GENERATION OP AMP.**

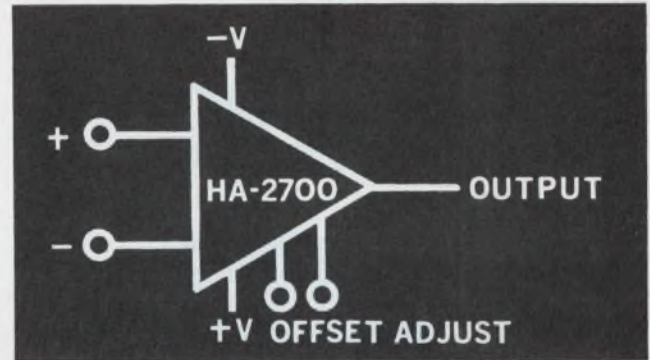

**OFF-THE-SHELF DELIVERY**

Operates at very low power levels without compromising large signal response or output drive capability.

- Slew Rate — 20V/μs
- Input Offset Voltage — 0.5mV
- Power Dissipation — 2.5mW at ±15V
- Open Loop Gain — 2.0 x 10<sup>5</sup> at R<sub>L</sub> = 2K
- Input Bias Current — 5.0nA
- Power Supply Range — ±5.5V to ±22V
- Built-in Short Circuit Protection
- Offset Null Capability
- Internally Compensated

The HA-2700 is available in the TO-99 package at \$10.20\* (0°C to +75°C), \$16.20\* (-25°C to +85°C) and \$24.00\* (-55°C to +125°C)

\*100 to 999 unit price.



**HARRIS  
SEMICONDUCTOR**

A DIVISION OF HARRIS-INTERTYPE CORPORATION

SALES OFFICES: P. O. Box 883, Melbourne, Florida 32901  
(305) 727-5430 / Lexington, Massachusetts (617) 862-1055 / Frederick, Maryland (301) 662-5400 / Oaklawn, Illinois (312) 423-6010 / Albuquerque, New Mexico (505) 268-3549 / Palo Alto, California (415) 321-2280 / Dallas, Texas (214) 231-9031 / Long Beach, California (213) 426-7687 / Norwalk, Connecticut (203) 853-3646 / EXPORT SALES, DAGE CORPORATION, STAMFORD, CONNECTICUT.

INFORMATION RETRIEVAL NUMBER 65



**How  
you profit  
from our**



**APTITUDE**

Magnetics has been a special talent of ours for more than two decades. The devices and systems to magnetize, demagnetize, stabilize, measure—in the lab, in production, in the product—we have consistently engineered the most complete line available anywhere. And the top-value line.

RFL's gaussmeters cover every requirement—from the low cost and portability of the Model 505, to the unparalleled precision of the 3265. Then there's the 101 flux-gate type Magnetometer for measuring extremely low level flux densities... five different types of Magnet chargers for every requirement ranging from the economical, rugged 107A Magnet Charger to the Model 942 that takes on *any* shape or type of permanent magnet... the Magnetreater® for precisely controlled stabilization... and many more. Where needed, we can integrate standard RFL equipment to make a custom system, too.

**Write or phone for our 16 page catalog of  
Magnetics Instruments and Systems.  
Descriptions, specs, prices.**



**RFL Industries, Inc.**

Instrumentation Division • Boonton, New Jersey 07005

Tel: 201-334-3100/TWX: 710-987-8352/CABLE: RADAIRCO, N.J.

## INSTRUMENTATION

### Premium 4-digit DMM starts as low as \$1395



*Dana Laboratories, Inc., 2401 Campus Dr., Irvine, Calif. Phone: (714) 833-1234. P&A: \$1395 to \$2395; 30 to 60 days.*

Stressing high accuracy with the versatility required in systems applications for speed, BCD output and remote-programming capability, a new premium four-digit multimeter offers a basic dc accuracy of 0.01% with 100- $\mu$ V resolution starting with a \$1395 price. It measures dc voltages from 10 mV to 1 kV full scale in 6 ranges. An optional preamplifier provides the 10-mV range with autoranging from 1  $\mu$ V to 1 kV.

A distortion-insensitive ac converter permits accurate ac measurements even in the presence of distortions commonly found in most applications. The converter features 10- $\mu$ V resolution and a 50 Hz to 1-MHz frequency response. Five ac ranges measure 100 mV to 1 kV rms full scale. Accuracy is  $\pm 0.03\%$  from 50 Hz to 20 kHz.

An optional ohms converter permits the 4800 to make true four-wire resistance measurements from as low as 100  $\mu\Omega$  to as high as 200 M $\Omega$  over 9 ranges. A unique ratiometric converter design assures an accuracy that ranges from  $\pm 0.01\%$  to  $\pm 0.15\%$ .

Additional capabilities of the 4800 include dc/dc and ac/dc ratio measurements and an analog output for driving strip chart recorders. Isolated solid-state BCD output is standard.

The 4800 is a dual-slope integrating unit with a 20-ms integration time making a minimum of 18 dc readings per second. A three-pole active filter is selected manually or remotely for noise rejection.

Other measurement speeds are 400 ms and 70 ms for ac and resist- Front-panel controls for hold single read, programming and BCD output enable are available in addition to programmable remote override command.

CIRCLE NO. 278



## Decorator Push Button Switches

Front panel bezel mounting      Sub-panel mounting



Their good looks are more than button-deep

Handsome is as handsome does. These push button switches represent the ultimate in engineering, materials, finishes and manufacture—Grayhill all the way.

Depending on style, momentary or alternate action, type of service, their life expectancies range from 200,000 to 1,000,000 cycles.

For an attractive front panel with the proper push button circuitry behind it specify the Grayhill Dec-

orator Line. Buttons are red, black, yellow, green, blue, or white; round or square. Square ones can be hot stamped with legend.

Like to know more? Write or phone for our latest general engineering catalog. Grayhill, Inc., 565 Hillgrove Ave., La Grange, Ill. 60525, (312) 354-1040.

# Grayhill

... the Difference Between Excellent and Adequate

INFORMATION RETRIEVAL NUMBER 67

## SOLDERING + DESOLDERING + RESOLDERING = SOLDERABILITY

WORLD'S MOST PRACTICAL SOLDER HANDLING TOOLS

### SOLDAPULLT® • SOLDAVAC™

Desoldering Tools

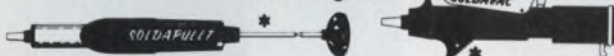

- LIGHT WEIGHT, PORTABLE
- SELF-CLEANING
- FAST, VACUUM ACTION

### ERSA® The World's Finest Soldering Tools



- EXPERT CRAFTSMANSHIP
  - FAST SOLDERING CYCLES
- Several models to choose from

### SOLDASIP™

Resoldering Tips

These tips sip up solder like a sponge or solders like a dream.



- \* Angle face Tip
- \* Pry Tip

Use as soldering aid to pry component leads free. One Tip applies, removes solder.

### SOLDASIP RESOLDERING FLUX

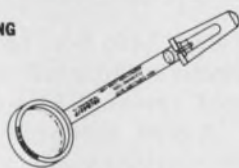

### BURNISHING TOOL

Double magnifying, cleans relay contacts and Solder-sip capillary slots.

\* U.S. and Foreign Patents Applied For.

**EDSYN** Send for our free 12 page SOLDERABILITY manual.  
15954 ARMINTA STREET  
VAN NUYS, CALIFORNIA 91406  
PHONE (213) 989-2324      TELEX NO. 65-1469 EDSYNEX VAN  
Advertised in EEM, MASTERS, EBG and EPAC Catalogs

INFORMATION RETRIEVAL NUMBER 68

ELECTRONIC DESIGN 4, February 18, 1971

# new

## BIPOLAR KEYBOARD ENCODER

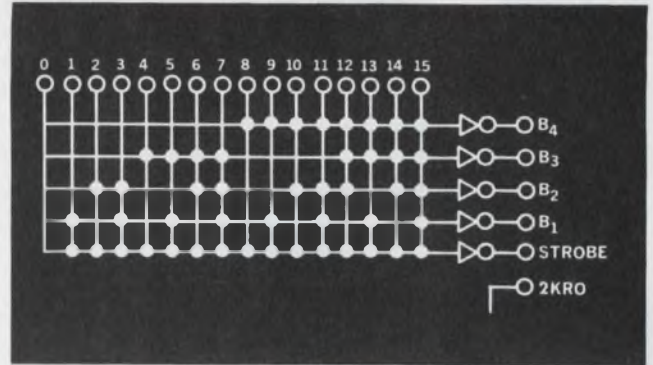

### OFF-THE-SHELF DELIVERY

Easy configuration to any binary code, including ASC11 and EBCDIC, without time-consuming keyboard modification.

- 16 x 5 Matrix — Adaptable in Parallel Operation for 256 keys
- Self-contained strobe compatible with DTL and TTL levels
- Detects two or more keys depressed at the same time
- Propagation Delay — 115ns
- Power Supply — 5V, 52mA
- Temperature Range — 0°C to +75°C

The HD-0165 is available in a 24-lead dual in-line package at: \$4.60\*ea.

\*100 to 999 unit price.



# HARRIS SEMICONDUCTOR

A DIVISION OF HARRIS-INTERTYPE CORPORATION

SALES OFFICES: P. O. Box 883, Melbourne, Florida 32901  
(305) 727-5430 / Lexington, Massachusetts (617) 862-1055 / Frederick, Maryland (301) 662-5400 / Oaklawn, Illinois (312) 423-6010 / Albuquerque, New Mexico (505) 268-3549 / Palo Alto, California (415) 321-2280 / Dallas, Texas (214) 231-9031 / Long Beach, California (213) 426-7687 / Norwalk, Connecticut (203) 853-3646 / EXPORT SALES, DAGE CORPORATION, STAMFORD, CONNECTICUT.

INFORMATION RETRIEVAL NUMBER 69



**1.5-MHz 3-in. scope  
retails at \$167**



*Kikusui Electronics Corp., 200 Park Ave., New York, N. Y. Phone: (212) 973-7152. P&A: \$167; stock.*

Containing a bandwidth of dc to 1.5 MHz and a sensitivity of 20 mV/cm, the 536A 3-in. oscilloscope costs \$167. Its vertical amplifier is ac/dc coupled and is fully compensated. Four sweep ranges from 10 Hz to 100 kHz are continuously adjustable. A built-in 5% calibrator plus a three-step attenuator with a trimmer are included.

CIRCLE NO. 279

**Impedance bridge  
is self contained**



*General Metrology Corp., Box 471, Edmonds, Wash. Phone: (206) 778-3610. P&A: \$510; stock.*

The 330A impedance bridge requires no external generators or detectors for the measurement of resistance, capacitance and inductance. Decimal point and range units are automatically displayed. The bridge operates from a battery or from 50 to 400 Hz. Accuracies are  $\pm 0.05\%$  for resistance measurements and  $\pm 0.2\%$  for capacitance or inductance measurements.

CIRCLE NO. 280

**\$390 10-MHz scope  
has triggered sweep**



*Dynascan Corp., 1801 W. Belle Plaine Ave., Chicago, Ill. Phone: (312) 327-7270. P&A: \$389.95; stock.*

The B&K 1460 5-in. professional oscilloscope includes fully automatic triggered sweep in 19 positions, a dc to 10-MHz bandwidth and 10-mV/cm sensitivity for a price of only \$389.95. It also has front-panel vector scope capability, a 5X magnifier and a built-in calibrator. The CRT has an 8 by 10-cm edge-lit graticule. Overall dimensions are 9 by 10 by 17 in.

CIRCLE NO. 281

**IEEE 71**

**One Time  
One Place  
Entire Industry**

**FOCUS**

**March 22-25, 1971**

New York Coliseum & New York Hilton

Great Contacts . . . Great Feedback . . . Great Convention

Pursue your interests in depth. Talk to authorities. Get the answers at this all-in-one, problem-solving event, focused on every segment of the industry! Over 400 demonstrating exhibitors and 80 technical sessions combine for an educational happening to benefit you immediately.

**12 Exhibit Categories (Coliseum)**

<b>Manufacturing</b>	<b>Microelectronics</b>	<b>Peripheral Equipment</b>
Processing	Enclosures	New Technologies
Packaging	Instrumentation	Communications
Components	Computers	Science

**50 Technical Program Sessions (Hilton) including:**

Computer-Aided Manufacture • Computers, Utilization, Programming • Electro Optics, Hard Copy Graphics • Communications Microwave Devices • Microelectronics • New Manufacturing Techniques Semiconductors & Magnetic Devices • Transportation & Aerospace Engineering Challenges for the Future

**30 Technical Application Sessions (Coliseum) including:**

Automated Test & Assembly • Components & Microelectronics • Computer Applications • Instrumentation • Application of New Technologies • Marketing (sponsored by EIA) Manufacturing, Processing, Packaging

**IEEE 71 INTERNATIONAL CONVENTION AND EXPOSITION**

Write IEEE Convention Department for Advance Program and registration discount details.

The Institute of Electrical and Electronics Engineers, Inc.  
345 E. 47th St., New York, N.Y. 10017





# Celco Yokes for CRT DISPLAYS



CELCO makes YOKES. They make them good. In fact, CELCO has been making the best CRT deflection yokes and focus coils in the industry for the past twenty years. CELCO makes yokes for precision displays when you must have the highest performance available. And CELCO makes yokes for computer terminal displays when you need reliable repetitive scan yokes for commercial purposes, at low cost. Not only does CELCO make good yokes, but they make sure you get the right yoke for your particular CRT display requirements. Call CELCO on your present display problem. A CELCO yoke will solve it. (It might even be one of the standard CELCO yokes listed below:)

**CELCO PRECISION DISPLAY YOKES:**  
 DNA702 Superfast DYNAYOKE  
 (2  $\mu$ sec recovery time to 0.1%)  
 HDN428 Low Zero Approach  
 HDQ428 Mini Spot (CRT Yoke matched)

**CELCO COMPUTER TERMINAL DISPLAY YOKES:**  
 PW Position-Write Yokes  
 PWM Position-Write with Pincushion Correction  
 YA Resonant Drive, M-Q

Go ahead and call CELCO. All you've got to lose are your yoke problems.



CONSTANTINE ENGINEERING LABORATORIES COMPANY  
 MAHWAH, N. J. 07430 TEL. 908-327-1143 FAX: 908-327-1019  
 UPLAND, CAL. 91784 TEL. 914-966-0218 FAX: 914-966-0211

INFORMATION RETRIEVAL NUMBER 71



## small wonders: big news

Denser PC packaging at low cost is now possible . . . thanks to CAMBION's low-profile standard variable inductors. They're wound on new, thin wall coil forms that allow higher Q's and inductance values.

Ultra-reliable as well as miniature, these high performance inductors are built for longer life . . . longer by a factor of ten in tuning torque. They have an operating temperature range of  $-55^{\circ}$  to  $125^{\circ}\text{C}$  and a tuning range of  $\pm 20\%$  from the mean inductance.

For total circuit reliability - at a small price - it pays to choose CAMBION inductors. They're available in a wide choice of values, sizes, styles and finishes for immediate delivery.

Cambridge Thermionic Corporation, 445 Concord Ave., Cambridge, Mass. 02138. Phone: (617) 491-5400. CAMBION Electronic Products, Ltd., Castleton, Near Sheffield, England. Phone: Hope 406/407.

Standardize on

**CAMBION**  
 The Guaranteed Electronic Components

INFORMATION RETRIEVAL NUMBER 72

ELECTRONIC DESIGN 4, February 18, 1971

# new

## 256-BIT PROM™

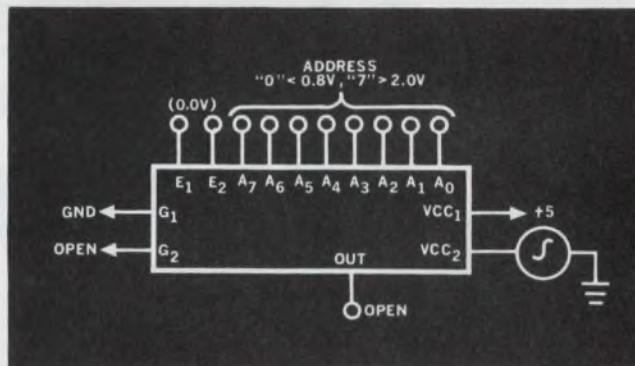

### OFF-THE-SHELF DELIVERY

Bipolar Schottky design, programmable by the user to give maximum flexibility in computer and process control systems. Compatible with standard DTL and TTL logic.

- Propagation Delay — 50ns
- Organization — 256 word x 1 bit
- Output "Three State", allowing both "OR-tie" and active pull-up
- Operating Power — 50mW
- Sink Current — 20mA

The HROM-1256 is available in a hermetically sealed 16-pin dual in-line package at: \$23.50\*ea. ( $0^{\circ}\text{C}$  to  $+75^{\circ}\text{C}$ ) and \$30.75\*ea. ( $-55^{\circ}\text{C}$  to  $+125^{\circ}\text{C}$ )

\*100 to 999 unit price.

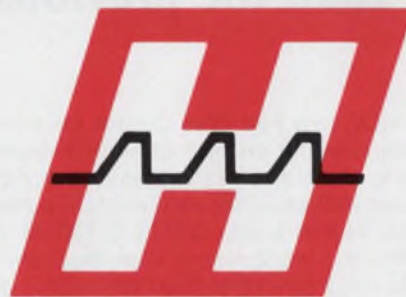

## HARRIS SEMICONDUCTOR

A DIVISION OF HARRIS-INTERTYPE CORPORATION

SALES OFFICES: P. O. Box 883, Melbourne, Florida 32901  
 (305) 727-5430 / Lexington, Massachusetts (617) 862-1055 / Frederick, Maryland (301) 662-5400 / Oaklawn, Illinois (312) 423-6010 / Albuquerque, New Mexico (505) 268-3549 / Palo Alto, California (415) 321-2280 / Dallas, Texas (214) 231-9031 / Long Beach, California (213) 426-7687 / Norwalk, Connecticut (203) 853-3646 / EXPORT SALES, DAGE CORPORATION, STAMFORD, CONNECTICUT.

INFORMATION RETRIEVAL NUMBER 73



# Look close or you may miss the world's smallest shielded inductor.



## New Pee-Wee Ductor 66% smaller than the previous smallest

Nytronics' new Pee-Wee Ductor for microminiature hybrid circuits is about an 1/8th of an inch from stem to stern . . . or about 1/3rd the size of the previous world's smallest magnetically shielded inductor. Yet its electrical performance is big time. It offers higher L and Q (MIL-C-15305) in ratio to volume than its famous predecessors Wee-Wee and Super Wee-Wee. Values run from .10 to 1000 uH  $\pm 10\%$ , a low of .025 to a high of 10,000 uH on special order. Minimum Q ranges from 34 to 55 at RF frequencies, and current capability from 43 mA to a whopping 1.5 amps.

Write for additional specs and temperature curves.  
Write small.

 **Nytronics, Inc.**  
THE QUALITY LINE OF STANDARD COMPONENTS

ORANGE STREET, DARLINGTON, S. C. 29532 • (803) 393-5421 • TWX 810-665-2182

INFORMATION RETRIEVAL NUMBER 74

## PACKAGING & MATERIALS

### Encoder/display unit identifies 999 wires



*Magnetic Head Corp., 250 Marcus Blvd., Hauppauge, N. Y. Phone: (516) 231-8647. P&A: \$600 to \$1000; 30 days.*

Although the new Y-MARK contains as much logic as a minicomputer, it can fit into a briefcase and operate from ac or a battery for testing and identifying up to 999 wires in a cable. It consists of two parts: an encoder and a display. The encoder is connected to the cable under manufacture and electronically marks each wire with its own identity.

CIRCLE NO. 282

### DIP IC extractor holds 14/16-pin units



*Electronic Molding Corp., 96 Mill St., Woonsocket, R. I. Phone: (401) 769-3800. Price: \$4.50.*

A new extraction tool is available for 14 and 16-pin dual-in-line packages. Designated part no. 6595, the tool's new design assures gentle lift-out with minimum IC lead damage. A sliding locking bar has two slotted positions for 14 or 16-pin sockets. The bar slides down to hold the IC firmly during removal. The tool is made of spring steel and has a plastic-coated handle.

CIRCLE NO. 283



## ROCKER & PADDLE **MINIATURES**

New series of economy "snap-in" switches have high 6 amps rating. Features ease of installation in .49 x .59" hole. Choice of SPDT & DPDT in 4 colors, adds distinction to front panel. Molded "silver" terminals & contacts.



SPDT ROCKER

SPDT PADDLE

**ALCOSWITCH®**

DIV. OF ALCO ELECTRONIC PRODUCTS, INC., LAWRENCE, MASS.

INFORMATION RETRIEVAL NUMBER 75

## ROCKER SWITCH

**ILLUMINATED**

New brilliance in a miniature rocker featuring front panel lamp replacement. Entire switch simply snaps into .655" x .728" hole. Choice of 3 doublepole switching actions; 4 lens colors & 4 voltages. Replaceable lamp. Rated 6A @ 125 VAC.

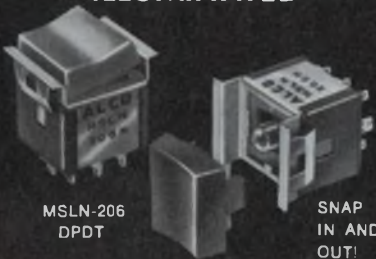

MSLN-206  
DPDT

SNAP  
IN AND  
OUT!

**ALCOSWITCH®**

MINIATURE SIZE

DIV. OF ALCO ELECTRONIC PRODUCTS, INC., LAWRENCE, MASS.

INFORMATION RETRIEVAL NUMBER 76

"IT'S GOOD BUSINESS  
TO HIRE THE HANDICAPPED."

ISN'T THAT A GREAT IDEA, SNOOPY?



THE PRESIDENT'S COMMITTEE ON EMPLOYMENT  
OF THE HANDICAPPED, WASHINGTON, D. C.

# new

## 16-BIT BIPOLAR RAM

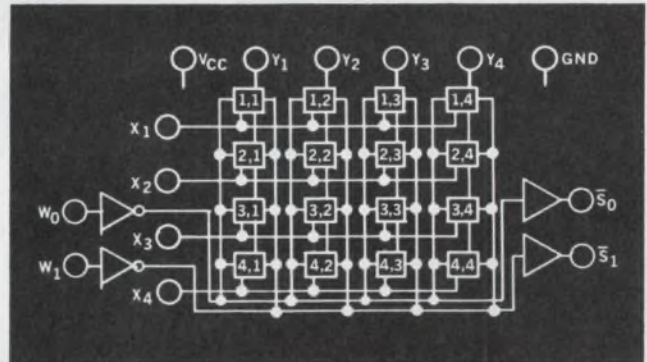

### OFF-THE-SHELF DELIVERY

Biopolar, Schottky design, permits extremely high switching speeds in scratch pad memories.

- Propagation Delay — 25ns
- 4 x 4 Matrix — Compatible with DTL and TTL logic
- Write Pulse Width — 25ns
- Uses single 5 volt power supply
- Power Dissipation — 300mW

The **HRAM-0016** is available in a standard 14-pin dual in-line package at: \$7.95\*ea. (0°C to +75°C) and \$11.15\*ea. (-55°C to +125°C)

\*100 to 999 unit price.

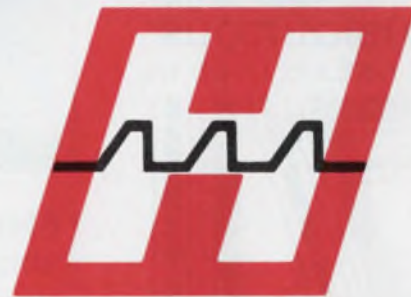

## HARRIS SEMICONDUCTOR

A DIVISION OF HARRIS-INTERTYPE CORPORATION

P. O. Box 883, Melbourne, Florida 32901 (305) 727-5430  
DISTRIBUTORS: HARVEY / R & D ELECTRONICS — Lexington, Mass (617) 861-9200 /  
R. V. WEATHERFORD CO. — Albuquerque, (505) 265-6112, Anaheim (714) 547-0891,  
Dallas (214) 231-6051, Denver (303) Enterprise 165, Glendale (213) 849-3451, Palo  
Alto (415) 321-5373, Phoenix (602) 272-7144, Pomona (714) 623-1261, San Diego  
(714) 278-7400, Seattle (206) 762-4200 / SEMICONDUCTOR SPECIALISTS INC. —  
Chicago, (312) 279-1000

INFORMATION RETRIEVAL NUMBER 77



## FREE SAMPLE

### The World's Smallest Temperature Recorder

Temp-Plate, the world's smallest temperature recorder, records surface temperatures within  $\pm 1\%$  accuracy. Heat-sensitive indicator turns permanently black upon exposure to critical temperatures for economical and irreversible record. 83 standard sizes from  $\frac{1}{8}$ " diameter to  $\frac{3}{4}$ " x  $1\frac{1}{4}$ " with 1 to 8 different calibrated temperature indicators per recorder. Self-adhesive installation. Max. thickness 0.006". Ranges from 100°F to 1100°F. As low as \$1.10 each. Qualified on Gemini, Apollo, F-111, DC-8. Specified by more than 1200 companies.

ACTUAL SIZE

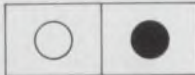

Write for Free Brochure  
with 101 Actual Uses and  
Free Temp-Plate® Sample!

Temp-Plate® Division • William Wahl Corp.  
12908 Panama St., Los Angeles, Ca. 90066

INFORMATION RETRIEVAL NUMBER 78

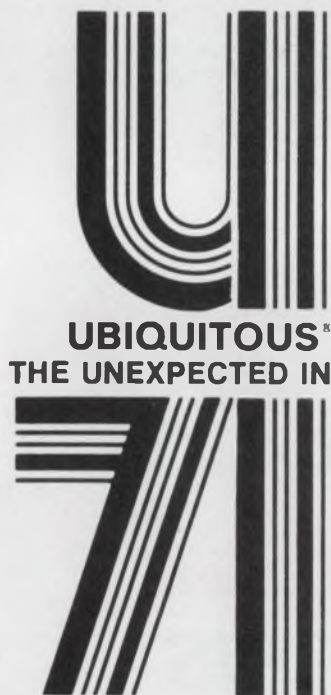

UBIQUITOUS®  
THE UNEXPECTED IN

FOR REAL-TIME ANALYSIS

Watch Electronic Design's "Design Data" section for announcements of new literature.

To be put on our mailing list, attach this to your letterhead and mail to

**FEDERAL SCIENTIFIC**

Federal Scientific Corp., a subsidiary of  
Elgin National Industries, Inc.,  
615 West 131 St., New York, N.Y. 10027.

INFORMATION RETRIEVAL NUMBER 79

## PACKAGING & MATERIALS

### DIP breadboards mount multi-pin ICs

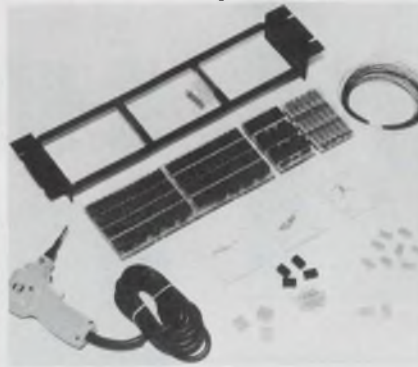

*Electronic Engineering Co. of California, 1441 E. Chestnut Ave., Santa Ana, Calif. Phone: (714) 547-5651.*

Three new breadboarding kits allow flexibility in locating 14, 16, 24 and 36-pin ICs. Kit H-7001 has 44 14-pin and 4 28-pin sockets. Kit H7002 contains 44 14-pin, 4 28-pin and 18 16-pin sockets. Kit H7003 has 96 14-pin and 36 16-pin sockets. All three contain single and double 14-pin microboards, a test clip and extractor, frame and wire.

CIRCLE NO. 284

### High-density panel uses 1/16-in. boards

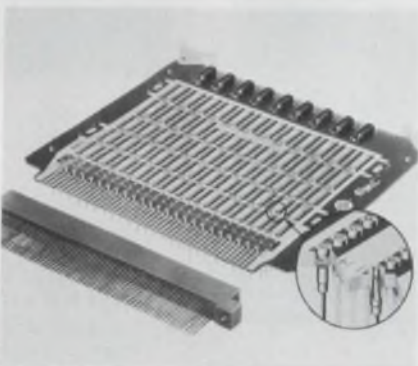

*Electronic Molding Corp., 96 Mill St., Woonsocket, R. I. Phone: (401) 769-3800.*

A new high-density packaging panel utilizes 1/16-in.-thick non-warping glass epoxy boards, and features low-profile terminals. Various patterns may be tailored to design specifications, such as 60-position mix patterns for 40 14-pin (voltage and ground committed) and 20 16-pin (uncommitted) dual-in-line ICs. Standard test jacks are accessible from the front.

CIRCLE NO. 285

### PC board holder locks at any angle

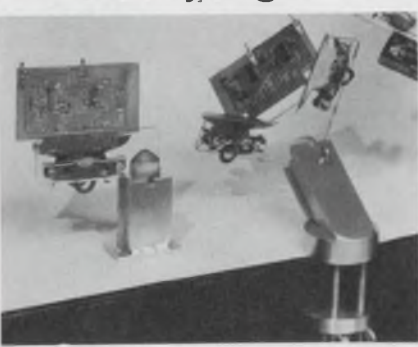

*LIN-CO, 3510 Balmars Ave., Jackson, Mich. Phone: (517) 783-5343. Price: \$18.70.*

The model Q PC board holder allows complete access to all components on a board while holding the board firmly at any desired angle. Clamping surfaces are non-conductive to prevent shorting out board conductors. To position a board, simply pull out the model Q's clamp, turn it to the desired angle and lock it with a thumb screw.

CIRCLE NO. 286

### Flat-cable connector simplifies termination



*Kings Electronics Co., Inc., 40 Marbledale Rd., Tuckahoe, N. Y. Phone: (914) 793-5000. Price: \$1 to \$5.*

A new type of flat cable connector for 50-mil cable centers eliminates the termination problems of flat and round conductor cables. Flat or round center-conductor cable from 17 to 64 conductors can be terminated, at one time, without soldering or special tools by inserting cable into slot and tightening two screws.

CIRCLE NO. 287



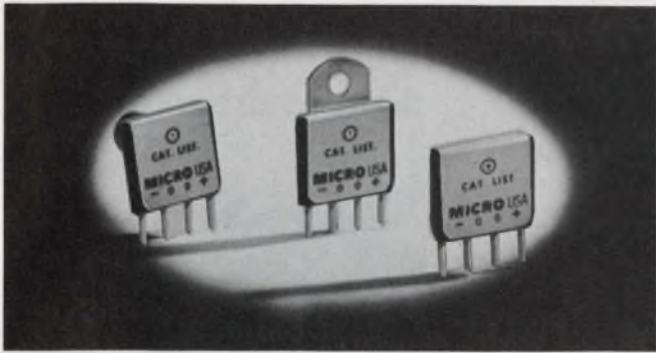

## Low cost solid-state switches.

Our economical 1SS switches have no moving parts. Rather, they utilize a Hall sensor with a trigger and amplifier—in a single integrated circuit—as a logic switching element.

The switching operation is produced by the magnetic field from either a permanent magnet or an electromagnet.

This tiny switch has been performance tested to four billion operations at speeds up to 10,000 operations per second.

For more information, call your MICRO SWITCH Branch Office (Yellow Pages under "Switches, Electric"). Or write for Product Sheet Series 1SS.

### MICRO SWITCH

FREEPORT, ILLINOIS 61032  
A DIVISION OF HONEYWELL  
INFORMATION RETRIEVAL NUMBER 80

## The power supply you plan to build is built!



OTHER MODELS 3 to 50 V available

It's on the shelf, ready for immediate delivery from Electrostatics. With specs proven in service. Low cost. Brief specs on our Model 50:

- 5V 5A Power Supply
- Input 105-125V, 47-420 Hz
- Regulation: Line 0.01% Load 0.1%
- Ripple: 500  $\mu$ V max.
- Temp: -20 to +70°C
- Foldback current limiting
- Size: 5" W x 4.13" H x 7" L

(\$69 with overvoltage protection)  
For full information call Robert McCartney, Manager of Application Engineering, (714) 279-1414. Or circle the number below for our latest data sheet.

### Electrostatics, inc.

7718 Clairemont Mesa Blvd., San Diego, California 92111 DEPT. 102

INFORMATION RETRIEVAL NUMBER 81

ELECTRONIC DESIGN 4, February 18, 1971

# now

## YOUR COMPLETE OFF-THE-SHELF SOURCE FOR MEMORY, LINEAR AND DIGITAL I.C.'s.

Harris offers you immediate delivery of I.C.'s that make your design jobs easier. And with Harris I.C. performance characteristics you never have to compromise your specs, cost or reliability. Mail the coupon below or contact your nearest Harris Sales Engineer.

#### MEMORIES

256 x 1 PRØM™  
64 x 8 PRØM™  
64-Bit RAM  
16-Bit RAM

#### LINEAR CIRCUITS

General Purpose Op Amp/Low Power  
High Impedance Op Amp  
High Slew Rate Op Amp  
Wide Band Op Amp  
Low Noise Op Amp  
8-Bit D/A Converter  
16-Channel Analog Multiplexer  
10-Bit Ladder Network

#### DIGITAL CIRCUITS

Keyboard Encoder  
Line Receiver  
Line Driver  
Party Line Transmitter/Receiver  
Diode Matrix

# HARRIS

## SEMICONDUCTOR

A DIVISION OF HARRIS-INTERTYPE CORPORATION

Harris Semiconductor  
P.O. Box 883, Melbourne, Florida 32901

Please send me more information on the Harris Off-the-Shelf I.C.'s checked below.

- Memories  
 Linear Circuits  
 Digital Circuits

NAME \_\_\_\_\_ TITLE \_\_\_\_\_

ADDRESS \_\_\_\_\_

CITY \_\_\_\_\_ STATE \_\_\_\_\_ ZIP \_\_\_\_\_

PHONE \_\_\_\_\_

RADIATION MICROELECTRONICS HAS CHANGED ITS NAME TO HARRIS SEMICONDUCTOR  
INFORMATION RETRIEVAL NUMBER 82



## DATA PROCESSING

### Fast 16k by 36 memory drops cost to 1.8¢/bit



Nemomic Data Systems Inc., 1301 W. Third Ave., Denver, Colo. Phone: (303) 892-7012. P&A: 1.8¢ to 3.5¢/bit; 30 to 60 days.

Featuring an access time of 250 ns and a cycle time (read and write) of 500 ns, the NM-3000 series plated wire memory system with basic configurations ranging from 8k words by 16 bits per word to 16k words by 36 bits per word offers a price range from as low as 1.8¢ to 3.5¢ per bit.

Maximum capacity of the new memory is 589,824 bits. Internally, it is organized as 1024 word lines by 576 bit lines. The word lines are selected by a transistor matrix. The bit lines are connected to one set of 36 sense amplifiers and 36 bit drivers. Data transfer is via 36 input and 36 output registers.

The new memory system with overall dimensions of 19 by 23 by 5-1/4 in. is characterized by complete modularity. A basic system mat consists of 256 word lines and 576 plated wires. One noise-canceling wire is used with 16 plated wires.

Each mat is made up of 630 tunnels on 0.02-in. centers in a 13-in.-wide structure and a word line laminate with 256 word lines etched on 0.05-in. centers. A mu-metal sheet is used with the laminate to minimize the effects of adjacent bit disturbances.

Two mats make up a basic plane which has planar dimensions of 16 by 1/2 by 16 in. Mounted on a plane are a transistor matrix and an IC decoder/driver.

A maximum NM-3000 stack consists of two planes. Data cards consisting of 16-digit circuitry and other logic cards are mounted on a backboard on top of the stacks. Each data card has 34 low-level gates and two sets of sense amplifiers and digit drivers.

CIRCLE NO. 288

### Message concentrators speed up data lines

Honeywell Information Systems, Old Connecticut Path, Framingham, Mass. Phone: (617) 879-2600.

H1621 and H1622, remote-message concentration systems, use hardware and software to convert 128 low-speed lines into one to four medium-speed lines. The H1621 leases at \$1000/month and the H1622 rents from \$1600/month.

CIRCLE NO. 289

### MOS RAM on PC card cycles in 600 ns

Standard Logic, Inc., 1630 S. Lyon St., Santa Ana, Calif. Phone: (714) 835-5466. Price: \$445 (8192 bits).

RAMM 1024 random-access MOS memory systems contain 1024 10-bit words on a PC card with read/write cycle times of 600 ns. Their refresh logic provides for automatic operation from the memory or from an external control source.

CIRCLE NO. 290

### Low-cost memory arrays stack up to 65 kbits

Signal Galaxies, Inc., 6955 Hayvenhurst, Van Nuys, Calif. Phone: (213) 988-1570. P&A: 0.7¢/bit; 90 days.

Low-cost Flux Ring 128-word by 64-bit memory arrays can be assembled into stacks up to 65,536 bits with 100-ns (nondestructive readout) or 250-ns (destructive readout) cycle times. Density is 800 bits/in.<sup>2</sup>

CIRCLE NO. 291

### 2400-bits/s modem leases at \$40/month

ITT Data Equipment and Systems Div., E. Union Ave., E. Rutherford, N. J. Phone: (201) 935-3900. P&A: \$40/month; 2nd quarter, 1971.

The new 2003 2400-bits/s modem can be leased for only \$40/month. It includes a built-in delay equalizer and may also be used over dial-up or unconditioned lines at 1200 bits/s.

CIRCLE NO. 292

### 10-bit graphics tablet digitizes drawings



Computek, Inc., 143 Albany St., Cambridge, Mass. Phone: (617) 864-5140.

Model GT40/10 graphics tablet is a high-speed 10-bit device for converting hand drawn data to digital form. The tablet uses an electromagnetic sensing technique incorporating a proprietary printed digital pattern. Pattern accuracy is  $\pm 0.005$  in. (0.05% of full scale) and linearity is  $\pm 0.05\%$  of full scale. Resolution is 90 lines/in. The writing surface is 11-1/4 by 11-1/4-in.

CIRCLE NO. 293

### Cassette-tape unit records at 500 bits/s



Video Systems Corp., 7300 N. Crescent Blvd., Pennsauken, N. J. Phone: (609) 665-6688. Price: \$1695 or \$85/month (for 12 months).

A new cassette-tape memory recorder called the VST-Termicord, adapts to any CRT data terminal and can record and reproduce data at the rate of 500 bits/s with a packing density of 250 bits/in. The Termicord comes with all the electronics and uses a standard Phillips C-60 cassette.

CIRCLE NO. 294



# HUGHES INTRODUCES 5V MOS. OR ANY VOLTAGE FROM 1.2 TO 10.

It's a brand new CMOS family. 15 standard 7000 series logic elements. Here now.

Speedy, too. 0.5MHz at 1.5 volts and 5 MHz at 5 volts.

Perfect for building your next circuit or breadboarding a custom LSI chip.

We can also give you the industry-standard CMOS family (6 volts to 15 volts) that is compatible, pin-for-pin, with our new 7000 series low voltage CMOS.

Standard or low voltage CMOS?

We've got both. Write

or call: Hughes MOS Division,  
500 Superior Avenue,  
Newport Beach, CA 92663.  
(714) 548-0671.

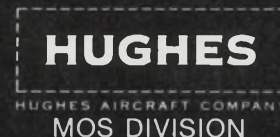

## HUGHES 7000 SERIES LOW VOLTAGE CMOS

- |   |  |
|---|--|
| HCOS7000D: Dual 3-Input NOR Gate                | HCOS7008D: 4-Bit Full Adder                    |
| HCOS7001D: Quad 2-Input NOR Gate                | HCOS7009D: Inverting Hex Buffer                |
| HCOS7002D: Dual 4-Input NOR Gate                | HCOS7010D: Non-Inverting Hex Buffer            |
| HCOS7004T: 7-Stage Ripple Counter/Freq. Divider | HCOS7011D: Quad 2-Input NAND Gate              |
| HCOS7005D: 16 Bit (NDRO) Memory                 | HCOS7012D: Dual 4-Input NAND Gate              |
| HCOS7006D: 18 Stage Static S/R                  | HCOS7013D: Dual D-Type Flip Flop               |
| HCOS7007D: Dual Complementary Pair              | HCOS7014D: 8-Stg. Parallel In. Serial Out. S/R |
|   | HCOS7015D: Dual 4 Stg. Serial In Par. Out S/R  |



# Best Buy

in 1% Tolerance  
1-Watt Zeners  
**SCHAUER**

Immediate Shipment

No fragile  
nail heads

All welded and  
brazed assembly

Gold plated  
leads

## Low Prices

ANY voltage from 2.0  
to 18.0

Quantity	Price each
1-99	\$1.07
100-499	.97
500-999	.91
1000-4999	.86
5000 up	.82

Write for complete rating data and other tolerance prices.

## Buy The Kit!



A  
\$54.57  
value  
for  
only

**\$24.50**

Kit contains a 51-piece assortment of SCHAUER 1% 1-watt zeners covering the voltage range of 2.7 to 16.0. Three diodes of each voltage in reusable poly bags. Stored in a handy file box. Contact your distributor or order direct.

Semiconductor Division

## SCHAUER

Manufacturing Corp.

4511 Alpine Ave. Cincinnati, Ohio 45242

Telephone: 513/791-3030

## COMPONENTS

### Thin-film resistors come in many shapes

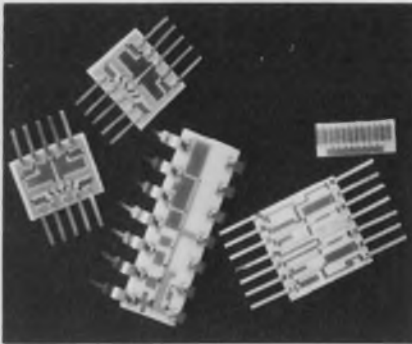

TRW, Inc., P. O. Box 887, Burlington, Iowa. Phone: (319) 754-8491.

Standard tantalum nitride thin-film resistor networks are available in many configurations in resistance values of 20  $\Omega$  to 100 k $\Omega$  with resistance tolerance of  $\pm 0.03\%$  to  $\pm 1\%$ . Temperature coefficient is rated over 0 to  $-80$  ppm/ $^{\circ}\text{C}$  and thermal coefficient of tracking is  $\pm 3$  ppm/ $^{\circ}\text{C}$ . The new resistor networks are also incorporated as ladder networks. Ladders are available with standard values of 5 k $\Omega$ .

CIRCLE NO. 295

### DIP resistor network houses 13 resistors

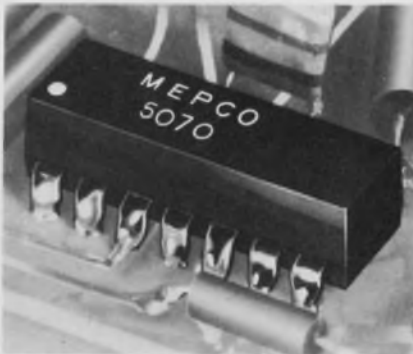

Mepco, Inc., Morristown, N. J. Phone: (201) 539-2000.

A new dual-in-line resistor network for automatic-insertion applications is available with 13 cermet resistors within a resistance range of 50 to 100 k $\Omega$  at a tolerance of 1%. The 14-pin TO-116 network uses a 96% alumina substrate and tin-plated alloy pins. Power dissipation is 1 W at 25 $^{\circ}\text{C}$ . Temperature coefficient is less than 200 ppm. The case is made of a high-temperature polymer and measures 0.75 by 0.3 by 0.2 in.

CIRCLE NO. 296

### 15-transformer kit covers 3 power ratings

Microtran Co., Inc., 145 E. Mineola Ave., Valley Stream, N. Y. Phone: (516) LO 1-6050. P&A: \$65; stock.

Model 6000K kit consists of 15 115-V 60-Hz plug-in transformers in three sizes with 1-1/2, 4-1/2 and 7-1/2 W ratings. Twenty-seven power/voltage ratings may be obtained by connecting windings in series or parallel with secondary voltages from 6.3 to 116 V center-tap.

CIRCLE NO. 297

### Microminiature inductor is hybrid compatible

Delevan Div. of American Precision Industries, Inc., 270 Quaker Rd., E. Aurora, N. Y. Phone: (716) 652-3600.

Micro-i series 155 inductor is a tiny device compatible with hybrid ICs. Each inductor has four leads that are adaptable for solder reflow connections. It is adaptable to a tuned circuit by the use of an out-board chip capacitor.

CIRCLE NO. 298

### Bandpass filters cover 90 to 150 Hz

Bulova Watch Co., Electronics Div., 61-20 Woodside Ave., Woodside, N. Y. Phone: (212) 535-6000. P&A: \$95; stock.

A new line of bandpass filters covers the low-frequency range of 90 to 150 Hz. Series 3300 units operate over  $-10$  to  $+50^{\circ}\text{C}$  and track within 0.1 dB over that temperature range. Typical size is 3-1/2 by 2-7/8 by 1-3/4 in.

CIRCLE NO. 299

### Mercury reed switch works in any position

McClintock Matrixes, Inc., Washington Rd., Woodbury, Conn. Phone: (203) 263-4624. Availability: stock.

An all-position-mounting mercury-wetted magnet-operated reed switch is the model 35-4-2. It retains the mercury only to the contact area. Contact arrangement is spst form A, dc contact rating is 10 W and actuation time is 300  $\mu\text{s}$ .

CIRCLE NO. 340



# NEW

NEW BEAUPUG® Catalog No. 76DA  
 NEW Tech Data on "Jones Type" Connectors  
 NEW Closed Back Barrier Terminal Strips  
 NEW Single Row Barriers



Just write for No. 76DA today, or ask a BEAU Distributor for a copy. Provides complete data on BEAU-PLUG Sockets and Plugs and on Open and Closed Back Barrier Terminal Strips. Prices also will be included.

This catalog will help you make a \*PDQ connection:

- \*PDQ
- Price — right
- Delivery — dependable
- Quality — proved

Beau Products Division



**Vernitron**  
**Electrical Components**

117 Union Avenue, Laconia, N.H. 03246  
 Tel: (603) 524-5101 TWX: 710-364-1843

In CANADA: Brimark Electronics Limited  
 340 Carlaw Avenue, Toronto 8, Ontario  
 INFORMATION RETRIEVAL NUMBER 85

## POWERTEC

THE POWER HOUSE

**OEM** SERIES  
 ADJUSTABLE POWER SUPPLIES

**\$24<sup>95</sup>**

**TO 12 AMPS**

- 4 TO 26 VDC 3 TO 12 AMPS
- RIPPLE: 1 MVRMS
- SHORT CIRCUIT PROTECTED
- FOLD BACK CURRENT LIMITING
- OPTIONAL OVER VOLTAGE PROTECTION
- REGULATION: LINE  $\pm 0.25\%$  LOAD  $\pm 0.25\%$



MODEL	PRICE		DIMENSIONS
	1-9	100	
2B5 - 3 AMPS	\$24.95	\$19.50	4.8 W X 4 L X 1.8 D
2C5 - 6 AMPS	\$44.00	\$36.00	4.8 W X 5.7 L X 2.8 D
2C5 - 12 AMPS	\$75.00	\$60.00	4.8 W X 9 L X 3 D

OEM CONTRACTS AVAILABLE

**POWERTEC** A DIVISION OF AIRTRONICS INC.

9168 DESOTO AVENUE  
 CHATSWORTH, CALIFORNIA 91311  
 (213) 882-0004 TWX 910-494-2092

INFORMATION RETRIEVAL NUMBER 86

ELECTRONIC DESIGN 4, February 18, 1971

## You say you want a

low-profile snap-in-mounting push button switch or matching indicator that is interchangeable with most 4-lamp displays... available in a full range of cap colors... with a choice of bezels with or without barriers in black, gray, dark gray or white.

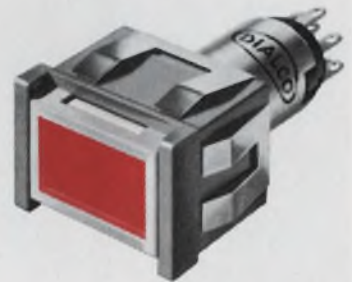

## and a

legend presentation that's positive (like this one) or negative (like the one below) or just plain (like the one above)... one that's white when "off" and red, green, yellow (amber), blue or light yellow when "on"... or colored both "on" and "off."



## and a

highly reliable switch proven in thousands of installations... available in momentary or alternate action... N.O., N.C. or two circuit (one N.O., one N.C.)... that accommodates a T-1 3/4 bulb with midget flanged base, incandescent, in a range of voltages from 6-28V.



*etc.*  
*etc.*  
*etc.*

*Now, for the first time Dialight gives you custom panel designing with a standard line of push-button switches and matching indicators*

Dialight offers a broader range of switch and indicator possibilities than you'll find anywhere in a standard single-lamp line. Sizes: 3/4" x 1", 5/8" and 3/4" square and round. Send today for our new catalog.

**DIALIGHT**

Dialight Corporation, 60 Stewart Ave., Brooklyn, N.Y. 11237

INFORMATION RETRIEVAL NUMBER 87

DT-125

125





YOU'RE  
WHISTLING  
IN THE  
DARK . . .

. . . if you think that heart disease and stroke hit only the other fellow's family. No one is immune. Protect the hearts you love. For authoritative information, ask your Heart Association. For medical advice see your doctor. To safeguard your family . . .

**GIVE...**  
so more will live  
**HEART  
FUND**



Contributed by the Publisher

## COMPONENTS

### PC ferrite inductors pack in L and Q

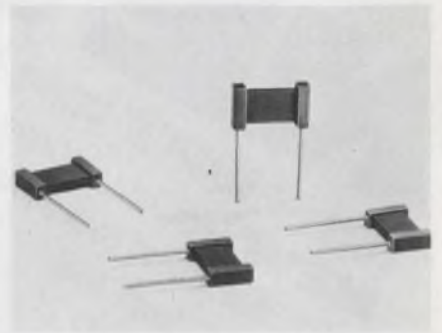

*Fair-Rite Products Corp., Walkill, N. Y. Phone: (914) 895-2055. P&A: \$85 (1000-unit lots); 1 to 2 wks.*

A new ferrite inductor in H-bobbin form for high-density PC board mounting on 0.3-in. centers provides twice the inductance and Q of axial-lead inductors occupying the same space. Part #9761404001 measures 0.375 by 0.1 by 0.250-in. and is DIP compatible. Frequency range is 0.1 to 5 MHz. Initial permeability is 125  $\mu$  (#9761404001) and 250  $\mu$  (#9764404001).

CIRCLE NO. 343

### Recording CRT deflects 26°

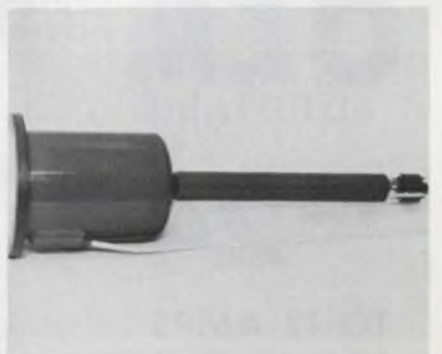

*Litton Industries Electron Tube Div., 960 Industrial Rd., San Carlos, Calif. Phone: (415) 591-8411.*

A new CRT specifically designed for recording computer output on microfilm features a 1-mil spot size at a low deflection angle of 26 degrees. Its use of a low deflection angle minimizes the requirement for linearity and focus correction and permits faster writing speeds. Designated the L-4251, its phosphor-screen quality is compatible with most system requirements.

CIRCLE NO. 344



**More wafers  
per furnace load.  
Longer furnace tube life.**

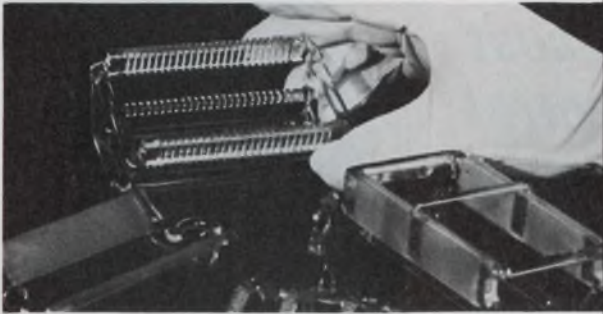

Newly designed carrier boats from Amersil are a marked improvement over slotted plate and slotted rod carriers for low and high temperature diffusion applications. This construction provides more secure wafer spacing for uniform diffusion.

For details on the above and our complete line of new spring boats and carriers to raise wafer output, write today to: Amersil, Inc., 685 Ramsey Ave., Hillside, N. J. 07205.



An Equal Opportunity Employer

2078

INFORMATION RETRIEVAL NUMBER 88

**The price of spacers  
comes  
tumbling**



**Steel-  
Aluminum**

Speedy shipment  
from stock of over  
1000 different sizes.

SEND FOR  
LITERATURE AND  
FREE SAMPLES!



**CEM COMPANY, INC.**

51 SCHOOL STREET, DANIELSON, CONN. 06239

INFORMATION RETRIEVAL NUMBER 89

ELECTRONIC DESIGN 4, February 18, 1971

**Good News:  
Your "Make or Buy" Problems  
are solved!**

## **Custom Miniaturized Sub-Systems**

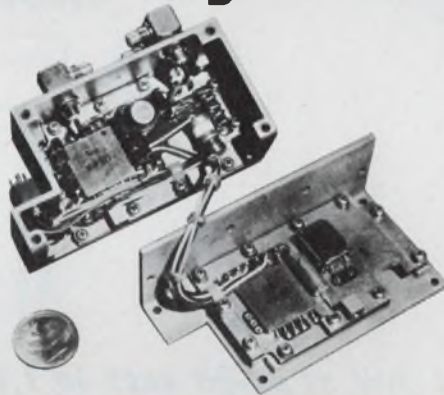

**Give CTI your Black Box Function and  
QC Requirements. Then relax!**

CTI will do the whole job for you. Completely. Right from the beginning. Right the first time.

With the complete sub-system designed, miniaturized, packaged, tested, ready to go to work. And delivered, as promised, on time.

Is it expensive to go this route? Not at all. You'll be amazed how inexpensive it is compared to making it in-house. In fact, it is the only way to go these days if you're going to remain competitive!

How does CTI do it? By using a unique combination of talents. • Top circuit engineering • Established-quality micro-circuit production (to MIL Std 883) • Innovative packaging capability, with the optimum combination of thick-film, monolithic and discrete components for maximum economy and performance • Quick turn-around.

**Custom Hybrid  
+ Hybrid  
+ Hybrid  
+ Hybrid  
= SubSystems**

See how great it is  
to do business with  
the Leader!

On the East Coast,  
call: Mel Spitz  
(516) 293-8686.

In the Mid-West,  
call: Bryan Geyer  
(502) 425-5434.

On the Pacific Coast,  
call: Syl Cole  
(213) 372-8419.

**CIRCUIT TECHNOLOGY  
INCORPORATED**

160 Smith St., Farmingdale, N.Y. 11735

INFORMATION RETRIEVAL NUMBER 90



# LED

## New low cost LED Vactrol photon isolator

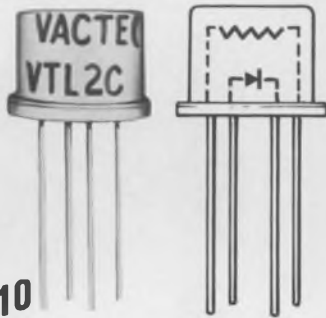

\$3.10

as low as ~~\$4.20~~ each in 1,000 quantities

- all solid state
- 4 types of photoconductors combined with LEDs
- hermetically sealed TO-5 enclosure
- unlimited life—no filaments
- ideal for environments where shock and vibration are a problem
- applications include photochoppers, linear isolators, noiseless switching, SCR and triac turn-on, audio level controls, etc.

Part Number	LED	PHOTOCELL		
	Current (ma) (1.65v typ.)	Max. Cell Resistance	Typical Rise Time (ms)*	Decay
VTL2C1	40	10 K $\Omega$	.5	3.5 ms **
VTL2C2	40	500 $\Omega$	3.5	500 ms †
VTL2C3	40	2 K $\Omega$	2.5	35 ms †
VTL2C4	40	100 $\Omega$	6.0	1.5 sec †

\* To 63% conductance

\*\* To 1 meg

† To 100 K $\Omega$

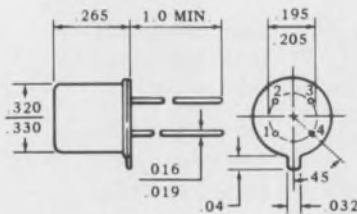

1-3 PHOTOCELL  
2-4 LED

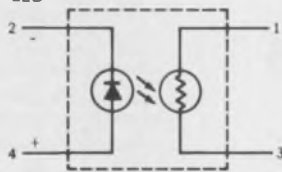

Write for Bulletin VTL2C. Also a complete line of neon and incandescent Vactrol photon isolators.

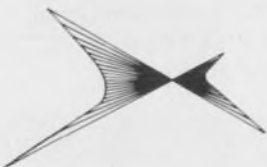

## VACTEC, INC.

2423 Northline Ind. Blvd.  
Maryland Heights, Mo. 63043  
Phone: (314) 872-8300

Specializing in standard Cds, Cdse, and Se sells; custom engineering for every photocell need.  
Listed in EBG under "Semi-Conductors" and in EEM Sec. 3700.

INFORMATION RETRIEVAL NUMBER 91

## MICROWAVES & LASERS

### Solid-state camera uses self-scanned array



Integrated Photomatrix Ltd., Teknis, Inc., Plainville, Mass. Phone: (617) 695-3591.

The IPL20H is a solid-state camera based on the IPL20 self-scanned array of 50 photodiodes spaced on 0.004-in. centers. The photodiodes are integrated on a single silicon chip which includes a 500-kHz shift register that scans and gives a serial video output. The 2.5-in.-dia and 3.75-in.-long camera incorporates a lens in the front which is mounted on a threaded bush for focus adjustments.

CIRCLE NO. 345

### Photo-array readers use up to 24 sensors

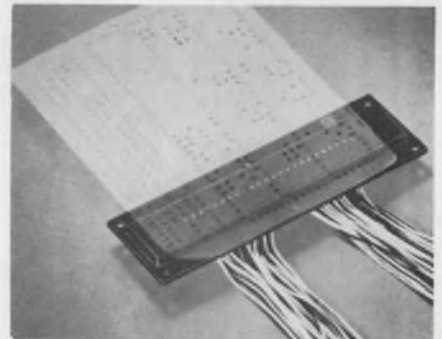

HEI, Inc., Jonathan Industrial Center, Chaska, Minn. Phone: (612) 448-3510. P&A: \$32.20; stock to 4 wks.

New card-reader photo arrays have 18 or 24 sensors to sense perforations in System/3 cards. They are available in three series: CR-600 for high-speed, CR-700 for low-cost and CR-800 (photo-darlington) for high-sensitivity applications. Each sensor is shielded to eliminate cross-talk. Arrays are 12-in. long and have color-coded leads. Sensors are mounted on 0.087-in. centers.

CIRCLE NO. 346



## TO-8 vhf/uhf amps gain 13 dBm to 2 GHz

Avantek, Inc., 2981 Copper Rd., Santa Clara, Calif. Phone: (408) 739-6170. P&A: \$130 to \$260; stock to 30 days.

Four new series of vhf/uhf amplifiers in TO-8 cans offer power gains to 13 dBm up to 2 GHz. Series UTO-500 covers 5 to 500 MHz and UTO-1000 covers 5 to 1000 MHz. UTO-1500 spans 5 to 1500 MHz and UTO-2000 spans 5 to 2000 MHz.

CIRCLE NO. 347

## Matched mixer-preamps span 1 to 18 GHz

RHG Electronics Laboratory, Inc., 94 Milber Blvd., Farmingdale, N. Y. Phone: (516) 694-3100. P&A: from \$725; 45 days.

Series MMP/10 phase and gain-matched mixer preamps span the range of 1 to 18 GHz including octave coverage. I-f frequencies are from 10 to 120 MHz and bandwidths are up to 40 MHz. Phase matching is to  $\pm 5$  degrees.

CIRCLE NO. 348

## Double-balanced mixer spans 0.01 to 12 GHz

Anzac Electronics, 39 Green St., Waltham, Mass. Phone: (617) 899-1900. Availability: stock.

A bandwidth from 10 MHz to 12 GHz is provided by a new double-balanced mixer. Model 112 has 10-dB noise figures at 4 GHz and a third-order intercept point of +23 dBm. Even though each of its three ports is rated for 10 MHz to 12 GHz, it can be used to 16 GHz.

CIRCLE NO. 349

## Ku-band varactors provide 40-W levels

GHZ Devices, Inc., Kennedy Dr., N. Chelmsford, Mass. Phone: (617) 251-4981. Availability: 2 wks.

The GC-3000 series multiplier varactor diodes with multi-chip designs generate harmonics through Ku band at output levels as high as 40 W from a single diode. Five diodes cover the output-frequency range from 0.5 to 18 GHz.

CIRCLE NO. 350

# the Giant Killer strikes again...

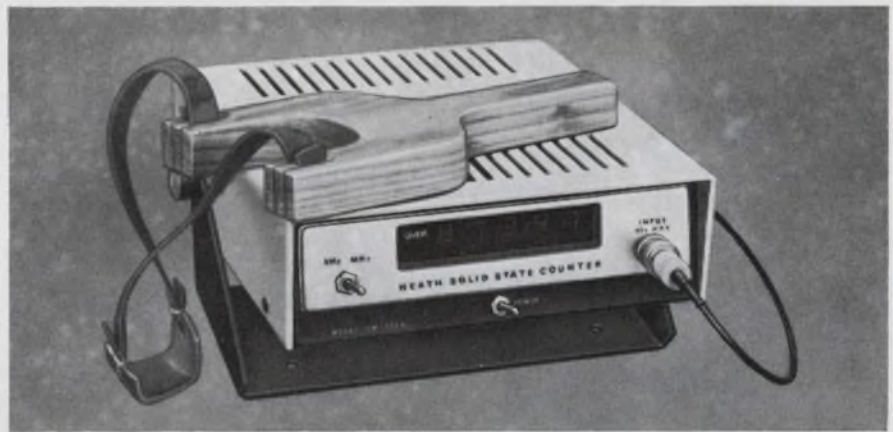

## New Heath SM-105A

# \$350.00\*

ASSEMBLED  
& TESTED

- 10 Hz to over 80 MHz range
- Advanced design — new Texas Instruments 74S Series superspeed Schottky TTL
- 5-digit LED readout
- Wide range input without adjustment
- 1 megohm input
- Crystal clock
- Send for free SM-105A spec sheet... and watch the giants fall!

**SM-105A SPECIFICATIONS** — Sensitivity: 100 mV RMS to 50 MHz; 250 mV RMS, 50 MHz to 80 MHz. Frequency Range: 10 Hz to 80 MHz. Input Impedance: 1 Megohm shunted by less than 15 pF. Overload: 50 V RMS from 10 Hz to 15 MHz; from 15 MHz to 80 MHz derate linearly at 0.8 V RMS/MHz from 50 V RMS. Maximum DC input is  $\pm 50$  V. Time Base: 1 MHz  $\pm 2$  Hz. 0° C to 40° C ambient,  $\pm 10$  ppm. Readout: Five 7-segment light-emitting-diode displays. One single light-emitting-diode for overrange. Overrange: Flashing, 40 ms on, 60 ms off. Power Requirements: 120/240 VAC, 12 watts. Dimensions: 9 1/4" D x 6 3/4" W x 2 1/4" H. Net Weight: 3 1/2 lbs. Shipping Weight: 6 lbs.

### FREE HEATH SCIENTIFIC INSTRUMENTATION CATALOG

Investigate these and other new ideas in Spectroscopy, Digital Instrumentation, Lab Equipment and Test Equipment. Send for your FREE catalog now.

HEATH COMPANY, Dept. 520-26  
Benton Harbor, Michigan 49022

**HEATH**  
a Schlumberger company

Please send free Heath Scientific Instrumentation Catalog

Name \_\_\_\_\_

Address \_\_\_\_\_

City \_\_\_\_\_

State \_\_\_\_\_

Zip \_\_\_\_\_

\*Mail order prices; FOB factory.

Prices & specifications subject to change without notice. EK-296

INFORMATION RETRIEVAL NUMBER 92



# HICKOK Digital Measuring System



3 1/2 DIGIT MAIN FRAMES FROM \$385



This all-solid-state precision measurement system offers unlimited expansion capability through plug-in additions, resulting in a specialized instrument for each type of measurement. New plug-ins now broaden the measurement capability of this field-proven unit.

Scaling controls make possible resolution of up to seven digits on the three-digit display by utilizing the overrange capability of many of the plug-ins, thus providing high resolution and accuracy with minimum investment. Companion devices such as the 4900 Digital Printer and 1050 Digital Set-Point Controller further extend the utility of the 3 1/2 Digit 3202 System.

- |  |              |
|--|--------------|
| DC VOLTMETER PLUG-IN DP 100<br>00.1 mV to 1500. volts<br>± 0.1% rdg ± 1 digit  | <b>\$150</b> |
| DC MICROVOLTMETER PLUG-IN DP 110<br>0.001 mV to 1300. volts<br>± 0.05% rdg ± 1 digit<br>4-digit resolution               | <b>\$475</b> |
| AC VOLTMETER PLUG-IN DP 130<br>0.01 mV to 1000. volts<br>± 0.1% rdg ± 1 digit<br>22 Hz to 1.0 MHz                        | <b>\$395</b> |
| EVENT COUNTER/SLAVE PLUG-IN DP 140<br>Up to 1,000,000 counts/sec<br>Cascade with second DMS to<br>obtain 6-digit display | <b>\$100</b> |
| 1 MHz COUNTER PLUG-IN DP 150A<br>0.1 Hz to 1 MHz<br>± 0.0005% rdg ± 1 digit<br>7-digit resolution                        | <b>\$255</b> |
| 100 MHz COUNTER PLUG-IN DP 160<br>00.1 Hz to 100.0 MHz<br>± 0.00005% rdg ± 1 digit<br>7-digit resolution                 | <b>\$395</b> |
| OHMMETER PLUG-IN DP 170<br>0.001 ohm to 1000. megohms<br>± 0.1% rdg ± 1 digit<br>Microamp test current                   | <b>\$305</b> |
| CAPACITY METER PLUG-IN DP 200<br>0.001 picofarad to 10.00 millifd<br>± 0.1% rdg ± 1 digit<br>Low DC test voltage         | <b>\$305</b> |
| TIME INTERVAL METER PLUG-IN DP 210<br>0.01 ms to 1,999. seconds<br>± 0.0005% rdg ± 1 digit<br>Period or time interval    | <b>\$295</b> |
| DC CURRENT METER ADAPTER D 310<br>.0001 microamp to 13.00 amps<br>± 0.15% rdg ± 1 digit                                  | <b>\$100</b> |

## evaluation samples



### Drawing sheets

Engineers and draftsmen can now make their own appliques of any repetitive diagram, specification, detail, title block or any other drawing with new Stanpat blank pressure-sensitive sheets. They give crisp, clean reproductions when used with any Xerox 720, 914 or 2400 copier. They adhere permanently and won't wrinkle when tracings are rolled. Non-reflective matte surfaces can be erased on many times and are receptive to pencil or ink markings. Blank sheets are 8-1/2 by 11 in. A free sample and literature are available. Stanpat Products Inc.

CIRCLE NO. 351

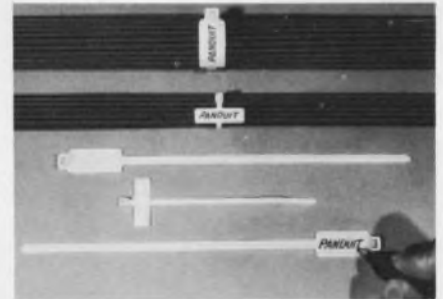

### Cable marker ties

Two new one-piece all-nylon identification marker ties are the Pan-Ty PLM1M miniature marker for 3/4-in. wire bundles and the Tan-Ty PLM2S standard marker for 1-3/4-in. wire bundles. Both can be installed by hand or with tension-controlled production harnessing tools. Serrations at top of the lead end of the markers provide a finger-grip tip which assists in pulling markers tight. The serrations also provide a temporary hold which is releasable when the tip is inserted in the head. Free samples are available. Panduit Corp.

CIRCLE NO. 352

# HICKOK

INSTRUMENTATION &  
CONTROLS DIVISION  
10514 Dupont Ave.  
Cleveland, Ohio 44108  
Phone 216-541-8060

INFORMATION RETRIEVAL NUMBER 93



# design aids



## Lettering set

The Tech-graph model 300 lettering set contains a precision-made scribe guided by a special tracer pen or stylus attached to a pilot bar, which can be adjusted to suit any desired slant of lettering. Each of the 14 tubular pens supplied with the set consists of a tube in which a plunger is fitted for perfect flow-control of writing fluid. These pens are suitable for use with all inks. Included are four templates and one 12-in. aluminum ruler guide. The complete set costs \$55.75. Hunter Assoc.

CIRCLE NO. 353

# application notes

## Digital controls book

"Digital Controls for Industry" handbook describes a series of digital modules and instruments for accurately measuring, displaying and controlling any measured parameter such as pressure, load, temperature, flow, position, acceleration or voltage for on-line monitoring and control. CGS/Data-metrics.

CIRCLE NO. 354

## Logic timing

Time-interval averaging and its application to high-resolution digital timing measurements are discussed in a new eight-page application note. Economical and accurate techniques are described for effective measurement of repetitive time intervals down into subnanosecond ranges. Hewlett-Packard.

CIRCLE NO. 355

## Video-amplifier FETs

An analysis of design considerations for the use of FETs in video amplifiers is given in an application note. Examined in detail are such FET characteristics as input resistance, intra-terminal capacitances and measured performances using different circuit configurations. Equations and curves are used abundantly. Siliconix Inc.

CIRCLE NO. 356

## P-i-n diodes

Two new rf application notes for low series-resistance p-i-n diodes are available. One contains general information on using p-i-n diodes in rf applications. The other contains design curves for rf switches using p-i-n diodes. Unitrode Corp.

CIRCLE NO. 357

# COMPLETE PACKAGING CAPABILITY

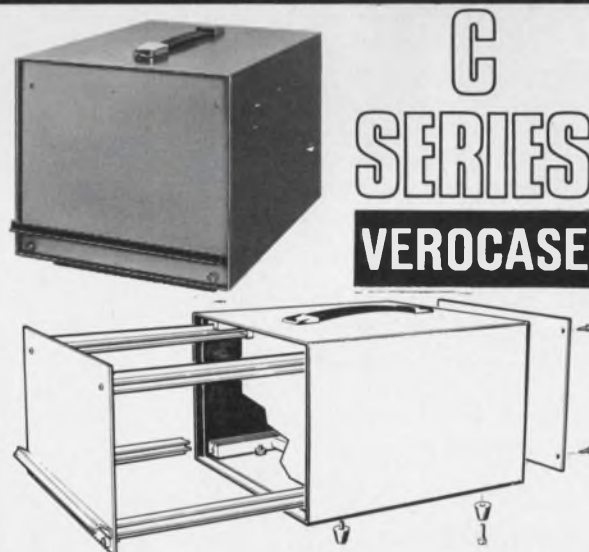
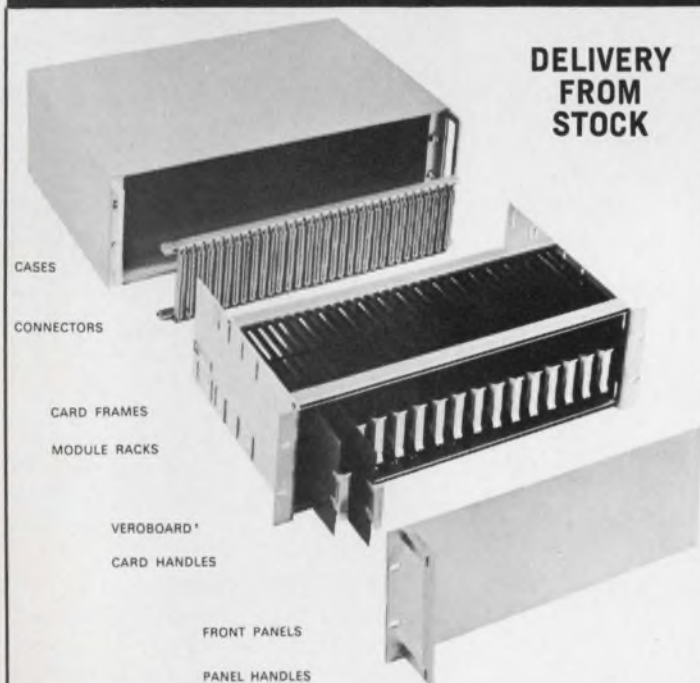

Vero PLUG-IN MODULE CASES provide portable enclosures for Vero modules as used in the popular Vero module rack. These plug-in module cases are available in 5¼", 7" and 8¾" heights and 4", 8" and 16" widths with built-in guides to accept various module combinations. Delivery is FROM STOCK.

vero

**VERO ELECTRONICS INC.** TWX510-227-8890  
171 BRIDGE ROAD, HAUPPAUGE, N. Y. 11787 TEL: 516-234-0400



# new literature

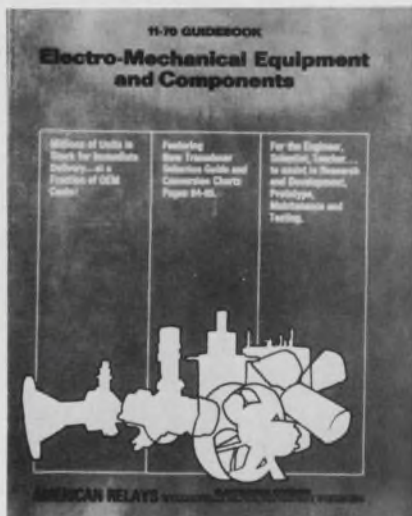

## Components

A new 116-page illustrated catalog contains information on electro-mechanical components, equipment, and test instruments. A few of the hundreds of items shown include blowers and fans, capacitors, gyros, oscillographs, potentiometers, relays, servo motors, synchros, test instruments and transducers. Electronics Div., American Relays.

CIRCLE NO. 358

## Computer

A 12-page brochure describes a small computer that provides cost/performance advantages by using a virtual memory concept. Systems Engineering Laboratories, Inc.

CIRCLE NO. 359

## Shrinkable tubing

Shrinkable tubing for custom cabling, cable shielding, high and low-temperature environmental protection and flat-ribbon cables is illustrated in a new catalog. The Zippertubing Co.

CIRCLE NO. 360

## Cable hardware

Clips, clamps, harnesses, straps, ties, guides and supports are in a new eight-page catalog. Detailed descriptions of the products are included, together with specifications, line drawings, and illustrations. Fastex Div. Illinois Tool Works Inc.

CIRCLE NO. 361

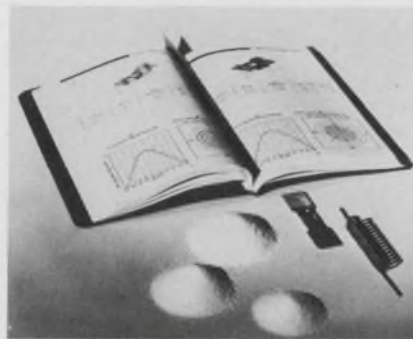

## Thin-film materials

A 160-page reference is available on thin-film evaporation techniques, materials and sources. It lists many configurations of boats, baskets, filaments and crucibles. The evaporation characteristics of over 90 metals and chemicals are given. Sloan Materials.

CIRCLE NO. 362

## Automatic test systems

A new six-page selection guide gives a quick overview of the capabilities and the many possible configurations of a series of automatic test systems. Hewlett-Packard.

CIRCLE NO. 363

## Cases and headers

A line of 4000 standard molded E-case encapsulation shells, headers, covers and module packages is presented in a 24-page catalog. Epoxy Plastic Molders, Inc.

CIRCLE NO. 364



## Servo systems

A revised and updated 68-page catalog includes over 3000 electro-mechanical components and servo systems. Clifton division of Litton Industries.

CIRCLE NO. 365



## Readouts and drivers

A complete set of literature is available for an extensive line of seven-segment incandescent and solid-state readouts and decoder/drivers. Luminetics Corp.

CIRCLE NO. 366

## Digital instruments

Complete lines of digital micro-voltmeters, digital comparators, data printers, digital panel meters and dc data amplifiers are in a catalog. Newport Laboratories, Inc.

CIRCLE NO. 367

## Photomultipliers

A photomultiplier-tube specifier together with a short-form catalog are available. Bailey Instruments Co., Inc.

CIRCLE NO. 368

## Recorder charts

A 36-page catalog contains a compilation of available charts for ink-recording instruments. Calibrated Charts Corp.

CIRCLE NO. 369

## Optical filters

A complete product line of optical thin-film filters are described in a catalog. Corion Instrument Corp.

CIRCLE NO. 370

## Photon equipment

A four-page illustrated catalog describes a wide range of digital synchronous computers, amplifier discriminators, data converter consoles, power supply consoles and photomultiplier tube housings. SSR Instruments Co.

CIRCLE NO. 371



# Now...phototransistors from Clairex!

right  
performance  
...right  
price

## DESIGN FEATURES

High current at low illumination  
Hermetically sealed  
Fast switching  
High breakdown voltages

## PURCHASING ADVANTAGES

Competitive pricing  
Fast, stock delivery  
Quality controlled  
Established vendor

Our 18 years of leadership in electro-optics can help you select the *right* phototransistor from our *growing* Clairex product line.

Let us help you balance the price/performance factors that are important to you!

For full data about our CLT 2000 series and CLT 2100 series call 914-664-6602 or write Clairex®, 560 South Third Avenue, Mount Vernon, N.Y. 10550.

## CLAIREX ELECTRONICS

A DIVISION OF CLAIREX CORPORATION

INFORMATION RETRIEVAL NUMBER 95



# New Micro-Miniature Form C Reed Relays

Only  
.290 OD!

- The First FORM C Micro-Min. Relay Available!
- Measures .435 x .290 OD, only 0.03 cu. in.!
- Min. Overall Length with Bent Leads .600
- High Speed 100 microsec. Operate Time (ex. Bounce)
- Stock Voltages 3, 6, 12 and 24
- Leads or Pins. Also Available with Form A.

Special voltages, resistances, electrostatic and/or magnetic shields available. Write for new Bulletin MR-9.2.



**COTO-COIL COMPANY, INC.**  
59 Pavilion Avenue, Providence, R. I. 02905  
Tel: (401) 941-3355

INFORMATION RETRIEVAL NUMBER 96

Forget shorting plugs . . .  
**USE A BREAK-OUT BOX!**

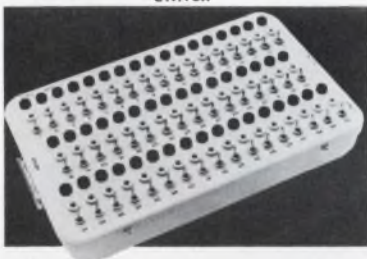
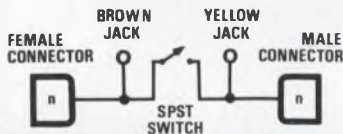

A break-Out Box is designed to reduce hook-up and testing time. It offers a convenient method to measure or interrupt voltages, currents, and/or the signals between any two pieces of equipment. A flip of a switch instantly opens or closes any circuit. Cumbersome shorting plugs are no longer necessary. It comes in a variety of connector configurations, is of rugged construction, low in cost, and available off-the-shelf.

**Technical Assistance Laboratories**  
12701 South Van Ness Avenue  
Hawthorne, California 90250  
(213) 757-9488

INFORMATION RETRIEVAL NUMBER 97

## NEW LITERATURE



### Capacitors

A 12-page brochure covers five segments of the capacitor market: plastic film, aluminum electrolytic, tantalum electrolytic, ceramic and mica capacitors. Also described are equipment services available for determining the most effective use of insulation and packaging products. 3M Company.

CIRCLE NO. 372

### Delay lines

A new guide shows how to specify delay lines and includes an engineering chart outlining their practical limits. Definitions of delay line characteristics, test-circuit diagrams and a variety of new delay lines are included. RCL Electronics, Inc.

CIRCLE NO. 373

### Spectrum analyzers

A four-page bulletin describes real-time spectrum analyzers and combined spectrum-analyzer/digital integrators. Signal Analysis Industries Corp.

CIRCLE NO. 374

### Data set

A medium-speed modem operating synchronously at 1200 or 1800 bits/s or asynchronously at rates up to 1800 bits/s is described in a brochure. Tel Tech Corp.

CIRCLE NO. 375

### Microwave switches

Characteristics and operating conditions for spst, spdt and spmt stripline microwave switches are given in a catalog. NESCO, Inc.

CIRCLE NO. 376



### Chokes and inductors

An expanded line of standard inductors and chokes is contained in a catalog. Included are complete specifications for encapsulated toroidal inductors which feature an inductance range of 50  $\mu$ H to 4 H with high Qs and wide selections of Q vs frequency. Dale Electronics, Inc.

CIRCLE NO. 377

### Stepper motors

A full line of four-phase variable-reluctance stepper motors are described in a new bulletin. IMC Magnetics Corp.

CIRCLE NO. 378

### Reed relays

Four new series of reed relays are described in technical data sheets. The four are standard, power and miniature-type reed relays. Guardian Electric Manufacturing Company of California.

CIRCLE NO. 379

### S/d converters

Detailed specifications of 38 synchro and resolver digital conversion systems are given in a new six-page brochure. DDC.

CIRCLE NO. 380

### Thick-film resistors

A detailed specification bulletin covers a line of non-insulated and insulated thick-film resistors. Pyrofilm Corp.

CIRCLE NO. 381

### Connectors

A new brochure covers interconnection and terminating devices for commercial and industrial applications. Deutsch.

CIRCLE NO. 382



# bulletin board

of product news and developments

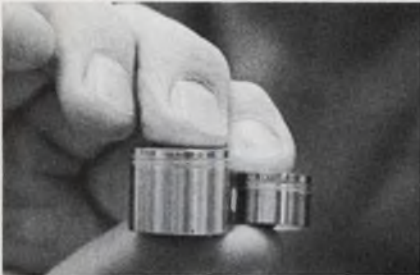

A miniature nonthermal radio-isotope-fueled betavoltaic battery has been developed by the Donald W. Douglas Labs of the McDonnell Douglas Astronautics Co., Richland, Wash. The battery is available in several sizes providing power levels from microwatts to a few milliwatts with useful lifetimes up to ten years.

CIRCLE NO. 383

National Cash Register Co. has introduced the Century 50 computer for small businesses that will rent for \$1500/month. The new computer system is reportedly price-competitive with IBM System 3 but can perform at faster processing speeds. The Century 50 has an 800-ns thin-film 16-kbit rod memory and can be supplied with an additional 16 kbits of memory if needed.

CIRCLE NO. 384

Six new ICs have been added to the Philco-Ford line of TTL/MSI circuits. The six new ICs are packaged in 14 and 16-pin dual-in-line cases and include a two-bit and a four-bit binary adder, a decade and a binary counter, a BCD-to-decimal decoder and a four-bit bi-stable latch.

CIRCLE NO. 385

Price reductions of up to 47% have been announced by Beckman Instruments, Helipot Div. on their model 845 8-bit thick-film hybrid d/a converter. According to Beckman, the 845 will now retail at \$39.75, for single-unit quantities, down from a price of \$75.

CIRCLE NO. 386

## Bulova has the answer to your crystal requirements



Whether it be for military communications or for data transmission, Bulova can satisfy your crystal needs. Advanced production techniques provide an accurate, stable and reliable frequency source to assure minimal frequency shift and low error rate for use in — Radio sets (military or commercial) • Facsimile • CATV • CCTV • Modems • Data Terminals • Multiplexers • Telemetry.

Bulova has a complete line of crystals from 2KHz to 150MHz in solder-sealed, precision glass and coldweld enclosures. For military users, Bulova supplies standard "CR" types to meet the latest MIL-C-3098 specs.

Contact your Bulova man to match your economic needs with your technical requirements. Call (212) 335-6000, See EEM Section 2300, or write —



### BULOVA

FREQUENCY CONTROL PRODUCTS

Electronics Division of Bulova Watch Company, Inc.

61-20 Woodside Avenue, Woodside, N. Y. 11377 / (212) 335-6000

INFORMATION RETRIEVAL NUMBER 98



## it's HELPED A LOT OF PEOPLE GLUE THINGS THEY THOUGHT COULDN'T BE GLUED.

For example, how do you bond neoprene to fluoroelastomer? (Eastman 910® Adhesive does a great job if you etch the fluoroelastomer with sodium before you apply the adhesive.) Or rubber to polyacetal? (Pretreating the polyacetal with chromic acid increases bond strength 500%.)

Questions like these come from a lot of big companies. And from a lot of smaller ones. The answers come from our technical service laboratory. And from our more than ten years of experience with cyanoacrylate adhesives. (We invented them.)

And we have more answers. Like how to make Eastman 910 set faster, or slower. How to make

your bonds stronger, or more heat-resistant, or more impact-resistant, or whatever.

So if you're trying to glue something, and you're having a problem, we may be able to help. Contact your Eastman 910 distributor, or call Dick Blair at (615) 246-2111 at Eastman Chemical Products, Inc. in Kingsport, Tennessee.

He and our lab people are pretty good at finding what's wrong and setting it right.

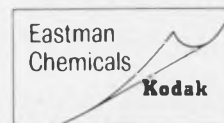

INFORMATION RETRIEVAL NUMBER 99



ELECTRONIC DESIGN'S function is:

- To aid progress in the electronics manufacturing industry by promoting good design.
- To give the electronic design engineer concepts and ideas that make his job easier and more productive.
- To provide a central source of timely electronics information.
- To promote two-way communication between manufacturer and engineer.

**Want a subscription?** ELECTRONIC DESIGN is sent free to qualified engineers and engineering managers doing design work, supervising design or setting standards in the United States and Western Europe. For a free subscription, use the postfree application form inside the back cover. If none is included, write to us direct for an application form.

If you do not qualify, you may take out a paid subscription for \$25 a year in the U.S.A., \$35 a year elsewhere. Single copies are \$1.50 each.

**If you change your address,** send us an old mailing label and your new address; there is generally a prepaid postcard for this inside the back cover. You will have to requalify to continue receiving ELECTRONIC DESIGN free.

**The accuracy policy of ELECTRONIC DESIGN is:**

- To make reasonable efforts to ensure the accuracy of editorial matter.
- To publish prompt corrections whenever inaccuracies are brought to our attention. Corrections appear at the end of the Letters column.
- To refuse any advertisement deemed to be misleading or fraudulent.

Microfilm copies are available of complete volumes of ELECTRONIC DESIGN at \$19.00 per volume, beginning with Volume 9, 1961. Work is now in process to complete the microfilm edition of Volumes 1-8. Reprints of individual articles may be obtained for \$2.00 each, prepaid (\$.50 for each additional copy of the same article) no matter how long the article. For further details and to place orders, contact the Customer Services Department, University Microfilms, 300 North Zeeb Road, Ann Arbor, Michigan 48106; telephone (313) 761-4700.

**Want to contact us?** If you have any comments or wish to submit a manuscript or article outline, address your correspondence to:

Editor  
ELECTRONIC DESIGN,  
850 Third Avenue,  
New York, N.Y. 10022.

## New Low Cost Mini Power Supplies



Power/Mate Corp. has introduced a new complete line of 119 models of miniature DC regulated power supplies—now described in this 6-page catalog. These 119 Mini Mate models collectively cover from 3.6 to 48 vdc and currents up to 2 amps. The Mini Mates feature adjustable DC outputs, low cost, high performance and Power/Mate's full five year warranty. The catalog covers complete specifications, model numbers, sizes and prices. Write, call or twx for your free copy.

**Power/Mate Corporation**  
514 South River Street  
Hackensack, New Jersey 07601  
(201) 343-6294 TWX (710) 990-5023

CIRCLE NO. 171

## Telephone Channel Simulation for Data Transmission



Simulation of the existing telephone channels has become exceedingly important as data transmission increases. For testing, training and evaluation, controlled impairments must be introduced. These include Phase Jitter, attenuation and envelope delay distortion, impulse hits, broadband noise, harmonic distortion and phase hits. SEG's new bulletin on the Phase Jitter Simulator with most additional impairments describes the first comprehensive instrument series to accomplish the required functions.

**SEG ELECTRONICS CORPORATION**  
120-30 Jamaica Avenue  
Richmond Hill, N. Y. 11418 212-441-3200

CIRCLE NO. 172

## FUNDAMENTALS OF INTEGRATED CIRCUITS

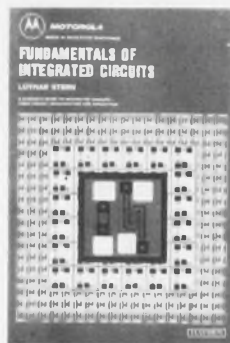

A practical guide to integrated circuits, their theory, manufacture, and applications. This new guide by Lothar Stern offers complete, highly readable coverage of the various techniques of circuit fabrication, and their effect on circuit design and performance. As to marketing considerations, it compares the characteristics of the numerous IC structures devised to date in terms of economics and logistics. A volume in the **Motorola Series in Solid-State Electronics**. 198 pages, 7 x 10, illustrated. \$8.95, clothbound. Circle the reader-service number below for 15-day examination copies.

**Hayden Book Company, Inc.**  
116 West 14th Street  
New York, N.Y. 10011

CIRCLE NO. 173



# Manufacturers

Advertisements of booklets, brochures, catalogs and data sheets. To order use Reader-ServiceCard (Advertisement)

## Time History of Low Frequency Real-Time Spectra Now Displayable on Your Scope



Now you can see the changing character of the frequency content of a signal in time, with Federal Scientific's Option 66-2 3-Dimensional Automatic Display Generator. It accepts inputs from any of Federal Ubiquitous® family of Spectrum Analyzers or Averagers and displays spectrum data on a CRT storage-display unit such as Tektronix 611. A three-dimensional display of spectrum amplitude vs frequency vs time is obtained — achieved by displacing successive spectrum traces vertically (in adjustable steps) and horizontally, to simulate a 3-D display through an isometric presentation.

### Federal Scientific Corporation

a subsidiary of Elgin National Industries, Inc.  
615 West 131st Street, New York, N. Y. 10027

CIRCLE NO. 174

## Pre-etched, Pressure-sensitive Copper Component Patterns for Instant PC Boards



Circuit Zaps® are 1 ounce copper circuit component patterns, pads, and conductor paths, precision-etched on 5 mil (.005") glass epoxy base material, backed by a special pressure-sensitive adhesive. Circuit Zaps® completely eliminate the artwork, photography, photoprinting, touch up, etching, stripping, and other time-consuming steps in PC board development.

Write today for the FREE TECHNICAL BULLETIN 1003 with FREE SAMPLE.

**Bishop Graphics, Inc.** 7300 Radford Avenue (ED)  
North Hollywood, California 91605 (213) 982-2000 Telex: 674672

CIRCLE NO. 175

## How To Write Technical Articles



A guide for the engineer-author, "How to Write Articles for Electronic Design" shows how easy it is to write for publication—once the engineer knows what to write and how to write it. The Author's Guide includes a complete run-down of the types of articles published by Electronic Design —plus detailed instructions on how to prepare technical articles and short special features. A MUST for every "would-be-writer" in the electronics industry. Send for your complimentary copy by circling the number to the right.

### Electronic Design

850 Third Avenue  
New York, N.Y. 10022

CIRCLE NO. 176

# Electronic Design

## Advertising Sales Staff

Keith Aldrich  
Sales Manager

### New York 10022

Robert W. Gascoigne  
Samuel M. Deitch  
Daniel J. Rowland  
850 Third Avenue  
(212) Plaza 1-5530  
TWX: 710-581-2874

### Philadelphia 19025

Mort Sullivan  
P.O. Box 126  
Dresher, Pa.  
(215) 884-6880

### Boston 02154

Joseph F. Palmer  
1268 Main Street  
Waltham, Mass.  
(617) 894-2700

### Chicago 60611

Thomas P. Kavooras  
Berry Conner, Jr.  
200 East Ontario  
(312) 337-0588

### Cleveland

Thomas P. Kavooras  
(Chicago)  
(312) 337-0588  
(call collect)

### Los Angeles 90303

Stanley I. Ehrenclou  
Jerry D. Latta  
2930 Imperial Highway  
Inglewood, Calif.  
(213) 757-0183

### San Francisco 94022

95 Main Street  
Los Altos, Calif.  
(415) 941-3084

### London W. 1

For United Kingdom and Holland  
Brayton C. Nichols  
44 Conduit Street  
Tel: REGent 4714

### Verviers, Belgium

For Continental Europe  
Andre Jamar  
1, Rue Mallar, 1  
(087) 253.83 Telex 41563

### Tokyo

Haruki Hirayama  
Electronic Media Service  
5th Floor, Lila Bldg.,  
4-9-8 Roppongi  
Minato-ku  
Phone: 402-4556  
Cable: Electronicmedia, Tokyo



**AMERICAN BUSINESS PRESS, INC.**





## Standard Bearer. Theirs      Standard. Ours

We've developed a series of probe tips that will breathe new life into your probe—enabling it to do jobs you wouldn't attempt before now.

### Mini-Grip.

- SMALL** enough for use with dual in-line packages and flat-packs
- STRONG** enough to grab on and hold . . . even allowing you to control the force

Mini-Grip probe tips. From Data Display. A Crowning Achievement.

### Data Display Systems, Inc.

139 Terwood Road, Willow Grove, Pa., 19090 (215) 659-6900

Available from Angus, Inc.; Harvey Radio Co.; Newark Electronics; and Pytronic Industries, Inc.

INFORMATION RETRIEVAL NUMBER 101

# advertiser's index

Advertiser	Page
AMP, Incorporated .....	8, 9
Advanced Microwave Labs.....	109
Alco Electronic Products, Inc.....	111, 119
Allen-Bradley Co. ....	33
American Lava Corporation .....	93
Amersil, Inc. ....	127
Augat, Inc. ....	139
Automatic Electric Company.....	4, 5
Avantek, Inc. ....	140
Beckman Instruments, Inc., Helipot Division .....	89
Bishop Graphics, Inc. ....	137
Bodine Electric Company .....	10, 11
Bourns, Inc. ....	139
Buckbee Mears Company .....	91
Bulova Frequency Control Products.....	135
Burroughs Corporation .....	20
CEM Company, Inc. ....	127
CTS Corporation .....	107
Cambridge Thermionic Corporation.....	117
CELCO (Constantine Engineering Laboratories Co.) .....	117
Centralab, the Electronics Division of Globe Union.....	15
Circuit Technology, Incorporated.....	127
Clairex Electronics, A Division of Clairex Corporation .....	133
Constantine Engineering Labs. Co. (CELCO) .....	117
Coto Coil Company, Inc.....	134
Cutler-Hammer, Specialty Products Division .....	39
Dale Electronics, Inc. ....	Cover III
Data Display Systems, Inc. ....	138
Delco Electronics, Division of General Motors Corporation .....	72, 73
Dialight Corporation .....	125
Digital Equipment Corporation .....	50, 51, 52
ERA Transpac Corporation.....	40
Eastman Chemical Products, Inc.....	135
Edsyn, Inc. ....	115
Electronic Engineering Co. of California .....	100
Electronic Measurements, Inc. ....	96E
Electrostatics, Inc. ....	121
English Electric Valve Co., Ltd.....	96A
Federal Scientific Corporation.....	120, 137
Garrett Micro-Circuits Corporation ..	38
Gould, Inc., Graphics Division.....	64, 65
Grayhill, Inc. ....	115
Hansen Manufacturing Co., Inc.....	108
Harris Semiconductor, A Division of Harris Intertype Corporation.....	109, 111, 113, 115, 117, 119, 121
Hayden Book Co., Inc. ....	44, 96H, 136
Heath Company .....	129
Heath Dynamics, Inc.....	7
Heinemann Electric Company .....	29
Hewlett-Packard .....	Cover II, 23, 104
Hickok Electrical Instrument Co., The .....	130
Honeywell, Inc. ....	138
Howard Industries, A Division MSL Industries, Inc. ....	12
Hughes Aircraft Company .....	123

## YOU AND Honeywell DO IT BETTER...

- PACKAGING YOUR SYSTEMS
- STYLING YOUR PRODUCT
- HARMONIZING COLORS
- SERVICING COMPONENTS
- IMPROVING MARKETABILITY

New Honeywell "Styleline" Series 4000 MODU-MOUNT cabinetry broadens your packaging horizon with far more design and styling features. Aluminum trim . . . vinyl inserts . . . extended side panels . . . and six standard colors . . . plus Honeywell craftsmanship, 14-gauge frame construction. **RAPID DELIVERY.** Worth checking for your systems!

**YOUR FACTBOOK**

A 52-page designer's and specifier's delight! Includes "how to" for functional excellence AND a new color-harmonizing guide, plus all the data you need for your finest systems.

**Honeywell** Wabash, Indiana 46992

INFORMATION RETRIEVAL NUMBER 102



# FLAT CABLE PLUG ACCESSORIES

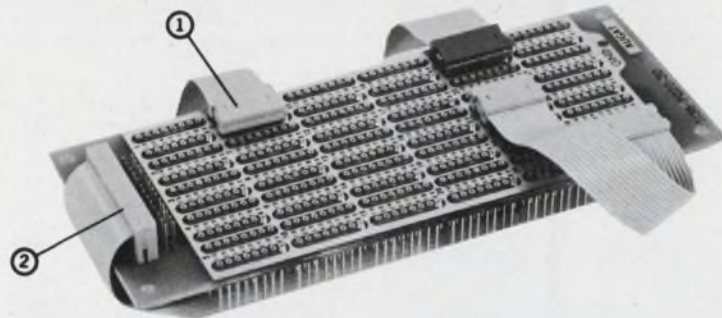

**Greater flexibility** in Prototyping and Packaging. Unique contact design eliminates cutting, stripping, soldering or crimping. Permits installation of plugs at ends of cable or any desired bussing location with a fast and simple press operation. Assembly tool available. Also comes in standard catalog lengths of complete assembly.

(1) 14 & 16 Pin Plug — Used for interfacing, input-output connections and testing. May also be used for cable termination into P.C. board. Pins are on .100" centers and .300" between rows.

(2) 26 Pin Plug — Designed for input-output connections on standard Augat panels. May also be used for interfacing and testing. Pins are on .100" centers and .100" between rows. Header Assembly also available, mates with plug.

## AUGAT

INC. TEL: 617-222-2202  
31 PERRY AVE., ATTLEBORO, MASS. 02703

Request Catalog 266

INFORMATION RETRIEVAL NUMBER 103

Advertiser	Page
IEEE .....	116
Indiana General, Electronic Products .....	63
Intel .....	96 F, G
Johanson Manufacturing Corp. ....	36
Johnson Company, E. F. ....	43
Keithley Instruments .....	6
Kurz-Kasch, Inc. ....	17
Mallory Capacitor Company .....	95
Mepco, Inc. ....	113
MicroSwitch, A Division of Honeywell .....	121
Midtex, Incorporated, Aemco Division .....	37
Molex, Incorporated .....	2
Monolithic Memories, Inc. ....	1
Monroe, The Calculator Company....	35
Mostek Corporation .....	80
Motorola Semiconductor Products, Inc. ....	16A—H
National Semiconductor Corporation .....	48, 49
North Atlantic Industries, Inc. ....	24
Nytronics, Inc. ....	118
Philips Electronic Components and Materials Division .....	96 B-C
Power/Mate Corp. ....	13, 136
Power-Tec Division, Airtronics, Inc. ....	125
Potter & Brumfield Division of AMF Incorporated .....	41
RCA Electronic Components and Devices ....	42, 102, 103, Cover IV
RFL Industries, Inc. ....	114
Rotron, Incorporated .....	81
Rogan Brothers, Inc. ....	101
Raytheon Company, Sorensen Power Supplies .....	54
SEG Electronics Corporation .....	136
Schauer Manufacturing Corp. ....	124
Schrack Electrical Sales Corp. ....	111
Sercel .....	96D
Siemens Corporation .....	44
Sigma Instruments, Inc. ....	16
Signalite Division of General Instruments .....	71
Simpson Electric Company.....	86, 87
Sprague Electric Company.....	18
TEC, Incorporated .....	112
TRW, Inc., Capacitor Division.....	27
Technical Assistance Laboratories....	134
Tektronix, Inc. ....	47
Triplett Corporation .....	77
Unitrode Corporation .....	31
Vactec Inc. ....	128
Vernitron Electrical Components.....	125
Vero Electronics, Inc. ....	131
Victoreen Instrument Div. of VLN Corp. ....	110
Wahl Corp., Wm. ....	120
Xerox Data Systems .....	14

## EXAMINE THIS 50¢ BARGAIN

Bourns presents a quality built cermet commercial potentiometer for printed circuit board use. Try to match it at twice the price.

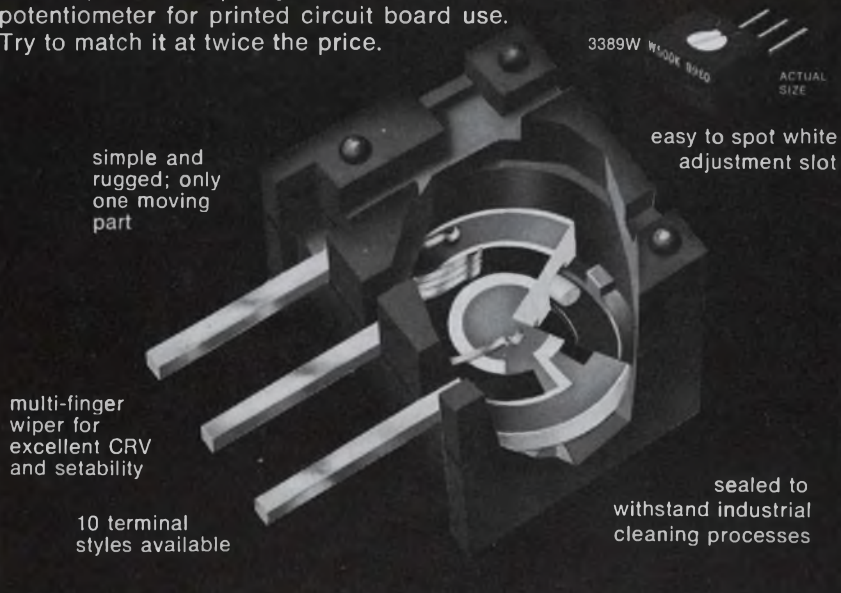

Only \$1.52 apiece, 50¢ in 50,000-piece quantity.

**24-HOUR DELIVERY FROM DISTRIBUTORS NATIONWIDE.**

Ask for full data on Model 3389 wherever Bourns potentiometers are sold.



TRIMPOT PRODUCTS DIVISION  
1200 COLUMBIA AVE., RIVERSIDE, CALIF. 92507  
TELEPHONE 714 684-1700 • TWX 910 332-1252

INFORMATION RETRIEVAL NUMBER 104



# Avantek VHF and UHF transistors

HIGHEST  $f_T$   
HIGHEST GAIN  
LOWEST NOISE FIGURE

When you need premium performance for MIL-spec radar or communications, cable TV or other industrial usage, data communications, ECM receivers, or any high-performance application, specify Avantek transistors.

A sampling of our specifications tells you why.

Model	Test Frequency	N.F. Max. (dB)	G@ low NF (dB)	I <sub>c</sub> (mA)	f <sub>r</sub> (GHz)
<b>VHF Types MHz</b>					
AT-16	60	1.0	25	5	3.5
AT-17	60	1.5	25	5	3.5
AT-23	200	2.0	20	30	3.5
AT-25	500	2.5	11	3	3.5
AT25A	500	2.0	12	3	3.5
AT-25B	500	1.5	13	3	3.5
AT-35	500	1.5	14	5	4.0
AT-35A	500	1.2	14	5	4.0
<b>UHF Types GHz</b>					
AT-52	1.0	5.0	9	5	3.0
AT-51	1.0	4.0	11	5	3.0
AT-50	1.0	3.0	13	5	4.0
AT-50A	1.0	2.5	13	5	4.0
AT-53	1.0	3.0	12	10	3.5
AT-54	1.0	4.0	10	10	3.5
AT-55	1.0	5.0	8	10	3.5

Make the transition to Avantek's high  $f_T$  transistors. For performance and reliability, there's none better.

All Avantek transistors are manufactured, including epitaxial growth, chip diffusion, gold metallization and packaging processes, entirely within Avantek's complete in-house semiconductor facility.

## Avantek

Avantek, Inc., 2981 Copper Road, Santa Clara, Calif. 95051. (408) 739-6170. Cable: AVANTEK

# product index

Information Retrieval Service. New Products, Evaluation Samples (ES), Design Aids (DA), Application Notes (AN), and New Literature (NL) in this issue are listed here with page and Information Retrieval numbers. Reader requests will be promptly processed by computer and mailed to the manufacturer within three days.

Category	Page	IRN	Category	Page	IRN
<b>Components</b>			<b>Packaging &amp; Materials</b>		
CRT, recording	126	344	breadboarding kits	120	284
filters, bandpass	124	299	connector, cable	120	287
inductor	124	298	extractor, DIP	118	283
inductor, ferrite	126	343	holder, PC board	120	286
resistor network	124	296	panel, high-density	120	285
resistors, thin-film	124	295	wire identifier	118	282
switch, reed	124	340			
transformer kit	124	297			
<b>Data Processing</b>			<b>new literature</b>		
arrays, memory	122	291	capacitors	134	372
concentrators, data memories,	122	289	cases	132	364
random-access	122	290	charts, recorder	132	369
memory, plated-wire	122	288	chokes and inductors	134	377
modem, high-speed	122	292	clamps	132	361
recorder, cassette	122	294	clips	132	361
tablet, graphics	122	293	components	132	358
			computer	132	359
<b>ICs &amp; Semiconductors</b>			connectors	134	382
counters, IC	108	266	converters, s/d	134	380
ICs, FM stereo	112	274	delay lines	134	373
ICs, phase-locked	108	267	digital instruments	132	367
op amp, monolithic	112	273	filters, optical	132	370
op amps	108	265	harnesses	132	361
parity checker	122	276	headers	132	364
register, shift	108	268	modem	134	375
register, shift	110	270	motors, stepper	134	378
regulator, voltage	112	275	photomultipliers	132	368
ROM, 1120-bit	110	271	photon equipment	132	371
SCRs, plastic	112	277	readouts	132	366
transistors, chip	108	269	relays, reed	134	379
transistors, power	112	272	resistors, thick-film	134	381
			servo systems	132	365
<b>Instrumentation</b>			spectrum analyzers	134	374
bridge, impedance	116	280	switches, microwave	134	376
multimeter, digital	114	278	test instruments	132	358
scope, 1.5-MHz	116	279	test systems	132	363
scope, 10-MHz	116	281	thin-film materials	132	362
			tubing, shrinkable	132	360
<b>Microwaves &amp; Lasers</b>					
amplifiers, vhf/uhf	129	347	<b>application notes</b>		
camera, solid-state	128	345	digital controls	131	354
diodes, varactor	129	350	diodes, p-i-n	131	357
mixer, double-balanced	129	349	FETs, video amplifier	131	356
mixer-preamps	129	348	logic timing	131	355
readers, photo-array	128	346			
<b>Modules &amp; Subassemblies</b>			<b>design aids</b>		
converter, d/a	105	253	lettering set	131	353
converter, d/a	106	263			
converter, dc-to-dc	106	264	<b>evaluation samples</b>		
digitizer, multiplexing	106	255	cable markers	130	352
display, LED	105	250	drawing sheets	130	351
displays, neon	106	259			
mixers, audio	106	258			
module, programming	106	260			
modules, power	106	262			
multiplexer, analog	106	257			
multiplier/divider	105	254			
multiplier, analog	106	256			
op amp, fast-setting	106	261			
op amp, FET	105	252			
op amps	105	251			





**DALE**  
**COIL  
COUNTRY**



Custom Toroids



Custom Bobbin Coils



Variable Pitch Inductors



RF Transformers and Inductors



Series Resonant Traps

**A good  
inductor  
source...  
just got  
better!**

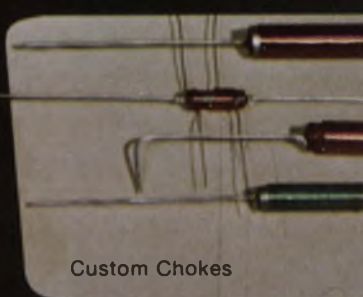

Custom Chokes



PC-Mount Toroids



DIP  
Pulse  
Trans-  
formers

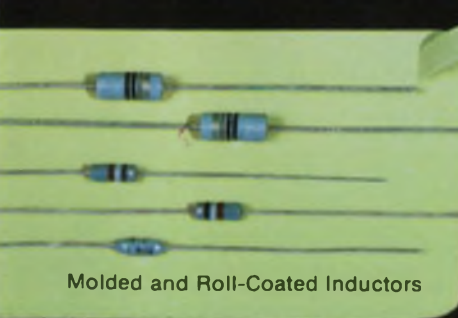

Molded and Roll-Coated Inductors

Dale is moving quickly to qualify as your preferred inductor source. In recent months we have:

**DOUBLED** our line of standard PC mount toroids (Mil-T-27C, Type TF5SX20ZZ). Standard inductances now available from  $.05 \mu\text{h}$  to  $20\text{h}$ , in a wide selection of Q vs frequency ranges.

**ADDED** Pulse Transformers in DIP configurations. Machine and hand insertable models (14,16 pins) are available containing up to four pulse transformers. Inductance range:  $1 \mu\text{h}$  to  $2 \text{mh}$ ; Tolerance  $\pm 20\%$ ; Leakage inductance: As low as .2% of total inductance; Interwinding capacitance: As low as 3 pf; ET product: Up to  $10 \text{volts}-\mu\text{sec}$ .

**EXTENDED** the values and frequencies available in molded inductors (Mil-G-15305D, Grade 1, Class A,B) and roll-coated chokes. Inductance:  $.10 \mu\text{h}$  to  $1000 \mu\text{h}$ . Self-resonant frequency: 680 to 3.5 Mhz.

This increased ability to supply standard inductors (many direct from stock) balances well with our custom capabilities in bobbins, rf transformers, chokes and toroids. For a fast quote or immediate design help get in touch with Dale—*lots of people are!* Call today: 605-665-9301

INFORMATION RETRIEVAL NUMBER 235

**DALE ELECTRONICS, INC.**, East Highway 50, Yankton, South Dakota 57078

A subsidiary of the Lionel Corporation



# COMPARE!

## In cost-effectiveness, RCA 1" Vidicons outperform 1" lead-oxide types!



### CAMERA USERS' AND DESIGNERS' GUIDE

Cost-Effective Factors	RCA		Registered Tmk XQ1070 Series	
Tube Type	8507A	7735	16XQ	16XQ-IG
Resolution (MTF at 400 lines)	60%	45%	30%	30%
Sensitivity at 0.1 fc	100 nA	100 nA	100 nA	100 nA
Automatic Sensitivity Control	Yes	Yes	No	No
Gamma Matched to Picture Tube Characteristics	Yes	Yes	No	No
Cost*	\$190	\$110	\$1730	\$ 810

\*Optional Distributor Resale Price

Add to this the typical life of 10,000 hours for a Vidicon at a cost of about 2¢ per hour. In educational and industrial CCTV, RCA Vidicons offer a combination of performance, reliability and low cost that lead-oxide types just can't meet. Take a look at the chart. Compare. Make your own decision. For more information on RCA's complete



line of long-life Vidicon tubes, see your local RCA Representative or your RCA Industrial Tube Distributor. For additional technical information, write: RCA, Commercial Engineering, Section 57B-18/ZC8, Harrison, N. J. 07029. International: RCA, 2-4 rue du Lièvre, 1227 Geneva, Switzerland, or P.O. Box 112, Hong Kong.