

Electronic Design

VOL. 18 NO.

2

FOR ENGINEERS AND ENGINEERING MANAGERS

JAN. 18, 1970

Come aboard the USS Roosevelt —a floating airfield, fortress, city of 4500 men, and a complex of electronic systems. Most of the equipment works fine, but it's

being updated to meet the needs of the high-performance nuclear-powered Nimitz carrier. There'll be more radar, data-processing, and automation. See page 58.



If price and performance are important— here's a 7 MHz value

This is a lab-quality, all-solid-state scope—at a price you'd ordinarily expect to pay for older vacuum-tube models.

Value—DC to 7 MHz bandwidth. This frequency range covers audio, video and most control circuit applications.

Value—5 mV to 20 V per division deflection factor. Here is sufficient capability to pick up most electronic or electro-mechanical system outputs without distortion or need for additional amplifiers.

Value—Rock solid triggering with capabilities ordinarily found only in more expensive lab type oscilloscopes . . . triggered or recurrent sweep, single-sweep, and automatic triggering.

Value—Low drift, long-term stability. Field effect transistors virtually eliminate drift from temperature changes, shock or vibration. Long-term stability means less frequent calibration.

Value—Easy to use. Logical arrangements of controls, beam finder, auto-triggering make operation easy. Interlocking controls on sweep time and magnifier prevent readout errors.

Value—Easy-to-see display. Internal graticule, 8 x 10 cm CRT for measurement accuracy. Bright, small spot-size trace increases visibility and resolution.

Value—Available in single channel cabinet or rack versions (1215A or 1215B), or in dual-channel cabinet or rack versions (1217A or 1217B). Electrical characteristics are identical. Rack version is only 5¼" high. Panel on the cabinet version is about the size of this page.

Value—Price, 1215A/B, \$950; 1217A/B, \$1175. Add up the features, then divide by price and you'll find this is the greatest performance/dollar value ever offered.

080/8

These 7 MHz oscilloscopes are new members of HP's growing family of low- and mid-frequency oscilloscopes. In addition to these new mid-range scopes you have 500 kHz scopes in 14 models with your choice of: Single or dual trace, 100 $\mu\text{V}/\text{cm}$ or 5 mV/cm deflection factors, conventional display or variable persistence and storage, all in cabinet or rack versions.

If you're looking for accurate mid-frequency measurements, ease of use, reliability—all at a low cost—here's a real 7 MHz value!

Call your local HP field engineer. Or, write to Hewlett-Packard, Palo Alto, California 94304. Europe: 1217 Meyrin-Geneva, Switzerland.

HEWLETT  PACKARD

OSCILLOSCOPE SYSTEMS





The \$1200 **Bad-Apple** Finder.....

... GR's New 1662 Resistance Limit Bridge!

You can't plug an apple into the new GR 1662 (it's only a one-terminal device), but if you have barrels of resistors to sort, the 1662 will find the out-of-tolerance components for you — quickly, easily, and inexpensively! It's the ideal instrument for selecting and qualifying resistors by percent deviation either manually or in an automatic system.

To handle all the resistance test requirements you're likely to face, the 1662 has percent-deviation ranges of ± 0.3 , ± 1.0 , ± 3.0 , ± 10 , and $\pm 30\%$. Test results are indicated by meter reading, dc-voltage levels, and HIGH-GO-LOW lights. The high limit and low limit can be adjusted independently (by front-panel controls or external dc voltage) to any value within the full-scale meter range.

Use the 1662 for manual sorting and get precise meter readings in one second or use the HIGH-GO-LOW lights for faster sorting limited only by the speed of the operator. Use

automatic sorting equipment like the GR 1782 Analog Limit Comparator (from \$550) to get maximum test rates of four components per second. The 1782 allows simultaneous multiple-tolerance-limit sorting. (Apples can be tested only with a core-memory device.)

For straight resistance measurements, 1662 has a basic bridge accuracy of 0.02%, a comparison accuracy of 100 ppm, and a total range of 1 ohm to 111.1111 megohms. The resolution of the 1662 is 0.01 ohm on the 111-kilohm range to 10 ohms on the 111-megohm range.

Oh, yes. Even at \$1200, the 1662 Resistance Limit Bridge is available with a quantity discount for two or more. For more information, write General Radio Company, West Concord, Massachusetts 01781 or telephone (617) 369-4400. In Europe write Postfach 124, CH 8034 Zurich, Switzerland.

Prices apply in U.S.A.

GENERAL RADIO



New Datapulse 112 gives you higher rep rates (to 125 MHz), faster rise times (1.3ns) and narrower pulses (to 3ns)—yet it costs you hundreds of dollars less.

What's more it has all the pulse parameter control you need to test high-speed circuits: simultaneous $\pm 5V$ outputs, single or double pulses, independent dc offset to $\pm 2V$, widths from 3ns to 5 ms, and delays to 5 ms.

You can control the pulse train with external gating pulses, produce complementary outputs for duty cycles approaching 100%, set the baseline at exact ground with a switch, and reduce rep rate to 10 Hz for low-speed testing.

No other high-speed pulser offers so much for just \$1595.00 . . . and the 112 is being delivered now. For a demo contact Datapulse Division, Systron-Donner Corporation, 10150 W. Jefferson Blvd., Culver City, Calif. 90230 213-836-6100.

Why buy a high-priced 100 MHz pulser? Here's 125 MHz for \$1595!



Oscilloscope photo. 2ns/div, 2v/div.

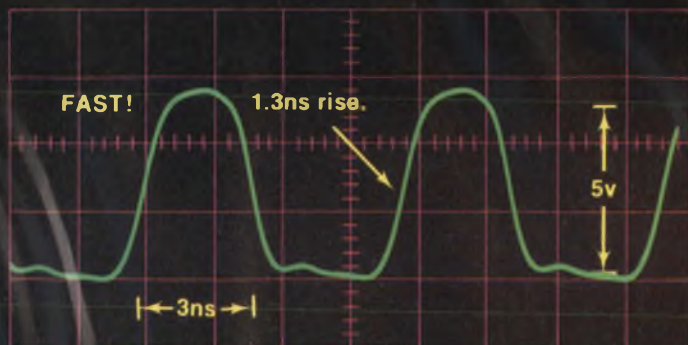

Another first. One of 135 Systron-Donner instruments

Electronic counters	Analog computers
Pulse generators	Digital panel meters
Microwave frequency indicators	Microwave signal generators
Digital clocks	Laboratory magnets
Memory testers	Data acquisition systems
Digital voltmeters	Microwave test sets
Time code generators	
Data generators	



SYSTRON  DONNER

NEWS

- 21 **News Scope**
- 24 **Casinos are finding the best 'system' is electronic**
Nevada's legal gambling establishments turn to engineering for help in catching cheats and running the games more efficiently.
- 32 **Fluidics: Why not try it, specialists suggest**
Speakers and equipment at Cleveland exposition point to a growing potential for air-powered logic.
- 37 **A 50% rise asked in satellite circuits.**
- 41 **Washington Report**

TECHNOLOGY

- 58 **Airfield in the ocean . . . floating electronic isle.** A special report on equipment trends in the Navy's carrier fleet.
- 70 **Go push-pull for magnetic deflection.** Despite yoke resistance changes caused by temperature, you'll get stable sweep amplitude and linearity.
- 76 **Improve receiver frequency stability** with digital automatic control. A counter is used for tuning flexibility at reasonable cost.
- 80 **Appraisal programs can be effective** if both supervisor and employee learn the rules of the evaluation game.
- 84 **Ideas for Design**
- 93 **Product Source Directory: Signal Generators**

PRODUCTS

- 101 **Components:** Hand-sized \$500 tube stores image for two weeks.
- 106 **Instrumentation:** Low-cost 50-MHz counter measures voltage too.
- 111 ICs & Semiconductors
- 113 Modules & Subassemblies
- 115 Data Processing
- 117 Tools & Engineering Aids
- 118 Packaging & Materials
- 120 Microwaves & Lasers

Departments

- 49 **Editorial:** Be your own boss this year—you and your job will benefit.
- 13 Designer's Calendar
- 46 Sidelights
- 122 Evaluation Samples
- 123 Design Aids
- 124 Application Notes
- 126 New Literature
- 134 Advertisers' Index
- 136 Information Retrieval Service

Information Retrieval Service Card inside back cover

Cover: Photographic montage taken on the aircraft carrier Roosevelt by John F. Mason, Military-Aerospace Editor.

How to get the world's first monolithic dual FET.

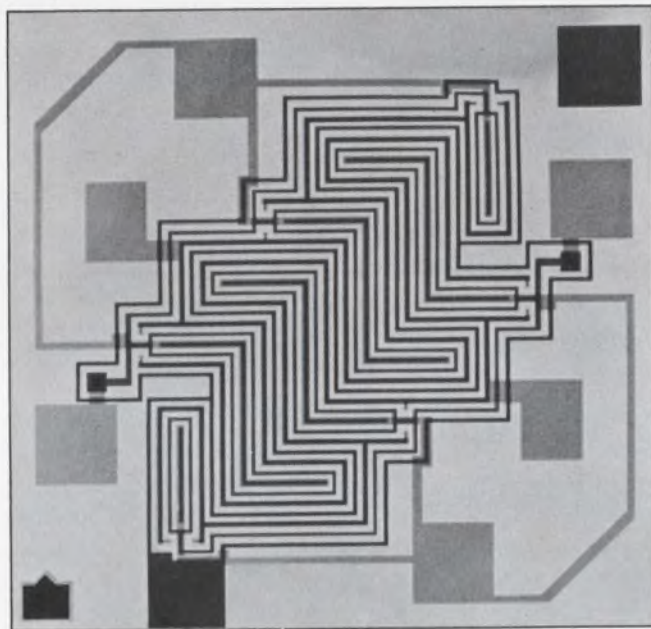

By design.

By tomorrow.

There's never been an N-channel dual FET remotely like it. We should know. With FETs by the millions under our belts, this little 2-in-1 device is something else again.

It's monolithic. It's matchless. It's National's FM3954. Wipes out the sticky problem of matching two separate FETs for identical specs. This revolutionary new dual eliminates the entire costly, time-consuming process. By designing both FETs on a single chip, the match is built in to stay.

Our monolithic marvel's a unique performer too. Even the best discrete matched duals can't touch its track record; offset voltage (5mV max.), temperature drift ($5\mu\text{V}/^\circ\text{C}$ max.), from $50\mu\text{A}$ to $500\mu\text{A}$.

Not to mention its flexibility of use or the reliability advantage because it's monolithic. And because it's National.

Available now. No maybe's about it. We've got monolithic dual FETs packed on the shelves, ready to ship without delay. Priced from \$2.40 to \$15.00 in hundred lots.

Write or call for complete spec data. We'll throw in a brief listing of our hundred or so other discrete FETs. National Semiconductor, 2900 Semiconductor Drive, Santa Clara, California 95051 (408) 732-5000 TWX: 910-339-9240
Cable: NATSEMICON

National/FET

REMEMBER



The full line of
Series 9000 TTL
is available from ITT.
Ask your ITT distributor
or field sales engineer
about our ceramic DIP
pin-for-pin
replacements
in both military
and commercial
temperature ranges.

semiconductors **ITT**

ITT SEMICONDUCTORS IS A DIVISION OF INTERNATIONAL TELEPHONE AND TELEGRAPH CORPORATION, 3301 ELECTRONICS WAY, WEST PALM BEACH, FLORIDA 33407. (305) 842-2411
FACTORIES IN FLORIDA • MASSACHUSETTS • ENGLAND • FRANCE • GERMANY • PORTUGAL • AUSTRALIA

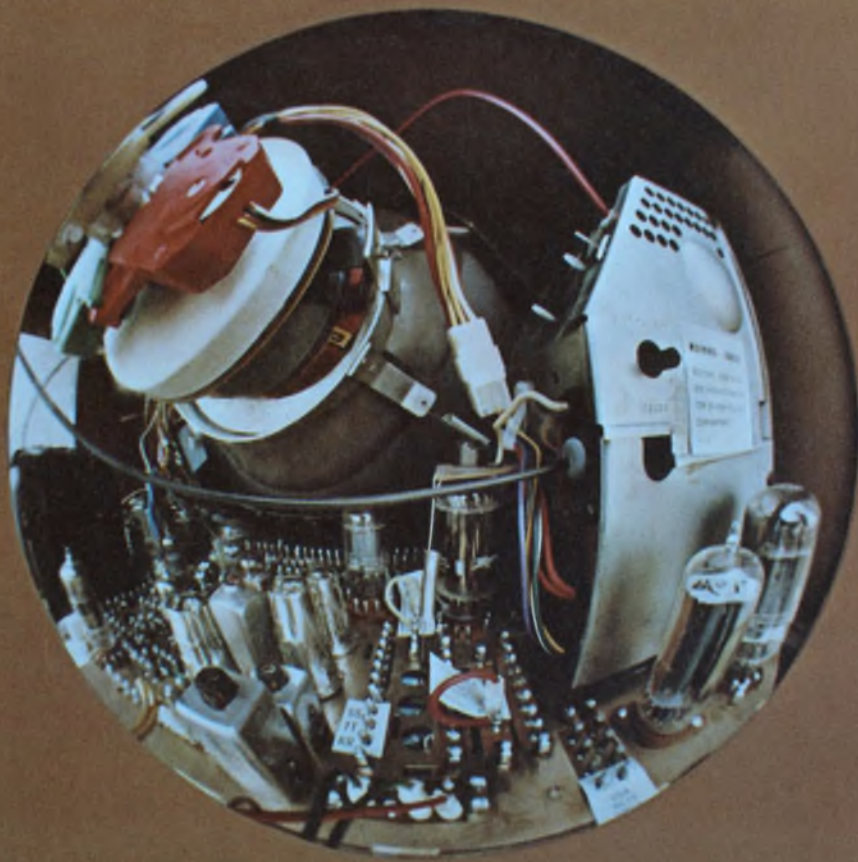

It takes guts to build a TV set

Lots of 'em. Dozens of assemblies and sub-assemblies and components. Each as important as the other. From plug to picture every item must perform. And perform well. The customer buys what he sees. And what he sees is determined by what he does not see. That's the guts of the story.

Stackpole makes more than a dozen types of components for black and white and color television receivers. Since 1947 mostly. But even before that we produced millions of high quality fixed composition resistors for the booming radio market. Still are, in fact.

From the earliest days of television, Stackpole supplied the first ferrite horizontal output transformer cores. First for black and white. Then for color. In 1954 Stackpole introduced

Ceramag[®] ferrite components for the 70° color deflection system. And again in 1964, the 90° color components. Today we're working on the color 110°. In addition, we've been involved with such major television advances as Automatic Pincushion Correction.

Stackpole engineering and production know-how has contributed much to the technology of television. Our components can be found in every domestic TV set. Not only ferrites and resistors, but variable resistors and linear potentiometers; slide and rocker switches; capacitors and hard ferrite magnets. More than any other manufacturer.

Have you got what it takes to build a good TV set? Be sure. Specify Stackpole electronic componentry wherever possible. You'll get the value and performance you need. Write or call: Stackpole Carbon Company, Electronic Components Division, St. Marys, Pa. 15857. Phone 814-834-1521. TWX: 510-693-4511.

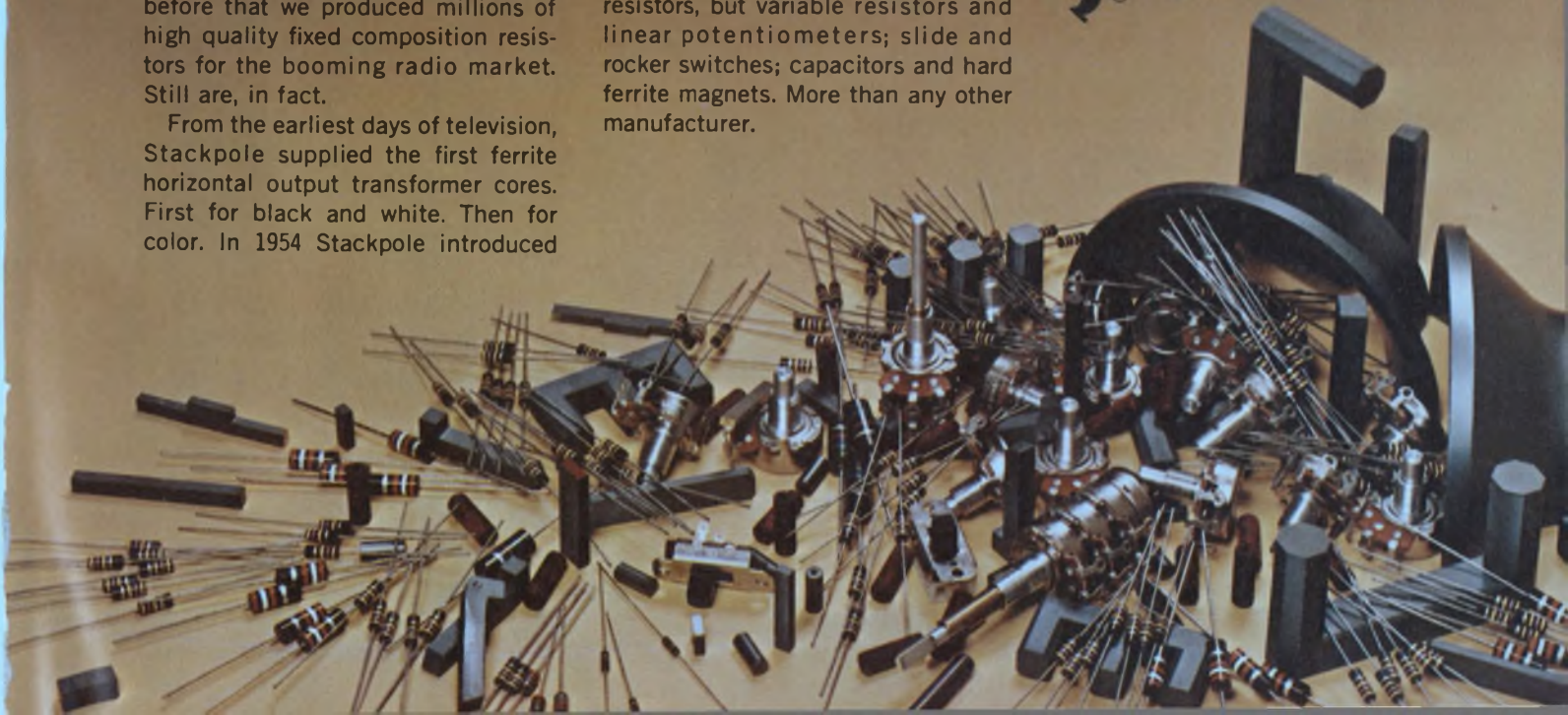

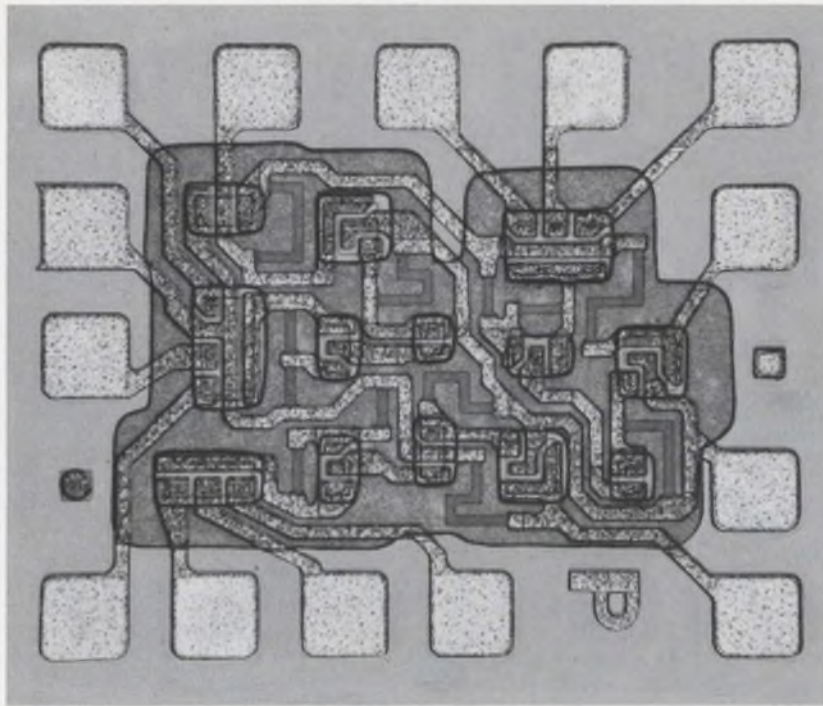

Next generation radiation-hardened IC's are here today.

Here's a better idea from Philco-Ford in radiation-hardened integrated circuits. It's a proven technique for mass production manufacturing which eliminates precision lapping and etching steps.

The payoff in performance: just by changing from conventional circuits to their Philco-Ford dielectrically isolated equivalents, you can get an order of magnitude increase in radiation tolerance; the circuit performance will no longer limit the overall system capability when exposed to a weapons environment.

The payoff in price: we expect that these circuits will turn out to be your most economical solution to radiation hardening.

The following circuits are immediately available in quantities for your evaluation:

Part No.	Description	Price: 100-499
PLR93051	DTL dual 4-input gate with expander	\$25.00
PLR93251	DTL dual 4-input buffer with expander	\$27.50
PLR94451	DTL dual 4-input power gate with expander	\$27.50
PLR94551	DTL RS/JK master-slave clocked flip-flop	\$37.50
PLR96251	DTL triple 3-input gate	\$25.00
PLR98051	dual level shifter	\$37.50
PLR90951	709-type operational amplifier	\$45.00

For a copy of recent technical literature, write Bipolar Products Marketing, **Philco-Ford Corporation, Microelectronics Division**, Blue Bell, Pa. 19422.

The better idea people in bipolar IC's.

PHILCO 

INFORMATION RETRIEVAL NUMBER 7

Breach the current barrier

Fast-switching
RCA SCR's
have high di/dt
capability

SCR families	Volts	Current (rms)	Typical Applications
TA7395	600 400 200	40A	modulators/inverters, small radars, sonars, high frequency inverters, pulse modulators
40555	600 400 200	5A	
40216	600	35A	
2N4101	600 400 200	5A	



Stick most SCR's with a 400 A/ μ s pulse and they're destroyed—they can't turn off fast enough. Slam the developmental RCA-TA7395 with the same kind of pulse, and it keeps working... and working... and working. (It literally breaches the current barrier!) That's because RCA SCR's turn off in 10 μ s and spread forward current faster—so switching losses are low—and less heat is dissipated internally.

In addition to fast turn-off times, the TA7395 and other RCA SCR families have high dv/dt characteristics, and may be used at frequencies up to 25 kHz.

Engineers take notice: RCA SCR's are subjected to the most stringent quality assurance tests in the industry. With case temperatures held at 120°C, the SCR's are pulsed by 100 A/ μ s and 250 V/ μ s (up to rated voltage) signals to check turn-on switching losses and turn-off times.

For further details, see your local RCA Representative or your RCA Distributor. Or write RCA Electronic Components, Commercial Engineering, Section G1-1/UR5, Harrison, N.J. 07029. In Europe: RCA International Marketing S.A., 2-4 rue du Lièvre, 1227 Geneva, Switzerland.

These new FET op amps are fast!

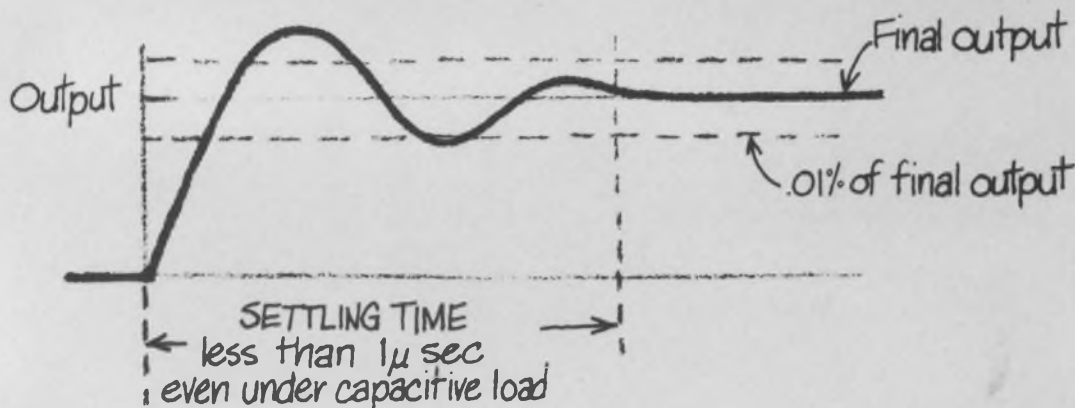

Now you can settle for less!

Here are two wideband FET operational amplifiers that deliver fast settling times under realistic circuit conditions. Equally fast in both inverting and non-inverting modes, these new Burr-Brown units are stable with up to 1000 pf of capacitive load without external compensation.

Their fast response, low output impedance and 6 dB/octave rolloff is ideal for such applications as A/D and D/A converters, high-speed buffer amplifiers, pulse amplification, sample/hold circuits and high-speed integrators. The 1.5" x 1.5" x 0.4" Burr-Brown package is compatible with high-density card spacing.



HIGHLIGHT SPECIFICATIONS

MODEL NO.	3278/14	3279/14
Settling Time, max. to .01% of final value including slew rate	1.0 μ sec	1.0 μ sec
Slew Rate, min.	32 V/ μ sec	32 V/ μ sec
Bandwidth		
Unity Gain	10 MHz	10 MHz
Voltage Drift, max.	$\pm 20 \mu$ V/ $^{\circ}$ C	$\pm 50 \mu$ V/ $^{\circ}$ C
Open Loop Impedances		
CM & Diff. Input	$10^{11} \Omega$	$10^{11} \Omega$
Rated Output	± 10 V @ ± 20 mA	± 10 V @ ± 20 mA
Price, 1-9	\$47.00	\$37.00
100 Unit Price	\$35.00	\$28.00

FOR COMPLETE TECHNICAL INFORMATION

on these new fast-response FET op amps, contact your Burr-Brown Engineering Representative or use this publication's reader service card.

BURR-BROWN
RESEARCH CORPORATION

International Airport Industrial Park • Tucson, Arizona 85706
TELEPHONE: 602-294-1431 • TWX: 910-952-1111 • CABLE: BBRCORP



Operational Amplifiers
Instrumentation Amplifiers
Function Modules
Active Filters
Power Supplies



an unfair comparison...

The new Cyclohm Fan from Howard vs. "the other fan"

The new Howard tubeaxial fan delivers a larger volume of air over a wider range, runs up to 10 years without service or lubrication, has a rugged cast aluminum frame, yet costs about the same as "the other fan" you're now using. (See why we call the comparison "unfair"?)

In all fairness, we admit the new Howard Cyclohm fan is exactly the same size as "the other fan." They're interchange-

able. But then we come to comparisons like Howard Cyclohm's six-blade impeller (vs. three) which is computer-mated to the famous Howard Unit Bearing Motor with a 5-year warranty based on an engineered lifespan of 10 years (vs. a traditional bearing motor). Then, too, there's 115 CFM air delivery (vs. 100). And cost: The new Howard Cyclohm never costs more than "the other fan" . . . and Howard delivery is overnight!

Be fair to yourself: Send for all the unfair facts.



HOWARD

HOWARD INDUSTRIES
A DIVISION OF MSL INDUSTRIES, INC.
2420 18th STREET, RACINE, WISCONSIN 53403
414-632-2731 TWX 910-271-2387

INFORMATION RETRIEVAL NUMBER 10

When it comes to high voltage dc power supplies, come to the

INNOVATORS

from Hipotronics. Here we are, one of the world's largest suppliers of HV Test Equipment and some people don't know we make HV DC Power Supplies. And we're getting bigger and better all the time: We just expanded our facilities by 150 percent, allowing us to more fully supply the needs of present — and future — customers.

CAPABILITIES:

- EHV DC Power Supplies; i.e., 1 million volts (a 20 ma, with reversible polarity)
- HV "Brute Force" Supplies; i.e., 500 KV (a 100 ma)
- HV High Energy Supplies; i.e., 200 KV (a 1 amp or 100 KV (a 2 amps, with reversible polarity)
- 100 kw Constant Current Monocyclic Capacitor Charging Supplies
- Power Packs, epoxy and oil filled
- Standard HV Power Supplies; i.e., 100 watts to 200 kw, 1000 volts to 1 million volts

FACILITIES:

- Capacitor manufacturing facility (Corson Electric Division of Hipotronics)
- Transformer manufacturing facility
- Vacuum, varnishing and impregnating system, for coils up to 7 foot diameter
- Advanced vacuum oil processing system
- Indoor high bay assembly and test area for operating units into the megavolt range
- Lift facilities in excess of 25 tons
- AND . . .
- 85,000 square feet of modern air-conditioned plant facilities.

**Call or send your specific requirements to
Mr. David Spiegelman, Chief Engineer, Power Supplies**



High Potential Electronics

BREWSTER, NEW YORK 10509 / (914) BR 9-8091



Designer's Calendar

FEBRUARY 1970

S	M	T	W	T	F	S
1	2	3	4	5	6	7
8	9	10	11	12	13	14
15	16	17	18	19	20	21
22	23	24	25	26	27	28

For further information on meetings, use Information Retrieval Card.

Feb. 10-12

Winter Convention on Aerospace and Electronics Systems (Wincon) (Los Angeles) Sponsor: IEEE. R. Banks, Los Angeles Council IEEE, 3600 Wilshire Blvd., Suite 1920, Los Angeles, Calif. 90005

CIRCLE NO. 336

Feb. 18-20

International Solid-State Circuits Conference (Philadelphia) Sponsor: IEEE, Univ. of Penna., L. Winner, 152 W. 42 St., New York, N.Y. 10036

CIRCLE NO. 337

Feb. 18-19

Instrumentation Fair (Los Angeles) Sponsor: Instrumentation Fair Inc., Calif. L. Courtney, Larry Courtney Co., 16400 Ventura Blvd., Encino, Calif. 91316

CIRCLE NO. 338

MARCH 1970

S	M	T	W	T	F	S
1	2	3	4	5	6	7
8	9	10	11	12	13	14
15	16	17	18	19	20	21
22	23	24	25	26	27	28
29	30	31				

Mar. 11-13

Scintillation & Semiconductor Counter Symposium (Washington, D.C.) Sponsor: NBS, IEEE. R. L. Chase, Brookhaven National Laboratory, Upton, N.Y. 11973

CIRCLE NO. 339



Simpson's NEW solid-state VOM with FET-Input

- **HIGH INPUT IMPEDANCE...**
11 Meg Ω DC 10 Meg Ω AC
- **PORTABLE..... battery operated**
- **7-INCH METER..... overload protected**

Simpson's new 313 gives you high input impedance for accurate testing of latest circuit designs . . . free of line cord connections. Over 300 hours operation on inexpensive batteries. And the new 313 is *stable*, which means positive, simplified zero and ohms adjustments. Protected FET-input handles large overloads. DC current ranges to 1000 mA. Sensitive Taut Band movement and 7-inch meter scale provide superior resolution down to 5 millivolts. Write today for complete specifications.

Complete with batteries, 3-way AC-DC-Ohms probe, and operator's manual **\$125.00**

GET "OFF-THE-SHELF" DELIVERY FROM YOUR LOCAL ELECTRONIC DISTRIBUTOR

Simpson

ELECTRIC COMPANY



5200 W. Kinzie Street, Chicago, Illinois 60644 • Phone (312) 379-1121

EXPORT DEPT.: 400 W. Madison Street, Chicago, Illinois 60606. Cable Simelco
IN CANADA: Bach-Simpson Ltd., London, Ontario • IN INDIA: Ruttonsha-Simpson Private Ltd., International House, Bombay-Agra Road, Vikhroli, Bombay

INFORMATION RETRIEVAL NUMBER 12

Buckbee-Mears offers the biggest variety of flexible circuits on the market today!

We also produce the best.



The most flexible, accurate way to produce flexible circuits is by precision photomechanical reproduction. As it happens, Buckbee-Mears invented the photomechanical technique. Our facilities are larger and more advanced than anyone else's.

Using the photomechanical process, we offer sharp definition and close tolerances in both Mylar* and Kapton* base circuits. We produce smaller wires to two mils apart on four mil centers. We also produce very large circuits. Once, for example, we etched two sided circuits that were five feet square. Another time we etched a single sided flexible circuit six feet long by just three inches wide. Most important, we hold tolerances to $\pm .0002$ inches on wires and space. You can't buy a more accurate circuit.

There are other advantages to having Buckbee-Mears produce your flexible circuits by photomechanical reproduction. We etch holes through the dielectric material, saving a drilling or punching operation. After etching the

holes, we can pull the wire down through the holes, or leave them hanging out for pin connectors.

The holes can be plugged with a conductive material for a good electrical path from top surface to bottom surface. We offer gold, 60% tin and 40% lead, or pure lead plating over the conductors. The plating can be done selectively or over the entire circuit. We guarantee shrinkage control on any flexible circuit pattern we produce.

More and more industries are finding applications for flexible circuits today. Major users include computer manufacturers, the auto industry and microcircuit packaging. But anyone who has a space or weight problem can use Buckbee-Mears flexible circuit technology.

If we can help you, call or write Bill Amundson, our industrial sales manager. He has a staff of experts in flexible circuitry who can solve your particular problems. Bill's phone number in St. Paul is 612-227-6371.

*DuPont trademark

PRECISION METAL AND GLASS ETCHING • ELECTRO FORMING • AUTOMATED DESIGN

bmc

SAINT PAUL, MINNESOTA 55101

BUCKBEE-MEARS COMPANY

INFORMATION RETRIEVAL NUMBER 13

New train of thought in rapid transit—
electrifying changes just around the bend.
IR can help close the loop.

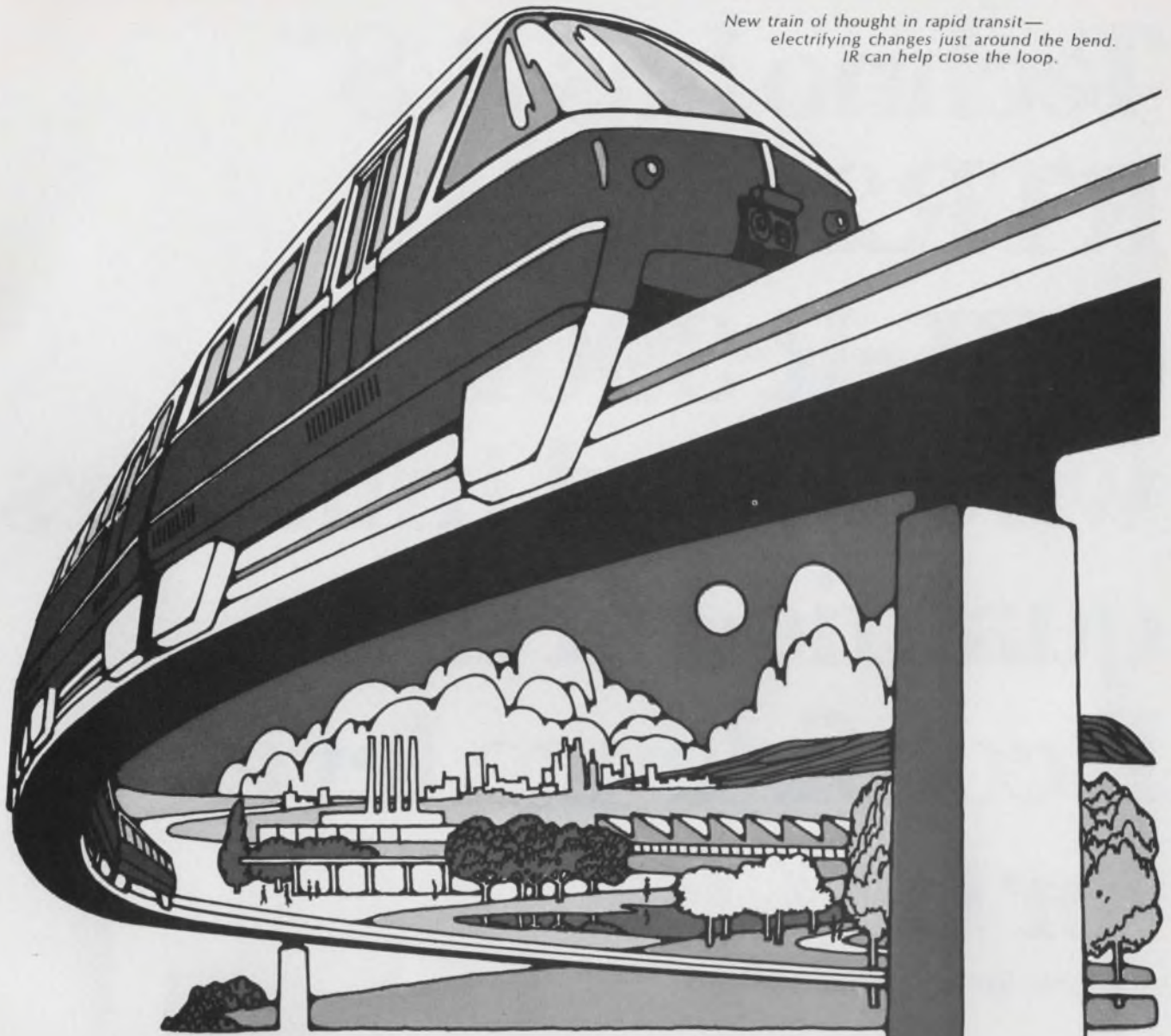

New 100 Amp free-wheeling rectifier from IR. With 1.5 μ sec recovery.

More power to you when you design in the industry's first fast recovery rectifier in the 100 Amp field—IR's exclusive 101KL. Clamps down on transients, stays cooler, cuts power dissipation during reverse recovery. Applicable as free-wheeler types in high power systems. Low recovery losses provide increased rating at very high frequencies. And, improve SCR performance when used in chopper and inverter circuits.

The 101KL & 101KLR (forward or reverse polarity) are available in a DO-8 Rock-top package, rated from 400 through 1300 volts. (400-1000V. units have optional 1.5 or 2.0 μ sec recovery times; 1200 & 1300V. units are 2.0 μ sec only.)

Other IR Fast Recovery Diodes include 250 Amp stud-mounted and 400 Amp Hockey-Puk types. All in distributor stock to help you speed tomorrow's electrifying change. Write for specs, application data, or engineering assistance.

Silicon Controlled Rectifiers Power Logic-Triacs Silicon Power Rectifiers Selenium Rectifiers
 Zener Diodes Custom-engineered Sub-assemblies and Systems Light Sensitive Devices

INTERNATIONAL RECTIFIER 

Semiconductor Division, 233 Kansas Street, El Segundo, California 90245, Phone (213) 678-6281
MANUFACTURING FACILITIES: UNITED STATES, CANADA, GREAT BRITAIN, INDIA, ITALY, JAPAN, WITH SALES OFFICES AND DISTRIBUTION IN MAJOR CITIES THROUGHOUT THE WORLD



INFORMATION RETRIEVAL NUMBER 14

Techno has 3/8" RTR24 style (MIL-R-39015) wirewound trimmers qualified at the P confidence level for 0.1% FR.

Available for immediate delivery.

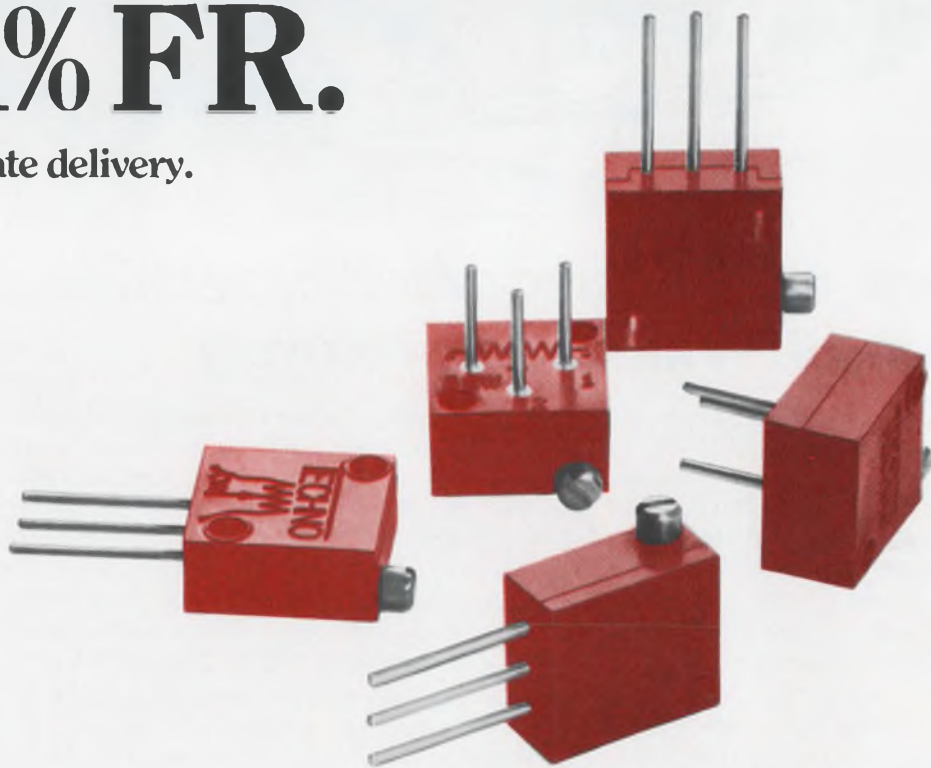

Write for Bulletin ER
TECHNO-COMPONENTS CORP.

A SUBSIDIARY OF OAK ELECTRO/NETICS CORP.
7803 LEMONA AVENUE / VAN NUYS, CALIFORNIA 91405
(213) 781-1642 TWX 910-495-2015

Op Amps go *High Voltage*

Tear-off and file for future reference . . .

MC1536 sets a new pace for Operational Amplifiers with low input currents, internal compensation, plus high-voltage capability!

Here's the one that changes the whole ball game for monolithic Op Amp applications where a large output swing is required. The MC1536 doubles the maximum supply voltage now available to Op Amp users . . . ± 40 Vdc . . . while still preserving input differential voltage protection and output short-circuit protection. And, with all that, typical input bias current is just 8.0 nA and offset current is 1.0 nA. Just think how you can utilize your full supply voltage in a wide variety of control-system applications. Even in servo-amplifier work, you can have both higher voltage and lower current.

Here are some other applications made possible by the high-voltage breakthrough of the MC1536:

- High-Voltage Differential Amplifiers and High-Impedance Differential Buffers.

- **Voltage Regulation**

Op Amp regulators that used to "float," can now be driven directly. This results in better regulation (both load and line) and, of course, fewer parts.

- **Current Regulation**

With the MC1536, it's possible to have a 5 mA current source with .01% regulation, where $R_L = 0$ to 10 K.

- **Wide-Range Sample and Hold Circuits**

A pair of MC1536's will simplify these traditional discrete device designs and will give an input voltage range of ± 30 V. A 2.0 V/ μ s Slew Rate allows moderate chopping speeds and the internal compensation provides for a stable unity gain buffer without external components.

For information about the specifications that make possible this wide range of new applications for monolithic operational amplifiers, simply turn the page. ▶

- Output Voltage — 60 V P - P (min)
 - Max. Supply Voltage ± 40 V
 - Input Bias Current — 8.0 nA (typ)
 - Input Offset Current — 1.0 nA (typ)
 - Internally Compensated



- where the priceless ingredient is care!

MOTOROLA
Integrated Circuits

Check these pace-setting specs for the **MC1536G, MC1436G**, industry's first high-voltage monolithic Op Amp

- Maximum Supply Voltage – ± 40 Vdc
- Output Voltage Swing – (min)
 - ± 30 V_{pk} ($V^+ = +36$ V, $V^- = -36$ V)
 - ± 22 V_{pk} ($V^+ = +28$ V, $V^- = -28$ V)
- Input Bias Current – 20 nA max
- Input Offset Current – 3.0 nA max
- Fast Slew Rate – 2.0 V/ μ s typ
- Internally Compensated
- Offset Voltage Null Capability
- Input Over-Voltage Protection
- A_{VOL} – 500,000 typ
- Characteristics Independent of Power Supply Voltages – (± 5.0 Vdc to ± 36 Vdc)

TYPICAL NON-INVERTING X10 VOLTAGE AMPLIFIER

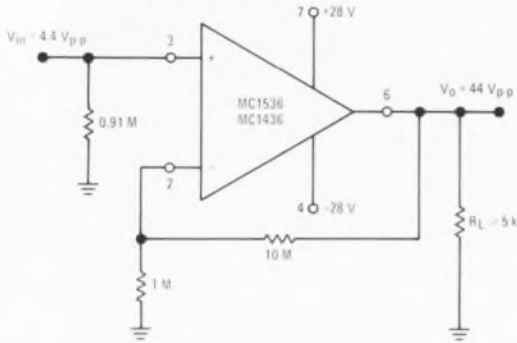

PEAK OUTPUT VOLTAGE SWING versus POWER SUPPLY VOLTAGE

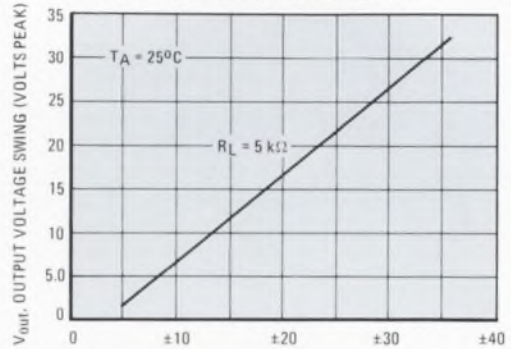

V⁺, V⁻, POWER SUPPLY VOLTAGE (Vdc)

CIRCUIT SCHEMATIC

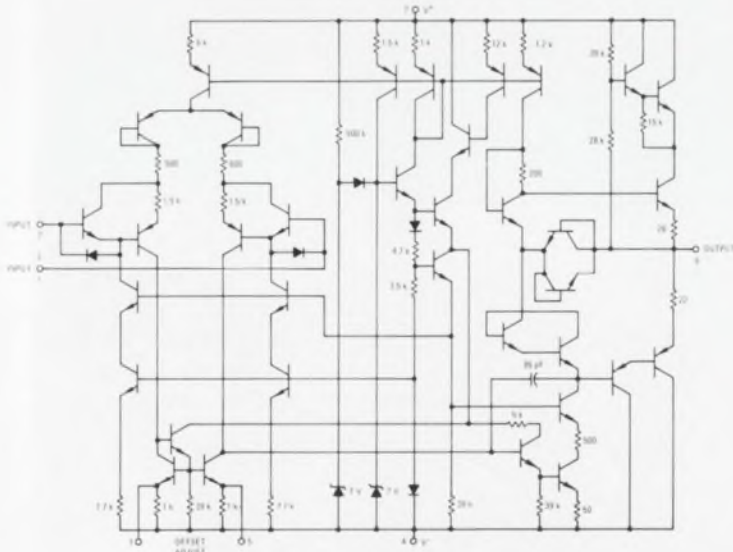

EQUIVALENT CIRCUIT

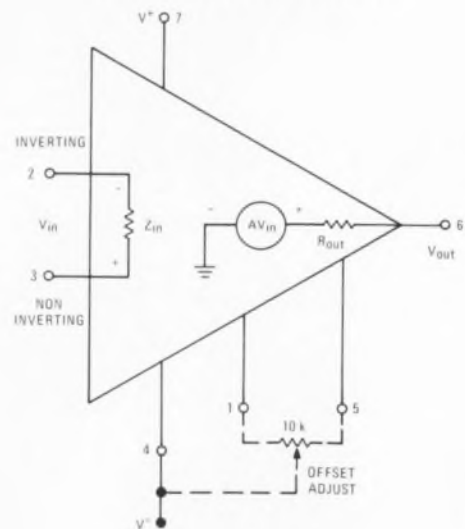

**Double your supply voltage
...double your Op Amp
applications range
with the MC1536**

The MC1536G and the low temperature-range MC1436G are available in the 8-pin (TO-5) package from distributor stock. The 100-up price for the MC1536G is \$39.00, and the MC1436G is \$18.00. For complete specifications and applications information, circle the reader service number on the opposing page, or write: P. O. Box 20912, Phoenix, Arizona 85036.

The circuitry shown external to Motorola products is for illustrative purposes only, and Motorola does not assume any responsibility for its use or warrant its performance or that it is free from patent infringement.



- where the priceless ingredient is care!

MOTOROLA
Integrated Circuits

If your circuit calls for **RELAY SOCKETS** check Continental's complete line...

FIXED CONTACTS

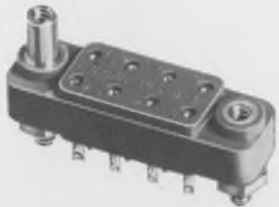

145-8-3/8 CONTACTS/FIXED



145-8-41/10 CONTACTS/FIXED

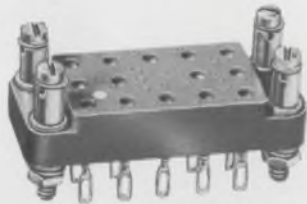

145-8-10/14 CONTACTS/FIXED



145-8-15/20 CONTACTS/FIXED

with fixed or removable contacts
in 8, 10, 14 and 20 sizes.

Terminations: solder cups, dip solder,
turret terminals, eyelet lugs.



For a free copy of our illustrated
brochure on Relay Sockets, including
outline drawings and technical data,
write to Advertising Department,
Continental Connector Corporation,
34-63 56th Street, Woodside, N. Y. 11377.
Or phone (212) 899-4422 for fast action.

REMOVABLE CONTACTS



145-8-51
14 CONTACTS/REMOVABLE

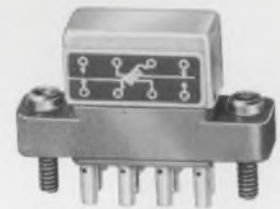

145-8-23
8 CONTACTS/REMOVABLE

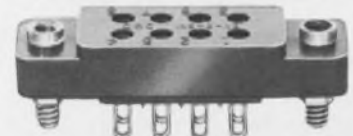

145-8-42
8 CONTACTS/REMOVABLE

ILLUSTRATIONS ACTUAL SIZE

Connect... with a Continental Connector!

CONTINENTAL CONNECTORS

CONTINENTAL CONNECTOR CORPORATION ■ WOODSIDE, NEW YORK 11377

For the Sales Representative Nearest You. See Our Listings in EEM and VSMF Directories.

INFORMATION RETRIEVAL NUMBER 18

Introducing our new 3-times-faster 16-channel, 12-bit A-to-D front end.

It's yours for the same old price.

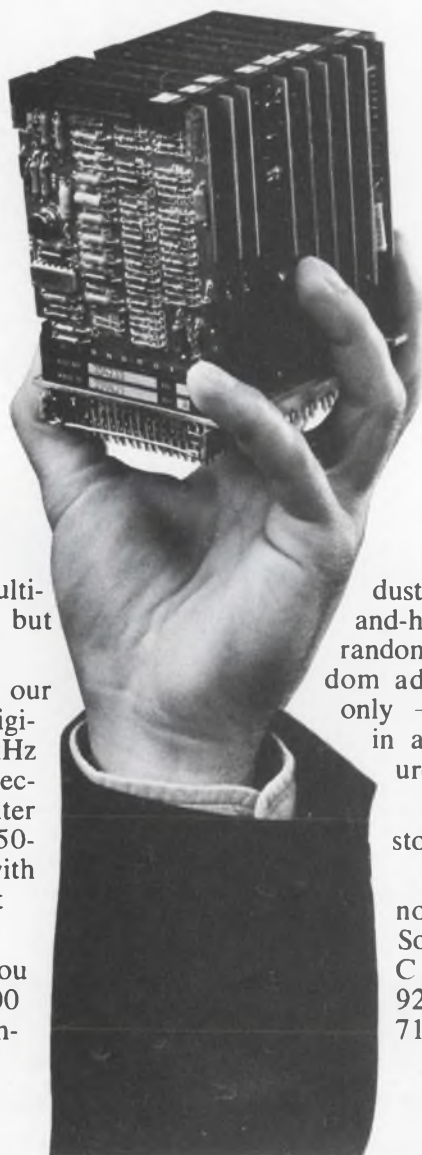

We've tripled the speed of our multiplexing 12-bit A-to-D converter, but we've left the price alone.

So now, for \$1950, you can get our new high-speed Miniverter™ and digitize 16 analog channels at a 100kHz word rate. Or change a few connections (manually or under computer control) and get throughputs of 150-kHz with 10-bit words, 200kHz with 8-bit words and 250kHz with 6-bit words.

Whichever rate you choose, you get 16 multiplex channels with 100 megohms input impedance. The in-

dustry's highest performance sample-and-hold amplifier. Four control modes: random, sequential, random start, random advance. A system that requires only +5 Vdc power. And everything in a 10-conductor block that measures just 4" x 5" x 4".

It's the best price/performance story in conversion equipment today.

Write or call for all the details now. Raytheon Computer, 2700 South Fairview Street, Santa Ana, California 92704, Phone 714/546-7160

RAYTHEON

Now, you can enjoy a choice of suppliers...

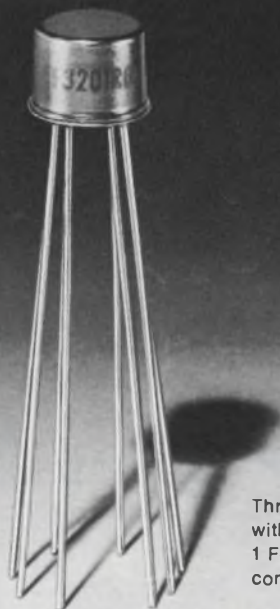

CLARE TF MILITARY RELAY
Three contact arrangements: 1 Form C
with base-connected movable contacts;
1 Form C and 2 Form C with movable
contacts insulated from case.

Clare's TO-5 meets or exceeds MIL-R-5757E!

In TO-5's, you can now enjoy a *choice* of suppliers—and you can sit back and enjoy Clare's dependable performance and prompt delivery. For Clare's TF (TO-5) Relays meet or exceed the requirements of MIL-R-5757E. TF features: a rigid frame to keep elements stable, balanced armature aligned; pressurized nitrogen to minimize arcing, extend contact life; hermetically-sealed case—all welded; optimized magnetic circuitry to assure maximum contact pressure. Withstands shock to 80 G, vibration to 30 G. Keeps going at temperatures from -65°C to $+125^{\circ}\text{C}$. 1,000,000 operations at low level, 100,000 at rated load.

For information, circle Reader Service number, call your Clare sales engineer or distributor, or write for Data Sheet 758. C. P. Clare & Co., Chicago, Illinois 60645... and worldwide.

LOOK FOR



CLARE ON THE RELAY

a GENERAL INSTRUMENT Company

...want a tantalum capacitor with proven performance?

Buy TYPE 150D TANTALEX[®] SOLID-ELECTROLYTE CAPACITORS

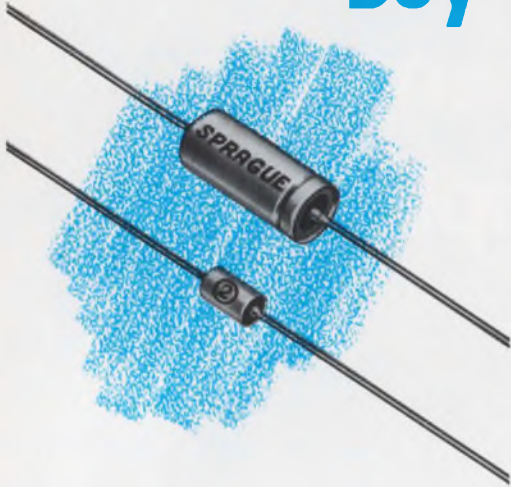

- Hermetically-sealed in metal cases
- Four case sizes, ranging from 1/4" to 3/4" length
- Value-packed performance characteristics—low impedances at high frequencies, low dissipation factor, minimal capacitance drift with temperature, practically no change in capacitance with life
- Low leakage current limits
- New higher capacitance ratings
- Request Engineering Bulletin 3520F

INFORMATION RETRIEVAL NUMBER 821

45C-9144R2

Buy resistors with built-in dependability...

Vitreous-enamel BLUE JACKET[®] POWER WIREWOUND RESISTORS

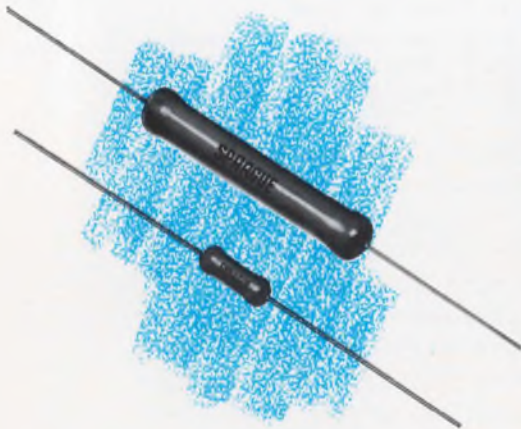

- All-welded end-cap construction eliminates moisture along leads, also anchors leads securely to resistor body
- Expansion coefficients of vitreous coating, ceramic core, and end caps are closely matched
- Standard wattage ratings include 1, 2, 2.5, 3, 5, 7, 10, and 11 watts
- Also available with radial tab terminals in ratings from 8 to 230 watts
- Request Engineering Bulletin 7410D

INFORMATION RETRIEVAL NUMBER 822

45R-9145R1

For Engineering Bulletins as noted above, write to:
Technical Literature Service, Sprague Electric Co., 347
Marshall Street, North Adams, Massachusetts 01247.



'Sprague' and ® are registered trademarks of the Sprague Electric Co.

THE BROAD-LINE PRODUCER OF ELECTRONIC PARTS

Industry edgy as NASA and Sylvania shut centers

Electronics research in the New England area has been dealt a sharp blow—and the industry is wondering whether it isn't a harbinger of similar misfortune elsewhere in the country.

NASA's Electronics Research Center in Cambridge, Mass., will be closed by June 30, resulting in the transfer or termination of \$25-million in contracts. The 831 employees are scheduled to lose their jobs.

And Sylvania's Applied Research Laboratory in Waltham, Mass., is also shutting down. According to a company spokesman, "It's the result of a Congressional rider to the defense budget that specifies that work not directly related to specific defense programs be limited." Dr. James E. Storer, director of the Sylvania Research facility, who has resigned, says about 150 employees will be shifted to other divisions in the company.

In reporting the demise of the space agency's center, Dr. Thomas O. Paine, NASA's Administrator, said: "We are simply faced with the hard fact that NASA cannot afford to continue to invest broadly in electronics research as we have in the past."

The NASA shutdown came as a distinct surprise. As late as December, there were openings for 19 more employees, which would have boosted the total personnel to 850. In addition a \$1-million program providing direct support to NASA's space-station and space-shuttle program had recently been assigned to the Cambridge center.

The center has a current payroll of about \$12-million. Of the 831 employees, about 100 hold PhDs. No transfers are scheduled at present to other NASA centers.

A spokesman for NASA says that there is a hiring freeze at all NASA centers and that this is part

of "an all-around belt-tightening effort."

One hope for the New England area is that the Dept. of Transportation will take over the \$36-million Electronics Research Center complex. According to Oscar Griffin, director of public affairs for the department, this is "under staff study"; the center is one of "as many as 10 places being considered."

The Federal Aviation Administration has indicated that it could use the center in Cambridge, but budgetary matters and policy considerations have not yet been formulated.

Experiments for Mars set for 1973 landing

The experiments and experimenters for NASA's unmanned Viking mission to Mars in 1973 have been selected. Besides trying to answer the age-old question of whether there is life on the "red" planet, instrumentation packages will make a number of other probes.

Two orbiting craft will make a visual map of Mars with some kind of optical device—television or perhaps a photographic camera. If a photographic camera is selected the film would be developed, electronically scanned and transmitted digitally to earth. This technique was used in the early lunar missions.

The orbiters will also measure the water distribution in the atmosphere and determine the variation in surface temperature and thermal balance.

Two landers that will descend from the orbiting craft will send back some form of pictures of the landing site. They will analyze the organic compounds in the soil and look for water in both the surface

material and atmosphere.

Other phenomena the landers will study, include meteorology, composition and structure of the atmosphere, seismic activity, the magnetic properties of surface particles and the physical properties of the soil.

Each experiment will be sponsored by five or more universities or industrial research centers. NASA's Langley Research Center, Hampton, Va., is charged with over-all project management and for the landers. Jet Propulsion Laboratory, Pasadena, will manage the orbiters, tracking and data acquisition.

The landing sites will not be chosen until two Mariner spacecraft orbit and photograph the planet in 1971.

New magnetrons offer bargain coherent radar

For radar users—missile ranges, ships, air control centers and others—a new family of high-power, injection-locked magnetrons holds high promise: The many advantages of coherent radar techniques can be incorporated into existing monopulse tracking radars, and at costs greatly below those normally paid for coherent systems. Transponders, too, can be improved.

A development of Varian Associates' Eastern Tube Div., Beverly, Mass., the new tubes can be used as follows:

The conventional magnetron in an existing radar is replaced with Varian's injection-locked unit and a stable reference oscillator. In addition some signal-processing circuitry and an improved receiver are needed. However, as a Varian spokesman explains, the additional equipment is low in cost compared with the equipment that need not be modified or replaced—the power supplies, pulse-forming networks, microwave plumbing, antennas, etc.

Basically the new tubes differ from conventional magnetrons in that their rf output frequency can be locked to that of a low-level injected signal. And they can do this over a 10% to 15% bandwidth. Thus they can be used in place of much more expensive microwave power amplifiers in such applica-

tions as moving-target-indicator transmitters and coherent transponders. In the former applications, the injected signal would come from a stable reference oscillator; in the latter, the received signal would serve as the reference.

Coherent transponders are used on aircraft and missiles to provide range-rate information as well as the range data provided by ordinary transponders. Range-rate information is obtained from the doppler shift between the transmitted and received signals on the ground.

Since the doppler shift is very small compared with the rf itself, coherent techniques must be used lest the random fluctuations and drifts of a free-running oscillator completely obscure the doppler data. The new tubes are single-port devices and are operated with very heavily loaded resonant circuits. Thus they can provide useful gains in excess of 15 dB.

So far the tubes have been delivered to the Control Science Corp., Alexandria, Va., to be used in coherent transponders at various missile-tracking ranges. The units have peak operating powers of 150 W at C-band, and Varian expects to have Ku-band units soon that will be capable of delivering hundreds of kilowatts.

Navy needs telemetry gear in L and S bands

The Navy is having a hard time finding L and S-band telemetry transmitters that work and are not too expensive. "About three out of 10 operate satisfactorily," says Capt. J. R. Foster, commander of the Air Test and Evaluation Squadron Four at Point Mugu, Calif. "And they are expensive. The old vhf transmitters cost \$128 each. These uhf transmitters cost between \$4500 and \$6000.

"It's a problem and a big one," he adds. "We're going to need 2500 to 3000 transmitters a year, mainly for testing air-to-air missiles,

but also for subsystems in aircraft."

Squadron Four waited a year for a quad transmitter from Giannini Voltex, Inc., of Whittier, Calif. Two were received, but neither passed inspection. They drifted and were off frequency, a Navy engineer says. With an allowed tolerance on the bench of 0.001%, or 15 kHz for the 1500-MHz transmitter, the device was 75 kHz low after five minutes, and 90 kHz low after 10 minutes.

Giannini Voltex was given 10 days to produce an acceptable device or forfeit the contract without pay. Instead, the company dissolved its telemetry transmitter business altogether—"at least for the time being and probably forever," the company's chief engineer, John Stelzried, told ELECTRONIC DESIGN.

"It's a pity," says Point Mugu's Capt. Foster. "The company builds some excellent equipment."

"There are two problems in designing good L-band telemetry transmitters," Giannini Voltex's Stelzried says. "We can't get transistors that will operate at the power we need, and it's hard to meet the extreme frequency stability specifications coupled with extreme modulation capability."

The power required for transistors varies widely, Capt. Foster says. "Sometimes we can get by with 1 watt but often we need more. Never more than 10 watts, however."

"We know we're pushing the state-of-the-art," says L. P. Melancon, a Squadron Four engineer. "We're trying to jam a lot of transmitter in a very small case. And," he adds, "there just aren't many people in the country who can design microwave power circuits that will do the job."

Melancon adds on a more hopeful note, "We've received three L-band transmitters from Teledyne, and two of them work. I just hope someone doesn't underbid them and give us junk."

Lee Mabee, at the Missile Test Center at Point Mugu, says, "Mainly the transmitters we get just don't work well, and we have to send them back. On the second go-round they operate pretty well. We haven't found a manufacturer who can turn out the transmitters in sufficient volume."

Mabee's group has tested "satisfactory transmitters" from Microcom Corp., Horsham, Pa., and from General Electric's Aerospace Electronics Dept., Utica, N.Y.

Coast-to-coast test for satellite TV

The Corp. for Public Broadcasting has begun a 16-week test in relaying educational TV programs via NASA satellites from the East Coast to the West. The company's president, John W. Macy, Jr., says that the experiments will yield data that can be used in commercial satellite telecasts.

The test programs are being transmitted from NASA's tracking facility at Rosman, N.C., for relay through either Applications Technology Satellite No. I or No. III, both of which are in synchronous orbit. The signals are received at the space agency's Mojave, Calif., tracking station and carried by commercial circuits to a Los Angeles TV station. At present they are being rebroadcast from Los Angeles to western portions of the National Educational Television Network. Later, programs will be sent from the west to the east.

New gear improves scuba communications

The ability to understand communications from divers wearing Scuba gear has been reported improved from 50% to 75% with new electronics gear.

Robert L. Adams, engineering manager for the Hydro Products Division of the Dillingham Corp. in San Diego, says the high degree of intelligibility has been achieved with a small 8.0875-kHz, single-sideband, amplitude-modulated transmitter attached to the diver's Scuba equipment. The transmitter puts out about 1/2 watt of acoustic energy and has a range of about a thousand yards with existing receivers.

Since a diver's ear canal fills with water, resulting in a hearing loss of from 30 to 50 dB, bone-conduction ear pieces are used.

Resonant cavity mouthpieces are used with piezoelectric transducer microphones.

TRY TO MATCH THIS

for size and reliability

you can't!

For their size, Type BB resistors pack a tremendous power dissipating ability. Rated 1/8 watt at 70°C in a 0.0004375 cu. in. volume.

And miniaturization has not reduced reliability. Tests prove it. They satisfy the highest level—the S level—of the latest MIL-R-39008 Established Reliability Specifications in all resistance values.

The key is hot molding—the Allen-Bradley way. A-B developed and built the machines. Only A-B uses them. They're fully automatic. Built-in precision control. A high degree of uniformity. Predictable performance from resistor to resistor—year after year.

For immediate delivery at factory prices call your authorized A-B industrial electronics distributor. Or write Marketing Dept., Electronics Division, Allen-Bradley Co., 1201 South Second St., Milwaukee, Wis. 53204. Export Office: 1293 Broad St., Bloomfield, N.J., U.S.A. 07003. In Canada: Allen-Bradley Canada Limited.

© Allen-Bradley Company 1969



Exclusive

Only A-B Type BB
RCRO5 meets MIL-R-39008
ER (established reliability)
for 1/8-watt resistors
at the S level.
Shown actual size.



ALLEN-BRADLEY
QUALITY ELECTRONIC COMPONENTS

EC69-80



Casinos are finding the best 'system' is electronic

Elizabeth deAtloy
West Coast Editor



Nevada's legal gambling establishments turn to engineering for help in catching stealthy cheats and running the games and office procedures more efficiently

Las Vegas

The atmosphere is convivial, the tension at the gaming tables taut, and the 86-proof is flowing freely because the drinks are on the house, and the careful customer—that part-time gambler from staid suburbia who comes to Vegas once in five years to pit his razor-edge intelligence against the wily pros of gambling—knows that he had better watch his step, because the dice are loaded, the cards are stacked and that sleezy-looking guy with a green eyeshade over there is pushing secret buttons to control the roulette wheel.

Right?

It's a picture that many novices have of gambling here, but the odds are enormously against its being true. The fact is that the customer need hardly ever worry about being cheated by the gambling house; strict laws of the state of Nevada protect him. Rather it's the house that has cause to worry about being cheated by the customer—and by its own employees sometimes. As a result, more and more legalized gambling houses are turning to electronics to detect fraud and to run their business more efficiently.

The owner of a gambling casino in Nevada has two big problems:

1. Closing the leaks that siphon

money into the wrong pockets.
2. Predicting his customers' idiosyncrasies.

The electronics he is turning to for a "fairer" shake are not in themselves exotic, but the devices and systems employ clever designs. Already these trends are in evidence:

- Electronic slot machines, Keno machines and poker games are found in most large casinos.

- On-line systems for monitoring slot machines and gaming tables and controlling keno are being tried.

- TV monitors of gaming tables are becoming a common sight in the manager's office of the large casinos.

- Electronic scales for counting money by weight are becoming available.

Outlook favors computers

Casino owners predict that in the future the computer will be used more and more to detect possible flaws in games that cause them to lose money over long periods of time.

Gambling is an industry in Nevada, and it is under tighter government controls than anywhere else in the country. House percentages run as low as 1.4% on craps and 2.5% on blackjack. To make a profit under these conditions, casino owners must have

tight accounting procedures, and they must be alert to the many ways that money can evaporate. Not only must they be on the lookout for outright theft. They must also watch the slot machines and gaming tables, to make sure there is no hidden "flaw" that may cause a slow but steady loss of money. And they must differentiate between such a flaw and a simple losing streak. For example, if a machine pays out more than it should over a period of time, is it defective or just "unlucky"? If a customer steadily wins more than the odds for that game should allow, does he have a "system" or is he lucky? Only time and data analysis will tell.

According to Robert Mulligan, agent for investigations of the Nevada Gaming Board, Carson City, some casino owners watch the so-called cycles of good and bad luck that every machine, player and dealer is said to experience and attempt to counteract the down periods—by shifting dealers from one table to another, for example.

Another big problem of the casino owner is his customers. People who gamble behave in ways that are difficult to explain or predict. William Bounds, sales manager of Bally Distributing Co., the largest distributor of slot machines in Nevada, says:

"Everything on these machines

has a psychological reason for being there—the colors, the style of the cabinet, where the coin selector is, how easy the handle pulls, every symbol on the reels. We went to card symbols on one model. I can show you 30 machines back there in the warehouse. Nobody would play them. People just don't accept playing cards on slot machines—or chickens or ducks. They do accept fruit. And not all kinds of fruit either. You'll see very few slot machines now with lemons on them. People don't trust lemons. If they see a lemon on a slot machine, they just know there's no pay."

All the decisions on the design of that machine were based on data analysis. Casino owners arrange their floor space on the same basis. They keep detailed records on such matters as the percentage realized by a particular machine or gaming table in one location compared with another, the effect of changing the color or type of machine in a particular location, the effect of decorations on the walls, attendants' uniforms, type of entertainment.

Electronic systems and devices could help in this data analysis and accounting, in the prevention of pilferage and in the running of the games themselves, but old-line casino owners formerly were reluctant to consider innovations. But

now with businessmen and corporations—such as Del Webb and the Hughes enterprises—this attitude is beginning to change.

Electronic coin games of several types are beginning to edge their way into the large casinos. Managers like them because they are more reliable than mechanical or electromechanical devices. In addition some models of electronic slot machines are "faster" than their mechanical counterparts. A single such machine will play up to three separate games. Thus players who normally play several slots at once can do so on a single electronic machine. As a result, says Chester May, slot director at Harold's Club in Reno, the electronic slots are often more profitable than their mechanical counterparts, despite their hesitant acceptance by the public.

A third reason why electronic slots are beginning to find favor with casino managers is the fact that they are more difficult to cheat. Robert Horton, vice president of Raven Electronics in Reno, the principal manufacturer of electronic slots, puts it this way:

"Even with a technician's training, you couldn't find the right part of the circuit fast enough to 'fix' the machine without attracting attention.

"On a mechanical slot a good cheater with a key—and you can often purchase a key from an employee—can open the machine, set the reels on a jackpot and close the door in three seconds. There are schools in Las Vegas that teach people how to cheat the slots.

"In one club a mechanic was opening the machine as if to work on it, setting the reels almost up to the jackpot and putting a little piece of dry ice underneath the control on one reel so it wasn't quite all the way down. He would close the machine and a confederate would come up and stand there until the dry ice had evaporated and the reel dropped down to the jackpot position. One day the fellow didn't have any dry ice, so he used an ice cube instead. When the inspectors opened the machine, they found a puddle of water under the reels. Then they knew what was happening."

In essence, electronic gaming devices are small computers that keep track of the player's score and control the payoff. The most widely used is the Raven slot machine, which accepts from one to three coins, each coin playing a separate row of three symbols. The symbols are printed on transparent color film mounted in projection lamps.

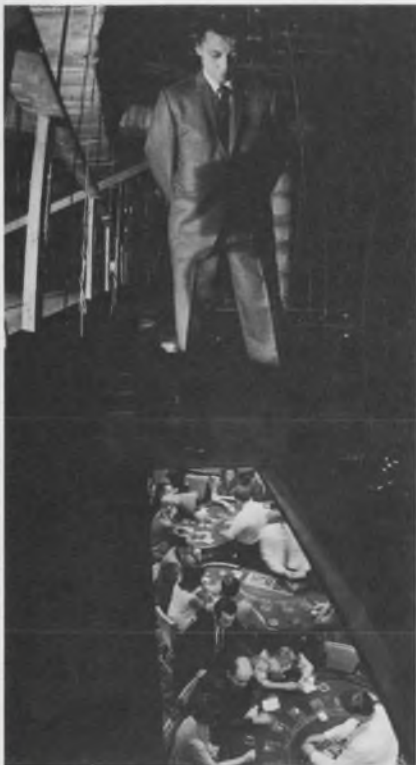

The old and the new. "Eye in the sky" (left) at the Las Vegas Mint Hotel observes gaming tables 30 feet below through a one-way mirror. Above, Walter Rabitaille, casino manager at the Landmark Hotel in Las Vegas, inspects a gaming table via TV. He can call any table by dialing a number.

When the player touches the contact plate, one of the lamps turns on. Which one it will be depends on the state of the two timing circuits, which simulate the reel in a mechanical slot machine. One timing circuit is a shift register, and the other is a simple counter. The projection lamps are controlled by a bank of flip-flops, one for each lamp. When a "1" is entered into the cherry flip-flop, for example, a cherry appears on the screen. Entrance to each flip-flop is through a two-input NAND gate.

The shift register continuously addresses each NAND gate in rotary fashion. When the player touches the contact plate, he sets the counter, which counts for a fixed period of time and then outputs to all the NAND gates in parallel. A "1" then enters the memory bank through whichever NAND gate the shift register is addressing at that moment. The symbol accessed by that NAND gate will appear on the screen and remain there until the machine is reset for a subsequent play.

Unbreakable switches used

Horton points out that the play buttons on the machines are contact switches, which are activated by the change in capacitance that occurs when someone touches a plate. They contain no moving parts.

"We use this type of switch," he says, "because it is virtually unbreakable—and a gaming casino is the most abusive environment you can imagine."

In addition to the electronic slots, there are two competing poker machines on the market—one built by Bally and the other by Latron, both of Reno. The machines are similar in design, but they select the cards by different means.

In the Latron machine, the player himself chooses each card. Timing circuits within the machine address each of the 52 cards in rotary fashion. When the player touches the contact plate, the card that is then being addressed by the timing circuits appears on the screen.

In the Bally device, the player initiates only the first card. The

Why the house wins without hardly trying

"People think there's something against them that causes the house to win all the time—some 'hidden percentage' in favor of the house," says Walter Rabitaille, casino manager at Howard Hughes' newest resort, the Landmark in Las Vegas.

"But actually," he goes on, "the only hidden percentage the house has is the player himself. I've seen it proved over and over again for the 40 years I've been in this business. Out of every 100 people, 99 are willing to lose 400% more than they will try to win.

"For example, suppose a man has \$10,000 in his pocket and he wants to play. If he wins \$2,000

to \$3,500, he quits. That's a nice winning for him. It will pay for his trip and he can buy the wife a dress that will keep her appeased.

"But if he loses the same amount, he is 'hooked,' and after he loses \$5,000, all he wants to do is get his money back. In effect, he tells the house, 'Look, you have \$5,000 of my money. If you win the other \$5,000, you are a \$10,000 winner, but if I win \$5,000, we're even.' Under those circumstances, the house cannot lose, and in fact has got to win the whole \$10,000. That's a pretty good 'hidden percentage,' but it's the only one the house has."

remaining four are chosen by pulses from a random noise generator.

Both Bally and Latron are confident that their methods of choosing cards provide a truly random selection. If this were not the case, of course, they would have to face sudden heavy losses as customers began to detect the pattern (see box).

Despite the influx of electronic gaming devices, the mechanical

and electromechanical slots continue to be popular with customers, and casino owners are searching for ways to counteract their deficiencies. One possible solution is to tie every slot to a central computer that would count the coins as they go in and out and flash a warning whenever a machine goes out of order or is any way tampered with. But the technical problems involved in designing such a system are formidable. Albert M.

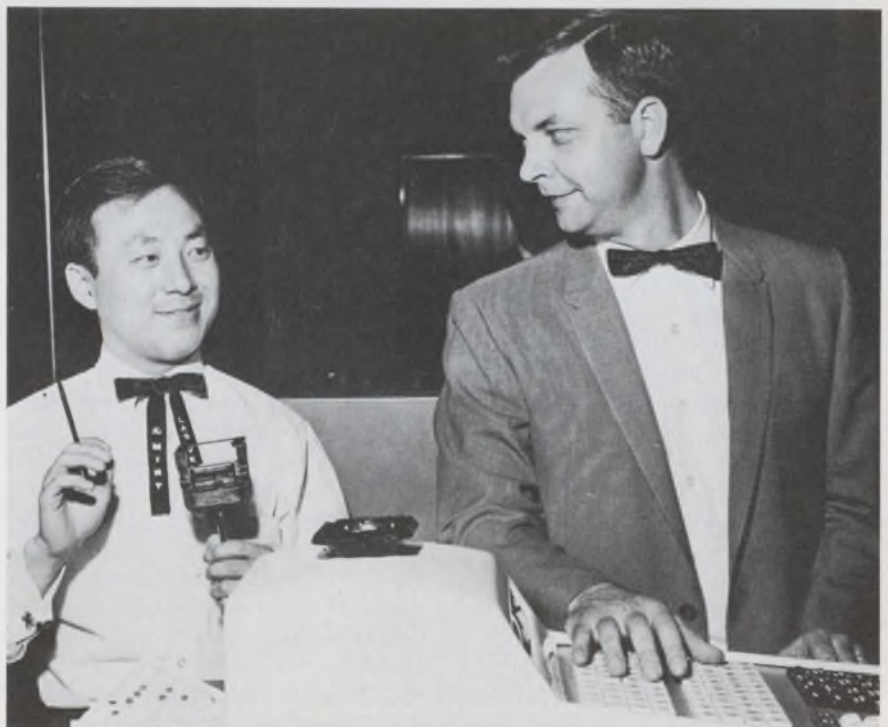

Crack keno writer Sammy Chung explaining why he was faster than a computerized keno system: "The man and machine had never done it before."

The random generator plays a central role in gambling

The casino is an excellent proving ground for a random generator—whether it is a roulette wheel, an electronic noise generator or the 21 dealer himself. If this “random generator” does not select numbers or cards in a truly random fashion, some alert customer will detect the fact and greatly increase the odds in his favor.

In the game of keno, for example, the random generator is a spinning wire cage from which numbered pingpong balls are removed one by one. For true random selection, the balls must be precisely sized. But, as an employee of one of the casinos

pointed out to an ELECTRONIC DESIGN, this can't be guaranteed in practice. With any set of balls, no matter how carefully they are machined, a pattern begins to appear after a few hours.

To prevent the customers from detecting such a pattern, casino managers use sets of balls and change the sets frequently. But they are never sure how often they should do this, as the “pattern” time differs for different sets of balls. By using computer analysis, the casinos can “calibrate” each set of balls—that is, determine how long each can be played

before an obvious pattern begins to appear.

Raven Electronics Corp. is proud of the random generator in its electronic keno machine. The payoffs in this game are very high (up to \$25,000 on a single win). Thus, says Robert Horton, vice president of Raven, “if anyone ever detected a pattern, we would soon know about it.”

But this has never happened, he says, despite the fact that one machine was missing for several months and finally turned up in Sweden, its interim whereabouts never accounted for.

Linnen, electronic systems engineer at Harrah's Club in Reno, observes:

“Let's say you have a thousand machines. You've got to scan all those machines and put all the data into a data bank in the time it takes for one play of the machines—and all the machines can be played simultaneously. In fact, they often are.”

Encoding at the machine level is expensive, Linnen notes: “Every time you spend a dollar on each of a thousand slots, that's \$1000. But if you don't encode at the machine level, then you may have 10 or more wires from each slot, which makes it a job to move the machines around. And most clubs move their machines frequently, apparently in a never-ending search for the most profitable arrangement.”

Despite the technical difficulties, such a system was actually installed by the Fremont Hotel in Las Vegas in 1962. It was a financial fiasco, however. After a cash outlay of \$600,000, it was finally abandoned in 1967. According to Frank Mooney, controller of the Fremont, the system was supposed to “record impulses every time a coin went into the machine or into the hold bucket and every time a coin was paid out.”

“But they couldn't get the proper electronic impulses,” he recalls. “More than one coin would go through at a time, and it would count two as one. Also, power fail-

ures would cause it to lose data out of memory—and we have a lot of power failures here in Las Vegas.”

According to William Messer, one of the system's designers and now a staff member of Typograph Corp., San Diego, the system tied 1000 slots to a central computer by hard wire through a set of multiplexing units—one for each table of eight machines, and one at the central computer.

“Each slot had 12 to 15 wires connected to the coin collection and payout systems,” says Messer, “plus 13 wires from a card-reading system used to identify any authorized employee who might be entering the machine. A local terminal at each table multiplexed the machines on that table and retransmitted the data over 80 parallel wires to a multiplex system associated with the central computer, which was a Packard Bell Model 350, now manufactured by Raytheon.”

Messer agrees with Mooney that the computer memory, being volatile, lost data during the frequent Las Vegas power failures.

Another of the system's designers, Ed Bon Durant, now president of Logic Sciences, Inc., San Diego, feels that “the weakest technical point in the system was the mechanical closures used to sense the coins.” The system was never off more than a few pennies a day, he says, but this was too much.

“If I were building the system

today,” says Bon Durant, “I would look for a better way to sense coins. One of the first sensors I would consider would be a photo-cell type. A coin could never get by that without being counted.”

Despite this sobering experience with on-line slot monitoring systems, William Bennett, vice president and general manager of Del Webb's Mint Hotel, thinks that the advances in technology since 1962 make it reasonable to try again. As for the cost of such a system today, Bennett says, “I'll take a ranch-house guess at \$100 a slot—not counting the computer.” Mint Hotel officials are convinced that this cost is more than justified by the current losses due to pilferage and malfunctioning machines. Joseph O'Rayeh, director of slots at the Mint, says:

“The slot business is close to a \$3-million a month business. We are sure there are at least thousands of dollars a month stolen, and we suspect the actual figures are staggering. For this reason, the cost of an on-line system could never be prohibitive.”

O'Rayeh points out that such a system will “allow us to photograph slot thieves in the act of committing the theft.”

Another advantage, he indicates, is that it will signal when an adverse trend occurs. “Slot machines—whether mechanical, electromechanical, or even electronic—may pay out excessively over a period of time,” he observes. “The only

way we can catch this is by a daily analysis of the percentage. If we see that a machine doesn't hold its percentage for the day, we aren't alarmed, but if for several days it loses continually, then we know something is wrong. The only way we can know this is by keeping track over a period of time. This all has to be done by hand now and requires a lot of people. With the on-line system, the computer will do the analysis and simply signal us when a machine reaches the point where it has had a certain number of handle pulls and still isn't realizing its expected percentage."

A new system planned

A new system for the Mint is being designed by Ricca Data Systems of Santa Ana, Calif. The details are not yet firm, but O'Rayeh points out that it will record every coin in and every coin out and give a breakdown as to whether the coins go out in jackpots or in small pays. It will also report just how much money should be in the drop bucket at the bottom of the machine.

Malcolm Niles, project engineer at Ricca, says the company is considering a system with local terminals that would receive data by hard wire from a bank of perhaps 20 slot machines—about 10 wires from each machine. The system would transmit the data in a multiplex mode to a central computer over a single, twisted-wire pair. The sensors in each machine would probably be reed relays, Niles notes.

Printer displays envisioned

The displays, he says, would probably consist of "two or three printers of some type stationed at various points: one perhaps in O'Rayeh's office, so he can get interim reports instantaneously; one or two at the cashier's cage, so that if a jackpot comes up anywhere in the room, a check girl will see it, pay the customer and punch a function key on the terminal to indicate that it has been paid."

"The location of the machine might be indicated on a big light board," Niles says, "and at the same time the printer would print



This keno machine, manufactured by the Raven Electronics Corp., is an electronic version of the game that is popular in most Nevada casinos. It makes payoffs up to \$25,000.

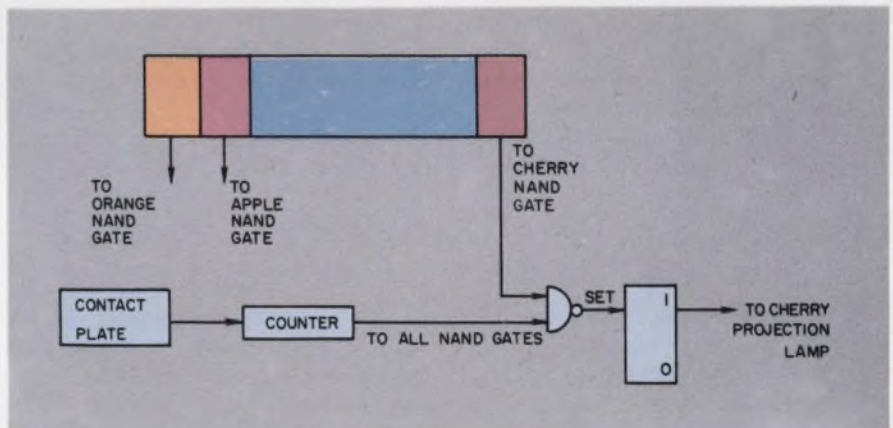

Two timing circuits—a shift register and a counter—determine which fruit symbol should appear on the screen of the Raven electronic slot machine.

out the amount to be paid by the girl."

The Mint Hotel is already experimenting with an "on-line" system for playing keno. It was designed by Ricca Data Systems. Each casino employee (called a

"keno writer") who receives the customer's tickets and money has a terminal, consisting of a keyboard, a card reader and a printer. If the customer presents a simple ticket, the writer merely enters it into the reader and presses a func-

What made Sammy run (faster than circuit)

The new computerized keno system being installed at the Mint Hotel ought to be a lot faster than a human. But at its first public showing last May before a group of Nevada government officials, casino executives and members of the press, a prototype of the system clocked in a minute and 15 seconds behind Sammy Chung, head keno writer at the Mint, who had nothing to assist him but a marking brush and a hand stamp.

When newsmen crowded excitedly around Sammy after the race to find out why he had won, he replied matter-of-factly: "I have done this work for five years and am very fast, but the other man and machine have never done it before."

Someone—apparently the pub-

lic relations department of the Mint—later issued a statement to the press that said: "In a post mortem investigation of the equipment, it was found that hot TV lights and flashes from the photographers' strobes were confusing the sensitive circuitry."

Questioned by ELECTRONIC DESIGN, however Malcolm Niles, the systems analyst from Ricca-Data Systems who had attempted to beat Sammy, took the full blame. "We had a whole bunch of complicated ways tickets to figure," he explained, "and I had never seen one before. Sammy had almost finished before I had even entered all the combinations into the keyboard."

Apparently the machine works faster with Sammy at the terminal.

tion button. The computer then prints out a duplicate of the customer's ticket, together with the number and the price, which the customer keeps until the numbers have been drawn. But if the customer presents a complicated "ways" ticket—that is, one that contains several ways, or sets, of numbers he wants to play, each of which pays a different amount in case of a win—the writer enters each set in the keyboard, pushes the "ways" button and enters the number of sets in the keyboard. The computer determines the price automatically, displays it at the terminal and prints out the customer's receipt.

The supervisor has a special terminal that allows him to enter the winning numbers and signal the computer to print out the winning tickets and the amounts won. The computer can scan and match 500 or more tickets in a few milliseconds.

Mint officials are enthusiastic about the new system. The present way of handling the game calls for human calculation and recording of the customers' bets, duplication of their tickets by hand, and a search through the files of tickets for possible winners. As a result, says Andrew Zorne, keno manager at the Mint, the game

tends to be a little slow, "particularly on weekends when the real gamblers come to town; these people love to play the ways tickets, which take the most time of all to compute."

On-line gaming is costly

A completely automated on-line monitoring system for the gaming tables would be prohibitively expensive, says Bennett of the Mint. The dealer at each table must keep track of currency, coins, credit slips and chips. A system that would sort all this and read it into the computer would cost in the neighborhood of \$90,000 a table, he says.

Several years ago a very simple off-line system was tried at the Mint. In this system, the dealer was supposed to "ring up" every cashbox entry on a keyboard. This punched a tape, which somebody collected at the end of the shift and fed into a computer. As an accounting procedure, Bennett says, the system was little better than just counting the contents of the cashbox at the end of the shift—particularly since the dealers sometimes forget to enter every transaction when they get very busy.

Since that time, Centronics Data

Computer Corp., Flushing, N.Y., the designers of the system, have modified it and installed an on-line version in several casinos in Puerto Rico. In the new system, says Robert Howard, president of Centronics, the cashbox is locked until the dealer causes it to open by entering a transaction into the keyboard. The cash button then lights up—along with a Nixie display of the amount—and both stay lighted until the next transaction is entered.

The system is not designed to prevent dealer cheating, Howard points out, but rather as an accounting system. However, it has tended to discourage cheating, he says.

"If the supervisor walking by sees \$100 on the Nixie display and the cash button lit, yet sees a new player sitting there with a thousand dollars' worth of chips in front of him, he knows something is wrong," Howard explains.

Big Brother watches dealers

Some casinos are turning to closed-circuit TV to monitor the actions of dealers in the pit. In most casinos this job is still done by the famous "eye in the sky"—a glass plate in the ceiling above each gaming table. Viewed from the table, the glass looks like a mirror in the ceiling, but from above it is a magnifying glass. An employee of the casino sits up in the "catwalks" above the eye and watches for hanky-panky at the tables below. According to Walter Rabitaille, manager of Howard Hughes' newest casino, the Landmark in Las Vegas, this system has built-in problems.

"Sitting up there is a stool job," he points out. "It's one hired man against the other. If a fellow sits up there for a week or so and doesn't see anything going on, he starts to worry for fear we'll think he isn't doing his job. So maybe he makes up a story about somebody he doesn't like—or maybe he embellishes it a lot. Anybody who tells a story on someone else always has to dress it up a little, just to make himself look good and the other fellow bad."

The TV monitor eliminates the problem of one hired man "stooling" on another, says Rabitaille. With the monitor in his office,

In Reno, they're counting up their money by the pound

Every day in a large casino, the coins, currency and chips that have been collected at the machines and gaming tables are hauled to the vault and counted by three or four trusted employees or by the bosses themselves. At Harrah's Club in Reno, the job of counting the slot-machine coins is being taken over by an electronic "scale" that translates pounds of weight into dollar values.

According to Albert M. Linnen, electronic systems engineer at Harrah's, the system consists

of a platform with a strain gauge that puts out an analog signal. The signal is proportional to the weight of the coins on the platform. A tag reader and a translator complete the setup. The system is manufactured by the Toledo Scale Co. of Toledo, Ohio. Linnen describes it this way:

"They pull a bag of money out from under a slot machine and attach an ID ticket to it. This ticket identifies which of the five Harrah's Clubs the bag came from, the denomination of

the machine and its identification number. The bag is set on the scale, and the ticket is put into the reader. The translation circuitry receives the analog signal from the transducer, digitizes and stores it. Simultaneously it picks up the information from the card reader and translates the weight to the correct dollar value. The dollar values of all the bags are accumulated and displayed on another card by a keypunch machine that is hooked to the scale."

Rabitaile can personally view the entire sequence of operation at each of 32 tables, either simultaneously or one at a time. He merely "dials" the number of the table he wants to observe, and it appears on the screen, together with the sound if he wants it. A video recorder can keep a permanent record of any activity at any table, and there is a device for putting a picture into slow motion or stopping any moment of action.

Although the surveillance equipment is operated only sporadically, no employee knows when it will be directed at him, says Rabitaile.

He watches the monitor for minor infractions, such as a dealer shuffling the cards in a sloppy fashion. "When I find somebody, I immediately get on the phone and call the pit boss," he says. "He'll walk over to the fellow and say 'Deal the cards like you're supposed to.' Now the dealer knows the pit boss wasn't looking at him, so the message must have come from upstairs. He goes to the dealers' room after the shift and says, 'Well, I guess somebody is really looking at us. I wasn't doing a thing but just shuffling the cards and he came along and told me to shuffle them the other way.' That's how the news gets around."

Leaders among casino executives agree that sophisticated data processing techniques will help take the guesswork out of gambling. Determining the optimum types and arrangement of games on the casino floor is largely done by humans now, says Bennett of the

Mint, but before long it will be computerized.

Rabitaile says data-processing techniques are being used at the Landmark Hotel to keep track of table percentages. A sudden drop in the percentage of a table may reveal use of a "system" that would be difficult to observe directly, he points out.

"I've got a certain percentage to keep up on all my games," he explains. "If one particular game keeps running below all the time and I've checked out all the possible leaks without being able to find the reason, then I've got to start looking at people. Some customer may have figured out a way to count—to keep track of the cards that have gone by."

Human memory still useful

This requires a good memory, Rabitaile points out, since the cards are dealt from a "shoe" containing four decks, or 208 cards. But there are a number of people in Las Vegas who are able to do this.

"I know a man," says Rabitaile, "who will put up \$50,000 on what you call a freeze-out. He won't win any more than \$50,000, and he won't lose any more than that. All he wants is for you to promise not to break up the deck (keep shuffling the cards so he can't memorize them). He'll guarantee to engage in conversation with anybody you want to put beside him and to drink so much whiskey per hour if you'll just let him play. And if you

take that proposition, he'll beat you out of your money."

Asked what he did about a customer he suspected of counting, Rabitaile replied, "you just let him work and work, and when you see he has the deck where he wants it and he makes a bet, you break the deck down."

From physicist to gambler

One of Las Vegas' most famous counters is Jess Markham, once a physicist with the Rand Corp. He did so well as a weekend gambler that he transferred over to the gambling world full-time and now manages the Bonanza Hotel in Las Vegas. Markham's approach to the problem of customers who count is quite different from Rabitaile's. He doesn't catch counters by watching table percentages. He catches counters by watching counters.

"I don't care whether a man is winning or losing," he says. "If I see he knows what he's doing, I just tell him to take his business somewhere else."

Markham insists that counting is a relatively simple "trick" that almost anyone can learn; it doesn't require a phenomenal memory at all. "What it takes is moxie," he insists, "the heart or courage to keep playing and betting even during the long unlucky streaks. And hardly anyone has this."

But even moxie may not be enough as electronics takes over more and more of the duties in legalized gambling. ■■

Fluidics: Why not try it, specialists suggest

Speakers and equipment at Cleveland exposition point to a growing potential for air-powered logic

Don Mennie
Circuits Editor

Should you use a fluidic control system on your next project? The fluidics industry is convinced air-powered logic has come of age, and it was out to demonstrate capabilities and applications at the recent Fluidic Exposition in Cleveland.

Industry spokesmen agreed that the most promising use of fluidics at present lies in control of large industrial machinery. But they are also convinced fluidics can be useful in other areas.

Leonard Gau of the Chrysler Corp. Research Div., for example, suggested that automobile exhaust control systems be adapted to fluidic technology. Gau's emission-control design makes use of the high hydrocarbon concentration occurring at the beginning and end of the internal combustion engine exhaust pulse. These hydrocarbons are separated from the exhaust stream and fed to an afterburner. By so reducing the volume of exhaust processed, afterburning techniques would be simplified, accord-

ing to Gau.

Another conference speaker, Dr. William Westerman, senior group engineer with McDonnell Douglas Astronautics Co., Titusville, Fla., indicated that experimental fluidic controls were being developed for aerospace vehicles. He pointed out that missile logic built in this fashion was not subject to radiation or electromagnetic jamming.

Dr. Westerman said about 35 Government agencies had let contracts for fluidic developments so far. He identified the Air Force as the big spender, with missile and jet-engine control contracts accounting for 40% of the \$20-million Government outlay for fluidics research.

Typical application cited

Describing the problems of adapting automobile turn signal test fixtures to fluidic control, Bruce Hoppe of General Motors Corp., Oldsmobile Div., said the final results were so encouraging that Oldsmobile was looking for further fluidic applications. Hoppe

said problems with limit switches and jammed relays, even though infrequent, had caused a serious loss in test time with the original electrical setup.

Conversion to fluidics was not an effortless task but once the new setup was understood and debugged, superiority over the electrical test fixture was clearly evident. Speaking with firsthand knowledge, Hoppe remarked that most user problems are due to errors in application, not fluidic device shortcomings.

Interface design important

Workshop sessions at the conference emphasized input and output fluidic system interface designs. One such session featured a four-decade counter from Pitney-Bowes, Glenbrook, Conn. The readout was not electronic; it operated directly from fluidic logic air-pressure signals. Spring-mounted cylindrical pistons, arranged in a 5-by-7 matrix, formed the numerals.

A fluidic input interface design—selector valves—was shown by Norgren Fluidics, Littleton, Colo. John Johnson, applications engineer at Norgren, described these valves as usable in fluidic and pneumatic control systems wherever multiposition function selection is required. He also demonstrated a fluidic visual indicator, an equivalent to a pilot light. This device consisted of an encapsulated rotating colored sphere that provided a visual go-no-go readout.

Ample choice available

Engineers using fluidics have a variety of design approaches to consider. Once a decision to buy has been made, however, fluidics users are wise to obtain all their hardware from one manufacturer, according to James Morgan of the National Fluid Power Association. Compatibility between competing fluidic products was said to be low.

Bowles Engineering Corp., Silver Spring, Md., and Corning



Fluidic 4-decade readout operates from air pressure. Logic pressure signals provide direct counter input without electrical or mechanical interfacing.

Draw your own conclusion

if you want to find out which company is such a far-and-away leader in TTL that an ever-increasing number of IC manufacturers are starting to second-source its 8000 series!

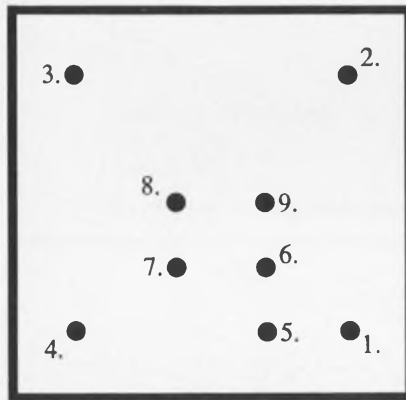

(P. S. Once you've connected the dots, connect with us—by writing for our DCL handbooks. They show why we're the leader in TTL—including the most-wanted MSI like Adders, Multiplexers, Shift Registers, Counters. Our address: Signetics, 811 East Arques Avenue, Sunnyvale, California 94086.)

A SUBSIDIARY OF CORNING GLASS WORKS

INFORMATION RETRIEVAL NUMBER 23

(fluidics, continued)

Glass Works, Corning, N. Y., both supply systems and components that depend on wall-attachment phenomena. The principle of operation is illustrated in Fig. 1a. Roland Jones, engineering manager for industrial applications at Bowles Engineering, explained the operation as follows:

A low-pressure area (curved arrows) attaches the input supply pressure jet to an adjacent wall. The result is a positive pressure signal at output Q_2 . Careful design insures that this same attachment will always occur when no control pressure is present at C_1 or C_2 . Switching the airflow to output Q_1 is accomplished by a control pressure inserted at C_2 . Once switched, the airflow to Q_1 will be maintained even when control pressure C_2 is removed. The flow to Q_1 will continue until a second control pressure is inserted at C_1 . This bistable element is the basis of wall attachment logic.

Corning Glass and Bowles Engineering representatives reported that fluidic systems built on the wall-attachment principle had long life and little need for maintenance. This was attributed to the logic operation, which is accomplished by airflow phenomena without the use of moving parts. Air-supply contamination was said to be detrimental to wall-attachment fluidics, but this was not considered a serious problem, since proper air filtering and periodic system flushing would remove any contamination buildup.

Moving impact plane

The Johnson Service Co. of Milwaukee uses two opposing streams of air to power its NOR logic element, an impact modulator (Fig. 1b). As explained by John Enright, manager of fluidic sales at Johnson, the opposing air jets form an impact plane. If one of the jets is weakened relative to the other, the impact plane moves toward the weaker jet.

In Johnson's monostable device, one supply jet is weakened by sideways attack from one of several transverse jets, so that the impact

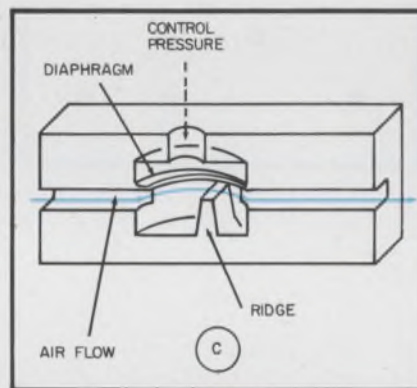
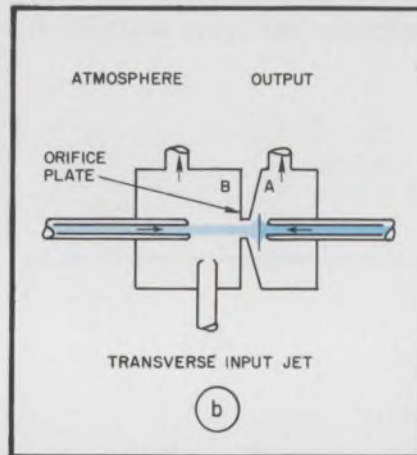
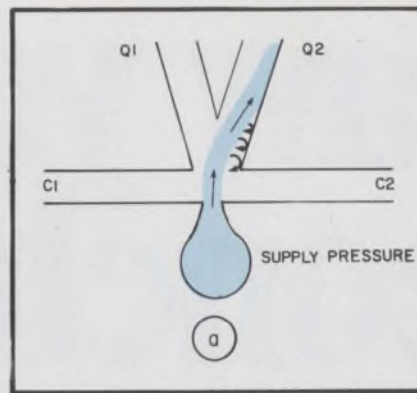

1. Three approaches to fluidic logic are shown above. The wall-attachment principle (a), the impact modulator (b) and the diaphragm-valve design (c).



Manual control of fluidic systems is provided by these selector valves.

plane will move from chamber A (in Fig. 1b) to chamber B. Positive pressure at the output port results with the impact plane in chamber A. When the impact plane moves to chamber B, slightly negative pressure (below atmospheric) occurs at the output port.

Johnson claims fanout for the impact modulator (pressure and flow available to drive succeeding stages) was three to four times that of other fluidic devices. They also reported their device could adapt to a wide range of input supply pressures without precision regulation.

An illustration of the fluidic circuit construction using the Johnson Service Co.'s impact modulator is shown in the top photo on page 36. Individual impact modulators are plugged into the circuit board at the top of the picture.

Diaphragm logic explained

Yet another approach to fluidic control design is the flexible diaphragm-valve unit developed by Double A Products Co., Manchester, Mich. Operation of this device is illustrated in Fig. 1c, which details a single control ridge and diaphragm. John Eppich, fluidics department manager at Double A, outlined the operating principle.

With no pressure applied to the top of the chamber, air flows unimpeded over the ridge (as shown in Fig. 1c). When sufficient pressure is applied to the upper side (dotted arrow), the diaphragm snaps down against the ridge, blocking airflow through the chamber. The chamber design is such that the diaphragm will not open again until the applied pressure falls well below the level needed to force the diaphragm down (closed).

Eppich further explained that Double A combined these control-ridge elements to form a single logic component containing eight identical NOR gates. Fluidic circuits are then built with several interconnected components.

The advantages claimed for Double A's fluidic logic include low cost, reliability, easy maintenance and insensitivity to contaminated air supplies. A clear plastic case allows each control ridge and diaphragm to be visible for quick trouble-shooting.

Integrated Circuits



The ABCs of MIL-STD-883: MACH IV

TI is ready now to deliver integrated circuits "in accordance to MIL-STD-883." We're committed to the task. Money, manpower and facilities.

What's more, we're ready to tell you exactly how we'll do it.

In detail.

You'll find most of the answers in TI's 40-page MACH IV procurement specification covering 883—supplemented by 100 pages of detailed product specifications.

It is the most comprehensive book of its kind. By far.

If you need more answers, you'll get them from the men pictured above. They're members of a special HI-REL Task Force organized for TTL ICs (we have Task Forces for DTL and linear, too).

These men are managers from

the areas of reliability engineering, process engineering, product planning, military marketing, product sales, product engineering, quality control, manufacturing, and HI-REL assembly.

They'll help you determine the specific procedures and reliability levels you'll need to meet 883.

Then they'll see your order through. Successfully. Even if they have to cross departmental boundaries and step on a few toes to break bottlenecks.

They'll focus TI's experience and abilities on your job. You see, we've been delivering 100% tested ICs for years. Millions of them for Minuteman, Sprint, Poseidon, F-111 and other programs.

And some of these had even tighter requirements than 883.

Another thing. You'll have the industry's best facilities going for you at TI. From more than 50,000 burn-in sockets to environmental shake, rattle and roll labs, to IR scanners, microprobes, Radiflo and variable data loggers.

With our commitment, experience and facilities, we're doing our best to make MIL-STD-883 as simple as ABC.

Write for "MACH IV High Reliability Procurement Specification MIL-STD-883" on your company letterhead. Texas Instruments Incorporated, PO Box 5012, MS 308, Dallas, Texas 75222. Or call your local TI Sales Office.



TEXAS INSTRUMENTS

INCORPORATED

(fluidics, continued)

Aro Corp., Bryan, Ohio, has developed a system of pneumatic logic controls. These devices, unlike other types of fluidic logic contain a small moving piston. Three types of logic elements are available from Aro: AND, OR and NOT. Compatible control valves, delay timers, read-out devices, enclosures and circuit boards allow users to design whatever system they require.

A significant advantage over other fluidic devices is claimed for the ability of pneumatic logic to work from a high-pressure air supply. This feature allows the logic control output to drive machinery directly without the need for pressure transducers. Aro engineers explain that the moving piston arrangement is no drawback to pneumatic logic reliability.

Fluidics at 50 kHz

A fluidic ear, the equivalent of an electric eye, was shown by Pitney-Bowes. Ernest DiPasquantonio, manager of engineering, explained its operation and applications (Fig. 2).

The transmitting element in the upper left of the figure is a 50-kHz, air-powered whistle. This device provides a continuous sound source.

Opposite the transmitting element is the receiver. Under steady state conditions, a continuous laminar airstream flows through the transmitter. This results in an even, positive pressure at the receiver output. The laminar flow, however, is tuned so that it becomes turbulent when disturbed with 50-kHz sound waves. Turbulent flow within the receiving element causes the internal air pressure to be vented before reaching the output port. A low, near-atmospheric output pressure is the result.

Figure 2 shows the fluidic ear counting a passing line of wooden blocks, analogous to many production-line situations. Pitney-Bowes says its design is usable without modification at spacings up to 5 feet. With focusing attachments, the range can be increased to 30 feet. The transmitting and receiv-



NOR impact modulator elements assembled to form a fluidic control circuit. Plastic tubing connects the logic elements.

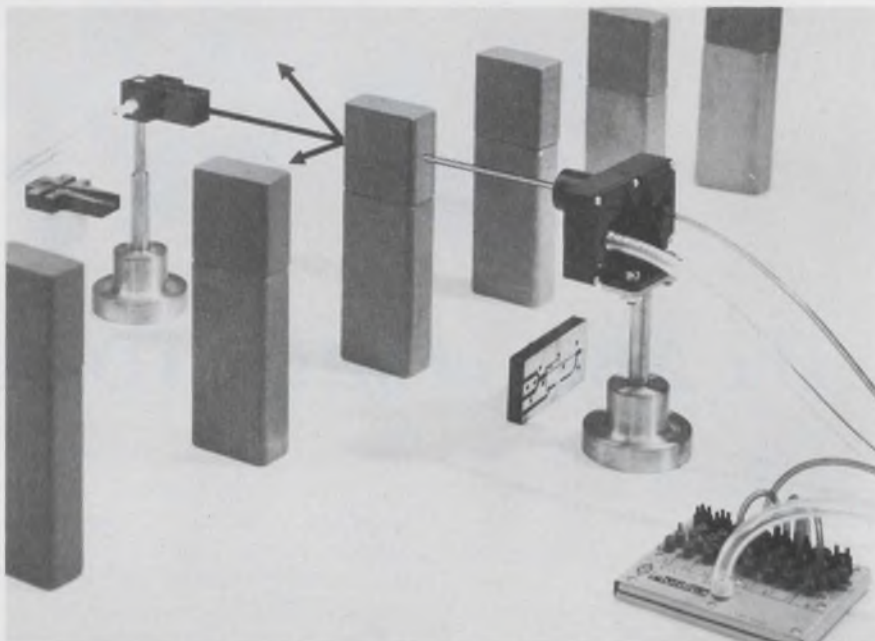

2. The fluidic ear, with a cutaway view of the transmitting and receiving elements. The receiver is reported to operate anywhere within five feet of the 50-kHz source.

ing elements are reported to be insensitive to air currents and wind blasts.

Successes reported

Western Electric's Ben Meyers, an engineer with the company's Oklahoma City Works, told *ELECTRONIC DESIGN* that he had had success with several fluidic applications. One such control system operates a machine that winds cores for telephone relays. Another mixes hydrogen with mercury to create a sealed mercury switch.

Still another automatically controls a riveting gun as it positions rivets on a circuit board. Meyers says the Oklahoma City plant has been working with fluidic devices since 1965, and many activities in this area are still experimental.

Industry spokesmen believe fluidic development is now at about the same stage that transistors were during the mid-1950s. Applications seem unlimited in the area of machinery control systems. Fluidics can also take on more unusual tasks, such as on-board missile logic, specialists say. ■■

A 50% rise asked in satellite circuits

A 50 per cent increase in the number of satellite communication circuits will be needed in 1970, says the American Telephone and Telegraph Co.

There are now 775 satellite circuits linking 42 countries and areas around the world. AT&T has asked the Federal Communications Commission to authorize 1148 circuits this year to meet growing demands for worldwide telephone service. This includes those countries initiating satellite communications service this year.

A breakdown of the present circuit use and projected needs for 1970, as given by AT&T, follows:

- Hawaii has 108 circuits; projected need is 225.
- Pacific area countries have 99 circuits; projected need is 194.
- Central and South America and West Caribbean have 122; projected need is 196.
- Europe, the Mideast and Africa have 446 circuits; projected need is 533.

Ocean cable expanded

AT&T is already adding a 720-circuit trans-Atlantic cable to its overseas network. The new circuits, part of the \$99-million cable and radio relay system linking the United States with Spain, Portugal and Italy, are scheduled for service in March.

Thirty-two earth stations for the satellite network, including four in the continental U.S., are now in operation in 25 nations. Fifty stations are needed by the end of 1970, AT&T says.

Last year about 20 million phone calls were completed between the U.S. and overseas points. This is a 25 per cent increase over 1968.

In addition to the present 775 satellite circuits, AT&T is now using 1054 cable, 179 high frequency radio and 151 over-the-horizon radio circuits for overseas telephone service.

AT&T, which pioneered in space communications with Telstar in the early 1960s, has been a strong advocate of developing both satellite and ocean cable technology to insure diversification of communications. ■■

Want A Special Plate Connector For That New Design?

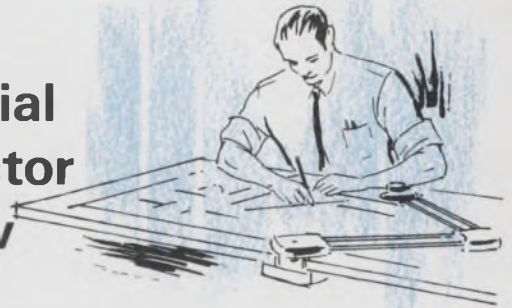

YOUR BEST SOURCE IS MALCO

Tooled Parts Unlimited...

MALCO has expanded the capability of its WASP and MINI-WASP Plate-Type Connector Systems to meet the special needs of printed circuit edge connector users. The CARDEC Modular Plate Connector System is tailored to fulfill your individual requirements. It provides maximum packaging density with instantaneous reaction to ground and power distribution, (without wiring) for low noise, high speed circuits. In one complete package, compatible with LSI's, IC's or any circuit, CARDEC offers you *all the built-in extras you need*, plus the advantages of modular component design for inexpensive and flexible replacement capability.

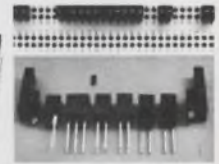
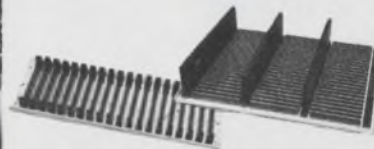
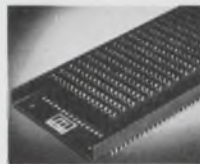

CARDEC 200—The Cardec 200 Card Edge Plate Connector System is designed for direct entry P. C. card applications. The Cardec 200 version accepts $\frac{1}{16}$ " printed circuit cards with contacts on .200" centers with .045" square wrap tails. This connector system features the ground plane concept and modular construction of the "Wasp" Connector line while affording the economy of edge connector systems. REQUEST BULLETIN NO. 681.



CARDEC 125—Cardec 125 is a modular card edge connector system with contacts on .125" centers for maximum packaging density (.047" cards on solid .250" centers). In addition to the features of Cardec 200, this system offers printed circuit card voltage bus hardware for low resistance voltage distribution. As with all the Malco Plate Connector lines, Cardec 125 is supplied in your configuration completely assembled and ready for automatic wire-wrapping right out of the package. REQUEST BULLETIN NO. 681.



Other Malco Tooled Products: Wasp and Mini-Wasp Fork and Blade Connector Systems, Plus A Complete Line Of Circuit Hardware and Precision Stampings.

Consult our engineering staff about your application and design problems.



PRECISION ELECTRONIC TERMINALS AND CONNECTORS
MALCO MANUFACTURING COMPANY INC
6150 W. ROOSEVELT RD. · CHICAGO, ILLINOIS 60660 · PHONE (312) 287-8700

INFORMATION RETRIEVAL NUMBER 25



We make components for guys who can't stand failures.

We make our capacitors and resistors to perform like 40 million people were watching in on the count down.

And we build an extra measure of performance into all of them, to let you make sure your equipment delivers all you designed into it. Because like you and the guys who use your equipment, we can't stand failures either.

Take our glass capacitors, for instance. There's only one reason why they've been designed into the Surveyor, Minuteman, Gemini, Apollo, Saturn, Titan, Syncom, Sparrow, Hawk, and a number of other major aerospace and missile projects. With our glass capacitors, circuit designers could get the proven stability and reliability that these important systems demanded. U.S. Air Force tests have established that our glass capacitors have much better stability and much higher insulation resistance than ceramic and mica capacitors can deliver.

And take our precision tin oxide resistors. They're the best of the metal film class. Because the resistive tin film is completely oxidized and

molecularly bonded to the glass substrate, our tin oxide resistors are impervious to moisture and environmental degradation. No other resistor can deliver the same stability and reliability over load life. They offer guaranteed moisture resistance across all ohmic values to set a standard of reliability that can't be matched by metal film, wire wounds, carbon comps or metal glaze resistors. After a 56-day-long heat test in an environment of extremely high humidity, our tin oxide resistors showed a resistance change of just 0.2 per cent. And in an ambient temperature test—now in its ninth year—not one of the 600 tin oxide resistors being tested has exceeded a resistance change of 1.5 per cent.

But don't only think of Corning for aerospace and other precision applications. We've got something to offer when economy and value are the prime considerations. At Corning we've been active in improving these important capacitor and resistor characteristics, too.

We've developed the Glass-K™ capacitor to give you the volumetric efficiency and economy of mono-

lithic ceramic capacitors, but with the much improved stability and reliability that only a glass dielectric can add.

In resistors, our tin oxide resistors already offer long term economy over metal film, precision wire wound and metal glaze resistors. And our new C3 resistors, in addition to giving you a small case size, compete costwise with carbon comps.

At Corning we make components for guys who can't stand failures. Guys like your most important customers. Guys like you. So, next time you're designing a system, reach for your CORNING® capacitor and resistor catalogs and call your local Corning authorized distributor for off-the-shelf delivery. They'll help you design-in that extra measure of performance.

If you don't have our catalogs, ask your Corning distributor for copies or drop us a line at: Corning Glass Works, Electronic Products Division, Corning, New York 14830.

CORNING
E L E C T R O N I C S

CORNING presents "THE YOUNG AMERICANS" an entertainment special
on ABC-TV, March 12, 1970, 9:00 PM EST. We invite you to watch.

INFORMATION RETRIEVAL NUMBER 26

Power Designs Uniply* is a laboratory of power supplies



0-7V at 5A / 0-15V at 3A / 0-25V at 2A / 0-50V at 1A / 0-60V at 0.5A

NEW REGULATOR TECHNIQUE FEATURES IN A SINGLE UNIT

- Multi-range output with transient free automatic electronic ranging
- All linear circuitry. No switching or high frequency noise
- Output up to twice ratings at line voltages over 105 VAC
- Flashing signal indicating regulator operating limit
- Overload and short circuit proof
- No performance sacrifice. .01% regulation, one millivolt peak-to-peak noise and ripple, etc.

Model 6050... \$195.

Write or call for detailed specifications *TM



WESTBURY, NEW YORK:
1700 Shames Drive, Westbury, New York 11590
Tel: 516-333-6200 ▪ TWX: 510-222-6561

PALO ALTO, CALIFORNIA:
3381 Miranda Avenue, Palo Alto, California 34304
Tel: 415-321-6111 ▪ TWX: 910-373-1251

INFORMATION RETRIEVAL NUMBER 27

ELECTRONIC DESIGN 2, January 18, 1970

Washington Report

CHARLES D. LA FOND, WASHINGTON BUREAU

F-15 fighter competition questioned

Air Force officials may be called before the House Armed Services Committee to explain their direction of the hotly contested F-15 advanced fighter program, Congressional informants say. They also predict very close scrutiny of Air Force supervision over the newly selected prime contractor, McDonnell Douglas. Concern is over cost control in the \$7-to-\$8-billion program. The initial cost-plus contract is for \$80-million; \$1.15-billion is projected for 20 flight test aircraft.

Two members of the House committee, Chairman L. Mendel Rivers (D-S.C.) and Rep. Otis Pike (D-N.Y.) question Air Force handling of the competition. According to Rep. Pike, the law governing such procurements dictates that competitors be told "precisely what weightings should be given to each element in the competition" and that "these weightings shall not be changed during the competition." But, says Pike, the Air Force has taken the position that this law, passed in 1926, is obsolete and thus it need not obey it. "Ignoring this law—and it is being ignored," the Congressman asserts, "allows the Air Force to come up with any winner in any competition that political expediency demands." Rep. Rivers has asked General Accounting Office to review contract procedures.

A new Executive office to coordinate communications?

Watch for establishment by the Nixon Administration of a new Office of Telecommunications Policy. The details for such an office are contained in a White House memorandum that was circulated to the Executive staff by Peter Flanigan, a Special Assistant to the President. The memorandum was obtained by Rep. Joseph E. Karth (D-Minn.) and made public by him recently.

The President reportedly is annoyed at the premature release of the memorandum, but ultimate approval of the new office is expected on Capitol Hill. Industry informants here aren't sure at this time just how such an office would affect the powers of the Federal Communications Commission. But one thing appears certain: If such a move is carried out, it will short-circuit a recommendation of Commerce Secretary Maurice Stans to centralize all communications policy control within his department. Establishment of the Executive office was recommended, however, in the IEEE/EIA Joint Technical Advisory Committee report "Spectrum Engineering—the Key to Progress," released in July, 1968.

RCA wins the biggest award in a decade

The selection of RCA by the Navy to direct the Advanced Surface Missile System, now called Aegis, provides the largest contract the company has won in the last 10 years—and it appears that the bulk of the R&D effort will stay within the firm, an RCA spokesman says. At its Moorestown, N.J., facility, RCA will be responsible not only for program management and integration of all shipboard systems of the new surface-to-air missile effort, but it will also develop the key hemispheric-coverage, phased-array radar. The R&D project will be performed under a \$252.9-million contract; the follow-on production could total out to \$1-billion.

RCA will be responsible for all shipboard elements of the system

except the missile and launcher. General Dynamics-Pomona will produce the Standard Navy Missile for the system and a dual-purpose launcher capable of firing the missile and antisubmarine rockets, all under separate contract. RCA has three principal subcontractors with which it is still negotiating: Raytheon will build the target radar illuminator, the weapons control system and probably the high-power radar transmitter; Computer Sciences Corp. will develop the necessary fire control and guidance computer software; and Gibbs & Cox, Inc., marine architects, will provide system configuration and structural design services.

As presently conceived, the RCA electronic scanning radar will be used for target detection, acquisition and tracking and feed directional data through the fire control system to the Raytheon target illuminator. The missile itself, employing a passive radar homing device, will zero in on the echoes reflected from the target. The system is intended to counter the threat of low-level supersonic attack aircraft and missiles of the Soviet Styx-type. It will be employed operationally during the mid-70s aboard the new DXG/DXGN conventional and nuclear-guided missile frigates.

The CAT mystery a long way from solution

A top official in the new Federal clear air turbulence (CAT) research program is pessimistic of early success for reliable detection and prediction of the phenomenon. CAT buffets airliners and other aircraft without warning, sometimes severely enough to damage the craft. A long recognized but not understood hazard, it is now the subject of a five-year study called the "Federal Plan for Clear Air Turbulence." The broad attack to extend fundamental knowledge of CAT is being waged by NASA and the Departments of Defense and Transportation. Over-all coordination is being conducted by the Environmental Science Services Administration (ESSA).

Total fiscal 1970 funding for the study is only about \$4-million, according to Clayton Jensen, chief of ESSA's Federal Plans and Coordination Div. "The trouble with the whole research funding is that scientists view the chance of achieving success—to detect and predict CAT—as being very low," he says, "and no one likes to fund a program whose chance of success is so low."

Lean industry seeks space-shuttle program

Both a manned space-station program and a recoverable space-shuttle program are necessary to bolster a steadily weakening U. S. aerospace industry, say a majority of manufacturing representatives in Washington. And they expect President Nixon to announce approval soon to proceed with both efforts as goals during the 1970s. This would assure sufficient total expenditures (at least \$10-billion) to hold the industry together, say the reps. While most of those polled by ELECTRONIC DESIGN had been confident for some time of a continuation, in some form, of manned orbital stations, they were less optimistic over Administration approval of the shuttle vehicle.

The President's anticipated disclosure of a plan to continue with a balanced manned and unmanned space program will come on the heels of a pessimistic annual market summary prepared by the Aerospace Industry Association. In its report, AIA showed a sales decline in 1969 of 4.1%, for a total of \$28.3-billion. Further, AIA predict a sales drop in 1970 of over 2%. The association attributes losses to reductions in military, NASA and commercial aircraft procurements.

In a world that offers a million different connectors, who needs 7 more?

We don't want to complicate your life.
We want to make it easier for you.

And we think these 7 printed circuit
connectors are just the ones that can do it.

Each one started as a special order for a
customer like Univac, Automatic Electric,
or Mohawk. Each had so many possibilities
that we got permission to make them for
everybody.

So here's the biggest little line of connec-
tors in the business. Utterly unique, not
available as standard items anywhere else.

216-pin, 8-position

196-pin, 2-position

44-pin, 1-position

27-pin, 1-position

220-pin, 5-position

All connectors are made with our famous
welded gold-dot contact design that puts
gold only where it's needed, yet holds
contact resistance below 5mV drop
at 5A.

Until recently, you couldn't
buy off-the-shelf connectors
like these for love or money.

You still can't buy them
for love. Sylvania Metals &
Chemicals, Parts Division,
Warren, Pennsylvania 16365:

98-pin,
1-position

40-pin, male-connecting module

SYLVANIA
GENERAL TELEPHONE & ELECTRONICS

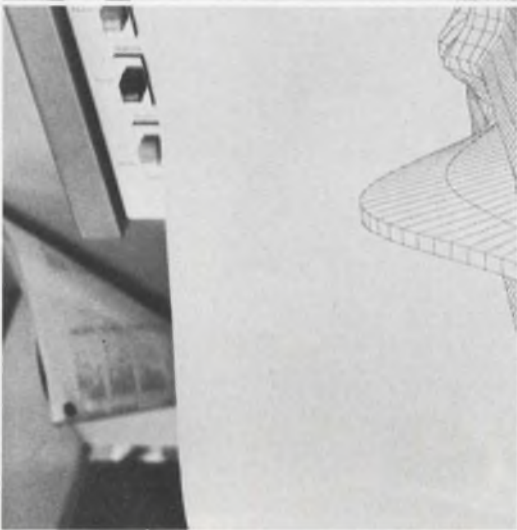
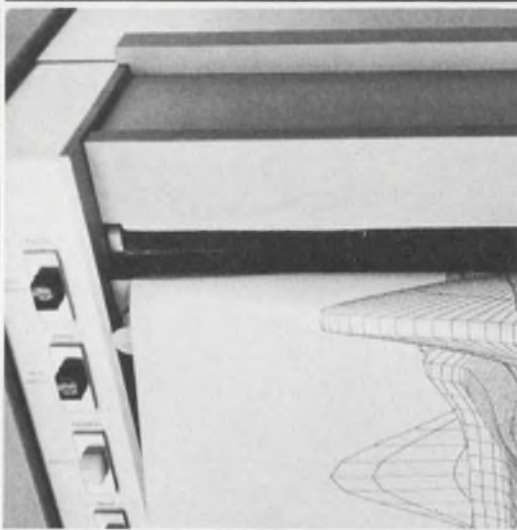
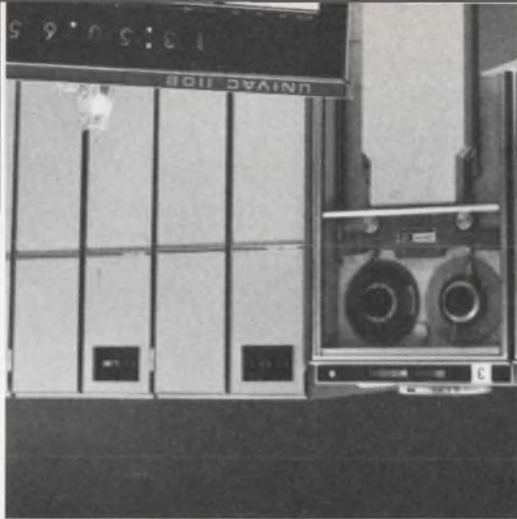

"The Clevite electrostatic printer increases our printout capability anywhere from eight to two hundred times."

That's how Mr. Stanley Y. Curry, President of Chi Corporation sums up their experience with the Clevite 4800 hardcopy printer.

A Cleveland-based computer service firm founded by Case Western Reserve University, Chi wanted a fast, versatile printer to complement its third generation Univac 1108. Chi uses its Clevite 4800 printer to perform a wide variety of highly sophisticated scientific and engineering computations, for both the university and over 100 customers currently using the firm's many services.

Here are some more of Mr. Curry's observations . . .

"We use the Clevite 4800 in three principle areas . . . text editing; intermixing text and pictures; circuit diagrams, plotting and perspective drawings. Currently, we're experimenting with applying it to our billing procedures and are exploring its use for high-speed label printing. It looks as if the printer is useful for just about any output.

"Take text, for example. The 4800 is ideal because of the speed with which it provides copies. Change, delete, add, then program the computer accordingly. Almost instantly the electrostatic printer provides a clean copy of the edited material.

"Our experience with core dump has been quite impressive. Here is an area where the printer's diagnostic

ability really comes to play. Our computer stores some four million binary bits of information, and core dumping used to take around twenty minutes.

With the Clevite Printer, we're now completing a core dump in just two minutes," Mr. Curry concludes.

MORE FACTS ON THE CLEVITE 4800

Clevite 4800 reproduces signals from any source of digital input or data transmission by telemetry, radio microwave, and/or land line. It produces accurate printouts of both alphanumeric and graphics almost as fast as the computer supplies them.

A productivity rate of 412,000 characters per minute means fast-acting computers are no longer hampered by mechanical equipment, noisily hammering out a few hundred lines per minute.

No other printer gets as much out of your computer as fast as Clevite 4800. And no other printer is so economical. The Clevite 4800 reduces capital investment, because conventional equipment costs more per unit. Also, there are few moving parts, reducing the need for constant maintenance and servicing.

Clevite 4800. It's faster, more versatile, quieter, and more dependable than anything else you can buy.

Drop us a line to find out how it fits into your computer room. Graphics Division, Gould Inc., 3631

Perkins Ave., Cleveland, Ohio 44114.

GOULD CLEVITE

Clevite 4800. The next generation of high-speed printers.

LOWEST COST . . . FULL WAVE BRIDGE RECTIFIERS & ASSEMBLIES

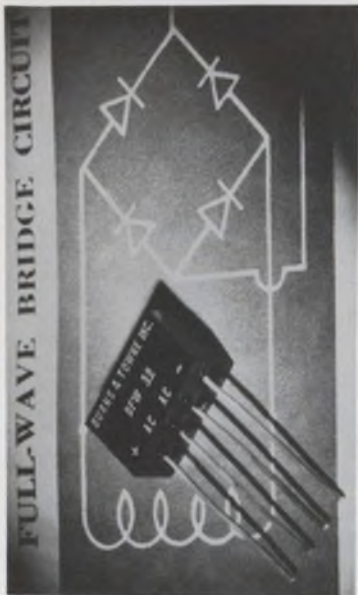

Burns & Towne pre-packaged rectifier circuits represent a significant cost savings over individual components used in multi-rectifier units. Yet, you are always assured of quality and reliability. The low cost BFW family of single phase full wave bridges . . . features high current capability of up to 2.0 amps.

Part No.	Max. PRV (volts)
BFW-50	50
BFW-100	100
BFW-200	200
BFW-300	300
BFW-400	400
BFW-500	500
BFW-600	600
BFW-800	800
BFW-1000	1000

Call or write for full specifications and price data.

Contact Fred Seigel

BURNS & TOWNE INC.
18-36 Granite St.
Haverhill, Mass. 01830. Tel (617) 373-1333

SIDELIGHTS

Our gal Nell goes to Las Vegas

Our West Coast Editor Elizabeth deAtley learned, while gathering material for a story on electronics in gambling (p. 24), that a game in one Las Vegas casino draws no house percentage. Proceeds, if any, go to charity.

Called Stakes and Odds, the game is part of a research project conducted by University of Michigan Prof. Ward Edwards. It uses a roulette wheel, a computer, and a CRT display. When the gambler presses a button, his choice is recorded on tape and sent to the university for analysis. The aim is to study the decisions people make under conditions of risk.

So far the game is in the red—not lively enough, says Johnny Ponticello who runs it. It is financed by a private foundation. The casino contributes its space and employees' time.



All in a day's work for West Coast Editor Elizabeth deAtley.

Growing role of floating airfields

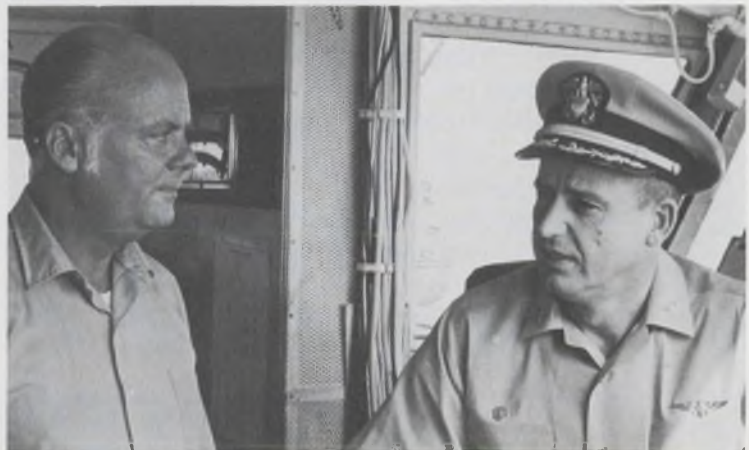

With overseas land bases shrinking, the Navy is modernizing its aircraft carrier force. Military-Aerospace Editor John F. Mason was flown to the carrier Roosevelt in the Atlantic. Here Capt. H. S. Sellers (right) briefs him on facts that will appear in the report on p. 58.

Cermet

AND THE

Model 3252

TRIMPOTTM POTENTIOMETER

Meets or exceeds MIL-R-22097, Style RJ-22
TC 100 PPM/°C over entire resistance and temperature range*

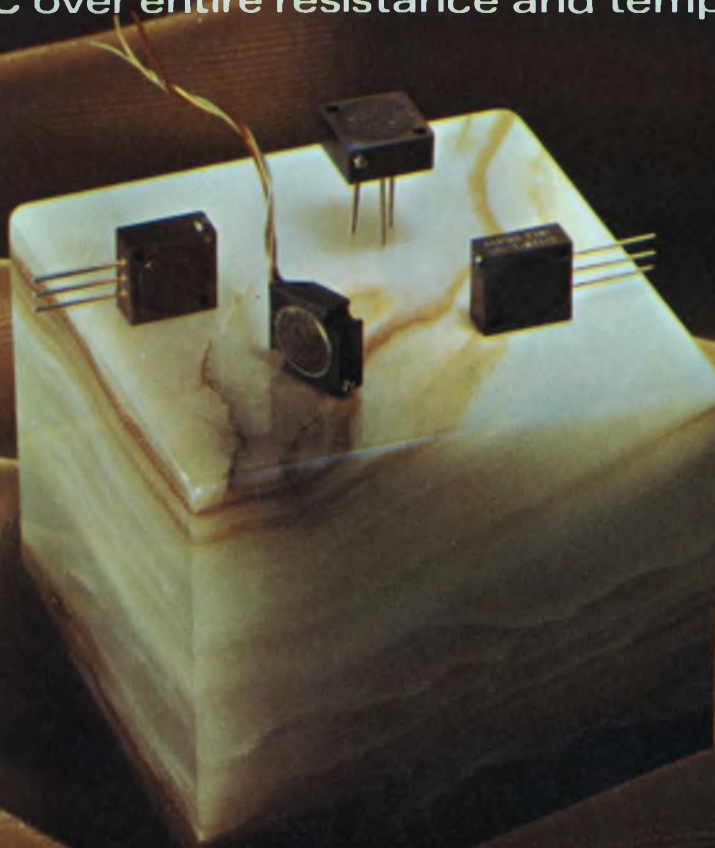

Why settle for less than the best in 1/2 inch square potentiometers? Specify units from the leaders in the field . . . potentiometers backed by years of engineering and manufacturing know-how . . . from Bourns, a company built on the concept of quality and service. Write or call the factory, your local field office or representative today for complete technical details.

*Resistance range: 10Ω to 2 Megohms
Temperature range: -65°C to +150°C



TRW Semiconductors *controls motion*

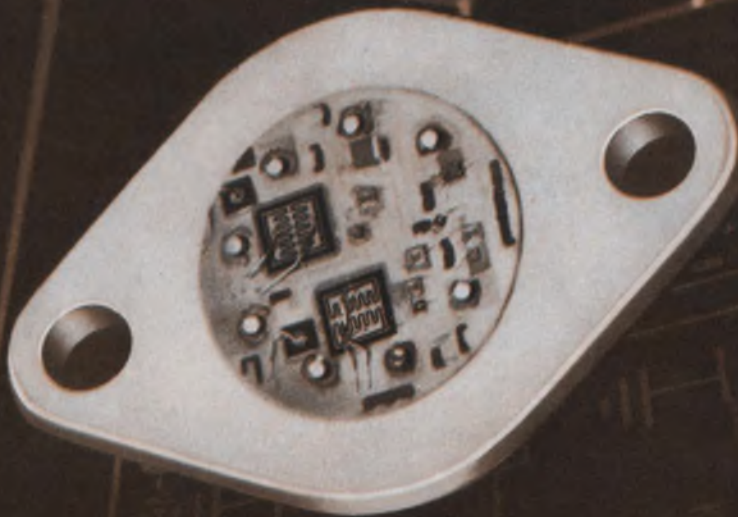

200 Watts Output...90% Efficiency...0.1% Linearity

TRW announces a hybrid switching mode amplifier that delivers 200 watts output power from an 8-pin TO-3 package. It represents an 8:1 size reduction over equivalent discrete component class B amplifiers.

Intended primarily for use in motor drive applications, these amplifiers provide a highly linear

current drive control system even when operated from an unregulated power supply. They utilize high speed switching techniques (10 amps output current in 500 ns) to implement the pulse width modulation operation.

For further information, including theory of operation and appli-

cations assistance, contact TRW Semiconductors Division, 14520 Aviation Blvd., Lawndale, Calif. 90260. Phone: (213) 679-4561. TWX: 910-325-6206.

TRW[®]

INFORMATION RETRIEVAL NUMBER 32

Publisher

Hugh R. Roome

Editors

New York Office
850 Third Ave.
N.Y., N.Y., 10022
(212) 751-5530

Editor, Howard Bierman
Managing Editor, Frank Egan
Computers, Milton J. Lowenstein
Circuits, Don Mennie
Microwaves, Michael J. Riezenman
Microelectronics, Raymond D. Speer
Management, Richard L. Turmail
News Chief, Ralph Dobriner
News, John N. Kessler
Military-Aerospace, John F. Mason
New Products, Roger Allan
New Products, Lucinda Mattera
Directory Manager, Greg Guercio
Copy, Marion Allen

Field Offices

Washington

Charles D. LaFond
P.O. Box 138
Burke, Va. 22015
(702) 461-7210

Massachusetts

Jim McDermott
P.O. Box 470
Easthampton, Mass. 01027
(413) 527-3643

San Francisco

Elizabeth de Atley
2051 Wellesley St. (Suite D)
Palo Alto, Calif. 94306
(415) 321-7438

Los Angeles

David Kaye
2930 Imperial Highway
Inglewood, Calif. 90303
(213) 757-0183

Editorial Production

Dollie S. Viebig
Richard D. Grissom

Art

Art Director, Clifford M. Gardiner
Assistant, William Kelly
Rita Jendrzewski
Lynn Thompson
JoJo Miskimmon

Production

Manager, Thomas V. Sedita
Helen De Polo
Kathleen McConkey
Leslie Stein

Circulation

Manager, Nancy L. Merritt

Information Retrieval

Genate Piccinetti

EDITORIAL



Be your own boss this year— you and your job will benefit

We keep hearing in various ways that the working engineer is an economic slave. Bosses should "motivate" their workers, some say—that is, induce them to work longer hours for less pay and like it. Engineers should organize, say others, and force their bosses to pay more money for shorter hours. Always the spotlight is on the boss. He holds the strings, and the worker puppets either dance or try to make him dance.

But is the boss really that important? Who signed your time card last year? He or someone else in the same chair? In this kaleidoscopic world of electronics, everything is transient—particularly bosses. The only thing you have to count on is yourself.

What do you want out of your job? A safe haven that pays enough to keep your family in relative comfort without straining you too much? If so, your work will seem hard and your hours long. You will always be trying to make yourself take dull courses to fight the feeling that you are a back number. And you will be afraid. You will fear the layoffs, the younger fellows and, of course, the boss.

But suppose you choose to live dangerously, to go after the high stakes—the opportunity to create something, to lead others, to make money? Then you will be less aware of your fear and more aware of life around you. From your vantage point in the driver's seat, you can look at the world, see what it needs and decide how you can fill that need.

Put yourself in the limelight. Don't wait for your boss to discover your talents and tell you how to use them. Act as if you had all the talents you need. Give a paper before a company seminar or write an article. Work out a new application for one of your company's products. Discuss it with your boss or work it out on your own time, if necessary. And when the criticism comes—as it surely will—evaluate it and learn from it, for negative feedback is as vital to people as to machines. But don't stop trying!

And if, in the end, the job is too small, change it. You're the boss.

ELIZABETH DEATLEY

Until now, designing with mercury relays meant taking the good with the bad. The trade-off for long life, high-speed closure and no contact bounce has been a bulky package (about $\frac{3}{4}$ cu. in.) that must be babied in a vertical position.

But not any more! Now Logcell® Mercury Film Relays offer all the advantages of mercury-wetted relays . . . plus miniature size (0.06 cu. in.), operation in **any** mounting position, and shock and vibration resistance suitable for many airborne, marine and other mobile applications.

Whether you require the specific advantages of mercury relays for computer logic circuits, advanced instrumentation or high-speed control systems . . . or just need a tiny rugged relay that will last and last and last, consider Logcells:

- Long life — units tested to billions of cycles
- No contact bounce
- Operation in any mounting plane
- Form "C" SPDT contacts
- Fast operating time — 2 ms
- No measurable AC contact noise
- Thermal noise less than 0.2 microvolt
- Switches dry circuits to 1 amp at 0-6 volts
- Inherent contact memory — requires no holding current (mono-stable models also available)

For complete information about revolutionary new Logcell Mercury Film Relays — and Logcell Mercury Film Switches — write Fifth Dimension Inc., Box 483, Princeton, New Jersey 08540 or call (609) 924-5990.



Also ask about our red, white and blue specifications which match Logcell performance and cost to your application.



FIFTH DIMENSION INC.

here at last . . .

a miniature mercury relay that operates IN ANY POSITION

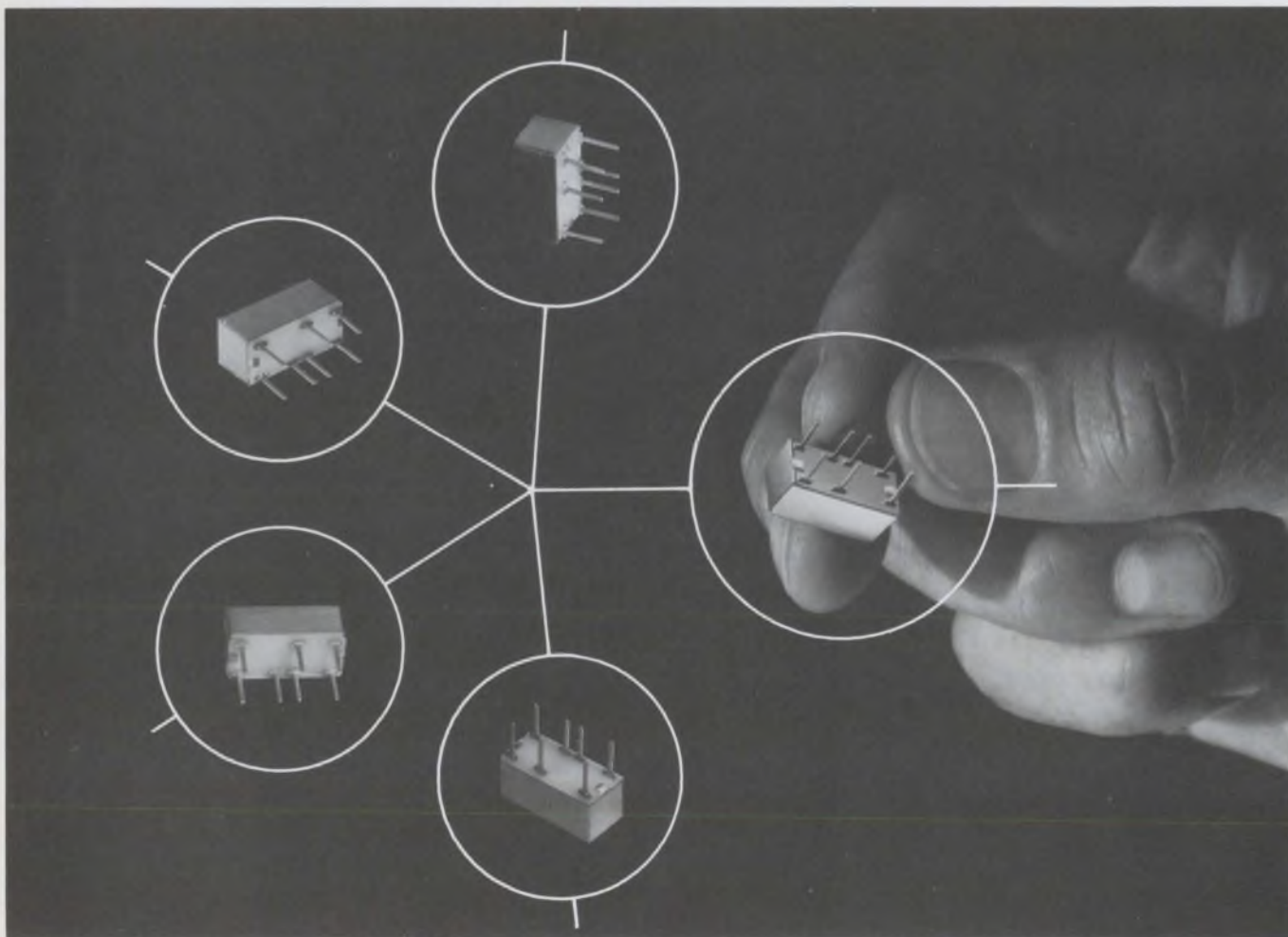



**NOW THAT THE PRICE IS LESS,
IT'S WORTH MORE.**



Our V3 Miniature Switches have always provided superior quality – at a little higher cost to you. So even though they won out on performance, they sometimes lost out on price.

Now we've come up with new ways to lower our prices. Without lowering quality. The result: a more favorable quality-to-price ratio. A better value all around.

Our new lower list prices and revised discounts will mean new cost savings in present and future applications. And perhaps new opportunities for us to serve you.

With more than 500 different design variations—in circuitry, electrical capacity, actuators, terminals, and resistance to various environments – V3 Switches offer you the ultimate in design freedom. Plus the kind of uniform quality that has put several V3's on the Military Qualifications Approval List.

Find out how the V3's new lower price can make them worth more to you. Call your nearest MICRO SWITCH branch office or distributor (Yellow Pages, "Switches, Electric"). Or write for Catalog 50.

MICRO SWITCH

FREEPORT, ILLINOIS 61032

A DIVISION OF HONEYWELL

THE PRACTICAL REFERENCE SHELF

FUNDAMENTALS OF INTEGRATED CIRCUITS

Lothar Stern

A practical guide to integrated circuits — their theory, manufacture and applications. This book offers complete discussion of the various techniques of integrated circuit fabrication and their strong influence on circuit design and performance. From a marketing viewpoint, it compares the relative qualities of the numerous IC's devised to date in terms of economics and logistics.

The book covers basic semiconductor principles, monolithic integrated circuits, thin-film circuits and their characteristics, hybrid and other integrated structures. There is also discussion of packaging, design and layout principles, and LSI. A volume in the *Motorola Series in Solid-State Electronics*. 208 pages, 7 x 10, illustrated, cloth cover.

#5695 \$8.95

LEVEL-HEADED LETTERS

Dr. Dugan Laird and Joseph R. Hayes.

Will help the executive to write better letters, faster. In practical, down-to-earth style, this book shows how to find the real reasons for writing; provides a simple plan for organizing ideas logically and psychologically, and points out ways to get affirmative responses from readers. Shows how to avoid cliches, verbiage and how to inject an air of informality into letters. Key feature is the programmed learning section on painless grammar. 134 pages, 6 x 9.

Paper cover, #5032 \$3.50
Cloth cover, #5033 \$4.95

PROJECT ESTIMATING BY ENGINEERING METHODS

Paul F. Gallagher.

A practical approach to attaining consistently accurate estimates by summarizing many general practices and introducing specific methods proven valuable in various kinds of work. Five methods of estimating are discussed, the fifth of which combines the two most important developments in the field: standard hours and the learning curve. To insure complete understanding, full coverage is given to construction and use of learning curves. Nearly 100 pages of learning curve tables appear in the appendix. 344 pages, 8½ x 11, illustrated, cloth cover.

#5018 \$15.00

PRACTICAL PA GUIDEBOOK: HOW TO INSTALL, OPERATE AND SERVICE PUBLIC ADDRESS SYSTEMS

Norman H. Crowhurst

A practical guide covering all aspects of the subject. The book shows how to select and install the appropriate equipment, covers routine operation and maintenance of the finished system. Special attention is given to solving the problems encountered in providing successful service. 136 pp., 6 x 9, illus., paper.

#0778 \$4.45

THEORY AND APPLICATIONS OF TOPOLOGICAL AND MATRIX METHODS

Keats A. Pullen.

The dependence of electrical circuit theory on topology (theory of line graphs) is of growing importance because line graphs for networks represent their flow patterns. Application of topological methods has lagged behind the use of matrix methods only because of minor application problems. This volume resolves these problems in a logical and understandable way. 100 pages, 5½ x 8½, paper cover.

#0300 \$2.50

INDUSTRIAL STROBOSCOPY

Gilbert Kivenson.

A comprehensive description of the history, development and use of stroboscopy in industry, commerce and research. Stroboscopy for analysis and measurement has spread to many specialized areas of science and engineering, such as high-speed cinematography, photometry, radiometry, torsional vibration and other areas. This book discusses the state of the art today and areas of further usage. 284 pages, 6 x 9, illustrated, cloth cover.

#5045 \$9.95

DESIGN OF LOW-NOISE TRANSISTOR INPUT CIRCUITS

William A. Rheinfelder.

Design engineers and others interested in low-noise circuit design will find this book a real time saver. Gives a multitude of labor saving graphs and design curves for the practical circuit designer. Simple derivations of all important formulas help the reader obtain a deeper insight into the fundamentals of practical low-noise design. 128 pages, 6 x 9, illustrated, cloth cover.

#5014 \$6.50

WAVEFORM MEASUREMENTS

Rufus P. Turner.

Complete how-to information on the various techniques of electrical waveform measurement—from troubleshooting to signal synthesis. Book details procedures for the isolation and measurement of a single harmonic from a multisignal mixture, measurement of total distortion, calculation of harmonic values from heights of the wave patterns, etc. 96 pages, 5¾ x 8¼, illustrated, paper cover.

#0775 \$2.95

UNDERSTANDING SILICON CONTROLLED RECTIFIERS

Saul Heller

A compact, illustrated guide to the capabilities and operation of the versatile SCR and the triggering circuits associated with these devices. Throughout the book, schematic diagrams illustrate the application of the various SCR's as static switches, phase-control switches, inverters, choppers, etc. Emphasis is placed on choosing the right SCR to do a given job. 134 pages, 5¾ x 8¼, illustrated, paper cover.

#0782 \$3.95

TRANSISTOR AND DIODE NETWORK PROBLEMS AND SOLUTIONS

Harry E. Stockman.

This two-way reference demonstrates the practical application of theory and serves as sourcebook of step-by-step mathematical solutions to practical problems. With schematic situations covering the entire field of transistor and diode networks, the reader develops effective techniques by comparing his own solution methods with the author's. 352 pages, 6 x 9, illustrated.

#5694 \$9.95

TRANSISTOR AND DIODE LABORATORY COURSE

Harry E. Stockman

Structured on engineering concepts and facts, this new course first provides a groundwork in transistor technology. Two-part theory viewpoints are applied continuously to give the work an engineering slant. The balance of the experiments deal with more intricate transistor networks, such as the theory and operation of multivibrators, and the concept of parametric action. 128 pages, 7¼ x 10, illus.

#5671 \$3.95

REVIEW ANY OF THESE BOOKS FOR 10 FULL DAYS—FREE!

HAYDEN BOOK COMPANY, INC. 116 W. 14 St., N. Y., N. Y. 10011

Please send me the books circled below, on a 10-day free examination. At the end of that time I will remit payment, plus postage, or return the books without obligation.

5695	0778	5014
5694	5032	0775
5671	5033	0782
5018	0300	5045

Payment enclosed (Hayden pays postage). Same return privilege.

Name _____

Firm _____

Address _____

City _____ State _____ Zip _____

On all overseas orders, payment in U.S. dollars must be enclosed. Publisher pays postage with same return privilege.

ED-270

Our center of attraction.

We're the only ones with .050 centers in our flat conductor cable connectors. We're the only ones with a metal shell to protect that fragile connector. And the only one whose connector will mate with any existing version. (No matter what type of wire is used.) Interchangeable. Intermountable. You can use them with any of your retrofit projects. And should repair be necessary, modular construction makes them easily repairable in the field. They can even be potted for environmental sealing. It's the newest idea yet in flat cable connectors. One more thing. We're trying to come up with a name for this connector. Something better than Flat Conductor Cable Connector. If you can think of a name we can use, it's worth a case of booze. And even if you don't win the booze, we'll be happy to send a genuine certificate recognizing your idea.

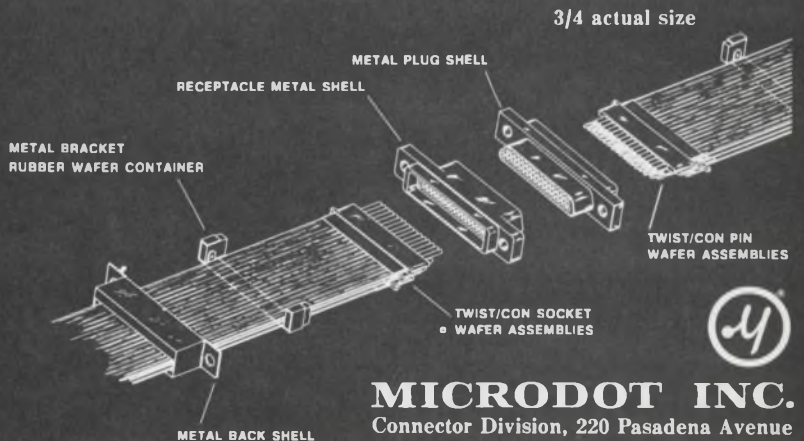

MICRODOT INC.
Connector Division, 220 Pasadena Avenue
South Pasadena, California 91030

Dielectric Fluid Problems

Seaton-Wilson solves fluid contamination problems you haven't been able to detect yet

If you are involved with high voltages in tight packages, the dielectric fluid you use probably isn't performing the job you thought it was.

The above statement is not an attempt to degrade the excellent quality of the most widely used dielectric fluids, which are listed here. The graphs on this page are to illustrate the alarming rate of voltage breakdown when dielectric fluids become contaminated

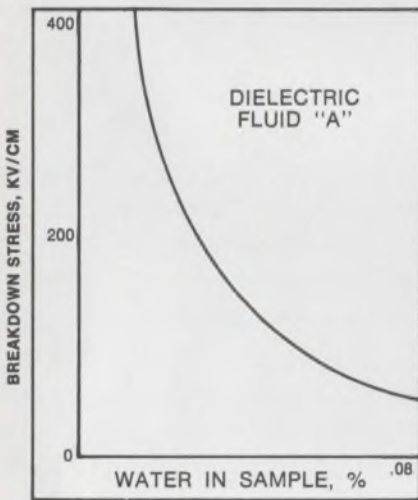

with water, dirt and — last but not least — dissolved air, the unseen contaminant which is the most difficult to detect.

The sharp downward curve in the first graph charts the loss of dielectric strength when Fluid "A" is contaminated with water. The independent test results on Fluid "B" similarly illustrate the debilitating effects of dirt as a contaminant.

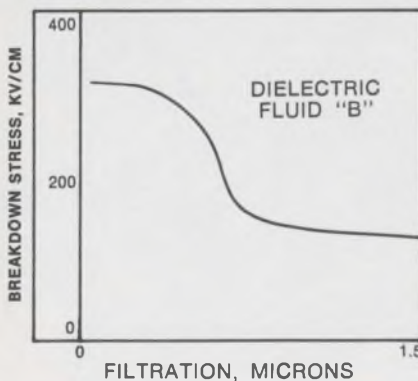

But it is in the little explored area of dissolved air that the trickiest problems arise. This contaminant is invisible and weightless. The below listing on this page spells out the dissolved air content of popular dielectric fluids as they are delivered to you.

SATURATED AIR VALUES

UNIVOLT 33	10%
UNIVOLT N34	10%
DIALA OIL-AX	10%
WEMCO C	10%
WEMCO CI	10%
STANDARD IOCA	10%
G.E.-10C	10%
THERMINOL FR-1	5%
THERMINOL FR-2	5%
CASTOR OIL	4%
COOLANOL 25	14%
COOLANOL 35	14%
FREON TF	40%
SILICONE DC200	20%

The graph on Fluid "C" translates these percentages into a curve which may be compared for effectiveness with the lower curve in the same graph showing the dielectric strength of air only. It is the large murky area in between where the potential danger lies, through fluctuating percentages of entrained and dissolved

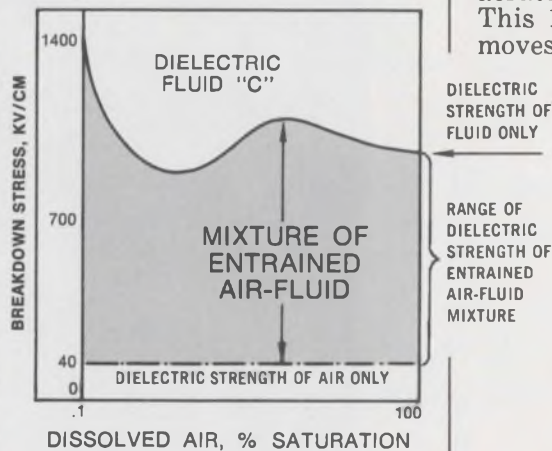

air content. Present quality control methods make it virtually impossible to determine if the fluid has really been bled of air.

Obviously, the threshold at which water, dirt and dissolved air will contaminate dielectric fluids to the point of permitting arcing depends on how tight a package you work with, your filling methods and present decontamination system, if any. It is readily apparent that total conditioning of dielectric fluids is necessary if optimum performance is to be obtained.



The demand for a single conditioning console which will solve all these problems has been mounting steadily. The answer has been provided by Seaton-Wilson's exclusive SAC-1002 Fluid Conditioner Console, designed to filter, dehumidify, deaerate, store and transfer fluid. This 11-gallon capacity unit removes solid contaminants and

water using a 5 micron, depth filter incorporating a molecular sieve. It deaerates most fluids to 2% dissolved air content by volume. Finally, the SAC-1002 provides a controlled vacuum for filling a closed system with *totally conditioned fluid*. Write for full capabilities data and complete specifications today.

SEATON-WILSON, INC.

SYSTRON + DONNER

911 NO. VICTORY BLVD., BURBANK, CALIF 91502 • TEL. (213) 849-3131

INFORMATION RETRIEVAL NUMBER 47

Here's a new way to make your own active filters.



You do it with a pencil.

My Active Filter application requires:

- Band pass filter with _____ center frequency and _____ band width.
- Low or high pass filter with _____ cut-off frequency and a Q of _____.
- More details. Please send me your new brochure.

Name _____
Title _____ Company _____
Street _____
City _____ State _____ Zip _____

Just fill this out. And mail it in.

We'll produce any number of quality active filters precisely to your parameters. And, we'll get them to you within 72 hours.

Our new Active Filter Group specializes in nothing but active filters. So, they'll be smaller, and probably better than the ones you've been making. No offense.

And, they'll be completely complete. No resistors or capacitors to add. No trimming required.

The clincher is, they're likely to cost you less money than your home-made jobs.

So, go ahead. Try this new way of making your own active filters. With a pencil. When they arrive, you'll have just one thing left to do. Plug them in.



COMPONENTS DIVISION
GENISCO TECHNOLOGY CORPORATION
18435 Susana Road
Compton, California 90221
(213) 774-1850



Makes the DIFFERENCE in MILLIMETER LNTWAs



● The difference is guaranteed performance. W-J's millimeter low-noise traveling-wave amplifiers provide the kind of performance usually found only in P-through X-band units. ● That means you have the advantages of low noise figure, high gain and high power output, plus the built-in reliability of integral power supply operation, at frequencies from 12 to 60 GHz.

Examples of these amplifiers are shown below. Variations in frequency, noise, gain and power are available for special applications.

Type	Frequency Range	Maximum Guaranteed Noise Figure	Minimum Guaranteed Small Signal Gain	Minimum Guaranteed Power Output	Size	Weight
WJ-371	12 - 18 GHz	9 dB	25 dB	+ 12 dBm	a	a
WJ-425	12 - 18 GHz	10 dB	25 dB	+ 10 dBm	b	b
WJ-3006	12 - 18 GHz	13 dB	30 dB	+ 20 dBm	a	a
WJ-393-6	18 - 26.5 GHz	11 dB	25 dB	0 dBm	a	a
WJ-393-8	18.5 - 20 GHz	9 dB	25 dB	0 dBm	a	a
*WJ-3000	18 - 40 GHz	14 dB	25 dB	+ 5 dBm	c	c
WJ-338	26.5 - 40 GHz	14 dB	25 dB	+ 3 dBm	c	c
WJ-338-5	34 - 36 GHz	13 dB	25 dB	+ 3 dBm	c	c
*WJ-449-1	40 - 50 GHz	17 dB	20 dB	+ 5 dBm	c	c
*WJ-449-2	40 - 60 GHz	19 dB	20 dB	+ 3 dBm	c	c
* Presently under development			a. 4.75 x 4.75 x 12	Inches	18 Pounds	
			b. 3 x 3 x 10.5	Inches	7 Pounds	
			c. 5.1 x 7.5 x 12.2	Inches	27 Pounds	



WATKINS-JOHNSON INTERNATIONAL

3333 HILLVIEW AVE., STANFORD INDUSTRIAL PARK, PALO ALTO, CALIF. 94304 • (415) 326-8830

INFORMATION RETRIEVAL NUMBER 49

Helipot slashes
voltage regulator prices
to

50%
\$

Now Models 809 and 859 Voltage Regulators are available
at \$5.82 each (1000 quantity) or \$8.95 (1-9) from local stock.

Beckman®

INSTRUMENTS, INC.
HELIPOT DIVISION
Fullerton, California 92634

INTERNATIONAL SUBSIDIARIES: AMSTERDAM; CAPE TOWN; GENEVA; GLENROTHES,
SCOTLAND; LONDON; MEXICO CITY; MUNICH; PARIS; STOCKHOLM; TOKYO; VIENNA

INFORMATION RETRIEVAL NUMBER 50



Airfield in the ocean...



Floating electronic isle

Story and photographs by John F. Mason, Military-Aerospace Editor

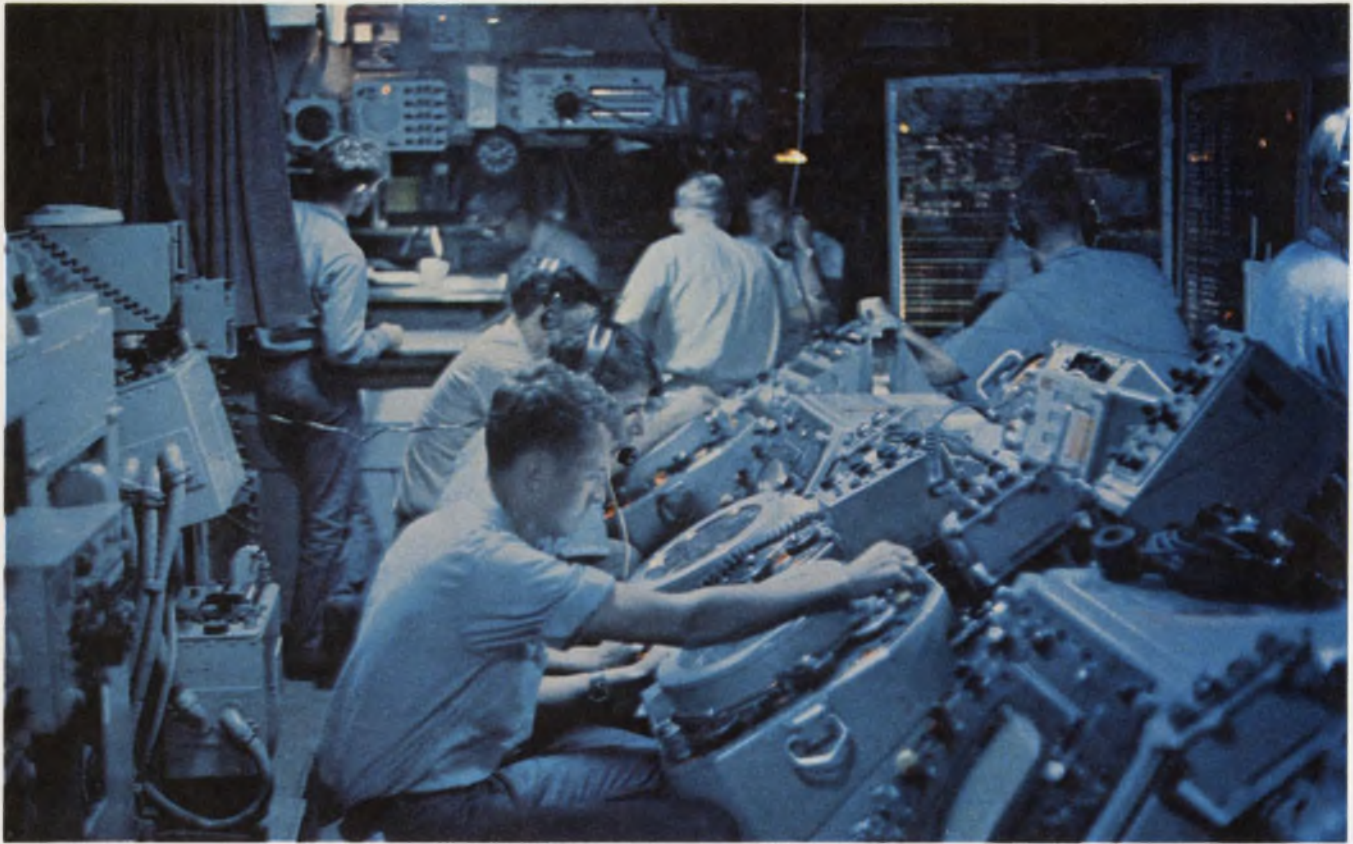

Combat Information Center on the Roosevelt keeps track of all enemy craft—sea and air—within radar range and

all friendly craft beyond 50 miles. Remote scopes enable operators to switch to almost any radar on board.

Aboard the aircraft carrier Franklin D. Roosevelt at sea

A tall, sandy-haired petty officer, who would look more at home on a basketball court than in front of a teletype machine, leans forward to watch the message clatter in. It's high priority, according to the initial code, from Atlantic Fleet Headquarters in Norfolk. The machine stops.

He tears off the original copy and writes "Captain" across the top and hands it to a communications messenger. "Rush," he says.

Other copies are also dispatched: one to the operations officer and one to the air intelligence officer. Two communications technicians stop putting addressee designations on routine messages coming in by high-frequency radios from shore stations and other ships. They step over to read the message:

Initiate a routine launch to investigate one or more unidentified surface ships. According to CL [cruiser] radar at 1000 hours, the target was 50 miles north northeast of Cape Canaveral, headed south. Photograph and fly film to Mayport Naval Station. Pilot will advise you by radio of target's description and identity. Please radio info to us."

Action is fast a hundred miles in the Atlantic off Jacksonville, Fla. In moments, loudspeakers are blaring: "Flight quarters—all hands man your flight quarters stations!" Some 400 to 500 crewmen go to their stations. And a maze of

electronics around the men lends support. A barrage of radios warms to the job. Radars eye the sky and surrounding sea. Computers search their memories. And displays light up softly in a dozen stations throughout the ship.

This is routine action on one of the most battle-proven aircraft carriers in the U.S. fleet, the 4500-man Franklin D. Roosevelt. During the prop-plane era an aircraft carrier was a floating airfield with a scattering of electronics; today, with high-speed jets, a carrier is a floating electronic system.

How does this myriad of electronics work, side by side, at the mercy of the wet, salty elements, hundreds of miles from the nearest maintenance depot? A visit to the Roosevelt turns up cheerful news for designers and electronics manufacturers: The equipment works surprisingly well most of the time. There are some bugs—tuners that tend to arc, radar components that desperately need labels for easy repair, software in a landing-radar system that could be better, and other largely minor shortcomings—but on the whole the electronics are doing just what they were designed to do. And, with planned improvements, they will do even better.

The new, high-performance aircraft require more efficient support. More automation is needed. Multifunctional gear is being sought. The gigantic carrier of today is becoming so crammed

with electronic equipment that "we now have to think about size for the first time," a Navy engineer says.

The mission begins

The operations officer notifies the air officer to get the flight deck ready and to pick an RF-8G photo-reconnaissance plane and a pilot for the job. The air intelligence officer looks through his files. If possible, he will show the pilot photographs of ships he might find. He will describe shipboard missile locations and how they look when they're camouflaged.

For the briefing, the initial message from Norfolk is typed on transparent tape and projected on displays in the ready room. Also displayed are flight and weather information.

The pilot calculates the probable position of the unidentified target—where it will be at five-minute intervals for the next hour—while the deck crew prepares the plane for flight.

Better and better equipment

On newer, updated carriers, like the John F. Kennedy, the more sophisticated RA-5C reconnaissance aircraft would be used. Besides photographic cameras, this Mach 2 twin-jet plane is equipped with infrared sensors, a sidelooking radar and a receiver-recorder that captures on tape electromagnetic signals from a target's radio, radar and electronic countermeasures equipment.

All aircraft with inertial navigation systems—including the more advanced fighter planes on the Roosevelt—must have their inertial systems aligned before take-off. Precise positioning is necessary. The attack planes need the precision to find their assigned targets and their way back to the carrier. And reconnaissance planes need to pinpoint the location of targets they find. So important is this precision that all carriers have been equipped for the job with the extremely accurate Ships Inertial Navigation System (SINS), developed originally for Polaris missile submarines.

But the alignment operation is unwieldy. Data from SINS, which is several decks below the flight deck, must be piped up to outlets on the hangar deck and the flight deck. From there, heavy umbilical cables must be attached to each aircraft, cluttering up an already congested deck and requiring 30 minutes or more to align each plane.

Although the SINS operator on the Roosevelt says he does not consider the cables an inconvenience, the Navy is working on a system whereby data will be transmitted by rf data link to receivers in the planes. Cables will be eliminated, and there will be no limit to the number of air-



Shipboard SPN-10 radar operator watches and gives corrections for pilot's glide-slope and azimuth errors.

craft inertial systems that can be aligned simultaneously. The job should take five minutes instead of 30.

A flying camera takes off

Now the RF-8G is ready on the Roosevelt's flight deck. Like a slingshot, the catapult thrusts the jet into flight. Three radars on the carrier sweep the sky as the craft heads to its target. One is the surface search radar—the AN/SPS-10C. The two others are air search radars: the SPS-37, very-long-range and two-dimensional, and the SPS-30, long-range and three-dimensional.

The recon plane finds the target—there are two ships, not one. Flying directly over them at 10,000 feet, the pilot takes his photographs. Fifty per cent of the mission is complete. Now the films must be delivered to the Mayport Naval Station near Jacksonville, Fla.

Some time later the recon plane returns to the Roosevelt. An air-traffic-control radar, the SPN-43, picks it up about 20 miles out. This radar helps guide the plane in until it is about four miles away. There, the SPN-10 landing radar takes over.

The shipboard controller in the carrier's Air Traffic Control Center watches the plane's glide-slope progress and its off-course error on

the landing radar, correcting the pilot orally for as little as a 10-foot error, until the plane is a half mile away. At this point the landing signal officer, standing at the end of the deck with radio equipment, takes over visually and talks the pilot down to the deck.

While the Roosevelt landing system must talk its planes down and then hand them off to the landing officer for visual guidance, the JFK has a fully automatic system. A radar linked to an autopilot flies the plane down to the deck without the pilot's help.

An intermediate, semi-automatic mode is also used on some carriers. Instead of controllers in the Air Traffic Control Center telling the pilot what to do, the shipboard radar information is sent to the aircraft by data link; it appears on a cross-hair display that guides the pilot down. The Roosevelt could go to this mode if it had a data link.

As the RF-8G comes screaming in, a hook trailing from the fuselage catches one of four cables lying across the Roosevelt's deck. The huge jet comes to a quick, minus-5g halt. Mission completed.

Throughout the recon plane's entire flight the Roosevelt's Combat Information Center was maintaining a close watch. This center is responsible for keeping track of all contacts—air, surface and subsurface—in the vicinity of the ship. Illuminating the relative darkness in the crowded

Superstructure of the Roosevelt is an electromagnetic clutter, providing space for more than 100 antennas.



room are remote radar displays that permit an operator to switch to almost every radar on the ship. Other illumination in the rooms comes from large, Plexiglas boards, on which crewmen, writing backwards with grease pencils, note the status of all craft that are spotted—their course, speed, probable destination, identity.

Friendly aircraft are plotted when they are more than 50 miles from the carrier; air-traffic control radar has them under surveillance when they are closer than that. Enemy aircraft are plotted at any range.

Had the message ordering reconnaissance photos of a target at sea been received by a more modern carrier than the Roosevelt—the JFK, say—the procedure would have differed slightly. Besides being delivered to the captain, the message would also have been taken to an Integrated Operation Intelligence Center, a large facility where data brought back by RA-5C reconnaissance aircraft is interpreted. The center has two computers for storing information, which can be recalled at the touch of a button to compare new data with old:

Was that sonobuoy there yesterday? Is that shore-based radar new? Has that ship that the RA-5C infrared sensor picked up been detected before?

The computer might answer: The sonobuoy was first seen a month ago. The radar appeared seven days ago. And a ship was detected by submarine sonar 20 minutes ago, five miles south of this position.

The Combat Information Center on the JFK and other advanced carriers is also more sophisticated; it employs the Naval Tactical Data System. Broadband rf data links between compatible computers on every ship in the task force permit quick exchange of all kinds of tactical data.

The main communications room on the Roosevelt, as well as on newer carriers, is still a manual facility. It may handle as many as 4000 messages a day, mostly routine, logistical exchanges and an occasional emergency message for a carrier crewman. Conventional high-frequency radios are used, both Westinghouse's WRT2 and Hoffman's URC32. The big problem, says an electronics maintenance chief on the Roosevelt, is with the tuners.

"They tend to arc," he says. "Plastic insulations have been known to melt during arcing."

The only complaint about the WRT2 is that "it's hard to get to the various parts in the power amplifier stage when repair work is necessary."

Besides hf radio, there is a low frequency transmitter for aircraft homing, a vhf for aircraft distress calls and uhf for talking with aircraft.

The Roosevelt's Pathfinder 1500 B short-range navigation radar (a half mile up to 32 miles),

built by Raytheon, is "a good radar with good resolution, but it doesn't stand up under continuous use," says Chief Petty Officer Richard R. Eaton, technician in the electronic environment section aboard the carrier.

"It just wasn't built to operate for a month at a time," he explains. "It is a commercial set designed for helping a ship's pilot make his final approach into port. But here, they use it for close maneuvering with ships and keeping an eye on the destroyers.

"We need a more rugged set, with better schematics, a better form of layout diagrams, and better instruction for alignment. It's a nightmare to repair, because only four or five components are labeled. If you want to look at something, you have to physically trace out all your components. It takes longer to find the component than to replace it.

"A military version was built and used in Vietnam, but its range was too short."

In describing a search radar, Eaton says: "The AN/SPS-10C, with a range between 1500 yards and 90 miles, is one of the most dependable radars we've got. It's so reliable that the only complaints we get are about the operator."

A modification under way on the SPS-10F version that is on the JFK is of particular interest to Lt. Cmdr. Cliff Laning, antiship missile defense coordinator for the Naval Ship Systems Command in Washington. The need is for a clear-

er radar picture at low elevation. Surface-to-surface cruise missiles, such as the Russian Styx, are low flyers and could be obscured by video clutter. The cure, Commander Laning says, is "a video clutter-suppression device that looks at the electronic environment around the radar and examines the clutter, whether it be from moisture in the air, the sea or land.

"It measures the returns from the clutter by determining the voltage level being displayed on the PPI scope," he notes. "After this, the radar will not display anything at that voltage level or below. It will display only higher voltages, which results in a clean scope except for the target."

A follow-on to the SPS-10F is being developed by Raytheon. It will move up in frequency to avoid interference with missile-control radar. Designated SPS-55, the new radar is being built with more solid-state components and will have a selectable circular polarization feature. This, it is hoped, will provide better visibility at greater ranges.

"We tried a number of things on the SPS-55 but most of them didn't turn out too well," says H. M. Nordenberg, section head for air-traffic-control, navigation and IFF (Identification, Friend or Foe) equipment in the Naval Ship System Command. "We tried dithering the frequency around a nominal frequency in the band, perhaps 30 MHz or 40 MHz, to try to cut down on sea return, but it didn't work because the

F-4 fighter rides up to the flight deck on giant elevator. The plane's inertial navigation system must be aligned

by unwieldy cables attached to the Ship's Inertial Navigation System. Later ships will have an rf data link.



The Navy's response to shelling by critics

The roughest battle for American carriers in recent years took place not on the high seas but in Congress last fall. Along with other weapon systems, the carrier was under attack from many quarters. There were Congressmen who felt another approach, or another kind of weapon, would be more efficient. Others said, "We have enough weapons." And still others had declared general war on what they called the "military-industrial complex."

The battle has subsided, but it may be far from over. So far, the pro-carrier forces are ahead.

The first nuclear-powered Nimitz carrier is fully funded—it will cost \$536-million. For a second such carrier, \$133-million has been funded for long lead-time items. Money for a third will be requested next year.

Aircraft for a carrier, according to Congressional testimony supplied by Admiral T. H. Moorer, amounts to \$409.5 million; if F-14s are bought instead of F-4s, the bill is \$200 million more. Four destroyers cost \$855 million bringing the cost for a group to about \$1,800 million.

In answer to critics who say that carriers are vulnerable to missile attack, Rear Admiral J. L. Holloway, head of the strike warfare division of the Office of the Chief of Naval Operations in Washington, and the program coordinator for development of the next generation of carriers, asserts: "Carriers have mobility plus protection by their own task force." Admiral Holloway also points out that carriers in the Gulf of Tonkin successfully operated beyond the range of the Soviet Styx, the surface-to-surface guided missile emplaced in sites in North Vietnam.

"No potential North Vietnamese missile landing platform, aircraft or PT boat has penetrated the U.S. carrier task force defense to within attack range of the carriers, the admiral notes.

Rear Admiral William D. Houser, Director of Aviation Plans and Requirements, says: "The carrier is gaining in importance, due to the somewhat less favorable position of the U.S. in terms of its overseas bases. As a floating airfield, the carrier is responsive to the orders of the President of the United States without negotiation with foreign countries."

Backing up this argument is the fact that in 1957 this country had 105 operational Air Force bases overseas. Now there are 35, with a big base in Libya soon to go.

"A major element of our foreign policy depends on having allies, who, in turn, depend on us for support," Admiral Holloway says. "To do this, we must have freedom of the seas. This calls for attack carriers. Also, our allies' forces are usually conventional, and they need air support. Our carriers can provide this."

waves don't really change that much from pulse to pulse."

One thing that was done, notes Capt. C. E. Martin, radar branch head of the Naval Ship Engineering Center in Washington, "was to put into the requirement a two-second tuning specification—the whole frequency range had to be searched in two seconds."

"We did this," he explains, "because we thought we'd have to shut down the radar while tuning it, and we couldn't afford to have it out very long. But we found that we could make the receiver follow the transmitter tuning, and the radar didn't go off at all. So, to reduce this added complexity, we decided to settle for a 30-second tuning capability.

"It really works well. To tune, you press a button, which causes it to tune automatically back and forth over the whole band. When you get the best picture, you take your finger off."

Of the Roosevelt's very-long-range search radar, the SPS-37, Chief Eaton says:

"It works well without problems, except that it's located near the stacks and the dipoles get dirty, causing them to arc or to short. This requires extra work keeping them clean.

"One bad thing about this radar is that a repeater in the circuitry causes the target to be chopped up on the scope. Every tenth sweep is used to form the cursor, thus leaving a blank strip in the target. Maybe someday someone will figure out a way to provide a cursor without sacrificing the video."

Instead of the SPS-37, most aircraft carriers use the SPS-43A, "a standard radar with no problems," Nordenberg says. "And it has a follow-on, the SPS-49, developed by Raytheon, but we haven't bought any yet."

The follow-on is L band, while the current one is uhf. "The disadvantage of uhf is that you can't operate near TV stations in certain channels," Nordenberg says. "We like a variety of frequencies, however, to make jamming more difficult for the enemy."

The uhf radar, which is for long range, is also being modified, Commander Laning says, to operate at short range, too—from 0 to 40 miles.

The Roosevelt's 3-D radar, the SPS-30, was replaced on the JFK, and will be on the Nimitz, by the SPS-48.

"The only maintenance problem with the old 3-D radar," Eaton says, "is that the dehydrator required to dry out moisture in the waveguide used the ship's regular low-pressure supply of air, and it was dirty. It contained both oil and water, requiring almost continuous maintenance. I think the radar should have its own pressurizing unit. All you need, after all, is a compressor and a desiccant or electric dryer."

Commander Laning says: "What we'd like for

the new SPS-48 is a moving target indicator, auto detection and auto tracking. This would enable us to eliminate the operator."

The AN/SPN-43 air-traffic-control radar that picks up incoming aircraft as far as 40 miles, evolved from one called the SPN-6. "We needed better performance to keep up with the high-performance jets," Nordenberg says. "We added a new transmitter, receiver and antenna reflector assembly. The new reflector—a cosecant squared antenna—enables us to cover from the horizon to 30,000 feet, as well as a 360° azimuth. The radar is all-solid-state, with a low-noise front end that operates at room temperature. It's not as quiet as a cooled device—sometimes the Varactor diodes in the preamplifier get noisy—but it's good enough for our needs, and we don't have

"An aircraft in that area wouldn't show up at all," Eaton says. "And this is the quadrant we use for final approach. We couldn't control the aircraft coming in."

Gilfillan engineers finally discovered two problems: The sensitivity time control [STC] circuit used to minimize sea return had a recovery time that was too long, and there was also quadrant blockage due to physical interference from another radar antenna. The STC had been set to reduce the gain for nearby targets, while increasing gain gradually with a parametric amplifier to cut in for targets at 12 miles on out to 25.

It was corrected by moving the blocking antenna and then modifying the trigger generator card, which controls the gain vs range on the STC. The STC curve on this radar, Nordenberg



to bother with liquid nitrogen cooling agents."

Chief Eaton on the Roosevelt says that every time the SPN-43 got a new modification, it became more like the SPN-6—"same resolution, same range, capability and picture size."

"We had a lot of problems with the SPN-43 in the beginning," he notes. "When we left port, it had a blind spot, poor resolution and a very short range—a maximum of 60 miles with an optimum range of 40 to 45 miles. A representative from the manufacturer, Gilfillan, came out and spent a month and a half going over the system, trying to isolate the problems. He went back, worked on it and sent another engineer out. The solutions were good."

The blind spot was in the southwest quadrant, from 8 miles to 17 miles.

explains, is a composite curve, consisting of two STC curves, one on the receiver i-f amplifier and one on the parametric amplifier. This was the first operational shipboard radar on which this technique was employed. The curve of the parametric amplifier is phased in with the other curve, with its additional gain at approximately 12 miles and with full gain at 25 miles.

The original design had the latter curve as a fixed value, with the dynamic range provided by verification of the first curve. However, the variations with installations, such as lengths of waveguide runs, proved to be too great. Therefore, as a "quick fix," the Roosevelt changed one resistor and one capacitor to change the time constant and eliminate the "hole" in the pattern.

"However, we are modifying the paramp STC



to provide adjustment for both starting point and rate-of-gain change with range as a permanent fix," Nordenberg notes.

The SPN-42, which takes over the job of landing the plane when it reaches a distance of four miles, takes a new approach to compensating for deck motion. Instead of using the computer's prediction for the position of the deck at time of touchdown, and bringing the plane down accordingly, the glide slope moves up and down with the pitch of the ramp. The reason for this is that the prediction method made the pilot nervous.

"It takes a lot of faith in the computer to look down at a rising deck and believe it will sink in time for you to make the proper touchdown," Nordenberg observes.

"Our main modification goal for the landing radar is to improve the software. We've got 120 aircraft and one landing system. It's easier to change the software for different landing requirements than the hardware.

"To make the aircraft show up better on the SPN-42 scope, we may put beacon transponders in the aircraft instead of relying on the passive corner reflectors we use now. This would improve the system's all-weather capability."

The auxiliary landing radar, the SPN-41, is a microwave scanning system that provides the pilot with a heads up, cross-pointer display in the cockpit. The Navy has ordered 23 systems from the producer, the AIL division of Cutler-Hammer—13 for carriers and 10 for shore-based landing strips.

The other radar that will go on the Nimitz is the SPN-44, a new solid-state, hand-steered doppler used for determining the airspeed of an approaching plane. The landing signal officer uses this information to decide whether or not the plane's flight characteristics are right for a successful landing. If they aren't, he turns a red light on, and the pilot goes around again.

"We'd like to have one radar to do everything, but instead, the Nimitz has four," says Jerry Hamilton, a Ship Systems Command engineer who is helping to plan the Nimitz class of carriers. Capt. James D. Small is project manager for developing these new ships.

Why isn't the Nimitz going to get a wrap-around, phased-array radar, like the one on the Enterprise? "It costs too much," Hamilton says. "Phased array is excellent for a carrier. All four sides of the island are covered, there's no mast to get in the way and cause a blind spot, and there are no moving dishes and mechanical failures. But phased arrays are custom-made and expensive. We had to use what was available off the shelf."

Nordenberg notes: "There has been talk of improving radar displays—bright displays that can be used in daylight on the bridge without the need for a hood. But there have been problems of getting adequate persistency without smearing. Also, there have been proposals for large-screen displays, but they would be in the Naval Tactical Display System room."

One innovation for the Nimitz will be an automatic test system that tells how the radars are working: whether they're being degraded and how they can be repaired. Called CATS (Computer Automated Test System), the system is being developed by the Naval Electronics Laboratory Center in San Diego.

Small-sized electronics needed

"The trend in all carrier electronics," Hamilton says, "is toward solid state in smaller packages, with small heat dissipation. Formerly we didn't worry about reduction in size because a carrier is a pretty big ship, but we're getting more and more equipment and have begun to think of size.

"Increased automation is calling for more computers and more memory capacity. We'd like to have integrated computers, or a system to which we could add more memory when the load became greater.

"The Nimitz is getting more computers to handle the increased automation. It will have 15 computers: two for the Integrated Operational Intelligence Center, six for the Naval Tactical Display System, three for the Message Processing and Distribution System, two for the SPN-42 radar, one for the Ships Inertial Navigation System and one for logistics.

"In building carriers beyond the Nimitz, the designers will probably look at all the automated operations on the ship, decide how much memory capacity is needed and buy a computer or a family of computers that can communicate with each."

The superstructure of a carrier, which may have to hold 100 antennas, can create a nightmare of electromagnetic interference.

"We've had problems with our radar antennas," a member of the engineering planning staff for Nimitz carriers concedes. "To minimize RFI we have reduced the side lobe and the back lobe of the antenna reflector. Or we put blinders on the feedhorn. This has been successful. It has also improved the performance of the radar itself, since it puts more energy back into the main lobe where you want it.

"The trend, of course, is to design antennas as part of the ship rather than putting them up after the ship is built.

No room at the top

"As for communications antennas, the maximum you can separate them is the length of the ship, about 1000 feet, but actually you're restricted to about 100 feet in the superstructure. This means a receiving antenna system will pick-up a lot of rf energy. Isolation between transmitting and receiving antenna systems is on the order of 15 to 20 dB attenuation. Sometimes it's down to 10 dB. Also, you get into the dynamic range problems of the receiver because of the large amount of rf energy present that can overload the front end. This creates spurious responses within the receiver. To preclude overloading problems, we go into a complicated frequency spacing and filtering system. If, for example, we have a receiver on 4 MHz and a transmitter on 4.5 MHz, we use a filter in front of the receiver that will reject the 4.5-MHz signals. This filter is part of the multicoupling system, which allows us to connect many receivers to one antenna. It allows fewer communications antennas to be used. Rather than one antenna per receiver, we could have as many as 8 to 15 receivers on one antenna. This is the manner in which larger ship communication designs are handled.

Instant tactical data

The Naval Tactical Data System on the JFK and the Nimitz does the work of the Combat Information Center on the Roosevelt. The difference is that the data system is automated and ties together an entire task force. One ship might detect a target and pass the information on to the display and computer of a ship with more appropriate weapons, or one in a more advantageous position to make the kill. The system is not new—the first was delivered to the Navy in 1959—but it's expensive and has been installed on only a few ships. When those vessels slated to get the system are finally equipped, the total will reach approximately 40.

But its success story has been phenomenal, according to Donald L. Ream, head of the Navy's Combat Systems Management Office in Washington. "It just won't wear out," he says. "In the old days we thought if you got 40,000 hours of life from equipment, it was great. We've got computers that have been running for 80,000 hours and are still good. We run them day and night. The equipment is two orders of magnitude better than projected.

"The biggest problem we have is finding components when we do need them, because the manufacturers stop producing them after the equipment is 10 years old. We have to pay a premium price for certain transistors today."

Two big innovations are being readied for carrier communications: Space is being reserved on the Nimitz for satellite communications equipment and for a new, computerized message processing and distribution system. Fully automatic, the latter system will speed the operation of the communications room and reduce its 100-man staff by 30. Instead of manual screening of messages for priorities, decoding and addresses, a computer will do the job. It will also log, file and send messages along to one or more of 10 remote terminals, which will display them on cathode-ray tubes or print them out on high-speed printers.

The message system, which is being developed by the Naval Electronics Laboratory Center in San Diego, is being installed piecemeal on the old attack aircraft carrier, the Bunker Hill, tied up in San Diego harbor. It is to undergo complete system testing late next summer. And by November, 1970, it will be ripped out, system by system, and sent to the Newport News Shipbuilding & Drydock Co. in Virginia for installation on the Nimitz.

The system uses a central general-purpose computer that accepts messages in teletypewriter code as digital data and then processes them. ■■





Now, ready for you in quantity.

The new Delco Radio DTS-701 and 702 NPN triple-diffused silicon high voltage transistors. They were designed for the tough requirements of off-line deflection in large screen TV.

However, they're built and tested for extra reliability in all high energy circuits. Proved by the surest peak energy capability rating in the business: Pulse Energy Testing.

And right now, they're available in both production and sample quantities.

Why will you want to use the Delco 701 or 702?

For the tough jobs—high inductive load switching or for circuits subject to transients or fault conditions.

For reduction of weight, size and component costs. Circuit complexity and number of components are reduced, so assembly costs go down, too. And fewer components mean higher reliability.

So now you know. The pioneer in high voltage silicon power has done it again.

For prices, samples or complete data, just call us or the nearest Delco Radio distributor listed below.

SEMICONDUCTOR DISTRIBUTORS

ALA., BIRMINGHAM • Forbes Distributing Company, Inc.
(205)-251-4104

ARIZ., PHOENIX • Sterling Electronics, Inc. (602)-258-4531
• Hyer/Cramer Electronics, Inc. (602)-263-1112

CAL., LOS ANGELES • Kierulff Electronics, Inc. (213)-685-5511
• Radio Products Sales, Inc. (213)-748-1271

CAL., PALO ALTO • Kierulff Electronics, Inc. (415)-968-6292

CAL., SAN DIEGO • Milo of California, Inc. (714)-232-8951

COLO., COLORADO SPRINGS • L. B. Walker Radio Co. (303)-636-1661

COLO., DENVER • L. B. Walker Radio Co. (303)-935-2406

COLO., ENGLEWOOD • Hyer/Cramer Electronics Inc. (303)-771-5285

FLA., MIAMI • Mountain Electronics, Division of
Mountain National Co. (305)-634-4556

FLA., WEST PALM BEACH • Mountain Electronics, Division of
Mountain National Co. (305)-833-5701

ILL., ROSEMONT • F-J-R/Midwest, Inc. (312)-678-8560

ILL., SKOKIE • Merquip Electronics, Inc. (312)-282-5400

IND., INDIANAPOLIS • Graham Electronics Supply, Inc.
(317)-634-8486

MD., BALTIMORE • Radio Electric Service Co. (301)-823-0070

MASS., NEWTON • The Greene Shaw Co., Inc. (617)-969-8900

MICH., KALAMAZOO • Electronic Supply Corp. (616)-381-4626

MINN., MINNEAPOLIS • Stark Electronics Supply Co. (612)-332-1325

MO., KANSAS CITY • Walters Radio Supply, Inc. (816)-531-7015

MO., ST. LOUIS • Electronic Components for Industry Co.
(314)-647-5505



1200V - 3.0A
800V - 0.5A

DTS-701	
Collector to emitter voltage (V_{CE0})	800V
Sustaining voltage ($V_{CE0(SUS)}$)	600V min.
Emitter to base voltage (V_{EBO})	5V
Collector current (I_C)	500mA
Base current (I_B)	100mA
Power dissipation (P_T)	25W

DTS-702	
Collector to emitter voltage (V_{CEX})	1200V
Collector to emitter voltage (V_{CE0})	1000V
Sustaining voltage ($V_{CE0(SUS)}$)	750V min.
Emitter to base voltage (V_{EBO})	5V
Collector current (I_C)	3A
Base current (I_B)	1A
Power dissipation (P_T)	50W

Available in solid copper. JEDEC TO-3 package.

Kokomoan's Regional Headquarters

Union, New Jersey* 07083
Box 1018 Chestnut Station
(201) 687-3770

Chicago, Illinois* 60656
5151 N. Harlem Avenue
(312) 775-5411

Santa Monica, Calif.* 90401
726 Santa Monica Blvd.
(213) 870-8807

Detroit, Michigan 48202
57 Harper Avenue
(313) 873-6560

Kokomo, Ind. 46901
700 E. Firmin
(317) 459-2175 Home Office

*Office includes field lab
and resident engineer
for application assistance.



THE KOKOMOANS ARE IN POWER

DELCO RADIO

DIVISION OF GENERAL MOTORS

KOKOMO, INDIANA

N.J. CLIFTON • Eastern Radio Corporation (201)-471-6600
N.M., ALBUQUERQUE • Hyer/Cramer Electronics Inc. (505)-265-5767
• Sterling Electronics Inc. (505)-247-2486
N.Y., BINGHAMTON • Federal Electronics, Inc. (607)-748-8211
N.Y., NEW YORK • Harvey Radio Co., Inc. (212)-582-2590
N.Y., WOODBURY, L.I. • Harvey Radio Company, Inc. (516)-921-8700
OHIO, CINCINNATI • United Radio, Inc. (513)-761-4030
OHIO, CLEVELAND • The W. M. Pattison Supply Co., Industrial
Electronics Division (216)-441-3000
OHIO, DAYTON • F-J-R/Ohio, Inc. (513)-278-9411
OKLA., OKLAHOMA CITY • Radio, Inc. (405)-235-1551
OKLA., TULSA • Radio, Inc. (918)-587-9123

PENN., PHILADELPHIA • Almo Electronics, Division of
Sterling Electronics (215)-676-6000
PENN., PITTSBURGH • RPC Electronics (412)-782-3770
TEXAS, DALLAS • Adleta Electronics Company (214)-742-8257
TEXAS, FORT WORTH • Adleta Electronics Co. (817)-336-7446
TEXAS, HOUSTON • Harrison Equipment Co., Inc. (713)-224-9131
UTAH, SALT LAKE CITY • Hyer/Cramer Electronics Inc. (801)-487-3681
VA., RICHMOND • Meridian Electronics, Inc., a Sterling Electronics
Company (703)-353-6648
WASH., SEATTLE • Kierulff Electronics, Inc. (206)-763-1550
WASH., TACOMA • C & G Electronics Co. (206)-272-3181
CANADA, ONT., SCARBOROUGH • Lake Engineering Co., Ltd.
(416)-751-5980

INFORMATION RETRIEVAL NUMBER 51

Go push-pull for magnetic deflection.

Despite yoke resistance changes caused by temperature, you'll get stable sweep amplitude and linearity.

Electromagnetic deflection of electron beams offers many advantages to the electronic designer. It costs less than electrostatic deflection, offers better bandwidth, requires much lower voltages, and provides high brightness where required.¹ However, the yoke resistance — and therefore the deflection linearity of electromagnetic displays — varies with temperature when low-inductance yokes are used, and precautions must be taken to compensate for this temperature sensitivity. One way is to use a differential push-pull deflection system.

First, get a linear current

For an ideal inductance

$$E = L \frac{di}{dt} \text{ or } i \approx \frac{E}{L} t.$$

Unfortunately, the ideal inductance does not exist. In order to obtain a linear current, i , through a physical inductor, L , we must know or define the terminal voltage that must be applied.

To briefly review the design of a linear current sweep circuit, a deflection yoke may be represented by the equivalent circuit shown in Fig. 1. The voltage equation for the circuit is:

$$e_{ab} = i_y R_y + L_y \frac{di_y}{dt} = (1/c_y) \int_{t_1}^{t_2} i_y dt \quad (1)$$

Initially, capacitor c_y is unchanged ($t = 0$). When e_{ab} is applied, c_y must charge in zero-time, and an impulse occurs. We can denote this as a unit impulse at $t = 0_+$.

After the impulse, a current must be applied to the capacitor, allowing its voltage to rise at the same rate as the terminal voltage e_{ab} . If the capacitance across the yoke terminals can be kept small, the current will be equal to a constant (thus

$E_{c_y} = \frac{It}{c}$ during the time e_{ab} is applied. We may rewrite Eq. 1, dropping the y subscripts:

$$e_{ab} = iR + L di/dt - i_0 \delta(t) \quad (2)$$

where $i_0 \delta(t) \equiv E_{c_y}$, assuming the yoke and stray capacitance is a constant.

We then equate terminal voltage to a straight-line function, for ease of generation:

$$e_{ab} = e(t) = e_0(1 + \gamma t) \quad (3)$$

where e_0 = initial voltage across terminals at $t = 0^+$

γ = slope

t = time.

From Eq. 2 and 3,

$$iR + L di/dt - i_0 \delta(t) = e_0(1 + \gamma t).$$

Taking the LaPlace transform of both sides and solving for the current:

$$RI(s) + LsI(s) - i_0 = \left(\frac{1}{s} + \frac{\gamma}{s^2} \right)$$

now,

$$I(s) = e_0 \left(\frac{s + \gamma}{s^2} \right) + i_0/R + Ls$$

$$= \frac{e_0}{L} \left[\frac{S + \gamma}{s^2 (s + R/L)} \right] + \frac{i_0}{L (s + R/L)}$$

The inverse LaPlace transform then yields²

$$i(t) = \underbrace{\frac{e_0}{R} \left[\gamma t - \left(\frac{\gamma L}{R} - 1 \right) \right]}_{\text{Steady state term}}$$

$$+ \underbrace{\left[\frac{e_0}{R} \left(\frac{\gamma L}{R} - 1 \right) + i_0 \right] e^{-Rt/L}}_{\text{Transient term}}$$

Consider the steady-state term

The yoke and capacitor current is now expressed as a function of time and shows a steady-state term and a transient term. Since we are interested in obtaining a linear sweep current during the active scan period (neglect retrace), only the steady-state term is considered. Considering the step function (to produce a linear rise in current due

A. M. Hildebrant, Design Engineer, Aerospace Electronics Dept., General Electric Co., Utica, N.Y.

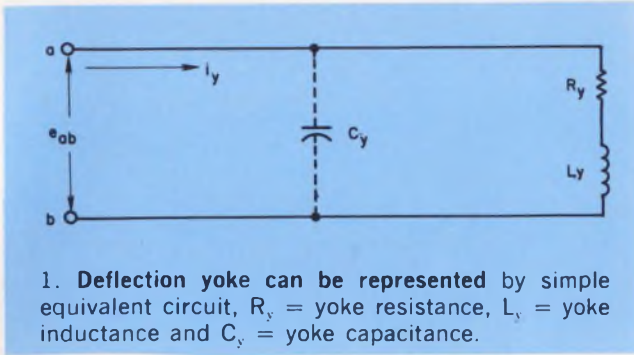

to inductance)

$$i(t) = -\frac{e_0}{R} \left(\frac{\gamma L}{R} - 1 \right) \quad (4)$$

and considering the resistance of the yoke:

$$i(t) = \frac{e_0}{R} \gamma t. \quad (5)$$

Equations 3 and 4 relate to moving the electron beam from deflection center to the edge of the CRT. Therefore, taking into account full deflection, Eq. 5 becomes

$$2i(t) = \frac{e_0}{R} \gamma t.$$

Since $i(t)$ is the steady-state current, we can let $i(t) = i_0$, so that

$$i_0 = -\frac{e_0}{R} \left(\frac{\gamma L}{R} - 1 \right) \quad (6)$$

and

$$2i_0 = \frac{e_0}{R} \gamma t. \quad (7)$$

Then, from Eq. 6 and 7,

$$\gamma = \frac{2i_0 R}{e_0 t}$$

$$e_0 = i_0 \left(\frac{2L}{t} - R \right) \quad (8)$$

so that

$$\gamma = \frac{2R}{2L - Rt} \quad (9)$$

As an example of the foregoing procedure we can find the voltage driving function, which will result in a linear deflection current, for a TV deflection yoke having the following parameters:

- $L = 20$ microhenries
- $2i_0 = 11$ amperes (peak-to-peak)
- $t_1 = 10$ microseconds (retrace time)
- $t = t_2 - t_1 = 53.5$ microseconds (active sweep)
- $R = 0.1$ ohm (yoke resistance)

The time periods correspond to a standard 525-line TV system, where the horizontal line frequency is 15.75 kHz. When using a class-A deflection amplifier, a preliminary step is to check the

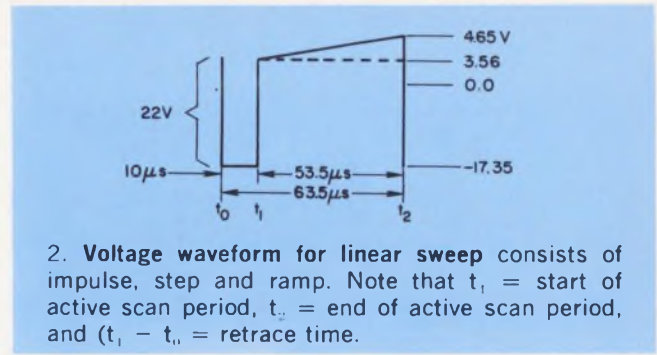

yoke flyback (retrace) voltage to determine if it is within the limits of the power supply.

Step 1, fly-back voltage:

$$E_f = L \frac{di}{dt}$$

or

$$E_f = \frac{20 \times 10^{-6} \times 11}{10 \times 10^{-6}} = \frac{220}{10} = 22 \text{ volts}$$

Step 2, from Eq. 8:

$$e_0 = i_0 \left(\frac{2L}{t} - R \right)$$

$$= 5.5 \left(\frac{40 \times 10^{-6}}{53.5 \times 10^{-6}} - 0.1 \right) = 5.5 \times 0.648$$

$$= 3.56 \text{ volts}$$

Step 3, from Eq. 9:

$$\gamma = \frac{2R}{2L - Rt}$$

$$= \frac{0.2}{(40 - 5.35) \times 10^{-6}} = \frac{0.2}{34.65 \times 10^{-6}} = 5760$$

Step 4, using straight-line equation for end point:

$$e(t_2) = e_0(1 + \gamma t)$$

$$e(t_2) = 3.56(1 + 5760 \times 53.5 \times 10^{-6})$$

$$= 3.56(1.308)$$

$$= 4.65 \text{ volts}$$

The voltage waveform for this example is shown in Fig. 2. Note that the total voltage excursion is equal to 22.00 volts. This is due to the transient term in the previously derived equation for $i(t)$. A class-A amplifier will saturate during flyback to the supply voltage limit because it cannot follow this transient.

Use feedback for stability

As mentioned previously, the resistance of the deflection yoke varies with temperature. This affects both the sweep amplitude and linearity.

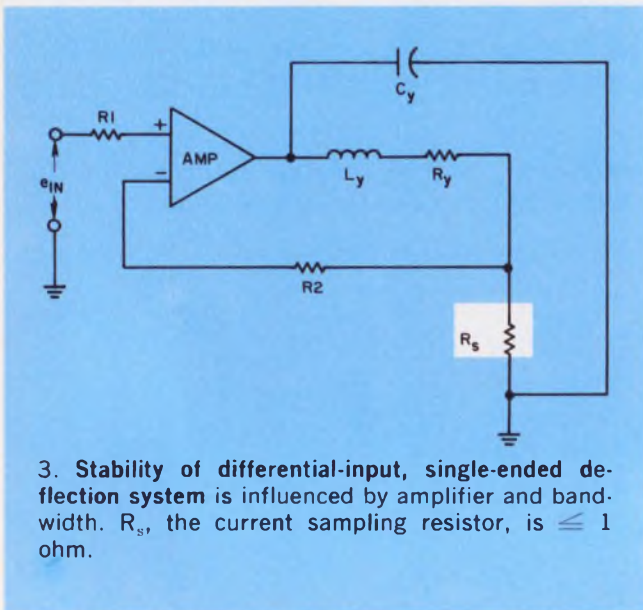

One means of compensation is to monitor the deflection yoke current with a sampling resistor. A voltage based upon the difference between the current in the sampling resistor and a reference signal can then be used to maintain constant amplitude and linearity.

To start with, the circuit shown in Fig. 3 could be used. This type of system may be called single-ended output, because only one end of the load is driven. Note that the system does have a differential input provided via the amplifier.

The equivalent circuit shown in Fig. 4 may be used to represent the load on the amplifier in Fig. 3. The loop equations for this circuit are:

$$e_{in} = \left(R_1 + \frac{1}{sC}\right)i_1 - \frac{1}{sC}i_2,$$

$$0 = -\frac{1}{sC}i_1 + \left(sL + R_v + R_s + \frac{1}{sC}\right)i_2.$$

Solving for $e_o = i_2 R_s$, we get

$$e_o = e_{in} R_s / \left[s^2 R_1 LC + s(R_1 R_v C + R_1 R_s C + L) + (R_1 + R_v + R_s) \right]$$

The transfer function is:

$$\frac{e_o}{e_{in}} = \left\{ \frac{R_1 LC}{R_s} \left[s^2 + s \left(\frac{R_1 R_v C + R_1 R_s C + L}{R_1 LC} \right) + \frac{R_1 + R_v + R_s}{R_1 LC} \right] \right\}^{-1}$$

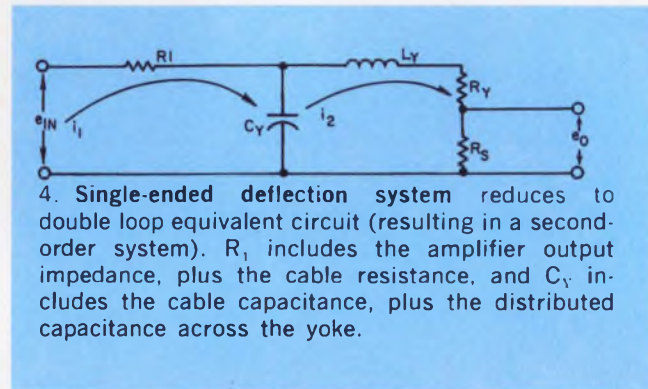

$$\approx \frac{1}{s^2 + 2\zeta\omega_n s + \omega_n^2}$$

where

$$\zeta = \text{damping factor} = \frac{R_1 R_v C + R_1 R_s C + L}{2\sqrt{(R_1 LC)(R_1 + R_v + R_s)}}$$

and

$$\omega_n = \text{natural frequency} = \left(\frac{R_1 + R_v + R_s}{R_1 LC} \right)^{1/2}.$$

Now ω_n and ζ , and therefore the system stability, are influenced by the amplifier gain and bandwidth. The system may become unstable if the gain is too high. This characteristic of a second-order system places limitations upon the system design.³

In addition, although this type of system has zero steady-state error, it has: (1) a static error constant that is proportional to the ratio of the velocity to the velocity constant, (2) a velocity error that is present during the ramp function input to the system, and (3) an acceleration error during flyback.

Furthermore, the capacitance, C , is dependent upon the cable length and the grounding of the Faraday shields within the deflection yoke. The value of C will thus affect ζ and ω_n . In order to keep the damping ratio large, the natural frequency ω_n must be decreased.

The open-loop amplifier bandwidth should be

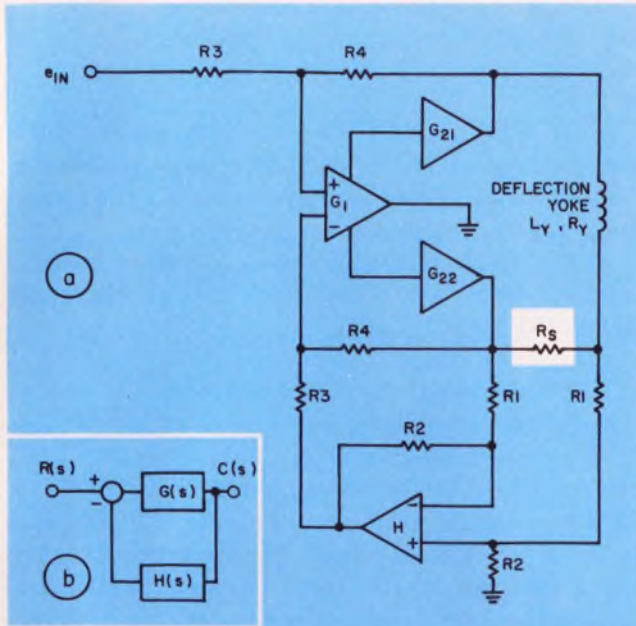

5. Differential-input, push-pull system (a) provides increased bandwidth. R_1 and R_2 are part of the bridge arrangement across the output yoke. This presents a differential input to amplifier H. Amplifier G_1 has a differential input and output, G_{21} and G_{22} are current boosters, and H is the amplifier in the feedback loop. A servo model of the system is shown in (b).

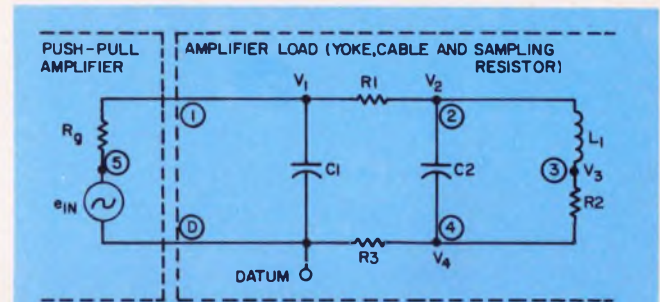

6. In equivalent circuit of double-ended push-pull deflection system, L_1 is the yoke inductance, R_1 the amplifier output resistance, R_2 the yoke resistance, R_3 the current sampling resistor, C_1 the amplifier output and intercable capacitance, and C_2 the yoke (distributed) capacitance.

made greater than the load bandwidth. The closed-loop response will then be determined by the load characteristics — that is, by the deflection yoke and cable capacitance. The system ω_n will be the natural frequency of the yoke itself, and the system gain will determine the damping ratio and static errors.

Such characteristics can be obtained using a differential push-pull system, as shown in Fig. 5. This type of system provides a floating load, which is an advantage in increasing the system bandwidth. In a single-ended system the cable capacitance and the capacitances associated with the Faraday shields must be taken to signal ground. In a double-ended (push-pull) system the capacitances are floating; therefore, the magnitude of the capacitance is smaller and not a significant factor in the transient period (retrace); likewise, the capacitance impulse and charging currents are small. Wider system bandwidth can thus be maintained with greater stability.

The double-ended, push-pull system may be related to the equivalent circuit of Fig. 6.

The nodal equations for the system are as follows:

$$\frac{V_i - e_{in}}{R_o} + V_i C_1 s + \frac{V_1 - V_2}{R_1} = 0,$$

$$\frac{V_2 - V_1}{R_1} + \frac{V_2 - V_3}{sL} + (V_2 - V_4) C_2 s = 0,$$

$$\frac{V_3 - V_2}{sL} + \frac{V_3 - V_4}{R_2} = 0,$$

$$\frac{V_4 - V_3}{R_2} + (V_4 - V_2) C_2 s + \frac{V_4}{R_3} = 0.$$

Computer speeds analysis

The stability analysis of the double-ended system of Fig. 6, based upon its transfer function, can be quite laborious. The work can be greatly simplified by using a suitable computer analysis program. For example, the GE linear network analysis computer program, known as BELAC¹ (written in FORTRAN IV), can be used. It will solve the nodal equations, find the transfer function for the network, and provide frequency plots (Bode diagrams) of the system response.

To illustrate the analysis of an actual system, consider one having the following parameters:

Active sweep time: 53.5 μ s (15.75 kHz line frequency)

Deflection yoke inductance: $L = 28.5$ mh

Deflection yoke resistance, R_y :

26.4 ohms at -55° C

37.3 ohms at 20° C

46.7 ohms at 85° C

Cable resistance, R_c :

1.17 ohms at -55° C

1.65 ohms at 20° C

2.07 ohms at 85° C

Current sampling resistor, R_s :

2.5 ohms (temperature compensation)

The load impedance seen at the output of the G_2 (push-pull) amplifier (Fig. 5) will be:

$$\begin{aligned} Z_{load} &= R_u + 2R_e + R_s + jX_L \text{ ohms} \\ &= 26.4 + 2(1.17) + 2.5 + j10.75 \\ &\quad \text{(where } X_L = 10.75 \text{ ohms)} \\ &= 31.24 + j10.75 \text{ (at } -55^\circ\text{C) ohms,} \\ &= 43.1 + j10.75 \text{ (at } 20^\circ\text{C) ohms,} \\ &= 53.34 + j10.75 \text{ (at } 85^\circ\text{C) ohms.} \end{aligned}$$

If the G_2 amplifier has a forward current gain of 1600 (minimum at -55°C), then the reflected impedance, Z' , to amplifier G_1 will be:

$$\begin{aligned} Z' &= 33(1600) / 19^\circ \text{ at } -55^\circ\text{C} \\ &= 52,800 / 19^\circ \text{ ohms.} \end{aligned}$$

Due to the push-pull differential output, the impedance at the input to each G_2 is

$$Z' = \frac{52,800 / 19^\circ}{2} = 26,400 / 19^\circ \text{ ohms.}$$

If the required terminal voltage is approximately 15.0 volts for this load impedance and an input reference ramp voltage of 5.0 volts is desired, the closed-loop gain should be $15/5$ or 3. For a closed-loop system³

$$\frac{\epsilon}{e_{in}} = \frac{1}{1+GH}$$

where

$$\epsilon = e_o \text{ (desired)} - e_o \text{ (actual)} = \text{error}$$

$G(s)$ = transfer function (forward components)

$H(s)$ = transfer function (feedback components)



Author Hildebrant about to test the linearity of a magnetic deflection system.

If $G_1 = 30$, $G_2 = 1$, and $H = 10$, then

$$\frac{\epsilon}{e_{in}} = \frac{1}{1+(30)(10)} = \frac{1}{301} = 0.33\% \text{ or } \epsilon = 0.33\% e_{in}$$

Since the gain of G_1 varies with temperature, due to changes in the deflection yoke resistance, the resistance values used are those for the lowest temperature, the case of minimum gain.

The over-all linearity error is determined by the open-loop gain of the system, plus the error due to the "KLC" factor²:

$$K = R / (R + R_y)$$

R = differential output impedance

R_y = yoke resistance,

L = yoke inductance,

C = yoke distributed capacitance.

This latter error is due to elimination of the step function prior to the start of the sweep current. For a feedback type system, it is not practical to include the step function in the reference signal, since inclusion of the step function would result in an acceleration, giving rise to two values for the damping ratio. Since the yoke resistance changes with temperature, addition of a step function would make an additional error because the step function amplitude on the positive slope would have to change with temperature (yoke resistance change). If a closed-loop system has sufficient open-loop gain and bandwidth, the output will follow the input signal with only the constant position error due to acceleration and the KLC product. ■ ■

References:

1. NASA Tech. Brief, "Magnetic CRT Driver Switches During Retrace," *Electronic Design*, Aug 1, 1968, p. 100.
2. Gardner and Barnes, *Transients in Linear Systems*, New York: John Wiley and Sons, 1963.
3. C. J. Savant, Jr., *Control System Design*, New York: McGraw Hill, 1964.
4. General Electric Co., Aerospace Electronics Dept., BELAC User's Manual, Aug. 15, 1968, Technical Data Center, Schenectady, N.Y.

Test your retention

Here are questions based on the main points of this article. Their purpose is to help you make sure you have not overlooked any important ideas. You'll find the answers in the article.

1. What are the three input voltage constituents of a magnetic deflection system with a linear current output?

2. Why must a magnetic deflection system be stabilized?

3. What are the advantages of a push-pull magnetic deflection system?



Quite simply, the most versatile preset counter ever.

It's the new 5330B Preset Counter from Hewlett-Packard. It can do about twice as much work as the second best preset counters. Yet it's priced about the same.

This 10 MHz counter can:

- Normalize counted data to units such as gpm, psi and rpm.

- Issue control signals when preset count or count rates are reached.

- Introduce a selected offset in the reading.

- Be programmed remotely by automatic systems.

- Totalize, find ratios and time intervals.

The 5330B gate times can be selected by a 5-decade front-panel "N" switch to any number of time units between 1 and 100,000. With a choice of 1 μ s, 10 μ s,

0.1 ms and 1 ms time units ("M"). So you can get normalizing factors from 1 to 10⁹.

This flexibility, together with the two limit control switches (L1 and L2), lets you virtually automate many processes such as batching. The limit switches generate output signals when the preset count is reached. These signals become the commands for your computer-run system.

The optional zero offset can be set at any number between 0 and 99,999. This lets your count start from a specific number and return to that number automatically.

All four of these functions can be remotely preset. It's also the first preset counter to offer an anti-noise option. This rejects high frequency noise that might mask low-frequency data.

You can also use this preset counter as a frequency divider. As a delay generator. Or as a precise, digitally selectable pulse generator.

If the 5330B is too versatile for you, the 5330A should be just right. It does slightly less (without limits, but zero offset option available), and costs slightly less.

The 5330A is \$1200. The 5330B is \$1550. To find out just how much they can do for you, call your local HP field engineer. Or write to Hewlett-Packard, Palo Alto, California 94304; Europe: 1217 Meyrin-Geneva, Switzerland.

HEWLETT  PACKARD

ELECTRONIC COUNTERS

Improve receiver frequency stability

with digital automatic frequency control. The technique uses a counter for tuning flexibility at reasonable cost.

All wide tuning-range receivers suffer to some extent from the problems of tuning-dial inaccuracy and local oscillator (LO) drift. The problems are particularly severe if the i-f bandwidth is narrow and the local oscillator frequency is high compared with the i-f. In such a receiver, a very small fractional error in the LO frequency can put the i-f signal completely out of the i-f pass-band.

A new stabilizing technique called digital automatic frequency control (dafc) can be used to combat this error—often with better results and at lower cost than are obtained with methods now used.

What's wrong with existing methods?

Presently used methods include the employment of:

- Automatic frequency control (afc).
- Crystal-controlled oscillators.
- Frequency synthesizers.
- Frequency counters.

When afc is used (Fig. 1) the stability of the receiver becomes a function of the stabilities of the incoming signal frequency and discriminator center frequency and of the loop gain. The receiver is never really locked to the incoming signal; a small offset error always remains.

The afc approach has two major disadvantages: It doesn't even attempt to solve the dial-accuracy problem, and it is difficult to apply to pulse, single-sideband, frequency-shift-keyed or continuous-wave signals. In its favor are its low cost and relative ease of application.

Both limitations of the afc approach are overcome by the use of a crystal-controlled local oscillator. This method has good accuracy and stability and is not affected by the nature of the received signal. In fact, it operates perfectly well with no incoming signal at all. Thus it can be set to a specific frequency when the transmitter

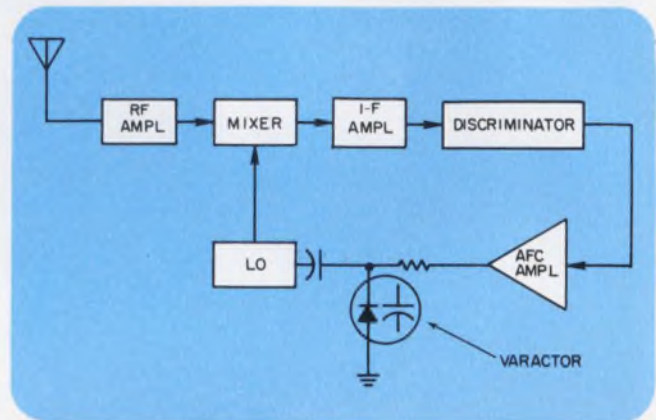

1. Conventional afc is simple and easy to apply. Unfortunately, it doesn't help the dial-accuracy problem, and it works only when an input signal is present.

is off the air and can be relied upon to be on frequency whenever a transmission occurs.

Unfortunately, a separate crystal is needed for each receiver channel. As soon as the required number of channels grows beyond a small number, the size and cost of the receiver can make this approach uneconomical.

Crystal oscillators are also limited in frequency. Above about 150 MHz, overtone crystals can no longer be used and frequency multipliers must be added to the circuitry.

Frequency synthesizers remove many of the disadvantages of crystal oscillators when they are used as local oscillators. They can be precisely tuned over a wide range of frequencies. The trouble with them is their size and cost. Units with an upper frequency limit of 500 MHz cost more than \$10,000, and microwave units are even more expensive. Synthesizers, obviously, cannot be economically justified except in the most sophisticated receivers.

An electronic counter can be used to measure the local oscillator frequency and subtract the i-f from it. The counter thus provides a very accurate digital readout of the received signal frequency. Although the receiver-counter combination allows precise logging of the frequency of an unknown signal, it does nothing whatever to reduce local oscillator drift. And a counter is a

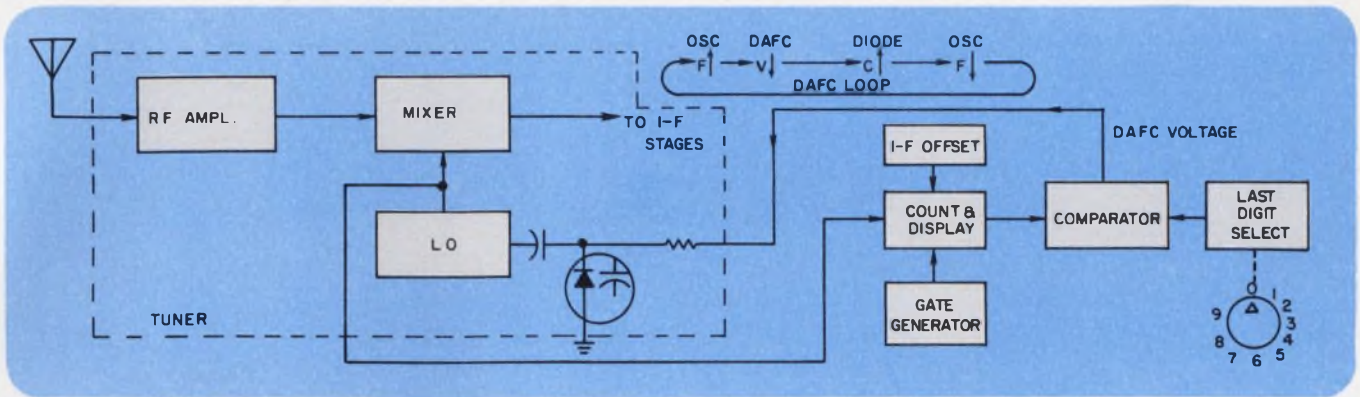

2. Digital afc slaves the local oscillator to a digital counter. The comparator unit compares the last digit

(or digits) of the display with the selected number (or numbers) and adjusts the LO as needed.

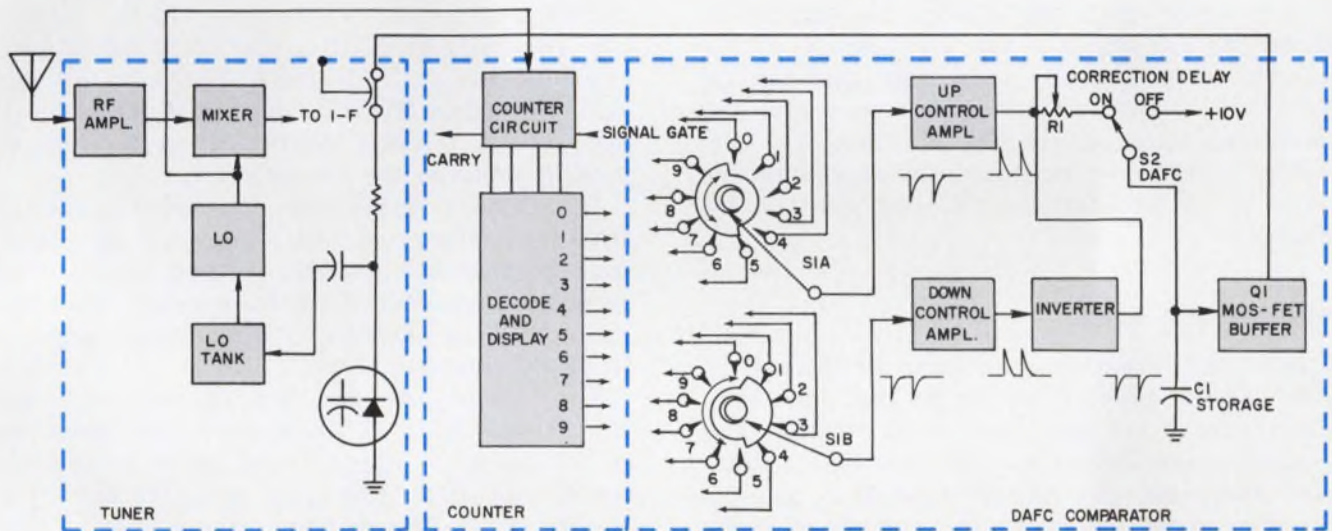

3. A single switch performs two functions in this implementation of the dafc technique. S_1 selects the last digit and compares it with the actual readout. Each

displayed digit is connected to the like-numbered terminals on both decks of S_1 . The actual connecting lines have been omitted for simplicity.

rather expensive replacement for a tuning dial—it can cost more than the rest of the receiver.

Lock the receiver to the counter

The new digital afc system provides many of the best features of a synthesizer at little more than the cost of a counter. Its use is particularly desirable when many channels are to be monitored simultaneously, because the counter used in the scheme can be time-shared among several receivers.

Its loop differs from the conventional afc loop in that the counter's time base, not the incoming signal, is used as a reference frequency. Also, the discriminator is replaced by a comparator unit that compares the last digit of the counter's readout with a preselected number (Fig. 2).

If the digits are not identical, the comparator will change the voltage fed back to the voltage-

variable capacitor (varactor) in the local oscillator. Thus any drift in the LO frequency will change the last digit and cause the comparator to put out a correction voltage that will lock the local oscillator to the preselected digit.

Note that the incoming signal is not in the digital afc loop. Thus a major advantage of this technique is that it's not affected by the nature of the received signal. Of course, if the incoming signal is unstable, the receiver will not follow it. This may be a disadvantage in some applications.

Extending the range

The digital afc loop is characterized by three basic range parameters: a locking range, an acquisition range and a holding range. The locking range, or resolution of the system, is simply the maximum error that can exist without a correction being made. The smaller the locking

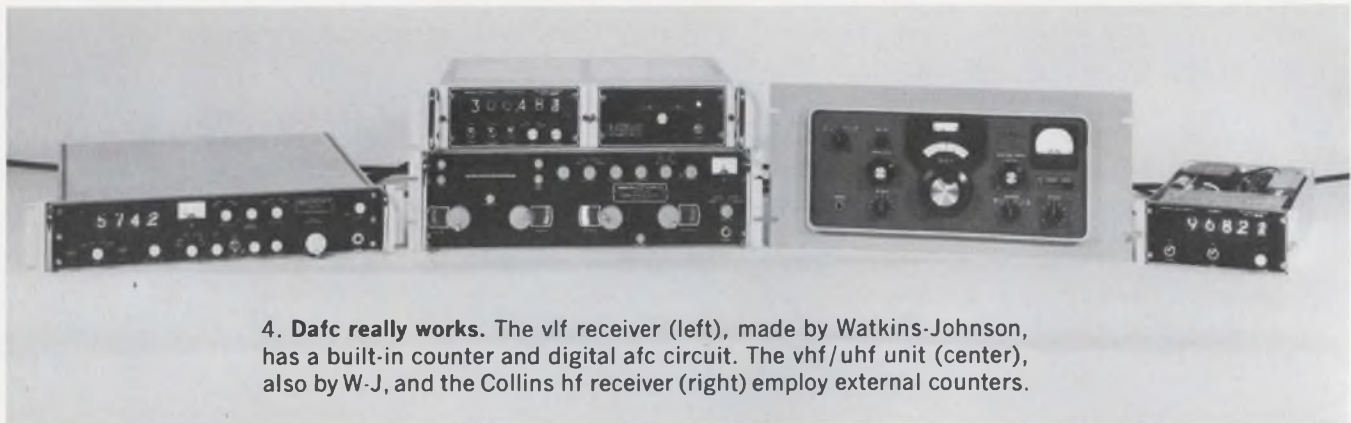

4. **Dafc really works.** The vlf receiver (left), made by Watkins-Johnson, has a built-in counter and digital afc circuit. The vhf/uhf unit (center), also by W-J, and the Collins hf receiver (right) employ external counters.

range, the tighter the frequency control. Clearly, the locking range of the system is set by the resolution of the counter.

The acquisition range is the maximum frequency error that the system can accurately sense and for which it can compensate. If the locking range is made very tight and the receiver is operated under severe environmental conditions—particularly high vibration—the local oscillator frequency may jump by an amount too large to be measured by the last digit of the display.

Add additional digits

In such a situation, additional digits must be added to the comparator. The locking and acquisition ranges are thus seen to be related: The locking range determines the required counter resolution, and the counter resolution and acquisition range determine the number of digits in the comparator.

The holding range is the total amount of local oscillator drift that the system can tolerate. It is determined by the maximum feedback voltage swing, the varactor sensitivity and the tightness of coupling of the varactor into the oscillator tank circuit.

One way to implement the digital afc scheme with simple hardware is illustrated in Fig. 3. A one-digit comparator is shown.

A sample of the local oscillator output is applied to the counter. The 10 signal lines from the last digit of the display are routed through switch S_1 to the up and down-control amplifiers. The switch is so wired that no signal gets through it if the displayed digit is the same as the selected digit. If the displayed digit is higher, the signal is routed to the down-control amplifier. If lower, it's routed to the up-control amplifier.

The up and down-control amplifiers charge capacitor C_1 in the positive and negative-going directions, respectively. Variable resistor R_1 is used to set the charging rate of the capacitor and hence the time lag of the loop. It is useful to have R_1 variable because a short time constant is needed when the selector switch is used for re-

mote tuning, while a longer time constant is needed after the station is acquired. If the time constant is not increased after acquisition, the correction signal will be audible in the continuous-wave mode because the loop will be continually frequency-modulating the local oscillator.

The voltage on C_1 is applied to the tuning varactor through a MOSFET buffer. A high-impedance source follower configuration is used to prevent draining the charge off C_1 .

In a typical application, the output voltage from the buffer could vary from +4 V to +24 V, thus keeping the varactor reverse-biased. The varactor's capacitance varies inversely with the applied voltage; hence corrections are applied in the right direction.

For example, assume that the local oscillator has drifted down in frequency. The wiper on switch S_{1A} sends up-command pulses to the up-control amplifier, which, in turn, increases the voltage on C_1 . This more positive voltage is sent through Q_1 to the varactor diode. The voltage decreases the capacitance across the local oscillator tank circuit, thereby increasing the frequency until the selector switch stops sending corrections.

Method is easy to use

Although mention was made earlier of the remote tuning application of the digital afc loop, it will probably be used most often to stabilize the receiver after a station has been manually tuned in. The procedure, then, is simplicity itself. Switch S_2 is turned off, thus applying a constant 10 V to the varactor. This biases the varactor to roughly the middle of its range. The desired signal is tuned in, and the last digit of its frequency is noted and set into switch S_1 . Finally, the loop switch, S_2 , is turned on and the loop is locked.

This technique has been used successfully in several applications. Examples of commercial receivers covering 1 kHz to 1 GHz are shown in Fig. 4. The vlf receiver has the counter and digital afc circuitry built in while the other two units use an external counter. ■■

Battery Powered!

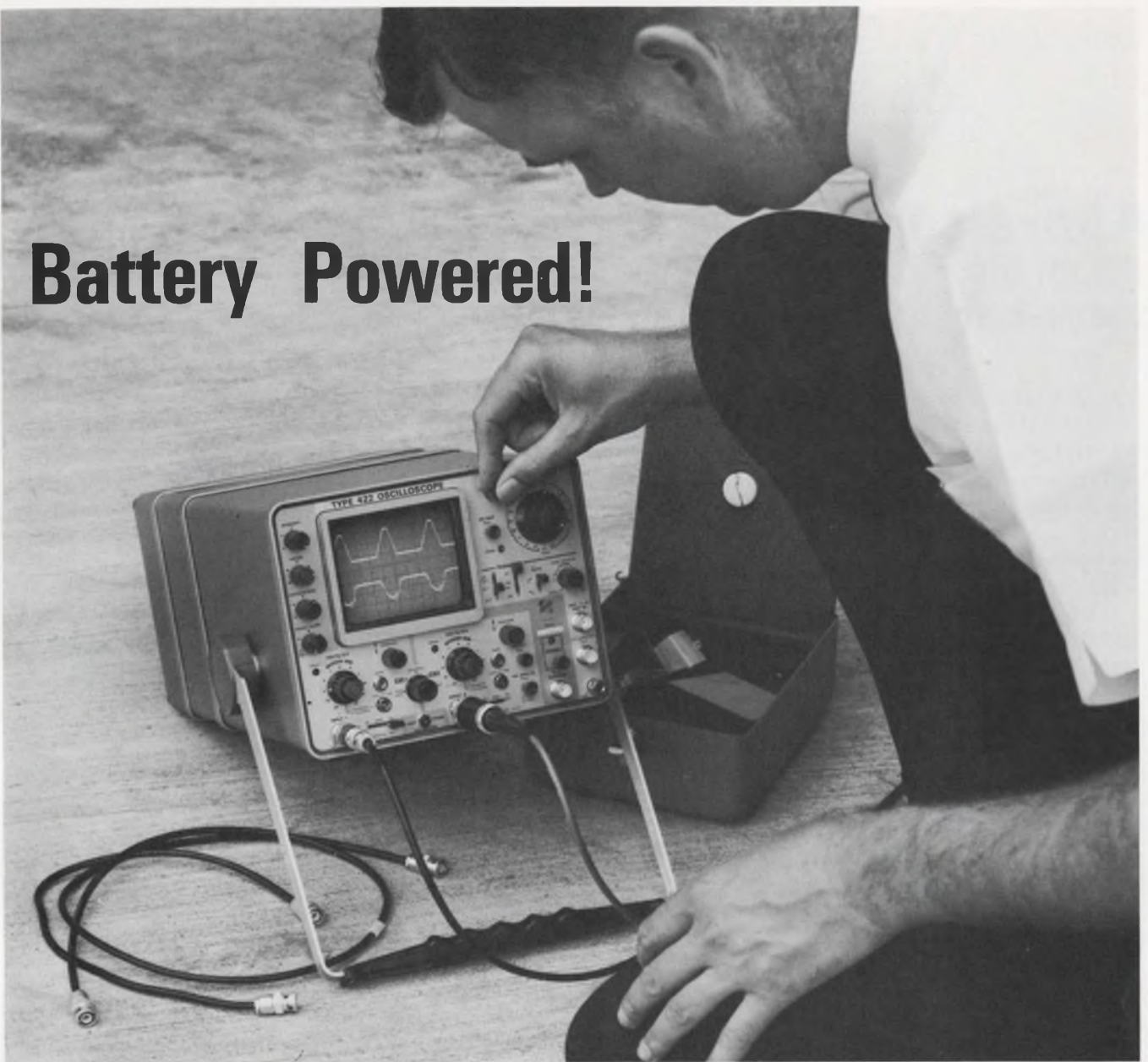

15-MHz, Dual-Trace Portable Oscilloscope

Your waveform measurements no longer need be compromised by adverse field conditions or the absence of a convenient power connection. The Tektronix Type 422 Portable Oscilloscope brings the precision of the laboratory "on site" to meet your measurement requirements.

This compact, rugged oscilloscope combines small size and light weight with 15-MHz, dual-trace performance! Two models are available. One is powered from AC; the other from AC, DC, or internal rechargeable batteries. The AC version weighs less than 22 pounds including accessories and operates from 115 or 230 VAC $\pm 20\%$, 45 to 440 Hz, 100 watts. The AC/DC version (MOD 125B) with built-in battery recharger weighs 30 pounds

including accessories and batteries and provides up to 5 hours continuous operation from an internal 24-volt rechargeable battery pack. The AC/DC version also operates from 115 or 230 VAC $\pm 20\%$, 45 to 440 Hz, 30 watts; or from 11.5 to 35 VDC, 26 watts.

For a demonstration of the Type 422 in your application call your Tektronix Field Engineer or write, Tektronix, Inc., P.O. Box 500, Beaverton, Oregon 97005.

Type 422 Oscilloscope, AC powered	\$1500
Type 422 MOD 125B Oscilloscope, AC/DC powered (without battery pack)	\$1850
Battery Pack for Type 422 MOD 125B (order 016-0066-02)	\$ 125

U.S. Sales Prices FOB Beaverton, Oregon



Tektronix, Inc.

committed to progress in waveform measurement

Appraisal programs can be effective

if both supervisor and employee learn the rules of the evaluation game before the day of judgment arrives.

In appraising the work of an actress in a play, a certain theater critic once wrote: "She was the epitome of eloquence and grace—a gifted performer indeed." Across town another critic saw it this way: "She gave the sort of performance that would have induced the audience in Shakespeare's day to shower the stage with an overabundance of well-ripened fruit."

Where appraisals are concerned, whether in the theater or in the engineering department, there will always be a certain amount of controversy, because the appraisers and those being appraised are, after all, only human.

However, much of the misunderstanding about appraisal systems can be eliminated simply by knowing why appraisals are necessary, how to conduct them, and what systems are used.

Pointing up the need to close the communication gap that exists between supervisor and employee is the result of a survey conducted recently at an electronics company.

In answer to the question, "How often does your supervisor conduct an appraisal review with you?" half of the employee respondents said never. When the respondents were questioned further, in an attempt to uncover the appraisal procedure that had been used, supervisors replied that they considered daily casual remarks made to the employee as part of a formal counseling process. The employees, however, considered these off-the-cuff remarks as being irrelevant. To them, a formal appraisal interview had never been held.

When employees were asked if they were satisfied with the appraisal system currently in use, 50% of them said they didn't know what system was in use. (For complete results of the survey, see tables 1 & 2 on opposite page.)

Why evaluations are made

You may ask, "Why do employees have to be appraised at all?" There are three main reasons:

- Employee's viewpoint: "An appraisal not only tells me how I'm doing on the job and what's expected of me in the future, but it gives me the opportunity to express my needs, ambitions and goals. It also gives me a chance to complain, criticize and gripe."

- Supervisor's viewpoint: "It tells me whether or not a man is right for his job, and helps me to select his successor if he's not. Appraisals also help me to distinguish between the 'livewires' and the 'short-circuits' on my staff, and gives me a better understanding of the job and goals of the department and a yardstick for measuring individual and group progress."

- Company president's viewpoint: "If we are to grow, we must determine whether or not our employees have the skills necessary to increase the quality and quantity of production. We should not only provide an opportunity for our people to practice these skills within the organization, but we should also motivate them to acquire these skills by setting goals that have as much meaning and value to the employee as they do to the company. The purpose of the appraisal interview is to inform our employees of these company goals."

Conducting a proper appraisal

The supervisor who wonders just how he should go about conducting an appraisal can be guided by the following five principles:

1. Assume that the employee knows more about himself than the boss does.

2. Understand that it is the employee who sets preplanned objectives with the help of the boss and not the other way around.

3. Realize that what is going to happen is more important than what has happened.

4. Put the accent on the employee's strengths, not his weaknesses.

5. Accept the idea that the boss should be a coach, not a psychoanalyst.

Once the supervisor is fully versed on the guidelines for evaluating an employee, his next logical step is to adopt a procedure for appraisal. Although the application of company-established

Robert Vijil, Jr., engineering instructor, Alabama A & M University.

Table 1. Employee survey

1. How often does your supervisor conduct an appraisal review with you?
Never, 50% of respondents answered. The remaining answers varied from every six months to every two years.
2. Do you discuss salary at these reviews?
The 50% who answered negatively to question No. 1 said no to this one. The remaining answers generally fell into a yes category.
3. Does your supervisor make definite recommendations for improvement in your work?
Yes, said 80%, while 20% answered no.
4. What do you feel is accomplished by a performance review?
The majority of respondents replied that a review would give them an insight into how their supervisors felt about them. They wanted to know where they stood.
5. Does your supervisor make a point of mentioning your good qualities?
Yes, said 100%.
6. Are you satisfied with the review system currently in use?
Half of them said they didn't know what it was. Only 10% expressed satisfaction with the present system.
7. Do you know what the salary evaluation procedure is?
The answer was 100% no.
8. Do you have good rapport with your supervisor?
Approximately 75% replied in the affirmative.
9. Do you know what is expected of you in your job?
Most of the responses were affirmative, but almost all respondents said the understanding was not on a long-range basis.
10. Do you feel you can offer recommendations for improvement in the appraisal procedure?
All responded yes—they should be held more often and at regularly scheduled intervals.

Table 2. Supervisory survey

1. How often do you hold performance reviews with your employees?
Approximately 25% claimed to hold reviews every six months. 60% said annually, while 15% said never.
2. Do you discuss salary at these reviews?
Most respondents answered in the affirmative. Some claimed that salary discussion was the only purpose in holding a review.
3. Do you make definite recommendations for performance improvement to the employee?
The replies were a categorical yes.
4. Does your employee know the significance of an appraisal review?
Yes, said 50%. Many supervisors considered this to be a poor question.
5. What do you try to accomplish during an appraisal review?
To let the employee know where he stands, almost 100% responded.
6. Are you satisfied with the review system currently in use?
Only 10% said they were satisfied.
7. Do your employees know what the salary-review procedure is?
Some 80% answered negatively.
8. How often are you appraised and interviewed by your own supervisor?
All but one answered never.
9. Do you have good rapport with your supervisor?
Almost 100% answered in the affirmative.
10. Do you have good rapport with your employees?
The reply was 100% affirmative.

PRODUCTIVITY	Always Above Average	Usually Below Average	Usually Average	Sometimes Above Average	WORK OUTPUT
EMOTIONAL STABILITY	Usually Excellent	Often Inadequate	Usually Adequate	Always Adequate	POISE AND SELF CONTROL
TECHNICAL ABILITY	Excellent	Adequate	Usually Above Average	Sometimes Inadequate	KNOWLEDGE AND EXPERIENCE

(a)

QUALITY OF WORK		
<i>Check most appropriate comment – considering accuracy, errors, waste, economy of material, neatness, etc.</i>		
<input type="checkbox"/> PERFECT	<input type="checkbox"/> EXCEPTIONALLY HIGH	<input type="checkbox"/> CONSISTENTLY HIGH
<input type="checkbox"/> ALWAYS SATISFACTORY	<input type="checkbox"/> SATISFACTORY	<input type="checkbox"/> USUALLY SATISFACTORY
<input type="checkbox"/> FREQUENTLY UNSATISFACTORY	<input type="checkbox"/> USUALLY UNSATISFACTORY	<input type="checkbox"/> ALWAYS UNSATISFACTORY

(b)

REACTION OF RATEE:					
Does he:	Definitely Agrees	Seems Inclined To Agree	Seems Doubtful	Definitely Disagrees	Non-Committal
Accept the delegation of responsibilities delineated in his position guide?					
Agree with the rightness of his position level?					

(c)

Appraisal forms vary from detailed (A) to more general (B). Some request ratee reaction (C).

evaluation procedures will naturally vary among supervisors, there are three elements common to all: setting standards; making judgments; and informing the employee.

Setting standards: Before a supervisor can evaluate an employee, both parties must understand what performance is expected from the subordinate. To determine that, the supervisor must know what the reasonable requirements are for the jobs under his direction. Each employee must know how the supervisor interprets these requirements. And these standards must be fair and attainable.

Making judgments: Many supervisors assume that their workers are doing all right unless they make some serious mistakes. A supervisor is not in a good position to appraise the job performance of employees unless he has all the facts.

The appraisal of an employee should represent the honest effort of a manager to collect sufficient relevant information about a particular application and evaluate it to the best of his ability.

Informing the employee: After the employee has been judged, the supervisor should tell him in a personal interview what he thinks of his performance.

Three methods used

In order to accomplish the objectives of an appraisal program, some of the major rating systems should be considered. Various methods used are:

- Chart or form, which lists a number of

traits or personal characteristics.

- Rank-order, in which the supervisor places all employees under him in order from best to poorest.

- Forced distribution in which employees are rated on only two characteristics; job performance and promotability.

With this system a five-point scale is used. One end of the scale represents the poorest. The supervisor is requested to slot 10% of his employees to the best end of the scale, 20% to the next category, 40% to the middle bracket, 20% in the bracket next to the low end, and the remaining 10% to the lowest category.

Last things first

Evaluation periods vary: quarterly, semiannually, annually. Recent trends favor quarterly action. To evaluate performance at more frequent intervals can cause the supervisor to remember "last things first," thus creating a critical incident that may be out of proportion with the employee's true performance record. ■■

Bibliography:

Brown, Milton, *Effective Supervision*, The MacMillan Co., New York, N.Y., 1961.
 Bittle, L. R., *What Every Supervisor Should Know*, McGraw-Hill Book Co., Inc., New York, N.Y., 1959.
 Drucker, P., *The Practice of Management*, McGraw-Hill Book Co., Inc., N.Y., 1961.
 Famularo, J. J., *Supervisors in Actions*, McGraw-Hill Book Co., Inc., N.Y., 1961.
 Kellogg, M. S., *What to Do About Performance Appraisals*, American Management Association, New York, N.Y., 1965.
 McGregor, Douglas, *Human Side of Enterprise*, McGraw-Hill Book Co., Inc., New York, N.Y., 1960.

TRANSMAGNETICS HAS 32 NEW WAYS TO MAKE CONVERSION FUNCTIONS EASIER

When your system calls for you to convert from one electronic mode to another, you have two choices. You can labor through the designing, prototyping, building and testing of your own sub-system to convert . . . or you can buy the packaged Transmagnetics device to do the same job faster, easier, more reliably and at lower cost.

Transmagnetics modules are solid state, as small as 0.6" x 2.3" x 2.0" (or on standard PC cards) and much more reliable than the most ingenious jerry-built system.

The modules, listed in the chart, are all available now, many off the shelf. So you'll save weeks of time.

Because Transmagnetics has built so many conversion modules, for so much longer than anyone else, you're more likely to find exactly what you need in our short form catalog or data sheets. Be sure you have them on hand.



TRANSMAGNETICS, INC.
134-25 Northern Boulevard
Flushing, New York 11354
212-539-2750

AC TO DIGITAL
SYNCHRO TO DIGIT
POLAR TO RECTANGI
SYNCHRO TO AC
SYNCHRO TO LINEAR
DIGITAL TO DC (D/A)
DC TO SIN-COS DC
DIGITAL TO RESOLVER

THE 32 MODULES

FROM	TO	MODEL NUMBER
Rectangular Polar Rectangular	Polar Rectangular Rotated	695 1618
	Rectangular	689
Digital	Synchro Resolver	1670
	DC (D/A)	1800
	Sin-Cos DC	1613
	AC (Multiplying D/A)	1690
Synchro	Digital Linear DC	1623 678
	Sin-Cos DC	655
	Linear AC	678 & 152
	Resolver (Buffer)	1620
	Synchro (Buffer)	1620
DC	AC (Modulator)	152
	Digital (A/D)	1500
	Sin-Cos DC	670
	Synchro Resolver	670 & 676 670 & 1614
	Resolver	670 & 1614
Sin-Cos DC	Digital	A 1623
	Linear DC	A 678
	Synchro Resolver	676 1614
	Linear AC	A 678 & 152
AC	Linear DC (Demodulator)	840
	Digital	840 & 1500
	Sin-Cos DC	854 & 670
Resolver	Sin-Cos DC	697
	Linear DC	678
	Synchro (Buffer)	1620
	Digital	1623
Frequency	DC	567

Ideas For Design

Decrease driver turn-off time without sacrificing efficiency

Turn-off time for typical output stages in line drivers and MOS clock drivers may be greatly reduced without appreciably increasing power dissipation in the circuit.

An ordinary output circuit driving a load capacitance of 1500 pF is shown in Fig. 1. The turn-on time of Q₁ is very fast if the saturation resistance is low. The turn-off time, however, is a function of R₁, the collector capacitance of Q₁, and the β of Q₂. Assuming a reasonable value for the β of Q₂ (30 nominal) and a collector capacitance for Q₁ of 20 pF, the turn-off time is essentially exponential with a time-constant of $T = (4.7 \text{ K})(20 + 1500/30) \text{ pF} = 330 \text{ ns}$. The rise time is approximately 2.3 time constants or 760 ns.

As shown in Fig. 2 the turn-off time can be greatly reduced with the addition of only two small passive components. The turn-on time is still fast since the capacitance load on the output is increased only 10%. During turn-off, positive feedback is produced from the charge on C₁, which was stored during turn-on of Q₁. This raises the voltage at the junction of CR₂, C₁ and

R₁, well above ground, thus providing a more positive voltage for the final value of the exponential rise time. In effect, the charge on C₁ is transferred to the equivalent capacitance at the base of Q₂. The result is a much faster time for the output to reach zero volts. This time is approximately 240 ns or less than one-third the previous rise time.

To achieve this rise time by decreasing R₁ to reduce the time constant would require a resistance of 1.5 kΩ producing an additional 180-mW dissipation during the time Q₁ is saturated. For one cycle, additional energy required is 0.36 microjoule. The energy stored in the 150-pF capacitor is only 0.03 microjoule. It can be seen that for a square-wave output of lower frequency, the difference in the efficiency of the two methods is even more pronounced.

L. R. Millsap, Member Technical Staff, Autonetics, Anaheim, Calif.

VOTE FOR 311

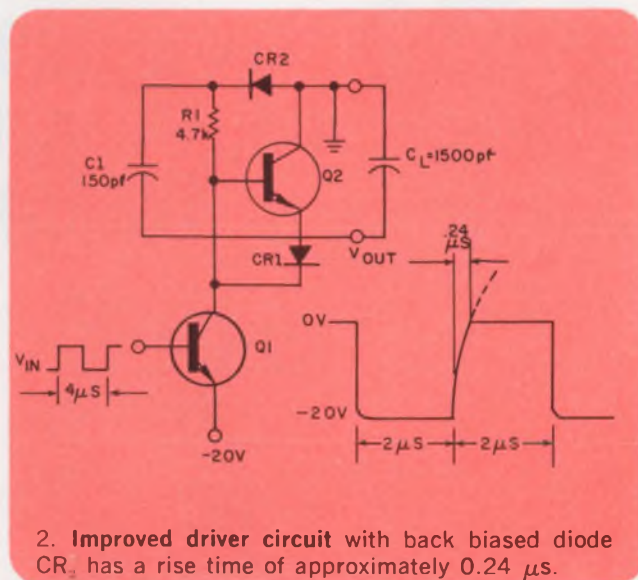
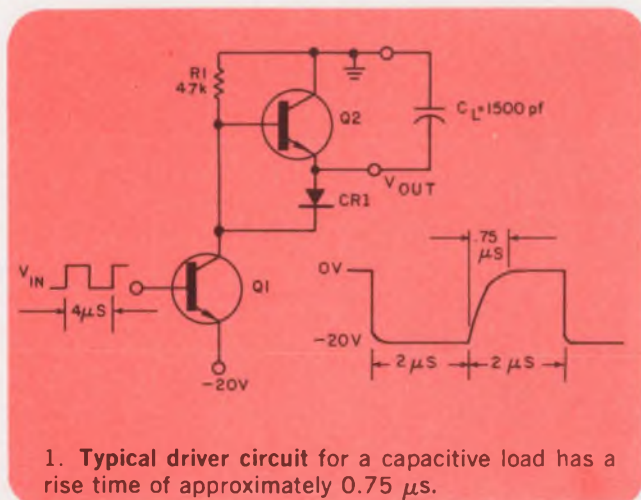

An exclusive: the Beckman ANSCAN™ system with INCLUSIVITY

We recently coined the word "inclusivity" as applied to the compatibility of system modules. To be truly flexible and versatile, modules must be as easy to apply as inserting a plug. Such modules must be compatible with one another, compatible with those made by all other manufacturers and compatible with the widest possible range of applications.

Beckman inclusivity covers the Model 3700 ANSCAN system, a complete analog data-acquisition system in one 19-inch x 7-inch x 22-inch package.

The ANSCAN system features automatic ranging and zeroing, and accurately measures very small signals in the presence of very large noise. Channel access can be sequential or random. Data can be fed to most types of digital recorders or the ANSCAN system can interface directly with couplers, computers or other peripheral equipment.



ANSCAN SPECIFICATIONS

Analog Inputs:	100 channels in 10-channel increments
Conversion Accuracy: (Guaranteed, 0-50°C)	± .01% of full scale
Sample and Hold:	Aperture-time uncertainty <200 nsec
Data Output:	Output word 16 bits BCD, Sign, Address and Range or 13 bits binary Sign, Address and Range

The following control functions are local or programmable

Sample Rate:	1, 10, 60, 100, 1000, 5000 samples/sec
Operating Modes:	Continuous, Single Scan, Single Channel, Remote Address
Channel Address:	Sequential or Random
Command Inputs:	Start, Stop, Reset, Channel Address, Address Load (remote start), Recorder Ready

For full information on Model 3700 or any of our systems modules, contact your local Beckman sales representative or the factory

Beckman INSTRUMENTS, INC.

ELECTRONIC INSTRUMENTS DIVISION
2500 Harbor Boulevard, Fullerton, California 92634

OTHER INTERNATIONAL SUBSIDIARIES: AMSTERDAM; CAPE TOWN; GLENROTHES, SCOTLAND; LONDON; MEXICO CITY; MUNICH; PARIS; STOCKHOLM; TOKYO; VIENNA

Major products include: voltage-to-binary converters, voltage-to-BCD converters, current-to-binary converters, current-to-BCD converters, frequency-to-BCD converters, events accumulator, binary-to-BCD converters, digital comparators, digital clocks, digital recorders, analog multiplexers, digital multiplexers, data formatter, teletype formatters, data processors.

Perform frequency scaling without rate multipliers

Do you need a circuit to multiply the frequency of a given square wave by a factor that is not an integer, while at the same time providing a symmetrical output signal? Burst generators and rate multipliers are not up to the task, but the method shown provides a convenient solution.

As long as input frequency f_{in} can be acquired by the phase-lock loop, the output of the phase-lock loop will be $(M)(f_{in})$. If a scale factor of K is required, then $M/N = K$. M and N are selected by first writing K in fractional notation. This ratio is then reduced to its simplest form.

A few examples will illustrate the technique:

Example 1 (K greater than 1)

Required: $f_{out} = 1.4 f_{in}$

therefore $K = 1.4 = 14/10 = 7/5 = M/N$

Example 2 (K greater than 1)

Required: $f_{out} = 2.7 f_{in}$

therefore $K = 2.7 = 27/10 = M/N$

Example 3 (K less than 1)

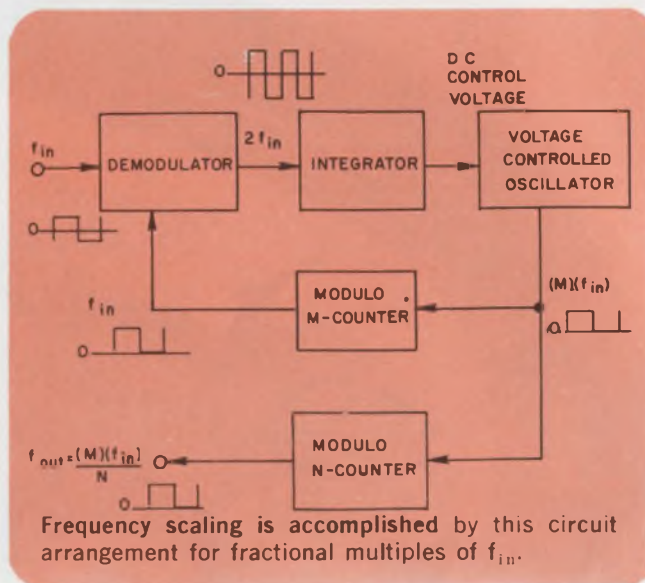

Required: $f_{out} = 0.6 f_{in}$

therefore $K = 0.6 = 6/10 = 3/5 = M/N$

Irwin Cohen, Theta Instrument Corp., Bogota, N.J.

VOTE FOR 312

Single transformer provides positive and negative voltages

Circuits such as operational amplifiers require the use of both positive and negative voltages. The common technique is to use independent windings on a transformer; however, it is possible to use a single winding to furnish both voltages.

In the circuit shown the negative side of the power supply is not returned to ground. Thus, if two zeners are placed in series across the output, their common point can be grounded. In this

way both positive and negative voltages are made available. For the circuit shown the outputs are +10 and -10 volts. This is sufficient to operate most operational amplifiers. In addition, this power supply is safe against short circuits.

When unsymmetrical voltages are required, zeners of different voltage are used.

Saul Ritterman, Assistant Professor, Bronx Community College, Bronx, N.Y.

VOTE FOR 313

VOTE

VOTE! Go through all Idea-for-Design entries, select the best, and circle the appropriate number on the Reader-Service-Card.

SEND US YOUR IDEAS FOR DESIGN. You may win a grand total of \$1050 (cash)! Here's how. Submit your IFD describing a new or important circuit or design technique, the clever use of a new component or test equipment, packaging tips, cost-saving ideas to our Ideas-for-Design editor. You will receive \$20 for each accepted idea, \$30 more if it is voted best-of-issue by our readers. The best-of-issue winners become eligible for the Idea Of the Year award of \$1000.

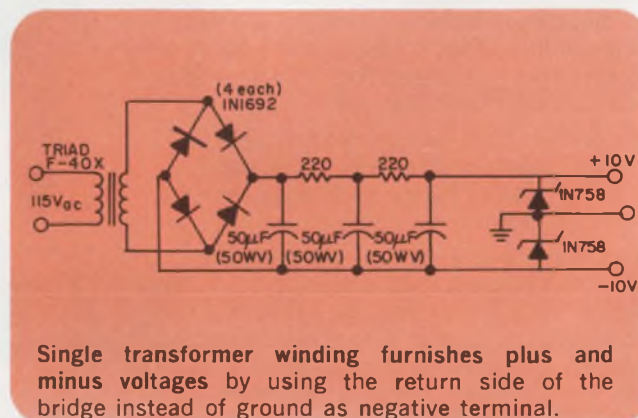

Our 1¼ oz. alarm will blast you with 80db of the most irritating noise in the world.

Nothing can drown out or cover up the persuasively piercing sound of the Mallory Sonalert® electronic audible signal. It's made to be heard.

The light, compact Sonalert is of solid state design for maximum efficiency and reliability and requires as little as 3 milliamps current. No arcing. No mechanical wear.

You can use Sonalert in hundreds of places—autos, trucks, boats, planes, laboratory, home and industry—anywhere a warning signal is required. Its penetrating audible signal scares burglars, warns of dangerous conditions and is an adjunct to many types of visual signals. It produces no RF noise, making it ideal for low-volt-



age circuits in computers, medical electronics, instrumentation and communications equipment.

Sound intensity range is 68db @ 6VDC to 80db @ 28VDC. Sound frequency levels are 2900 ± 500 Hz and 4500 ± 500 Hz, depending on model. Warbling, pulsing and AC models also are available. You can get Sonalert from your local Mallory distributor.

For a free 48-page idea booklet of applications, #9-406 "How to Use Sonalert," write to Mallory Capacitor Company, a division of P. R. Mallory & Co. Inc., Indianapolis, Indiana 46206.

Sonalert® — Registered trademark, P. R. Mallory & Co. Inc.

MALLORY

MALLORY CAPACITOR COMPANY

a division of P. R. MALLORY & CO. INC.

3029 E. Washington St., Indianapolis, Indiana 46206; Telephone: 317-636-5353

Electrical and Electronic Components • Sequence Timers • Metallurgical Products • Batteries



3 That are ready

For Top Quality Testing Performance



I

Triplet's Model 630-M Type 1 V-O-M

1. 1,000,000 Ohms per volt DC for greater accuracy on high resistance circuits. 20,000 ohms per volt AC.
2. 1 μ a Suspension Meter Movement. No pivots, bearings, or rolling friction. Extremely rugged. Greater sensitivity and repeatability.
3. 61 ranges, usable with frequencies through 100 kHz. Temperature compensated. 1 $\frac{1}{2}$ % DC accuracy, 3% AC in horizontal position.

\$231⁰⁰

II

Triplet's Model 630-NS V-O-M

1. 200,000 Ohms per volt DC sensitivity for greater accuracy on high resistance circuits. 20,000 ohms per volt AC.
2. Suspension Meter Movement. No pivots, no bearings, no hairsprings; no rolling friction. Extremely rugged.
3. 62 ranges. Temperature and frequency compensated $\pm 1\frac{1}{2}$ % DC Accuracy, ± 3 % AC.

\$116⁰⁰



III

Triplet's Model 630-NA Type 3 V-O-M

1. One selector switch minimizes chance of incorrect settings and burnouts.
2. 70 ranges: 1 $\frac{1}{2}$ % DC accuracy on meter; with mirrored scale and diode overload protection.
3. Temperature and frequency compensation; polarity reversing.



from the Instrument Makers... Established 1904



TRIPLETT
CORPORATION

BLUFFTON, OHIO 45817

Inexpensive interface works with both DTL and EIA levels

In the development of some portable equipment it became necessary to design an interface that would allow the equipment to be used with standard DTL logic, as well as with the EIA levels used by the telephone system that has level shifts from -6 to +6 V.

The solution was to feed the input signal to the DTL logic through an FET connected as a constant-current logic diode and clamp the input at ground potential with a diode (see figure). The MPF 105 has a typical drain current of 9 mA with the gate connected to source. This protects the driving circuit from current overload in the negative direction.

When using standard DTL logic levels with a false level on the input to the interface, the gate voltage ranged from 0.3 V to 0.47 V over a small sample of FETs. If the equipment has to work in a high noise environment, some selection of the FET may be necessary in order to insure opti-

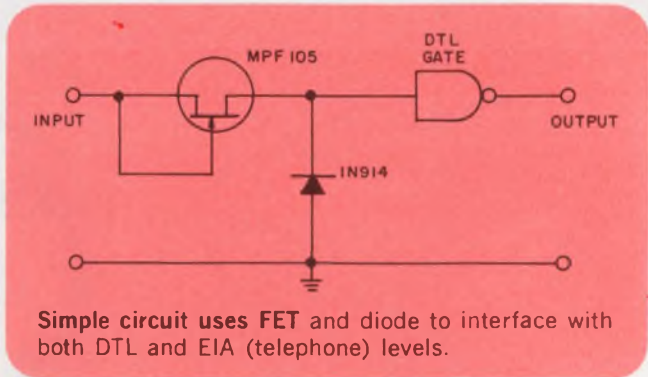

Simple circuit uses FET and diode to interface with both DTL and EIA (telephone) levels.

imum performance. Tests run on the circuit both with and without the interface showed no change in rise time, fall time and propagation delay time for the circuit.

A. W. Hoecherl, Research Engineer, University of Utah, Salt Lake City, Utah.

VOTE FOR 315

Improved SCR speed control achieves 100% motor regulation

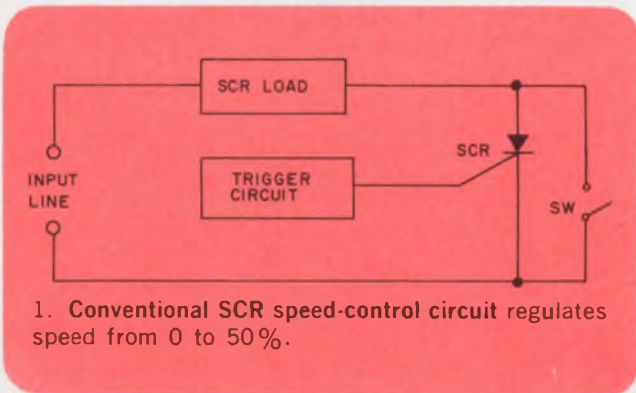

1. Conventional SCR speed-control circuit regulates speed from 0 to 50%.

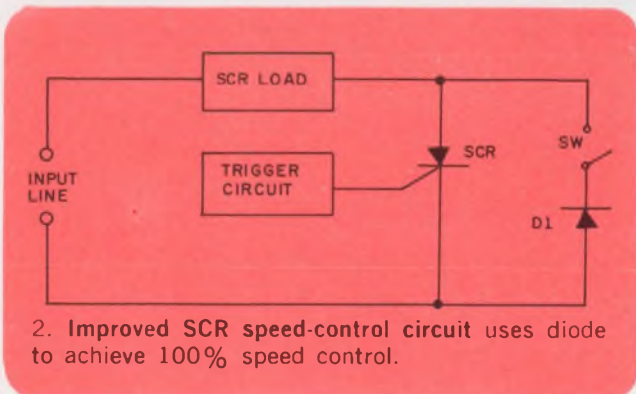

2. Improved SCR speed-control circuit uses diode to achieve 100% speed control.

Most universal motor SCR speed controls regulate motor speeds from zero to approximately one-half of rated speed. For full power, a switch is used to short the SCR, effectively connecting the motor across the line input as shown in Fig. 1.

By adding a switch and a diode compatible with the SCR rating (Fig. 2), full speed control can be achieved.

Normal operation with the switch open achieves zero to 50% speed control, permitting full commutation of one-half cycle of the input line. When the switch is closed, the diode fully commutates the other half cycle of the input line while the SCR permits variable commutation of the opposite half cycle.

Richard V. Iwanski, Applications Project Engineer, Spacerays, Inc., Burlington, Mass.

VOTE FOR 316

IFD Winner for September 13, 1969

Robert Billon, Design Engineer, UNITEC, Grenoble, France. His Idea "Schmitt Trigger and Comparator Combine To Form Window Detector" has been voted the Most Valuable of Issue Award.

Vote for the Best Idea in this Issue.

Great Milestones in Packaging

BEING NUMBER ± 0.00301 IN A "PEOPLE PACKAGING"
SERIES WILLFULLY UNDERTAKEN BY
JONATHAN MANUFACTURING COMPANY



At the Duke's command, a bunch of knights-errant were seeking the one untroubled lass in the domain with nary a problem cluttering her life. Or so the legend goes. Mounted in typical Early-Medieval fashion, they narrowed the search to a castle where dwelt newly-wed Lady Cordelia, reputed far and wide to be trouble-free. Wearing a smile upon her comely countenance,



she prettily satisfied their every inquiry until the quest seemed achieved. Then abruptly she led them to an upstairs closet housing a skeleton, that of her new husband's former rival for her rosy hand. "I try," she said, "to keep my troubles to myself, but every night at bedtime, my spouse compels me to kiss this darned skeleton." Whereupon she wandered away muttering a strangely nostalgic line, "dem bones, dem bones," which later became the basis for a popular camp song.

If you're sheltering a skeleton in the form of a worrisome packaging problem, why not unburden yourself to Jonathan the slide-makers? If you need to rack electronic chassis for accessibility, you may slide it, pivot it in behalf of service, or quickly-disconnect it for bench repairs. Whatever your requirement, the Jonathan Ultra-Thin full

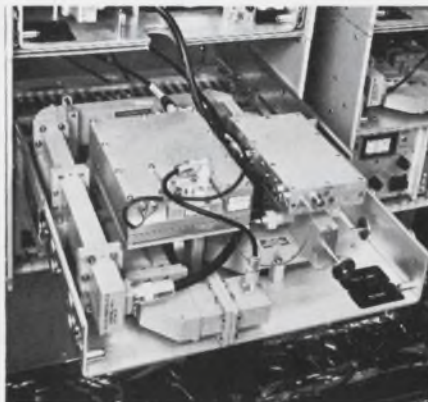

ball-bearing Type 110 Steel Chassis Slides (available in matched pairs beginning at \$6 the set) will most assuredly carry up to 200 lbs., while measuring only $\frac{3}{8}$ " thin. Let Jonathan tuck your problem out of sight!

At Collins Radio Company our little lovelies are now part of a new independent sub-system design for its MW-109E (i-f heterodyne) and MW-108D (remodulating) series of microwave systems. (see photo) The new Collins design, also incorporated in auxiliary equipment, greatly improves system reliability and simplifies ordering, plant engineering, system expansion, station rearrangements and maintenance procedures.



JONATHAN MANUFACTURING COMPANY

1101 S. ACACIA AVE., FULLERTON, CALIF. 92631 • 1258 TEANECK RD., TEANECK, N.J. 07666

INFORMATION RETRIEVAL NUMBER 58

New from the new DUMONT...

the 1050, the scope that wants to trigger!

Featuring a remarkable new triggering capability.

- No loss of trigger, either channel, any position.
- No trace flicker in dual trace.
- No trigger level readjusting after repositioning.

PLUS unequalled simplicity of operation for a 50 MHz bandwidth, 1MV sensitivity scope.

For full information write
DUMONT OSCILLOSCOPE LABORATORIES, INC.
40 Fairfield Place, West Caldwell, N.J. 07006
(201) 228-3665/TWX (710) 734-4308

DUMONT
OSCILLOSCOPE LABORATORIES, INC.

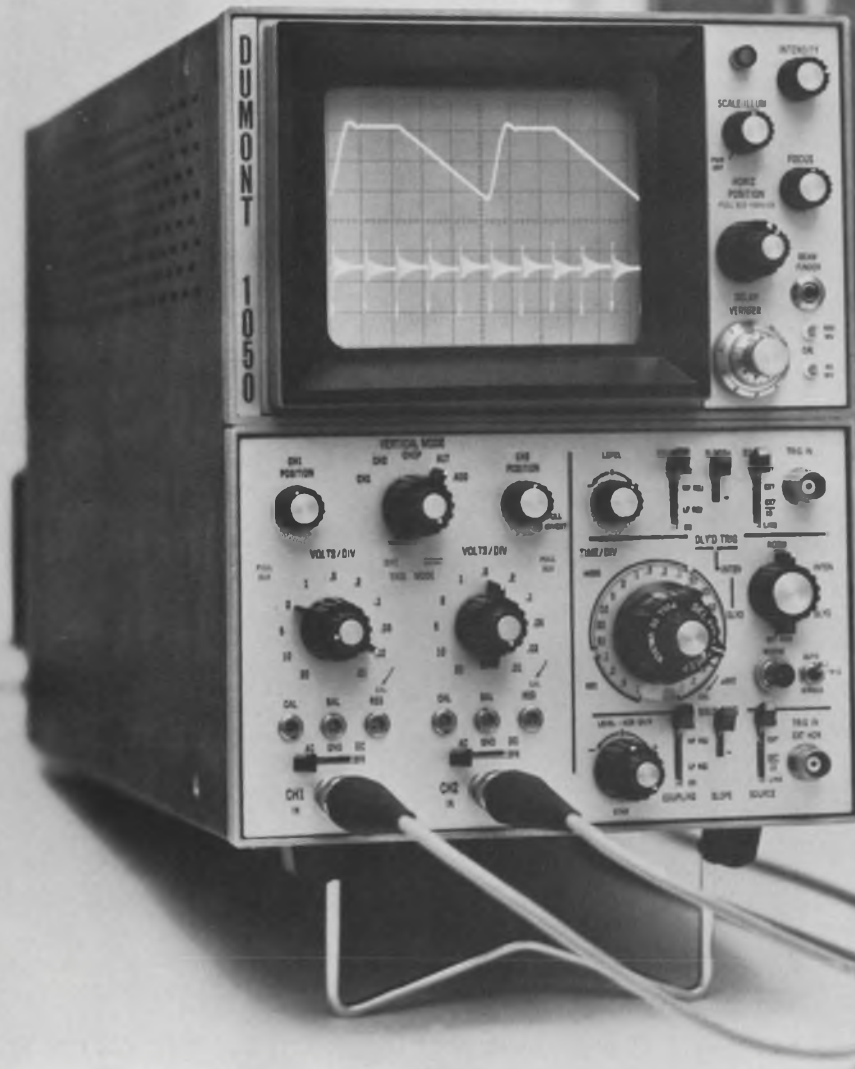

Product Source Directory

Signal Generators

This Product Source Directory, covering Signal Generators, is the fifth in a continuing series of product selection data that will list comparative specifications and prices for products frequently purchased by design engineers. All categories will be arranged according to some primary parameter so that items having similar functional capabilities can be instantly compared.

How to use the table

The tables in this section list the specifications for signal generators.

Unless otherwise noted in the tables, all signal

generators have input requirements of 95-135 Vac single phase. The following abbreviations apply to all instruments listed.

ina—information not available.

n/a—not applicable.

An index of models by manufacturer is included at the end of each table.

For each table, the instruments are listed in ascending order of one major parameter. The column containing this parameter is color-coded white. Manufacturers are identified by abbreviation. The complete name of each manufacturer can be found in the following Master Cross Index.

Abbrev.	Company	Reader Service No.
AMI	Advanced Measurement Instruments 109 Dover St. Somerville, Mass. (617) 623-2008	462
Babcock	Babcock Electronics Corp. 3501 Harbor Blvd. Costa Mesa, Calif. 92626 (714) 540-1234	463
GR	General Radio Co. 22 Baker St. Concord, Mass. 01781 (617) 369-4400	464
H-P	Hewlett-Packard 1501 Page Mill Road Palo Alto, Calif. 94304 (415) 326-7000	Contact local sales office
Kay	Kay Electric Co. Maple Ave. Pine Brook, N.J. 07058 (201) 227-2000	465
Marconi	Marconi Instruments 111 Cedar Lane Englewood, N.J. 07631 (201) 567-0607	466
Measure	Measurements P.O. Box 180 Boonton, N.J. 07005 (201) 334-2131	467

Abbrev.	Company	Reader Service No.
Polarad	Polarad/Nelson Ross 5 Delaware Drive Lake Success, N.Y. 11040 (516) 328-1100	468
R-S	Rohde & Schwarz Sales Co. 111 Lexington Ave. Passaic, N.J. 07005 (201) 773-8010	469
Radiometer	Radiometer Electronics The London Company 811 Sharon Drive Westlake, Ohio	470
Sage	Sage Laboratories, Inc. Instrument Div. 14 Huron Drive Natick, Mass. 01760 (617) 653-0844	471
Sierra	Sierra Electronic Philco Corp. 3885 Bohannon Drive Menlo Park, Calif. 94025 (415) 322-7222	472
Singer/Gert	Gertsch Products Singer Instrument Division 3211 La Cienega Blvd. Los Angeles, Calif. 96016 (213) 870-2761	473
Singer	Singer Instrumentation Division 915 Pembroke St. Bridgeport, Conn. 06608 (203) 366-3201	474

	Manufacturer	Model	FREQUENCY				OUTPUT		Modulation	Misc. Features	Price \$
			Minimum MHz	Maximum MHz	Acc. %	Stab. ppm	Minimum μ V	Maximum V			
SG 1	Measure R-S	65B	0.075	30	± 0.5	ina	0.1	2.2	am	b	1075
	R-S	SMLR	0.1	30	± 1	± 50	1	3	am		1425
	R-S	SMAR	0.03	31	0.5	± 30	0.01	10	am	g	5495
	R-S	SMDH	dc	50	$2/10^{-9}$	$1/10^{-9}$	0.1	2.5	am, fm	ah	10450
	Measure	82	0.08	50	± 1.0	ina	0.1	1.0	am		985
	GR	1001-A	0.005	50	± 1	ina	0.1	2	am		1450
	H-P	606A	0.05	65	± 1	0.005%/10min	0.1	3	am	fjp	1540
	H-P	606B	0.05	65	± 1	0.005%/10min	0.1	3	am, fm	fprs	1650
	Marconi	TF2002AS	0.01	72	1	30	0.1	1	am, fm	k	2940
	GR	1003	0.067	80	0.1	1/10min	0.1	6	am	df	2795
SG 2	R-S	SMSF	87	108	0.2	± 50	0.1	0.3	fm		985
	Measure	188	86	110	± 0.5	ina	0.1	0.1	fm		700
	Measure	189	86	110	± 0.5	ina	0.1	0.1	fm	m	890
	H-P	211A	88	140	ina	ina	0.1	0.2	am		2900
	Sierra	470A-200	50	200	± 1	0.005%/10min	50mW	50W	am	j	reg
	Radiometer	MS-27	0.3	240	0.002	0.005%	0.1	0.1	am, fm		1595
	H-P	202j	195	270	0.5	0.02%	0.1	0.2	am, fm		1595
	H-P	232A	329.3	335	0.0065	ina	1	0.2	am		3200
	Measure	180	2	400	± 0.5	ina	0.1	0.1	am	k	760
	Measure	80	2	400	± 0.5	ina	0.1	0.1	am		690
SG 3	Measure	95	50	400	± 0.5	ina	0.1	0.1	fm		1980
	AMI	303A	215	420	0.5	$\pm 0.005\%/10min$	0.1	0.1	fm	j	3500
	H-P	608F	10	455	± 1	0.005%/10min	0.1	0.5	am, fm	fqs	1800
	Measure	801	25	470	± 0.5	ina	0.1	0.1	fm		790
	Measure	80R	5	475	± 0.5	ina	0.1	0.1	am		690
	Measure	180R	5	475	± 0.5	ina	0.1	0.1	am	k	760
	H-P	608E	10	480	± 0.5	0.005%/10min	0.1	1	am	fj	1640
	Singer/Gert	FM-9E	20	486	0.0001	1/ma	0.1	0.5mV	fm	fq	1825
	Singer/Gert	FM-10	0.1	500	0.0001	1/yr	0.1	0.5mV	am, fm	a	2995
	GR	1026	9.5	500	0.05	50	0.1	10	am, pm	df	7150
SG 4	Sierra	470A-500	200	500	± 1	0.005%/10min	50mW	70W	am	l	reg
	R-S	SMFA	1.39	510	± 0.5	± 30	0.3	1	am, fm		7260
	AMI	303H	380	520	ina	$\pm 0.005\%$	0.1	0.3	fm	j	2800
	Babcock	BSG-23A	215	550	0.005	ina	0.1	0.07	fm	b	reg
	AMI	303B	400	550	± 0.01	ina	ina	ina	fm	i	2450
	Babcock	BSG-19A	406	550	0.005	ina	1.0	0.1	fm	jt	reg
	Babcock	BSG-17	406	550	0.005	ina	1.0	0.1	fm	b	reg
	AMI	303	225	800	0.5	$\pm 0.05\%$	0.1	0.1	fm	i	1800
	Measure	800	25	960	± 0.5	ina	0.1	0.1	fm		790
	R-S	SDFA	30	970	0.5	± 10	-110dBm	-6dBm	am, fm		4367
SG 5	Marconi	TF2006	4	1000	1	15	0.1	0.1	am, fm	k	6125
	Measure	840	400	1000	± 0.5	ina	0.1	0.1	fm		790
	Measure	84TVR	400	1000	± 0.5	ina	0.1	0.5	am		865
	Sierra	470A-1000	470	1000	± 1	0.003%/10min	50mW	65W	am	j	reg
	Singer	SG-1001	0.061	1024	0.001	10	0.01	2.2	am, fm	ab	4640
	Singer	SG-1000	7.75	1024	0.001	10	0.01	2.2	am, fm	a	7790
	H-P	612A	450	1230	± 1	0.005%/10min	0.1	0.5	am	fjq	1600
	Kay	1522A	1400	1599.9	0.002	2kHz	-120dBm	0dBm	fm, pm	n	4900
	R-S	SMA1	500	1800	± 0.5	ina	ina	+10dBm	am, fm, pm	a	4345
	Sierra	470A-1800	1000	1800	± 1	0.003%/10min	50mW	40W	am	i	reg
SG 6	Sage	831-L-1	1000	2000	± 0.1	1	80mW	150mW	am		6400
	Sage	851-L-1	1000	2000	± 1	ina	n/a	100mW	am	c	2995
	Sage	841C-L-1	1000	2000	± 0.1	1/wk	80mW	150mW	am	e	9195
	H-P	614A	800	2100	± 1	0.005%/°C	0.1	0.223	am, fm, pm	cj	2400
	AMI	3000	1435	2310	0.01	0.001%/°C	-130dBm	-10dBm	am, fm	v	6960
	H-P	8614A	800	2400	$\pm 5MHz$	0.005%/°C	-127dBm	+10dBm	am, fm, pm	cdj	2350
	H-P	8614B	800	2400	± 0.5	0.005%/°C	n/a	15mW	am, fm, pm	cdj	1600
	Polarad	1605	950	2400	± 0.5	0.0008%/V	-130dBm	0dBm	fm, pm	cj	2230
	Polarad	1105	950	2400	± 0.5	0.0008%/V	-130dBm	0dBm	fm, pm	cij	1990
	Sierra	470A-2500	1800	2500	± 1	0.003%/10min	100mW	25W	am	i	reg

- a. Digital frequency readout.
- b. Cavity tuned source.
- c. Klystron signal source.
- d. Phase Locked.
- e. Backward wave oscillator.
- f. External pulse modulation.
- g. Can be synchronized to internal crystal or external crystal
- h. Stability per day.
- i. 0.0005%/°C
- j. Internal, external modulation.
- k. Solid state.

Signal Innovator



SG-1000

Uniqueness in Signal Generation

Singer has advanced the state-of-the-art with a signal generator so New it almost requires a new name.

The Model SG-1000 obsoletes every other signal generator within its frequency range . . . singly or in combination. Its performance is so superior that no other instrument available can equal or even approach it.

That's why we call it the Innovator.

Here's why you'll call it unbelievable . . .

- Digital readout of frequency.
- Broadband frequency coverage from 61kHz to 512MHz (to 1024MHz with a simple passive doubler) in a small 5¼" high package.
- Exceptional frequency accuracy and resolution . . . typically 0.005% . . . and no human readout errors.
- Full modulation capability AM FM Pulse Video Internal 1,000Hz modulation . . . and combinations of the above.
- Output levels from +20dBm to -146dBm.
- An automatically leveled output . . . within ± 0.5 dB over the entire frequency range.
- Use it as a 2MHz counter for counting modulating signals or rep rates directly.
- A spectrally pure output signal approaching that of a crystal . . . extremely low residual and incidental FM.
- Total elimination of dial tracking errors.
- The availability of BCD frequency output and a

programmable attenuator to assure system integration.

This is only part of the SG-1000 story. A more complete technical description is available in Singer Application/ Data Bulletin SG-10 upon request.

For additional information contact your local Singer Representative, or write or call —

The Singer Company
Instrumentation Division
915 Pembroke Street
Bridgeport, Conn. 06608.
203-366-3201.

In Europe contact: Singer
Sewing Machine Company,
Instrumentation Division, P.O.
Box 301, 8034 Zurich, Switzerland,
Telephone: (051) 47 25 10
TWX 710-453-3483

SINGER

INSTRUMENTATION

	Manufacturer	Model	FREQUENCY				OUTPUT		Modulation	Misc. Features	Price \$
			Minimum MHz	Maximum MHz	Acc. %	Stab. ppm	Minimum μ V	Maximum V			
SG 7	Sage	851-S-51	2000	2500	± 1	ina	n/a	100mW	am	c	2995
	Sage	814A-L-9	2000	2500	± 0.1	0.05	n/a	100mW	am	c	5950
	Sage	814A-S-1	2500	3050	± 0.1	0.05	n/a	75mW	am	c	4250
	Sage	851-S-52	2500	3600	± 1	ina	n/a	100mW	am	c	2995
	Sage	814A-S-2	2950	3600	± 0.01	0.05	n/a	80mW	am	c	4250
	Sage	831-S-1	2000	4000	± 0.1	1	40mW	200mW	am	e	6400
	Sage	841B-S-1	2000	4000	± 0.1	0.2	40mW	200mW	am	e	7950
	Sage	841C-S-1	2000	4000	± 0.1	1/wk	40mW	200mW	am	e	9195
	H-P	616B	1800	4200	± 1	0.005%/°C	0.1	0.223	am, fm, pm	cj	2400
	Sage	814A-S-31	3700	4300	± 0.1	0.05	n/a	1000mW	am	c	8350
SG 8	H-P	8616B	1800	4500	± 0.5	0.005%/°C	n/a	15mW	am, fm, pm	cdj	1600
	H-P	8616A	1800	4500	± 10 MHz	0.005%/°C	-127dBm	+10dBm	am, fm, pm	cdj	2350
	Polarad	1106	1950	4600	± 0.5	0.0008%/V	-127dBm	+3dBm	fm, pm	cij	1990
	Polarad	1606	1950	4600	± 0.5	0.0008%/V	-127dBm	+3dBm	fm, pm	cij	2230
	R-S	SMBI	1700	5000	± 0.5	ina	-130dBm	+5dBm	fm, pm	a	4345
	Sage	851-C-51	5100	5900	± 1	ina	n/a	100mW	am	c	2995
	Sage	814A-C-1A	5100	5900	± 0.1	0.05	n/a	60mW	am	c	4250
	Sage	814A-C-10	5400	5900	± 0.1	0.05	n/a	200mW	am	c	4500
	Sage	814A-C-31	5925	6525	± 0.1	0.05	n/a	1W	am	c	ina
	Sage	851-C-52	5925	6525	± 1	ina	n/a	200mW	am	c	2995
SG 9	R-S	SLRC	2300	7000	± 1.5	ina	-100dBm	ina	square	f	5335
	Sage	851-C-53	6575	7125	± 1	ina	n/a	200mW	am	c	2995
	H-P	618C	3800	7600	± 1	0.006%/°C	0.1	0.223	am, fm, pm	cdj	2350
	Sage	841C-C-1	4000	8000	± 0.1	1/wk	20mW	100mW	am	e	9195
	Sage	831-C-1	4000	8000	± 0.1	1	20mW	100mW	am	e	6400
	Sage	341B-C-1	4000	8000	± 0.1	0.2	20mW	100mW	am	e	7950
	Polarad	1107	3800	8200	± 0.5	0.0008%/V	-127dBm	+3dBm	am, fm	cij	1990
	Polarad	1607	3800	8200	± 0.5	0.0008%/V	-127dBm	+3dBm	fm, pm	cij	2230
	Sage	854-X-55	7500	8500	± 1	0.2	n/a	200mW	am	cd	5995
	SG 10	Sage	851-X-55	7500	8500	± 1	ina	n/a	200mW	am	c
Sage		814A-X-5	7500	8500	± 0.1	0.05	n/a	200mW	am	c	4700
Sage		851-X-53	8500	10000	± 1	ina	n/a	100mW	am	c	2995
Sage		851-X-51	8500	10000	± 1	ina	n/a	500mW	am	c	2995
Sage		814A-X-21	8500	10000	± 0.1	0.05	n/a	500mW	am	c	4150
Sage		814A-X-2	9000	10000	± 0.1	0.05	n/a	80mW	am	c	4250
Sage		814A-X-21S	9600	10200	± 0.1	0.05	n/a	500mW	am	c	4300
Sage		814A-X-12	9800	10300	± 0.1	0.05	n/a	200mW	am	c	4450
Polarad		1608	6950	11000	± 0.5	0.0008%/V	-127dBm	+3dBm	fm, pm	cij	2230
H-P		620B	7000	11000	± 1	0.006%/°C	0.1	0.223	am, fm, pm	cdj	2350
SG 11	Sage	851-X-52	9800	11200	± 1	ina	n/a	200mW	am	c	2995
	Sage	814A-X-3	9800	11200	± 0.1	0.05	n/a	500mW	am	c	4750
	Sage	814A-X3M	10600	11800	± 0.1	0.05	n/a	100mW	am	c	4750
	Sage	841B-X-1	8000	12400	± 0.1	0.2	50mW	350mW	am	e	7950
	Sage	831-X-1	8000	12400	± 0.1	1	50mW	350mW	am	e	6400
	Sage	841C-X-1	8000	12400	± 0.1	1/wk	50mW	350mW	am	e	9195
	R-S	SMCI	4800	12600	± 0.5	ina	-130dBm	0dBm	fm, pm	a	4495
	Sage	851-K-51	12400	14500	± 1	ina	n/a	100mW	am	c	2995
	Sage	814A-K-21	12800	14500	± 0.1	0.5	n/a	100mW	am	c	4150
	H-P	626A	10000	15500	± 1	0.005%/°C	-90dBm	+10dBm	am, fm, pm	cj	3900
SG 12	Polarad	1709	10000	15500	± 1	0.0008%/V	-100dBm	0dBm	fm, pm	cij	3210
	Polarad	1809	10000	15500	± 1	0.0008%/V	-100dBm	0dBm	fm, pm	cij	3450
	Sage	814A-K-22	15000	17300	± 0.1	0.05	n/a	200mW	am	c	5150
	Sage	831-K-1	12400	18000	± 0.1	1	40mW	200mW	am	e	6400
	Sage	841B-K-1	12400	18000	± 0.1	0.2	40mW	200mW	am	e	7950
	Polarad	1810	15000	21000	± 1	0.0008%/V	-100dBm	0dBm	fm, pm	cij	3450
	Polarad	1710	15000	21000	± 1	0.0008%/V	-100dBm	0dBm	fm, pm	cij	3210
	H-P	628A	15000	21000	± 1	0.005%/°C	-90dBm	+10dBm	am, fm, pm	cj	3900
	Sage	814A-K-24	23000	25000	± 0.1	0.05	n/a	100mW	am	c	6950
	Sage	817A-K-35	34000	36000	± 0.1	0.5	n/a	50mW	am	c	8200

- m. Provides 10.7 MHz output
- n. Programmable.
- p. Signal source, triades & pentades.
- q. Signal Source - triades
- r. External frequency modulation.

- s. Internal amplitude modulation
- t. 20 IRIG channels.
- u. 10 IRIG channels.
- v. In two bands 1435-1540 MHz and 2200-2310 MHz.



High speed commercial memory system — **NANOMEMORY 2600** Full cycle time of 600 nanoseconds, and word capacities of 16K by 18 or 8K by 36. It's all done with a second-generation 2-1/2D drive system with efficient circuit and logic design, for reduced component count and high MTBF, and wide operating margins—the real feature of the 2-1/2D configuration. It is easily expandable in the field, and comes in a standard 19" rack.

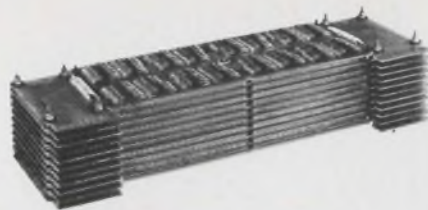

Perfect for high speed, large capacity mainframe memory systems... **NANOSTAK 3020**... technology breakthrough in 3W, 2-1/2D stacks. Stackable, compact size is an amazing 25% of competitive planar stacks and offers a significant advantage in form factor for system packaging. Extremely fast 650 nanosecond cycle time for 8K or 16K by 40, or 32K by 20 word memories.



Compact, ATR compatible memory system **SEMS-6** for use in military and rugged commercial aircraft applications. Reliable performer is optimized around 8K or 16K with maximum capacities of 8K by 40 or 16K by 20. Full cycle time of 2 microseconds, with access time of 700 nanoseconds. Meets MIL-E-5400, low power consumption and lightweight.



Five new memory cores for your next stack or system. All are medium or high drive, all coincident current, and all are fast switching for your high speed applications. Four new cores available in 18 mil, 20 mil, and two types of 30 mil sizes for use from 0° to 70°C. Also, a new wide temperature range 18 mil core for severe environments of -55° to +100°C.

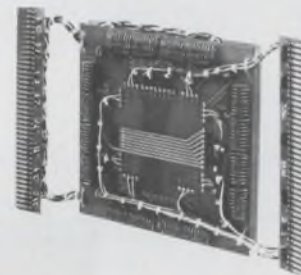

Rugged design for ground based mobile equipment, **NANOSTAK 020** commercial memory stack. High speed 850-nanosecond full cycle time for 4K memories. Features 3W, 3D organization with word capacities to 16K by 40. Built-in reliability and dependability. Available with wide temperature range cores for operation in severe environments.

Who else but Electronic Memories could introduce five brand spanking new memories—at once

Only Electronic Memories, the technology leader, could introduce five important new memories at once. Each one offers significant advances to provide you with faster, more reliable, and lower cost memories. Each one is loaded with outstanding new design features to give you faster access, larger capacity, and more economical operation. From cores and stacks to megabit memories, Electronic Memories has the memory products for your next, faster, more powerful computer system. For more facts and figures, just write.

EM **electronic memories**
a division of electronic memories & magnetics corporation
12621 chadron avenue, hawthorne, california 90250
telephone (213) 772-5201 TWX: 910-325-6213

INFORMATION RETRIEVAL NUMBER 61

How to test semiconductors five times faster.



The least efficient part of semiconductor testing is the mechanical handling of the devices being tested. Systron-Donner's Model 6200B/P Programmable Curve Tracer is five times faster than a manual tester. It automatically performs 5 different parameter measurements on any two and three terminal device... with just one hand operation. If the volume of units you test doesn't justify a \$25,000 automatic system, S-D's programmable instrument is the ideal solution. Price? Under \$2,000.

FOR CIRCUIT DESIGNERS: We also have a non-programmable unit, Model 6200B, which gives the same full range testing capability as the Model 6200B/P. It sells for under \$1,700 and is the perfect tool for circuit design and critical component selection.

For complete details, call or write Measurements Division, 888 Galindo Street, Concord, California 94520. Phone (415) 682-6161.



Index by Model Number

Name	Model	Code	Name	Model	Code
AMI	303A	SG3		SMBI	SG8
Advanced	303	SG4		SMCI	SG11
Measurement Instruments	303B	SG4		SMDH	SG1
	303H	SG4		SMFA	SG4
	3000	SG6		SMLR	SG1
Babcock	BSG-17	SG4		SMSF	SG2
Babcock Electronics Corp.	BSG-19A	SG4	Radiometer	MS-27	SG2
	BSG-23A	SG4	Radiometer Electronics		
GR	1001-A	SG1	Sage	814A-C-1A	SG8
General Radio Co.	1003	SG1	Sage Labs, Inc.	814A-C-10	SG8
	1026	SG1		814A-C-31	SG8
H-P	202J	SG2		814A-K-21	SG11
Hewlett-Packard Co.	211A	SG2		814A-K-22	SG12
	232A	SG2		814A-K-24	SG12
	606A	SG1		814A-L-9	SG7
	606B	SG1		814A-S-1	SG7
	608E	SG3		814A-S-2	SG7
	608F	SG3		814A-S-31	SG7
	612A	SG5		814A-X-2	SG10
	614A	SG6		814A-X-3	SG11
	616B	SG7		814A-X-3M	SG11
	618C	SG9		814A-X-5	SG10
	620B	SG10		814A-X-12	SG10
	626A	SG11		814A-X-21	SG10
	628A	SG12		814A-X-21S	SG10
	8614A	SG6		817A-K-35	SG12
	8614B	SG6		831-C-1	SG9
	8616A	SG8		831-K-1	SG12
	8616B	SG8		831-L-1	SG6
Kay	1522A	SG5		831-S-1	SG7
Kay Electric				831-X-1	SG11
Marconi	TF2002AS	SG1		841B-C-1	SG9
Marconi Instruments	TF2006	SG5		841B-K-1	SG12
				841B-S-1	SG7
Measure Measurements	65B	SG1		841B-X-1	SG11
	80	SG2		841C-C-1	SG9
	80R	SG3		841C-L-1	SG6
	82	SG1		841C-S-1	SG7
	84TVR	SG5		841C-X-1	SG11
	95	SG3		851-C-51	SG8
	180	SG2		851-C-52	SG8
	180R	SG3		851-C-53	SG9
	188	SG2		851-K-51	SG11
	189	SG2		851-L-1	SG6
	800	SG4		851-S-51	SG7
	801	SG3		851-S-52	SG7
	840	SG5		851-X-51	SG10
Polarad	1105	SG6		851-X-52	SG11
Polarad Electronic Inst.	1106	SG8		851-X-53	SG10
	1107	SG9		851-X-55	SG10
	1605	SG6		854-X-55	SG9
	1606	SG8	Sierra	470A-200	SG2
	1607	SG9	Sierra Electronics, Philco Corp.	470A-500	SG4
	1608	SG10		470A-1000	SG5
	1709	SG12		470A-2500	SG6
	1710	SG12	Singer/Gert Gertsch Products,	FM-9E	SG3
	1809	SG12		FM-10	SG3
	1810	SG12	Singer	SG-1000	SG5
R-S	SDFA	SG4	Singer Instrumentation Div.	SG-1001	SG5
Rohde & Schwarz	SLRC	SG9			
	SMAI	SG5			
	SMAR	SG1			



Now we've got the biggest line of tiny Snap-Actors



LM
Series

With the introduction of the new LM subminiature series, Unimax now offers you the widest choice of snap-acting subminiature and miniature subminiature switches in the industry. Designed to meet applicable military specifications, the entire line offers extra long life and a complete range of forces and motions. Sub-miniatures are rated to 10 amps at 250 volts AC and are available in any of 10 standard terminal configurations. Miniature subminiatures are rated at 7 amps and can be supplied with differential motion as low as .0005" max. Integral actuators are available on all models and a wide variety of toggle and push button assemblies are standard.



Unimax Switch

Division of Maxson Electronics Corporation / Wallingford, Connecticut 06492

The newest, fastest and easiest way to specify indicator lights, push button switches and readouts.



**Dialco's new 56-page product
selector guide helps you select
from over 1,500,000 visual indicators**

This book is the result of an all-out effort to provide you with fingertip data on all Dialight components and to make it very easy for you to locate the detailed specs and information you desire. Designers and engineers will find the "Product Selector Guide" invaluable in their work. Send for your copy today. Dialight Corp. 60 Stewart Ave., Brooklyn, N.Y. 11237.

DIALCO

DIALIGHT

A North American Philips Company

new mil-performance square cermet trimmers from CTS

Now . . . with CTS Cermet Multi-Turn Square Trimmers you get Characteristic C Mil-spec performance for all military applications. All new series 165 (style RJ24) and series 175 (style RJ22) meet tough Characteristic C of Mil-R-22097C. These same environmental characteristics are available . . . at lower cost . . . for commercial and industrial applications.

Both small $\frac{3}{8}$ "-square series 165 and compact $\frac{1}{2}$ "-square series 175 trimmers assure infinite resolution over a 20 ohm to 2.5 megohm range . . . and power rating of $\frac{1}{2}$ watt @ 85°C. TC ± 150 ppm/°C for 2k ohms and above. $-0 +175$ ppm/°C from 50 ohms through 250 ohms and $-0 +250$ ppm/°C from 500 ohms through 1k ohm. All available at no extra cost.

Low cost*, proven quality, and top performance—combined with **fast distributor delivery**—make CTS your best industrial trimmer choice. Can't use one of our standard series? Ask how we can solve specific application problems. Call or write for complete details to CTS of Berne, Inc., Berne, Indiana 46711. Phone (219) 589-3111.







*Check these prices for 4-6 week production delivery. (Small quantities from stock)

Quantity	Series 165		Series 175	
	25-49 (each)	1000 (each)	25-49 (each)	1000 (each)
Commercial (+20% Tol.)	\$4.55	\$3.25	\$4.20	\$2.95
MIL-type (=10% Tol., Char. C)	5.30	3.80	5.10	3.65

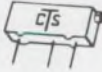
Other CTS Cermet Trimmers include:



CTS CORPORATION
Elkhart, Indiana

						
Series 185 1- $\frac{1}{4}$ " x .290" x .364" multi-turn	Series 190 $\frac{3}{4}$ " x .160" x .310" multi-turn	Series 340 $\frac{1}{4}$ " x $\frac{1}{4}$ " square x .270" high—single-turn	Series 360 $\frac{7}{16}$ " x $\frac{1}{4}$ " x $\frac{25}{64}$ " single-turn	Series 385 $\frac{1}{32}$ " round x .225" high—single-turn	Series 660 $\frac{3}{8}$ " round x $\frac{1}{4}$ " high— single-turn	Series 630 $\frac{1}{8}$ " round x $\frac{11}{32}$ " high— single-turn

New Products

Miniature storage tube for \$500 can hold an image for two weeks



Princeton Electronic Products, Inc., P.O. Box 101, New Brunswick, N.J. Phone: (201) 297-4448. P&A: \$500; 4 wks.

Inexpensively store black-and-white images on an ordinary television set for two weeks? Nonsense?—No, reality!

It's all possible with a new miniature storage tube that sells for only \$500 in small quantities and has a resolution of 800 television lines (640,000 bits). Key to the new unit's reduced price and size is its structured target, which is actually a monolithic silicon wafer. This structured silicon tar-

get allows use of a gun assembly which is identical to that employed in vidicon camera tubes.

Lithocon model 1M-800-HS actually acts as an electronic buffer memory. It can store a full-gray-scale image for 12 minutes with constant refreshing, and a black-and-white image for 30 minutes with power applied or for two weeks if the power is turned off or the tube removed from its socket.

Special sockets or cables are not necessary; the Lithocon will operate with standard vidicon hardware. In addition, its associated

electronics only involves a dc power supply and a magnetically deflected yoke.

Operating voltage level is only 450 V, not in the order of kilovolts as with previous storage tubes. This means that high-voltage corona is no longer a problem and lower system operating temperatures are possible.

Besides a decisive cost advantage, the Lithocon permits broad applications flexibility because the display is separated from the storage system. Now the user can selectively edit the stored image, rather than erase the entire display and then repaint, as with previous systems.

Other advantages include being able to zoom-in on any portion of the image for blow-up studies. Television monitors can also be time shared, thereby reducing required computer time.

The 1M-800-HS is the first product in a series of under-development silicon-target devices. In the near future, the 1M-1200-HS storage tube will offer a resolution of 1200 lines for only \$1000.

Also available is the model 400 storage terminal, which contains the necessary electronics (except for display) and controls for the Lithocon. Cost is \$3750; delivery is six to eight weeks.

CIRCLE NO. 250

Low-cost 50-MHz counter can also measure voltage at seven digits. p. 106.

Computerized test system for complex wiring makes 9000 checks/minute. p. 108.

Large-scale bipolar read-only memory chip stores up to 1024 bits. p. 112.

A/d converter for \$179.50 resolves 12 bits to 0.05% accuracy, p. 113.

Evaluation Samples, p. 122.....**Design Aids**, p. 123.

Application Notes, p. 124.....**New Literature**, p. 126.

Indicating pilot light uses only two lamps

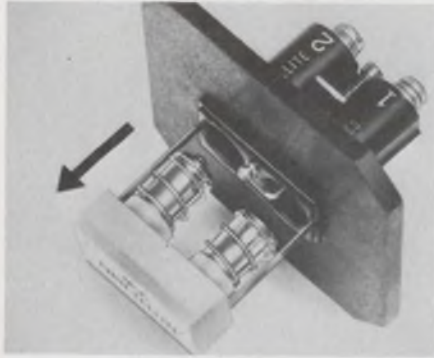

Master Specialties Co., 1640 Monrovia, Costa Mesa, Calif. Phone: (714) 642-2427.

Able to display as many as three lines of words in any one of six illuminated colors, a new indicating pilot light features two-lamp reliability. In addition, the 201 Twin-Tellite unit mounts in two drilled holes instead of square panel cutouts like previous devices. Its lens assembly can be pulled out and turned down for easy access to the lamps.

CIRCLE NO. 251

Bidirectional switch works by push buttons



Janco Corp., 3111 Winona Ave., Burbank, Calif. Phone: (213) 845-7473.

By depressing one of two buttons on its front, a new bidirectional printed circuit rotary switch can change its position. It is available with 8, 10 or 12 positions with all standard codes. Ratings include 3 A at continuous duty; and make and break ratings are 0.125 A resistive at 28 V dc or 115 V ac, and 0.05 A inductive at 28 V dc. A viewing light is optional.

CIRCLE NO. 255

Modular 3-piece relays plug into PC boards

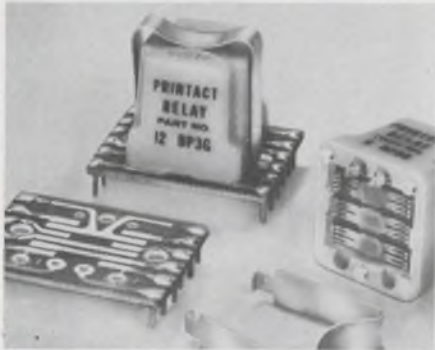

Executone Inc., Printact Relay Div., Austell Pl., Long Island City, N. Y. Phone: (212) 392-4800. P&A: \$3.12 to \$5.37; 4 to 6 wks.

Consisting of a header, a housing assembly and a clamp, a new series of latching and non-latching relays mount into PC boards with a plug-in bead pin header. This eliminates using sockets and allows replacement without soldering. These relays can be inserted and soldered to a PC board without the attached housing assembly.

CIRCLE NO. 252

Tiny lamp assembly replaces lamps easily



Alco Electronic Products, Inc., Box 1348, Lawrence, Mass. Phone: (617) 686-3887. P&A: \$1.29; stock.

Easily serviced from the front, a new panel indicator lamp assembly features finger-tip lamp replacement. The Brite Glo assembly has a removable round dome lens and a supplied #680 incandescent T-1 lamp rated for 5 V at 60 mA. It mounts with a 9/32-32 nut. Lens colors are in red, green, blue, yellow or white.

CIRCLE NO. 253

Dry-reed rhodium switch withstands 600 V min

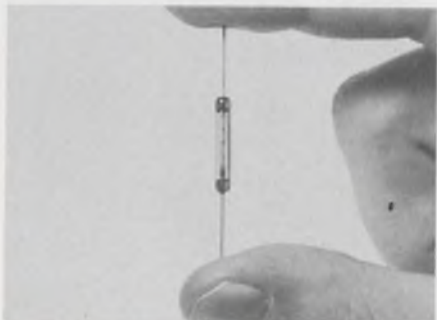

Hathaway Instruments Inc., 5250 E. Evans Ave., Denver, Colo. Phone: (303) 756-8301.

Developed for switching extremely high stand-off voltages, a new dry-reed rhodium switch has a minimum dielectric strength of 600 V. The switch has a contact rating of 1 A and power rating of 5 W. Insulation resistance is $10^6 \Omega$ and initial contact resistance is 0.2 Ω . The switch is 0.8-in. long and 0.106 in. in dia.

CIRCLE NO. 254

Tiny dry-reed relay switches up to 1 ms

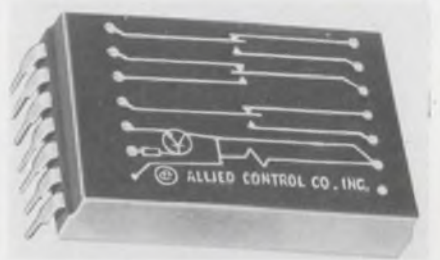

Allied Control Co., Inc., Plantsville, Conn. Phone: (203) 628-9654.

Measuring only 0.0275-in. high and suitable for mounting on PC boards spaced as close as 0.5-in. apart, a new dry-reed relay switches at 1 ms. The Tri-R unit has contact ratings of 10 W resistive, 50 V dc or 0.5 A dc, power requirement of 75 mW/pole, and a life expectancy of 2×10^7 operations. It can incorporate other solid-state devices such as diodes, op amps and time-delay circuits in the same package.

CIRCLE NO. 256

TRW 5 watt 3 GHz S-band transistor

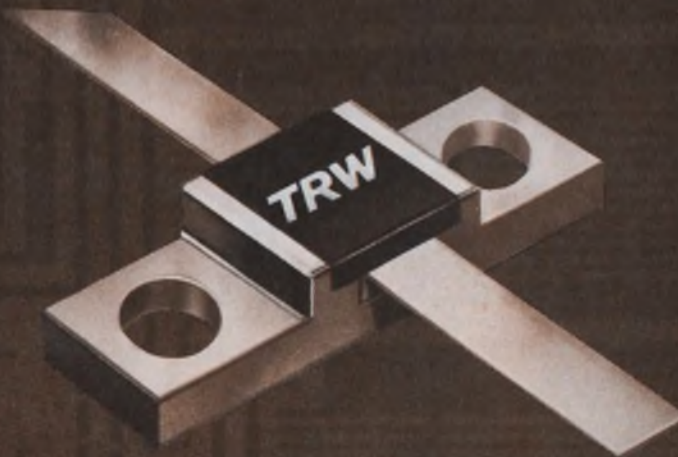

...New Broadband MIC package

The TRW Gigahertz Family takes another step forward in power and frequency: a new compatible series of microwave transistors, operating at 3 GHz—the heart of S-band. The new family includes four devices with the highest available output power bandwidth and gain at 3 GHz:

PT6669	300 mW	6 dB gain
PT6618	1.0 Watt	5 dB gain

PT6635	2.5 Watts	4 dB gain
PT6636	5.0 Watts	3 dB gain

This new common base series is consistent with microwave integrated circuits and/or conventional stripline. The package is also specially designed for low parasitics. Like the rest of the Gigahertz Family, they operate from a 28 volt source.

For complete information and

applications assistance, contact TRW Semiconductors Division, 14520 Aviation Blvd., Lawndale, California 90260. Phone: (213) 679-4561. TWX: 910-325-6206.



ACTUAL SIZE

TRW®

INFORMATION RETRIEVAL NUMBER 66

push with ALCOSWITCH

These miniature push button switches control heavy currents with outstanding reliability and consistent performance. Snap-action mechanism allows quick make-and-break along with solid silver contacts for efficient switching operations.

LIGHTED MODELS

The illuminated push button Series MSPN have over 50 varied colored buttons and sizes to fit your specific applications. Versatile DPDT model with isolated lamp terminals.

WATERPROOF

The "E" Series is made to rigid specifications exceeding industry standards. Miniature in size, but exceptional in performance. Available as momentary, or Push-ON or Push-OFF, in one, two and 4PDT models.

Whether you need one or one thousand switches you have a greater variety to choose from when you specify an ALCOSWITCH.



SEND FOR COMPLETE
ALCOSWITCH CATALOG

ALCO

ELECTRONIC PRODUCTS, INC.

Lawrence, Massachusetts 01843

COMPONENTS

Compact fluidic relay simplifies interfacing



Corning Glass Works Fluidic Products Dept., Corning, N.Y. Phone: (607) 962-4444. P&A: \$16 to \$19.50; 2 wks.

A new fluidic time-delay relay eliminates the bulky resistor-capacitor networks and mechanical timing devices that were formerly required to set up time delays of 1 to 10 seconds or longer. The compact unit offers a repeatability of $\pm 5\%$ over its full adjustable time range, which can be expanded by adding capacitance.

CIRCLE NO. 257

Teledyne Relays, 3155 W. El Segundo Blvd., Hawthorne, Calif. Phone: (213) 679-2205. P&A: under \$20; stock.

Housed in a TO-5 case, a new line of four-pole magnetic latching relays actuate in 1.5 ms. Series 424 relays have 26.5-V dc reset coils and 0.1-V dc trip coils that will accept 80% of the required trip current without tripping. They are adjusted to trip between 80 and 120% of the nominal trip current.

CIRCLE NO. 258

Latching 4-pole relays actuate in only 1.5 ms

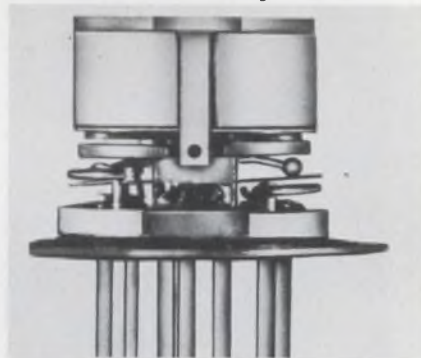

Rundel Components, Inc., 740 Broadway, Redwood City, Calif.

A miniature solid-state relay, mounted on a small pilot light, together with a small solid-state amplifier, form a complete annunciator system that gives off audible signals. The annunciator has stand-alone sequence buttons and separate test and acknowledge buttons. The three units can be mounted together or separately to provide 10 annunciator points that can be powered by a single supply.

CIRCLE NO. 259

Annunciator system is 3 tiny modules



Cutler Hammer, Inc., Specialty Products Div., 4201 N. 27 St., Milwaukee, Wis. Phone: (414) 442-7800. P&A: \$4.55 to \$6.69; 8 to 10 wks.

Only the size of a thimble, a new pushbutton module can be snapped into place on illuminated pushbutton assemblies for efficient and inexpensive switching. The Diamin unit is interchangeable with snap-action low-travel limit switches, and is available with silver or gold contacts for different ratings.

CIRCLE NO. 260

Pushbutton module brings down size



◀ INFORMATION RETRIEVAL NUMBER 67

Panel indicators widen selection

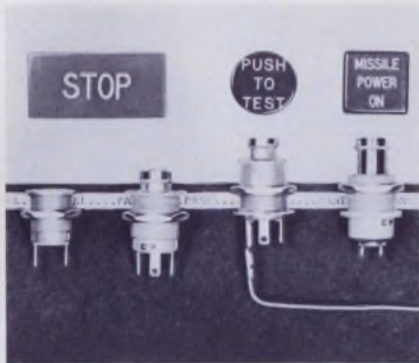

Clare-Pendar Co., P.O. Box 785, Post Falls, Idaho. Phone: (208) 773-4541.

Including standard and press-to-test models, a new line of panel indicators offers versatility of selection with front and rear-mounting styles. The new line offers front-removable single-light lenses in over a dozen shapes and a choice of nine colors, environmentally sealed indicator bases, and clip-on or solder-lug terminal connections.

CIRCLE NO. 261

Fast rf limit switch actuates in 10 μ s

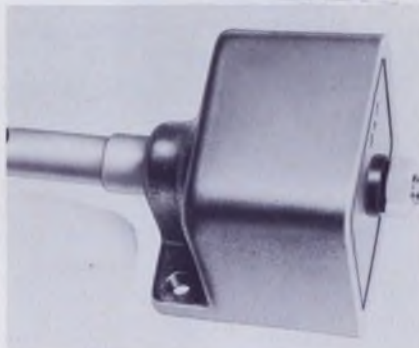

Johnson Controls, Inc., 227 South St., Rochester, Mich. Phone: (313) 651-0218.

The model 7610 rf limit switch is a solid-state device that actuates in less than 10 μ s on 110 V dc when there is enough capacitance between its antenna probe and a ground. It has no moving parts and is guaranteed for an unlimited number of actuations. It is available prewired with an inductive output of 1 A—10 A inrush and 1 A continuous.

CIRCLE NO. 262

EXTRA DRY



In a martini, it's a matter of taste — in a K-Grip Jr. RF connector in wet, humid climate, it's essential. That's why our new series of plugs and jacks is moisture-proof.

The dry is extra. All the rest is K-Grip Jr. — the lowest cost, high-reliability RF connector installed. Almost 50% smaller, 50% lighter, it's a crimp type version of our standard RF connector reduced to its simplest form. Assembly is foolproof — in seconds.

With K-Grip Jr. RF connectors it's a matter of savings. We save you time, weight, space and, in our new series of plugs and jacks, we save you from weather-worry. Write for details.

KINGS

ELECTRONICS CO., INC.
40 Marbledale Road/Tuckahoe, N.Y. 10707
(914) SW 3-5000 / TWX 710-562-0110

INFORMATION RETRIEVAL NUMBER 68

Your best choice in enclosures

- oil and dust tight
- EMI/RFI shielded
- rigid one-piece construction
- available from stock



Consoles in versatile stock design, 50" x 24" x 23", with gasketed front and rear doors. Options include rack angles, swing-out and stationary subpanels and writing desk. **Consolets** are offered in eleven stock sizes for desktop mounting of remote controls. Floorstand optional.

All units are heavy gauge steel with all-welded seams, easily shielded.



FREE-STANDING
ENCLOSURES

NEMA 12 units in stock sizes up to 90" x 36" x 24". Rigid 12 gauge steel with all-welded seams, gasketed doors front and/or rear. Oil and dust tight. Options include several interior panel arrangements, rack angles and shielding.

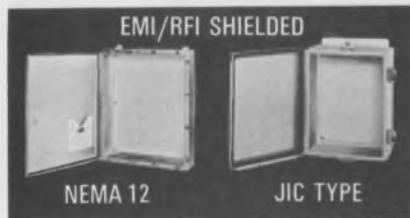

EMI/RFI SHIELDED

NEMA 12

JIC TYPE

Heavy gauge steel boxes with hinged doors, all cadmium plated. Oil and dust tight, fully shielded. Interior mounting panels and terminal block kits optional. Shipment from stock, all sizes.



NEMA 1
ENCLOSURES

For mounting controls where oil, dust and water are not a problem. One-piece heavy gauge steel construction, finished in gray prime. Flush latches. Interior panels for mounting components. Wide size range in stock.

Hoffman

HOFFMAN ENGINEERING COMPANY
Division of Federal Cartridge Corporation
Anoka, Minnesota, Dept ED-433

ELECTRICAL ENCLOSURES

INFORMATION RETRIEVAL NUMBER 69



Low-cost 50-MHz counter doubles as a seven-digit DVM

Hewlett-Packard, 1501 Page Mill Rd., Palo Alto, Calif. Phone: (415) 326-7000. P&A: \$1150 (A), \$1450 (A/B); 4 wks.

Incorporating a 50-MHz electronic counter and a digital voltmeter in one instrument for under \$2000 is one of the most versatile universal counters available.

The basic instrument is the model 5326A counter/timer. Adding an integrating digital voltmeter to the counter timer results in the model 5326A/B.

The model 5325A/B counter/DVM measures frequencies from 0 to 50 MHz of either periodic or random signals by period average measurements.

It has a dual-channel input, either ac or dc-coupled, and features level-controllable differential input amplifiers. A three-step attenuator changes the control-range maximum voltages in decades of ± 2 , ± 20 and ± 200 V.

Inputs to the two channels can be from either common or separate signals. This design results in high stability and sensitivity and an impedance of 1 M Ω shunted by 25 pF.

Time-interval averaging ranges from 15 ns to 1 s with a single-shot resolution of 100 ns. Since a measurement can be averaged over 10^3 intervals, resolutions down to 10 ps can be obtained.

The counter's gate time is selectable in nine decades from 0.1 μ s to 10 s, with automatic display of the decimal point and units.

Periods are fully displayed with a seven-digit readout (eight digits optional), and an overflow lamp lights up on the front panel for counts in excess of the seven digits.

Time-interval measurements can be made from 0.1 μ s to 10 s. A rear-panel connector furnishes 1- μ s marker pulses from channel A and B for trigger-level display on an oscilloscope.

The 5326A/B offers dc voltage measurement in three decades of 10, 100 and 1000 volts. Auto-polarity and measurement times from 1 ms (2 digits) to 1 s (5 digits) are front-panel selectable.

The digital voltmeter achieves an accuracy of 0.05% with excellent linearity by the use of a highly linear and very stable voltage to frequency converter.

This seven-digit DVM has a unique function in that it can accurately measure channel A and B input trigger points to within 0.05% and display that value.

Consequently 50% points and 10% to 90% rise and fall-time points can be accurately set for time-interval measurements by using the internal meter functions.

The input impedance of the voltmeter ranges from 10 M Ω for the 1000-V range to greater than 1000 M Ω for the 10-V range.

Ac normal-mode rejection is greater than 60 dB for multiples of 10 Hz and integration time is 100 ms. The DVM suppresses the display of unwanted zeros.

CIRCLE NO. 263

Inexpensive tester zeros-in on FETs



Sencore, Inc., 426 Westgate, Addison, Ill. Phone: (312) 543-7740. Price: \$94.50.

Specifically designed to measure field-effect transistors, a new low-cost tester checks FETs as they should be checked—like cold vacuum tubes. Testers intended to measure transistors only cannot usually give a true performance indication for FETs. The new instrument, model FT155, is particularly designed to measure the new generation of field-effect transistors.

CIRCLE NO. 264

Three-in. oscilloscope goes out to 7 MHz



Leader Instruments, 37-27 27th St., Long Island City, N.Y. Phone: (212) 729-7411. P&A: \$189.50; stock.

With sweep rates from 1 Hz to 200 kHz in six steps, a new 3-in. oscilloscope spans the frequency band of dc to 7 MHz. The model LBO-32B unit has easily balanced horizontal and vertical amplifiers allowing it to be used as a vector scope. It has an input sensitivity of 10 mV/cm and a calibration voltage of 0.03 V pk-pk at 60 Hz.

CIRCLE NO. 265



Our Driver Manual.

(It's a free license to control all driving situations.)

Fault-free control of load driving can be yours when the motor matches (or exceeds) your product or system requirements and avoids the performance compromises inherent in common motors.

The Motor Catalog offers you literally thousands of choices — size, type, horsepower, torque, input — to obtain exactly the motor you need. In addition, there's comprehensive theory and applications information.

IMC Magnetics Corp., Eastern Division, 570 Main Street, Westbury, N.Y. 11591, Tel. (516) 334-7070, TWX 510-222-4469

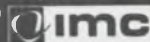

INFORMATION RETRIEVAL NUMBER 70



“Don't tell me your damned p.c. boards are alright...I've just had 'em tested electrically by MULTI/SCAN!”

Introducing MULTI/SCAN
... a new, low cost method of 100% electrically testing for continuity and shorts on any multi-layer, single or double sided printed circuit boards.

MULTI-SCAN finds the problems in your p.c. boards before assembly, paying for itself by reducing trouble-shooting time and establishing a confidence factor.

Tooling costs average between \$50 - \$100, with 2-3 weeks delivery for initial orders ... less than 2 weeks for subsequent orders. And, all tests are guaranteed.

Interested? Write or phone for Bulletin No. 100 today ...

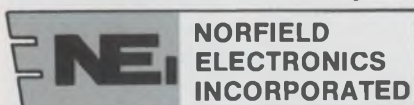

**NORFIELD
ELECTRONICS
INCORPORATED**

3 Depot Pl., East Norwalk, Conn. 06855
phone: 203/853-2777

INFORMATION RETRIEVAL NUMBER 71

Computerized wiring tester performs 9000 checks/min

Automation Dynamics, div. of Resalab Inc., 35 Industrial Parkway, Northvale, N.J. Phone: (201) 768-9200. P&A: from \$37,500; from 120 days.

Delivering a complete diagnostic analysis of complex wiring systems, a new high-speed computerized test system can perform up to 9000 tests per minute. Checking for shorts, opens, leakage and impedance, model QC 448 represents the complete integration of a measuring system, a digital computer, and software. Primary applications are computer backplanes, aircraft harnesses, multi-layer printed circuit boards and multi-conductor cables.

The new system triples operating speed over conventional punched-tape-controlled circuit analyzers. This high-speed performance reduces testing costs and permits complete retesting after each error has been repaired. The retesting ensures that the rework has not introduced a new fault in previously tested circuits.

Model QC 448 employs Zip-Talk, a user-oriented conversational language, for both programming and diagnostic output data. The language uses the common terms of product descriptions, such as con-

ductor, pin number, or wire color.

Complete identification of faults, wiring errors, short-circuit paths, missing connections and components are automatically computed and displayed whenever a no-go condition exists. In addition, by using the computational capability of the digital computer, programming efforts can be reduced up to 50% over conventional paper-tape-controlled systems. A subroutine allows operation of the systems in a self-program mode.

The digital computer is a Hewlett-Packard model 2114B with a storage of 8192 words having 16-bit lengths. A photo-electric tape reader is used to load the programs into the computer. A model ASR 33 teletypewriter and punch acts as the output data logger.

Optional measurement modules can expand the system's capability to dc and ac voltage, current and crosstalk. System capacity, which is normally 2500 terminations, can be increased to 100,000 test terminations. Optional peripheral equipment includes a high-speed punch, a CRT display, a magnetic tape drive, data-phone compatibility, and a Zip-File storage system.

CIRCLE NO. 266

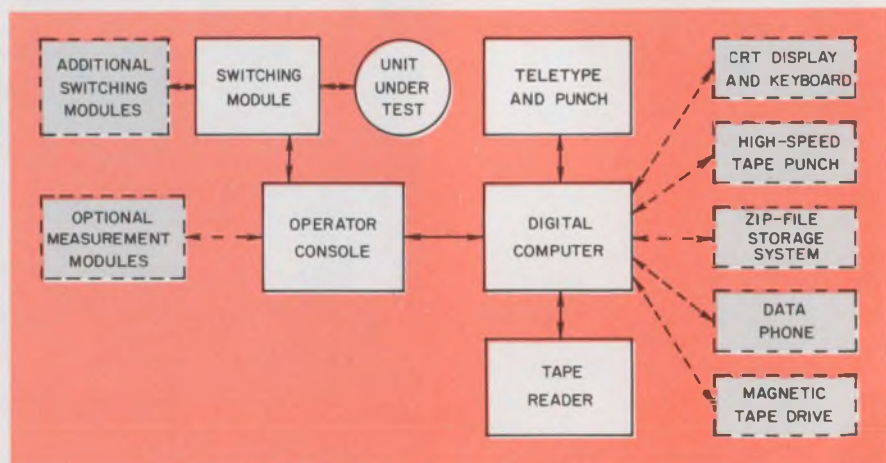

Computerized test system checks out complex wiring at speeds of 9000 tests per minute. Its complete diagnostic analysis includes short, open, leakage and impedance checks. A full array of options meet special needs.

Ac to dc converter
is accurate to 1%

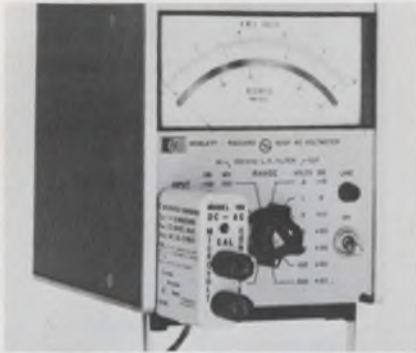

Electronic Applications Co., 2213
Edwards Ave., S. El Monte, Calif.
Phone: (213) 442-3212. Price:
under \$50.

Transforming any ac millivoltmeter into a direct-reading dc microvoltmeter, a new low-cost microvolt dc converter accomplishes this at a 1% accuracy. The model 100's accuracy is limited only by the linearity of the ac millivoltmeter. It has a 1- μ V resolution and features zero drift. Input impedance is 10 M Ω .

CIRCLE NO. 267

Voltmeter/phasemeter
measures 1-ms pulses



Ocean Data Equipment, 883 Waterman Ave., E. Providence, R. I.
Phone: (401) 434-7780.

Measuring pulse or cw, a new two-channel ac digital voltmeter/phasemeter measures bursts of 1 ms. The model VIP-100 computing pulse meter responds from 500 to 20,000 Hz at 20 independent voltage readings per channel. It measures voltages from 10 mV to 1000 V at 100- μ V resolutions and phase angles from 0 to 360 degrees at 0.1-degree resolutions.

CIRCLE NO. 268

*Sweating out an RFI/EMI
requirement between
1 and 10GHz?*



STODDART'S NOW HOME ON THIS RANGE

Fully portable new Model NM-65T EMI Receiver spans the range from 1 to 10 GHz. Simple to operate, easy to handle, precise enough for the laboratory, rugged enough for the field. Uses integral, rechargeable batteries. Meets requirements of all applicable commercial and military specifications.

Special features and salient specs:

- Makes field intensity (average), direct peak, and slide-back peak measurements
- Selectable 6 dB bandwidths, 100 kHz, 500 kHz, or 5 MHz
- Voltage measurement capability to 120 dB
- Over-all measurement accuracy within 2.5 dB
- True frequency within 2% of indicated value
- Excellent sensitivity over the frequency range
- Shielding effectiveness 80 dB minimum
- FM detector for aural and visual display
- Automatic frequency control
- 21.4 MHz IF output
- "X" and "Y" outputs for external recording or remote indication
- Four simultaneous video outputs: log IF, lin IF, "stretch" lin IF, and FM detected video
- Expanded output indication
- Built-in mercury switch impulse calibrator
- Size: 16 $\frac{3}{4}$ "W x 8 $\frac{3}{4}$ "H x 18"D
- 45 pounds.

Model NM-65T meets your needs ideally for determining the source and analyzing the characteristics of electromagnetic interference.

Field strength measurement of microwave sources; propagation studies and radiation pattern measurements; scatter propagation studies; low-power-level VSWR measurements; spectral power distribution analysis; and two-terminal microvoltmeter applications.

The Model NM-65T joins the Stoddart family of portable, battery operated EMI receivers, covering the range from 10 kHz to 10 GHz.



MODEL NM-12AT

10-250 kHz • Measures voltage within 2 dB, frequency

within 2% • Excellent sensitivity • Voltage range 160 dB • Weight 22 pounds



MODEL NM-25T

150 kHz to 32 MHz • Measures voltage within 2 dB,

frequency within 2% • Voltage range 140 dB • Solid-state impulse calibrator • Weight 22 pounds



STODDART ELECTRO SYSTEMS

A Division of Tamar Electronics, Inc.

2045 West Rosecrans Avenue • Gardena, California 90249

Phone (213) 770-0270

INFORMATION RETRIEVAL NUMBER 72

SCHAUER

1%

tolerance

1 WATT ZENERS ARE A REAL BUY!

ANY voltage from 2.0 to 16.0 at the industry's LOWEST PRICES!

Quantity	Price each
1-99	\$1.07
100-499	.97
500-999	.91
1000-4999	.86
5000 up	.82



THE HI-RELIABLE!

No fragile nail heads. Silicon junction aligned between two, parallel, offset tantalum heat sinks . . . great lead tension strength. All welded and brazed assembly. High pressure molded package. Gold plated nickel-clad copper leads. Write or phone for Form 68-4 for complete rating data and other tolerance prices.

Semiconductor Division

**SCHAUER
MANUFACTURING
CORP.** 4511 Alpine Avenue
Cincinnati, O. 45242
Ph. (513) 791-3030

INSTRUMENTATION

dBm/kHz test set is one instrument



Telecommunications Technology Inc., 920 Commercial St., Palo Alto, Calif. Phone: (415) 326-9217. P&A: \$1185; 60 days.

Sampling at 10 readings per second, a new dBm/kHz test set measures frequency and transmission levels in one instrument. The model 1101A has automatic ranging for digital readouts -50 to +10 dBm. It has frequency resolutions of 0.1, 1 and 10 Hz and a level resolution of 0.1 dB.

CIRCLE NO. 269

Cordless signal source pulses a wide spectrum

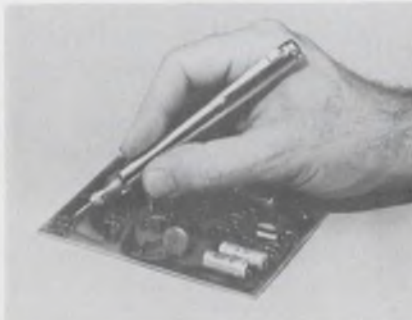

Don Bosco Electronics, Inc., 525 Broad St., Bridgeport, Conn.

Ideal for applications in DTL, TTL and RTL circuits, a new cordless pen-sized signal source generates and injects pulses over the audio, i-f and rf spectrums. Known as the "Mosquito," it operates on a single 1.5-V battery and weighs only 1 oz. It can be used to troubleshoot and test digital equipment, computers, telephone circuits, instruments and audio systems.

CIRCLE NO. 270

Mirror-scale VTVM widens ac response



Singer Products Co., Inc., Electronics Div., 95 Broad St., New York. Phone: (212) 944-8700. P&A: \$39.95/kit, \$49.95/wired; stock.

Available in both wired and kit form, a new vacuum-tube-voltmeter includes a wide frequency response for color-television service compatibility, fm multiplex and general-use applications. The model 1700C mirror-scale unit measures 0 to 1500 V ac and dc in seven ranges at a full-scale accuracy of $\pm 5\%$ and 0 to 1 G Ω in seven ranges.

CIRCLE NO. 271

Gain-stable amplifier lowers noise to 25 nV



Keithley Instruments, Inc., 28775 Aurora Rd., Cleveland, Ohio. Phone: (216) 248-0400. Price: \$400.

Providing a high degree of feedback over the operating range of 1 Hz to 1 MHz, a new low-noise amplifier exhibits a gain-stability of 0.5% per $^{\circ}\text{C}$ and noise of (shorted input) less than 25 nV rms per root Hz above 1 kHz and 100 nV per root Hz at 10 kHz. The model 825 has harmonic distortion of less than 0.05% and variable gain in five 10-db steps from 40 to 80 dB.

CIRCLE NO. 272

Power 1200-V SCR carries 1500 A



Power Semiconductors Inc., 90 Munson St., Devon, Conn.

Said to be the world's largest SCR, a new silicon controlled rectifier with a 48-mm pellet diameter is capable of supplying up to 1500 A at up to 1200 V. Called Astro-Pack, this high-power device eliminates the need for paralleling, thereby reducing the size and cost of the equipment into which it is designed. It can be supplied as a component or a heat-sink sub-assembly.

CIRCLE NO. 273

Metal-can triacs can handle 15 A



Texas Instruments Inc., Components Group, P.O. Box 5012, Dallas, Tex. Phone: (214) 238-2011. P&A: \$1.70 to \$4.15; stock.

Useful as a substitute for electromechanical relays and contactors, a new line of metal-can triacs feature current ratings as high as 15 A rms. Models 220, 230 and 240 can handle load currents of 6, 10, and 15 A, respectively, and offer voltage ratings of 200, 400 or 500 V. They are available in three package configurations.

CIRCLE NO. 274

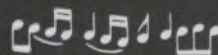

YOU'RE
WHISTLING
IN THE
DARK . . .

. . . if you think that heart disease and stroke hit only the other fellow's family. No one is immune. Protect the hearts you love. For authoritative information, ask your Heart Association. For medical advice see your doctor. To safeguard your family . . .

GIVE...
so more will live
**HEART
FUND**



Contributed by the Publisher

**CHECK
NORTRONICS
HEAD SPECS FOR YOUR
MINI-DIGITAL
APPLICATION—**



Model Number	BQQN	W2R
	B3187	B1884
Tape Width—Inches	.250	.150
Tracks on Tape	4	2
Channels in Head	4	2
Track Width—Inches	.037	.056
Channel Spacing (Center to Center)	.071	.088
Gap Spacer	0.5 Mil	0.2 Mil
Inductance, 1 KHZ	85 Mhy	10 Mhy
Resistance, D.C.	290 Ohms	39 Ohms
Saturation Current—ma. to Produce 90% Peak Output @ 200 BPI (Measured Zero to Peak, Alternate Polarity)	0.9	2.7
Write Current—ma. 150% Saturation Current @ 200 BPI	1.4	4.0
Read Output—mv. P-P (Open Circuit) 3.75 ips	11.8	4.2
NRZI @ 200 BPI 15 ips.	44	15
Read Output—mv. P-P 800 BPI Ref 200 BPI	85% min.	85% min.

These and 7 MORE
NOW AVAILABLE
Request Bulletin #7253
and Supplement #7310

available free from the
World's Most Experienced Manufacturer of
Magnetic Heads

Nortronics
COMPANY, INC.

8101 Tenth Avenue North
Minneapolis, Minnesota 55427

INFORMATION RETRIEVAL NUMBER 75

ICs & SEMICONDUCTORS

**LSI memory chip
accepts 1024 bits**

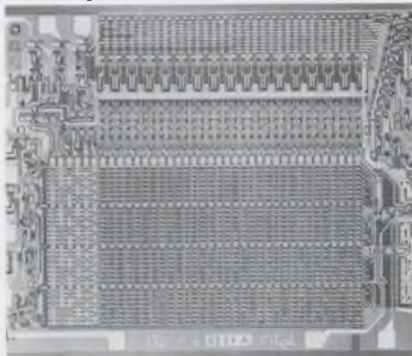

Intel Corp., 365 Middlefield Rd., Mountain View, Calif. Phone: (415) 969-1670. P&A: \$120; 4 to 6 wks.

Providing random access in 60 ns maximum, a Schottky-process LSI bipolar read-only memory stores 1024 bits organized as 256 words by four bits. Model 3301 is fully decoded and has two chip-select leads that permit expansion to a 1024-word memory without the need for external decoding. Power dissipation is only 0.5 mW per bit.

CIRCLE NO. 275

**Small rectifiers
take 300-A surge**

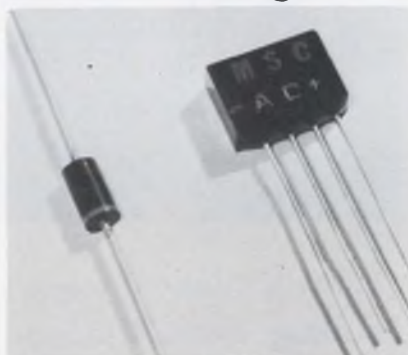

Microsemiconductor Corp., 11250 Playa Court, Culver City, Calif. Phone: (213) 391-8271. P&A: 23¢; stock to 2 wks.

Capable of handling 300-A surges at 100°C, series MHR 3-A silicon rectifiers offer peak inverse voltage ratings of 100 to 1000 V. These plastic devices meet or exceed the requirements of MIL-STD-202B, method 103A, and all other specifications of NEMA-EIA class A2. They are 0.2 in. in diameter × 0.38-in. long.

CIRCLE NO. 276

**Fast-recovery diodes
carry up to 750 mA**

Electronic Devices, Inc., 21 Gray Oaks Ave., Yonkers, N.Y. Phone: (914) 965-440. Price: 26¢ typical.

Miniature axial-lead fast-recovery silicon rectifiers offer a recovery time of 250 ns and a forward current rating of 750 mA over the range of 50 to 1000 PIV. Series CB-F units, which measure 0.12 in. in diameter and 0.25 in. in length, are designed for use in high-density PC-board packages. Applications include computers, terminals, and test instruments.

CIRCLE NO. 277

**IC memory drivers
propagate in 60 ns**

Texas Instruments Inc., Components Group, P.O. Box 5012, Dallas, Tex. Phone: (214) 238-2011. Price: \$4.25 to \$8.50.

Three new system interface IC memory drivers provide a typical average propagation delay time of 60 ns and a nominal output sink current of 400 mA. The SN75303 interfaces bipolar logic levels and magnetic memory systems; the SN75308 can be used as word-line driver; and the SN75324 replaces discrete high-current transistor-transformer circuits.

CIRCLE NO. 278

**Power 100-A diodes
recover in 1.5 μs**

International Rectifier, Semiconductor Div., 233 Kansas St., El Segundo, Calif. Phone: (213) 678-6281. P&A: \$25; stock.

Series 101KL and 101KLR fast-recovery diodes feature reverse recovery times of 1.5 and 2 μs with up to 100-A ratings at voltages from 400 to 1300 V. They are supplied in a DO-8 Rock-top package. Applications include inverters, phase-controlled SCR assemblies, and use as a free wheeling diode across an SCR bridge.

CIRCLE NO. 279

A/d 12-bit converter boasts \$179.50 price

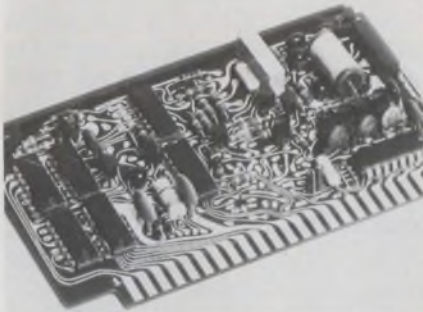

Analogic Corp., Audubon Rd., Wakefield, Mass. Phone: (617) 246-0300. P&A: \$179.50; stock to 2 wks.

Digitizing analog signals to an accuracy of 0.05%, a new 12-bit a/d converter slashes 12-bit converter costs to \$179.50. The model AN2612 has operating rates of 1000 conversions/s in eight-bit configurations and 100 conversions/s in 12-bit configurations. Temperature coefficient is 0.004%/°F.

CIRCLE NO. 280

Dual power supplies give 100 mA/output



Phipps Precision Products, 7641 Densmore Ave., Van Nuys, Calif. Phone: (213) 785-3109. P&A: \$41; stock.

Providing dual ± 15 -V dc or single 30-V dc outputs in modules, a new line of power supplies delivers up to 100 mA per output. Model 401 units operate from 115 V ac at an output-accuracy of ± 0.05 V dc. They have a temperature coefficient of 0.02%/°C and no-load to full-load regulation of 0.005%.

CIRCLE NO. 281

GUARANTEED

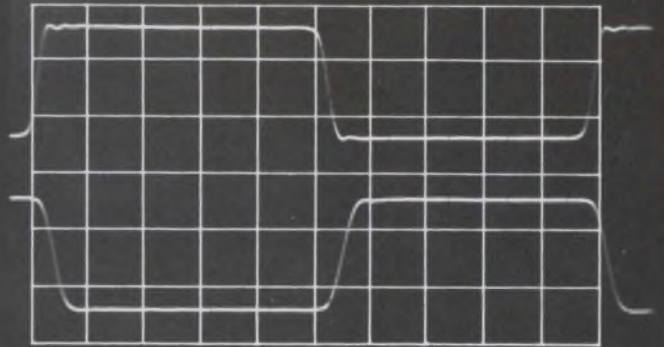

**1000V/ μ sec Slew Rate
100 MHz Gain Bandwidth**

Need a high performance operational amplifier for high frequency inverting applications? INTRONICS' Model A501 will drive loads up to ± 50 mA at ± 10 V while slewing at 1000V/ μ sec . . . Combine this with 100 MHz Gain Bandwidth, and you've got faithful reproduction of high speed signals faster than any other operational amplifier.

The A501 is especially well suited for:

- high speed integrator
- video summing
- coaxial line driver
- deflection control amplifiers
- summing amplifier for high speed A - D conversion
- output amplifier in D - A conversion

Packaged in a low profile (0.40), encapsulated module, the A501 offers standard (and nonstandard) pin configurations. It operates over a temperature range of -25°C to $+85^{\circ}\text{C}$ with short circuit protection built-in.

Write for full information.

*A501 operating as a unity gain inverter
Upper: Square wave input
Lower: Inverted square wave output
Horizontal: 50nS/div
Vertical: 10V/div

 **intronics**

TWX 710-335-6835
(617) 332-7350
57 CHAPEL STREET, NEWTON, MASS. 02158
INFORMATION RETRIEVAL NUMBER 76

9524-B

Another superb
photomultiplier from



Dark current at
200 Amps/Lumen typically
 2×10^{-9} Amps



A rugged versatile tube utilizing the special EMI CsSb box and grid design. Typical gain of 3×10^6 at 1100 volts makes it an excellent tube for portable instruments. Variants are available with "S", S-10, and S-20 cathodes as well as with quartz windows for U.V. work.

The characteristics of the 9524-B exemplify the type of performance to be expected from the more than sixty different photomultipliers made by EMI in sizes from 1 to 12" in diameter. Most types are available from stock in the U.S.

Write for our latest catalog and the name of your local representative.

GENCOM DIVISION
varian/EMI

80 EXPRESS STREET PLAINVIEW, N.Y. 11803
TELEPHONE (516) 433-5900

INFORMATION RETRIEVAL NUMBER 77

MODULES & SUBASSEMBLIES

Stable analog divider is accurate to 10 mV



California Electronic Mfg. Co.,
Inc., Box 555, Alamo, Calif. Phone:
(415) 932-3911. P&A: \$58 to \$94;
stock to 2 wks.

Improving trip point stability by voltage comparators drift only 10 to 1, a new series of precision 0.05 mV/°C. The series -01 Voltensors have a hysteresis of 0.5 mV, and output rise and fall times of 1 μ s. They are available in single and dual-set-point, and dual-set-point/dual-output types.

CIRCLE NO. 398

Differential op amp drifts only 0.5 μ V/°C

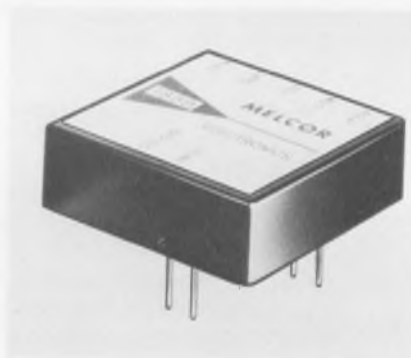

Transmagnetics, 134-25 Northern
Blvd., Flushing, N.Y. Phone:
(212) 539-2750. P&A: \$250; 4 to
6 wks.

Converting three-wire synchro inputs to dc sine-cosine outputs, a new converter replaces less accurate and bulkier mechanical servos. The model 655MP4 has an accuracy of five minutes of arc, accepts 11.8 V rms (line-to-line) $\pm 10\%$, and has an ac reference of 26 V rms (isolated) $\pm 10\%$ at 30 mA.

CIRCLE NO. 283

Hybrid Systems Corp., 95 Terrace
Hall Ave., Burlington, Mass.
Phone: (617) 272-1522. P&A:
\$120; stock to 2 wks.

Taking ratios of two analog signals with denominator amplitudes from 50 mV to 10 V, a new analog divider displays an accuracy of 0.1% (10 mV). The model 106A encapsulated unit is linear to 0.05% and can take square roots to 0.1%. Gain vs temperature is 0.005%/°C and offset vs temperature is 50 μ V/°C.

CIRCLE NO. 397

Voltage comparators drift just 0.05 mV/°C



Melcor Electronics Corp., 1750
New Hwy., Farmingdale, N.Y.
Phone: (516) 694-5570. P&A:
\$64; stock.

Featuring a gain of 10^7 and an output of ± 10 V at 5 mA, a new chopper-stabilized differential amplifier exhibits a voltage drift of 0.5 μ V/°C and offset current drift of 1 pA/°C. Model 1859 operates over the temperature range of 0 to 66°C, has a small-signal response to 500 kHz, 20-kHz full-power, 5- μ V of noise to 10 kHz and is powered by ± 15 V dc at 20 mA.

CIRCLE NO. 282

Tiny synchro converter replaces bulky servos



I/O data terminal prints 30 characters/s



Sperry Rand Corp., Univac Div., P.O. Box 3100, Philadelphia, Pa. Phone: (215) 646-9000. P&A: \$3285; Spring, 1970.

Designed to be compatible with most computer systems, a new asynchronous input-output printer operates in a full or half-duplex mode at speeds of 10, 15, or 30 characters per second. The DCT-500 data communications terminal consists of an advanced 132-column printer mechanism, a control unit and a keyboard.

CIRCLE NO. 284

Fast clock recorder tracks disc memories



Pioneer Magnetics Inc., 1745 Berkeley St., Santa Monica, Calif. Phone: (213) 393-0136. Availability: stock.

In less than two minutes, a new rotating-memory clock recorder can automatically record clock tracks on disc or drum memories with undetectable closure error. Model PM 1976 can record frequencies from 10 Hz to 5 MHz with a bit capacity of 2 to 524,287 bits, readily selectable from front-panel switches. Set-up time is generally under 10 minutes.

CIRCLE NO. 285

Digital tape system programs cw and ccw



Ampex Corp., Computer Products Div., 9937 W. Jefferson Blvd., Culver City, Calif. Phone: (213) 836-5000. Price: from \$2000.

Offering full computer compatibility and restriction-free programming, a complete digital tape memory system features bidirectional programming and read-after-write operation. The TMX uses 8-1/2-in. reels and has packing densities of 200, 556, and 800 bits/in. on standard 1/2-in. computer tape. Maximum tape speed is 12-1/2 in./s.

CIRCLE NO. 286

Magnetic/Electrostatic Shielded Coil Forms and Custom Wound Coils

Miller engineers will be happy to help with your coil designs, and also will furnish custom wound coils to your performance or detailed specifications.

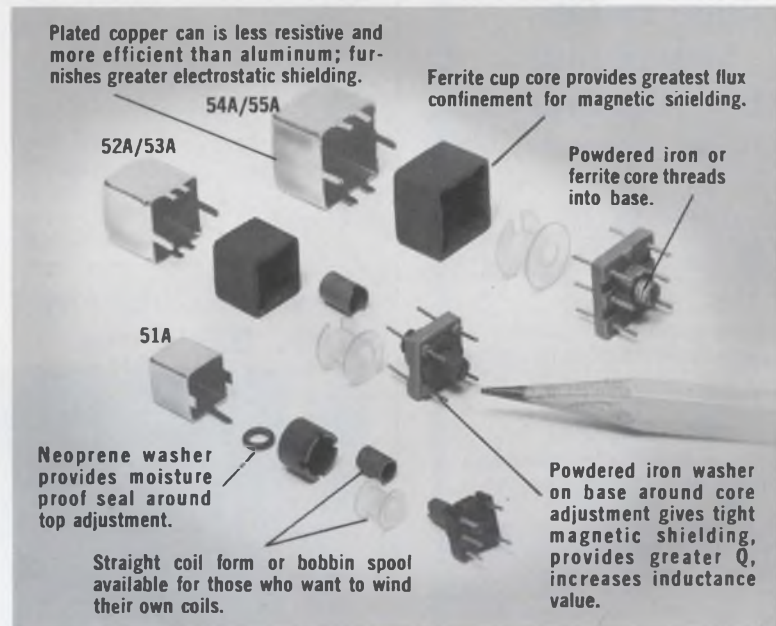

51A (Top Tuned)			52A (Bottom Tuned) 53A (Top/Bottom Tuned)			54A (Bottom Tuned) 55A (Top/Bottom Tuned)		
Dash	Freq MHz	Core	Dash	Freq MHz	Core	Dash	Freq MHz	Core
- 1	.3-1	CARBONYL C	- 1	.3-1	CARBONYL C	- 1	.3-1	CARBONYL C
- 2	.4-10	CARBONYL E	- 2	.4-10	CARBONYL E	- 2	.4-10	CARBONYL E
- 3	.1-.6	CARBONYL HP	- 3	.01-.4	CARBONYL HP	- 3	.01-.4	CARBONYL HP
- 6	10-50	CARBONYL SF	- 6	10-50	CARBONYL SF	- 3F	.01-4	FERRITE
- 7	5-30	CARBONYL TH	- 7	5-30	CARBONYL TH	- 6	10-50	CARBONYL SF
-10	25-100	CARBONYL W	-10	25-100	CARBONYL W	- 7	5-30	CARBONYL TH
-12	50-150	IRN - 8	-12	50-150	IRN - 8	-10	25-100	CARBONYL W
-50	.01-.6	FERRITE				-12	50-150	IRN - 8
-51	.01-.4	FERRITE						

NOTE: Resinite coil forms or nylon bobbin forms available for all models.

Write for more detailed specifications and general catalog.



J.W. MILLER COMPANY

19070 REYES AVE. • P.O. BOX 5825 • COMPTON, CALIFORNIA 90224

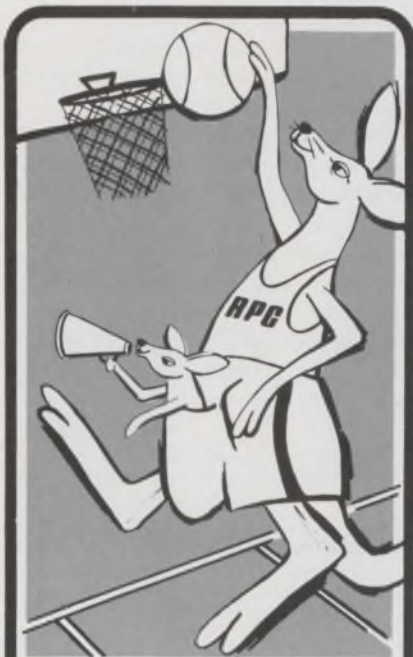

RPC scores with its line of high voltage high ohmic carbon film resistors

For example, 15 basic styles are available:

WATTS: .25 to 100w.

RESISTANCE: 10 to $10^{14}\Omega$

TOLERANCE: to $\pm 1\%$

STAND. SIZES: .563" L x .1" dia. to 19.687" L x 2" dia.

A variety of terminal configurations are available such as: radial lugs or bands, axial wire leads and ferrule ends.

APPLICATIONS

Typical applications include those requiring high resistances, voltage capability from 250 to 125,000 v and high frequency or pulse circuits including power supplies, generators, X-ray equipment, electro-static air cleaners, paint sprayers, photo-copiers and high voltage-dropping monitors.

RPC's carbon film resistors will often exceed the requirements of metal oxide types, and with the lowest rejection rate in the industry.

SPECIALS

No order is too small . . . too large . . . or too unusual

Only RPC has a special interest in solving those "special" problems. Resistors up to 40" long have been manufactured on request.

Call RPC . . . and see how fast you SCORE against resistance problems.

RPC Resistance Products Co.

914 South 13th Street

Harrisburg, Pa. 17104 • (717) 236-5081

DATA PROCESSING

Portable coupler transmits 300 baud



Info-Max, 470 San Antonio Rd., Palo Alto, Calif. Phone: (415) 327-5470. P&A: \$395; 30 days.

Featuring broad compatibility with data-terminal equipment and high immunity to external and line noise, a new compact portable acoustic coupler performs at a maximum data rate of 300 baud. It has switch-selectable half or full-duplex transmit/receive modes. Interface cables are available for Teletype 20-mA equipment and all RS-232-B equipment.

CIRCLE NO. 287

Electronic Memories, 12621 Chadron Ave., Hawthorne, Calif. Phone: (213) 772-5201. P&A: 3¢ to 5¢/bit; first quarter, 1970.

Nanomemory 3650 is a ferrite core memory system with a minimum mean time between failures of 2000 hours and a cycle time of 650 ns. It is available in capacities that range from 16k to 128k words by 8 bits to 76 bits per word. The drive circuitry of the new memory provides rise and fall times of approximately 50 ns.

CIRCLE NO. 288

Reliable core memory has 650-ns cycle time

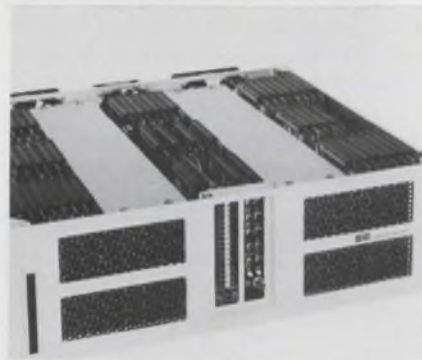

Mass core memory stores 65k bytes

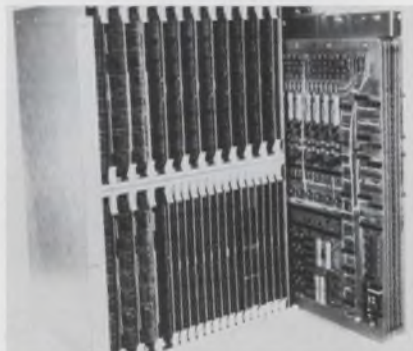

Interdata, 2 Crescent Place, Oceanport, N.J. Phone: (201) 229-4040. Price: from \$25,000.

Organized as 32,768 words, a new 65k-byte mass core memory employs a 16 or 18-bit two-wire coincident-current 2-1/2-D system. The design uses multi-pole switches in the bit access system, and a unipolar readout from the memory. Applications include information retrieval, real-time functions and communications systems. Cycling time is 1.8 μ s.

CIRCLE NO. 289

Comutek, Inc., 143 Albany St., Cambridge, Mass. Price: \$1000.

Model JS low-cost joystick graphic-input accessory requires no mandatory options and can be used with any CRT display. It assures high resolution and linearity by using metal-film potentiometers that turn 360° with the full 5-in. travel of the joystick handle. Three pushbuttons on the joystick generate commands for lines, points, and end.

CIRCLE NO. 290

Inexpensive joystick is self-contained unit



Pneumatic pliers swing through 90°



Techni-Tool, Inc., 1218 Arch St., Philadelphia, Pa. Phone: (215) 566-4457.

Without requiring a large capital investment or expansive exhaust equipment, a new abrasive cleaning pencil comes complete and ready to operate. The unit consists of a pick-up assembly with cannister, a pencil and hoses, a cabinet with light and shield, a vacuum system, a foot valve, and a pressure regulator. The pencil can be used with wet or dry media.

CIRCLE NO. 292

Motorized wire twister makes tiny harnesses



Russell Industries, Inc., 96 Station Plaza, Lyubrook, N.Y. Phone: (516) 887-9000. Price: \$17.95.

Labeled as Heat Tunnel, a new lightweight portable hand tool can shrink tubing in as little as five to seven seconds to 50% of its original diameter. The unit has a weight of less than one pound. It is a general-purpose product that is designed for industrial, experimental and hobbyist use in electronic, marine, electrical, automotive and home applications.

CIRCLE NO. 294

Hunter Associates, 182 Clairmont Terr., Orange, N.J. Phone: (201) 672-0423. P&A: \$84.95 or \$91.95; 3 to 4 wks.

A new lightweight compact pneumatic pliers has working heads that can be rotated through 90 degrees. The PZ Electronica is available with two interchangeable jaw inserts: one for cutting only, and the other for simultaneous cutting and crimping. The second jaw can be used to trim components and lock them in place on PC boards.

CIRCLE NO. 291

Abrasive clean pencil is full mini-system

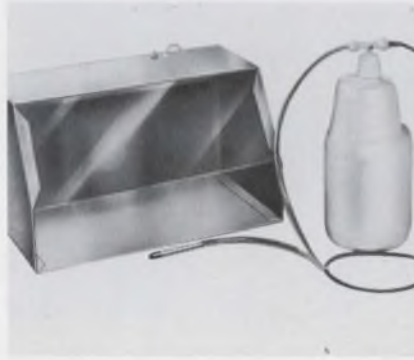

Storm Products Co., 2251 Federal Ave., Los Angeles, Calif.

The Mini-Twister motorized wire twister allows the fabrication of twisted pairs, triads and miniature wiring harnesses. Terminals, pins or lugs can be attached prior to twisting. Even AWG #30 and smaller computer wire can be automatically processed into twisted configurations. Costly hand-work operations such as untwisting of pairs and hand stripping can now be eliminated.

CIRCLE NO. 293

Circular tubing shrinker works in five seconds



SOLVING
electro-optical
problems
is OPTRON's
ONLY business....
SO, WE HAVE
TO BE GOOD!

You can count on Optron for high interest and undivided attention to your most exacting optoelectronic device requirements. And, you'll get product design, development and manufacturing benefits that only Optron experience can offer.

For example, through continuous process monitoring made possible by the use of diffusion lot traceability, Optron maintains the highest possible reliability. Still other special Optron manufacturing techniques make possible optimum device performance in variable light and temperature conditions. You get sensors with a lens/device relationship previously thought impossible.

Versatile OP 600 Series NPN planar silicon light sensors eliminate cross-talk and are ideally suited for high density arrays. In addition, these small, rugged devices will satisfy virtually any application requirement in optical character recognition. But, if your application isn't standard, you'll especially like Optron's fast reaction to your custom programs, too.

Write today for
Optron product
technical data
and the name
of your nearest
sales
representative.



OPTRON, INC.

1201 Tappan Circle
Carrollton, Texas 75006
214/242-6571

DIP test sockets invert device leads

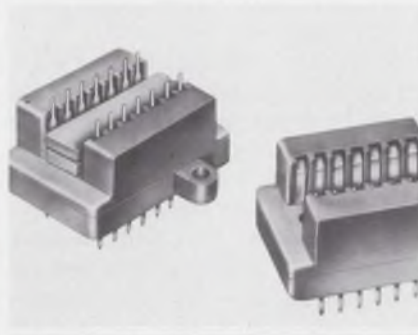

Barnes Corp., 24 N. Lansdowne Ave., Lansdowne, Pa. Phone: (215) 622-1525. P&A: \$1.58 to \$2.95; 3 wks.

Designed for high-speed hand testing of dual-in-line devices, series 121-0102 inverted DIP test sockets accept devices with the leads up. This allows test probes to be connected to the top of mounted devices while all the leads are excited. Even with inexact alignment, DIP devices can be inserted quickly and easily.

CIRCLE NO. 295

Modular IC test cards bring out device pins

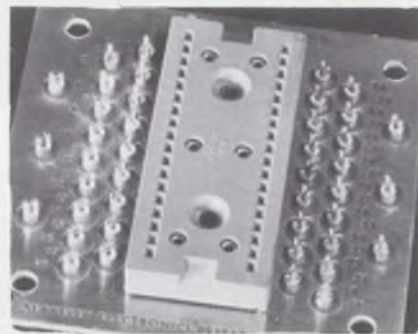

Berkeley Electronics Research Co., P.O. Box 1021, Berkeley, Calif. Price: \$9.50 to \$13.50

CmII test module cards contain an integrated circuit socket in all popular configurations, including those with 24 and 36 pins. Each pin is brought out to a numbered terminal; other terminals are available as tie points. There is a ground plane around each terminal for easy access to ground, and for preventing oscillations and ground loops. Auxiliary brackets are also available.

CIRCLE NO. 296

Connector interface mates with PC cards

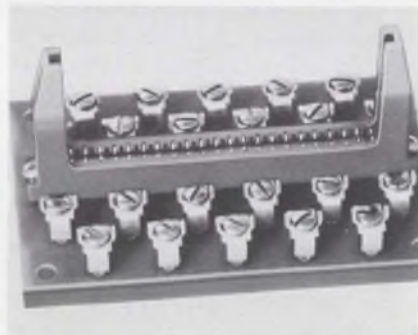

Farmer Electric Products Co., Inc., Tech Circle, Natick, Mass. Phone: (617) 653-8850. P&A: \$12; stock.

Bridging the gap between printed circuit technology and factory control panel installations, the model 22 edge connector interface socket allows the insertion of a 22-pin printed circuit board into a panel-mounted connector with screw terminals. This eliminates soldering, wire-wrap connections and cumbersome PC mounting panels.

CIRCLE NO. 297

Hollow rfi gaskets seal out environment



Chomerics, Inc., 77 Dragon Court Woburn, Mass. Phone: (617) 935-4850.

Molded from electrically conductive silicone elastomers, new hollow strip gaskets provide both rfi and environmental protection. Because of their hollow core, these gaskets can be compressed as much as 75% without compression set, and with extremely low closure forces. Shielding effectiveness is said to be high even when deflection is small. Various cross-sections are available.

CIRCLE NO. 298

PixiePrice!

the biggest point about Pixiepot[®] is the \$3.47 price tag

We'd like to make just one big selling point: Duncan's proven Pixiepot[®] is the one and only precision 10-turn wirewound miniature potentiometer in the world today with all these listed features at a price tag under \$3.50. Period. ■ Length: ONLY 3/4" ■ Diameter: ONLY 7/8" ■ Linearity: ±0.25% ■ Resistance Range: 100 ohms to 100K ohms ■ Power Rating: 2 watts @ +20°C ■ Temperature Range: -25°C to +85°C ■ Resolution: Better than ANY wirewound pot TWICE its size ■ Slotted Stainless Steel Shaft/IC ring ■ Save big dollars on your instrument and system requirements. Specify Model 3253 Pixiepot for as low as \$3.47 in production quantities and only \$4.95 each for 1-24 units. In-stock delivery, of course. Call, write or wire Duncan Electronics today for complete specifications. Get the point?

DUNCAN ELECTRONICS
SUBSIDIARY

SYSTRON • DONNER
2865 FAIRVIEW ROAD
COSTA MESA,
CALIFORNIA 92626
(714) 545-8261

TYPE HRV



HEAT REACTIVE VINYL ZIPPERTUBING®

best for skin-tight jacketing of cables and wire bundles in minutes!

HRV is made from material that shrinks when heat is applied. (Also available to meet military specifications.)

For full information on specialized, high-performance jacketing, contact

THE ZIPPERTUBING® CO.

CORPORATE HEADQUARTERS
13000 S. BROADWAY
LOS ANGELES, CALIF. 90061
Los Angeles Phone: (213) 321-3901
New Jersey Phone: (201) 256-4980



BALTIMORE • BOSTON • CHICAGO • CLEVELAND • DALLAS
NEW YORK • ORLANDO • PHOENIX • SAN FRANCISCO • WEST GERMANY

INFORMATION RETRIEVAL NUMBER 82

YOUR HEART FUND FIGHTS

**HEART ATTACK
STROKE
HIGH BLOOD PRESSURE
INBORN HEART DEFECTS**



Resistive cermet paste stabilizes to 100 ppm

Conshohocken Chemicals, Inc.,
Consh-Ohm Div., Box 244, Flourtown, Pa. Phone: (215) 836-5700.
Price: \$50 to \$90 per troy oz.

Resistive cermet pastes in the very low ranges, with stable and reproducible temperature coefficients to much less than 100 ppm are now available. Series CC200 thick-film pastes meet all military specification requirements. They fire at 565 to 610°C and offer, in process, range and temperature coefficient adjustments.

CIRCLE NO. 299

Masking latex coating strips away easily

Baer Bros. Paint & Varnish Co.,
Inc., Box 217, Rye, N.Y. Phone: (914) 698-0358.

A strippable latex coating which provides a rapid masking or protective coating for plastics, wood and metals, dries in 30 minutes, then peels off quickly and easily. Known as #6-27A, it will cover approximately 450 square feet per gallon, bringing its cost to less than 1¢ per foot. It is available in 55-gallon drums, five-gallon pails and one-gallon cans.

CIRCLE NO. 340

Solder creams match thick films

Alpha Metals, Inc., 56 Water St., Jersey City, N.J. Phone: (201) 434-6778.

A new line of solder creams, which are homogeneous combinations of finely powdered solder and flux, can be used on any solderable metallic or thick-film surface. These new formulations can be replaced by spraying, screening, masking, automatic dispensing, roller transfer, or by hand. They are available in curable and non-curable forms.

CIRCLE NO. 341

INFORMATION RETRIEVAL NUMBER 84 ►

the most popular ALCOSWITCH®

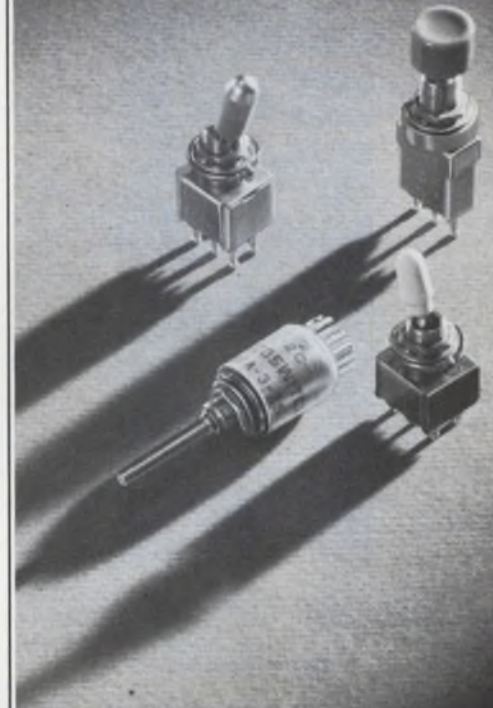

WE'RE NOT NO. 1, 2 OR 3

But we are popular in the miniature switch field.

You'll find our ALCOSWITCH® in test equipment, medical equipment, electronic controls, computers, and in thousands of installations where design engineers want the best without having to pay outrageous prices.

We're popular too, because ALCOSWITCH® has one of the broadest lines available in miniatures — toggles, push buttons, rotaries, locking, slide, and rockers, along with a host of needed accessories.

ALCOSWITCH® is made for engineers — and you can fill your immediate requirements from our stocks or from one of our many ALCOSWITCH® stocking distributors in your area.

ALCO®

ELECTRONIC PRODUCTS, INC.

Lawrence, Massachusetts 01843

OPTIMIZE

your avionic cooling system
with AiResearch.

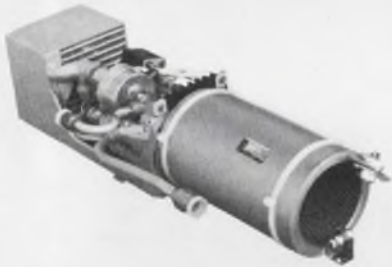

There are a lot of benefits when you start working with AiResearch on avionic cooling in the early design stages.

We can help you work out your thermal optimization studies, and then design a system that offers the maximum savings in power consumption, size, weight and time. Obviously, the total result will be another major step toward complete system economy and efficiency.

The system above cools the traveling wave tube of a radar transmitter. It provides 2800 watts of cooling with only 570 watts of power.

AiResearch capability includes over 30 years of experience and complete in-house component and system control.

For detailed specifications contact: AiResearch Manufacturing Company, 9851 Sepulveda Blvd., Los Angeles, Calif. 90009. Ph. (213) 776-1010 or (213) 670-0131.



AiResearch
Heat Transfer Systems
one of The Signal Companies

INFORMATION RETRIEVAL NUMBER 85

MICROWAVES & LASERS

Rf 470-MHz transistors belt out a dozen watts

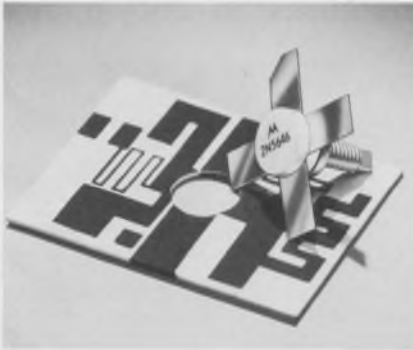

Motorola Semiconductor Products, Inc., Box 20924, Phoenix, Ariz. Phone: (602) 273-3466. P&A: \$8.30 to \$22.50; stock.

Operating with a 12.5-V power supply, a new chain of balanced-emitter rf power transistors supply 12 W from 450 to 470 MHz. The 2N5644 through 2N5646 units need no dc-to-dc converter and are used as power amplifiers in mobile transmitters. They are supplied in 3/8-in. ceramic stripline opposed-emitter packages.

CIRCLE NO. 342

S-band transmitter provides 2-W power



Vector, an Aydin Co., Box 328, Newton, Pa. Phone: (215) 968-4271.

Operating in the S band, a new miniature transmitter supplies a minimum output of 2 W. The model T-102S incorporates an integral circulator for operation into any load including open and short circuits. Its frequency response is dc to 2 MHz with a ± 2 MHz carrier deviation, and stability is $\pm 0.003\%$. Harmonic distortion is 1% at ± 500 kHz. It measures less than 12 cubic in.

CIRCLE NO. 343

Uhf power amplifier shows 2 W at 0.2 GHz

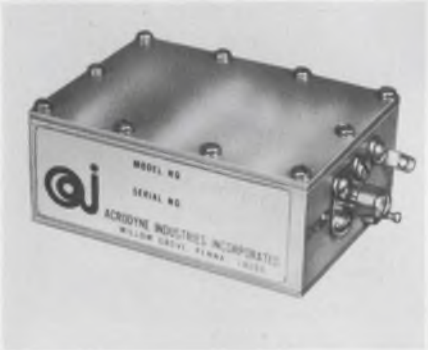

Acrodyne Industries, Inc. 666 Davisville Rd., Willow Grove, Pa. Phone: (215) 657-1800.

Spanning the frequency range of 500 to 2000 MHz is a new compact solid-state uhf power amplifier with an output of 2 W. The model A-2004/L is used for class-C operations with a 3-dB bandwidth of 150 MHz. Its power gain is rated from 7 to 13 dB and it is powered by +28 V dc. Dc-to-rf efficiency is 35%, and the amplifier measures $2\frac{3}{4} \times 2\frac{1}{4} \times 1$ in.

CIRCLE NO. 344

Low-noise amplifier spans 0.5 to 1 GHz



Optimax, Inc., 258 Main St., Ambler, Pa.

Without compromising noise figure, a new high-power, high-gain linear amplifier covers the frequency range of 500 to 1000 MHz. The model A52D2-M is capable of producing an output of +22 dBm with a noise figure of 5.5 dB. It has a gain of ± 0.5 dB and its input-to-output VSWR (voltage standing wave ratio) is a maximum 1:7.1. This allows class A amplification at no loss of parameters.

CIRCLE NO. 345

Tiny radar altimeter weighs just 21 oz



General Dynamics, Electronics Division, San Diego, Calif.

Capable of measuring altitudes to 2000 ft, a new IC radar altimeter weighs 21 oz and measures only 3-1/2 x 2-1/2 x 1-1/2 in. (including antenna). This analog-readout device displays from 0 to 5 V and works at a minimum altitude of 20 ft. Its accuracy is within 2 ft and 3% of altitude and it uses fm and cw transmissions in the K frequency band. A slot array antenna is an integral part of the unit.

CIRCLE NO. 346

Power transistors go out to 1 GHz

TRW Semiconductors Inc., 14520 Aviation Blvd., Lawndale, Calif. Phone: (213) 679-4561. Price: \$24 or \$48 per 100.

Offering significant performance advantages over two older types (2N4330 and 2N4331) which they will replace, two new transistors, 2N5764 (3 W) and 2N5765 (5 W), perform to 1 GHz. They will withstand severe mismatches under any load or phase conditions with a gain-increase of 6 dB and an efficiency increase of 40% over the older ones.

CIRCLE NO. 347

YIG-tuned receiver covers 10 to 40 GHz

Electro/Data, Inc., 1621 Jupiter Garland, Tex. Phone: (214) 341-2100. P&A: \$2995; 45 to 60 days.

With a single sweep, a new plug-in YIG-tuned panoramic receiver covers 10 to 40 GHz. The model PN1014 can plug into Textronix 560 and letter-series oscilloscopes. It uses an electronically swept yttrium-iron-garnet bandpass filter, which has a decade-tuning range, as a preselector, followed by a sensitive crystal detector and a low-noise video amplifier.

CIRCLE NO. 348

GaAs impatt diodes lower a-m/fm noise

Raytheon Co. Micro State Electronics Operation, 152 Floral Ave., Murray Hill, N.J.

A new line of gallium-arsenide avalanche impatt diodes offers minimum a-m and fm noise. These high-power X and Ku-band diodes are designed to give higher dc to rf efficiencies for high power cw levels, with regulated dc inputs, compared to other solid state microwave devices and include matched characteristics for interchangeability and parallel operation.

CIRCLE NO. 349

Ku-band Gunn diodes supply noiseless 36 mW

Varian Solid State Microwave Operation, 611 Hansen Way, Palo Alto, Calif. Phone: (415) 326-4000.

When inserted properly in a tunable microwave cavity, two new series of low-voltage gallium-arsenide Gunn-effect diodes deliver a typical output of 9 mW (series VSU-9206) or 36 mW (series VSU-9202) from 12.4 to 15 GHz. Output for both series is said to be noise free. Maximum threshold bias current is 750 mA dc for the VSU-9202 units and 500 mA for the VSU-9206 ones.

CIRCLE NO. 350

brite glo[®] ALCOLITE

Alco's new Brite Glo[®] miniature lamp series is achieved through painstaking workmanship that assures the best pilot assembly on the market.

The new T-1 3/8 MNE neon series has an exclusive ring electrode construction that glows on the entire surface with direct current. Available as individual lamps or as miniature panel assemblies.

All our miniature incandescent pilot assemblies contain the most popular and long-life MIL-grade T-1 5 volt lamps. Choice of domed or cylindrical assemblies, in a variety of colors.

Our standard neon series are all equipped with NE2 lamps and are available in many lens styles and colors, with or without built-in series resistors.

For design-service assistance and price quotations, call (Area 617) 686-3887.

SEND FOR COMPLETE
ALCOLITE
CATALOG



ALCO

ELECTRONIC PRODUCTS, INC.
Lawrence, Massachusetts 01843

BULOVA Can Fill Your Magnetic Component Needs Fast



We have over 3,200 prints to choose from. Should you need something special, we can design and produce to your specs quickly.



BULOVA
FREQUENCY
CONTROL PRODUCTS

Electronics Division of Bulova Watch Co., Inc.
61-20 Woodside Ave., Woodside, N.Y. 11377

For prompt action on your immediate needs
call Mel Liberman at (212) 335-6000 — Or



check the MAGNETIC COMPONENT
type(s) you are interested in and direct your
request to —

BULOVA WATCH COMPANY, INC.
ELECTRONICS DIVISION
61-20 Woodside Avenue
Woodside, New York 11377

WE'LL SEND YOU OUR LATEST DATA

- RC Networks
- Amplitude and Phase (Delay) Equalizers
- Modulators and Demodulators
- Lumped Constant Delay Lines
- Discriminator Transformers
- Band Reject Filters (up to 200 kHz)
- High Pass Filters (cutoff down to 10 Hz)
- Low Pass Filters (cutoff up to 50 MHz)
- Band Pass Filters (up to 50 MHz)
- Hybrid Transformers
- High 'Q' Coils
- Radio Frequency Inductors and Transformers (50 kHz to 50 MHz)
- Ultrasonic Transformers (20 kHz to 50 kHz)
- Audio Transformers and Inductors (0.5-20 cubic inches)
- Broadband Transformers (10 kHz to 100 MHz)

NAME _____

FIRM _____

ADDRESS _____

CITY _____ STATE _____

ZIP _____ PHONE _____

INFORMATION RETRIEVAL NUMBER 87

Evaluation Samples

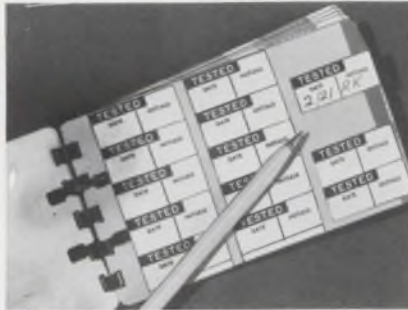

Portable labels

Porta-Packs are new pocket-size books containing self-sticking write-on labels for fast on-the-spot marking. Now available as a free evaluation sample, these new products make it easy to handle and carry a full supply of labels at all times. The labels accept written information to indicate inspection, testing, calibration, numbering, inventory, coding or identification. Various sizes and assortments are available. W. H. Brady Co.

CIRCLE NO. 351



Masking dots

Masking discs, called "Kwiky Dots," a practical idea for cutting masking time over holes and orifices, are offered as a free sample. To use, simply strip off a short string of dots and place the first one over the area to be masked. With the index finger of the other hand, press into position and hold as you gently pull to detach the rest of the strip. The dots easily separate from the strip and you are ready for the next one. By-Buk Co.

CIRCLE NO. 353



Foam tapes

Two new folders contain actual samples of Arnofoam tapes, along with details on the tapes' specifications and potential applications. Made of polyurethane or plasticized vinyl, Arnofoam is offered in four basic types with thicknesses ranging from 1/32 to 1/2 inches. The tapes come in widths from 1/4 to 36 inches. Suggested applications include cushioning, insulating and protection. Arno Adhesive Tapes, Inc.

CIRCLE NO. 352

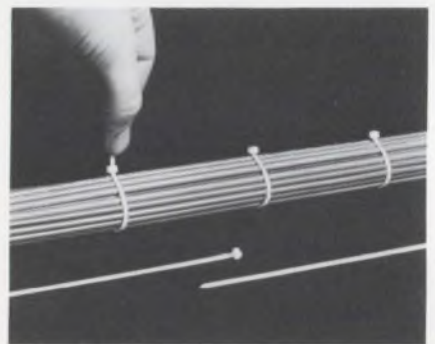

Long cable tie

Extra long to accommodate harnesses up to 0.25 inches in diameter, a new Sta-Rap cable tie, the SST1.5M, offers a loop tensile strength of 18 pounds minimum. The unit meets the requirements of military standards MS-3367-4, -17821-4, and -18034-4. It is all nylon and can be installed either by hand or with a tool. Now a free evaluation sample, this new tie is available in 11 colors, including natural white. Panduit Corp.

CIRCLE NO. 354

Design Aids

Transformer wallet card

Putting a selection guide in a nutshell, a handy wallet-size plastic card contains reference tables to determine rated line amperes for single-phase dry-type transformers. The units range in power from 1 to 500 kVA with voltages of 120, 240, 480 and 600 V. Three-phase transformers are rated at 3 to 2000 kVA for 208, 240, 480 and 600 V. Federal Pacific Electric Co.

CIRCLE NO. 355

Elastomer guide

Condensing basic data on 17 Vibrathane liquid prepolymers is this new urethane elastomers selection guide. Listed are both polyester and polyether types. Product applications include belting, pads, rollers, draft gear, seals, wheels, diagrams, heel lifts and coatings. Also described are durometer hardness values and special characteristics of the discussed types. Uniroyal Chemical.

CIRCLE NO. 356



IR/wavelength chart

A new circular chart correlates infrared wavelengths to chemical compounds. Simply set the cursor to any given wavelength, and one side automatically identifies most compounds producing absorption at that wavelength. It also includes the formula to convert wavelengths to wavenumbers. The other side of the chart presents wavelengths of the main absorption bands of 61 classes of chemical compounds. It is available at a nominal cost of \$3.00 per unit. Barnes Engineering Co.

CIRCLE NO. 357

ANNOUNCING:

Cool power



Model CP-5-5
Price: \$145.00

for IC logic

These new power modules from ERA provide *cool performance, total protection* for specialized use in IC, computer, telemetry, strain gauge and transistor applications.

The Transpac CP series is equipped with unique heat sinking for cool (71°C, free air) operation at high currents, protects itself and your equipment through built-in short circuit protection with instant recovery,

adjustable current limiting and over-voltage protection.

For extra protection, a special burn-in test program at the factory assures highest on-the-job reliability while compact silicon design means space savings in equipment design.

Compare specs and features — and use Transpac in your next design. Send for catalog showing full line, full specs, and low prices.

STANDARD MODELS

Output Voltage VDC	Current @			Sizes	Model	Price
	50°C	60°C	71°C			
3.6	3.2	2.8	2.5	3 ³ / ₈ x 4 ¹ / ₈ x 6 ¹ / ₄	CP-3P6-2P5	\$125.00
5	3.2	2.8	2.5	3 ³ / ₈ x 4 ¹ / ₈ x 6 ¹ / ₄	CP-5-2P5	\$125.00
3.6	6.5	5.7	5.0	3 ³ / ₈ x 4 ¹ / ₈ x 8 ¹ / ₈	CP-3P6-5	\$145.00
5	6.5	5.7	5.0	3 ³ / ₈ x 4 ¹ / ₈ x 8 ¹ / ₈	CP-5-5	\$145.00
3.6	13.0	11.4	10.0	4 ¹ / ₈ x 7 ¹ / ₂ x 8 ³ / ₈	CP-3P6-10	\$185.00
5	13.0	11.4	10.0	4 ¹ / ₈ x 7 ¹ / ₂ x 8 ³ / ₈	CP-5-10	\$185.00
3.6	22.0	19.5	17.0	4 ¹ / ₈ x 7 ¹ / ₂ x 10 ³ / ₈	CP-3P6-17	\$230.00
5	22.0	19.5	17.0	4 ¹ / ₈ x 7 ¹ / ₂ x 10 ³ / ₈	CP-5-17	\$230.00
3.6	32.0	28.5	25.0	4 ¹ / ₈ x 7 ¹ / ₂ x 14 ³ / ₈	CP-3P6-25	\$310.00
5	32.0	28.5	25.0	4 ¹ / ₈ x 7 ¹ / ₂ x 14 ³ / ₈	CP-5-25	\$310.00



Write today — before you design.

ERA TRANSPAC CORPORATION

A Subsidiary of Electronic Research Associates, Inc.
67 Sand Park Rd., Cedar Grove, N.J. 07009 (201) 239-3000

INFORMATION RETRIEVAL NUMBER 88

Application Notes

MOS/LSI design

An MOS/LSI guide enables anyone with a reasonable knowledge of MOS fundamentals to design his own MOS/LSI circuits. It includes electrical characteristics, process parameters and implementation guidelines for MOS devices. Included are tables for item definitions, values and dimensions. Other tables show undesirable and allowable design situations and suggested device input protection. A discussion follows on quality acceptance and masks. Cartesian, Inc.

CIRCLE NO. 358

Magnetic testing

The use of magnetic test methods and instrumentation is described in the latest issue of the "Motorgram" (Vol. 49, No. 5). Outlined are various procedures and equipment requirements for evaluating the magnetic properties of electrical steels used in motors and transformers. The issue also contains a case study of a portable recorder that uses several precision fractional-horsepower motors. Bodine Electric Co.

CIRCLE NO. 359

Printed circuit design

A short course on printed circuit design is contained in a booklet entitled "Printed Circuit Design and Documentation." It describes a system in which a printed circuit designer can communicate circuit requirements from the board fabricator to the responsible engineer for modifications. Included in this booklet is a printed circuit layout guide and specification sheet in tabular form, template diagrams and illustrated masking processes. High Altitude Products Co.

CIRCLE NO. 360

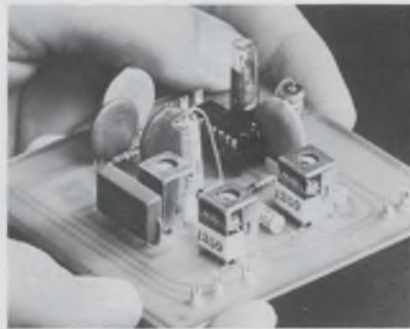

IC stereo decoder

A six-page construction article describes a monolithic integrated circuit fm stereo decoder system. Designed around an integrated circuit, the decoder provides excellent channel separation across the entire audio range. It incorporates series coils to help assure optimum channel separation characteristics. J. W. Miller Co.

CIRCLE NO. 361

Chemical machining

The engineering parameters that must be considered in designing for photofabrication or photochemical machining are thoroughly detailed in a 13-page design manual. Besides a concise description of the process itself, the manual talks of problems and their solutions, metal properties, and dimensions. Fotofabrication Corp.

CIRCLE NO. 362

Thin-film measurement

An eight-page article describes two new interference objectives for measuring thin-film thickness and surface roughness. These objectives can be used with almost any standard microscope. The booklet is amply illustrated with diagrams of the equipment and photographs of various surfaces. Hacker Instruments Inc.

CIRCLE NO. 363

Thermal drifts

Reprints of a recent article entitled "Minimizing Self-Heating Drift in Power Supplies" are available. It discusses the commonly overlooked factor of thermal feedback created by heat generated in the power supply itself. Load-induced and line-induced thermal drifts are considered as direct results of variation in internal temperatures of the power supply following a change in power dissipated by the supply. Application of a compensated amplifier, which exhibits freedom from thermal transients and has a steady-state temperature coefficient approaching zero, is described. Deltron, Inc.

CIRCLE NO. 364

Zero-voltage switch

Primarily used as a trigger circuit for thyristors, the model CA3059 zero-voltage switch is a multi-stage monolithic circuit. A 12-page application note shows the use of this IC in thyristor power switching and control circuits. Specific examples include various temperature controllers, a differential comparator, and a transient-free switch controller. RCA Electronic Components.

CIRCLE NO. 365

Cryogenic metals

The advantages of low-temperature processing in various metallurgical applications is described in a new booklet entitled "Metals Respond to Ultralow Temperatures." It covers many phases of low-temperature treatment including austenitic transformation, shrink assembly, as well as advantages which may be anticipated. This information will be of interest to production supervisors, design engineers, and pilot plant operations. Cincinnati Sub-Zero Products, Inc.

CIRCLE NO. 366

Time control for all data systems



Durant Calendar clock with electric readout

The Durant 59005 Digital Clock gives you a wide choice of models which supply visual and electrical readout in combinations of hours, minutes, seconds, tenths of minutes and thousandths of hours. And, if you wish, day of the month and calendar year.

Simple connections, made on the back panel, provide remote electrical readout. For visual readout, a signal holds all figures motionless; time pulses generated during readout are stored and recorded later.

Durant's 59005 Digital Clock has several mountings available. Operates on 115 or 230 volt AC, 50-60 cycle, or from your own system's time base generator. For full information, write for catalog 90-J, 622 North Cass Street, Milwaukee, Wisconsin 53201.

DURANT
MANUFACTURING COMPANY
COUNT / CONTROL INSTRUMENTS
MECHANICAL / ELECTROMECHANICAL / ELECTRONIC
In Europe: Durant (Europa) N.V. Barneveld, Netherlands
INFORMATION RETRIEVAL NUMBER 89

ELECTRICAL



E2B

Life Tests:

Electrical impulse E2B counters, running at 600 counts per minute under laboratory conditions, have achieved the following—

50,000,000 counts—DC units;
15,000,000 counts—AC units;
Testing still in progress.

Accuracy: Complete reliability under variable test conditions.

Figures: 6-digits, black on white.

Voltages: 115 V. AC; 230 V. AC; 24 V. AC; and 24 V. DC. (4 watts)



Drive: New patented reciprocating Delrin verge.

Mounting: Base or panel mount.

Face Size: 1.72" W x 1.19" H x 2.34" D. (Net wt. 5 oz.)

Recognition: Meets U.L. and C.S.A. standards.

Delivery: Most voltages available from stock.

Price: \$1.85 in OEM quantities.

Covered by Patent No. 3,470,361

Write for literature. Application help available.

ENM COMPANY
5306 W. Lawrence Ave., Chicago, Ill. 60630
PHONE: (312) 282-8787 TELEX: 02-5468
Representatives in principal cities

INFORMATION RETRIEVAL NUMBER 90

ELECTRONIC DESIGN 2, January 18, 1970

scr series

Power Supplies

for high power applications

Smallest volume per watt

Low ripple, both voltage & current

Constant voltage/constant current

0.1% constant current regulation

High efficiency

Remote programming/mhogramming

Plug-in circuit boards



Low output ripple plus constant voltage and current makes the SCR Series ideal for a wide range of industrial uses — including CW and pulse lasers, capacitor forming, electro plating, battery charging, focusing coils for accelerators, aging racks for semiconductors, electronic memory systems and cryogenic magnet applications. The SCR Series includes standard models with DC outputs of 0-500V, 5-500 amps, regulating at 0.1% for both constant voltage and constant current, with a price range from \$995 to \$1700. Four new 10 KW models which use only 12¼" of rack space. Rated at 0-20V, 0-40V, 0-50V and 0-100V priced from \$2500 to \$2900.

Our Applications Engineers are always available to help you solve your power supply problems.

For instant E/M power supply information call 800 - 631-4298

that's our new WATS Line number. Toll free . . . dial direct.

From New Jersey, 201 - 229-8800

ELECTRONIC MEASUREMENTS
2 Crescent Place ■ Oceanport, N.J. 07757

INFORMATION RETRIEVAL NUMBER 91



COMPACT POWER PACKS



The new Compact "M" Series Power Packs offer you:

- Rated output voltages from 1000 to 75,000 DC
- Rated output currents of 1.5, 5, and 10 milliamperes
- Input voltages of 118, 220, 230, and 240 volts AC
- Variable output from 0 to rated voltage
- Input frequency range 50 to 500 CPS output ripple 1% RMS at rated voltage
- Hermetically sealed construction

Why pay more, and settle for less... PC's new compact power packs give more quality, more versatility, more dependability, plus smaller size, and best of all, most sizes are available in stock to meet your immediate needs.

Write for complete information and new catalog today!



Plastic Capacitors, INC.

2620 N. Clybourn • Chicago 14, Ill.
DI 8-3735

New Literature



Hard-to-find tools

Useful hard-to-find tools can now be found in a 24-page, fully illustrated catalog. It contains precise and detailed descriptions and applications of each unique tool such as tungsten carbide saw blades, miniature riffler files, torch lamps, miniature screws, nuts, bolts, washers, stainless steel pliers and hard-chromed needle files. Also included are wood working tools, electronic tools, jewelers' tools, diamond pencil and glass cutters, unusual solders, rust removers, hard-wire cutters and glass drills. Scores of other versatile hand tools and small power tools are also shown. Brookstone Company.

CIRCLE NO. 367

Time sharing

"Time Sharing and You" is the title of a free booklet now being offered. Designed as an aid to the understanding of the computer time sharing concept, the booklet aims to explain how and why time sharing developed, how it works and also provides a glimpse of its future. The booklet is offered because of a belief that a wider understanding of computer time sharing is necessary and desirable. Call-A-Computer.

CIRCLE NO. 368

Motors

An expanded and redesigned catalog includes stock motors and speed controls. In 20 pages it provides data on more than 325 stock fractional motors and gearmotors ranging from 1/2000 to 1/4 hp, as well as SCR-adjustable speed/torque drive systems. Included are 14 new gearmotors and enlarged photographs, dimension drawings and increased type size for easier reading. The line of motor speed controls listed include both chassis and enclosed types. Also listed is a selection of new optional and accessory parts available for use with both types of controls. Bodine Electric Co.

CIRCLE NO. 369

Engineering tools

Special purpose slide rules, calculators, kits, books, precision measuring tools and other information aids are described in a 32-page catalog. Besides the many items with broad engineering and management appeal, products for specific fields such as mechanical, electronic, reliability and fluids are covered with special emphasis on quality control and inspection. Info Inc.

CIRCLE NO. 370

Computer time

Computer time marketing is the subject of a 36-page quarterly magazine called "Computer Time Report." It analyzes and reports computer and market trends and developments. Listed are computer availabilities in major cities across the nation along with prices and special features. Also listed are large scale computers available coast to coast with configurations and prices. Included are suggestions for buyers and sellers on services in demand and for efficient use of time. Time Brokers, Inc.

CIRCLE NO. 371

Power conversion

Features, specifications, modifications and mounting dimensions of miniature and subminiature power conversion equipment are described in a four-page condensed catalog. It covers ac-dc, miniature solid-state dc-dc and subminiature three-watt dc-dc converters. Also discussed are dc-sine-wave inverters, dc-dc high voltage regulated power supplies, miniature power transformers, inductors, current limiters and filters. Basic pricing information is included. Arnold Magnetics Corp.

CIRCLE NO. 372

Instrument journal

The December 1969 issue of the Hewlett-Packard Journal is now available. It contains articles on wideband network analysis with a network analyzer that operates from 100 kHz to 110 MHz and high-impedance probing with a 500-MHz probe. Hewlett-Packard.

CIRCLE NO. 373

Power supplies

A new 12-page catalog detailing a selection guide for all types of modular power supplies is now available. The catalog shows both commercial and off-the-shelf military types of power supplies. Powertec Division of Airtronics.

CIRCLE NO. 374

Modular components

Solid state modules for a large line of electronic components are shown and discussed in a short-form catalog. Included are such devices as telemetering systems, a/d and d/a converters, oscillators, pulse generators, frequency mixers, phase detectors and amplifiers. Also described are isolators, transducers, voltage-controlled oscillators, discriminators, choppers, relays, coils and transformers. Solid State Electronics Corp.

CIRCLE NO. 375



Where can you get
a package like this all year long?

ROBINTECHTM

offers complete printed circuit board
service from prototype preparation to high
volume production.

- Custom engineering to exacting specifications
- All types of laminates and platings
- Fabrication
- Assembly
- Complete, modern facilities for all aspects of printed circuit board manufacture

Send sketch and your requirements
for design recommendation and quotation.



ROBINTECH electromechanical
division
INCORPORATED

3423 Vestal Road, Vestal, New York 13850
phone: (607) 798-5011

Manufacturers of Flexible Shafts and Push-Pull Mechanical Remote Controls; Custom Electromechanical Assemblies and Electric Wiring Harnesses; Printed Circuit Boards; Shock Control and Vibration Isolation Systems. ROBINTECH 1969

ENGINEERS

- Evaluation and Test
- Manufacturing
- Others

Automatic Electric, a leading innovator of computerized electronic switching systems and the largest producer of communications equipment for the independent telephone industry, has numerous entry level and experienced technical positions available in the following areas:

EVALUATION & TESTING Electronic and electrical engineers to initially learn the design of new electronic and computer systems and then perform prototype and/or field evaluation thereon. Entry level requirements — BS degree in EE, ET, or computer science with some knowledge of programming. Higher level positions exist for those with experience in electronic common control systems.

MFG. ENGINEERING Degreed electronic or electrical engineers (new or experienced) initially learn new computerized electronic telephone switching systems, design test equipment and associated test procedures and troubleshoot the mass production of this equipment.

Additional Positions currently available include:

- Software and Hardware Design Engineers
- Automation Engineers
- Ceramic Engineers
- Switching System Planning Engineers
- Traffic Analyst

If you are interested in a progressive, growing company that offers well equipped modern facilities, a policy of promotion from within, and a pleasant West suburban location (15 miles from downtown Chicago), send your resume in confidence to:

Larry Wisniewski

Professional Employment Representative

AUTOMATIC ELECTRIC

Subsidiary of General Telephone & Electronics
400 North Wolf Rd., Northlake, Ill. 60164

An Equal Opportunity Employer

NEW LITERATURE



Flatpack ICs

Flatpack hermetic packages for housing integrated and hybrid circuits are fully described in a new short-form catalog. The publication details the 62 hermetically sealed packages and lists the packages by size. It includes such information as the number of leads, part numbers, base materials and minimum bonding pad areas. Detailed drawings and dimensions of 23 basic package types with the lids and solder preforms are clearly shown. Sprague Electric Co.

CIRCLE NO. 376



Switches and displays

Lower-cost lighted matrix displays and switches are described in a new 46-page catalog. Described are matrix display/switching systems, four-lamp and single-lamp push-button switches for individual mounting, power and rotary switches and miniature indicator lights. Also presented are product series features, performance and environmental specifications dimensioned views, schematic diagrams, legend availability and arrangements, and outlined drawings and exploded views. Staco-switch.

CIRCLE NO. 377

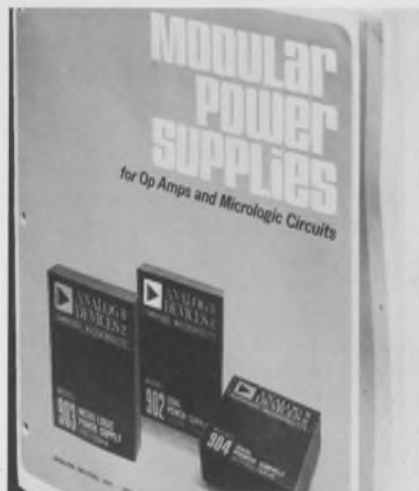

Modular power supplies

Specifications and applications on eight modular dc sources are described in a 12-page catalog. Included are bi-polar operational amplifier supplies and single-polarity micrologic circuit supplies. Also shown are highly stable dual-polarity units that develop precision reference voltages for a/d and d/a converters. Analog Devices, Inc.

CIRCLE NO. 378

Coaxial transistors

The design, construction and performance of microstrip circuits using coaxial transistors is discussed in a six-page brochure. Two circuits are described: a 1.5-GHz amplifier which can provide 1.5 watts of output power with an 8-dB power gain at 50% collector efficiency; and a 2-GHz amplifier which can provide 1.2 watts of output power with a 6-dB power gain at 40% collector efficiency. RCA Electronic Components.

CIRCLE NO. 379

Precision instruments

A score of precision laboratory instruments and components is contained in a 12-page catalog. Included are such instruments as potentiometers, bridges, dividers, detectors, voltage and resistance standards, ac/dc consoles and precision resistors. Julie Research Laboratories, Inc.

CIRCLE NO. 380

SCRs

Critical ratings and characteristics as well as photos and outline drawings of a complete line of silicon controlled rectifiers (SCRs) are contained in a 16-page catalog. Rectifiers listed range in current values from 16 to 470 A and voltage ratings from 25 to 1300 V. Also included are high-dv/dt and di/dt types. A complete listing of symbols and definitions of terms used in SCR data sheets are shown. National Electronics, Inc., a Varian subsidiary.

CIRCLE NO. 381

Instruments

A condensed 24-page publication describes a complete line of electronic test and measuring instruments. Products and systems described include oscillographs, X-Y and magnetic tape recorders, signal-conditioning equipment, digital multimeters, transducers, biomedical and recording instrumentation, and rfi/emi surveillance and analysis equipment. Honeywell Test Instrument Div.

CIRCLE NO. 382

Audio switches

A line of multi-channel go/no-go audio switches are thoroughly discussed in a 22-page manual. It illustrates these switches as used in audio systems with a technical discussion of their operational characteristics and shows block diagrams and circuit representations. Specifications and illustrations are also included. Gosh Instruments, Inc.

CIRCLE NO. 383

Crystals

A customer product and information source on single crystals is contained in a new 76-page booklet. It includes product listings and information pertinent to each crystal such as growth method, structure and purity. Illustrated on each page is a breakout of the element from the periodic table. Alfa Crystals, Ventron Materials Div.

CIRCLE NO. 384

LIFE ASSURANCE!

BARNES QUICK-INSERTION LONG-LIFE SOCKETS FOR RAPID DUAL-IN-LINE PRODUCTION TESTING

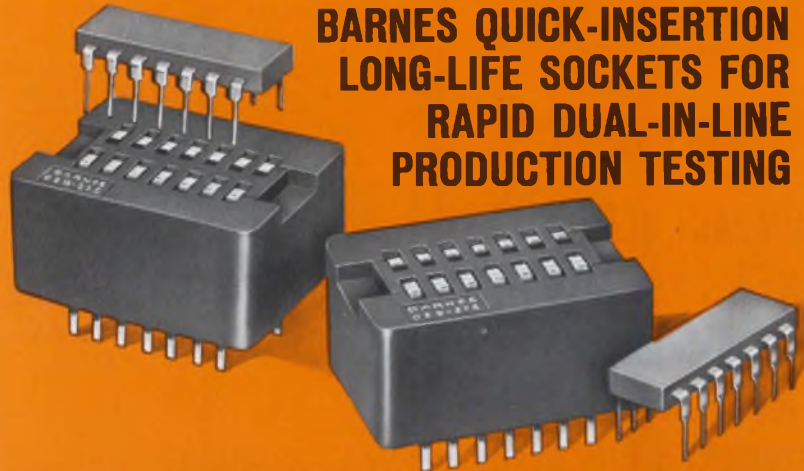

Faced with having to check out large quantities of DIP's . . . quickly and reliably? No problem! The large tapered lead entrances and highly flexible contacts in Barnes 029-275 sockets permit fast and easy device insertion and withdrawal for a typical life of 50,000 to 100,000 cycles. No deformation of lead taper . . . yet reliable electrical contact is maintained for round or flat leads. Available for 14 or 16 lead DIP's, and with Kelvin contacts. Write for data.

barnes
CORPORATION

Lansdowne, Pa. 19050 • 215/MA2-1525

barnes / THE FIRST WORD IN CARRIERS, CONTACTORS AND SOCKETS FOR I.C.'S

INFORMATION RETRIEVAL NUMBER 94

Precision X-Y CRT Displays

Beta builds better. It's as simple as that. Our CRT displays have proven themselves in situations ranging from applesauce processing to creating the recently televised Apollo moon pictures. Take our new PD1400. It resolves over 4000 elements/diameter. It can be used for film recorders and readers, flying spot scanners, bubble chamber experiments, video recorders, scan converters, even hard copy printers.

	PD900	PD1100	PD1200	PD1400
Resolvable Elements/Diameter	1700	2100	3400	4200
CRT Diameter	5 inches	5 inches	5 inches	7 inches
Maximum Spot Size	0.0025	0.002	0.00125	0.0015
Small Signal Bandwidth	1 MHz	1 MHz	1 MHz	1 MHz
Settling Time	10 μ sec	12 μ sec	20 μ sec	50 μ sec



BETA INSTRUMENT CORPORATION

20 Ossipee Road, Newton Upper Falls,
Massachusetts 02164 / Tel. 617 969-6510 / TWX 710-335-6973

INFORMATION RETRIEVAL NUMBER 95

C-COR AMPLIFIER

10 Hz — 200 MHz
Output +13 dBm

ONLY \$395

**COMPACT, VERSATILE,
NEW LABORATORY
AMPLIFIER
MODEL 4376 WITH
ADVANCED CIRCUITRY**

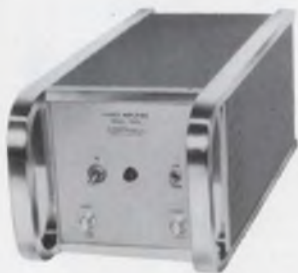

Features	Facts
High Input Impedance	1 M Ω 10 pf
Wide Bandpass	10 Hz — 200 MHz
High Gain	20/40 dB Selectable
Low Input Noise	60 μ V rms

Wide Dynamic Range
Input Protection Circuitry
Extends Range of Oscilloscopes
and RF Voltmeters

Package Includes Power Supply



C-COR
ELECTRONICS, INC.

60 Decibel Road
State College, Pennsylvania 16801
(814) 238-2461

OR SEE EEM CATALOG
FOR NEAREST REPRESENTATIVE

NEW LITERATURE

Fans

Precision cooling devices consisting of a complete line of fans for electronic and other applications are included in a new 16-page "airmovers" catalog. Included are complete descriptions, electrical specifications and outline drawing with mechanical dimensions. Boxer, propeller and blower fans are shown. IMC Magnetics Corp. New Hampshire Division.

CIRCLE NO. 390

Film trimming

An abrasive-jet machining technique which permits trimming thick-film resistors, as well as thin-film and capacitance trimmers, is detailed in a 38-page bulletin. Four abrasive systems are covered with price and specification lists, as well as on-the-job photos. Included in the manual are a laboratory unit for prototype work and research and design, semi-automatic systems with or without an indexing table, and a fully automatic system. Also included is a description of a probe designed for testing of microcircuits. S. S. White Div., Pennwalt Corp.

CIRCLE NO. 391

Connectors

An expanded series of multiple coax connectors for rack-and-panel/cable applications is fully described in a 52-page catalog. It includes completely updated specifications, plus application and dimensional data for nearly 350 items of a coax connector series. Included is information about standard, miniature and subminiature crimp-type connectors for use with coaxial cable, shielded wire and twisted pairs. Connector blocks with 2 to 156 contact positions, and a full array of accessory hardware such as jackscrews, hoods and clamps, are described. AMP Inc.

CIRCLE NO. 392

Resistors

Up-dated technical information on vitreous enamel resistors is now available in two new bulletins. One bulletin covers a family of tab-type resistors in wattage ratings from 8 to 210 W. The other describes axial-lead type resistors in wattage ratings from 1 through 11 W. Both bulletins contain complete listings of standard resistance values and the maximum permissible current for each resistance rating, as well as complete performance specifications for the resistors. Sprague Electric Co.

CIRCLE NO. 393

Fluidics

A complete family of fluidic industrial control modules and associated mounting manifolds are described in a 28-page illustrated booklet. A two-page introduction to fluidics and a two-page explanation of basic fluidic technology are followed by five pages of component descriptions. A fold-out chart gives symbols and truth tables for the various elements and their corresponding symbols in other technologies. Corning Glass Works.

CIRCLE NO. 394

Filters and modulators

Passive and active electronic filters and modulators are discussed in a 12-page brochure. It describes and illustrates high-pass, low-pass, rejection and bandpass filters and lumped constant delay lines. Included are discussions and specifications. KDI Navcor West.

CIRCLE NO. 395

IC amplifier array

Applications of an array of four identical amplifiers on a single monolithic silicon chip are described in an eight-page brochure. Each amplifier in the array has a typical open-loop gain of 58 dB and an input impedance of 90 k Ω . The arrays are in a 16-lead dual-in-line package. RCA Electronic Components.

CIRCLE NO. 396

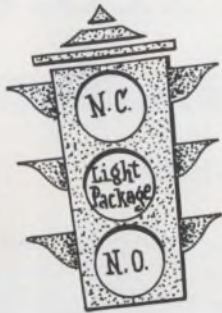

COLOR-CODED CIRCUITRY



SWITCHES and INDICATORS

Modular Design for utmost Flexibility and Versatility!

Specify literally millions of different units from a few basic parts! Up to six color-coded modules per component. Switches may be activated by pushbuttons (flush or mushroom heads) or by selectors (knobs, levers, wings or keys) . . . with or without indicator light or auxiliary push-button for test conditions. Ratings: 10A-300V continuous . . . 6A-300VAC interrupt . . . 1/2A-125VDC resistive interrupt. Max. making current 60A . . . dielectric withstanding voltage 2500VAC. Mech. life over 1,000,000 operations. Available as finished components or modules or sub-assemblies. Write for Bulletin 32.

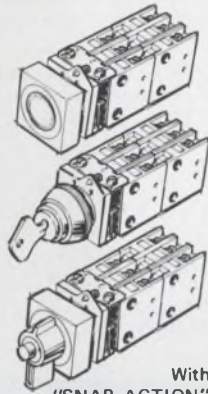

With "SNAP ACTION" Switch Modules!



ELECTRO SWITCH CORP.

Weymouth Massachusetts 02188
Telephone: 617/335/5200 TWX: 710/388/0377

INFORMATION RETRIEVAL NUMBER 97



CIRCUIT DESIGN ENGINEERS

A leader in inertial navigation systems, such as the F14 and S3A programs, announces openings for circuit design specialists. BSEE's with 5-10 years experience in either platform electronic and control systems, power conversion or signal processing.

Please write J. D. Anderson
5500 Canoga Avenue,
Woodland Hills, California 91364

GUIDANCE & CONTROL SYSTEMS DIVISION
LITTON INDUSTRIES

An equal opportunity employer M/F

INFORMATION RETRIEVAL NUMBER 903

ELECTRONIC DESIGN 2, January 18, 1970

Breakthrough in low frequency filtering!

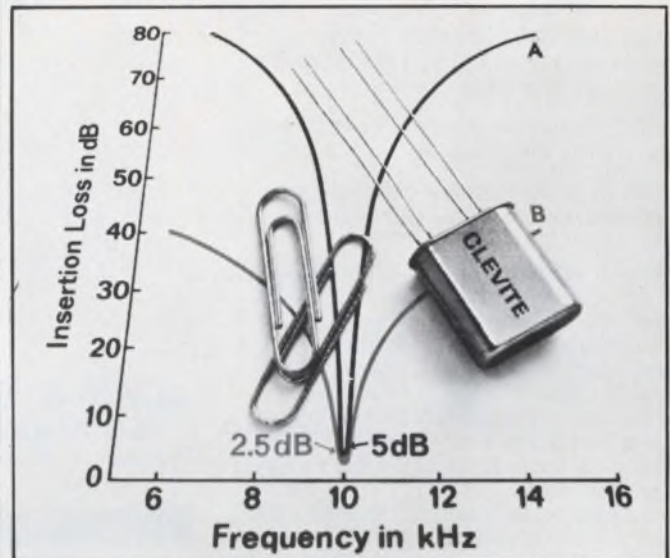

A — CASCADE OF 2 LF FILTERS

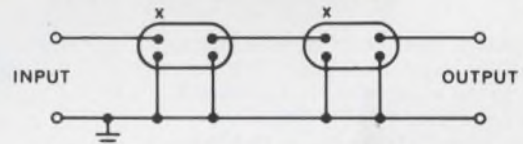

B — SINGLE LF FILTER

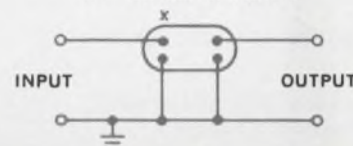

New Clevite ceramic bandpass filter puts big performance into 1/4 oz.

Clevite low frequency (LF) ceramic filters—from 9 to 50 kHz—are about one-tenth the size and weight of comparable conventional types—have narrower bandwidths, lower insertion loss and greater stability. This means you can pack more channels into a given portion of the spectrum with less sacrifice in volume and weight. They're fixed tuned, so you have no installation adjustments, simpler assembly and inspections.

Typical characteristics: 1% min. 3 dB pass bandwidth, 20 dB/3 dB bandwidth ratio not exceeding 13, and passband insertion loss less than 5 dB. Stopband attenuation exceeds 30 dB from dc to above 100 kHz. For even better selectivity they can easily be cascaded without worrying about matching or big insertion losses.

All this performance comes in a miniature HC-6/U can that weighs just 1/4 ounce (it's shown here actual size). They're hermetically sealed, immune to environments . . . there's no need for magnetic shielding. And LF filters are independent of the power source, so there's no current drain.

New Clevite LF filters are ideal for low frequency communications receivers, control circuits, selective calling systems, underwater sound systems and military/navigation systems. Write today for full specs and technical data. Piezoelectric Division, Gould Inc., 232 Forbes Road, Bedford, Ohio 44146, U.S.A. Or: Brush Clevite Company, Ltd., Southampton, England.

GOULD CLEVITE

INFORMATION RETRIEVAL NUMBER 98

ELECTRONIC DESIGN's function is:

- To aid progress in the electronics manufacturing industry by promoting good design.
- To give the electronic design engineer concepts and ideas that make his job easier and more productive.
- To provide a central source of timely electronics information.
- To promote two-way communication between manufacturer and engineer.

Want a subscription? ELECTRONIC DESIGN is sent free to qualified engineers and engineering managers doing design work, supervising design or setting standards in the United States and Western Europe. For a free subscription, use the postfree application form inside the back cover. If none is included, write to us direct for an application form.

If you do not qualify, you may take out a paid subscription for \$25 a year in the U.S.A., \$35 a year elsewhere. Single copies are \$1.50 each.

If you change your address, send us an old mailing label and your new address; there is generally a prepaid postcard for this inside the back cover. You will have to requalify to continue receiving ELECTRONIC DESIGN free.

The accuracy policy of ELECTRONIC DESIGN is:

- To make reasonable efforts to ensure the accuracy of editorial matter.
- To publish prompt corrections whenever inaccuracies are brought to our attention. Corrections appear at the end of the Letters column.
- To refuse any advertisement deemed to be misleading or fraudulent.

Microfilm copies are available of complete volumes of ELECTRONIC DESIGN at \$19.00 per volume, beginning with Volume 9, 1961. Work is now in process to complete the microfilm edition of Volumes 1-8. Reprints of individual articles may be obtained for \$2.00 each, prepaid (\$.50 for each additional copy of the same article) no matter how long the article. For further details and to place orders, contact the Customer Services Department, University Microfilms, 300 North Zeeb Road, Ann Arbor, Michigan 48106; telephone (313) 761-4700.

Want to contact us? If you have any comments or wish to submit a manuscript or article outline, address your correspondence to:

Howard Bierman, Editor,
ELECTRONIC DESIGN,
850 Third Avenue,
New York, N.Y. 10022.

Design Data from

Free — New Alvin Template Catalog



A must for every electronic engineer and draftsman! The comprehensive 36 page Alvin catalog clearly illustrates and describes over 400 templates for practically every use. This template catalog is categorized in sections and shows the templates used for each field, ie, electrical and electronic symbol templates, mechanical engineering templates and many others. Alvin's precision made, time-saving templates cover completely the needs of draftsmen and engineers in all categories. Send for free catalog now.

ALVIN & CO., INC.
611 Palisado Avenue
Windsor, Connecticut 06095

174

High Output/Reliability DC Airmovers



Illustrated bulletin NT6 describes IMC's new line of high output DC Boxer fans.

Eight models deliver up to 120 cfm, accept DC inputs from 12 to 38 Volts. Units are available with ball or sleeve bearings . . . both patented designs rated at 10 or more years life. Integral solid-state inverter mates precisely with the quality proven Boxer (4-11/16-in. sq. by 1-1/2-in. deep). Mounts easily, inside or outside equipment enclosures. Requires no extra connections or fasteners.

For complete details . . . performance data, dimensions, electrical and mechanical specifications, applications information . . . send today for your free copy.

IMC Magnetics Corp.
New Hampshire Division
Route 16B, Rochester, New Hampshire 03867

175

Ubiquitous + 1/3 octave

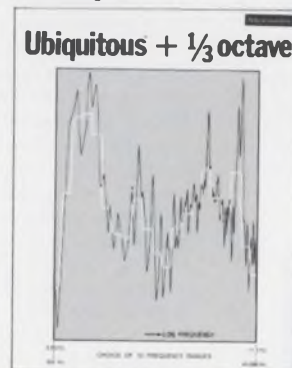

Only the Ubiquitous® Spectrum Analyzer makes possible 500-point real-time spectra of noise plus simultaneous 1/3-octave for very little more. For high speed analysis of noise, vibration and other low-frequency random data, and for detection of low-level periodic signals buried in noise. All you add is the new Option 150A Broadband Adapter — at less than 1/2 the price of a separate 1/3-octave analyzer, less than 1/4 the cost of a computer approach. Additional features include: wide coverage, from 0.1 Hz to 40,000 Hz; high accuracy and repeatability through digital integration; preferred center frequencies and filter shapes; 1/2-octave and octave analysis also included; CRT or X-Y plotting in log or linear scales.

Federal Scientific Corporation
a subsidiary of Elgin National Industries, Inc.
615 West 131st Street, New York, N.Y. 10027

176

Manufacturers

Advertisements of booklets, brochures, catalogs and data sheets. To order use Reader-ServiceCard (Advertisement)

Quality Fasteners For All Designs

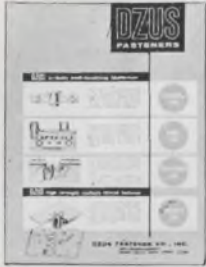

This 8-page catalog provides design data on the complete group of DZUS 1/4-turn self-locking fasteners for standard, high speed and panel applications, as well as universal high strength multiple thread fasteners for high tensile and shear stresses. Dzus stud assemblies, wire forms and receptacles offer an exceptional, wide variety of combinations from stock to fit specific fastening requirements. Diagrams and tables give full details for rapid, unlimited design selection. Condensed or complete Catalog available on request.

Dzus Fastener Co., Inc.
425 Union Boulevard
West Islip, L. I., N. Y. 11795

177

Free: Fiberglass Laminated Insulator Brochure

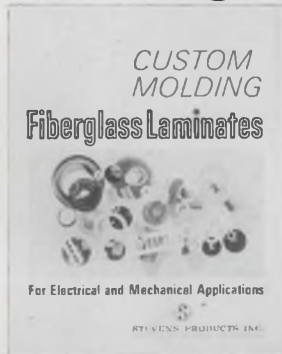

Four page brochure presents procedures and applications for **Custom Molded** fiberglass laminated electrical insulation components. Specially molded glass epoxy and silicone insulators solve problems better than fabrications from sheet stock, tapes, paste-ups, or coatings in tough Aerospace, Marine, and Commercial applications. Thicknesses from .003" offer strength and shock resistance. Prototype tooling from \$60.00. Standard line of tubing for coil and **potting forms** also available. Write for literature and samples.

Stevens Products Inc.
128 North Park Street
East Orange, N. J. 07019
201-672-2140

178

1970 Electronic Components Drafting Aids Catalog



Free Catalog! Free Samples! Exciting innovations in pressure-sensitive electronic component drafting aids and methods are detailed in the new 1970 edition of the combined Bishop Technical Manual and Catalog 104A.

68 illustrated pages of over 15,000 multi-pad configurations, symbols, tapes, sequential reference designations plus hundreds of time-and-money-saving hints in making artwork for PC boards. Includes instructions for using the industry's only red and blue tape system for making two-sided boards in perfect registration. Send now for free Catalog 104A and free samples.

Bishop Graphics, Inc.
7300 Radford Avenue
North Hollywood, California 91605
(213) 982-2000 Telex: 674672

179

Electronic Design

Advertising Sales Staff
Keith Aldrich
Sales Manager

New York 10022
Robert W. Gascoigne
Thomas P. Barth
Samuel M. Deitch
850 Third Avenue
(212) Plaza 1-5530
TWX: 867-7866

Philadelphia 19066
William C. Repetto
P. O. Box 206
Merion Station, Pa.
(215) MA-3-5888

Boston 01945
Richard Parker
P. O. Box 645
Clifton Station
Marblehead, Mass.
(617) 742-0252

Chicago 60611
Thomas P. Kavooras
Berry Conner, Jr.
200 East Ontario
(312) 337-0588

Cleveland
Thomas P. Kavooras
(Chicago)
(312) 337-0588
(call collect)

Los Angeles 90303
Stanley I. Ehrenclou
W. James Bischof
2930 Imperial Highway
Inglewood, Calif.
(213) 757-0183

San Francisco 94022
Arthur R. Shields, Jr.
175 San Antonio Rd., S 243
Los Altos, Calif.
(415) 941-3084

London W. 1
For United Kingdom and Holland
Brayton C. Nichols
44 Conduit Street
Tel: REGent 4714

Verviers, Belgium
For Continental Europe
Andre Jamar
1, Rue Mallar, 1
(087) 253.83 Telex 41563

Tokyo
Haruki Hirayama
Electronic Media Service
Rm. 601, Daini Miyauchi Bldg.
6-8-14, Roppongi,
Minato-ku
Phone: 402-4556
Cable: Electronicmedia, Tokyo



AMERICAN BUSINESS PRESS, INC.

IC BREADBOARD AND TEST PANELS

TIME SAVING • FLEXIBLE

PANELS FOR:
Flat Packs
TO-5 Case size units
Dual-In-Line packages

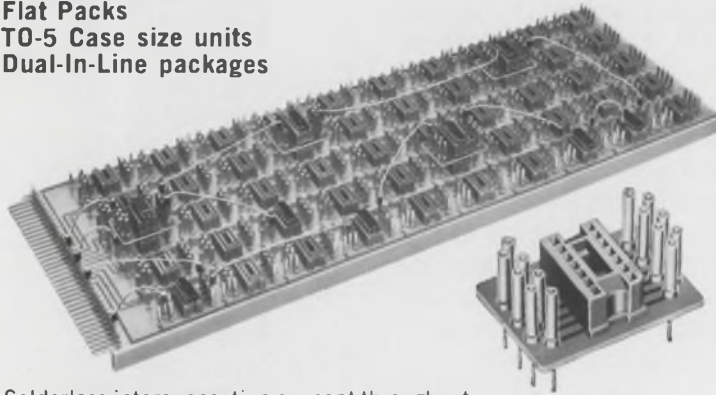

- Solderless interconnection concept throughout
- 10 to 50 patterns standard
- Fast loading and operation — easy IC interchangeability
- Single pattern units provide interchangeability of all three packages
- Power and ground connection at each pattern
- Panel plugs into 36 position edge connector with contacts spaced on .156 centers
- 6 $\frac{1}{8}$ " x 17 $\frac{3}{8}$ " panels (50 patterns)

Request IC Folder
Tel: 617/222-2202

AUGAT INC.

31 PERRY AVE., ATTLEBORO, MASS. 02703

INFORMATION RETRIEVAL NUMBER 101

...not a

SHADOW
of a doubt...

BURNS & TOWNE EPOXYS

Burns & Towne has a wide selection of reliable low cost NPN and PNP Silicon Planar Epitaxial Transistors for amplifier and switching applications

- SMALL-SIGNAL
- HIGH-SPEED
- MEDIUM-POWER
- HIGH-FREQUENCY

SMALL-SIGNAL			
NPN		PNP	
2N3565	2N4967	2N4248	
2N3681	2N4968	2N4249	
2N3682	2N5127	2N4250	
2N3683	2N5131	2N4964	
2N3684	2N5132	2N4965	
2N4966	2N5133	2N5138	
		2N5139	

MEDIUM-POWER			
NPN		PNP	
2N3566	2N4227	2N3638	
2N3567	2N4969	2N3638A	2N4228
2N3569	2N4970	2N3644	2N4971
2N3641	2N5128	2N3645	2N4972
2N3642	2N5129	2N4142	2N5142
2N3643	2N5135	2N4143	2N5143
2N4140	2N5136		
2N4141	2N5137		

HIGH-SPEED	
NPN	
2N3646	2N4275
2N4274	2N5134

HIGH-FREQUENCY	
NPN	
	2N3563
	2N3564

CALL OR WRITE FOR FULL SPECIFICATIONS AND PRICE DATA

CONTACT FRED SEIGEL



BURNS & TOWNE, INC.

550 OLD COUNTRY ROAD
HICKSVILLE, L.I., N.Y. 11801 TEL (516) 935-0522

INFORMATION RETRIEVAL NUMBER 99

Advertisers' Index

Advertiser	Page
Alco Electronic Products, Inc.	104, 119, 121
Alvin & Co.	132
Allen-Bradley Co.	23
Augat, Inc.	134
Barnes Corporation	129
Beckman Instruments, Inc., Electronic Instruments Division	85
Beckman Instruments, Inc., Helipot Division	57
Beta Instrument Corp.	129
Bishop Graphics, Inc.	133
Bourns, Inc.	47
Buckbee Mears Company	14
Bulova Frequency Control Products	122
Burns & Towne, Inc.	46, 134
Burr-Brown Research Corporation	10
C-Cor Electronics, Inc.	130
CTS Corporation	100
Clare & Co., C. P.	19
Computer Products	135
Continental Connector Corporation	17
Corning Glass Works, Electronic Products Division	38, 39
Dale Electronics, Inc.	Cover III
Delco Radio, Division of General Motors	68, 69
Dialight Corporation	99
Dumont Oscilloscope Laboratories, Inc.	92
Duncan Electronics, Inc.	118
Durant Manufacturing Company	125
Dzus Fastener Co., Inc.	133
Electro Switch Corp.	131
Electronic Measurements	125
Electronic Memories, Inc.	97
EMN Company	125
ERA Transpac Corporation	123
Federal Scientific Corp.	132
Fifth Dimension, Inc.	50
Garrett Corporation, A Research Division	120
Gencom Division, Varian/EMI	114
General Radio Company	1
Genisco Technology Corporation	55
Gould Inc., Graphics Division	44, 45
Gould Inc., Piezoelectric Division	131
Hayden Book Company, Inc.	52
Hewlett-Packard	Cover II, 75
Hipotronics, Inc.	12
Hoffman Engineering Co.	106
Howard Laminations, A Division of Howard Industries, Inc.	11
IMC Magnetics Corp.	107, 132
ITT Semiconductors, A Division of International Telephone and Telegraph Corporation	6
International Rectifier Corp.	15
Intronics, Incorporated	113
Jonathan Manufacturing Company	91
Kings Electronics Co., Inc.	105

The thermistors VECO produces
 Will suffer a lot of abuses.
 They quickly defeat
 Any problems of heat
 In Mil. & Industrial uses. *



Got a special thermistor application problem? Victory Engineering's complete lines of thermistor disks and rods are manufactured to meet or exceed MIL-T-23648 standards. Instant response coupled with precision measurement makes them ideal for temperature control uses, such as transistor circuitry. VECO produces positive and negative temperature coefficient thermistors in a wide range of body styles and resistance values. Every Victory thermistor is backed by a long-held reputation as the industry leader solely devoted to the research, development and manufacture of temperature and voltage sensitive components.

*ENGINEERS ARE INVITED TO SUBMIT VECO LIMERICKS. BEST WILL RECEIVE A VECO THERMISTOR DESIGN KIT AND/OR HAVE LIMERICK APPEAR IN FUTURE ADVERTISING.



Advertiser Page

Malco Manufacturing Company, Inc. 37
 Mallory Capacitor Company 87
 Microdot, Inc. 53
 MicroSwitch, A Division of Honeywell..... 51
 Miller Company, J. W. 115
 Motorola Semiconductor Products, Inc. 16A-B

National Semiconductor Corporation..... 4.5
 Norfield Electronics, Inc. 108
 Nortronics Company, Inc. 112

Optron, Inc. 117

Philco-Ford Corporation,
 Microelectronics Division 8
 Plastic Capacitors, Inc. 126
 Power Designs, Inc. 40

RCA Electronic Components and
 Devices 9, Cover IV
 Raytheon Computer 18
 Resistance Products Company 116
 Robintech Incorporated 127

Shauer Manufacturing Corp. 110
 Seaton-Wilson, Inc. 54
 Signetics Corporation 33
 Simpson Electric Company 13
 Singer Company, The 95
 Sprague Electric Company 20
 Stackpole Carbon Company 7
 Stevens Products, Inc. 133
 Stoddart Electrosystems, A Division of
 Tamar Electronics, Inc. 109
 Sylvania Electric Products, Inc. 43
 Systron-Donner Corporation 2, 98

TRW Inc., Capacitor Division 103
 TRW Semiconductors,
 A Subsidiary of TRW, Inc. 48
 Techno-Components Corp. 16
 Tektronix, Inc. 79
 Texas Instruments Incorporated,
 Components Group 35
 Transmagnetics, Inc. 83
 Triplett Corporation 89

Unimax Switch, Division Maxon
 Electronics Corporation 99

Victory Engineering Corporation 135

Watkins-Johnson International 56

Zipperubing Corp., The 119

Career Advertising:

Automatic Electric 128
 Litton Industries, Guidance &
 Control Systems 131



VICTORY ENGINEERING CORPORATION

VICTORY ROAD, SPRINGFIELD, NEW JERSEY 07081 • (201) 379-5900 • TWX 710-983-4430

INFORMATION RETRIEVAL NUMBER 102

3.999 REASONS WHY



**4000 COUNT
 DIGITAL PANEL METER
 \$196.00***

Computer Products' new DP400 series digital panel meter measures DC voltage with extreme accuracy: .05% ± ½ count . . . and with 4000 count resolution. It's priced with the DPMs and performs with the DVMs. Using revolutionary encoding techniques, it offers 8 voltage ranges (200mV to 400V) and 6 current ranges (2mA to 400mA) with internally selectable decimal point position.

The DP400 series' styling will enhance the appearance of your system. All this, and behind-panel space required is only 2.5" x 3.0" x 4.2".

As if that weren't enough, DP400s have remote display capabilities.

The temperature coefficient of the DP400 series is .005%/°F and the operating temperature range is 30° to 140°F.

In quantity orders, the DP400 series is available for measuring AC voltage and resistance.

GUARANTEED SHIPMENT 15 TO 30 DAYS ARO

Prices	1-3	4-9	*10-29
	\$222	\$206	\$196

We also make: OP-AMP and logic power supplies, pulse generators, D/A and A/D converters and decimal display modules (with counter).

Call or write for complete information on our entire line

Computer Products, Inc. • P.O. Box 23849 Ft. Lauderdale, Florida 33307 • 305-565-9565



COMPUTER PRODUCTS™
 FORT LAUDERDALE

INFORMATION RETRIEVAL NUMBER 103

From Dale—the pots you don't ship back...

<1% customer rejection rate!

Less than 1% customer rejection for all causes. That's the record established by Dale T-Pots. Consider the savings this can bring you in time, paper work. Then consider the added efficiency of consolidating more of your buys at this versatile source. Almost 50% more models added in two years. Military (RT-10, 11, 12, 22, 24), Industrial, Commercial ... wirewound and film elements. All are very competitively priced. Check today and find out. We can deliver them quickly—and you won't have to send them back.

MILITARY GRADE T-POTS

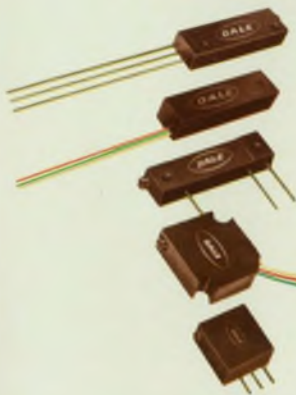

- 600 Series:** Mil. Equiv. RT-10; 10 Ω to 100K Ω , \pm 5%; 1 watt at 70°C, derated to 0 at 175°C; .18 H x .32 W x 1.00 L.
- 1200 Series:** Mil. Equiv. RT-11; 10 Ω to 100K Ω , \pm 5%; 1 watt at 70°C, derated to 0 at 175°C; .28 H x .31 W x 1.25 L.
- 1600 Series:** Mil. Equiv. RT-12; 10 Ω to 100K Ω , \pm 5%; 1 watt at 70°C, derated to 0 at 175°C; .19 H x .32 W x 1.25 L.
- 5000 Series:** Mil. Equiv. RT-22; 10 Ω to 50K Ω , \pm 5%; 1 watt at 70°C, derated to 0 at 175°C; .19 or .22 H x .50 W x .50 L.
- 5800 Series:** Mil. Equiv. RT-24; 10 Ω to 50K Ω , \pm 5%; 1 watt at 70°C, derated to 0 at 175°C; .145 or .150 H x .375 W x .375 L.

COMMERCIAL GRADE ECONO-TRIM T-POTS



- WIREWOUND ELEMENT**
- 2300 Series:** Sealed/Unsealed; 10 Ω to 50K Ω , \pm 10%; 0.5 watt at 25°C, derated to 0 at 105°C; .36 H x .28 W x 1.00 L.
 - 2400 Series:** Sealed/Unsealed; 10 Ω to 50K Ω , \pm 10%; 1 watt at 40°C, derated to 0 at 125°C; .31 H x .16 W x .75 L.
- FILM ELEMENT**
- 8300 Series:** Sealed/Unsealed; 10 Ω to 2 Meg., \pm 10% 100 Ω thru 500K, \pm 20% all other values; .75 watt at 25°C, derated to 0 at 105°C; .36 H x .28 W x 1.00 L.
 - 8400 Series:** Sealed/Unsealed; 10 Ω to 2 Meg., \pm 10% 100 Ω thru 500K, \pm 20% all other values; .75 watt at 25°C, derated to 0 at 125°C; .31 H x .16 W x .75 L.

INDUSTRIAL GRADE T-POTS

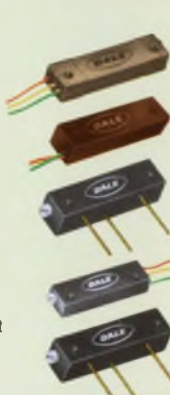

- WIREWOUND ELEMENT**
- 100, 200, 300 Series:** 10 Ω to 100K Ω .
 - 100 Series: \pm 5%; 0.8 watt at 70°C, derated to 0 at 135°C.
 - 200 Series: \pm 10%; 0.5 watt at 70°C, derated to 0 at 105°C.
 - 300 Series: \pm 15%; .25 watt at 70°C, derated to 0 at 85°C. Dimensions: .22 H x .31 W x 1.25 L (also 1.32 L for 100, 200).
 - 1100 Series:** 10 Ω to 100K Ω , \pm 10%; 1 watt at 70°C, derated to 0 at 175°C; .28 H x .31 W x 1.25 L.
 - 2100 Series:** Industrial counterpart RT-11; 10 Ω to 100K Ω , \pm 10%; 1 watt at 70°C, derated to 0 at 125°C; .28 H x .31 W x 1.25 L.
 - 2200 Series:** Industrial counterpart RT-10; 10 Ω to 100K Ω , \pm 10%; 1 watt at 70°C, derated to 0 at 125°C; .18 H x .32 W x 1.00 L.
- FILM ELEMENT**
- 8100 Series:** Industrial counterpart RJ-11; 10 Ω to 2 Meg., \pm 10% 100 Ω to 500K, \pm 20% other values; .75 watt at 70°C, derated to 0 at 125°C; .28 H x .31 W x 1.25 L.

Call 402-564-3131 for complete information or write for Catalog B



DALE ELECTRONICS, INC., 1328 28th Ave., Columbus, Nebraska 68601

In Canada, Dale Electronics Canada, Ltd. • A subsidiary of The Lionel Corporation

INFORMATION RETRIEVAL NUMBER 106



OTA—NEW DIMENSION IN OP AMPS FOR THE CREATIVE DESIGNER

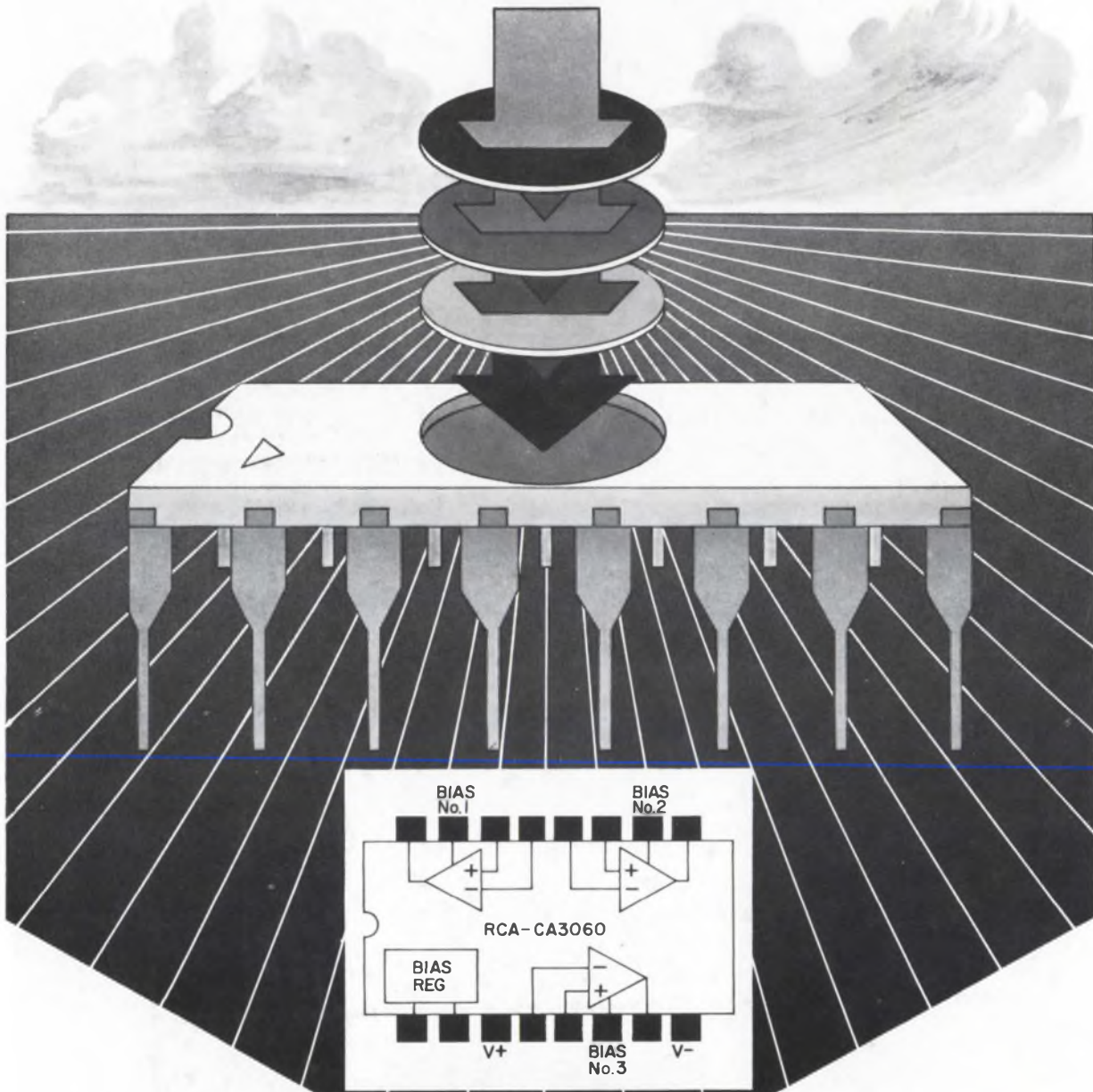

Here's the IC design breakthrough that may change your entire approach to op amps. In the CA3060, RCA brings you a monolithic array of three independent Operational Transconductance Amplifiers and a bias regulator with features that will send you back to the drawing board on current designs and start a new chain of ideas for the future. You can externally adjust the supply current for each amplifier over the range from 10 μ A to 1 mA. At the low end of this range, you can have three amplifiers working for you on less than 300 μ watts.

The CA3060 has the characteristics of classical op amps with the added feature of externally variable transconductance (g_m). Hence, open-loop voltage gain is a function of $g_m R_L$. Think about it and look into it for applications calling for low-power op amps, active filters, gyrators, mixers, modulators, or multipliers. Price \$5.95 (1000 units) in 16-lead dual-in-line ceramic package (full military temperature range -55°C to $+125^\circ\text{C}$).

Typical Highlight Parameters (Per Amplifier)

Amplifier Bias Current	1 μ A	100 μ A
Supply Voltage	± 2 to ± 6 V	± 2 to ± 6 V
Power Consumption	≤ 100 μ W	≤ 10 mW
Input Bias Current	33 nA	2500 nA
Transconductance (g_m)	380 μ mho	35 mmho
Output Resistance	200 M Ω	2 M Ω

(No compensation required in many applications)

For further information, contact your local RCA Representative or your RCA Distributor. For technical bulletin, File No. 404, write RCA Electronic Components, Commercial Engineering, Section F-1-2/CA 24, Harrison, N. J., 07029. In Europe: RCA International Marketing, S. A., 2-4 rue du Lièvre, 1227 Geneva, Switzerland.

THINK ABOUT IT.

RCA Integrated
Circuits