

Electronic Design

VOL. 18 NO.

1

FOR ENGINEERS AND ENGINEERING MANAGERS

JAN. 4, 1970

Adaptive Systems Conglomerates

High-Speed Ground Transportation *peace*

ELECTRIC CARS *POPULATION*

Artificial Organs

Crime detection LASERS

Weather control

Supersonic transport

TECHNOLOGY IN THE
70's

Ecology

Overpopulation

HOLOGRAPHY

MOON AND MARS

MILITARY-INDUSTRIAL

Medical LSI COMPLEX

Electronic

COMPUTER-AIDED DESIGN



YOUR COMPETITIVE EDGE

CINCH PRINTED CIRCUIT CONNECTORS

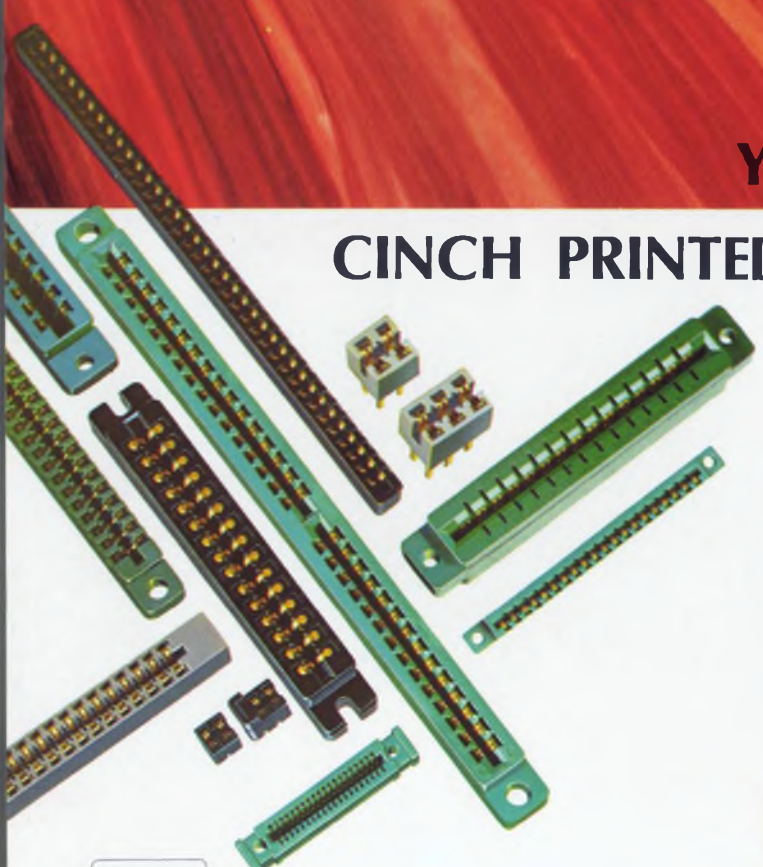

Improved performance and lower cost are the best competition beaters . . . and you get either or both with Cinch PC connectors. There are 22 basic designs described in the new Cinch PC Connector catalog. If the one you need isn't there, Cinch can develop a special connector for your application.

It can incorporate any of six methods of gold deposition (including two selective plating techniques), eight types of contacts, eight types of terminations and six insulator materials . . . whatever best gives you your competitive edge. The resulting product can be produced in quantity in a surprisingly short time.

Write for the Cinch Printed Circuit Connector catalog to Cinch Manufacturing Company, 1501 Morse Avenue, Elk Grove Village, Illinois 60007.

IMMEDIATE DELIVERY of many Cinch printed circuit connectors—from stock—can be obtained through Cinch Electronic distributors.



CINCH MANUFACTURING, CINCH-GRAPIK, CINCH-MONADNOCK, CINCH-NULINE AND PLAXIAL DIVISIONS OF UNITED-CARR INC., A SUBSIDIARY OF TRW INC.

INFORMATION RETRIEVAL NUMBER 202

R.M.S. VOLTS -- the scale says -- but what about the circuits behind that scale?

All of us have been making rms readings of ac voltages for years. We know we have, it says so right on the front of the meter.

If someone were to ask what we mean by rms voltage, we could quickly explain the concept of "root mean square." In the interest of accuracy we might add that the rms voltage indication on most meters is true only for a sinusoidal wave. Unfortunately, most measurements are not made on true sinusoidal waves. However, for many applications, average responding meters are adequate.

But it would seem logical, where accuracy is important, to use a meter that measures true rms voltage no matter what the wave shape—a true rms voltmeter.

Why isn't this done more often? Well, until recently, most true rms voltmeters were expensive, limited

in capability and rather slow responding.

Now Hewlett-Packard has adapted the thermocouple concept used in standard laboratories; added protective amplifiers to insure overload protection (800 V p-p); and reduced final-value step function response to less than 5 seconds.

When you combine these features with a low price of \$575, it adds up to the HP 3400A—the first practical true rms voltmeter for general use in the 10 Hz to 10 MHz range. And, a high crest factor (ratio of peak to rms) allows you to measure noise and other non-sinusoidal wave forms at a ratio of 10:1 full scale or 100:1 at 10% of full scale. You get accurate noise and pulse measurements — without having to make non-standard corrections.

The 3400 isn't just a fine true rms

voltmeter—although that's plenty in itself. It can also be used as an ac/dc converter and a current meter. Typical dc output accuracy is 0.75% of full scale from 50 Hz to 1 MHz. Use the HP 456A AC Current Probe (\$250) and you get quick dependable current measurements. The 456A probe has a 1 mA to 1 mV conversion allowing direct readings up to 1 amp rms.

So, if all your measurements aren't made on true sinusoidal wave shapes and if you like direct accurate rms voltage indication no matter what you're measuring, it's time to check into the HP 3400A true rms voltmeter. For more information, contact your local HP field engineer. Or, write to Hewlett-Packard, Palo Alto, California 94304. Europe: 1217 Meyrin-Geneva, Switzerland.

099/19A

INFORMATION RETRIEVAL NUMBER 2

HEWLETT  PACKARD
ANALOG VOLTMETERS



This counter has been copied, but never equalled!

Many have tried—all have failed—to produce a counter equal to Systron-Donner's 50 MHz Model 1037. The reason is that nobody else's counter mates with plug-ins that:

- Allow direct readout of frequencies to 40 GHz.
- Yield fully automatic readings of frequencies to 18 GHz.
- Boost the range to 500 MHz with an automatic prescaler.
- Bridge the VHF gap to 3 GHz with only one plug-in.

Cost? Surprisingly low. The basic 1037 50 MHz Counter-Timer is a bargain at \$2,240. And with any of the unique S-D plug-ins, S-D counters will still be first for years to come. Don't settle for less!

Be sure to check S-D's new counter catalog before you buy. For your copy, write Measurement Products Division, 888 Galindo Street, Concord, California 94520, or call (415) 682-6161.



SYSTRON  DONNER

Another first! One of 157 S-D instruments. Electronic counters/Pulse generators/Microwave frequency indicators/Digital clocks/Memory testers/Analog computers/Time code generators/Data generators/Digital voltmeters/Spectrum analyzers/Digital panel meters/Microwave signal generators/Laboratory magnets/Data acquisition systems/Microwave test sets.

NEWS

- 21 **News Scope**
- 25 **Smallest electronics advance in years**
Tight money, lower Government spending to limit market increase in 1970 to 1.4%, says Electronics Industries Association.
- 30 **Workshop in the sky, then factories**
Processing of opto-electronic materials in zero gravity environment is forecast.
- 36 **FCC urges control of 'electronic smog'**
Self-regulation of electromagnetic interference is advocated by NEC speakers.
- 41 **Washington Report**
- 46 **Sidelights**
- 51 **Editorial: Technology in the Seventies: It's how it's used that counts**
-

TECHNOLOGY

- 68 **Technology in the 1970s**—a special report in which the experts predict the direction electronics will take in the next decade.
- 100 **Designing with microstrip can be easy.** This microwave oscillator, based on a standard Colpitts design, shows how it's done.
- 106 **Need to design a switching regulator?** It's simple, low in cost and high in efficiency—if you build the control circuitry with linear ICs.
- 114 **New desk-top calculators** close the gap between the slide rule and the large computer. This Fourier analysis shows their usefulness.
- 118 **A franchise system** generated to spark electronics sales provides the best reps possible, says this manufacturer.
- 124 **Ideas for Design**
- 133 **Product Source Directory: Pulse Generators**
-

PRODUCTS

- 144 **ICs & Semiconductors:** Ion-implanted 64-bit shift register clocks at 20 MHz.
- 160 **Data Processing:** Precision cassette is designed for computer use.
- 166 **Modules & Subassemblies:** Wideband op amp features 80-ns settling time.
- | | |
|------------------------------|---------------------------|
| 172 Components | 178 Packaging & Materials |
| 176 Instrumentation | 181 Microwaves & Lasers |
| 177 Tools & Engineering Aids | |
-

Departments

- | | |
|------------------------|-----------------------------------|
| 13 Designer's Calendar | 188 Application Notes |
| 184 Evaluation Samples | 190 New Literature |
| 185 Design Aids | 200 Advertisers' Index |
| 186 Annual Reports | 203 Information Retrieval Service |
-

- 204 **Electronic Design's 1970 "Top Ten" Contest**
Win a free trip for two from New York to Paris and back.
-

Information Retrieval Service Card inside back cover

Cover: Designed by art director Cliff Gardiner portraying the technological language of the 1970s.

To make a Quad Latch that's both R/S and D compatible,



Fairchild's new MSI 9314 Quad Latch is a versatile, high-speed device that can be used in any application requiring a single-input D-type latch or an R/S-type latch. It has no undefined states in the R/S mode. Its unique multi-function capabilities make it useful in a number of applications:

four-bit storage latches, contact bounce eliminators, multi-input active high set/reset latches, counting and holding display systems, eight-bit addressable latches, A/D conversions, zero and ones catching storage.

The addition of this device to our MSI family gives you everything you need for just about any latching application you could name. Use the new 9314 for maximum function versatility. Or the 9308 Dual Four-Bit Latch when minimum package count is most important. Your Fairchild Distributor has complete specs on both MSI devices.

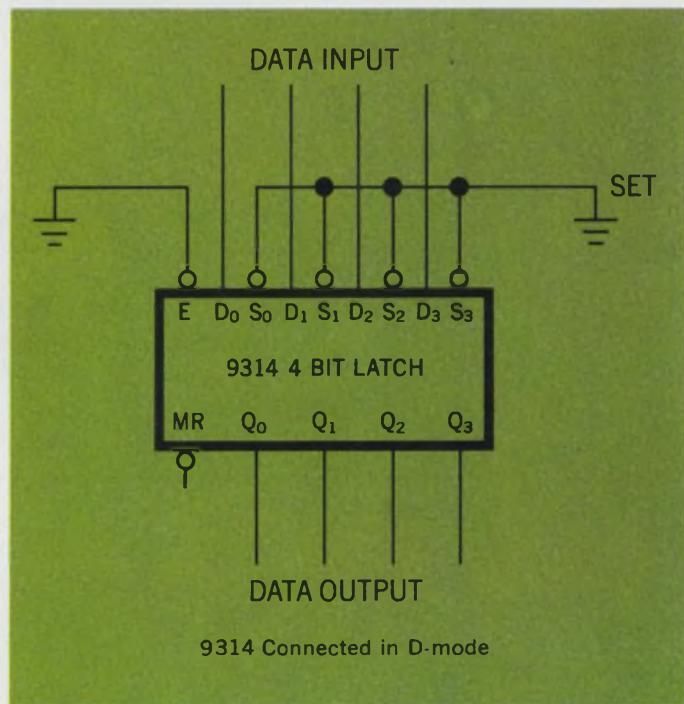

To order the 9314, ask for:

PART NUMBER	PACKAGE	TEMPERATURE RANGE	PRICE (1-24)	PRICE (25-99)	PRICE (100-999)
U6B931451X	DIP	-55°C to +125°C	\$19.40	\$15.50	\$13.00
U6B931459X	DIP	0°C to +75°C	9.70	7.75	6.50
U4L931451X	Flat	-55°C to +125°C	21.35	17.05	14.30
U4L931459X	Flat	0°C to +75°C	10.70	8.55	7.15

To order the 9308, ask for:

PART NUMBER	PACKAGE	TEMPERATURE RANGE	PRICE (1-24)	PRICE (25-99)	PRICE (100-999)
U6N930851X	DIP	-55°C to +125°C	\$25.40	\$20.20	\$17.00
U6N930859X	DIP	0°C to +75°C	12.70	10.10	8.50
U4M930851X	Flat	-55°C to +125°C	27.95	22.20	18.70
U4M930859X	Flat	0°C to +75°C	13.95	11.10	9.35

you have to get serious about MSI family planning.

We put together a family plan by taking systems apart. All kinds of digital systems. Thousands of them.

First we looked for functional categories. We found them. Time after time, in a clear and recurrent pattern, seven basic categories popped up: Registers. Decoders and demultiplexers. Counters. Multiplexers. Encoders. Operators. Latches.

Inside each of the seven categories, we sifted by application. We wanted to design the minimum number of devices that could do the maximum number of things. That's why, for example, Fairchild MSI registers can be used in storage, in shifting, in counting and in conversion applications. And you'll find this sort of versatility throughout our entire MSI line.

Finally, we studied ancillary logic requirements and packed, wherever possible, our MSI devices with input and output decoding, buffering and complementing functions. That's why Fairchild MSI reduces—in many cases eliminates—the need for additional logic packages.

The Fairchild MSI family plan. A new approach to MSI that's as old as the industrial revolution. It started with functional simplicity, extended through multi-use component parts, and concluded with a sharp reduction in add-ons. Simplicity. Versatility. Compatibility. Available now. In military or industrial temperature ranges. In hermetic DIPs and Flatpaks. From any Fairchild Distributor.



OPERATORS
9304 - Dual Full Adder/Parity Generator



LATCHES
9308 - Dual 4-Bit Latch
9314 - Quad Latch



REGISTERS
9300 - 4-Bit Shift Register
9328 - Dual 8-Bit Shift Register

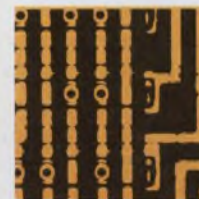

MULTIPLEXERS
9309 - Dual 4-Input Digital Multiplexer
9312 - 8-Input Digital Multiplexer

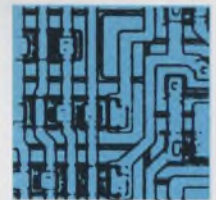

DECODERS AND DEMULTIPLEXERS
9301 - One-Of-Ten Decoder
9315 - One-Of-Ten Decoder/Driver
9307 - Seven-Segment Decoder
9311 - One-Of-16 Decoder
9317 - Seven-Segment Decoder/Driver



COUNTERS
9306 - Decade Up/Down Counter
9310 - Decade Counter
9316 - Hexadecimal Counter



ENCODERS
9318 - Priority 8-Input Encoder

Nobody makes MSI the way
Fairchild does.

FAIRCHILD
SEMICONDUCTOR

predictable

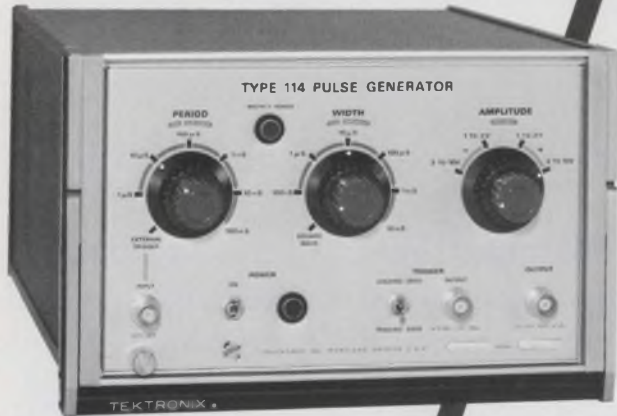

*from
Tektronix®*

TYPE 114 PULSE GENERATOR

- 10-Hz to 1-MHz Repetition Rate
- 10-ns Risetime and Falltime
- Pulses or Symmetrical Squarewaves
- ± 10 V into 50 Ω , Short-Proof Output

Pulses or Squarewaves—You may have either using this solid-state generator! The compact Type 114 provides pulses with 10-ns risetimes and falltimes, periods variable from 1 μ s to 100 ms and widths variable from 100 ns to 10 ms. Pulse amplitudes are adjustable from ± 1 V to ± 10 V into 50 Ω . Aberrations are $\leq 5\%$ at ± 10 V into 50 Ω . Symmetrical squarewaves are instantly available by setting the Width control to the squarewave position. Squarewave period and amplitude ranges are the same as for pulses. External trigger input permits synchronizing the Type 114 output with other events up to 2-MHz repetition rate. An optional rack adapter provides for mounting one or two Type 114 or Type 115 Pulse Generators in only $5\frac{1}{4}$ inches of panel height. Consult your Tektronix Catalog for detailed description of the Type 114 and the optional rack adapter.

Type 114 Pulse Generator \$340

U.S. Sales Prices FOB Beaverton, Oregon

*pulse
performance*

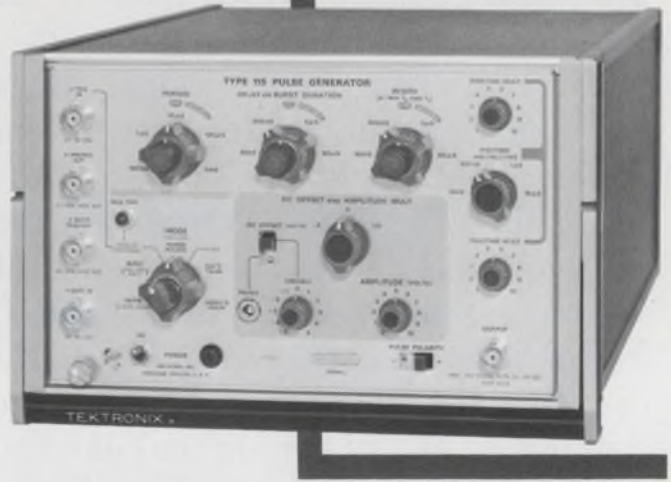

NEW! TYPE 115 PULSE GENERATOR

- 100-Hz to 10-MHz Repetition Rate
- Variable Risetime and Falltime, 10 ns to 100 μ s
- Variable DC Offset, ± 5 V
- ± 10 V into 50 Ω , Short-Proof Output

This multi-purpose, solid-state generator produces exceptionally clean pulses with aberrations less than 3% P-P at ± 10 V into 50 Ω . Pulse risetime, falltime, width, delay, period, amplitude and baseline offset are separately variable, permitting precise waveform simulation. Five operating modes offer a variety of outputs—undelayed pulses, delayed pulses, paired pulses, burst of pulses and gated pulses. Risetimes and falltimes are continuously variable from 10 ns to 100 μ s and periods are variable from 100 ns to 10 ms. Pulse widths are variable from 50 ns to 500 μ s with duty factors to 75% (50-ns minimum pulse separation). A continuously variable DC offset feature permits positioning pulse baseline through a range of +5 volts to -5 volts. Triggering is selectable, internally or externally. A detailed description of the Type 115 Pulse Generator is found in your Tektronix Catalog.

Type 115 Pulse Generator \$865

To evaluate either of these pulse generators in your application, call your Tektronix Field Engineer, or write Tektronix, Inc., P.O. Box 500, Beaverton, Oregon 97005



Tektronix, Inc.
committed to progress in waveform measurement



Spice of life...

. . . means Drake has almost an unlimited variety of these "MF" — midget flange — indicator lights. Adapts to many commercial or military requirements, including aerospace, missile, automation, instrumentation, panel read-out, safety equipment, heavy duty controls, office equipment and specialties.

Choose from many shapes, styles and sizes . . . For a starter, we have Press-to-Test, variable intensity and waterproof, types; neons, incandescents; front or rear mounting — all have front lamp replacement; lampholder bodies are corrosion resistant black or natural finish.

Color, shape or style . . . You name it, Drake's got it.

Readily available from authorized distributors, and you'll find Drake's personal service to be valuable throughout every phase of your project. Call today, Drake's 35 years' experience will prove helpful.

Ask for a brochure, too.



DRAKE

Oh, you'll put it together, all right, and after a while, it'll work, more or less. Then you'll take the prototype to engineering for board design, get it back, attach the components, test it, make a few compromises, try it again. What you have then is an engineering model.

Then the manufacturing design. Back to engineering for debugging. More testing. Parts procurement. Incoming inspection. Telephone calls. Late deliveries. More testing. Heartache. Final release and the module is ready for manufacture. Maybe.

All this time, an already designed, fully debugged, guaranteed, computer-tested, solid state module sits on Digital's shelf. Fifty engineers in offices around the country wait for your call to help. Application notes, installation drawings, catalogs sit in our mail room. Power supplies, hardware, racks are piled high in the stock room.

M Series modules are the most complete, fully compatible, fast, all IC, TTL, inexpensive solid state logic available anywhere. With a few million modules in our recent history, and a few million dollars worth of test equipment, we really know how to put them out. Read all about them in the new Logic Handbook. Free.

digital
COMPUTERS • MODULES

INFORMATION RETRIEVAL NUMBER 7

Hold it, right there.



DIGITAL EQUIPMENT CORPORATION.
Maynard, Massachusetts 01754. Telephone:
(617) 897-5111 / Cambridge, Mass. / New
Haven / Washington, D.C. / Parsippany, Palisades
Park, N.J. / Princeton, N.J. / Rochester, N.Y. / Long
Island, N.Y. / Philadelphia / Pittsburgh / Cleveland /
Dayton / Huntsville / Cocoa, Fla. / Chicago / Denver /
Ann Arbor / Salt Lake City / Houston / Albuquerque /
Los Angeles / Palo Alto / Seattle. INTERNATIONAL,
Carleton Place and Toronto, Ont. / Montreal,
Quebec / Edmonton, Alberta, Canada / Reading and
Manchester, England / Paris, France / Munich and
Cologne, Germany / Oslo, Norway / Stockholm,
Sweden / Sydney and West Perth, Australia.

You've got to move fast to be number one in high-power UHF

We've delivered hundreds of high-power S- and L-band telemetry transmitters with outstanding specs, like those of the EMR 3620 S-Band Telemetry Transmitter:

- Continuous 20-watt operation at temperatures from -20°C to $+75^{\circ}\text{C}$.
- Flight-qualified at 1500 G's shock.
- Typical frequency stabilities of $\pm 0.001\%$.

That's why our 20- and 50-watt UHF transmitters are on the C-5A, F-4, Titan III, 747, Nike X, CH-47, and many more. For a FREE RF Brochure, call or write our Sales Manager, EMR-Telemetry, Box 3041, Sarasota, Fla. 33578; (813) 958-0811.



EMR TELEMETRY

EMR DIVISION OF WESTON INSTRUMENTS, INC - A SCHLUMBERGER COMPANY

INFORMATION RETRIEVAL NUMBER 8



JANCO BUILDS ROTARY SWITCHES JUST A LITTLE BETTER THAN TODAY'S REQUIREMENTS!

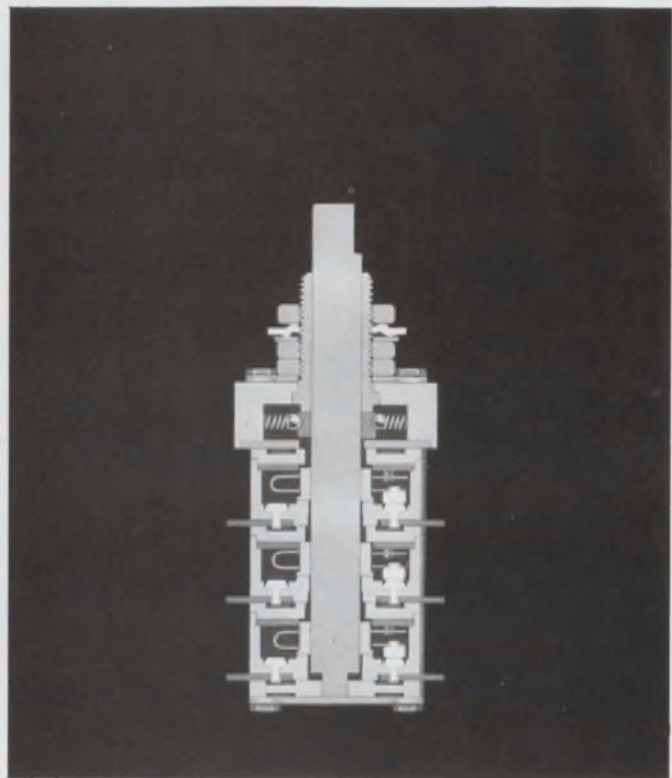

[HERE'S THE INSIDE STORY]

If you were to slice away half of a Janco Rotary Switch, you would see the reason why "Janco Builds Rotary Switches Just A Little Better Than Today's Requirements!"

CONSTRUCTION

Upon examination you would immediately recognize a design simplicity meticulously constructed into a totally enclosed, explosion-proof package affording you the highest degree of protection when operating in a volatile, chemically mixed atmosphere at sea level or altitudes. It is this same design simplicity that utilizes the U-shaped rotor concept which results in low contact resistance throughout the life of the switch.

MATERIALS

Before reaching the optimum in design simplicity a manufacturer must reach for the optimum in materials. Janco Rotary Switches are totally enclosed in high impact, glass-reinforced alkyd MAI-60 for superior mechanical and electrical characteristics. Current conduction is handled by Beryllium copper and solid silver alloy contacts.

FREE WALL CHART

If you are interested in rotary switches that are built to exceed present day requirements, Janco Corporation will send you a wall chart of basic Janco rotary switches. From this chart you can determine the correct switch for your requirements . . . the proper degree of indexing, exact make or break current capacity, and whether single or multi pole construction is available. This chart is your building block to a rotary switch that is built a little better than today's requirements. Send for it today.

JANCO
CORPORATION

3111 WINONA AVENUE ■ BURBANK, CALIFORNIA

Try to do this with semiconductors

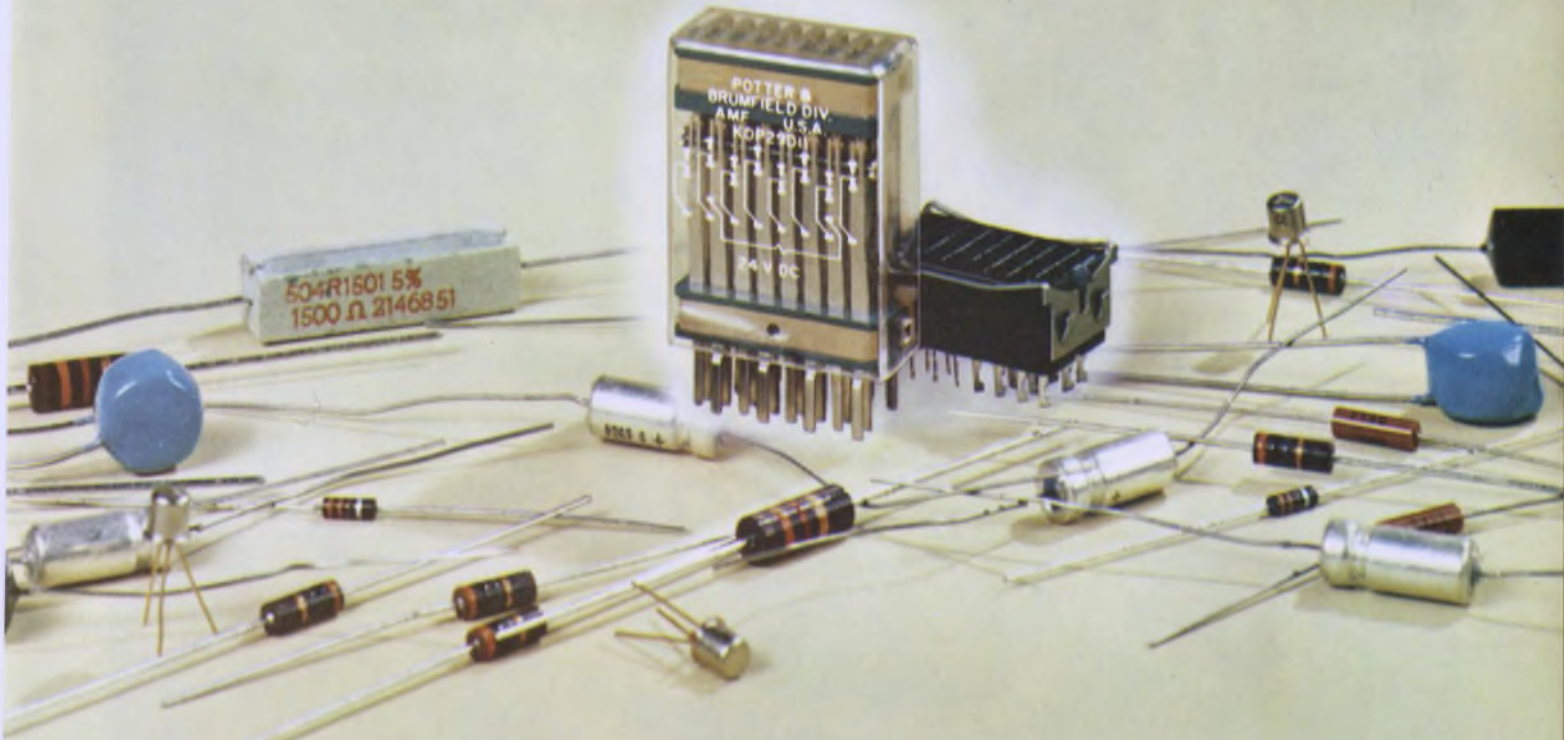

Where else can you get 8 Form C switching in a package that measures just over a cubic inch and costs less than 50¢ per pole? You can't with semiconductors. You'd wind up with a much larger, more expensive array.

Speaking of cost, the KDP has a single lot price of \$9.35. The list price, by the way, is less than two of our most popular 4-pole relays.

The compact KDP is ideal for logic circuits where a single input will give you a fan-out of eight. Open-minded engineers will find that a strong case for this relay over solid state switching. Remember, too, you get electrical isolation on both the input and switching sides.

Bifurcated contacts are rated at 1 ampere at 30V DC or 120V AC, resistive. Standard relays have an 8 Form C contact arrangement. Combinations of Form C and Form D (make-before-break) are available on special order. Coil voltages range from 6 to 48V DC.

Order prototype models today from your local P&B representatives or call us direct. Potter & Brumfield Division of American Machine & Foundry Company, Princeton, Indiana 47570. 812-385-5251.

*Maximum discount

KDP SPECIFICATIONS

General
Temperature range -45° to +70°C.

Contacts
Arrangements: 8 Form C (8PDT).
Rating: 1 amp at 30V DC or
120V AC, resistive.

Coils
Voltages: To 48V DC
Duty: Continuous
Pick-up @ 25°C: DC, 75% of nominal
voltage.
Operate Time: 15 ms maximum at nomi-
nal voltage @ 25°C.

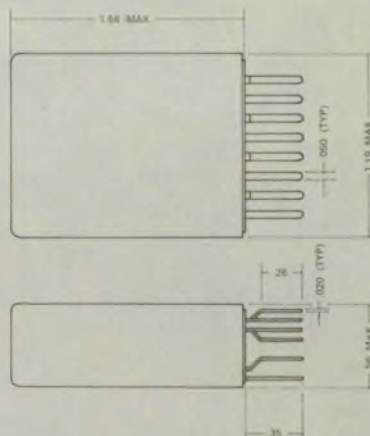

NOTES:
1. DIMENSIONS APPLY TO TERMINAL CENTERS

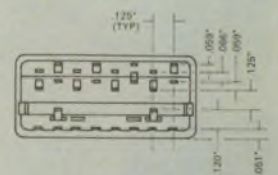

POTTER & BRUMFIELD



*The
Standard of
Excellence*

S/D D/S converters by CLIFTON

Excellent means — "first class, of great worth, eminently good." Definite qualities of our ADverter S/D, D/S converters. But we should add one other feature: *not expensive!* (Model SD12A1, \$795 qty. 1-9.)

In fact, their low cost, combined with such other features as: reliable, all solid state circuitry, easily interchangeable

encapsulated sub-modules, no calibration or adjustments, multi-channel capability, wide variety of options, make them superior in many ways to brush encoders.

Although designed especially for the process control and machine tool fields, this system can easily be modified for military applications.

So take advantage of our

application engineering know-how which is yours for the asking. Call our DITRAN division in Burlington, Mass. (617) 272-6210, or your local Clifton sales office. When you consider Litton, Clifton, Ditrans quality, you couldn't do better!

CLIFTON 
DIVISION OF LITTON INDUSTRIES

Pearls by J. E. Caldwell Co., Philadelphia—\$5,600

Designer's Calendar

FEBRUARY 1970

S	M	T	W	T	F	S
1	2	3	4	5	6	7
8	9	10	11	12	13	14
15	16	17	18	19	20	21
22	23	24	25	26	27	28

Feb. 10-12

Winter Convention on Aerospace and Electronics Systems (Wincon) (Los Angeles) Sponsor: IEEE, R. Banks, Los Angeles Council, IEEE, 3600 Wilshire Blvd., Suite 1920, Los Angeles, Calif. 90005

CIRCLE NO. 409

Feb. 18-19

Instrumentation Fair (Los Angeles) Sponsor: Instrumentation Fair Inc., Calif. L. Courtney, Larry Courtney Co. 16400 Ventura Blvd., Encino, Calif. 91316

CIRCLE NO. 410

Feb. 18-20

International Solid-State Circuits Conference (Philadelphia) Sponsor: IEEE, Univ. of Penna. L. Winner, 152 W. 42nd St., New York, N.Y. 10036

CIRCLE NO. 411

MARCH 1970

S	M	T	W	T	F	S
1	2	3	4	5	6	7
8	9	11	12	13	14	
15	16	17	18	19	20	21
22	23	24	25	26	27	28
29	30	31				

Mar. 11-13

Scintillation & Semiconductor Counter Symposium (Washington, D.C.) Sponsor: NBS, IEEE, R. Chase, Brookhaven National Laboratory, Upton, N.Y. 11973

CIRCLE NO. 412

A Smart Way to Beat Your Power Supply Size Problem



abbott

1½" thin, 2¾" short, yet this converter produces 1000 volts DC, regulated, from a battery input of 28 VDC! It weighs less than 15 ounces. This is only one of our wide variety of many small light weight converters inverters and power supplies — there are over 3000 models listed in our newest catalog, including size, weight, and prices. If you have a size problem, why not send for an Abbott catalog?

MIL SPEC ENVIRONMENT — All of the power modules listed in our new catalog have been designed to meet the severe environmental conditions required by modern aerospace systems, including MIL-E-5272C and MIL-E-5400. They are hermetically sealed and encapsulated in heavy steel containers. New all silicon units will operate at 100°C.

Please write for your FREE copy of this new catalog or see EEM (1969-70 ELECTRONIC ENGINEERS MASTER Directory), Pages 1834-1851.

abbott transistor

LABORATORIES, INCORPORATED

5200 W. Jefferson Blvd./ Los Angeles 90016
(213) WEBster 6-8185 Cable ABTLABS

RELIABLE — Highest quality components are used in Abbott power modules to yield the high MTBF (mean time between failure) as calculated in the MIL-HDBK-217 handbook. Typical power modules have over 100,000 hours MTBF — proving that the quality was built in from the beginning.

WIDE RANGE OF OUTPUTS — Any voltage from 5 volts DC to 10,000 VDC is available by selecting the correct model you need from our catalog with any of a variety of inputs including:

- 60 Ω to DC, Regulated
- 400 Ω to DC, Regulated
- 28 VDC to DC, Regulated
- 28 VDC to 400 Ω , 1 ϕ or 3 ϕ
- 60 Ω to 400 Ω , 1 ϕ or 3 ϕ

TO: Abbott Transistor Labs., Inc., Dept. 57
5200 West Jefferson Blvd.
Los Angeles, California 90016

Sir:
Please send me your latest catalog on power supply modules:

NAME _____ DEPT. _____
COMPANY _____
ADDRESS _____
CITY & STATE _____

INFORMATION RETRIEVAL NUMBER 12

SWITCH CRAFT FORUM



on the new
DW
"Multi-Switch"®*

I can tell you right now, if the new DW "Multi-Switch" doesn't save on space and cost, and offer plenty of versatility it's going to be a dud!

That's the point. Switchcraft designed this compact pushbutton switch to do both. It's not just a scaled down version of an existing "Multi-Switch".

I'll buy your design philosophy so long as you haven't sacrificed the versatility and quality we've been accustomed to on your larger switches. And, don't forget economy.

Let's tackle your points one by one, and see how the new Series 65000 DW "Multi-Switch" shapes up!

We've guaranteed versatility by using simplified modular construction. Essentially, the switch consists of a frame up to 18 stations long, latch bar for function control and switching modules that provide up to 2C (DPDT) circuitry.

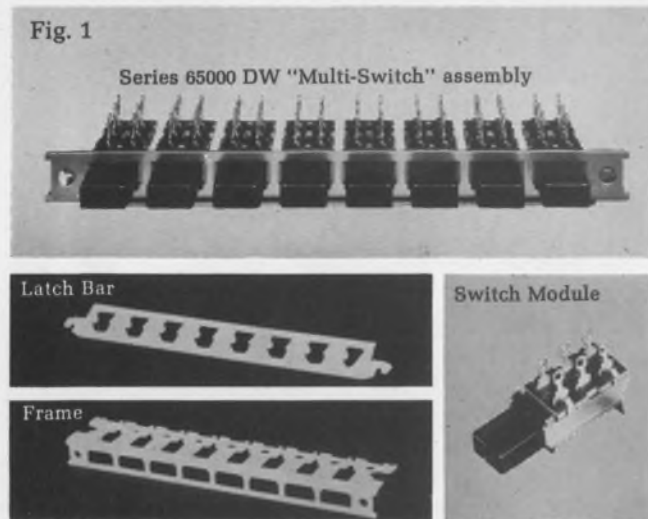
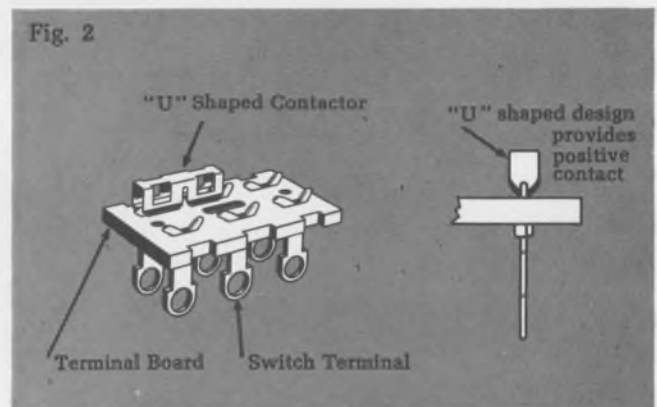

Fig. 1 shows how these elements are combined to complete the switch. The latch bar and mating actuator configuration determine the functional operation, such as: Interlock, All-lock, Non-lock, and even special functions. The push-to-lock, push-to-release function is also available and can be combined with Interlock, All-lock, Non-lock on the same switch frame without any interaction between the various functions.

We don't have space to cover all the versatility details, such as, printed circuit terminals, pushbutton engraving, accommodation for mounting with Tinnerman nuts, etc. JUST CIRCLE THE READER SERVICE NUMBER FOR NEW PRODUCT BULLETIN #174.

*Patent applied for

An example of quality construction is the rigid frame, and double-wipe contactors used for extreme reliability. Fig. 2 shows how the "U" shaped contactor provides positive contact and minimizes "bounce". Also, the molded nylon pushbutton actuators are an integral part of the module. They can't be lost or pilfered. Our quality story ties right into economy. You can't buy a better made, compact multiple-station pushbutton switch for the money.



We'll accept the commercial, only because you have the reputation to back it up. The design looks great, but what about ratings and special circuit applications?

Typical ratings for silver-plated contactors would be 3 amps. A.C., 0.5 amps. D.C. 125v. non-inductive. For dry circuit applications, gold flashed contactors and terminals could be furnished. As usual, we're glad to engineer specials to accommodate your volume requirements.

I'll probably have more questions after we get a few samples on test. In the meantime, I'd like certain members of my staff to get complete engineering details on the DW "Multi-Switch" switch.

Just have them drop us a request on your company letterhead for complete technical scoop. Also, we'll add their name to our TECH-TOPICS mailing list to receive this engineering-application magazine every-other month. Over 10,000 engineers find the application stories very interesting and useful in their work.

*Patent applied for

SWITCHCRAFT
INC.

5529 North Elston Avenue • Chicago, Illinois 60630



Ultramation: the digital controller
you can build with your bare hands.

Honeywell's new H112 digital controller is made of simple, basic components. Just pick out the ones you need and plug them in.

Start with the basic 12-bit H112 controller - 4K ICM-160 core memory, control logic, power supply and drawer. Costs under \$5K.

Need more? Add on μ -PAC logic modules. Extra memory. A/D converters. Digital subsystems. A unique control panel - great for unattended installations. It moves from controller to controller for start-up, service, or

reprogramming. Unplug the panel and nobody can tinker with the operation.

Since all components are Honeywell's, they all go together. No need to engineer your own interfaces. No repackaging.

That's Ultramation - the ultimate in controller adaptability from Honeywell.

Find out more. Write for the new H112 Technical Bulletin. Honeywell, Computer Control Division, Framingham, Massachusetts 01701.

The Other Computer Company:
Honeywell

Microdot's 445 power oscillator is perfect for RFI/EMC testing, antenna pattern measurement, wattmeter and attenuator calibration, and transistor testing. And you can probably think of 10 other jobs requiring such a high-powered signal source. That much power over such a broad frequency range makes this oscillator the most versatile yet. (Plug-in heads available.)

You can sweep the whole 50 watts. A full 10% of any range. And there's *AM* capability and an *FM* capability. (Lets you test to MIL STD 461 and MIL STD 826.) Positive mismatch and no-load protection. A built-in wattmeter for forward and reflected power indication. And a temperature compensated high-Q tuned cavity.

So next time you're running around looking for this oscillator for that job, and that oscillator for this job, remember one thing. We've made an oscillator that'll do it all.

A 50-watt power source
with a 2 to 2500 MHz range.



 **MICRODOT INC.**

Instrumentation Division, 220 Pasadena Avenue, South Pasadena, California 91030



25 years in the thick of it



Centralab introduced thick film technology in 1945.

The result—microcircuits with superior design and performance today.

No one offered thick film microcircuitry as a serious answer to reliability and miniaturization requirements 25 years ago. But Centralab got right into the thick of it. And it's difficult to catch someone with a 25 year head start. In numbers alone our lead is commanding. We've produced more than 500,000,000 units, with some 5,000 custom designs. No one can approach this production record. In material selection our experience again gives us a sharp edge. Ceramics, metallizing compounds, resistor inks, glaze and sealing materials have all been

specially developed by Centralab's Material Sciences Group to our specifications for durability in processing and application. The Semiconductor Division is a ready source for a wide variety of chips. We even manufacture our own ceramic substrates through an exclusive thin sheet process that is superior to any other method in the industry. And our computer-aided analysis service provides prompt, practical answers to circuit design problems. We don't mean that thick film chip hybrids are the answer to every problem in microcircuitry.

But you'll be surprised at how many solutions these low-cost custom units provide. For more information on how you can get into the thick of it with Centralab, turn the page.



CENTRALAB

Electronics Division
GLOBE-UNION INC.

5757 NORTH GREEN BAY AVENUE
MILWAUKEE, WISCONSIN 53201

1945-1970

A quarter century of technology on your side



First use of Centralab's thick film microcircuit

Centralab pioneered thick film microcircuitry in 1945 when we developed a miniature oscillator-amplifier circuit for a mortar shell proximity fuse. This first-of-a-kind unit, admittedly crude by today's standards, consolidated carbon composition resistors, silver-ceramic capacitors and silver circuit paths screened onto a ceramic substrate, which met tough shock requirements. The completely sealed unit was about 3 inches in diameter and 4 inches long.

carbon composition resistors, silver-ceramic capacitors and silver circuit paths screened onto a ceramic substrate, which met tough shock requirements. The completely sealed unit was about 3 inches in diameter and 4 inches long.



100,000,000th microcircuit

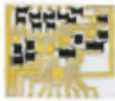

Centralab's new thick film chip hybrid

This assembly, which became known as a Packaged Electronic Circuit (PEC), opened the door to an entirely new technology. By 1959, we had produced our 100,000,000th unit. A plaque commemorating this historic production is on permanent display at the Smithsonian Institute, a milestone in the electronic industry.

PECs are still being used extensively for industrial, military and consumer applications. But continued technological developments have brought a new degree of sophistication to the art of thick film microcircuitry. So we've developed our new thick film chip hybrid microcircuits. Chip active devices — diodes, transistors, and ICs — are combined with fired on resistors, wiring and capacitors to provide a reliable circuit module. These are smaller, harder working, more sophisticated devices that are custom designed for specific applications.

These are smaller, harder working, more sophisticated devices that are custom designed for specific applications.

We're uniquely qualified to provide thick films because our 25 years of experience have given us an intimate knowledge of materials, technology, design, production and service. Following, in more specific terms, is what we mean:

Materials to service: The Centralab capability

Basic to the ultimate performance of thick film chip hybrid microcircuits is the evaluation, selection and development of materials that will withstand sophisticated manufacturing processes as well as demanding applications. The Centralab Material Sciences Group of specialized technical personnel determines what materials will best support the special requirements of our design and production facilities.



Materials developed specifically by Centralab

One example of the work of this group is the ceramic substrate used in our thick film circuits. To meet design parameters for maximum thermal conductivity and mechanical strength, as specified by our engineers, an exclusive thin sheet ceramic production process was developed that produces substrates of unexcelled surface finish and reliability. These are so superior to others available, that Centralab is a leading supplier to other microcircuit manufacturers. Our ceramic capability has also provided high performance hermetic packages.



Centralab substrates and packages

Another joint effort of our materials and engineering development personnel resulted in a monolithic chip capacitor (Mono-Kap) that has virtually eliminated pin holes that destroy capacitor reliability and long life.

Micrographs of Mono-Kaps and competitive units



Mono-Kap Competitor A Competitor B Competitor C

We've also produced molybdenum/gold substrates with amazingly complex pattern geometry. These substrates, and our proprietary process (patent applied for) for producing them, permit thicker gold deposits and are ideally suited to ultrasonic and thermocompression bonding methods.



Molybdenum/gold substrates

Our computer-aided design and circuit analysis services can provide optimum design to minimize failures, enhance performance, and reduce cost. Our comprehensive thick film background gives us another head start in being able to program our computer so that improved design is assured at the most reasonable cost.

All of our experience and technological skills are reflected in the design and production of Navy Standard Hardware Modules. These plug-in modules combine circuit functions to constitute a complete electronic system that is reliable, flexible and economical.



Navy Standard Module

One more thing. With all our capabilities, we realize that speed is often the most important criteria for judging a thick film microcircuit manufacturer. That's why we are geared to provide production samples to your specifications in as little as three weeks; production quantities eight weeks after prototype approval.

It all adds up to one fact: No other manufacturer is better qualified to help you find the most efficient use of thick film chip hybrids in your circuit design. And if you'd like to find out precisely how we can help you, send your requirements or circuit design to Centralab Application Engineering. There's no better way to get into the thick of it.



CENTRALAB

Electronics Division
GLOBE-UNION INC.

5757 NORTH GREEN BAY AVENUE
MILWAUKEE, WISCONSIN 53201

HAPPENINGS IN ELECTRONICS

January, 1970

Save Time and Money with Chopper Circuit Designer's Kit

Quan.	Type	Price	Structure	f_{DS} (on) @ 1 kHz	I_D	V_{GS}	
2	2N4091	5.25	JFET (N)	30	1.0mA	0v	
2	2N4093	3.45	JFET (N)	80	1.0mA	0v	
4	2N4351	5.25	IGFET (N)	300	0.0mA	10v	
4	2N4352	5.25	IGFET (P)	600	0.0mA	10v	
6	2N5555	1.20	JFET (N)	150	0.1mA	0v	
2	MFE2009	6.75	JFET (N)	20	1.0mA	0v	
2	MFE2012	9.75	JFET (N)	10	1.0mA	0v	
2	3N155	6.30	MOSFET (P)	600	0.0mA	-10v	
			Bipolar	MAX. $V_{EC(OFS)}$	I_B	I_E	
2	2N2944	2.76	PNP	0.3mV	200uA	0	
1	2N2945	2.52	PNP	0.5mV	200uA	0	
6	2N2946	2.88	PNP	0.8mV	200uA	0	
5	2N5231	3.75	PNP	0.8mV	100uA	0	
5	MM4052	4.50	PNP	2.0mV	1.0mA	0	
Total Value 178.77			Schweber Price 84.50				You Save 94.27

Here is a kit that will surely prove both a time and money savings aid in the design and prototyping of chopper circuits. It contains a broad assortment of popular field effect and bipolar types of transistors, all packaged in a convenient, sturdy, vinyl-covered carrying case. Included with the kit is a comprehensive brochure which contains selector guides, data sheets on all the transistors, and application notes covering both FET and bipolar design considerations. To assist you in evaluating the kit, a chart is on the left listing the transistor types, their prices, and some key characteristics important in both chopper and analog switching circuits. This kit (MK48C) was put together by Motorola and would carry a total price of 178.77 at current 1 to 99 published prices. The kit price, however, is just 84.50, which means a saving to you of 94.27. Individual transistors may be purchased at the prices shown on the chart. Call any of the locations listed below, mention HAPPENINGS, and get Super-Service in shipping, or just plain information.

Schweber Offers Low-Cost IC Voltage Regulator from G.E.

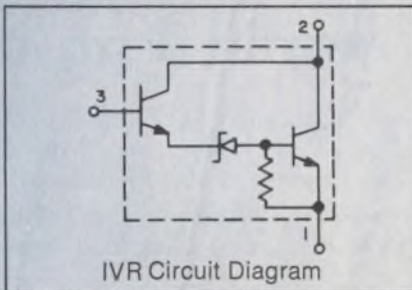

A new 3-lead monolithic IC voltage regulator in epoxy case opens door to low-cost regulation in high-volume applications. The GE D13V is a monolithic integrated circuit voltage regulator (IVR) in a standard epoxy TO-98 package. Designed for use as a shunt voltage regulating element, it will enable conventional power supplies to deliver constant, ripple-free voltage over a range of 10 to 40 volts at up to 400 mW average power. It features a specified low temperature coefficient of regulated voltage: 0.1%/°C max. (.03%/°C typical). The IVR may be utilized as the reference amplifier of a series pass voltage regulator to make a precision power supply which can be programmed from zero to 30v. Prices: 1 to 99, 65¢; 100 to 999, 44¢; 1000 and up, 36¢. Call any of these locations below.

Building Blocks for Nonconformist Circuit Designers

Type #	Description	1-99	100-999
CA3018	Four NPN Transistors. Two are isolated. Other two have emitter-to-base interconnections	1.62	1.18
CA3018A	Similar to CA3018 but features tighter control of current gain, leakage and offset parameters	2.22	1.62
CA3026	Six Transistors Connected as two differential amplifiers with constant current sinks	2.06	1.50
CA3036	Two Independent Low-Noise Wide-band Amplifier Channels	1.47	1.07
CA3045	Three Isolated Transistors and One Differentially Connected Transistor Pair	2.47	1.80
CA3046	The CA3046 is electrically like the CA3045 but is in a dual in-line plastic package	1.61	1.17

Monolithic integrated circuits may be a blessing to the circuit designer, but they leave hardly any room for the exercise of the circuit designer's imagination. "The latest op amps have eliminated all external components," the industry proudly announces. So now it's a case of love me, love my bias resistors, load resistors, frequency compensation capacitors. To obtain the advantages of close electrical and thermal matching inherent in integrated circuit construction you swallow the whole package. There is an alternative. If you have a circuit that requires maximum application flexibility, why not try the RCA transistor arrays? In that way the active elements retain the inherent advantages of monolithic construction while permitting you to vary the remaining components, or even use non-integrable components such as tuned circuits, large value and variable resistors, and large by-pass capacitors. On the left are some suggestions for your consideration. Call any of the locations listed below to order and obtain information.

We are in an age of fast turn-on time and fast reaction time. If anything on this page attracts your interest, why not satisfy your curiosity now by calling any of the seven locations listed below? They are at your service for ordering, pricing, delivery information, and technical literature.

WESTBURY, NEW YORK: 516/334-7474 □ WALTHAM, MASS: 617/891-8484
 ROCKVILLE, MD: 301/427-4977 □ CLEVELAND, OHIO: 216/333-7020
 HOLLYWOOD, FLA: 305/927-0511 □ HUNTSVILLE, ALA: 205/539-2756 □ TORONTO, CANADA: 416/925-2471



Something *New* Has Been Added!

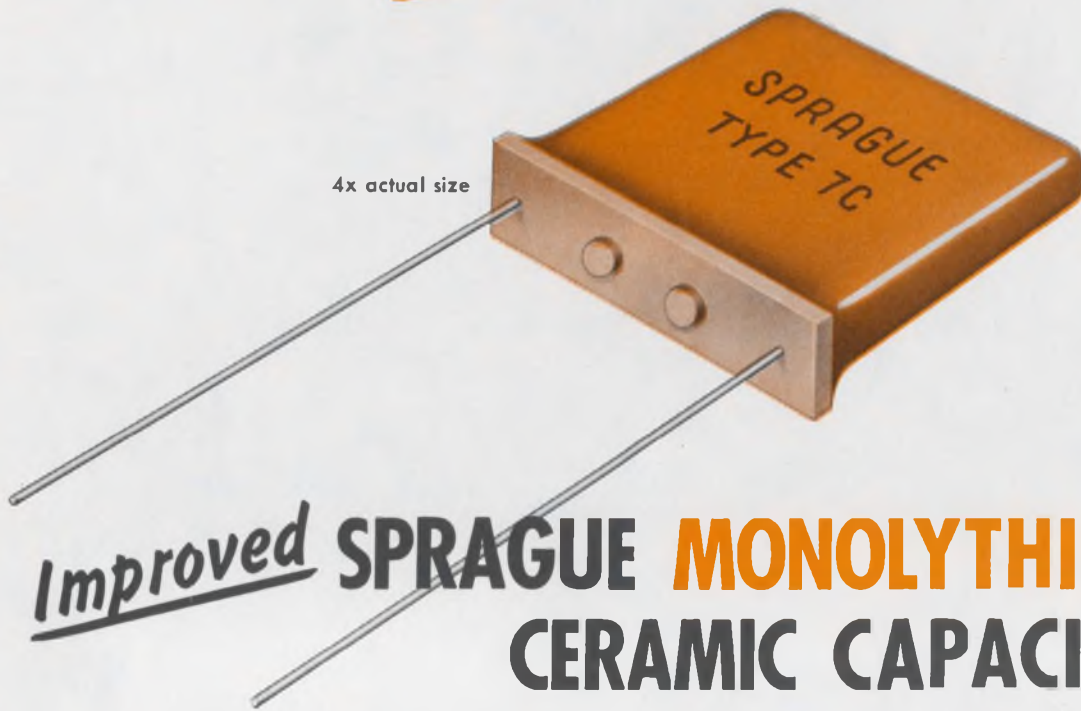

Improved SPRAGUE MONOLYTHIC[®] CERAMIC CAPACITORS

now have a phenolic terminal base

Type 7C Radial-lead Capacitors are made with alternate layers of sprayed ceramic dielectric material and screened metallic electrodes, fired into a solid homogeneous block and coated with a tough phenolic resin. Their new bossed terminal base construction provides these advantages: (1) No resin run-down on leads. (2) Uniform lead spacing is automatically maintained. (3) No dirt and moisture entrapment; degreasing fluid flows freely between capacitor and board.

Body Code	EIA Characteristic	Operating Temperature Range	Maximum Cap. Change over Temp. Range	WVDC	Capacitance Range	Capacitance Tolerance
082	NPO	-55 C to +125 C	±60ppm/°C	50 100 200	51 pF to .024 μF	±20% ±10% ±5% ±2%
075	N750	+25 C to +85 C	-750 ± 120 ppm/°C	50 100 200	.001 μF to .082 μF	±20% ±10% ±5% ±2%
		-55 C to +125 C	Meets MIL-C-20 Char. UJ			
067	X7R	-55 C to +125 C	±15%	50 100	.0018 μF to 1.5 μF	±20% ±10%
023	Z5U	+10 C to +85 C	+22% -56%	50	.01 μF to 3.3 μF	+80, -20% ±20%

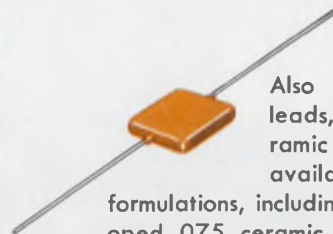

Also made with axial leads, Monolythic[®] Ceramic Capacitors are available in four body formulations, including a newly-developed 075 ceramic material, as described in the adjacent chart.



For complete technical data write for engineering bulletins on Monolythic Ceramic Capacitors to: Technical Literature Service, Sprague Electric Co., 347 Marshall St., North Adams, Mass. 01247.

SPRAGUE COMPONENTS

CAPACITORS
TRANSISTORS
RESISTORS
INTEGRATED CIRCUITS
THIN-FILM MICROCIRCUITS

PULSE TRANSFORMERS
INTERFERENCE FILTERS
PULSE-FORMING NETWORKS
TOROIDAL INDUCTORS
ELECTRIC WAVE FILTERS

CERAMIC-BASE PRINTED NETWORKS
PACKAGED COMPONENT ASSEMBLIES
BOBBIN and TAPE WOUND MAGNETIC CORES
SILICON RECTIFIER GATE CONTROLS
FUNCTIONAL DIGITAL CIRCUITS

450-8107R3



[®] 'Sprague' and '®' are registered trademarks of the Sprague Electric Co.

INFORMATION RETRIEVAL NUMBER 16

News

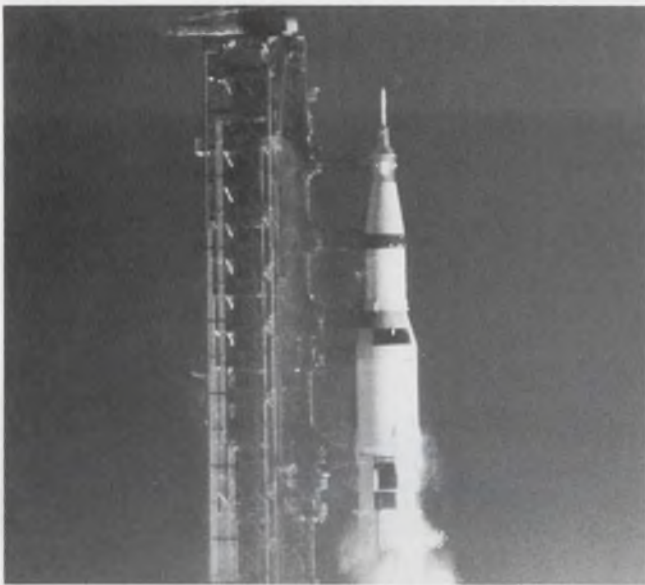

What's in store for electronics in 1970? A decline in Government spending for military and space programs and tight money policies



will contribute to a small 1.4% growth in the U. S. market, according to forecasts of the Electronics Industries Association. p. 25.



Tomorrow's materials and components may be processed and manufactured in space under zero gravity conditions. p. 30.



NEC speakers urge that devices generating electromagnetic interference be tested in shielded rooms, as well as free space. p. 36.

Also in this section:

Monitor keeps tab on noisy vehicles. p. 35.

News Scope, p. 21 . . . **Washington Report,** p. 41 . . . **Editorial,** p. 51.

Why National Semiconductor buys Teradyne J259's by the dozen

National Semiconductor can trace its considerable success as an IC manufacturer to many factors. One of the most important is the productivity of its testing facility, built around a lineup of 12 Teradyne J259 computer-operated test systems. "The Teradyne systems," according to Jeff Kalb, National's TTL product manager, "give us the economy of testing that is so important to profitable high-volume production."

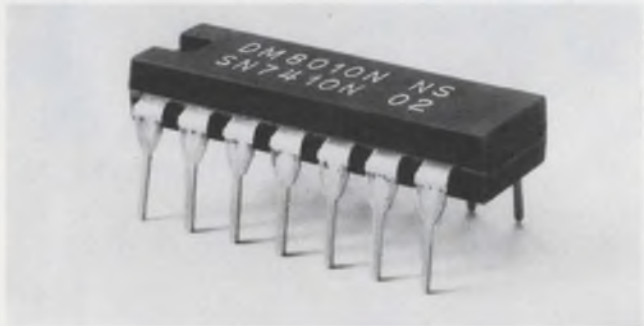

National, along with most other major IC producers, has found that the J259 boosts productivity in many ways. No other test system, for example, gives its user as much multiplexing freedom as does the J259, which lets National leverage its investment by making each J259 support several test stations doing several different jobs.

Reliability is another all-important key to productivity. National experiences minimal downtime with its J259's. This is as it should be; we design and build our equipment to work shift after shift, year after year, in *industrial* use. Teradyne systems are right at home on production lines like National's, where the workload is heavy and continuous. And operation never has to be interrupted for calibration; the J259 has no calibration adjustments.

The J259's great versatility is also put to good use at National. The same systems that test wafers and packages also generate the distribution and end-of-life data that engineers need to control production processes and ensure high device reliability. Production, engineering, QC, and final test – all share simultaneously in the benefits from National's J259's.

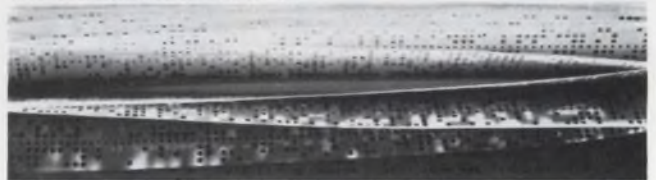

A computer-operated system is only as good as its software, which in the case of the J259 is the best there is. National's J259's are orchestrated by Teradyne-supplied master operating programs for datalogging, classification, and evaluation. As Teradyne updates and improves its software, National is kept fully informed.



National's array of J259's handle the testing of its digital IC's smoothly and economically. For its linear-IC testing, National has turned to Teradyne's J263 computer-operated linear-IC test system.

Teradyne's J259 makes sense to National Semiconductor. If you're in the business of testing circuits – integrated or otherwise – it makes sense to find out more about the J259. Just use reader service card or write to Teradyne, 183 Essex St., Boston, Mass.

Teradyne makes sense.

Fluidics still striving for wider acceptance

"We are no longer a fad technology we are a mature technology." With this comment, Dr. Fredric Ezekiel, independent engineering consultant, underlined the theme of last month's Fluidics Exposition and Conference in Cleveland.

Compressed-air-powered fluidic devices have found specialized use under extreme radiation, temperature and vibration environments, he said, but they are still far from being fully exploited.

Another speaker, Leonard Gau of Chrysler Corp.'s research department, displayed confidence in fluidics by predicting their eventual use in automotive transmissions and emission-control systems. He said that fluidic designs will be accepted by Detroit when manufacturers are convinced that better performance cost savings can be realized. Competition between the various designs, plus the challenge posed by existing automotive hardware, is responsible for slowing fluidic applications, according to Gau.

Technical presentations and exhibits at the show emphasized the low maintenance cost, high reliability and ease of assembly that make fluidics attractive for general manufacturing applications.

Successful fluidic control of common industrial processes was demonstrated with motion pictures. Pitney-Bowes, Glenbrook, Conn., presented a film featuring fluidic sorting and counting of metal plates. Movies from the Apparel Research Foundation showed the use of fluidics in automated fabric handling. Production lines, automatic lathes and packaging equipment adapted to fluidic technology were also covered.

Besides overcoming the inertia of potential customers, the fluidics industry has another problem to

contend with: lack of standardization. James Morgan of the National Fluid Power Association, Washington, D. C., observed that compatibility between competing fluidic products is low because many designs operate on differing physical principles.

This was illustrated by the variety of fluidic logic elements offered by conference exhibitors. Bowles Engineering Corp., Silver Spring, Md., and Corning Glass Works, Corning, N.Y., presented a line of low-pressure fluidic devices that require a clean air supply for long operation. They have no moving parts. In contrast, Double A Products Co., Manchester, Mich., displayed logic elements that use a flexible diaphragm-valve. These devices can operate off contaminated air without serious drawback. Another approach, from Aro Corp., Bryan, Ohio, is pneumatic logic. These elements work directly off high-pressure air, eliminating the need for pressure transducers. The Johnson Service Co., of Milwaukee, has yet another concept with its impact modulator. This device features a plug-in arrangement of cylindrical fluidic elements allowing quick replacement.

Fairchild looks into its IC future

Commenting on the IC outlook this year at Fairchild Semiconductor, Harry Neil, director of IC Subsystems Marketing predicted that within two to three years, semiconductor memories—in the 500- μ s to 1- μ s class—would be priced at under 2¢ a bit. And though they will be used first in the small random-access computers, Neil sees their eventual use in the larger processors. "That's where the economy comes in first. Right

now the large processors would consume more silicon than the entire industry is producing."

Neil sees custom MOS growing at a fantastic clip. "This month Fairchild will be turning out four to five LSI arrays (about 150 functions per chip) a week. By the close of 1970 we'll be doing about double that."

In the linear IC area, Neil says the company is developing circuits for the automotive industry. These, he says, are likely to be incorporated in the 1972 models.

Electronics makes ski slopes safer

Later this month, four skiers equipped with vest packs containing 5 amplifiers, 5 oscillators, a mixer, an fm radio transmitter, a battery pack and a regulated power supply will be on the slopes at Mittersill Ski Area, Franconia, N. H. At the foot of the mountain, Prof. Lawrence O. Sher of the Moore School of Electrical Engineering at the University of Pennsylvania will be recording on magnetic tape continuous day-long measurements of the strain and torques exerted between ski binding and ski boot for all four skiers.

The purpose of these measurements is to acquire enough information to determine the ideal ski binding—and to make the sport of skiing safer.

As a skier himself, Sher is interested in minimizing the 30,000 major injuries to the legs of U.S. skiers. Two thirds of such injuries are caused by the skis acting as levers. As an electrical engineer, Sher has designed an experiment to measure:

- Vertical and lateral forces at the toe.
- Vertical and lateral forces at the heel.
- Longitudinal forces.

Sher used five strain gauges placed between the ski boot and the binding to measure these forces. An fm receiver for each of the four skiers will accept the telemetered information that will be recorded on tape for decoding, digitizing, and computer analysis later on.

Sher's investigations are being funded by the U.S. Public Health

Service. Variables such as age, weight, sex, and degree of expertise of the skier will be considered. This information will be correlated with pre-existing data on types of ski injuries, strengths of bone, tendon, ligament and cartilage, and models embodying these facts.

Reserve train seats with vending machine

You may have reserved seats by computer before, but never like this. Here's what you can do in 60 seconds at New York City, Philadelphia and Washington, D. C., terminals of Penn Central's Metro-liner express train: with one computerized vending machine you can select your seat and buy your ticket. The process was developed by Ticket Reservation Systems, Inc., New York City, and the machines are said to be the only computerized reservations vending system available in the transportation industry.

To get this high-speed service, you put a quarter in an inquiry slot—your quarter will be returned. By pressing the proper button you learn what seats are available and in addition the departure time. The price of the fare appears, you deposit the exact amount (a change-making machine is next to the vending machine), the ticket is printed on the spot, and comes out a slot. An audit copy is printed on a machine in the main ticket office. If you want to try to beat the machine, don't do it: there are both audible and visual alarms.

Computer functions as ship's doctor

An advanced computer system that even performs some of the functions of a ship's doctor is being installed by Tokyo Shibaura Electric Co., Ltd. of Toshiba, Tokyo, on a 138,370-ton tanker now being built in Japan.

According to Takuzo Sakamoto,

general manager for Los Angeles of Toshiba America, Inc., any time a crewman is ill on board the tanker, the ship's officers can report the patient's symptoms and conditions to the computer and receive a diagnosis, along with prescription of medicines and treatment. This system will handle only simple problems. The same service can be performed for nearby ships that do not have a doctor aboard.

So many functions will be performed by the computer that the tanker crew will be reduced from about 30 to around 15. Besides doctoring, the computer will:

- Monitor all of the ship's operational and safety precautions.
- Plot the courses of the 10 ships in closest proximity to within 200 meters and sound an alarm if any are on a potential collision course.
- Supervise all loading and unloading of crude oil, calculating displacements, tank capacities, and the optimum loading distribution.

The ship is due to be launched in mid-1970.

Fast image analyzer for materials research

A high-resolution, high-speed image analyzer, said to be several orders of magnitude better than any on the market, has been developed by Metals Research Ltd., Hertfordshire, England.

Though designed primarily for use in metallurgical applications, the system can also be used in electronic materials research.



A fast image analyzer

Called the Quantimet 720 Image Analyzing Computer System, it can detect surface deformities down to one-micron widths. And it can scan up to 650,000 surface gradations in one second, the company says. A typical system costs about \$30,000.

Air Force ends study of UFOs

The Air Force has officially ended its investigation of unidentified flying objects.

Dr. Robert C. Seamans Jr., Secretary of the Air Force, said in a memorandum that continuation of the study "no longer can be justified either on the ground of national security or in the interest of science."

Project Blue Book, the program's code name, has investigated 12,618 sighting reports at a cost of several million dollars since its start nearly 22 years ago.

The Air Force said reports of "unknowns" had fallen from a high of 1501 in 1952 to 146 this year.

Both a committee of the National Academy of Sciences and a group at the University of Colorado concluded in a report earlier this year that further studies of the so-called flying saucers would be a waste of money.

Dr. Edward U. Condon of the University of Colorado, the physicist who headed the committee that turned in the 1485 page report last January, said recently that his investigation "was a bunch of damned nonsense" and that he was "sorry I ever got involved in such foolishness."

American Airlines uses 3-D navigation

American Airlines announced that it has begun using three-dimensional area navigation equipment that enables pilots to create their own "express" routes outside the established airway system. Included are precise navigational devices that not only determine distance and course position but also provide vertical measurements for takeoffs and landings.

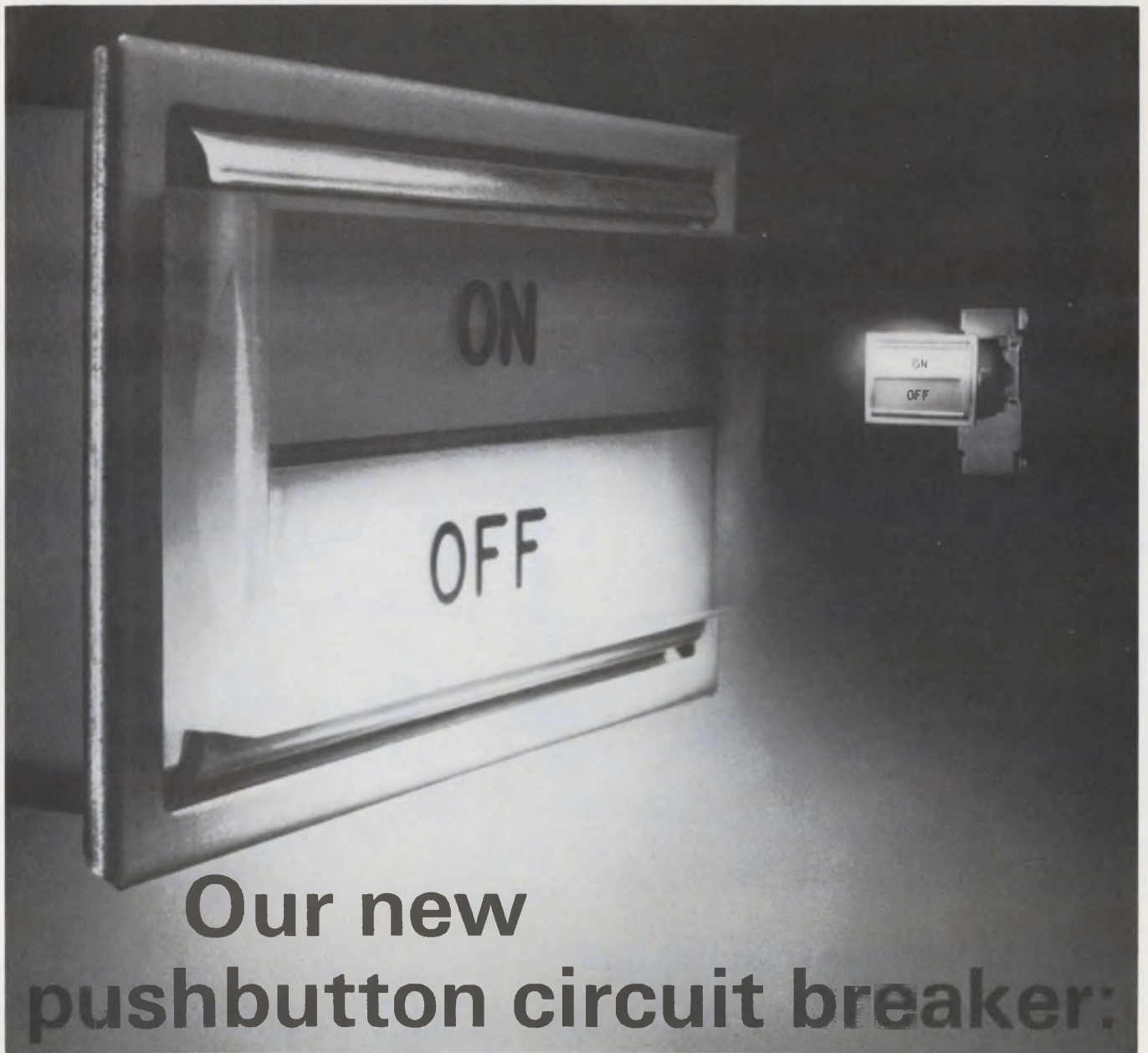

Our new pushbutton circuit breaker: it lights—even when it's "off"

You wouldn't find Heinemann dabbling in halfway measures. No pilot lights that go out when the protected circuit goes out. We give you something better—a handsome pushbutton-actuated breaker that lights in a soft green to show the circuit is "on," and lights up white when the circuit is "off."

The breaker is essentially our familiar Series JA, adapted for push-push operation through a lighted pushbutton actuator. The two modules snap together (with the breaker in any of four positions), and can thus be stacked on your instrument panel either vertically or horizontally. You wire them together almost as easily as you wire the breaker's line and load connections.

If you're up on your JA lore, you know the current range—any rating from 0.020 through 30 amperes, 240 volts AC or 65 volts DC. For your convenience, though, we've made lighted pushbutton breakers for immediate delivery in 1, 5, 10, 15, 20, and 30 amp. If you're thinking of our more outlandish ratings, kindly observe our regular lead time.

A final note: We call the pushbutton breaker our Series JL (sort of a JA, but lighted). We offer you a nice new bulletin describing it. Write for Bulletin 3351. Heinemann Electric Company, 2616 Brunswick Pike, Trenton, N.J. 08602. 4445

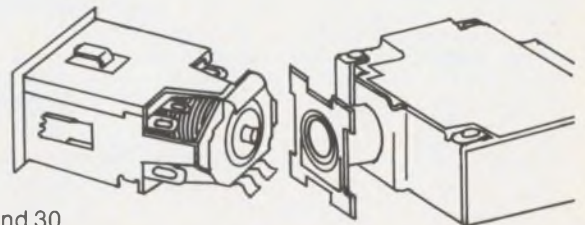

HEINEMANN

INFORMATION RETRIEVAL NUMBER 18

CROWBAR...?



The One Inside is FREE

Not so many years ago, the prudent transmitter engineer discharged a high voltage capacitor bank by dropping a shorting "crowbar" across its terminals. Today's "crowbar" is a protective overvoltage circuit found on DC power supplies — usually at extra cost. Now HP includes a crowbar as standard on its recently updated series of low-voltage rack supplies . . . at no change in price.

Long established as preferred system supplies for component aging, production testing, and special applications, these supplies have now been redesigned and expanded to meet the stringent demands of today's power supply user. Advantages include low ripple (peak-to-peak as well as rms), well-regulated constant voltage/constant current DC with outputs to 60 volts and 100 amps.

Where loads are critical and expensive, the extra pro-

tection — say, against inadvertent knob-twiddling — from a crowbar is invaluable. On all internal crowbars in this series, the trip voltage margin is set by screw-driver at the front-panel.

Pertinent specifications are: triggering margins are settable at 1V plus 7% of operating level; voltage ripple and noise is 200 μ V rms/10mV peak-to-peak (DC to 20 MHz); current ripple is 5 mA rms or less depending on output rating; voltage regulation is 0.01%; resolution, 0.25% or better; remote programming, RFI conformance to MIL-I-6181D.

Prices start from \$350. For complete specifications and prices, contact your local HP Sales Office or write: Hewlett-Packard, New Jersey Division, 100 Locust Avenue, Berkeley Heights, New Jersey 07922 or call (201) 464-1234 . . . In Europe, 1217 Meyrin, Geneva.

HEWLETT  **PACKARD**
POWER SUPPLIES

Additional data sheets available upon request

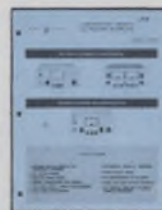

LAB SERIES
smaller package,
lower power,
optional crowbar



CROWBARS
A Technical
Discussion



**1969 Power
Supply Catalog**
— includes total
HP power supply line.

Circle # for details

326

327

328

329



Industry forecast for 1970

Smallest electronics advance in years

Tight money, lower Government spending to limit market increase to 1.4%

sum it would appear that the theoretical case for recession is quite strong."

Richard Hall, vice president of marketing, Amphenol Components Group, The Bunker Ramo Corp. observes:

"The tight money policy of 1969, the decline in defense spending and NASA funding cuts will force a 'pause' in the growth of the overall economy and the electronics industry, next year."

Dr. Jaromir Ledecy, vice president at Quantum Science—a technological forecasting corporation—noted, "Inflation will continue at an even higher rate in 1970 despite the Nixon Administration's fiscal and monetary anti-inflation measures. At the same time, the U.S. economy during the coming year will teeter between slow-down and genuine recession."

Drop in Government spending

In 1969, and for the first time since the 1940's, Government products and services dropped to less than 50% of the electronic industry's total. This trend will continue during 1970, according to EIA president George Butler, who foresees a 3.5% decline from \$12.4-billion to \$12-billion in Government purchases of electronic goods and services.

The Government remains the industry's largest customer, but from a growth standpoint is seen surpassed by increases in sales of industrial and consumer products this year.



Ralph Dobriner
Chief News Editor

Government anti-inflation policies, a decline in defense spending and NASA funding cuts are expected to result, next year, in one of the smallest advances in the U.S. electronics market in recent history.

The Electronics Industries Association predicts that total sales in 1970 will reach \$25.5-billion—up only \$400-million, or 1.4% over the figure for 1969.

Despite the EIA predictions of continued growth in the consumer, industrial and component areas, in the year ahead, a number of companies expressed concern over continuing inflation and Government tight money policies.

Fred Borch, board chairman of General Electric Co. says:

"The Government's anti-inflationary policies are beginning to take hold, braking the economy's real growth. Gains in a real output have slowed markedly, influenced by such factors as little growth in the money supply, virtually "flat" Government spending, weakened profits and credit restrictions that pinch the mortgage market. In

While expenditures for military and space programs are being scaled downward, increased emphasis will be placed on research and development, according to Butler.

An estimated \$7.2 billion to \$7.5-billion will be spent by the Dept. of Defense on R&D in fiscal 1970. This figure is expected to climb to \$7.9-billion in fiscal 1971.

NASA R&D spending is seen as declining from \$3.2-billion to \$3.1-billion during the same period.

Industrial product sales, Butler said, are expected to climb 5.6% to reach \$7.6-billion. The increase here is due to anticipated gains in computer shipments that should be up 7.1% from the estimated 1969 level of \$4-billion.

A banner year for computers

In computers, all signs point to another banner year. The total computer industry—including hardware, software, information and support services—will surpass \$12-billion in sales in 1970. This figure could reach more than \$27-billion by 1975, according to projections by The Diebold Group,

(forecast, continued)

Inc., New York City.

These figures contrast with sales of \$10-billion in 1969 and \$4-billion scarcely five years ago, Diebold notes.

Over 18,000 computers are expected to be shipped during 1970, bringing the number of systems in use to 90,000. Again as a contrast, some 4500 computers were in use in 1960 and deliveries were averaging 1000 a year.

The fastest growing segment of the small computer market is the mini-computer for monitoring and control applications. These machines are finding increasing use in discrete manufacturing systems, as well as the more traditional continuous process systems.

According to Diebold projections, shipments of computers for monitoring and control applications, while insignificant just a few years ago, will exceed 5000 units in 1970.

The increasing use of large computers performing sophisticated applications will stimulate the sales

of peripheral equipment. These systems will be using a growing number of input/output devices per computer, and will require large peripheral storage devices to handle the massive data bases with which they will be dealing.

Sales of peripheral equipment (including remote terminal devices) are expected to reach \$3.5-billion in 1970, according to Diebold.

Consumer outlook is mixed

Factory sales of consumer products should climb about 7.6% to \$5.2-billion in 1970, EIA figures indicate. Estimated domestic 1969 sales volume is \$4.8-billion. When imports sold in this country under foreign labels are added to domestic shipments, total U.S. sales are expected to reach \$5.7-billion during 1970, increasing by 7% from sales of \$5.4-billion during 1969.

Despite the 7.6% predicted increase in the consumer-electronics market this year, the outlook is beset with uncertainties.

With the President's plan to slow down the economy and as dis-

posable income continues to decline, consumer items will be hit the hardest, according to industry spokesmen.

Once again, color television will be the hottest single item in both unit and dollar volume. Factory sales this year are expected to total some 5.5-million sets, a slight increase over 1969. Domestic sales of black and white sets are expected to decline.

Until mid-1969, color TV sales were running about 10% ahead of the previous year. During the past few months, however, sales have been down 8 to 9%, according to EIA figures.

As far as other home entertainment items are concerned, such as tape recorders, stereo systems, etc., the outlook is also cloudy.

Microelectronics the leader

The EIA foresees some favorable trends in shipments of electronic components during 1970. Total components shipments are expected to rise 5% to reach nearly \$6-billion.

Increases are anticipated for color TV picture tubes, power and

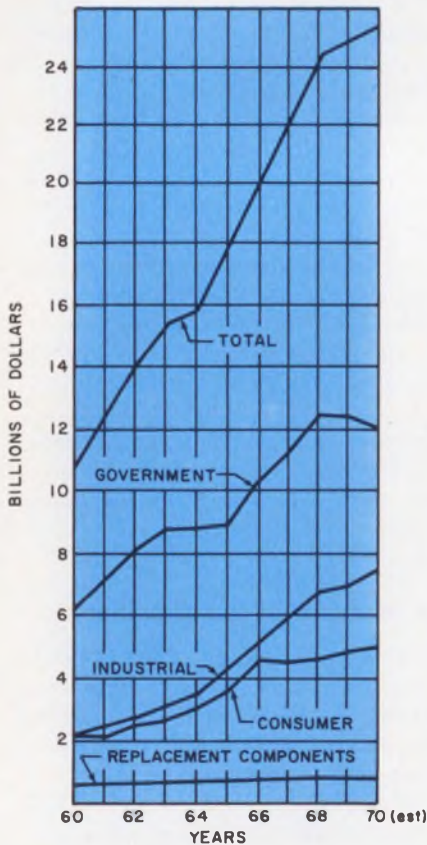

All electronic sectors, except Government, are expected to grow.

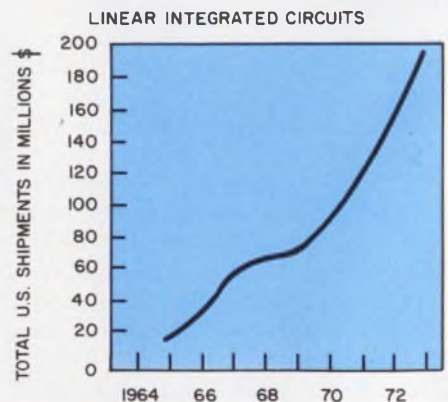
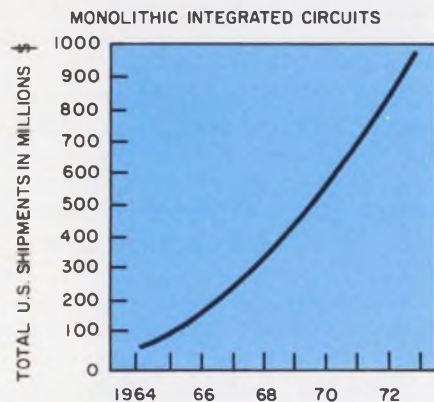
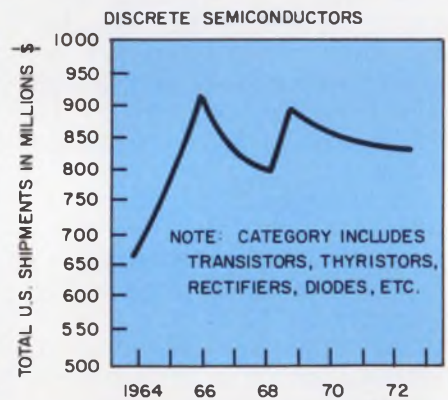
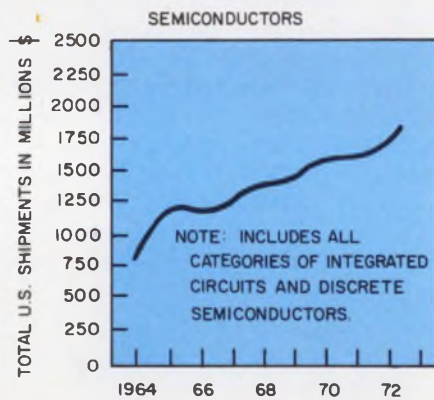

Microelectronics will continue its spectacular growth in 1970, and beyond. The curves are from National Semiconductor Corp.

Signetics was on the ball.



We've also been to Mars.

And Venus.

And, all in all, we've taken part in 76 major space probes. So far.

Which really means nothing to our earthbound friends. Except for this: Here at home, you need reliability too. The highest you can get.

So, wherever you're heading, shouldn't Signetics integrated circuits go along for the ride?

Signetics

Signetics Integrated Circuits, 811 E. Arques Ave., Sunnyvale, Calif. 94086 / A subsidiary of Corning Glass Works

INFORMATION RETRIEVAL NUMBER 19

(forecast, continued)

special-purpose tubes, microelectronics and capacitors, among other electronic components. The biggest gainer will be microelectronics where a 58% increase will push the value of production up to \$750 million.

Charles E. Sporck, president of National Semiconductor Corp., Santa Clara, Calif.—in a long-range view—predicts that the total dollar volume of monolithic IC shipments in the U.S. will hit \$900-million by 1973.

Addressing a security analysts' meeting in New York City recently, Sporck predicted a total 1973 semiconductor market (ICs and discretely) of \$1-3/4-billion, with the linear IC market accounting for \$200-million in that year. Sporck includes only U.S. shipments in these figures; he predicts that total U.S. semiconductor shipments will be about 50% of the 1973 market.

Alan B. Grebene, manager of circuit research at Signetics Corp., Sunnyvale, Calif., notes: "Two things have permitted linear ICs to move into consumer electronics. They have been improved, providing more functions on a chip. And there is better coordination now between the IC manufacturer and the maker of the consumer product—still not enough but better than it was." He adds, "ICs are more economical. When they can replace a large chunk of circuits they become cheap enough to use."

This year will see integrated circuits cropping up in more and more home entertainment prod-

ucts. A Motorola Semiconductor survey reveals that the market for linear ICs in entertainment and automotive products should hit the \$15-million figure in 1970, compared to \$9-million in 1969. This figure is likely to reach \$93-million within four years, according to the survey.

David L. Campbell, manager of linear circuit development at National Semiconductor in Santa Clara, Calif., says: "ICs are going into consumer products now because they're cheaper. We foresee a strong trend toward the use of more ICs in home entertainment products over the next two years—products such as audio preamplifiers, signal processing sections of equipment and fm sets."

The move to IC memories

In digital integrated circuits, the area to watch is semiconductor memories (See "Memory Designers Looking to Semiconductors," ED 24, Nov. 22, 1969, pp. 36-37).

Dr. Jan A. Rajchman, of RCA Laboratories, Princeton, N. J., predicts that within three years, MOS random-access memories would be available at roughly 2¢ a bit in sizes up to 100,000 bits. They are not expected to be as cheap as core memories—which will cost in the neighborhood of 1.5¢ a bit—but they will be much faster, he says.

Quantum Science Corp. of New York City, which specializes in long-range technological forecasts, generally concurs with EIA figures on the short-term growth of the components market.

However, it foresees domestic production of electronic components coming under increasing pressure from imports of components from Europe and the Far East.

"The net foreign trade deficit in components will expand at 24% per year, from \$94-million in 1970 to more than \$248-million in 1974," according to David Parks, director of the company's data base division.

In addition to the pressure on component markets from imports, Parks believes that manufacturers will suffer from the continued shift of electronic equipment production to foreign locations.

"This trend," he says, "started by consumer electronics equipment manufacturers, has now accelerated to computer and other industrial equipment as well. As a result, most of the growth opportunities in component markets now lie abroad."

Thus, although the commercial electronics equipment markets are expected to expand at an annual rate of 10.4%, the use of electronic components in the U.S. will grow only at 7.2%, Park says.

He sees microcircuits, in particular MSI and LSI arrays, becoming the largest electronic component market. "Their usage growth rate will rise at a rate of more than 24% per year, reaching \$1.6 billion by 1974."

Imports growing fast

In the international sector, imports of electronics are seen growing at a faster rate than exports through 1970. For 1970 imports of selected electronic and related products are estimated at \$2.5-billion—an increase of 28.3% over the anticipated import level during 1969, according to EIA figures.

Exports of these commodities are seen rising from 21.9% to reach \$3.3-billion. With the exception of two, each of the major product categories is expected to show gains in both U.S. export and import levels. Particularly significant is the anticipated increase in semiconductor exports of 59.9% during 1970, due in large measure to the rapid growth of microelectronic shipments to foreign countries. ■■

Estimated U.S. sales of electronics (millions of \$)

Markets	1968	1969	1970	1969-1970 percent change
Consumer	4619	4824	5189	+7.6
Industrial	6693	7200	7605	+5.6
Government	12,504	12,431	12,000	-3.5
Replacement components	675	690	710	+2.9
Total industry	24,491	25,145	25,504	+1.4
Total components	5294	5693	5977	+5.0

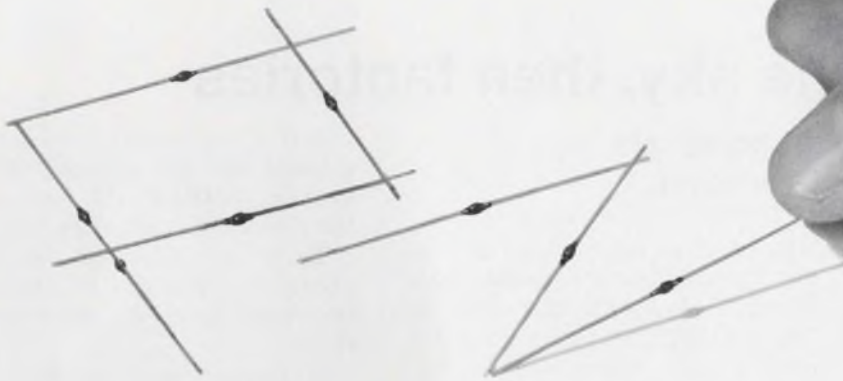

Introducing the PZ Zener

The new fused-in-glass
1 watt zener . . .

Typical Unitrode fused-in-glass
stability and high-performance at
the price of an ordinary device

Order your free samples today

- Fills the bill from 400 mw thru 1 watt
- Voltages from 6.8 to 200 V
- 8 millisecond surges to 30 watts
- Low reverse current — to 500 nA
- A quarter the size of a conventional 1 watt
- Weighs less than 1/4 gram
- No plastics, epoxies, silicones, oxides, gases, or solders are used

580 Pleasant St., Watertown, Mass. 02172 • (617) 926-0404

UNITRODE



TOUGH AS ALL GET-OUT FROM THE INSIDE OUT

With the silicon die metallurgically bonded between terminal pins of the same thermal coefficient, the hard glass sleeve is fused to the entire outer silicon surface. Result — a voidless, monolithic structure.



4 EASY WAYS TO GET FREE SAMPLES AND SPECS

1. Call Bud Anderson COLLECT, at (617) 926-0404.
2. Call your nearest Compar office.
3. Call your nearest Daniel & Co. office.
4. Check off the magazine Reply Card number.

INFORMATION RETRIEVAL NUMBER 20

Workshops in the sky, then factories

Processing of opto-electronic materials in zero gravity environment forecast.

John N. Kessler
News Editor

Processing and manufacturing materials in space under zero gravity and in a vacuum may permit the production of:

- large single crystals not possible to grow on earth.
- superstrong composite materials containing tiny whisker crystals.
- perfect optical lenses.
- new superconductors that can be stranded into long filaments without breaking.

The space environment is unique. "Containerless" processing, particularly of liquids, an infinite vacuum pump, and permanent "weightlessness" are the conditions that make it possible to develop and fabricate materials that may greatly alter and extend the capabilities of electronic components, devices, and systems.

Hans F. Wuenscher, assistant director for advanced projects at the Marshall Space Flight Center, Huntsville, Ala., says that sets of high-frequency rf coils are already being developed by NASA and the General Electric Co. to control the position of materials, including liquids, inside a furnace in a space station. The coils would be powered by batteries or by conversion of solar energy. Electromagnetic fields would move the materials in any direction or keep them a certain distance from the walls of the furnace.

Prepare for zero g technology

Wuenscher also told *ELECTRONIC DESIGN* that the hardware for the first orbital workshop is now being developed. Scheduled for 1972, this workshop will carry up to 12 astronauts.

By the late Seventies, Wuenscher expects that a large space station with a permanent astronaut popu-

lation will be established. Its supply line would be a re-usable space shuttle. (See *ED* 25, Dec. 6, 1969, p. 24, "Designing for the coming space-station era.")

American industry, Wuenscher says, would be invited to conduct research in such space stations for a nominal fee. He made it clear that commercial manufacturing would not be included in such a proposal, but that the use of a space station to advance national capabilities would be welcomed.

The uniqueness of the space environment was demonstrated by the experiments performed by astronauts in their flight to the moon and back. They demonstrated how a liquid can be freely suspended in space and how gas bubbles can be distributed in a water bag without rising to the surface. More sophisticated experiments could be performed to show, for example,



Space manufacturing module with a permanent astronaut population may be established by the late Seventies.

that if a fine powder is mixed with a liquid and gas injected into the medium, bubbles will nucleate at the powder particle sites.

These are some of the basic phenomena that can be applied to the processing of materials in space.

Wuenscher points out the factors that will enhance materials processing in a space environment:

- liquids in space will form a perfect sphere.
- dopants or additives to a material will be homogeneously distributed.
- lack of convection currents will enhance the uniform heating of materials.
- lack of gravity permits the injection of a gas that can be evenly distributed throughout a liquid and not bubbled to the surface.

Crystal growing in space

In growing single crystals from a free-floating melt, Wuenscher suggests that a seed, lighter than the melt, will be carried to the center of the mass of the floating liquid which will be spun around the seed.

At the Space Processing and Manufacturing Meeting held at the Marshall Space Flight Center, in October, L. D. Fullmer and R. M. Housley of North American Rockwell Corp., Thousand Oaks, Calif., suggested that a modified Czochralski method—rather than a free-floating melt—would be simpler and more versatile for growing crystals in space.

Their proposal would not require positioning of the melt inside the furnace. The design consists of two pullers: one to position the crystal to be melted, another to position the seed. The "seed" puller "pulls" the crystal as in the Czochralski technique, and the "feed" puller replenishes the supply at a steady rate.

According to Fullmer and Housley, production of 100 crystals with a value of several million dollars

D/A CONVERTERS

10-BIT D/A



5 BUCKS/BIT

A HYBRID CIRCUIT
PRICE/PERFORMANCE
BREAKTHROUGH.

Check these specs:

- $\pm 1/2$ LSB accuracy
- 100 kHz bit rate
- 25 k Ω output impedance
- 5 ppm/ $^{\circ}$ C T_C max.
- 0 to +70 $^{\circ}$ C operating temperature

Now you can get a complete thin-film 10-bit D/A converter—buffer amp, ladder switch, and tantalum nitride ladder network—all in a single package with DIP compatible pinning. And for \$5.00 per bit.

We've also got a 4-bit D/A, a 4-bit expander module to get 8 bits, and a three package kit to get 12 bits.

Find out about all of them.

SAMPLES? PRICE? DELIVERY? LOCAL DISTRIBUTORS? TECHNICAL LITERATURE?
GET THE ANSWERS AT ANY OF THE NUMBERS LISTED BELOW.

ALA. Huntsville, no charge call operator, WX4000 ARI. Phoenix (602) 279-5435 CALIF. Burlingame (415) 347-8217 Los Angeles, Bell Tel., (213) 870-0161, Gen. Tel., (213) 391-0611 San Diego (714) 278-7640 COLO. Denver (303) 756-3611 CONN. Trumbull (203) 261-2551 DC. Washington (202) 244-6006 FLA. Orlando (305) 831-3636 ILL. Schiller Park (312) 678-2262 IND. Indianapolis (317) 546-4911 MASS. Newton (617) 969-7640 North Adams (413) 664-4411 MICH. Ann Arbor (313) 761-4080 Detroit, no charge call operator, Enterprise 7498 MINN. Minneapolis (612) 335-7734 MO. St. Ann (314) 291-2500 NJ. Cherry Hill (609) 667-4444/(215) 467-5252 Wayne (201) 696-8200 NY. Melville (516) 293-6710 Upstate call (413) 664-4411 NC. Winston-Salem (919) 722-5151 OHIO Chagrin Falls (216) 247-6488 Dayton (513) 223-9187 Cincinnati, no charge call operator, Enterprise 3-8805 TEX. Richardson (214) 235-1256 WASH. Seattle (206) 632-7761.

SPRAGUE

THE MARK OF RELIABILITY

INFORMATION RETRIEVAL NUMBER 21

(sky factories, continued)

would require on the order of 1000 kilowatt hours of energy. Assuming this power is available, quantity production would begin in a 1975 space station, they say.

In earlier tests, only battery power will be available, and Fullmer and Housley point out the need to use low-melting-point materials.

"Many potentially useful crystals," they say, "have not realized their promise because it has not proven possible so far to produce them of suitable size and perfection. In a number of cases, this seems to be solely due to the unavailability of a crucible material that will hold the melt from which the crystal can be grown."

Examples of melts that are difficult to contain, they say, are "transition metal oxides including rare earth iron garnets, and compounds with high alkali and alkali earth content.

"We believe," they say, "this class can be grown relatively easily from containerless melts in space."

Toughest whiskers known

Jack H. Davis of the University of Alabama, Huntsville, looked into the effects of gravity on the growth of crystal whiskers the strongest materials, for their size, known to man. He told those at

the meeting that "the best quality whiskers are the ones most likely to be destroyed by gravity." And he added, "Whiskers now available are either too short, have multiple branches, or are too scarce to be used in the reinforcement of high-strength composites."

A method of preparing stable superconducting cables comprising a filamentary phase of one superconductor in a matrix of another was proposed by J. T. A. Pollock and Fritz Wald of Tyco Laboratories, Inc., Waltham, Mass. They say that metallurgical microstructure plays a major role on the current density of superconductors. Their paper at the meeting outlines how "by taking account of recent theoretical and experimental advances, carefully chosen eutectics solidified under conditions of zero g would have major advantages over materials presently available."

E. C. Henry and L. R. McCreight of the General Electric Co., Philadelphia, Pa., noted that the near absence of convection that zero g provides should permit the growth of crystals with fewer vacancies and dislocations. This factor they say, "is expected to provide a means for achieving crystals with much higher perfection and improved electronic properties."

Henry and McCreight recommended electronic ceramic compositions in particular for processing in space because:

- they have a high density

which makes them difficult to grow under the influence of gravity.

- they are used in many areas of electronics—computers, radar, sonar, infrared sensors, lasers and miniaturization of electronic circuits.

- they are used now in polycrystalline form because "they are not produced at all as single crystals or cannot be supplied in adequate size or perfection."

Space benefits worth the cost?

But as the results of the Space Processing and Manufacturing meeting become known, there is expected to be some dissent. Scientists at a large industrial laboratory are not agreed that the benefits of a space environment are really worth the cost.

So far as the lack of convection is concerned, one expert told *ELECTRONIC DESIGN* that "Even if you grow a crystal in space, you have to put some forces on it. These are going to result in a kind of circulation. The irregularities in temperature and growth rate at the growing interface will be hard to avoid." He added that there are other containerless methods of processing materials on earth that would be even more expedient to use.

Nonetheless, a workshop in space presents intriguing manufacturing possibilities to Helmut F. Bauer and Julius Siekmann of the Georgia Institute of Technology, Atlanta. In their paper at the meeting, they said that the lack of gravity and the vacuum "are the basis for the development of unique technologies which are absolutely impossible in an earthbound workshop."

"It is believed," they said, "that one is able to cast perfect optical lenses, to produce perfect ball bearings, to create unique materials, alloying various metals or by mixing gas in any ratio into liquefied materials. For such applications, the gas bubbles have to be managed in a certain fashion according to the purpose of the process."

Bauer and Siekmann point out that degassing of a material during the liquid phases is aided by buoyant forces that cause the bubbles to surface and escape. "This process," they say, "is aided

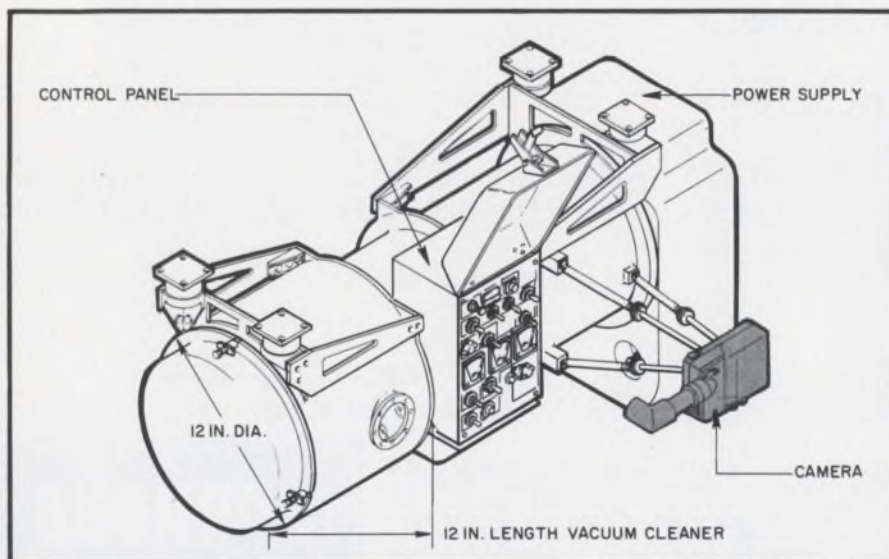

Design of first orbital workshop which will consist of a chamber safe and evacuated space in which to conduct experiments.

TELEVISION

New phosphor system makes color bright 85[®] tubes brightest yet.

Improved dusting techniques and new phosphor system boost brightness to 30% greater than former industry standard.

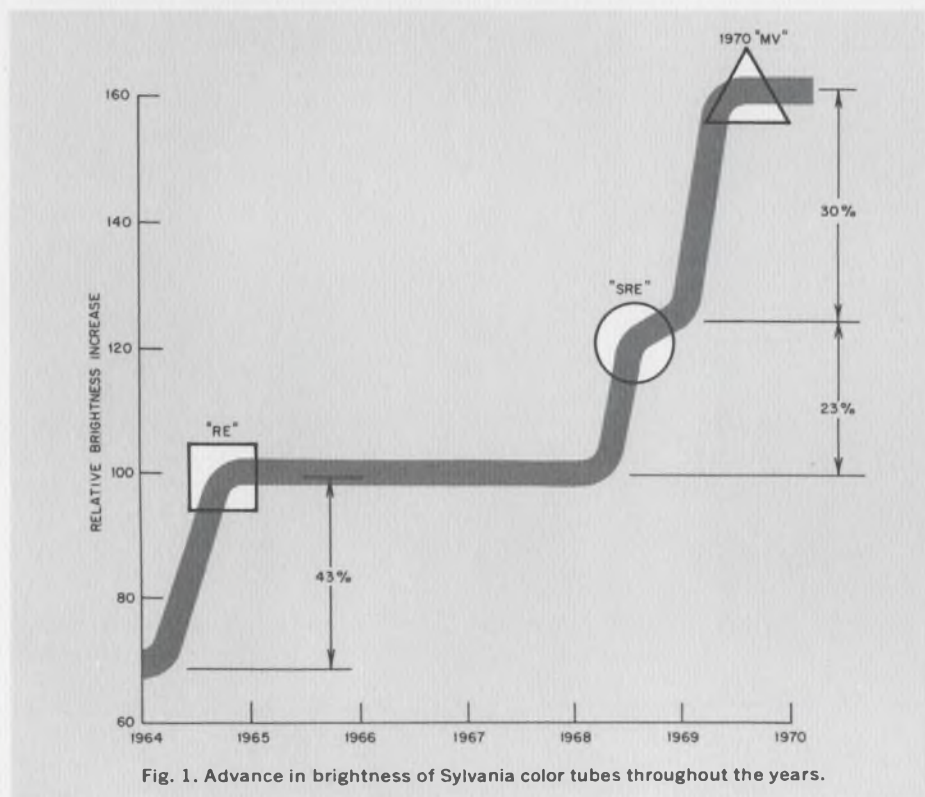

Fig. 1. Advance in brightness of Sylvania color tubes throughout the years.

Sylvania has traditionally led the way in color-tube brightness. Now we've done it again with a 30% increase in brightness at no increase in cost. The result is a tube that is competitive with recently announced "brighter" tubes, but without the added complexity and cost.

The new color bright 85[®] MV tube depends upon new developments in manufacturing processes and basic changes in the phosphor system to achieve its greater brightness.

In manufacturing color picture tubes, many other manufacturers use the slurry technique to deposit phosphors. This method inherently limits the size of the phosphor particles that

can be deposited. The result is that the density of the phosphor powder on each dot is not necessarily optimum for maximum brightness. It is also difficult to obtain a smooth, uniform coating.

Sylvania developed and patented the original dusting process many years ago. Now we've refined these techniques to provide an even more uniform distribution of Sylvania's larger phosphor particles. In dusting, the photolithographic material is applied as a thin uniform film on the face of the picture tube. While the film is still wet, the appropriate dry phosphor is injected into the system in the form of an air-dispersed particulate cloud.

The phosphor particles deposited on the film are absorbed by the wet photolithographic material. The result is, in effect, a rapid-drying mixture of uniform thickness and density. The overall effect of the differences in screening processes is an intrinsic brightness advantage for Sylvania's unique dusting system.

In phosphor technology, Sylvania has always been out in front. The increase in brightness of Sylvania color tubes over the years is shown in Fig. 1. Sylvania has now developed a europium-activated yttrium oxide phosphor that gives a net increase of more than 50% in red brightness over the pre-1968 Sylvania vanadate phosphor. This increase was obtained through the improvement of raw materials and carefully controlled manufacturing processes.

All color picture tubes use a zinc-cadmium sulfide as the basic green

continued on next page

This Issue in capsule

Integrated Circuits

How to use full adders to make binary converters.

CRT Modules

Integrated display module line expands.

Circuit Modules

New techniques cut NAFI module cost.

Hybrid Microelectronics

How to use our versatile video amplifier.

Microwaves

These rugged tunnel diodes can really take it.

Diodes

Silicon high-voltage diodes can cut TV costs.

phosphor. Sylvania has achieved a substantial green brightness increase by optimizing particle size, changing the activator from silver to copper, and by changing the zinc-cadmium ratio.

The basic blue phosphor for all color tubes is zinc sulfide. By proper selection and control of the types and amounts of activators, Sylvania has been able to increase the brightness of the blue phosphor.

The net result of all of this development work is the new *color bright 85 MV*, a tube that offers you a choice of more brightness or more contrast than any competitive tube and a balance between the two that is competitive with any other tube on the market. Fig. 2 shows the white-field brightness as related to glass transmission characteristics. Note that the *color bright 85 MV* achieves a brightness level of 40 foot-lamberts with 60% transmission panel.

Other features of the MV tube include a temperature compensated shadow mask and Sylvania's sharp focus electron gun. But, and probably most important, all of these advances have been attained at no increase in cost over our previous tube. Isn't the *color bright 85 MV* the tube to consider in your next design?

CIRCLE NUMBER 300

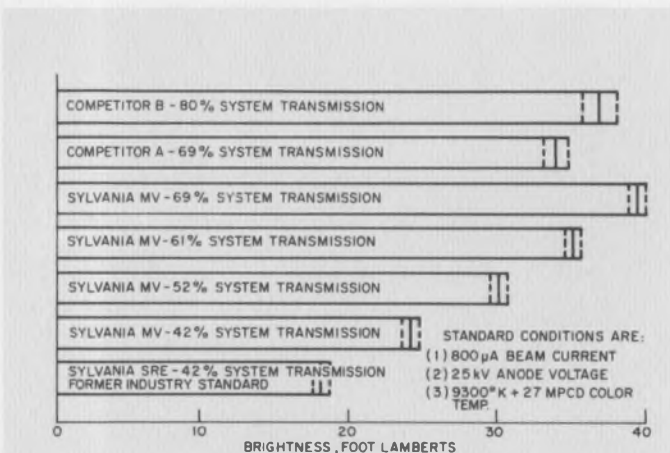

Fig. 2. White-field brightness of the *color bright 85 MV* as compared to competitive types.

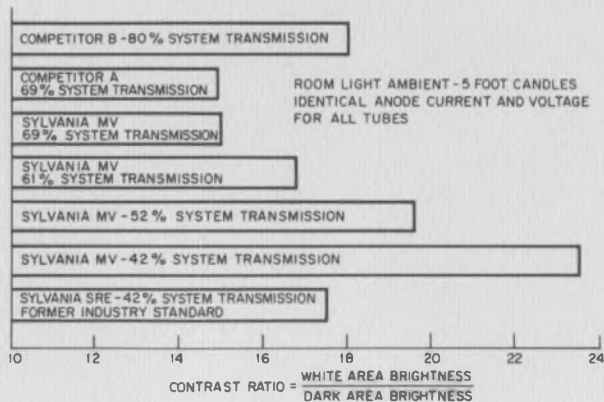

Fig. 3. Contrast ratio of the MV tube in comparison with other types.

INTEGRATED CIRCUITS

How to use full adders to make BCD-to-Binary converters.

Simple design gives high-speed operation, eliminates need for clock pulse.

Conversion of binary-coded-decimal (BCD) numbers to straight binary numbers can be simplified by using full adders instead of shift registers which require a clock pulse.

The design principle involved is easily understood once the basic notation is expanded in a certain manner. For example, the decimal number 79 can be expressed as 7 X 10 plus 9 X 1. The X 10 and X 1 are implied by position. A complete expression for 79 in BCD is $(0111)_2 (10)_{10} + (1001)_2 (1)_{10}$.

This value can also be represented by $(0111)_2 (8+2)_{10} + (1001)_2 (1)_{10}$. It can be seen from this that the value of this number can be obtained by adding the BCD bits after they have been multiplied by the proper value of 2.

$$\begin{aligned} \text{That is: } & (1001)_2 (1)_{10} = 0001001 = 9 \\ & (0111)_2 (2)_{10} = 0001110 = 14 \\ & (0111)_2 (8)_{10} = 0111000 = 56 \\ & \hline & 1001111 = 79 \end{aligned}$$

A general expression for a BCD character is $A2^3 + B2^2 + C2^1 + D2^0$. If we use U to represent the units character and a T to represent the tens character, a BCD number may be expressed as $T_4 T_3 T_2 T_1 U_4 U_3 U_2 U_1$.

Applying these representations to the preceding table, we have:

$$\begin{array}{r} U_4 U_3 U_2 U_1 \\ T_4 T_3 T_2 T_1 0 \\ \hline T_4 T_3 T_2 T_1 0 0 0 \\ \hline 2^6 2^5 2^4 2^3 2^2 2^1 2^0 \end{array}$$

where multiplication by the proper power of 2 is obtained by the positions of the T's and U's in the addition.

This notation is used in the diagrams of Fig. 1 and Fig. 2. Both of these logic diagrams are designed to convert BCD numbers to binary numbers.

The form of Fig. 1 makes use of eight/full SM-10 adders arranged as a ripple adder. The output of any one stage cannot begin to settle until all of its inputs have settled. Using ripple adders is a relatively slow technique, but the circuit is simple and its response is more than adequate when the inputs may be coming from BCD switches. Conversion time is typically less than 100 nanoseconds.

The circuit of Fig. 2 makes use of eight SM-30 independent-carry adders and 2 SM-40 carry decoders. In this configuration, the output of any stage can start to settle as soon as the independent carry from all preceding stages has settled. These independent carriers settle in parallel and thus the conversion time is faster, typically less than 70 nanoseconds.

Both of these systems make use of the fact that the 8th adder does not generate a carry out. This is because T_4 and T_3 can never be true at the same time in a BCD number. The same fact is also true of the last stage of the adder that produces the 2^6 output.

These methods of BCD-to-binary conversion have the advantages of high speed and simple design. In addition, a clock pulse or pulse train is not required.

When using BCD number of more than two characters, the procedure is the same. In this case, the hundreds character, H, is multiplied by $(64+32+4)$ and the thousand character, K, is multiplied by $(512+256+128+64+32+8)$.

CIRCLE NUMBER 301

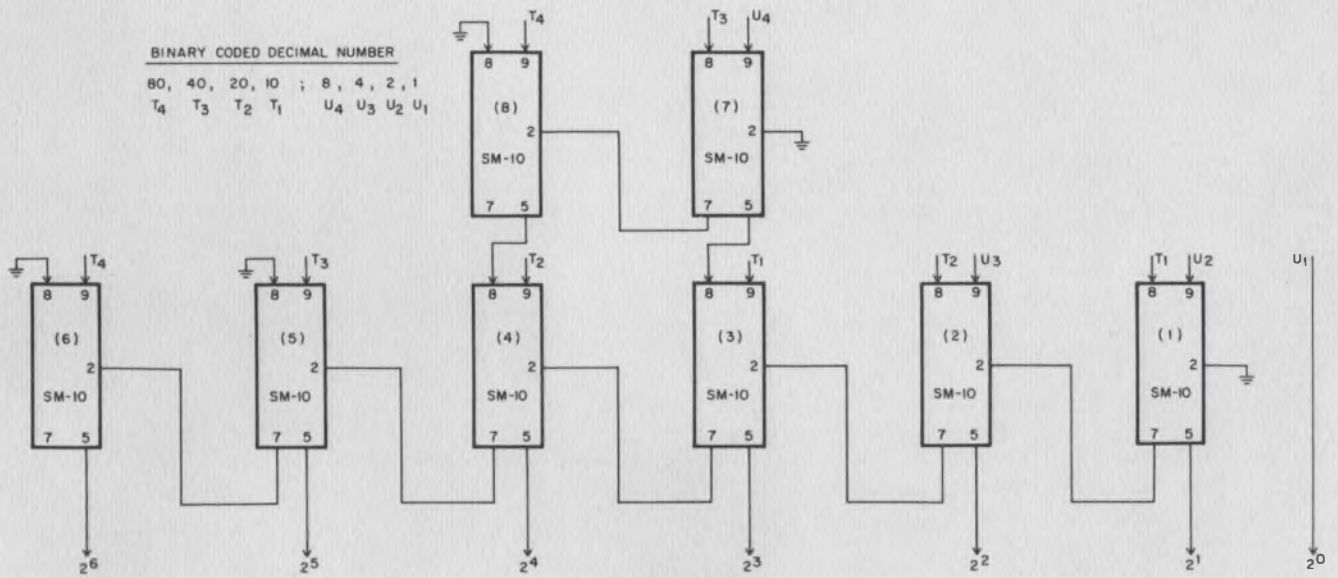

Fig. 1. Simplest form of BCD-to-binary converter uses 8 full adders in a ripple-carry circuit.

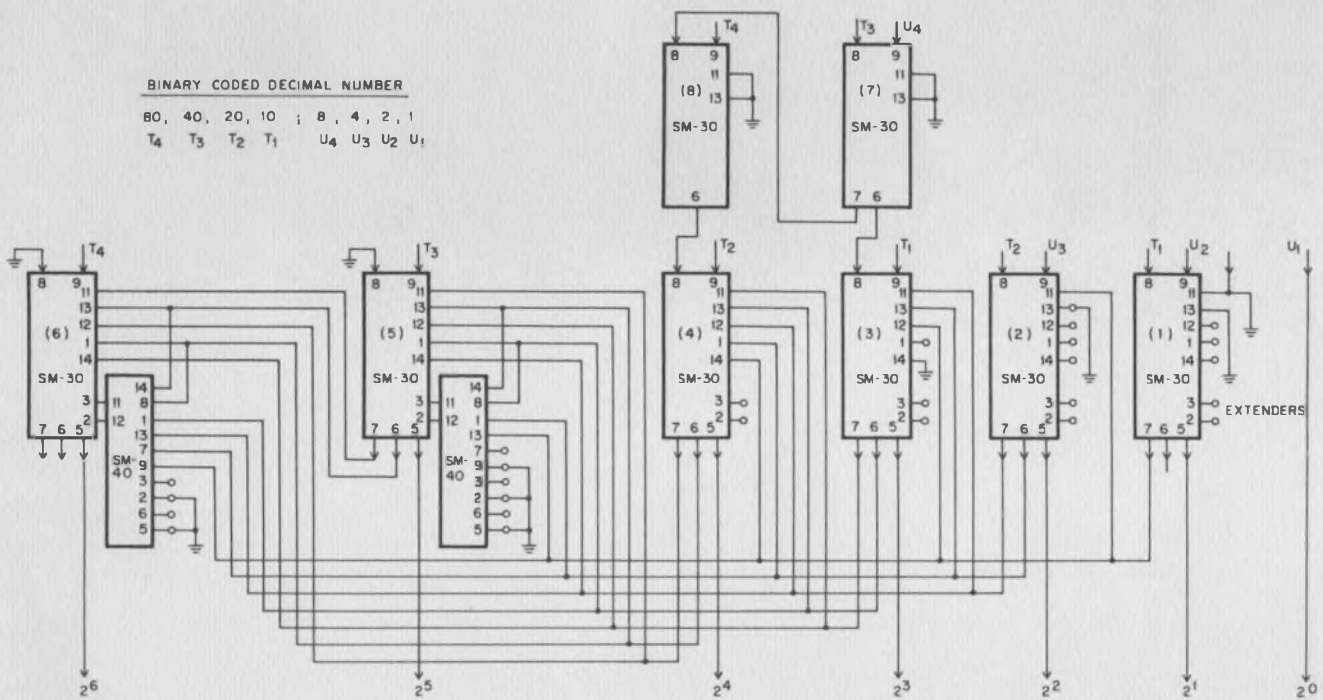

Fig. 2. More complex BCD-to-binary converter uses 8 independent carry adders and 2 carry decoders to obtain conversion time of less than 70 nanoseconds.

CRT MODULES

Integrated display module line expands.

We've added variety to our popular line of compact CRT readout systems.

A few issues ago, we introduced our new 12" CRT display module. This module contains all of the electronics needed to drive the CRT and is available with or without cabinet. Apparently, we introduced something a lot of people had been waiting for, because the response has been a pleasant surprise. So far, we've received individual orders for up to 1000 units.

Now, we've expanded the line still further to give you a wider range of 90° tube sizes, all in the same chassis, modified physically and electrically to fit the particular tube size chosen. The all-solid-state chassis contains circuits for tube electrode voltages, power supplies, and video or blanking amplifiers. All you supply are the input signals.

Our long experience with cathode-ray tubes and associated circuitry enables us to offer you a wide variety of options within a single standard package. For example, you can have your choice of tube phosphors, and we can provide anti-reflection panels bonded to the face of the tube selected.

Although the monitor chassis may look standard, we can also make many variations in the circuitry to adapt it to your particular needs including the addition of correction

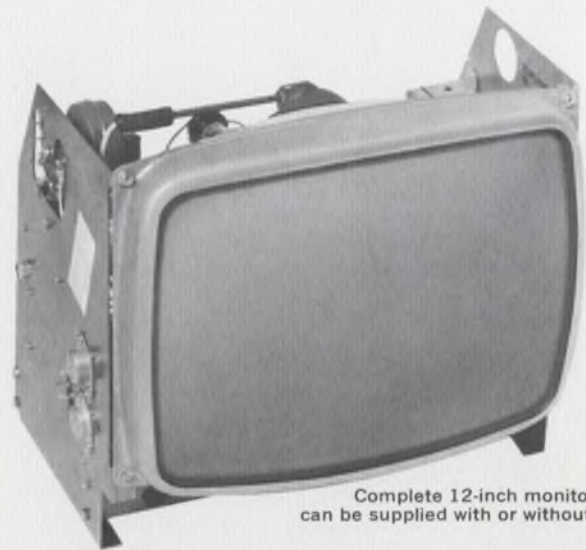

Complete 12-inch monitor module can be supplied with or without cabinet.

circuitry, for example. Systems are available for either AC or DC operation.

These monitors are suitable for rack, console or cabinet mounting. Units supplied with cabinet come complete with anti-reflection panel.

Price is another advantage of our new module line. We can probably supply a module tailored to your specifications at a price lower than it would cost you to build it yourself.

All you have to do is let us know the size tube you want and what your X, Y and Z input requirements are. We'll do the rest.

CIRCLE NUMBER 302

CIRCUIT MODULES

New techniques cut NAFI module cost.

Thick-film resistors are used in new modules to lower cost and increase reliability.

We've now expanded our line of NAFI modules to 82 types. Three of the latest types are the MDL line driver, MDM line receiver, and MDN line terminator.

In the line terminator we've combined Standard Hardware Program techniques with thick-film technology to obtain a compact, reliable unit that can be produced at lower cost.

The MDL line driver module consists of six driver circuits and a 1.3 μ s one-shot circuit. Each driver is capable of driving 500 feet of cable. When a logic "1" is applied to both timing inputs, a 5-Volt, 1.3 μ s pulse is generated at those output terminals whose corresponding data input terminals have been set to a logic "1". The timing output signal is a complementary 1.3 μ s pulse, approximately coincident with the other output signals.

The MDM line receiver module is designed to work with the line driver. The module consists of six receiver circuits with transformer coupled inputs. The output of each of these circuits drives a flip-flop. There are two ENABLE and two RESET inputs. Each services three of the receiver circuits. When the ENABLE circuit is set at logic "0", the flip-flops are independent of the transformer coupled input signals. Application of a logic "0" to the RESET terminals will clear the flip-flops. The test input terminals can be used as output terminals when use of the flip-flops is not required. Each receiver has a built-in propagation delay of 500 μ s so that the unit will not respond to transients.

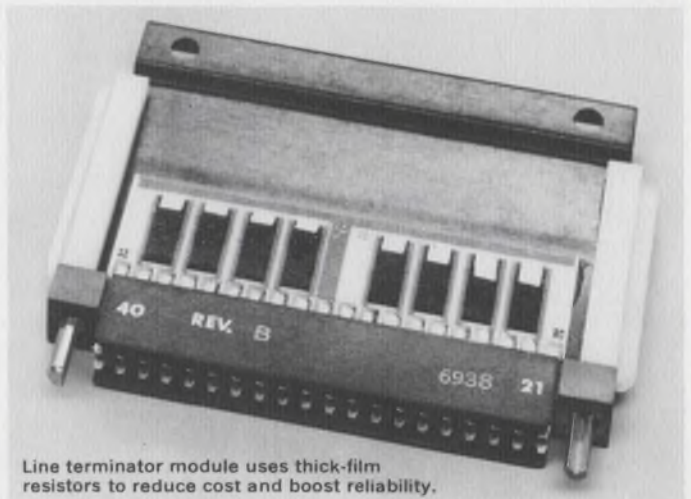

Line terminator module uses thick-film resistors to reduce cost and boost reliability.

The MDN line terminator is a module containing sixteen 75-ohm thick-film resistors. Each resistor is capable of dissipating an average power of 100 mW or a peak power of 430 mW with a 1.45 μ s duration.

Like the other modules in the NAFI series, these units meet the stringent requirements of the Navy's Standard Hardware Program. For example, reliability specifications for NAFI modules require a 30,000-hour minimum operating life. Also, makers of NAFI modules must maintain their qualification through periodic testing by government quality assurance personnel.

At our circuit assemblies facility at Muncy, Pa. we have produced over 25,000 NAFI modules to date. As a qualified supplier of NAFI modules for the Poseidon program, we have developed and manufactured a broad line of modules. We'd be only too happy to give you complete specifications on the entire line.

CIRCLE NUMBER 303

HYBRID MICROELECTRONICS

How to use our versatile video amplifier.

Here are three applications for Sylvania's wide-range MS-100A hybrid microelectronic unit.

Our MS-100A is a versatile 0 to 20 MHz video amplifier that packs 700 mW of output power (175 mA of output current) into a one-inch-square package. The three applications described here are only typical of the many uses for this microelectronic video amplifier.

In the application of Fig. 1, the problem was to design a unity-gain DC/video summing amplifier with 10 inputs. The amplifier had to be able to handle large-amplitude 100-ns pulses with fast risetime and low overshoot. The performance of the MS-100A in this application is shown in Fig. 1 and the accompanying waveforms.

The second application required a DC/video amplifier for a 50-ohm system. The amplifier had to have a 50-ohm input impedance and a voltage gain of 10. It was required that the circuit be capable of driving a 50-ohm load to ± 5 Volts. The solution was to use the MS-100A as a video power amplifier as shown in Fig. 2. The accompanying waveform shows the large-signal, high-frequency performance of the MS-100A. The signal shown is a 2-MHz sine-wave output into a 50-ohm load.

In the third design, a wideband DC/video amplifier was

required for a non-inverting unity-gain application. The system required that the amplifier have a high input impedance and a low output impedance at video frequencies. The solution to this design problem was to use the MS-100A in the non-inverting configuration shown in Fig. 3. The resulting circuit provided an input impedance of 5000 ohms and an output impedance of less than 2 ohms.

In addition to these applications the MS-100A has been used in many other ways; for example, as a low IM distortion preamplifier for 100-kHz RF signals. All IM products in the preamplifier were down 65 dB or more with the MS-100A driving two 1-Volt rms 100-kHz signals into a 50-ohm load.

Another application is the use of the MS-100A as a high speed sample-and-hold circuit with an FET gate. This circuit was capable of sampling 200-ns pulses to 10-mV accuracy.

A final example of the versatility of the MS-100A is its use as a wide dynamic range, ultra-linear AM detector for a 455 kHz IF system. This detector supplied an IF gain of 20 dB as well as 1 dB linear detection from 0 to -50 dBm at the input.

Although the MS-100A video amplifier is one of our growing list of off-the-shelf hybrid microelectronic devices, we are able to provide complete design facilities for custom devices as well.

We have the long experience in hybrid technology that allows us to make many variations on basic designs and to develop new designs to your specifications. Our design engineering team is ready and waiting to solve your microelectronics problems.

CIRCLE NUMBER 304

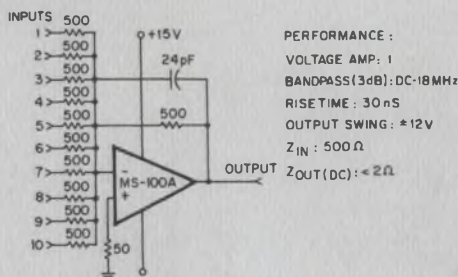

Fig. 1. The MS-100A used as a summing amplifier.

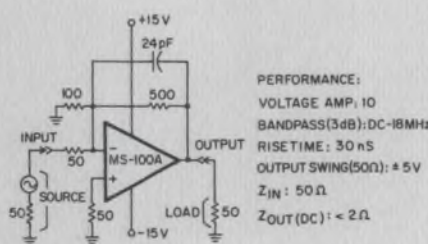

Fig. 2. The MS-100A as a video power amplifier.

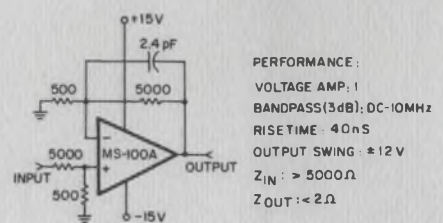
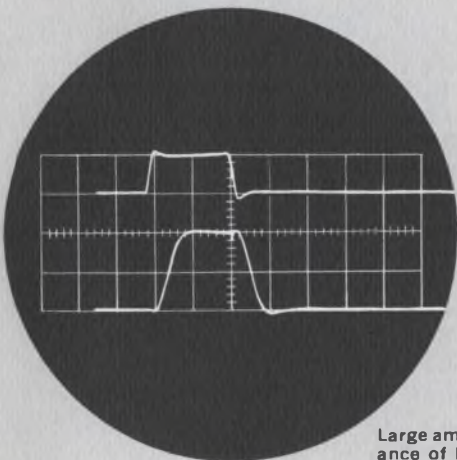
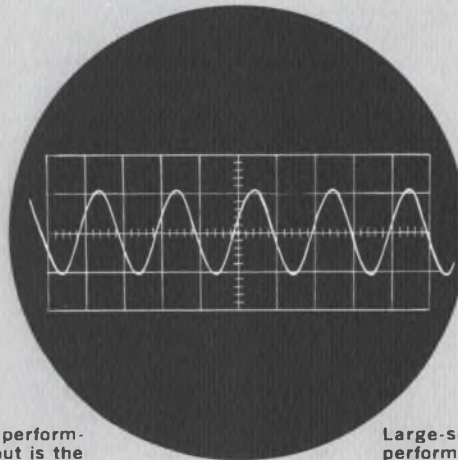

Fig. 3. MS-100A in the non-inverting configuration.



Large amplitude pulse performance of MS-100A. Input is the top scale and output is at the bottom. Vertical scale: 1V/cm (bottom). Horizontal sweep is 50 ns/cm for both traces.



Large-signal, high-frequency performance of MS-100A. Signal shown is a 2-MHz sine-wave output into a 50-ohm load. Vertical scale: 5V/cm.

MICROWAVES

These rugged tunnel diodes can really take it.

Germanium diodes use solid-structure planar techniques to get high reliability.

We've got a complete line of planar tunnel diodes that can really stand up to rugged environments. They're ideal for use in microwave medium-noise amplifiers, oscillators and as RF amplifiers in phased array radars. Typical V-I characteristics and the small-signal equivalent circuit are shown in Fig. 1.

The planar construction contributes to the extreme ruggedness of these devices. All of these devices are capable

of withstanding the shock and vibration characteristics encountered in space applications. Silicon dioxide passivation is used on all junctions.

As an example of the ruggedness of these tunnel diodes, diode chips were subjected to cryogenic cycling. All electrical characteristics were tested after this treatment and were found to be unchanged.

Physically, the diode structure remained intact and the passivating oxide layer did not peel or crack. Temperature characteristics of these diodes from +135°C to -195°C are shown in Fig. 2.

All of the diodes in this family are available in packages, pin mounted, or in chip form. All diodes are fully tested at the factory before shipment.

If you have a tunnel diode application, why not investigate this rugged, low-cost family of diodes today?

CIRCLE NUMBER 305

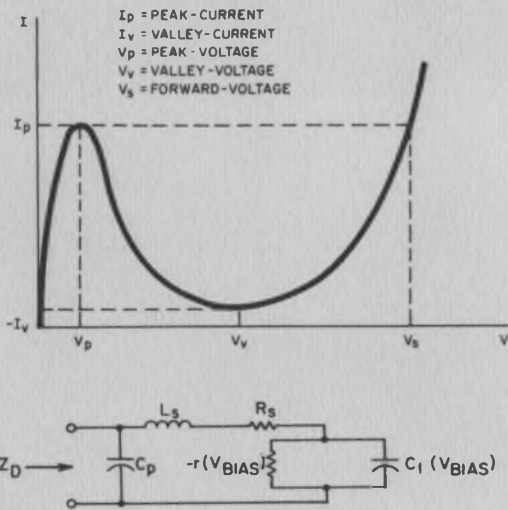

Fig. 1. Typical tunnel diode V-I characteristic and small-signal equivalent circuit.

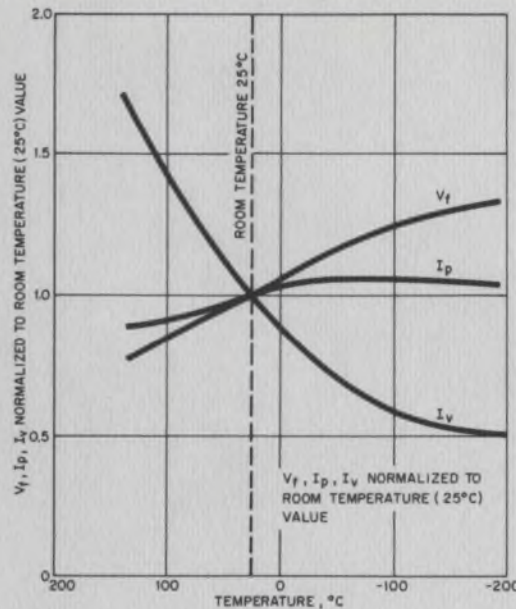

Fig. 2. Tunnel diode DC temperature characteristics normalized to 25°C room temperature value.

Characteristics of tunnel diode family

Line Number	Type* Number	Package Outline	Type Number	Package Outline	Type Number	Package Outline	I_p^1 ma ±20%	τ_j ohms typ.	R_s ohms max.	C_j pf max.	f_o GHz min.
195	D5361	048	D5561	084	D5571	082	1.8	67	7.0	2.0	5.0
196	D5361A	048	D5561A	084	D5571A	082	1.8	67	3.0	0.60	25
197			D5561B	084	D5571B	082	1.8	67	6.0	0.70	15
198	D5362	048	D5562	084	D5572	082	2.7	44	6.0	3.0	5.0
199	D5362A	048	D5562A	084	D5572A	082	2.7	44	2.5	0.75	25
200			D5562B	084	D5572B	082	2.7	44	6.0	1.0	12
201	D5363	048	D5563	084	D5573	082	3.9	31	6.0	5.0	5.0
202	D5363A	048	D5563A	084	D5573A	082	3.9	31	2.0	1.00	25
203			D5563B	084	D5573B	082	3.9	31	6.0	1.60	10
204	D5364	048	D5564	084	D5574	082	5.6	22	6.0	7.0	5.0
205	D5364A	048	D5564A	084	D5574A	082	5.6	22	1.5	1.40	25
206			D5564B	084	D5574B	082	5.6	22	6.0	2.30	7.5
207	D5365	048	D5565	084	D5575	082	8.2	15	6.0	10.0	5.0
208	D5365A	048	D5565A	084	D5575A	082	8.2	15	1.0	2.00	25
209			D5565B	084	D5575B	082	8.2	15	6.0	3.30	5.5

* Three basic categories are specified for each value of peak current, the type number suffix indicates the category: Blank Suffix—General Purpose UHF "A" Suffix—High Cutoff Frequency "B" Suffix—Short Circuit Stabilized

DIODES

Silicon high voltage diodes can cut TV costs.

Diode tripler and quadrupler assemblies can provide the anode supply voltage needs of modern color sets with improved high voltage regulation.

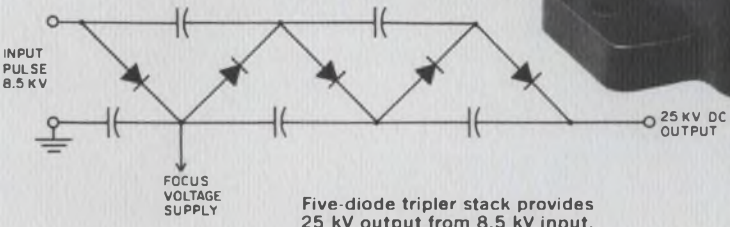
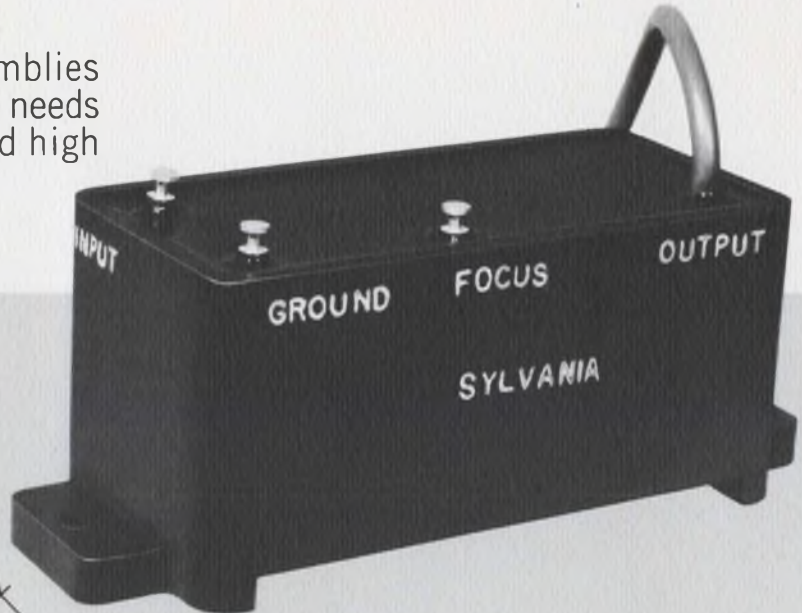

If you're trying to cut costs in TV set designs without cutting corners, you should talk to our diode engineers. They have developed high-voltage multiplier circuits that may be just what you need. They'll work with you to adapt these units to your design.

The big advantage of designing-in our HV multipliers is that you can eliminate the high-voltage cage and all of its associated hardware. You also get better high-voltage regulation since the loosely coupled tertiary flyback winding is eliminated.

The circuit of one of our triplers is shown in the illustration. With an 8.5 kV input from the flyback transformer it puts out 25 kV DC to the color tube anode and can be loaded up to 2.5 mA output current with minimal drop in

output voltage. Note that a suitable tap for focus supply voltage is provided.

Each diode stack in the tripler circuit is carefully matched and can be delivered molded along with the capacitors in a plastic package. The resulting unit will meet all the environmental requirements of solid state and hybrid color sets; such requirements include over-voltage surges, arcing, and ambient temperature conditions.

Since each application is unique, we aren't offering these voltage multipliers as off-the-shelf items. Our engineers will work with you to design a unit tailored specifically to your needs. And they'll show you how you can cut costs in the design of your high-voltage power supplies.

CIRCLE NUMBER 306



Use Sylvania's "Hot Line" inquiry service, especially if you require full particulars on any item in a hurry. It's easy and it's free. Circle the reader service number(s) you're most interested in; then fill in your name, title, company and address. We'll do the rest and see you get further information by return mail.

BUSINESS REPLY MAIL

No Postage Stamp Necessary if Mailed in the United States

FIRST CLASS
Permit No. 2833
Buffalo, N.Y.

POSTAGE WILL BE PAID BY

Sylvania Electric Products Inc.
Sylvania Electronic Components
1100 Main Street
Buffalo, New York 14209

Dept. E 1 1 1 1

MANAGER'S CORNER

The marketable advantage in color tubes.

Recently two major manufacturers almost simultaneously announced the development of "improved" color picture tube systems. Although the systems differ slightly, each achieves a substantial increase in brightness—and brightness has been the name of the claim-game for the past five years. More recently other manufacturers have announced production plans to switch to the new system to stay competitive.

For the first time since 1964 the Sylvania leadership in brightness appeared to have been dramatically challenged. This development confronted Sylvania with several problems. First of all, at the time of these developments, Sylvania was preparing to announce a new, even brighter *color bright 85*[®] tube which did not employ the new techniques. Secondly, and most important, there was the question of what would be the marketable advantages provided by the competing systems.

In 1964 Sylvania introduced the first rare earth europium phosphor screen which replaced the all-sulfide system and provided bright, rich reds that unleashed the then suppressed blues and greens. Although every other color picture tube manufacturer has since adopted this basic system, Sylvania has maintained a traditional leadership in brightness. In 1964 Sylvania announced a 42 percent increase in brightness and again in early 1968 another 23 percent white-field brightness increase was achieved.

For 1970 the new *color bright 85 MV* offers a 30 percent brightness increase over the 1969 version. More important, now that the industry has had time to compare the other new tubes to our new tube, it is apparent that the *color*

bright 85 MV offers certain distinct marketable advantages to the set manufacturer.

The first is flexibility in both brightness and contrast. The TV set manufacturer is not locked in on a standardized transmission panel. Where one manufacturer decides that maximum contrast is critical, a 42-percent transmission panel in conjunction with the new *color bright 85 MV* phosphor system will provide greater contrast than is attainable from any other available tube. Conversely, a 69-percent transmission panel on a *color bright 85 MV* tube will provide the brightest picture available to the industry. It should be noted here that an average transmission panel will provide brightness and contrast which are visually very close to the other new tubes.

There is an even greater benefit in cost to set manufacturers. The new *color bright 85 MV* is being offered at no increase in price because the vast improvements come from a new phosphor system and improved dusting techniques. The competitive tubes, on the other hand, require extra processing steps which add substantially to the cost of manufacturing. And this comes at a time when there is extreme pressure on manufacturers to lower set costs: at a time when cutting a nickel out of the price of a picture tube is considered significant.

While the competitive systems have allowed other manufacturers to be brightness competitive there is still no tube which offers a significant advantage over the *color bright 85 MV*. Sylvania believes our increased flexibility and lower unit cost outweigh the value of closing the brightness gap. The ultimate decision will, of course, be with our customers.

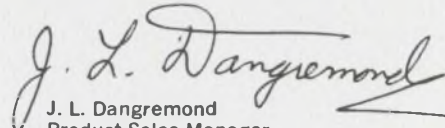
J. L. Dangremond
Product Sales Manager

This information in Sylvania ideas is furnished without assuming any obligations.

SYLVANIA

GENERAL TELEPHONE & ELECTRONICS

NEW CAPABILITIES IN: ELECTRONIC TUBES • SEMICONDUCTORS • MICROWAVE DEVICES • SPECIAL COMPONENTS • DISPLAY DEVICES

E1

NAME _____
PLEASE PRINT
 TITLE _____
 COMPANY _____
 ADDRESS _____
 CITY _____ STATE _____ ZIP _____

Circle Numbers Corresponding to Product Item

300 301 302 303 304 305 306

Please have a Sales Engineer contact me.

Visit Phone ... Phone No. _____ Area Code _____



HOT LINE INQUIRY SERVICE

Need information in a hurry? Clip the card and mail it. Be sure to fill in all information requested. We'll rush you full particulars on any item indicated.

You can also get information using the publication's card elsewhere in this issue. Use of the card shown here will simplify handling and save time.

We put so much in this hybrid thick-film sandwich, we call it our hero.

But it's a hero for more reasons than that. For while our exclusive custom package gives you 50% more circuit area than conventional TO-8 substrates, it doesn't use any more space.

A typical package has 16 leads on 0.100" centers.

Conforming to a TO-8 pin configuration.

The outer dimension is .610" square, with height depending upon the number of substrates. A metal cover is sealed to the header to give an hermetic seal of 1×10^{-8} CC per second of helium, at a differential pressure of one atmosphere.

So now you can design a complete system into one module. For instance, a four substrate unit may consist of an operational amplifier, switching circuits, resistor networks and a D/A converter.

What's more, it's not expensive like other hybrid thick-film packages. First, because it contains more. Also, because it's more economical to produce. Since each substrate is analyzed individually, unacceptable ones are replaced without affecting the others.

That means we have higher yields and lower costs.

Also, it means extremely high reliability of the delivered product.

Economy of space and cost, system capability and high reliability make a great combination for a sandwich. To find

out what you can put on it, call or write:

Columbia Components Corporation, 60 Madison Avenue, Hempstead, N. Y. 11550, (516) 483-8200. On the West Coast: (213) 272-9525.



COLUMBIA COMPONENTS CORP.

A SUBSIDIARY OF COMPUTER INSTRUMENTS CORP.

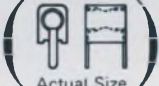

Looking for a little jack?  How's this for size?
Actual Size

We've been making miniature jacks for over 10 years. But this new one is half again as small as any horizontal mounting type we've offered before. It accepts a 0.080" diameter tip plug on either end and has a maximum current capacity of 5 amperes. Operating voltage is 1500 volts RMS at sea level, 350 at 50,000 feet. Contact resistance is less than 2 milliohms. Capacitance between adjacent jacks is less than 1 pF at 1 MHz. Comes in 10 colors meeting Federal Standard #595.

Johnson makes hundreds of different jacks and plugs . . . and carries most of them in stock for immediate delivery. Or perhaps you have a unique need. Our engineers will work it out for you. Just give us a call. Meanwhile, return the coupon.

 E. F. JOHNSON COMPANY/3301 Tenth Ave. S.W./Waseca, Minnesota 56093

- Send me a sample of your new miniature jack and complete design details.
- Send me information on your complete connector line and other Johnson components.

NAME _____ TITLE _____

FIRM _____ ADDRESS _____

 CITY _____ STATE _____ ZIP _____

E. F. JOHNSON COMPANY

INFORMATION RETRIEVAL NUMBER 23

NEWS

(sky factories, *continued*)

and enhanced by degassing in a vacuum."

The elimination of gas bubbles in an orbital workshop may be a serious problem, they add, because buoyant forces are not available. But bubbles can be made to migrate inside a liquid if a centrifugal field is applied.

They propose theoretical investigations of: degassing of materials during the liquid phase, migration of bubbles in a centrifugal force field, and distribution of a gas in a liquefied materials.

Products of the future

In his concluding remarks at the meeting Hans Wuenscher categorized the product groups that can be visualized in future space manufacturing activities as follows:

- Solid and hollow balls, precision parts.
- High-strength temperature components, filaments, membranes, composite structures, coatings.
- Optical blanks and components.
- Abrasives, isotopes, nuclear fuels.
- Electric components and crystals, superconductors.
- Vaccines.

Wuenscher said that "today's technology started 300 years ago with the discovery of the vacuum."

"We have," he added, "since then brought energy under control and established a closed cycle in food production . . . we do not only harvest, we produce what we need as well. There is only one gap left: that is in the open-loop fuel economy.

"We cannot reproduce the fuels we take from the earth," he said. "Maybe we are now on the way toward learning how to someday replenish our fuel needs from space." ■■

For those interested in obtaining proceedings of the Space Processing and Manufacturing Meeting, write to James R. Bray, manufacturing laboratory, George C. Marshall Space Flight Center, Huntsville, Ala.

Monitor keeps tab on noisy vehicles

In an effort to put "teeth" into Connecticut's drive against excessive traffic noise, Gov. John Dempsey recently unveiled an electronic highway noise-monitoring system.

Developed by CBS Laboratories, Stamford, Conn., under contract with the state's Research Commission, the system not only measures noise levels but produces a split-screen photograph of the offending vehicle and its license plate along with a superimposed graphic picture of the noise-level recording.

Dr. Warren Stoker, chairman of the Research Commission, believes that "Connecticut will be the first state in the nation to be able to produce documentary evidence which will stand up in court when a driver has been cited for violation of the State's traffic noise ordinances."

The noise-monitoring system consists of four parts: a noise-level microphone, a vehicle sensor, a main control unit and a dashboard unit for a highway patrol car.

As shown in the photos, the system is positioned near a highway. When a vehicle passes, the noise-level microphone decides, in con-

junction with the main control unit, whether the acceptable noise level has been exceeded. About 50 feet down the road, the vehicle sensor determines the precise moment for photographing the vehicle. At the appropriate moment, the split-screen camera in the control unit takes a simultaneous picture of the offending vehicle and of the chart recording of the noise level (also mounted in the control unit).

Stationed at the site of the monitoring equipment is a highway patrolman with a dashboard unit in his car, synchronized with the equipment. A light goes on in the dashboard unit when the sound-level threshold has been exceeded, and a second light flashes to indicate that a photo has been taken. The patrolman then radios ahead to another patrolman who flags down the violator and issues a citation.

Of some 2900 measurements taken on the Connecticut Turnpike, it was discovered that 11% of the vehicles produced a noise level of 94 or more decibels at 25 feet—a level considered to be well above objectionable by many noise-pollution experts. ■■



Electronic noise monitor is positioned along a Connecticut highway (top photo). Traffic noise levels are monitored by highly sensitive microphone which triggers unit (rear) containing a noise-level chart recorder and split-image camera. The system is actuated when a vehicle exceeds noise-level threshold. Lower photo shows split-image photo of a vehicle exceeding noise-level limits.

INFORMATION RETRIEVAL NUMBER 24 ►

ELECTRONIC DESIGN 1, January 4, 1970

If you think
uniquely styled
enclosures have to
cost a bundle...
then take a look at
INTERFACE-33



IT'S A WHOLE NEW
CONCEPT THAT WILL SAVE
UP TO 75% OF YOUR
STYLING COSTS.

READ ABOUT IT... JUST
CHECK THE READER
SERVICE NUMBER BELOW.



AMCO ENGINEERING CO.
7333 West Ainslie Street
Chicago, Illinois 60656



FCC urges control of 'electronic smog'

Self-regulation by industry of electromagnetic interference suggested at Chicago conference

Jim McDermott
East Coast Editor

How do you control "electronic smog" produced by today's host of consumer and industrial devices that generate electromagnetic interference (EMI)? One solution is the creation of an elementary industry organization that will police itself. And it was urged by speakers of two widely different backgrounds—Herman Garlan of the Federal Communications Commission and Fredrick J. Nichols, an electromagnetic control engineer and company head, at the EMC session of the recent 1969 National Electronics Conference in Chicago.

Both men agreed that the most effective method of controlling EMI, both in cost and performance—was to eliminate or minimize it at the design stage of the equipment or device creating the interference.

But in other areas Nichols took the FCC to task. It has failed to take into account the usefulness of filtering and minimizing the effects of interference at the receiving end of the equipment. For test requirements, Nichols claims that screen-room use should be allowed, instead of, or as well as, the free-space EMI measurements—at a distance in the open—now generally specified by the FCC.

EMI grows on all fronts

Herman Garlan, chief of the RF Devices Branch of the FCC in Washington, commented on the growing problem of EMI on all fronts.

"The day is long past," he said, "when interference from home appliances and consumer electric products can be tolerated. Our communications services are expanding at a furious rate."

Garlan pointed out that receivers are becoming more sensitive every year, which means that they

can detect weaker signals, as well as pull in more interference. And a new factor is the fact that we are moving toward more complex communications such as digital data communications, pulsed modulation" and other pulse-type systems. These have receivers that cannot distinguish between a desired pulse or one coming from the opening of a thermostat or relay, and thus cause errors. As a result, he predicted, "measures must be taken to minimize interference. If industry does not undertake to police itself, the commission will have to do the job for them."

But Garlan was quick to point out that "at present, regulations dealing with incidental radiation devices such as motors, relays, thermostats, solid-state dimmer controls, and a large number of other devices, are simple. The only FCC requirement is that they be operated so as not to cause interference."

As a result, Garlan indicated that Section 302 of the Communications Act signed into law in July of 1968 would not yet immediately apply to the manufacturers of most consumer electrical products. However, he cautioned, "before you manufacturers and distributors congratulate yourselves on avoiding federal regulation, let me caution you . . . that a separate proceeding may be instituted to deal with technical specifications," which would control the interference from these devices.

"In this connection," Garlan said, "the FCC would prefer that industry voluntarily set up and enforce its own technical standards. In fact, we are hopeful that the industry will recognize its obligation to the public and will take measures to limit the interference from these incidental radiation devices, possibly by means of an industry standard."

As an example of what he meant, Garlan pointed to the automobile industry. "Some 10 years ago," he said, we approached the car manufacturers and told them that ignition interference was a problem. The Society of Automotive Engineers made an investigation of the problem and came up with a voluntary standard for measurement procedures, as well as a proposed limit on ignition interference."

The outcome, Garlan explained, was that the Automobile Manufacturers Association required that all vehicles built after 1962 should have special interference-suppressing spark-plug wiring when they left the factory, to satisfy the SAE standard J-155A.

"As far as I know," Garlan said, "the auto manufacturers are meeting their obligation. But we still have complaints about ignition noise. Some of the fleet operators have been known to remove the factory-installed resistance wire and replace it with copper ignition cable on the mistaken assumption that the copper would give better performance."

Where Nichols differs

Fred Nichols, president of Lectromagnetics, Inc., Los Angeles, agreed with Garlan, but for a different reason.

"In order to have FCC enforcement on an equal basis," Nichols told the EMC group, "and also to have an equal competitive position for all commercial interests, I believe we need an organization, one like the National Underwriter's Association, and with a similar enforcement system."

"The limits on radio frequency interference can be as easily established as those on leakage currents and shock hazards. If each commercial equipment or device has the RFI radiation, or power-line conducted voltages within approved limits, this information could

be submitted, along with other tests reports, to the proposed industry organization, for type approval."

Such voluntary RFI-policing organizations may meet success with manufacturers of so-called "incidental radiation devices," or those which emit RFI by accident rather than design. But makers of restricted radiation devices, in particular the 100-mW walkie-talkie and also radio-controlled garage-door openers, have given the FCC problems.

Garlan told the EMC session that while the commission had moderate success in convincing manufacturers to voluntarily comply with its technical specifications, it found that this was not enough to keep the noncomplying devices mentioned off the market.

To protect the public

For this reason, and also because the FCC wished to protect the public—under the old law the consumer was responsible when his equipment caused interference, even though purchased in good faith—the FCC asked for and was given the "new" Section 302. This "gives the Commission, consistent with the public interest, convenience and necessity, the power to make reasonable regulations governing the interference potential of devices . . . causing harmful interference to radio communications."

The justification for this law was based, according to Garlan, on the "impossibility of controlling interference on a case-by-case basis from devices . . . distributed in large quantities to the general public."

Examples he gave were the walkie-talkies and garage-door openers. It became apparent to the FCC that the only effective control program would be one that controlled the interference at the design stage, or during manufacture.

As a result, under Section 302 the FCC can now "prohibit the manufacture and sale, as well as the use of equipment or devices capable of causing interference."

To make Section 302 workable, the FCC, on Jan. 15 of this year, issued Notice of Proposed Rule making in Docket No. 18426, which will have substantial changes



Electromagnetic interference is a growing, critical problem. Typical of the services affected are communications aboard the tanker SS Manhattan.

over past procedures and which will markedly tighten the requirement placed on the manufacturers.

Only after the FCC is satisfied that the equipment complies, would the manufacturer be allowed to sell, ship, or distribute his equipment.

For those involved in type approval programs, Garlan pointed out that the procedure would remain the same, but whereas previous compliance was voluntary, it will now be compulsory.

Change handling procedures

There will be a change in handling procedures for most rf devices regulated by Parts 15 (incidental and restricted radiation devices) and 18 (industrial, scientific and medical equipment). For equipments such as medical diathermy, fm wireless microphones, and microwave ovens, no change is involved.

For radio receivers, the manufacturer will have to wait for FCC acceptance before shipping, instead of now shipping when the report is filed.

Garlan emphasized: "For low-power communication devices, such as 100-mW walkie-talkies in the 27-MHz band and also the radio-controlled garage-door openers, this program imposes a radical change."

At present, Garlan explained, the manufacturer makes no filing. He merely labels device as comply-

ing. "But" Garlan cautioned, "we are drafting an amendment to Part 15 which would also impose a type acceptance procedure on these devices. That is, we propose to require a detailed filing by the manufacturer and require him to wait for equipment acceptance before he can label and distribute his equipment."

Nichols suggests . . .

Fred Nichols, like Garlan, agrees that the best and cheapest way to produce EMI-free equipment is by proper design. Nichols cited, as a prime example, the commutator-type fractional horsepower motor such as used in mixers, hand tools, vacuum cleaners and elsewhere.

"The typical fractional horsepower electric motor," Nichols stated, "proves time and time again that one dollar spent in engineering and quality control saves two dollars in suppression."

A principal recommendation of Nichols was that "the FCC establish shielded-room limits and allow the manufacturer the choice of either free-space or shielded-room measurements." A principal reason here is that development work with shielded rooms costs substantially less than free-space measurements. Also, Nichols claims that it is easy to correlate between shielded-room measurements and open-space measurements for a limited number of electrical/electronic items. ■■



We make components for guys who can't stand failures.

There's no such thing as a little failure to some guys. Either your system will perform as you designed it, or it won't. Either the right answer comes out, or it doesn't. Anything less is too much to bear.

At Corning we make our resistors and capacitors like all your customers were just that demanding. We build in an extra measure of performance into everything we do. Because like you and the guys who use your equipment, we can't stand failures either.

Take our precision tin oxide resistors, for example. They're the best of the metal film class. Because the resistive tin film is completely oxidized and molecularly bonded to the glass substrate, our tin oxide resistors are impervious to moisture and environmental degradation. No other resistor can deliver the same stability and reliability over load life. They offer guaranteed moisture resistance across all ohmic values to set a standard of reliability that can't be matched by metal film, wire wounds, carbon comps or metal glaze resistors.

After a 56-day-long heat test in an environment of extremely high humidity, our tin oxide resistors

showed a resistance change of just 0.2 per cent. And in an ambient temperature test—now in its ninth year—not one of the 600 tin oxide resistors being tested has exceeded a resistance change of 1.5 per cent.

You can get this kind of extra performance in miniature size, too. With our CORNING® C3 Resistors, circuit designers are now reducing the volume and weight of their boards a full 65 per cent.

Our tin oxide resistors represent extremely good value. They offer long-term economy over metal film, precision wire wound and metal glaze resistors. And our miniature C3 resistors compete costwise with carbon comps.

And take our glass capacitors. In an extensive lab test program, the U.S. Air Force has found that our glass capacitors have much better stability and much higher insulation resistance than the ceramic, mica and the other capacitor-types they tested. That's why glass capacitors are being designed into so many major aerospace and missile projects.

Then there's our line of Glass-K™ capacitors that give you the volumetric efficiency and economy of monolithic ceramic

capacitors, but with the much improved stability and reliability that only a glass dielectric can add. They're now being used in a number of computer systems.

We have other developments, too. Like our flame proof resistors. Ideal for circuitry where functions, environments and duty cycles demand low power resistors with excellent frequency characteristics, our flame proof tin oxide resistors can withstand overloads of up to 100 times rated power without any trace of flame. And, because they open under overload, they provide protection for your other, more expensive components.

At Corning, we make components for guys who can't stand failures. Guys like your most important customers. Guys like you.

Next time you're designing a system, reach for your Corning capacitor and resistor catalogs and call your local Corning authorized distributor for off-the-shelf delivery. They'll help you design-in an extra measure of performance.

If you don't have our catalogs, ask your Corning distributor for copies or drop us a line at: Corning Glass Works, Electronic Products Division, Corning, New York 14830.

CORNING
ELECTRONICS

Surprise!

Our engineers weren't clowning around when they redesigned the GR 1310 Oscillator. Now, it's all solid-state and fifty dollars cheaper.

There's no sacrifice in performance either — 2-Hz to 2-MHz range, better than 20-V open-circuit output (10 V into 600 Ω), and less than 0.25% distortion from 50 Hz to 50 kHz. In fact, the 1310 will even drive a short circuit without clipping because distortion is independent of load. Output characteristic is flat within $\pm 2\%$ from 2 Hz to 200 kHz.

How's that for performance?

HOW TO BUY A 1310-B FOR LESS THAN \$275

Why not combine your 1310-B requirements into a single order and take advantage of our quantity discount plan? The following schedule of prices apply in U.S.A.; the quantity discount applies everywhere.

Quantity	1	2-4	5-9	10-19	20-49	50-99	100
Discount	—	3%	7%	10%	13%	17%	20%
Price	\$275	\$266.75	\$255.75	\$247.50	\$239.25	\$228.25	\$220



For complete information, write General Radio, West Concord, Mass. 01781; Telephone (617) 369-4400. In Europe: Postfach 124, CH 8034, Zurich, Switzerland.

GENERAL RADIO

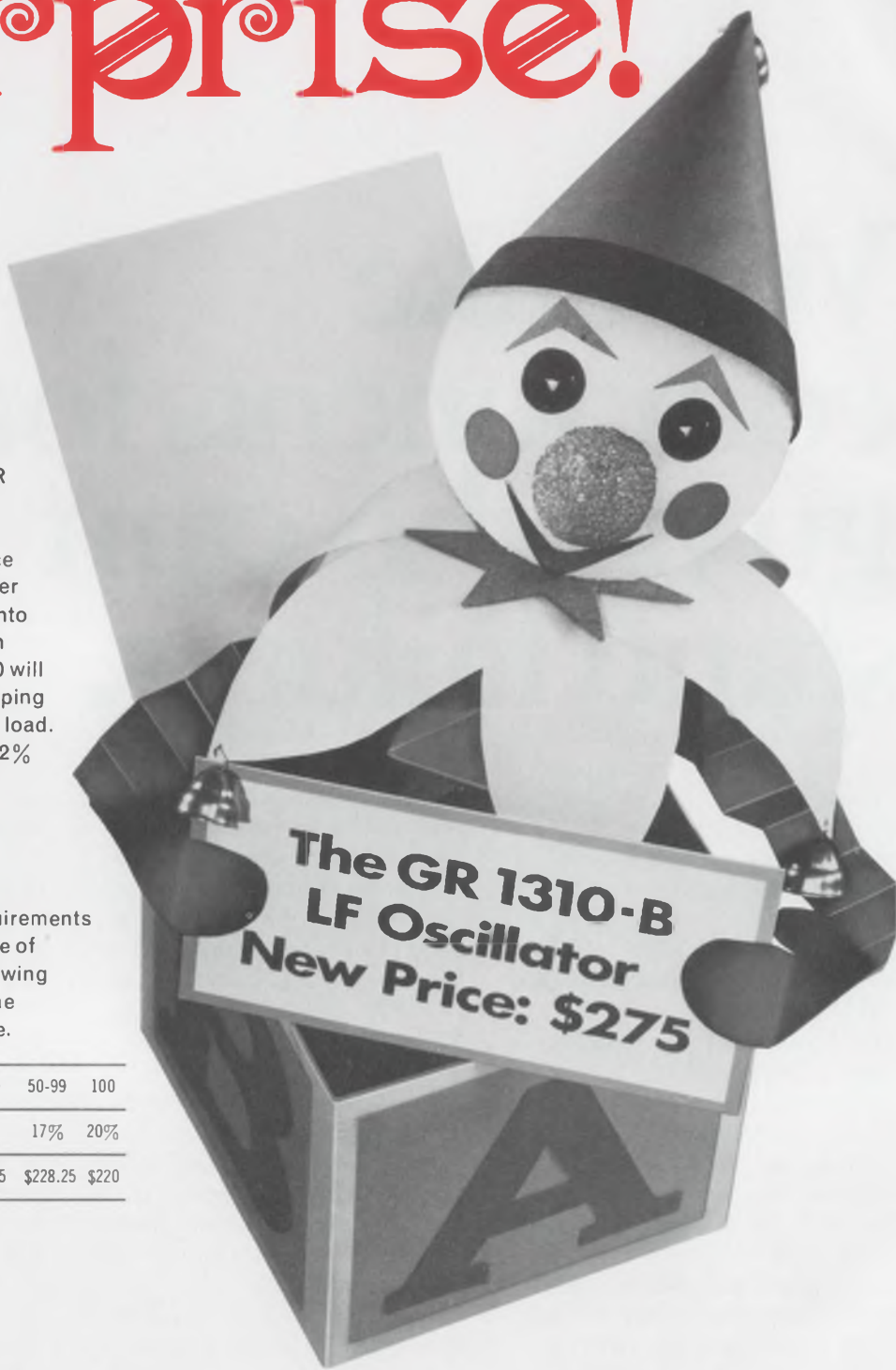



MIRV moratorium in '70 doubted

The likelihood of an early agreement between the U.S. and the Soviet Union to limit further testing and development of MIRVs (multiple independently-targeted re-entry vehicles) appears dim. Many Washington officials had presumed that discussion of such a moratorium would ride high on the agenda during this year's arms-limitation negotiations between the two countries. The U.S. has stated a willingness for such discussion, and there were reports that the Soviet team might also agree to early discussion.

But reports now leaking out of the preliminary meetings that began in Helsinki Nov. 17 say that initial negotiations will not be centered on limiting missile deployment. The feeling among many Congressmen and electronics industry representatives here, who have heard the reports, is that the Soviet military will delay discussion on limiting deployment of strategic missiles with multiple warheads at least until the Russians have completed development and flight tests. It is no secret that many in the U.S. military feel the same way, but this country has the advantage of being probably two or three years ahead of the Soviet in MIRV R&D—both in the highly critical re-entry phase dynamics and guidance.

... meanwhile, Air Force pushes R&D

As preliminary arms limitation discussions continue in Helsinki, the U.S. Air Force is keeping up its guard: The Defense Dept. has released transcripts of testimony given before Congress, and they reveal two new areas of Air Force interest in strategic missile R&D. The first involves a different approach to an old system—a mobile ICBM launching scheme. The second is a more accurate large yield weapon.

In the early Sixties the Air Force

Washington Report

CHARLES D. LAFOND
WASHINGTON BUREAU

initiated a broad study for deployment of Minuteman missiles on large tractor trailers and railroad flatcars. The effort was discarded, due partly to excessive cost and partly to technological problems in achieving accuracy from mobile platforms. Defense Research and Engineering Director Dr. John S. Foster, Jr., testified last spring: "Mobile ICBMs or deceptive-based ICBMs are possibilities for improving our force survivability."

Under consideration, he said, are trailer-borne ICBMs that might be moved to any of a large number of semi-hardened revetments. Thus, some sites would be armed, some not, providing target confusion for any potential enemy.

More recently before the House Defense Appropriations Subcommittee, Air Force Chief of Staff Gen. John D. Ryan revealed a concerted effort by his service to develop larger yield strategic missile warheads. Said Gen. Ryan: "We have a program we are pushing to increase the yield of our warheads and decrease the circular error of probability so that we have what we call a hard-target killer which we do not have in the inventory at the present time."

It might be noted that while a mobile launch system would inherently be designed for defense to assure second strike capability, any move to a large yield weapon with improved guidance can only be considered by the Soviets as a first-strike missile system.

New satellite to study atmosphere

A new series of very low-orbiting spacecraft that would permit atmospheric measurements closer to the earth's surface than were previously obtainable from orbital craft is proposed by NASA, which has awarded two \$250,000 contracts for detailed specifications.

During the next four months, Hughes Aircraft Co., El Segundo, Calif., and the RCA center in Princeton, N.J., will perform competitive design efforts. One company will then be selected to build two Atmospheric Explorers, AE-C and AE-D.

The spacecraft will be instrumented to study the composition and characteristics of the atmosphere with particular emphasis in the 50-to-100-mile altitude, according to officials at Goddard Space Flight Center, Greenbelt, Md. Under terms of the present contracts, designers are expected to provide instrumentation capable of making measurements down to an altitude of 75 miles. The results of such orbital experiments should aid meteorologists and help formulate future instrumentation needs for an Earth Resources Technology Satellite.

Search and recovery ship planned

Plans to build a highly advanced oceanographic ship, for use in ocean-bottom search and recovery operations, were recently announced by a joint venture of Aluminum Co. of America, Pittsburgh, Pa. and Ocean Science and Engineering, Inc., of Washington, D.C. The vessel, to be called the Alcoa Seaprobe, will have a unique design containing a center well through which sensors, lift cables or a drill string can be lowered to depths of 600 feet. Under the joint venture, a subsidiary, Ocean Search Inc., will be established to operate the ship on a lease basis. It is expected to be ready for use in about two years.

The research vessel was designed by Ocean Science and will be built by Alcoa. The cost of the ship itself is expected to approach \$5-million, and possibly as much as another \$1-million may be required for instrumentation, both electronic and mechanical. The aluminum ship will measure 243 feet in overall

length and will displace 2000 tons. Its design calls for a range of 10,000 miles with an operating speed of 10 knots.

Critical for the ship's operation, according to Ocean Science project engineer Arthur Ruder, are the positioning and search instrumentation. Both Decca Marine radar and navigational aids (Loran C) are being considered.

Although not yet ordered, search equipment required includes underwater TV and side-scanning sonar, Ruder says. He also notes that while the ship will carry basic instrumentation, those who lease it will be expected to supply additional equipment to meet their specific research needs.

David & Goliaths: bout canceled

Last August a small firm, Photo Magnetic Systems, Inc., Beltsville, Md., initiated a suit against IBM and AT&T alleging patent infringements on many devices based on touchtone-type phone receivers. Last month Photo Magnetic agreed to dismiss the suit without prejudice although at the time of filing of the \$1-billion action, Photo Magnetic said it holds a patent for all touchtone-type telephones employed in the transfer of computer data.

The patent was described as being very broad and the suit specifically indicated those instruments currently produced by IBM and AT&T which involved tone generation, tone-to-tone digital converters, picture phones and so forth. Both IBM and AT&T denied validity of the patent.

In dismissing its suit, Photo Magnetic still claims ownership of a dominant patent but says it cannot afford at present either the time or the cost of such a law suit. There is a possibility, however, that part of the company's reasoning in ending this suit results from a Supreme Court ruling last month. This says, in effect, that a patent based on the combination of a number of older concepts or ideas cannot necessarily be void.

The Supreme Court ruled that such a design combination's becoming a "commercial success" does not indicate sufficient novelty to support a patent issuance.



The book you can't buy

It's free! If you are working in the areas of VHF, UHF, microwave on up through light frequencies you need the Fairchild Microwave and Optoelectronics Division (MOD) catalog. If you are working in communications you need to know about solid state sources and IC Hybrids. If you are engineering high frequency instruments and components you need to know about transistors and chips. If you are designing computers and card readers you need to know about optical devices and arrays. Send for Fairchild MOD catalog. It's free!

Fairchild Microwave and Optoelectronics Division is application oriented. Our job is to make your job easier. In the process we may come up with some money saving ideas too. Even this catalog illustrates this principle. Product information is listed including major specifications and prices. There is a set of post cards so that you can request additional information. And wait till you see what we've done to make your filing easier.

Whether you are working with components, instruments, subsystems, systems or just breadboarding you need to know

more about Fairchild MOD products. All you have to do is circle, check, punch or otherwise indicate number 101 on this magazine's reader service card (or write or call us). Do your thing today and we'll send you the catalog. It's free!

FAIRCHILD

MICROWAVE AND OPTOELECTRONICS
A DIVISION OF FAIRCHILD CAMERA AND INSTRUMENT CORPORATION

2513 Charleston Rd. Mt. View, Calif. 94040

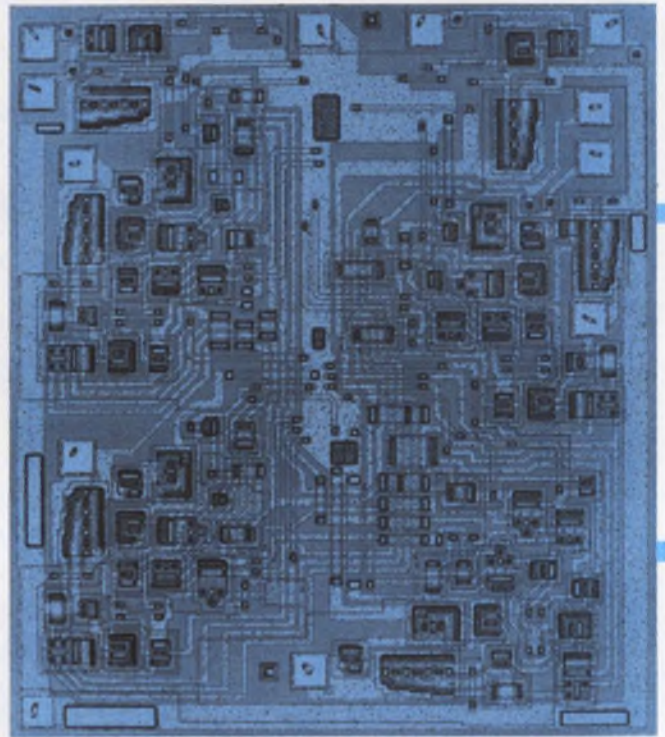

MC7490

You're in the (NIXIE[®]) drivers seat

CHECK THESE 54/74 MSI CIRCUITS...

Available Now

MC7441A	BCD-To-Decimal Decoder Driver
MC7475	Quad Latch
MC7480	Gated Full Adder
MC7490	Decade Counter
MC17482	2-Bit Full Adder
MC27482	2-Bit Full Adder w/Exclusive OR Outputs
MC7493	4-Bit Binary Counter

Coming Soon

MC7442	BCD-To-Decimal Decoder
MC7443	Excess-3-To-Decimal Decoder
MC7444	Excess-3-Gray Code-To- Decimal Decoder
MC7446	Seven Segment Decoder
MC7447	Seven Segment Decoder
MC7448	Seven Segment Decoder
MC7449F	Seven Segment Decoder
MC7483	4-Bit Full Adder
MC7491A	8-Bit Shift Register
MC7492	Divide-By-Twelve Counter
MC7495	4-Bit Universal Shift Register

- where the priceless ingredient is care!



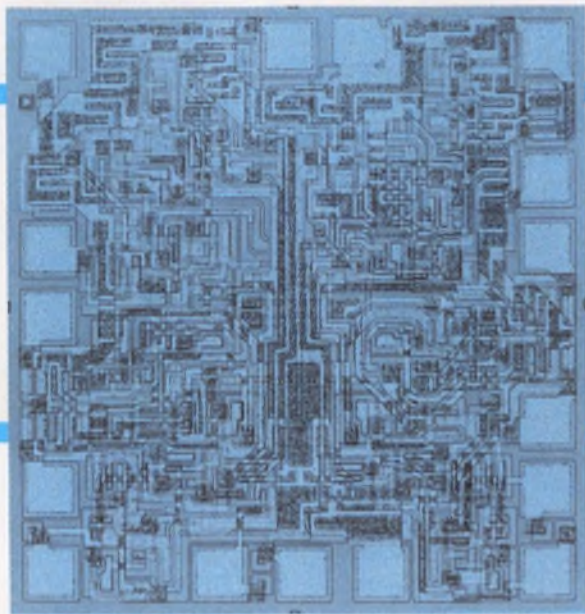

MC7475

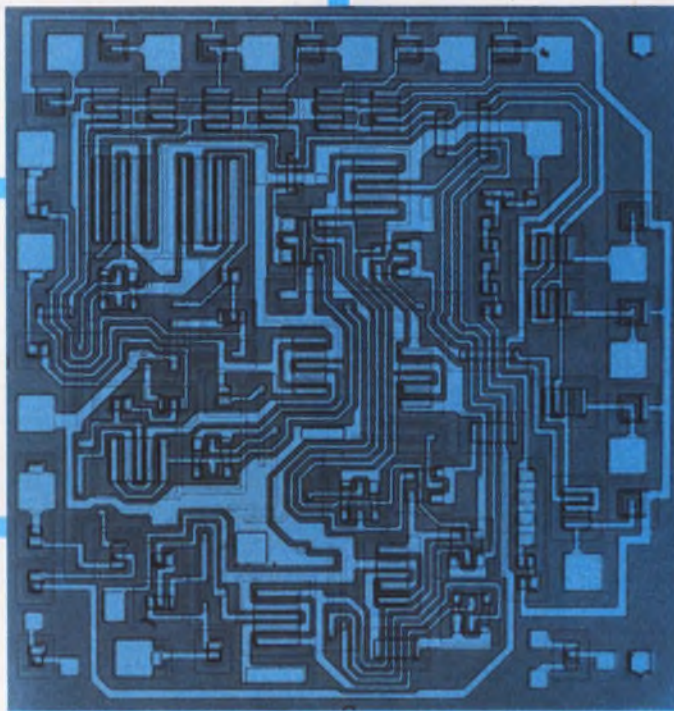

MC7441A

with these MTTL complex functions

Now you can develop completely integrated read-out systems with the intrinsic advantages of reduced circuitry, lower costs, and increased reliability. Design flexibility is yours when you consider the numerous configurations possible. For example, take one BCD-TO-DECIMAL DECODER AND HIGH-LEVEL DRIVER (MC7441A) and include a DECADE COUNTER (MC7490) to provide a basic counter-readout operation. Pin compatibility allows the two devices to be mounted side by side and no external logic or additional components are required. Additional decades may be added and the display can be provided with a sequential pulse train into the first decade for use as a multi-digit counter or timer, or many other applications.

Or add a QUAD LATCH (MC7475) and the MC7490 can follow the input sequence and, at specified intervals, the count is strobed through the latch and presented to the MC7441A. In this

way the display tubes are not continuously cycling and are easier to read at specific times. Provide a zero suppression circuit and all unused tubes will remain blank making it easier to read actual numbers.

And, by designing in four MC4004 16-BIT SCRATCH PAD MEMORIES you can expand the counter-readout concept to an economical multiplexing operation. In this case one driver is utilized to display a given number on the readout tubes thereby eliminating the sequential counting sequence.

These are only a few of many potential uses for the MC7490, MC7475 and MC7441A. Each device is a versatile design tool and can be used in varied applications to develop new systems or extend present ones.

Detailed specifications on these MTTL complex functions and a newly available application note "Direct Digital Display Using MTTL Complex Functions" are yours for the asking. Simply write to us at P. O. Box 20912, Phoenix, Arizona 85036 and ask for MOTOROLA TTL DESIGN KIT #1. Let Motorola's growing TTL capability work for you.

MTTL Trademark of Motorola Inc.
NIXIE Trademark of Burroughs Corporation

MOTOROLA 5400 / 7400 TTL

INFORMATION RETRIEVAL NUMBER 28

METERS ARE OUR BUSINESS!



Ambassador with
Taut Band Movement

Ideal Precision has a meter to satisfy every meter need — fit any specification — or cost requirement.

- Imperial Series
- Ambassador Series
- Capitol Series
- Edgewise Series
- Statesman Series
- Diplomat Series
- Moving Magnet Indicator Series
- 250° Long Scale Series
- Plus a full line of Military & Avionic Meters

And if you have special applications or unique design specifications, our Custom Service manufactures to fit individual specifications.

For detailed specifications and ranges write for your free catalog to

IPM IDEAL
PRECISION
METER CO., INC.

214 Franklin St., Brooklyn, New York 11222
Telephone: 212-383-6904

A look into the crystal ball

What better way to launch a brand-new decade than to peer into the inevitable crystal ball? So naturally that is what Ralph Dobriner, News Chief of ELECTRONIC DESIGN, planned to do for this first issue of 1970.

He had many questions. What will the next ten years bring in the "exploding" world of technology? What role will the engineer play in solving the problems of the booming cities? What impact will two-way cable TV have on the home of tomorrow? Will computer software problems hold back hardware progress, or vice versa? Will penny-a-bit IC memories become a reality by 1980? Ralph and the staff went to work to get the answers.

But since crystal balls are often cloudy and unpredictable, they also decided to ask these same questions and others of leading authorities. Representative of the experts consulted on each subject are the following.

On urban engineering, Robert C. Wood, former Secretary of the Department of Housing and Urban Development was queried. Consumer electronics was considered by Donald Perry, vice president and general manager of General Electric's Consumer Electronics Division. Computers were discussed by Dr. Jay Hillary Kelley, former science adviser to John F. Kennedy and Lyndon B. Johnson. For semiconductor forecasts, Gordon K. Teal, vice president and chief scientist for corporate development at Texas Instruments was consulted. A communications expert visited was Dr. John R. Pierce of Bell Telephone Laboratories. And education was discussed with Dr. H. Guyford Stever, president of Carnegie-Mellon University. The report on the future begins on p. 68.



News Chief Ralph Dobriner looks into a crystal ball—then checks with the experts.



**Allen-Bradley Type G
variable resistors
help seal Sylvania's
rescue transceivers against**

**ocean
dunkings**

Built primarily for aiding in the location and recovery of downed airmen, Sylvania's emergency rescue transceiver must be reliable under extremely adverse conditions. It is lightweight and compact enough to be carried in the pocket of a flight jacket. It must withstand impact and immersion in salt water without damage.

Essential to meeting these requirements is Allen-Bradley's Type G variable resistor. It's rugged. It's compact. And it provides the necessary seal against water. This particular Type G has two "O" rings—one between the bushing and shaft, and one between the bushing and mounting panel. This dual seal prevents water entering the enclosure, as well as the control.

The Type G variable resistor features the Allen-Bradley solid, hot-molded resistance track. It gives long life—less than 10% resistance change after 50,000 complete cycles. The noise level is extremely low, and the smooth adjustment provides virtually infinite resolution. Low inductance permits operation across a broad frequency spectrum.

For complete details and immediate delivery on this 1/2-inch diameter Type G 1/2-watt variable resistor, call your authorized A-B industrial electronics distributor. Or write: Marketing Dept., Electronics Div., Allen-Bradley Co., 1201 South Second Street, Milwaukee, Wis. 53204. Export Office: 1293 Broad St., Bloomfield, N. J., U.S.A. 07003. In Canada: Allen-Bradley Canada Limited.



Type G
variable
resistor
shown
actual size

Sylvania AN/PRC-90 dual channel rescue transceiver permits two-way voice communication, the transmission of Morse code or the sending of a homing beacon.



ALLEN-BRADLEY
QUALITY ELECTRONIC COMPONENTS

AM plus FM-plus solid-state stability

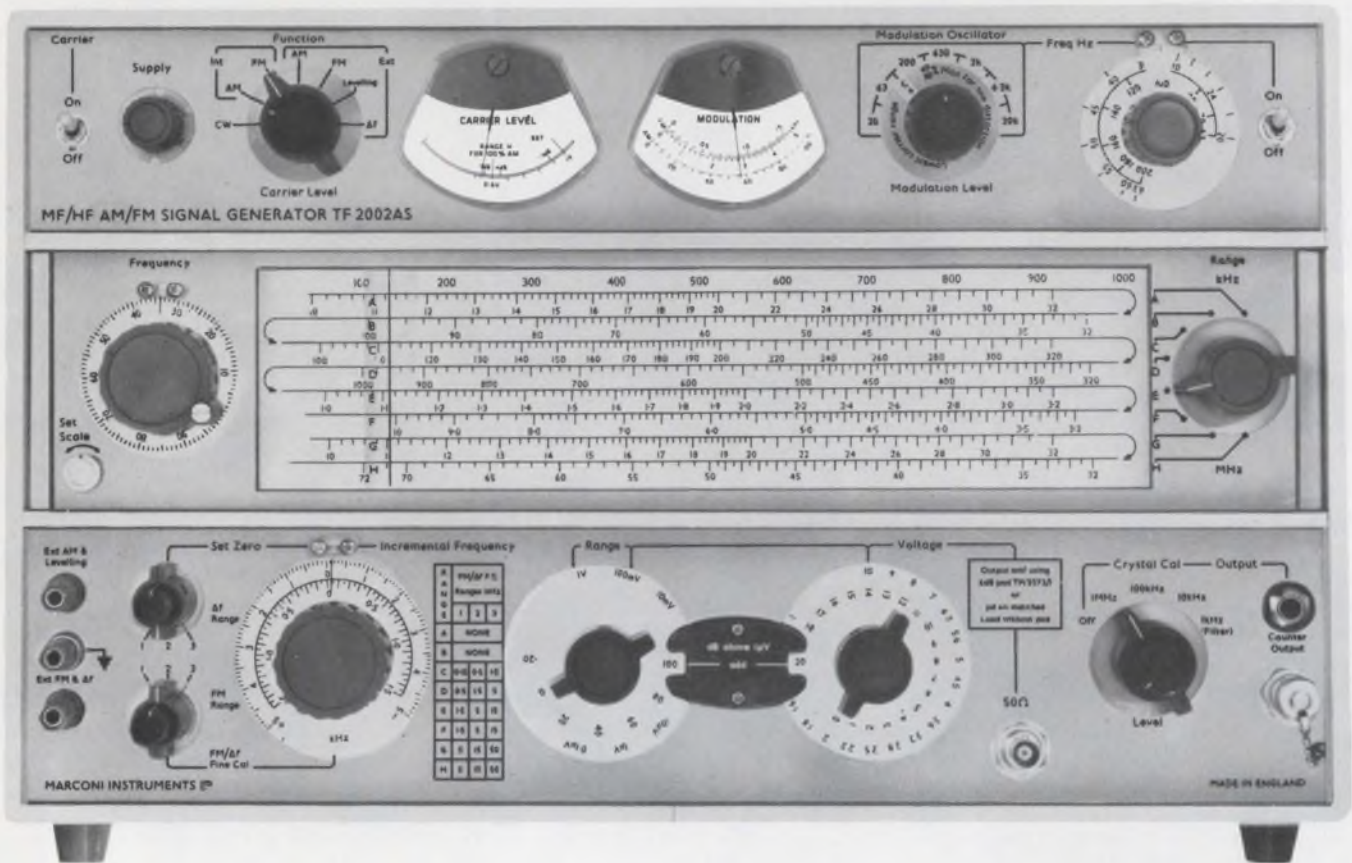

NEW MARCONI HF SIGNAL GENERATOR TF 2002 AS FEATURES

- Frequency range: 10KHz to 72MHz.
- FM deviations from ± 1.5 KHz at 100 KHz, up to ± 50 KHz above 10MHz variable and monitored.
- AM 0 to 100%, 20Hz to 20KHz.
- Directly calibrated incremental frequency control with xtal calibrator standardization.
- External leveling; ± 6 volts dc control gives 100% variation.
- Automatic level control maintains carrier within 0.5 dB over entire range.
- Total output accuracy ± 1 dB up to 32MHz, ± 2 dB above.
- VSWR better than 1.15:1.
- Counter output provided.
- Spurious FM or CW less than 5Hz + 1 ppm.
- Output variable from $0.1 \mu\text{v}$ to 1000 mv into 50Ω . Leakage permits measurement on ferrite antenna devices close to signal generator.

SIG. GEN. BOOK 1 Available upon request

The Sig. Gen. Book 1 presents detailed discussions on signal generators and receiver measurements including: source impedance of feeder connected receivers, coupling to loop antennas, signal-to-noise ratio, automatic gain control, plotting response characteristics, measurement of adjacent channel suppression and spurious responses, etc.



mi MARCONI
INSTRUMENTS
DIVISION OF ENGLISH ELECTRIC CORPORATION

111 CEDAR LANE □ ENGLEWOOD, NEW JERSEY 07631
TELEPHONE: (201) 567-0607



Dale connector line grows with new SHP-40 modular style

Make sure you have Dale on your list of connector sources. Describe Dale's connector line as: *"Small, but growing...able to supply volume quantities of all items in line...capable of meeting special design requirements."*

Among the new models now being produced by Dale is the SHP-40. This NAFI design conforms to BUWEPS 63A49F100 and gives us a strong entry into the modular field. For a quick look at some of the popular models we can

supply, see below. Then make sure you have our new connector catalog. It lists complete details on these styles:

PRINTED CIRCUIT • Direct card edgeboards as well as two-piece right angle and straight-thru types.

TEST POINTS • Printed Circuit Jacks or Points

RACK & PANEL (Rectangular)

- Miniature, Subminiature and Microminiature
- Shelled versions of Rack & Panel

UMBILICAL • Missile & Avionics Models • Shorting Plugs

NAFI • 40 pin

Write today for your catalog. Phone 402-564-3131 for price & delivery information.



DALE ELECTRONICS, INC. 1300 28th Ave., Columbus, Nebr. 68601

In Canada: Dale Electronics Canada, Ltd. • A subsidiary of The Lionet Corporation



They're on our shelf



The "special" audio transformers you need are "standard" at UTC.

When you're ready to specify transformers and inductors, before you turn to costly specials, check UTC. Chances are there's a *standard* unit that fits your special electrical and mechanical requirements exactly.

UTC has over 500 audio types in stock, ready for immediate delivery. And UTC engineers are constantly adding to the line. Microwatts to kilowatts. Less than $\frac{1}{4}$ Hz to greater than 1 MHz. MIL-T-27 or industrial. Metal-encased or open frame. Input, output, mixing, matching, modulating, phase shifting, hybrid,

baluns, ring modulator. All in continuous production for sample or high-volume requirements.

If the specific unit you need isn't on our shelf, we'll tailor a standard unit to your special requirements—saving the time and costs of starting from scratch. Check your local distributor for immediate off-the-shelf delivery. For catalog, write: United Transformer Company, Division of TRW INC., 150 Varick Street, New York, N.Y. 10013.

TRW
UNITED TRANSFORMER COMPANY

Publisher

Hugh R. Roome

Editors

New York Office
850 Third Ave.
N.Y., N.Y., 10022
(212) 751-5530

Editor, Howard Bierman
Managing Editor, Frank Egan
Computers, Milton J. Lowenstein
Circuits, Don Mennie
Microwaves, Michael J. Riezenman
Microelectronics, Raymond D. Speer
Management, Richard L. Turmail
News Chief, Ralph Dobriner
News, John N. Kessler
Military-Aerospace, John F. Mason
New Products, Roger Allan
New Products, Lucinda Mattera
Directory Manager, Greg Guercio
Copy, Marion Allen

Field Offices

Washington

Charles D. LaFond
P.O. Box 138
Burke, Va. 22015
(702) 461-7210

Massachusetts

Jim McDermott
P.O. Box 470
Easthampton, Mass. 01027
(413) 527-3643

San Francisco

Elizabeth de Atley
2051 Wellesly St. (Suite D)
Palo Alto, Calif. 94306
(415) 321-7438

Los Angeles

David Kaye
2930 Imperial Highway
Inglewood, Calif. 90303
(213) 757-0183

Editorial Production

Dollie S. Viebig
Richard D. Grissom

Art

Art Director, Clifford M. Gardiner
Assistant, William Kelly
Rita Jendrzewski
Lynn Thompson
JoJo Miskimmon

Production

Manager, Thomas V. Sedita
Helen De Polo
Kathleen McConkey
Leslie Stein

Circulation

Manager, Nancy L. Merritt

Information Retrieval

Genate Piccinetti

EDITORIAL



Technology in the Seventies: it's how it's used that counts

As we stand on the threshold of the Seventies, technological forecasting (see Special Report on p. 68) is naturally of widespread interest. We wonder, though, whether the big question is not what advances technology will make in the next decade but how we will use them.

A computer on a chip is a technical achievement of significance—but even more significant is how the computer will be used. Again, television beamed directly to the home via satellite would be an engineering milestone. But will the programming be educational, propagandistic, or just more of Newton Minnow's "vast wasteland"?

Technology is advancing at such a rapid pace that questions such as these, which could be ignored in the Fifties and deferred in the Sixties, will have to be faced squarely in the Seventies. In some areas, like spectrum crowding and pollution, the problems created are so acute that time is beginning to run out. And here enlightened legislation is undoubtedly the only thing that in the long run will prevent chaos or disaster.

In other areas, though, notably computers, manufacturers and users still have time to promote beneficial end use. For example, manufacturers can aim for a greater degree of compatibility between their products, so that the day when my computer can "talk" to your computer will become a reality. And steps should be taken to insure that users of time-sharing systems have complete privacy.

Computer users, for their part, should attempt to restore some of the human element that is always lost when a computer takes over a job previously handled by people. To date, computerized billing systems are probably the biggest offenders. Delays caused by trying to communicate with a human being to point out that the machine made an error in your bill are merely inconveniences. But with certain computer uses projected for the future, such delays could be catastrophic.

There are some who even argue that technology is in danger of outstripping demand—that in the future many of the fruits of our R&D labors will just wither on the vine. Whether this might be true will not be known until we move further into the Seventies. However, it would appear that technology will be watched and appraised far more critically than it has been in the past. And the engineer who could at one time contentedly limit his attention to the technical aspects of his designs had better develop wide-angle vision. Otherwise, the problems caused by those designs might have to be legislated to solution.

FRANK EGAN











**Tired
of running
the crystal
can relay
maze?**



You don't have to any more!

■ Because we've got them all. Everything from power crystal cans to TO-5 relays, from military types to industrial/commercial devices. All built to the same exacting Clare quality. And, as you'd expect from Clare, the world's greatest selection of operating characteristics and mounting styles.

Military Relays. Every Clare military relay is designed to meet the requirements of MIL-R-5757. All feature hermetically sealed cases to eliminate contamination under the most severe conditions. Withstand temperatures from -65°C to $+125^{\circ}\text{C}$; shock to 100 G; vibration to 30 G.

<p>Type TF. TO-5 transistor size; low-level to 1 amp.</p>		<p>Type TF. Sensitive. To 40 mw sensitivity; low-level to 1 amp.</p>		<p>Type MF. One-sixth size; low-level to 0.5 amp.</p>		<p>Type HF & HFW. Low profile; low-level to 2 amp.</p>	
<p>Type F & FW. Full size; low-level to 3 amp.</p>		<p>Type SF. 40 mw sensitivity; low-level to 2 amp.</p>		<p>Type LF & LFW. Magnetic latching; low-level to 2 amp.</p>		<p>Type PF. 10 amp. power.</p>	

Industrial/Commercial Relays. A combination of economy and rugged construction to meet industrial/commercial requirements. Industrial/commercial versions are rated for 30 G shock and 10 G vibration.

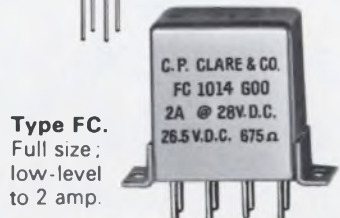
<p>Type TFC. TO-5 transistor size; low-level to 1 amp.</p>		<p>Type MFC. One-sixth size; low-level to 0.5 amp.</p>		<p>Type HFC. Rugged "metal" cover; low-level to 2 amp.</p>	
<p>Type FC. Full size; low-level to 2 amp.</p>					

For information, circle Reader Service number, call your Clare Sales Engineer or your local Clare Distributor. Or write for data on the types you need. C. P. Clare & Co., Chicago, Ill. 60645...and worldwide.

LOOK FOR  **CLARE** ON THE RELAY
a GENERAL INSTRUMENT company



*Who ever heard
of a computer
that*

TALKS CONTROL?

The GRI 909 computer is the closest thing to it.
We call the technique Direct Function Processing.

"If meter output is less than zero, go to alarm."

"Turn on tape reader."

*"Send complemented output of analog-to-digital
converter to controller."*

These instructions are representative of GRI's
unique functional approach to assembly language.
When you have defined the functional operations
of your system, you have very nearly written the
control program for the GRI 909.

Direct Function Processing adds many new
dimensions to computerized system control.
To find out more, write for our new brochure
describing the GRI 909 computer.

gn **GRI Computer Corp.**
76 Rowe Street,
Newton, Mass. 02166
(617) 969-7346

gn-909
You have never seen a computer
like this before. Now in production.

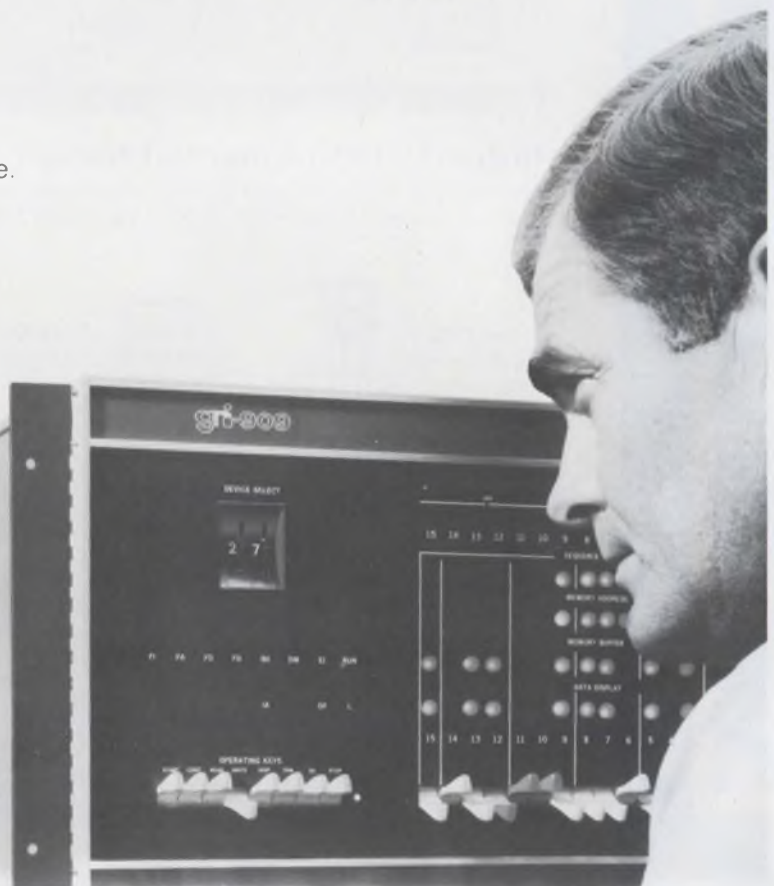



One-track mind.

Only need one make-and-break?
Now that's all you have to buy:
this new one-pole relay by Comar.
Gives you the exact number
of poles needed.

If you only need one or two
functions performed,
specify the single-pole relay.

Need two makes-and-breaks?
Specify the two-pole relay.
Same for the three-pole relay.

They're all the same compact size:
1 1/4" x 5/8" x 5/64".
They're compatible with one another
so that two three-pole relays

placed side by side, for example,
will give you six poles . . .
in less space than you needed
before for two 4-pole relays.

Less expensive than the 4-pole
relay too. Better balanced.
Yet built with the same exacting
quality that Comar builds
in all their relays.

If you've designed a circuit
that has but one function in mind,
try our one-track mind.
The CR-2 single-pole relay.

Complete with dust cover.
Socket available.

Contact Rating: 4 amps at 120 volts A.C.
resistive and 4 amps at 30 volts D.C.
resistive.

Coil Voltage Range: Up to 115 volt D.C.



3349 Addison Street/Chicago, Ill. 60618
Phone: (312) JU 8-2410

Send me one free!

Single-Pole Double-Pole Three-Pole
Available to qualifying purchasing agents and
engineers. Please fill in completely.

Name _____

Title/Function _____

Company _____ Phone _____

Address _____

City _____ State _____ Zip _____

Your Product Line _____

New! Comar CR-2 Relays • Single-Pole • Double-Pole • Three-Pole

30 COMPANIES BUILD A/D CONVERTERS. WHY PICK ANALOGIC?

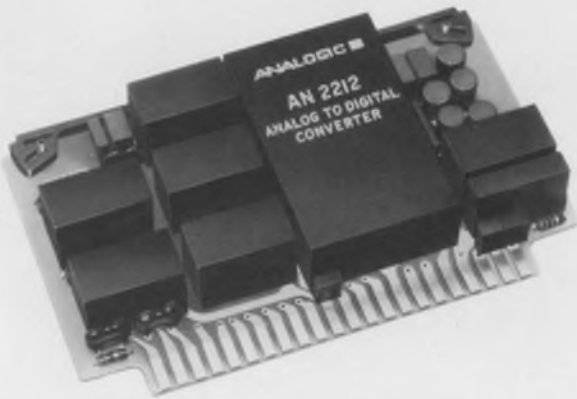

1. EXPERIENCE: The combined experience of 15 senior project engineers, most of whom have been in the data reduction business since a couple of them built the first high-speed A/D 15 years ago. They've experienced all the usage problems as well as the design problems. Common mode. Noise and ground loops. Drift with temperature. They'll help you.

2. CUSTOMER RELATIONSHIP: We know the mark-up problem, and we'll work with you to meet both performance and cost objectives. We'll review possible trade-offs. In fact, if we think you might successfully build some of the conversion system in-house to make it all happen, we'll even help you. An unusual attitude, perhaps, but it may make your new product possible.

3. PRODUCT: Our only business is analog to digital conversion. We build and ship more different basic types of A/D converters than any two of our competitors combined. For example:

▪ The AN2317. A *true* 0.01% (from turn-on) integrating converter at only \$249. ▪ The AN2612. A com-

plete 12 bit moderate speed converter with differential input at \$179.50. ▪ The ultra high speed AN2715. 15 bits in a total conversion time of 4 us with optional sample and hold on only three plug-in cards — for less than \$2000. ▪ The AN2013 and AN2413 13 bit AC ratiometric and synchro to digital high speed converters at \$1300 and \$1500 respectively. ▪ The AN2212. Lowest cost, highest stability 12 bit high speed A/D converter on the market at only \$695. ▪ The AN2214. 14 high-speed bits or 4 BCD digits at \$995. ▪ Plus all the compatible products . . . four kinds of multiplexers. A dozen special-purpose amplifiers. Sample and holds. Five modular power supplies. Displays. Logic modules for programming and interfacing. All the modular hardware and enclosures needed to rack up any complete system required.

**30 companies build A/D converters.
Analogic is in the business.**

ANALOGIC ■

Audubon Road, Wakefield, Mass. 01880.
(617) 246-0300



Optima enclosures...

For information, call or write

Optima, Box 13654

Atlanta, Georgia 30324

Telephone 404-939-6340

A product of

Scientific-Atlanta

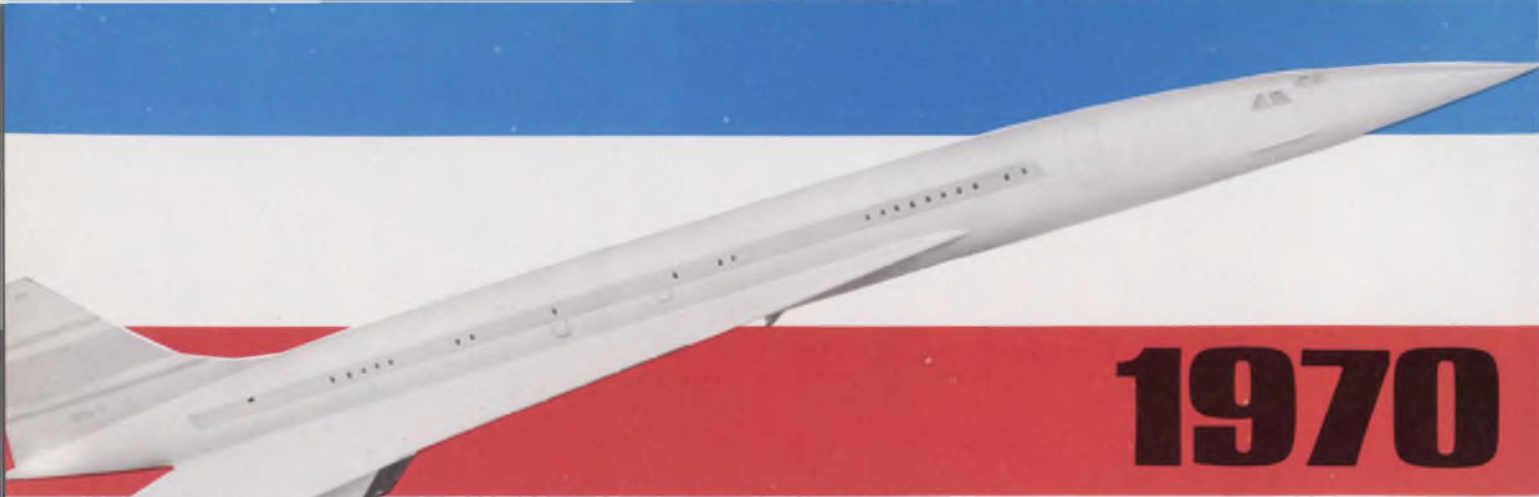

1970

1ST PRIZE - ROUND TRIP AIRLINE TICKETS FOR TWO BETWEEN NEW YORK AND PARIS

You can schedule your flight any time during 1970 to coincide with business or vacation plans—stay up to 21 days before returning.

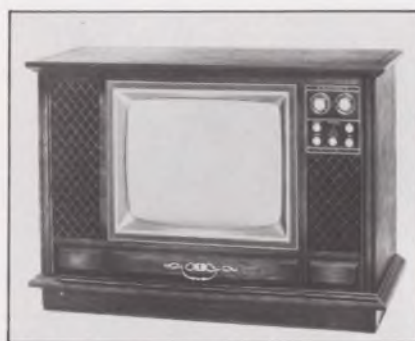

SECOND PRIZE

New Heathkit® ultra deluxe 295 sq. in. GR 681 color TV kit with cabinet. Automatic fine tuning on all 83 channels, power push button VHF channel selection, built-in cable-type remote control, high and low AC taps, 2-speed transistor UHF tuner, hi-fi sound output, plus many other features.

THIRD PRIZE

Heathkit® 227 sq. in. GR 227 color TV kit with cabinet and cart. Power push button VHF channel selection, built-in self-servicing aids, high and low AC taps, 2-speed transistor UHF tuner, hi-fi sound output, two VHF antenna inputs, etc. Roll-about cart included.

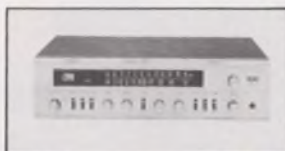

FOURTH & FIFTH PRIZES

EICO "Cortina" No. 3770 all solid state 70 watt AM-FM stereo receiver. Powerful silicon amplifier. Kit includes HFS-8 two-way, two-speaker system. 8-inch woofer. Capacity 25 watts peak power.

SIXTH THROUGH TWELFTH PRIZES

Bulova Accutron® "Spaceview" electronic timepieces. The tuning fork (visible through the transparent dial) permits the first guarantee of on-the-wrist accuracy to within 60 seconds a month.



13TH THROUGH 110TH PRIZES Copies of "Fundamentals of Integrated Circuits"—a complete guide to integrated circuits, their theory, manufacture, and application—by Lothar Stern. 198 pages, hardbound.

SEE LAST PAGE OF THIS

TRY YOUR LUCK!

WIN A FLIGHT TO PARIS! —110 VALUABLE PRIZES IN ALL—

TOP TEN CONTEST



1 Pick the 10 ads that you think will be best read in this issue . . .



2 List your selections on the top ten entry blank . . .



3 Mail to Electronic Design before February 28.

HERE'S ALL YOU HAVE TO DO TO ENTER...

(1). Examine this issue of Electronic Design with extra care. (2). Pick the ten advertisements that you think will be best remembered by your fellow engineer-subscribers. (3). List these advertisements (in the rank order you think our readers will select them) on the special entry forms bound in this issue. Your *Top Ten* list will be compared with the ten ads ranking highest in the "Recall Seen" category of Reader Recall—Electronic Design's method of measuring readership.

Remember . . . in making your choices, be sure to consider not only your own interests in the subject matter of each particular advertisement, but also those of the other engineer and engineer-manager readers of this magazine. Last year's winning ads ran the gamut from multiple page inserts, four-color displays to black and white pages.

See if you can pick the *Top Ten* . . . 110 valuable prizes are waiting for the winners!

SEPARATE CONTEST—SEPARATE PRIZES FOR ADVERTISERS

There's a separate *Top Ten Contest* for advertisers! All advertising personnel with manufacturers (companies) and their advertising agencies are eligible to enter. (You need not be an advertiser in Electronic Design to qualify.)

PRIZES—ADVERTISER CONTEST

- 1ST PRIZE:** 20" Motorola "Quasar" color TV.
- 2ND PRIZE:** EICO "Cortina" No. 3770 all solid state 70 watt AM-FM stereo receiver plus HFS-8 two-way, two-speaker system.
- 3RD & 4TH PRIZES:** Bulova Accutron® "Spaceview" electronic timepiece. Accuracy guarantee is 99.9977% during actual wear on the wrist!

If you are a 1st prize winner in the contest for advertisers, and have an ad in the January 4 issue, you will receive a free rerun of a like ad of your choice!

FREE RERUNS FOR THE TOP TEN ADS

Each advertisement ranking in the *Top Ten* will receive a free rerun. (See last page in this issue for details.)

ISSUE FOR TOP TEN CONTEST RULES AND ENTRY BLANKS



It's new. Our Molex 1820 Switch. You can use one, or a gang of them, for an infinite variety of applications. Its lighted push button can be wired to light independently of the switch. And there are colors galore. But what's really nice is price. About seventy cents in quantity.

It's a good example of the Molex creative approach to design problems. And the ability to design reliability and ease of assembly into a product without letting costs run wild due to over-engineering.

The 1820 is really one you have to see to believe.

And we would like to show it to you. For a free sample of our new switch, write or phone (312) 969-4550.



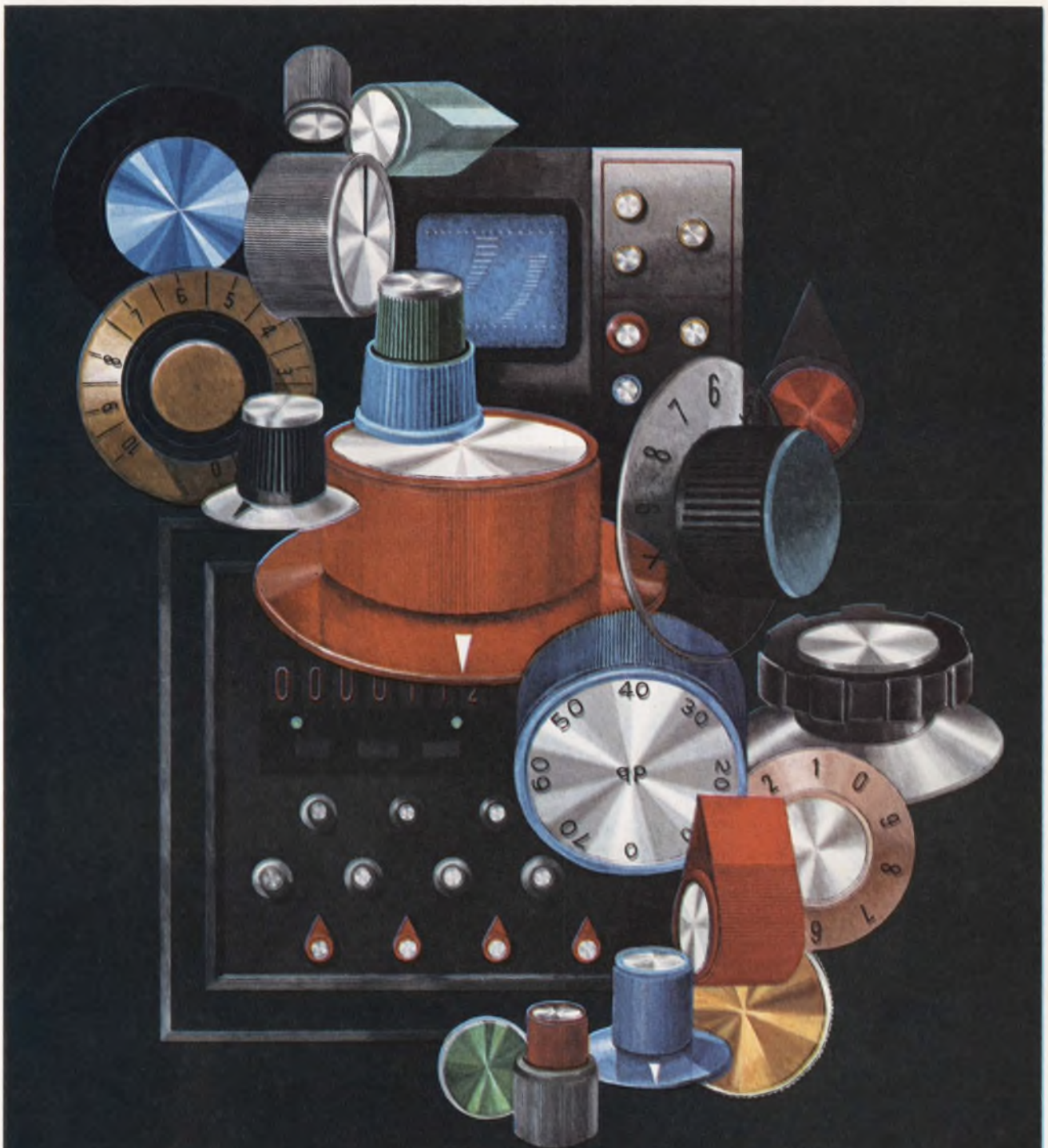

RELIABILITY

Sets the pace in product performance — quality — service. And, when it comes to control knobs and dials, the reliable name is Rogan . . . the pace-setter of the knob industry since 1939.

Outline your requirements for quotation and free knob sample. Write for free color catalog.

Rogan

BROTHERS, INC.

8019 N. Monticello Ave. Skokie, Illinois 60076
Phone: (312) 675-1234

We're after your next order

for power transistors.

Pirgo makes planar silicon transistors rated from 2 to 90 amps. The resemblance to other companies in the field stops there.

Because we want your next order, Pirgo, an affiliate of Sprague Electric Company, makes all products just a little better than we have to. One out of every six employees works in quality control or reliability assurance. We purposely keep our design and manufacturing standards high, but our pricing results in important savings on your power transistor purchases.

Pirgo provides engineering assistance. Application engineers will work with you on your specific problems. What's more, they're flexible. They will make changes or custom-tailor an entirely new product to meet special requirements.

Send for our new catalog. Or call your local Sprague Electric sales engineer. Let us show you just how much we want your next order... and every one after that.

Pirgo products are available from authorized Sprague semiconductor distributors.

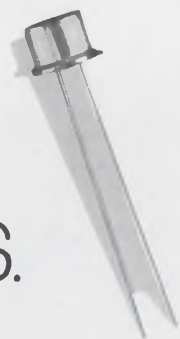

PIRGO  **ELECTRONICS INC.**
A SPRAGUE ELECTRIC COMPANY AFFILIATE

130 CENTRAL AVENUE
FARMINGDALE, NEW YORK 11735
Tel: 516-694-9880 • TLX: 96-1498

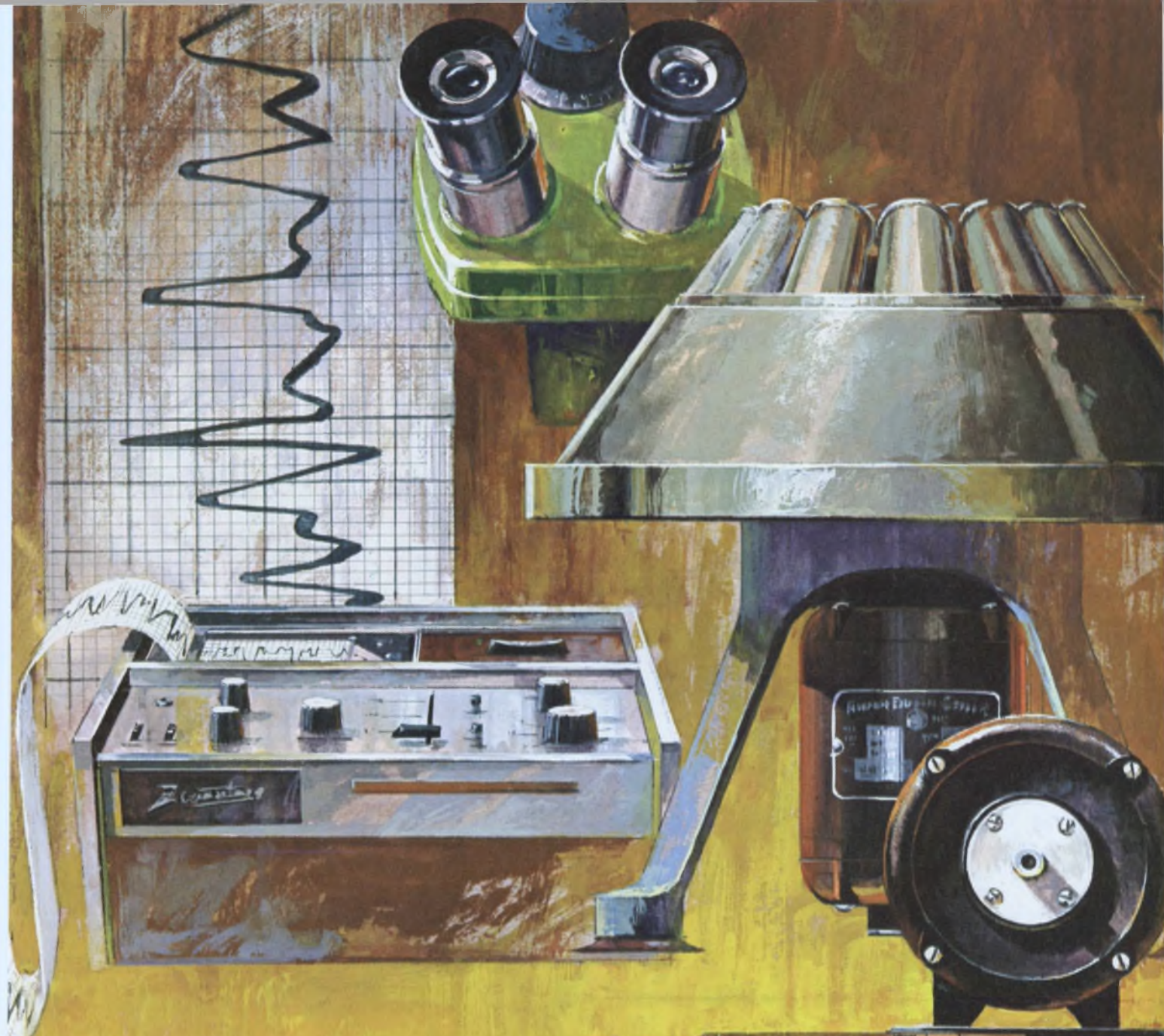

Bodine helps keep medical equipment strong hearted...

Bodine fractional horsepower drives. Small. Quiet. A complete line designed to keep medical equipment and apparatus powered precisely, reliably, for a long, long time. Motors built with all the integrity you've designed into your product—that deliver as specified with fewer callbacks and service problems. If this is the kind of power you're looking for, you'll find no better source.

Over 3,500 standard specifications to choose from. Bodine also builds custom and special fhp motors to design requirements. Our engineers will be happy to help you pinpoint the right one for your specific application need. Mechanical organ, heart recorder, test unit, pumps—whatever your product, specify Bodine fhp drives. The power behind the leading products for some 63 years. Write for bulletin. Bodine Electric Company, 2528 W. Bradley Place, Chicago, Illinois 60618.

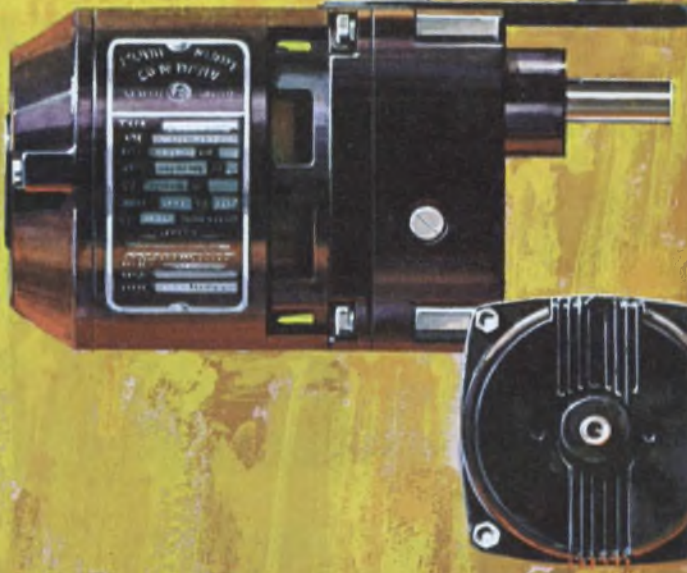

Bodine Motors Wear Out—It Just Takes Longer.

BODINE MOTORS/CONTROLS

Ask about Bodine SCR motor speed controls

Model SP601 shown actual size.

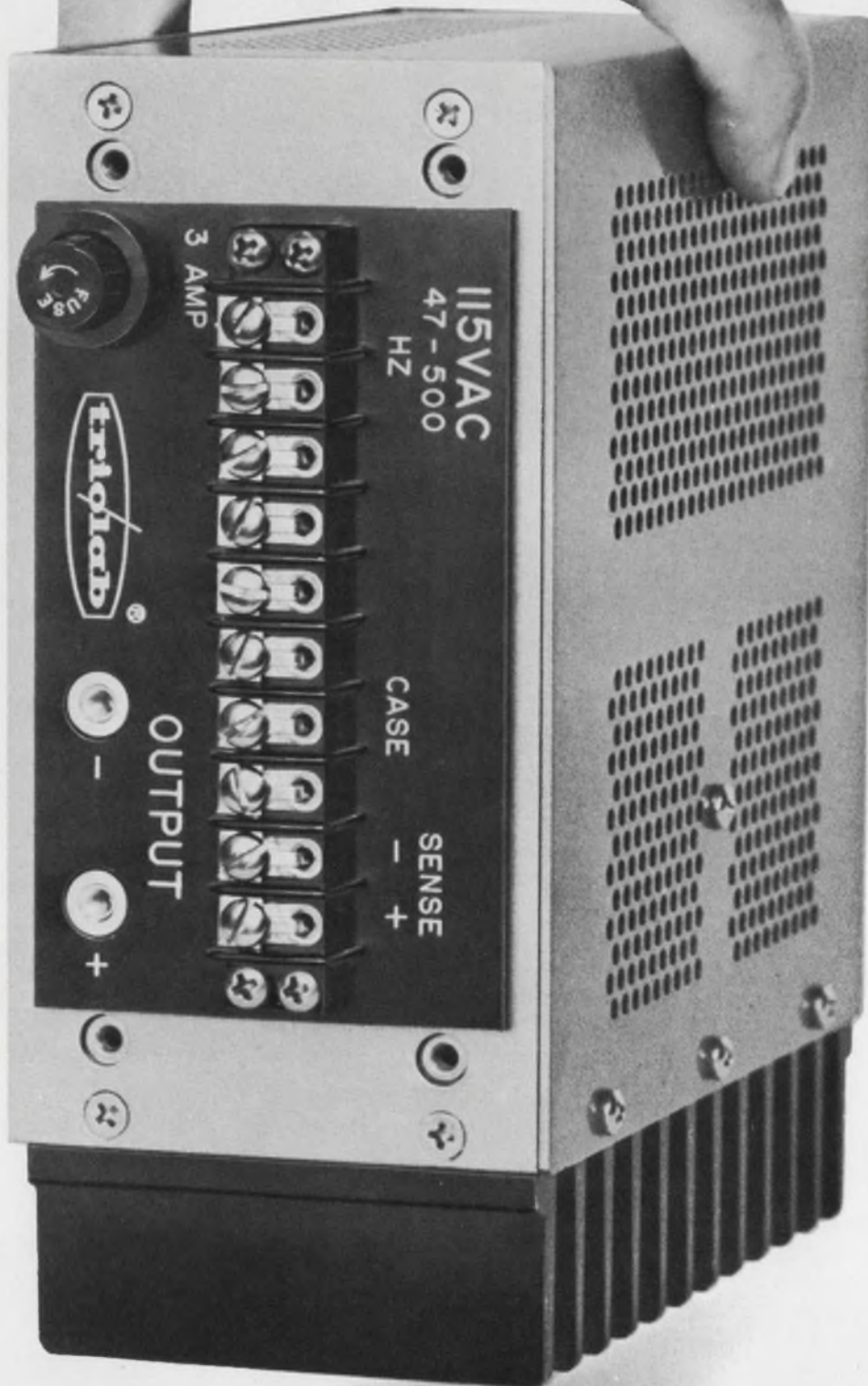

We make it possible by harnessing the space-saving advantages of the switching regulator—but have pulled its RFI fangs (input and output meet MIL-I-6181).

When you read our data sheet carefully, you'll also find it full of hidden features that other manufacturers would loudly acclaim.

Such as an IC regulating amplifier, automatic overvoltage crowbar, self-resetting automatic overload and short circuit protection, and even 30 ms full-load storage after the input voltage disappears.

Efficiency is so high that the very hottest spot on the heat sink has a rise of only 25°C.

You can actually hold our unit after hours of full-load bench operation without smelling burning flesh!

And is there any other unit you've heard about that will continue to deliver full-load at 71°C.—without derating, heat sinking or forced air cooling.

Single, dual, or triple outputs at voltage levels of 3V to 30V can be provided to your specific needs.

By the way, if you think our \$400 price is high, try adding the "optional extras" to anybody else's standard you had in mind.

Trio Laboratories, Inc., 80 Dupont Street, Plainview, L. I., N.Y. 11803. Tel.: (516) 681-0400.

TWX: (510) 221-1861.



Now you can squeeze your 5V/20A power supply down to fit your microcircuitry.



When you can't afford a "wrong number"...

Symbolic representation of the TV, voice, ranging data and biomedical telemetry signals from the moon. Photograph courtesy of NASA.

bring ERIE in early.

Where are they? How are they? What do they see... and say? NASA and the world want to know. And, the only way to find out is over the special Motorola S-band equipment on both the Command and Lunar Modules. Once the Apollo Astronauts are over 30,000 miles out, it's their *only* communications link with Earth. It simply can't fail. That's why Motorola called on ERIE TECHNOLOGICAL to develop the EMI filters and Monobloc capacitors that would help this equipment perform flawlessly on every Apollo mission since Motorola has been involved. Proof, once again, that it pays to bring ERIE in early.

ERIE TECHNOLOGICAL PRODUCTS, INC.
644 West 12th Street, Erie, Pennsylvania 16512
(814) 456-8592

The D/A for stingy engineers



You want to convert from 4 bits at 25 MHz; or 9 bits at 10 MHz (or anywhere in between); and be ± 2 millivolts accurate in less than 90 nanoseconds.

But you also want to vary external bias and reference from dc to 25 MHz.

That way, your converter can be used as a function generator, a modulator, or a programmable attenuator.

But you want to pay only \$1480 to \$1760 for any of six models.

You're not stingy. You're thrifty.

You want our HS-2000 Series D/A Converters.



Not only that . . .

As a thrifty engineer, you would also like our A/D converters that require no external test equipment.

Word conversion rates can vary from 1 MHz to 25 MHz; and aperture time is as low as 0.2 nanosecond!

COMPUTER LABS

for tomorrow's technology today

(919) 292-6427 • 1109 SOUTH CHAPMAN ST.
GREENSBORO, N. C. 27403



Kurz-Kasch instrument knobs turn the action on!

A knob is to start something. Or stop it. Or make it faster or or slower. Or more or less.

But a well designed knob on a well designed piece of equipment (electronic or otherwise) does more than this. It not only turns the equipment on—it turns the user on!

After all, the knobs are what an equipment user (and buyer) sees first, last, and most often. If they don't do more for him than turn the equipment on, the whole design leaves him cold.

Kurz-Kasch knob designers know this. They've put together a line of 347 instrument knobs in a variety of sizes, colors and thermosetting plastic materials. Each one is calculated to turn the action on—with *your* equipment, *your* users, *your* buyers.

You can join 4,000 action oriented original equipment manufacturers who already turn on with KK Knobs. Write today for free Kurz-Kasch Designer Catalog.



Write for new catalog and free knob samples.



Kurz-Kasch, Inc.

Standard Parts Division • Dayton, Ohio 45401

INFORMATION RETRIEVAL NUMBER 44

Have coils gone about as far as they can go?



Chances are, you're using some pretty darned good coils right now. So you may have decided that you'll never be able to find any better ones. Nonsense. If you aren't using our brand at the moment, the solution is simple. Switch. You'll get a noticeably higher degree of reliability. (After all, we've been the leader in R. F. chokes ever since the days we helped establish the military specifications for inductors.) We also deliver a greater depth of technical assistance. And our prices? Very competitive. Or perhaps you're already using our coils. If so, the future is still promising. Because we'll be continuing to improve our present models and develop new ones. For a sample order of our pace-setting coils, write AIRCO SPEER ELECTRONIC COMPONENTS, St. Marys, Pennsylvania 15857. Then see where they go from here.

Ask the passive innovators at **AIRCO** Speer

Speer resistors Resistor and conductor paste Jeffers JC precision resistors Jeffers JXP precision resistors and networks Jeffers inductors Jeffers capacitors PEC variable resistors and trimmer potentiometers.

Technology



What will engineers be talking about in the 1970s? Certainly about magneto-optical



memories, teaching aids for engineers and ecology. And what else? See p. 68.

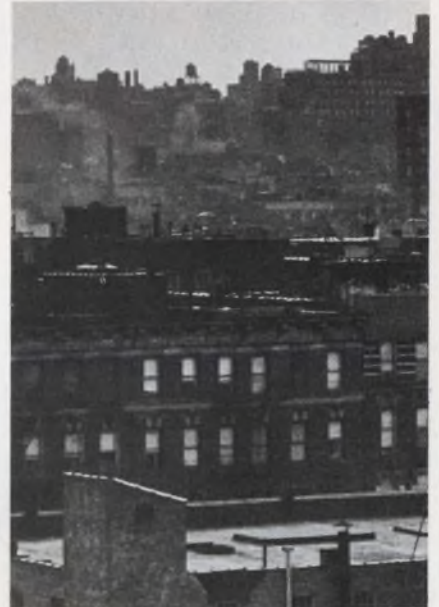

A low-cost, highly efficient switching regulator was designed by Michael English, who tells how on p. 106.

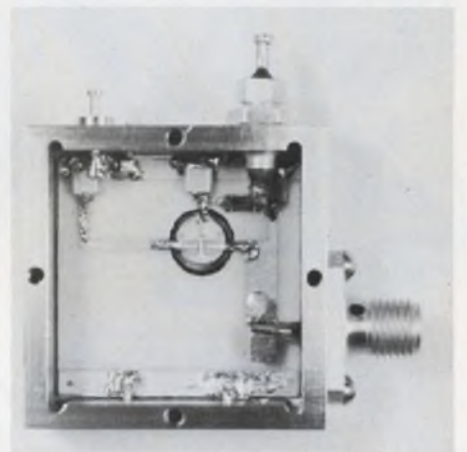

Design with microstrip. It's easy, with the tips on p. 100.

Also in this section:

Desk-top calculators close gap between slide rules and large computers. p. 114.

A franchise system generated to spark electronic sales is described. p. 118.

Ideas for Design. p. 124.

Product Source Directory: Pulse Generators. p. 133.

TECHNOLOGY IN THE

ZOO'S

ZOO'S

ZOO'S

ZOO'S

You can unmask a civilization by examining its language.

LSI, modularization, urban engineering, holographic memory, cable TV, domestic satellite—these are a few of the words that engineers will be bandying about day after day in the decade ahead. By 1980, they will be as common as the words of the Sixties: transistor, Atlas, X-15, laser, SCR, ferrite cores. . . .

What engineering developments can we expect in the 1970s? *ELECTRONIC DESIGN* interviewed leading specialists in a variety of disciplines to get the answers. Their exclusive reports on the pages that follow give valuable insights.

Electronics will be turning up in places and situations that few would have predicted even 10 years ago. And the engineer may well emerge as a new and respected figure in American society—a minor hero, perhaps, as in the Soviet Union. Will engineers save our beleaguered cities from poisoned air, tainted water, hopeless traffic jams? They're going to try—that much seems certain. A new discipline—urban engineering—is taking shape, and it will be using computers, systems techniques, new power sources—anything that ingenuity suggests—to help free the American metropolis from its hydra-headed problems.

In the American home, electronics will make possible new luxuries. TVs, radios, phonographs and tape recorders will be smaller and more reliable, thanks to semiconductor progress. One company is even planning a digital wristwatch-radio combination—how's that for Dick Tracy coming true? Today's consumer electronics market is pegged at about \$22-billion in annual sales. By 1980 that figure is expected to rise to \$37-billion (in today's dollars; there's no telling how high it will be if inflation persists). Cable TV will bring the stock market, the meat market, the grocer's, the local bank into the home. ICs will allow appliances to perform complex tasks with a minimum of attention from the housewife.

Computers? They'll be everywhere, naturally. And developing and improving all the time. There's no unanimity of opinion among specialists on where the major developmental problems will lie. The hardware men say the software men are dragging their feet. The software men say hangups in hardware are holding them back. Will time-sharing networks or the mini-computer dominate the consumer field? You can find experts who will support either alternative—and some maybe both.

The ubiquitous semiconductor will make a small but mighty impact on the American scene. ICs will make possible more complexity in memories, more computer-aided design. The price of the IC memory will drop drastically—down to a penny a bit by 1980, some specialists say. Precision hybrid circuits will assume great importance: They'll offer low cost and improved performance, especially in high-frequency and microwave applications. In processing, look for a significant commercial effort in III-V semiconductor compounds.

Designers will move toward complete dependence on computers to do their jobs. The engineer who can't use a computer in the 1970s will be obsolete. Computers may even direct slave computers early in the decade.

A definite trend toward modular construction will set in. Circuit boards no longer will be repaired; they'll be thrown away or returned to the factory. A new module will be inserted quickly, and the equipment will be as good as new.

Communications are in for radical change. Picture a system that will distribute mail and deliver your daily newspaper over data channels, and you have some idea of the progress that innovators have in store for the American public. But there's a problem here—a small, but significant problem. The innovators need a cheap, reliable, compact terminal device. Sending the data is no problem, you see; contactless magnetic keyboards can be built that are both cheap and reliable. But something to receive the data is urgently being sought.

Expect long-haul transmission of data to be by millimeter waveguide. Although costly to install, it will greatly reduce long-distance rates because of its ability to carry tremendous loads of information. A single two-inch pipe will carry 250,000 to 500,000 telephone circuits. As for laser communications, don't expect a practical, workable system for public use much before the end of the decade.

To meet all of these needs and more, the engineer of the Seventies will need a lot more knowledge in a hurry. Updating and refresher courses will be essential for the man on the job. In schools of engineering, there'll be increasing use of practicing engineers as teachers. The result: A master's degree will be routine for the engineer of tomorrow. There are some educators who say he will even need a doctorate to survive.

For details, turn the page.

URBAN TECHNOLOGY



A new technology—urban engineering—is about to come of age.

URBAN ENGINEERING: HELP FOR U.S. CITIES

John N. Kessler, News Editor

The problems facing American cities give planners the shudders. Here is what they see by 1980:

- An increase of 43 million in the population of the United States, with four-fifths of this growth living in the cities. Total U.S. population: close to 245 million.
- An increase in refuse generated annually by Americans from 190 million tons to 250 million.
- A rise in automobiles from 97 million to 120 million.
- A jump in energy requirements from 59 quadrillion BTUs to 79.2 quadrillion a year.
- Water use of 600 billion gallons a day, against average use of 400 billion gallons today.

The future of the cities will depend in large measure on the air its dwellers must breathe. Yet in November, 1967, when President Lyndon B. Johnson signed the Air Quality Control Act, he said:

"We are pouring at least 130 million tons of poison into the air each year. This is two-thirds of a ton for every man, woman and child in America. Either we stop poisoning our air, or

we become a nation in gas masks groping our way through dying cities and a wilderness of ghost towns."

Ultimately, the future of cities will depend on the interplay of political, economic and social changes with the proposals of technology.

A new kind of technology—urban engineering—is about to take hold in universities, government agencies and industry in an attempt to alleviate the growing environmental problems. Three of the leaders of the new technology are Robert C. Wood, former Secretary of the Department of Housing and Urban Development and now director of the Joint Center for Urban Studies of Harvard and the Massachusetts Institute of Technology; Dwight M. Baumann, professor of mechanical engineering at MIT and chairman of the Urban Engineering Study Committee of the American Society for Engineering Education, and Paul DeCicco, technical director of the Center for Urban Environmental Studies at the Polytechnic Institute of Brooklyn. What roles do they see for engineering?

When Robert Wood went to Washington in

1966 to become Undersecretary of the Department of Housing and Urban Development, funds for urban research amounted to \$300,000. That summer Wood set up a study group, published a book called "Science and the City" and wound up with a budget of \$10-million. With Robert C. Weaver, then Secretary of the department, Wood began to apply the power of science and technology to city problems.

"We defined the city in terms of densities, of high-velocity interchanges in communication and sophisticated technology," he says today. "And it became apparent that such densities and interactions change biological and physical behavior.

"The automobile exhaust is only dangerous in high concentrations. The kid throwing a brick through a country store can only bust one window—he won't set off a chain reaction. So we began to get the concept of components and interrelations and second and third-order consequences as a way to understand an in-city project. This was the kind of thinking that came into play in the middle Sixties when the urban crisis busted."

But when Wood returned to MIT, he found that his colleagues in engineering and science had become increasingly suspicious of the role of science and engineering in urban affairs.

"I found myself in an atmosphere where half of the engineering students at MIT were suspicious of what their own minds discovered and hell-bent on mysticism and romanticism as a way to help the poor and solve traffic problems," he recalls.

"I say that the internal anguish of the engineering and scientific community and its increasing self-doubt about the products of the laboratory will be a major conditioning factor in what will be done in the Seventies in urban science and technology.

"Oppenheimer said, 'Folk wisdom can cry in pain, but it cannot solve problems.' But we do enter the Seventies feeling that the approaches to the problem of the cities taken in the Fifties and Sixties in innovation and development may not be right.

Housing: 2.6 million units a year

"We're going to have 43 million new Americans by 1980, and they will be deposited in 227 metropolitan areas. We will have to spend in housing and community facilities \$155-billion in the next 10 years. We're going to have to build 26 million units of housing. That's 2.6 million a year. The best the industry has ever done was 2 million units in 1950. And when you ask yourself, 'What kind of industry is it that reached its record growth 19 years ago?' you begin to get a sense of where we have to go."

Wood sees the mobile home competing with on-site construction: "Mobile homes now constitute 90% of the housing \$15,000 and under. The question is: 'Will there be a high number of factory-produced housing units—smaller in total space but cheaper and most compactly organized, closer in design to marine engineering and Pullman architecture—or will conventional on-site construction survive?'"

Wood points out that the decisions on building in the cities have been barren of the empirical, quantitative analysis that goes into engineering.

"The steam power plant and the elevator built the cities, and they got thrown in as subcomponents to broader developments and broader projects," he observes.

"I don't know of a major innovation in tunneling since 1910. I don't know of a major innovation in transportation since the automobile and subway.

"The major potential is on the environmental side—waste disposal, clean air, clean water, the regulation of traffic, the movement of people.

"My hunch is that the payoff will be almost as big as it was in atomic physics in the Thirties, or in electronics in the late Forties and early Fifties.

"But the condition is whether there are institutions capable of using such developments. With electronics, there was the Dept. of Defense that had enormous requirements, great resources and a single decision-making apparatus. This is not true in the city business. We have 15,981 cities.

"In the Seventies you will see hardware innovation—some deployment of new transportation systems—but it's more likely that you'll be getting the substituting of communication for transportation. The development of high-volume coaxial cables will reduce the cost of communication. Instead of asking, 'Do I write or do I phone?' the choice will be, 'Do I fly or do I phone?'"

"The visual capabilities of written telecommunications and the rapid transference of written messages will replace nonadversary, non-confrontation meetings. When there is a need for physical presence, meetings will be held at an airport in the conference room of the nearest hotel. The participants will meet and then fly home."

New role for university

Dwight Baumann sees the university playing a new and important role in urban technology. The aerospace-military-electronics era, Baumann believes, is about to close.

"In the Radiation Lab days," he says, "the university was heavily involved in research and



in putting together new ideas. Now there are companies that have more PhDs in a lab than a university. What companies don't have is a social sciences sector. And it is the estimation of many people, who have tried to look under the curtain of the next act, that the principal actors will be entitled 'interdisciplinary.'

"We are now coming into a time when some of the traditional practices of engineering are going to come into play in transportation, housing and environment. Electronics will play a supporting role. Other people who will enter the act will be from the fields of management, architecture, city planning.

"For six years, we have run projects in the [MIT] graduate school that have been interdisciplinary. Students and faculty have come from a wide number of departments. We have done things such as the Glideway System and the Metran report [for urban transportation]; designed a city for 100,000 people that floats in the harbor; designed a combined airport-seaport that is miles outside the harbor to keep the noise down.

"The Interdisciplinary Research Topics in Urban Engineering report [available from the American Society for Engineering Education, Washington, D.C.] is our device by which we hope other universities will get involved in this field. It tells how we run these courses, how we find topics, and it includes an annotated bibliography for researching urban engineering.

"Our present report is divided into transportation, housing, and environment."

General Motors, Ford and the General Research Corp. in Santa Barbara are three companies that Baumann says have carried out urban engineering projects with interdisciplinary teams of engineers, economists, social scientists and others.

Baumann sees the rise of what he calls consortia—composed of university, business and government—to attack urban problems.

"There is a popular myth—which may be partially true, as all myths are—that the method-





To replace large underground cars for moving people through a city, urban engineers propose small above-ground automated buses on guideways. This design is from Stanford Research Institute.

ology of the electronic systems engineer is a general-purpose tool," Baumann says. "And that if it was good enough for an Apollo program, it'll be good enough for building a city.

"But there is a large political component. This means that society is not willing to relegate responsibility to some white-coated scientist in those areas that society understands. Going to the moon is a scientific problem which society agreed to let someone else do for them. But when you talk about urban transportation, you find that every American is an expert. This means it is a political issue."

What technology can do, he suggests, is to provide a new alternative. And automated transportation offers one of the most exciting possibilities.

"We find the channel capacity of manually operated systems to be too low for present congestion," Baumann says. "If you put automobiles on the equivalent of a moving belt in the subway tunnels of New York and run them at 60 miles an hour, they would have the same channel capacity—even though there is only one person in each car—as the subway does.

"So we don't have to have big boxes full of people to get high capacity. We believe we can provide individual transportation without causing people to stand at every station and wait for interconnecting vehicles.

"The basis of this 'individual' transit system would be the automobile. When not on the transit system, the automobile can provide conventional transportation. When the automobile is automated in part of its mode, it is a component of a transit system; it can be ridden and operated by nondrivers. When it is manually operated, it has all the flexibility of the other system. But when we put down a mile of guideway, we have solved a transit problem *and* a highway problem, according to Baumann.

"Half the population is not licenseable to drive. So in an automobile society they have to be ferried, chauffeured. An ultimate system will auto-

mate almost all of urban transportation. This dual-mode approach, using the automobile, is an evolutionary one. As tracks are built, more and more of the system is automated.

"So, for example, a guideway is put into a city. Someone comes along and develops apartments. Would it be worthwhile for a guideway extension to be built from those apartments to the center city? In the case of 500 units and the apartments one mile from the end of the guideway, the developer would have to charge about \$10 a month more for making the downstairs of the apartment into a terminal on the guideway. Then, automated transportation of groceries and goods and services of all kinds become available to the dweller of that apartment."

Baumann envisions several type of vehicles:

- The private car—parked either close by or 15 minutes ride away from the owner's apartment (depending on how much of a fee the owner is willing to pay).

- The rented car—this can be "dialed for" in the morning, and it can be used for the day and dropped off somewhere.

- The taxicab—driverless, but used for making trips along the guideway. It would be automatically picked up at one end of the trip and parked or reused.

- A dial-a-bus—a vehicle that would carry 10 to 12 people. It would operate automatically on the guideway, but at the end of its route, a driver would climb in and take each passenger where he wanted to go.

"Each of these phases has a strong electronic component in terms of automation equipment: headway control, speed control and, perhaps more importantly, fail-safe computer systems, and automated vehicle-inspection systems," Baumann projects.

"Some of these ideas of automation of transportation have been around for a long time."

Why haven't they happened? What makes them want to happen now?

"There are a number of answers. Our society hasn't focused on the problem. A guy watching a blastoff to the moon on TV who has just come home after being stuck in traffic for an hour finally decides technology has been cheating him. They have been working on the wrong problems.

"One thing that has to be pointed out to electronics firms is that as we go into automated transportation, in particular, we are confronted with the issue of whether or not it is government or privately financed. Transportation has always

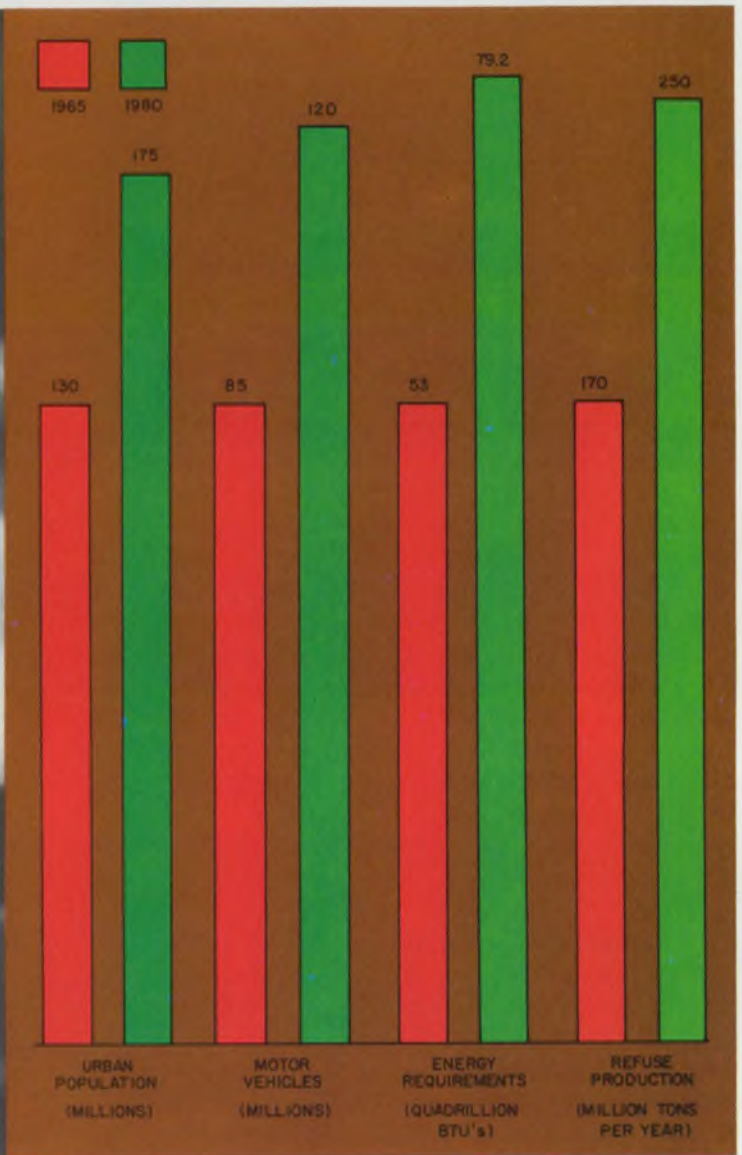

Trends affecting air pollution in the United States. The demand for energy leads other major trends. Refuse

production is second. (Source: National Air Pollution Control Administration.)

been at the interface of federal vs private. Highways are publicly owned and are used by private vehicles; railways are privately owned with private vehicles, and yet a regulated system; airlines are another mix.

"Transportation is one-fifth of the GNP. Should the automobile or steel companies pay for the next development or should government?"

Planning by computer

Paul DeCicco regards electronics as the means of optimizing the engineering systems applied to the cities. "I believe," he says, "that in the next three to five years, the computer will completely turn around the procedural aspects of urban engineering."

The urban planner often starts with a map. But instead of sending out a field party with transit and level, today's approach is to use pho-

togrammetric techniques—taking photos from airplanes and reducing that information to a map format.

DeCicco points out that the urban engineer "has machines which permit him to traverse the map with a movable stylus and determine the X, Y and often the Z [height] ordinates on such a map."

"You can also assign values to a point via a typewriter keyboard to the computer," he continues. "In this way, points can be coded so that water drainage areas, high crime areas, or communication trouble spots can be automatically called up from the computer. The computer can express this information pictorially on a graphic terminal.

"Photogrammetric mapping can be used to design sewers, pumping stations and, finally, sewage-treatment plants. In spelling out specific design requirements, an electronic digitizer can

pick out the important streets, the intersections and so forth.

"Computer graphic terminals will be used in all phases of design and development. Suppose a map of an area is projected on a cathode-ray tube and the system designer wants to move a pumping station. He simply takes his light pen, changes the location and asks the computer to evaluate system efficiency.

"Now the motivation for changing the pumping station may come about from nontechnical reasons. It may come about because the people in one area object to such a structure in their neighborhood. But whatever the motivation for changing the location, the system designer can see the implications of moving the pumping station. Such a move might cost \$10 or \$100,000.

"These are the nonscientific, nonengineering aspects of relating to a community. But without the ability to see the effects of such a change immediately, a system designer would be disinclined to rearrange his plan. Especially if he had spent six months making estimates and coming up with figures and then was asked, 'Why don't we move this two blocks east?' But now he knows that the change can be rapidly evaluated."

Once the graphic design is decided on, DeCicco says, the computer could take all this information and, with specific programs, do everything that's needed to come up with an operational system: It would select the pipes, decide their location, determine their optimum lengths; fix the location and number of manholes; pick the best unit prices based on recent bids and give the total cost. Through an evaluative or simulation program, the computer would also analyze the total system, to give us some insight into its effectiveness.

"Then comes the monitoring system," DeCicco says. "If waste is to be collected, treated and dumped in the near-shore ocean, we had better be sure we're not doing something that will add to the problems that we're trying to correct. So monitoring becomes very important. And here electronics will be used to sense temperature, wave action, tidal depth, saline content in estuarine environments. For large systems, remote sensors via satellites or aircraft—using infrared photography, or side-looking radar—could be used to help us see what effects we are creating."

Solid-waste disposal is a costly item in any community. According to DeCicco, it costs \$4 to \$16 a ton for collection and disposal. And while the population of the United States has doubled in the last 50 years, the amount of solid waste has increased fourfold. Our cities are seemingly incapable of handling the growth of garbage. DeCicco says that less than half the cities in the country have adequate refuse-disposal systems.

DeCicco points out that the collection of refuse

is the most costly aspect of refuse disposal. "It is," he says, "more expensive to collect than it is to incinerate." This is why it's important to know where the refuse is being generated, what the quantities are and what the optimum pick-up route happens to be. Even the methods of collection—trucks, truck-trains, or the introduction of waste into conduits (to eliminate trucking altogether) are important factors in evaluating disposal systems. All these variables can be sent into a computer, and various approaches can be simulated before implementing a system. This can save a great deal of money.

Of all the processes that have to do with pollution control, DeCicco says that incineration "has been the most difficult to contend with."

"We've built incineration plants, attempting to be more scientific now than in the past, and we still have problems with temperature control, heat exchanger tubes that fail, and getting rid of the heat itself without adding to pollution problems," DeCicco explains.

"Every person in a metropolitan area generates four to six pounds of refuse a day. Each pound has 4000 or 5000 BTUs of heat energy. And so in a city like New York, with eight million people, the total amount of energy available each day totals up to 128 billion BTUs—if we knew how to get it and use it.

"We should begin thinking of integrating sewage-treatment disposal plants with incineration plants. One of the problems in treating sewage is drying the sludge. Such an integrated plant would solve the problem of waste heat and provide a means for transforming sludge into a usable by-product.

"Incineration systems can also be simulated on a computer. We can vary the moisture content of the refuse, the heat values in the constituents, the rate of feeding fuel in, and we can get the resultant temperatures we have to deal with. We can look at how much excess air should be added.

"So by having a model, we can make a number of tests which can be used to determine the operational and cost efficiencies of such units. Of course, we do this in our noncomputerized engineering, but we don't do as much of it as we should or have time to do."

Preventing the creation of slums is another problem. Poverty alone doesn't make a slum. DeCicco says that a number of computer programs have been developed to help provide early warning of future slum areas.

"The computer," he says, "can evaluate such criteria as truancy, records of arrest, types of medical treatment—such as venereal disease—unemployment, unpaid taxes and these can be used to predict the eruption of slum areas. With foreknowledge, we may be able to prevent slums from happening." ■■

CONSUMER



The world market for consumer electronics should double by 1980.

FOR THE CONSUMER, IT'S SOLID STATE

Ralph Dobriner, Chief News Editor

In the next decade, the world market for consumer electronics will grow to nearly twice its present size—from \$22-billion in 1969 to nearly \$37-billion—according to General Electric Co. What factors will spur this healthy growth in the decade ahead?

“A tuned-in and turned-on generation oriented to music and entertainment; consumers with more money, more leisure time and a growing involvement and concern with their environment,” is the answer given by Donald Perry, vice president and general manager of GE's Consumer Electronics Div., Syracuse, N.Y.

Perry sees the pace of technological change resulting in the creation of a wide range of unique new products and sophisticated versions of present-day color television, radios, phonographs and tape recorders.

One of the biggest influences on the design of these products will be advances in microcircuitry that will permit “miniaturization, portability and personalization.”

Here are some of the predicted new product developments in the consumer area during the

next decade:

- Two-way cable television, which will permit a subscriber to do his shopping at home, verify his checking account balance with the flick of a dial and select a variety of educational and entertainment programs from as many as 30 channels.
- Almost completely solid-state monochrome and color television sets modularized for ease of serviceability.
- A true clock wristwatch radio with digital readout and personal alarm system.
- A programmed food-freezer and microwave oven combination.
- Solid-state heated appliances such as irons, toasters and coffee-makers.

What CATV holds in store

It is predicted that within five years, as many as 30-million homes—half the households in the United States—will be wired for cable TV. Its capacity to carry messages is awesome. Cable will have 1000 times the capacity of a telephone

wire and at least four times the effective capacity of standard television transmission.

Besides offering a multitude of special programs on as many as 30 unused channels, two-way cable TV could be the basis for a series of specialized services such as facsimile print-outs, opinion polling, utility meter reading, burglar and fire alarms and home-based computer terminals.

"CATV will definitely have an impact on the design of future TV sets, particularly in the tuning package," according to I. L. Griffin, vice president and general manager of General Electric's Television Div. in Hampton, Va.

"To receive the multitude of channels that might be available in cable service will require a shift to electronic tuning, perhaps with varactor diodes, and away from the mechanical approach," he said.

Griffin predicts that the annual total number of television sets sold in the U.S. will reach 15 million by 1974, of which 10 million will be color and 5 million monochrome. In 1969, the industry sold about 12 million sets, and the split was nearly 50-50 for the first time, he noted.

As far as design changes are concerned, Griffin says that within the decade TV sets will be nearly 100% sold-state. "This will probably happen in monochrome before it occurs in color sets."

Where is the CRT going?

He refused to speculate on whether the three-gun CRT will eventually be replaced by the one-gun Trinitron tube.

General Electric's contribution is the in-line set in which the three electron guns are in a single plane instead of the more conventional delta configuration. The in-line CRT requires only mechanical and no electrical adjustment as in most sets today.

This results in higher reliability, he notes: "The set can take more knocking around."

Griffin predicts continued progress toward a more compact CRT. Observing that CRT deflection angles increased from 70 to 90 degrees in the past 10 years, he predicts this figure will increase to 110 degrees in the decade ahead.

General Electric recently demonstrated a projection TV system selling for about \$50,000. This device, says Griffin, will project pictures as large as a movie screen. It's conceivable that an economical version of such a system could be developed for the home."

Color TV servicing is complex

Griffin is somewhat more pessimistic on the problems of maintenance and serviceability for

color sets. He warns:

"Color TV circuitry is about three times as complex as that in monochrome sets. With all solid-state circuitry, the problems of servicing will require a high degree of sophistication and technical competence on the part of the servicemen. Their skills will need to be upgraded."

The problems of servicing these solid-state modules or components, Griffin says, will require instruments that "I'm not sure will be in every service shop."

"The ultimate goal of course," he says, "is to reduce servicing by increasing set reliability, and that's the direction in which the industry is going. Few color sets today are down to the level of reliability of monochrome sets," he notes.

"I think that Motorola's approach to breaking up the parts of the set into serviceable components may very well be the way to go. Those components likely to break down will be more easily accessible to the serviceman. But you still have the problem of determining whether a solid-state device has gone bad or not," Griffin points out.

Housewares to get ICs

"Electric housewares during the 1970s will serve all members of the family and perform needed functions in all the rooms in the house," says Cecil S. Semple, vice president of General Electric's Housewares Div. in Bridgeport, Conn.

"Tomorrow's products will become increasingly sophisticated, utilizing integrated circuitry for more accurate temperature control and commutatorless motors for quieter and more reliable operation.

"Integrated circuitry will make it possible to program sequences of operation and provide more accuracy of control. Appliances will perform complex tasks with less effort and attention. Cooking appliances will be capable of following a sequence of steps automatically. Floor-cleaning appliances will be designed to follow a prescribed course throughout the home without attention by the homemaker."

Time-indication devices and environmental-control appliances are going into all parts of the home, Semple observes.

Battery-operated timepieces are becoming increasingly popular for home use, he notes, as opposed to the rather inaccurate balance-wheel.

"Owners of automobiles with clocks will appreciate the need for greater accuracy," Semple notes. "Several more accurate systems are now being used, such as the tuning fork system with a coil energized by a desensitized feedback circuit."

"Crystal oscillators show promise of even greater accuracy and reliability, and may become

ICs to grab the spotlight

Integrated circuits have so far been used primarily in electronic entertainment products such as radios and televisions, but "within the decade their use may dominate the whole consumer electronics market," says Ralph Greenburg, manager of consumer and industrial applications engineering, Motorola Semiconductor Products.

"Linear ICs used in entertainment and automotive products in the free world will jump from a \$9-million market this year, to a \$44-million market in 1972. In 1974 the market could hit \$93-million," Greenburg says.

The six major consumer market segments, he notes, are TV, audio/radio, large appliance, small appliance, hobbyist/recreation, and automotive.

Motorola is pursuing two basic approaches to consumer ICs, Greenburg says. One is to use the reasonably complex circuits similar to those in industrial and military equipment.

"Such circuits," he says, "usually consist of several high-gain differential amplifier stages with considerable resistive degeneration and outputs buffered with emitter-followers. Such designs provide very consistent unit-to-unit gain and feature extremely low reverse gain. Control functions such as agc, are easily inserted, and the functions are limited only by the number of package pins.

"The second Motorola approach involves design of very simple 'gain blocks.' Some of these simple circuits involve as few as three transistors and five resistors. They perform a single function and are extremely low in cost.

The company recently introduced a new line of these integrated circuits for the consumer market. These functional circuits are housed in 4, 6, or 8-pin packages with widespread—150-mil spacing—pins, compared to the more sophisticated devices in 14-pin and 8-pin configurations. In fact, with their wide pin spacing, the new circuits can accommodate printed-circuit board layouts used in large-volume consumer equipment manufacture.

One of the plastic-package monolithic devices is a 250-mW low-power audio amplifier containing six transistors, three diodes and five resistors. The four-lead package which requires a 9-V power supply, is designed for use in battery-powered pocket radios. It sells for a unit price of \$1.40.

The other device is a high-gain (60-dB minimum) wideband amplifier with a typical output noise of 1-mV rms. The four-lead plastic package contains three transistors and five resistors. It is designed for use as a general-purpose gain block in microphone amplifiers and tape and cassette recorders. This circuit can also be used as a 455-kHz a-m i-f amplifier and as a driver for the audio amplifier above. It sells for \$1.25.



Microcircuit advances are expected to have a profound effect on the design of consumer items.

the timekeeping system of the future. An integrated circuit will reduce the frequency produced by the crystals to a level suitable for driving a synchronous motor."

Digital displays are now on the market using a strictly mechanical approach, Semple says.

"A clock with no moving parts can be made with electronic display tubing such as Nixies or 7-bar tubes. However, drastically lower cost is needed before these can be sold to the mass market."

Perry, of the Consumer Electronics Div., predicts development of a true clock wrist-watch radio with a digital display on the face and a built-in alarm. The biggest design problem here, he says, is how to get a loud sound out of a small speaker.

More deluxe apartments due

"The move from the suburbs back to the city has already started in many areas of the country, and the trend will undoubtedly increase during the next decade," according to Arthur BecVar, manager of GE's Appliance & Television group at Louisville, Ky. What BecVar sees is an urban apartment-oriented society.

"More deluxe apartments will develop," he



Color TV sales in the U.S. could reach 10 million sets a year by 1974, according to estimates. Above is RCA's

futuristic-looking Model 2000 color TV console. It contains an 82-channel remote control.

says, "with more inner gardens and courtyards and more controlled environments." These will be conditioned, he notes, for proper cooling, heating and for pollen, dust and noise control. And there will be more sophisticated kinds of area and mood lighting and intruder warning devices.

Traditional methods of preparing meals may change drastically during the next decade, BecVar says.

"Preparing food from scratch is already on the way out. What lies ahead is perhaps more food reconstituting than food preparation, with microwave ovens becoming popular because of their speed in food preparation." He foresees a continuing trend toward reductions in the cost of microwave ovens and a continuing move toward prepackaged, portion-size, ready-to-eat frozen foods.

Apartment dwellers, he notes, may have access to cooking cores, consisting of microwave ovens and other equipment, which could be inserted and hooked up for special occasions when needed, as supplementary devices.

BecVar foresees "a programmed relationship between the food freezer and the microwave oven developing, so that the homemaker can select her menu, at the time she wants the menu ready, and have the machinery extract the food from

the storage location at the right time."

The role of electronics here, he says, is in the intricacies of logic in this kind of operation—"remembering the locations of specific foods in the freezer."

In the 1970s, says BecVar, we may see solid-state technology extended to heated appliances such as irons, toasters, and coffee makers.

"Thermistors," he notes, "can provide extremely accurate temperature control compared to bimetallic sensors. In combination with integrated circuits, they can provide complex control functions such as fast heating, followed by a slow simmer, or achieve a more elaborate programming sequence."

Thermistors may be deposited as multiple films over large areas of the heated surface to detect variations in the operating temperatures that occur during use, BecVar says.

The Triac, he adds, may be used for full-wave control systems necessary with high wattage appliances. "The use of solid-state technology in the future requires lower cost components that can withstand the hostile environment of a cooking appliance or iron. Operating temperatures of up to 500°F combined with the lack of a natural heat sink are just some of the problems that will challenge the components industry. ■■

COMPUTERS



Holographic memories, such as this experimental Bell Laboratories model, promise storage densities of 10^8 bits per square inch.

THE COMPUTER AND ITS GROWING PAINS

Jim McDermott, East Coast Editor

Computers are going to make dramatic advances in the Seventies. Virtually all responsible leaders in the industry are agreed on that. But big advances are seldom made without problems. And it's here that sharp differences of opinion crop up.

Where will the major problems be in computer development in the next decade?

Ask a hardware specialist, and he says that the big headaches will be in software—programming techniques simply haven't kept up with the hardware. Ask a software specialist, and he says, no, the hangup will be in hardware development—present configurations and capability are hindering programming efforts.

Another point of contention: time-sharing. The hardware men say time-sharing in a big way is just around the corner. The software specialist says time-sharing is "here to stay" but it's not necessarily the wave of the future—the mini-computer is.

Software is a big problem today, and will be *the* big one in the coming decade, according to both Winston Hindle, vice president in charge

of large computers, and Nicholas Mazzaresse, vice president in charge of small computers, at Digital Equipment Corp., Maynard, Mass.

"Today," Mazzaresse says, "computer industry software is five years behind the hardware capabilities. We're designing computers and hardware that are electrically and mechanically modular, so that you can literally take any standard peripheral device, such as a printer or magnetic tape unit, and add it to the basic central processor. But adding new software becomes complicated and difficult, because our software knowledge and techniques are nowhere so near refined as the hardware."

Mazzaresse believes that much greater emphasis on software, as a basic design element, will be needed in the future.

"We used to design hardware and sort of paste the software on," he comments. "At present we spend as much time on software as we do on hardware. But in the next few years software will require a substantially increasing proportion of the effort."

For a somewhat different reason, Hindle also

feels that the "significant developments of the next 10 years are going to be in the software, rather than the hardware," and that it will be in the "development and understanding of huge software programs."

"Some prophets," he says, "feel that in the coming years the world will be covered by gigantic networks. I don't share that view."

Instead, he sees conglomerations of large computers, like Digital Equipment's PDP-10 and PDP-15, tied together at central points, and then perhaps connected to a top tier of supercomputers like the IBM 360 and the Control Data 7600.

Hierarchies of computers seen

In fact, Hindle envisions hierarchies of computers connected together, with the small computers at the user level feeding medium computers which will be collecting and processing data, while a large central computer does the bulk of the "number crunching" calculations for the system.

"So I see computer networks as a very important future development," he says. "We're already heading in this direction with our medium and small computers tied together in a number of systems. But while the hardware today can do the job, the key developments must be in the software area."

"The difficulties of programming such a large-scale, monitor system are immense. The codes for these programs would be so large that it's difficult for any one person to comprehend the entire program. And we haven't yet learned how to manage such gigantic software packages."

The software man's view

But Dr. Jay Hillary Kelley, former science adviser to Presidents John F. Kennedy and Lyndon B. Johnson, and now president of Urbdata Associates, Inc., Philadelphia, doesn't agree with hardware men who reason this way.

"They say that the big problem is going to be in generating the software to realize the potential of future computers and networks." Kelley says, "But I'm not quite sure that's true. While there are more problems with software than with hardware, I think that the present hardware configurations and capability aggravate software problems."

"Many things could be done with hardware which are not done at the present. For example, the problem of pattern recognition has been worked on for many years. And it's not yet solved. And pattern recognition is a hardware problem. If it could be solved, it would do a lot in helping the software problems. For example,

the development of majority logic would help computers in associative kinds of relationships, which is sorely needed for digital computers. This type of hardware reduces software needs.

"And we must remember that there's a trade-off between hardware and software. It's possible to have a universal computer which does all the programming and software specialization internally, by the use of read-only memories [micro-programming]. In this manner, universal machines can be made special-purpose. Where there are great volumes of specialized things to be done, it is best accomplished by specialized machines."

As an example, Dr. Kelley points to the U.S. Census Bureau. For its specialized operations, he says, "we can use more hardware programming than software."

The incompatibility problem

Another flaw that Dr. Kelley cites is the programming problem caused by incompatibility with hardware, especially with peripherals.

"Take coding formats," he says. "While one manufacturer uses a certain code for a particular key or symbol on the input-output teleprinter, another manufacturer will use a different symbol."

"This makes, say a Cobol program, incompatible for both systems. It is necessary to change the program to apply it to the second computer. The hardware is at fault here, and it will be quite some time yet before computers become truly compatible, as far as software interfacing is concerned."

The next few years will see considerable change in this area, the Urbdata president continues, "because there are a lot of forces today pressing the computer manufacturers." But the speed with which software will become standardized and interchangeable, he says, is not too clear at this time, "because we have two forces pulling against each other, one towards standardization, the other towards innovation."

"There is the standards work being done by the American Standards Association, Dr. Kelley notes. "And the Federal Government is continuously applying pressure on the manufacturers for interchangeable software."

But innovation in the industry may offset the gains made, he says. As an example, he points to the new, small System/3 built by International Business Machines. A principal feature is the nonstandard, card it uses—much smaller than for other systems on the market. "Now, it's unique to IBM, but we'll have to wait and see if other manufacturers pick up this new input device, or whether they'll follow their own unique approaches," Dr. Kelley observes.

He believes that "ultimately it will be possible

to develop an algorithm in natural language.”

“It’s now been almost 15 years since work began in mechanical translation of languages,” he notes. “It bogged down, and the reason was that the algorithm for the natural language simply was never developed.”

Programming the big computers “that have the memory and computational capabilities to handle the natural-language algorithm, which would be massive, might be coming in the next five to 10 years,” Dr. Kelly says.

Within that period, he believes, an interim pseudo-natural language will be developed—a “hierarchically structured language based on application programs.” Engineers, as well as scientists, in such fields as economic modeling and simulation, and other urban and nonscientific subjects, would each have their own unique micro-program stored on read-only memories. A series of these programs could be created for the small computer, but the programs would be stored in a larger computer—in which case it would be “a matter of pushing several buttons to pick up one particular set of application programs,” Dr. Kelley says.

Hardware designers speak of the future in terms of having the machines taking over more and more of the programming internally. Dr. Kelley doesn’t see it that way.

“This particular point,” he says, “is one which the natural-language people have been making for years: ‘Let the computer make the decisions.’ But the computer can’t make decisions, because it does not understand ‘meaning.’ It can only understand words that have a meaning. And since words have all kinds of ambiguous meanings, both in and out of context, the computer will be unable to make an algorithm that the programmer wants.

“We have meaning when we speak, but the way we express it is so complex that present-day computers are unable to determine what we mean.”

In the next 20 years, Dr. Kelley believes, a natural language will be developed for the computer. It will “understand our voice and make decisions on our voice.” The result, he says, will be to “preclude all programming; you’ll be able to talk, or write directly, to the computer.”

Time-sharing networks expected

Both Hindle and Mazzaresse of Digital Equipment Corp. are enthusiastic about the future of time-sharing networks.

Networks of all sizes, Hindle predicts, will grow rapidly in the next few years, and hierarchies of computers will make such growth possible.

“In fact,” he says, “we’re already heading in this direction, with our medium and small com-



Large computer time-sharing systems, such as RCA’s Spectra 70/61, may some day be tied together into a nationwide time-sharing network, experts forecast.

puters tied together in a number of systems. Today’s principal users of time-sharing systems tend to be engineers and scientists, but some computer service bureaus supply business needs—one segment that will grow rapidly.”

Ultimately time-sharing networks are envisioned reaching into the home—“first, it will be used by the affluent, but at some point it will be as inexpensive as telephone service,” Hindle says.

A principal impetus in this direction will be given by low-cost terminals, he points out.

“Low-cost terminals are the dream in everybody’s mind, including ours,” he continues. “But things such as hard copy or visual displays are expensive. And the development of graphics is important.

“For example, a large part of the future market will depend on the ability to edit text and to have access to the program, so as to change characters or lines. But such a capability is costly.”

Mazzaresse agrees that “time-sharing is going to grow by leaps and bounds in the next few years.” But he points out that the real contribution to its expansion will be reduced peripheral equipment costs. While the price of such equipment as keyboards, teletypes, line printers, discs and tape transports is gradually coming down, he says, “new items, particularly low-cost document scanning devices, will appear on the scene.”

But high-volume production of peripheral equipment will not, in itself, substantially lower prices, Mazzaresse contends, because “most of the equipment already developed has been performance-oriented—that is, for a small margin of



Advance display system developed by Sanders Associates for NASA research is typical of advanced peripheral equipment under development.



Technician at Sperry Rand Univac inspects diode modules on a plated wire aerospace memory plane. LSI will spur development of ever smaller memories.

higher performance, costs have been substantially increased."

So to attain the low-cost goal, future peripheral units will be produced "on a cost-effective basis," he says, with only the minimum required performance built in. As an example, Mazzaresse points out that the "household computer will have nowhere near the requirements of one for a scientist."

"Instead of a high-performance printer, the consumer user may need only a simple alphanumeric display from which he copies data with a pencil and pad," Mazzaresse says.

A current trend is already evident in the use of standard, low-cost magnetic tape cassettes for data storage.

A dissent on time-sharing

But Dr. Kelley doesn't share the hardware men's enthusiasm for time-sharing.

"Time-sharing is here to stay," Kelley admits, "but how much or how fast it will expand is a moot question. I'm not so optimistic as some of the others, because the area where I see computers of great advantage in the future is not necessarily in the systems configuration, where remote terminals are tied to a large, central processor, but rather it's the smaller computer.

"Remember, the powerful computer is good for one thing. It can process large programs internally and can do a massive analysis of work within itself. But it falls down on handling a large input-output volume. And this is one of the main reasons you don't see many time-shared systems

offering the Cobol language, because Cobol is a business-oriented language that requires a large amount of both input and output data.

"So I think that the large computer complexes, located at a distance from where the data is wanted, are not going to be widespread. Instead, I see a great expansion in the small, desk-top computer."

If it's cheap enough, it could be "on line," Dr. Kelley indicates. But he warns that if low-cost home terminal applications become widespread, programming will be a definite problem because of the wide variety of users. Which means that the user "must either understand what goes on inside the computer," he says, "or must, with the present state of the art, have special, application-oriented programs." The consumer will not, Dr. Kelley concludes, be able to program his small computer in simple, natural language for possibly the next 20 years.

The application of computers to problems other than science and engineering will be greatly widened in the next few years, Dr. Kelley believes. As an example, he points out that "in the sociological areas, application of the scientific methods of the computers is becoming more and more useful." This includes statistical analysis, factor analysis and simulation modeling.

"But what the digital computer hasn't been able to do so far is handle probabilities directly," the Urbdata president says, "Instead, it handles them by means of large matrices and statistics. When we develop better methods of digital manipulation, computer use in the urban and sociological areas will be greatly enhanced." ■■

MICROELECTRONICS

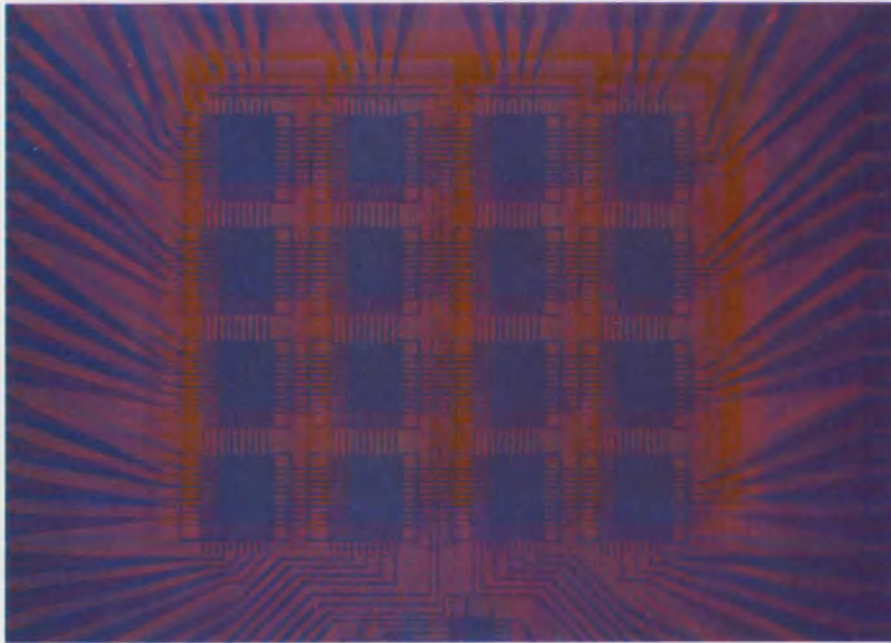

Face-down bonded LSI chips on ceramic substrates promise cheaper memories.

A CHANGING WORLD WITH MICROCIRCUITS

Raymond D. Speer, Microelectronics Editor

Wide application of large-scale IC memories, extensive custom design and a fantastic increase in the linear IC market. That's the next 10 years in semiconductors, according to Steve L. Levy. And from his vantage point as vice president and general manager of Motorola Semiconductor Products in Phoenix, Ariz., he also sees a great expansion in computer-aided design.

"Medium-scale and large-scale memories, designed with computer aids, will be the most significant semiconductor developments in the 1970s," he says. "These components are going to have a profound effect on our business. We expect to see a \$500-million semiconductor memory market by 1980 in bipolar and MOS circuits."

This vast growth will not necessarily mean a change in fields of application, although some new market areas are bound to open up.

"I'm talking about the use of memory components in computers and data processing in general, in the kinds of applications in which they are used now," says Levy.

And now does he account for the proliferation of LSI?

"Large-scale integration and computer-aided design will give us lower costs per function—as low as 1¢ per bit, depending on the kind of memory and the application," he replies.

Levy feels that the range of memory products to be offered will be very wide, and he's not sure just what complexity the customers will want in memory components.

"We can build memory assemblies with capacities of up to 8000 bits now," he says, "but we can sell individual planes or bit packages or chips, depending on what the customer wants. We have to talk in generalities about the memories that will be needed, because the exact nature of the need isn't known yet. In what products the volume market will be is not at all predictable at the moment."

How, then, will Motorola enter the market?

"We're offering assembled memories—at a complexity of 8000 bits per module at first. We think that this is a good size to start with, but it may be that our customers will want units with twice, or half, that capacity."

Will semiconductor prices decline further?

"Of course," says Levy, "we'll see the same general trend toward lower prices that we've seen in the entire industry in the past. But the prices of more mature products, like RTL and DTL will tend to level out. These prices won't drop nearly as much as the prices of low-volume, high-cost sophisticated devices."

More custom design expected

Levy predicts economic pressures will force the logic market to a position where it will be more than half custom design by the end of the decade.

"With LSI it becomes impractical to carry a standard line of parts in the same sense as we do now," he says. "In order for components to be integrated on a large scale, the end use has to be factored into the initial design. This means that to take advantage of the economies which LSI permits, one will probably wind up doing a substantial amount of custom design work.

"An exception is in the memory area, of course. Here you can build really useful standard products. But if LSI arrays are to be used in control-logic circuitry, we'll have to engage in a much greater number of custom designs to satisfy the needs of our customers. They're going to want LSI because it can be cheaper, and we're going to have to make it to satisfy their needs."

Levy sees some very good things coming in computer aids: "Development in both software and hardware will let us take a system description and do partitioning, automatic chip layout and automatic test generation to provide custom semiconductor components which perform the function."

What will the developments be that will make all of this possible? Again, no revolution.

"We're working on all of these problems now and we still have a lot of work to do," Levy says. "All of it is basically a hardware problem, and it will require a lot of effort by a lot of people to solve.

"By mid-decade a competent semiconductor house should be able to take the description of a system comparable to one of today's mini-computers and deliver prototype parts in six weeks for less than \$25,000."

\$500-million linear market expected

The future looks good for other IC markets, too. Levy expects the total linear IC market to reach roughly \$500-million by 1979.

"The IC consumer market will literally explode in the early 1970s," he says. "Consumer linear ICs will account for approximately 40% of the total IC sales, roughly double their present 20%."

The computer/industrial IC market will grow

from its present 30% share of the total IC market to 35%, Levy says, and the government-oriented sector will decrease from 50% of the total IC market to approximately 25%.

"Linear ICs will dominate the consumer industry in the Seventies," the Motorola executive predicts. "Color TV receivers will be developed that contain six to 10 ICs and a minimum of external parts. And low-cost hybrid modules will include all needed capacitors, power or tuning components.

"The color TV set of the near future will be a simple, reliable, low-cost assembly of a few easily replaced modules. Numerous other consumer systems—such as the auto radio, a-m and fm stereo, phonograph, home video playback and so on—will ultimately consist of simple, easily repaired assemblies of integrated modules."

Complexity will grow along with sales, according to Levy. "The next 10 years," he says, "will see linear ICs moving into the category of MSI and LSI, chiefly in the area of analog-digital interface circuitry. Chips will be developed to provide complete, high-speed A to D and D to A converters in the six to eight-bit range."

Exact speeds are difficult to predict, but the new linear integrated circuits will be comparable in this respect to sub-nanosecond gate-delay logic circuits, Levy says.

"Higher-power analog circuits will have significantly higher current-handling capability—currents of 10 to 20 A at voltages of 50 to 200 V—and larger chips will offer power capability in the 200-W region. In fact, linear monolithics will have power characteristics equal to present discrete semiconductors. This also means that new developments in power packages for ICs will keep pace."

Strong growth in hybrid circuits

Hybrids, according to the Motorola executive, are in for a great boost. "Precision hybrids built with monolithic chips and trimmed thin-film networks will assume great importance," he says. "Analog multipliers, dividers, function generators, RC-active filters and oscillators, and complex analog subsystems will be built with this technology. Laser and anodic trimming will be refined for volume production to give 0.1 to 0.01% film accuracies at low cost.

In the processing area, there will be a great refinement in the III-V compound semiconductor technology, Levy expects, making possible low-cost devices—infrared and visible light emitters and bulk-effect microwave devices—that use such materials.

"We're just beginning to see some significant commercial effort in III-V compounds," he says. "We've talked about them for years, but now



"MSI and LSI memories are going to have a very profound effect on our business in the 1970s"—Steven L. Levy, vice president and general manager, Motorola Semiconductor Products Inc., Phoenix, Arizona.

we're starting to build more devices and play with them, and we're making significant investments in equipment."

What do the new compounds offer?

"Far better light emission per unit power input and better spectrum control. It appears that these compounds will be better than gallium arsenide. Large monolithic arrays of light-emitting diodes may become suitable for replacement of cathode-ray tubes." ■■

Engineers who don't use computers won't be doing much designing in 70s

"The future for the designer is spelled computer," says Seymour Schweber, president of Schweber Electronics in Westbury, N.Y.

A distributor of electronic components, he sees big changes coming for the electronics engineer of the Seventies—in his tools, in the way he builds and packages circuits, even in the way he'll get his education. Most of these changes will involve new uses of computers.

"There will also be a definite shift of engineering talent in the country, from military-oriented work into the computer industry," Schweber believes.

No question about it, he is impressed with the

potential of the computer.

"One of the most important changes in design engineering in the Seventies, one that has already begun, is the move toward complete dependence on computers in design," he says. "Computer-aided design will soon be the standard approach for creative engineers, especially in the design of IC chips. MSI and LSI components are becoming so complicated, and the technology is moving so quickly, that computers will soon be an absolute necessity.

"Standard practice for determining whether an integrated design is practical, for instance, will be to input that design to a properly programmed computer, which will check it and reject it, if it isn't going to work. Mask drawing will have to be done by computer, too, of course, and the manufacturers are moving in this direction now.

"In business, time is money, and designs must be done quickly. There are very few really top designers in the industry, and we must milk these people for their talents. We must properly assist them with the latest equipment in engineering aids, and we must try to multiply their productivity wherever possible.

"The price of digital computers, too, will drop to under \$5000 sometime during the 1970s. But engineering time will become more expensive. As salaries keep moving up, engineers will, by necessity, seek to increase their productivity, and they'll look to the computer. The engineer of the Seventies will have to learn to program and communicate with computers, because they will be his working environment."

Modular construction envisioned

Coupled with the trend toward dependence on computers, Schweber sees a definite move to modular construction and redundant circuitry.

"Circuits will get smaller and packaging denser," he says, "and because it will be impossible to repair on the job, all equipment will have to be built with plug-in modules. The boards will be thrown away or returned to the factory if they fail.

"Computers will have trouble programs in the 1970s. Running these programs will yield results that can be telephoned into a supplier's central computer for instructions as to which circuit board is to be removed or replaced.

"Computers and complex equipment will be self-healing and self-correcting in the 1970s. The farther we go into complicated circuitry the less effective repair people can be in correcting circuit faults—they will have to carry too much equipment around with them to analyze a malfunction. It will become much more economical to build double or triple redundancy into the cir-

cuitry, so that if one function fails, another can take over."

A new employment trend

Changes in design techniques and their results are not the only trends Schweber sees in the future. He expects a significant shift in job applications by the top technical innovators.

"In the 1970s," he says, "the designers in the computer industry will lead the technology. Up to now the military people have been the only group who could afford to finance technical advance. They'd say, 'We want an equivalent of one Mack truck compressed to one cubic foot, and we don't care what it costs.' And the top technical talent in the country would do it. But the computer industry is taking on such fantastic importance that the top technical people are shifting to it from the military and NASA.

"Right now 90% of the engineers and scientists in the country are in military or NASA-related work. I predict that in the next decade we will see a maximum of only 50% of our engineering talent involved in the military-industrial complex.

"The people who will initiate this move are the leaders—the tastemakers, as they say in the art or fashion world. They are looked upon as the innovators, the people who set the pace. These are people who do not believe in stringent controls or in being put into corners. They are individuals, creative people, who design circuits and technical innovations while they are, say, playing a Beethoven sonata. They are extremely creative, and they aren't money or power-hungry.

"They seek out homes and jobs in environments in which they feel comfortable, and I feel that the regimented military-industrial complex puts such tremendous demands on their personalities that they'll find the computer industry more rewarding. They will find that they cannot function happily in the military atmosphere. This plus the fact that the computer industry can now afford to hire them and occupy them, will lead to a great shift in the placement of engineering talent."

Engineers: curious and furious

As far as learning about semiconductor technology is concerned, Schweber says, formal education will not be enough.

"The engineer in the Seventies will have to learn on the job, attend special courses and read up on the subject in which he needs a background. Seminars, even visits to the IC factory, will be a must for every responsible designer.

"And keeping up won't be easy. We'll find that older engineers will come in two classes in



"In the 1970s it will be the designers of the computer industry, not the military people, who will lead the technology"—Seymour Schweber, president, Schweber Electronics, Westbury, N.Y.

the next decade: One will be curious, the other furious. The first, inquisitive type will keep up with the pace, and continuous attendance at seminars, meetings and reading will be the order of their day, every day. The older, bewildered engineers, the second class, will drift slowly in the field and actually remain static as far as their careers are concerned."

Schweber sees successful design engineers in the Seventies, again, as two different groups.

"One group will be the state-of-the-art designers who will lead the semiconductor industry into new IC designs," he says. "The other group will be the innovators, the ones who will take existing subsystem or IC designs and by their own individuality create unique systems.

"There will have to be a closer liaison between the circuit design engineer and the semiconductor manufacturer for many circuit needs, and a need for proprietary control of designs may cause hundreds of medium-sized companies to invest in in-house semiconductor facilities to keep their secrets." ■■

For average American in next decade, it will be an electronic way of life

The most profound changes in the history of the home, the factory, the hospital and the battlefield will occur in the next 10 years because of electronics, in the view of Gordon K. Teal, vice president and chief scientist for corporate development at Texas Instruments, Dallas.

Teal sees the man-on-the-street in the Seventies living in a world controlled by and dependent on semiconductor electronics. "Although the average American will be only vaguely aware of it," he says, "electronics will literally pervade his day-to-day existence in the 1970s.

"Businesses, factories, national defense installations and even professional offices will be specially designed to make the best use of computers," says the semiconductor executive. "The consumer will be pampered and entertained by environmental control systems, automatic food-shopping computers and flat-screen TV.

Luxury for the consumer

"Low-cost electronic controls will make it possible to economically control the climate of our homes," the TI executive says. "Not only will we electrostatically cleanse the air and control the moisture, but we will even be able to maintain independent temperatures in various parts of the house, regardless of varying ambient heat or solar exposure. And external temperature sensors will provide anticipatory response to sudden weather changes.

"The most obviously electronic device in the home—the television set—will still be there in the 1970s. However, flat, wall-hung screens will be available to give the housewife greater flexibility in her furniture arrangement.

"Television programming, unfortunately, will probably not be too different. However, for a fee and via CATV, we will probably be able to expand the choice of programs to include selective-interest material, such as concerts and opera, or reruns of previous programs whose viewing was interrupted. And libraries of videotaped programs will be available.

"The nation's telephone service is just beginning to go solid-state. In the next decade, a wealth of telephone functions will emerge, made economically possible by solid-state electronics. Water, gas and electric meters will be read automatically and the data transmitted to billing centers over telephone wires."

Better cities through semiconductors

Two of the biggest problems affecting our cities are traffic control, both vehicle and human,



"The most profound changes in the history of the home, the office, the factory and the hospital will occur in the next ten years"—Gordon K. Teal, vice president and chief scientist for corporate development, Texas Instruments, Dallas.

and crime prevention. Semiconductor technology, according to Teal, is at work on the solutions.

"In Washington, D.C.," he says, "an in-car electronic route guidance system is in pilot operation, projecting route directions on windshield viewing screens, directing drivers to their destinations. In Dallas, a computer-controlled freeway access system will soon be installed. It will provide smoother traffic flow on the main arteries. And closed-circuit television monitoring of vehicular tunnels and freeways is already commonplace.

"In the automobile alone, electronics can perform many functions that will increase highway safety, reduce air pollution and improve performance. Texas Instruments has already worked with Kelsey-Hayes, for instance, to produce a skid-control system, now available as optional equipment on Lincolns and Thunderbirds. And Volkswagen uses electronically controlled fuel injection, which increases fuel economy and decreases pollution through more complete combustion."

Mass transit, an absolute must in dense cities of the future, will be given a big boost by semiconductors, Teal asserts. San Francisco's Bay Area rapid transit system has been designed for almost total computer control, and Pittsburgh's new monorail system will also be largely computer-controlled.

"Most of the nation's major railroads already employ electronic systems to scan boxcar numbers in major marshaling yards, transmit this data to a computer, and thereby maintain loca-



"The coming generations of computers will strongly influence the way we run our businesses, our factories, our professions and our national defense," according to Teal. Our schools will be computerized, he says, and individual instruction programs will make education

much more personal. The average citizen will see more comfortable homes, better telephone service, greater use of credit cards and better entertainment. Traffic control and crime prevention, too, will be much improved. Photo courtesy American Data Systems, Inc., Chatsworth, Calif.

tion control of all rolling stock throughout the country," Teal notes.

"Electronics in the Seventies will help restore law and order in our cities. The National Crime Information Center at the FBI in Washington, for instance, makes information on stolen property and wanted persons immediately available to any police department.

"Computerized police dispatcher systems are now in operation, too. New York, Minnesota, Louisiana and several other states already have their own state-wide computerized crime information systems."

Computers for individual instruction

Electronics will not replace the teacher, in Teal's view, but it will perform many non-teaching functions, such as test grading and class scheduling.

"Our schools will become computerized, but they will not necessarily become less personal," he observes. "In fact, individualized and personalized instruction programs will become feasible only through use of the computer.

"And our students will not be restricted to the material contained in a few textbooks. Computerized information retrieval systems will supply references to other books, as well as to articles, films and videotapes. Libraries of videotaped instructional material will be sent by closed-circuit television into individual classrooms and even to individual desk-top displays."

The Dallas executive also expects the semicon-

ductor industry to serve the medical patient in the coming decade.

"It will multiply the effectiveness of diagnosticians, surgeons, medical technicians and nurses," he says, "and will permit early detection of illness, more skillful treatment of illnesses that cannot be prevented, and effective substitutes for body parts and senses that are impaired or lost."

ICs for 'instrumented battlefields'

In the Seventies, enemy forces will be located, tracked and targeted in real time through the use of sensor systems, data links, computer-assisted intelligence evaluation and automated fire control, Teal says.

"Night will no longer be a cover for clandestine operations. Many night-observation devices are now being used, and the next generation of equipment will completely strip away the cloak of darkness, allowing both manned and unmanned observation of enemy movements.

"Microelectronics and microminiaturization techniques will lighten the load of the soldier and of supporting aircraft and other transportation systems, while providing a greater quantity of sophisticated equipment. This lightened load will lead to increased mobility, and this increased mobility will provide us with a true military 'stand-off' capability, so that the larger part of our military forces and equipment can be kept at home, capable of quick delivery to a trouble spot by jet transport and helicopter." ■■

COMMUNICATIONS



More stored-program electronic switching systems are on the horizon.

URGENTLY WANTED: A DATA TERMINAL

Michael J. Riezenman, Microwaves Editor

You might think that the perfection of a practical laser communication system, or some other such exotic development, would head Dr. John R. Pierce's list of exciting projects for the 1970s. After all, Dr. Pierce is the visionary thinker who enthusiastically urged the use of earth satellites for communications more than 15 years ago. And now, as executive director of research in the communications sciences division of Bell Telephone Laboratories, Murray Hill, N.J., he's still concerned with the future growth of communications in the U.S.

Yet the development that Dr. Pierce is really anxious to see is the design of a "cheap, compact, reliable, maintenance-free—but above all, cheap—and acceptable terminal device" for data communications. Problems in the more exotic areas, Dr. Pierce feels, are well in hand. But the development of an acceptable data terminal—for widespread use in both homes and offices—is, he says, "apparently much more difficult than landing a man on the moon."

Dr. Pierce is concerned about the development of these terminals because of the profound effect

they will have on the whole communications picture in the U.S. If and when the devices are produced and universally accepted, they'll have a two-fold effect on transmission systems:

1. They'll greatly increase the volume of traffic, taking over even the distribution of mail and newspapers. Electronic signals, rather than delivery men, will carry this material into people's homes.
2. They'll change the mix of transmitted traffic from mostly analog to mostly digital.

These factors will stimulate the development and installation of both high-capacity digital transmission systems and time-division switching equipment. Conversely—and this is probably a better expression of Dr. Pierce's views on the subject—the lack of progress in terminal devices is slowing developments in these two other areas.

Does Dr. Pierce see any hopeful signs for a solution to this problem in the 1970s?

"I can always hope," he says. "But I don't see anyone with an idea that will bring it to fruition."

He narrows the problem a bit by explaining

that sending the data is no problem—contactless magnetic keyboards can be made that are both cheap and reliable.

“But something to receive the stuff is needed,” Dr. Pierce emphasizes. “Nothing I’ve seen is what you want. I don’t know what it will look like, but if somebody brought it and set it on my desk, I’d recognize it.

“There’s such a gap in cost and reliability between a telephone and a teletypewriter, and yet the small teletypewriter is the cheapest and most reliable terminal today.”

What about the new Inktronic teletypewriter? It prints by electrostatically deflecting a stream of ink. It writes as fast as you can read and has fewer moving parts than an ordinary teletypewriter.

“The Inktronic is promising. But it’s not it,” Dr. Pierce says.

When asked why, he explains that it is too costly and will probably have maintenance problems. He goes on:

“I’m very skeptical about printing out on paper, especially for the home, and maybe for the office. You want to be able to get a paper copy when you want one. But it would be nicer if it appeared on a screen first, and then you could push a button for a hard copy. Otherwise you will have a continual stream of stuff out onto your floor.

“Suppose you could put the New York Times into your home electronically. You wouldn’t do it. You wouldn’t want the rolls of paper in your basement, and you wouldn’t want the stuff streaming out all over your living room—unless you could make paper out of thin air and dissolve the stuff back into thin air.”

Waveguide is coming

There is, however, one area about which Dr. Pierce speaks with certainty—long-haul transmission via millimeter waveguide.

“Millimeter waveguide will be getting into substantial commercial use in the Seventies,” he says.

The waveguide, although extremely expensive to install, will greatly reduce long-distance rates because of its ability to carry tremendous quantities of information. A single two-inch pipe can carry 250,000 to 500,000 telephone circuits or 250 to 500 TV circuits, Dr. Pierce explains. The system will be digital, using phase-shift keying (PSK) modulation. Solid-state repeaters will be employed, and they will be spaced roughly 20 miles apart, he says.

The use of all-solid-state repeaters is particularly significant, Dr. Pierce explains, not only for waveguide systems but in wire, cable and radio circuits, as well. The key word here is re-

liability, although cost and bandwidth are pretty important, too.

In discussing the future of coaxial cable systems, the Bell research chief predicts that bandwidths will increase as repeater spacing gets smaller:

“Improvements in the solid-state art make it possible to have many more repeaters and have them operate reliably for very long times. You can get a lot more over a given medium than in the days of vacuum tubes.”

How, exactly, are bandwidth, repeater spacing and transistor reliability related?

“Attenuation goes up as the square root of the frequency,” he explains. “And so, as you use broader bands of frequencies, you have to put the repeaters closer together. You can do that only if you have very broadband, very high-quality repeaters.

“The transistor gives you a very broadband repeater, and it has such good amplifying qualities that you can have a lot more feedback than you could in the days of the vacuum tubes—which tends to lower the amount of distortion so you can afford to have more repeaters in the line. Also, the transistor is more reliable, again allowing you to have more repeaters in the line.”

“Transistorization,” as Pierce calls it, has a similar effect on radio systems.

“It’s possible, because of transistors and other advances, to put microwave repeaters, say, five or so miles apart,” he notes. “This opens up the possibility of using the 15-to-30-GHz range.”

Does he mean one can actually have reliable transmission through the atmosphere at millimeter-wave frequencies?

“That’s right,” he says. “If you put the repeaters close enough together and if you get diversity by running parallel routes, or something like that, you can get [reliable] transmission in that frequency range.”

Dr. Pierce goes on to explain that extensive studies of rainfall patterns have been made and “everything looks very good—rain, you see, goes on very heavily in one place while it’s clear in another.” Thus route diversity is an effective way to provide reliability.

Laser systems far from ready

A rather different picture emerges when lasers are considered. First of all, there are problems with the devices themselves.

“We don’t yet have good semiconductor lasers or any laser that is very economical and looks awfully nice for a system,” Dr. Pierce notes. “We do have ways of guiding beams with solid or gas lenses over long distances. The terminal art doesn’t have everything in as good a state as we’d like, although Stewart Miller published

something in the last *BSTJ* about miniature integrated optical circuits. We're getting there.

"Also, a lot of work is being done on fibers for guiding light. The present state is such that although you could build a variety of laser communication systems, they wouldn't compete with anything. The art isn't far enough along. . . .

"By 1980 we'll probably have something in use, but it's hard to tell what it will be because the facts aren't in yet. It could be a very broadband system competing with waveguides and satellites, or it might be a very economical short-haul system using glass fibers.

"It's believed that there's nothing to keep one from getting the attenuation of glass fibers down to the point where you could send signals over them for half a mile or a mile. But nobody has produced such fibers yet."

Laser beams must be guided

Solid and gas lens systems and fiber optics are all expensive guided-wave transmission systems. Would it be possible to simply use the atmosphere as a transmission medium?

"No," Dr. Pierce replies. "We've made a lot of measurements through the atmosphere, and it just doesn't seem to be good enough.

"Just the least little fog puts [laser systems] out completely. Optical frequencies aren't any good on earth, they aren't any good from space to earth, and that's about that—even for the very long wavelengths."

But can't you apply path diversity, as with millimeter radio?

"No, I don't think so because the 10-micron wavelength was out about 30% of the time in our experiments. And it seems to go out over large areas. The least little haze would take the light out, and that might extend over quite a large area.

"So far as I can see, optical transmission through the atmosphere is out, if you expect any reliability. Shorter radio waves [like 60 GHz] might be useful over half a mile or so in suburban areas or in cities. But not optical wavelengths."

Satellites may prove disappointing

Speaking about the really long-term picture—50 to 100 years from now—Dr. Pierce says:

"I think that the waveguide and microwave radio and cable will go for quite a while, and then guided lasers will come in when the technology advances enough."

But what about satellites?

"Certainly there'll be increasing use of satellites for transoceanic communication," he says. "But for domestic use, the satellite must com-

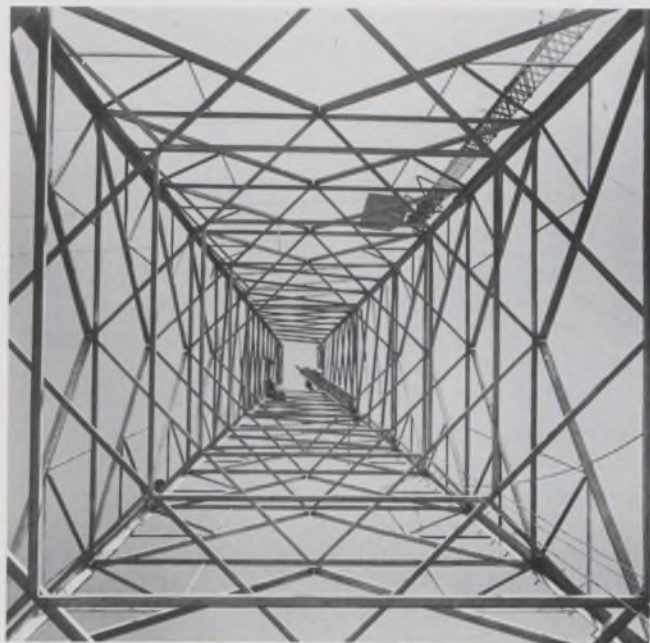

Microwave radio frequencies will go higher—into the millimeter region. The relay towers will be closer together so they needn't be as tall as this 220-footer.

pete with waveguide, cable and radio."

There are several advantages and disadvantages in using satellites for domestic communications, Dr. Pierce explains.

"You can certainly get very cheap circuits," he notes, "especially if you build very large satellites as Tillotson discusses." He showed that you could get hundreds of millions of telephone channels. But to get really large numbers of circuits, you would have to go up above 10 GHz."

Another well-known advantage of satellite circuits is that their cost is independent of the distance between earth stations.

"On the other hand," Pierce observes, "for telephony, there are the problems of delay and echo suppression. People are sometimes bothered by this in international circuits, but they aren't bothered enough to bother them, I guess."

Echoes are a problem in circuits that are longer than 1,500 miles. The hybrids in the telephone sets (or switching centers) couple part of the incoming signal back to the sender. If the circuit is long enough, the delay is great enough to cause an annoying echo.

The usual cure is to install an echo suppressor. This device cuts off a sender's incoming line while he's talking. And it doesn't reconnect the line as soon as he stops talking; it waits long enough for any echoes to have passed. Now, as Pierce explains:

"For short delays this isn't bad. But for a satellite with a round-trip delay of 0.6 s, the following thing happens:

"A person asks the other fellow a question. He doesn't get any response. He starts to speak again



Millimeter waveguide is coming. Circular guide will be used for its low loss characteristics. This experimental installation is at Bell Labs, Holmdel, N. J.

—just about the time the other fellow is answering. And so the answer of the other fellow gets cut off.”

There are ways out of this, Dr. Pierce notes. One is to make a self-adapting network that cancels the echoes. Such a device compares what's going out with what's coming in. And if the signals are the same, it readjusts the equalizing networks to cancel the echo.

“But this is pretty expensive,” Dr. Pierce observes. “So there's some question about the economics of satellites for the telephone.”

He summarizes his attitude towards domestic satellites as follows:

“I'm very optimistic about satellites in the medium run. In the very long run, there'll be so much communication that you'll run out of frequencies. But that's probably 50 years or so away. In the very short run, the economics and flexibility may not be as good as people think.”

No more spectrum

Pierce doesn't expect the world to run out of spectrum in the 1970s. But he points out that it is already impossible to get any more common-carrier microwave radio into Los Angeles on any frequency. He goes on:

“Sometime, maybe 50 or 100 years from now, we'll use up the whole usable radio spectrum. This is on the assumption that communication will grow without bound, which I believe it will do. The spectrum won't grow without bound. We'll push it up to the point where fog will get in the way—and that's life.”

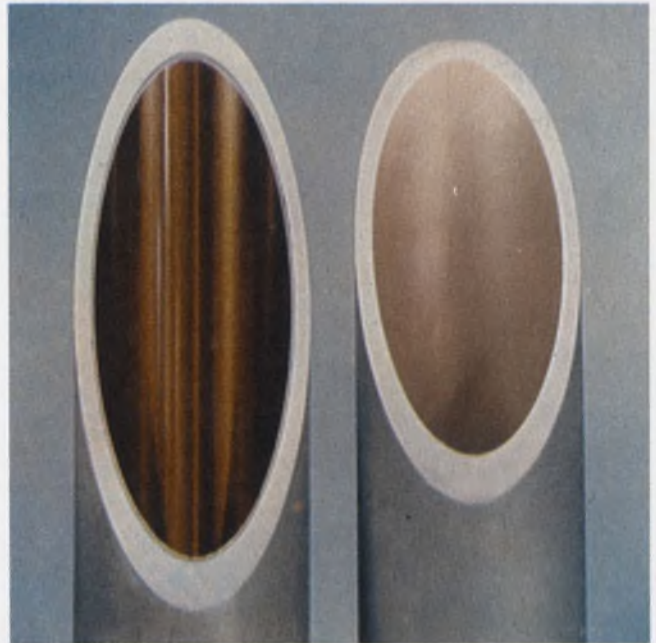

Even tiny flaws cause multimoding in circular guide. Two linings that combat the problem are helically wound insulated wire (darker) and dielectric-coated copper.

At that point, Pierce explains, we'll have to reserve radio frequencies for transmission tasks that can only be done economically by radio—mobile communications, transoceanic satellite communications, etc. Other services, such as TV and radio broadcasting, telephone service and data communication, will have to be handled by guided-wave systems.

But this will have certain advantages. Instead of only seven TV channels coming into a city the size of New York, as at present, perhaps 20 will be available. Viewers will have a much wider choice of program material from which to make their selections.

Instead of trying to produce more and more expensive productions in order to compete with each other, broadcasters may suddenly find a need for low-budget programs to fill the large number of channels that will become available. Special educational or professional services, not now economically feasible, may become commonplace.

Pierce pointed out another advantage—the elimination of ghosts in TV reception—by quoting Cleveland Amory's remark upon first watching a cable TV transmission:

“Now when I watch a game, there are only two teams on the field instead of four.” ■■

References:

1. Miller, S. E., “Integrated Optics: An Introduction,” *Bell System Technical Journal*, September, 1969, Vol. 48, No. 7, p. 2059.
2. Tillotson, L. C., “A Model of a Domestic Satellite Communication System,” *Bell System Technical Journal*, December, 1968, Vol. 47, No. 10, p. 2111.

EDUCATION



A major trend in engineering education is to bring the classroom to industry and industry to the classroom via television.

BY 1980, YOU MAY NEED A DOCTORATE

David N. Kaye, West Coast Editor

Two major needs are apparent as electrical engineering education heads into the Seventies: The engineer must be made more aware of the social implications of his designs, and a doctor's degree may be necessary for professional practice before the end of the decade.

Several leading educators share this belief. They point to the following directions in the next decade:

- Many young people are rebelling against a super-technological society, which seems to have no concern for humans. Engineering education must stress that the engineer can improve the quality of life.

- The emphasis will be on more education, so that a master's degree will be a requisite. The undergraduate engineer must have far greater exposure to the humanities and social sciences, to help make him "an educated man."

- Engineering education is not prepared for tomorrow's technology. The schools need more educational resources, such as modern laboratories and computers. Flaws also exist among the teachers themselves—a bureaucratic attitude

and an antipathy to machines and, consequently, to technology.

- As of now, the engineer just out of school isn't usually ready for a company job. There are several ways in which industry and the university can cooperate: Among them, men from industry can go into the classroom and teach, and students can serve an "internship" in industry.

"In the last decade a substantial number of engineers have been carried up into high places in government and industry," according to Dr. Francis H. Clauser, chairman of the Division of Engineering and Applied Science at the California Institute of Technology in Pasadena. "They find that they need an understanding of the deeper problems associated with the social sciences. I believe that we are asking the engineer to become a better educated man."

Many young people feel, he thinks, that we have become a super-technological society, and they rebel against it. One of the causes, he says, is that engineers have not assumed sufficient responsibility for any adverse effects that their engineering creations might produce in the en-

vironment. They have set out to provide useful products—such as automobiles or airplanes—and have left the responsibility as to whether these polluted the atmosphere or created traffic chaos to someone else.

"The engineer," says Dr. Clauser, "must develop a sense of responsibility. He must do things for the betterment of the race. I predict that during the Seventies the engineer's goals will tend more toward improving the quality of life.

"When it becomes apparent that the engineer can play a fruitful role and a helpful role, I believe that the younger people in our society will respond in kind. There will be a return to engineering as an honorable profession."

How will this new orientation come about? Dr. H. Guyford Stever, president of Carnegie-Mellon University in Pittsburgh has one answer.

"More and more," he says, "engineers are becoming involved in what I call society-limited technology rather than performance-limited technology. Performance-limited technology is something like the lunar landing vehicle or a supersonic airport. Society-limited technology is something like developing a new urban transportation system, where the sociological and political problems of the city must be considered. I think that in the education phase of an engineer's life we're going to have to get him exposed to the social sciences and the software of these problems."

Dr. Chauncey Starr, dean of the School of Engineering at the University of California at Los Angeles, adds, "Schools that are turning out the problem-solving engineers are going to have to include applied behavioral science as part of the curriculum."

And Dr. James Gere, head of the Civil Engineering Dept. at Stanford University, points out that "we have a much more flexible curriculum now than we had 10 years ago; this gives the student a chance to broaden his outlook."

How to broaden the outlook

What courses might help broaden the students' outlook?

"We had a course," says Dr. Joseph Pettit, dean of the School of Engineering at Stanford, "which considered the problem of whether the use of a satellite could provide better education to widely dispersed areas of India, Brazil or Indonesia."

The group included, he explained, about 50 students from different branches of engineering; from the department of communications (including journalism, radio, TV) and from the law school (since international legal complications were involved).

Isn't it true, then, that much broader and more extensive education than exists now will be need-

ed to meet worldwide problems?

"Yes," says Dean George Maslach of the College of Engineering at the University of California at Berkeley, "I believe that we will see the rise of multi-disciplinary programs, which still remain within engineering, in order to deal with large-scale systems. This will result in an integrated bachelor's-master's-degree program. We want to encourage students to go on from the bachelor's to the master's level."

Dean Starr at UCLA goes even further. "Some of the more advanced schools are likely to insist that engineering be completely a graduate function," he says. "There will be a pre-engineering undergraduate function and a doctor's-degree graduate function, just as in medicine. At that point, engineering will have made a complete transition from being just another education pad to a highly professional field. I don't think that there is anything that can stop this trend.

"What's going to happen is that almost all those that go into advanced technology engineering are going to be PhDs. Even the routine engineer will have a master's degree."

Dean Clauser at Cal Tech also feels very strongly on this subject.

"Many universities," he says, "will defer until the late undergraduate or graduate years many of the more specialized engineering courses. They will use for the four years of the undergraduate curriculum those courses that are fundamental in engineering, mathematics and science, and those courses in the humanities and social sciences that will make the engineer an educated man."

This will lead, he believes, to a growing number of students who go on for graduate work in engineering. They will realize that the only way to obtain the necessary knowledge for their profession is by going on for either the master's or the doctor's degree.

"I believe," says Dean Clauser, "that in electrical engineering the move toward the doctor's degree as the necessary degree for professional practice is likely to come before the decade of the Seventies is out."

Technical courses must change

As the technology changes, doesn't the emphasis have to change, even in technical course work?

Certainly, says Prof. Robert Meyer, assistant professor of electrical engineering and computer science at Berkeley. "The design of circuits is being done by a smaller and smaller group of people as time goes on. These people, however, are of a higher caliber, on the average, than they used to be and require very extensive training. I don't think you're going to get the situation where every university graduates a small number



Students can learn digital logic and computer fundamentals by correctly connecting patchcords in Digital Equipment Corp.'s "Computer Lab."

of circuit designers."

On the contrary, he believes, "a small number of universities will specialize in circuit design to supply the integrated-circuit industry."

"Yes," says Dr. Arthur Hopkin, chairman of the Electrical Engineering Dept. at Berkeley. "We've also got to do a better job of teaching the student how to deal with large-scale systems."

Is engineering education ready for the new technology?

"No," says Prof. Anthony Oettinger, professor of linguistics and applied mathematics at Harvard. In his new book, "Run Computer, Run: The Mythology of Educational Innovation" (Harvard University Press, Cambridge, Mass. 1969), Oettinger says that the conditions that would make systems analysis a useful technique, for example, are notably absent in our educational system: It is not independent enough of other systems; it does not have well-developed research and design tools; and its objectives aren't explicit enough.

There is, he believes, a lack of professionalism among teachers, a deadening bureaucratic atmosphere, a fundamental antipathy to machines—and therefore to technology—and an apparent limitation on the resources available for educa-

tion both now and in the future.

According to Dean Starr, technology will cause a split in the electrical engineering profession and so cause education to change.

"The development of data processing," he points out, "has removed the necessity for the chore work that goes into creative engineering. The creative engineer no longer needs to be a mechanic or a machinist or a draftsman. He can do all his design work using advanced display and data-processing equipment. The equipment will do the drafting for him. He doesn't even have to be a super mathematician any more. The computing systems will do the work for him.

The result, Dean Starr believes, is that the middle level of engineering is disappearing—that is, the people who did the chore work on an R&D team. We'll end up, he says, with two distinct groups: the advanced creative group, which will carry the big R&D load, and the group that operates, maintains and tests the engineering systems already developed. The educational requirements of each group will be different.

"In terms of prestige, importance and salary," says Dean Starr, "there is nothing second-rate about the operation, maintenance and testing area. I'm not saying that there will be first and second-class engineers but that there will be two separate branches of the profession."

How about teaching machines?

At Carnegie-Mellon, where a good deal of experimentation is going on in the field of teaching machines and their application to electrical engineering education, a high degree of pessimism prevails at the top. President Stever feels that teaching machines will have a use. "However, it will be somewhat limited," he says. "Education is so open-ended. A new educational experience broadens a student's experience, but a teaching machine tends to narrow the experience. I think it's much better to have a human teacher around, in order to expand on a new concept. Almost every student needs an individual exchange with a professor.

"I don't believe that we can automate teachers out of existence," he concludes; education without them would become stereotyped.

Dean Pettit at Stanford points out a drawback of teaching machines.

"Productivity does not increase," he says. "Technological increases in education have improved the quality but haven't resulted in economies. The cost per student has gone up, rather than even remaining the same."

Dr. Hopkin at Berkeley agrees: "Cost is a real problem. Almost every place where you find a university that has an exciting computer teach-

ing experiment, you'll find somewhere behind it there's a foundation that has put an exciting amount of money into it.

TV helps continuing education

How about television as a medium for learning?

"Absolutely," says Cal Tech's Dean Clauser. "I think that we will see a great upsurge, during the Seventies in the use of two-way TV links between colleges and industry, in order to establish an exchange of information."

Such an experimental system already exists at Stanford (see "TV Brings the University to Industry," ED 17, Aug. 16, 1969, p. U84). And companies have felt it worthwhile to lend financial help, Dean Pettit notes, because their employees don't lose time driving to the university. A major advantage of such a TV system is pointed out by Dean Starr from UCLA: "It allows the school to reach more students at a lower cost per student."

A common complaint of engineers when they first get out of college is that they are not immediately prepared to produce effectively for the companies where they go to work. An on-the-job training period is always necessary. Educators agree that this will always be the case.

Stever at Carnegie-Mellon puts it this way: "I don't think any school can give handbook courses which can be immediately applied." The reason, he explains, is that all engineering schools are preparing their students for so many different industries and so many different projects that the student must stick to basic knowledge, basic techniques, and the types of courses that allow them to put these basics together in the solution of problems."

How can the industry help?

"We have to establish," says Dean Clauser, "better channels of communication from those industries that are having to design and manipulate large systems, and bring this back into the classroom."

This is a rapidly evolving branch of engineering, the dean explains, and a good deal of the knowledge that is forthcoming isn't properly presented in the textbooks. The best practitioners of the art must, in some way, bring their newly found skills back into the classroom.

"I think," he says, "we are going to find that, during the Seventies there will be increasing emphasis upon bringing people from the frontiers of these developing areas, in industry, back into the classroom for a sufficient time, so they can impart their knowledge to students and to faculty members."

Dean Starr sees not only several ways in which

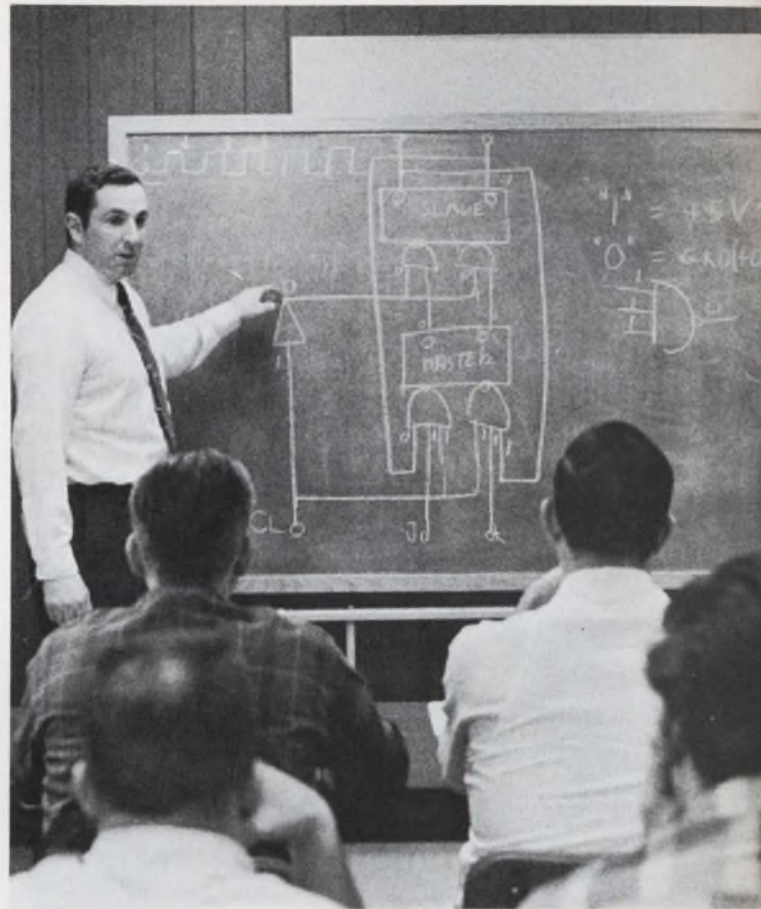

Logic functions are taught to engineers attending an in-plant course at Monitor Systems Corp., Fort Washington, Pa.

industry can help the educators but also a new responsibility that must be taken on by the universities to aid industry.

"One of the biggest current problems on a national basis," he says, "is the lack of interaction between industry and the engineering schools. Industry ought to participate at several levels."

He defines these levels as follows:

- Industry people ought to be part of the teaching group available to the university. They should be involved with the planning of courses and the course curriculum.

- Every major company should be making a number of internships available every year, so that students can be moved around within the company and get a variety of experiences.

- Industry should help support basic, academic research.

"I believe," Dean Starr continues, "that the state university must assume a responsibility for the continuing education of the professional people in the community. This responsibility should be equal to the responsibility for normal undergraduate and graduate education."

"It has been suggested that 20% of an engineer's time be devoted to more education." ■■



THESE **G-V**
hermetically sealed
ELECTRICAL
THERMOSTATS . . .

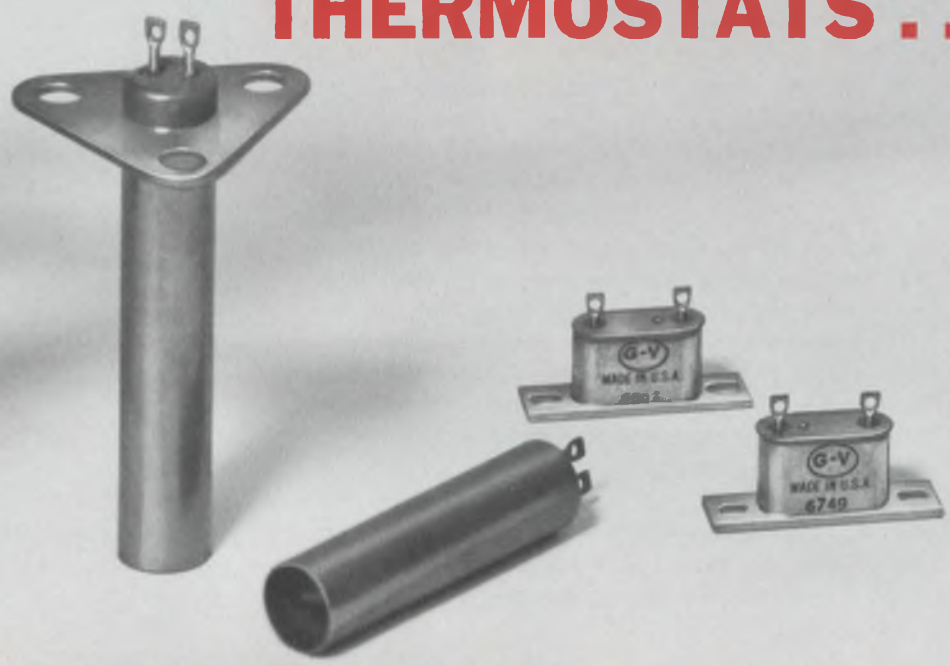

***QUICK CONNECT TYPE INDUSTRIAL THERMAL RELAY**

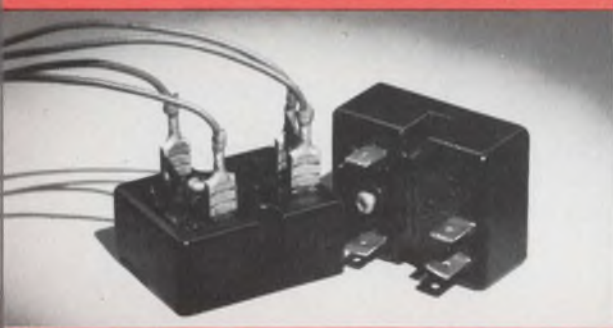

The Quick Connect thermal relays are designed to withstand the most demanding industrial applications. They reduce installation time and cost. Require only two mounting screws. Eliminates need for brackets, sockets, retainers. **Features:** time delays, 2 to 180 sec.; contacts, SPST, NO/NC; heater voltages, 6.3, 26, 115V AC or DC; resistive rating, 2A 115V AC or 1A 28V DC; mounts in any position.

*Recognized Under The Components Program Of Underwriter's Laboratories, Inc.



***RED LINE INDUSTRIAL THERMAL TIMING DEVICES**



Designed to meet the most demanding applications. They are housed in shatter-proof, dust-proof metal enclosures and feature stainless steel mechanisms and encased heaters for reliable, quiet operation in any plane. **Features:** delays up to 3 minutes, operating voltages 6.3 to 115V, AC or DC.

*Recognized Under The Components Program Of Underwriter's Laboratories, Inc.



***THERMETTE 9 PIN RELAY**



Metal enclosed thermal time delay is dust proof and shatter proof — designed for industrial applications requiring reliable operation and long life. **Features:** temp. compensated; time delays, 2 to 180 sec.; heater voltages, 6.3, 26, and 115V. AC or DC; contacts, SPST, NO or NC.

*Recognized Under The Components Program Of Underwriter's Laboratories, Inc.



solve temperature control problems

OFFER PRECISE TEMPERATURE CONTROL, RAPID RESPONSE, MINIMAL DIFFERENTIAL . . . *from G-V*

G-V offers a wide selection of electrical thermostats for over and under temperature indication, alarm or cut-off service. They are designed to meet the rugged and precise requirements of both military and commercial applications including missiles, data processing equipment, etc. Both surface sensing and immersion types are available. For surface temperature sensing, crystal can size VE Series features a tolerance of $\pm 3^{\circ}\text{C}$, a differential of $\pm 1.5^{\circ}\text{C}$. Various models cover settings between -55°C and $+150^{\circ}\text{C}$. The C8 Series cartridge immersion or air sensing thermostats are available with a variety of mounting brackets and terminals. They are supplied with a setting tolerance of $\pm 5^{\circ}\text{F}$ ($\pm 3^{\circ}\text{C}$), and repetitive operation within $\pm 1^{\circ}\text{F}$ can be expected. These units will withstand indefinite exposures to temperatures of -65°F to $+300^{\circ}\text{F}$ without damage. The C8 Series can be adjusted without damage to the hermetic seal. Contact ratings: VE Series, up to 3 amps; C8 Series up to 5 amps.



G-V CONTROLS INC.
LIVINGSTON, NEW JERSEY 07039
(201) 992-6200

INFORMATION RETRIEVAL NUMBER 191

*AIR FLOW SENSING SWITCH



*ELECTRICAL THERMOSTATS FOR INDUSTRIAL USE

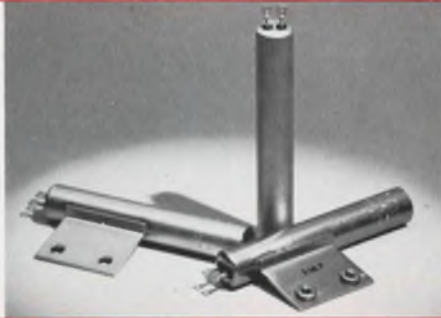

DIRECT-LINE FIELD ENGINEERING SERVICE



A new design concept and technique is utilized to monitor presence of air flow. When air flow drops below a safe level, it operates an alarm or automatic shut-off. Used in electronic equipment, cooling packages, air conditioners, computers, etc.
Features: Operates in any plane, no moving parts. No special adjustments.

*Recognized Under The Components Program Of Underwriter's Laboratories, Inc.

The D8 Series is suitable for a wide range of temperature control applications, offering exceptional stability. Since the encasing shell is the temperature sensing element, response to temperature change is very rapid.
Features: contact ratings up to 5 amps, operating range -65° to $+300^{\circ}\text{F}$.

*Recognized Under The Components Program Of Underwriter's Laboratories, Inc.

G-V assistance is always available to help you design and produce a better product. G-V Regional Field Engineers in your area will assist you and your design group in new applications and proper selection of your controls. G-V Product Engineers will help you with special applications. When you require experience, products and services in electro-mechanical and solid-state controls . . . call your man from G-V.

only from 





Designing with microstrip is easy

when you know how. This microwave oscillator, based on a standard Colpitts design, shows how it's done.

Most low-power microwave circuits of the future will be built in the microstrip configuration. This is practically certain because of the availability of good dielectric materials coupled with demands for reduced size and low cost.

Designing circuits in microstrip is essentially a two-step process: First a lumped-element design is chosen; then the circuit elements are synthesized in distributed form.

The first step is a familiar one to electronics engineers. But the realization of ideal lumped-element circuits in the microstrip geometry needs some elaboration.

What is microstrip?

A microstrip line (Fig. 1) consists essentially of a strip conductor and a ground plane separated by a dielectric medium. The dielectric material serves as a structural substrate upon which the metal conductors are deposited.

Since the electric field lines between the strip and the ground plane are not contained entirely in the substrate, propagation along the strip is not purely TEM and an exact analysis is difficult. When a high-permittivity substrate is used, however, most of the field is contained in the dielectric and the actual propagating mode is close enough to TEM for it to be treated as such in practical design work.

If the TEM mode is assumed, the velocity of propagation in microstrip is given by

$$v = c/(\epsilon_r')^{1/2} \quad (1)$$

where c is the speed of light in vacuum and ϵ_r' is the effective relative dielectric constant of the substrate material. The quantity ϵ_r' differs from ϵ_r , the relative dielectric constant, in that it allows for the amount of field external to the substrate.

In the design example in this article, the approximation $\epsilon_r = \epsilon_r'$ will be made. It's a fairly good approximation because the dielectric under consideration has an ϵ_r of 9, which means that the

fields are largely confined to the substrate. Furthermore, the tolerances on other circuit variables, such as transistor parameters, make greater accuracy unnecessary.

The wavelength in microstrip is given by

$$\lambda = v/f \quad (2)$$

where v is given by Eq. 1 and f is the frequency in hertz.

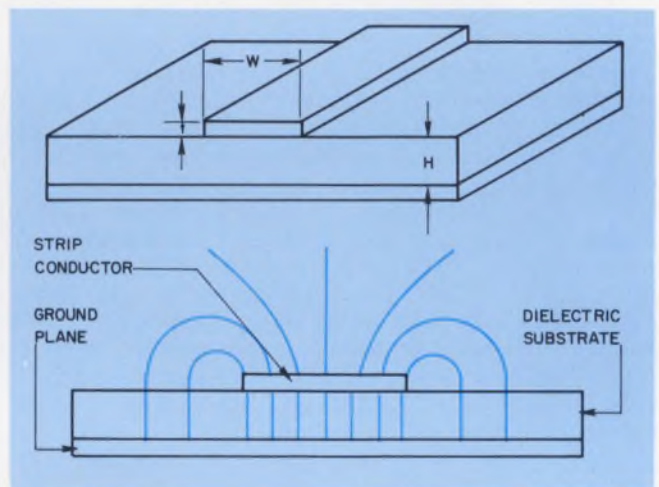

1. Microstrip propagation is not purely TEM, because the field lines are not confined to a region of uniform dielectric constant.

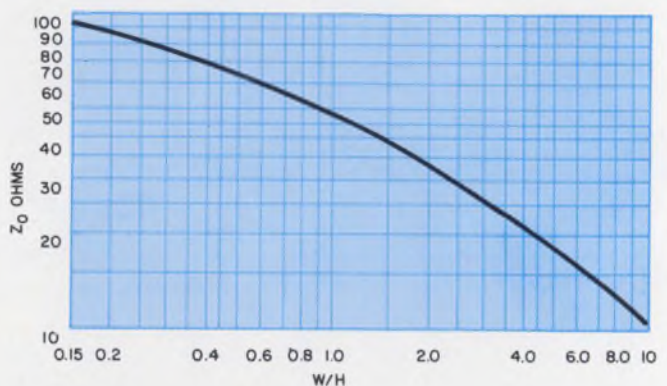

2. The characteristic impedance of a microstrip line is a function of the substrate material and the ratio of strip width to substrate thickness. This curve is for alumina ($\epsilon_r = 9$), and it assumes a t/H ratio of 0.005. W , H and t are defined in Fig. 1.

Carl F. Klein, Research Engineer, Johnson Service Co., Milwaukee, Wis.

The impedance of a transmission line is given by $Z_0 = 1/\sqrt{C}$ where C is the capacitance per unit length. Because of the discontinuity at the air-insulator boundary and the radiation losses in the fringing fields, the capacitance C is not easy to calculate. However, from the electric field distribution of a cross section of microstrip transmission line, C can be divided into three easily analyzed capacitances: C_p , C_f and C_s . C_p is the parallel-plate capaci-

tance between the strip conductor and the ground plane; C_f is the fringing capacitance at the edge of the strip conductor, and C_s is the capacitance between the strip conductor's upper surface and the ground plane.¹

Assuming that the field of the upper surface capacitance, C_s , is in air and that the rest of the field is in the solid low-loss dielectric, we can calculate the capacitive components individually as:

Impedance simulation

By applying transmission-line theory to microstrip geometry, a variety of very useful passive circuits can be designed. Here's a small library of six of the most common ones:

1. The tapered transmission line is a simple, but very effective, impedance-matching device. The curve of Fig. 2 is used to calculate the line widths at the extremities.

2. and 3. The open-circuited and shorted shunt stubs simulate shunt reactances as shown in the diagrams. The case of open-circuited stub with $\lambda/4 < x < \lambda/2$ is discussed in detail in the text. The formula for each case changes sign at $x = \lambda/4$; hence the nature of the reactance changes as indicated in the diagram. When the stub is exactly a quarter-wave long, the open-circuited one acts like a series-resonant L-C circuit and hence displays zero impedance. The shorted stub acts like a parallel-resonant L-C circuit and hence displays infinite impedance.

4. and 5. These pi and tee circuits are only approximations. They work pretty well if the ratio of high to low impedance, in each case, is about 3:1 or more. In all the formulas, the Y_0 and Z_0 apply to the main line, not the center section. Note that the exact height or depth of the center section does not enter the equation; it's necessary only to know that the 3:1 ratio criterion is satisfied. In all cases, v is the propagational velocity given in the text (Eq. 1). For simplicity, the capacitances have been given as susceptances and the inductances, as reactances.

6. This is the shorted quarter-wave line used in the design example. It's actually a special case of the shorted stub (No. 2).

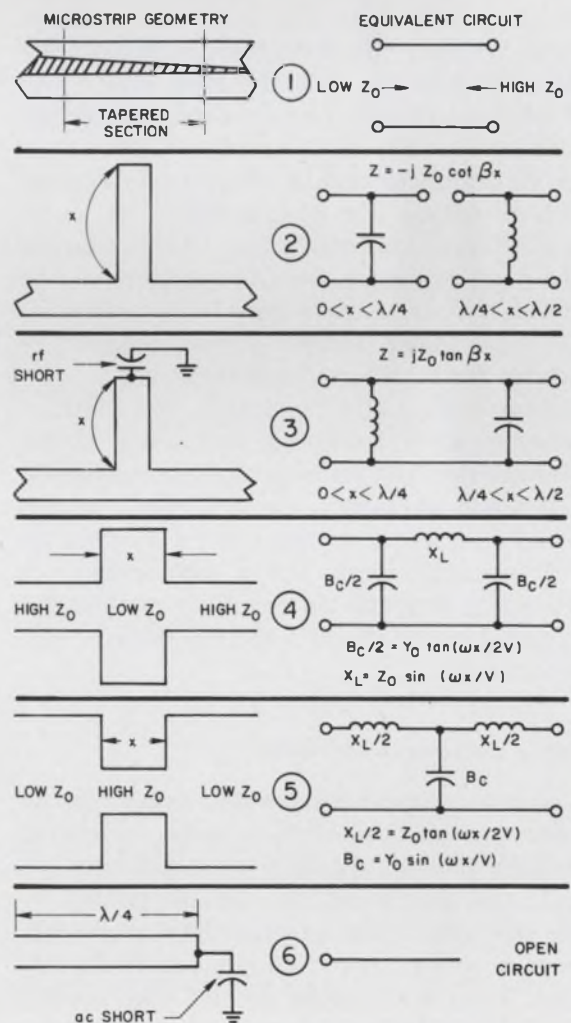

$$C_p = \epsilon W/H \quad (3a)$$

$$C_f = 2.7\epsilon/\log(4H/t) \quad (3b)$$

$$C_s = 2\epsilon W/3H\sqrt{\epsilon_r} \quad (3c)$$

where ϵ is the permittivity of the substrate material ($\epsilon = \epsilon_0\epsilon_r = 8.85 \times 10^{-12} \epsilon_r$ farads per meter) and the dimensions are taken from Fig. 1.

Since calculating the impedance of a line is obviously a tedious process and since it is often necessary to work backward (design a line for a given impedance), most designers prefer to use a set of curves of Z_0 vs H/W for a given ϵ_r . Figure 2 shows such a curve for alumina ($\epsilon_r = 9$); similar plots for ϵ_r values from 1 to 70 are available.²

Lumped-impedance simulation

One obvious conclusion that can be drawn from the preceding discussion is that the impedance of a line is easily varied by varying the width of the conducting strip. Thus, impedance matching can often be done by simply using a section of tapered line.

Sections of line can also be used to synthesize both capacitive and inductive reactances. Stub sections in shunt with the line behave like shunt reactances. Whether the stubs behave capacitively or inductively depends upon the stub length and method of termination (see box on impedance simulation).

Series capacitances can be obtained in several ways. Large values are best achieved by overlapping sections of microstrip line, thus producing a parallel-plate capacitor. Small capacitors can be made by leaving very narrow gaps in the transmission line. Also, small lumped-element capacitors are available for both series and shunt use.

By making abrupt step changes in the width of the conducting strip, tee and pi L-C networks can be fabricated (see box on impedance simulation).

A particularly valuable microstrip component is the shorted quarter-wave line. Such a line has an infinite impedance at rf but a low impedance at dc. Hence it provides an excellent method for biasing transistors without affecting their ac circuit properties.

Designing a microwave oscillator

The foregoing impedance-simulation and biasing techniques can be applied to a wide variety of designs. Let's consider a microwave oscillator.

Initially, one must select the oscillator configuration to be used, along with a transistor that can provide the gain needed for self-starting at the desired frequency. Then it should be decided whether the transistor's parasitic reactances, such as the input and output capacitances, can be advantageously

used as part of the oscillator or if they should be compensated for and ignored. Finally, the self-starting conditions and the frequency-determining equations must be translated into component values.

The Colpitts oscillator of Fig. 3 lends itself very well to high-frequency operation. The inductor can be realized by a section of transmission line, and the transistor's input and output capacitances can serve as C_1 and C_2 .

At microwave frequencies, substantial modifications are needed in the standard hybrid-pi model to form a really adequate representation of a transistor. However, the simplified equivalent circuit of Fig. 4 is quite useful for many applications. C_{IN} and C_{OUT} include both packaging and interelectrode capacitances. The current source $g_m V_{be}$ can be replaced by its equivalent— $h_{fe} i_b$ —since manufacturers usually specify h_{fe} rather than g_m .

By plugging the transistor model of Fig. 4 into the circuit of Fig. 3, the Colpitts oscillator circuit of Fig. 5a results. From the lumped-impedance form of the circuit (Fig. 5b), the following matrix equation can be written:

$$\begin{vmatrix} (Y_1 + Y_3) & -Y_3 \\ (g_m - Y_3) & (Y_2 + Y_3) \end{vmatrix} \begin{vmatrix} V_{be} \\ V_{ce} \end{vmatrix} = 0. \quad (4)$$

Clearly, to have nontrivial solutions for V_{be} and V_{ce} , the determinant of the coefficients must be equal to zero. When the real part of the determinant is set to zero, the conditions for oscillation are obtained.³ The result says that the circuit will oscillate provided that

$$h_{fe} > C_2/C_1. \quad (5)$$

By setting the imaginary part of the determinant to zero, the frequency of oscillation is found to be given by

$$\omega^2 = 1/LC_T \quad (6)$$

where $C_T = C_1 C_2 / (C_1 + C_2)$. The circuit thus oscillates at the resonant frequency of the loop formed by C_1 , C_2 and L .

Biasing the circuit

The dc bias potentials must be applied to the oscillator through networks that prevent leakage of the rf signals. A good way to do this is by using shorted quarter-wave sections of microstrip. The ac shorting would be provided by a capacitor, of course, in order not to interfere with the dc biasing.

Rf isolation can also be provided by means of square or circular spiral inductors. These rf chokes, however, make it necessary to use a multilayer circuit to provide a layer of insulation between the spiral inductor and the lead to its center.

In some cases, biasing can be accomplished by

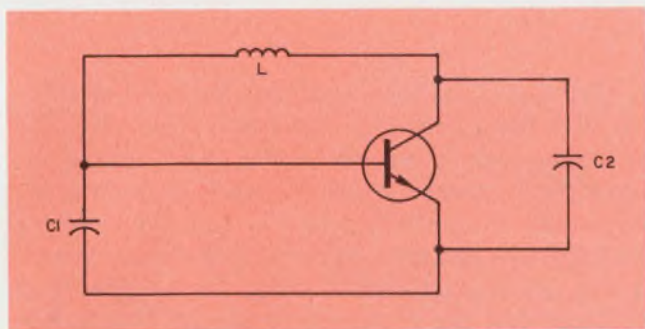

3. The Colpitts oscillator is an excellent choice for microwave operation. The capacitances shown in this simplified model can be provided by the transistor's parasitics. The inductor can be realized with a transmission-line section.

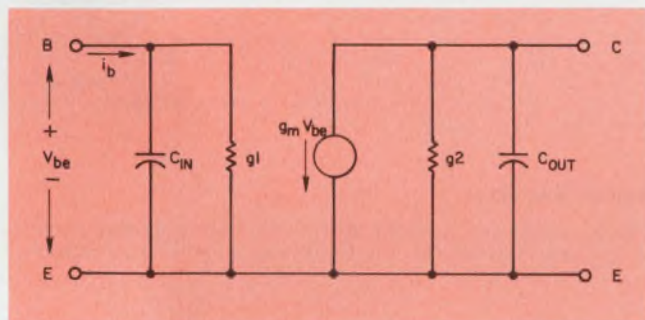

4. This simplified hybrid-pi model of a microwave transistor is more complicated than it looks. The capacitances include both interelectrode and packaging effects.

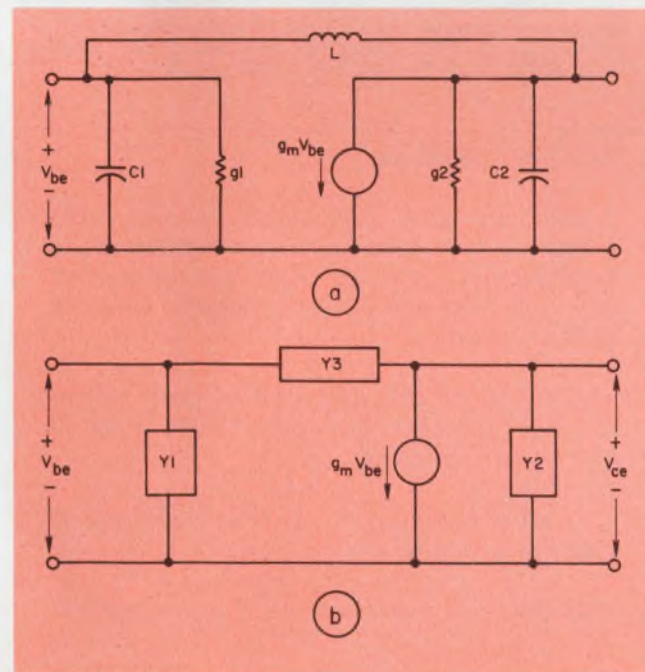

5. Combining the transistor model of Fig. 4 with the Colpitts circuit of Fig. 3 yields circuit (a) where C_1 and C_2 actually represent C_{IN} and C_{OUT} of Fig. 4. By adding the parallel admittances, a simplified circuit (b) is obtained. In (b), $Y_1 = g_1 + j\omega C_1$; $Y_2 = g_2 + j\omega C_2$; and $Y_3 = -j/\omega L$.

shunting the rf directly to ground through a large capacitor. This is done to the base of the transistor in the following design example.

Getting down to particulars

For instance, let's design a 2.25-GHz oscillator with a 20-mW output. A Colpitts circuit will be used along with a 2N3835 transistor. For this transistor, $C_{IN} \approx 3.5$ pF and $C_{OUT} \approx 1.5$ pF.

Clearly, the self-starting condition of Eq. 5 is met since $h_{re} \approx 2.5$ and $C_2/C_1 = 0.428$. (Obviously, we have equated C_1 with C_{IN} and C_2 with C_{OUT}).

All that remains to complete the job is to calculate the length of transmission line needed to simulate the inductance L in the Colpitts oscillator. By multiplying both sides of Eq. 6 by L/ω , a relationship yielding the desired inductive reactance is obtained:

$$\omega L = 1/\omega C_T. \quad (7)$$

To calculate the length of line needed to provide the reactance, we recall, from elementary transmission-line theory, that the impedance, Z , presented by a lossless line of length, x , terminated with a load, Z_L , is given by:

$$Z = Z_o \left[\frac{1 + \Gamma \exp(-2j\beta x)}{1 - \Gamma \exp(-2j\beta x)} \right] \quad (8)$$

where Z_o is the characteristic impedance of the line; $\beta = 2\pi/\lambda$, is the line's phase constant; and $\Gamma = (Z_L - Z_o)/(Z_L + Z_o)$, is the voltage reflection coefficient of the load.⁴ For an open-circuited stub, Z_L is infinite and Γ is unity. Substituting this into Eq. 8 and multiplying both numerator and denominator by $\exp(+j\beta x)$, the line impedance is found to be given by

$$Z = Z_o \left[\frac{\exp(j\beta x) + \exp(-j\beta x)}{\exp(j\beta x) - \exp(-j\beta x)} \right]. \quad (9)$$

The Euler identities for sine and cosine can easily be plugged into Eq. 9 to yield the desired result:

$$Z = -jZ_o \cot \beta x. \quad (10)$$

The left-hand side of Eq. 10 is obviously a pure reactance; for it to be inductive, x must be chosen so that the right-hand side is positive. Keeping x between $\lambda/4$ and $\lambda/2$ will do this by keeping βx between $\pi/2$ and π .

Thus to find x , we equate the right-hand side of Eq. 7 to the reactance expression of Eq. 10:

$$1/\omega C_T = -Z_o \cot(2\pi x/\lambda). \quad (11)$$

For a 50-ohm line and the other variables as given earlier, the length x turns out to be 0.69708 inch.

This circuit was constructed on an alumina substrate using lumped-element resistors and capacitors, along with the microstrip circuitry (Fig. 6).

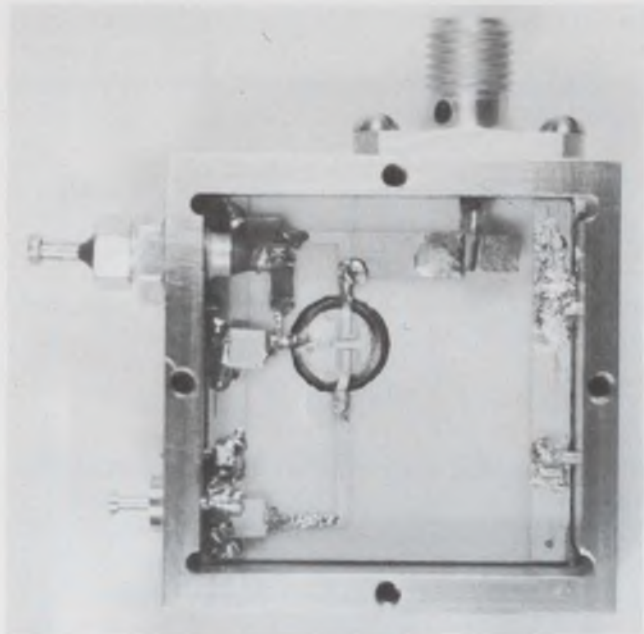
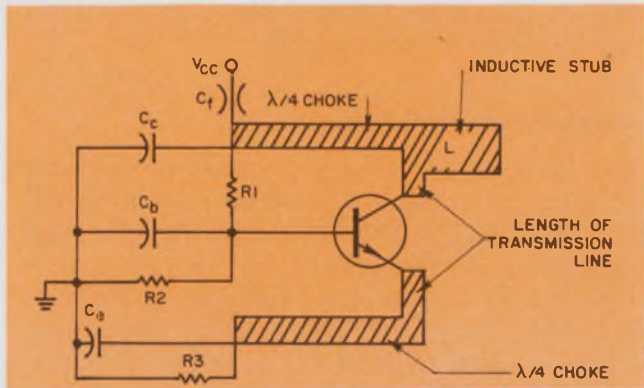

6. Here's the completed design. The ac-shortened quarter-wave sections act as rf chokes to isolate the dc bias circuitry (Fig. 7a) from the ac circuit (Fig. 7b). Capacitors C_c , C_b , and C_e do the rf bypassing, and feed-through capacitor C_f decouples the rf from the power supply.

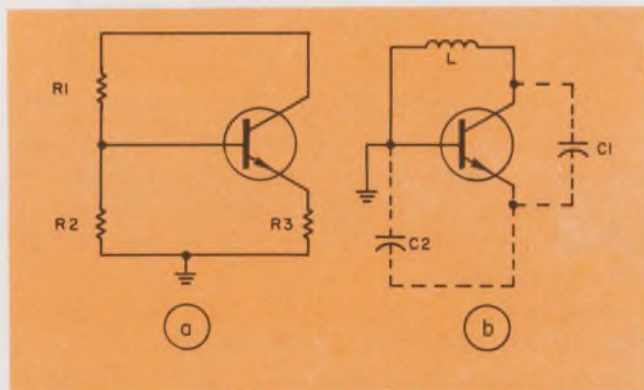

7. The bias resistors don't affect the ac circuit at all. The dc equivalent (a) of Fig. 6 is formed by treating all capacitors as opens and all microstrip lines as shorts. The ac equivalent (b) is obtained by replacing the capacitors by shorts and treating the shorted quarter-wave sections as opens. C_1 and C_2 are transistor parasitic capacitances.

By treating all of the capacitors as open circuits and all of the microstrip elements as short circuits, the dc equivalent circuit of Fig. 7a is obtained. Similarly, by treating the rf bypass capacitors as shorts and remembering that a shorted quarter-wave line acts like an open circuit, the ac equivalent of Fig. 7b is produced. Clearly, the ac circuit is identical with the prototype model of Fig. 3. ■ ■

References:

1. Schwarzmann, A., "New Techniques in Microwave Design," *RCA's Advanced Communications for the 1970's*, 1966.
2. *The Microwave Engineer's Handbook and Buyers' Guide*, Horizon House, 1969.
3. Chirlean, P. M., *Analysis and Design of Electronic Circuits*, McGraw-Hill, New York, 1965, p. 450.
4. Adler, R. B.; Chu, L. J.; Fano, R. M., *Electromagnetic Energy Transmission and Radiation*, John Wiley and Sons, New York, 1960, p. 102.

Acknowledgment:

The author wishes to thank Al Giovanelli and George Sether of Johnson Service Co. for their able technical assistance.

Bibliography:

- Daly, D. A.; Knight, S. P.; Caulton, M., "Lumped Elements in Microwave Integrated Circuits," *IEEE Trans. on Microwave Theory and Techniques*, Vol. MTT-15, Dec., 1967.
- Grieg, D. D., and Engelmann, H. F., "Microstrip — A New Transmission Technique for the Kilomegacycle Range," *Proc. IRE*, Vol. 40, Dec., 1952, pp. 1644-1650.
- Klein, C. F., "Microwave Oscillator Design," Johnson Service Co., RR-135, May, 1968.
- Texas Instruments, Inc., "Study of Solid State Integrated Microwave Circuits," NASA N66 26245, Dec., 1965.
- Vossberg, W. A., "Stripping the Mystery from Stripline Laminates," *MicroWaves*, Jan., 1968, pp. 104-112.

Test your retention

Here are questions based on the main points of this article. Their purpose is to help you make sure you have not overlooked any important ideas. You'll find the answers in the article.

1. When is the assumption that microstrip propagation is purely TEM likely to lead the designer astray?
2. What are the principal determinants of microstrip impedance?
3. Why are quarter-wave lines so useful?
4. Is it always necessary to compensate for or swamp out a device's parasitic impedances?
5. What conditions must an oscillator satisfy to be self-starting?

Breakthrough For Automation!

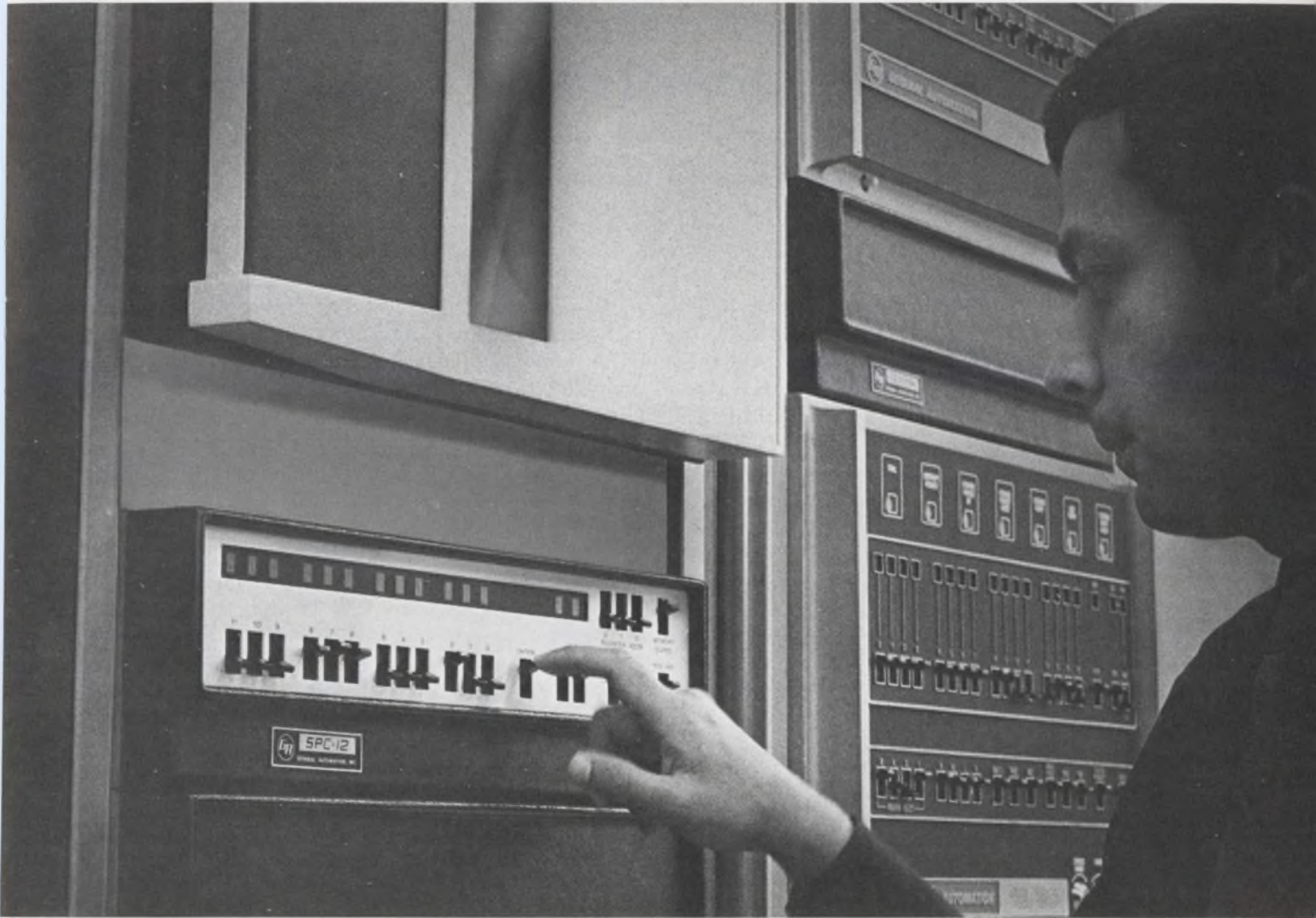

A COMPLETE, LOW-COST AUTOMATION SOLUTION

If you need an OEM computer for your next automation product, General Automation has the complete, low-cost solution . . . pre-engineered and ready to install . . . and that includes all the computers, interfaces, software and services.

Our SPC-12 automation computer offers you new levels of computer value and reliability . . . it's specifically designed to work in industrial environments. The SPC-12 plugs in and works, the first time, and keeps on working. Hundreds are on the job working.

And to add even more value to your product, our unique family of mini-controllers tie the SPC-12 directly to

machines, devices, communications networks, sensors and instruments, eliminating excessive and redundant electronics. Your products can serve more markets.

If you require software or services our Automation Sciences Division will provide you with complete software programs and technological services to get your product to the market faster.

Put this complete low-cost automation computer in your product today for only \$5000.00 . . . and much less in OEM quantities. You'll be surprised just how easy it is. Call or write today, there's a General Automation office near you.



GENERAL AUTOMATION, INC.
Automation Products Division

706 West Katella, Orange, Calif. (714) 633-1091, TWX 910-593-1601

Need to design a switching regulator?

It's simple — as well as low in cost and high in efficiency — if you build the control circuitry with linear ICs.

Designing a switching-mode regulator is very simple if a linear voltage-regulator IC is used to build the control circuitry. Nearly all of the components required for the control function are included in the IC package. Besides being easy to design, the new regulator offers the efficiency and cost advantages inherent in switch-mode operation.

A typical switching regulator will operate at efficiencies of 75% or more, while it is common for series regulators to operate at efficiencies of less than 20%. And the switching-mode regulator can use an inexpensive low-dissipation transistor with no heat sink as the control element, keeping circuit cost low.

Power dissipation is minimized

In operation, the switch transistor Q (Fig. 1) is in either saturation or cutoff, so that power dissipation is kept to a minimum. Diode D₁ conducts during the time that Q is cut off, thus maintaining current flow through inductor L₁.

When Q is turned on, D₁ is reverse-biased and does not conduct. The current *i_L* through L₁ increases approximately linearly, according to the relation

$$E_{in} - E_{out} = L_1 (\Delta i_L / t_{on}). \quad (1)$$

This current flows through the load and charges capacitor C₁.

If we assume that R₂ >> R₁, then the voltage at the inverting input to the error amplifier is given approximately by

$$V'_{ref} = V_{ref} + E_{in} (R_1 / R_2) \quad (2)$$

where E_{in} (R₁/R₂) is equal to V_{II}, the hysteresis introduced to the error amplifier. V_{II} is supplied as positive feedback to ensure oscillation.

When E_{out} reaches V'_{ref}, the error amplifier turns off transistor Q. The current through L₁ then starts to decrease, causing the voltage at point A to swing

negatively until D₁ is forward-biased. At this point the inductor current flows through D₁ and decreases at a rate approximated by

$$E_o = L_1 (\Delta i_L / t_{off}). \quad (3)$$

When the inductor current falls below the load current, the output capacitor starts to discharge and E_{out} decreases. As soon as E_{out} falls to a level slightly less than V_{ref}, the error amplifier turns Q back on, and the cycle repeats.

The output from the regulator ripples above and below a dc level set by V_{ref}. The peak-to-peak ripple is slightly greater than V_{II}, since the inductor current continues to charge the capacitor for a short time after Q is switched off. The significant voltage and current waveforms are given in Fig. 2.

All of the elements needed to control the operation of a switching regulator are contained in monolithic IC voltage regulators like that shown in Fig. 3. They are designed primarily for use as series-type linear voltage regulators with positive or



Checking the specs on a switching transistor, author English proves out his regulator design. It offers typical efficiencies of greater than 75%.

Michael J. English, Applications Engineer, Instrumentation and Control Systems, Fairchild Semiconductor, Mountain View, Calif.

negative supplies, and include built-in reference voltage sources, error amplifiers, and the output circuitry necessary for driving various configurations of external switching transistors. The devices also provide output current limiting by driving an internal current-limiting transistor from an external current-sensing resistor. They can easily be incorporated into switching regulator control circuitry.

Let's design a regulator

Consider the design of a switching regulator with the following specifications: $E_{in} = +28$ V dc; $E_{out} = +5$ V dc; $I_{out} = 2$ A; $I_{max} = 2.1$ A; $f = 20$ kHz; $\Delta V_{out} = 40$ mV peak to peak.

Note that E_{in} is the unregulated dc input voltage, E_{out} is the regulated dc output voltage, and I_{out} is the dc output current of the regulator. I_{max} is the maximum inductor current (also the maximum nontransient "freewheeling" diode current and the maximum nontransient switch transistor current), f is the switching frequency, ΔV_{out} is the peak-to-peak output ripple, and V_H is the hysteresis of the error amplifier.

The first step is to calculate the required inductance L_1 . From Fig. 2b and Eq. 1 we have:

$$L_1 = (E_{in} - E_{out}) t_{on} / \Delta I_L$$

$$= (E_{in} - E_{out}) t_{on} / 2 (I_{max} - I_{out}) \text{ henries.} \quad (4)$$

Also, solving Eqs. 1 and 3 for ΔI_L and combining yields

$$E_o (t_{off}) / L_1 = (E_{in} - E_{out}) t_{on} / L_1.$$

Rearranging,

$$E_{out} (t_{off} + t_{on}) = E_{in} t_{on}$$

and since

$$t_{off} + t_{on} = T = 1/f$$

we have

$$t_{on} = (E_{out} / E_{in}) (1/f). \quad (4a)$$

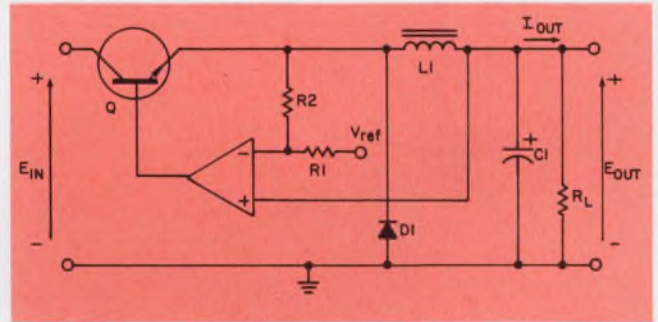

1. The switching-mode regulator is highly efficient because the control transistor Q operates either in full conduction or in cutoff. Since Q can be low-power transistor, the circuit is very economical to build.

Switching regulation gives high efficiency

Switching-mode voltage regulators offer more efficiency than series or shunt regulators, particularly when the difference between the input voltage and the regulated output voltage is large. With an input of 28 V and an output of 5 V at 1 A, for instance, a conventional series regulator requires a drop of 23 V across the pass transistor. Thus 23 W are wasted; the efficiency is only 18%. But under the same input and output voltage restrictions, switching regulators can give efficiencies greater than 75%.

The efficiency is better in switching regulators because the main current-handling element, a transistor, is operated as a switch. When the transistor is conducting current, the voltage drop across it is small ($V_{CE(sat)}$), and the power dissipated is minimized. And when the transistor is in cutoff it dissipates no power because no current flows. The pass transistor of a conventional series regulator, on the other hand, dissipates substantial power because it conducts

the full load current at all times, and the voltage drop across the transistor is equal to the difference between the input voltage and the output voltage. This power is not delivered to the load, and the efficiency of the regulator suffers.

Switching-mode regulators show even better efficiency as output voltage increases. If the output voltage is doubled (at a fixed load current), for instance, the load power is doubled but the regulator losses remain relatively constant since they are related primarily to the output current. Thus the losses constitute a smaller percentage of the load power, and efficiency is better.

Switching-mode regulators offer economies, too. The high efficiency of the switching regulator often allows a small, low-power switching device to replace the large power transistor and heat-sink assembly required by an equivalent series or shunt regulator. This can result in large savings on parts and assembly costs, as well as conservation of chassis space.

Substituting the design specifications into Eq. 4 and combining with Eq. 4a, we have:

$$L_1 = [(28 - 5)/2 (2.1 - 2)] (5/28) [1/(2 \times 10^4)] = 1.025 \text{ mH.}$$

Next, we choose a value for V_H . Controlling the hysteresis is a convenient means for trimming the operating frequency, as well as supplying positive feedback to enhance switching action and ensuring

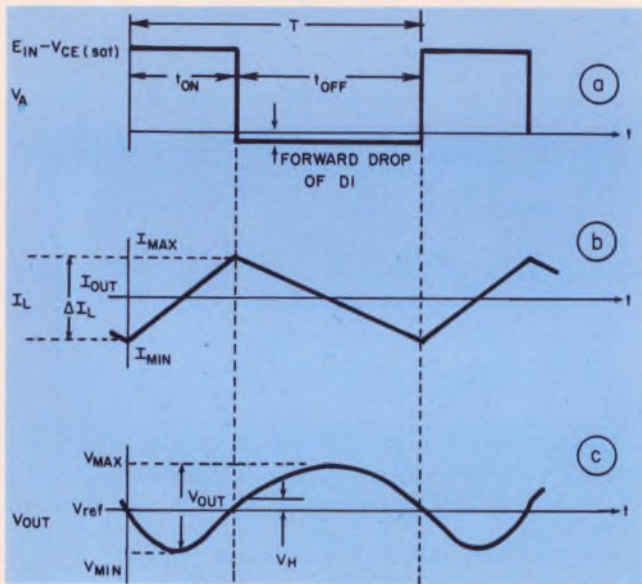

2. The switching action of the regulator yields square-wave voltage at the input to the smoothing inductor (a). This voltage waveform results in a triangular current waveform through the inductor (b), and an approximately sinusoidal output voltage (c).

that the circuit begins switching. A reasonable value for V_H is 10 to 20 mV less than the allowable peak-to-peak output ripple.

For example, take a V_H of 30 mV. Then

$$V_H \cong E_{in} (R_1/R_2), (R_2 \gg R_1), \quad (5)$$

so, if $R_1 = 1 \text{ k}\Omega$, then

$$R_2 = (E_{in}/V_H) (R_1) = 28 (10^3)/(30 \times 10^{-3}) \quad (6)$$

and

$$R_2 \cong 1 \text{ M}\Omega.$$

The third step is to calculate the value of capacitor C_1 . To do this we first consider the case in which Q_1 has just turned on. Applying Kirchoff's Law to the current at the output node of the regulator, and referring to Fig. 2b, we obtain

$$I_{cap} = I_L - I_{out} = [(E_{in} - E_{out}) t/L_1] + I_{min} - I_{out}. \quad (7a)$$

Integrating the above expression and including the initial condition that $E_{out}(0) = V_{ref}$ (see Fig. 2c), we obtain an expression for the instantaneous output voltage, V_{out} :

$$V_{out} = V_{ref} + [(I_{min} - I_{out})(t)/C] + [(E_{in} - E_{out})(t^2)]/2L_1C. \quad (7b)$$

Equation 7b holds when $0 < t < t_{on}$. Differentiating Eq. 7b and setting the derivative equal to zero gives the value of t for which V_{out} is a

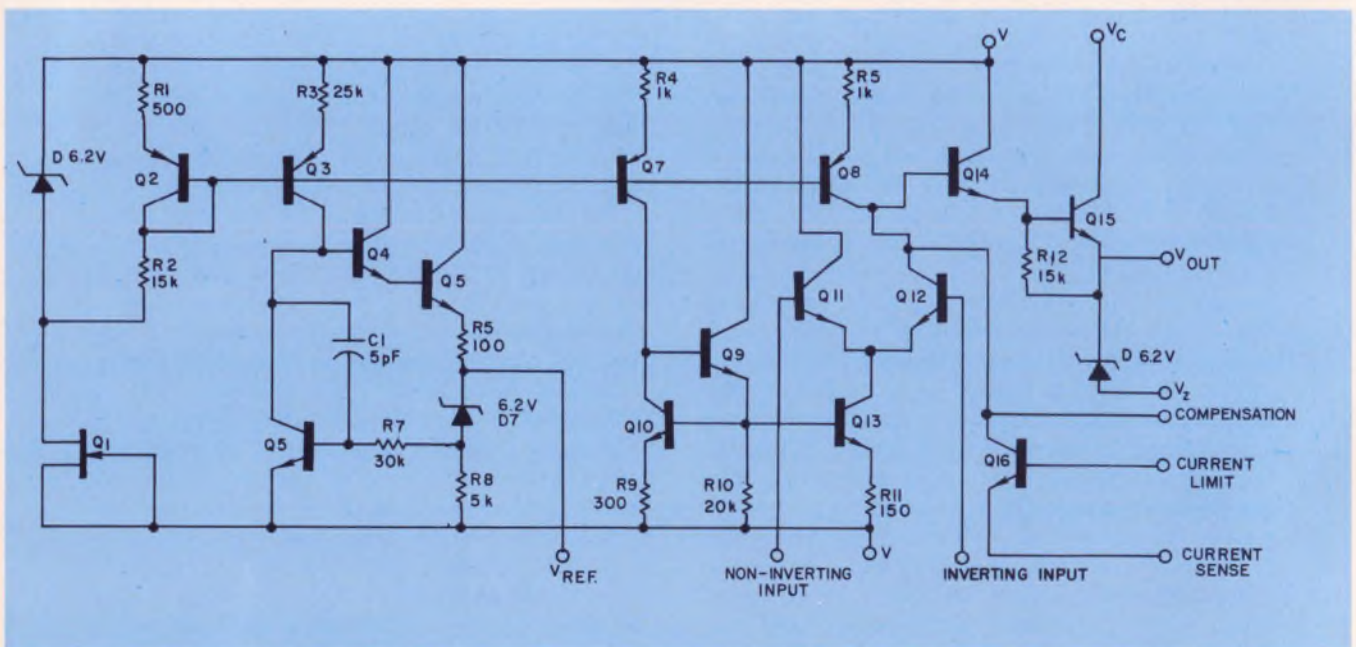

3. A typical linear IC voltage regulator, the Fairchild $\mu A723$, contains almost all of the components required

in the control circuitry of the switching regulator. It also provides a current-limiting feature.

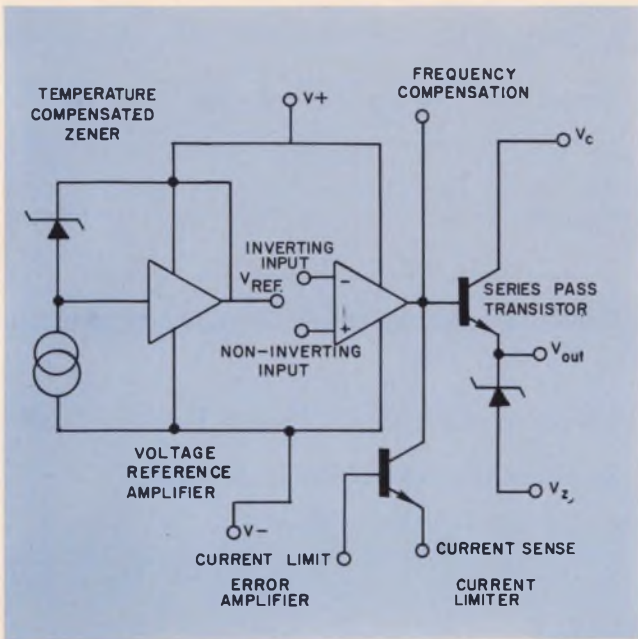

4. The equivalent circuit of the regulator contains a zener reference, an error amplifier, output drive circuitry and provision for current limiting.

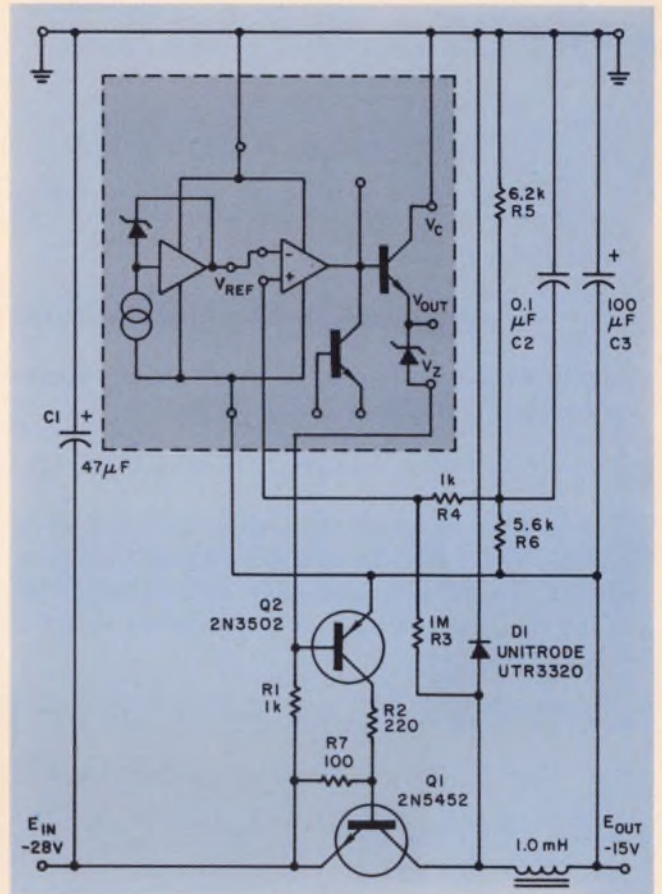

6. A negative switching regulator is like the positive circuit except that the drive signal to the switching transistors is applied from V_{zener} output of the monolithic regulator. The zener provides level shifting and allows the device to drive the switches.

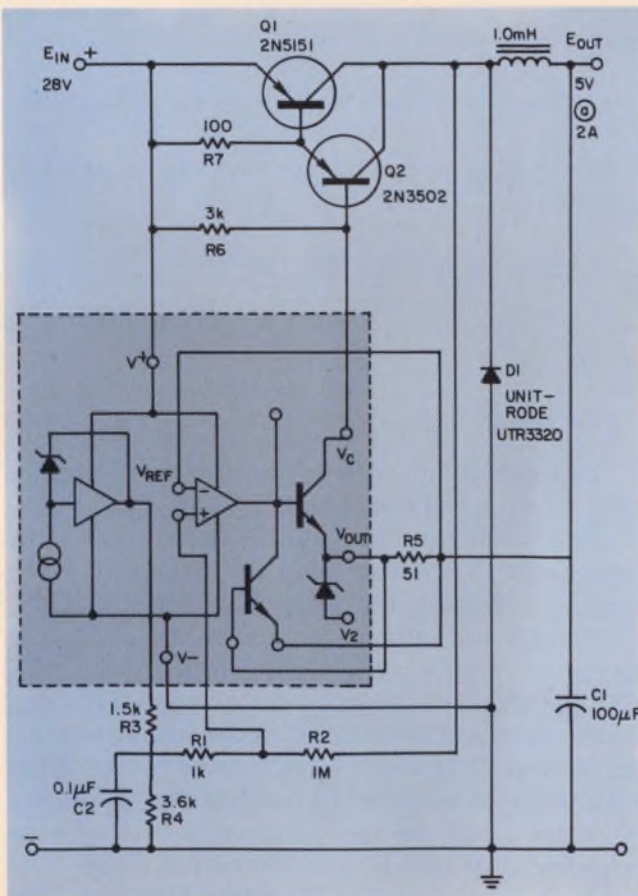

5. A positive switching-mode regulator using a linear IC voltage regulator as control circuitry achieves 73% efficiency with a 5-V, 2-A output and an input of 28 V. The series inductance L_s is 40 turns of #20 enameled copper wire wound on a Ferroxcube P36/22-3B7 core with 0.009-inch air gap (or equivalent).

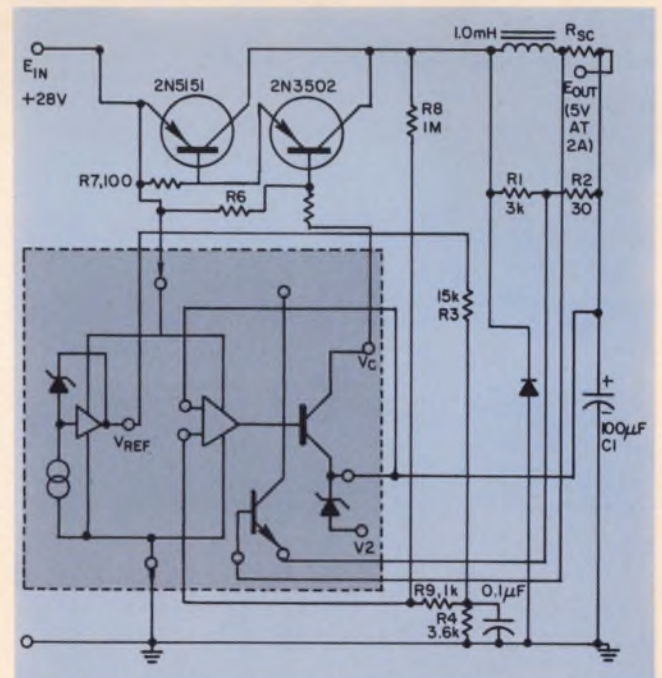

7. Short-circuit protection is added by incorporating the current limiting feature of the linear IC. The inductor current is sensed by a small series resistor R_{sc} .

minimum :

$$\begin{aligned} d(V_{out})/dt &= [(I_{min} - I_{out})/C] \\ &+ [(E_{in} - E_{out})(t)]/L_1 C \\ &= 0. \end{aligned} \quad (7c)$$

Solving for t,

$$t_{min} = [(I_{out} - I_{min}) L_1 / (E_{in} - E_{out})]. \quad (7d)$$

Using this value for t in Eq. 7b we obtain an expression for the minimum output voltage:

$$V_{min} = V_{ref} - [(I_{out} - I_{min})^2 L_1 / 2 (E_{in} E_{out}) C]. \quad (7e)$$

The voltage at which the switch Q_1 turns off is $V_{ref} + V_H$ (Fig. 2c). An analysis similar to the one above can be carried out to give an expression for E_{out} during the time t_{off} . This analysis yields the following results:

$$\begin{aligned} V_{out} &= V_{ref} + V_H + [(I_{max} - I_{out})(t - t_{on})/C] \\ &- [E_{out}(t - t_{on})^2 / 2L_1 C], \end{aligned} \quad (7f)$$

$$t_{max} = t_{on} + [(I_{max} - I_{out}) L_1 / E_{out}], \quad (7g)$$

and

$$V_{max} = V_{ref} + V_H + [(I_{max} - I_{out})^2 L_1 / 2CE_{out}]. \quad (7h)$$

The peak-to-peak output ripple, ΔV_{out} , is given by

$$\begin{aligned} V_{max} - V_{min} &= V_{ref} + V_H \\ &+ [(I_{max} - I_{out})^2 L_1 / 2CE_{out}] - V_{ref} \\ &+ [(I_{out} - I_{min})^2 L_1 / 2 (E_{in} - E_{out}) C], \end{aligned} \quad (7i)$$

and since $(I_{max} - I_{out})^2 = I_{out} - I_{min})^2$

we have

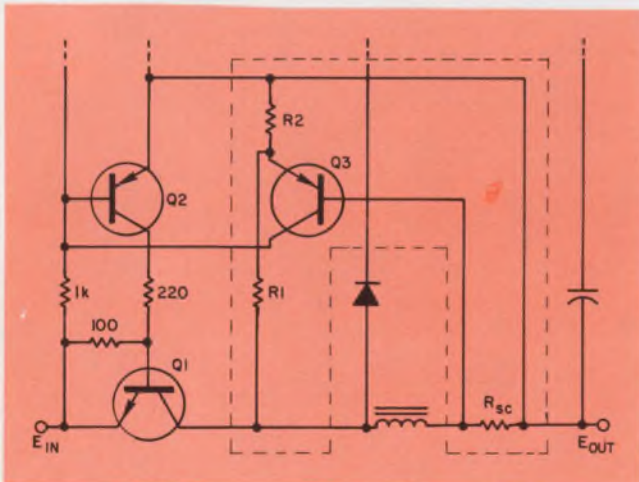

8. Short circuits on the negative regulator can be guarded against by adding an extra pnp transistor to cut off the base drive to transistor Q_2 .

$$\begin{aligned} \Delta V_{out} &= V_H \\ &+ [(I_{max} - I_{out})^2 L_1 / 2C] [(1/E_{out}) + (1/(E_{in} - E_{out}))], \end{aligned}$$

or

$$\begin{aligned} \Delta V_{out} - V_H \\ &= (I_{max} - I_{out})^2 L_1 E_{in} / 2CE_{out} (E_{in} - E_{out}). \end{aligned} \quad (7j)$$

Equation 4 may be solved for t_{on} and combined with Eq. 4a, giving

$$2 (I_{max} - I_{out}) L_1 / (E_{in} - E_{out}) = E_{out} / E_{inf}. \quad (7k)$$

Squaring both sides of Eq. 7k, we obtain

$$\begin{aligned} 4 (I_{max} - I_{out})^2 L_1^2 / (E_{in} - E_{out})^2 \\ &= (E_{out} / E_{in})^2 (1/f^2). \end{aligned} \quad (7l)$$

Solving Eq. 7j for $(I_{max} - I_{out})^2$ and substituting into Eq. 7l gives

$$\begin{aligned} 4 (\Delta V_{out} - V_H) 2CE_{out} (E_{in} \\ &- E_{out}) L_1^2 / L_1 E_{in} (E_{in} - E_{out})^2 \\ &= (E_{out} / E_{in})^2 (1/f^2), \end{aligned} \quad (7m)$$

and rearranging and canceling terms in Eq. 7m we have

$$C = E_{out} (E_{in} - E_{out}) / 8L_1 f^2 E_{in} (\Delta V_{out} - V_H). \quad (7)$$

Substituting circuit values into the expression, we have:

$$\begin{aligned} C_1 &= (28 - 5) 5/8 (1.025 \times 10^{-3}) (2 \times 10^4)^2 (28) \\ &(40 - 30) (10^{-3}), \end{aligned}$$

or

$$C_1 = 125 \mu F.$$

The actual component values used in the design (Fig. 4) are $L_1 = 1.0$ mH, and $C_1 = 100 \mu F$.

The 51-ohm resistor R_3 limits the base drive of Q_2 to about 15 mA (by using the internal current limiting of the device). Since E_{out} is less than the 7.1 V, reference voltage supplied by the $\mu A723$, the internal reference is divided down to 5 volts.

If the required output were greater than V_{ref} , the divider could be attached to the output voltage, the division ratio would be calculated to divide the desired output down to the reference level, and the reference would be applied directly to the error amplifier. Note that C_2 couples the full ripple voltage back to the input of the error amplifier. The resistive divider, composed of R_1 and R_2 , furnishes the voltage V_H .

The efficiency of this circuit is 73% at $I_{out} = 2$ A. When I_{out} is 1 A, the efficiency is 76%. These efficiencies are calculated from the expression:

$$\begin{aligned} \text{Efficiency (\%)} &= [P_{\text{out}}(\text{dc})/E_{\text{in}}I_{\text{in}}(\text{ave})] \times 100\% \\ &= [E_{\text{out}}I_{\text{out}}/E_{\text{in}}I_{\text{in}}(\text{ave})] \times 100\%. \end{aligned}$$

All of these quantities can be measured directly.

Similar design for negative regulator

A circuit for a switching regulator with negative output voltage is shown in Fig. 5. The operation is similar to that of the positive regulator circuit, except that the drive signal to the switching transistors is supplied from the V_{zener} output of the device. The zener provides the level shifting required to allow the device to drive the switches. The (μ A723's voltage regulators in the 10-pin metal package do not have a V_{zener} output. When using these devices, it is necessary to add an external 6.2-V zener between V_{out} and the switch transistors).

Since the μ A723 takes its power from the regulated output, it is immune to line transients of up to 60 V (the ultimate voltage limit is established by the breakdown voltages at Q_1 and Q_2). This circuit configuration is useful for output voltages more negative than -9.5 V, since the device is operated from the output of the regulator and requires at least 9.5 V across its power terminals for proper biasing. Output less negative than -9.5 V can be obtained if a positive voltage is available to which the positive supply terminal of the device can be returned. This voltage must be sufficiently positive to allow a 9.5-V supply to the device.

Short-circuit protection is easy

Short-circuit protection for the switching regulator can be provided by taking advantage of the built-in current-limiting feature of the μ A723. A schematic of a regulator with output current-limiting is shown in Fig. 6.

The inductor current is sensed by a small series resistance R_{sc} . When this current exceeds a set limit, there is sufficient voltage drop across R_{sc} to turn on the internal current-limiting transistor of the μ A723 and thus remove drive from the series switching transistor.

The voltage necessary to turn on the current-limiting transistor is the sum of V_{BE} for the limiting transistor and the voltage fed to the emitter of the transistor from the R_1, R_2 voltage divider. Since overcurrent protection is needed only when the switch is conducting, the drop across R_{sc} (the current sensing resistor) must be

$$V_{\text{Rsc}} = V_{\text{BE}} + (R_2/(R_1 + R_2)) (E_{\text{in}} - E_{\text{out}}).$$

The limit current is obtained from the expression

$$I_{\text{LIM}} R_{\text{sc}} = V_{\text{BE}} + (R_2/(R_1 + R_2)) (E_{\text{in}} - E_{\text{out}}).$$

Therefore, since V_{BE} is roughly 0.7 V,

$$I_{\text{LIM}} = 0.7 + (R_2/(R_1 + R_2)) (E_{\text{in}} - E_{\text{out}}) / R_{\text{sc}}.$$

The voltage divider formed by R_1 and R_2 supplies positive feedback to the emitter of the current-limiting transistor. Once the inductor current exceeds

the limit and the series switch transistor is cut off, the current must drop to a lower level before the μ A723 can again turn on the series switch transistor. This feedback ensures that the regulator will continue to switch under short-circuit conditions.

The division ratio of R_1 and R_2 should be chosen so that the second term in the numerator of Eq. 8 is about 0.3 V.

A similar scheme can be used for short-circuit protection of the negative output regulator. In this case the internal current-limiting transistor cannot be used. Instead, an additional pnp transistor is used to cut off the base drive to Q_2 (Fig. 7).

Power losses from two causes

Power is lost in a switching regulator in two significant ways: through conduction and switching losses.

The conduction loss in the switch transistor is a function of $V_{\text{CE (sat)}}$, I_{out} , and the fraction of a full cycle that the transistor is in conduction. The power lost is given by

$$\begin{aligned} & [V_{\text{CE (sat)}}] [I_{\text{out}}] [t_{\text{on}}/(t_{\text{on}} + t_{\text{off}})] \\ & \cong [V_{\text{CE (sat)}}] [I_{\text{out}}] [E_{\text{out}}/E_{\text{in}}]. \end{aligned} \quad (9)$$

The diode D_1 is conducting during the time the switch transistor is off. The conduction loss of the diode is determined by the forward drop of the diode V_{F} , I_{out} , and the fraction of a cycle that the diode conducts. This conduction loss is given by:

$$V_{\text{F}} I_{\text{out}} (t_{\text{off}}/(t_{\text{off}} + t_{\text{on}})) \cong V_{\text{F}} I_{\text{out}} (E_{\text{in}} - E_{\text{out}})/E_{\text{in}}. \quad (10)$$

Switching losses contribute a substantial proportion of the total power loss. The highest peak powers are dissipated when Q begins to turn on. Current from the transistor must remove the charge stored in D_1 , which is still in forward conduction. A transient current, limited primarily by the drive capability of Q , flows for a time equal to the reverse recovery time of D_1 . During this interval the full input voltage appears across Q , and the peak dissipation is quite high.

To minimize the power lost due to this current spike, D_1 should be a fast-recovery power diode. Ordinary power devices not intended for switched operation will seriously degrade the regulator efficiency.

Some power is also lost during the rise and fall times of the switch transistor, but this loss is usually negligible.

Some power is dissipated in the μ A723, of course, and should be considered in any detailed efficiency calculations. In general, though, the greatest power loss will be due to switching. ■ ■

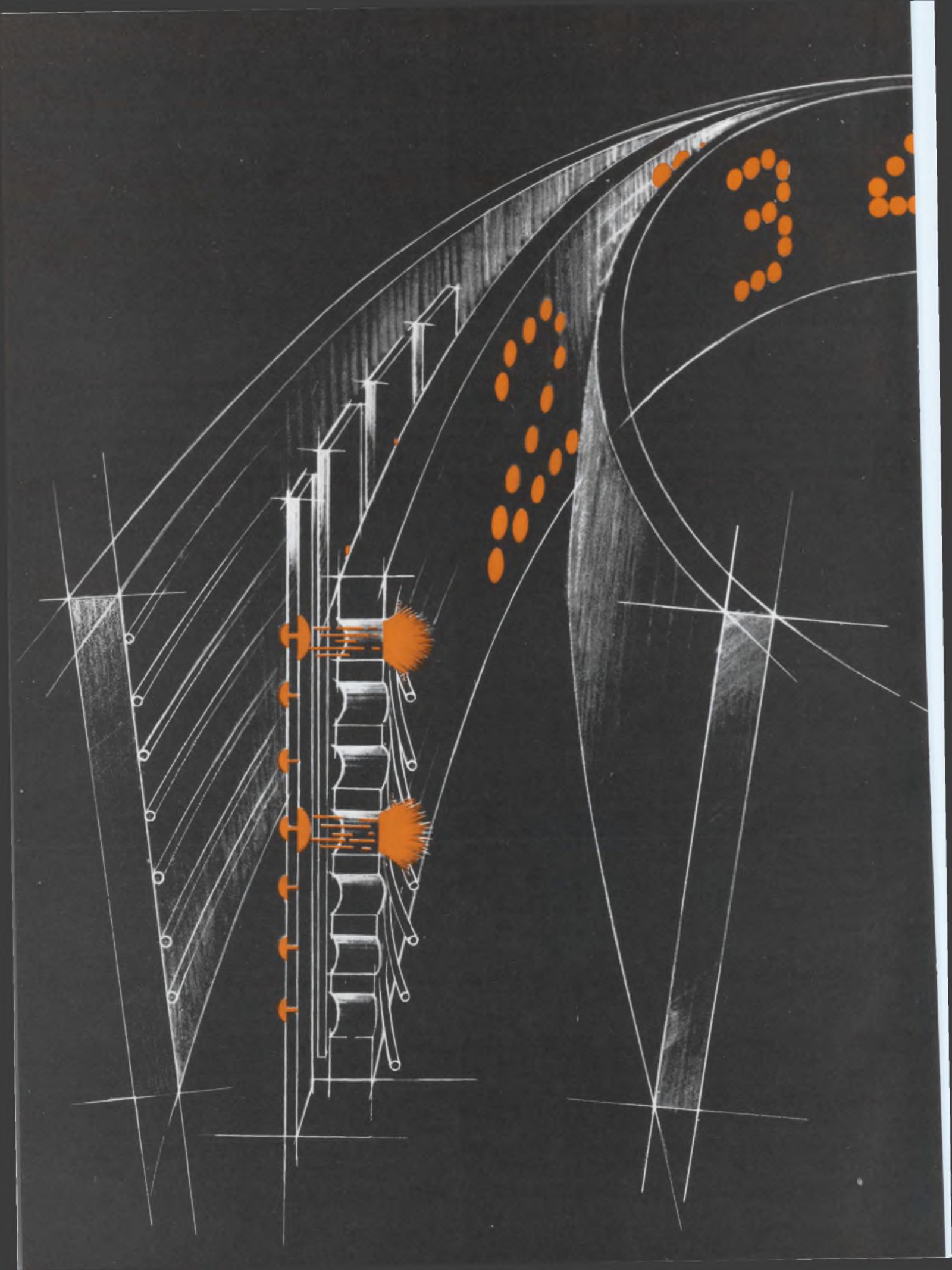



SELF-SCAN™ PANEL DISPLAY eliminates up to 90% of drive electronics

SELF-SCAN panel displays represent a Burroughs invention of panel design and circuitry that permits time sharing of the cathode electrode drivers in a flat panel display using gas discharge light emitters. Consequently a savings of up to 90% of the electronics required to drive the dot matrix display is realized.

For informational purposes the SELF-SCAN panel display can be thought of as a dot matrix panel with common cathode strips capable of glowing on both front and back sides. The glow on each side of the cathodes is independently controlled by a set of anodes located on the front and back of the panel. The rear portion of the display consists of 7 glow-priming anodes which work in conjunction with 111 vertical cathode strips (common to both sets of anodes). These cathodes are interconnected in three groups of 37 cathodes each and connected to a three

phase clock which sequentially brings each cathode to ground potential. As each cathode is grounded in sequence, the glow is transferred to the adjacent cathode. This transferred glow at the rear of the panel is not discernible from the front. (The illustration shows the first cathode grounded and glow at the 7 rear anode intersections.)

When it is desired to display a dot on the viewing surface, the front glow transfer anodes are utilized. (The glow transfer anodes and common cathodes make up the front matrix.) The appropriate transfer-anode is selected in synchronism with the cathode and the glow transfers forward to the panel front for viewing. (The illustration shows the top and center dots on the first cathode trans-

ferred for viewing.) The whole display panel is refreshed and updated to produce a bright flicker-free display.

As a normal dot matrix panel requires a cathode driver for each cathode (80 high-voltage drivers required for a 16 digit display) and the SELF-SCAN panel display requires *only* 3 clock controlled cathode drivers regardless of the number of digits, the significance of this development is immediately apparent.

The SELF-SCAN panel display has unlimited applications, as alphanumeric and graphic messages can be presented with simplicity.

Write today for descriptive brochure, Burroughs Corporation, Box 1226, Plainfield, N.J. (201) 757-5000.



Burroughs



INFORMATION RETRIEVAL NUMBER 47

Desk-top calculators close the gap between the slide rule and the large computer. Fourier analysis shows how this new class of machines can be helpful.

The electronic desk-top calculator, which can also be programmed, is a design tool that is rapidly closing the gap between large digital computers and either slide rules or mechanical calculators. But many engineers are still unaware of the versatility that these desk-top units possess.

Not only can they be used to calculate functions but they can also solve numerous problems without the user having to learn programming. With some units, preprogrammed cards or tape can be used to set up problems. In cases where there are no preprogrammed instructions, a program can be set up by means of a simple set of rules.

The calculation of a Fourier series by numerical integration provides a good example of how an electronic desk-top calculator can simplify design work.

Periodic functions become series

A periodic signal can be defined mathematically by the following equation, because the waveform repeats itself at regular intervals:

$$f(t) = f(t + nT) \quad n = 1, 2, 3 \dots$$

An example of a periodic function is

$$f(t) = \sin\left(\frac{2\pi t}{T}\right)$$

where T is the time required for one full fluctuation or complete cycle.

Most periodic signals in practice can be expanded into a series of the form

$$f(t) = \sum_{i=1}^{\infty} c_i \phi_i(t)$$

where $\{\phi_i(t)\} i = 1, 2, 3 \dots$ is an orthonormal set of functions on some interval (a, b) . The c_i 's are the coefficients to be determined.

This set is mutually orthonormal over the interval $a < t < b$ if the functions satisfy

$$\int_a^b \phi_m(t) \phi_n(t) dt = \begin{cases} 0 & \text{if } m \neq n \\ 1 & \text{if } m = n \end{cases}$$

Ivar W. Larson, Applications Manager, Calculator Section, Loveland Div., Hewlett Packard Co., Loveland, Colo.

A set of orthonormal functions is a complete or closed set if there exists no function $x(t) \neq 0$ for which

$$\int_a^b x(t) \phi_i(t) dt = 0 \quad x(t) = \phi_i(t) \text{ for } i = 1, 2 \dots$$

It can be shown that for a complete set of orthonormal equations, $c_i = \int_a^b \phi_i(t) f(t) dt$, and that these coefficients minimize the mean square error over the interval (a, b) .

One example of a complete set of orthonormal functions is

$$\left[\frac{1}{\sqrt{T}}, \frac{1}{\sqrt{T/2}} \cos \frac{2n\pi t}{T}, \frac{1}{\sqrt{T/2}} \sin \frac{2n\pi t}{T} \right]$$

$$n = 1, 2, 3 \dots$$

and it leads to the well-known Fourier series. Using this orthonormal set, $f(t)$ can be represented in the interval

$$t_0 < t < (t_0 + T)$$

by

$$f(t) = \frac{c_0}{\sqrt{T}} + \sum_{n=1}^{\infty} \left(c_n \frac{1}{\sqrt{T/2}} \cos \frac{2n\pi t}{T} + c'_n \frac{1}{\sqrt{T/2}} \sin \frac{2n\pi t}{T} \right) \quad (1)$$

Equation 1 can be rewritten

$$f(t) = \frac{a_0}{2} + \sum_{n=1}^{\infty} \left(a_n \cos \frac{2n\pi t}{T} + b_n \sin \frac{2n\pi t}{T} \right)$$

where

$$a_n = \frac{2}{T} \int_{t_0}^{t_0+T} f(t) \cos \frac{2n\pi t}{T} dt \quad n=0, 1, 2, 3 \dots \quad (2)$$

$$b_n = \frac{2}{T} \int_{t_0}^{t_0+T} f(t) \sin \frac{2n\pi t}{T} dt \quad n=1, 2, 3 \dots \quad (3)$$

Now $f(t)$ is broken into discrete frequency com-

ponents. The next task is to evaluate the coefficients a_n and b_n by carrying out the integrations of Eqs. 2 and 3. This can be done most easily by numerical means.

Evaluate coefficients numerically

There are many approaches to numerical integration. One of the most commonly used is Simpson's rule.¹ The method is based on the use of parabolic arcs to approximate the curve through equally spaced sample data points. The parabolas pass through a consecutive set of three points on the curve. As each set of three points (Fig. 1) accounts for two intervals or panels, the total number of intervals, n , is an even number.

Simpson's rule states:

$$\int_{t_0}^{t_0+T} f(t) dt = \frac{\Delta t}{3} (f_0 + 4f_1 + 2f_2 + 4f_3 + \dots + 2f_{n-2} + 4f_{n-1} + f_n)$$

and the error is proportional to $(\Delta t)^5$.

A desk-top calculator, such as the Hewlett Packard 9100A for example, can be used to evaluate the Fourier coefficients by carrying out the integrations of Eqs. 2 and 3 numerically. Prepared instructions and program steps establish the sequence required to perform the numerical integration for an arbitrary time function by Simpson's rule. The time function in Fig. 2 is used as an example:

First, the user enters the prepared program, which follows the flow chart (Fig. 3). For this calculator, a magnetic card (Fig. 5) is used to enter the program. The program for a specific task has been previously recorded on the magnetic surface of the card. The program is either developed by the user or it may be supplied as keyboard instructions by the manufacturer. Next, the user keys in the program steps to form $f(t)$ as a subroutine, the number of integration panels, and the interval of interest (Fig. 4). After instructing the calculator to execute, he gets a print-out of the Fourier coefficients. The data and calculated coefficients for

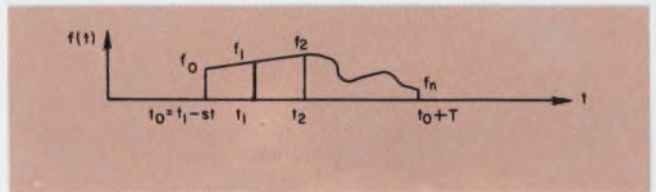

1. Time function is divided into equally spaced intervals for numerical integration by Simpson's rule.

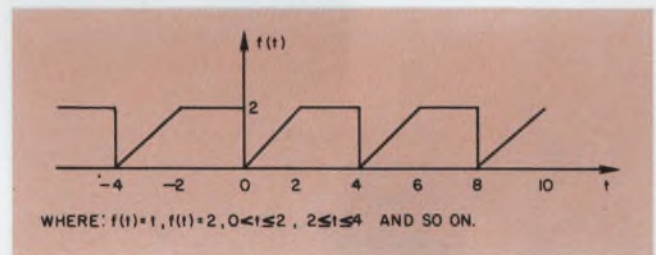

2. Arbitrary time function is used as an example of a method for determining Fourier coefficients.

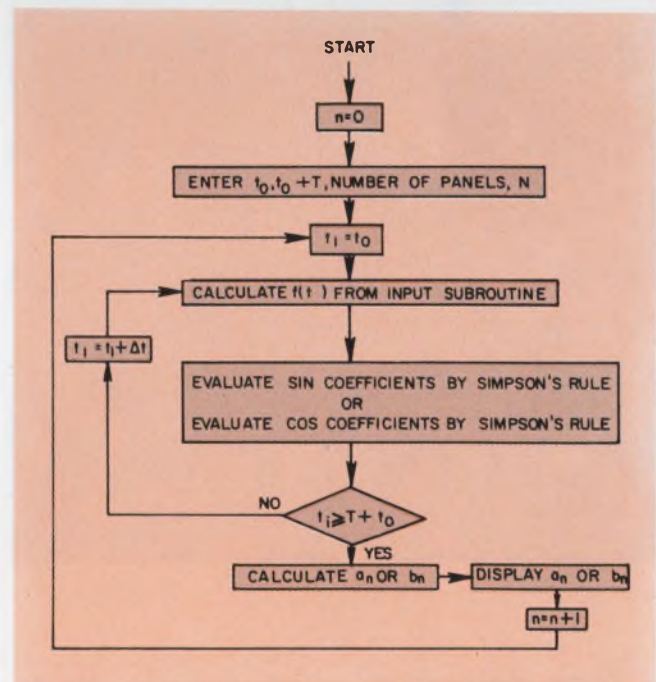

3. Flow chart of Fourier coefficient program describes steps in the computation.

SET:

ENTER PROGRAM: (Starting Address is 0 - 0)

PRESS: GO TO () ()

PRESS: 6

PRESS: 4

SET:

ENTER: Steps to take t from the X register (t is also stored in the e register) and form f(t). Leave f(t) in the Y register and exit to location 8-4. Steps 6-4 through 8-3 are available for forming f(t). The FLAG is not available.

SET:

PRESS: GO TO () ()

PRESS: 9

PRESS: 9

SET:

PRESS: sin X or cos X depending on desired sine or cosine coefficients. If series involves both sine and cosine, then initialize program to cos X.

SET:

PRESS: GO TO (0) (0) [or END]

PRESS: CONTINUE

DISPLAY

0	—	Z
0	—	Y
1	—	X

(n is set to 0)

ENTER DATA:

Number of panels
must be an even number → Z

$t_0 + T$ → Y

t_0 → X

Note: n is contained in the a register.

PRESS: CONTINUE

DISPLAY

$t_0 + T$	—	Z
a_n or b_n	—	Y
n	—	X

To change from cosine series to sine series—

PRESS: GO TO () ()

PRESS: 9

PRESS: 9

SET:

PRESS: sin X

SET:

PRESS: CLEAR

PRESS: X → ()

PRESS: a

(n is set to 1)

PRESS: GO TO () ()

PRESS: 5

PRESS: 7



5. Magnetic card is one method by which programs can be entered into the calculator.

this example follows:

Data:

$$T = 4$$

$$t_0 = 0$$

$$\text{Number of panels} = 50$$

Solution:

$$t_0 + T = 4.0$$

$$a_0 = 3.00053 \quad b_1 = -.63662$$

$$a_1 = -.40582 \quad b_2 = -.31832$$

$$a_2 = .00054 \quad b_3 = -.21223$$

$$a_3 = -.04557 \quad b_4 = -.15921$$

$$a_4 = .00057 \quad b_5 = -.12744$$

$$a_5 = -.01676 \quad b_6 = -.10631$$

$$a_6 = .00062 \quad b_7 = -.09128$$

$$a_7 = -.00883 \quad b_8 = -.08809$$

$$a_8 = .00069$$

After obtaining the coefficients, a plot of the first few sine and cosine terms approximating $f(t)$ can be made by connecting an x-y plotter to the calculator output. ■ ■

References:

1. William T. Weeks, "Interpolate Data for Your Computer," *Electronic Design* (ED 17) Aug. 15, 1968, p. 202.

Bibliography:

Hildebrand, H. B., *Introduction to Numerical Analysis*, McGraw-Hill Book Co., New York, 1956.

Lathi, B. P., *Signals, Systems and Communications*, John Wiley & Sons, Inc., New York, 1965.

Test your retention

Here are questions based on the main points of this article. Their purpose is to help you make sure you have not overlooked any important ideas. You'll find the answers in the article.

1. What statement can be made about the error when generalized Fourier coefficients are used?

2. When using Simpson's rule, what type of curve is used for fitting data points?

3. Under what conditions is the use of a desk-top calculator most convenient?

4. Fourier coefficient input information is keyed into the desk-top calculator after the program has first been entered by magnetic card (Fig. 5).

WANG 700



Calculator or computer?

It's compact enough to be a calculator, thanks to the most advanced integrated circuit technology. But who ever heard of a calculator with 960 step programming capability? Or one with an 8192-bit magnetic core memory organized as 120 data registers, each of which can add, subtract, multiply and divide like 120 individual calculators? The 700 is very computer-like in its ability to loop, branch, do subroutines and make decisions. But unlike most computers, you don't have to wait to get on-line and you don't have to know a special language to use it. You'll get calculator-like convenience from its instantaneous dual NIXIE® display for both X and Y registers and computer-like efficiency from an optional automatic typewriter. You can use the 700 to conquer large and small numbers from 10^{+98} to 10^{-100} , to invert a 10×10 matrix, or to perform special functions like bond yields, life expectancy, nuclear half-life, or process formulas. It will execute + and - functions in $300 \mu\text{sec}$, \times and \div in 3 to 5 msec. Log_e^x and e^x in 17 to 35 msec and trig functions in 250 msec. The 700 can give you the right answer to a complex statistical, financial, or scientific problem before an ordinary calculator understands it or a full-scale computer is even aware of it.

To simplify matters we're calling the 700 an electronic calculator, because who ever heard of a computer for \$4900?*



Dept. ICB, 836 North St.,
Tewksbury, Massachusetts 01876
Tel. 617 851-7311

SALES/SERVICE OFFICES

Alabama (205) 881-5360	New York (212) 736-0084
Arizona (602) 274-2110	(516) 437-2500
Arkansas (501) 666-7115	(518) 785-3234
California (213) 776-2985 (714) 276-8464 (415) 692-0584 (805) 962-6112	(716) 328-2510 (315) 463-9770
Colorado (303) 364-7361	North Carolina (704) 372-9660 (919) 272-5683
Connecticut (203) 288-8481	Ohio (216) 331-6525 (513) 531-2729 (513) 771-3445 (614) 268-3511
Florida (305) 841-3691 (305) 563-8458 (813) 872-7347	Oregon (503) 297-2501
Georgia (404) 633-6327	Oklahoma (405) 524-4489 (918) 743-2571
Hawaii (808) 536-5359	Pennsylvania (215) 642-4321 (412) 243-3642 (717) 675-3879 (717) 236-4782
Illinois (309) 673-6620 (312) 297-4323	Rhode Island (401) 421-0710
Iowa (515) 288-5991	Tennessee (615) 266-5055 (615) 889-1408 (615) 524-8648 (901) 327-8241
Kansas (316) 262-1388	Texas (915) 683-3304 (512) 454-4324 (214) 361-7156 (915) 565-9927 (713) 666-2451 (214) 758-1810
Kentucky (502) 897-5143	Utah (801) 487-2551
Louisiana (504) 729-6858	Vermont (802) 223-6398
Maryland (301) 588-3711 (301) 821-8212	Virginia (703) 595-6777 (703) 359-6320
Massachusetts (413) 734-2230 (617) 851-7311 (617) 542-7160	Washington (206) 525-2000
Michigan (313) 352-7112 (616) 458-6595	Wisconsin (608) 255-4411 (414) 442-0160
Minnesota (612) 884-7328	Wyoming (303) 364-7361
Mississippi (601) 875-5588	Calgary (403) 266-1804
Missouri (816) 444-8388 (314) 997-5866	Don Mills, Ont. (416) 499-7890
Nevada (702) 322-4692	Montreal (514) 482-0737
New Hampshire (603) 669-0404	Ottawa (613) 728-4445
New Jersey (201) 272-7160	Vancouver (604) 685-2835
New Mexico (505) 255-5775	

*Price in 48 contiguous states and District of Columbia.

Anxious about the sale of your design?

A franchise system generated to spark electronics sales provides the best reps possible, says this manufacturer.

Richard L. Turmail, Management Editor

You're either a design engineer or an engineering manager. Whatever course your career takes, you'll be in a more competitive position if you keep informed about the business part of your industry.

An engineer, who is informed, for example, about the way in which his devices are marketed, will no doubt learn how to design a more marketable item. The engineering manager who picks up information about corporate operating procedures can't help improving his chances for promotion.

Minding your own business will enable you to understand more clearly the role you can and will play in the drama of the electronics industry. The following article-interview depicts one scene from that drama.

Released at a press conference in Concord, Calif., on August 1, 1969 was this statement: "A unique, mutually owned sales franchise system, the first of its kind in the electronics industry, was announced today by the Systron-Donner Corp.

"Under the new concept a newly created sales subsidiary, Scientific Devices, Inc., jointly owned by Systron-Donner and independent field representatives, will establish regional franchises."

Of what interest could a sales franchise system be to a design engineer?

A great deal, according to James R. Cunningham, recently named president of Scientific Devices, Inc. He told ELECTRONIC DESIGN that engineers at Systron-Donner are very product-oriented, that they're concerned about the manner in which the products they design are marketed, and they're concerned about whether or not the sales representatives understand the product well enough to present it to other engineers.

Cunningham says, "If sales are bad, our engineers want to know if we have the best reps possible in any given territory, and if not, why not? That's the reason our EEs are really excited about our sales franchise system—because they

know that this selling operation will provide the best reps possible in any given territory for their products."

A sales-representative company sells, distributes and services, on a regional basis, from five to 20 product lines. The rep company is comprised of from two to 25 salesmen, with most companies generally employing an average of about six men, whose sales commissions range from 8% to 15%.

A franchise situation is one in which a company sells, on a regional basis, facilities, products, supplies and trade name to an individual. The franchiser handles all the advertising and sales promotion and trains the individual to run the business.

Somebody drops the other shoe

In explaining how the system works, and why his company decided on this approach to sales, Cunningham says that he feels it's necessary for him to first recount the historical conflict between the sales rep and the manufacturer that has existed in the industry.

"Let's say you start a small company," Cunningham says, "and contract a sales-representative organization to sell your product. The rep company eventually gathers together about ten companies the same size as yours, and together you all build and grow." According to Cunningham, the relationship is effective because:

- The rep is an independent local businessman with whom most customers like to deal.

- He has a broad product line because he represents a lot of companies. The customer likes to hand his orders to one salesman.

- He's aggressive because working on a straight commission gives him incentive to earn as much as he's capable of earning.

- And you can compete with a major corporation in your market area because the rep gives you a national sales force.

Cunningham points out that suddenly two separate conflicts of interest start to erode the rep-manufacturer relationship.

First, a rep company requires no capital, and

Tuning up an instrumentation company

As one of the major manufacturers of electronics instruments Systron-Donner has carved out both a piece of the market in the industry and a home in the hills of Concord, Calif.

Since Systron Corp. and Donner Scientific Co. merged to form Systron-Donner Corp. 11 years ago, the manufacturer has grown internally by adding, periodically, to its line. In the past year alone, it has developed and brought 40 products to market. It has also grown by company acquisition, including most recently Micro-Radionics, Wavelabs, Seaton-Wilson, Bagno Electronic, Kruse-Storke Corp. and Mekel Associates. During this period the company has increased its staff from 572 to 1283.

Systron-Donner officials claim that the company has never experienced a loss year. Since 1964, the company has tripled its annual sales

from \$9,404,000 to \$28,851,000 and more than tripled its annual earnings from \$605,000 to \$2,016,000. Its international division, completing its first full year of operation, produced sales of \$1,150,000 against \$790,000 for the preceding year.

In a move to stabilize its rep force and boost sales, the manufacturer launched its franchise system nationwide last August under the banner—"Scientific Devices." Two of Systron-Donner's reps, Ward Davis Associates and Burlingame Associates, promptly dropped the manufacturers product line. A Burlingame spokesman stated: "We prefer the path of independent growth."

As of November, 1969, Systron-Donner had seven regional marketing subsidiaries under the Scientific Devices name, which covered 72% of the manufacturer's domestic sales.

therefore does not need to build equity. The temporary relationships (30-day cancellation clause) with manufacturers prevent a continuous growth. The young rep cannot buy into his company because it's worth only the amount of its receivables; he's dependent on the manufacturer's commission. Eventually, the rep is going to be concerned about his long-term capital gains and his investments. He would prefer to own a piece of a company so that he can share in the profits. He hasn't done that in a rep company.

"Then the small manufacturers start to grow," Cunningham says, "and they find that to compete with the giants of the industry, they must produce a broader line of products. When they become broad-based, they start to compete with the other nine companies within the sphere of the rep organization. Because the rep obviously cannot handle two competing products, he is forced to choose one company, and the other company is forced to find another rep."

Knowing that dissatisfaction exists in its former rep organization, Cunningham says that the manufacturer that has been dropped induces two or three from the rep outfit to leave and

start an organization of their own. These salesmen now own their own rep company. They have a chance to make more money because there are fewer of them to share the commissions, and because they can handle as many noncompetitive product lines as they want.

The result is that the manufacturer has lost its former sales force, and the rep company is forced to look for more salesmen and another line of products.

Aging industry slows down

Complicating these conflicts further is the change that the industry itself has undergone in the past ten years. It is rapidly maturing.

"In the old days," Cunningham says, "a small instrumentation company could quickly become a dominant factor in a market area because its investment was minimal compared to today, and the competition was not as tough."

So, according to Cunningham, the smaller companies starting today are entering the fringe areas of the market (computers) simply because they have difficulty in getting the capital or the

marketing force to tackle the major market areas.

"So the industry consists of a number of large companies all shooting at the major market area of measurement instruments (counters, scopes, signal generators, voltmeters) in the neighborhood of \$500 million," Cunningham says.

The major manufacturer would like to use the rep structure because it has worked in the past. "But," says Cunningham, "the rep now finds that he must really make a decision: He must find out how to exist with one instead of ten of these instrumentation companies if he is to stay in the mainstream of the industry."

One of the alternatives open to the rep is to become what Cunningham calls a "merchandiser who sells himself rather than the image of the company." He is not dependent upon one major company, and Cunningham says that he can rely on his own ability to solve a problem at the customer site without worrying about the turnover of his manufacturers.

This is where it stands now and according to Cunningham, both manufacturers and reps are in a dilemma.

Where do we go from here?

"The first manufacturer's approach in trying to solve the conflict," Cunningham says, "is to go direct; that is, when the commissions paid out equal what the manufacturer thinks would be the cost of supporting his own people in the field."

Cunningham suggests the following analysis of going direct:

Advantages of going direct:

1. Company control over what the salesman does.
2. Salesman doesn't have a lot of other lines, so he can concentrate on company products.

Disadvantages of going direct:

1. Suddenly this field salesman does not have a complete brand line to offer so his effectiveness at the customer point is diminished.
2. He has become involved with the political power structure of the corporation. Very quickly the sales manager can see that the salesman is making more money than he is; another manager might not like the way the salesman combs his hair or the way he sells. More and more salary and less and less commission are offered to cut down on company costs.

As a result, incentives come down. He is told how to sell: "We do well in Texas, and this is the way you should sell there," etc., etc. He loses his aggressive, entrepreneurial attitude, his local-businessman style. The company ends up with an order taker instead of a salesman.

"We don't have this problem at Systron-

Donner," Cunningham says, "because we don't have a direct sales force."

A company solves its dilemma

According to Cunningham, Systron-Donner does not believe that the existing answers to sales problems will fill its sales needs. It feels that the best way to meet its objectives for growth is to retain the independent rep structure of its sales force if it is to grow from its present \$24 million to, say, \$74 million in instrumentation sales in the next three years.

"Because we have a broad base of instruments we can benefit from the rep structure if we can eliminate the instability of rapid turnover. What we're trying to do is improve the association between a rep and a major manufacturer," Cunningham says.

He feels that the conventional rep structure must build equity so that the young salesman will buy into the company. "We don't want to manage this company; we don't want to own it. All we want is a bona fide business corporation that is profit-oriented, disperses the profits among the salesmen, and offers every salesman a chance for part ownership in the company," Cunningham says.

Systron-Donner has gone to its existing reps, and where that was not possible, it has gone to top area salesmen and explained to them that a franchise operation is the best solution to turnover and growth.

In California, for instance, Systron-Donner took a number of sales people from existing rep organizations and helped them to establish a corporation. They have a plan where each new salesman can buy into the company at book equity. They also have a plan where the profit is split into three equal pools. The first pool is based on individual sales volume, which gives the salesman an incentive to sell; the second pool is based on a salary and profit-sharing type of disbursement, which makes everyone worry about expenses; the third pool is based on ownership, which gives everyone incentive to purchase stock.

This is an independently owned corporation, and Cunningham says that they have been given a franchised rep agreement that:

- Establishes the commission rate and the territory.
- Gives them the franchise right to use the name "Scientific Devices." Using one name throughout on a national basis is an important factor in building equity in book. If a company is to grow it must get a national marketing and merchandising image.
- Eliminates the normal arbitrary rep termination that plagues this industry (30-day cancellation clause).
- Allows the rep corporation to represent



Jim Cunningham's career has progressed as steadily as his employer's earnings. After graduating from the University of California in 1952 with a BSEE, Jim advanced from engineer to sales manager at the Berkeley Division of Beckman Instruments in California, and from sales manager to director of marketing in Systron-Donner's instrumentation group, until his recent promotion to president of Scientific Devices—National, S-D's sales franchise system.

other noncompetitive companies so that they can retain the benefit of the broad line of products. They are completely independent local businessmen, but they have another hat—that of national unity.

What the franchise accomplishes

"There's no conflict now," Cunningham concludes, "because the rep wants Systron-Donner to get big, because it is part of the national name. If we get big, the rep gets big, and all of a sudden Systron-Donner has a field sales force. We also have a marketing force that gives us inputs we can listen to. These men know what lines to get that won't conflict with us. And we open our product plans to them, so that they know we're not off in a secret room building a product that's going to reduce their commission.

"Now, if we grow from \$24 million to \$74 million over the next three to five years, the rep will grow also, because we have created good interface with the customer; the rep has a long-term contract and has been given incentive to earn, and we've created a national sales force but are not involved in the managing of it."

So Systron-Donner has taken the old franchise idea, like that of the restaurant and gas station chains, and adapted it to the electronics industry.

One step further

"But we want to go one step further," says Cunningham. "To get a better interface with this rep organization, we have set up a national holding corporation called Scientific Devices National that is run by the reps. There are six reps and three company officials from Systron-Donner on the board of directors. Other reps are chairmen of major committees that were formed to handle commission disputes; new product development; service problems; leasing cars and working on advertising, sales, mailing, and promotions with Systron-Donner.

"We formed the holding company to cooperate with the reps on all of the things that can be done more efficiently together," Cunningham says. "We want the rep to participate in Systron-Donner's growth through their stock, and also to participate in the holding-company equity build-up. We have allowed for a transfer of stock of their company with this national holding company."

Systron-Donner has put \$600,000 into this national corporation for 60% control. All of the reps have put in 20% of their company for 40% of the national. What does this do?

Cunningham says: "With investment in stock like Systron-Donner, growth in the instrument field means growth in the stock and thus a multiple buildup of equity in the national and the rep corporation. The rep corporation, of course, continually builds equity as long as it grows.

"Now we have established a rep corporation that has stability. The principal owners can sell shares of stock back to the company because there's a corporation to sell it to."

Even sales are bigger in Texas

Systron-Donner now has franchise organizations in California, the Rocky Mountains, Philadelphia, the Northwest, the Northeast, New York State, Long Island, New York City, and Texas.

Cunningham says that although it's too early to tell how their franchised rep sales are doing nationwide, he has been encouraged by the sales figures of the Texas franchise operation.

"We started the rep system in Texas because there was poor rep coverage there," Cunningham says, "and the risk would be minimal if the franchise didn't work out. So far, however, our sales there have increased from \$200,000 to \$2 million in the past year and a half."

It just goes to show what a scant ounce each of dedication and concentration, and a full pound of incentive can do. ■■

How to get the world's first monolithic dual FET.

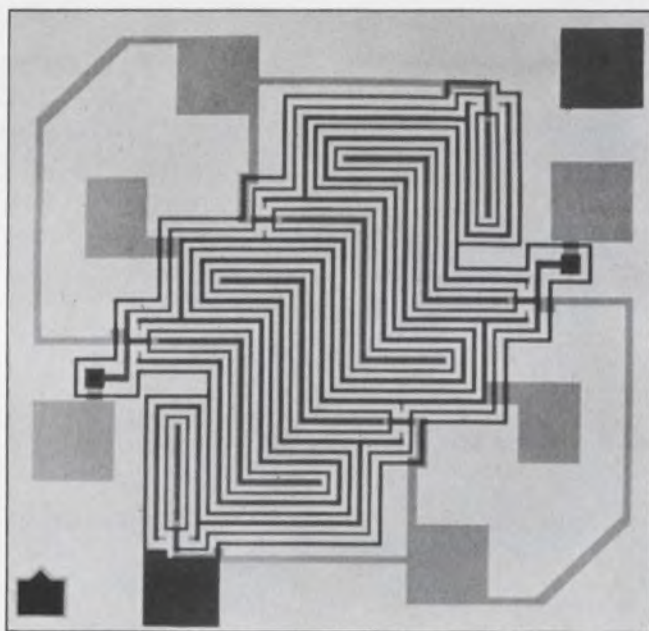

By design.

By tomorrow.

There's never been an N-channel dual FET remotely like it. We should know. With FETs by the millions under our belts, this little 2-in-1 device is something else again.

It's monolithic. It's matchless. It's National's FM3954. Wipes out the sticky problem of matching two separate FETs for identical specs. This revolutionary new dual eliminates the entire costly, time-consuming process. By designing both FETs on a single chip, the match is built in to stay.

Our monolithic marvel's a unique performer too. Even the best discrete matched duals can't touch its track record; offset voltage (5mV max.), temperature drift ($5\mu\text{V}/^\circ\text{C}$ max.), from $50\mu\text{A}$ to $500\mu\text{A}$.

Not to mention its flexibility of use or the reliability advantage because it's monolithic. And because it's National.

Available now. No maybe's about it. We've got monolithic dual FETs packed on the shelves, ready to ship without delay. Priced from \$2.40 to \$15.00 in hundred lots.

Write or call for complete spec data. We'll throw in a brief listing of our hundred or so other discrete FETs. National Semiconductor, 2900 Semiconductor Drive, Santa Clara, California 95051 (408) 732-5000 TWX: 910-339-9240
Cable: NATSEMICON

National/FET

Addition of current source to regulator improves performance

The use of a current source to replace the series-dropping resistor in a zener voltage regulator provides higher circuit efficiency, lower zener power dissipation and improved voltage regulation for large variations in voltage input. This is especially true when the input voltage minimum is near the zener voltage.

Figures 1 and 2 illustrate, respectively, a conventional zener voltage regulator and one using a current source. Note the greatly decreased power input variations of the circuit shown in Fig. 2. This is also reflected as lower power

dissipation in the zener.

Decreased current fluctuations in the zener means improved voltage regulation while the high dynamic impedance of the current source improves rejection of hum on the input line. Any increase in cost due to the additional components will be offset by the use of a 0.5-W zener instead of a 1-W zener.

Robert M. Groh, Electrical Engineer, RF Communications Inc., Rochester, N.Y.

VOTE FOR 311

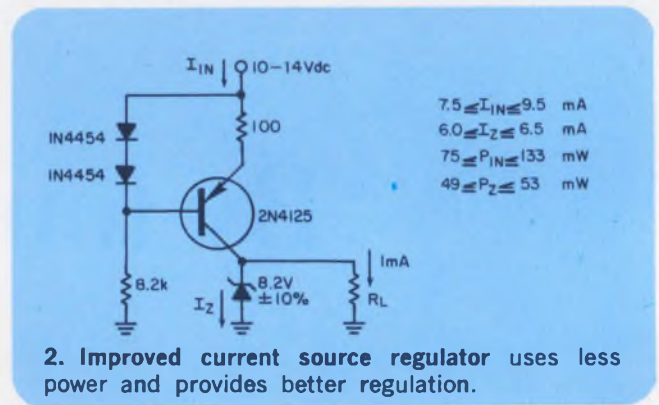
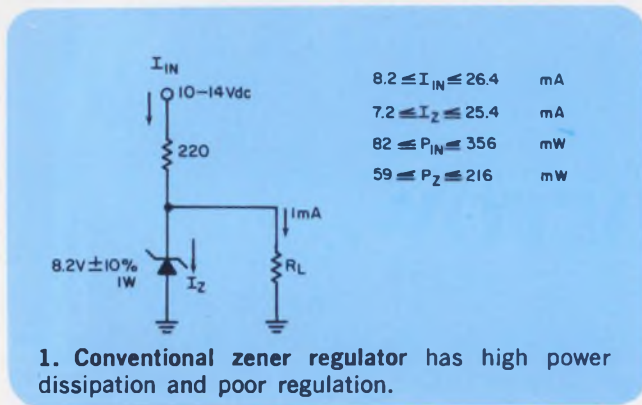

Linear temperature monitor uses silicon diodes as sensor

A simple, low-cost, linear temperature monitor can be built using diodes as sensors. The original scale numbering on a zero to 100-microampere panel meter is used to cover a zero to 100° F temperature range. The circuit, battery included, will mount behind the meter.

The sensor consists of two inexpensive silicon diodes connected in series to double the temperature coefficient of the forward voltage drop.

These are biased at about 1 mA by R_B . The 1.2- Ω k and 3 Ω k resistors and calibration pots determine offset and sensitivity. A low-temperature-coefficient zener diode regulates battery voltage, and its dynamic resistance is canceled by R_D to provide a stable voltage source as the battery ages.

Calibration is accomplished by placing the sensor in a known 0°F environment and setting

$\pm 50 \text{ ppm}/^{\circ}\text{C}$

in all Helipot Cermet Trimmers

This significant advance in Helipot's cermet technology is now available at only a dime/unit more . . . 100 ohms thru 2 megohms. In addition, you get essentially infinite resolution, environmental stability, reliability, no catastrophic failures — all superior to wirewound trimmers. We'll also deliver off-the-shelf, locally stocked trimmers with a standard tempco of $\pm 100 \text{ ppm}/^{\circ}\text{C}$ in the 100 ohm thru 2 megohm range.

Beckman

INSTRUMENTS, INC.

HELIPOT DIVISION

FULLERTON, CALIFORNIA • 92634

INTERNATIONAL SUBSIDIARIES: AMSTERDAM; CAPE TOWN; GENEVA; GLENROTHES, SCOTLAND; LONDON; MEXICO CITY; MUNICH; PARIS; STOCKHOLM; TOKYO; VIENNA

IDEAS FOR DESIGN

R_o . Then R_G is set with the sensor at a known room temperature. By using the 0°F (zero current) point for offset setting, interaction of the adjustments is avoided. A press-to-read button ensures long battery life.

High-conductance silicon diodes were found to have remarkably uniform characteristics in this application. Of 40 1N4153 diodes selected at random, all were found to be interchangeable within $\pm 5^\circ\text{F}$, and several within $\pm 1^\circ\text{F}$. In all cases, only a slight offset adjustment was needed to restore calibration.

Maxwell Strange, Design Engineer, National Aeronautics & Space Admin., Goddard Space Flight Center, Greenbelt, Md.

VOTE FOR 312

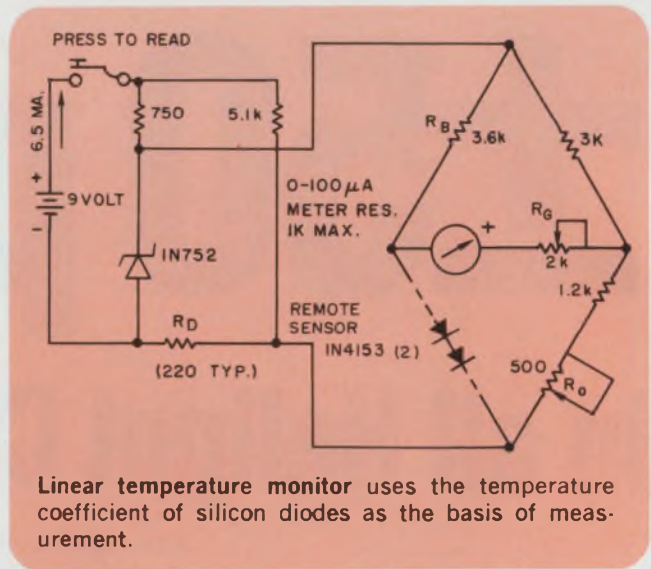

Linear temperature monitor uses the temperature coefficient of silicon diodes as the basis of measurement.

Adjustable time-delay relay is controlled by overload current

Frequently high-voltage arcs occur in equipment such as electron beam welders, and this trips the overload relay unnecessarily. By adding an adjustable time-delay relay, short-term overloads of several times the normal rating can be handled without affecting the continuous current rating of the machine.

The circuit shown in Fig. 1 has an adjustable range of up to 0.5 second and shunts the existing overload protection relay, which is a 12-V dc latching-type and is operated by the voltage developed across a resistor in the high-voltage return line.

A silicon-controlled switch (2N3008) is the active element of the circuit and was chosen because of its high sensitivity, low holding current capability, and its positive switching action. The 8.7V

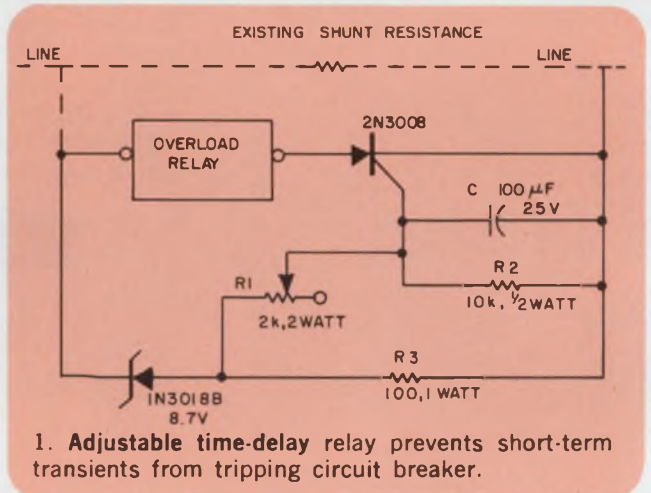

1. Adjustable time-delay relay prevents short-term transients from tripping circuit breaker.

VOTE

VOTE! Go through all Idea-for-Design entries, select the best, and circle the appropriate number on the Reader-Service-Card.

SEND US YOUR IDEAS FOR DESIGN. You may win a grand total of \$1050 (cash)! Here's how. Submit your IFD describing a new or important circuit or design technique, the clever use of a new component or test equipment, packaging tips, cost-saving ideas to our Ideas-for-Design editor. You will receive \$20 for each accepted idea, \$30 more if it is voted best-of-issue by our readers. The best-of-issue winners become eligible for the Idea Of the Year award of \$1000.

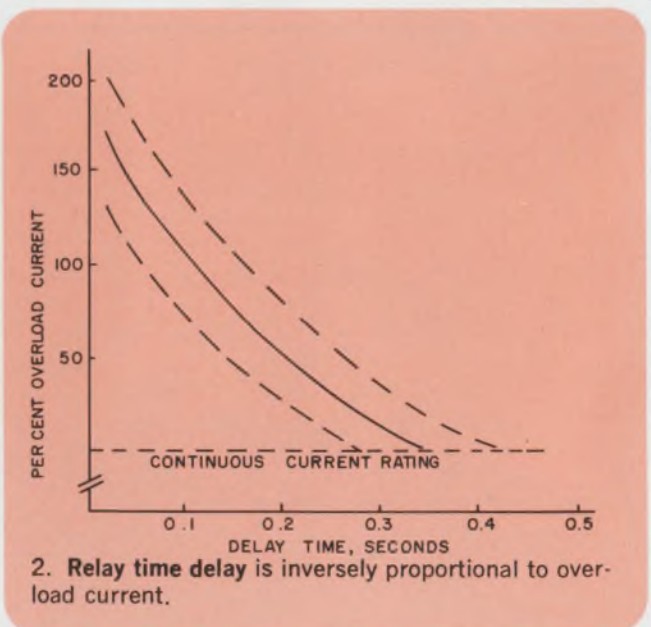

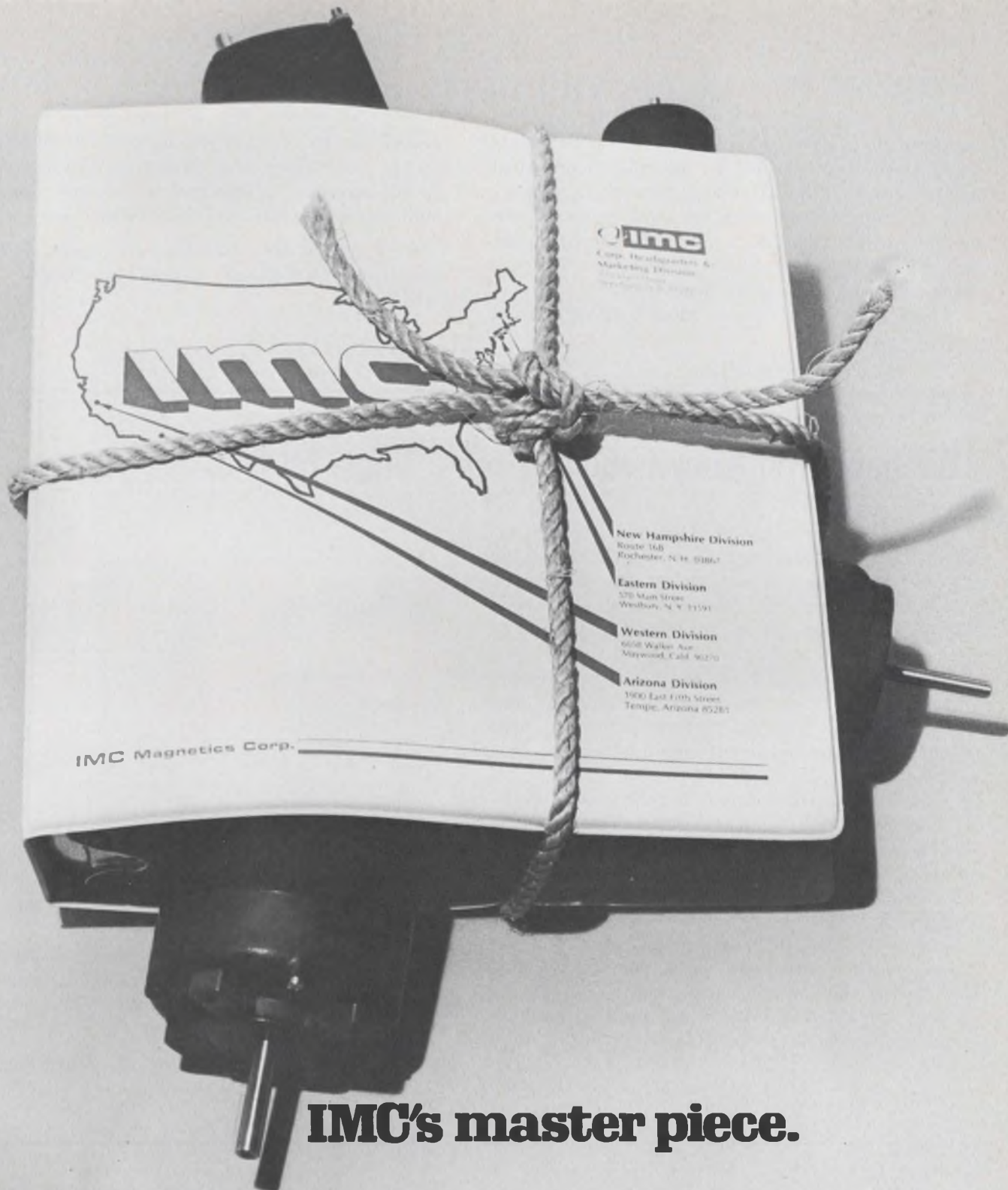

2. Relay time delay is inversely proportional to overload current.



IMC's master piece.

**It's entitled, "The Master Catalog."
We squeezed all our products into it.
This limited edition available only from
your IMC sales representative.**

Arizona Division  Rotary solenoids/Electrohydraulic subsystems/Solenoid valves/Hydraulic and pneumatic components

Eastern Division  Airmovers: centrifugals, fans, tubeaxials and vaneaxials/Motors: induction, synchronous hysteresis, reluctance, polarized, torque and servomotors/Solid-state AC-motor controller systems

New Hampshire Division  Boxer, MiniBoxer, SuperBoxer, IMCair and Condor fans/IMCair centrifugal blowers

Western Division  Tormax stepper motors and controllers/Synchros/Resolvers/Solenoids/Flag indicators

All members of the IMC corporate family  IMC Magnetics Corp., 570 Main Street, Westbury, N.Y. 11591, (516) 334-7195

zener diode is used to apply all voltages in excess of this value to the gate of the silicon-controlled switch, through the adjustable resistor, R_1 . Charging the capacitor provides the time delay to turn on the switch (approx. 1 volt). R_2 bleeds charge from C for re-cycling. Figure 2 shows the performance characteristics of the time delay.

This circuit can be "retro-fitted" to any electrical

system that has a shunted-relay type of breaker, or can be installed in any unprotected system. The circuit requires no external power and could be built into a standard circuit-breaker case.

W. A. Roden, Mfg. Development Engineer, General Dynamics Convair, San Diego, Calif.

VOTE FOR 313

Wideband frequency doubler from a single MOS IC

Wideband frequency doubling can be accomplished using a standard four-element MOS IC. The arrangement is shown in the figure. A Marconi-Elliott ladder element MOS IC (type E6015) is arranged to provide the necessary phase inversion and squaring action.

IC elements A and B act as a unity gain linear inverter since their aspect ratios are nominally the same and the square law distortion will cancel. The input sine wave (fundamental) *does not* appear at the output since the gates of IC elements C and D are driven out of phase. Resulting fundamental drain currents cancel in the common load resistance. The second harmonic *does* appear because it is proportional to the square of the input signal. A balancing potentiometer is required at the effective sources of elements C and D to completely null out the fundamental component. With the 2.2-k Ω load resistance shown, good squaring action is obtained up to 100 kHz. The output signal at maximum level is about 10 dB down from the input.

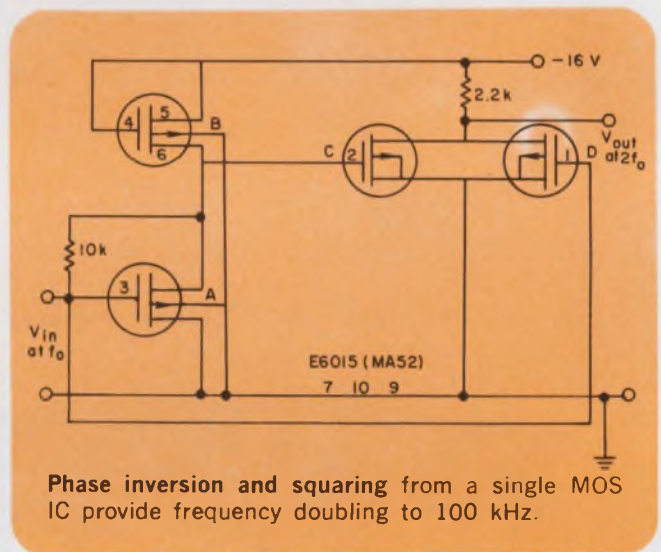

Phase inversion and squaring from a single MOS IC provide frequency doubling to 100 kHz.

J. A. Roberts, Design Engineer, University College of Swansea; and A. MacDonald, Marconi-Elliott, Microelectronics, Witham, Essex, United Kingdom.

VOTE FOR 314

Improved switch-contact-bounce eliminator uses fewer parts

Contact bounce is a universal problem in digital equipment. A novel solution uses fewer parts than do conventional techniques.

Figure 1 shows the standard technique. A two-element bistable is used. This involves at best using one-half of an integrated-circuit package. Figure 2 shows how, by using positive feedback from a non-inverting device, a single-element bistable can be constructed that uses one-third of an IC. An additional advantage is

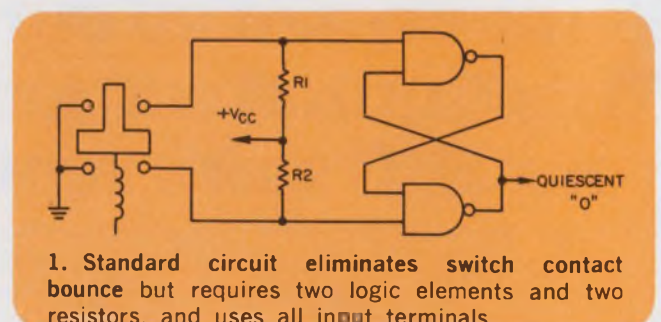

1. Standard circuit eliminates switch contact bounce but requires two logic elements and two resistors, and uses all input terminals.

But Cutler-Hammer does give designers an almost unlimited choice of switch types, forms, shapes, and colors.

We put this Rube Goldberg together to demonstrate the tremendous range of choice you have with Cutler-Hammer switches.

Take our Designer Line toggle switches. Our AC-rated and AC/DC switches come in the greatest selection of switch bodies, current ratings, toggle shapes and colors available anywhere. And with our wide variety of decorator face nuts, you can customize all Designer Line switches to the Nth degree.

Cutler-Hammer Rockette AC Switches have the same flexibility—and then some. They're available in smooth and serrated rockers;

single, double, and triple rocker designs; futuristic—even proprietary—styling. Multiple choices in colors. Plus lighted versions and special circuits when requested.

And have we got pushbuttons! Pushbuttons for every function. Pushbuttons in an amazing variety: push-button switches, ultra-miniature pushbuttons, and revolutionary new reed pushbuttons.

Delivery: "Off the shelf" on most everything. Or, we'll build to your specifications. When? Call your Cutler-Hammer Sales Office or Stocking Distributor for a fast answer.



This is a partial showing of the basic types of commercial switches we offer. With all of these size, color, style and functional options, you have complete design freedom.

We don't stock it.



Switch
to No. 1

More than just switches;
prompt availability,
field help, innovation,
quality assurance, too.

INFORMATION RETRIEVAL NUMBER 53



CUTLER-HAMMER
SPECIALTY PRODUCTS DIVISION, Milwaukee, Wis. 53201

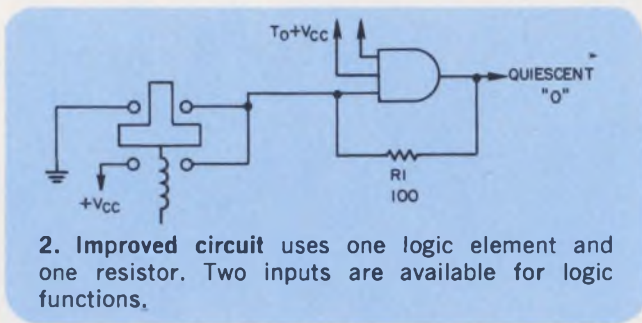

2. Improved circuit uses one logic element and one resistor. Two inputs are available for logic functions.

realized in having two input terminals free for logical enabling or clocking functions.

Any system with two or more push buttons can reduce its IC package count and use fewer interconnections between its logic cards and switch panel by using single-element bistables.

L. A. Berger, Jr., Design Engineer, Nuclear-Chicago Corp., Des Plaines, Ill.

VOTE FOR 315

Neon-bulb circuit doubles as pilot light and trouble light

Most power supplies contain at least one fuse and a neon pilot light. With the addition of two diodes, two resistors, and one capacitor the neon light can serve a dual purpose.

As shown in the figure, if the fuse is good, the neon light functions as a pilot light. However, when the fuse blows, the neon light indicates that fact by blinking on and off.

When the fuse is good, D_2 acts as a rectifier and applies current to the neon bulb. D_1 acts as a blocking diode, thus preventing a short. In this mode, the light is on continuously. When the fuse blows, D_2 blocks while D_1 rectifies. R_1 and C serve as a time constant for the flashing effect. R_2 and the forward resistance of D_2 increase bulb life. Resistance values should be adjusted for each type of neon bulb used.

Howard Raphael, Design Engineer, Singer Corp., Friden Division, San Leandro, Calif.

VOTE FOR 316

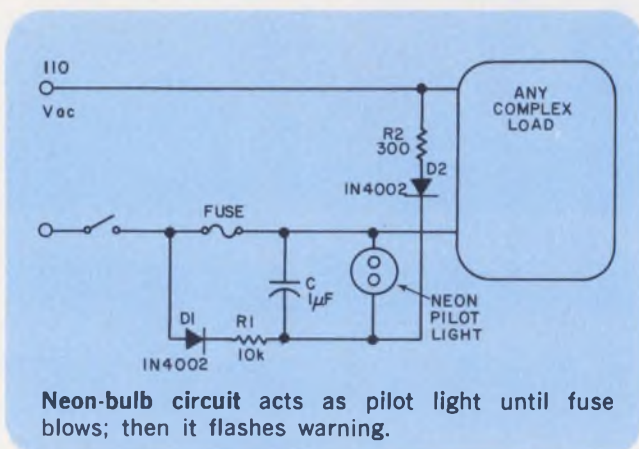

Neon-bulb circuit acts as pilot light until fuse blows; then it flashes warning.

Simple technique removes multilead components from PCs

A problem frequently encountered in repairing PC boards is the removal of multilead devices such as ICs. A simple but effective solution has been found.

Dip a piece of tinned copper braid, such as the shielding from RG/174 coax, in noncorrosive solder flux. Place the braiding against the PC-board pad from which the solder must be removed. Apply heat from a soldering iron to the braid. The solder on the PC board will melt and be drawn into the braid by capillary action.

Most multilead devices can be removed in this way with very little or no damage to the PC board.

Martha Lewandowski, Assembler, Mastech, Inc., Syracuse, N.Y.

VOTE FOR 317

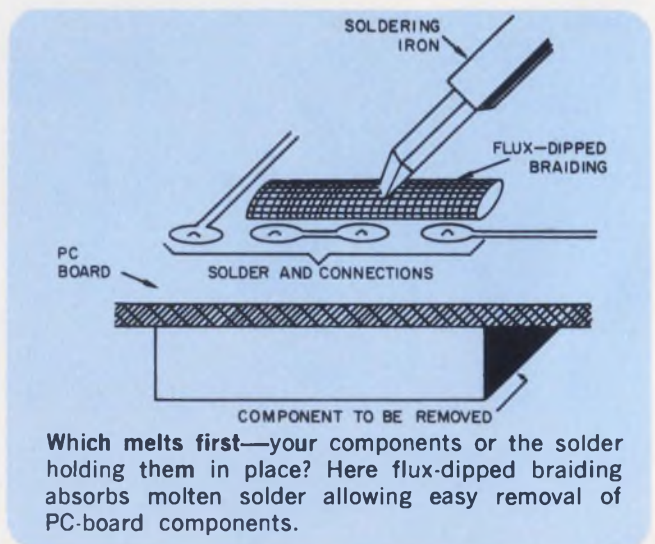

Which melts first—your components or the solder holding them in place? Here flux-dipped braiding absorbs molten solder allowing easy removal of PC-board components.

Whether you *build* or *buy* many *Hi-Rel* semiconductors, do you ever wonder how you can get hold of them faster, at less cost?

Don't hire yourself a High Production Pyromaniac. Ogden's new BURN-EZE custom semiconductor burn-in systems are a much better idea.

It's really economical to own and operate BURN-EZE systems because we've overcome the problems associated with other makes — low density, costly maintenance, and high operating costs.

Others use a large PC board for socket mounting. Expensive, easy to break. — Forget them! — Taped over and dummy sockets filled with broken leads? — Forget them too! — We've devised a unique, little, inexpensive PC board for each socket. Broken lead sockets are simply replaced with new ones.

The unusual way we mount these little boards in BURN-EZE system trays also permits dollar saving densities of up to 1000 devices per cubic foot. More output per oven means fewer ovens and less of that expensive floor space. Lower fuel bills too!

More savings. — An external cable and parallel tray connector arrangement permits devices to cool *outside the oven under bias*. Reduced heat loss means more devices processed per hour, less fuel. Meets bias/cooling Mil Specs too.

BURN-EZE systems are made for TO-5 and TO-18 Transistors, TO-5 ICs, Dual In-Lines and Flat Paks. They operate from 20° to 200° C. We'll supply the oven or install our systems in your old one. All easily programmable. With or without power supplies.

Ask for our new BURN-EZE brochure from any of our facilities.

Ogden Technology Laboratories, Inc.

Facility locations:

Deer Park, New York
(516) 667-7200

Oklahoma City, Oklahoma
(405) 946-9986

Sunnyvale, California
(408) 739-5900

Beaumont, California
(714) 845-1103

Woodside, New York
(212) 478-2010

Monterey Park, California
(213) 289-4425

Fullerton, California
(714) 879-6110



High Production Pyromania?



SEE US AT NEPCON Booth P-105
INFORMATION RETRIEVAL NUMBER 54

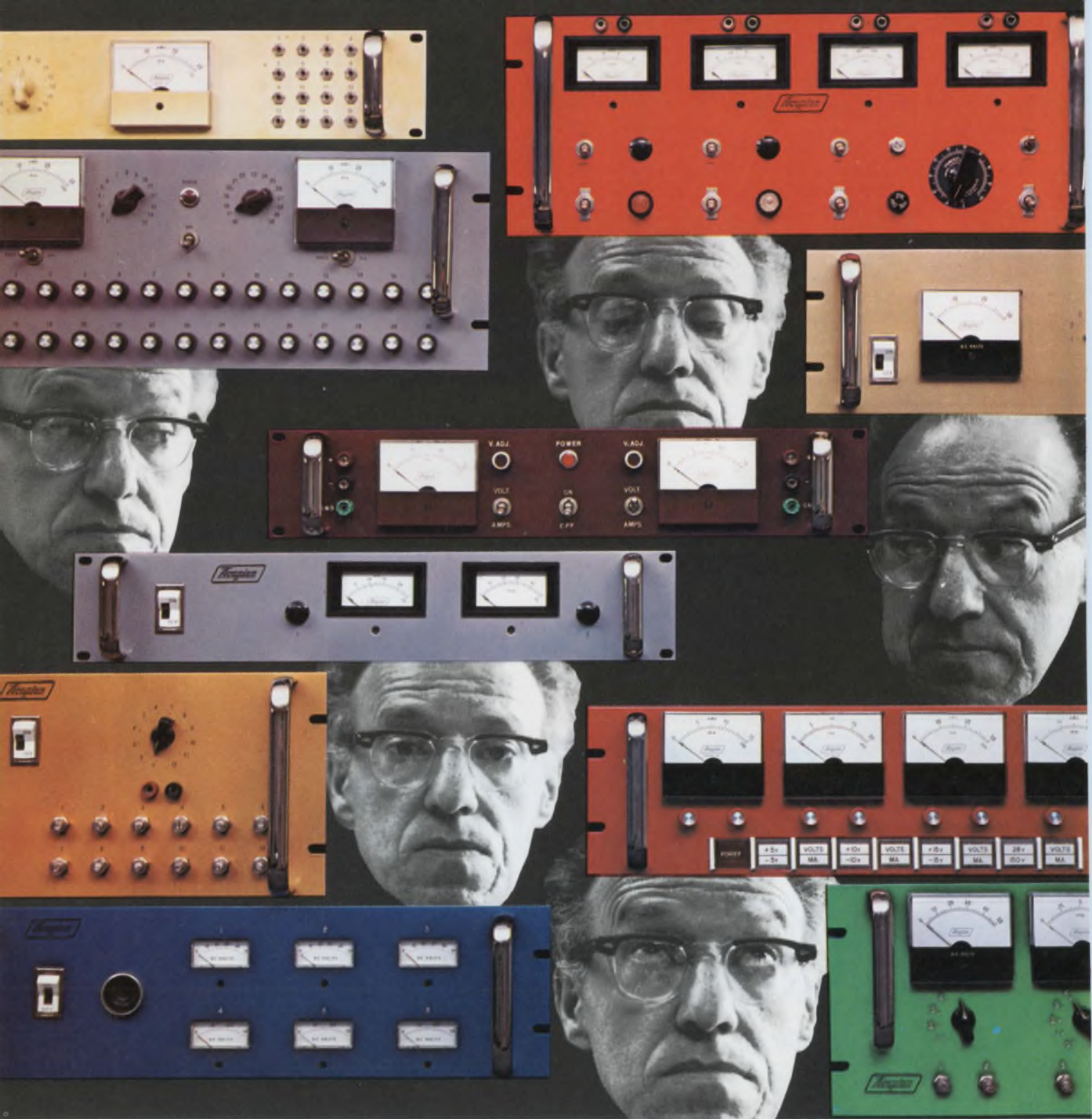

**Looking for a special power supply system?
Acopian will ship it in just 9 days!**

When you're looking for a multiple-output power supply system, and you need it in a hurry, look no further. Acopian will design it, build it, test it, and ship it...fully wired...*in just 9 days!*

Call 'hot line' 215-258-5441. Simply tell us the DC voltages and currents you need. We'll discuss—on the phone—the power modules, the panel size, accessories such as meters, terminations, test jacks, rotary

switches or any other feature you feel is important. Then—on the phone—we'll give you a firm price—and get the order going for guaranteed 9-day shipment.

Others make promises. Acopian makes power supplies. Power modules in 3 days, and now power systems in 9 days. For immediate service, call 215-258-5441. For literature, write Acopian Corporation, Easton, Pa. 18042.



Product Source Directory

Pulse Generators

This Product Source Directory, covering Pulse Generators, is the fourth in a continuing series of product selection data that will list comparative specifications and prices for products frequently purchased by design engineers. All categories will be arranged according to some primary parameter so that items having similar functional capabilities can be instantly compared.

How to use the tables

The tables in this section list the specifications for pulse generators.

Unless otherwise noted in the tables, all pulse

generators have input requirements of 95-135 Vac single phase. The following abbreviations apply to all instruments listed:

ina—information not available.

n/a—not applicable.

An index of models by manufacturer is included at the end of each table.

For each table, the instruments are listed in ascending order of one major parameter. The column containing this parameter is color-coded white. Manufacturers are identified by abbreviation. The complete name of each manufacturer can be found in Master Cross Index.

Abbrev.	Company	Reader Service No.
Adar	Adar Associates, Inc. 73 Union Square Somerville, Mass. (617) 492-7110	454
AEL	American Electronics Labs P.O. Box 552 Landsdale, Pa. 19446 (215) 822-2929	455
Beckman	Beckman Instruments 2200 Wright Ave. Richmond, Calif. 94804 (415) 526-7730	456
Berk-Nuc	Berkeley Nucleonics Corp. 1198 Tenth St. Berkeley, Calif. 94710 (415) 527-1121	457
CMC	CMC 12970 Bradley Ave. San Fernando, Calif. 91342 (213) 367-2161	458
Chronetics	Chronetics 500 Nuber Ave. Mt. Vernon, N.Y. (914) 699-4400	459
Cimron	Cimron Div. Lear Siegler Inc. 1152 Morena Blvd. San Diego, Calif. 92110 (714) 276-3200	460
Datapulse	Datapulse Div. Syston Donner Corp. 10150 Jefferson Blvd. Culver City, Calif. (213) 836-6100	461
Data Royal	Data Royal Corp. 8014 Armour St. San Diego, Calif. 92110 (714) 279-4020	462
Digiac	Digiac Ames Court Plainview, N.Y. 11803 (516) GE 3-7800	463
E-H	E-H Research Labs Box 1289 Oakland, Calif. 94604 (415) 834-3030	464

Abbrev.	Company	Reader Service No.
GR	General Radio. 22 Baker Ave. W. Concord, Mass. 01781 (617) 369-4400	465
H-P	Hewlett-Packard Co. 1501 Page Mill Rd. Palo Alto, Calif. 94304 (415) 326-7000	Contact local sales office
Int Cont	International Contronics 1038 W. Evelyn Ave Sunnyvale, Calif. 94086 (408) 736-1620	466
Kay	Kay Electric Corp. Maple Ave. Pine Brook, N.J. 07058 (201) 227-2000	467
Ling	Ling Electronics 1515 S. Manchester Ave. Anaheim, Calif. 92803 (714) 774-2000	468
Measure	Measurements Box 180 Boonton, N.J. 07005 (201) 334-2131	469
Monsanto	Monsanto Electronics 620 Passaic Ave. W. Caldwell, N.J. 07006 (201) 228-3800	470
R-S	Rohde & Schwarz 111 Lexington Ave. Passaic, N.J. 07055 (201) 773-8010	471
Stoddart	Stoddart Electro Systems 2045 W. Rosecrans Ave. Gardena, Calif. 90249 (213) 770-0270	472
Tau-Tron	Tau-Tron Inc. 685 Lawrence St. Lowell, Mass. 01852 (617) 458-6871	473
Tektronix	Tektronix Inc. Box 500 Beaverton, Oregon 97005 (503) 644-0161	474
Velonex	Velonex Div. Pulse Engineering Inc. 560 Robert Ave. Santa Clara, Calif. 95050 (408) 244-7370	453

Pulse Generators

	Manufacturer	Model	FREQUENCY		MAIN PULSE				OUTPUT			Type C-Cab R-Rack	Misc. Features	Price \$
			Min. Hz	Max. Mhz	Width Min. μs	Width Max. ms	Rise ns	Fall ns	Min. Volts	Max. Volts	Imp. Ohms			
PG 1	Tektronix	109	550	720Hz	0.5ns	100ns	0.25	ina	0	55	50	C		420
	Digiac	1554	0.05	0.005	80	13s	1000	1-15μs	1	15	400	C		139
	Tektronix	161	0.1	0.01	10	100	500	ina	0	50	1.8k	C	k	165
	Tektronix	162	0.1	0.01	10	50	1000	ina	50	50	1000	C	k	165
	Berk-Nuc	RP-2	1	0.05	ina	ina	50ns- 5μs	2μs- 100μs	0	2.2	100	C, R		890
	H-P	2138	n/a	0.1	2	n/a	0.1	n/a	n/a	0.2	50	C	*	300
	Data Royal	F210B	0.1	0.1	0.167	10000	75	75	0.016	16.25	50,600	C, R		785
	Data Royal	F230B	0.1	0.1	0.167	10000	75	75	0.016	16.25	50,600	C, R		1095
	Velonex	350/LOZ	3	0.1	0.3	0.01	150	100	0	40	0.1	C, R	g	4285
Velonex	350	3	0.1	0.1	0.3	30	50	0	2100	200	C, R	g	3990	
PG 2	Velonex	350/HIZ	3	0.1	3	0.1	2500	3000	0	20k	20k	C, R	g	4285
	Velonex	570/HIZ	3	0.1	3	0.1	2500	3000	0	20k	20k	C, R	g	5685
	Tektronix	111	10	0.1	0.002	1.5μs	0.5	ina	10	10	50	C	d	435
	E-H	131	10	0.1	0.1	0.5	10	10	±0.1	±50	50	R		575
	Measure	179	60	0.1	0.5	0.06	100	150	0	200	ina	C		400
	Tektronix	R293	10000	0.1	0.002	250ns	1	1	6	12	50	C, R	am	1150
	Velonex	570/LOZ	3	0.4	0.3	0.01	150	100	0	40	0.1	C, R	g	5685
	Velonex	380	3	0.4	0.025	0.025	8	11	50	500	50	C, R	g	4500
	Velonex	380/LOZ	3	0.4	0.05	0.005	15	20	5	50	0.5	C, R	g	4795
	Velonex	380/HIZ	3	0.4	0.05	0.02	20	20	100	1000	200	5	g	4795
PG 3	Digiac	521	5	0.5	0.8	120	100	100	1	15	400	C		125
	Berk-Nuc	GL-3	1	1	0.3	0.1	50	600	0.001	10.1	100	C, R		1460
	Tektronix	114	10	1	0.1	1	10	10	1	10	50	C, R	ij	340
	Tektronix	163	10	1	1	10	200	ina	0	25	500	C	k	165
	H-P	214A	10	1	0.05	10	15	15	±0.2	±100	50,100	C, R	bc	975
	Berk-Nuc	BH-1	10	1	ina	ina	20ns- 50μs	50ns- 1000μs	0.001	10	50	C, R		490
	E-H	125A	10	1	0.001	0.1	0.3	0.5	-10	-10	50	C, R		2910
	H-P	215A	100	1	0	0.0001	1	1	±10	±10	50	C, R	*	1975
	GR	1395	2.5	1.2	0.1	1000	90	90	±20	±20	1000	C, P	p	1040
GR	1398A	2.5	1.2	0.1	1000	70	70	60	60	1000	C		625	
PG 4	GR	1217-C	2.5	1.2	0.1	1000	70	70	40	40	1000	C		315
	GR	1396-B	dc	2	.25	00	n/a	n/a	n/a	n/a	25	C		575
	Velonex	570	3	2	0.1	0.3	30	50	0	2100	200	C, R	g	5390
	E-H	130	10	2	0.1	50	10	10	±0.1	±50	50, 93, 125, 185, 200	C, R	c	1175
	CMC	B-7B	20	2	0.05	10	15	15	0	50	50	C, R		695
	CMC	B-7D	20	2	0.05	10	15	15	0	50	50	C, R	r	695
	CMC	B-7F	20	2	0.05	10	15	15	0	50	50	C, R	c	825
	Chronetics	D5	0.01	3	0.03	100s	5ns- 10ms	5ns- 10ms	0	±30	50	C, R	abcd	6500- 9000
Datapulse	102-S1A	2	3	0.05	10	10-500	10-500	±50	±50	50	C, R	dn	1650	
Datapulse	102	2	3	0.05	10	10-500	10-500	±50	±50	50	C, R	cd	900	
PG 5	E-H	132A	5	3.5	0.1	10	12-100	ina	±0.1	±50	50	R		715
	Datapulse	103M/P901	5	5	0.05	2	20-300	ina	±15	±15	50	C, R	d	1450
	Datapulse	103M/P902	5	5	2	50	0.1	ina	1	15	50	C, R	d	1350
	Datapulse	103M/P903	5	5	0.05	2	5	7	±5	±5	50	C, R	dp	1150
	Datapulse	103M/P904	5	5	0.2	0.0002	50	ina	5	50	50	C, R	d	1065
	Datapulse	103M/P905	5	5	0.05	0.5	20ns- 1μs	20ns- 1μs	±25	±25	50	C, R	d	1490
	Datapulse	103M/P906	5	5	2ns	200ns	0.8	0.9	±10	±10	50	C, R	d	1860
	R-5	SPD	5	5	0.1	100	50	50	0	±20	0-500	C	c	902
CMC	B15	5	5	0.015	10	10	10	0	10	50	C		390	
E-H	133A	1000	5	0.05	0.3	10ns- 10μs	20ns- 10μs	±0.2	±50	50	C, R	z	2275	
PG 6	Chronetics	1012	10	9.99	0.04	9.99	5ns- 9.9ms	5ns- 9.9ms	0	±9.9	50	C, R	a	4000
	Ling	System 6	0.001	10	0.02	1000	5	5	0	20	50	C, R	t	t
	AEL	155	0.01	10	10	1000	3	3	0.01	250	2500	C, R		725
	Datapulse	100A	0.1	10	0.035	10s	5	7	0.5	10	50	C, R	d	470
	Cimron	3101	1	10	0.03	10	8	8	5	5	50	C, R		325
	Inf. Cant	CPG200-2	1	10	0.04	20	6	6	3.5	3.5	50	C		335

HIGH POWER PULSE GENERATORS

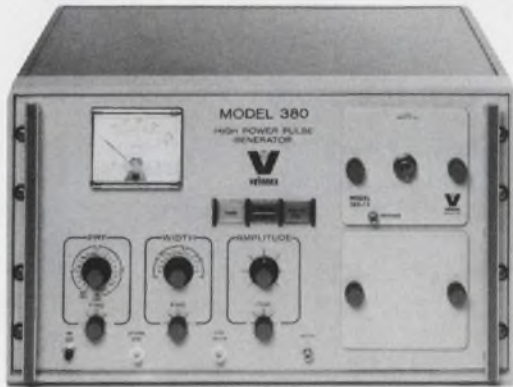

Velonex Model 380



Velonex Model 350

(The Specs tell all!)

50 to 500 V @ 10 A 100 Amp @ 50 V* 1 KV @ 5 A*	Output Voltage (Pulse)	0 to 2,100 V @ 10.5 A 400 Amp @ 40 V* 19 KV @ 0.95 A*
5 KW	Output Power (Peak)	22 KW**
< 8 NS†	Rise Time	< 30 NS†
< 11 NS†	Fall Time	< 50 NS†
25 NS to 25 μS	Pulse Width	0.1 μS to 300 μS
<3% @ max. pulse width	Droop	<3% or 0.05% per μS
<5%	Overshoot	<5%
Negligible	Ripple on Pulse Top	Negligible
1% @ 5 KW peak	Duty Factor	1% @ 22 KW peak, 5% @ 4.2 KW peak
3 pps to 400,000 pps, plus manual (single pulse)	Pulse Repetition Rate	3 pps to 100,000 pps (for high duty-factor bursts, ask about Model 570)
\$4,500	PRICE	\$3,990

*Parameters available with accessory plug-in units. †Rise and Fall Times variable with accessory plug-in units
** 26 KW @ 0.1% duty factor



Research scientists and engineers in growing numbers are discovering the beauty of a compact, versatile, high-power, clean-waveform pulse generator for testing noise susceptibility, for developing semiconductor microwave devices, for pulsing lasers, for ultrasonic investigations, and for many other forms of laboratory research. For data bulletins describing Models 350 and/or 380, including information on a wide selection of accessory plug-ins, write Velonex at 561 Robert Avenue, Santa Clara, Calif. 95050. Telephone (408) 244-7370. TWX 910-338-0114.

	Manufacturer	Model	FREQUENCY		MAIN PULSE				OUTPUT			Type C-Cab R-Rack	Misc. Features	Price \$
			Min. Hz	Max. MHz	Width Min. µs	Width Max ms	Rise ns	Fall ns	Min. Volts	Max. Volts	Imp. Ohms			
PG 6 cont	Int. Cont	CPG300	1	10	0.04	22.5	6	6	10	10	50	C		395
	Int. Cont	CPG200-1	1	10	0.05	20	6	6	4	4	50	C		310
	Chronetics	D4	1	10	0.03	10	5	5	0	±12	50	C, R	acd	1000
	Datapulse	101	10	10	0.04	10	5	7	10	10	50	C, R	cd	395
	Datapulse	108	10	10	0.025	5	7-50	7-50	±50	±50	50	C, R	d	1480
PG 7	H-P	222A	10	10	0.03	5	4	4	±0.05	10	50	C, R	d	690
	E-H	121	10	10	0.03	0.001	5	6	±5	±50	50	C, R		1675
	Adar	EC-22	10	10	0.05	0.01	5	5	3	4	ina	R		2500+
	Digiacc	721	50	10	0.02	50	10	10	1	10	100	C		239
	Tektronix	115	100	10	0.05	0.5	10ns- 100µs	10ns- 100µs	0.02	10	50	C, R	dj	865
	Tektronix	R116	100	10	0.05	0.55	10ns- 100µs	10ns- 100µs	0.4	10	50	C, R	ad	1825
	E-H Datapulse	138 106A	300 10	10 12	0.05 0.025	1 5	10ns- 1ms	10ns- 1ms	0.1 ±12	7.5 ±12	50 50	C, R C, R	r cd	890 950
Adar Beckman	SQ260/280 9052	- 10	15 15	0.03 0.3	0.01 30ms	10ns- 10ms	10ns- 10ms	0 0.1	±8 10	51 3k	R C, R		5600+ 995	
PG 8	Chronetics	PG-2	1	16	0.035	200	10ns- 20ms	10ns- 20ms	0.2	±20	50	C, R		925
	Chronetics	PG-31	0.1	20	0.03	1000	10	10	±0.02	±20	50, 500		ef	1225
	Chronetics	PG32	0.1	20	0.03	1000	10ns- 1s	10ns- 1s	±0.02	±20	50	C, R	ef	1385
	Chronetics	PG33	0.1	20	0.03	1000	5ns- 1s	5ns- 1s	±0.01	±10	50	C, R	ef	1350
	GR	1340	0.2	20	0.025	2500	5±2	5±2	10	10	50, 1k	C, R		395
	Cimron	3202	1	20	0.03	10	12	12	-1	11	50	C		945
	Monsanto	300A	10	20	0.025	100	10	10	0.2	10	50	C, R	a	1250
	Chronetics	PG-11	10	20	0.030	10	4	4	0	±15	8	C		375
CMC	B16	20	20	0.015	10	5-200	5-200	0	10	50	C	c	595	
CMC	B14	20	20	0.015	10	10	10	0	10	50	C		340	
PG 9	E-H	120E	100	20	0.01	100ns	1.2	ina	-7mV	-20	50	C, R	b	1675
	E-H	120D	100	20	0.01	100ns	1.2	ina	-7	-20	50	C, R	b	1375
	E-H	123A	1000	20	0.02	300	7	ina	±0.2	±50	50	C, R	z	1775
	Cimron	3102	1	20	0.03	10	8	8	10	10	50	C, R		395
	Chronetics	PG-13A	1	25	0.03	500	10ns- 50ms	10ns- 50ms	0	±100	50	C, R	c	1750
	Chronetics	PG-13A/P	1	25	0.03	500	10ns- 50ms	10ns- 50ms	0	±100	50	C, R	ac	1950
	H-P	1901A/ 1905A/ 1908A/ 1917A	25	25	0.01	40	7-500	7-500	±0.2	±10	50	C, R	aw	1375
	H-P	1901A/ 1905A/ 1910A/ 1917A	25	25	0.01	40	7-500	7-500	±0.2	±10	50	C, R	adx	1325
H-P	1900A/ 1905A/ 1908A/ 1915A	25	25	0.01	40	7ns- 1ms	7ns- 1ms	±2.5	±50	50, 5k	C, R	ady	2750	
PG 10	H-P	1901A/ 1905A/ 1910A/ 1920A	25	25	0	0.01	0.35	0.4	±0.5	±5	50	C, R	ady	2550
	Adar	SQ320	250	25	0.02	20ns	5	5	ina	ina	ina	R	a	6600
	Stoddart	93453-1	500	35	0.010	0.010	ina	ina	0dB	126dB	50	C		535
	Datapulse	111	4	40	0.008	0.5	2-500	3-500	±5	±5	50	C, R	cd	1480
	Datapulse	109	4	40	0.01	50	5	5	±10	±10	50	C, R	d	690

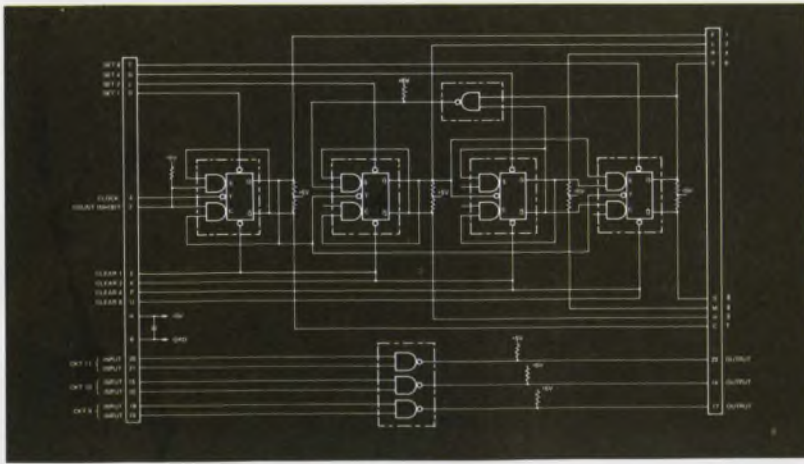

E-H the systematic solution

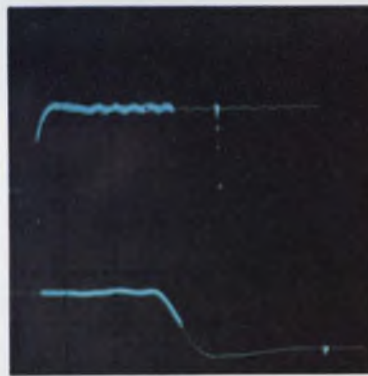

Whether you need a complete dynamic test system or the ideal components to integrate with your present system, look no further. E-H Research Laboratories, Inc. and its subsidiary, Automated Measurements Corporation, offer you the perfect solution.

For example, the **E-H 1139/1420 programmable timing unit and pulse driver combination** is a new generation in pulse instruments that fits the needs of any systems designer. These two rack-mounted units are so completely programmable that there are no front-panel knobs to twist. They're ideal for any systems applications requiring pulses from 1kHz to 10MHz. And they offer the designer such features as complete waveform control, with programmable width and delay from 10ns to 100 μ s, amplitude from $\pm 3V$ to $\pm 10V$ with programmable attenuation from X1 to X40 and rise and fall times programmable from 5ns to 13 μ s.

The perfect mate to the E-H 1139/1420 is the **AMC Model 1000 Waveform Analyzer**. The AMC 1000 was designed specifically for programmed systems application. It combines in one compact box the functions of sampling oscilloscope, digital counter and digital voltmeter to provide time and voltage measurements of sampled waveforms. The AMC 1000 is the most advanced instrument of its kind, with features including $\pm 1\%$ time measurements all ranges, fastest measurement rates, 10 remote sampling channels, all solid-state construction, serial-by-character or parallel programming, built-in program memories, stored BCD outputs, built-in floating DVM, and digital readout.

This is just a sample of the broad line of E-H and AMC equipment available from your E-H representative. He can offer you a complete system or the most advanced components to give you the systematic solution to your problems today. And tomorrow.



E-H RESEARCH LABORATORIES, INC.

515 Eleventh Street • Box 1289, Oakland, California 94604 • Phone: (415) 834-3030 • TWX 910-366-7258
 In Europe: E-H Research Laboratories (Ned) N.V., Box 1018, Eindhoven, The Netherlands, Telex 51116
 In Japan: Iwatsu Electric Company, Ltd., 7-41, 1-Chome Kugayama Sugunami-Ku, Tokyo 167, Japan

INFORMATION RETRIEVAL NUMBER 57

What do you really want in your scope?

HP asked practicing engineers this question for a reason.

The answers were used to give you what you need and want in a scope... not just what happens to be available. The result is the 180 Scope System.

Some of your suggestions...like infinite bandwidth...were impossible to meet. But as a result of trying, HP did hit 250 MHz, about twice the real-time frequency of any other general-purpose scope available today!

And, by carefully screening the many suggestions, a definite pattern of preference emerged. Most engineers wanted:

1. Highest possible performance.
2. Plug-in versatility.
3. Ease of operation.
4. Capability of future expansion, to prevent early obsolescence.
5. The smallest possible package, with largest CRT display.



Naturally, we feel that 180 scope system is today's best answer to these requirements. However, you may want more information before



making your decision. Consider the following facts.

"We want performance."

The introduction of the **183A scope**—with its 250 MHz **real-time** bandwidth and 10 mV sensitivity—gives you the undisputed leader in high-frequency, real time measurements. The true performance champ!

But 250 MHz real-time is only part of the story. With the 180 series you start with a choice of three mainframes, in either rack or cabinet configuration.

The **HP 180A Mainframe** is designed for general use through 100 MHz real-time and 12.4 GHz sampling. You have your choice of 9 plug-in units. With this combination you can tailor a 180 to meet your present requirements—and still have the ability to expand in the future.

Big picture CRT display is a full 8 x 10 cm. Yet, front-panel size is no larger than this page. (Small package to eliminate clutter — big CRT to increase measurement accuracy.)

The **HP 181A Mainframe** brings storage to the 180 System. It is the only mainframe that offers both variable persistence, and storage—and it is the only storage scope in the 50 or 100 MHz range. For versatility, the 181A accepts all plug-ins that the 180A uses.

The **HP 183A Mainframe CRT** is an HP exclusive. Utilizing a unique transmission line deflection system in the CRT, the mainframe provides real-time bandwidth beyond 500 MHz.



This means you will not be mainframe-limited tomorrow, when new, state-of-the-art plug-ins become available. Right now, all 11 of the present 180 series plug-ins operate in the 183A mainframe, at their specs. (Another example of HP's fight against obsolescence.)

"We want easy operation."

As for ease of operation, a quick glance at the front panel is your best assurance of that. The 180 system is

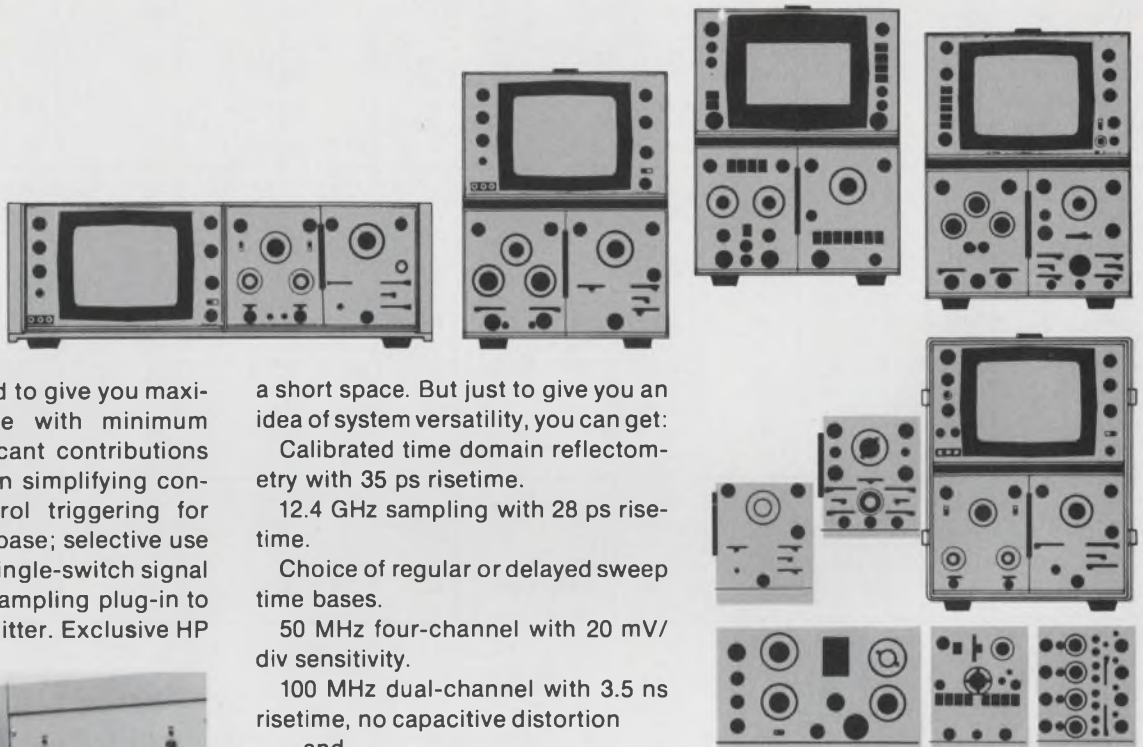

human-engineered to give you maximum performance with minimum confusion. Significant contributions have been made in simplifying controls: Single-control triggering for the 250 MHz time base; selective use of push-buttons; single-switch signal averaging in the sampling plug-in to reduce noise and jitter. Exclusive HP



mixed sweep control lets you expand a selected portion of the signal for precise measurements in areas of critical importance.

Carry the rugged 180 Scopes anywhere you need it—with plug-ins, weight is only 30 to 35 pounds. Put it on your bench without crowding—takes only 8" x 20" of space. Use it in racks where space is at a premium—rack version is only 5¼" high.

"We want plug-in versatility."

Plug-in compatibility is one of the many plus features you suggested. All the high-performance capabilities of the 11 plug-ins can't be covered in

a short space. But just to give you an idea of system versatility, you can get:

Calibrated time domain reflectometry with 35 ps risetime.

12.4 GHz sampling with 28 ps risetime.

Choice of regular or delayed sweep time bases.

50 MHz four-channel with 20 mV/div sensitivity.

100 MHz dual-channel with 3.5 ns risetime, no capacitive distortion and

250 MHz real-time dual-channel with 10 mV/div sensitivity.

"Now, and in the future ..."

To prevent mainframe obsolescence in the 180 Series, HP has adopted a design philosophy of driving the CRT vertical plates directly from the vertical plug-in. This design approach keeps the full capability of the CRT available to future plug-ins, so you can take advantage of tomorrow's technology in today's mainframe. (The 183A Mainframe is an example of this philosophy in action—when 500 MHz vertical amplifiers are designed, they will work in this existing mainframe.)

Today oscilloscope technology is at a crossroads. The system you choose now is the one you will have to live with for a good many years to come.

The HP direction points to getting the best, now; at a low price; with assurance of increased measurement capabilities down the road, using existing mainframes.

If you have read this far, you probably agree with at least some of the

points mentioned. If you are not completely convinced, we're willing to rest our case on a side-by-side comparison with any other high-frequency scope you may be considering. If you think the other scope is better... buy it! Conversely...

To arrange a comparison, call your local HP field engineer. Ask him about HP's new concept of oscilloscope service... have him show you HP's video training tapes.

Or, for a complete full-color 180 system brochure, write to Hewlett-Packard, Palo Alto, California 94304. Europe: 1217 Meyrin-Geneva, Switzerland. Price examples: 50 MHz system, \$2065; 250 MHz system, \$3150.

080 / 2

HEWLETT  PACKARD
OSCILLOSCOPE SYSTEMS

	Manufacturer	Model	FREQUENCY		MAIN PULSE				OUTPUT			Type C-Cab R-Rack	Misc. Features	Price \$
			Min. Hz	Max. MHz	Width Min. µs	Width Max. ms	Rise ns	Fall ns	Min. Volts	Max. Volts	Imp. Ohms			
PG 10 cont	CMC	220	0	50	0.01	10	5ns- 1ms	5ns- 1ms	0	10	50	C, R	c	1225
	Chronetics	PG-14	1	50	0.005	500	2ns- 50ms	2ns- 50ms	0	±20	50, 10k	C, R		1250
	Datapulse	110B	5	50	0.01	5	4ns 500µs	4ns 500µs	±10	±10	50	C, R	cd	1250
	Datapulse	110FP	5	50	0.01	5	4ns- 500µs	4ns 500µs	±10	±10	50	C, R	adq	2530
	E-H	127	10	50	0.01	10	2.5	4	±0.2	±20	50	C, R		2615
PG 11	E-H	128	10	50	0.01	10	3.5	4	0.125	5	50	C, R	r	980
	E-H	139B	10	50	0.01	30	6ns- 3ms	6ns- 3ms	±0.03	±10	50	C, R		1275
	Monsanto	3500A	5	70	0.007	100	6	6	10	10	50	C, R	s	1200
	E-H	137	10	100	0.005	1	2ns- 160µs	2ns- 160µs	±0.1	±5	50	C, R		1950
	Datapulse	141/142	100000	100	0.005	0.011	2-11	2-11	±10	±10	ina	C, R	ad	9000
	H-P	216A	1MHz	100	0.005	0.0001	2.5	2.5	±0.4	±10	50	C, R		1775
	GR	1394	10MHz	100	0.004	99ns	2	2	0	4	ina	C		995
	Kay	5070B	10MHz	120	0.1	100µs	10	10	0.5	0.5	50	C, R		930
Datapulse	112	10	125	0.003	5	1.4	1.4	0.5	5	50	C, R	d	1595	
Tau-Tron	PG-100	1	150	0.003	10	1	1	0.3	12	50	C, R	c	2450	
PG 12	E-H	122	1000	200	0.002	1	1	1	±0.1	±5	50	C, R		2875
	Datapulse	113	0.5MHz	250	0.025	1	1.3	1.3	±5	±5	50	C, R	d	3375
	Kay	5071B	10MHz	250	0.1	100ns	10	10	0.5	0.5	50	C, R		1295
	E-H	129	10000	500	0.001	0.05	0.5	0.5	±0.2	±2	50	C, R		3925
	Stoddart	91263-1	60	1000	0.0005	0.0005	ina	ina	10dB	101dB	50	C		525

- a. Programmable.
- b. Also dual channel.
- c. Double pulse.
- d. Delayed pulse.
- e. Also current source.
- f. Two independent channels.
- g. Complete line of standard plug-ins available for matching impedance.
- h. Preset.
- i. Also squarewave generator.
- j. Rack mount available at extra cost.
- k. Operates with 160A power supply, can power 5-7 type 163 generators.
- m. Also voltage and current regulated power supply.
- n. Provides a variety of multipulse formats.
- p. Plug-in generator, price includes mainframe and plug-in.
- q. Available with digital control of pulse amplitude at extra cost.
- r. Simultaneous + and - output pulses and independent rise/fall time controls.
- s. Plug-in generator, price shown is for mainframe only.
- t. Price depends on modular configuration chosen.
- u. Tunnel diode pulse generator with fixed risetime and rep rate.
- v. Trigger advance in respect to output pulse.
- w. 1900 plug-in pulse system, 1901A low power mainframe, 1905A rate generator, 1908A delay generator, 1917A variable transition time output.
- x. Same as note w except for 1910A incremental delay generator in place of 1908A.
- y. Same as note w except for 1900A high power mainframe and 1910A delay generator in place of 1901A and 1908A.
- z. Remote amplitude control optional.

Index by Model Numbers

Name	Model	Code	Name	Model	Code	Name	Model	Code
Adar	EC22	PG7		B16	PG8	Systron	102	PG4
Adar	SQ 260/280	PG7		220	PG10	Donner	102-S1A	PG4
Associates, Inc.	SQ 320	PG10	Chronetics	D4	PG6	Corp.	103M/P901	PG5
AEL	155	PG6		D5	PG4		103M/P902	PG5
American Electronics Labs.				PG-2	PG8		103M/P903	PG5
Beckman	9052	PG7		PG-11	PG8		103M/P904	PG5
Beckman Instruments				PG13A	PG9		103M/P905	PG5
Berk-Nuc	BH-1	PG3		PG13A/P	PG9		103M/P906	PG5
Berkeley	GL-3	PG3		PG14	PG10		106A	PG7
Nucleonics	RP-2	PG1		PG31	PG8		108	PG6
CMC	B-7B	PG4		PG32	PG8		109	PG10
	B-7D	PG4		PG33	PG8		110B	PG10
	B-7F	PG4		1012	PG6		110FP	PG10
	B14	PG8	Cimron	3101	PG6		111	PG10
	B15	PG5	Cimron Div.,	3102	PG9		112	PG11
			Lear Siegler,	3202	PG8		113	PG12
			inc.				141/142	PG11
			Datapulse	100A	PG6	Data Royal	F210B	PG1
			Datapulse Div.,	101	PG6	Data Royal	F230B	PG1

Digiac	521	PG3
	721	PG7
	1554	PG1
E-H	120D	PG9
E-H Research	120E	PG9
Labs	121	PG6
	122	PG12
	123A	PG9
	125A	PG3
	127	PG10
	128	PG11
	129	PG12
	130	PG4
	131	PG2
	132A	PG5
	133A	PG5
	137	PG11
	138	PG7
	139B	PG11
GR	1217-C	PG4
General Radio	1340	PG8
Co.	1394	PG11
	1395	PG3
	1396-B	PG4
	1398A	PG3
H-P	213B	PG1
Hewlett-	214A	PG3
Packard Co.	215A	PG3
	216A	PG11
	222A	PG7
	1900A/1905A/ 1908A/1915A	PG9
	1901A/1905A/ 1908A/1917A	PG9
	1901A/1905A/ 1910A/1917A	PG9
	1901A/1905A/ 1910A/1920A	PG10
Int Cont	CPG200-1	PG6
International	CPG200-2	PG6
Contronics	CPG300	PG6
Kay	5070B	PG11
Kay Electric	5071B	PG12
Corp.		
Ling	System 6	PG6
Ling		
Electronics		
Measure	179	PG2
Measurements		
Monsanto	300A	PG8
Monsanto	3500A	PG11
Electronics		
R-S	SPD	PG5
Rohde &		
Schwarz		
Stoddart	91263-1	PG12
Stoddart	93453-1	PG10
Electro		
Systems		
Tau-Tron	PG100	PG11
Tau-Tron Inc.		
Tektronix	R116	PG7
Textronix Inc.	R293	PG2
	109	PG1
	111	PG2
	114	PG3
	115	PG7
	161	PG1
	162	PG1
	163	PG3
Velonex	350	PG1
Velonex Div.,	350/HIZ	PG2
Pulse	350/LOZ	PG1
Engineering	380	PG2
Inc.	380/HIZ	PG2
	380/LOZ	PG2
	570	PG4
	570/HIZ	PG2
	570/LOZ	PG2

adar

EC-22 Byte Generator

*for simulation
and testing
of all digital
equipment*

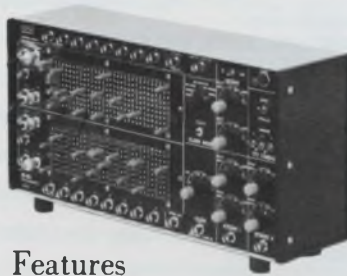

Features

- 32 or 64 eight-bit bytes
- Serial or parallel output
- Variable program length
- Automatic ASCII code formatting
- Pattern expandable in length and width by stacking units
- Up to 8 MHz bit or byte rate

Applications

TESTING of peripherals, data communications terminals, modems, CRT displays, IC's, LSI's, PC's.

SIMULATION of computer output, memory output, telemetry, teletype.

GENERATION of analog functions.

EC-22 \$2500.

Write for complete EC-22 performance data.

adar

Adar Associates, Inc.

85 Bolton Street,
Cambridge, Mass. 02140
(617) 492-7110

ALL-PURPOSE PULSE GENERATOR

\$395

Need we say more?



**Just a few words
of assurance:**

0.2-Hz to 20-MHz PRF

25-ns to 2.5-s duration

5-ns rise/fall time

±10-volt outputs across 50Ω

±1-volt DC offset

Independent control of
amplitudes and offsets for +
and - pulses

Square-wave output

Amplitude fully analog-
programmable

Period and duration modulatable

Quantity discounts for two or more
Price applies in U.S.A.

1340 pulse generator by

GENERAL RADIO

West Concord, Mass. 01781.

Telephone (617) 369-4400.

In Europe Postfach 124,

CH 8034 Zurich, Switzerland.



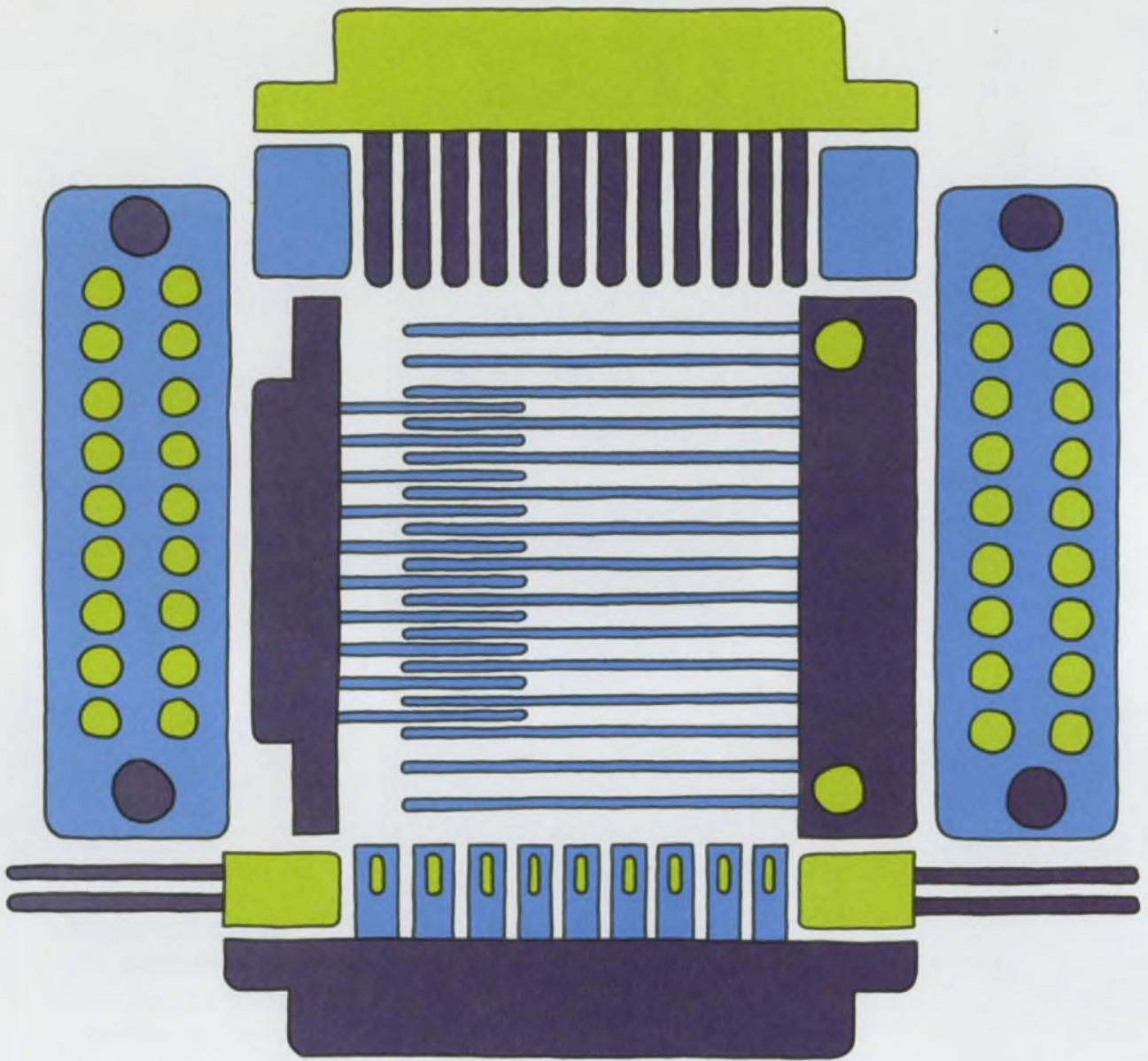

Winchester Electronics

where in-stock printed circuit connectors are closing today's communications gap.

Typical of Winchester Electronics' capabilities in printed circuit connectors are our lines of card edge and board joiners pin and socket connector. And for even more exacting applications, our military approved HB/HBD series.

Available in single and double row terminations, these connectors not only meet

MIL-C-21097 requirements but exceed them in quality and reliability at an economical price.

So, before you go to the expense of ordering a special printed circuit connector, look into the in-stock selection at Winchester Electronics. Just write Winchester Electronics, Main Street and Hillside Ave., Oakville, Conn. 06779.



**WINCHESTER
ELECTRONICS**

DIVISION OF LITTON INDUSTRIES



INFORMATION RETRIEVAL NUMBER 61

Products

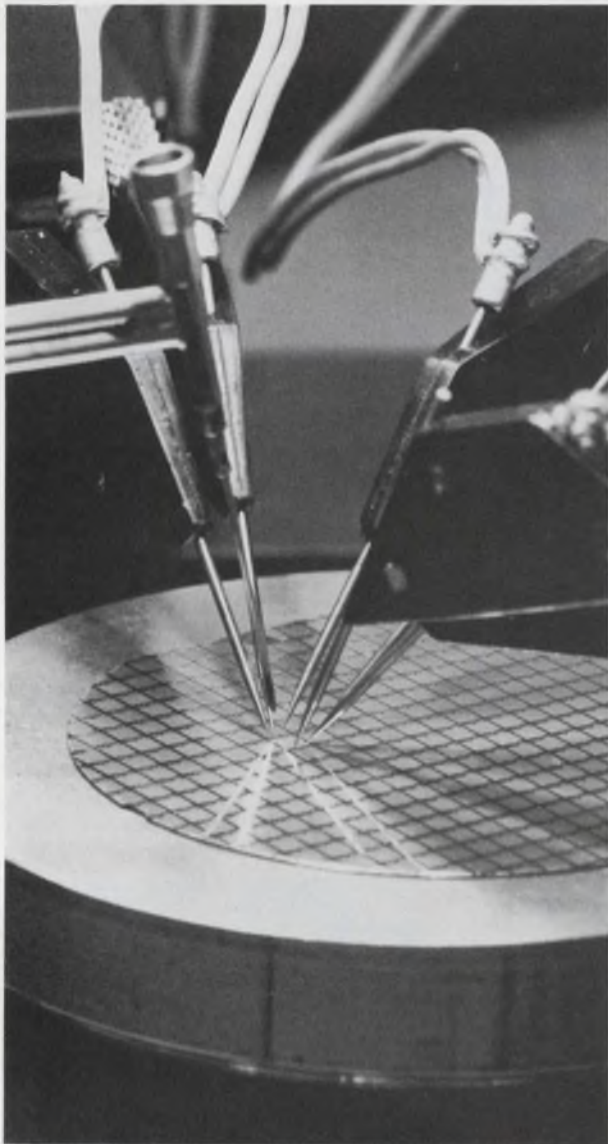

Ion-implanted 64-bit MOS shift register clocks at rates up to 20 MHz. p. 144.

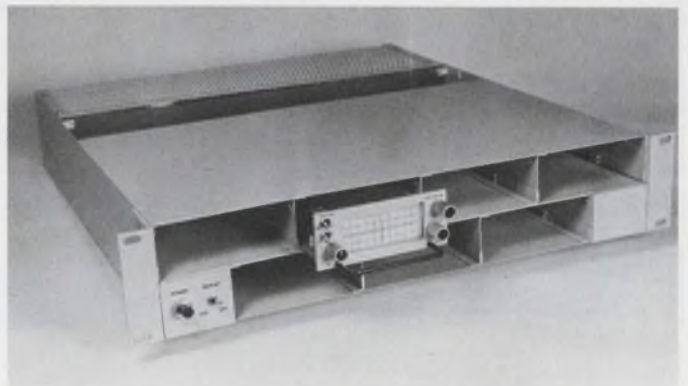

As many as seven compact 10-MHz scope modules can fit into a single 19-in. rack. p. 176.

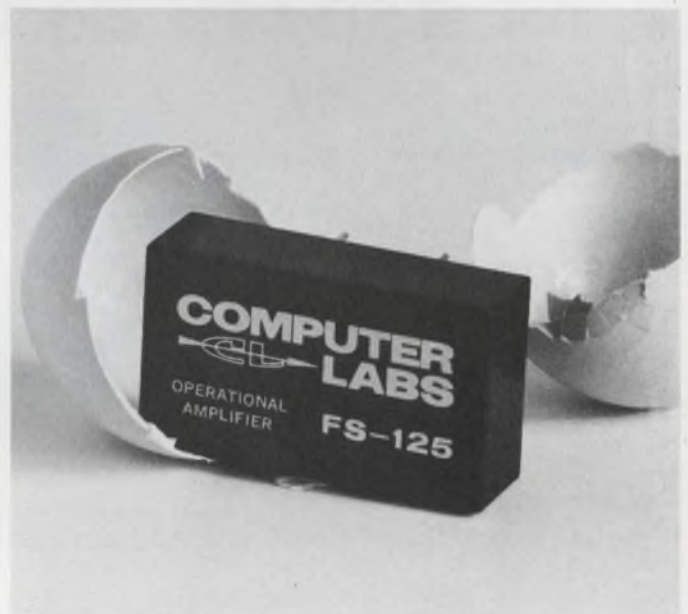

Wideband operational amplifier settles in under 80 ns from application of input. p. 166.

Also in this section:

Power gate-turn-off SCRs can switch 5 A in only 2 μ s. p. 145.

Flatpack d/a converter is 5-MHz thin-film hybrid network. p. 146.

Precision cassette boasts design for computer applications. p. 160.

Evaluation Samples, p. 184 . . . **Design Aids**, p. 185 . . . **Annual Reports**, p. 186.

Application Notes, p. 188 **New Literature**, p. 190.

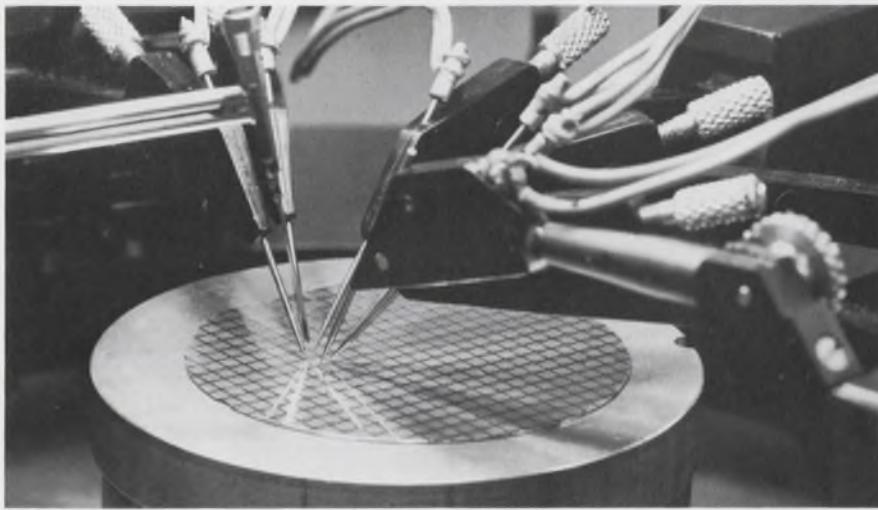

Ion-implanted 64-bit register works at 20-MHz clock rates

Hughes Aircraft Co., 500 Superior Ave., Newport Beach, Calif. Phone: (714) 548-0671. P&A: \$200; 2 wks.

Here at last is an ion-implanted metal-oxide semiconductor that really works. The new device is a monolithic p-channel two-phase dynamic shift register that can operate at clock rates up to 20 MHz. Other performance advantages include a low power dissipation of 200 mW and a low threshold voltage of only 2 V.

Model LIS0064 is a 64-bit MOS IC that is compatible with bipolar circuits. Both its supply and clock voltages can be varied over a wide range for added circuit flexibility.

Using a gate-masked ion-implantation technique to fabricate MOSFETs reduces the gate overlap of the source and drain to nearly zero. The resultant elimination of the parasitic gate overlap capacitances permits faster circuit operation.

Both metal and thick-oxide are used as implantation masks. The surface resistivity of implanted p-regions is 10 to 50 times greater than those having p-diffusions. Implanted regions, therefore, are kept as small as possible, constrained only by the allowable mask alignment error.

The speed of ion-implanted de-



Ion-implanted 64-bit dynamic MOS shift register can clock at rates as fast as 20 MHz.

vices depends mainly on channel length. However, both channel length and overlap are important for non-implanted devices.

Yet another performance factor is the deleterious feedthrough effects that are present in non-implanted devices. With implantation, these feedthrough effects are greatly reduced or eliminated. The net result means that the ion-implanted device can operate twice as fast as a non-implanted device on the same power, or as fast on half the power.

Negative voltage at any pin is -25 V, while positive voltages are $+0.3$ V.

CIRCLE NO. 250

Triple amplifier chip varies transconductance

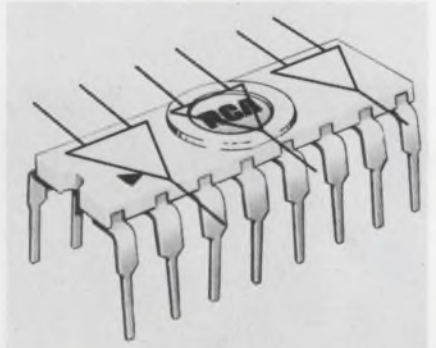

RCA/Electronic Components, 415 S. Fifth St., Harrison, N.J. Phone: (201) 485-3900. P&A: \$5.95; stock.

Model CA3060 operational transconductance amplifier features an adjustable transconductance (typically 35 mV/mA) and a broad range of operating currents (10 μ A to 1 mA). This monolithic array of three identical independent amplifiers comes in a 16-lead dual-in-line ceramic package. It operates from -55 to $+125^{\circ}$ C.

CIRCLE NO. 251

High-power LEDs radiate 10 mW



Monsanto Electronic Special Products, 10131 Budd Rd., Cupertino, Calif. Phone: (408) 257-2140. P&A: \$8 to \$30; stock.

At 1-A continuous input currents, two new series of high-power light-emitting diodes provide a guaranteed total radiated minimum output power of 10 mW from a 50 by 50-mil emitting area. Series ME2 and ME5 have spectral emissions in the near-infrared range peaking at 9000 Å. Also available are versions with a 7.5-mW output.

CIRCLE NO. 252

COMES WITH EVERY GE
METALIZED POLYESTER
CAPACITOR

Rigorous testing

General Electric is a hard school for metalized polyester capacitors. GE gives diplomas in high reliability and long operating life only to those graduates of a rugged three-stage test prior to shipment for use in your electronic circuit.

A curriculum of three quality measurements is required of every unit: (1) Capacitance measurement for tolerance spread and correct nominal value, (2) Dissipation factor measurement to assure conformance to standard specifications, (3) Dielectric withstand voltage measurement that assures total reliability (example, a 100-volt design is checked at 200 volts withstand).

Choose from standard ratings of Metalized Polyester Capacitors

Voltage Ratings: 100V and 200V DC at + 85C

Capacitance Ratings: .01uf to 10uf

Temperature Ratings: — 55C to + 85C (and + 125C with proper derating)

or let GE's 20 years of experience special-design metalized polyester capacitors to fill your need for reliable, long-life performance.

Call your GE Electronic Distributor or GE ECSO District Sales Manager, or write Section 43040, General Electric Co., 1 River Road, Schenectady, N. Y. 12305.

Electronic Capacitor & Battery Dept., Irmo, S. C.

GENERAL  ELECTRIC



increase ic yield

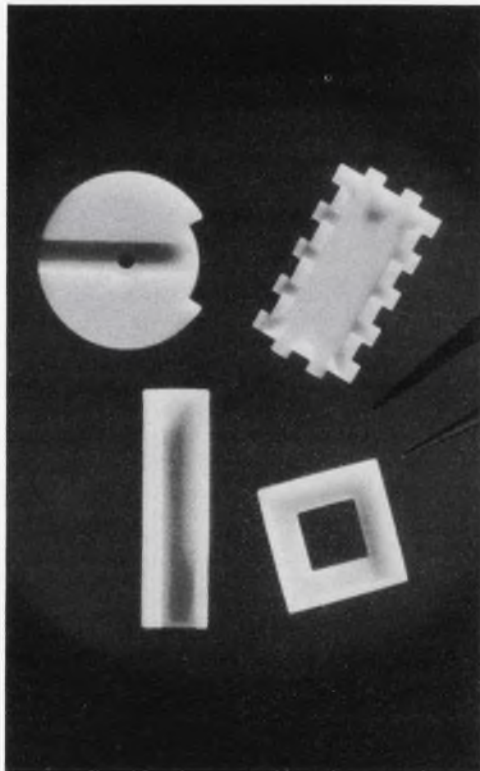

With Coors microceramics. Parts and complete packages. Of alumina and beryllia. Strong, chemically inert, dimensionally stable. Unaffected by age or environment. Part-to-part uniformity from 1st to nth. Precision-ground or as-fired surfaces. Easy to metallize, by you, by us. Most any size, any shape. Fast delivery. Prototype quantities, millions, or anything in between. Get higher yield, more profit. Start with the most reliable circuit packaging. Coors microceramics. Send for data pack.

Coors Porcelain Company
Golden, Colorado 80401

Coors/CERAMICS

Gate turn-off SCRs switch 5 A in 2 μ s

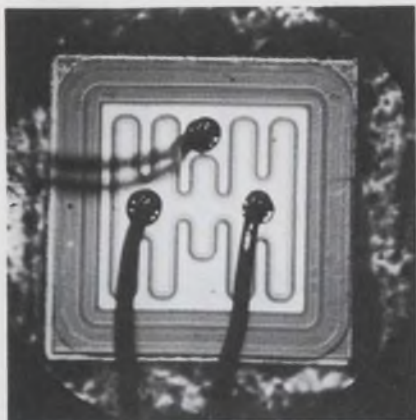

Transitron Electronics Corp., 168 Albion St., Wakefield, Mass. Phone: (617) 245-4500. P&A: \$3.25 to \$8.50; stock to 8 wks.

Without sacrificing their on-triggering sensitivity of 15 mA maximum, a new series of power gate-turn-off SCRs features a typical turn-off time of 2 μ s and a minimum turn-off gain of 10, both at 5 A. Series RTGD02 units have voltage ratings from 60 to 400 V and can withstand surge currents to 60 A. In addition, they can operate at temperatures as high as 125°C.

Besides their capability to be triggered off, the new devices are unlike conventional SCRs because they employ an interdigitated geometry, similar to that used for power transistors. This structure produces a junction with minimum temperature gradients and reduced failure rates.

Along with performance and reliability advantages, the new semiconductors carry an attractive price tag. Depending on voltage rating, costs range from \$3.25 to \$8.50 in 100-unit quantities.

These power gate-turn-off SCRs are also said to be the first such devices employing planar technology. They are supplied in a TO-5 case, and are primarily oriented toward pulse applications of less than 30% duty cycle.

Major applications include a wide range of pulse switching circuits at several amperes—for example, print hammer drives, inverters, video deflection circuits, and high-voltage high-current pulse generators.

CIRCLE NO. 253

**NOW...
YOU CAN
PUT THEM
TO WORK IN
MORE
PLACES**

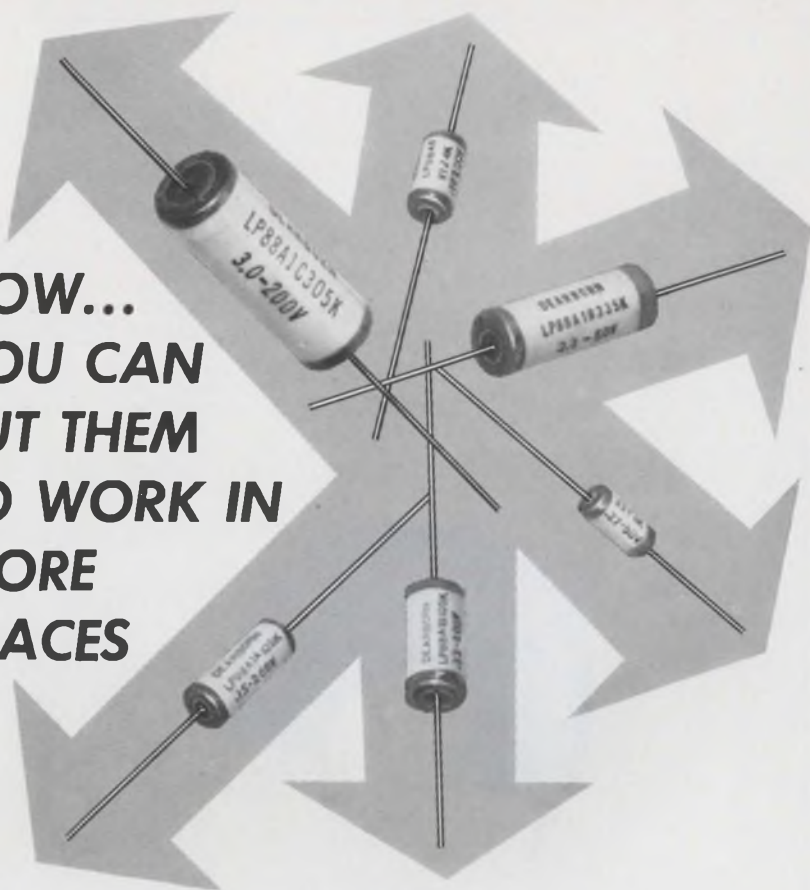

DELTAFILM® LP88 POLYCARBONATE CAPACITORS

now available with capacitance values up to 9 times higher!

get the big advantages of metallized polycarbonate-film in smaller capacitors!

- **EXCEPTIONAL PERFORMANCE:** Extended life characteristics. Very low temperature coefficient. High insulation resistance. Low dissipation factor (high Q). Excellent resistance to shock and vibration.
- **FUZ-ION SEALED®:** Heat-shrinkable plastic case is fused to epoxy for

maximum seal efficiency. Casing is nonconductive, fungus-proof, corrosion-proof, and humidity resistant.

- **OPERATING TEMPERATURE RANGE:** -55 C to +125 C
- **CAPACITANCE VALUES:** from .027 to 50 μ F.
- **VOLTAGE RATINGS:** 50, 75, 100, 150, and 200 VDC.
- **IDEAL FOR A-C AND D-C APPLICATIONS**

For complete technical data, request Engineering Bulletin 154A by writing to Dearborn Electronics, Inc., Box 530, Orlando, Fla. 32802.

Dearborn Electronics, Inc.
(a subsidiary of the Sprague Electric Company)
FOREMOST IN FILM CAPACITORS

10-0103

INFORMATION RETRIEVAL NUMBER 64



we have an aptitude

Magnetics has been a special talent of ours for more than two decades. The devices and systems to magnetize, demagnetize, stabilize, measure—in the lab, in production, in the product—we have consistently engineered the most complete line available anywhere. And the top-value line.

RFL's gaussmeters cover every requirement—from the low cost and portability of the Model 505, to the unparalleled precision of the 3265. Then there's the 101 flux-gate type Magnetometer for measuring extremely low level flux densities... five different types of Magnet chargers for every requirement ranging from the economical, rugged 107A Magnet Charger to the Model 942 that takes on *any* shape or type of permanent magnet... the Magnetreater® for precisely controlled stabilization... and many more. Where needed, we can integrate standard RFL equipment to make a custom system, too.

Write now for our new magnetics catalog.



RFL Industries, Inc.

Instrumentation Division • Boonton, New Jersey 07005

Tel: 201-334-3100/TWX: 710-987-8352/CABLE: RADAIRCO, N.J.

Tiny four-bit converter is fast thin-film hybrid



Micro Networks Corp., 5 Barbara Lane, Worcester, Mass. Phone: (617) 756-4635. P&A: \$72; stock.

Halving package size and reducing price by one-half to one-third over previous units, a new four-bit current-summing d/a converter combines, for the first time, thin-film d/a ladder networks with appropriate switching circuitry in the same package. Primarily intended for military and aerospace applications, the new converter requires only an operational amplifier and three voltage inputs (+5, +10 and +15 V) to provide a complete d/a function.

Model MN201 provides accuracies of 6 to 8 bits (0.2 to 1.5%), and has a worst-case error of 256 mV. Its operating frequency is greater than 5 MHz, while settling time is less than 100 ns. Its speed is actually limited only by the operational amplifier used in the output.

The complete d/a converter is contained in a 1/4 by 3/8-in. flat-pack. The housing is a hermetic ceramic-metal package that is eutectically bonded without epoxy or glass frit to meet the requirements of MIL-STD-883. Operating temperature range is -55 to +100°C.

CIRCLE NO. 254



**Model 630-A
Laboratory V-O-M**

1. $\pm 1\frac{1}{2}\%$ DC, $\pm 3\%$ accuracy.
2. One selector switch minimizes chance of incorrect settings and burnouts.
3. Rugged $5\frac{1}{2}$ " suspension meter movement with $4\frac{1}{2}$ " mirrored scale. \$75 suggested USA user net price



**Model 630-APL
Laboratory V-O-M**

1. $\pm 1\frac{1}{2}\%$ DC, $\pm 3\%$ accuracy.
2. One selector switch minimizes chance of incorrect settings and burnouts. Polarity reversing for DC.
3. Suspension meter movement diode protected against instantaneous overloads. \$75 suggested USA user net price



**General Purpose V-O-M
Model 630-PL**

1. One selector switch minimizes chance of incorrect settings and burnouts. Polarity reversing for DC.
2. 4.4 Ohms center scale, 0.1 ohm to 100 megohms resistance.
3. Meter movement diode protected against instantaneous overloads. \$64 suggested USA user net price



**General Purpose V-O-M
Model 630**

1. One selector switch minimizes chance of incorrect settings and burnouts.
2. 4.4 Ohm center scale, reads from 0.1 ohm up to 100 megohms resistance in 4 ranges.
3. 20,000 ohms per volt DC sensitivity; 5,000 AC. \$64 suggested USA user net price

Laboratory or General Purpose Triplet meets the need precisely

Products of Triplet's long experience in the design and manufacture of high-quality, high-performance V-O-Ms, these representatives of the great Model 630 series offer the most-wanted features combined as perfectly as the skills of dedicated craftsmen can guarantee.

See your Triplet representative or distributor for a free demonstration of any or all of these versatile instruments.



MANUFACTURERS OF THE WORLD'S MOST COMPLETE LINE OF V-O-Ms

INFORMATION RETRIEVAL NUMBER 66



MEASURES MILLIAMPERES TO PICOAMPERES AND NARROWS THE GAP BETWEEN PRICE AND PERFORMANCE

See the first digital picoammeter above? It's our new \$1495 autoranging Model 445. It simplifies measurements from 10^{-2} ampere f.s. to 10^{-9} ampere and provides both analog and BCD outputs. The second is the Model 440, new too. At \$995, it features 10^{-2} to 10^{-10} ampere f.s. current ranges, has an analog output and an option for BCD.

Both picoammeters are packed with convenience features designed to minimize operator error and maximize performance. Stable to 0.5% of full scale per week, they make low level measurements accurate to 0.2% almost routine. And provide variable display rate to 24 readings per second. But isn't that what you'd expect from a firm with years of analog picoammeter design experience? And an industry-wide reputation for quality? Like Keithley.

See if you don't agree we have the best digital approach to picoampere level measurements. Call your Keithley Sales Engineer for demonstration and details. Or contact Keithley Instruments, Inc., 28775 Aurora Rd., Cleveland, Ohio 44139. In Europe: 14 Ave. Villardin, 1009 Pully, Suisse. Prices slightly higher outside the U. S. A. and Canada.



KEITHLEY

INFORMATION RETRIEVAL NUMBER 67

ICs & SEMICONDUCTORS

Versatile quad latch doubles operating modes

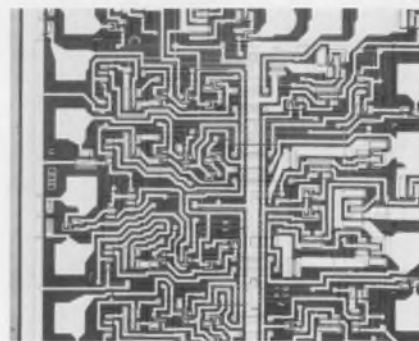

Fairchild Semiconductor, 313 Fairchild Drive, Mountain View, Calif. Phone: (415) 962-3563. P&A: \$9.70 to \$21.35; stock.

Able to operate in a D-type mode or a set/reset mode, a new multi-functional four-bit latch completely avoids the undefined-state problem common with R-S flip-flops. When both active inputs are low, the logic of model 9314 causes the R-input to dominate the S-input, thus creating a defined state.

CIRCLE NO. 255

Read-only memories perform five jobs



National Semiconductor Corp., 2975 San Ysidro Way, Santa Clara, Calif. Phone: (408) 245-4320. P&A: \$67.50 to \$120; stock to 4 wks.

Two 1024-bit read-only memories, the HH421/521, a 256-word four-bit memory, and the MM422/522, a 128-word eight-bit memory, are now available programmed for five different applications. These include: a sine look-up table, an arctangent table, an IBMBCD-to-ASCII converter, a BCD-to-Selectric converter and a Selectric-to-BCD converter.

CIRCLE NO. 256



MONOLITHIC BIPOLAR/MOS DRIVER-SWITCHES

Why Bipolar/MOS? By using bipolars in your analog switch driver circuits you get high breakdown voltages, fast switching speeds and low power dissipation.



The industry approach has been a chip for bipolars and a chip for the MOS FETs, or an all-MOS configuration at the expense of critical parameters.



New Siliconix technology puts the bipolar and MOS transistors on one chip, reducing the number of bonds and die-attach steps and simplifying assembly. You get better mechanical and electrical integrity, increased reliability, lower cost.

- Switches are normally OFF P-channel MOS FETs
- Zener diodes protect all MOS gates
- Metal areas are glass passivated
- Each channel complete – no other components needed
- Input compatible with DTL, TTL and RTL logic
- Switches analog signals up to 20 volts

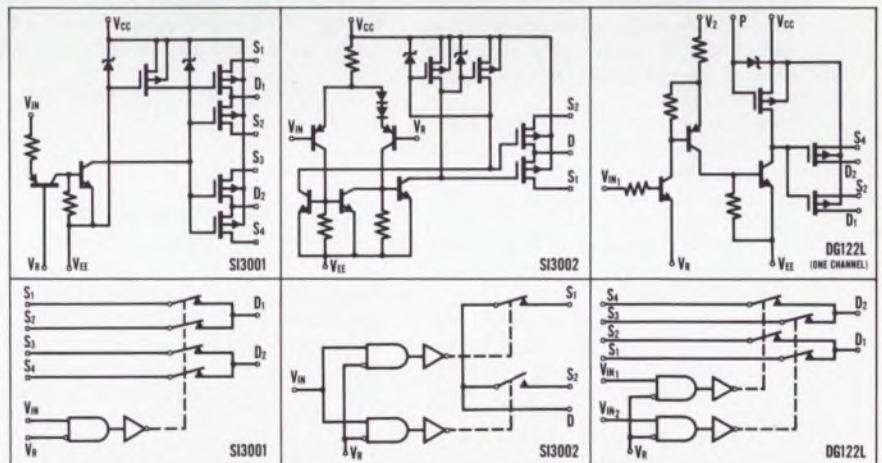

These are just three of more than 30 Siliconix multichannel driver-switch combinations with MOS or junction FET switches. A standard line of separately packaged drivers and switches is also available. Write or call for complete data on the industry's broadest line of driver-switches.

* **Applications Power:** A wide variety of driver/FET switch combinations and an in-depth applications team waiting to serve you!



Siliconix incorporated

2201 Laurelwood Road • Santa Clara, Calif. 95054
Phone (408) 246-8000 Ext. 201 • TWX 910-338-0227

in Europe... Siliconix Ltd., Siliconix House, Sketty Park, Saunders Way, Swansea, U. K.

RCA Solid-State Data for Designers

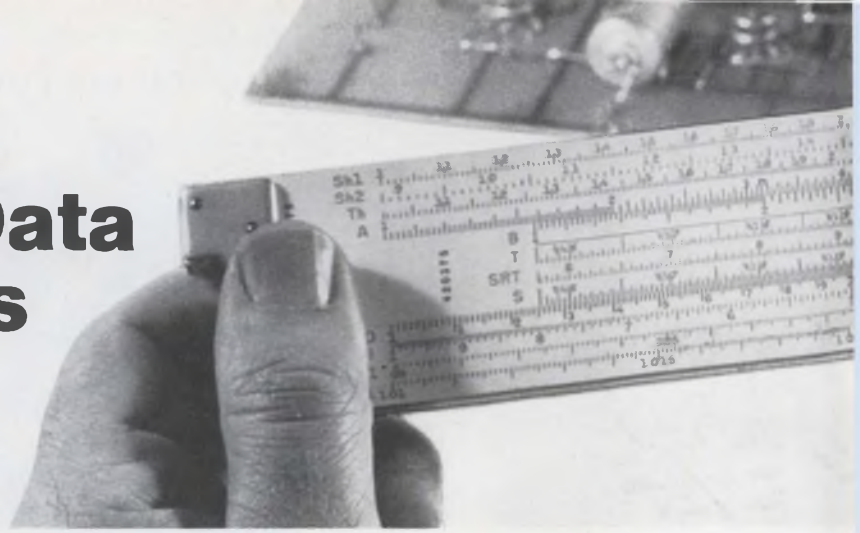

Switch current at high speeds — new power transistors meet your current needs



At high frequencies, design engineers prefer RCA-2N5038 and 2N5039 power transistors. With 12 discrete emitter sites connected in parallel in each unit, these epitaxial, silicon devices are designed as high current, high speed switches — providing 20-ampere current handling capabilities, and adding significantly to freedom from forward second breakdown.

Take a look at their characteristics:

These transistors have low saturation voltage (1 volt maximum at 12 A for the 2N5038, and 10 A for the 2N5039). Turn-on times are less than 0.5 microsecond.

The 2N5038 and 2N5039 are ideal for a variety of applications such as converters. (Some converters operate at frequencies as high as 25 kHz. By using these two transistors in converters, an output of 250 watts at 85% efficiency may be achieved.)

Other applications?

When they are used in high frequency switching regulators that operate at frequencies up to 50 kHz, 700 watts output at 95% efficiency is possible.

The 2N5038 and 2N5039 also make excellent amplifiers at frequencies up to 5 MHz. For example, in an audio amplifier where flat response is required, a pair of units in AB push-pull (or quasi) configuration will put out 25 watts up to 1 MHz. Two of these single units will put out 300 watts at 50 kHz for ultrasonic applications, or provide 20 watts at 2.5 MHz from a 13-volt supply for marine band transmitter use.

An added attraction: at 1,000 unit quantities, the 2N5038 has been

price-slashed from \$20.00 to \$10.00; the 2N5039 from \$15.00 to \$8.00.
Circle Reader Service No. 211.

RF power transistors for mobile applications

When you design mobile or portable communications equipment, use the RCA-TA7477. This 2-watt (typ) output device has 13 dB gain at 175 MHz.



An epitaxial silicon n-p-n planar transistor featuring "overlay" construction, developmental type TA7477 can be used in a broad range of applications. It is capable of a 2-watt output even at 470 MHz; thus this transistor is ideal also for use in Class C VHF/UHF amplifiers for Citizen Band radios, sonobuoys, and beacons.

Circle Reader Service No. 212.

COS/MOS buffers solve power problems

RCA COS/MOS (COmplementary Symmetry Metal-Oxide-Semiconductor) devices continue to gain in popularity among digital design engineers concerned with low-power dissipation, low-package count or high-noise immunity requirements in aerospace and airborne computers, portable military equipment, instrumentation or industrial control equipments.

Two new COS/MOS Hex Buffer/Logic-Level Converters are now available. The RCA-CD4009D is designed for use as a hex COS/MOS inverter, a hex COS/MOS to DTL or TTL logic-level converter, or a hex COS/MOS current driver. Conversion ranges are from COS/MOS logic operating at +6 V to +15 V

supply levels to DTL or TTL logic operating at +3.8 V to +6 V supply levels. Conversion to logic output levels greater than +6 V is permitted providing V_{CC} (DTL/TTL) $\leq V_{DD}$ (COS/MOS). The RCA-CD4010D is similar in performance to the CD4009D except that it provides a non-inverting output.

Each of the two new COS/MOS IC's features quiescent power dissipation—100 nW (typ); high current sinking capability—6 mA (min.); high noise immunity—45% of V_{DD} , and high input impedance— 10^9 ohms (typ), protected inputs.

Circle Reader Service No. 213.

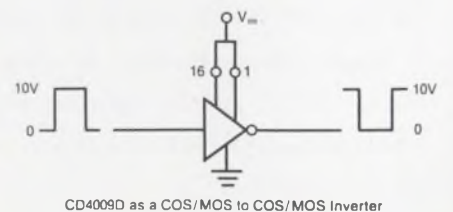
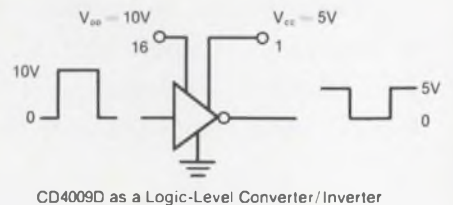
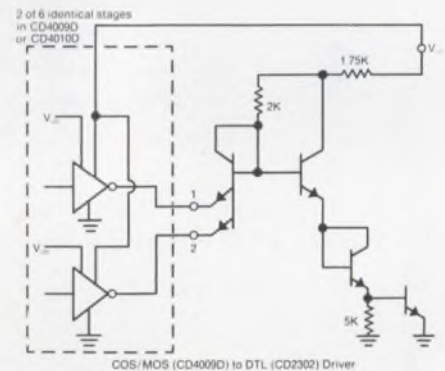

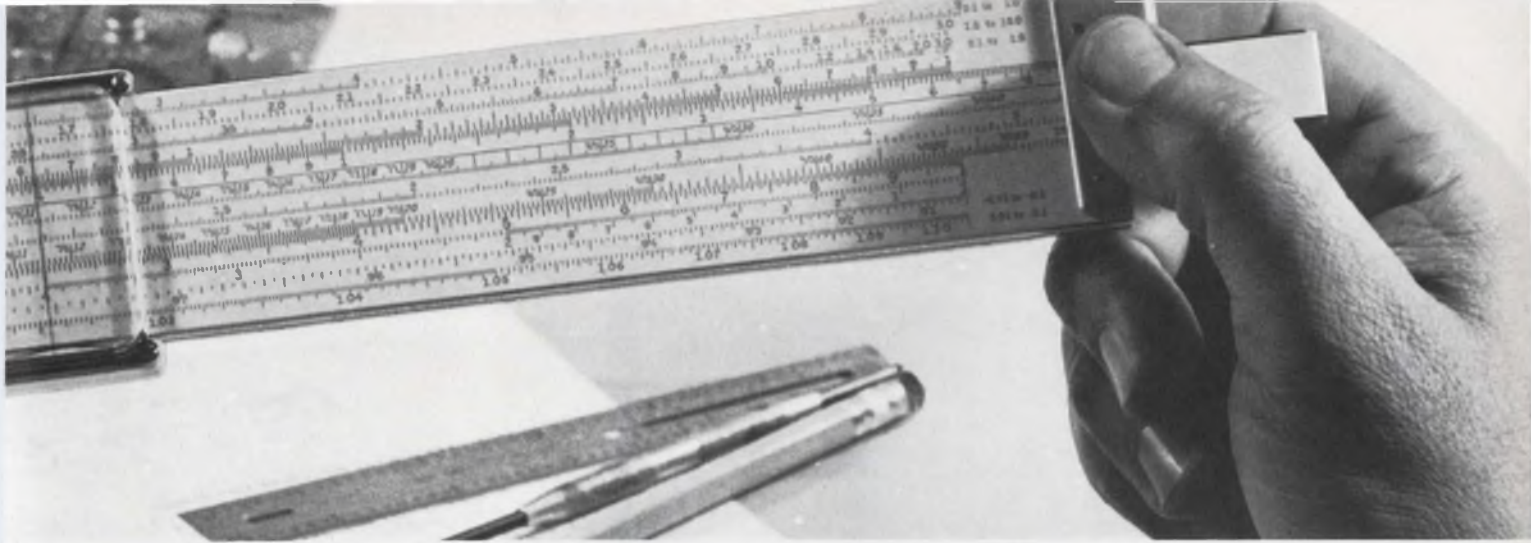

More bandwidth with RCA op amps!

When an op amp offers *more* performance and design latitude for *less* money... that's news. And that's the important news designers are discovering in RCA's CA3029. At 98¢ (1000 units), the CA3029 in the 14-lead DIP package may offer more bandwidth than the "709" op-amp series you are now specifying. Compare the data in the accompanying graph against that of other op amps.

You will find similar savings—and the same operating and design features—across the board in this RCA family in flat pack, TO-5 style package, and dual-in-line ceramic. These IC's can provide the broad, flat frequency response required for video amplifiers or the peaked response of shaping amplifiers. Use them as comparators, integrators, differentiators, and summing amplifiers.

And, while you're checking, look into the performance and economy available to you in RCA's op-amp types for supply voltages to ± 18 volts and power output to 1/4 watt. Circle Reader Service No. 214.

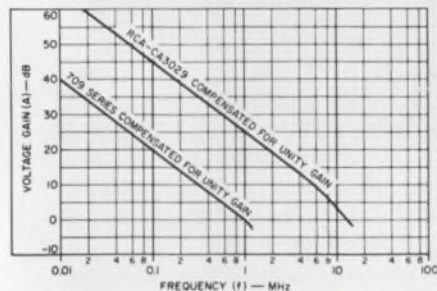

"Close Confinement" puts power in GaAs laser arrays

"Close Confinement" laser technology is a manufacturing technique that reduces the absorption of light in the GaAs junction and assures efficient radiation from the junction exit surface. This technology now has been extended to larger multi-



ple-chip arrays with higher power outputs.

A number of GaAs laser diode arrays (the TA7687 through TA7692) are now available from RCA. These devices offer peak power outputs up to 300 watts at 25 A drive current. They are available in OP-4A ("Close Confinement") modified TO-5 stud unit packages.

	Peak Power Output (watts)		Emitting Area (typ.) (inches)
	min.	typ.	
TA7687	25	50	.1 x .001
TA7688	35	75	.15 x .001
TA7689	50	100	.11 x .04
TA7690	75	150	.16 x .04
TA7691	100	200	.11 x .06
TA7692	150	300	.16 x .06

These GaAs laser diode arrays may be operated at pulse widths up to 200 ns and duty cycles of .02% (1 KHz at 200 ns).

In addition, custom arrays are available with peak power in the kilowatt range and average powers of 1-100 watts in the temperature range of 77°-150°K at 1%-2% duty cycles.

GaAlAs laser diode arrays are also available with wavelengths of 8100-8700 Angstroms.

Circle Reader Service No. 215.

Standard with RCA—triacs that trigger in all four firing modes

RCA has always controlled triac gate characteristics in all four firing modes...as standard product. Generally, in the industry, this is done by special selection. The fact is, RCA is the only manufacturer that *specifies*

its triac line for applications from 0.5 to 40 A rms, from 100 to 600 V, for:

- In-phase triggering with the line
- Inverse phase control from an ac line
- Positive dc logic control
- Negative dc logic control

Any of these four operating modes opens up a wide range of potential uses across broad application areas in light control, heat control, motor speed control, power supplies, and other power switching systems.



Have you investigated the control performance qualities of RCA triacs? Do it! One RCA triac can often replace two SCR's and frequently can handle — electronically — a job that traditionally employs relays.

RCA's triac family offers designers the industry's most complete assortment of packaging configurations: which include stud, press-fit, and the recently introduced VERSAWATT cases (illustrated), plus others.

Circle Reader Service No. 216.

For price and availability information on all solid-state devices, see your local RCA Representative or your RCA Distributor. For specific technical data, write RCA Electronic Components, Commercial Engineering, Section G-1-1-UM3, Harrison, N. J. 07029. In Europe: RCA International Marketing S.A., 2-4 rue du Lievre, 1227 Geneva, Switzerland.

RCA

500 CHARACTERS PER SECOND

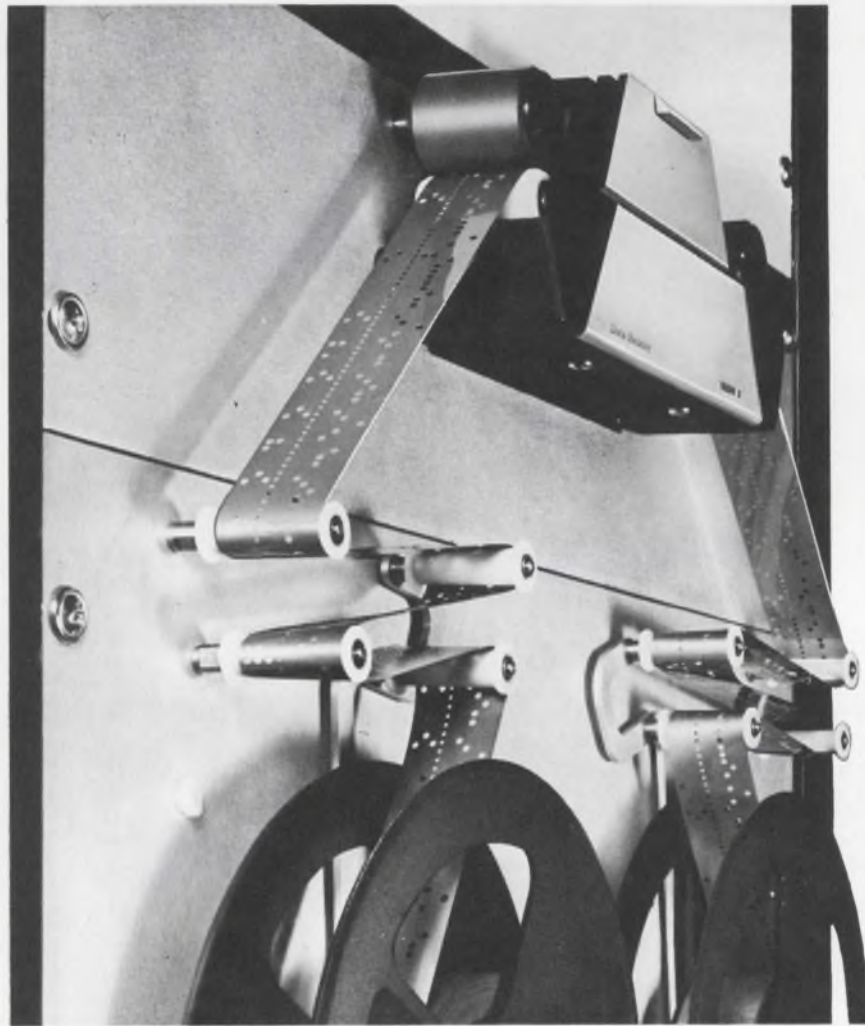

- Stop on a character
- High reliability

\$745*

MARK V data-reader TAPE READERS

Speed, reliability and economy are combined in Datascan's new paper tape reader to offer you more value than presently available. Photo-electric sensing and capstan drive assure long trouble-free life and a heavy-duty casting provides dimensional stability. And it's bi-directional, too.

Datascan's 7 years of experience has led to a most reliable series of tape readers for use in the most caustic environments such as found in the Graphic Arts and machine tool industries.

Interfaces available for all small computers.

*Consists of a readhead assembly, control electronics and power supply.

See our new Spooler too at Booth 7415 FJCC



Write for new brochure.

Datascan

DATASCAN, INC.

906

1111 Paulison Avenue, Clifton, N. J. 07013 • Telephone 201-478-2800

INFORMATION RETRIEVAL NUMBER 68

ICs & SEMICONDUCTORS

Fast data selector propagates in 11 ns

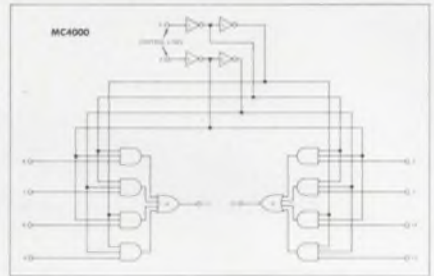

Motorola Semiconductor Products Inc., Box 20924, Phoenix, Ariz. Phone: (602) 273-6900. P&A: \$7.10 per 100; stock.

A new high-speed, dual four-channel data selector, Type MC-4000, exhibits typical propagation delays of 11 ns from data input to output and 18 ns from control input to output. The 150-mW unit selects data on any one of the four inputs according to the binary code on the control lines and routes the data to the output.

CIRCLE NO. 257

Reference amplifiers drive down size

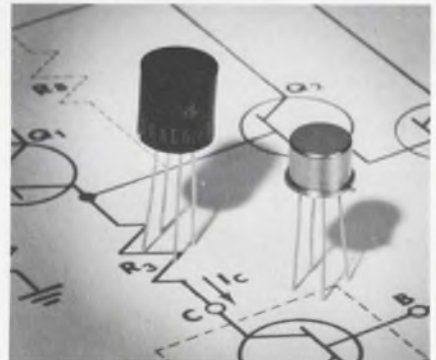

Dickson Electronics Corp., Box 1390, Scottsdale, Ariz. Phone: (602) 947-2231. P&A: \$3.25 to \$10.50 per 100; 2 wks.

Miniature temperature-compensated reference amplifiers for military and industrial applications are available in 6.8, 9 and 11.7-V ranges. Both types use opposite temperature coefficients of a transistor and a diode to stabilize over the range of -55 to +100°C and 0 to 70°C. Available temperature coefficients are 10, 25 and 100 ppm ±5%.

CIRCLE NO. 258

Prime time. Gibbs.



If doing your thing depends on stable frequency control, then you'll be interested in Gibbs' ratings.

We define our frequency standard and crystal oscillator stability a little differently than most others. Frequency deviation in parts per million is only half the story. In order to be meaningful, you must define the time period over which the stability will be maintained.

For instance, any LC oscillator could have a stability of $\pm 1 \times 10^{-6}$ for one

second, but we doubt if it could hold that stability for over twenty-four hours.

At Gibbs, stability normally means long term stability for periods of at least thirty days. For laboratory type frequency standards, we insist that the period cover one year.

Gibbs has been in the frequency standard and crystal oscillator business for many years doing a lot of basic research and turning out a lot of top quality gear for the U.S. Government.

How's that for a sponsor?

**GIBBS MANUFACTURING
& RESEARCH CORP.**
450 North Main Street
Janesville, Wisconsin 53545



**GIBBS
MANUFACTURING
& RESEARCH
CORPORATION**

A Subsidiary of Hammond Corporation

Two great bench-top temperature chambers

to match your testing needs at great low prices from Tenney!

PLAIN

The new TENNEY SST

Sturdy new "Hermeticool" mechanically refrigerated chamber now available at a great low price. Check these features:

Range: -95° F to +350° F, $\pm 1/2^\circ$ F control

Chamber Dimensions: 16" wide x

11" deep x 12" high

Heatup: To +350° F in 35 minutes

Pulldown: From ambient to -95° in 55 minutes

Power: 115 volts

FULL PRICE:

\$890

including temperature indicator.
Available from stock.

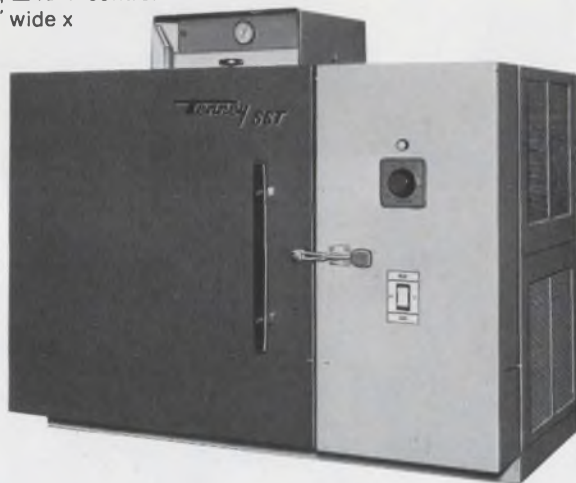

& FANCY

TENNEY JR.

The ultimate in a bench-top high-low temperature chamber. "Hermeticool" mechanically refrigerated, solid-state SCR instrumentation, and many other exceptional features!

Range: -120° F to +350° F, $\pm 1/4^\circ$ F control

Chamber Dimensions: 16" wide x 11" deep x 12" high

Heatup: To +350° F in 35 minutes

Pulldown: From +75° F ambient to -100° F in 35 minutes

Power: 115 volts

FULL PRICE:

\$1080

Available from stock

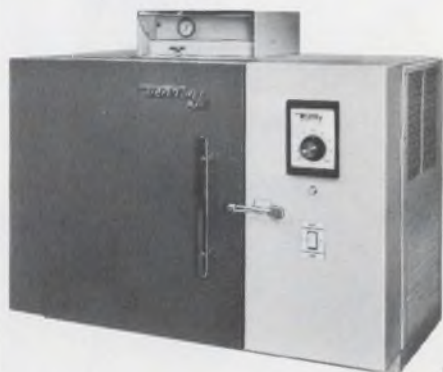

Tenney

ENGINEERING, INC.

1090 Springfield Rd., Union, New Jersey 07083 • (201) 686-7870
Western Division: 15721 Texaco St., Paramount, Calif. 90723

5148

ICs & SEMICONDUCTORS

Thin-film preamplifier covers dc to 10 MHz

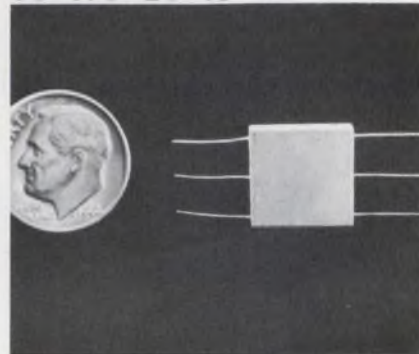

Odetics, Inc., 1845 S. Manchester Ave., Anaheim, Calif. Phone: (714) 530-6050.

Measuring only 0.5 by 0.5 by 0.1 in., a new thin-film hybrid preamplifier offers a bandwidth from dc to 10 MHz, while maintaining a gain of 40 dB. Maximum noise figure for this tiny device is 2 dB at 2 kHz for a source resistance between 1 and 5 k Ω . It has an input capacitance of 4 pF maximum, and a power supply requirement of ± 12 V at 7 mA.

CIRCLE NO. 259

Plastic zener takes 2.5 W

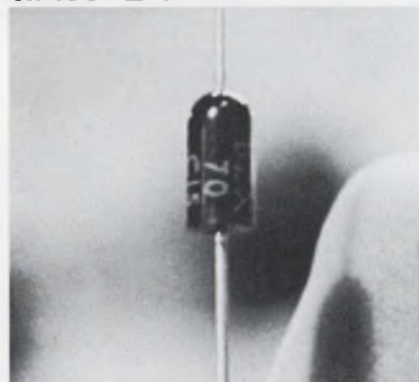

Mullard, Inc., 100 Finn Court, Farmingdale, N.Y. Phone: (516) 694-8989.

A new plastic zener diode, model BZX70, provides a voltage range of 7.5 to 75 V, a surge rating of 100 W, and a power rating of 2.5 W. The new zener measures approximately 0.5 by 0.25 in. (12.5 by 6.5 mm) and has leads of just under one inch (24 mm). It is an addition to a line of zeners with power ratings from 400 mW to 75 W.

CIRCLE NO. 260



Solid state displays

The MAN 1 is a seven-segment light-emitting all-semiconductor alpha-numeric readout.

Put the attention-demanding red light from electrically excited GaAsP to work in your digital displays for industry, computer peripherals, or avionic/marine instrumentation. Our MAN 1 is shock-resistant and long-lived. Offers styling advantages because it's flat, parallax-free and visible within 150°. Reads out all numbers plus A, C, E, F, H, J, O, P and U. Available now. Any quantity.

Brightness: 200 ft-lamberts @ $I_f = 20$ ma, 3.4V, per segment

Compatibility: directly interfaces with off-the-shelf IC decoder/drivers

Price: 1-9, \$48; 1,000 or more, \$25

GaAsLITE Update

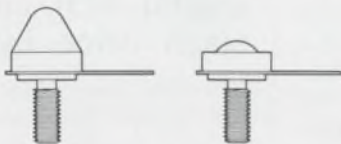

12 mW @1A IR emitters

New high power low cost 9000 Å GaAsLITEs give you extra mW for your \$.

Design these powerful infrared sources into your next card or tape readers, intrusion alarms, or calibration units. Anything that uses silicon detectors wants our ME 2 and ME 5 GaAs infrared emitters. They give you a 2500-mil² emitting area with either lambertian (ME 2) or collimated (ME 5) radiation patterns. Guaranteed minimum output: 10 milliwatts at 1 amp. (Less expensive ME 2A and 5A versions radiate 7.5 mW.)

Peak forward current: (1µs pulse width, 300 pps) 25 amps

Forward voltage: 1.3 V typ ($I_f = 1.0$ A)

Rise time: 10 nanoseconds

Prices: ME 2, 5: 1-9, \$30; 1,000, \$12.50
ME 2A, 5A: 1-9, \$14.75; 1,000, \$8.00



GaAsLITEs by the millions

Bright red solid state lights are here. And affordable!

Want high performance and low price? Immediately? Order our new MV 50:

750 ft-lamberts @ 20ma; thousands ready to be shipped from your Monsanto distributor at \$1.50 each.

Finally, a price that lets you justify GaAsLITEs for high volume applications. MV 50s can replace miniature and sub-miniature lamps down to the T3/4 size. Their solid-state reliability makes them ideal for indicator lights in computer systems, data processing equipment, communications systems, and as diagnostic lights on pc boards. And just think what you could do with them in large arrays and in optical logic systems. . . .

Size: 0.10" diameter

Output: 750 ft-lamberts (6500 Å) @ 1.6V, 20 ma

Switching time: 1 nanosecond

Price: 1-9, \$2.30; 1,000, \$1.50

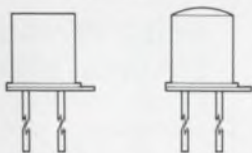

The superfast detector

Our 500-picosecond silicon PIN photodiodes, MD 1 and MD 2, complement our light-emitting diodes.

High speed optical switching has all kinds of sexy uses today: Laser detecting, for instance, and optical encoding. Even simple burglar alarms can use it.

Their half-a-nanosecond response cycle makes them perfect mates for Monsanto GaAsLITEs. And they work with other sources, too. Packaged in standard transistor cans, they're easy to handle and mount. Available with either flat lens or built-in optics.

Rise time: .5 nanoseconds ($V_R = 20V$; $R_L = 50$)

Breakdown voltage: 50V ($I_R = 10\mu A$)

Sensitivity: MD 1 1.5 µA/mW/cm² (min) (.9 microns, $V_R = 20$ volts)

MD 2 3.0 µA/mW/cm² (min) (.9 microns, $V_R = 20$ volts)

Price: 1-9, \$6.25; 1,000, \$3.40

Monsanto

All available through Schweber, Semiconductor Specialists, Kierulff or K-tronics. For additional technical information and world-wide distributor list, write Monsanto Electronic Special Products, 10131 Bubb Road, Cupertino, California 95014. (408) 257-2140

Matched npn/pnp pairs hold 60-V breakdown

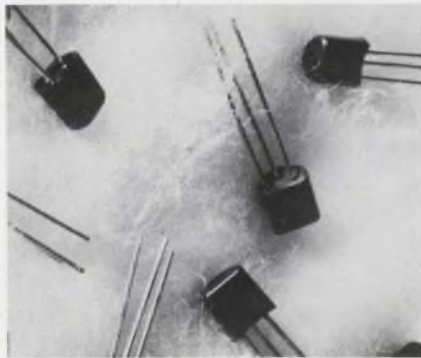

General Electric Co., Semiconductor Products Dept., 1 River Rd., Schenectady, N.Y. Phone: (315) 456-2396. P&A: 28¢ to 32¢ each for 10,000; stock.

Matched pairs of general-purpose complementary signal transistors offer breakdown ratings of 25, 40 and 60 V at 750 mA. Their power dissipation is 500 mW at 25°C. Models D34E (pnp) and D32D (nnp) are available with or without heat sink in an epoxy TO-18 pin configuration package.

CIRCLE NO. 261

Varactor diode pairs tune back-to-back

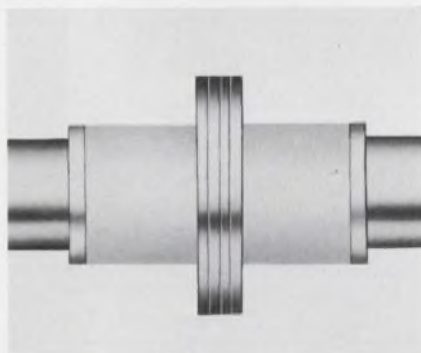

MSI Electronics Inc., 34-32 57th St., Woodside, N.Y. Phone: (212) 672-6500. P&A: \$28; 3 wks.

Electronic tuning using back-to-back diodes is simplified by a double-ended package containing a pair of matched varactor diodes. Series DEP 1712 -1726 units are available with nominal capacitance values from 1.2 to 12 pF, and with Qs of over 1500 measured at 50 MHz. Only one bias voltage, either ac or dc, must be applied to the common flange contact.

CIRCLE NO. 262

Versatile plastic FETs withstand up to 125°C

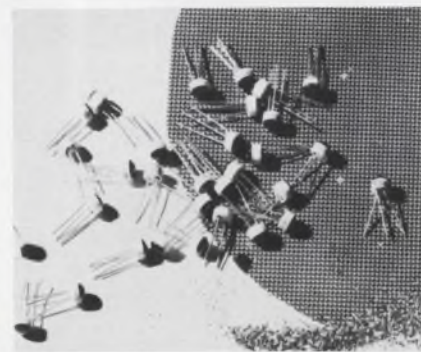

Intersil Inc., 10900 N. Tantau Ave., Cupertino, Calif. Phone: (408) 257-5450.

With guaranteed operation over the temperature range of -55 to +125°C, n-channel FETs in TO-106 epoxy packages cover a variety of 2N-equivalent-device types for commercial-industrial uses. Included are: low-level low-noise choppers, low-on-resistance switches, general-purpose amplifiers, and devices for audio and multiplexing applications.

CIRCLE NO. 263

Thermotab-type triacs carry 16 A at 800 V

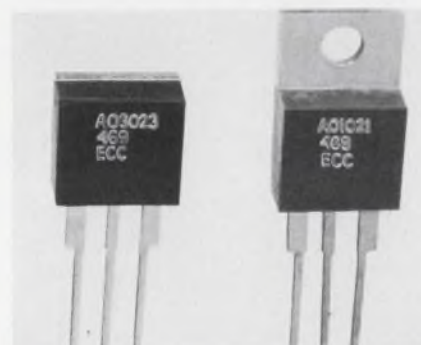

Electronic Control Corp., 1010 Pamela Dr., Euless, Tex. Phone: (817) 267-2601.

Handling up to 800 V at 16 A, a new line of electrically isolated triacs are supplied in a Thermotab package for enhanced performance. The package, which has an electrically isolated mounting tab, allows direct mounting on a PC board, or to a heat sink without loss of thermal efficiency. In addition, the triacs can be supplied with an integral trigger.

CIRCLE NO. 264

Disc-like SCRs go up to 175 A

National Electronics, Inc., Semiconductor Div., a Varian sub., Geneva, Ill. Phone: (312) 232-4300.

Available in disc packages, a new line of silicon controlled rectifiers are rated at 175 A rms with voltage ranges from 100 to 1000 V. Series NL-F350 and NL-C350 units also feature fast turn-off capabilities to 10 μ s and voltage rates of change to 500 V/ μ s. Operation can be as fast as 20 kHz with low switching losses and a low-power gate drive.

CIRCLE NO. 265

Digital MSI circuits slash price by 46%

Fairchild Semiconductor, 313 Fairchild Drive, Mountain View, Calif. Phone: (415) 962-3563. Price: \$5.30 to \$8.50.

Price reductions up to 46% are now effective for six digital MSI circuits from Fairchild's 9300 series. The ICs are: the 9300 four-bit register; the 9301 one-of-ten decoder; the 9304 dual full adder; the 9308 dual four-bit latch; the 9309 dual four-bit multiplexer; and the 9312 eight-bit multiplexer. The newly posted unit prices, for devices in a dual-in-line package, range from \$5.30 to \$8.50 for quantities of 100 to 999.

CIRCLE NO. 266

Selector/multiplexer strobes independently

Texas Instruments Inc., Components Group, P.O. Box 5012, Dallas, Tex. Phone: (214) 238-2011. P&A: \$4.83 to \$10.88; stock to 4 wks.

Featuring separate strobe lines, a new MSI data selector/multiplexer, model SN54153/SN74153, contains two sets of four AND/OR gates, each with its own output. Common address circuitry selects data from one of four inputs for each set. A strobe line is provided for each four bits to enable the data inputs. The strobe lines also allow the data selectors to be cascaded without using external gatings.

CIRCLE NO. 267

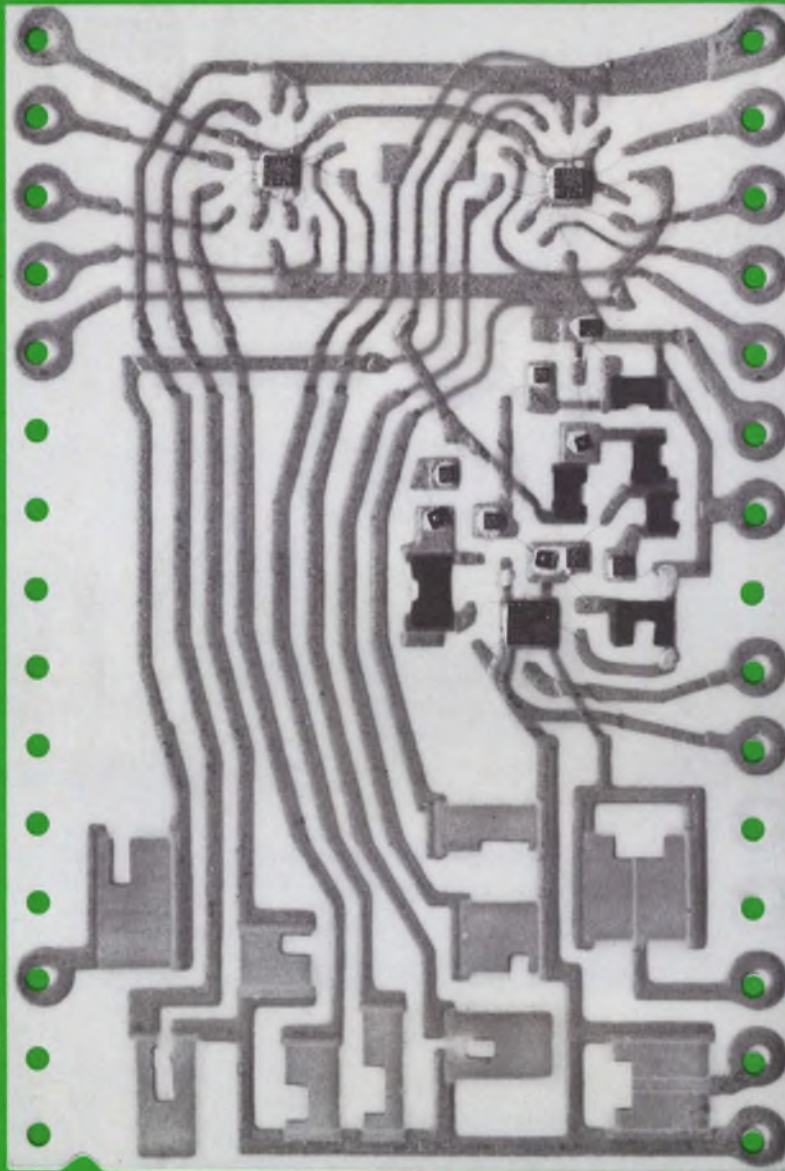

4 X Actual Size.

A complete 8-bit Digital-to-Analog Converter for \$75!

The new Helipot Model 845 is a thick-film, miniaturized hybrid digital-to-analog converter (DAC) that converts an 8-bit binary word into an analog output. The input gates, switches, resistor network, reference voltage, and output amplifier are all in the hybrid module.

Because of its operating temperature range (-20°C to $+85^{\circ}\text{C}$), Model 845 can be used for any industrial digital-to-analog conversion, process control being a typical application. Price is \$75/unit in 1-9

quantities (less in greater numbers). The package size is 1.0 inch x 1.5 inches x 0.170 inch. The unit accepts an 8-bit, parallel, binary word that is TTL- and DTL-compatible, and an enable gate is provided. Four different output-voltage ranges are available as standard models: two unipolar (0 to +5 v, 0 to +10 v) and two bipolar (-5 to +5 v, -10 to +10 v). Power-supply requirements are +15 v at 60 ma and -15 v at 10 ma. The output accuracy is $\pm 1/2$ least-significant bit at $25^{\circ}\text{C} \pm 1$ mv

per percent of supply-voltage variation. The output-current range is 0 to ± 2.5 ma, and the output slew rate is 0.3 v/ μsec .

And, it's available from stock.

Beckman

INSTRUMENTS, INC.

HELIPOT DIVISION

2500 HARBOR BOULEVARD

FULLERTON, CALIFORNIA 92634

INTERNATIONAL SUBSIDIARIES: AMSTERDAM; CAPE TOWN; GENEVA; GLENROTHES, SCOTLAND; LONDON; MEXICO CITY; MUNICH; PARIS; STOCKHOLM; TOKYO; VIENNA

ELECTRONIC MATERIALS

DOW CORNING®

3140 RTV coating

clear, flowable silicone rubber coating; non-corrosive to copper and other metals
TWO OUNCES

DOW CORNING

ELECTRONIC MATERIALS

DOW CORNING®

3140 RTV coating

clear, flowable silicone rubber coating; non-corrosive to copper and other metals
TWO OUNCES

DOW CORNING®

3141 RTV coating

white, flowable silicone rubber coating; non-corrosive to copper and other metals
NET WT. 2 oz/57 g

DOW CORNING

DOW CORNING®

3141 RTV coating

white, flowable silicone rubber coating; non-corrosive to copper and other metals
NET WT. 2 oz/57 g

DOW CORNING®

3144 RTV adhesive/sealant

translucent, room-temperature-curing silicone rubber adhesive sealant; non-corrosive to copper and other metals
NET WT. 2 oz/57 g

DOW CORNING

DOW CORNING®

3144 RTV adhesive/sealant

translucent, room-temperature-curing silicone rubber adhesive sealant; non-corrosive to copper and other metals
NET WT. 2 oz/57 g

ELECTRONIC MATERIALS

DOW CORNING®

3145 RTV adhesive sealant

grey, non-slump silicone rubber sealant; non-corrosive to copper and other metals
TWO OUNCES

ELECTRONIC MATERIALS

DOW CORNING®

3145 RTV adhesive sealant

grey, non-slump silicone rubber sealant; non-corrosive to copper and other metals
TWO OUNCES



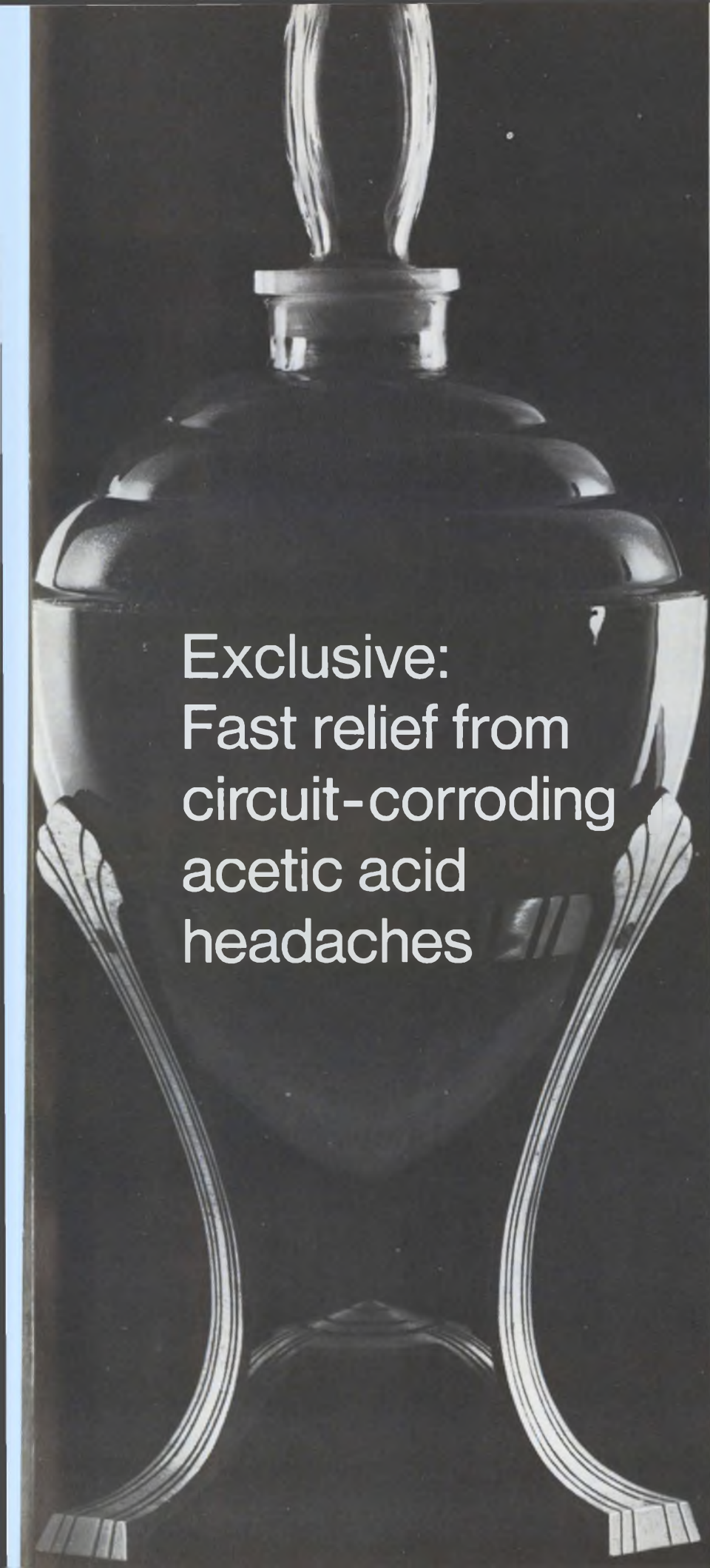

Exclusive:
Fast relief from
circuit-corroding
acetic acid
headaches

Dow Corning® silicone sealants and protective coatings are the only ones that do *not* release acetic acid or other corrosive by-products during cure. They were specifically developed to protect delicate circuit boards and other electronic components from corrosion, dust, dirt, abrasive particles, solvents and chemicals. They are strong, have excellent bond strength, electrical strength; are easy to apply, and cure quickly. There's no "vinegar" smell, either. Dow Corning 3140 (clear) and 3141 (opaque) RTV coatings are ready-to-use silicone rubbers that cure at room temperature. They are ideal for conformal coatings on printed circuit assemblies or for encapsulating small circuits or connectors. Dow Corning 3144 (clear) and 3145 (opaque) RTV adhesive/sealants are high-strength, non-corrosive, nonflowing silicone rubbers used to bond components and seal housings and connectors.

Stop component corrosion with these Dow Corning coatings and sealants. For more information, write Dow Corning Corporation, Dept. B-9342, Midland, Michigan 48640.

*Electrical / Electronic
materials from*

DOW CORNING

DOW CORNING

INFORMATION RETRIEVAL NUMBER 73

a complete digital system



- circuit breadboarding
- for: • customized digital instruments
- learning digital techniques

HEATH 801 Digital System...

buy the complete system or discrete components

Now . . . A Complete System to Enable You to Get the Most Out of Digital Electronics. Here is a system that is revolutionizing instrumentation in labs and classrooms throughout the world. The basic design concepts of Professors H. V. Malmstadt and C. G. Enke combined with the engineering of Heath's scientific instrument group have resulted in the unique 801 Analog Digital Designer (ADD) and the EU-51A breadboard and parts group. This versatile system can perform equally well in constructing high performance research-quality instruments, in performing hundreds of experiments in the teaching laboratory, in rapid testing of new digital ideas, or in interfacing to computers.

Start . . . By Learning the New Digital Electronics. Drs. Malmstadt and Enke have written a pioneering new text "Digital Electronics for Scientists" (published by W. A. Benjamin, Inc.) that provides a systematic introduction to the digital circuits, concepts and systems that are basic to the new instrumentation — computation revolution. The book is written for engineering and science students and for practicing engineers, scientists, and technicians so that all may effectively utilize the startling recent advances in digital electronics.

Never before have the latest "state-of-the-art" methods been made so rapidly and conveniently accessible through an integrated combination of new text and versa-

tile equipment. The experimental section of the text is written specifically for utilizing the Heath 801A and 51A to provide experience and working knowledge with hundreds of digital and analog-digital circuits, instruments and systems.

Write . . . for Complete Information on Cards, Modules and Parts in the Heath Digital System. The basic Analog-Digital Designer (EU-801A) contains 3 modules (power supply, binary information, and digital timing) and 13 circuit cards including TTL gates, flip-flops, monostable MVs, relays, op amps, and V-F converter. The EU-51A Experimental Parts Group is a highly flexible breadboard system for circuit design and teaching. The group includes a desk chassis, 493 components, a patch card accepting these components, and a power patch card.

The system is open-ended. New cards and modules are continuously being introduced so you can construct your own special frequency meters, counters, timers, DVMs, rate meters, and many dozens of other instruments.

Take . . . advantage of the digital revolution — order your Heath Digital System now.

EU-801A, Analog-Digital Designer \$435.00*

EU-51A, Experimental Parts Group \$135.00*

EUP-19, text "Digital Electronics For Scientists" by H. V. Malmstadt and C. G. Enke (published by W. A. Benjamin, Inc.) \$9.50*

DATA PROCESSING

Precision cassette is for computer use



Ampeg Corp., Magnetic Tape Div., 401 Broadway, Redwood City, Calif. Phone: (415) 367-4151.

Claimed as an industry first, a precision digital cassette is now available for cassette tape drives used as computer peripheral devices. Model PC-800 utilizes a new design to provide high reliability, and optimum tape skew and tape pack characteristics. It employs steel-bearing mounted fixed hubs and a four-point tape path system.

CIRCLE NO. 268

Digital data plotter needs no special input



Hewlett-Packard, 1501 Page Mill Rd., Palo Alto, Calif. Phone: (415) 326-7000. P&A: \$3300; 90 days.

Using data directly from an on-line or off-line teletypewriter, a new digital data plotter draws graphs from numbers or from algebraic equations without special programming. Model 7200A can draw graphs and also handle scaling and curve fitting, as well as perform other basic plotting operations.

CIRCLE NO. 269

<p>FREE Heath Scientific Instrumentation Catalog</p> <p>Describes these and other precision instruments for laboratory, engineering, education and R & D applications. Send for your FREE copy now . . . just write on your school or company letterhead.</p>	<p>HEATH COMPANY, Dept. 580-21 Benton Harbor, Michigan 49022</p> <p><input type="checkbox"/> Please send FREE Heath Scientific Instrumentation Catalog</p> <p>Name _____</p> <p>Address _____</p> <p>City _____ State _____ Zip _____</p> <p>Prices and specifications subject to change without notice. *Mail Order Prices; F.O.B. Factory</p>	<p style="text-align: center;">HEATH</p> <p style="text-align: center;"><i>a Schlumberger company</i></p>
	<p style="text-align: center;">EK-278</p>	

INFORMATION RETRIEVAL NUMBER 74

think- in

An exchange of ideas about relays and related devices.

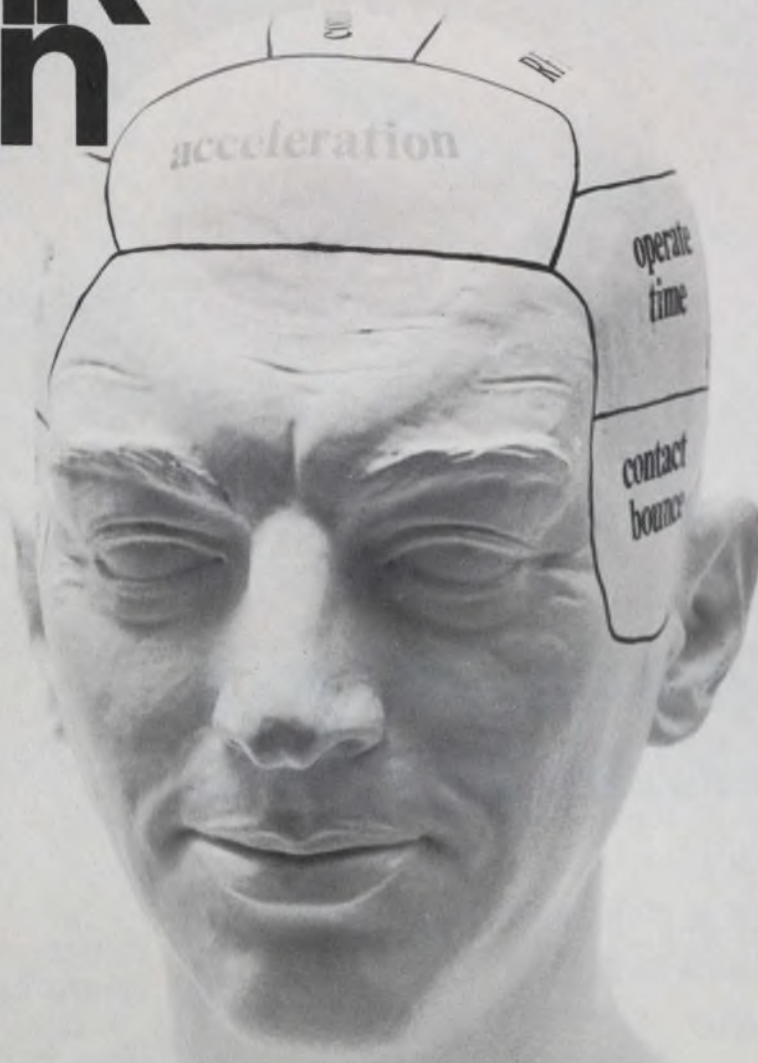

RELAY MISAPPLICATION . . . a THINK-IN report

Communication gaps aren't anything new to the relay industry. That's why Ohmite sponsors Think-In relay application seminars. First, we feel that the idea-exchange aspects of our seminars helps to close the gaps. Secondly, we can be objective in our reporting since we manufacture a broad range of relays including electromechanical and solid-state types.

As one of the speakers at our last Think-In seminar put it . . . "Don't make a 'spectacular' out of your relay specification." In other words, don't build a relay, but define your needs. This permits the relay manufacturer to expose his latest technology to your specific application requirements.

As a for-instance, with the Ohmite SSA relay, the term "coil voltage" is practically meaningless. This solid-state relay will operate anywhere from

2.75 to 200 VDC or 4 to 140 VAC which provides a universal input voltage range. Also, it has approximately 500 Giga-ohms to infinity coil-to-contact isolation which is supposed to be available only on electromechanical type relays.

One good idea-exchange seminar deserves another. That's why Ohmite is sponsoring Think-In #3 scheduled for next February 18, 1970 in Los Angeles. We have the facilities . . . the application information need is always there . . . and we have the



experts to present authoritative engineering papers on relay application problems.

Participate in Think-In by attending the February 1970 seminar. You can also receive copies of the engineering papers and discussion periods from the live Think-Ins that took place in Chicago 2/26/69 and New York City 9/10/69 by checking the reader service number below.

THINK-IN #3
February 18, 1970
INTERNATIONAL HOTEL
Los Angeles, California
\$10.00 PRE-REGISTRATION—
\$15.00 AT DOOR

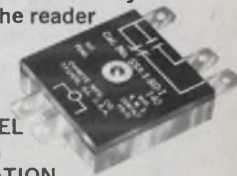

Ohmite Manufacturing Co.
3601 W. Howard Street
Skokie, Illinois 60076
(312) 675-2600

OHMITE

A NORTH AMERICAN PHILIPS COMPANY

Service...Engineering...Experience

MAKE THE **BIG** DIFFERENCE
BETWEEN A YOKE SPECIALIST
AND A YOKE SUPPLIER



1" ID 12 oz. Single Gap
Shielded Dynamic/Static
Focus Coil

Syntronic Yoke Specialists have more yoke knowledge and provide more engineering assistance than anyone else in the field.

The most extensive line of deflection yokes available is offered by Syntronic... in production quantities or custom designed to special requirements. See the BIG Difference for yourself the next time you specify a yoke.

syntronic INSTRUMENTS, INC.
100 Industrial Road, Addison, Illinois Phone 312, 543-6444

INFORMATION RETRIEVAL NUMBER 76

HIGH DENSITY IC PACKAGING PANEL Modular Type

INCREASES FLEXIBILITY
IN PROTOTYPING,
PRODUCTION AND
FIELD SERVICE.

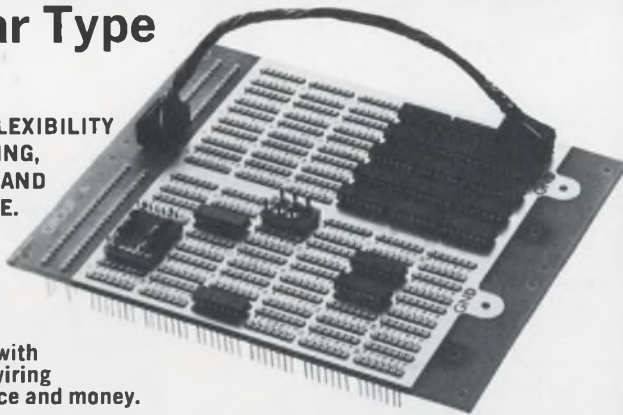

P Series Panel with
Point to Point wiring
saves time, space and money.

- Available in multiples of 30 IC pattern sections up to 180 patterns.
- Two pins of each pattern tied directly to power and ground planes. Different numbers available for different pin assignments.
- IC pattern also accepts I.O. plugs and adaptor plugs for discrete components.
- Excellent contact retention and low contact resistance.
- Wire Wrap terminations with Tri-level connection length.

Request Complete IC Folder

AUGAT INC.

Tel: 617-222-2202
31 Perry Ave., Attleboro, Mass. 02703

INFORMATION RETRIEVAL NUMBER 77

DATA PROCESSING

Acoustic coupler works by itself



Beckman Instruments, Inc., Electronic Instruments Div., 2500 Harbor Blvd., Fullerton, Calif. Phone: (714) 871-4848.

Operating with a conventional telephone handset over public telephone lines, a new self-contained acoustic coupler links serial binary data sources and a remote terminal. The dual interface capability of model 3040 enables it to perform interchangeably with Teletypes 33, 35, and 37.

CIRCLE NO. 270

Battery-operated eraser clears cassettes at once



Audio Applications, Inc., 78 E. Palisade Ave., Englewood, N.J.

Service-free and guaranteed indefinitely, Voice-Master MX-500 Erase-O-Matic bulk eraser instantly wipes off all previous recordings on magnetic tape cassettes. This battery-operated device may be used anywhere. It is ideally suited for clearing cassette recordings for security reasons, or prior to re-use. It has dimensions of 3-3/4 by 4 by 2 in.

CIRCLE NO. 271

THE PRACTICAL REFERENCE SHELF

FUNDAMENTALS OF INTEGRATED CIRCUITS

Lothar Stern

A practical guide to integrated circuits — their theory, manufacture and applications. This book offers complete discussion of the various techniques of integrated circuit fabrication and their strong influence on circuit design and performance. From a marketing viewpoint, it compares the relative qualities of the numerous IC's devised to date in terms of economics and logistics.

The book covers basic semiconductor principles, monolithic integrated circuits, thin-film circuits and their characteristics, hybrid and other integrated structures. There is also discussion of packaging, design and layout principles, and LSI. A volume in the Motorola Series in Solid-State Electronics. 208 pages, 7 x 10, illustrated, cloth cover.

#5695 \$8.95

LEVEL-HEADED LETTERS

Dr. Dugan Laird and Joseph R. Hayes.

Will help the executive to write better letters, faster. In practical, down-to-earth style, this book shows how to find the real reasons for writing; provides a simple plan for organizing ideas logically and psychologically, and points out ways to get affirmative responses from readers. Shows how to avoid cliches, verbiage and how to inject an air of informality into letters. Key feature is the programmed learning section on painless grammar. 134 pages, 6 x 9.

Paper cover, #5032 \$3.50
Cloth cover, #5033 \$4.95

PROJECT ESTIMATING BY ENGINEERING METHODS

Paul F. Gallagher.

A practical approach to attaining consistently accurate estimates by summarizing many general practices and introducing specific methods proven valuable in various kinds of work. Five methods of estimating are discussed, the fifth of which combines the two most important developments in the field: standard hours and the learning curve. To insure complete understanding, full coverage is given to construction and use of learning curves. Nearly 100 pages of learning curve tables appear in the appendix. 344 pages, 8 1/2 x 11, illustrated, cloth cover.

#5018 \$15.00

PRACTICAL PA GUIDEBOOK: HOW TO INSTALL, OPERATE AND SERVICE PUBLIC ADDRESS SYSTEMS

Norman H. Crowhurst

A practical guide covering all aspects of the subject. The book shows how to select and install the appropriate equipment, covers routine operation and maintenance of the finished system. Special attention is given to solving the problems encountered in providing successful service. 136 pp., 6 x 9, illus., paper.

#0778 \$4.45

THEORY AND APPLICATIONS OF TOPOLOGICAL AND MATRIX METHODS

Keats A. Pullen.

The dependence of electrical circuit theory on topology (theory of line graphs) is of growing importance because line graphs for networks represent their flow patterns. Application of topological methods has lagged behind the use of matrix methods only because of minor application problems. This volume resolves these problems in a logical and understandable way. 100 pages, 5 1/2 x 8 1/2, paper cover.

#0300 \$2.50

INDUSTRIAL STROBOSCOPY

Gilbert Kivenson.

A comprehensive description of the history, development and use of stroboscopy in industry, commerce and research. Stroboscopy for analysis and measurement has spread to many specialized areas of science and engineering, such as high-speed cinematography, photometry, radiometry, torsional vibration and other areas. This book discusses the state of the art today and areas of further usage. 284 pages, 6 x 9, illustrated, cloth cover.

#5045 \$9.95

DESIGN OF LOW-NOISE TRANSISTOR INPUT CIRCUITS

William A. Rheinfelder.

Design engineers and others interested in low-noise circuit design will find this book a real time saver. Gives a multitude of labor saving graphs and design curves for the practical circuit designer. Simple derivations of all important formulas help the reader obtain a deeper insight into the fundamentals of practical low-noise design. 128 pages, 6 x 9, illustrated, cloth cover.

#5014 \$6.50

WAVEFORM MEASUREMENTS

Rufus P. Turner.

Complete how-to information on the various techniques of electrical waveform measurement—from troubleshooting to signal synthesis. Book details procedures for the isolation and measurement of a single harmonic from a multisignal mixture, measurement of total distortion, calculation of harmonic values from heights of the wave patterns, etc. 96 pages, 5 3/8 x 8 1/4, illustrated, paper cover.

#0775 \$2.95

UNDERSTANDING SILICON CONTROLLED RECTIFIERS

Saul Heller

A compact, illustrated guide to the capabilities and operation of the versatile SCR and the triggering circuits associated with these devices. Throughout the book, schematic diagrams illustrate the application of the various SCR's as static switches, phase-control switches, inverters, choppers, etc. Emphasis is placed on choosing the right SCR to do a given job. 134 pages, 5 3/8 x 8 1/4, illustrated, paper cover.

#0782 \$3.95

TRANSISTOR AND DIODE NETWORK PROBLEMS AND SOLUTIONS

Harry E. Stockman.

This two-way reference demonstrates the practical application of theory and serves as sourcebook of step-by-step mathematical solutions to practical problems. With schematic situations covering the entire field of transistor and diode networks, the reader develops effective techniques by comparing his own solution methods with the author's. 352 pages, 6 x 9, illustrated.

#5694 \$9.95

TRANSISTOR AND DIODE LABORATORY COURSE

Harry E. Stockman

Structured on engineering concepts and facts, this new course first provides a groundwork in transistor technology. Two-part theory viewpoints are applied continuously to give the work an engineering slant. The balance of the experiments deal with more intricate transistor networks, such as the theory and operation of multivibrators, and the concept of parametric action. 128 pages, 7 1/4 x 10, illus.

#5671 \$3.95

REVIEW ANY OF THESE BOOKS FOR 10 FULL DAYS — FREE!

HAYDEN BOOK COMPANY, INC. 116 W. 14 St., N. Y., N. Y. 10011

Please send me the books circled below, on a 10-day free examination. At the end of that time I will remit payment, plus postage, or return the books without obligation.

5695	0778	5014
5694	5032	0775
5671	5033	0782
5018	0300	5045

Payment enclosed (Hayden pays postage). Same return privilege.

Name _____

Firm _____

Address _____

City _____ State _____ Zip _____

On all overseas orders, payment in U.S. dollars must be enclosed. Publisher pays postage with same return privilege.

ED-170

Our D servomotor is mad with power.

That's our SU-680D-29 permanent-magnet D-C servomotor. We call it our D motor for short. It's small, rugged and powerful. It delivers 12.7 watts of continuous power output at 8600 rpm and is a natural for any servomechanism that requires a prime mover. It has a high repeatability-to-time ratio which makes it immensely stable, a 0-10,000 rpm speed range and a high acceleration Torque/Inertia. Torque peaks at 15 oz-in., 2 oz-in. continuous at 8600 rpm. It measures only 1 1/8 inches in diameter and weighs just 8 1/4 ounces.

SERVO-TEK PRODUCTS COMPANY
1086 Goffle Road, Hawthorne, New Jersey 07506.

SERVO-TEK
PRODUCTS COMPANY

For full details write for our interesting technical sheets and get mad with power yourself.



INFORMATION RETRIEVAL NUMBER 79

DATA PROCESSING

Digital mini-computer stores 16-bit words



Technitrend, Inc., 7300 N. Crescent Blvd., Pennsauken, N.J. Phone: (609) 665-4910. P&A: \$1600; stock to 30 days.

Designed for computer-controlled voice-response data communications systems, the RP-2800 transmitter/printer terminal provides full-alphanumeric printed copy output from a centrally located computer. It also transmits ordinary Touch-Tone frequencies to the computer. The new terminal accepts inputs via a keyboard.

CIRCLE NO. 273

IC data terminals take 40 characters/s



Sanders Associates, Inc., Electro-Sciences Div., 8700 Main St., Buffalo, N.Y.

An error-minimized full-duplex data set can transmit and receive asynchronous signals at 0 to 1800 bits per second, as well as eliminate adjustments for frequency and delay equalization. Called the Modem Pack, the unit features 8-ms turn-on/turn-off times for quick polling. It can be connected to two or four-wire conditioned lines.

CIRCLE NO. 275

Raytheon Computer, 2700 S. Fairview, St., Santa Ana, Calif. Phone: (714) 546-7160. Price: \$10,000.

Offering more than 300 proven programs and subroutines, a new digital mini-computer provides a 16-bit word capacity and a 1.5- μ s cycle time for under \$10,000. In its minimum configuration, the 704 includes a central processor unit with 74 instructions, 4096 words of core memory, byte manipulation instructions and direct and indexed addressing.

CIRCLE NO. 272

Voice-response terminal prints hard-copy output



Texas Instruments Inc., Industrial Products Div., P.O. Box 66027, Houston, Tex. Phone: (713) 526-1411. Availability: 120 days.

New additions to series 720 electronic data terminals, which are compatible with keyboard send-receive model 33 and 35 teletypewriters, are now offered in USA-SCII and BCD codes and in keyboard and receive-only models. Models 15, 20, 21, 22, 30 and 31 give near silent operation at speeds up to 40 characters/s.

CIRCLE NO. 274

Equalized data set sends 1800 bits/s



INFORMATION RETRIEVAL NUMBER 80 ►

What price performance? Not much. These two new solid state DC Calibrators have been designed to satisfy both performance-minded engineers and their budget-battered bosses. Both of these fine instruments offer the kind of specs that will cost you up to fifty percent more elsewhere—and still not give you the performance you always get when the Fluke name goes on the front panel. Check them out.

Model 343A. Here's a calibrator equal in resolution (0.1 ppm) to the most expensive instrument on the market in only 3½" of panel space. Price is \$1695 for an absolute accuracy of 0.003% over a 0 to 1100 volt range. Stability is 0.0005%/hour. Quick amplifier response provides an output within 25 ppm five seconds after any range or setting

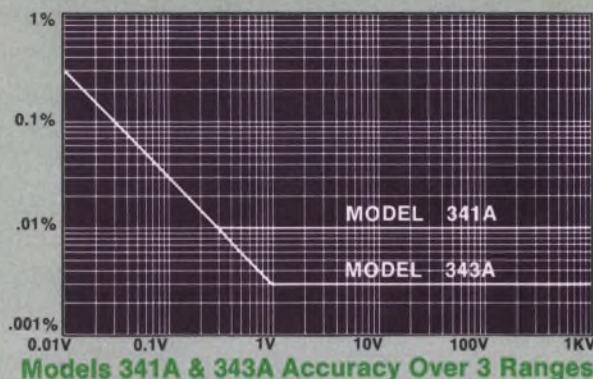

Model 341A. Here's the best buy in the calibrator market today. You get an accuracy of $\pm 0.01\%$ over a 10°C range for a low-low price of \$1195. Resolution is 1 ppm. Stability is 0.0007%/hour. All other specs are the same as the Model 343A.

For full details, see your Fluke sales engineer or contact us directly.

change. Four-terminal floating output is featured. Current is automatically limited at any preset level between 1 ma and 30 ma. Line and load regulation are 0.0005% of setting. Shock, vibration, and altitude specs of MIL-T-21200 are met. The Model 343A is housed in an attractive package for bench use and rack mounting weighing 23 pounds.

MODEL 341A DC Calibrator

MODEL 343A DC Calibrator

**They're our
new tight
money**

**DC
Calibrators!**



Fluke, Box 7428, Seattle, Washington 98133. Phone: (206) 774-2211. TWX: 910-449-2850. In Europe, address Fluke Nederland (N.V.), P.O. Box 5053, Tilburg, Holland. Phone: (04250) 70130. Telex: 884-50237. In the U.K., address Fluke International Corp., Garnett Close, Watford, WD2 4TT. Phone: Watford, 27769. Telex: 934583.

VITREOSIL[®] INDUSTRIAL WARE



Whether you're concentrating, evaporating, or crystallizing acid solutions . . . or melting, sintering, or heat treating metals, Thermal American VITREOSIL Industrial Ware is your best bet.

VITREOSIL is exceptionally resistant to thermal shock (having a coefficient of expansion of: 0.45×10^{-6}), chemical reactions at high temperatures, has high dielectric strength, high purity, and extreme resistance to catalytic action. It is available in the forms of crucibles, dishes, trays, tanks, retorts, pots, tubes and pipes, and can also be fabricated in other configurations for specific requirements. It is light in weight and suitable for operating temperatures between 1000°C and 1300°C.

For complete technical and application data, write or phone.

79

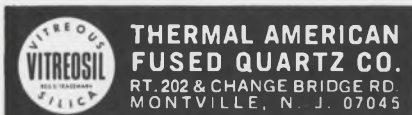

INFORMATION RETRIEVAL NUMBER 81

MODULES & SUBASSEMBLIES

Wideband op amp settles in 80 ns



Computer Labs., 1109 S. Chapman St., Greensboro, N.C. Phone: (919) 292-6427. P&A: \$97; stock to 30 days.

Specifically designed for fast settling on step-function input signals is a new wideband operational amplifier that settles in less than 80 ns after the input signal is applied. The FS-125 unit settles to 0.1% of full-scale with a closed-loop gain of 1. It remains within 0.1% of its dc accuracy at rates to 12 MHz.

CIRCLE NO. 276

Broadband op amp slews at 750 V/μs

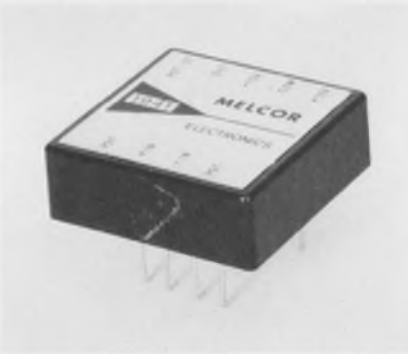

Melcor Electronics Corp., 1750 New Hwy., Farmingdale, N.Y. Phone: (516) 694-5570. P&A: \$88; stock.

Featuring a small-signal bandwidth of 75 MHz, a new FET-input operational amplifier has a slew rate of 750 V/μs. The model 1941 inverting/non-inverting unit has a voltage drift of 50 μV/°C, offset current of 100 pA and a power bandwidth of 7.5 MHz. Its output is ±10 V at 20 mA, and minimum gain is 25,000.

CIRCLE NO. 277

Dual power supply handles 15 decades



Instrument Displays, Inc., 18 Granite St., Haverhill, Mass. Phone: (617) 373-1501. Price: \$60.

Designed exclusively for cold-cathode display tubes, a new dual voltage power supply can drive up to 15 decades of display with outputs of 200 and 5 V simultaneously. The model PS2A has an unregulated 200-V output at 50 mA and a regulated 5-V output at 1 A. It operates from 115 V ac and is protected against short circuits and overloads.

CIRCLE NO. 278

Tiny crowbar switches clamp out transients

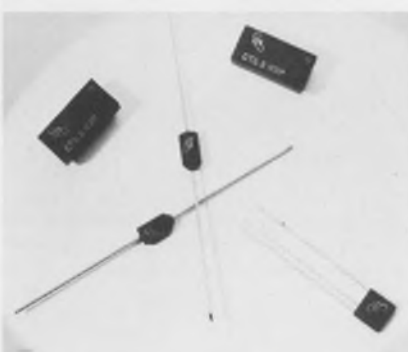

California Microcircuits, Inc., 111 Main St., El Segundo, Calif. Phone: (213) 772-2161.

Offering efficient and inexpensive protection against voltage transients is a new line of miniature crowbar switches. Known as Cal-Tectors, they can clamp transients of 500 ns or less to ground and reset by themselves, by a fuse or circuit breaker or automatically for ac and dc applications. They consume 100 μW and exhibit losses of 1 mW on stand-by.

CIRCLE NO. 279

TRW announces new ruggedized 1 GHz transistors



Infinite VSWR...improved gain...Ultraceramic package

TRW was first to break the Gigahertz barrier in RF Power Transistors. Now our technology has produced new state of the art ruggedized power at 1 GHz. The new 3 watt 2N5764 and 5 watt 2N5765 offer significant performance advantages over the older 2N4430 and 2N4431.

They will withstand severe mismatch — any load, any phase. Gain is increased to 6 dB and efficiency to 40%. Both operate from a 28 volt source. Both are in advanced ultraceramic strip-line packages.

Contact any TRW distributor or TRW Semiconductors Inc.,

14520 Aviation Blvd., Lawndale, California 90260. Phone: (213) 679-4561. TWX: 910-325-6206.

TRW Semiconductors Inc., is a subsidiary of TRW Inc.

TRW[®]

INFORMATION RETRIEVAL NUMBER 82

9682

FROM



HEADS the LIST of 7 CURRENT BOOSTERS

— from 100 mA to 10 Amps, DC to 100 MHz

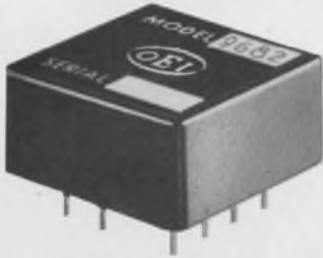

1" x 1" x 1/2" deep.

MODEL 9682 OFFERS:

- ± 0.5 Amp Output Current
- 40 MHz Bandwidth
- $\pm 600V/\mu S$ Slew Rate
- No Crossover Distortion
- 70,000 Ohms Input Impedance
- Size: 0.5 Cubic Inch

Complete specifications on request.

Units in stock for immediate shipment. Note these low prices:

- \$62.00 — 1-2
- \$56.00 — 3-9
- \$51.00 — 10-29
- \$46.00 — 30-99
- \$42.00 — 100-299



OPTICAL ELECTRONICS INC.
P. O. Box 11140 Tucson, Arizona 85706
Phone 602/624-8358

MODULES & SUBASSEMBLIES

Constant-current units stabilize to 0.01%/°C

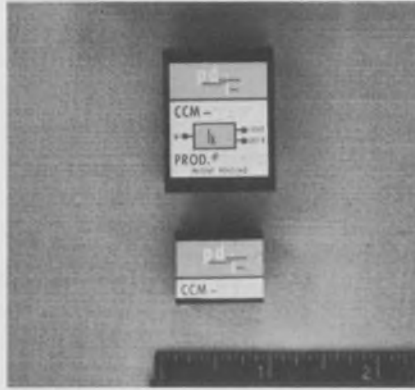

Product Designs, Inc., 111 Cardenas N.E., Albuquerque, N.M. Phone: (505) 265-3551. P&A: \$11; stock to 1 wk.

Providing outputs of 10 to 35 V dc, a new series of constant-current modules exhibits a temperature coefficient of 0.01%/°C from -55 to +125°C. CCM-T units have 1 to 50-mA output currents, $\pm 0.5\%$ settling accuracy, 4-MHz frequency response, and level and load stabilities of $\pm 1\%$ at 28 ± 4 V and $\pm 1\%$ at a 100% load change, respectively.

CIRCLE NO. 280

FET-input op amp settles in 3 μs

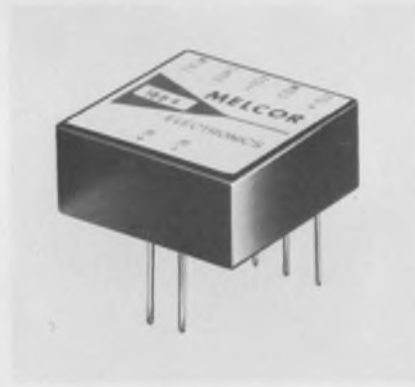

Melcor Electronics Corp., 1750 New Hwy., Farmingdale, N.Y. Phone: (516) 694-5570. P&A: \$70; stock.

Featuring a 1-1/8 by 1-1/8 by 1/2-in. case, a new inverting FET-input operational amplifier has a maximum settling time of 3 μs to 0.01%. The model 1884 operates from -55 to +85°C, has a gain of 10^5 minimum, a 25-MHz frequency response (small signal), 2-MHz full-power, 50- $\mu V/^\circ C$ voltage drift, 100-pA offset current, output of ± 10 V at 20 mA and is powered by ± 15 V at 30 mA.

CIRCLE NO. 281

Sine/cosine module retails for only \$95

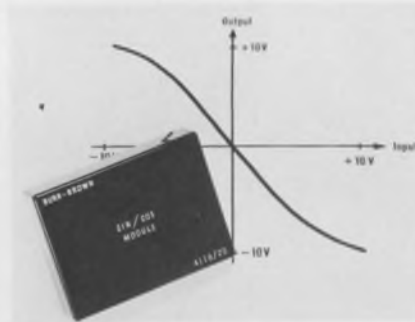

Burr-Brown Research Corp., International Airport Industrial Park, Tucson, Ariz. Phone: (602) 294-1431. P&A: \$95; stock to 4 wks.

Providing various trigonometric gain responses, a new sine/cosine function module costs only \$95. The model 4118/25 device has an output of $-10 \sin \theta$ when an input of ± 10 V represents $\pm 90^\circ$ of the angle θ . Its accuracy is 1% of full-scale for an input of ± 10 V and a frequency response of dc to 1 kHz.

CIRCLE NO. 282

Chopper amplifiers drift but 0.2 $\mu V/^\circ C$



Philbrick/Nexus Research, Allied Dr. at Rte. 128, Dedham, Mass. Phone: (617) 329-1600. P&A: \$98 to \$115; stock.

Three new chopper-stabilized amplifiers include one model that will operate from -25 to +85°C with an offset-voltage temperature coefficient of 0.2 $\mu V/^\circ C$ at a gain of 10^5 . Series 1700 units have a gain-bandwidth product of 200 MHz, a slew rate of 200 V/ μs and a settling time of 2.5 μs to 0.1% of final value.

CIRCLE NO. 283



Many of our best customers were Card Reader "skeptics"... until they tried the 6002.

MDS 6002 CARD READER

Specify the speed you prefer... 225 or 400 cards/minute... no extra cost. The 6002 requires only 2 sq. ft. of space. Ideal for peripheral use with small computers... or in remote terminals and data communications systems.

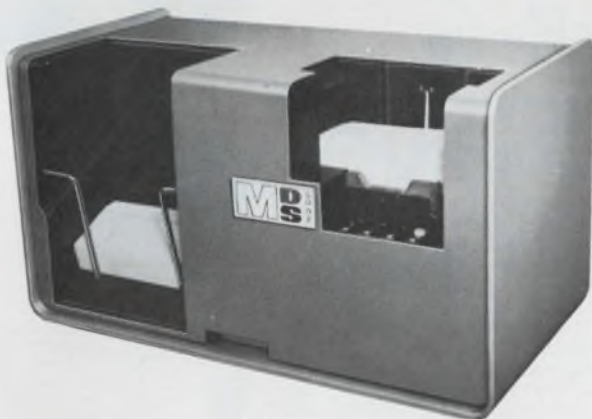

HELP FOR OEM
DECISION-MAKERS

The 6002 is the "runt" in the MDS Card Reader line... 12½" H x 12½" D x 23" W. But it packs a terrific wallop!

Although the 6002 is a low-cost unit, it contains features ordinarily found only in more expensive Card Readers.

Input and output hoppers each hold 500 cards, face up. Cards can be replenished or removed during operation. No adjustments necessary for different types of cards.

Picker/Reader Head is the same as the head used in larger MDS units. It incorporates the picker mechanism, a pneumatic picker throat, photoelectric read station and metering capstan in a single, precision-built assembly. This permits simple interface and flexible operation when combined with end-fed reading and pick-on-demand card processing.

Cards are driven through the read station by metering capstans which also provide 16 precise clock pulses for each column of card motion. These signals... and those from sensors which detect the leading and trailing edges of the card... enable highly accurate column registration ($\pm 0.0054"$), as well as a check of known vs. measured card length.

MDS sealed units and modular design hold servicing to a minimum.

The 6002 is available with or without logic circuitry (without, it is designated as 6001)... and with options accommodating 51-column cards.

Ask about other MDS Card Readers.

Phone or write for literature. Your Man from MDS will gladly help you make your decision.

MOHAWK **MDS**
DATA SCIENCES CORPORATION
OEM MARKETING

Palisade Street, Herkimer, N. Y. 13350
Phone 315/866-6040

REGIONAL MANAGER OFFICES:

Orlando, Fla., Phone 305/841-3091 • Waltham, Mass., Phone 617/891-5870 • Des Plaines, Ill., Phone 312/298-4141 • Los Angeles, Calif., Phone 213/685-5165
BUFFERED TAPE UNITS • DIGITAL STRIP PRINTERS • LINE PRINTERS • CARD PUNCHES AND READERS • PAPER TAPE PUNCHES AND READERS

INFORMATION RETRIEVAL NUMBER 84

A/d 13-bit converter is just 2 PC modules



Redcor Corp., 7800 Deering Ave., Canoga Park, Calif. Phone: (213) 348-5892. P&A: \$275; 30 to 45 days.

Made up of two PC modules, each 5.2-cubic in., is a new 13-bit analog-to-digital converter. The model 770-754 unit has five outputs: straight binary, offset binary, one's complement, two's complement and BCD. It has a $50 \pm 4\text{-}\mu\text{s}$ conversion time, and an accuracy of $\pm 0.015\%$ of full-scale, $\pm 1/2$ the least significant bit.

CIRCLE NO. 284

D/a converter line resolves to 12 bits

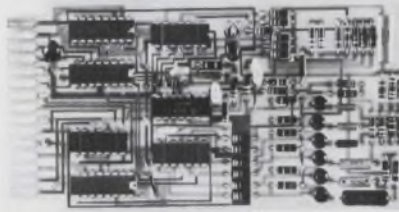

Computer Products, Inc., 2709 N. Dixie Hwy, Fort Lauderdale, Fla. Phone: (305) 565-9565. P&A: from \$69; 15 to 30 days.

Incorporating an output buffer amplifier, low-impedance output and isolation between ladder summing junction and converter output, series DA035 binary and d/a converters can resolve 8, 10 or 12 bits. Six analog ranges are available up to $\pm 10.24\text{ V}$ into a $1\text{-k}\Omega$ load with conversion rates to 200 kHz and $50\ \mu\text{s}$ full-scale settling time.

CIRCLE NO. 285

One-card MOS memory stores up to 3200 bits

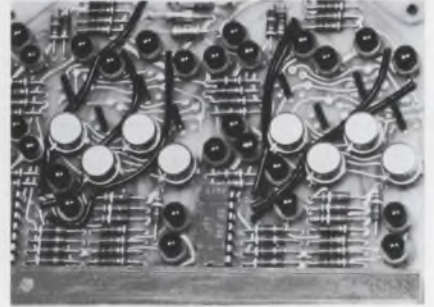

Standard Logic, Inc., 1630 S. Lyon St., Santa Ana, Calif. Phone: (714) 835-5466. Price: \$200.

Containing MOSFET devices, a new MOS memory system on a single PC card has a maximum storage capacity of 3200 bits. Known as the model MM602 memory system, it is designed for serial storage and random access applications. It is compatible with and interfaces to DTL/TTL levels, and is contained on a PC board measuring only 3.5 by 4.3 in.

CIRCLE NO. 286

Hathaway or Equal!

HATHAWAY MICRO-MINIATURE DRIEED SWITCH



Impossible! There is no equal to a Hathaway micro-miniature Dreed switch. Others try, oh how they try. We try, too, and continue to come up with the reliable solution.

Our micro-miniature is .5" long and .088" in diameter. 100 volts max., .125 amps and 2 Watts. And don't let the size fool you—the DCS is tough as nails.

Send for our full line mini-catalog.

Address: 5250 East Evans Avenue, Denver, Colorado 80222, (303) 756-8301 — TWX 910-931-0569.

HATHAWAY

components

A DIVISION OF HATHAWAY INSTRUMENTS, INC.

To buy less
would cost you more

INFORMATION RETRIEVAL NUMBER 85

PANDUIT announces the PENNY-TYTM cable tie

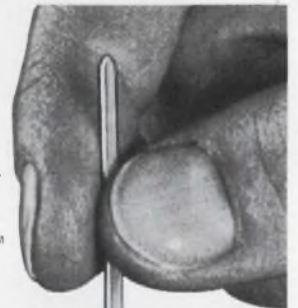

The PANDUIT SST1M "PENNY-TY" Miniature Cable Tie is now available for 1¢ each in quantities of 50,000* or more.

- On Qualified Products List (QPL) of MIL-S-23190B since 1964. Meets new Military Standard MS-3367-4 and previous Standards MS-17821-4, MS-18034-4.
- Harness diameter range 0 to $\frac{3}{4}$ "; loop tensile strength 18 lbs. minimum.
- Self-locking and releasable prior to final tightening by hand or with tension-controlled PANDUIT GS2B Harnessing Tool. No twisting or tugging. No metal barbs.



At your PANDUIT Distributor. FREE SAMPLES

PANDUIT[®] CORP.

Tinley Park, Illinois 60477 • Phone: 312-532-1800 • Telex 25-4560

FROM THE MANUFACTURERS OF PANDUIT[®] PLASTIC WIRING DUCT

* In accordance with standard conditions of PANDUIT Price Sheet effective 12-1-89

VISIT PANDUIT NEP/CON WEST BOOTH #709

INFORMATION RETRIEVAL NUMBER 86

Square-wave oscillators are keyed to within 3 ns



Computer Devices Corp., 63 Austin Blvd., Comack, N.Y. Phone: (516) 543-4220. P&A: \$50; 4 to 6 wks.

A new series of square-wave oscillators can be started or stopped by a keying or gating signal to provide close phase alignment of output to gating signal to within 3 ns of each other. The OG5000 oscillator units range in frequency from 5 to 25 MHz and 0.5 to 5 MHz in two different module sizes.

CIRCLE NO. 287

Oscillator modules meet SHP specs



Accutronics, Inc., 628 North St., Geneva, Ill. Phone: (312) 232-2600. Price: \$125 to \$575.

Oscillators of various natures can now be furnished to meet the U. S. Navy NAFI (Naval Avionics Facility at Indianapolis) WS6116 Standard Hardware Program (SHP) by either functional specification or design disclosure. This program requires the utmost quality control on all oscillators that are designed into the Poseidon Missile Systems.

CIRCLE NO. 288

Soliton RF Power

Covers the Spectrum!

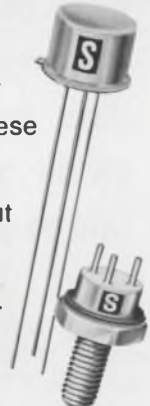

Soliton's wide range of RF power transistors can provide the right devices for your required applications. These transistors cover a useful frequency range from 30 to 1.2 GHz and output power levels of 1 to 60 Watts. All popular package types are available.

Take your pick from Soliton's power frequency spectrum and contact us today.

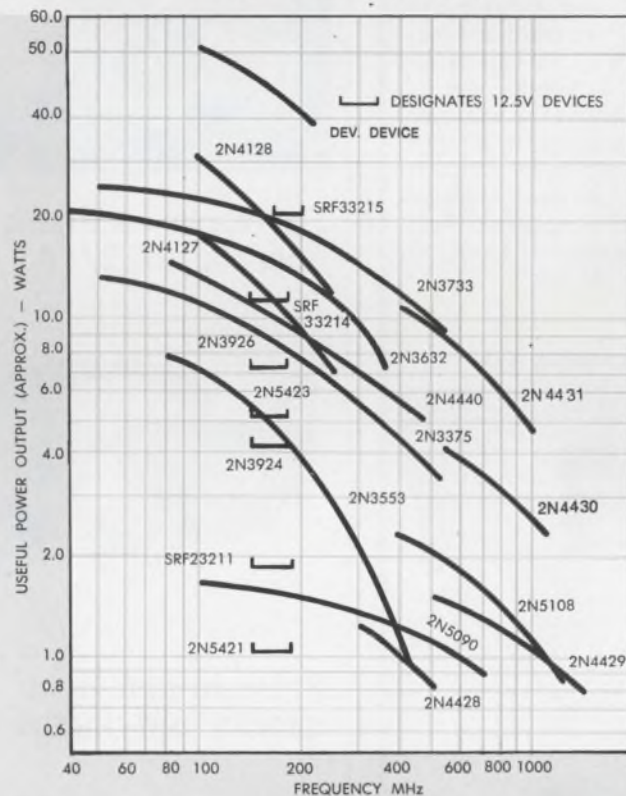

Dial 1-800-327-3243 for a "No Charge" telephone call and further information

Soliton

DEVICES, INC.

1177 BLUE HERON BLVD. / RIVIERA BEACH, FLA. / (305) 848-4311 / TWX: (510) 952-6676

DSE

DOES IT

Data acquisition equipment feeds data from 400 strain gauges into computer

A leading aircraft manufacturer uses units of DSE's First Family of Data Acquisition equipment to monitor stress data at over 400 different points on an aircraft wing. As the wing is flexed and stressed, the high-speed and low-level capability of the data acquisition system — together with its resolution ability—allow this user to gather large quantities of highly accurate stress data for computer analysis. Do you have a similar problem? DSE's job-proved First Family of equipment is waiting to help. Contact DSE now!

AUTOVERTER 860



Low-level, auto-ranging, multiplex and analog-to-digital system. $\pm 10\text{mv}$ to $\pm 10\text{V}$ Full Scale. 12 bits, binary. Differential input. Programmable gain or Automatic range determination.

DSE

DYNAMIC SYSTEM ELECTRONICS

1040 West Alameda Drive,
Tempe, Arizona 85281

Phone (602) 967-8644 TWX 910-950-1941

Subsidiary of
Southwestern Research Corporation

COMPONENTS

T-1-3/4 neon lamp builds-in resistor



Master Specialties Co., 1640 Monrovia, Costa Mesa, Calif. Phone: (714) 642-2427. P&A: 78¢; stock.

Featuring a midjet flange base and operating from 105 to 150 V ac or dc, a new T-1-3/4 neon lamp eliminates the need for external resistors with its built-in current-limiting resistors. The MSC 115 lamp provides high intensity and is available in three types with average lives of 1500, 10,000 and 25,000 hours. It meets all applicable requirements of MIL-E-5272.

CIRCLE NO. 289

Silicon rectifiers handle 50 amperes



Sarkes Tarzian, Inc., Semiconductor Div., 415 N. College Ave., Bloomington, Ind. Phone: (812) 332-1435. Price: from \$2.16.

Used singly as half-wave voltage doublers or in pairs for full-wave bridge circuits, a new series of silicon rectifiers are rated for 50 A continuous duty at a 60°C case temperature. The S6276 series units offer eight peak inverse voltages from 100 to 800 V, have surge currents to 400 A, and dissipate 40 W.

CIRCLE NO. 290

Full-wave rectifiers operate to 27 A



Motorola Semiconductor Products Inc., P.O. Box 20924, Phoenix, Ariz. Phone: (602) 273-3466. P&A: \$2.40, \$3; stock.

Two new series of single-phase full-wave rectifier bridges extend their current ratings up to 27 A. Type MDA980 has a dc output current rating of 12 A, while type MDA990 is rated at 27 A. Both types have peak repetitive reverse voltages from 50 to 600 V, and can take nonrepetitive current surges to 300 A.

CIRCLE NO. 291

Press-to-test light checks out lamps



Vemaline Products Co., Franklin Lakes, N.J. Phone: (201) 891-3200. Price: from \$2.09.

Available with moisture-proof front seals and rfi shielding, a new indicator light pretests lamps (when no signal is present to energize them) by a simple press-to-test method. The 7052-52 unit is a dimmer-type light with either blackout or semi-blackout features. It accommodates T-3-1/4 bayonet bulbs and has lens caps in many transparent colors.

CIRCLE NO. 292

RUBBERIZED ABRASIVES

DEBURR SM-O-O-T-H POLISH



COMPLETE KIT \$750

CONTENTS: 8 tapered edge wheels $\frac{3}{8}$ " dia. x $\frac{3}{8}$ "; 16 cylinder points $\frac{1}{4}$ " dia. x $\frac{3}{8}$ " long; 16 bullet points $\frac{3}{8}$ " dia. x 1" long; 8 bullet points $\frac{3}{8}$ " dia. x $\frac{3}{8}$ " long; 8 straight wheels $\frac{1}{2}$ " x $\frac{1}{4}$ " x $\frac{1}{16}$ " hole; 16 straight wheels $\frac{3}{8}$ " x $\frac{1}{8}$ " x $\frac{1}{16}$ " hole; 8 straight wheels 1" x $\frac{3}{16}$ " x $\frac{1}{16}$ " hole; 2 wheel mandrels $\frac{1}{8}$ " shank; 2 point mandrels $\frac{1}{8}$ " shank. For use at speeds up to 25,000 RPM.

\$7.50 BUYS IT ALL — 80 piece introductory Kit 777 equally assorted in 4 grit textures: coarse, medium, fine and extra fine. **TRY IT** — Cratex Rubberized Abrasives improve the surface while preserving critical workpiece dimensions by its unique cushioning action. **FINISH THE JOB** — to your most exacting specifications—often in a single operation. **SEND FOR KIT 777** — or your **FREE SAMPLE** and catalog illustrating the full Cratex product line and its applications.

CRATEX[®] RUBBERIZED ABRASIVES

1600 Rollins Road • Burlingame, California
Sold through leading industrial distributors

INFORMATION RETRIEVAL NUMBER 89

DELAY TIMERS



Any mounting style; voltage specification; time cycle; operational method. No special engineering required. Good delivery schedules. Our stock is ample.

**INDUSTRIAL
TIMER**
CORPORATION

U. S. Highway 305, Parsippany, N. J.

Subsidiary of the Singer Company

INFORMATION RETRIEVAL NUMBER 90

ELECTRONIC DESIGN 1, January 4, 1970

LAFAYETTE RADIO ELECTRONICS



FREE!

**1970 LAFAYETTE
CATALOG 700
496 Pages**

Lists Lafayette's Own Value Engineered Components plus Quality Designed Equipment From Many Leading Manufacturers for

• HOME • INDUSTRY
• LABORATORY

Semiconductors • Capacitors • Connectors • Controls • Fuses and Circuit Breakers • Relays • Resistors • Wire and Cable • Transformers • Test Equipment

All Components Are Immediately Available From Stock!

LAFAYETTE Radio ELECTRONICS Dept. 45010 P.O. Box 10

Syosset, L.I., N.Y. 11791

Please Send the FREE 1970 CATALOG 700

45099

Name _____
Address _____
City _____
State _____ Zip _____

INFORMATION RETRIEVAL NUMBER 91

173

Small solid-state relay operates to 6000 baud



Multiplex Communications, Inc., 70-C Bell St., W. Babylon, N.Y. Phone: (516) 694-5225.

Handling speeds from dc to 6000 baud, a new solid-state relay enhances the basic good features of reed-type mercury units and eliminates the inherent poor features of these devices. The Md series encapsulated relay eliminates magnetic coil kickback, radiation, contact bounce and chatter. It will operate with currents from 800 μ A and voltages from 2.5 V.

CIRCLE NO. 293

Light source and cell form tiny assembly



Scanning Devices Co., 179 5th St., Cambridge, Mass.

Two new devices combine to provide true miniaturization in a photocell assembly. Model L-1 light sources has a 1/4-in. dia and is 1/2-in. long. It has a focused lens and a bulb that is rated for 40,000 hours at 5 V. Model P-1 photocell has a 1/10-in. dia and is 1/2-in. long. It responds in 2 μ s and can work with the L-1 source at a distance of 6 in.

CIRCLE NO. 294

Tiny spike suppressors clamp 60 to 360 volts

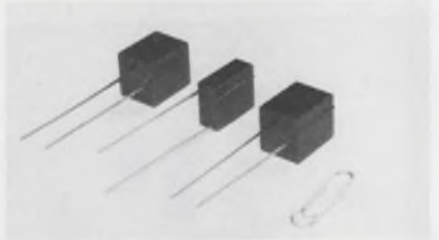

Semikron International, Inc., Box 323, Scarsdale, N.Y. Phone: (914) 725-2529. P&A: 73¢; stock.

Offering voltage and spike protection for solid-state devices and relay coils, a new line of voltage spike suppressors are available with clamping voltages of 60 to 360 V. These low-cost epoxy-molded units are non-polarized from 25 to 150 V ac, and have a discharge current of 14 A for 10 ms. They are only slightly larger than a paper clip.

CIRCLE NO. 295

THE WORLD'S MOST ACCURATE FREQUENCY SWITCH

FASTER DATA TRANSMISSION

New, GO-NO-GO Audio Switches which fire whenever the input frequency goes above, below, or is within certain definite frequency limits are now available. Accuracies as close as 1 cycle per thousand can be maintained. Maximum response time is the length of two input cycles. All units are completely solid state.

The input frequency can be in the form of a sine or square wave. Or even in pulses in which case it measures the length of time between pulses. Frequencies from 1 hz to 40,000 hz can be handled easily and directly. Higher frequencies can be handled if dividers and/or mixers are incorporated.

Highpass, lowpass, and band-pass functions are all available.

GOSH instruments inc

P.O. BOX 36 • WETHERSFIELD, CONNECTICUT 06109 • (203) 527-4794

NEW
TELEMETERING
FREQUENCY
SWITCHES
1 hz to 40,000 hz
RESPONSE LIKE
THIS

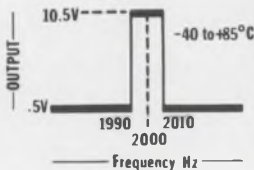

from
\$99⁵⁰
Single piece

INFORMATION RETRIEVAL NUMBER 92

ONE will get you FIFTY

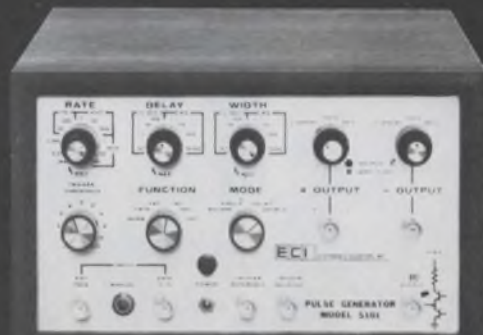

One pulse generator, the new EC1 model 5101, produces pulse rates from 1 Hz to 50 mHz, and includes features only found in much more expensive equipment. For example: Single or double pulse output, integrated circuit output, 10 nanosecond to 1 second pulse width, 10 nanosecond to 1 second pulse delay, and synchronous or asynchronous gating.

Send for complete specifications, or call us collect and ask for an in-plant demonstration.

ONE will get you FIFTY for \$525.



**ELECTRONIC
COUNTERS, INC.**
235 Jackson Street
Englewood, N. J. 07631
(201) 567-5300

INFORMATION RETRIEVAL NUMBER 93

PC-board trimmer uses axial leads



Angstrom Precision Inc., 7811 Leona Ave., Van Nuys, Calif. Phone: (213) 989-3064.

Measuring only 0.2-in. long by 0.085-in. high by 0.09-in. wide, a new adjustable molded film resistor utilizes radial leads for PC-board applications. Fix-Trim trimmers use tinned copper leads with 0.125-in. centers and provide infinite resolution and immunity from vibration. Resistance values range from 10 Ω to 100 k Ω and temperature coefficients are ± 25 ppm.

CIRCLE NO. 296

Subminiature T-1 lamp is only 0.165-in. long



Industrial Electronic Engineers, Inc., 7720-40 Leona Ave., Van Nuys, Calif. Phone: (213) 787-0311. Availability: 30 days.

Offering the electrical and mechanical dimensions (other than length) of a standard T-1 unbased lamp, a new subminiature "Shortie" lamp is available with a maximum over-all length of only 0.165 in. This compares with currently available lamps having standard lengths of 0.250 in. The lamp is available as types AS15 and AS25.

CIRCLE NO. 297

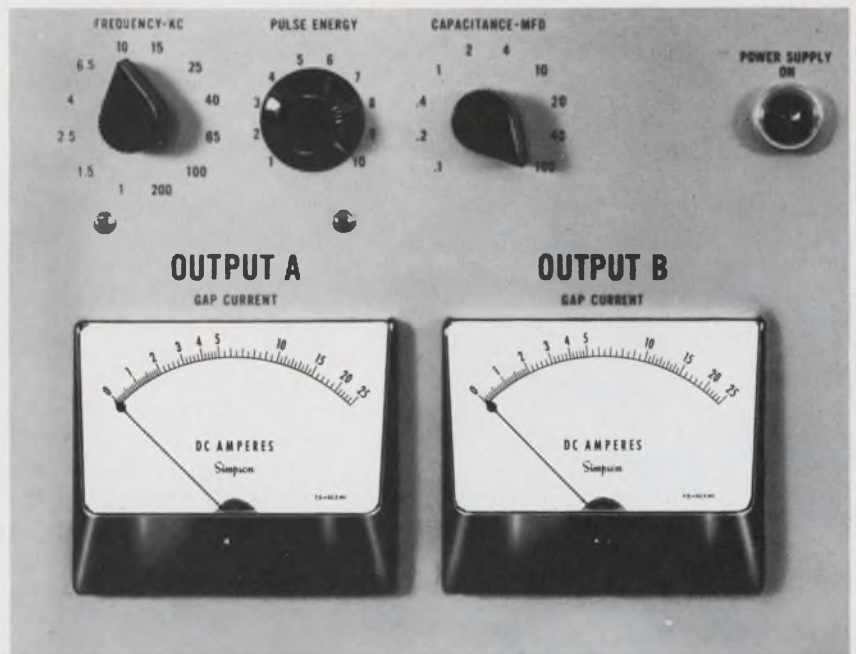

the sure way to let customers know you care about quality...

Simpson panel instruments on your equipment

Simpson's advanced self-shielding annular and core magnet construction provides optimum torque-to-mass ratio. Rugged Taut Band and Pivot & Jewel movements can withstand punishing shock and vibration. Your assurance of an instrument that will *stay* accurate. No wonder so many manufacturers with reputations to protect (or build!) specify Simpson.

Over 1,400 stock ranges, sizes, and types. Get "off the shelf" delivery from your local electronic distributor.

For special needs contact your local Simpson Representative. He's ready to help.

Simpson

ELECTRIC COMPANY



5200 W. Kinzie Street, Chicago, Illinois 60644 • Phone (312) 379-1121

EXPORT DEPT.: 400 W. Madison Street, Chicago, Illinois 60606. Cable Simelco
IN CANADA: Bach-Simpson Ltd., London, Ontario • IN INDIA: Ruttonsha-Simpson Private Ltd., International House, Bombay-Agra Road, Vikhroli, Bombay

INSTRUMENTS THAT STAY ACCURATE

INFORMATION RETRIEVAL NUMBER 94

Seven 10-MHz scopes plug into 19-in. racks



Vu-Data Corp., 7595 Convoy Ct., San Diego, Calif. Phone: (714) 279-6572. P&A: \$2995; 30 days.

Up to seven series MS200 oscilloscopes, each with a 10-MHz bandwidth, can be plugged into a single 3-1/2-in. high by 19-in. wide track. This allows a continuous monitor of signals and real-time phenomena under test conditions. Specifications include an input sensitivity of 0.1 to 10 V rms/in., and a sweep rate of 10 Hz to 1 MHz.

CIRCLE NO. 340

Four-digit panel meter is accurate to 0.05%



United Systems Corp., 918 Woodley Rd., Dayton, Ohio. P&A: \$295; stock.

Featuring four digits and 100- μ V resolution, a new digital panel meter displays an accuracy of 0.05%. The model 275 meter features a crystal-controlled oscillator and takes up 2-1/16 by 4-1/2-in. of panel space. It has an input impedance of 100 M Ω , displays a full-scale reading of 999.9 mV dc and has optional 1-2-4-8 BCD output.

CIRCLE NO. 341

Five low-cost counters widen selection scope

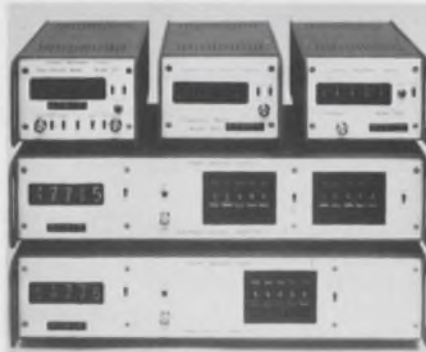

Computer Measurements, 12970 Bradley Ave., San Fernando, Calif. Phone: (213) 879-2511. P&A: \$295 to \$650; stock.

A family of five low-cost counters includes: The model 915 1- μ s to 1-ms time interval meter for \$450; the model 905 15-MHz frequency meter for \$395; the model 925 100-kHz electronic totalizer for \$295; the model 913 dual preset counter for \$650; and the model 912 single preset counter for \$550.

CIRCLE NO. 342

Push-to-test probe clips on easily

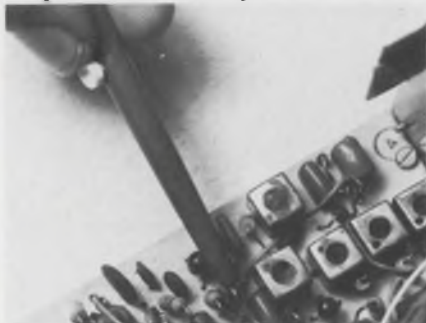

Beutronics Laboratories, Inc., Kenilworth, N.J. Price: \$5.95.

Available with a 48-in. test lead and measuring 3-3/16-in. long, a new test probe facilitates circuit checks with a push-to-test mechanism. This mechanism allows the probe to instantaneously clip into any circuit component without disturbing adjacent parts or introducing short circuits. The probe is available in red or black with a straight or angle banana jack.

CIRCLE NO. 343

Here's your quick order source for 512 stock relays!



- General Purpose
- Power Relays (U. L. Listed)
- Telephone Type
- Dry Reed
- Mercury-Wetted
- Time Delay Relays
- Solid State
- Coaxial
- Hermetically Sealed
- And Many More!

Tear out and keep this 24 page manual handy for whenever you need the finest quality relays in a hurry. Magnecraft offers one of the largest selections of stock relays for custom applications. And they are available from the distributors across the nation shown on page 2. If you need further assistance, write us.

IF YOUR COPY HAS BEEN REMOVED CHECK 248 ON READER SERVICE PAGE.

Magnecraft
ELECTRIC CO.
5575 NORTH LYNCH AVENUE
CHICAGO, ILLINOIS 60630 • 312 282-5500

Air-powered dispenser controls tube collapse



Techni-Tool, Inc., 1216 Arch St., Philadelphia, Pa. Phone: (215) 568-4457.

Grooved and channeled for 10, 14 or 16-lead dual-in-line packages, a new soldering tool can effectively desolder a complete 16-lead DIP in one pass. Model 4918 desoldering tip is easily inserted in standard 3/8-in. screw-type soldering guns of 35 W or more. In addition, the end tips of the tool can be used for straightening bent DIP connector pins.

CIRCLE NO. 345

Motorized stripper trims coax in 5 s



Luxo Lamp Corp., Monument Park, Port Chester, N.Y. Phone: (914) 937-4433.

Designed for medical and industrial use, the Surg/illuminator lamp provides a finger of light that can be focussed to a tight circle with no appreciable rise in temperature. As a result, it can be used in microelectronics, where there is danger of a heat rise and chemical change occurring under bright light. Light intensity is 3500 foot-candles.

CIRCLE NO. 347

Jesco Products Co., Inc., 20749 Ryan Rd., Warren, Mich.

Intended for applying small spots or precision controlled beads of RTV silicone, a new air-powered dispenser eliminates squeezing the compound from a tube by hand, thereby reducing material waste by an average of 30%. After a tube is placed inside the dispenser pressure chamber, a plastic nozzle is attached to the dispenser head. Regulated air is then directed into the pressure chamber.

CIRCLE NO. 344

Desoldering tip frees DIP leads

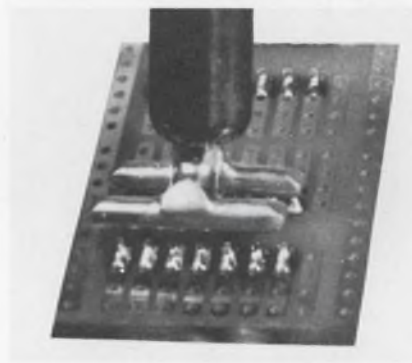

Western Electronic Products Co., 107 Los Molinos, San Clemente, Calif. Phone: (714) 492-4677. Price: \$249.50.

In only 5 to 10 seconds, a new motorized coaxial cable stripper can prepare a cable with a full three-step strip for the appropriate connector. Model CX-2 has three independent cutting members with precision screw adjustments for depth of cut. Variable spacers between cutting members provide proper stripping dimensions.

CIRCLE NO. 346

High-intensity lamp throws cool beam

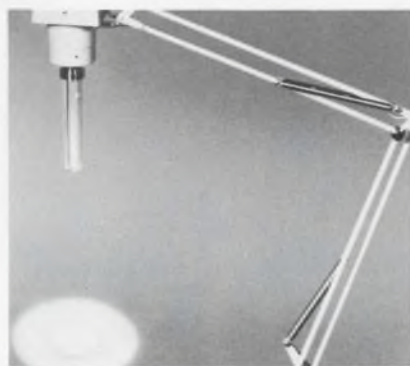

INFORMATION RETRIEVAL NUMBER 103 ▶

COMPARE CLOSE-UPS

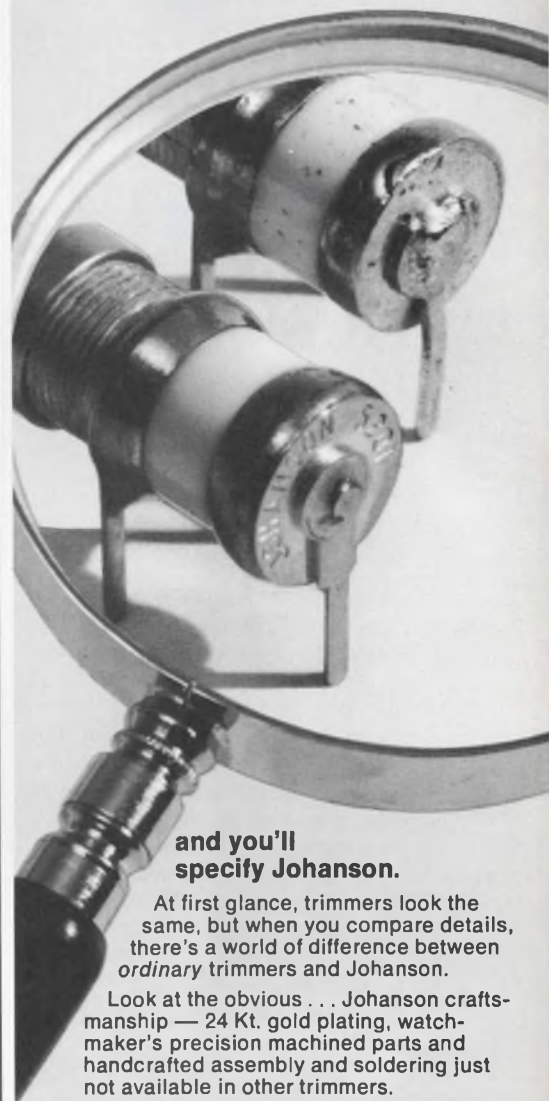

and you'll specify Johanson.

At first glance, trimmers look the same, but when you compare details, there's a world of difference between ordinary trimmers and Johanson.

Look at the obvious... Johanson craftsmanship — 24 Kt. gold plating, watchmaker's precision machined parts and handcrafted assembly and soldering just not available in other trimmers.

This built-in quality means you get superior performance characteristics... 16 pF in a 10 pF package, Q greater than 5000 at 100 Mz, a temperature coefficient of 0 ± 15 PPM°/C, with tuning stability and long life.

Why settle for ordinary trimmers when the best is available — send today for our new catalog sheet on our 5200 series... and start comparing.

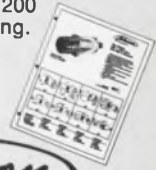

Johanson

MANUFACTURING CORPORATION

400 Rockaway Valley Road, Boonton, N.J. 07005
(201) 334-2676 TELEX: 13-6432

3,741



Standard Cases,



Headers and Covers

WOW!

When you want fast delivery on an encapsulating case, cover or header — check our 3,741 standard cases. Chances are you'll find one to fit your needs. And at the right price. There is no tooling charge for our standard cases.

If we don't have a standard case to fit your application, we'll absorb a major portion of the tooling cost. Our business philosophy is to sell encapsulating cases, headers and covers. Not tooling. You'll find our tooling cost as much as 50% lower than our competitors.

If you need prototype quantities for testing, we have developed an exclusive, short run, tooling technique which enables us to deliver you prototype quantities 3 weeks after receipt of order. We mold in all standard thermoset and thermoplastic materials.

Send today for complete information. Or, better yet, phone collect 201-371-3131 and ask for Ted Ruskin or John Gray. They'll be glad to quote on your part, without obligation.

EPOXY MOLDED PRODUCTS CORP.

121 Coit Street

Irvington, New Jersey 07111

INFORMATION RETRIEVAL NUMBER 104

PACKAGING & MATERIALS

Card-edge connector evens contact pressure

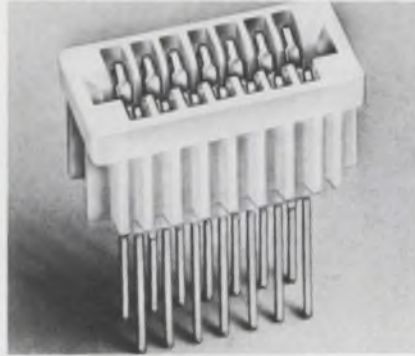

Hugh H. Eby Co., 4701 Germantown Ave., Philadelphia, Pa. Phone: (215) 324-7000.

Designated as Ce-Con 9775-89, a new miniature 14-contact card-edge connector provides predictable pressures for automatic solderless wrap terminations. The unit has precisely located and formed 0.025-in. square contact tails on a 0.1-in. square grid pattern. Its dual read-out contacts feature cantilever-beam construction for uniform contact pressure.

CIRCLE NO. 348

DIP breadboards cost just \$5.95

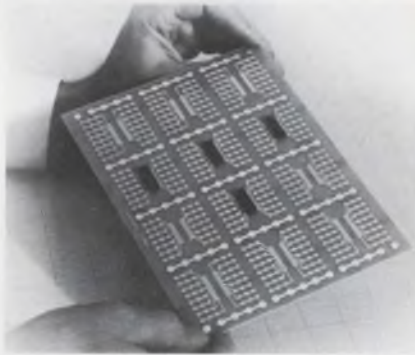

Systrex Corp., Circuit Sales Div., 303 Child St., Rochester, N.Y. Phone: (716) 235-3753. P&A: \$5.95; stock.

Selling for only \$5.95 each, new DIP breadboards are a low-cost time-saving aid for the development of logic systems, analog op-amp circuits, and related applications employing 14 and 16-pin packages. The units may be used once and discarded, reused, or employed in the construction of permanent pieces of equipment.

CIRCLE NO. 349

Conductive felt metal shields and seals



Technical Wire Products Inc., 129 Dermody St., Canford, N.J. Phone: (201) 272-5500.

Teckfelt is a thin felt metal/elastomer material that simultaneously solves both environmental seal and emi/rfi shield problems. It is manufactured by sinter bonding randomly arranged stainless-steel metal fibers and a silicone elastomer to produce a resilient cohesive structure. Sheets and one-piece gaskets are available in sizes up to 24 by 30 in.

CIRCLE NO. 350

Fiber-optic tubes show color images



Edmund Scientific, 380 Edscorp Building, Barrington, N.J. Phone: (609) 547-3488. Price: from \$25/ft.

Able to transmit images in their actual colors, new fiber-optic image tubes are so flexible that they can be tied in knots without interrupting proper transmission. Either end of the tubes can be used for viewing; resolution is comparable to a halftone photograph. For precision work, a magnifying lens can increase the resolution.

CIRCLE NO. 351

SOCKET TO ME! RELAY SOCKET ASSEMBLIES

CURTIS

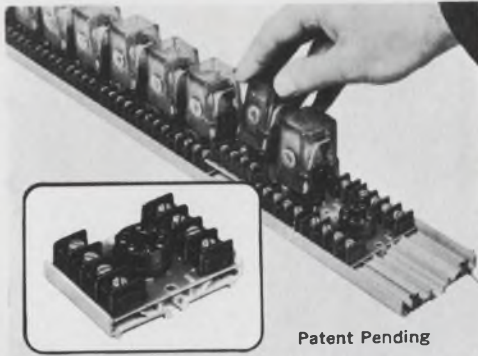

Patent Pending

TYPE RS8 PRINTED CIRCUIT, SNAP-IN, TRACK MOUNT

The new RS8 octal relay socket assemblies offer compact mounting of up to 24 2 P.D.T. relays in a 4" prepunched vinyl track requiring only 2 or 3 mounting screws. Features Curtis GB-type terminal blocks and recessed octal relay socket. P.C. construction, rated 10 amps, 250 volts.



Models RS15 and RS11 also available for 15 pin 4 P.D.T. relays and 11 pin 3 P.D.T. relays.

Send today for further information.



CURTIS DEVELOPMENT & MFG. CO.
3236 N. 33rd St. • Milwaukee, Wis. 53216

INFORMATION RETRIEVAL NUMBER 105

Motorola VIBRASPONDER Resonant Reeds

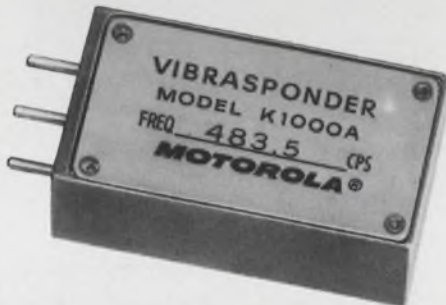

Performance proven, they're the industry's smallest and most rugged reeds.

Proven in thousands of remote control and signaling applications, VIBRASPONDER reeds provide unlimited potential in supervisory control, aerospace, military, and telemetry applications, or whenever selective tone signaling or stable audio tones are required.

Special construction gives VIBRASPONDER reeds maximum protection against shock and vibration. Contactless design allows its use as either a tone generator or a decoder. Multiple reeds may be used for sequential coded tone applications.

Over one hundred-fifty standard tone frequencies are available from 67 Hz to 3150 Hz. Other frequencies available on request.

For more information on VIBRASPONDER reeds, write for Bulletin TIC-3521 to Component Products Dept., Motorola Communications & Electronics, Inc., 4501 W. Augusta Blvd., Chicago, Illinois 60651. Or call (312) 772-6500.



MOTOROLA

INFORMATION RETRIEVAL NUMBER 106

DISPLAY CIRCUIT MODULES

DYNAMIC FOCUS FUNCTION GENERATOR

FG100

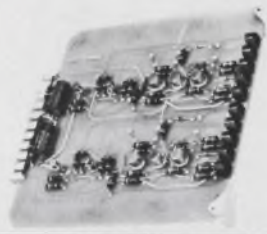

Converts X and Y deflection current samples into parabolic voltage wave forms to maintain beam focus anywhere on the CRT face.

LINEARITY CORRECTOR

LC101A



Gives on-axis linearity correction for geometric distortion occurring when a flat-faced CRT is used. Ideal for line-scan applications.

CENTERING COIL CURRENT REGULATOR

CR200



Supplies highly stable constant current to two axes of centering, alignment or static astigmatic correction coils in CRT, storage tube or vidicon systems.

VIDEO AMPLIFIER

VA105



Linear, featuring high output capability, fast rise and fall time, excellent full power output and bandwidth. Unique damping control.

STATIC FOCUS CURRENT REGULATOR

SR1000

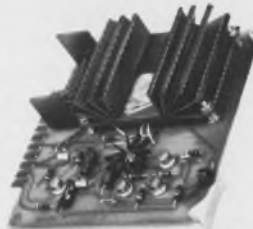

Provides a fully adjustable constant dc current supply to the static focus coil in magnetically focused systems. Low ripple, adjustable.



Constantine

Engineering Laboratories Company

Mahwah, N. J.
201-327-1123

Upland, Cal.
714-982-0215

INFORMATION RETRIEVAL NUMBER 107

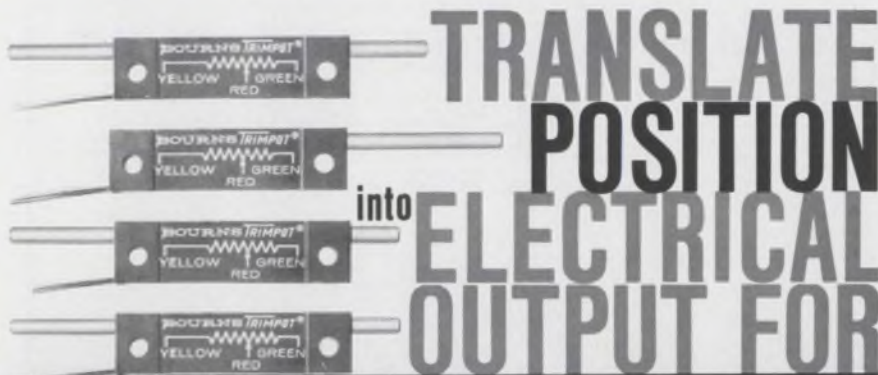

**TRANSLATE
POSITION
into
ELECTRICAL
OUTPUT FOR**

\$4.65* with this new
RECTILINEAR POTENTIOMETER

Call or write your nearest Trimpot Products Division sales office for more information on Model 3049, a high performance rectilinear potentiometer for industrial applications, at a price you wouldn't believe—*\$4.65 in 500-piece quantities.



BOURNS, INC., TRIMPOT PRODUCTS DIVISION • 1200 COLUMBIA AVE RIVERSIDE, CALIF. 92507

INFORMATION RETRIEVAL NUMBER 108

UNBELIEVABLE ADHESIVE



It's a fact: EASTMAN 910® Adhesive can form remarkably strong, long-lasting bonds between just about any materials you can think of — and do it with surprising speed, without the need for any mixing, heat, solvents, catalysts or more than contact pressure.

Hard to believe? Find out for yourself what this unique adhesive can do, and how it can help you cut assembly costs. Get your copy of the EASTMAN 910 Adhesive information kit by writing to Chemicals Division, EASTMAN CHEMICAL PRODUCTS, INC., Kingsport, Tennessee.

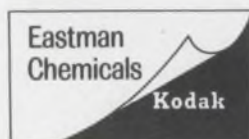

INFORMATION RETRIEVAL NUMBER 109

Flexible silicone has 10-yr guarantee

*Devcon Corp., Danvers, Mass.
Phone: (617) 774-1990. P&A:
\$1.95 for 3 oz; stock.*

Silite 100 is a new true-elastic silicone rubber that remains flexible under temperature extremes from -75 to $+500^{\circ}\text{C}$ for 10 years or more. It comes as a translucent non-sagging paste, which can be applied to vertical surfaces and requires no mixing. Small traces of moisture in the air act as a catalyst and begin curing the material almost immediately after it is applied.

CIRCLE NO. 352

High-strength adhesive bonds all materials

3M Co., Adhesives, Coatings and Sealers Div., 3M Center, St. Paul, Minn.

Designated as Scotch-Grip 1897, a new waterproof fast-setting general-purpose mastic adhesive is said to bond almost any type of material—including wood, glass, metal, textiles, rubber, cork and felt. This high-strength adhesive is ideal for bridging gaps between uneven surfaces and for bonding mismatched or loosely fitting parts.

CIRCLE NO. 353

Silver-coated powder can replace pure silver

Sigmatronics, Box 105, Moores-town, N.J. Phone: (609) 235-9429.

Siliclad G-100 is an exceptionally stable silver-coated ceramic powder that can be substituted for pure silver in conductive gaskets, coatings and plastics at lower costs. It has typical resistances of 0.008Ω at room temperature and less than 0.04Ω after 1000 hours at 500°F . Its particle size is less than 44 microns and its density is 1/3 that of silver while costing only 25% as much as pure silver.

CIRCLE NO. 354

Low-noise amplifier covers 1 to 2 GHz



Avantek, Inc., 2981 Copper Rd., Santa Clara, Calif. Phone: (408) 739-6170. P&A: \$1300 to \$1500; 30 days.

Specifically designed to replace traveling wave tubes, a new low-noise amplifier spans the range of 1 to 2 GHz. The model Am-200N provides a maximum noise figure of 5.5 dB and a minimum gain of 25 dB. Output power for a 1-dB compression is a minimum of +10 dBm while saturation occurs at approximately +14 dBm.

CIRCLE NO. 355

Tiny rf p-i-n diode accepts 75 kW peak



Unitrode Corp., 580 Pleasant St., Watertown, Mass. Phone: (617) 926-0404. P&A: from \$13; 2 wks.

Measuring only 0.04-in. high by 0.06 in. in dia, a new p-i-n diode can handle 75 kW of peak power at a 1- μ s pulse. The UM7000P series Micro-Pill device is designed for stripline and microstrip applications. It can dissipate 40 W of average power. Units are available with peak inverse voltages to 1 kV and capacitances of 0.6 pF maximum.

CIRCLE NO. 356

Tomorrow arrived early....

with the tremendous pot performance of new MystR[®] conductive plastic

Compare this "Second Generation" pot performance of Waters' exclusive new MystR with any other conductive plastic! This is tomorrow — here today.

- Infinite Resolution
- Resistance Ranges from 10 ohms to 5 megohms
- Excellent Linearities
- Output Smoothness — less than 0.1%
- Rotational Life — upwards from 10 million cycles
- Dither Life in excess of 400 million cycles
- Operational Temperature to 150°C
- Hysteresis 0.25°

From Waters now — a complete line of MIL Spec rated precision potentiometers, standard or custom, wire-wound, linear or non-linear or with MystR conductive plastic. Also Trimmers and Torque Measuring Devices.

WRITE FOR NEW CATALOG



WATERS MANUFACTURING, INC. WAYLAND, MASSACHUSETTS 01778

LR

Product of
Sigmund
Cohn
Corp.



Low Resistivity Gold Alloy Wire for Potentiometers

Developed and produced exclusively in the Sigmund Cohn plant... The LR series comprises four Noble Metal alloys for wire-wound potentiometers... They are distinguished by these quality advantages: extremely low noise, excellent corrosion-resistance and extraordinarily long shelf-life.

Write for updated engineering data.

LR Alloy	Resistivity	Tensile Strength
LR 29*	29 Ω /cmf	150,000 PSI
LR 45*	45 Ω /cmf	160,000 PSI
LR 65*	65 Ω /cmf	160,000 PSI
LR 80	80 Ω /cmf	160,000 PSI

U.S. Patent 3,354,208

Sigmund Cohn Corp.

121 So. Columbus Ave.,
Mount Vernon, N. Y. 10553
(914) 664-5300



Since 1901

MICROWAVES & LASERS

Npn power transistor takes 15 W at 400 MHz

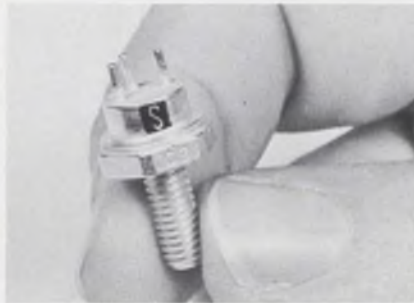

Solitron Devices, Inc., 1177 Blue Heron Blvd., Riviera Beach, Fla. Phone: (305) 848-4311. P&A: \$35.10; 3 to 4 wks.

Packaged in a TO-60 case, a new silicon npn rf power transistor delivers output power of 15 W at 400 MHz. The 2N5016 includes emitter resistors for increased stability. It can dissipate 30 W at case temperatures of 50°C and saturates at 21 W. Typical applications include use as a power or broadband amplifier.

CIRCLE NO. 357

X-band oscillator spans 9 to 9.7 GHz

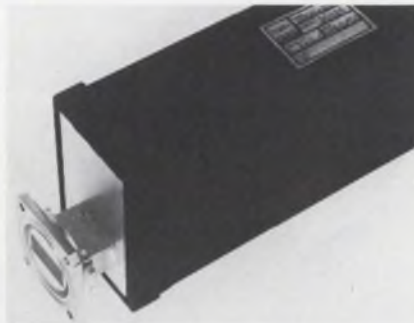

Trak Microwave Corp., 4726 Eisenhower Blvd., Tampa, Fla. Phone: (813) 884-1411.

With a control sensitivity of 100 MHz per volt, a new X-band solid state oscillator operates from 9 to 9.7 GHz. The Resonatron 5008-9900 can be modified for a sensitivity of 600 MHz per volt. It has a frequency response of dc to 10 MHz at a stability of ± 50 ppm/°C. Minimum output power is 59 mW and power requirement is +28 V at 400 mA.

CIRCLE NO. 358

X-band oscillators cost only \$98 each

OKI Electronics of America, Inc., 500 S.E. 24th St., Fort Lauderdale, Fla. Phone: (305) 523-7202. Price: \$98.

Producing a minimum of 30 mW of power from 8.2 to 12.4 GHz, a line of X-band avalanche diode oscillators are available at unit prices of \$98. They are available in either coaxial or waveguide-output versions with specified center frequencies. They can be tuned mechanically to ± 100 MHz of center frequency.

CIRCLE NO. 359

Cryogenic GaAs diodes operate for 1000 h

Seed Laser Technology Corp., 9 Cypress Dr., Burlington, Mass. Phone: (617) 272-5171. P&A: \$500 to \$1000; 2 to 3 wks.

Operating at liquid nitrogen temperatures is a new series of 1/2-W cw gallium-arsenide (GaAs) diode lasers. The S-44 series diodes have no threshold degradation and are guaranteed for 1000 hours of operation at specified parameters. Top-of-the-line 1/2-W units are priced at \$1000 and 50-mW units are priced at \$500.

CIRCLE NO. 360

X-band klystron tube generates 1-MW cw

Varian Associates, 611 Hansen Way, Palo Alto, Calif. Phone: (415) 326-4000.

A new X-band klystron tube, using an extended-interaction output cavity and a 0.9 micropervance beam, generates up to 1 million watts cw of rf power at 7840 MHz. It operates at 95 kV at the 1-MW level and produces a 1%, 1-dB bandwidth with a gain of 50 dB and efficiency of 45%. Output power is dissipated in two specially designed water loads.

CIRCLE NO. 361

FOR EXCELLENCE IN ROTARY SWITCHES

SPECIFY GRAYHILL

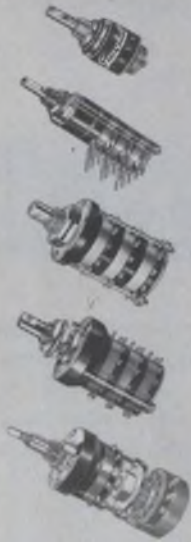

- 15°, 30°, 36°, 45°, 60° or 90° Angle Of Throw
- 2 To 24 Positions Per Pole
- Ratings Up To 15 Amps.
- 1 To 6 Poles Per Deck
- 1 To 12 Decks
- Diameters 1/2" To 2 1/4"
- Shorting Or Non-shorting Contacts
- Explosion Proof
- Military Or Commercial Styles
- Single Or Concentric Shafts
- Solder Lug Or Printed Circuit Terminals
- Switch And Potentiometer Combinations
- Key Lock Option
- Homing Rotor (Bridging And Shorting) Option
- Spring Return Option
- Power or Signal Switching
- Isolated Position (Pull-To-Turn) Option
- Adjustable Stop Option



For your Grayhill
Engineering Catalog
offering complete technical
data—contact

565 Hillgrove Avenue
LaGrange, Illinois 60525
Area Code 312, Phone 354-1040



... the Difference Between Excellent and Adequate

INFORMATION RETRIEVAL NUMBER 113

TACKLE THOSE BIG JOBS ON MINIATURE PROJECTS!!



FREE CATALOG!

SEND FOR YOUR FREE 128-PAGE TOOL & SUPPLY CATALOG... Contains over 10,000 time-saving tools and supplies including Hand Tools; Measuring Tools; Precision Machinery; Cutting Tools; Magnifiers... plus many other items used in the electronics, instrument making and precision industries... Every industry where precision tools are used!

Ask for Catalog No. 695

HAMMEL, RIGLANDER & CO., INC.
Post Office Box 222 • New York, N. Y. 10014

INFORMATION RETRIEVAL NUMBER 114

ELECTRONIC DESIGN 1, January 4, 1970



What do you need in Multi-Conductor Cable?

Victor
will make it.

Get exactly what you need in multi-conductor cable. We'll design and produce multi-conductor cable to meet just about any individual requirement.

We have the plant, the equipment, the personnel and the know-how to solve your particular problem.

Victor
Electric Wire & Cable Corp.
WEST WARWICK, RHODE ISLAND

INFORMATION RETRIEVAL NUMBER 115

JFD PISTON TRIMMERS

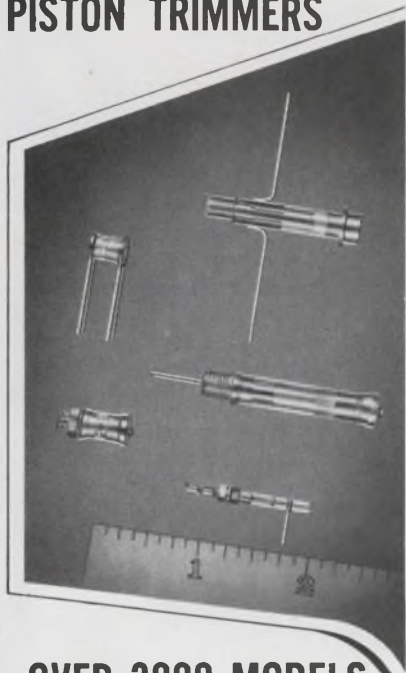

OVER 3000 MODELS

JFD offers the industries largest selection of Piston Trimmer capacitors to meet every circuit requirement. More than 3000 standard and special designs assure exactly the right component for every application.

The Miniature Telescopic Capacitor Series — offers a variety of glass and quartz dielectric materials in a wide range of capacitance values. For example: the VC10GWY is available from .8 to 4.5 pf for printed circuit mounting. Body length is only 5/16". Another example is the NVC 24G panel mount — available in a 1 — 38 pf capacitance range. Body length measures 1-19/32".

The Max-C High Range Miniature Telescopic Capacitor Series — utilizes an embedded electrode for greatly increased capacitance range. Models are available from 10 pf — 250 pf sizes ranging from 17/64" — 1-61/64" in body length. The Max-C series offers a wide variety of sealed and unsealed models.

Beyond this is an immense array of standard and special units covering almost every requirement: from minute diameters for space considerations to heavy walled units for high voltage applications.

More JFD Piston Trimmers meet or exceed present military specifications, than any other brand.



JFD ELECTRONICS CORP. / COMPONENTS DIVISION

15th Avenue at 62nd Street
Brooklyn, New York 11219
Phone 212-331-1000

SUBSIDIARY OF RIKER-MAXSON CORPORATION

Evaluation Samples

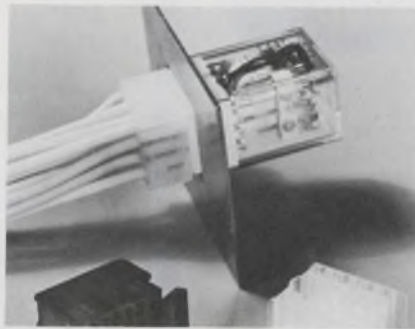

Relay socket

A new nylon plastic socket for miniature four-pole double-throw 5-A relays is now available as a free evaluation sample. About 30% less expensive than competitive sockets, the unit has plastic mounting clips that simplify installation and eliminate the need for accessory mounting devices. All necessary wiring can be done to the chassis-mounted socket from below, without removing the socket. Model SD-1852 accepts crimp-type terminals that can be easily snapped into its 14-contact connector. Molex Products Co.

CIRCLE NO. 362



One-cent cable tie

Now available as a free evaluation sample is the Penny-Ty SSTIM miniature Sta-Strap cable tie, which normally costs only 1¢ each in quantities of 50,000 or more. The tie offers a harness diameter of 0 to 3/4 in. with a loop tensile strength of 18 lb minimum. It is on the Qualified Products List (QPL) of MIL-S-23190B and meets the new military standard MS-3367-4, and the previous standards MS-17821-4 and MS-18034-4. Panduit Corp.

CIRCLE NO. 363



Drafting aids

Free evaluation samples are supplied with a catalog of pressure-sensitive printed circuit drafting aids. The line covers individually die cut pads, elbows, tees, corners, fillets and symmetrical shapes. Included are all shapes and sizes covered by military specifications. In addition to standard opaque black tape finishes, all shapes and tapes are available in transparent red and transparent blue film for use in two-color drop-out processes, which produce two-sided printed-circuit boards from a single master artwork. By-Buk Co.

CIRCLE NO. 364



Air-bubble bags

A choice of 28 off-the-shelf sizes of pre-formed AirCap bags is now available in sizes ranging from 3 by 4 in. to 12 by 24 in. Products to be packaged can be quickly inserted and heat-sealed shut. The bags are transparent to ensure easy identification of contents. Air-Cap cushioning material consists of two layers of barrier-coated polyethylene, one of which is embossed to entrap air bubbles between the two sheets. An evaluation sample bag is available free. Sealed Air Corp.

CIRCLE NO. 365

Design Aids



No-ink drawing system

A free "Make Your Mark" kit demonstrates the unique properties of an ink-free drawing system called Quantar. The system is comprised of coated drafting material, writing fluid and eradicating fluids. When the writing fluid is applied to the treated drafting material, a chemical reaction occurs that yields an ultra-dense extremely opaque black mark which will not chip, peel, flake or abrade. Try it out for yourself, and see if your designs can be more permanent. Frederick Post, a Teledyne Co.

CIRCLE NO. 366

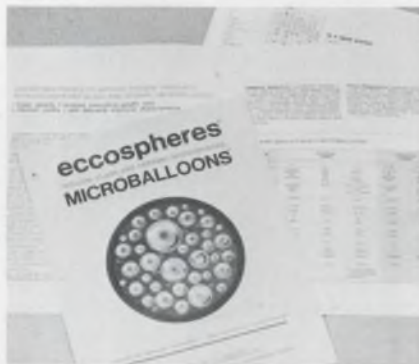

Microballoon chart

Glass/ceramic microballoons called Eccospheres are the subject of a new chart that lists applications and property data on six different types, including electrical, industrial and hydrospace grades. Eccospheres are free-flowing, thin-walled, hollow, glass and ceramic spheres ranging from 10 to 300 microns in diameter. They provide a controlled means of loading resins to increase strength while reducing weight. Emerson & Cuming, Inc.

CIRCLE NO. 367

Looking for an economical system building block?



REDCOR 720 MUX/A-D CONVERTER

REDCOR's Model 720 Multiplexer/A-D Converter is an economical and versatile system-building block that accepts up to 32 channels of analog data. Time-shared multiplexing and successive approximation analog-to-digital conversion are utilized to process the analog input data into a format suitable for inputting directly into a computer. The basic 720 contains modular multiplexers, high-input impedance buffers, a sample and hold, an ADC, power supplies, and a voltage reference.

The 720 Multiplexer/A-D Converter offers distinct cost-performance advantages for a wide variety of data-acquisition problems where high resolution and attendant accuracy must be compared to system cost and throughput rates. The 720 is available in 8 to 12 bits binary, with system throughput rates ranging from 40 KHz to 20 KHz. Either single-ended or differential inputs are provided, with full-scale input ranges from 5v to 20v in bipolar or unipolar configurations.

The 720 is completely self-contained in a forced-air-cooled 19-inch chassis that requires only 1¾ inches of panel space. Modular concepts are employed throughout the instrument, with all circuitry contained on plug-in circuit modules that are removable from the master interconnect mother PC board. All test points required for system test calibration and maintenance are available from the swing-out front panel. The modular structure of the 720 ensures ease of maintenance and simplifies field expandability of channels.

Simplified operation, low-cost, ease of interfacing, and guaranteed system performance specifications make the Model 720 Multiplexer/A-D Converter attractive for any computer-controlled data-acquisition or process-control application.

R
C **REDCOR**
CORPORATION

Complete Systems Capability / 7800 Deering Avenue, P.O. Box 1031,
Canoga Park, California 91304—(213) 348-5892

INFORMATION RETRIEVAL NUMBER 116

Annual Reports

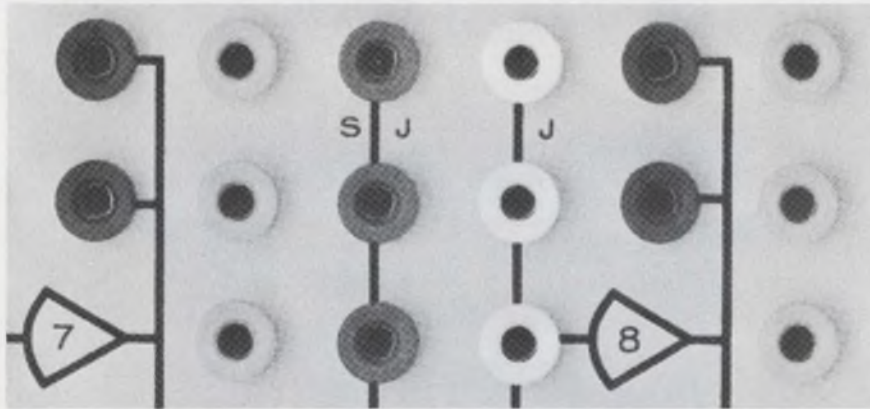

Electronic counters are only one of many products of the **Systron Donner Corp.**, 1 Systron Dr., Concord, Calif. Others include analog computers, digital voltmeters, pulse generators and spectrum

analyzers. Net sales of \$29,523,678 and net income of \$1,690,712 were reported for fiscal 1969 and net sales of \$27,199,737 and net income of \$1,976,203 for 1968.

CIRCLE NO. 368

Astrodata, Inc., 240 E. Palais Rd., Anaheim, Calif.

Analog and digital computer systems, data system, precision instrumentation.

1969: total sales, \$21,698,000; net income, \$164,000.

1968: total sales, \$26,439,000; net income (loss), (\$6,755,000).

CIRCLE NO. 369

Cook Electric Co., 6401 Oakton St., Morton Grove, Ill.

Telephone communications equipment, tape readers, airborne direction finders.

1969: net sales, \$19,791,417; net income, \$1,241,561.

1968: net sales, \$17,498,988; net income, \$1,905,460.

CIRCLE NO. 370

Datatron Inc., 1562 Reynolds Ave., Santa Ana, Calif.

Data acquisition, timing instrumentation, broadcast equipment, microelectronics testing.

1969: net sales \$2,179,227; net income \$203,672.

1968: net sales, \$736,370; net income, \$28,033.

CIRCLE NO. 371

Eastman Kodak Co., 343 State St., Rochester, N.Y.

Photography, radiography, education and entertainment, fibers, chemicals, plastics.

1968: total sales, \$2,644,064,000; net earnings, \$375,370,000.

1967: total sales, \$2,391,542,000; net earnings, \$352,257,000.

CIRCLE NO. 372

Ex-Cell-O Corp., P.O. Box 386, Detroit, Mich.

Machinery systems and tools, memory systems, data printers, optical and numerical controls.

1968: net sales, \$373,230,887; net earnings, \$22,030,765.

1967: net sales, \$343,974,371; net earnings, \$21,529,452.

CIRCLE NO. 373

Hathaway Instruments, Inc., 5250 E. Evans Ave., Denver, Colo.

Transient recording systems, photo printers, event recorders, annunciators, scanners.

1969: net sales, \$4,997,949; net income, \$347,412.

1968: net sales, \$4,046,215; net income, \$136,932.

CIRCLE NO. 374

Riker-Maxson Corp., 280 Park Ave., New York, N.Y.

Defense electronics, broadcasting, computer programming.

1968: net sales, \$50,658,010; net income, \$1,014,778.

1967: net sales, \$106,841,311; net income, \$3,196,356.

CIRCLE NO. 375

Southwestern Research and General Investment Co., 10204 N. 19th Ave., Phoenix, Ariz.

Data systems, optics, lasers.

1969: net sales, \$9,440,499; net income, \$735,733.

1968: net sales, \$8,037,557; net income, \$1,117,505.

CIRCLE NO. 376

Systems Engineering Laboratories, 6901 W. Sunrise Blvd., Fort Lauderdale, Fla.

Aircraft systems, nuclear reactors, videofile systems, computers.

1969: revenues, \$17,298,000; net income, \$1,453,000.

1968: revenues, \$12,032,000; net income, \$989,000.

CIRCLE NO. 377

Tandy Corp., 2727 W. 7th St., Fort Worth, Tex.

Consumer electronics, hobbies and handicrafts, general retailing, manufacturing and distribution.

1969: net sales, \$179,999,342; net earnings, \$7,771,243.

1968: net sales, \$117,410,529; net earnings, \$6,332,709.

CIRCLE NO. 378

Tyco Laboratories, Inc., 16 Hickory Drive, Waltham, Mass.

Printed circuit boards, transducers, switches, photocells, batteries, digital instruments.

1969: net sales, \$41,971,000; net income, \$2,345,000.

1968: net sales, \$34,925,000; net income, \$2,345,000.

CIRCLE NO. 379

one of our advanced subsystems, the opto-hybrid*

detects small changes of input, amplifies and digitizes output • channel-to-channel uniformity of $\pm 10\%$ (important with translucent tape) • digital output DTL or TTL compatible • available with either low or high true level output • amplification right at the detector minimizes influence of noisy electrical environment • cost comparable with discrete component amplifiers and sensing array—a dramatic size/weight advantage • works equally well with LED or incandescent source • fits into existing systems with little or no redesign... any number of detectors in almost any specified package

*Shown — 9 channel tape reader version.

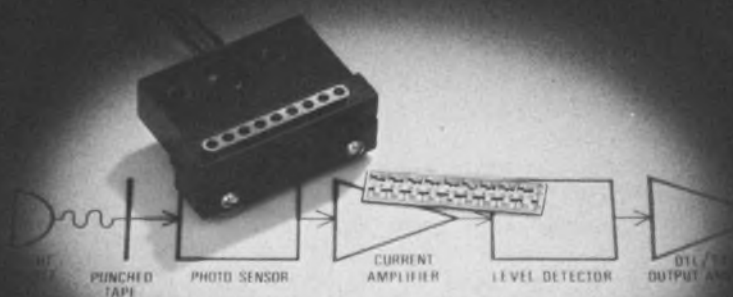

actual size

proof of the benefits of controlled crossbreeding— our new opto-hybrid

We've been making semiconductors a long time. Our list of "firsts" is impressive... particularly so in miniaturization of discrete silicon hi-rel devices. And, our assignment to produce silicon solar cells for the U.S. Space Program (we're #1) has kept us extra sharp in photovoltaics. Add to that our recent high-level R & D and technical work force build-up and you can see why right inside our plant is the best source for solutions to your hybrid circuit problems — whatever they may be. Bring us those problems. We'll solve them quickly and economically!



**CENTRALAB
SEMICONDUCTOR**

Division • GLOBE-UNION INC.
4501 NORTH ARDEN DRIVE
EL MONTE, CALIFORNIA 91734

zeners, temp.-compensated devices, tunnel diodes, rectifiers, scr's, semiconductor chips, hi-rel hybrids and photovoltaic products

Application Notes



Microcircuit design

An eight-page brochure gives some ground rules on the optimum combination of performance and space considerations for thin-film hybrid microcircuit design. The booklet discusses the selection of

active and passive component types, packaging, factors affecting reliability, resistor design rules, tolerances and circuit design layout approach. The electrical characteristics of precision thin-film nickel-chromium resistors are also described, as well as form factor considerations. Micro Networks Corp.

CIRCLE NO. 380

Coating analysis

How to obtain meaningful infrared spectra of surface coatings by attenuated total reflectance is detailed in a 10-page booklet. With this direct technique, there is no need for troublesome sample preparation—materials are simply cut to size, mounted, and spectra recorded. A spectrum of unpigmented alkyd resin is reproduced as a reference, and how to interpret departures from this standard spectrum is discussed. The techniques described are applicable to

analyzing the composition of surface coatings of almost any type. Barnes Engineering Co.

CIRCLE NO. 381

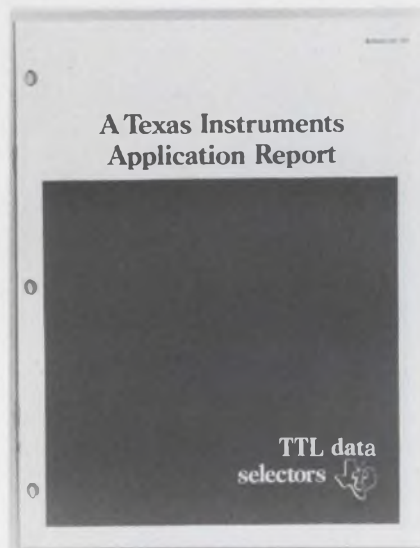

TTL data selectors

Series 54/74 TTL data selectors are the subject of a new 18-page application report. These circuits provide selective access to multiple information sources where data must be processed, stored or transferred. The report discusses such applications as random and sequential data selection, parallel-to-serial conversion, multiplexing to multiple lines, binary word comparison, character generation, and implementation of logic functions. Texas Instruments.

CIRCLE NO. 382

THIS DELAY LINE IS TAPPED AT ONE NANOSECOND INCREMENTS

ECC's new 25 nanosecond lumped constant delay line is tapped at one nanosecond increments from one to twenty-five. Available in either 50 or 90 ohm impedance versions, rise time is less than 4 ns. Attenuation of the 50 ohm unit is .15db (max.) and .07db (max.) for the 90 ohm unit. This delay line is epoxy encapsulated in a Diallyl Phthalate case, 1.40W x 2.00L x .225H. All twenty-five tap locations are clearly identified. Delay lines are manufactured and tested to applicable portions of MIL-D-23859A and meet the vibration, shock, and life test requirements of MIL-STD-202C; they are available from stock to 3 weeks ARO. For complete details, contact the factory for bulletins.

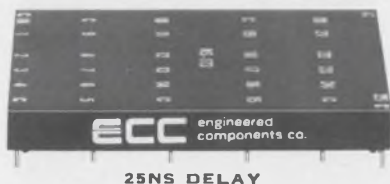

ECC engineered components company

2134 W. Rosecrans Ave., Gardena, Calif. 90249 · (213) 321-6565 / 321-8294

INFORMATION RETRIEVAL NUMBER 118

Custom-case kit

A new custom carrying case design kit makes it easier for package designers and engineers to specify the case design best suited for a particular product. The kit includes diagrams of basic construction designs, explains the kind of hardware available, describes customary applications, and shows how to select the various components to fit the particular requirements. It also describes and illustrates a variety of cover and lining materials. A&J Manufacturing Co.

CIRCLE NO. 383

INFORMATION RETRIEVAL NUMBER 119 ►

Intech's trimming their sales.

It may be nautical nonsense, but our customers are helping us do just that.

Using creative technology and a firm below-the-market standard price, we've launched another flagship: the A-125. With its ultra-low bias current, it's creating quite a wake for the competition.

Advantages? A low noise, high common mode rejection, junction FET input stage with less than 0.5 pA (0.2 typ.) bias current through either input.

This capability-in-a-package enables the A-125 to take over where electrometer or MOS-FET amplifiers used to excel. And watch the improvement in noise, thermal stability and reliability.

Try us out, even if you think our sails are full of wind. We would like nothing better. Then you'll see why Intech's trimming the sales of the Op Amp Boys.

The A-125 is \$95.00 and it is immediately available from stock. Quantity discounts available on request.

For more information on our high performance modular products, contact your local Intech representative, or write us directly.

Intech Incorporated, 1220 Coleman Avenue, Santa Clara, California 95050
Phone: (408) 244-0500  **intech**

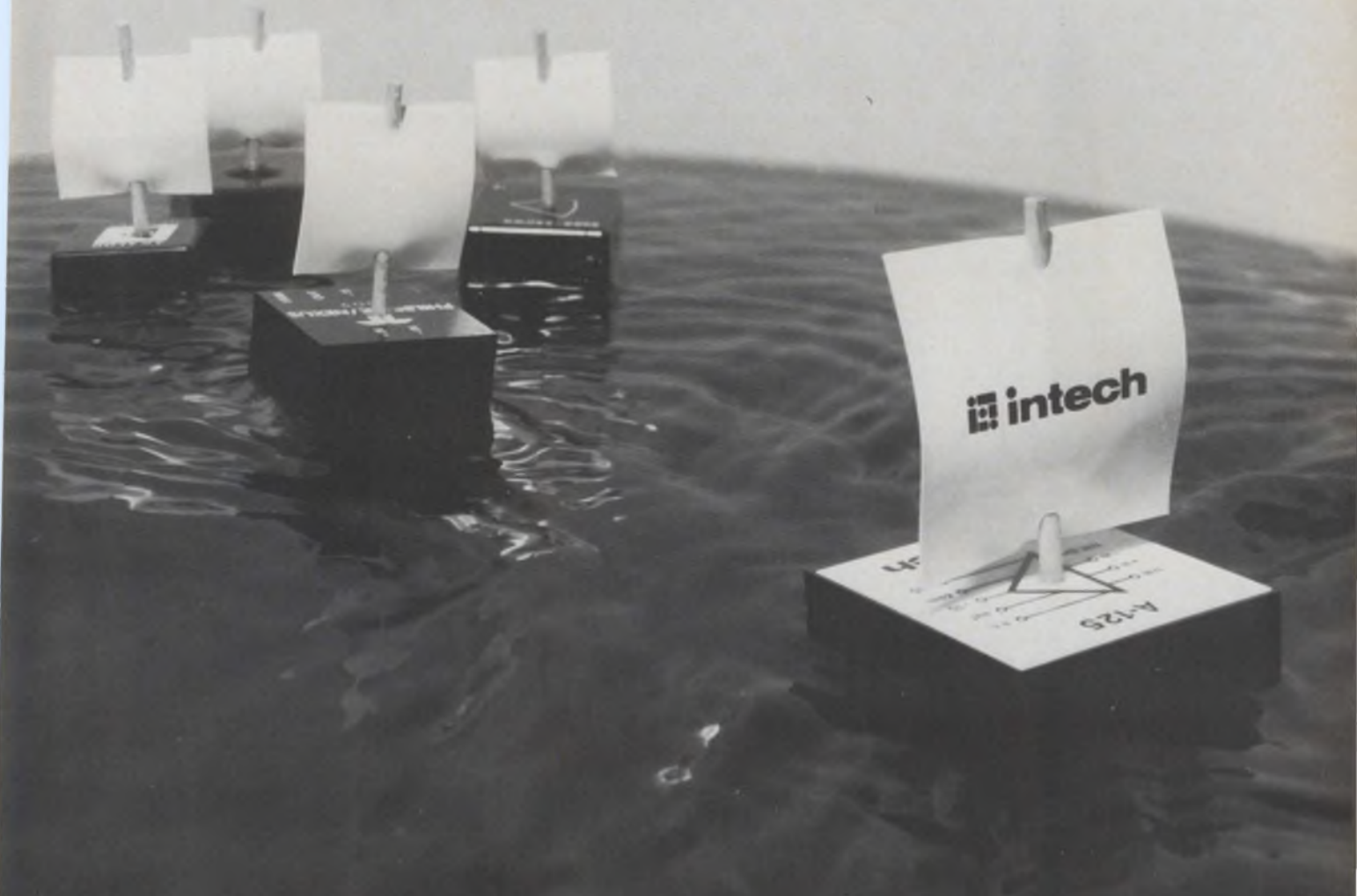

Intech takes on the Op Amp Boys.

New Literature



Lights and readouts

The new 56-page "Product Selector Guide" aids in the selection and procurement of more than a million and a half indicator lights, readouts and illuminated push-button switches. Data is given in illustrated sections each devoted to indicators by size (subminiatures, miniatures and large) or by product groupings (oil-tight, press-to-test and transistorized indicators). Separate sections are also devoted to illuminated push-button switches and readouts. Four indexes, including one with military cross references, assist the user in obtaining the desired information. Dialight Corp.

CIRCLE NO. 384

Audio fidelity

A prospectus on a to-be-published magazine entitled "Audio Amateur" is available. The four-page brochure explains what this magazine intends to present, to whom it is addressed, what kind of people it intends to enlist as readers, its editorial and subscription policies and why the magazine, which is to be published in January 1970, is needed. The Audio Amateur.

CIRCLE NO. 385

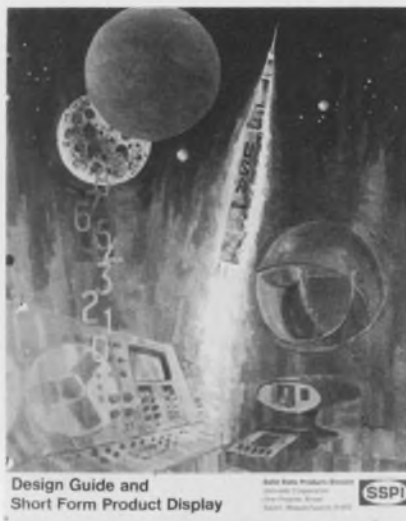

Semiconductor devices

Thyristors, high-power transistors, gate turn-off SCRs and hybrid power integrated circuits are all included in a new short-form catalog. For the reader's convenience, SCRs are categorized by military, high-speed and industrial types, and transistors are categorized by power, power switching, high-voltage and high-voltage power switching types. The catalog also includes a design-guide section listing recommended devices for design. Unitrode Corp.

CIRCLE NO. 386

Transistor amplifiers

A complete listing of standard dual Darlington and differential amplifier transistors available on the market is contained in a new comprehensive eight-page cross-reference guide. It provides electrical specifications for all registered devices with equivalent products for each device, designates the package associated with each transistor type and provides dimension diagrams for these packages. Fairchild Camera and Instrument Corp.

CIRCLE NO. 387



Power supplies

Entitled "The Latest in the State of the Art" is a new updated six-page power supply catalog supplement. Covered are five separate power supply groups: Modules for IC systems, dual modules for linear circuits, ferroresonant regulators, bipolar power amplifiers up to ± 72 V at ± 5 A, and high voltage operational power supplies of 0 to 500, 0 to 1000 and 0 to 2000 V all at 20 W. Kepco, Inc.

CIRCLE NO. 388

Plastic transistors

Some 107 plastic-encased transistors in both TO-98 and TO-92 packages as well as 22 dual transistors with pins compatible with TO-5 can spacing are described in a new eight-page short form catalog. Included are eleven geometries in npn and pnp polarities in low-noise high-gain, small-signal audio, large-signal audio, high-frequency, high-current and premium performance large-signal amplifiers, plus high-voltage indicator-drivers, high-speed switches, four darlington amplifiers and two low-voltage 0.1-W silicon controlled rectifiers. Sprague Electric Co.

CIRCLE NO. 389

Seven new hybrid analog switches

from DICKSON



These versatile Dickson hybrid analog switches may be just the circuits you need for your data transmission systems. They offer a variety of functions in standard 6, 10, 12 and 16 lead packages.

Models DAS 2126, 2132 and 2136 operate directly from DTL, RTL or TTL logic. The other four switches require a 0 to +15V drive signal. All of these standard Dickson units provide fast switching speeds, handle AC signals through 1 MHz, and have the quality and dependability you expect from a leading supplier of high-reliability semiconductors. Shipments are being made from stock. Custom analog switches are also available. For complete specifications, use this publication's reader service card.



MODEL NUMBER	TYPE	LOGIC LEVEL	R_{on} Ω	t_{on} μ sec	V_{out} volts	PACKAGE	PRICE 100-999
DAS 2107	SPST	high-level inverting	50	.3	5	TO-5 6 lead	\$ 5.50
DAS 2110	SPST	high-level inverting	30	.3	10	TO-5 6 lead	\$ 8.00
DAS 2114	SPDT/DPST	high-level alternating	30	.9	10	TO-8 12 lead	\$15.00
DAS 2126	SPDT/DPST	low-level alternating	30	1.5	10	TO-8 12 lead	\$18.00
DAS 2128	QUAD SPST	high-level inverting	30	1.0	7	TO-8 16 lead	\$30.00
DAS 2132	DUAL SPST	low-level non-inverting	30	0.5	10	TO-5 10 lead	\$18.00
DAS 2136	DUAL SPST	low-level inverting	30	0.5	10	TO-5 10 lead	\$18.00

COMPLETE DETAILS ON CUSTOM HYBRID CAPABILITIES

For your copy of a 16-page brochure giving complete information on Dickson custom hybrid capabilities and a copy of the Dickson Hybrid Specifications Guide, use this publication's reader service card.



DICKSON

ELECTRONICS CORPORATION

PHONE (602) 947-2231 TWX 910-950-1292 TELEX 667-406
P. O. BOX 1390 • SCOTTSDALE, ARIZONA 85252

INFORMATION RETRIEVAL NUMBER 120

•PASSIVE •ACTIVE
•CRYSTAL •DIGITAL
Filters!



Which is best for you?

If you have an application for passive, active, crystal, digital or hybrid filters, contact us for an objective evaluation. Our computer program library can offer you a choice of optimum realizations of your specification.

We also design and manufacture a line of solid state function modules, multiplier/dividers, VCO's, VCXO's and TCVCXO's. Browsers welcome.



NU-DEVICES, INC.
18 MARSHALL STREET,
NORWALK, CONN. 06854
(203) 853-3410

INFORMATION RETRIEVAL NUMBER 121

YOUR HEART FUND FIGHTS

**HEART ATTACK
STROKE
HIGH BLOOD PRESSURE
INBORN HEART DEFECTS**



NEW LITERATURE

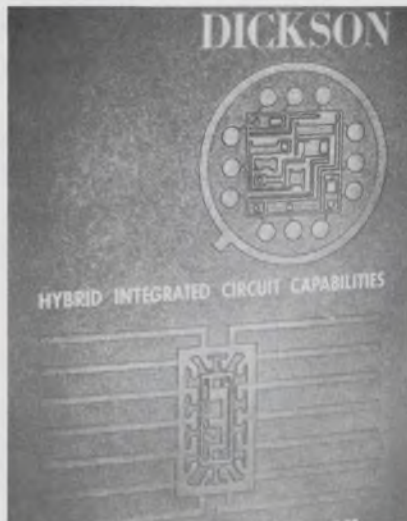

Hybrid ICs

A brief rationale on hybrid ICs plus some useful considerations and guidelines for microcircuit designers are included in a new capabilities brochure. Also included are a description of a hybrid manufacturing capability and a presentation of thick and thin-film component and packaging capabilities. Dickson Electronics Corp.

CIRCLE NO. 390

ICs, hybrids and chips

A new 40-page short form catalog gives salient information on TTL and high-speed TTL integrated circuits. It includes compatible MSI IC arrays, linear ICs, thin-film and hybrid circuits. Also included are transistors, transistor chips, and flat-pack hermetic packages. Sprague Electric Co.

CIRCLE NO. 391

Woven cables

Woven multi-conductor cables of all types are shown in a new fully illustrated six-page brochure. It has full-color illustrations and technical descriptions of more than 30 types of electrical, electro-mechanical, electro-fluidic, hydraulic and pneumatic cables. Tabulated charts of the basic physical characteristics of weaving material and design characteristics of electrical insulations are also included. Electroweave, Inc.

CIRCLE NO. 392



Solid state choppers

A complete line of solid state choppers (30 types) is described in a new 62-page catalog. Shown are encapsulated units which can be used as modulators or demodulators. They are capable of linearly switching or chopping voltages from a fraction of a millivolt to over 150 V. They can also operate over the frequency range from dc to hundreds of kiloHertz. Described are military, industrial and research application types. Solid State Electronics Corp.

CIRCLE NO. 393

Instruments/components

Contained in a 48-page bulletin are hundreds of laboratory instruments and electronic components in various conditions at reduced-price sales. Such manufacturers as Tektronix, Lambda, FXR, General Radio, Hewlett-Packard, GE, Ballantine, Boonton, Kay, Rutherford, Fluke, Kepco, Raytheon, Polarad, Telonic, Sperry and Berkeley are represented with oscilloscopes, power supplies, generators, meters, counters, test consoles and microwave instruments at fractions of their original cost. The bulletin also contains a large section on electronic components and materials. Baynton Electronics Corp.

CIRCLE NO. 394



Crystal oscillators

A complete line of voltage-controlled crystal oscillators is described in a new eight-page booklet. It details eight typical voltage-controlled crystal oscillator applications, giving necessary data for specifying these devices, and contains a table of oscillator characteristics. Also included are a specifications guide, and information relating to stability and spectral purity, as well as crystal filters. Damon Corp.

CIRCLE NO. 395

Subminiature lamps

A range of T-1, T-1-1/4 and T-1-3/4 subminiature lamps and indicator lights are described in a new catalog. Shown are specifications such as rated voltages and currents, average lives and filament types. Also shown are outline drawings of lamp configurations with dimensions, and characteristic curves of lamp performance. Inter-Market Inc.

CIRCLE NO. 396

Power amplifiers

New literature in the form of data sheets covers the supply of transistorized power amplifiers over the frequency range of 2 MHz to 2.4 GHz. These data sheets describe the operation, characteristics and specifications of various narrow and wideband amplifiers in power levels from 1 to over 100 W. Microwave Power Devices, Inc.

CIRCLE NO. 397

NEED A 3000 VOLT ZENER DIODE?

Corotron actual size: Photo-multiplier power supply, showing Corotron location, 1/3 size.

You could string together several hundred zeners. Or you could specify *one* Victoreen Corotron. It is the gaseous equivalent of the zener with all the advantages of an *ideal* HV zener diode.

For space research and other rugged applications requiring absolute power supply stability, GV3S Series, shown, provide the ideal reference voltage anywhere in the range of 400 to 3000 volts. They enable circuitry to maintain constant high voltage regardless of battery source voltage or load current variations. Cubage and weight (GV3S Corotron weighs only 4 gm.) are important considerations. So is temperature variation (Corotrons operate from 200°C down to -65°C). Ruggedized versions withstand shock to 2000 G, vibration 10 to 2000 cps.

If you're trying to simplify circuits . . . to cut cost, size and weight . . . to upgrade performance—you need Corotron high voltage regulators. Models are available now from 400 to 30,000 volts. A consultation with our Applications Engineering Dept. will speed up the countdown.

DMA 525



Components Division

VICTOREEN INSTRUMENT DIVISION

10101 WOODLAND AVENUE • CLEVELAND, OHIO 44104

EUROPE: ARNDAL HOUSE, THE PRECINCT, EGHAM, SURREY, ENGLAND • TEL: EGHAM 4887

INFORMATION RETRIEVAL NUMBER 122

EUTECTIC PREFORMS

for semiconductor assembly



with quality service to match quality products

CRM makes perfect preforms of eutectic alloys of Gold-Tin, Gold-Silicon, and Gold-Germanium.

CRM preforms can help you to produce perfect ICs, hybrids, transistors, and diodes. Quality is controlled from the ingot on, including not only standard tests, but also checks of foil surface finish and flow characteristics. The extensive die inventory at CRM makes most preforms available without delay and without a tooling charge.

CRM will meet your strictest specifications.

CRM delivers what it promises. CRM delivers on TIME.

Call or write CRM for a quotation on your preforms or the CRM catalog with a list of over 300 stock dies.

**CONSOLIDATED
CRM REACTIVE
METALS, INC.**

a Division of CONSOLIDATED REFINING CO. Inc.
113 Hoyt Avenue, Mamaroneck, N.Y. 10543
Tel: (914) 698-2300 □ TWX 710-566-1112

INFORMATION RETRIEVAL NUMBER 123

NEW LITERATURE



D/a converters

A series of digital-to-analog converters (40 separate models) is discussed in a new six-page bulletin. The series consists of plug-in PC boards with 8, 10 and 12-bit converters (binary and BCD) with or without input data storage. Included in the bulletin are complete specifications, mounting cases, 16-channel packages and appropriate companion power supplies. Also included are application notes, ordering information and customer usage documentation such as input code configurations and pin identifications. Computer Products.

CIRCLE NO. 398

Thermocouples

A new updated four-page thermocouple protection material guide lists material recommendations for thermowells, protection tubes and Ceramocouple protected thermocouples. Specific corrosive mediums such as phosphoric, hydrochloric and carbolic acids, various phosphates and oxides, corrosive elements of sea water and steam and the many organic compounds of which beer, milk and vinegar are a few. Applications and maximum limits are listed where temperature is critical to the life of the thermowell. Thermo Electric.

CIRCLE NO. 399

Microwave components

Featuring more than 70 new products and improved specifications is a new 1970 152-page microwave component and instrumentation catalog. It encompasses a large number of products which span the microwave range of 1 to 12.4 GHz. For ease of reference and to enable rapid selection of key components, each major section of the catalog is preceded by a summary section. Narda Microwave Corp.

CIRCLE NO. 400

Rf switches

Hundreds of different types of coaxial rf switches are illustrated and fully described in a comprehensive loose-leaf-bound 145-page catalog. It features an easy-to-use switch selection chart, whereby the user merely picks the switch function required, then turns to a simple diagram, which leads him to the exact page in the catalog where the right switch for his application is shown. Complete specifications for each switch type are included. Amphenol RF Div.

CIRCLE NO. 401

Plastics

A 16-page, two-color plastics booklet features 40 tables of the latest prices, standard and special dimensions, plastic products and fabrications for chemical, construction, electronic, metal finishing and laboratory applications. Included are sheets, rods, bars, pipes, fittings and flanges of PVC, PVDC, polyethylene, polypropylene and other plastics engineered to meet temperature, pressure and solution specifications for corrosion-proof requirements. Aztec Products Inc.

CIRCLE NO. 402

SOME ENGINEERS DON'T KNOW WHEN TO QUIT

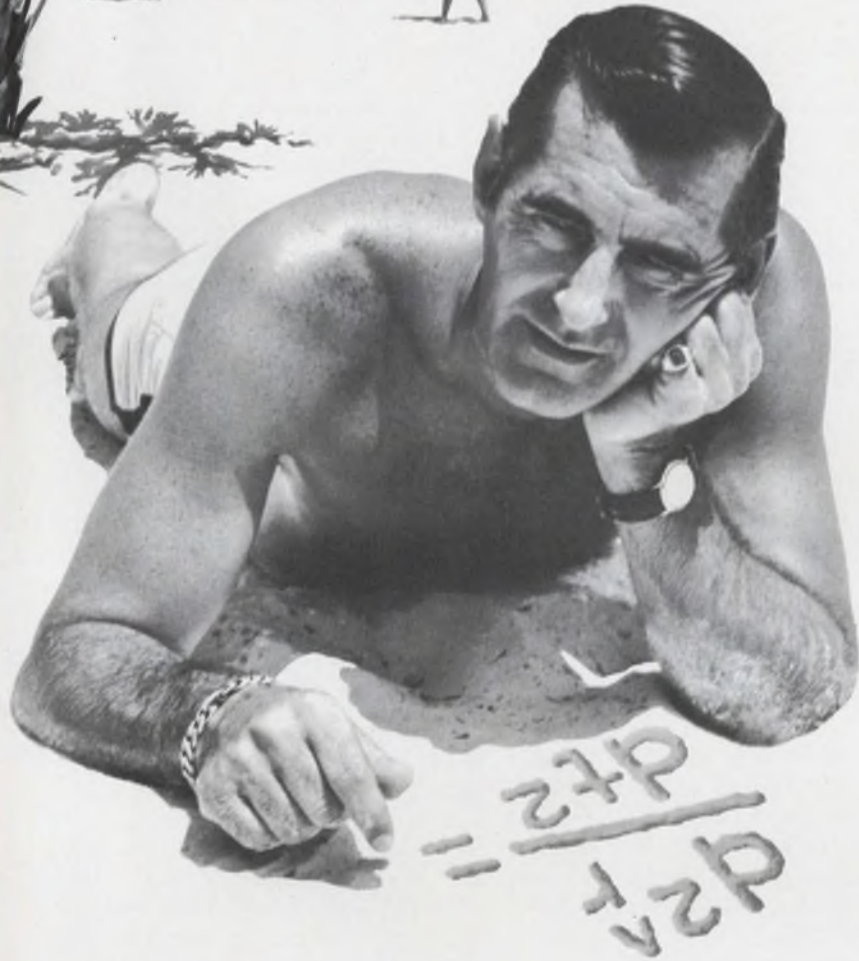

Give a guy a mile of sandy beach as a blackboard and you might find him doing equations from here to the moon . . . thinking about navigation and guidance systems.

At Honeywell-Florida we've got a lot of people who think engineering is an adventure. They create some of the world's most sophisticated equipment . . . computers . . . monolithic subsystems . . . plated wire memories . . . precision components. We give 'em room to think . . .

provide a stimulating environment and then recognize their creative individuality.

We can't promise you can do all your engineering on the beach but we can promise an atmosphere where you'll always have the engineering freedom you need to do something significant. Of course while you're relaxing on the white sand beaches of the Gulf of Mexico you may get some of your best ideas.

If you and your family fit into the Florida picture tell us about your qualifications today. We have great opportunities for engineers with experience in logic, components, integrated circuits, computer memories, circuit or programming analysis, advanced packaging, manufacturing or industrial engineering, materials or quality assurance.

Write now to Owen M. Spring, Dept. 120-1
Honeywell Inc., 13350 Highway 19, St. Petersburg, Florida 33733

Honeywell-Florida

An equal opportunity employer

To investigate professional openings in other Honeywell facilities,
send resume to F. F. Laing, Honeywell, Minneapolis, Minnesota 55408.

INFORMATION RETRIEVAL NUMBER 902

ENGINEERS

- Evaluation and Test
- Manufacturing
- Others

Automatic Electric, a leading innovator of computerized electronic switching systems and the largest producer of communications equipment for the independent telephone industry, has numerous entry level and experienced technical positions available in the following areas:

EVALUATION & TESTING Electronic and electrical engineers to initially learn the design of new electronic and computer systems and then perform prototype and/or field evaluation thereon. Entry level requirements — BS degree in EE, ET, or computer science with some knowledge of programming. Higher level positions exist for those with experience in electronic common control systems.

MFG. ENGINEERING Degreed electronic or electrical engineers (new or experienced) initially learn new computerized electronic telephone switching systems, design test equipment and associated test procedures and troubleshoot the mass production of this equipment.

Additional Positions currently available include:

- Software and Hardware Design Engineers
- Automation Engineers
- Ceramic Engineers
- Switching System Planning Engineers
- Traffic Analyst

If you are interested in a progressive, growing company that offers well equipped modern facilities, a policy of promotion from within, and a pleasant West suburban location (15 miles from downtown Chicago), send your resume in confidence to:

Larry Wisniewski

Professional Employment Representative

AUTOMATIC ELECTRIC

Subsidiary of General Telephone & Electronics
400 North Wolf Rd., Northlake, Ill. 60164

An Equal Opportunity Employer

NEW LITERATURE

Reed switches

A four-page catalog introduces new relay and reed switch products. This introduction briefly describes a line of mercury-wetted relays, reed relays and reed switches, with contact ratings and operating parameters for each. Physical characteristics, life and reliability data are also included. Shown are miniature and standard reed relays, PC-mount and plug-in mercury-wetted relays and standard miniature and subminiature reed switches. New Product Engineering, Inc., sub. of Wabash Magnetics, Inc.

CIRCLE NO. 403

Mylar capacitors

A 55-page test report deals with a line of Mylar-dipped 200-V dc capacitors, designed to resist the degradation effects of corona and for operation with pulses. This extensive document contains photographs of corona and resulting acoustic activity at different voltage levels, results of 60-Hz ac and dc life tests with cycled and static temperature, and results of a physical and an environmental test program. The test plan was designed to exceed any known government or commercial test specification. The Electro Motive Manufacturing Co., Inc.

CIRCLE NO. 404

Bobbins

A new eight-page catalog contains flange designs and specifications for over 600 stock bobbins. Designs include round core, cup core, square stock, transformer square stock, terminal-lugged and reed switches. These bobbins are molded of nylon, nylon glass-reinforced, delrin, nylatron, polycarbonate, polypropylene and fluorocarbon materials. Thermotech Coil Forms and Components, Inc.

CIRCLE NO. 405

Neon lamp applications

Application ideas for neon glow lamps as circuit components and voltage regulators are described in a new 12-page technical brochure. The brochure, entitled "Application Ideas," lists general and detailed discussions on 22 circuit applications for neon lamps in vidicons, photomultipliers, power supplies, remote controls, memories and timers. Other applications include proportional controls, moving signs, suppressors, photochoppers, binary decoding, frequency dividers, flash tube triggering and energy transfer. Signalite Inc.

CIRCLE NO. 406

Power semiconductors

Npn and pnp silicon planar power transistors are fully detailed with characteristics and ratings in a new 28-page catalog. Shown are transistors with ratings from 2 to 90 A. They are packaged in TO-3, TO-5, TO-46, TO-61 (isolated), TO-66 and TO-111 cases. The catalog also contains a section on triacs with complete ratings, an interchangeability chart for silicon power transistors and a page of outline drawings with physical dimensions for TO cases. Sprague Products Co.

CIRCLE NO. 407

Switches

Ten series of industrial and military precision switches are described and shown in a four-page two-color catalog. Included are three series of thumbwheel units, one series of unique add/subtract switches, five series of rotary types and a series of panel-sealed pushbutton types. Also included are custom assemblies consisting of pre-wired modules, panels and special switch modifications. Chicago Dynamic Industries, Inc., Precision Products Div.

CIRCLE NO. 408

Free Career Inquiry Service

Absolutely Confidential

Respond to the career opportunities advertised in this issue. Fill out and send us this handy resume. **Electronic Design** will do the rest – neatly typed copies of this form will be mailed to the companies of your choice, indicated by the circled Career Inquiry Numbers at the bottom of this page.

1

Name		Home Phone	
Home Address (Street)		City	State
			ZIP Code
Age	U.S. Citizen <input type="checkbox"/> Yes <input type="checkbox"/> No	Security Clearance	

Prime Experience	Secondary Experience

Desired Salary	Availability Date
-----------------------	--------------------------

Employment History – present and previous employers

Company	City, State	Dates	Title
		to	
		to	
		to	

Education – indicate major if degree is not self-explanatory

Degree	College	City, State	Dates
			to
			to
			to

Additional Training – non-degree, industry, military, etc.

Professional Societies

Published Articles

Career Inquiry Numbers:

- | | | | | | | | | | |
|-----|-----|-----|-----|-----|-----|-----|-----|-----|---------|
| 900 | 901 | 902 | 903 | 904 | 905 | 906 | 907 | 908 | 909 |
| 910 | 911 | 912 | 913 | 914 | 915 | 916 | 917 | 918 | 919 925 |

ELECTRONIC DESIGN
850 Third Avenue
New York, New York 10022

Advertising Sales Staff

Keith Aldrich
Sales Manager

New York 10022

Robert W. Gascoigne
Thomas P. Barth
Samuel M. Deitch
850 Third Avenue
(212) Plaza 1-5530
TWX: 867-7866

Philadelphia 19066

William C. Repetto
P. O. Box 206
Merion Station, Pa.
(215) MA-3-5888

Boston 01945

Richard Parker
P. O. Box 645
Clifton Station
Marblehead, Mass.
(617) 742-0252

Chicago 60611

Thomas P. Kavooras
Berry Conner, Jr.
200 East Ontario
(312) 337-0588

Cleveland

Thomas P. Kavooras
(Chicago)
(312) 337-0588
(call collect)

Los Angeles 90303

Stanley I. Ehrenclou
W. James Bischof
2930 Imperial Highway
Inglewood, Calif.
(213) 757-0183

San Francisco 94022

Arthur R. Shields, Jr.
175 San Antonio Rd., S 243
Los Altos, Calif.
(415) 941-3084

London W. 1

For United Kingdom and Holland
Brayton C. Nichols
44 Conduit Street
Tel: REGent 4714

Verviers, Belgium

For Continental Europe
Andre Jamar
1, Rue Mallar, 1
(087) 253.83 Telex 41563

Tokyo

Haruki Hirayama
Electronic Media Service
Rm. 601, Daini Miyauchi Bldg.
6-8-14, Roppongi,
Minato-ku
Phone: 402-4556
Cable: Electronicmedia, Tokyo



AMERICAN BUSINESS PRESS, INC.

Design Data from

Toggle, Push-button, Rotary Switch, Panel Environmental Seals



Hexseals® positively seal standard switches and rotary shafts against air, gas and fluids — without redesign of present components or equipment. Hexseals (and RubRglas® Seals, which are transparent seals designed to fit switches, indicator lights and other "see-through" devices) are moveable, single unit, high-pressure seals that in no way interfere with the free motion of a shaft or lever. In addition to their positive sealing function they serve as a vibration-resistant mounting nut. Custom molded panel sandwich seals and special RFI shielding models also available. Hexseals® meet applicable Military Specifications. Write today for free samples and Bulletin HEX-4.

APM-Hexseal Corporation

44 Honeck Street, Englewood, New Jersey 07631
(201) 569-5700

174

PEM Concealed-head Studs & Stand-offs



PEM self-clinching fasteners are available as concealed-head studs and stand-offs for permanent, invisible mounting on metal panels as thin as 0.093". These PEM fasteners satisfy applications where stand-offs or studs must project from one side of a panel and the finish of the opposite side may not be pierced or marred, or where part clearances will not accommodate bolt heads. Send for a free PEM bulletin describing self-clinching, concealed-head studs and stand-offs in thread sizes from 4-40 to 1/4-20.

Penn Engineering & Mfg. Corp.

Box 311
Doylestown, Pa. 18901

175

FUNDAMENTALS OF INTEGRATED CIRCUITS

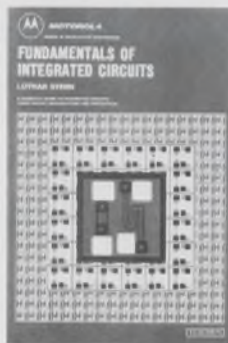

A practical guide to integrated circuits, their theory, manufacture, and applications. This new guide by Lothar Stern offers complete, highly readable coverage of the various techniques of circuit fabrication, and their effect on circuit design and performance. As to marketing considerations, it compares the characteristics of the numerous IC structures devised to date in terms of economics and logistics. A volume in the **Motorola Series in Solid-State Electronics**. 198 pages, 7 x 10, illustrated. \$8.95, clothbound. Send for 15-day examination copies.

Hayden Book Company, Inc.

116 West 14th Street
New York, N.Y. 10011

176

Manufacturers

Advertisements of booklets, brochures, catalogs and data sheets. To order use Reader-ServiceCard (Advertisement)

DRAFTING AIDS CATALOG



Send today for the By-Buk Printed Circuit Drafting Aids P-45 Catalog featuring the most comprehensive listings of basic pressure sensitive printed circuit drafting shapes, tapes and aids. Contains thousands of pads, tees, elbows, corners, donuts, connectors, fillets, colored tapes, multi-pads for dual in-lines, flat packs, TO cans and more. Here is your guide to better printed circuit drafting. Scores of ideas to speed master artwork preparation time and reduce drafting costs. Send for your free catalog and samples.

By-Buk Company

4326 West Pico Blvd., Los Angeles, Calif. 90019
Phone: (213) 937-3511

177

Free: 2,500 Plastic Parts Catalog



New from Nylomatic, molders and fabricators of mechanical plastic components, a highly informative 48-page catalog of more than 2,500 standard parts. It can help you save time and money in design, test and production. Advantages of Nylomatic standard parts: no tooling charges, low unit costs, quick delivery, complete range of sizes. Nylomatic standard parts are made of Nylon, Delrin® and other thermoplastic materials. You'll find our new free catalog a real problem solver for designers, send for it today.

Nylomatic Corporation

Dept. P
Nolan Ave., Morrisville, Pa. 19067

178

New R.F.I. Fastener Data



Camloc's 32F-623 bulletin illustrates a new quarter turn fastener specifically designed for Radio Frequency Interference problems.

Technical information is diagrammed for all assembly parts, dimensions, and installation data. The contents include a stud part number Selection Chart.

The fastener offers every advantage of threaded devices plus the convenience, reliability and speed of quarter-turn operation. Send for bulletin No. 32F-623.

Camloc Division, Rex Chainbelt, Inc.

22 Spring Valley Road
Paramus, New Jersey 07652

179

Electronic Design

ELECTRONIC DESIGN's function is:

- To aid progress in the electronics manufacturing industry by promoting good design.
- To give the electronic design engineer concepts and ideas that make his job easier and more productive.
- To provide a central source of timely electronics information.
- To promote two-way communication between manufacturer and engineer.

Want a subscription? ELECTRONIC DESIGN is sent free to qualified engineers and engineering managers doing design work, supervising design or setting standards in the United States and Western Europe. For a free subscription, use the postfree application form inside the back cover. If none is included, write to us direct for an application form.

If you do not qualify, you may take out a paid subscription for \$25 a year in the U.S.A., \$35 a year elsewhere. Single copies are \$1.50 each.

If you change your address, send us an old mailing label and your new address; there is generally a prepaid postcard for this inside the back cover. You will have to requalify to continue receiving ELECTRONIC DESIGN free.

The accuracy policy of ELECTRONIC DESIGN is:

- To make reasonable efforts to ensure the accuracy of editorial matter.
- To publish prompt corrections whenever inaccuracies are brought to our attention. Corrections appear at the end of the Letters column.
- To refuse any advertisement deemed to be misleading or fraudulent.

Microfilm copies are available of complete volumes of ELECTRONIC DESIGN at \$19.00 per volume, beginning with Volume 9, 1961. Work is now in process to complete the microfilm edition of Volumes 1-8. Reprints of individual articles may be obtained for \$2.00 each, prepaid (\$.50 for each additional copy of the same article) no matter how long the article. For further details and to place orders, contact the Customer Services Department, University Microfilms, 300 North Zeeb Road, Ann Arbor, Michigan 48106; telephone (313) 761-4700.

Want to contact us? If you have any comments or wish to submit a manuscript or article outline, address your correspondence to:

Howard Bierman, Editor,
ELECTRONIC DESIGN,
850 Third Avenue,
New York, N.Y. 10022.

Advertisers' Index

Advertiser	Page	Advertiser	Page	Advertiser	Page
APM-Hexseal Corporation	198	Fluke Mfg. Co., Inc., John	165	Panduit Corp.	170
Abbott Transistor Laboratories Incorporated	13	GRI Computer Corp.	54	Penn Engineering & Mfg. Corp.	198
Acopian Corporation	132	G-V Controls, Inc.	98, 99	Pirgo Electronics, Inc.	62
Adar Associates, Inc.	141	General Automation, Inc.	105	Potter & Brumfield Division of American Machine & Foundry Company	11
Airco Speer Electronic Components	66	General Electric Company	144A	RCA Electronic Components and Devices	150, 151 Cover IV
Allen-Bradley Co.	47	General Radio Company	40, 141	RFL Industries, Inc.	146
Amco Engineering Co.	35	Gibbs Mfg & Research	153	Redcor Corporation	185
Analogic Company	56	Gosh Instruments, Inc.	174	Rogan Brothers, Inc.	61
Augat, Inc.	162	Gould Inc., Piezoelectric Division	201	Schweber Electronics	17
Beckman Instruments, Inc., Helipot Division	125, 157	Grayhill, Inc.	183	Scientific Atlanta, Inc.	57
Bodine Electric Company	63	Hammel Riglander & Co. Inc.	183	Servo-Tek Products Company	164
Bourns, Inc.	180	Hathaway Instruments, Inc.	170	Signetics Integrated Circuits, A Subsidiary of Corning Glass Works	27
Burroughs Corporation	112, 113	Hayden Book Company, Inc.	163, 198	Siliconix Incorporated	149
By-Buk Company	199	Heath Company	160	Simpson Electric Company	175
Camloc Div., Rex Chainbelt, Inc.	199	Heinemann Electric Company	23	Solitron Devices, Inc.	171
CELCO (Constantine Engineering Laboratories Co.)	179	Hewlett-Packard	1, 24, 138, 139	Sprague Electric Company	18, 31
Centralab Division, Globe-Union, Inc.	16 A-B	Honeywell, Computer Control Division	15	Switchcraft, Inc.	14
Centralab Semiconductor Division, Globe-Union, Inc.	187	Honeywell, Florida	195	Sylvania Electric Products, Inc., Electronic Components Group	32A-H
Cinch, Division of United-Carr	Cover II	IEEE	201	Syntronic Instruments, Inc.	162
Clare & Co., C. P.	52, 53	IMC Magnetics Corporation	127	Systron-Donner Corporation	2
Clifton, Division of Litton Industries	12	Ideal Precision Meter Co. Inc.	46	TRW Semiconductors, Inc.	167
Cohn Corp., Sigmund	182	Industrial Timer Corporation	173	Tektronix, Inc.	6
Columbia Components Corporation	33	Intech, Incorporated	189	Tenney Engineering, Inc.	154
Comar Electric Company	55	JFD Electronics Corp./Components Division	184	Teradyne	20
Computer Labs	64B	Janco Corporation	10	Thermal American Fused Quartz Co., Inc.	166
Consolidated Reactive Metals, Inc.	194	Johanson Manufacturing Corp.	177	Trio Laboratories, Inc.	64
Coors Porcelain Company	144B	Johnson Company, E. F.	34	Triplett Electrical Instrument Company	147
Corning Glass Works, Electronic Products Division	38, 39	Keithley Instruments, Inc.	148	United Transformer Co., Division of TRW, Inc.	50
Cratex	173	Kinetic Technology, Incorporated	202	Unitrode Corporation	29
Curtis Development & Mfg. Co.	179	Kurz-Kasch, Inc.	65	Victor Electric Wire & Cable Corp.	183
Cutler-Hammer Specialty Products Division	129	Lafayette Radio Electronics	173	Velonex, A Division of Pulse Engineering Inc.	135
Dale Electronics, Inc.	48 A-B, 49	Magnecraft Electric Company	176, 176A-X	Electric Wire & Cable Corp.	183
Datascan, Inc.	152	Marconi Instruments Division of English Electric Corporation	48	Victoreen Instrument Division	193
Dearborn Electronics, Inc.	145	McDonnell & Miller, Inc.	201	Wang Laboratories, Inc.	117
Dickson Electronics Corporation	191	Microdot, Inc.	16	Waters Manufacturing, Inc.	181
Digital Equipment Corporation	8	Mohawk Data Sciences Corporation	169	Winchester Electronics Division Litton Industries	142
Dow Corning Corporation	158, 159	Molex Products Company	60	Career Advertising:	
Drake Manufacturing Company	7	Monsanto Company	155, Cover III	Automatic Electric, Subsidiary of General Telephone & Electronics	196
Dynamic Systems Electronics	172	Motorola Communications & Electronics, Inc.	179	Honeywell-Florida	195
E-H Research Laboratories, Inc.	137	Motorola Semiconductor Products, Inc.	44, 45		
EMR Division of Weston Instruments, Inc.	9	National Semiconductor Corporation	122, 123		
Eastman Chemicals Products, Inc.	180	Nu-Devices, Inc.	192		
Electronic Counters	174	Nylomatic Corporation	199		
Electronic Design	58, 59, 204	Oden Technology Labs, Inc.	131		
Engineered Electronics Company	188	Ohmite Manufacturing Co.	161		
Epoxy Molded Products Corp.	178	Optical Electronics, Inc.	168		
Erie Technological Products, Inc.	64A				
Fairchild Microwave Products	43				
Fairchild Semiconductor, A Division Fairchild Camera and Instrument Corporation	4, 5				

Newest—McDONNELL Dual Action Flow Switch

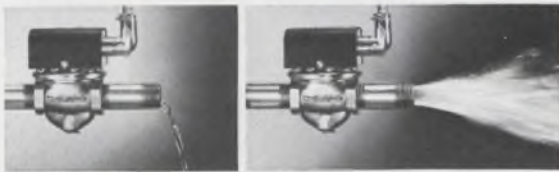

Actuated by a trickle . . . delivers a torrent . . .

Makes or breaks an electric circuit when flow in a pipe starts or stops

The McDonnell FS6 Series combine these unique capabilities: 1, actuation by flow rates as low as 0.12 gpm; 2, large volume flow-through capacity. Other features include:

- Easily adjustable for sensitivity to flow
- Available in 3/4" or 1" pipe size
- For pressures to 100 psi, temperatures to 225° F.
- Underwriters Listed

McDonnell Flow Switches can be used to start or stop alarms, signal lights, burners, motors, metering devices. Models available for pipe sizes 1/2" and larger, pressures to 1000 psi.

Write for complete information

McDONNELL & MILLER, Inc.

3500 N. Spaulding Ave., Chicago, Ill. 60618



INFORMATION RETRIEVAL NUMBER 124

Breakthrough in low frequency filtering!

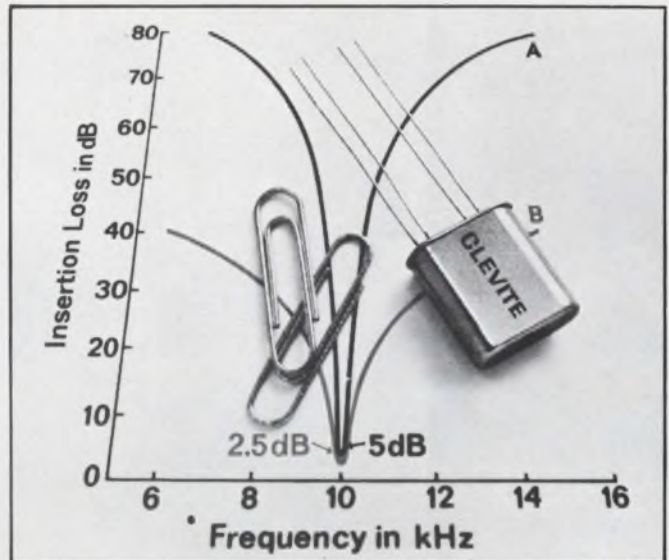

A—CASCADE OF 2 LF FILTERS

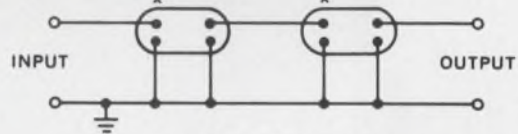

B—SINGLE LF FILTER

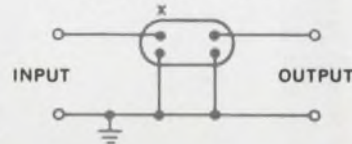

New Clevite ceramic bandpass filter puts big performance into 1/4 oz.

Clevite low frequency (LF) ceramic filters—from 9 to 50 kHz—are about one-tenth the size and weight of comparable conventional types—have narrower bandwidths, lower insertion loss and greater stability. This means you can pack more channels into a given portion of the spectrum with less sacrifice in volume and weight. They're fixed tuned, so you have no installation adjustments, simpler assembly and inspections.

Typical characteristics: 1% min. 3 dB pass bandwidth, 20 dB/3 dB bandwidth ratio not exceeding 13, and passband insertion loss less than 5 dB. Stopband attenuation exceeds 30 dB from dc to above 100 kHz. For even better selectivity they can easily be cascaded without worrying about matching or big insertion losses.

All this performance comes in a miniature HC-6/U can that weighs just 1/4 ounce (it's shown here actual size). They're hermetically sealed, immune to environments . . . there's no need for magnetic shielding. And LF filters are independent of the power source, so there's no current drain.

New Clevite LF filters are ideal for low frequency communications receivers, control circuits, selective calling systems, underwater sound systems and military/navigation systems. Write today for full specs and technical data. Piezoelectric Division, Gould Inc., 232 Forbes Road, Bedford, Ohio 44146, U.S.A. Or: Brush Clevite Company, Ltd., Southampton, England.

GOULD **CLEVITE**

INFORMATION RETRIEVAL NUMBER 126

LAUNCHING
THE
SPECTACULAR



IN ELECTRICAL and
ELECTRONICS ENGINEERING



4 Floors of Exhibits

NEW YORK COLISEUM / 10 a.m.-8 p.m. 4 Days.

50 Technical Sessions

NEW YORK HILTON / 10:00-12:30; 2:00-4:30 5 Days.

Registration — Good all days — Technical Sessions and exhibits. In and out privileges. IEEE Members \$4.00. Non-members \$8.00. Ladies \$2.00. High School Students \$3.00 if accompanied by adult (One student per adult). Thursday only — limit of 3 students per adult.

IEEE INTERNATIONAL
CONVENTION and EXHIBITION
MARCH 23-26, 1970



INFORMATION RETRIEVAL NUMBER 125

Lots of people have told us they could use an active filter with low power requirements and a low enough price.

How does 0.3 mW at \$10* sound?

Ask for carload prices or send \$12 for an evaluation sample.

You'll find there's a lot to evaluate. Like that power spec—ideal for all kinds of battery-powered gear. Plus a price/performance combination that we think will eliminate a lot of in-house filter making, even for commercial applications. Mail the coupon and a check or P.O. for \$12.00 today (please attach your company letterhead). We'll respond by air with a sample FS-60 and our brand new Filter Design Handbook. 'Till then, here are the basic specifications: Delivers band-pass, high-pass and low-pass outputs simultaneously Any desired form of the second order transfer function Complex zeros anywhere in the S-plane Multi-loop negative feedback for added stability F_c and Q of basic unit can be tuned by adding external resistors Frequency range from DC to 10 kHz Q range from 0.1 to 500 Voltage gain is adjustable to 40dB Supply voltages from $\pm 2V$ to $\pm 15V$ with 0.3 mW power consumption Dimensions: (14-pin DIP) 0.804" x 0.366" x 0.474" IC hybrid construction.



Gentlemen at KTI:

Please send me an FS-60 evaluation sample. Our check P.O. is attached, in the amount \$12.00. Send me more information on:

- FS-60 All active filters Hybrid subsystems
 Please add my name to your permanent mailing list

Name _____

Company _____

Address _____

City _____

State _____ ZIP _____

My applications are: _____

PRICES:	1 - 49	\$28	5,000 - 9,999	\$14
	50 - 199	\$23	10,000 - 19,999	\$12
	200 - 999	\$19	*20,000 - 49,999	\$10
	1,000 - 4,999	\$16		

KTI

KINETIC TECHNOLOGY, INCORPORATED

3393 De La Cruz Boulevard
Santa Clara, California 95051
(408) 246-8100 TWX: 910-338-0279

The name to remember for Hybrid Integrated Systems and Active Filters . . .

Information Retrieval Service

All products, design aids (DA), application notes (AN), new literature (NL), and reprints (R) in this issue are listed here with Page and Information Retrieval numbers. Reader requests will be promptly processed by computer and mailed to the manufacturer within three days.

Category	Page	IRN	Category	Page	IRN	Category	Page	IRN
Components			zener, 2.5-W	154	260	rubber, silicone	180	352
audio fidelity (NL)	190	385	Instrumentation			shield/seal	178	350
bobbins (NL)	196	405	audio fidelity (NL)	190	385	socket, relay (ES)	184	362
capacitors (NL)	196	404	counters	176	342	Tools & Engineering Aids		
choppers (NL)	192	393	instrument kit (AN)	188	383	desolderer, DIP	177	345
components (NL)	192	394	instruments (NL)	192	394	dispenser, tube	177	344
components (NL)	194	400	meter, digital panel	176	341	drafting aids (ES)	184	364
discrete devices (NL)	190	386	oscilloscopes, 10-MHz	176	340	drawing system (DA)	185	366
ICs, hybrid (NL)	192	391	power supplies (NL)	190	388	lamp, high-intensity	177	347
lamp, neon	172	289	probe, test	176	343	stripper, coax	177	346
lamp, subminiature	175	297						
lamps (NL)	193	396	Microwaves & Lasers					
lamps, neon (NL)	196	406	amplifier, low-noise	181	355			
light, indicator	172	292	amplifiers (NL)	193	397	New Literature		
lights/readouts (NL)	190	384	components (NL)	194	400	amplifiers, power	193	397
oscillators (NL)	193	395	diode, p-i-n	181	356	amplifiers, transistor	190	387
photocell assembly	174	294	diode lasers, GaAs	182	360	audio fidelity	190	385
rectifiers, full-wave	172	291	klystron, 1-MW	182	361	bobbins	196	405
rectifiers, silicon	172	290	oscillator, X-band	182	358	cables, woven	192	392
relay, solid-state	174	293	oscillators, X-band	182	359	capacitors, mylar	196	404
resistors, trimmer	175	296	switches, rf (NL)	194	401	choppers, solid-state	192	393
socket, relay (ES)	184	362	transistor, rf power	182	357	components, microwave	194	400
suppressors, spike	174	295				converters, d/a	194	398
switches (NL)	196	408	Modules & Subassemblies			ICs, hybrid	192	390
switches, reed	196	403	a/d converter, 13-bit	170	284	ICs and hybrids	192	391
switches, rf (NL)	194	401	amplifier, operational	166	276	instruments/ components	192	394
thermocouples (NL)	194	399	amplifier, operational	168	281	lamps, neon	196	406
			amplifiers (NL)	190	387	lamps, subminiature	193	396
Data Processing			amplifiers, chopper	168	283	lights and readouts	190	384
cassette, digital	160	268	amplifiers, power (NL)	193	397	oscillators, crystal	193	395
cassette eraser	162	271	choppers (NL)	192	393	plastics	194	402
coupler, acoustic	162	270	converters, d/a	170	285	power supplies	190	388
data terminals	164	274	converters, d/a (NL)	194	398	semiconductor devices	190	386
mini-computer	164	272	ICs, hybrid (NL)	192	391	semiconductors, power	196	407
modem, high-speed	164	275	lamps (NL)	193	396	switches	196	408
plotter, graphic	160	269	lamps, neon (NL)	196	406	switches, reed	196	403
transmitter/printer	164	273	lights/readouts (NL)	190	384	switches, rf	194	401
			memory card, 3.2k-bit	170	286	thermocouples	194	399
ICs & Semiconductors			op amp, FET-input	166	277	transistors, plastic	190	389
amplifier, reference	152	258	oscillators	171	287			
amplifiers (NL)	190	387	oscillators (NL)	193	395	Application Notes		
choppers (NL)	192	393	oscillators, SHP	171	288	coating analysis	188	381
converter, d/a	146	254	power supplies (NL)	190	388	custom-case kit	188	383
data selector	152	257	power supply, dual	166	278	data selectors, TTL	188	382
diodes, varactor	156	262	sine/cosine module	168	282	microcircuit design	188	380
FETs, plastic	156	263	supplies, current	168	280			
ICs, digital	156	266	switches, crowbar	166	279	Design Aids		
ICs, hybrid (NL)	192	390				chart, microballoon	185	367
latch, four-bit	148	255	Packaging & Materials			drawing system, no-ink	185	366
LEDs, high-power	144	252	adhesive	180	353			
memories, read-only	148	256	bags, air-bubble (ES)	184	365	Evaluation Samples		
microcircuits (AN)	188	380	bobbins (NL)	196	405	bags, air-bubble	184	365
op amp, triple	144	251	breadboards, DIP	178	349	cable tie	184	363
preamplifier, hybrid	154	259	cable tie (ES)	184	363	drafting aids	184	364
register, 20-MHz	144	250	cables, woven (NL)	192	392	socket, relay	184	362
selector/multiplexer	156	267	coating analysis (AN)	188	381			
semiconductors (NL)	190	386	connector, card-edge	178	348			
SCRs, 175-A	156	265	custom-case kit (AN)	188	383			
SCRs, gate-turn-off	145	253	fiber optics	178	351			
semiconductors (NL)	196	407	microballoons (DA)	185	367			
transistors (NL)	190	389	microcircuits (AN)	188	380			
transistors, signal	156	261	plastics (NL)	194	402			
triacs	156	264	powder, silver-coated	180	354			
TTL data (AN)	188	382						



Electronic Design 1970 TOP TEN CONTEST

PICK THE TOP TEN ADVERTISEMENTS IN THIS ISSUE... WIN A FLIGHT TO PARIS OR ONE OF 109 OTHER VALUABLE PRIZES

READER CONTEST Examine this issue of *Electronic Design* with extra care. Pick the ten advertisements that you think will be best remembered by your fellow engineer-subscribers. List these ten advertisements (in the order you think readers will rank them) on the special entry form included on *Electronic Design's Information Retrieval Card*, bound in at right. (Be sure to check the box marked "Reader Contest".) Your selections will be measured against the ten ads ranking highest in the "Recall Seen" category of Reader Recall—*Electronic Design's* method of measuring readership. In making your choices *do not* include "house" advertisements placed by *Electronic Design* or Hayden Publishing Company, Inc. (such as this ad describing the contest). Don't miss your chance to be a *Top Ten* winner! All entries must be postmarked no

later than midnight, February 28, 1970. Winner will be notified by March 23, 1970.

ADVERTISER CONTEST There's a separate contest open to all advertising personnel at companies and agencies. Use the entry blank included on the *Information Retrieval Card* bound in this issue, at right. (Be sure to check the box marked "Advertiser Contest".) In addition to valuable prizes, all ads that place in the *Top Ten* will be given free reruns. If you are a winner in the advertiser contest, and if you ran an ad in the January 4 issue that did not place in the *Top Ten*, that advertisement, or a like ad of your choice, will be given a free rerun. See rules below if the winning ad is an insert.

USE ENTRY BLANKS ON INFORMATION RETRIEVAL CARD AT RIGHT

ELECTRONIC DESIGN 1970 TOP TEN CONTEST RULES

READER CONTEST RULES

1. Enter your *Top Ten* selections on the entry blank provided, or on any reasonable facsimile. Be sure to indicate the name of the advertiser and page number for each of your choices. These choices should be placed in the order you think readers will rank them. (Ads placed by Hayden Publishing Company in *Electronic Design* should not be considered in this contest.)
2. No more than one entry may be submitted by any one individual. Entry blank must be filled in completely, or it will not be considered. The box on the entry blank marked "Reader Contest" must be checked. *Electronic Design* will pay postage for official entry blanks only.
3. To enter, readers must be engaged in electronic design engineering work, either by carrying out or supervising design engineering or by setting standards for design components and materials.
4. First prize is two economy class, round-trip airline tickets between New York and Paris. Transportation to and from point of embarkation in N.Y. or Paris, and any other expenses incurred as part of this trip, are not included in the prize. No cash payments, or other substitutes, will be made in lieu of any prize.
5. Contest void where prohibited or taxed by law. Liability for any taxes on prizes is the sole responsibility of the winners.
6. Entries will be compared with the "Recall Seen" category of Reader Recall (*Electronic Design's* method of measuring readership). That entry which in the opinion of the judges most closely matches the "Recall Seen" rank, will be declared the winner.
7. In case of a tie, the earliest postmark will determine the winner. Decisions of *Top Ten* contest judges will be final.

ADVERTISER CONTEST RULES

1. All rules for the Reader Contest will similarly apply for this contest, with two exceptions: readers engaged in electronic design engineering work, as defined in the reader contest rules, are not eligible to participate in this special contest. The box on the entry blank marked "Advertiser Contest" must be checked.
2. Entrants in this contest may use the official reader contest entry blanks or any reasonable facsimile.
3. This special contest is open to advertising personnel only at all manufacturing companies and advertising agencies whether or not their companies or agencies have an advertisement in the January 4, 1970 issue. However, only those companies (or divisions thereof) advertising in the Jan. 4 issue, and the advertising agencies placing such advertisements are eligible for a free rerun of their advertisement should a member of their organization win.
4. Free reruns of any advertisement will be made only from existing plates or negatives. If the advertisement qualifying for a free rerun is an insert, *Electronic Design* will bind and run the insert, but furnishing the inserts is again the responsibility of the winner. The winner may run a two-page spread instead of the insert if he chooses.
5. Hayden Publishing Company, Inc., reserves the right to schedule reruns at its discretion.

**FOR A COMPLETE
DESCRIPTION OF PRIZES
FOR BOTH READER AND
ADVERTISER CONTESTS
SEE PAGES 58 AND 59.**



**This counter fell off a plane.
It didn't need service
(but when one does, we're ready).**

This Model 100A Counter-Timer was enroute to a customer. A freight handler laid it on the wing of the airplane—and forgot it. The package finally slid off as the wheels left the runway. Instantly freed of its container, the "Small Wonder," as our customers sometimes call it, chased the plane for about a hundred yards, then ground-looped.

Our nearby Service Center, bored with inaction, brightened at the thought of a real challenge when it was brought in. But they were disappointed: electrically, the "Small Wonder" picked up right where it left off in Final Inspection. (Of course, *mechanically* there were a few abra-

sions to take care of, as you can see.)

Please help us keep our 37 Service Centers with their factory-trained technicians alive and well. Call the one nearest you anytime you feel that a Monsanto instrument requires service or calibration... or even verification of its performance. In addition to their expertise and factory specified test equipment, all carry a complete stock of spare parts. If there should be a defect in materials or workmanship during the 2-year warranty period, it won't cost you anything.

Monsanto Company, Electronic Instruments, West Caldwell, New Jersey 07006.

RCA DISPLAY TUBES DELIVER CLEAR,

BRIGHT VISUAL INFORMATION ... LOOK:

USE RCA DISPLAY TUBES FOR ALL TYPES OF VISUAL INFORMATION: ALPHA-NUMERIC -- WAVEFORMS -- PICTORIAL -- AND COMBINATIONS. READOUT IN 2-COLORS PLUS IN-BETWEEN SHADES ON 1-GUN CRTS. THEY EXPAND COMMUNICATIONS POSSIBILITIES IN AIR TRAFFIC CONTROL SYSTEMS, MILITARY IFF SYSTEMS, STOCK MARKET QUOTATION DISPLAYS, TRANSPORTATION STATUS BOARDS, TEACHING MACHINES AND ELECTRONIC TEST INSTRUMENTS.

Ask your local RCA Representative or RCA Industrial Tube Distributor for more information on these tubes which add new dimension to computer readout. For technical data, write: RCA Electronic Components, Commercial Engineering, Section A-1-18/ZC-3, Harrison, N.J. 07029. In Europe, contact: RCA International Marketing S.A. 2-4 rue du Lièvre, 1227 Geneva, Switzerland.

RCA