

Electronic Design 26

VOL. 17 NO

FOR ENGINEERS AND ENGINEERING MANAGERS

DEC. 20, 1969

Display systems are growing more complex. Already, graphics, alphanumerics and color can be combined into single units. But expanding such integrated displays

for viewing by groups of people, rather than individuals, is not so easy. The problems of resolution, color quality and cost still exist. For details, see the report on p. 56.



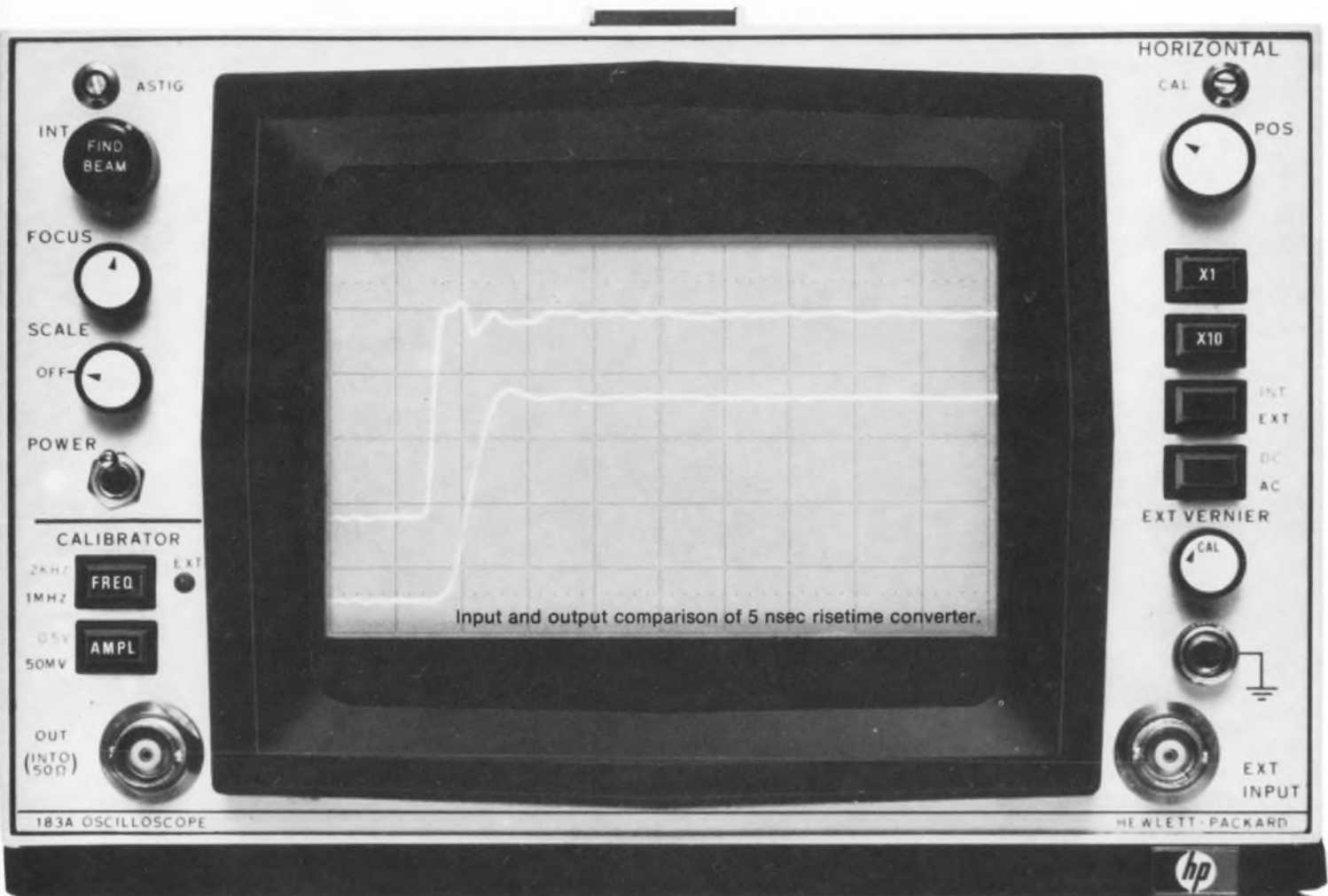

The Performance Champ – world's fastest general-purpose real-time scope!

The HP 183A Oscilloscope system adds one more way that you **see more—do more** with the field-proven 180 scope system.

Now you can measure from dc to 250 MHz—real time! Now you have a vhf scope that also gives you a bright dual-trace with a fast-writing speed of 4 cm/nsec on a big 6 x 10 cm screen. Plus, a sensitivity of 10 mV/div for low-level signal measurements—sweep speeds of up to 1 nsec/div for easier viewing of high frequency signals—and complete compatibility with the entire 180 series of plug-ins.

Sound expensive? Well, the 183A mainframe with a 250 MHz dual-channel vertical amplifier and a > 250 MHz time base costs only \$3150. That's less than some systems that don't even approach this kind of high frequency performance.

The basic 183A mainframe uses the all-new step-ahead technique of a CRT transmission line deflection system to provide real-time bandwidth beyond 500 MHz. And since it contains only the CRT and power supplies,

future, improved plug-ins will give you full performance in the mainframe you buy now. You won't have to worry about built-in mainframe limitations—now or in the future.

If you're interested in maximum scope performance per dollar invested, then the HP 180 system is the answer. From 50 MHz, to 100 MHz, to sampling, to variable persistence and storage scopes, the 180 system has the right combination to meet your requirements. You get more for your dollar today. You get more for your dollar in the future. You get the best performing, most versatile high-frequency scope system available today!

For more information, call your local HP field engineer. Or, write to Hewlett-Packard, Palo Alto, California 94304. Europe: 1217 Meyrin-Geneva, Switzerland.

089/14A

HEWLETT  PACKARD

OSCILLOSCOPE SYSTEMS

ACTUAL SIZE

INFORMATION RETRIEVAL NUMBER 212

**WHAT'S THE
POINT OF
MEASURING
CAPACITANCE
HERE?**



**WHEN THE
ACCURACY IS
SPECIFIED
HERE!**

**USE THE 1682 1-MHz AUTOMATIC
CAPACITANCE BRIDGE
FROM GENERAL RADIO -
WITH ACCURACY SPECIFIED
AT THE UNKNOWN!**

At 1-MHz, the typical 3-terminal capacitance tester, with a 4-foot cable to a 1000-pF unknown, adds about a 4-percent error to the readout. GR's 1682 has four-terminal Kelvin connections that minimize lead-impedance effects and preserve the accuracy of the bridge *at the component*, even with low-impedance unknowns. And an additional guard terminal provides a similar safeguard for high impedances, whose measurement might be affected by stray capacitance to ground.

The true accuracy of the 1682 is 0.1% of the unknown value from 1 to 2000 pF and 1% up to 20 nF. Conductance accuracy is 1% from 1 to 2000 μ mhos; 10% up to 20 millimhos. The front panel displays 5 digits of capacitance and 4 digits of conductance simultaneously, plus automatic decimal points and units of measurement.

20 measurements per second can be made for $\pm 10\%$ -of-full-scale differences in unknowns, and up to 50 per second for closer tolerance components.

An internal bias of 0 to 100 V is supplied; up to 200 V can be applied externally. Low-level or high-level BCD output and remote programmability can be added. Test fixtures are available for axial leads and GR900® or GR874® terminals.

Prices in U.S. start at \$3940; quantity discounts are available for lots of two or more. For more information write General Radio Company, West Concord, Mass. 01781 or telephone (617) 369-4400. In Europe write Postfach 124, CH 8034 Zurich, Switzerland.

GENERAL RADIO



Here's the fastest, most accurate source of programmable pulses available anywhere. The new Datapulse System 140 generates rep rates to 100 MHz, pulse widths from 5 ns, and independently variable rise and fall times from 2 ns.

Your program sets the upper and lower levels of the output waveform to any values between +10v and -10v. Each level can be independently positioned with an accuracy of $\pm 2\%$ of programmed value ± 20 mv. Pulse amplitude (the difference between levels) may be varied from 50mv to 5v into a 50 ohm load. Accuracy is typically $\pm 2\%$ of value for the other programmable pulse parameters: rep rate, pulse delay, pulse width and transition times.

System 140 can be programmed from computer, punched tape, magnetic tape, or other logic sources. All pulse parameters are controlled by BCD inputs compatible with DTL logic levels.

For complete information contact Datapulse Division, Systron-Donner Corporation, 10150 W. Jefferson Blvd., Culver City, California 90230. Phone (213) 836-6100.

Tests fast ICs automatically: the only 100 MHz programmable pulser!

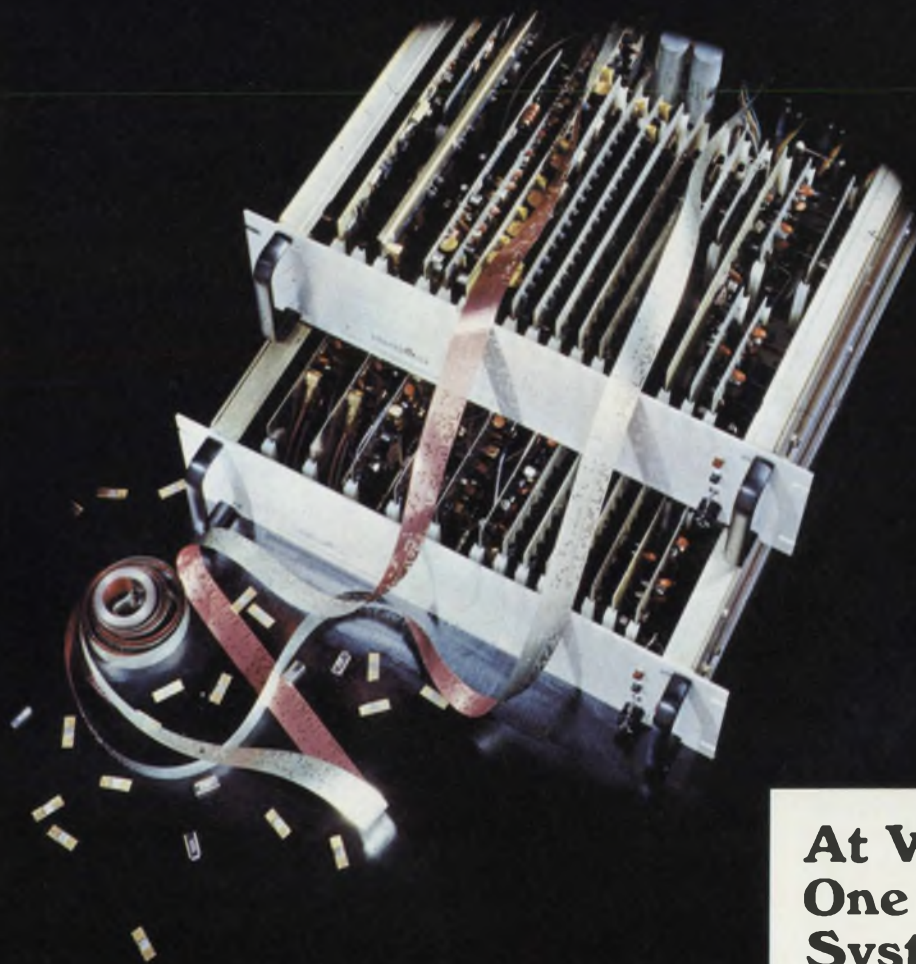

**At WESCON.
One of 157
Systron-Donner
instruments.**

Electronic counters	Digital voltmeters
Pulse generators	Spectrum analyzers
Microwave frequency indicators	Digital panel meters
Digital clocks	Microwave signal generators
Memory testers	Laboratory magnets
Analog computers	Data acquisition systems
Time code generators	Microwave test sets
Data generators	

DATAPULSE
DIVISION

SYSTRON  DONNER

NEWS

- 21 **News Scope**
- 25 **It's time for a change in computer peripherals**
Major advances are on the way for this hardware, a tour of the Las Vegas fall conference suggests.
- 30 **Will computers eliminate the specialist?**
By 1980, engineering knowledge could be reduced to routine practice by complex machines.
- 32 **Mapping the sky at low frequencies**
- 39 **Washington Report**
- 44 **Sidelights**
- 47 **Editorial: We could shun controversy, but wouldn't it be deadly?**
-

TECHNOLOGY

- 56 **Wanted: Easy-on-the-eye displays.** Part II of a special report on the present state of displays and where they are going.
- 66 **Single-map method speeds design** of sequential logic circuits. A triple flip-flop illustrates the technique.
- 70 **Convert digital data** from parallel to serial and from serial to parallel, using ICs and applying logical design techniques.
- 76 **Engineers should broaden their education** if they want to be socially conscious and industrially competitive, says this noted scientist.
- 81 **Ideas for Design**
- 89 **Product Source Directory: Field Strength Meters**
-

PRODUCTS

- 94 **ICs & Semiconductors:** Differential-like transistor senses magnetic fields.
- 97 **Data Processing:** Desk-top 10-key 14-digit calculator costs only \$875.
- 100 **Components:** Chip resistors enhance reliability with gold beam leads.
- 104 **Modules & Subassemblies** 107 **Packaging & Materials**
- 106 **Instrumentation** 108 **Microwaves & Lasers**
-

Departments

- 16 **Designer's Datebook** 112 **New Literature**
- 109 **Evaluation Samples** 118 **Advertisers' Index**
- 110 **Design Aids** 120 **Information Retrieval Service**
- 111 **Annual Reports**

Information Retrieval Service Card inside back cover

Cover: Contact analog display built by United Aircraft's Norden Div. to test human factors involved in viewing.

When reliability and performance are essential, Airco Temescal specifies General Electric components



General Electric meters, SCRs, capacitors, selector switches, indicating lights, Volt-Pacs®, gear motors, current transformers and arc pilot devices are used in Airco Temescal's line of Integrated Electron Beam Systems and products such as this Thin-Film Electron Beam Deposition System. (For more information, circle 811.)

Contaminant-free, high quality, thin-film coated substrates are produced by Airco Temescal's Model FC-1100 Thin Film Deposition System with the CV-10 Electron Beam Power Supply. It was designed for either manual or automatic operation for research or production applications.

Systems such as this require hundreds of components — components that are rugged, reliable, capable of top-notch performance.

The complexity of this equipment requires many types of meters which constantly monitor various functions and controls. These meters, designed by General Electric, check such things as voltage, evaporation rates, current emissions, focus current, gun filament current, and others.

Systems designers, such as Airco Temescal's, look to General Electric when they need a certain component to meet specific criteria. They know, for example, GE SCRs are highly sensitive, very versatile . . . and more important, extremely reliable as well as economical.

Capacitors are another of the many GE components used in this equipment. Designers specified General Electric for this application because high capacitance was required in minimum space, and long life was important.

Companies like Airco Temescal specify General Electric components because the name, General Electric, stands for quality, reliability and performance.

LOOK TO GENERAL ELECTRIC — your best source for electronic components.

285-51

GENERAL  **ELECTRIC**



What can GE do for you?



GE's new magnetic material increases magnetic energy 75%

You can have either greater magnetic performance for the same size, or equal performance with less volume and magnet weight with GE's new Alnico 9 magnetic material. It increases the energy product of cast Alnico 8 to a minimum of 8 million gauss-oersteds—a 75% increase in magnetic energy.

Alnico 9 was developed especially for applications requiring superior performance with minimal space and weight, such as focusing of microwave tubes, motor fields and rotors, torque couplings, accelerometers or other "radial gap" designs.

TYPICAL DEMAGNETIZATION CURVE OF CAST ALNICO 9

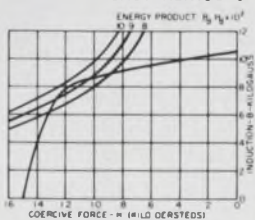

Consult our engineers about designing a Cast Alnico 9 magnet for your application. For details, circle 812.



New "Hi-TECH" ceramics line... top-flight ceramics plus custom engineering

Need a customized ceramic-metal component to do a tough job? General Electric's Hi-TECH line offers a broad variety of alumina, forsterite and other special ceramic materials... sealed to virtually any metal... and custom-designed to your specifications.

End use and operating environment are all our engineers need to know in most cases to design and manufacture the exact component you need.

If your device is one that must operate in a severe environment; or if you need a dimensionally-stable abrasion-resistant machine part; or if you are working on electrical equipment, vacuum or gas-filled devices, or hermetically sealed electronic components... check the Hi-TECH line. Circle number 813.



Now available—3SBV half-size relay for multiple applications

Attention, manufacturers of:

- COMPUTERS
- COMPUTER PERIPHERALS
- AVIONICS
- STUDIO & BROADCAST EQUIPMENT
- VISUAL COMMUNICATION PRODUCTS
- INSTRUMENTATION
- TEST EQUIPMENT
- MICROWAVE & MOBILE COMMUNICATIONS
- MOTOR CONTROLS
- PHOTO-ELECTRIC CONTROLS
- GEOPHYSICAL EQUIPMENT
- SECURITY WARNING EQUIPMENT

Specify the new 3SBV 200-grid half-size relay for those applications where high reliability, top performance and low cost are essential. The 3SBV is an adaptation of the 3SAV type, and has a nylon, heat-sealed metal case. It is ideal for use in environments less severe than aerospace and military applications. For more information on the GE 3SBV, DPDT, relay, circle 814.



Solve unijunction design problems with the new programmable UJT

GE's D13T is a programmable unijunction transistor (PUT) with characteristics (η , R_{bb} , I_p , I_v) that can be selected to fit your circuit. Just two circuit resistors give the D13T1 and T2 programmability which permits the designer to:

- reduce a risk of thermal runaway
- use PUT in battery and other low-voltage circuits
- use base 2 as low impedance pulse output terminal
- use PUT in high volume applications.

Especially suited for long-interval timers, D13T2 features very low leakage and peak point currents. D13T1 is for more general use in high gain phase controls and relaxation oscillators.

Both are 3-terminal planar passivated PNP devices in the low-cost plastic TO-98 case. Circle number 815.



GE 69F900 wet slugs give highest volumetric efficiency

69F900 wet slugs meet high-density application needs with highest volumetric efficiency of any capacitor. We halved the military (CL64) wet slug size, and essentially kept its electrical and performance traits.

The 69F900 has excellent capacitance retention at low temps... can be stored to -65C. Operating range is -55C to +85C. It's tough too—withstands vibration to 2000Hz; 15G acceleration!

GE's capacitor is fully insulated; has low, stable leakage current. Ratings are available from 6 to 60 volts; capacitance ranges from 0.5 to 450 μ f.

RATING	CASE SIZE	VOL. VOLUME
50V, 30 μ f		
solid (CS12)	341X.750	100%
wet slug (CL64)	281X.681	58%
69F900	145X.600	15%
15V, 80 μ f		
solid (CS12)	341X.750	100%
wet slug (CL64)	281X.681	58%
69F900	145X.600	15%
6V, 180 μ f		
solid (CS12)	.279X.650	100%
wet slug (CL64)	281X.641	100%
69F900	145X.600	15%

For data, circle 816.



Miniature oil-tight push buttons control almost any function

GE's line of industrial miniature oil-tight push buttons, CR104, is available to control almost any function. They are suitable for use on machine tool control

panels — especially where space is limited. For example, twenty of these units can be easily mounted on a 6" x 5 1/2" panel.

Units are rated 5 amps carry, 115 volts max., 30 amps make and break at 115-125 volts. Double-break

1NO-1NC and 2NO-2NC contact blocks are available for pilot duty control.

Forms include push-buttons, select switches, indicating lights, special forms, and oil-tight enclosures and stations. Color-coding is easy: knobs and rings

come in many colors. Flush and surface-mounted stations make GE's miniature oil-tight push button line the most versatile in the industry.

For detailed information on the entire line of push buttons, circle reader card 817.



Pick the types you need from the line that offers more

Although a majority of industrial small-signal amplifier circuits can be designed adequately using no more than six or eight basic transistor types, many designs do require devices which vary substantially from those of the basic handful. Motorola produces and supplies 147 standard economical, reliable, performance-proven small-signal amplifiers (at last count) to meet the requirements of all industrial circuit designers.

Not all applications are best served by

packages of the same size and configuration, either. Motorola offers a choice of three outstanding plastic packages, the medium-power Uniwatt,* the famous Unibloc,* and the tiny Micro-T.*

Refresh your memory on (or discover) the broadest line of plastic small-signal amplifiers available by sending for the selector guide, Plastic-Encapsulated Small-Signal Transistors For Industrial Applications, to Motorola Semiconductor Products Inc., P. O. Box 20912, Phoenix, Arizona 85036.

*Trademark Motorola Inc.

-where the priceless ingredient is care!



MOTOROLA
Plastic Transistors

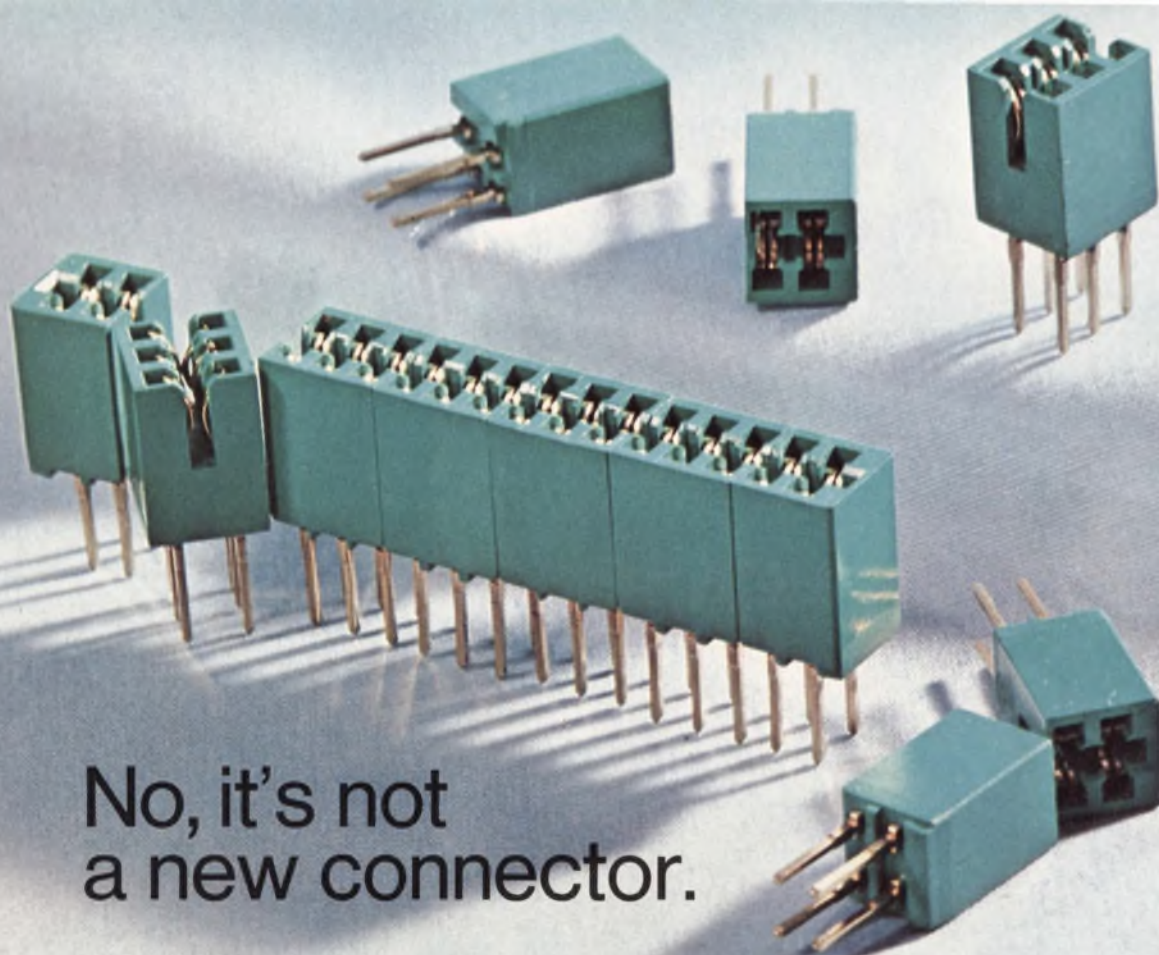

No, it's not
a new connector.

It's a new kind of connecting.

The little connectors above are really one connector. You take as many pieces as you need, mix them together, and use them to connect any size of p.c. board to a mother board.

That's not spectacularly new. Connector modules for use in bread-boarding have been around for a while.

But these new Mojo™ Series 6308 p.c. connector modules* are not just for bread-boards and prototypes.

Not hardly.

When used with plated-through holes on the mother board, they are one of the slickest production tricks to come along in quite a while. Contact tails combine a square wire-wrapping post with a specially designed locking feature which, when press-fitted into a plated-through hole, provides a gas-tight and reliable electrical connection.

No, you don't have to solder.

Yes, you can wire-wrap if you want.

And, yes, you'll save time and money in moving from prototype into production. Because connectors

of virtually any size can be built up economically from just two sizes of modules, you don't need a large inventory. Or custom connectors. And you only have to insert modules where connectors are required, saving a few more pennies.

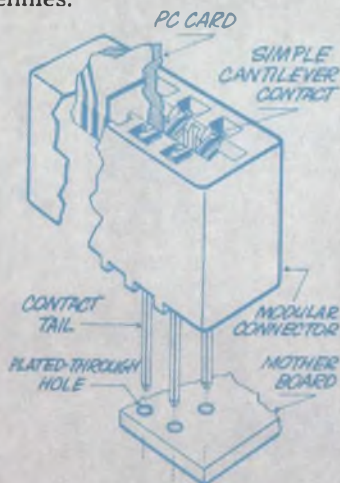

And, no, you don't give up a bit of connector reliability. The exclusive swaged single-beam design of the dual-readout contact provides optimum spring rate and deflection characteristics. A preload applied

to the contact nose in the insulator makes sure that the contact really holds on to the card, while keeping the contacts well apart when the card is removed from the connector.

Mojo™ p.c. connector modules:
Specs in brief

Material

Glass-filled DAP

Contacts

Cantilevered-beam, dual read-out, bifurcated nose. .150" centers. Center modules have 6 contacts. End modules have 4 contacts, molded-in card guide.

Tails

.031" square wire-wrapping type

Mounting

Press fit, in .048" dia. plated-through holes, 3/32" to 1/8" thick board.

For more information, write, wire, call, or TWX us for our Mojo™ p.c. connector module data sheet. Elco Corporation, Willow Grove, Pa. 19090. 215-659-7000; TWX 510-665-5573.

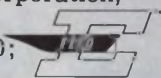

ELCO Mojo™ p.c. Connectors

* Patent pending

the
GIANT™

GENERAL INSTRUMENT ADVANCED NITRIDE TECHNOLOGY

QUADS

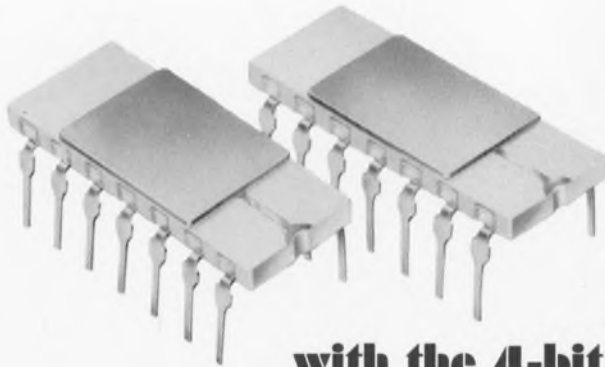

with the 4-bit byte

the first and only 25-bit and 32-bit QUAD Static Shift Registers directly compatible with TTL/DTL and MOS are GIANTS.

Logic Diagram
QUAD 25-Bit or 32-Bit
Static Shift Register

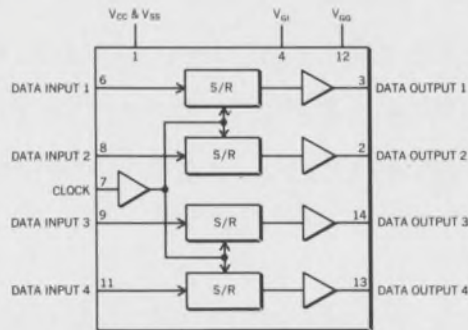

TTL/DTL Operation

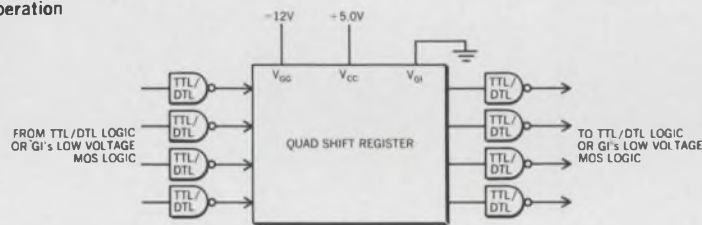

MOS Operation

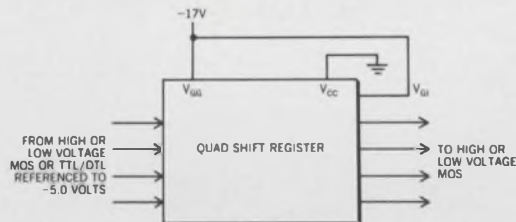

General Instrument's 4-bit byte 25-bit and 32-bit QUAD Static Shift Registers are the newest additions to the growing family of GIANTS. And, like all GIANTS, they are products of General Instrument's exclusive MTNS (Metal-Thick Oxide-Nitride-Silicon) process.

A most significant feature of these GIANT QUADS—and of every standard GIANT product—is the V_{G1} terminal, which gives the user the choice of interfacing directly with TTL/DTL or MOS.

Each register has one serial input and one serial output, and the clock input is common to the four registers. All inputs, including clock, can be driven directly from TTL/DTL logic levels, and each output can directly drive TTL/DTL without external interfacing components.

Additional features of the GIANT QUADS include: opera-

tion over the full military temperature range of -55°C to $+125^{\circ}\text{C}$ and series or parallel operation. And the well-known performance and reliability advantages inherent to MTNS devices are, of course, also present in the GIANT QUADS.

Both the 25-bit (#SL-6-4025) and the 32-bit (#SL-6-4032) QUADS are available in 14 lead dual in-line ceramic packages at your authorized General Instrument Distributor. For full information write, General Instrument Corporation, Dept. Q, 600 West John Street, Hicksville, L.I., N.Y. 11802.

(In Europe, write to General Instrument Europe S.P.A., Piazza Amendola 9, 20149 Milano, Italy; in the U.K., to General Instrument U.K., Ltd., Stonefield Way, Victoria Road, South Ruislip, Middlesex, England.)

Price in quantities of 100 pcs: QUAD 25-bit (#SL-6-4025) @ \$18.20 ea.; QUAD 32-bit (#SL-6-4032) @ \$26.50 ea.



GENERAL INSTRUMENT CORPORATION • 600 WEST JOHN STREET, HICKSVILLE, L. I., NEW YORK

Look at what Mallory has done to audio systems design.

Use these three new, low-cost Mallory IC's to design a complete stereo system with a minimum of external parts. They dramatically improve systems performance... at lower systems cost.

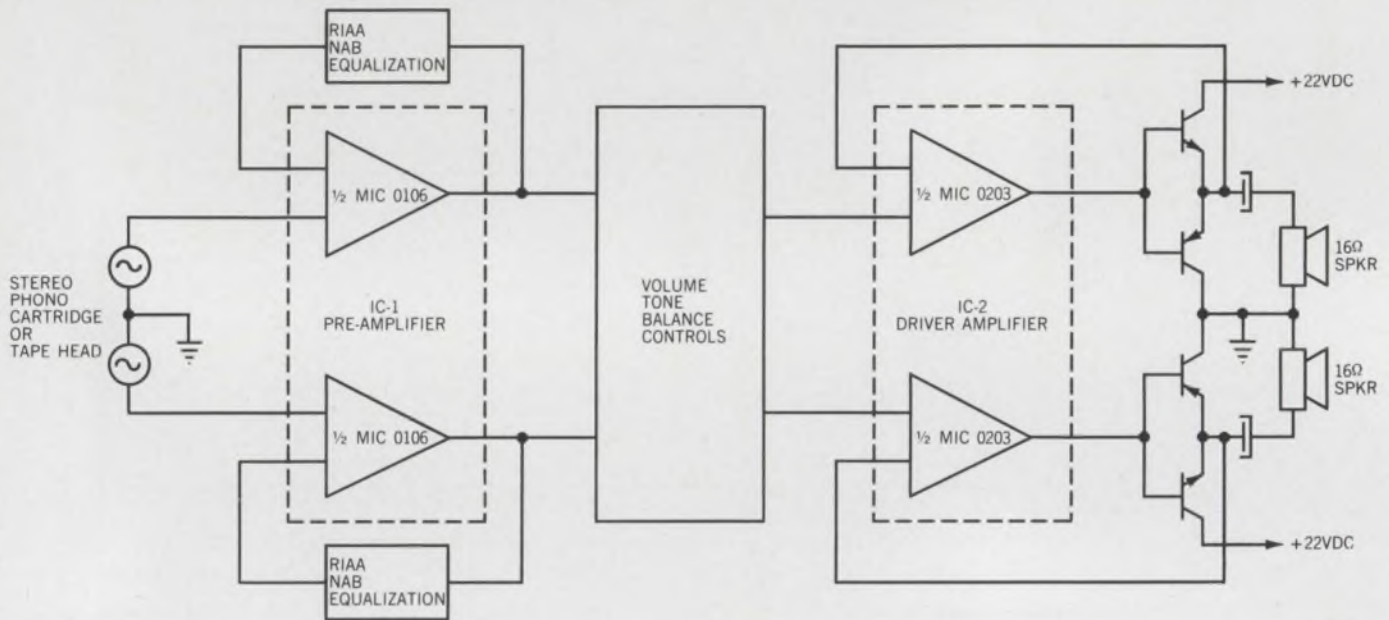

5 WATT STEREO AMPLIFIER
UTILIZING MALLORY INTEGRATED CIRCUITS

MIC 0102 Single-Channel, and MIC 0106 Dual-Channel Preamplifiers

- 60-db minimum gain.
- Feedback-frequency compensation provisions.
- 100K input impedance.
- Low distortion.
- Internal power supply filtering.
- Wide voltage-range supply.

MIC 0203 Dual Driver Amplifier

- 55-db minimum gain at $V_{cc} = 20$ Vdc.
- 10-ma drive current.
- Low input bias current.
- Low distortion.
- Power drive capability over 10- to 24-Vdc supply range.
- Direct drive for complementary or quasi-complementary output devices.
- Internal feedback resistors.
- External feedback capabilities.
- Two- and twelve-watt-per-channel drive capabilities.

Find out about these ultra-flexible IC's today... just three examples of our full range of value-packed IC's. Contact your Mallory Sales Offices, or P. R. Mallory & Co. Inc., Integrated Circuits Dept., Indianapolis, Indiana 46206. 317-636-5353.

MALLORY

125°C HOT

Nobody can make a 125°C capacitor this small with Polystyrene.



ACTUAL SIZE

Naturally, this one is a Kemet® Flat-Kap with Parylene.

And small size isn't the only important advantage you can design into circuits that absolutely require close tolerances, repeatable temperature coefficients, and rigid capacitance stability. Union Carbide's Parylene not only retains the low dissipation factor and high insulation resistance of

Polystyrene, but it has a melting point above 400°C, is impervious to solvents up to 200°C, and can be deposited on high purity aluminum foil as an ultra-thin, continuous, pinhole-free film. The advantages to you are clearly shown in the following comparison of specifications.

	KEMET FLAT-KAP	POLYSTYRENE
Temperature	-55°C to +125°C	-55°C to +85°C
Volume (.1µF 50VDC)	.072 in³	.280 in³
Temperature Coefficient	-200PPM	-120PPM
Dissipation Factor	<.15%	<.10%
Insulation Resistance		
25°C	10⁶ Meg.	10⁶ Meg.
85°C	10⁵ Meg.	10⁵ Meg.
125°C	10⁴ Meg.	N/A
Dielectric Absorption		
25°C	.03%	.02%
85°C	.06%	.08%
125°C	.20%	N/A
Retrace and Drift	±0.1%	±0.1%
Solvent Resistance	Excellent	Poor

Available off-the-shelf. Capacitance ranges from .001 µF to 1.0 µF at 50 VDC. Standard or custom tolerances. For complete information, see your local Union Carbide representative, or write to P.O. Box 5928, Greenville, S. C. 29606.

**COMPONENTS DEPARTMENT
MATERIALS SYSTEMS DIVISION**

P.O. Box 5928, Greenville, South Carolina 29606 · Tel: (803) 963-7421/TWX: 810-287-2536



THE DISCOVERY COMPANY

December is a good month for you to think about the years ahead



Career progress isn't always just a matter of ability. It's related to place and time, as well.

At National Cash Register, we're in a period of rapid, sustained growth. We're sure you know we haven't been in "just" the cash register business for years—but did you know we're now the second largest company in the world in the computer systems business? And we're so widely diversified in other directions that our products and engineering activities would fill a long, long list.

As a result, we're interested in talking about employment with engineers of all degrees. And physicists. And software people.

Our activities are so varied, we can probably place you in work in which you have a high degree of personal interest. And our expansion is such that you can expect to find yourself handling more responsibility than you do now, soon after you join us.

Write us an expression of your interest, and let's find out more about each other. We will not contact any past or present employer without your prior approval.

**Address: Mr. William Stephan
Dept. ED-1220
Executive and Professional Placement
The National Cash Register Company
Dayton, Ohio 45409**



We are an Equal Opportunity Employer M/F



Systems Engineers

Duties would include participation in system design and analysis of future on-line terminal systems as well as specialization in system problems entailing these on-line applications. Positions require a BS in Engineering; an MS in Engineering, Computer Science or Business is desirable.

Data Communications Engineers

These positions require a BSEE plus three years' pertinent experience. An Advanced EE degree is desirable. The experience required should be in these areas: switched telephone networks and private lines, communication procedures, software implications at central processor, digital control, modems, signal transmission and modulation theory.

On-Line Systems Engineers

A BS in Engineering or sciences is required. Advanced technical degree and/or MBA is preferred. Duties would include design of commercial on-line systems involving terminals, communication networks and central processing systems.

Terminal Hardware Design Engineers

A BSEE required. Primary responsibilities are varied but include MOS-LSI, logic design, system transaction analysis, terminal unit design and electronic packaging.

Test Equipment Engineers

These positions involve the development of complex test systems for MOS-LSI arrays and array PC assemblies. Minimum requirements include three years' experience in logic assembly design of IC test systems.

MOS/LSI

A MSEE or Physics degree required. Primary responsibilities include the following: mask making and photo-resist operations; oxidation and heat treatment; assembly and packaging design automation and testing.

Software/Systems Engineers

These positions require creative individuals with proven leadership ability. A BS degree in Engineering with 3-5 year' experience as Systems Engineer/Systems Analyst with hands-on experience with 360 systems software, related to teleprocessing, DOS or OS is desired. Duties would include interfacing NCR terminals and communication systems with other computer equipment.

Engineering Design Evaluators

BS-MSEE minimum requirement. For detail design evaluation of product designs, before product is approved, for final stage of development or purchase of equipment from other sources is approved. Sound technical judgment as well as a good working relationship with others is essential.

Section Head — Test Equipment Engineer

BS/MSEE 5-7 years' experience in test equipment design or EDP products. Duties include responsibility for design of equipment needed for test and inspection of EDP processing equipment, supervision of section (11-15 employees) and frequent contact with organizational section heads.

Circuit Design and Analysis

Electrical Engineers who have the desire to specialize in circuit design and analysis will be interested in this position. The work entails designing and developing special advanced circuits for computers and special accounting machines. This group also consults with product engineering departments in the development of new concepts.



We are an Equal Opportunity Employer M/F



TWO ROUND TRIP AIRLINE TICKETS BETWEEN NEW YORK AND PARIS!

HEATHKIT® COLOR TV—EICO "CORTINA" STEREO RECEIVER
ACCUTRON® WATCH—110 VALUABLE PRIZES IN ALL!



Electronic Design

1970 TOP TEN CONTEST

COMING JANUARY 4

HERE'S ALL YOU HAVE TO DO TO ENTER . . .

(1). Examine the January 4 issue of Electronic Design with extra care. (2). Pick the ten advertisements that you think will be best remembered by your fellow engineer-subscribers. (3). List these advertisements (in the rank order you think our readers will select them) on the special entry forms bound in the January 4 issue. Your *Top Ten* list will be compared with the ten ads ranking highest in the "Recall Seen" category of Reader Recall—Electronic Design's method of measuring readership.

See if you can pick the *Top Ten*—watch for the January 4 issue—then try your luck. 110 valuable prizes are waiting for the winners!

PRIZES—READER CONTEST

1ST PRIZE:	Round trip airline tickets for two between New York and Paris.	4TH & 5TH PRIZES:	EICO "Cortina" No. 3770 all solid state 70 watt AM-FM stereo receiver plus HFS-8 two-way, two-speaker system.
2ND PRIZE:	New Heathkit® deluxe 295 sq. in. GR-681 color TV kit with cabinet.	6TH THROUGH 12TH PRIZES:	Bulova Accutron® "Spaceview" electronic timepieces. 99.9977% accurate.
3RD PRIZE:	Heathkit® 227 sq. in. GR-227 color TV kit with cabinet and cart.	13TH THROUGH 110TH PRIZES:	Copies of "Fundamentals of Integrated Circuits" by Lothar Stern. 198 pages, hardbound.

NOTE TO ADVERTISERS AND THEIR AGENCIES

There's a separate *Top Ten Contest* for advertisers. All advertising personnel with manufacturers (companies) and their advertising agencies are eligible to enter. (You need not be an advertiser in Electronic Design to qualify.) Separate prizes will be awarded. **Each ad placing in the Top Ten will receive a free rerun.** In addition, if the first prize winner in the advertiser contest has an ad in the January 4 issue, he will receive a free rerun of a like ad of his choice. Contact your local Electronic Design sales representative for details—or check the January 4 issue.

**COMPLETE INFORMATION, RULES, AND ENTRY BLANKS
WILL APPEAR IN ELECTRONIC DESIGN'S JANUARY 4 ISSUE**



NEW AMI/MOS FAMILY — Random Access Memory Circuits. Mass produced RAMS by AMI can be programmed in your system for various word lengths, providing complete system design versatility. The 128 bit matrix, for example, can be hooked up as a 4 x 32, 2 x 64, or 1 x 128. Available now, these low cost, solid state memories are only part of the AMI/MOS story, which includes RAMS, ROMS, Shift Registers and other standard MOS products. Send for details. Better yet, hop a jet and visit our production facility — America's largest.

NOW IN PRODUCTION
RAMS
IN HANDY MATRIX



AMERICAN MICRO-SYSTEMS, INC.

3800 Homestead Road, Santa Clara, California 95051

Telephone 408-246-0330, TWX 910-338-0018

CUSTOM & STANDARD MOS ARRAYS/MEMORIES/REGISTERS/LOGIC

INFORMATION RETRIEVAL NUMBER 8

WE'VE GOT A BETTER WAY TO MAKE PRINTED CIRCUITS!

Here's some Industrial History you should know!

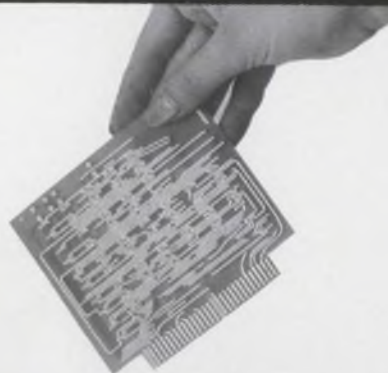

F-104

Developed new technique to produce circuit boards with more reliable plated-through holes.



PHOENIX

Required new techniques for manufacturing heat sinks and insulation by chemical milling.

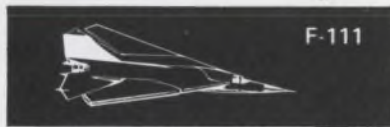

F-111

New industry technique was used to produce multilayer circuit boards with an internal heat sink.



POSEIDON

Developed new technology for sequential laminating multilayer circuit boards with aluminum backbone.



707

Reliable circuit boards in high volume at low cost were produced for this project.

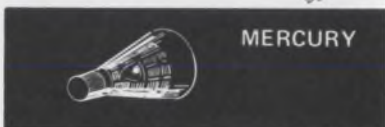

MERCURY

Our company used a unique etch-back method for plated-through holes in large quantities.

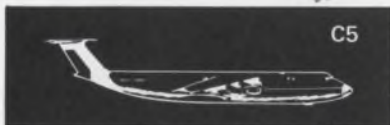

C5

We introduced circuit boards that had the highest density circuitry ever used before on a production basis.



GEMINI

Again, top reliability was required and delivery on-time was made to the customer.



OTHERS

Hundreds of projects use our circuit boards in all phases of civilian and military equipment. We've got a better way to make printed circuitry.



APOLLO

Our circuit boards were on Apollo, LEM, and sea, experiment. Sequential laminating, extra-fine line width and spacing, plated slots and edges.



This design & production experience can give you a BIG JUMP on your next project. CALL US NOW!

CONTROL DATA CORPORATION

CONTROL DATA CORPORATION

PRINTED CIRCUITS OPERATION
7800 COMPUTER AVENUE
MINNEAPOLIS, MINN. 55435
PHONE: (612) 920-8600

INFORMATION RETRIEVAL NUMBER 9

Designer's Datebook

JANUARY 1970						
Sun	Mon	Tue	Wed	Thu	Fri	Sat
				1	2	3
4	5	6	7	8	9	10
11	12	13	14	15	16	17
18	19	20	21	22	23	24
25	26	27	28	29	30	31

FEBRUARY 1970						
Sun	Mon	Tue	Wed	Thu	Fri	Sat
1	2	3	4	5	6	7
8	9	10	11	12	13	14
15	16	17	18	19	20	21
22	23	24	25	26	27	28

For further information on meetings, use Information Retrieval Card.

Jan. 14-16

International Conference on Systems Sciences (Honolulu, Hawaii) Sponsor: IEEE, Univ. of Hawaii. R. Chattopadhyay, Univ. of Hawaii, 2565, The Mall, Honolulu, Hawaii 96822

CIRCLE NO. 381

Jan. 25-30

Winter Power Meeting (New York City) Sponsor: IEEE. Technical Conference Services, 345 E. 47 St., New York, N.Y. 10017

CIRCLE NO. 382

Feb. 10-12

Winter Convention on Aerospace and Electronics Systems (Wincon) (Los Angeles) Sponsor: IEEE. R. Banks, Los Angeles Council IEEE, 3600 Wilshire Blvd., Suite 1920, Los Angeles, Calif. 90005

CIRCLE NO. 383

Feb. 18-19

Instrumentation Fair (Los Angeles) Sponsor: Instrumentation Fair Inc., Calif. L. Courtney, Larry Courtney Co., 16400 Ventura Blvd., Encino, Calif. 91316

CIRCLE NO. 384

Feb. 18-20

International Solid-State Circuits Conference (Philadelphia) Sponsor: IEEE, Univ. of Penna. L. Winner, 152 W. 42 St., New York, N.Y. 10036

CIRCLE NO. 385

Mar. 11-13

Scintillation & Semiconductor Counter Symposium (Washington, D.C.) Sponsor: NBS, IEEE. R. L. Chase, Brookhaven National Laboratory, Upton, N. Y. 11973

CIRCLE NO. 386

COMES WITH EVERY GE
TANTALUM FOIL CAPACITOR

Meticulous quality control

Is it possible to test in reliability? Hardly. It must be built in — then tested for verification. There is no better example of this than the GE tantalum foil capacitor. To verify its design parameters every unit gets 382 quality control checks during its manufacture.

After uncompromising quality control . . . a dissipation factor reading, capacitance test and leakage current test at room and high temperature provide extra verification. Each production lot is then sampled for rugged environmental testing to add even more assurance of performance to product specification.

This adds up to a tantalum foil capacitor with: (1) low leakage current, (2) long, stable shelf life, (3) no limit on charge or discharge current, eliminating the need for external impedance limitation. Units available with standard elastomer seals or with high-reliability glass-to-tantalum hermetic seals.

GE tantalum foil capacitors meet or exceed the requirements of MIL-C-3965 and MIL-C-39006 and are available in all specified sizes.

Choose from many standard units

	<u>Tubular Type</u>	<u>Rectangular Type</u>
Voltage Ratings:	3VDC-450VDC	10VDC-150VDC
Capacitance Ratings:	.5uf - 1450uf	20uf - 3500uf
Temperature Ratings:	— 55C to 125C	— 55C to 125C

Call your GE Electronics Distributor or GE ECSD District Sales Manager, or write Section 43037, General Electric Co., 1 River Road, Schenectady, N. Y. 12305

Electronic Capacitor & Battery Dept., Irmo, S. C.

GENERAL  ELECTRIC



Flame retardancy!

that's not all you get
with **GE Silicone
Rubber Insulation**

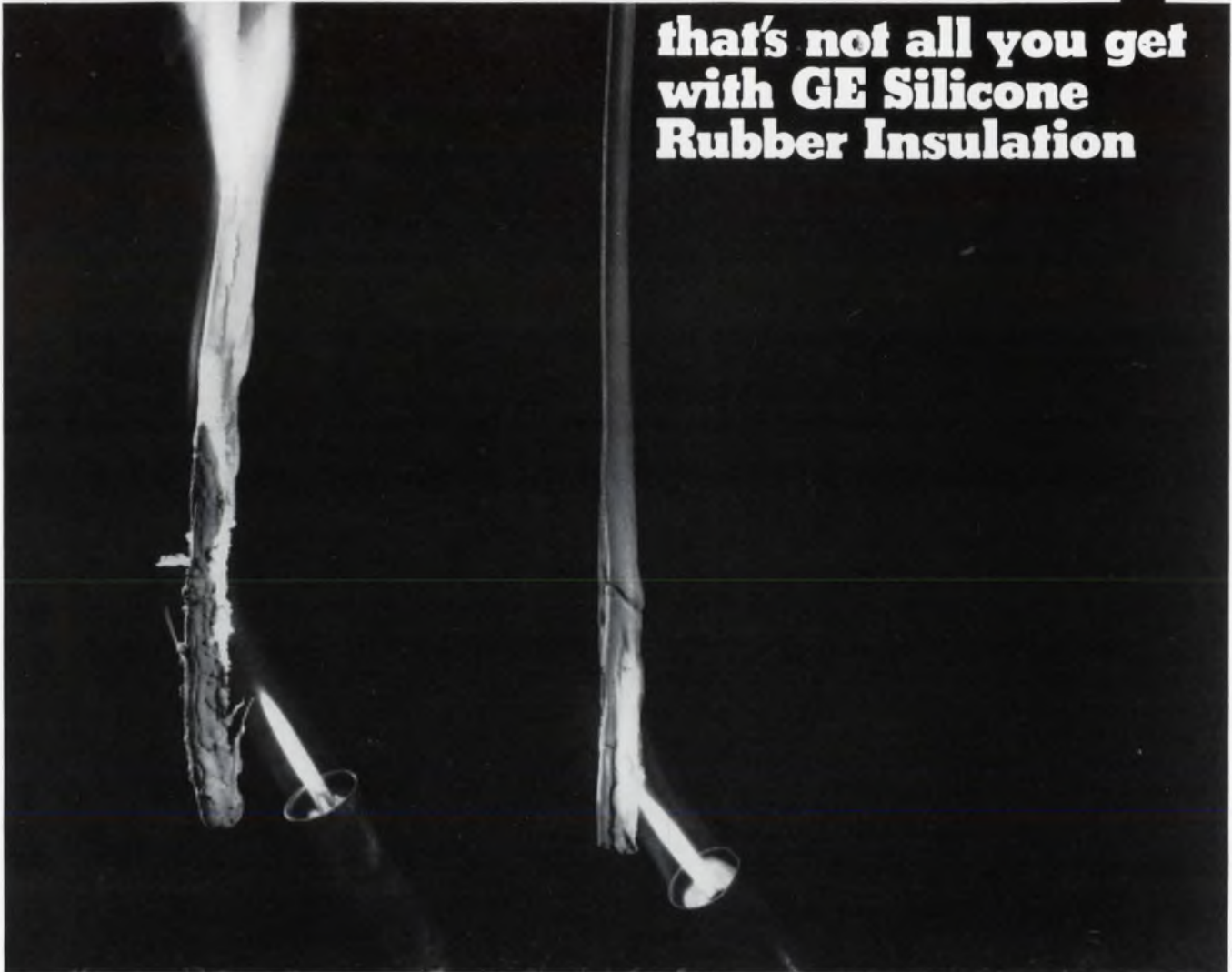

New ultra-tough SE-9090 braidless wire and cable insulation (right) doesn't support combustion like conventional insulation. It's shown here passing the UL vertical flame test. SE-9090 has both outstanding insulation resistance and dielectric strength.

The big news in silicone rubber this year is flame retardancy *plus* high physical strength.

But don't overlook the other design advantages of GE silicones: radiation, ozone, corona, and fungus resistance ... reliable performance from -150°F to 600°F ... and the proved dependability of silicones for the most demanding dielectric requirements. Weigh them all and you'll find that GE silicones offer the best combination of desirable values in insulation.

Versatile silicones take many shapes and forms to adapt to your specific problems. For a new booklet illustrating electronic applications for GE silicones, write Section L12294, General Electric Company, Waterford, N.Y. 12188.

GENERAL  ELECTRIC

Use GE flame-retardant silicones for...

Potting applications



Conformal coatings



Wire & cable insulation

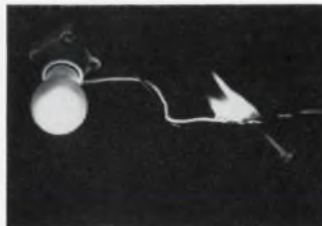

Fabricated parts

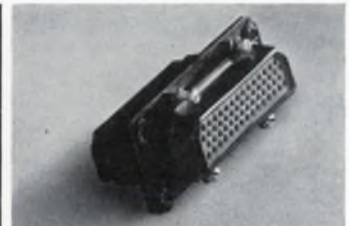

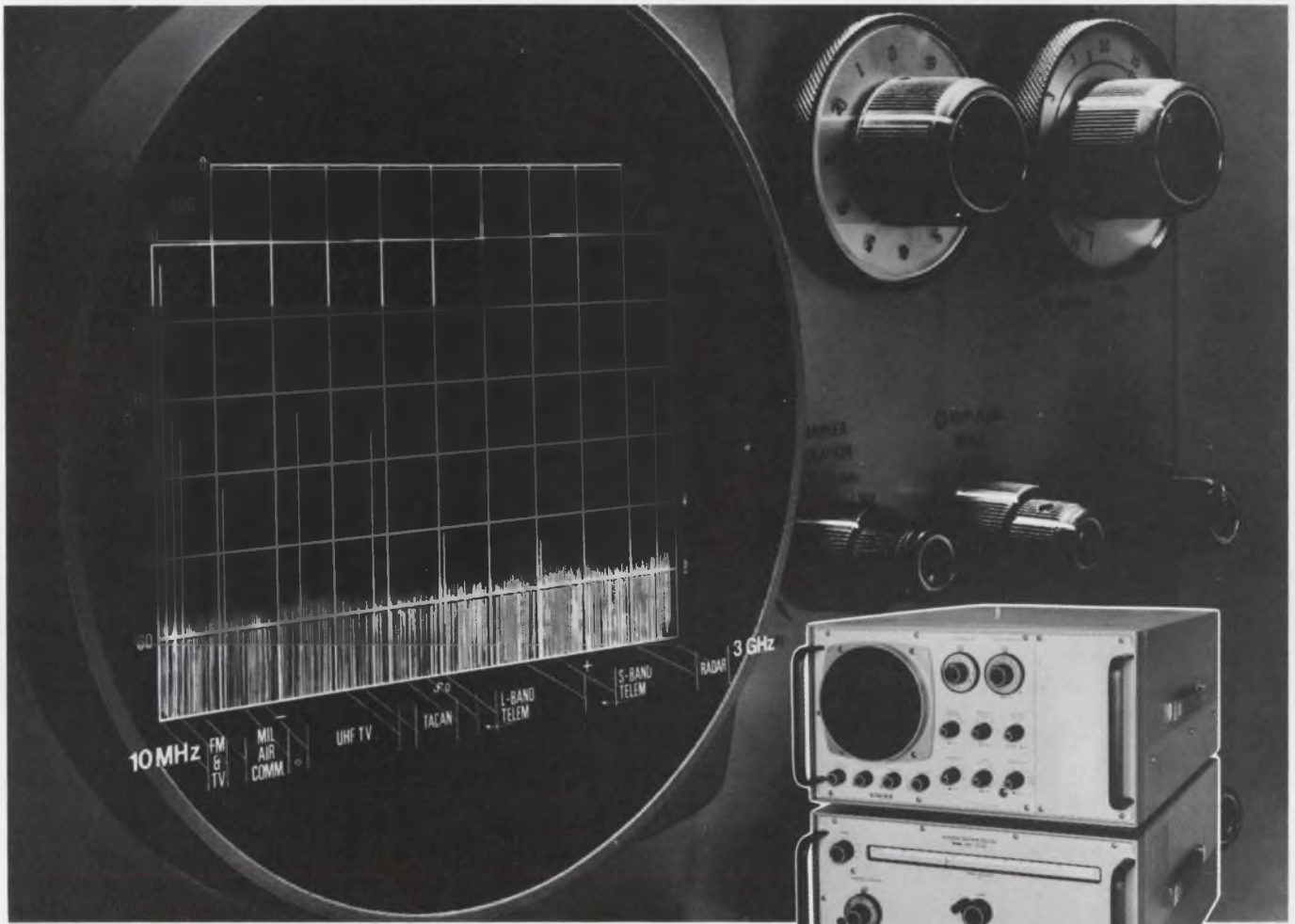

Singer opens the broad spectrum surveillance window, but keeps unwanted multiple responses out ... with the SPA-3000

Spectrum Surveillance is made easy with the Singer SPA-3000 wide dispersion microwave spectrum analyzer (10 MHz to 40 GHz) because of a unique set of bandpass filters . . . the combination of no inherent inband multiple responses coupled with the filters ability to eliminate out-of-band multiple responses provides an uncluttered display of the selected frequency spectrum.

- The FL-3000 filters require no tuning or tracking with the analyzer local oscillator
- Passive filter design assures minimum effect on response flatness
- Sharp skirt selectivity of the filter set maximizes multiple response rejection

- Filter eliminates direct i-f feedthru
- Filters can be purchased individually, as a set, or installed directly in the SPA-3000 with appropriate switching

Other features that make the Singer SPA-3000 the most versatile wide dispersion (3GHz) microwave spectrum analyzer available are . . .

- INTERNAL CALIBRATING MARKERS — provide a complete and rapid self-check of the entire system
- UNIQUE LOG AMPLITUDE SCALE— enables the measurement of narrow band pulse spectrums in a 1HMz bandwidth mode for maximum sensitivity and dynamic range

Frequency domain measurements are explained in Singer Instrumentations new Application/Data Bulletin SA-11 and in the Singer Instrumentation Review . . . a new technical journal. Copies are obtainable by contacting your nearest Singer Field Representative or by writing directly to The Singer Company, Instrumentation Division, 915 Pembroke Street, Bridgeport, Connecticut 06608.

In Europe contact: Singer Sewing Machine Company, Instrumentation Division, P.O. Box 301, 8034 Zurich, Switzerland, Telephone: (051) 47 25 10

SINGER
INSTRUMENTATION

...want a tantalum capacitor with proven performance?

Buy TYPE 150D TANTALEX[®] SOLID-ELECTROLYTE CAPACITORS

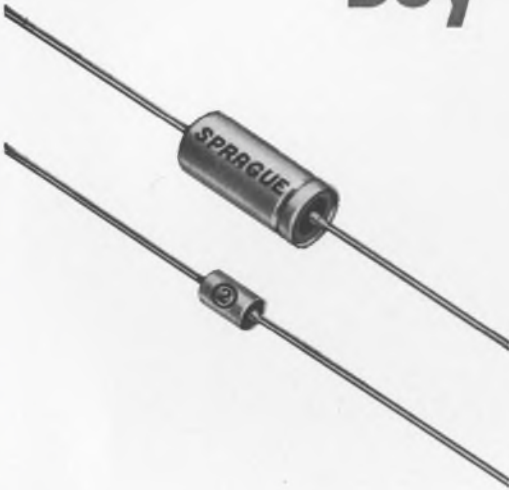

INFORMATION RETRIEVAL NUMBER 821

Hermetically-sealed in metal cases. Four case sizes, ranging from 1/4" to 3/4" length. Value-packed performance characteristics — low impedances at high frequencies, low dissipation factor, minimal capacitance drift with temperature, practically no change in capacitance with life. Low leakage current limits. Investigate new higher capacitance ratings.

450-9144R1

...stymied by costs of stacked-mica capacitors?

Try SPRAGUE DIPPED SINGLE-FILM MICA CAPACITORS

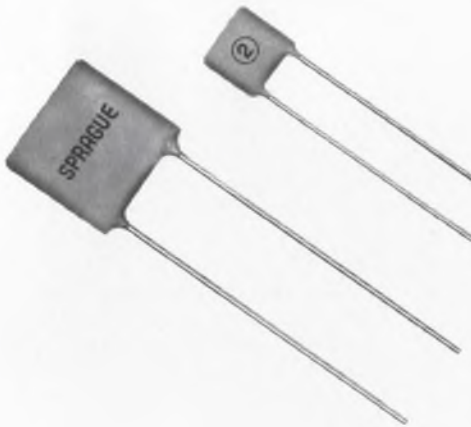

INFORMATION RETRIEVAL NUMBER 822

Mass produced silvered-mica capacitors for entertainment and commercial equipment. Combine excellent stability and retrace characteristics with economy. Ideal alternative to more expensive stacked-mica and ceramic disc capacitors. Exclusive manufacturing process prevents dielectric delamination as a result of temperature cycling. Designed for operation at 500 volts d-c. Capacitance values from 10 pF through 470 pF.

450-9151

For complete technical data on Type 150D Tantalex Capacitor, write for Engineering Bulletin 3520F. For information on Dipped Mica Capacitors, request Engineering Bulletin 1010A. Write to: Technical Literature Service, Sprague Electric Co., 347 Marshall St., North Adams, Mass. 01247.

SPRAGUE[®]
THE MARK OF RELIABILITY

Sprague[®] and [®] are registered trademarks of the Sprague Electric Co.

THE BROAD-LINE PRODUCER OF ELECTRONIC PARTS

News

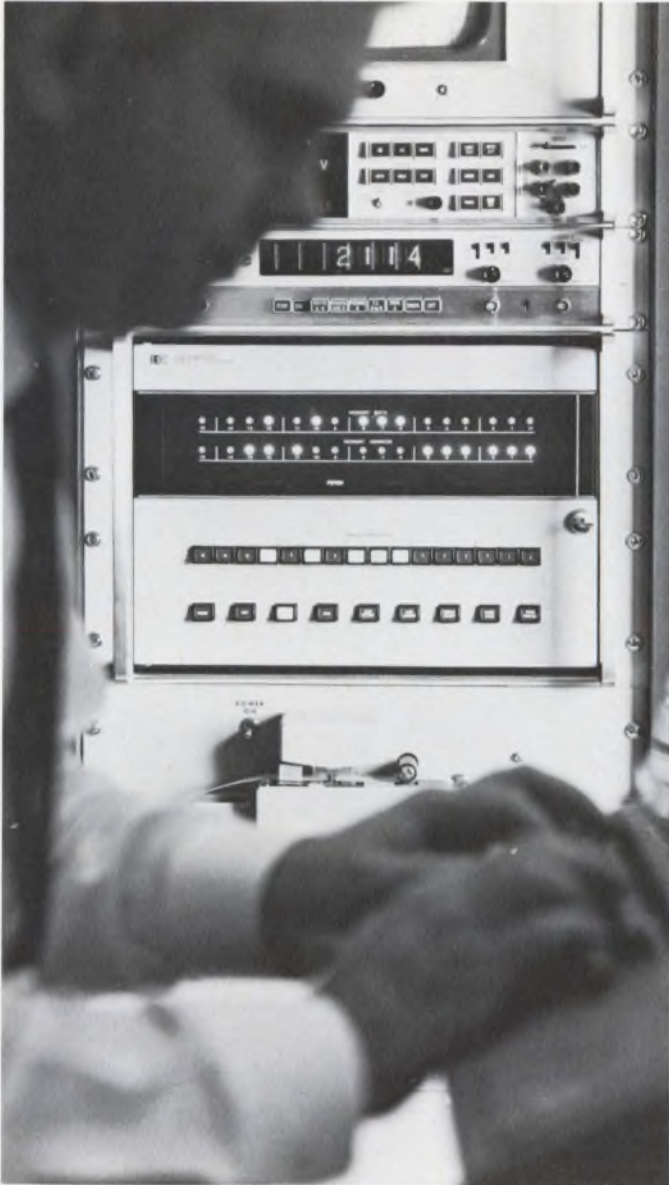

What kind of engineer will man tomorrow's superfast special-purpose computers? Will he be an artist or a blue-collar worker? p. 30.



A fast monorail system will whisk passengers from terminal to parking lot at Dallas-Fort Worth airport. p. 28.



The next most important advance in computer hardware will be in the area of peripheral equipment. p. 25.

Also in this section:

Mapping the sky at low frequencies, p. 32.

Fast switch devised for light system, p. 28.

News Scope, p. 21 . . . **Washington Report**, p. 39 . . . **Editorial**, p. 47.

Switching Diodes

9 from the pines

You may get weary. Bleary-eyed. And a mite confused.

With the thicket of 1,637 switching diodes to choose from.*

But stout heart!

TI's nine meet the majority of switching diode applications.

We make them by the millions. High quality. Double-plug construction. Keenly competitive prices. With ultra fast delivery from TI factory or distributor stocks.

All are part of TI's preferred semiconductor line. Selected after

months of computer demand analysis. To save you time and money in specifying discrete components.

So turn to TI switching diodes first. For computers. Calculators. Memories. Peripherals. Or any diode application that calls for low capacitance and fast switching speed.

If one of the nine doesn't fill your specific needs, TI makes dozens more switching diodes. Also logic and core drivers for computers and high-voltage diodes for TV.

*1969 Worldwide figure from D.A.T.A., Inc., publishers of *Electronic Data*.



TI's Preferred Switching Diodes

1N251	1N4148
1N661	1N4154
1N914	1N4448
1N914B	1N4454
1N3070	

Write for your copy of TI's new *1970 Preferred Semiconductors and Components* catalog: Texas Instruments, PO Box 5012, MS 308, Dallas, Texas 75222. Or just circle reader service card number 168.



TEXAS INSTRUMENTS
INCORPORATED

Drive focuses on perils in medical equipment

Medical electronics continues to draw the fire of professional groups concerned with consumer safety.

Citing hazards outlined by speakers at the National Conference on Medical Devices in Bethesda, Md., last September, the International Institute for Medical Electronics and Biological Engineering this month opened a drive to publicize the problems.

The Institute consists of some 3000 physicians, scientists and engineers concerned with the use and advancement of biomedical equipment. It is headquartered in Paris.

"We know there have been instances of device failure which resulted in patient injuries and fatalities," Dr. Herbert L. Ley, Commissioner of Food and Drugs in the Dept. of Health, Education and Welfare, told the September conference.

At the same conference Mrs. Virginia Knauer, Special Assistant to the President for Consumer Affairs, called attention to what she described as defective defibrillators, poorly designed dialysis units and accidental electrocutions in hospital operating rooms. Physicians are reluctant to report adverse experiences with electronic devices, Mrs. Knauer said, because of fear of malpractice suits and the difficulty of establishing a casual relationship between the adverse reaction and the use of a specific device.

"It is distressing to me as a consumer," Mrs. Knauer told the conference, "that the doctrine of *caveat emptor* still exists in this major health field."

Another conference speaker, Dr. Harry S. Lipscomb, co-chairman of the education and communication committee of the Association for the Advancement of Medical Instrumentation, noted that physi-

cians were confronted with an estimated total of 5000 different devices produced by more than 1300 manufacturers.

But all was not criticism at the Bethesda meeting. The life-saving contributions were also cited. For example, prior to the advent of pacemakers, the mortality rate for patients was 69%; with pacemakers, it is 7%, the Association for the Advancement of Medical Instrumentation noted.

A number of companies manufacturing medical instruments went on record at the conference as opposed to legislation that would require pre-clearance from the Government before equipment could be marketed—the way drugs are controlled. John T. Kimbell, executive vice president of Boxter Laboratories, Inc. Morton Grove, Ill., argued that such legislation would:

- Slow and possibly prevent the availability of life-saving devices, because of the cost of pre-clearance procedures.

- Regulate out of existence small companies that do not have staffs to perform extensive procedures.

A program for control of medical devices was proposed by Dr. James Goddard, vice president for health services of EDP Technology, Inc. Washington, D.C.. He suggested that a group of qualified, non-governmental scientists test company devices. If the device showed promise and safety, broader testing could then be applied for. If a proposal were rejected, review would be provided at the National Academy of Sciences-National Research Council level.

A National Center for Biomedical Engineering was suggested by Dr. R. F. Rushmore, director of the bioengineering program at the University of Washington. Such

an organization, he said, could perform unbiased investigations under the supervision of an appropriate governmental agency.

The coordinator of the safety and standards committee of the International Institute for Medical Electronics and Biological Engineering is Hans A. von der Mosel of Cliffside Park, N.J., a professor of biomedical engineering. "There is quite a serious risk involved in the use of biomedical devices," he told ELECTRONIC DESIGN.

Many of the hazards, he continued, are "still unknown to many instrument manufacturers and to the majority of physicians, medical and paramedical personnel, hospital architects, hospital engineers, hospital administrators and governmental agencies."

The House Interstate and Foreign Commerce Committee, headed by Rep. Harley O. Staggers (D-W.Va.), has received a number of bills to control therapeutic devices. But no hearings have yet been held, he said.

New Univac division to develop peripherals

Looking for significant growth in the computer peripheral equipment market, Sperry Rand Corp. has set up a new division—Univac Communications and Terminals Div.—to develop new devices and to sell them.

Univac's president, Robert E. McDonald, and Cecil M. Shuler, general manager of the new division, point to these marketing trends and projections:

- Sales of computer terminals are expected to increase 43% in 1970 over the 1969 totals, but an increase of only 22% is forecast in sales of central processors.

- Central processors now account for 37.7% of the computer sales market, and this figure should increase to 38% in 1975. But terminals, now only 8% of the market, should rise to 16% by 1975.

In conjunction with its new effort, Univac's marketing strategy is also undergoing a change in emphasis. The products of the new division are to be aimed at the original equipment manufacturer market, as well as at incorporation

into Univac systems.

As a start, the company announced two new peripheral products, both compatible with equipment produced by competitors. One is the DCS-1C data communications system, which can be used with Univac's 9000 series computers or with IBM's 360 family. The other is the DCT-1000 terminal, which is built around a low-cost buffered printer and which can be expanded with a keyboard, paper tape reader/punch, card reader/punch or other auxiliaries still to be developed.

The DCT-1000 is similar to the older DC-500, which does not include a buffer. Both terminals are compatible with teletype equipment but operate at 30 characters a second, about 2.5 times as fast as the standard teletype.

Univac's Communications and Terminals Div. will be headquartered in Salt Lake City and will make use of facilities formerly used by the Sperry Utah Div. of the corporation.

NASA plans tests in '72 of laser communications

NASA has ordered development of a laser communications system for testing by 1972. The system will be built by Aerojet-General Corp., Azusa, Calif., under a \$5-million contract.

Tests are planned of communications between the earth and Applications Technology Satellite-F, scheduled for launching into a stationary equatorial orbit in 1972. If that communications link is successful, a spacecraft-to-spacecraft laser communications test will be made in 1974 when ATS-G is launched into orbit.

The ATS-F test will be the first of laser communications with an unmanned satellite. An earlier system, using an infrared laser, was developed by International Business Machines and flight-tested unsuccessfully between an

aircraft and a fixed station at the White Sands Missile Range, N.M., in the early 1960s. Later, during the Gemini program, an RCA laser was similarly tested without success.

Aerojet-General will develop both space and ground laser terminals, and provision will be made to permit a full range of wideband and conventional data communications, including teleprinter, voice, facsimile, color TV and still photographs. Both ATS-F and ATS-G will be equipped with a deployable, 30-foot-diameter, high-gain, steerable antenna.

MIT and Caltech plan a Clean Air Car Race

A Clean Air Car Race, featuring low-pollution vehicles—such as steam, turbine and electric—is planned for September, 1970, from the Massachusetts Institute of Technology to the California Institute of Technology.

The vehicles may be designed and built by an individual or organization, but according to the race's organizers—Dr. Richard M. Thornton, professor of electrical engineering at MIT, and Dr. Jerome Shapiro, professor of engineering at Caltech—the cars must be student-driven. Potential entrants are asked to notify both Dr. Thornton and Dr. Shapiro by Feb. 28. Qualifying trials will be held at MIT on Sept. 2, and the cross-country race will start from there on Sept. 9.

The race is designed to encourage the development of low-pollution vehicles. Significant qualifications are that the car be able to go 60 miles in no more than 90 minutes without refueling or recharging, and that it accelerate from 0 to 45 mph in a maximum of 14 seconds.

Amateur radio satellite scheduled for launch

Radio amateurs all over the world, who are interested in the art of tracking satellites and participating in radio propagation experiments, will soon be able to practice on an amateur satellite called the Australis Oscar-A. What

is it? It's a 39-pound spacecraft that is scheduled to be launched as a secondary payload on the Tiros-M mission on January 9.

The Australis was constructed by a group of amateur radio operators at Melbourne University in Australia—hence the name. The second portion of the name is derived from Project Oscar, a U.S. West Coast organization of radio amateurs that has constructed and secured launches for four amateur satellites to date.

The West Coast group, called Radio Amateur Satellite Corp., has its headquarters in Washington, D.C. It was formed earlier this year to foster radio amateur participation in space projects.

The satellite will be placed into a near polar orbit at an inclination of 101.56 degrees to the earth's equator at an altitude of about 790 nautical miles. It will transmit low-power signals on two amateur bands—at 29.45 MHz in the 10-meter band and at 144.05 MHz in the 2-meter band.

Beacon transmissions will carry telemetry data pertaining to the condition of the spacecraft, including temperatures and the satellite's orientation with respect to the earth.

EIA adopts new system for numbering TV tubes

A new system for numbering the cathode-ray picture tubes in television sets has been adopted by the Electronic Industries Association. The purpose is to indicate more accurately the diagonal dimension of a television screen—the usable picture area.

The new "type designation system" replaces the previous method of assigning numbers that indicated the outside dimension of the bulb itself.

Under the new system, the letter "V" will be added to the type designation to distinguish picture tubes based on the new system.

A color picture tube having a picture diagonal of 28 1/4 inches, for example, might be assigned type number 30ABP22 under the old system. Under the new, the designation would be 28VABP22, accurately reflecting the actual picture diagonal measurement.

Stop tapping...
there's no friction
or roll-in jewel error
in a Westinghouse
portable instrument.



Westinghouse taut-band suspension instruments have no repeatability error because there is no pivot friction, no roll-in jewel error, and no measurable hysteresis in the taut-band materials.

The *tbl*[®] instrument mechanism is

so stable that the usual three- to six-month certification cycle may be safely extended to one or two years.

Westinghouse Type P-151 instruments are preferred by sophisticated instrument users in field service or in the laboratory—wherever electri-

cal quantities must be read reliably month after month.

Get full information from your Westinghouse distributor or salesman; or write Westinghouse Electric Corporation, P.O. Box 868, Pittsburgh, Pennsylvania 15230.

J-43011

You can be sure... if it's Westinghouse



Our center of attraction.

We're the only ones with .050 centers in our flat conductor cable connectors. We're the only ones with a metal shell to protect that fragile connector. And the only one whose connector will mate with any existing version. (No matter what type of wire is used.) Interchangeable. Intermountable. You can use them with any of your retrofit projects. And should repair be necessary, modular construction makes them easily repairable in the field. They can even be potted for environmental sealing. It's the newest idea yet in flat cable connectors. One more thing. We're trying to come up with a name for this connector. Something better than Flat Conductor Cable Connector. If you can think of a name we can use, it's worth a case of booze. And even if you don't win the booze, we'll be happy to send a genuine certificate recognizing your idea.

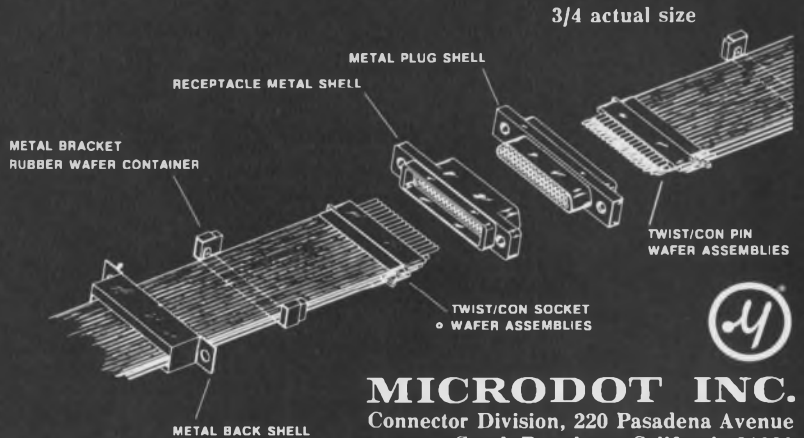
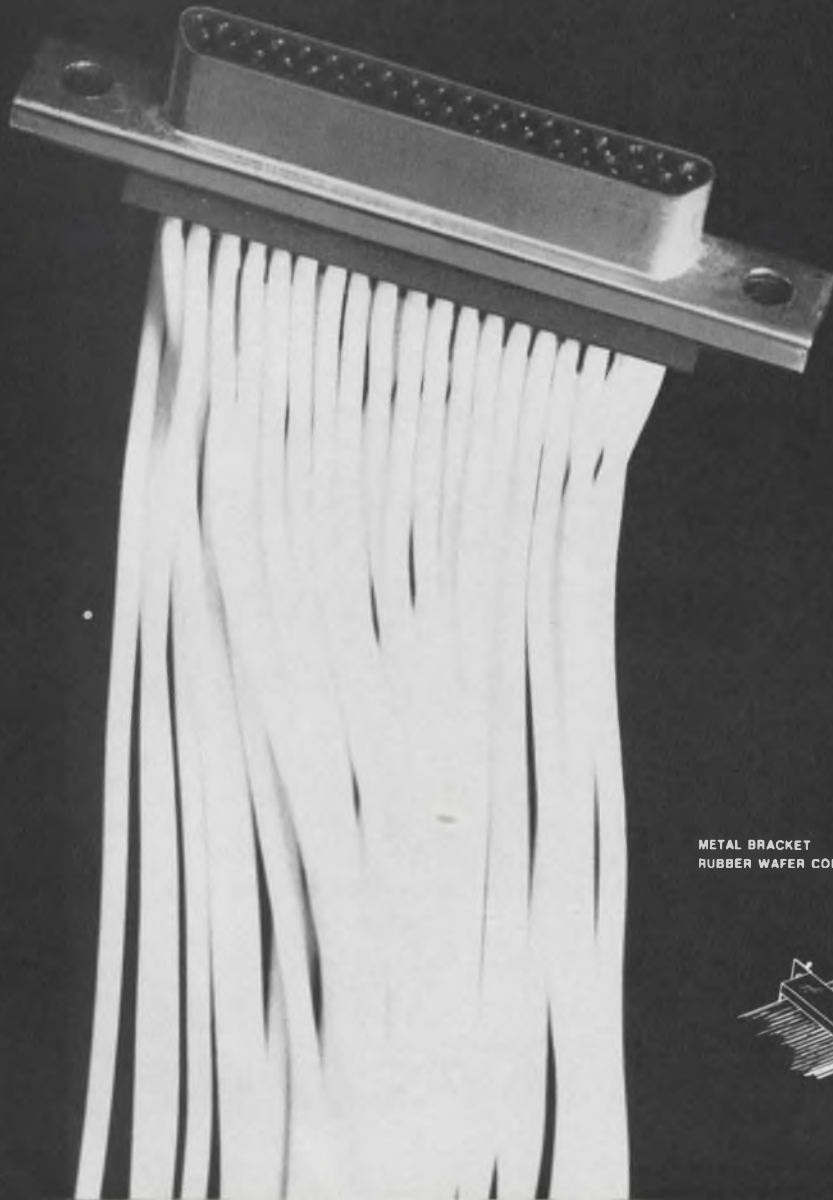

MICRODOT INC.
Connector Division, 220 Pasadena Avenue
South Pasadena, California 91030

It's time for change in computer peripherals

Major advances are on the way for this hardware, a tour of the Las Vegas fall conference suggests

Milton J. Lowenstein
Technical Editor

One of the most significant trends discernible at the Fall Joint Computer Conference was one that wasn't on view. It came from behind the scenes, after a tour of the exhibits and discussions with knowledgeable computer men.

It's this: The next important advance in computer hardware will be in the area of peripheral equipment.

Most of the computer peripherals that were on view in Las Vegas last month—tape, disc and drum memories, and the various input-output devices—were designed many years ago. But central processors have been undergoing radical changes in recent years, with huge sums invested in improvements. As a result, the computer main frames have capabilities that cannot be exploited by existing peripheral equipment.

At the same time the mini-computer has made its debut and is gaining wide acceptance because of its relatively low cost. Peripherals are falling behind here, too. There has been no development of low-priced peripheral devices to match the economy of the minis. Coupling a \$50,000 disc memory to a \$10,000 mini-computer just doesn't make economic sense.

Advances expected soon

The representatives of many computer-equipment manufacturers, both large and small, disclosed privately that they were expecting the peripheral field to advance, starting in 1970 and continuing for several years beyond that. Manufacturers are beginning to increase their investments in research, development, design and production activities.

One development on exhibit, originally tagged as a main-frame component, may very well be in the

forefront of the new peripheral devices. This is the semiconductor memory that uses large-scale integration technology.

Compact and inexpensive LSI memories are now in the last stages of development and will begin to appear as production components during 1970. Their advantages of small size and low cost are marginal in central processors, where so many other components account for the size and price of the completed computer. But what about an interactive graphic CRT terminal, in which the memory is now the most expensive and one of the largest components? LSI memories might remove the cost barrier to use of this type of device and make its use more general. LSI might be the key to the long-delayed fulfillment of the promise of graphic terminals. And it would make them portable, too.

Any peripheral device that requires random-access memory can profit from the advent of the LSI semiconductor memory. Data concentrators and high-speed line printers are other possible applications.

Low-cost peripherals due

What can be expected in peripheral equipment aimed at the burgeoning mini-computer market? Some possibilities were shown at the conference. Included were low-cost disc and drum memories, tape-cassette drives for low-speed memory capability, and phonograph records for storing program libraries.

Data Technology's California Peripherals Div. in San Jose showed its Model 588 mini-drum memory system, designed for applications that require a fast, economical data base. The price for the unit, with associated electronics, is expected to be about

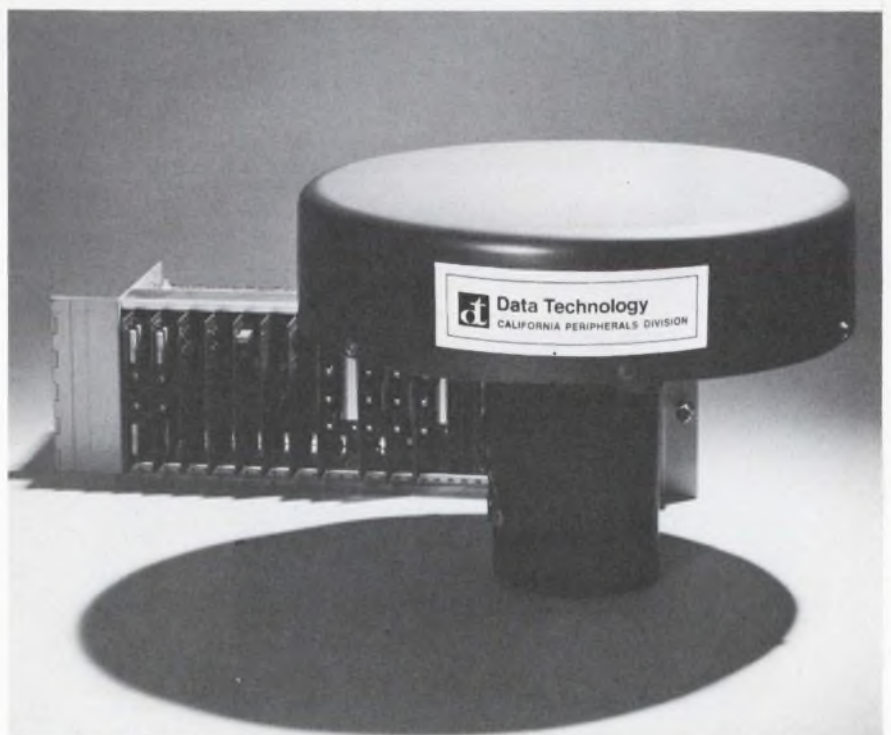

A small drum memory for use with mini-computers was shown by Data Technology. The low-cost device has a full line of electronic auxiliaries.

(computer, continued)

\$1500. Without the electronics, it will cost about \$800. The unit measures $9 \times 9 \times 9$ inches and it can store over 130 kbits on eight tracks. The average access time is 8.3 ms, and the bit transfer rate is approximately 1 MHz.

A larger, more elaborate and more expensive disc memory—the Iodisc Model 1012—was exhibited by Iomec, Inc., Santa Clara, Calif. It uses two discs, one removable and one nonremovable. It can store up to 22 million bits and read out at 720 kbits per sec. The access time is 20 ms, and motion time averages 60 ms. The unit fits into a standard relay track 30 inches deep and 64 inches high.

Iomec has a contract to supply Hewlett-Packard with \$2.5-million worth of Iodisc memories. Deliveries will start in January. Hewlett-Packard will market the disc memory for \$12,000, including controller, for its 2114, 2115 and 2116 stand-alone computers.

Cassettes and cartridges have blanketed the audio recording field

because of their handling ease, and they are now in a position to do the same in data recording. The relative merits of the cassette and cartridge depend on their packaging. The cartridge uses wider tape, which makes for somewhat easier tape handling and less need for precision, but it has only a single reel, which permits only unidirectional tape motion. The cassette, with its narrower tape, has two reels and bidirectional tape motion. It is, therefore, quicker to access a given bit with the cassette.

The cartridge has one additional advantage: It is available now.

Tri-Data Corp., Mountain View, Calif., is offering a complete data-recording system based on the tape cartridge, called Cartri-File. The cartridges used are not the same as the familiar eight-track audio cartridge. They operate on the same principle, but each contains two tapes. Each tape can store up to 150,000 six-bit words. The transfer rate is 857 six-bit words per second. The average search time for a 150-foot long tape is 90 seconds. The Model 4096 Cartri-File can accommodate two cartridges each containing two tapes,

thus allowing the handling of up to 3.6 million bits at one time.

Cartri-File is styled to blend with any typical mini-computer, and it is only 17 inches wide, 7 inches high and 13.5 inches deep. It sells for \$5,200, ready to plug in.

The cassette approach, using standard Philips cassettes, was shown by at least four different companies at the conference. The cassettes were just prototypes, however, so that availability is some time in the future. The devices varied from bare tape transports (analogous to the hi-fi tape deck) to systems with complete read in/read out electronics. All were aimed at the mini market.

International Computer Products, Inc., Dallas, had its Digi-Deck on display—a tape transport for use as a component. The simplest model includes read heads for two tracks. The most elaborate model can read/write and read after write. The unit is $4 \frac{1}{4} \times 5 \frac{1}{4} \times 6 \frac{3}{4}$ inches. Storage capacity for a 300-foot tape is given as 3.76 million flux changes.

International also showed an interesting application of its tape deck in a key-to-cassette tape system. By coupling an electric typewriter to the cassette recorder, the user can make a record of the typed information directly on magnetic tape, with no need for paper-tape or punched-card intermediates.

Both Sykes Datatronics, Inc., Rochester, N.Y., and Dicom Industries, Sunnyvale, Calif., showed packaged cassette recorders for use directly with mini-computers. Both use 300 feet of tape. The Dicom unit stores 1.44 million bits, and the Sykes, 3.6 million bits per cassette. Both operate at about 5000 bits per second. Average access time is about 15 s. Dicom has three models that can accommodate one, two or three cassettes, respectively. The Sykes recorder can handle one cassette at a time; Dicom's fits a relay rack. No prices were quoted by either manufacturer.

One other cassette recorder—the Telex Termicorder—was shown by Telex's Midwestern Instruments Div., Tulsa, Okla. However, no detailed information was available. The Termicorder bears a close resemblance to the conventional audio cassette recorder, and it is intended for desk-top use. ■■

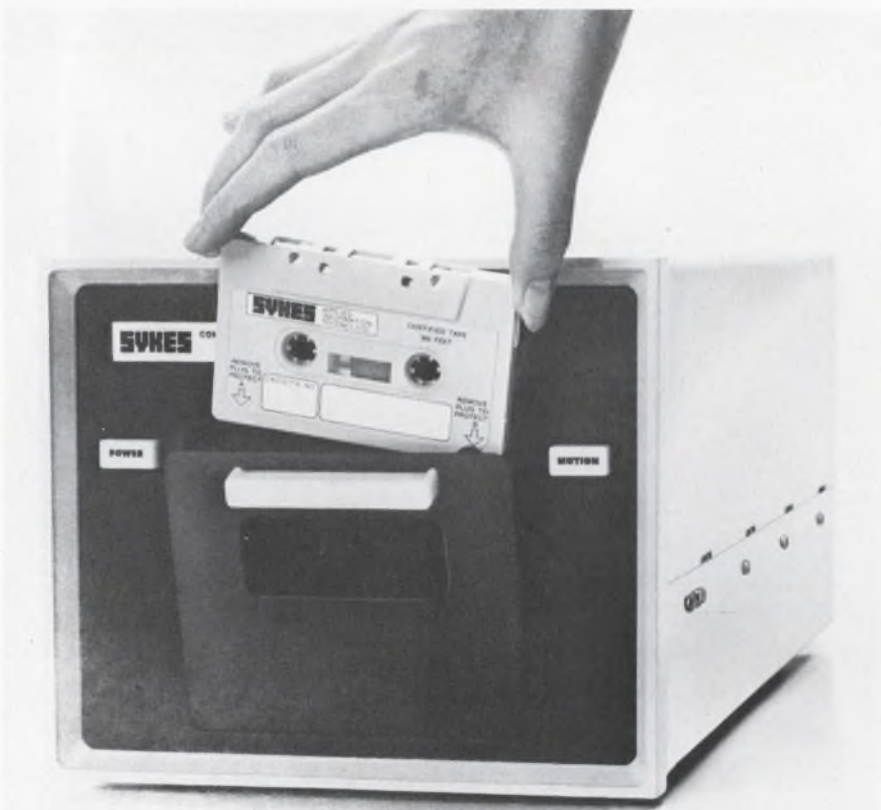

One of several cassette data recorders on view was this Compu/Corder 100. The tape is computer grade and has a preformatted address track.



less
than
\$1.00*

for new high performance
A-B solid hot-molded
variable resistor...

A-B Type W
variable resistor
shown about 5 times
actual size

The QUALITY is Allen-Bradley—the price is COMPETITIVE! This new Type W variable resistor is a commercial version of the Type G control.

This Type W variable resistor features a solid, hot-molded resistance track for long operating life. Life tests show less than 10% resistance change after 50,000 complete cycles. Noise level is low initially and actually becomes less after normal use. Furthermore, the resolution is essentially infinite, and the low inductance permits operation at high frequencies where wirewound controls are useless.

The Type W control, while only $\frac{1}{2}$ inch in diameter, is immersion-proof. The shaft is sealed with an "O" ring, making it watertight at that point.

Rated $\frac{1}{2}$ watt at 70°C, the Type W can be operated at 120°C ambient with zero load. Nominal resistance values are from 100 ohms to 5.0 megohms.

You can get immediate delivery at factory prices from your authorized A-B industrial electronics distributor. Or write: Marketing Dept., Electronics Div., Allen-Bradley Co., 1201 S. Second St., Milwaukee, Wis. 53204. Export Office: 1293 Broad St., Bloomfield, N. J., U.S.A. 07003. In Canada: Allen-Bradley Canada Limited.



ALLEN-BRADLEY
QUALITY ELECTRONIC COMPONENTS

*Standard unit with plain bushing and hardware, 20% tolerance in 1,000 piece quantities. Price subject to change without notice.

Fast switch devised for light systems

A light gate that switches in 5 trillionths of a second—1000 times better than the best commercial Kerr cell—has been developed by physicists M. A. Dugay and J. W. Hansen of Bell Telephone Laboratories, Murray Hill, N.J.

The light gate, which may eventually be used as a light modulator for a laser communication system, or in high-speed photography, is switched on and off by a pulsed laser beam, similar to the way electrical pulses are used in a Kerr cell.

A powerful light pulse from a laser (at 1.06 microns) polarizes the molecules in a liquid dielectric (carbon disulphide or nitrobenzene) cell. This, in turn, produces birefringence and changes the refractive index of light passing through the liquid.

Pulses of green laser light (at 0.53 microns) pass through a polarizer before striking the carbon disulphide cell. As they pass through the cell, they are affected by the birefringence created by the 1.06-micron laser beam. The green light

is then changed in polarization by 90 degrees, and this permits it to pass through the second polarizer.

The energy of the output pulses is monitored by a photomultiplier tube, recorded on tape, and displayed on an oscilloscope.

Dugay says that live sampling can be achieved once the pulse repetition rate of the laser is 1 kHz or better.

Other liquid dielectrics, besides nitrobenzene and carbon disulphide, are being studied by Dugay and Hansen. ■■

Computer-run monorail for airport transit

"The passenger presses one button designating his destination. The vehicle then goes express via the shortest route to the destination." Simplicity is the beauty of this new airport transit system, according to Ray Brunson, manager of electronic and electrical engineering on the Monocab, at Varo, Inc., in Garland, Texas.

Designed for transferring passengers from one terminal to another, and for moving passengers between terminals and parking lots a mass transit system will be built for the new 18,000-acre Dallas-Fort Worth Regional Airport. Due to open in the mid-1970s, the airport will act as a hub where most of the passengers leave one airline and transfer to another. Varo has one of two contracts let to build prototypes.

Called the Monocab Transit System, its prototype consists of numerous six-passenger, cab-type vehicles operating on a suspended steel guideway above surface traffic. The cabs travel at 20 mph and can be brought to a stop in 3 seconds. A complex of special-purpose computers controls all operations.

According to Brunson, "We have a logic module on each vehicle. We have a logic package at the station, and we have a central surveillance module for status, track location,

vehicle location on track and malfunction location. The on-vehicle package controls operating and homing commands. The on-station package handles dispatching of merging vehicles. The central surveillance package interrogates every vehicle five times every second as to over-all vehicle condition."

It is a demand system, says Brunson. "You have vehicles only where you need them. If a vehicle is not in use it will be parked at a station. If a cab is not waiting at a station, a passenger can push a button that will call the nearest empty cab over to pick him up."

If more than one passenger gets on the cab, it will accept commands to stop at more than one station. However, if more than six passengers get on, the cab will instruct the extra passengers to get off before the cab will move. Weight sensors detect more than six average passengers.

Highly advanced technology has gone into the design of this system. "We are using light as a communication media," reports Brunson. "We're using analog and digital control systems. We use electrical propulsion and electrical actuation on our controls. The system is mostly integrated circuit and solid-state." ■■



Computer-run monorail being readied for airport service. The Varo Monocab is a reinforced, molded fiberglass vehicle that will comfortably seat six passengers and has space for luggage. Air conditioning, thermal insulation and sound-proofing are featured. It will go into service at the new Dallas-Fort Worth Regional Airport.



Here's your answer to shock and vibration problems

■ Allen-Bradley Type R adjustable fixed resistors are unexcelled for holding precise settings through extreme conditions of shock and vibration. This unusual ruggedness is the result of a manufacturing process—perfected and used only by Allen-Bradley—which hot molds the resistance and collector elements, terminals, and insulating material into an almost indestructible component. Thus, the controls can be mounted by their own rugged terminals *without* additional support.

The solid resistance track assures such smooth control that it approaches infinite resolution. Its smoothness cannot be compared with the abrupt wire-wound turn-to-turn resistance changes which may cause circuit transients. Since Type R controls are essentially non-inductive and have low distributed capacity, they can be applied in high frequency circuits where wire-wound

controls are impractical. The Type R molded enclosures are both dustproof and watertight, permitting encapsulation after adjustment.

Allen-Bradley Type R controls are suitable for use from -55°C to $+125^{\circ}\text{C}$ and are rated $\frac{1}{4}$ watt at 70°C , 300 volts max. RMS. Available as standard in total resistance values from 100 ohms to 2.5 megohms with tolerances of $\pm 10\%$ or $\pm 20\%$. As special, can be furnished down to 50 ohms. For immediate delivery at factory prices, call your authorized A-B industrial electronics distributor. Or write: Marketing Dept., Electronics Div., Allen-Bradley Co., 1201 S. Second St., Milwaukee, Wis. 53204. In Canada: Allen-Bradley Canada Limited. Export Office: 1293 Broad Street, Bloomfield, N. J., U.S.A. 07003.

Allen-Bradley Type R Adjustable Fixed Resistors—Shown actual size

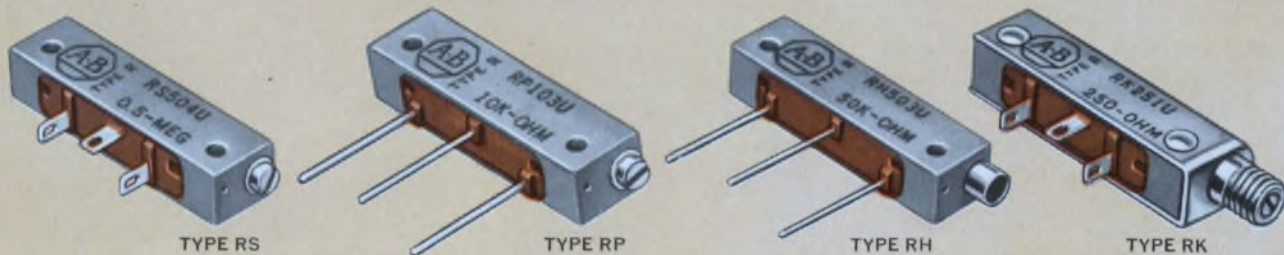

ALLEN-BRADLEY
QUALITY ELECTRONIC COMPONENTS

Will computers eliminate the specialist?

By 1980, engineering knowledge could be reduced to routine practice by complex machines

Ralph Dobriner
Chief News Editor

Imagine the world of 1980 in which there are a few million computers—a thousand times faster than today's machines, and with terminals available wherever they might be needed.

A pipe dream? An entirely reasonable prediction, according to Robert Barton, professor of computer science at the University of Utah. But it is a forecast that raises some important questions: Will there be engineers to man the consoles? And for that matter, what role will an engineer play?

Speaking on the uses of computers in engineering before the recent "Technology Forecast for 1980" meeting held in New York City, Barton cites the case of an acquaintance of his.

"He used computers heavily during work on his PhD in mechanical engineering, but he soon discovered that the specialized knowledge acquired during his graduate studies had been reduced to routine practice and been made obsolete by new computer programs then becoming available."

Supplanting the slide rule

Barton observes that the demonstrated capability of machines to carry out lengthy, complex, arithmetically demanding procedures in tremendous volume and with high reliability could end engineering specialization.

Buckminster Fuller, the renowned architect, says Barton, has already stated that the computer means the end of specialization.

"Specialists could, as their final contribution," he observes, "record the procedures of our highly quantified technology in the form of computer programs before they, too, retire to creative thinking."

Today's graduate engineers, according to Barton, use computers

as the older ones once used slide rules, and they "tend to like machines a little bit more than people."

In today's engineering schools, he observes, you will often find less interest in political activism than in computer science.

Computer science taking over

"In some schools electrical engineering, two decades after it became electronic engineering, is rapidly changing into computer engineering. In others, computer science is taking over all engineering both from within and without."

Barton notes that the engineers

of 1980, if they are to be more than "blue-collar workers, applying canned computer programs prepared by unseen experts, will have to be more artists than technicians and design with the paramount idea of service to people.

"This would imply striking changes in engineering curricula, even the disappearance of engineering as a field of specialization," he says.

With a thousandfold improvement in computing power within the decade, Barton foresees the exciting potential of the computer as a device for simulating systems that are too costly in money or time to model physically.

"Simulations," he notes, "of physical phenomena in nuclear reactors, electronic circuits and mechanical devices, for instance, are possible since mathematical models



Complex computer systems of tomorrow, which will carry out lengthy, complex, arithmetically demanding procedures in huge volumes, could spell the end of engineering specialization.

exist that demand heavy computation.

"In order to be useful in control applications these computations must be performed at greater than real-time rates. In other words, the computation must be carried out at a speed that exceeds the unfolding of the corresponding physical phenomena."

The simulated process, says Barton, will be observed perhaps by means of three-dimensional computer graphics, with dynamic interaction from the observer.

Computer graphics loom

"For those who tend," says Barton, "to think of computer output as consisting mainly of numbers, a sampling of today's best work in computer graphics is revealing."

With the predicted increase in computing speed by 1980, the possibilities of computer-produced line drawings in motion are limitless, and so are the more realistic near-photographic half-tone views of objects.



"Future engineers will have to be more artist than technician"—Robert Barton.

When Designing Your Solid-State System, Specify ATI Preamps

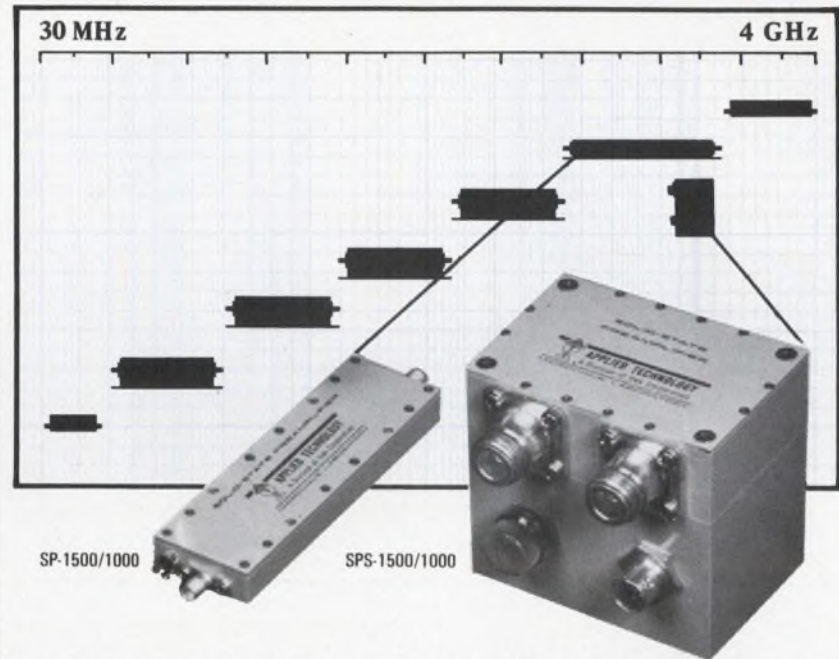

The SP-1500/1000 L-Band preamplifier is now available with an integrated power supply for direct TWTA replacement. Designated the SPS-1500/1000, the unit covers the frequency range from 1000 to 2000 Megahertz. Microstrip construction of the all solid state design permits significant reductions in size, weight, power consumption, and heat dissipation.

- Frequency Range: 1–2 GHz
- Intercept Point: +7.5 dBm (3rd order intermod)
- Max. Noise Figure: 7.0 dB
- 1 dB compression point: +3 dBm min.
- Gain: 25 dB
- Power: 115 ± 10 VAC, 2W
- Gain Flatness: ± 1.0 dB
- Size: 2X3X3 in.

Optional gain and bandwidth increments also available.

Write or call collect for additional information or application assistance.

Employment Opportunities for Qualified Engineers

An equal opportunity employer.

SOLID-STATE OSCILLATORS • MIXER-PREAMPS • PREAMPS • FREQUENCY MULTIPLIERS

APPLIED TECHNOLOGY
 MICROWAVE LABORATORY
 A Division of Itek Corporation
 3410 Hillview • Palo Alto, Calif. 94304 • (415) 321-5135 • TWX 910 373-1218



(specialist, continued)

To accomplish this would require development of special-purpose algorithm machines like those already in wide use in geophysical calculations and in fast Fourier transform applications. We would have to give up the widely held notion that ever larger general-purpose computers are always best."

Programs need improvement

Along with the explosive use of computers in the next decade, Barton sees the need for considerable improvement in programs.

It will be necessary, he says, to produce extraordinarily complex programs to do anything of significance. What has been done so far in the area of programming, he notes, is "toylike."

If the engineer is really going to

be capable of using tomorrow's computer systems as effective tools, programming has got to be made into a "communications skill."

And how do you go about doing that?

Barton suggests that we will have to learn to look at computer programs as the "preferred embodiment of technical knowledge."

What this means, he says, is that throughout the various specialized fields, programlike "languages" will be used to a much greater extent than they are now.

Programs must be made easy to use in a communications sense, Barton says—"not just easy to read, but easy to write.

"There's no language at present that is suited for this kind of thing. We have got to find ways of improving the construction and reliability of computer programs, and one of the ways is to stress the dual language idea."

In another two or three decades, says Barton, a good part of the

population will be bilingual—using a natural language suitable for human discourse on technical non-subjective materials, and another language for the control of machines.

"Because of the great popularity of computer science among today's students, I think such technical languages will be in wide use before the end of the century."

Barton believes that the computer field is not yet ready for the thorough systemization that electronic engineering was subjected to in the late Fifties.

Many engineers, he says, will continue to use machines only through intermediaries equipped to make the necessary adjustments to the idiosyncracies of the computers and programming methods that are then in use.

"Standardization of programming languages either by agreement or de facto cannot be effective until the field is more mature," Barton concludes. ■■

Mapping the sky at low frequencies

An antenna twice as high as the Washington Monument is proposed by Penn State radio astronomers as the best means of obtaining a low-frequency map of the sky.

The inflatable antenna would be compressed into a metal cannister and carried in a satellite to a point several thousand miles above the earth. The antenna would then be launched into orbit, expelled from its metal cannister, and inflated by compressed gas, much like the Echo balloon satellites of the early 1960s. The antenna would monitor radio waves from the sun and the galaxy at 300 kHz (1000 meters), 1 MHz (300 meters), 3 MHz (100 meters), and 10 MHz (30 meters).

According to John P. Hagen, head of Penn State's astronomy department, most radio astronomers have studied the universe through high-frequency radio waves from 15 MHz to 20,000 MHz, corresponding to wavelengths of 20 meters to 1.5 centimeters, because the earth's atmosphere is transpar-

ent to most.

Hagen says that, to advance our knowledge, we need to complete the observations by monitoring low-

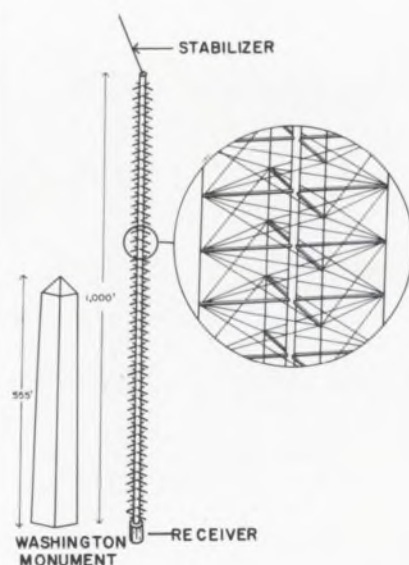

A 1000-foot antenna is proposed for low-frequency mapping of sky.

frequency radio waves from 300 to 200 meters long.

In a feasibility study funded by NASA, Maurice Sevik, an aerospace engineer, and a group of radio astronomers designed the antenna system. It would be 1000 feet high and 6 feet wide. Projecting from the main cylinder would be four inflatable antenna elements forming a cross. More than 100 such elements would be placed along the length of the cylinder.

Proposed material for the cylinder and the antenna elements is metallized plastic, which conducts radio waves.

When placed in orbit, the earth's gravity would keep the receiver end of the antenna pointing toward earth. The satellite will receive signals from most regions of the sky.

Radiometer receivers in the lower end of the antenna would operate continuously, storing information on magnetic tape and transmitting it to earth when the antenna passes over a telemetry station. ■■

Need a fast, accurate solution to an IC problem? E-H Research Laboratories, Inc. teams up with Iwatsu Electric Company, Ltd. to offer you the ideal test instrumentation.

E-H breaks through with the **E-H 129 pulser** which is capable of driving the fastest digital logic circuits. Until this compact, all solid-state instrument came along, no practical commercial pulse generator offered repetition frequency capability beyond 200 MHz. The E-H 129 offers 500 MHz, 2-volt pulses with less than 500 ps risetime and such extras as baseline offset, pulse-top/baseline inversion function, and synchronous gating.

And the ideal mate for this instrument is the **Iwatsu 5009B sampling scope** which allows you to observe and control the waveforms you generate. The Iwatsu 5009B with 18GHz bandwidth lets you evaluate fast circuits with high accuracy—in fact, direct measurements on 100 ps edges with less than 2% display error. Features include less than 20 ps risetime, sensitivity from 10mV/cm, dual-trace performance with seven operating modes, separate miniature sampling heads, big CRT and triggering to full bandwidth for extra convenience.

If these two instruments can't solve your problems, E-H can offer you E-H and Iwatsu instrumentation that can. Contact an E-H representative and get a fast solution. Today.

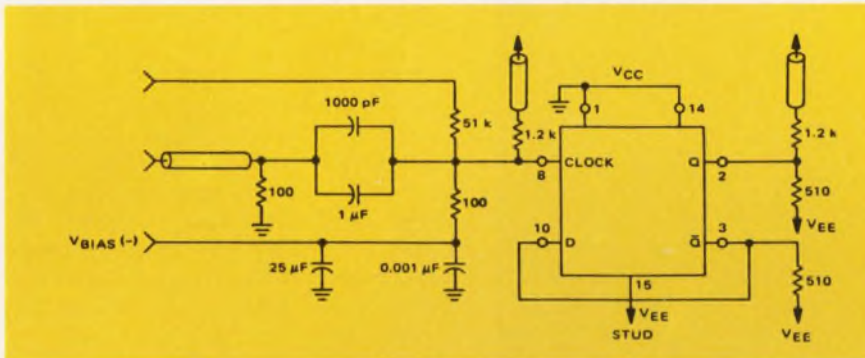

E-H
the
fast
solution

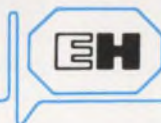

E-H RESEARCH LABORATORIES, INC.

515 Eleventh Street • Box 1289, Oakland, California 94604 • Phone: (415) 834-3030 • TWX 910-366-7258
 In Europe: E-H Research Laboratories (Ned) N.V., Box 1018, Eindhoven, The Netherlands, Telex 51116
 In Japan: Iwatsu Electric Company, Ltd., 7-41, 1-Chome Kugayama Sugunami-Ku, Tokyo 167, Japan

INFORMATION RETRIEVAL NUMBER 20

Computer speeds spectral analysis

Measurements of the spectral content of audio noise have been speeded up by a factor of up to 5 million by means of a new technique that includes a mini computer in the measurement system.

Normally, spectral analysis is accomplished by analyzing a specific bandwidth at a time. In the audio range, this means that an unacceptable amount of time is required to obtain meaningful spectral resolution. For example, to scan the range from 10 Hz to 2000 Hz with a filter having a 10-Hz bandwidth would take about 33 minutes.

A real-time spectrum analysis system has been designed by Spectral Dynamics Corp. of San Diego, Calif., which speeds up the measurement. The technique involves processing the entire input waveform as it occurs.

How the system works

Tony Keller, an applications engineer at Spectral Dynamics, describes the operations of the system.

"The input waveform," he says, "is digitized at a sample rate three times that of the high limit of the range being analyzed. The digitized samples are buffered and then entered into a recirculating memory which has a cycle time of 100 μ s."

The reason for buffering, he explains, is so that the entry of each successive sample can be timed with respect to the memory cycle. Each successive sample is entered into the memory at a slightly later time in the memory cycle than the preceding one so that the order of samples is preserved.

Keller goes on, "When the input waveform has been scanned for an appropriate interval, and all the digital samples obtained from that scan have been stored in the recirculating memory, the contents of the memory are unloaded in a



Meet the "Mite".
Only .218" diameter. The toughest ceramic disc trimmer capacitor its size.

New from E. F. Johnson. And it's this small: 
Designed for printed circuit applications where space is at a premium. Stator of High Alumina for greater shock and vibration resistance. The rotor plate is encapsulated in ceramic for environmental stability and long life. The Q factor at 1 MHz is 500 minimum. Precision lapped bearing surfaces give you smooth linear tuning. Pick from a wide capacitance range: 1.0-3.0 pF, 2.5-9.0 pF, 3.5-20.0 pF, 5.0-25.0 pF. Designed to meet or exceed applicable requirements of MIL-C-81A.

Return the coupon today for information on Johnson's new Micro-J.[™] And if you have a special capacitor need, we'd like to work with you. The same engineering that made our air variable capacitors the standard of excellence goes into every new Johnson product.

E. F. JOHNSON COMPANY/3312 Tenth Ave. S.W./Waseca, Minnesota 56093

- Send product specification information on new Micro-J capacitor.
 Include information about your full capacitor line and other Johnson components.

NAME _____

TITLE _____

FIRM _____

ADDRESS _____



CITY _____

STATE _____

ZIP _____

E. F. JOHNSON COMPANY

INFORMATION RETRIEVAL NUMBER 21

single cycle and read out to a high-speed digital-to-analog converter."

The output of the D/A converter, he notes, is a waveform that is essentially identical to the input waveform except that it has been compressed in time.

"This compressed output," he says, "is mixed with the output of an oscillator whose frequency is varied in 500 precise steps, and the sum and difference signals are fed to a crystal filter. For each frequency step of the oscillator, the analyzer is tuned to an increased spectral component frequency; that is, for each oscillator frequency, the sum signal that is passed by the crystal filter contains the signal component at a specific frequency."

In conclusion, he says, "The filter output signal is supplied to a linear detector to obtain a spectral scan signal consisting of 500 spectral components. This signal is fed into an output amplifier that drives an oscilloscope or a plotter in order to generate a spectrum scan or record in terms of amplitude versus frequency."

Mini computer used

According to Laurie Burrow, Jr., president of Spectral Dynamics, the system, designated the SD301, utilizes a General Automation SPC-12 mini computer in order to aid in the processing of spectral data.

Bill Hawkins, Sales Mgr. at Spectral Dynamics, points out that "The human ear is not as discriminating to narrowband signals as the SD301, but, because the techniques used by the analyzer overcome the inherent slowness of spectral analysis in the audio range, it is practical to further process the narrowband analysis to provide a constant-percentage type of display for certain types of acoustic studies."

This processing of the narrowband output is accomplished by the SPC-12 computer. The analyzer supplies the 500 samples to the computer in digital form, and the computer sums data belonging to each one-third octave band. The resultant data is returned to the analyzer where it converted into analog form and used to drive the display. ■■

Power AND economy in Pressfit Packages*

35
AMPERES



44
AMPERES

For current requirements of 35 and 44 amperes, you no longer need the conventional stud-mounted rectifier. You can save on the component cost and on installation time and expense by using Tung-Sol pressfit, diffused junction, silicon power rectifiers.

These 35 and 44 ampere devices are rated at 150° case temperature. Cases are hermetically sealed to provide the highest order of reliability. Overload surge capacity of either rectifier is 500 amperes.

Many years as a supplier to the electronic and automotive industries have made Tung-Sol a leader in pressfit rectifier technology.

Write for technical data sheets CT-42 and CT-43. They contain complete information about these Tung-Sol high-power pressfit rectifiers. Tung-Sol Division, Wagner Electric Corporation, 630 W. Mt. Pleasant Avenue, Livingston, New Jersey 07039. TWX: 710-994-4865. Phone: (201) 922-1100; (212) 732-5426.

TUNG-SOL®

HIGH POWER, PRESSFIT

Silicon Rectifiers

*Modified DO-21 Outline

© Trademark TUNG-SOL Reg. U.S. Pat. Off. and Marcas Registradas

INFORMATION RETRIEVAL NUMBER 22



We make components for guys who can't stand failures.

Everybody hates failures in their electronic gear. It's just that some guys hate failures a little bit more than others.

These are the guys that we try to please.

At Corning, we make our resistors and capacitors to perform like your whole system depended on them, because many times it does. We build an extra measure of performance into all our components to let you build extra reliability into the equipment you design.

Take our precision tin oxide resistors, for example. They're the best of the metal film class. Because the resistive tin film is completely oxidized and molecularly bonded to the glass substrate, our tin oxide resistors are impervious to moisture and environmental degradation. No other resistor can deliver the same stability and reliability over load life. They offer guaranteed moisture resistance across all ohmic values to set a standard of reliability that can't be matched by metal film, wire wounds, carbon comps or metal glaze resistors.

After a recent 56-day-long heat

test in an environment of extremely high humidity, our tin oxide resistors showed a resistance change of just 0.2 per cent. And in an ambient temperature test—now in its ninth year—not one of the 600 tin oxide resistors being tested has exceeded a resistance change of 1.5 per cent.

Take our glass capacitors. The U.S. Air Force has found that our glass capacitors have much better stability and much higher insulation resistance than the ceramic, mica and the other capacitor types they tested. That's why glass capacitors are designed into so many major aerospace and missile projects.

And we've got something to offer when economy and value are the prime considerations. We've developed the Glass-K™ capacitor to give you the volumetric efficiency and economy of monolithic ceramic capacitors, but with the much improved stability and reliability that only a glass dielectric can add. In resistors, our tin oxide resistors already offer long term economy over metal film, precision wire wound and metal glaze resistors.

Our new C3 resistors, in addition to giving you a small case size, compete costwise with carbon comps.

Another important Corning development is the flame proof resistor. These resistors can withstand overloads of up to 100 times rated power without any trace of flame. And because they open under overload, they provide protection for the rest of the system.

At Corning we make components for guys who can't stand failures. Guys like your most important customers. Guys like you. So, next time you're designing a system, reach for your CORNING® capacitor and resistor catalogs and call your local Corning authorized distributor for off-the-shelf delivery. They'll help you design-in an extra measure of performance.

If you don't have our catalogs, ask your Corning distributor for copies or drop us a line at: Corning Glass Works, Electronic Products Division, Corning, New York 14830.

CORNING
ELECTRONICS



Cimron leapfrogs the DVM industry —and there's a reason!

A number of reasons, to be exact! The all-IC Model 6753 is the next generation in digital multimeters—the lowest-priced autoranging instrument that will read DC from 100 nanovolts to 1099.9 volts and DC ratios. A fast-tracker, too—ideal for systems work. The closed loop tracking logic continually samples output at the rate of 14 readings a second, with accuracies of $\pm 0.001\%$ full scale $+0.005\%$ of reading. Like to learn about automatic desensitization? repetitive mode? out-of-range indication? Just ask how they can

help you. Important to you is the basic design, featuring optional IC plug-ins to extend capability which you can install yourself without technical service! Options include a 4-range AC converter with 10 microvolt sensitivity, a 5-range ohms converter, remote programmability, five print-out options. You can't beat the base price of \$2990! Cimron *customer concern* continues to provide what you really need at the lowest possible price. Write Cimron, Dept. D-125, 1152 Morena, San Diego, Calif. 92110.

LEAR SIEGLER, INC.



CIMRON DIVISION

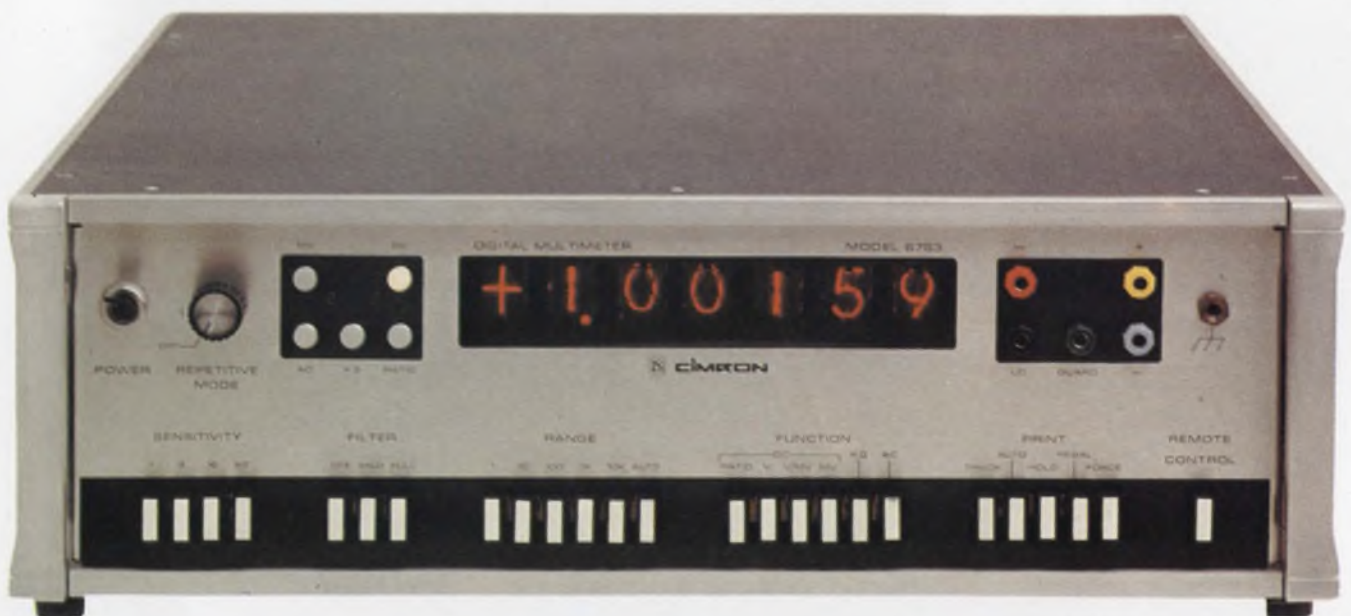

It could fly by 1976



Space shuttle team gains muscle

Six subcontractors, chosen to join the team of Boeing Co. and Lockheed Aircraft Corp. that is competing with other aerospace firms for NASA's proposed space shuttle system, have added immense strength to the powerful pair. Selected for avionics development, the new teammates are:

- AC Electronics Division of General Motors, for guidance and navigation.
- Bell Aerosystems Co., a division of Textron, Inc., for the approach and automatic landing systems.
- Navigation and Control Division of the Bendix Corp., for the flight control system.
- The Defense Electronic Products Group of RCA, for the communications system and data-management studies.
- Space Craft, Inc., for support to RCA in data-management studies.
- Systems Management Division of Sperry Rand Corp. for spacecraft displays and control instruments.

Of the team principals, Boeing will serve as launch-vehicle developers, while Lockheed will develop the space shuttle and have over-all avionic systems responsibility.

The space shuttle is intended to be re-usable and to carry both men and supplies between the earth and orbiting space stations. It will represent a new generation of space hardware and the first radical change from the present parachute recovery at sea for returning spacecraft. The most optimistic estimate of a first flight would be in the 1976 time frame, and the system would be operational at least through 1985, according to NASA officials.

Avionic systems to be used in the craft will draw heavily on Apollo technology. Aerodynamic designs and associated adaptive flight control systems will be

Washington Report

CHARLES D. LA FOND
WASHINGTON BUREAU

based in part on technology gained from the X-15 research plane and the X-20 Dyna-Soar, which was cancelled before flight.

Under Phase A feasibility studies funded by NASA, four reports are being completed by General Dynamics, Lockheed, McDonnell Douglas, and North American Rockwell. NASA is planning to soon request Phase B proposals for systems design. Expected to respond, in addition to Boeing-Lockheed, are a North American team including Honeywell and IBM, McDonnell Douglas teamed with TRW Systems Inc., and Grumman Aerospace Corp. All are primarily interested in the space shuttle. Martin Marietta and General Dynamics may seek only the first-stage booster. However, Martin has performed a company-funded study for the entire system and has also produced a preliminary design for the shuttle craft.

Dollar pinch hits NORAD

Last month, the Department of Defense disclosed that measures to cut expenditures during fiscal year 1970 have resulted in orders to de-activate three regional centers and three division centers now required for the North American Air Defense (NORAD) Command and Control System. The closing of these command centers is in addition to the previously announced elimination of three antiaircraft missile groups, five fighter interceptor squadrons, four ground radar squadrons, five aircraft radar and control warning squadrons, and one space-surveillance radar facility.

In view of the ease with which a defecting Cuban fighter pilot was able to penetrate Florida coastal defenses and to land undetected in Miami earlier this fall, it can be expected that many in Congress will question the wisdom of further reductions in U.S. perimeter air defense.

Washington Report

CONTINUED

The Pentagon says that upon a recent agreement between Canadian military leaders and NORAD Headquarters, the entire Command and Control System has been realigned. This combines the functions of the previous Air Defense Divisions with those of the Air Defense Regions and establishes seven regional commands within Canada and the Continental U.S.

NORAD says that the new configuration will employ command and control facilities already in place. Each new Air Defense Region has a control center for the deployment and direction of intercept missiles and aircraft, and each is provided with two Back-up Interceptor Control System control centers.

Can systems study revitalize D.C.?

Our nation's capital is no model for urban development, and RCA president Robert W. Sarnoff pointed this out in an address to the Fourth Annual Computer Age Conference of the National Industrial Conference Board in New York City. He proposed a massive pilot program to apply a systems approach to revitalizing Washington, D.C.

"The time has come," he said, "for a demonstration project to determine whether the techniques that have succeeded in other fields can be applied to the urban and environmental crises." To ensure the program's completion, he recommended that Congress authorize at the outset total funding and phase appropriations annually.

The pilot program, Sarnoff proposed, should involve all elements including housing, transportation, communications, law enforcement and environmental control. The effort should go beyond physical planning for city regeneration and include the study of interacting problems by applying advanced techniques of operations research, system analysis, model building, simulation and long-range planning.

"As the program progressed, it would provide an immense inventory of new knowledge and new methods that could be applied to other beleaguered cities across the nation," Sarnoff asserted.

The first part of the program, he suggested, might be scheduled for completion in 1976 to coincide with the celebration of the country's 200th anniversary.

"The capital belongs to all our people," he declared. "A comprehensive systems effort to revitalize the city and its environs should invoke a nationwide response."

Sky-high rocket price may drop

High-altitude instrumented meteorological rockets have been priced as high as they soar, but now, because of some Navy-funded research, a relatively simple craft requiring simplified launch facilities may be in the offing.

At present, multistaged rockets that reach altitudes above 400,000 feet—where the rarity of the atmosphere and the immense overview of the earth are invaluable to the meteorologist—approach six figures in cost.

Now a vehicle under development by The United Technology Center, a division of United Aircraft Corp., looks good in preliminary design, and the Navy is funding construction of several flight test craft. Measuring only 10 feet in length by 6-1/2 inches in diameter, it can be launched from an inclined rail.

Appropriately dubbed Kangaroo, the rocket has its second stage and its instrumented payload "pouched" within the first stage. The canister making up the payload will be instrumented to measure cosmic rays and solar radiation, concentrations of charged particles, and the frequency of micrometeoroid impacts. Such data, when telemetered to the earth, will be applied to the study of broad-area weather conditions, early warning of embryonic storm generation, and will also assist in the forecast of natural radio interference. The Kangaroo will be tested by the Navy from the Pacific Missile Range in California.

AMP makes the only no-solder, no heat, SMA, MIL-C-39012 connectors in the world.

And that's telling you everything except details:

- terminate semi-rigid subminiature cable in one-tenth the time required by conventional heat-and-solder method
- no special skills required to achieve consistently reliable electrical and mechanical performance levels
- completely pre-assembled plug
- single tool does the entire operation
- 70-pound (plus) tensile strength
- salvageable for reapplications
- field maintainable
- intermateable with *all* presently available SMA connectors

More details? They're available right now.
So is an AMP sales engineer with
samples. Write: **AMP Incorporated,**
Harrisburg, Pa. 17105
today.

AMP
INCORPORATED



The new small rack and panels with the big difference.

Bendix is the difference.

The difference in distribution, delivery and supply. The difference that means you can get the rack and panels you need when you need them.

A big difference. A big advantage. But there are others. Bendix Regal B subminiatures are built to MIL-C-24308. Application potentials are practically unlimited. Use them in switching circuits, computers, business machines. In industrial equipment, communications, test equipment. And in rack and panel modular or printed circuit technology.

The selection of mounting options is just about endless, too. Choose from among .120 or .154-inch diameter, straight-through holes, clinch nuts, float mounts, lock posts, plain flange and through-bulkhead types. Neoprene spacers or grommets. And solder or printed circuits. Even a crimp version with rear-release contacts comes in a variety of shell sizes and mounting configurations. All interchangeable with existing rack and panel connectors.

For more details, write: The Bendix Corporation, Electrical Components Division, Sidney, New York 13838.

Bendix

Electronics

INFORMATION RETRIEVAL NUMBER 26



BENDIX

Now in the Potter & Brumfield family!

Parelco cradle and SLIMLINE® relays give you many design options

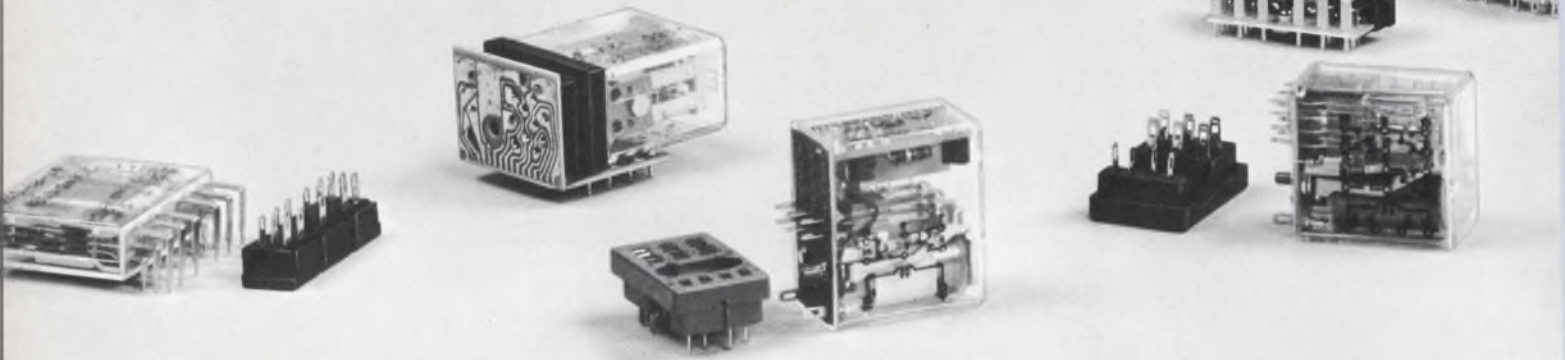

Reliable cradle relay switches up to 8 poles from dry circuit to 10 amperes

Compact, versatile, dependable . . . these features have won for the R10 cradle relay wide recognition in a host of critical applications such as computers, data processing equipment and precision instruments.

Contact arrangements up to 8 PDT (AC relays up to 4 PDT) are available. Six contact styles including single or bifurcated may be specified for switching currents from dry circuit to 10 amperes.

Mechanical life is rated at 100 million operations with electrical life ranging from 100,000 to 100 million operations, depending on load and voltage.

Design innovations, resulting in the optimum distribution between the magnetic core, the pole piece cross sections and coil volume, with a low reluctance armature bearing produce a large force-displacement product. The result: high contact pressure and generous over-travel.

Designers are given many options of terminals and sockets for a wide variety of mountings. A new, right-angle socket (shown above) allows for the R10 to be mounted on a PC board at minimum height.

High density PC board stacking is practical with SLIMLINE® relays



The Slimline (R40) has the lowest profile of any industrial relay available anywhere (dry reeds excepted)! When mounted flat on a printed circuit board, its 0.43" height allows for board spacing on 0.60" centers.

Two or four Form C contacts are available in a package measuring only 1.200" x 1.40" x 0.43". Select from five different contacts with switching capacities ranging from true dry circuit to 10 amperes. For low levels, bifurcated contacts may be specified.



Choose from solder or printed circuit terminals . . . or specify sockets having straight or right-angle terminals. Coil voltages range from 3.0 VDC for IC interfacing to 115 VDC. Mechanical life is rated at 100 million operations. Write or call today for complete information.



Small, variable time delay will switch 4 PDT at 10 amperes

Here is the only solid state variable time delay capable of switching (with a choice of contacts) 4 Form C from dry circuit to 10 amperes. Our R12 Series utilizes the field proved R10 relay plus a high quality solid state circuit. Features include: no false operation, small size, high resolution 15-turn potentiometer, timing ranges from 0.1 to 120 seconds (to 300 seconds on special basis).

SPECIFICATIONS

Repeatability	± 2%
Timing	Adjustable with 15-turn potentiometer.
Reverse polarity	Protected.
Timing capacitor	Mil type.

For complete information about the full line of Parelco and Potter & Brumfield relays, call your nearest P&B representative or write direct: Potter & Brumfield Division of American Machine & Foundry Company, Princeton, Indiana 47570. 812/385-5251.

West Coast states, call or write Parelco Operations, 26181 Avenida, Aeropuerto, San Juan Capistrano, California 92675. 741/493-4507.

STANDARD PARELCO RELAYS ARE AVAILABLE FROM P&B DISTRIBUTORS



**PARELCO OPERATIONS
POTTER & BRUMFIELD**

The monster in the Mojave

Not rattlesnakes, nor scorpions, nor tarantulas, nor the blazing sun of the Mojave desert could keep Managing Editor Frank Egan from visiting NASA's Deep Space Tracking Network station at Goldstone, Calif. On his way to last month's Fall Joint Computer Conference at Las Vegas, he persuaded West Coast Editor David Kaye to arrange a full day's detour by which he could view a real "monster"—the space agency's 210-foot Mars Station parabolic antenna.

The big, fully steerable antenna performs close-up jobs like receiving TV pictures transmitted from the moon. It is also used for intermediate-range uses, such as receiving the recent Mariner 6 and 7 Mars photos. And it does really distant work involving space vehicles more than 100 million miles from the earth.

The monster has a bite that is apparent only when the dish is examined close by. The enormity of the great antenna is most impressive when you get right next to it or even climb the massive pedestal. But the structure is painted reflecting white from top to bottom, and it can give the observer without sunglasses an uncomfortable case of what might be called "Mojave snow blindness."

Goldstone is really a collection of six separate antenna sites, none within sight of the others because of their setting in the surrounding hills.

What impressed the editors most besides the total antenna complement, which includes the 210-dish, 85-foot dishes, and a 40-foot one, was the caliber of the equipment. The receiving and transmitting systems and the test and monitoring equipment were all up-to-date. There were backups for all critical functions except, of course, the antennas themselves.

"But," says Frank, "what it gets down to is where would you store a spare 8000-ton antenna, anyway?"



Out in the Mojave desert, Managing Editor Frank Egan (right) talks with Steve Verosko of Bendix Corp., who acted as his guide at the Goldstone, Calif., satellite tracking station.

Looking
beyond
the 'specs'
with P&B

Time Delay Relays



With  CD-38 style

±5% Accuracy

±1% Repeatability

Dependable!

A wide range of time delay requirements can be met with these accurate, easy-to-use solid state relays. All built to P&B's exacting standards of reliability, the series offers a multitude of advantages, including timing repeatability of ±1%; nearly instantaneous (milliseconds) reset; a choice of sizes, mountings and terminations; long-life inherent with non-mechanical solid state switching. Three modes of timing are available — knob-adjustable, resistor-adjustable, and fixed.

The CD Series is available for delay on operate or on release with the relay in the same enclosure as the solid state unit or with an external auxiliary relay. There are four case styles in this series:

The CD-21 designed for use with an external KRP relay can also be supplied with an internal DPDT relay.

The CD-31 style designed for use with an external KHP relay.

The CD-38 style has an internal 10 amp DPDT relay.

The CD-45 style designed for use with an external PR relay.



CD-21 style

CD-31 style

CD-45 style

PLUS P&B Capabilities and Facilities that insure

- Controlled Quality ■ Reliability
- Long Life ■ On Time Deliveries

AMF
POTTER & BRUMFIELD
Division of American Machine & Foundry Co.
Princeton, Indiana 47570

INFORMATION RETRIEVAL NUMBER 28

Gold, silver, stainless steel and uncompromising design produce the Shallcross Series 1 Rotary.

We begin our Shallcross Series 1 rotary switches with the best materials. Materials that promise superior performance and long service.

Like stainless steel in non-current carrying parts. Coin silver contacts and terminals. Gold plating available on all current-carrying parts.

We deploy these materials in an uncompromising design. Enclosed diallyl phthalate construction keeps out airborne contaminants. Contact resistance is 2.5 milliohms max. initially and remains unusually stable. Our double-wipe-to-air action takes care of that.

Solid detent feel is provided by a set of stainless steel balls riding a hill-and-valley stainless plate. Special lubricants are used on all friction points.

Conform to MIL-S-3786/SR 28A

Shallcross one-inch Series switches are built to MIL-S-3786/SR 28A. Temperature range -65° to $+125^{\circ}$ C. Our new ratings are: 2 amperes (115 vac or 28 vdc)—5000 cycles; 1 ampere (115 vac or 28 vdc)—25,000 cycles.

End-of-life contact resistance typically 5 to 10 milliohms. 30° indexing, up to 12 positions per pole available.

Fast local service

Evaluate our Series 1 for military applications and your most demanding industrial and commercial needs. We're ready to supply prototypes to your specs on short notice. And deliver production quantities to your schedules. Contact your local Cutler-Hammer Stocking Switch Distributor.

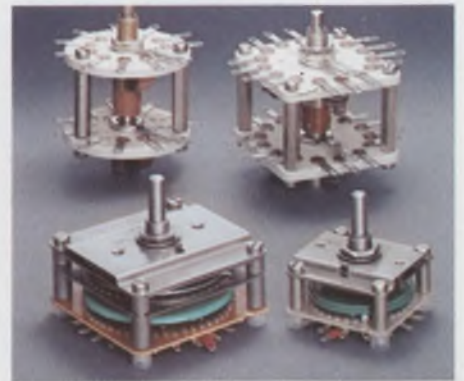

Cutler-Hammer's extensive line of Shallcross quality rotary switches includes $1\frac{3}{4}$ " and $2\frac{1}{2}$ " deck models as well as round and oval ceramics to fit your most demanding requirements.

shallcross

A CUTLER-HAMMER COMPANY Selma, N.C. 27576



Ingredients for greatness.



Switch
to No. 1

More than just switches:
prompt availability,
field help, innovation,
quality assurance too.

Publisher

Hugh R. Roome

Editor

Howard Bierman

Managing Editor

Frank Egan

Technical Editors

Milton J. Lowenstein
 Charles G. Marrara
 Don Mennie
 Michael J. Riezenman
 Raymond D. Speer

Management Editor

Richard L. Turmail

News Editors

Ralph Dobriner, Chief
 John N. Kessler

Washington News Bureau

Charles D. LaFond, Chief

Military-Aerospace Editor

John F. Mason

East Coast Editor

Jim McDermott

West Coast Editors

Elizabeth deAtley
 David N. Kaye

New Products Editors

Lucinda Mattera
 Roger Allan

Directory Manager

Greg Guercio

Copy Editor

Marion Allen

Editorial Production

Dollie S. Viebig
 Richard D. Grissom

Art Director

Clifford M. Gardiner

Art Assistant

William Kelly

Technical Illustrators

Rita Jendrzewski
 Lynn E. Thompson
 JoJo Miskimmon

Production Manager

Thomas V. Sedita

Asst. Production Manager

Helen De Polo

Production Assistants

Bernard Wolinsky
 Kathleen McConkey

Circulation Manager

Nancy L. Merritt

Information Retrieval

Genate Piccinetti

EDITORIAL



We could shun controversy, but wouldn't it be deadly?

Several days ago an engineering manager from a West Coast company dropped in to discuss this magazine's editorial needs and objectives, with the intent of starting an article-writing program for his staff when he returned. When the discussion was over, he leaned back in his chair, lit a cigarette and commented: "By the way, I read your magazine regularly and find it very useful and interesting."

"Fine," I answered, "we enjoy compliments. But what don't you like? Anything annoying come to mind?"

My guest abandoned his relaxed position, meditated for a brief moment and then blurted out: "Yes, as a matter of fact, I take exception to some of the editorials you publish. Shouldn't you confine your views solely to the technical area of the electronics industry rather than tackle issues that are not directly related to the design engineer?"

He wasn't questioning the pertinence of editorials on such topics as a domestic satellite program decision by the FCC, or the need to apply the nation's technical resources to control pollution and other urban problems, or the benefits awaiting design engineers who become more involved with computer-aided design.

But why, my visitor wondered—as some of you may have—do we get involved with campus unrest, automobile safety standards or the pros and cons of an engineering union? And why should we gamble on antagonizing readers by asking them if they are cry-babies on the job or really mistreated engineers?

The answer: We believe our readers are alert humans and citizens first, engineers second. Editorials in the nation's newspapers, consumer magazines and business press are calling for increased involvement in all aspects of our daily life, not merely in the narrow specialty of our work or our local neighborhood. When timely topics related to engineering come up and lend themselves to editorial interpretation, we do our best to get the facts and take a position. We invite direct participation by readers sometimes. But we keep our opinions on the editorial page. The rest of the magazine is concerned with gathering the facts and presenting them as objectively as possible.

Maybe you don't agree with all of our opinions. You hold the final card. If you don't like our editorials, you can always write your own. We'll be happy to publish your comments too—in the Letters to the Editor section.

When your letters come in, applauding our position or denouncing a stand we took, we're human. We love the applause; we wince at the barbs. But both forms of comment make us aware that the editorial page is not being ignored. Silence in this case is not golden.

HOWARD BIERMAN

Test yourself:

When you purchase an IC tester, would you rather do business with:

- a.) a company that merely makes testers, or
- b.) a company that also makes IC's themselves, and thus completely understands their design, their production and—most importantly—their evaluation?



If your answer is b, your company is Signetics. For digital testers, linear testers, classifiers—even testers that await your special specs! To obtain application details on our whole modestly priced, portable line, write or call Marketing, Signetics, Measurement Data (415) 961-9399 or 961-9384. And put us to the test.

Signetics 
MEASUREMENT/DATA

Signetics, Measurement/Data, 341 Moffett Blvd., Mountain View, Calif. 94040 / A subsidiary of Corning Glass Works

If you thought all Daystrom pots were squares



...look again!

Rectilinear components are still a necessary requirement in many circuit applications. That's why Weston has rounded out its high-performance potentiometer line with two new rectilinear models. RT-12 styles 534 and 535 are designed for both general-purpose and military applications. They feature the same $\pm 5\%$ tolerance, 10 ohm to 50K range, and slip clutch stop protection that are standard with Daystrom Squaretrim[®] units, plus 24-turn adjustability and

humidity proofing. Also new this year . . . models 553 half-inch and 543 three-eighth-inch Squaretrim potentiometers in military and commercial versions. Save board space as well as money with our field proven 501 Series multi-turn and 504 Series single-turn $\frac{1}{16}$ " Squaretrims offering values to 20K in a 0.02 cubic inch case. All Squaretrim Diallyl-Phthalate cased pots give you Weston's patented "wire in the groove" construction and your choice of flexible leads,

pin and screw configurations. Whether your trimmer needs are military, industrial or commercial, you'll find the answer in this complete new low-cost line. Write today for data sheets and evaluation samples. DAYSTROM potentiometers are another product of WESTON COMPONENTS DIV., Archbald, Pennsylvania 18403, Weston Instruments, Inc., a Schlumberger company

WESTON[®]

Model SP601 shown actual size.



We make it possible by harnessing the space-saving advantages of the switching regulator—but have pulled its RFI fangs (input and output meet MIL-I-6181).

When you read our data sheet carefully, you'll also find it full of hidden features that other manufacturers would loudly acclaim.

Such as an IC regulating amplifier, automatic overvoltage crowbar, self-resetting automatic overload and short circuit protection, and even 30 ms full-load storage after the input voltage disappears.

Efficiency is so high that the very hottest spot on the heat sink has a rise of only 25°C.

You can actually hold our unit after hours of full-load bench operation without smelling burning flesh!

And is there any other unit you've heard about that will continue to deliver full-load at 71°C.—without derating, heat sinking or forced air cooling.

Single, dual, or triple outputs at voltage levels of 3V to 30V can be provided to your specific needs.

By the way, if you think our \$400 price is high, try adding the "optional extras" to anybody else's standard you had in mind.

Trio Laboratories, Inc., 80 Dupont Street, Plainview, L. I., N. Y. 11803. Tel.: (516) 681-0400.

TWX: (510) 221-1861.



Now you can squeeze your 5V/20A power supply down to fit your microcircuitry.

$\pm 50 \text{ ppm}/^{\circ}\text{C}$

in all Helipot Cermet Trimmers

This significant advance in Helipot's cermet technology is now available at only a dime/unit more . . . 100 ohms thru 2 megohms. In addition, you get essentially infinite resolution, environmental stability, reliability, no catastrophic failures — all superior to wirewound trimmers. We'll also deliver off-the-shelf, locally stocked trimmers with a standard tempco of $\pm 100 \text{ ppm}/^{\circ}\text{C}$ in the 100 ohm thru 2 megohm range.

Beckman

INSTRUMENTS, INC.

HELIPOT DIVISION

FULLERTON, CALIFORNIA • 92634

INTERNATIONAL SUBSIDIARIES: AMSTERDAM; CAPE TOWN; GENEVA; GLENROTHES, SCOTLAND; LONDON; MEXICO CITY; MUNICH; PARIS; STOCKHOLM; TOKYO; VIENNA

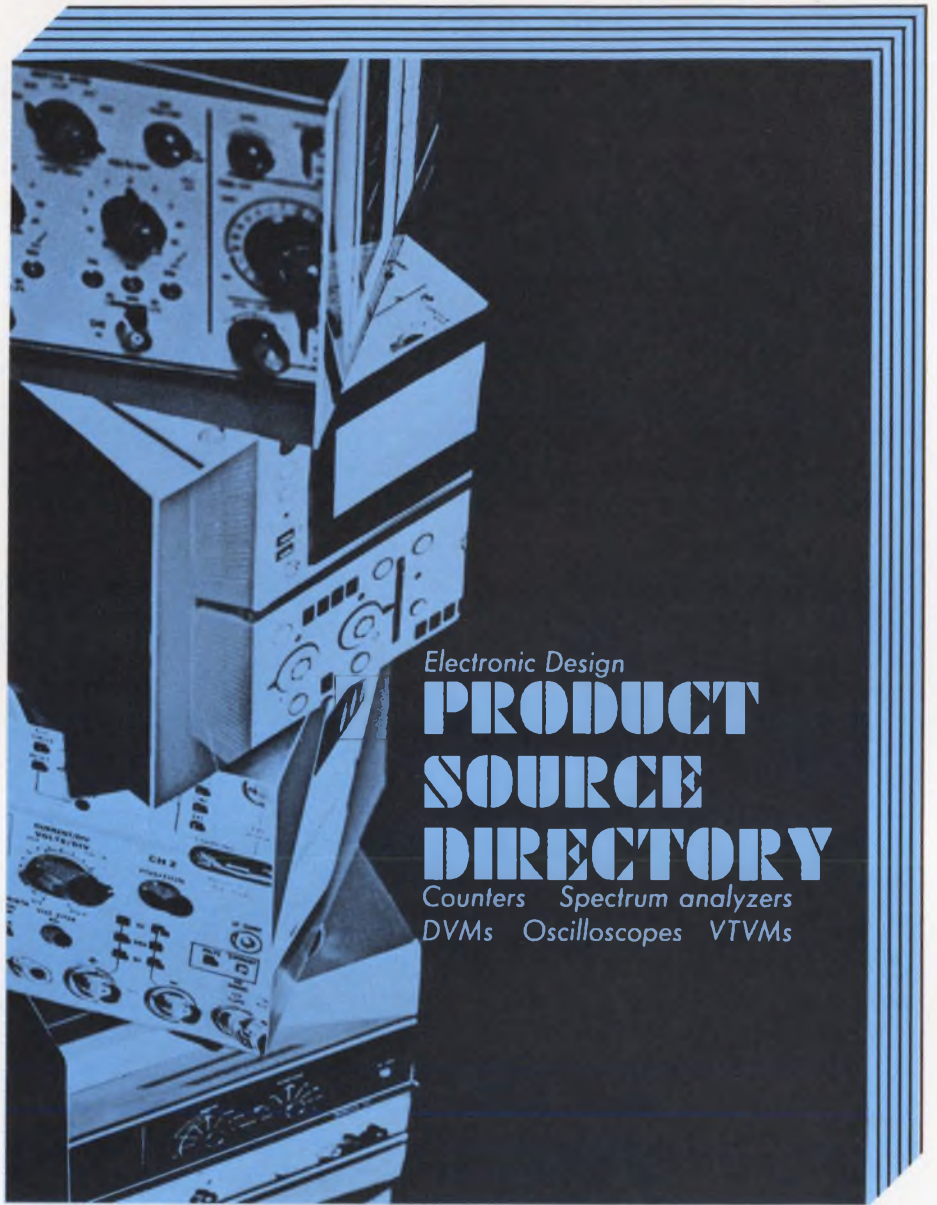

Electronic Design

PRODUCT SOURCE DIRECTORY

*Counters Spectrum analyzers
DVMs Oscilloscopes VTVMs*

This special section of **Electronic Design's MEASURING INSTRUMENTS Product Source Directory** is available in a special 72 page reprint at \$2.00 per copy. Included are the complete tables—giving pertinent facts on over 1,000 instruments—as well as the advertising in the section. For your own handy copy, or for extra copies for use by your associates, fill-in and mail the blank below.

ORDER EXTRA COPIES

Please send me _____ copies of MEASURING INSTRUMENTS Product Source Directory at \$2.00 per copy, including handling and postage. I enclose \$ _____

check

money order

Check or money order must accompany this order blank.

Name _____

Firm _____

Street _____

City _____

State & Zip _____

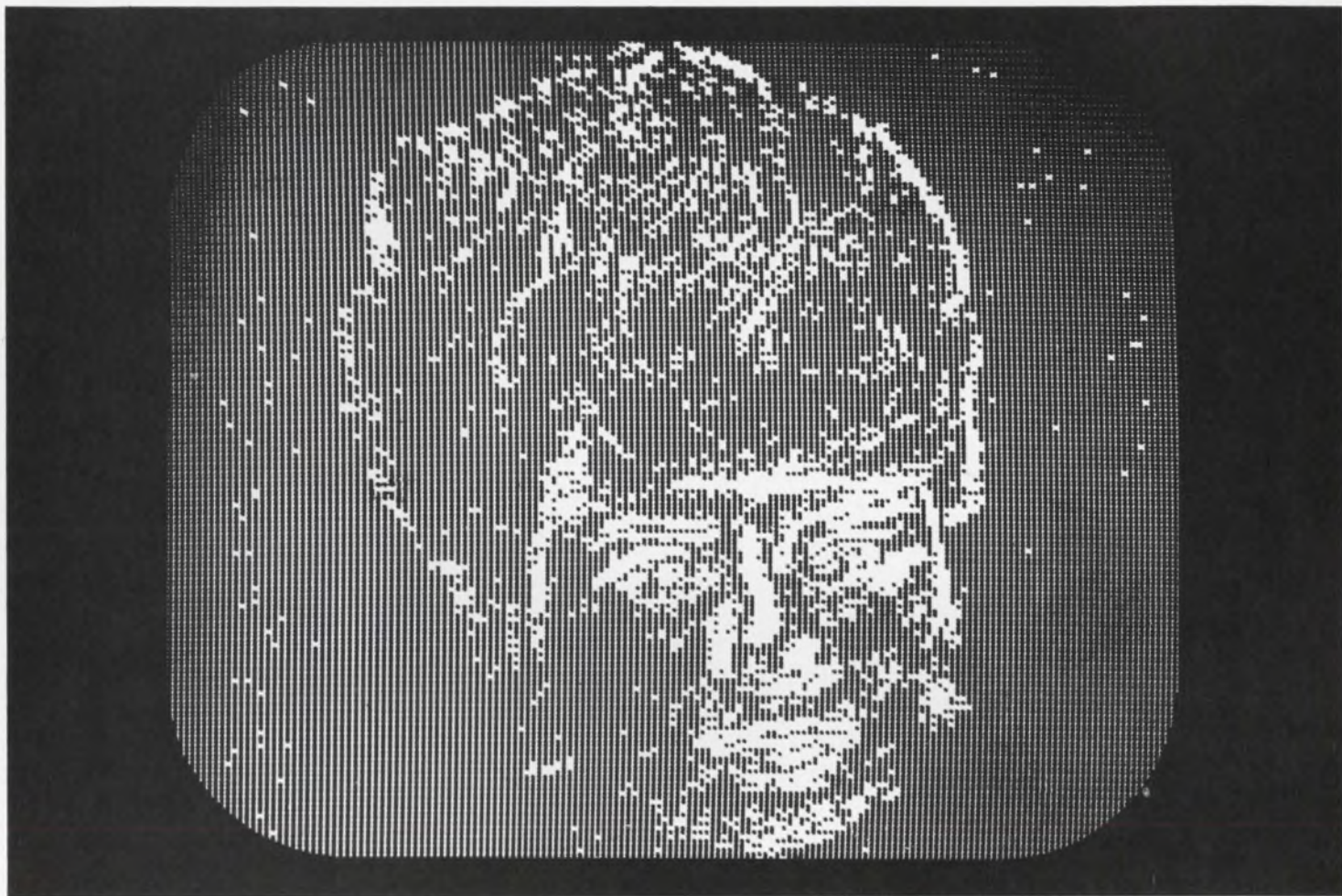

Transmitting the changing scene

This girl's picture was produced on a special Picturephone® system; it will never look like this in your home. The white areas mark the only picture points which changed in 1/30 second (the duration of one video frame). The remainder of the picture was blanked out.

This emphasizes how Picturephone use differs from ordinary television: the Picturephone camera usually points at a single scene throughout a call and most of the motion is confined to the subject's lips and eyes. Everything else—perhaps 90 percent of the picture—remains stationary.

Frank W. Mounts of Bell Laboratories used this fact to design an experimental video system that may

make it possible to transmit three Picturephone calls over a channel that otherwise could carry just one.

An ordinary Picturephone system sends thirty complete pictures each second. In Mounts' experimental system, only changes from one picture to the next are transmitted. A complete picture (information about dot positions and brightnesses) is stored at both the transmitting and receiving ends. As the camera's electron beam scans the original image, the brightness at each point is compared with the stored value. Whenever there is a significant difference, the system updates the stored frame and transmits the new brightness level and dot position.

At the receiving end, as the

picture tube's beam arrives at each point, the incoming information is checked to see whether a picture-point revision has arrived. If so, it is displayed and stored.

Because some areas of the picture do not change, while others change extensively, revised points may come in bursts. Transmitter buffers smooth the flow by reading the information out onto the line at a constant rate.

This new technique, one of several now being investigated at Bell Laboratories, promises to help keep transmission costs down when the Picturephone service becomes generally available.

From the Research and Development Unit of the Bell System—



Bell Labs

Buckbee-Mears etches metal on glass masters that can be used and reused and reused...

We call them the Unscratchables.

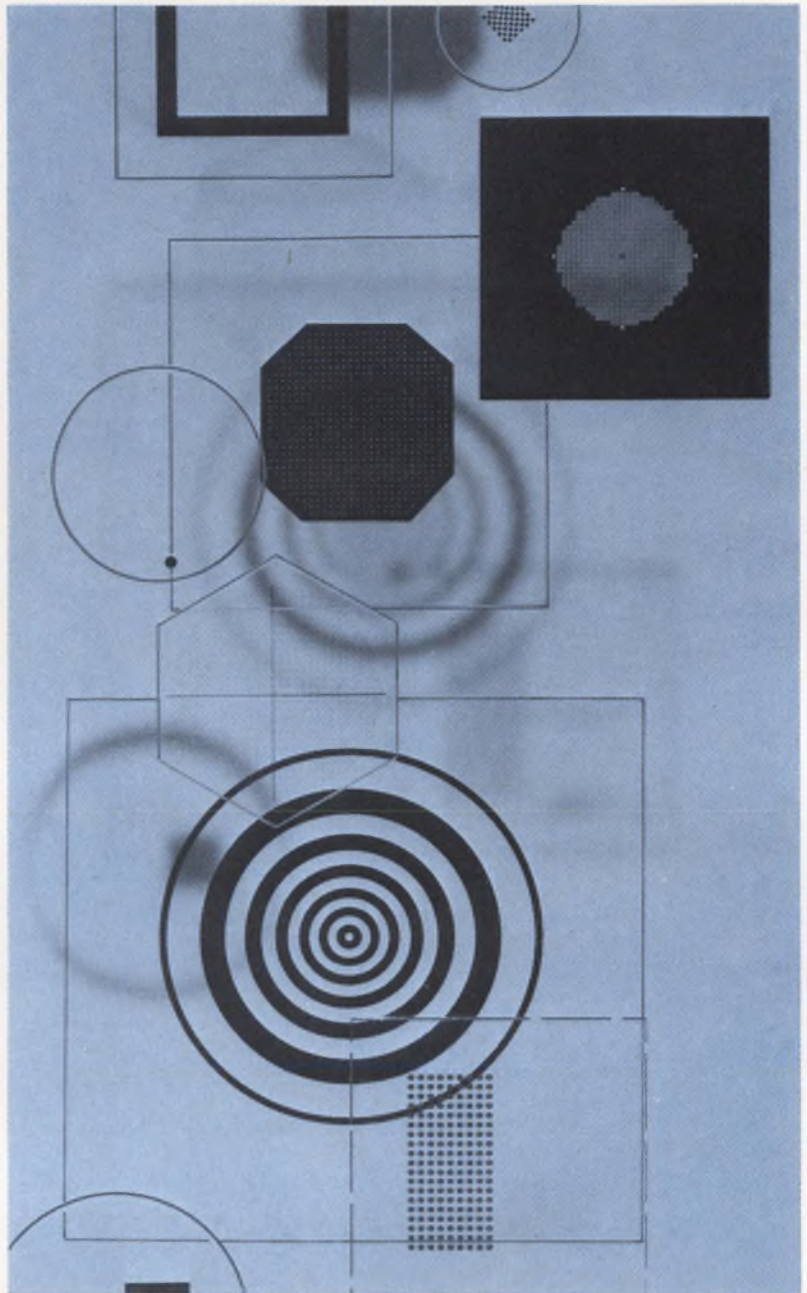

Up to now the only kind of glass master available for tooling had an emulsion coating that usually scratched after one or two uses. Costs to replace these emulsion masters were extremely high, and the production downtime to change masters was equally expensive.

Buckbee-Mears scientists have solved this problem by creating a way to etch metal on glass. Our metal on glass masters can be used over and over. The danger of scratching is eliminated.

The metals we etch include chrome, Ni-200 and copper. Copper on glass masters can be produced in sizes up to 24" x 32". Chrome and Ni-200 masters are available in a 2" x 2" size or smaller.

Buckbee-Mears will produce chrome or nickel masks to your specifications with tolerances of \pm two microns on

any line width or on-center measurement. Small copper on glass masters can be etched to \pm .0005" (line widths up to \pm .002" on large masters). On-center specifications for small size masters are \pm two microns; \pm .0005" for large size masters.

Buckbee-Mears' new metal on glass masters can be used in a variety of production situations where a photomechanical operation is involved, including printed circuits, semiconductors, integrated circuits and photoetching.

Solving your problems through improved photomechanical production techniques is our business. Buckbee-Mears has the most complete photoetching capabilities in the world.

For more information, call or write Bill Amundson, industrial sales manager. Phone 612-227-6371.

PRECISION METAL AND GLASS ETCHING • ELECTRO FORMING • AUTOMATED DESIGN
bmc BUCKBEE-MEARS COMPANY
SAINT PAUL, MINNESOTA 55101

Technology

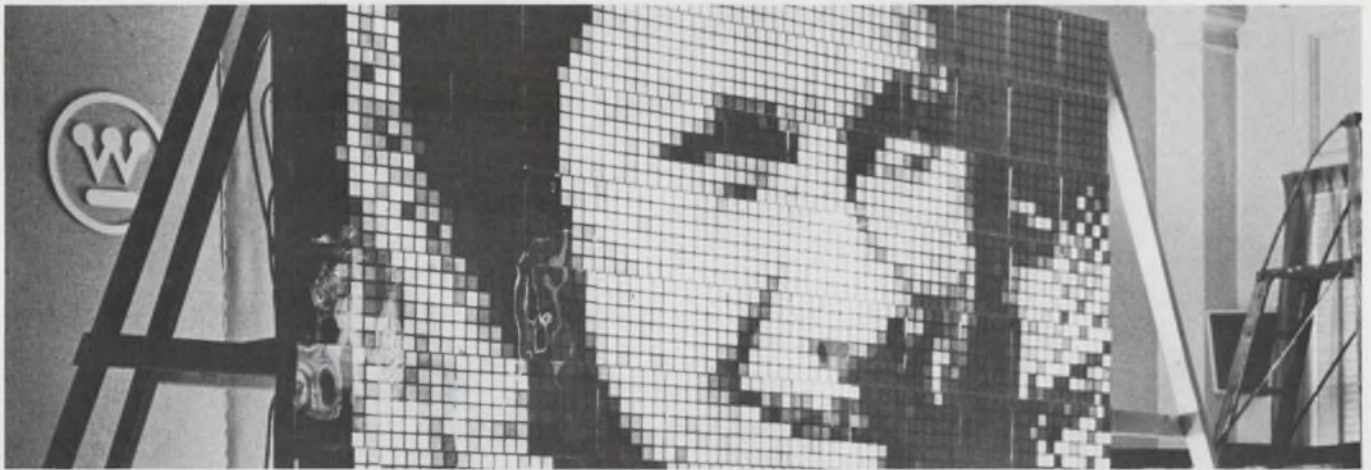

Easy-on-the-eye displays are much in demand. When they get this big it's hard to

integrate scans, alphanumeric, graphics and TV. But we're on our way. p. 56.



"The next step in space is headed toward earth," says Dr. Krafft Ehrlicke. This noted

scientist explains why while offering advice to young EEs. p. 76.

Also in this section:

Single-map method speeds design of sequential logic circuits. p. 66.

Convert digital data from parallel to serial and from serial to parallel. p. 70.

Ideas for Design. p. 81.

Product-Source Directory: Field Strength Meters. p. 89.

WANTED EASY-ON- THE-EYE DISPLAYS

By John N. Kessler

Dropping cautiously through mist and rain on final approach to a runway, the pilot of a modern airliner is up to his eyeballs in work. As he scans a wide instrument panel so crammed with data that it would be hard to squeeze in another display, his eyes move back and forth, up and down . . . altitude, airspeed, temperature, artificial horizon, fire-warning lights, navigation-beacon lights, glide-scope data, ADF needle, DME . . . scanning, scanning . . . until finally he breaks out of the overcast with the runway just ahead of him.

Wouldn't it be great, he says later, to have one compact display with all the information conveniently in front of you?

It's a growing problem in the electronic display field—not only in aviation but in all other activities where displays are vital to successful operation. There is a broad need to consolidate masses of data and display them in simple form.

Progress is being made, both in small-screen and large-screen displays. Information is being sorted, updated, grouped, scaled, erased, restored and manipulated to match the capabilities of the machine to the needs of the operator.

In aviation, for example, a "contact analog"

display has been developed by United Aircraft Corp.'s Norden Div. in Norwalk, Conn. It exemplifies the integration of a multitude of data on one small screen.

Contact analogs are images produced on a CRT by a small computer. In the Norden display, they show the pilot what his landing strip looks like, how it changes relative to the position of his plane, his airspeed, altitude and direction.

The contact analog is not a television image or camera image of the real world; it is a wholly artificial and stylized representation of the real world. (The contact analog display on the cover of this issue, for example, is an experimental system developed at Norden to test the human factors involved in viewing such displays.)

Norden has combined the readouts of many instruments in a single display: pitch scale, roll scale, airspeed, altitude and heading. Through mode switching, a pilot can call up different combinations of instruments or change the scaling for takeoff, in-flight navigation or a landing.

The same basic systems approach underlies the presentation of data on interactive graphic consoles on the ground. Carl Machover, vice president

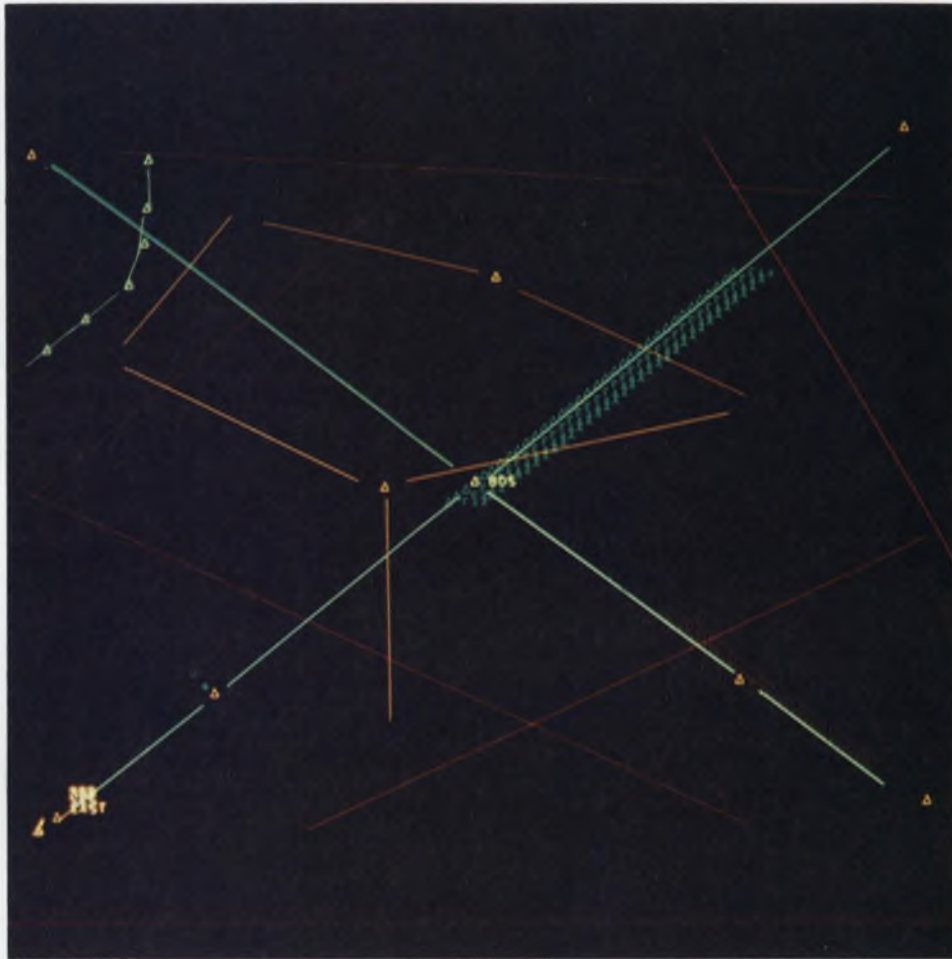

Multicolor TV display for command and control, developed at GT&E.

of marketing at Information Displays, Inc., Mount Kisco, N.Y., makes the point that "data has always been easier to gather than to evaluate."

What are graphic displays made of?

According to Machover, an interactive graphic terminal consists basically of the following:

- A cathode-ray tube—where the electron beam is deflected electrostatically or electromagnetically to produce graphic elements.
- A display generator—which converts computer digital data to analog signals, such as alphanumeric characters, vectors, circles and dots.
- A storage element—which "refreshes" the display so it doesn't flicker, such as core memory, delay lines or digital computers.
- An interface—to convert computer output to a form suitable for a terminal.
- A variety of input devices—which enable the operator to manipulate displayed data—such as light pen, joystick, track ball, RAND tablet and function keys.

With this system, a terminal can generate a nonflickering display of typical graphics elements—characters, lines, circles, etc. In addition

sophisticated interactive displays can also present and scale charts, maps, line drawings and photographs onto the phosphor screen.

Circles in various sizes, charts, curves, lists of figures can be composed, analyzed and displayed. Three-dimensional projections can be viewed and manipulated. Text can be composed and edited in four or more type sizes; hard copy can be generated. The display can be generated simultaneously on a multiple screen or as a wall-sized presentation. Memories of various sizes can be included with the terminal, which can be connected to a large digital computer via voice-band telephone lines.

To go from graphic CRT computer terminals to large-screen displays is a jump in cost, size, complexity, brightness, resolution and color capability. Also, the technology changes from cathode-ray tubes to largely experimental systems.

Large-screen displays

The need for large-screen displays has come primarily from the Government: command and control for air traffic, space missions and the like.

Manufacturers have developed complete systems rather than large-screen techniques or large-screen components.

Edmund J. Kennedy, chief of section analysis for information displays at the Rome (N.Y.) Air Development Center, explains why the systems approach has come about. "The large-screen display market up to now, and possibly in the near future is relatively limited," he says. "There is only one SAC headquarters; there is only one NORAD headquarters. At each location there is one display, or perhaps a half-dozen displays.

"With a limited market like this, industry is understandably reluctant to invest a lot of their resources; so the present technology in the field is one provided under a 'systems buy'. In other words, somebody buys a whole command and control system, and as part of this, they buy a display."

At the Rome Air Development Center, large-screen displays may vary from 3 × 4 feet to 16 × 16 or larger. They consolidate information from intelligence sources via teletypewriters, radar, electronic sensors, telephone calls, etc. According to Kennedy, such situation displays may have "a map background with identification of your troops, airfields, man-made objects, plus what changing information is pertinent—a flight of aircraft, the disposition of your own forces." The information may be in tabular form or in "battle-line formation."

Intelligence reports flow into a control data processor. Here the information is integrated, and a character generator in the computer creates the appropriate images on a cathode-ray tube. The images on the CRT are then projected onto a screen.

Using "wet" film, the Rome center can photograph information on a CRT and project it in about 15 seconds. Dry-process film reduces this time to milliseconds, says Pierce Siglin, chief of display techniques at the Army Electronics Command, Fort Monmouth, N.J.

Reusable film for displays

Siglin's group has been experimenting with photochromic film. This is a material that is normally transparent. When exposed to ultraviolet light, it becomes opaque; when heated, it becomes transparent again. This can be repeated many times before the film shows signs of fatigue.

These two features—self-development and reusability—make photochromic material an excellent candidate for film-projection systems for large-screen military displays. "While the data is being written on the faceplate of the cathode-ray tube, you're seeing it written on the screen," says Siglin. There is no time lag caused by de-

veloping, fixing and drying.

The National Cash Register Co., Dayton, Ohio, invented photochromic film in 1955. The Army Electronics Command, according to Siglin, developed the optical techniques for large-screen projection. Previously, the projected image was about 14 × 24 inches. Now this has been enlarged to display 4.5 feet high and 6 feet wide.

Siglin is now experimenting with a monochromatic system: blue letters on a white background. But his objective is to achieve full color presentation. He hopes to accomplish this in about two years.

To get full color with silver-halide films, three exposures must be taken and the three different image frames must be projected and carefully aligned one on top of the other.

"But even with photochromic film," says Siglin, "registration is still a major problem. Our goal is to derive three colors from one image frame."

Improve resolution, add color

"Resolution is principally a function of the cathode-ray tube—not the film. Here we are getting around 600 lines resolution, which is not so much as we'd like to have."

Such companies as Litton Industries Electron Tube Div., San Carlos, Calif., developed the type of fiber-optic CRTs that make it possible to expose many dry-process films, such as photochromic.

A fiber-optic faceplate is made up of millions of these tiny light-conducting pipes, all parallel. The end surface is ground and polished until it is optically flat. The distance between centers (fiber pitch) ranges from 5 to 15 microns. Such a faceplate can increase the light-energy transfer from phosphor to film—in many cases by more than 12 dB over conventional CRTs.

In photochromic large-screen display systems, a dichroic mirror is deposited on the fiber-optic faceplate of the CRT, so all wavelengths of light are reflected except the ultraviolet. Photochromic film is placed on the coated fiber-optic faceplate. As the electron beam writes, ultraviolet light generated from the phosphor through the faceplate of the CRT exposes the photochromic film. This creates an opaque character on a transparent background. Light from a projection lamp is passed through two dichroic mirrors, where all except the blue is filtered out. This light is reflected onto the dichroic coating of the CRT, and from there through a lens onto a screen.

While the resolution, reusability and self-development aspects of photochromic film are excellent, the cost is high—\$30 a square foot, according to a report by Jim E. Wurtz, applications engineer at Litton Industries. (Costs for direct-print paper are considered high at 15¢ to 20¢ a



Chart used to test color and resolution of images for large-screen displays at Rome Air Development Center.

Circles from a new graphic terminal developed by Digital Equipment Corp.

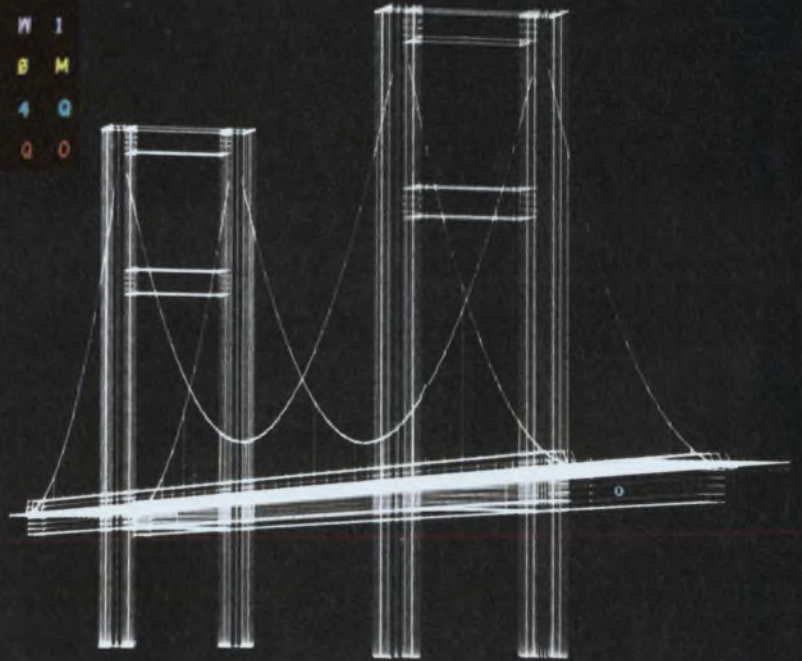

This CRT display of a bridge was generated at the University of Illinois.

Large-screen TV display developed at Stromberg-Datagraphix uses Schmidt optics.

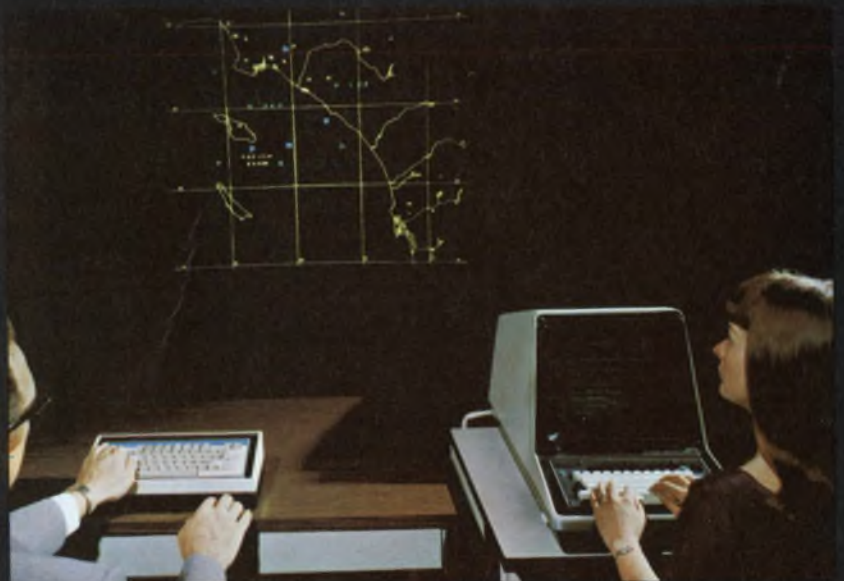

square foot.) Interim reports submitted to Fort Monmouth by National Cash Register, which designed the basic system, show that the luminous output of the phosphor on the CRT falls approximately 50% after 140 hours of operation. Although there are no specific figures on the persistence of the photochromic image, it decreases with heat, such as a high-wattage light source. And because of the optical losses in this type of system, screen brightness is an important system parameter.

One of the programs being worked on by Salvatore F. La Forgia, an engineer at the Army Electronics Command, is "progressive fixation" of photochromic film. The aim is to produce a permanent film record. This is done by mixing a dye in with the photochromic material. To retain images, the film is exposed to a reducing agent, such as sulphur dioxide gas. This permanently fixes the dye. But those parts of the film that are not fixed can be reused again.

"So if you were operating a county airport, for example," says Siglin, "you could use a CRT to describe the runways, the permanent markers, the various identification marks and permanently fix that part of the pattern. Then you could use the rest of the film to record the progress of aircraft in and out of the airport. Here you have your map and your overlay data all in a single-frame image."

La Forgia has also reduced the projection distance from CRT to screen to 7 feet. This is particularly important, says Siglin, for displays used in battlefield areas, where space is limited.

The next step in improving the resolution of photochromic film displays—and it will be achieved soon, Siglin says—is to replace the cathode-ray tube with an ultraviolet laser. A xenon arc lamp would still be used to project the image onto the screen.

Magneto-optics—a reflective display

A magneto-optic display with memory is also being studied at Fort Monmouth. This is an extension of the work begun about three years ago at General Electric's Electronics Laboratory at Syracuse, N.Y. Magneto-optic displays form images by diffracting the light that shines on them from an external source. The display consists of a substrate on which are placed x-y conductors, covered by a film of 83% nickel and 17% iron. On top of this magnetic film is a colloidal suspension of magnetite.

Siglin reports: "Strain lines, a micron apart, develop in the magnetic material. When current is passed through an x-y matrix in close proximity to this film, the strain lines can be made to rotate 90 degrees. The magnetite particles in the colloidal suspension tend to conglomerate over

the strain lines, thus forming the hills and valleys of a diffraction grating."

When light is projected onto the display panel, the viewer will see the grating, or if the strain lines are rotated 90 degrees, he will see nothing.

The magneto-optic display at Fort Monmouth is a 5 × 5-inch panel. There are 50 lines to the inch. There are 80 drivers for addressing information: 40 for the x and 40 for the y conductors.

"The display has all the characteristics of a blackboard," Siglin says, "You can write on it with a magnetite 'pencil' or erase it with a magnetic eraser." This is, of course, in addition to producing displays by pulsing currents through the conductors.

According to General Electric, "of the various solid-state display techniques, magneto-optics seems the most logical candidate for competing with the cathode-ray tube in applications where pictures must be produced. Tone quality might be obtained by controlling the degree of magnetization of particles at each spot, thereby producing gray scaling."

The problems being worked on at Fort Monmouth are viewing angles and control of the color. The display has a long-term memory, and there is no chemical or other processing required to produce images.

A million dot matrix

A broadband laser display system—initiated at Fort Monmouth in 1967—is being developed. The goal is to use 20 stages of electro-optic and birefringent crystals [10 in the x and 10 in the y direction] to produce a million-dot matrix. The field will consist of 1024 × 1024 discrete beam positions. Work on this project is being hindered by a lack of high-quality crystal materials from which to make deflector elements. A laser would be used in the system to write on opaque or translucent screens, photographic films and so forth.

Lasers have been a promising instrument for large-screen displays, because they have been used functionally as a CRT. If one considers the CRT as a zero inertia beam that is being deflected electronically, with its light produced by fluorescence from an impinging surface, one can draw the analogy that a laser display system is, in effect, a corresponding form: The room that the laser is in becomes the CRT bottle; the laser is analogous to the electron beam, and the surface that it strikes is analogous to the phosphor screen.

Texas Instruments, Inc., in Dallas has developed a large-screen laser display. It has created a kind of pseudo-random display by generating 16 simultaneous sweeps across a screen with a single beam. It does this by splitting up

Large-screen laser display
from Texas Instruments.

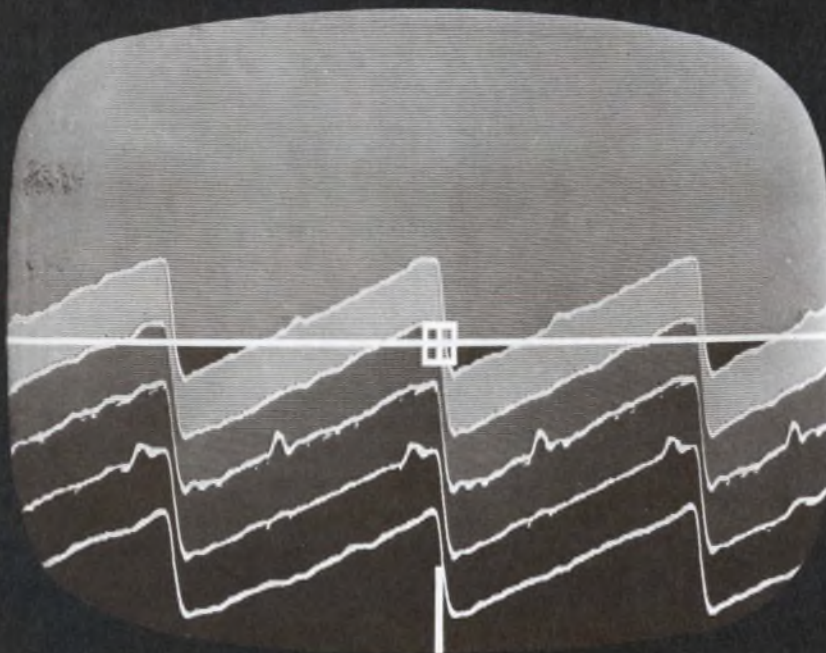
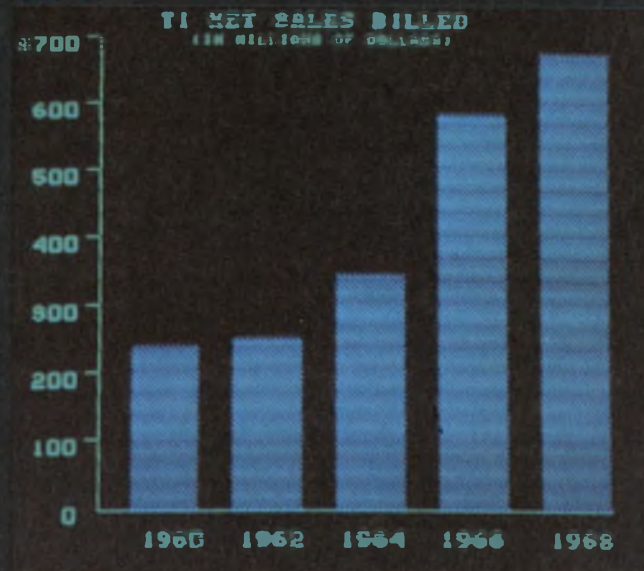

Terrain-following radar
display built by Norden Div.
of United Aircraft Corp.



Light pen moves data
on map overlay on Bunker-Ramo's
BR-90 computer display terminal.

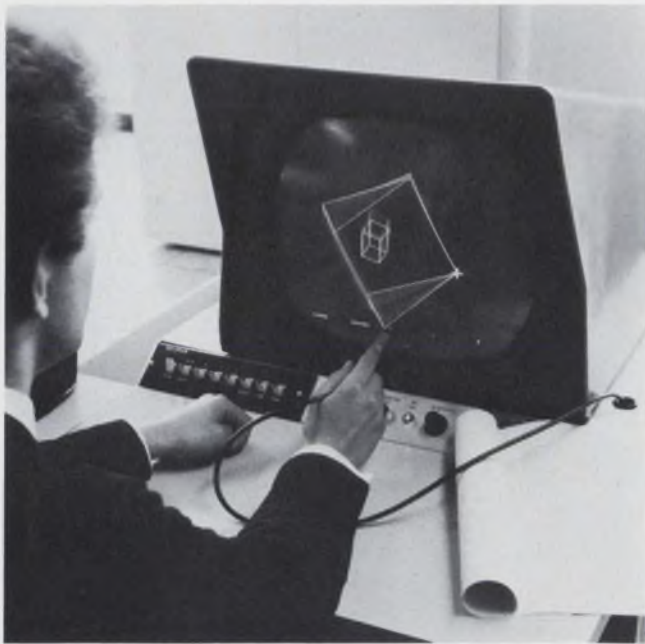

Computer graphics from Britain—the Elliott 928 display includes light pen, character and vector generators and graphic control unit.

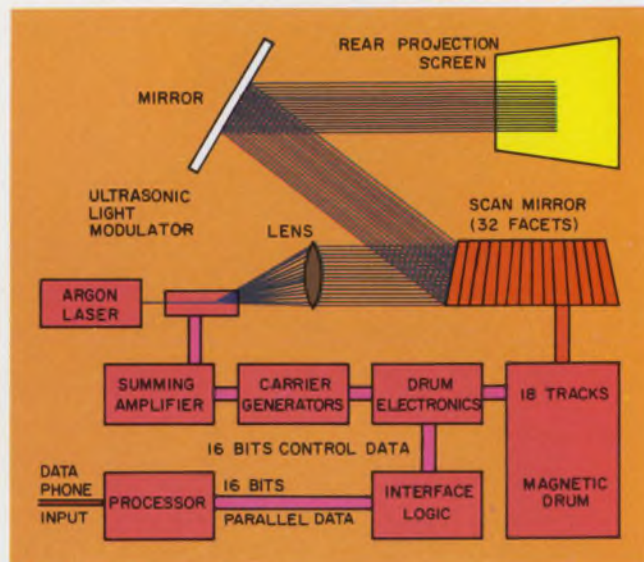

Block diagram of TI's large-screen laser display, which projects alphanumeric and graphics generated by computer software.

the argon laser beam into the blue line (4880 Å) and the green line (5145 Å). A dual-channel multibeam ultrasonic diffraction modulator produces 16 independently modulated blue and green light beams. These are then scanned by a 32-facet rotating mirror.

Lasers for management displays

TI calls its system MIDS—Management Information Display Systems. It will generate alphanumeric and special symbols, bar charts, circles, vectors and schematics (such as IC graphics). The company says MIDS can be adapted to air traffic control by providing displays in a common Instrument Flight Rules room. Images are projected in blue, green, and cyan onto a 5 × 5 foot flat screen. Resolution is 512 × 512 data points, expandable to 1024 × 1024 data points. TI also says full color can be achieved by adding a red laser to the 5-W argon laser used as the light source.

A typewriter-sized console is used to select, enter, modify and delete information between the operator, display-system and remote computer. A magnetic drum-scanning mirror stores the image to be displayed and controls the multi-beam light modulators.

General Telephone and Electronics Laboratories, Inc., Bayside, N.Y., has developed an experimental laser color display system. It used two lasers: a krypton gas laser to provide red light and an argon gas laser to provide blue and green. The three beams are electro-optically modulated by signals from a standard color TV set, combined into one beam and split into a pair of full-color beams. These beams are scanned by a 15-sided rotating mirror and reflected to a vi-

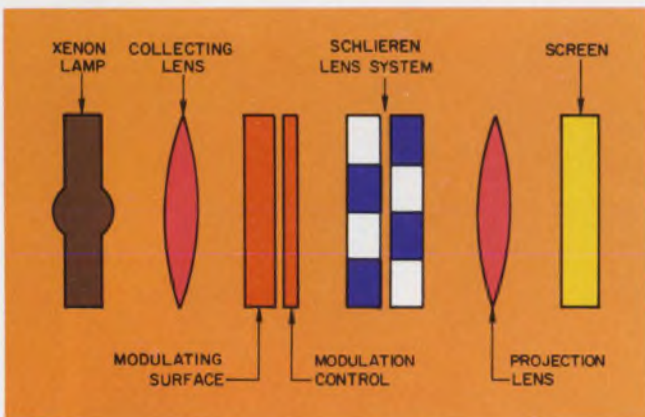

Light-valve display requires a 2-to-4-kW xenon lamp. The light is modulated on a fluid surface and passed through Schlieren optics to a screen.

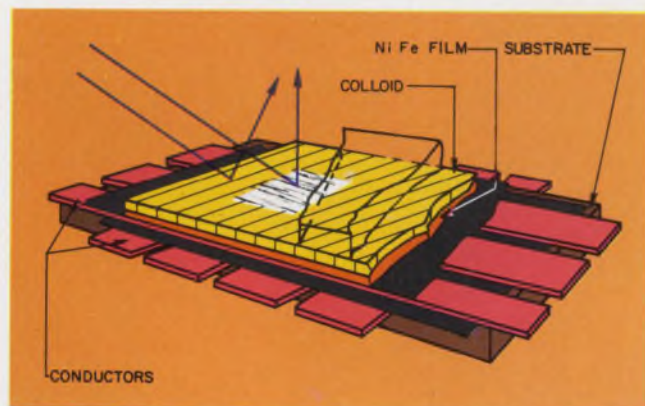

Magneto-optic display acts similarly to a diffraction grating. Display reflects light from external source. Magnetic particles create strain lines.

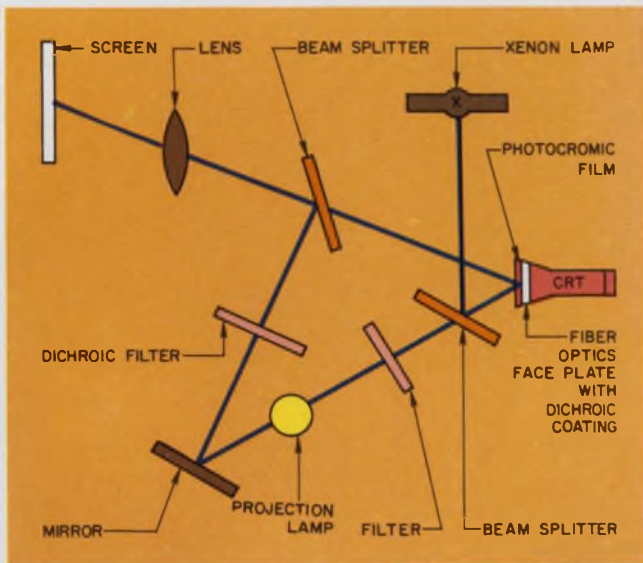

Simplified schematic of photochromic film system being developed for large-screen projection by Army Electronics Command at Fort Monmouth, N.J.

brating mirror that produces the required vertical motion. From there, the light rays are reflected to a 3 × 4-foot screen.

Schmidt optics plus Charactron

Stromberg Datagraphix, San Diego, is developing a large-screen display that they expect to be used for management information systems and military command and control. The system consists basically of a high-brightness CRT, Schmidt optics for projecting the images onto a screen and a separate projection system for displaying photo transparencies on the screen. Its uniqueness lies in the CRT, which combines Charactron-generated alphanumeric with a spot-writing capability. Character size can be varied via the computer. With appropriate driving circuitry, a TV raster could be projected. Scan-converted radar could also be added.

Brightness in the present system is about 3 foot-lamberts, but Paul H. Gleichauf, manager of Charactron engineering at Datagraphix, says that by changing from a rear projection to forward projections onto a beaded or lenticular screen, brightness can be increased to about 15 foot-lamberts. The screen is 5 × 7-feet; Gleichauf expects this can be increased to about 10 × 10 feet.

A 24 × 32-foot display

The Defense Communication Agency has ordered a new fluid-film, light-valve TV projection system from GE. The projector can display black-and-white television pictures on screens 24 × 32 feet (or larger) for 1000 hours of operation. In the past, according to GE, reliability

problems and short component life limited the use of light-valve systems.

The basic light-valve system consists of a xenon-lamp light source, a collecting lens, a modulating surface, a Schlieren lens system, a projections lens and a screen. The modulating surface consists typically of clear glass substrate covered with a thin layer of oil. When an electron beam strikes the oil surface, it creates a charge, and this distorts the flat surface. As the light hits that spot in the fluid, the modulating surface "valves" the light through the Schlieren lens system and the image is projected onto the screen.

The GE system can project computer-generated alphanumeric and standard video inputs. The reliability of the solid-state electronics is expected to be 12,000 hours. Operating time between major overhauls is expected to be 3500 hours. GE uses a 4000-W xenon arc lamp that performs for 1000 hours and gives a brightness of 3000 lumens.

Canadian Westinghouse has built a 20 × 27-foot electroluminescent display for the Canadian Pavilion at Expo'70 in Osaka, Japan. It consists of 16,000 light-emitting panels, each 2 inches square and interconnected. Each panel is composed of a phosphor film sandwiched between two glass plates. The front plate is treated with a transparent layer of tin oxide, which serves as a conductor. The screen requires 6000 W of power and will be in use 12 hours a day, seven days a week.

NASA's big display

The Manned Spacecraft Center in Houston is not only the most elaborate non-military command and control system in the world, but one of the pioneering efforts in the use of visual displays for computer-aided decision-making.

The display system was installed by Philco-Ford, Philadelphia, Pa. Ling-Temco-Vought, Inc. Dallas, Texas, built the central 10 × 20 foot display. On each side of this screen are two 10 × 10 foot displays made by Philco-Ford. Each display is produced by Eidaphor rear-screen projection.

Map or other fixed reference slides can be projected, and changing information—such as an orbit path—is overlaid by "scribing" on 35-mm slides. Scribing is done by a computer-controlled stylus that draws lines on a slide's mirror-like surface. Although the display techniques and systems for the Manned Spacecraft Center are not new they represent a highly complex and reliable development.

The future of displays will be greatly affected by LSI and mini and perhaps micro-computers. The trend toward electronic visualization will continue—proving what pictures are worth. ■■

DTL
goes
National.

930 DTL is a price and delivery business. We're in that business. Digital IC's are volume products and that's also our business.

With the addition of DTL to our digital line of MOS and TTL, we now cover 85% of the most popular digital sockets in the world.

Price, volume, delivery. That's us.

Write for our spec sheet, if you need one, as well as our cross reference guide. Completely covers our new brand 930, dual in-line, silicone, 0° to 75°C. DTL line. We'll also send you our silicone molded rel report as a bonus. National Semiconductor Corporation, 2900 Semiconductor Dr., Santa Clara, California 95051. (408) 732-5000. TWX: 910-339-9240. Cable: NATSEMICON.

National/Digital

Single-map method speeds design

of sequential logic circuits. A triple flip-flop illustrates the technique.

Flip-flop sequential logic circuits can be designed by either multiple Karnaugh maps or a single Karnaugh map.¹⁻⁵ But when the techniques are compared, the advantages of the single-map method are obvious.

It is important to note that, no matter which method is used, the number of flip-flop rules is the same. The essential difference between the two methods lies in where in the procedure the rules are applied.

The earlier, or multiple map, technique applied the flip-flop rules to draw a Karnaugh map from a flow table for each input for each type of flip-flop (Fig. 1). This required a separate map for the R and S inputs to an R-S flip-flop, for the J and K inputs to a J-K flip-flop, and for the input to a T flip-flop.^{1,2,6}

The more recent and concise technique⁶ applies the flip-flop rules in reading a single map that is obtained from the flow table (Fig. 2).^{3,4}

Counter circuit illustrates methods

By way of illustrating these two methods, a three-flip-flop counter will be designed to sequence repetitively through the six states shown in the flow table of Fig. 3. The rules in the multiple-map method can take many forms. To facilitate the comparison, the rules shown in Fig. 4 for the R-S, J-K and T flip-flops will be used.^{4,5,6}

Figure 5 shows the individual map that must be drawn for each input of each flip-flop when the multiple-map method is used. Each initial flow table state corresponds to the entry location defined by the A, B and C coordinates on the maps. The initial and the next flip-flop state, together

Mitchell P. Marcus, Senior Engineer, IBM Corp., Systems Development Div., Endicott, N. Y.

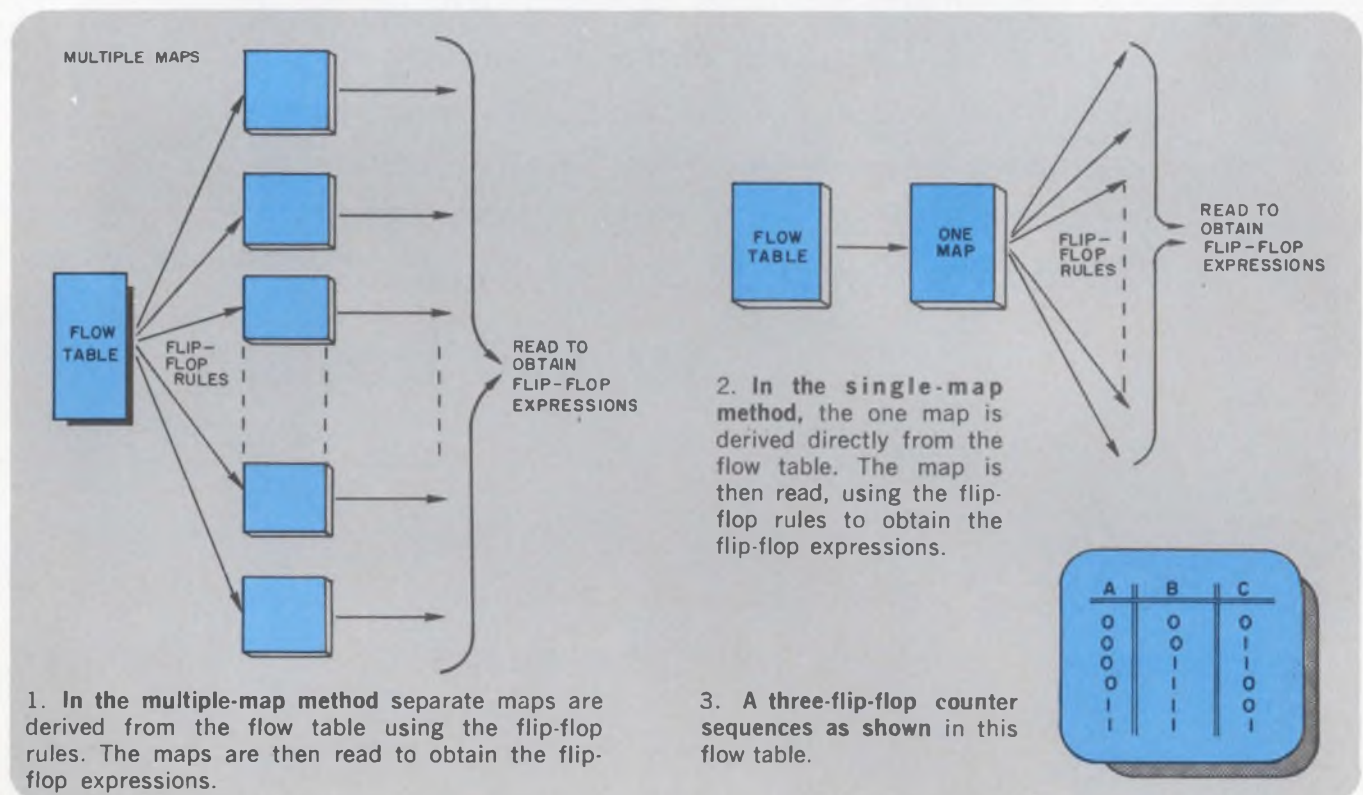

with the flip-flop rules, determine the map entry, which can be 0, 1 or X.

As an example of how the flip-flop rules are used in making the multiple-map entries, consider the S input of the R-S flip-flop (Fig. 4). If the flip-flop turns on, that is, the initial state is 0 and the next state is 1, the map entry is 1. If the flip-flop turns off, the map entry is 0. If the flip-flop stays on, the map entry is X. If the flip-flop stays off, the map entry is 0. The map entry is X for any optional condition.

As an example of how map entries are made, assume $ABC=010$. The next state will be $ABC=$

FLIP-FLOP ACTION	INITIAL FLIP-FLOP STATE (T)	NEXT FLIP-FLOP STATE (T+1)	ONE-MAP ENTRY SYMBOL	FLIP FLOP RULES: (1) TO ENTER MULTIPLE MAPS (2) TO READ SINGLE MAPS				
				R-S		T	J-K	
				R	S	T	J	K
TURN-ON	0	1	1	0	1	1	1	X
TURN-OFF	1	0	0	1	0	1	X	1
STAY-ON	1	1	1	0	X	0	X	0
STAY-OFF	0	0	0	X	0	0	0	X
OPTIONAL			X	X	X	X	X	X

4. Flip-flop rules are shown for both single and multiple maps.

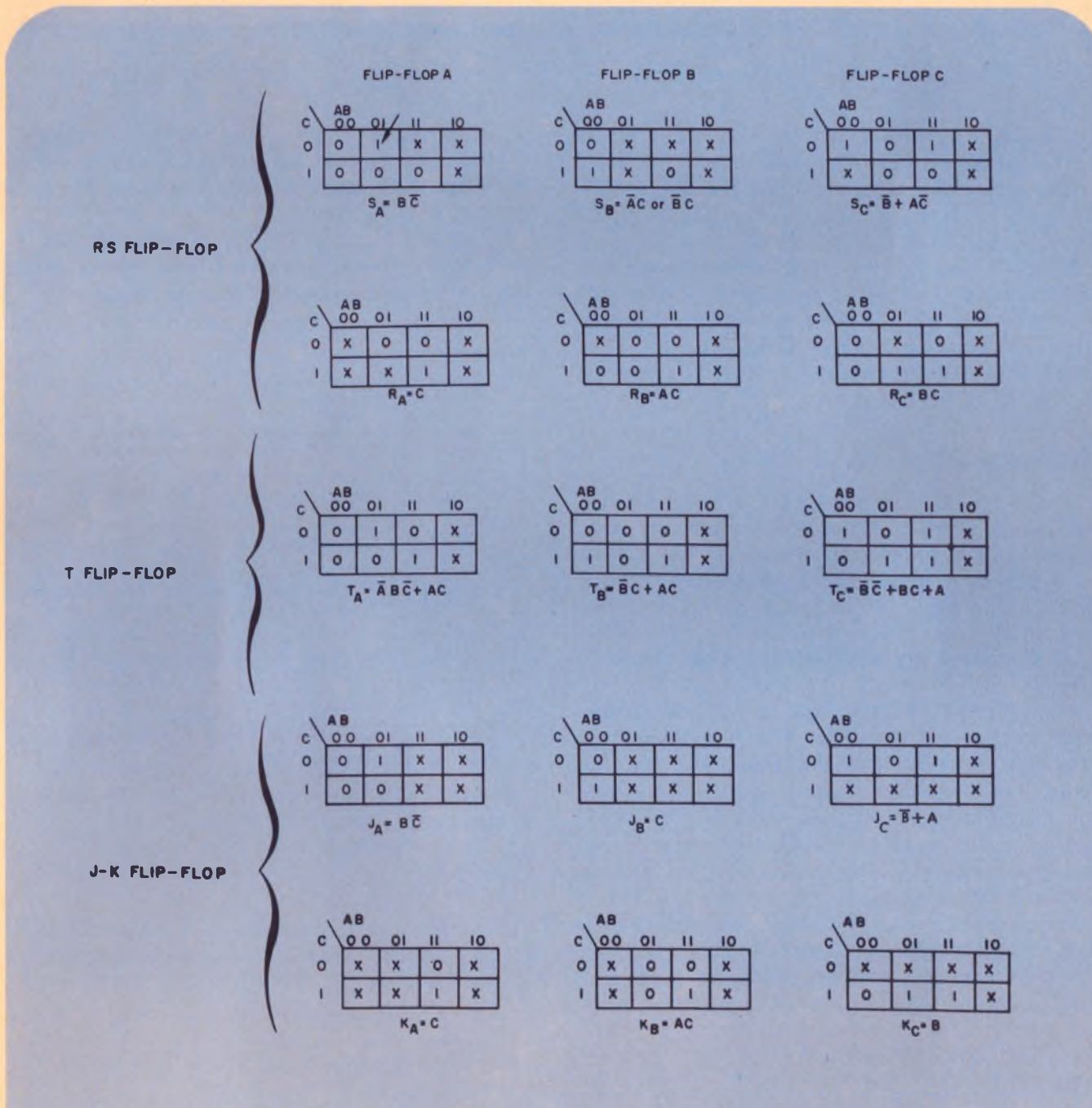

5. The three flip-flop sequential counter flow table (Fig. 3) translates into this multiple set of maps.

Note that each flip-flop requires its own set of maps.

FLIP-FLOP ACTION	T	T+1	MAP SYMBOL
TURN-ON	0	1	1
TURN-OFF	1	0	0
STAY-ON	1	1	1
STAY-OFF	0	0	0
OPTIONAL			X

6. The symbols used in the single-map method are defined in this chart.

FLIP-FLOP A				FLIP-FLOP B				FLIP-FLOP C						
C	AB		IO	C	AB		IO	C	AB		IO			
0	00	01	11	10	0	00	01	11	10	0	00	01	11	10
0	0	1	1	X	0	0	1	1	X	0	1	0	1	X
1	0	0	0	X	1	1	0	X	1	1	0	0	X	1

$S_A = B\bar{C}$	$S_B = \bar{A}C \text{ or } \bar{B}C$	$S_C = \bar{B} + A\bar{C}$
$R_A = C$	$R_B = AC$	$R_C = BC$
$T_A = \bar{A}B\bar{C} + AC$	$T_B = \bar{B}C + AC$	$T_C = \bar{B}\bar{C} + BC + A$
$J_A = B\bar{C}$	$J_B = C$	$J_C = \bar{B} + A$
$K_A = C$	$K_B = AC$	$K_C = B$

7. The three flip-flop counter flow table transforms into this one set of maps. It is universal for all flip-flops.

110; flip-flop A thus turns on. For the S input of that R-S flip-flop, the map entry for this action is a 1. The 1 is, therefore, entered in the ABC=010 location of the R-S flip-flop S input map for flip-flop A (arrow in Fig. 5).

After all map entries are made, the maps are read to obtain the flip-flop expressions. Note that only three types of flip-flops have been considered. If D, R-S-T and J-K-T flip-flops were also considered, 21 more maps—a total of 36 maps in all—would have to be drawn.

'Universal' maps apply to any flip-flop

In the one-map method (Fig. 7) no matter how many different types of flip-flops are considered, only a single map need be drawn. These are "universal" maps, applicable to any type of flip-flop. The map entries are made, without regard to flip-flop rules, directly from the flow table. The rules are applied later when the map is read.

Each initial flow-table state corresponds to the entry location on the map. The initial and the next flip-flop state determine the map entry. As a means of carrying the flip-flop action information to the map, simple map symbols (0, 1, 0, 1 X) are used in (Fig. 6). Using the previous example—namely flip-flop A turning on as the flow-table state goes from ABC=010 to 110—a 1 is entered in the ABC=010 location of the single map for flip-flop A (arrow in Fig. 7).

After the map entries are made, the maps are read to obtain the flip-flop expressions; it is at this point in the one-map method that the flip-flop rules come into play.

As an example, consider the S input of the R-S flip-flop (Fig. 4): the 1 entries are read as 1s, the 1 and X entries are read as Xs, and the 0 and 0 entries are read as 0s. It should be noted

particularly that there are no additional rules.

Note, too, that no matter how many types of flip-flops are considered only the map for each flip-flop need be drawn.

Another advantage of the one-map method is that the optimum choice of flip-flop is often obvious from inspection of the one map. ■■

References:

1. Golenski, S. S., "Simplified Sequential Counter Design," *Electro-Technology*, February, 1967.
2. Beraru, J., "A One-Step Process for Obtaining Flip-Flop Logic Equations," *Computer Design*, October, 1967.
3. Marcus, M. P., "Universal Maps Yield Sequential Counter Logic," *Electro-Technology*, February, 1968.
4. Marcus, M. P., "A One-Map Method for Obtaining Flip-Flop Input Expressions," *Computer Design*, March, 1968.
5. Beraru, J., "Map Entry Method for Sequential Counter Logic," *Electro-Technology*, December, 1968.
6. Marcus, M. P. *Switching Circuits for Engineers*, Prentice-Hall, Inc., Englewood Cliffs, N.J., 2nd Edition, 1967.

Test your retention

Here are questions based on the main points of this article. Their purpose is to help you make sure you have not overlooked any important ideas. You'll find the answers in the article.

1. Does the single-map or the multiple-map method require a larger number of flip-flop rules?
2. Are the maps for the inputs of an R-S flip-flop the same as the maps for the inputs of a J-K flip-flop in the single-map method? In the multiple-map method?
3. How do the two methods differ as to when the flip-flop rules are applied?

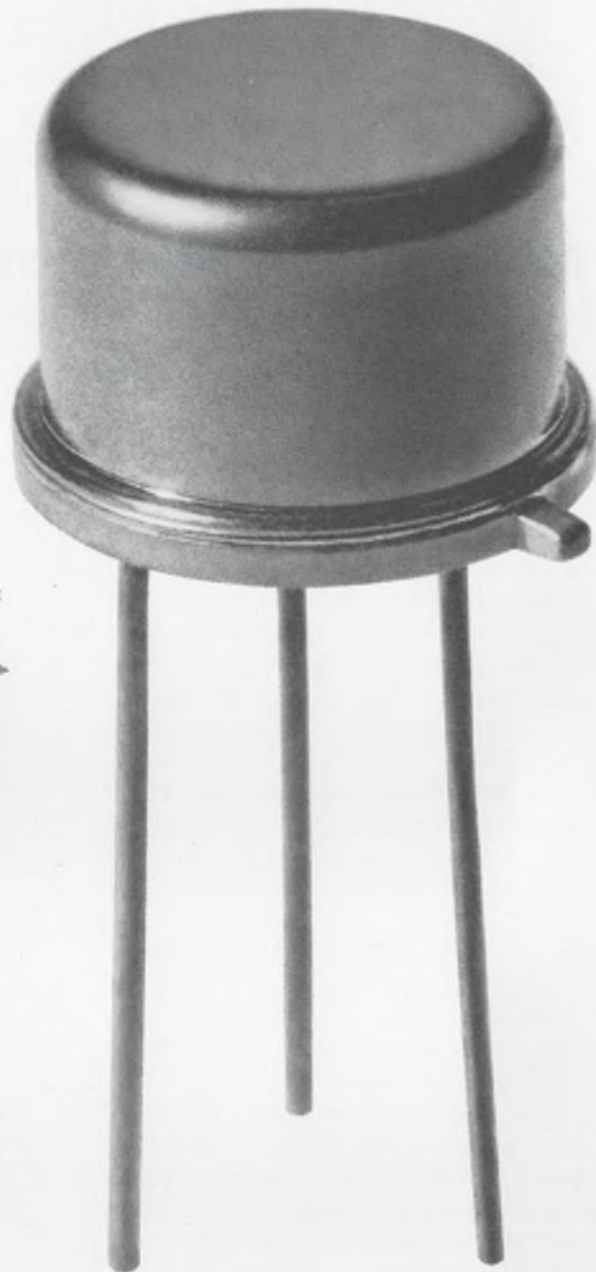

RCA-TA7477
(actual size)



Companion types:
RCA-TA7408 &
TA7409
(actual size)

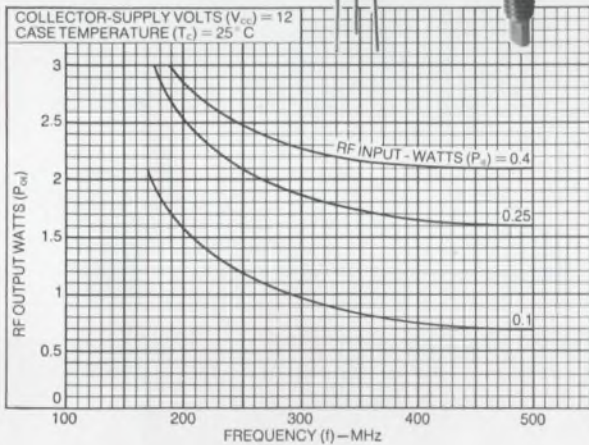

Headed for an important role in mobile and portable communications equipment, the high-gain RCA-TA7477 is now available in production quantities. This silicon n-p-n "overlay" transistor, designed for 12 V service, also is capable of 2 W minimum output at 470 MHz (7 dB gain). It is intended for Class C vhf/uhf amplifier service in CB, sonobuoy and beacon, as well as other mobile and portable applications.

Either an RCA-TA7477 or a TA7408 (also 7 dB gain at 470 MHz) may be used to drive a TA7409 final amplifier to 6 W (min.) output at 470 MHz. The latter two are stripline devices.

Ask your local RCA Representative or your RCA Distributor for more detailed information. For technical data, write: RCA Electronic Components, Commercial Engineering, Sec. G-12-2/UF4, Harrison, N. J. 07029. In Europe: RCA International Marketing S.A., 2-4 rue du Lièvre, 1227 Geneva, Switzerland.

**2 W (typ) output,
13 dB gain, at
175 MHz in 12 V service—
the RCA-TA7477**

RCA

Convert digital data from parallel to serial and from serial to parallel using ICs and applying logical design techniques.

Part 3 of a three-part article

Logical design information in the form of Karnaugh maps, truth tables and logic diagrams has been presented for a variety of code and arithmetic digital converters in Parts 1 and 2 of this article. Similar information is presented here for parallel-to-serial and serial-to-parallel converters. The conventions and definitions used in Parts 1 and 2 are also valid for this part of the article.

The serial/parallel converters are used when the method of reading and using data must be interchanged. One type of parallel-to-serial and two types of serial-to-parallel converters are presented.

The converter in Fig. 15 is used to change binary information on four parallel lines (F_i) into a serial binary signal on one input line (G). Circuit elements include four DTL gates (Z_1 - Z_4) for timing and decoding, a divide-by-five counter, and a four-bit storage register. If the number of parallel input lines is increased, then the number of converter stages must be increased accordingly. The design of a typical stage of the storage register is shown in Fig. 13.

A synchronous DTL circuit to convert four-bit serial input into a four-bit parallel output is shown in Fig. 16. The serial input is fed into a shift register and is strobed out through parallel gates (Z_1 , Z_2) on the fourth input pulse. The strobe signal is obtained from the AND combination of the outputs of a divide-by-four counter and a delayed clock.

Another type of synchronous DTL four-bit serial-to-parallel converter is shown in Fig. 17. In this case, the serial input is applied directly to a set of NAND gates (Z_1 , Z_2). The serial data is read sequentially into the four bit storage when the divide-by-five counter is operative. At the end of the counter cycle, the four bits are stored and they can be read out in parallel. A typical stage of the storage register is shown in Fig. 14. ■■

A. H. Frim and M. M. Miller, Radio Corporation of America, Defense Electronic Products, Aerospace Systems Div., Burlington, Mass.

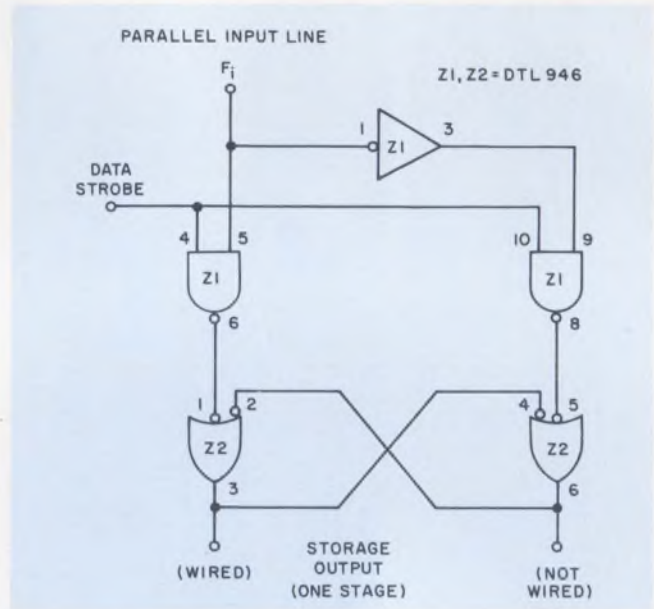

13. Two DTL 946 packages make one stage of an n-bit storage register. This is the register used in the parallel-to-serial converter of Fig. 15.

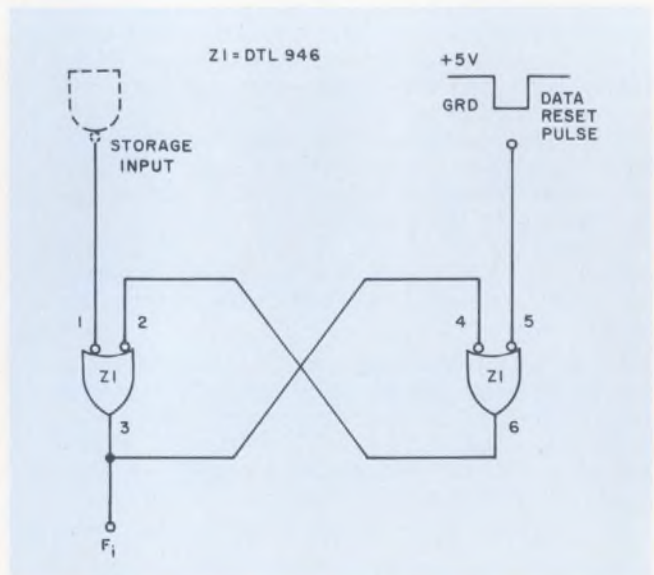

14. Another storage register uses only one DTL 946 package. It is used in the serial-to-parallel converter of Fig. 17.

15. Parallel-to-serial converter

Operation:

This converter provides a 4-bit serial output (G) from a 4-bit parallel input (F_i). For the waveforms illustrated below, operation is as follows:

- (a) Counter is cleared ($A = 0, B = 0, C = 0, \bar{A} = 1, \bar{B} = 1, \bar{C} = 1$) on cp_1 . Also, F_i are applied to 4-bit storage register.
- (b) When cp_2 and start-stop signals are both HIGH, Z1-6 is HIGH, so that Z4-1, -2, -4, and -5 are HIGH, Z1-8 is HIGH and data is strobed into 4-bit storage register. The trailing edge of cp_2 also starts the counter, so that the counter output C goes HIGH ($C = 1$).
- (c) During clock pulse cp_3 , $C = 1, B = 0$, and $F_0 = 1$ so that Z2-1, -2, -4, and -5 are HIGH, and therefore Z2-6 is LOW and Z4-8 is HIGH. This is the first pulse of the serial output G.
- (d) During clock pulse cp_4 , $F_1 = 0$, so that Z2-9 is LOW. In effect, Z4-8 is LOW and no serial output pulse occurs.
- (e) During clock pulse cp_5 , $F_2 = 1, B = 1, C = 1$, so that Z3-8 is LOW, and therefore output pulse occurs at Z4-8.
- (f) During clock pulse cp_6 , $F_3 = 1$ and $A = 1$, so that Z3-6 is LOW, and therefore output pulse occurs at Z4-8.

Thus, the parallel input 1011 appears as a serial output 1011.

Truth tables:

Counter Stage			Parallel Input				Serial Output	
A	B	C	Data Strobe	F_0	F_1	F_2	F_3	G
0	0	0	1	0	0	0	0	0
0	0	1	0	1	0	0	0	1
0	1	0	0	0	1	0	0	1
0	1	1	0	0	0	1	0	1
1	0	0	0	0	0	0	1	1

X = Don't Care = 5, 6, 7

Karnaugh maps:

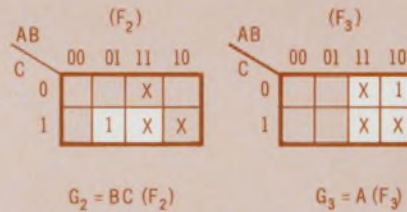
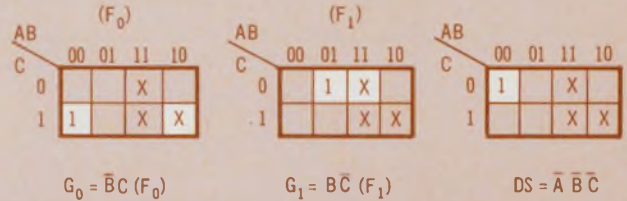

$$G = G_0 + G_1 + G_2 + G_3$$

$$= BC F_0 + B\bar{C} F_1 + BC F_2 + A F_3$$

Logic Diagram:

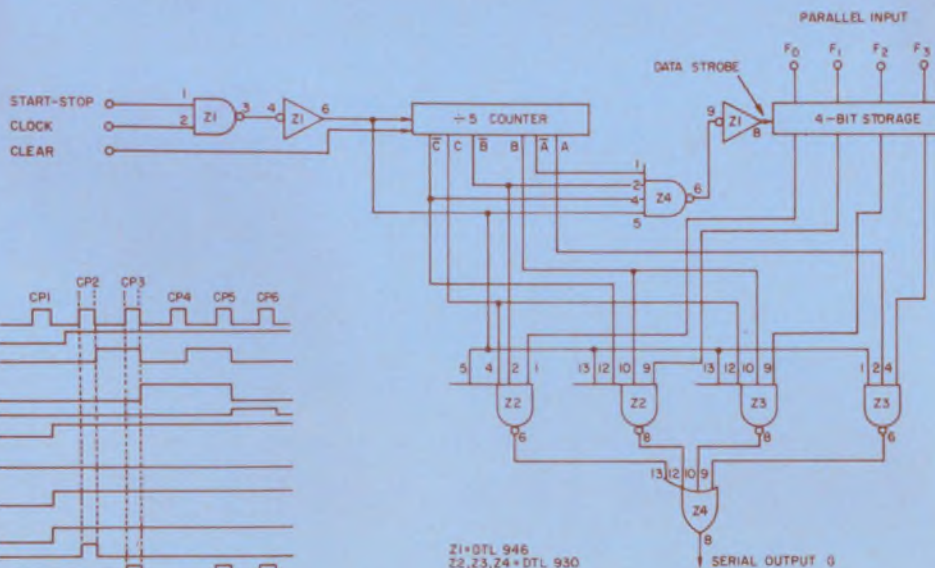

Waveforms:

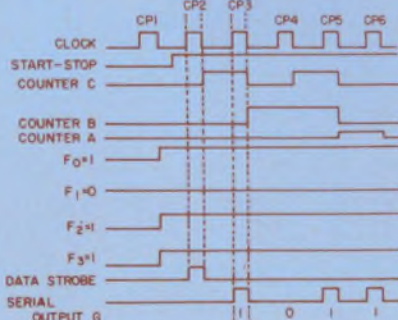

17. Serial-to-parallel converter

Operation:

This serial-to-parallel converter utilizes three DTL 930 gate packages (Z1, Z2, Z3), a divide-by-five counter, and a 4-bit storage register. During normal operation, as illustrated by the waveforms, the counter is first cleared (A,B,C=0) and the storage register is reset (F₁, F₂, F₃, F₄=0). When the start-stop signal and clock are both HIGH, Z3-6 is LOW, so that Z3-8 is HIGH, enabling the counter and gate lines Z2-12, Z2-5, Z1-13, and Z1-5. On the trailing edge of the second clock pulse, the counter is triggered, and output C is HIGH (C=1). Output B remains LOW (B=0, $\bar{B}=1$). When the serial input is a ONE, Z1-6 goes LOW on the leading edge of the third clock pulse, so that F₁ is HIGH (F₁=1). During the next three clock pulses, the counter is cycled, at which time Z1-8 is HIGH (F₂=0), Z2-6 is LOW (F₃=1), and Z2-8 is LOW (F₄=1). In this way, the 4-bit serial input is stored sequentially in the storage register, ready for parallel transfer. Following data readout, the storage register is reset, and a new 4-bit serial word is read in at the desired time.

Truth table:

Counter Stage			Output Data			
A	B	C	F ₁	F ₂	F ₃	F ₄
0	0	0	0	0	0	0
0	0	1	1	0	0	0
0	1	0	0	1	0	0
0	1	1	0	0	1	0
1	0	0	0	0	0	1

X = Don't Care = 5, 6, 7

Karnaugh maps:

	AB	00	01	11	10
C	0			X	
	1	1		X	X

$$F_1 = \bar{B}C$$

	AB	00	01	11	10
C	0		1	X	
	1			X	X

$$F_2 = \bar{B}\bar{C}$$

	AB	00	01	11	10
C	0			X	
	1		1	X	X

$$F_3 = BC$$

	AB	00	01	11	10
C	0			X	1
	1			X	X

$$F_4 = A$$

Waveforms:

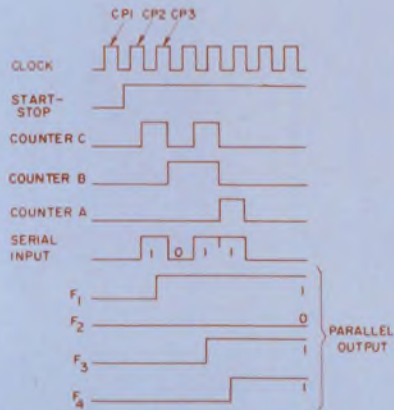

Logic diagram:

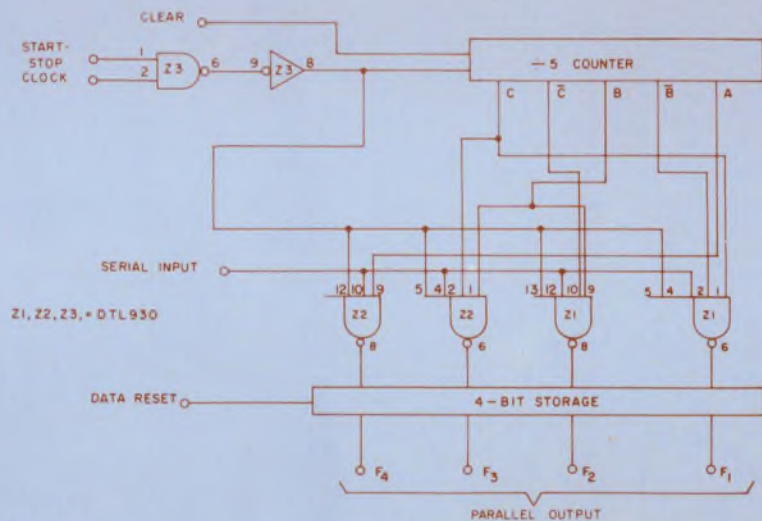

**This new keyboard
will give you
some idea
of just how much
our computerized
counter can do.**

Our 5360A Computing Counter is much, much more than a counter. A computerized digital measuring system would be more accurate, because it measures frequency, period, and time interval at speeds and resolutions never before possible.

And now this unique measuring system can be even more useful to you, with the addition of the 5375A Keyboard.

You can enter programs and have the keyboard learn and run them automatically. For example, phase, standard deviation, ranging, rate-of-change, FM deviation, VCO linearity, residual FM, averages. In fact, this keyboard lets you program the counter to display, in real time, solutions to equations whose variables are the measurements made by the counter.

As you can see in the photograph, the keyboard will handle all basic math, including root, branching and looping within the program.



In short, it's designed to keep up with the capabilities of the counter.

This is quite a feat in itself. The counter makes measurements to 320 MHz on its own, and goes all the way to 18 GHz with plug-ins. Another plug-in affords the first 100 picosecond time interval resolution ever available in a counter. Besides being faster and more accurate than any previous instrument of its kind, the 5360A has eleven-digit resolution, with fixed decimal display, automatic units and blanking, to give you error-free readout.

You'll find that the 5360A Computing Counter makes measurements you could never make before. And it saves you time and the expense of setting up elaborate measuring systems. It will do all this for just \$6500, plus \$1350 for the 5375A Keyboard.

For all the data and applications, call your local HP field engineer. Or write to Hewlett-Packard, Palo Alto, California 94304; Europe: 1217 Meyrin-Geneva, Switzerland.



HEWLETT  PACKARD

ELECTRONIC COUNTERS
INFORMATION RETRIEVAL NUMBER 38



Engineers need to stretch their minds

by broadening their education if they want to be socially conscious and industrially competitive, says this noted scientist.

Richard L. Turmail, Management Editor

Overheard on engineering campuses across the nation:

"Sure, I'd like to take an elective, but I can't because I'm loaded down with required engineering courses."

"If I go to that English Lit seminar, I'll miss the computer symposium."

"Take a course in philosophy! What for? The only philosophy I need is 'optimum efficiency.'"

Many engineers have lived to regret not taking college courses in the humanities when they discover that often their careers broaden only in proportion to the scope of their educational background.

"I have always deplored specialized educational programs in the cases where the student took too much too fast," says Dr. Krafft Ehrlicke, chief scientific advisor for advanced programs at the space division of North American Rockwell Corp. in California.

Dr. Ehrlicke, one of the foremost creative scientists in the country today, and a guiding influence on NASA, says that there is an immense value to engineers in such courses as history, foreign languages, and astronomy, because they teach him the social implications of what he is doing. A specialized education makes it possible for an engineer to build the best spacecraft in the world while being at a loss to gauge or to explain to the hazing general public the broader social and economic implications of his accomplishments.

Next step in space: the earth

The overriding theme of Dr. Ehrlicke's message is that there is an urgent need for engineers to expand their education and develop a sense of social responsibility. And it's never too late for the older engineer who's willing to improve himself.

"The next step in space is headed toward earth," he says. "I mean that, before we can go further out in space, we must develop a planetary consciousness about our own earth."

Dr. Ehrlicke says that this consciousness is

vital because our planet can no longer sustain more human beings and their demands unless steps are taken to use the natural resources we haven't yet touched, and to curb the excessive drain on those we have. He recommends the following actions to overcome this "crisis":

- Conduct and maintain an inventory of our planet's resources.
- Form alliances of the major powers to cooperate on activities such as space and sea exploration, the search for new resources, and anti-pollution programs.
- Improve the earth's capability of sustaining more people by transferring part of the economy into the solar system by exploiting the moon, asteroids and uninhabited planets.

According to Ehrlicke, much of the success of a planetary consciousness rests on the attitudes of creative and well-informed engineers.

"The creative ones," he says, "have a drive that comes from a sense of obligation to the community. They must examine their engineering activities in the light of social, political, ethical, historical and philosophical considerations."

The longer you talk with Dr. Ehrlicke the more you realize that the consciousness about which he is concerned cannot come either from men who know only how to reach maximum efficiency or from men who claim technology is ruining the world. It must come from the scientifically and socially trained engineer who really believes that he is the translator of scientific knowledge for the benefit of human society.

Why is it so important for the engineer to be socially trained? Because, Ehrlicke says, in spite of much enlightenment, man remains strongly opinionated about himself and what he can do with his environment. "For ages we've had an emphasis on personal moral problems," Ehrlicke says, "but we have not until recently been told that we couldn't exploit and pollute the world without backlash."

Problems that plague

So the engineer will need a broader education if he wants to take part in humanizing the world



Krafft A. Ehricke has ridden rocket systems to technological prominence during the past three decades. From the early 1940s, when he began his career fresh out of the Technical University of Berlin as a research scientist on the German V-2, and later when he helped to develop the Atlas missile, and then directed NASA funded studies on space flight projects, to the present as Chief Scientist of Advanced Programs, Space Division, North American Rockwell Corp., his heart and mind have been among the stars. He is concerned about space operations not only in the context of their technological and scientific aspects, but also with their social and cultural implications for humanity. He has shared his thoughts on space flight with us as author of 21 books, and over 100 articles in scientific and technical publications. While Ehricke is listed in "Who's Who in America", the scientific community has further recognized him by awarding him an Honorary Doctorate in Humane Letters from the National College of Education, and electing him to the International Aerospace Hall of Fame.



of the future. Meanwhile, he has to make a living, and Dr. Ehrlicke believes that to compete in today's advanced technology an EE must obtain at least a master's degree.

"A diversified education is needed," Ehrlicke advises, "to combat the everyday career problems that can plague an engineer." Some of those problems are manifest in communicating, in presenting ideas, in career direction and future of the engineer, and in compromising.

The following guidelines offered by Ehrlicke should help the engineer no matter what direction his career takes—to the stars, or to a position of management, or both.

On writing

Engineers very often are notoriously poor writers. They write sentences filled with acronyms because they are accustomed to writing in terms of specialized language. They have trouble explaining in laymen's language what their subject is all about. If you can't explain it in plain terms you don't understand it yourself.

Most engineers can write reports for other engineers that are intelligible but not easily readable. Sentences are generally too long and basic logic is missing because the writer jumps from subject to subject without concern whether the reader is following him. Engineering courses emphasize specific methodologies but not systems of logic, such as a course in foreign language.

On ideas

When I was young I had trouble getting my ideas across, just like the young engineer today. I soon realized that since this is an imperfect world, there is no objective, unbiased attitude toward ideas. When people are already committed to other ideas, it's difficult to change their minds even if you have a better idea. So think ahead. Time your presentation to the period when their minds aren't yet made up—when they're prepared to listen."

Creative people, or those in high positions, don't like to be told that they've made the wrong decision; they also don't like to get all their ideas from others. Be cognizant of the other guy's pride and exercise tact and diplomacy. Don't focus on competitiveness or conflict only. Try interpretation and synthesis as well.

On the future of the engineer

It is frustrating that more often than not, the only way you can climb in engineering is to become an administrator instead of an engineer. The problem is that the EE begins to think that what really counts is not his engineering knowledge but the politics of the organization. Some engineers treat the profession as a stepping stone. We must make it important enough so that they'll want to remain engineers.

What can be done? Companies should give an engineering manager a good second man of the administrative type who would be responsible for purely administrative matters. This would give the manager more time to attend to engineering duties. Companies should also give engineers as much active influence in decision making on engineering problems as possible.

On career directions

But if you are interested in becoming an engineering manager, then I would suggest that you get a job with a large company so that you can get a variety of experience in management areas. Your advantage in working in a small company is that your individual responsibilities may broaden faster. But they are more limited, and you may not advance in knowledge.

If you are interested in specific components—if you are an electronics engineer, for example—don't go to a broad systems company, because the electronic aspects play a subordinate role to the total system. Start with an electronics company, then when you've had experience as a subcontractor, you can go on to a larger company if you desire to apply your special talents in a broader frame of reference.

On compromise

In a free society such as ours, only your own conscience can decide where compromise ends, and cowardice begins. You may be certain you should or should not participate in the building of a missile, or other weapon. Education and basic knowledge more than specialized training will allow you to make an informed decision. Emphasis must be on responsibility for your opinions and actions. If you don't dare to express your convictions or act on them responsibly, you have no cause to complain covertly. I find that in this country a person can have the courage of his convictions without fear of company reprisal.

There's no short cut

"What we as a society must do," Ehrlicke summarizes, "is make a long-range investment in our technology. Besides the educational investment that's necessary we must invest in planning. We must try to plan further ahead than just every four years between elections.

When settling into a new technical environment as we have in the space age, Ehrlicke says that the attending period of changes is always tortuous because many changes and adaptations are required. Vested interests are affected.

He concludes: "As the philosophers told King Midas, 'There is no king's road to mathematics; you've got to work hard'. So it is with engineers and their road to social understanding and competitive position: they've got to work hard." ■■

Even in power supplies, somebody makes progress once in a while. This is the new NIMS high voltage power supply.



It's a Fluke.

Fluke's new NIMS (nuclear instrument module system) high voltage power supply is priced about the same as the three major competitors, \$460. That's where the similarity ends.

In every other pertinent spec, the new Fluke 423A exceeds or at the very least meets the competition. And, in addition, it offers some exclusive features all its own. Let's go down the list. Only Fluke offers a full 0 to 3000 volts, line and load regulation of 0.001 and 0.002 percent across the board. Only Fluke offers portable bench case or NIMS bin module. Only Fluke offers remote analog slewing of the output or manual operation. Only Fluke offers a current limit of 15 ma. Other specifications are output current, 0 to 10 ma, Resolution, 100 mv. Accuracy, 0.25%. Ripple and noise, 5 mv peak-to-peak (10 Hz to 1 Mhz). Polarity is reversible at the rear panel. Size is 2.7" x 8.7" x 9.7". Price with case is \$495.

For full details, see your Fluke sales engineers or contact us directly.



Fluke, Box 7428, Seattle, Washington 98133. Phone: (206) 774-2211.
TWX: 910-449-2850. In Europe, address Fluke Nederland (N.V.), P.O. Box 5053,
Tilburg, Holland. Phone: (04250) 70130. Telex: 884-50237. In the U.K., address
Fluke International Corp., Garnett Close, Watford, WD2 4TT.
Phone: Watford, 27769. Telex: 934583.

INFORMATION RETRIEVAL NUMBER 39

New IC Switch from the Triac Leader

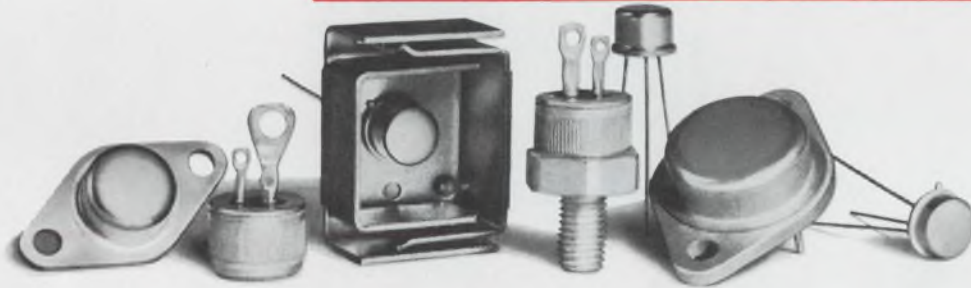
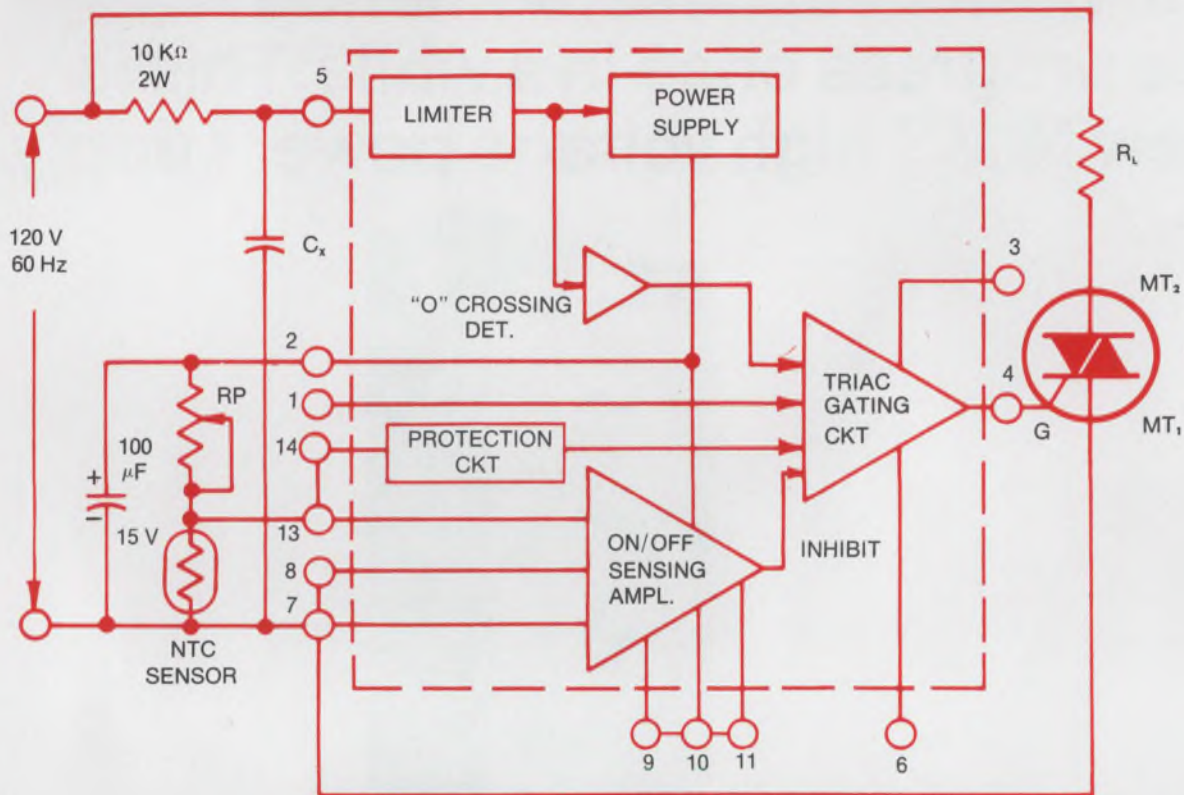

RCA-CA3059 Zero-Voltage Switch for New Economy, New Simplicity in Thyristor Trigger Circuits \$1.95 (1000 units)

Here's RCA's economical, new approach to Thyristor triggering—the CA3059 monolithic zero-voltage switch, at \$1.95 (1000 units). For efficient triggering of Triacs and SCR's with current ratings to 40 amperes—in applications such as electric heating, motor on/off controls, one-shot controls, and light-flashing systems—CA3059 offers these important new design advantages:

- Triggers Thyristors at zero-voltage crossing for minimum RFI in applications at 50, 60, 400 Hz.
- Self-contained DC power supply with provision for supply of DC bias current to external components.
- Built-in protection against sensor failure.
- Flexible connection arrangement for adding hysteresis control or proportional control.
- External provisions for zero-current switching with inductive loads.

- On/off accuracy typically 1% with 5 kΩ sensor; 3% with 100 kΩ sensor.

- Range of sensor resistance at control point—2 kΩ to 100 kΩ.

- 14-lead DIP package for -40°C to +85°C operation.

For further details, check your local RCA Representative or your RCA Distributor. For technical data bulletin, file no. 397, and Application Note ICAN4158, write RCA Electronic Components, Commercial Engineering, Sec. IGG12-2, /CA0014, Harrison, N.J. 07029. In Europe, contact: RCA International Marketing S.A. 2-4 rue du Lièvre, 1227 Geneva, Switzerland.

RCA Integrated Circuits

Multivoltage monitor circuit uses only a single transistor

A large number of positive or negative voltages can be continuously monitored using a very simple resistor-transistor circuit. The single transistor will change state with the loss, either by open or short, of any one of its monitored voltages. The multivoltage monitor is made by balancing any number of positive voltages against one negative voltage at the transistor base. If all of the voltages are present, the transistor is held in saturation. The circuit works just as well for negative voltages, where they are balanced against one positive voltage, to hold the transistor off when all the negative voltages are present.

The conditions to be satisfied are:

- For positive voltages:
 1. Provide a specified base current (I_b) if all voltages are present.
 2. Back-bias the base emitter junction by a specified voltage (V_{BEr}) with the loss of any one voltage.
- For negative voltages:
 1. Back-bias the base emitter junction by a specified voltage (V_{BEr}) when all voltages are present.
 2. Provide a specified base current (I_b) with the loss of any one voltage.

The monitor circuit is based on a voltage going to ground when it is lost; this is because a circuit so designed will also work if the voltage fails open.

For the positive voltage monitor shown in Fig. 1a we can obtain the equivalent shown in Fig. 1b, from which:

$$E_{oc} = \frac{V_1/R_1 + V_2/R_2 \dots + V_n/R_n + V_a/R_a}{1/R_1 + 1/R_2 \dots + 1/R_n + 1/R_a} \quad (1)$$

$$= I_b R_p + V_{BEr}$$

where n is the number of positive voltages being monitored.

If this voltage must change by the same amount for the loss of any one positive voltage, we can write:

$$V_1/R_1 = V_2/R_2 \dots = V_n/R_n \quad (2)$$

Simplifying Eq. 1 by letting

$$K = V_1/R_1 + V_2/R_2 \dots + V_n/R_n \quad (3)$$

so that

$$K = nV_1/R_1 = nV_2/R_2 \dots = nV_n/R_n \quad (4)$$

and noting that

$$1/R_p = 1/R_1 + 1/R_2 \dots + 1/R_n + 1/R_a \quad (5)$$

Eq. 1 can be written as:

$$E_{oc} = [K - (V_a/R_a)]/(1/R_p) = I_b R_p + V_{BEr} \quad (6)$$

With the loss of one voltage, E_{oc} must drop to

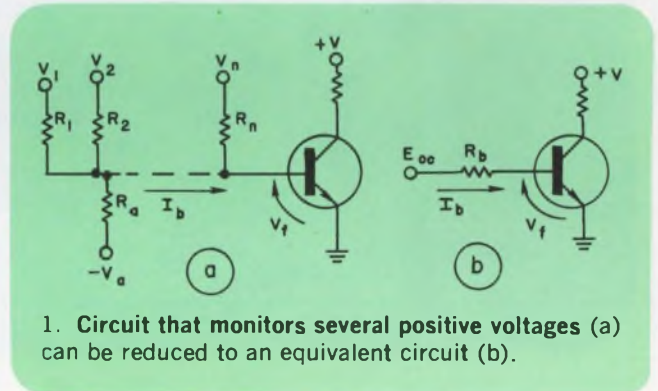

1. Circuit that monitors several positive voltages (a) can be reduced to an equivalent circuit (b).

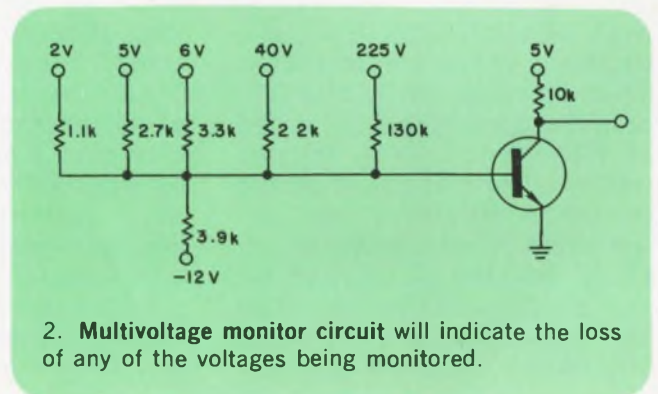

2. Multivoltage monitor circuit will indicate the loss of any of the voltages being monitored.

TRW 2 GHz Broadband Transistors



Infinite VSWR...8 dB Gain...28 Volts

High gain, high efficiency, and excellent VSWR are characteristics of a new family of 2 GHz broadband transistors developed by TRW. Type 2N5766, the one watt unit, has 8 dB gain at greater than 30% efficiency, and can withstand infinite VSWR at any phase. Both the 2.5 watt 2N5767, at 8 dB gain and greater than 30% efficiency, and the 5 watt 2N5768 at 7 dB gain and greater

than 35% efficiency, can withstand 3:1 VSWR at any phase.

All three transistors provide excellent stability in a common base circuit. All are contained in exceptionally rugged, ultracermic, hermetically sealed stripline packages, and operate from a 28 V source.

For further information or application assistance, contact any TRW distributor or TRW

Semiconductors Inc., 14520 Aviation Boulevard, Lawndale, Calif. 90260. Phone (213) 679-4561; TWX: 910-325-6206. TRW Semiconductors is a subsidiary of TRW Inc.

TRW[®]

back-bias the base emitter junction by a voltage V_{BEr} and no base current will flow.

$$+ V_{BEr} = [(K/n)(n-1) + (V_a/R_a)] / (1/R_p) \quad (7)$$

From Eq. 4 individual resistor sizes can be expressed as:

$$R_1 = nV_1/K \quad (8)$$

$$R_2 = nV_2/K, \text{ etc.}$$

Substituting Eq. 8 into Eq. 5

$$\begin{aligned} 1/R_p &= K/nV_1 + K/nV_2 \dots + K/nV_n + 1/R_a \\ &= K/n [(1/V_1) + (1/V_2) \dots + (1/V_n)] + 1/R_a \end{aligned} \quad (9)$$

As an example, suppose that we need to monitor: +2 V, +5 V, +6 V, +40 V and +225 V simultaneously, and that $I_b = 0.1 \text{ mA}$, $V_{BEf} = 0.7 \text{ V}$, $V_{BEr} = -0.2 \text{ V}$, $V_a = -12 \text{ V}$ and $n = 5$.

From Eqs. 6, 7 and 9 solved simultaneously, we obtain:

$$K = 8.69 \times 10^{-3}$$

$$R_n = 3.83 \text{ K}$$

$$1/R_p = 1.82 \times 10^{-3}$$

Solving for the individual resistor values, using Eq. 8,

$$R_1 = nV_1/K = (5 \times 2 / 8.69 \times 10^{-3}) = 1.1 \text{ k}\Omega \dots$$

Now a math check should be made by substituting these resistor values into Eq. 5 and comparing the results with the simultaneous solution for $1/R_p$.

The completed circuit is shown in Fig. 2. Total circuit dissipation is 496 mW.

The following three expressions are those required for a circuit that will monitor n negative voltages with a positive reference voltage:

$$K - (V_1/R_1) + (V_{BEr}/R_p) = 0$$

$$\frac{n-1}{n} K - \frac{V_1}{R_1} + \frac{V_{BEf}}{R_p} = I_b$$

$$-\frac{K}{n} \left(\frac{1}{V_a} + \frac{1}{V_b} \dots + \frac{1}{V_n} \right) + \frac{1}{R_1} - \frac{1}{R_p} = 0$$

Peter Lefferson, Senior Engineer, Electronic Communications, Inc., St. Petersburg, Fla.

VOTE FOR 311

Pulse sequence generator uses delay line and NAND gates

Many digital systems require a sequence of control pulses of a specific width in given time instants during the operating cycle of an asynchronous unit. A typical example is a ferrite core memory with sequence of read-control, write-control, strobing, etc. The simple circuit shown can be used for this purpose. It consists of an LC tapped delay line, the taps of which are directly

connected to the inputs of NAND gates.

In operation, a negative-going initiate pulse of width T enters the delay line. The leading edge of this pulse, after reaching tap A, sets the flip-flop (built from two NAND circuits) to the ONE state, and after reaching tap B, resets it to the ZERO state.

Both the control pulse and its complement, the width of which corresponds to the propagation

VOTE

VOTE! Go through all Idea-for-Design entries, select the best, and circle the appropriate number on the Reader-Service-Card.

SEND US YOUR IDEAS FOR DESIGN. You may win a grand total of \$1050 (cash)! Here's how. Submit your IFD describing a new or important circuit or design technique, the clever use of a new component or test equipment, packaging tips, cost-saving ideas to our Ideas-for-Design editor. You will receive \$20 for each accepted idea, \$30 more if it is voted best-of-issue by our readers. The best-of-issue winners become eligible for the Idea Of the Year award of \$1000.

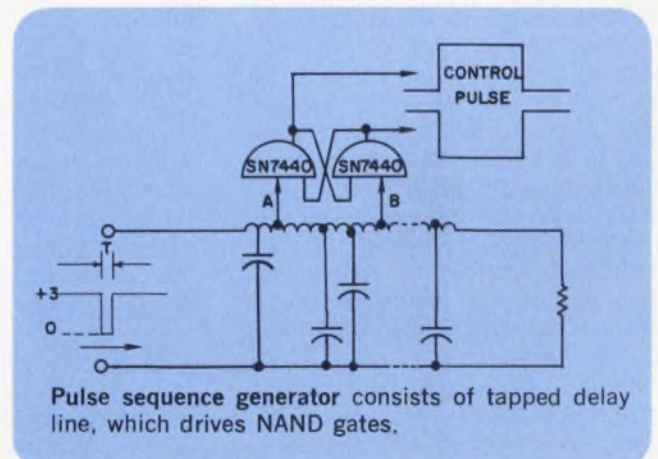

Now, Complete Network Analysis... the easy way!

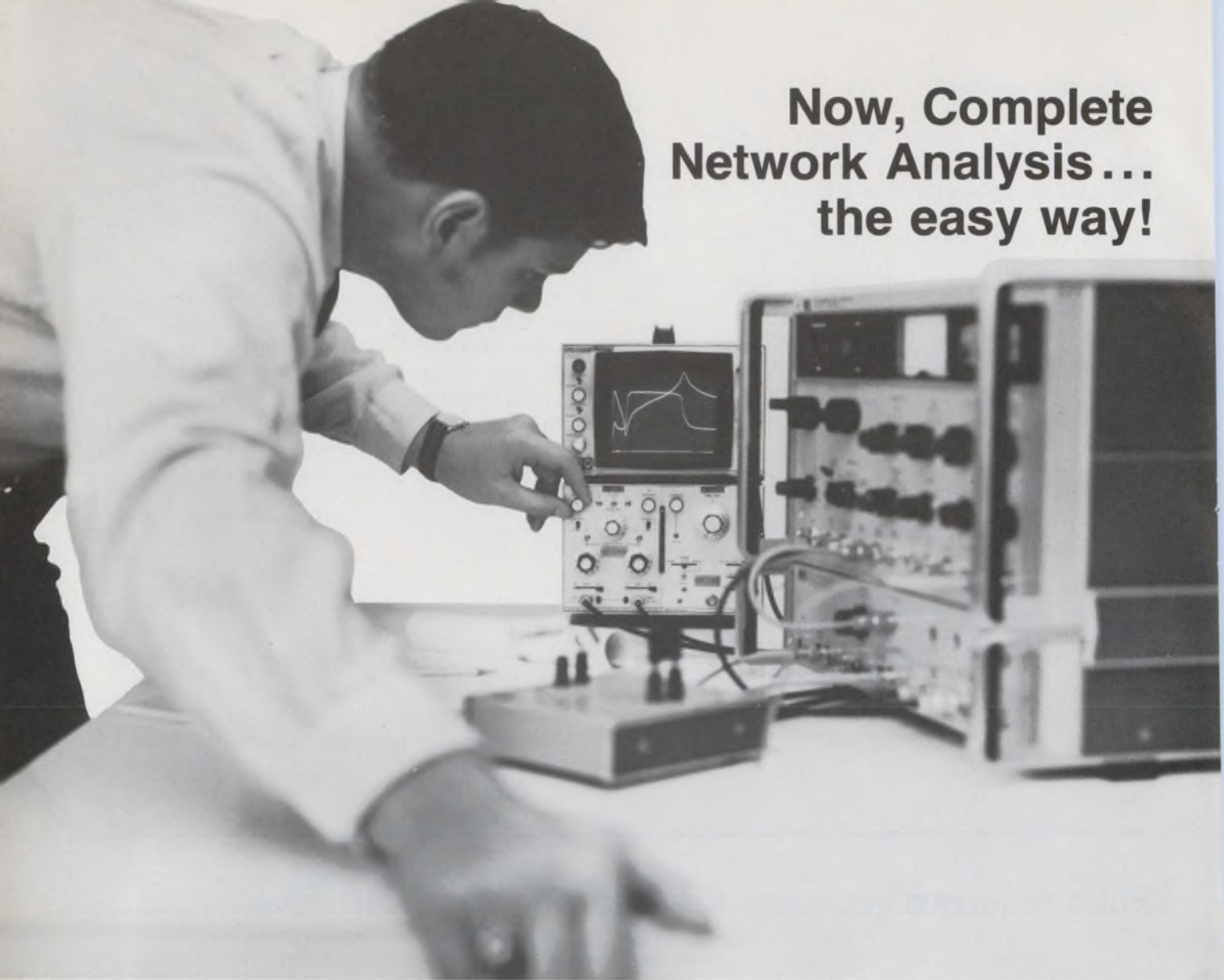

Get amplitude, phase and complex impedance measurements on a swept basis to 32 MHz... automatically with the HP 675A/676A network analysis system.

Anyone who has set up and determined complete network characteristics knows what a time-consuming and frustrating job it can be. To make a point-by-point analysis over a $3\frac{1}{2}$ decade frequency range was often impractical in terms of the time and money available.

But now with the combination of the 675A/676A system and the HP 11138A impedance measuring accessory, you can get complete network analysis from 10 kHz to 32 MHz... quickly and easily.

You can make driving point or output impedance measurements. Check wide band amplifier and attenuator response, filter characteristics,

network transfer characteristics, system flatness, return loss, small-signal analysis, and open- and closed-loop response.

And these are only some of the possible network analysis applications. This is a system accurate enough for any lab use and rugged enough to provide the day-in and day-out testing you need for quality production work.

The 675A Sweeping Signal Generator has a 10 kHz to 32 MHz range with start/stop and $F_0/\Delta F$ settings anywhere in this range for single or continuous sweep. The 676A Phase/Amplitude Tracking Detector adds a full 360° phase measurement capability and an 80 dB dynamic amplitude range.

Channel A and B outputs on the 676A provide simultaneous amplitude measurements of two devices for comparison. With Amplitude A-B and Phase A-B you can accurately

HEWLETT  PACKARD

NETWORK ANALYZERS

090/2

compare two devices. Makes production line testing and adjustments easier. Dc outputs in linear dB and linear phase are available.

Take a look around your design and production areas. You'll be amazed at the number of places that this truly complete network analyzer can save you time and money... plus give you the extra information you need to do an even better job.

Call your local HP field engineer for complete specifications. Or, write to Hewlett-Packard, Palo Alto, California 94304. Europe: 1217 Meyrin-Geneva, Switzerland. Price: HP 675A, \$2300; HP 676A \$1375; HP 11138A, \$175.

delay between taps A and B, are obtained at the NAND outputs. Original clearing of the flip-flops after power supply switch-on is automatic, due to the delay line. The initiate pulse width, T, must be less than the width of any control pulses in order to obtain well defined control pulses.

NAND circuits connected directly to the delay line taps represent a load that causes the distortion of the propagating pulse and reflections. An analytic approach can be used to determine the maximum number of NAND gates allowed to load the

taps. For a delay line with a 180-ohm characteristic impedance, the maximum number of gates is about 10, using SN7440 NAND gates.

Greater loads require smaller line characteristic impedances. The same type of circuit can be built using NOR gates, such as the 7450, and positive-going initiate pulses.

Dr. Vaclav Dvorak, Department of Electrical Engineering, University of Alberta, Edmonton, Canada.

VOTE FOR 312

Simple crystal oscillator uses monostable integrated circuit

A simple oscillator can be built by using a monostable IC and a crystal.

The basic circuit uses a Motorola MC851P monostable IC package and a 1-MHz crystal. This circuit oscillates freely over a V_{cc} span of from 3 to 10 volts. The output waveform at pin 1, although not a true square wave, is capable of driving any of the SN7400 series divider ICs.

The basic circuit does not oscillate well at low frequencies (that is, below 189 kHz). Replacing the feedback connection between pins 6 and 9 with a 15-k Ω resistor allows operation from about 100 kHz to over 1 MHz, simply by inserting the appropriate crystal.

The frequency may be "pulled" to the exact desired value by adding a 4- to 50-pF trimmer capacitor in series (the usual case) or in parallel with the crystal. The series connection raises the frequency, and the parallel connection lowers it.

If the crystal is removed, the circuit free-runs at a frequency determined by the internal and external R and C values that exist between pins 10 and 11 and pins 6 and 9.

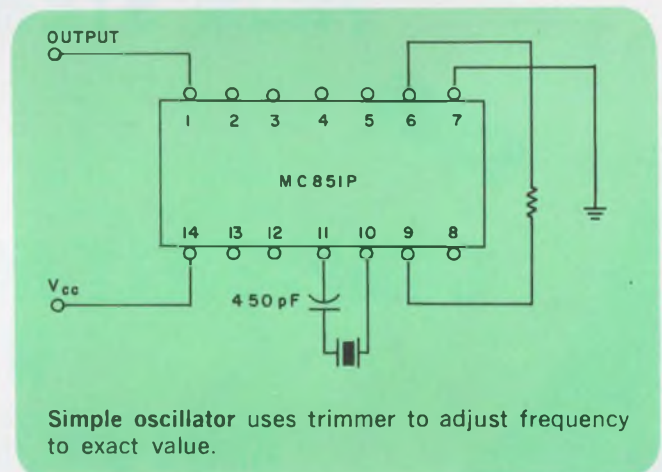

Typically, the free-running frequency without any crystal is about 1.6 MHz.

Warren G. Oliver, Engineer Staff Associate, Johns Hopkins University, Applied Physics Lab., Silver Springs, Md.

VOTE FOR 313

Solid-state spdt switch has high speed and isolation

A high-speed electronic switch was required having the following specifications:

- Single-pole double-throw switch.
- Switching time of 10 μ s.
- Forward voltage drop of less than 0.5 V.
- Capable of switching 100 V rms.
- High load impedance.
- At least 40 dB of isolation.

No switches on the market are capable of satis-

fyng all of these requirements. Available switches utilize silicon-controlled rectifiers and have an inherent forward voltage drop of 0.7 V which eliminates their use. The only remaining devices are mechanical and cannot meet the switching-time needs. Also, the contact bounce usually associated with these devices is unacceptable.

The circuit shown meets all of the require-



NOW
FROM STEWART-WARNER
28 HIGH-SPEED ECL II
MILITARY CIRCUITS
COMPLETELY INTERCHANGEABLE
WITH
MOTOROLA MECL II



FAST...RELIABLE...INEXPENSIVE...AVAILABLE !

Fast—Stewart-Warner ECL II military circuits have typical times of only 4 nanoseconds.

Reliable—These ECL II's offer the designer the same reliability and design freedom he has with the slower logics, and they will be tested to the tough Class A level of the new MIL-STD-883.

Inexpensive—Stewart-Warner ECL II's are priced competitively with TTL's.

Available—These 28 high-speed ECL II military circuits are available now from your local Stewart-Warner Microcircuits Distributor in both ceramic flat-pack and dual in-line packages.

For more information, send for our ECL data sheets. And, for off-the-shelf delivery, call your local Stewart-Warner Microcircuits Distributor.

STEWART-WARNER SYMBOL OF
COMPANIES **SW**
EXCELLENCE

STEWART-WARNER MICROCIRCUITS, INC.
730 EAST EVELYN AVENUE, SUNNYVALE, CALIFORNIA 94086
PHONE 408/245-9200 TWX 910-339-9210

IDEAS FOR DESIGN

ments. One inexpensive way to develop the switching voltage using low-voltage semiconductor devices is to drive an audio output transformer in reverse. This will easily develop the 400 V p-p square wave required for the switch. Of course, this limits the on time of the switch.

Circuit operation is as follows: Assume that a positive voltage is applied to input 1 and a negative voltage to input 2. The only requisite for this voltage is that it must be greater than the voltage being applied to inputs A or B. Under these conditions, diodes CR₁, CR₂, CR₃, and CR₄ are forward-biased, and CR₅, CR₆, CR₇ and CR₈ are reverse-biased. The voltage drops of the conducting diodes are not exactly equal, and resistors R₁ through R₄ are used to compensate for these differences and eliminate their effect on the operation of the switch.

A signal applied to input A maintains the junction of CR₁ and CR₃ at that potential. In turn the junction of CR₂ and CR₄ follows that voltage, because it is in parallel with input A, and the voltage drops of the diodes are equal and forward-biased. The signal is thereby "connected" to the output. Input B is not connected to the output because the diodes associated with it are reverse-biased and thus not conducting. The

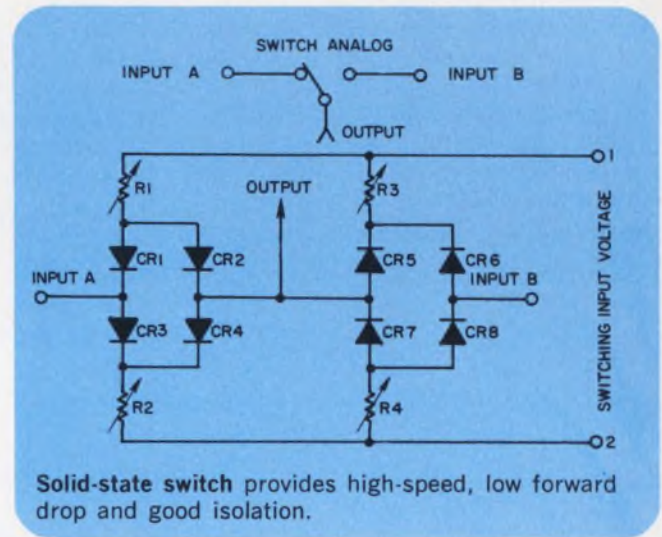

signal at input B is therefore disconnected from the output.

The maximum switching time of the switch is dependent on the internal capacitance of the diodes and can be compensated for. This, though, limits the attenuation capabilities of the switch. The input B is connected to the output when the switching input voltage is reversed. The switch is useful for multiplexing high-level ac voltages.

Vito Del Guercio, Senior Engineer, Aerojet-General Corp., Azusa, Calif.

VOTE FOR 314

Subminiature shielded wire made by using plating kit

A simple and inexpensive method of manufacturing subminiature shielded wire consists of processing conventional magnet wire of any suitable insulation with any of the commercially available electroless nickel or copper plating kits. Such kit manufacturers are Enthone, Shipley, and others. Formvar, polyurethane, and Teflon-coated wires of various insulation thicknesses have all been successfully plated, but single-coating wire is not recommended because of possible pinholes in the insulation that result in shorted shields.

If the dimensions of the final wire or jumper are known in advance, the wire should be precut to those dimensions, and the ends bared and tinned. The tinned portions, and a small area of insulation beyond them, should then be masked with Mylar tape, and the wire processed as recommended. It is suggested that the wire be plated loosely coiled rather than straight, since coiling or repeated bending of the material after processing may fracture the plating. Connections between circuit grounds and the shield are made with conductive epoxy.

Such shielded wires have been used as jumpers on printed-circuit boards where leakage had to be kept to a minimum. Another application is as coaxial cables or high-frequency delay cables, whose characteristics will depend upon the dielectric properties of the insulating film. Teflon-insulated wire has the best high-frequency transmission characteristics, and for a given wire size the impedance varies directly with the insulation thickness.

R. Michel Zilberstein, Senior Project Engineer, Microsonics Div., Sangamo Electric Inc., Weymouth, Mass.

VOTE FOR 315

IFD Winner for September 1, 1969

Walter C. Dillon, Design Engineer, Oregon State University, Corvallis, Oregon. His Idea "Low-Frequency Multiplier Uses Twin-T Network" has been voted the Most Valuable of Issue Award.

Vote for the Best Idea in this Issue.

Before you make book on any other pot, we suggest you take a good close look at the small print. Pixiepot® is the smallest precision 10-turn wirewound potentiometer on the market today, and the only pot under \$3.50 with all these high performance features:

- Length: ONLY 3/4"
- Diameter: ONLY 7/8"
- Linearity: ±0.25%
- Resistance Range: 100 ohms to 100K ohms
- Power Rating: 2 watts @ +20°C
- Temperature Range: -25°C to +85°C
- Resolution: Better than ANY wirewound pot TWICE its size
- Slotted Stainless Steel Shaft/C ring

Specify Model 3253 Pixiepot for as low as \$3.47 each in production quantities and only \$4.95 each for 1-24 units. In-stock delivery, of course. Call, write or wire Duncan Electronics today for complete specifications. When it comes to mini-pots, we wrote the book.

One PIXIEPOT® is worth 1,000 words



DUNCAN ELECTRONICS

SUBSIDIARY



SYSTRON • DONNER

2865 FAIRVIEW ROAD
COSTA MESA,
CALIFORNIA 92626
(714) 545-8261



Product Source Directory

Field Strength Meters

This Product Source Directory, covering Field Strength Meters, is the third in a continuing series of product selection data that will list comparative specifications and prices for products frequently purchased by design engineers. All categories will be arranged according to some primary parameter so that items having similar functional capabilities can be instantly compared.

To make best use of the directory, compare the specifications and get a feeling for performance and cost ratios. Then obtain complete manufacturers data by using the reader service numbers in the master index.

Look for the following product categories through April 1970:

Pulse Generators	January 4, 1970
Signal Generators	January 18, 1970
Slotted Lines	February 1, 1970
Power Supplies (dc)	February 15, 1970
Frequency Meters	March 1, 1970
Noise Generators	March 15, 1970
Multitesters	April 1, 1970
AC Power Supplies	April 12, 1970
Oscillators	April 26, 1970

How to use the tables

The tables in this section list the specifications for field strength meters.

Unless otherwise noted in the tables, all field strength meters have input requirements of 95-135 Vac single phase. The following abbreviations apply to all instruments listed:

ina — information not available.

n/a — not applicable.

An index of models by manufacturer is included at the end of each table.

For each table, the instruments are listed in

ascending order of one major parameter. The column containing this parameter is color-coded white. Manufacturers are identified by abbreviation. The complete name of each manufacturer can be found in this Master Cross Index.

Abbrev.	Company	Reader Service No.
B-T	Blonder-Tongue 9 Alling St. Newark, N.J. 07102 (201) 622-8155	467
F/EMC	Fairchild Electro Metrics Corp. 88 Church St. Amsterdam, N.Y. 12010 (518) 843-2600	468
Narda	Narda Microwave Corp. Commercial St. Plainview, N.Y. 11803 (516) 433-9000	469
Polarad	Polarad/Nelson Ross 5 Delaware Drive Lake Success, N.Y. 11040 (516) 328-1100	470
R-S	Rohde & Schwarz 111 Lexington Avenue Passaic, N.J. 07055 (201) 773-8010	471
Sadelco	Sadelco Inc. 299 Park Avenue Weehauken, N.J. 07087 (201) 866-0912	472
Singer	The Singer Co. Instrument Division 915 Pembroke St. Bridgeport, Conn. 06608 (203) 366-3201	473
Stoddart	Stoddart Electro Systems 2045 W. Rosecrans Avenue Gardena, Calif. 90249 (213) 770-0270	474

Field Strength Meters

	Manufacturer	Model	FREQUENCY		FIELD STRENGTH		I-F MHz	Bandwidth MHz	Image Ratio dB	Internal Calibration	Accuracy dB	Meter Calibration	Input Impedance Ω	Output Types	Mounting	Misc Features	Price Approx. \$
			Min. MHz	Max. MHz	Min. μ V	Max. V											
FS1	Stoddart	NM-40A	20Hz	0.015	1	1	0.025	8-60Hz	75	tuning fork	± 1	μ V, dB	50 600 10k 100k	xy audio scope	R	e	2950
	F/EMC	EMC-10	20Hz	0.05	0.006	10	none	5Hz-0.5MHz	80	yes	± 0.5	linear	50-100,000	audio video VFO BFO	C, R		4350
	Singer	NF-315A	20Hz	0.25	0.001	10	0.1	7Hz 70Hz 0.02 0.25	80	osc.	± 1	none	50 600 100K	audio video xy	C, R	g	4295
	Stoddart	NM-12AT	0.01	0.25	0.01	1	0.455	0.0001 0.0027	80	impulse	± 2	μ V, dB	50	I-F, xy, audio scope	C, R	ac	4000
	R-S	HFH/HFHL	0.01	30	1	1	0.46 1.65 0.062	100Hz 500Hz 1kHz	75-100	osc.	± 1.5	dB	60	audio I-F recdr	C	m	10220
	R-S	HFH	0.1	30	1	1	0.46 1.65 0.062	100Hz 500Hz 1kHz	75-100	osc.	± 1.5	dB	60	audio I-F recdr	C	m	7695
	Stoddart	NM-25T	0.15	32	0.1	1	1.6	0.005	50	impulse	± 2	μ V, dB	50	IF, xy audio scope	C, R	abcd	4000
	R-S Stoddart	HUZ NM-30A	47 20	225 400	1 1	0.1 7	10.7 15	0.1 0.12 -0.18	ina 40-70	osc. impulse	± 3 ± 2	μ V, mV μ V, dB	50 50	audio I-F, xy audio scope	C C, R	e	879 3750
	R-S	HUZE	470	850	30	0.1	150 21.4	0.5	50	osc.	± 6	μ V, dB	60	audio scope recdr	C	m	2409
FS2	Sadelco	FS-3X	54	890	10	2	ina	ina	ina	ina	± 1.75	μ V, dB	75	audio video	C		request
	B-T	FSM-2	52	900	100	3	40	ina	ina	ina	± 1.5	none	75	none recdr audio video	C	b	778.93
	F/EMC	EMC-25	0.014	1000	0.01	1	0.175 1.6 8.7	0.005 0.5	60	yes	± 2	linear	50	audio video	C, R		16100
	Singer	NF-105A	0.014	1000	0.1	0.1	h	2.5- 500kHz	30-80	impulse	± 2	none	50	i	C	hij	3500- 10400
	Stoddart	NM-37/57	30	1000	0.2	1	20.5 160	0.01 0.1 1	60	yes	± 3	μ V, dB	50	I-F xy audio video	C, R	b	8000
	Narda	8100	915 fixed	2450 fixed	10 μ W/ cm^2	200mW/ cm^2	n/a	n/a	n/a	n/a	± 1	n/a	n/a	n/a	C	p	725
	Polarad	CFI	950	10,000	5	10	260	1, 5, 8	60	impulse	ina	μ V, dB	50	audio video recdr	C	n	15850
	Stoddart	NM-65T	1000	10,000	1	1	21.4	0.1 0.5 5	30-60	impulse	2.5	μ V, dB	50	f	C, R	bf	13000
	Narda	886B3	450	12400	0.5mW/ cm^2	20mW/ cm^2	n/a	n/a	n/a	n/a	± 1	n/a	n/a	n/a	C	p	695
Polarad	CFI	950	21000	5	10	260	1, 5, 8	60	impulse	ina	μ V, dB	50	audio video recdr	C	n	24650	
Singer	EMA-910	1000	26500	1	1	60 240	0.5 1 5	70	impulse 1-10.5 GHz	± 2	none	50	i	C	ik	22000- 40000	

- a. Field strength given in terms of voltage across 50 Ω .
- b. Battery operation optional.
- c. Solid state.
- d. First i-f, 0.455 MHz second i-f.
- e. External power supply at extra cost.
- f. Output type: audio, video, lin & log, xy, fm detector.
- g. Beat frequency oscillator, internal battery automatic scan.
- h. I-f: 225, 455, 1600 kHz, 10.73 MHz, 42 MHz depending on tuning unit.
- i. Output types: audio, video, post i-f, pre i-f, xy, remote meter.
- j. Depending on frequency required.
- k. Price: 1-10.5 GHz, \$22,000; 1-26.5 GHz, \$40,000.
- m. Per meter.
- n. Price includes complete range of plug-in heads, for specific requirements check with factory.
- p. Radiation monitors.

Index by Model Number

B-T Blonder-Tongue	FSM-2	FS2
F/EMC Fairchild Electro Metrics	EMC-10 EMC-25	FS1 FS2
Narda Narda Microwave Corp.	8100 B86B3	FS FS2
Polarad Polarad/Nelsen Ross	CFI	FS2
R-S Rohde & Schwarz	HFH HFH/HFHL HUZ HUZE	FS1 FS1 FS1 FS1
Sadelco Sadelco Inc.	FS-3X	FS2
Singer The Singer Co. Instrument Div.	EMA-910 NF-105A NF-315A	FS2 FS2 FS1
Stoddart Stoddart Electro Systems	NM-12AT NM-25T NM-30A NM-37/57 NM-40A NM-65T	FS1 FS1 FS1 FS2 FS2 FS2

Heat problems? Give 'em the air...

Condor. A new high performance high reliability propeller fan providing up to 575 cfm for a wide range of cooling applications. The compact design (10-inch diameter, 3.5-inch depth) and light weight make it easy to install in a variety of equipments. 6 models with different connectors add to its versatility.



The Super boxer's exclusive new aerodynamic impeller design provides exceptional output characteristics at high back pressures. Super dependability. 2 patented bearing designs are rated at 10 years life under normal conditions. Super versatility. Compact (4.687-inch square, 1.5-inch depth), mountable inside or outside an enclosure, to intake or exhaust. Accepts all standard Boxer accessories.



**THE SUPER
BOXER**

DC Boxer. The small module mounted integrally on the Boxer frame accepts DC and converts it to drive the Boxer's AC motor. Does away with usual DC motor problems, such as brush wear, arcing contacts, short life, and RF noise. 8 models span the range of 12 to 38 VDC input. Cools heat sensitive equipment such as, TV cameras, sound systems, telephone equipment, etc. Accepts all standard Boxer accessories.



DC

with 3 new air- givers from IMC.

Distributor stocked nationwide for immediate delivery. As are standard Boxers, MiniBoxers, Tandem Boxers, IMCair fans and IMCair centrifugal blowers.

A new 16-page catalog provides drawings, performance parameters and complete specifications for all our airmovers. It's available from IMC Magnetics Corp., New Hampshire Division, Route 16B, Rochester, N. H. 03867, Tel. (603) 332-5300.

Close Confinement— Especially Here!

New "CC" Laser Diodes

How would you double the power output of a GaAs infrared injection laser diode — and halve the threshold current of previous lasers — and improve the uniformity of laser emission — all at room temperature?

Here's how RCA does it: Packs the works in a new Close Confinement diode structure that holds radiation strictly in the junction area.

Internal absorption is reduced substantially. This means you get greater power output and lower drive current.

RCA's new line of Close Confinement laser diodes is offered in the single chip construction that's most suitable for simple optic systems and driving circuits. These "CC" lasers feature a stud mount-coaxial lead package.

RCA OP-3 Pkg.	Peak Power Min.	Output (Watts) Typ.	Largest Emitting Area Dimen- sion	Amps Peak I_{th}	Current I_{FM}
TA7606	1*	2	3 mils	4	10
TA7608	5*	6	6 mils	7	25
TA7610	10*	13	9 mils	10	40

*Selections offering power output up to 25 W at 25°C and 5 W at 70°C are available.

Custom Arrays

Room Temperature — 50-300 W peak power @ 25 A drive. Low Temperature (77-150°K) — 1-50 W average power @ 1-2% duty cycles.

Also Available — GaAl As laser diodes and arrays with wavelength range of 8100-8700 Å.

Call your local RCA Representative today for more information. Or see your RCA Distributor. For technical data on the new TA7606, TA7608 and TA7610 Close Confinement GaAs lasers, write: RCA Electronic Components, Commercial Engineering, Section No. SG12-2, Harrison, New Jersey 07029.

RCA

Products



Plastic IC amplifiers for consumer-oriented use drop price tag to \$1 range, p. 94.

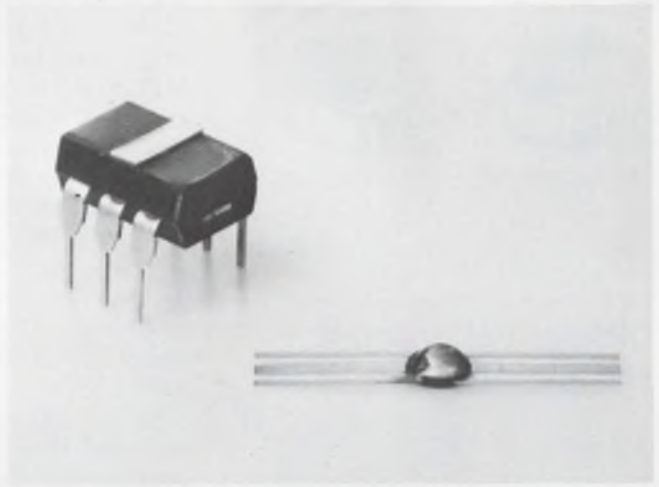

Magnetically sensitive transistor called Mag-nistor detects 0.5 mV/gauss, p. 94.



Three-digit 0.5% panel meter costing \$139 incorporates large-scale MOS ICs, p. 106.



Desktop calculator with 10-key input and 14-digit display sells for only \$875, p. 97.

Also in this section:

Magnetic tape terminal transmits up to 2400 words per minute, page 97.

Chip resistors measuring 50-mils square feature gold beam leads, p. 100.

Tiny power supply delivers 5.5 kV at 500 μ A from 1-in.³ package, p. 104.

Evaluation Samples, p. 109 **Design Aids**, p. 110.

Application Notes, p. 111 **New Literature**, p. 112.

Plastic amplifiers slash price to \$1+

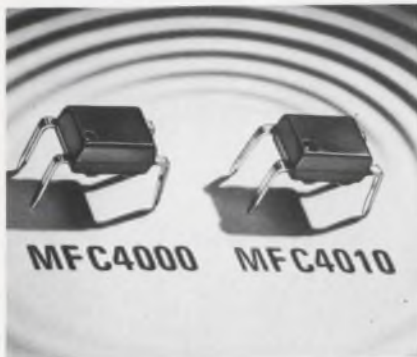

Motorola Semiconductor Products Inc., P.O. Box 20924, Phoenix, Ariz. Phone: (602) 273-6900. P&A: \$1.25 or \$1.40; stock.

Initiating a new line of low-cost consumer-oriented ICs, two new plastic amplifiers sell for \$1.25 or \$1.40 each in 100-unit lots. Type MFC4000 is a low-power (250 mW) audio amplifier, which has a typical harmonic distortion of 0.7% at 50 mW. Type MFC4010 is a wideband amplifier with a minimum gain of 60 dB.

CIRCLE NO. 250

Differential transistor senses magnetic fields

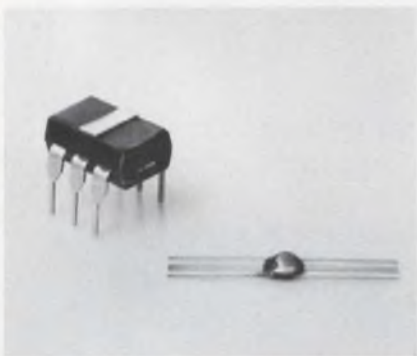

Hudson Corp., P.O. Box 867, Manchester, N.H. Phone: (603) 669-8570.

Called Magnistor, a magnetically sensitive transistor with two collectors and one emitter gives a linear output to 1000 gauss with a sensitivity of 0.5 mV/gauss. When the device is connected to biasing circuitry similar to that used for differential amplifiers, a differential signal is available from the two collectors that is proportional to the magnetic field intensity.

CIRCLE NO. 251

LSI shift registers operate to 10 MHz

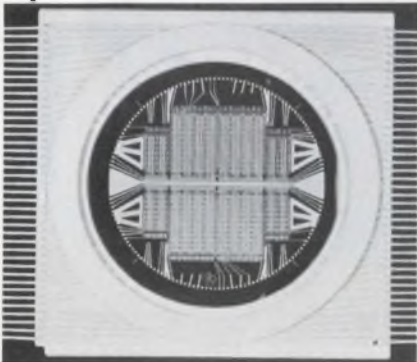

Texas Instruments Inc., Box 5012-MS308, Dallas, Tex. P&A: \$295, \$335 or \$390 per 100; 8 wks.

Three new bipolar LSI shift registers, including a dual 253-bit, a dual 349-bit and a dual 501-bit model, operate from dc to 10 MHz over the temperature range of -55 to +125°C. Types DSA-2001, -2002 and -2003 are packaged in a 78-pin 2-1/8-in.-square ceramic package and contain cells of four bits each discretely routed in series plus a one-bit output driver.

CIRCLE NO. 252

Eight-input encoder assigns priority bit

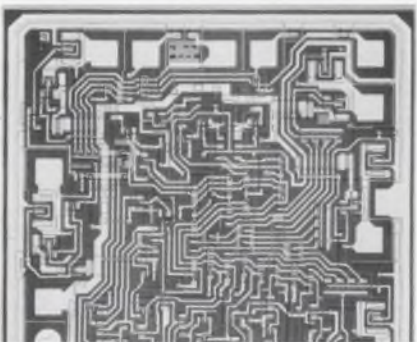

Fairchild Semiconductor, 313 Fairchild Dr., Mountain View, Calif. P&A: \$15.35 to \$33.80; stock.

Reducing system costs for a wide variety of encoding, multiplexing and conversion operations, an MSI eight-input priority encoder converts eight active-level low-input signals to a three-bit binary code, giving priority to the most significant input. Model 9318 replaces discrete encoder designs and can do the work of eight dual adders using discrete logic.

CIRCLE NO. 253

IC voltage regulator stabilizes 0.0025%/°C



RCA Electronic Components, Commercial Engineering, 415 S. 5th St., Harrison, N.J. Phone: (201) 485-3900. Price: \$2.95 per 1000.

A new 100-mA monolithic IC voltage regulator for local regulation offers a reference and output voltage temperature coefficient of 0.0025%/°C. The CA3055 regulates for line and load at 0.025%, has input and output voltage ranges of 7.5 to 40 V and 1.8 to 34 V, respectively, an output resistance of 0.075 Ω and is housed in a TO-5 eight-lead case.

CIRCLE NO. 254

FET-amplifier line cuts cost under \$1



National Semiconductor Corp., 2975 San Ysidro Way, Santa Clara, Calif. Phone: (408) 245-4320. P&A: \$1.35 to \$1.50 per 100; stock.

Offering outstanding characteristics such as low noise of 2.5 dB, low leakage currents of 100 pA and low capacitances of 2 pF, a family of general-purpose field-effect amplifiers is priced at less than \$1 per unit in 1000-piece quantities. Types 2N4220, 2N4220A, 2N4221, 2N4221A, 2N4222 and 2N4222A also offer on-resistance of 1 kΩ.

CIRCLE NO. 255

We give it to you straight! If our new Tru-Glide® Slides didn't slide that way we would have given them another name. Honest!



Being conscientious, upright people, we simply couldn't have devised a brand new ball bearing steel slide that wouldn't have been approved by Mother. We named it "Tru-Glide" because it slides so good and so precisely. And even though we have priced it right down in the small change category you can be sure it's an OK slide. Not cheap, just inexpensive. Applicable to hundreds of design situations

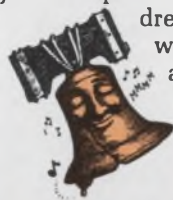

where space allotments are minimal and where quality action and ease of movement are of special importance. And where low cost is a factor! A big one.

Yes, Tru-Glide is a hum-dinger. A bell ringer. A true blue MADE IN THE USA slide. We hope it wobbles your clapper. How can we make such a good all-purpose industrial / commercial / etc. slide? Well, let us remark that it's not exactly easy. Six years ago we had the basic design. Since then, we've come up with some completely new concepts in part fabrication (our parts), including a whizzer of an electronically-controlled production system that assures close tolerance, volume runs. Here at Jonathan we've had plenty of practice in this sort of thing. We keep on producing our famous Thinline extruded aluminum slides that gave us our shiny bright reputation in the first place. And our respected Ultrathin steel slides that we also produce for defense, aerospace and other sophisticated-type applications. We just keep



(left, Type 310; right, Type 311)

doing our best. Tru-Glide slides come in 150 lb. capacity Type 310 three-section ($\frac{5}{8}$ " wide x 2" high) or 100 lb. capacity Type

311 two-section ($1\frac{15}{32}$ " wide x $1\frac{1}{8}$ " high) versions, with or without mounting brackets. Lock-out in "open" position or disconnecting models are optional. Both models are available in standard lengths and travels, based on 2" increments. The mo-o-o-ving mechanisms are free-riding, precision-placed steel ball bearings contained in special rigid vinyl ball retainers. Lubricated bearings. Trouble-free multi-thousand cycling. Tru-Glide slides make designers happy. Just right for computers, business machines, office copiers, appliances, desks and equipment, audio/visual systems, medical-dental equipment, good furniture, telephone systems and vending machines,



for instance. Or send along your special problems — we love 'em! So remember "Tru-Glide," an honest name for a straightforward slide. An OK slide. Built by mothers' sons' — everyone of them!



© 1969, Jonathan

Clip, mail to: **Jonathan Mfg. Co.**
1101 S. Acacia,
Fullerton, Ca. 92631.

Quit fooling around, send facts.

NAME _____ TITLE _____
ADDRESS _____
CITY _____
STATE _____ ZIP _____



Voltage reference units stabilize to 10 ppm/°C

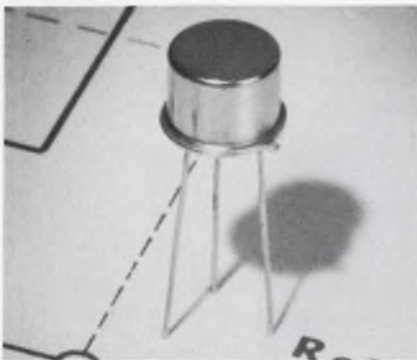

Dickson Electronics Corp., Box 1390, Scottsdale, Ariz. Phone: (602) 947-2231. P&A: \$6.50 to \$23.20 per 100; 2 wks.

Incorporating a self-contained constant-current source and a temperature-compensated voltage reference diode to provide temperature compensation and stability to +100°C, a new line of reference voltage sources is available with coefficients of 10, 25, 50 and 100 ppm/°C at 6.4 V +5%, and operates from 12 to 40 V.

CIRCLE NO. 256

Dual 100-bit register lowers cost to 4¢/bit

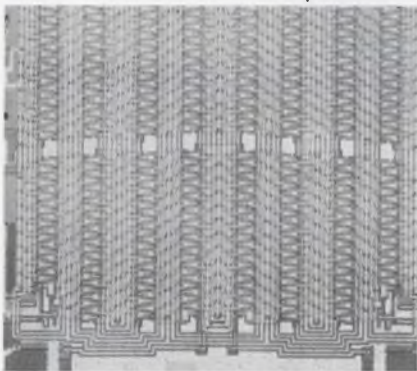

Fairchild Semiconductor Corp., 313 Fairchild Dr., Mountain View, Calif. Phone: (415) 962-3563. P&A: \$36; stock.

A dual 100-bit static shift register provides 200 bits of storage at shift frequencies to 1 MHz, at a cost of less than 4¢ a bit. The 3307 unit is an MOS IC with a p-channel enhancement mode and a power drain of 1.5 mW per bit. It is available in a TO-100 case with an operating temperature range of -55 to +85°C.

CIRCLE NO. 257

Fast p-i-n photodiodes show 2-nA dark current

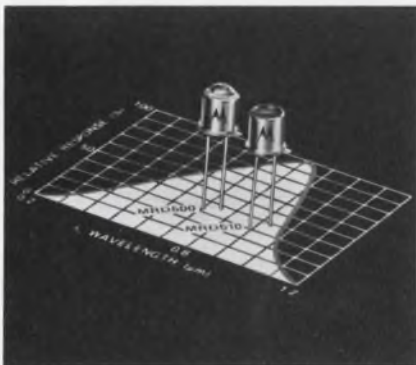

Motorola Semiconductor Products Inc., Box 20924, Phoenix, Ariz. P&A: \$7.25 or \$6.60 per 100; stock. Featuring radiation sensitivities of 1.8 $\mu\text{A}/\text{mW}/\text{cm}^2$ and 0.4 $\mu\text{A}/\text{mW}/\text{cm}^2$, respectively, MRD-500 and MRD-510 p-i-n photodiodes display a 1-ns response time and 2-nA dark current at 25°C. Both devices, which are packaged in TO-18 cases, are sensitive over a wavelength range of 0.4 to 1.1 μm , dissipate 100 mW and have reverse breakdown ratings of 200 V.

CIRCLE NO. 258

Quad power driver gives 40 V at 0.3 A



Micro Networks Corp., 5 Barbara Lane, Worcester, Mass. Phone: (617) 756-4635. Price: \$33.75.

Model MN204 is a hybrid quad two-input non-inverting power driver consisting of a TTL IC gate and four transistor output stages. Each output stage has a voltage rating of 40 V at a current of 300 mA. Internal voltage limiting is provided to reduce microcircuit power consumption. Operating temperature range is -55 to +125°C. The unit is a 14-lead flatpack.

CIRCLE NO. 259

Hybrid regulator holds 0.05% at 1 A

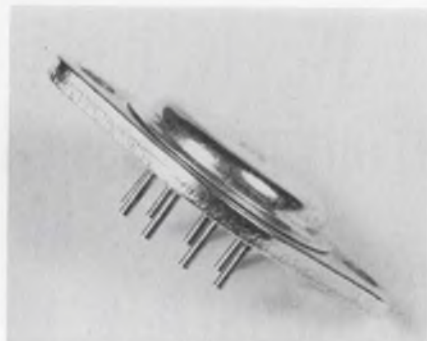

Solitron Devices, Inc., Transistor Div., 1177 Blue Heron Blvd, Riviera Beach, Fla. Phone: (305) 848-4311. Availability: stock.

Identified as the HCCA 100, a new high-power hybrid dc voltage regulator offers a regulation of 0.05% maximum (0.01% typical), from no load to a 1-A load. The unit has a voltage range of 8 to 50 V with a maximum output current of 3 A. Power dissipation is 25 W (with heat sink) and temperature coefficient is 0.005%/°C.

CIRCLE NO. 260

Thin-film ladder units are accurate to ±0.1%

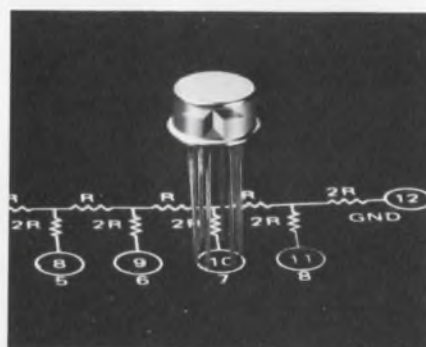

Crystalonics, A Teledyne Co., 147 Sherman St., Cambridge, Mass. Phone: (617) 491-1670. P&A: \$90; stock.

Operating over the temperature range of -55 to +125°C, a new series of tantalum-nitride thin-film 10 or 20-k Ω ladder networks provides an accuracy of $\pm 0.1\%$ (1/4 bit). Type CDAL1 R/2R units have built-in feedback resistors for gains of 1/2, 1 or 2, are designed for use with hybrid d/a ladder switches and are housed in TO-5 cases.

CIRCLE NO. 261

DATA PROCESSING

National Cash Register Co., Dayton, Ohio. Phone: (513) 449-2150. Price: \$875.

Selling for only \$875, a new 10-key 14-digit electronic calculator requires a maximum time of 430 ms for any calculation, and performs simple addition and subtraction in only 2 ms. Model 18-1 is a general-purpose unit that performs arithmetic functions via a single memory. It has automatic round-off, a constant multiplier and divisor, and decimal setting.

CIRCLE NO. 262

Calculator for \$875 works in 430 ms max



Concord Electronics Corp., Communications Systems Div., 1935 Armacost Ave., Los Angeles, Calif. Phone: (213) 478-2541.

Hailed as a new concept for in-house communication, a desktop audio-video communicator allows the operator to simultaneously communicate, both visually and verbally, to as many as five different locations without leaving his desk. The AVC-10 makes it possible to relay visual information without exposing a camera.

CIRCLE NO. 263

Desktop communicator monitors five areas



Sanders Associates, Inc., Daniel Webster Highway, South, Nashua, N.H. Phone: (603) 885-4741.

Designed for use with desktop CRT terminals for entering and retrieving computer-stored information, a new plug-in keyboard permits pictures, charts and diagrams to be displayed along with the usual letters and numbers. Pictorial data, which is comprised of a series of short strokes, can appear as solid lines, or dotted lines for three-dimensional drawings.

CIRCLE NO. 264

Keyboard for displays adds graphic capability



American Telephone and Telegraph, 195 Broadway, New York, N.Y. Phone: (212) 393-3570. Availability: July, 1970.

Featuring a compact magnetic tape cartridge with a storage capacity of approximately 150,000 characters, the new Dataspeed magnetic tape terminal is capable of send or receive operation at speeds up to 2400 words per minute. In addition, the terminal has a bidirectional search mechanism that can scan 400 characters/s.

CIRCLE NO. 265

Magnetic tape terminal zips out 2.4k words/min



SOLVING
electro-optical
problems
is Optron's
ONLY business....
SO, WE HAVE
TO BE GOOD!

You can count on Optron for high interest and undivided attention to your most exacting optoelectronic device requirements. And, you'll get product design, development and manufacturing benefits that only Optron experience can offer.

For example, through continuous process monitoring made possible by the use of diffusion lot traceability, Optron maintains the highest possible reliability. Still other special Optron manufacturing techniques make possible optimum device performance in variable light and temperature conditions. You get sensors with a lens/device relationship previously thought impossible.

Versatile OP 600 Series NPN planar silicon light sensors eliminate cross-talk and are ideally suited for high density arrays. In addition, these small, rugged devices will satisfy virtually any application requirement in optical character recognition. But, if your application isn't standard, you'll especially like Optron's fast reaction to your custom programs, too.

Write today for
Optron product
technical data
and the name
of your nearest
sales
representative.



OPTRON, INC.

1201 Tappan Circle
Carrollton, Texas 75006
214/242-6571

INFORMATION RETRIEVAL NUMBER 48

Time-sharing system doubles in-house use



Interplex Corp., 400 Totten Pond Rd., Waltham, Mass. Phone: (617) 899-2261. P&A: \$1803 per month; Spring, 1970.

Capable of supporting from 4 to 16 terminals, a new multi-purpose in-house time-sharing system combines both BASIC language programming and sophisticated computer-supported calculator functions in one desktop terminal. It has a terminal with a language-oriented functional keyboard and a hard-copy printer.

CIRCLE NO. 266

Read-only memory packs 98,304 bits

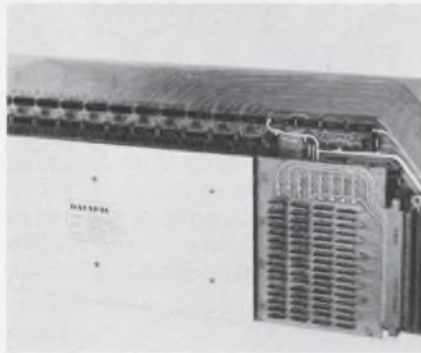

Datapac, Inc., 3839 S. Main St., Santa Ana, Calif. Phone: (714) 546-7781. P&A: 1¢/bit; 30 days.

Intended for use in general computing and data processing systems, a new high-density read-only memory system stores as many as 98,304 bits on a single 8 by 18-in. motherboard. The Mempac 100 consists of a motherboard and plug board, which contains the cores and a braid matrix. The plug board and motherboard are mated by a single interconnector.

CIRCLE NO. 267

Graphics terminal contains processor



Control Data Corp., 8100 34th Ave., S. Minneapolis, Minn. Phone: (612) 888-5555.

Able to be operated remotely from a central computer over telephone lines, the GRID (Graphic Remote Integrated Display) terminal has its own processor with a 4k 12-bit memory. This relieves the central computer of such routine tasks as the generation and processing of display lists. Data inputs to the new terminal can be via of a light pen or a keyboard.

CIRCLE NO. 268

Accurate graphic tablet uses electromagnetism



Comutek, Inc., 143 Albany St., Cambridge, Mass. Phone: (617) 864-5140.

A new graphic tablet converts hand-drawn data to digital form via a novel electromagnetic sensing technique, which incorporates a proprietary printed digital pattern. Pattern accuracy is ± 0.005 in. (0.05% of full scale) and linearity is $\pm 0.05\%$ of full scale. The model 50/10 provides a 10-bit resolution, while the model 50/8 has an eight-bit resolution.

CIRCLE NO. 269

Single-card memory cycles fully in 1 μ s

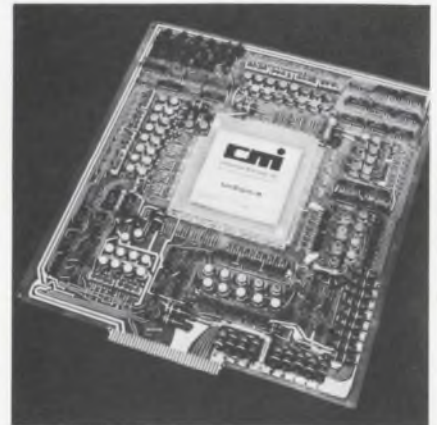

Cambridge Memories, Inc., Newtonville, Mass. P&A: from \$1490; 30 days.

Said to be the fastest single-card core memory available, the Unicore-9 random-access memory system features a 300-ns access time and a 1- μ s full-cycle time. The entire memory is mounted on an 11 by 11-3/4-in. card that plugs into a 72-pin connector; component height is less than 0.6 in. It stores up to 1024 nine-bit words, and is available in eight-bit word lengths.

CIRCLE NO. 270

Digital multiplexer concentrates 70 lines



Timeplex, Inc., 15 Charles St., Westwood, N.J.

A time-division multiplexer-concentrator can multiplex and/or concentrate up to 70 asynchronous full-duplex low-speed terminals in any configuration, to form one high-speed voiceband signal for transmission over public or private telephone lines. The M/C-70 includes a multiplexer, concentrator, demultiplexer, as well as a deconcentrator. It can send and receive simultaneously.

CIRCLE NO. 271

DOES PROCESSING YOUR TEST DATA TAKE 30 MINUTES OR 30 DAYS?

MARK II RECORDS TEST DATA
ON COMPUTER-COMPATIBLE MAG TAPE
TO SPEED YOUR MISSION ANALYSIS

Carry it under your arm.
Anywhere. The Mark II is a
complete data system including
a multiplexer, analog to digital
converter, programable
data formatter, digital clock
and magnetic tape recorder.
The computer-compatible
tape enables you to analyze a
complete mission — up to 1.2
million readings — in minutes.



 **incre - data**
CORPORATION



The Mark II incremental digital data acquisition system is 6 $\frac{3}{4}$ " high, 7 $\frac{3}{4}$ " wide, 13 $\frac{5}{8}$ " deep and weighs 29 lbs. Cartridge loading simplifies operation; computer-compatible magnetic tape speeds mission analysis. FOR INFORMATION ON MARK II contact Incre-Data Corporation, 6401 Acoma Rd., S.E., Albuquerque, New Mexico 87108. AC 505 265-9575.

Chip resistor line spans 5Ω to 5 MΩ

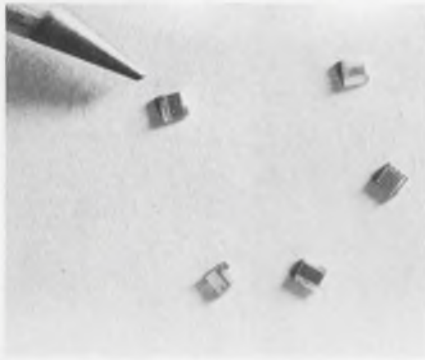

IG Engineering, 103 Morse St., Watertown, Mass. Phone: (617) 924-1830. Availability: stock.

Using standard gold metallization for optimum wire bonding acceptance, a complete line of thin and thick-film chip resistors for microwave and hybrid circuits is available in values from 5 Ω to 5 MΩ. Chip sizes are as low as 0.05 by 0.05 by 0.01 in., and temperature coefficients extend below 100 up to approximately 200 ppm, depending on the resistance range.

CIRCLE NO. 272

Thick-film resistors span 10⁸Ω to 10¹¹Ω



Eltec Instruments, Inc., P.O. Box 46, Lancaster, N.Y. Phone: (716) 683-8421. P&A: \$8; 1 wk.

Featuring homogenous thick-film construction and fired-dumet leads, a new line of resistors spans the range of 10⁸ to 10¹¹Ω. Model 100 resistors have standard values of 1.5 × 10⁸ Ω, 1.5 × 10⁹ Ω, 1.5 × 10¹⁰ Ω and 1.5 × 10¹¹ Ω with tolerances of ±35%, a temperature coefficient of -0.5%, a 200 V rating and an operating temperature range of -50 to +150°C.

CIRCLE NO. 273

Tiny indicators use GaAsP LEDs

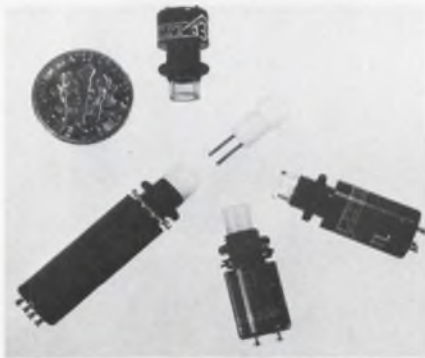

TEC, Inc., 6700 S. Washington Ave., Eden Prairie, Minn. Phone: (612) 941-1100.

With a 0.36-in. dia and 3/8-in. mounting centers, series SS indicators use gallium-arsenide-phosphide light-emitting diodes as a light source. One model has internal logic that interfaces with DTL and TTL levels, another has a momentary switch that is actuated by depressing the indicator lens, while the remaining models operate from a 5-V source.

CIRCLE NO. 274

Miniature resistors form discrete pellets



Pyrofilm Corp., 60 S. Jefferson Rd., Whippany, N.J. Phone: (201) 887-8100.

Revolutionizing resistor design are new microminiature solid discrete resistor pellets in sizes of 0 by 0.062 in. These resistor pellets are available in three models with resistance values ranging from 10 Ω to 500 kΩ at tolerances to ±1%. They exhibit good stability under extreme environmental conditions and offer low noise and shunt capacitance characteristics.

CIRCLE NO. 275

Tiny 500-MΩ divider accepts 10 kV

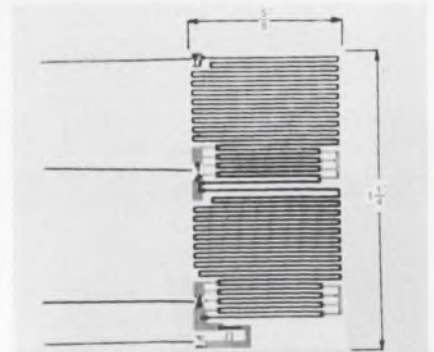

Microtek Electronics, Inc., 138 Alewife Brook Parkway, Cambridge, Mass. Phone: (617) 491-4330. P&A: \$20; 3 to 4 wks.

Tracking to less than 25 ppm for changes in temperature and 10 ppm per volt per in. of resistor track length for changes in voltage, a new precision 500-MΩ 10-kV voltage-divider measures 1-1/4 by 5/8 in. The unit is tapped at 250 MΩ, 250 MΩ, and 300 kΩ, and individual tolerances are ±5% with ratios between the tapped parts held to ±1%.

CIRCLE NO. 276

Square chip resistors have gold beam leads

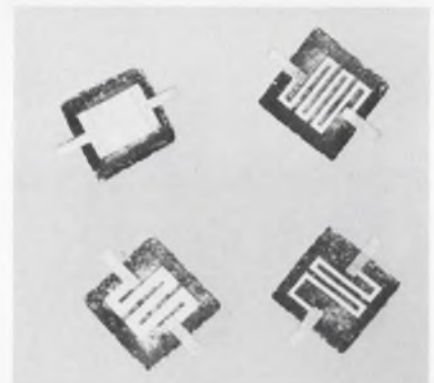

Motorola Semiconductor Products Inc., Box 20924, Phoenix, Ariz. Phone: (602) 273-6900. P&A: \$1.60 to \$1.90 per 100; stock;

A series of unencapsulated miniature 50-mil-square chip resistors feature gold beam leads with resistance values ranging from 5 to 5000 Ω. Type MCH5862, -67, -71, -75, -80 and -83 thin-film units are made of a 400-angstrom-thick glass substrate. They feature a temperature coefficient of 50 ppm/°C and power dissipation of 125 mW.

CIRCLE NO. 277

**TRW/Globe
sells motion**



Application #6: Precision Torque

Actually there's no magic in the way TRW/Globe designers do it. Just in the results. Take the new one inch cube-shape DC torque motor, for example. Compare it to what you have had to settle for in the past.

Double the stall torque of conventional designs of comparable size. (6.65 in. oz. at 26 VDC/1.4 amps).

Armature inertia: 6.5 GM CM² (11 slot lamination).

Straight line linearity from no load to stall. Torque sensitivity 4.5 in. oz./amp. Speed torque gradient 1000 RPM/in. oz.

Continuous duty rating from no load to 3 in. oz. (you can eliminate the gear train or reduce number of stages previously used).

Inherent magnetic shielding. TRW/Globe has been extending the designer's reach for more than 20 years. The one inch cube is just one of a series of new sol-

utions to precision motor problems. If your system requires precision torque, contact Globe Industries Division of TRW Inc., 2275 Stanley Ave., Dayton, Ohio 45404. Phone: (513) 228-3171.

TRW[®]

To appear in: Aviation Week & Electronic Design

INFORMATION RETRIEVAL NUMBER 50

Illuminated switches are 0.7-in. square

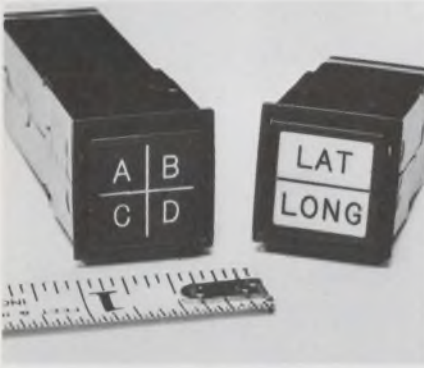

Clifton Div. of Litton Industries, 425 E. Fillmore, Colorado Springs, Colo. Phone: (303) 632-2691.

Accommodating two or four lights in T-1 or T-1-3/4 styles is a new C series of 0.7-in.-square illuminated pushbutton switches and matching N type indicators. They are easily relampable and are available with individually colored filters, colored bulbs or colored silicon boots in spdt or dpdt styles at 3-A resistive ratings. All units mount on 0.7-in. centers.

CIRCLE NO. 278

Indicator lights ease installation

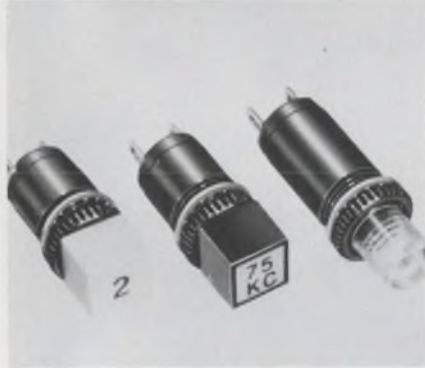

Drake Mfg. Co., 4626 N. Olcott Ave., Harwood Heights, Ill. Phone: (312) 867-7227.

Using T-1-3/4 incandescent and T-2 neon lamps, two new series of indicator lights offer ease of installation. Series 5154 units have a cylindrical transparent or translucent lens, or a lens cap with a perfect light refracting pattern. The 5515 series units feature 3/8-in.-square lens caps with friction fit shank for orientation. Units mount in 3/8-in. dia holes.

CIRCLE NO. 279

Wideband transformers respond up to 500 MHz

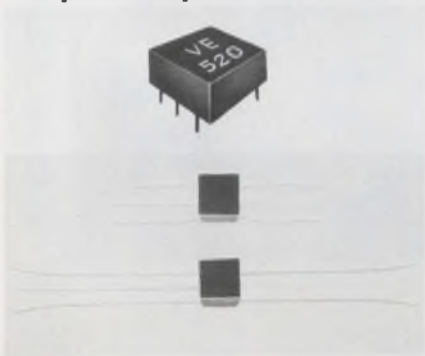

Vanguard Electronics Div. of Wyle Laboratories, 930 W. Hyde Park, Inglewood, Calif. Phone: (213) 678-7161.

Measuring only 0.125-in. square, two new transformer series widen their frequency response to beyond 500 MHz. Series LUB and LBB balanced and unbalanced units operate in the temperature range of -55 to $+125^{\circ}\text{C}$, are available in many impedance ratios with or without dc isolation and feature low power loss.

CIRCLE NO. 280

High-visibility readout sets and resets simply



Allard Instrument Corp., 770 Main St., Westbury, N.Y. Phone: (516) 334-8742.

Providing a seven-segment array with latching (bi-stable) action for pulse operation and high visibility in ambient light, a new 1/2-in. readout can be set or reset by simple electrical pulses requiring no shafts or bearings. Type 213 segments are viewed by reflected light for increased visibility and lamp life and decreased power consumption.

CIRCLE NO. 281

Miniature inductor is 66% smaller

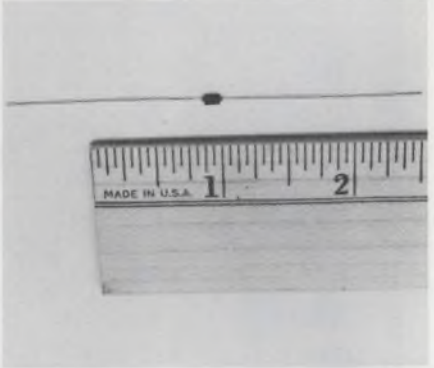

Nytronics Inc., Standard Components Group, Essex Electronic Div., 550 Springfield Ave., Berkeley Heights, N.J. Phone: (201) 464-9300.

Known as the Pee-Wee Ductor, a new magnetically shielded axial-lead inductor measures 0.085 in. in dia and 0.155 in. in length for a 66%-smaller size than other inductors of its type. It has minimum Q values of 34 to 55, inductance tolerances of $\pm 10\%$, a temperature range of -55 to $+125^{\circ}\text{C}$ and handles currents of 43 mA to 1.5 A.

CIRCLE NO. 282

Display storage tube shows nonstored data



Westinghouse Electronics Tube Div., Box 284, Elmira, N.Y. Phone: (607) 739-7951. P&A: \$2600; 30 days.

Nonstoring data can be written over stored data on a new display storage tube with a four-inch display area and a writing speed of 5×10^5 inches per second to give a composite picture. Type WX-30593 tube is electrostatically focused and deflected, has a display brightness of 1000 foot-lamberts, a resolution of 60 lines per inch and high contrast.

CIRCLE NO. 283

We're big in bipolars.

Big because we've got fast-thinking, bright young engineers working with some of the real pioneers in the business. All supported by the resources of a \$14 billion corporation. Take a look at the results.

High-speed T²L: 30 types in production, more to come—Series 9600, pin-compatible with SUHL* II.

Medium-speed T²L: 20 types in production, more coming—Series 74 with clamp diode input . . . improved hermetic cerdip packaging.

DTL: More than 30 commercial, hi-rel, and radiation-hardened circuits . . . Series 9930 now in high-volume production.

RTL: Popular Milliwatt and Micrologic** types in volume production.

Linear IC's: 11 standard types—in cerdip packaging for top reliability.

MSI: 9300 Series on the way.

A comprehensive line? You're right. It's backed by an established reputation for quality. And by high-volume production capability. We're one of the largest IC facilities in the country. No wonder our sales have increased 50% in the past year.

So if it's a bipolar IC, check with us. Write or call Bipolar Marketing, Philco-Ford Microelectronics Division, Blue Bell, Pa. 19422. (215) 646-9100.

*Trademark of Sylvania Electric Products, Inc.

**Trademark of Fairchild Camera & Instrument Corp.

The better idea people in bipolar IC's.

PHILCO

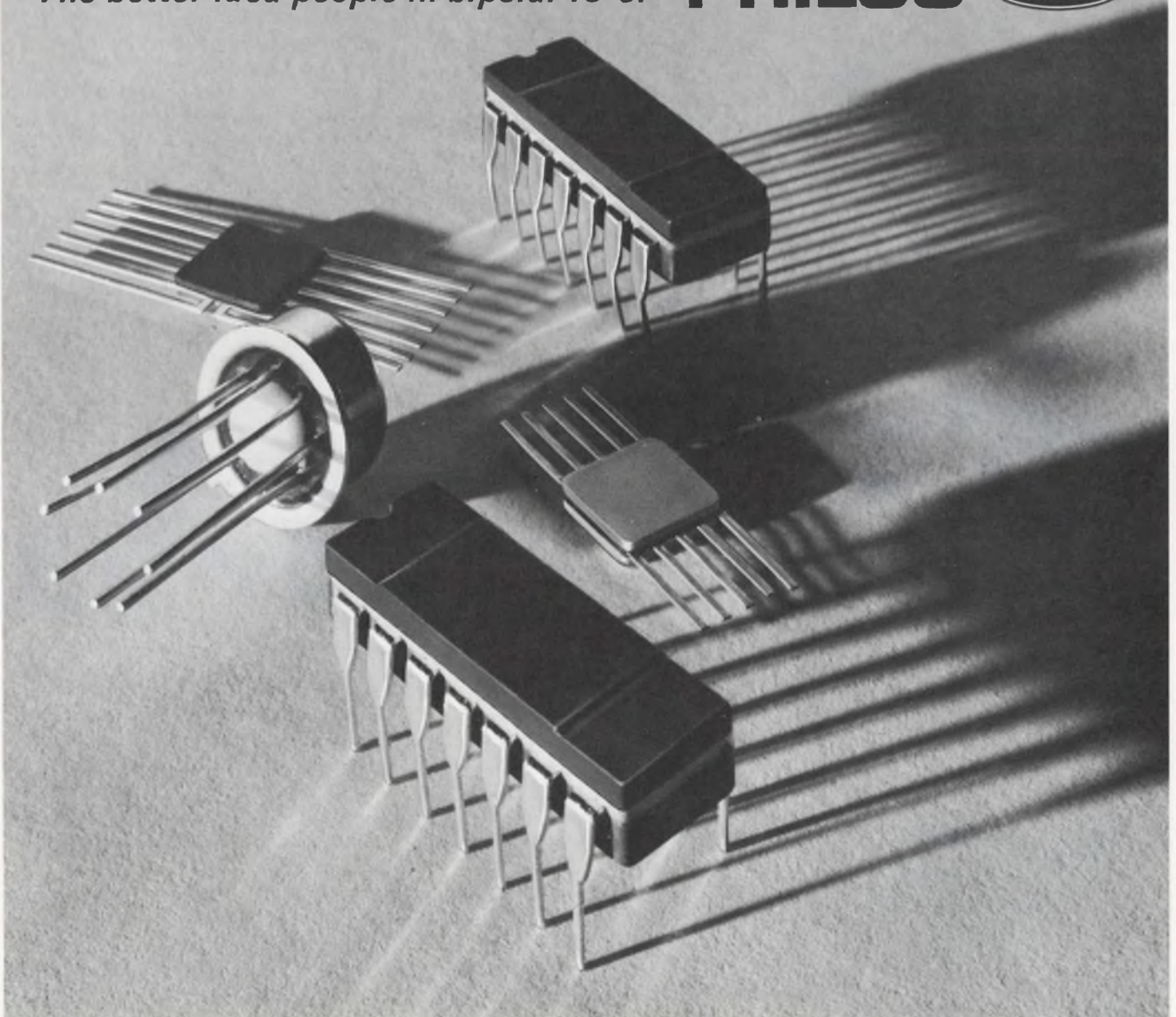

INFORMATION RETRIEVAL NUMBER 51

One-cubic-inch supply socks out 5.5 kV dc

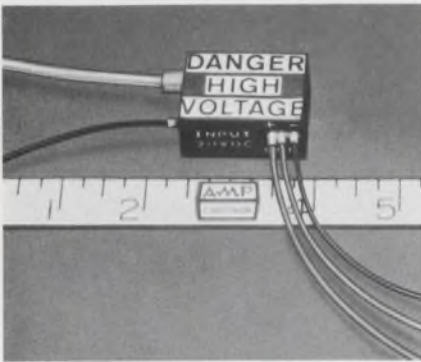

Capitron Div. of Amp, Inc. 155 Park St., Elizabethtown, Pa. Phone: (717) 564-0101.

Measuring only 1-1/2 by 1 by 11/16 in., a tiny high voltage power supply delivers 5.5 kV dc at 500 μ A. The unit is fully encapsulated in thermally conductive epoxy, and when provided with heat sinking will maintain the rated current output from -55 to +75°C. It can charge a 0.6 μ F capacitor in parallel with a 10-M Ω resistor in 2 s with a 20% duty cycle.

CIRCLE NO. 284

High-impedance op amp drifts just 2 μ V/°C

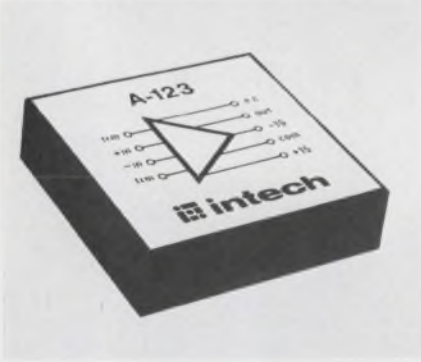

Intech Inc., 1220 Coleman Ave., Santa Clara, Calif. Phone: (408) 244-0500. P&A: \$70; stock.

With a slewing rate of 50 V/ μ s and a settling time of 2 μ s to 0.01% of final value, a new FET-input operational amplifier claims a low drift of only 2 μ V/°C. The model A-123 unit has an input impedance of 10¹² Ω , 10-pA bias current, a 5-MHz bandwidth, 94-dB common-mode rejection, 20- μ V/V sensitivity and a low-profile case of 1.5 by 1.5 by 0.4 in.

CIRCLE NO. 285

D/a converter series settles in only 5 μ s

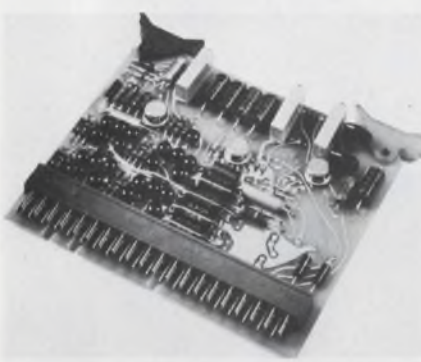

Standard Logic Inc., 1630 S. Lyon St., Santa Ana, Calif. Phone: (714) 835-5466. Price: from \$85.

Displaying a high resolution of up to 12 bits on a 3.5 by 4.3-in. printed-circuit card, a new digital-to-analog converter series, which includes optional-amplifier outputs and precision voltage-reference options, shows a low settling time of 5 μ s. The series is fully compatible to DTL and TTL levels, provides outputs of 10 V and includes units of eight-bit resolution.

CIRCLE NO. 286

Wideband op amp covers 1300 MHz

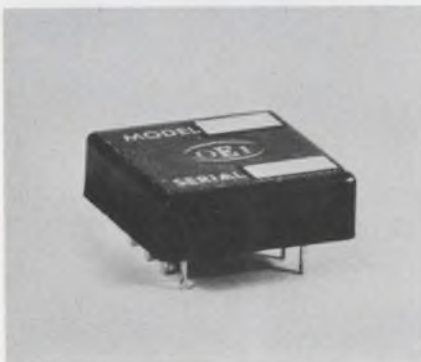

Optical Electronics Inc., Box 11140, Tucson, Ariz. Phone: (602) 624-3605. P&A: \$54; stock.

Featuring a 60-dB open-loop voltage gain and a \pm 360-V/ μ s slewing rate, a new FET hybrid operational amplifier boasts a 1300-MHz gain-bandwidth product. The model 9706 has a 10¹⁰ Ω input impedance, 15- μ V pk-pk noise and an operating temperature range of -55 to +85°C. It is packaged in an eight-lead jumbo dual-in-line case costing \$54 in unit quantities.

CIRCLE NO. 287

Active-filter modules cutoff down to 0.001 Hz



Frequency Devices, Inc., 25 Locust St., Haverhill, Mass. Phone: (617) 372-6930. P&A: from \$39; 6 wks.

Series 100 active filters are unity-gain non-inverting modules with cutoff frequencies from 20 kHz down to 0.001 Hz. Standard models include two to six poles of low-pass, high-pass, bandpass or band-reject filters with Butterworth, Tchebyscheff, Bessel or twin-T transfer functions. They have \pm 0.2-dB passband gain tolerance and \pm 5% cutoff frequency accuracy.

CIRCLE NO. 288

Low-pass active filters cost as little as \$25



Burr-Brown Research Corp., International Airport Industrial Park, Tucson, Ariz. Phone: (602) 294-1431. P&A: \$25, \$45; 2 wks.

Two-pole and four-pole active low-pass filters, models 5720 and 5721 cost \$25 and \$45, respectively. The former has a cutoff-frequency range from 10 Hz to 20 kHz while the latter's range is from 1 Hz to 20 kHz. Both have 20- Ω output impedance, 0 \pm 0.1-dB passband gain and outputs of \pm 10 V at \pm 1 mA.

CIRCLE NO. 289

NPN-PNP pairs to 60 amps

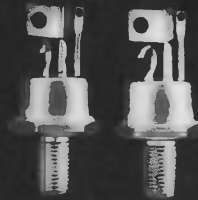

TRUE NPN-PNP PLANAR POWER TRANSISTOR COMPLEMENTS IN RATINGS FROM 1 TO 60 AMPERES..... NOW, FROM TRANSITRON

More Complementary Pairs — More NPN-PNP complements than any other manufacturer. Pairs available in all ratings up to 60 Amps.

Wider Selection — Well over a thousand silicon planar types — both high power and high voltage . . . all available for fast delivery. NPN and PNP types with power dissipation 5 to 300 watts; collector current 1 to 100 amps; BV_{CEO} (NPN) to 200 V; BV_{CEO} (PNP) to 140 V; high-voltage NPN types with BV_{CEO} to 400 V.

Single-chip reliability — Single-chip construction

provides greater reliability than standard multiple-chip designs.

More Packaging Flexibility — Standard packages include TO-3, TO-5, TO-59, TO-61, TO-63, TO-66 and TO-114. (TO-5, TO-59 and TO-61 available in isolated cases.) High power types available in smaller-than-usual packages, providing important space and weight savings.

Proved Performance — Transitron power transistors are in use in many military and aerospace programs where reliability and performance are critical.

TYPICAL POWER TRANSISTORS						HIGH VOLTAGE TRANSISTORS				
Typical NPN type	Typical Complementary PNP type	Package	Maximum Power Dissipation (Watts)	BV_{CEO} (Volts)	I_C (max) (Amps)	Typical NPN type	Package	(Watts) Maximum Power Dissipation	BV_{CEO} (Volts)	I_C (max) (Amps)
ST14031	ST40003	TO-63	300	100	60	ST18007	TO-63	150	400	20
2N5250	—	TO-114	300	100	90	ST18009	TO-63	150	200	20
ST15044	ST54005	TO-63	187	100	40	ST18011	TO-61	75	400	10
ST17061	ST10008	TO-63	150	100	30	ST18013	TO-61	75	200	10
ST86021	—	TO-61	75	100	5	ST18015	TO-59	45	400	5
ST91058	ST76019	TO-59	60	100	10	ST18017	TO-59	45	200	5
ST91086	ST72037	TO-59	45	100	5					
ST91055	ST72040	TO-5	15	100	5					
ST74050	ST75005	TO-5	11	100	2					
ST84028	—	TO-5	7.5	140	1					

Want more information on Transitron power transistors? Call today for complete data and specifications. Specify types of particular interest.

Transitron
electronic corporation
168 Albion Street Wakefield, Massachusetts 01880

C-COR AMPLIFIERS

— PULSE — Fast Rise-Time for

- High Resolution Video
 - Nuclear Instrumentation
 - Laser-Optics
 - Digital Computer Design
- 1 nS to 10 nS Rise times
5 Hz Response
12 V Peak, 50 Ω Load
Matched In/Out Impedances
\$95 — \$775

— FAMILY FEATURES —

- Low Frequency Response
- Output thru $\pm 25V$ Peak
- High Gain 20 thru 60 dB
- Spin-offs from AEC/NASA Advanced Design Projects
- Missile Reliability
- Adjustable Gain in Some Versions

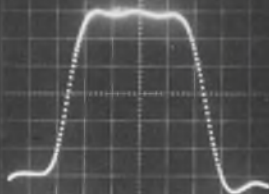

1 nS Response (10-90% levels)
Rise Time of a 5 nS Positive Pulse
Oscilloscope: Tektronix 561-B
Vertical: 200 mV/cm.
Horizontal: 1 nS/cm.

EXAMPLES

R.T.	Gain	Output	Model
1 nS	23dB	$\pm 6 V_p$	3010-AP
2 nS	40dB	$-6 V_p$	3364-G
3 nS	20dB	+4 Vp $-8 V_p$	3329-F
4 nS	60dB	+4 Vp $-8 V_p$	3388-F
5 nS	20dB	$\pm 1\frac{1}{2} V_p$	3518

Select from 17 models off-the-shelf.
"C-COR Amplifiers . . . Rated First
Where Performance is Rated First."



C-COR

ELECTRONICS, INC.

60 Decibel Road
State College, Pennsylvania 16801
814 238-2461

INSTRUMENTATION

Versatile test clip eases DIP handling

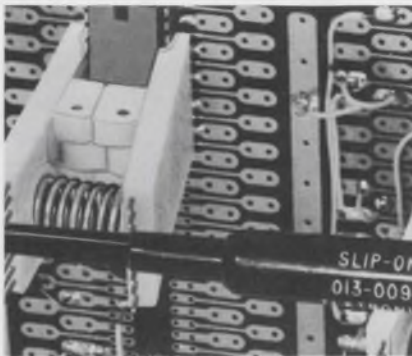

A P, Inc., 72 Corwin Dr., Cleveland, Ohio. Phone: (216) 357-5597. P&A: \$7.50; stock.

Ideal for field service work and for laboratory and production circuit checking, a new test clip provides easy accessibility to hard-to-reach pins on dual-in-line integrated circuits. Particularly useful with oscilloscope probes, the unit can also be used as an inspection test fixture and as a tool for easy damage-free removal of dual-in-line packages.

CIRCLE NO. 290

Logic-status test set displays 40-ns pulses



Dataprobe, Inc., 290 Huyler St., S. Hackensack, N.J. Phone: (201) 489-5588. P&A: \$95; stock.

Designed to test high-threshold logic systems, a new logic unit indicates logic levels and displays pulses as short as 40 ns, and includes a latching mode to detect and capture noise or a single pulse. Pulse-detection systems for the ST-15 Status Seeker unit are independent of a self-contained generator, enabling the unit to generate and detect pulses simultaneously.

CIRCLE NO. 291

Economy 3-digit meter uses large-scale ICs



Dixon Inc., P.O. Box 1449, Grand Junction, Colo. Phone: (303) 242-8863. P&A: \$139; stock.

Incorporating large-scale MOS integrated circuits, a new three-digit panel meter features 0.5% accuracy, an automatic zero, an internal calibration voltage, and a 100- μV resolution. Model VT 500, which is capable of operating from 117 V ac or 12 V dc, is designed for general industrial applications and analog meter replacement. It costs only \$139.

CIRCLE NO. 292

Amplifier/filter unit triples as a voltmeter



Dynatronics Co., Inc., 4800 Evanswood Dr., Columbus, Ohio. Phone: (614) 885-3303. P&A: \$990; stock.

Known as the model 717S, a new instrument is a narrowband filter, an amplifier, and a narrowband voltmeter in one unit. As a filter it is tunable over the frequency range of 20 Hz to 20 kHz; as an amplifier its gain can be varied from -50 to $+60$ dB; and as a voltmeter with an input impedance of 10 M Ω , full-scale sensitivity can be varied from 1 mV to 300 V.

CIRCLE NO. 293

Ace Chemical Co., 4401 N. Ravenswood Ave., Chicago, Ill. Phone: (312) 728-1065. Price: \$14.95 per gallon.

Simply by brushing on Rust-Removo then flushing with water, you can easily remove rust from iron and steel, corrosion from chrome and aluminum and tarnish from copper, brass and bronze. This new jell is a blend of mineral acids, special solvents and wetting agents. It leaves a protective coating after being flushed away.

CIRCLE NO. 294

Rust-removing jell is water rinsable



Fiber-optic cones stop distortion



Optics Technology, Inc., 901 California Ave., Palo Alto, Calif. Phone: (415) 327-6600.

A new line of fiber-optic products includes 40-mm-dia cones that can magnify or demagnify images 2 to 3 times (in cones as short as 1 in.) without distortion, and resolutions from 50 line-pairs/mm to 150 line-pairs/mm. The family also includes 3-in.-dia vacuum tight faceplates. Both products are frit-sealable with no scintillation under high voltage.

CIRCLE NO. 295

Starnetics Co., 10639 Riverside, N. Hollywood, Calif. Phone: (213) 769-8437. Price: \$19.50 per gallon, \$6.50 per quart.

Easily peeled from masked surfaces of ceramic and plastic circuit boards, a new flexible material masks solder applications on undesired board areas. SC-300 material can withstand short exposures to solder temperatures of 500°F, cures in 30 minutes at 72°F or 10 minutes at 150°F. It is easily brushed on.

CIRCLE NO. 296

Dual-in-line boards accept discretes

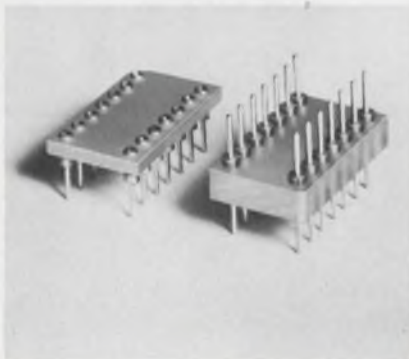

SAE Advanced Packaging, Inc., 1357 E. Edinger Ave., Santa Ana, Calif. Phone: (714) 547-3935. P&A: \$1.02 to \$1.26; 1 wk.

Available with 14 or 16 gold-plated phosphor-bronze pins, types A and B plug-in component mounting boards accept discrete components for systems with DIP cases. Type A has hollow pins while type B has posts, for soldering and hooking component leads. They have epoxy-glass bases and a locating chamfered corner.

CIRCLE NO. 297

the impossible ALCOSWITCH

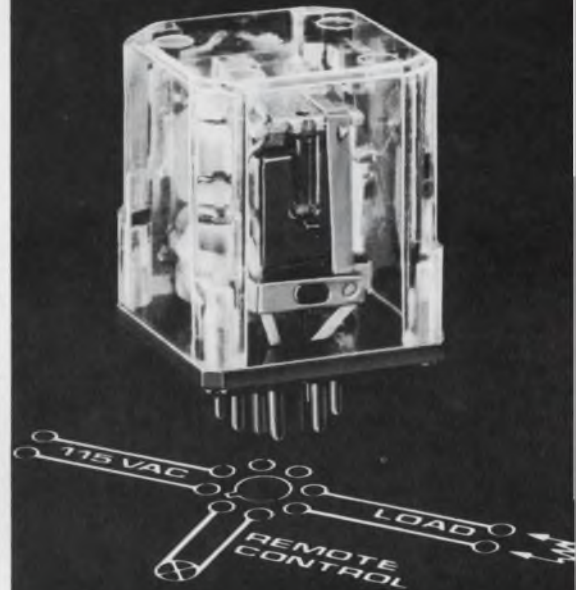

Since when does ALCOSWITCH make relays? Since we learned how to make the impossible switch. All we've done is to combine a step-down transformer and a relay in a single core, all in miniature.

If your product operates on 115 VAC and has possibilities of remote operation chances are you could use this ALCOSWITCH-RELAY!

Refer to the figure below: by simply shorting the remote control leads "xx" the flux path changes thereby closing the relay armature.



The only product in the world of this type that allows you to control up to 600 watts remotely, safely, and economically.

Whether you manufacture hi-fi amplifiers, electric fans, vacuum cleaners, projectors, thermostat controls, consumer appliances or industrial equipment, you may have a need for this revolutionary switching product.

If you are seeking a marketing advantage for your products, we will be happy to assist you by suggesting one of our ALCOSWITCH-RELAYS.

ALCO

ELECTRONIC PRODUCTS, INC.
Lawrence, Massachusetts 01843

SCHAUER

1%

tolerance

1 WATT ZENERS ARE A REAL BUY!

ANY voltage from 2.0 to 16.0
at the industry's LOWEST
PRICES!

Quantity	Price each
1-99	\$1.07
100-499	.97
500-999	.91
1000-4999	.86
5000 up	.82



THE HI-RELIABLE!

No fragile nail heads.
Silicon junction aligned between two, parallel, offset tantalum heat sinks . . . great lead tension strength.
All welded and brazed assembly.
High pressure molded package.
Gold plated nickel-clad copper leads.
Write or phone for Form 68-4 for complete rating data and other tolerance prices.

Semiconductor Division

**SCHAUER
MANUFACTURING
CORP.** 4511 Alpine Avenue
Cincinnati, O. 45242
Ph. (513) 791-3030

INFORMATION RETRIEVAL NUMBER 55

MICROWAVES & LASERS

Tiny S-band oscillator scans 2.2 to 2.3 GHz

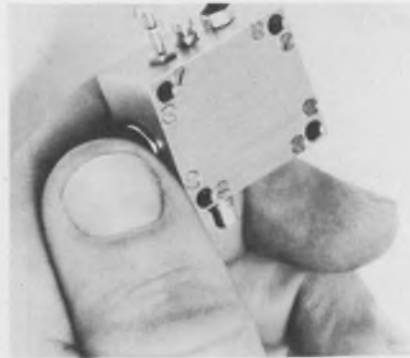

*Microwave Products Group, Inc.,
100 Express St., Plainview, N.Y.
Phone: (516) 938-8200. P&A:
\$395; stock to 30 days.*

Centered at 2250 MHz, a new miniature S-band oscillator manually tunes from 2200 to 2300 MHz with typical output power of 70 mW. Model M2250-50 keeps its second harmonic content down by 20 dB from its fundamental frequency and is powered by -28 V at 25 mA while measuring only 1 by 1-1/2 in.

CIRCLE NO. 335

Small light modulators respond up to 100 MHz



*Synergistics, Inc., 10 Tech Circle,
Natick, Mass. Phone: (617) 655-
1340. Price: \$1800 to \$16,300.*

A compact line of light modulators responds from dc to 100 MHz in single or multi-channel units up to 100 in-line or 200 mosaic-pattern channels. They temperature-stabilize over the operating range of -20 to +50°C, without an oil bath or oven, need only 100 V for 100% modulation, have 0.5 to 2.5-mm apertures per channel and measure from 1 by 3-1/2 in.

CIRCLE NO. 336

Step-recovery diodes show 70-ps transition

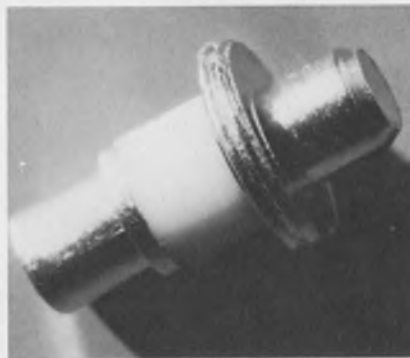

*GHZ Devices, Inc., Kennedy Dr.,
N. Chelmsford, Mass. Phone: (617)
774-0577.*

Offering orders of multiplication from 2 through 20, Series GC-2500 step-recovery silicon diodes for X and Ku-bands feature a maximum snap time of 70 to 100 ps with maximum series resistance of 0.6 to 0.9 Ω. Also featured are output power efficiencies ranging from 1/N to 2/N and an operating and storage temperature range from -65 to +200°C.

CIRCLE NO. 337

Frequency synchronizer converts rf oscillators



*Microdot, Inc., Instrumentation
Div., 220 Pasadena Ave., S. Pasadena,
Calif. Phone: (213) 682-3351.*

Converting rf power oscillators into accurate power sources, the model 1929 frequency synchronizer handles up to 50 W of output power from 2 to 2500 MHz. It receives an oscillator's rf signal, mixes it with a local oscillator, amplifies and limits the difference, applies it to a discriminator for a dc signal to frequency-lock the oscillator.

CIRCLE NO. 338

Evaluation Samples



Rfi gasketing

Five actual sample pieces of rfi strip gasketing material are supplied free, along with a four-page brochure entitled "Rfi/Environmental Strip Gaskets." The samples are D-strips and O-strips, in both Cho-Seal and Cho-Sil materials, and a combination conductive/nonconductive Cho-Seal strip gasket. This gasketing provides both rfi and environmental protection by using highly conductive fillers dispersed in silicone binders, rather than wires or wire mesh. Chomerics, Inc.

CIRCLE NO. 339

Plastic spacers

Tough, rigid and strong—plastic spacers are now available as free evaluation samples for use in either prototype or production assembly. The plastic units represent a substantial saving in cost and in weight over metal spacers. They are made for #4, #6, #8 and #10 screws in lengths from 1/4 to 1 in. Their temperature resistance is as high as 225°F. Richco Plastic Co.

CIRCLE NO. 340

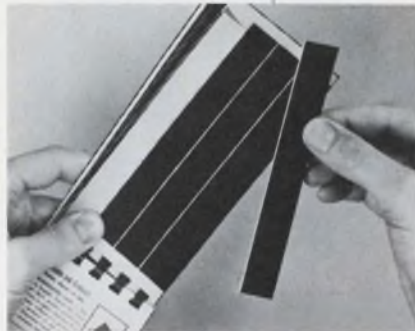

Pre-cut tapes

Called Handi-Pac tapes, new pre-cut strips of tape in pocket-size dispenser books provide a new convenient method to splice, insulate, tie or code wires and cables. There are 14 different Handi-Pacs containing from 40 to 240 strips of electrical-grade tape in different lengths, widths and colors. The varied supply from a compact source eliminates the need to carry several different rolls. Because only the length of tape itself is involved in wrapping the wire, hands are free to complete the application firmly, with ease and speed. Free evaluation samples are available. W. H. Brady Co.

CIRCLE NO. 341

Sheet insulation

Quintex I and II are improved types of asbestos electrical sheet insulations that are presented to potential users via a new booklet of actual free samples of both types. There is a variety of thicknesses: 3 to 15 mils for Quintex I and 5 to 29 mils for Quintex II. These flexible dielectrics are principally composed of specially processed asbestos fibers, uniformly dispersed high-temperature synthetic textile fibers, and a small quantity of heat-stable elastomeric binder. In addition to high strength, Quintex also has excellent thermal stability and high thermal conductivity. Johns-Manville.

CIRCLE NO. 342

variety with ALCOSWITCH

The greater the variety, the more flexibility you have when designing a miniature ALCOSWITCH into your quality equipment. The broad ALCOSWITCH line offers over a hundred different models.

Miniature Toggle Switches are available in five series including high performance waterproof types, locking handles, and switches with 15/32" bushings.

Miniature Push Button Switches include the new illuminated series, top-grade SPDT-DPDT-4PDT types, 15/32" bushings, and economy priced miniatures.

1/2" Dia. Miniature Adjustable-Stop Rotary Switches are built to meet the highest reliability standards and are available with or without their own specially mated knobs.

Whether you need one or one thousand switches you have a greater variety to choose from when you specify an ALCOSWITCH.

SEND FOR
20-PAGE
ALCOSWITCH
CATALOG



ALCO

ELECTRONIC PRODUCTS, INC.

Lawrence, Massachusetts 01843

BOTTOMS UP!

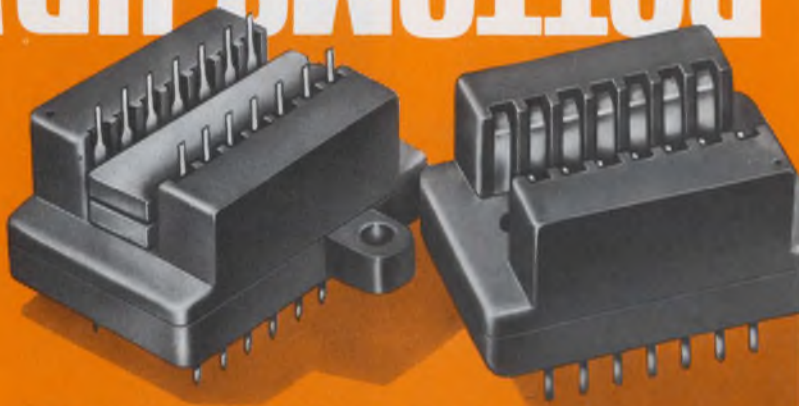

NEW INVERTED DUAL-IN-LINE SOCKETS FROM BARNES FOR FASTER HAND TESTING

Wish you had a "third hand" when inserting DIP devices into sockets in I.C. Testers or P.C. Boards? Not with Barnes inverted DIP sockets. They require no manipulation of leads into individual holes; 14 and 16 lead DIP devices are quickly and easily slipped into this socket with leads up! Direct wiping action contacts are recessed in deep grooves that guide device leads into position during insertion. Socket can also be used as a test probe for I.C.'s already mounted on boards. Turn thumbs down on bothersome DIP hand test operations with the bottoms up sockets by Barnes. Write today!



Lansdowne, Pa. 19050 • 215/MA 2-1525

barnes / THE WORLD'S MOST COMPLETE LINE OF SOCKETS, CARRIERS AND CONTACTORS FOR I.C.'S

INFORMATION RETRIEVAL NUMBER 57

MAKE IT VECTOR PLUGGABLE

**ASSEMBLE
YOUR LATEST
STATE-OF-THE-ART
CIRCUIT ON A VECTOR PLUGGABLE**

Various models come with 7, 8, 9, 11, 12, or 14 pin tube base plugs and inside mountings for dual-in-line integrateds, flat packs, transistors or other components ● Older equipment can perform like new without expensive chassis rewiring ● Modular plug-ins solve field repair problems ● Vector Pluggables come in many sizes to meet nearly all requirements ● For high R.F. Shielding requirements special units are available ● For rack mounted modules adjustable versatile Vector Strut Cages are available ●

Send for complete literature
VECTOR ELECTRONIC CO., INC.
12460 Gladstone Ave., Sylmar, California 91342
Phone: (213) 365-9661 • TWX (910) 496-1539

INFORMATION RETRIEVAL NUMBER 58

Design Aids

Design sketch paper

Record your brilliant design ideas for posterity (or for your boss) while they are still fresh in your mind. Can't decide whether to use pen or pencil? You can use either with a new engineer's work paper for sketching and calculations. It has 16 squares to the inch printed in non-reproducing blue ink. The absence of accented lines allows the grid to be adapted to many scales. The new forms, which are pre-punched for a three-ring binder, are just the right design aid for you. Ross-Martin Co.

CIRCLE NO. 343

QC sample calculator

Called Sample Scope, a heavy-plastic circular slide rule presents all of the sample plans in MIL-STD-105. It gives the sample size required for single, double, and multiple-sampling plans as a function of lot size and the level of inspection required. It also finds the acceptance and rejection numbers for each of these plans as a function of acceptable quality level. Costing only \$10, Sample Scope is a handy device for solving inspection and quality-control problems. TAD Products Corp.

CIRCLE NO. 344

Periodic table

Printed on plastic-coated durable cardboard, a colorful copy of one of the newest versions of the Periodic Table of the Elements is now available in two sizes—either 8-1/2 by 11 in. or 11 by 17 in. This special edition of the Periodic Table uses an unusual arrangement that readily distinguishes between the regular elements and the transition elements. The chart also includes the latest data on properties not usually found in periodic tables, making it, in effect, an abbreviated chemical handbook. Kawecki Berylco Industries Inc.

CIRCLE NO. 345

Application Notes

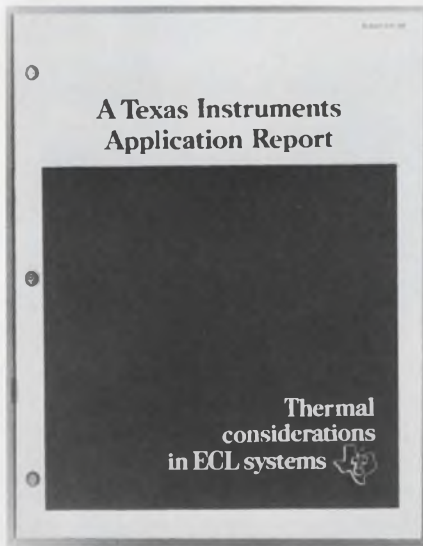

ECL thermal effects

A 12-page application report discusses the effect of temperature on logic levels in emitter-coupled-logic (ECL) circuits and describes a method of designing an air-cooled ECL system. ECL modules, the bulletin notes, dissipate a considerable amount of heat while achieving their under-5-ns propagation delay. The publication details a method for estimating the temperature limits within which an air-cooled ECL system can be operated error-free. Texas Instruments, Inc., Components Group.

CIRCLE NO. 346

Packaging guide

Interesting facts on packaging, including examples and package testing techniques, are discussed in the latest issue of "Motorgram" (Vol. 49, No. 4). The discussion points out that industrial packaging should reach two primary goals: protect the product during shipment, and make it easy to handle. Also included is an article about a fractional-horsepower gear motor used in a line of equipment that measures and records microscopic surface features. Bodine Electric Co.

CIRCLE NO. 347

Diode detectors

Definitions, discussions, and formulas are all included in a concise four-page brochure on tunnel-diode detectors. The technical information includes tangential signal sensitivity, dynamic range, noise characteristics, temperature stability, bias application, and power handling capability. There is also a graph showing typical transfer characteristics. Aertech Industries.

CIRCLE NO. 348

Cable system noise

A technical discussion of noise in cable systems is given a thorough treatment in an eight-page booklet. A general description of electrical noise and its origins opens the talk, which goes on to cover coaxial cable, ground loops, and common-mode returns. Also discussed are radiated fields, twin-ax and triax cable, two types of guarded cable, and bonding and grounding problems. Trompeter Electronics, Inc.

CIRCLE NO. 349

Energy control

Design Monograph No. 9 is an eight-page two-color article that presents several methods for controlling mechanical energy in the interest of product improvement. The three basic approaches are constrained accommodation of motion, isolation of energy flow, and suppression of energy effects. The discussion spells out six objectives of taking these uncommon approaches to mechanical energy control, and presents illustrated examples of how they have been achieved in specific applications. Lord Manufacturing Co., div. of Lord Corp.

CIRCLE NO. 350

designer's keyboard

SB-033 — INTERLOCK
SB-034 — MOMENTARY



28.50 User Net

The ALCO modular idea is a simple concept for the design engineer to create his own custom push button layouts from "stock" switch modules and assemblies.

The basic modules allow use of up to twelve (shown at right) switches per section. A designer may stack any number of these switch sections in a group by themselves or in conjunction with the ALCO mating 12-segment keyboard assemblies (shown above).

Highly efficient, single pole "normally open" reed switches are used throughout, thus assuring reliability and extremely long life expectancy.

For design-service assistance and price quotations, call (Area 617) 686-3887.

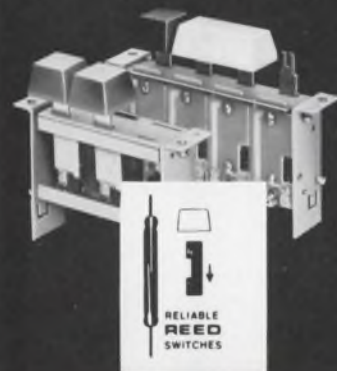

Available as
Momentary
and Interlock

ALCO

ELECTRONIC PRODUCTS, INC.

Lawrence, Massachusetts 01843

New Literature



Diodes and converters

Diodes, diode arrays, pulse generators and converters are detailed in a new data file. Included are a description of a Ga-As injection laser diode, hetero-structure Ga-As laser diodes, laser diode arrays, miniaturized laser pulse generators, laboratory laser pulse generators and dc to dc converters. Given is such data as performance and operating characteristics with photographs and dimensional outlines. Laser Diode Laboratories, sub. of The United Corp.

CIRCLE NO. 351

Switches

A complete line of precision snap-action, thumbwheel and lever-wheel switches is shown in a new 44-page catalog. Included are photographs, cutaway illustrations, descriptions, detailed specifications and application data for hundreds of standard switches. Also included is a handy new switch selector-locator table and 20 pages devoted to snap-action switch terminology. Cherry Electrical Products Corp.

CIRCLE NO. 352

Calibration standards

The latest dc techniques for precision test and measurement in general production and engineering areas, as well as standards and calibration laboratories, are described in detail in a 12-page catalog. Featured is a special section devoted to theory and application information and specifications for manual, automated and computerized systems for use in test, measurement and control. Julie Research Laboratories, Inc.

CIRCLE NO. 353

Circular connectors

Two popular families of high density microminiature circular connectors are described in a new 16-page catalog. It features color photographs, line drawings, electrical characteristics and mechanical specifications on the complete line of two series of connectors. A selection guide and a detailed "how to order" section complete information necessary for finding the right high density microminiature connector of any given circuit application. Amphenol Industrial Div.

CIRCLE NO. 354

Crimping tools

Crimping tools for a wide variety of applications, including class I and class II specifications of MIL-T-22520, are detailed in a 38-page loose-leaf catalog. It explains crimp tool phraseology and lists better crimping techniques. The catalog includes tools in standard and miniature sizes of four and eight-indent, automatic and manual feed, and C-frame configurations, plus an assortment of crimping tool kits. Buchanan Electrical Products Corp.

CIRCLE NO. 355

Computer terminals

A computer terminal that combines plotting and typing capabilities in a single mechanism is described in an eight-page technical brochure. It contains specific examples of the terminal's plotting and typing capabilities, application information and a description of the software. Shown are units having plots with a resolution of 0.02 in. at up to 10 computed points per second. Any character on the standard teleprinter keyboard can be used for plotting, and plotting and text typing can be intermixed on the same sheet of paper. Typagraph Corp.

CIRCLE NO. 356



IC multiplexer

Applications information on a new MOS P-channel IC six-channel multiplexer is provided in a new brochure. Included is such information as its use as a high-reliability multiplexer or as a group of six electrical switches for a variety of functions. The brochure also includes maximum ratings, characteristics, mechanical data, diagrams and a test circuit for switching time detail. Union Carbide Corp.

CIRCLE NO. 357

Copper alloys

A broad line of copper alloys in rod and wire form is described in a new 16-page brochure. These special-purpose alloys include coppers, copper nickels, phosphor bronzes, brasses, nickel silvers, silicon bronzes and silicon manganese bronzes. Also included is a discussion of such applications as springs, free machining parts, welding wire, and optical parts. Bridgeport Brass Co., Div. of National Distillers & Chemical Corp.

CIRCLE NO. 358

Space exploration

A six-page reprinted folder on communications on the moon and limited quantities of a 32-page booklet entitled "Man and Space" are available. They provide a brief summary, complete with photographs, on communications methods employed on lunar spacecraft and a summary of the Apollo lunar program with information on major space programs already completed. RCA/Defense Electronic Products.

CIRCLE NO. 359

ground to air ranging system

The Vega Model 637X X-Band Ground-to-Air Ranging System is designed to accurately measure the distance between a ground location and an aircraft. This equipment is indispensable wherever there is a need for a relatively short range tracking mission such as up to 10,000 yards. It may be modified for extended tracking ranges, if desired.

The Model 637 consists of two basic subsystems: an airborne subsystem and a ground based subsystem. The airborne portion consists of a Vega Model 319X Transponder and a Vega Model 808X bi-conical X-Band antenna. The ground portion consists of a tripod-mounted telescope, a Vega Model 827X dish antenna and a Vega Model 635X Ranger.

The ground-based ranger operator visually acquires the aircraft by means of the telescope, and thereafter keeps the aircraft in scope sights to ensure that the dish antenna is always beamed directly at the aircraft. The ranger sends out a single interrogation pulse at the rate of 305 pulses per second which starts a counter that operates until the airborne transponder replies. This return pulse from the transponder stops the counter and displays the range in yards.

For further information contact:

**VEGA PRECISION
LABORATORIES, INC.**
239 Maple Avenue W.,
Vienna, Virginia
Phone: (703) 938-6300



60 dB Stop band rejection

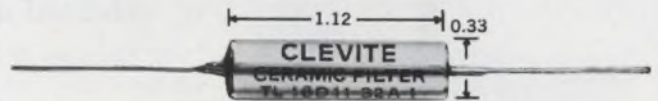

in a mil spec ceramic filter for less than \$15.

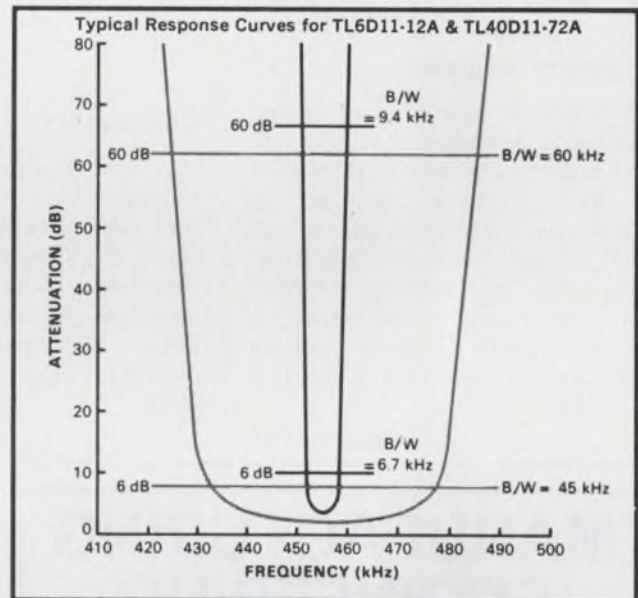

Here's the smallest (less than 0.1 cu. in.), most rugged fixed-tuned filter of its kind on the market today!

Clevite's 11-disc miniature filter is packaged in a hermetically-sealed cylinder, exceeds all military environmental specifications, is ideal for transistorized i-f amplifier circuitry in AM and FM sets plus many other applications that call for a fixed-tuned filter. Stop band rejection: 60 dB. Center frequency tolerance: ± 2 kHz to ± 3 kHz. Stability: within $\pm 0.2\%$ for 5 years; within 0.2% from -40°C to $+85^\circ\text{C}$. Impedance (in and out) 2000 ohms for B/W less than 12 kHz; 1000 ohms for broader bandwidths.

Following models standard at 455 kHz.

Model Number	min. @ 6 dB	B/W	max. @ 60 dB
TL6D11-12A	6 kHz		12 kHz
TL10D11-20A	10 kHz		20 kHz
TL16D11-32A	16 kHz		32 kHz
TL20D11-38A	20 kHz		38 kHz
TL30D11-57A	30 kHz		57 kHz
TL40D11-72A	40 kHz		72 kHz

PRICES: 1—\$25 ea; 25—\$20 ea; 100—\$17.50 ea; 500—\$15 ea; 1000—\$13.75 ea; 2500—\$12 ea.
(Prices subject to change without notice)

Send order or request for Bulletin 94029 to: Piezoelectric Division, Gould Inc., 232 Forbes Rd., Bedford, Ohio 44146, U.S.A. Or: Brush Clevite Company, Limited, Southampton, England.

GOULD CLEVITE

INFORMATION RETRIEVAL NUMBER 61

INFORMATION RETRIEVAL NUMBER 60



Dc power supplies

A series of regulated dc power supplies is described in a new six-page bulletin. It details 16 models of power supplies packaged on plug-in printed circuit cards, and gives all the necessary specifications, prices and delivery information. Also described are attractive enclosed cases where chassis mounting is required. Computer Products.

CIRCLE NO. 360

IC wideband amplifier

A 12-page application note describes the operation, electrical characteristics and ratings of a monolithic IC wideband video and i-f amplifier to frequencies as high as 100 MHz. Application information includes schematics, block diagrams, bias modes notes, and a stability discussion with relevant equations. RCA/Electronics Components.

CIRCLE NO. 361

Connectors

A new group of miniature rectangular plug and socket connectors for solderless-wrap applications is shown in a four-page brochure. Included are complete electrical and mechanical specifications, illustrations and outline drawings. Continental Connector Corp.

CIRCLE NO. 362



Tilt switches

Called Golden-Merc, a new line of gold-plated all-steel mercury tilt switches are described in a two-color catalog. Presented are complete electrical and physical specifications and operating information. Gordos Corp.

CIRCLE NO. 363

MANUFACTURING ENGINEERING

Test Equipment Design
Production Troubleshooting

Automatic Electric, a leading innovator of computerized electronic switching systems and the largest producer of communications equipment for the independent telephone industry, has numerous entry level and experienced positions available for **MANUFACTURING ENGINEERS**.

We are seeking new and experienced degreed electronic or electrical engineers (or equivalent work experience) to initially learn new computerized electronic telephone switching systems, design test equipment and associated test procedures and trouble-shoot the mass-production of this equipment.

If you are interested in a progressive, growing company that offers well-equipped, modern facilities, a policy of promotion from within, and a pleasant Suburban location (17 miles West of downtown Chicago), send your resume in confidence to:

Larry Wisniewski
Professional Employment Representative

AUTOMATIC ELECTRIC

Subsidiary of General Telephone & Electronics
400 North Wolf Rd., Northlake, Illinois 60164
An equal opportunity employer

INFORMATION RETRIEVAL NUMBER 902



APT-1; 1 cu. in., 3.15 oz. (actual size)

More torque, Less weight in moving coil mechanism

Highly stable, linear and accurate mechanism for indicating, control or recording systems. 18-0-18° linearity is 1%. Coil design with over 75% of winding "working" in high energy, uniform field air gap assures greater accuracy. Coil system weighs 0.85 gm, develops 26.4 mmg of torque; 31:1 T/W. Mechanism offers negligible vibration pivots and jewels — custom damping — wide range of sensitivities.

AMMON

AMMON INSTRUMENTS, INC.
345 Kelley St., Manchester, N.H. 03105

INFORMATION RETRIEVAL NUMBER 62

Free Career Inquiry Service

Absolutely Confidential

26

Respond to the career opportunities advertised in this issue. Fill out and send us this handy resume. **Electronic Design** will do the rest – neatly typed copies of this form will be mailed to the companies of your choice, indicated by the circled Career Inquiry Numbers at the bottom of this page.

Name		Home Phone	
Home Address (Street)		City	State ZIP Code
Age	U.S. Citizen <input type="checkbox"/> Yes <input type="checkbox"/> No	Security Clearance	
Prime Experience		Secondary Experience	

Desired Salary	Availability Date
-----------------------	--------------------------

Employment History – present and previous employers

Company			
City, State			
Dates	to	to	to
Title			
Specialty			

Education – indicate major if degree is not self-explanatory

Degree			
College			
City, State			
Dates	to	to	to

Additional Training – non-degree, industry, military, etc.

Professional Societies

Published Articles

Career Inquiry Numbers:

900	901	902	903	904	905	906	907	908	909	
910	911	912	913	914	915	916	917	918	919	925

ELECTRONIC DESIGN
850 Third Avenue
New York, New York 10022

Electronic Design

ELECTRONIC DESIGN'S function is:

- To aid progress in the electronics manufacturing industry by promoting good design.
- To give the electronic design engineer concepts and ideas that make his job easier and more productive.
- To provide a central source of timely electronics information.
- To promote two-way communication between manufacturer and engineer.

Want a subscription? ELECTRONIC DESIGN is sent free to qualified engineers and engineering managers doing design work, supervising design or setting standards in the United States and Western Europe. For a free subscription, use the postfree application form inside the back cover. If none is included, write to us direct for an application form.

If you do not qualify, you may take out a paid subscription for \$25 a year in the U.S.A., \$35 a year elsewhere. Single copies are \$1.50 each.

If you change your address, send us an old mailing label and your new address; there is generally a prepaid postcard for this inside the back cover. You will have to requalify to continue receiving ELECTRONIC DESIGN free.

The accuracy policy of ELECTRONIC DESIGN is:

- To make reasonable efforts to ensure the accuracy of editorial matter.
- To publish prompt corrections whenever inaccuracies are brought to our attention. Corrections appear at the end of the Letters column.
- To refuse any advertisement deemed to be misleading or fraudulent.

Microfilm copies are available of complete volumes of ELECTRONIC DESIGN at \$19.00 per volume, beginning with Volume 9, 1961. Work is now in process to complete the microfilm edition of Volumes 1-8. Reprints of individual articles may be obtained for \$2.00 each, prepaid (\$.50 for each additional copy of the same article) no matter how long the article. For further details and to place orders, contact the Customer Services Department, University Microfilms, 300 North Zeeb Road, Ann Arbor, Michigan 48106; telephone (313) 761-4700.

Want to contact us? If you have any comments or wish to submit a manuscript or article outline, address your correspondence to:

Howard Bierman, Editor,
ELECTRONIC DESIGN,
850 Third Avenue,
New York, N.Y. 10022.

Design Data from

Electronic Component Drafting Aids Design Guide



Free Catalog! Free Samples! The industry's largest selection of electronic component drafting aids! All in a new 68-page printed circuit design guide and catalog. Includes the most advanced technical information — with hundreds of illustrations — on printed wiring master artwork. Plus the industry's only tested-and-proved system for absolute registration for two-sided printed wiring boards with the only complete photographically compatible Red and Blue System. Send now for Catalog 104. Free samples included.

Bishop Graphics, Inc. The Innovators
7300 Radford Avenue
North Hollywood, Calif. 91605 (213) 982-2000

174

Terminal Block Selector



A new 24-page, completely illustrated catalog contains photos, descriptions, ratings, engineering drawings, and prices of the complete line of Curtis terminal blocks. Included are printed circuit, insulated feed-thru, quick disconnect, track type, and high current terminal blocks. Handy selection chart quickly locates the perfect block for your particular requirements. Send today for your free copy.

Curtis Development & Mfg. Co.
3236 North 33rd Street
Milwaukee, Wisconsin 53216

175

FUNDAMENTALS OF INTEGRATED CIRCUITS

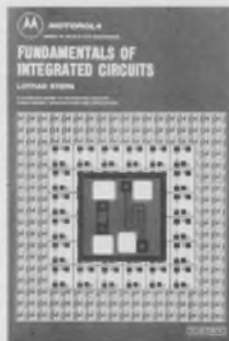

A practical guide to integrated circuits, their theory, manufacture, and applications. This new guide by Lothar Stern offers complete, highly readable coverage of the various techniques of circuit fabrication, and their effect on circuit design and performance. As to marketing considerations, it compares the characteristics of the numerous IC structures devised to date in terms of economics and logistics. A volume in the **Motorola Series in Solid-State Electronics**. 198 pages, 7 x 10, illustrated. \$8.95, clothbound. Send for 15-day examination copies.

Hayden Book Company, Inc.
116 West 14th Street
New York, N.Y. 10011

176

Manufacturers

Advertisements of booklets, brochures, catalogs and data sheets. To order use Reader-ServiceCard (Advertisement)

The Latest In the State of the Power Supply Art



Kepco's Power Supply Catalog (B-693) is updated by a new six-page supplement entitled "The Latest in the State of the Art." Covered are five separate Power Supply groups: Modules for I-C systems, dual modules for linear circuits, and a new extension of Kepco's "PRM" ferroresonant regulators in a 60VA package. The new PRM's feature voltage selection by internal taps.

The supplement also covers three new bipolar power amplifiers up to $\pm 72V$ at $\pm 5A$, and a group of high voltage operational power supplies 0-500V, 0-1000V and 0-2000V at 20 watts.

Check number below for your copy of The Latest in the State of the Art . . . from Kepco.

Kepco, Inc.
131-38 Sanford Avenue
Flushing, New York 11352

177

PEM Preassembled Captive Screw Fasteners

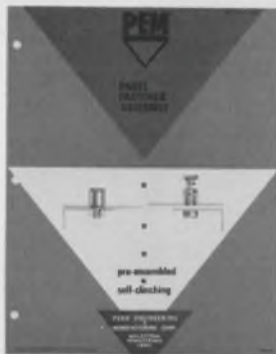

PEM self-clinching panel fasteners are completely preassembled with captive screw, spring and retaining washer in stainless steel retainers ready for permanent mounting in panels as thin as 0.060". Knurled and slotted captive screws with tapered leads can be removed if desired from their permanently mounted retainers. Send for free PEM bulletin describing self-clinching, pre-assembled panel fasteners in thread sizes #4-40 through 1/4-20. Each thread size is available in three screw lengths.

Penn Engineering & Mfg. Corp.
Box 311
Doylestown, Pa. 18901

178

AUTOMATIC REAL-TIME PSD SYSTEM

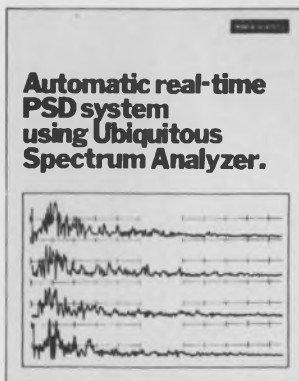

Hands-off automatic averaging, display, plotting, and readout (to computer) of PSD data in real-time, can now be performed using PSD-6/AU Ubiquitous® Power Spectral Density System. Options provide complete automatic cycling and control of external peripheral equipment for a time history display or repetitive plotting. MOD AU option provides for rapid previewing of averaged data or digital recording, in conjunction with various interface units; ACU-6 Control Unit controls input tape recorders and output X-Y plotters. System is built around the proven Real-Time Ubiquitous® Spectrum Analyzer for high-speed analysis of noise, vibration and other low-frequency random data, and for detection of low-level periodic signals buried in noise.

Federal Scientific Corporation
a subsidiary of Elgin National Industries, Inc.
615 West 131st Street, New York, N. Y. 10027

179

Electronic Design

Advertising Sales Staff
Keith Aldrich
Sales Manager

New York 10022
Robert W. Gascoigne
Thomas P. Barth
Samuel M. Deitch
850 Third Avenue
(212) Plaza 1-5530
TWX: 867-7866

Philadelphia 19066
William C. Repetto
P. O. Box 206
Merion Station, Pa.
(215) MA-3-5888

Boston 01945
Richard Parker
P. O. Box 645
Clifton Station
Marblehead, Mass.
(617) 742-0252

Chicago 60611
Thomas P. Kavooras
Berry Conner, Jr.
200 East Ontario
(312) 337-0588

Cleveland
Thomas P. Kavooras
(Chicago)
(312) 337-0588
(call collect)

Los Angeles 90303
Stanley I. Ehrenclou
W. James Bischof
2930 Imperial Highway
Inglewood, Calif.
(213) 757-0183

San Francisco 94022
Arthur R. Shields, Jr.
175 San Antonio Rd., S 243
Los Altos, Calif.
(415) 941-3084

London W. 1
For United Kingdom and Holland
Brayton C. Nichols
44 Conduit Street
Tel: REGent 4714

Verviers, Belgium
For Continental Europe
Andre Jamar
1, Rue Malliar, 1
(087) 253.83 Telex 41563

Tokyo
Haruki Hirayama
Electronic Media Service
Rm. 601, Daini Miyauchi Bldg.
6-8-14, Roppongi,
Minato-ku
Phone: 402-4556
Cable: Electronicmedia, Tokyo



CRYSTAL CLEAR EPOXIES, SILICONES, ETC. FOR ELECTRONICS & DISPLAY



ECCOCLEAR designates a broad line of transparent casting resins useful for visual display and inspection of electrical electronic components. New folder presents 11 systems, including dig-out & repair types, complete with properties selector chart.

INFORMATION RETRIEVAL NUMBER 141

CONDUCTIVE ADHESIVE MAKES ELECTRICAL BOND WITHOUT HEAT

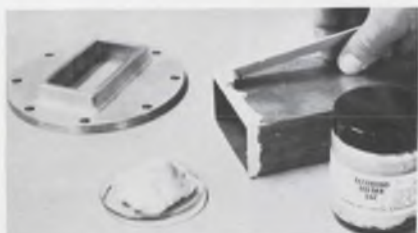

ECCOBOND SOLDER 56-C is the original silver-loaded epoxy cement which can be used for making electrical connections whenever hot-soldering is impractical. Cures at 120°F; volume resistivity less than 0.0002 ohm-cm. Send for Technical Bulletin.

INFORMATION RETRIEVAL NUMBER 142

FAST-CURING EPOXY FOR HIGH SPEED POTTING



STYCAST® 1240 is a low viscosity epoxy system designed for potting units at high production rates. It cures rapidly without high exotherm. Protects heat-sensitive components, and units can be handled minutes after potting.

INFORMATION RETRIEVAL NUMBER 143

Emerson & Cuming, Inc.



CANTON, MASS.
GARDENA, CALIF.
NORTHBROOK, ILL.
Sales Offices
in Principal Cities

EMERSON & CUMING EUROPE N.V., Devel, Belgium

Advertisers' Index

Advertiser	Page	Advertiser	Page
AMP, Incorporated	41	Kepeco, Inc.	117
Alco Electronic Products, Inc.	107, 109, 111	Lear Siegler, Inc., Cimron Division	38
Allen-Bradley Co.	27, 29	Mallory & Co., Inc., P. R.	10
American Micro-Systems, Inc.	15	Microdot, Inc.	24
Ammon Instruments, Inc.	114	Motorola Semiconductor Products, Inc.	6
Applied Technology A Division of Ittek Corporation	31	National Semiconductor Corporation	64, 65
Barnes Corporation	110	Optron, Inc.	97
Beckman Instruments, Inc., Helipot Division	51	Penn Engineering & Mfg. Corp.	117
Bell Laboratories	53	Philco-Ford Corporation	103
Bendix Corporation, The Electrical Components Division	42, 43	Potter & Brumfield Division of American Machine & Foundry Company	44, 45
Bishop Graphics, Inc.	116	RCA Electronic Components and Devices	69, 80, 92, Cover IV
Buckbee Mears Co.	54	S. O. G. I. E.	96A
C-Cor Electronics, Inc.	106	Shallcross, A Cutler-Hammer Company	46
CELCO (Constantine Engineering Laboratories Co.)	119	Shauer Manufacturing Corp.	108
Control Data Corporation	16	Signetics Measurement/Data	48
Corning Glass Works, Electronic Products Division	36, 37	Singer Company, The, Instrumentation Division	17
Curtis Development & Mfg. Co.	116	Sprague Electric Company	18
Cutler-Hammer	46	Stewart Warner Microcircuits Inc.	86
Dale Electronics, Inc.	Cover III	Systron-Donner Corporation	2
Duncan Electronics, Division of Systron-Donner Corporation	88	TRW, Inc., Globe Industries Division	101
E-H Research Laboratories, Inc.	33	TRW Semiconductors, A Subsidiary of TRW, Inc.	82
Eastman Chemical Products, Inc.	119	Texas Instruments, Incorporated, Components Group	20
Elco Corporation	7	Transitron Electronic Corporation	105
Electronic Design	14, 52	Trio Laboratories, Inc.	50
Emerson & Cuming, Inc.	118	Tung-Sol Division, Wagner Electric Corporation	35
Federal Scientific Corp.	117	Union Carbide Corporation, Components Dept.	11
Fluke Mfg. Co., Inc., John	79	Vector Electronic Co. Inc.	110
General Electric Company, Electronic Components	4, 5	Vega Precision Labs, Inc.	113
General Electric Company, Capacitor & Battery Dept.	16A	Vitramon, Incorporated	119
General Electric Company, Silicone Products Department	16B	Westinghouse Electric Corporation	23
General Instrument Corporation	8, 9	Weston Instruments, Inc. Components Division	49
General Radio Company	1	Johnson Company, E. F.	34
Golay, S. A. Bernard	96B	Jonathan Manufacturing Company	95
Gould, Inc. Piezoelectric Division	113	IMC Magnetics Corporation	91
Hayden Book Company, Inc.	116	Incre-Data Corporation	99
Hewlett-Packard	Cover II, 74, 75, 84	Career Advertising	
		Automatic Electric	114
		National Cash Register Company, The	12, 13

Constantine Engineering Laboratories Company

PRECISION DISPLAY SYSTEM

The CELCO Precision Cathode Ray Tube Display System is a completely self-contained high resolution monitor featuring wide bandwidth, excellent linearity, fast slewing rates and high repeatability and stability.

The main electronics package contains all of the necessary power supplies, amplifiers and controls as well as input and output connections. In the CRT enclosure are the high resolution cathode ray tube, micro-positioning mechanisms, CELCO precision coils and the input connections. This unit is furnished with mounts for most CRT camera adapters.

This CELCO Precision System provides the utmost in high resolution display and is also ideal for flying spot scanners, film and hard copy printers and recorders, film readers and other applications where a high resolution light source is required.



The system is comprised of two packages, a main electronics box and a CRT enclosure which are separated to provide a maximum degree of flexibility.

Mahwah, N.J. 07430
Tel. 201-327-1123
TWX 710-986-1018

Celco

Upland, Cal. 91786
Tel. 714-982-0215
TWX 910-581-3401

INFORMATION RETRIEVAL NUMBER 63

CHIP CURE for Hybrid Headaches



Vitramon Chip Capacitors!

These tiny, monolithic units can make your selection of chip capacitors easy and painless.

- Capacitance range: 10 pf to 470,000 pf.
- Temperature range: -55°C to $+125^{\circ}\text{C}$.
- Dielectrics: NPO and general purpose.
- Ten sizes: from .050 x .040 thru .220 x .240.
- Exclusive noble metal terminations assure exceptional bonding capabilities.

Vitramon "Vee Jem" Capacitors are immediately available in all sizes and values — in quantity — with delivery assured to meet your production schedule.

Vitramon[®]

VITRAMON, INCORPORATED
BOX 544
BRIDGEPORT, CONNECTICUT 06601

INFORMATION RETRIEVAL NUMBER 64

ELECTRONIC DESIGN 26, December 20, 1969

UNBELIEVABLE ADHESIVE



It's a fact: EASTMAN 910[®] Adhesive can form remarkably strong, long-lasting bonds between just about any materials you can think of — and do it with surprising speed, without the need for any mixing, heat, solvents, catalysts or more than contact pressure.

Hard to believe? Find out for yourself what this unique adhesive can do, and how it can help you cut assembly costs. Get your copy of the EASTMAN 910 Adhesive information kit by writing to Chemicals Division, EASTMAN CHEMICAL PRODUCTS, INC., Kingsport, Tennessee.

EASTMAN 910 Adhesive is also sold by Armstrong Cork Co., Industry Products Division; Treck Photographic, Inc.; and Wilson & Geo. Meyer & Co. (West Coast).

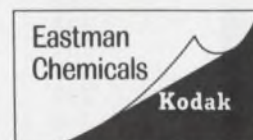

INFORMATION RETRIEVAL NUMBER 65

119

Information Retrieval Service

All products, design aids (DA), application notes (AN), new literature (NL), and reprints (R) in this issue are listed here with Page and Information Retrieval numbers. Reader requests will be promptly processed by computer and mailed to the manufacturer within three days.

Category	Page	IRN	Category	Page	IRN	Category	Page	IRN
Components			ladder networks	96	261	supplies, dc (NL)	114	360
amplifier, IC (NL)	114	361	LED indicators	100	274	Packaging & Materials		
amplifier, operational	104	287	logic tester	106	291	asbestos sheets (ES)	109	342
amplifiers, low-cost	94	250	memory, one-card	98	270	boards, component	107	297
boards, component	107	297	memory system	98	267	cable noise (AN)	111	349
cable noise (AN)	111	349	multiplexer, IC (NL)	112	357	calculator, QC (DA)	110	344
clip, test	106	290	photodiodes, p-i-n	96	258	connectors (NL)	112	354
connectors (NL)	112	354	reference sources	96	256	connectors (NL)	114	362
connectors (NL)	114	362	register, shift	96	257	copper alloys (NL)	112	358
detectors, diode (AN)	111	348	registers, shift	94	252	fiber-optic products	107	295
diodes (NL)	112	351	regulator, dc	96	260	mask material, solder	107	296
diodes, step-recovery	108	337	regulator, IC voltage	94	254	monograph, energy (AN)	111	350
fiber-optic products	107	295	transistor, magnetic	94	251	packaging guide (AN)	111	347
filters, active	104	288	Instrumentation			periodic table (DA)	110	345
filters, active	104	289	amplifier, operational	104	287	rfi gasketing (ES)	109	339
indicators, LED	100	274	amplifier/voltmeter	106	293	rust remover	107	294
inductor, axial-lead	102	282	calibration (NL)	112	353	spacers, plastic (ES)	109	340
ladder networks	96	261	converter, d/a	104	286	sketching paper (DA)	110	343
light modulator	108	336	generators, pulse (NL)	112	351	tapes, pre-cut (ES)	109	341
lights, indicator	102	279	meter, digital panel	106	292	tools, crimping (NL)	112	355
motor, gear (AN)	111	347	multiplexer, digital	98	271			
op amp, FET-input	104	285	op amp, FET-input	104	285	New Literature		
op amps, FET	94	255	oscillator, S-band	108	335	amplifier, wideband	114	361
photodiodes, p-i-n	96	258	power supply, HV	104	284	connectors	114	362
readout, 1/2-in.	102	281	regulator, dc	96	260	connectors, circular	112	354
resistor divider	100	276	regulator, voltage	94	254	copper alloys	112	358
resistor pellets	100	275	source, reference	96	256	crimping tools	112	355
resistors, chip	100	272	space exploring (NL)	112	359	diodes and converters	112	351
resistors, chip	100	277	supplies, dc (NL)	114	360	multiplexer, IC	112	357
resistors, thick-film	100	273	synchronizer, frequency	108	338	power supplies, dc	114	360
spacers, plastic (ES)	109	340	test clip	106	290	space exploration	112	359
storage tube	102	283	tester, logic	106	291	standards, calibration	112	353
switches (NL)	112	352	Microwaves & Lasers			switches	112	352
switches, illuminated	102	278	detectors, diode (AN)	111	348	switches, tilt	114	363
switches, tilt (NL)	114	363	diodes (NL)	112	351	terminals, computer	112	356
transformers, wideband	102	280	diodes, step-recovery	108	337			
transistor, magnetic	94	251	fiber optics	107	295	Application Notes		
			modulators, light	108	336	detectors, diode	111	348
Data Processing			oscillator, S-band	108	335	ECL thermal effects	111	346
calculator, desktop	97	262	pulse converters (NL)	112	351	energy monograph	111	350
communicator	97	263	rfi gasketing (ES)	109	339	noise, cable system	111	349
graphic tablet	98	269	synchronizer, frequency	108	338	packaging guide	111	347
graphics terminal	98	268	Modules & Subassemblies					
keyboard, graphics	97	264	amplifier, operational	104	287	Design Aids		
memory, one-card	98	270	amplifier/voltmeter	106	293	calculator, QC	110	344
memory system	98	267	amplifiers, low-cost	94	250	periodic table	110	345
multiplexer, digital	98	271	communicator	97	263	sketching paper	110	343
terminal, magnetic tape	97	265	converters, d/a	104	286			
terminals, data (NL)	112	356	driver, quad	96	259	Evaluation Samples		
time-sharing system	98	266	filters, active	104	288	asbestos insulation	109	342
			filters, active	104	289	rfi gasketing	109	339
ICs & Semiconductors			indicators, LED	100	274	spacers, plastic	109	340
amplifier, IC (NL)	114	361	ladder networks	96	261	tapes, pre-cut	109	341
amplifiers, low-cost	94	250	light modulator	108	336			
amplifiers, FET	94	255	lights, indicator	102	279			
chips, resistor	100	272	op amp, FET-input	104	285			
chips, resistor	100	277	op amps, FET	94	255			
converter, d/a	104	286	power supply, HV	104	284			
detectors, diode (AN)	111	348	pulse converters (NL)	112	351			
diodes (NL)	112	351	readout, 1/2-in.	102	281			
diodes, step-recovery	108	337	resistor divider	100	276			
driver, quad	96	259						
ECL design (AN)	111	346						
encoder, priority	94	253						

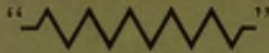
“”

“Funny,
you don't
look
resistive”



Dale reacts faster to your non-standard needs.

The resistive function you design doesn't have to have a standard shape and size...not when you deal with Dale. Look at these examples. The big one is a point for a vending machine can opener. Inside a Dale resistor provides heat for sterilization after each use. The small one is deceptively powerful—capable of 21 watts when heat sink mounted inside a computer to terminate line drive impulses. Of course, your problems will be different. But Dale has a head start toward solving them. Production blueprints on hundreds of special design situations including special packaging, termination, performance extremes, matching let us slash the lead time you'd expect for a non-standard part. Wirewound or film, single component or network, if you can't find it in your catalogs, call Dale first...402-564-3131.

Write for Dale's
**FUNCTIONAL GUIDE
TO NON-STANDARD
RESISTORS**

...listing by function
hundreds of readily
available design combina-
tions involving special
size, shape, performance
and other variables.

**FUNCTIONAL
GUIDE TO
NON-STANDARD
RESISTORS**



DALE ELECTRONICS, INC.

1352 28th Avenue,
Columbus, Nebr. 68601
In Canada, Dale Electronics, Ltd.



INFORMATION RETRIEVAL NUMBER 213

A new lead to a 300 W, 100 A silicon power transistor in a TO-3 case

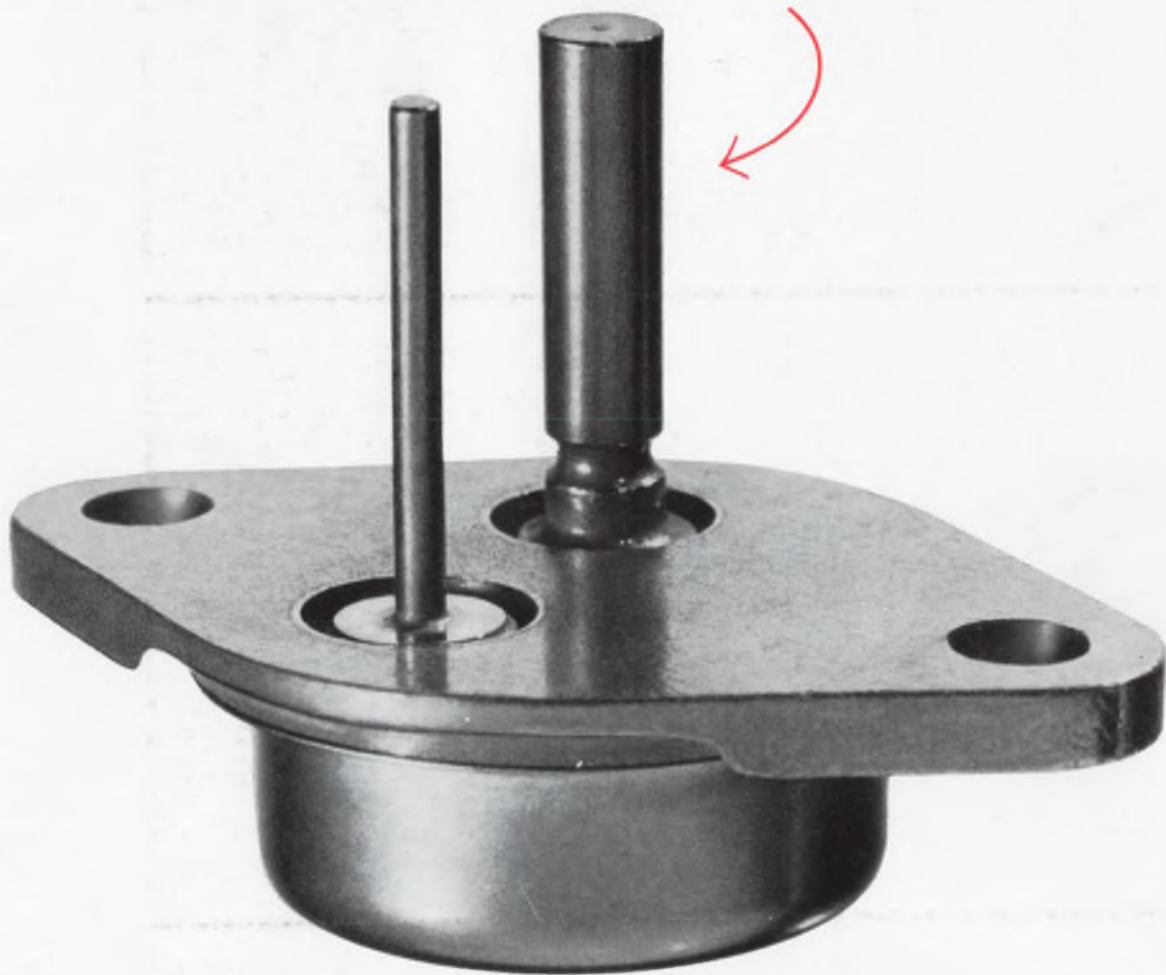

2N5578 showing new, heavy pin terminal design.

What are you looking for in your linear and switching applications? 100 ampere pulsed current capability? 300 watts power dissipation? The highest second breakdown capability of any device on the market in a modified TO-3 package?

Look no further. Here's another first from the silicon power leader—RCA's new 2N5578 family...six high-power, high-current Hometaxial-base silicon n-p-n transistors designed for applications in military, industrial, and commercial equipment.

2N5575, for example, has a pulsed collector current of 100 A. Dissipation

is 300 watts at 25°C with V_{CEX} (sus) of 70 V. The useful beta range is 10-40 at 60 A.

For complete design flexibility, there are three terminal variations: 2N5575 and 2N5578 have heavy pins; 2N5576 and 2N5579 have soldering lugs; and 2N5577 and 2N5580 have flexible leads with solderless connectors.

This family of types all adds up to circuit cost savings in inverters, regulators, motor controls, and other linear and switching applications. Check the chart. For more information, see your RCA Representative or

your RCA Distributor. For technical data, write: RCA Electronic Components, Commercial Engineering, Section No. IG12-2, Harrison, N. J. 07029.

Characteristic	Test Conditions			2N5575 2N5576 2N5577		2N5578 2N5579 2N5580		Units
	V_{CE} V	V_{BE} V	I_C A	Min.	Max.	Min.	Max.	
r_{th}	4		40	—	—	10	40	
V_{CE0} (sus)			60	10	40	—	—	
$I_{S/O}^{\dagger}$	25		0.2	50	—	70	—	V
$E_{S/O}^{\bullet}$		—1.5	7	12	—	12	—	A
M_{2c}				0.8	—	0.8	—	J
				—	0.5	—	0.5	°C/W

[†]With base forward biased

[•]With base reverse biased and $R_{th} = 100$, $L = 33mH$