

# Electronic Design 17

VOL. 17 NO.

FOR ENGINEERS AND ENGINEERING MANAGERS

AUG. 16, 1969

Man's greatest scientific journey began in 1961 when President Kennedy launched Project Apollo. Since that time, the electronics industry has contributed much—

from mini-computers to precision navigators. Managing the efforts of 400,000 workers at 20,000 plants was also a major problem. For a complete report, see p. 24



*... "I believe that this Nation should commit itself to achieving the goal, before this decade is out, of landing a man on the moon and returning him safely to earth." May 25, 1961*

**Also in this issue, Wescon USA...Page U81**



# Pulsepower



## UTC miniature transformers assure high pulse integrity at ET constants exceeding 7500 volt-microseconds

The high ET constants of UTC miniature pulse transformers give you fast rise time plus low droop at highest peak-power for size in the industry. That's pulsepower.

UTC's BIT-P and PIP standard lines are the smallest metal-encased pulse transformers made. Unique structures, plus manufacturing controls, enable UTC pulse transformers to achieve high flux densities and unrivalled temperature stability. All units are individually adjusted in a standard blocking oscillator circuit, assuring parameter uniformity unavailable elsewhere.

UTC's broad lines cover most pulse applications. Note particularly: use in high-gain, low-level, high-density packaged circuits made possible by high shielding of units; SCR di/dt failure reduction due to fast rise time and high pulse-

energy capability. The units are also suitable for wide-band applications of 1 kHz to 100 MHz.

UTC's metal-encased standard lines exceed MIL Grade 6 (MIL-T-21038B). They're ruggedized, hermetically sealed, and electromagnetically shielded. Molded units to MIL Grade 7, Class S temperature (+130°C), are available with a dielectric strength of 1250 volts. Where special parameters are needed we'll tailor them to your circuits.

When your design calls for pulsepower—high pulse integrity—UTC has the answer. Check your local distributor for immediate off-the-shelf delivery, or contact United Transformer Company, Division of TRW INC., 150 Varick St., New York, New York 10013.

**TRW**  
UNITED TRANSFORMER COMPANY



When you buy a low-cost electronic counter from us, you get a unique bonus. Us.

With 55 service offices in the United States and Canada and 86 offices worldwide, we're always close by if you need help. And we give the same complete, dependable back-up to customers who spend a few hundred dollars for a counter as we do to those who spend a few thousand. That's a good thing to keep in mind when you're looking for an inexpensive way to solve your counting problems. And when you add the price and service to the performance you can expect from these counters, you know you're onto a real bargain.

For instance the Hewlett-Packard

5321A counts frequencies up to 10 MHz, has a 100 mV sensitivity and 1 M $\Omega$ /30 pF input impedance, 4-digit readout with display storage, zero blanking for easier, faster reading. All this is \$425.

The more versatile and more accurate Hewlett-Packard 5321B gives you BCD recorder output, 5-digit readout, frequency ratio and pulse duration measurement, additional gate times and a quartz crystal time base. Yet the price is just \$775.

The Hewlett-Packard 5221A/B Counters are the same in everything but shape. They're higher, narrower and not as long as the 5321A/B.

If you need greater capability, the Hewlett-Packard 5216A will provide it for \$985. This counter will totalize, measure

frequency, period, multiple period averages, ratio, multiple ratios and pulse duration. It has a 7-digit readout, gate times of 0.01 to 10 seconds, 10 millivolt sensitivity, BCD recorder output, and a maximum count rate of 12.5 MHz.

So when you need a low-cost counter, talk to the people who can deliver the goods *and* whatever service you need, whenever you need it. Call your local Hewlett-Packard field engineer for all the details. Or write to Hewlett-Packard, Palo Alto, California 94304; Europe: 1217 Meyrin-Geneva, Switzerland.

**HEWLETT  PACKARD**

**ELECTRONIC COUNTERS**

02912

INFORMATION RETRIEVAL NUMBER 2

**Count on us  
for as little as  
\$425.**





Here's the fastest, most accurate source of programmable pulses available anywhere. The new Datapulse System 140 generates rep rates to 100 MHz, pulse widths from 5 ns, and independently variable rise and fall times from 2 ns.

Your program sets the upper and lower levels of the output waveform to any values between +10v and -10v. Each level can be independently positioned with an accuracy of  $\pm 2\%$  of programmed value  $\pm 20$ mv. Pulse amplitude (the difference between levels) may be varied from 50mv to 5v into a 50 ohm load. Accuracy is typically  $\pm 2\%$  of value for the other programmable pulse parameters: rep rate, pulse delay, pulse width and transition times.

System 140 can be programmed from computer, punched tape, magnetic tape, or other logic sources. All pulse parameters are controlled by BCD inputs compatible with DTL logic levels.

For complete information contact Datapulse Division, Systron-Donner Corporation, 10150 W. Jefferson Blvd., Culver City, California 90230. Phone (213) 836-6100.

## Tests fast ICs automatically: the only 100 MHz programmable pulser!

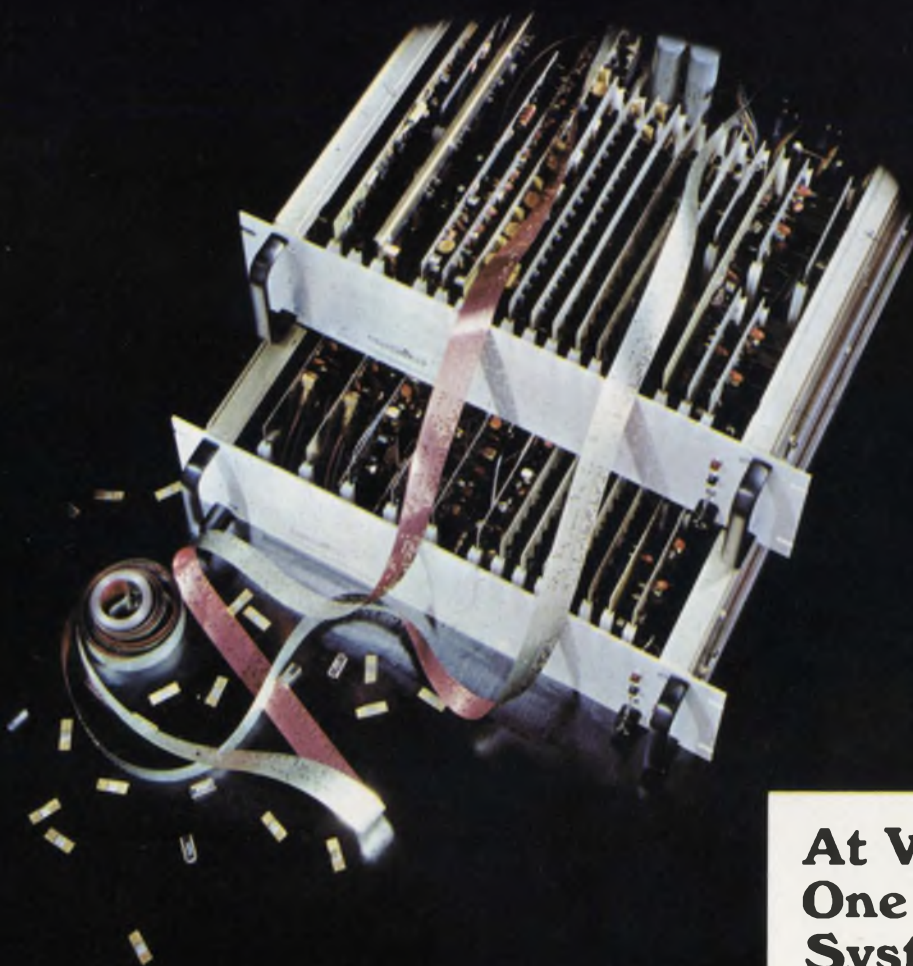

### At WESCON. One of 157 Systron-Donner instruments.

Electronic counters	Digital voltmeters
Pulse generators	Spectrum analyzers
Microwave frequency indicators	Digital panel meters
Digital clocks	Microwave signal generators
Memory testers	Laboratory magnets
Analog computers	Data acquisition systems
Time code generators	Microwave test sets
Data generators	

DATAPULSE  
DIVISION

SYSTRON  DONNER



# Electronic Design 17

VOL. 17 NO.

FOR ENGINEERS AND ENGINEERING MANAGERS

AUG. 16, 1969

---

## NEWS

- 21 News Scope
- 24 Man on the moon—A special report
- 30 Next: Era of discovery
- 34 The management was 'superlative'
- 40 The indispensable men
- 44 Apollo's success rubs off on earth
- 51 Washington Report
- 76 Sidelights
- 79 Editorial: The impossible just takes extra effort to achieve

---

Wescon-USA—A special section Pages U81 to U188

---

## TECHNOLOGY

- 190 Don't be fooled by risetime specs on pulsed microwave tubes. The Darlington modulator is the key to producing narrower pulses.
- 196 Avoid pitfalls in computerized testing. These design ground rules cover data acquisition, processing and transmission.
- 205 Block reverse gain in your transistor amplifier—if your problem is caused by transistors passing signals in both directions.
- 213 Make systems fail-operational by using multiple channels with automatic voters to select the best signal.
- 218 Amplify biological signals with ICs. Monolithic op amps in special circuits offer high CMRR and high input impedance..
- 228 Don't just fight semiconductor noise. Learn its sources, predict its magnitude and design your circuits to tolerate it.
- 238 Ideas for Design

---

## PRODUCTS

- 254 ICs & Semiconductors: Operational amplifier settles in 300 ns
- 262 Modules & Subassemblies: Low-cost FET op amp offers military specs
- 272 Components: Compact status indicators display 12 messages
- 278 Data Processing
- 284 Instrumentation
- 290 Packaging & Materials
- 294 Microwaves & Lasers
- 298 Production

---

## Departments

- 16 Designer's Datebook
- 300 Evaluation Samples
- 302 Design Aids
- 304 Annual Reports
- 306 Application Notes
- 308 New Literature
- 328 Advertisers' Index
- 331 Information Retrieval Service

Information Retrieval Service Card inside back cover

Cover Design by Clifford Gardiner, Art Director

---

ELECTRONIC DESIGN is published biweekly by Hayden Publishing Company, Inc., 850 Third Avenue, New York, N.Y. 10022. James S. Mulholland, Jr., President. Printed at Brown Printing Co., Inc., Waseca, Minn. Controlled circulation postage paid at Waseca, Minn., and New York, N.Y. Copyright © 1969, Hayden Publishing Company, Inc. 77,523 copies this issue.



- Four full digits plus "1" for 20% overranging
- Rechargeable battery operation optional
- Measures ac and dc volts in four ranges to 1200 volts
- Measures ohms in five ranges to twelve megohms
- Active 2 pole switchable filter
- Automatic polarity indicator
- All functions push-button selectable



## The digital multimeter you can believe

**Announcing the Fluke 8100A, a completely portable 0.02% digital multimeter for \$695.**

The only way to build a multimeter with no last digit uncertainty is to add an "extra digit." That's exactly what we've done with the new Fluke 8100A. Here is an instrument with nine times the accuracy of three digit units selling at only half the price of comparable four digit multimeters.

How?

We've used an A to D conversion technique new to the DVM field. The result is an instrument with low power drain, simplicity of circuitry, troublefree oper-

ation and the uncommon accuracy you expect from Fluke.

Standard features include ac measurement accuracy of 0.2% and resistance, 0.1%. For real portability, batteries will operate the multimeter continuously up to eight hours without recharging. Battery operation, the only option, is priced at \$100. Accessories available include high frequency and voltage probes, switched ac-dc current shunts and a ruggedized case.



Fluke, Box 7428, Seattle, Washington 98133. Phone: (206) 774-2211, TWX: 910-449-2850. In Europe, address Fluke Nederland (N.V.), P. O. Box 5053, Tilburg, Holland. Phone: (04250) 70130. Telex: 884-50237. In the U. K., address Fluke International Corp., Garnett Close, Watford, WD2 4TT. Phone: Watford, 27769. Telex: 934583.



- Five full digits plus "1" for 20% overranging
- Basic unit measures 0 to 1100 volts dc in three ranges
- Auto ranging and polarity with active 3-pole switchable filter
- 25 millisecond sampling speed
- Full systems capability with timing signals and ready indicator
- Low cost options include ac voltage, millivolt-ohms, external reference (ratio) and fully isolated remote programming and data output.

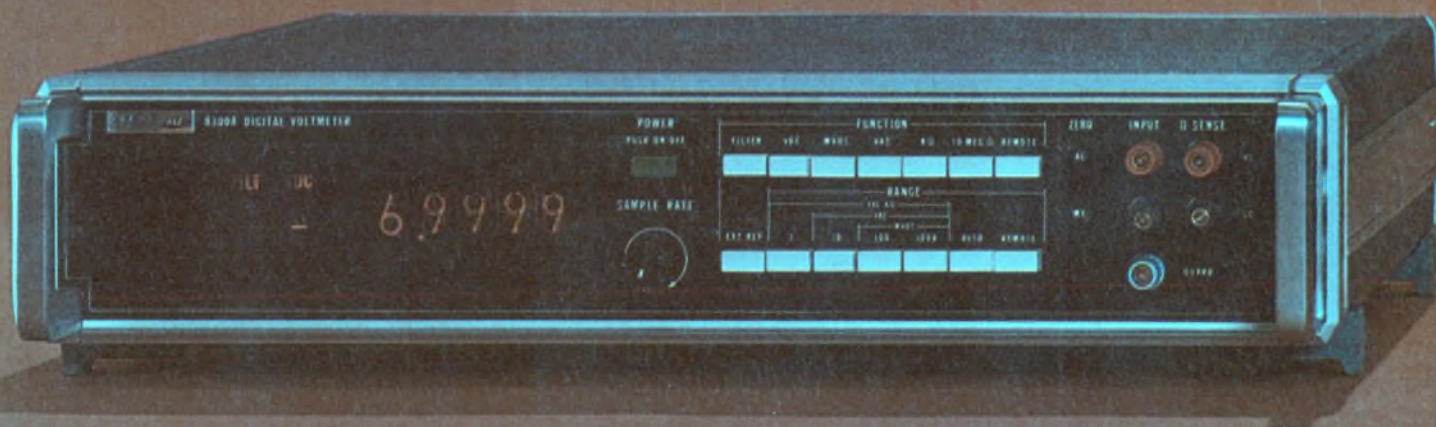

## The first really new DVM in a decade

**Announcing the Fluke 8300A, a 0.005% digital voltmeter with full systems capability for \$1295**

There are a lot of good DVM's around. All but one share a common set of faults—overwhelming complexity and high cost. And as you might guess, the DVM that beats the others cold is the new Fluke 8300A.

Why?

Because Fluke uses a new A to D technique which reduces componentry by up to 500 percent. Obviously, when components are eliminated, good things happen. Power requirements go down, reliability goes up, circuitry is simplified, troubleshooting is speeded and reduced. Most important to the system

designer, lowered costs mean we can invest some of the savings in features you need in a DVM.

With all its features and accuracy, the Fluke 5-digit DVM sells for less than many 4-digit units. We price the options low, too. A fully loaded Fluke 8300A sells for \$2995. Comparable but not equal competitive instruments cost as much as \$5000.

And when the Fluke name goes on the front you know you're getting quality instrumentation... in keeping with the Fluke philosophy of bringing you standards lab performance in portable instrumentation.

Fluke, Box 7428, Seattle, Washington 98133. Phone: (206) 774-2211. TWX: 910-449-2850. In Europe, address Fluke Nederland (N.V.), P.O. Box 5053, Tilburg, Holland. Phone: (04250) 70130. Telex: 884-50237. In the U.K., address Fluke International Corp., Garnett Close, Watford, WD2 4TT. Phone: Watford, 27769. Telex: 934583.





The 5104 knows . . . and tells . . . automatically. The new Philbrick/Nexus Model 5104 performs 15 different tests in under 3 seconds. Programmable GO/NO GO limits. Readout in engineering units. Maximum input/output flexibility for interface with handling equipment and data acquisition

peripherals. Test conditions, supply voltages, and meter scaling front panel control or programmable. Test IC, hybrid or discrete op amps through versatile plug-in sockets. To remove any shadow of doubt from your op amp testing, get the full report on the Philbrick/Nexus Model 5104 Op Amp

Tester. Price \$4,500  
 Contact your local Philbrick/Nexus field engineering representative or write, Philbrick/Nexus Research, 46 Allied Drive at Rt. 128, Dedham, Mass. 02026



PHILBRICK/NEXUS RESEARCH

A TELEDYNE COMPANY

# Who knows what evil lurks in the heart of that \$1 Op Amp?



Eout  
 Ecm Eos PSRR  
 Gain los CMRR Icc  
 Stability Ibias



# New. A true micro-system connector. Look at what you can do with it.

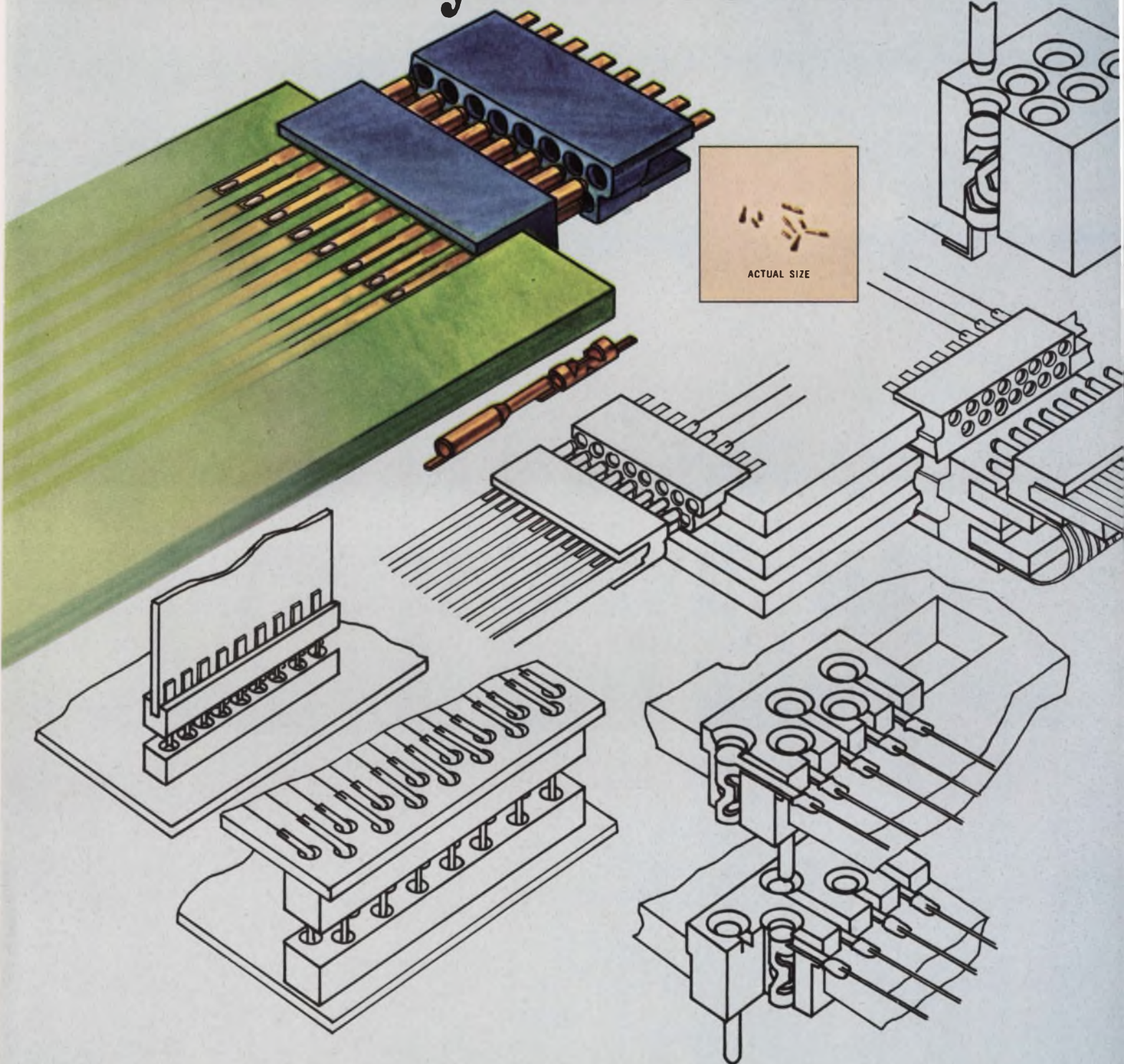

This is our new .025"/.050" Connector.

It fits all micro-system packaging situations. In all environments. Reliably. The redundant points of contact provided by the spiral springs of the receptacle assure it.

With stacked or staggered centers, the receptacles don't lose any critical contact spacing. Circuit centers of .050" and .025" are standard. The receptacles and pins come housed. The circuit contact tines are pre-solder coated so all you have to do is reflow and plug in. Easy? The low insertion

force and the wide misalignment allowance make it even easier.

So, what could be better for sophisticated electronic requirements? A reliable connector that's dense, convenient and versatile.

For further information write to Industrial Division, AMP Incorporated, Harrisburg, Pa. 17105.

**AMP**  
INCORPORATED



**We've made child's play  
out of toroid selection  
for pulse transformers.**



# INDIANA GENERAL

*We make it easy for the design engineer.*

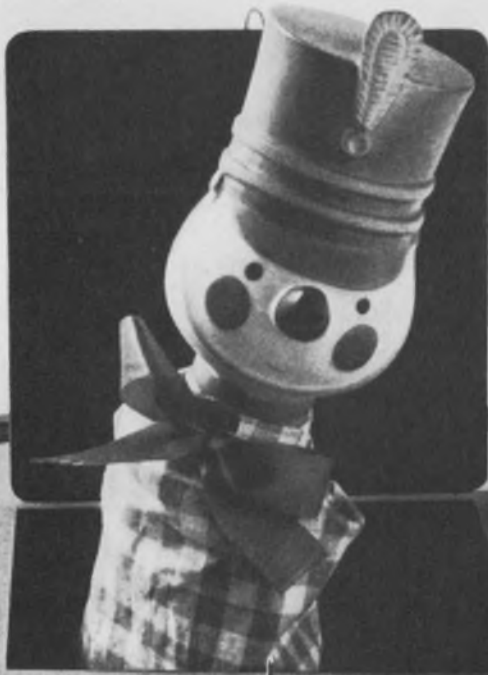

Indiana General's popped up with an end to trial-and-error spec'ing: the first and only toroids with specified characteristics for pulse transformer applications.

Not just the usual irrelevant magnetic properties, either. Each part is designed as a pulse component, and listed by its pulse inductance, pulse magnetizing current and ET product. All according to ASTM methods.

And thanks to our automatic high speed testers, we can guarantee all parameters. Every pulse transformer toroid we make is 100% pulse-tested to performance specifications. So reliability is assured, from samples to production quantities. And all toroids can be coated, to prevent the wire's insulation from being scraped when winding, or penetrated later.

Various toroid sizes from 0.080" are available. Tell us your pulse transformer core problems.

Indiana General Corporation  
Electronics Division/Ferrites  
Keasbey, New Jersey

Let's see how your pulse-rated toroids can make it easier for me. Attached are details of my pulse transformer core problems.

NAME \_\_\_\_\_

TITLE \_\_\_\_\_

COMPANY \_\_\_\_\_

ADDRESS \_\_\_\_\_

CITY \_\_\_\_\_ STATE \_\_\_\_\_ ZIP \_\_\_\_\_



# We don't know who'll design it. But we know where he can get the batteries.

At the nearest Burgess Distributor. They're probably somewhere in his stock of batteries.

One's bound to be right for the electric spaghetti windlass. And one's exactly what you need for whatever you're designing. Another thing. Whether it's a standard or special, your Burgess Battery will be power-fresh. All distributor inventories are checked, rotated, and filled-in according to a systematic schedule.

So the battery you get comes on strong . . . and stays that way.

When you need batteries, check with your Burgess Distributor. He's a great source of power.

And when you need technical information, give us a call. Burgess has a library filled with the latest, most complete engineering data and technical battery material in the business.

Meanwhile, send for our new engineering manual and do a little window shopping. It's got comprehensive listings of all batteries available through Burgess. Clevite Corporation, Burgess Battery Division, Freeport, Illinois 61032.



## CLEVITE BURGESS

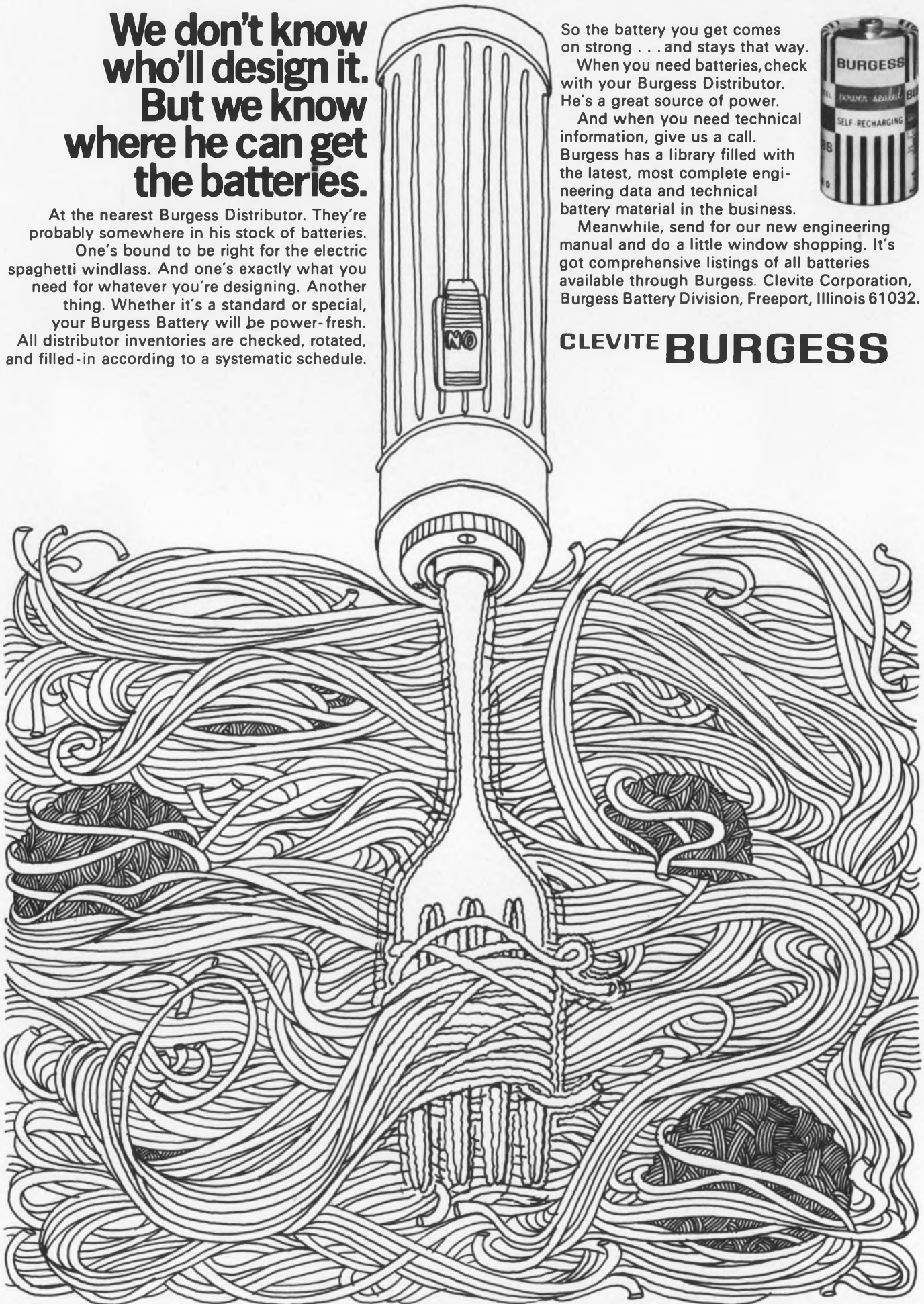



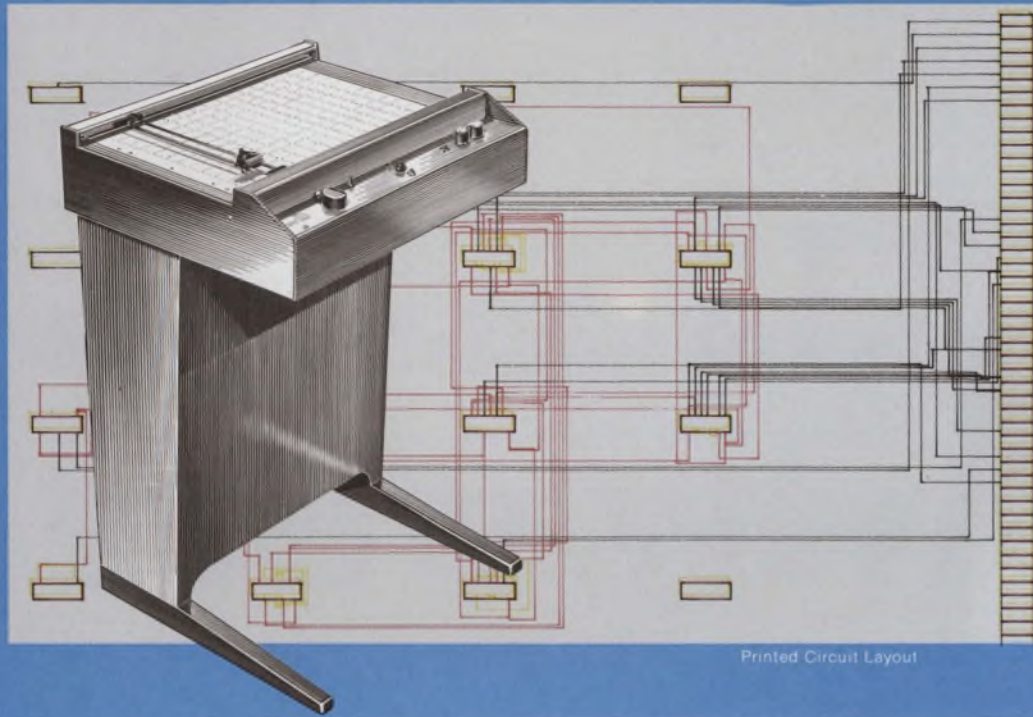

## We have a plot to get you out from under the data avalanche.

Putting those mountains of information inundating today's design engineers into usable graphic form is a wearisome, time-consuming job. End messy, inaccurate hand plotting chores with the ITC Data Interface Plotter Terminal Model PT-1 and save priceless design hours. Working with any Teletype time-sharing terminal, the PT-1 plots 30 points per minute, draws bar graphs and other orthogonal work at the rate of a 15-inch horizontal line and 10-inch vertical line in under two seconds. Seven software packages included with the PT-1 Plotter Terminal at no extra cost give you real freedom from tedium:

**Bode and Nyquist Plotting.** Program plots phase and amplitude data in both Cartesian and polar form either from your data or output from a time-sharing CIRC/ECAP program. Sixty-point plot takes two minutes.

**Antenna Pattern Plotting.** Antenna gain in both polar and Cartesian form from your data.

**Statistical Data Plotting.** Test data is plotted in point form first. Then program asks you to name the range of data. Program then figures out the central tendency and frequency distribution and draws histogram.

**Timing Diagram Drafting.** You name beginning logic levels, transition times, and cyclic repetition. Program produces binary wave forms in your dimensions.

**Block Diagram Drafting.** You make rough layout, specify block locations, dimensions, and interconnections. Program draws finished diagrams automatically.

**Printed Circuit Layout.** Exclusive SKETCH program cuts way down on circuit board layout time and cost. Quickly and accurately produces primary layout from connection list. When plotter finishes, drawing goes to draftsman for taping artwork.

**Transient Response Plotting.** Plots your tabular data or data from CIRC/ECAP in four quadrants concurrently.

The PT-1 Plotter Terminal is easy to install, simple to use. Connects quickly to any Bell System data set or telephone coupler. Ten by 15-inch drawing area and the plotter and Teletype together take up less room than a desk.

Now for the real plot: *Under \$4,500 complete.* Less than half any other time-sharing plotter terminal. Rental and lease plans available also at lowest cost. Get out from under the data avalanche today.

Contact ITC Data Interface, a Division of Industrial Technology Corporation, a Subsidiary of Republic Corporation, 950 Sepulveda Boulevard, El Segundo, Calif. 90245. Telephone (213) 322-4950.



VISIT OUR BOOTH, UNIT D  
\* WESCON/69

# ITC DATA INTERFACE

INFORMATION RETRIEVAL NUMBER 10



# 33 reasons why we're No. 1 in DVMs.

Dollar for dollar we shipped more DVMs last year than anyone else, including the industry giant.

One of the reasons is our Model 5700. It's the DVM used by laboratories to calibrate other DVMs. Without question it's the

best DVM on the market.

But since not everyone needs the kind of performance and features offered by the 5700, we offer 32 other models. Models for labs and for production lines, bench units and systems' units, militarized models,

four digit DVMs and five, from \$1150 to over \$8,000. (In fact, with plug-in modules you can come up with 300 different configurations.) In short, we make a model for every application and every budget. All as part of our standard line.





And every DVM we make is put together on the same production line, by the same people, using many of the same components and boards. In fact, quite often the assemblers don't know in advance which models they're assembling.

Which means that we've got to build every DVM as though it were our most expensive, over \$8000, unit.

And that may be reason number 34 why we're No. 1 in DVMs.

*For a detailed description of our 33 models, write Dana Laboratories, Inc., 2401 Campus Drive, Irvine, Calif. 92664*

**DANA**

INFORMATION RETRIEVAL NUMBER 11



The  
Choice  
is TTL.

# TI announces the “one-shot” heard 'round the world.

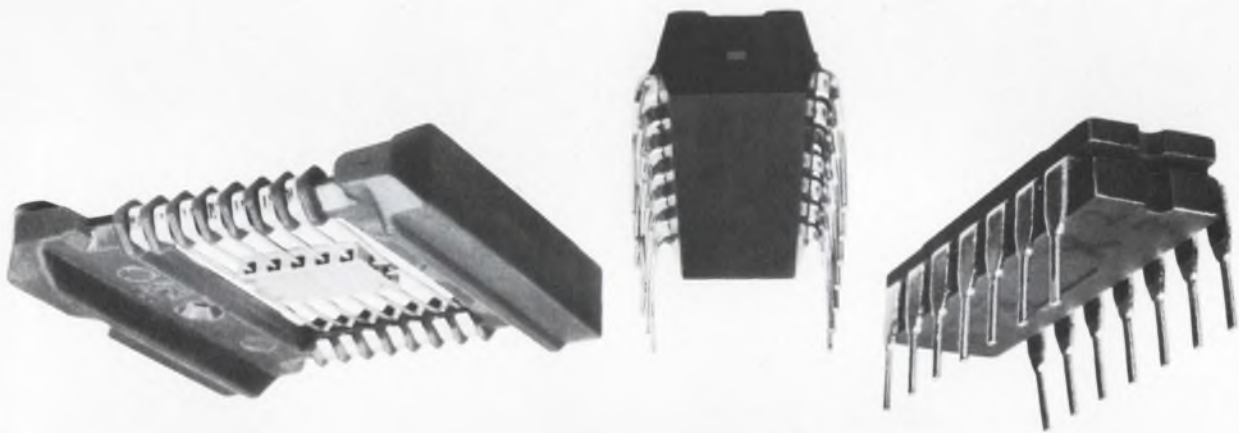

**(Listen. It could revolutionize your designs.)**

The pulse width of this new monolithic TTL monostable multivibrator is variable from 40 nanoseconds to 40 seconds. Stability is  $\pm 0.2\%$ . Tagged SN74121, it is primed to trigger off 50 nanosecond pulses or from slow ramps up to one volt per second. Full fan-out to 10 loads and fully compatible with all Series 54/74 ICs. The new “one-shot” comes in a choice of packages: flat-pack and plastic or ceramic dual-in-line. Immediate delivery and

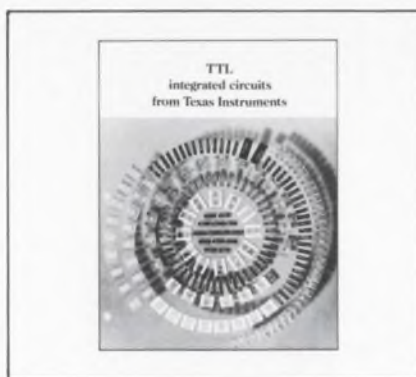

reasonably priced. In 100-999 quantities, the plastic dual-in-line is \$4.40.

Deploy the SN74121 and start your own revolution. For data sheet, application report and a copy of our new 80-page TTL brochure, circle 182 on the Reader Service Card or write Texas Instruments Incorporated, P. O. Box 5012, M. S. 308, Dallas, Texas 75222.



**TEXAS INSTRUMENTS**  
INCORPORATED





NEW AMI/MOS — 256 x 10 Bit Read Only Memory. This unique ROM is one of a family of LSI ROM's mass produced by AMI for your immediate needs. Even if you don't need to miniaturize your system, you can stand a substantial reduction in complexity

and a startling increase in reliability, can't you? Send for the MOS facts of life. Better yet, hop a jet and visit the new, expanded AMI/MOS production facility — America's largest.

**NOW IN PRODUCTION**  
**2560**  
**BIT/READ ONLY MEMORY**



**AMERICAN MICRO-SYSTEMS, INC.**

3800 Homestead Road, Santa Clara, California 95051  
Telephone 408-246-0330, TWX 910-338-0018  
CUSTOM & STANDARD MOS ARRAYS/MEMORIES/REGISTERS/LOGIC



# Who Built the Converter Used on the Army's Minigun?



*Abbott did.* Out of 931 converters delivered during 14 months, only two were returned for repair. Maybe that's the reason, Abbott's Model BL5D-11A converter was selected as a power supply for installation in the SUU-11A/A minigun system, used on helicopters in Vietnam. This system employs a 7.62 millimeter minigun pod with firing rates of 6000 rounds per minute and therefore demands high reliability. This Abbott converter has an MTBF (mean time between failures) of 129,379 hours as calculated from the MIL-HDBK-217 handbook.

Abbott power modules use only the highest quality semiconductors and MIL-T-27B transformers in their construction to obtain the high degree of reliability under tough environments demanded by today's military requirements. To withstand heat sink temperatures of 100°C all silicon semiconductors are used exclusively.

High density electronics packaging, coupled with good design, give Abbott power modules a minimum size and weight for their rated power

output. One group of Abbott's DC to DC converter line, for example, the Model B05D, is smaller than a package of cigarettes, weighs less than a pound and produces five watts of regulated output voltage. All of the models described in the Abbott Catalog have correspondingly small sizes and weights.

If you have a need for a reliable converter, inverter or modular power supply, take a look at Abbott's. There are over 3000 models listed in their new catalog. They are built to operate in military environment of MIL-E-5272C at 100°C. They include output voltages from 5 volts to 10,000 volts DC with output currents from 2 milliamperes to 20 amperes. A wide range of different types of input power is available:

- 60 $\phi$  to DC, Regulated
- 400 $\phi$  to DC, Regulated
- 28 VDC to DC, Regulated
- 28 VDC to 400 $\phi$ , 1 $\phi$  or 3 $\phi$
- 60 $\phi$  to 400 $\phi$ , 1 $\phi$  or 3 $\phi$

TO: Abbott Transistor Labs., Inc., Dept. 07  
5200 West Jefferson Blvd.  
Los Angeles, California 90016

Sir:  
Please send me your latest catalog on power supply modules:

NAME \_\_\_\_\_ DEPT. \_\_\_\_\_  
COMPANY \_\_\_\_\_  
ADDRESS \_\_\_\_\_  
CITY & STATE \_\_\_\_\_

## Designer's Datebook

AUGUST 1969						
Sun	Mon	Tue	Wed	Thu	Fri	Sat
3	4	5	6	7	8	9
10	11	12	13	14	15	16
17	18	19	20	21	22	23
24	25	26	27	28	29	30
31						

SEPTEMBER 1969						
Sun	Mon	Tue	Wed	Thu	Fri	Sat
	1	2	3	4	5	6
7	8	9	10	11	12	13
14	15	16	17	18	19	20
21	22	23	24	25	26	27
28	29	30				

For further information on meetings, use Information Retrieval Card.

### Aug. 24-27

**Electronic Materials Technical Conference** (Boston, Mass.) Sponsor: AIME, Edward L. Kern, Metallurgical Society of AIME, 345 E. 47th St., New York, N.Y. 10017

CIRCLE NO. 695

### Sept. 7-11

**Electrical Insulation Conference** (Boston) Sponsor: IEEE et al, H. P. Walker, NAVSEC, Code 6156D, Washington, D. C. 203060

CIRCLE NO. 696

### Sept. 8-10

**Aerospace Computer Conference** (Los Angeles) Sponsor: AIAA, R. W. Rector, American Institute of Aeronautics and Astronautics, 1290 Sixth Ave., New York, N.Y. 10019

CIRCLE NO. 697

### Sept. 15-17

**International Telemetry Conference** (Washington, D.C.) Sponsor: ITC et al, R. J. Blanchard, Defense Electronics Inc., Rockville, Md. 20854

CIRCLE NO. 698

### Sept. 21-26

**Intersociety Energy Conversion Engineering Conference** (Washington, D.C.) Sponsor: IEEE, ASME, AIAA et al, T. G. Kirkland, U.S. Army R&D Center, Fort Belvoir, Va. 22060

CIRCLE NO. 699

### Sept. 24-26

**Ultrasonics Symposium** (St. Louis, Mo.) Sponsor: IEEE, C. K. Jones, Westinghouse R&D Div., Churchill Boro, Pittsburgh, Pa. 15235

CIRCLE NO. 700

Please write for your FREE copy of this new catalog or see EEM (1968-69 ELECTRONIC ENGINEERS MASTER Directory), Pages 1727 to 1740.

**abbott transistor**

LABORATORIES, INCORPORATED

5200 W. Jefferson Blvd./ Los Angeles 90016  
(213) WEBster 6-8185 Cable ABTLABS

INFORMATION RETRIEVAL NUMBER 13

INFORMATION RETRIEVAL NUMBER 227 ►



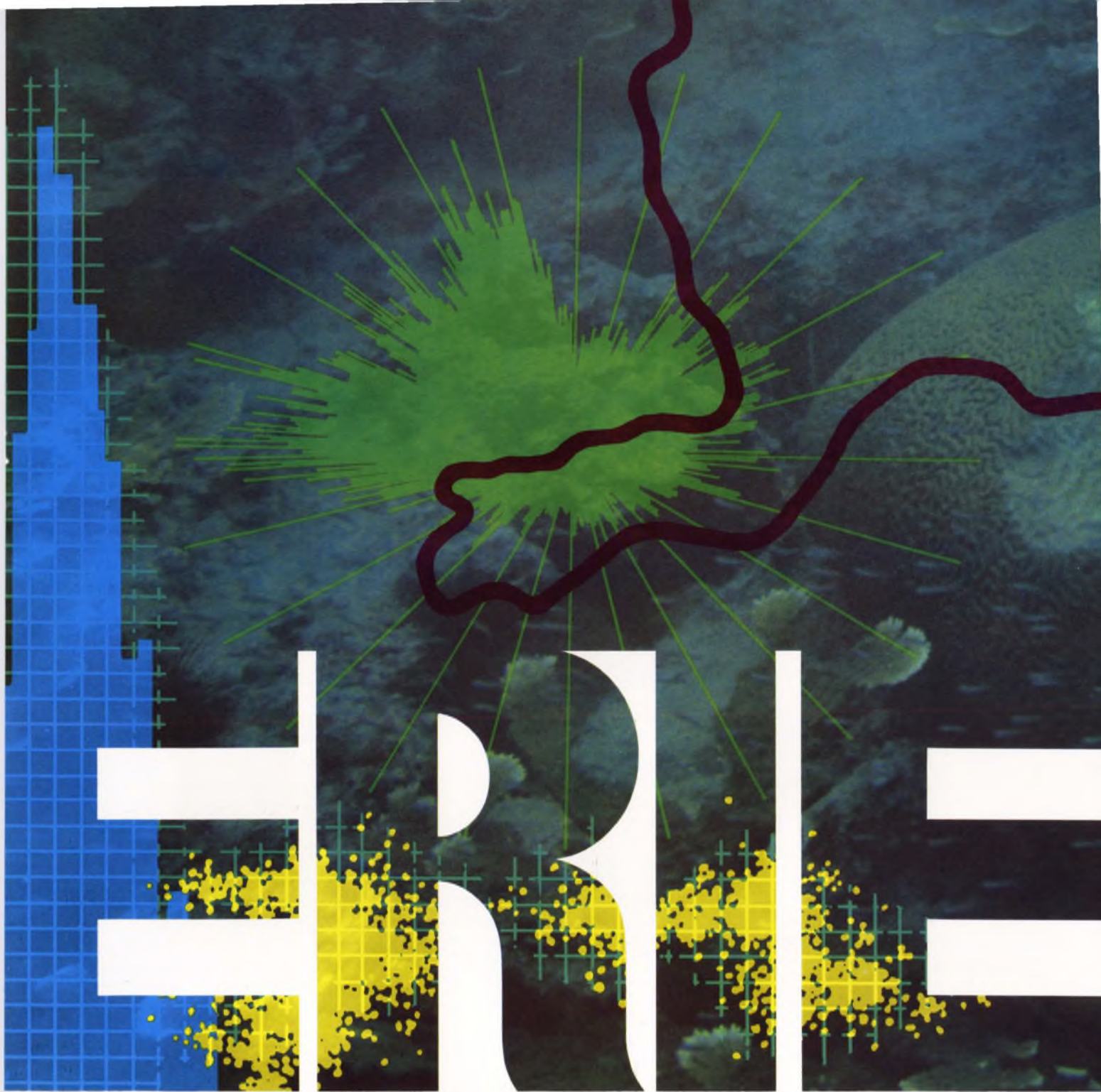

When you're under pressure (8,000 psi) to get facts fast...

Composite Histogram showing 4 oceanographic parameters. Photograph by Anthony Balogh.

## bring ERIE in early.

Current speeds and directions... temperatures... pressures... salinities. Essential data if Oceanography is to achieve its predicted \$9 Billion potential by 1978. Geodyne Division of EG & G International makes instruments combining multiple sensor packages... each capable of measuring up to eight such parameters. And, through new high-speed digitizing systems, all parameters are recorded almost simultaneously. From the start, Geodyne has relied on ERIE TECHNOLOGICAL for the Thick Film Hybrid Circuitry so vital to these new systems. Our unique single-source capability assures total control of substrates, precious metal formulations, components and encapsulants. Proof, once again, that it pays to bring ERIE in early.

**ERIE TECHNOLOGICAL PRODUCTS, INC.**  
644 West 12th Street, Erie, Pennsylvania 16512  
(814) 456-8592



*Sweating out an RFI/EMI requirement between 1 and 10 GHz?*

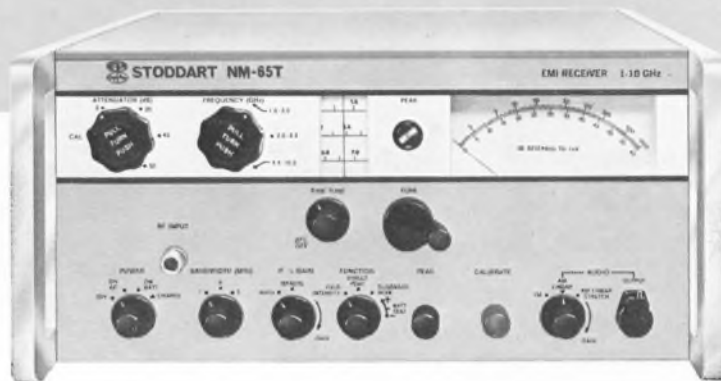

## STODDART'S NOW HOME ON THIS RANGE

Fully portable new Model NM-65T EMI Receiver spans the range from 1 to 10 GHz. Simple to operate, easy to handle, precise enough for the laboratory, rugged enough for the field. Uses integral, rechargeable batteries. Meets requirements of all applicable commercial and military specifications.

### Special features and salient specs:

- Makes field intensity (average), direct peak, and slide-back peak measurements
- Selectable 6 dB bandwidths, 100 kHz, 500 kHz, or 5 MHz
  - Voltage measurement capability to 120 dB
  - Over-all measurement accuracy within 2.5 dB
  - True frequency within 2% of indicated value
- Excellent sensitivity over the frequency range
  - Shielding effectiveness 80 dB minimum
  - FM detector for aural and visual display
    - Automatic frequency control
    - 21.4 MHz IF output
  - "X" and "Y" outputs for external recording or remote indication
- Four simultaneous video outputs; log IF, lin IF, "stretch" lin IF, and FM detected video
  - Expanded output indication
  - Built-in mercury switch impulse calibrator
- Size: 16<sup>3</sup>/<sub>4</sub>" W x 8<sup>3</sup>/<sub>4</sub>" H x 18" D
  - Weight: 35 pounds

WESCON  
EMI Receiver Model NM-65T will be premiered by Stoddart in Booth 1030.

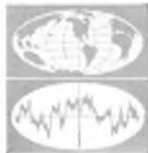

The Model NM-65T will meet your needs ideally for determining the source and analyzing the characteristics of electromagnetic interference: Field strength measurement of microwave sources; propagation studies and radiation pattern measurements; scatter propagation studies; low-power-level VSWR measurements; spectral power distribution analysis; and two-terminal microvoltmeter applications.

The Model NM-65T joins the Stoddart family of portable, battery operated EMI receivers, covering the range from 10 kHz to 10 GHz.



**MODEL NM-12AT**  
10 - 250 kHz • Measures voltage within 2 dB, frequency within 2% • Excellent sensitivity • Voltage range 160 dB • Weight 22 pounds



**MODEL NM-25T**  
150 kHz to 32 MHz • Measures voltage within 2 dB, frequency within 2% • Voltage range 140 dB • Solid-state impulse calibrator • Weight 22 pounds

## STODDART ELECTRO SYSTEMS

A Division of Tamar Electronics, Inc.  
2045 West Rosecrans Avenue · Gardena, California 90249  
Phone (213) 770-0270

# Hottest Product of the Year #2

## Schweber Introduces the First Monolithic Voltage Regulator that breaks the voltage barrier.

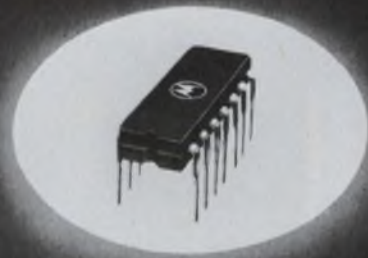

Motorola's MC1566L/1466L is a precision wide-range voltage and current regulator (Monolithic Epitaxial Passivated). This unique "floating" regulator can deliver hundreds of volts—limited only by the breakdown voltage of the external series pass transistor. Output voltage and output current are adjustable. The MC1566L/MC1466L integrated circuit voltage and current regulator is designed to give "laboratory" power-supply performance.

Some of the typical applications are: 0 to 15 VDC, 10 Amperes Regulator / 0 to 40 VDC, 0.5 Amperes Regulator / 0 to 250 VDC, 0.1 Amperes Regulator / Remote Programming.

Here are some of the features:

- Voltage/Current Regulation with Automatic Crossover.
- Excellent Line Voltage Regulation, 0.01% +1.0 mV.

- Excellent Load Voltage Regulation, 0.01%, +1.0 mV.
- Excellent Current Regulation, 0.1% +1.0 mA.
- Short-Circuit Protection.
- Output Voltage Adjustable to Zero Volts.
- Internal Reference Voltage.
- Adjustable Internal Current Source.

For more detailed information, write to Schweber Electronics, Westbury, N. Y. 11590. Circle No. 242

Product	Temperature	1-24	25-99	100-999
MC1566L(Mil)	-55 to +125 C	36.75	30.60	24.50
MC1466L(Com)	0 to 75 C	12.75	10.60	8.50

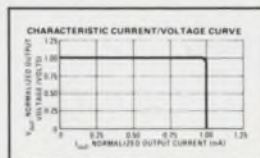

**Call any of these locations for immediate delivery**

Your franchised Motorola distributor: **Schweber Electronics, Westbury, New York: 516/334-7474**  **Rockville, Maryland: 301/427-4977**

Other Sales Offices: Waltham, Mass: 617/891-8484  Cleveland, Ohio: 216/333-7020  Hollywood, Fla: 305/927-0511  Huntsville, Ala: 205/539-2756  Toronto, Canada: 416/925-2471





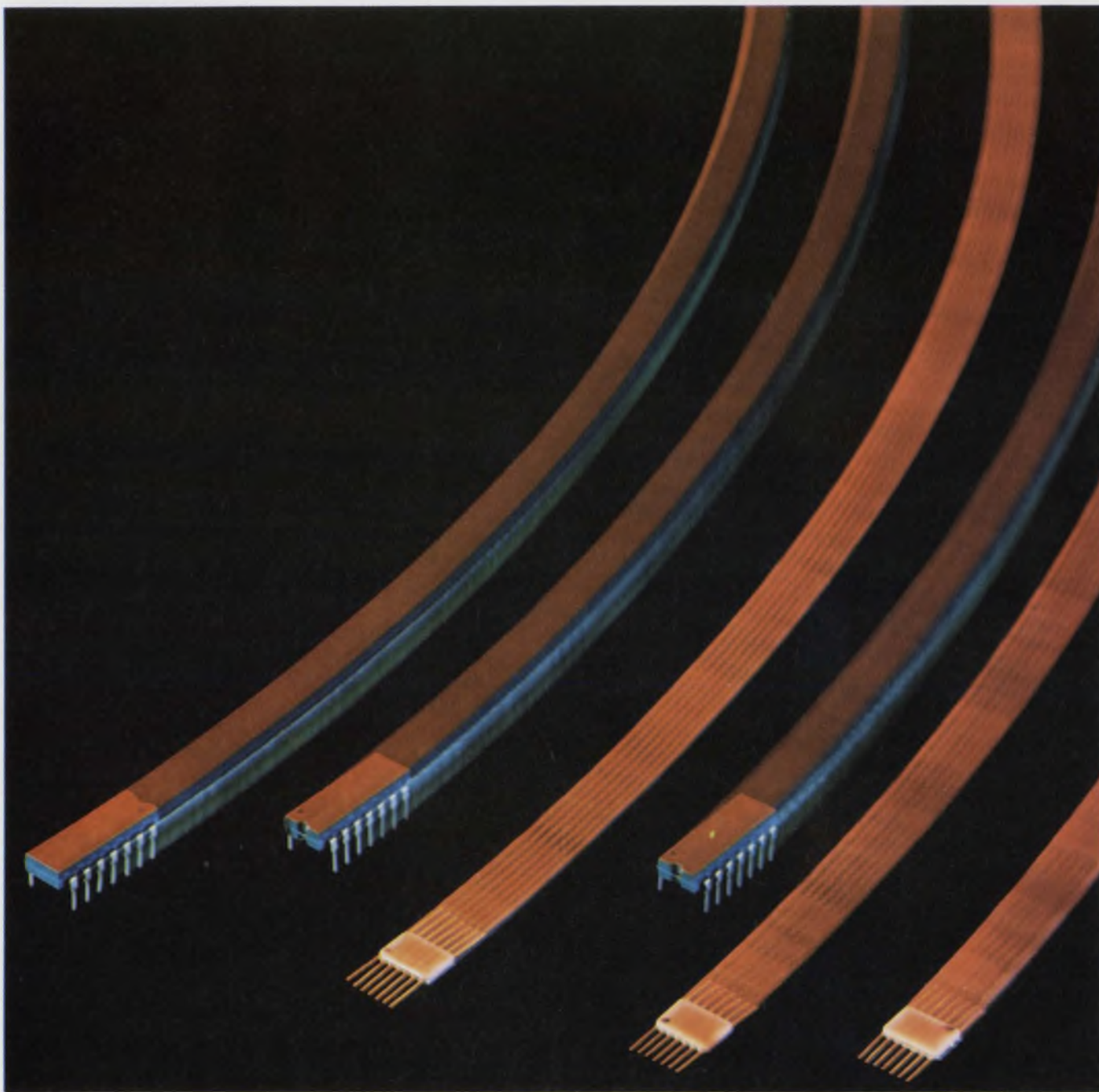

Sprague Digital ICs. Illustration: Series 54H/74H in flatpack and DIP

## Just arrived. Series 54H/74H. The fast ones.

Just about the fastest saturated logic circuits around. Series 54H/74H from Sprague. The whole family. Flip-flops and all.

Use them in arithmetic and processing sections, where speed really counts. Mix and match them with Sprague's standard Series 54/74.

**Get off to a fast start with Sprague Series 54H/74H.**

Call Sprague Info-Central (617) 853-5000 extension 5474.

Or call your Sprague industrial distributor. He has them on the shelf. For complete specifications, circle the reader service number below.

TYPICAL CHARACTERISTICS	GATES	FLIP-FLOPS
Propagation Delay	6 nsec	17 nsec
Power Dissipation	22 mW	80 mW
Noise Immunity	1 V	1 V
Temperature Range	-55 to +125° C	
Series 54H	0 to +70° C	
Series 74H		
Packages	DIP or Flatpack	



# News



**Wescon, 1969**, which will be held in San Francisco's huge Cow Palace, is expected to wel-

come more than 45,000 visitors. Over 600 companies will display products. p. U81



**From liftoff to splashdown**, the Apollo manned space program, capped by the Apollo 11 moon landing, proved the need for man in



space, the efficiency of NASA's management approach and the significance of the project to the U.S. economy. p. 24

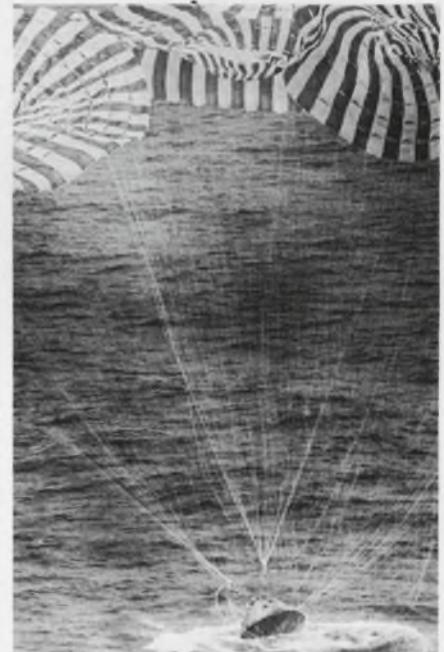

## Also in this section:

**News Scope**, p. 21 . . . **Washington Report**, p. 47 . . . **Editorial**, p. 79



**...looking for a specific self-mounting 'lytic?**

# Choose from **TWIST-LOK<sup>®</sup>** or **WRAP-LOK** **CAPACITORS**



INFORMATION RETRIEVAL NO. 821

Two styles for use in entertainment electronics and other commercial equipment with similar environmental conditions. The widely-used *Twist-Lok* has integral mounting ears which are twisted after fitting through slots in chassis or mounting plate. The *Wrap-Lok* has sharp-cornered terminals for wire-wrap type connections.

Both styles have unique sandwich-type end seal and dependable venting system. All connections between terminals and capacitor sections are welded to assure freedom from intermittents or open circuits. Available with bare case, Kraftboard tube, or plastic sleeve.

480-8148

**...need a reliable wirewound resistor?**

# Specify **ACRASIL<sup>®</sup>** **PRECISION/POWER** **RESISTORS**



INFORMATION RETRIEVAL NO. 822

Excellent stability and reliability, even under extended load life, extremely high humidity, and other adverse operating conditions. Expansion coefficient of silicone coating is closely matched to that of ceramic base to insure against damage to resistance winding. Coating provides exceptional protection against moisture, shock, vibration, fungus. Available with standard and non-inductive windings. Resistance tolerances as close as  $\pm 0.05\%$ .

482-8118

For complete technical data on Twist-Lok and Wrap-Lok Capacitors, write for Engineering Bulletin 3140A. For information on Acrasil Resistors, request Bulletins 7450A and 7450.1. Write to: Technical Literature Service, Sprague Electric Co., 347 Marshall St., North Adams, Mass. 01247.



'Sprague' and '®' are registered trademarks of the Sprague Electric Co.

**THE BROAD-LINE PRODUCER OF ELECTRONIC PARTS**

# News Scope

## New Mars photos show a fourfold gain in detail

In just four years, photos of Mars obtained by U.S. space probes have improved at least fourfold. That's the significance of the latest Mariner fly-bys, according to Lawrence Gallagher, program manager for Electro-Optical Systems, designer of the space cameras.

NASA sources put their estimate of the photographic achievement another way: The new Mariner pictures of Mars are at least 500 times better than any taken to date by cameras on the best earth-based telescopes.

Objects as small as 900 feet across were photographed as Mariner 6 and 7 passed within 2000 miles of the surface of Mars. In 1965, during the Mariner 4 mission, the best resolution obtained was 2 miles.

The major findings so far? Though evidence of water ice was found in the Martian atmosphere, the apparent lack of nitrogen, scientists say, "makes it highly un-

likely that life as we know it exists on Mars."

The cameras designed by the Xerox subsidiary in Pasadena, Calif., were of two types for the latest Mariners. One had a wide-angle lens with an 18-degree field of view. The other had a telescopic lens with a 1.8-degree field of view. The cameras had vidicon tubes made by General Electrodynamics Corp., Garland, Tex. The tubes contained 700 lines, against 200 in Mariner 4. This means that not only were the objects three and one half times clearer, by virtue of a higher line density in the vidicon, but they were even sharper than those of a home television screen, which has a picture tube that contains 525 lines.

Mariner 4 returned 21 pictures with a "gray scale," or contrast, of 64 levels. That means that there were 64 possible shades between black and white. Pictures returned from Mariner 6 and 7 had a sig-

nificantly higher contrast capability, with 256 levels separating black and white.

The two cameras, on the new Mariners operated alternately. They were timed to provide overlapping coverage. Each camera took one picture every 84.48 seconds.

The vidicon tubes in the cameras had a surface that was sensitive to light striking the surface. An electron beam scanned 665,280 points on the target in 42.24 seconds and generated an electrical current proportional to the charge loss at each point, and therefore in proportion to the light value for each point. This converted the image to intensity information, which was stored in analog and digital tape recorders.

Transmission to earth was always in binary form.

When received on earth, the binary coding was reconverted to electrical impulses representative of the pattern of light and dark elements of the original image on the vidicon tube. These impulses were used to modify the intensity of a beam of light that was swept across a 70-mm negative to expose it at 665,280 points to recreate the original image.

## New systems concern attacks urban problems

Street-gang warfare control using computers instead of police action is just one of the radical departures from traditional methods of solving urban problems proposed by Urbdata Associates, Inc.

The new organization, specializing in computerized systems analysis of urban problems, was formed by Dr. Jay Hillary Kelley, a pollution and systems engineer who was formerly a member of the White House Science Staff under both President John F. Kennedy and President Lyndon B. Johnson. He is now negotiating with the Pennsylvania Crime Commission to develop a systems approach to street-gang problems that would substitute computer and technological conflicts for present confrontations.

Kelley, who is president of Urbdata Associates, which has an office in Philadelphia's new Universi-

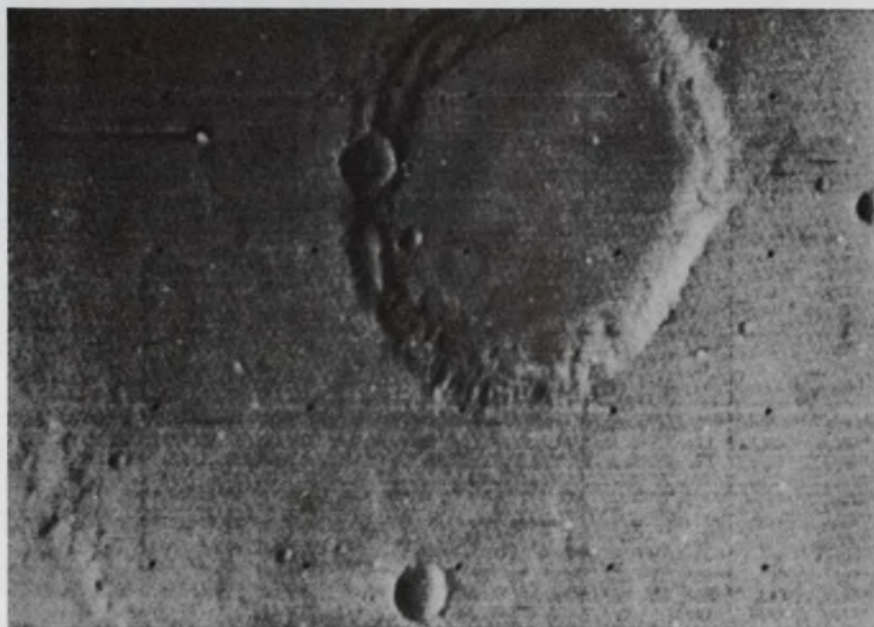

Rugged moon-like surface of Mars was photographed at a distance of 2300 miles. The large crater is about 24 miles across.



ty City Science Center adjacent to the University of Pennsylvania and Drexel Institute of Technology, says that while the gang-warfare study is of unusual interest, it is just one segment of the urban problem. Systems analysis of pollution monitoring, urban structure and services, and law enforcement on a broader scale are being conducted or are under negotiation.

Another basic problem that Kelly hopes to overcome is the fact that it is virtually impossible to police air pollution today. But with a computer simulation of nuisance sources and data collection, as well as meteorological inputs, sources of pollution may one day be predicted ahead of time.

## Long analysis precedes Navy's S-3A award

If anything goes wrong during development of the Navy's S-3A antisubmarine warfare aircraft, it won't be because there wasn't more than the usual soul-searching before the contract was awarded.

Five contractors competed on designs for the carrier-based plane for a year. Then two, Lockheed and General Dynamics, were asked to rework their efforts for five more months. Navy experts studied the results of this work for seven months—at the same time delving into the unpleasant business of General Dynamics' involvement in the overweight and now canceled F-111B and Lockheed's role in developing the now-defunct Army AH-56 helicopter and the costly Air Force C-52 cargo plane.

Lockheed, with its teammates—Ling-Temco-Vought and Sperry-Rand-Univac—won the contract.

The selection, the Defense Dept. says, "was reviewed and concurred in at all levels within the Navy," after which the Secretary of Defense approved the Navy's recommendation.

"The initial award is for \$461-million, to be funded over approximately five years. It is to lead to production of six R&D aircraft.

The contract also gives the Navy the option to buy 193 production models, contingent upon successful development. Approximately half the cost of the plane—which could run to \$3.2 billion—will be for electronics.

Data processing will be handled by a Univac 1832 general-purpose digital computer, supplied by the Federal System Div. in St. Paul, Minn. Univac will provide the computer programming in Burbank, Calif.

## Light-emitting diodes headed for wider use

Four big manufacturers—Hewlett-Packard, RCA, Texas Instruments and General Electric—are looking for a big jump in the market for light-emitting diodes (LEDs) in the next few years.

The price is now several dollars apiece, depending on the type of LED and the quantity of the purchase. But designers can expect to see this drop to less than a dollar next year, the three manufacturers say.

Howard C. Borden, manager of solid-state development at Hewlett-Packard, Palo Alto, Calif., says that the market for LEDs "within the next few years will go from less than \$1-million to between \$50-million and \$100-million. Borden and a company colleague, Egan E. Loebner, are presenting a paper on this subject at Wescon this week.

Spokesmen for RCA, Texas Instruments and General Electric agreed in interviews that the diversity and complexity of electronic systems has created a need for more man-machine interfaces, and that LEDs are becoming a basic element in such displays.

For example, phosphors recently developed by Bell Laboratories convert infrared light to blue, green, yellow or red light, and this adds great flexibility to system displays (see "New Phosphors Convert Infrared to 4 Colors," ED 16, Aug. 2, 1969, p. 42). Since this light can be changed from green to red by stepping up the intensity of the infrared source, such phosphors may be highly useful in diagonal systems of all types.

Hewlett-Packard is developing a

gallium-arsenide-phosphide LED that emits in the red region of the spectrum. Engineers there say that other materials are being investigated for green and other color emissions.

## Troubles still snag Intelsat's expansion

Attempts by the International Telecommunications Satellite Consortium (Intelsat) to set up an expanded worldwide network continue to be slowed by mechanical problems. A bad burn in the third stage of a launching vehicle kept a consortium satellite from going into synchronous orbit over the Atlantic on July 25.

It was the third Intelsat III satellite to run into trouble over the Atlantic. The first one, launched Sept. 18, 1968, failed to achieve orbit and was destroyed by the range safety officer. The second, launched Dec. 18, 1968, was plagued by problems with its mechanically despun communications antenna, which finally froze up completely last June 29. Since then, engineers who have been testing and monitoring the satellite, have succeeded in getting it to function, and it is now in service again.

## IBM's System/3 design questioned by critics

IBM has entered the low-cost, small-business computer field with a punched-card system, the System/3, that requires only 150 square feet of floor space, can be operated by one girl, and rents for \$945 a month.

The market, IBM says, includes retail and wholesale distributors, manufacturers and food processors. The system comes in two basic models: one that uses only punched-cards and one with direct-access disk storage.

The system uses a new 96-column punched-card that is about one-third the size of an 80-column card yet holds 20% more information.

Competitors criticize the use of "out-moded" punched cards, lack of compatibility with the 360 series, lack of communications capability, and the small card size.





# Bodine helps data devices tell it like it is...

Bodine fractional horsepower drives. Small. Quiet. A complete line designed to power information-handling devices precisely, accurately, dependably. Motors built with all the integrity you've designed into your product—that deliver as specified with fewer callbacks and service problems. If this is the kind of power you're looking for, you'll find no better source.

Over 3,500 standard specifications to choose from. Bodine also builds custom fhp motors to meet design requirements. Our engineers will be happy to help you pinpoint the right one for your particular application need. Computers, business machines, instrumentation, copiers—whatever your product, specify Bodine fhp drives. We've been the power behind the leading products for some 63 years. Write for bulletin. Bodine Electric Company, 2500 W. Bradley Place, Chicago, Illinois 60618.



*Bodine Motors Wear Out—It Just Takes Longer*

**BODINE MOTORS/CONTROLS**

Ask about Bodine SCR motor speed controls



# Man on the





# moon



## **Apollo 11 overcomes close calls as mission nears lunar surface and proves that humans and electronics can team up successfully to achieve an 'unbelievable' goal**

Charles D. LaFond, Chief, Washington News Bureau

*"Here men from planet earth first set foot upon the moon, July, 1969, A.D. We came in peace for all mankind."*

It's still, to most people in the world, an incredible success. It was the engineering expertise at its pinnacle.

"We've entered a new era . . . it's still hard to believe," says Dr. Thomas O. Paine, Administrator of NASA.

The Apollo 11 flight, from liftoff at Cape Kennedy on July 16 to splashdown in the Pacific on July 24, demonstrated vividly that man and sophisticated electronics can blend successfully in a cooperative, closed-loop system. The three-man crew worked and relied on computers aboard their spacecraft as one might lean on a human companion on earth.

But in going to the moon and landing and walking on that distant planet, man, as usual, learned through his mistakes. None of the errors were close enough to threaten the completion of the mission, but some caused deep concern. One did give rise to brief consideration of aborting the mission within sight of the landing area.

One big lesson that NASA learned: There are limits to the workload that man and electronics can successfully handle in space. When these limits are exceeded, trouble occurs.

Among the problems were these:

- The lunar-module guidance and navigation computer became dangerously overloaded as Eagle approached the lunar surface. But for prompt recognition of the cause



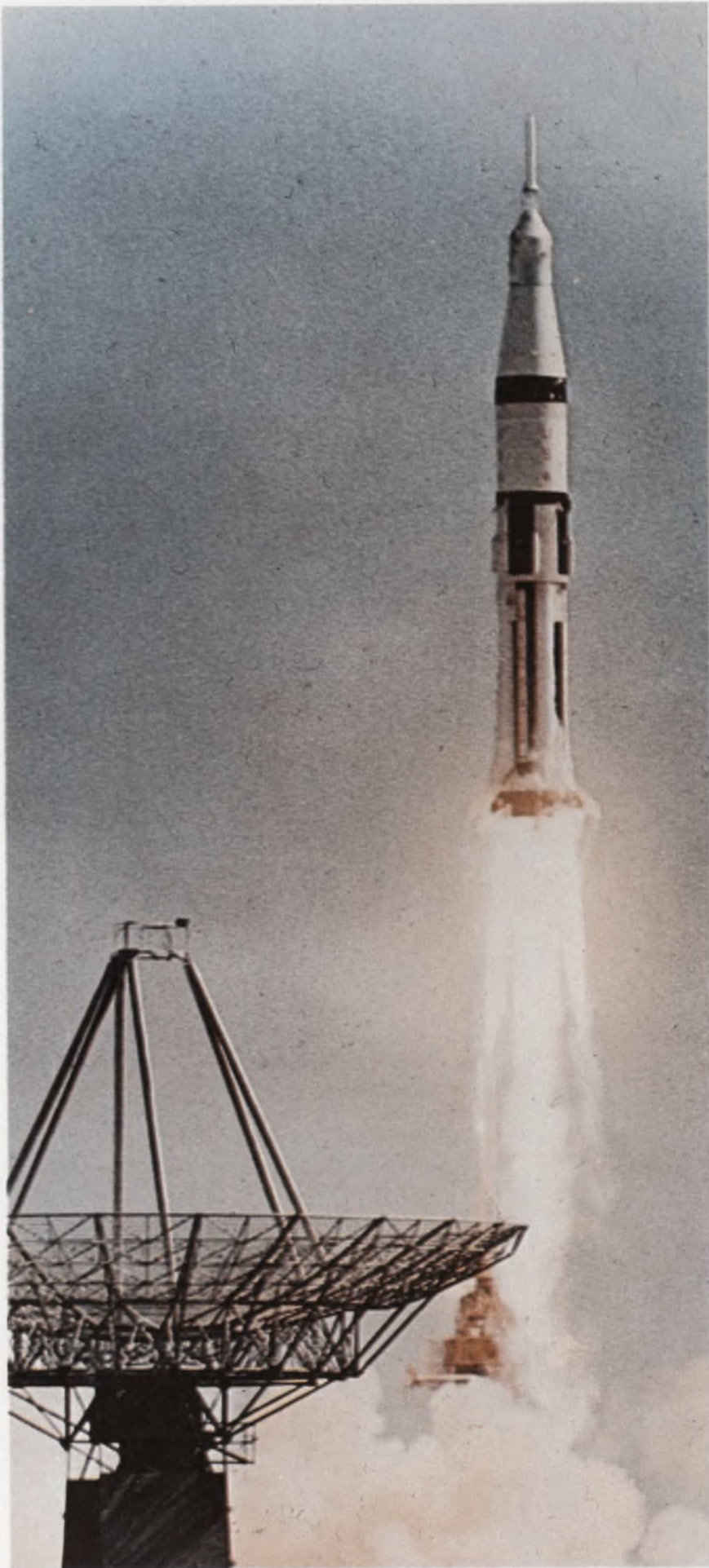

and the competence of flight controllers in Houston in providing remedial action, an abort might have occurred.

- Fully automatic programming on Eagle, if left untouched, would almost certainly have led the craft to destruction in a boulder-filled crater. The overworked crew could not see the landing site clearly until at low level. Fortunately there was a semi-automatic manual control that permitted last-minute alteration of the flight plan.

- Loss of communications, including telemetry, occurred early in the flight and later during descent of the lunar landing module from a moon orbit to landing. Luckily the radio breaks occurred at non-critical times and then only for short periods.

On the plus side:

- NASA planners had developed the procedures and designers had included sufficient redundancy to handle every difficulty encountered in the mission.

- Inertial navigation accuracy going to and from the moon was almost flawless.

- Voice communications and ground tracking were, on the whole, excellent.

- Television transmission was superb.

As with every mission, experience produces changes in procedures and sometimes in equipment. This certainly will hold true for improving the safety and reliability of Apollo 12, now scheduled for launching on Nov. 14. It can be assumed that NASA will require the crew to pay more attention to maintaining communications lock-on with earth and that the computer problem will not occur again. Other changes will have to await detailed analyses of recorded telemetry data and the debriefing of the three-man crew: Neil Armstrong, Col. Edwin E. Aldrin and Col. Michael Collins.

### Computer trouble quelled

Eagle's guidance and navigation computer began to act up when the descending craft was about 40,000 feet above the lunar surface. Warning lights began to flicker on in the form of two display numbers: "1201" and "1202." These were coded instructions to the crew that



the computer was rejecting the demands for additional information. In short, the computer was saying: "I'm overworked; stop requesting new data."

The crew queried Mission Control in the Manned Spacecraft Center in Houston and was told the flight was still "go."

Again, at 27,000 feet, the alarm flashed insistently. Indications were that a radar problem was involved. Again Houston said "go."

The difficulty, according to officials at Mission Control, resulted from data congestion created by simultaneous inputs of the landing radar, which was keeping track of Eagle's velocity and altitude, at the same time that the rendezvous radar was cranking in Eagle's position relative to the command module overhead. According to some NASA officials, the rendezvous data was required in the event the descent operation was aborted, so Eagle could link up again with the command module. An industry informant, a guidance expert, denies this. "There's no need to use the rendezvous radar during landing or ascent," he says.

It has now been determined by NASA that a three-position switch, calling for different operational modes of the rendezvous radar, was in the wrong position. However, NASA officials say that Eagle's crew had set the switch in the position called for by the Apollo 11 flight plan—"auto track." The result was a repeating electronic interrupt to the computer memory that was nonproductive and took up 14 per cent of the computer's total capacity.

The rendezvous radar antenna is a two-degree-of-freedom steerable unit. The lunar-module switch controlling system operational modes can be set at "LCG" (to search, acquire and lock onto the command-module transponder), "auto track" (to hold automatically onto the command module after lock-on) and "slew" (to permit manual acquisition and lock-on to the command module transponder).

The only reason NASA did not abort the descent was because a specialist in the Houston ground-control team, Stephen G. Bales, recognized the problem and through the flight controller directed the crew to stop querying the

computer on the operation of the landing radar. (Houston knew through telemetry that it was operating fine). This reduced the computer congestion and, despite recurring overload alarms, permitted the computer to guide Eagle to a safe landing.

After the mission, Lt. Gen. Samuel C. Phillips, Apollo project director, said: "In my opinion, we almost didn't make it. I could be wrong . . . but I think we came awfully close to having to abort."

Christopher C. Kraft Jr., flight operations director in Houston, commented: "The computer was right on the ragged edge. It was sending alarms that it was working right up to 100 per cent capacity." Asked if officials in Mission Control were concerned about the computer response and feared an aborted mission, Kraft replied: "You're damn right we were."

Kraft also made a point of clearing the computer design of any blame. He said: "I wouldn't want you to get the impression that the guidance system was improperly designed or that we had some improper problems with the program, because we did not."

Later, industry experts, who requested anonymity, told ELECTRONIC DESIGN that the computer alarms "1201" and "1202" were never intended to indicate a danger that might require a decision to abort. Rather, they said, the signals merely indicated that the computer, which had an automatic restart, was working at capacity on priority tasks and could not accept lower-priority requests. If the overload of queries continued and a point of total congestion occurred, these experts said, the computer would simply reject all further requests, stop and start all over again to accept requests on a priority basis; it would not have broken down.

Industry sources pieced the computer problem together this way:

As the lunar module came around the back side of the moon after firing its engines for descent, there was a time during the coast phase, but prior to the powered descent phase, during which the crew could have checked the operation of the rendezvous radar system. In doing so, it would first energize the rendezvous radar with the antenna position at LGC. On verifying that

the antenna had indeed locked onto the command-module transponder, the antenna switch would then have been turned to auto track. But after this, no matter what the flight plan checklist said, the experts say, the rendezvous radar should have been turned off and the antenna switch flicked back to the original LGC position.

Industry informants say they know of no reason for use of the rendezvous radar during descent to the moon's surface. With the radar on and the switch at auto track in Eagle, the antenna servo kept the dish searching throughout the descent in an attempt to locate the command module, and outputs indicating this fruitless search were fed continuously into the computer. This caused the computer overload warnings, the experts explained.

### Manual controls prove worth

James Nevins, deputy administrative director of MIT's Instrumentation Laboratory, which designed the computers and developed the mission software, said: "As far as the man interface is concerned, it's the most complicated program we've ever flown."

Yet the wisdom of a decision made years ago by NASA officials to give man the ability to bypass automatic control and take over manually was never better illustrated than in the final landing approach made by Astronaut Armstrong, the first man and engineer to set foot on the moon. Despite all the planning by the best minds in developing the final descent techniques, Armstrong found it impossible to clearly pick out his target site from an altitude of 7200 ft and still perform all his assigned cockpit tasks. There simply was too much for him to cope with.

The descent was fully automatic down to between 400 and 500 feet before Armstrong realized that the touchdown point would be in a dangerous, rock-strewn crater. At this point he switched over to a semi-automatic control program—P66—and flew the craft to a gentle landing in a clear plain some four miles away.

In the P66 "hover" mode, the guidance system provided throttle and descent rate control, and Armstrong controlled attitude and di-



rection. He also could change the descent rate in increments of  $\pm 1$  foot per second. It has since been calculated that only 40 seconds of fuel time remained at engine cut-off—or about half the fuel supply planned.

Dr. Thomas O. Paine, NASA Administrator, noted later: "We would have had difficulty with a fully programmed landing." And other space officials said that the experience demonstrated that previous successful landings by unmanned spacecraft on the moon were "very, very lucky."

There were other lapses but most appeared to ground observers to be failures in operational technique rather than equipment. For example, early in the flight as the two spacecraft separated from the Saturn V third stage and then redocked, there was a communications cut-off. This interruption was attributed to failure of the Apollo 11 crew to select the correct antenna position.

Both S-band and vhf transmissions were employed to assure transmission continuity, but similar communication breaks occurred throughout the flight. In each case Houston control was heard requesting the spacecraft to alter its attitude to help the ground stations lock onto the craft's steerable high-gain antenna.

Breakup in transmissions occurred at times with use of the vhf radio in the backpacks of the Astronauts Armstrong and Aldrin as they explored the lunar surface. On one occasion it was observed that Aldrin, after donning his equipment, had failed to erect his antenna fully. This was quickly corrected with direction from Houston. Aldrin's technique when speaking into the microphone was blamed at other times.

Astronaut Collins, orbiting the

moon in the command module while Armstrong and Aldrin were on the surface, helped relay messages from earth from time to time.

Another unscheduled incident arose when an ascent-stage engine arming switch was broken off as Armstrong and Aldrin re-entered Eagle after the moon walk, but circuit redundancy avoided difficulty.

### Highly accurate navigation

Accuracy figures are hard to obtain from the space agency. ELECTRONIC DESIGN has on three occasions requested from one

only a three-second burn to adjust the spacecraft velocity by 20.9 feet per second. Only a very minor second firing was needed. An even lesser correction was required on the return flight to earth.

As a partial measure of system performance, the spacecraft crew reported the day after launch that the worst drift being encountered by the gyroscopes in the inertial platform was 0.03 degree per hour—and that only with X-axis gyro. The crew also indicated that the worst error for the accelerometers was only 0.006 feet per second—well within the optimistic NASA specifications.

In the final analysis, the guidance system in both craft during the eight-day mission controlled a journey of nearly one million miles, accepted all the real-time changes inherent in such a mission, including a late splashdown target change of over 200 miles, and still returned the astronauts to a point only 2.5 miles off target and only 20 seconds off the original estimated time of arrival.

### Communication good

Communications performance, both vhf and S-band, were good throughout the Apollo 11 mission. NASA commu-

nicators are unanimous in their belief that had communications not been so successful, particularly during the critical lunar landing phase, the flight might well have been aborted.

Ozro Covington, chief of tracking communications at the Goddard Space Flight Center, Greenbelt, Md., when asked by ELECTRONIC DESIGN for his critique of over-all system performance, said: "If someone had asked me four or five years ago how I would like this network to function, I probably couldn't have cited a better example than the recent mission." ■■



Ascent stage of the Apollo lunar module is photographed from the command module prior to docking in lunar orbit. The photo was made during the Apollo 10 mission.

manufacturer, AC Electronics, performance figures following earlier Apollo missions, and each time the response has been that NASA refuses to make these figures available. It can only be assumed that the sensitivity results from the similarities between the MIT-designed Apollo system and the MIT-designed Polaris-Poseidon fleet ballistic missile guidance systems.

Nevertheless some figures were released during the Apollo mission. En route to the moon the accuracy was so great that the first mid-course correction was bypassed and the second required



## Strict control kept out semiconductor flaws

With billions of dollars and the hopes of the world at stake, NASA could hardly risk failure of the Apollo 11 mission because of some obscure transistor or IC defect. Semiconductor manufacturers made sure the risk wasn't taken.

In their quality-control efforts for the space program, the manufacturers have learned that pre-cap internal visual inspection, burn-in on all parts, separate high-reliability facilities and employe motivation are important steps to reliability.

Joseph Flood, director of reliability and quality assurance at Motorola Semiconductor Products, Inc., Phoenix, Ariz., says that all parts, at NASA's insistence, were inspected visually for workmanship faults before final packaging. These checks uncovered potential problems—bits of wire or foreign particles in the package, for instance—that would probably not have been detected in electrical or burn-in tests. The effect was to minimize the number of latent failures—and the manufacturers ecstatically point to the success of Apollo as proof of their high reliability.

Motorola's Bert Stelzer, manager of administrative services in the Reliability and Quality Assurance Dept., says the department even considered extending its visual inspection to include X-ray of the packages. X-ray techniques are especially useful in spotting die-bond voids—the cause of hot spots in operating ICs—and in checking lead bonds. But aluminum metallization and bonding wires are transparent to X-rays, and Motorola was using aluminum bond wires (a monometallic aluminum system is widely accepted as the most economical and reliable interconnection choice); so visual inspection was performed before final packaging.

Stelzer points out that no major process innovation was involved in getting high-reliability components for Apollo. "The problem has been to assure ourselves of the reliability levels that we already have," he says. "We don't lose much product in our burn-in tests. Average losses were about 1 to 2 per cent, and

many of them were not outright failures but just borderline on some specification or other."

Stelzer is convinced that a smoothly running process is the key to reliability. "You must have constant production," he says "under good controls, and at a rate sufficient that you can monitor the process. If you run a start-stop operation, you can't monitor the process reliably."

Gordon Russell, national sales manager for aerospace and defense marketing at Fairchild Semiconductor, Mountain View, Calif., reports: "Apollo really taught us a lot about reliability. We implemented internal visual inspections and designed traceability procedures that had never been done before. Our quality-control people can trace lots all the way back to wafer processing."

But Russell found some of the procurement arrangements uncomfortable. In supplying transistors to Raytheon, he says, Fairchild agreed that it would supply the devices and Raytheon would perform visual and environmental tests—leak test, shake, centrifuge, etc.—plus 100 per cent screen and burn-in.

"If more than an acceptable percentage of a lot failed this critical inspection, we got the whole lot back," Russell notes. "And we could not give back to them any part of rejected lots."

The result, of course, was a happy customer, but Russell doesn't consider it a suitable arrangement for a vendor. "We need control of screen and burn-in in our own house," he says. "If we don't have that control, we don't have a good monitor on our process. And we can't control what a customer does to our circuits if he tests them at his facility."

Russell found also that to build to the extreme Apollo reliability criteria, Fairchild needed separate production lines. "Asking girls on a standard line to build to Apollo standards is like asking a guy to study in a room where three other guys are having a bull session," he says. "The girls must have a separate facility where they can concentrate and maintain their high standards."

Segregation alone is not enough, of course; the staff must be motivated to do high quality work. And semiconductor manufacturers in Apollo have recognized this. Astronaut Frank Borman, for instance, visited the Motorola plant to tour the production areas and to speak to the staff working on Apollo parts. "The visit," says Stelzer, "had a very significant effect on the girls on the line. Each girl became very conscientious about doing her job and doing it right. She identified personally with the end result—a safe flight to the moon."

The girls working in high-reliability areas were given special smocks to wear that identified them with their work, and all containers holding Apollo parts were boldly marked as such. The object of all of this was to fix the attention of the production staff on the end use of the products and the need for quality. It worked admirably.

All in all, Russell found Apollo a fascinating project. He notes that the guidance computer was one of the first projects to be committed to the use of ICs, and finds the design a unique example of the use of repetitive elements in circuitry.

The computer was built of RTL 3-input NAND gates throughout. Flip flops were formed of cross-coupled NAND gates, and buffers were built by masking out a collector resistor.

There were two advantages to this approach. By using identical parts in large quantities, the designers at the MIT Instrumentation Laboratory, in Cambridge, Mass., benefited from the efficiencies of volume production. And because of the repetitive nature of the circuitry it was much easier to predict reliability. "The prime consideration of the whole program," says Russell, "was reliability. This thing had to work." The reliability, of course, has proven out; there have been no failures to date.

—Raymond D. Speer  
Microelectronics Editor



# Next: Era of





# discovery

## **NASA planning nine more missions to the lunar surface with improved equipment – The goal: a manned ‘Little America’**

David N. Kaye, West Coast Editor

It's only the beginning, so far as NASA is concerned. Repeated manned missions to the moon must be made in the next decade, if the world is to gain any real knowledge of the planet, says Dr. George E. Mueller, NASA's Associate Administrator for Manned Space Flight.

Four more lunar landings are planned by NASA in relatively rapid succession—roughly every four months through November, 1970. These are to extend man's "learning curve" by probing different lowland and highland regions of the moon.

Five subsequent landings are to cover other, more rugged regions and to deploy more advanced scientific instrumentation. By the mid-1970's, NASA officials would like their lunar exploration program to include:

- A lunar rover vehicle, capable of providing manned travel on the moon's surface and carrying heavier instrumentation and lunar samples.

- A lunar flyer, to permit rapid coverage by astronauts of otherwise inaccessible areas of the planet.

- A permanent habitat, resembling the early Little America station at the South Pole, where scientists and engineers could work in a safe, shirt-sleeve environment.

Earlier this year, in testimony before a Congressional committee, Dr. Mueller warned of the folly of incomplete lunar exploration. "If we do not take this next step," he said, "we face the hazard of repeating the error of Leif Ericson, who discovered America three centuries before Columbus but failed either to return or to stimulate others to return because he found nothing of interest."

The first follow-on landing—like Apollo 11, which landed in the Sea of Tranquility—is to set down in the safer, flat lowland, or maria area of the moon. Apollo 12 is scheduled to land in Oceanis Procellarum. Apollo 13 and 14 are to

Saturn V stands poised to blast off for further manned missions to the moon. Nine more lunar landings are planned by NASA in the next decade.



land in the highlands, first in the Fra Mauro formation and then near the large crater Censorinus, says Dr. Donald Wisc, NASA's chief lunar exploration scientist.

"We will start with the plains, then go to a high plateau, like the plateau around Denver. Then we will go to the rugged places, like the Grand Canyon and Yellowstone," he explains.

All of these early missions are in the lunar equatorial region. Apollo 15, however, is to land in a more northerly spot, the Littrow Area, near the edge of the Sea of Serenity.

Each of these spacecraft is to carry the Apollo Lunar Surface Experiments Package (ALSEP), built by Bendix Aerospace Systems Div., Ann Arbor, Mich.

Two different ALSEP arrays have been designed, each with the same experimental subsystems. They differ only in the selection of subsystems designated primary (four) and backup (three). Each package includes experiments for passive and active seismic measurements, a magnetometer, a solar wind subsystem, a suprathreshold ion detector and instruments to measure lunar heat flow and charged particles in the local environment.

The ALSEP telemetry system was designed to receive commands from the earth and to transmit collected data to earth through the unified S-band system. All experimental subsystems, when deployed, are connected by flat ribbon cables to a central station, which includes a data subsystem, electronics for the seismic instruments, and the control and communications subsystem. Electrical power for each ALSEP is provided by a SNAP-27 Radioisotope Thermoelectric Generator producing a minimum output of 46 watts.

When installed in the lunar module, an ALSEP array occupies 15 cubic feet and weighs about 210 pounds.

The astronauts in the Apollo 12-14 missions are to be permitted to walk on the lunar surface for up to about 1 kilometer from the lunar module. This is considered the limit that a man can accurately determine distance by eyeball estimate. The modules are to be equipped for stays of up to 36

hours on the moon. An attempt will be made to increase this capability to 72 hours for Apollo 15.

### Apollo 16-20 missions

More significant changes in instrumentation and capability are to be attempted in later flights—Apollo 16-20. For example, RCA is developing for NASA an instrumented staff, or walking stick, to be carried by one of the astronauts. It will include, at the top, a laser tracker and other devices to provide very accurate range (less than 1 meter error in 5 miles) and azimuth readings, and also to indicate true vertical. The unit was field-tested successfully for the first time last month. A small TV camera may also be included on the staff.

Some time after Apollo 16, possibly on Apollo 17, a small lunar vehicle is to be transported to the Moon. It would not only increase the mobility of the explorers but further improve their position determination capability during long lunar surveys. The small rover is expected to be equipped with a navigational unit employing a simplified inertial system and an accurate odometer.

By Apollo 20, it is hoped that several types of ground rovers will be in use, including a more highly advanced dual-mode type now under feasibility study by Bendix and Grumman.

Apollo 16-20 missions will most probably carry what is now called the modified, or advanced, Apollo Lunar Surface Experiments Package. These include new sensors and a preliminary astronomical experiment that will explore the practicality of deploying a lunar telescope or more fully equipped observatory on the moon.

Advanced ALSEP packages, according to Donald Beattie, staff engineer in the Apollo Lunar Exploration Office, will include the following:

- Electric field meters.
- A large area heat-flow experiment.
- Instruments to measure sky brightness hemispherically.
- A newly developed, highly advanced deep drill.

The latter will permit drilling

down to 10 meters to search for subsurface permafrost. The drill, says Beattie, was developed by Westinghouse for the Marshall Space Flight Center and represents a breakthrough in the technique of dry drilling.

Advanced ALSEP instrumentation, according to Bendix, will be designed for a minimum two-year operational life, but five years will be sought as a goal. Instruments will be designed to permit carrying up to nine experiments per flight.

Studies to determine the feasibility of building a lunar flyer are continuing for NASA under contracts with Bell Aerosystem, Buffalo, N. Y., and North American Rockwell, Downey, Calif. Devices under consideration include both back-pack propulsion systems and one-man platforms capable of traveling at altitudes of several hundred feet and at ranges of 10 to 20 kilometers.

A logical next step in lunar exploration would be the establishment of a permanent lunar station. It could be deployed as early as 1976 or 1977, says Beattie. Two concepts are under consideration, he says. One involves a succession of flights to carry modules to the moon for assembly on the lunar surface. The modules would use largely existing hardware.

A somewhat different approach, however, would employ an orbital lunar station, from which astronauts would shuttle to and from the lunar surface in an Apollo lunar module vehicle. This concept, says Beattie, could offer greater freedom for lunar exploration, but it would also create other problems in logistic supply from earth.

From a safety standpoint and for ease of operation, a majority of scientists tend to support the lunar surface station as offering a greater potential for long-term reliability at lower cost.

NASA studies have shown, Beattie says, that a six-man station to be occupied for six months could be supported by an 8-kw regenerative solar-cell-and-fuel-cell system. This would weigh about 13,000 pounds. For a 12-man station occupied for 12 months, a nuclear SNAP-8 power supply, providing 25-33 kw, would be required. ■



## CRTs

### **Multibeam tubes are now a complete family.**

These computer terminal readout tubes can be supplied in a range of standard sizes and configurations.

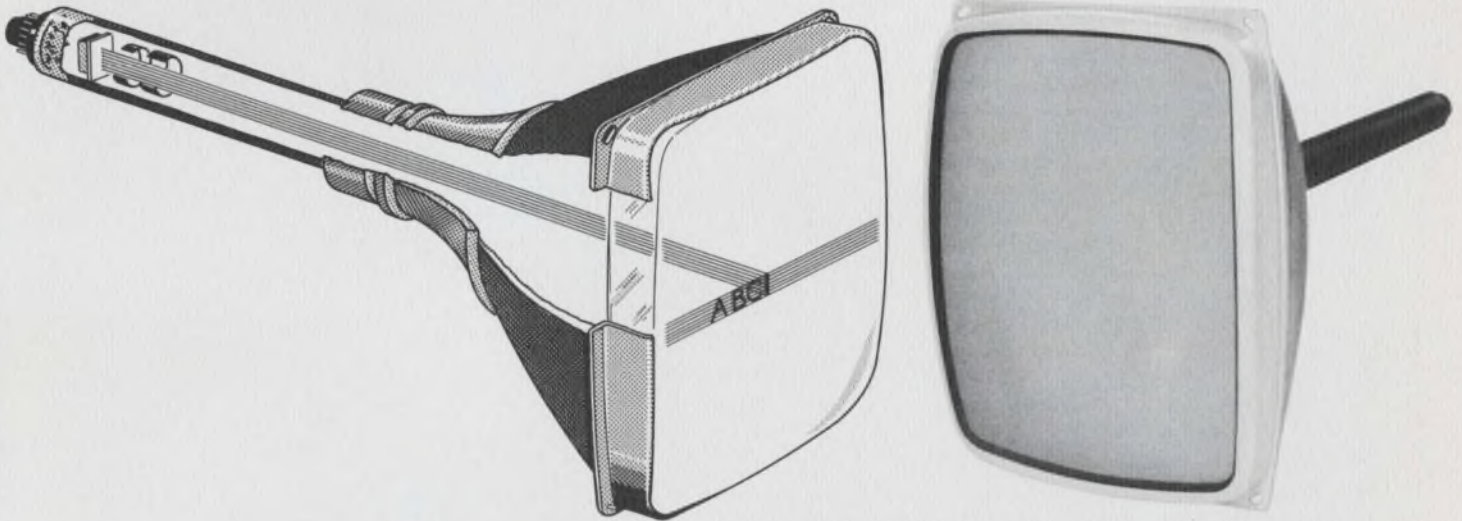

A few months ago we introduced our first multibeam tube, a seven-beam job designed to give brighter and faster readouts for computer terminals. Now we've expanded the line to give you a wide choice of tube sizes, configurations, and phosphor colors. In fact, we can put our multibeam gun in many standard tubes.

Our multibeam approach is a new and unique way of getting more out of a CRT. In conventional single-gun CRTs, brightness and writing speed are intimately related. The higher the writing speed the lower the brightness level. Our seven-beam multibeam tube actually allows you to increase writing speed seven times without loss of brightness. Or conversely, you can get a brightness increase of up to seven times without loss of writing speed.

As an example of what multibeam can do for you, take a look at our 12" SC-5299 seven-beam CRT. Seven separate electron beams are controlled by a common focus coil. Typical written character size is 5/32", but size can be varied by changing the position of the focus coil on the neck of the tube. Line width of individual spots is typically less than 0.010". Each beam may be individually modulated and all may be simultaneously varied in intensity with a single variable control grid bias. These multiple electron sources increase the brightness potential of the tube by a factor of seven.

Typically, this tube may be used to great advantage in alphanumeric displays, graphics or mapping. The advantages are even greater where high writing speed or viewing in a high ambient is required.

Since alphanumeric character writing is done in this tube simply by scanning lines across the screen and blanking and unblanking at appropriate points, the high speed

"diddle" or write-through yoke requirement is eliminated. The yoke current for the horizontal line scan, normally a step function, now becomes a simple ramp. Thus, you eliminate the step-settling time problems usually associated with single-beam operation.

Among the many applications we see for this new family of tubes are air traffic control systems, military identification systems, stock market quotation units, teaching machines, electronic test equipment and airline status boards.

CIRCLE NUMBER 300

## **This issue in capsule**

### **Integrated Circuits**

How to design with fast adders.

### **Television**

Add economy and versatility to your new portable TV designs.

### **Circuit Boards**

Is multilayer your best bet?

### **Microwaves**

Meet our full-line PIN diode family.

### **Microelectronics**

Fast custom service solves your interface problems.

### **Manager's Corner**

Hybrid microelectronics . . . where does it go from here?



## INTEGRATED CIRCUITS

### How to design fast adders.

Four basic adder systems give you maximum flexibility in operating speed and package count.

When integrated circuits are used to build an adder there are many design considerations—cost, speed, power drain, etc.—that must be weighed to arrive at the optimum system.

Our fast adder series—SM-10, -20, -30, -40—makes it easy to devise the optimum system. The SM-10 full adder is useful for low cost, low power systems where the delays of ripple carry techniques can be tolerated. Only one package is used per bit and only one carry wire is needed per package.

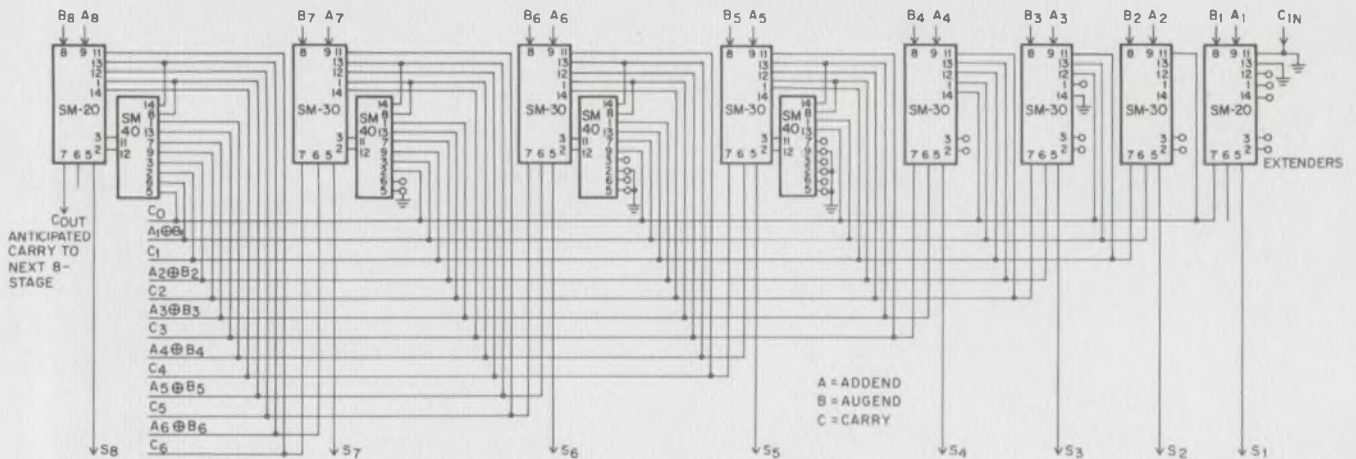

Fig. 1. Anticipatory carry adder is up to 4.5 times faster than adder systems using ripple carry propagation.

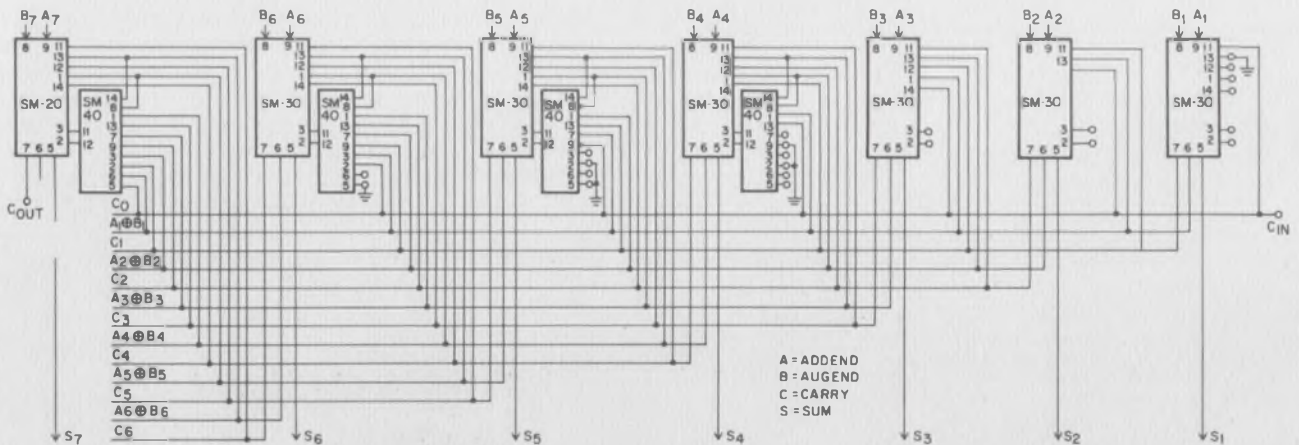

Fig. 2. Seven-bit section can be used to expand 8-bit unit shown in Fig. 1.

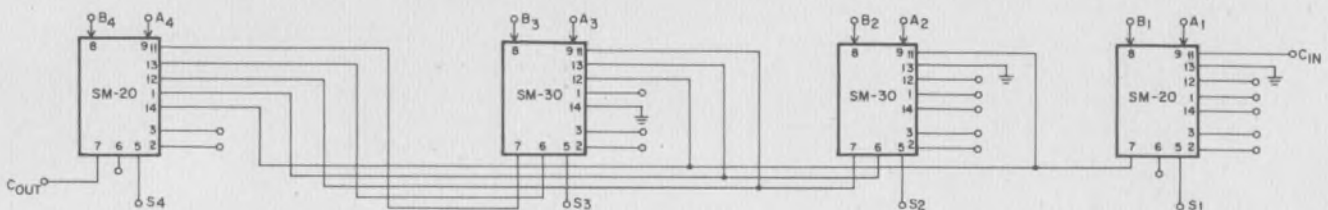

Fig. 3. Four-bit adder is based on first four stages of 8-bit adder.



If higher speed is required, the anticipated carry adders SM-20, -30, -40 can be used in several different configurations. For maximum speed, the 8-bit adder section shown in Fig. 1 should be used. This system will add two 8-bit numbers in 65 ns, and two 16-bit numbers in 105 ns. (These figures are based on the specified maximum propagation delays.) This approach uses 1½ packages per bit and power drain is typically 135 mW per bit.

For any word length greater than 8 bits but not equal to 16 bits, the fastest addition is obtained by adding 7-bit sections (Fig. 2) to the basic 8-bit adder sections. The 7-bit section is similar to the basic 8-bit section except that the SM-20 dependent carry adder is not used for the least significant bit. The ripple carry out from the preceding stage is connected to all 7 bits in parallel. Each added section must wait 20 ns for the carry out from the SM-20 of the preceding section, so the total addition time is 65 ns for the basic 8-bit section plus 20 ns for each added 7-bit section.

When slightly longer addition times can be tolerated, but ripple carry is still too slow, the anticipated carry adders can be connected in 3- and 4-bit sections to reduce package count and wiring complexity. This is accomplished by reducing the need for the SM-40 expander packages.

The basic 4-bit adder section (Fig. 3) is similar to the first 4 bits of the 8-bit adder except that an SM-20 has been substituted for the SM-30 at the fourth bit. This change provides single wire ripple carry to the next section. Anticipated carry is used to add 4 bits in 65 ns. Two of these 4-bit sections can be connected together to add two 8-bit numbers in 105 ns, as compared with 65 ns for the 8-bit section.

For any word length greater than 4 bits but not equal to 8 bits, 3-bit sections should be added to the basic 4-bit section as shown in Fig. 4. This arrangement adds 20 ns to the basic 65 ns addition time for each 3-bit section added. Two 16-bit numbers can be added in 145 ns. Note that this configuration uses only one package per bit. This is a good way to get the speed advantages of anticipated carry with the same package count as a ripple carry system. Power drain is typically 125 mW per bit.

Slightly faster addition times can be achieved by using the system shown in Fig. 5. Here an SM-40 expander package is used so that 4-bit sections can be added to the basic 4-bit section of Fig. 3. This adds 20 ns to the basic 65 ns add time for each 4-bit section. Two 16-bit numbers can be added in 125 ns using this system. Performance of the four basic adder systems is shown in Fig. 6.

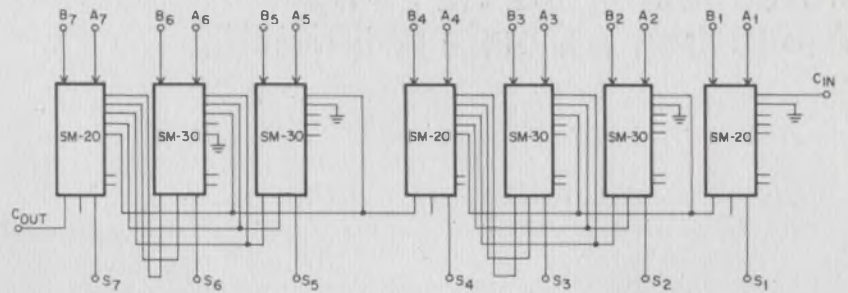

Fig. 4. Three-bit section can be used to expand 4-bit adder.

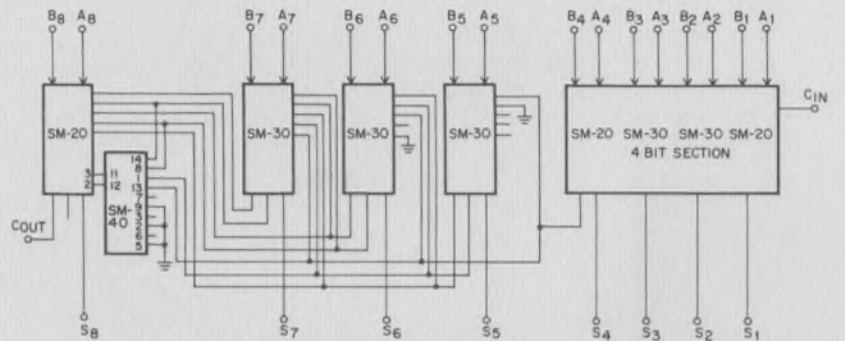

Fig. 5. Somewhat faster addition times can be obtained by using SM-40 expander to add 4-bit sections to basic 4-bit system.

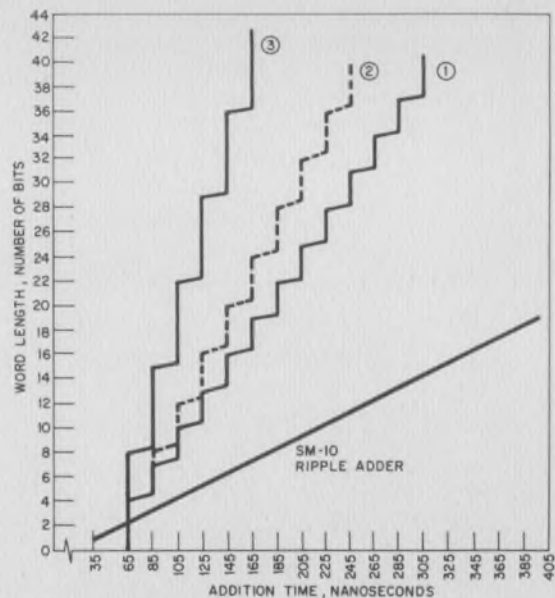

Fig. 6. Operating speed for (1) 3-bit stage added to 4-bit stage, (2) 4-bit stage with SM-40 expander added to 4-bit stage, and (3) 7-bit stage added to 7-bit stage.







## CIRCUIT BOARDS

### Is multilayer your best bet?

As makers of all types of boards—single, double, and multilayer—Sylvania can help you make the right choice.

Are you looking for a high-speed circuit board? If you need high-density packaging, high-speed operation and low noise levels, multilayer boards may be your answer. Sylvania is especially equipped to aid you in making the right decision. Since our printed-circuit board facilities make all types of boards, our engineers can aid you in choosing the right one for your application.

Sylvania has been producing multilayer boards for over nine years and has made boards with up to 19 layers. Our multilayer operation is a modern 10,000-square-foot facility. Most of this space meets class III clean-room standards. Rigid process controls allow us to meet standards set by the Institute of Printed Circuits, military specifications and varied customer requirements.

Capacity of the plant is presently 1,400 one-foot-square boards per shift with plans now under way to increase this capacity to 2,800 boards per shift.

To provide highest-quality production we continue to use a plan written to meet the requirements of MIL-Q-9858A Quality Program Requirements, and specification NSA No. 68-8, NSA Specification for Printed Wiring Boards.

This plan is a working document, detailing and referencing procedures that will provide a total quality system. This assures compliance with all company and customer reliability and quality requirements.

Incoming raw materials are inspected and tested to meet standards established at the time of purchase. Testing and inspection are carried out at every step of manufacture and assembly.

Our multilayer facility is capable of handling boards in sizes from 4 to 350 square inches on a regular production basis. We can hold layer to layer tolerances which meet the demands of today's multilayer board requirements. Our boards can be made in thicknesses up to seven times the diameter of the smallest plated-through hole with a minimum tolerance of  $\pm 0.005$ ".

Our engineering staff is ready and willing to help you solve your printed circuit board problems. Why not talk to them soon.

CIRCLE NUMBER 303

Large-size multilayer board illustrates complexity of designs that can be handled by Sylvania.

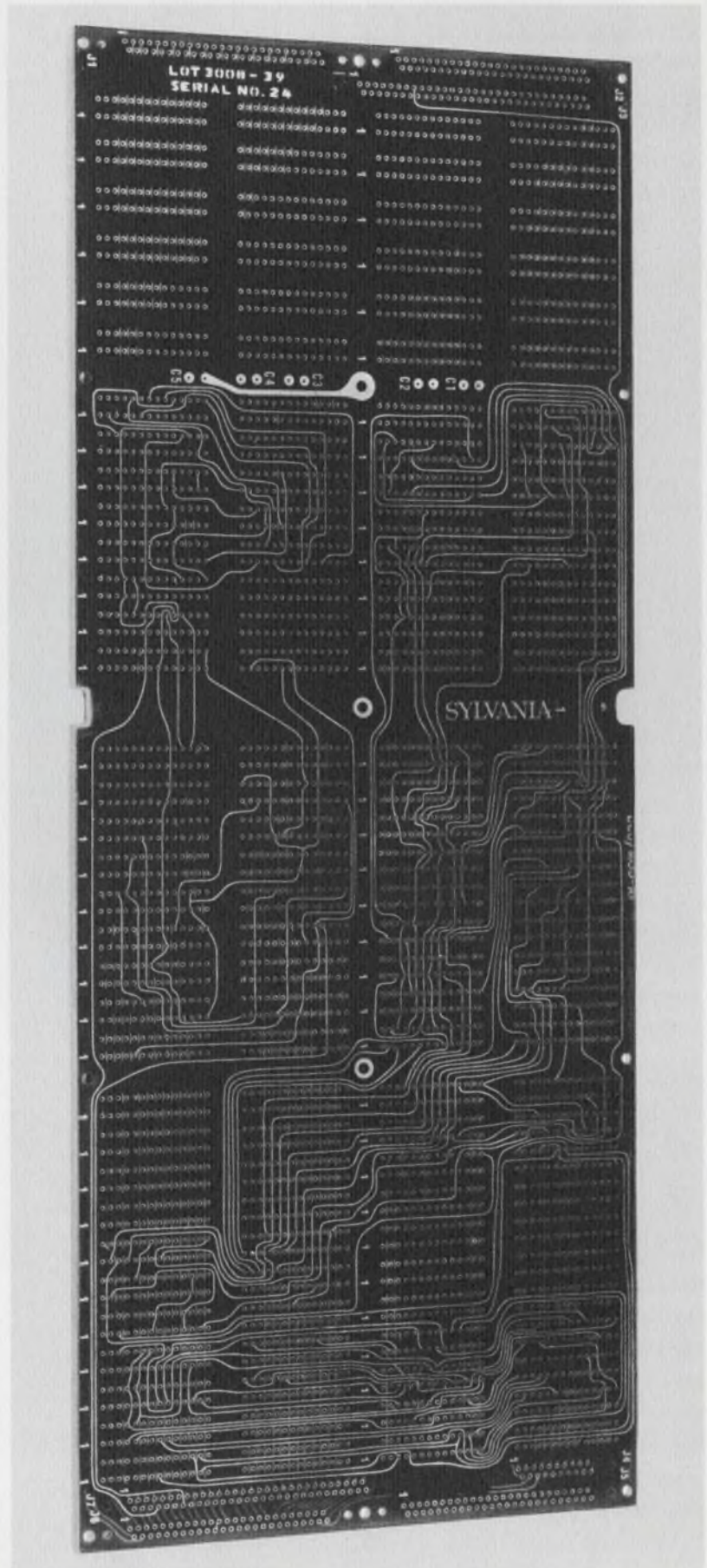



## MICROWAVES

### Meet our full-line PIN diode family.

Both epitaxial and non-epitaxial types are available in a wide-ranging line of devices.

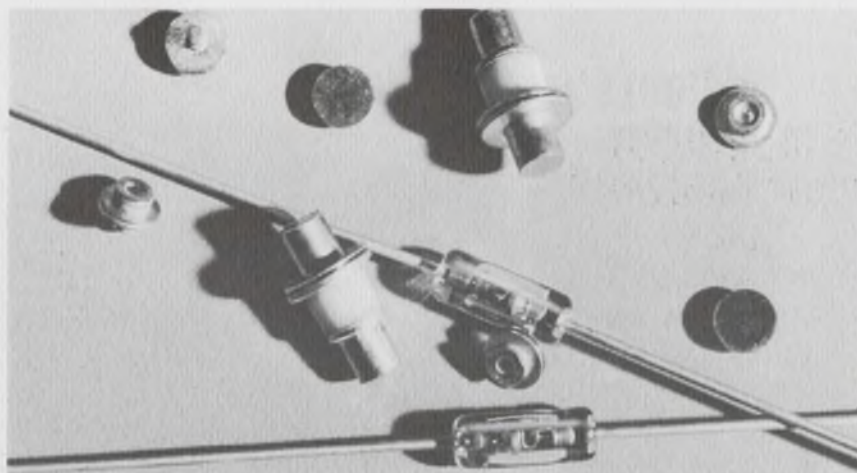

Variation of series resistance of PIN diode with forward current.

One of the industry's broadest lines of PIN microwave switching diodes is available from Sylvania. The unique properties of these devices make them suitable for such applications as low- and high-power switches, limiters, phase shifters, voltage-controlled attenuators and modulators.

A PIN diode is made by diffusing P and N type impurities into opposite sides of a wafer of pure intrinsic silicon that has high resistivity. This intrinsic layer provides the PIN diode with its unique properties at microwave frequencies. At low frequencies, a PIN diode exhibits rectification properties similar to an ordinary PN junction. However, at higher frequencies charge storage in the intrinsic region prevents rectification.

Thus, when a forward bias is applied to the device it operates as a voltage-dependent variable resistance. A slight increase in series resistance is observed up to a bias current of 10  $\mu$ A. This change occurs because the width of the depletion layer in the intrinsic region decreases; therefore, the thickness of the intrinsic layer increases slightly. As the forward current is increased beyond 10  $\mu$ A, the series resistance decreases rapidly because carriers are being injected into the intrinsic region.

When a reverse bias is applied to the device, a gradual decrease in series resistance is observed since the depletion layer is widened. This widening of the depletion layer continues until breakdown occurs and conduction increases

rapidly. Fig. 1 shows the small-signal equivalent circuit of a PIN diode in the forward and reverse biased conditions.

One of the most common applications for PIN diodes is as a high power digital phase shifter for phased array radars. The three major types of shifters are shown in Fig. 2.

The switched-line phase shifter uses two line lengths and two SPDT switches per bit. This means it can switch in either a reference line or a particular length of line depending on the amount of phase shift wanted. As many bits as needed can be added to obtain the accuracy desired in phase shift. The loss for each bit is identical and good accuracy can be obtained.

The periodically loaded line phase shifter uses the PIN diode as a switch. The diodes switch in load susceptances spaced a quarter wavelength apart on a transmission line. Phase shift per diode is small; thus it requires many more diodes to do the same job as the switched line phase shifter.

The hybrid-coupled-bit phase shifter uses a 3-dB hybrid junction with balanced phase shift bits connected to the coupled arms. This type uses fewer diodes than the switched line and has less loss. The problem with this approach, however, is that its loss varies with bits and it has only half the power-handling capacity of the switched line.

If you have an application where PIN diodes can be used, why not discuss it with Sylvania. We're sure to have the right diode for you. CIRCLE NUMBER 304

#### Typical PIN diode specifications

	D5964B	D5964C	D5964D	D5964E	Outline 075
Breakdown Voltage	100	100	100	100	Volts Min.
Total Capacitance, 50V	0.15-0.20	0.20-0.30	0.30-0.40	0.40-0.50	pF
Series Resistance, 100 mA	1.0	0.7	0.5	0.4	ohms typ.
Series Resistance, 10 mA	2.5	2.0	1.5	1.3	ohms Max.
Thermal Resistance	400	400	400	400	$^{\circ}$ C/W

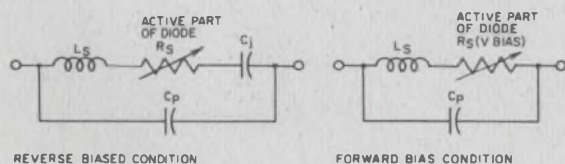

Fig. 1 Small-signal equivalent circuit of PIN diode.

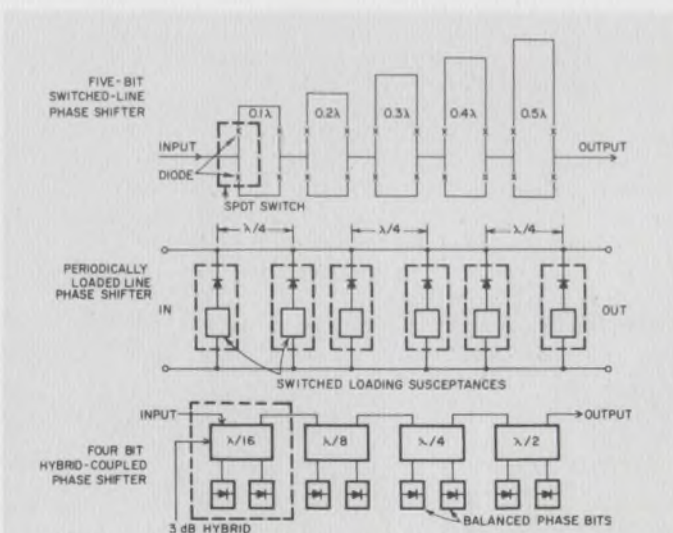

Fig. 2 Three-types of phase shifters used in phased-array radars.



## MICROELECTRONICS

### Fast custom service solves your interface problems.

Our standard circuit submodules let us tailor an interface circuit to your specs and get it to you within two weeks.

Using our advanced hybrid circuit techniques, Sylvania can give you high reliability and proven designs, and we can do it fast, too.

The secret is in our standard circuit submodule approach. By combining these standard input and output submodules into one 12-lead TO-8 can, we can give you an interface driver circuit that will handle your specific application. Since all the design work has already been done, we can promise delivery in two weeks after receipt of order.

Input circuit functions available (see table) include voltage and current detection, level shifting, gating, inversions and pulse shaping. Schmitt trigger circuits are used for voltage and current detection and to provide a clearly defined output threshold. Logic functions are being added to make the family even more universal in its application.

In the output section, a thyristor, a medium current transistor and a high current transistor driver is available. Our thyristor circuit can handle up to 300 Volts at one Ampere. The medium current output circuit gives you 360 mA at 6 Volts or can be used to drive your own power transistor and load. The high-current transistor driver can be used to drive power transistors and is capable of switching 10 Amperes.

Our interface drivers are now available for positive and negative supply voltages ranging from 4 to 24 Volts. Input voltages can be either positive or negative over a range from 0 to  $\pm 25$  Volts. CIRCLE NUMBER 305

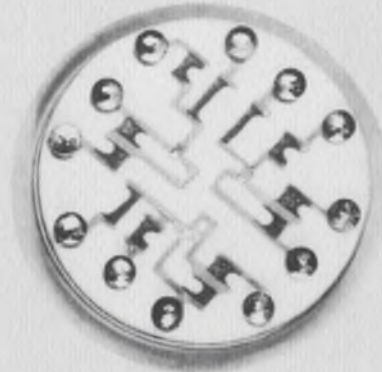

#### General Characteristics of interface driver submodules

**Input sections**  
**Schmitt trigger:**  
On at +3V, Off at 0V

**+ or - current sense**  
User supplies 1 resistor selected to sense in a range of 1 mA to 1A.

**+ or - voltage sense**  
Standard levels 1, 2, 5, 10, 15, 20, 25 Volts or user can add resistor for any specific level from 1 Volt up.

**+ or - logic**  
Switches at 1V nominal

**+ or - high noise immunity logic**  
Switches at 2.5V nominal

**Output sections**  
**Thyristor**  
Load current to 500 mA. Voltage ratings of 50, 100, 200 and 300V.

**Medium-current transistor**  
Load current ratings of 150 and 500 mA.  
Voltage ratings of 20, 30 and 50V.

**High-current transistor driver**  
To drive power transistors switching up to 10A.



Use Sylvania's "Hot Line" inquiry service, especially if you require full particulars on any item in a hurry. It's easy and it's free. Circle the reader service number(s) you're most interested in; then fill in your name, title, company and address. We'll do the rest and see you get further information by return mail.

BUSINESS REPLY MAIL  
No Postage Stamp Necessary if Mailed in the United States

FIRST CLASS  
Permit No. 2833  
Buffalo, N. Y.

POSTAGE WILL BE PAID BY

Sylvania Electric Products Inc.  
Sylvania Electronic Components  
1100 Main Street  
Buffalo, New York 14209

D 6 6 6

---

---

---

---

---

---

---

---

---

---



## MANAGER'S CORNER

### Hybrid microelectronics...where does it go from here?

Reading any of the design electronics magazines, an engineer can get the feeling that he is "out of it" unless he is committed to several active hardware designs using film hybrid microelectronics. Scarcely an issue goes by that a new technical advance or new utilization is not described.

Is there sufficient justification for all this technical publicity? Has the technology really arrived yet? Where will it develop from here?

The apparent popularity of hybrid technology, coupled with the relatively low dollar investment required, has led to upwards of 500 hybrid film facilities being started within the last 12 to 18 months. Of course, some of these facilities were formed to support in-house engineering groups, but many are oriented toward industry sales activity.

EIA statistics for 1968 certainly do not justify all of this activity in hybrid film technology. In 1968, sales were about \$54.6 million in "non-captive" markets (not including in-house usage of self-manufactured circuits). Half of this sales level is in "passive-only" film circuits. The remainder is in film circuits with active components added.

The accelerating interest in hybrid films comes from a growing accumulation of successful applications. Engineers have found that hybrids can solve design problems not readily resolved by available monolithic circuits and/or printed circuit approaches.

With increasing usage of hybrid circuits the vendor-user engineering liaison loops have become more workable and more efficient. The initial strangeness of working with a new technology has worn off. Engineers who have been suc-

cessful in their first applications are now confidently designing hybrid films into future jobs where they meet the economic and technical requirements.

For this reason, we at Sylvania believe that the growth of film circuit technology will be explosive in the next 12 to 18 months. By 1971, we see engineers designing systems using such devices as multiple beamleaded, nitride passivated integrated circuits arrayed on multi-level alumina substrates. The whole device will be hermetically sealed in a 1"-square flat pack.

To obtain this level of technology by 1971, certain developments are required. These developments include fine-line, low-cost film registration to accommodate beamleads; availability of a broad range of beamlead devices at reasonable prices; and a reliable multi-level substrate interconnect capacity. All of these factors should be available by 1971.

At Sylvania we're similarly confident of the future place of film circuits in the industry picture as a packaging technology. Hybrid films will complement single chip monolithic devices and printed-circuit board approaches. Each technique will find its proper application through economic and technological review.

Sylvania's program in hybrid film technology is oriented toward supplying analog and digital circuits in module form. These modules incorporate our own solid-state devices using advanced technologies in design and packaging. Our ten years of film circuit and packaging experience, our in-house source of beamleaded chips, and extensive new developments in film processing techniques allow us to offer broad design and production support to the user of film circuits.



W. D. Hogan

This information in Sylvania Ideas is furnished without assuming any obligations.

# SYLVANIA

## GENERAL TELEPHONE & ELECTRONICS

NEW CAPABILITIES IN: ELECTRONIC TUBES • SEMICONDUCTORS • MICROWAVE DEVICES • SPECIAL COMPONENTS • DISPLAY DEVICES

D6

NAME \_\_\_\_\_  
PLEASE PRINT

TITLE \_\_\_\_\_

COMPANY \_\_\_\_\_

ADDRESS \_\_\_\_\_

CITY \_\_\_\_\_ STATE \_\_\_\_\_ ZIP \_\_\_\_\_

#### Circle Numbers Corresponding to Product Item

300      301      302      303      304  
305

Please have a Sales Engineer call



#### HOT LINE INQUIRY SERVICE

Need information in a hurry? Clip the card and mail it. Be sure to fill in all information requested. We'll rush you full particulars on any item indicated.

You can also get information using the publication's card elsewhere in this issue. Use of the card shown here will simplify handling and save time.



# The management was 'superlative'

**Richard L. Turmail**  
Management and Careers Editor

Historians will have to thumb their way back over 25 recorded years to find a management job that approaches the one responsible for placing our astronauts on the moon. Not since the Allies joined forces to invade Normandy in the spring of 1944 had so many people, industrial complexes and resources been united to reach a common goal. But when Apollo 11 touched down on the lunar surface, the National Aeronautics and Space Administration had managed to overcome the obstacles with a gigantic and specifically designed team that fulfilled President Kennedy's decree of eight years ago.

Because of the significance of Apollo 11's accomplishment, ELECTRONIC DESIGN wanted to know how the Apollo program was held together, and how the generally high reliability of the program was achieved. To find out, we put some management questions to George H. Hage, Deputy Director of the Apollo Program.

Hage has been entrusted with top program and technical management responsibilities with NASA for the past two years. Before that he served the Boeing Company for 19 years. Our questions and his comments follow:

**Did you ever doubt that the goal of the Apollo program would be reached?**

I think in view of the massive research and development nature of the project, there has always been an element of concern that this very ambitious objective would

not be met on the time scale laid down by President Kennedy in 1961. But because of the superlative quality of NASA's planning and research, there has never been any doubt in my mind that the goal of landing men on the moon and returning them safely would be accomplished.

**What is the main function of the Apollo management team?**

A high percentage of our time is devoted to definition and planning. At least half of the job is planning, and half is execution. The ratio is tempered of course by the level of management. Lower levels spend more time on execution than on planning. At the higher levels we may occasionally spend a



**George H. Hage**, Apollo Program Deputy Director and Mission Director for NASA's Apollo 11 space flight stands by a full-scale model of the Lunar Module.

great deal of planning time looking up a blind alley, but at least we'll know it when we see it the next time, and we won't go down the same alley again. The Mercury program was bold and ambitious, and mistakes were made. Gemini learned from those mistakes, and Apollo, of course, learned even more from Gemini.

**Have any managerial innovations been realized during the Apollo program?**

The rudiments of management that have been applied to the Apollo Program have been available for some time, and have been applied to many of the big programs such as the Polaris, the Minuteman, and some of the larger aircraft development programs. However, there have been some new applications of technology in the area of communications. Since the project has required a great deal of close coordination among the Apollo team members who are widely dispersed geographically, we established a unique conferencing system last year. It utilizes a wire network that permits us to carry on a conference by telephone in several locations simultaneously. In Houston, Huntsville, Cape Kennedy and Washington, we can also project, simultaneously, printed material in viewgraph form. It is possible during such a conference to create and transmit to all of these locations, or to any one of the four, a viewgraph sketch or a series of written points in something like 10 seconds.

We have, as a part of the TIE contract (Technical Integration and Evaluation) provided by the



## APOLLO PROGRAM MANAGEMENT

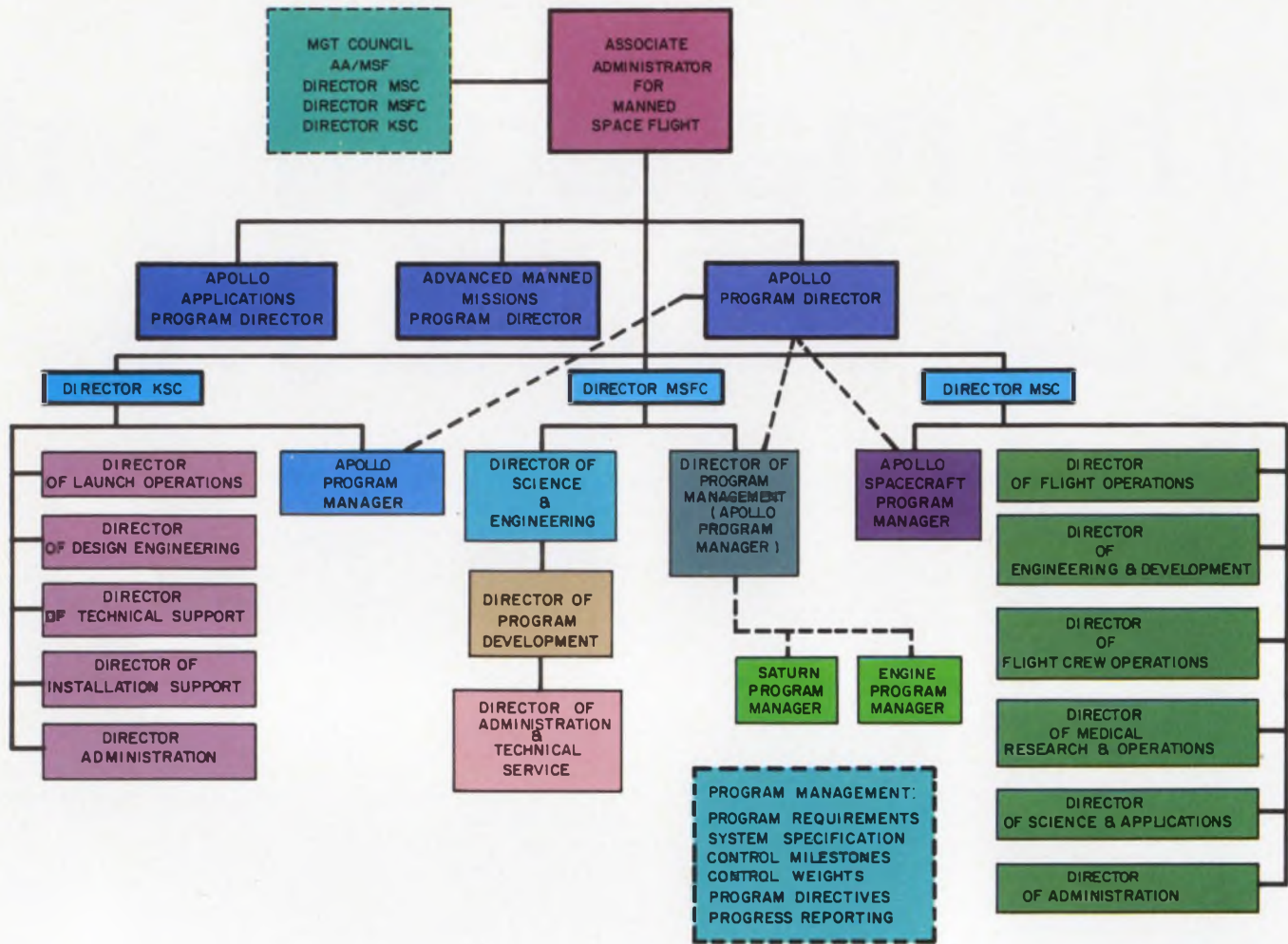

Boeing Co. at all three NASA locations and here in Washington, a rapid data-retrieval system. It has been computerized to permit us to get information quickly about problems and anomalies so that we can be knowledgeable on the status of their resolution. I don't believe that there has been a central source of this type of information maintained in such a viable quick call-up form in any other program.

### What management procedures does NASA utilize?

We have used many of the management disciplines on each phase of the program. For example, we conduct preliminary design reviews when we're trying to settle on a design concept. Then, when we've chosen a design, we stage a critical review that involves a detailed look at the design we're going to commit to hardware. We also conduct

many types of technical reviews. We have "change board" meetings, where every change made as a result of some deficiency or weakness in a system is reviewed. Before we're ready to commit to flight, we conduct a design certification review involving a senior management team. The Apollo Program also conducts a flight-readiness review where we sit down with all the principals of the program. In the case of Apollo 11, a nine-hour review was conducted of all the questions and issues that were carried along in preparation for this flight.

These reviews are not innovative in the classical sense, but I think the degree of discipline and insistence used may be more thorough than in any previous program.

**How did NASA unite the thousands of units under its management into a cohesive force capable of placing men on the moon?**

I would expand that to the management beyond NASA, to the tremendous industrial complex that is under contract to the space agency. I think that key organization techniques used were these: setting up specifications early in the program, defining what it is we're going to build and how we were going to use it; requiring a series of subordinate documents and specifications at several levels below the top Apollo specs. In this way, each element of the project could look to a set of criteria and requirements at each level and know what was expected.

### How was the Apollo program maintained during layoffs?

Strikes have not really caused the program any serious delays in the months that I've been involved. We've had excellent cooperation from the unions. We've been very lucky.



DAMON ANNOUNCES...

A new 7-pole monolithic crystal filter line that surpasses those previously available in shape factor and spurious mode suppression. Provides performance comparable to the highest state-of-the-art currently available with discrete filters – yet incorporates all of the inherent advantages monolithics have over conventional multi-component configurations. Now Damon provides the best of both worlds: critical performance, superior temperature characteristics, improved aging, small size, and significantly lower price. All are available in hermetically-sealed metal cases within miniature rectangular packages ranging in size from 0.080 cu. in. to 0.274 cu. in. Immediate off-the-shelf delivery of evaluation quantities. Damon also offers a wide variety of computer-assisted designs, but these take a little longer. Damon/Electronics Division, 115 Fourth Ave., Needham, Mass. 02194, Tel: (617) 449-0800.

# The second generation in Monolithic Crystal Filters.



"STANDARD" 7-POLE MONOLITHIC CRYSTAL FILTERS					CASE "A" 0.274 cu. in.	CASE "B" 0.080 cu. in.
Model No.	6457MA	6457MB	6458MA	6458MB		
Center Frequency:	10.7 MHz $\pm$ .7 KHz	10.7 MHz $\pm$ 1 KHz	21.4 MHz $\pm$ 0.7 KHz	21.4 MHz $\pm$ 1 KHz		
Bandwidth, 3 dB:	6 KHz min.	15 KHz min.	6 KHz min.	15 KHz min.		
Bandwidth, 60 dB:	18 KHz max.	40 KHz max.	18 KHz max.	45 KHz max.		
Ripple, Max.:	1 dB	1 dB	1 dB	1 dB		
Insertion Loss, Max.:	6 dB	6 dB	6 dB	6 dB		
Spurious Returns:	> 55 dB down	> 50 dB down	> 55 dB down	> 50 dB down		
Terminations (Resistive):	2.0 kilohms	5.1 kilohms	0.38 kilohms	1.3 kilohms		
Ultimate Atten.:	80 dB	70 dB	80 dB	70 dB		
Op. Temp. Range:	0°-60° C	0°-60° C	0°-60° C	0°-60° C		
Case Size:	"A"	"A"	"A"	"B"		

SEE THE SECOND GENERATION IN MONOLITHIC FILTERS AT WESCON - BOOTH 5206.





## **After losing 22 months to unscheduled testing, how did you manage to place a man on the moon within the time schedule?**

The Apollo program was stabilized before January 1967, so that there was leeway in scheduling until mid-summer of last year. Then, of course, we changed the mission sequence. The pre-fire version of the projected Apollo 7 had no launch designation. If the Apollo 7 had performed as planned, there is no question that we would have been on the moon by now. But when a program of this kind runs into a deficiency of the magnitude of the fire, you have no alternative but to do whatever is required to fix it. Only then were Apollos 8, 9 and 10 sent on their way. During the testing and redesign of the spacecraft, three unmanned flights were launched.

## **What effort was necessary to compensate for management mistakes?**

Any program of this size is going to be faced with errors in human judgment. I suspect there are those who would be critical of this management in trying to determine the cause of the fire that killed the three astronauts three years ago. I suggest that circumstance was created by a technical blind spot—because we did not recognize the hazard in having present simultaneously all the conditions that could lead to a catastrophic fire of that type. The three conditions are: *fuel*, and we had materials in the spacecraft that were combustible; *ignition sources*, and any time you have an electrical system inside a machine you have potential ignition sources; and *atmosphere*, that will cause the fire to propagate. If all three of these elements are present, you have a potential fire threat. Actions taken as a consequence of that circumstance have been extremely thorough. The interior of the spacecraft, both the Lunar Module and the Command Module, have been redesigned to rigorously remove flammable material. Wiring has been carefully protected to minimize the possibility of short-circuits, and great care has been taken to protect against over-

loading circuits. Finally, the atmosphere of the spacecraft at launch was changed to be less of an oxidizing agent. We changed the mixture from pure oxygen to 40% nitrogen and 60% oxygen, an environment that is less sensitive to propagating a fire. Also, a very demanding test program was conducted after this redesign: the interior of an actual boilerplate spacecraft was built with materials, wiring, etc., to duplicate the flight unit. By spotting various ignition sources, we set fires in many places throughout the spacecraft to determine if, in fact, they would propagate.

Resolution of this problem cost us time between January, 1967, and October, 1968.

## **Is it ever possible to correct minor mistakes before they become public knowledge?**

The policy of the spaceflight program has been one of complete exposure, not only nationally, but to the world. That's a very powerful incentive for those of us who are involved in turning out these programs to be extremely careful, and critical, and to do everything that's reasonably within our power to make every flight a success. Our "power" takes the form of a very complete and extensive ground test program.

## **How else do you motivate your people to maintain the program's generally high reliability?**

We have to accomplish with our ground test programs what airplane developments normally do by building 20 or more vehicles before stabilizing on a configuration that will do the job.

We just don't fly that much. So to insure to the best of our ability that when we do fly we are going to fly right, we use a very thorough disciplined approach to design fabrication and quality control and pay infinite attention to details. Every single anomaly that's identified in the processing of equipment on the ground, and every one that's identified in flight, is carefully examined and carefully reviewed, and, where necessary, corrective action is taken.

A tremendous effort is made to

train people to be aware. If a guy screws a nut on a bolt up tight, and he feels the thing yield though it doesn't fall off, it's an indication that there's a weakness and he should tell us about it.

## **What was the most consistently nagging problem in the management of this project?**

It's hard to single out any specific problem. I think the most unique aspect of the program is its size. There have been a number of programs in this country requiring the geographic dispersion of project manufacturing plants, but I doubt if there has been a program in the history of the world where so many different communities and companies and organizations have had a role to play. At the peak of the Apollo program we had about 400,000 people and 20,000 corporations involved in preparation of the moon shot. If I had to worry about something, I would probably worry about the magnitude of the organization and the resources that have to be directed in this ambitious project.

## **How would you compare the management of Apollo with, say, the direction of the invasion of Normandy during World War II?**

If you compare the momentum required of each project, certainly eight years is a long time to maintain momentum with a space program. When you're dealing with a single objective invasion, the length of the initial activity is relatively short, although the planning that went into it goes back many, many months.

## **What are the prerequisites for a job like yours and General Phillips?**

The general has successfully managed the Minuteman Program, so has already had experience in running this kind of program. He and I are both electrical engineers, but my background is industrial rather than military. Before I left the Boeing Company I served as Chief Engineer of the Lunar Orbiter Program and many of the problems I encountered in carrying through the completion of that

# The little things that count.

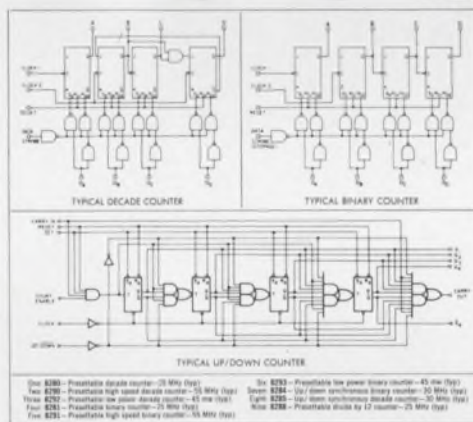

The magic number is nine.

Because that's how many MSI counters we make at Signetics—more than anybody else. Which lets you choose exactly the counter that's right for you. (No more buying too much. Or, worse yet, too little.)

You want high-speed counters? We've got 'em. Medium- or low-power counters? Take your choice. Binary, decade, divide-by-12 modes?

Just say the magic word. And all are

available in either flat packs or DIP's.

In short: each Signetics counter gives you more complex magic, dollar for dollar, than any other counters in the industry.

And, when you get right down to it, isn't that the one thing that really counts?

P.S. Coming to WESCON? Look us up in Unit F, and we'll tell you about a number of these numbers. Or write for specs on the whole line. We'll rush them to you.

Count on it.

More complex magic from

# Signetics

Signetics Corporation / 811 E. Arques Ave., Sunnyvale, Calif. 94086 / A subsidiary of Corning Glass Works

INFORMATION RETRIEVAL NUMBER 20



program were directly applicable to the Apollo Program.

### How did NASA compensate for the variation in the yearly budgets allotted by Congress?

I think you're referring to the fact that the NASA budget peaked out in 1966 and 1967 and has been somewhat reduced in the last couple of years. The Apollo pro-

gram, however, is carried in the NASA authorization bill as a line item.

### What does the future hold for the Apollo program?

The Apollo 12 vehicle is on pad 39 for a September launch. The elements of Apollo 13 are being delivered to Cape Kennedy on a schedule that would support a

third attempt for a successful moon landing and return in November. Equipment, hardware and personnel and crew are in a high state of readiness to support these remaining two attempts this year. I have every confidence that we will meet our objectives.

There have been 6 Mercury, 10 Gemini, and 5 Apollo flights. Apollo 11 was our 21st manned space flight. You might say we've come of age. ■■

## Anatomy of a failure, with a happy ending

There were several small mishaps in the Apollo program as it emerged from development, any one of which, if left unresolved, might have led to the downfall of the entire program. Following is a short case history of one of these incidents:

On April 4, 1968, during the launching of Apollo 6, pieces of the spacecraft's lunar module adapter shell, which houses the lunar module at launching, broke away 2 minutes and 13 seconds after blastoff.

This unforeseen development, the earlier Apollo fire tragedy and cuts in NASA's 1968 budget, limiting the number of Saturn, Apollo test flights, threatened to disrupt the space schedule.

On June 14, 1968, Wyle Laboratories of El Segundo, Calif., received a \$3.2-million contract from North American Rockwell Corp. to perform static and dynamic tests on the "short stack" portion of the Saturn/Apollo vehicle. This assembly stands 60 feet high, is 22 feet in diameter and weighs close to 22 tons.

It includes the Apollo service module and the spacecraft lunar module adapter; the lunar module; the Saturn instrument unit and the Saturn S-IVB third-stage forward skirt.

Wyle's job was to verify the structural integrity of the assembly under simulated lift-off, at first-stage boost and at first-stage separation.

Identifying the cause of the Saturn malfunction and finding a solution called for a test pro-

gram that ordinarily would have required at least a year to complete. Wyle's contract specified a four-month deadline—90 days for testing to begin and 30 more days to complete it. NASA insisted on this tight schedule so that any modifications required on the Saturn vehicle could be made before the Apollo 8 circum-lunar mission.

The problem of assembling a vehicle of this size at Wyle Laboratories' testing facility in Huntsville, Ala., was huge.

The assembly was done in large concrete pits that resembled fore-shortened missile silos bristling with test structures and instrumentation, all connected to a computer complex.

By Sept. 15, 1968, the instrumentation and data system were installed and testing began. These tests, according to Wyle, were unique in that none previously conducted in the laboratory had simultaneously applied as many different types of loadings for such a large vehicle. The complex structure was subjected to 72 controlled environmental or mechanical conditions, and in each test condition 2000 channels of data were simultaneously checked and read out by Wyle's CDC 3300 computer. Only five years earlier 60 channels had been considered a sophisticated test setup.

These tests simulated the worst conditions expected during an Apollo flight. They included acceleration loads, aerodynamic loads, heating conditions and

side loads that simulated launch-site winds and engine gimballing.

The magnitude of the technological and management tasks according to Wyle is illustrated by the following:

- A data acquisition system that was designed to handle high-speed dynamic data in the range from 20 cycles to 2 kHz had to be converted to a system that accepted 2000 channels—in the range from dc to 10 cycles.

- Sixteen hundred transducers had to be wired to the test setup with a quarter million feet of special transducer cable. Wyle purchasing agents bought every foot available in the United States.

- On-line computer techniques were developed that permitted "instant readout" for the 2000 channels of data. This permitted a test of the stack to be completed and another to proceed within three to five minutes.

- Simulation of aerodynamic heating called for 5 million watts of power, requiring Huntsville Utilities Co. to set poles and string cable swiftly to Wyle-Huntsville and to install the associated transformers, switches and circuit breakers.

On Oct. 7, the tests were concluded. The results confirmed the structural integrity of the short stack. The malfunction was attributed to longitudinal oscillations in the Saturn V stage caused by structural deficiency.

The first stage was subsequently strengthened.



and now...  
**UNITRODE**  
 invents the 12 amp  
**UCR—**  
 the industry's first  
 fused-in-glass SCR.

It has so many superior features it  
 deserves to be called "something else".

- Ideal for pulse modulator applications
- Smallest medium-power SCR
- Efficient switching of high pulse currents
- Peak repetitive pulse current 150A in high frequency modulators
- Anode voltage 100 to 600V
- Low forward voltage drop
- Forward current 12A
- Peak gate current 100A
- 3.5°C/watt thermal impedance

TAKE A LOOK AT THE WAY IT'S BUILT

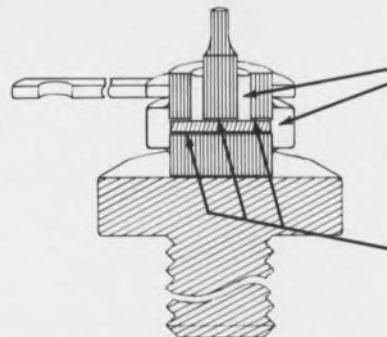

Two fused-in-glass seals melted, wetted and fused to both silicon and metal surfaces permanently protecting and stabilizing the SCR die in a voidless Unitrode package.

Thermal coefficients of glass, pins, and silicon are matched to withstand extremes in temperature shock and cycling.

True metallurgical bonds from terminal pins to the silicon provide rapid heat transfer and high current capability.

580 Pleasant Street, Watertown, Mass. 02172 (617) 926-0404

**UNITRODE**



Check off the reply card now for a really comprehensive set of specs, charts, graphs, and curves. Or if you want really fast service, call John McCusker collect at (617) 926-0404.

INFORMATION RETRIEVAL NUMBER 21



# The indispen

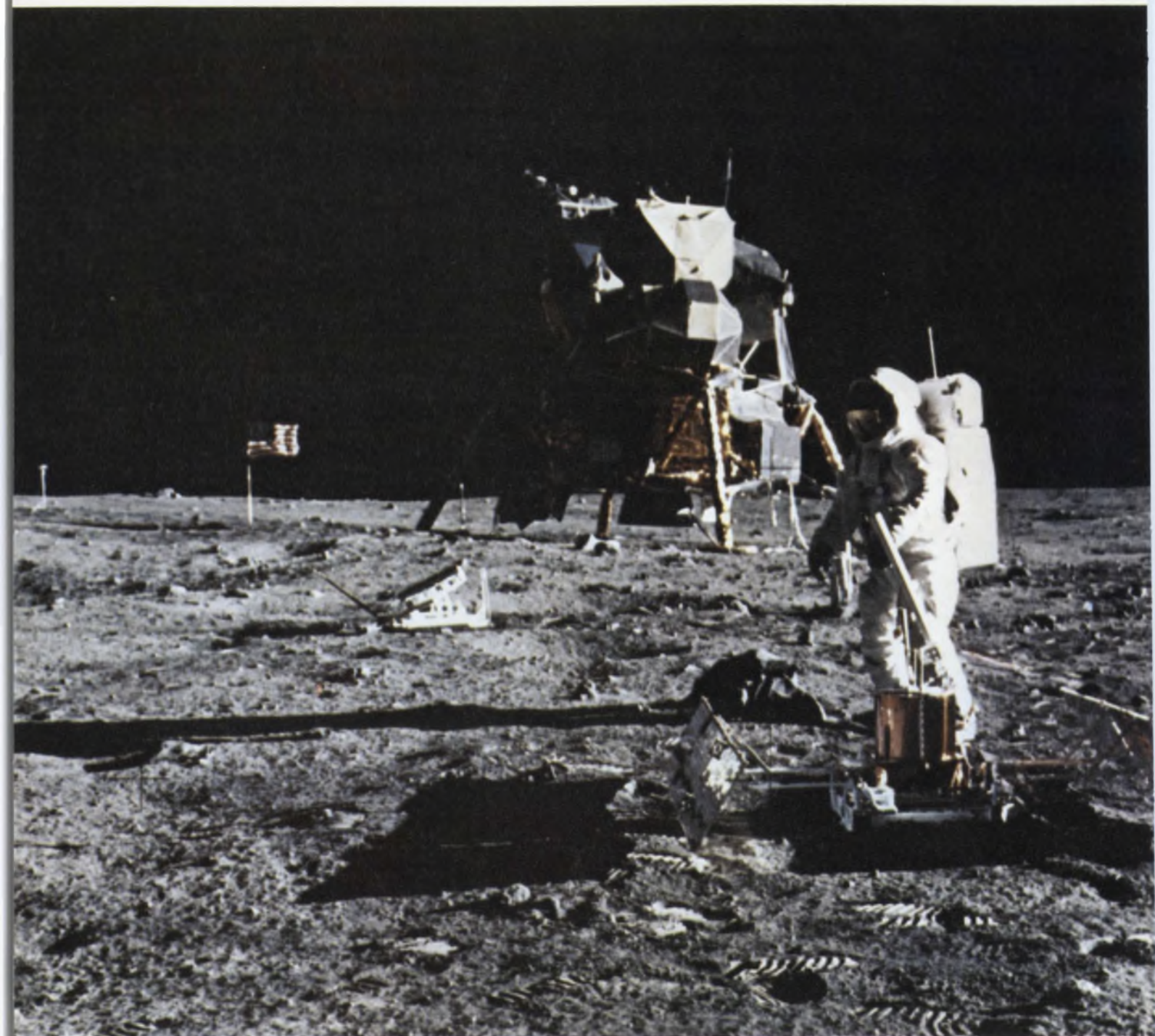



# sable men

**David N. Kaye**  
West Coast Editor

Isn't it preferable to send instruments instead of men into space to gather data and samples and to transmit them to earth?

Dr. Wernher von Braun, director of the Marshall Space Flight Center in Huntsville, Ala., answers the question this way: "Well, back in the 15th century Columbus and his men could have stayed at home, waiting until European science and technology could build unmanned ships to cross the Atlantic. These robots could then have scooped up a handful of sand and transmitted photographs of the Americas. But history would have been different."

When asked the same question, Lt. Col. Michael Collins, pilot of the Apollo 11 spacecraft, also referred to Columbus, a hero to most of the astronauts. "Scrap the manned exploration mission in favor of placing instrument packages on the moon?" he repeated. "That would be the same as Columbus sailing to within 60 miles of the Florida coast and deciding to turn around and go home."

## Man's role in the loop

With few exceptions, the consensus of scientists interviewed by *ELECTRONIC DESIGN* was that man must always be in the loop in space, in one capacity or another.

The most important contribution that man can make to space travel today is his judgment. That was the opinion of Dr. William Picker-

ing, director of the Jet Propulsion Laboratory in Pasadena, Calif. A dramatic example of this came on the Apollo 11 flight when Neil Armstrong seized the manual controls of the lunar module to avoid a boulder-strewn crater and bring the spacecraft to a safe landing on a smooth plain of the moon.

Another contribution is man's ability to evaluate data at the source, said an Air Force officer high in the manned space flight program. In the case of an unmanned system, "bringing it all down" for examination would pose quite a transmission problem.

Still another contribution is man's ability to increase the reliability of a space system by performing maintenance, the Air Force officer pointed out. "We wouldn't have put a LEM on the moon if man hadn't been able to override that gyration Apollo 9 went through," he noted.

And all of these advantages of man in space pertain to the present. In the future, space stations, colonies, travel to the outer planets and military command posts have all been suggested.

"Whether the vehicle is manned or unmanned, man fits into the loop," said Dr. Pickering. "If the vehicle is unmanned, man is on the ground directing it or has the capacity to give it a certain number of commands."

## Manned-unmanned mix

As to proportion of control: "I believe that the optimum is a manned-unmanned mix," said Dr.

**Seismic experiment package is deployed** by Edwin Aldrin Jr. Already in place at left center is the laser reflector. To the left of it is the American flag and, far left, the lunar surface TV camera.



Krafft A. Ehricke, chief scientist for advanced programs, North American Rockwell Corp. Space Div. in Downey, Calif.

Dr. Ehricke went on to say that although the proportions of the mix will vary as the technology progresses, man will always have a place in it.

There are those, on the other hand, who argue that exploration can be better accomplished unmanned. Dr. Bruce C. Murray of the California Institute of Technology in Pasadena, Calif., strongly supports this view. He said:

"If one takes any particular function and sets out to do it, he can pretty well arrive at the fact that it's cheaper to do it unmanned than manned. Often you can do it better. For example, in making astronomical measurements from orbit, man interferes. He interferes with the stabilization system. If you want to get a second of arc accuracy in pointing, having a man aboard is a very serious problem. He moves around, and his heartbeat causes problems."

### Man's judgment useful

Dr. Pickering countered: "Man's judgment in making observations allows him to take advantage of targets of opportunity which would be missed if he weren't there on the spot. Take the example of an unmanned Surveyor sitting on the moon. The television camera can report to earth that there is a rock that looks interesting. But a man accompanying the same Surveyor could say: 'That rock isn't very interesting, but there is one over here, just out of sight, which looks very interesting. Let's go over and get that one.' Man adds the dimension of performing functions which were unanticipated."

### Steps in outer space

What of the future, now that the U.S. has opted for putting astronauts in the loop?

"Whenever you go into a new environment, there are three basic steps," Dr. Ehricke said. "They are *exploration, occupation and utilization.*

"The exploration is the investment. In other words, you find out what is there and what are the

conditions of the environment. After you have found out what it is all about, you have to go into the occupation phase.

"That means you have to assure yourself of a good foothold; that you can exist there, work there and you can get there and back. Access and residence are the two major objectives of the occupation phase.

"The final phase is when you finally start to utilize the new environment on a practical basis."

The next step in this nation's moon program is the occupation phase. NASA plans to establish space stations and to develop residence and good access capabilities.

To advance into the utilization phase, Dr. Ehricke said, we must answer two questions: Are there useful resources in space? If the answer is yes, then is man needed to tap them?

"The answer to question one is definitely yes," Dr. Ehricke said, "Space is useful in three respects primarily:

"1. *Information transmission.* We are using this already with communication satellites. We will expand this into education from orbit. For example, I can see a portion of our foreign aid being instructions to farmers in lesser developed countries on how to improve their crops.

"2. *Information acquisition.* This refers to observing and taking inventory of our planet. Earth can be thought of as a spaceship. In order to operate our ship properly, we must have proper status reports. There must be a global inventory of our resources.

"3. *Value generation.* Processing the environment of space, for example, could include focusing light and beaming it down at certain territories. Rescue operations could go on around the clock. Certain areas of cities could be illuminated to fight crime at night. That would be processing a natural environment, like sunlight, from space. And that gets us into processing other materials utilizing the environment.

"Weightlessness and vacuum are two very important factors that can be used. I would like to expand on this by saying that space offers the ability to choose your own g level. Weightlessness is just one

extreme. Space offers the possibility of extreme weights that can't be produced on the earth. This is due to the fact that centrifuges in space don't have to deal with air drag. Certain alloys can be formed at 10,000 g's. The technique on the earth is called explosive forming, since these g levels can only be provided momentarily rather than for long periods of time as in space."

Yes, Dr. Ehricke affirmed, wherever judgment, intelligence and rapid responsiveness to unforeseen situations are necessary, man must be in the loop. He fits into all three steps in the space program: exploration, occupation and utilization.

"His place in exploration is with reconnaissance flights," Dr. Ehricke summed up, "but only after unmanned probes. Man really comes into his own in the occupational phase."

Support for this position is widespread, even outside the scientific community.

Col. John H. Glenn, the first American astronaut to circle the globe and now the president of Royal Crown Cola International in New York City, told ELECTRONIC DESIGN in an interview:

"Up to now, most of the effort in the space program has been concerned with trying to define man's role—what he can do best and what he can't do—and developing the transportation system for him to use.

"I think that the next major thrust in space will be utilizing this transportation system, which we have spent over \$20-billion to develop, to get a maximum scientific return from it. We should get as much information as we can: earth resources, and earth orbiting laboratory and new techniques to utilize the weightlessness in space in manufacturing."

Dr. Issac Asimov, professor at Boston University and a writer of science fiction, said: "Men are curious. Men want to go. To not go would ruin the whole thing psychologically.

"A self-supporting colony on the moon is the most important possibility of all. It will establish a psychological frontier once again. The earth has largely vanished as a frontier." ■■





Edwin Aldrin Jr. walking at Tranquility Base, as photographed by Astronaut Neil Armstrong. The lunar module, TV camera, experimental equipment and Armstrong are reflected in Aldrin's gold visor.



# Apollo's success rubs off on earth

Elizabeth deAtley,  
West Coast Editor

Winning the "race" to the moon has cost this country billions. Is it all money down a lunar crater now that the feat has been proved feasible?

Not at all, says NASA. Aside from the breakthrough in scientific research, more than 2500 significant technological advances in the American economy are directly attributable to the space program. "Cross-fertilization" and spinoffs from the national space effort have produced improvements in everything from paints, materials and medicine to communications, computers and television, the space agency says.

Among major electronics industry advances are these:

- The Carousel IV inertial guidance system that has been installed on the new Boeing 747 jumbo jets is based on the same principles as the onboard Apollo system (see "\$1 million for 747 Superjet Electronics," ED 15, July 19, 1969, p. 28). The two were developed in parallel.

Engineers are applying software techniques they learned in developing the inertial systems to the computer control of everything from rush-hour traffic to shifts in the economy.

- TV display techniques used to simulate the rendezvous of the Apollo Lunar Module and Command Module are being used in highway safety research and computer-generated movies.

- Disc-recording techniques used to convert color TV pictures from the moon for commercial telecasting are similar to techniques now

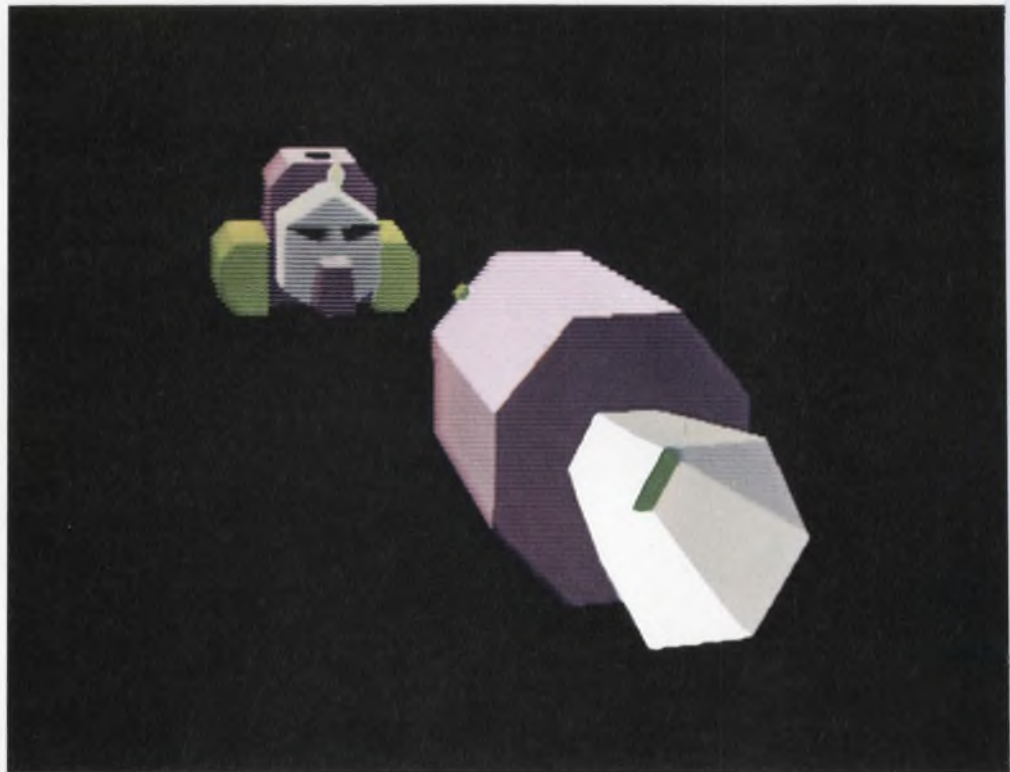

**Computer-generated TV display** shows a simulated docking of a lunar module and command module. By manipulation of a control stick, the objects can be shifted to any position.

being used in X-ray television photography for "stopping" the X-rays at a critical moment. The same technique is being applied to the transmission of graphic displays over telephone lines.

## Inertial guidance for planes

Present jetliners use radio or radar systems to navigate. Over the ocean, star sightings by a crew navigator may be used. On the Boeing 747 jetliners that are coming into service, the pilot feeds his takeoff point and destination into

the Carousel IV inertial guidance system; the system's computer calculates the shortest course to fly. Enroute the pilot has a continuous display of longitude and latitude, true heading, wind direction and speed, ground track and speed, and time and distance to destination.

When connected to the autopilot, Carousel IV steers the plane, while the pilot monitors flight progress on the continuously updated control and display unit. On a recent test flight, the guidance system flew the aircraft automatically across

the Atlantic from Canada to the English coast.

Pan American World Airways says its test flights show the Carousel to be five times more accurate than present forms of navigation. It hopes the improved long-range accuracy will allow ocean air corridors to be narrowed so that twice as many planes can fly in the same airspace. Now planes must stay within assigned corridors over the North Atlantic—corridors fixed by international agreement at 120 miles wide in areas where traffic is heavy. With inertial guidance in general use, airline officials estimate that it would be safe to narrow the lanes to about 60 miles.

The Carousel navigation system includes an inertial reference unit—a stable platform—a digital computer, electronic and heat-control elements, and a power supply. Complete with a case and mounted in the aircraft, the system weighs some 50 pounds. It is less than one cubic foot in volume—smaller than an office file drawer. Federal Aviation Administration regulations specify that each aircraft must have three of these units for redundancy.

The Apollo guidance and control system is far more complex than Carousel IV, but the basic principle is the same. Both systems have an inertial platform. In the Apollo system, the platform is held fixed in space, regardless of vehicle motion, whereas in the Carousel it is held perpendicular to the earth's surface by rotation at a fixed rate. Both systems have a computer that calculates the trajectory in "inertial space"—that is, in the coordinate system determined by the inertial platform.

### New software techniques

The ability of a small space or airborne computer to perform complex trajectory calculations stems from new software techniques developed for the space program, says Harlan Neuville, group head of engineering systems for the Apollo program, AC Electronics Div., General Motors Corp., Milwaukee. In the older technique of processing trajectory data—called least-square fitting—all the velocity/position readings were retained over a

period of time in the computer memory. For each new reading, the computer recalculated the average trajectory by performing the software analog of drawing a smooth curve through all the readings plotted on a graph.

This technique requires too much memory to be practical for a space computer, says Neuville. "After all, you can't very well send a whole IBM complex to the moon." The technique used in airborne space computers, he says, is based on programming a computer to evaluate data statistically as it is received.

"We make a mathematical model of the Apollo and use all the information from simulated flights, as well as from previous real flights, to update the model," he explains. "In this mathematical model, we put data on the statistical accuracy of every measuring device that will give information to the computer, as well as the statistical accuracy with which each astronaut makes measurements. The computer continuously calculates the estimated trajectory of the spacecraft, updating it as new measurements come in. It weighs every measurement it receives according to the statistical information preprogrammed in its memory. Based on this information, it may choose to accept, modify or even reject a measurement, if necessary. In this way the computer only needs to remember a specific position and velocity for a short increment of time, rather than for the duration of the flight, as with least-square fitting. So it doesn't need a huge storage capability."

The same technique of statistical analysis and mathematical modeling, Neuville points out, can be applied to control or monitor any complex process that can be modeled. "You can take measurements from which you derive a model that lets you predict what can happen," he notes.

Traffic control is an obvious application. "You can measure the traffic rate through a certain tunnel at different times and make a mathematical model of it," Neuville says. Then, based on this model, you can set up traffic lights that will allow just enough traffic in the tunnel so that everybody gets home as quickly as possible. Somebody may have to sit on

the ramp for 20 minutes, but if you let him go ahead immediately, it would take him a lot longer than that because of the congestion in the tunnel."

### Simulating the unknown

One of the biggest developments in the Apollo program has been simulation techniques, says Gordon Heffron, manager of the Guidance and Navigation Dept. of Bellcom, Inc., a part of the Bell System that performs systems analysis and study, planning and technical support for NASA and the Bell System. Heffron says computer simulations are used to check out every part of the Apollo system.

For example, in checking out the onboard computer, not only is the computer itself simulated, but also its program, the measurements it receives and even the world outside the spacecraft. To simulate what the program calls the "actual world," Heffron says, "we set aside one part of the computer program as the actual world, and we assume that the information it contains is perfectly correct, whereas the information in the rest of the program is off by some amount. For example, we don't know the gravitational attraction of the earth to better than about 1 part in  $10^5$ , so we make it bigger by that amount in the actual-world model than in the rest of the program. We also put some atmospheric drag in the actual-world model."

Although the idea of simulating one computer on another is not brand new to Apollo, Heffron says, "we certainly demonstrated that it was feasible to do this on a very high level of complexity." He believes that simulation techniques will be used in many different areas of computer control in the next few years. In addition to rush-hour traffic simulations, which he says most major cities will be using in the next five years, he sees the measurement of the national economy as a big application area.

"I think we have finally reached the stage in our ability to simulate where probably we will be able to find out how to control our economy better," Heffron says, "and I know there is going to be a big push toward this over the next 10 years."



A powerful tool for generating TV displays by computer and moving them about on the screen has been developed by the General Electric Co.'s Electronics Laboratory in Syracuse, N.Y. In a system built for the Guidance and Control Div. of the Manned Spacecraft Center, Houston, a picture of an object, such as the Lunar Module or a simulated lunar surface, can be projected onto a screen in front of the observer. By manipulating a control stick, he can, in effect, enter the scene and move around in it. On his screen, he can observe the object from any angle and at any distance, in effect moving himself toward or away from the object at an apparent speed that he controls with the stick.

The scenes are produced by computer. The system contains no mockup models or cameras. Instead, a description of the various objects to be displayed are fed into the computer in the form of numbers. These numbers define the shape, color and size of each object. The observer can call up any object in the computer's memory. As he moves his control stick, the system continuously recomputes the appearance of the displayed object from the angle and distance that correspond to the instantaneous position of his stick.

### NASA's 3-display system

The Apollo system, called the NASA Electronic Scene Generator, has three displays. It can be set up so that an observer at one display may see, for example, the Lunar Module on his screen, while a second observer at another display acts the part of the astronaut who guides the Lunar Module. The second observer sees the Command and Service Module and moves himself relative to it. Each observer sees not only the effects of his own motion relative to the other spacecraft, but also the movements made by the other observer. In addition an observer at a third display can see both spacecraft and control his own motions with respect to the two others.

William Miller, manager of the Simulator Guidance Development and Applications, Guidance and Control Div., Manned Spacecraft Center, says the displays are used

mainly to check out system performance. For example, the equipment was used in the development of the guidance and control systems.

"The scene generation equipment," he explains, "is tied in with special 'problem' computers that are programmed to simulate the behavior of systems you want to check out. Sitting in a mockup of the spacecraft, the engineer or astronaut can manipulate controls that are connected to the problem computers, causing the display to respond as if he were looking out the window of the spacecraft in flight. What he sees in the display can either be a simulated lunar surface, if he is doing a landing study, or another space vehicle if he is doing a docking or rendezvous simulation."

Most scene generators use a TV camera, which moves relative to a mockup real object. The mathematically modeled display has many advantages, according to Rodney S. Rougelot, manager of visual simulation at GE. For example:

- Mathematically formed images are always in focus.

- The observer can maneuver within his simulated environment with complete dynamic freedom. This capability allows an architect, for example, to inspect the interior of a house, or the driver of a car to pass beneath an overpass.

- Objects in the environment can freely move. Because they are simply numbers, one need not support them with gimbals or tracks.

In the NASA Electronic Scene Generator, the displays are 21-inch color monitors built originally for commercial TV at 525 lines per frame. These monitors have been improved, however, to allow display of a 600-line by 600-element TV raster. The equipment that drives the display monitors consists of two special-purpose digital computing units, controlled by a modified Raytheon 520 general-purpose computer.

The system creates TV images by computing them fast enough to keep up with the TV scanning rate. Consequently the computing units have a large logic capability—85,000 logic gates—but a relatively small memory—6000 30-bit words and 4000 24-bit words of magnetic core memory. The objects

to be shown in the image are stored as coded numbers in the memory, and the computing units reconstruct them in TV form as they are being displayed.

The computing units produce images at a rate of 20 frames per second—fast enough so that there is no flicker—and a scene can be represented by as many as 240 straight edges.

### Applications for highway safety

Since the NASA system was built, says Rougelot, GE has developed a technique for generating up to 1500 straight edges per image at a rate of 30 per second. Such an expanded capability is useful for many purposes, he says.

"For example, according to a study we have just completed for the U.S. Department of Transportation through UCLA, it could be used for highway safety research," he notes. "The user could drive along a simulated highway and look for problem areas—such as dangerous intersections or sudden curves—as they appear on the screen.

"We have also proven the feasibility of making realtime changes in a complex display. Suppose, for example, that you have designed a highway and have simulated it in the computer. In a realtime system, you could make changes as you drove along. One obvious way to implement such a system would be to store in computer memory a catalog of precomputed items, like bridges, signs, overpasses, underpasses, etc. By touching the display with a light pen and perhaps pushing a button, you could call up one of these items and place it where you wanted it. Then, by pressing some more buttons, you could change its color and perhaps its scale."

This interactive capability requires very sophisticated software, Rougelot points out, "but it is definitely feasible."

In the Apollo TV built by Westinghouse, Baltimore, the color signals that arrive from the moon in serial form are stored on a disc recorder at Houston and played back in parallel for retransmission over commercial network channels. Essentially the same technique is being used in other fields—for ex-



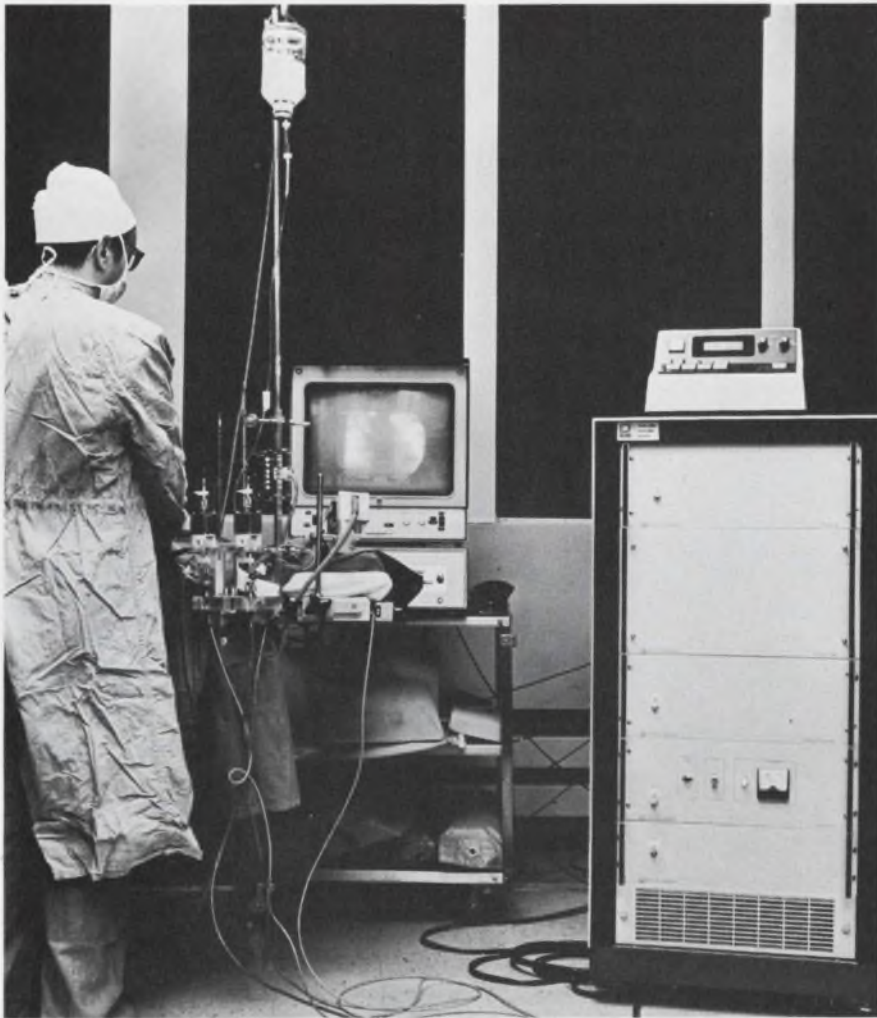

**Video disc recording system (right)**, developed by Data Disc Corp., is connected to standard X-ray equipment at Stanford University Medical Center in Palo Alto, Calif. The X-ray motion pictures are recorded and played back at slow speed for the physician.

ample, in stop-action X-ray photography and the transmission of high-resolution images over telephone lines.

The technique is simple in concept. The video signal is recorded on a disc, one frame or field per track, and played back in such a way as to obtain some desired effect. For example, in stop-action TV, a single track (or TV frame) is played back continuously to a TV monitor, causing it to scan the same frame repeatedly.

The Apollo camera—to hold size and weight to a minimum—contains a single tube instead of three (one each for red, blue and green light), as is standard in color TV cameras. Before the light enters this tube, it passes through a rotating wheel that is divided into red, blue and green segments. The wheel rotates at a speed that allows an entire scene to be scanned in each color. Thus the resulting

video signal consists of red, blue and green fields transmitted serially. On the ground, a video switch sorts out the fields, so that each is recorded on a separate disc track. The tracks are then read out in parallel to the commercial TV color encoder, just like the output of a standard three-gun color camera.

Stanley Lebar, program manager for the Apollo camera at Westinghouse, says disc storage is the only medium possible for this application. "We need many channels at a time," he points out, "and it is very difficult to get more than one high-level video channel onto tape because of the wide bandwidth required per channel."

The total weight of the Apollo camera is less than 14 pounds. Its single tube is a very low-light-level vidicon of the type used in Vietnam for taking nighttime pictures. According to Lebar, the camera, without the color wheel, will take

pictures at illuminations down to  $10^{-3}$  foot-candles. "This is about the illumination you get on earth from a quarter moon," he explains. "But to take pictures in color, you need the color wheel, and that filters out the light. So you need about 1 foot candle illumination."

### Medical applications predicted

Data Disc of Palo Alto, Calif., the company that built the disc storage converter used with the Apollo camera, has recently announced a new system for recording X-ray moving pictures. This system has several possible medical applications, according to Dr. Lou Wechsler, head of the Radiological Dept. at Stanford University Medical Center, Palo Alto. Its primary application, he says, is in recording X-rays of the heart during a cardiac catheterization.

"This is a minor surgical operation," he explains. "We run a catheter into the heart and inject a material that contains iodine through the catheter, so that the particular area of the heart we want to see will show up in an X-ray. We put a fluoroscopic device over the patient's chest to see the heart. The iodine only remains visible for 4 to 10 seconds—too fast for us to see what is going on in real time—so we take motion pictures at a rapid frame rate—50 to 80 frames per second—and play them back at slow speed."

Dr. Wechsler points out that ordinarily "you can't be sure you have gotten the area you wanted in the pictures until you develop them—and that takes at least a half hour, assuming you have a dark room in the hospital."

"You can't let your patient lie there with a catheter in his heart for a half hour or more while the X-rays are being developed," he points out. "On the other hand, you hardly want to remove the catheters, send him home, and risk having to repeat the whole operation if you didn't get what you wanted the first time."

This problem—and others like it—can be solved, Dr. Wechsler says, by storing the sequence on a video disc and playing it back immediately. ■■







# We make components for guys who can't stand failures.

We make our capacitors and resistors to perform like 40 million people were watching in on the count down.

And we build an extra measure of performance into all of them, to let you make sure your equipment delivers all you designed into it. Because like you and the guys who use your equipment, we can't stand failures either.

Take our glass capacitors, for instance. There's only one reason why they've been designed into the Surveyor, Minuteman, Gemini, Apollo, Saturn, Titan, Syncom, Sparrow, Hawk, and a number of other major aerospace and missile projects. With our glass capacitors, circuit designers could get the proven stability and reliability that these important systems demanded. U.S. Air Force tests have established that our glass capacitors have much better stability and much higher insulation resistance than ceramic and mica capacitors can deliver.

And take our precision tin oxide resistors. They're the best of the metal film class. Because the resistive tin film is completely oxidized and

molecularly bonded to the glass substrate, our tin oxide resistors are impervious to moisture and environmental degradation. No other resistor can deliver the same stability and reliability over load life. They offer guaranteed moisture resistance across all ohmic values to set a standard of reliability that can't be matched by metal film, wire wounds, carbon comps or metal glaze resistors. After a 56-day-long heat test in an environment of extremely high humidity, our tin oxide resistors showed a resistance change of just 0.2 per cent. And in an ambient temperature test—now in its ninth year—not one of the 600 tin oxide resistors being tested has exceeded a resistance change of 1.5 per cent.

But don't only think of Corning for aerospace and other precision applications. We've got something to offer when economy and value are the prime considerations. At Corning we've been active in improving these important capacitor and resistor characteristics, too.

We've developed the Glass-K™ capacitor to give you the volumetric efficiency and economy of mono-

lithic ceramic capacitors, but with the much improved stability and reliability that only a glass dielectric can add.

In resistors, our tin oxide resistors already offer long term economy over metal film, precision wire wound and metal glaze resistors. And our new C3 resistors, in addition to giving you a small case size, compete costwise with carbon comps.

At Corning we make components for guys who can't stand failures. Guys like your most important customers. Guys like you. So, next time you're designing a system, reach for your CORNING® capacitor and resistor catalogs and call your local Corning authorized distributor for off-the-shelf delivery. They'll help you design-in that extra measure of performance.

If you don't have our catalogs, ask your Corning distributor for copies or drop us a line at: Corning Glass Works, Electronic Products Division, Corning, New York 14830.

**CORNING**  
ELECTRONICS

INFORMATION RETRIEVAL NUMBER 22



# What's the best Monolithic Chip Capacitor?

Centralab Mono-Kap\*



CENTRALAB MONO-KAP

## See for yourself.

ACTUAL MICROGRAPHS OF RANDOMLY SELECTED MONOLITHIC CHIP CAPACITORS.

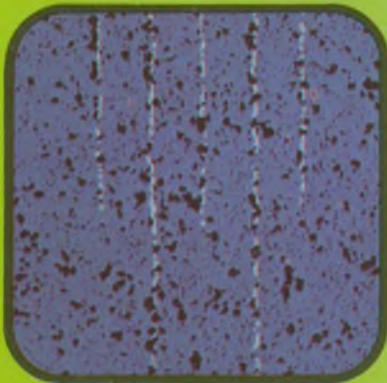

COMPETITOR A

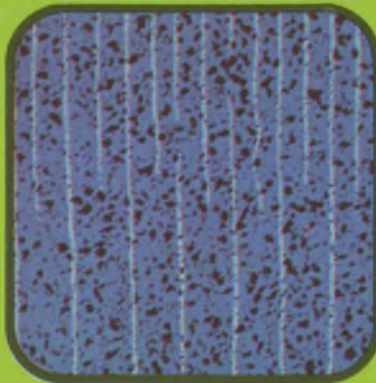

COMPETITOR B

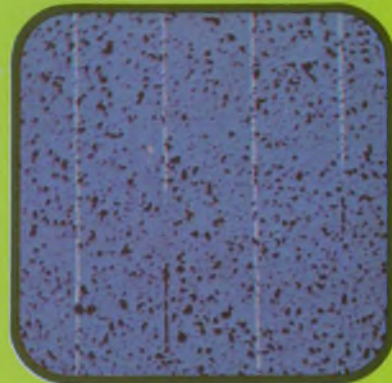

COMPETITOR C

The superiority of Centralab Mono-Kap chips is clearly visible . . . pin holes that destroy reliability and long life are virtually eliminated. The beauty and superiority of these new monolithic chip capacitors is much more than skin deep, too. Centralab is alone in testing 100% for flash, insulation resistance, dissipation factor and capacitance. We also manufacture our own ceramics, thick film microcircuits and a broad line of capacitors. As a designer of microcircuits, Centralab developed the Mono-Kap to increase the scope of

circuits we could manufacture. Centralab's Mono-Kaps have been tried and proven in a wide variety of industrial and military microcircuits. We have a wide variety of materials, physical sizes and capacitance values, all priced competitively and delivered in as little as four weeks. If seeing is believing, and you'd like a closer look, call on your local Centralab Representative for samples and product data. Have requirements for encapsulated Mono-Kaps with terminations? Send your specifications to Centralab, Application Engineering Dept.



**CENTRALAB**

Electronics Division

GLOBE-UNION INC.

5757 NORTH GREEN BAY AVENUE  
MILWAUKEE, WISCONSIN 53201

\*TM

M-6919



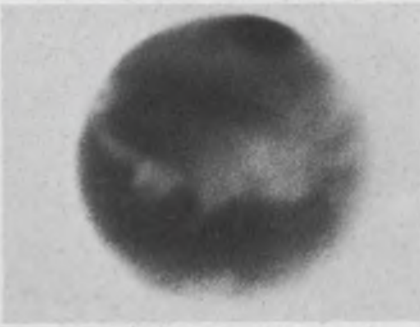

# Washington Report

CHARLES D. LAFOND  
WASHINGTON BUREAU

## Today the moon, tomorrow . . . . ?

With the nation and its leaders still in the full flush of a spectacular moon landing and return, the question on many lips is: "Where do we go from here?" Many believe that the first hint of a future manned Mars probe has been made by the Nixon Administration. On July 16 at the Kennedy Space Center, just after the launch of Apollo 11, Vice President Agnew stated that he didn't want to see the "wonderful team" assembled in this program dispersed "because someone was too short-sighted to provide enough of the material support to continue with these programs." This view was strongly seconded by NASA's Dr. Wernher von Braun who was also present at the launch.

With each successful accomplishment during the Apollo 11 mission, optimism of key officials increased. President Nixon made several public statements indicating the need to continue this manned adventure with planetary probes and further indicated a possible goal of achieving planetary exploration on a multination basis by the turn of the century.

NASA officials, during Apollo 11's return to earth, were even more exuberant. At a press conference, Dr. George P. Mueller, associate administrator for Manned Space Flight, said: "We are this evening on the way back from the moon after one of the most historic occasions, one of the greatest achievements man has ever carried out." Dr. Robert Gilruth, director of the Manned Spacecraft Center in Houston then said: "This is the way to go to Mars when the time comes." Dr. Mueller, in answer to a question concerning the future declared: "It seems quite clear that the planets of the solar system are well within our ability to explore, both manned and unmanned at the present time."

But, of course, there will be a resistance to an early move for a national commitment to a Mars manned exploration. Dr. Lee DuBridge, the President's science advisor and director of the Executive Space Task Force, has stated his belief that "at least 10 to 15 years" will be needed for unmanned planetary investigation before sending man to Mars.

There is in the industry a real fear that our great space team will indeed suffer during the next few years. Of the \$24 billion roughly committed to the Apollo program, \$22 billion has been spent. There are now only nine more planned lunar missions to complete the Apollo effort by the end of 1972.

Overlapping this is the Apollo Applications Program, several times delayed, which would put a 12-man research station into earth orbit, hopefully by 1972. Also under consideration is a larger 50-man space station to be put into earth orbit by the end of the decade, and the development of a re-usable maneuverable space shuttle to supply it. (North American Rockwell Corp. and McDonnell-Douglas last month were awarded contracts to perform competitive design studies for both orbital stations. But today these efforts are largely on paper.

## Defense profit formula hard to work

"We are going to do this—it's going to happen," says Barry J. Shillito, assistant defense secretary for installations and logistics, referring to proposed Defense Dept. contract guidelines prepared more than 18 months ago but still not implemented.

The proposed guidelines would place more emphasis for allowable profits on the contractor's investment rather than simply on direct costs. Thus, in the new procedure, roughly half of the military contractor's



allowable profit for a given program might be based on a return from his capital investment and the other half on direct costs. The intent is to encourage cost-cutting by contractors and at the same time provide incentive to the firm for investing more of its own money in the program.

The problem, says Shillito, is the complexity inherent in applying the guidelines. Military negotiators must have some clear-cut method of establishing how much of a firm's investment can be allocated to a particular program.

The approach is controversial. As might be expected, electronics and aerospace firms are cool to the idea. Opposition from large diversified industrial firms whose defense business represents only a portion of annual sales have remained expectedly quiet, since they normally have expended heavily in capital investment.

However, some of the largest defense contractors are almost totally supported by government contracts, and their investments are relatively small. The latter have the most to lose by the new guidelines and have been quietly fighting the proposed profit formula behind the scenes.

## Senate cuts could hit electronics

If the military procurement reductions in some major programs are accepted by the Senate, the reaction certainly will be felt throughout the electronics industry.

Last month the Armed Services Committee reported out a \$20.1-billion authorization bill for fiscal 1970, representing a new cutback of \$1 billion. Among those losses the closest to the heart of the electronics industry were complete elimination of a \$75-million request for R&D in the SAM-D ground-to-air defense missile; a reduction of \$25 million in the Navy S3-A antisubmarine warfare aircraft development effort (leaving

\$140 million); a reduction in the airborne warning and control system (AWACS) from \$60 million to only \$16 million; and a cut of nearly \$479 million worth of A-7D and A-7E fighter aircraft. The latter item actually involves a procurement swap; the Air Force lost \$375 million for A-7Ds but got it back to purchase F-4E fighters.

Untouched, but expected to encounter lengthy argument on the Senate floor were the full request of \$345.5 million for the Safeguard ABM, \$758 million for the C-5A transport, and merely \$460 million for the Navy Poseidon-submarine retrofit program. No argument is expected on the full \$239 million for the Navy's F-14A fighter.

## Universities establish space group

The Lunar Science Institute in Houston may soon have new management. The institute, to which NASA has made available its new Lunar Receiving Laboratory—quarantine center for the Apollo 11 astronauts—is now operated by the National Academy of Sciences, but its contract with NASA ends this fall.

Meanwhile, 48 universities have joined together to form a consortium called Universities Space Research Association (USRA). The intent of this organization, says the National Academy of Sciences, is to "foster cooperation among universities, other research organizations and the U.S. government for the advancement of space research."

USRA plans to acquire, build and operate laboratories and other research facilities. It has already proposed to NASA that it be given management responsibility for the Lunar Science Institute.

The institute functions as both a work and study center for scientists associated with any aspect of lunar science, including the current studies of materials carried back from the moon.





# FETs



# TI introduces 8 new ones.

## With some new design ideas, too.

Once again, TI extends your circuit design spectrum with new FET products and design ideas.

Here's a variety of eight new field-effect transistors that can spark ideas for your circuits. We have a brand-new design brochure, too, which contains a score of FET circuits you can use.

### 3N160 and 3N161 MOS FETs

If you're interfacing IC logic, you'll want these new 25-volt MOS FETs. Low threshold voltages of 1.5 to 5 V make them ideal for bridging the gap between MOS and TTL or DTL bipolar circuits.

Low leakage and high input impedance keeps drift to a minimum in operational amplifiers and provides high accuracy in electrometer circuits. Use them too for shift-register circuitry, timers, or proximity detectors.

The 3N161 features a zener-protected gate to guard against static-charge damage.

In 100-piece quantities, the 3N160 is \$4.50 and the 3N161 is \$4.70.

For a data sheet circle reader service card number 145.

### 2N5545-47 Dual FETs

Designing operational, general purpose or differential amplifiers? Try TI's new n-channel FET duals:

2N5545, 2N5546, and 2N5547. In 100-999 piece quantities for \$15, \$9 and \$7.50.

They're tightly matched: 5, 10 and 15 mV max gate-source differential. Temperature drift of the 2N5545, for example, is less than  $10 \mu\text{V}/^\circ\text{C}$  and its output admittance is matched within  $1 \mu\text{mho}$  for superior common-mode rejection.

For a data sheet circle reader service card number 146.

### 2N5549 High-Frequency FET

For designers of low-level choppers, logic switches, multiplexers and RF, IF and VHF amplifiers... there's the new n-channel 2N5549 switching FET. Only \$3.30 in 100-piece quantities.

It gives you high gain and low noise—typically 15dB gain and 3.5dB noise at 100 MHz. For three good reasons: high transconductance—greater than 6,000  $\mu\text{mhos}$ . Low feedback capacitance—2pF max. And low on-resistance— $100 \Omega$  max.

For a data sheet circle reader service card number 147.

### 2N5543, 2N5544 High-Voltage FETs

Want to replace a tube with a transistor? Plug in the new 2N5543 or 2N5544 high-voltage n-channel FET. \$3 and \$2.50 in 100-999 piece quantities.

Use them as one-to-one replacements tubes. In high-voltage switching. Large-signal amplifiers. CRT deflection circuits. And line-operated amplifiers in industrial, communications and home-entertainment equipment.

They have high gate-drain breakdown voltages—300 V (2N5543) or 200 V (2N5544). High transconductance—750  $\mu\text{mho}$  min. And low feedback capacitance—2pF.

For a data sheet circle reader service card number 148.

All eight new FETs are available from authorized TI distributors or TI field sales offices.



"FET Design Ideas" is a must for every circuit design engineer's reference file. It contains: 20 circuit diagrams covering

a wide range of applications. How to bias field-effect transistors. Applications literature available. And short-form data on all of TI's standard FETs.

To get your copy, write direct to Texas Instruments Incorporated, PO Box 5012, MS308, Dallas, Texas 75222. Or just circle reader service card number 149.

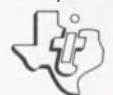

Prices are manufacturer's suggested list; subject to change without notice.

TEXAS INSTRUMENTS  
INCORPORATED



# Intech takes on the Op Amp Boys.

We're a David among Goliaths. And we know it.

So does Philbrick/Nexus, Analog, Burr-Brown, et cetera, et cetera.

They're our competition, and maybe your present Op Amp supplier.

We're out to change that . . . and to give you better FET input op amps.

Here's our story.

We've gotten the best component and design engineering talent the industry had available. We let them have the run of the house.

What they do constantly amazes us.

Like the A-130: a high speed, FET input Op Amp that has a slewing rate of  $600V/\mu s$  (typ) and a settling time to 0.1% of final value in less than  $1\mu s$  in an amplifier with a 6 dB roll-off. The price is almost half of the competition's.

Don't believe us, or our engineers, though. In this business specifications, performance, and price are the considerations. A test is worth a thousand words.

For more information on our operational amplifier line, contact your nearest Intech representative, or call or write us direct. Intech Incorporated, 1220 Coleman Avenue, Santa Clara, California 95050. (408) 244-0500.

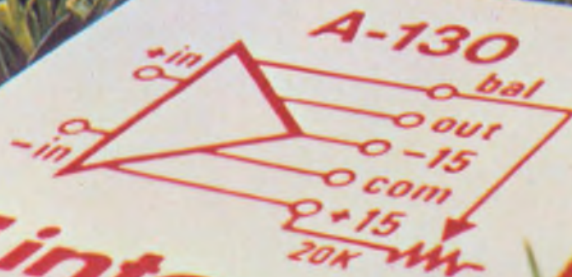

 **intech**





## Here are some of our boys

### REPRESENTATIVES

Washington, Oregon, Idaho, Montana  
British Columbia, Alberta

Arneson Associates, Inc.  
5950 6th Avenue South  
Seattle, Washington 98108  
(206) 762-7664

Arneson Associates, Inc.  
200 N.E. Canyon Road  
Beaverton, Oregon 97005  
(503) 646-3416

California, Nevada  
Measurement Associates  
789 E. El Camino Real  
Sunnyvale, California 94086  
(408) 739-7785

Measurement Associates  
219 West Manchester Boulevard  
Inglewood, California 90309  
(213) 671-7651

Texas, Arkansas, Louisiana, Oklahoma  
Carter Associates  
400 South Forrest Gate  
Garland, Texas 75040  
(214) 276-7151

Alabama, Mississippi, Georgia, Tennessee  
20th Century Marketing, Inc.  
902 Bob Wallace Avenue, S.W.  
Huntsville, Alabama 35801  
(205) 536-1596

Eastern Iowa, Minnesota, Wisconsin,  
Northern Illinois, Indiana  
Gassner & Clark Company  
6644 N. Western Avenue  
Chicago, Illinois 60645  
(312) 764-6121

Massachusetts, Maine, New Hampshire,  
Vermont, Connecticut  
KCA Components Inc.  
7656 Massachusetts Avenue  
Lexington, Massachusetts 02173  
(617) 861-9024

Northern New Jersey, Southern New York,  
Fairfield County, Connecticut  
Salsbury Associates, Inc.  
331 W. John Street  
Hicksville, New York 11801  
(516) 938-1080

Florida  
Conley-May Associates, Inc.  
P.O. Box 668  
Oviedo, Florida 32765  
(305) 365-3283

Conley-May Associates, Inc.  
1010 E. Atlantic Boulevard  
Pompano Beach, Florida 33060  
(305) 943-8284

Conley-May Associates, Inc.  
P.O. Box 13283  
St. Petersburg, Florida 33733  
(813) 822-0161

 intech

# Letters

## How can electronics be wed to education?

Sir:

Re "Classroom Electronics Still in Groping Stage," (ED 1, Jan. 4, 1969, p. 64): I could not agree more. But are there real opportunities here? Perhaps, but it will take much effort to bring them about.

Few, if any, school administrators are technically able to judge the equipment they buy. They are quite willing, however, to hire an educational consultant to help them make decisions. What they end up hiring is another educator who very nearly duplicates their own knowledge, but in addition has acquired some familiarity with hardware, gained largely through observation and use of the equipment.

Underneath this front, the educational consultant very likely cannot distinguish between a microcircuit and a potentiometer! Such mere technical jargon is relegated to the "hardware salesman" who "know such things." Is it any wonder that dime-store trinkets can be sold at Tiffany prices?

What about the technical engineer who took time to learn about educational needs and practices, and who has become fluent in the educators' terms to better his understanding? This fellow gets short shrift for his efforts, since he cannot claim to be the "head of xyz university, audio/visual department."

Let us imagine a technical graduate who then moved over to the educational field and thus managed to spend some 10 years at a university. His knowledge of theory would be high, but his chances to practice the applications of his theory would be nil . . . Ten years spent at a university will not provide the answers to such problems as device design, integrity, and reliability, nor teach one to see the relation between field conditions and product design. These are the very areas where major problems exist.

In the early attempts to wed electronics to medicine, many of

the problems were similar to those now facing educational electronics. I suggest that we re-examine some of these early efforts with the hope that it will disclose ways to overcome the educators' present resistance.

If you are wondering about my background, I have a career spanning more than 30 years in electronic instrumentation and systems, covering fields from batteries to microwaves, with broad experience in audio, fm, TV and communications systems; have chaired several national IRE-EIA-IEEE committees, hold some 19 patents, and have been working in educational electronics about two years.

*Charles A. Cady*

Consulting Engineer  
Wayland, Mass.

## No moss grows on this reader of MOS report

Sir:

A number of errors and omissions have crept into your excellent special report on MOS devices (ED 8, April 12, 1969, p. 49). On page 58 you state that the p-type enhancement device is formed by diffusing two wells of phosphorous into the substrate. Actually, phosphorous is an electron-rich dopant that will, therefore, form n-type wells; to form a p-type source and drain, a dopant with an abundance of holes, such as boron, must be used.

On page 59 the cryogenic gain of the MOS is detailed, but no mention is made of the fact that, for the p-type MOS device, power dissipation is a maximum at such temperatures and can be a problem to control.

The statement on page 66, that low-threshold voltages allow direct interfacing with DTL and TTL, is misleading. To properly communicate with these logic types requires

*(continued on p. 67)*



## Standard Circuit of the Month

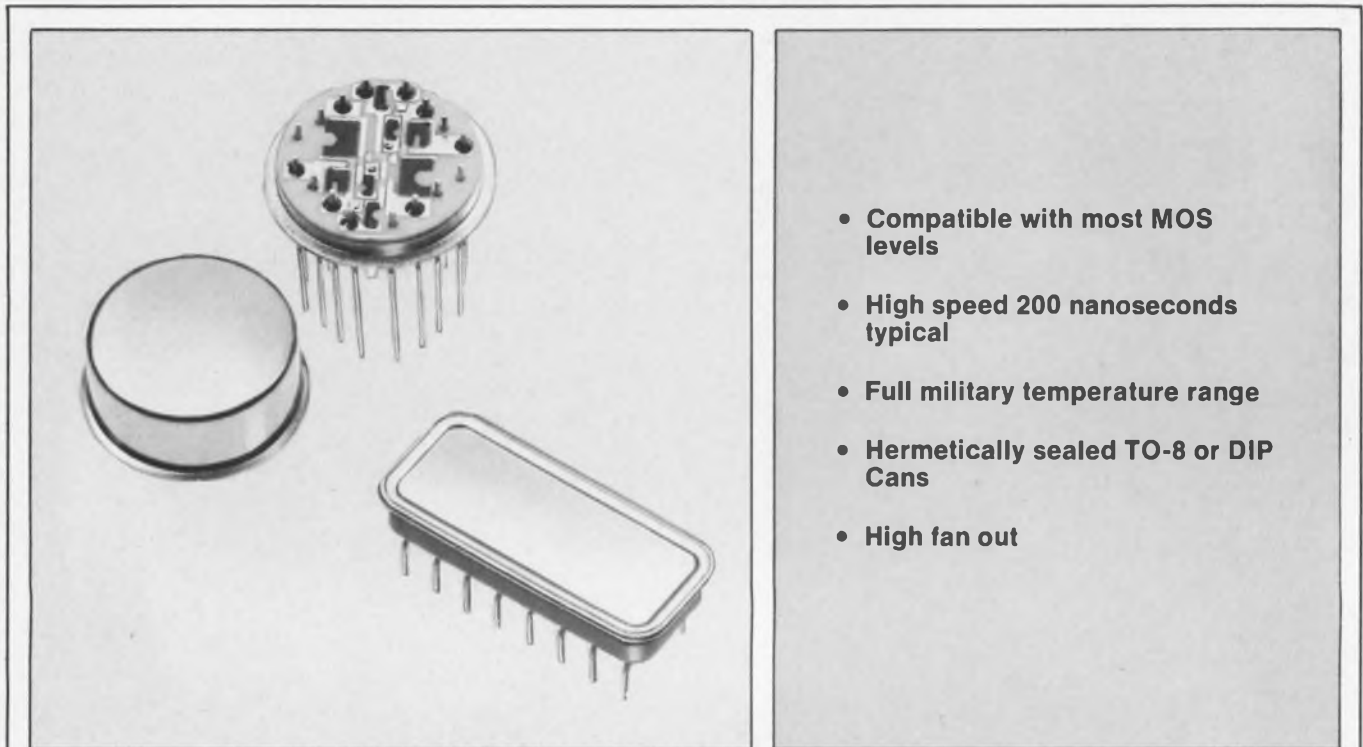

- Compatible with most MOS levels
- High speed 200 nanoseconds typical
- Full military temperature range
- Hermetically sealed TO-8 or DIP Cans
- High fan out

# DTL to MOS LEVEL SHIFTER

### Maximum Ratings

Power Dissipation:	180 mw per shifter
Operating Temperature:	-55°C to +125°C
Storage Temperature:	-65°C to +175°C
Supply Voltage:	40V

**Mepeco DTL/MOS Level Shifters** eliminate the need for discrete components and add the benefit of miniaturization with higher reliability. This new microcircuit provides high speed operation and is compatible with most MOS levels.

These level shifters furnish the only DTL/MOS buffer stage necessary and require less room on your PC

board than with discrete components. The "worst case" design operates over the full military temperature range with all DTL, TTL levels. Packaging compatibility is offered with most system designs.

For complete information, phone collect or write for data sheet MC6-669.



MEPCO INC., COLUMBIA ROAD, MORRISTOWN, N. J. 07960 • (201) 539-2000 • TWX: 710-986-7437

INFORMATION RETRIEVAL NUMBER 27

INFORMATION RETRIEVAL NUMBER 28 ►





## MASTER MULTI-PURPOSE FM-1/FM-5 SYSTEMS

**HAND-HELD... MAN-PACK... PORTABLE... MOBILE... BASE... REPEATER**

Designed for, tested and proved in the jungles of Southeast Asia, *Models FM-1 and FM-5* transceivers meet the needs of 2-way communications: Commerce, industrial plant, waterfront, law enforcement, fire protection, civil defense, etc. A general purpose radio-telephone, Hallicrafters' *Model FM-5* is solid-state, all environment master of all communications needs. It may be used, with equal success as a fixed, portable man-pack, repeater or mobile unit.

Teamed in a single FM system for the 148-172 MHz range, *FM-1/FM-5* and available accessories give you the versatility and reliability to be in command of communications requirements. For full details, write for descriptive bulletins, available free on request.

**You're in the Global Communications Community with a Hallicrafters.**

*the hallicrafters co.*  
A Subsidiary of Northrop Corporation



600 HICKS ROAD • ROLLING MEADOWS, ILLINOIS 60008 • 312/259-9600

See us in WESCON Booths 5219 & 5220 at the Cow Palace.

# 3 exciting reasons to specify

## D I G I T A L

**NEW** 1



Model 262

### Digital Multimeter

(AC, DC, ohms)

A most uncommon .1% Multimeter for those common, everyday measurements. A necessity for design and development, production, quality control, or anywhere that DC volts and current, AC volts, and ohms are measured. Battery pack available.

**\$375**

**NEW** 2



Model 311

### Precision Calibrator

(voltage & current source)

An .01% precision voltage and current Calibrator that serves as a working standard. In addition, the high current capability may be used as a lab source for developing those critical circuits so essential in electronics today.

**\$650**

**NEW** 3



Model 691

### 21 Column Printer

(3 lines per second)

A Drum Printer which is expandable from 4 to 21 columns to satisfy your specific requirements. This versatile printer accepts all standard BCD inputs and provides 38 symbols along with "floating" decimal point.

starting at **\$770**

See us at booth  
1024 and 1025

**WESCON/69**

**DIGITEC** by **UNITED SYSTEMS CORPORATION**

918 Woodley Road • Dayton, Ohio 45403 • (513) 254-6251  
Representatives Throughout the World

For Complete  
Specifications  
request new  
catalog D69A



# Solid State Relays

Another **big** breakthrough from the "little relay" people

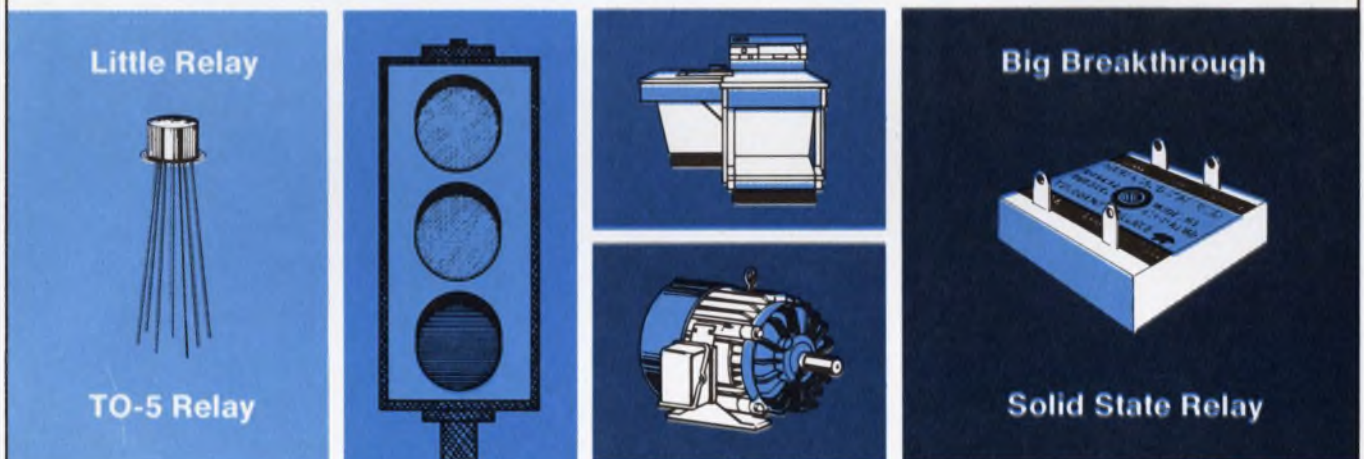

We got our nickname "little relay" people because we usually put our *big* breakthroughs in *small* packages. (Our success started when we introduced the TO-5 relay.) Now, we've made another breakthrough . . . a completely solid state, four terminal relay with enormous power gain. Only 1 milliwatt switches up to 5 KVA, and it can be resistive, inductive, capacitive, tungsten or quartz lamp loads.

Our new relay operates on inputs up to 280 VAC or from

3.5 to 300 VDC (either polarity) permitting direct interface with TTL logic. Input-output isolation is 10<sup>11</sup> ohms "coil" to "contact" and "coil" to mounting plate. Dielectric is 2000 VRMS. Output characteristics include contact ratings up to 21 amperes, 280 VAC, 60 Hz. Surge current ratings of 200 amperes, and "contact" resistance as low as 50 milliohms. And, . . . these are real *breakthroughs* for a relay which doesn't have "coil" or "contacts."

Available options include zero

voltage switching for RFI suppression and lamp life extension.

Prices start as low as \$18.30 in quantities of 100. For complete technical data on our Series 6 Solid State Relay . . . contact us . . . the "little relay" people.



**TELEDYNE RELAYS**  
A TELEDYNE COMPANY

3155 West El Segundo Boulevard Hawthorne, California  
90250 Telephone: (213) 679-2205

# Why does the best-selling digital printer sell for \$335?

Because Victor sells so many of them.

The Victor Imperial digital printer does superbly what any top-quality serial entry printer does. For less money. Because we sell so many.

It prints 8 column figures from remote sources on either 24 or 48 volt solenoids. Addition and subtraction for just \$50 more. Ten column capacity? Add \$20. Victor's exclusive printing press action reduces wear (and extra parts), and assures legibility and long, long life, under the roughest use.

OEM and quantity discounts available, with factory-trained service representatives covering every county in the U.S.

Does craftsmanship combined with volume manufacturing economies sell digital printers?

The most.  **VICTOR**

Victor Comptometer Corporation  
Business Machines Group  
3900 North Rockwell Street  
Chicago, Illinois 60618

Tell me more about your best-seller,  
the Victor Imperial digital printer:

Name \_\_\_\_\_

Title \_\_\_\_\_

Address \_\_\_\_\_

City \_\_\_\_\_

State \_\_\_\_\_ Zip \_\_\_\_\_

...

# Call on Victor and you're in business.



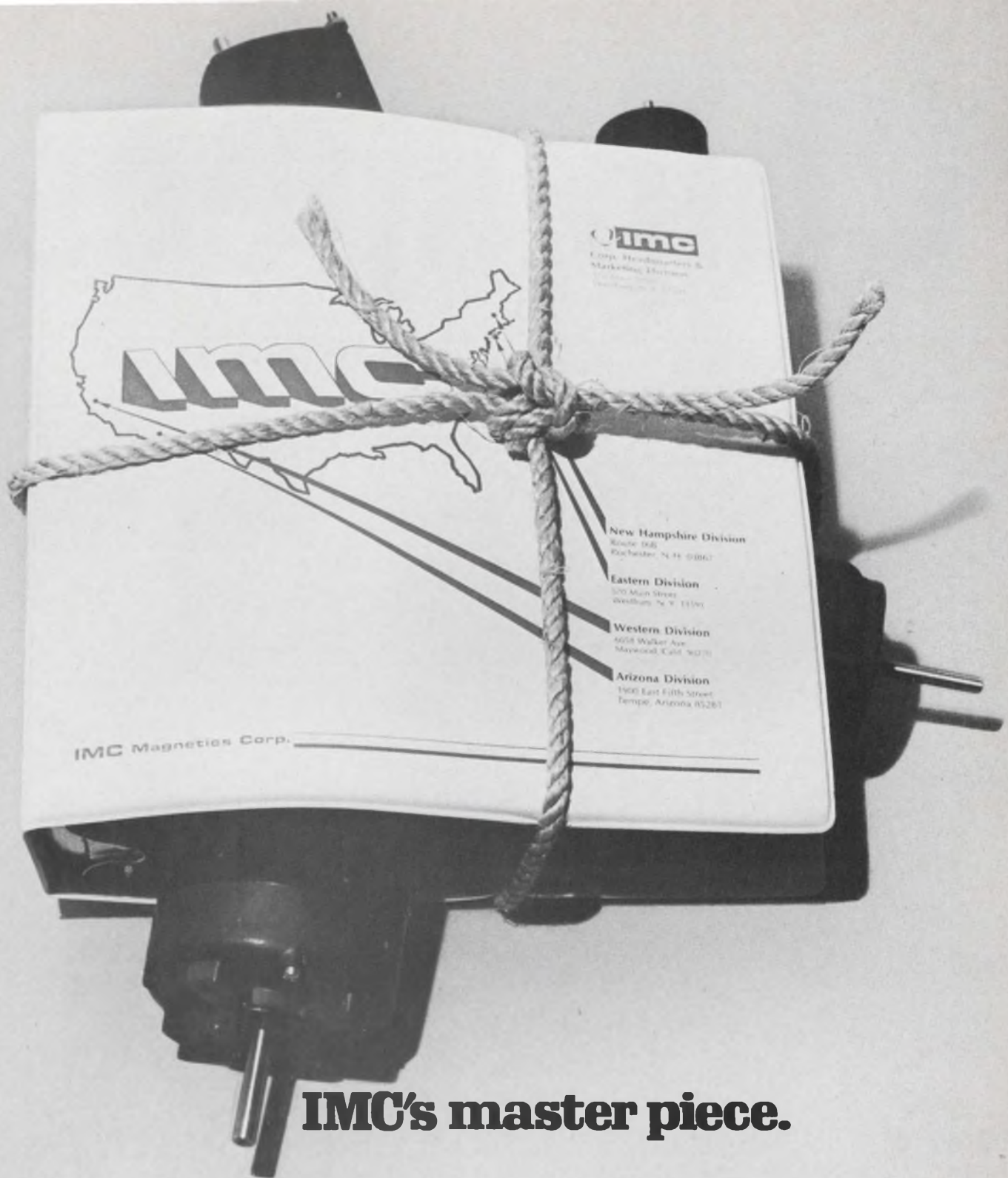

**IMC's master piece.**

**It's entitled, "The Master Catalog."  
We squeezed all our products into it.  
This limited edition available only from  
your IMC sales representative.**

Arizona Division ➤ Rotary solenoids/Electrohydraulic subsystems/Solenoid valves/Hydraulic and pneumatic components

Eastern Division ➤ Airmovers: centrifugals, fans, tubeaxials and vaneaxials/Motors: induction, synchronous hysteresis, reluctance, polarized, torque and servomotors/Solid-state AC-motor controller systems

New Hampshire Division ➤ Boxer, MiniBoxer, SuperBoxer, IMCair and Condor fans/IMCair centrifugal blowers

Western Division ➤ Tormax stepper motors and controllers/Synchros/Resolvers/Solenoids/Flag indicators

All members of the IMC corporate family ➤ IMC Magnetics Corp., 570 Main Street, Westbury, N.Y. 11591, (516) 334-7195

# Chip specs.

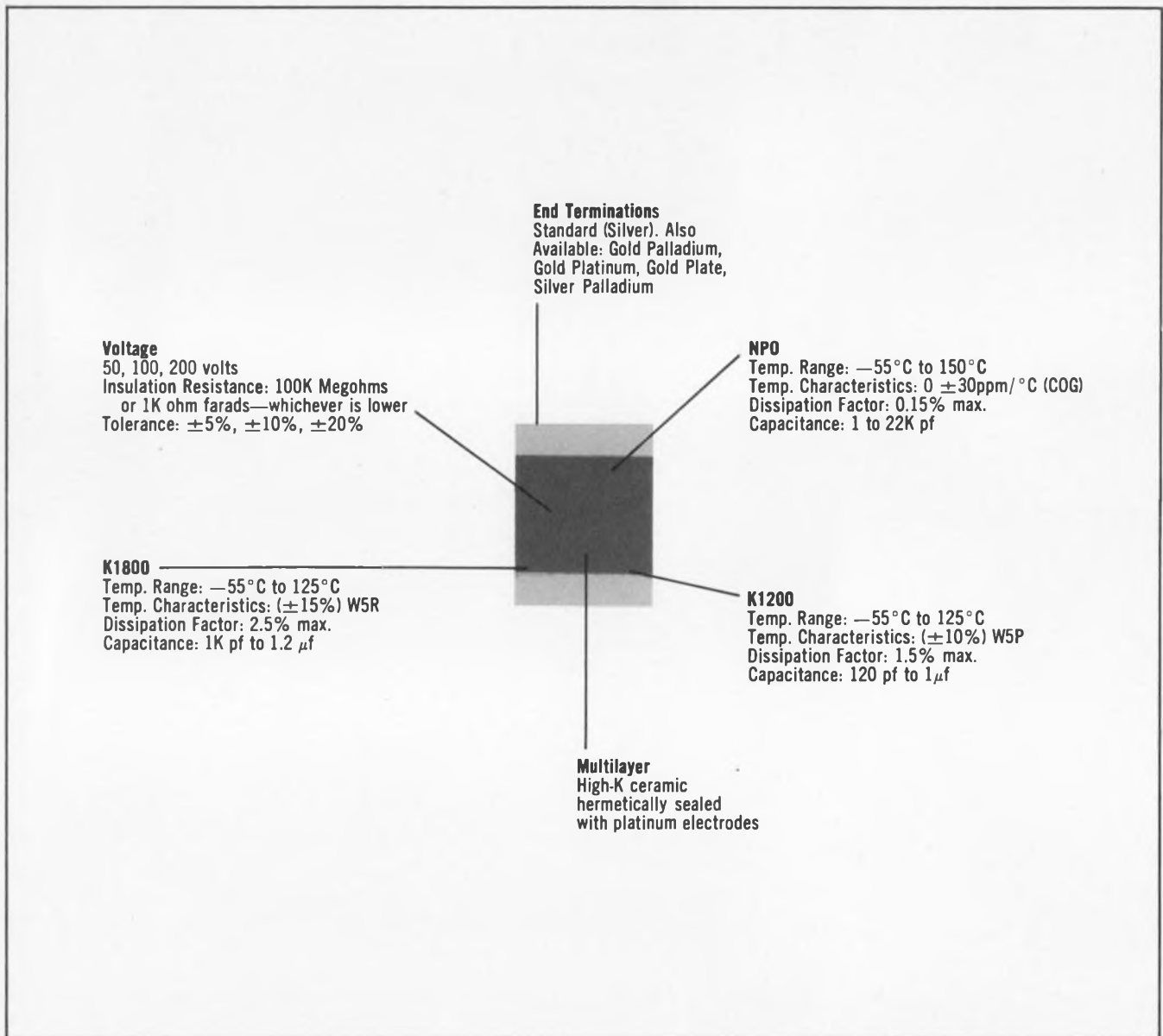

The above specs pretty well tell the story on our standard line of ceramic chip capacitors. Except that they're available in a variety of sizes in rectangular and near-square types.

And they're off-the-shelf items with COMPAR, our nationwide distribution network.

But you also should know that we can provide you with many other end terminations, capacitance val-

ues, ceramic valuations and voltage ratings.

Just get in touch with our Engineering Department. You'll find that even though you've seen one of our chips, you haven't seen 'em all.

**Electro Materials** 

11620 Sorrento Valley Rd., San Diego, Calif. 92121, Phone (714) 459-4355, TWX 910 322-1130  
Division Illinois Tool Works Inc. Represented by COMPAR

INFORMATION RETRIEVAL NUMBER 33





This multiple pair, Beldfoil shielded cable is typical of the types of Belden cable used in recording critical measurements on the Goldstone tracking antenna.

**BELDFOIL\* SHIELDED CABLE**

# SOLVED

## CRITICAL NASA INSTRUMENTATION PROBLEM!

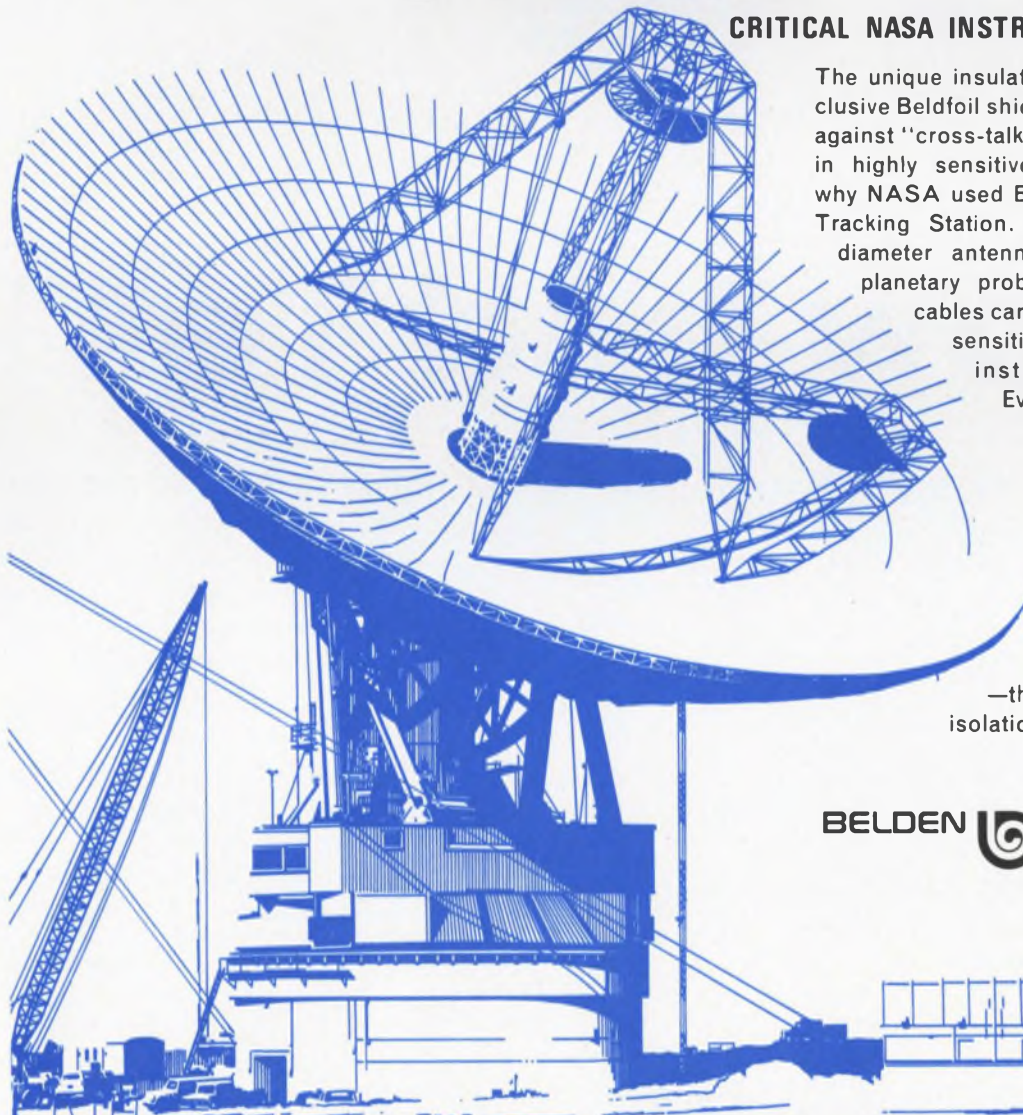

The unique insulating properties of Belden's exclusive Beldfoil shielding provides 100% protection against "cross-talk" and spurious signal impulses in highly sensitive circuit applications. That's why NASA used Beldfoil cable for its Goldstone Tracking Station. ■ In this massive 210 foot diameter antenna, built to track lunar and planetary probes, Belden Beldfoil shielded cables carry instrumentation signals from sensitive structural detectors to an instrumentation facility nearby. Every measurement of critical structure deflection, angular position, structure temperatures, and bearing pressures are recorded and analyzed prior to tracking operations. ■ Get the same precision analyzation in your critical instrumentation. Specify Belden Beldfoil shielded cable —the only cable providing 100% isolation.

\*Belden Trademark Reg. U.S. Pat. Off.



FOR COMPLETE INFORMATION  
CONTACT YOUR BELDEN  
DISTRIBUTOR.

BELDEN CORPORATION • P.O. Box 5070-A • Chicago, Illinois 60680 • Phone 312-378-1000

INFORMATION RETRIEVAL NUMBER 34



SEE IT AT  
 \* WESCON/69  
 BOOTH NO. 3715-16

# "Show and Tell"

**nimo™** wins the "Show and Tell" of the readout art. A single plane presentation of four bright, legible decades delivered at the low, low price of \$3.50 per decade. No contest.

**nimo™**, an electronic display tube only 1.135" in diameter, boasts 3/8" high characters, variable brightness, temporary data storage . . . but primarily a price tag *no one can touch*.

## The Tell portion

	<b>nimo™</b> 4-decade tube	gas discharge 4-decade display
Cost per decade	\$ 3.50	\$ 3.95
Mounting Hardware	3.50	2.00
Driver/Decoder	3.75	4.50
Power Supply	3.15	5.00
<b>Total cost per decade</b>	<b>\$13.90</b>	<b>\$15.45</b>

All figures relate to 1,000 quantity.

We can tell you many additional features inherent only in the **nimo™**, four decade display tube, but the real proof of the story is the *show* portion.

IEE Sales Representatives (listed opposite), will be happy to schedule a demonstration so they can "Show and Tell" you why **nimo™** is the only way to display. Call now!

The uncommon readout.



Industrial Electronic Engineers, Inc.  
 7720 Lemona Ave., Van Nuys, California 91405  
 Telephone: (213) 787-0311 • TWX 910-495-1707





## Ready to "Show and Tell"

<b>ALABAMA</b> Huntsville Mekco Associates, Inc. Tel. (205) 881-3721	<b>NEW JERSEY</b> Wayne B. B. Taylor Corp. Tel. (516) 223-8000
<b>ARIZONA</b> Phoenix Gramer & Company Tel. (602) 279-1231	<b>NEW MEXICO</b> Albuquerque Hyer Associates, Inc. Tel. (505) 265-5961
<b>CALIFORNIA</b> Los Angeles IEE Factory Sales Office Tel. (213) 787-0311	<b>NEW YORK</b> Baldwin B. B. Taylor Corp. Tel. (516) 223-8000
<b>CONNECTICUT</b> Belmont IEE District Sales Office Tel. (415) 591-2551	<b>ROCHESTER</b> Ossmann Component Sales Corp. Tel. (716) 442-3290
<b>FLORIDA</b> San Diego L. L. Stoakes, Inc. Tel. (714) 274-6281	<b>SYRACUSE</b> Ossmann Component Sales Corp. Tel. (315) 454-4477
<b>COLORADO</b> Englewood Hyer Associates, Inc. Tel. (303) 771-5424	<b>RED HOOK</b> Ossmann Component Sales Corp. Tel. (914) 297-7773
<b>CONNECTICUT</b> North Haven Kitchen & Kutchin, Inc. Tel. (203) 239-0212	<b>VESTAL</b> Ossmann Component Sales Corp. Tel. (607) 785-9949
<b>FLORIDA</b> Orlando Mekco Associates, Inc. Tel. (305) 841-2215	<b>NORTH CAROLINA</b> Burlington Mekco Associates, Inc. Tel. (919) 226-7177
<b>ILLINOIS</b> Chicago Magnuson Associates Tel. (312) 622-6322	<b>OHIO</b> Cleveland Comtel Components Tel. (216) 442-8080
<b>KANSAS</b> Leawood Poly-Onics, Inc. Tel. (913) 648-4173	<b>DAYTON</b> Comtel Components Tel. (513) 298-7573
<b>MARYLAND</b> Towson Marktron, Inc. Tel. (301) 825-8222	<b>PENNSYLVANIA</b> Narberth Biechler Associates, Inc. Tel. (215) 667-1827
<b>MASSACHUSETTS</b> Lexington Kitchen & Kutchin, Inc. Tel. (617) 862-8230	<b>PITTSBURGH</b> Russell F. Clark Co. Tel. (412) 242-9500
<b>MICHIGAN</b> Southfield Comtel Components Tel. (313) 357-3700	<b>TEXAS</b> Dallas Norvell Associates, Inc. Tel. (214) 357-6451
<b>MINNESOTA</b> St. Paul Magnuson Associates Tel. (612) 227-8495	<b>HOUSTON</b> Norvell Associates, Inc. Tel. (713) 774-2568
<b>MISSOURI</b> Hazelwood Poly-Onics, Inc. Tel. (314) 837-0597	<b>UTAH</b> Salt Lake City Hyer Associates, Inc. Tel. (801) 487-7747
	<b>WASHINGTON</b> Seattle Electronic Sales Corporation Tel. (206) 767-3160



## LETTERS

(continued from page 57)

at best diffused resistors and another power supply, and at worst extensive buffering and logic shifting circuits at the MOS inputs and outputs to maintain proper bipolar voltage and current levels. Similarly, you have neglected to mention that the 1-0-0 crystal orientation used to attain low thresholds has much higher pn junction leakage currents at elevated temperatures than does 1-1-1, and has problems with unwanted lower voltage field oxide inversions due to the lower  $Q_{ox}$ . In addition, 1-0-0 has lower yields because of the greater number of stacking faults and dislocations inherent in this orientation.

Robert E. Dwyer

Microelectronics Section  
Data Systems Division  
Litton Systems, Inc.  
Van Nuys, Calif. 91409

## Says no to cure offered for 'Donald Duck' speech

Sir:

I wish to comment on a recent letter, "Take the 'Donald Duck' out of divers' speech" in ED 10, May 10, 1969, page 52, in which Mr. Zilberstein suggested using an artificial larynx (similar to the type Bell Telephone Laboratories developed to aid people who have had laryngectomies).

The "Donald Duck" effect, as I understand it, is not caused by an increase in the "voice" frequency that is produced by the oscillations of the vocal cords. It is caused rather by an upward shift in the formant (or resonant) frequencies of the supra-glottal vocal tract. This is a result of the fact that the velocity of propagation of sound in the helium medium is about 1.8 times as fast as in air. If we treat the supra-glottal vocal cavity as a resonant pipe (which is a fairly good approximation) the resonant frequency can be shown to vary directly with the velocity of sound.

Changing the source function (voice frequency), as suggested, by the use of an artificial larynx has no significant effect on the

resonant frequencies of the vocal cavity.

Since one of the primary cues for speech recognition appears to be the formant frequencies and their transitions, the use of an artificial larynx would not alleviate the lack of intelligibility in "Donald Duck" speech. The use of an artificial larynx also has the disadvantage of requiring manual control for ON/OFF switching and for voice frequency variation. This might severely restrict the diver from performing any other functions while he is speaking.

James E. Atkinson

Electronic Engineer  
USN Underwater Sound  
Laboratory  
New London, Conn.

## Accuracy is our policy

Sir:

A mistake crept into my article, "Don't Shun the Shunt Regulator," in the July 5, 1969, issue (ED 14). On page 72, the equation for  $R_6$  should include  $E_o$  in the numerator and read:

$$R_6 = \frac{E_o - [V_{be}(Q6) + V_{ce sat}(Q4 Q5)]}{I_{max}}$$

Walter G. Jung

Senior Engineer  
Maryland Telecommunications,  
Div. of KMS Industries, Inc.  
Cockeysville, Md.

Gunnar Richwell, author of "Design and match rf amplifiers" (ED 10, May 10, 1969, p. 106) has brought to our attention four errors in the computer printouts. The lines should read as follows:

RFAMP program statements  
line 193 If (K) 91, 91, 161  
(note the two 91's);

ZMATCH program statements  
line 112 O=6.2831853\*FQ (The left side of the equation is the letter "O")

line 146 16 K=149 (149 was incorrectly shown as 140)

line 316 C=- (R\*, etc.) (The minus sign has been added).

# Bare facts...

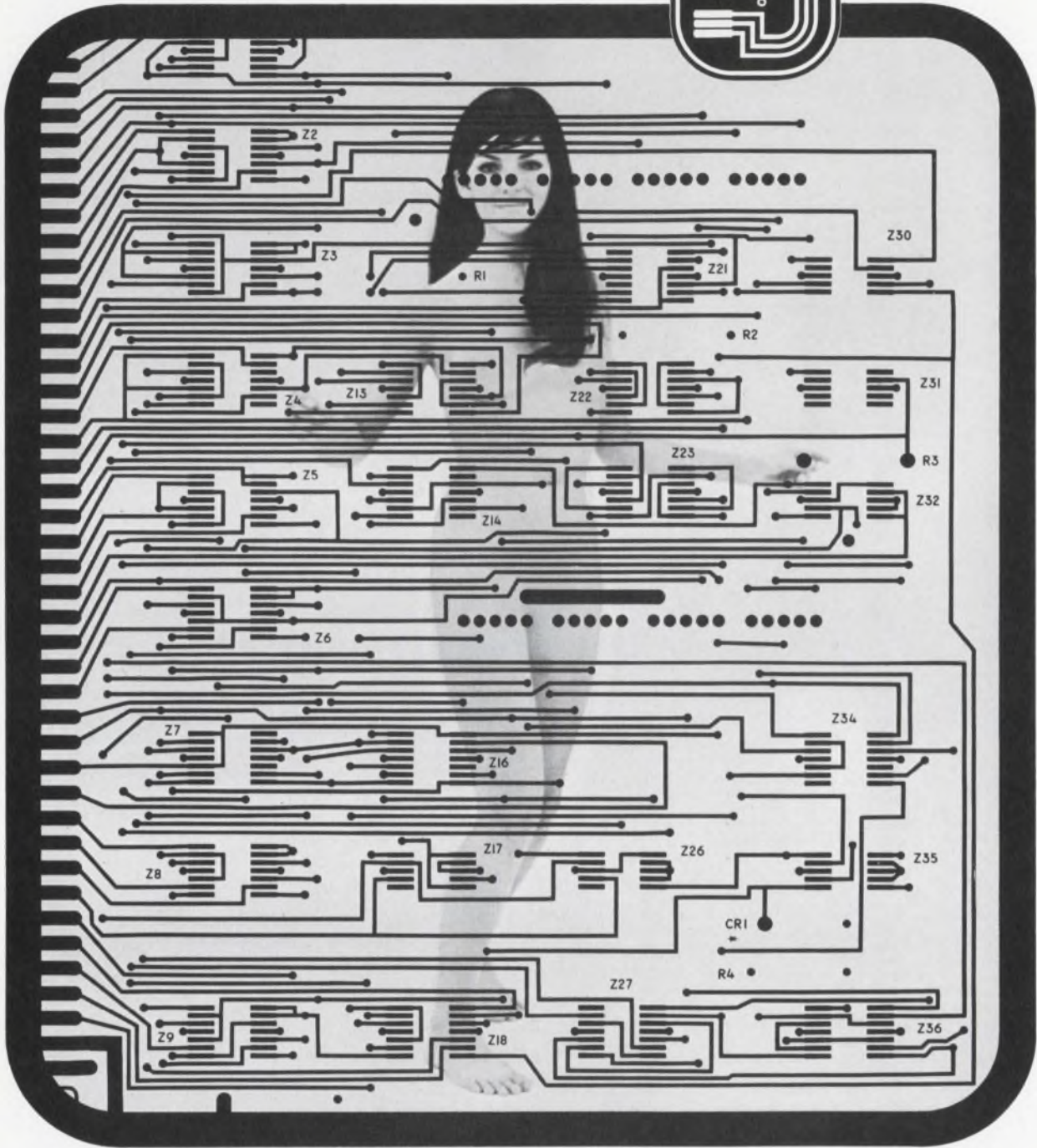

## ...why Diceon P/C boards are your best buy!

- Diceon produces consistent top quality.
- Diceon meets delivery commitments.
- Diceon local sales offices offer on-the-spot service.
- Diceon provides customers P/C design engineering assistance.
- Diceon "split-site" production (California or Puerto Rico) allow special purchasing price advantages.

## **DICEON ELECTRONICS, INC.**

644 TERMINAL WAY  
COSTA MESA, CALIFORNIA 92627, U.S.A.  
TELEPHONE (714) 642-7100

© Copyright 1969 Diceon Electronics, Inc.



# Save \$500 - plus pick your purchase plan

That's right, the outstanding acceptance of the HP 9100A computing calculator now allows us to reduce the price \$500—from \$4900 to the new price of \$4400.

Plus you now have a choice of purchase plans. Buy, rent, or lease—you pick the purchase plan that best meets your needs.

How is HP able to do all this? Volume production. In fact, we're adding a new plant to produce more calculators.

Which brings up another important point. Volume production means you don't have to wait in line 6 weeks or 6 months to put this calculator to work for you. Call any of the 135 world-wide HP Sales and Service Offices today. You'll have a 9100A computing calculator on your desk faster than you thought possible.

So, if you have been sitting on the fence—now is the time to jump.

Lease/rental plans start as low as \$1.50/computing hour based on average usage. Pick your purchase plan and save money by ordering the HP 9100A computing calculator today.

For additional information, contact Hewlett-Packard, Box 301, Loveland, Colorado 80537. (303) 667-5000. Europe: 1217 Meyrin-Geneva, Switzerland.



754 0307 z temporary  
8.336 046 015 05 y accumulate  
22.30 x keyboard

**Dynamic range**  
10<sup>-99</sup> to 10<sup>99</sup>,  
nearly 200 dec-

ades. Observation of math operations on 3 displayed registers. Up to 16 more registers for data storage.



**Complex and vector arithmetic** simplified with coordinate transformation keys, rectangular-to-polar and vice-versa, in milliseconds.



**Trig functions** covering all quadrants and any size angle in degrees or radians.



**Branching and looping flexibility** provided by "IF" keys expands programming capability.



**Edit programs easily.** Single-step through programs to check and de-bug. Address an individual step and make corrections without re-entering the entire program.



**Designed for expansion.** Printer and plotter are available.



**Program from the keyboard.** Record and store 196-step programs on credit-card-size magnetic cards for repeated use.

HEWLETT  PACKARD

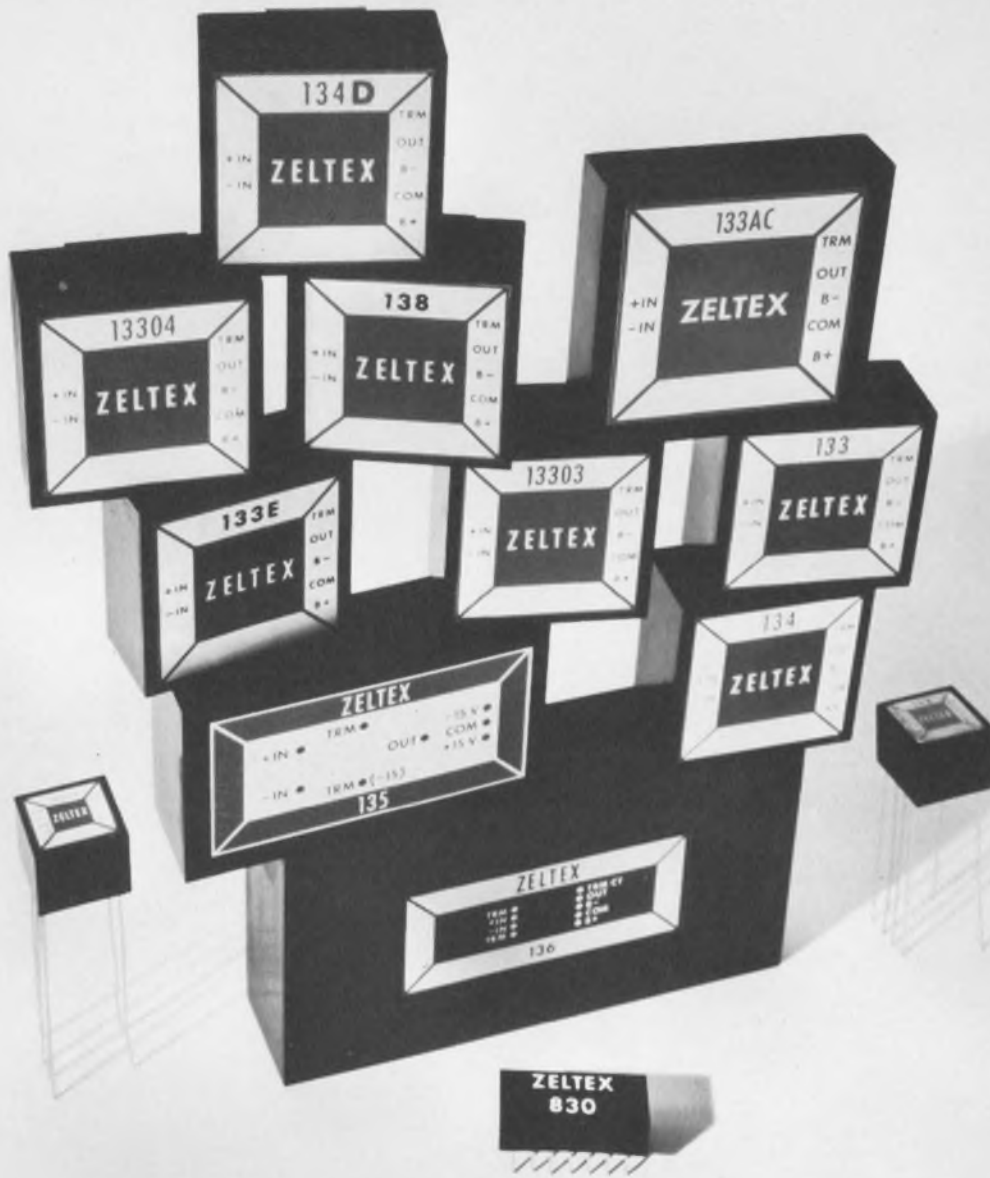

IF YOU THINK **13** IS AN UNLUCKY NUMBER...  
MEET THE ZELTEX FET SET!

Thirteen FET-input differential op amps that fit just about any application you can name! Low drift—one model has only  $2 \mu\text{V}/^\circ\text{C}$ . For high output, another has  $\pm 100\text{V}$ . On top of this, we have a very fast  $100 \text{ V}/\mu\text{s}$  FET, a dual in-line FET and one that sells for only \$15.

Still think thirteen is unlucky? Write or phone today for a complete FET SET data sheet and pick a winner!



WHERE THINGS ANALOG  
... HAPPEN!

**ZELTEX, INC.**  
A Subsidiary of REDCOR CORP.

1000 Chalamar Road, Concord, Calif. 94520/(415) 686-6660



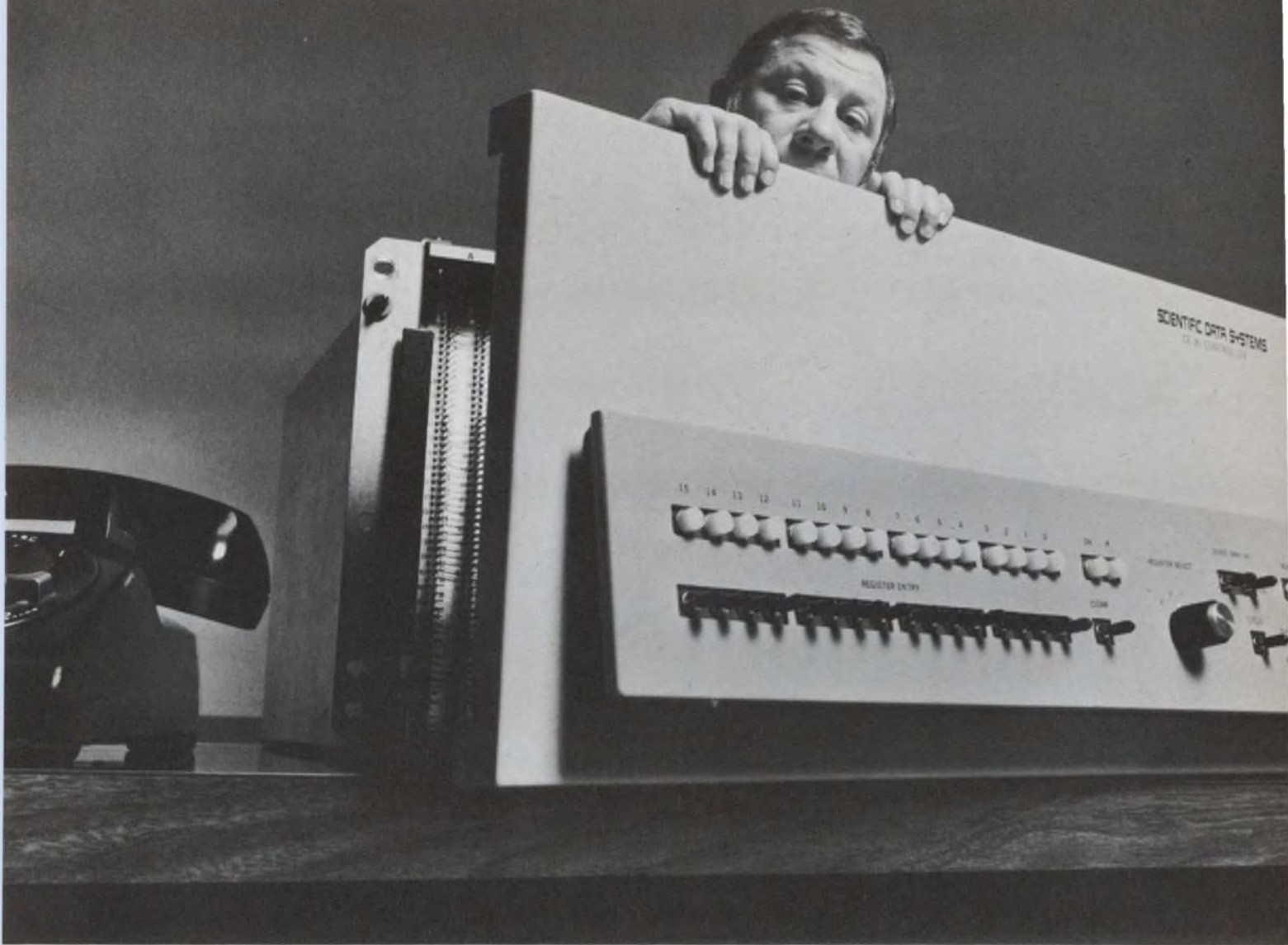

# Our new mini-computers have built-in programmers.

Most small computers are designed for programmers. Ours are designed for people.

Just tell our 16-bit machines what you want done. The CE16 and CF16 will do it, because their "built-in programmers" (a comprehensive set of sophisticated instructions) let any engineer use them with ease. For example, the single instruction "scan memory" makes our machines compare a given number with the contents of the entire memory.

The CE16 and CF16 have 125 other heroic instructions that specify comprehensive maneuvers. So you give fewer instructions and use far less core memory than with any other small computer. Problem run times are shortened and Input/Output operations are simplified.

The CE16 and CF16 are designed to control and exchange information with a large number of external devices while doing related computation. Their "automatic I/O" enables them to talk back and forth between memory and a group of interrupting peripherals, in order of priority,

without needing attention from the on-going program.

Automatic I/O isn't a high priced option. Neither is a teletype, nor three priority interrupts, one of which is indefinitely expandable. They're all standard. The only thing you might pay extra for is speed. The CF16 can do a fully signed software multiply in 42 micro-seconds. But it costs a little more than the CE16 which takes 126 micro-seconds (which isn't bad) for the same job.

Don't take our word for all this. Drop us a line asking for:

- A brochure with straight from the shoulder specs so you can compare.
- A representative with more information than could fit in a brochure.
- Or a meeting between our sales engineer and one from any competitor you want, at your office. The competition can even bring a programmer along. We won't have to.

**SDS**  
Scientific Data Systems,  
El Segundo, California

# These new, low-priced Burr-Brown op amps

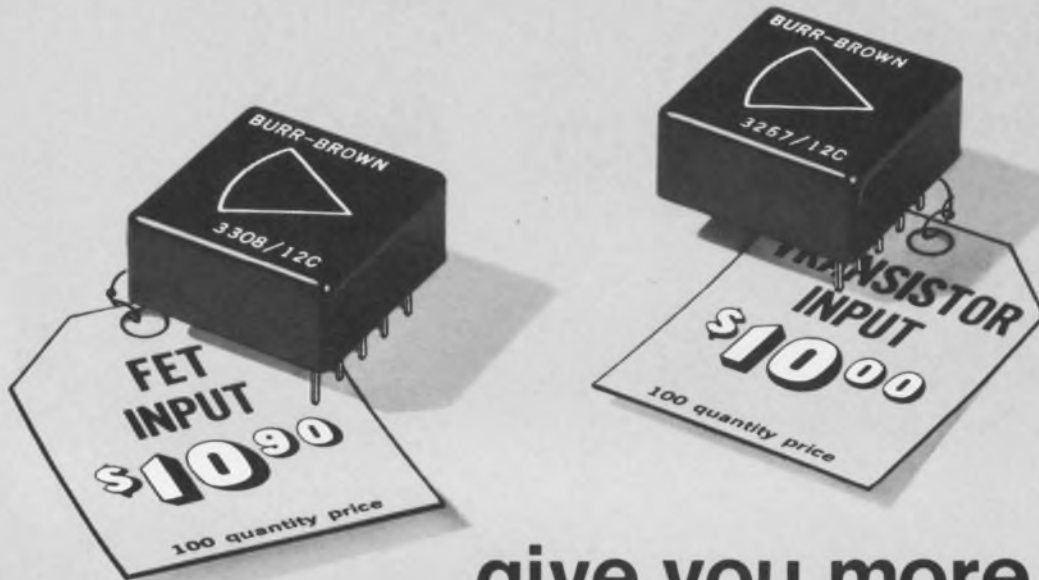

give you more than you bargained for!

Here are two new general purpose operational amplifiers that will meet the performance and price requirements of your most economy-minded applications. There's a FET input unit and a transistor input unit, both with the built-in quality you expect from Burr-Brown . . . at the unexpected low price of less than \$10 in large quantities.

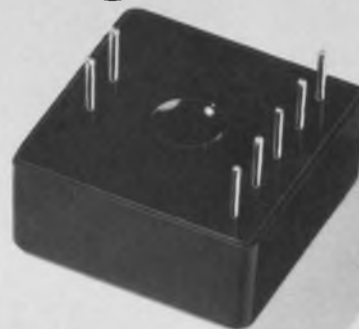

Standard 7 pin package

HIGHLIGHT SPECIFICATIONS	FET INPUT	TRANSISTOR INPUT
Model Number	3308/12C	3267/12C
Voltage Drift, max., -25 to +85°C	50 $\mu\text{V}/^\circ\text{C}$	20 $\mu\text{V}/^\circ\text{C}$
Bandwidth, full power	100 kHz	100 kHz
Bias Current, max., @ 25°C	100 pA	50 nA
Bias Current Drift, max., -25 to +85°C	*	0.6 nA/°C
Open Loop Gain, min.	106 dB	114 dB
Slew Rate, min.	6 V/ $\mu\text{sec}$	6 V/ $\mu\text{sec}$
Rated Output	$\pm 10\text{ V @ }5\text{ mA}$	$\pm 10\text{ V @ }5\text{ mA}$
100 quantity price	\$10.90	\$10.00

\*Bias current doubles for every +10°C.

#### FOR COMPLETE TECHNICAL INFORMATION

on the new economy FET input series or the new economy transistor input series, contact your Burr-Brown Engineering Representative or use this publication's reader service card.

**BURR-BROWN**  
RESEARCH CORPORATION

International Airport Industrial Park • Tucson, Arizona 85706  
TELEPHONE: 602-294-1431 • TWX: 910-952-1111 • CABLE: BBRCORP



Operational Amplifiers  
Instrumentation Amplifiers  
Function Modules  
Active Filters  
Power Supplies

FOR MODEL 3308 CIRCLE 225 ON INQUIRY CARD

FOR MODEL 3267 CIRCLE 226 ON INQUIRY CARD



# Buckbee-Mears research developed the absolute filter.

*Tasting our success  
was a great experience.*



A key step in producing beer is pasteurization. Some of America's leading breweries have found they can produce a smoother beverage by using a precision-etched, Buckbee-Mears fine screen as a filter in the pasteurizing process.

It's no wonder. We make the only absolute filter available. With our process, we can hold the uniformity of holes in the filter screen constant. Our filter customers can choose just about any material they want, including stainless steel, molybdenum, nickel, monel and titanium — in any array.

Buckbee-Mears offers small or large holes in the array. Unlike die stamping, the on-centers can be adjusted close or far apart. Our absolute filters are self-cleaning because of planer construction. That's another exclusive advantage of our photomechanical reproduction process.

We etch absolute filter screens at a one-to-one ratio be-

tween metal thickness and hole size. Maximum hole size tolerance to  $\pm 10\%$  of metal thickness, minimum to  $\pm .0002''$ .

While we're delighted to help the nation's brewmasters upgrade their product, our absolute filters have many other uses. They include centrifuge, synthetic fiber filters, coffee brewer screens, particle size determination and back-up screens for sub-micron filters. Anyone with a filtering application where an absolute filter is required can use our capabilities.

Producing the only absolute filter screen on the market is another example of creative technology from Buckbee-Mears. We're in business to help you solve your problems. Call or write Bill Amundson, our industrial sales manager, about your absolute filter requirements. Phone 612-227-6371. Skoal!

PRECISION METAL AND GLASS ETCHING • ELECTRO FORMING • AUTOMATED DESIGN  
**bmc** BUCKBEE-MEARS COMPANY  
SAINT PAUL, MINNESOTA 55101

INFORMATION RETRIEVAL NUMBER 42

**PARDON OUR  
SHOUTING  
BUT...**



**FOR 25 YEARS  
WE'VE BEEN  
QUIETLY  
SURPRESSING NOISE.**

POTTER PRODUCTS are

**Available,**

fast delivery and design flexibility  
whenever and wherever needed

**Reliable,**

with 25 years experience  
and proven performance

and the  
**PRICE is  
Right...**

try us and see...

POTTER PRODUCTS FROM WESSON, MISSISSIPPI



METALIZED  
MYLAR  
DIPPED  
CAPACITORS

INFORMATION RETRIEVAL NUMBER 239



COMMUNICATION  
AND SIGNAL LINE  
FILTERS

POTTER PRODUCTS FROM INGLEWOOD, CALIFORNIA



MICROMINIATURE  
EMI FILTERS

INFORMATION RETRIEVAL NUMBER 240



CKR'S  
ESTABLISHED  
RELIABILITY  
CERAMIC CAPACITORS

SEE YOU AT THE WESCON SHOW, LOOK FOR US AT BOOTH 5112 !

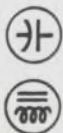

**THE POTTER  
COMPANY**

500 W. FLORENCE AVE., INGLEWOOD, CALIF. 90301  
TEL. (213) 678-2651 TWX: 910-328-6138  
NORTH HIGHWAY 51 WESSON, MISSISSIPPI 39191  
TEL. (601) 643-2216 TWX: 510-981-4072



# Data Technology comes out on top again!



**The new Model 370 is the most accurate 5 digit DVM in the industry.**

What does the smallest and most accurate 5 digit DVM cost? \$2,400. Repeat: \$2,400. Range 1  $\mu$ V to 1,000 Volts. What more can we say? Available Options include ac Volts, Ohms, and Ratio. Call collect for more facts.

*"Make the best, then make it better"*



**Data Technology**  
Instrument Division

1050 East Meadow Circle Palo Alto, Calif. 94303 (415) 321-0551

# If speed drives you wild, we've got the control.

Our precision Adjustable-Speed Drives will give you precise control over the speed of your application with constant torque regardless of load change. They're infinitely adjustable from 24 to 3600 rpm (150:1 speed range) with load regulation of better than 1/3 of 1% of rated speed. The Remote Control Head provides precise speed adjustment and continuous monitoring. Built for long service life, the modular plug-in design requires only a screwdriver for servicing. Over 250 models from 1/8 to 2 hp, with or without gear reduction or braking and reversing.

SERVO-TEK PRODUCTS COMPANY  
1086 Goffle Road, Hawthorne, New Jersey 07506.

## SERVO-TEK

PRODUCTS COMPANY

Write for our  
500/600 Series catalog  
and get back  
in control.

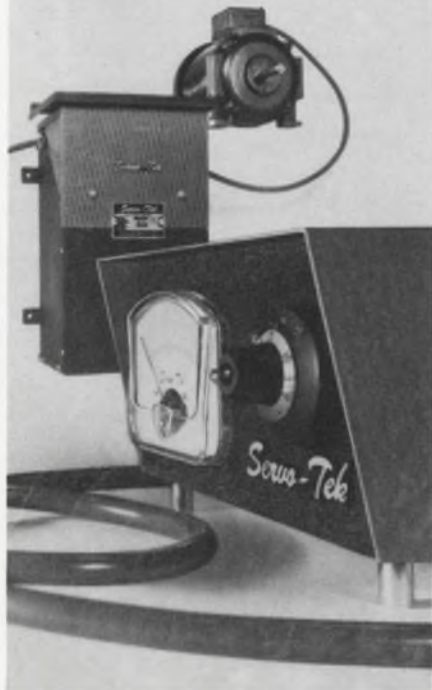

## SIDELIGHTS

### The moon and Wescon, too

The Apollo moon landing was a must story for this issue of *ELECTRONIC DESIGN*—no doubt about that. But it wasn't an easy assignment.

The editors were already busy on a 108-page special section covering *ED*'s traditional August preview of the Western Electronic Show and Convention. This takes months of planning and scrambling to get advance details of technical papers that often have not yet been fully written, and of products that sometimes are barely off the drawing boards.

Somehow the dual effort sped on—a 20-page special lunar news section, plus the Wescon preview—to produce the weighty issue now in your hands.

Special moon-shot features were prepared by several editors. Dick Turmail, Management and Careers Editor, interviewed George Hage, Apollo deputy director. San Francisco Editor Elizabeth deAtley talked with NASA officials and project managers at various West Coast aerospace companies about Apollo spinoffs. The launch at Cape Kennedy and subsequent activities at the Houston Manned Spacecraft Center were covered by our Washington News Chief, Charlie LaFond. And Los Angeles Editor David Kaye interviewed various scientists for his "man-in-the-loop" article.

That joint push, aided by the skills of a talented art department, made this two-star issue possible.

The moon features start on p. 24 and the Wescon "tour" on p. U81.



This moon-struck group made the lunar news section in this issue really shine. The talented *ED* art department includes, left to right, art assistant Bill Kelly; art director Cliff Gardiner; and technical illustrators Rita Jendrzewski and Lynn Thompson.



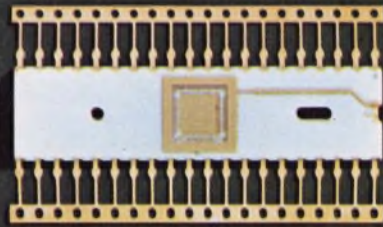

40 leads  
.600 row center

Device area:  
.215 x .215

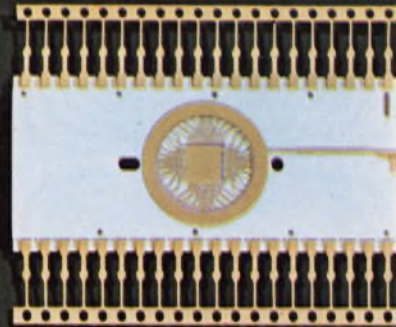

40 leads  
1.050 row center

Device area:  
.210 x .210

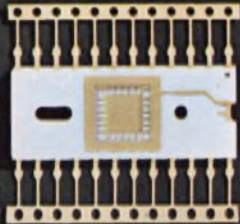

24 leads  
.600 row center  
Device area:  
.200 x .200

28 leads  
.600 row center  
Device area:  
.200 x .200

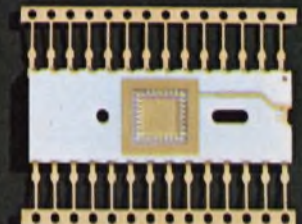

14 leads  
.300 row center  
Device area:  
.170 x .200

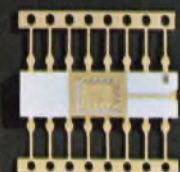

16 leads  
.300 row center  
Device area:  
.126 x .176

# New ALSiPAK<sup>®</sup> STANDARD Packages

Shown Actual Size

The monolithic construction of the new ALSiPak<sup>®</sup> package gives rugged RELIABILITY. It eliminates problems of hermeticity and has greatly improved strength. It has superior thermal conductivity because there is no glass in this package.

The leads are brazed to the metallized ceramic on the bottom which allows maximum chip cavity and bonding room. The number one lead and every fifth lead are identified inside the cavity for your convenience. Within limits, the standoff height can be tailored to meet special needs. The same basic lead frame is used on all packages. ALSiPak packages are dimensionally accurate and uniform with an index hole and slot for your automated handling. All packages having the same lead row spacing use the same lid. Solder preform tooling and metal lid tooling are available for each package.

Standard designs have the seal ring and chip pad grounded to No. 1 lead. For a slight extra charge you can have seal ring and/or chip pad connected to any other specified lead(s). Electrical flexibility is provided by a disconnect notch which can electrically isolate both the seal ring and chip pad.

The standard ALSiPak packages shown here have been in production for a number of months. They have been developed through many prototype production steps. We are indebted to engineering and production men in leading electronic firms for their collaboration and excellent recommendations. Other sizes and styles are in development and will be standard when demand and developments indicate.

We are now in volume production and can discuss realistic deliveries. Tell us what you need and we can work out firm schedules.

CODE IDENT. NO. 70371

PHONE 615 265-3411 • CHATTANOOGA, TENNESSEE 37405, U.S.A.

## American Lava Corporation 3M COMPANY

A SUBSIDIARY OF

For service, contact American Lava representatives in Offices of Minnesota Mining and Manufacturing Company in these cities (see your local telephone directory): Boston: Needham Heights, Mass. • Chagrin Falls, Ohio • Chicago: Elmhurst, Ill. • Dallas, Tex. Indianapolis, Ind. • Laurens, S. C. • Los Angeles, Calif. • Metropolitan New York: Ridgefield, N. J. • Up-State New York and Canada: Phoenix, New York • Orange, Conn. • Philadelphia, Penna. • Roanoke, Virginia • St. Louis: Lee's Summit, Mo. South San Francisco, Calif. • International: c/o American Lava Corporation, Chattanooga, Tenn. 37405, U.S.A. TELEX 558432

68th  
YEAR  
OF  
CERAMIC  
LEADERSHIP





**We just stole  
the automatic  
stick shift**

**and put it on our new Counters.**

The automatic stick shift. That's the whole idea behind our new family of Counters. Snap to "pre-set" for automatic, knob-free sine wave measurements to 50 MHz or go stick shift with full trigger control if your signal is unsymmetrical.

But there's a lot more to our new Counters than just convenience:

- 500 Microvolt Sensitivity from 10 MHz to 500 MHz with automatic gain control for perfect triggering.
- 8 digits in 1 second with auto-ranging.
- Complete solid state input/output interface in systems models.

And, incidentally, automatic operation improves accuracy, too.

Prices for the DANA Model 8100 start at \$1495.

**DANA**

Dana Laboratories, Inc./2401 Campus Drive/Irvine, California 92664





**Publisher**

Hugh R. Roome

**Editor**

Howard Bierman

**Managing Editor**

Frank Egan

**Technical Editors**Milton J. Lowenstein  
Michael J. Riezenman  
Raymond D. Speer  
Stella Lawrence**Management and Careers Editor**

Richard L. Turmail

**News Editors**Ralph Dobriner, Chief  
John N. Kessler**Washington News Bureau**

Charles D. LaFond, Chief

**Military-Aerospace Editor**

John F. Mason

**East Coast Editor**

Jim McDermott

**West Coast Editors**Elizabeth deAtley  
David N. Kaye**New Products Editor**

Lucinda Mattera

**Copy Editor**

Marion Allen

**Editorial Production**Dollie S. Viebig  
Anita F. Needleman**Art Director**

Clifford M. Gardiner

**Art Assistant**

William Kelly

**Technical Illustrators**Rita Jendrzewski  
Lynn E. Thompson**Production Manager**

Thomas V. Sedita

**Asst. Production Manager**

Helen De Polo

**Production Assistants**Bernard Wolinsky  
Carl A. Merkin**Circulation Manager**

Nancy L. Merritt

**Information Retrieval**

Genate Piccinetti

## EDITORIAL



## The 'impossible' just takes extra effort to achieve

Well, we did it! We did what the average citizen thought impossible even a decade ago. And now that we've walked on the moon, the temptation is strong to ask: If we did this, why can't we put our national mind and will and resources to work to solve some of the great pressing problems on earth?

To name just a few: National air and water pollution. The international hunger problem. Decaying cities. Traffic jams and needless traffic accidents. Cancer. The common cold.

"Why not?" thousands are asking. "Why can't we wipe out such evils?"

Project Apollo has demonstrated that given the time and money—nine years and \$24-billion, in this case—and the skills and efforts of thousands of workers—400,000 to reach the moon—the "impossible" can be turned into reality. But it took more than numbers to do it. What really made NASA's space effort such a magnificent success?

Organization. Good management. And dedication.

Given these qualities, a talented team of workers and the funds to do the job, we could indeed begin to rebuild the earth.

Cannot a technology that built a navigation system that safely guided the astronauts to a pinpoint moon landing a quarter of a million miles away find a way to save the lives of the more than 50,000 people who die each year in traffic accidents?

Cannot a technology that kept three astronauts alive in the vacuum of space and on the alternately boiling-freezing lunar surface provide enough food to feed the world's hungry?

Cannot a technology that enables man to propel a complex payload in space with millions of interdependent parts find a way to purify the air and rivers of this nation?

Those "impossible dreams" await fulfillment.

As Elizabeth deAtley points out in her story on Apollo spinoffs (p. 30), the manned space flight program has resulted in more than "2500 significant technological advances—from paints, materials and medicine to communications, computers and television." These spinoffs, though impressive, cannot alone solve the complex problems of civilization.

What is needed are NASA-like programs, of smaller or greater magnitude.

We have the resources and the technology to continue to explore space *and* to begin to come to grips with these problems.

RALPH DOBRINER



# It won't work!

There's a lot more to making modules than buying a few IC's and slapping them on a board. For one thing, the modules almost never work – the first time. Almost never the second time. Occasionally the third time. And that's only the prototype.

Chances are, Digital already has the optimum design, computer tested, fully debugged, manufactured, and sitting there on the shelf. Frustrating, isn't it?

Digital's M Series is the most complete, fully compatible, high speed, integrated circuit, inexpensive line of modules anywhere. We manufacture several million a year – many for our own computers – and know how.

Send for our new Logic Handbook. It tells you what, why, and how to build logic systems from modules. But, alas, not how to build the modules themselves.

DIGITAL EQUIPMENT CORPORATION, Maynard, Massachusetts 01754. Telephone: (617) 897-5111 / Cambridge, Mass. / New Haven / Washington, D.C. / Parsippany, Palisades Park, N.J. / Princeton, N.J. / Rochester, N.Y. / Long Island, N.Y. / Philadelphia / Pittsburgh / Cleveland / Dayton / Huntsville / Cocoa, Fla. / Chicago / Denver / Ann Arbor / Salt Lake City / Houston / Albuquerque / Los Angeles / Palo Alto / Seattle. INTERNATIONAL, Carleton Place and Toronto, Ont. / Montreal, Quebec / Edmonton, Alberta, Canada / Reading and Manchester, England / Paris, France / Munich and Cologne, Germany / Oslo, Norway / Stockholm, Sweden / Sydney and West Perth, Australia.

**digital**  
MODULES · COMPUTERS



# WESCON USA

An exclusive VIP visit to an  
exciting four-day exhibition





# WESCON, 1969...

Adjectives are the stock in trade of the show barker. Most shows prefer the superlatives "bigger," "better," "grander"...Not so, this year's Wescon. The stress is on "useful," "practical," "fewer but better."

Wescon, 1969, at the Cow Palace in San Francisco expects 45,000 vis-





# Accent on quality

iting engineers Aug. 19-22. There are 23 technical sessions (compared with 32 last year), but all emphasize what designers can achieve today. On display at 1192 booths are the star products of 600 companies.

You can take the grand tour right now. Read on.



photo by GAF Corp., USA

## TV Brings the University to

<b>Industry</b> .....	<b>U84</b>
<b>Technology in the World of Today</b> ..	<b>U90</b>
Design trends in the major engineering disciplines, as reflected in the technical papers	
Aerospace .....	U90
Circuit Design .....	U93
Communications .....	U94
Computers .....	U96
Microelectronics .....	U97
Microwaves .....	U98

## Here's the Full Technical Program

A complete listing with times and places .....	U100
--	------

## Outstanding New Products

Instrumentation .....	U118
Microwaves and Lasers .....	U136
Components .....	U142
ICs and Semiconductors .....	U152
Modules and Subassemblies .....	U160
Data Processing .....	U172
Packaging and Materials .....	U180
Production .....	U186

# TV brings the university to industry

Stanford's new instructional network allows engineers to take courses for credit without leaving their plants

**Jim McDermott**  
News Editor

Continuing education for graduate students employed in engineering, management, and other careers is being rapidly implemented in California with what is claimed to be the most cost-effective TV network instruction system so far devised anywhere. The new system, which recently began operation with four channels at Stanford University in the San Francisco Bay Area will eventually extend southward to San Diego. System potential and plans are the subject of Wescon's largest conference session: "University Instructional TV Networks and What They Mean to Industry."

Although similar systems have been operating for over five years in Florida and Texas, Albert J. Morris, president of Genesys Systems Inc., and Wescon session organizer, says that the Stanford system is the most cost-effective because it is a third-generation system and is based on a two-year study of how to best accomplish the university-industry tie. Morris further claims that the new system has not only become the pattern for other forthcoming California networks, but is rapidly being adopted throughout the country as well.

## How the system works

All of these university instructional networks have an on-campus TV studio-classroom; a classroom in the industrial plant; and a means of transmitting the TV signal from the university to the remote off-campus room. There must also be a means for the students to talk back to the instructor.

An important advantage of the Stanford system is the low-cost method of student talk-back via a low-power fm transmitter located at the industry site. In contrast, the Florida system, with programs piped between Gainesville, Cape Kennedy, Daytona Beach, and Orlando, uses regular telephone lines. And the Texas network,

with transmissions between Southern Methodist University, Texas Christian University, University of Dallas, and the Southwest Center for Advanced Studies, uses telephone-system microwave repeaters.

One advantage of all these systems is that the employe need not commute to the university; he can attend the TV classroom set up in his plant. Furthermore, the lesson can be video-taped and played back later in-plant, for those who missed it due to the pressure of their jobs.

Of the present 1500 graduate students on the Stanford University Campus, the majority are full time, but some 300 to 400 of these students are employed in Bay Area industrial, government or research organizations. Because the classes are presented only during the day, much time is lost driving to and from the campus.

According to Joseph M. Pettit, Dean of the School of Engineering, one large company estimated that in one year, the commuting loss of time equalled two and one-half years of engineering time. Now, many students who could not normally be given time off to attend classes can do so through the university-industry TV setup.

## Network supported by industry

The Stanford network, when fully implemented, will cover the entire San Francisco Bay area, as shown in Figure 1. This is largely because of the considerable interest in that locality, in combatting professional obsolescence. In fact, a non-profit corporation, the Association for Continuing Education (ACE) was formed, in 1968, by 18 prominent Bay Area industries together with Stanford University for the purpose of conducting a large-scale, continuing education program using Stanford's TV facilities.

According to Robert Turk, general manager of ACE, the organization is unique among university-industry television complexes. Actually ACE is an extension of Stanford University, in that it cooperates with industry members in organizing classes and courses appropriate to grad-



uate and other study needs at the particular location.

The curriculum that ACE presents is controlled by participating members, and the courses stress applied knowledge, rather than theory. ACE officially began telecasting in May of this year, with 89 industrial students and four courses.

Present ACE hours are: 7-8 a.m.; 12 m-1 p.m.; and 4-7 p.m. Later, hours will be extended from 7 to 11 p.m. and weekends.

The regular Stanford University daytime graduate courses are handled and programmed by the university. ACE will also provide these same courses, from other schools, through the Stanford network facilities. For example, San Jose State plans to offer, through this network, graduate engineering courses for credit, while graduate courses in business are planned by the University of Santa Clara.

In addition, ACE will program seminars in state-of-the-art engineering classes for which no engineering credit is received. These are taught by industry or university personnel who have done research on the latest developments in engineering, mathematics, and the sciences.

Equipment at the industrial classroom consists of one or two 21-inch TV monitors, plus a micro-

phone for each student, for talk-back facilities through the FM audio link.

### How the joint effort began

The Stanford University efforts began, in 1967, with a feasibility study concerned with linking Stanford with classrooms in some 30 industrial organizations participating in the part-time graduate program. This study, Dean Pettit has pointed out, came up with a total capital cost of \$600,000 for the Stanford facilities for the four-channel network. This sum was obtained from industry participants on a basis that was graduated according to the size of the organization. The share could be paid in a lump sum or prorated over 5 or 10 years.

It turned out that, for even the largest company, the total annual cost is less than a technician's salary. And according to session organizer Albert Morris, analysis of records for a large company has shown that with a sizable number of graduate students over 10 years, the prorated cost is only twenty cents per student, per classroom hour, for amortization and operating costs of the in-plant facilities.

The Stanford industrial-TV curriculum empha-



Fig. 1. Educational TV coverage in the Stanford-San Francisco Bay Area is shown by geographical distribution. The size of each black dot represents the number

of companies in a section participating in the graduate study program. The Stanford network will be shared by other colleges and universities.



sizes graduate courses at the master's level for which no thesis is required. It is theoretically possible to obtain a degree via the televised course, but Dean Pettit cautions that this is not entirely practical nor desirable. Some courses don't lend themselves to TV treatment. He also suggests that the student take at least one seminar on the campus to become acquainted with one or more of the faculty.

In expanding the TV-education benefits, Stanford created a "non-registered" option that permits students in industry to take the TV classes without being matriculated at the university. They are tested and graded along with the regular students, but their performance does not affect the statistical standards of the others.

Included in the non-registered category are those who already have degrees, those who don't want to complete all of the work for a degree, and those who want a degree but are not yet academically qualified. In this last case, Dean Pettit points out, Stanford allows these students to matriculate, and to transfer completed units by petition, provided they perform well enough as non-registered students in competition with the matriculated students.

#### Future coverage to be broad

Stanford network coverage of the Bay Area is planned to include a two-way link to the University of California at Berkeley for sharing lectures, seminars and courses. Cooperative arrangements with the University of Santa Clara

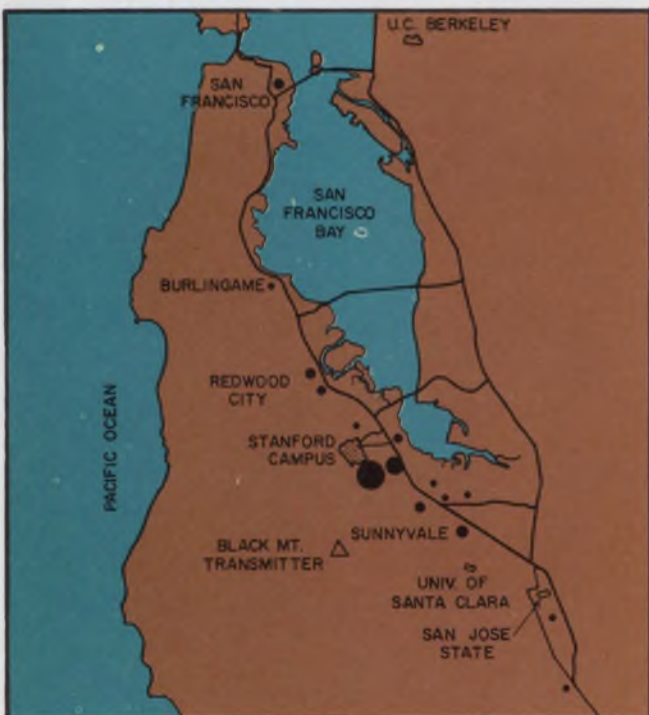

Stanford network coverage will eventually include links to the University of California at Berkeley, University of Santa Clara and San Jose State.

and San Jose State are also being worked out.

For coverage in the Southern California area, plans are being made to link the University of California at Los Angeles with the campus at Irvine: these two, together with the University of Southern California, will serve the Los Angeles basin. Robert M. Saunders, Dean of the School of Engineering at Irvine, told ELECTRONIC DESIGN that they have recently been awarded four ITFS (instructional television, fixed station) channels for the area. According to the FCC notice, construction is scheduled to be finished by mid-February of next year.

Saunders also said that it is eventually hoped to link Irvine, Los Angeles and the University of Southern California with Santa Barbara College, Riverside College, and San Diego State.

The new Stanford educational TV system uses channels in the band of 31 which the FCC designated in 1963 for microwave operation of this type of station. The band extends from 2500 to 2686 MHz, giving a 6-MHz channel to each station, using the standard TV signal format. The channels are allocated in groups of four, with adjacent channels being separated by 6 MHz from another assigned locality.

The audio talk-back capability is obtained by utilizing fm radio talk-back in a 4-MHz band (2686-2690 MHz) adjacent to the top end of the ITFS band for each of the available channels. This system required a rule-making decision from the FCC, which was effective in June of this year. The first type-acceptance models of the talk-back system have been designed by Genesys Systems, Inc., for the Stanford network.

TV signals from the Stanford classrooms are carried by cable to a master control room, then relayed via a 12-GHz link, with 4-foot dishes, to the main transmitter on Black Mountain, which is 7.9 miles from the campus.

Each company requires only one receiving antenna, mast, and down-converter for all four channels. The system is of broadcast quality.

Seven of the 10 available watts are radiated from an antenna covering an arc of 160 degrees, with a horizontal gain of 17 dB. This gives an effective coverage of up to 25 miles for a 6-foot receiving dish. To reach San Francisco (36 miles) 1 watt is fed from a 10-foot parabola, and 8-foot parabolas are used at the industrial receiving sites.

To reach the Emeryville-Berkeley area (39 miles) 2 watts are fed from a 6-foot dish, and 10-foot parabolas are used for receiving.

The talk-back transmitting antennas at the industrial location are mounted in a plane with the receiving antennas and are cross-polarized to reduce cross-talk. On Black Mountain, the talk-back receiving antennas are mounted colinearly with the transmitter antennas. ■■



# with your reputation at stake, which resistor line would you specify?

take a close look—there'll be no question



Allen-Bradley



Manufacturer X



Manufacturer Y



Manufacturer Z

The above illustrations are from unretouched photomicrographs taken of four  $\frac{1}{2}$ -watt fixed resistors. Compare the anchoring of the leads, the seal provided by the insulating jacket at the ends, the homogeneity of the resistance material, the sharp color code bands—and decide for yourself.

For more details on Allen-Bradley hot-molded resistors, please write for Technical Bulletin 5000: Allen-Bradley Co., 1201 S. Second St., Milwaukee, Wis. 53204. Export Office: 1293 Broad St., Bloomfield, N.J., U.S.A. 07003. In Canada: Allen-Bradley Canada Ltd.

© Allen-Bradley Company 1967

EC69-56

QUALITY ELECTRONIC COMPONENTS



A-B hot-molded fixed resistors are available in all standard resistance values and tolerances, plus values above and below standard limits. **A-B hot-molded resistors meet or exceed all applicable military specifications including the new Established Reliability Specification.** Shown actual size.

TYPE BB  $\frac{1}{8}$  WATT

TYPE CB  $\frac{1}{4}$  WATT

TYPE EB  $\frac{1}{2}$  WATT

TYPE GB 1 WATT

TYPE HB 2 WATTS



## ALLEN-BRADLEY



**Reliability is six things we do  
that nobody else does.**

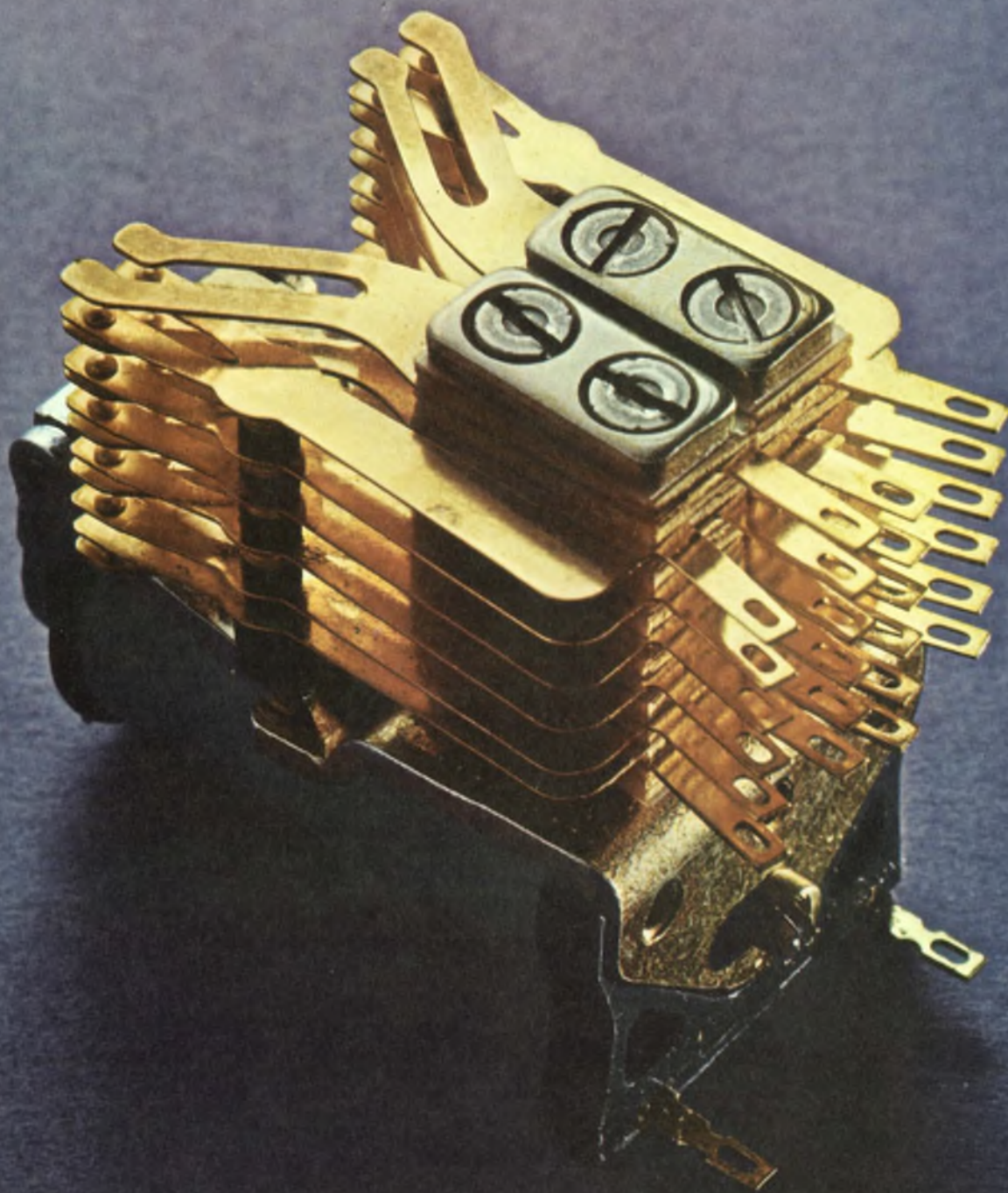





### **We're fanatics.**

We build our relays stronger than we have to. That way, they last lots longer than they ever have to. Our Class E relay (shown on the opposite page) is a good example of our way of thinking.

### **The industry's strongest heelpiece.**

We make the strongest heelpiece in the industry. A gigantic machine bangs them out extra fat and extra flat.

Extra fat to carry a maximum of flux. To handle big loads. Extra flat so that once an AE relay is adjusted, it stays adjusted.

Since our backstop is part of the heelpiece, it's just as thick and flat. But, tough as it is, the slightest wear here would throw the entire contact assembly out of whack. So, to be safe, we weld two tiny, non-magnetic pads where the armature arms meet the backstop. You might say we created the no-stop backstop.

### **Three parts that'll wear like crazy.**

When you build a relay like a small tank, you have to think of everything. We try. Right down to the tiniest part. For example, we make our armature arms and bearing yoke extra thick.



Thicker than years of testing and use say they have to be. Then, to make sure they don't cause wear problems, we insert a hardened shim between the hinge pin and the frame. The pin rides on the shim, instead of wearing into the heelpiece. (You can forget the bearing, it's permanently lubricated.)

### **Buffers with lots of muscle.**

We make our buffers of a special tough phenolic material that lasts. And lasts. And lasts. All without wear or distortion. Another reason why our relays stay in whack.

To make sure our buffers stay in place, we weld the buffer cups to the armature arms. We weld, instead of using rivets, because our lab found that rivets have a habit of falling out.

For the very same reason, we weld buffer cups to the contact springs. And also use the same special tough phenolic buffers.



### **No, we didn't forget the contact springs.**

We have some strong feelings as to what makes a contact spring reliable. Our sentiment is that two contacts are better than one. So, we bifurcate all the springs, not just the make and break. This slotting and the addition of another contact to each spring means you get a completed circuit every time.

We make each set of contact points self-cleaning. The bad stuff doesn't have a chance to build up.

### **Now, what's different about our bobbin?**

Our bobbin is one piece—molded of glass-filled nylon. This provides the maximum in insulation resistance.

Because our bobbin is nylon, we don't have to impregnate with varnish. Moisture and humidity have no effect on the stubborn nylon material. No effect means no malfunctions for you to worry about.



### **What all this means to you.**

What this all adds up to is reliability. The kind of toughness no one else can give you. It means an AE relay works when it's supposed to, longer than it has to.

Isn't this the kind of reliability you really need? Automatic Electric Company, Northlake, Ill. 60164.

# **AUTOMATIC ELECTRIC**

SUBSIDIARY OF GENERAL TELEPHONE & ELECTRONICS

# Technology in the world of today

Papers at Wescon stress the practical applications available now in developments that also have a future

## Aerospace

### Satellites preparing to explore the earth

How to bug the earth and its atmosphere with unmanned sensors that report to stationary satellites is described in detail in session No. 12. The report, part of a session devoted to data-relay satellites, is by S. D. Dorfman of Hughes Aircraft's Space Systems Div., El Segundo, Calif. Examples of the in situ sensors include buoys, balloons, seismic detectors, volcanic detectors, agricultural sensors that even measure the temperature of soil moisture, smoke detectors and weather stations.

Users of such systems are expected to include the U. S. Depts. of Commerce, Interior, Transportation and Agriculture, as well as agencies in other countries. By 1975 Dorfman foresees as many as 26,000 platforms, all serviced by three or four satellites. The cost of the data communication system over a five-year period—not including the platform sensors—would come to about \$100 million, Dorfman says. A conventional system, not using satellites, would cost \$1.25 billion.

Frequency choices are 149 MHz for the uplink and 137 MHz for the downlink.

#### Wide areas of interest

The session will appeal to a surprisingly large variety of engineers and scientists, session organizer S. H. Durrani of the Comsat Corp. in Washington, D. C., told ELECTRONIC DESIGN. Those who will find it particularly valuable include not only engineers working in the environmental sciences—meteorology, geology, agriculture, oil exploration, geodesy, fishing—but those working for oil or other companies that must collect information from remote, often unmanned,

stations. Their equipment suppliers will also be interested.

Another big group consists of communicators—companies that now supply the public with telephone service by high-frequency and microwave radio, as well as those interested in providing industry with quick transmission of correspondence and records.

A satellite communications network for domestic use to provide an "entirely new approach to telecommunications in the United States" is described by W. B. Gross, Program Manager, General Electric, Philadelphia. Whereas a call from Los Angeles to New York via terrestrial means passes through approximately ten distinct switching offices, a call by satellites goes through two.

The system GE proposes would use a minimum of two satellites in synchronous orbit. The earth station is modular in design and uses commercial equipment for the antenna, feeds and rf portions. The automatic digital exchange is a special-purpose digital computer oriented to communications control and processing. Local loop (telephone line) interface equipment is built in modules to provide flexibility in deploying the system.

To fully implement the system by 1980, Gross says, would cost \$321 million. This includes initial research and development, the cost of five satellites and boosters, earth facilities, and the continued research that would be needed through 1980. The largest single investment would be the earth facilities, which, Gross estimates, would cost approximately \$140 million. This includes 175 earth stations, one routing center, and other administrative facilities.

#### Building a satellite network

The problem of how to weave a large number of ground users into a satellite network is aired by P. J. Heffernan of the National Aeronautics and Space Administration's Goddard Space Flight Center in Greenbelt, Md.



Heffernan uses as a hypothetical case a system with 70 ground stations. He covers such problems as how multiple access techniques can accommodate this number, how the satellite can be tracked, and how the signal should be designed and modulated.

Multiple access will be different for a domestic system than for that used with Apollo, Heffernan says. Apollo ground stations acquire the carrier and remodulate the received code sidebands and send them back on another carrier. For the domestic system, Heffernan recommends that the user lock on carrier and code, regenerate the code and send it back to the satellite.

Very high frequency should be used rather than S-band or L-band to make the terminal equipment simpler. And tracking will be accomplished by a pseudo noise spread spectrum technique.

Those interested in transmitting photographic data will be interested in W. J. Gill's report on an experiment made by Philco-Ford of Palo Alto, Calif., in which photographs were transmitted via the Defense Department's interim communications satellite network.

The key elements in the system are the analog-to-digital conversion and the image-recording equipment—the image appears on a cathode ray tube that is photographed. Although originally designed for the military, such a system could be used commercially.

Coding and signal selection for the data relay satellite interrogation is probably the most tech-

nical paper in the session. It is given by G. D. Boyce of General Dynamics Convair in San Diego.

Boyce doesn't claim to have the best of all possible approaches, but he prefers the majority voting approach to error detection or error coding. He feels that phase lock loops are too complicated; he prefers to use frequency shift keying.

#### Defense Dept. unhappy over avionics

Recent criticism of avionics systems by the Defense Dept.'s Systems Analysis office should add a sense of immediacy to the session on "Future Avionics System Architecture" (No. 19).

The dissatisfaction the Defense Dept. expressed, however, came as no surprise to session organizer John A. Alexander of TRW Systems Group, Redondo Beach, Calif.

"We've known for a long time that a new approach to designing avionics is needed," he told ELECTRONIC DESIGN. "That's why we used the word 'architecture' in our session title. Architecture means the total disciplines and procedures needed to build something—in this case avionics systems." There is too much redundancy, he says; too many add-ons.

The session begins with a bid for integrated avionics by Richard D. Alberts, Air Force Avionics Laboratory, Wright Patterson AFB, Ohio. Alberts describes work under way by the Air Force on techniques to integrate the communications, navigation and identification functions to



Computer-controlled test system from Bendix Corp. automatically checks on the performance of analog, digital

and high-frequency avionic systems aboard commercial aircraft (Paper 21/3).



operate on a single radio frequency.

Will one computer solve all the problems in the aircraft or will each subsystem have its own processing unit? This much-debated controversy over "federated vs. integrated computer systems" is discussed by J. H. Crenshaw of IBM Federal Systems Div., Owego, N.Y.

While federated systems (one computer for every task) seems on the way out, a fully integrated system, using a single, central computer, has not yet arrived. Today's advanced aircraft use a combination of the two. After recounting the advantages and disadvantages of both extremes, Crenshaw concludes that integrated systems will continue to gain, with the actual system still remaining something of a hybrid.

To design for military avionics, L. S. Guarino, Naval Air Development Center, Johnsville, War-

minster, Pa., tells the engineer where his effort should be directed. If the pilot is to be given more time for decision making with all the collection, integration and processing of information performed by avionics there must be more confidence in the avionic systems.

To do this the engineer should concentrate on:

- The electrical interfaces between black boxes. "This has been a main cause of avionic system failures," Guarino says. "The number of wires between boxes must be drastically reduced. The use of MINCOMS (multiplexed interior communication system) appears promising and should be developed for the avionic system."

- Displays are important. The use of CRT tubes should be replaced with solid-state devices, and color should be added. For more realistic representation, engineer Guarino suggests holo-

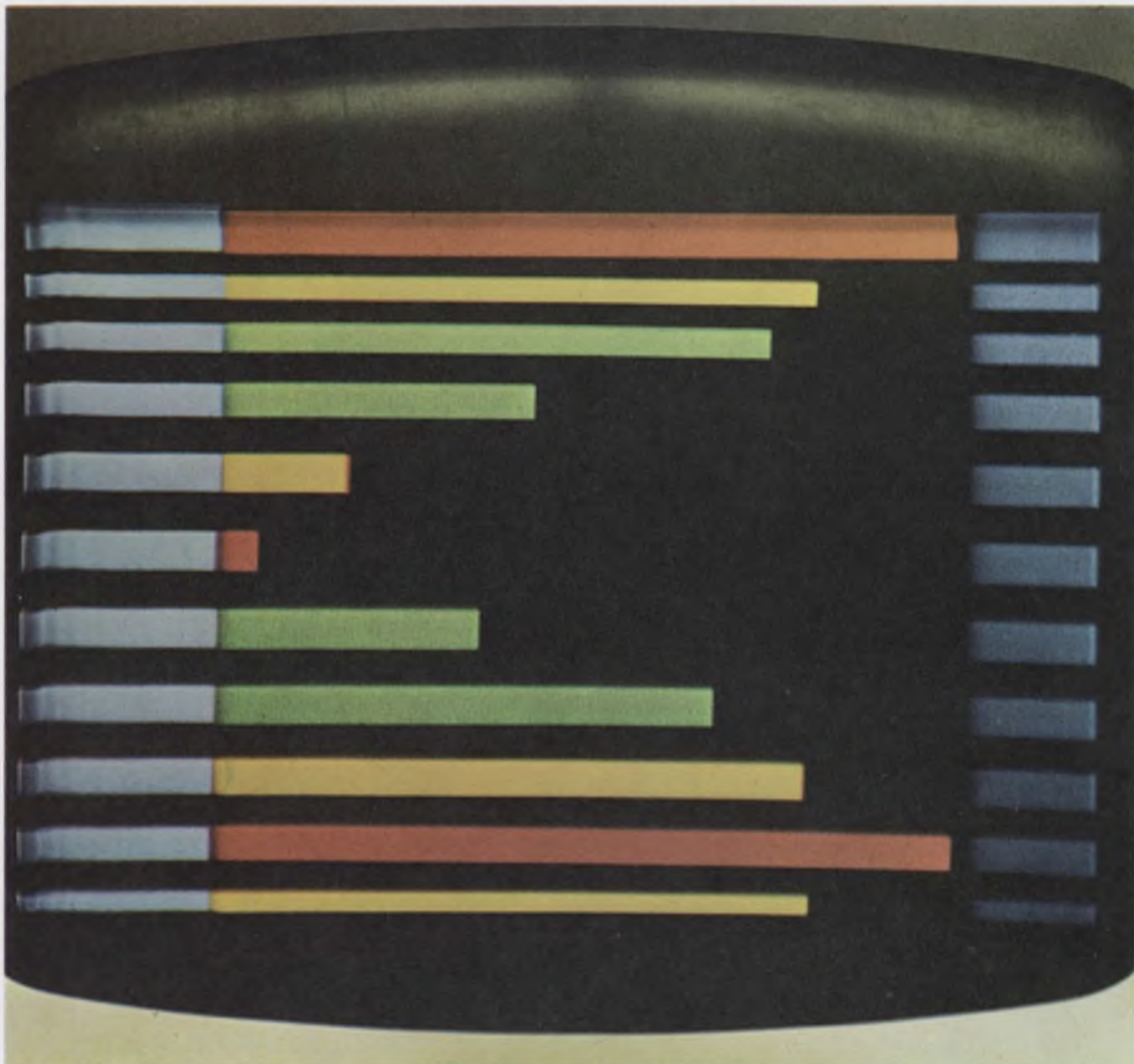

Experimental color CRT display, which is scanned in a standard 525-line television format, displays practically

any type of engineering data, according to W. H. Tew Jr. of General Electric Co. (Paper 18/2).



graphic techniques be used.

■ Man-machine simulators "should be the designer's most valuable tool."

The final paper, authored by J. R. Goodykoontz and V. A. Karpenko of TRW Systems Group, reports an interesting convergence taking place between the design of avionics and space equipment. Avionics on the one hand is getting more complex, while space equipment is becoming cheaper and more reliable, due to more enlightened techniques. ■■

## Circuit Design

# ICs and computers growing in influence

Circuit design and analysis are coming increasingly under the influence of the computer and the integrated circuit. Wescon coverage of such areas as filter design, mathematical modeling and oscilloscope techniques reflects the trend.

Session 4 on "Integrated Circuits in Active Filters" carries filter design through thick and thin films. Dr. George S. Moschytz of Bell Telephone Laboratories, Holmdel, N.J., uses tantalum thin-film RC networks and general-purpose silicon integrated operational amplifiers to construct a family of basic second-order filter building blocks, from which a wide variety of filters can be assembled. His paper, "FEN (Frequency Emphasizing Network) Using Hybrid Integrated Building Blocks," describes three pairs of blocks that operate from 100 Hz to 100 kHz. There is a pair for low-Q and one for medium-Q applications. A combination of the two is used for high-Q applications.

Moschytz derives the response of a medium-selectivity-frequency-emphasizing network and shows how his building blocks can be combined. He also describes techniques to construct the tantalum thin-film devices he uses.

The thick-film technique is upheld by Dennis Hollenbeck of Kinetic Technology, Los Gatos, Calif., in a paper on "Multiloop Negative Feedback Active Filters Using Thick-Film Integrated Circuit Techniques," and by William Broyles of Sprague Electric Co., North Adams, Mass., in "ICs and Thick Films Add Up to Improved RC Active Filters."

Broyles describes a method of producing custom filters that meet tight specifications and tolerances. Four standard topologies can be combined to meet a wide variety of needs. The frequency range is 0.01 Hz to 20 kHz, with Qs up to 300. Input impedance is high, and the output impedance is low. The significant aspects of the approach are to use thick-film resistor networks

and bonded-on capacitors. Gain is obtained from IC amplifiers. The desired requirements are programmed into an interactive computer. The designer can continue the computation with refinements, until he is satisfied that he has obtained the best design. The computed thick-film networks are then produced and assembled, along with the ICs, into finished networks.

The combination of accurate computation plus the stability and reproducibility of the thick films make for a superior product, Broyles contends. The size of a completed sixth-order filter is about one cubic inch. "This approach can turn theory into an economical product," he says.

Hollenbeck's designs allow the user of the product to make the final determination of its characteristics. This is done by external trimming. His filters also cover the audio band and may have Qs up to 2000, with high input and low output impedance. The user can choose high-pass, low-pass or bandpass operation, as well as the center frequency. The filters are individually packaged on aluminum substrates, with screened-on resistors in the passive networks and 80-dB operational amplifiers in the active networks. Each package contains one pole pair, and packages can be combined for more complex transfer functions. A key feature of the design is the very low supply power required for operation—between  $\pm 2$  V and  $\pm 15$  V.

Other Session 4 papers include "Active Filters Employing Silicon Monolithic Gytrators," by Robert Hove, Boeing Co., Seattle; "A State Variable and Gytrator Realization Comparison," by Robert Newcomb, Stanford University, and "Filter Design Using Integrated Operational Amplifiers," by Sanjit K. Mitra, University of California, Davis.

This Wescon session, organized by Gunnar Hurtig 3d of Kinetic Technology, Los Gatos, Calif., probably holds the greatest interest for the engineer in circuit design.

"High-Speed Oscilloscope Recording," is the subject of Session 13, organized by James R. Pettit of Hewlett-Packard, Colorado Springs, Colo. The ubiquitous computer appears even in this haven of measurement in a paper that discusses the mating of single transient oscilloscopes to on-line machines. Other papers cover photography of transients on oscilloscopes and high-frequency trigger circuit design.

The last listed session of Wescon is No. 23, "Computer-Aided Circuit Design," organized by Ron Rohrer, Fairchild Semiconductor, Mountain View, Calif., and Gabor Temes, Ampex Corp., Redwood City, Calif. This is another of the difficult-to-classify sessions, dealing as it does with both circuit design and computers. A paper presented by Harry B. Lee of Lincoln Laboratory,

Massachusetts Institute of Technology, Lexington, Mass., points out design-difficulties in programming circuits. Entitled "Circuit Simulation Present and Future," the paper states that as computers progress from the research stage to daily use, better programs must be written to meet the needs of the circuit designer. In particular, Lee thinks that the programs should be "human engineered" better to enable anyone to use a computer with little or no knowledge of programming. He also advises that new analysis techniques, such as the sparse matrix and implicit integration, be incorporated into computer programs. Implicit integration, by the way, can eliminate the problem of long computation time that arises when a circuit has widely spaced time constants.

Lee is strongly in favor of graphic output displays as an aid to the designer. He especially likes storage CRTs, which permit the designer to study the results of his efforts. He does not believe that elaborate input devices, like the light pen and graphic input terminal, can justify their cost.

Other Session 23 papers cover such diverse topics as transistor modeling, network optimization and layout. ■■

## Communications

# Solutions offered for digital hangups

Wescon is offering only a limited technical agenda for communications engineers, but what there is promises to be very worthwhile.

The most important session appears to be "Signal Processing Techniques in Digital Communications" (Session 11), which is being held in Meeting Room B on Wednesday afternoon. The chairman, Adam Lender of Lenkurt Electric Co., San Carlos, Calif., says the session is entirely devoted to new designs and techniques, presented from a practical point of view. It is considering the three most significant areas in digital communication:

- Signal design.
- Adaptive equalization.
- Error control.

The lead-off paper, by W. J. Melvin of Collins Radio, Newport Beach, Calif., discusses the digitalization of a communications terminal—both transmitter and receiver—so as to eliminate such analog devices as filters and modulators. The terminal actually becomes a small, special-purpose computer. The idea is explained by referring to a particular differentially coherent, four-phase PSK system with a matched-filter re-

ceiver. Performance data includes error rates in the presence of additive Gaussian noise.

## Practical adaptive equalizers

The next two papers are concerned with adaptive equalization. This is the automatic adjustment of the receiver to compensate for changes in the transmission medium.

In their paper "A Simple Adaptive Equalizer for Efficient Data Transmission," D. Hirsch and W. J. Wolf, of Bell Telephone Laboratories, Holmdel, N.J., discuss several algorithms for directing the equalizer towards the properly matched condition. The methods vary from zero-forcing to minimizing the mean-square error. A practical example, employing a modified zero-forcing algorithm, is described.

Gerald K. McAuliffe of the IBM Watson Research Center, Yorktown Heights, N.Y., discusses adaptive equalization from an entirely different viewpoint. He focuses on a proposed method employing fast Fourier transform (FFT) techniques. He compares this with the tapped delay-line approach and the carrier-cancellation approach.

The final paper of the session—"Recent Developments in Error Control Techniques," by Allen H. Levesque of General Telephone and Electronics Laboratories, Waltham, Mass.—emphasizes the selection of an appropriate error-control coding technique for any transmission channel.

As many engineers already know, the optimum type of error control depends upon the error statistics of the channel. The usual simple assumption that errors occur singly and independent of one another is rarely valid.

It applies only in deep-space communications and some satellite links. Most other channels, such as hf, tropo and wire, tend to have clusters of errors. Therefore Levesque begins his discussion with a review of the statistics of the different channels and then analyzes the error-control methods appropriate for each.

In the case of channels with bursts of errors, a major objective is to break up the bursts. For block codes, this is done by interleaving the blocks at the decoder. The concept of concatenated codes—codes that make up long blocks by cascading many short ones—is discussed. A dual-mode type of error control, called burst-bracketing, is also described. Burst-bracketing codes actually switch the mode of decoding, depending upon whether densely clustered or independent errors are occurring. A discussion of convolutional codes wraps up the consideration of ways to combat burst errors.

The final error-control procedure being considered is the sequential decoding of convolutional





**Array systems engineer** Charles Mclean of Viatron Computer Systems Corp. is busy designing a composite layout for a complex MOS array (Paper 15/3).

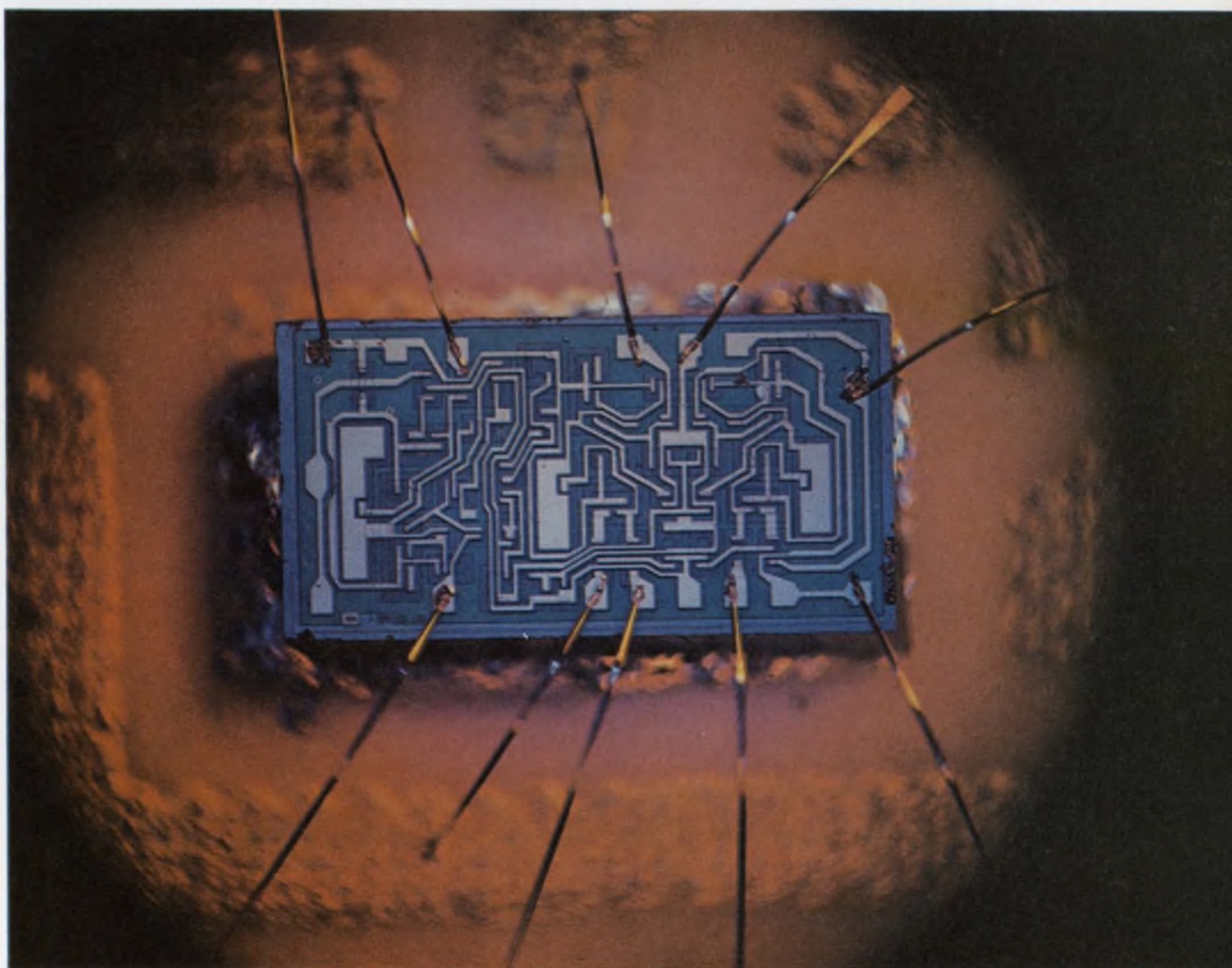

**Monolithic integrated circuit chip** containing three operational amplifiers will be used in a hybrid active

filter. These filters will be discussed in Paper 4/4 by Dennis Hollenbeck of Kinetic Technology Corp.



codes. This method is really useful only with independently occurring errors, but it approaches the ultimate theoretical performance promised by the analysis of optimum codes.

The entire session is being sponsored by the Communications Systems Discipline Committee of the IEEE Communications Technology Group.

Also of interest to communications engineers is Session 9 on "Linear Integrated Circuits in Communications" and Session 12 on "Data Relay Satellites." For further information on Session 12, see the Aerospace section of the review of technical papers. ■■

## Computers

# Automation spurring efficiency in factories

Two sessions at Wescon are devoted to a growing phenomenon: the use of the computer in factory quality control. Across the country, computers are being used to monitor test lines, control manufacturing processes, collect factory data and assist management. In at least one case, a computer is also being used in the field to test and trouble-shoot airborne navigational equipment from commercial airliners.

Session 8, organized by George H. Ebel of Conrac Corp., Caldwell, N.J., and S. Levy of RCA, Camden, N.J., considers "Manufacturing and Computers." In a paper on "Computer-Controlled On-Line Testing and Inspection," Peter H. Goebel of General Radio Co., Cambridge, Mass., describes how his company was able to make a routine task of the testing of electronic subassemblies used in measuring instruments. A test system was assembled to perform functional logic testing, test-fixture standardization, diagnostic trouble-shooting and go no go testing. An important consideration was to make the entire test system operable by personnel with no special training.

The computer in General Radio's test system is a standard Digital Equipment PDP-8/L, and it serves as the control device for all peripheral system components. When not in use in the test system, it can be used to prepare test programs and tapes.

The other parts of the system hardware are the system interface, where computer and peripheral equipment interconnections are made; the control panel, which serves as the medium between operator and system; a readout scope, which aids in both go no go and diagnostic testing, and a high-speed reader, which operates from punched paper tape. A device adapter is used to connect the device that is being tested

into the system.

The system software includes an easy-to-use and versatile programming language that can be used by personnel with no prior computer knowledge. Simple and logical commands are provided to perform the test on electronic modules. Some of the statements possible allow listing of test points, forcing of inputs, checking of outputs, repetition of tests and the calling of subroutines.

Among the benefits claimed for the system are reduction of lead time in module testing, fewer false indications of failure, a saving in set-up time and a higher yield of usable modules.

Four aspects of automatic testing—hardware, software, hardware-software package and management—are covered in Session 21, "Computer-Aided Testing, Management and Implementation," organized by A. Machi of Bendix Navigation and Control Div., Teterboro, N.J. A paper on the hardware-software package describes a significant departure from the usual computer test system. Entitled "A Computer Controlled Test System," by Frank M. Stutesman of Bendix, it describes a field test system for airlines.

Airliners use many pieces of electronic communication and navigation equipment. These systems, which may be either analog or digital, are housed in individual boxes. Failures in these boxes are usually reported by flight crews. Ordinarily the trouble is diagnosed manually by specialists, and the repairs are made at convenient airports.

### Computer testing made easy

In the system designed by Stutesman, diagnosis of the faults and checkout of the repaired equipment is performed by computer, and these two tasks can be done by relatively unskilled personnel. The central computer in the system is the Bendix BDX 6200. The software is based on the Atlas language, developed by ARINC (Aircraft Radio, Inc.). Inputs to the system can be on perforated tapes or via keyboard. Unskilled personnel can interact with the system in a language that closely resembles English.

At this time the system can test 30 to 40 different avionic boxes of different manufacture. An extra dividend is use of the system in the Bendix plant for final inspection of airliner equipment.

Other Wescon sessions are devoted to time-sharing and computer display devices. The time-sharing session stresses applications. The papers in the display session emphasize on-line and real time displays.

In all, at least 13 Wescon papers report on computer applications in some aspect of manufacturing—either quality control or automatic processing. ■■



# ICs are changing design picture

From Anaheim, Calif., to Boston, engineers are examining the changes that ICs are causing. Circuit design, system design, engineering communications and vendor-customer relations—all are different in age of the IC. But exactly what are the changes? And what are their effects?

In Session 1, "IC Systems: The Changing Interface," you learn that systems houses are becoming concerned. Their share of value added to their products is dropping drastically, and they fear that their profits may follow. They are making a serious analysis of the situation.

For instance, the Singer Co., Palo Alto, Calif., finds that about 40% of the factory cost of its Friden desk calculators is accrued in the purchase from outside vendors of semiconductor parts. Parts purchased in the past, from outside the company, for a mechanical calculator accounted for only 10% of factory cost.

How can systems houses make up their loss in value added? George Hare of Singer says, in the first paper of the session, that they probably should plan to produce ICs in-house.

Other papers in Session 1 discuss the growing use of computer aids in the production and testing of ICs, and the changing role of the circuit designer. How, for instance, does a system designer avoid design redundancy?

Typically, an engineer who wants to order a special IC will design and breadboard a prototype, and order the IC only after he has done this. The vendor's engineers then duplicate much of the original work in learning the circuit problem, developing the IC and preparing tests for it. But how can the needless duplication of effort be reduced? Clearly, by communicating more concisely, but how is this accomplished? Answers are given in Session 1.

### Designers in a dilemma

You can take a close look at MOS ICs in Session 15, "MOS ICs: A Critical Review."

"Every systems designer," says Glen Madland, president of Integrated Circuits Engineering Corp., Phoenix, Ariz., in the first paper, "must decide whether to go MOS, bipolar, or hybrid, and the technical and economic success of his project depends on getting the right answer." Madland discusses the implications of MOS in device design, circuit design, and partitioning.

In the second paper, Ralph Parris, staff engineer at Burroughs Corp.'s Circuits and Packag-



Designers find that ICs account for as much as 40% of the factory cost of their systems.

ing Dept., presents guidelines on choosing MOS processes, and packaging and testing schemes, and he gives his views on the proper choice of an MOS vendor. In another paper, Dr. Leland Seely, general manager of General Instrument's Microelectronics Div., tells how the vendors are achieving TTL compatibility in their MOS.

For the designer who is having nightmares over his vulnerable single-source situation, Larry Drew, manager of engineering development at Viatron Computer Systems Corp., Burlington, Mass., has some soothing words. Drew sees single sourcing as inevitable, and MOS procurement as a joint business venture between vendor and customer. And a glimpse of the MOS future is provided by Al Phillips, assistant to the president at Autonetics, Anaheim, Calif.

### Filters, linears, and power ICs

For engineers whose interest is in circuit design, there are papers galore, covering active filter design, linear ICs and high-power microcircuits.

Possibly the most interesting of these sessions is No. 4, "ICs in Active Filters". It was organized by Gunnar Hurtig, executive vice-president of Kinetic Technology, Inc., Los Gatos, Calif., and he has chosen speakers for a "practical session, with as much information on hardware as possible". He says that his company deals with "a lot of engineers who expect to use active filters but don't have a good practical knowledge of their capabilities. They don't know what's available and don't know where the pitfalls are."

The session opens with a paper by Sanjit Mitra,



a professor at the University of California, on the over-all problems encountered in building active filters. He gives a description of the types that can best be built with ICs. He says that IC active filters are the only economically practical ones.

The next paper discusses the popular methods of designing active filters, with gyrators and with multiple-loop negative feedback circuits, and the merits and disadvantages of each. The remaining four speakers describe the design and construction of actual filter circuits, including a monolithic silicon gyrator and thin-and thick-film negative feedback filters. They speak from valuable experience with hardware, and they have some invaluable tips for attending designers.

For the linear designer, Alan B. Grebene of Signetics Corp., Sunnyvale, Calif., has arranged Session 9, "Linear ICs in Communications." Fairchild Semiconductor's Richard Q. Lane presents a new MOS design for vhf receiver front ends, and Sumner B. Marshall of Sprague Electric Co., Worcester, Mass., discusses the use of linear ICs in consumer television and a-m fm receivers.

On the packaging and interconnection side, Robert A. Hirschfeld of National Semiconductor, Santa Clara, Calif., gives some valuable design tips on how to use pins efficiently in complex communication systems. And Hans R. Camenzind of Signetics Corp., Sunnyvale, Calif. describes the merits of a system approach to the design of IC communication circuits.

#### A 'high-power' session

And for the designer who works with power—in voltage regulators, amplifiers, or control circuits—there is Session 17, "High Power Microcircuits." Thomas M. Frederikson of Motorola's In-

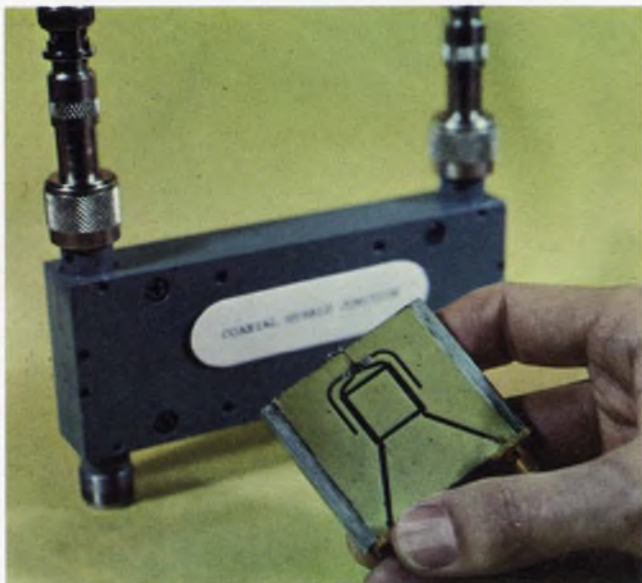

**Uhf hybrid receiver module** fabricated by IIT Research Institute is contrasted with a conventional coaxial mixer (Paper 3/5).

tegrated Circuits Center, Mesa, Ariz., and George Smith of Beckman Instruments Inc., Fullerton, Calif., explore the design and the capabilities of new monolithic and hybrid voltage regulators.

Herb Miezal, Dale Baughes and Leon Balents of RCA, Somerville, N.J., discuss high-power hybrid amplifiers, and William Whittekin Sr. of Texas Instruments, Dallas, Tex., present techniques for controlling power on an IC chip.

James Williams of Hughes Aircraft Co., Culver City, winds up the session with some valuable remarks on what he thinks is needed in power microcircuits. Williams feels that if ICs are to be used extensively in power circuits they will have to cost less, have improved temperature coefficients, and be used in systems designed to exploit their properties—perhaps in digital replacements for present analog circuits. ■■

## Microwaves

# EDP is password to clever design

Computer-aided design is the key phrase this year in the microwave sessions at Wescon. The digital designers are not only being used to design microwave integrated circuits; they are developing active devices as well.

Most of the papers on this subject are in Session 6, "Computer-Aided Design of High Frequency Circuits." Microwave engineers will probably be most interested in hearing the fourth paper, "Microwave Circuit Synthesis and Measurement," by H. Stinehelfer and W. Atwood of Microwave Associates, Burlington, Mass. It emphasizes the modeling problem in computer-aided design.

The usual design procedure, when computers are used, is to model the active devices and then to use these models to develop passive matching circuits. Often the original model is less than perfect, resulting in the design of less than optimum circuits.

To solve this problem, one can model the circuit by means of a theoretical circuit, with parameters adjustable to fit experimental data. As Stinehelfer and Atwood point out, however, the selection of an algorithm to adjust the theoretical circuit parameters isn't easy.

Essentially the problem boils down to minimizing a multi-dimensional function of many variables.

Most existing techniques consist basically of searching in some systematic fashion for the desired minimum point. To speed the process, other programs evaluate the gradients of the functions and use them to form a new estimate for the



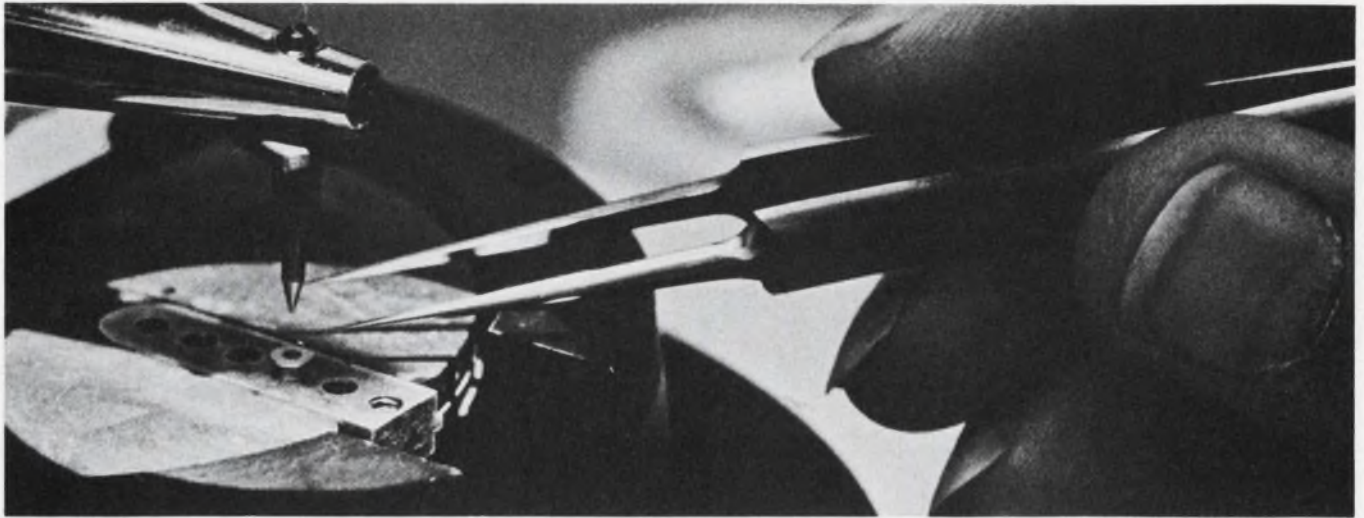

**Computers help design GaAs diodes**, as Chung K. Kim of Micro State Electronics, Murray Hill, N.J., will explain

theoretical circuit model. An example of the latter approach is given by Stinehelfer and Atwood.

The example is a one-section, capacitively coupled filter. The attenuation of the line is measured as a function of frequency, and the model's gap size and line thickness are allowed to vary until a good agreement with the measured data is obtained. The presentation includes a flow graph of the program.

#### Uhf microwave ICs

Another paper of high interest to the microwave designer is "Uhf Integrated Microcircuits," by Robert M. Knox of IIT Research Institute, Chicago. It is being presented in Session 3, "Current Solid-State Microwave Circuits." Knox's major thesis is that distributed-circuit techniques can be profitably employed at the lower microwave frequencies (0.3 to 3.0 GHz) if high dielectric constant substrate materials are used. He points out that area reductions of nearly an order of magnitude have been achieved by making MICs on a high- $\epsilon$  substrate instead of on alumina.

Traditionally, Knox points out, the design of circuits in the uhf range has been formidable because the performance of lumped circuits is generally regarded as inferior to that of distributed circuits, and distributed circuits have been too large to be practical.

Alumina, the substrate material on which most MICs are built, has a dielectric constant in the range of 9 to 15. Titanium dioxide, on the other hand, can provide dielectric constants up to 90.

What are the disadvantages of this high- $\epsilon$  material? For one thing, the propagation losses of a transmission line at a particular impedance level are higher than for the lower- $\epsilon$  case, because the conductor stripes are narrower. Fortunately the wavelength decreases in the high- $\epsilon$  material, so that the propagation loss per unit wavelength

in his paper in Session 6. The Varian unit shown here is about to be bonded to a single tuning screw.

does not increase unacceptably.

Other than that, Knox says, titanium dioxide is at least comparable to alumina in all important physical parameters.

For engineers who may have slipped behind the times, two other papers in Session 3 provide a review of the state of the art in two important areas: acoustic delay devices and solid-state sources. In his paper "Solid State Microwave Acoustic Variable Delay Devices," Ernst K. Kirchner of Microwave Electronics, Palo Alto, Calif., reviews the requirements for variable delay devices and then examines the hardware available to meet these requirements. The major areas of application he cites are array antennas, radar test equipment and electronic countermeasures gear. The first of these areas requires delays of up to 100 ns, with bandwidths of 500 MHz and center frequencies from 0.5 to 10 GHz. The second area needs a much longer range of delay: from about 1 to 150  $\mu$ s. Most of the characteristics desired for ECM delay lines are classified and cannot be discussed further.

To meet these requirements, a fairly large selection of devices is available. Kirchner believes that the mechanically variable magnetoelastic delay line is particularly promising. Other devices that he reviews include the electrically variable magnetoelastic delay line, the elasto-optical delay line, sliding acoustic crystals, ferroelectric materials and repetitive pulse-memory systems.

The other review paper is "Bulk GaAs and IMPATT Microwave Sources," by W. Keith Kennedy Jr. of Watkins-Johnson Co., Palo Alto. He compares the avalanche-diode sources (both IMPATT and TRAPATT) with the bulk GaAs sources. He does not distinguish between the various modes of diode operation in bulk GaAs because of the current disagreement in the literature on the exact locations of the boundaries between the different modes. ■■



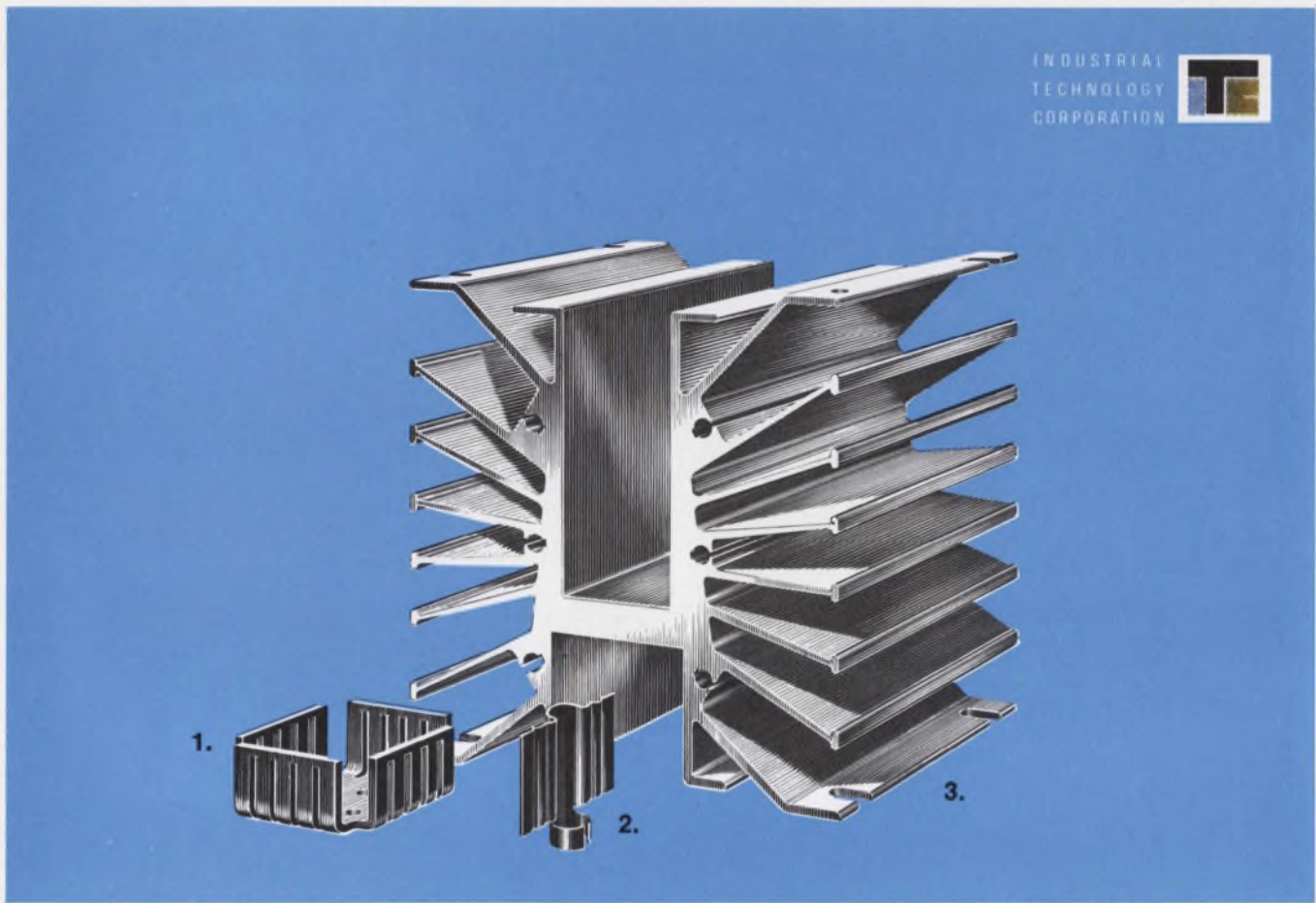

## Over 200 styles and sizes with 24 hour delivery

If your heat dissipation requirements include:

- Maximum selection of heat sink styles
- Fast delivery
- Consistent quality
- Reliability of design
- Specialized engineering

Then heat sinks by ITC TOR are for you.

From a simple flag type dissipator to complex blower-cooled heat sinks; to dissipate ¼-watt or 500-watts; to cool one component or hundreds; ITC TOR offers a choice of over 200 styles and sizes, in-house control of all engineering and manufacturing phases, and creative engineering to solve any specialized heat dissipation problems.

**AVAILABILITY.** ITC TOR maintains a complete stock of standard heat sink styles and sizes and assures shipment of most orders within 24-hours.

**SPECIAL SERVICES.** Prototype through production-run quantities can be produced—economically and to your schedule—to the most exacting specifications by TOR machinists and fabrication specialists.

**ENGINEERING.** ITC TOR retains a complete engineering department to provide effective design for specialized heat sink applications. Since all engineering and

die making is accomplished at ITC TOR, the fastest design and delivery of specialized devices are assured.

**NEW PRODUCTS.** ITC TOR has just completed development of a line of liquid cooled heat dissipators capable of effectively replacing devices 20 to 40 times larger.

**1.** LP12 Series heat sinks are ideal for small space requirements and printed circuit applications. Measuring only 1.60 x 1.60 x .75 with less than 1 mil surface smoothness, they are capable of dissipating 16-watts for 100 degrees centigrade temperature rise. Prestamped configurations include both TO3 and TO66 transistor outline, and are available in a variety of finishes. Also available are special brackets for mounting multiple LP12's on a single side or back-to-back.

**2.** 400 Series flag-type heat sinks are one of several types available for TO-5 transistors. Friction mounting, the series provides high heat dissipation while requiring minimum layout space.

**3.** Series 1647 are specially engineered heat sinks providing heat dissipation up to 500 watts without forced con-

vection cooling. Heat sinks within this series can be pre-drilled to mount any type component or semiconductor device requiring high heat dissipation. Construction is extruded aluminum, and heat sinks are available unfinished or finished to customer specification.

**4.** Modular cooling units utilizing forced convection provide maximum heat dissipation performance of air cooled heat sinks. Special multiplane mounting surfaces accept all semiconductor types providing easy access and reduced circuitry. Units are available unassembled or assembled, with or without fan, pre-drilled or undrilled. Heat sink finish is black anodized with end plates of cadmium plated steel.

Heat dissipation problem? ... contact ITC TOR, a division of Industrial Technology Corporation, a Subsidiary of Republic Corporation, 1960 West 139th Street, Gardena, California 90249. Telephone (213) 334-4907. Complete catalog and wall chart on heat dissipators are available on request.

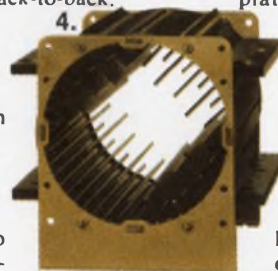

# ITC TOR



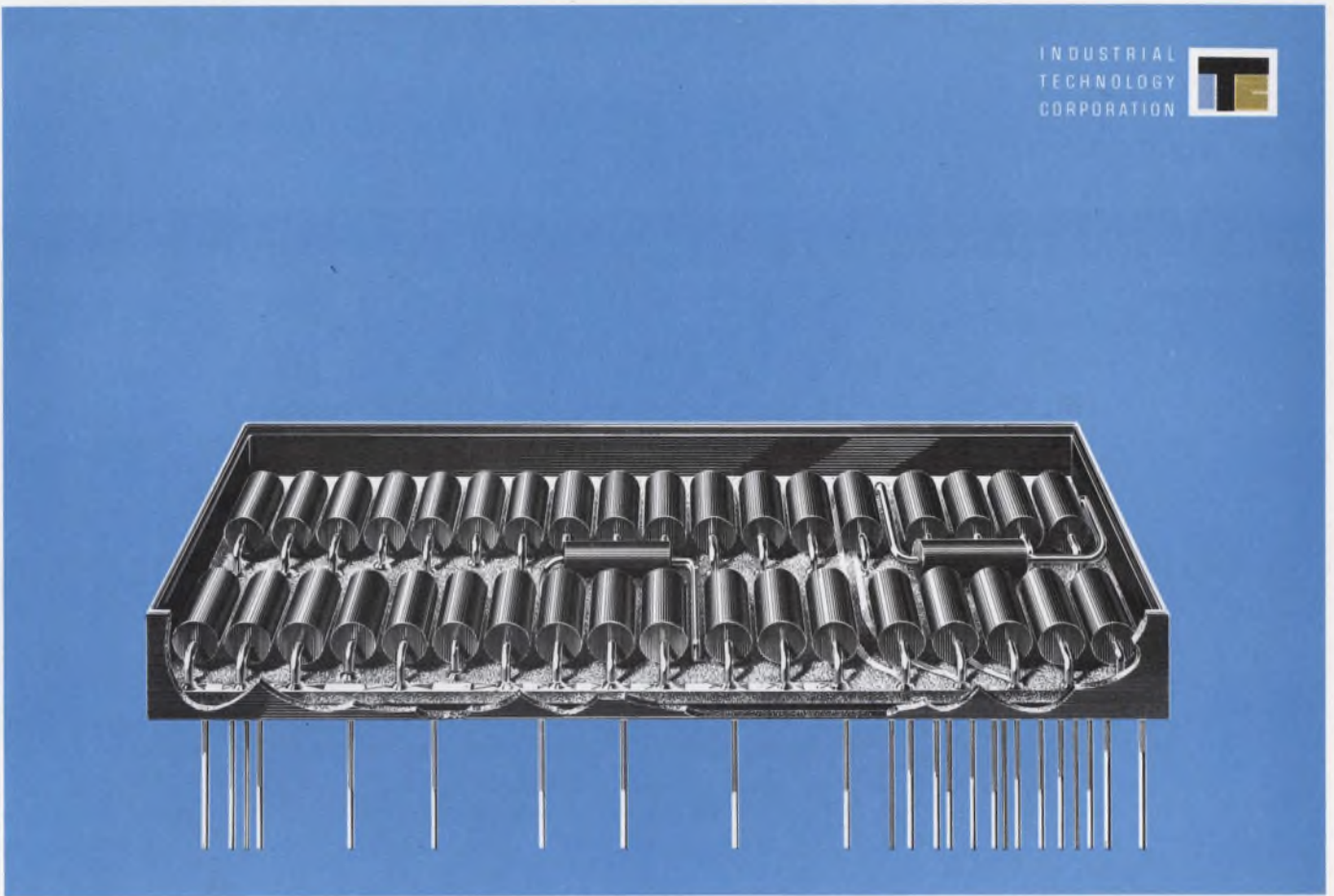

## 16 million hours of test time without a single failure.

**ITC Riedon precision wirewound resistors combine this high reliability with close temperature coefficients, close tolerances, fast rise time and small size.**

More specifically, they give you:

- Stability to 0.002%, provided by actually fusing resistance elements to terminations. Thermal emf is negligible.
- Standard temperature coefficient of  $0 \pm 10$  ppm/°C above 100 ohms to  $0 \pm 30$  ppm/°C for 0.1 to 9 ohms between -65°C and +150°C.
- Standard tolerance range from 1% down to 0.005%, measured at 25°C.
- Operation to 175°C, made possible by unique hot encapsulation, which eliminates virtually all moisture and voids.
- Rise time as fast as 10 nanoseconds up to 100KHz frequency input. (This puts

wirewounds where metal film was once the only solution.)

This performance should come as no surprise. Riedon originated the molding process for encapsulating resistors in epoxy. They were first to produce a molded epoxy encapsulated precision wirewound resistor that exceeded MIL-R-39005 and MIL-R-38100. They have qualified to the latest military specifications covering "Hi-Rel" parts (a failure rate of less than 0.01%/1,000 hours at 125°C and 60% confidence level).

These same resistors go into Riedon networks. We design and package

them in ladders, voltage dividers, analog-to-digital converters, operational amplifiers or miniaturized components. Combined with capacitors, conductors or diodes in a hermetically sealed package, one ITC Riedon element can replace 20 or more individual items.

We have a new 12-page folder that tells the full performance story of Riedon resistors. Why not send for a copy? ITC Riedon, a division of Industrial Technology Corporation, a subsidiary of Republic Corporation, 7932 Haskell Avenue, Van Nuys, California 91406 (213) 873-3464.



VISIT OUR BOOTH, UNIT D

**\* WESCON/69**

**ITC RIEDON** 

INFORMATION RETRIEVAL NUMBER 52



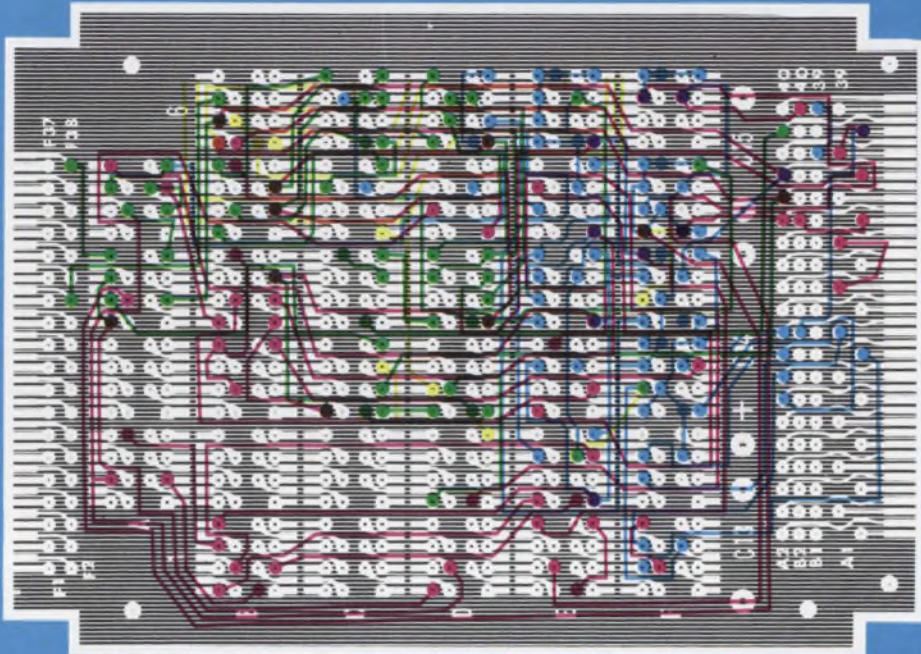

## A few no-nonsense words about Multilayer Circuit Board cost vs. quality

We at ITC Circuit Products would like to set the record straight about the cost-to-quality relationship of multilayer boards.

When a multilayer circuit board manufacturer installs the most advanced equipment obtainable, institutes the best possible processes, places all development and production activity under rigorous engineering control, he will produce quality multilayer circuit boards.

*And the net effect of all of this on cost is to lower it.*

**Yield is the key to cost** Sound illogical? Not at all. The reason is that quality processes and equipment produce greater yield, and yield is the primary determinant of cost in any multilayer board production operation.

So when we set up our multilayer circuit board capability, that's the philosophy we built it on—the finest state-of-the-art facilities, equipment, and processes available in order to produce the best boards at lowest cost.

### ITC's Laminating Presses finest in industry

Take our laminating press system, for instance. It's the most advanced of any circuit board manufacturer in the nation. The new system gives an unprecedented  $\pm 1.5^\circ\text{F}$  temperature control over the entire platen which means absolute uniformity of resin state and cure. What does this do for us? To date, not a single board has been rejected at ITC for layer shift since the new laminating system was installed, a phenomenal record. Another example is precision cool and cure temperature control. Because the temperature curve is so perfectly defined, we know the exact state of cure at all times and can take the board out of the press for oven-bake at just the right moment to achieve

predictable electrical characteristics. We never have to guess on oven curing.

**Advanced equipment proving cost concept** Precision laminating presses, numerically controlled, high-capacity drills, advanced photoresist processes—all these and many others daily are proving out ITC's concept of low cost through high-yield quality processes and equipment. ITC Circuit Products is ready for your order, be it quick turn-around prototype or long production run. Really, when at ITC Circuit

Products quality equals low cost, why take less?

ITC Circuit Products, a division of Industrial Technology Corporation, a subsidiary of Republic Corporation, 1111 Grand Street, El Segundo, California 90245, Telephone (213) 772-2531



VISIT OUR BOOTH, UNIT D  
\* WESCON/69

# ITC CIRCUIT PRODUCTS



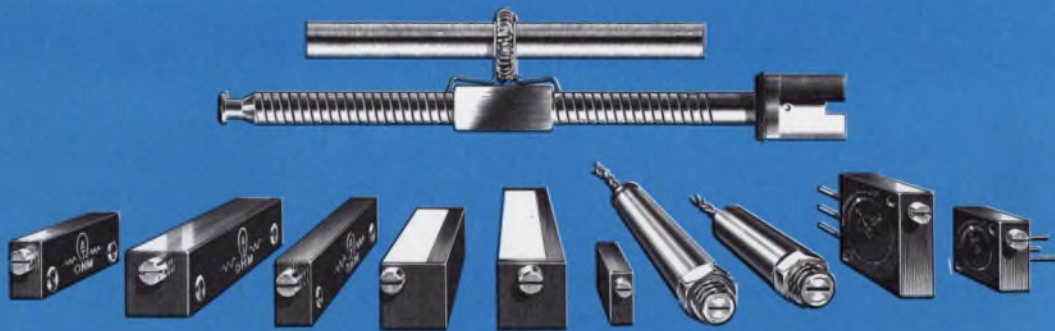

## one source potentiometer buying

COMPARE THESE FEATURES BEFORE MAKING ANY POTENTIOMETER BUYING DECISIONS:

- SINGLE SOURCE FOR ALL REQUIREMENTS. More than 9000 basic models, styles, resistance values and lead configurations assure the exact potentiometer for every application.
- WIDE RESISTANCE RANGE. Rectangular, square, tubular, and slide wire configurations combine to provide resistance selection from 1/2-ohm to 150K ohms.
- PATENTED WIPER trademarked "Quite Trim" is a most unique wiper design. Utilizing a ring of multiple contacts 360° around the resistance element, the wiper makes sequential contacts on each
- turn of resistance wire, greatly increasing resolution and decreasing noise even under extreme shock and vibration.
- LOW NOISE. "Quiet Trim" wiper design provides extremely low contact noise. Every "Quite Trim" potentiometer is 100% inspected to assure noise of 20 ohms maximum.
- LOW TC of only 50 ppm/° C of "Quiet Trim" potentiometers is far better than that required by MIL-R-27208.
- ESSENTIALLY ZERO END RESISTANCE. An advanced technique of welding the leads to the resistance element permits the "Quite Trim" wiper to completely encompass the element and resulting in essentially zero end resistance.
- LOW COST INDUSTRIAL units designed utilizing all MIL-SPEC techniques complement a complete line of MILITARY styles per MIL-R-27208.

Enough said . . . ? Not quite! We haven't told you about our dual metal end clutch; insulated metal mandrell, imbedded in heat transfer epoxy for highest heat dissipation; emersion proof styles; and, how wire wound potentiometers have greater resolution, higher power capability, and lower TC than film types.

For complete specifications and prices, contact: ITC Control Components, a division of Industrial Technology Corporation, a subsidiary of Republic Corporation, 950 No. Sepulveda, El Segundo, California 90245, (213) 322-4950.

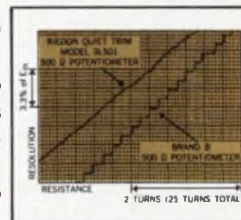

# ITC CONTROL COMPONENTS

INFORMATION RETRIEVAL NUMBER 54

# Here's the full technical program

A timetable showing who's giving papers, what the subjects are, and when and where the sessions are being held

## Avionics and Aerospace

Collection of Data From in Situ Sensors Via Satellite—S. D. Dorfman, Hughes Aircraft Co. (12.1/Wed./p.m./C)

Application of Satellites to Domestic Record Data and Video Transmission—W. B. Gross, General Electric (12.2/Wed./p.m./C)

A Multiple Access Satellite Relay System for Low Data Rate Users—P. J. Heffernan, NASA-Goddard Space Flight Center (12.3/Wed./p.m./C)

Wideband Transmission of Photographic Data Using the IDCSP Satellites—W. J. Gill, Philco-Ford (12.4/Wed./p.m./C)

Coding and Signal Selection for the Data Relay Satellite Interrogation Channel—G. D. Boyce, General Dynamics Convair (12.5/Wed./p.m./C)

Integrated Avionics—Richard D. Alberts, AF Avionics Lab. (19.1/Fri./a.m./A)

Federated vs. Integrated Computer Systems—J. H. Crenshaw, IBM Federal Systems Division (19.2/Fri./a.m./A)

Role of Man and Machine in Future—L. S. Guarino, Naval Air Development Center (19.3/Fri./a.m./A)

Realizing Objectives for Complex Avionic Computer Systems—H. Barry Schoenky, Teledyne Computer Systems Division (19.4/Fri./a.m./A)

Design Concepts in Avionics and Space Equipment—J. R. Goodykoontz, V. A. Karpenko, TRW Systems Group (19.5/Fri./a.m./A)

Designing Avionic Equipment for Automatic Testing—Richard O. Barrett, Honeywell Aerospace Division (21.1/Fri./a.m./A)

## Circuit Theory

Microwave Circuit Synthesis and Measurement—H. Stinehelfer, W. Atwood, Microwave Associates (6.4/Tues./p.m./C)

A Novel Approach to High Frequency Trigger Circuit Design—Richard McMorrow, William Farnbach, Hewlett-Packard Co. (13.2/Thur./a.m./A)

Computer-Aided Circuit Analysis—Harry B. Lee, Mass. Institute of Technology (23.1/Fri./p.m./B)

Bipolar Transistor Modeling for Computer-Aided Design—William G. Howard Jr., University of California (23.2/Fri./p.m./B)

Network Design by Mathematical Optimization—S. W. Director, Univ. of Florida (23.3/Fri./p.m./B)

Computer-Aided Layout—Les Hazlett, Motorola (23.4/Fri./p.m./B)

Automatic Test Synthesis—E. R. Jones, Fairchild Semiconductor (23.5/Fri./p.m./B)

## Papers by categories:

Avionics and Aerospace  
Circuit Theory  
Communications  
Computers and Computer-Aided Design  
Education  
Industrial Electronics  
Material and Packaging  
Management and Marketing  
Microelectronics  
Microwaves  
Solid-State Devices and Theory  
Test Equipment and Measuring Techniques

## Communications

VHF MOS Receiver "Front-End"—Richard Q. Lane, Fairchild Semiconductor (9.1/Wed./a.m./C)

Linear ICs in Consumer Television and AM/FM Receivers—S. B. Marshall, G. W. Haines, Sprague Electric Co. (9.2/Wed./a.m./C)

Efficient Use of Pins in Complex Communication Subsystems—Robert A. Hirschfield, National Semiconductor (9.3/Wed./a.m./C)

The Systems Approach to the Design of Integrated Communication Circuits—Hans R. Camenzind, Signetics Corp. (9.4/Wed./a.m./C)

University-Industry Television, Radio and Telephone Links—Albert J. Morris, Genesys Systems (10.1/Wed./p.m./A)

Stanford Instructional TV Network—Joseph M. Pettit, Donald J. Grace, Stanford University (10.2/Wed./p.m./A)

Association for Continuing Education (ACE)—Julian Johnson, ACE (10.3/Wed./p.m./A)

UC at Berkeley-TV Plans and Status—George Maslach, University of California (10.4/Wed./p.m./A)

University of Santa Clara-TV Plans and Status—Charles Dirksen, Univ. of Santa Clara (10.5/Wed./p.m./A)

Television Instruction at San Jose State College—Norman O. Gunderson, San Jose State (10.6/Wed./p.m./A)

UC at Irvine-UCLA-TV Systems, Plans and Status—Robert M. Saunders, UC, Irvine (10.7/Wed./p.m./A)

Univ. of Southern California-Instructional TV Network—Jack Munshian, USC. (10.8/Wed./p.m./A)



Digital Implementation of Data Transmission Modulators and Demodulators—W. J. Melvin, Collins Radio (11.1/Wed./p.m./B)

A Simple Adaptive Equalizer for Efficient Data Transmission—D. Hirsch, W. J. Wolf, Bell Telephone Lab. (11.2/Wed./p.m./B)

Practical Adaptive Equalizers for Data Transmission—Gerald K. McAuliffe, IBM Watson Research Center (11.3/Wed./p.m./B)

Recent Developments in Error Control Techniques—Allen H. Levesque, General Telephone and Electronics Labs. (11.4/Wed./p.m./B)

Collection of Data From in Situ Sensors Via Satellite—S. D. Dorfman, Hughes Aircraft Co. (12.1/Wed./p.m./C)

Application of Satellites to Domestic Record Data and Video Transmission—W. B. Gross, General Electric (12.2/Wed./p.m./C)

Multiple-Access Satellite Relay System for Low Data Rate Users—P. J. Heffernan, NASA-Goddard Space Flight Center (12.3/Wed./p.m./C)

Wideband Transmission of Photographic Data Using the IDCSP Satellites—W. J. Gill, Philco-Ford (12.4/Wed./p.m./C)

Coding and Signal Selection for the Data Relay Satellite Interrogation Channel—G. D. Boyce, General Dynamics Convair (12.5/Wed./p.m./C)

Bulk Semiconductor Devices for Microwaves, Millimeter Waves, and Beyond—John A. Copeland, Bell Telephone Labs. (20.3/Fri./a.m./B)

Linear Circuits for Communications Applications—Derek Bray, Fairchild Semiconductor (20.4/Fri./a.m./B)

## Computers and Computer-Aided Design

Using Computer-Aided Design in Production and Testing of Custom LSI—Robert Ulrickson, Fairchild Semiconductor (1.2/Tues./a.m./A)

Stripline Characterization by Computer—H. E. Brenner, Bell Telephone Labs. (6.1/Tues./p.m./C)

Computer-Aided Small Signal Transistor Modeling—F. H. Musa, Motorola Semiconductor (6.2/Tues./p.m./C)

Computer-Aided Design of GaAs Impatt Diodes—C. K. Kim, Micro-

state Electronics (6.3/Tues./p.m./C)

Microwave Circuit Synthesis and Measurement—H. Stinehelfer, W. Atwood, Microwave Associates (6.4/Tues./p.m./C)

Computerized Wide-Band Amplifier Design—Les Besser, Hewlett-Packard (6.5/Tues./p.m./C)

Computer-Aided Design of Microwave Integrated Circuits—Gary J. Policky, Texas Instruments (6.6/Tues./p.m./C)

Time Sharing: Why, When, Whither?—Robert Forest, Datamation Magazine (7.1/Wed./a.m./A)

What can the Electronics Industry do for Time-Sharing?—Kas Terhorst, Computer Design Corp. (7.2/Wed./a.m./A)

Computer Languages—Why so Many, and What is the Application for each in the Engineering Community?—Paul Sleeper, Remote Computing Corp. (7.3/Wed./a.m./A)

Time-Sharing in Engineering Education—And After—Eugene H. Koff, California State College at Los Angeles (7.4/Wed./a.m./A)

The Stand Alone, Central or Satellite Approach for Computer Control of Manufacturing Processes—James E. Stuehler, IBM (8.1/Wed./a.m./B)

Factory Data Collection—A Case Study—James D. Edwards, Lockheed Missiles & Space (8.2/Wed./a.m./B)

Computer Controlled On Line Testing and Inspection—Peter H. Goebel, General Radio (8.3/Wed./a.m./B)

Automated Factory: An Overview and Predictions—Walter R. Anderson, IRA Systems (8.4/Wed./a.m./B)

## Code to abbreviations

a.m.—Morning sessions (10 a.m. to 12:30 p.m.)

p.m.—Afternoon sessions (2 p.m. to 4:30 p.m.)

All sessions will be held in the following meeting rooms at the Cow Palace:

A—Meeting Room A

B—Meeting Room B

C—Meeting Room C

Numerals refer to sessions and to papers within a session—for example, 6/1 is paper 1 in session 6.

Computer Techniques in High Frequency Circuit Design—Alan J. DeVilbiss, Hewlett-Packard (13.1/Thur./a.m./A)

Theory of Automatic Processing—Frank E. Boerger, IBM Corp. (16.1/Thur./p.m./A)

Equipment for Automatic Processing—Donald G. Pedrotti, Hugel Industries (16.2/Thur./p.m./A)

Case History of Automatic Processing— (16.3/Thur./p.m./A)

The Future of Automatic Processing—C. Clifford Roe, Fairchild Semiconductor (16.4/Thur./p.m./A)

Status Trends & Predictions of Display Devices—Edwin H. Holborn, NASA Electronics Research Center (18.1/Thur./p.m./C)

Displaying Engineering Data in Systems Applications on a Color CRT—I. M. C. Griesacker, General Electric Co. & Walter H. Tew, General Electric (18.2/Thur./p.m./C)

Image Distribution System, An Approach Toward Personal Displays—Joe T. Ma, IBM Corp. (18.3/Thur./p.m./C)

The Application of Digital Television Displays to Computer-Directed Control Systems—S. E. Grooms, Philco-Ford (18.4/Thur./p.m./C)

On-Line Graphics for Information Handling & Display—John E. Peyton Jr., Boeing (18.5/Thur./p.m./C)

Designing Avionic Equipment for Automatic Testing—Richard O. Barrett, Honeywell Aerospace Division (21.1/Fri./a.m./C)

Development of Software Systems for Automated Test Equipment (CATE)—Eddie J. Johnson, James V. McCarthy, SDC (21.2/Fri./a.m./C)

A Computer Controlled Test System—Frank M. Stutesman, Bendix Navigation & Control Division (21.3/Fri./a.m./C)

Hardware/Software Management—Computer Aided Testing—D. S. Bassett, Emerson Electric Co. (21.4/Fri./a.m./C)

Computer-Aided Circuit Analysis—Harry B. Lee, Mass. Institute of Technology (23.1/Fri./p.m./B)

Bipolar Transistor Modeling for Computer-Aided Design—William G. Howard Jr., University of California (23.2/Fri./p.m./B)

Network Design by Mathematical Op-

# Exclusive Technical Session Order Form

Please send me the following WESCON technical session preprints at \$2.00 per session (average: four papers per session), plus \$1 mailing charge per complete order. I understand this order will be mailed to my address within two weeks after receipt. Offer good until November 1, 1969. Packaging symposium record is also available.

(Note: Papers bound by sessions; no individual papers available).

Session No.	Quantity	Session No.	Quantity
1		15	
2		16	
3		17	
5		18	
6		19	
8		20	
9		21	
10		22	
11		23	
12			
13			
14			

Packaging Symposium Record \$12.00

Total Sessions x \$2.00 = \$ \_\_\_\_\_

Plus \$1.00 Mailing Charge = \$ 1.00 \_\_\_\_\_

Total Cost = \$ \_\_\_\_\_

Make check payable to WESCON and mail with this form to:

**WESCON**  
3600 Wilshire Blvd.  
Los Angeles, Calif. 90005

DATE \_\_\_\_\_

NAME \_\_\_\_\_

FIRM \_\_\_\_\_

STREET ADDRESS \_\_\_\_\_

CITY, STATE, ZIP CODE \_\_\_\_\_

timization—S. W. Director, Univ. of Florida (23.3/Fri./p.m./B)

Computer-Aided Layout—Les Hazlett, Motorola (23.4/Fri./p.m./B)

Automatic Test Synthesis—E. R. Jones, Fairchild Semiconductor (23.5/Fri./p.m./B)

## Education

Time-Sharing in Engineering Education—And After—Eugene H. Koff, California State College at Los Angeles (7.4/Wed./a.m./A)

University-Industry Television, Radio and Telephone Links—Albert J. Morris, Genesys Systems (10.1/Wed./p.m./A)

Stanford Instructional TV Network—Joseph M. Pettit, Donald J. Grace, Stanford University (10.2/Wed./p.m./A)

Association for Continuing Education (ACE)—Julian Johnson, ACE (10.3/Wed./p.m./A)

UC at Berkeley—TV Plans and Status—George Maslach, University of California (10.4/Wed./p.m./A)

University of Santa Clara—TV Plans and Status—Charles Dirksen, Univ. of Santa Clara (10.5/Wed./p.m./A)

Television Instruction at San Jose State College—Norman O. Gunderson, San Jose State (10.6/Wed./p.m./A)

UC at Irvine—UCLA—TV Systems, Plans and Status—Robert M. Saunders, UC, Irvine (10.7/Wed./p.m./A)

Univ. of Southern California—Instructional TV Network—Jack Munushian, USC (10.8/Wed./p.m./A)

## Industrial Electronics

The Stand Alone, Central, or Satellite Approach for Computer Control or Manufacturing Processes?—James E. Stuehler, IBM (8.1/Wed./a.m./B)

Factory Data Collection—A Case Study—James D. Edwards, Lockheed Missiles & Space (8.2/Wed./a.m./B)

Computer Controlled On Line Testing and Inspection—Peter H. Goebel, General Radio (8.3/Wed./a.m./B)

Automated Factory: An Overview and Predictions—Walter R. Anderson, IRA Systems (8.4/Wed./a.m./B)

Theory of Automatic Processing—Frank E. Boerger, IBM Corp. (16.1/Thur./p.m./A)

Equipment for Automatic Processing—Donald G. Pedrotti, Hugel Industries (16.2/Thur./p.m./A)

Case History of Automatic Processing— (16.3/Thur./p.m./A)

The Future of Automatic Processing—C. Clifford Roe, Fairchild Semiconductor (16.4/Thur./p.m./A)

## Material and Packaging

Solid Logic Technology Manufacturing—Walter J. Schuelke, IBM (2.1/Tues./a.m./B)

Bonding Techniques for Integrated Circuits—Robert W. Helda, Motorola Inc. (2.2/Tues./a.m./B)

Beam Lead Assembly Technology—Brian Dale, Sylvania Electronics System (2.3/Tues./a.m./B)

Manufacturing Concept for Beam Lead Assembly—D. K. Thomson, Western Electric Co. (2.4/Tues./a.m./B)

## Management and Marketing

Impact of LSI Technology on the Electronic Market—Glenn E. Penisten, Texas Instruments (1.3/Tues./a.m./A)

The Vendor User Interface With MOS Universal Arrays—M. M. Kaufman, G. E. Skorup, RCA Defense Electronics (1.4/Tues./a.m./A)

The Many Routes to the Money Market—William B. Hugel, Hugel Industries (5.1/Tues./p.m./B)

Selling the Package: What They Want to Hear—David C. Thompson, Linear Systems (5.2/Tues./p.m./B)

Holding Your Own in the Money Market—Gordon L. Ness, Ness Industries (5.3/Tues./p.m./B)

Why, How and When to go Public—David S. M. Lanier Jr., Compar Corp. (5.4/Tues./p.m./B)

European Electronics Market: 1969—R. J. Larkin Jr., Ampex Corp. (14.1/Thur./a.m./B)

Marketing Electronic Products in Japan—James K. Imai, Mentor Japan (14.2/Thur./a.m./B)

The New Asian Electronics Market Outside of Japan—G. B. Levine,



Mentor International (14.3/Thur./a.m./B)

Alternatives to Direct Sales, License, Joint Venture, and Subsidiary—Carl J. Bradshaw, Oad Electronics Corp. (14.4/Thur./a.m./B)

Hardware/Software Management—Computer Aided Testing—D. S. Bassett, Emerson Electric Co. (21.4/Fri./a.m./C)

## Microelectronics

Who Needs LSI In-House Capability—George Hare, The Singer Co. (1.1/Tues./a.m./A)

Using Computer-Aided Design in Production and Testing of Custom LSI—Robert Ulrickson, Fairchild Semiconductor (1.2/Tues./a.m./A)

Impact of LSI Technology on the Electronics Market—Glenn E. Penisten, Texas Instruments (1.3/Tues./a.m./A)

The Vendor User Interface With MOS Universal Arrays—M. M. Kaufman and G. E. Skorup, RCA Defense Electronics (1.4/Tues./a.m./A)

Solid Logic Technology Manufacturing—Walter J. Schuelke, IBM (2.1/Tues./a.m./B)

Bonding Techniques for Integrated Circuits—Robert W. Helda, Motorola Inc. (2.2/Tues./a.m./B)

Beam Lead Assembly Technology—Brian Dale, Sylvania Electronics System (2.3/Tues./a.m./B)

Manufacturing Concept for Beam Lead Assembly—D. K. Thomson, Western Electric Co. (2.4/Tues./a.m./B)

Solid State Microwave Variable Delay Devices—Ernst K. Kirchner, Microwave Electronics (3.1/Tues./a.m./C)

Bulk GaAs and Impatt Microwave Sources—W. Keith Kennedy, Jr., Watkins-Johnson (3.2/Tues./a.m./C)

Microwave Transistor Amplifier Design—James R. Reid, Avantek Inc. (3.3/Tues./a.m./C)

Parameters Used in Specifying Varactor-Tuned Solid State Oscillators—William D. Heichel, Thomas R. Bushnell, Stewart Div., Watkins-Johnson Co. (3.4/Tues./a.m./C)

UHF Integrated Microcircuits—Robert M. Knox, IIT Research Institute (3.5/Tues./a.m./C)



Miniature microwave counter by Systron-Donner counts from 300 MHz to 3 GHz. It will be on display at booth 1412.

Survey of Active Filtering Techniques Using Integrated Circuits—Sanjit Mitra, University of California (4.1/Tues./p.m./A)

A State Variable and Gyrator Realization-Comparison—Robert Bewcomb, Stanford University (4.2/Tues./p.m./A)

Active Filters Employing Silicon Monolithic Gyration—Robert Hove, Boeing Company (4.3/Tues./p.m./A)

Multiloop Negative Feedback Active Filters Using Thick Film Integrated Circuit Techniques—Dennis Hallenbeck, Kinetic Tech. (4.4/Tues./p.m./A)

FEN Filter Design Using Hybrid Integrated Blocks—George Moschytz, Bell Telephone Laboratories (4/5/Tues./p.m./A)

ICs and Thick Films Add Up to Improved RC Active Filters—William Broyles, Sprague Electric (4.6/Tues./p.m./A)

VHF MOS Receiver "Front-End"—Richard Q. Lane, Fairchild Semiconductor (9.1/Wed./a.m./C)

Linear ICs in Consumer Television and AM/FM Receivers—S. B. Marshall, G. W. Haines, Sprague Electric Co. (9.2/Wed./a.m./C)

Efficient Use of Pins in Complex Communication Subsystems—Robert A. Hirschfeld, National Semiconductor (9.3/Wed./a.m./C)

The Systems Approach to the Design of Integrated Communication Circuits—Hans R. Camenzind, Signetics Corp. (9.4/Wed./a.m./C)

MOS ICs: The Designer's Dilemma—Glen Madland, Integrated Circuit Engineering Corp. (15.1/Thur./a.m./C)

MOS ICs: Answers to Systems Problems—Ralph Parris, Burroughs Corp. (15.2/Thur./a.m./C)

MOS/LSI: A Joint Business Venture—Larry Drew, Viatron Computer Systems Corp. (15.3/Thur./a.m./C)

MOS ICs: Bipolar Compatibility Is Here—Leland Seely, General Instrument Corp. (15.4/Thur./a.m./C)

MOS ICs: The Promise of Things to Come—Al Phillips, Autonetics (15.5/Thur./a.m./C)

Monolithic Voltage Regulators—Thomas M. Frederiksen, Motorola Integrated Circuits Center (17.1/Thur./p.m./B)

Voltage Regulator Capabilities Using Hybrid Techniques—George W. Smith, Beckman Instruments Inc. (17.2/Thur./p.m./B)

High Power Hybrid Amplifiers—Herb Miezal, Dale Baugher, and Leon Balents, RCA (17.3/Thur./p.m./B)

Controlling Power on a Chip—William D. Whittekin Sr., Texas Instruments (17.4/Thur./p.m./B)

What is Needed in Power Microcircuits—James W. Williams, Hughes Aircraft Co. (17.5/Thur./p.m./B)

New Solid-State Products—Digital Circuits—Morris Chang, Texas Instruments, Semiconductor Circuits Division (20.2/Fri./a.m./B)

Linear Circuits for Communication Applications—Derek Bray, Fairchild Semiconductor (20.4/Fri./a.m./B)

## Microwaves

Solid State Microwave Variable Delay Devices—Ernst K. Kirchner, Microwave Electronics (3.1/Tues./a.m./C)

Bulk GaAs and Impatt Microwave Sources—W. Keith Kennedy, Jr., Watkins-Johnson (3.2/Tues./a.m./C)

Microwave Transistor Amplifier Design—James R. Reid, Avantek Inc. (3.3/Tues./a.m./C)

Parameters Used in Specifying Varactor-Tuned Solid State Oscillators—William D. Heichel, Thomas R. Bushnell, Stewart Div., Watkins-Johnson Co. (3.4/Tues./a.m./C)

UHF Integrated Microcircuits—Robert M. Knox, IIT Research Institute (3.5/Tues./a.m./C)

Stripline Characterization by Computer—H. E. Brenner, Bell Telephone Labs. (6.1/Tues./p.m./C)

Computer-Aided Small Signal Transistor Modeling—F. H. Musa, Motorola Semiconductor (6.2/Tues./a.m./C)

Computer-Aided Design of GaAs Impatt Diodes—C. K. Kim, Microstate Electronics (6.3/Tues./

p.m./C)

Microwave Circuit Synthesis and Measurement—H. Stinehelfer, W. Atwood, Microwave Associates (6.4/Tues./p.m./C)

Computerized Wide-Band Amplifier Design—Les Besser, Hewlett-Packard (6.5/Tues./p.m./C)

Computer-Aided Design of Microwave Integrated Circuits—Gary J. Policky, Texas Instruments (6.6/Tues./p.m./C)

Bulk Semiconductor Devices for Microwaves, Millimeter Waves, and Beyond—John A. Copeland, Bell Telephone Labs (20.3/Fri./a.m./B)

Linear Circuits for Communications Applications—Derek Bray, Fairchild Semiconductor (20.4/Fri./a.m./B)

## Solid-State Devices and Theory

Solid State Microwave Variable Delay Devices—Ernst K. Kirchner, Microwave Electronics (3.1/Tues./a.m./C)

Bulk GaAs and Impatt Microwave Sources—W. Keith Kennedy, Jr., Watkins-Johnson (3.2/Tues./a.m./C)

Microwave Transistor Amplifier Design—James R. Reid, Avantek Inc. (3.3/Tues./a.m./C)

Parameters Used in Specifying Varactor-Tuned Solid State Oscillators—William D. Heichel, Thomas R. Bushnell, Stewart Div., Watkins-Johnson Co. (3.4/Tues./a.m./C)

UHF Integrated Microcircuits—Robert M. Knox, IIT Research Institute (3.5/Tues./a.m./C)

Ecological Niches for Optoelectronic Devices—E. E. Loebner, H. Borden, Hewlett-Packard Co. (20.1/Fri./a.m./B)

New Solid-State Products—Digital Circuits—Morris Chang, Texas Instruments, Semiconductor Circuits Division (20.2/Fri./a.m./B)

Bulk Semiconductor Devices for Microwaves, Millimeter Waves, and Beyond—John A. Copeland, Bell Telephone Labs (20.3/Fri./a.m./B)

Linear Circuits for Communications Applications—Derek Bray, Fairchild Semiconductor (20.4/Fri./a.m./B)

## Test Equipment and Measuring Techniques

A Novel Approach to High Frequency Trigger Circuit Design—Richard McMorrow, William Farnbach, Hewlett-Packard Co. (13.2/Thur./a.m./A)

Transient Oscillography with Photographic Media—A. E. Ames, R. C. Jones, G. R. Bird, Polaroid Corp. Research Labs (13.3/Thur./a.m./A)

High Speed Single Transient Oscilloscopes, the State of the Art, and Current Potential for Mating to On-Line Computers—Gordon Long-erbeam, Jay Wiedwald, Larry Ferd-erber, Lawrence Radiation Lab (13.4/Thur./a.m./A)

The TRAC System—G. St. Leger-Barter, Lawrence Radiation Lab. and S. Walter, EG&G (22.1/Fri./p.m./A)

Wideband Attenuation and Phase Measurements on High Quality Coaxial Cables—R. L. Rhoads, A. M. Evans, Lawrence Radiation Lab. (22.2/Fri./p.m./A)

Wideband System Function Analyzer Employing Time to Frequency Domain Translation—A. M. Nicolson, Sperry Rand (22.3/Fri./p.m./A)

An Iterative, Time Domain Method of System Response Correction—M. P. Ekstrom, Lawrence Radiation Laboratory (22.4/Fri./p.m./A)

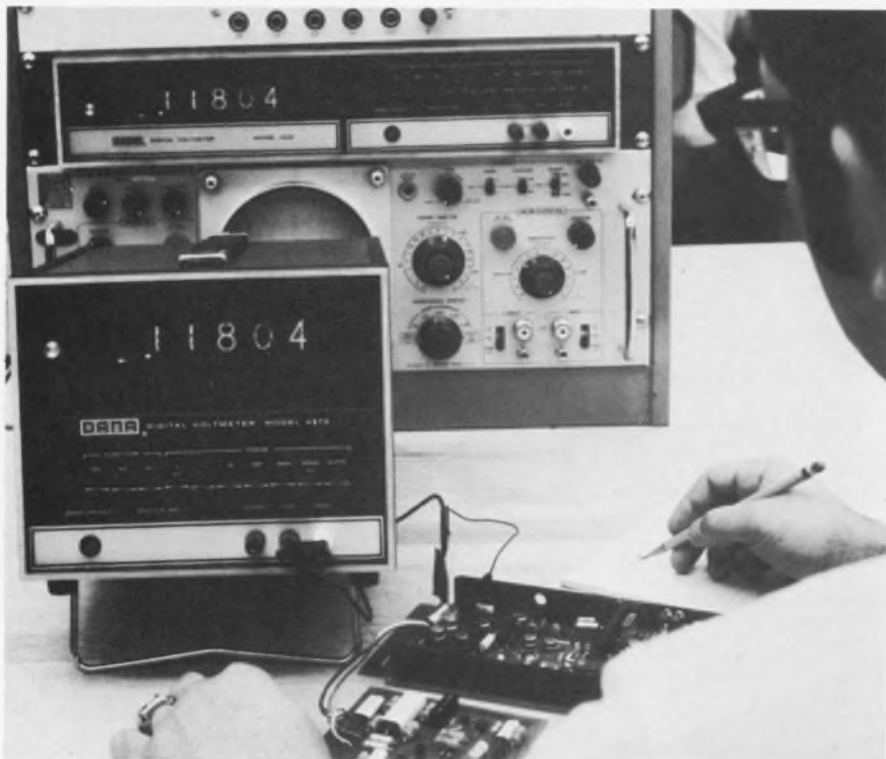

Model 4500 digital voltmeter in two packaging configurations for rack mount and bench applications will be on display at Dana Laboratories booth 2008.



# It's a GRrrrand Counter

Aye, that's what you'll think of our new counter. From its wee size to its big performance, the 1192 is new in every respect.

- It's only 8½ inches wide by 3½ inches high.
- It measures frequency (from dc to 32 MHz), period (single and multiple), time interval, frequency ratio, and, of course, it counts.
- Units of measurement and decimal point are automatically displayed.
- Input sensitivity is another surprise, a wee 10 mV is all you need (up to 25 MHz); and you can control trigger threshold and attenuation.
- An internal crystal oscillator gives more than enough stability for most work.

You can select an 1192 with 5, 6, or 7 digits, with or without BCD output, and for bench or rack use. And if 32 MHz is not enough frequency range for you, add our new 1157-B scaler (same size) to the 1192 and zoom up to 500 MHz. The counter/scaler combination, the 1192-Z, has a common cabinet. There's more, lots more, to tell about the 1192; we'll gladly send you a free data sheet upon request.

But the grandest part of all about the 1192 is the money you'll save when you buy one. Prices\* range from \$575 for the 5-digit bench model without data output to \$845 for a 7-digit rack model with data output. You can add the scaler for another \$850. Imagine, a 500-MHz counter for as little as \$1425. Man, that's a real bargain. You can save quite a few more dollars by ordering two or more units and taking advantage of GR's quantity-discount plan. Discounts range from 3% for 2-4 units to 20% for 100 units.

For free literature (postpaid) or a demonstration at our expense, write or call General Radio Company, West Concord, Massachusetts 01781; telephone 617 369-4400. In Europe (except Scotland), write Postfach 124, CH 8034 Zurich 34, Switzerland. In Scotland, write General Radio Company (U.K.) Limited, Bourne End, Buckinghamshire, England, for special attention.

\*Prices apply only in the U. S. A.

GENERAL RADIO 





# What's NEW at GUARDIAN<sup>®</sup>



GUARDIAN<sup>®</sup> ELECTRIC MANUFACTURING COMPANY 1550 W. Carroll Ave., Chicago, Illinois 60607

# NEW

## GUARDIAN LEVER SWITCHES

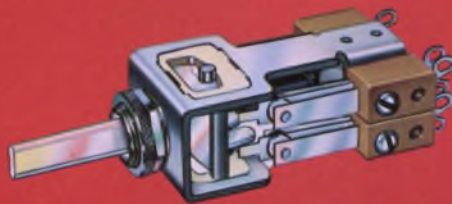

- Available with two or three switching positions.
- Nine versions combining off, momentary or locked positions.
- Snap-in inserts permit changing actuator switching positions at any time.
- Non-illuminated or illuminated with color coding.
- Contacts rated at both 1½ and 10 amps at 115V AC resistive.
- Up to 4 pole double throw per station.
- .110 Quick Connect Terminals and/or Solder Terminals.



Circle No. 231 For Literature.

# NEW

## GUARDIAN PRINTED CIRCUIT PLUG-IN RELAY



- Unique, compact design.
- All terminals on .1 grid spacing for standard printed circuit board.
- Solders right on PC board.
- Conforms to UL requirements for Business Machines.
- 1 watt normal power—½ watt on request.
- 3500 OHMS coil resistance (120V AC-60Hz).
- Standard voltages 6 to 120 AC—6 to 24 DC.
- Mechanical life over 10,000,000 operations.
- 3 AMP. resistive 115V. 60Hz contact rating.



Circle No. 232 For Literature.



# new

## GUARDIAN SOLID STATE RELAYS



- Universal AC or DC control voltage with complete circuit isolation from load switching circuit.
- Externally-adjustable pull-in voltage level from 80-130V AC or DC, with close differential between pull-in and drop-out where accurate voltage sensing is required.
- Control of high inrush lamp, inductive or normal resistive loads from 10 ma to 3 amps.
- Internal filtering prevents random turn-on of "off" contacts.



Circle No. 233 For Literature.

# NEW

## GUARDIAN PUSH BUTTON SWITCH BANKS

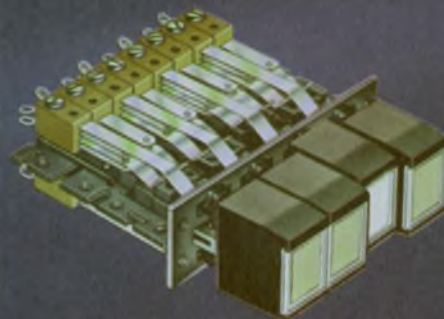

- Sleek, compact design—only 1½" high.
- Non-illuminated or illuminated with color coding.
- Buttons on 5/8" centers.
- Up to 12 stations in multiples of 2.
- Contacts rated at both 1½ amp and 10 amps at 115V AC resistive.
- Up to 4 pole double throw per station.
- .110 Quick Connect Terminals.
- End panel has four 9/32" tapped mounting holes.
- Long life—100,000 mechanical operations.



Circle No. 234 For Literature.

# NEW

## GUARDIAN LIFT OFF STEPPERS

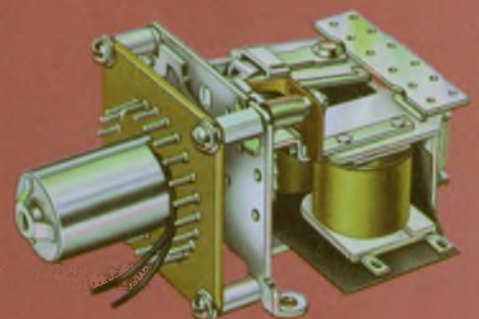

All the features of the widely used Guardian MER 24 point electrical reset stepper . . .

### PLUS

- Solenoid "lifts" wiper contacts when stepping to reduce friction . . . and arcing.
- Increased contact ratings to 5 amps resistive at 120V AC.
- Increased function capability.
- Increased dependability.
- Increased life expectancy—now up to 10,000,000 steps.
- Compact design.



Circle No. 235 For Literature.

If Hybrid IC Active Filters  
with passive filter  
stability could solve your  
problems,  
you'd  
probably  
pay more  
for them  
than \$30  
per pole pair.



Try our FS-20 (delivery is off the shelf!)

■ Here's what you get: Band-pass, high-pass and low-pass outputs simultaneously ■ Any desired form of the second order transfer function ■ Complex zeros anywhere in the S-plane ■ Multi-loop negative feedback for added stability ■  $F_c$  and Q of basic unit can be tuned by adding external resistors ■ Frequency range from DC to 50 kHz ■ Q range from 0.1 to 500 ■ Voltage gain is adjustable to 40 dB ■ Supply voltages from  $\pm 9V$  to  $\pm 15V$  with 250 mW power consumption ■ Dimensions: (14-pin DIP) 0.804" x 0.366" x 0.474".

PRICES:	1-5	\$47	26-99	\$37
	6-10	\$42	100-999	\$35
	11-25	\$39	1000-2000	\$28

**KTI**

**KINETIC TECHNOLOGY, INCORPORATED**  
17465 Shelburne Way, Los Gatos, California 95030  
(408) 356-2131 TWX: 910-597-5390  
The name to remember for Hybrid Integrated  
Systems and Active Filters . . .

Gentlemen at KTI:

Please send me more information on:

- FS-20       All Active Filters       Hybrid Subsystems  
 Put me on your permanent mailing list

Name \_\_\_\_\_

Company \_\_\_\_\_

Address \_\_\_\_\_

City \_\_\_\_\_

State \_\_\_\_\_ ZIP \_\_\_\_\_

My applications are: \_\_\_\_\_



# New ways in digital automation with:

- Shaft Encoders, 34 types
- Synchro-to-Digital Converters, 6 types
- Analog-to-Digital Converters, 10 types
- Solid-State Digital Modules, 136 types

FREE . . . 58 Pages

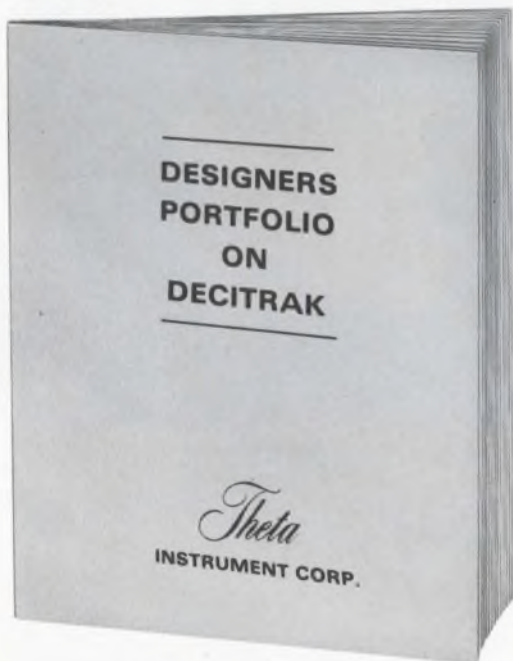

Includes copy of  
"A Primer on Shaft Encoders"

## We call it the DECITRAK® SYSTEM

Selecting from hundreds of off-the-shelf digital transducers and circuits, we assemble a remarkably low-cost, customized digital system for control/display/logging. DECITRAK can perform as simple a job as providing remote digital display of antenna pedestal position. Or, as impressive a task as the precise control of massive prime movers in response to punched-card commands.

Need a computer interface? A code converter? A typewriter driver? Set-point controls? Let a Theta Application Specialist tailor a system to your specific needs from the field-proven line of DECITRAK digital components.

More than 1,000 of these systems are now in use in nuclear installations, satellite tracking stations, wind tunnels, and aboard ships.

*Theta*

**INSTRUMENT CORPORATION**

FAIRFIELD, NEW JERSEY 07006

• PHONE: 201 - 227-1700

• TELEX: 138353

INFORMATION RETRIEVAL NUMBER 57

# Curtains Up! It's showtime.

Instrumentation .....	U118
Microwaves & lasers .....	U136
Components .....	U142
ICs & semiconductors .....	U152
Modules & subassemblies ...	U160
Data processing .....	U172
Packaging & materials .....	U180
Production .....	U186

Dual-trace oscilloscope boasts a real-time frequency response from dc all the way out to 250 MHz.

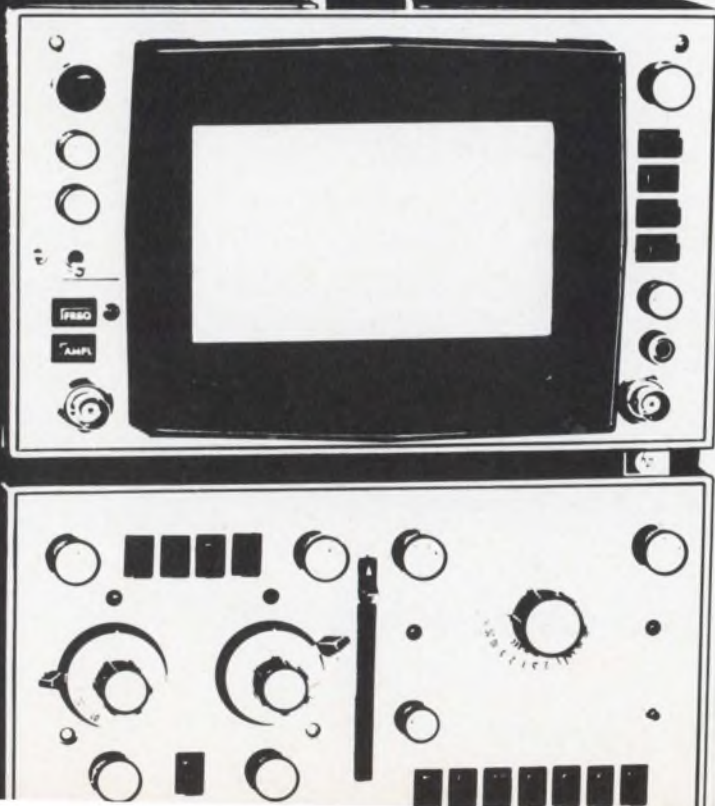

Segmented fluorescent readout with alphanumeric capability shrinks envelope to T-5-1/2 size for high-density packaging.

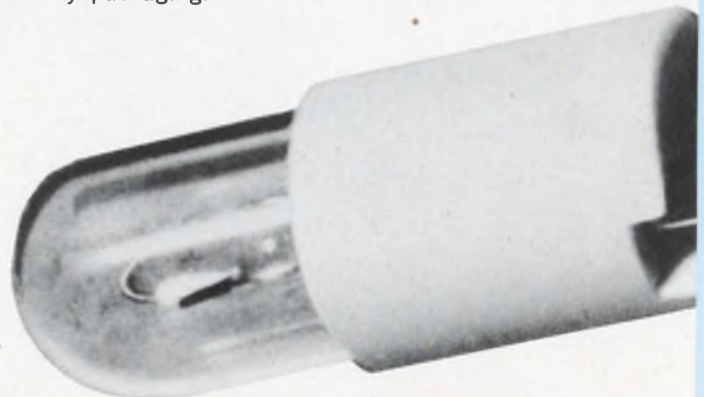



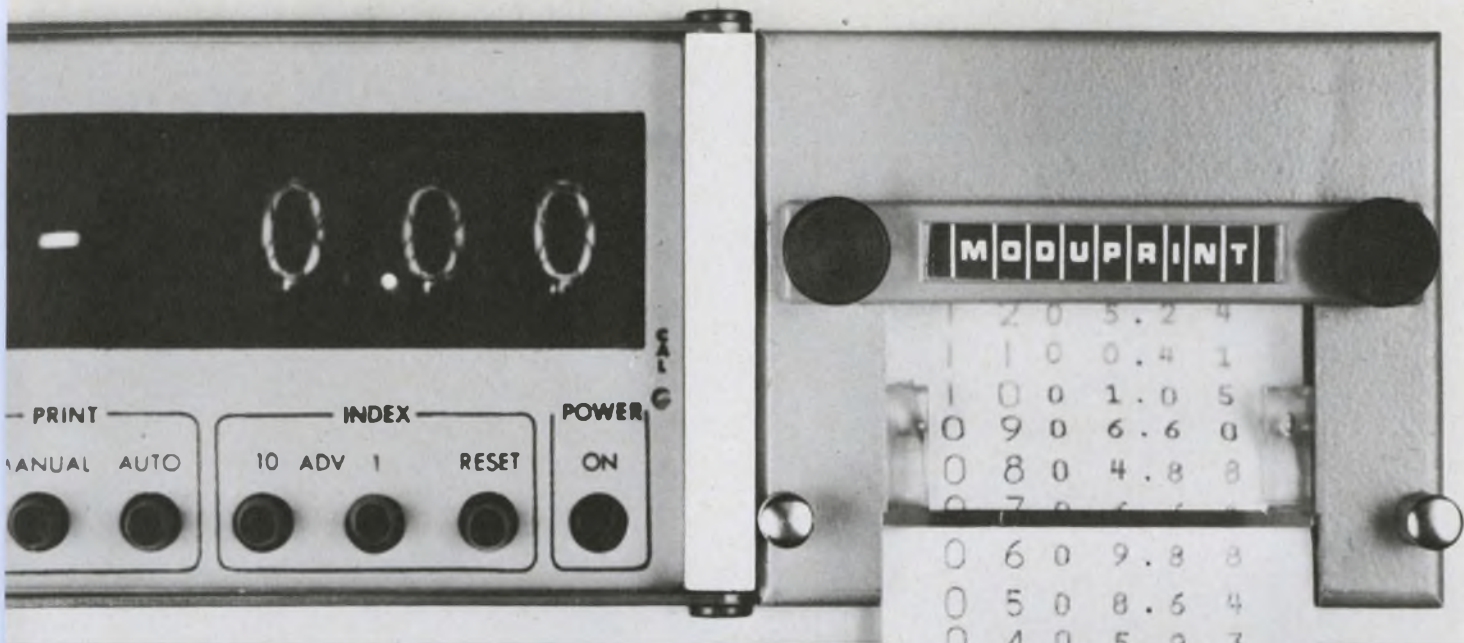

**Printing digital voltmeter** with 3-1/2-digit readout occupies only 3-1/2 by 8 in. of a front panel.



**Bi-pin T-1-3/4 lamps**, which come in five different styles, have a tough plastic base.

**Streamlined digital multimeter**, which costs only \$345, never loads the circuit being measured. It has a 3-1/2-digit readout.







## Now, ready for you in quantity.

The new Delco Radio DTS-701 and 702 NPN triple-diffused silicon high voltage transistors. They were designed for the tough requirements of off-line deflection in large screen TV.

However, they're built and tested for extra reliability in all high energy circuits. Proved by the surest peak energy capability rating in the business: Pulse Energy Testing.

And right now, they're available in both production and sample quantities.

Why will you want to use the Delco 701 or 702?

For the tough jobs—high inductive load switching or for circuits subject to transients or fault conditions.

For reduction of weight, size and component costs. Circuit complexity and number of components are reduced, so assembly costs go down, too. And fewer components mean higher reliability.

So now you know. The pioneer in high voltage silicon power has done it again.

For prices, samples or complete data, just call us or the nearest Delco Radio distributor listed below.

### SEMICONDUCTOR DISTRIBUTORS

ALA., BIRMINGHAM • Forbes Distributing Company, Inc.  
(205)-251-4104

ARIZ., PHOENIX • Sterling Electronics, Inc. (602)-258-4531

CAL., LOS ANGELES • Kierulff Electronics, Inc. (213)-685-5511  
• Radio Products Sales, Inc. (213)-748-1271

CAL., PALO ALTO • Kierulff Electronics, Inc. (415)-968-6292

CAL., SAN DIEGO • Milo of California, Inc. (714)-232-8951

COLO., COLORADO SPRINGS • L. B. Walker Radio Co. (303)-636-1661

COLO., DENVER • L. B. Walker Radio Co. (303)-935-2406

COLO., ENGLEWOOD • Hyer Electronics Co. (303)-771-5285

FLA., MIAMI • Mountain Electronics, Division of  
Mountain National Co. (305)-634-4556

FLA., WEST PALM BEACH • Mountain Electronics, Division of  
Mountain National Co. (305)-883-5701

ILL., ROSEMONT • F-J-R/Midwest, Inc. (312)-678-8560

ILL., SKOKIE • Merquip Electronics, Inc. (312)-282-5400

IND., INDIANAPOLIS • Graham Electronics Supply, Inc.  
(317)-634-8486

MD., BALTIMORE • Radio Electric Service Co. (301)-539-3835

MASS., NEWTON • The Greene Shaw Co., Inc. (617)-969-8900

MICH., KALAMAZOO • Electronic Supply Corp. (616)-381-4626

MINN., MINNEAPOLIS • Stark Electronics Supply Co. (612)-332-1325

MO., KANSAS CITY • Walters Radio Supply, Inc. (816)-513-7015

MO., ST. LOUIS • Electronic Components for Industry Co.  
(314)-647-5505



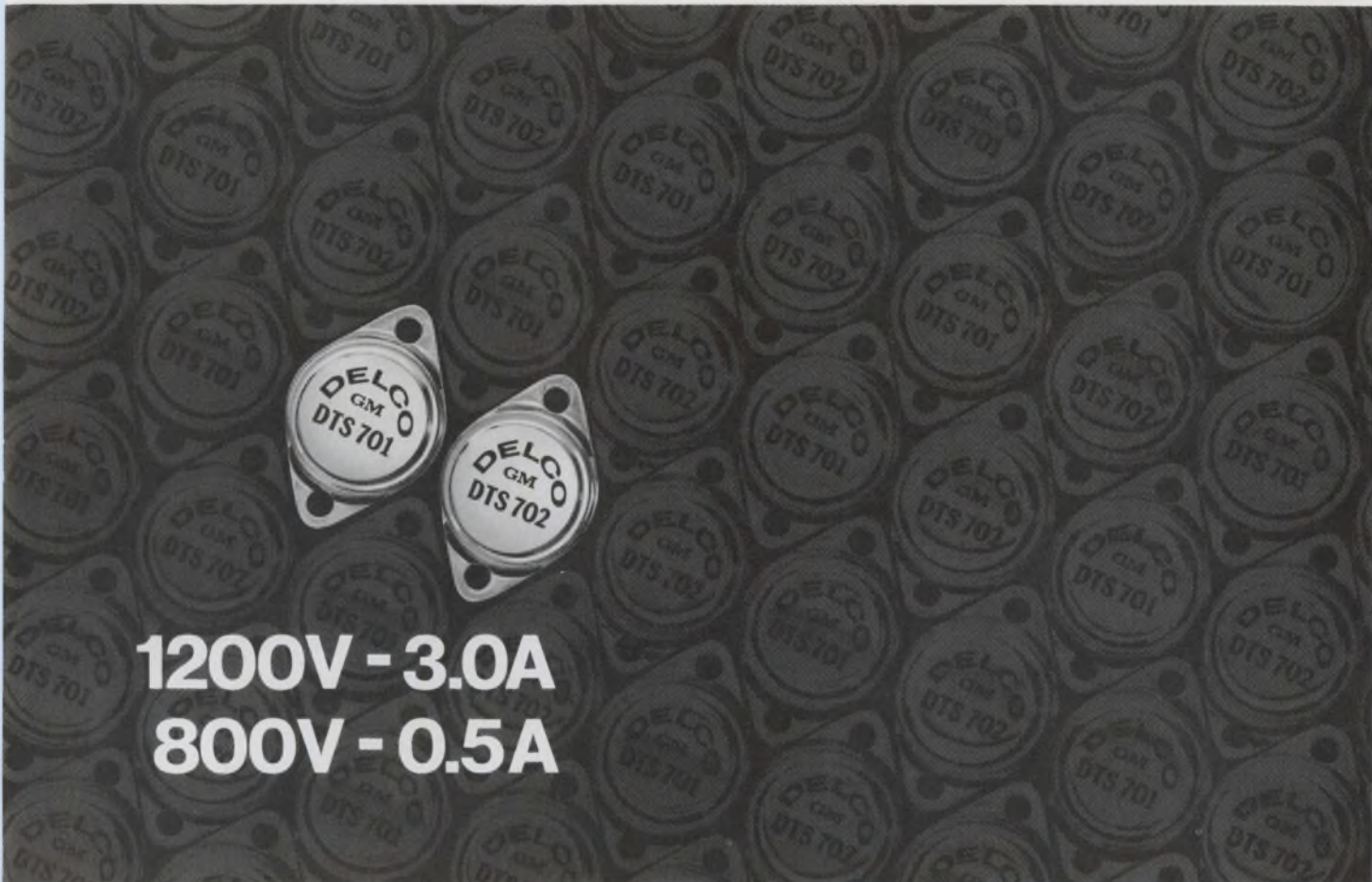

**1200V - 3.0A**  
**800V - 0.5A**

**DTS-701**

Collector to emitter voltage ( $V_{CE0}$ )	800V
Sustaining voltage ( $V_{CE0(SUS)}$ )	600V min.
Emitter to base voltage ( $V_{EBO}$ )	5V
Collector current ( $I_C$ )	500mA
Base current ( $I_B$ )	100mA
Power dissipation ( $P_T$ )	25W

**DTS-702**

Collector to emitter voltage ( $V_{CEX}$ )	1200V
Collector to emitter voltage ( $V_{CE0}$ )	1000V
Sustaining voltage ( $V_{CE0(SUS)}$ )	750V min.
Emitter to base voltage ( $V_{EBO}$ )	5V
Collector current ( $I_C$ )	3A
Base current ( $I_B$ )	1A
Power dissipation ( $P_T$ )	50W

Available in solid copper. JEDEC TO-3 package.

**Kokomoan's Regional Headquarters**

Union, New Jersey\* 07083  
Box 1018 Chestnut Station  
(201) 687-3770

Chicago, Illinois\* 60656  
5151 N. Harlem Avenue  
(312) 775-5411

Santa Monica, Calif.\* 90401  
726 Santa Monica Blvd.  
(213) 870-8807

Detroit, Michigan 48202  
57 Harper Avenue  
(313) 873-6560

Kokomo, Ind. 46901  
700 E. Firmin  
(317) 459-2175 Home Office

\*Office includes field lab  
and resident engineer  
for application assistance.



**THE KOKOMOANS ARE IN POWER**

**DELCO RADIO**  
**DIVISION OF GENERAL MOTORS**  
**KOKOMO, INDIANA**

- N.J., CLIFTON • Eastern Radio Corporation (201)-471-6600
- N.M., ALBUQUERQUE • Hyer Electronics Company (505)-265-5767  
• Sterling Electronics Inc. (505)-247-2486
- N.Y., BINGHAMTON • Federal Electronics, Inc. (607)-748-8211
- N.Y., NEW YORK • Harvey Radio Co., Inc. (212)-582-2590
- N.Y., WOODBURY, L.I. • Harvey Radio Company, Inc. (516)-921-8700
- OHIO, CINCINNATI • United Radio, Inc. (513)-761-4030
- OHIO, CLEVELAND • The W. M. Pattison Supply Co., Industrial  
Electronics Division (216)-411-3000
- OHIO, DAYTON • F-J-R/Ohio, Inc. (513)-278-9411
- OKLA., OKLAHOMA CITY • Radio, Inc. (405)-235-1551
- OKLA., TULSA • Radio, Inc. (918)-587-9124

- PENN., PHILADELPHIA • Almo Electronics, Division of  
Sterling Electronics (215)-676-6000
- PENN., PITTSBURGH • RPC Electronics (412)-782-3770
- TEXAS, DALLAS • Adleta Electronics Company (214)-742-8257
- TEXAS, FORT WORTH • Adleta Electronics Co. (817)-336-7446
- TEXAS, HOUSTON • Harrison Equipment Co., Inc. (713)-224-9131
- UTAH, SALT LAKE CITY • Hyer Electronics Company (801)-487-3681
- VA., RICHMOND • Meridian Electronics, Inc. (703)-353-6648
- WASH., SEATTLE • Kierulff Electronics, Inc. (206)-763-1550
- WASH., TACOMA • C & G Electronics Co. (206)-272-3181
- CANADA, ONT., SCARBOROUGH • Lake Engineering Co., Ltd.  
(416)-751-5980

INFORMATION RETRIEVAL NUMBER 58



# Dual-trace oscilloscope performs from dc to 250 MHz

*Hewlett-Packard, 1501 Page Mill Rd., Palo Alto, Calif. Phone: (415) 326-7000. P&A: \$1750 for mainframe; November, 1969.*

Providing real-time response from dc all the way to 250 MHz, a new dual-trace oscilloscope, model 183A, does not sacrifice viewing ease, operating ease, sensitivity, or plug-in versatility. This means that the 183A can be used to view digital words and other groups of short-duration fast-rise pulses found in computers and high-speed

digital systems.

It is also useful for displaying single short pulses that occur at low repetition rates, like those generated by laser beam detectors. In addition, the new 250-MHz oscilloscope can analyze communications systems performance, and makes possible pre-detection display of modulation envelopes on rf carriers.

The 183A is a compact, all-solid-state, plug-in instrument that can be operated like any well-behaved dual-trace oscilloscope—with either

of two input signals displayed alternately on successive sweeps or at the same time in a chopped (time-shared) mode. It can also present the sum or difference of two input signals.

Calibrated deflection factors are switch selected from a sensitivity of 10 mV per division of 1 V per division. The sweep circuits trigger reliably on internally picked-off 250-MHz signals that produce 1-cm deflections, or on 250-MHz external signals with amplitudes as low as 20 mV pk-pk. Signal delay in the vertical channel allows viewing the leading edge of the signal that triggers the sweep.

The new 183A oscilloscope achieves its 250-MHz performance with a new cathode-ray tube that has distributed deflection electrodes to obtain high-frequency performance while preserving deflection sensitivity. Each deflection electrode is a metallic ribbon, wound in a helix and slightly flattened to improve the electrostatic field deflection between the two electrodes. This new CRT is actually capable of performance beyond 500 MHz.

The high-frequency performance of the new oscilloscope is obtained without restricting its usefulness for general-purpose applications. The mainframe works with all plug-ins designed for Hewlett-Packard's series 180 oscilloscopes. These include a four-channel 50-MHz amplifier, a delaying-sweep time base, and a 12.4-GHz sampling and time-domain reflectometer plug-in.

With its 1840A time base, the 183A triggers at repetition rates from dc to 250 MHz. A variable hold-off control allows stable display of pulse groups by permitting repeated triggering on a particular pulse in the group. Sweep times are selectable from 10 ns/cm to 0.1 s/cm.

Further contributing to precision measurements, the mainframe's calibrating waveform has risetime specified, as well as amplitude and frequency. The waveform is a pulse train with 10% duty cycle and 0.8-ns risetime. Its amplitude can be either -50 mV or -500 mV; repetition rate is 2 kHz or 1 MHz.

Booth No. 1040 Circle No. 412

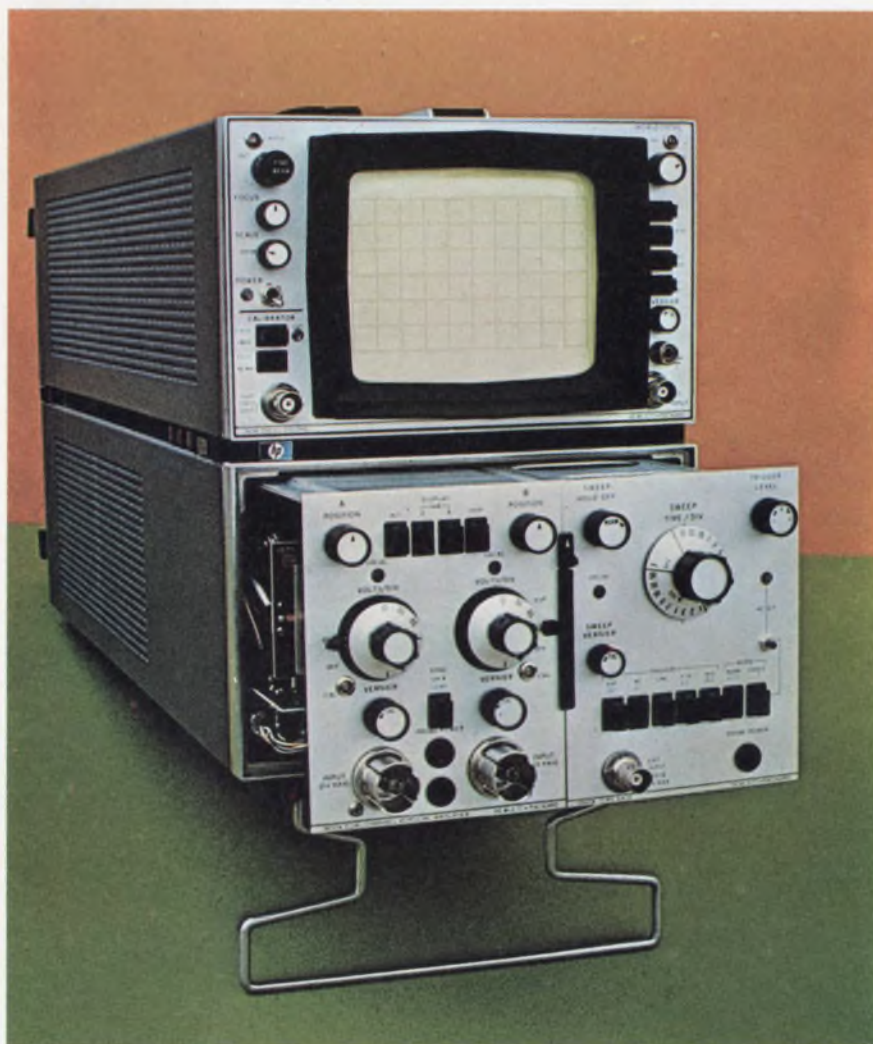

**High-performance dual-trace oscilloscope** with distributed-electrode CRT features a real-time response from dc out to 250 MHz. It can be used to analyze the short-duration fast-rise pulses of high-speed digital systems.



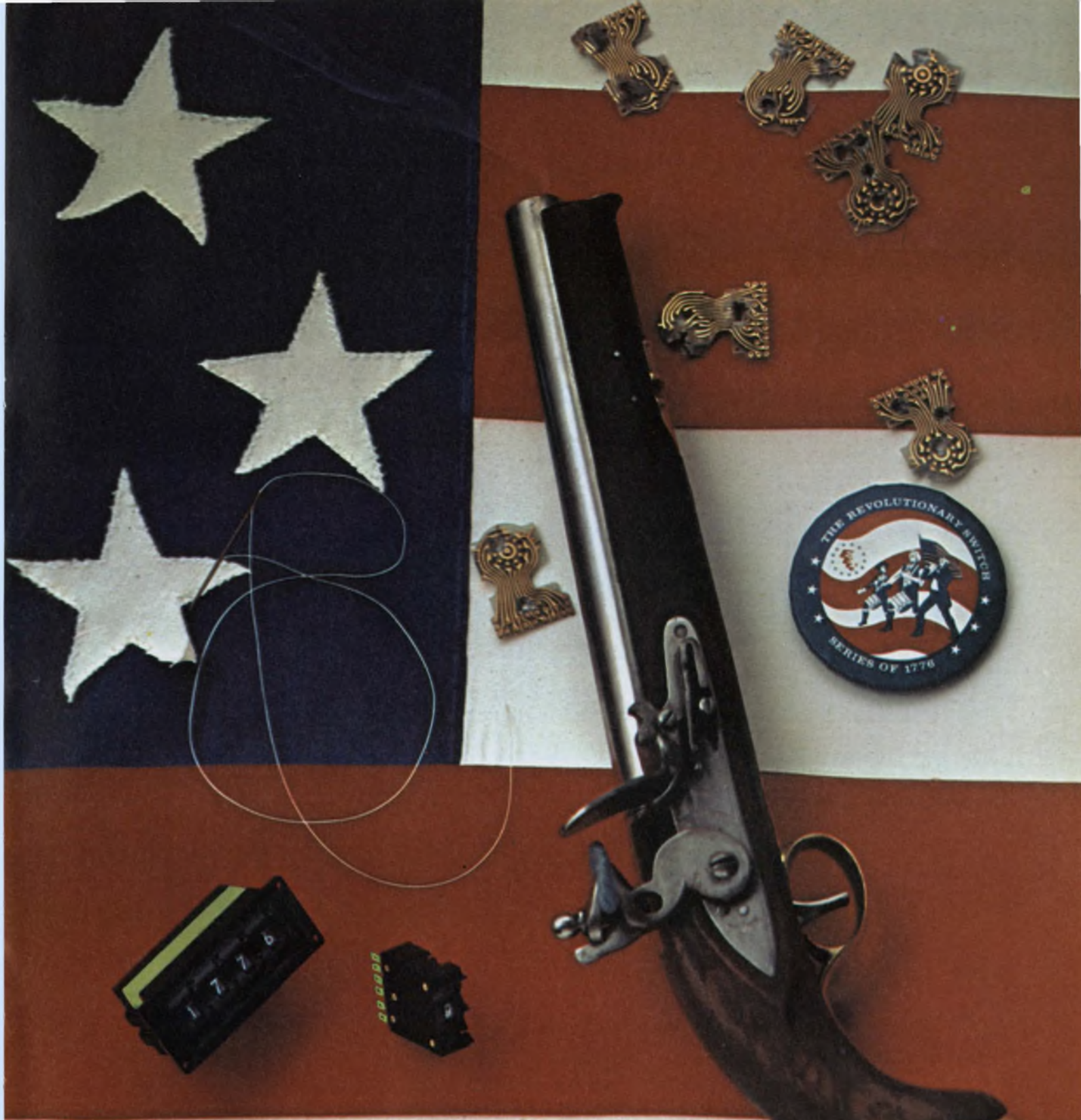

***EECO just shot switch prices full of holes...  
with the NEW revolutionary 1776 series miniature thumbwheel switch***

The first thing we did away with was the PC boards. *We completely eliminated them.* Imagine what that did to the price. Now you can purchase high quality EECoSWHCH<sup>®</sup> thumbwheel switches for only \$3.00 in 1 to 9 quantities. How's that for representation without taxation? We've also developed a simplified technique for fast, low-cost assembly of multiple switch stations for this revolutionary new product. The 1776 is the all-American answer to your switch requirements.

**Join the revolution!** Write today for your campaign button and data sheet on the Series of 1776.



**ELECTRONIC PRODUCTS DIVISION | ELECTRONIC ENGINEERING COMPANY OF CALIFORNIA**

1441 East Chestnut Avenue | Santa Ana, California 92702 (714) 547-5651

See EECO's Series of 1776 at **WESCON** Booth numbers 3814 thru 3817.



## Digital \$345 multimeter ends loading problems



*Digilin Inc., div. of Cura-Containers, 6533 San Fernando Rd., Glendale, Calif. Phone: (213) 246-8161. P&A: \$340; 30 days.*

Able to virtually eliminate circuit loading at all times, a new digital multimeter sells for only \$345 in quantities of one to four, with price dropping to \$299 in quantities of five to nine. Portable and compact, model 340 is a 3-1/2-digit completely self-contained instrument, free of all plug-ins.

Using a new patent-pending a/d conversion method called an input-amplifier technique, the 340 multimeter keeps its high input impedance constant so that the circuit being measured is not disturbed at all. In many other a/d techniques, such as dual-slope integration, input impedance drops after the measuring cycle. This can interject transient noise into the circuit being measured.

The readout display consists of three Nixie-type plug-in tubes, with memory capacity for a non-blinking display, and a neon "1" indicator. Decimal points are auto-

matically programed by a range key; a minus sign lights to indicate negative signals.

To eliminate drift and assure instant stability, the new multimeter incorporates an automatic zero adjustment. The unit can operate directly from any ac line since it has a self-contained power supply.

The 340 can measure full-scale ac and dc voltages from 1 to 1000 V, full-scale ac and dc currents from 100  $\mu$ A to 1 A, and full-scale resistances from 1 k $\Omega$  to 10 M $\Omega$ . It offers 100% overranging on all ranges and an overvoltage protection of 100 times the range setting.

Its maximum sensitivity is 1 mV for voltage, 100 nA for current, and 1  $\Omega$  for resistance. Full-scale accuracies are  $\pm 0.1\%$ ,  $\pm 1$  digit, for dc voltage;  $\pm 0.2\%$ ,  $\pm 1$  digit, for ac voltage; and  $\pm 0.2$  to  $\pm 1\%$ ,  $\pm 1$  digit, for resistance.

This 3-lb instrument has a measurement cycle of approximately five times per second. Its response time is 20 ms. Dimensions are 6 by 9 by 5-1/2 in., including the integral handle.

*Booth No. 1014      Circle No. 406*

## Dual-beam oscilloscope displays scale factors



*Tektronix Inc., P.O. Box 500, Beaverton, Ore. Phone: (503) 644-0161. P&A: \$1850; fourth quarter, 1969.*

Using fiber optics to digitally indicate current or voltage deflection factors plus the time set on its deflection controls, a new dual-beam oscilloscope is a high-gain, differential, low-frequency instrument. Type R5030 also offers color-coded sections of controls to outline functions and a CRT viewing area that is increased by 50% over conventional 8 by 10 cm units.

*Booth No. 2101      Circle No. 297*

## Digital panel meter has 0.1% accuracy



*API Instruments Co., 11655 Chilli-cothe, Chesterland, Ohio. Phone: (216) 729-7377.*

A new digital panel meter, with four digits for a display to 1999, has an accuracy of 0.1%, a resolution of 1 part in 4000, and a continuous BCD output that is DTL/TTL compatible. Other standard features include automatic polarity, display hold, print command, polarity and overrange outputs, and selectable decimal points. Model 4304 offers a seven-bar segmented display.

*Booth No. 1404      Circle No. 352*



# Gold, silver, stainless steel and uncompromising design produce the Shallcross Series 1 Rotary.

We begin our Shallcross Series 1 rotary switches with the best materials. Materials that promise superior performance and long service.

Like stainless steel in non-current carrying parts. Coin silver contacts and terminals. Gold plating available on all current-carrying parts.

We deploy these materials in an uncompromising design. Enclosed diallyl phthalate construction keeps out airborne contaminants. Contact resistance is 2.5 milliohms max. initially and remains unusually stable. Our double-wipe-to-air action takes care of that.

Solid detent feel is provided by a set of stainless steel balls riding a hill-and-valley stainless plate. Special lubricants are used on all friction points.

## Conform to MIL-S-3786/SR 28A

Shallcross one-inch Series 1 switches are built to MIL-S-3786/SR 28A. Temperature range  $-65^{\circ}$  to  $+125^{\circ}$  C. Our new ratings are: 2 amperes (115 vac or 28 vdc)—5000 cycles; 1 ampere (115 vac or 28 vdc)—25,000 cycles.

End-of-life contact resistance typically 5 to 10 milliohms.  $30^{\circ}$  indexing, up to 12 positions per pole available.

## Fast local service

Evaluate our Series 1 for military applications and your most demanding industrial and commercial needs. We're ready to supply prototypes to your specs on short notice. And deliver production quantities to your schedules. Contact your local Cutler-Hammer Stocking Switch Distributor.

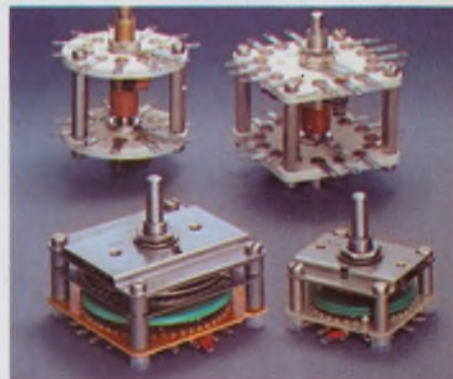

Cutler-Hammer's extensive line of Shallcross quality rotary switches includes  $1\frac{1}{4}$ " and  $2\frac{1}{2}$ " deck models as well as round and oval ceramics to fit your most demanding requirements.

**shallcross**

A CUTLER-HAMMER COMPANY Selma, N.C. 27576



# Ingredients for greatness.



Switch  
to No. 1

More than just switches:  
prompt availability,  
field help, innovation,  
quality assurance too.



# TRYGON HAS THE POWER

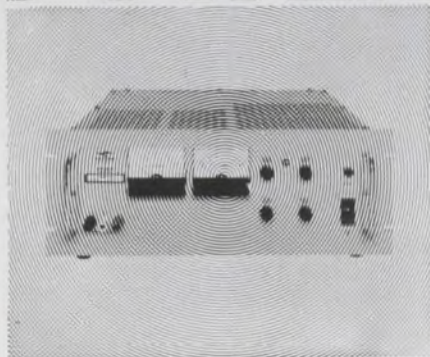

**to deliver wide  
range constant voltage  
constant current  
performance for  
every lab and system  
application.**

- All silicon design—precision performance
- Wide voltage ranges—currents to 100 amps
- Positive convection cooling—no derating
- Overvoltage and ultra-high stability options
- Automatic load share paralleling
- Priced from \$575.

Super-Mercury from TRYGON . . . the competitively-priced series of fully programmable wide-range power supplies, power and value packed.

Super-Mercury: Designed for bench or rack installation with slide provisions at no extra cost . . . in ranges up to 160 volts and up to 100 amps. Regulation of 0.005% and 0.015% stability are standard (0.005% stability optional) as is MIL Spec, RFI-free performance. Total ripple and noise: less than 1 mV RMS; Master-slave tracking, auto-load share paralleling and remote sensing and programming also standard. Write for the full TRYGON power story

TRYGON DOES HAVE THE POWER!



## TRYGON POWER SUPPLIES

111 Pleasant Avenue, Roosevelt, L.I., N.Y. 11575  
Trygon GmbH 8 Munchen 60, Haidelweg 20, Germany  
Write for Trygon 1968 Power Supply Handbook.  
Prices slightly higher in Europe.

INFORMATION RETRIEVAL NUMBER 61

## Printing digital voltmeter occupies only 8-in. width

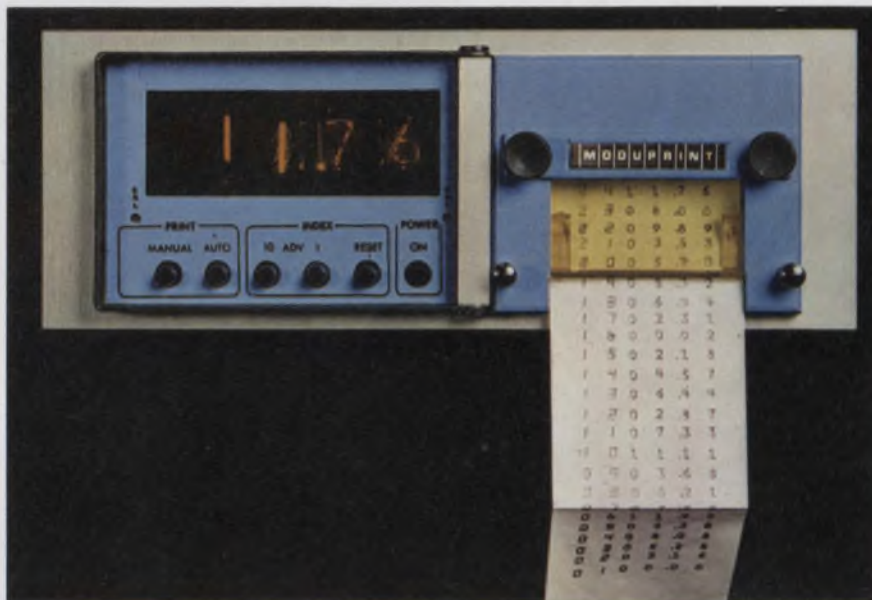

Presin Co., Inc., Trap Falls Rd., Shelton, Conn. Phone: (203) 929-1495. P&A: \$500, \$550 with index; 4 wks.

Designed for either half-rack or base mounting, a new printing voltmeter incorporates a 3-1/2-digit readout within a front-panel space measuring only 3-1/2-in. high by 8 in. wide. The PDM 611 operates from any line voltage; all its power supplies are built in. Measured values are displayed on illuminated numeric readout tubes.

Ranging is indicated automatically on the digital display by a decimal point, and by a fixed decimal point in the printer. Overranging to 100% is shown by a "1" in both the tube and printed readings.

This new digital printing voltmeter has an accuracy of 0.1%,  $\pm 1$  digit, and a normal-mode rejection ratio of 20 dB at 60 Hz. It also offers overload protection and an operating temperature range of 0 to 50°C.

The PDM 611 is a fixed-range device available for full-scale voltages from 1.999 mV to 199.9 V and full-scale currents from 1.999  $\mu$ A

to 199.9 mA.

Printing can be in one of two modes, either manual or automatic. In the manual mode, a pushbutton is used to trigger a drive pulse to the print solenoid. In the automatic mode, printing occurs at the completion of each encode. Automatic printing speeds can be as high as three lines per second.

As printing proceeds, a two-digit index advances and prints on each line. This serves to help identification.

These two index columns, with a separate type font for the data, can be changed by pushbutton pulsing into both the tens and units registers. The index can be reset by a single command pulse.

The recorded voltage reading is visible immediately after printing, and does not have to be extracted to be read. Fanfold paper, 2-1/4-in. wide, is used in the printer.

Optionally, the paper can be taken up in a box attached to the front panel. Printing is by means of a throw-away inked platen that is adequate for 40,000 lines of print.

Booth No. 1141 Circle No. 407





**We call it INCONNECT®. Our new Molex modular system that provides five ways of interconnecting electrical-electronic printed circuit assemblies: Two ways to connect circuit boards to chassis, three ways to interconnect printed circuit boards. It's a giant step forward in helping speed production and assembly techniques in the area of printed circuits. Unique flexibility enables you to tailor connector components to your specific product needs. Easily. Simplifies assembly, testing, servicing and model change requirements. It's another example of the Molex creative approach to circuitry problems. One that demonstrates just how reliable and economical printed circuit connections can really be. But see for yourself. Write for details. Or you can make connections by calling (312) 969-4550.**





## THE MATING REASON

In the course of human events, it is that intangible something. In the relationship between cable and RF connector, it is that tangible K-Grip.<sup>®</sup> That's the mating reason. A crimp design, its unique 3-piece configuration makes assembly foolproof and simple, and guarantees a lasting cable-to-connector attachment. Where space and weight are design factors, Kings has the K-Grip Jr.<sup>®</sup> that's 50% smaller and lighter (with moisture-proof plugs and jacks), plus a new SMA series of miniature RF Connectors that can be assembled in 1/5 the time required for conventional types.

Time-saving, cost-saving K-Grips are matched to your cables — matched to fit, to last, to perform. For the K-Grip product story, see EEM Section 2100, or write —

### **KINGS**

ELECTRONICS CO., INC.  
40 Marbledale Road/Tuckahoe, N.Y. 10707  
(914) SW 3-5000 / TWX 914-793-5879

Visit us at WESCON Booth 3706 Cow Palace  
INFORMATION RETRIEVAL NUMBER 63

## INSTRUMENTATION

### Plug-in oscilloscopes show scale factors

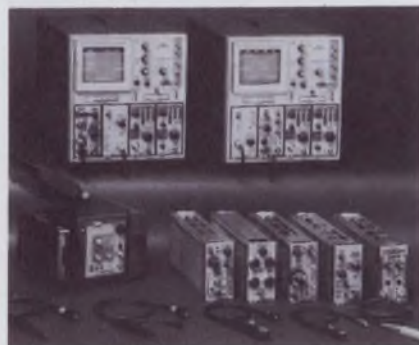

*Tektronix, Inc., P. O. Box 500, Beaverton, Ore. Phone: (503) 644-0161. P&A: \$250 to \$2500; fourth quarter, 1969.*

Forming a full measurement system, series 7000 plug-in oscilloscopes consist of two mainframes and 13 plug-in units. The new instruments feature a CRT that displays deflection factors, polarity, and any uncalibrated condition for all channels, corrected for probe attenuators and magnifiers. The plug-ins include six amplifiers, four time-base units, and three sampling units.

*Booth No. 2101      Circle No. 388*

### Digital bridge tests impedance



*General Radio Co., 300 Baker Ave., West Concord, Mass. Phone: (617) 369-4400.*

Model 1683 is a general-purpose, low-frequency, automatic series-impedance bridge with digital readout that measures capacitors, inductors, and resistors with loss expressed as equivalent series resistance or dissipation factor. Provisions for five-terminal connections to the unknown component ensure accurate measurements by minimizing errors due to lead impedances and stray capacitances.

*Booth No. 1726      Circle No. 359*



## Transistor analyzer reads noise directly



Hewlett-Packard, 1501 Page Mill Rd., Palo Alto, Calif. Phone: (415) 326-7000. Price: \$4450.

A new transistor noise analyzer directly measures all three bipolar transistor noise characteristics: noise figure, noise current, and noise voltage. Model 4470A has a noise-figure measurement range for both bipolars and FETs from 0 to 40 dB, with source resistance selectable from 10  $\Omega$  to 10 M $\Omega$ . Noise voltage is measured with essentially short-circuit transistor input impedances; bipolar noise current is measured with practically infinite input impedances.

Booth No. 1040 Circle No. 295

## Inexpensive DVMs reject 80-dB noise



Dana Laboratories, Inc., 2401 Campus Drive, Irvine, Calif. Phone: (714) 833-1234. Price: \$2000.

Series 4500 economy digital voltmeters offer 0.01% long-term accuracy, 80-dB normal-mode noise rejection, and full multimeter capability including dc/dc ratio measurements. Using dual-slope integration, the new instruments provide a full four-digit readout, with a fifth digit for 20% over-ranging. Other features include pushbutton operation, and auto-ranging and autopolarity in all functions except ratio.

Booth No. 2008 Circle No. 354

## Digital phase meter resolves to 0.1°



Wavetek, P.O. Box 651, San Diego, Calif. Phone: (714) 279-2200. P&A: \$1500; 30 days.

Using a closed loop design to insure stable long-term phase measurements in varying temperature environments, a new digital phase meter gives 0.1° resolution with a plus or minus sign indicating the lead/lag relation. Model 750 has two ranges, -180 to +180° and 0 to 360°, to assure continuous phase data without discontinuities at 0 and +180°.

Booth No. 2027 Circle No. 349

## Parametric supplies ignore line changes



Wanlass Instruments, 1540 E. Edinger Ave., Santa Ana, Calif. Phone: (714) 547-5171. P&A: from \$375; stock.

Providing parametric dc power, series PDC supplies allow input voltage to drop as low as 60 V ac and go as high as 150 V ac without affecting their dc output; voltages above and below this level merely turn off the units. In addition, normal-mode noise rejection is 80 dB to 1 MHz. Response time is 25  $\mu$ s.

Booth No. 2119 Circle No. 357

# THE MATING REASON

K-Grip Jr.® — A crimp design whose unique 3-piece configuration makes assembly foolproof and guarantees a lasting cable-to-connector attachment.

K-Grip Jr.® — 50% smaller, 50% lighter... the design answer to better RF connectors.

### Typical Types\*

P/N	Series	Type	Finish
<b>for RG Cable 174, 179A, 179B, 187, 187A, 188 &amp; 188A/U</b>			
KC-59-95	BNC	Plug	Silver
KC-59-152	BNC	Plug	TR-5™
KC-59-109	BNC	Angle Plug	Silver
KC-39-34	BNC	Jack	Silver
KC-39-50	BNC	Jack	TR-5
KC-19-68	BNC	Bulkhead Jack	Silver
KC-19-93	BNC	Bulkhead Jack	TR-5
KA-59-69	TNC	Plug	Silver
KA-59-120	TNC	Plug	TR-5
KA-59-70	TNC	Angle Plug	Silver
KA-39-27	TNC	Jack	Silver
KA-19-42	TNC	Bulkhead Jack	Silver
KA-19-60	TNC	Bulkhead Jack	TR-5
<b>for RG Cable 122, 180, 180A, 195 &amp; 195A/U</b>			
KC-59-107	BNC	Plug	Silver
KC-59-169	BNC	Plug	TR-5
KC-59-108	BNC	Angle Plug	Silver
KC-59-171	BNC	Angle Plug	TR-5
KC-39-36	BNC	Jack	Silver
KC-39-52	BNC	Jack	TR-5
KC-19-67	BNC	Bulkhead Jack	Silver
KC-19-96	BNC	Bulkhead Jack	TR-5
KA-59-58	TNC	Plug	Silver
KA-59-142	TNC	Plug	TR-5
KA-59-74	TNC	Angle Plug	Silver
KA-39-28	TNC	Jack	Silver
KA-39-44	TNC	Jack	TR-5
KA-19-41	TNC	Bulkhead Jack	Silver
<b>for RG Cable 58, 58A, 58C &amp; 141/U</b>			
KC-59-78	BNC	Plug	Silver
KC-59-123	BNC	Plug	TR-5
KC-59-101	BNC	Angle Plug	Silver
KC-59-153	BNC	Angle Plug	TR-5
KC-39-26	BNC	Jack	Silver
KC-39-38	BNC	Jack	TR-5
KC-19-61	BNC	Bulkhead Jack	Silver
KC-19-83	BNC	Bulkhead Jack	TR-5
KA-59-44	TNC	Plug	Silver
KA-59-103	TNC	Plug	TR-5
KA-59-71	TNC	Angle Plug	Silver
KA-59-151	TNC	Angle Plug	TR-5
KA-39-17	TNC	Jack	Silver
KA-39-34	TNC	Jack	TR-5
KA-19-38	TNC	Bulkhead Jack	Silver
KA-19-68	TNC	Bulkhead Jack	TR-5
<b>for RG Cable 223, 55A, 142 &amp; 142A/U</b>			
KC-59-80	BNC	Plug	Silver
KC-59-162	BNC	Plug	TR-5
KC-59-103	BNC	Angle Plug	Silver
KC-39-27	BNC	Jack	Silver
KC-39-51	BNC	Jack	TR-5
KC-19-64	BNC	Bulkhead Jack	Silver
KC-19-140	BNC	Bulkhead Jack	TR-5
KA-59-45	TNC	Plug	Silver
KA-59-87	TNC	Plug	TR-5
KA-59-72	TNC	Angle Plug	Silver
KA-39-18	TNC	Jack	Silver
KA-39-35	TNC	Jack	TR-5
KA-19-40	TNC	Bulkhead Jack	Silver
KA-19-65	TNC	Bulkhead Jack	TR-5

\* Also available moisture-proofed to meet Mil Spec. M 39012.

**KINGS**  
ELECTRONICS CO., INC.  
40 Marbledale Road  
Tuckahoe, N. Y. 10707





Meet the "Mite".  
Only .218" diameter. The toughest ceramic disc trimmer capacitor its size.

New from E. F. Johnson. And it's this small:   
Designed for printed circuit applications where space is at a premium. Stator of High Alumina for greater shock and vibration resistance. The rotor plate is encapsulated in ceramic for environmental stability and long life. The Q factor at 1 MHz is 500 minimum. Precision lapped bearing surfaces give you smooth linear tuning. Pick from a wide capacitance range: 1.0-3.0 pF, 2.5-9.0 pF, 3.5-20.0 pF, 5.0-25.0 pF. Designed to meet or exceed applicable requirements of MIL-C-81A.

Return the coupon today for information on Johnson's new Micro-J!™ And if you have a special capacitor need, we'd like to work with you. The same engineering that made our air variable capacitors the standard of excellence goes into every new Johnson product.

E. F. JOHNSON COMPANY/3308 Tenth Ave. S.W./Waseca, Minnesota 56093

- Send product specification information on new Micro-J capacitor.
- Include information about your full capacitor line and other Johnson components.

NAME \_\_\_\_\_ TITLE \_\_\_\_\_

FIRM \_\_\_\_\_ ADDRESS \_\_\_\_\_

CITY \_\_\_\_\_ STATE \_\_\_\_\_ ZIP \_\_\_\_\_



**E. F. JOHNSON COMPANY**  
INFORMATION RETRIEVAL NUMBER 65

## INSTRUMENTATION

### Time-interval counter averages 1000 times

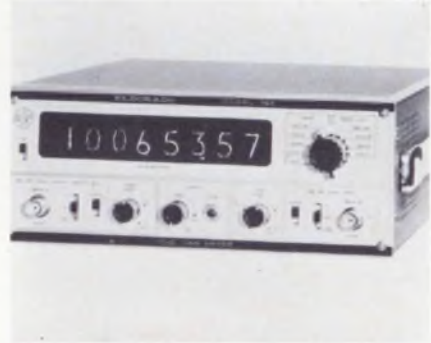

Elorado Electronics, 601 Chalomar Rd., Concord, Calif. Phone: (415) 686-4200. Price: from \$1750.

Able to measure 10-ns pulse rise-times, a new single-event time-interval counter is capable of averaging 1000 times. Model 784 has an eight-digit stored display. It can measure time interval, pulse width, risetime and period through an input signal conditioning discriminator on both channels. Options are available for greater stability and BCD

Booth No. 1722 Circle No. 298

### Lab-test protector covers 5 to 50 V



Transtector Systems, M & T Chemicals Inc., sub. of American Can Co., 3025 W. Mission Rd., Alhambra, Calif. Phone: (213) 283-9278.

Incorporating 23 voltage protection levels from 5 to 50 V dc, a new lab-test protector guards laboratory breadboards, production components under test, and subsystems during checkout against damaging voltages. If a voltage above the protection level is applied, the unit clamps the line to 1 V dc in approximately 500 ns.

Booth No. 4712 Circle No. 365



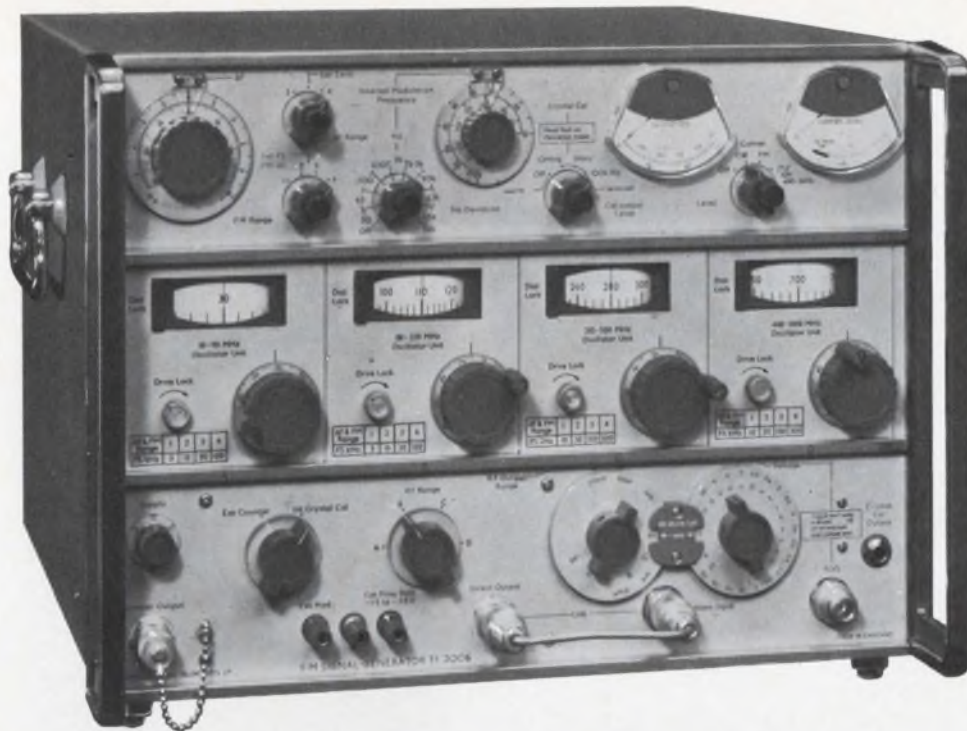

- **Wide Range:**  
4-1000 MHz
- **Stability:**  
Better than  
15 PPM/15 minutes
- **Non-Microphonic**
- **No Range Change  
Drift**
- **Fully Solid State**

# the clean FM Signal Generator

F.M. Signal Generator TF 2006 is another "first" in the field of wide-range solid-state signal generators. Based on separate high Q resonant-line transistor oscillators, this instrument provides wide deviation f.m. on highly stable carriers up to 1 GHz. Rigid mechanical construction ensures that the precision oscillators have very low drift and microphony. Automatic levelling maintains constant r.f. output over the entire carrier frequency range, which extends down to 4 MHz, and accurate step attenuators offer a dynamic range of 120 db. Electrical fine tuning and f.m. may be simultaneously applied by the drive circuitry. As a result of their electrical relationship within the instrument f.m. as well as the fine tuning may be adjusted to a higher accuracy against the comprehensive crystal calibrator. This oven-controlled calibrator indicates carrier frequencies by meter nulls at 10, 1 or 0.1 MHz intervals and therefore provides almost 10,000 check points of the carrier frequency.

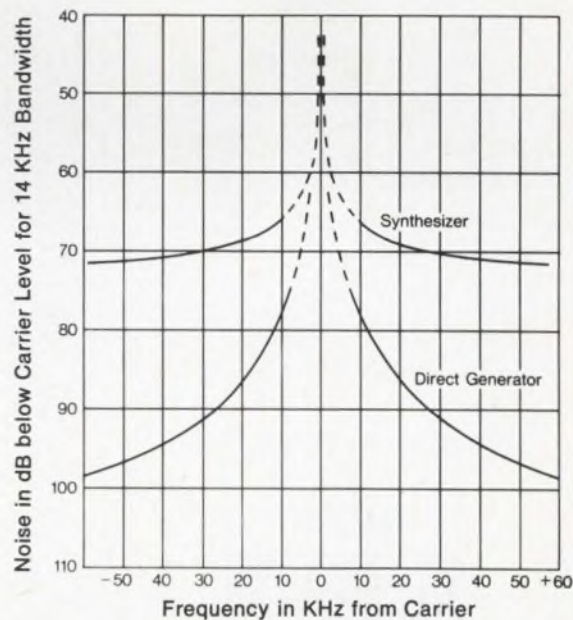

Comparison of Synthesized and Direct Frequency Signal Generator U.H.F. Spectra.

**mi** **MARCONI**  
**INSTRUMENTS**  
DIVISION OF ENGLISH ELECTRIC CORPORATION

111 CEDAR LANE □ ENGLEWOOD, NEW JERSEY 07631  
TELEPHONE: (201) 567-0607



AVAILABLE UPON REQUEST . . .

Detailed specification brochure including operating principles, mechanical, electrical and environmental specifications.

SEE US AT WESCON BOOTH #1824-25-26

INFORMATION RETRIEVAL NUMBER 66



# C-COR AMPLIFIER

-10 Hz — 200 MHz  
Output +13 dBm

**ONLY \$395**

**COMPACT, VERSATILE,  
NEW LABORATORY  
AMPLIFIER  
MODEL 4376 WITH  
ADVANCED CIRCUITRY**



Features	Facts
High Input Impedance	1 M $\Omega$ 10 pf
Wide Bandpass	10 Hz — 200 MHz
High Gain	20/40 dB Selectable
Low Input Noise	60 $\mu$ V rms

Wide Dynamic Range  
Input Protection Circuitry  
Extends Range of Oscilloscopes  
and RF Voltmeters

**Package Includes Power Supply**

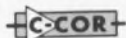

**C-COR**  
ELECTRONICS, INC.

60 Decibel Road  
State College, Pennsylvania 16801  
(814) 238-2461

OR SEE EEM CATALOG  
FOR NEAREST REPRESENTATIVE

## INSTRUMENTATION

**Half-rack multimeter  
is 0.0025% accurate**



Data Technology Corp., 1050 E. Meadow Circle, Palo Alto, Calif. Phone: (415) 321-0551. P&A: \$2400; 60 days.

Claimed to be the most accurate five-digit voltmeter/multimeter in the industry today, a new digital instrument features a dc accuracy of 0.0025% in a half-rack-size package only 3-1/2 in. high. Model 370 is also capable of measuring ac volts to 100 kHz, ohms to a resolution of 1 m $\Omega$ , and ratios to 0.99999:1.

Booth No. 1827 Circle No. 346

**Digital instrument  
divides and generates**



Anadex Instruments Inc., 7833 Haskell Ave., Van Nuys, Calif. Phone: (213) 782-9527. P&A: \$645; 4 wks.

With a crystal-controlled 1-MHz oscillator, a new instrument will generate periods from 10  $\mu$ s to 100 s and perform frequency division from 1 to 9,999,900. Model CF-611R frequency divider and period generator features plug-in TTL integrated circuits in a space saving 1-3/4-in.-high chassis. Maximum input frequency in the divider mode is 1 MHz.

Booth No. 1904 Circle No. 351

**Dual-function instrument  
measures and calibrates**



Wavetek, P.O. Box 651, San Diego, Calif. Phone: (714) 279-2200. P&A: \$2395; 45 days.

Without resorting to plug-in accessories, a new multi-function instrument provides six precision measurement functions and two accurate calibration capabilities in a single compact package. Model 220 Dialomatic multimeter/calibrator measures dc voltage, dc ratio, ac voltage, ohms, ohms ratio, and frequency. Its digital/analog readout has a six-digit resolution.

Booth No. 2027 Circle No. 348

**Low-ohm DMM  
ignores noise**



Dana Laboratories, Inc., 2401 Campus Drive, Irvine, Calif. Phone: (714) 833-1234. Price: \$3000.

Able to measure resistances as low as 1 m $\Omega$ , a new four-digit multimeter can make measurements of high-speed rms ac voltages in the presence of distortion. Model 5400/035, which has a fifth-digit for 10% overranging, can also measure dc volts, millivolts and dc/dc ratios. Normal-mode noise rejection is 80 dB; common-mode noise rejection is 120 dB at 60 Hz.

Booth No. 2008 Circle No. 355





## You'll never get a bum wrap.

Not with a CDE wrapped tubular. For Cornell Dubilier has set the industry standard in wrap-and-fill capacitors. And we offer the most comprehensive stock in depth. Over 500 items, round and oval, covering capacities from .001 to 5 mfd, voltages from 50 to 600V DCW, and tolerances from 1% through 20%.

In polyester, polycarbonate, or polystyrene, in foil/film or metalized dielectrics—to meet every industrial or military need. And all are Sprint stock standards. SPRINT is the CDE program that assures you quick delivery of standardized components covering 98% of industry requirements.

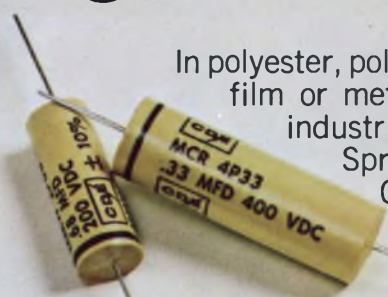

50 Paris Street, Newark, New Jersey 07101



# STOCK STANDARDS—WRAPPED TUBULAR CAPACITORS

## **TYPE WCR. General purpose, round, polycarbonate capacitor**

Voltage—50 to 600V DCW  
Capacitance—.001 to 2.0 mfd  
Tolerance— $\pm 5\%$ , 10%  
Temperature— $-55^{\circ}\text{C}$  to  $+125^{\circ}\text{C}$  without derating  
 **$\pm 1\%$ ,  $2\%$ ,  $5\%$ ,  $20\%$  available on special order over 50V**

## **TYPE WCP. General purpose, oval polycarbonate capacitor**

Voltage—50 to 600V DCW  
Capacitance—.01 to 2.0 mfd  
Tolerance— $\pm 10\%$   
Temperature— $-55^{\circ}\text{C}$  to  $+125^{\circ}\text{C}$  without derating  
 **$\pm 5\%$  available on special order**

## **TYPE WPR. General purpose, round, polystyrene capacitor**

Voltage—100 to 600V DCW  
Capacitance—.001 to 1.0 mfd  
Tolerance— $\pm 1\%$ , 2%, 5%, 10%, 20%  
Temperature— $-55^{\circ}\text{C}$  to  $+85^{\circ}\text{C}$

## **TYPE MFP. General purpose, oval, polyester miniature capacitor**

Voltage—50 to 600V DCW  
Capacitance—.01 to 5.0 mfd  
Tolerance— $\pm 10\%$ , 20%  
Temperature— $-55^{\circ}\text{C}$  to  $+85^{\circ}\text{C}$  without derating;  
 $+125^{\circ}\text{C}$  with derating  
 **$\pm 5\%$  tolerance available on special order**

## **TYPE MCR. General purpose, round, metallized polycarbonate capacitor**

Voltage—50 to 600V DCW  
Capacitance—.01 to 5.0 mfd  
Tolerance— $\pm 10\%$ , 20%  
Temperature— $-55^{\circ}\text{C}$  to  $+125^{\circ}\text{C}$   
 **$\pm 5\%$ ,  $10\%$  tolerances available on special order over 50V**

## **TYPE MCP. General purpose, oval metallized polycarbonate capacitor**

Voltage—50 to 600V DCW  
Capacitance—.1 to 5.0 mfd  
Tolerance— $\pm 10\%$ , 20%  
Temperature— $-55^{\circ}\text{C}$  to  $+125^{\circ}\text{C}$  without derating  
 **$\pm 5\%$ ,  $10\%$  available on special order over 50V**

## **TYPE MMW. General purpose, round, metallized, polyester miniature capacitor**

Voltage—50 to 600V DCW  
Capacitance—.01 to 5.0 mfd  
Tolerance— $\pm 1\%$ , 2%, 5%, 10%, 20%  
Temperature— $-55^{\circ}\text{C}$  to  $+85^{\circ}\text{C}$  without derating;  
 $+125^{\circ}\text{C}$  with derating  
 **$\pm 1\%$ ,  $2\%$ ,  $5\%$  tolerances available on special order over 50V**

## **TYPE MMP. General purpose, flat metallized, polyester miniature capacitor**

Voltage—50 to 600V DC  
Capacitance—.1 to 5.0 mfd  
Tolerance— $\pm 1\%$ , 2%, 5%, 10%, 20%  
Temperature— $-55^{\circ}\text{C}$  to  $85^{\circ}\text{C}$  without derating;  
 $+125^{\circ}\text{C}$  with derating

## **TYPE WMF. General purpose, round, polyester miniature capacitor**

Voltage—50 to 600V DCW  
Capacitance—.001 to 5.0 mfd  
Tolerance— $\pm 1\%$ , 2%, 5%, 10%, 20%  
Temperature— $55^{\circ}\text{C}$  without derating;  
 $+125^{\circ}\text{C}$  with derating  
 **$\pm 1\%$ ,  $2\%$ ,  $5\%$  tolerances available on special order over 50V.**

## **TYPE CTM. Military round, polyester per MIL-C-27287**

Voltage—50 to 100V DCW, 200V DC to 300V DC at  $125^{\circ}\text{C}$   
Capacitance—.0033 to 1.0 mfd, .001 to .15 mfd  
Tolerance— $\pm 5\%$ , 10%  
Temperature— $-55^{\circ}\text{C}$  to  $+125^{\circ}\text{C}$

Entries in red available on special order only. All other items stocked in depth at your CDE authorized distributor.

*For complete descriptions, see your component selector.*

**CDE** **CORNELL-DUBILIER**

50 Paris Street, Newark, New Jersey 07101



## Pulse generator reps to 100 MHz

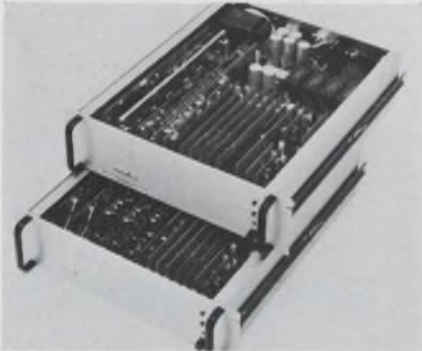

Systron-Donner Corp., Datapulse Div., 10150 W. Jefferson Blvd, Culver City, Calif. Phone: (213) 836-6100. P&A: \$10,000 to \$15,000; 90 days.

Model 140 fully programmable pulse generating system provides repetition rates to 100 MHz, pulse widths to 5 ns, and independently variable risetimes and falltimes from 2 ns. Accuracies are typically  $\pm 2\%$  of programed values; the upper and lower levels of the output waveform may be any values between +10 and -10 V.

Booth No. 1412 Circle No. 293

## Lab power source calibrates output

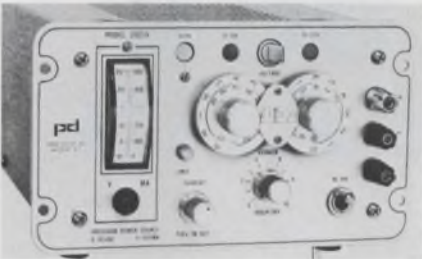

Power Designs Inc., 1700 Shames Drive, Westbury, N.Y. Phone: (516) 333-6200.

Combining precision calibrator and laboratory power source functions in a single compact unit, model 2005A power supply provides an output range of 0 to 20 V dc at 0 to 500 mA with a calibration accuracy of 0.1%. Front-panel, dual, concentric decade switches and a vernier potentiometer with 10- $\mu$ V resolution allow a digital readout to five places with a continuously adjustable fifth place.

Booth No. 1020 Circle No. 360

# MODULAR TYPE IC PACKAGING PANEL

## For High Density

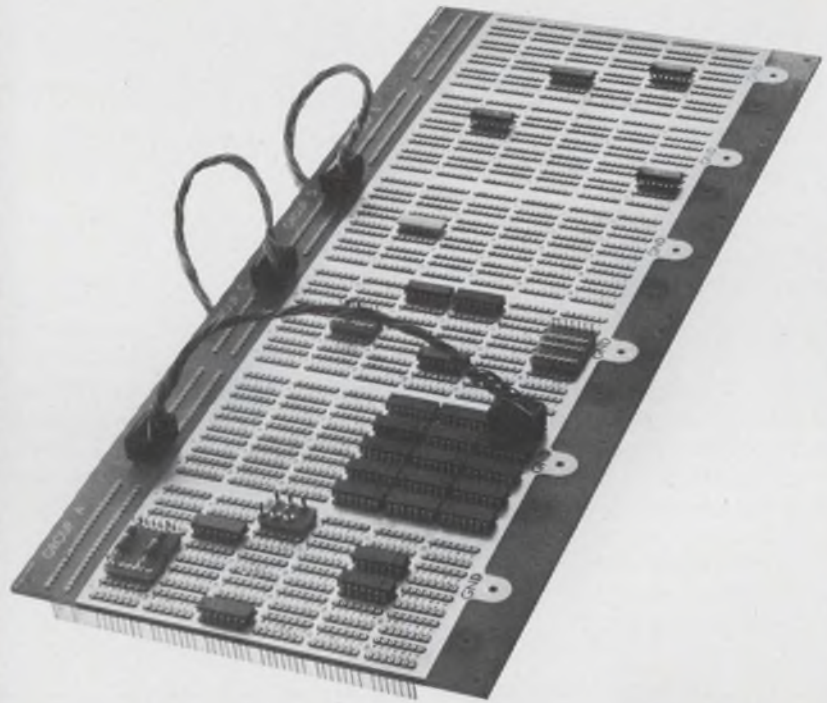

Simplifies design and production operations. Saves time and space. Direct mounting chassis eliminates need of logic cards — increases flexibility in prototyping, production and field service. A unique two dimensional approach to IC packaging with these outstanding features:

Multiple of 30 pattern sections, up to 180 patterns.

Two pins of each pattern tied directly to power and ground planes.

Provisions for input-output plugs and adaptor plugs for discrete components.

Excellent contact retention of flat lead dual-in-line (.022 max.) with machined closed entry design.

Choice of Wire-Wrap® or solder pocket terminations.

Three levels of connection on Wire-Wrap pins.

®Trademark Gardner-Denver Co.

Request Complete I. C. Folder

# AUGAT

TEL: 617/222-2202  
INC. 31 PERRY AVE., ATTLEBORO, MASS. 02703

WESCON Booth 2721-22



**Logarithmic amplifier  
has 90-dB power range**



Telonic Instruments, Inc., 60 N. First Ave., Beech Grove, Ind. Phone: (317) 787-3231.

Accepting any rf input from 400 kHz to 130 MHz over a power range of -70 to +20 dBm, a new logarithmic amplifier provides a linear detected output for oscilloscope, voltmeter, or graphic recorder presentation. Model 6001 is a solid-state instrument with an output that is accurate to  $\pm 3$  dB. It can make both steady-state and swept-frequency measurements.

Booth No. 1724      Circle No. 292

**Solid-state instrument  
analyzes servo systems**



Servo Corp. of America, 111 New South Rd., Hicksville, N.Y. Phone: (516) 938-9700.

Featuring all-solid-state design, a new servo system analyzer combines a function generator, phase shifter, internal modulator and a precision attenuator in one compact instrument. Model 1999 can be used for analysis and test of servo-mechanisms and complex control systems by observing phase and amplitude response with respect to various frequencies and wave shapes.

Booth No. 2206      Circle No. 358

**Small IC counter  
goes out to 15 MHz**



Computer Measurements div. of Newell Co. Industries, 12970 Bradley Ave., San Fernando, Calif. Phone: (213) 367-2161. Price: \$395.

Selling for as much as 35% less than comparable competitive instruments, a new compact 15-MHz IC counter incorporates a 1-MHz crystal oscillator and provides a five-digit readout. Model 905 comes in a small package, measuring only 3-1/2 by 5 by 7 in., that features a tip-up stand for easy visibility in bench work.

Booth No. 1006      Circle No. 347

**now available . . . STOCK  
BUS  
BARS**

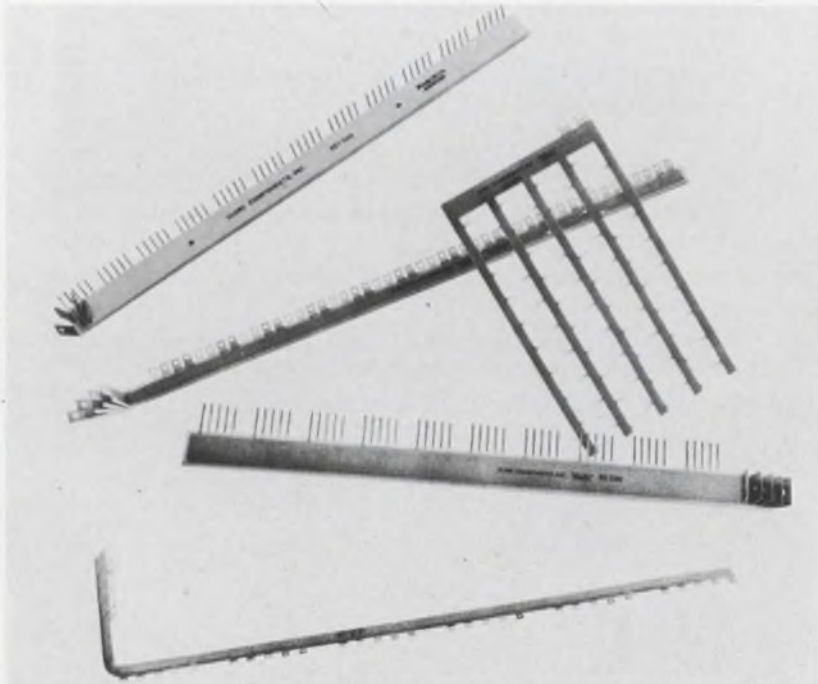

**Designed for prototypes,  
small quantities and  
immediate delivery.**

*Write for price list and  
technical data . . .*

**ELDRE** 

**COMPONENTS, INC.**

1239 UNIVERSITY AVENUE  
ROCHESTER, NEW YORK 14607

 **WESCON/69**

See us at booths  
5221 & 5222

INFORMATION RETRIEVAL NUMBER 69



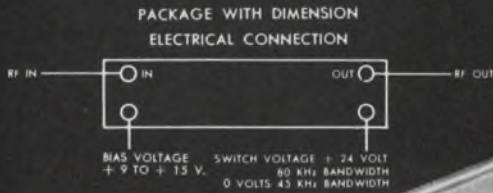

# design freedom

yours with the new switchable dual bandwidth  
crystal filters

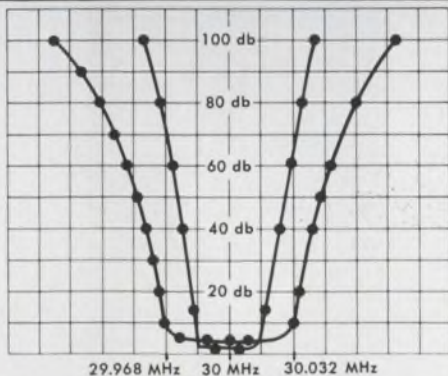

SPECIFICATION	CENTER FREQUENCY 30 MHz
filter (A)	filter (B)
1 db Bandwidth 35 KHz Min.	1 db Bandwidth 64 KHz Min.
6 db Bandwidth 45 KHz Min.	6 db Bandwidth 80 KHz Min.
60 db Bandwidth 90 KHz Max.	60 db Bandwidth 160 KHz Max.
Ultimate Attenuation 80 db	Ultimate Attenuation 80 db
Impedance 50 $\Omega$ in & out	Impedance 50 $\Omega$ in & out
Ripple 1 db Max.	Ripple 1 db Max.
I.L. $\leq$ 4 db	I.L. $\leq$ 4 db
ENVIRONMENTAL:	Tol.
TR -55°C to 105°C	Center Frequency $\pm$ .005%
Vibration—Mil. Std. 202	Method 204 A      Test Cond. D
Shock—Mil. Std. 202	Method 205 C      Test Cond. C

For multi-mode communication systems, M<sup>C</sup>Coy has added another technological achievement in expanding applications for crystal filters. The switchable filter is custom-made to your specifications, economically, and in a small package.

At M<sup>C</sup>Coy Electronics, the integration of crystal and filter engineering technology is your assurance of the finest crystal filter performance available today. And we'll be ready for tomorrow with the next dimension in crystal filters to suit your future needs.

Put our experience to work for you!



**MCCOY ELECTRONICS COMPANY**  
MT. HOLLY SPRINGS, PENNSYLVANIA 17065  
Tel. 717-486-3411      TWX: 510-650-3548  
a subsidiary of OAK ELECTRO/NETICS CORP.



# New Concept AC Regulator Outperforms them all!



## Compare!

	ERA SOLID STATE MODELS	CONVENTIONAL MAGNETIC TYPES
Small Size	Yes	No
Light Weight	Yes	No
Wide Freq. Range	Yes	No
Tight Regulation	Yes	No
Fast Transient Response	Yes	No
Silent Operation	Yes	No
Fully Repairable	Yes	No
Stable with Temperature	Yes	No
High Efficiency	Yes	No
Wide Temp. Range	Yes	No
High Surge Rating	Yes	No
Minimum RFI	Yes	No
Series Operation	Yes	No
Remote Sensing	Yes	No
Sinusoidal Output	Yes	Special Order

### SPECIFICATIONS

Input: 105-130 VAC, 47-440cps  
 Output: 115 VAC nom (See table for power rating)  
 Line Regulation: Within  $\pm 0.1\%$  for full input change.  
 Load Regulation: Within 0.2% for full load change  
 Frequency Regulation: Less than 0.002% per cycle  
 Wave Form Distortion: Less than 5%  
 Load Power Factor Range: +0.7 PF through -0.7 PF  
 Response Time: Less than 16 millisecond  
 Operating Temperature:  $-20^{\circ}\text{C}$  to  $+71^{\circ}$  free air

### STANDARD MODELS

Power Rating	Size (Inches)	Weight	Model	Price*
250 VA	6 $\frac{1}{2}$ "x7 $\frac{1}{4}$ "x4 $\frac{7}{8}$ "	13 lbs.	RT250	\$130
500 VA	6 $\frac{7}{8}$ "x8 $\frac{7}{8}$ "x7 $\frac{1}{2}$ "	16 lbs.	RT500	\$175
1000 VA	7 $\frac{1}{2}$ "x9 $\frac{1}{2}$ "x7 $\frac{3}{8}$ "	22 lbs.	RT1000	\$235

\*Liberal Discounts for Larger Quantities



Send for full technical data.

## ELECTRONIC RESEARCH ASSOCIATES, INC.

67 Sand Park Road, Cedar Grove, N. J. 07009  
 INFORMATION RETRIEVAL NUMBER 71

## INSTRUMENTATION

### D/ac converter gives $10^4$ ratios

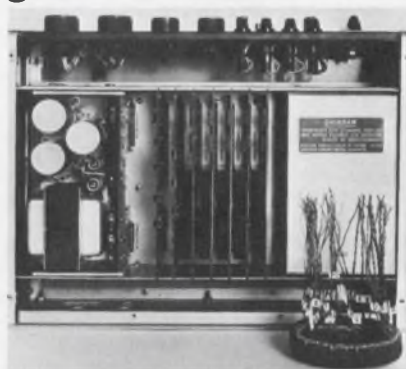

North Atlantic Industries, Inc.,  
 Terminal Drive, Plainview, N.Y.  
 Phone: (516) 681-8600. P&A:  
 \$3000; 8 wks.

Using precision tapped transformers for 0.01% long-term accuracy, a new all-solid-state digital-to-ac converter provides 10,000 discrete input-output voltage ratios or levels of digital-to-ac conversion. Model 508/10 can be set, under digital control, in 0.0001:1 ratio increments, feeding out a precise fraction of the 115-V 400-Hz reference excitation in response to BCD input commands.

Booth No. 1127 Circle No. 363

### Time-code generator clocks and pulses



Eldorado Electronics, 601 Chalmar Rd., Concord, Calif. Phone:  
 (415) 686-4200. P&A; \$1950; 30 days.

Displaying time in days, hours, minutes and seconds, a new time-code generator can supply up to five serial codes simultaneously, has standard parallel and pulse rate outputs, and offers precision synchronizing to an external standard. Model 1710 extensively uses integrated circuits to achieve low cost and high capability.

Booth No. 1722 Circle No. 294

### Digital counter-timer utilizes plug-in ICs

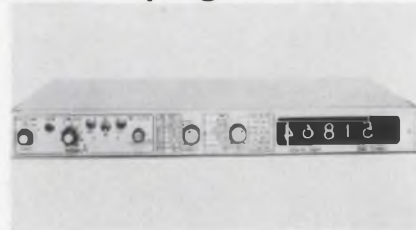

Anadex Instruments Inc., 7833 Haskell Ave., Van Nuys, Calif.  
 Phone: (213) 782-9527. Availability:  
 3 to 4 wks.

Featuring plug-in integrated circuits, a new 1-3/4-in-high counter-timer is designed for frequency, time-interval, ratio, period-averaging, and totalized measurements in both laboratory and system applications. Model CF-635R has a 1-MHz crystal-controlled time base. Its sensitivity is 10 or 100 mV; count rate is 15 MHz.

Booth No. 1904 Circle No. 350

### Spectrum analyzer ends distortion



Siger Co., Instrumentation Div.,  
 915 Pembroke St., Bridgeport,  
 Conn. Phone: (203) 366-3201.  
 P&A: \$6810; 30 to 60 days.

Intended for single-sideband, a-m, fm, and multiplexed communications work, a new high-resolution spectrum analyzer has a frequency range of 10 Hz to 40 MHz, useable to 200 MHz, and a distortion-free dynamic range of 70 dB. Model SSB-50-1 provides a 10-Hz resolution over its entire tuning range. It also offers steep skirt selectivity and freedom from internal hum.

Booth No. 2015 Circle No. 361



## Dual-pulse generator separates outputs

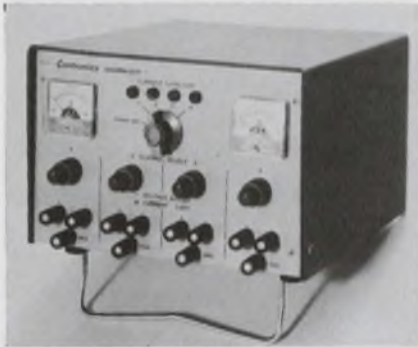

International Contronics Inc., 1038 W. Evelyn Ave., Sunnyvale, Calif. P&A: \$395; stock.

Said to be an industry first, a new logic pulse generator provides independently variable simultaneous complementary 10-V outputs. Called the Lochpulse CPG-300, the new instrument also offers an independently variable  $\pm 2$ -V dc offset on each pulse. Other features include a 100% duty cycle at 10 MHz, and precise and stable gating circuits.

Booth No. 5603 Circle No. 356

## Double-pulse generator delivers 2 A at 100 V

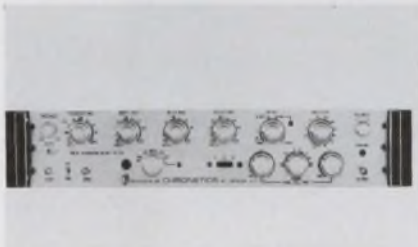

Chronetics, Inc., 500 Nuber Ave., Mount Vernon, N.Y. Phone: (914) 699-4400. P&A: \$1750; 60 to 90 days.

In a single- or double-pulse mode, model PG13A pulse generator can supply current pulses as large as  $\pm 2$  A and voltage pulses to  $\pm 100$  V, at repetition rates to 25 MHz. Continuously variable parameters include pulse repetition frequency, amplitude, risetime, falltime, delay, pulse width and dc offset. Triggering sensitivity is variable to  $\pm 2$  V into 50 or 500  $\Omega$ .

Booth No. 1419 Circle No. 402

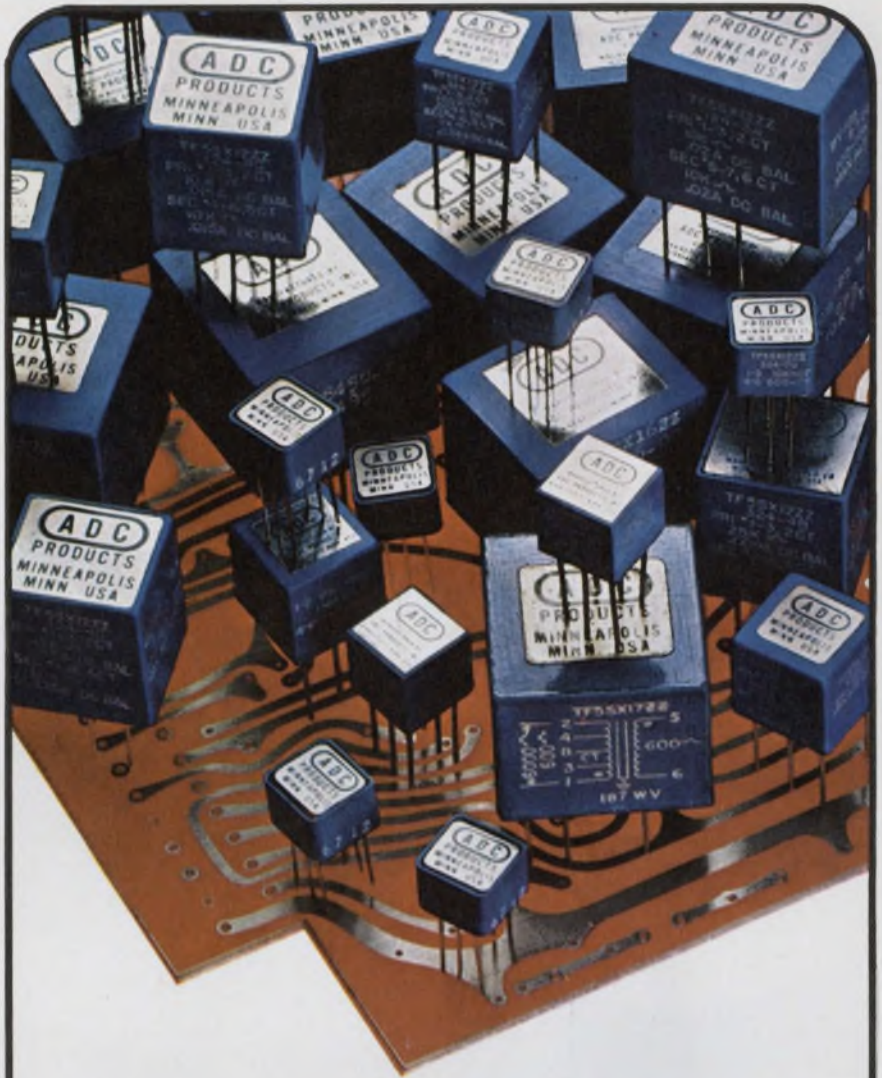

# HOW MANY CHOICES?

"BLUE CHIP" TRANSFORMERS offer 71 different off-the-shelf versions that enable you to custom select transformers for printed circuit applications. The combination of choices in size, frequency, power and impedances available allows you the utmost in design flexibility. ■ Parameter choices available: Impedance: 4 ohms to 100,000 ohms, Frequency: 60 Hz to 100,000 Hz, Power: 30 MW to 7.5 W, Volume: .060 cubic inches to 1.16 inches (6 sizes), Weight: .09 oz. to 2.5 oz. ■ All Blue Chip transformers meet Mil-T-27B, Grade 5, Class S requirements.



## ADC PRODUCTS

A DIVISION OF MAGNETIC CONTROLS CO.  
6405 CAMBRIDGE STREET ■ MINNEAPOLIS, MINN. 55426



# METALIZED POLYESTER CAPACITORS

ACTUAL SIZE



M2W  
SERIES

ANY SIZE, VALUE,  
VOLTAGE AND  
TOLERANCE

## to your exact specifications... at stock prices

Unique, self-healing units that remain in circuit during voltage surges with little or no loss of electrical properties. Use the M2W's where size and weight are limiting factors and long life and dependability are required. The units utilize metalized Polyester Dielectric with film wrap and custom formulated epoxy resin end fill. Available in round and flat styles.

Samples available on  
your letterhead request



**CONDENSER CORPORATION**

Dept. ED 9 1065 W. Addison St.,  
Chicago, Ill. 60613 • 312-327-5440

INFORMATION RETRIEVAL NUMBER 73

U134

## INSTRUMENTATION

### Metered picoammeter goes down to 0.3 pA



*EG & G Laboratory Products Div.,  
150 Aero Camino Way, Goleta,  
Calif. Phone: (805) 967-0456.*

Model 706A general-purpose picoammeter with meter display measures direct current from 0.3 pA to 10 mA full scale. The instrument features a built-in current source that can be used as a current suppressor, an internal calibrator, or a calibration source for an external instrument. Accuracy of the output multiplier is 0.05% of the multiplier setting.

*Booth No. 1129 Circle No. 404*

### Time-code generator is size of a phone



*Systron-Donner Corp., 888 Galindo  
St., Concord, Calif. Phone: (415)  
682-6161. P&A: \$950; stock.*

About the size of a desk telephone, a new time-code generator provides a standard series code in IRIG B code format in terms of BCD hours, minutes and seconds. Model 8220 is a precise digital clock for use in indexing analog magnetic tape during data acquisition or for transmission over standard telephone lines for remote use and display. Time is initially preset by means of thumbwheel switches.

*Booth No. 1412 Circle No. 398*

### Low-cost pulser reps to 20 MHz



*Chronetics, Inc., 500 Nuber Ave.,  
Mount Vernon, N.Y. Phone: (914)  
699-4400. P&A: \$375; stock to 2  
wks.*

Operating from 10 Hz to 20 MHz in a single- or double-pulse mode, a new low-cost pulse generator provides a delayed or double pulse output to  $\pm 15$  V. Model PG-11 may be triggered from dc to 20 MHz and can be synchronously or asynchronously gated. Risetimes and falltimes are 5 ns maximum at full output amplitude.

*Booth No. 1419 Circle No. 401*

### Waveform generator programs remotely



*Data Royal Corp., 8014 Armour  
St., San Diego, Calif. Phone: (714)  
279-4020. P&A: \$1545; 30 to 45  
days.*

Covering the frequency range of 0.01 Hz to 1.1 MHz, model F280A waveform generator can deliver up to 11 V pk-pk into 50  $\Omega$  in the manual mode, or can be programmed to generate up to 16 V pk-pk into a similar load (32 V pk-pk into an open circuit). All manual controls are remotely programmable; signal and programming commons are isolated to reduce system ground loop problems.

*Booth No. 1113 Circle No. 399*

INFORMATION RETRIEVAL NUMBER 74 ►



# High-performance Pen Pals

## **Honeywell's 530 X-Y Recorder: true differential input and proven reliability . . . for under \$1250.**

Our 530 X-Y Recorder not only records low-level signals from any source, grounded or floating, it records them so efficiently and so reliably, you can depend on it, day in and day out.

And for good reason. This 530 X-Y Recorder has the same kind of improved snap fit pen assembly (with a polished sapphire tip), carriage assembly and cable arrangement that have made our model 550 and 560 Recorders the standard of the industry.

You'll be happy to know, too, that the Honeywell 530 X-Y Recorder is so simple to operate that even your non-technical people can learn to use it. And yet, it delivers high speed (30 in/sec. on X-axis, 20 in/sec. on Y-axis) and common mode rejection up to 130 db; offers a trouble-free vacuum holddown; and accepts either 8½" x 11" or 11" x 17" paper.

## **Honeywell's 540 X-Y-Y' Recorder: a two-pen recorder with double capability for a price less than \$2100.**

Even though our 540 X-Y-Y' Recorder costs less, it doesn't give you any less. In fact, it's operating characteristics are almost identical to our 530 Recorder, giving you the exact same true differential input, the same proven mechanical design features, the same unsurpassed reliability. Plus it offers 30 ips. slewing speed on each axis and 1 megohm input impedance on all calibrated ranges, as well as when operating at variable sensitivity. It also provides one millivolt sensitivity (each axis), a stylish appearance, vacuum holddown, and will accept either 8½" x 11" or 11" x 17" paper.

For more information on either of these new X-Y recorders, write or call (collect) Roy Washburn, 303-771-4700, Honeywell Test Instruments Division, P.O. Box 5227, Denver, Colorado 80217.

**Honeywell**

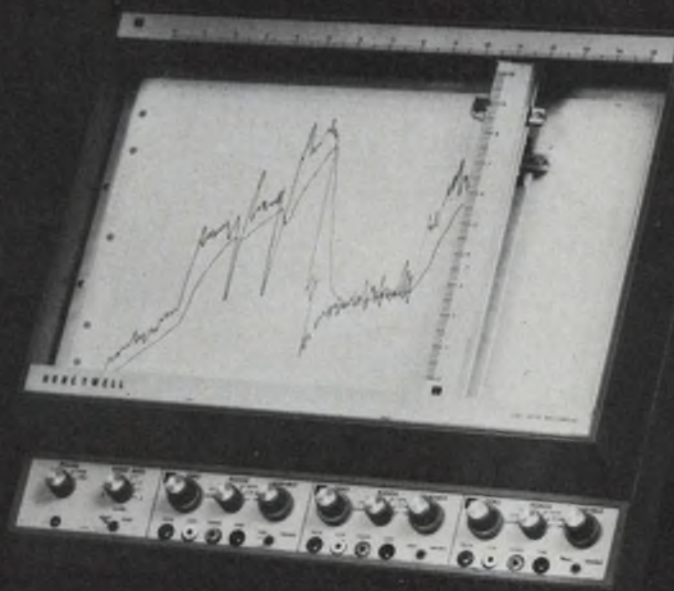
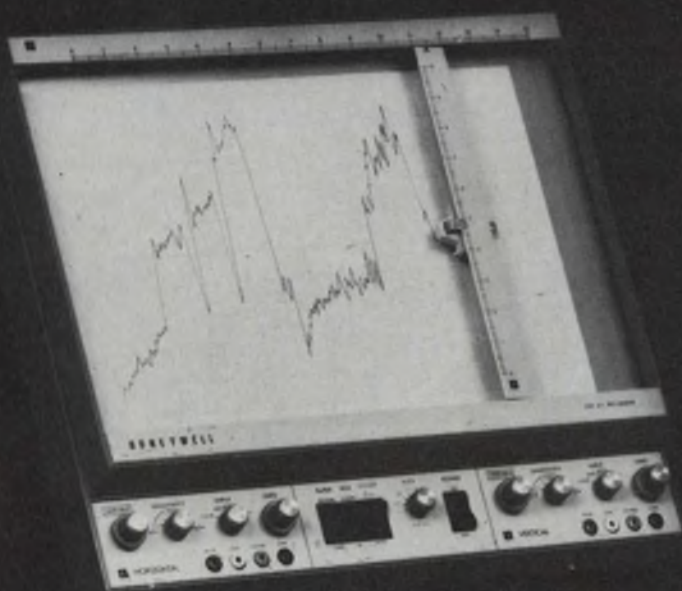

See us at WESCON, Booths 1306-1309

Honeywell engineers sell solutions



# Solid-state signal generator programs frequency and level

*Kay Electric Co., 12 Maple Ave., Pine Brook, N.J. Phone: (201) 227-2000. P&A: \$4950; 4 to 6 wks.*

Offering superior phase-lock characteristics, a new solid-state L- and S-band signal generator features programmability of its rf output frequency and of 21 standard IRIG subcarrier frequencies as well as rf output level. Model 1522 can also be operated remotely.

This new generator has peak fm deviations as high as  $\pm 3$  MHz, modulated on its self-contained calibrated deviation meter. The calibrated rf output is adjustable from 0 to  $-120$  dBm.

Packaged for action, the 1522 offers distinct operating controls that are well defined for ease of operation. Output connections are rear mounted for 19-in. rack slides, or may be positioned on the front panel for the cabinet version.

Internal sub-chassis construction is also designed with forethought. Swing-out printed circuit cards facilitate easy and speedy alignment, maintenance and troubleshooting.

The new signal generator performs in L band from 1.4 to 1.5999

GHz and in S band from 2.2 to 2.2999 GHz. Settability of the rf frequency is digitally controlled to 100 kHz.

After one-half hour warm-up, its calibrated accuracy is  $\pm 0.002\%$ . Drift plus incidental fm is less than  $\pm 2$  kHz pk for one minute, less than  $\pm 5$  kHz pk for 10 minutes, and less than  $\pm 15$  kHz pk for one hour.

The rf output can be attenuated from 0 to 119 dB in 1-dB steps, and is continuously variable and metered from 0 to 3 dB. Leveling is 1.5 dB pk-pk across each band; overall calibration accuracy is  $\pm 1$  dB.

All in-band spurious signals are held more than 50 dB below the calibrated output level. Harmonically related spurious signals are greater than 20 dB below the calibrated output.

Frequency linearity is within 1% of a straight line for all deviations up to  $\pm 1$  MHz at modulation frequencies from dc to at least 1 MHz. Frequency response is  $\pm 1$  dB from dc to 750 kHz,  $\pm 1.5$  dB to 1 MHz, and  $+2$  and  $-3$  dB to 2 MHz.

*Booth No. 1613 Circle No. 408*

## Rf power meter reads digitally

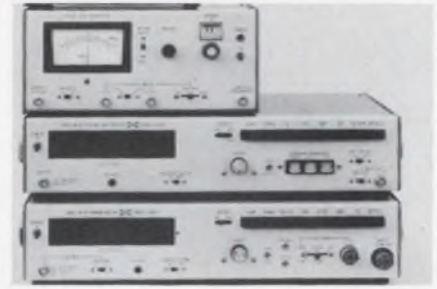

*Pacific Measurements Inc., 940 Industrial Ave., Palo Alto, Calif. Phone: (415) 328-0300. Price: \$1850.*

Shown at the bottom of a line of logarithmic instruments, a new digital meter makes direct measurements of rf power, on either a linear or dB scale. Model 1009 is designed for both swept- and single-frequency power measurements from 10 MHz to 12.4 GHz. It has a 50-dB dynamic range and, in a completely automated test system, can perform 1000 measurements per second.

*Booth No. 1320 Circle No. 379*

## Phase-controlled filters fit waveguide and coax

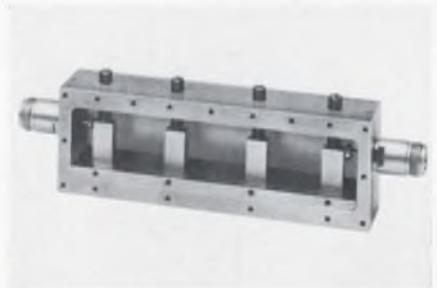

*RHG Electronics Laboratory, Inc., 94 Milbar Blvd., Farmingdale, N. Y. Phone: (516) 694-3100.*

A new line of L- and X-band phase-controlled waveguide and coaxial filters are computer-designed devices with precisely controlled phase characteristics. Available as fixed-tuned or tunable units, the FC coaxial series provides multipole performance coupled with a very wide tuning range, while the FW waveguide series offers low insertion loss and a readily adjustable passband characteristic.

*Booth No. 5403 Circle No. 289*



Combining the reliability of solid-state construction with the desirability of remote operation, a new L- and S-band signal generator can be programmed for rf output frequency and level, as well as subcarrier frequency.



See us at WESCON-Booth #1040-1046

# The **FIRST** Major Advance in **RASTER DISPLAYS** Since The "50's"

## **FROM NOW ON . . . OTHER RASTER DISPLAYS ARE FOR YESTERDAY'S SYSTEMS**

A complete kit on Raster Displays is yours for the asking, including:

- Comparison Chart illustrating unity interlace, linearity, resolution, stability, staircase display and adjustable aspect ratio.
- Technical Data Sheets on 14" and 17" Raster Displays with optional line rates from 525 to 1029.
- Reprint of Article on "Precision Raster Displays" — An in-depth discussion of state-of-the-art circuitry in Hewlett-Packard Displays.



HP Model 6947A

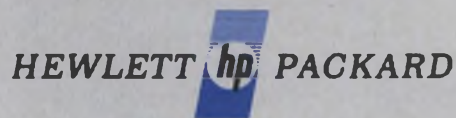

COMMUNICATION INSTRUMENTS

100 Locust Avenue, Berkeley Heights, New Jersey 07922 • (201) 464-1234



### Directional detectors swing out to 8 GHz

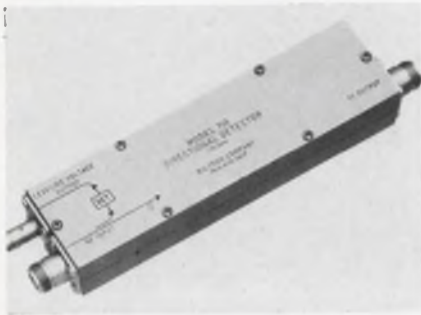

Wiltron Co., 930 E. Meadow Drive, Palo Alto, Calif. Phone: (415) 321-7428. Price: \$235 to \$275.

Covering octave bands from 500 to 8000 MHz, a new line of directional detectors consists of a maximally flat directional coupler with a crystal detector built into the coupled arm. By including the detecting element in the coupler, the new units feature a net leveling flatness of  $\pm 0.2$  dB over any octave band.

Booth No. 1138 Circle No. 382

### Small balanced mixer mounts like DIP IC

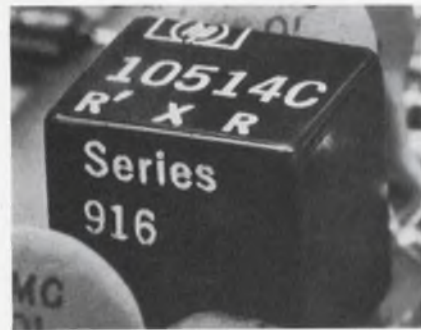

Hewlett-Packard, 1501 Page Mill Rd., Palo Alto, Calif. Phone: (415) 326-7000. P&A: \$80; 30 days.

Said to be the smallest unit of its kind, a new 500-MHz double-balanced mixer features a pin spacing that is exactly the same as that of standard dual-in-line integrated circuits. When mounted on a circuit board, model 10514 occupies a space of only 0.4 by 0.35 in., less than 0.15 square inches. Its volume is under 0.07 cubic in., and its weight is less than 0.06 oz (1.5 grams).

Booth No. 1040 Circle No. 381

### Transfer switches isolate to 18 GHz

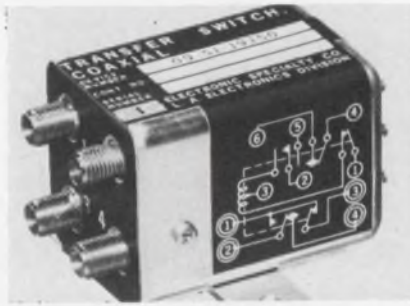

Electronic Resources Inc., 4561 Colorado Blvd., Los Angeles, Calif. Phone: (213) 246-6761.

Providing broadband rf performance in a lightweight subminiature package, a new series of coaxial transfer switches features a low VSWR of 1.25 at 12.4 GHz and unusually high interchannel isolation from 0 to 18 GHz. Actuating current for series 09-51 units is just 53 mA at 26.5 V for latching, and 177 mA for fail-safe operation.

Booth No. 1115 Circle No. 373

### Multichannel sources oscillate to 9.6 GHz

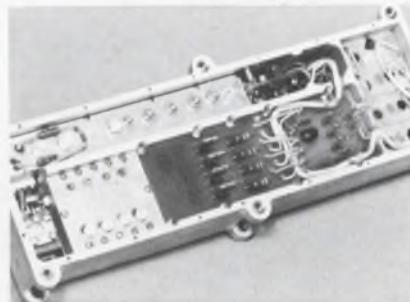

Hughes Aircraft Co., Electron Dynamics Div., 3100 W. Lomita Blvd., Torrance, Calif. Phone: (213) 534-2121.

A new line of solid-state multichannel crystal-controlled sources provide discrete output frequencies at any point in the frequency range from 800 to 9600 MHz. Series 40000H units achieve tight frequency stability (0.005%) and low-noise operation. Minimum power outputs range from 25 mW to 8 W, and 1-dB bandwidths go from 48 to 800 dB.

Booth No. Unit H Circle No. 380

### Small attenuator spans 2-GHz band



Telonic Instruments Div., Telonic Industries, Inc., 60 N. First Ave., Beech Grove, Ind. Phone: (317) 787-3231. P&A: \$125; 30 days.

Slightly over 2 in. long and weighing less than 5 oz, a new rotary attenuator provides up to 60-dB attenuation in 10-dB steps from dc to 12 GHz. Model 8103 has an impedance of 50  $\Omega$  and an insertion loss of only 0.7 dB at 2 GHz. Its accuracy varies with frequency, ranging from  $\pm 1\%$  at 500 MHz to  $\pm 5\%$  at 2 GHz.

Booth No. 1724 Circle No. 389

### J-band generators deliver up to 5 mW



M-O Valve Co. Ltd., Metropolitan Overseas Supply Corp., 468 Park Ave. South, New York, N. Y. Phone: (212) 686-2120.

Two new microwave devices, compact J-band solid-state power generators, are low-noise electronically tunable units. Type SSJ9 has an operating frequency range of 12.4 to 14 GHz, a tuning range of 250 MHz and a power output of 5 mW. Type SSJ10 operates from 14 to 16 GHz, tunes over 250 MHz and has a power output of 1 to 2 mW.

Booth No. 4607 Circle No. 383



*Introducing Potter & Brumfield's unique*

# dual thin-line dry reed relays

An entirely new magnetic structure makes possible an exceptionally low seated height of only 0.275 inch for high density board packaging. Circuit boards employing JDT relays may be spaced on 0.5 inch centers.

This design minimizes magnetic flux dispersion, resulting in a very efficient magnetic circuit. This decreases coil power requirements and often permits direct operation of JDT relays in low-power semi-conductor logic circuits. An interfacing amplifier may be eliminated in many applications.

Terminals are similar to those on IC packages, permitting spot testing on either side of a circuit board. The dual in-line terminals on 0.1 inch centers simplify circuit board design. The reed switches are rated at 10 watts maximum resistive (50V or 0.5A DC maximum) switching.

A solid state time delay circuit may be incorporated in this small package. Or a Darlington amplifier can be included to compensate for low current applications. However, the number of available poles for switching is reduced by the addition of either of these circuits.

The JDT is completely encapsulated in epoxy, giving protection against environmental contamination. The Series is presently available in many combinations of Forms of A, B and C.



Get full information today by calling your local P&B representative or call direct to Potter & Brumfield Division of American Machine & Foundry Company, Princeton, Indiana. 812-385-5251.

Mounted height  
is only 0.275"

Power requirements:  
only 75mw per pole

Combinations of Forms  
A, B and C are available

**Single Lot Prices:**

JDT 4000 Series (4-pole) \$ 7.65

JDT 8000 Series (8-pole) \$12.95

Quantity discounts apply.



AMF

POTTER & BRUMFIELD



### Missing pulse detector takes 5-kHz rep rates



Del Electronics Corp., 250 E. Sandford Blvd., Mt. Vernon, N. Y. Phone: (914) 699-2000. Price: \$1500.

Able to measure the rf energy stability of magnetrons, a new missing pulse detector accepts input video pulse widths of 0.1 to 100  $\mu$ s and repetition rates from 200 Hz to 5 kHz. Input pulse amplitude can be between 50 and 400 MV and reference pulse (trigger) amplitude can range from  $\pm 5$  to 50 V. The unit is completely solid state.

Booth No. 3705 Circle No. 291

### Laser radiometers gauge power and energy



International Light Inc., Dexter Industrial Green, Newburyport, Mass. Phone: (617) 465-5923. P&A: \$250 to \$1100; stock.

Designed specifically for uniform acceptance of narrow beams, a new series of radiometer detectors is capable of measuring instantaneous power, integrated energy, and peak power of both cw and pulsed lasers. Series PT200/A203 units cover the wavelength region from 200 to 1200 nanometers. Their power range covers 3 nW to 60 W for cw lasers; their energy range goes from 3 nJ to 6 J for pulsed lasers.

Booth No. 1214 Circle No. 288

### Vhf/uhf generator features stability



Wiltron Co., 930 E. Meadow Drive, Palo Alto, Calif. Phone: (415) 321-7428. P&A: \$4450; 4 wks.

Covering the frequency range of 220 to 410 MHz, a new solid-state a-m/fm signal generator (with the 63081 rf plug-in) provides a frequency stability of 1 in  $10^5$  per 10 minutes after only 30 minutes of warm-up. Model 6301 offers audio modulation to 80%, frequency modulation to  $\pm 100$  kHz or phase modulation, together with 2 V (+19 dBm) of rf output.

Booth No. 1138 Circle No. 290

### Digital rf meter responds linearly



Millivac Instruments, Inc., P.O. Box 997, Schenectady, N.Y. Phone: (518) 355-8300. P&A: \$1095; 8 to 10 wks.

Model MV-722A solid-state digital rf millivoltmeter features a unique linearizing feedback circuit that allows true linear response with  $\pm 1$ -digit tracking. It has a three-digit readout with overrange indicator. Full-scale voltage ranges are from 3 mV to 10 V. Frequency response is  $\pm 3\%$  from 10 kHz to 100 MHz,  $\pm 5\%$  from 100 to 400 MHz, and  $\pm 10\%$  from 400 MHz to 1.2 GHz.

Booth No. 1411 Circle No. 392

### Rf telemetry filter tunes out to 420 MHz



Telonic Engineering Co., P.O. Box 277, Laguna Beach, Calif. Phone: (714) 494-9401. P&A: \$485 or \$545; stock.

A new rf filter designed especially for the 210-to-420-MHz telemetry band is capable of tuning any center frequency over this range. Model TTF-315-3-3EE, is a three-section device with a 30-dB form factor of 3. Typical insertion loss is only 1.3 dB at the center frequency and average power rating is 30 W. A five-section version, model TTF-315-3-5EE, is also available.

Booth No. 1411 Circle No. 393

### Programmable CFA gives 20-dB gain



Warnecke Electron Tubes, Inc., affiliate of Northrop Corp., 175 W. Oakton St., Des Plaines, Ill. Phone: (312) 299-4436.

Rugged enough for airborne system or pod-mounted applications, a new S-band gridded injected-beam crossed-field amplifier (CFA) operates with 20-dB gain in any one of three modes. The power output of model RW-617 can be programmed over its full output range in any mode by simply varying the grid-to-cathode voltage.

Booth No. 5219 Circle No. 384





## all fhp motors are alike?

Now that you're surprised at how different this Howard fhp motor looks on the *outside*, let's talk about *output*:

When Howard rates a motor 1/20 hp, we're not about to underpower your system with a 1/25 hp motor. We've always True Rated our fhp motors this way.

Now engineers and designers are finding that a carelessly overrated or underrated motor can cause system problems. And they want no part of either. That's why engineers look to Howard for True Rated fractional horsepower motors. . . .

and they get them. Our computer guarantees it. And your products benefit.

Next time you look at the outside of a Howard motor, you won't find mod painting. You will find that if the label says 1/20 hp, we don't mean 1/25 hp. Or 1/15 hp, either.

Get the complete Howard True Rated story. Find out in detail why it makes no difference that all fhp motors *look* alike. It's the output that counts. Write or call Howard for Fractional Horsepower Motor Information Packet ED-89.



# HOWARD

HOWARD INDUSTRIES  
MSL INDUSTRIES, INC./MOTOR GROUP  
2420 18th STREET, RACINE, WISCONSIN 53403  
414-632-2731 TWX 910-271-2387



# Multi-color single-gun CRT responds to current density

*International Telephone & Telegraph Corp., 3700 Pontiac St., Fort Wayne, Ind. Phone: (219) 743-7571. P&A: \$500; 30 to 90 days.*

Using a new type of phosphor screen, a new multi-color single-gun cathode-ray tube generates color shifts from green to orange as the beam current density is changed. This new approach avoids the need for color masks, multiple-electron guns or beam-velocity modulation, previous methods of generating color displays in cathode-ray tubes.

The F3522 is a 5-in.-diameter round CRT that uses electrostatic focusing and magnetic deflection. It can provide the four distinct colors of yellow, red, green and orange, besides various hues of these.

The color shift is obtained by combining two different phosphors; one having a super-linear intensity versus density behavior, and another with linear or sub-linear behavior and a different emission

color.

At low current densities, the emission color will be that of the sub-linear phosphor. However, as current density is increased, the super-linear phosphor will contribute more, and the color will shift towards its characteristic emission.

Along with the color shift and higher current density, the brightness of the display will also increase. This is because the sub-linear phosphor continues to contribute, although not dominantly. The resulting color is a blend of the two phosphor emissions.

The new cathode-ray tube operates with a heater voltage of 6.3 V at 600 mA. Maximum anode voltage is 20 kV dc and the second grid voltage is 300 V.

Besides the 5-in. round tube, two other versions will be available. These are an 8-in. rectangular unit and a 10-in.-diameter round one. They will be priced slightly higher than the F3522.

*Booth No. 3808 Circle No. 409*

## Cermet trimmers sell for \$1.14

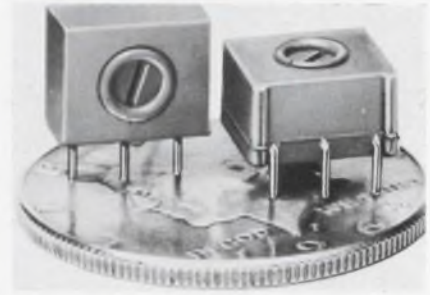

*CTS Corp., 1142 W. Beardsley Ave., Elkhart, Ind. Phone: (219) 523-0210. Price: \$1.14.*

Costing as little as \$1.14 in quantities of 100, a new line of industrial cermet trimmers features a setability of  $\pm 0.03\%$ , an average equivalent noise resistance of 1.5% and an average contact resistance variation of only 0.5%. Series 360 units have a power rating of 0.5 W at 70°C and a resistance tolerance of  $\pm 20\%$ . Standard resistance values range from 50  $\Omega$  to 1 M $\Omega$ .

*Booth No. 3913 Circle No. 259*

## Tiny slide switch has 30-year life



*Chicago Switch, Inc., 2035 Wabansia Ave., Chicago, Ill. Phone: (312) 489-5500. P&A: 54¢ to \$2.50; 4 to 8 wks.*

Offering the ultra-high reliability of a 30-year life or  $5 \times 10^6$  flawless operations with low-energy circuitry, a new microminiature switch features a true over-center toggle mechanism for precision snap-action inside a slide switch package. The unit can handle a resistive load of 0.5 A at 125 V ac. Contact bounce on make is 0.5 ms in the spdt version and 1 ms in the dpdt version.

*Booth No. 4711 Circle No. 252*

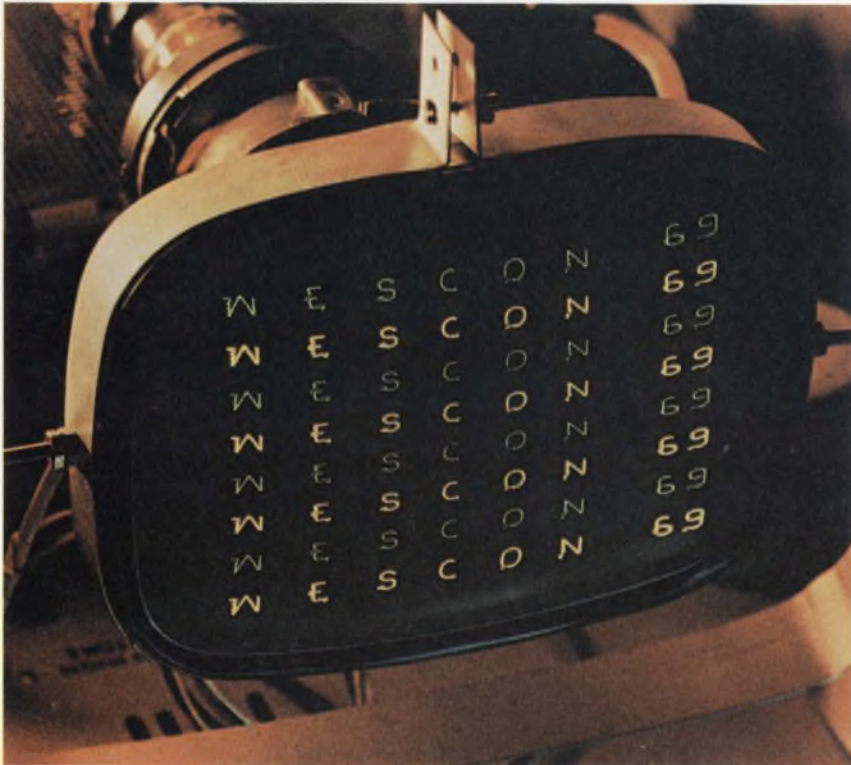

**New multi-color single-gun cathode-ray tube** shifts from green to orange as beam current density is varied. At least four distinct colors can be generated—yellow, red, green and orange—besides their tints.



# Is the 901 counter-timer just too good to be true?



Shown with optional 1.3-GHz plug-in.

# NO!

## But we can't blame you if you think so.

Picture a state-of-the-art, 200-MHz, universal counter-timer selling for \$250 to \$1000 below the competition. Having trouble? Picture won't focus? Of course not. Cheap price tags usually mean cheap products.

Focus in again. This time, picture technological breakthroughs — new circuitry and new components that the competition hasn't caught up with yet. Now, see how easy it is to make a better product and sell it for less, too?

How much better is the CMC 901? Take a look. Range: 200 MHz (instead of 125 or 135) without prescaling or plug-ins. Gate times:  $1\mu\text{sec}$  to 100 sec instead of to just 10 sec. TIM: built-in, with a resolution of 10 nsec instead of 100. Input sensitivity: 20 mV instead of the usual 50 or 100. Read-out: 9 decades not just 8.

But specs aren't everything. How about the Model 901's "universality"? Besides counting to 200 MHz directly

(and 1.3 GHz or 3.3 GHz with optional plug-ins) the 901 also scales signals, measures time interval, period, and multiple-period average. It provides frequency and multiple-frequency ratios as well as total count; and, as an optional extra, it can be operated completely by remote control. The basic price tag? Just \$2475. So we can't blame you if you're skeptical, but would you be happy if you bought a lesser model and paid more?

*For the full facts, circle the reader service card.*

COMPUTER MEASUREMENTS



A DIVISION OF NEWELL INDUSTRIES

12970 Bradley/San Fernando, Calif. 91342/(213) 367-2161/TWX 910-496-1487

SEE IT AT WESCON BOOTH 1006-8!

INFORMATION RETRIEVAL NUMBER 78



### Pushbutton breakers light green and white

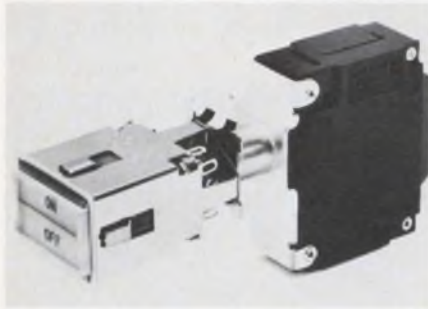

Heinemann Electric Co., 248 Magnetic Drive, Trenton, N.J. Phone: (609) 882-4800.

The top half of series JL lighted pushbutton circuit breakers lights in a soft green to indicate an on circuit, and the bottom half lights in white to indicate an off circuit. The new units are available with either a fast or a slow time-delay response; non-time-delay models are also available. Standard maximum voltage ratings are 240 V ac (60 or 400 Hz), and 65 V dc. Booth No. 3801 Circle No. 372

### Lighted pushbuttons standardize colors



Switchcraft, Inc., 5555 N. Elston Ave., Chicago, Ill. Phone: (312) 774-1515. Availability: stock.

New Uniswitch pushbuttons are now available in red, white, blue, green and yellow colors as standard; clear amber and other colors may be obtained on special order. Series LUS units are compact momentary-action pushbutton switches supplied in both illuminated and non-illuminated types. They provide side, as well as front, lighting that is constant and independent of switching action. Booth No. 3909 Circle No. 260

### Lighted switches adapt to needs



Arrow-Hart, Inc., Specialty Switch Div., 103 Hawthorn St., Hartford, Conn. Phone: (203) 249-8471.

Using a building-block concept, a new line of lighted pushbutton switches makes possible more than 25,000 switching variations with just 31 stock components. Called Adapt-a-Switch, the easy-to-mount snap-action units have two contact blocks, standard duty and low energy, which can be used to build up to four-pole switches. Booth No. 5121 Circle No. 263

### Pushbutton switches accept 2 lamp types



Jay-El Products, Inc., 1859 W. 169th St., Gardena, Calif. Phone: (213) 323-7130. Availability: 6 wks.

Designed for maximum panel density for aircraft control and display requirements, Mark Eight illuminated pushbutton switches or indicators can accept T-1-3/4 lamps or T-1 lamps with an adapter. These type 10620 units are available in matrix mountings on 0.689-in. square centers or with individual bezel and integral mounting hardware on 0.75-in. square centers. Booth No. 4515 Circle No. 262

### Miniature protector safeguards to 116 V

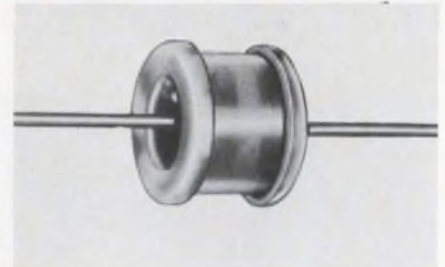

Siemens America Inc., 350 Fifth Ave., New York, N. Y. Phone: (212) 564-7674.

A new miniature gas-filled surge-voltage protector guards semiconductors and other electrical and electronic components against power surges and other transients. SVP type B1-C145, which measures only 0.38 in. in diameter and 0.272 in. long, provides protection for equipment with peak operating voltages up to 116 V.

Booth No. 1505 Circle No. 387

### Circuit protector responds in 50 ns



Transtector Systems, M & T Chemicals Inc., sub. of American Can Co., 3025 W. Mission Rd., Alhambra, Calif.

Developed for integrated circuits, transistorized equipment and complete electronic systems, a new protective device can sense and deflect damaging transient voltages and currents in less than 50 ns. This solid-state circuit protector can also guard against sudden losses of voltage below acceptable operating levels. In less than 500 ns, the device will return a transient to nominal line voltage. Booth No. 4712 Circle No. 250



---

# "NO NOISE WORRIES with Dale Metal Film Resistors"

---



Dale Metal Film Resistors provide precise voltage attenuation in the Brush Mark 200 Recorder. This highly accurate direct writing system is now in use in the Apollo Deep Space Program.

**"Piece by piece selection to insure  
low noise was eliminated when we began  
using Dale Metal Film Resistors"...**

*C. M. Jeffries, Works Manager, Clevite Corporation  
Brush Instruments Division, Cleveland, Ohio*

Getting optimum value from a resistor may hinge on a single performance characteristic. For Brush Instruments, this characteristic was the outstanding low noise construction of Dale Metal Film Resistors. For you, optimum value may come from Dale's ability to supply metal film parts with tightly controlled T.C.; or from the excellent stability of Dale MF resistors in critical high frequency applications. Optimum value can also result from the assured fast delivery made possible by Dale's expanded metal film facilities. ■ Check metal film suppliers from every angle — including price and the ability to provide special parts tailored to your special needs. Then call Dale.



**for optimum value in precision resistors**

Dale Electronics, Inc. 1300 28th Avenue, Columbus, Nebraska









## We're really rolling on metal film delivery!

Erase delivery from your procurement problems! Expanded metal film production facilities in Norfolk, Nebraska, have enabled us to slash delivery schedules to the bone. Production increases daily on all types listed below. Call Dale for the best *all-around value* in metal film resistors. The number is 402-564-3131.

### QUICK DELIVERY REFERENCE DALE METAL FILM RESISTORS

<b>TYPE MF</b> 	Epoxy-molded metal film resistor. Meets MIL-R-10509F (Char. C, D and E). Combines high stability with low noise and offers exceptional moisture protection.	<b>Power:</b> 1/20, 1/10, 1/8, 1/4, 1/2, 1 and 2 watt sizes <b>Resistance Range:</b> 10 $\Omega$ to 10 Megohms, depending on size and T.C. <b>Resistance Tolerance:</b> .1%, .25%, .5%, 1% <b>T.C.:</b> $\pm 25$ , $\pm 50$ , $\pm 100$ , $\pm 150$ PPM standard
<b>TYPE MFF</b> 	Epoxy roll-coated metal film resistor. Designed primarily for commercial applications. Meets electrical and environmental specifications of MIL-R-10509F. Small size. Low cost.	<b>Power:</b> 1/8, 1/4, 1/2, 1 and 2 watt sizes <b>Resistance Range:</b> 10 $\Omega$ to 10 Megohms, depending on size and T.C. <b>Resistance Tolerance:</b> .1%, .25%, .5%, 1% <b>T.C.:</b> $\pm 25$ , $\pm 50$ , $\pm 100$ , $\pm 150$ PPM standard
<b>TYPE D</b> 	Precision power film resistor molded into an aluminum housing for complete environmental protection and high stability. Wide resistance range, low reactance at high frequencies.	<b>Power:</b> 4, 8, 12 watt sizes <b>Resistance Range:</b> 50 $\Omega$ to 2.6 Megohms, depending on size <b>Resistance Tolerance:</b> .1%, .25%, .5%, 1% and 2% standard
<b>TYPE MP</b> 	Epoxy-molded metal film package with from 2 to 6 elements. Meets MIL-R-10509F. Available with matched T.C., matched resistance ratio. Excellent H.F. characteristics. Very low noise levels.	<b>Power:</b> 50 milliwatts per element at 125° C <b>Resistance Range:</b> 30.1 $\Omega$ to 80.6K $\Omega$ each element <b>Resistance Tolerance:</b> .1%, .25%, .5%, 1%, 2%, 5%

Gard Testing is available to meet Established Reliability requirements at significant time/cost savings over typical 100 hr. burn in. Write for Test Report #19590.

Write for **Catalog A**—complete information on precision metal film, precision wirewound and industrial wirewound resistors.

For complete information circle 181

**DALE ELECTRONICS, INC.**

1300 28th Avenue, Columbus, Nebraska  
 In Canada: Dale Electronics Canada, Ltd.







## Call us for more information on the dry test bath

Yes, that telephone is working perfectly in its bath of Fluorinert® Brand Electronic Liquid.

In your testing procedures, Fluorinert Liquids will show up flaws and leaks with great accuracy. In fact, the MIL-Standard 883 and the MIL-Standard 750A tests for gross leak-

age in microcircuits approve the use of Fluorinert Liquids...which says a lot about dependability.

They are efficient over a wide temperature range and compatible with the most sensitive materials. Fluorinert Liquids are non-flammable and won't conduct electricity.

And because tested units drain clean and dry fast upon removal from the bath, you can use or package your product right out of the bath.

We have lots of interesting information about these unusual liquids. Send the coupon...or call your local 3M representative.

### Fluorinert® Electronic Liquids 3M

3M Company, Chemical Division, 3M Center  
St. Paul, Minn. 55101

Dept. KAP-8-69

Send me all the details about Fluorinert Brand Electronic Liquids.

Name \_\_\_\_\_

Company \_\_\_\_\_ Title \_\_\_\_\_

Address \_\_\_\_\_

City \_\_\_\_\_ State \_\_\_\_\_ Zip \_\_\_\_\_

INFORMATION RETRIEVAL NUMBER 79



### PC 10-A relays operate in 10 ms

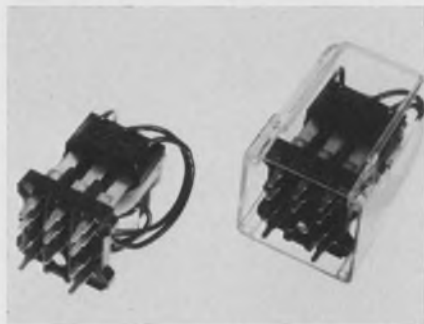

Cornell-Dubilier Electronics, div. of Federal Pacific Electronic Co., 50 Paris St., Newark, N. J. Phone: (201) 624-7500. P&A: \$4.89 to \$8.55; stock.

Available as a standard item, a new series of 10-A printed circuit general-purpose relays features a release time of 8 ms and a mechanical life in excess of  $20 \times 10^6$  operations. Series 30 units have a minimum dc coil resistance of 10 k $\Omega$ . Contact configuration can be spdt, dpdt, or 3pdt.

Booth No. 4403 Circle No. 255

### Spst reed relay switches 10 kV

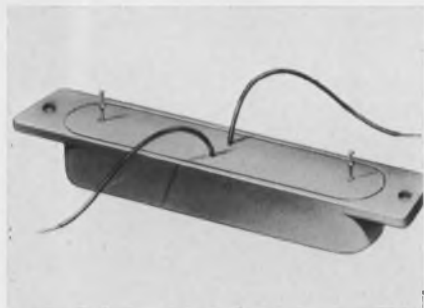

Magnecraft Electric Co., 5575 N. Lynch Ave., Chicago, Ill. Phone: (312) 282-5500. P&A: \$11.93 to \$19.88; stock.

With a peak contact load rating of 10 kV at 1 mA, a new high-voltage reed relay has a specially designed insulation system that provides maximum dielectric strength. This class 102HV spst normally open relay offers a nominal coil power of 850 mW, an operating time of 20 ms and a contact resistance of 100 m $\Omega$ . Typical life at rated load is one million operations.

Booth No. 4311 Circle No. 253

### Fast impulse counters have readout switch



Landis & Gyr, Inc., 45 W. 45th St., New York City. Phone: (212) 586-4644.

Sodeco ES4 high-speed impulse counters are compact single-digit units equipped with a 10-position readout switch, a transfer contact, a zero contact and a predetermining switch. They can perform a wide range of functions including programing, impulse storage, predetermining, counting and control. These new counters are enclosed in a clear molded case that protects the units from dust while allowing full observation of the mechanism during operation.

Booth No. 4208 Circle No. 266

### Double-gun CRT separates X and Y



M-O Valve Co., Ltd., Metropolitan Overseas Supply Corp., 468 Park Ave. South, New York City. Phone: (212) 686-2120.

Developed for applications where it is necessary to compare waveforms with widely differing frequency characteristics, a new double-gun cathode-ray tube features completely independent X and Y deflection systems. Genalex LD 708 is a 13 by 10-cm rectangular flat-faced tube having a scan size of 6 by 10 cm for each beam with a 5-cm overlap.

Booth No. 4607 Circle No. 264

### Monolithic filters yield seven poles

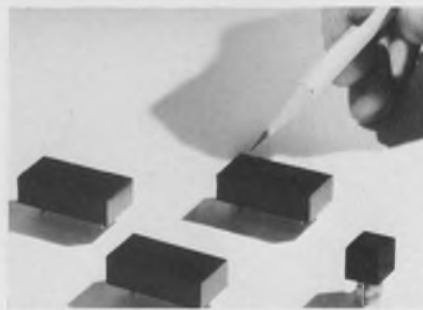

Damon Engineering, Inc., Electronics Div., 115 Fourth Ave., Needham, Mass. Phone: (617) 449-0800.

Four new monolithic crystal filters provide a seven-pole characteristic, with a center frequency of 10.6 or 21.4 MHz. Types 6457MA, 6457MB, 6458MA and 6458MB offer a minimum 3-dB bandwidth of 6 to 15 kHz; maximum 60-dB bandwidth is 18, 40 or 45 kHz. Their ripple is 1 dB maximum, and insertion loss is 6 dB maximum.

Booth No. 5206 Circle No. 254

### Fixed delay lines up risetime ratio



Allen Avionics, Inc., 255 E. 2nd St., Mineola, N. Y. Phone: (516) 747-5450. Availability: stock.

Spiradel distributed-constant fixed delay lines boast delay-to-rise-time ratios of over 20 to 1, with good temperature stability and pulse fidelity. The new units cover a delay range of 100 to 1000 ns. Standard impedance is 325  $\Omega \pm 10\%$ , but any impedance from 200 to 600  $\Omega$  is available. The compact delay lines are encapsulated for maximum environmental protection.

Booth No. 4713 Circle No. 275



# New IRC rectangulars trim circuit space and cost

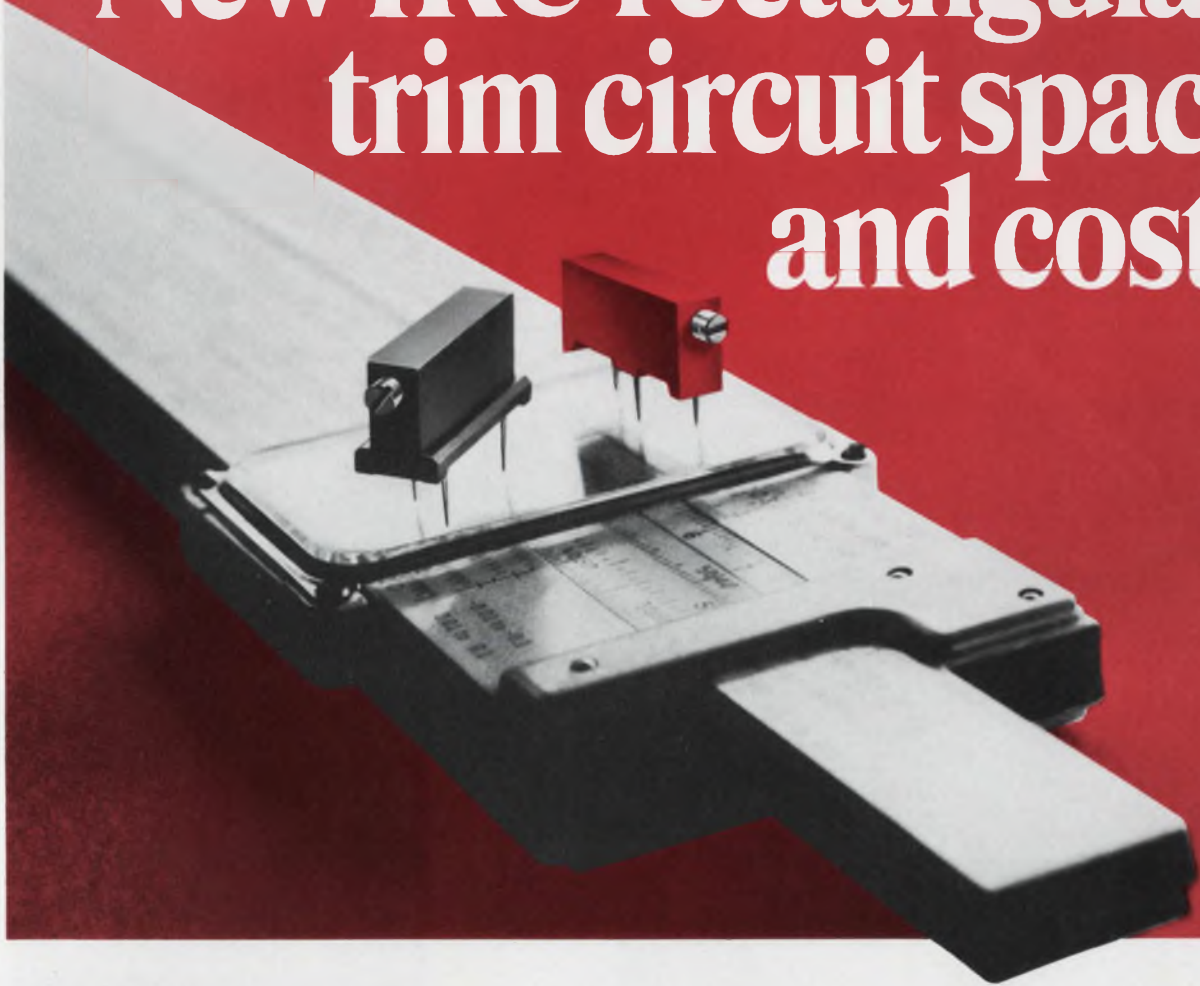

## Metal Glaze and Wirewound types

These 3/4-inch-long rectangular trimmers are made and perform like bigger, more costly units. Only IRC offers a miniature general-purpose unit with these features:

- All-metal adjustment shaft that eliminates breakage or distortion, even under repeated use.
- Silver brazed terminations on Metal Glaze and Wirewound types end resistance buildup associated with pressure connections.
- Ultrasonic bonding of the housing into a one-piece unit that is free of seams or laps.
- Resistance to normal board washing. Units sealed to MIL-R-27208 are also available.

Metal Glaze Type 950 has a rugged, thick-film element that provides excellent high-frequency characteristics and infinite resolution over the entire resistance range of 100 $\Omega$  to 1 megohm. 3/4-watt @ 25°C.  $\pm 10\%$  tolerance.

Precision Wirewound Type 900 has a long-wearing precious metal wiper spring that reduces noise and contact resistance. 1 watt @ 40°C. 100 $\Omega$  to 20K.  $\pm 10\%$  tolerance.

### PIN CONFIGURATIONS

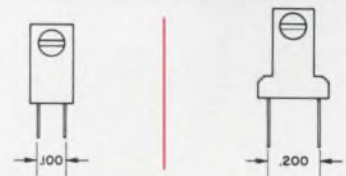

WIREWOUND	METAL GLAZE	WIREWOUND	METAL GLAZE
900-20 Std.	950-20 Std.	920-20 Std.	970-20 Std.
910-20 Sealed	960-20 Sealed	930-20 Sealed	980-20 Sealed

Immediate delivery from stock or from IRC Industrial Distributors. For information and prices write:

IRC St. Petersburg Division of TRW INC.  
2801 72nd St., North, St. Petersburg, Fla. 33733



**DIVISION OF TRW INC.**



### Bi-pin T-1-3/4 lamps have plastic bases



Industrial Electronic Engineers, 7720 Lemona Ave., Van Nuys, Calif. Phone: (213) 787-0311. P&A: 18.7¢ to 23.4¢; stock.

Supplied with a tough plastic base, standard bi-pin T-1-3/4 lamps are now available in five styles. These new lamps require less space than bayonet or screw-base lamps and sockets, yet provide comparable protection for the glass seal. Gas vent slots are designed into the base to prevent solder blowout during dip-solder operations.

Booth No. 3715 Circle No. 283

### Broadband emi filters handle 60 mA to 10 A



Potter Co., 500 W. Florence Ave., Inglewood, Calif. Phone: (213) 678-2651. P&A: \$4 to \$15; stock to 8 wks.

Ideal for low-voltage ac or dc applications, Micro-Brute sub-miniature emi suppression filters operate over the frequency range of 30 kHz to 10 GHz with a current capacity of 60 mA to 10 A. Series 8330 units fulfill the requirements of broadband emi situations where size and weight must be held to a minimum, such as in airborne computers and radar.

Booth No. 5112 Circle No. 265

### Segmented readouts have mosaic look

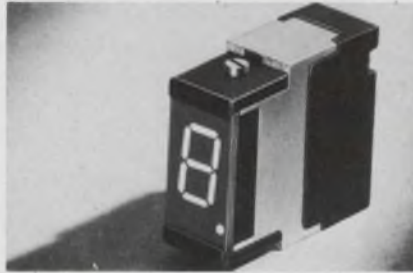

Alco Electronic Products, P. O. Box 1348, Lawrence, Mass. Phone: (617) 686-3887. P&A: \$8.25; stock.

Series MSM single-phase mosaic-style readouts display numerals 0 through 9 and some alphabetic indications by illuminating a combination of incandescent lamps through a simple diode matrix or encoding switch. The closely interlocked illuminated segments provide a wide viewing angle of approximately 150°. Miniature T-1 lamps are used.

Booth 5120 Circle No. 395

### Pressure switch takes 30,000 psig



Bristol Div., American Chain & Cable Co., Inc., P.O. Box 1790, Waterbury, Conn. Phone: (203) 756-4451.

Used for switching circuits in response to pressure changes in gases and liquids, a new adjustable pressure switch features a calibration range of 100 to 10,000 psig and a burst pressure up to 30,000 psig. Weighing less than 4 oz, model 506351 has an externally adjustable range that may be field set with a screwdriver or can be furnished factory set. Setting accuracy is from  $\pm 5$  to  $\pm 50$  psig, depending upon calibration range.

Booth No. 3921 Circle No. 261

### Magnetic heads track 48 mils

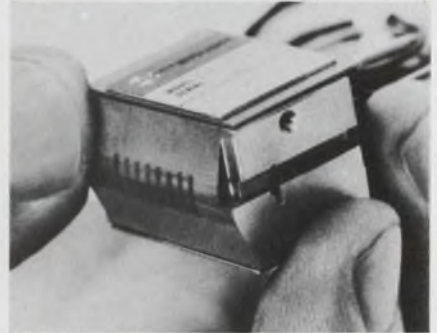

Clevite Corp., Brush Magnetic Products, E. 37th and Perkins, Cleveland, Ohio. Phone: (216) 361-3315.

Featuring satellite erase heads and connectors, a new series of digital magnetic heads offers track widths of 48, 30 or 40 mils for a seven-track format and 44 or 40 mils for a nine-track format. These IBM-compatible devices have a gap length of 250 microns and a gap depth of 0.016 in. nominal. They also feature a full metal face and 12-in. lead terminations.

Booth No. 4522 Circle No. 251

### Readout tubes shrink envelope

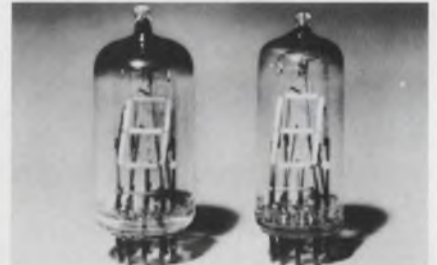

Tung-Sol Div., Wagner Electric Corp., 630 W. Mt. Pleasant Ave., Livingston, N.J. Phone: (201) 992-1100. Price: \$2.55 typical.

Suitable for high-density component packaging, three new Digivac S/G digital readout tubes now come in a small T-5-1/2 envelope. The DT1704B is 9-pin-base alphanumeric readout, the DT1705D is 10-pin-base alphanumeric readout with a decimal, and the DT1707B is a " $\pm 1$ " readout. All three are single-plane segmented fluorescent indicators.

Booth No. 4710 Circle No. 394



# CROWBAR...?

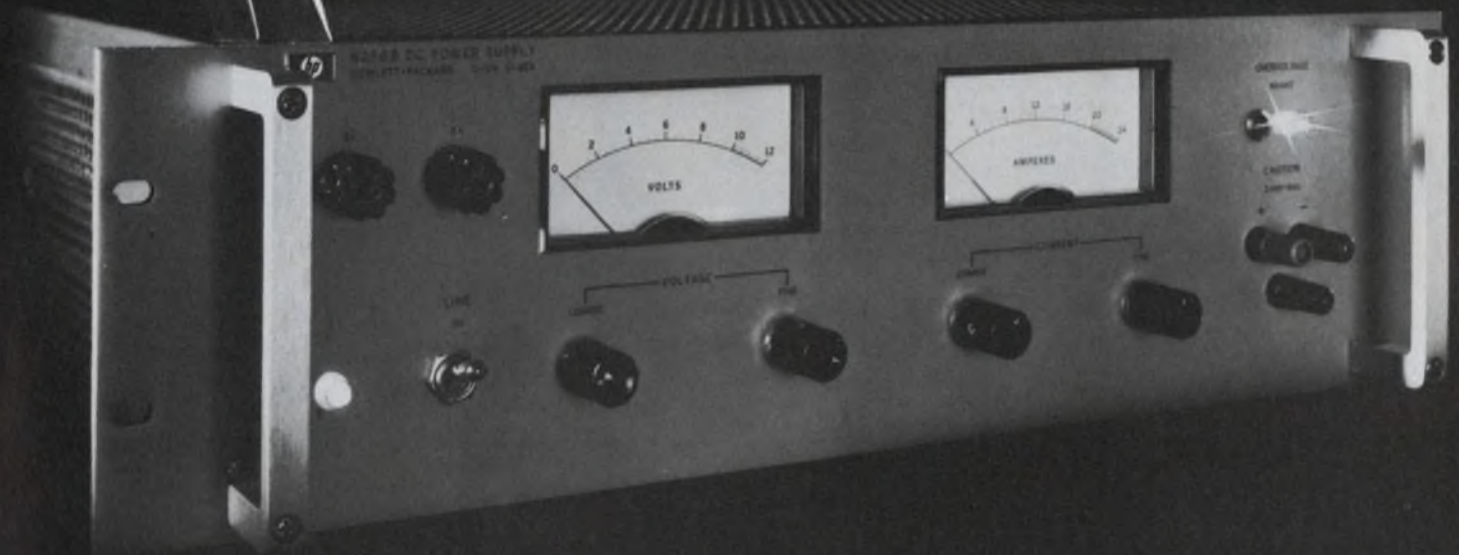

## The One Inside is FREE

Not so many years ago, the prudent transmitter engineer discharged a high voltage capacitor bank by dropping a shorting "crowbar" across its terminals. Today's "crowbar" is a protective overvoltage circuit found on DC power supplies — usually at extra cost. Now HP includes a crowbar as standard on its recently updated series of low-voltage rack supplies . . . at no change in price.

Long established as preferred system supplies for component aging, production testing, and special applications, these supplies have now been redesigned and expanded to meet the stringent demands of today's power supply user. Advantages include low ripple (peak-to-peak as well as rms), well-regulated constant voltage/constant current DC with outputs to 60 volts and 100 amps.

Where loads are critical and expensive, the extra pro-

tection — say, against inadvertent knob-twiddling — from a crowbar is invaluable. On all internal crowbars in this series, the trip voltage margin is set by screw-driver at the front-panel.

Pertinent specifications are: triggering margins are settable at 1V plus 7% of operating level; voltage ripple and noise is 200  $\mu$ V rms/10mV peak-to-peak (DC to 20 MHz); current ripple is 5 mA rms or less depending on output rating; voltage regulation is 0.01%; resolution, 0.25% or better; remote programming, RFI conformance to MIL-I-6181D.

Prices start from \$350. For complete specifications and prices, contact your local HP Sales Office or write: Hewlett-Packard, New Jersey Division, 100 Locust Avenue, Berkeley Heights, New Jersey 07922 or call (201) 464-1234 . . . In Europe, 1217 Meyrin, Geneva.

**HEWLETT  PACKARD**  
**POWER SUPPLIES**

"See us at WESCON — Booth 1040-1046"

Additional data sheets available upon request

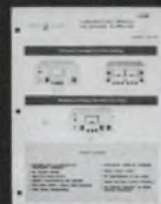

**LAB SERIES**  
smaller package,  
lower power,  
optional crowbar



**CROWBARS**  
A Technical  
Discussion



**1969 Power  
Supply Catalog**  
— includes total  
HP power supply line.



# Far Superior TO ANY VTVM OR VOM A NEW STANDARD OF THE INDUSTRY...

- Only Sencore makes a true field effect meter
- Less circuit loading than VTVM/obsoletes VOM
- Zero warm-up time — instant stability
- Complete circuit and meter protection
- Complete portability
- Greater frequency responses than most scopes

## FE149 SENIOR FET METER

The only true Senior FET meter available today with outstanding accuracy and unbelievable ease of operation.

- **Unmatched Accuracy.** 1.5% on DC, 3% on AC, plus large 7-in. meter and mirrored scale, assure the most accurate tests possible.
- **Eight AC and DC ranges** .5V to 1500V full scale.
- **Zero center scale** with .25 v. either side assures measurements to less than .1 v. for transistor bias measurements.
- **AC peak to peak** readings to 4500V maximum with freq. response of 10HZ to 10MHZ  $\pm$  3DB.
- **Eight resistance ranges** to R x 10 megohms with 6 OHMS center scale.
- **Nine DC and nine AC current ranges** 150  $\mu$ a to 5 amps.
- **Eight decibel ranges** for audio measurements.
- **Three HI-Voltage ranges**, 5 KV, 15 KV, 50KV with 39A21 high voltage probe. .... \$14.95
- **Absolute meter and circuit protection** against circuit overload.
- Non-breakable, scuff-proof, vinyl-clad steel case.
- **Three-way power.** Operates on AC, on self-contained rechargeable batteries, or on AC with batteries plugged in. Same readings all three ways.



\$149.50

**Exclusive push-button design.** Just push two buttons for any test — top row selects function, bottom row selects range. Action is instant and automatic.



\$69.95

### FE14 — STANDARD FET METER

ACCURACY DC  $\pm$  2.5%  
AC  $\pm$  4.5%

- 4½-inch meter, vinyl-clad steel case.

## FE14 and FE16 popular 4 1/2 inch FET Meters

- **Hi Accuracy.** For unsurpassed measurements. Mirrored scales prevent parallax errors.
- **Minimum circuit loading.** 15 megohm input resistance on DC; 10 megohm on AC.
- **Zero center scale**  $\pm$  0.5 v. readings for transistor bias measurement.
- **Full meter & circuit protection** against possible circuit overload.
- **7 DC & AC voltage ranges** 1 to 1000 volts full scale.
- **AC peak to peak readings** 2800 v. maximum with freq. response of 10HZ to 10MHZ  $\pm$  3DB.
- **5 resistance ranges** to 1000 megohms.
- **5 DC current ranges** 100  $\mu$ a to 1 amp.
- **3 Hi-Voltage ranges**, 3 KV, 10 KV, 30 KV, extended with 39A19 (\$9.95) high voltage probe.



\$84.50

### FE16 HI ACCURACY FET METER

ACCURACY DC  $\pm$  1.5%  
AC  $\pm$  3%

- 4½-inch high-styled meter, high-styled knobs, and special meter-tilting metal handle. Vinyl-clad steel case.



See your Sencore distributor today or write factory for complete line catalog.

**SENCORE**  
STANDARD OF THE ELECTRONIC INDUSTRY

426 SOUTH WESTGATE DRIVE,  
ADDISON, ILLINOIS 60101

INFORMATION RETRIEVAL NUMBER 81

INFORMATION RETRIEVAL NUMBER 82 ►



# THE 5000 PERM TOROID

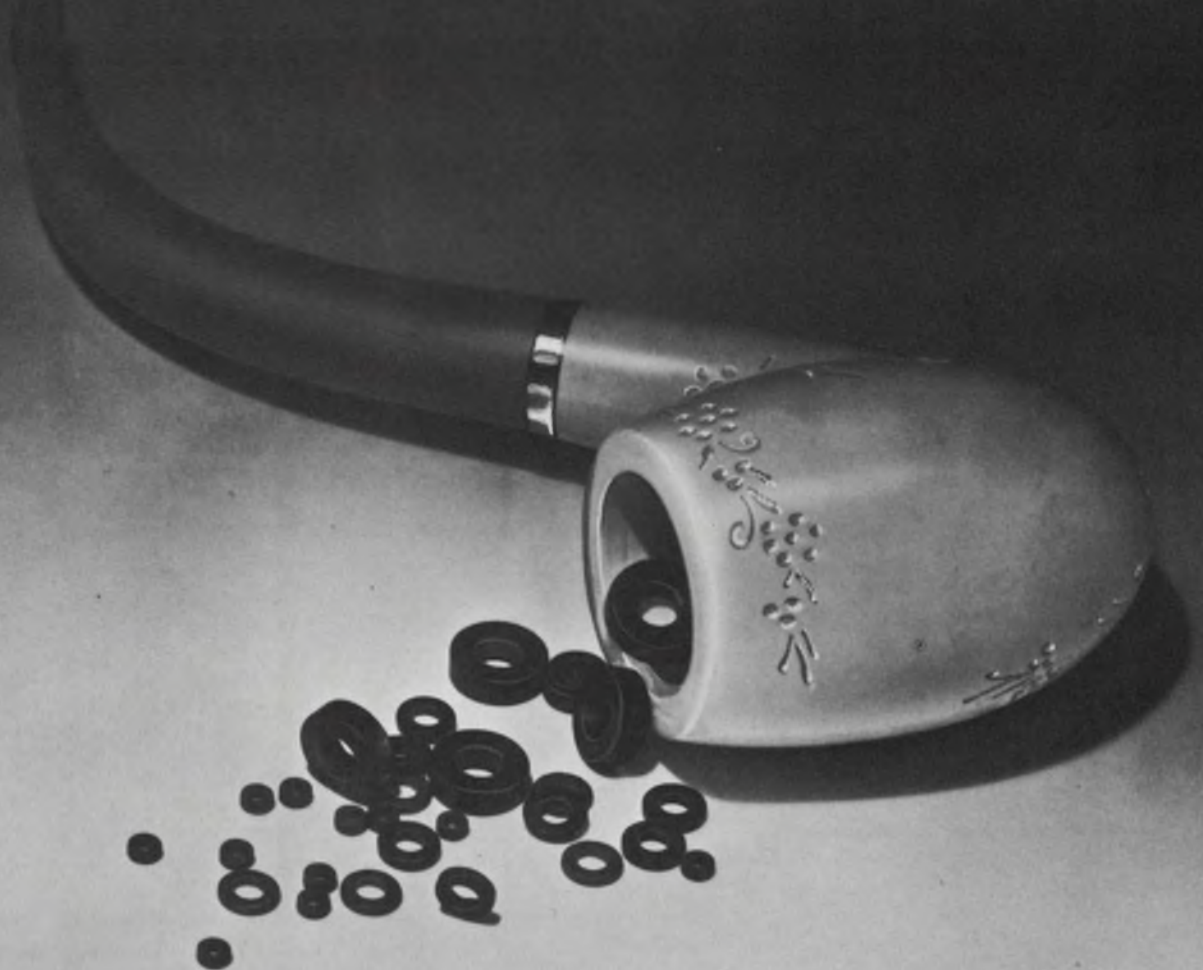

## NO LONGER A PIPE DREAM

That's right. 5000 initial permeability. And we mean it!

Perhaps your designs for pulse transformers have gone up in smoke for want of a powerful enough material. Well, now you've got it. And then some. Stackpole Ceramag® 24H ferrite material.

Ceramag® 24H is a precision engineered product. Exact processing, density checks, rigid kiln controls and precise

sintering. You get more out of it simply because we put more into it.

Here are a few more conservative characteristics. Maximum permeability, 6900. Typical. Saturation flux density, 4100 gauss and residual magnetism of 850 gauss. If curie point is significant to your operation, how about one of 175° C. Then there's temperature coefficient. Ceramag® 24H goes + 0.700% / ° C at -25°

C to 25° C and -0.450% / ° C at 25° C to 75° C. And all of this with a disaccommodation factor of  $1.4 \times 10^{-6}$ .

Ceramag® 24H is ready. Are you? Drop us a line and we'll send you some even more interesting facts about this fantastic new material. And the charts to prove it. Stackpole Carbon Company, Electronic Components Division, St. Marys, Pa. 15857. Ph: 814-834-1521



**STACKPOLE**  
Electronic Components Division

ALSO A LEADER IN THE MANUFACTURE OF QUALITY FIXED COMPOSITION RESISTORS



# LSI analog multiplexer chip combines bipolars and FETs

Radiation Inc., sub. of Harris-Intertype Corp., Microelectronics Div., P.O. Box 37, Melbourne, Fla. Phone: (305) 727-4295. P&A: \$360; September, 1969.

Using large-scale integration, a new monolithic bipolar 16-channel analog multiplexer combines n-channel junction field-effect transistors with complementary npn/pnp bipolar transistors on the same dielectrically isolated substrate. This combination of both vertical and horizontal integration technologies doubles the number of bipolar-compatible data channels available to the systems designer.

Said to exceed the performance of discrete IC or MOSFET systems, the new RS-1000 multiplexer offers the advantages of complexity on a single chip, weight reduction and reliability. Systems applications for the new device include telemetry and guidance systems, and process control computers. Circuit applications include a/d and d/a converters, function generators, and sample-and-hold and analog cross-point circuits.

The device features near-ideal on-chip analog switches with a 100-nA off-state input leakage, 500- $\Omega$  on resistance, 4-pF off-channel in-

put capacitance, and an access time of 800 ns. The high off impedance virtually eliminates signal leakage to the load; the very low on impedance greatly reduces signal loss in the switch. In addition, there is effective isolation between the on-channel signal and all other input signals.

Operating at twice the rate of MOS devices, the RS-1000 has a commutation speed of 1.3 MHz because of its extremely fast access time. It requires a single negative and single positive power supply, accepts bipolar analog inputs of -10 to +10 V, and is compatible with standard DTL and TTL circuits.

There are 16 analog input lines and two analog outputs that can be used independently, or bussed together for 16-channel operation. Since the JFET switch elements are symmetrical, the new circuit can also be used as a demultiplexer where a one- or two-line input is commutated to eight or 16 output lines.

Random-access channel selection is accomplished through a four-bit binary address input. There is also an address enable input that can be used as an address expander for

applications employing several multiplexer circuits. A mode control input provides one-out-of-16 or two-out-of-16 channel selection. In addition, an external bias control allows optimization of signal input range and switching time.

Besides all these performance benefits, the RS-1000 can operate over the full military temperature range from -55 to +125°C. It meets the mechanical and environmental requirements of MIL-S-883 via its 28-pin hermetically sealed flatpack.

Two other new products from Radiation Inc. on display at Wescon are high-speed internally compensated operational amplifiers. Model RA-2510 has a unity-gain slew rate of  $\pm 50$  V/ $\mu$ s and a large-signal bandwidth in excess of 500 kHz. Model RA-2500 slews at  $\pm 20$  V/ $\mu$ s at unity gain and offers a large-signal bandwidth of greater than 200 kHz.

The RA-2500 has a voltage gain of 35,000, an offset current of 20 nA, and an offset voltage of 2 mV. The RA-2510, on the other hand, gives a voltage gain of 15,000 and offers input characteristics identical to those of the RA-2500.

Output impedance is 100  $\Omega$  and output current is  $\pm 20$  mA for both amplifiers. They are packaged in TO-86 and TO-99 metal cans.

Also on display is an expanded line of radiation-hardened TTL integrated circuits.

Booth No. 4503 Circle No. 413

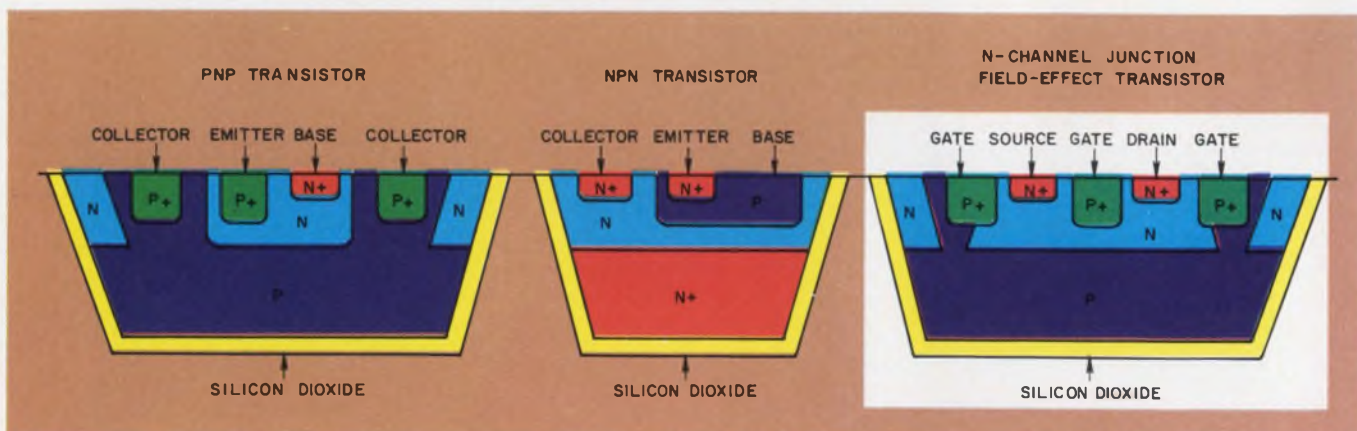

Achieving true interchannel isolation, a new monolithic 16-channel analog multiplexer forms near-ideal on-the-chip analog switches by combining complementary

bipolar transistors with n-channel junction FETs. This large-scale integrated circuit uses dielectric isolation to separate all structures, both horizontal and vertical.



# WE'VE BLOSSOMED!

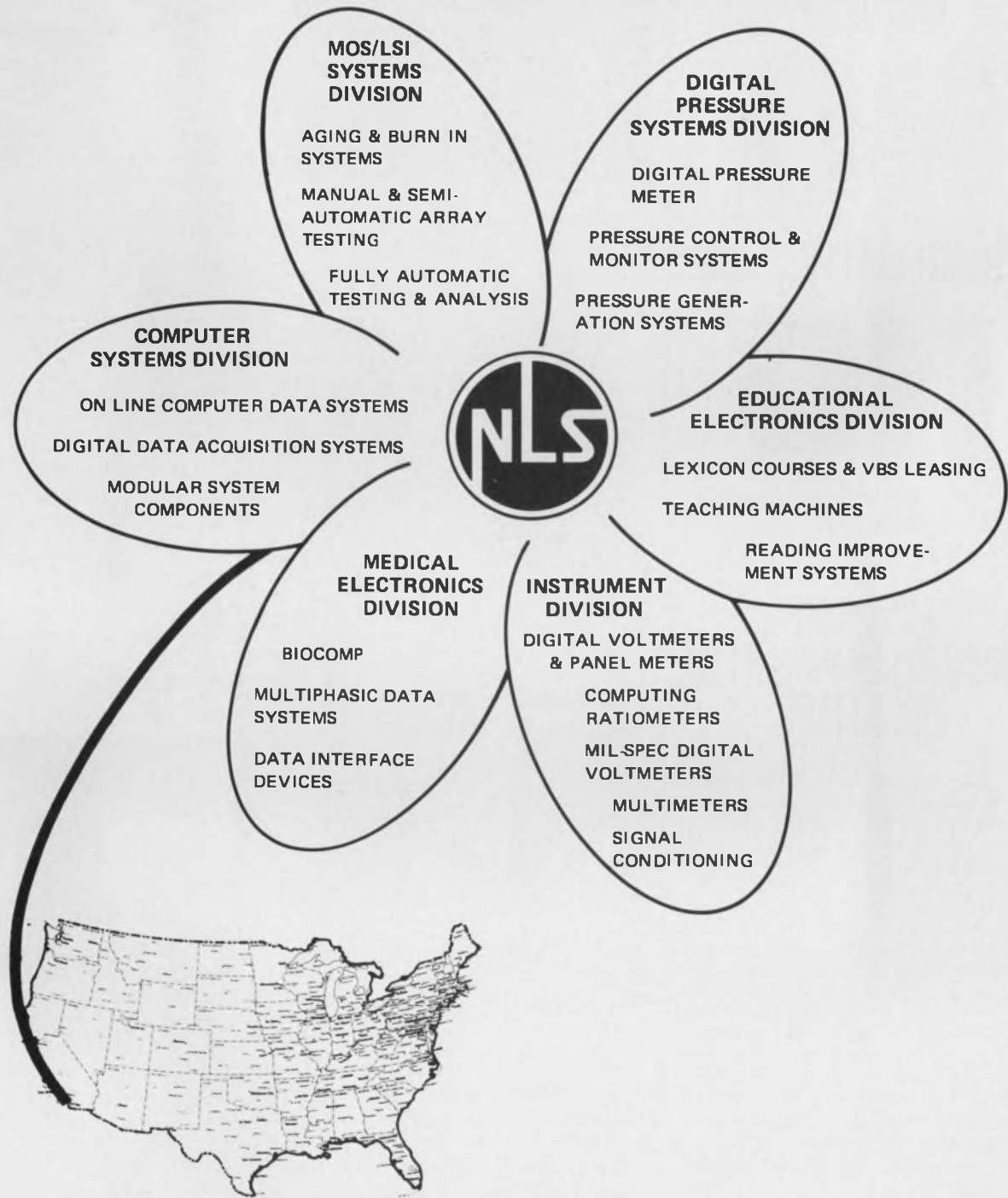

Employment Opportunities in Sales & Engineering



*Originator of the Digital Voltmeter*  
**NON-LINEAR SYSTEMS, INC.**  
 DEL MAR, CALIFORNIA 92014

Call COLLECT (714) 755-1134 to request detailed brochures and/or applications engineering assistance.

INFORMATION RETRIEVAL NUMBER 83



**NO  
OIL FILLING  
NO  
SATURATION AT FULL LOAD  
NO  
RINGING**

■

**"LOSSYLINE"  
SCREEN ROOM/POWER LINE  
EMI FILTERS**

"LossyLine" screenroom/power line filters provide unsurpassed EMI suppression by use of a lossy approach. Conventional filters use L-C networks to reflect, reject or transfer unwanted RF energy. Lundy filters use "lossy" elements which absorb and completely dissipate this energy. No chance for it to escape, feedback or leak. By absorbing and dissipating the RF energy, shunt capacitance is minimized and reactive current is negligible. Attenuation does not fall off with current, since there are no saturable inductors.

- No oil leaks to worry about, either. A lossy type filter develops a minimum amount of heat, therefore does not require oil for cooling.

- 100 dB from 14KHz to 100GHz
- Oper. Cur: 25-1000 amps
- Oper. Volt: 110, 220, 240, 440, & 550 VACW
- Freq: 25, 50, 60, 400, & 1000 cps



**LUNDY ELECTRONICS & SYSTEMS, INC.**  
Glen Head, New York 11545  
516-OR 6-1440 TWX 510-223-0605  
INFORMATION RETRIEVAL NUMBER 84

ICS & SEMICONDUCTORS

**Plastic rectifiers  
take 30-A surges**



Sylvania Electric Products, Semiconductor Div., West Main St., Hillsboro, N.H. Phone: (603) 464-5533. P&A: 45¢ to 90¢; 2 to 4 wks.

Designed to conserve space in computer, industrial, and consumer applications, seven new plastic miniature diffused silicon rectifiers are capable of delivering 1 A of output current and of withstanding overload currents as high as 30 A. Types 1N4001 through 1N4007 offer peak reverse voltages of 50 to 1000 V.

Booth No. Unit B Circle No. 367

**Hot-carrier diodes  
trigger at 410 mV**

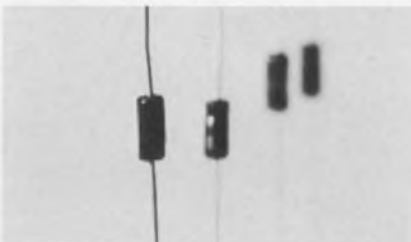

Hewlett-Packard, 1501 Page Mill Rd., Palo Alto, Calif. Phone: (415) 326-7000. Price: 99¢ or \$1.50.

Suited for mixer and detector applications at frequencies up to 3 GHz, a new line of hybrid hot-carrier diodes have a junction capacitance of only 1.2 pF, a forward conductance of 20 to 35 mA at 1 V, and a low turn-on voltage of 410 mV. The new units also boast the near absence of recovery time. Peak inverse voltage is 20 V for type 5082-2810 and 15 V for type 5082-2811.

Booth No. 1040 Circle No. 370

**Power SCRs  
go to 150°C**

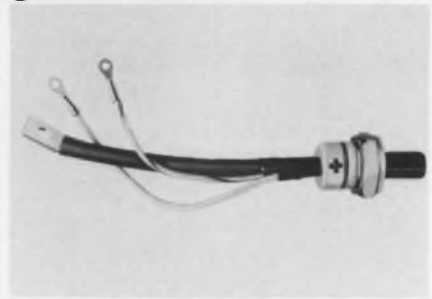

Westinghouse Electric Corp., Semiconductor Div., P.O. Box 868, Pittsburgh, Pa. Phone: (412) 255-3693. Price: \$50.50 or \$56.50.

Two new high-temperature silicon-controlled rectifiers will operate at a junction temperature of 150°C. Type 2615 has a forward current of 200 A rms and is rated at 125 A half-wave average. Type 2605 has a forward current of 275 A rms and is rated at 175 A half-wave average. Both SCRs have a guaranteed voltage change of 300 V/μs and forward blocking voltages to 600 V.

Booth No. 4601 Circle No. 345

**Tiny LEDs  
emit IR**

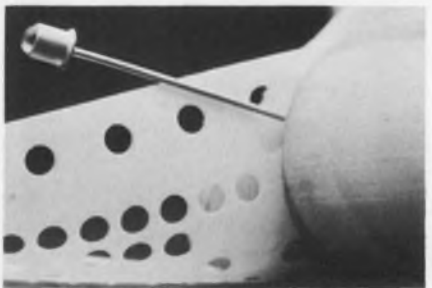

General Electric Co., Miniature Lamp Dept., P.O. Box 2422, Cleveland, Ohio. Phone: (216) 266-2258. Price: \$3 or \$4.

Measuring only 0.1 in diameter, two new solid-state lamps produce noncoherent infrared radiation that peaks at 9400 Å. Type SSL-15 is a hermetically sealed unit with a standard top-mounted glass lens, while type SSL-25 is a plastic encapsulated device. Power output when driven at 20-mA forward current is 9.5 mW for the SSL-15 and 1.5 mW for the SSL-25.

Booth No. 4304 Circle No. 371



# TWO ENGINEERS WITH THE SAME PROGRAMMING PROBLEM



**USING ROTARY SWITCHES** requires 330 soldered joints . . . over 8 hours of labor . . . occupies 293 square inches of panel space . . . costs \$88.00 installed.  
(That's \$0.29 per switching point.)



**USING CHERRY SELECTOR SWITCH** requires no soldering . . . less than 5 minutes of labor . . . occupies 41 square inches of panel space . . . costs \$32.95 installed.  
(That's \$0.11 per switching point.)

**WHICH ONE WOULD YOU LIKE TO CHECK FOR A MISTAKE IN WIRING?**

**WRITE TODAY** for full details on the totally new Cherry Selector Switch. It may change all your old ideas about programming devices.

**SEE THIS  
CHERRY  
INNOVATION  
AT  
WESCON!**

booths  
5117  
5118 5119

**CHERRY** 

CHERRY ELECTRICAL PRODUCTS CORP. • 1667 Old Deerfield Road • Highland Park, Illinois 60035

INFORMATION RETRIEVAL NUMBER 85



# WHAT? Still chopping light with a wheel?

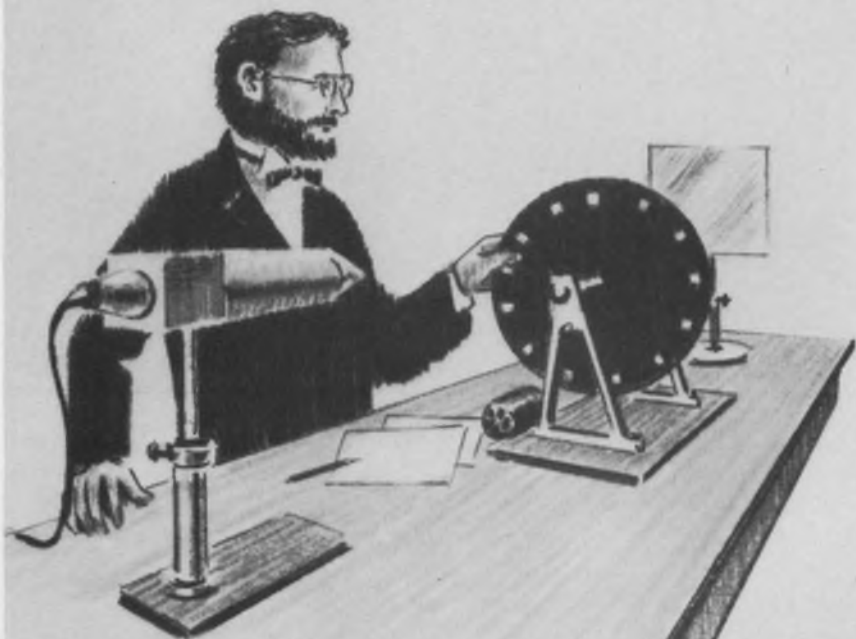

# Hey Mister, get a FORK!



Many engineers already use Bulova/American Time Products tuning forks to chop light and similar energy beams. Those who are not are a bit behind the times, and should know the fork's tremendous advantages over motor-driven light choppers —

- No wearing parts / No lubrication needed
- Low power requirements / Much longer life
- More efficient light handling / Smaller and lighter

How is all this achieved? By attaching to a fork's tines a pair of vanes — slotted, notched, or pierced, to suit the need. Then the vibrating fork chops light or similar energy beams to produce optical effects never before achieved. What's more, it's all done in a very, very small package. For example, a 2 cubic inch package can chop 1,000 times per second!

Another variation is a scanner that uses a torsional fork scanning at a uniform repeat rate. A mirror or other optical device can be attached to vibrate the device torsionally.

Whatever your application, from burglar alarms to infrared spectrophotometers, if you've got some light to chop or scan, call American Time Products 212-335-6000, see EEM Section 3800, or write —



## **BULOVA** AMERICAN TIME PRODUCTS

Electronics Division of Bulova Watch Company, Inc.  
61-20 Woodside Ave., Woodside, N.Y. 11377 (212) 335-6000

Go Bulova, and leave the designing to us!

INFORMATION RETRIEVAL NUMBER 86

## ICS & SEMICONDUCTORS

### Tiny glass diodes rectify 160 mA



*Sylvania Electric Products Inc.,  
Semiconductor Div., Hillsboro, N.H.  
Phone: (603) 464-5533. P&A: 65¢  
to \$1; 30 days.*

Encased in a DO-34 whiskerless package, five new silicon epitaxial diodes can dissipate 500 mW of power in free air and can handle average rectified output currents of 160 mA. Reverse breakdown voltage for types IN4531 through IN536 ranges from 35 to 100 V. Applications include frequency detectors, fast logic circuits, and clamping and chopping circuitry.

Booth No. Unit B Circle No. 405

### Hybrid regulators supply 5 to 36 V



*Transformer Electronics Co., P. O.  
Box 910, Boulder Industrial Park,  
Boulder, Colo. Phone: (303) 442-  
3837. P&A: \$28; stock.*

Supplied in a 14-lead dual-in-line package, series VR hybrid voltage regulators provide fixed output voltages of  $\pm 5$  to  $\pm 36$  V. All units deliver 500 mA of output current with a voltage regulation of 0.01%. Attenuation of noise and ripple is typically 10,000:1 (80 dB). The built-in reference voltage has a temperature coefficient of 0.005%/C°.

Booth No. 3601 Circle No. 272

SEE US AT NJE BOOTH 1332-1333 ▶

INFORMATION RETRIEVAL NUMBER 247 ▶



We are so sure  
of our new  
PVC Power Supplies  
we will let you use one  
in your own plant or  
laboratory for 30 days  
at no cost or  
obligation to you!

RATINGS			
Voltage-	0 —	0 —	0 —
	50V	20V	10V
Current	0 —	0 —	0 —
	1A	2A	4A

**Including these features**

- Precision Voltage Regulation (.01%)
- Precision Current Regulation (.01%)
- Voltage/Current Regulation with Integrated Circuits
- Identical Plug-in Printed Boards for both Voltage and Current Regulation
- Three Range Voltmeter
- Three Range Ammeter
- Full Current Ratings (0-60°C)
- High Quality
- Low Price

**\$195<sup>00</sup>**



**Now!**  
**NJE**  
**“LAB POWER”**  
**Free for**  
**30 DAYS!**

To: **NJE Corporation**, a subsidiary of  **CONDEC Corporation**, Kenilworth, New Jersey 07033

\_\_\_\_\_ Yes, I want to try a PVC. Send me an 0-50V @ 1A , 0-20V @ 2A , 0-10V @ 4A  model for a free 30 day trial.

\_\_\_\_\_ I can't use one now, but I would like some information. Please send your new catalog.

\_\_\_\_\_ Have a representative call so we can talk about my problems and your products.

2

NAME \_\_\_\_\_ TITLE \_\_\_\_\_

COMPANY \_\_\_\_\_

ADDRESS \_\_\_\_\_

CITY \_\_\_\_\_ STATE \_\_\_\_\_ ZIP \_\_\_\_\_

I use power supplies in these applications: \_\_\_\_\_

\_\_\_\_\_  
\_\_\_\_\_



# NJE LAB POWER



2 PVC-20-1  
Dual 0-20V @ 1A



PVC-10-8  
0-10V @ 8A

First Class  
Permit No. 9  
Kenilworth, N.J.

## BUSINESS REPLY CARD

No Postage Stamp Required if Mailed in the U.S.

Postage will be paid by:

NJE Corporation

20 Boright Avenue

Kenilworth, New Jersey 07033

The following  
PVC Power Supplies  
are also available!

25 Watts — \$148

100 Watts — \$295

200 Watts — \$590

**NJE Corporation**

Kenilworth, New Jersey 07033

A subsidiary of **CONDEC** Corporation



# Tantalum Foil



3 ways better  
than solid in  
non-polar  
applications

- smaller than solid tantalum
- more reliable than solid tantalum
- delivers more microfarads than solid tantalum

Design is the big difference between General Electric's Type 29F non-polar tantalum foil capacitor and an equivalent solid tantalum capacitor. A design that's specifically for **non-polar** applications.

GE Type 29F non-polar tantalum foil is about half the case size of an equivalent solid, yet accepts voltage and current variations in either direction. And from one small, single roll that in no way impairs the inherent reliability characteristics of tantalum foil. (Totally unlike its bulky solid counterpart that requires two slugs connected back-to-back and, in most cases, within a single case.)

The difference doesn't end with just size and reliability. Consider microfarads. GE tantalum foil delivers 50 percent more microfarads per case size, in practically all cases, when compared with solid tantalum.

So for your next non-polar application, contact your General Electric Sales Representative and ask to see the Type 29F tantalum foil capacitor. It could make a big difference. In size. In reliability. In microfarads.

Electronic Capacitor and Battery Dept., Irmo, S.C.  
430-36

GENERAL  ELECTRIC



# Sonotone's Sub-C Cell.



**One size, four power ratings supply the power needed for any cordless product.**

Now you can match power to product with one of Sonotone's Sub-C nickel-cadmium sealed cells. Pick from these four:

**S113, the industry standard**, is a dependable, nickel-cadmium sealed cell rated at 1.2 ampere hours. This is the one that started the cordless revolution. Now in use in cordless toothbrushes, slicing knives, communications and standby power equipment.

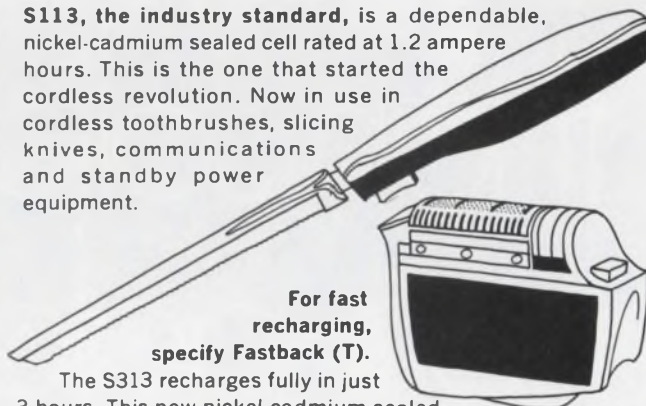

**For fast recharging, specify Fastback (T).**

The S313 recharges fully in just 3 hours. This new nickel-cadmium sealed cell is rated at 0.9 ampere hours. Currently used in cordless shavers and cordless hair clippers.

**S413 is a high rate discharge** nickel-cadmium sealed cell with 1.0 ampere hours. Puts out up to 75 amps. of surge power . . . ideal for engine-starting applications.

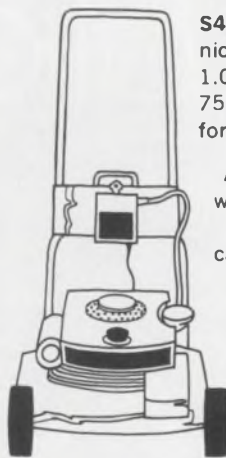

**And finally, the economical S213** with performance the same as the S113, except 0.7 ampere hour capacity. It is used in many of the same applications as the S113 where running time is less critical and economy most essential.

What we've done with the Sub-C cell, we can do with any of our battery products.

Write for full information: Battery Division, Sonotone Corporation, Elmsford, N. Y. 10523.



**CLEVITE SONOTONE**



# Scotchpar's producer uses more supporting players than any other big name film producer.

3M Company has the largest sales force—all engineers and insulation specialists calling exclusively on the electrical market—to make sure SCOTCHPAR® polyester film turns in a stellar performance for its customers.

They're supporting a great film. It's thin, tough, transparent, flexible

and durable. It also has high dielectric strength, great temperature stability, and resistance to moisture and solvents.

Our men help capacitor manufacturers get the right kind of SCOTCHPAR film for their product—they can choose from a complete lineup of thin films down to .25 mils, plus SCOTCHPAK® film if they want heat sealable features.

They work equally hard for manufacturers who use SCOTCHPAR film as insulation in transformers, motors, wire and cable.

With all these men on the job, we still work harder than anybody else helping electrical men get the most out of polyester film.

All because we want our SCOTCHPAR film to win over a very critical audience.

3M Company, Film & Allied Products Division, 3M Center, St. Paul, Minnesota 55101.

**Scotchpar 3M**  
BRAND POLYESTER FILM COMPANY





# A 2 KVA 400 CYCLE, SOLID STATE BIPPY?



Around here, it's affectionately called just that. But you can simply refer to our newest creation as the CML Model CRS-2000A Frequency Converter until you get used to the idea of a Bippy hanging around. It features low distortion sine wave output and excellent regulation... less than 1% voltage regulation, less than 0.5% frequency regulation. Full power is available into leading and lagging power factor loads. The Bippy is solidly built (as all Bippys are), air cooled, and extremely quiet (as all Bippys are not)... measures 19" x 26 1/4" x 20". Ideal for marine and ground support installation, portable shelters, communications vans, radar systems, aircraft maintenance depots. This truly is the Bippy you can bet on. It socks the power to you!

**CML, Inc.**

a subsidiary of  
Tennet Engineering, Inc.  
350 Leland Avenue  
Plainfield, N.J. 07062  
(201) 754-5502 • TWX 710-997-9529



See us at WESCON, Booth 2210  
INFORMATION RETRIEVAL NUMBER 88

## MODULES & SUBASSEMBLIES

### Miniature regulators handle up to 20 W



Powercube Corp., sub. of Unitrode Corp., 214 Calvary St., Waltham, Mass. Phone: (617) 924-1758. P&A: \$225; stock to 2 wks.

Able to handle up to 20 W, a new line of linear regulators measures only 0.5 cubic in. and weighs only 0.8 oz. These type R dc/dc regulators are available for inputs from 10 to 150 W, corresponding to regulated outputs from 4 V at 4 A to 110 V at 10 mA. Standard features include a zener-protected input, and short-circuit and current-overload protection.

Booth No. 4516 Circle No. 257

### Modular transformers mount on PC boards

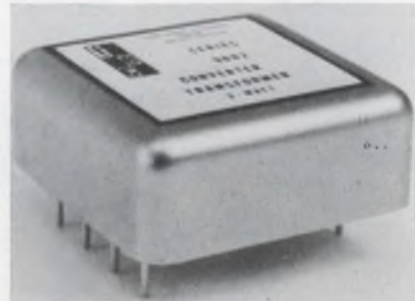

Transformer Electronics Co., P.O. Box 910, Boulder Industrial Park, Boulder, Colo. Phone: (303) 442-3837. Price: \$15.50 to \$21.30.

Housed in shielded metal cases that measure 1.5 by 1.5 by 0.75 in., a new series of dc-to-dc converter toroidal transformers can be conveniently mounted on a PC board. Fourteen models allow selection of output voltages from 3 to 1000 V dc. Improved regulation can be obtained by preregulating the inverter input voltage.

Booth No. 3601 Circle No. 256

### Hybrid amplifier drains only 75 $\mu$ A



Philbrick/Nexus Research, a Teledyne Co., Allied Drive at Route 128, Dedham, Mass. Phone: (617) 329-1600. P&A: \$49; stock.

Designed for low-quiescent-power applications like long-term battery operation, a new hybrid operational amplifier draws a maximum quiescent current of only 75  $\mu$ A. Operating from supply voltages between  $\pm 2$  and  $\pm 18$  V, model 1404 has a typical offset current of 15 nA, typical common-mode rejection ratio of  $10^5$ , and initial offset voltages from 1 mV.

Booth No. 2014 Circle No. 385

### Wideband op amp costs only \$11.90



Burr-Brown Research Corp., International Airport Industrial Park, Tucson, Ariz. Phone: (602) 294-1431. P&A: \$11.90; stock to 4 wks.

Selling for only \$11.90 in single quantities, a new FET-input operational amplifier features a minimum unity-gain frequency response of 4 MHz and a minimum full-power response of 100 kHz. Model 3308/12C has a maximum voltage drift of  $\pm 50 \mu$ V/ $^{\circ}$ C over the temperature range of  $-25$  to  $+85^{\circ}$ C. Its output is  $\pm 10$  V at 5 mA.

Booth No. 3801 Circle No. 374





# KEPCO'S SECRET IS THE I-C!

FROM THE LARGEST TO THE SMALLEST REGULATED POWER SUPPLY



KEPCO has 62 models whose voltage or current regulators employ a modern linear integrated circuit.

The result: **REMARKABLY WELL-BEHAVED POWER!**

The performance of our monolithic amplifier in the d-c comparison circuits of these 62 power supplies is properly impressive in the usual specifications of power supply performance.... *Line regulation* is well under 0.0005%; *load regulation* less than 0.005%. The performance is also spectacular in the not-so-frequently discussed specifications.

For example, the sensitivity to thermal shock is about nil. The Kepco I-C regulator, eliminates the small differences in component temperature due to self-heating or minor environmental changes, which in conventional designs causes much of the jitter, noise and "bobulation" in the output of d-c power supplies. Our I-C regulators are virtually immune to these influences. Their offsets change less than 20  $\mu$ V per  $^{\circ}$ C and 5 nanoamperes per  $^{\circ}$ C, respectively!

There are six diverse groups offering you the advantages of I-C regulation.



### CPS

6V-15V, 60-750W, crowbar-protected regulators for delicate I-C's



### JQE

6V-100V, 60-750W, linear programmable regulators.



### PAT

7V-100V, 20W programmable modules



### PCX

7V-100V, 20W programmable modules  
0.2-2A, 20W modular or plug-in metered models



### CC

0.2-2A, 20W fast recovery current regulators



### OPS

7V-100V, 20W high speed power amplifiers.

For complete specifications write Dept. CP-05



with **KEPCO...IT'S CONTROL!**

KEPCO, INC. • 131-38 SANFORD AVENUE • FLUSHING, N.Y. 11352 • (212) 461-7000 • TWX #710-582-2631 • Cable: KEPCOPOWER NEWYORK

INFORMATION RETRIEVAL NUMBER 89





**TINY....  
BUT - MVMs  
CAN TAKE IT!**

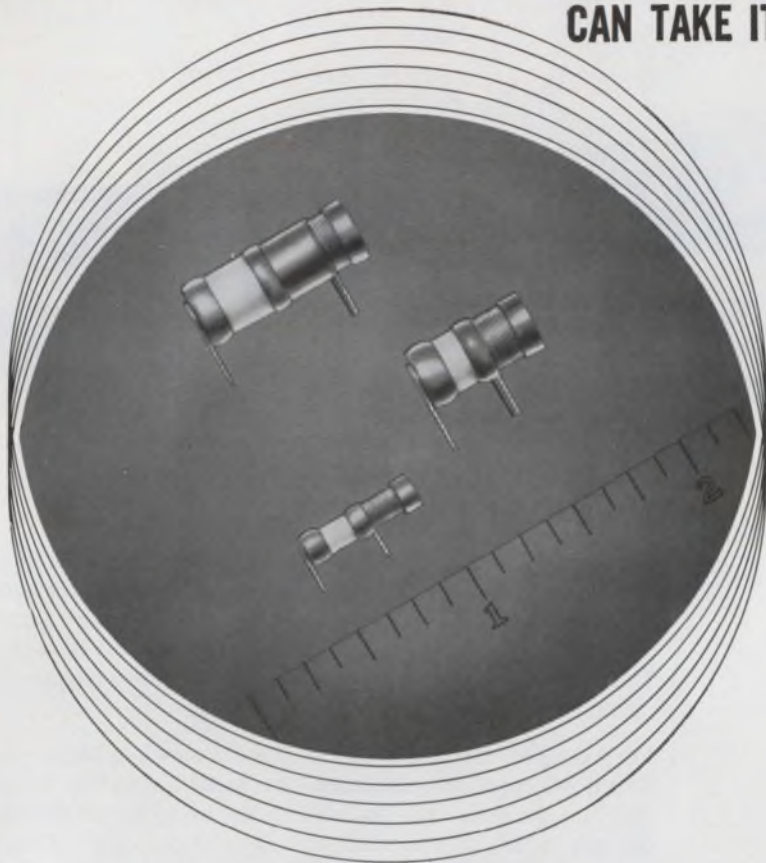

## THESE NEW HIGH Q AIR VARIABLES ARE RUGGED

JFD has developed three sizes of unusually rugged air variable capacitors. All three feature a unique internal guiding mechanism with a positive stop. The result: concentricity is constant and these capacitors can withstand conditions of extreme shock and vibration.

Further, newly developed metal biasing elements provide smoother, more constant torque during and beyond life cycling.

Other unique features of the series are:

- Engineered to withstand heat — during soldering.
- Internal air meshing shells are silver plated to provide best surface conductivity and long life.

All MVM's are completely interchangeable with competitive models.

Write for MVM catalogs.

**MVM-003** — Microminiature in size. Capacitance range is 0.35 pf to 3.5 pf. The Q factor measured at 3.5 pf and 100 MHz is 5,000. Available in 2 models.



**MVM-010** — Adjustable from 0.8 pf to 10 pf. Q greater than 3,000 measured at 10 pf and 100 MHz. Available in 4 models.

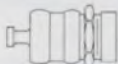

**MVM-020** — Adjustable from 1 to 20 pf. Q ranging from 3,000 at minimum capacitance, to 1200 at maximum capacitance. Available in 4 models.



Illustrations actual size.

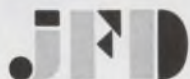

"TODAY'S COMPONENTS BUILT FOR TOMORROW'S CHALLENGES"

**JFD ELECTRONICS CORP. / COMPONENTS DIVISION**

15th Avenue at 62nd Street / Brooklyn, New York 11219 / Phone 212-331-1000

SUBSIDIARY OF RIKER-MAXSON CORPORATION

See us at the WESCON Show Booths #3911 and #3912.

INFORMATION RETRIEVAL NUMBER 90

## MODULES & SUBASSEMBLIES

### Preregulator fits in hand

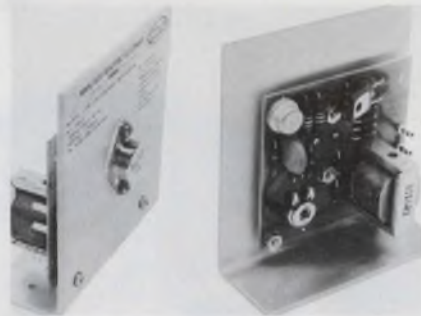

Wanlass Electric Co., sub. of  
AMBAC Industries Inc., 2165 S.  
Grand Ave., Santa Ana, Calif.  
Phone: (714) 546-8990. P&A:  
\$26.50; stock.

Providing either single or multiple dc outputs, a new economy power-supply preregulator measures only 4 by 4 by 2 in. and weighs but 10 oz. Operating from an ac input of 100 to 130 V, 47 to 420 Hz, model CVR-120 supplies 120 VA of regulated ac output at 135 V peak. Line, load and power factor regulation is  $\pm 1\%$ .

Booth No. 2119 Circle No. 386

### Audio tone modules encode and decode



Motorola Inc., Communications  
Div., 4501 W. Augusta Blvd., Chi-  
cago, Ill. Phone: (312) 772-6500.

Two new solid-state audio tone modules are designed for secure selective signaling and switching applications. One series S-1400 unit performs as an encoder, a highly accurate and stable tone generators while its companion module acts as a decoder, a selective switch responding to a particular received tone. They can be operated in parallel, simultaneously or sequentially.

Booth No. 1708 Circle No. 267





**We make our frequency components too good  
rather than merely good enough.  
Because sometime, somewhere, it might make a difference.**

**Motorola's dependable,  
precision frequency components  
are now available.**

Many of our frequency components are used in emergency communications equipment. That's one reason why we will not compromise our insistence on quality.

And now, for the first time in 30 years, you and other designers and OEM manufacturers can take advantage of Motorola's experience and large production capa-

bilities for frequency components: crystals, filters, oscillators, tone modules, and resonant reeds.

You can choose from an extensive line of off-the-shelf precision components. Or we'll gladly design and produce your devices on a custom basis. If you need it, you'll get application assistance. And all components are made under clean room conditions.

Whatever application you have

in mind for our frequency components, you can count on one thing. All are designed with the same precision, the same quality, the same dependability. Because we won't settle for second best.

And neither should you.

Send for Bulletin TIC-3401. Write Component Products Dept., Motorola Communications & Electronics, Inc., 4501 W. Augusta Blvd., Chicago, Illinois 60651.



**MOTOROLA TOTAL COMMUNICATIONS**



**below \$100 (full 3½ digits) for the OEM to package — we'll supply you with a digital volt-meter to meet your specifications — contact us today (201) 478-2800 Ext. S**



**as you like it-**



**below \$300 in quantities of 100 — you can get the best specified new 4½ digit panel meters — Model 720 — write today.**

Whatever your requirement, open or shut, look into Data-scan . . . we have Uni-polar digital panel meters with or without under-range "Zeroing" capability, 3½ digit and 4½ digit Bi-polar DPM's and an engineering department ready to go to work on your design.



Get your copy of our new DPM catalog-D201.

# Datascan

1111 Paulson Avenue, Clifton, N. J. 07013  
Telephone 201-478-2800

905

SEE US AT WESCON-BOOTH #1815  
INFORMATION RETRIEVAL NUMBER 92

## MODULES & SUBASSEMBLIES

### Time-delay relays go solid state



*Cornell-Dubilier Electronics, div. of Federal Pacific Electronic Co., 50 Paris St., Newark, N. J. Phone: (201) 624-7500. P&A: \$24 to \$28; stock.*

A new line of high-accuracy, long-life variable-time-delay relays consist of a solid-state timing device operating an electromechanical relay. Standard units are supplied in a medium-sized octal-type plastic case with a dpdt function suitable for output switching from dry circuit to 10 A. They have variable delays from 0 to 15 s or 0 to 60 s.

Booth No. 4403 Circle No. 268

### Low-cost op amp drifts 20 $\mu\text{V}/^\circ\text{C}$

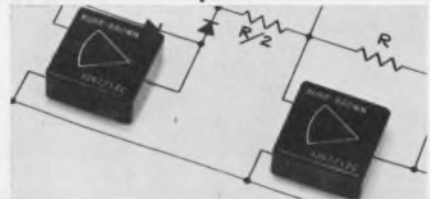

*Burr-Brown Research Corp., International Airport Industrial Park, Tucson, Ariz. Phone: (602) 294-1431. P&A: \$11; stock to 4 wks.*

Providing a maximum voltage drift of  $\pm 20 \mu\text{V}/^\circ\text{C}$  over the temperature range of  $-25$  to  $+85^\circ\text{C}$ , a new low-cost operational amplifier offers a minimum full-power response of 100 kHz and a minimum open-loop gain of 114 dB. Model 3267/12C supplies an output of  $\pm 10$  V at  $\pm 5$  mA and a minimum frequency response of 1 MHz. Its minimum slew rate is  $6 \text{ V}/\mu\text{s}$ .  
Booth No. 1115 Circle No. 375



# CHECK OUR DJINNI'S BUILD.

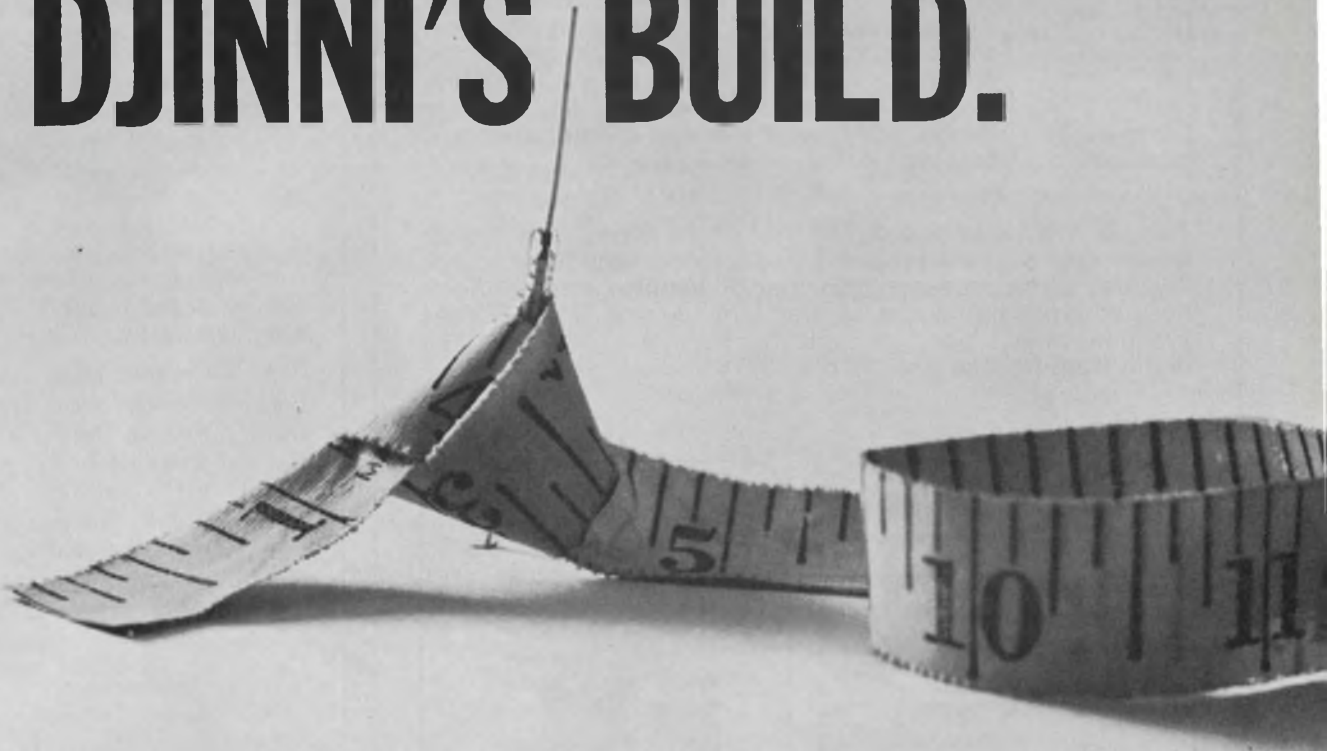

## Low profile.

Which means you can build a complete relay only .187" high to fit dual in-line spacing using Hamlin's new Mini-2 reed switch. It has a sensitivity range of 7.5 to 32.5 ampere turns which will rate your relay at 100 milliwatts with an operate time of 200 microseconds.

Like all Hamlin Djinnis, it's built to last longer whatever your application. That's why we're asked to build more types of reed switches for more people than any other manufacturer.

For instance, our Micro-miniature Djinni is the world's smallest. Then, there's the Tiny, Subminiature, Miniature, Compact and Standard sizes just to make sure you won't have any packaging problems.

If your application calls for RF switching, we have a Djinni that will switch frequencies from 30-100 MHz with low resistive losses and an impedance level of 52 ohms. The tiny MTRF-2 measures only .092" glass diameter by .635" glass length.

Ultra-high voltage applications call for the type DRTV that will

switch voltages up to 20,000 VDC. Life expectancy is 1 million operations at full load and practically infinite life at lower voltage levels.

Work a little magic of your own the next time you have a control problem. As a starter, send for our free "Switch Lab" kit. Just write to Hamlin, Inc., "Baghdad on the Lake," Lake Mills, Wisconsin 53551.

**HAMLIN** INC.



**How's that for low-cal magic?**



# Pinlites Inc.

manufacturer of the world's smallest incandescent lamps, offers a total of 16 different micro-miniature lamps. Ranging in size from .016 to .030 in diameter. Pinlites continue to offer unique design capabilities: Display modules with 200 individual lamps per square inch, optical multi-tracking heads, film encoding units, weapon status, readouts. Styles available are lens head, flat top, and axial leaded, with a broad spectrum of light outputs.



The all new, lower cost, Midgi-Lite® M series is a further advancement in digital and alphanumeric readout displays. The use of incandescent tungsten filaments permits brightness control, wide angle, single plane viewing. The M series are now in a rugged ceramic, metal, glass package. The depth from front to back is only 3/16".



## M SERIES

Midgi-Lites® and Alpha-Lites represent a new design approach in the direct viewing of incandescent tungsten filaments as light bars. The use of filaments permits the most efficient use of power for display purposes. The seven segment Midgi-Lites are now in a new and slimmer, ceramic, metal, glass package for severe shock and vibration environments. Segment brightness has been further increased for readability in direct sunlight . . . up to 12,000 foot lamberts/segment. Alpha-Lites are 16 segment alphanumeric displays with the same new design features and sunlight readability.

For complete design data specification and pricing, write or call: Pinlites Inc., 1275 Bloomfield Ave., Fairfield, N. J. 07006 • Attention: Mr. Bruce Bundy, Sales Manager • (201) 226-7724. Visit us at the Wescon Show in San Francisco, August 19-22, 1969, Booths 4814-4815.

# Pinlites Inc.

World's Smallest Incandescent Lamps • Digital Readouts • Micromodules  
1275 BLOOMFIELD AVENUE • FAIRFIELD, NEW JERSEY 07006

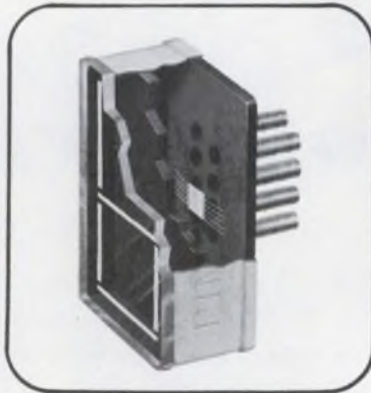

## M6-IC

Midgi Coder-Lite — An "M" series, 5/16 character height, seven segment digital display with integral 8-4-2-1 BCD to seven segment decoding/driving. TTL 5 volt logic level is accepted for both decoding and lamp drive. The M6-IC is only 3/16" in front to back depth and allows a display density of 6 characters per square inch. Overall dimensions are .305 width and .465 high, with a total weight of 1½ grams. The combination of the inherent life expectancy of the I.C. and 100,000 hour segment design life team up for an ultra reliable and low cost readout system.

## MODULES & SUBASSEMBLIES

### Synchro converter replaces gear trains

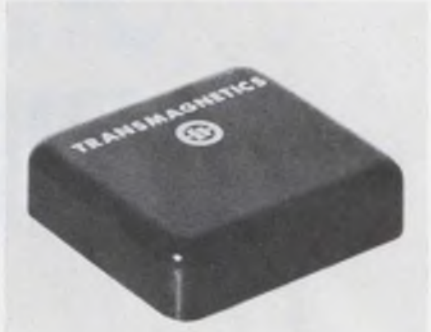

Transmagnetics, Inc., 134-25 Northern Blvd., Flushing, N. Y. Phone: (212) 539-2750. P&A: \$100; 4 to 6 wks.

A new solid-state synchro-to-linear dc converter can replace gear train servos in dozens of applications at a saving in price and size. Model 1637 converts three-wire synchro inputs to linear dc outputs that are proportional to the synchro angle. The dc output is available directly or after a simple analog-to-digital conversion for computing recording and remote indication.

Booth No. 4180 Circle No. 271

### Failsafe amplifier puts out 100 W



Redifon Ltd., Communications Div., Redifon Electronics Inc., 210 Summit Ave., Montvale, N. J. Phone: (201) 391-2627.

Delivering an output power of 100 W from 1.5 to 12 MHz, a new transistorized wideband linear amplifier needs no tuning and cannot be damaged by incorrect loading, even if the output socket is open or short-circuited. Model GA 480 is protected against excessive drive, is insensitive to wide variations in supply voltage and is safeguarded against supply transients.

Booth No. 5202 Circle No. 270



# NEW TI ELECTRONIC CHEMICALS.

They've already made  
our first customer  
very happy.

For years, Texas Instruments has been manufacturing electronic chemicals for just one customer: ourselves.

They've worked so well for us, we'd like you to try them. The same chemicals we use in silicon production, high-temperature gas reactions and epitaxial technology. All of which require, as you know, purity to parts-per-billion standards plus extremely high integrity in lot-to-lot uniformity.

Perhaps the wealth of experience behind TI chemicals can offer you some improvements... even if it's just the security of a new source. In either case, your files should contain the following data sheets:

- Epitaxy Grade Trichlorosilane (5 and 55 gallon stainless drums)
- Epitaxy Grade Silicon Tetrachloride (5 and 55 gallon stainless drums)
- Boron Tribromide Dopant (50 and 100 gram ampules)

Please write. You'll find us very eager to double our satisfied customer list.

TEXAS INSTRUMENTS INCORPORATED  
Chemical Materials Division  
P. O. Box 5621 • M/S 924  
Dallas, Texas 75222



## TEXAS INSTRUMENTS INCORPORATED

A small part of our new, high-capacity electronic chemicals facility.

INFORMATION RETRIEVAL NUMBER 95



# Amperex 'Two-In-One' packaging gives you Plastic IC's with the Reliability you'd expect only from hermetics.

Through a new, double-encapsulation packaging technique which combines the economy of plastic with the reliability of hermetic sealing, Amperex is able to bring you, at regular plastic prices—a line of off-the-shelf, digital IC's...the most reliable line of all-plastic 74N TTL's in the business. The encapsulation approach is unique... here's how it's done:



1. The chip is mounted on a gold-plated grid and is protected with a lacquer coating. The assembly is then packaged in soft epoxy resin which protects the chip against moisture penetration and prevents thermal fatigue of the bonding wires.



2. This sub-assembly is then welded into the final tin-plated grid structure and packaged in the dual-in-line encapsulation. A special ultra-strong plastic is used for the body of the device to withstand severe bend-pull stresses on the external leads. The leads are specially designed for maximum adhesion to the plastic body. The tin-plating on the leads continues right inside the body of the device, ensuring excellent corrosion-resistance and high quality soldered connections even after storage under tropical conditions.

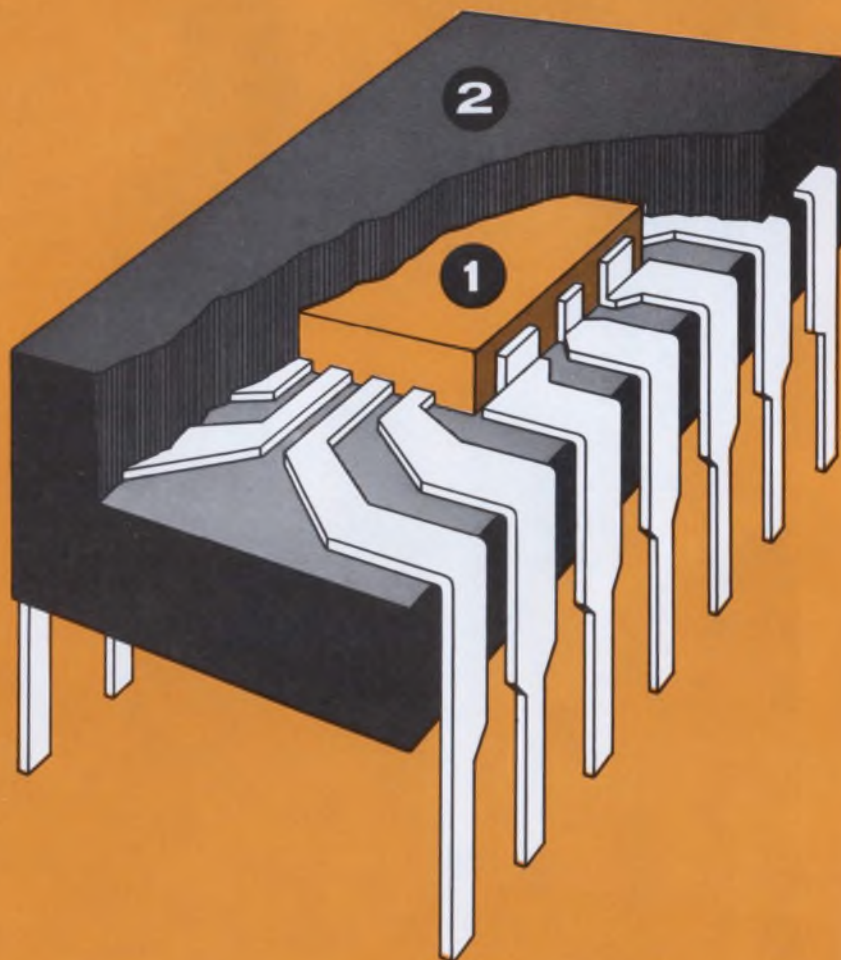

## Amperex®

TOMORROW'S THINKING IN TODAY'S PRODUCTS

A NORTH AMERICAN PHILIPS COMPANY





## HERE'S HOW WE PROVE OUR RELIABILITY:

Apart from stringent quality control during each step of manufacture, batches from each production run are tested for reliability under every conceivable kind of stress... electrical, thermal, mechanical and climatic, including: ■ Resistance to thermal fatigue ■ Endurance under conditions of intermittent dissipation ■ Bond strength ■ Bulk leakage ■ Degradation of electrical performance under severe thermal stress ■ RTR-circuit endurance ■ Ability to withstand high and low temperature storage ■ Switching capabilities under maximum fan-out and temperature conditions ■ Full sequential temperature treatment tests to MIL-specifications ■ Solderability, Shock Resistance, Acceleration and Vibration Step-Stress



A specially prepared Reliability Report, based on three years of constant test procedures, is available. Write for your free copy, on your company letterhead.

**Amperex 74N TTL's are available off-the-shelf from Amperex Distributors listed below.**

SERIES 74N		AMPEREX ULTRA RELIABLE IDENTICAL TYPE	
<b>GATES</b>			
SN 7400N.....	FJH131		
SN 7401N.....	FJH231		
SN 7402N.....	FJH221		
SN 7410N.....	FJH121		
SN 7420N.....	FJH111		
SN 7430N.....	FJH101		
SN 7440N.....	FJH141		
SN 7450N.....	FJH151		
SN 7451N.....	FJH161		
SN 7453N.....	FJH171		
SN 7454N.....	FJH181		
SN 7460N.....	FJY101		
<b>FLIP-FLOPS</b>			
SN 7470N.....	FJJ101		
SN 7472N.....	FJJ111		
SN 7473N.....	FJJ121		
SN 7474N.....	FJJ131		
SN 7476N.....	FJJ191		
<b>HIGHER ORDER FUNCTIONS</b>			
SN 7475N.....	FJJ181		
SN 7490N.....	FJJ141		
SN 7492N.....	FJJ251		
SN 7493N.....	FJJ211		

### PACE/AVNET

3961 Pace Court, Schiller Park, Illinois  
Telephone: (312) 678-6310

### ALMO ELECTRONICS

Roosevelt Blvd., at Blue Grass Rd., Phila., Pa.  
Telephone: (215) 676-6000

### INDUSTRIAL ELECTRONICS ASSOCIATES

P.O. Box 12444, Palm Beach Gardens, Florida  
Telephone: (305) 848-8686

### COMPUTER COMPONENTS CORPORATION

P.O. Box 30423, Dallas, Texas  
Telephone: (214) 239-0271

### HOLLYWOOD RADIO & ELECTRONICS, INC.

5250 Hollywood Blvd., Hollywood, Calif.  
Telephone: (213) 446-3181

For data, write:  
Amperex Electronic Corp., Microcircuits Division  
Slatersville, Rhode Island 02876

**Amperex**  
TOMORROW'S THINKING IN TODAY'S PRODUCTS  
A NORTH AMERICAN PHILIPS COMPANY

## MODULES & SUBASSEMBLIES

### IC power modules regulate to 0.005%



*Deltron, Inc., Wissahickon Ave., North Wales, Pa. Phone: (215) 699-9261. P&A: \$79 to \$289; 4 to 6 wks.*

Free of thermal transients, a new series of power modules uses integrated circuits to provide a regulation of 0.005%. Series N units feature adjustable current limiting, remote sensing, remote programming and fast recovery times. They also offer convection cooling to 71°C, as well as electrostatically shielded transformers.

*Booth No. 1508 Circle No. 269*

### Dual-output converters power entire system



*RO Associates, Inc., 3705 Haven Ave., Menlo Park, Calif. Phone: (415) 322-5321. P&A: \$225 to \$375; stock to 3 wks.*

Designed for digital and analog integrated circuits, any single unit in a new line of multiple-output miniature power converters can supply an entire instrument or system. Models 211, 212 and 213 have one output of  $5 \pm 0.5$  V at 5 A; and a second output of 24 V at 1 A, 200 V at 25 mA, or  $\pm 15$  V at 400 mA, depending on the model.

*Booth No. 3609 Circle No. 378*

### OEM power sources satisfy many needs



*Power/Mate Corp., 514 S. River St., Hackensack, N. J. Phone: (201) 343-6294. P&A: \$75; stock.*

UNI OEM power supplies offer the advantages of an all-purpose wide-range source with the compact size of a narrow-range slot supply. They are available with internal or external controls, internal or external sensing, complete overload and short-circuit protection, and the convenience of three mounting surfaces. They meet the requirements of MIL-E-16400, MIL-E-6272, MIL-E-5422, MIL-E-4970 and MIL-I-6181D.

*Booth No. 1423 Circle No. 377*

### Low-profile supply puts out 6 V at 2 A

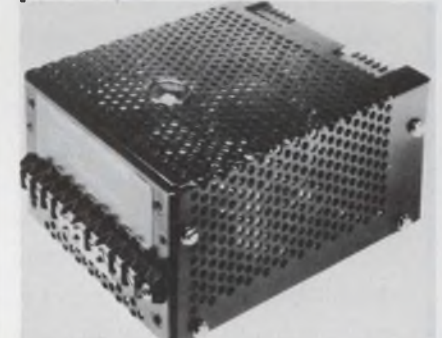

*Dressen-Barnes Electronics Corp., 250 N. Vinedo Ave., Pasadena, Calif. Phone: (213) 681-0643.*

Model 1301 is a low-profile high-performance dc power supply with an output of 0 to 6 V at 0 to 2 A. The new unit features an unregulated isolation transformer-rectifier followed by a stable high-gain regulator. It may be mounted on two sides, and it has remote voltage adjustment and remote sensing features for installation flexibility.

*Booth No. 4419 Circle No. 376*



# New S. S. White system trims microelectronic hybrid resistors at 1,000 per hour...or more



If you're into hybrid circuitry in a big way, or hope to be, our Model AT-701AR may be just what you need. It offers high capacity, accurate trims, high yield — or, just what you need to keep your customers and your comptroller happy.

Model AT-701AR is similar to our highly successful Model AT-701A, but with the addition of a rotary feeding system which lets operator load and unload substrates during the machine's trimming cycle. Capacity is limited only by the man-

ual dexterity of your operator.

Accuracy of the AT-701AR is guaranteed — within 0.5%. 0.1% is attainable with care and some sacrifice of speed. Trimming is monitored by a precision system of electronics featuring a four-wire Kelvin bridge, and tolerances may be programmed from  $\pm 0.1\%$  through  $\pm 11\%$ . (No use making them better than the specs require!)

*But suppose the Model AT-701AR is too big or too small for you?*

Call us anyway. If you can get by with something like 600 accurate trims an hour, we can offer you our Model AT-701A, to which you can add the turntable feature later. If you're still experimenting, we have Model LAT-100 for breadboarding. It is accurate to 1% better, takes substrates up to 4 x 4 inches and sells for only \$5,950. If you're *really* big, there's the Model AT-704A, a rotary-feed

machine that trims four resistors simultaneously, monitors, and inspects them at the breathtaking rate of 4,000 per hour. And if *that's* not fast enough for you, buy two.

All the S. S. White resistor trimming systems are based on the proven Airbrasive® method of removing resistance material which produces neither heat nor shock, does not alter the substrate.

Call 212-661-3320 to arrange for a live demonstration. Speak to Hal Skurnick or Don Davis. These same gentlemen will be demonstrating the Model AT-701AR and the Model LAT-100 at major electronics trade shows around the country, and if that's not quick enough for you, we will arrange for you to visit our factory. We have also prepared an extensive technical bulletin on this equipment, called, rather cryptically, the "RT-14", a copy of which is yours for the asking.



**RT-14**

Write to S. S. White Division, Pennwalt Corporation, Dept. 28, 201 East 42nd Street, N.Y., N.Y. Tel.: 212-661-3320

**SEE US BOOTH 3411  
WESCON SHOW**

**PENNWALT**

**S.S. WHITE**  
INDUSTRIAL PRODUCTS



**Model AT-701AR**

INFORMATION RETRIEVAL NUMBER 97



When run-of-the-mill won't do...

# Transitron THYRISTORS solve your problems.

## in opto- electronics

Our new RTPC Photo-SCR's for example – most advanced in the industry – operational over full MIL temperature range.



Design Engineers . . . looking for better circuit performance? Need a thyristor with special characteristics? Tell us your problem. Write details, or call collect (617) 245-4500 – ask for Thyristor Marketing.

## in power conversion

Transitron fast turn-off TO-66, TO-64, TO-48 and press-fit thyristors are very big in inverter/converter applications



## in hi-current pulse generation

Radar modulators and other pulse circuits perform better with our ultra-fast turn-on/turn-off thyristors



## in video displays

Our TRIACs, power gate turn-off SCRs and fast turn-off SCRs provide new economical deflection circuit switching.

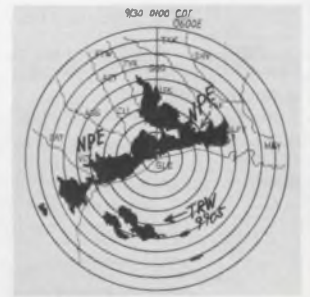

Send for **FREE**  
Application Data  
and **NEW**  
Thyristor Selection  
Guide

**Transitron**  
electronic corporation  
168 Albion Street Wakefield, Massachusetts 01880



# New Johanson capacitors help you make ends meet.



Solder directly on P/C board  
(minimum stray capacity).



Solder one end to coupling link  
and other end to cavity wall.



Solder ends to terminals of  
another component.



Solder one end to P/C board  
and attach lead to other end.

The new Johanson 7200 capacitor is ideal for balancing of semi-conductors and microwave components, for trimming of small fixed capacitors, for UHF oscillators, for coupling (VHF and UHF), for terminations for UHF coupling links, and for strip lines and modular blocks.

The 7200 features tubular electrodes which provide for low losses and low inductance at microwave frequencies. They also feature a low minimum capacitance 0.1 pF (10:1 tuning ratio) and Q of 500 at 200 MHz. Call or write for complete information.

**Johanson**

**MANUFACTURING  
CORPORATION**

400 Rockaway Valley Road  
Boonton, N.J. 07005 • (201) 334-2676

Electronic Accuracy Through Mechanical Precision

INFORMATION RETRIEVAL NUMBER 101

U172

## PACKAGING & MATERIALS

### Transistor heat sink handles up to 20 W

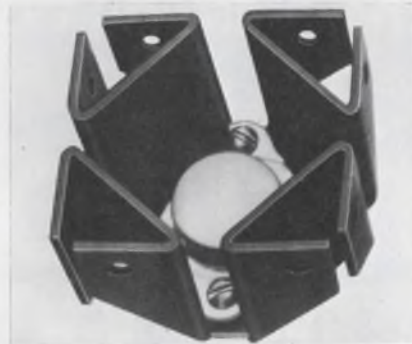

Wakefield Engineering, Inc., Audubon Rd., Wakefield, Mass. Phone: (617) 245-5900. Price: 25¢.

Dissipating power of 10 to 20 W, a new transistor aluminum heat sink is a flat blank that is folded into a well-ventilated form and slotted in the direction of heat flow. Type 690 1100-H14 accepts the following transistors: TO-3, TO-8, TO-36, TO-59, TO-61, TO-62, TO-63, TO-66, TO-82, DO-8, DO-9, and DO-30. It is a 1.81-in. square, supplied without any finish or with black anodize.

Booth No. 2604 Circle No. 282

### Modulator connector eliminates solder



Elco Corp., Willow Grove, Pa. Phone: (215) 659-7000. P&A: 15¢; 4 wks.

Designed for array mounting on a mother board, the new MOJO 6308 card-edge receptacle combines the advantages of modular design with a unique contact that eliminates soldering. Its contact tail combines a square wire-wrapping post with a specially designed shoulder which, when press-fitted into the plated-through hole in the mother board, provides a permanent gas-tight electrical connection without soldering.

Booth No. 4105 Circle No. 278

### Simple heat pipes beat metal ducts



Energy Conversion Systems, Inc., 3821 Commercial, N.E., Albuquerque, N. M. Phone: (505) 242-1495. P&A: 50¢ to \$15; stock.

Compact and simple, a new heat-transfer device, the heat pipe, is said to have many times the heat transfer capability of metal conductors. Available in rigid or flexible versions, heat pipes are especially adaptable to the cooling of semiconductors, integrated circuits, electron tubes, and other electronic components. They can be inserted deep inside electronic packages.

Booth No. 4524 Circle No. 299

### Snap-in panel catch opens with a pinch

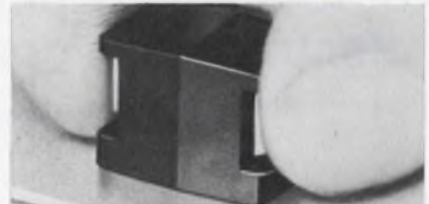

Southco, Inc., 200 Industrial Highway, Lester, Pa. Phone: (215) 521-0800. Availability: stock.

Improving the appearance and function of access panels, compartment doors, and hoods and covers of all types, model 60 squeeze-release catch is easily grasped by the fingertips and released in the same motion. Installation is literally a snap, as the body of the fastener is merely pushed into a rectangular hole (0.5 x 0.312 in.) in the door or panel, where it seats permanently. A slightly larger hole in the frame is caught by its spring-like gripping fingers as the panel closes.

Booth No. 2504 Circle No. 368

INFORMATION RETRIEVAL NUMBER 102 ►



# Signalite

## Sets The Pace In Gas Discharge Tubes and Glow Lamps

Signalite started supplying neon glow lamps as an indicator device almost two decades ago. Since then, Signalite developed the neon lamp into a circuit component that has solved problems in areas from voltage regulation to photocell drivers . . . from SCR triggering to unregulated power supplies.

**Today, Signalite is a leading source** for Neon Glow Lamps as indicators and circuit components.

**Today, Signalite is a leading source** for spark gaps designed to transfer energies and act as voltage sensitive switches.

**Today, Signalite is a leading source** for noise tubes and miniature noise sources for noise figure test equipment and monitoring system receiver sensitivities.

Only Signalite offers you this in-depth experience, capability, facility and technology in gas discharge devices and glow lamps . . . backed by an R&D program to explore new markets and devices.

Signalite Application Engineers are available to you. Share your design problems with them. They'll choose the right product for your application or design custom units to meet unique requirements.

*Yours For The Asking . . . brochures on  
neon lamps, spark gaps, noise sources.  
Application Newsletter on technique and  
application of these products.*

A General  
Instrument  
Company



Signalite INCORPORATED  
1933 HECK AVENUE  
NEPTUNE, NEW JERSEY 07753





# Single Channel

## DIRECT WRITING RECORDER



### Model 20 Features

- Portable — self-contained
- Two chart speeds in ratio of 2/1
- 10 mv/mm sensitivity
- DC to 125 Hz frequency response
- Gain, position and pen heat controls
- Low paper indicator
- Front loading
- Event marker

**PRICE \$450.00**

An ideal accessory to other instrumentation in laboratory or field applications.

This instrument can be private branded in your color at OEM prices.

MFE offers stock recorders from one to six channels or will design custom recorders to suit your exact needs. Let us know your requirements — we will send complete information.

\*See MFE at the WESCON SHOW, Holiday Inn, San Francisco Airport (415) 589-7200

## MFE

MECHANICS FOR ELECTRONICS  
Telephone (617) 864-8130  
152 Sixth St., Cambridge, Mass. 02142

INFORMATION RETRIEVAL NUMBER 103

## PACKAGING & MATERIALS

### Card-edge connector builds in power lines

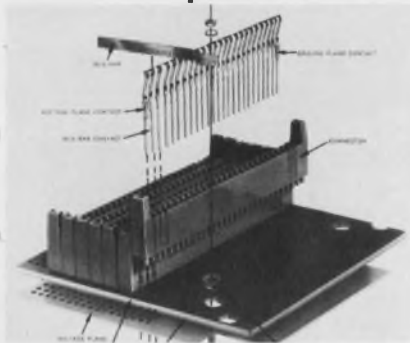

Elco Corp., Willow Grove, Pa.  
Phone: (215) 659-7000. P&A:  
\$1.50; 4 to 6 wks.

Within the connector body, a new metal-plate printed-circuit card-edge receptacle provides multiple power distribution lines, and voltage and/or ground plane connections. Since all power line connections are made without external wiring a low-noise high-speed system can be easily produced. Series 6305 units use a specially designed contact for each connection between the PC card and power line.

Booth No. 4105 Circle No. 277

### IC logic hardware decouples on board

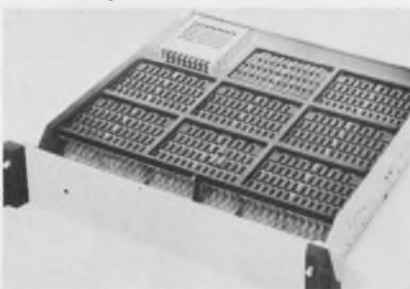

Electronic Engineering Co. of Calif., 1601 E. Chestnut Ave., Santa Ana, Calif. Phone: (714) 547-5501. Availability: 30 days.

A new line of 2-D computer-automated IC logic hardware features high-density packaging, laminated power bussing, and high- and low-frequency decoupling capacitors. The new line uses standard off-the-shelf hardware with IC plug-in sockets and computer-automated wiring. Before wiring, a computer provides an exception report from the customer-provided pin-logic list.

Booth No. 3814 Circle No. 280

### Positive-mount socket ends misalignments

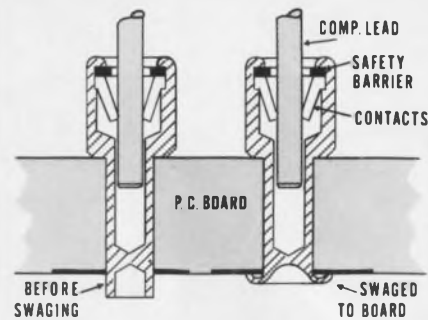

Milross Controls Inc., 511 Second St., Pike, Southampton, Pa. Phone: (215) 355-0200.

Intended for applications requiring a great deal of component insertions and withdrawals, the new Permatoc socket assures positive mounting and solid support right on the printed circuit board. Providing a mechanical as well as an electrical connection, the body of the socket is a tubular rivet design which, when swaged, assures accurate stable positioning of the contact during soldering.

Booth No. 4413 Circle No. 281

### Polyimide tape takes 7800 V



Mystik Tape, Borden Inc., 1700 Winnetka Ave., Northfield, Ill. Phone: (312) 446-4000.

Designated as Mystik 7367, a new pressure-sensitive polyimide film tape has a total thickness of 2.5 mils and a dielectric strength of 7800 V. This new tape can function as a carrier material in the manufacture of memory sensing devices or as a design component for microcircuitry. It covers the temperature range from -80 to +350°F.

Booth No. 2611 Circle No. 273





# NEW UNIVERSAL IC FLAT-PAK SOCKET

FOR TEST BREADBOARD



- For any custom-hybrid flat-pak style with leads on .050 spacing or multiples thereof. Up to 70 leads per side (3¾" long) x any width between sides.
- Allows custom tailoring of socket for any special or odd-size device, eliminating large tooling costs, long lead times or expensive hand-fabricated special sockets.
- Allows wide-open access to entire package when mounted in socket.
- Choice of terminations — fanned out on PCB to individual pin sockets or terminals (illustrated), or direct staggered contact terminations below socket.
- All materials good for -65° to 150°C.
- Combination of rugged spring clips on hold-down pressure bar and sliding action of cantilevered contacts against leads provide good wiping action.
- Large guide grooves at end insure precise mating of pressure bar to contact strip every time. Tolerances: Decimals ±.005 Fractions ±1/64 — unless otherwise specified

**ORDERING INFORMATION:** All sockets are supplied as 2 identical strips, or sets, fully assembled and tested. Just mount them on the spacing desired with the self-tapping screws provided.

1) Specify number of contacts per side: Available in 20, 30, 40 or 50.

2) Specify termination style as follows:

**Dash A** — Contact termination exit directly below socket on .1" staggered spacing.

**Dash B** — Contacts are terminated on a PCB on .1" staggered spacing with male terminals

**Dash C** — Contacts terminated as — Dash B above, except uses individual female pin sockets rather than male terminals.

**EXAMPLE:** Universal IC Socket part number for an LSI device with 60 leads (30 per side) with contacts terminating at male terminals on PCB would be: NP-305 (See #1 above) — (see #2 above), — or — NP-305-30-B



802 E. EIGHTH ST. NEW ALBANY, IND. 47150  
AREA CODE (812) 945-0211 TWX 810-355-2912

INFORMATION RETRIEVAL NUMBER 104

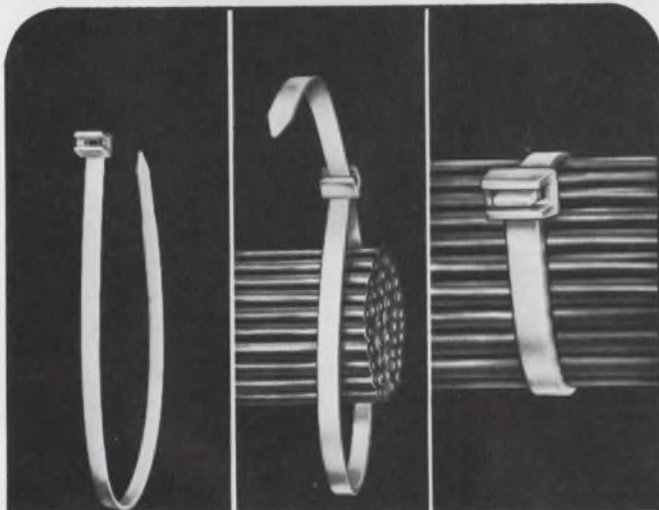

## NEW CABLE TIES

... with improved self-locking mechanism. Easily applied either by hand or tool. Wrap... Cinch... Cut. Available in four sizes, each infinitely adjustable within its size range. Provides permanent, non-twisting, neat harnessing. Molded of virgin nylon in white, black and assorted colors. Meets MIL-S-23190 and MS-17821.

Send for Free Samples

**ELECTROVERT** INC.  
Components Division  
86 Hartford Ave., Mt. Vernon, N. Y. 10553  
Milwaukee, Wis. • Burbank, Calif.



SOLD COAST-TO-COAST THROUGH AUTHORIZED DISTRIBUTORS

Visit **ELECTROVERT** at **WESCON SHOW, BOOTH NO'S. 3115-16-17.**  
INFORMATION RETRIEVAL NUMBER 105

ELECTRONIC DESIGN 17, August 16, 1969



**Best way**  
to heat sink  
TO-5 case style transistors

Flat face of the transistor header provides the most effective heat sinking surface. Wakefield Series 254 Thermal Retainers are designed to contact this preferred area.

Four types of No. 254 are available for mounting with stud, with a screw, or with soft-solder or by bonding. Type 254-SI (shown enlarged) has built-in 500v a-c electrical isolation. Thermal resistance range of 4 to 6°C/watt case to chassis for the various types.

For full details, request Distributor Products Catalog.

**WAKEFIELD**  
**ENGINEERING, INC.**

WAKEFIELD, MASS. 01880 ■ (617) 245-5900 •

WESCON SHOW BOOTH #2604-5

INFORMATION RETRIEVAL NUMBER 106

U175





## Simpson's new 2725.

# Compare it with the electronic counter you were going to buy:

SPECIFICATIONS	SIMPSON 2725	YOUR COMPARISON
Wide frequency range?	<b>YES.</b> 5 Hz to 20 MHz.	
Measures frequency ratios?	<b>YES.</b> 1 to $1.99999 \times 10^5$ .	
Measures time periods?	<b>YES.</b> 300 $\mu$ seconds to 0.2 second.	
Measures time intervals?	<b>YES.</b> 300 $\mu$ seconds to $1.99999 \times 10^3$ seconds.	
Totalizes?	<b>YES.</b> 0 to $1.99999 \times 10^5$ counts.	
Crystal controlled time bases?	<b>YES.</b> 6 xtal-controlled bases, switch selected.	
Self-test circuitry?	<b>YES.</b> Front panel switch tests logic circuitry.	
Dependable solid state design?	<b>YES.</b> Integrated circuits.	
Number of full time digits	<b>5.</b> Plus automatic overrange indication.	
Accuracy	<b><math>\pm 0.01\%</math></b> $\pm 1$ digit	
Price	<b>\$525.</b> complete with probe and operator's manual. \$	

4-digit Model 2724 also available: \$450.

GET "OFF-THE-SHELF" DELIVERY OF THE NEW SIMPSON DIGITAL ELECTRONIC COUNTERS AT DISTRIBUTORS STOCKING SIMPSON INSTRUMENTATION PRODUCTS

# Simpson

**ELECTRIC COMPANY**

5200 W. Kinzie Street, Chicago, Illinois 60644 • Phone (312) 379-1121  
 Export Dept: 400 W. Madison Street, Chicago, Illinois 60606. Cable Simeco  
 IN CANADA: Bach-Simpson Ltd., London, Ontario • IN INDIA: Ruttonsha-Simpson Private Ltd., International House, Bombay-Agra Road, Vikhroli, Bombay



INFORMATION RETRIEVAL NUMBER 107

## PACKAGING & MATERIALS

### Heavy-duty film tape shuns insulating oils



*Mystik Tape, Borden Inc., 1700 Winnetka Ave., Northfield, Ill. Phone: (312) 446-4000.*

Expressly designed for heavy-duty holding in electrical applications, a new rayon filament reinforced acetate film tape is compatible with insulating oils. Designated Mystik 7850, the new pressure-sensitive tape has a tensile strength of 215 pounds per inch and a dielectric strength of 5500 V. Its non-corrosive rubber resin system resists stress and is thermosetting.

Booth No. 2611 Circle No. 276

### IC packaging panel has connector mate

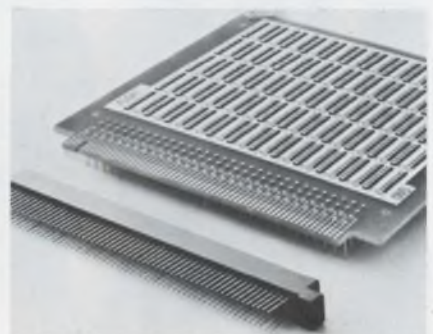

*Augat Inc., 33 Perry Ave., Attleboro, Mass. Phone: (617) 222-2202. P&A: \$75 to \$150/panel, \$18 to \$13/connector; stock to 4 wks.*

Series 8136-R high-density packaging panels are now available with mating edge connectors. The new panels will accept 14- and 16-lead dual-in-line integrated circuits. The connector is a dual-read-out edge unit with 60 dual contacts on a 0.1-in. grid spacing. Panel contacts are beryllium-copper gold over nickel.

Booth No. 2721 Circle No. 279

INFORMATION RETRIEVAL NUMBER 108 ►



# The Friden 1150 Digital Printer.

## It didn't fail us. So it won't fail you.

For nearly two years now, the Friden\* 1150 Digital Printer has been an integral part of our electronic printing calculator.

So we know all about its reliability from first-hand experience, out in the field.

This 50-character-a-second printer is *durable* because it has fewer moving parts than ordinary medium-speed printers. It is easier to maintain. This means less downtime for your OEM product. The 1150 Digital Printer contains a single 20-character print wheel and a synchronized print hammer. Both are driven across the tape from right to left at a uniform speed. The hammer's short impact time insures quality printing from the continuously rotat-

ing wheel. And we have eliminated messy ribbons with our disposable ink roller.

Logic requirements are simple, making it easy to integrate the 1150 Digital Printer into your OEM product.

One more important thing: the 1150 Digital Printer is *not* expensive. It just sounds expensive. With its low initial cost and desirable operating features, the 1150 Digital Printer gives you a price/performance ratio unique among OEM printers.

The complete specs are all in our Specification 1001.

For your copy, write: Friden Division, Component Products, The Singer Company, San Leandro, California 94577.

\*A TRADEMARK OF THE SINGER COMPANY

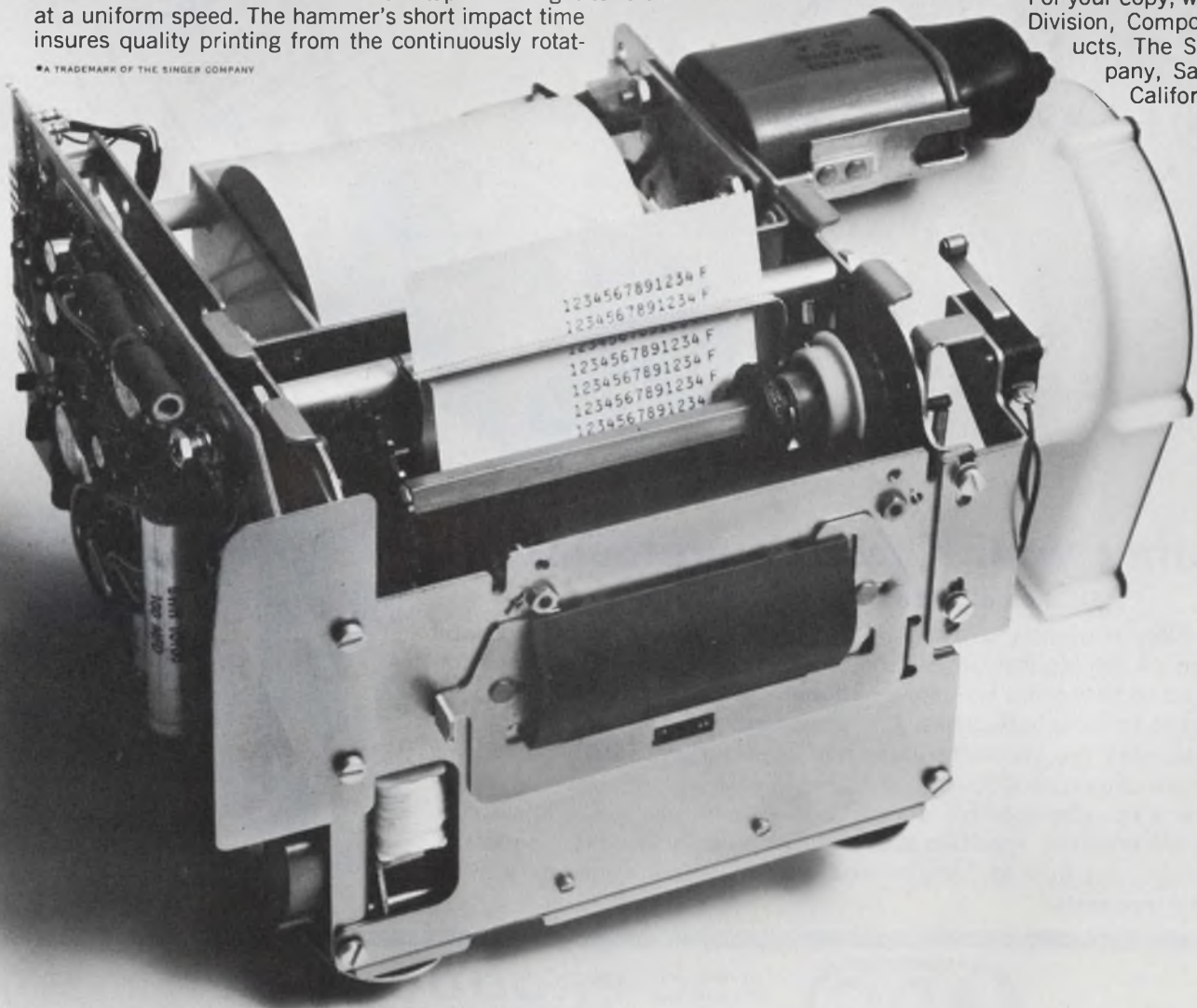



# Chebyshev—you'd be amazed at what ADC puts into a custom designed Filter.

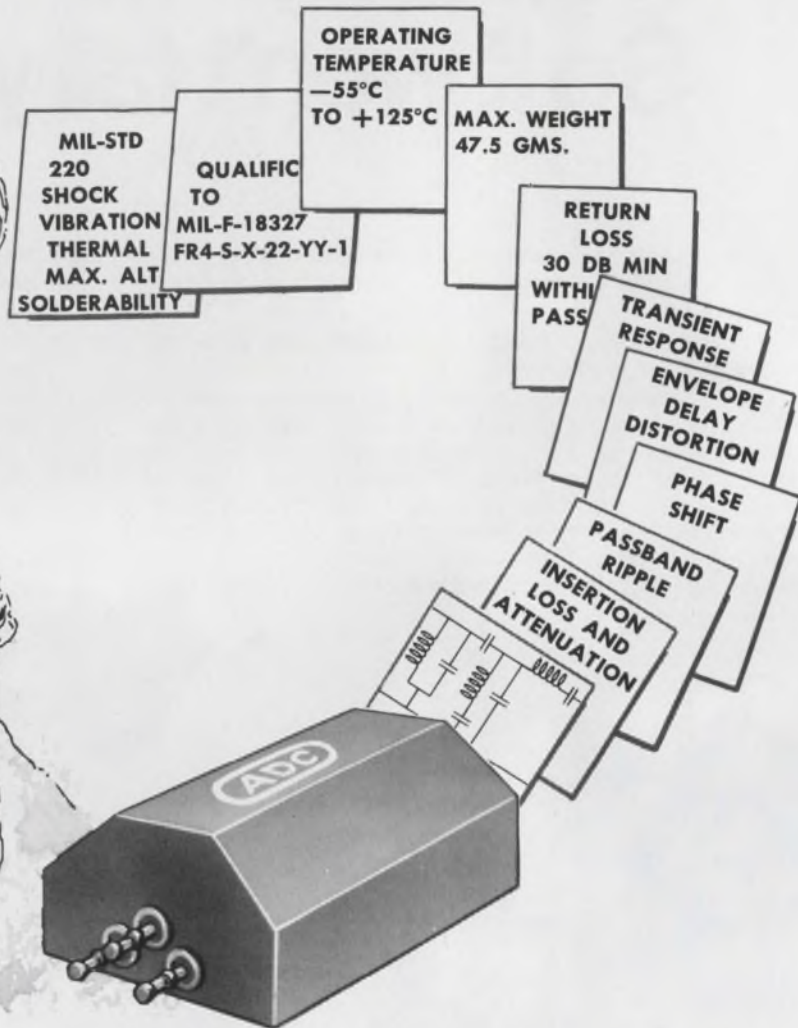

## Whether your Filter requirements are

**ADC has a staff to solve your problem**

Modern filter design is a complex art. Good designs call for careful innovation of the highest order. Sometimes parts of classic designs can be applied to problems, but more and more a highly creative approach is needed to tailor a network to your parameters. Of course, a computer helps determine the element values and their required efficiencies and temperature characteristics for predetermined performance. Still we find there is no substitute for a staff that understands the mathematics, physics, and material specifications peculiar to complex filter networks. This staff is your key to "engineered filters." We'll engineer a filter to fit your requests.

**simple**

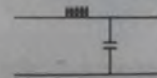

**or complex**

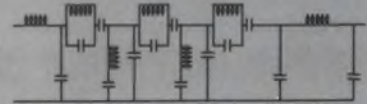

**ADC PRODUCTS**  
A DIVISION OF MAGNETIC CONTROLS CO.  
6405 CAMBRIDGE STREET • MINNEAPOLIS, MINN. 55426



# Sunrise, Sunset Courtesy of Amersil—Spectrolab— NASA.

NASA needed an earthbound sun...technically, a Solar Simulator.

They went to Spectrolab.

Spectrolab needed a lens, 36" in diameter, 6" center thickness, that would conform to the stringent requirements set forth by NASA.

They came to Amersil.

Working closely with the Spectrolab designers and engineers, Amersil determined that Infrasil Grade T-18 Fused Quartz had the characteristics to meet the specifications for the Solar Simulator. The lens was molded by Amersil, assembled into the Simulator by Spectro-

lab, and is now being placed into research operation at the NASA Langley Research Center, Hampton, Virginia.

This cooperation from the raw material to the finished products is common practice at Amersil. Our scientists, engineers and designers have the experience, know-how and facilities to meet the needs of industry for high purity Fused Quartz and Fused Silica. These include the finest casting, molding and drawing equipment available.

Get full information and/or technical assistance by writing Amersil today.

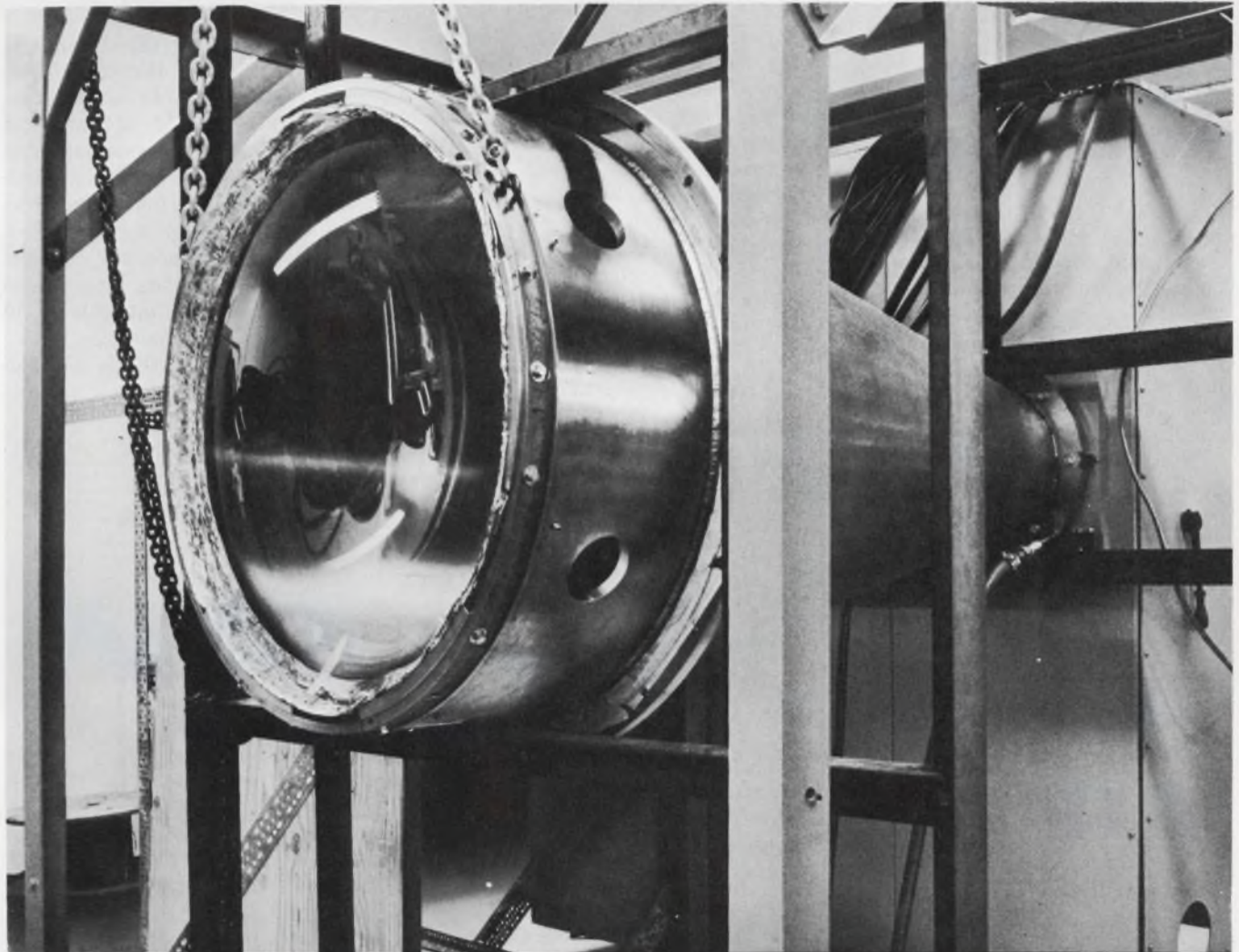

**AMERSIL**  
INC.

**FUSED SILICA  
AND QUARTZ**

685 RAMSEY AVE., HILLSIDE NEW JERSEY 07205

SEE US AT WESCON, BOOTHS #3124 AND 3125.

INFORMATION RETRIEVAL NUMBER 110



# New High Voltage High Power Rectifiers

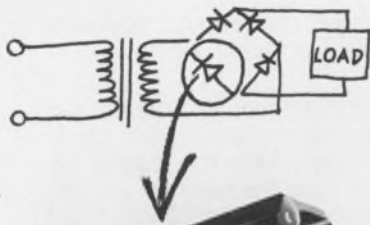

## VC Series from Varo.

Our new VC Series rectifiers may be tiny (3" long, 3/4" high, 3/4" wide), but they're plenty tough enough to stand up under high voltage, high power conditions.

They have voltage ratings of from 2 KV to 8 KV, current ratings of 1 to 2 amps, and they're available with an optional 300 nanoseconds recovery time.

Varo VC Series rectifiers are made to handle the biggest jobs. Like X-ray power supplies, radio and radar transmitters, and things like the new microwave oven power supplies.

And they'll handle most of the new high voltage, high power system demands that'll be coming along in the future, too.

The new VC Series from Varo.

It's the kind of thing we know you've come to expect from us.

# \$4.18

 EACH

VC-80 (8,000 Volts — 1 Amp).  
1,000 quantity.



VARO

SEMICONDUCTOR DIVISION  
1000 N. SHILOH ROAD, GARLAND, TEXAS  
75040 (214) 272-4551  
INFORMATION RETRIEVAL NUMBER 111

## DATA PROCESSING

### High-speed calculator finds square roots



Singer Co., Friden Div., 2350  
Washington Ave., San Leandro,  
Calif. Phone: (415) 357-6800;  
P&A: \$1195; stock.

Specially designed for engineering, statistical and scientific use, a new electronic calculator contains a key that extracts square roots instantly. Model 1162 calculates in milliseconds and flashes answers silently on its built-in miniature cathode-ray tube. There are five registers, each holding up to 14 digits, for calculation and storage.  
Booth No. 2021 Circle No. 343

### Wideband system keys data quickly



RFL Industries, Inc., Communica-  
tions Div., Boonton, N.J. Phone:  
(201) 334-3100. Price: \$325.

To answer the need for data-channel or data-terminal field keying, a new data keyer is capable of keying nonsynchronous data transmitters over wide ranges to facilitate adjustment and maintenance of data systems. Model 3865 permits neutral negative, neutral positive and EIA interfaces. Keying speeds from 2 dot cycles to 22k dot cycles are possible.

Booth No. 1606 Circle No. 342

### Computer/calculator handles 16 terminals



Mathatronics Div., Barry Wright  
Corp., 241 Crescent St., Waltham,  
Mass. Phone: (617) 893-1630.

A new computer/calculator system permits up to 16 remotely located keyboards or 16 page printers (typewriters) to be operated at the same time. The terminals may be direct wired for short distances (1000 ft.) using four-wire telephone-type cable, or for unlimited distances with an acoustic coupler. The CS3 simultaneous central station performs all operations in floating point arithmetic.

Booth No. 5517 Circle No. 296

### Memory system cycles in 900 ns

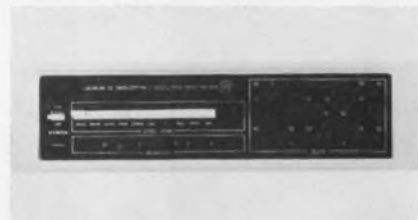

Varian Data Machines, 2722  
Michelson Drive, Irvine, Calif.  
Phone: (714) 833-2400.

A new coincident-current core memory system operates asynchronously with a full-cycle time of 900 ns and an access time of 350 ns. Two VersaSTORE IV models are available: one with a storage capacity of 4096 words of 40 bits, or 8192 words of 20 bits; the second can store up to 8192 words of 40 bits or 16,284 words of 20 bits. Bit length is available in 8-bit increments for both versions.

Booth No. 3709 Circle No. 344





### Ultra Compact Rotary Switch 1/2" does a man-sized job

Rugged rotary outperforms its nearest competitors by the widest of margins, gives you man-sized performance at a bargain price. Don't believe it? Compare:

FEATURES	OAK 1/2" SWITCH	BRAND "A" SWITCH	BRAND "B" SWITCH
Double-wiping contacts	Yes	No	No
1/2" Diameter	Yes	Yes	Yes
Multiple Decks	Yes	No	Yes
P. C. Capability	Yes	Yes	Yes
Tri-Ball Detent	Yes	No	No
Adjustable Stops	Yes	No	No
Designed to Meet Mil-S-3786/19	Yes	No	No
Available through Electronic Distributors	Yes	No	No
COMPARE!	OAK LOWEST in Cost	Cost is 60% HIGHER	Cost is 140% HIGHER

#### GET OAK QUALITY PLUS THE LOWEST PRICE IN THE INDUSTRY

For full details on the sub-miniature switch that does more, write today for Bulletin SP-299.



OAK MANUFACTURING CO.  
A Division of OAK ELECTRO/NETICS CORP.  
Crystal Lake, Illinois 60014  
Phone: 815-459-5000 TWX: 910-634-3353

INFORMATION RETRIEVAL NUMBER 112

**PROVEN RELIABILITY—  
SOLID-STATE POWER INVERTERS,  
over 260,000 logged operational hours—  
voltage-regulated, frequency-controlled,  
for missile, telemeter, ground support,  
135°C all-silicon units available now—**

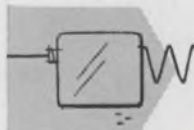
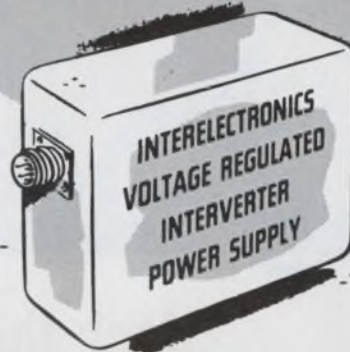

Interelectronics all-silicon thyatron-like gating elements and cubic-grain toroidal magnetic components convert DC to any desired number of AC or DC outputs from 1 to 10,000 watts.

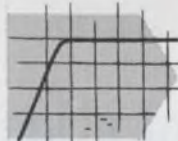

Ultra-reliable in operation (over 260,000 logged hours), no moving parts, unharmed by shorting output or reversing input polarity. High conversion efficiency (to 92%, including voltage regulation by Interelectronics patented reflex high-efficiency magnetic amplifier circuitry.)



Light weight (to 6 watts/oz.), compact (to 8 watts/cu. in.), low ripple (to 0.01 mv. p-p), excellent voltage regulation (to 0.1%), precise frequency control (to 0.2% with Interelectronics extreme environment magnetostrictive standards or to 0.0001% with fork or piezoelectric standards.)



Complies with MIL specs. for shock (100G 11 mls.), acceleration (100G 15 min.), vibration (100G 5 to 5,000 cps.), temperature (to 150 degrees C), RF noise (I-26600).



AC single and polyphase units supply sine waveform output (to 2% harmonics), will deliver up to ten times rated line current into a short circuit or actuate MIL type magnetic circuit breakers or fuses, will start gyros and motors with starting current surges up to ten times normal operating line current.



Now in use in major missiles, powering telemeter transmitters, radar beacons, electronic equipment. Single and polyphase units now power airborne and marine missile gyros, synchros, servos, magnetic amplifiers.



Interelectronics—first and most experienced in the solid-state power supply field produces its own all-silicon solid-state gating elements, all high flux density magnetic components, high temperature ultra-reliable film capacitors and components, has complete facilities and know how—has designed and delivered more working KVA than any other firm!

**INTERELECTRONICS CORPORATION  
550 U. S. Route 303, Congers, N. Y.  
Telephone: 914 ELmwood 8-8000**

INFORMATION RETRIEVAL NUMBER 113



**Logic cards  
shun noise**

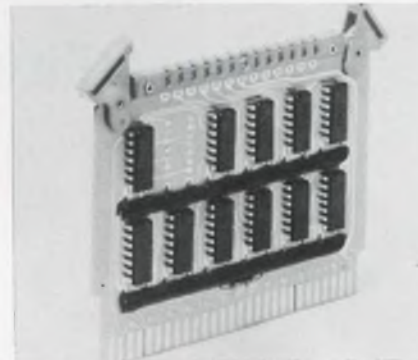

*Electronic Engineering Co. of Calif., 1601 E. Chestnut Ave., Santa Ana, Calif. Phone: (714) 547-5501.*

A new line of high-noise environment logic cards is designed for industrial applications requiring a high degree of inherent electrical noise immunity. The initial 15 members of the D-4400 series cover almost all system designs. They are mechanically compatible with current EECoLogIC 2 cards, but are easily distinguished by their red handles and test points.

*Booth No. 3814 Circle No. 274*

**Fast a/d converters  
work 10 bits at 200 kHz**

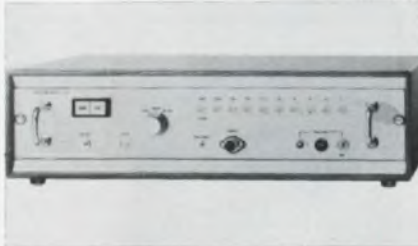

*Biomation/Datalab, 1076 E. Meadow Circle, Palo Alto, Calif. Phone: (415) 321-9710. Price: \$1650 or \$2250.*

Using a successive approximation conversion technique, series 700 analog-to-digital converters, combine fast conversion times with high resolution, low aperture times and good temperature stability. Model 710 is a 10-bit converter with a conversion rate of 200 kHz including sample-and-hold; model 712 is a 12-bit converter with a conversion rate of 125 kHz.

*Booth No. 1711 Circle No. 341*

**KROHN-HITE MODEL 4200 VS MAJOR COMPETITORS**

MFR	H-P	H-P	G-R	K-H
Model Number				4200
Price				\$350
Frequency Range				10 Hz to 10 MHz
Power Out				500 mw
Waveform Distortion				<0.1%



**Stack this  
\$350 oscillator  
against the  
competition**

**regardless of price!**

Visit Us  
Booth No.  
1828

You'll be surprised! In spite of its low price, the Model 4200 exhibits extraordinary performance. It excels in those specifications most eagerly sought by men who really know oscillators. Krohn-Hite's twenty years of frequency-generator know-how has produced a unique circuit\* that makes low-priced high performance a reality at last.

Here's how the Model 4200 stacks up against several competitors:

**BROADER FREQUENCY RANGE:** The Model 4200 out-ranges most of the others, including more expensive units.

**MORE OUTPUT POWER:** The Model 4200 has from 2.5 to 50 times the power of the other units.

**BEST WAVEFORM PURITY:** The Model 4200 is unexcelled.

**BEST BUY:** The \$350 price speaks for itself.

See for yourself. Write for data. Then contact your Krohn-Hite Representative for a no-holds-barred demonstration. The Model 4200 is a lot of oscillator for \$350.

\*Patent applied for.



580 Massachusetts Ave., Cambridge, Mass. 02139, U.S.A.  
Phone: (617) 491-3211 TWX: 710-320-6583

Oscillators / Filters / AC Power Sources / DC Power Supplies / Amplifiers

INFORMATION RETRIEVAL NUMBER 114



# This is the world's smallest all-pluggable DPM.



Weston Model 1290  
**\$204**

## Then there's our less expensive model.



Weston Model 1260  
**\$99.50**

We brought out our 3½-digit compact DPM\* just last March. It's the one that plugs into a panel slot only seven inches square, and pulls out for servicing or replacement. If you need the accuracy of 3½ digits, Model 1290 is still your best buy. But if you can settle for a digit less, you can have our new Model 1260 at less than half the price. Don't be fooled by the price tag, though . . . there's nothing "cheap"

about this 2½-digit version. Housed in the very same plug-in case and fully compatible with its more sophisticated brother, Weston Model 1260 offers 0.5% ±1 digit accuracy—with far greater resolution capability than mechanical movements provide. Full scale reading is 199, with 25% over and under-range capability, remote command signal and Weston's usual high rejection characteris-

tics. In addition to the convenience of front panel pluggability and circularly polarized viewing, we've included front panel calibration as a built-in bonus feature on the 1260. Write to the originators of the DPM. WESTON INSTRUMENTS DIVISION, Weston Instruments, Inc., Newark, N.J. 01774.

a Schlumberger company  
**WESTON®**



# Look-NO HANDS!

## BARNES ELIMINATES MANUAL LEAD STRAIGHTENING/CARRIER LOADING... FOR TO-STYLE IC'S

Are you tired of the high cost of straightening IC leads *by hand*? Then it's high time you tried the Barnes Oriole® Lead Straightener/Carrier Loader. You'll straighten 3 to 12 leads on TO-5's, 3 or 4 leads on TO-18's, or load them into Barnes Carriers. There's a manual model that straightens leads, or loads carriers, at 600 devices an hour. The semi-automatic model is pneumatically operated at 800 an hour. And conversion kits are available that add almost unlimited flexibility. Write or call us for the complete story.

**barnes**  
CORPORATION

Lansdowne, Pa. 19050 • 215/MA2-1525

**barnes** / THE WORLD'S MOST COMPLETE LINE OF SOCKETS, CARRIERS AND CONTACTORS FOR I.C.'S



\*Patent Pending

INFORMATION RETRIEVAL NUMBER 116

## DATA PROCESSING

### Fast a/d converter works 10 bits/μs



Analog Devices, Inc., Pastora Div., 221 Fifth St., Cambridge, Mass. Phone: (617) 492-6000. P&A: \$1990; 6 to 10 wks.

Model ADC-F analog-to-digital converter combines successive-approximation methods and single-card modularity to achieve complete 10-bit conversions within 1 μs. This new technique results in the elimination of sample-and-hold and multiplexing circuitry in many interfacing applications. Relative accuracy is 0.05%, and temperature coefficient is 50 ppm/°C from 0 to 70°C.

Booth No. 1706 Circle No. 258

### High-speed tape system verifies and duplicates

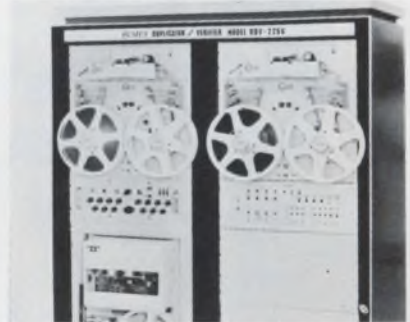

Remex Electronics, div. of Ex-Cell-O Corp., 5250 W. El Segundo Blvd., Hawthorne, Calif. Phone: (213) 772-5321. P&A: \$5295 to \$13,655; 10 wks.

A new high-speed punched-tape duplicator/verifier performs tape-to-tape verifications, from opaque to 70% transparent, at 300 characters per second with reader-spooler combinations. Model RDV-225-D can also duplicate tapes at speeds of 225 characters per second.

Booth No. 5503 Circle No. 410

INFORMATION RETRIEVAL NUMBER 118 ►

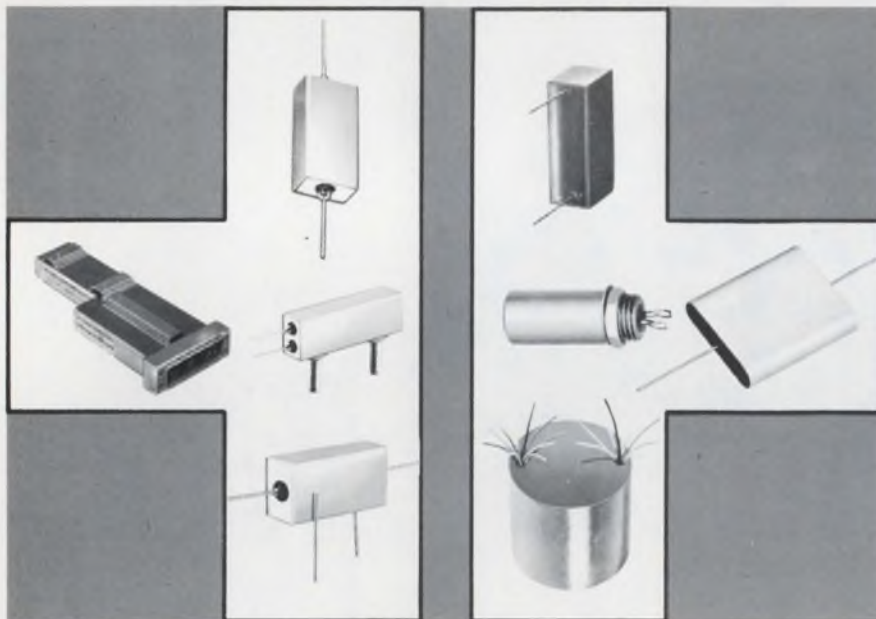

**We Build That Special Capacitor...** So if you should have an existing packaging problem and thinking in a new dimension, chances are S & E I can build you one, and in many cases at no extra cost or delivery delays. S & E I designs and manufactures specially applied capacitors for many aerospace, electronics and commercial programs with these added features: **Environmental Burn-in • Special Tests • Form Factor • Variety of Sizes and Ranges • Case Materials • Leads and Terminal Compositions • Dielectric Combinations • Special Mountings.** We invite you to call and discuss any configuration techniques, that could solve your problem.

**S&E I** Manufacturing/Capacitors

18800 Parthenia Street, Northridge, California 91324 • (213) 349-4111 • TWX 910-493-1252

INFORMATION RETRIEVAL NUMBER 117



**How much space can I save by using the new "tini-telephone" jack panels and accessories?**

You can figure on a fifty-percent reduction in space by using the Switchcraft "tini-telephone" patching system. And, we do mean system!

These aren't just scaled-down versions of standard-size patching components. The "tini-telephone" jack panels and accessories (see Fig. 1.) were designed from scratch to offer quality and convenience features never before available. (Just circle the reader service number to receive complete information.)

**Sounds good, but how about the accessories? I don't want any compatibility problems in matching components from different vendors.**

Let's take the accessories one-by-one and you'll see what we mean by "tini-telephone" system:

**PATCH CORDS —**

Circuit-wise, you can have two or three conductor single plug patch

ords or three or five conductor twin plug patch cords in a variety of cable lengths. The cable is high quality stranded plastic-jacketed type with shielding rated at 70-80%. All connections are soldered, and improved strain relief is accomplished by crimping a long tubular metal sleeve 360° around the cable jacket and plug sleeve.

Flexible, molded PVC handles minimize cable breakage and absorb any tolerance variations between twin plugs and mating panel jacks. Terminating, dummy and looping plugs are also available.

**SWITCHES —**

A gusseted extra-strength frame is provided on "tini-telephone" switches. Plenty of throw is provided to assure contact wipe and required pressure for low contact resistance. The switches are rated 2 amps 200 watts max., A.C. non-inductive load with circuit configurations up to 2C (or 3A) and momentary or push-pull actuation may be specified.

**LAMP JAX —**

"tini-telephone" lamp jax accept standard bi-pin lamps and offer convenient front panel relamping. Special heat sink fins dissipate heat and a unique jewel and sleeve

assembly eliminates the need for special insertion or withdrawal tools when relamping. (See Fig. 2.)

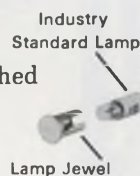

Fig. 2.

The jack panel, itself, has an extra wide flange for better rigidity and the molded panel inserts permit the jack bushings to protrude slightly from the panel face for more positive electrical continuity in the sleeve circuit with the mating jack. Then there's the snap-on designation strips and reusable marking strips for fast, frustrationless nomenclature changes. Additional accessories such as, blank panel inserts, opaque-black hole plugs, plus designation strip kits gives you the most versatile, compact patching system ever designed.

**Looks like you've thought of everything. I'll need complete specifications for my engineering group.**

Just request our "FORUM FACTS" catalog on "tini-telephone" jack panels & accessories on your company letterhead.



5529 North Elston Avenue  
Chicago, Illinois 60630

# SWITCHCRAFT FORUM

Introducing the new "tini-telephone" patching system

See us at WESCON Booths 3909-3910, Cow Palace

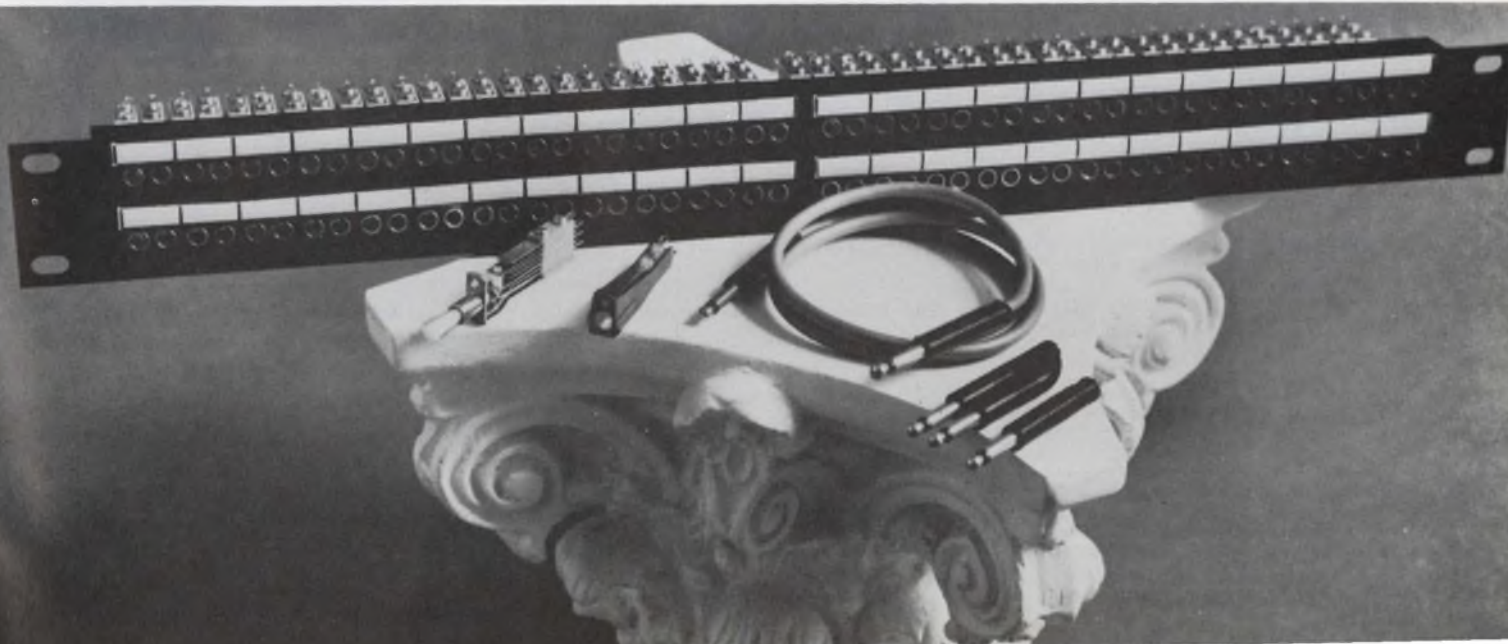



TUBULAR,  
BULKHEAD  
MOUNTING TYPE

# RFI/EMI FILTERS



**Rtron**

## Cylindrical Style Interference Filters

that reduce or eliminate unwanted noise or signals. Small size, light weight, maximum attenuation. Voltage current or insertion loss characteristics required, determine physical size. Maximum isolation of terminals and high frequency performance are assured by threaded neck design for bulkhead mounting. Feed-thru capacitor circuitry conservatively rated for both military and commercial applications.

**Rtron** corporation

P.O. Box 743 Skokie, Illinois 60076

- Send catalog and prices.
- Have Representative call for appointment.
- Specifications enclosed on Multi-circuit or custom design filters. Send estimate.

Name \_\_\_\_\_

Firm \_\_\_\_\_

Address \_\_\_\_\_

City \_\_\_\_\_

State \_\_\_\_\_ Zip \_\_\_\_\_

INFORMATION RETRIEVAL NUMBER 122

## PRODUCTION

### Ultrasonic cleaner goes solid state



*Esterline Angus, div. of Esterline Corp., P. O. Box 24000, Indianapolis, Ind. Phone: (317) 244-7611.*

Designed for continuous operation, a new ultrasonic cleaner features completely transistorized all-solid-state circuitry. Model EA12 has a fine-action cleaning system that works on pens without damaging their points, the print wheels on strip-chart recorders, and many other items. It supplies 50 W of cleaning power.

Booth No. 1022 Circle No. 285

### Semiconductor bonder handles 2-in. wafers



*Unitek Corp., Weldmatic Div., 1820 S. Myrtle, Monrovia, Calif. Phone: (213) 359-8361. P&A: \$10,000; 60 days.*

Performing thermocompression bonding, a new flip-chip and beam-lead bonder works on substrates up to 2-in. square. Model 8-152-01 is a semi-automatic unit that produces bond characteristics that are totally controllable and repeatable. Critical adjustments are programmed and preset to make operation extremely simple.

Booth No. 2924 Circle No. 340

### Dual-action cleaner consolidates its tanks



*L & R Manufacturing Co., 577 Elm St., Kearny, N. J. Phone: (201) 991-5330. Price: \$299.50.*

A new dual-action ultrasonic cleaner features two transducerized tanks capable of simultaneous ultrasonic cavitation to double cleaning capacity and cut cleaning time; each tank may also be run separately. Handsomely packaged in a console cabinet with built-in generator, model 320D-2 has two 1-1/4-quart tanks with a multi-selector switch and automatic electrical timer.

Booth No. 3304 Circle No. 287

### Lead straighteners correct TO packages



*Barnes Corp., 24 N. Lansdowne Ave., Lansdowne, Pa. Phone: (215) 622-1525. P&A: \$2200 to \$3450; 4 to 6 wks.*

Series 450-021 Oriole lead straighteners and series 450-022 carrier loaders can straighten leads on TO-5 and TO-18 packages or can load the packages into series 029-535 carriers. Both series accept TO-5-type axial-lead packages with 3 through 12 leads in TO-5 styles and 3 or 4 leads in TO-18 styles. Lead lengths can be 1/2 and 3/4 in. Both manual and semi-automatic versions are available.

Booth No. 2606 Circle No. 411



**Component printer  
marks 16,000/hour**

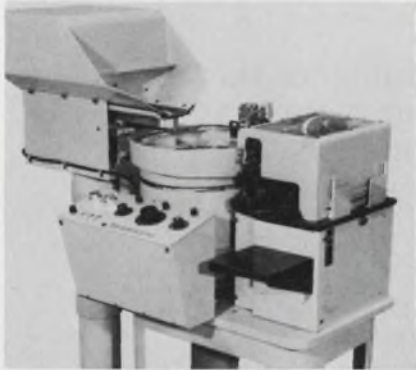

Markem Corp., 150 Congress St., Keene, N.H. Phone: (603) 352-1130.

Model U-1184 high-speed component printer can mark components, such as TO-5 and TO-18 packages, on both their top and side, at speeds up to 16,000 parts per hour. Pieces are bulk stored in a bin and automatically fed to the conveyor from a vibratory feed bowl. The new system can also perform associated functions like component counting and packaging. Booth No. 3407 Circle No. 369

**Detector/controller  
counts 400 parts/min**



Eagle Signal Div., Gulf Western Co., 736 Federal St., Davenport, Iowa. Phone: (319) 324-1361.

Model EW 70 metal detector system accurately counts and controls metal products in all shapes and sizes, from pins to locomotives. This compact solid-state system can count up to 400 parts per minute in any attitude. Dirt, oil, moisture and vibration are said to have little or no effect on its accuracy.

Booth No. 5207 Circle No. 284

**Two great bench-top  
temperature chambers**

to match your testing needs at great low prices from Tenney!

**PLAIN**

**The new TENNEY SST**

Sturdy new "Hermeticool" mechanically refrigerated chamber now available at a great low price. Check these features:

- Range:** -95° F to +350° F,  $\pm 1/2^\circ$  F control
- Chamber Dimensions:** 16" wide x 11" deep x 12" high
- Heatup:** To +350° F in 35 minutes
- Pulldown:** From ambient to -95° in 55 minutes
- Power:** 110 volts

FULL PRICE:

**\$890**

including temperature indicator.  
Available from stock.

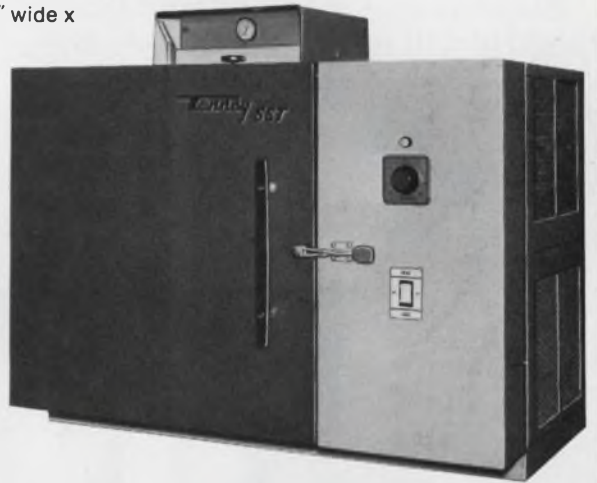

**& FANCY  
TENNEY JR.**

The ultimate in a bench-top high-low temperature chamber. "Hermeticool" mechanically refrigerated, solid-state SCR instrumentation, and many other exceptional features!

- Range:** -120° F to +350° F,  $\pm 1/4^\circ$  F control
- Chamber Dimensions:** 16" wide x 11" deep x 12" high
- Heatup:** To +350° F in 35 minutes
- Pulldown:** From +75° F ambient to -100° F in 35 minutes
- Power:** 115 volts

FULL PRICE:

**\$1080**

Available from stock

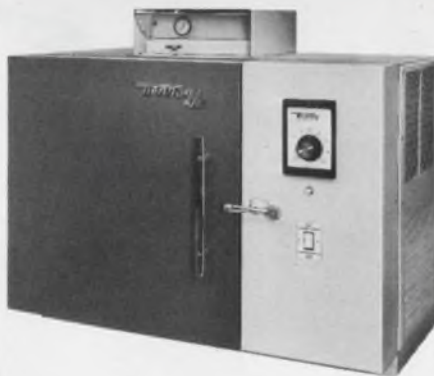

**Tenney**  
ENGINEERING, INC.

1090 Springfield Rd., Union, New Jersey 07083 • (201) 686-7870  
Western Division: 15721 Texaco St., Paramount, Calif. 90723

514A

INFORMATION RETRIEVAL NUMBER 123



# New bank book for savings

Send for our new 1969 Relay Catalogue and we guarantee it will open your eyes to ways of saving money on most frequently used Industrial Type Relays.

It will help you save time, which is worth money. Avoid production delays, which is worth money. And cut rejections to the bone, which is also worth money.

Besides, a quotation from Line Electric will be competitive every-

time, which could save you a lot more money, too.

We send out catalogues the same day we receive your request and, if you are in a great hurry, we will even try to give you a quotation over the phone. Just call 201-887-8200 and ask for our Relay Sales Manager. We're dedicated to service.

**LINE ELECTRIC COMPANY**  
*U.S. Highway 287, Parsippany, N.J. 07054*  
*Manufacturers of Relays and the best service in the business. SUBSIDIARY OF THE SINGER COMPANY*

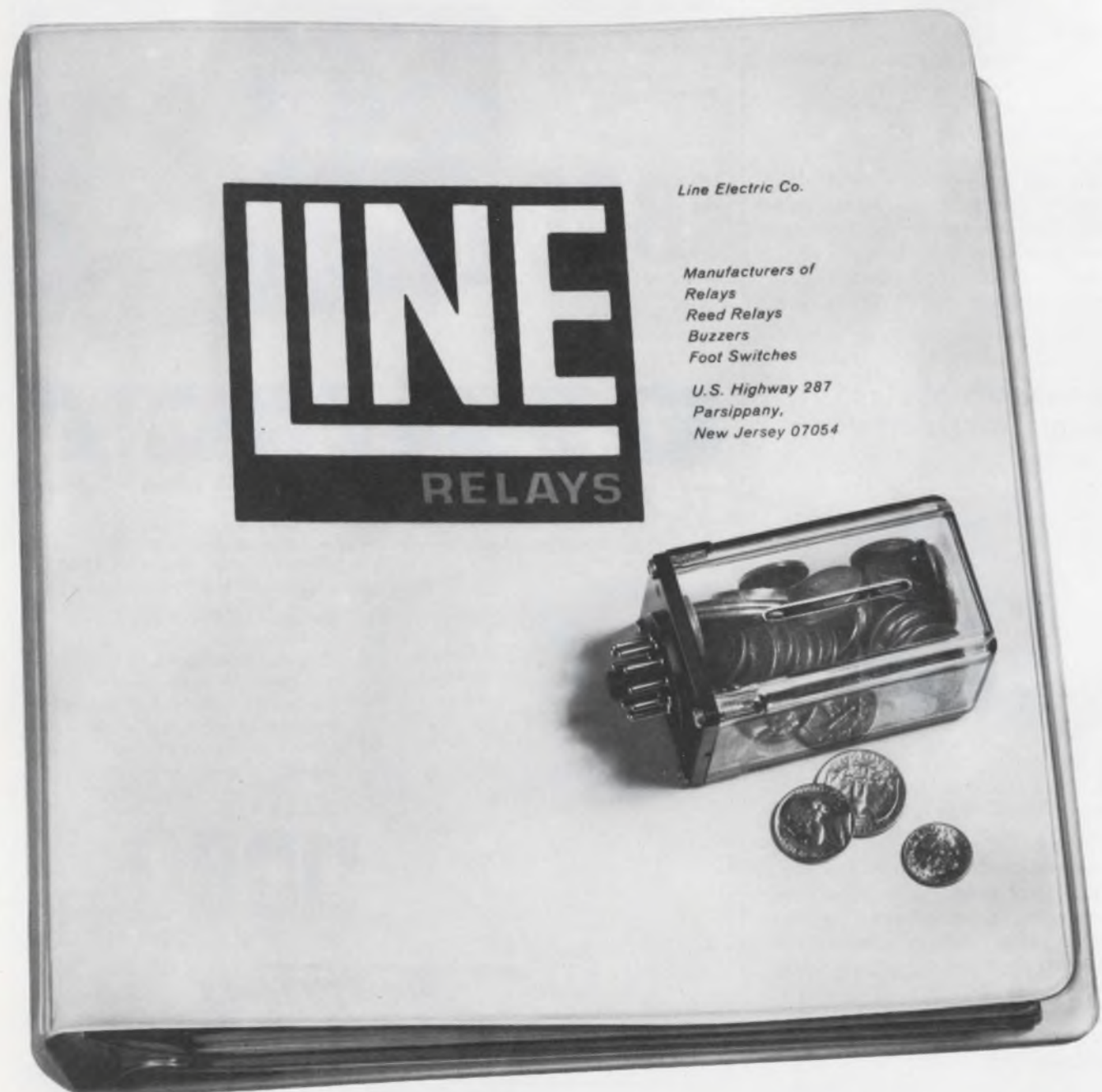



# Technology

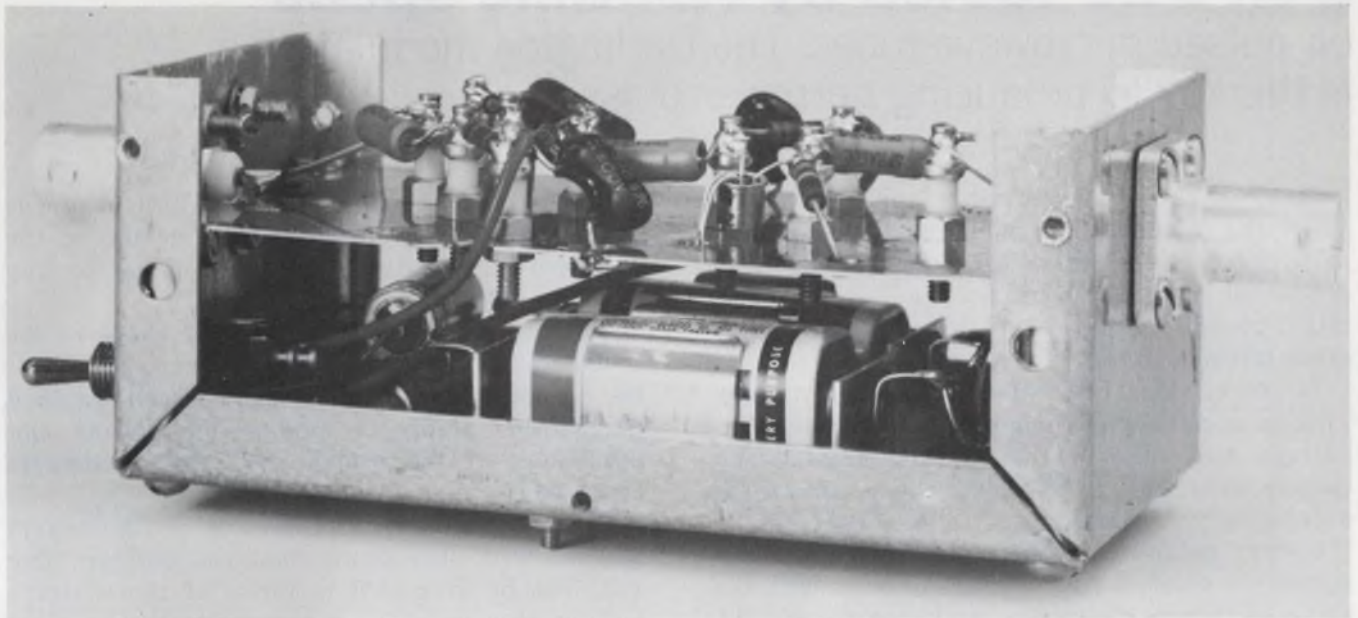

**Transistors pass signals** in both directions. If this is your problem, you can correct it by

blocking the reverse gain in your transistor amplifier. p. 205.

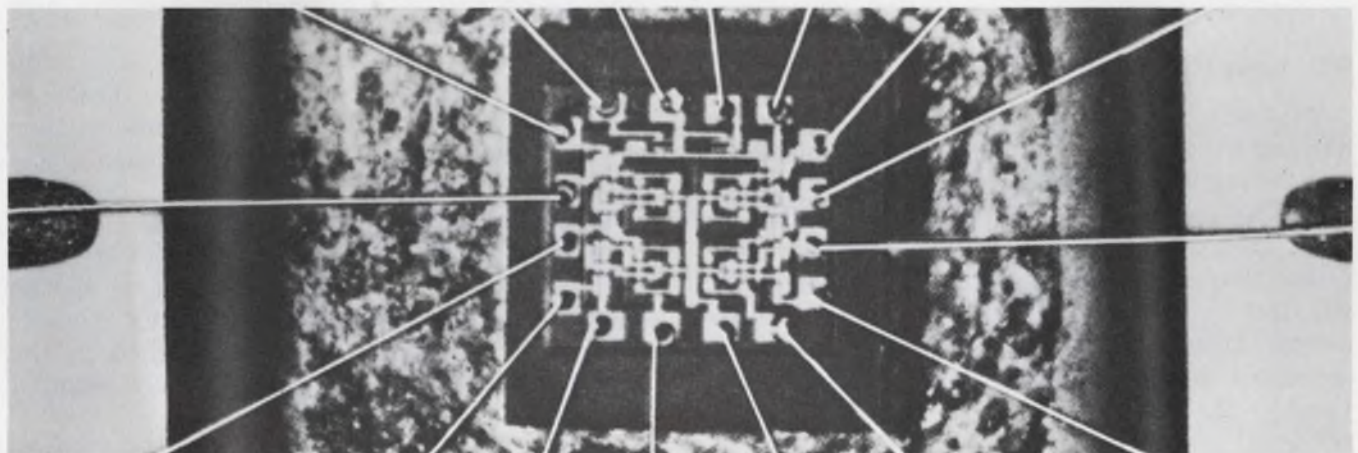

**Amplify biological signals** with ICs. Monolithic op amps in special circuits offer high

CMRR, high input impedance and tolerance to dc noise. p. 218.

## Also in this section:

**Don't be fooled by risetime specs** on pulsed microwave tubes. p. 190.

**Avoid pitfalls in computerized testing** with these ground rules. p. 196.

**Make systems fail-operational** by using multiple channels. p. 213.

**Don't just fight semiconductor noise**—analyze it. p. 228.

**Ideas for Design.** p. 238



# Don't be fooled by risetime specs on pulsed microwave tubes. The Darlington modulator is the key to producing narrower pulses.

Many high-resolution radar applications require the transmission of narrow pulses with very high peak powers. The chief drawback in producing these pulses is that the risetime limitation placed on the radar's power output tube is often misunderstood.

In particular, the rate of rise of voltage (RRV) specification imposed on users of magnetrons and other cathode-pulsed crossed-field devices unnecessarily restricts the pulse widths obtainable from high-power radars. By learning the story behind the RRV specification, the designer can construct modulators to work with the tubes so that performance levels far beyond the published ratings can be achieved. For example, we have built several radar systems in which the maximum specified RRV has been exceeded by as much as seven times.

## RRV limited to critical range

Typically, magnetron specifications place a limit on the maximum rate of rise of voltage that may be applied to the cathode for proper operation. The transmitter designer presumes this to mean that, if the modulator voltage pulse rises faster than this specified limit, the magnetron will fail to start, or else that moding, missing pulses, tube arcing, excessive jitter and/or shortened tube life will result. If this limitation (usually 200 to 300 kV/ $\mu$ s for high-power conventional magnetrons and 75 to 160 kV/ $\mu$ s for high-power coaxial magnetrons) is observed, it practically precludes the generation of pulses with durations of less than a few tenths of a microsecond at power levels above 100 kW.

Fortunately, the RRV limitation does not have to be observed except during a small fraction of the total risetime of the modulator pulse. It is only for the critical range of voltage—called the starting-voltage range—over which the rf oscillation is being established that a minimum time limitation must be observed. The other two

voltage ranges—from zero to the bottom of the starting-voltage range and from the top to the full operating voltage—are not subject to any such limitations.

The only other restriction on the shape of the modulator pulse is that it should not overshoot the maximum operating voltage; in well designed magnetrons, improper moding and arcing can occur only if the proper operating voltage is exceeded.

What is the time required for oscillations to start? Pierce<sup>1</sup> has found that the buildup time ( $\Delta t$ ) can be expressed in terms of the effective buildup  $Q$ , namely  $Q_n$ , of the cavity as:

$$\Delta t = -Q_n \log_e \tilde{V} / \omega \quad (1)$$

where  $\tilde{V}$  is the rf voltage and  $\omega$  is the radian frequency. For a typical high-power magnetron ( $Q_n = -25$ ),  $\Delta t = 36.6/f$ , where  $f$  is the frequency in Hertz.

Thus, for a conventional magnetron operating at X-band, the buildup time is in the order of four nanoseconds. At K-band, the buildup time can be less than one nanosecond. Considerable experimental evidence has confirmed that this relationship is approximately correct.

All that the designer must do, therefore, is to make sure that the modulator pulse spends enough time traversing the starting voltage range for oscillations to be established in the proper mode. As we shall see, simply using a

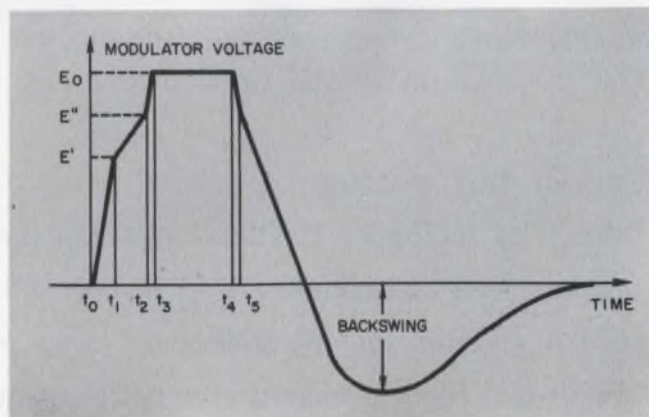

1. The critical period from  $t_1$  to  $t_2$  is the only interval over which there is a limitation on the RRV.

J. T. Tymann, S. I. Rambo and A. L. Quesinberry, Westinghouse Electric Corp., Defense and Space Center, Baltimore, Md.



Darlington modulator will assure this result.

The ideal pulse shape for narrow-pulse magnetron applications<sup>2</sup> is shown in Fig. 1. The risetime from zero to  $E'$  is usually of little concern since only noise is produced in the tube during this period. The length of the interval from  $t_0$  to  $t_1$  is dependent primarily on the output impedance of the modulator and the input impedance presented by the tube before it starts drawing current. The voltage  $E'$  is the lower limit of the starting voltage range.<sup>3</sup>

The voltage  $E''$  is the upper limit of the starting-voltage range, and it also is dependent on the pulser impedance. This voltage is approximately 80% of the operating voltage. The time interval  $t_1$  to  $t_2$  must be of sufficient duration to permit oscillations to become established in the desired mode. Once the oscillations have been established, the voltage can then rise to full operating level in a very short time, because at time  $t_2$  the tube is oscillating in the proper mode and is drawing approximately 10% of full current.

Once the voltage has reached the operating level ( $E_0$ ) it should be held constant for the duration ( $t_3$  to  $t_4$ ) of the rf pulse. It can then fall as rapidly as possible on the trailing edge until it again reaches the voltage  $E''$  ( $t_4$  to  $t_5$ ); at this point steady-state oscillations are no longer sustained. Ideally, the voltage should then fall

slowly to zero to alleviate backswing difficulties.

It is one thing to describe a desired wave-shape and quite another to generate it. The usual type of modulator used in radar work is the line-type pulser<sup>4</sup> (Fig. 2). Units of this type can be designed to produce pulses only as narrow as approximately  $0.25 \mu\text{s}$  in these high-power microwave applications. The resulting rf pulses can be as small as perhaps  $0.18 \mu\text{s}$  if optimum design techniques are used.

#### Problems in generating the ideal pulse

However, overshoot is inherent in modulators of this type because of the leakage inductance of the transformer and the capacitance of the transformer secondary and the tube. Because the pulse shape produced by the line-type circuit is rather steep through the starting voltage range, the despiking circuit and primary delay coil shown are often required to slow down the rate of rise of voltage for proper magnetron operation.

It is this characteristic of the line-type modulator that probably first gave rise to the formulation of maximum RRV specifications. As we have seen, however, the specification isn't very useful unless it is accompanied by a description of the modulator for which it was formulated.

Various special line-type modulators have been tried for overcoming the pulse-width limitations

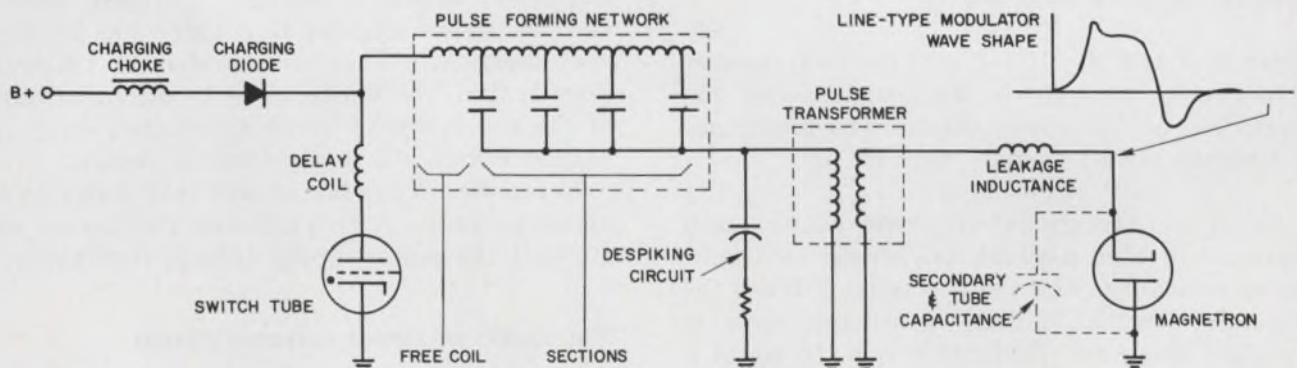

2. **Risetime limitations** make the conventional line-type pulse modulator unsuitable for the generation of very

narrow pulses. About the best they can do is 0.25 microsecond in these high-power radar applications.



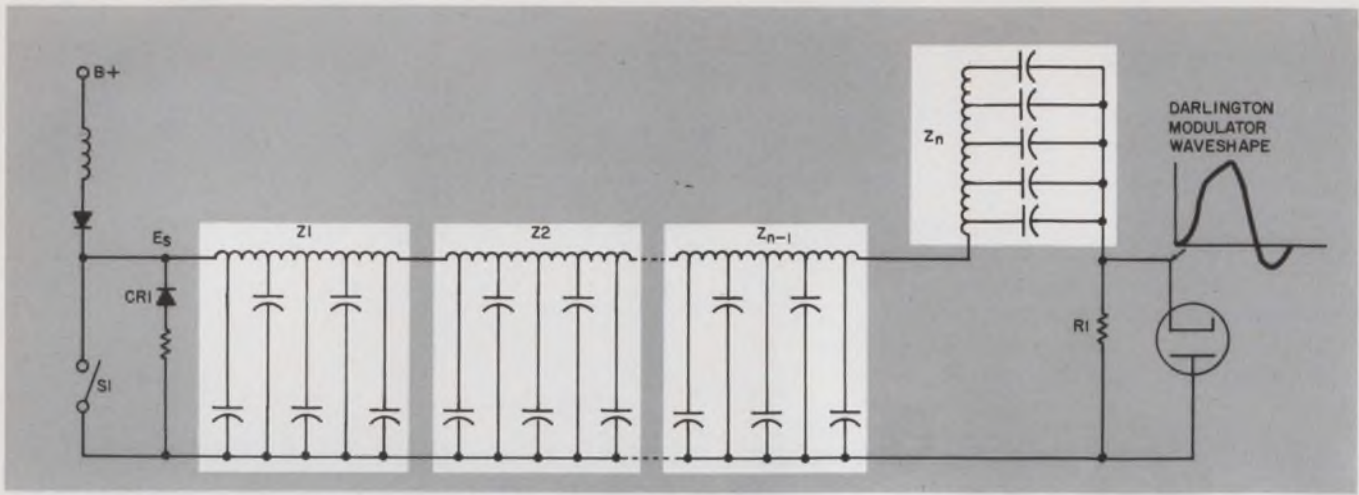

3. Extremely narrow pulses are produced by the Darlington-line pulser without violating the build-up time restric-

tions. The key is that the rate of rise of voltage decreases when the tube starts drawing current.

of the conventional pulser. The simple Darlington modulator' shown in Fig. 3 has been found to be the optimum choice in most narrow-pulse applications. This circuit produces pulses whose risetimes far exceed the maximum specified RRV for typical magnetrons. By its very nature, however, the modulator tends to slow down the rate of rise at the time of current drain into the tube. It does so in a way that assures adequate starting time and no overshoot.

### The Darlington modulator

The Darlington modulator consists of a series of four-terminal pulse-forming networks ending with a final two-terminal network. The resistor  $R_1$ , shown across the load, provides the charge path for the last network and also dissipates the positive-voltage portion of any post-pulse energy. The diode,  $CR_1$ , is a backswing device that allows the energy in any negative backswings and negative transients to be dissipated in  $R_2$ .

All of the networks must have the same delay and phase characteristics for a single voltage pulse to result. The impedance of each four-terminal network is given by:

$$Z_k = R_L k(k + 1) / n^2 \quad (2)$$

where  $k = 1, 2, 3, \dots, n-1$ ,  $n$  is the total number of networks, and  $R_L$  is the resistance of the magnetron at full power output. The impedance of the last (two-terminal) network is:

$$Z_n = R_L / n. \quad (3)$$

As in a conventional line-type pulser, each capacitor in each network is charged to a voltage approaching twice the  $B+$  voltage. When the modulator switch is fired, a voltage wave is launched along the Darlington line. It meets a discontinuity (impedance mismatch) at each network boundary in the line. The discontinuity causes the magnitude of the wave to increase,

and it also causes a wave to be reflected back toward the source.

The magnitude of the reflected wave,  $V_r$ , is given by:

$$V_r = V[(R_L - Z_o) / (R_L + Z_o)] \quad (4)$$

where  $V$  is the magnitude of the forward-traveling wave, and  $Z_o$  is the output impedance of the Darlington line. All networks in the line are designed to have the same two-way propagation delay so that reflections between networks are canceled out.

The voltage multiplication of the forward-traveling wave begins when the first network is shorted by the modulator switch  $S_1$ . This reverses the potential across the first network, placing it effectively in series with the second network. The voltage reversal process then continues down the line until a single pulse appears across the load. Theoretically, the amplitude of the pulse across the load will be equal to  $nE_s/2$ , where  $E_s$  is the voltage to which the line was charged before  $S_1$  was closed.

Since  $E_s$  can be on the order of 1.9 times the power-supply voltage ( $B+$ ) when a low-loss charging circuit is employed, the load voltage can ideally approach  $0.95nB+$ . Actually, experience has shown that the Darlington line becomes very inefficient when the number of networks exceeds five. The limitation is in the capacitance of the  $n-1$  network, which approaches stray capacitance values in a six-network design.

In practice, it has been found that with careful network design, a five-network Darlington can multiply the power-supply voltage four times.

### The payoff: an almost universal design

Because the Darlington line is a "soft" modulator—that is, its rate of rise decreases when it is loaded—there is very great flexibility in its



## Table: Performance of Darlington modulator radars

Application	Freq. Band	Peak Power	Tube Type	Cath. Volt.	Min. Pulse Width (ns)	Max. Spec. RRV (kV/ $\mu$ s)	Max. Appl'd. RRV. (kV/ $\mu$ s)
Air reconnaissance	Ka	125 kW	M4155A	20 kV	30	225	1000
Air reconnaissance	Ka	150 kW	L4064	22 kV	40	220	820
Air reconnaissance	Ka	150 kW	L4064A	22 kV	30	220	1100
Air reconnaissance	X	1 MW	SFD242	40 kV	30	...	1800
Periscope detector	Ku	125 kW	SYN4064B	22 kV	20	225	1700
Splash detector	X	700 kW	RK6959	33 kV	125	250	700

design. It is not necessary to know the exact values of  $E'$ ,  $E''$  and  $Q_{\mu}$  to design a modulator. The softness of the line prevents the voltage from rising too fast during the starting period.

To specify a line, choose the number of networks,  $n$ , to provide the necessary cathode voltage, bearing in mind that it is impractical to have  $n$  greater than five. The individual network impedances are then calculated from Eq. 2.

Specifying the desired pulse width then makes it possible to calculate the number of sections in each network and the values of each inductor and capacitor. Standard methods, like those described in Ref. 4, may then be used to design the networks, although the usual practice today is to supply the specifications (voltage level,  $Z_k$ , pulse width) to a company specializing in network design.

Most of the crossed-field devices used in our work have been of approximately the same power level and so have had roughly the same impedance. Therefore, we have been able to use the same network designs in different transmitters.

### It really works

Because of the complete absence of overshoot and the controlled risetime during the starting period, we have detected no missing pulses. Most of the transmitters (see table) have been delivered in large quantities and have had tube lives typically over 1000 hours. It is probable that the life improvement is at least partially because the voltage never exceeds the operating voltage (no overshoot minimizes arcing).

Because the rate of rise is extremely high prior to tube conduction, the Darlington technique should be beneficial in obtaining narrow pulses from coaxial magnetrons in which lower

voltage modes can exist. It would seem that by passing through the areas of low-voltage oscillations as rapidly as possible, the tendency for these modes to cause difficulties should be reduced.

One final point should be made for the benefit of the device manufacturers: More meaningful information, such as the buildup  $Q$  of the device cavity, is in order on tube data sheets to aid the modulator engineer in selecting an optimum design for narrow pulse applications. ■■

### References:

1. J. R. Pierce, "Oscillator Behavior," *Bell Telephone Laboratories Memorandum MM-42-140-60*, Sept. 8, 1942.
2. P. R. Gillette and K. Oshima, "Pulser Component Design for Proper Magnetron Operation," *IRE Trans., Component Parts*, March, 1956.
3. G. B. Collins, *Microwave Magnetrons*, McGraw-Hill, New York, 1948.
4. G. N. Glasoe and J. V. Lebacqz, *Pulse Generators*, McGraw-Hill, New York, 1948.

### Test your retention

Here are questions based on the main points of this article. Their purpose is to help you make sure you have not overlooked any important ideas. You'll find the answers in the article.

1. What is the thinking behind the RRV specification on crossed-field cathode-pulsed microwave tubes?

2. Why is the Darlington modulator recommended for use in narrow-pulse applications?

3. What practical limitation exists on the number of networks you can incorporate into a Darlington line?



# MOS/LSI

## 250 ns memory at a new low cost...

Typical system speeds—from Series 74  
TTL decoder inputs to sense amplifier  
outputs

Read cycle time — 250 ns  
Access time — 230 ns

Now you can get *both* high speed *and* low cost in the same memory system...and you can save space at the same time.

TI's new TMS 4003 MC is one of the fastest standard memories on the market. It yields total system speeds of 80 to 250 nanoseconds, depending on whether ECL or TTL decoders are used.

The cost is low. Systems are in the same cost range as many slower memory systems.

Power dissipation is modest... less than two milliwatts per gate for the entire system.

And it's compact. The 256-bit array, shown here actual size, measures only 1.99" x 0.60" x 0.25".

The TMS 4003 MC is a 256 word by 1-bit random-access array with

non-destructive readout. Memory elements are cross-coupled MOS flip flops. No clocks are necessary. Only one 18-volt supply voltage is required, and it may be pulsed to reduce power consumption.

These new arrays are ideal for high speed scratch pad and buffer memories or for main memories in large computers where utmost speed is essential.

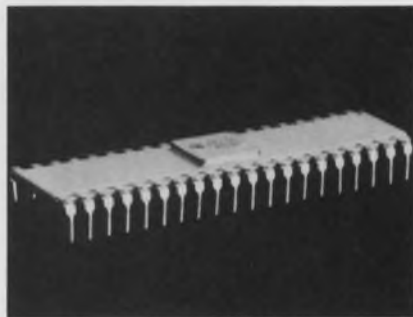

### Other Memories

The TMS 7A 4800 series are 1024-bit read only memories that may be

set up as 128-by-8 or 256-by-4 arrays.

The TMS 2A 4840 series are 2240-bit read only memories (character generators) that are used to drive five-by-seven dot matrices. Output is column sequential. Storage capacity is 64 characters.

The TMS 2A 4880 series are 2660-bit read only memories (character generators) that are also used to drive five-by-seven dot matrices. This series features 74-character storage and full 35-dot simultaneous output.

Find out more about the entire line of MOS integrated circuits from TI. Ask your TI sales representative, your authorized TI distributor, or, drop us a note on the back of your business card. For a complete application report on the 256-bit RAM, circle 120 on the reader service card. Texas Instruments Incorporated, P.O. Box 5012, M.S. 308, Dallas, Texas 75222.



TEXAS INSTRUMENTS  
INCORPORATED



# Series 74 TTL

## ...and MSI decoders to drive it.

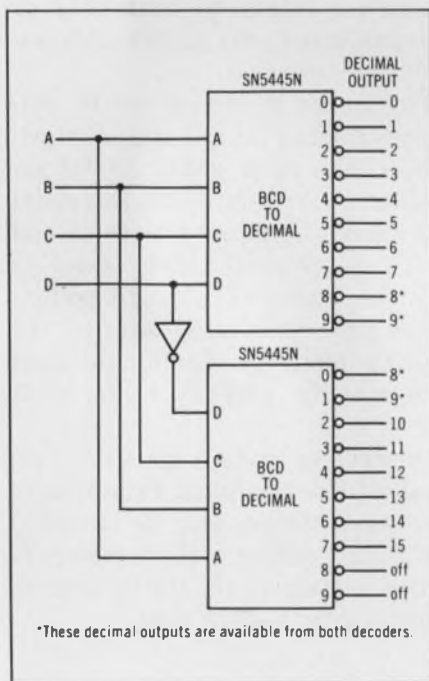

SN7445 BCD-to-decimal MSI decoder/drivers combine the high-speed decoding and the high voltage drive required to take full advantage of the TMS 4003 MC memory arrays shown on the opposite page. The result is a memory system that gives extremely fast cycle times at a moderate cost.

The NPN output transistors, used in the circuit, feature full 30V break-down and 80 mA sink current capability to drive the memory without any added interface.

Open collector outputs may be wire-OR connected...a real advantage in large memory systems.

Inputs are buffered to reduce loading of driving circuits. Each input is one normalized Series 74 load. No additional buffering is necessary.

Only four SN7445s are required to drive each 256-bit memory array. Two circuits, connected as shown at the left, drive the X address lines and two more drive the Y lines.

High sink-current capability make SN7445s—and the 15V SN74145s—ideal as lamp or relay drivers, also.

And there are 21 more MSI TTL circuits from TI including shift registers, adders, counters, and bipolar memories. For full information on all these, circle number 121 on the Reader Service Card for our Integrated Circuit Catalog supplement. If you prefer, ask your distributor or write Texas Instruments Incorporated, P.O. Box 5012, MS 308, Dallas, Texas 75222.



**TEXAS INSTRUMENTS**  
INCORPORATED



# Avoid pitfalls in computerized testing

by using these design ground rules that cover data acquisition, processing and transmission.

Demand for the flexibility and speed of computer-controlled test systems has increased the need for the design of interfacing hardware that will permit effective inter-machine communication. By following a few general ground rules, the designer of the interface is able not only to simplify the basic design but also to develop an interface "black box" that will be independent of the operating speeds of the computers and testers to be joined.<sup>1</sup>

## Buffer system saves computer time

Computer-controlled systems may be divided into two general classes: where computer and tester are in close proximity (10 feet or less); and where computer and tester are remote from each other (more than 10 feet apart).

Where the computer and the system it controls are physically close, the designer can concentrate on the data acquisition and processing functions, since data transmission will be a relatively simple task.

In general, interfacing a tester to a computer requires that the computer transfer a memory word to the tester, wait for some action to be taken, and then proceed with another transfer or receive a word from the tester. It's needless to tie up computer time with useless waiting when it can be processing some task or controlling other devices. Therefore, the foremost objective is to have buffered operation.

In this way, the computer transfers a memory word to the interface buffer, signals the tester that data is available, and is freed to perform other tasks. When the tester is ready, it accepts data from the buffer and signals the computer (through an interrupt line, for example) that it's ready to accept another piece of data. In the case where the tester provides data to the computer, it loads an output buffer and signals the computer that data is available. The computer then retrieves this data at its earliest free moment

and signals the tester that it may load another word.

The signal from computer to tester may be generated either internally by the computer, or in the interface by reserving a bit position in the memory word so that the bit position, on transfer to the interface input buffer, generates a pulse notifying the computer or tester that data is present in its input buffer. Additional bits in the memory word may indicate to the tester that the word is a piece of data or an instruction word that has to be interpreted by the tester.

In general, then, with buffered operation and control signals, the computer is tied up with a particular tester for a minimum length of time. In addition, due to the "handshaking" type of operation, the system runs closed loop and data won't be lost because of differences in timing between computer and tester.

For the case where the computer controls a number of test systems, the interface should have an address decoding capability so that data or an instruction is transferred only to the addressed tester.

Even though data cannot be lost, it can be outdated if the computer takes a lot of time acknowledging that a tester has data ready to be accepted. Most computers have only one interrupt line that has to be shared by many functions and external testers. To determine which tester is interrupting requires some kind of polling scheme. This can be time-consuming and, by the time the interrupting tester is found and data accepted, the data may be several milliseconds old.

For real-time control or data acquisition, an interrupt system should be designed to minimize polling time. Since some testers may be assigned higher priority than others, the interrupt system, or computer software, should be able to service the higher-priority testers first.

## Remote systems need low noise

For controlling a test system that is remote from the computer—as, for example, in a manufacturing plant where a central computer con-

---

Dimitry A. Bobroff, Systems Engineer, Hewlett-Packard Company, Palo Alto, Calif.



trols a number of scattered test stations—several precautions will ensure maximum reliability:

1. Digital transmission between computer end and test-station end of a transmission channel is favored because of low error rate and established error correction techniques. (If the tester needs analog voltages, a digital-to-analog converter should be placed at the tester end of the transmission channel.) However, noise problems in digital transmission can be more severe, since a most significant bit is just as likely to be picked up or dropped as the least significant bit.

2. For long transmission distances, serial transmission is desirable to keep costs of interconnecting cables and transmitting and receiving circuitry down. The trade-off is a reduced transfer rate for a given transmission channel bandwidth.

3. A delayed-strobe technique should be used at the receiver so that transients in the data lines are allowed to die away before sampling the received bit or bits. For serial transmission, a common method is to synchronize the receiver clock on a received start bit so that one edge of a 50% duty cycle clock coincides with the beginning of a bit, and the other edge coincides with the midpoint of the received bit (when all transients have died down). The midpoint of the received bit is then strobed into a receiving shift register (hence, the term "delayed strobe").

4. Bandwidth limiting and low-impedance termination at the receiver end and risetime limiting at the transmitter end (especially when multiconductor cables are used) increase ac noise immunity and reduce crosstalk between lines. The bandwidth, however, must be wide enough for accurate transmission; a bandwidth of three to four times the bit rate is more than enough if edge triggering at the receiver is not utilized

(i.e., a delayed-strobe technique is used).

5. Shielded twisted pairs (preferably each pair shielded) should be used for transmitting data to reduce the effect of noise pickup. The shield affords protection against capacitive-coupled noise from external noise sources, while the twist cancels the effects of magnetically coupled noise. The twisted-pair, balanced-line scheme makes it possible to eliminate pickup due to other external sources by having the receiver discriminate against common-mode noise contributions. Twisted pair transmission is practical for distances up to a thousand feet and bit rates up to 1 megabit per second.

6. The computer and all remote test stations should be ground-isolated from each other to reduce ground-loop noise and to guard against ground differential between systems. Isolation may be provided, for example, by transformers for pulse transmission, or by optical isolators where transmission extends to dc. Optical isolators are capable of providing isolations in terms of hundreds of volts.

#### Computer I/O follows ground rules

As an example of how the ground rules can be put into practice, let's examine the makeup of I/O (Input-Output) features of a Hewlett-Packard computer family that was designed with the interfacing problem in mind.<sup>2</sup> These computers were designed to work in an instrumentation environment with temperatures ranging from 0°C to 55°C and where humidity may reach 95%. In addition, the computers will work with a  $\pm 10\%$  line voltage variation and with line frequencies varying from 50 to 60 Hz.

Machine word length is 16 bits, and memory cycle times range from 1.6  $\mu\text{s}$  to 2.0  $\mu\text{s}$ , depending

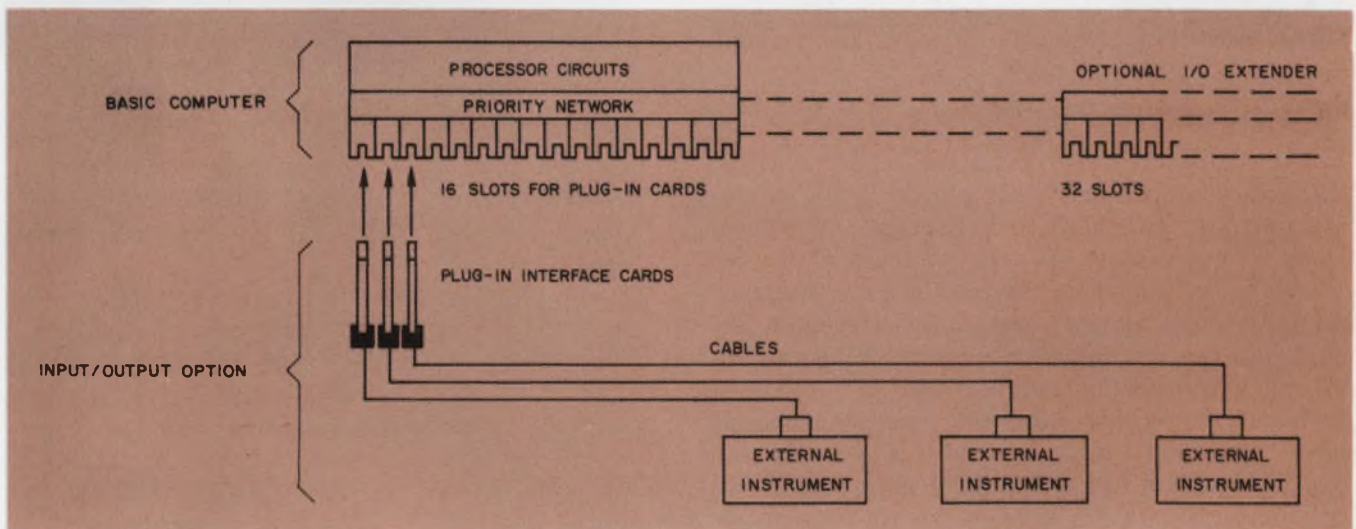

1. Computer interfaces with testers through a series of plug-in interface cards. Circuitry on the cards can be

tailored to the requirements of the tester although all cards feature a certain degree of standardization.



on the model.

A portion of the computer main frame is devoted to the input-output system. This consists of a rack into which up to 16 interface cards may be plugged. (This can be increased to 48 by an additional I/O extender). Each slot accepts an interface card that mates the computer to an instrument, as shown in Fig. 1. A number of interface cards exist for interconnecting to standard Hewlett-Packard instruments, as well as general-purpose interface cards to interconnect to customer-designed devices. But all of them feature a certain amount of standardization.

The backplane of the I/O system rack is identically wired for each of 16 slot positions. The backplane signals consist of the following:

- An input bus, consisting of 16 lines for the 16 bits. Data placed on this bus is steered to the computer A or B register (accumulators).
- An output bus, consisting of 16 lines. Data placed on this bus is accepted into the input buffer of an addressed interface card.
- Control signals that are actuated by software. For instance, an assembly language statement "OTA 12" (output from A register) will place the contents of the A register on the output bus and will produce a strobe pulse that strobes the data bits into the input buffer. The "12" in the statement selects the interface card in slot 12 so that only that interface card will strobe the data bits into the input buffer. Seventeen such signal lines are available on the backplane to translate software commands to hardware pulses. These software commands have been incorporated into the computer instruction repertoire and are used specially to control the I/O system.
- Address decoding lines, which enable a particular device to be software addressed so that it, and only it, interprets the backplane signals.
- A number of lines necessary for the interrupt system.

### Interrupt system raises efficiency

The computer family has a multichannel priority interrupt system that allows it to service instruments interfaced to it rapidly and in real time. The priority of each instrument is determined by the slot occupied by its interface card, and each slot is assigned a different interrupt location in computer memory. When an instrument signals the computer that it is ready to transmit or receive data, the computer doesn't have to poll all interface cards to find out which one is interrupting, but instead goes directly to the computer memory location for that interrupting device.

When several instruments are trying to inter-

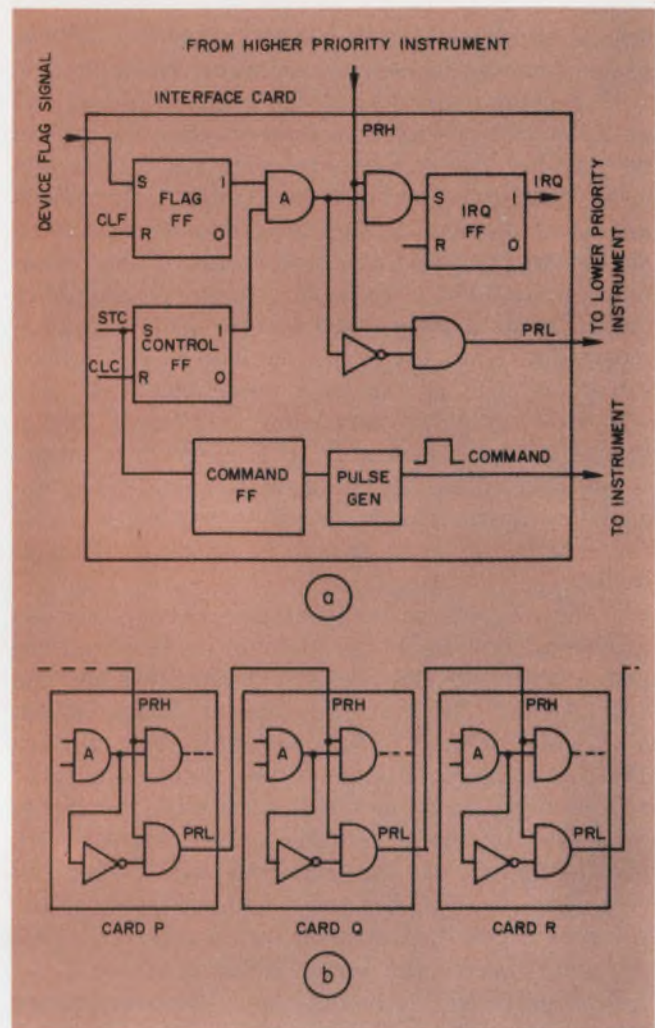

2. Interrupt circuitry directs computer's attention to the test instrument having the highest pre-established priority. When interrupt service is completed, other instruments may interrupt the computer.

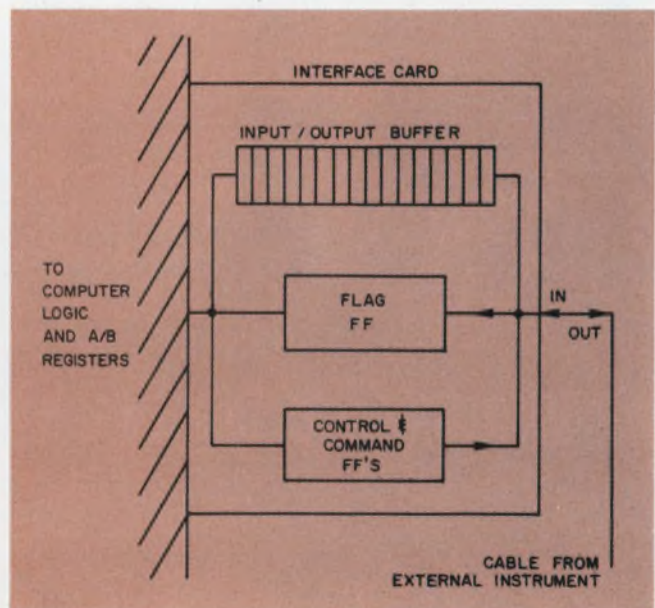

3. Typical interface card shown here contains storage and control circuitry.



rupt at the same time, only the instrument with highest priority is allowed to interrupt. Once it is serviced, the instrument next in priority is allowed to interrupt. In this way, the computer locates the highest-priority interrupting instrument and its computer service subroutine in a few microseconds, transfers the data, and goes on to the next-lower-priority instrument in turn. When all interrupting instruments have been serviced, the computer returns to its regular program, having spent a minimum of time away from it. The ability of the instrument interface card to cause an interrupt is software-controlled, and so the computer can inhibit interrupt signals from one or more instruments.

Figure 2a shows the circuitry on each interface card associated with the interrupt system. To enable an instrument to interrupt, the computer sets the CONTROL FF by means of a software instruction STC X (set CONTROL FF at slot position X). Alternatively, it can inhibit an instrument to cause an interrupt by clearing the CONTROL FF. At the same time, for instruments that require it, the STC instruction sets the COMMAND FF, which provides a command line that causes the instrument to take some action.

When the tester is ready to transmit data, or accept data, it sets the FLAG FF. This causes the setting of the interrupt request FF (IRQ), provided no higher-priority instrument is interrupting. The IRQ signal causes a computer interrupt, and, since there is a distinct IRQ signal line from each slot position, it encodes the address of the interrupting device. The encoded address is the address of the location, in computer memory, of the service subroutine for this instrument.

Figure 2b shows how several interface cards are connected to form the priority chain. Assume that Card Q interrupts. The high output of Gate A forces the priority low (PRL) output to go low. The low PRL output is the priority high (PRH) to Card R, and hence inhibits Card R to cause an interrupt while its PRH line is low. The low PRH line on Card R also forces its PRL line to be low and inhibits all succeeding lower priority cards from interrupting.

Note that if Cards P and Q want to interrupt at the same time, the Card P interrupt will be recognized first, since it is in a higher priority position on the interrupt chain. When the Card P interrupt signal is recognized by the computer, which enters the Card P service subroutine, the subroutine may turn off the entire interrupt system if this is desirable. If the entire interrupt system is not turned off by the service subroutine, then it may be interrupted by higher-priority instruments. When these higher priority instruments have been serviced, the computer

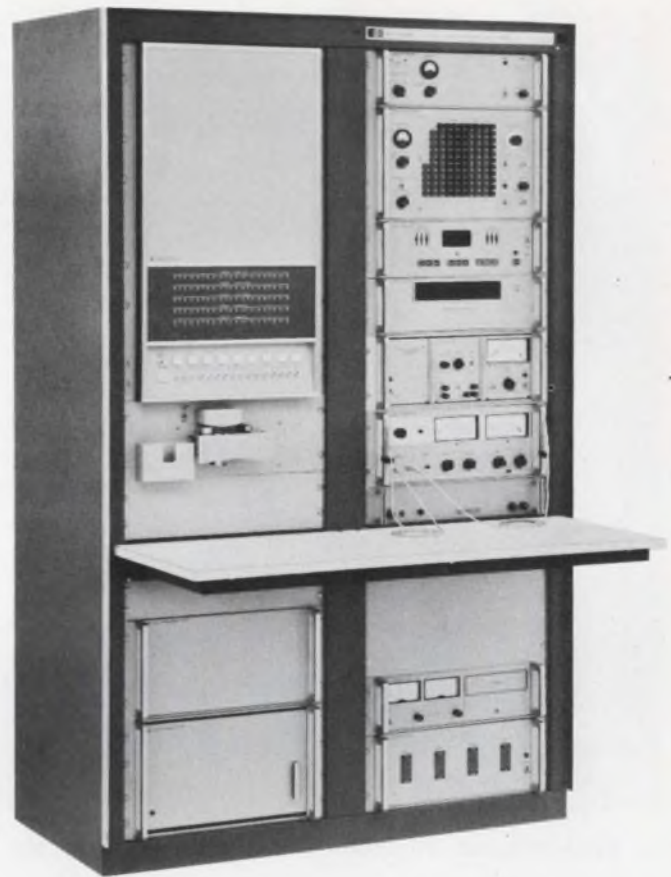

4. H-P Model 9500A Automatic Test System is used as an example of the application of the interface design ground rules described in the article.

returns to the lower-priority service subroutine.

Once the service subroutine is completed, or to allow lower-priority instruments to cause an interrupt while in the service subroutine, the computer has to clear the interrupting card FLAG FF by means of the CLF X instruction (Clear FLAG FF at position X).

#### Interface card is key element

Figure 3 shows the typical ingredients in an interface card. The interrelationship of the components may be understood by looking at the following typical input and output interrupt sequence:

**Input interrupt:** The typical operation sequence for an input interrupt involves the following steps (refer also to Fig. 2):

1. An STC instruction sends a command (equivalent to "read" for many instruments) to the external device.
2. The device reads its inputs, then puts the data into the Input/Output buffer on the interface card.
3. Simultaneously, the device supplies a flag signal (equivalent to "record" or "print" for many instruments) to the interface card.
4. The flag is converted to an interrupt request



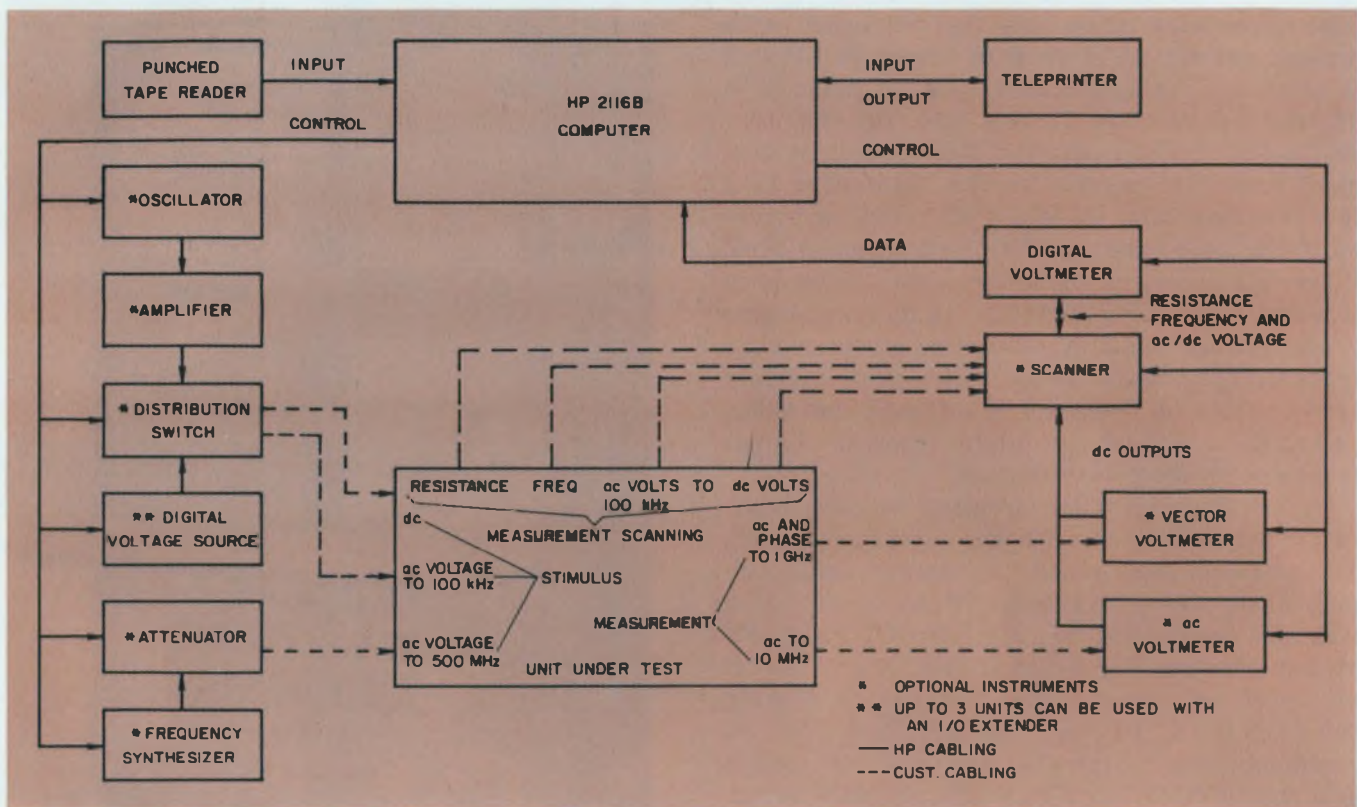

5. Block diagram of 9500A shows relationship of test Instruments to data acquisition and processing system.

## Test program

PROGRAM	COMMENT
100 CALL (8, 1, 0, 1)	SETS POWER SUPPLY 1 TO ZERO
110 CALL (8, 2, 0, 1)	SETS POWER SUPPLY 2 TO ZERO
120 PRINT "PLUG IN AMPLIFIER"	ASKS OPERATOR FOR INFORMATION
125 PRINT "SERIAL NUMBER IS"	
130 INPUT S	OPERATOR TYPES IN SERIAL NO.
140 CALL (6, 4, 3, 0, 0)	CONNECTS SUPPLY #1 TO OUTPUT 4 SUPPLY #2 TO OUTPUT 3
150 CALL (8, 1, -12, 100)	SETS SUPPLY #1 TO -12, 100 MA MAX.
160 CALL (8, 2, 12, 100)	SETS SUPPLY #2 TO +12, 100 MA MAX.
170 FOR F = 1000 TO 5000 STEP 1000	ESTABLISHES LOOP FOR CHANGING FREQUENCY
180 CALL (5, F, .10)	SETS OSCILLATOR TO 1000 (THEN 2000, 3000, 4000, 5000 HZ), 0.1 V
190 CALL (7, 7, 0, 0, 2)	CONNECTS OSCILLATOR TO OUTPUT 7
200 CALL (9, 5)	CONNECTS OSCILLATOR OUTPUT TO DVM
210 WAIT (30)	DELAYS 30 MSEC TO ALLOW SETTLING
220 CALL (10, 2, .1, 1)	MEASURES INPUT ACV ON 0.1 RANGE
230 CALL (9, 23)	CONNECTS OSCILLATOR OUTPUT TO DVM
240 WAIT (30)	DELAYS 30 MSEC TO ALLOW SETTLING
250 CALL (10, 2, 10, V)	MEASURES AMP OUTPUT
260 LET G = V/I	CALCULATES GAIN
270 IF G<5 THEN 320	CHECKS FOR LOW GAIN
280 IF G>10 THEN 340	CHECKS FOR HIGH GAIN
290 NEXT F	RETURN TO 170 FOR NEXT FREQUENCY
300 PRINT "AMPLIFIER SERIAL" S "GAIN OK, GAIN =" G "AT" F "HZ"	
310 GO TO 100	
320 PRINT "AMPLIFIER SERIAL" S "GAIN LOW, GAIN =" G "AT" F "HZ"	
330 GO TO 100	
340 PRINT "AMPLIFIER SERIAL" S "GAIN HIGH, GAIN =" G "AT" F "HZ"	
350 GO TO 100	
360 END	



by the device interface card (if no higher-priority device is interrupting this time).

5. The resulting interrupt causes a service subroutine for that device to begin, temporarily suspending operations of the main program.

6. The service subroutine enters data from the buffer into the computer, then returns control to the main program.

**Output interrupt:** The typical operation sequence for an output interrupt is as follows:

1. An OTA or OTB instruction puts data from the A or B register into the Input/Output buffer on the interface card.

2. An STC instruction sends a command to the external device.

3. The device accepts (records) the data currently in the buffer.

4. After the data has been accepted, the device returns a flag signal (equivalent to the end of "hold off" or "inhibit" signal in many instruments) to the interface card.

5. The flag is converted to an interrupt request by the device interface card.

6. The interrupt causes a service subroutine for that device to begin.

7. The service subroutine loads new data into the buffer, repeating the sequence.

### Computer controls test system

Figure 4 shows the Hewlett-Packard 9500A Automatic Test System, which is an example of a high-speed automatic, computer-controlled test system.<sup>3</sup> Figure 5 is a block diagram of the system. Each instrument is interfaced to the computer with a fully buffered interface card. The card accepts instructions in computer language and converts the information to a form that controls the instrument.

The block diagram of Fig. 5 shows the system complete with all options. System control is either through manual keyboard entry on the teleprinter or by previously prepared programs via the punch tape reader. The stimuli consist of dc, ac to 100 kHz and ac to 500 MHz. Dc and low-frequency ac stimuli are routed through the distribution switch to the unit under test.

Measurement inputs consist of dc, ac to 1 GHz, ohms, and frequency. Ac measurements above 100 kHz are recorded on the digital voltmeter (DVM) as a dc voltage by routing the dc outputs of the ac meters through the measurement scanner to the DVM. The input scanner also has signal switching to route ohms, frequency, and ac/dc inputs to the appropriate DVM connector for direct measurement.

A program, written in BASIC,<sup>4</sup> for testing an audio amplifier with the 9500A test system is shown in the box. This program includes setting all power supplies, checking the gain at five fre-



**Author Bobroff** conveniently enters system control data from his teletypewriter keyboard.

quencies from 1000 Hz to 5000 Hz, and outputting appropriate messages, including amplifier serial number.

After the program is typed in on the teleprinter, the operator types RUN to start the program. If he wishes a copy of the program, he types LIST. The program may be changed by retyping a statement. New statements may be added between existing statement numbers, and statements may be deleted by typing only the statement number with nothing following. ■■

### References:

1. Richard C. Reyna, "Wanted: Standards for Instrument Systems," *Electro-Technology*, April, 1968.
2. Kay B. Magleby, "A Computer for Instrumentation System," *Hewlett-Packard Journal*, Vol. 19, No. 11, March, 1967.
3. Robert A. Grimm, "An Automatic Test System Utilizing Standard Instruments and Abbreviated English Language," presented at the 1968 Automatic Support Systems Symposium, St. Louis, Missouri.
4. Gerald L. Peterson, "BASIC, the Language of Time Sharing," *Hewlett-Packard Journal*, Vol. 20, No. 3, November, 1968.

### Test your retention

*Here are questions based on the main points of this article. Their purpose is to help you make sure you have not overlooked any important ideas. You'll find the answers in the article.*

1. *At what separation distance between tester and computer will data transmission become a major consideration?*

2. *What is the purpose of an interface buffer?*

3. *What function does an interrupt system perform?*



# TTL. PDQ.



# RSVP: Your National distributor

## Gates

DM8000N (SN7400N)	Quad 2-Input, NAND gate
DM8001N (SN7401N)	Quad 2-Input, NAND gate (Open Collector)
DM8003N (SN7403N)	Quad 2-Input, NAND gate (Open Collector)
DM8010N (SN7410N)	Triple 3-Input, NAND gate
DM8020N (SN7420N)	Dual 4-Input, NAND gate
DM8030N (SN7430N)	Eight-Input, NAND gate
DM8040N (SN7440N)	Dual 4-Input, Buffer
DM8050N (SN7450N)	Expandable Dual 2-Wide, 2-Input AND-OR-INVERT gate
DM8051N (SN7451N)	Dual 2-Wide, 2-Input AND-OR-INVERT gate
DM8053N (SN7453N)	Expandable 4-Wide, 2-Input AND-OR-INVERT gate
DM8054N (SN7454N)	Four-Wide, 2-Input AND-OR-INVERT gate
DM8060N (SN7460N)	Dual 4-Input expander
DM8086N (SN7486N)	Quad Exclusive-OR-gate

## Flip Flops

DM8501N (SN7473N)	Dual J-K MASTER-SLAVE flip flop
DM8500N (SN7476N)	Dual J-K MASTER-SLAVE flip flop
DM8510N (SN7474N)	Dual D flip flop

## Counters

DM8530N (SN7490N)	Decade Counter
DM8532N (SN7492N)	Divide-by-twelve counter
DM8533N (SN7493N)	Four-bit binary counter
DM8560N (SN74192N)	Up-down decade counter
DM8563N (SN74193N)	Up-down binary counter
DM8520N	Modulo-n divider

## Decoders

DM8840N (SN7441N)	BCD to decimal nixie driver
DM8842N (SN7442N)	BCD to decimal decoder

## Shift Registers

DM8570N	Eight-bit serial-in parallel-out shift register
DM8590N	Eight-bit parallel-in serial-out shift register

## Miscellaneous

DM8200N	Four-bit comparator
DM8210N	Eight channel digital switch
DM8220N	Parity generator/checker
DM8820N	Dual line receiver
DM8830N	Dual line driver
DM8800H	Dual TTL to MOS translator
DM8550N (SN7475N)	Quad latch

TTL devices for industrial applications. Stocked in depth—available immediately, through National distributors. For our TTL Specification Guide and pricing, write or call National Semiconductor, 2975 San Ysidro Way, Santa Clara, California 95051. (408) 245-4320. TWX: 910-339-9240. Cables: NATSEMICON.

# National/TTL

P.S. We've got low power TTL too. Meets 883 mil standards; off-the-shelf availability.



The Transient Trappers are in the RCA-40673, the industry's FIRST dual-gate MOSFET with INTEGRATED PROTECTION-CIRCUITRY.

Back-to-back diodes, diffused within the same silicon pellet as the MOS Field-Effect Transistor, guard each gate against:

- static discharge during handling operations prior to circuit installation without the need for external shorting mechanisms.
- in-circuit transients.

Now you can design and build around the inherent, superior performance characteristics of dual-gate MOSFETs with assurance that RCA's TRANSIENT TRAPPERS are the real answer to transient-voltage problems.

Typical characteristics of the RCA-40673 are:

- Power Gain (MAG) = 20 dB @ 200 MHz
- Noise Figure (NF) = 3.5 dB @ 200 MHz
- Superior Cross Modulation Characteristics
- Wide Dynamic Range Without Diode Current Loading
- Reduced Spurious Response
- Extremely Low Feedback Capacitance = 0.02 pF
- Simplified AGC Circuitry
- Excellent Gain-Reduction Characteristics
- Reduced Oscillator Feedthrough

For more information, see your local RCA Sales Representative or your RCA Distributor. For technical data write to RCA Electronic Components, Commercial Engineering, Section EG-8-2 Harrison, New Jersey 07029.

## The MOSFET Transient Trappers

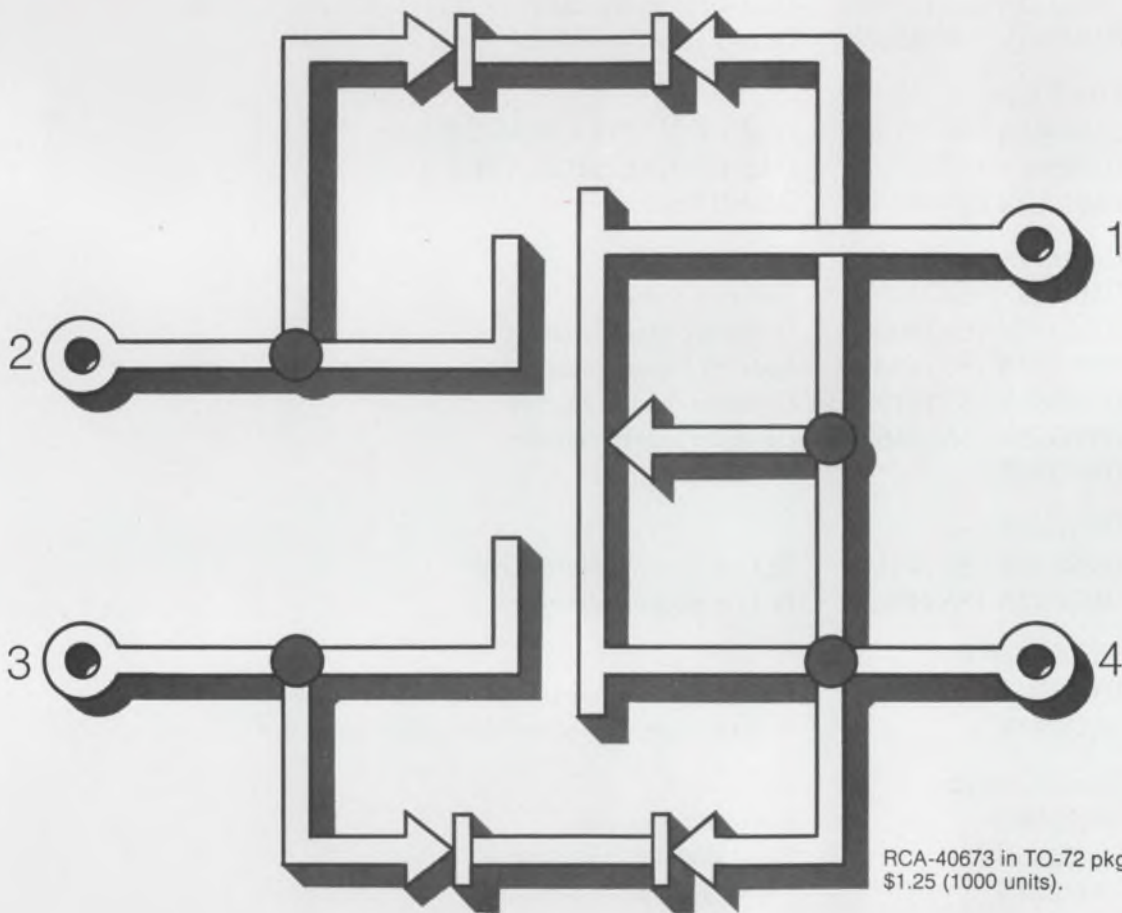

The major technical challenge associated with the development of the RCA-40673 was that gate protection must not significantly degrade the RF performance.

Special back-to-back diodes were developed as the answer to this objective. These back-to-back diodes are diffused directly into the MOS pellet and are electrically connected between each insulated gate and the FET's source. The back-to-back configuration of the diodes permits the device to handle a wide dynamic signal-swing. In addition, the low junction capacitance of the diodes adds little to the total capacitance shunting the signal gate. Further, the resistive components of these diodes are such that they do not materially affect the overall noise performance of the unit.

The net result of this engineering program is a MOSFET which is more rugged than any other solid-state amplifier providing comparable RF performance.

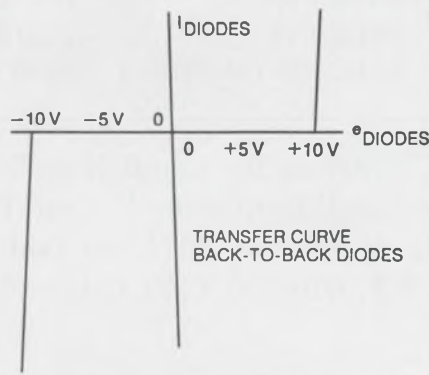

**RCA**  
Integrated  
Circuits

Visit the RCA Electronic Components Exhibit at WESCON, Unit C, in the Cow Palace Arena.

INFORMATION RETRIEVAL NUMBER 126



# Block reverse gain in your transistor amplifier.

Transistors pass signals in both directions—if this is your problem, correct it with this technique.

Circuit designers are familiar with unwanted signals. Noise and spurious oscillations are two well-known culprits. Another is the signal that is considered desirable in one part of a circuit but has shown up where it's not wanted. Often this happens because transistors pass signals in the reverse as well as the forward direction.

To deal with this problem, both the forward and reverse power gains of the various transistor configurations must be studied.

To find forward current and voltage gain, a transistor model is selected, an input signal is assumed and the resulting output is determined. Similarly the reverse current and voltage gain can be determined by injecting a signal at the output and measuring the signal that appears across the source resistance. The three basic transistor amplifier configurations, as well as the  $y$ -parameter equivalent circuits that are used to determine reverse current and voltage gain are shown on the next page. The forward and reverse gains can be calculated in a straightforward manner and are also shown on the next page.

## Compare reverse gains

We can compare the reverse gains of the common-emitter, common-base and common-collector configurations by assuming a moderately high-performance transistor:  $y_{re} \cong j10^{-6}$ ,  $y_{oe} \cong 10^{-4}$ ,  $y_{ie} \cong 10^{-3}$ ,  $y_{fe} \cong 10^{-1}$ , and  $\Delta y = y_{ie} y_{oe} - y_{re} y_{fe} \cong 10^{-9}$  and substituting in the appropriate equations. The analysis is carried out on the next page.

Good signal isolation is a process of precluding power transfer in an undesired direction along some path. Where this path exists because of improper shielding, etc., it is essentially a packaging problem. But when the path is there because it is being used for other desired purposes, careful analysis is required. Both current and voltage isolation are necessary because we are concerned with a power transfer mechanism. Since no one configuration for a transistor stage has both good current and voltage isolation, a two-stage amplifier

---

Roy Leventhal, Lawrence Radiation Laboratory, Livermore, Calif.

## Design procedure

- Step 1 Select amplifier configuration.
- Step 2 Choose transistor and power supplies.
- Step 3 Select operating point.
- Step 4 Determine power dissipation.
- Step 5 Determine parameter values.
- Step 6 Determine  $R_c$  and  $R_E$  for common-emitter stage.
- Step 7 Determine bias network for common-emitter stage.
- Step 8 Choose  $R_E$  for common-collector stage.
- Step 9 Determine bias network for common-collector stage.
- Step 10 Determine common-emitter bypass capacitor.
- Step 11 Determine coupling capacitor.
- Step 12 Determine  $R_L$  and  $R_g$ .
- Step 13 Determine  $Z_o$  and  $Z_{in}$ .
- Step 14 Determine  $A_v$  and  $A_v'$  for the common-emitter stage.
- Step 15 Determine  $A_v$  and  $A_v'$  for the common-collector stage.
- Step 16 Determine  $A_{v_{(tot)}}$  and  $A_{v_{(tot)}}$ '.
- Step 17 Compare results with requirements.

is required. A common collector stage with good current isolation and low output impedance driving a common-emitter stage with excellent voltage isolation is the optimum combination.

## Design examples show how

The general procedure for designing amplifiers will be the same, regardless of type. This is illustrated by two examples:

*Case I.* A single-ended mixer with a voltage gain of at least 20 dB at 20 MHz and a reverse voltage gain of at most -40 dB at 18 MHz.

*Case II.* An amplifier for a 70-MHz phase lock loop with a voltage gain of at least 10 dB and a reverse voltage gain of at most -40 dB.

In both cases, the same 17-step procedure outlined in Box 3 will be used. Let's begin with the single-ended mixer.

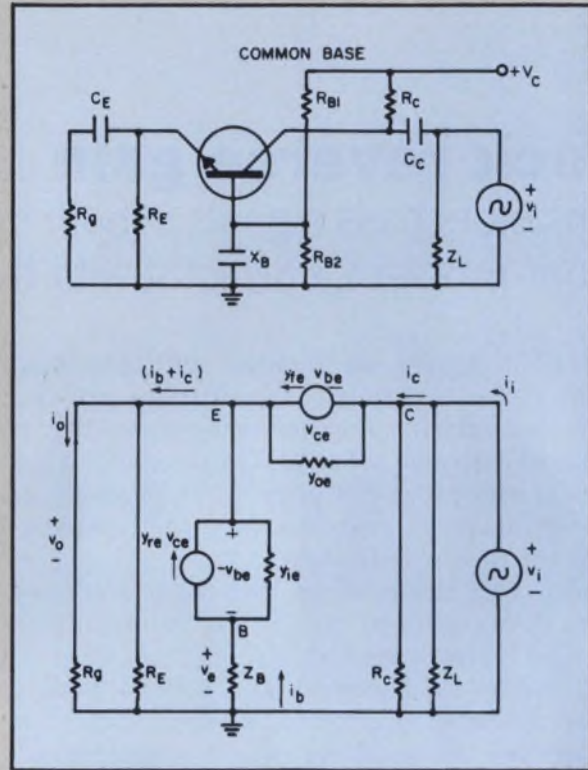
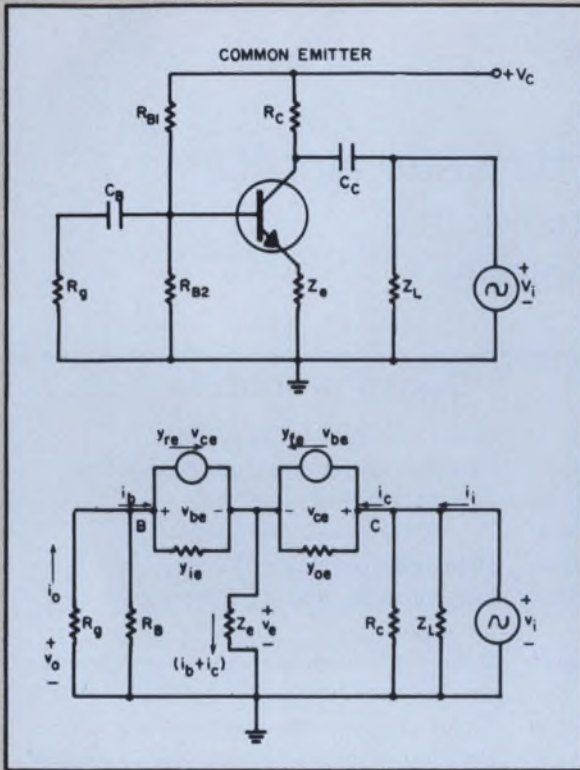

## Comparative circuit performance

### I—Common emitter

$$A_i' = \left( \frac{j10^{-6} - 10^{-9}Z_e}{(R_o' + Z_e) 10^{-9} + 10^{-4}} \right) \left( \frac{\alpha_o}{\alpha_i} \right)$$

assume  $R_o' \leq 10$ . Then, if  $Z_e$  is small or zero

$$A_i' \cong j10^{-2} \left( \frac{R_B}{R_B + R_o'} \right) \left( \frac{R_L}{R_L + Z_o} \right)$$

That is, we get fair current isolation and input-output bias circuit current splitting. If  $Z_e$  is on the order of  $10^3$  or higher, we get  $A_i' \cong (-1 + j) \times 10^{-2} \alpha_o/\alpha_i$ . There is a phase shift and the isolation is impaired. The higher  $Z_e$  is made, the worse will be the current isolation. The larger  $R_o'$  is made, the better will be the current isolation.

$$A_v' \cong \frac{(j10^{-6} - 10^{-9}Z_e) R_o'}{1 + 10^{-3}R_o' + 0.1Z_e + 10^{-9}R_o'Z_e}$$

assume  $R_o' \leq 10$ . Then,

$$A_v' \cong \frac{(j10^{-5} - 10^{-8}Z_e)}{1 + 0.1Z_e + 10^{-8}Z_e} \cong \frac{j10^{-5} - 10^{-8}Z_e}{1 + 0.1Z_e}$$

If  $Z_e$  is small or zero,  $A_v' \cong j10^{-5}$  which gives excellent voltage isolation. If  $Z_e$  is on the order of  $10^3$ ,  $A_v' \cong -10^{-7} + j10^{-7}$  which is even better isolation with an additional phase shift. Increasing  $R_o'$ , however, worsens the isolation in an almost direct proportion.

Thus the common emitter has fair current isolation and excellent voltage isolation.

### II—Common base

$$A_i' \cong \left( \frac{10^{-4} + 10^{-9}Z_B}{10^{-4} + 10^{-9}(Z_B + 10)} \right) \left( \frac{\alpha_o}{\alpha_i} \right)$$

Assume  $R_o' \leq 10$ .

If  $Z_B$  is small or zero,

$$A_i' \cong (1) \left( \frac{R_E}{R_E + R_o'} \right) \left( \frac{R_L}{R_L + Z_o} \right)$$

Aside from input and output bias circuit current splitting, no current isolation results. Increasing  $Z_B$  will not increase the current isolation significantly.

If  $R_o'$  is increased, it will tend to improve the performance but only by an infinitesimal amount. For voltage isolation

$$A_v' \cong \frac{10^{-4} + 10^{-9}Z_B}{1 + 0.1(10) + (10^{-3} + 10^{-8})Z_B}$$

If  $Z_B$  is small or zero,

$$A_v' \cong 0.5 \times 10^{-4}$$

This is good voltage isolation. Increasing  $Z_B$  increases the voltage isolation only slightly.

If  $R_o'$  were of the order of  $10^3$  we would get  $A_v' \cong 10^{-6}$  for small values of  $Z_B$ .

It can be concluded that a common-base stage provides good voltage isolation and poor current isolation.



## Circuit gain equations

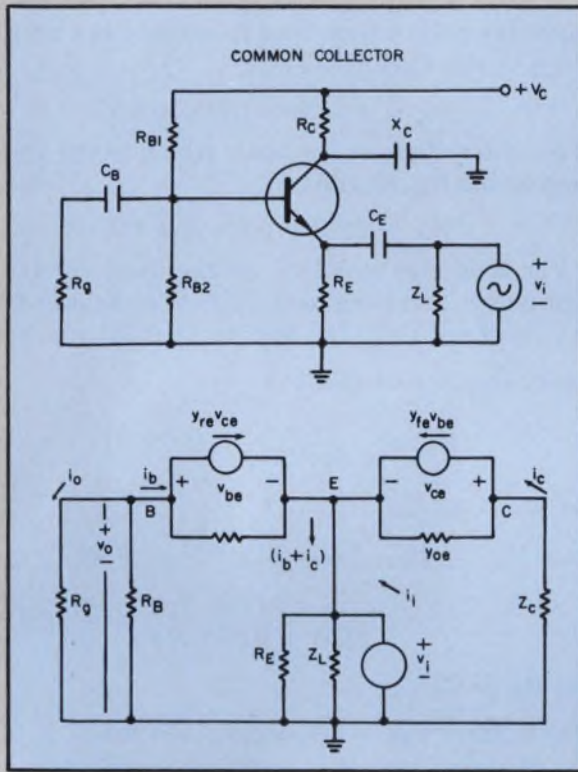

### III—Common collector

$$A_i' \cong \left( \frac{10^{-3} + 10^{-9}Z_c}{0.1 + 10^{-9}(10 + Z_c)} \right) \left( \frac{\alpha_i}{\alpha_o} \right)$$

Let  $R_g' \leq 10$   
If  $Z_c$  is small or zero:

$$A_i' \cong (10^{-4}) \left( \frac{R_B}{R_B + R_g} \right) \left( \frac{R_L}{R_L + Z_o} \right)$$

We get good current isolation besides the usual current splitting. Increasing  $Z_c$  does not have a great effect nor does increasing  $R_g'$ . For voltage isolation:

$$A_v' \cong \frac{10^{-2} + 10^{-8}Z_c}{1 + 10^{-4}Z_c}$$

If  $Z_c$  is small or zero,  
 $A_v' \cong 10^{-2}$

which is mediocre voltage isolation for low  $R_g'$ .  
If  $R_g'$  is on the order of  $10^3$ ,

$$A_v' = \frac{10 + 10^{-6}Z_c}{11 + 10^{-6}Z_c}$$

It can be seen that just about no voltage isolation is achieved.

It can be concluded that a common-collector stage provides good current isolation and poor voltage isolation.

### I—Common emitter

$$A_v = y_{ie}Z_L' (Z_c\Delta y - y_{fe}) / [1 + (y_{ie} + y_{re}) Z_c] \\ [y_{ie} + \Delta y (Z_o + Z_L')] + (y_{fe} - \Delta y Z_c) [y_{ie}Z_c \\ + y_{re} (Z_c + Z_L')]$$

$$A_i = \frac{Z_c\Delta y - y_{fe}}{y_{ie} + (Z_c + Z_L') \Delta y} \alpha_i \alpha_o$$

$$A_i' = \frac{(y_{re} - \Delta y Z_c) \alpha_o}{[(R_o' + Z_c) \Delta y + y_{oe}] \alpha_i}$$

$$A_v' = (y_{re} - \Delta y Z_c) R_o' / [1 + y_{ie}R_o' + \\ (y_{ie} + y_{oe} + y_{re} + y_{fe}) Z_c + \Delta y R_o' Z_c]$$

where  $\Delta y = y_{ie}y_{oe} - y_{re}y_{fe}$   $\alpha_i = (R_L + Z_o)/R_L$

$$Z_L' = Z_L R_C / (Z_L + R_C) \quad R_o' = R_B R_o / (R_B + R_o)$$

$$\alpha_o = R_B / (R_B + R_o) \quad R_B = R_1 R_2 / (R_1 + R_2)$$

### II—Common base

$$A_v = \frac{(y_{fe} + y_{oe}) Z_L'}{1 + y_{oe} Z_L'}$$

$$A_i = \frac{(y_{fe} + y_{oe}) \alpha_i \alpha_o}{y_{ie} + y_{oe} + y_{re} + y_{fe} + \Delta y Z_L'}$$

$$A_i' = \left[ \frac{y_{oe} + y_{re} + \Delta y Z_B}{y_{oe} + \Delta y (Z_B + R_o')} \right] \left( \frac{\alpha_o}{\alpha_i} \right)$$

$$A_v' = (y_{oe} + y_{re} + \Delta y Z_B) / [1 + (y_{ie} + y_{oe} + y_{re} + \\ y_{fe}) R_o' + (y_{ie} + \Delta y R_o') Z_B]$$

where  $Z_B = R_B X_B / (R_B + X_B)$

$$\alpha_o = R_E / (R_E + R_o)$$

$$R_o' = R_o R_E / R_o + R_E$$

And  $\Delta y$ ,  $R_B$ ,  $Z_L'$  and  $\alpha_i$  are the same as in the common-emitter case.

### III—Common collector

$$A_v = \frac{(y_{ie} + y_{fe}) Z_L'}{(y_{ie} + y_{oe} + y_{re} + y_{fe}) Z_L' + 1}$$

$$A_i = \frac{y_{ie} + y_{fe}}{y_{ie} + \Delta y Z_L'} \alpha_i \alpha_o$$

$$A_i' = \frac{(y_{ie} + y_{re} + \Delta y Z_c) R_o'}{1 + y_{ie} R_o' + y_{oe} Z_c + \Delta y R_o' Z_c}$$

$$A_v' = (y_{ie} + y_{re} + \Delta y Z_c) \alpha_i / [y_{ie} + y_{oe} + y_{re} + \\ y_{fe} + \Delta y (R_o' + Z_c)] \alpha_o$$

where  $Z_c = R_c X_c / (R_c + X_c)$

$$Z_L' = \frac{R_E Z_L}{R_E + Z_L}$$

And  $\Delta y$ ,  $R_B$ ,  $\alpha_i$ ,  $R_o'$  and  $\alpha_o$  are the same as in the common-emitter case.

The complete derivation of these formulas in both  $h$  and  $y$  parameters is in UCRL 70888.

Step 1. Choose a common-collector stage driving a common-emitter stage.

Step 2. The 2N918 has a gain-bandwidth product of 900 MHz, and complete data on it is available. Since  $V_{ce0} = 15$  V, select  $V_{DC(+)} = 15$  volts and  $V_{DC(-)} = 15$  V.

Step 3. Common-emitter stage: Assume an output swing of 10 V peak-to-peak as the maximum necessary. With  $V_{ce} = 8$  V, there is sufficient voltage across the transistor for it to stay out of saturation on the positive input peak. This leaves 7 V across the dc path, which should be enough to prevent clipping on negative input peaks.

We are free to choose one more variable in the circuit; this is usually done by setting the collector current. Let  $I_c = 4$  mA. At this point,  $I_c = 4$  mA,  $V_{ce} = 8$  V, and not much correction to the parameters on the data sheet ( $I_c = 5$  mA,  $V_{ce} = 10$  V) is necessary.

Common-collector stage. For a voltage gain of 10:1 (20 dB) on the common-emitter stage, there will be a maximum output swing of 1 V peak-to-peak. Select the same operating point as for the common-emitter stage. (This will result in operation at a favorable point on the 2N918 characteristics.) This leaves more than enough dynamic range. Hence we have:  $V_{cc} = 15$  V,  $V_{ce} = 8$  V,  $I_c = 4$  mA.

Step 4. For each stage  $P_{diss} = V_{ce} I_c = 8 \times 4 \times 10^{-3} = 32$  mW. The 2N918 is rated at 200 mW at 25°C ambient. This is well within the allowable range.

Step 5. From the spec sheet, at the required operating point and in the 18-20 MHz region:

$$y_{ie} \cong 2.5 \times 10^{-3} + j1.5 \times 10^{-3} = 2.92 \times 10^{-3} \angle 31^\circ$$

$$y_{oe} \cong 0.1 \times 10^{-3} + j0.15 \times 10^{-3} = 1.8 \times 10^{-4} \angle 56.3^\circ$$

$$y_{re} \cong -j0.09 \times 10^{-3} = 9 \times 10^{-5} \angle 270^\circ$$

$$y_{fe} \cong 82 \times 10^{-3} - j27 \times 10^{-3} = 8.65 \times 10^{-2} \angle -18.2^\circ$$

Thus

$$y_{ie} + y_{oe} + y_{re} + y_{fe} = 84.6 \times 10^{-3} - j25.44 \times 10^{-3} \\ = 8.85 \times 10^{-2} \angle -16.7^\circ$$

and

$$\Delta y = y_{ie} y_{oe} - y_{re} y_{fe} = (2.45 + j7.92) \times 10^{-6} \\ = 8.3 \times 10^{-6} \angle 72.8^\circ$$

Step 6. Since  $A_v \cong 10$  and  $e_o \cong 10$  V p-p,  $e_{in} = 1$  V p-p. The negative input swing will be 0.5 volt, so that

$$R_E \geq \frac{0.5}{4 \times 10^{-3}} = 125 \text{ ohms.}$$

Let  $R_E = 150$  ohms. With a total resistive drop of 7 V at 4 mA,

$$R_E + R_c \cong \frac{7}{4 \times 10^{-3}} = 1.75 \text{ k.}$$

Hence  $R_c \cong 1750 - 150 = 1600$ . Let  $R_c = 1.6$  k,

which is a standard 5% resistor.

Step 7. From the spec sheets at the desired operating point we see that  $I_B \cong 0.054$  mA and  $V_{BE} \cong 0.8$  V. For  $I_B \cong I_c \cong 4$  mA,

$$V_{R_E} = 4 \times 10^{-3} \times 150 = 0.6 \text{ V;}$$

hence the voltage at the base, which is the voltage drop across  $R_{B2}$ , should be

$$V_{R_{B2}} = 0.62 + 0.8 = 1.4 \text{ V.}$$

For good bias stability, let the bias circuit current be ten times the base current so that changes in  $I_B$  will not shift the operating point markedly.

Hence  $I_{R_{B2}} \cong 0.54$  mA and

$$R_{B2} \cong \frac{1.4}{0.54 \times 10^{-3}} = 2.6 \times 10^3$$

Let  $R_{B2} = 2.7$  k.

Now  $V_{R_{B1}} \cong 15 - 1.4 = 13.6$  V, hence  $R_{B1}$

$$\cong \frac{13.6}{(0.54 + 0.054) \times 10^{-3}} = 22.9 \times 10^3$$

Let  $R_{B1} = 22$  k.

Step 8. Since  $V_{RE} = 7$  V and  $I_E \cong 4$  mA,

$$R_E = \frac{7}{4 \times 10^{-3}} = 1.75 \times 10^3 \Omega.$$

Let  $R_E = 1.8$  k for the common-collector stage, which is a standard 5% resistor.

Step 9.  $V_{RE} = I_E R_E \cong 4 \times 10^{-3} \times 1.8 \times 10^3 \cong 7.2$  V.

Hence the voltage at the base, which is the drop across  $R_{B2}$ , will be  $V_{R_{B2}} = V_{RE} + V_{BE} = 8.0$  V.

Again choosing the bias circuit current to be 0.54 mA,

$$R_{B2} \cong \frac{8}{0.54 \times 10^{-3}} = 14.8 \times 10^3.$$

Let  $R_{B2} = 15$  k for the common-collector stage. Now  $V_{R_{B1}}$  will be  $15 - 8 = 7$  V. And

$$\text{hence } R_{B1} = \frac{7}{(0.54 + 0.054) \times 10^{-3}} = 11.8 \times 10^3.$$

Let  $R_{B1} = 12$  k.

Step 10. The bypass capacitor must have an impedance of a few ohms or less at 20 MHz; 0.01  $\mu$ F should be sufficient. At these frequencies capacitors must have high self-resonant frequencies, and leads must be kept short. For good design, bypass only 100 ohms of the emitter resistor and put in a 51-ohm degenerating resistor.

Step 11. The coupling capacitors should have an impedance of 10 ohms or less at 20 MHz. Select 0.005  $\mu$ F.

Step 12. For this type of circuit, realistic values are  $R_L = 5$  k-ohms and  $R_g = 50$  ohms (that is, a coaxial cable).

Step 13. The output impedance of the common collector stage is found by noting that  $Z_i = 0$ .



## Amplifier performance

F (MHz)	$A_v$ (dB)		$A_v'$ (dB)	
	Predicted	Measured	Predicted	Measured
20	24.9	33.0	-77.5	-73.0
70	14.3	16.9	-54.5	-51.0

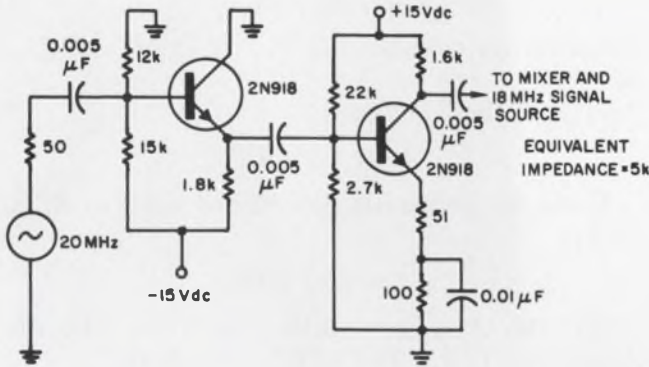

1. Two-stage amplifier satisfies the requirements of both of the design examples.

Therefore,

$$Z_o = \frac{1 + y_{ie} R_o'}{y_{ie} + y_{oe} + y_{re} + y_{fe} + \Delta y R_o'}$$

$$R_o' = \frac{R_B R_o}{R_B + R_o} \quad R_B = \frac{R_{B1} R_{B2}}{R_{B1} + R_{B2}}$$

$$R_B = \frac{12k \times 15k}{12k + 15k} = 6.67k$$

$$R_o' = \frac{50 \times 6.67k}{6.72k} = 49.5$$

$$Z_o \cong 11.3 \angle 16.7^\circ = 10.8 + j3.24$$

The input impedance of the common-emitter stage is given by

$$Z_i = \left\{ Z_e (y_{ie} + y_{re}) (y_{ie} + y_{fe} + \Delta y Z_L') + y_{ie} + \Delta y Z_e + y_{oe} y_{ie} Z_L' - y_{rc} \Delta y Z_e Z_L' \right\} / \left\{ y_{ie} [y_{ie} + \Delta y (Z_e + Z_L')] \right\}$$

where

$$Z_L' = \frac{Z_L R_c}{Z_L + R_c} = \frac{(1.6k)(5k)}{6.6k} = 1.21k$$

$$Z_i \cong 439 \angle -70.7^\circ = 145 - j415$$

The output impedance of the common-emitter stage is given by

$$Z_o = \frac{1 + y_{re} R_o' + (y_{re} + y_{oe} + y_{ie} + y_{fe}) Z_o + \Delta y R_o' Z_e}{y_{oe} + \Delta y (R_o' + Z_e)}$$

$$\text{where } R_o = \frac{Z_o R_E}{Z_o + R_E} \cong 11.3 \angle 16.7^\circ,$$

$$R_o' = \frac{R_o R_B}{R_o + R_B} \quad R_B = \frac{R_{B1} R_{B2}}{R_{B1} + R_{B2}}$$

$$R_B = \frac{2.7k \times 22k}{24.7k} = 2.41k$$

$$R_o' \cong 11.3 \angle 16.7^\circ$$

$$Z_o \cong 8 \times 10^3 \angle -7.8^\circ = 7940 - j1088$$

The input impedance of the common collector stage is found from

$$Z_i = \frac{(y_{ie} + y_{oe} + y_{re} + y_{fe}) Z_L' + 1}{\Delta y},$$

where  $Z_L'$  = input impedance of the common-emitter stage in parallel with its bias resistor and the emitter resistor of the common collector stage.

$$R_L = \frac{Z_i R_B}{Z_i + R_B} = 410 \angle -61.5^\circ$$

$$Z_L' = \frac{R_L R_E}{R_L + R_E} = 364 \angle -51.3^\circ$$

$$Z_i = \frac{(8.85 \angle -16.7^\circ)(3.64 \angle -51.3^\circ) + 1}{8.3 \angle 72.8^\circ (10^{-6})}$$

$$Z_i = 3.92 \times 10^6 \angle -139.1^\circ = -(2.92 + j2.57) \times 10^6$$

Step 14. The equations for  $A_v$  and  $A_v'$  for the CE case are in Box 1.  $Z_L' = 1.21k\Omega$  and  $Z_e = 51\Omega$ . Therefore,  $A_v \cong -18 \angle -8.5^\circ$ .

$A_v'$  is given by  $A_v' =$

$$\frac{(y_{re} - \Delta y Z_e) R_o'}{1 + y_{ie} R_o' + (y_{ie} + y_{oe} + y_{re} + y_{fe}) Z_e + \Delta y R_o' Z_e}$$

$R_o'$  has already been determined to be  $\cong 11.3 \angle 16.7^\circ$ .  $A_v' \cong -1.05 \times 10^{-3} \angle 105.8^\circ$

Step 15. The equations for  $A_v$  and  $A_v'$  for the CC case are in the Table.  $Z_L'$  has already been determined to be  $364 \angle -51.3^\circ$

$$A_v = 0.983 \angle -1.8^\circ$$

$$\text{For } Z_e = 0, A_v' = \frac{(y_{ie} + y_{re}) R_o'}{1 + y_{ie} R_o'}$$

$R_o'$  has already been determined to be  $49.5\Omega$ .

$$A_v' = 0.127 \angle 29.4^\circ$$

$$\text{Step 16. } A_{v(\text{TOT})} = A_{v(\text{CE})} \times A_{v(\text{CC})}$$

$$A_{v(\text{TOT})} = -17.7 \angle -10.30 = 24.9 \text{ dB}$$

$$A_{v(\text{TOT})}' = A_{v(\text{CE})}' \times A_{v(\text{CC})}'$$

$$A_{v(\text{TOT})}' = -0.133 \times 10^{-3} \angle 135.2^\circ = -77.5 \text{ dB}$$

Step 17. The over-all design requirements have been met and exceeded. However, if the forward and reverse current gains are calculated, the results are  $A_i = -8.75 \text{ dB}$  and  $A_i' = -47 \text{ dB}$ . That is, this amplifier lacks current gain but has good reverse current attenuation.

### Phase-lock amplifier is another example

Now, let's examine case II, the 70 MHz phase lock amplifier.

Step 1. (Same as case I)

Step 2. (Same as case I)

Step 3. Assume that an output swing of 3 V peak-to-peak is the maximum necessary. The operating points and signal levels should therefore be about the same as in case I.

Thus, for the common-emitter case,  $A_v = 3.2 = 10$  dB (design goal),  $V_{CE} = 8$  V,  $I_C = 4$  mA and  $V_{CC} = 15$  V. And for the common-collector case,  $V_{CE} = 8$  V,  $I_C = 4$  mA and  $V_{CC} = 15$  V.

Step 4. (Same as Case I)

Step 5. From the spec sheet at the required operating point and at  $f = 70$  MHz,

$$y_{ie} \cong 4 \times 10^{-3} + j4 \times 10^{-3} = 5.66 \times 10^{-3} \angle 45^\circ$$

$$y_{re} \cong j0.5 \times 10^{-3} = -0.5 \times 10^{-3} \angle 90^\circ$$

$$y_{fe} \cong 44 \times 10^{-3} - j39 \times 10^{-3} = 59 \times 10^{-3} \angle 138.4^\circ$$

$$y_{oe} \cong 0.25 \times 10^{-3} + j1.0 \times 10^{-3} = 1.03 \times 10^{-3} \angle 76^\circ$$

$$y_{ie} + y_{oe} + y_{re} + y_{fe} = (48.25 - j35.5) \times 10^{-3} \\ = 60 \times 10^{-3} \angle -36.4^\circ$$

$$\Delta y = y_{ie}y_{oe} - y_{re}y_{fe} = -(22.6 + j17.1) \times 10^{-6} \\ = 28.3 \times 10^{-6} \angle 217.2^\circ$$

Step 6. Since  $e_o = 3$  V p-p,  $V_{in} = 1$  V p-p and the negative input will be 0.5 volt. Therefore

$$R_E \geq \frac{0.5}{4 \times 10^{-3}} = 125 \Omega. \text{ Let } R_E = 150 \Omega.$$

Now with a total resistive drop of 7 V at 4 mA we have  $R_E + R_c \cong 7/4 \times 10^{-3} \cong 1.75$  k.

Hence  $R_c \cong 1750 - 150 \cong 1600 \Omega$ .

Let  $R_c = 1.6$  k, which is a standard 5% resistor.

Step 7. (Same as Case I)

Step 8. (Same as Case I)

Step 9. (Same as Case I)

Step 10. Bypass the emitter resistor with a capacitor that will have an impedance of about 1 ohm at 70 MHz. Thus  $0.01 \mu\text{F}$  should be sufficient. At these frequencies capacitor leads must be kept short, and capacitors with high self-resonant frequencies must be used. It is good practice to bypass the  $0.01\text{-}\mu\text{F}$  capacitor with a  $330\text{-pF}$  capacitor because of self-resonance phenomena. As good practice, bypass only 100 ohms of the emitter resistor and put in a 51-ohm degenerating resistance.

Step 11. Select a capacitor that gives an impedance of 10 ohms or less at 70 MHz. Therefore,  $C = 0.005 \mu\text{F}$ .

Step 12. (Same as Case I).

Step 13.  $Z_c = 0$ , therefore  $Z_o$  is given by the same expression as in Case I.  $R_b$  and  $R_o'$  are also the same, and the output impedance turns out to be  $Z_o = 17 \angle -35.66^\circ$ .

In a similar manner the input impedance of the common-emitter stage is found to be  $82 \angle 99.2^\circ$ .

Step 14. Using procedures identical to those of Case I, we find:

$$A_v \cong 5.75 \angle -56.3^\circ.$$

Noting that, in this case,  $R_o$  is the output impedance of the common-collector amplifier in parallel with its emitter resistor — that is,  $R_o \cong 17 \angle -35.6^\circ$  — we find that  $A_v' = 8.6 \times 10^{-3} \angle 121.6^\circ$ .

Step 15. To calculate  $A_v$  for the CC case, we'll need to know  $Z_L'$ .

$$Z_L' = Z_L R_E / (Z_L + R_E) \text{ and}$$

$$Z_L = Z_i R_B / (Z_i + R_B).$$

From earlier calculations,  $R_B = 2.41$  k $\Omega$  and  $Z_i = 88 \angle 99.2^\circ$ .

And using these numbers,

$$A_v \cong 0.9 \angle 9.1^\circ.$$

Using the previously determined value of  $R_o'$  of  $49.5 \Omega$ ,

$$A_v' = 0.22 \angle 41.2^\circ.$$

Step 16.  $A_{v(\text{TOT})} = -5.18 \angle 142.8^\circ = 14.3$  dB.  $A_{v(\text{TOT})}' = -1.89 \times 10^{-3} \angle 17.2^\circ = -54.5$  dB.

Step 17. The design objectives of at least 10 dB of voltage gain and at most -40 dB of reverse voltage have been met. Comparing this with Case I, which is the same amplifier, we observe that there is now 10.6 dB less of  $A_v$  and 23 dB less of  $A_v'$ . This is due to the degradation of the transistor parameters at higher frequencies.

Figure 1 shows the actual amplifier resulting from the design examples. From a practical viewpoint, stray capacitance and inductance must be kept to a minimum. Also, power-supply decoupling is a must. In this case, self-contained batteries were used to minimize power-line coupling and radiation. Measured and calculated results are compared in the table. ■ ■

### Test your retention

Here are questions based on the main points of this article. Their purpose is to help you make sure you have not overlooked any important ideas. You'll find the answers in the article.

1. What are the reverse gain characteristics of the common-emitter and the common-collector configurations?

2. Why should an amplifier with good reverse characteristics have both a common-collector and a common emitter stage?

3. Why did the two cases, with different requirements, wind up needing the same amplifier?





## Display of strength

There are several sound reasons to use our solid state numeric displays. One of the most important is this: they're so strong, they won't die of shock. So they can be used in the most demanding applications.

Another decisive factor is size: each display package measures just 1" x 0.5" x 0.16". And that's all there is to it. In this tiny framework, you get everything necessary to display numerals 0-9. The chip includes an IC driver/decoder and gallium arsenide phosphide diodes that make the bright red numerals visible clear across a room, even at an acute angle.

The display needs less than 5 volts to drive it, and takes a straightforward four line 8-4-2-1 BCD input. You can vary the brightness.

And, as the modules are IC compatible, no special interfacing is required. You can buy our solid state numeric display in three-character packages, as well as the solo component. And our small displays of strength cost just \$42 each in 1000 quantities.

For all the bright details about this new technology for numeric indicators, call your local HP field engineer. Or write Hewlett-Packard, Palo Alto, California 94304; Europe: 1217 Meyrin-Geneva, Switzerland.

HEWLETT  PACKARD

SOLID STATE DEVICES



**R-Series**  
2-sizes: 3-1/2", 4-1/2"

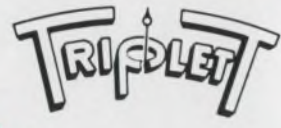

## "CLEAN SWEEP" PANEL INSTRUMENTS

A fresh approach to ultra-modern instrument design provides a "clean sweep" of the pointer over the full scale.

- 1** You get instant readability easier and at greater distances—plus more attractive designs to integrate into your equipment.
- 2** Self-shielded, accurate, reliable D.C. instruments have the exclusive Triplet BAR-RING movements.
- 3** Whatever your panel instrument requirement, look to Triplet for the right size and style, the right capability at the right price.



**G-Series**  
5 sizes: 1 1/2", 2 1/2", 3 1/2", 4 1/2", 5 1/2"



**MODEL 120 Edgewise Panel Meters**

**SHIELDED BAR-RING MOVEMENTS**

ALNICO MAGNET IS MOUNTED INSIDE SOFT IRON RING; FULLY SELF-SHIELDED

Not affected by magnetic panels or substantially by stray magnetic fields for D.C.

More Torque  
Lower Terminal Resistance  
Faster Response  
Exceedingly Rugged and Accurate

DIE CAST ONE-PIECE FRAME HOLDS IRON CORE IN EXACT ALIGNMENT

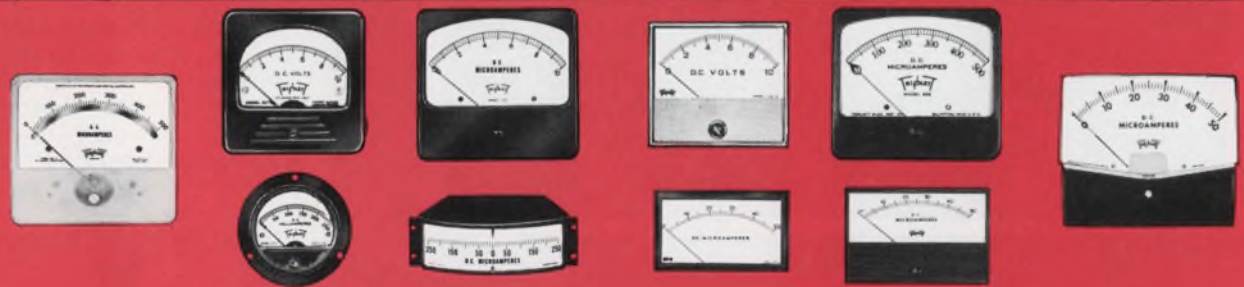



# Make systems fail-operational

by using multiple channels with automatic voters to select best signal.

A fail-operational system is one that will continue to operate properly in spite of a failure in one or more signal channels. Signal redundancy provides the necessary backup signals to keep critical controls in operation, and a selector circuit (voter) chooses the best signal from among several sources. The voter, Fig. 1, is the key to the use of such multichannel signal redundancy.

Three redundant channels can survive any one failure, while four channels can survive any two failures. The choice of control signal for the good channel is made according to a predetermined schedule; the largest signal, the smallest, or an in-between signal may be the one chosen to control this channel. The voter circuit then transmits only the chosen signal to the rest of the system.

Voters may be used at several points along each channel. Besides preventing any channel failure from being transmitted throughout the system, a voter can compensate for tolerance buildup, or it can eliminate tracking errors by means of signal redundancy.

## Different kinds of voters

The voter may be viewed as an automatically controlled selector switch, as shown in Fig. 1. Actual implementation of the circuit can be a diode gate that selects the more negative or the more positive of two signals, Fig. 2 or Fig. 3, respectively. In this case, the diode drop,  $V_d$ , is introduced as an error by these gates.

Another type of voter circuit makes use of pnp and npn transistors, as shown in Fig. 4. This more elaborate gate chooses for transmission the next to the most positive of the inputs. That is, if  $E_1 > E_2 > E_3 > E_4$ , then  $E_{out} = E_2$ , and if  $E_4 > E_1 > E_2 > E_3$ , then  $E_{out} = E_1$ . There are 24 possible combinations of the four inputs, and they can be arranged in a truth table to define the outputs. An advantage of this voter is that the

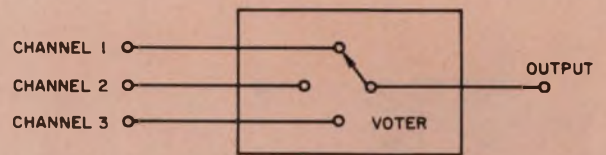

1. A voter is a selector switch that automatically chooses the best output.

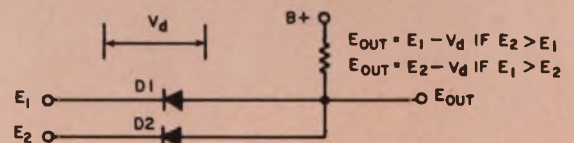

2. The more negative output is chosen by this diode gate arrangement.

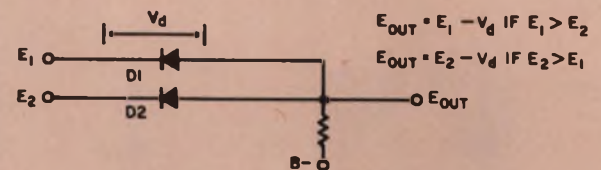

3. The more positive output is chosen by this diode gate arrangement.

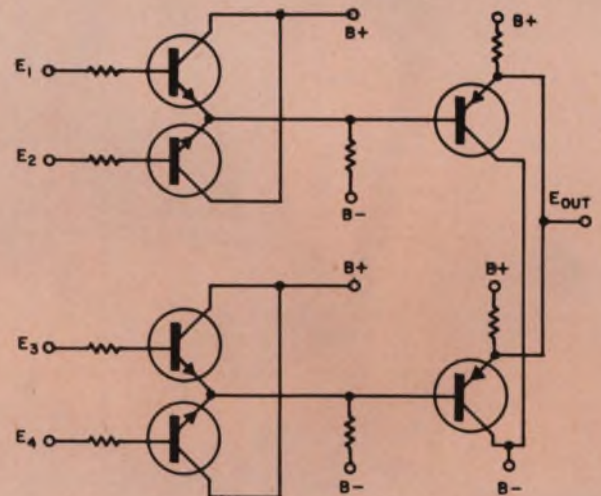

4. Transistor circuit compares four inputs and passes the second most positive.

Paul M. Rostek, Senior Electronic Engineer, Interstate Electronics Corp., Anaheim, Calif.



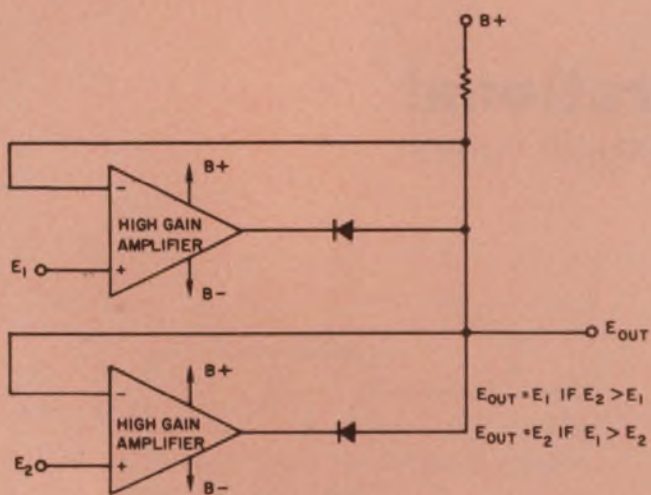

5. Operational-amplifier gate passes the more negative signal and avoids the drawbacks of simple diode and transistor gates. This operational amplifier configuration is the N gate of Figs. 7 and 8.

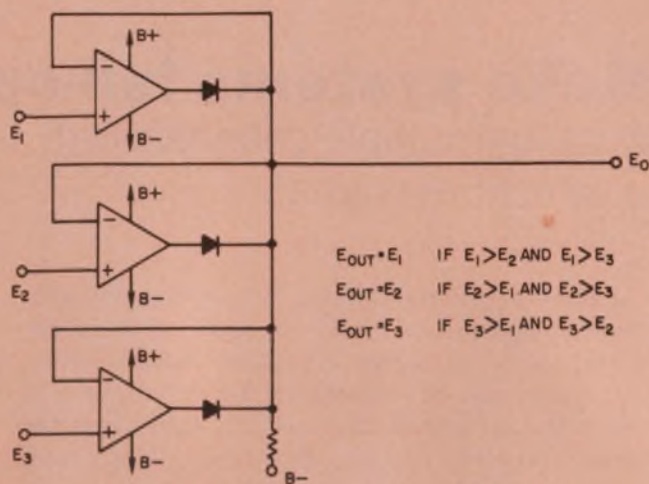

6. A trio of operational amplifiers passes the most positive signal. The effect of the diode drop is reduced by the loop gain of the amplifier. This is the P gate of Figs. 7 and 8.

$$E_{OUT} = E_1 \quad \text{IF } E_1 > E_2 \text{ AND } E_1 > E_3$$

$$E_{OUT} = E_2 \quad \text{IF } E_2 > E_1 \text{ AND } E_2 > E_3$$

$$E_{OUT} = E_3 \quad \text{IF } E_3 > E_1 \text{ AND } E_3 > E_2$$



Author Rostek sketches various voter configurations.

$V_{be}$  drop of the npn transistors in the first gates is canceled in the pnp transistors in the second gate. Circuit accuracy, however, depends on the stability of bias levels and on the accuracy with which the transistors are matched.

An operational-amplifier voter avoids these problems because of its greater flexibility, linearity, accuracy and low offset errors. An operational-amplifier gate that selects the more negative of two inputs is shown in Fig. 5. Figure 6 shows a similar gate that chooses the most positive of three inputs. In both cases the diode drop is reduced by the loop gain of the amplifier. If the gate in Fig. 5 is designated by *N*, and that in Fig. 6 by *P* then Fig. 7 shows how these *N* and *P* gates may be combined so that the output signal is the middle absolute magnitude of the three inputs. Figure 8 shows this selection as a truth table.

In any multi-input voter where  $m$  is the number of inputs,  $m!$  is the number of possible combinations of signals. A four-input voter with 24 possible combinations is shown in Fig. 9. The output in this case is not at all obvious. One must assign an order of magnitude to the four inputs and then trace the output of each gate. Note the asymmetry of this example: channels 1 and 4 are used as the inputs to one gate each, while channels 2 and 3 are used as inputs to two gates each.



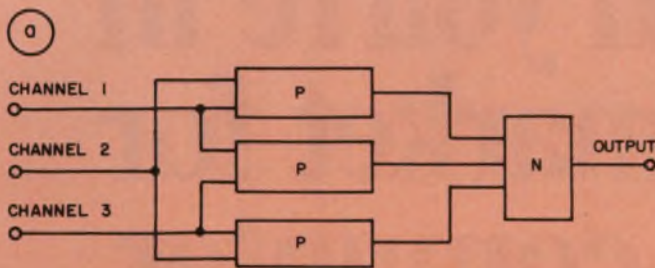

(b)

	INPUT SIGNALS				
MOST POSITIVE	1	1	2	2	3
	2	3	1	3	1
MOST NEGATIVE	3	2	3	1	2

7. Three two-input P gates are combined with a three-input N gate (a). The  $3!$  combinations are arranged in a truth table (b). The chosen signal, always the middle magnitude, is circled.

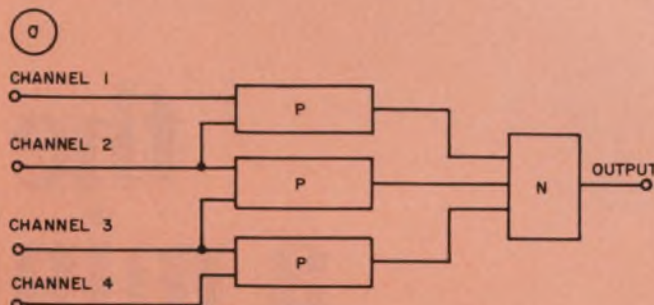

(b)

	INPUT SIGNALS																							
MOST POSITIVE	1	1	1	1	1	2	2	2	2	2	3	3	3	3	3	4	4	4	4	4	4			
	2	2	3	3	4	4	4	3	3	4	4	1	1	2	2	1	1	2	2	3	3			
MOST NEGATIVE	3	4	2	4	2	3	1	4	1	3	3	4	1	2	2	4	1	4	2	3	1	3		
	4	3	4	2	3	2	4	1	3	1	4	3	2	1	4	2	4	1	3	2	3	1	2	1

8. Using the same combination of gates as in Fig. 7, but with four inputs instead of three, one of the middle signals will pass (a). The circled number in the truth table (b) shows which one it is.

Figure 10 shows the output for each of the 24 possible combinations.

There are several possibilities of selecting middle inputs by rearranging input connections to the gates or by using additional gates. This flexibility is especially important in applications where three sensors must drive four channels. In such cases, at least one sensor must drive two channels. Protection against the failure of this "common" sensor is illustrated in Fig. 10. Observe that if both channels 1 and 4 are most positive or most negative, neither can be chosen.

### Fail-safe comparators monitor system

Almost all fail-safe operational systems include fail-safe comparators that monitor the entire system. These comparators can detect and indicate a failure. In addition, they can take such corrective action as grounding out any failed channel. When a sensor is used to drive more than one channel, the fail-safe comparators can detect a sensor failure by cross-monitoring all channels, and can take appropriate action, such as grounding out the signals at the voter inputs. The voter then passes only good signals into the control system.

The most desirable way to operate  $m$  redundant channels is to use  $m$  separate, independent

sources. In this way, a true  $m$ -plex system can be made virtually fail-operational for any  $m-2$  sensor failures.

The use of integrated circuits makes feasible the economical construction of complex systems that can survive multiple failures. This is extremely important as automation takes over more and more critical applications. ■■

### Test your retention

Here are questions based on the main points of this article. Their purpose is to help you make sure you have not overlooked any important ideas. You'll find the answers in the article.

1. What are the advantages of operational-amplifier gates?

2. Why are fail-safe comparators used in fail-operational systems?

3. How does the number of signal combinations vary with the number of signals present?

4. If one sensor must drive more than one signal channel, how may the system be protected against the failure of this sensor?

**If you're in  
the market for  
a mini computer,  
look at the  
Micro 800 first.**





# You'll probably end up with one anyway.

## Here's one reason why: Microprogramming

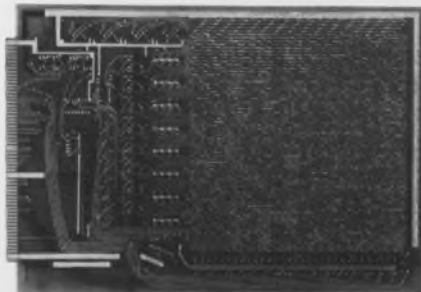

Microprogramming gives you a more efficient system, tailor-made to your requirements, for less money. Since firmware absorbs many functions normally handled by core memory and interface hardware, requirements for both are reduced substantially. On the other hand, standard hardware can be retained even while changing architecture to match your particular demands. With little time and practically no

effort, you can optimize computer characteristics for a particular operation without making a single hard wire change.

## Here's another: Delivery

We began building 800's before we began selling them, and now we're in volume production. It's only natural then that delivery is off-the-shelf with custom variations taking a modest 30 days extra. Try us. Especially if your requirements are urgent.

## Here's one more: Price

The Micro 800 costs \$3200 with quantity discounts ranging up to 40%. For \$3200 you get a basic processor with 16 multi-purpose registers, 256 words of read-only store, basic console, enclosure and power supply to function as a micro programmed controller. In

addition, you get the fastest digital computer in its class with a  $1.1\mu s$  memory cycle time and a 220ns micro command execution time. Core memory capacity is 0-32K bytes.

We also sell a microprogrammed adaptation of the 800 with 512 words of read-only store, a 4096-word by 8-bit core memory and a teletype interface. We call it the Micro 811 and it goes for \$6300. Our third model, the \$6900 Micro 810, is like the 811 except that 768 words of read-only store are used to implement an expanded instruction repertoire, including multiply and divide.

Just about any question you'll have is answered in our new mini-seminar booklet. We'll send you a copy gladly. But we'd really rather have you ask for a call from our marketing representative. You'll save a lot of time if you do because we're sure you'll end up with an 800 anyway. It's irresistible.



MICRO SYSTEMS INC. 644 EAST YOUNG STREET • SANTA ANA, CALIFORNIA 92705 • TELEPHONE (714) 540-6730

INFORMATION RETRIEVAL NUMBER 129

# Amplify biological signals with ICs.

Monolithic op amps in special circuits offer high CMRR, high input impedance and tolerance to dc noise.

The human body is virtually a bag of poorly conducting fluid. Measurements on a small part of it always result in large background signals being superimposed on the much smaller desired signals, and this places a severe burden on the amplifiers used.

Three main factors — large common-mode signals, high source impedance and unpredictable dc noise signals — set the specifications for all biological amplifiers.

To distinguish the signals from the noise, designers of biological equipment use balanced or differential amplifiers. The background noise is then common to both inputs, provided the electrodes are not too widely separated, and the desired signal appears between the two inputs. The two signals are discriminated as common-mode and differential-mode components, and are separated by the amplifier.

## Amplifiers face severe requirements

Biological sources generate signals of very low energy. Currents are small, and tissue conductance is low. A typical source has a high impedance, about 100 k $\Omega$ , and generates only 100 mV. At the skin surface, of course, these signals are attenuated and the impedance is increased (Fig. 1). Voltages measured within muscle tissue are usually less than 1 mV, and the source resistances are between 2 k $\Omega$  and 150 k $\Omega$ .

The interface between the body and the measuring device — the skin — is a fairly good insulator, but it also acts as a membrane that is semi-permeable to ions. When the detector electrodes (usually discs of metal or metal-halide) are placed on the skin, they inevitably set up metal-ion half-cells. An attempt is generally made to stabilize these half-cell potentials by providing a supply of ions in metal-halide conductive gels used beneath the electrode. This tends to minimize the potential difference between the pair of electrodes and to hold it constant, but slight movement, temperature

change, or perspiration can cause changes. A good biological amplifier must reject these changes as unwanted dc noise.

Among the many low-cost IC amplifiers available are some bipolar differential amplifiers with gains around 50,000, common-mode rejection ratios (CMRR) of 80 to 120 db, and input impedances of greater than 500 k $\Omega$ . They are ideal for biological use but must be properly applied.

The essential core of these amplifiers is the balanced differential stage (Fig. 2a) with the common emitter tail. In many cases the tail is replaced by a constant current source (Fig. 2b) presenting an effective large resistance, and often this is fed from a second differential stage (Fig. 2c) to improve the common-mode rejection and reduce temperature effects. The analysis of these circuits is adequately covered elsewhere<sup>1,2,3,4</sup>.

The matching of the transistors in the basic IC differential stages is much better than that achieved in discrete versions, because of the production techniques employed and the fact that the transistors are formed simultaneously. Some of the current devices have exceptional matching of characteristics, even at collector currents of a few microamperes, but even small differences can become important in biological applications.

## Gain adjustment can be a problem

One of first requirements of a biological amplifier is that the gain should be adjustable. The standard voltage-divider feedback connection (Fig. 3), however is unacceptable. The input impedance of the amplifier is low compared with that of the source, and the source impedance is somewhat variable. This leads to an uncertain overall gain. Also, the CMRR is poor, where it is defined as the ratio of differential-mode to common-mode gain.

A change of feedback to achieve higher input impedance and to reduce the gain uncertainty (Fig. 4) simply produces further deterioration in the CMRR. Even the non-inverting amplifier connection, with its very high input impedance and accurately determined gain ( $A = 1 + R_2/R_1$ ), does not improve the CMRR.

---

A. K. Godden, Engineer, Department of Engineering Science, University of Oxford, Oxford, England.



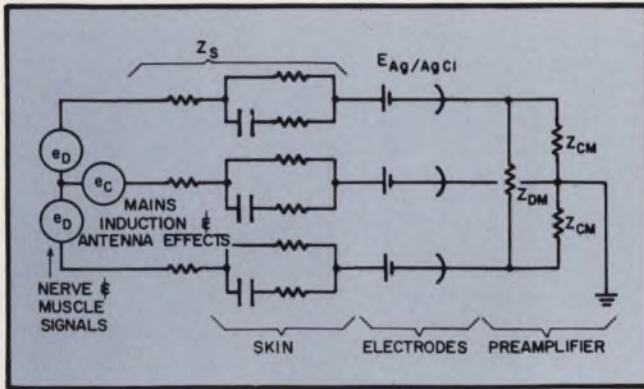

1. Biological signal sources generate millivolt signals and exhibit high output impedance. The skin layer adds series impedance, electrode-skin contacts add dc noise in the form of contact potential, and common-mode induced noise acts to swamp out the signal making detection of nerve or muscle signals difficult and high-gain op amps must be used.

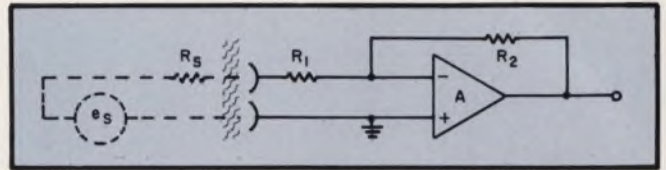

3. The conventional op amp connection is unsuitable for biological use, because the over-all gain depends on the unstable value of the source resistance,  $R_s$ . Common-mode rejection is poor. Typically,  $R_s = 2 \text{ k}\Omega$  to  $150 \text{ k}\Omega$ ,  $R_1 = 10 \text{ k}\Omega$ ,  $R_2 = 1 \text{ M}\Omega$ ,  $A_o = 30,000$ ,  $R_{in} = 10 \text{ k}\Omega$ , and the gain is 10 to 100.

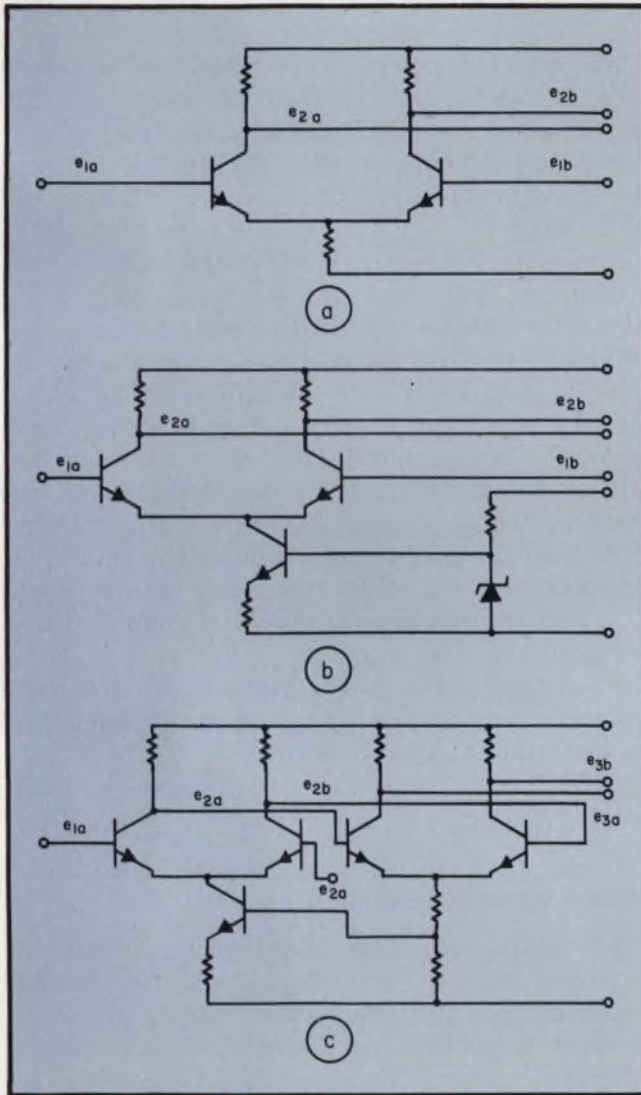

2. The differential pair is an essential part of every biological amplifier (a). For better common-mode rejection the common emitter resistor is replaced by a constant current source (b), which can be controlled by the common-mode output of a second differential stage (c).

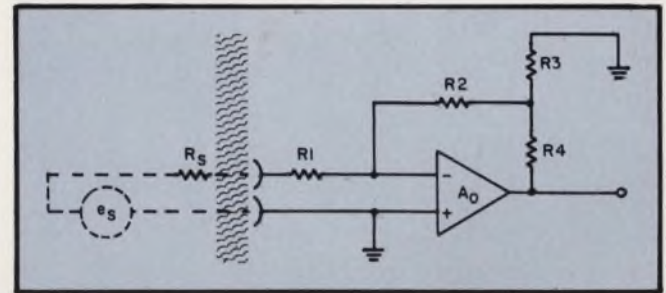

4. A further deterioration in CMRR results from this modification of the voltage divider feedback arrangement, although gain stability is improved due to increased input impedance. Typically,  $R_s = 2 \text{ k}\Omega$  to  $150 \text{ k}\Omega$ ,  $R_1 = 1 \text{ M}\Omega$ ,  $R_2 = 1 \text{ M}\Omega$ ,  $R_3 = 100 \Omega$ ,  $R_4 = 10 \text{ k}\Omega$ ,  $A_o = 30,000$ , and gain is 90 to 100.

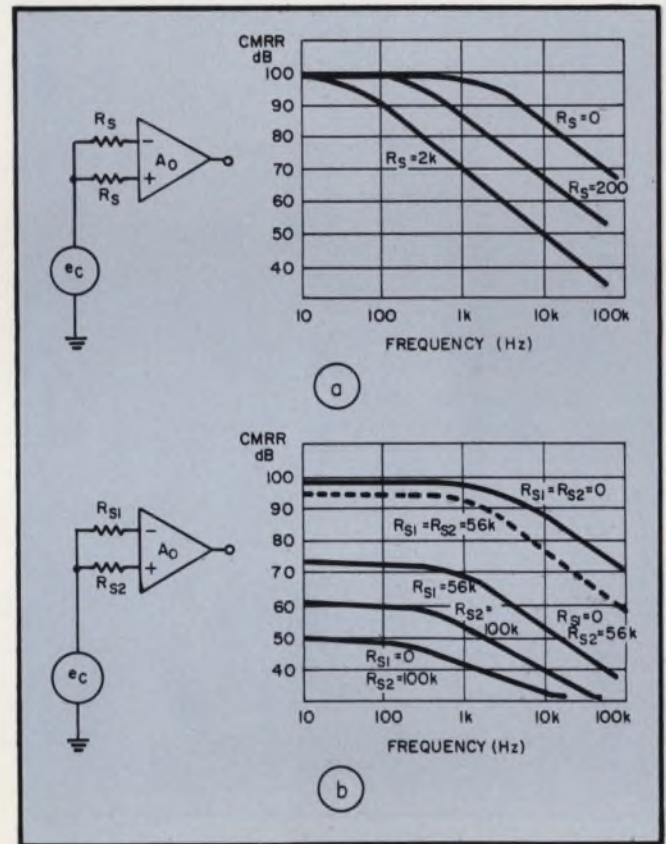

5. The CMRR of a 709 op amp is reduced, and the corner frequency is lowered, if the source impedance is increased (a). If the source impedances are unbalanced (b), the CMRR is decreased at all frequencies, and the corner frequency is further reduced.



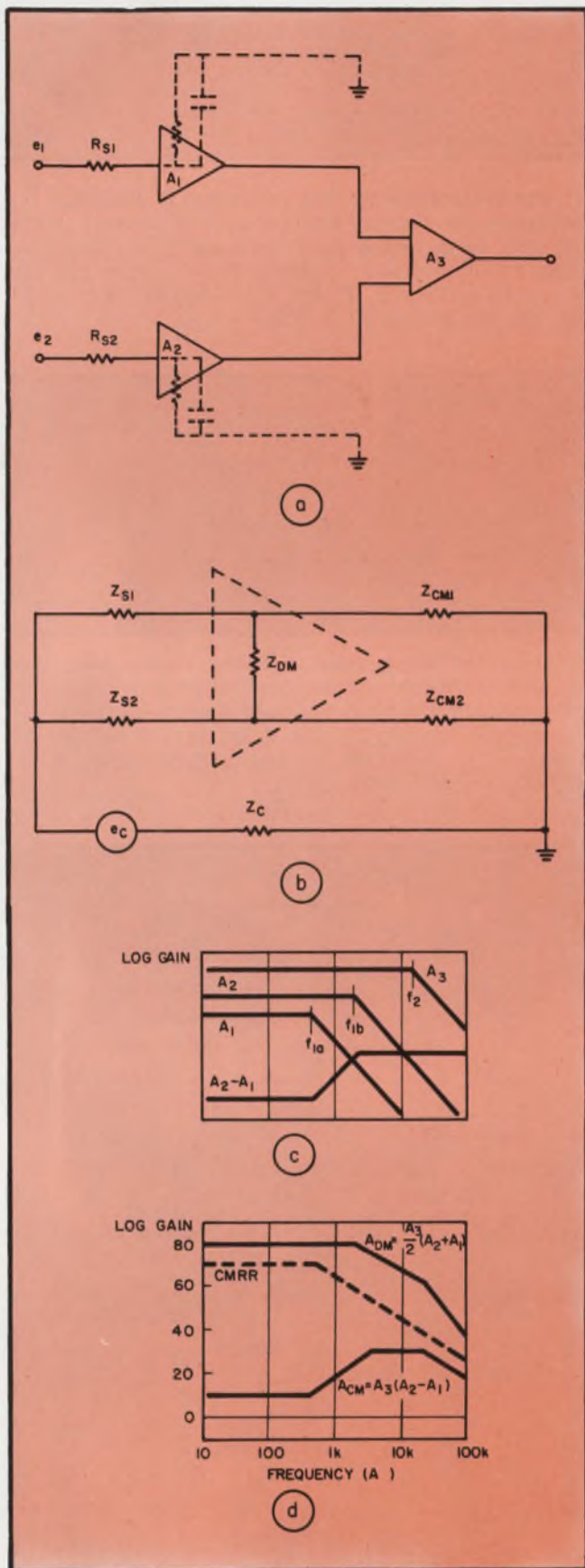

6. Common-mode rejection problems result from imbalances in the input stages of the op amp (a), which results in an imbalance of the equivalent bridge circuit (b). The difference in the input impedances of  $A_1$  and  $A_2$  results in gain curves as shown in (c). Subtraction of log gains  $A_{DM}$  and  $A_{CM}$  gives the CMRR (d).

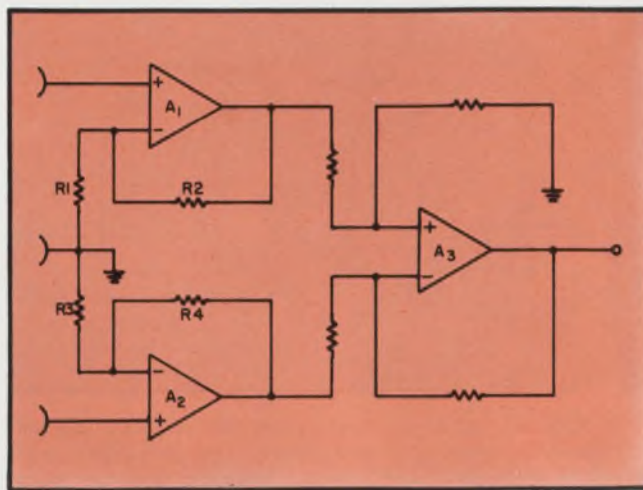

7. The compound differential circuit uses matched-gain, non-inverting preamplifiers before the common-mode rejection stage. Differences in gain between  $A_1$  and  $A_2$  lead to poor CMRR, of course, but the problems associated with the high, but variable, impedance of the biological source are avoided.

And even if the source impedances are balanced (Fig. 5a), an increase in them causes the CMRR to fall off at lower frequency. When the source impedances are unequal, the CMRR is lower at the outset and begins to fall off at still lower frequency (Fig. 5b).

These effects are due mainly to the base-emitter impedances in the op amp input stages (Fig. 6a). At low frequencies the resistive components cause an imbalance of the input bridge,<sup>5,6</sup> represented in Fig. 6b, and this side-to-side difference of gain, shown much exaggerated in Fig. 6c, gives rise to lower common-mode gain. The base-emitter capacitance difference leads to the difference in break points,  $f_{1a}$ ,  $f_{1b}$ , and causes the characteristic mid-frequency increase in common-mode gain. The amplifier gain roll-off at still higher frequencies,  $f_2$ , can be assigned to later stages of amplification, shown in Fig. 6 as  $A_3$ .

Since the CMRR is the ratio of differential-mode to common-mode gains, it is the difference in the logarithmic gains shown in Fig. 6d. For a high CMRR, then, the stages at which the rejection is effected must see low, balanced source impedances.

#### Balance the amplifiers, not the sources

The simple expedient of interposing matched amplifiers between the biological sources and the rejection stage allows separation of the problems of input impedance and balance. This has been attempted, using a non-inverting connection, as shown in Fig. 7.<sup>7</sup> Although this arrangement presents large input impedances to the electrodes, the CMRR is now more dependent on the matching of the gains of  $A_1$  and  $A_2$ , and thus the precision of the divider resistors  $R_{1-4}$ .<sup>6</sup>



Assuming the rejection stage to be perfect, the CMRR depends on the closed-loop gains, so

$$\begin{aligned} \text{CMRR} &= 20 \log (A_1 + A_2) / 2(A_1 - A_2) \\ &= 20 \log (1 - R_1 R_4 / R_2 R_3). \end{aligned}$$

These gains are greater than unity but substantially less than the open-loop gains. Resistor tolerances of 1% can produce a CMRR as low as 28 dB, and 0.1% tolerances improve this to only a little better than 48 dB.

Component tolerance difficulties can be eliminated, however, if the unity-gain (voltage follower) connection is used (Fig. 8). The accuracy matching gains is now dependent only on the difference of the open-loop gains, and

$$\begin{aligned} \text{CMRR} &= 20 \log (A_1 + A_2) / 2(A_1 - A_2) \\ &= 20 \log [A_1 A_2 / (A_1 - A_2)]. \end{aligned}$$

If these gains spread between 15,000 and 45,000, the CMRR arising from this input configuration can still exceed 87 dB. This means that the CMRR is limited, almost entirely, by the design of the next, differential stage.

#### Re-examine the common-moding stage

If the common-mode rejection is determined by the nature of the second stage, we must consider the factors that are important at this point.

The source impedances seen by this stage are the output impedances of the voltage followers. With large feedback, these impedances are reduced to about an ohm or two (the device output impedance is nominally 100  $\Omega$ ) and can be safely ignored.

Consider the amplifier as providing two uncoupled voltage gains,  $A_{10}$ ,  $A_{20}$ , from the input terminals to the output (Fig. 9a). For simplicity, let the input resistors be the same,  $R$ , but the resistor ratios on respective sides be  $\alpha$  and  $\beta$ . It can easily be shown that the output voltage is

$$V_o = \frac{1 + \alpha}{1 + \alpha + A_{10}} \left( \frac{\beta A_{20}}{1 + \beta} V_2 - \frac{\alpha A_{10}}{1 + \alpha} V_1 \right).$$

With some approximations, the differential-mode gain is  $A_{DM} = \alpha$  and the common-mode gain is

$$A_{CM} = \frac{1 + \alpha}{1 + \alpha + A_{10}} \left( \frac{\beta A_{20}}{1 + \beta} - \frac{\alpha A_{10}}{1 + \alpha} \right).$$

Separating the effects of gain and resistance variations, we have

$$\text{CMRR} = 20 \log [A_{20} / (A_{20} - A_{10})],$$

when  $\alpha = \beta$ , and

$$\text{CMRR} = 20 \log [\alpha(1 + \beta) / (\beta - \alpha)],$$

when  $A_{10} = A_{20}$ .

The difference  $(A_{10} - A_{20})$  is very small if the source resistances are near zero, as discussed earlier. With the differential-pair circuit and common-mode stages, this difference is smaller than one part in 40,000 (CMRR = 90 dB).

The same insensitivity cannot be claimed for the resistor-ratio error (Fig. 9b). For various nominal

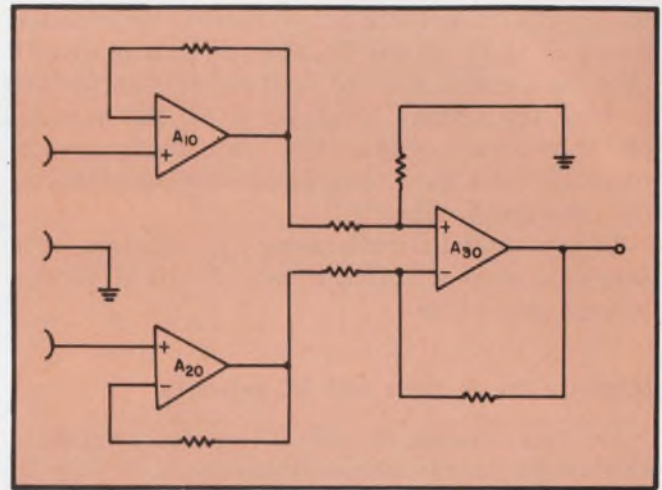

8. Voltage follower preamps improve the compound circuit because preamp gains are closely matched (close to unity), and the CMRR is limited only by the CMRR of the optimized differential stage  $A_3$ .

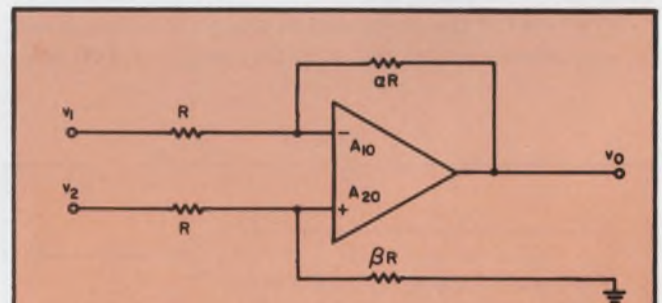

$$\text{CMRR} = 20 \log \left[ \frac{A_{10}}{A_{20} - A_{10}} \right] \text{ if } \alpha = \beta$$

$$\text{CMRR} = 20 \log \left[ \frac{\alpha(1 + \beta)}{\beta - \alpha} \right] \text{ if } A_{10} = A_{20}$$

(a)

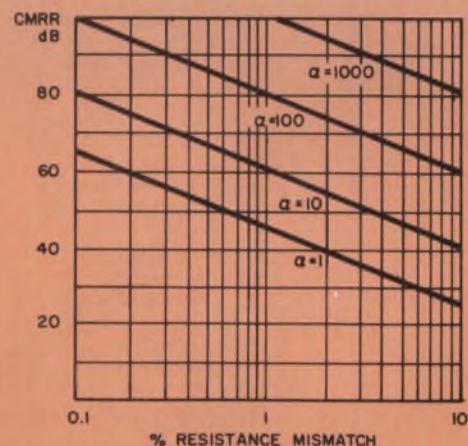

(b)

9. The common-mode rejection stage can be considered as an amplifier providing two uncoupled voltage gains to the signals applied to the two inputs. The CMRR is dependent on the matching of both the amplifier gains and the resistor ratios ( $\alpha$ ), and increases as the closed-loop gain,  $\alpha$ , is increased (b).



values of  $a$  (closed-loop gain), there is the expected decrease of 20 dB per decade, per unit mismatch between  $a$  and  $\beta$ . But the most interesting feature is that the CMRR increases with the nominal closed-loop gain of this stage. It is thus better to place the gain here than in succeeding stages of the measuring circuit.

In a practical circuit, using 1% resistors, it is easy to achieve a CMRR of over 70 dB at a stage voltage gain of 100.

### Minimize the dc noise with RC networks

In simple balanced and differential amplifiers designed with discrete components, it is easy to decouple the direct voltages that arise from dc noise due to electrode movement. Series decoupling capacitors can be used, for instance, with alternate paths provided for the dc input currents of the first-stage transistors. With ICs, however, the scope for such additions is severely limited.

The level of the noise signal due to the variations in electrode conditions is of the order of 100 mV.

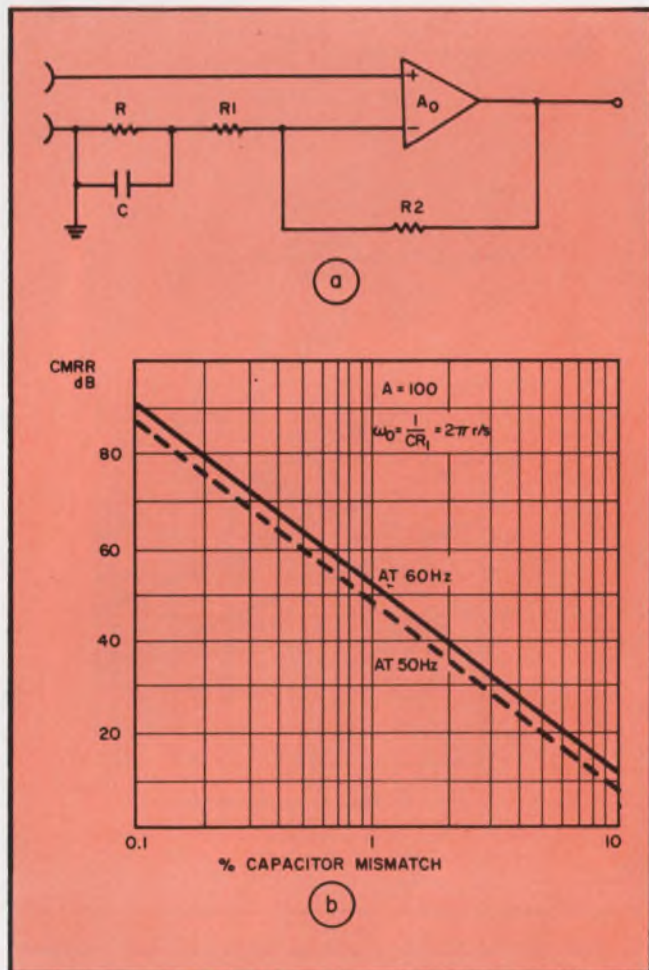

10. Dc noise can be blocked by a series RC circuit (a), but the capacitors must be carefully matched or they will degrade the CMRR (b). Such degradation is often the controlling factor in determining CMRR.

This magnitude of differential-mode signal is certain to saturate the IC input amplifier.

A workable solution is to provide for bias paths with suitably large resistors and then to bypass as much of this series resistance as required to fix the gain in the working frequency band (Fig. 10). The low-frequency break point is determined by  $R_1C$ , and below  $\omega RC = 1$  the gain approaches  $(R + R_1 + R_2)/(R + R_1)$ ; (unity gain if  $R \gg R_1 + R_2$ ). Thus the gain for the noise signals is approximately unity, and, except for some charging transients, they are no longer objectionable.

A word of caution about the matching of the capacitors: Intuitively, one supposes that if the break points of two preamplifier stages before the differential stage are located well below the power line frequency — say at 1 Hz compared with 60 Hz — the difficulties of matching the capacitors would be eliminated. This is not the case. If low-frequency roll-off is designed only a decade below the power line frequency, it will produce a CMRR at the latter frequency roughly 14 dB below that shown in Fig. 10b.

In compound differential circuits, in which frequency shaping is arranged in the preamplifiers before the stage at which common-mode is removed, there can be a serious deterioration of CMRR due to mismatch of the capacitors. Fig. 10b shows the effect of this mismatch when it is the controlling factor in the CMRR and the nominal low frequency breakpoint is 1 Hz.

The CMRR can be shown to be given by:

$$\text{CMRR} = 20 \log \left( \frac{A}{A-1} \right) \left( \frac{\omega}{\omega_0} \right) \left( \frac{C}{\Delta C} \right)$$

in which  $\omega_0 = 1/CR_1$ ,  $A$  is the closed-loop gain and  $\Delta C/C$  is the fractional mismatch of capacitance between the two stages. Observe that if one uses low values of  $R_1$  for high CMRR within the preamplifier stage, then  $C$  must be large to achieve a low cutoff frequency. This usually implies electrolytic capacitors, and consequently inherent mismatch.

### Avoid latch-up difficulties

Latch-up occurs when the voltage excursions cause a transistor in an amplifier to saturate, in turn causing a sign reversal to be associated with the incremental gain. With such a condition the output holds the input to a stable saturated level through the feedback divider path.

The usual protection technique is to limit either the input, the output or the feedback excursions to avoid the initiating saturating conditions (Fig. 11).

By using the unity dc gain configuration, the problems of inadvertently overloading an amplifier when the operator adjusts an electrode or switches ranges are removed. In fact, in the whole



measuring system there is no tendency to latch-up under any signal or operating condition.

Of course, there are other factors that can influence the proneness to latch-up. Of these, the three most important are: the IC amplifier type (experience and trials are the only sure criteria); satisfactory provision of bias current<sup>8</sup> and fixing of biological potentials relative to the supply voltages; and favorable conditions of feedback (low resistances and good grounding). These are fairly well known and need not be elaborated on.

### AC noise is not a problem

Until quite recently, the noise characteristics of transistors formed in monolithic constructions ruled them out for use in biological amplifiers. But now transistors can be formed that operate at collector currents of a few microamperes, with noise voltages, referred to the input, of a few microvolts.

The manufacturers' data<sup>9</sup> for the 709 and MC 1533 devices indicated noise voltages of about  $16 \mu\text{V}$  for a 10 kHz bandwidth and a source impedance of 100 k $\Omega$ . For the voltage follower stages only one input is used, so that the effective noise voltage is expected to be around  $11 \mu\text{V}$ , and succeeding common-mode stages see low source impedances that add less than  $1 \mu\text{V}$ . In the actual circuit the noise level was observed by oscilloscope to be around  $16 \mu\text{V}$ , p-p, referred to the input. This is only a few decibels above the integrated thermal noise from the source resistance of 100 k $\Omega$ .

### Shape the frequency response

It is advisable with biological amplifiers, as with most others, to reduce the bandwidth to that required to handle the desired signals. Excessive bandwidth decreases the signal-to-noise ratio by about 6 dB per decade for high source impedances, and 10 dB per decade for low source impedances.

Most IC amplifiers have terminals to which a variety of lead and lag compensation circuits may

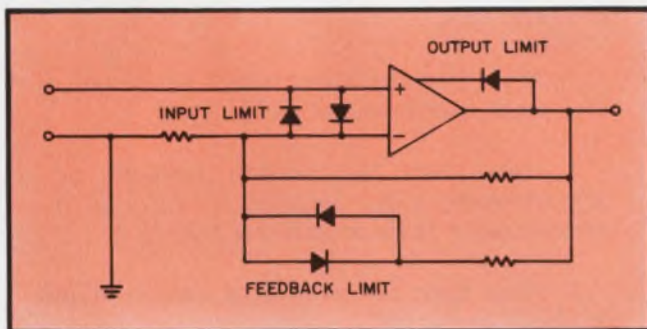

11. Latch-up is prevented by limiting the input or output voltage excursions with diodes or by increasing the feedback with diodes or zeners in the feedback line. Protection is needed because input transients are common.

be connected. Simple schemes of lag compensation reduce the upper break frequency of the open-loop amplifier, but this is adequate for situations requiring limited bandwidths and low gain. Fig. 12 shows the components that are involved in the process.

The above circuits were evolved after considerable unrewarded effort was expended on packaged FET amplifiers and hybrid FET circuits. Much of this development was intended to raise the input impedance, but the increase did not justify the high costs and certain other disadvantages.

The matching and biasing of FET devices is a problem. And MOSFETs can easily be destroyed by voltages that exceed their input ratings — voltages that are common in biological sources.

### Use the three-axis myoelectric amplifier

Figure 13 shows the results of applying the theoretical considerations described to the problem of a three-axis measurement of myographic (muscular) response. The data measured was used to determine the optimum alignment of electrode

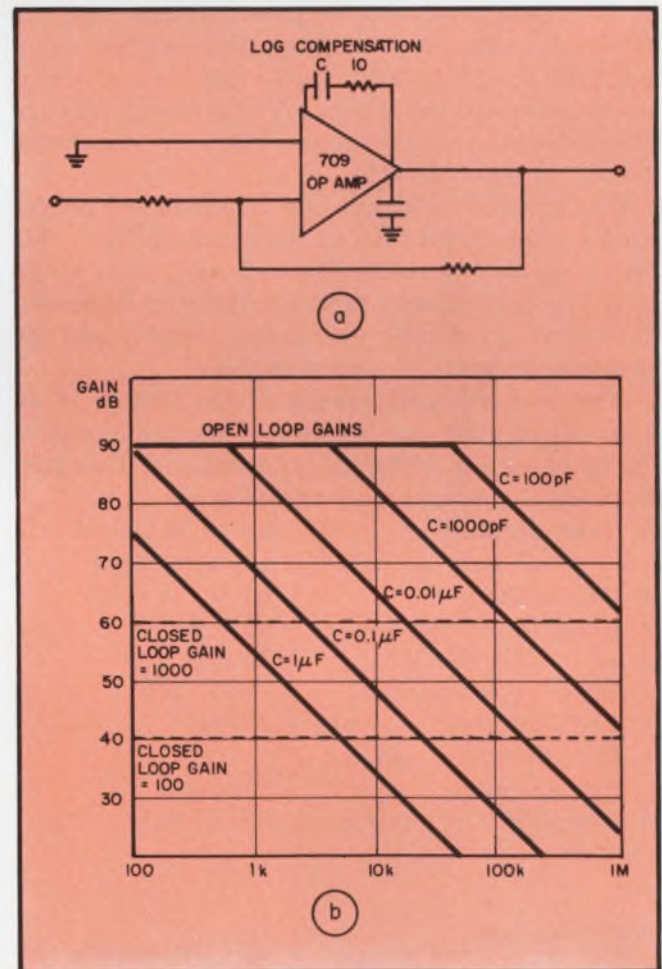

12. Frequency response is shaped by simple lag compensation networks connected to the op amp, as suggested by the manufacturer. The bandwidth can easily be set to that desired, to eliminate out-of-band noise.



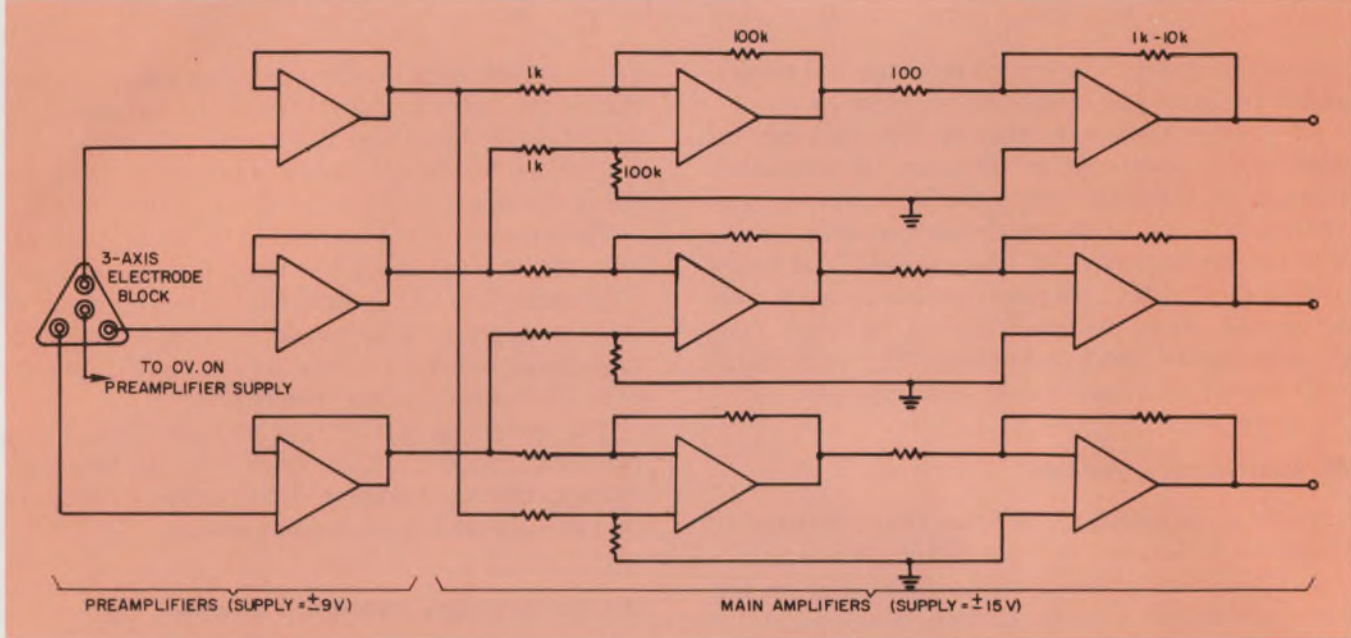

13. A 3-axis biological amplifier uses the techniques discussed to measure low-level signals in muscle tissue. Data collected with this amplifier is being used to de-

termine optimum alignment of electrode pairs on the trunks of handicapped children for electronic control of artificial limbs.

pairs on the trunks of children who are candidates for myoelectric control of artificial limbs.

The system consists of preamplifiers near the three-axis electrode block on the patient, main amplifiers and several signal processing units. (The latter are not shown.) The preamplifiers are separated from the main amplifiers by some three meters of coaxial cable.

The rejection of power line induction was poorer on the final circuit than on the bench version. This was eventually traced to the common supply leads, and was dramatically reduced when the preamplifiers were given their own battery supply and the common ground link was removed.

The over-all performance of the system is an example of what can be achieved with inexpensive IC amplifiers in biological applications. This performance is summarized as follows:

- Over-all gain: 1000 to 10,000 at  $\pm 4\%$  accuracy
- Bandwidth: 1 Hz to 10 kHz
- Input impedance:  $> 50 \text{ M}\Omega$
- 50/60 Hz CMRR:  $> 70 \text{ dB}$
- Input referred noise:  $\leq 16 \mu\text{V}$ , p-p
- Voltage offset at output:  $< 150 \text{ mV}$
- Direct voltage transient time constant:  $\approx 100 \text{ ms}$
- Complete freedom from latch-up. ■ ■

#### Acknowledgment:

This development was part of work sponsored by the U.K. Dept. of Health and Social Security to investigate feasibility of electromyographic control of artificial limbs by handicapped children. The Lady Hoare Thalidomide Appeal provided related support and facilities.

Sincere thanks to P. J. Jarvis, who assisted in the practical work throughout.

#### References:

1. R. D. Middlebrook, *Differential Amplifiers*, John Wiley & Sons, N. Y. 1964.
2. Robert H. Okada, "Stable transistor wideband d-c amplifiers," *Trans. AIEE*, Elec. and Comm., March, 1960.
3. P. J. Beneteau et al, "Drift compensation in dc amplifiers," *Solid State Design*, May, 1964.
4. R. D. Middlebrook, A. D. Taylor, "Differential amplifier with regulator achieves high stability, low drift," *Electronics* 28, July, 1961.
5. M. Graham, "EEG preamplifier," *IEEE Trans. Bio-Med. Engg.*, BME-12, July-October, 1965.
6. D. Taskett, "Common-mode considerations for differential operational amplifiers," *Electro-Technology*, May, 1967.
7. B. Murari, "EGG and EGG preamplifiers," *World Med. Elec.* October, 1967.
8. Leo L. Wisseman, "A high voltage monolithic operational amplifier," Motorola app. note AN-248.
9. Various data sheets on the MC 1533 and 709 series of amplifiers.

#### Test your retention

Here are questions based on the main points of this article. Their purpose is to help you make sure you have not overlooked any important ideas. You'll find the answers in the article.

1. What are the three main problems of biological instrumentation?

2. How does the author suggest you achieve high input impedance without incurring poor balance and low CMRR?

3. How does the suggested circuit avoid latch-up problems?

4. How does the author overcome the problem of dc noise?



# Give your designs the flexibility of these newest RCA "Building Blocks"

**Box full of linear circuit "building blocks"**—Your RCA Distributor has QK2202, RCA's linear circuits sampler containing 10 types of circuits (23 devices). Here's thorough documentation—virtually everything you need to sharpen your circuit ingenuity using linear "building blocks." The QK2202 is available at \$37.95 (optional distributor resale price). Get yours today.

Ask your local RCA Representative or your RCA Distributor for full details. For specific product data, write RCA Electronic Components, Commercial Engineering, Sec. ICG 8-3, Harrison, N. J. 07029.

**RCA**  
Integrated  
Circuits

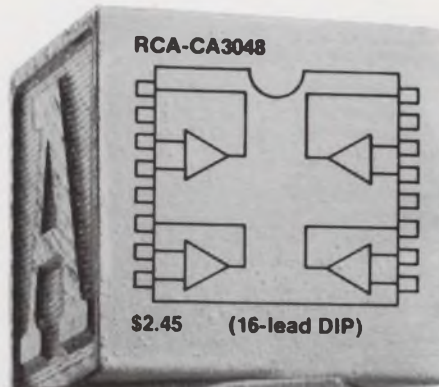

\$2.45 (16-lead DIP)

#### 4 AC Amplifiers in a Package

Four independent AC amplifiers with 53 dB (min.) voltage gain per amplifier @ 10 kHz, for use to 300 kHz. For low-noise and general AC applications in industrial service.

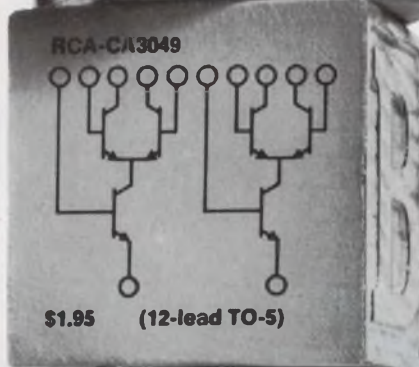

\$1.95 (12-lead TO-5)

#### DC to 200 MHz Dual Diff Amp

Dual independent diff amps for low-power applications. Power gain 23 dB (typ.) @ 200 MHz; noise figure 4.6 dB (typ.) at 200 MHz. Wide application potential over the full military temperature range.

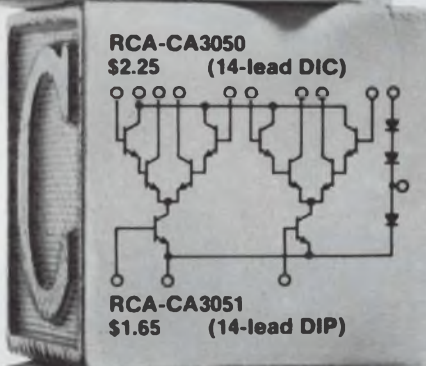

#### Darlington-Connected Dual Differential Amplifier

Two Darlington-connected diff amps with diode bias string for low-power applications from DC to 20 MHz. CA3050 for full military temperature range; CA3051 for  $-25^{\circ}\text{C}$  to  $+85^{\circ}\text{C}$  operation. Both feature high impedance input, low bias current, low offset current.

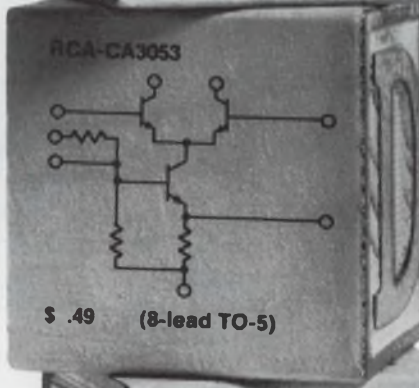

\$ .49 (8-lead TO-5)

#### Economy Multi-Purpose Linear IC

New economy linear IC combining performance and versatility—at a new low in cost. 40 dB (typ.) cascode voltage gain @ 10.7 MHz, 30 dB (typ.) differential voltage gain @ 10.7 MHz. Recommended for IF and general-purpose applications. 6- or 12-V operation.

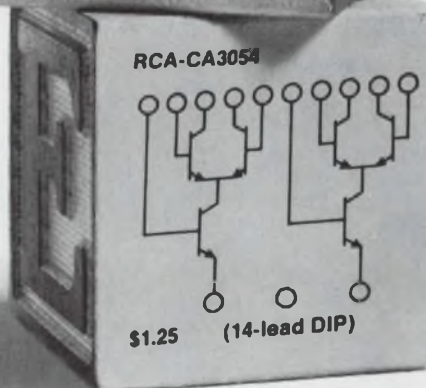

\$1.25 (14-lead DIP)

#### 120 MHz Dual Diff Amp in 14-lead DIP

Matched diff amps with independently accessible inputs and outputs. Max. input offset voltage = 5 mV; max. collector current = 50 mA. Forward current transfer ratio ( $h_{fe}$ ) (typ.) = 110. For  $0^{\circ}$  to  $85^{\circ}\text{C}$  operation. Also available as CA3026 in TO-5 package for full military temperature range.

Visit the RCA Electronic Components exhibit at WESCON, Unit C, in the Cow Palace Arena

All prices 1,000 unit level.

INFORMATION RETRIEVAL NUMBER 130

**Everybody talks about beam lead.**





This is the dawning of the age of the leaded chip. In other words, sports fans, August is the month Raytheon uncorks beam lead, and the old semiconductor business will never again be the same.

- Simply meaning that now you can buy semiconductor chips with leads already formed and integrally attached. This lets you control packaging, save system assembly time and boost reliability.

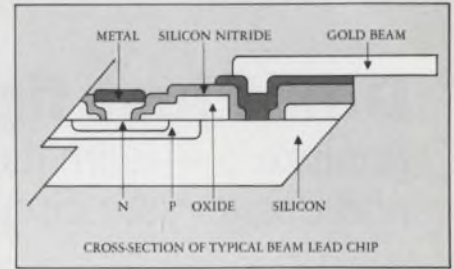

- Take a for instance. With a beam lead chip, bonding's a step, not a career. Every lead's bonded at once, whether you're working with diodes or LSI.
- And the chip stays healthier. Your operator can mash down on those little leads and cook them to a turn. The chip sits there, to one side of the action, calm, cool and uncracked.

□ But there's more. Every beam lead chip sports a Silicon Nitride passivation coat to give it complete hermetic sealing at all junctions. Raytheon's wafer separation process exorcises that evil old chip-cracker, the scribe.

Chips are separated by a delicate anisotropic etching process that eases those little babies apart with TLC.

No more hidden cracks to surprise you in final testing, or after your system's been fired up for a week. And just to sweeten the pot, in case you *really* hate surprises, we can provide 100% chip testing against all AC and DC parameters at -55 to +125°C.

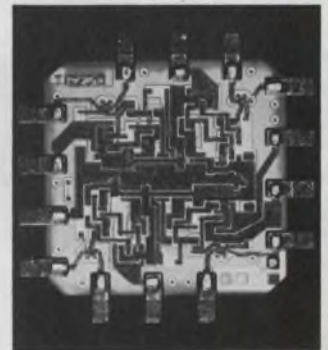

**But we deliver it.**



Type No.	Device (-55 to +125°C)	100-999
RM709	Op amp	\$6.80
RG250	Expandable quad 2 input OR gate	4.05
RG220	Quad 2 input NAND gate	4.05
RG240	Dual 4 input NAND gate	4.05
RG200	Expandable single 8 input NAND gate	4.05
RG230	Quad 2 input OR expander gate	2.60
RF200	JK flip flop (AND inputs)	6.00
RF100	Dual JK flip flop (separate clock)	7.10
1N914	Fast switching diode	1.25
1N3600	High conductance fast switching diode	1.30
2N2484	Low level amplifier NPN	1.75
2N2605	Low level amplifier PNP	2.15

*In segments of 5 chips only. Commercial grade units at lower prices; delivery to start 4th quarter 1969.*

- We're kicking off our Beam Lead Derby with an even dozen types, available in quantity from our exclusive beam-lead-franchised distributors, Avnet Electronics and Cramer Electronics. Later on you can buy our whole line in beam lead... TTL, DTL, linears, transistors, diodes.
- After that, onward and upward to multi-chip arrays, MSI, LSI and so on. Proving once again the wisdom of doing business with the company that puts its chips where its mouth is. Send for data, including Raytheon-approved list of sources for beam lead bonders. Raytheon Semiconductor, Mountain View, California. (415) 968-9211.

# Don't just fight semiconductor noise.

Analyze it — learn its sources, predict its magnitude and design your circuits to tolerate it.

There is no such thing as a noiseless semiconductor. All devices — resistors, diodes and transistors — generate internal electrical noise that cannot be eliminated. But it can be tolerated, even in critical designs, if its sources are known and its magnitude is predicted.

The designer must understand the origins of noise and develop circuit models that accurately simulate the devices he designs with. He must ask: Where does the noise come from? How much is there? How can I best live with it? And the answers come only from a thorough analysis of the devices themselves.

## Model of noise mechanism needed

Noise analysis is fairly easy, especially at intermediate frequencies, from about 1 kHz to 1 MHz. Here, thermal and shot noises predominate, and they have been described by Johnson<sup>2</sup> and Nyquist,<sup>3</sup> and by Schottky.<sup>4</sup> But at high and low frequencies, discrepancies develop.

Noise observed experimentally exceeds thermal and shot noise predictions at frequencies under about 1 kHz. The excess noise varies inversely with frequency ( $1/f$  noise), and it appears that, in some cases, it is related to surface states within the semiconductor device. At high frequencies, too, excess noise is observed, but here the discrepancy is caused by the decreasing gain of the semiconductor device.

Whatever the cause or the effect, the designer must have a model of the noise mechanism if he is to allow for it in his design. And a good model can be derived very easily. It's based on the noise mechanisms that are important in resistors and vacuum diodes, and it's supported by experimental data.

## Begin with the basic mechanisms

Due to the random thermal motion of free electrons within a resistor, an open-circuit voltage

Andrew S. Grove, Director of Engineering, Intel Corp., Mountain View, Calif., and S. T. Hsu, Member of the Technical Staff, Fairchild Semiconductor Research and Development Laboratory, Palo Alto, Calif.

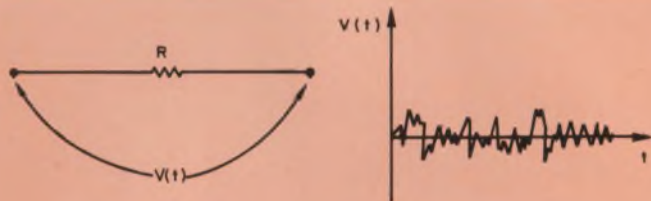

1. Noise in a resistor is caused by the random thermal motion of free electrons within it. An open-circuit voltage fluctuation is developed across its terminals.

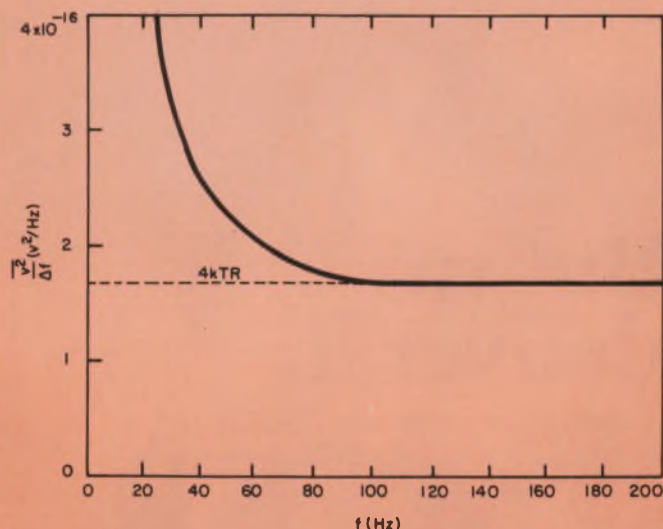

2. Resistors generate  $1/f$  noise, so called because its power spectrum is roughly proportional to the reciprocal of frequency, in addition to the thermal noise component described by Johnson and Nyquist.

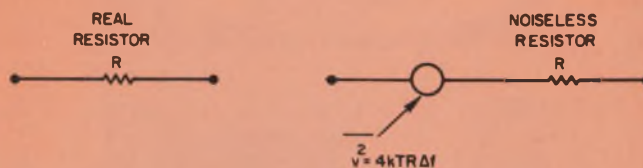

3. A simple circuit model of a resistor, useful at frequencies above the spectrum of  $1/f$  noise, consists of an ideal resistance in series with the thermal noise source described by Johnson and Nyquist.



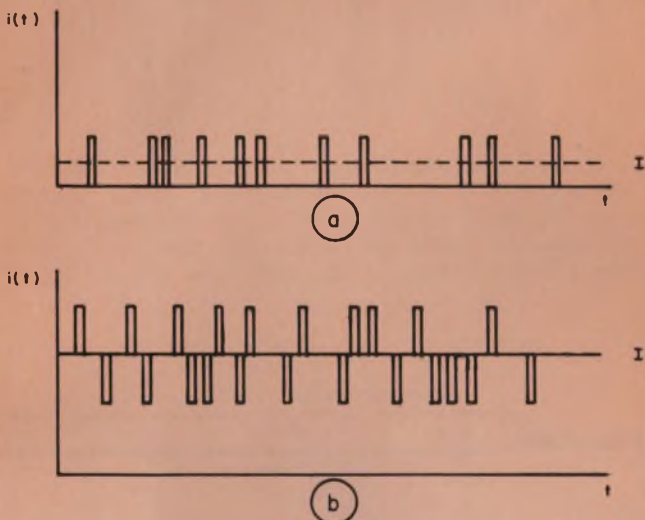

4. Shot noise is caused by the particle-flow of electrons. Each electron carries a discrete amount of charge, and as it arrives at, say, an anode, it contributes a very short pulse of high current (a). At high dc current levels the pulses merge (b), but the shot noise contribution remains superimposed.

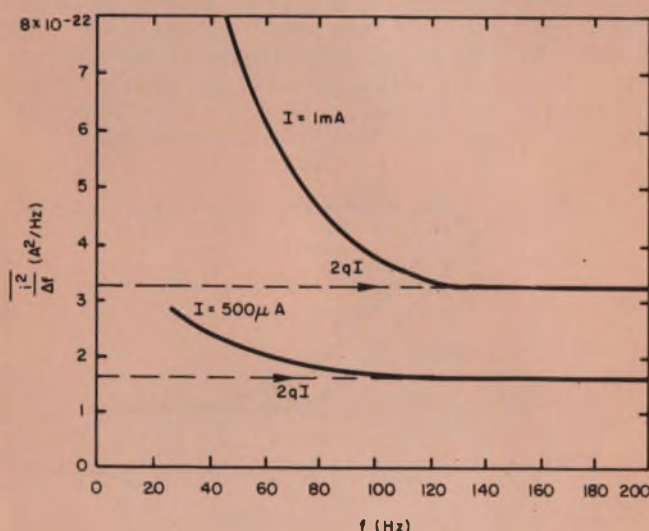

5. The noise spectrum of a vacuum diode follows the shot-noise prediction developed by Schottky, except at low frequencies. Below 100 Hz the  $1/f$  excess noise becomes very significant.

fluctuation is developed across its terminals, as indicated in Fig. 1. This voltage fluctuation, or thermal noise, was first discussed and studied by Johnson and by Nyquist, and is consequently often referred to by their names.

Johnson and Nyquist have shown that the mean-square value of the open-circuit voltage fluctuation  $\overline{v^2}$  across any resistor with resistance  $R$  is given by

$$\overline{v^2} = (4kTR) \Delta f \quad (1)$$

where  $\Delta f$  designates the bandwidth of interest in Hertz ( $k$  is Boltzmann's constant,  $8.62 \times 10^{-5}$  electron volt/ $^{\circ}\text{K}$ ;  $T$  is the temperature in  $^{\circ}\text{K}$ ; and  $R$  is the resistance in ohms). The spectrum of the thermal or resistance noise, which is the quantity inside the parenthesis, is independent of frequency.

Experimental data on the noise spectrum of a  $10^4 \Omega$  resistor are shown in Fig. 2, where the dashed line indicates the theoretical noise value calculated from Eq. 1. The experimental results are in agreement with Eq. 1 for frequencies above about 100 Hz, but below this frequency considerable excess noise is observed.

The excess noise is frequency dependent, rising in power approximately in proportion with  $1/f$ , and is referred to as  $1/f$  noise. It is observed in all types of electronic devices, including resistors, vacuum tubes, and all semiconductor devices. No definite explanation of its physical origin has yet been established.

Thermal noise, above the frequency range where  $1/f$  noise is observed, can be represented in circuit designs by replacing a real, and therefore noisy, resistor with a noiseless one of equal resistance in series with a noise voltage generator (Fig. 3).

While the current in a resistor is carried by free conduction electrons, it is carried in many other electronic devices by individual electrons that flow as particles. The simplest example of such an electronic device is a vacuum diode, in which current is carried by electrons traveling from cathode to anode.

The current flowing in a vacuum diode fluctuates because each electron carries a discrete amount of charge. Current varies with time, and at low current levels it appears as shown in Fig. 4a. Each of the pulses corresponds to the charge carried



by one electron traveling from the cathode to the anode. If the current level is higher, the individual pulses will merge together, but current versus time is ragged in appearance as shown in Fig. 4b. The discrete-particle nature of charge carried by the individual electrons leads to a fluctuation of current, and hence to noise.

This type of noise, called shot noise, has been analyzed by Schottky,<sup>4</sup> who has shown that the mean-square current fluctuation is

$$\overline{i^2} = (2qI) \Delta f \quad (2)$$

where  $I$  is the dc current in amperes,  $q$  is the electronic charge— $1.6 \times 10^{-19}$  coulomb—and  $\Delta f$  is the bandwidth in Hertz. The spectrum of shot noise (quantity inside of parenthesis) is independent of frequency.

Experimental data on the noise spectrum of a vacuum diode operated at two different dc current levels are shown in Fig. 5. The experimental results follow Eq. 2 above about 100 Hz; below this frequency  $1/f$  noise is observed.

The noise in a vacuum diode can be represented by replacing a real vacuum diode with a similar but noiseless vacuum diode and a noise current generator of the magnitude given by Eq. 2 connected in parallel, as shown in Fig. 6.

### Shot and $1/f$ noise in pn junctions

The nature of the current flow in a junction is illustrated schematically in Fig. 7a. Holes flow across the resistance provided by the  $p^+$  region; then they move as particles across the junction depletion region and recombine with electrons, either within the depletion region or in its vicinity. The electrons flow to the point of recombination through the resistance provided by the  $n$ -type region. Thus we expect to find resistance noise, associated with the motion of carriers through the regions in which they are majority carriers, and shot noise, associated with the particle flow across the depletion region.

The appropriate noise sources for a model of the pn junction are shown in Fig. 7b. The mean-square magnitudes of these noise sources are given by the formulas developed by Johnson and Nyquist, and by Schottky:

$$\overline{i^e} = 2qI_F \Delta f \quad (3)$$

$$\overline{v_n^2} = 4kTR_n \Delta f \quad (4)$$

$$\overline{v_p^2} = 4kTR_p \Delta f \quad (5)$$

where  $I_F$  is the forward dc current in the diode, and  $R_n$  and  $R_p$  are the series resistances of the  $n$ - and  $p$ -regions, respectively.

Figure 8 shows the results of experimental measurements on a planar silicon pn junction diode in which the series resistances were small and therefore the resistance noise was negligible.<sup>5</sup>

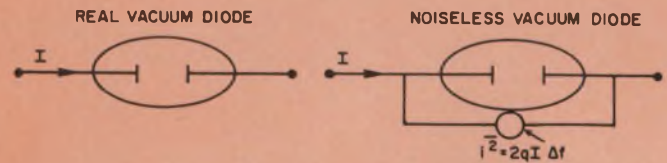

6. A simple circuit model of a vacuum diode, useful at frequencies above the spectrum of  $1/f$  noise, consists of an ideal diode in parallel with the current generator developed by Schottky.

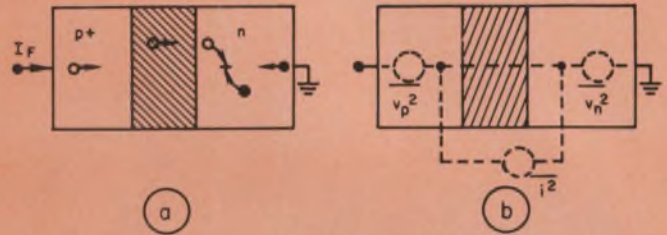

7. Current flow through a pn junction includes resistive flow of electrons and holes through the  $n$  and  $p$  regions, with associated resistance noise, and recombination in the depletion region, with associated shot noise (a). A simple model includes all of these noise sources (b).

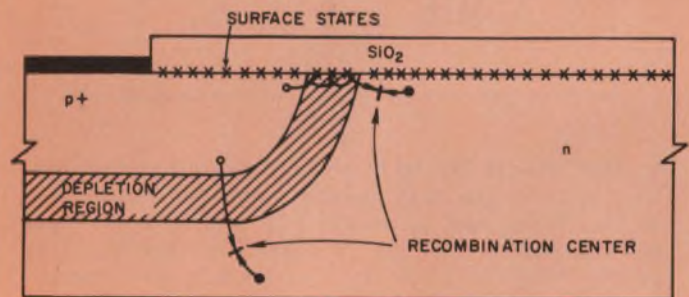

8. The noise spectrum of a silicon pn junction diode shows excellent agreement with the shot-noise prediction at mid frequency, and has the inevitable  $1/f$  excess noise at frequencies under 1 kHz. In this diode the series resistances are very small, and the noise associated with them is negligible. The two curves indicate noise performance before and after the density of surface states was increased, demonstrating a correlation between surface states and low-frequency noise.

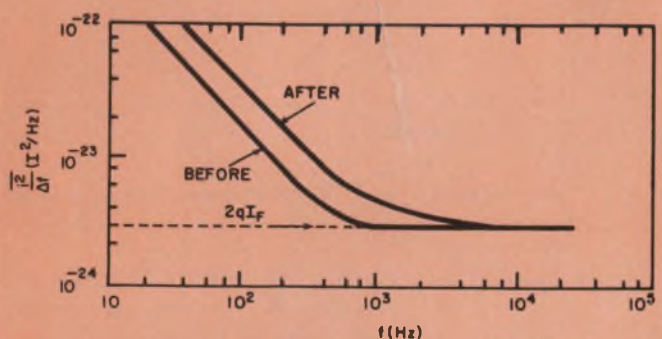

9. Surface states lead to excess noise because some carriers are trapped, and subsequently escape, many times on their way across the depletion region, causing a pseudoshot-noise effect.



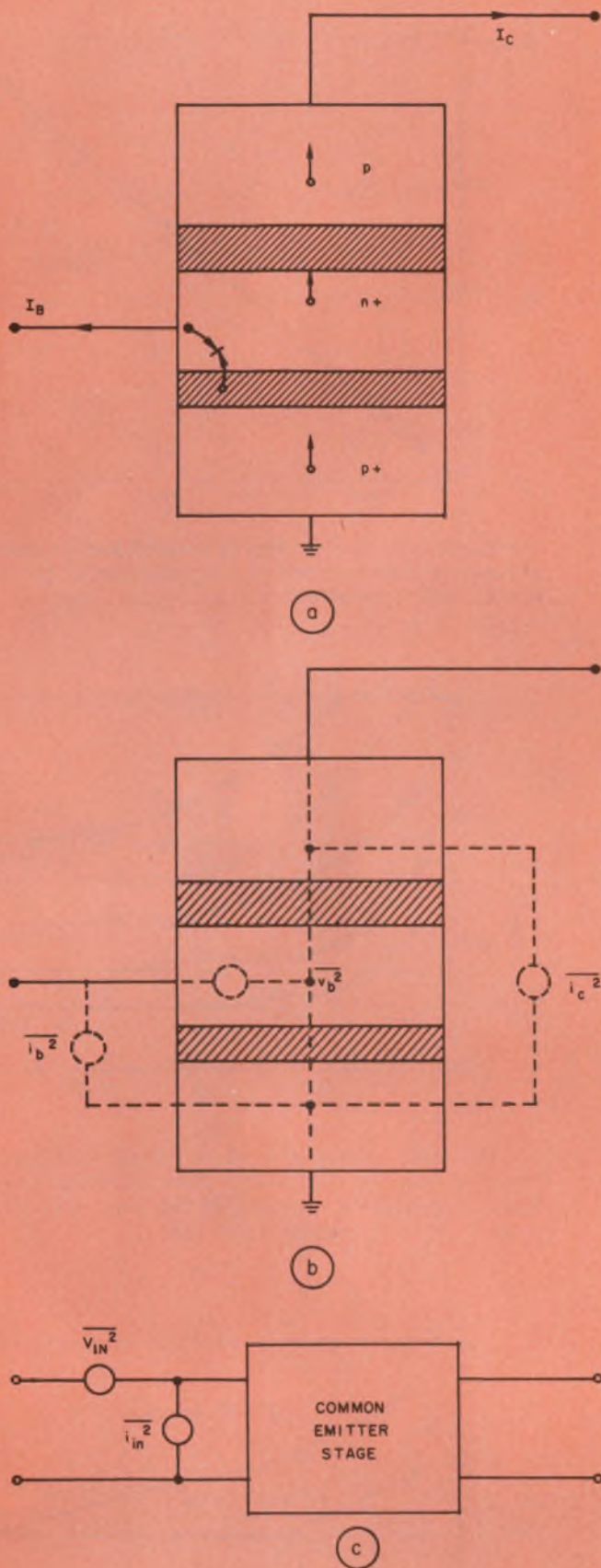

10. The noise generated in a transistor, in the common-emitter mode, is due to shot noise in the collector current and resistance noise and shot noise in the base current (a). A circuit model includes these effects by using the standard noise generators (b) and can be modified to refer all noise to the amplifier input (c).

In this figure the noise spectrum is shown plotted as a function of frequency. Above approximately 1 kHz the noise spectrum is flat, and its magnitude is given by the shot-noise formula, Eq. 3. Further measurements show such agreement over a wide range of current. Below 1 KHz, however, the noise spectrum rises in proportion to  $1/f$ .

A certain type of surface state (a permissible energy level, normally forbidden, that electrons can occupy at the semiconductor surface), when introduced at the silicon-silicon dioxide interface in a silicon pn junction, leads to an increase of  $1/f$  noise,<sup>5</sup> according to the results of recent experiments. Some of these results are given in Fig. 8, in which the noise spectrum of the pn junction is indicated both before and after the density of surface states has been increased. The current fluctuation  $\bar{i}^2$  at low frequencies is evidently proportional to the density of surface states introduced.

A qualitative picture of how surface states can lead to excess current fluctuation is shown in Fig. 9. Some carriers travel straight across the depletion region, but some get trapped in surface states several times. It is reasonable to expect that in the latter case the current as a function of time will be more ragged than in the former case; hence, for a given dc current, there will be an increase in fluctuation.

According to this model the excess noise will be much like shot noise, except that it will be larger, since each trapping event will increase the noise over and above shot noise. In fact, experimental data show that this excess noise has a dependence on dc current very much like that of shot noise. It is found, experimentally, that the mean-square excess noise component in a pn junction can often be adequately represented as

$$\frac{\bar{i}^2}{\Delta f} \propto \frac{1}{f} N_{st} I_F^n \quad (6)$$

where  $n$  is between 1 and 1.5,  $N_{st}$  is the surface-state density per square centimeter, and  $I_F$  is the forward dc current in amperes. Unfortunately, the necessary proportionality constant remains undefined to date.

There is no good general explanation of this type of noise, but McWhorter<sup>6</sup> has proposed one that appears to be relevant to cases where the excess noise can be tied to surface states. According to him, the frequency dependence of the excess noise is due to the distribution of the trapping times (the periods during which the carriers would be localized in surface states).

#### Junction transistors — a simple model

A picture of the dominant noise contributions in a junction transistor can be constructed in a manner similar to the pn junction case (Fig. 10). The collector current consists of holes that flow across the emitter-base space-charge region, through the



base itself, through the depletion region of the collector-base junction as particles, and then pass through the series resistance of the neutral collector region.

Note that the injected carriers drift across the base in much the same way as they would drift across the region between the cathode and anode in a vacuum tube. If the collector series resistance is small, the dominant noise associated with collector current is shot noise.

The base current consists of electrons that flow through the resistance of the n-type base region and then recombine with the injected carriers in the emitter space-charge region or within the neutral base or emitter. The base-current noise includes both resistance noise and shot noise.

Figure 10b indicates three important noise contributions: the shot noise  $\overline{i_c^2}$  associated with the motion of the collected carriers, the voltage fluctuation  $\overline{v_b^2}$  due to the resistive flow of majority carriers in the base; and the current fluctuation  $\overline{i_b^2}$  due to the particle motion associated with the base current. The magnitude of these three components is given by

$$\overline{i_c^2} = 2qI_C\Delta f \quad (7)$$

$$\overline{v_b^2} = 4kTr_b'\Delta f \quad (8)$$

$$\overline{i_b^2} = 2qI_B\Delta f \quad (9)$$

where  $I_C$  and  $I_B$  are the collector and base dc currents, respectively, and  $r_b'$  is the base resistance.

To calculate the noise figure of a transistor amplifier, we have to express all noise contributions as a noise voltage source and a noise current source at the input of the device. In the case of a common emitter transistor, these input noise sources can be obtained by referring the collector current fluctuation  $\overline{i_c^2}$  back to the input and dividing by the gain of the device. Thus the input noise voltage source will be

$$\overline{v_{in}^2} = \overline{v_b^2} + \overline{i_c^2}/g_m^2 \quad (10)$$

where  $g_m = dI_C/dV_{EB} = qI_C/kT$  (the transconductance of the transistor) and the input noise current source is

$$\overline{i_{in}^2} = \overline{i_b^2} + \overline{i_c^2}/\beta^2 \quad (11)$$

where  $\beta = dI_C/dI_B$ , the current gain of the transistor (Fig. 10c).

Experimental results support this model. Figure 11 shows input voltage measurements as a function of base resistance.<sup>8</sup> These data were taken using different transistors at a collector current high enough so that the principal contribution to the input noise voltage was just the first term of Eq. 10. The input noise voltage fluctuation closely follows Eq. 8, even at frequencies as low as 10 Hz.

The noise current of a planar silicon transistor,

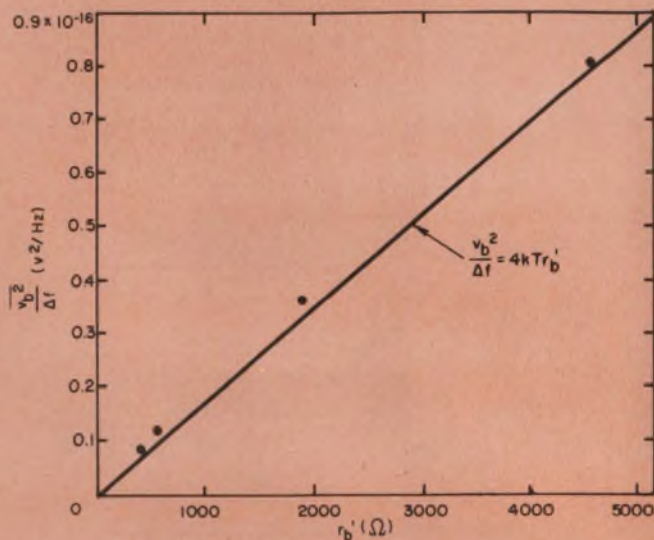

11. Transistor noise is directly proportional to base resistance according to these data, obtained at 10 Hz on planar silicon transistors.

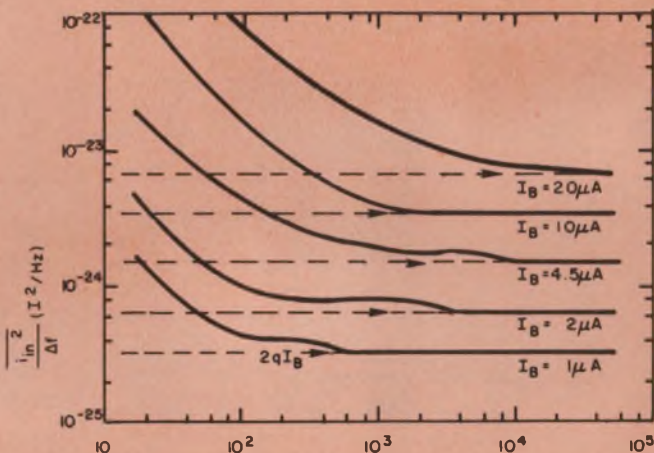

12. The noise current of a planar silicon transistor, referred to the input, closely follows Schottky noise at frequencies above a few kHz. At the lower frequencies, excess  $1/f$  noise become significant.

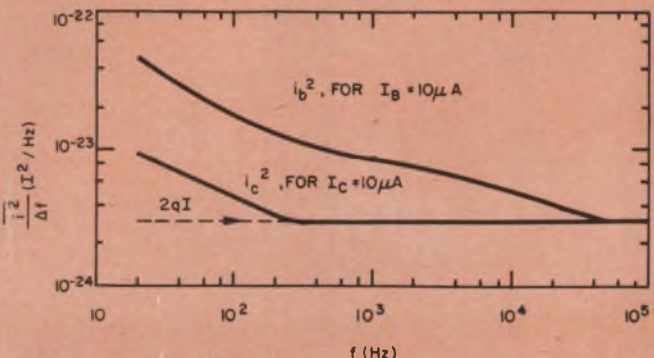

13. The base current shows more excess noise than the collector current in the planar silicon transistor. It appears that the excess noise in junction transistors is mainly due to fluctuation of the recombination current.



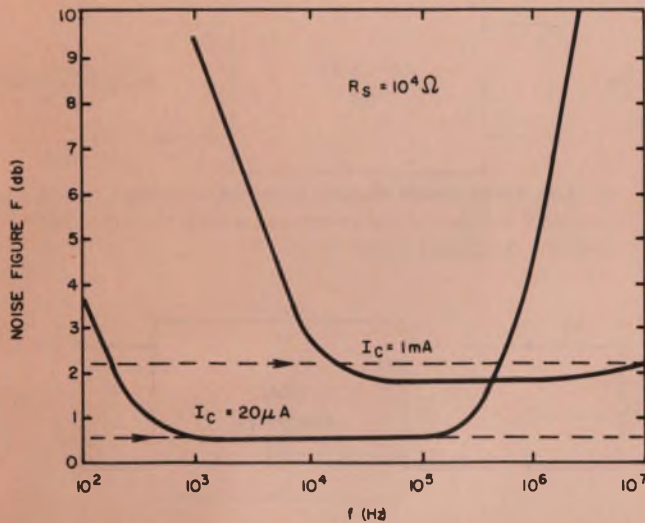

14. The measured noise figure of a planar silicon transistor corresponds to the noise figure calculated from the model only for mid-range frequencies. At low frequencies the  $1/f$  excess noise predominates, and at high frequencies the decreased current gain of the transistor leads to an increase in the noise figure.

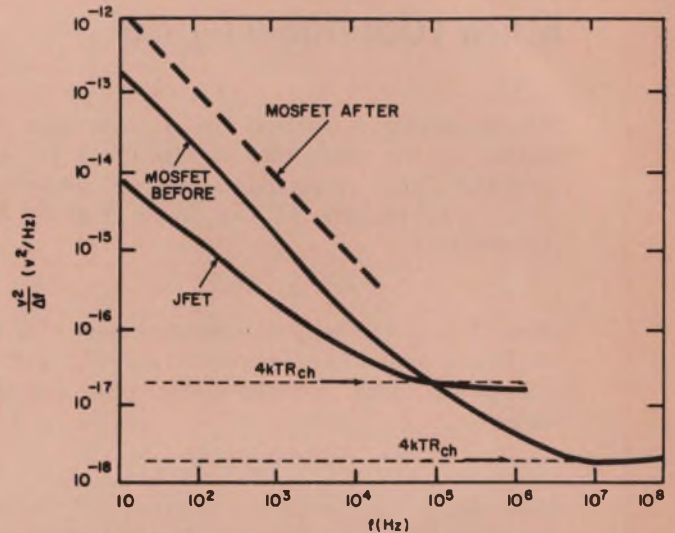

15. Noise voltages of field effect transistors, referred to the input, show that low-frequency excess noise predominates over a wide range, and that the junction FET has less low-frequency noise than the MOSFET. This is to be expected, since in the MOSFET, conduction occurs in the vicinity of surface states.

referred to the input as a function of frequency for several values of base current, is shown in Fig. 12. At high enough frequencies, say above  $1\text{ kHz}$ , the measurement results are predicted by  $\overline{i_{in}^2} = 2qI_B\Delta f$ . (Note that the second term in Eq. 11 is negligible for a device with a reasonably large current gain.) As the frequency is lowered, excess noise becomes significant and its magnitude, as in the case of the pn junction diode, increases as  $1/f$ .

The noise spectra of the collector and the base current of another planar silicon transistor are shown in Fig. 13. In each case, the dc current was  $10\ \mu\text{A}$ . It is obvious from these results that the base current contains far more frequency-dependent excess noise than the collector current.

It appears, therefore, that the excess noise in junction transistors is principally associated with the fluctuation of the recombination current.<sup>9,10</sup> This observation is consistent with the fact that  $1/f$  noise in pn junctions is found to be a fluctuation of the diode current, since in a pn junction the entire current represents recombination current. Excess low-frequency noise can be represented by adding a term analogous to Eq. 6 to Eq. 9, which should then read

$$\overline{i_b^2}/\Delta f = K (1/f) I_B^n + 2qI_B \quad (12)$$

where  $n$  is between 1 and 1.5. The constant  $K$  is determined experimentally.

Transistor data sheets usually present noise data in the form of noise figure plots (See box). To establish the connection between such plots and the preceding equations, we combine Eqs. 7 through 11 with the general expression for noise figure,

$$F = 1 + \frac{\overline{v_{in}^2}}{4kTR_s\Delta f} + \frac{\overline{i_{in}^2} R_s}{4kT\Delta f} \quad (13)$$

The noise figure at high frequencies (high enough so that the excess  $1/f$  noise is negligible) is then given by

$$F = 1 + \frac{r_b'}{R_s} + \frac{kT/q}{2I_C R_s} + \frac{I_C R_s}{2 \frac{kT}{q} \beta} \left[ 1 + \frac{1}{\beta} \right] \quad (14)$$

For  $\beta \gg 1$ , and  $I_C \gg kT/q r_b'$ , this takes on the simpler form,

$$F \cong 1 + \frac{r_b'}{R_s} + \frac{I_C R_s}{2kT\beta q} \quad (15)$$

Note the similarity of this equation to Eq. 13: The second term on the right-hand side represents a voltage fluctuation; the third term represents a current fluctuation.

Figure 14 shows the noise figure of a planar silicon transistor, as a function of frequency, for two different collector current levels. The dashed lines indicate the corresponding values calculated from Eq. 14. Reasonable agreement is found between these values and the experimental results over the intermediate-frequency range, but below and above this range the noise figure increases rapidly.

The low-frequency excess noise, according to the preceding discussion, is due to excess fluctuation of the base current. Accordingly, the noise figure increase at low frequencies should be greater at

# Know your noise figure

The maximum sensitivity of an amplifier is limited by the noise that it introduces to the amplified signal. A popular measure of amplifier noise performance is the noise figure  $F$ , expressed as

$$F = N_{out}/GN_{in}$$

where  $N_{out}$  is the total output noise power,  $G$  is the power gain of the amplifier, and  $N_{in}$  is the noise power input from the source (Fig. A). Of course

$$N_{out} = GN_{in} + N_{amp}$$

where  $N_{amp}$  is the noise power generated within the amplifier, referred to the output. Substituting this expression for  $N_{out}$  in the definition of noise figure, yields

$$F = 1 + \frac{N_{amp}}{GN_{in}}$$

For a perfectly noiseless amplifier,  $F = 1$ .

It is convenient, for circuit design purposes, to represent an actual noisy amplifier as an ideal amplifier, with two noise sources,  $\overline{v_{in}^2}$  and  $\overline{i_{in}^2}$ , connected at its input (Fig. B). Both sources must be included if the magnitude of the noise sources of the model are to be independent of the source resistance. They are chosen to cause the same output noise as is observed in the real amplifier. Both quantities vary, in general, with the dc bias applied to the amplifier and with signal frequency.

If the two noise sources represent different physical causes of noise, which is often the case, the noise figure of the amplifier can be expressed in terms of these two input noise sources by the relationship

$$F = 1 + \frac{\overline{v_{in}^2}}{4kTR_s\Delta f} + \frac{\overline{i_{in}^2}R_s}{4kT\Delta f}$$

where  $\Delta f$  is the bandwidth of interest.<sup>1</sup>

The magnitudes of the mean-square noise voltage and current generators depend on the physical causes of noise generated within the amplifier. If we can calculate these quantities in terms of the characteristics of the semiconductor devices from which the amplifier is made, we can then readily calculate the noise figure of the amplifier.

The noise powers and the representative voltage and current generators are functions of frequency. They may represent the value of noise at a particu-

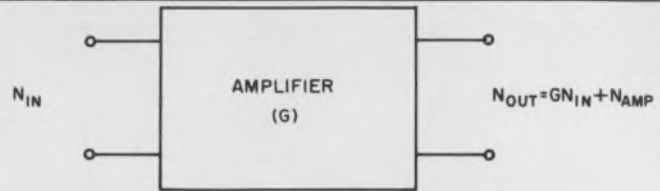

A. The noise power output from an amplifier is the sum of the noise power generated within the amplifier and the amplified input noise.

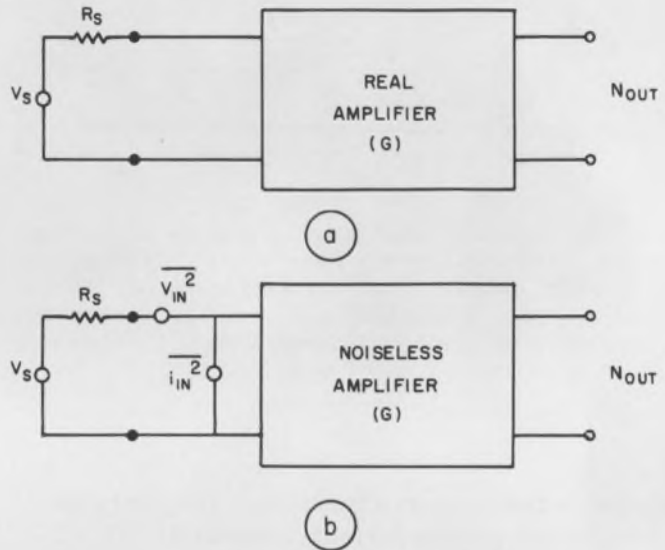

B. A circuit model of a noisy amplifier consists simply of a noiseless or ideal amplifier with noise sources  $\overline{v_{in}^2}$  and  $\overline{i_{in}^2}$  connected to its input. The noise sources represent the mean square values of the corresponding voltage and current fluctuations, and are chosen so that the resultant output noise power is equivalent to that of the real amplifier.

lar frequency or a total noise power over a specified band of frequencies — the frequency band passed by the amplifier, for instance. The noise figure at a particular frequency is called the spot noise figure; if average noise powers over a band are compared it is called an average noise figure. Spot and average values coincide if the gain is constant over frequency and the internal noise source is white noise over the band of frequencies considered. (White noise has an available mean power bandwidth that is constant over frequency, and noise current or voltage sources are white if the functions  $\overline{i_{in}^2}$  and  $\overline{v_{in}^2}$  are constant over frequency. A white noise source supplies all frequencies in equal magnitudes and with random phases).



higher base, and hence higher collector currents. The data shown in Fig. 14 bears this expectation out. It is also evident from Eq. 15 that the current fluctuation becomes increasingly important as source resistance  $R_s$  is increased. Since the low-frequency excess noise is a current fluctuation, its effect will be more noticeable with higher source resistances.

As is evident from Fig. 14, the noise figure also increases at high frequency. As the measurement frequency approaches the cutoff frequency of the transistors, the current gain of the transistor begins to decrease. This in turn brings about an increase in the noise figure (Eq. 14).

#### FETs — excess noise at low frequencies

The dominant conduction mechanism in both junction field-effect transistors and surface field-effect transistors is resistive. In both devices the resistance of a conducting channel is modulated by an applied gate voltage. Accordingly, the expected noise contribution of the channel resistance is ideally given<sup>11,12</sup> by

$$\overline{v_{ch}^2} = 4kTR_{ch}\Delta f \quad (16)$$

where  $R_{ch}$  is the channel resistance.

Experimental data on the input noise voltage fluctuation of MOS<sup>5,43</sup> and junction field-effect transistors as a function of frequency is shown in Fig. 15. Low-frequency excess noise dominates over a wide frequency range, but the low-frequency noise of junction FETs is considerably lower than that of the MOS surface field-effect transistor. This is to be expected since the entire current flow in such devices is in the vicinity of surface states.

The excess noise may again be associated with surface states, as indicated by the experimental results shown in Fig. 15. The data show the noise of the MOS transistor as a function of frequency both before and after introduction of surface states, using the same method that was employed in the case of junction devices.<sup>5</sup>

Since the channel-resistance fluctuation of field-effect transistors appears within the input circuit, the noise figure of the device can be calculated by setting  $\overline{v_{in}^2} = \overline{v_{ch}^2}$ . This yields

$$F = 1 + \frac{R_{ch}}{R_s} \quad (17)$$

using Eq. 13.

According to Eq. 17 the noise figure should monotonically decrease as the source resistance increases, but this is not observed experimentally; a slight increase, in fact, is observed at relatively high frequencies.

There can be several reasons for such an increase. It has been proposed<sup>15,16</sup> that the increase is due to neglected parasitic resistances and capacitances associated with the device. Alternatively,

the increase could be due to the fact that the nature of the current flow, through the depleted or pinched-off region of the channel near the drain, has been completely neglected in the above experiment.

According to the generally accepted picture, the current flow here takes place by particle-type motion across a depleted region. One would expect a shot-noise contribution to the output current associated with this current flow, but shot noise would lead to much more noise at high source resistances than is observed experimentally. This discrepancy between the predicted noise figure and the observed noise figure remains unresolved. ■ ■

#### References:

1. F. J. Hyde, *Noise in Electron Devices*, Chapman (1961)
2. J. B. Johnson, "Thermal agitation of electricity in conductors," *Phys. Rev.* 32 (1928), p. 97.
3. H. Nyquist, "Thermal agitation of electric charge in conductors," *Phys. Rev.* 32 (1928), p. 110.
4. W. Schottky, "Über spontane Stromschwankungen in verschiedenen elektrizitätsleitern," *Ann. Phys.* 57 (1918), p. 541.
5. S. T. Hsu, D. J. Fitzgerald, and A. S. Grove, "Surface-state related 1/f noise in p-n junctions and MOS transistors," *Appl. Phys. Lett.* 12 (1968), pp. 287-289.
6. A. L. McWhorter, in *Semiconductor Surface Physics*, R. H. Kingston, ed., University of Pennsylvania Press (1956).
7. A. van der Ziel, *Fluctuation Phenomena in Semiconductors*, Academic Press (1959).
8. R. J. Whittier and J. P. Downing, experimental data.
9. J. L. Plumb and E. R. Chenette, "Flicker noise in transistors," *IEEE Trans. Electron Devices* ED-10 (1963), pp. 304-308.
10. C. A. Bittmann, G. Wilson, R. J. Whittier, and R. K. Waits, "Technology for design of low power circuits," Paper FAM12.2, 1969 IEEE Int. Solid-State Circuits Conference, Philadelphia, Pa.
11. A. van der Ziel, "Thermal noise in field-effect transistors," *Proc. IEEE* 50 (1962), pp. 1808-1812.
12. A. G. Jordan and N. A. Jordan, "Theory of noise in metal oxide semiconductor devices," *IEEE Trans. Electron Devices* ED-12 (1965), pp. 148-156.
13. B. L. Jones and R. E. Hurlston, "VHF noise due to surface states in MOS devices," Paper 24.6, 1968 Int. Electron Devices Meeting, Washington, D. C.
14. P. O. Lauritzen, "Low-frequency generation noise in junction field effect transistors," *Solid-State Electron.* 8 (1965), pp. 41-58.
15. R. Q. Lane, "The comparative performance of FET and bipolar transistors at VHF," *IEEE J. Solid-State Circuits* SC-1 (1966), pp. 35-39.
16. J. Mavor, "Noise parameters for metal-oxide semiconductor transistors," *Proc. IEE* 113 (1966), 1437-1467.

#### Test your retention

Here are questions based on the main points of this article. Their purpose is to help you make sure you have not overlooked any important ideas. You'll find the answers in the article.

1. What are the three most important types of noise in semiconductor devices?
2. What types of noise predominate in semiconductor devices at the intermediate frequencies?
3. What three types of noise are important in the junction transistor?

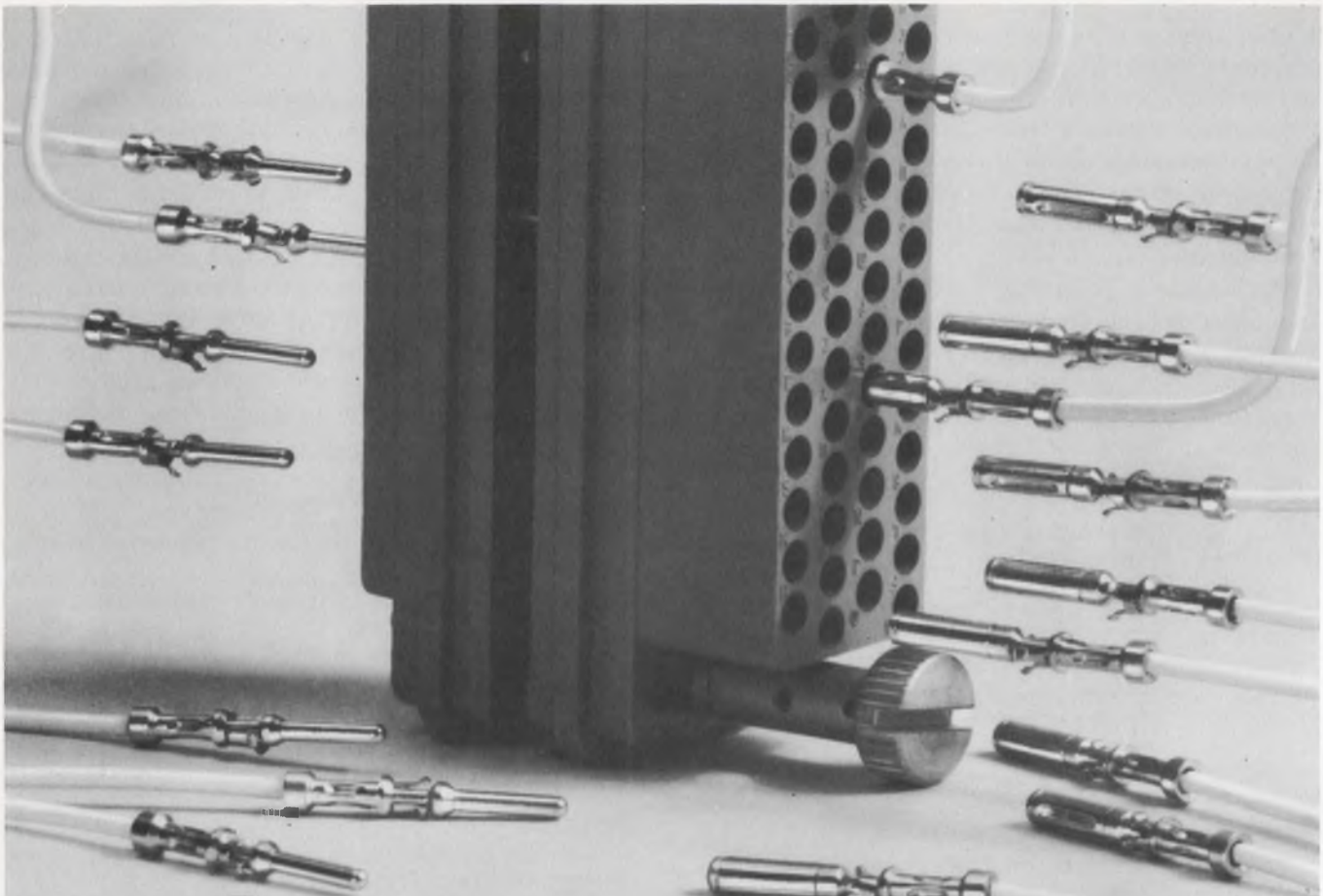

# wire when ready

For solderless wiring, nothing is more versatile than Continental's removable contact connectors with wire crimp terminations. The contacts are supplied separately and wired independently of the connector body so you can mount the plug and socket units at any convenient time. Our miniature, microminiature and center screwlock styles are available in a wide range of pin sizes from 5 to 200. Series 25 conforms completely to MIL-C-22857 specifications. With Continental's crimp insertable connectors you may... wire when ready! For free 28-page catalog providing complete description and specs, write us.



## **CONTINENTAL CONNECTOR CORPORATION**

WOODSIDE, NEW YORK 11377 / TELEPHONE: (212) 899-4422

FOR SALES REPRESENTATIVE NEAREST YOU, SEE OUR LISTINGS IN EEM AND VSMF DIRECTORIES.

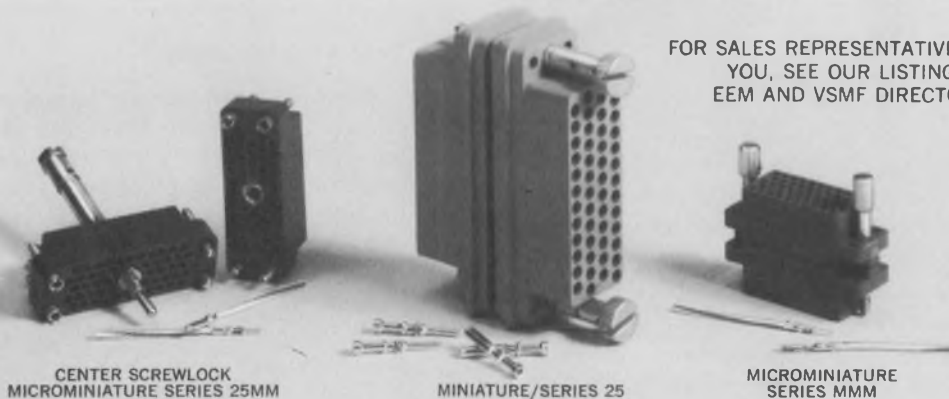

CENTER SCREWLOCK  
MICROMINIATURE SERIES 25MM

MINIATURE/SERIES 25

MICROMINIATURE  
SERIES MMM



**Introducing  
a little revolution  
in fail-safe  
reed switching.**

This new Cunningham Hystareed™ Magnetic Latching Relay operates *without permanent biasing magnets* or holding currents. Latches and

stays latched. Won't change its programmed state because of vibration, shock, power interruptions or transients. Needs no adjustment or calibration. Available up to 6 form A's, 4 form C's in a single assembly. Operates as standard relay for scanning.

Ideal for: data acquisition, low-level switching, computer interfacing, logic control, industrial machinery control.

**Samples available.** For complete facts, request Brochure No. 606B. Write or phone Cunningham Corporation, Carriage St., Honeoye Falls, N. Y. 14472. Phone (716) 624-2000.

**Cunningham  
Corporation**

SUBSIDIARY OF GLEASON WORKS

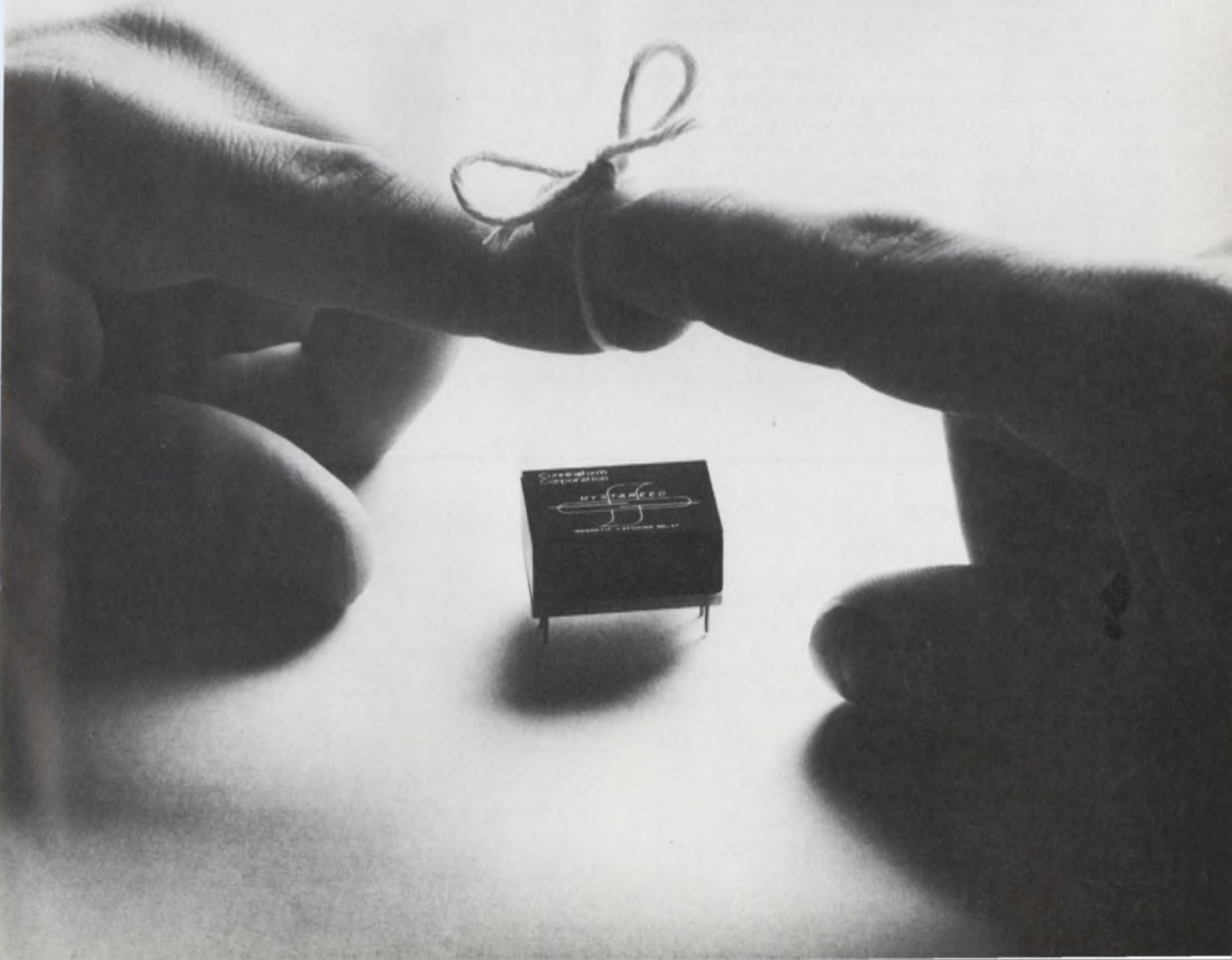

## Timing circuit has independent turn-on and turn-off delays

Power supply design requirements often necessitate a turn-on delay after input power has been applied. And these requirements can be easily realized using a unijunction transistor timing circuit to energize an SCR. In some applications, however, occasional power interruptions of several milliseconds duration, short enough to be tolerated by the load, can occur at the dc power source, causing the timing circuit to be reset. The result is unnecessary equipment down time. The modified timing circuit shown provides a simple but effective remedy.

The timer is intended to operate from 12 to 36 volts dc, and has a turn on delay of about 30 s, controlled by the time constant of  $R_1C_1$ . In addition, a reset, or turn-off, delay is incorporated and controlled by the time constant  $R_2C_2$ . Resistor  $R_3$  serves both to lock out the UJT oscillator after it has provided the turn-on delay, as well as to hold a fixed voltage on  $C_1$ .

In the event of power interruption, the UJT loses bias on base 2, which immediately allows  $C_1$  to discharge through the emitter, and hence to charge  $C_2$ . The longer time constant of  $C_2R_2$  maintains this voltage to prevent SCR commutation during short power interruptions, yet still

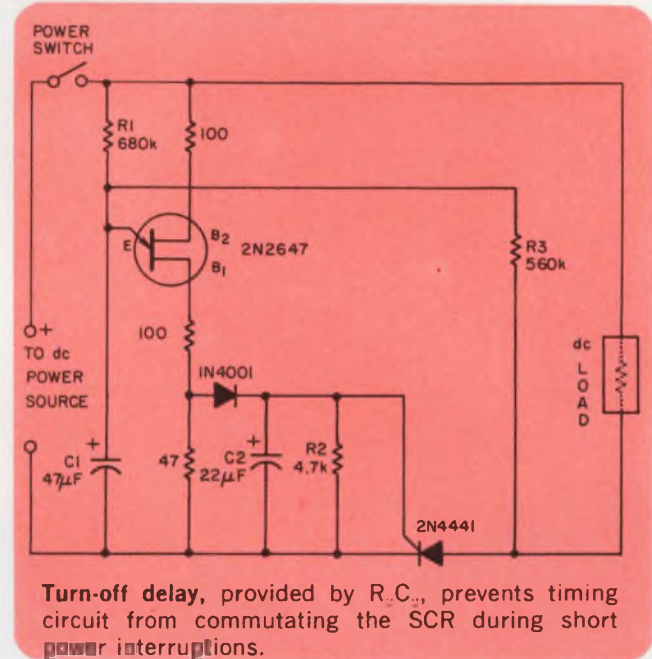

allows the circuit to reset under actual shut-down conditions.

Gary W. Vest, Project Engineer, Clevite Corp., Piezoelectric Div., Bedford, Ohio.

VOTE FOR 311

## Low-power timer drives stepping relay

A low-power and inexpensive timing circuit that can drive inductive loads (stepping relays, etc.) can be constructed using the low forward blocking current of some SCR's (for example, the General Electric C106B, which has  $I_{fz} \approx 0.1 \mu\text{A}$  typical).

The time interval is determined by  $R_1C$ , while  $R_2$  determines the minimum time interval. The neon lamp conducts at approximately 65 volts, triggering the SCR. The capacitor is thus rapidly discharged through the relay coil, causing the resetting of  $C$  to a low voltage, and the

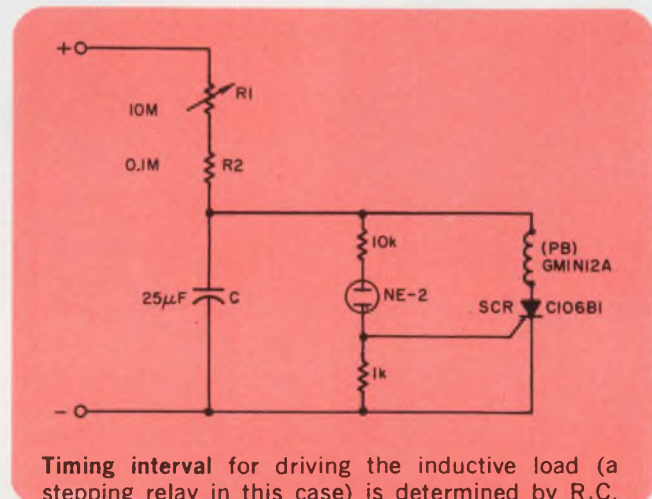



# new

## 16 CHANNEL ANALOG MULTIPLEXER

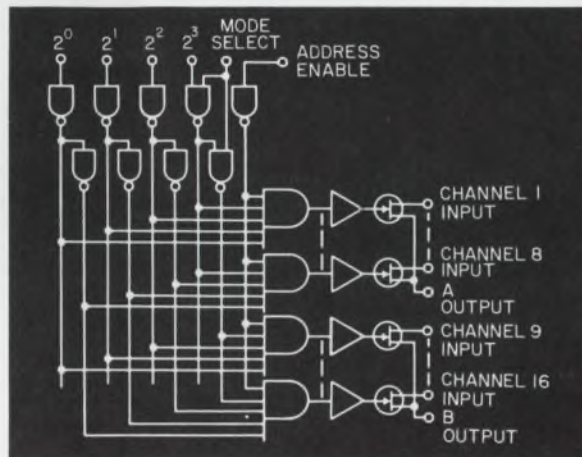

The first LSI subsystem employing NPN's, PNP's and J-FET's in a monolithic structure.

- Bipolar signal handling range in excess of 20 volts
- Full military temperature range
- Lowest input leakage current
- Most versatile multiplexer with random access capability
  - 16 channel
  - Dual 8 channel
  - Differential 8 channel
  - Enable input for all channel blanking or address expansion
- TTL address decoding logic for TTL or DTL compatibility
- Complies with MIL-STD-883
- Off-the-shelf delivery

You get the BEST IC for the job from Radiation's fast expanding linear line.

P. O. Box 476, Lexington, Massachusetts 02173  
Area Code 617, 862-1055

600 Old Country Road, Garden City, New York 11530  
Area Code 516, 747-3730

2600 Virginia Avenue, N.W., Washington, D.C. 20037  
Area Code 202, 337-4914

P. O. Box 30667, Dallas, Texas 75230  
Area Code 214, 239-0378

6151 West Century Boulevard, Los Angeles,  
California 90045 - Area Code 213, 670-5432

260 Sheridan, Palo Alto, California 94306  
Area Code 415, 321-2280

P. O. Box 37, Melbourne, Florida 32901  
Area Code 305, 727-5430

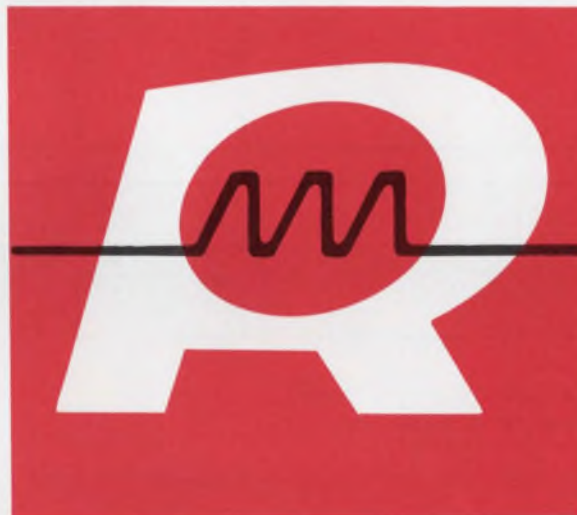

**RADIATION**  
INCORPORATED  
SUBSIDIARY OF HARRIS-INTERTYPE CORPORATION  
MICROELECTRONICS DIVISION

See us at WESCON / 69!  
Booth 4503, 4, 5

INFORMATION RETRIEVAL NUMBER 134

energizing of the relay.

Some of the advantages of this technique are:

- low power
- self commutating SCR
- drives inductive load (trigger signal is present until SCR is fully conducting)
- recycle time can be short (C is discharged through the SCR and not through the neon)
- SCR has low leakage in blocking mode (trigger, or 4-layer, diodes are available but usually require  $10^{-1}$  A trigger currents).

The circuit input can be rectified ac (half-wave, full-wave), or it can be battery driven.

With the component values shown, half-wave rectified 110-V ac power gives 10-minute intervals, while a 90-volt battery yields 5 minute intervals. The current drain is around  $25 \mu\text{A}$  for a one ppm rate, permitting a portable battery-operated unit.

Larry Eaton, Design Engineer, University of Nevada, Reno, Nev.

VOTE FOR 312

## Analog-to-period converter can simplify telemetry systems

Many telemetering systems employ analog-to-frequency conversion to facilitate reliable information transmission over communication links. One accurate and precise method for recovering the analog information is by using a frequency

counter to measure the frequency of the converted signal over a relatively long period of time. A much faster method of recovering the analog information is to measure the period of the converted signal or multiples of the period.

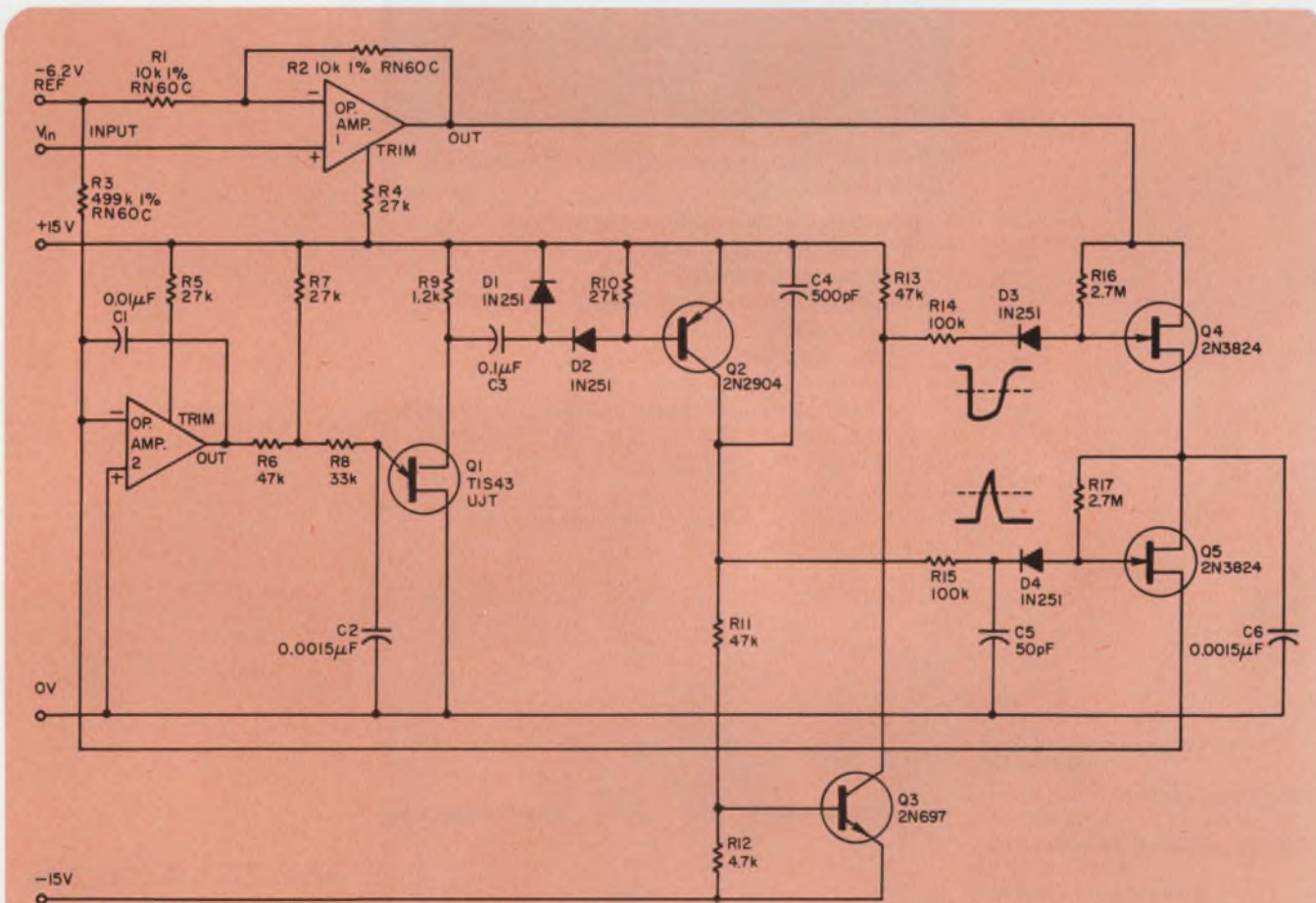

NOTES: 1. ALL RESISTORS 1/4W, 10% OR AS SPECIFIED.  
 2. OP. AMPS.—ANALOG DEVICES 105A.  
 3. C<sub>6</sub>—HIGH STABILITY SILVER MICA.

Addition of op amp 1 circuit converts basic analog-to-frequency converter into an analog-to-period converter.



# new

## HIGH SLEW RATE AMPLIFIER

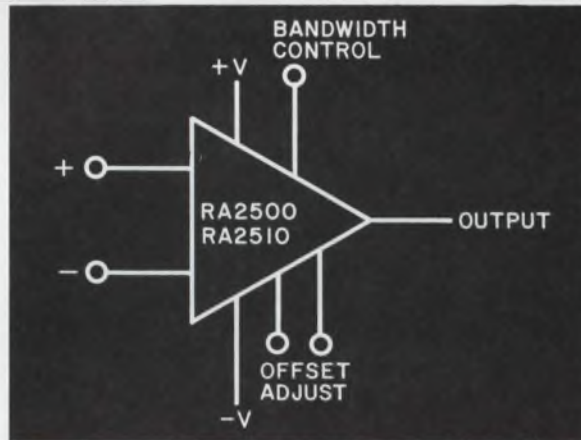

- The highest speed fully compensated-stable at unity gain-Op Amp available today
- Full military temperature range
- Complies with MIL-STD-883
- Off-the-shelf delivery

	RA-2510	RA-2500
• Slew Rate (at unity gain)	$\pm 50\text{v}/\mu\text{s}$ min.	$\pm 25\text{v}/\mu\text{s}$ min.
• Gain	15000	35000
• Large Signal Bandwidth	500 KHz	200 KHz
• Gain Bandwidth	15 mHz	15 mHz
• Offset Current	20 nA	20 nA
• Offset Voltage	2 mV	2 mV
• Output Current	$\pm 20\text{mA}$	$\pm 20\text{mA}$
• Input Impedance	50 megohms	25 megohms

You get the BEST IC for the job from Radiation's fast expanding linear line.

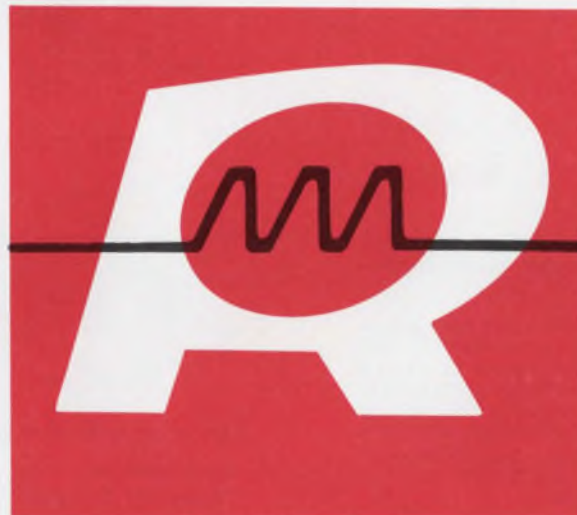

P. O. Box 476, Lexington, Massachusetts 02173  
Area Code 617, 862-1055

600 Old Country Road, Garden City, New York 11530  
Area Code 516, 747-3730

2600 Virginia Avenue, N.W., Washington, D.C. 20037  
Area Code 202, 337-4914

P. O. Box 30667, Dallas, Texas 75230  
Area Code 214, 239-0378

6151 West Century Boulevard, Los Angeles,  
California 90045 - Area Code 213, 670-5432

260 Sheridan, Palo Alto, California 94306  
Area Code 415, 321-2280

P. O. Box 37, Melbourne, Florida 32901  
Area Code 305, 727-5430

**RADIATION**  
INCORPORATED  
SUBSIDIARY OF HARRIS-INTERTYPE CORPORATION  
MICROELECTRONICS DIVISION

See us at WESCON / 69!  
Booth 4503, 4, 5

INFORMATION RETRIEVAL NUMBER 135

Unfortunately, this technique requires an additional computation, since the analog information is usually directly proportional to the frequency of the converted signal—hence inversely proportional to its period. It would be advantageous, therefore, to make the initial conversion linear with respect to the period rather than the frequency.

The analog-to-period converter shown will convert an input voltage,  $V_{in}$ , to a sawtooth signal whose period,  $T$ , is a linear function of the input voltage.

The converter is built around an analog-to-frequency converter previously described (ED 14, July 4, 1968, p. 96), but includes an additional operational amplifier that is used as a summing amplifier (op amp 1). It was shown that the output frequency of the original converter can be expressed by

$$f = I/V_g C_0, \tag{1}$$

where  $I$  = input current to op amp 2.

$V_g$  = voltage supplied to the FET gates (Q4, Q5) Hence, the period,  $T$ , is

$$T = 1/f = V_g C_0 / I. \tag{2}$$

But in this case,

$$I = -V_{ref}/R_3,$$

and

$$V_g = 2 V_{in} + V_{ref}. \tag{4}$$

Combining equations (2) through (4),

$$T = A + B V_{in},$$

where

$$A = C_0 R_3,$$

$$B = 2A/V_{ref}.$$

With the values shown on the illustration,

$$A = 750 \mu s,$$

$$B = 240 \mu s.$$

The converter is linear within 0.02% over an input signal range of  $-1$  V to  $+1$  V. Zero shift over the temperature range of 0 to  $85^\circ\text{C}$  is  $0.25 \mu s/^\circ\text{C}$ . This may be improved by replacing the operational amplifiers and the critical components ( $R_1, R_2, R_3, C_0$ ) with extremely stable types.

*Sam Ben-Yaakov, Electronic Engineer, Dept. of Geology, Univ. of California, Los Angeles.*

VOTE FOR 313

## Accurate digital clock uses inexpensive IC gates

An accurate digital clock can be made from 1-1/2 inexpensive IC packages and a few discrete components. In the circuit, a single DT $\mu$ L914 IC is used as an oscillator, and one-half of the other 914 is used as a shaper and buffer. The resulting clock will work from 100 kHz to around 2 MHz at a supply voltage of only 3.6 V dc. The oscillator is produced by biasing

the two halves of the 914 linearly (class-A), to make them operate as amplifiers. The output of one is then fed back through a crystal to the in-

# VOTE

**VOTE!** Go through all Idea-for-Design entries, select the best, and circle the appropriate number on the Reader-Service-Card.

**SEND US YOUR IDEAS FOR DESIGN.** You may win a grand total of \$1050 (cash)! Here's how. Submit your IFD describing a new or important circuit or design technique, the clever use of a new component or test equipment, packaging tips, cost-saving ideas to our Ideas-for-Design editor. You will receive \$20 for each accepted idea, \$30 more if it is voted best-of-issue by our readers. The best-of-issue winners become eligible for the Idea Of the Year award of \$1000.

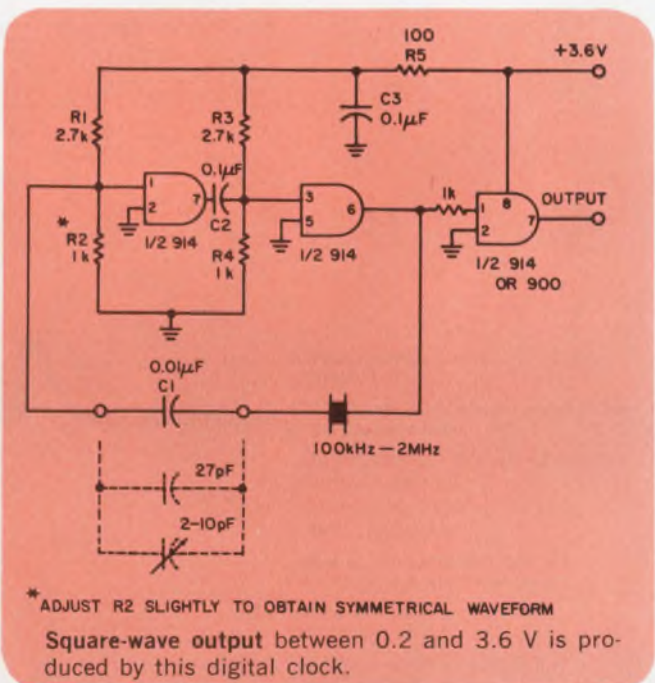



# new

## HIGH INPUT IMPEDANCE OP AMP

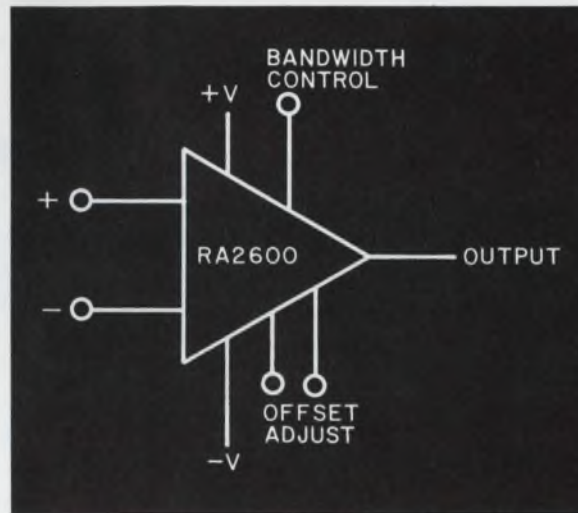

- Input Current = 3 nA
- Input Impedance = 50 megohms
- Slew Rate (at unity gain) =  $\pm 5\text{V}/\mu\text{s}$
- Gain = 200,000
- Gain Bandwidth = 12 MHz
- Short Circuit Protected
- Fully compensated (stable at unity gain)
- Full military temperature range
- Complies with MIL-STD-883
- Off-the-shelf delivery

You get the BEST IC for the job from Radiation's fast expanding linear line.

P. O. Box 476, Lexington, Massachusetts 02173  
Area Code 617, 862-1055

600 Old Country Road, Garden City, New York 11530  
Area Code 516, 747-3730

2600 Virginia Avenue, N.W., Washington, D.C. 20037  
Area Code 202, 337-4914

P. O. Box 30667, Dallas, Texas 75230  
Area Code 214, 239-0378

6151 West Century Boulevard, Los Angeles,  
California 90045 • Area Code 213, 670-5432

260 Sheridan, Palo Alto, California 94306  
Area Code 415, 321-2280

P. O. Box 37, Melbourne, Florida 32901  
Area Code 305, 727-5430

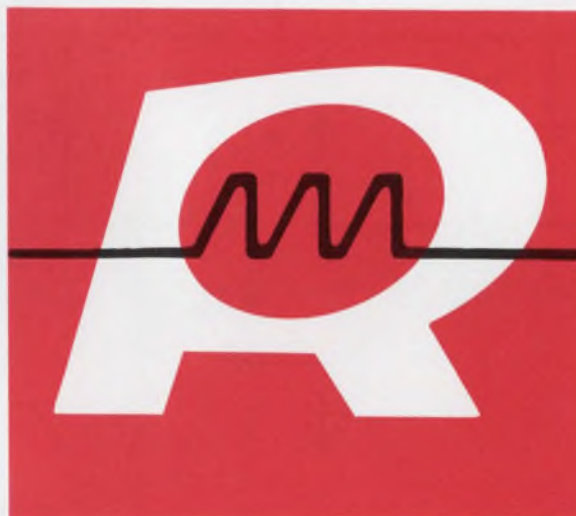

**RADIATION**  
INCORPORATED  
SUBSIDIARY OF HARRIS-INTERTYPE CORPORATION  
MICROELECTRONICS DIVISION

See us at WESCON / 69!  
Booth 4503, 4, 5





# new

## PARTY-LINE RECEIVER

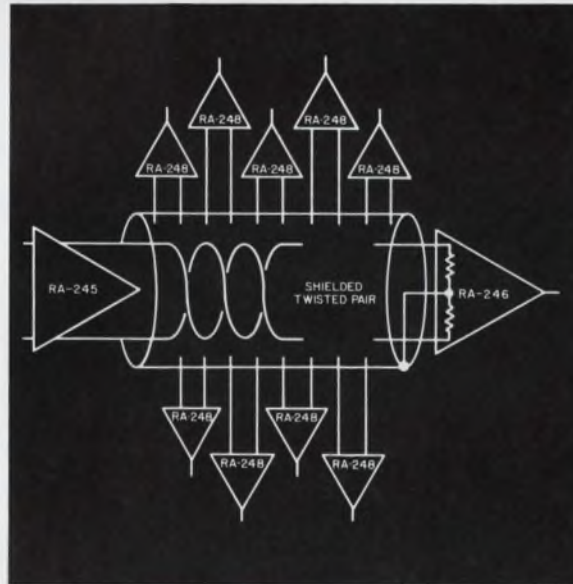

- 10 Party-Line Receivers driven by a line transmitter
- Balanced current mode eliminates switching transients
- Extremely low power consumption
- 3 circuits per package
- No standby power required for idle circuits
- Compatible with TTL and DTL
- Full military temperature range
- Complies with MIL-STD-883
- Off-the-shelf delivery

You get the BEST IC for the job from Radiation's fast expanding linear line.

P. O. Box 476, Lexington, Massachusetts 02173  
Area Code 617, 862-1055

600 Old Country Road, Garden City, New York 11530  
Area Code 516, 747-3730

2600 Virginia Avenue, N.W., Washington, D.C. 20037  
Area Code 202, 337-4914

P. O. Box 30867, Dallas, Texas 75230  
Area Code 214, 239-0378

6151 West Century Boulevard, Los Angeles,  
California 90045 • Area Code 213, 670-5432

260 Sheridan, Palo Alto, California 94306  
Area Code 415, 321-2280

P. O. Box 37, Melbourne, Florida 32901  
Area Code 305, 727-5430

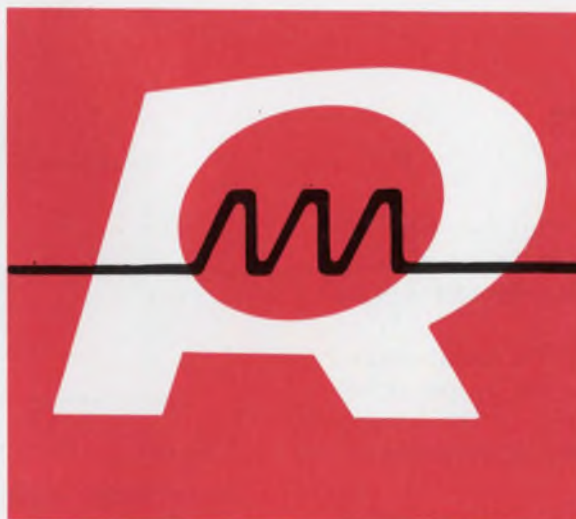

**RADIATION**  
INCORPORATED  
SUBSIDIARY OF HARRIS-INTERTYPE CORPORATION  
MICROELECTRONICS DIVISION

See us at WESCON/69!  
Booth 4503, 4, 5

INFORMATION RETRIEVAL NUMBER 137

## Circuit keys twin-T oscillator without generating transients

The keying of an oscillator can often result in unwanted and bothersome transients. Here is a way to start and stop a twin-T oscillator smoothly without generating such transients.

In the popular twin-T design, the shunt resistor in the twin-T network determines the amount of regeneration. Above a critical value of resistance the circuit will not oscillate. In the circuit shown, this resistor is replaced by two adjustable resistors,  $R_1$  and  $R_2$ , in series. The values are such that the circuit will not oscillate unless  $R_2$  is short-circuited. The rate at which oscillation builds up when  $R_2$  is short-circuited depends on the setting of  $R_1$ . The rate at which oscillation decays when the short circuit is removed depends on the setting of  $R_2$ . Both build-up and decay can be varied over a wide range.

A single npn transistor,  $Q1$ , serves satisfactorily as the switch, because the circuit is dc isolated by  $C_1$  and  $C_2$ . A 100- $\mu$ A base current is sufficient to turn the stage on.

The frequency of oscillation of the circuit is, of course, determined by the capacitors.  $C_1$  and  $C_2$  should be the same value, and  $C_3$  should be twice the value of  $C_1$ .

In one application of this technique, a 160-Hz signal pulsating at 1 pulse per second was needed. To accomplish this, the base of the switching transistor was connected to one emitter of a multivibrator.  $C_1$  and  $C_2$  in this application were 1000 pF, and  $C_3$  was 2000 pF.

Donald E. Johnson, Chief Engineer, Carolina Medical Electronics, Inc., King, N.C.

VOTE FOR 316

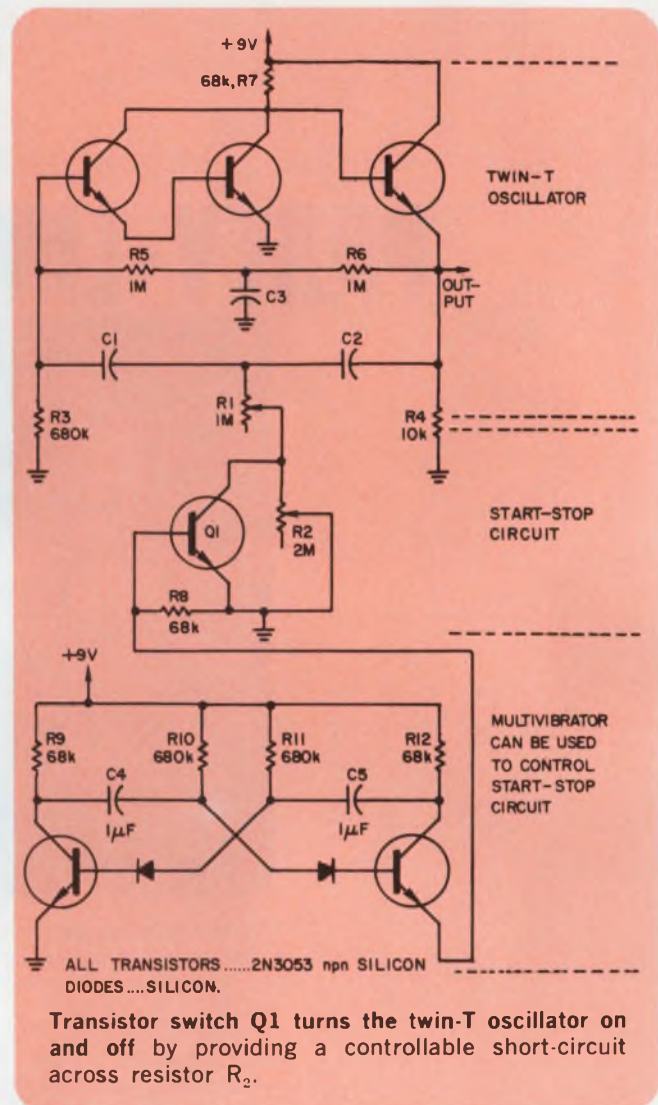

## Diode bridge protects sensitive circuits

Many a battery operated circuit has been inadvertently wiped out by the simple act of plugging the battery in backwards. Here is a solution for this type of problem.

Wire a full-wave bridge into the front end of the circuit, polarized to provide the proper polarity for the circuit to be protected. The battery can now be plugged in, in either direction, without damaging the circuit.

One word of caution: Observe surge ratings

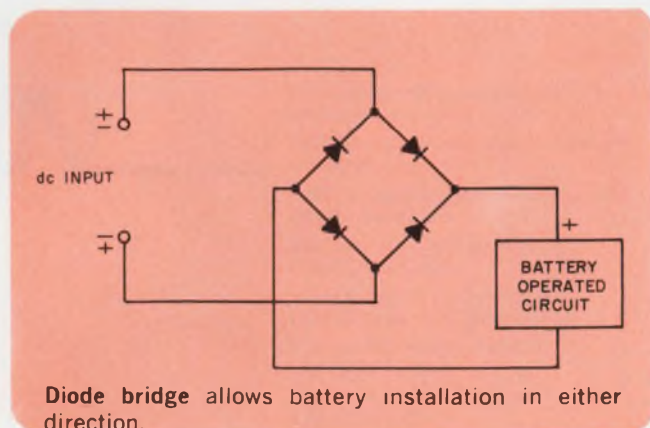



# new

## HARDENED SERIES 54H CIRCUITS



- Dual type D Flip-Flop
- Quad 2-Input NAND Gate
- Dual 2-Input AND-OR INVERT Gate
- Dual 4-Input NAND Gate
- Quad 2-Input AND-OR INVERT Gate
- Two orders of magnitude more resistant to radiation environment
- Dielectrically isolated
- Thin film resistors
- Optimized device geometries
- Low Z mono-metallic metalization system
  - Aluminum interconnect
  - Aluminum die attach
  - Aluminum wire bond
  - Aluminum package posts
- Compatible with 930 Hardened DTL product line
- Full military temperature range
- Complies with MIL-STD-883
- Off-the-shelf delivery

You get the BEST IC for the job from Radiation's fast expanding hardened circuit line.

P. O. Box 476, Lexington, Massachusetts 02173  
Area Code 617, 862-1055

600 Old Country Road, Garden City, New York 11530  
Area Code 516, 747-3730

2600 Virginia Avenue, N.W., Washington, D.C. 20037  
Area Code 202, 337-4914

P. O. Box 30667, Dallas, Texas 75230  
Area Code 214, 239-0378

6151 West Century Boulevard, Los Angeles,  
California 90045 • Area Code 213, 670-5432

260 Sheridan, Palo Alto, California 94306  
Area Code 415, 321-2280

P. O. Box 37, Melbourne, Florida 32901  
Area Code 305, 727-5430

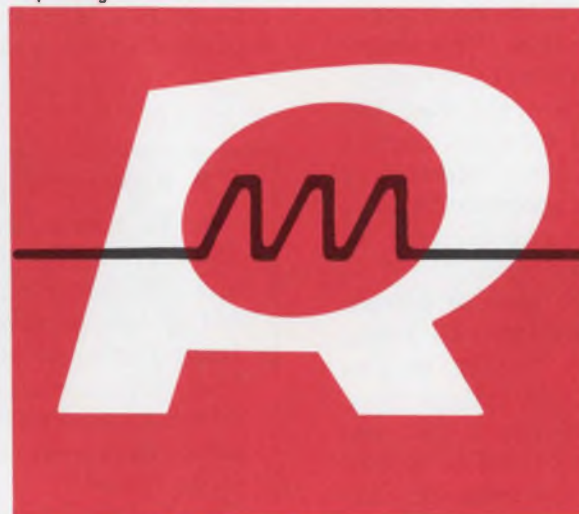

**RADIATION**  
INCORPORATED  
SUBSIDIARY OF HARRIS-INTERTYPE CORPORATION  
MICROELECTRONICS DIVISION

See us at WESCON / 69!  
Booth 4503, 4, 5

INFORMATION RETRIEVAL NUMBER 138

for the bridge and be sure that the rectifier can handle the full-load current. The input voltage will be lower by two diode drops; therefore, if the circuit is voltage sensitive the input voltage may need to be raised about one and a half volts.

*Charles Lichtenstein, Engineer, Microwave Associates, Inc., Sunnyvale, Calif.*

VOTE FOR 317

## Reliable semiconductor replaces centrifugal motor starting switch

A single-phase induction motor starting circuit makes use of a solid-state switch to improve reliability. Usually these motors require a start winding which is only used until the rotor reaches a speed of approximately 75% of full-load speed. Most motors of this type use a mechanical centrifugal switch which deenergizes the start winding after the proper speed is reached. These switches tend to be unreliable since they interrupt high current. They also are subject to corrosion and pitting, and cannot be used in hostile atmospheres.

A triac is naturally suited to this application since it will conduct current in both directions and it can be triggered ON by either positive or negative gate drive.

The schematic shows the motor starting circuit. In this circuit, a triac is connected in series with the start winding, replacing the centrifugal switch. The main winding inrush current during starting of the motor is several times the running current. It drops as the speed-dependent back EMF rises. Thus the main winding inrush current can be used as the source of control for the start winding. The voltage developed across resistor  $R_1$ , which is proportional to the main winding current, is used to gate the triac. The resistance must be large enough for start current to develop sufficient voltage to turn on the triac, but not so large that the full load running current will keep it on. Some trial and error selection of this value may be necessary to accommodate the triac that is used; a slide-wire resistor may be used to select the proper trigger level.

When the current drops to zero in a triac with an inductive load, the device turns OFF and the voltage across it increases rapidly to line voltage. If the rate of rise of this voltage ( $dv/dt$ ) is too great, the triac will again turn on. Therefore, a circuit must be provided to assure that the  $dv/dt$  is low enough. The network, consisting of  $R_2$  and  $C_1$ , is used to limit the  $dv/dt$

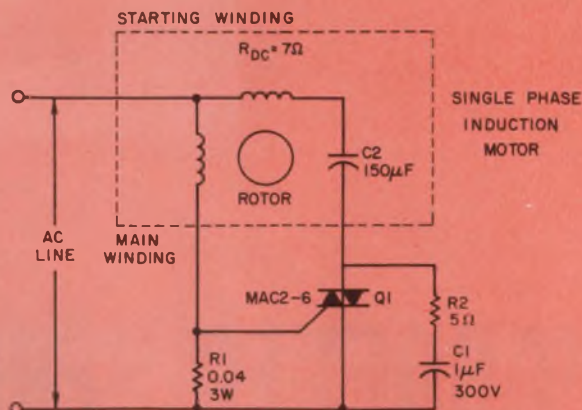

Triac allows current to flow in start winding until backs EMF reduces main winding current to near steady-state level.

across the triac to within the capability of the device. This rating is lowest at high temperatures; thus, the network values should be chosen for proper operation at the highest expected temperature.

The values shown on the schematic were used with a 1/2-hp, 115-volt motor. The peak starting current of the motor was 40 A, while the peak running current was 8 A. The value of the resistor was chosen so the triac would not turn on when current was less than 12 A. This occurred after 12 cycles. It should be possible to use the triac shown for integral-horsepower motors since the triac conducts for only a few cycles. Of course, maximum current ratings must be observed. The circuit, as shown, has been operated at temperatures as high as 80°C, but the motor-starting capacitor limits the maximum ambient temperature to +65°C. In addition, the duty cycle of the capacitor limits the circuit to a maximum of 60 starts of one-second duration per hour. The triac has performed satisfactorily under these conditions.

*G. V. Fay, Design Engineer, Motorola Semiconductor Products, Inc., Phoenix, Ariz.*

VOTE FOR 318

### IFD Winners for April 26, 1969

**E. E. Barnes**, Research Assistant, Penn State University, University Park, Pa. His Idea "Simple circuit 'tags' beginning and end of square-wave signals" and **Walter G. Jung**, Engineer, MTI, Div. of KMS Industries, Inc., Cockeysville, Md. His Idea "IC differential amplifiers yield matched zener pairs" have been voted the Most Valuable of Issue Award.

Vote for the Best Idea in this Issue.



# new

## PLATED-WIRE, HARDENED SENSE AMP

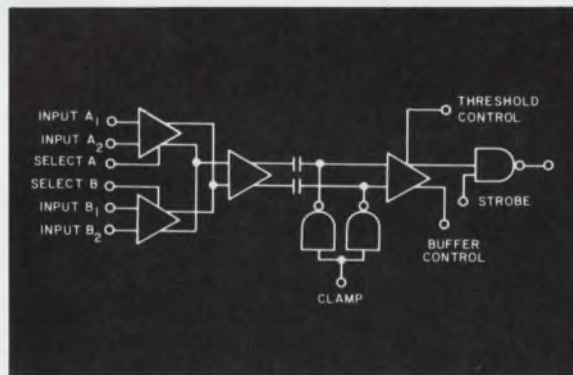

- The first application of linear and digital technology in one monolithic subsystem
- The RA-2540 system in a single chip performs the functions of a hardened differential amplifier and a hardened voltage comparator
- 1 mv signal sensitivity in high noise environment
- 10 ns access time
- Internal D.C. restoration
- Selectable dual channel
- Hardened
  - Photo current compensation
  - Dielectric isolation
  - Thin film resistors
  - Advanced device design
- Complies with MIL-STD-883
- Off-the-shelf delivery

You get the BEST IC for the job from Radiation's fast expanding hardened digital line.

P. O. Box 476, Lexington, Massachusetts 02173  
Area Code 617, 862-1055

600 Old Country Road, Garden City, New York 11530  
Area Code 516, 747-3730

2600 Virginia Avenue, N.W., Washington, D.C. 20037  
Area Code 202, 337-4914

P. O. Box 30667, Dallas, Texas 75230  
Area Code 214, 239-0378

6151 West Century Boulevard, Los Angeles,  
California 90045 - Area Code 213, 670-5432

260 Sheridan, Palo Alto, California 94306  
Area Code 415, 321-2280

P. O. Box 37, Melbourne, Florida 32901  
Area Code 305, 727-5430

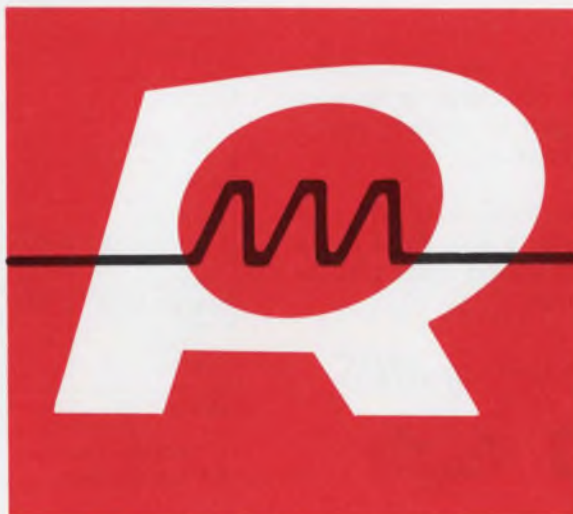

**RADIATION**  
INCORPORATED  
SUBSIDIARY OF HARRIS-INTERTYPE CORPORATION  
MICROELECTRONICS DIVISION

See us at WESCON/69!  
Booth 4503, 4, 5

INFORMATION RETRIEVAL NUMBER 139



# MOS. Now.

## 20 standard Philco types are ready to ship from stock.

Our line of standard production MOS integrated circuits keeps growing broader every day. From our Lansdale plant, one of the largest MOS facilities in the country, you can now get instant delivery of many of the devices that you'll need for your next generation designs. For example:

- Shift registers; including the longest (256 bits) and the fastest (5MHz clock) commercially available in production quantities.
- Compatible gates, up to 2MHz clock, in a variety of configurations.
- Binary counters . . . 16-channel sequential/random access multiplexer . . . 1024-bit dynamic read-only memory, programmed to your bit pattern; off-the-shelf model is a sine look-up table.

Many more are being readied for production. When you want MOS *now*, we're the people to see. Write or call MOS Marketing, Philco-Ford Microelectronics Division, Blue Bell, Pa. 19422. (215) 646-9100.

*the better idea people in MOS*



Device	Description
pL4C07C pL4C07AC(1)	7-stage binary counter 7-stage binary counter
pL4G10C pL4G10AC(2)	Hex 2 input NOR + 2 inverters Hex 2 input NOR + 2 inverters
pL4G11C pL4G11AC(2)	Dual 4 input NOR + dual 5 input NOR Dual 4 input NOR + dual 5 input NOR
pL4G12C pL4G12AC(2)	Dual 9 input NOR Dual 9 input NOR
pL4S16C	16 channel multiplexer
pL5R32C	Dual 8/16-bit shift register
pL5R40C	Dual 20-bit shift register
pL5R100C	Dual 50-bit shift register
pL5R96C	Dual 48-bit shift register
pL5R128C pL5R128AC(3)	Dual 64-bit shift register Dual 64-bit shift register
pL5R250C pL5R250AC(3)	250-bit shift register 250-bit shift register
pL5R256C pL5R256AC(3)	256-bit shift register 256-bit shift register
pM1024C	1024-bit read-only memory

(1) Clock rate 500KHz    (2) Clock rate 2MHz  
(3) Clock rate 5MHz



# Magnetic laboratory equipment

WALKER  
MAGNETIC  
GROUP



## Walker Integrating Fluxmeter and Hall Gaussmeter

A line of precision magnetic measurement instruments to accurately measure magnetic flux and produce an accurate analogue voltage proportional to the flux for recording hysteresis loops or measurement of magnetic fields. Light weight, solid state design. Fast, accurate, easy to use.

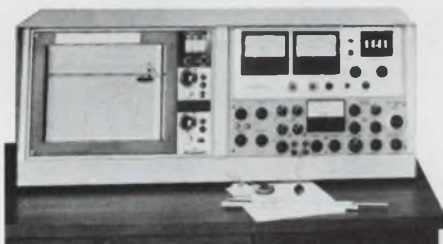

## Walker Hysteresisgraphs

A line of magnetic material test equipment including the Model MH-1 Hysteresisgraph for materials with coercivities ranging from 100 to 3000 oersteds and saturation inductance up to 18,000 gauss, the Model MH-2 Hysteresisgraph for soft magnetic material testing and the Model MC-1 Coercivity Meter.



## Walker Regulated Power Supplies

- 5, 11 and 15 Kilowatt Current Regulated Models
- One Part in 100,000 or Better Stabilities
- All Silicon Solid State Circuitry
- Ultra Stable Low Noise Input Circuitry
- Automatic Polarity Reversal (Optional)
- Electronic Sweep Circuitry (Optional)
- Impedance Matched to the Walker Line of Precision Laboratory Magnets

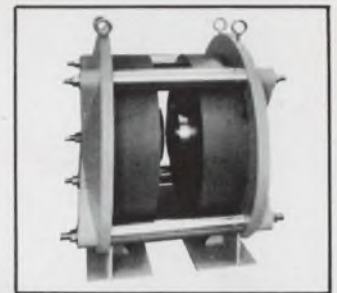

## Walker Precision Laboratory Electromagnets

Moderately priced and specifically designed for high performance with flexibility and accessibility. Five models - 4, 4V (4 inch diameter), 7, 7V (7 inch diameter) and 10 (10 inch diameter). Magnet pole cap surfaces are precision ground and polished to optical tolerances to achieve optimum magnetic uniformity. 4V and 7V models are variable gap models with continuously adjustable spans. All magnets are capable of providing a stepped variable gap by means of precision ground spacer blocks.



## Walker Superconductor Magnets

Available in bores up to 3" with intensities up to 65 kilogauss. Compensated solenoids are available for applications requiring high field uniformity. A complete line of accessories is available for these magnets.

## Walker Custom Coils

The O.S. Walker Company produces to customer order numerous coil systems including Helmholtz coils, air core and iron core solenoids, plasma coils and laser coils.

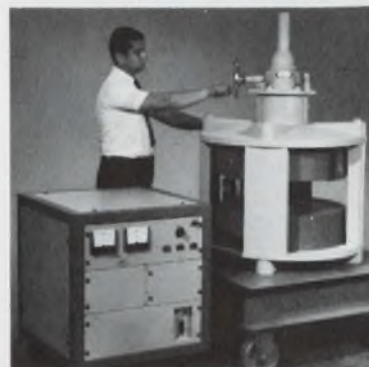

## Walker Special Magnet Systems

Typical special magnet systems, designed and produced at O.S. Walker.

**O. S. WALKER COMPANY, INC.**  
ROCKDALE STREET, WORCESTER, MASS. 01608 617-853-3232

WALKER  
MAGNETIC  
GROUP

**BUX-SHRADER MAGNETIC PRODUCTS**  
12080 SOUTH WESTERN AVE., GARDEN GROVE, CALIFORNIA 92641 714-894-3391

INDUSTRIAL MAGNETICS DIVISION / MAGNETRICS DIVISION / EASTERN SCIENTIFIC DIVISION / WALKER-HAGOU N.V. HOLLAND

INFORMATION RETRIEVAL NUMBER 141

# COS/MOS

RCA's unique approach to digital design  
—at new low prices



## For practical circuit designs...

High performance and new low prices combine to make COS/MOS—RCA's unique Complementary Symmetry MOS integrated circuits—an even greater value for a broader range of digital equipment designs. Now you can re-evaluate—and find even more advantages in—these COS/MOS features that no other logic circuitry has matched to date:

- Quiescent power dissipation in nanowatts
- Noise margin—4.5 volts
- Fanouts up to 50
- Single power supply required—6 to 15 V; positive or negative
- Logic level swing—"0" to power supply voltage
- Compatible gate level and MSI functions
- Frequency capabilities from DC to 5 MHz
- Single-phase clocking
- Full military operating temperature range—from  $-55^{\circ}\text{C}$  to  $+125^{\circ}\text{C}$
- Hermetic packages—DIC or ceramic flat pack

To get acquainted with COS/MOS, see your RCA Distributor for the COS/MOS Sampler QK2201, yours for only \$50.00 (optional distributor resale price).

## For new economy...

Effective now, new low prices—combined with unrivalled application advantages—put COS/MOS squarely in the picture for all your digital designs. Check the list of device numbers, descriptions and prices. Then ask your local RCA Representative or your RCA Distributor for details. For specific circuit data, write RCA Electronic Components, Commercial Engineering, Sec. ICG8-3, Harrison, N. J. 07029.

CD4000D	Dual 3-Input Gate and Inverter (DIC)	NOW \$ 4.00
CD4001D	Quad 2-Input Gate (DIC)	NOW \$ 4.75
CD4002D	Dual 4-Input Gate (DIC)	NOW \$ 4.50
CD4003D	Dual "D" Type Flip-Flop (DIC)	NOW \$ 8.00
CD4004T	7-Stage Counter-Divider (12-lead TO-5)	NOW \$10.00
CD4005D	16-Bit NDRO Memory (DIC)	NOW \$10.00
CD4006D	18-Stage Static Shift Register (DIC)	NOW \$17.25
CD4007D	Dual Complementary Transistor Pair and Inverter (DIC)	NOW \$ 3.00

(All prices at 1,000 unit level. These COS/MOS IC's also available in ceramic flat-pack at slightly-higher prices.)

Consider the systems advantages to be provided by these developmental types, soon to be added to the growing COS/MOS series. See your local RCA Representative.

	Dev. Type No.	Description
Buffers	TA5660	Hex Inverting Buffer
	TA5668	Hex Non-Inverting Buffer
MSI	TA5519	4-Bit Full Adder
	TA5578	8-Stage Synchronous Parallel-Input/Serial-Output Register
	TA5579	Dual 4-Stage Serial-Input/Parallel-Output Register
	TA5684	Decade Counter
	TA5971	5-Stage Binary/Decade Counter
	TA5500	Presetable Divide by "N" Counter

**RCA**  
Integrated  
Circuits

Visit the RCA Electronic Components exhibit at WESCON, Unit C, in the Cow Palace Arena

INFORMATION RETRIEVAL NUMBER 142



# Products

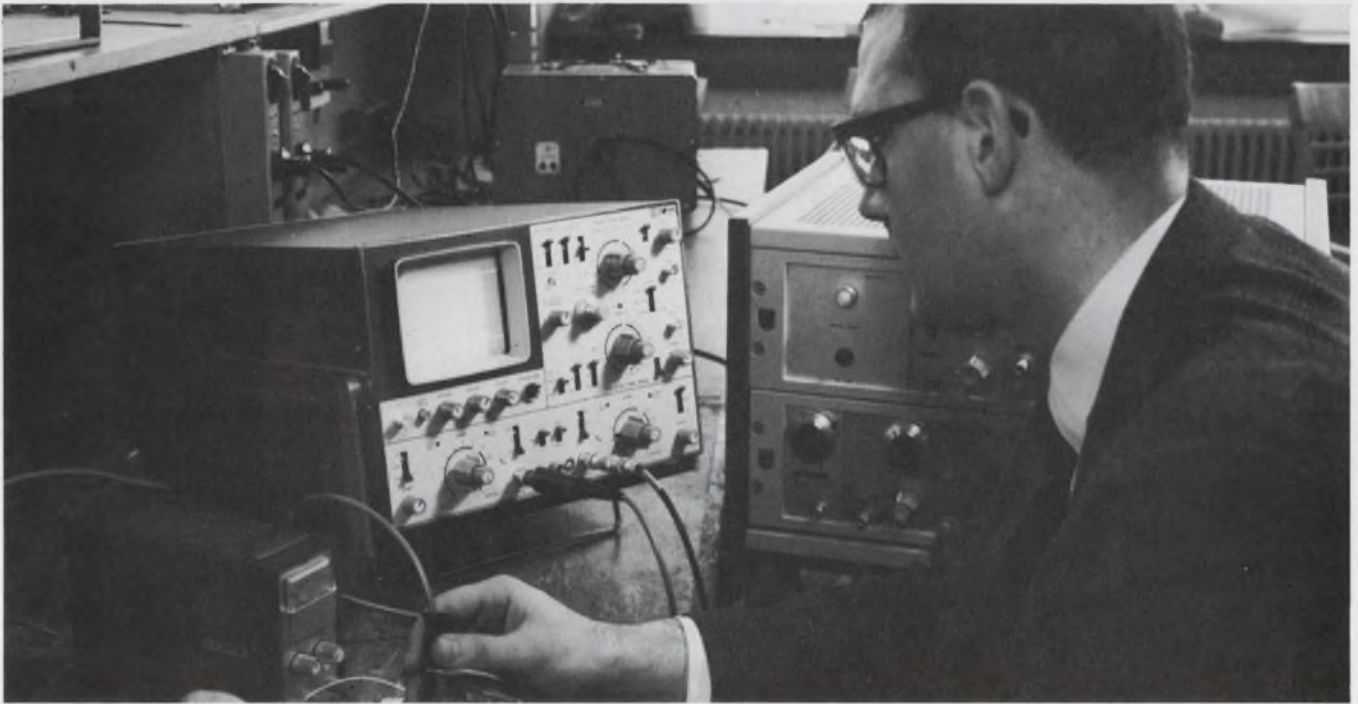

**Dual-trace oscilloscope** views dc-to-5-MHz signals with an accuracy of 200  $\mu\text{V}/\text{cm}$ . It

is accurate to 2 mV/cm over the frequency range of dc to 50 MHz, p. 284.

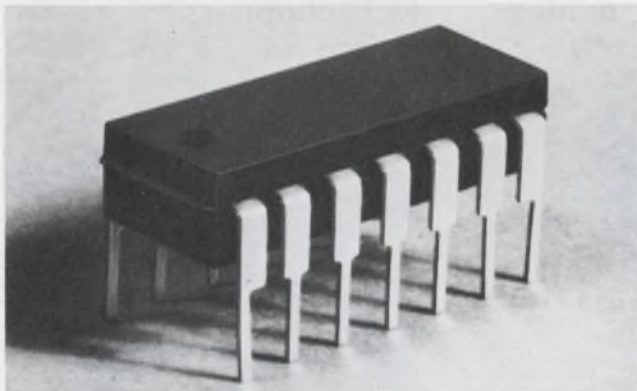

**Monolithic integrated circuit** is a complete a-m radio receiver on a single chip, p. 254.

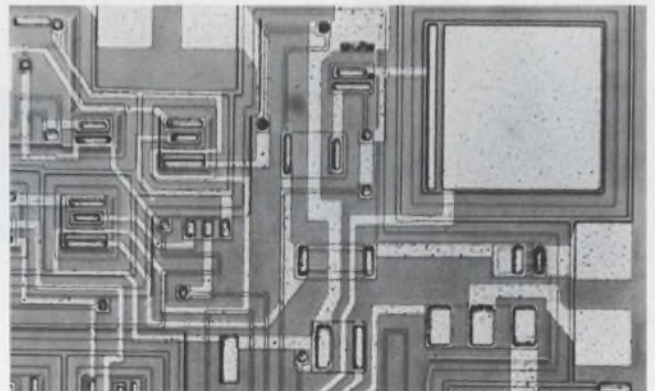

**Single-chip high-speed operational amplifier** gets settling time down to 300 ns, p. 254.

## Also in this section:

**Low-cost FET op amp** offers military specs in hermetic TO-8 case, p. 262.

**Compact status indicators** display 12 messages within 2-in. square, p. 272.

**High-speed data modem** shows line status on its front panel, p. 278.

**Evaluation Samples**, p. 300 . . . **Design Aids**, p. 302 . . . **Annual Reports**, p. 304

**Application Notes**, p. 306 . . . **New Literature**, p. 308.

### Linear IC op amp settles in 300 ns

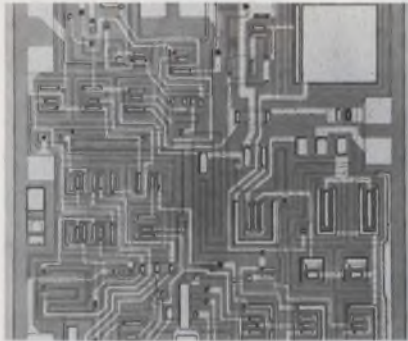

Fairchild Semiconductor, 313 Fairchild Drive, Mountain View, Calif. Phone: (415) 962-3563. Price: \$72.

Said to be over ten times faster than any IC operational amplifier now on the market, the  $\mu A715$  is a monolithic linear integrated circuit that features a typical settling time of only 300 ns. The new op amp also offers a unit-gain non-inverting slew rate of 20 V/ $\mu$ s to give an acquisition time of 800 ns.

CIRCLE NO. 415

### MSI TTL circuits dissipate 16 mW

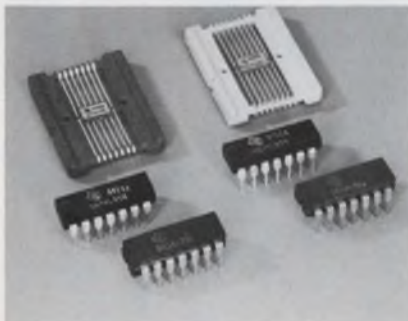

Texas Instruments Inc., Components Group, P.O. Box 5012, Dallas, Texas, Phone (214) 238-2011. P&A: \$13.30 to \$46.41; 6 or 10 wks.

Two new low-power MSI TTL integrated circuits, the SN54L95/74L95 and the SN54L93/74L93, feature power dissipations of only 19 and 16 mW, respectively. The SN54L93/74L93 is a 4-bit binary register that will perform right-shift or left-shift operations. The SN54L93/74L93 is a 4-bit binary counter consisting of four master/slave flip-flops.

CIRCLE NO. 416

### Voltage-variable diodes offer Qs as high as 200

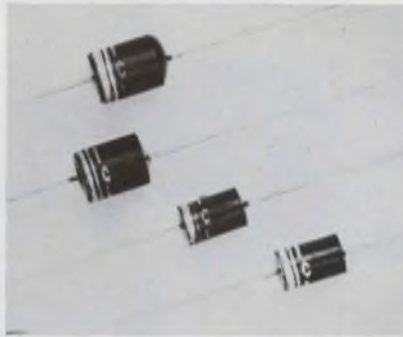

Crystalonics, Inc., a Teledyne Co., 147 Sherman St., Cambridge, Mass. Phone: (617) 491-1670. P&A: from \$16; stock.

Featuring all-epitaxial construction, twelve new silicon voltage-variable capacitance diodes boast Qs up to 200, and dc ratings up to 100 V. Series VA521-824 units offer capacitances up to 1320 pF and tuning ratios as high as five. They are ideal for such applications as uhf/vhf frequency multiplication.

CIRCLE NO. 417

### Plastic tuning diodes sell for 60¢ each



Motorola Semiconductor Products Inc., P. O. Box 20924, Phoenix, Ariz. Phone: (602) 273-6900. P&A: 60¢; stock.

With a price tag of 60¢, EPI-CAP silicon voltage-variable capacitance diodes are now available in a low-cost injection-molded plastic package. Designated as types MV2101 through MV2115, these new plastic tuning diodes cover the capacitance range from 6.8 to 100 pF nominal, with typical tuning ratios of 3.

CIRCLE NO. 418

### Complete a-m radio is monolithic IC

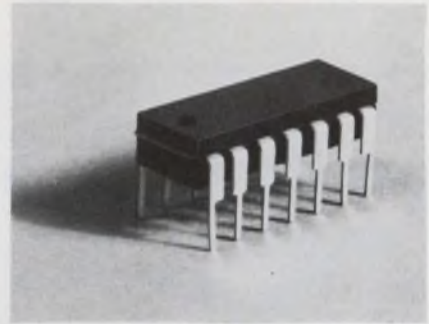

Amperex Electronic Corp., Semiconductor and Microcircuits Div., Providence Pike, Slatersville, R. I. Phone: (401) 762-9000.

Available in a 14-lead dual-in-line package, a new monolithic IC is a complete a-m radio receiver on a single chip. Model TAD100 contains all the active components for a complete receiver: oscillator, mixer, i-f amplifier, detector, and agc, audio preamp and driver stages. Its a-m sensitivity is 50  $\mu$ V/m for a 100-mW audio output.

CIRCLE NO. 419

### FET choppers switch in 15 ns



National Semiconductor Corp., 2950 San Ysidro Way, Santa Clara, Calif. Phone: (408) 245-4320. P&A: \$2.50 to \$3.50; stock.

Three new FET choppers feature a typical fast switching time of 15 ns and a low leakage of 100 pA maximum. Types 2N4391, 2N4392 and 2N4393 are also said to offer very high reliability. They are designed for optimum performance in microvolt amplifiers and meters, multiplexers, commutators and oscilloscopes.

CIRCLE NO. 420



# 100PPM/°C

---

# Ω & °C\*

\* Our diagram signifies Bourns now offers  $\pm 100$  ppm/°C TC over the entire temperature and resistance range of all its 12 cermet models

*Once you've said that,  
you've said it all...*

*...except Bourns said it first!*

Complete data on this breakthrough in Trimpot® cermet potentiometers is available from your local Bourns Sales Office, representative or the factory.



# dc voltage standards

THE FACTS ARE  
IN THE  
CARDS

## ACCURACY

### GOOD

Model 351 0.003% Accuracy

### BETTER

Model 353 0.002% Accuracy

### BEST

Model 355 0.001% Accuracy

### COHU MEETS THE TEST

We could have said, "COHU BEATS THE REST," but the technically knowledgeable engineer will see the 0.001% of the Model 355 and ask "WHY STATE THE OBVIOUS?"



So, to get the DC Voltage Standard YOU need, it's obvious:

**ASK COHU FOR IT**

**COHU**  
ELECTRONICS, INC.  
SAN DIEGO DIVISION

BOX 623, SAN DIEGO, CALIFORNIA 92112 • PHONE 714-277-6700 • TWX 910-335 1244

Cohu will be at WESCON, Booth 2001  
INFORMATION RETRIEVAL NUMBER 152

## ICs & SEMICONDUCTORS

### Miniature rectifiers can carry up to 6 A

*Semtech Corp., Newbury Park, Calif. Phone: (805) 498-2111.*

Said to approach theoretical electrical limits, Metoxilite rectifiers are rated at 3 or 6 A with peak reverse voltages as high as 1000 V. Their metal oxides are fused to a metallurgically bonded-junction tungsten-pin assembly to form a tough subminiature package. Recovery times vary from 150 ns to 2  $\mu$ s.

CIRCLE NO. 421

### Hermetic SCRs sell for 45¢

*Transitron Electronic Corp., 168 Albion St., Wakefield, Mass. Phone: (617) 245-4500. P&A: 45¢ to \$1.50; 3 to 4 wks.*

Hermetically packaged in a TO-5 metal can, a new series of planar SCRs with up to 400-V ratings cost as little as 45¢ each. Series RTD04 units have a gate sensitivity of under 100  $\mu$ A and a holding current of under 5 mA. They will handle 1.6 A rms at 80°C case temperature and will operate up to 125°C at lower current levels.

CIRCLE NO. 422

### Flatpack transistors are dual/quad units

*Raytheon Co., Semiconductor Operation, 350 Ellis St., Mountain View, Calif. Phone: (415) 968-9211.*

Dual and quad versions of the npn 2N2222 and pnp 2N2907 transistors are now available in TO-89 and TO-86 flatpacks, respectively. These devices have a guaranteed short-circuit forward current gain, saturated collector-emitter voltage and saturated base-emitter voltage, with up to 500-mA collector current and a breakdown voltage of 60 V.

CIRCLE NO. 423



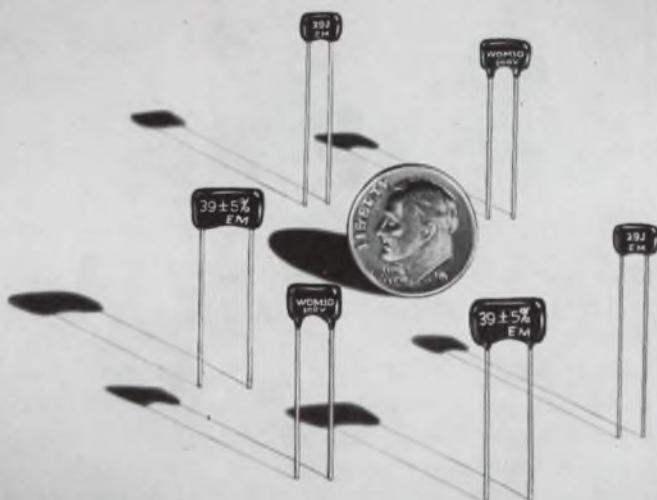

## They're Small and Reliable\*

### EL-MENCO DM5 — DM10 — DM15 — ONE COAT DIPPED MICA CAPACITORS

STYLE	WORKING VOLTAGE	CHARACTERISTIC	CAPACITANCE RANGE
DM5	50VDC	C	1pF thru 400pF
		D, E	27pF thru 400pF
		F	85pF thru 400pF
DM5	100VDC	C	1pF thru 200pF
		D, E	27pF thru 200pF
		F	85pF thru 200pF
DM10	100VDC	C	1pF thru 400pF
		D, E	27pF thru 400pF
		F	85pF thru 400pF
DM15	100VDC	C	1pF thru 1500pF
		D, E	27pF thru 1500pF
		F	85pF thru 1500pF
DM5	300VDC	C	1pF thru 120pF
		D, E	27pF thru 120pF
		F	85pF thru 120pF
DM10	300VDC	C	1pF thru 300pF
		D, E	27pF thru 300pF
		F	85pF thru 300pF
DM15	300VDC	C	1pF thru 1200pF
		D, E	27pF thru 1200pF
		F	85pF thru 1200pF
DM10	500VDC	C	1pF thru 250pF
		D, E	27pF thru 250pF
		F	85pF thru 250pF
DM15	500VDC	C	1pF thru 750pF
		D, E	27pF thru 750pF
		F	85pF thru 750pF

Where space and performance are critical, more and more manufacturers are finding that El-Menco miniaturized dipped mica capacitors are the reliable solution. The single coat is available in three sizes: 1-CRH, 1-CRT and 1-CE.

The 1-CRH DM "space savers" easily meet all the requirements of MIL and EIA specifications, including moisture resistance. The 1-CE and 1-CRT units also meet the requirements of MIL and EIA specifications, except that they have less moisture protection because of their thinner coating; these capacitors, therefore, are ideally suited where potting will be used. Note: DM10 and DM15 units are still available in the standard 4-CR size.

**Specify "El-Menco" and be sure . . .** the capacitors with proven reliability. Send for complete data and information.

\*Normally, El-Menco 39 pF capacitors will yield a failure rate of less than 0.001% per thousand hours at a 90% confidence level when operated with rated voltage and at a temperature of 85°C. Rating for specific applications depends on style, capacitance value, and operating conditions.

## THE ELECTRO MOTIVE MFG. CO., INC.

WILLIMANTIC, CONNECTICUT 06226

Dipped Mica • Molded Mica • Silvered Mica Films • Mica Trimmers & Padders  
Mylar-Paper Dipped • Paper Dipped • Mylar Dipped • Tubular Paper

West Coast Manufacturers contact: COLLINS & HYDE CO., 900 N. San Antonio Rd., Los Altos, California 94022  
5380 Whittier Blvd., Los Angeles, California 90022

ALSO SOLD NATIONALLY THROUGH ELECTRONIC PARTS DISTRIBUTORS

INFORMATION RETRIEVAL NUMBER 153



# CAS Series... industrially oriented cassette decks



The Auricord CAS series of two channel, record/playback CASSETTE decks has been designed for a wide range of applications: computer, AV, space and medical, communications... to name a few. Outstanding features include three-motor design and completely electrical actuation, making the system ideal for remote controlability. Also, simplified slot loading and dynamic braking. Add our EP-1 electronics package for a complete system.

MODEL CAS-3 is similar to CAS-1, but adds the advantage of read-out in fast forward and fast reverse modes and has random access capability.

For complete details on the CAS series and other Auricord products for tape mechanism requirements, contact:

SPECIALISTS IN QUALITY TAPE DECKS

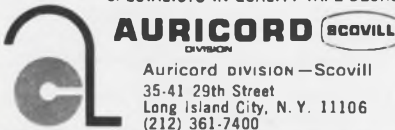

INFORMATION RETRIEVAL NUMBER 154

## ICs & SEMICONDUCTORS

### Pnp transistors carry up to 20 A



*Solitron Devices, Inc., Transistor Div., 1177 Blue Heron Blvd., Riviera Beach, Fla. Phone: (305) 848-4311. Availability: stock.*

Packaged in TO-3 and TO-66 cases, a new line of industrial pnp power transistors can handle currents of 10 and 20 A. Types 2N5737, 2N5738, 2N5739 and 2N5740 are 10-A devices with collector voltages of -60 or -100 V. Types 2N5741, 2N5742, 2N5743 and 2N5744 are 20-A transistors also having rated collector voltages of -60 and -100 V.

CIRCLE NO. 424

### Pnp transistors turn-on in 20 ns

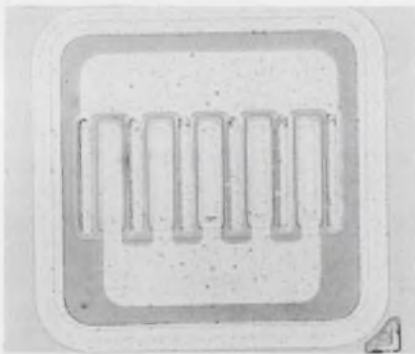

*Fairchild Semiconductor, 313 Fairchild Drive, Mountain View, Calif. Phone: (415) 962-3563. Price: \$4.50 or \$5.40.*

Two new high-speed pnp transistor switches boast a turn-on time of 20 ns maximum and a turn-off time of 30 ns at 300-mA collector current. They are intended for a variety of saturated and non-saturated switching applications, including complementary switching circuits. Type 2N5456 has a breakdown voltage of 15 V, while type 2N5456 is rated at 25 V

CIRCLE NO. 425

### Silicon thermistors vary package type

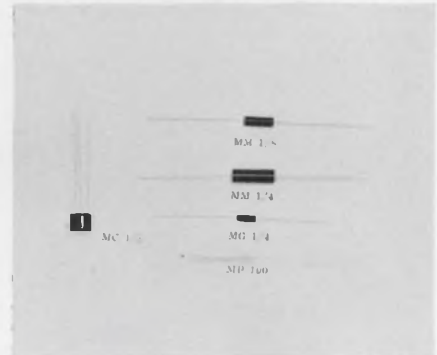

*Microsemiconductor Corp., 11250 Playa Court, Culver City, Calif. Phone: (213) 391-8271. P&A: from \$1.56; stock to 2 wks.*

Addohm silicon positive-temperature-coefficient thermistors can be packaged as molded, glass hermetic, transistor can or miniature probe types. Designed to meet the specifications of MIL-T-2364ΩA, the new devices have standard resistance ranges from 10 Ω to 10 kΩ with either ±5 or ±10% tolerances.

CIRCLE NO. 426

### Power transistors dissipate 350 W



*Solid Power Corp., 440 Eastern Parkway, Farmingdale, N.Y. Phone: (516) 694-2883. Availability: stock to 4 wks.*

Offering collector-emitter voltages as high as 300 V, a new line of silicon power transistors feature a power dissipation of 350 W. The new devices, which come in a TO-3 package, have a low saturation resistance of 0.3 Ω as well as low leakage currents and low thermal impedances. Maximum collector current can be 30 A.

CIRCLE NO. 427



# When RCA quietly calls its RF power transistors "reliable," RCA means "highly reliable." Read why.

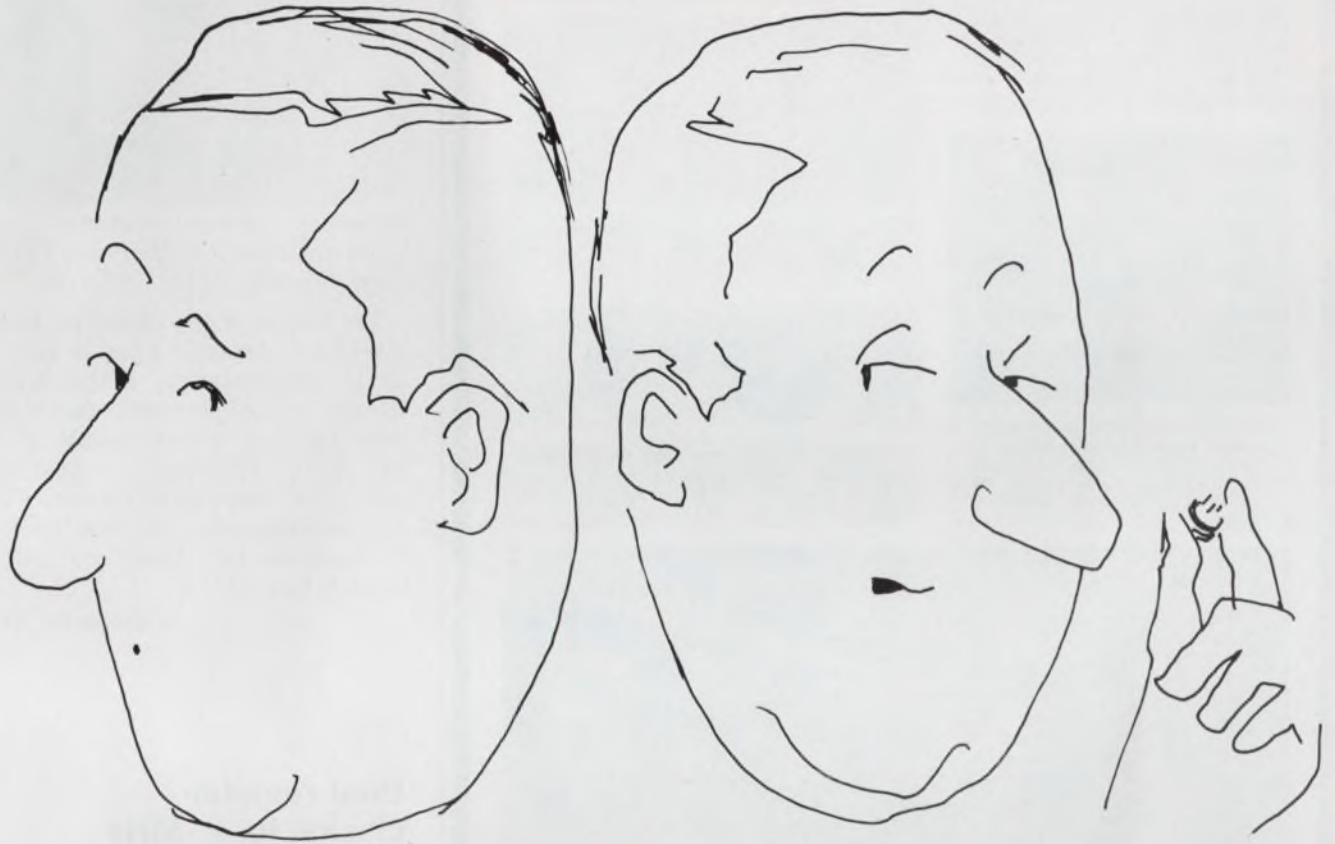

**RCA**

The reliability of RCA RF Power Transistors is designed-in, built-in and finally proved-in.

Evaluation criteria of every RCA RF Power Transistor are determined initially by design engineering—and are used during the analysis of first yields of prototypes. Procedures include tests to destruction, examination of failure mechanisms, checking the expectability of results, and extensive life tests under various rigorous conditions—all aimed at the final determination that every aspect of the new design is "go" for volume production.

In the second stage of assuring reliability, RCA follows a program of *dual* factory-process control: in-line testing at every major point of manufacturing, plus continuous quality audits on samples. The program consists of life tests, data analysis and failure analysis. Results are fed back to every technical group concerned with each product's evolution—from design through applications engineering.

The final stage, the proving-in of RCA reliability, is high to ultra-high screening. This follows four reliability levels: two meeting MIL-STD requirements and two meeting even more exacting criteria set by RCA—many of which precede the issuance of the military specs. Note the following chart of high-reliability RCA RF Power Transistors—all immediately available.

Visit the RCA Electronic Components exhibit at WESCON, Unit C, in the Cow Palace Arena.

RCA RF Power Transistors—High-Reliability Types

Parent Type	Jan Type Or Equivalent	Jan TX Type Or Equivalent	High-Reliability Type	Premium High-Reliability Type
2N3553	JAN	JAN TX		
	2N3553	2N3553	40305	40605
2N4440	JAN	JAN TX		
	2N4440	2N4440	—	—
2N3632	—	—	40307	40606
2N3375	JAN	JAN TX		
	2N3375	2N3375	40306	40279
2N3118	JAN			
	2N1493	—	—	40577
2N3866	TA7090*	TA7327*	—	40578
2N5016	TA7091*	TA7359*	—	40607
2N5071	TA7360*	TA7358*	—	—

\*Developmental number; military specification pending

For detailed information on any of these RCA high-reliability RF Power Transistors, see your local RCA Representative or your RCA Distributor. For technical data, write: RCA Electronic Components, Commercial Engineering, Section PG8-3, Harrison, N. J. 07029.

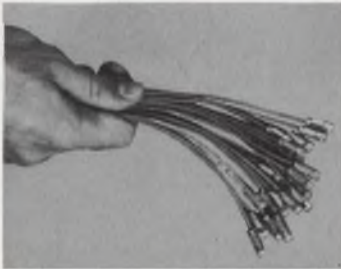

Miniature coaxial cable assemblies in any quantity, shipped complete. Our assembly speed is faster. Our yield greater. Your cost is lower.

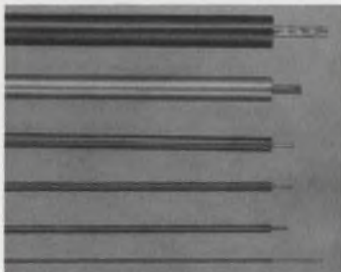

Miniature coaxial cable available in sizes from .020 inches to .325 inches. Tolerance as low as  $\pm 1/2$  ohm on characteristic impedance of 50 ohm. Minimum VSWR.



Assemblies used in LEM program. Directly soldered into circuits. Operate successfully in temperatures ranging from  $-54^{\circ}\text{C}$  to  $+140^{\circ}\text{C}$  under environmental pressure of  $10^{-6}$ .

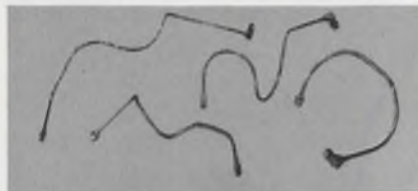

Assemblies to meet highly individual requirements all fitted with new PDM miniature microwave connectors.



Custom designed miniature coaxial cable impedance matching device. Cable is .034 inches diameter and 6 1/2" long. Coil is 1/4 inch I.D. and 3/16" high.

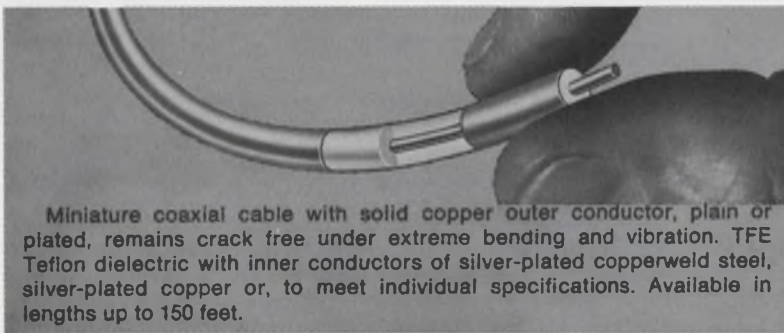

Miniature coaxial cable with solid copper outer conductor, plain or plated, remains crack free under extreme bending and vibration. TFE Teflon dielectric with inner conductors of silver-plated copperweld steel, silver-plated copper or, to meet individual specifications. Available in lengths up to 150 feet.

# MINIATURE CABLE ASSEMBLIES

We do all the work. You get 100 percent yield, low-cost and guaranteed performance. As the only integrated manufacturer of miniature semi-rigid coaxial cable and matching connectors we'll cut cable (our semi-rigid or any you specify) to precise mechanical and electrical lengths, bend to your individual requirements, terminate with selected

connectors, test to your established parameters and guarantee performance. And we can do this at a price lower than your cost if you were to buy your own coax and connectors and do the job yourself.

Find out how. Write to: *Phelps Dodge Communications Company, 60 Dodge Avenue, North Haven, Connecticut 06473.*

**PHELPS DODGE COMMUNICATIONS COMPANY** 

INFORMATION RETRIEVAL NUMBER 156

## ICs & SEMICONDUCTORS

### Small hybrid network compensates op amps

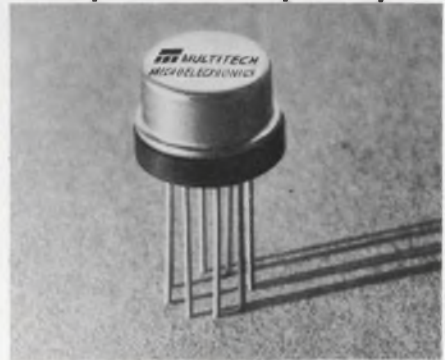

*Multitech Microelectronics, 583 Monterey Pass Rd., Monterey Park, Calif. Phone: (213) 282-3161.*

Claimed to be less expensive than internal or external discrete forms of IC compensation, model M709 hybrid roll-off network functions over the temperature range of 0 to  $72^{\circ}\text{C}$ . Physically compatible with all op amps employing the 709 pin configuration, the new device is available for closed-loop gains from 1 to 1000.

CIRCLE NO. 428

### Dual register clocks to 2 MHz



*American Micro-systems, Inc., 3800 Homestead Rd., Santa Clara, Calif. Phone: (408) 246-0330.*

Compatible with TTL, DTL or CCTL ICs, a new dual 100-bit dynamic MOS shift register performs with clock repetition rates up to 2 MHz. This p-channel device, model RD-16, employs a two-phase clocking system and can be operated at low duty cycles. It is supplied in a TO-5, flatpack or optional dual-in-line package.

CIRCLE NO. 429



# With EECO 2D computer-automated plug-in IC Hardware...

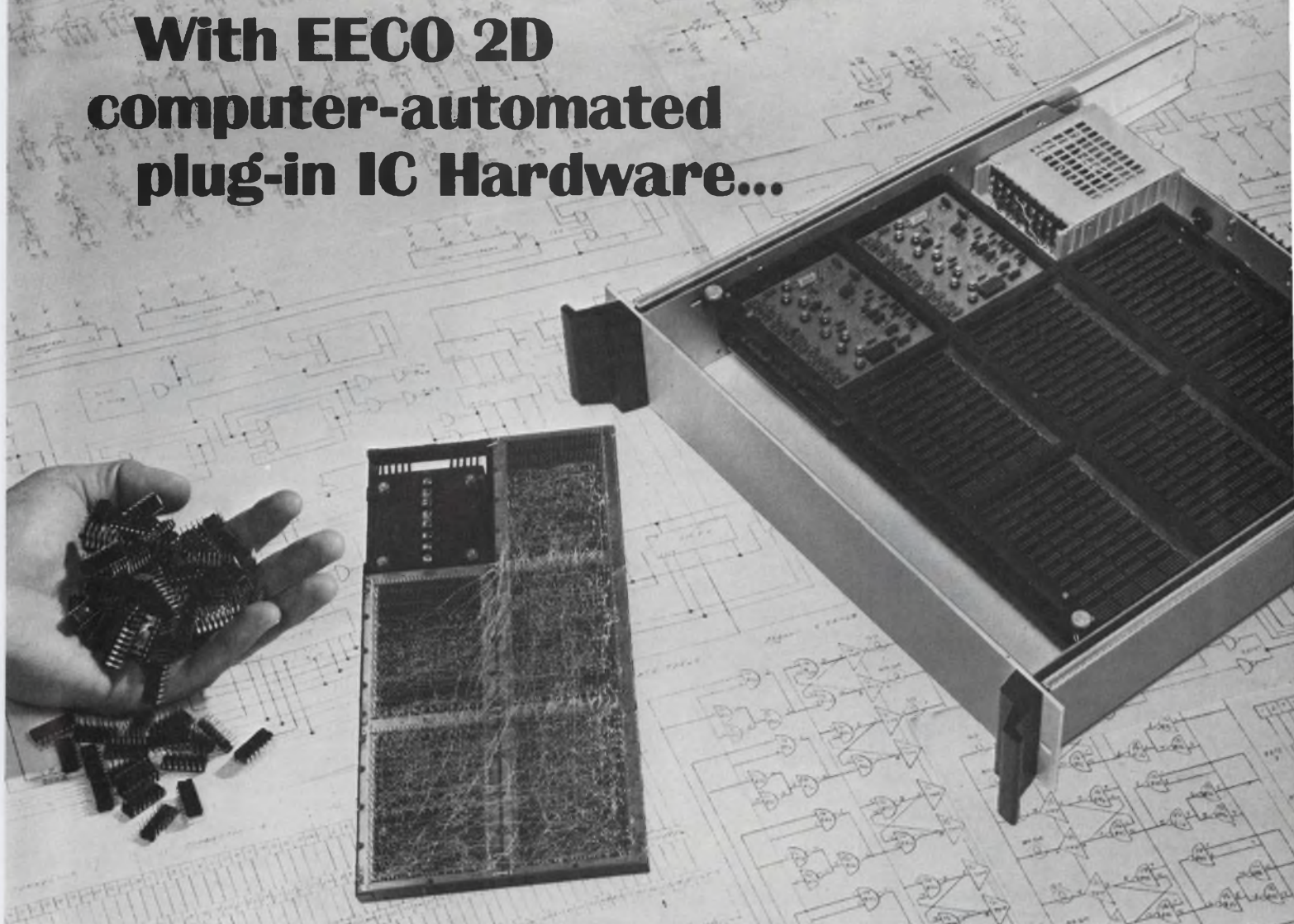

## less than 30 days separate schematic and final system...

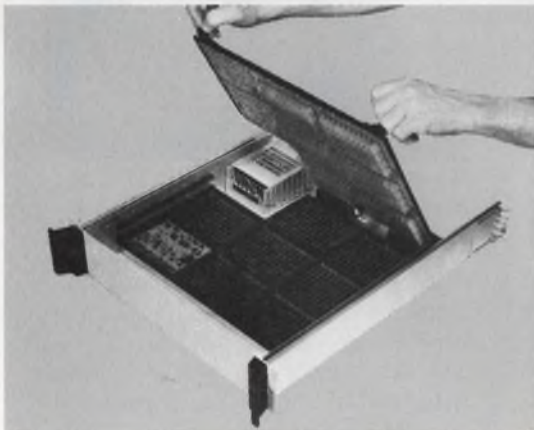

When you specify EECO 2D Hardware a computer converts your "Pin Logic List"\* into a wire plan and checks for errors and omissions before wiring begins. EECO plugs in the IC's, machine Wire-Wraps the back-planes and in days...your schematic is a drawer of working electronics with all necessary computer generated support documentation.

EECO 2D Hardware System provides more than time savings...it's up to 30% more economical...and it's versatile...ready for digital or analog IC's, discrete components, MSI or LSI. It offers higher density — up to 768 IC's and a power supply fit in one 3-1/2" high standard drawer.

Your first step is simple...just phone, write or circle the reply number.

\*You simply choose the module and write the signal name by each pin number. You don't worry where the wires go or the order of listing.

Catalog available.

See EECO 2D  
at Wescon Booth  
numbers 3814 thru 3817



**ELECTRONIC PRODUCTS DIVISION**

ELECTRONIC ENGINEERING COMPANY OF CALIFORNIA

1441 EAST CHESTNUT AVENUE · SANTA ANA, CALIFORNIA 92701 · (714) 547-5651



**2 SPEED  
10", 10 MV  
1/2%  
\$305.00**



**MODEL 28  
SERVO GRAPHIC**

A RUGGED, DEPENDABLE, RACK MOUNTED, SERVO RECORDER WITH ACCURACY TO MEET YOUR REQUIREMENTS, BUT AT A PRICE TO SATISFY YOUR BUDGET. AVAILABLE IN SINGLE OR DUAL PEN MODELS FROM YEISER LABORATORIES, THE LEADERS IN SERVO RECORDER DESIGN FOR OVER FIFTEEN YEARS. DUAL OVERLAPPING CHANNELS FROM \$600.00.



- ALL SILICON SOLID STATE ELECTRONICS
- PLUG-IN CIRCUITRY
- FET CHOPPER
- ZENER REFERENCE

Remember! If you have an OEM requirement, Y-LAB can furnish strip chart or X-Y recorders to meet your specific needs, so call or write:



881 W. 18th ST.  
COSTA MESA,  
CALIF. 92627  
714 - 548-2458

MODULES & SUBASSEMBLIES

**Low-cost op amp  
is military device**



*Bell & Howell Control Products Div., 706 Bostwick Ave., Bridgeport, Conn. Phone: (203) 368-6751. P&A: \$30; stock.*

Claimed to be cost competitive with plastic units, a new hybrid FET-input operational amplifier is packaged in a hermetically sealed TO-8 case and is operable over the full military temperature range. Model 20-248 has a maximum input bias current of 5 pA plus internal phase compensation. Its voltage offset is internally trimmed to less than 1 mV.

CIRCLE NO. 430

**\$12 FET amplifier  
senses 10-pA inputs**

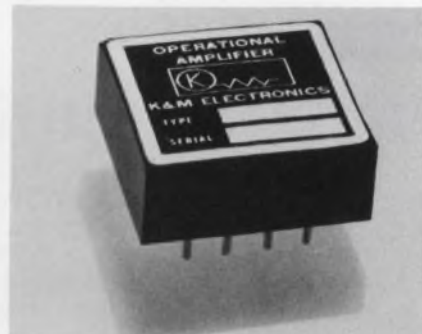

*K & M Electronics Corp., 408 Paulding Ave., Northvale, N.J. Phone: (201) 768-8070. Price: \$12.*

Costing only \$12 in single-unit quantities, a new general-purpose FET operational amplifier offers a input bias current of only 10 pA. Model KM479 provides an input impedance of  $10^6$  M $\Omega$  and an output of  $\pm 11$  V at 20 mA. It can be used in integrators, buffers and high-impedance instrumentation systems.

CIRCLE NO. 431

**Thick-film regulators  
supply 120 V to  $\pm 1\%$**



*Beckman Instruments, Inc., Helipot Div., 2500 Harbor Blvd., Fullerton, Calif. Phone: (714) 871-4848. P&A: \$35; stock.*

Providing output voltages preset to within  $\pm 1\%$  of the desired value, two new series of hybrid, cermet, thick-film dc voltage regulators deliver outputs as high as 120 V. Series 807 units cover the voltage range of 30 to 60 V, while series 808 devices range from 60 to 120 V. The new regulators offer programmable current limiting.

CIRCLE NO. 432

**FET amplifiers  
have 3-pA bias**

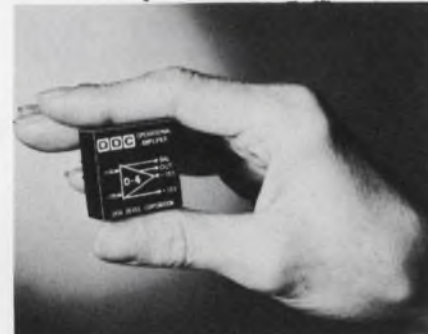

*Data Device Corp., 200 Tec St., Hicksville, N.Y. Phone: (516) 433-5330. P&A: \$14.50; stock to 2 wks.*

A new series of low-cost FET-input operational amplifiers feature a bias current of only 3 pA. The new devices, series D-4, have internally short-circuit-protected outputs of  $\pm 12$  V at  $\pm 6$  mA. Their unity-gain frequency is 3 MHz, and frequency for full output is 130 kHz. Slew rate is 9 V/ $\mu$ s; voltage drift is 25  $\mu$ V/ $^{\circ}$ C.

CIRCLE NO. 433



## What is the life of a good aluminum capacitor?

Sample #7, shown below, survived 100,000 hours. It is one of a group of computer grade aluminum electrolytic capacitors that we put under test back in 1957.

All capacitors were operated at rated DC working voltage, surge voltage, ripple current and temperature range found in typical computer type power supply circuits.

Sample #7 works almost as well today as it did eleven years ago.

Mallory capacitors enjoy long, reliable life because they are built to exacting standards and tested for surge voltage, vibration resistance, container seal tightness, shelf life, and capacitance, ESR, DC leakage current

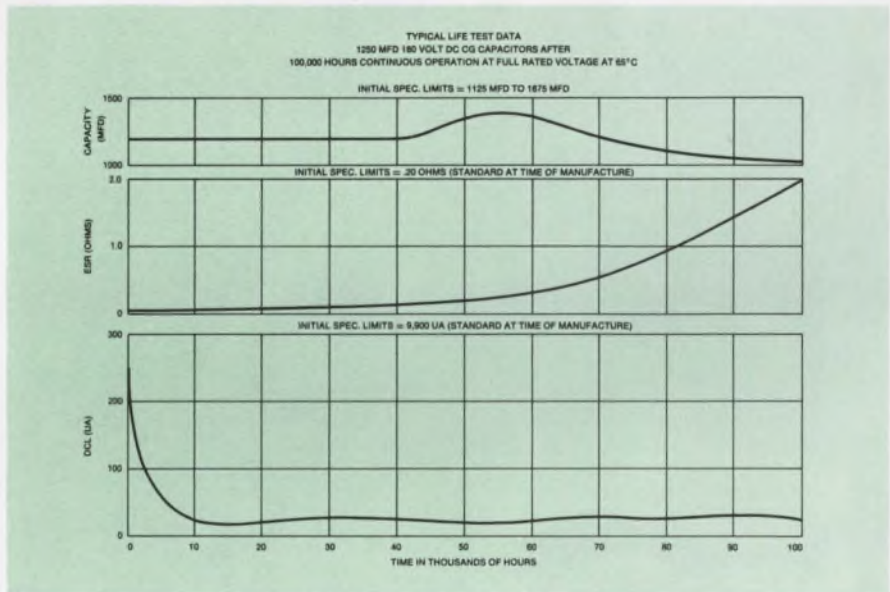

and electrolyte leakage.

All Mallory CG capacitors should have a useful life of about ten years, when operated at specified conditions. They will last even longer if derated in one or more operating conditions.

### Temperature Range

CG capacitors are designed to operate within a range of  $-40^{\circ}\text{C}$  to  $+85^{\circ}\text{C}$ . They have been tested at  $105^{\circ}\text{C}$  at less than rated voltage without immediate catastrophic failure. Extended operation under these conditions, however, will shorten their life.

### Capacitance

Capacity is measured at 120 cps and at  $25^{\circ}\text{C}$ . Tolerance of capacitors rated at 3 to 150 volts is  $-10, +75\%$ . For capacitors rated at 151 to 450 volts, the tolerance is  $-10, +50\%$ .

### Low Temperature Capacitance

Capacitance of Mallory CG capacitors at reduced temperatures and 120 cps does not fall below

the following percentage of nominal rated room temperature ( $+25^{\circ}\text{C}$ ) capacity.

Rated DC Voltage	Percent of Nominal Rated Capacitance		
	$-20^{\circ}\text{C}$	$-30^{\circ}\text{C}$	$-40^{\circ}\text{C}$
0-15	65	50	30
16-100	80	65	40
101 and up	85	75	50

### Equivalent Series Resistance

ESR measurements are made at 120 cps and  $25^{\circ}\text{C}$ . ESR for Mallory computer grade capacitors is very low.

Mallory wants the highest possible rating for its CG capacitors—but not at the expense of long life and reliable operation. The object of all our research and care in manufacturing and testing is to provide our customers with the “best” capacitor. For data, write or call Mallory Capacitor Company, a division of P. R. Mallory & Co. Inc., Indianapolis, Indiana 46206.

# McDonnell Phantom: the hot one



## Eastern keeps its radar cool

Each day of flight operation continues to confirm the McDonnell "Phantom" as the most advanced all-around fighter aircraft in the world today. But high density electronics and the heat loads of high speed flight would soon put the radar nose of the Phantom out of business.

That's where Eastern Industries' cooling systems come in. A liquid-to-air heat exchanger and hydraulic pack combine to remove over 8 KW from the radar, keeping it within safe temperature limits under all flight conditions. For all its performance, the total system weighs less than 17 lbs. and is remarkably compact (hydraulic pack: 3 $\frac{3}{16}$ " x 6 $\frac{1}{16}$ " x 11" and exchanger: 6 $\frac{5}{8}$ " x 8" x 17".)

Other Eastern cooling systems are now under development or in production for such aircraft as the Lockheed AH-56A, North American RA5C and F-104.

Write for new literature on Eastern capabilities in thermal control — or for the answer to your particular problem. We may have some cool answers.



## EASTERN INDUSTRIES

A Division of Laboratory For Electronics, Inc.  
100 Skiff Street • Hamden, Connecticut

INFORMATION RETRIEVAL NUMBER 160

## MODULES & SUBASSEMBLIES

### Compact module houses 5 op amps

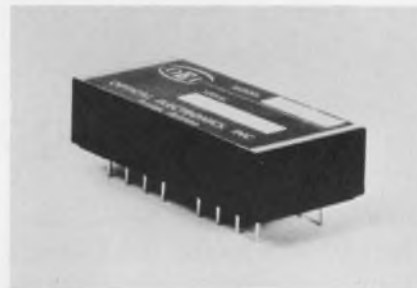

Optical Electronics Inc., P.O. Box 11140, Tucson, Ariz. Phone: (602) 624-8358. P&A: \$89; stock.

Occupying a volume of only 1 cubic in., model 9432 module contains five separate high-performance operational amplifiers. The new unit is said to provide the designer with a small analog manifold or analog computer. Each amplifier has an open-loop gain of 100 dB, temperature drift of 2  $\mu\text{V}/^\circ\text{C}$  and a bias current of 100 nA.

CIRCLE NO. 434

### Hybrid multipliers need no added parts

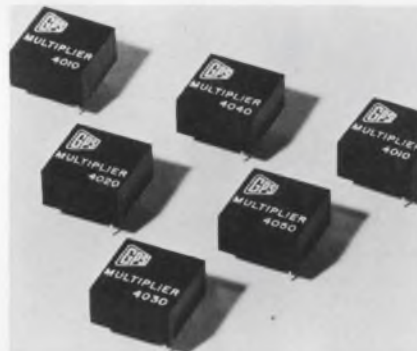

GPS Instrument Co., Inc., 14 Burr St., Framingham, Mass. Phone: (617) 875-0607. Price: \$55 to \$295.

Fully encapsulated and designed for PC-board mounting, series M-4000 hybrid analog multipliers are high-performance units that require no external components for complete operation. The six models in the new series feature wide bandwidths (dc to over 5 MHz), accuracies to 0.1%, fast slewing and high output currents. Their power supply requirement is only  $\pm 15$  V.

Booth No. 1425 Circle No. 396



# Think Straight.



## RESOLON® CONDUCTIVE PLASTIC RECTILINEAR ELEMENTS UP TO 36" LONG

Now, Duncan Electronics builds new conductive plastic precision rectilinear elements, to take their rightful place beside our proven RESOLON® CP rotary elements. They're the direct result of over five years' developmental work and production experience in rotary elements and pots. Rectilinear elements are provided with standard electrical travel of 1/4" to 16", or custom designed up to 36" on special order. Servo-trimmed for improved linearity tolerances, elements can be ordered as separate segments or in custom housings engineered to your requirements. Write today for full information — if you want the 'straight' story.

### RESOLON® CP Rectilinear High Performance Features:

**Resistance per Inch:**  
200Ω to 50KΩ depending on track width

**Resistance Tolerance:**

Std: ±10%

best practical: ±2%

**Linearity:**

Std: ±2.0%

best practical: ±0.3%

(Where L = Electrical Travel In Inches)

**Power Rating per Inch:**

0.25 to 1.0 watt depending on track width

**Tempco:**

—300 ppm/°C max

**Taps:**

Voltage & current taps can be supplied.

**Non-linear:**

Many types of non-linear functions can be supplied. Conformity tolerance depends on the nature of the function and the electrical travel.

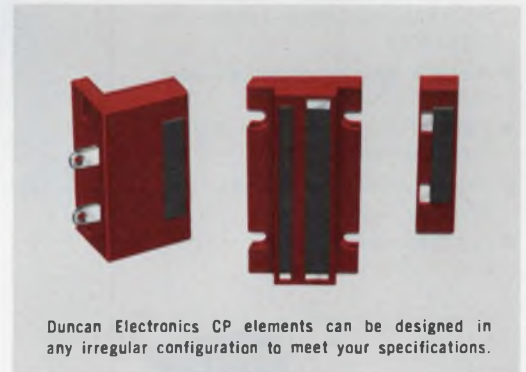

Duncan Electronics CP elements can be designed in any irregular configuration to meet your specifications.



**DUNCAN ELECTRONICS**

SUBSIDIARY

**SYSTRON**  **DONNER**

2865 FAIRVIEW ROAD □ COSTA MESA, CALIFORNIA 92626

PHONE: (714) 545-8261 □ TWX 910-595-1128

save  
chassis  
chamfering!

you need  
**Sealectro**

**Riv-Loc**<sup>TM</sup>

semi-assembled  
**Teflon\* Insulated  
terminals**

SIMPLE FAST ECONOMICAL INSTALLATION

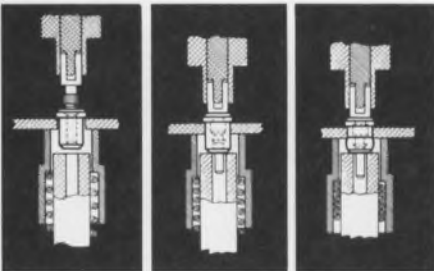

**PUSH! POP! IT'S IN!**

- Exclusive design—assembles from major diameter side—the right way.
- Installs *against* chassis—assures uniform height.
- Perfect installations in chamfered holes too!
- Less costly than semi-assembled designs.
- Enables easy, economical automatic assembly.

Write for complete catalog.



CIRCUIT HARDWARE DIVISION

**SEAELECTRO CORPORATION**

MAMARONECK, N. Y. 10543

PHONE: 914 698-5600 TWX: 710-566-1110

Sealectro Ltd. Portsmouth, Hants, England

Sealectro S.A. Villiers-le-Bel, Paris, France

\*Registered Trademark E. I. Du Pont De Nemours & Co.

Visit SEAELECTRO at WESCON SHOW, BOOTH NO'S. 4416-17-18.

INFORMATION RETRIEVAL NUMBER 162

MODULES & SUBASSEMBLIES

**FET-input op amps  
boast 10<sup>5</sup> CMRR**

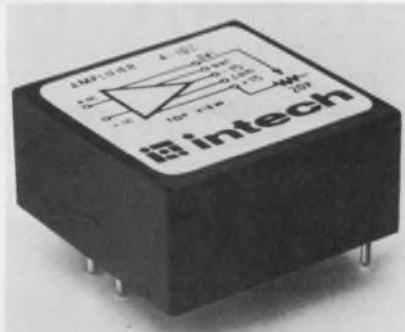

*Intech, Inc., 1220 Coleman Ave., Santa Clara, Calif. Phone: (408) 244-0500. P&A: \$33 or \$40; stock.*

Two new FET operational amplifiers have a minimum common-mode rejection ratio (CMRR) of 10<sup>5</sup> measured with a ±5-V input. Models A-102 and A-103 feature a minimum gain of 10<sup>5</sup> and a minimum power supply rejection of 20 μV/V. Their minimum slewing rate is 10 V/μs and typical settling time to 0.01% is 5 μs. Gain-bandwidth product is 2 MHz.

CIRCLE NO. 435

**Overvoltage crowbar  
responds in 20 μs**

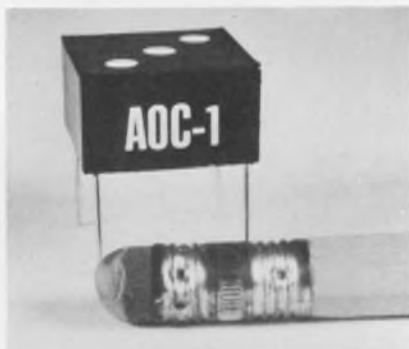

*Space Age Microcircuits, P.O. Box 426, Chatham, N.J. Phone: (201) 635-8484. P&A: \$12; stock.*

Operating in less than 20 μs, a new overvoltage crowbar protects critical loads over the temperature range of -55 to +85°C. Model AOC-1 has a voltage that is internally adjustable; it may be used over a very wide voltage range. The tiny epoxy-encapsulated module has a volume of 0.17 in.<sup>3</sup> and measures 0.68 by 0.68 by 0.36 in.; weight is less than 1/2 oz.

CIRCLE NO. 436

**Untrimmed multiplier  
is accurate to ±1%**



*Philbrick/Nexus Research, a Tele-dyne Co., Allied Drive at Route 128, Dedham, Mass. Phone: (617) 329-1600. P&A: \$75; stock.*

When untrimmed, model 450 four-quadrant multiplier operates at typical accuracies of ±1% to 10 kHz with full output voltage capabilities to 100 kHz. Its output is representative of the instantaneous product of two input signals. With external trimming, accuracy can be improved to ±0.6% typical, ±1% maximum, referred to a 10-V full-scale output.

CIRCLE NO. 437

**Comparator relays  
match ICs and reeds**

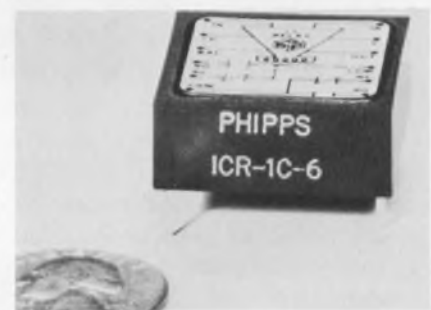

*Phipps Precision Products, 7749 Densmore Ave., Van Nuys, Calif. Phone: (213) 785-3109. P&A: from 24.95; stock to 2 wks.*

Consisting of an IC operational amplifier precisely matched to a reed relay, a new family of differential comparator relays combine the advantages of integrated circuit technology with reed-relay life, speed, and reliability. Self-contained in one integral package, the ICR units are less than one half the size of existing op-amp/relay assemblies.

CIRCLE NO. 438



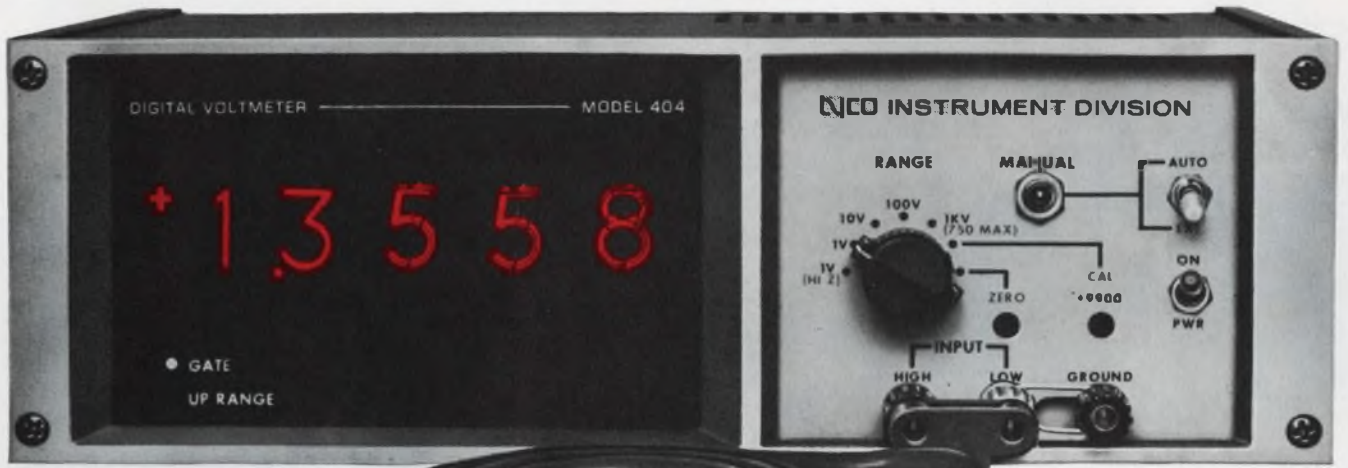

## Best DVM on the market. For all practical purposes.

It's the simplest way to measure DC levels . . . visually and with BCD outputs. The 404 is an extremely accurate DVM at a very reasonable price. It's portable. Easy to operate. Has four full digits with a fifth overrange. Accuracy of  $0.02\% \pm$  one digit. The 404 offers input flexibility

of five voltage ranges with an ultra-high input of 1,000 megohms on 1-volt range. And high noise rejection with differential input and integration techniques providing common mode rejection greater than 100 db at 60 Hz. It has BCD outputs and remote programming for system compatibility. And it costs only \$595. That's a lot of DVM for a relatively small investment. Call or write us for a

demonstration today. We'll have a 404 operating in your lab tomorrow. Practically. Tyco Instruments Division, Tyco Laboratories, Inc., Hickory Drive, Waltham, Mass. 02154, (617) 891-4700.

**For \$595,  
this can lead to  
almost anything.**

# 404

### Miniature relays operate 10<sup>8</sup> times

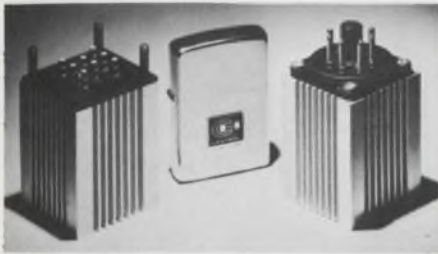

Cutler-Hammer, Inc., Specialty Products Div., 4201 N. 27th St., Milwaukee, Wisc. Phone: (414) 442-7800. P&A: \$28.20 to \$40.50; 6 wks.

Capable of replacing electro-mechanical relays, a new line of environmentally sealed miniature solid-state relays boast an electrical life of 100 million operations. Series SX3 units are 5.2-oz. devices.

CIRCLE NO. 439

### High-speed multiplexer accepts six channels



Datcon Electronics Corp., 150 S. Terrace Ave., Mount Vernon, N.Y. Phone: (914) 664-2050. P&A: \$158; stock to 2 wks.

With TTL control signals, a new six-channel multiplexer card has a delay and settling time of 12  $\mu$ s to 0.05% of full scale and 3  $\mu$ s to 0.01% of full scale. Model MUX-06 can be used in cascade to increase the number of channels in sets of six. The unit can also operate as a sample-and-hold-amplifier.

CIRCLE NO. 440

### Custom Wound Bobbins ■ In 10 Days

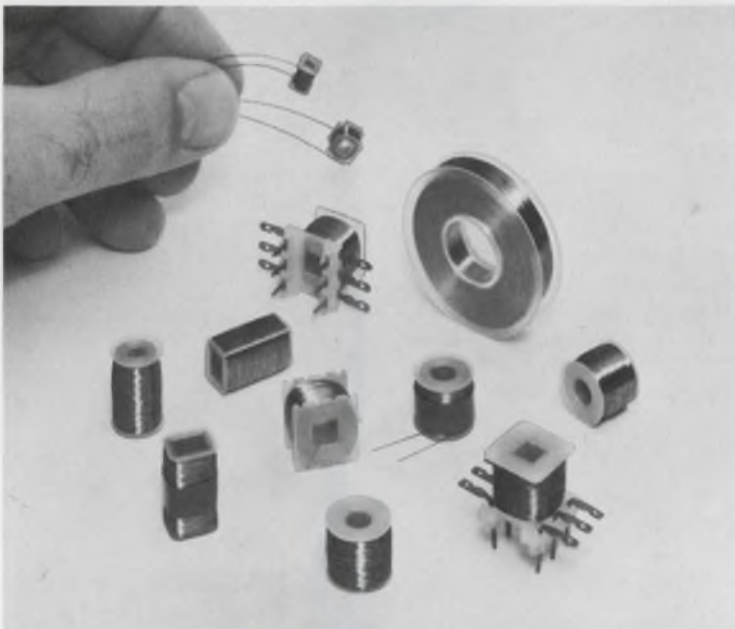

Custom wound bobbin samples are available in ten days; production shipments start within three weeks after sample approval.



Special 16 Pi/30 KV windings for oil-filled high voltage transformers . . . special coils also are furnished on 10-day sample/3-week production delivery cycle.



Bobbins furnished in wide range of inductance and current ratings. If desired, Miller engineers will make recommendations for optimum performance.



## J.W. MILLER COMPANY

P.O. BOX 5825 ■ COMPTON, CALIFORNIA 90224

Write for your copy of the latest full line catalog

### MOS clock driver has 1-A output



Cermetek, Inc., 660 National Ave., Mountain View, Calif. Phone: (415) 969-9433.

Capable of operating from dc to 10 MHz, a new universal MOS clock driver features a 1-A output current with risetimes and fall-times of 18 ns into a critically damped 500-pF load. The input of model CH1033 accepts conventional logic levels with a low-impedance bidirectional drive such as TTL. The output swing may be clamped from 0 to -27 V or from +5 to -11 V.

CIRCLE NO. 441



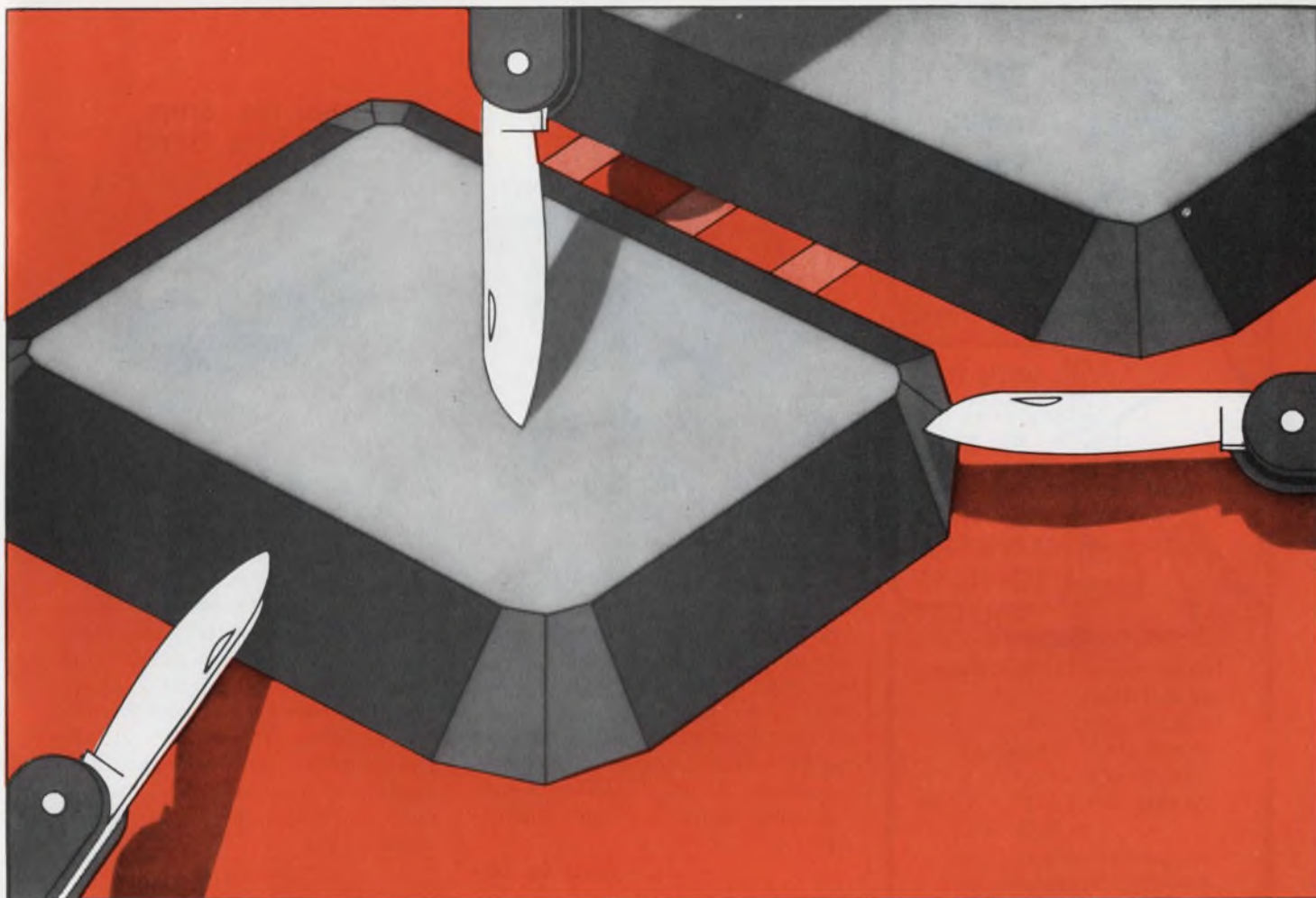

We sharpen a chemical knife.

We make many integrated circuits at a time . . . on a single wafer of silicon crystal. Then, we divide the wafer into individual circuits (and, sometimes, the circuits into electrically isolated components) by etching narrow slots through the silicon.

But conventional etchants don't cut downward only. They cut sideways, too, making a slot that's wide as well as deep. So, for safety, we have had to leave plenty of space between circuits. Then, Bell Laboratories scientists Herbert A. Wagner, Roger C. Kragness, and A. Lamont Tyler discovered a means of "one-directional" etching.

The new technique makes wedge-shaped slots, separating the circuit elements along precise lines. It depends on a "preferential" etchant, which most strongly attacks the semiconductor perpendicular to a particular crystal-lattice plane. The slot is wedge-shaped

because its walls are other planes toward which the etchant is almost inert.

The process is self-limiting; once a slot goes through a wafer, there is very little further etching. So, we can leave the wafer in the etchant long enough for complete separation of the parts without the careful thickness control formerly required. And, because of the fixed slope of the slot walls, minimum slot width can be much less than wafer thickness.

In the drawing, the light, medium, and dark surfaces represent three crystal-

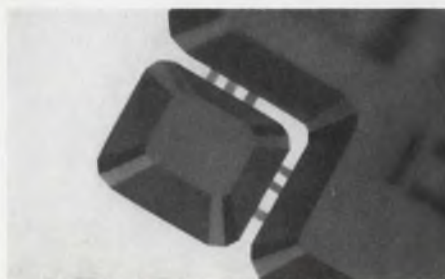

lographic planes in silicon. The solution etches perpendicular to each of these at different rates. The surface shown light, for example, etches away most rapidly. To cut out an area, a mask is applied onto the fastest—"light"—plane, with the mask edges parallel to the slowest—"dark"—planes of the crystal.

In one example of the new technique, hundreds of 1-mm-square circuits, each with 10 transistors, 14 diodes, and 12 resistors on nine air-isolated areas, were etched at once on a single wafer. Slots were about 17 microns wide with strong "beam leads" for structural and electrical connections. The slot in the photo is only 6 microns wide.

This technique is another step toward making ever better and smaller integrated circuits. From the Research and Development Unit of the Bell System—



Bell Labs

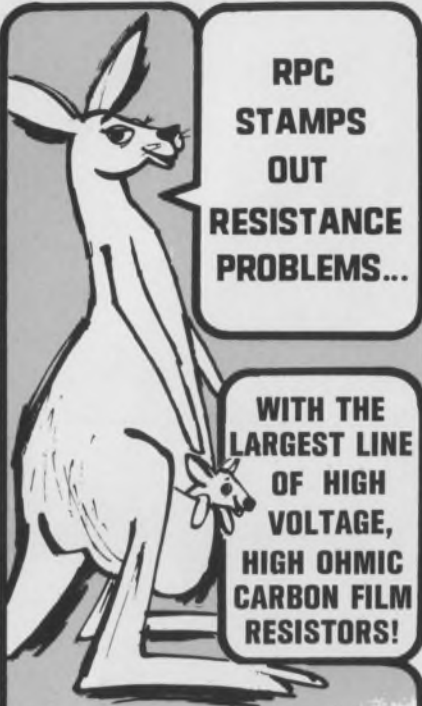

**RPC  
STAMPS  
OUT  
RESISTANCE  
PROBLEMS...**

**WITH THE  
LARGEST LINE  
OF HIGH  
VOLTAGE,  
HIGH OHMIC  
CARBON FILM  
RESISTORS!**

For example, 15 basic styles are available:

- WATTS: .25 to 100w.
- RESISTANCE: 10 to  $10^{14} \Omega$
- TOLERANCE: to  $\pm 1\%$
- STAND. SIZES: .563" L x .1" dia. to 19.687" L x 2" dia.

A variety of terminal configurations are available such as: radial lugs or bands, axial wire leads and ferrule ends.

#### SPECIALS

Only RPC has a special interest in solving those "special" problems. Resistors up to 40" long have been manufactured on request.

#### APPLICATIONS

Typical applications include those requiring high resistances, voltage capability from 250 to 125,000 v and high frequency or pulse circuits including power supplies, generators, X-ray equipment, electro-static air cleaners, paint sprayers, photo-copiers and high voltage-dropping monitors.

RPC's carbon film resistors will often exceed the requirements of metal oxide types, and with the lowest rejection rate in the industry.

For more information, call RPC . . . and give your resistance problems a real kick.

**RPC Resistance Products Co.**

914 South 13th Street  
Harrisburg, Pa. 17104. (717) 236-5081

## MODULES & SUBASSEMBLIES

### Transducer amplifier varies voltage gain



*Integrated Controls, Inc., P.O. Box 17296, San Diego, Calif. Phone: (714) 453-5800. P&A: \$59.50; stock to 2 wks.*

Able to amplify ac- or dc-coupled signals, a new self-powered transducer amplifier/power supply/conditioner has three selectable voltage gains of 20, 40 and 60 dB. The unit is designed as a battery-powered low-level signal conditioning data system. Input overvoltage protection is  $\pm 30$  V maximum and input impedance is greater than 1 M $\Omega$ .

CIRCLE NO. 442

### Small photocell relays switch 300 V ac or dc

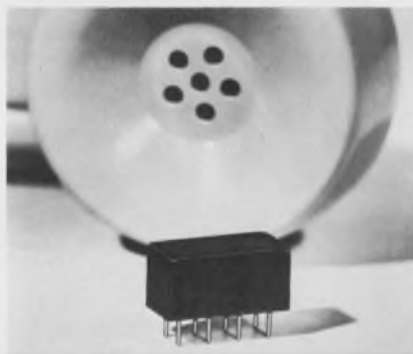

*Electro-Tec Corp., Div. of KDI Corp., P.O. Box 667, Ormond Beach, Fla. Phone: (305) 677-1771.*

Offering complete circuit isolation, a new line of miniature solid-state photocell relays in single-pole and multi-pole configurations can switch up to 300 V ac or dc. Off-on resistance ratios vary from 100 to 1 to greater than  $10^6$  to 1; control voltages range from 6 to 120 V ac or dc. The new units pack light source and detector in a single epoxy housing about half the size of a crystal-can relay.

CIRCLE NO. 443

### Universal log amp spans 10-kHz band

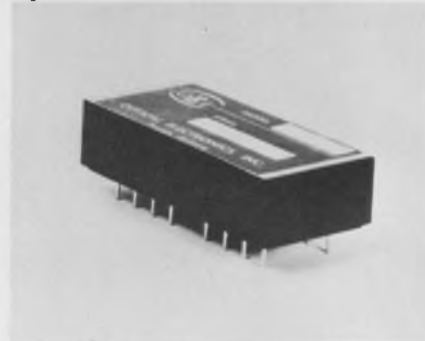

*Optical Electronics Inc., P.O. Box 11140, Tucson, Ariz. Phone: (602) 624-8358. P&A: \$155; stock.*

Housed in a jumbo dual-in-line package, a new universal amplifier can perform any logarithmic function in the frequency range from dc to 10 kHz. Model 2457 has a 100-dB dynamic range with a  $\pm 1\%$  typical error. Applications include polar, bipolar and quad logarithmic amplifiers, anti-logarithmic amplifiers and logarithmic multipliers and dividers.

CIRCLE NO. 444

### Line conditioners program remotely



*Lambda Electronics Corp., Route 110, Melville, N.Y. Phone: (516) 694-4200. Price: from \$200.*

Consisting of nine remotely programmable models, series LD solid-state ac power line conditioners offer maximum ratings of 250, 500 and 1000 VA at 40°C. All models provide fast-acting rms regulation that is independent of power factor and input frequency. Efficiency is greater than 80% at rated load at 115-V ac input; line and load regulations are less than 1%.

Booth No. 3918 Circle No. 397





**Solitron** announces

**10 AMP AND 20 AMP**

**INDUSTRIAL PNP  
Power Transistors!**

**10 AMP  
SERIES**

Type Number TO-3	Type Number TO-66	RATED BREAKDOWN VOLTAGES			PERFORMANCE SPECIFICATIONS					
		BV <sub>CBO</sub>	BV <sub>CEO</sub> (SUS)	BV <sub>EBO</sub>	h <sub>FE</sub>		V <sub>CE</sub> (sat) Volts	V <sub>BE</sub> (sat) Volts	I <sub>CEX</sub> μA	
					@ I <sub>C</sub> = -5.0A V <sub>CE</sub> = -5.0V	@ I <sub>C</sub> = -5.0A I <sub>B</sub> = -0.5A	@ I <sub>C</sub> = -5.0A I <sub>B</sub> = -0.5A	V <sub>EB</sub> = -1.5V (REV BIAS)		
Min.	Min.	Min.	Min.	Max.	Max.	Max.	Max.	Max.	@ V <sub>CE</sub>	
2N5737	2N5739	-60	-60	-5	20	80	-0.5	-1.2	-10	-60
2N5738	2N5740	-100	-100	-5	20	80	-0.5	-1.2	-10	-100

**20 AMP  
SERIES**

Type Number TO-3	Type Number TO-66	RATED BREAKDOWN VOLTAGES			PERFORMANCE SPECIFICATIONS					
		BV <sub>CBO</sub>	BV <sub>CEO</sub> (SUS)	BV <sub>EBO</sub>	h <sub>FE</sub>		V <sub>CE</sub> (sat) Volts	V <sub>BE</sub> (sat) Volts	I <sub>CEX</sub> μA	
					@ I <sub>C</sub> = -10A V <sub>CE</sub> = -5.0A	@ I <sub>C</sub> = -10A I <sub>B</sub> = -1.0A	@ I <sub>C</sub> = -10A I <sub>B</sub> = -1.0A	V <sub>EB</sub> = -1.5V (REV BIAS)		
Min.	Min.	Min.	Min.	Max.	Max.	Max.	Max.	Max.	@ V <sub>CE</sub>	
2N5741	2N5743	-60	-60	-5	20	80	-1.5	-1.5	-10	-60
2N5742	2N5744	-100	-100	-5	20	80	-1.5	-1.5	-10	-100

For complete information, contact:

**Solitron** DEVICES, INC.

1177 BLUE HERON BLVD. / RIVIERA BEACH, FLA. / (305) 848-4311 / TWX: (510) 952-6676

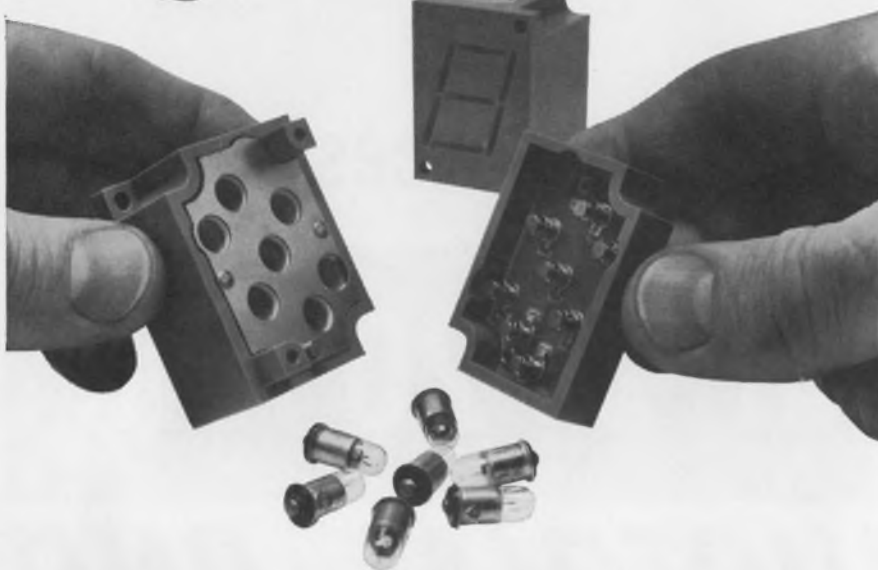

## What makes low-cost Dialight readouts so reliable and easy-to-read?

Reliable because of simple module construction and long life lamps. Designed for use with neon or incandescent lamps to meet circuit voltage requirements. Easy-to-read from any viewing angle. 1" high characters are formed by unique patented light-gathering cells, and may be read from distances of 30 feet. Sharp contrast makes for easy viewing under high ambient lighting conditions.

### Dialight Readout Features

1. Operate at low power.
2. 6V AC-DC, 10V AC-DC, 14-16V AC-DC, 24-28V AC-DC, 150-160V DC or 110-125V AC.
3. Non-glare viewing windows in a choice of colors.
4. Available with RFI-EMI suppression screen.
5. Available with universal BCD to 7 line translator driver.
6. Can be used with integrated circuit decoder devices now universally available.
7. Caption modules available; each can display 6 messages.

## Send for catalog

Catalog-folder contains complete specifying and ordering data on numeric and caption modules, translator drivers, mounting accessories. Dialight Corporation, 60 Stewart Avenue, Brooklyn, New York 11237. Phone: (212) 497-7600.



# DIALIGHT

INFORMATION RETRIEVAL NUMBER 167

DT-126

### COMPONENTS

#### Status indicators show 12 messages



Industrial Electronic Engineers, Inc., 7720 Lemona Ave., Van Nuys, Calif. Phone: (213) 787-0311. P&A: \$17.50 to \$20; stock.

Compact, back-lighted, 12-message displays permit their message areas to be illuminated individually, in combination, or simultaneously. Numbers, letters, words, symbols—anything that can be put on film—can be displayed, in any color. Overall size of series 280 status indicators is 2.4 by 1.9 by 2.6 in.

CIRCLE NO. 445

#### Amplifier valve is 2-in. square



Gagne Associates, Inc., 50 Wall St., Binghamton, N.Y. Phone: (607) 723-9556. Price: \$14.95.

A new miniature all-air fluidic amplifier valve, the Sensiflex SFA3 is a three-way normally closed device with an over-all size of 2.4 by 2.31 in. It will pass more than two cubic feet per minute of free air to the atmosphere at 100-psi inlet pressure. The minimum actuating pressure registers from 0.05 to 0.65 psig, depending on controlled pressure.

CIRCLE NO. 446



## Binary switch module holds 64 messages



Chicago Dynamics Industries, Inc., Precision Products Div., 1725 Diversey Blvd., Chicago, Ill. Phone: (312) 935-4600. P&A: \$85; 4 to 6 wks.

Providing a six-bit binary output, a new switch module can display 64 messages, with up to 500 messages available on special order. The window opening of model MM-2700 is 1/4 by 3/4-in. to expose up to 12 letters per message. Each module occupies only 3/4 by 1-3/8 in. of front-panel space and 3-7/8-in. back-of-panel depth.

CIRCLE NO. 447

## Fluidic converters change Hz to psi



General Electric Co., Specialty Fluidics Operation, 1 River Rd., Schenectady, N.Y. Phone: (518) 374-2211.

Two new fluidic circuits convert a frequency signal into a steady-state output pressure that is proportional to the value of the input frequency. Model 24MC12A operates at 50 to 400 Hz, while model 24MC12B covers 100 to 1000 Hz. These new frequency-to-analog circuits can be used as building blocks in modulated carrier systems.

CIRCLE NO. 448

# New VICTOREEN Mini-Mox Resistors for higher resistance/size ratios

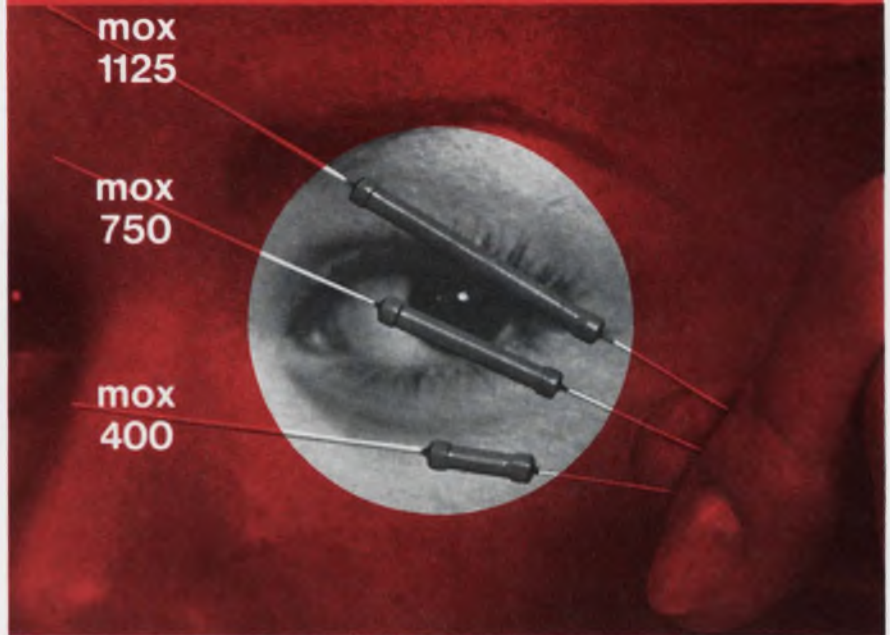

We promised you a wider range of quality Victoreen MOX (metal oxide glaze) resistors for sophisticated electronic applications. And we're delivering on our promises, too, for we're now in volume production on the subminiature Mini-Mox resistor line. Just eyeball these specifications:

Model	Resistance	Rating @70°C	*Max. Oper. Volts	Length Inches	Diameter Inches
MOX-400	1-2500 megs	.25W	1000V	.420 ± .050	.130 ± .010
MOX-750	1-5000 megs	.50W	2000V	.790 ± .050	.130 ± .010
MOX-1125	1-10,000 megs	1.00W	5000V	1.175 ± .060	.130 ± .010

\*Max operating temp 220°. Encapsulation — Si Conformal.

\*Applicable above critical resistance.

Stability is better than  $\pm 2\%$  for 2000 hours at full load, shelf-life drift less than 0.1% per year. Standard tolerances are 1 to 10% depending on resistance value.  $\frac{1}{2}\%$  resistors in limited values, on request.

So let your circuit design imagination run rife. Victoreen MOX and new Mini-Mox Resistors can satisfy all your requirements for ultra-critical applications involving high voltage... high impedance... high stability... high wattage. Check our Applications Engineering Department today. Call (216) 795-8200.

A-3876

**VICTOREEN INSTRUMENT DIVISION**  
10101 WOODLAND AVENUE · CLEVELAND, OHIO 44104  
EUROPE: ARNDALE HOUSE, THE PRECINCT, EGHAM, SURREY, ENGLAND · TEL: EGHAM 4887



INFORMATION RETRIEVAL NUMBER 168



# POWER YOUR IC'S FOR 25¢



The LIC5-7A is another of Elasco-Eastern's new series of low-cost, high-quality power supplies. This power supply is designed to power approximately 200 IC's. The unit delivers 5 volts D.C. at 7 amperes with regulation and ripple specifications commensurate with integrated circuit requirements. This unit is available with an overvoltage protection option. When this option is desired the model number becomes LIC5-7A-B.



**\$55 in Single Quantity**

## FEATURES

- SHORT CIRCUIT PROOF
- LOW COST OVERVOLTAGE OPTION
- DELIVERY: STOCK TO 2 WEEKS

WRITE FOR BULLETIN  
869 FOR DATA ON THE LIC5-7A  
POWER SUPPLY



**ELASCO-EASTERN, INC.**  
5 NORTHWOOD ROAD, BLOOMFIELD, CONN. 06002  
TELEPHONE: (203) 242-0708

INFORMATION RETRIEVAL NUMBER 169

## COMPONENTS

### Microwave capacitors are porcelain chips

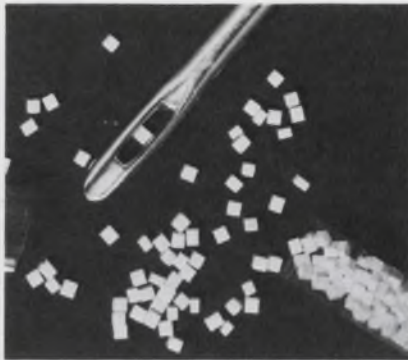

American Technical Ceramics, 1 Norden Lane, Huntington Station, N.Y. Phone: (516) 271-9600. Availability: 1 to 3 wks.

Providing high Q and high stability on a 50-mil square, MiniCube porcelain capacitor chips are intended for use in microwave hybrid circuits, phased-array radar, and coupling, tuning, and microstrip applications. Series 100 units have a capacitance range of 0.1 to 100 pF, insertion loss of 0.03 dB and a power capacity of 15 W.

CIRCLE NO. 449

### Cermet resistors look like dots



ASC Microelectronics, Shelter Rock Lane, Danbury, Conn. Phone: (203) 744-1900. P&A: 12¢; stock to 4 wks.

Dwarfed by a 6¢ postage stamp, two new types of cermet chip resistors for soldering (type RS) and wire bonding (type RW) assembly are claimed to be the smallest available in high-resistance values. The chips measure only 50 by 50 by 10 mils and cover resistances of 100  $\Omega$  to 15 M $\Omega$ . Power dissipation is 0.1 W at 85°C.

CIRCLE NO. 450

### Feed-through chips go up to 1.5 $\mu$ F

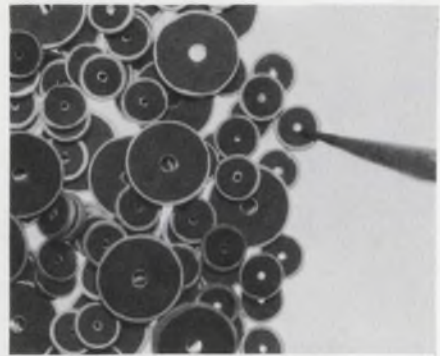

Varadyne, Inc., 1805 Colorado Ave., Santa Monica, Calif. Phone (213) 394-0271.

Offering high volumetric efficiency, a new line of feed-through monolithic ceramic capacitors cover the voltage range from 50 to 400 V dc and capacitance values from 0.01 to 1.5  $\mu$ F. Other features include low inductance, good temperature and voltage stabilities, readily solderable inner and outer electrode terminations and uniform size. Multi-section units for special rf filters are available on special order.

CIRCLE NO. 451

### Tantalum chips shape up 2 ways



Tansistor Electronics, Inc., West Rd., Bennington, Vt. Phone: (802) 442-5473. P&A: from 45¢; 4 to 6 wks.

Two new types of microminiature solid tantalum chip capacitors offer a choice of shapes. Type UTC units are unencapsulated flat rectangular chips, while type UHA devices are unencapsulated cylindrical chips. Capacitance values range from 0.01 to 220  $\mu$ F; voltage ratings are between 1 and 50 V dc.

CIRCLE NO. 452



# KNOBBS



Write today for  
FREE Full color  
Control Knob Catalog.

**Rogan**  
BROTHERS, INC.

8031 N. Monticello Ave.  
Skokie, Illinois 60076  
312/675-1234

Outline your  
requirements  
for quotation and  
FREE knob sample

INFORMATION RETRIEVAL NUMBER 228

## FOR EXCELLENCE IN TERMINATION HARDWARE SPECIFY GRAYHILL



Test Clips

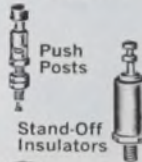

Push Posts

Stand-Off Insulators



Binding Posts



Sockets



Plastic Molded Parts

### Test Clips

Adjustable tension, threaded studs or plug in bases, various sizes.

### Push Posts

Plunger action lets you connect and disconnect quickly and easily, assures positive contact.

### Binding Posts

Screw type or spring loaded, banana plug or stud mounting, single or multiple units, with various colors for circuit identification.

### Stand-Off Insulators

High dielectric strength, low loss insulation, low moisture absorption, various mounting styles.

### Sockets

Lamp or transistor, various colors, various mountings including printed circuit.

### Custom Molded Parts

Tight tolerances provide you with "assembly ready" units. Thermosetting plastics to meet most specifications.

For your Grayhill Engineering  
Catalog offering complete technical  
data—contact



565 Hillgrove Avenue  
LaGrange, Illinois 60525  
Area Code 312, Phone 354-1040



... the Difference Between Excellent and Adequate

INFORMATION RETRIEVAL NUMBER 229

ELECTRONIC DESIGN 17, August 16, 1969

## 60 dB Stop band rejection

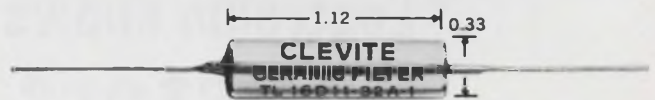

in a mil spec  
ceramic filter for  
less than \$15.

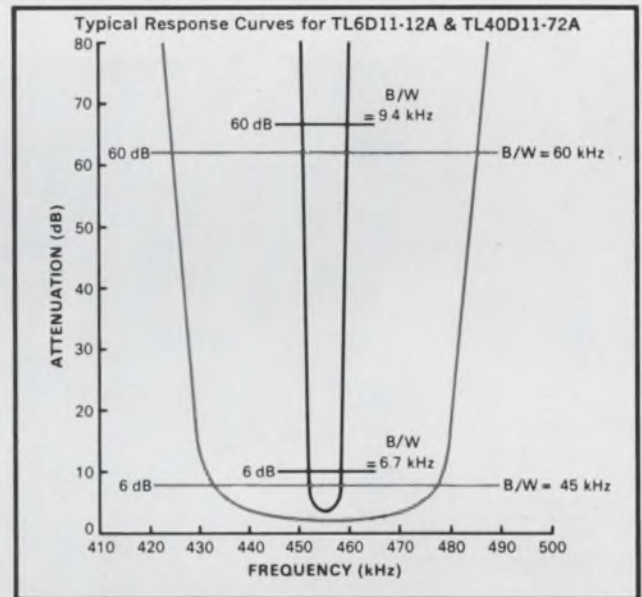

Here's the smallest (less than 0.1 cu. in.), most rugged fixed-tuned filter of its kind on the market today!

Clevite's 11-disc miniature filter is packaged in a hermetically-sealed cylinder, exceeds all military environmental specifications, is ideal for transistorized i-f amplifier circuitry in AM and FM sets plus many other applications that call for a fixed-tuned filter. Stop band rejection: 60 dB. Center frequency tolerance:  $\pm 2$  kHz to  $\pm 3$  kHz. Stability: within  $+0.2\%$  for 5 years; within  $0.2\%$  from  $-40^\circ\text{C}$  to  $+85^\circ\text{C}$ . Impedance (in and out) 2000 ohms for B/W less than 12 kHz; 1000 ohms for broader bandwidths.

Following models standard at 455 kHz.

Model Number	min. @ 6 dB B/W	max. @ 60 dB
TL6D11-12A	6 kHz	12 kHz
TL10D11-20A	10 kHz	20 kHz
TL16D11-32A	16 kHz	32 kHz
TL20D11-38A	20 kHz	38 kHz
TL30D11-57A	30 kHz	57 kHz
TL40D11-72A	40 kHz	72 kHz

PRICES: 1—\$25 ea; 25—\$20 ea; 100—\$17.50 ea; 500—\$15 ea; 1000—\$13.75 ea; 2500—\$12 ea.  
(Prices subject to change without notice)

Send order or request for Bulletin 94029 to: Clevite Corporation, Piezoelectric Division, 232 Forbes Rd., Bedford, Ohio 44146, U.S.A. Or: Brush Clevite Company, Limited, Southampton, England.

# CLEVITE

INFORMATION RETRIEVAL NUMBER 230

# Lectrohm knows Resistors...

## We should, they're our only business!

Fixed or Adjustable  
Standard or Custom

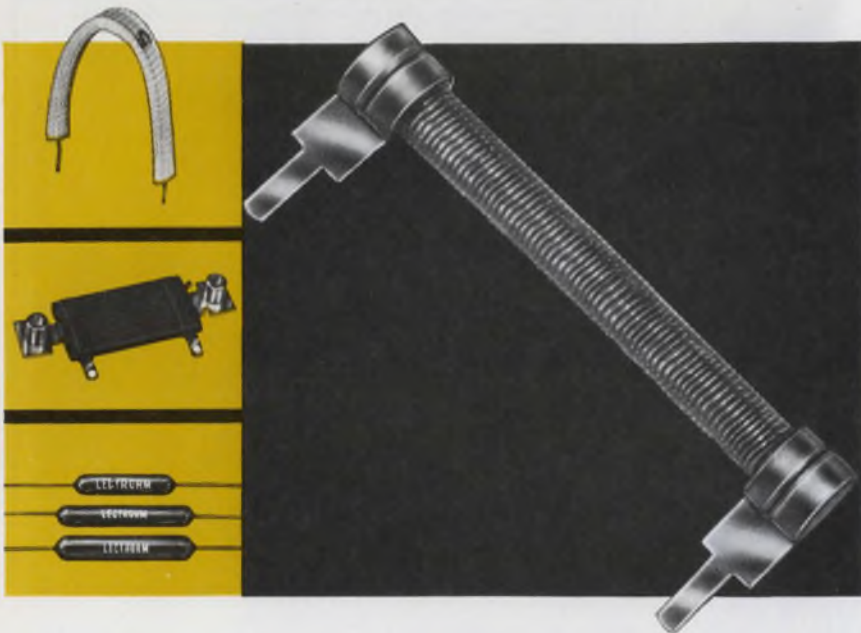

Specialization in the design and production of wire-wound resistors has established LECTROHM'S leadership in the resistor field.

For example, LECTROHM type FP and XFP is one of the lowest cost power resistors available for P-C board applications. They can be inserted in 0.050" or 0.070" diameter holes. Center-to-center distance of prongs on terminals are variable from 0.5" to 2.5". Power rating is 4 watts per inch and resistance range is from 0.2 ohms per inch to 1,000 ohms per inch.

Check your resistor needs today . . . send specifications, prints or requirements, no obligation . . . you can trust LECTROHM to match those needs quickly and economically.



**FREE!**

Full line  
**LECTROHM**  
catalog.

Send for your  
copy today!



**Lectrohm, Inc.**

a subsidiary of



**COOK ELECTRIC**

5562 Northwest Highway, Chicago, Ill. 60630

INFORMATION RETRIEVAL NUMBER 184

## COMPONENTS

### Pulse transformers have 0.625-in. dia

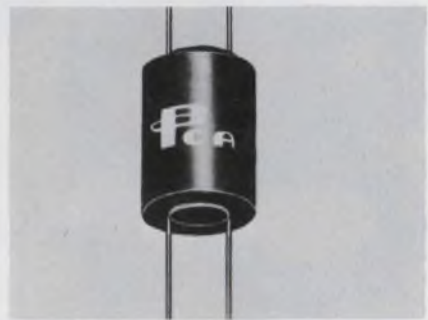

*PCA Electronics, Inc., 16799 Schoenborn St., Sepulveda, Calif. Phone (213) 892-0761. P&A: 60¢; 4 to 6 wks.*

Designed for use in military and commercial SCR applications, a new line of low-cost pulse transformers measure only 0.625 in. in diameter and 0.85 in. in length. The new units offer turns ratios from 1:1 to 4:1, minimum primary inductances from 100 to 2500  $\mu$ H, and maximum leakage inductances from 5 to 1000  $\mu$ H.

CIRCLE NO. 453

### Numerical indicator indexes with buttons

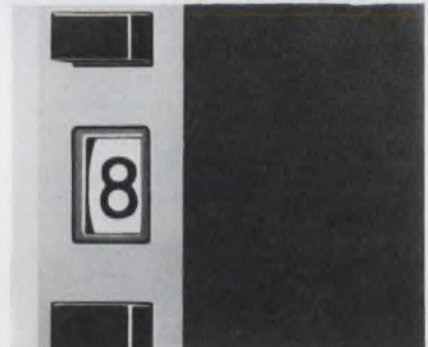

*Kessler Ellis Products Co., 120 First Ave., Atlantic Highlands, N.J. Phone: (201) 291-0500. Availability: stock.*

A new digital switch with bi-directional pushbutton indexing is available with electrical readout in either decimal or one of several binary codes. Small pushbuttons above and below the number display permit indexing of the number wheel in either the forward or reverse direction. Numbers are 1/4-in. high.

CIRCLE NO. 454



## Reed switch uses mercury



FR Electronics Div., Flight Refueling Ltd., Wimborne, Dorset, England.

The MRC-3 is a miniature mercury-wetted reed switch that combines the advantages of high-speed switching with the low contact resistance and high-power capacity of a mercury switch. Its power rating is 28 W, initial contact resistance is 50 mΩ maximum, and breakdown voltage is 1000 V. It is a single-pole normally open unit.

CIRCLE NO. 455

## Air-variable capacitor trims from 1 to 20 pF

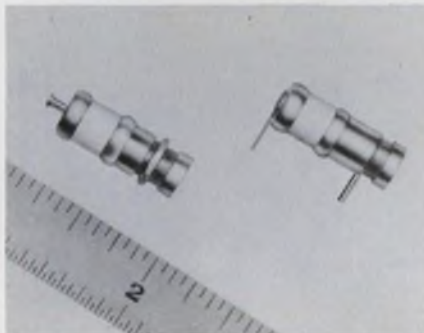

JFD Electronics Co., Components Div., 15th Ave at 52nd St., Brooklyn, N.Y. Phone: (212) 331-1000. Availability: stock.

A new all-metal air-variable capacitor now covers capacitance values from 1 to 20 pF. Model MVM020 utilizes metal biasing elements to maintain smooth torque and minimize noise levels. It is available for panel mounting with turret terminals, lug terminals or threaded terminals, and for printed-circuit-board mounting.

CIRCLE NO. 456

# Reed Relays that deliver more of what you need most...

## VERSATILITY • RELIABILITY • ECONOMY



Standard and Miniature  
Reed Relays



Special Design  
Reed Relays

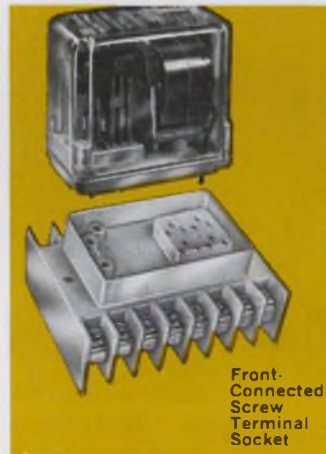

Front-  
Connected  
Screw  
Terminal  
Socket

Automatic Controls' Reed Relays — standard, miniature, or your special designs — offer individually supported reed switches, magnetic foil wrapped coils, non-magnetic terminals, and rhodium plated contacts, providing peak performance and reliability. Standardized contact configurations assure off-the-shelf delivery and maximum economy. For **more** of what you need most — specify Automatic Controls' Reed Relays everytime!

**NEW** from Automatic Controls...  
Front-Connected Screw Terminal Socket.

Accommodates the Automatic Controls' "family" of general purpose plug-in relays and time delay relays.

### FREE LITERATURE!

Write for illustrated brochures and technical information:

- #800 Industrial Relays
- #700 Pressure Switches
- #940 Reed Relays
- #720 Military Relays
- #830 Ice Detection Systems
- #874 Contactors
- #859 Program Timers

Specify above by numbers

## Automatic Controls

Division



COOK ELECTRIC

200 East Daniels Rd., Palatine, Ill. 60067

INFORMATION RETRIEVAL NUMBER 185









**we have a dozen reasons...**

**why you should use our MCJ-12 jack . . .**

**one for each circuit.**

- The Multi-Circuit Jack MCJ-12 is a 12-circuit self-normalling jack which eliminates costly circuit duplication.
- Any source may be connected to any load by use of patchcord.
- 16 jacks may be mounted in a standard 3½" x 19" panel.
- Cover is of ferrous metal for maximum isolation.
- Patch-cord is completely shielded.
- Connections are made easily to rear terminations with standard wire-wrap tool.
- Entire jack may be unplugged from its cover for maintenance without disturbing external wiring.
- Completely wired enclosures are available to customer specifications.

MCJ-12 Multi-Circuit Jack



For complete technical information contact:

**COOKE ENGINEERING COMPANY**

735 N. Saint Asaph St., Alexandria, Virginia 22314 (703) 548-3889

INFORMATION RETRIEVAL NUMBER 187

**TC/VCXOs  
ARE A BETTER  
WAY TO  
COMMUNICATE**



**Center Frequency:** 7.5 MHz  
**Deviation:** ± 5 KHz  
**Distortion:** less than 5%  
**Modulation Rate:** DC to 10 KHz  
**Frequency Stability:** ± 1 PPM  
**Temp. Range:** -40°C to +70°C

Put Arvin's new wide deviation TC/VCXO in your circuits and you'll have better communications equipment—lighter weight, smaller size, more precise frequency control, greater reliability.

The new oscillator permits direct frequency modulation with exceptionally low distortion and a high degree of frequency stability. It'll make your design jobs easier. Write for complete specifications, or phone (317) 463-2589.



**ARVIN FREQUENCY DEVICES**

ELECTRONIC SYSTEMS DIV., ARVIN INDUSTRIES, INC.  
2505 N. Salisbury, West Lafayette, Indiana 47906

INFORMATION RETRIEVAL NUMBER 188

ELECTRONIC DESIGN 17, August 16, 1969

**TRANSTECTOR**

CIRCUIT PROTECTOR



**prevents transients from  
causing "unexplainable" circuit failures.**

Don't blame circuit failures on bad luck.

Voltage transients can cause circuits to fail or suffer undetected and progressive damage.

Transtector® circuit protector, a new solid state device, senses transients within nanoseconds, absorbs the surge and resets itself. Gives continuous protection for tubes, transistors, diodes and integrated circuits.

Find out about Transtector Systems from M&T Chemicals Inc., 3025 W. Mission Rd., Alhambra, California 91803.

\*Trademark of M&T Chemicals Inc.

Phone (213) 283-9278

**M&T Chemicals Inc.**  
SUBSIDIARY OF AMERICAN CAN COMPANY



INFORMATION RETRIEVAL NUMBER 189

279

**NEW DATA  
APPLICATION GUIDE  
EMI/RFI GASKETS**



ECCOSHIELD® folder describes the broadest line of conductive plastic gaskets, including forms and applications. All materials feature high insertion loss, hermetic seal, low closing pressures, low compression set, low maintenance. Send for FREE copy.

INFORMATION RETRIEVAL NUMBER 236

**STYCAST®  
CASTING RESINS CHART  
COMPLETELY REVISED**



This chart for notebook or wall mounting has just been brought up to date. It contains comparative property data on over 20 Sty-cast® epoxies and urethanes.

INFORMATION RETRIEVAL NUMBER 237

**LOW-LOSS THERMOSET  
FOR RF AND MICROWAVE  
MACHINED PARTS**



ECCOSTOCK® HI-Q is clear thermosetting rod and sheet. Machineable; won't creep under load; loss tangent below 0.0005 from 1 MHz to 10 GHz. Dielectric constant is 2.4. Highest temp., lowest loss plastic available; use for insulation and support in coax, waveguide, stripline, etc.

INFORMATION RETRIEVAL NUMBER 238

**Emerson & Cuming, Inc.**



**CANTON, MASS.  
GARDENA, CALIF.  
NORTHBROOK, ILL.**  
Sales Offices  
in Principal Cities

EMERSON & CUMING EUROPE N.V., Oevel, Belgium

**DATA PROCESSING**

**Microfilm reader  
enlarges 40 times**

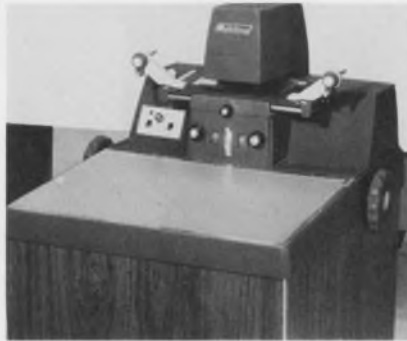

*Charles Bruning Co., div. of Addressograph Multigraph Corp., 1800 W. Central, Mount Prospect, Ill. Phone: (312) 255-1900.*

Continuously magnifying all types of microforms from 10 to 40 times, a new mobile free-standing microfilm reader readily accepts aperture cards, 35-mm and 16-mm rolls, microfiche, and up to 105-mm microfilm. Called Multifocus, the new reader produces an image that is dimensionally accurate to all points on its viewing glass.

CIRCLE NO. 461

**Parallel mini-computer  
cycles fully in 2.6 μs**



*Computer Automation, Inc., 895 W. 16th St., Newport Beach, Calif. Phone: (714) 642-9630. P&A: \$5990; stock.*

Particularly useful as a communications controller, a new eight-bit stored-program parallel control mini-computer contains a high-speed memory with a 2.6-μs full-cycle time. Small but powerful, model 208 offers the instruction power of a 16-bit computer with the efficiency of an eight-bit machine. Its random-access 3-D core memory is expandable from 4096 to 16,384 words.

Booth No. 1120 Circle No. 391

*Superimposed  
Noise  
Problems*  
**Solved!**



**-TR-5589L 250MHz Universal Counter**

This counter employs a unique **ANS Circuit** (Automatic Noise Suppressor...patent pending) in its input circuit. If a large signal to be measured and superimposed noises are fed to a counter, the counter may count both the signal and noise since the trigger threshold level is extremely narrow.

The **ANS** solved the noise problems by keeping the input signal level constant at all times regardless of the magnitude of the input, thereby maintaining the trigger threshold level at the optimum value.

When considered from the input side, the trigger threshold level will increase when a large signal is received, or decrease when a small signal is received. These operation reduces the error due to noise mixed in the input signal. Since the counter has an input sensitivity of 10mV rms, frequency measurement of an extremely low voltage signal is possible, and measurement of 100V rms signal is also possible with the single range without the use of an attenuator because of the 80dB dynamic range.

**FREQUENCY RANGE**—Counts directly up to 250 MHz in decimal, up to 500 MHz with prescaler plug-in unit, covers 10 Hz to **12.5 GHz** with frequency converter plug-in unit.

**HIGH STABILITY**—Long term stability **5 parts in 10<sup>10</sup>** per day.

**HIGH SENSITIVITY**—10mV to 100V rms in a single range—wide dynamic range—80dB.

**DISPLAY**—9-digit storage display.

**BCD OUTPUT**—8-4-2-1 code output.

**PLUG-IN VERSATILITY**—8 plugin units increase the counter's versatility as required.

*Universal Counter, Digital Voltmeter, Digital Integrator, Electrometer, Frequency Counter, Frequency Synthesizer, Frequency Standard, Data Acquisition System, Operational Amplifier.*



**Takeda Riken  
Industry Co., Ltd.**

1-32-1 Asahi-cho, Nerima-ku, Tokyo, 176, Japan. Tel: Tokyo 930-4111 Telegramme: TRITRONICS TOKYO  
Agents:  
Lifton Precision Products International Inc.—(West Germany, France, Belgium, Switzerland, England)  
Ing. S & Dr. Guido Belotti Ltd.—(Italy) Nores & Co.—(Finland)  
Ingenjorsfirma Carl-Eric Larsson AB—(Sweden)  
Semco Semlar & Co.—(Denmark)

INFORMATION RETRIEVAL NUMBER 190

ELECTRONIC DESIGN 17, August 16, 1969



## Compact processor accepts d/a data



Beckman Instruments, Inc., Electronic Instruments Div., 2400 Harbor Blvd., Fullerton, Calif. Phone: (714) 871-4848.

Model 816 is a completely self-contained data processing system, capable of accepting both digital and analog information, processing the data in digital form, and producing an output that can directly interface with a variety of recording devices. It contains a 4096-word core memory.

CIRCLE NO. 462

## Electronic calculator prints 90 characters/s



North American Philips Corp., 100 E. 42 St. New York. Phone: (212) 697-3600. Price: \$1195.

Incorporating a mosaic printout device and advanced integrated circuitry, a new high-speed electronic calculator model P-251, performs at the rate of 90 characters per second. Characters are formed by a mosaic of dots, imprinted by seven solenoid-activated blunt needles that flick against the ribbon and paper at speeds of 720 dots per second. Since the impact is very light, the new machine is very quiet.

CIRCLE NO. 463

# RMC DISCAPS

## the complete Ceramic Disc line

Over the years Radio Materials Company has maintained its leadership in the production of ceramic disc capacitors. A complete line offering outstanding quality has been the key to continuing growth.

### STANDARD

Type C, B, BA, JF, JL and JE

### SUBMINIATURE

Type SM, BT, TA and Magnacaps

### GREENCAPS

Type CG, JG, and BG

### SPECIAL

U.L. Listed Discaps, T.C. High Voltage, High K High Voltage and Dual Section By Pass

### SOLDER-IN T.C. DISCAPS

For application in equipment where lead inductance effects must be reduced to an absolute minimum.

### U.L. LISTED T.C. DISCAPS

Should be specified when the use is an integral part of an antenna coupling network where compliance with Underwriters' Laboratories specifications are required.

If your application requires special physical or electrical characteristics, contact RMC's Engineering Department.

RMC  
.0039

DISCAP  
CERAMIC  
CAPACITORS

RMC

**RADIO MATERIALS COMPANY**

A DIVISION OF P. R. MALLORY & CO., INC.  
GENERAL OFFICE: 4242 W. Bryn Mawr Ave., Chicago 46, Ill.  
Two RMC Plants Devoted Exclusively to Ceramic Capacitors  
FACTORIES AT CHICAGO, ILL. AND ATTICA, IND.

INFORMATION RETRIEVAL NUMBER 191

## Your best choice in enclosures

- oil and dust tight
- EMI/RFI shielded
- rigid one-piece construction
- available from stock



**Consoles** in versatile stock design, 50" x 24" x 23", with gasketed front and rear doors. Options include rack angles, swing-out and stationary subpanels and writing desk. **Consolets** are offered in eleven stock sizes for desktop mounting of remote controls. Floorstand optional.

All units are heavy gauge steel with all-welded seams, easily shielded.



FREE-STANDING  
ENCLOSURES

NEMA 12 units in stock sizes up to 90" x 36" x 24". Rigid 12 gauge steel with all-welded seams, gasketed doors front and/or rear. Oil and dust tight. Options include several interior panel arrangements, rack angles and shielding.

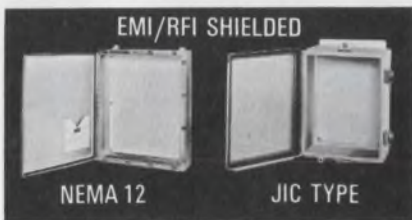

EMI/RFI SHIELDED

NEMA 12

JIC TYPE

Heavy gauge steel boxes with hinged doors, all cadmium plated. Oil and dust tight, fully shielded. Interior mounting panels and terminal block kits optional. Shipment from stock, all sizes.



NEMA 1  
ENCLOSURES

For mounting controls where oil, dust and water are not a problem. One-piece heavy gauge steel construction, finished in gray prime. Flush latches. Interior panels for mounting components. Wide size range in stock.

# Hoffman

HOFFMAN ENGINEERING COMPANY  
Division of Federal Cartridge Corporation  
Anoka, Minnesota, Dept 431

## ELECTRICAL ENCLOSURES

INFORMATION RETRIEVAL NUMBER 192

## DATA PROCESSING

### Modular disc memories handle up to 72 channels

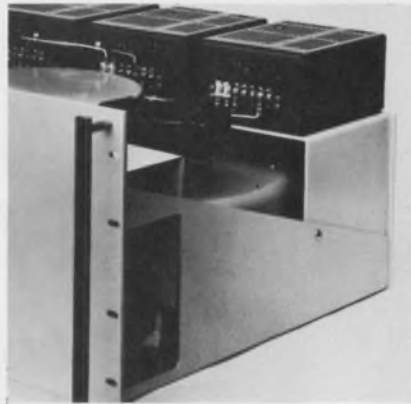

*Data Disc Inc., 1275 California Ave., Palo Alto, Calif. Phone: (415) 326-7602.*

Incorporating a modular building-block system approach, series 5200 parallel disc memories provide up to 72 independent read/write channels. All of the eighteen models in the new series have a low-cost hysteresis-synchronous motor drive. Two servo drive options are available, a single-loop servo control or a double-loop servo control.

Booth No. 5510 Circle No. 390

### IC core memory cycles in 1.75 $\mu$ s



FILE-STORE

STANI  
LOC  
IN

*Standard Logic Inc., 1630 S. Lyons St., Santa Ana, Calif. Phone: (714) 835-5466.*

File Store memory system is a four-wire, coincident-current, IC magnetic core unit that features a 1.75- $\mu$ s full-cycle time, multiplicity of address options, DTL/TTL interface, and full- and half-cycle operation. It is designed for high-speed random/sequential access applications and can operate as a stand-alone or functional memory module.

CIRCLE NO. 464

### Linking multiplexer handles 18 terminals



*Communications Logic, Inc., 6400 Westpart, Suite 355, Houston, Tex.*

A new time-division linking multiplexer is capable of accepting data from 18 simultaneously active data terminals at multiple locations, and channeling it for transmission over one 2400-baud data circuit. Model TDML is designed to work with single-speed terminals (110 baud), and is compatible with Teletype models 33 and 35. It can be adapted to serve data speeds other than 110 baud.

CIRCLE NO. 465

### High-level multiplexers digitize 256 channels

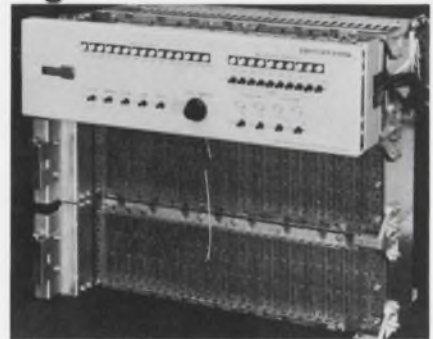

*Scientific Data Systems a Xerox Co., 701 S. Aviation Blvd, El Segundo, Calif. Phone: (213) 772-4511. P&A: \$4300 or \$7350; 30 to 60 days.*

Two new high-level solid-state 256-channel multiplexing/digitizing systems will accommodate input signal ranges of  $\pm 10$  or  $\pm 100$  V with optional automatic gain changing. Model CD51 makes 15-bit analog-to-digital conversions in 15  $\mu$ s; model CD41 needs only 30  $\mu$ s for a complete acquisition/conversion cycle.

CIRCLE NO. 466



# TERMINAL BLOCKS

CURTIS

## INSULATED FEED-THRU GFT SERIES



RATED: 20 Amps.  
300 Volts

Versatile, compact GFT Series eliminate costly insulating and mounting procedures to meet UL and CSA requirements. Fully insulated inserts give  $\frac{1}{4}$ " solder terminal to ground clearance on  $\frac{1}{8}$ " thick chassis.

**SURFACE TERMINALS:**  $\frac{3}{16}$ " center-to-center spacing of #6 or #8 screws take up to #12 AWG wire.

**INTERNAL CONNECTIONS:** Variations include turret-type solder posts, printed circuit pin (.062 dia.), #6-32 screws, or turret-type posts with axial #53 taper pin receptacle.

**AVAILABLE:** 1-18 bright tin plated terminals per block with end mounting positions or flush ends with Tinnerman nut mounting.

**FREE!** Full details, descriptions and prices in Curtis 24-page illustrated catalog.



**CURTIS DEVELOPMENT & MFG. CO.**  
3236 N. 33rd St., Milwaukee, Wis. 53216

SEE US AT WESCON - BOOTH 4911  
INFORMATION RETRIEVAL NUMBER 193



# 2-piece traps are out!

## Zenith uses Dale hybrid Series-Resonant Trap in FM circuitry

Zenith wanted a better way to bypass 10.7 MHz in its FM receivers. To replace the standard 2-component inductor-capacitor trap, Dale provided this unique hybrid.

Dale's Series-Resonant Trap has the electrical characteristics of an inductor and a capacitor in series and provides a method of controlling both functions. The result: Controlled self-resonance in a miniaturized circuit.

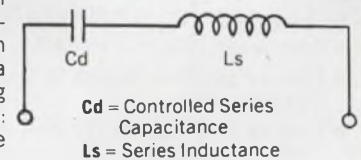

After four years of production use, Zenith says of the Series-Resonant Trap: "It saves space, saves time, works satisfactorily." Here are the basic specs:

- **Resonant Frequency:** 10.7 MHz  $\pm$  .5 MHz (Other frequencies available)
- **Impedance at Design Frequency:** 15 $\Omega$  or less
- **Impedance at  $\pm$ 50% of Design Frequency:** 1500 $\Omega$  min.

Space and money-saving components like this are a growing part of Dale's Sioux Division. Write for more information or call Dale at 605 - 665-9301.



**DALE ELECTRONICS, INC.**  
**SIoux DIVISION** Dept. ED  
Yankton, South Dakota 57078

Producers of: Toroids, Series Resonant Traps, Variable Pitch Inductors, Miniature High Frequency Inductors, Degaussing Coils, Industrial and Military Coils, Sub-Miniature Coils, Surge and Lightning Arresters, Custom Assemblies, Motor Driven Potentiometers.



## RF INTERFERENCE KEEPING YOU AWAKE?



Rest easy with reliable Littelfuse RFI shielded fuse posts. Wide range available for military and commercial applications.

# LITTELFUSE

DES PLAINES, ILLINOIS

INFORMATION RETRIEVAL NUMBER 194

INFORMATION RETRIEVAL NUMBER 195





## "Black Magic" FROM Plastic Capacitors

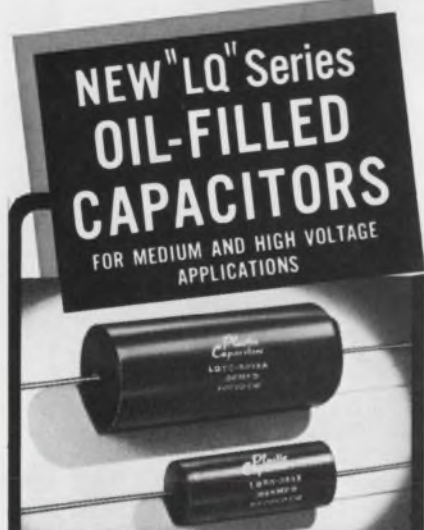

- Voltage range, 1000 to 10,000 volts DC
- Power Factor, 0.5% at 60 and 1000 Hz.
- Peak to Peak Ripple Voltage, 20% of DC Voltage Rating
- Designed for continuous operation of 10,000 hours at 65°C
- Black phenolic shell, epoxy end fill
- Axial wire lead terminations
- Excellent corona characteristics

Here's new "Black Magic" from PC, delivering more power and reliability at extremely low cost. Compact size and stability increase their versatility.

Quality construction assures peak performance. Intensive testing to insure field performance applications unlimited.

Write for free samples and complete engineering data today!



**Plastic Capacitors**  
INC.  
2620 N. Clybourn • Chicago 14, Ill.  
DI 8-3735

## INSTRUMENTATION

### Dual-trace oscilloscope senses 200 $\mu$ V at 5 MHz



Philips Electronic Instruments, 750 S. Fulton Ave., Mount Vernon, N.Y. Phone: (914) 664-4500. Price: \$2175.

A new dual-trace vhf oscilloscope accurately displays signals between dc and 5 MHz to 200  $\mu$ V/cm plus signals between dc and 50 MHz accurate to 2 mV/cm. Model PM 3250 can examine pulse leading edges with minimum signal distortion. In addition, an intensity control circuit allows adjustment of beam intensity without defocusing the CRT.

CIRCLE NO. 467

### Pushbutton DPMs measure V or I



Time Systems Corp., 265 Whisman Rd., Mountain View, Calif. Phone: (415) 961-9321. P&A: \$279 or \$295; stock to 30 days.

Two new multi-range digital panel meters feature pushbutton selection of range setting. Model 703 provides four full-scale voltage ranges of 1.999, 19.99, 199.9 and 1000 V. Model 704 provides six full-scale current ranges from 1.999  $\mu$ A to 199.9 mA, in decades. Polarity and decimal point indication are automatic.

CIRCLE NO. 468

### Programmable supply swings 200 V in 200 $\mu$ s



Hewlett-Packard, 1501 Page Mill Sd., Palo Alto, Calif. Phone: (415) 366-7000. Price: \$1500.

Model 6131B digitally programmable power supply can swing its output voltage from -100 to +100 V, or vice versa, in less than 200  $\mu$ s while supplying any current between 0 and 0.5 A. The new unit can also function as a high-power digital-to-analog converter or as a digitally controlled waveform synthesizer because of its high speed.

CIRCLE NO. 469

### Transmission test set offers versatility



International Data Sciences, Inc., 100 Nashua St., Providence, R. I. Phone: (401) 274-5100.

Range Rider is a new pseudo-noise transmission test set that greatly simplifies a variety of tests on any synchronous digital data transmission system. Model 1000, which contains both transmitter and receiver, has a self-test capability and operates with simplex, half-duplex or full-duplex systems. Its capabilities include testing and evaluating modems, dynamically testing digital multiplexing systems, and testing and evaluating error control systems.

CIRCLE NO. 470





**Somebody  
beat you to it.**

It was intended for you. But if the 24-page Kearfott brochure we had bound into this magazine is missing, somebody took off with it.

No wonder. The 24 pages are filled with vital statistics and valuable information on Kearfott's products. On servo motors, tach generators, stepper motors and other DC rotary components.

But you can still get it if it's gone. Either circle the number shown on this page on the reader service card, or write us directly requesting it. Singer-General Precision, Inc., Kearfott Division, 1150 McBride Avenue, Little Falls, N.J. 07424.

That'll show 'em.

**SINGER**  
KEARFOTT DIVISION

INFORMATION RETRIEVAL NUMBER 248

## INSTRUMENTATION

### Dc current sources regulate to 25 ppm



*Hewlett-Packard, 1501 Page Mill Rd., Palo Alto, Calif. Phone: (415) 326-7000. P&A: \$425; 4 wks.*

Two new constant-current power sources provide an output current that changes less than 25 ppm ( $\pm 5$  ppm of range setting) with a load change that swings the output voltage from zero to maximum. Maximum output for model 6177B is 500 mA, with voltage limiting continuously adjustable between 0 and 50 V. Model 6181B has a maximum output of 250 mA with limiting from 0 to 100 V.

CIRCLE NO. 481

### Wideband oscillator distorts only 0.25%



*Data Royal Corp., 8014 Armour St., San Diego, Calif. Phone: (714) 279-4020. P&A: \$795; 30 to 45 days.*

Over the frequency range of 10 Hz to 10 MHz, a new test oscillator holds output amplitude flat to within  $\pm 0.25\%$ . Model F324A provides simultaneous low-distortion square and sine waves. Its 90-dB step attenuator, in 10-dB steps, and its 3.16-V rms full-scale meter give precise amplitude control for a variety of laboratory test applications.

CIRCLE NO. 482

# Low cost, component-test system

Choice of tape or computer control

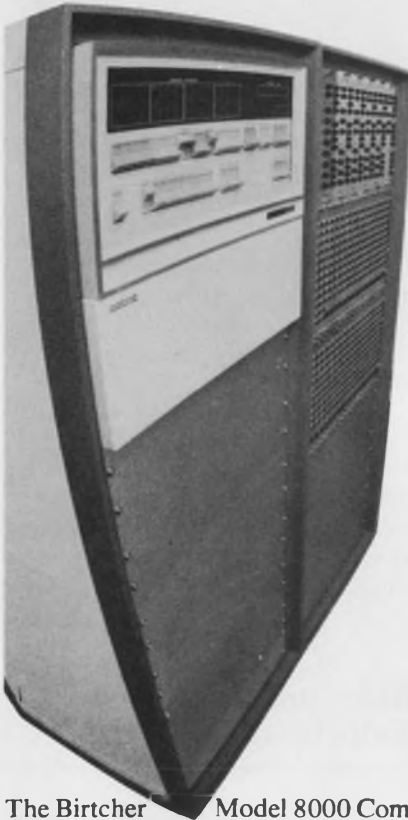

The Birtcher Model 8000 Component Test System automatically tests multiple lead components and circuits from simple IC's to over 200 lead logic cards, MSI, LSI units. Modular design allows flexible test applications providing a system that is never obsolete.

**Tape control** features basic go/no go production wafer probing plus incoming and final inspection testing capabilities.

**Computer control** is ideal for process control, sorting and high reliability testing. Displayed at Wescon Booths 3104, 3105, 3224 and 3225.

## the BIRTCHER CORPORATION

INSTRUMENT DIVISION  
1200 Monterey Pass Road  
Monterey Park, California 91754  
(213) 264-6610

Free 16 page descriptive brochure on request.

## INSTRUMENTATION

### Noise generator is flat to 12.5 MHz



Quan-Tech Laboratories, Inc., 43 S. Jefferson Rd., Whippany, N.J. Phone: (201) 887-5508. Price: \$1100.

Supplying true Gaussian amplitude distribution and constant spectral density with frequency, model 421 random noise generator meets the need for an accurately calibrated source that is flat from 10 kHz to 12.5 MHz. The output of this all-solid-state instrument is continuously metered with a variable attenuator and a step attenuator.

CIRCLE NO. 483

### Switching matrix simplifies testing



Tele-Dynamics Div., AMBAC Industries, Inc., 5000 Parkside Ave., Philadelphia, Pa. Phone: (215) 878-3000.

Primarily designed to replace patching modules in communications terminals, a new multi-line switch matrix rapidly switches a large number of wired circuits, making possible instant spare replacement during emergencies, simplified on-line monitoring, and back-to-back testing. Model 7255 consists of two independent 30-switch matrices, one for send lines and the other for receive lines.

CIRCLE NO. 484

### Digital counter varies time base

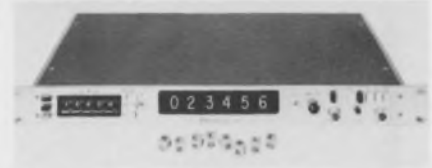

Atec, Inc., P.O. Box 19426, Houston, Tex. Phone: (713) 468-7971. P&A: \$940; 30 days.

Designed to measure rate data, a new variable-time-base electronic counter displays the measurement in engineering units rather than in events per second. Employing front-panel digital switches, model 2300 allows the operator to select any time base from 10  $\mu$ s to 1 s in 10- $\mu$ s increments, 100  $\mu$ s to 10 s in 100- $\mu$ s increments, and 1 ms to 100 s in 1-ms increments.

CIRCLE NO. 485

### Digital multimeter quadruples functions



EG & G Laboratory Products Div., 150 Aero Camino Way, Goleta, Calif. Phone: (805) 967-0456.

Using a differential MOSFET input, a new digital multimeter can function as an electrometer-voltmeter, a coulombmeter, an ammeter or an ohmmeter. Model 736A features a 200% overrange capability (2.999 maximum display) for all functions. Range information for each function is clearly identified for ease of operation; function grouping virtually eliminates any confusion or misinterpretation of readings.

Booth No. 1129 Circle No. 403



## Solid-state programmer solves system problems



*Chronologics, Inc., 24 Martin St., Webster, N.Y. Phone: (716) 872-1470. P&A: \$295; 30 days.*

Fulfilling the need for a versatile and accurate time-sequence generator, the SP101 solid-state programmer consists of a series cascade of five individually adjustable time-function modules, each having an isolated spdt output contact. Standard features include internal or remote start, multiple cascading of programmers, single- or repeat-cycle operation and master/slave operation with slaves local or remote.

CIRCLE NO. 486

## Digital comparator decides in 20 ms



*Micro Instrument Co., 12901 Crenshaw Blvd., Hawthorne, Calif. Phone: (213) 697-8237. P&A: from \$800; 4 to 6 wks.*

Model 6003B universal digital comparator adds computer decision-making capability to any digital device having an output in parallel BCD form. The new comparator can receive single- or multiple-input data groups, compare the input to programmed preset limits, and make and indicate one of five possible comparative decisions within 20 ms after the start of the compare signal.

CIRCLE NO. 487

## Announcing...

# A Directional Coupler That Covers 1 to 12.4 GHz

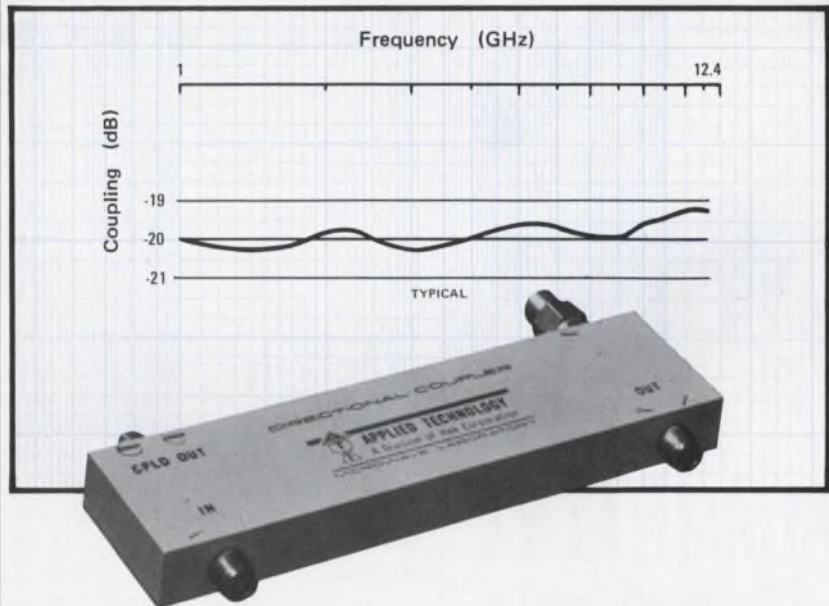

The Model DCM1-20 broadband 20 dB directional coupler covers the frequency range from 1,000 to 12,400 MHz. Its small size, light weight and excellent specifications make it useful for internal leveling, broadband power monitoring and reflectometer measurements. It is ideal for airborne systems which operate under severe environmental conditions.

- Freq Range: 1-12.4 GHz
- Coupling, nominal: 20 dB
- Coupling, deviation:  $\pm 1.0$  dB Maximum
- Directivity:  $>20$  dB L-, S-, C-Bands,  $>15$  dB X-Band
- VSWR (maximum): 1.5:1
- Insertion Loss: 0.2 dB L-, S-Bands  
0.3 dB C-Band  
0.4 dB X-Band
- Size: 4.3" x 1.1" x 0.4"
- Weight: 4 ounces

Write or call collect for additional information or application assistance.

### Employment Opportunities for Qualified Engineers

An equal opportunity employer

SOLID-STATE OSCILLATORS • MIXER-PREAMPS • PREAMPS • FREQUENCY MULTIPLIERS

MICROWAVE LABORATORY

3410 Hillview • Palo Alto, Calif. 94304 • (415) 321-5135 • TWX 910 373-1218

**APPLIED TECHNOLOGY**

A Division of Itek Corporation



INFORMATION RETRIEVAL NUMBER 198



## IMMUNITY! (From Noise)

### BY SOLID STATE SCIENTIFIC

The highest High Noise Immunity Logic (HNIL) available is in our new SD300 series Digital Circuits. The SD300 series is ideally suited for applications requiring excellent line driving capability.

Buffered outputs and 12 volt logic eliminate the need for interface circuits in most applications.

Supplied in two case styles. 15 volt logic levels are available.

Other quality product lines are complementary MOS logic, High Frequency Transistors, Thin Film Resistors/Ladder Networks and Custom Monolithic Bi-polar Integrated Circuits.

SEE US AT THE WESCON SHOW  
BOOTH NO. 3724-25

 **SOLID STATE  
SCIENTIFIC INC.**

A SUBSIDIARY OF TRESKO SCIENTIFIC DEVICES  
MONTGOMERYVILLE, PENNA. 18936  
215-855-8400 TWX-510-861-7267

INFORMATION RETRIEVAL NUMBER 199

## INSTRUMENTATION

### Tri-function meter powers and tests

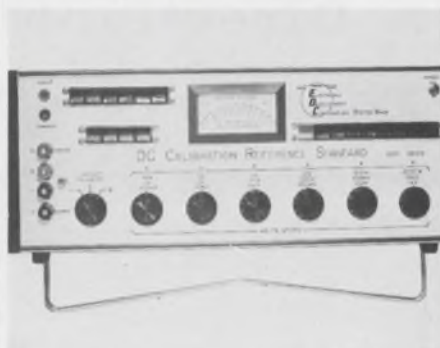

*Electronic Development Corp., 423 W. Broadway, Boston, Mass. Phone: (617) 268-9696. Price: \$1650.*

Combining the best features of discrete components and ICs, a new triple-function instrument can supply input voltage to a breadboard circuit while simultaneously measuring its output. Model 2900 is a differential voltmeter, a transistor voltmeter, and a calibrator with an accuracy of 0.002%. The new unit offers a dc output of  $\pm 100$  nV to  $\pm 100$  V at 100 mA.

CIRCLE NO. 488

### IC counter/timer functions six ways



*Atec, Inc., P.O. Box 19426, Houston, Tex. Phone: (713) 468-7971. P&A: \$850; 30 days.*

With a range of dc to 12.5 MHz, a new slim-line universal IC counter/timer performs six different measurement functions including frequency, time interval, period, multiple period, ratio and totalizing. Model 2000 has an input sensitivity of 10 mV from dc to 5 MHz and 30 mV from dc to 12.5 MHz, with a 150-V overload protection.

CIRCLE NO. 489

### Accurate multimeter digitizes at 1 kHz



*Lear Siegler, Inc., Cimron Div., 1152 Morena Blvd, San Diego, Calif. Phone: (714) 276-3200. P&A: \$1740; 30 days.*

Featuring a 1-kHz digitizing rate with sample and hold, a new digital multimeter measures dc voltages and dc/dc ratios with an accuracy of  $\pm 1$  digit from 0 to 1999.9 V. Model 6653A is an all-IC four-digit instrument with a fifth digit for 10% overranging. Plug-in function options include ac in four ranges, ohms in five ranges, and millivolts in three ranges.

CIRCLE NO. 490

### Precision power source supplies 3 kV at 10 mA



*Velonex Div., Pulse Engineering, Inc., 560 Robert Ave., Santa Clara, Calif. Phone: (408) 244-7370. \$480.*

Providing an output voltage that is continuously adjustable from 500 to 3000 V at 10 mA, a new precision high-voltage power supply features a ripple and noise of less than 5 mV pk-pk. Line and load regulation for model 150 are within 0.001%. Output polarity can be conveniently switched; full overload and short-circuit protection is standard.

CIRCLE NO. 491



# 1750 ways to keep in touch

At H. A. Wilson we have over 1750 precious and sintered metals and alloys available for electrical contact applications. Yes! Even more than any other company. This wide variety enables us to produce every conceivable form of contact in sizes ranging from the microminiature forms used on Apollo spacecraft to up to 1 1/4 in. square (NEMA #6 and #7) motor starters. Combine this wide selection of materials with our engineering and production capabilities, and it's obvious there are few, if any, contact problems we can't solve. Even yours.

Contact the H.A. Wilson Technical Service Department today.



**ENGELHARD**

ENGELHARD INDUSTRIES DIVISION  
ENGELHARD MINERALS & CHEMICALS CORPORATION  
2685 U. S. ROUTE 22, UNION, NEW JERSEY 07083

INFORMATION RETRIEVAL NUMBER 200

## CRATEX RUBBERIZED ABRASIVES

**DEBURR  
SM-O-O-TH  
POLISH**



**\$7.50 BUYS IT ALL**—80 piece introductory Kit 777 equally assorted in 4 grit textures: coarse, medium, fine and extra fine **TRY IT**—Cratex Rubberized Abrasives improve the surface while preserving critical workpiece dimensions by its unique cushioning action. **FINISH THE JOB**—to your most exacting specifications—often in a single operation. **SEND FOR KIT 777**—or your **FREE SAMPLE** and catalog illustrating the full Cratex product line and its applications.

**CRATEX<sup>®</sup> RUBBERIZED ABRASIVES**

1600 Rollins Road • Burlingame, Calif. 94010  
Sold through leading industrial distributors

INFORMATION RETRIEVAL NUMBER 201

ELECTRONIC DESIGN 17, August 16, 1969

**TRUE  
SOLID-STATE  
RELAY**



Opening New Relay Applications in Multiplexing, Isolated Sensing, High Speed Isolated Control, etc. Offered in A - B - C Contact Configurations for Direct Replacement of Mechanical Types.

- Switching Time . . . . . less than 65 $\mu$  sec
- Contact Open Resistance . . . . . 10<sup>9</sup> ohms
- Contacts Capable of switching D C to 4 M HZ
- Non-Polarized Effective Coil
- Effective Coil Accuate/Release Voltage Hysteresis . . . less than 10 mV . . .
- Non-Polarized Contacts
- No Reference Required Between Effective Coil and Effective Contacts
- Life Expectancy—tested to 10<sup>10</sup> operations with no failure.

**SHAFFSTALL-BALL CORPORATION**

5149 E. 65th Street, Indianapolis, Indiana 46220  
Phone: 317-257-6296

INFORMATION RETRIEVAL NUMBER 202

# Give Us a Requirement to Build to

## Broad Frequency Response?



**AMF VIDEO PREAMPLIFIER**  
 •  $f_1$  .1 Hz thru  $f_2$  25 MHz

## Ultra Low Noise?



**AMF SOLID STATE MODULAR PREAMPLIFIER**  
 • -165 dbV per cycle

... tailor an AMF Cybertran Preamplifier to fill your needs.

Cybertrans fulfill your needs whether they be ultra-low noise, subsonic requirements or extreme broadband video specifications. The flexibility of our "off-the-shelf" preamplifiers enables AMF to satisfy a wide range of special or standard needs... we call it Cybertran Technology. This new expertise makes it possible for you to specify your preamplifier requirements and have AMF ship it to you. Write or call Jim Campman, Applied Cybernetics Products, AMF Alexandria Division, 1025 North Royal Street, Alexandria, Virginia 22314 Phone (703) 548-7221. TWX 703-931-4209. Representatives in major cities of U.S.A.



INFORMATION RETRIEVAL NUMBER 203

## PACKAGING & MATERIALS

### Spooled fiber optics trim to exact length



Edmund Scientific Co., 380 Edscorp Building, Barrington, N. J. Phone: (609) 547-3488. Price: from \$4.75/spool.

Individual fiber-optic strands are now available in any length for custom building of light guides, either square or odd sized. They come in two sizes, diameters of 10 or 20 mils, and are conveniently wound on spools for easy cutting and measuring. They are capable of transmitting wavelengths from 400 to 1100 millimicrons.

CIRCLE NO. 492

### DIP IC retainer sinks heat too

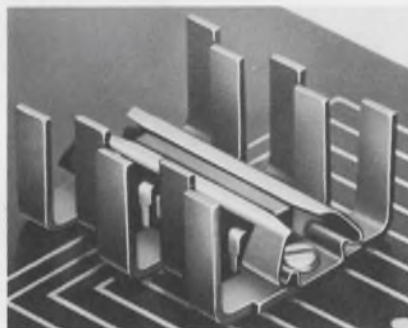

International Electronic Research Corp., 135 W. Magnolia Blvd., Burbank, Calif. Phone: (213) 849-2481. Price: 52.4¢.

A new heat dissipator/retainer is now available for dual-in-line integrated circuit packages with up to 14 leads. The new part consists of a conduction base and a retainer clip that can be used to cool DIPs when sockets are used in the assembly or when the ICs are soldered directly to a board. The conduction base fits between the circuit board and the bottom of the DIP case.

CIRCLE NO. 493

### Wire chassis helps cooling



E. H. Titchener and Co., 1 Titchener Place, Binghamton, N.Y. Phone: (607) 772-1161.

Replacing conventional stamped and welded aluminum panels, a new skeletonized wire chassis provides maximum air flow for cooling components, as well as easy insertion and removal of circuit cards. Built-in wire guides channel circuit cards into perfect alignment with their connectors. The new chassis holds a row of circuit cards in both its right and left sections, while other components are mounted in the center.

CIRCLE NO. 494

### All-purpose epoxy room-cures in 60 s



Tescom Corp., Instrument Div., 2633 S. E. 4th St., Minneapolis, Minn. Phone: (612) 331-1311.

Called Minit-Cure, a new multi-purpose epoxy has a complete curing time of less than 60 seconds at room temperature (75°F). It can be used to bond metals, woods, plastics, rubber and glass. Applied with a brush, the new epoxy provides a tensile strength of 2900 pounds per square inch.

CIRCLE NO. 495



## Indicating fuse blocks aid troubleshooting



Thomas & Betts Co., 36 Butler St., Elizabeth N.J. Phone: (201) 354-4321.

Able to pinpoint blown-out fuses in a hurry, a new line of fuse blocks illuminates an indicator on a master control panel to tell the operator exactly where the trouble is located. The blocks use indicator fuses and have a bus that is contacted by a fuse plunger, automatically completing a circuit to the indicator lamp. As many as 20 circuits can be installed in a 12-1/2-in. length.

CIRCLE NO. 496

## Electronic aerosols form complete line



Emerson & Cuming, Inc., Dielectric Materials Div., 59 Walpole St., Canton, Mass. Phone: (617) 828-3300. P&A: \$2 to \$10; stock.

Eccospray aerosol spray products for electronics include: a silver lacquer for rf shielding and making electrical connections; a mold release for use when making plastic encapsulations; a moisture and fungus resistant varnish for components and circuit boards; an acrylic lacquer for transparent surface coating protection; and a fluorocarbon release, anti-stick, and low-friction agent.

CIRCLE NO. 497

# Until our new Unipulser II came along,



## single decade counters were pretty much alike.

Compare it with any competitor on these eight points:

- 1. Size.** Unipulser II is more compact than any comparable electric counting decade.
- 2. Durability.** Mechanical and electrical transfer lives are longer than those of comparable decades. That's because Neyoro g wiper contacts provide the highest quality electrical contacts available.
- 3. Power.** Three voltages are standard, not just one. 12, 24 and 48 VDC.
- 4. Readability.** Large figures, wide-angle viewing.
- 5. Unitized metal diecast frame.** This makes Unipulser II self-supporting from the front and simplifies installation. Push button preset model has the same frame dimensions.
- 6. Input.** Counts from transistorized circuits, photocell impulses or standard contact closures. Speeds up to 40 cps; count is retained even if power fails.
- 7. Modular.** Each Unipulser II has its own drive input circuit, transfer and reset circuit and an eleven-line output for control or electrical readout. This lets you combine Unipulser II's in series for sequential counting or parallel entry. Control circuitry also lets you use them as recycling or single cycle predetermined counters—or as counters with remote display. Or even as readout devices for other counters or recording units.
- 8. Price.** Here's the best part. Our prices begin at \$18 and go down just as fast as anyone else's on quantity buys. Push button reset model begins at \$19. All in all, you won't find another decade that does so much for so little. For full information and specifications, write for Unipulser II catalog. 622 N. Cass Street, Milwaukee, Wisconsin, 53202.

The modular Unipulser II has hundreds of uses, from metering to data processing to all types of production control.



**DURANT**  
DIGITAL INSTRUMENTS

A CUTLER-HAMMER COMPANY

INFORMATION RETRIEVAL NUMBER 204



# LOWEST COST . . . FULL WAVE BRIDGE RECTIFIERS & ASSEMBLIES

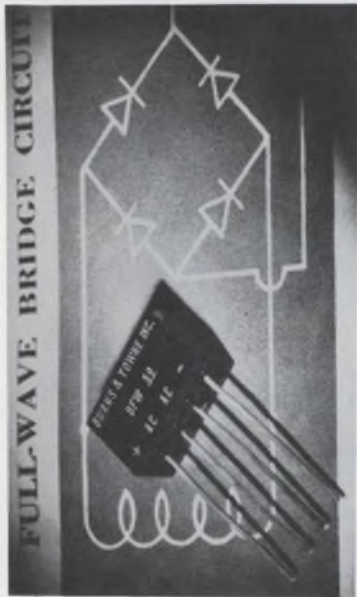

Burns & Towne pre-packaged rectifier circuits represent a significant cost savings over individual components used in multi-rectifier units. Yet, you are always assured of quality and reliability. The low cost BFW family of single phase full wave bridges . . . features high current capability of up to 2.0 amps.

Part No.	Max. PRV (volts)
BFW-50	50
BFW-100	100
BFW-200	200
BFW-300	300
BFW-400	400
BFW-500	500
BFW-600	600
BFW-800	800
BFW-1000	1000

Call or write for full specifications and price data.

**BURNS & TOWNE INC.**  
18-36 Granite St.  
Haverhill, Mass. 01830. Tel (617) 373-1333

## PACKAGING & MATERIALS

### Terminal block bends to job



*Kessler Ellis Products Co., 120 First Ave., Atlantic Highland, N.J. Phone: (201) 291-0500. Availability: stock.*

A new flexible terminal block can be mounted on rough, uneven, or curved surfaces. This plastic unit completely encloses solderless-type screw connectors, leaving no metal parts exposed. It comes in strips of 12 poles and can be cut with a razor blade to the number of poles required. Three sizes cover wire ranges from AWG #26 to #4.

CIRCLE NO. 601

### Test connector speeds wiring

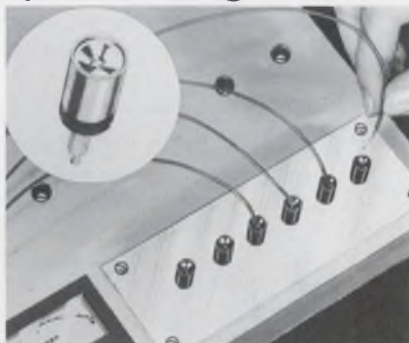

*Testron, Inc., P.O. Box 48237, Chicago, Ill. Phone: (312) 775-2477. P&A: 79¢ to 90¢; 30 days.*

Intended to speed testing, inspection, and breadboarding, Zip-Clip test connector saves time when running leads from a circuit under test to associated test instruments, or when making other quick temporary connections. The new device has a unique holding mechanism that permits fast effortless one-hand insertion of wires for a firm low-resistance contact.

CIRCLE NO. 602

**BRANSON**

## HALF-SIZE CRYSTAL CAN RELAYS

### FOR HIGH DENSITY PACKAGING



#### TYPE SR 4-POLE RELAY

Available in standard, bracket mounting, stud mounting, or flat mounting cases. Hook, plug-in or solder terminals may be selected. Coil voltage range: 6 to 48 VDC. Contacts rated at 2 amps 28 VDC resistive. Meets MIL-R-5757D and MIL-E-5272C.



#### TYPE SR 2-POLE RELAY

Obtainable in same case and header configurations as the 4-Pole Type SR. Two Form C DPDT contacts handle 2 amps to dry circuit load. Operates and releases in 5 ms max. Life expectancy is 100,000 operations min. Meets MIL-R-5757D and MIL-E-5272C.



#### TYPE LS LATCHING RELAY

Selection of four case and three header styles. A short duration low power pulse (150 mw) shifts the bi-stable contacts from one position to the other. Contact arrangements is 2 Form C DPDT and rating is 2 amps 28 VDC resistive. Meets MIL-R-5757D.



#### TYPE QR TIME DELAY RELAY

Three models cover time delay ranges of: .010 to .100 sec., .050 to .500 sec., and .500 to 60 sec. Operates on 20 to 32 VDC. All solid state. Switches 10 ma at 20 to 32 VDC. Two case and three header styles available. Unaffected by shock and vibration.



Write for Branson's Designers Catalog

*Relays...  
Our Only Business*

**BRANSON CORP.**

VANDERHOOF AVENUE  
DENVER, NEW JERSEY  
(201) 625-0600

INFORMATION RETRIEVAL NUMBER 206

ELECTRONIC DESIGN 17, August 16, 1969

INFORMATION RETRIEVAL NUMBER 205



## Cermet ink kit eases evaluation



Bourns, Inc., Technical Materials, 3231 Kansas Ave., Riverside, Calif. Phone: (714) 684-1744. Price: \$200.

An evaluation kit of cermet resistive and conductive inks is now available. Four resistor inks include two positive- and two negative-temperature coefficient materials of two adjacent values. There is one conductive ink, in addition to an instruction manual. All resistivity values are blendable.

CIRCLE NO. 603

## Rectangular connectors have removable contacts

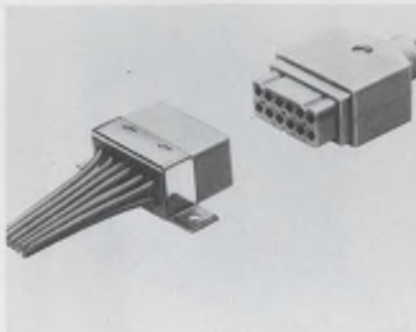

Elco Corp., Willow Grove, Pa. Phone: (215) 659-7000. P&A: \$2.04; 5 to 7 wks.

Featuring 12 insertable/removable hermaphroditic contacts, series 8024 rectangular connectors can be supplied with crimp, wire-wrap, tapered-tab, or solder terminations. Both plugs and receptacles can be equipped with stainless-steel panel-mounting hardware (for single or side-by-side mounting), or with a polycarbonate cover for cable applications.

CIRCLE NO. 604

# NEW VACTEC "PLASTIC" PHOTOCELLS

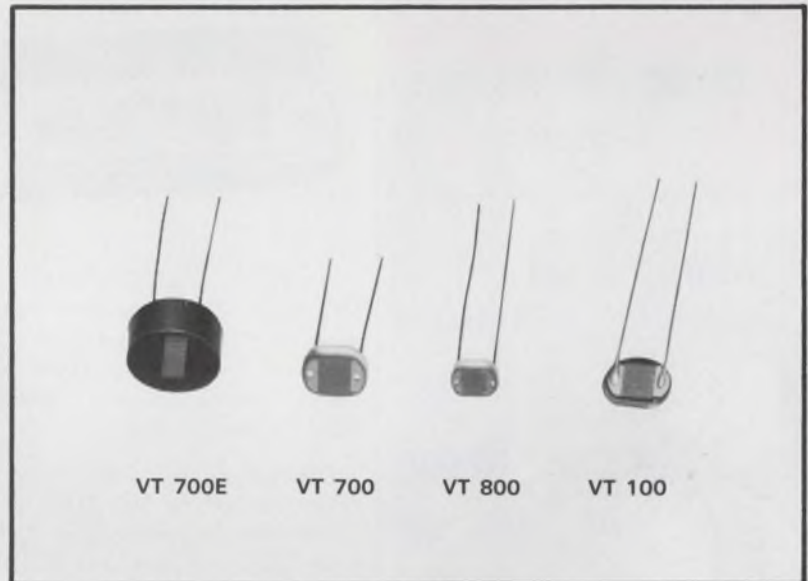

Actual size, priced as low as .25 each ( $\pm 33\%$  tolerance) in 100,000 quantities.

## Low Cost Way to Meet Most Photocell Requirements

Are you spending up to a dollar for photocells when Vactec can satisfy your needs for far less? Here's a complete line made the same, and with the same quality characteristics and precise tolerances as their metal cased counterparts. Yet they cost about *half* as much, because instead of sealing, they are protected by a thin transparent plastic coating.

Vactec "plastic" cells are conveniently controlled by ambient light, or from closely coupled low voltage lamps for remote control. Special processing provides resistance to humidity, making these devices suitable for indoor industrial and commercial applications like controlling relays in line voltage circuits; switching SCR's on or off; phase control in proportional circuits; or as feedback elements for motor speed controls in consumer appliances.

### GENERAL SPECIFICATIONS

<b>Material</b>	Two Cdse and three Cds materials, including the new type 3 with exceptionally high linearity and speed.
<b>Voltage Maximum</b>	(dark 300V.)
<b>Dissipation at 25°C</b>	200 mw (VT 100) 250 mw (VT 700 and VT 700E) 125 mw (VT 800)
<b>Ambient Resistance</b>	-40°C up to +75°C Wide range as low as 600Ω at 2 F.C.

Write today for Bulletins PCD-41, 57, 57E, and 58.

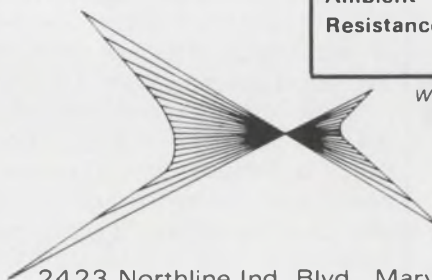

## VACTEC, INC.

2423 Northline Ind. Blvd., Maryland Heights, Missouri 63042  
(314) 872-8300

Specializing in standard Cds, Cdse, and Se cells. Custom engineering for every photocell need. Listed in EBG under "Semi-Conductors" and EEM Sec. 3700.

INFORMATION RETRIEVAL NUMBER 207

**THEY'VE  
GOT  
OUR  
NUMBER!**

**Computer Access  
Systems**

**Hewlett-Packard**

**International  
Computer Products**

**Omnitec**

**Sycor**

**Viatron**

**Wang**

**Laboratories**

**Westinghouse**



**FOR**

**MINI-DIGITAL  
READ / WRITE  
HEADS**



YOU TOO CAN GET THE HEADS  
YOU NEED FOR DESK-TOP,  
INPUT/OUTPUT, TERMINAL, AND  
PERIPHERAL EQUIPMENT,  
BY CALLING THIS NUMBER:

**(612) 545-0401**

***Northronics***  
COMPANY, INC.

*World's Largest Tape Head Manufacturer*

8101 Tenth Avenue North  
Minneapolis, Minnesota 55427  
Phone—(612) 545-0401

INFORMATION RETRIEVAL NUMBER 208

**MICROWAVES & LASERS**

**Hybrid preamplifier  
holds noise down**

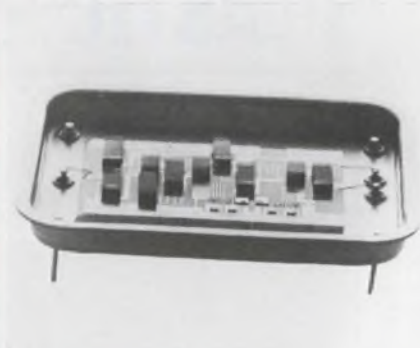

*Fairchild Semiconductor Micro-  
wave and Optoelectronics Div., 313  
Fairchild Drive, Mountain View,  
Calif. Phone: (415) 962-3563.  
P&A: \$350; 30 days.*

Operating over the frequency range of 100 to 500 MHz, a new microwave i-f preamplifier yields a noise figure of less than 2.5 dB at 100 MHz and less than 4 dB at 500 MHz. It operates with a dc input of +12 V, a current drain of 55 mA, and a power output of +5 dBm at 1-dB compression.

CIRCLE NO. 605

**S-band varactors  
tune over octaves**

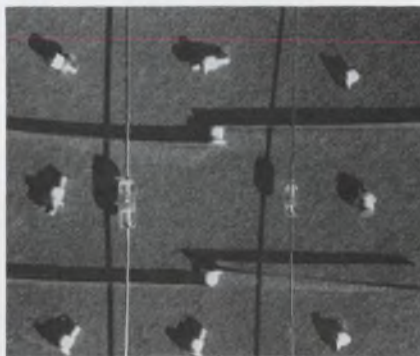

*GHz Devices, Inc., Kennedy Drive,  
N. Chelmsford, Mass.*

Featuring octave tuning capability through S band, a new line of microwave varactors offer capacitances ranging from 1.2 to 22 pF with tuning ranges from 0.3 to 0.6 GHz and 2 to 4 GHz. Series GC-1700 devices have standard capacitance tolerances of  $\pm 10\%$  and an operating temperature range from  $-60$  to  $+125^\circ\text{C}$ . Their maximum capacitance-temperature coefficient is 300 ppm/ $^\circ\text{C}$  at  $-4$  V.

CIRCLE NO. 606

**Fast-pulse rf source  
delivers up to 150 W**

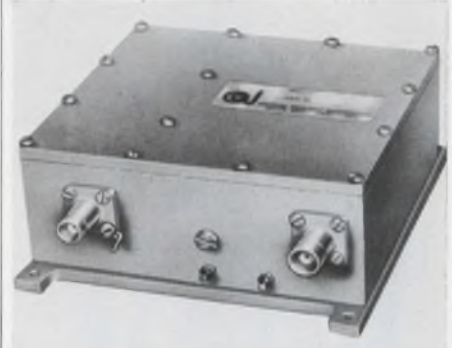

*Acrodyne Industries, Inc., 666  
Davisville Rd., Willow Grove, Pa.  
Phone: (205) 675-1800.*

Socketing out 150 W of power, a new lightweight solid-state crystal-controlled pulsed rf source features a fast falltime pulse of 50 ns or less. Model S-1001 can operate from its own internal pulse generating circuits or may be triggered from an external source. Over the frequency range of 100 to 500 MHz, its frequency stability is  $\pm 0.005\%$ .

CIRCLE NO. 607

**Variable attenuators  
span 2 to 12.4 GHz**

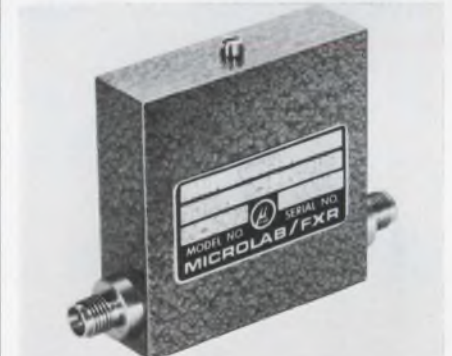

*Microlab/FXR, 10 Microlab Rd.,  
Livingston, N.J. Phone: (201)  
992-7700. P&A: from \$165; stock  
to 6 wks.*

Three new continuously variable attenuators cover the frequency range from 2 to 12.4 GHz. Types AJ-500F and AJ-400N are knob- or screwdriver-driven, while type AJ-410N has a calibrated dial. Average power is 5 W for the AJ-400N and AJ-410N, and 2 W for the AJ-500F; attenuation is 40 or 30 dB minimum, respectively.

CIRCLE NO. 608



## Fast p-i-n diode switches in 10 ns



Varian Associates Solid State Microwave, Salem Rd., Beverly, Mass. Phone: (617) 922-6000.

The VSD-211 planar p-i-n switching diode offers typical switching speeds of 10 ns and will operate over a wide dynamic range of rf series resistances from 1.4  $\Omega$  to 15 k $\Omega$ . Suitable for applications requiring rf power control and fast switching speeds, the new device will perform efficiently over a frequency range from 1 to 18 GHz, depending upon rf power and package parasitics.

CIRCLE NO. 609

## Power transistors gain 7 dB at 2 GHz



Microwave Semiconductor Corp., 100 School House Rd., Somerset, N. J. Phone: (201) 469-3311.

Two new L- and S-band power transistors, types 2003 and 2005, are capable of delivering power outputs of 5 or 6 W at 2 GHz with 7-dB power gain. At 1 GHz, type 2003 provides 3 W and 10-dB gain, while type 2005 supplies 10 W and 10-dB gain. The new transistors are housed in a stripline package that has extremely low input Q.

CIRCLE NO. 610



## MEASURES MILLIAMPERES TO PICOAMPERES AND NARROWS THE GAP BETWEEN PRICE AND PERFORMANCE

See the first digital picoammeter above? It's our new \$1495 autoranging Model 445. It simplifies measurements from  $10^{-2}$  ampere f.s. to  $10^{-9}$  ampere and provides both analog and BCD outputs. The second is the Model 440, new too. At \$995, it features  $10^{-2}$  to  $10^{-10}$  ampere f.s. current ranges, has an analog output and an option for BCD.

Both picoammeters are packed with convenience features designed to minimize operator error and maximize performance. Stable to 0.5% of full scale per week, they make low level measurements accurate to 0.2% almost routine. And provide variable display rate to 24 readings per second. But isn't that what you'd expect from a firm with years of analog picoammeter design experience? And an industry-wide reputation for quality? Like Keithley.

See if you don't agree we have the best digital approach to picoampere level measurements. Call your Keithley Sales Engineer for demonstration and details. Or contact Keithley Instruments, Inc., 28775 Aurora Rd., Cleveland, Ohio 44139. In Europe: 14 Ave. Villardin, 1009 Pully, Suisse. Prices slightly higher outside the U. S. A. and Canada.



# KEITHLEY

INFORMATION RETRIEVAL NUMBER 209





Please send me the brand new 1969 Acopian catalog that lists

**82,000  
DIFFERENT  
POWER  
SUPPLIES**

available for shipment in 3 days.

Name \_\_\_\_\_

Title \_\_\_\_\_

Company \_\_\_\_\_

Address \_\_\_\_\_

City \_\_\_\_\_

State \_\_\_\_\_

ZIP \_\_\_\_\_

ACOPIAN CORP.  
EASTON, PENNSYLVANIA  
TEL: (215) 258-5441



INFORMATION RETRIEVAL NUMBER 213

MICROWAVES & LASERS

**Microstrip transition eliminates matching**



*Tek-Wave Inc., Raymond Rd., Princeton, N.J. Phone: (609) 921-8910.*

Ending the need to match or modify circuits, a new microstrip-to-coax transition implements true integration and miniaturization. Model 10-2040 chip launcher permits direct transition from microstrip circuitry into the remainder of the system. Typical VSWR through X-band is 1.2 maximum and dielectric constants range from 9 to 10. The new unit contacts the circuit without soldering.

CIRCLE NO. 611

**Variable attenuator goes out to 20 GHz**



*Narda Microwave Corp., Plainview, N.Y. Phone: (516) 433-9000. P&A: \$475; stock.*

A miniature calibrated variable attenuator features a flat frequency response from 12.4 to 18 GHz, and can be used from 2 to 20 GHz as a variable level set attenuator. Model 4797 has an attenuation range of 0 to 45 dB and an accuracy of  $\pm 1.5$  dB. Maximum insertion loss is 1 dB and VSWR is 1.3.

CIRCLE NO. 612

**Economy gas laser offers 1-mW output**



*Metrologic Instruments, Inc., 143 Harding Ave., Bellmawr, N.J. Phone: (609) 933-0100. P&A: \$149.50; stock to 2 wks.*

Supplied as a complete system ready to plug in and turn on, a new low-cost helium-neon gas laser operates at the visible red wavelength of 632.8 nm and puts out 1 mW minimum with a beam divergence of less than 0.8 milliradian. Model 410 houses its laser tube and solid-state power supply in a rugged aluminum extrusion.

CIRCLE NO. 613

**S-band source delivers 0.5 W**

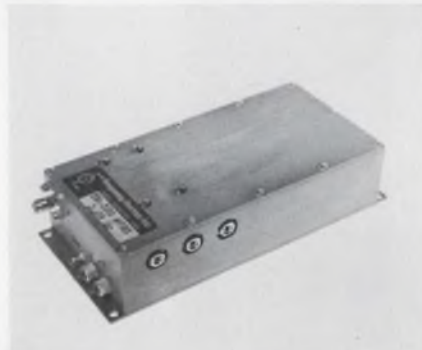

*Frequency Sources Inc., P.O. Box 159, N. Chelmsford, Mass. Phone: (617) 251-4921.*

A new high-power crystal-controlled frequency source develops 0.5 W at 3 GHz with low a-m and fm noise characteristics for communication applications. Model FS-220 is completely solid state and requires only a +28-V dc supply. It uses a 95-MHz crystal oscillator as the base frequency, followed by an amplifier/multiplier chain.

CIRCLE NO. 614



## High-gain amplifiers hold noise to 6 dB



Varian Associates, LEL Div., Akron St., Copiague, N.Y. Phone: (516) 264-2200.

Supplying an output power of +5 dBm minimum at 1-dB compression, series OXT-1 solid-state octave rf amplifiers hold noise figures to 6 dB maximum. The new devices operate over the frequency range of 1 to 2 GHz with a 1-dB bandwidth. Their gain is 60 dB, while ripple is only  $\pm 1$  dB. Both input and output impedances are 50  $\Omega$ , and maximum VSWR is 2:1.

CIRCLE NO. 615

## Cw local oscillator supplies 10 mW at 9 GHz



General Electric Co., Tube Dept., 316 E. 9th, Owensboro, Ky. Phone: (502) 683-2401.

Using a small planar X-band ceramic triode, a new cw local-oscillator microwave circuit module typically delivers 10 mW of power output from 9.1 to 9.6 GHz. According to the company, pulsed versions of model C-3007A have been designed to give power outputs of 10 to 100 W at duty factors near 0.001 and pulse durations of 1  $\mu$ s.

CIRCLE NO. 616

## Meet the Members of The Board...

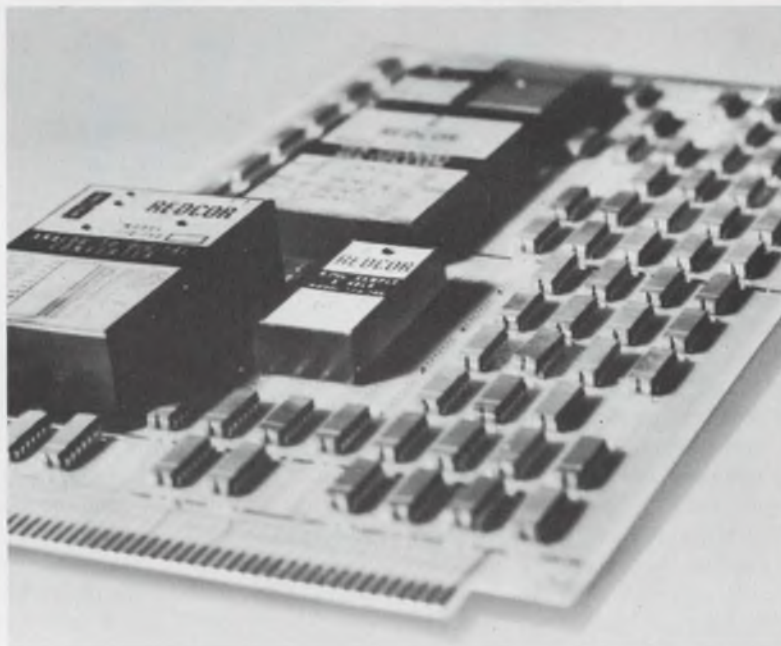

## ...Dual In-Line Conference

For the successful management of analog circuit design, the designer's board members must have background characteristics based upon dynamic response specifications and a proven performance with known sources and loads. The designer's board members must also have the ability to "fit in" with the others whether they be dual in-lines, discrete or flat-pack components. Our packaging configuration allows the designer this freedom.

The guaranteed performance of REDCOR's closed loop module concept frees the system designer from the concern, risk and expense normally experienced with other analog modules.

To support those special circuit and system design requirements, REDCOR can supply not only the modules, but the boards, chassis, and power supplies.

Analog-to-Digital Converters	BUF-FET Ultra Fast Settling Amplifiers
Digital-to-Analog Converters	Dynamic Bridge Amplifiers
Multiplexers	REDIREF Voltage Reference Supplies
Sample and Hold Amplifiers	Comparators
TRICON Fast Settling Amplifiers	

REDCOR's board members come prepared to meet any situation. For a complete catalog listing specified performance, write or call:

**REDCOR**  
CORPORATION

Complete Systems Capability / 7800 Deering Avenue, P.O. Box 1031, Canoga Park, California 91304—(213) 348-5892

INFORMATION RETRIEVAL NUMBER 214

### Terminal tool speeds wiring

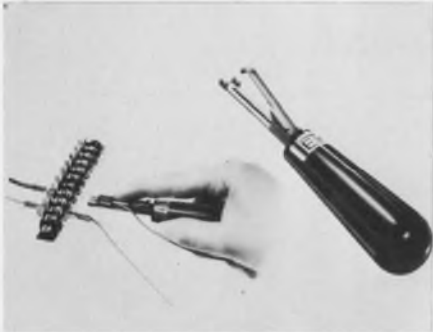

*ETC Inc., 990 E. 67th St., Cleveland, Ohio. Phone: (216) 432-0855.*

Designed for use with both insulated and non-insulated parts, a new tool conveniently and rapidly inserts and removes in-line quick-connect receptacles from male tabs. This new inserter/extractor eliminates the need for operators to hold the receptacle in place with their thumbs since it has a metal finger that locates the receptacle for installation or removal. Three models are available, for tab sizes of 0.11, 0.187 and 0.25 in.

CIRCLE NO. 617

### Ship/store container is made of plastic

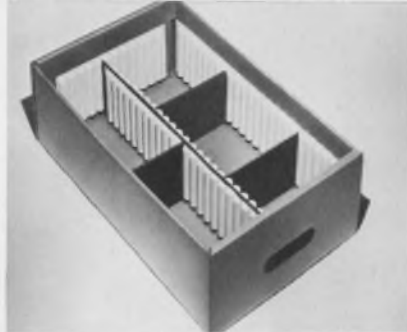

*Shell Containers, Inc., 777 Northern Blvd., Great Neck, N.Y. Phone: (516) 466-4505.*

Claimed to cut costs by as much as 50%, a new durable container is a fusion of rigid plastic members to a plastic-coated fiberboard shell. The Plasticator tray features adjustable slotted inserts for positioning a variety of components, including printed circuit boards, circuit cards and panels. When compartmentized with plain inserts, it can function as a spare-parts container and storage bin.

CIRCLE NO. 618

### Total spray system cleans instruments



*M. P. Odell Co., 26612 Center Ridge Rd., Westlake, Ohio. Phone: (216) 871-8000.*

Providing a practical and economical way to thoroughly cleanse modern electronic equipment, a new cleaning system, model 16, sprays away dirt, dust, oily smoke residue and other leakage-causing contaminants. Such items as large oscilloscopes, digital voltmeters, recorders, and other equipment weighing up to 150 pounds are readily accommodated. Standard features include flood lamp illumination and semi-automatic function controls.

CIRCLE NO. 619



**IEC...**

a world of ideas

### like:

**IEC's MX 500 low level, high speed analog multiplexer**

- 50,000 samples per second
- 5 mv full scale sensitivity
- about sixty dollars per channel (in a 300 channel system)
- no external amplifiers required.



For full information call or write John Norburg,



**INTERSTATE ELECTRONICS CORPORATION**

707 East Vermont Avenue, P.O. Box 3117, Anaheim, California 92803 (714) 772-2811

A Subsidiary of "Automatic" Sprinkler Corporation of America



## Single-stage rinser bubbles wafers clean

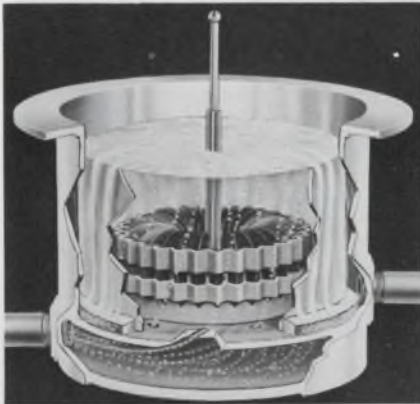

Fluoroware, Inc., Industrial Pk  
County Road 17, Chaska, Minn.  
Phone: (612) 448-3131. Price: \$65.

A new single-stage rinser uses moving water and nitrogen bursts to achieve rapid cleaning of wafers, substrates, and optical lenses. The rinser is a tank within a tank; water and nitrogen are introduced through angle-drilled holes in the bottom of the inner vessel. The gentle swirling of the incoming water and the scrubbing action of thousands of nitrogen bubbles creates a fast efficient cleansing action.

CIRCLE NO. 620

## Laser tooling system offers repeatability

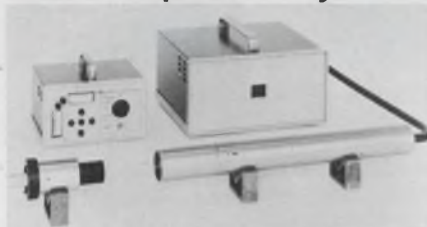

Electro Optics Associates Inc., 974  
Commercial St., Palo Alto, Calif.  
Phone: (415) 327-6200. P&A: from  
\$5445; 30 to 60 days.

Featuring precise measurement repeatability, a new laser tooling system with autoreflexion can repeat angular measurements of 0.2 arc-seconds or linear measurements of 10 microns per foot. Called LTSAR, the new system can also be used also for the determination and monitoring of small angles and angular deformations.

CIRCLE NO. 621



# Generation Gap

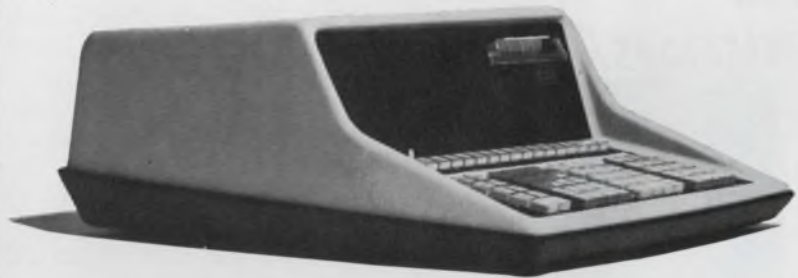

## The Wang 700 Calculator is a whole lot smarter than its predecessors.

It's the first of a new breed, a third generation programmable calculator. The difference is more revolutionary than evolutionary. It's ten times faster and more powerful than the best of the 2nd generation machines. It handles far longer programs (learns on a built-in 8192-bit core and stores permanently up to 10 blocks of 960 steps each on snap-in magnetic tape cassettes), has many more data storage registers (up to 120), and provides more hardware operations (like logs to base e and base 10,  $\pi$ ,  $e^x$ ,  $10^x$ , etc.), than any existing calculator or so-called desk-top computer.

Execution speeds for various functions range from 300  $\mu$ sec for + and - to 250 msec for trig functions. A dual Nixie-type display produces 12 digit answers plus 2-digit (-98 to +99) exponents each register.

The Wang 700 has commands for loops, branches and subroutines, unmatched power for matrix and array operations. Exclusive integrated circuit design concentrates all these capabilities into a self-contained, convenient desk-top package. It's the logical heir to Wang leadership in high performance problem-solving.

 **WANG**  
LABORATORIES, INC.

Dept. 00, 836 North St., Tewksbury, Massachusetts 01876 • Tel. 617 851-7311

### Call today!

(201) 272-7160	(301) 588-3711	(314) 727-0256	(505) 255-5775	(612) 881-5324	(714) 234-5651
(203) 288-8481	(301) 821-8212	(315) 463-9770	(512) 454-4324	(614) 488-9753	(716) 381-5440
(205) 881-5360	(303) 364-7361	(317) 631-0909	(513) 531-2729	(615) 523-8648	(717) 236-4782
(206) 525-2000	(304) 344-9431	(404) 633-6327	(515) 288-5991	(616) 454-4212	(805) 962-6112
(212) 682-5921	(305) 563-8458	(412) 366-1906	(516) 437-2500	(617) 851-7311	(808) 536-5359
(213) 776-2985	(305) 841-3691	(414) 442-0160	(517) 835-7300	(617) 542-7160	(813) 877-6590
(214) 361-7156	(309) 674-8931	(415) 692-0584	(518) 463-8877	(702) 322-4692	(816) 444-8388
(215) 642-4321	(312) 297-4323	(502) 426-1116	(601) 982-1721	(703) 595-6777	(817) 834-1433
(216) 333-6611	(313) 352-2144	(504) 729-6858	(608) 244-9261	(703) 359-6320	(918) 747-0018
				(713) 668-0275	(919) 272-5683

INFORMATION RETRIEVAL NUMBER 216



**WHY SHOULD YOU  
SPECIFY  
MECATORN®  
SPUN  
REFLECTORS?**



The exclusive Torngren Mecatorm® hydraulically controlled spinning process has produced thousands of spun-to-specification "dishes" in use today by both military and commercial communication networks — at substantial savings over other more costly fabricating methods.

If you have a requirement for parabolic reflectors from 4 inches to 16 feet in diameter call Torngren today for complete details on the cost saving and metallurgical advantages of the Mecatorm® process.

*Send for a free copy of our new capabilities brochure today!*



**C.W.**

**TORNGREN**  
COMPANY, INC.

INFORMATION RETRIEVAL NUMBER 217

# Evaluation Samples



## Dafting aids

Eliminating much of the material waste and increasing the regularity of master artwork for printed circuits, a line of electronic component drafting aids now includes sequential reference numbers from 1 through 200, plus 12 letters. The new numbers and letters are available in five sizes for 1X, 2X, 4X, and 5X scales. They are precisely printed on matte acetate film with pressure-sensitive backing. These die-cut products are ready for instant use. Free samples are available. Bishop Graphics, Inc.

CIRCLE NO. 622



## Tabbed PC board

Bridging the gap between interconnect wiring of conventional components and contemporary solid-state printed circuit boards, a new PC terminal board features standard fast-connect terminal tabs. The tabs, which are available from existing tooling, include 0.11, 0.187, 0.205 and 0.25 in. and enable designers to use existing equipment to produce wiring cables. The new terminal boards adapt directly to all standard fast-connect connectors, thus lowering interconnect wiring costs. Wiring layouts are custom-made to suit individual needs. Free samples are available. Doran Manufacturing Co.

CIRCLE NO. 623

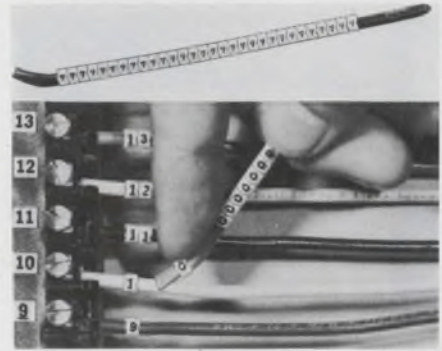

## Wire markers

Clip-Sleeve wire markers are now mounted on a new applicator wand for direct wand-to-wire application. The markers move off the flared end of the wand with a simple finger motion, flex open, and snap firmly onto the wire without slipping or sliding. This means that the markers can be fixed in place any time, before, during or after hook-up, without disturbing the connection; they can also be easily removed to change identification. Free evaluation samples are offered. W. H. Brady Co.

CIRCLE NO. 624

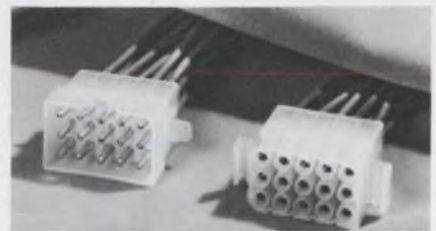

## Universal connector

A new international connector, model 1991-15 is designed to meet European and Japanese, as well as United States, specifications. This 15-circuit nylon connector features integrally molded mounting ears that enable it to be snap-locked into a panel without hardware. Maximum terminal protection is provided by a honeycomb design that essentially isolates each male terminal; the plug and receptacle are also keyed to prevent mis-mating. Crimp-type male and female terminals may be inserted in either plug or receptacle. For a free sample, use the information retrieval card. Molex Products Co.

CIRCLE NO. 625



# When the chips are down, they ought to be on our IC packages.

It's not just because we want to sell our products (which we do).

Or because we're proud of them (which we are).

We think you should buy our IC packages for a number of reasons.

First of all, we make all our own parts. (Many of our competitors must buy frames and ceramics for assembly.)

We assemble the packages ourselves.

We test our packages for insulation, thermal shock resistance, hermeticity, lack of internal shorts, excess glass-ceramic flow.

And if one of our growing line of packages

doesn't fit your requirements, we'll design one that will.

One more thing. Just because you're getting the best IC package money can buy, don't think it takes a lot of money. In fact, ours probably costs less than any others.

Isn't that where you should put your chips? Sylvania Metals & Chemicals, Parts Division, Warren, Pennsylvania 16365.

**SYLVANIA**  
GENERAL TELEPHONE & ELECTRONICS

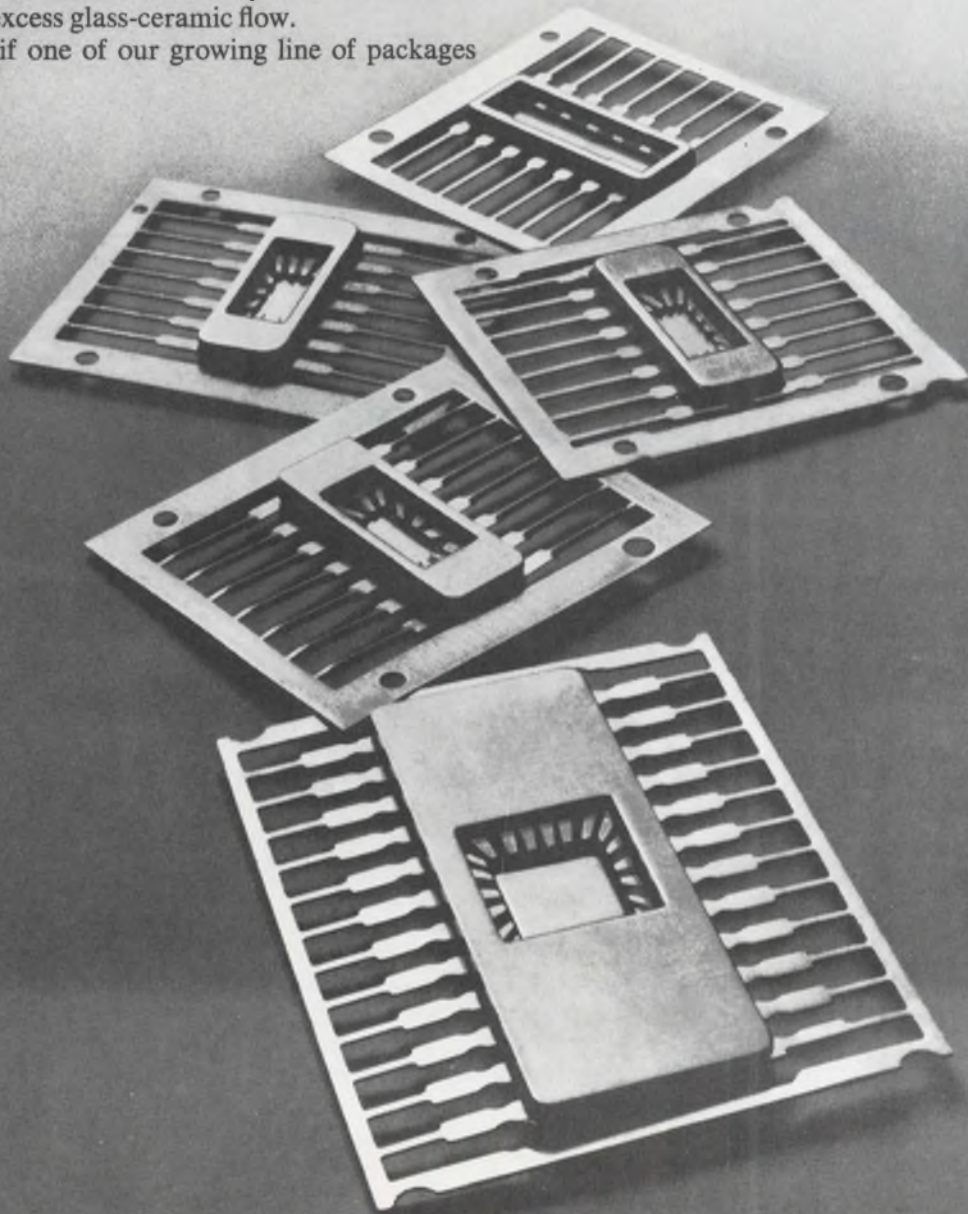



# Design Aids



**EMI**  
**four  
 stage  
 magnetically  
 focused  
 image  
 intensifier  
 9694**

... offers an overall light gain of  $10^6$  with a typical background of  $10^{-10}$  lumens/cm<sup>2</sup>. (light equivalent input.)

Typical operating voltage for these conditions is 40kV. The background indicated is for a tube having bialkali photocathodes,—tubes are also available with a range of S-20 cathodes for use out to 8,000 Angstroms. Input and output windows are flat Zinc crown glass, 50 mm diameter. Type 9693 is available with sapphire input window for use in the UV. Developmental types are now being made with fibre optic windows. All present types are furnished with P-11 phosphors throughout although other types of phosphors are under investigation. □ Tubes are normally supplied potted in silicon rubber and a number of variations are available. A complete package, including electromagnet, divider chain, high voltage power supply and magnet supply is offered. A permanent magnet is also available. □ An extensive technical manual, as well as useful application notes, are available on request. Write on your company letterhead to:

**GENCOM DIVISION**  
**varian/EMI**

80 EXPRESS STREET, PLAINVIEW, N. Y. 11803  
 TELEPHONE: (516) 433-5900

INFORMATION RETRIEVAL NUMBER 219

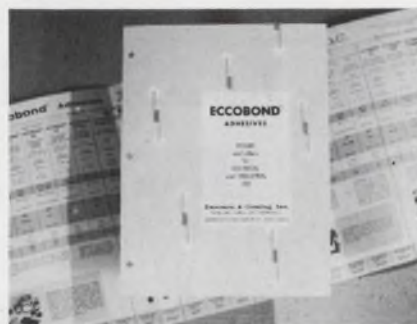

## Adhesives chart

A chart from which Eccobond adhesives may be selected is now available at no charge. Many of these adhesives are presented in such a manner as to allow comparison of various data—for example, shear strength, viscosity, and thermal expansion coefficient. There are also many other specifications included in this colorful presentation. Emerson & Cuming, Inc.

CIRCLE NO. 626

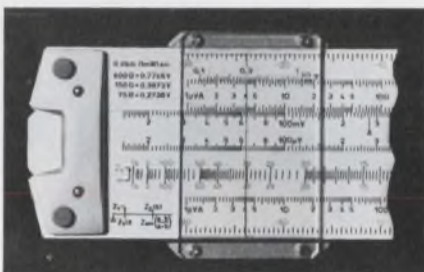

## Electronic slide rule

Specially developed for resolving problems in the electronic and electrical fields, a new easy-to-read slide rule comprises 18 scales with clear gradations that permit calculations with a relative error as low as 1 to 2% and a saving in time of up to 60%. Decimal-point setting by evaluation is unnecessary since the scales allow a direct reading. Applications include Ohm's law, output power law, apparent and effective reactive power, amplification and attenuation, dBm level, parallel connections of resistance or inductance, and series connections of conductors or capacitance. It costs \$27.75; a leather case, full instructions and graphic illustrations are included free. Cal-tronic Lab.

CIRCLE NO. 627



## Core calculator

A durable powder core and ferrite pot core calculator quickly solves equations relating flux to voltage, current to magnetizing force, wire to space factor, inductance to turns, capacitance to frequency, and inductance to frequency and dc resistance. Intended to help inductor, choke and filter designers, the new slide rule easily selects the core that best meets physical requirements and gives the highest valuable Q. An instruction book is included. The calculator is supplied free to qualified engineers. Magnetics Inc., Components Div.

CIRCLE NO. 628

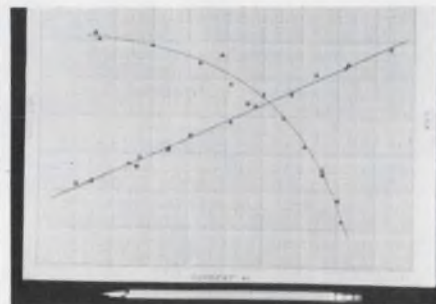

## Log graph paper

Ideal for probability plots, extended-range logarithmic graph paper is designed to handle data where the range of the variable observed covers many orders of magnitude. Type SA-8 graph paper eliminates the old-fashioned and time-consuming chore of trimming, matching and taping together several pieces of graph paper with limited ranges. The extended range also permits plotting of several sets of data on the same sheet for comparison and/or multiple displays. There are up to 10 log cycles on a single sheet. Free samples are available. INFO Inc.

CIRCLE NO. 629



### microglass zeners

1, 3 and 5 watt units in voltages ranging from 6.8 to 200 volts.

### microglass rectifiers

1, 3 and 4 amp units with recovery times as low as 80 nanoseconds.

**They're priced below comparable microglass devices. Ask us about them!**

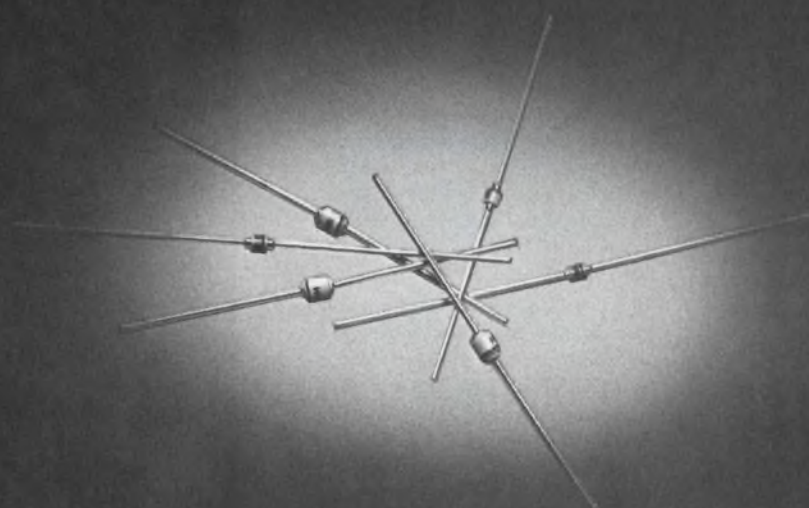

actual size

**we're getting very large  
in very small components  
built for macro performance  
at micro prices**



**CENTRALAB  
SEMICONDUCTOR**

Division  
GLOBE-UNION INC.  
4501 NORTH ARDEN DRIVE  
EL MONTE, CALIFORNIA 91734

Zeners, temperature-compensated devices, tunneling diodes, rectifiers, scr's, silicon semiconductor chips and photovoltaic products

# Remex 3000 Series Readers have Fiber Optics



Fiber optics are a Remex exclusive. That's why a Remex reads with the greatest perception. The greatest sensitivity. The greatest reliability.

The reading light source is a quartz iodine lamp that has a 15,000-hour life (another Remex exclusive). A fiber optic distributor converts the uniform spot beam



from a round to rectangular shape. Prevents signal confusion by improper diffusion. Super-sensing of data is the job of a combination fiber optic faceplate and rejection tunnel scheme. Enabling a Remex to successfully read program tapes up to 70% transparent. Or tapes that vary in color.

If you're designing computers, numerically controlled systems, or automatic test equipment, call us at 213-772-5321 or write for free literature: Remex Electronics, 5250 W. El Segundo Blvd., Hawthorne, California 90250. Remex will give program tapes some extra sensory perception.

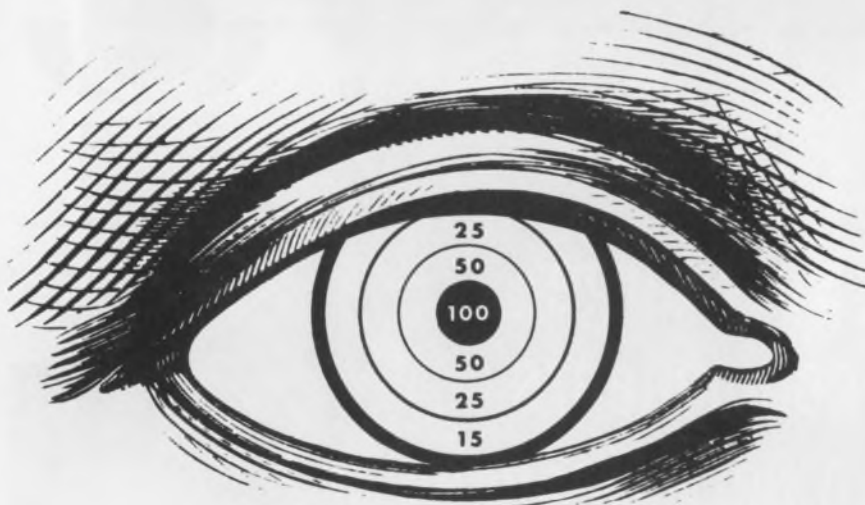

See us at the WESCON Show Booths 5503-5504.



In Europe and the U.K., contact S.p.A. Microtecnica, Torino, Italy.

INFORMATION RETRIEVAL NUMBER 784

## Annual Reports

Learn how to read annual reports in "How to investigate a company." For a copy, circle no. 474.

**AMP, Inc.,** Harrisburg, Pa.: connectors, connection systems, production equipment, cables, lab instruments; net sales, \$167,172,000; net income, \$16,227,000; total assets, \$87,137,000; total liabilities, \$30,747,000.

CIRCLE NO. 630

**Indiana General Corp.,** 405 Elm St., Valparaiso, Ind.: magnetic materials, magnets, memory cores, plated wire, motors, test equipment, castings; net sales, \$32,175,930; net earnings, \$2,227,004; assets, \$14,388,344; liabilities, \$3,059,826.

CIRCLE NO. 631

**International Electronics Corp.,** Melville, N.Y.: semiconductors, ICs, vacuum tubes, components, meters, amplifiers; net sales, \$8,288,895; net income, \$382,330; assets, \$3,937,344; liabilities, \$2,128,190.

CIRCLE NO. 632

**Kings Electronics Co., Inc.,** 40 Mabledale Rd., Tuckahoe, N.Y.: rf, computer, medical and radiation-resistant connectors; net sales, \$4,968,399; net income, \$372,982; assets, \$2,202,664.

CIRCLE NO. 633

**Missouri Research Laboratories, Inc.,** 2109 Locust St., St. Louis, Mo.: radar target simulators, defense products, aircraft tools and fixtures, cabinets; net sales, \$15,607,614; net earnings, \$1,061,632.

CIRCLE NO. 634

**Transvac Electronics Inc.,** 270 Newton Rd., Plainview, N.Y.: recorders, instruments, metal fabrication, data processing, cable; net sales, \$909,221; net income, \$109,010; assets, \$854,054.

CIRCLE NO. 635



# Pay 25% Less\* and get 500% Greater Reliability

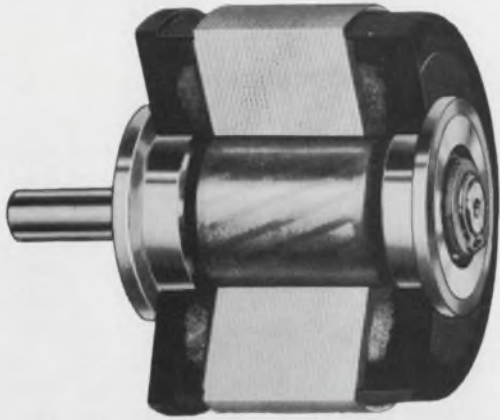

## with CEDAR'S New JETLINE Servo Motor

No one else offers  
so many features designed to increase  
reliability and lower cost.

FEATURE	ADVANTAGE
FILLED-EPOXY MOTOR BODY	SIMPLICITY OF DESIGN (FEWER PARTS) • LOWERS COST
FULL-DIAMETER STATOR	NO METAL HOUSING • STATOR IS FULL DIAMETER OF THE MOTOR • ALLOWS MORE ROOM FOR THE WINDINGS
MACHINE-WOUND STATOR	ELIMINATES HAND INSERTION OF COILS • ASSURES HIGHEST RELIABILITY • LOWERS COST
LARGE FLANGED BEARINGS	DISSIPATE HEAT FASTER • RUN COOLER TO PROTECT THE LUBRICANT • OUTLAST CONVENTIONAL MOTOR BEARINGS
MOLDED STATOR INSULATION	CONTROLS INSULATION THICKNESS • ELIMINATES THIN SPOTS IN CRITICAL AREAS
SINGLE-DIAMETER BORE	ELIMINATES CONTAMINANT TRAPS INSIDE MOTOR
AVAILABILITY	STANDARD SIZE 8, 10 AND 11 MOTORS FROM STOCK • SPECIALS ON REQUEST
PRICE	LOWEST IN THE BUSINESS • *FROM \$16.50 EACH

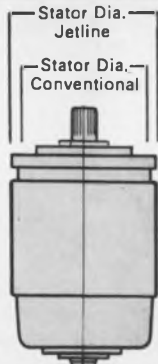

Size 8 Jetline  
Shown Full Scale

JETLINE Motor-Tachs to be available soon.

Digital Indicators • DC Low Inertia Motors • Stepper Motors • Stepper Drive Circuits • DC Torquers • Rotary Solenoids • AC Motors • Motor-Tachs • Resolvers • Accelerometers • Synchronous Hysteresis Motors • LVDTs • Motor Gear Heads • Subminiature Rate Gyros • Synchros • Servo Packages • Servo Motors

**CEDAR CONTROL DATA**  
DIVISION CORPORATION

5806 West 36th Street, Minneapolis, Minn. 55416  
Phone: 612/929-1681

INFORMATION RETRIEVAL NUMBER 785

ELECTRONIC DESIGN 17, August 16, 1969

# target/radar alignment



MODEL 345C

The Vega C-Band Transponder Model 345C features a single-knob tuning control which simultaneously tunes both receiver and transmitter from the front panel. This eliminates the need for support equipment for tuning to the tracking radar frequency. Even untrained personnel can tune to radar frequency in 5 minutes in the field or aboard ship. The 345C is extremely useful in airborne applications where the exact tracking frequency is not specified prior to the operation. This unit is compact (56 cu. in.), lightweight (43 oz.) and maintains the electrical and environmental characteristics required of superheterodyne transponders in missile, satellite, drone and target applications.

**Vega Precision Laboratories, Inc.,**  
239 Maple Avenue W., Vienna, Virginia 22180  
Phone: (703) 938-6300



INFORMATION RETRIEVAL NUMBER 786

# Application Notes

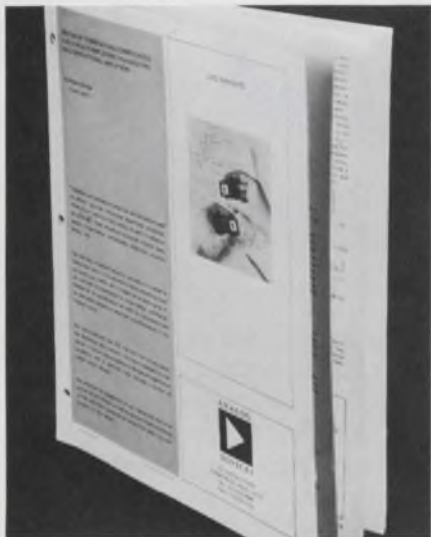

## Op amp log circuits

Combining theoretical analysis and practical circuit design information, a 12-page technical article summarizes the concept of logarithmic elements for use in operational amplifier external feedback circuitry. The booklet reviews basic transistor characteristics, the error problems caused by transistor sensitivity to junction temperature variation, guidelines for amplifier selection, and a practical discussion of six representative op amp circuits. Analog Devices, Inc.

CIRCLE NO. 636

## High-alumina ceramics

The new 16-page edition of "Standards of the Alumina Ceramic Manufacturers Association for High-Alumina Ceramics" provides information for variety of dielectric, mechanical, chemical, and abrasion-resistant applications. Data and tables are included on high-alumina ceramic properties, test methods, manufacturing procedures, design fundamentals, dimensional tolerances, surface finish, visual requirements, quality assurance, nuclear radiation resistance, metallizing, and recommended uses. Diamonite Products Manufacturing Co., Div. of U. S. Ceramic Tile Co.

CIRCLE NO. 637

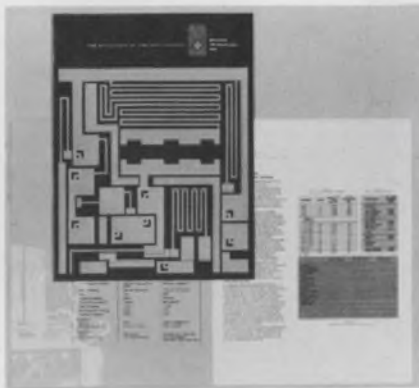

## Thin-film hybrids

"The Structure of Thin Film Hybrids" is a 12-page brochure that contains a technical review of thin-film hybrids, the seven steps of manufacture, the comparative merits of thin-film and thick-film configurations, and the specifications required for ordering from a manufacturer. In addition to this basic information, the text includes a table for the conversion of thin-film dimensional units which are often used interchangeably to describe thickness. Sensor Technology Inc.

CIRCLE NO. 638

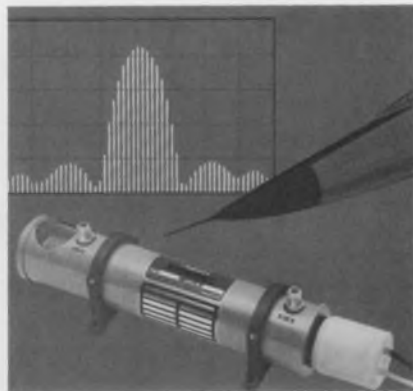

## Pulse TWTs

High-power pulse traveling wave tubes are the subject of a 10-page brochure. Phase and amplitude sensitivity, phase linearity, intermodulation distortion and harmonic power output are discussed. Also given is performance data, applications information and power/frequency curves. Varian, TWT Div.

CIRCLE NO. 639

## Inductor facts

Equivalent circuits for inductance and capacitance, an explanation of distributed capacitance, and the meaning of inductor specifications are discussed in a 16-page engineering handbook. Specifications are given for communications-grade variable inductors that mount on printed circuit boards and have a recommended frequency range of 500 Hz to 50 kHz. Performance curves depict typical Q versus frequency, typical tuning range, inductance versus temperature, and typical self-resonant frequency versus time inductance. Sangamo Electric Co.

CIRCLE NO. 640

## Laser applications

Several new and effective techniques for applying CO<sub>2</sub> lasers to difficult material cutting problems are summarized in a six-page illustrated report. Sheets of hard-to-work metals, microelectronic ceramic substrates, synthetic textiles, superstrength composites as well as many types of plastic, glass, rubber and wood can be separated with ease compared to conventional methods. Coherent Radiation Laboratories.

CIRCLE NO. 641

## Motor control

Shunt-motor control and load-matching methods are simplified in the most recent issue of "Motorgram" (Vol. 49, No. 3). Seven equations and how to apply them are given for motor operation in terms of field and armature current variables. The control used determines the speed-torque characteristics and motor responses that will result. A properly controlled shunt motor incorporated into a radioisotope scanner is featured in a related article. Bodine Electric Co.

CIRCLE NO. 642





What does our **muffin<sup>®</sup> fan** have that other 4<sup>11</sup>/<sub>16</sub>" square fans do not?

# RELIABILITY

Performance in excess of 90,000 hours can be expected from 90% of all "muffin fans" manufactured. That's reliability unmatched by any other 4<sup>11</sup>/<sub>16</sub>" square fan. So . . . where life really counts, and where 100 cfm of cooling air is required you can rely on "muffin fans" to perform longer than others, in computer equipment, copying machines, receivers and transmitters, power supplies, and countless other applications.

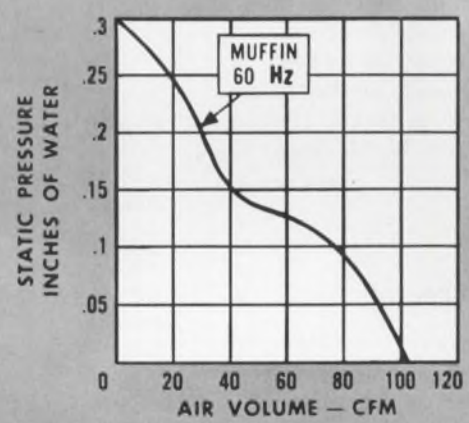

For full details on performance, application, life and other pertinent data be sure to send for our latest catalog sheet. Write to Rotron, Incorporated, Woodstock, New York 12498.

CALL YOUR ROTRON

**4-WARD**  
DISTRIBUTOR

<p>WEST R. V. WEATHERFORD CO. GLENDALE, CALIF. 213-849-3451</p>	<p>MIDWEST ALLIED ELECTRONICS CHICAGO, ILL. 312-829-9121</p>	<p>SOUTH HALL-MARK ELECTRONICS CORP. DALLAS, TEXAS 214-231-6111</p>	<p>EAST SCHLEY ELECTRONICS CORP. WATERTOWN, MASS. 617-926-0235</p>
---	--	---	--



Visit ROTRON at WESCON Show Booth No's 3901-02-03.

# New Literature



## Temperature paints

Covering the line of 34 DetectoTemp temperature-indicating paints and pigments, a six-page brochure presents applications, techniques and conditions for use, advantages, specifications, and availability charts for ordering and pricing. Generally used for preplanned monitoring and recording of temperature changes on large surfaces, DetectoTemp paints cover temperature ranges from 104 to 2462° F. Each color change is distinctive and readily visible even from a distance. Metal Chem Div., W. H. Brady Co.

CIRCLE NO. 643

## Instrument rentals

A new 20-page two-color publication listing electronic instruments available for lease or rental, presents evaluations of the instruments offered, in terms of their range, function, accuracy, balanced against their cost and most useful applications. Thus, many instruments are singled out as "best deals" by a system of single and double check marks. Included are digital voltmeters, multimeters, counter/timers, oscilloscopes, recorders, pulse/signal/function generators, microwave instrumentation, analog meters, bridges, and power supplies. Scientific Leasing Services, Inc.

CIRCLE NO. 644

## Visual aid guide

Offering practical data for the selection of the correct visual aid, a new publication incorporates a dozen useful charts and tables. These range from one that shows audience capacity in terms of size of screen, seating area, and number of persons, to one that tells the playing time of tape, based on reel size, length of tape, and speed. Other tables show the size of letter needed for various audiences, relative color contrasts, and size of screen required. Admaster.

CIRCLE NO. 645

## Light sources

Covering a line of high-intensity light sources, electronic accessories and related products, a new 12-page two-color publication offers general and technical information on mercury and xenon short-arc lamps, flash lamps, mercury capillary lamps, power supplies, pulse generators and lamp housings. PEK Inc.

CIRCLE NO. 646

## Computer terminal

A new reference manual provides complete specifications for the AGT/5 computer graphics terminal. The AGT/5 contains its own digital processor that has a 30-bit 2- $\mu$ s memory, expandable to 32k directly addressable words. Adage, Inc.

CIRCLE NO. 647

## Power supplies

Containing specifications, dimensions and prices, a new short-form catalog lists dc power supplies, over-voltage protectors and filters in output voltages from 3 to 200 V dc and currents from 35 mA to 48 A. Also shown are unregulated, dual-output, vacuum-tube and custom power supplies, as well as filters compatible with the unregulated units. Dressen-Barnes Electronics Corp.

CIRCLE NO. 648



## Antennas and lines

Offering performance data for antenna system engineers, a new 100-page catalog contains complete information on antennas and transmission lines. Described are microwave antennas and waveguides, telemetry and fixed station antennas, antenna positioners and solid dielectric cables, flexible and rigid coaxial lines, and switching and pressurization equipment. Andrew Corp.

CIRCLE NO. 649

## Naval SHP connectors

Amplly illustrated, a new 16-page catalog features complete mechanical specifications on many of the basic headers and connecting receptacles used in the NAFI Standard Hardware Program (SHP). Methode Electronics, Inc., Connector Div.

CIRCLE NO. 650

## Digital readouts

A new six-page bulletin gives information on miniature digital display readouts, decoder/driver modules, and incandescent lamps. Along with design specifications, coding requirements, truth tables and electrical requirements is included design information on a complete line of miniature connectors. Pinlites Inc.

CIRCLE NO. 651



This new automation solution can reduce your operating costs and increase the yield of better quality products. It's a whole new 4th generation product line . . . we call it System 18/30.

System 18/30 is a family of compatible GA automation computers designed to work in distributed management information and control systems. The GA worker-level computers permit the user to automate at the primary control loop first, with predictable results and costs — and then add to these automation functions GA supervisory-level computers for total process optimization.

Heart of our new System 18/30 is the 1804 processor, which is software compatible at the binary code level with the IBM 1800 and 1130 computers and will work with or extend existing IBM 1800 installations . . . and do the work more effectively and at a lower cost.

The 1804 acts as a supervisory computer for several SPC-12 dedicated computers. SPC-12 is our primary control loop computer or worker computer. It ties to your machines, devices, communication networks, sensors and instruments through our unique family of mini-controllers to form a primary control loop automation system. With GA unique Product Software, control pro-

grams can be accomplished quickly, economically, and on a fixed price basis.

GA terminals, communication pre/post processors, process I/O, and data processing I/O, and computer to computer couplers provide the system building blocks required to take on large scale automation projects on a predictable cost and result basis.

Our Automation Sciences Division will provide all the process analysis, engineering, programming, installation and start-up service you need.

Our System 18/30 Brochure will tell you all about this new computerized automation solution. Write for it today.

# Breakthrough In Automation Solutions

## From General Automation



**GENERAL AUTOMATION, INC.** 706 West Katella, Orange, Calif. (714) 633-1091  
Automation Products Division

Sales Offices: Waltham, Mass. (617) 899-6170 • New Rochelle, N.Y. (914) 235-9300 • Silver Spring, Md. (301) 593-6010 • King of Prussia, Pa. (215) 265-6525 • Atlanta, Ga. (404) 261-6203, 261-6204 • Cleveland, O. (216) 351-2275 • Des Plaines, Ill. (312) 298-4650 • Dallas, Tex. (214) 358-0271 • Los Altos, Calif. (415) 941-5966 • Orange, Calif. (714) 639-3791

SEE SYSTEM 18/30 AT WESCON, BOOTH 4734

**NEW**



**SHIELDED BOXES with CARD GUIDES**

Rugged die-cast aluminum boxes, slotted to accept  $\frac{1}{8}$ " circuit boards and shielding dividers. Excellent for packaging electronic circuitry. Boxes have removable top and bottom covers. Useable inside space: 4"x2"x1 $\frac{1}{2}$ ". Several models with various connectors.

Write for 1969 Catalog

**POMONA ELECTRONICS CO., INC.**  
1500 E. Ninth Street, Pomona, California 91766

INFORMATION RETRIEVAL NUMBER 789



**NEW HERMETIC  
TINY PAK™  
201 & 741 OP AMPS**

**For Hybrids and  
Conventional  
Circuit Boards.**

New TINY-PAK™ OP AMPS by MINI-SYSTEMS, INC. provide guaranteed electrical performance in a miniature hermetic flat pack much smaller than any now available in the industry. The diameter of this package is approximately twice the maximum dimension of I C OP Amp dice.

This package has been perfectly tailored to the die, thus maintaining its "size advantage" and at the same time providing ideal environmental protection. Standard Lead spacing of .050" eliminates the need for special equipment and skills in handling, testing and mounting. Each TINY-PAK™ OP Amp is thoroughly tested for compliance with device specifications and further screened for abnormally high noise and capacitive loading instability. This provides a bonus in performance and reliability.

Applications include all those of conventional "101" and "741" types, plus those now made possible and practical by the miniature size of the TINY-PAK™. TINY-PAK™ "101/201" and "741/741C" I C OP Amps are available from stock. Other types are available on special order, e.g.: 100, 101A, 102, 107 & 108.

**Price: \$9.50,** "201" or "741C", quantity 1-24.  
f.o.b. North Attleboro, Massachusetts.

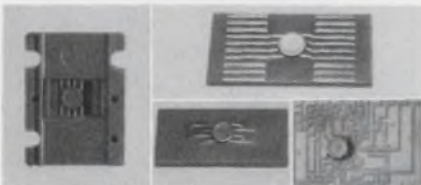

TINY-PAK™ op amps are handled and tested in standard Barnes carriers. Leads can be bent for insertion into PC boards or soldered or welded to ceramic substrates.

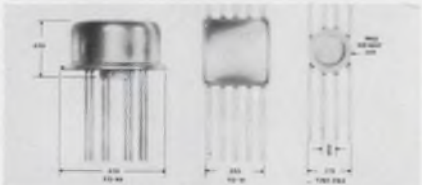

Note standard .050" spacing between .017" x .005" TINY-PAK™ leads.



For further information, write or call:

MINI-SYSTEMS, INC., P.O. Box 429, North Attleboro, Massachusetts 02781 (617) 695-0208  
INFORMATION RETRIEVAL NUMBER 790

NEW LITERATURE

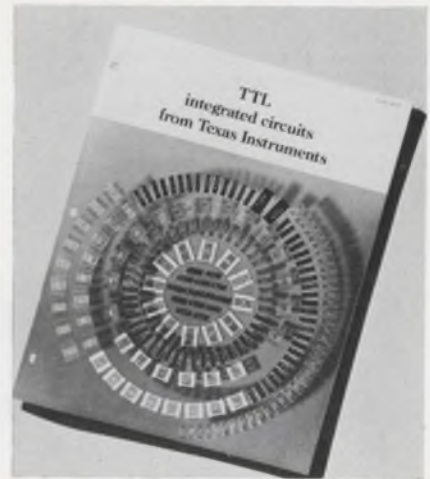

**TTL integrated circuits**

Three series of TTL integrated circuits are described in an 80-page catalog that features typical applications, truth tables, design loading rules and pin configurations. The three series comprise standard, high-speed and low-power devices. In addition, there are 35 MSI integrated circuits presented, including data selectors/multiplexers, decoders, memories/latches, shift registers, counters, parity generator/checker and arithmetic elements. Texas Instruments Inc.

CIRCLE NO. 652

**Count controllers**

Telling of series 310D impulse count controllers, a new four-page bulletin describes their principles of operation, shows three methods for incorporating them into control circuits, and illustrates switch operation throughout the counting cycle. In addition, detailed specifications are provided, along with outline and mounting dimensions. Automatic Timing & Controls, Inc.

CIRCLE NO. 653

**PC-board machines**

Complete with descriptions, specifications and dimensions, a new 16-page catalog describes seven numerically controlled drilling machines with from 4 to 12 drilling spindles, a tape programmer and inspection machine, and a new computerized controller. Digital Systems Inc. a sub. of Resdel Engineering Corp.

CIRCLE NO. 654





### Telemetry modules

A 40-page catalog describes a line of fm-fm telemetry modules, including voltage-controlled oscillators, dc amplifiers, dc signal isolators, frequency-to-dc converters, tone oscillators, pressure transducers and a laboratory telemetry system. All of these units are miniature solid-state devices and can be used for military, industrial and research applications. Solid State Electronics Corporation

CIRCLE NO. 655

### Switches

Rotary and pushbutton switches are the subject of a 20-page bulletin. Included are miniature rotary switches for printed-circuit use, tamper-proof key-lock versions, isolated positions and spring return styles; and miniature and lighted pushbutton switches, and bi-pin lamp sockets. Grayhill, Inc.

CIRCLE NO. 656

### Switching hints

Eight switch applications for industry, recreation and research are offered for plant engineers, electricians and maintenance men in the latest issue of "Micro Tips." The four-page two-color publication reviews the prevention of jamming on conveyor belts, the counting of hot steel strips, instrument protection, and a sequencing control in radio transmitters. Micro Switch, a div. of Honeywell Inc.

CIRCLE NO. 657

# Waters' AND ONLY WATERS' JP/2 RK09 POT conforms to MIL-R-39002/1B

This miniature wirewound trimmer (half inch diameter, quarter inch deep and half an ounce) is designed for extended reliability with performance specified at end of life, and ruggedly built for high temperature operation (150°C). Operational life is long term, with negligible degradation; ENR less than 5 ohms regardless of resistance values.

Options, many not available elsewhere, include non-standard resistance values; sealed bases, special mounting configurations; plain or split bushings; continuous rotation.

Only Waters, with the JP/2, conforms to MIL-R-39002/1B and it is available to you now at competitive price for industrial applications.

#### JP/2 SPECIFICATIONS — STANDARD

Resistance Range	20Ω to 20K
Standard Resistance Values	50, 100, 200, 500, 1K, 2K, 5K, 10K, 20K
Independent Linearity	±3%
Equivalent Noise Resistance	5Ω Max.
Temperature Range	-65° to +150°C
Power Dissipation Rating	2W @ 85°C derated to 0 at 150°C

From Waters now — a complete line of MIL-Spec precision potentiometers, standard or custom, wirewound, linear or non-linear, or with MystR Conductive Plastic. Write for complete catalog.

**WATERS** MANUFACTURING, INC.  
WAYLAND, MASSACHUSETTS 01778



# 75 MILLION CYCLES

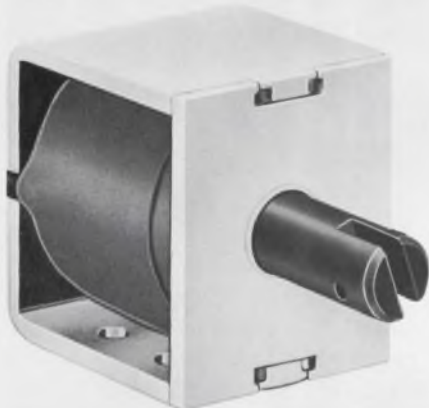

## 15 TIMES BETTER than average solenoid life

75,000,000 cycles of operation...yes, that's what we said! All of the wide range of solenoid types made by Deltrol Controls are available with an optional fusion-bonded, plastic coated plunger that has been life-tested up to 75 million cycles and is still going strong. Will it quit? Yes, but we don't know when.

One of America's largest line of solenoids also feature:

- PULL AND PUSH TYPES
- NO RESIDUAL MAGNETISM
- HIGH FORCE "POWER SURGE" RATINGS
- OPTIONAL MOLDED COILS
- COATED PLUNGERS RESIST CORROSION
- DELIVERY FROM STOCK ON STANDARD TYPES & RATINGS



RELAYS SOLENOIDS TIMERS

## DELTROL CONTROLS

1374

2745 So. 19th St. Milwaukee, Wis. 53215  
Phone (414) 671-6800 Telex 2-6871

INFORMATION RETRIEVAL NUMBER 792

### NEW LITERATURE



#### Welding equipment

Precision welding equipment is described in a new 20-page catalog that covers a complete line of modular stored-energy welding equipment and accessories. Included are welding heads for every application, all solid-state supplies in a wide choice of power and energy ranges, and welding accessories like air actuators for heavy-duty welding heads. There is also a complete listing of electrodes with a helpful guide to the proper selection of electrode material. Unitek Corp./Weldamatic Div.

CIRCLE NO. 658

#### Pressure-sensitive tape

A new multi-color folder describes a wide variety of products made from pressure-sensitive tape. These include double-faced die-cut masks, identifying numbers and letters, printed panel circuit pads, valve and tool symbols, chart and graph tapes, and emblems and dots. M & C Specialties Co.

CIRCLE NO. 659

#### Piezoelectric ceramic

A four-page bulletin describes a piezoelectric ceramic intended for applications in the ultrasonics industry. Properties such as mechanical Q, useful temperature range and aging are discussed. A complete table of constants for the material and graphs showing the effects of temperature on its properties are included. General Electric Co.

CIRCLE NO. 660

### Q - What is a Break-Out Box?

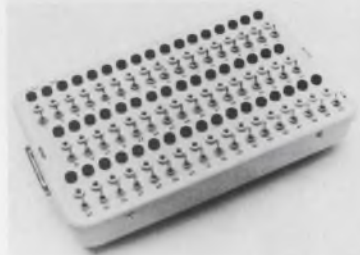
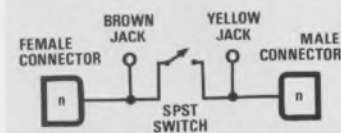

A — A Break-Out Box is designed to reduce hook-up and testing time. It offers a convenient method to measure or interrupt voltages, currents, and/or signals between any two pieces of equipment. A flip of a switch instantly opens or closes any circuit. Cumbersome shorting plugs are no longer necessary. It comes in a variety of connector configurations, is of rugged construction, low in cost, and available off-the-shelf.

**TECHNICAL ASSISTANCE LABORATORIES**  
3530 Torrance Blvd.  
Torrance, California 90503  
(213) 371-2536

INFORMATION RETRIEVAL NUMBER 793

### 21.4 MHz quartz crystal monolithic filter. Miniature series.....

### TO SAVE SPACE TOYOCOM HAS THE ANSWER

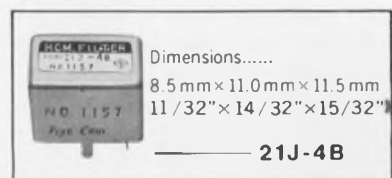

#### ■ 21J-4B

Center Frequency.....21.4MHz  
Bandwidth ..... 6dB: ± 7.5KHz,  
60dB: ± 15KHz,  
80dB: ± 22KHz  
Max. insertion loss.....4dB  
Max. pass band variation.....2dB  
Terminal Impedance.....1KΩ//1pF

**TOYOCOM**  
TOYO COMMUNICATION  
EQUIPMENT CO., LTD.

EXPORT DEPARTMENT:  
TORANOMON BLDG.,  
1-1, SHIBA TORANOMON,  
MINATO-KU, TOKYO, JAPAN.  
TEL: EXPORTOYOCOM TOKYO

INFORMATION RETRIEVAL NUMBER 794

ELECTRONIC DESIGN 17, August 16, 1969





### Perforated tapes

Depicting a broad line of perforated tapes and related accessories, a new 20-page catalog describes tapes, in oiled and unoled paper, and mylar laminates and photoelectric varieties in roll and fan-fold formats. Among the accessories is a series of high-speed motorized winders. Robins Industries Corp.

CIRCLE NO. 661

### Strip products

Giving general and technical information, a four-page folder tells of thin strip products in stainless steels, nickel alloys, special metals and electrical resistance alloys. Presented are mill and manufacturing limits, coil sizes, and comparative weights table. Techalloy Co., Inc.

CIRCLE NO. 662

### Control system

Featuring the Positool 90 numerical control system for new and existing machine tools, an eight-page brochure includes a complete description of the system's capabilities plus 15 illustrations showing accessory features. Available with from one to four axes, the unit offers automatic backlash compensation without overshoot, one-hand jog control for all axes, plus the ability to stop in mid-program without loss of program. Auto-neramics, Inc.

CIRCLE NO. 663

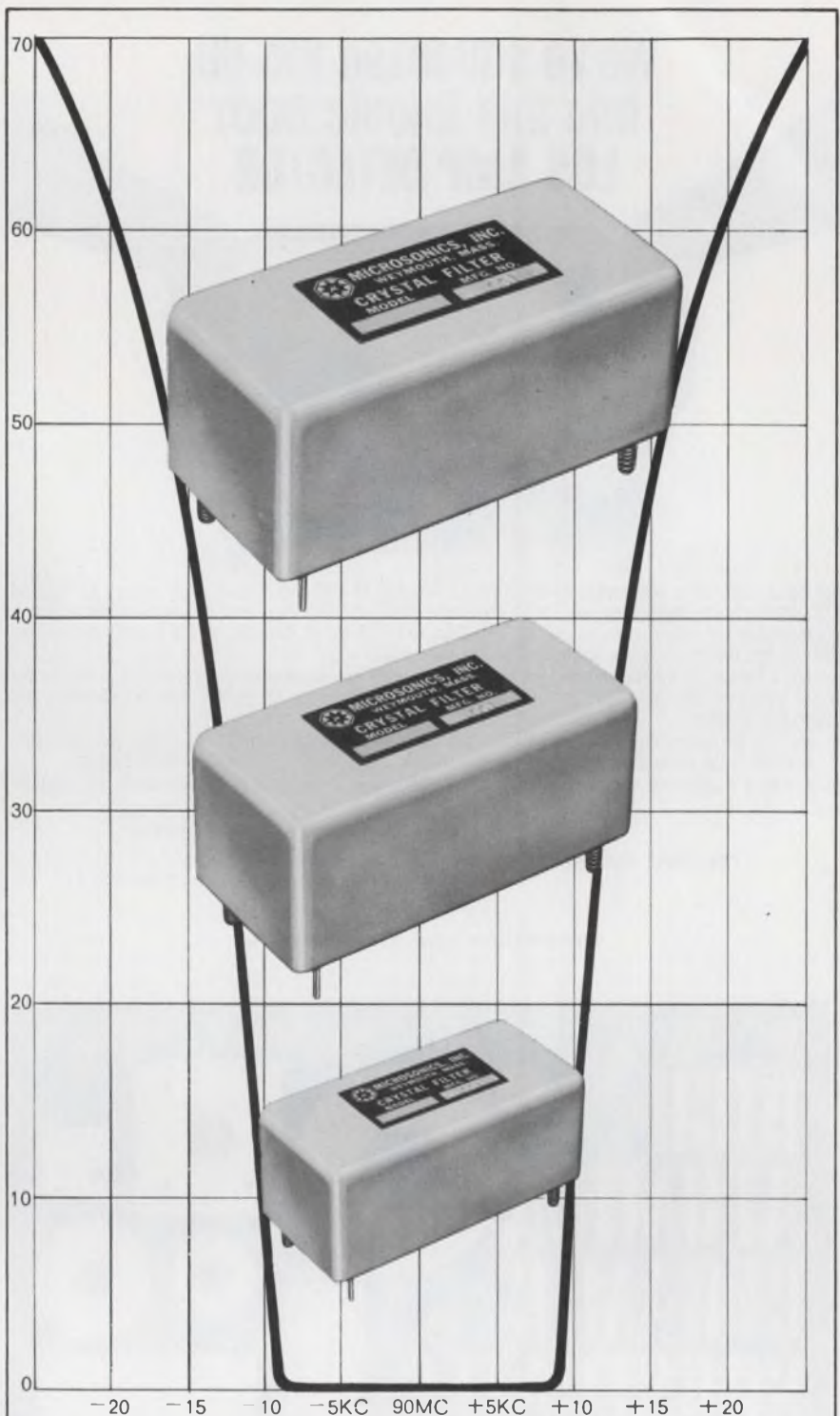

## MICROSONICS

for proven design, reliability & performance in

# CRYSTAL FILTERS



Write for Bulletins today

## MICROSONICS

60 Winter Street, Weymouth, Mass. 02188

Tel: 617 337-4200

A division of the Sangamo Electric Company

INFORMATION RETRIEVAL NUMBER 795

# We've squeezed 105 dB into this Telonic 6001 LOG AMP DETECTOR



The solid state 6001 will accept RF inputs from 400 kHz to 130 MHz with voltage swings as wide as 178,000 to 1. It's calibrated over a 90 dB range (-70 to +20 dBm) and is even equipped with a range switch for closer looks at -40 to +10 dBm and -16 to +4 dBm. An offset control also allows shifting the meter range as much as 70 dB either way.

For fixed frequency measurements, the input signal level can be read directly from the meter — for swept measurements the 6001 provides an output to a 'scope or XY plotter, plus a reference line calibrated in dBm.

In addition to the model shown, smaller versions, without power supply and meter, are available as discrete modules and as a plug-in for the Telonic 2003 Sweep/Signal Generator System.

Data sheets containing complete specs on the 6001 and other models are available on request.

**TELONIC INSTRUMENTS**  <sup>TM</sup>  
A Division of Telonic Industries, Inc.  
60 N. First Avenue  
Beech Grove, Indiana 46107  
Tel: 317 787-3231 · TWX 810 341-3202

INFORMATION RETRIEVAL NUMBER 796

## BOURNS TECHNICAL MATERIALS

# HIGH ALUMINA CERAMIC SUBSTRATES

**PROTOTYPE QUANTITIES  
IN 2 TO 3 WEEKS !!!**

Thicknesses range from 0.010" to 0.050". Nominal configuration sizes from 0.040" square to 2.0" x 4.0". Other sizes available as specials. Typical camber is 0.003 inch per inch. Specials are offered as fine as 0.001 inch per inch.

Send for Product Bulletin on High Alumina Ceramic Substrates

For low-volume, prototype delivery, call or write:

## BOURNS TECHNICAL MATERIALS

3231 KANSAS AVE., RIVERSIDE, CALIF. 92507 · PHONE 714 684-1744 · TWX: 910 332-1252

INFORMATION RETRIEVAL NUMBER 797

## NEW LITERATURE



### Capacitors

A new short-form six-page catalog describes a line of flatpack, axial- and radial-lead metalized polyester capacitors. All three capacitor types are rated at 50 V and are available in more than 100 standard values. Engineered Components Co.

CIRCLE NO. 664

### Trimmer capacitors

"Trimmer Topics", a periodical technical information service, discusses the subject of sealing precision piston trimmer capacitors. The discussion covers the reasons for sealing, the various methods used to provide the seal, and where each is used. Non-rotating piston design, rotating piston designs, and variable air-dielectric trimmer capacitors are covered. A major portion of the text is devoted to capacitance changes at high humidity, and why these changes occur. Voltronics Corporation

CIRCLE NO. 665

### Proximity control

A new four-page brochure describes a new proximity control that is completely transistorized and designed specifically for rugged industrial applications. Presented are some specific applications, a description of how the sensing distance varies with respect to material, material thickness and object area, the operating characteristics for both fast-response and adjustable-delay models, and dimensional drawings and prices. Delavan Manufacturing Co.

CIRCLE NO. 666





### Core memories

Describing in detail a variety of standard Store 33 core memory systems, a 12-page two-color brochure includes such detailed information as standard word sizes and capacities, system organization, operating modes, and signal interfaces. Also discussed are magnetic construction and in-process testing of these magnetic assemblies. Data Products Corporation

CIRCLE NO. 667

### IC readout

A four-page technical folder details specifications for a rear projection readout that uses integrated circuit electronics to decode 8-4-2-1 binary input signals to decimal equivalents. Also given are illustrations and explanations of the use of 12 parallel miniature optical projector systems that display different messages on a single-plane viewing screen. Shelly Associates, Inc.

CIRCLE NO. 668

### Circuit protectors

Describing an economical line of panel-mount, single- and multi-pole circuit protectors for consumer, appliance and industrial uses, a new 12-page bulletin gives engineering data like delay curves, trip time for overload ratings, and complete electrical and mechanical specifications. The protectors serve as on/off switches, circuit condition indicators and overload circuit breakers. Ratings are from 20 mA to 30 A, 250 V ac, 60 or 400 Hz, or 50 V dc. Airpax Electronics, Cambridge Div.

CIRCLE NO. 669

**Twice as fast as hand lettering!**

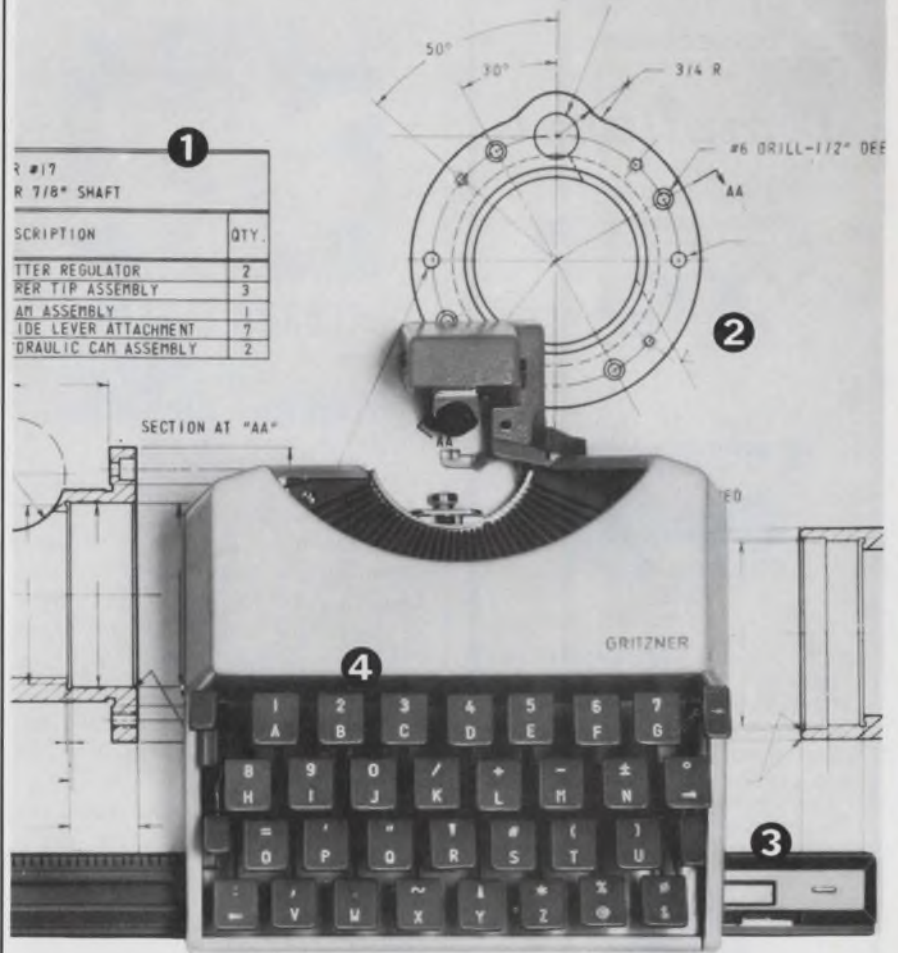

## New GRITZNER Precision DRAWING BOARD TYPEWRITER

Types uniform nomenclature and dimensions with typewriter-quality letters, numerals and symbols. Block letters comply with Mil. Spec. 100-A, erase easily, reproduce well in microfilming, diazo and other reproduction methods. Speeds fill-in work, allows more time for drawing. Tested averages show the Gritzner lettering technique is 1.75 times faster than hand lettering, 3.5 times faster than stenciling.

①

② Sets up quickly right on your drawing board, types directly on all drafting surfaces, including film . . . horizontally or at any angle.

③

Spaces automatically along indexing rail. Each strike of a key shifts typewriter to next precise letter position. Indexing rail fits standard drafting machines or can be held against T square or parallel bar.

④

Letters are in alphabetical order. With brief orientation, any draftsman can easily use the Gritzner typewriter without conventional typing skills. Special symbols available. Typewriter is 6" x 7" x 3" overall. Suggested retail price, \$300.00.

Write or phone today for comprehensive brochure and name of your Gritzner dealer.

## GRITZNER GRAPHICS

*East of the Mississippi*

3127 Colvin St.  
Alexandria, Va. 22314  
(703) 549-3434

*West of the Mississippi*

620 South 7th St.  
Renton, Wash. 98055  
(206) AL 5-8656

INFORMATION RETRIEVAL NUMBER 798



For a true record  
of temperature  
in service...

**Tempilabel<sup>®</sup>**

Easy to use . . .

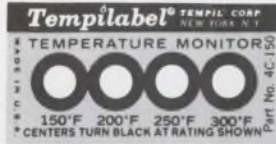

BEFORE

Easy to read

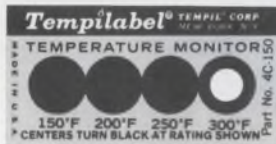

AFTER

Self-adhesive Tempilabels<sup>®</sup> assure dependable monitoring of attained temperatures. Heat-sensitive indicators, sealed under the little round windows, turn black and provide a permanent record of the temperature history. Tempilabel<sup>®</sup> can be removed easily to document a report.



AVAILABLE

Within the range 100° to 500°F Tempilabels<sup>®</sup> are available to indicate a single temperature rating each — and also in a wide choice of four-temperature combinations per Tempilabel<sup>®</sup>.

**JUST A FEW OF  
THE TYPICAL APPLICATIONS**

- Electrical Apparatus
- Electronic Assemblies
- Appliance Warranties
- Aircraft and Rockets
- Machinery and Equipment
- Storage and Transportation of Heat Sensitive Materials.

For descriptive literature and a sample Tempilabel<sup>®</sup> for evaluation . . . (please state temperature range of interest).



132 WEST 22nd St., NEW YORK, N.Y. 10011  
Phone: 212 • 675-6610 TWX: 212 • 640-5478

NEW LITERATURE



**Clutches and brakes**

Fully assembled, ready-to-install electric clutches and brakes are the subject of a 16-page bulletin. These units range in diameter from 5.5 to 15 inches and cover rated torque capacities of 40 to 725 foot-pounds. They have a simple accurate self-adjust mechanism that assures consistent engagement times. Stearns Electric Corp.

CIRCLE NO. 670

**Metals and chemicals**

A new 24-page supplement lists over 100 additions to an earlier 1969 catalog of over 2500 inorganic and organometallic chemicals, pure metals and single crystals. The supplement includes lanthanum oxide for calcium determination, nickel halide glymes, grignards, and several new organotin and organolead compounds. Technical data and references are presented on several of these new compounds. Alfa Inorganics, Inc.

CIRCLE NO. 671

**Spectrophotometry**

A comprehensive 24-page bibliography on spectrophotometric applications in the ultraviolet, visible and near-infrared fields is now available. The articles, which are arranged in 15 categories, include: luminescence, reflectance, scattered transmission, polarizations, magnetic and electric fields, temperatures and pressures, difference spectroscopy, kinetics, computer applications and spectrophotometric evaluation. Cary Instruments

CIRCLE NO. 672



**Wire markers**

Listing 6000 stock items, a new 24-page wire marker catalog includes information on self-laminating wire markers with a transparent protective shield, clip-sleeves applied with an applicator wand, circuit identification numbers, terminal markers for labeling hook-up points identically with leads, suffix numbers for a variety of marking codes, consecutive numbers in pairs for identical marking of both wire ends, write-on-cable markers that accept variable coding, and a line of marking sleeves. W. H. Brady Co.

CIRCLE NO. 673

**Moldable polyimide**

Five new technical data bulletins cover XPI polyimide, a thermoplastic molding compound offering unique advantages in chemical resistance, mechanical properties, dimensional stability, high heat resistance and electrical properties. Of particular interest are its compressive strength of 23,000 psi and a dielectric constant of 3.47. American Cyanamid Co., Plastics Div.

CIRCLE NO. 674

**Laser applications**

Containing more than 50 pictorial illustrations, a new 16-page brochure shows innumerable applications of laser technology in action. A complete section is devoted to resistor trimming, including chrome thin films, tantalum thin films, helixing, and palladium-silver thick films. Hole drilling and welding applications are also covered. Laser Nucleonics Inc.

CIRCLE NO. 675



...HERE IT IS AGAIN...

# WESCON



## ELECTRONIC DESIGN

**WELCOMES YOU**  
To Our Booths Nos. 3819-3820-3821

COW PALACE • SAN FRANCISCO • AUGUST 19-22



No matter who you are...



No matter what you do...



Your #1 enemy is the heart and blood vessel diseases



**GIVE . . . so more will live**  
**HEART FUND**



Contributed by the Publisher

NEW LITERATURE



**Analog adders**

Series AA-1100 analog adders are the subject of a new two-color four-page fold-out brochure. Listed are performance specifications along with the base diagrams and pin connections. The units described will sum from one to five inputs and provide performance to 0.05% static accuracy with a bandwidth of 2 MHz. GPS Instrument Co., Inc.

CIRCLE NO. 676

**Gases and mixtures**

Listing all essential information including gas composition, contents in grams and liters, container pressure, hazard classification and prices, a new catalog describes more than 40 laboratory gases and mixtures, most of which are available in high-purity and research grades. Catalogued mixtures cover applications in air pollution, biology, calibration, crystal doping, epitaxial crystal growing, medical research and nuclear counting. Lif-O-Gen, Inc.

CIRCLE NO. 677

**Gold plating**

Techni Gold-25, a new non-cyanide, mirror-bright, 24-karat gold electroplating solution, is the subject of a six-page technical bulletin. Described are operating conditions and special use information for electroplating with the new solution, which is shipped ready to use and requires no formulation. Replenishment cycles and equipment for electroplating with Techni Gold-25 are also discussed. Technic, Inc.

CIRCLE NO. 678





### Visual controls

Including both price and specification information, a new 28-page catalog on magnetic visual control systems lists 20 sizes of standard boards and over 80 accessories. Packed with ideas and pictures, the catalog describes a wide variety of boards for maintaining perpetual visual data for daily, weekly, monthly or yearly use. These include computer scheduling, organization charts, sales incentive, and controls for production and maintenance. Methods Research Corporation.

CIRCLE NO. 679

### Military wires

A new 24-page catalog describes a line of wire and cable products meeting military specification requirements. Brand-Rex Division, American Enka Corporation.

CIRCLE NO. 680

### Maritime silicones

"Silicone Materials for Marine Applications" is a four-page brochure that discusses the underwater evaluation and material uses for a line of RTV silicone rubber and silicone fluids. The brochure details some of the findings of a study sponsored by the Naval Applied Scientific Laboratory where samples of silicone polymers and copolymers were immersed in sea water for one year. General Electric Co., Silicone Products Dept.

CIRCLE NO. 681

# EMI filters shouldn't be a big deal so we make the smallest ones

— You've convinced me EMI filters shouldn't be a big deal. So send me specs before I forget about them completely.

— I'm still worried, and anyone can write specs. Send a representative with loads of solutions to the problem I've attached.

Name \_\_\_\_\_

Company \_\_\_\_\_

Title \_\_\_\_\_

Address \_\_\_\_\_

City \_\_\_\_\_ State \_\_\_\_\_ Zip \_\_\_\_\_

Send to: Genisco Technology Corporation, Components Division  
18435 Susana Road, Compton, California 90221

Our 50,100 and 200 VDC miniature filters for  $\pi$ , T, L, 2L circuits are at least 20% smaller than any others.

But size isn't their only advantage: resistance is as low as .005 ohms typical, combined with high insertion loss per Mil-Std 220A. And each gold-plated filter meets the ever-popular MIL-F15733.

If the 49 filters described in our spec sheets can't solve



GENISCO TECHNOLOGY CORPORATION  
18435 SUSANA ROAD  
COMPTON, CALIFORNIA 90221  
(213) 774-1850

your problems, it's not a big problem. We've been designing EMI filters for 15 years. So designing one for you won't cause a hassle. Or high prices.

So send in the big coupon. It can solve a multitude of small problems.

## NEW FROM McGraw-Hill

### ELECTRONIC APPLICATIONS OF THE SMITH CHART

*Phillip Smith.* Provides engineers, lab technicians, and students with comprehensive, practical guidance on the Smith chart and its extensive applications in waveguide, circuit, and component analysis and synthesis. The author and originator of the chart details the construction and uses of this chart in a most comprehensible manner—even to nonspecialists. \$17.50

### HANDBOOK OF ELECTRONIC PACKAGING

*Charles Harper.* An outstanding array of experts from the nation's leading electronics firms give you all the background material you need on every aspect of electronic packaging. This practical, authoritative handbook—the first to provide such comprehensive, step-by-step guidance—combines all the basic elements and principles in one volume. \$29.50

### COMPUTER-AIDED INTEGRATED CIRCUIT DESIGN

*Gerald Herskowitz.* Stressing practical applications, this book provides specific techniques vital to the design of integrated circuits by computer. The volume includes modeling procedures, and ways for determining modeling procedures experimentally; the relation of network and system computer techniques to designing integrated circuits; and the use of modeling and computer methods to realize specific integrated circuit designs. \$15.00

At your bookstore or direct from publisher for 10 days free examination.

**McGraw-Hill Book Company**  
330 West 42nd Street  
New York, N.Y. 10036

Please send me the books checked for 10 days on approval. In 10 days I will remit for the books I keep, plus a few cents for delivery costs and local tax (if any) and return the others postpaid.

- 589309 **ELECTRONIC APPLICATIONS OF SMITH CHART**  
 266718 **HANDBOOK OF ELECTRONIC PACKAGING**  
 283952 **COMPUTER-AIDED INTEGRATED CIRCUIT DESIGN**

Name \_\_\_\_\_

Address \_\_\_\_\_

City \_\_\_\_\_

State \_\_\_\_\_ Zip \_\_\_\_\_

23-EDS-816

## NEW LITERATURE

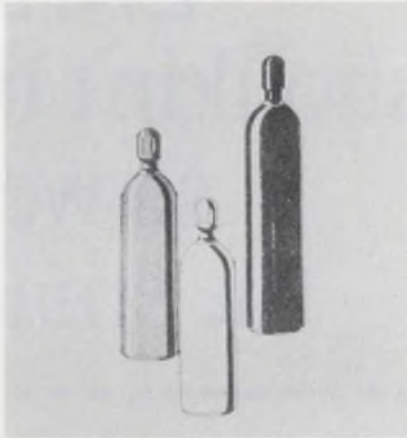

### Gas mixtures

Specifically designed to give the prospective gas-mixture user a basic understanding of gas-mixture technology, an 18-page guide details all the steps that must be taken in the preparation, analysis and use of a gas mixture to assure its dependable performance. A key feature of the brochure is the comparative study of the partial-pressure gas-mixing procedure with the method called Primary Standards. Matheson Gas Products, a Div. of Will Ross, Inc.

CIRCLE NO. 682

### Ammeter shunts

Ten types of dc ammeter shunts in 175 standard models are shown in a new catalog. Both portable and switchboard types are shown, along with diagrams, dimensions and prices. Included are 50- and 100-mV styles, with current ratings to 30 kA. Empro Manufacturing Co., Inc.

CIRCLE NO. 683

### Socket literature

Four new socket lines — including miniature chassis, tube and low-cost SCR versions — are described in four separate product bulletins. Each bulletin includes photographs, line drawings, electrical characteristics and mechanical specifications. The sockets are designed for both solderless wire-wrap terminations and printed-circuit-board terminations. Amphenol Industries Division, The Bunker-Ramo Corporation

CIRCLE NO. 684

## STABILITY & QUALITY



# MATSUO

### SOLID TANTALUM CAPACITORS FOR HYBRID ICs - "MICROCAP"

Capacitance exceeding 10,000 picofarads obtained despite miniature size. "MICROCAP" features excellent heat resistance, solderability and mechanical strength comparable to conventional discrete components, for easy use in hybrid integrated circuits.

#### Specifications:

Operating Temperature Range:  $-55^{\circ}\text{C}$  to  $+85^{\circ}\text{C}$   
Standard Voltage Rating: 6.3, 10, 16, 20, 25, 35 VDC  
Standard Capacitance Value: .001 to 22MFD (E6 series)  
Standard Capacitance Tolerance:  $\pm 20\%$  (M)

MATSUO'S other capacitors include:

#### Metallized Polyester Film Capacitor:

Type FNX-H mylar wrapped.

#### Solid Tantalum Capacitors:

Type TAX hermetically sealed in metallic case,

Type TSX encased in metallic case and sealed with epoxy resin,

Type TSL encased in metallic case and sealed with epoxy resin.

#### Polyester Film Capacitors:

Type MFL epoxy dipped,

Type MFK epoxy dipped, non inductive,

Type MXT encased in plastic tube, non inductive.

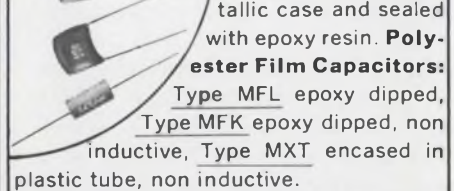

For further information, please write to:

### MATSUO ELECTRIC CO., LTD.

Head Office: 3-5, 3-chome, Sennari-cho, Toyonaka-shi, Osaka, Japan

Cable: "NCCMATSUO" OSAKA Telex: 523-4164 OSA

Tokyo Office: 7, 3-chome, Nishi-Gotanda, Shinagawa-ku, Tokyo











### Lock washer guide

Showing various design options, a handy pocket-sized guide tells how to select the right lock washer. This 12-page booklet covers a wide range of general and special applications and shows which lock washer to use and why. For example, a folded-rim lock washer will meet high load requirements while providing an effective mechanical seal at the same time. Shakeproof Div., Illinois Tool Works Inc.

CIRCLE NO. 692

### Relay catalog

The third issue of the Micro-Scan relay catalog is now available. It features eight pages of specifications on these high-speed relays, showing a full range of models and illustrative package drawings. In addition, there is applications information on low-level multiplexing for process control, communication systems switching and data acquisition. James Electronics Inc., Components Div.

CIRCLE NO. 693

### Analog computer

Describing Comcor 550 analog computer, a 16-page illustrated brochure covers user benefits, details patching facilities, explains keyboard and console controls and hybrid linkage, and lists total component complement. The Comcor 550 is a medium-sized solid-state computer, designed for hybrid performance that provides large-scale capabilities in a compact economical systems package. Astrodata, Inc.

CIRCLE NO. 694



# Mission: Equipment Protection

## Skydyne MIL SPEC Transportation Cases

Skydyne offers a complete line of Transportation/Combination cases that meet all requirements of MIL-T-945, MIL-T-21200, and MIL-T-4734. Over 35 standard fiberglass sizes and countless designs in aluminum sandwich material are available with custom options which include shock and vibration absorbing interiors, equipment mounting facilities, and an extensive variety of special hardware.

Standard fiberglass units are available without special tooling charges while the fastest possible delivery on MIL SPEC sandwich cases is realized through Skydyne's unique case design. Write for our complete technical design manuals. They're yours for the asking.

*Skydyne, Inc.*

RIVER ROAD, PORT JERVIS, N. Y. 12771  
Telephone (914) 856-5241



Visit SKYDYNE at WESCON SHOW, BOOTH NO'S 2713 & 2714.  
INFORMATION RETRIEVAL NUMBER 807

## CUT CONSTRUCTION DELAY

**CUT CONSTRUCTION DELAY WITH PRE-PUNCHED MICRO-VECTORBORD®, PLUGBORDS AND PUSH-IN TERMINALS**

Make circuits the fast, easy way . . . simply insert Vector push-in terminals (wide variety available) and component wires into pre-punched Micro-Vectorbord and Vectorbord, or use new matrix type boards with etched I.C. pads and busses ● New Micro-Klip and Mini-Wrap wire-wrap terminals now available ● Twelve punched patterns available with .025", .042", .062", .093" holes in XXXP phenolic, glass silicone, glass or paper epoxy and copper clad ● Plugbords supplied in many sizes with etched pads, .040" dia. Edge-Pins or Elco Varicon contacts ●

\*Trademark

Send for complete literature

**VECTOR ELECTRONIC CO., INC.**  
12460 Gladstone Ave., Sylmar, California 91342  
Phone: (213) 365-9661 • TWX (910) 496-1539

INFORMATION RETRIEVAL NUMBER 808

# If you know you can do better than you're doing, communicate.

Engineers: We have immediate openings on these advanced programs: **①** COMMUNICATIONS SYSTEMS TEST. Prepare and execute test plans and procedures in the RF area. Strong instrumentation and systems test background required. **②** COMMUNICATIONS SYSTEMS DESIGN. Conceptual design in communications, radar, sonar and ECM. Design and develop systems, subsystems and components; generate requirements and prepare specs. **③** ANTENNA DESIGN. Design, develop and test antennas and feed systems for aircraft, missile and space applications. Required background in electromagnetic theory and experience in sophisticated broadband feed systems. **④** RF DESIGN. Design circuit, component and overall systems for transmitting and receiving. Establish solid-state component specs for RF filters, pre-amps, mixers, local oscillators and detector elements. **⑤** ELECTRONIC SYSTEMS ENGINEERING. Analyze operational requirements and define hardware specs for broadband monopulse receiving/data processing systems. Optimize system/subsystem requirements within constraints imposed by nontechnical limits. **⑥** IR/OPTICAL SENSOR SYSTEMS DESIGN. Design near, intermediate and long-wave IR systems. Comprehensive knowledge of detectors, optics and scanning techniques, with experience in effects of launch environments on sensor systems.

Applicants must be able to translate state-of-the-art knowledge into practical hardware. Applicable degree plus minimum of 4 years' experience. For further information, please write Mr. H. W. Bissell, Professional Placement Manager, P.O. Box 504, Sunnyvale, California 94088. An equal opportunity employer.

**LOCKHEED**  
**MISSILES & SPACE COMPANY**  
A GROUP DIVISION OF LOCKHEED AIRCRAFT CORPORATION



# Free Career Inquiry Service

## Absolutely Confidential

Respond to the career opportunities advertised in this issue. Fill out and send us this handy resume. **Electronic Design** will do the rest – neatly typed copies of this form will be mailed to the companies of your choice, indicated by the circled Career Inquiry Numbers at the bottom of this page.

# 17

<b>Name</b>		<b>Home Phone</b>	
<b>Home Address (Street)</b>		<b>City</b>	<b>State</b>   <b>ZIP Code</b>
<b>Age</b>	<b>U.S. Citizen</b> <input type="checkbox"/> Yes <input type="checkbox"/> No	<b>Security Clearance</b>	
<b>Prime Experience</b>		<b>Secondary Experience</b>	
<b>Desired Salary</b>		<b>Availability Date</b>	

**Employment History – present and previous employers**

Company			
City, State			
Dates	to	to	to
Title			
Specialty			

**Education – indicate major if degree is not self-explanatory**

Degree			
College			
City, State			
Dates	to	to	to

**Additional Training – non-degree, industry, military, etc.**

---



---

**Professional Societies**

---

**Published Articles**

---

- Career Inquiry Numbers:**
- |     |     |     |     |     |     |     |     |     |     |     |
|-----|-----|-----|-----|-----|-----|-----|-----|-----|-----|-----|
| 900 | 901 | 902 | 903 | 904 | 905 | 906 | 907 | 908 | 909 |     |
| 910 | 911 | 912 | 913 | 914 | 915 | 916 | 917 | 918 | 919 | 925 |

**ELECTRONIC DESIGN**  
850 Third Avenue  
New York, New York 10022

ELECTRONIC DESIGN's function is:

- To aid progress in the electronics manufacturing industry by promoting good design.
- To give the electronic design engineer concepts and ideas that make his job easier and more productive.
- To provide a central source of timely electronics information.
- To promote two-way communication between manufacturer and engineer.

**Want a subscription?** ELECTRONIC DESIGN is sent free to qualified engineers and engineering managers doing design work, supervising design or setting standards in the United States and Western Europe. For a free subscription, use the postfree application form inside the back cover. If none is included, write to us direct for an application form.

If you do not qualify, you may take out a paid subscription for \$25 a year in the U.S.A., \$35 a year elsewhere. Single copies are \$1.50 each.

**If you change your address,** send us an old mailing label and your new address; there is generally a prepaid postcard for this inside the back cover. You will have to requalify to continue receiving ELECTRONIC DESIGN free.

**The accuracy policy of ELECTRONIC DESIGN is:**

- To make reasonable efforts to ensure the accuracy of editorial matter.
- To publish prompt corrections whenever inaccuracies are brought to our attention. Corrections appear at the end of the Letters column.
- To refuse any advertisement deemed to be misleading or fraudulent.

Microfilm copies are available of complete volumes of ELECTRONIC DESIGN at \$19.00 per volume, beginning with Volume 9, 1961. Work is now in process to complete the microfilm edition of Volumes 1-8. Reprints of individual articles may be obtained for \$2.00 each, prepaid (\$.50 for each additional copy of the same article) no matter how long the article. For further details and to place orders, contact the Customer Services Department, University Microfilms, 300 North Zeeb Road, Ann Arbor, Michigan 48106; telephone (313) 761-4700.

**Want to contact us?** If you have any comments or wish to submit a manuscript or article outline, address your correspondence to:

Howard Bierman, Editor,  
ELECTRONIC DESIGN,  
850 Third Avenue,  
New York, N.Y. 10022.

## PEM Self-clinching Solder Terminals



Bulletin ST-469 describes a complete line of PEM self-clinching solder terminals for permanent mounting on thin panels. Information discloses data on PEM spline and concealed head types as well as the regular type ST. These solder terminals provide permanent electrical connections, resistant to vibrations and environmental disturbances and are electroplated with tin and stearic acid wax for ease of soldering and resistance to oxide development during storage. Bulletin ST-166 includes dimension, installation suggestions and design limitations.

**Penn Engineering & Manufacturing Corp.**

Box 311  
Doylestown, Pennsylvania 18901

174

## How to Order



Free Mandrel List shows available sizes of Black Fiberglass Laminated Epoxy, Class F - 155°C, Header Plates and Potting Forms.

Thousands of sizes of square, round, and rectangular tubes are listed with details on materials, tolerances, and special features.

Accompanying Data Sheet gives Mil Spec certifications, design details, and ordering data for our line of component encapsulation shells.

## POTTING FORMS

**Stevens Tubing Corp.**

128 North Park Street,  
East Orange, N. J. 07019  
(201) 672-2140

175

## X-Band Waveguide Delay Lines



Bulletin 201 describes fixed-length and tapped waveguide delay-lines for X-band (8.2-12.4 Gc) frequencies. Constructed of thin-wall aluminum tubing supported by an alloy casting. Micro-Delay lines are compact, rugged and light in weight. Any number of delay values can be obtained from a tapped delay line, depending on total overall delay. Fixed-length delay lines are available for delay values from 0.02 to 1.5 microseconds in 0.1 microsecond increments. Attenuation can be as low as 20 db per microsecond. VSWR input values are low, and all MicroDelay lines are supplied with bilateral, full bandwidth, input VSWR test data. MicroDelay lines have no moving parts nor any electrically controlled switches to mar their reliable performance.

**MicroDelay Division / Uniform Tubes, Inc.**

Collegeville, Pa. 19426  
Visit Booth No. 2616 at WESCON

176



# Manufacturers

Advertisements of booklets, brochures, catalogs and data sheets. To order use Reader-ServiceCard (Advertisement)

## A FREE Cross Reference Guide



### to better Printed Circuit drafting

No engineer or draftsman should be without the NEW By-Buk Printed Circuit Drafting Aids P-45 Catalog with color-coded MIL-SPEC sizes. Also contains over 2000 pads, shapes, tapes, transistor tri-pads, spaced integrated circuit terminal pad sets and many other drafting aids for faster, more accurate, distortion-free printed circuit master drawings. Send for your FREE catalog.

### By-Buk Company

4326 West Pico Blvd., Los Angeles, Calif. 90019  
Telephone: (213) 937-3511

177

## Free: 2,500 Plastic Parts Catalog



New from Nylomatic, molders and fabricators of mechanical plastic components, a highly informative 48-page catalog of more than 2,500 standard parts. It can help you save time and money in design, test and production. Advantages of Nylomatic standard parts: no tooling charges, low unit costs, quick delivery, complete range of sizes. Nylomatic standard parts are made of Nylon, Delrin® and other thermoplastic materials. You'll find our new free catalog a real problem solver for designers, send for it today.

### Nylomatic Corporation

Dept. P  
Nolan Ave., Morrisville, Pa. 19067

178

## Welded stud fasteners — no holes or distortion



This new brochure describes a solid-state-controlled system for welding threaded stud fasteners to steel and aluminum as thin as .016" and .040", respectively. Welds are reliable and consistent because the control may be adjusted quickly and conveniently to all conditions. The one-side fasteners may be located wherever the best design requires. No holes involved — which means no expenses for sealing, drilling, through-bolting, staking. Standard studs, up to 1/4" in diameter, from stock. System operates from 115-volt AC outlet, welds studs at production rate of 8 per minute, 15 per minute for short periods.

### Nelson Stud Welding Co.

A United-Carr Division Of TRW Inc.  
Lorain, Ohio 44055

179

# Electronic Design

## Advertising Sales Staff

### New York 10022

Edward F. Clancy  
Sales Service Manager  
Robert W. Gascoigne  
Thomas P. Barth  
Samuel M. Deitch  
Byron K. Adams  
850 Third Avenue  
(212) Plaza 1-5530  
TWX: 710-581-2874

### Philadelphia 19066

William C. Repetto  
P. O. Box 206  
Merion Station, Pa.  
(215) MA-3-5888

### Boston 01945

Richard Parker  
48 Commercial Wharf  
Boston, Mass. 02110  
(617) 742-0252

### Chicago 60611

Thomas P. Kavooras  
Berry Conner, Jr.  
200 East Ontario  
(312) 337-0588

### Cleveland

Thomas P. Kavooras  
(Chicago)  
(312) 337-0588  
(call collect)

### Los Angeles 90303

Stanley I. Ehrenclou  
John V. Quillman  
W. James Bischof  
2930 Imperial Highway  
Inglewood, Calif.  
(213) 757-0183

### San Francisco 94022

Arthur R. Shields, Jr.  
175 San Antonio Rd., S 243  
Los Altos, Calif.  
(415) 941-3084

### London W. 1

For United Kingdom & Holland  
Brayton C. Nichols  
44 Conduit Street  
Tel: REGent 4714

### Verviers, Belgium

For Continental Europe  
Andre Jamar  
1, Rue Mallar, 1  
(087) 253.83 Telex 41563

### Tokyo

Yoshiro Takemura  
IPS Group Ltd.  
Box 36, Ohsaki Post Office  
Phone (504) 1485  
Cable Joshplans, Tokyo







**Advertiser**

**Page**

S&E1 Mfg./Capacitors .....U184  
 Schweber Electronics ..... 17  
 Scientific Data Systems, Inc. .... 71  
 Scaelectro Corporation .....266  
 Sencore .....U150  
 Servo-Tek Products Company ..... 76  
 Shallcross, A Subsidiary of Cutler  
 Hammer .....U121  
 Shaffstall Ball Corporation ..... 289  
 Signalite, Incorporated .....U173  
 Signetics Corporation ..... 37  
 Simpson Electric Company .....U176  
 Singer Company, The, Friden Division ..U177  
 Singer-General Precision, Inc.,  
 Kearfott Products Division 284 A—X, 285  
 Skydyne, Inc. ....323  
 Solid State Scientific, Inc. .... 288  
 Solitron Devices, Inc. .... 271  
 Sonotone Corporation, Battery Division..U158  
 Sprague Electric Company .....18, 20  
 Stackpole Carbon Company .....U151  
 Standard Condenser Corporation .....U134  
 Stevens .....326  
 Stoddart Electrosystems, A Division  
 of Tamar Electronics, Inc. ....16-B  
 Switchcraft, Inc. ....U185  
 Sylvania Electric Products, Inc. ....32 A—H  
 Sylvania Electric Products, Inc.,  
 Metals & Chemicals Parts Division .....301  
 Systron-Donner Corporation ..... 2

Takeda Riken Industry Co. Ltd. ....280  
 Technical Assistance .....312  
 Teledyne Relays A Teledyne Company ..... 61  
 Telonic Industries, Inc. ....314  
 Tempil Division of Big Three Industrial  
 Gas and Equipment Co. ....316  
 Tenney Engineering, Inc. ....U187  
 Texas Instruments Incorporated,  
 Components Group .....14, 54, 55, 194, 195  
 Texas Instruments Incorporated,  
 Components Materials Division .....U167  
 Theta Instrument Corporation .....U113  
 Torngren Co., Inc., C. W. ....300  
 Toyo Communication Equipment  
 Co., Ltd. ....312  
 Triplett Electrical Instrument Company .....212  
 Transiltron Electronic Corporation .....U171  
 Trygon Power Supplies .....U122  
 Tyco Laboratories, Inc. ....267

Uniform Tubes, Inc. ....326  
 United Systems Corporation ..... 60  
 United Transformer Co., Division of  
 TRW, Inc. ....Cover II  
 Unitrode Corporation ..... 39

Vactec Inc. ....293  
 Varo, Semiconductor .....U180  
 Vector Electronic Co. Inc. ....323  
 Vega Precision Laboratories, Inc. ....305  
 Victor Comptometer Corporation ..... 62  
 Victoreen Instrument Division .....273

Wakefield Engineering, Inc. ....U175  
 Walker Company, Inc., O. S. ....251  
 Wang Laboratories, Inc. .... 299  
 Wanlass Electric Co. ....316 A—B  
 Waters Manufacturing, Inc. .... 311  
 Weston Instruments, Inc., Newark  
 Division .....U183  
 White Industrial, S. S., A Division of  
 Pennwalt Corporation .....U170  
 Wilson Technical Service, H. A. ....289

Y-Lab .....262

Zeltex, Inc. .... 70

Career Advertising

Lockheed Missiles & Space Company ..... 324

# STOCK EXCHANGER

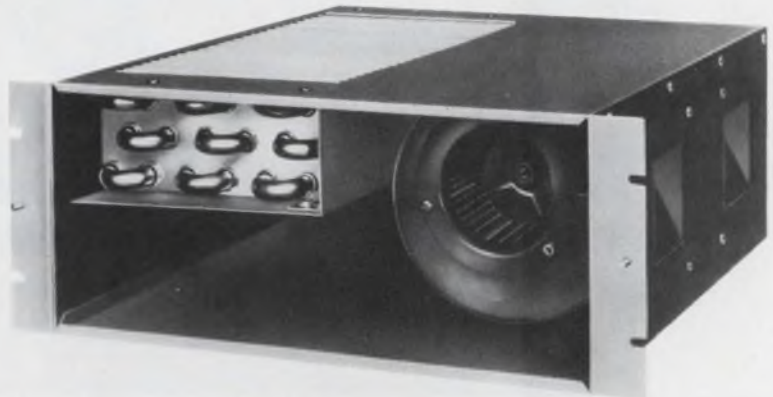

**A hot tip on a new offering that provides long-term capital gains in cooling economy.**

Using either warm or cool water as the circumstances require, the McLEAN Heat Exchanger maintains even electronic cabinet temperature in the most simple and reliable manner.

Heat Exchanger models are designed and manufactured to meet individual specifications and applications. Using 66°F to 70°F chilled water, an interior cabinet temperature of 80° maximum is maintained with a 1 KW heat dissipation. Air is re-circulated within the electronic enclosure and cooled by the Exchanger. The system does not use room ambient air, nor does it exhaust warm inside cabinet air into the atmosphere.

The Heat Exchanger is one of many McLEAN temperature control devices for electronic equipment. Write for full information.

**Send for our 1969 Catalog**

**McLEAN** ENGINEERING LABORATORIES 

Princeton Junction, New Jersey 08550 • Phone: 609-799-0100 • TELEX: 84-3422

See us at the WESCON Show, Booth 1721.

INFORMATION RETRIEVAL NUMBER 809

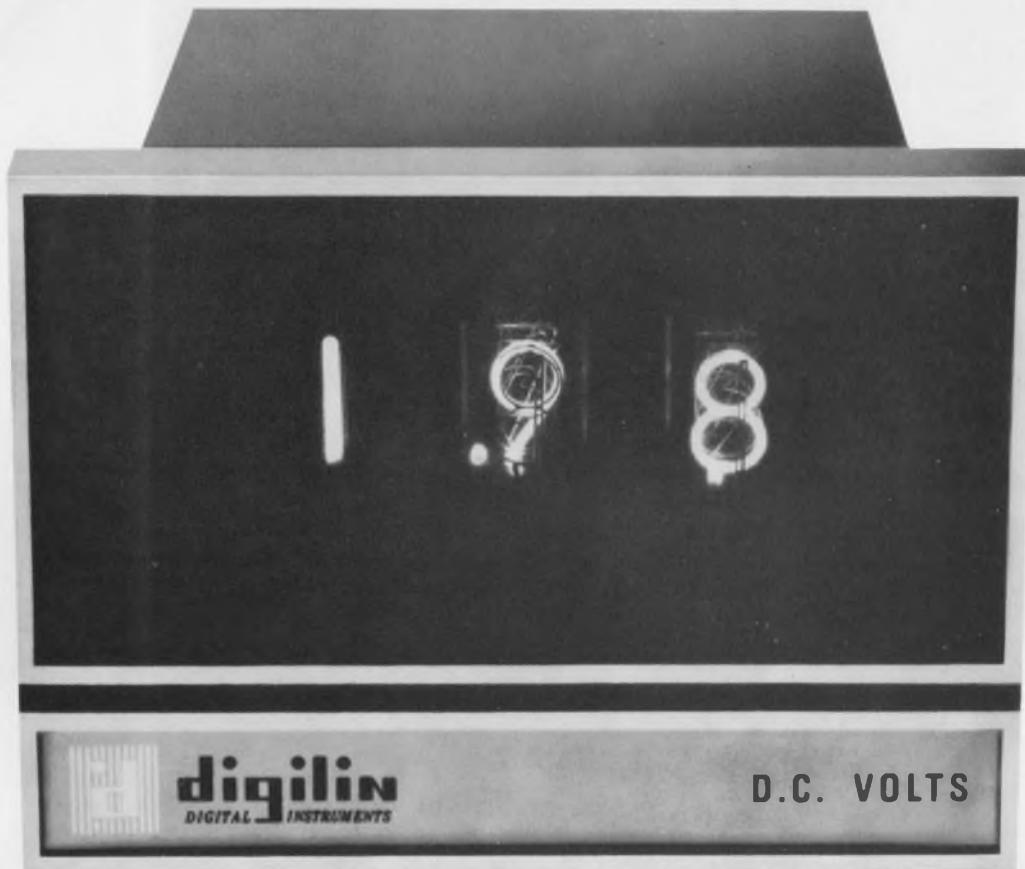

**The \$99.00  
digital panel meter  
you never have  
to zero adjust**

Get away from quivering needles. End interpolations, extrapolations, and meter readings by conjecture. Now you can move up to digital readout with the one low cost digital panel meter with automatic zero adjust. With the new Digilin Type 250 you never worry about accuracy or unchecked drift. The 250 takes away the opportunity to make mistakes.

And while you gain day-in, day-out solid-state reliability and digital accuracy, the Type 250 — an industrial designer's masterpiece in brushed aluminum — brings an appearance of elegant precision to your system.

**Now check these other important features:**

**Easy, external programming.** With the

250, it's easy to take advantage of quantity prices. Stock one meter type. Change to a wide variety of current, voltage, or resistance ranges and change decimals all from the rear.

**No internal adjustments.** All ranges and functions are programmable from the rear panel. Calibration is accomplished by a single front panel vernier adjustment.

**Constant high input impedance.** No errors due to circuit loading.

**Best visibility.** Big 0.6" numbers. Parallax-free, filtered wide-angle viewing. Memory capacity gives no-blink display.

**Fit-anywhere size.** Just 4.38 by 3.13 inches. Only 3.12 inches behind panel.

**Assured reliability.** Exclusive Digilin 100-hour factory burn-in test is the most

rigorous in the industry.

How do we give you more features and better quality at the same low price? Because of Digilin innovations in circuitry, design, and manufacturing processes, the step-ahead technology that never means compromise.

At \$99.00 each in lots of 100, now you can well afford digital readout where you can't afford to make mistakes. Get in touch with Digilin today and get off the needle. Digilin, Inc., 6533 San Fernando Rd., Glendale, Calif. 91201. Telephone 213-246-8161, Ext. 404 (A division of Dura-Containers, Inc.)

Need 3-digit readout? Type 330 has same features as the 250, costs just \$129 (100-units).

**digilin**  
DIGITAL INSTRUMENTS



INFORMATION RETRIEVAL NUMBER 810



# Information Retrieval Service

(continued on p. 332)

All products, design aids (DA), application notes (AN), new literature (NL), and reprints (R) in this issue are listed here with Page and Information Retrieval numbers. Reader requests will be promptly processed by computer and mailed to the manufacturer within three days.

Category	Page	IRN	Category	Page	IRN	Category	Page	IRN
<b>Components</b>			data modem	278	457	impedance bridge	U124	359
adders, analog (NL)	318	676	data mode, direct	278	459	multimeter/calibrator	U128	348
amplifier, fluidic	272	446	data set	278	460	multimeter, digital	U128	355
capacitors (NL)	314	664	data terminal	278	458	multimeter, digital	U128	346
capacitors (NL)	321	685	data processor	281	462	multimeter, digital	U120	406
capacitors, chip	274	449	keyer, data	U180	342	multimeter, digital	288	490
capacitors, chip	274	452	logic cards	U182	274	multimeter, digital	286	403
capacitors, feed-thru	274	451	memories, core (NL)	315	667	multimeter, digital	286	403
capacitors, trimmer	277	456	memories disc	282	390	noise analyzer	U125	295
circuit breakers	U144	372	memory core	U180	344	oscilloscope, dual-beam	U118	412
circuit protector	U144	250	memory, core	282	464	oscillator, test	285	482
clutches and			microfilm reader	280	461	panel meter, digital	U120	352
brakes (NL)	316	610	mini-computer	280	391	panel meters, digital	284	468
connector (ES)	300	625	multiplexer/digitizers	282	466	phase meter, digital	U125	349
connectors, SHP (NL)	308	650	multiplexer, linking	282	465	picoammeter	U134	404
converters, fluidic	273	448	tape duplicator	U184	410	power supplies	U125	357
core calculator (DA)	302	628	tapes, perforated (NL)	313	661	power supplies (NL)	308	648
counters, impulse	U146	266				power supply	U129	360
CRT, dual-gun	U146	264	<b>ICs &amp; Semiconductors</b>			power supply	284	469
CRT, multi-color	U142	409	choppers, FET	254	420	power supply, HV	288	491
delay lines	U146	275	compensator, op amp	260	428	programmer	287	486
filters, emi	U148	265	diodes, hot-carrier	U154	370	protector, lab-test	U126	365
filters, monolithic	U146	254	diodes, miniature	U156	405	scope, dual-beam	U120	297
ICs, TTL (NL)	310	652	diodes, tuning	254	418	scope, dual-trace	284	467
indicators, status	272	445	diodes, voltage-			scopes and plug-ins	U124	388
inductors (AN)	306	640	variable	254	417	servo system analyzer	U130	358
lamp, bi-pin	U148	283	ICs, MSI TTL	254	416	spectrum analyzer	U132	361
light sources (NL)	308	646	ICs, TTL (NL)	310	652	supplies, current	285	481
magnetic heads	U148	251	LEDs, infrared	U154	371	switch matrix	286	484
memories, core (NL)	315	667	multiplexer, analog	U152	413	switching hits (NL)	311	657
motor control (AN)	306	642	radio multiplexer	254	415	transmission test set	284	470
op amps (AN)	306	633	rectifiers	254	419	voltmeter/calibrator	288	488
PC board (ES)	300	623	rectifiers, plastic	256	421	voltmeters, digital	U125	354
power supplies (NL)	308	648	regulators, hybrid	U154	367			
protector, surge	U144	387	SCRs, hermetic	U156	272	<b>Microwaves &amp; Lasers</b>		
pushbuttons, lighted	U144	263	SCRs, high-temp	256	422	amplifier, crossed-field	U138	384
readouts, digital (NL)	308	651	shift register	U154	345	amplifiers, rf	297	615
readout, IC (NL)	315	668	thermistors	260	429	attenuator	296	612
readout tubes	U148	394	transistor, power	258	426	attenuator, rotary	U138	389
readouts, segmented	U148	395	transistors, dual/quad	258	427	attenuators	294	608
relays, PC	U146	255	transistors, power	256	423	detectors, directional	U138	382
relay, reed	U146	253	transistors, switching	258	424	diode, p-i-n	295	609
resistors, chip	274	450				filter, rf	U138	393
strip products (NL)	313	662	<b>Instrumentation</b>			filters, phase-controlled	U136	289
switch, digital	276	454	ammeter shunts (NL)	320	683	frequency source	296	614
switch module	273	447	amplifier, logarithmic	U130	292	generator, signal	U136	289
switch, reed	277	455	comparator, digital	287	487	generators, signal	U138	290
switch, pressure	U148	261	converter, d/ac	U132	363	generators, power	U138	383
switch, slide	U142	252	counter, 15-MHz	U130	347	laser, He-Ne	296	613
switches (NL)	311	652	counter, digital	286	485	microstrip transition	296	611
switches, lighted	U144	260	counter, time-interval	U126	298	mullivoltmeter, rf	U138	392
switches, pushbutton	U144	262	counter/timer	288	489	mixer, balanced	U138	381
switching hints (NL)	311	657	counter-timer	U132	350	oscillator module	297	616
transformers, pulse	276	453	divider/generator	U128	351	power meter, rf	U136	379
trimmers, cermet	U142	259	DVM, printing	U122	407	preamplifier, if	294	605
TWTs, pulse (AN)	306	639	generator, noise	286	483	pulse detector	U138	291
wire markers (ES)	300	624	generator, pulse	U129	293	radiometers	U138	288
wire markers (NL)	316	673	generator, pulse	U133	402	source, pulsed rf	294	607
			generator, pulse	U134	401	sources, frequency	U138	380
			generator, pulse	U133	356	switches, transfer	U138	373
<b>Data Processing</b>			generator, time-code	U134	398	transistors, power	295	610
calculator, electronic	U180	343	generator, time-code	U132	294	TWTs, pulse (AN)	306	639
calculator, printing	281	463	generator, waveform	U134	399	varactors, S-band	294	606
computer/calculator	U180	296	graph paper (DA)	302	629			
converter, a/d	U184	258				<b>Modules &amp; Subassemblies</b>		
converters, a/d	U182	341				adders, analog (NL)	318	676





from dc to 3 GHz  
with only  
one plug-in



**This new "4th generation"  
I-C plug-in counter/timer  
Outperforms all others...**

**And will for years to come!**

Why compromise for less? The Model 1500A has a main frame counting range from dc to 125 MHz (to 3 GHz with a single plug-in). This instrument is fully programmable, has provision for external time base up to 10 MHz, and many other significant features, including the well recognized advantages of Monsanto's "4th generation" 90% integrated circuit design.

Shown above is the Model 1104B 3 GHz frequency converter plug-in. Also available: Model 1100A uncommitted

plug-in; Model 1101A 500 MHz prescale plug-in; Model 1102A 6-digit preset plug-in; Model 1103A 500 MHz frequency converter plug-in; Model 1107A time interval plug-in; Model 1201A DVM plug-in.

Unparalleled performance plus award-winning design make the Model 1500A the ultimate counter for the no-compromise engineer. The price for the main frame is \$2850.00, FOB West Caldwell, N. J. Other models of the 1500 Series offering a wide selection of fea-

tures and capabilities begin at \$1800.00.

Most engineers take Monsanto's reliability for granted because of our 2-year warranty. But, just in case, we maintain 37 Service Centers located strategically throughout the United States and overseas.

For a demonstration, or for full technical details, call your local Monsanto Field Engineer now or contact us directly at: Monsanto Company, Electronic Instruments, West Caldwell, New Jersey 07006, (201) 228-3800.

INFORMATION RETRIEVAL NUMBER 223

WESCON Booths 1017-19 and 1026-28

# Monsanto



**Here's 15 A to 50 A Performance for your High-Speed Switching Circuits.**

Now, RCA brings you high-speed, high-current switching in four of the industry's newest high power units—2N5671 and 2N5672 in regular TO-3 case available in production quantities, and developmental types TA7337 and TA7337A in modified TO-3 case (two 60-mil pins) available on a sampling basis.

These high-current transistors now make available for industrial and commercial users a state-of-the-art combination of high performance and reliability originally dictated by the rigid requirements of aerospace.

All four devices are characterized by double-diffused, double-epitaxial design techniques. As a result, you get reduced saturated switching times, increased current handling capability, and low saturation voltage. These silicon transistors have enhanced second breakdown capability under forward and reverse-bias conditions...backed by safe area operating curves.

Among the applications for these units: switching control amplifiers, power gates, switching regulators, DC-DC converters, DC-AC inverters, DC through RF linear power amplifiers and oscillators.

Check the chart for some of the key parameters of these four new types. Then ask your local RCA Representative or your RCA Distributor for prices and delivery details.

Unit	$V_{CE(sus)}$ (V)	$I_C$ (A)	$V_{CE(sat)}$	$f_T$ MHz	$t_{on}$
2N5672	120	30	0.75 V @ 15 A	50	0.5 $\mu$ s @ 15 A
2N5671	90	30	0.75 V @ 15 A	50	0.5 $\mu$ s @ 15 A
Above types available now in production quantities.					
TA7337A	120	40	1.2 V @ 40 A	50	1.0 $\mu$ s @ 40 A
TA7337	90	50	1.5 V @ 50 A	50	1.0 $\mu$ s @ 40 A
Above types available now in sample quantities.					



**We know  
transistors like the  
back of our hand**

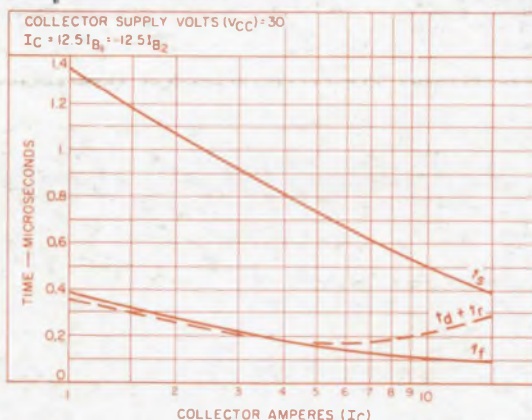

Typical saturated switching characteristics for types 2N5671 & 2N5672.

For technical data, write: RCA Electronic Components, Commercial Engineering, Section IG8-3, Harrison, N. J. 07029.