

Electronic Design 10

VOL. 17 NO.

FOR ENGINEERS AND ENGINEERING MANAGERS

MAY 10, 1969

This gear works in South Korea. Clustered on a hilltop south of Seoul, the communication center has withstood the rigors of cold, heat, transportation and storage

to link successfully the hundreds of ground and airborne elements in the longest airborne assault in history. For designs wanted in the field, turn to page 34.



There's a New Look to the Scope System That Gives You Better Performance In Any Direction



Two new rectangular CRT's have been added to the Hewlett-Packard 140 scope system—the system that covers the entire oscilloscope spectrum from dc to 12.4 GHz with the extraordinary versatility you need to get step-ahead measurements—now and in the future!

The new HP 140B mainframe has an 8 x 10 cm CRT that provides additional display area for expanded measurement capability. The new HP 143A mainframe has an extra-large 8 x 10 inch CRT for group-viewing or monitoring at a distance. Both of these mainframes and the HP 140A give you standard CRT persistence. For variable persistence and storage, there's the HP 141A mainframe. Or, for spectrum analysis, select the 140S or 141S.

Only the HP 140 scope system gives you this combination of capabilities: Sampling to 12.4 GHz . . . delayed sweep time base for sampling . . . 50 $\mu\text{V}/\text{cm}$ sensitivity dc-coupled *with no drift* . . . four channel amplifier . . . plug-ins for direct readout of TDR, swept-frequency and spectrum analysis—with full compatibility between mainframes and all plug-ins.

With 20 plug-ins and three sampling heads to choose from, you can match your scope to your measurement requirements. Check the selection chart, see page 508 in your 1969 HP catalog, then contact your HP field engineer. Or, write to Hewlett-Packard, Palo Alto, California 94304. Europe: 1217 Meyrin-Geneva, Switzerland. Price: 140 Mainframes, \$640 to \$1525; plug-ins, \$250 to \$1900.



HP 140 Scope System PLUG-IN CAPABILITIES	VERTICAL PLUG-INS										COMPATIBLE TIME BASES					SPECIAL PLUG-INS					
	1400A	1401A	1402A	1403A	1404A	1405A	1406A	1407A	1410A	1411A	1420A	1421A	1422A	1423A	1424A	1425A	1415A	1416A	8552	8553L	8554L
1. Wide Band			*		*	*			*	*	*	*	*	*	*	*					
2. Sampling										*	*	*	*	*	*	*					
3. High Gain Differential	*			*	*	*	*	*	*	*	*	*	*	*	*	*					
4. Dual Trace		*	*	*	*	*	*	*	*	*	*	*	*	*	*	*					
5. Four Channel										*	*	*	*	*	*	*					
6. X-Y	*	*	*	*	*	*	*	*	*	*	*	*	*	*	*	*					
7. Delayed Sweep										*	*	*	*	*	*	*					
8. No Drift										*	*	*	*	*	*	*					
9. High Common Mode Rejection				*	*	*	*	*	*	*	*	*	*	*	*	*					
10. Algebraic Addition		*	*	*	*	*	*	*	*	*	*	*	*	*	*	*					
11. Time Domain Reflectometry													*	*	*	*	*				
12. Wide Band TDR										*	*	*	*	*	*	*					
13. Swept Frequency																	*	*	*	*	*
14. Spectrum Analysis																		*	*	*	*

INFORMATION RETRIEVAL NUMBER 215



OSCILLOSCOPE SYSTEMS

089/17





What can you expect from a **\$395** pulse generator?

- 0.2-Hz to 20-MHz PRF
- 25-ns to 2.5-s duration
- 5-ns rise/fall time
- ± 10 -volt outputs across 50Ω
- ± 1 -volt DC offset
- Independent control of amplitudes and offsets for + and - pulses
- Square-wave output
- Amplitude fully analog-programmable
- Period and duration modulatable

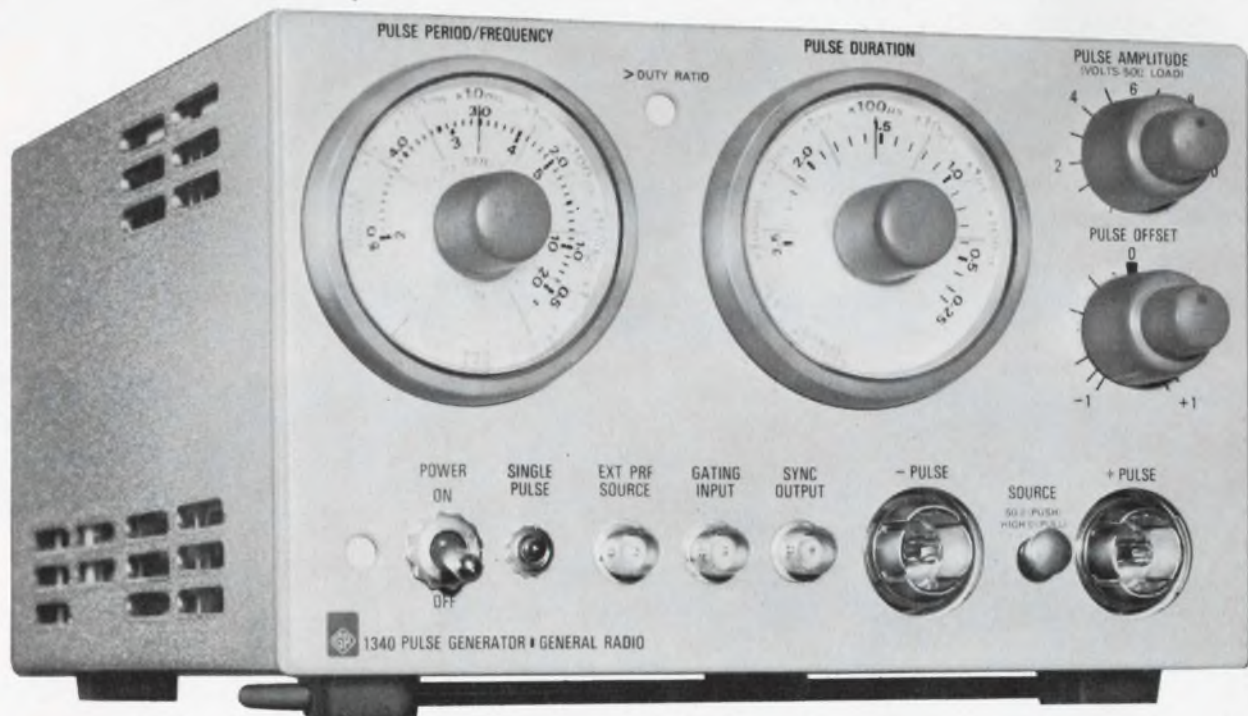

You get all these features and more in the NEW 1340 Pulse Generator. For more information call your nearest GR District Office, or write General Radio, West Concord, Mass. 01781. Telephone (617) 646-0550. In Europe Postfach 124, CH 8034 Zurich 34, Switzerland.

GENERAL RADIO

INFORMATION RETRIEVAL NUMBER 2

New Datapulse 112 gives you higher rep rates (to 125 MHz), faster rise times (1.3ns) and narrower pulses (to 3ns)—yet it costs you hundreds of dollars less.

What's more it has all the pulse parameter control you need to test high-speed circuits: simultaneous $\pm 5V$ outputs, single or double pulses, independent dc offset to $\pm 2V$, widths from 3ns to 5 ms, and delays to 5 ms.

You can control the pulse train with external gating pulses, produce complementary outputs for duty cycles approaching 100%, set the baseline at exact ground with a switch, and reduce rep rate to 10 Hz for low-speed testing.

No other high-speed pulser offers so much for just \$1595.00 . . . and the 112 is being delivered now. For a demo contact Datapulse Division, Systron-Donner Corporation, 10150 W. Jefferson Blvd., Culver City, Calif. 90230 213-836-6100.

Why buy a high-priced 100 MHz pulser? Here's 125 MHz for \$1595!



Oscilloscope photo. 2ns/div, 2v/div.

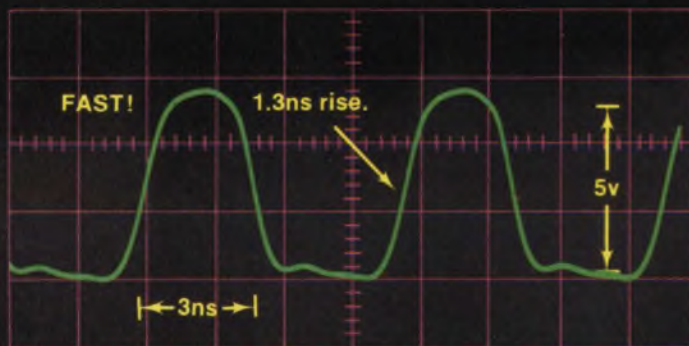

DATAPULSE

SYSTRON  DONNER

Another first. One of 135 Systron-Donner instruments

- | | |
|--------------------------------|-----------------------------|
| Electronic counters | Analog computers |
| Pulse generators | Digital panel meters |
| Microwave frequency indicators | Microwave signal generators |
| Digital clocks | Laboratory magnets |
| Memory testers | Data acquisition systems |
| Digital voltmeters | Microwave test sets |
| Time code generators | |
| Data generators | |

NEWS

- 25 **Hop to Jupiter: Takeoff, 1972; Arrival, 1974**
U. S. planning to send probes 340 million miles,
and they could lead to a 'grand tour' of the planets
- 30 Strap-down guidance system passes test
- 34 **'Portable war' electronics gets first Pacific test**
A Special Report on Korea
- 47 Washington Report
- 52 Letters
- 64 Sidelights of the Issue
- 71 **Editorial: Smart engineering, the European way**

TECHNOLOGY

- 75 **Directory of MOS ICs**—all standard products and their manufacturers
are listed for your convenience.
- 106 **Design and match rf amplifiers** using two QUIKTRAN programs to simplify
device analysis and selection of matching network.
- 114 **Cut differential-amplifier design time.** Don't work out equations
for each design—use tables, based on popular configurations.
- 120 **Looking for a summer study session?** Design engineers and engineering
managers can choose from over 200 short-term courses
- 130 Ideas for Design

PRODUCTS

- 150 **Components:** Cermet trimmers drop price tag for industrial applications.
- 158 **ICs & Semiconductors:** Plastic complements work in 35-W audio amplifiers.
- 168 **Instrumentation:** Portable shirt-pocket VOM has FET input.
- 182 Modules & Subassemblies
- 194 Microwaves & Lasers
- 202 Data Processing
- 214 Production
- 222 Packaging & Materials

Departments

- 14 Designers' Datebook
- 146 Books
- 226 Evaluation Samples
- 228 Design Aids
- 230 Application Notes
- 234 New Literature
- 246 Advertisers' Index
- 248 Information Retrieval Service
Information Retrieval Service Card inside back cover
COVER PHOTO by John F. Mason, Military/Aerospace Editor
Communications central for airborne assault exercise in South Korea
was manned by the Eighth Army's 304th Signal Battalion.

If you want better designs,

Fairchild MSI lets you design a system in the time you used to spend designing a circuit. A few MSI building blocks will do more work than a hundred ICs. We have versatile, compatible off-the-shelf devices that function like shift registers, counters, decoders, latching circuits, storage elements, comparators, function generators, etc. Just about all you need for any digital application. *Like a scanning keyboard encoder:*

If you'd like a simple method of converting keyboard switch closures to a binary code, you need only 5 of our CCSL building blocks and the logic diagram on the right. (Conventional design techniques would require about 30 conventional ICs to do the same job.) Besides simplicity, this design provides fast rollover, insensitivity to contact bounce, and eliminates ambiguity when several keys are depressed.

The two major elements of the design are a 64-position matrix and a six-bit synchronous counter. (The counter is composed of a 9316 four-bit binary counter and a 9020 dual JK flip-flop.) The three Most Significant Bits of the counter output address the 1-of-8 decoder (9301) forming one side of the matrix, sequentially driving its outputs "low". The three Least Significant Bits address the 9312 scanning multiplexer (the other side of the matrix), sequentially looking at its eight inputs. With this arrangement, all multiplexer inputs are scanned once for every change in the decoder output.

Each intersection of the decoder outputs and the multiplexer inputs can be used as a key position. If one of the keys is depressed, a "low" from the decoder is detected by the multiplexer and converted to a "high" on its negation output. This triggers a one-shot that inhibits the counter from advancing further and provides a "data ready" signal. The duration of the one-shot is set to cover any possible contact bounce. The output of the counter can now be used as

the encoded signal, and the matrix can be arranged so that any key closure provides any binary code from 000 000 to 111 111.

The code that appears corresponds to the first key depressed. As long as that key remains down, the retriggerable one-shot continues to receive reset pulses that hold the counter at the count independently of any other switch closures on the board. Once that key is released, the counter resumes its scanning after the one-shot time period has run out.

The addition of a few more MSI elements would add even greater capability to this design. As an example, the addition of another 9312, 9316 and 9601 can result in a single serial binary PDM output group in response to each key depression. Additional control inputs could be used to restrict the range of the scan counter if only certain keys should be enabled in a certain mode as is the case in key punch machines. Addition of a 9304 Read-Only Memory would allow the selection of any code output with a single keyboard design. A single monolithic parity generator could be added to provide parity at very little additional cost. Or, you might want to add two Read-Only Memories to drive a character display and a normal output simultaneously.

Our universal CCSL logic blocks let you build circuits that you couldn't even consider with less complex or less flexible ICs. We now have 15 off-the-shelf MSI devices that you can use to lower costs and increase performance. More are on the way. Write for additional specs and application notes. We'll put you on our list for future mailings, too.

FAIRCHILD SEMICONDUCTOR / A Division of Fairchild
Camera and Instrument Corporation
Mountain View, California 94040 **FAIRCHILD**
(415) 962-5011 / TWX: 910-379-6435 SEMICONDUCTOR

use fewer components.

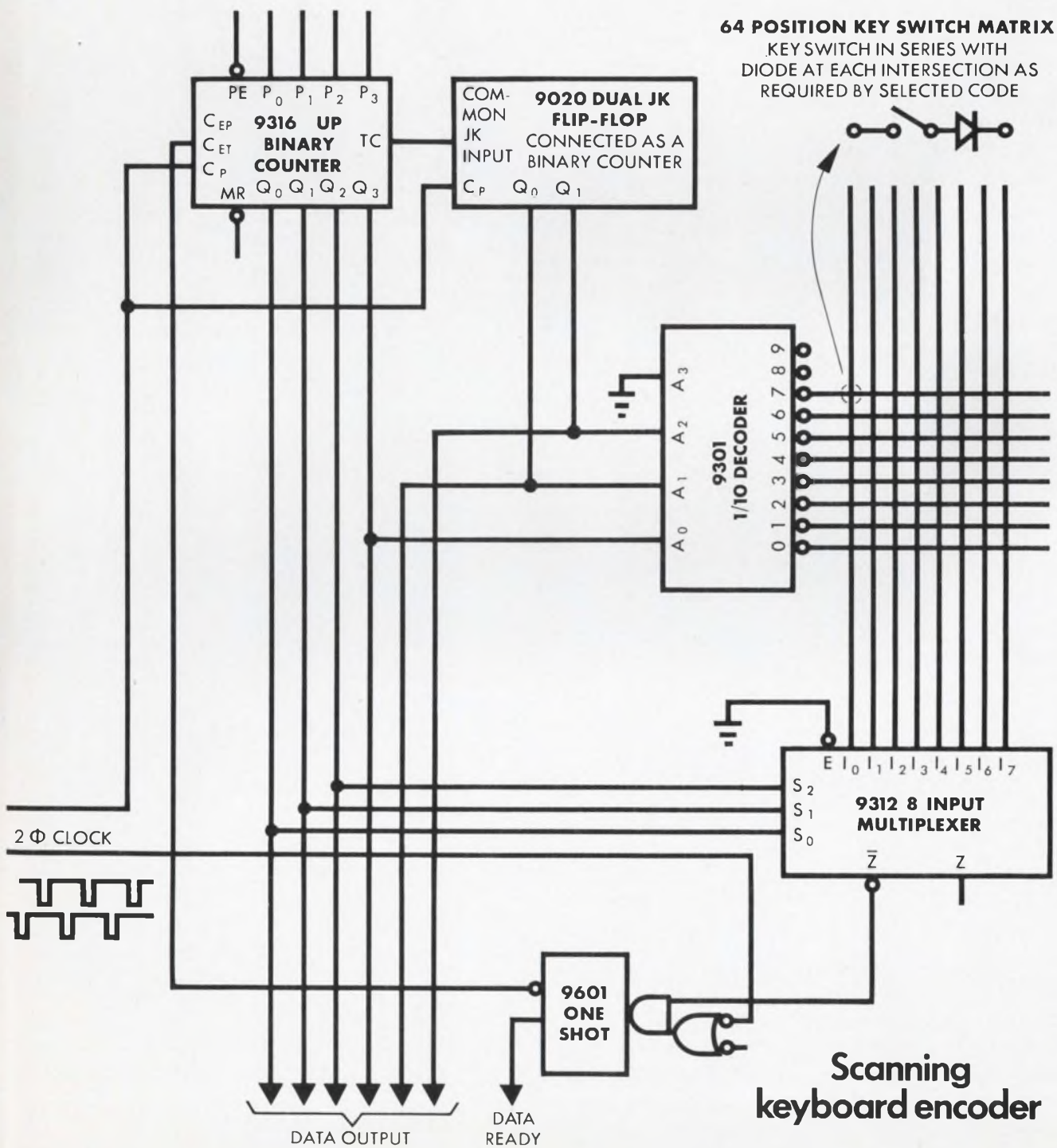

This, the second in a series of Licon heroics, bears little resemblance to the first episode.



Caution: Although Licon's Type 63 environment free sealed switch is rated at 60,000 feet, most angels are ineffective at such heights.

A Licon blimp at 3500 feet. Pity, the Hindenburg was not equipped with Licon switches.

Shown above, the Incredible Wazuma, master of disguise, cleverly camouflaging a Licon toggle switch



An incredible free offer is hidden somewhere on this page. Hint: look for a fish.



Actual size Type 18 double break sub-miniature switches with oak leaf cluster.



Free! Life size poster of the most amazing aircraft yet designed (shown here immediately before take-off). To get your very own space craft, write on your letterhead to: Licon Division, Illinois Tool Works Inc., 6615 West Irving Park Road, Chicago, Illinois 60634. Or circle No. 783 on the response card in the rear of this magazine.

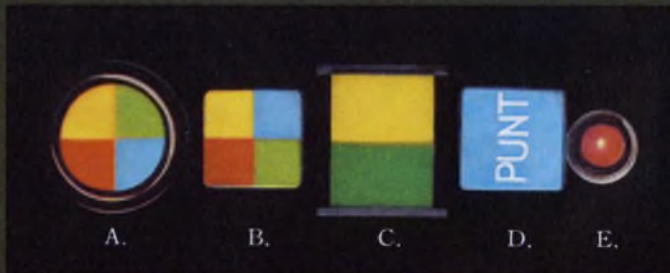

A. Licon's original Fly By Night Switch. The multi-colored Type 44 illuminated indicator.
 B. Type 01 Four Lite illuminated pushbutton switch in actual use on the battlefield.
 C. A Type 02 illuminated pushbutton switch shot in the dark.
 D. Type 04 illuminated pushbutton switch in dress blue.
 E. The tiny 01-700 lighted switch. (Toughest little fella in the squad.)

Licon's butterfly® double break switches have a greater capacity than you could ever imagine—20 million mechanical cycles.



"For what military machines do we make Type 65 hermetically sealed switches?"
 "Tanks."
 "You're welcome."

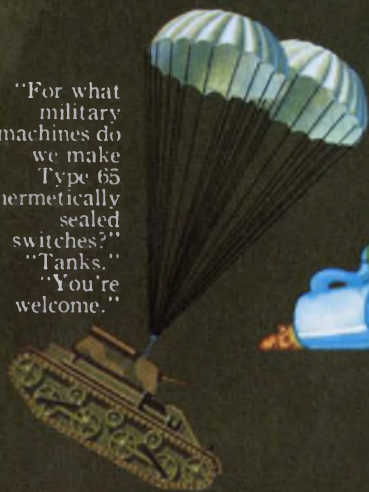

itw
 LICON®
 Division Illinois
 Tool Works Inc.



**Sometimes the strangest things
happen where you least expect...**

**like the
revolution
in
San Diego**

Union Carbide is a total supplier to the Electronics Community offering the finest in Capacitors (circle 234), Crystal Products (circle 235), Lasers (circle 236), and Water Quality Instruments (circle 237).

Great Technology . . .

Union Carbide has the technology today to offer you custom MOS devices for a wide range of applications.

There's P channel low V_T multiplexers and shift registers and high V_T memories (low V_T offers full bipolar compatibility like you see in our SRD-25).

This technology breeds new capabilities not offered anywhere else in the industry, like N channel devices.

For instance, custom fabrication of N channel designs such as **Nixie drivers . . . BCD to Decimal Decoders . . . and SRD-25's.**

The finest and tightest masking capability available.

Union Carbide's new mask repeater, a David Mann 1480 AF can dice up to .3" x .3" on the side.

These are just part of the most advanced MOS custom capability — a result of a new and exciting Union Carbide technology.

(Information Retrieval Number 238)



breeds great new products like ROM1K

ROM1K is Union Carbide's new 1024 bit read only memory. It's available in **four** different word and bit organization made possible by a unique on-chip 3 dimensional decoder. (128 words x 8 bits . . . 256 words x 4 bits . . . 512 words x 2 bits . . . 1024 words x 1 bit).

ROM1K has the typical speed of core — 1.0 μ sec. Its packaging is 50 times denser than core. It uses less power than core—by a factor of 3-4. ROM1K's, MTFB, is reliable. It features static operation, bipolar compatible outputs, and for expanded memory organizations it has chip inhibit capability.

Why use Core?

ROM1K applications includes control logic, table lookup, code conversion, microprogramming, software emulation, input/output interfacing and numerous function tables like log, trig and memory location as well as character conversion and transducer calibration.

Great technology breeds great products like ROM1K and it's all happening in Union Carbide/San Diego.

(Information Retrieval Number 239)

Union Carbide Corporation Semiconductor Department
P. O. Box 23017 • 8888 Balboa Avenue • San Diego, California 92123



Time was when refractory metals were used only as filaments and tube frame grids.

Times change.

Consider some more current design applications. Evaporating boats for vapor deposition. Spectrographic analysis equipment. Springs and washers in high temperature environments. And more.

Refractory metals could be the answer to some of your tough design problems. Examine the family characteristics. All readily lend themselves to forming, machining and welding. Melting point to 3410° C. Electrical resistivity to 20 microhms/cm. No other metals even approach in corrosion resistance capability. Or can hold a candle in high temperature environments. And the way we work them—with precision tolerances down to .00005"—there's no problem in getting predictable, repeatable performance out of your circuit designs.

You have a lot of flexibility, too. Because within the family each metal possesses a set of unique qualities which could make it a natural for your particular application—if it can be formed to just the dimensions you need.

That's where we come in. We roll to the tightest specs in the business. Ribbons, strips, whatever you need. Any width to .006". Any thickness to .0005". Any metal suitable for fabrication. With such superior results even the competition comes to us for the tough jobs.

If you'd like to know more about what refractory metals can do for you in circuit design call (201) 863-1134 or write H. Cross Co., 363 Park Ave., Weehawken, New Jersey. We'll take it from there.



**H. Cross
Company**

Tungsten — for filaments, heaters, grids, etc. **Rhenium Tungsten** — Tungsten containing 3% Rhenium. Used in application where resistance to recrystallization, room temperature, elongation, and pliability, after heating, are needed. **Thoriated Tungsten** — Tungsten containing 1% or 2% thorium. Used where relatively high electron emission is required. **Molybdenum** — Used as support for lamps and electron tube mandrels, for tungsten coil winding, traveling wave tube helices, furnace windings, tube grids, etc. **Molybdenum Rhenium** — 50% Molybdenum and 50% Rhenium used for grids, heaters, supports etc. where high electrical resistivity and low thermal conductivity, ductility, weldability are of importance. **Rhenium** — Used for filaments in mass spectrographs and ion gauges and other electronic components where electrical resistivity, electron emission weldability and ductility are important. **Tantalum** — Used for heat exchanges. Electron tube capacitors, filaments, grid wires and getters. **Columbium** — Used for getters in electron tubes and electrical rectifiers.





multichannel
**ANALOG
SWITCHES
& OP AMPS**
for data
transmission
systems

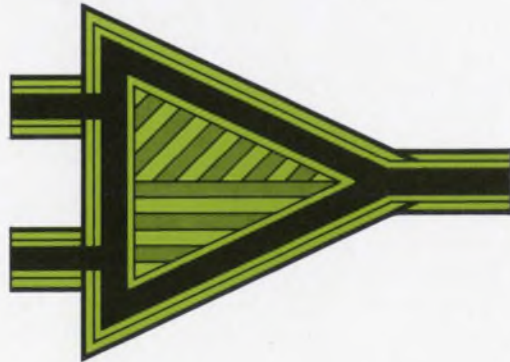

* Applications Power: A wide variety of driver/FET switch combinations and an in-depth applications team waiting to serve you!

Siliconix offers over 32 integrated driver/switch combinations particularly suited to data transmission systems. Choose from a wide variety of junction or MOS FET switches, depending on your system requirements. These, combined with a Siliconix OP AMP, can be applied to a great variety of data transmission requirements.

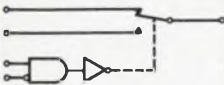
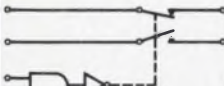
Functional Description	Type	Max. $r_{DS(ON)}$ (ohms)	Switch Type
 SPDT 1-CHANNEL	DG136	600	PMOS
	SI3002	600	NMOS PMOS
 SPDT 1-CHANNEL	DG113	600	PMOS
	143	80	N
	144	30	N
	146	10	N

A number of switches with the ON resistance ranges best suited to your application are available from Siliconix. These driver-switches accept standard DTL, RTL, and TTL logic control inputs.

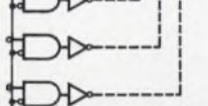
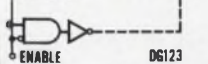
Functional Description	Channels	Type	Max. $r_{DS(ON)}$ (ohms)	Switch Type
  	2	DG102	100	N
		103	100	N
		104	100	N
		110	600	PMOS
		111	600	PMOS
		112	600	PMOS
		133	30	N
		134	80	N
		141	10	N
		147	600	PMOS
		148	40	PMOS
		4	DG116	600
118	600		PMOS	
5	DG123	600	PMOS	
	125	600	PMOS	

System requirements will dictate which of the above combinations are best for your multiplexer combination.

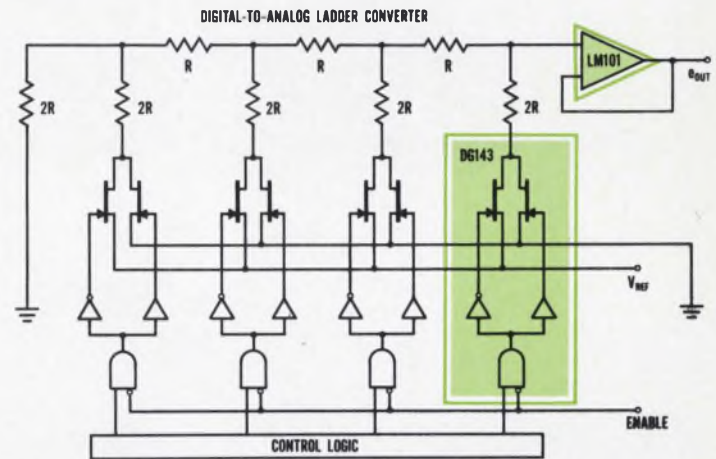

We recommend Junction FETs for this popular digital to analog converter, but if you prefer MOS FETs, we have them, too.

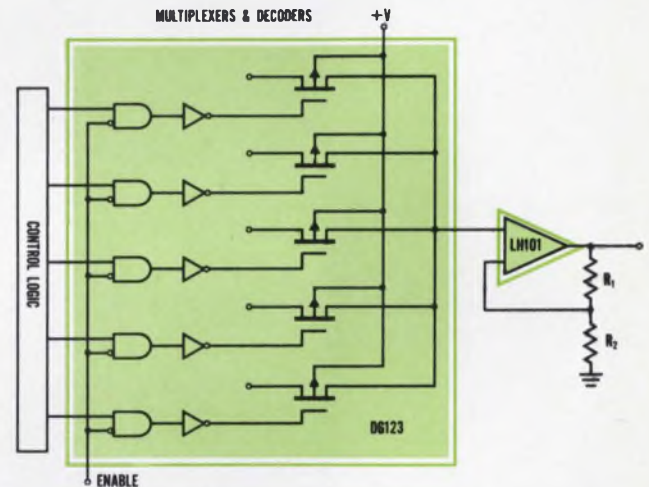

Only one TO-86 package is required to accomplish the above switching functions. Packages include switch drivers that accept standard DTL, RTL, or TTL logic signals.

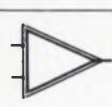
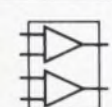
SILICONIX OP AMPS	Max. input offset voltage -55 to +125°C	Max. input current	Min. open loop gain	Output voltage swing	Slew rate	
 LM 101 LH 101 (Internally compensated)	6 mV	200 nA	50K	±12V	.25V/μsec.	<ul style="list-style-type: none"> • Operation from ±5 to ±20V power supplies • Low current drain • Continuous short circuit protection • Same pin configuration as 709 amplifier
 L 120	200 mV	50 pA	100	±12V	20V/μsec.	<ul style="list-style-type: none"> • Low input leakage • High slew rate • Unity gain stable • Ideal for sample and hold, integrating and fast voltage comparisons

Working on data transmission? Write today for complete information on all Siliconix FET switch combinations and OP AMPS.

For instant applications assistance, call the number below. Ask for Extension 19.

 **Siliconix incorporated**
 1140 West Evelyn Ave. • Sunnyvale, Calif. 94086
 Telephone (408) 245-1000 • TWX 910-339-9216

INFORMATION RETRIEVAL NUMBER 7

Improved brightness
solid-state lights
are attention-getting
panel indicators.

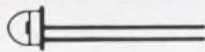

MV10B
Actual Size



MV10A
Actual Size

Solid-state lights from Monsanto are brighter than ever. 1,000 foot-lamberts is typical. They're RELIABLE—1,000,000 hours life*; FAST—1 ns switching time; and SMALL—.10 inch diameter for the MV10A3. SPECTRAL EMISSION is an attention-demanding 6,700 Å red.

Low current requirements, down to 5 ma for 50 ft/L output, make them compatible with low cost integrated

circuits. The long life and solid state ruggedness of these emitters eliminates the need for redundant indicators and in-field servicing, even in the most critical applications.

For more information on our MV10A and MV10B red indicators and other Gallium Arsenide Semiconductors, write or call Monsanto Electronic Special Products, 10131 Bubb Rd., Cupertino, Ca. 95014, (408) 257-2140.

* $T_A = 25^\circ\text{C}$, $I_F = 50$ ma. Result of step-stress testing with end of life projections.

Monsanto

Designer's Datebook

JUNE 1969						
Sun	Mon	Tue	Wed	Thu	Fri	Sat
1	2	3	4	5	6	7
8	9	10	11	12	13	14
15	16	17	18	19	20	21
22	23	24	25	26	27	28
29	30					

JULY 1969						
Sun	Mon	Tue	Wed	Thu	Fri	Sat
		1	2	3	4	5
6	7	8	9	10	11	12
13	14	15	16	17	18	19
20	21	22	23	24	25	26
27	28	29	30	31		

For further information on meetings, use Information Retrieval Card.

June 9-10

Chicago Spring Conf. on Broadcast & Television Receivers (Des Plaines, Ill.) Sponsor: G-BTR, N. T. Waters, Zenith Radio Corp., 6001 W. Dickens Ave., Chicago, Ill. 60606

CIRCLE NO. 821

June 9-11

Int'l. Communications Conference (Boulder, Colo.) Sponsor: G-Com-Tech, M. Nesenbergs, Inst. for Telecommunications Science, R-614, Boulder, Colo. 80302

CIRCLE NO. 822

June 17-19

Computer Conference (Minneapolis) Sponsor: IEEE, D. L. Epley, Dept. of EE, Univ. of Iowa, Iowa City, Iowa 52240

CIRCLE NO. 823

June 17-19

Electromagnetic Compatibility Symposium (Asbury Park, N. J.) Sponsor: IEEE, C. Joly, Honeywell, Inc., POB 54, Eatontown, N. J. 07724

CIRCLE NO. 824

July 7-11

Nuclear & Space Radiation Effects Conf. (Philadelphia) Sponsor: IEEE, NASA, et al., E. A. Burke, Air Force Cambridge Research Lab., Hanscom Field, Bedford, Mass. 01730

CIRCLE NO. 825

July 20-25

Engineering in Medicine & Biology (Chicago) Sponsor: IEEE, L. Stark, Univ. of Illinois, Chicago 60612

CIRCLE NO. 826

◀ INFORMATION RETRIEVAL NUMBER 8
INFORMATION RETRIEVAL NUMBER 9 ▶



These specialists can't wait to get their hands on our new plastic transistors. How about you?

If you fit one of these descriptions, our new family of B-133000 plastic power transistors is for you:

You're a power-circuit designer. Interested in V_{CE0} up to 80 volts? Good gains up to 4 amps? And isolated collector? You know you are.

You're a manufacturing man. Get rid of those extra insulating washers and bushings. Our plastic transistors are electrically isolated. Mount them in a one-step operation with just a self-tapping screw.

You're a mechanical engineer. Here's a plastic package surrounded by a corrosion-resistant, protective metal form.

You're a components specialist. Now you can get interchangeability with other plastic configurations and TO-66 mounting arrangements.

You're a circuit reviewer. We're offering safe operating areas for all the 20-watt ($T_C = 25^\circ\text{C}$) B-133000's. They're rugged, second-breakdown-resistant, silicon mesa NPN devices.

You're a purchasing man. You get low cost two ways—a low price tag and you don't need any expensive mounting kits. Delivery is fast—from distributor stock or directly from us.

No matter who you are, you've got a good reason for checking on our B-133000's. Write: The Bendix Corporation, Semiconductor Division, Holmdel, New Jersey 07733.

B-133000-008 SERIES

Symbol	Characteristics
I_C Max.	4.0A
$V_{(BR)CEO}$	40, 60 or 80V
V_{CES}	60, 80 or 100V
P_T	20W at Case Temp. $T_C=25^\circ\text{C}$
P_T	2.8W in free air at $T_A=25^\circ\text{C}$
h_{FE}	100-300 at $I_C=0.5A^*$
h_{FE}	12-48 at $I_C=4.0A^{**}$
f_T Min.	1 MHz

*B-133000,3,6

**B-133002,5,8

Bendix **Electronics**

Chicago—(312) 637-4633; Denver—Electronic Component Sales, (303) 771-6200; Detroit—(313) 548-2120; Greenwich, Conn.—(203) 869-7797; Holmdel, N.J.—(201) 946-9400; Horseheads, N.Y.—(607) 732-1882; Lexington, Mass.—(617) 861-8350; Los Angeles—(213) 776-4100; Merriam, Kansas—Mid-America Marketing, (913) 432-8678; Minneapolis—(612) 926-4633; Orlando, Fla.—(305) 423-6048; Richardson, Texas—P. J. Scanlon Co., (214) 213-4661; Rochester, N.Y.—(716) 266-5550; Runnemede, N.J.—(609) 933-2550; Seattle—Ray Johnston Co., Inc. (206) 542-5170; Timonium, Maryland—(301) 828-6877; Export—Cable: "Bendixint," 605 Third Avenue, New York, (212) 973-2121; Ottawa, Ont.—Computing Devices of Canada, P.O. Box 508 (613) 829-1800; San Juan, Puerto Rico—Southern International Sales Co. 723-3879.

We don't know who'll design it. But we know where he can get the batteries.

At the nearest Burgess Distributor. They're probably somewhere in his stock of batteries.

One's bound to be right for the electric spaghetti windlass. And one's exactly what you need for whatever you're designing. Another thing. Whether it's a standard or special, your Burgess Battery will be power-fresh. All distributor inventories are checked, rotated, and filled-in according to a systematic schedule.

So the battery you get comes on strong . . . and stays that way.

When you need batteries, check with your Burgess Distributor. He's a great source of power.

And when you need technical information, give us a call. Burgess has a library filled with the latest, most complete engineering data and technical battery material in the business.

Meanwhile, send for our new engineering manual and do a little window shopping. It's got comprehensive listings of all batteries available through Burgess. Clevite Corporation, Burgess Battery Division, Freeport, Illinois 61032.



CLEVITE BURGESS

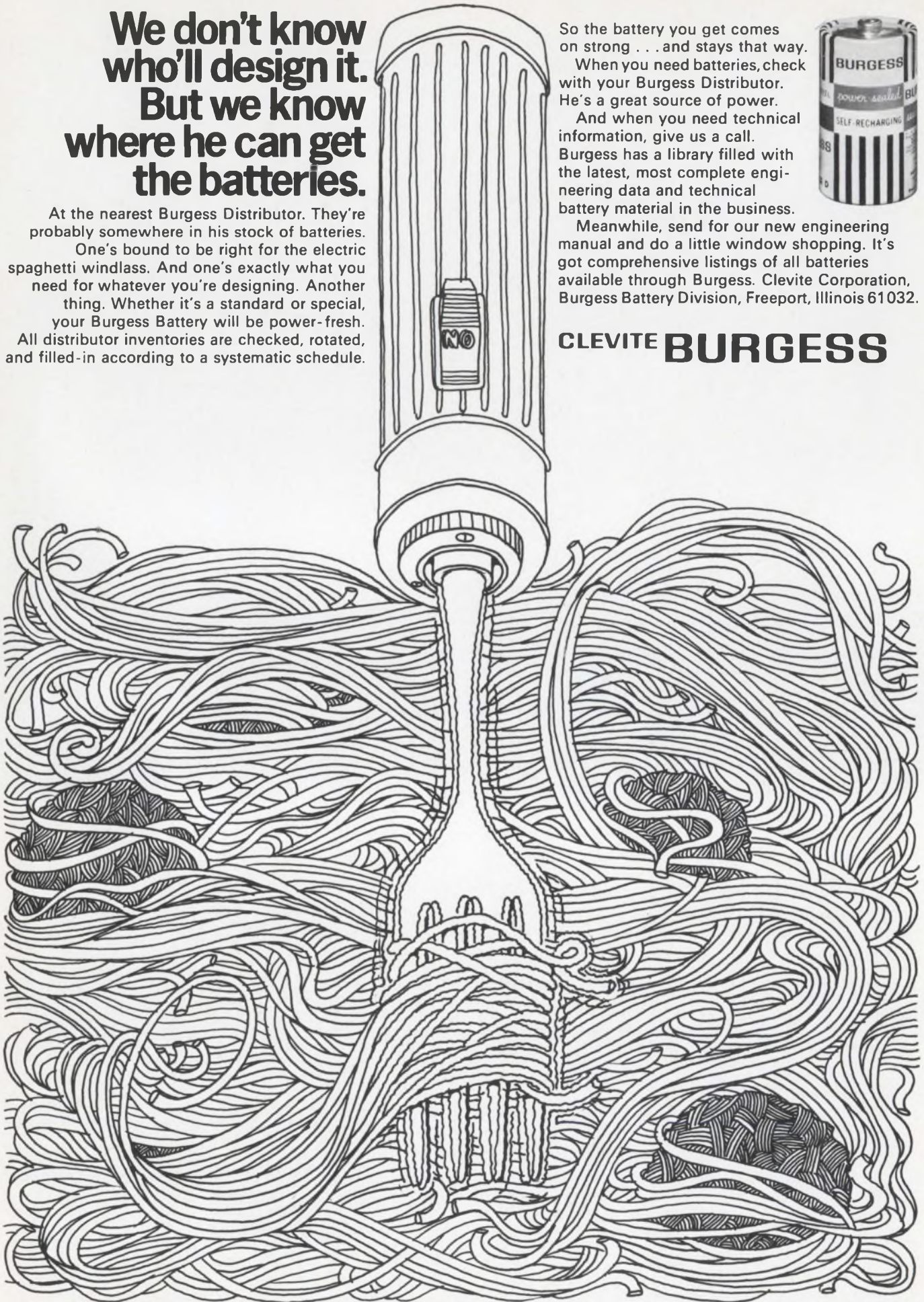



LINEAR BRIEF 2

Bob Dobkin
National Semiconductor

FEEDFORWARD COMPENSATION SPEEDS OP AMP

A feedforward compensation method increases the slew rate of the LM101A from 0.5/μs to 10V/μs as an inverting amplifier. This extends the usefulness of the device to frequencies an order of magnitude higher than the standard compensation network. With this speed improvement, IC op amps may be used in applications that previously required discretes. The compensation is relatively simple and does not change the offset voltage or current of the amplifier.

In order to achieve unconditional closed loop stability for all feedback connections, the gain of an operational amplifier is rolled off at 6 dB per octave, with the accompanying 90 degrees of phase shift, until a gain of unity is reached. The frequency compensation networks shape the open loop response to cross unity gain before the amplifier phase shift exceeds 180 degrees. Unity gain for the LM101A is designed to occur at 1 MHz. The reason for this is the lateral PNP transistors used for level shifting have poor high frequency response and exhibit excess phase shift about 1 MHz. Therefore, the stable closed loop bandwidth is limited to approximately 1 MHz.

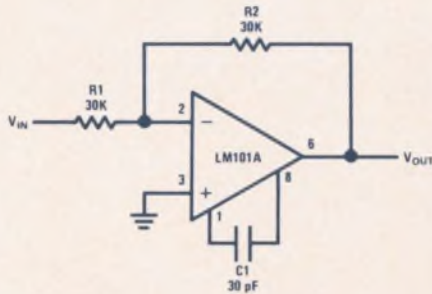

FIGURE 1. Standard Frequency Compensation

Usually, the LM101A is frequency compensated by a single 30 pF capacitor between Pins 1 and 8, as shown in Figure 1. This gives a slew rate of 0.5V/μs. The feedforward is achieved by connecting a 150 pF capacitor between the inverting input, Pin 2, and one of the compensation termi-

nals, Pin 1, as shown in Figure 2. This eliminates the lateral PNP's from the signal path at high frequencies. Unity gain bandwidth is 3.5 MHz and the slew rate is 10V/μs. The diode can be added to improve slew with high speed input pulses.

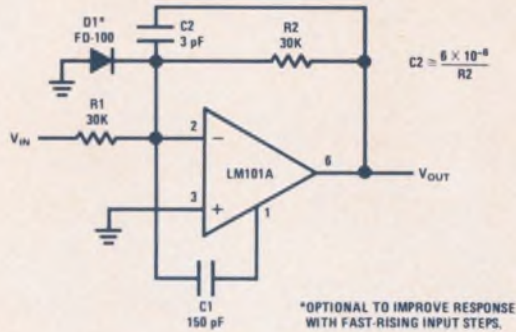

FIGURE 2. Feedforward Frequency Compensation

Figure 3 shows the open loop response in the high and low speed configuration. Higher open loop gain is realized with the fast compensation, as the gain rolls off at about 10 dB per octave until a gain of unity is reached at about 3.5 MHz. Figures 4 and 5 show the small signal and large signal transient response. There is a small amount of ringing; however, the amplifier is stable over a -55°C to +125°C temperature range. For comparison, large signal transient response with 30 pF frequency compensation is shown in Figure 6.

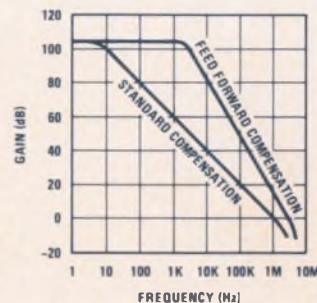

FIGURE 3. Open Loop Response for Both Frequency Compensation Networks

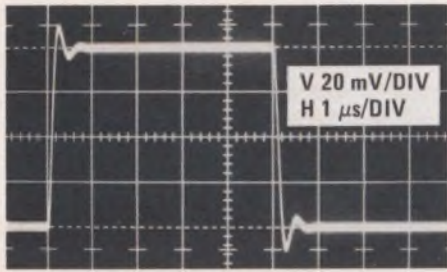

FIGURE 4. Small Signal Transient Response with Feedforward Compensation

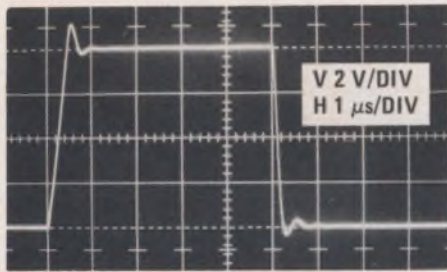

FIGURE 5. Large Signal Transient Response with Feedforward Compensation

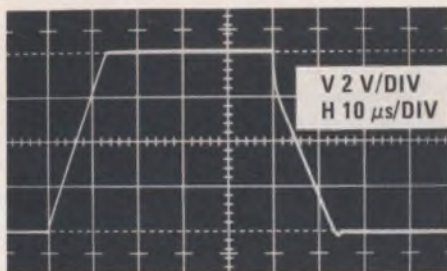

FIGURE 6. Large Signal Transient Response with Standard Compensation

As with all high frequency, high-gain amplifiers, certain precautions should be taken to insure stable operation. The power supplies should be bypassed near the amplifier with $.01 \mu\text{F}$ disc capacitors. Stray capacitance, such as large lands on printed circuit boards, should be avoided at Pins 1, 2, 5, and 8. Load capacitance in excess of 75 pF should be decoupled, as shown in Figure 7; however, 500 pF of load capacitance can be tolerated without decoupling at the expense of bandwidth

by the addition of 3 pF between Pins 1 and 8. A small capacitor C_2 is needed as a lead across the feedback resistor to insure that the rolloff is less than 12 dB per octave at unity gain. The capacitive reactance of C_2 should equal the feedback resistance between 2 and 3 MHz . For integrator applications, the lead capacitor is isolated from the feedback capacitor by a resistor, as shown in Figure 8.

Feedforward compensation offers a marked improvement over standard compensation. In addition to having higher bandwidth and slew, there is vanishingly small gain error from DC to 3 kHz , and less than 1% gain error up to 100 kHz as a unity gain inverter. The power bandwidth is also extended from 6 kHz to 250 kHz . Some applications for this type of amplifier are: fast summing amplifier, pulse amplifier, D/A and A/D systems, and fast integrator.

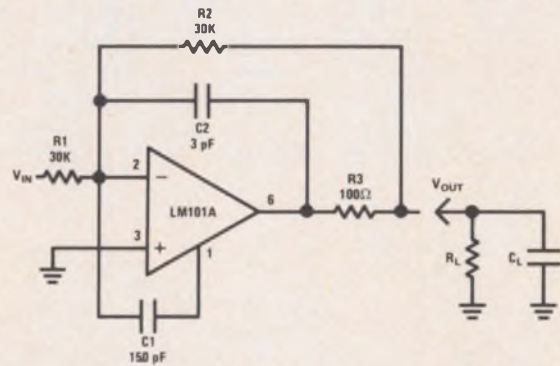

FIGURE 7. Capacitive Load Isolation

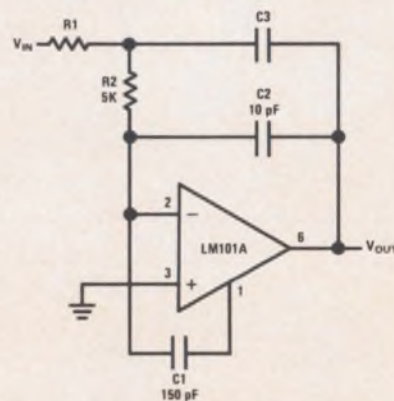

FIGURE 8. Fast Integrator

National Semiconductor Corporation

2975 San Ysidro Way, Santa Clara, California 95051
(408) 245-4320/TWX (910) 339-9240



"The Pill"

for price control

TELEDYNE



TO-5 Relay

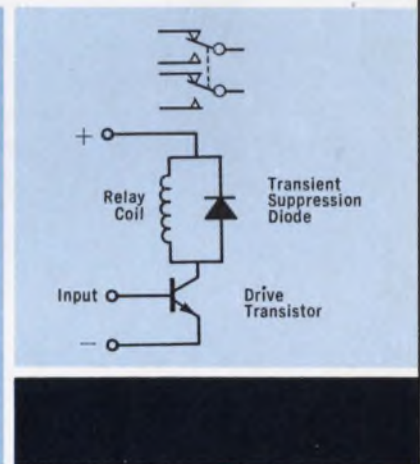
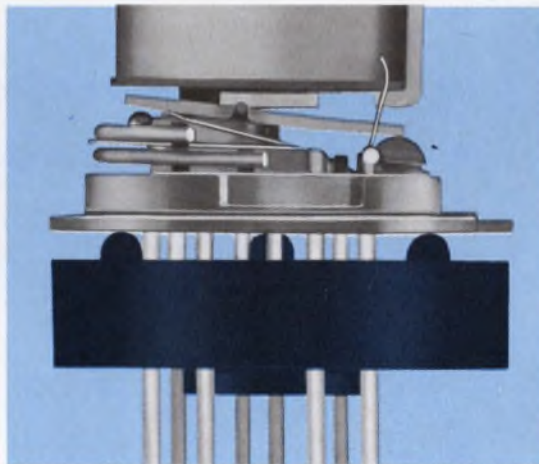

We keep our promises! Last month we promised a low-priced industrial application DPDT TO-5 case relay with an internal transistor driver. We call this new contraption "THE PILL." "THE PILL" contains a transistor driver and suppression diode, attaches externally to our DPDT industrial 712 relay to form the 712T . . . and does double duty as a transapad.

The 712T combines the advantages of relay operation, i.e., high isolation, low contact resistance, double throw contacts, high current and overload capability with the low signal drive requirement offered by the transistor front-end.

It's hermetically sealed; utilizes all welded construction; requires a turn on (trigger) power of only 200 microwatts or less depending on coil voltage; and may be driven directly from standard T²L or similar logic. The relay coil is paralleled with a diode to suppress transients.

The entire package is only 0.405 high by 0.370 in diameter (including "THE PILL"), and is available from stock at your local Teledyne Relay distributor or from the factory at the following price schedule:

Quantity	100	1,000	10,000
Price	\$12.50	\$10.40	\$ 9.25

We call our first price control PILL the 712T . . . Look for an op-amp

PILL in July for DO-IT-YOURSELF time delays and level sensing applications.

No blue sky promises from us . . . just fast delivery for quick price relief.

Phone, wire or write for technical data.



TELEDYNE RELAYS
A TELEDYNE COMPANY

3155 West El Segundo Boulevard Hawthorne, California
90250 Telephone: (213) 679-2205

MODULINE[®] Memory-drive Hybrid Circuit Modules combine miniaturized inductive elements with thick-film ceramic-based technology.

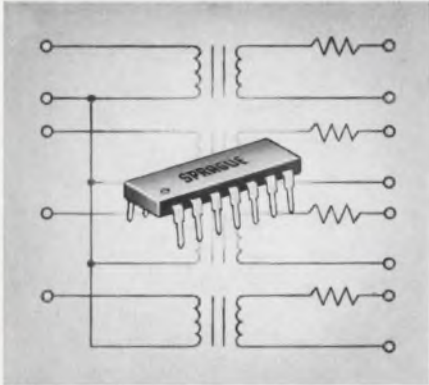

You get pulse transformers and resistors (diodes and capacitors can also be included) in a circuit tailored to your specifications.

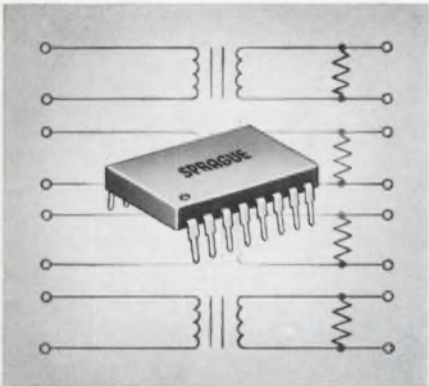

A single module may contain up to four identical circuits. They're particularly useful in memory systems where a similar repetitive pattern exists.

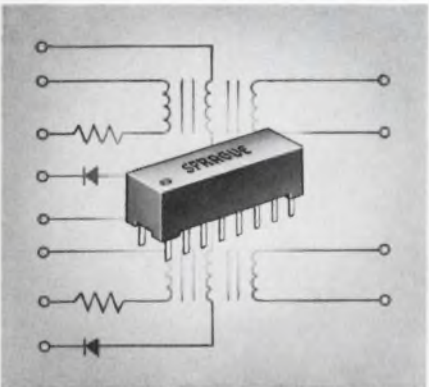

Flexibility offered by modular concept simplifies specific designs.

3 package styles: standard dual in-line, jumbo dual in-line, molded case with pin leads. They're all compatible with conventional in-line circuit layout.

High component density permits substantial size and cost reduction.

For complete technical data, write
for Engineering Bulletin 22210 to:
Technical Literature Service, Sprague Electric Co.,
347 Marshall St., North Adams, Mass. 01247.

498C-B134



Sprague' and '®' are registered trademarks of the Sprague Electric Co.

THE BROAD-LINE PRODUCER OF ELECTRONIC PARTS

INFORMATION RETRIEVAL NUMBER 12

News



Focus Retina proved today's combat electronics can take the strain of an airdrop mission to Korea. Men working in this hostile en-

vironment, however, have complaints worth hearing. The opinions they expressed may be tomorrow's specifications. Page 34.



A solar-powered space probe, of the type that took this photo of the surface of Mars, will be sent to Jupiter in 1972. Page 25.

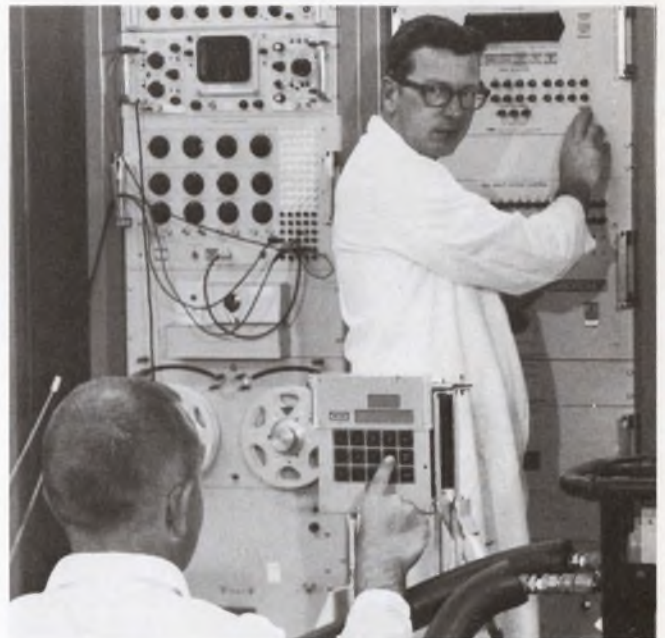

The safety of the moon landing mission, especially the critical descent, depends on an intricate abort guidance system. Page 30.

Also in this section:

News Scope. Page 21 . . . **Washington Report.** Page 47 . . . **Editorial.** Page 71.

*the only
IC Decimal Counters
available!*

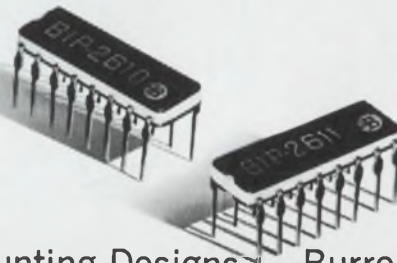

An Economical Approach to all your Decimal Counting Designs.™ Burroughs' new dual-in-line packaged decimal counters were designed to satisfy an industry need for a low-priced, highly-reliable, IC decimal counter that would replace the two packages now required to provide a decimal count. This Burroughs innovation fulfills these requirements through the use of 10-stage SCS ring-counter logic and provides the extra advantages of high noise immunity, (up to 6V peak); preset inputs; re-settable to any number; plus the inherent advantages of Bi-polar MSI. Designed for applications with 12 volt logic, this new hermetically-sealed counter is available in two configurations: the BIP-2610, designed with output voltage sufficient to directly drive a NIXIE® tube, and the BIP-2611, a lower-cost unit designed with output voltage sufficient for all applications not requiring a NIXIE tube readout. Call or write Burroughs Corporation, Electronic Components Division, Box 1226, Dept. C1, Plainfield, N.J. 07061. Tel: (201) 757-5000.

Burroughs



News Scope

Eastern Test Range getting ready for MIRV

Although there has been no official announcement, it's apparent that the Air Force Eastern Test Range is preparing even now for tests of a multiple-warhead atomic missile in fiscal 1972-73.

The missile is MIRV (Multiple Independently Targeted Re-Entry Vehicle), now in the R&D stage, and hints of Eastern Test Range preparations for it are contained in "Report to Industry on Instrumentation Programs," an outline of the range's procurement needs. The emphasis in the report is on major modifications to two Advanced Range Instrumentation Ships in the next two years and new and modified equipment for under-water acoustic locator systems. The latter would be systems that could locate several targets at once. Radars would also be improved for ultimate tracking of multiple targets.

If the funds are approved, procurement by the test range for fiscal '70 should come to around \$14 million, according to Henry Barrows, chief of the range's Instrumentation Branch. This would be just slightly under the sum authorized last year but far below the fiscal '67 total, which included \$38 million for a major telemetry rehabilitation program.

MIRV is being developed for use with the Navy's Poseidon rocket and the Air Force Minuteman III.

Some \$12 million of the funds sought by the test range would equip the two range ships for radar-signature recording measurements and with telemetry for multiple-re-entry vehicles. The C-band radars would be modified to double their operating range. A splashdown-detection radar, TACAN (Tactical Air Navigation equipment) and coherent uhf radars for collecting atmospheric wake data on re-entering missiles

would also be installed.

The range's Broad Ocean Area Acoustic Impact Location System—which covers an area beginning 300 miles down-range from Patrick Air Force Base, Fla., to a point 3400 miles beyond—would be modernized in preparation for a more advanced system, to be requested in fiscal '71. The latter, called the Redeployable Advanced Impact Location System, would resemble the Project Mohole platform used for ocean-bottom deep drilling. The platform would be deployable anywhere down-range and would be equipped to permit precise location of multiple, closely spaced warhead impacts.

Beginning in fiscal '72, three major trajectory-determination systems would be procured. An advanced metric tracking radar system would require pulse radars of high power and high sensitivity, and would be capable of tracking several objects simultaneously from launching to impact, the Air Force says.

A new continuous-wave advanced metric measurement system would be required to determine the operational performance of self-guided weapon systems. The network would include high-precision, very-long-range cw radars.

A laser ranging system would be procured for determining trajectory of missiles in the phase immediately after launching.

IBM gets into the telephone business

Despite mounting legal pressure to put a lid on IBM's growth and diversification, the company's phenomenal talent and resources have spawned still another product: a voice and data switching system that integrates data processing and

private telephone services. So far the system, called IBM 2750, is being marketed only in France and Italy, but, according to the IBM World Trade Corp., the list will grow.

Built for banks, insurance companies, manufacturers and other major users of data-processing equipment, the 2750 combines a private telephone system and a low-cost data-collection system capability—using push-button telephones as terminals. Voice features and data capabilities can work in combination or separately.

The system can serve over 700 extension lines, as many as 80 outgoing trunk lines and from two to eight operator control desks. Switching is entirely electronic, including up to 25,000 cross point switches. The switching and all other related functions, such as scanning, path marking and signal distribution, are under the permanent control of a built-in computer. The switching section is made up of a matrix of semiconductor thyristors or switching diodes.

The over-all system design was carried out at IBM France's laboratory at La Gaude.

Sea study is seeking better clues to weather

On May 3 an array of electronically equipped planes, ships, buoys and satellite terminals converged off the east coast of Barbados to begin the most intensive investigation ever made of the interaction between the sea and the air above it. The result will, it is hoped, enable meteorologists to predict weather longer in advance.



Bomex "weather" ship Discoverer releases meteorological balloons.

Using the services of 1500 people, 24 planes, 10 ships, several satellites and a dozen buoys, tests will be made over a 90,000-square-mile area of ocean stretching vertically from the sea floor, 18,000 feet down, to 100,000 feet above the surface.

Called Bomex (Barbados Oceanographic and Meteorological Experiment), the investigation will continue through July 28. Headed up by the Dept. of Commerce's Environmental Science Services Administration, the project will be carried out by the Dept. of Defense, the Atomic Energy Commission, the National Aeronautics and Space Administration and the Government of Barbados. Nineteen universities and seven industrial laboratories also have roles.

The 82 planned experiments use such sensors as hot wire anemometers, sonic and mechanical anemometers, thermistor arrays on buoys and telemetering and recording buoys. For navigation the Omega system and the Navy's Navigation Satellite will be used. Stationary satellites will photograph the test area. All data will be flown back to NASA's Mississippi Test Facility's computerized data management system where they will be processed.

One area that stands to benefit from the experiment is antisubmarine warfare. The ability to predict sea state from the air-sea interface will enable better measurement of undersea sound propagation—still the major approach for detecting enemy submarines.

First U.S.-made LSI-MOS calculator introduced

The first U.S.-made electronic calculator using large-scale integration with MOS elements has been introduced by the Smith-Corona Marchant Division of the SCM Corp., New York City. The 8-pound unit, named the Cogito 414, was designed to compete against similar foreign imports

such as Hayakawa Electric Co.'s smaller 3-1/8-pound QT-8D calculator, which sells for less than \$500 (ED No. 8, Apr. 12, 1969, p. 118).

The machine, which has a 14-digit capacity, is suitable for general office or accounting work rather than for engineering computations. It will sell at \$895, with deliveries in the fall of 1969.

An outgrowth of an early SCM electronic calculator, it has been progressively whittled down in size from the original 600 transistor, resistor and diode components in 1964, to 20 integrated circuits in 1967, to the present eight MOS chip elements that are equivalent to 4800 discrete components.

The keyboard is logically arranged with a 14-place credit-balance adding machine, plus separate multiplication and division registers. A special "transfer" keyboard memory links all mathematical functions together by transferring figures back and forth between registers.

Chain multiplication and division can be performed without re-entering figures. Answers to individual problems are accumulated and stored in an "adder" register, providing a grand total in one operation.

The Cogito 414 has automatic decimal positioning, and answers are automatically rounded off in multiplication and division with all insignificant numbers eliminated to the right.

Electronic failures in Mariners discounted

The "trouble" that has been rumored to plague the two Mariner '69 spacecraft speeding toward Mars has been spotted as telemetry and Star Tracker malfunctions, say NASA officials. Corrections were made, and the probes are expected to fly-by the planet as planned.

From a range of 2000 miles, Mariner VI will look at the equatorial regions of Mars, while Mariner VII will scan the polar cap. Televised photos and infrared and ultraviolet spectrometric data will be transmitted to Earth detailing the Martian surface and atmosphere.

Mariner VI is now estimated to

come closest to Mars at 1:18 a.m. E.D.T. on July 31; Mariner VII will pass closest at 1:00 a.m. on August 5.

Late in April, says Assistant Program Manager Robert Kennedy, the Mariner VI telemetry downlink revealed fluctuations, probably caused by the local oscillator in the transponder. These were small—"less than one watt," he says—and the received signals are now operating nominally. Similar signal variations occurred during the launch last February 4, he reports. That problem was generated by the low-gain antenna drive, but it, too, self-corrected.

The Star Tracker problem could have become more serious. The subsystem is employed to locate and lock-on to the star Canopus to assure proper vehicle spatial orientation with respect to Earth. The Canopus sensor, says JPL, has been "distracted" several times by bright reflective particles emanating from the spacecraft. The particles are believed to be produced by pyrotechnic squibs used for the staging or deployment of various subsystems. The result is that the tracker loses lock-on, and the vehicles begin a roll mode in attempting to relocate Canopus.

To prevent this from happening—particularly when the vehicles make their critical Mars lock-on maneuvers this summer—both crafts have been reprogrammed to use the Honeywell 3-axis inertial reference subsystem for stabilization. The Canopus Star Tracker can still be used to provide the navigational fix necessary for gyro alignment, but no problem is anticipated for this operation.

Delay-line expert returns

After realizing that the state of the art in delay-line manufacture was still as he had left it a year ago, Walther M. A. Andersen—called "Father of the delay-line industry"—has started a new company in Tariffville, Conn. Known as Walther M. A. Andersen and Associates, the company will manufacture high-frequency, broad-band crystal filters and acoustic delay lines. Andersen has been doing consulting work since he left Laboratory for Electronics Inc.

But Cutler-Hammer does give designers an almost unlimited choice of switch types, forms, shapes, and colors.

We put this Rube Goldberg together to demonstrate the tremendous range of choice you have with Cutler-Hammer switches.

Take our Designer Line toggle switches. Our AC-rated and AC/DC switches come in the greatest selection of switch bodies, current ratings, toggle shapes and colors available anywhere. And with our wide variety of decorator face nuts, you can customize all Designer Line switches to the Nth degree.

Cutler-Hammer Rockette AC Switches have the same flexibility—and then some. They're available in smooth and serrated rockers;

single, double, and triple rocker designs; futuristic—even proprietary—styling. Multiple choices in colors. Plus lighted versions and special circuits when requested.

And have we got pushbuttons! Pushbuttons for every function. Pushbuttons in an amazing variety: push-button switches, ultra-miniature pushbuttons, and revolutionary new reed pushbuttons.

Delivery: "Off the shelf" on most everything. Or, we'll build to your specifications. When? Call your Cutler-Hammer Sales Office or Stocking Distributor for a fast answer.



This is a partial showing of the basic types of commercial switches we offer. With all of these size, color, style and functional options, you have complete design freedom.

We don't stock it.



Switch
to No. 1

More than just switches;
prompt availability,
field help, innovation,
quality assurance, too.



CUTLER-HAMMER

SPECIALTY PRODUCTS DIVISION, Milwaukee, Wis. 53201

INFORMATION RETRIEVAL NUMBER 34

ANOTHER BOURNS FIRST...

10 MIL-SPEC TRIMPOT® POTENTIOMETERS

MIL-R-27208



RT10



RT11



RT12



RT22



RT24

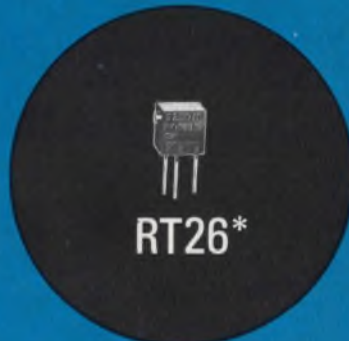

RT26*

MIL-R-22097



RJ11



RJ12



RJ22



RJ24*

AVAILABLE FROM YOUR LOCAL BOURNS DISTRIBUTOR!

Bourns is the world's largest manufacturer of Adjustment potentiometers with 22 years of leadership. Bourns is also the largest manufacturer of MIL-Spec potentiometers backed by a total of 10 RT and RJ models in our line.

The 6 RT and 4 RJ models not only meet the specifications of MIL-R-27208 and MIL-R-22097, but each is designed and manufactured to consistently exceed each facet of these requirements.

As in the past, you can depend on Bourns to deliver the potentiometer you need. In this tradition of service, we now offer the MIL-Spec unit you may need for your next critical application with 10 RT and RJ models.

Full data is available from the factory, local field office, representative or your stocking distributor.

* Not yet stocked in depth by distributors.



BOURNS, INC., TRIMPOT PRODUCTS DIVISION
1200 COLUMBIA AVENUE, RIVERSIDE, CALIFORNIA 92507
714 684-1700 • TWX: 910 332-1252 • CABLE: BOURNSINC

Hop to Jupiter: Takeoff, 1972; Arrival, 1974

U. S. planning to send probes 340 million miles, and they could lead to a 'grand tour' of the planets

Elizabeth deAtley
West Coast Editor

NASA plans to build two enlarged Pioneer solar-electric-power spacecraft for a trip to Jupiter—far beyond the outermost flights of any space probe to date.

The first flight is scheduled for launch in February or March, 1972, and the second will follow it about one year later. Both unmanned flights will take about two years to reach Jupiter, some 340 million miles away from the earth. The spacecraft will have to fly through such potential hazard areas as the asteroid belt of flying rocks and the region of high-energy particles trapped by Jupiter's magnetic field—and thought to be far more intense than the Van Allen belt.

If the flights are successful, a spectacular grand tour of the outer planets some time between 1976 and 1980 may become a reality. During that time the planets will be astronomically lined up so that a spacecraft could be sent bouncing from one to the next like a celestial billiard ball. Launched from earth with just enough thrust

to reach Jupiter, the spacecraft would be deflected by Jupiter's enormous mass and pushed on its way toward the outer planets with greatly increased speed.

By use of the slingshot effect of a close approach to Jupiter, says Dr. Homer J. Stewart, manager of the Advanced Studies Office, Jet Propulsion Laboratory, Pasadena, Calif., it would be possible to visit Jupiter, Saturn, Uranus and Neptune in a single 9-year trip. Once Jupiter moves ahead of Uranus and Neptune in 1980, however, the opportunity for such a grand tour will be over until about the year 2150. Hence there is a sense of urgency in plans for the Pioneer flights to explore the hazards of Jupiter.

Jupiter—the first lap

According to plans currently under study at NASA's Ames Research Center, Moffett Air Force Base, Calif., the Pioneer spacecraft will carry scientific instruments to measure the fields and charged particles around Jupiter,

explore the asteroid belt and send back data on the surface characteristics of the planet itself. The spacecraft would be some 341,000 miles from Jupiter at its points of closest approach.

Instruments likely to be chosen for the mission are, according to Charles Hall, Pioneer project manager at Ames:

- A simple imager to record and transmit brightness readings of Jupiter's surface as the spacecraft spins on its axis. The spacecraft will probably carry instruments of this type for imaging both the visible and the infrared.

- A magnetometer.

- Detectors for both high- and low-energy particles.

Second-choice candidates are:

- An ultraviolet sensor that will measure radiation in the 300- to 1500-angstrom range, where hydrogen and helium emit wavelengths. By measurements in this region, scientists hope to determine the abundance of these gases in Jupiter's atmosphere.

- An X-ray detector.

- An electric-field detector.

- Radio-Astronomy equipment.

The spacecraft will probably carry a 9-foot paraboloid antenna.

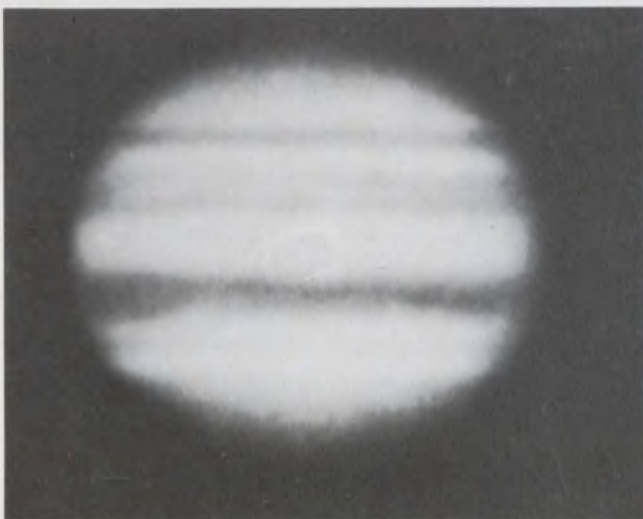

The planet Jupiter (left), some 340 million miles from earth, is the target for two Pioneer spacecraft scheduled to be launched in 1972 and 1973. Saturn (right) would

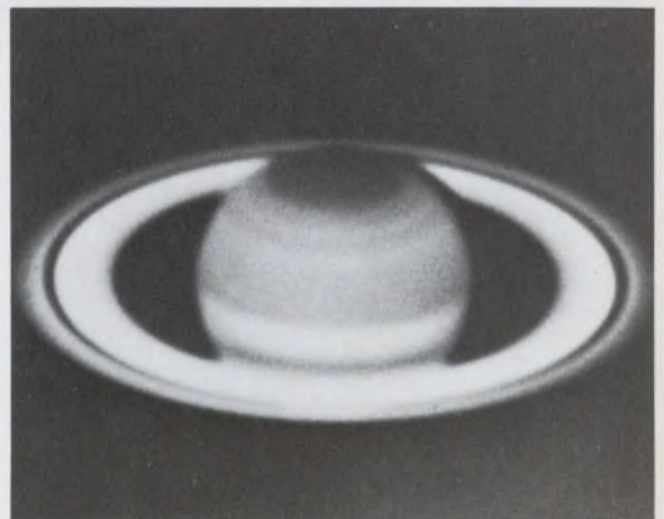

be visited by other probes as part of a proposed "grand tour" of the planets beginning in 1976. Photos courtesy of Mt. Wilson-Palomar Observatories.

(Jupiter, continued)

Both flights are scheduled for launch with an Atlas/Centaur 364—the vehicle used for sending the Mariners to Mars. It will however, have an added third-stage booster, the TE 364, to give the Pioneers the extra initial thrust they need to go beyond Mars to Jupiter.

The spacecraft will use solar energy, but, because of the distance from the sun—more than 400 million miles at Jupiter encounter—the solar panels will be much larger than those for a Mars flight. The vehicle will carry a mid-course-maneuver motor with sufficient propellant to redirect it slightly in midflight. The position of Jupiter is not known with precision. Based on data telemetered back from the first Pioneer, therefore, the second vehicle would be redirected if necessary.

Rock and rubble

To reach Jupiter, the Pioneer flights must cross the asteroid belt, a region some 300 million miles wide between Mars and Jupiter, where flying rocks abound. Presumably debris from small

broken planets, these rocks travel at speeds ranging from about 6 to 43 miles per second. About 50,000 of them are large enough to be viewed by telescope—some of them being hundreds of miles in diameter.

These visible rocks are scarce enough so that the likelihood of a spacecraft striking one of them is considered small. "However," says Charles Hall, "we don't know the density of the particles that can't be seen from the earth—particles the size of, say, a grain of sand. We don't know whether we may be going into an environment like a sandblasting machine."

Several interesting instruments have been suggested to measure the density and momentum of these particles, according to Hall, although there is no certainty that any of them will be included on the flight. One method suggested for measuring fairly large particles (10^{-9} to 10^{-6} grams) is to fasten a microphone to the spacecraft. The larger the microphone, of course, the greater the likelihood of a hit.

For smaller particles, (10^{-15} to 10^{-9} grams), Hall says, "You could put two thin-film sensors some distance apart, and behind the second

sensor you would put a microphone. As the particle hits each sensor, it gives off a signal. The time difference between the two signals would give the particle's velocity. When it hits the microphone behind the second sensor, the microphone rings. The extent of the ring would indicate how hard the particle had hit, and hence its momentum."

A hydrogen magnet?

The prime purpose of the missions is to measure the fields and charged particles around Jupiter. These particles, which come from the sun, are apparently trapped in a doughnut-shaped region around Jupiter by a magnetic field that emanates from the planet. Many scientists now believe that Jupiter may have a metal-like core, which acts as an electric generator to create a magnetic field. They believe, however, that this "metal" may be composed of solid hydrogen.

One possible technique for determining the number of charged particles at a given energy level, says Hall, is to use an instrument consisting of two curved plates with a sensor at one end and a space to admit particles at the other. A voltage across the plates would cause charged particles traveling between them to move toward the plate whose charge is opposite to their own.

Since this plate curves away from the line of flight, particles traveling at a certain critical speed, determined by the voltage, would strike the sensor at the far end. Particles traveling below this speed would hit the plate, and those traveling faster would hit the other plate. By increasing the voltage level across the plates, one could cause particles of higher energy to curve and strike the sensor. Thus it would be possible to detect particles over a range of energy levels by changing the voltage.

A star is born

Not only will the Pioneer missions examine the hazards of the journey to Jupiter—they will also investigate some of the characteristics of this strange planet. Jupiter is of particular interest to

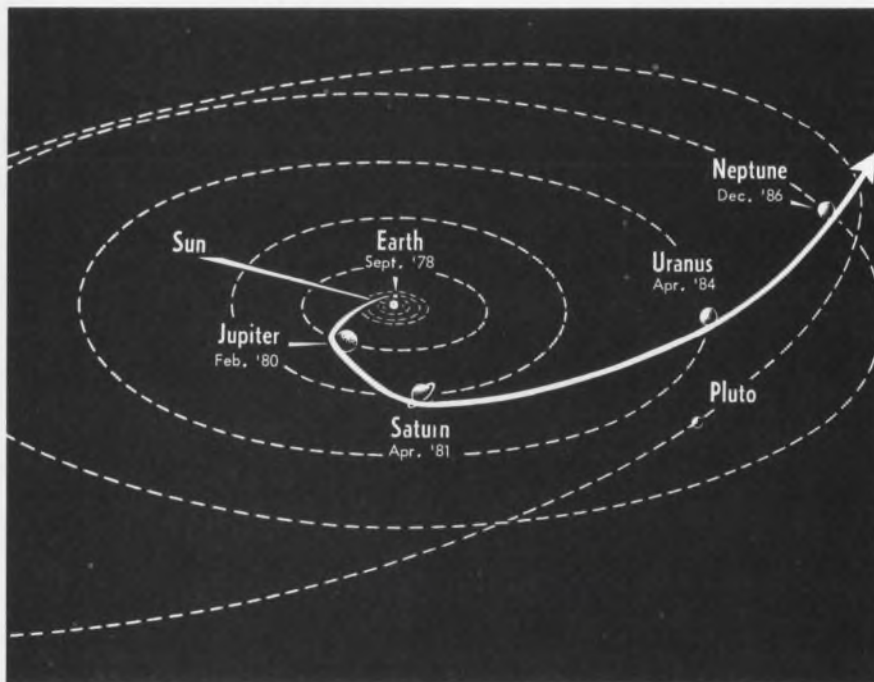

A "grand tour" of four planets could be made by a spacecraft launched from earth in September, 1978, scientists say. Such a tour would begin with Jupiter and end with Neptune in December 1986. Using the mass of Jupiter to give it extra boost, the spacecraft would "bounce" from one planet to the next, coming close enough to each to transmit to the Earth TV photos and other data.

Speed costs

particularly when you don't need it.

COST/PERFORMANCE — UTILOGIC II vs "THE OTHERS"

DECISION FACTOR	UTILOGIC II	930 DTL	MC800 RTL	7400 TTL	MC830 DTL	SUHL I TTL	SUHL II TTL
D. C. NOISE MARGIN (mv)							
"O" Level	800	450	300	400	450	650	550
"I" Level	1100	450	300	400	500	600	600
FAN OUT	16	8	5	10	8	6	6
SPEED (ns typical)	25	25	25	13	25	10	6
PRICE (100-up)							
Quad Gates	\$1.07	\$1.55	\$1.25	\$1.55	\$1.55	\$2.40	\$2.65
Dual Binaries	\$1.99	\$4.75	\$2.30	\$3.85	\$4.75	\$5.95	\$6.60

What the chart says is simply this: except where TTL speed is essential, Utilogic II is the best buy in both performance and cost. Utilogic II not only provides fan out up to 16 and noise immunity up to 1.1V (nearly twice what you get in other IC families) but is available in reliable silicone DIPs. In addition, it is the only logic family that allows you to implement functions any way you choose — with AND, OR, NAND or NOR elements. Last thing. Check the prices below.

Now, wasn't that fast?

UTILOGIC ELEMENTS (+10°C to +55°C) IN 14-LEAD DUAL IN-LINE PAK (100-UP)

SP300A	Dual 3-Input Gate Expander	\$0.99
SP301A	Diode Expander	0.99
SP305A	6-Input AND Gate	0.99
SP306A	Dual 3-Input AND Gate	0.99
SP314A	7-Input NOR Gate	0.99
SP317A	Dual 4-Input NOR Gate	1.07
SP321A	Dual J-K Binary	1.99
SP322B	Dual J-K Binary	2.35
SP333A	Dual 3-Input OR Gate	1.07
SP334A	Dual 4-Input OR Gate	1.11
SP337A	Dual 4-Input Expandable NAND Gate	1.11
SP356A	Dual 4-Input Line Driver	1.45
SP370A	Triple 3-Input NOR Gate	1.07
SP374A	Triple 3-Input OR Gate	1.11
SP375A	Triple 2-Input OR Gate	1.11
SP377A	Triple 3-Input NAND Gate	1.11
SP380A	Quad 2-Input NOR Gate	1.07
SP384A	Quad 2-Input OR Gate	1.11
SP387A	Quad 2-Input NAND Gate	1.11

For more information call your nearest Signetics sales office or distributor.

Signetics Integrated Circuits

A SUBSIDIARY OF CORNING GLASS WORKS

811 East Araucos Ave., Sunnyvale, California 94086



NEWS

(Jupiter, continued)

astronomers because of its enormous size. It is far the largest of the planets. Superimposed on its surface, the earth would look like a blue bottlecap on a gray dinner plate.

Jupiter is 11 times larger than the earth and 300 times heavier. In fact, astronomers now believe that it may be close to the maximum limit in size a planet can attain without collapsing in on itself and starting a thermonuclear reaction that would cause it to become a star.

Jupiter's atmosphere consists largely of hydrogen, helium, ammonia, and methane. In its outer cloud layers, the forces of gravitation are 2.6 times as strong as those of the earth. As a result, objects are extremely heavy and pressures are great. A few thousand miles below the cloud tops, the pressure is believed to be so large that hydrogen turns into a frothy slush. Still farther down it becomes a kind of metallic solid, causing Jupiter's magnetic field.

In some layer of Jupiter's atmosphere, water may exist, and possibly some early forms of life. In fact, astronomers now believe that

an atmosphere like Jupiter's may have existed on earth when life first appeared here.

In addition to carrying instruments to study the planet and its surroundings, says Hall, the spacecraft can itself be used to determine many of the constants of celestial mechanics.

Jupiter—and beyond

The total weight of the enlarged Pioneer—including the spacecraft itself, 55 pounds of scientific instruments, and the launch-vehicle adapter fitting—will be less than about 500 pounds. Its flight will be directed by earth-based computers.

A subsequent grand tour across some 3 billion miles of space to Neptune, and passing close to three other planets on the way, would require a sophisticated on-board guidance system. This would have to be capable of turning the instruments on and off as the spacecraft approaches and leaves a planet, and of correcting its direction and speed of flight. With a four-hour time lag in communications to Neptune, this cannot all be done from the earth. On the other hand, the on-board equip-

ment must be minimized to stay within weight requirements.

A flight program under study at the Jet Propulsion Laboratory calls for a 1200 to 1500-pound spacecraft including 150 pounds of scientific instruments, an auxiliary on-board engine—possible an ion engine—and an on-board computer. According to Dr. Stewart of JPL, the spacecraft would be tracked on the earth by a deep space net that would determine its velocity and distance from the earth and other planets.

An on-board computer would determine the angular position of the spacecraft with respect to the sun and one of the stars. This information would be telemetered to earth, where it would be combined with the velocity and distance information obtained by the ground tracking system. Instructions for correcting the direction of flight would then be transmitted to the spacecraft, where the on-board computer would make the necessary adjustments in speed and direction.

Because the positions of the planets are not precisely known, says Dr. Stewart, it will be necessary to make corrections in the direction of travel as the spacecraft approaches each one. "You could get by without this at Jupiter," he points out, "but the uncertainties for the most distant planets are about twice as great, so you have to make corrections as you go."

For this purpose, some kind of optical system on board—probably a TV camera—would be used, he says, to determine the position of the planet with respect to the sun and one star. This information would be telemetered to earth and processed there with the other flight data.

The spacecraft cannot depend on solar energy for its flight beyond Jupiter, because of the enormous distance from the sun. Therefore, it will carry some other power source. A likely candidate is the so-called RTG—a system that makes use of a radioactive isotope to generate heat that is converted to electrical energy. The vehicle will have to carry a large antenna—about 15 feet in diameter—to communicate across the vastness of space with minimum power. ■■

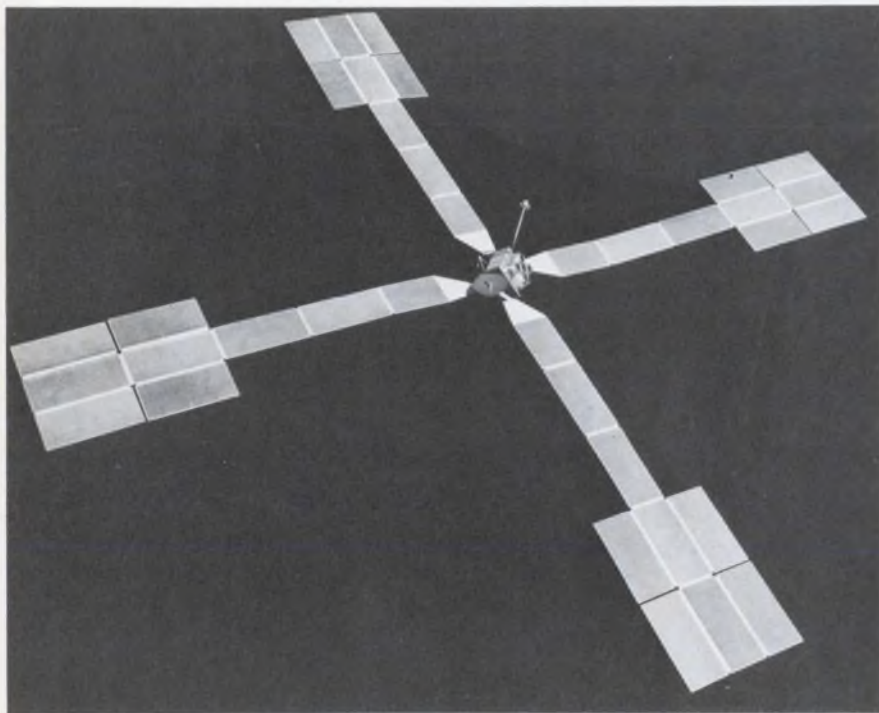

This model of a solar-electric power spacecraft for a Jupiter mission was developed at the Jet Propulsion Laboratory, Pasadena, Calif. The large size of the panels is required because the spacecraft will be more than 400 million miles from the Sun at Jupiter encounter.

For years, Varian's Minipac low-noise TWA's have been the key ingredient in our exclusive weight reduction plan for S, C and X band airborne systems.

Now the line has expanded in X and Ku bands with new models covering 7-12.4 and 12-18 GHz.

Only 11 inches long, weighing 6½ pounds, these SRPM focused, integrally powered TWA's are the smallest ultra-low-noise tubes anywhere. Every broadband Minipac model boasts 7.5 dB maximum noise figure (10 dB in Ku band). And narrow-band models vary from 4.5 dB at S band to 6.5 dB at X band.

Minimum power output is +10 dBm, minimum gain 25 dB.

The line features rugged metal-ceramic construction with all-solid-state power supply, to meet environmental requirements of MIL-E-5400 and MIL-E-16400.

Send for details or get the precise tube you need from any of our more than 30 Electron Tube and Device Group Sales Offices throughout the world, or from our TWT Division, 611 Hansen Way, Palo Alto, California 94303.



varian
twt division

Take ugly pounds off your sensitive system.



S to Ku band Minipac LN TWA's

Strap-down guidance system passes test

The astronauts have just finished their landing mission on the moon and are back in their Lunar module ready to blast off and rejoin the command service module orbiting patiently some 60,000 feet above. Suddenly warning lights flash—the primary navigation system has gone out! They're stranded on the moon—or would be, except that a multimillion-dollar piece of equipment, hopefully designed never to be used, is standing by and ready to take over: the abort guidance system.

This abort system gives the astronauts a vital backup means to guide the lunar module to a rendezvous with the command module at any point during its descent from the command-module parking orbit or during the ascent phase from the moon's surface.

The first in-space test of the abort system was made during the Apollo 9 flight. Its performance pleased everyone, according to David Meginnity, project manager of the abort guidance program at TRW, Systems, Inc., Redondo Beach, Calif.—except for a few shaky moments after the astronauts first turned the system on and warning lights appeared.

But rapid ground evaluation of in-flight telemetered data, comparing the performance of the abort system with the primary guidance system, showed that the warnings were obviously due to a fault in the alarm system.

The abort guidance system, developed and produced by TRW for Grumann Aircraft Engineering Corp., Bethpage, N.Y., is a strapped-down, inertial navigation system that provides an attitude reference, navigation facilities, system monitoring, and abort guidance for the lunar module.

The system is comprised of three units: an abort sensor package provided by Hamilton Standard Systems Center, Farmington, Conn., for TRW; a data entry and display unit with a keyboard by which the astronauts communicate with the abort-system computer; and the abort electronics unit containing the system "brain"—a navigation and guidance computer, plus input-output electronics and memories.

A first for strap-downs

Strap-down control systems have been used before, according to Dave Meginnity of TRW, but the Apollo 9 flight is the first time a complete strap-down system has been used for long-term guidance.

That function has been traditionally performed by three accelerometers and three gyros mounted on a stable platform, and isolated from vehicle motion, usually by three gimbals, each referenced to one axis of the vehicle. The platform remains motionless in space while the vehicle rotates about it, and the navigation system keeps track of vehicle motion by com-

paring the attitude of the vehicle with that of the stable platform.

But platform costs are high. And they suffer from gimbal lock, which can throw the system out of kilter. Constant attention is required from the astronauts to prevent this—time that has to be taken from other tasks.

In contrast, the abort system gyros and accelerometers are assembled in a rigid frame that is bolted to the vehicle skin. These sensors are aligned with the axes of the vehicle and they move along with the changes in attitude. In this system, space-vehicle motions are tracked by outputs from the accelerometers and gyros that are fed into the abort system's navigation computer, the memory and "brains" of the strap-down system.

As Dave Meginnity describes it, "... the equivalent of the stable platform is provided by the mathematical calculations of the computer. The sensors pick up the motions and rates and the computer takes into account where a stable platform would be pointing if there were a stable platform. It's really a mathematical model of a platform."

Computations sub for gear

Advantages of the strapdown platforms are several, Meginnity claims. For the abort mission in particular, and others in general, they are lighter and use less power than the gimballed platform systems. Further, there is no such thing as a gimbal lock with the strap-down system, since the motions of the "platform" are mathematical computations.

There are limitations, however. Accuracy of the equivalent "platform" is lower than that of its gimballed counterpart. But for navigation purposes it is more than sufficient, as evidenced by its use in the backup system of the Apollo 9 lunar module.

Another important advantage of the strapped-down system pointed out by Meginnity is simpler maintenance; high skill is required for electromechanical platforms. ■■

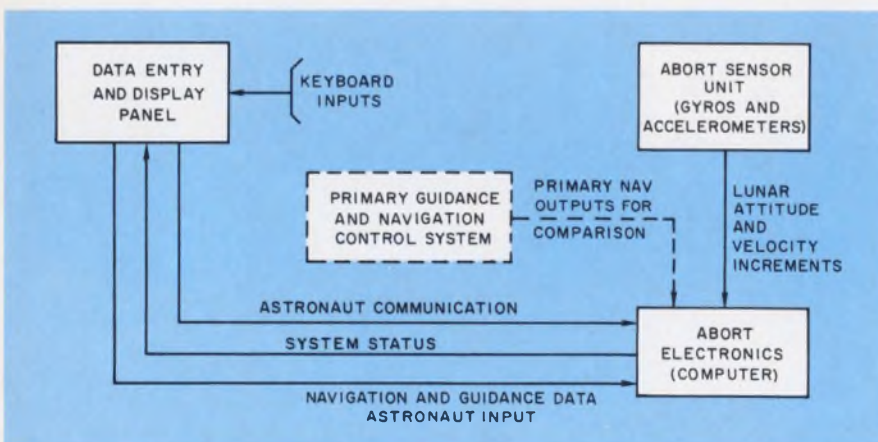

Lunar-module abort guidance-system is checked by comparing performance with inputs from the primary system displayed on the panel. The system was developed by TRW Inc., Redondo Beach, Calif.

Top-Ten contest winners announced by magazine

Round-trip tickets for two between New York and Paris go to James P. Gross, an electronic systems engineer at LTV Aerospace, Dallas, Tex.

Gross won first prize in ELECTRONIC DESIGN's 1969 "Top Ten" contest by correctly picking nine of the ten advertisements best remembered by his fellow engineer-subscribers in the January 4, 1969 issue.

His selections were measured against the ten ads ranking highest in the "Recall Seen" category of Reader Recall—ELECTRONIC DESIGN's method of measuring readership.

Second prize went to Robert Hedin, member of the Technical Staff at SDS Corp., El Segundo, Calif. Hedin won a Heathkit/Thomas "Paramount" transistor Theater Organ.

Third prize, a Heathkit color TV, was awarded to F. A. Raymond, project engineer at the Goss Co., Chicago, Ill.

The 4th to 10 prize winners won Bulova Accutron "Spaceview" electronic timepieces. The winners are:

C. Ulrick, Collins Radio Co., Cedar Rapids, Iowa.

R. F. Hintz, Bissett/Berman Co., Santa Monica, Calif.

J. M. Gerstenberger, TRW Inc., Redondo Beach, Calif.

D. J. Matson, Atlantic Research Corp., Alexandria, Va.

F. W. Furland, Systems Science Corp., San Diego, Calif.

R. L. Kauffman, IBM Corp., Hopewell Junction, N. Y.

J. Derby, Collins Radio, Dallas, Tex.

The winners in a separate "Top Ten" contest for marketing-sales people were:

D. M. "Mike" Smith, copywriter at Hugh Dwight advertising agency, Portland, Ore. He also won a Paris trip for two.

Dennis F. Hayes, sales engineer with Dentronics Inc., Hackensack, N.J., who won a 14-inch portable color TV.

Alan Maier, advertising manager for Raytheon Co., Waltham, Mass. He was given a Bulova Accutron. ■■

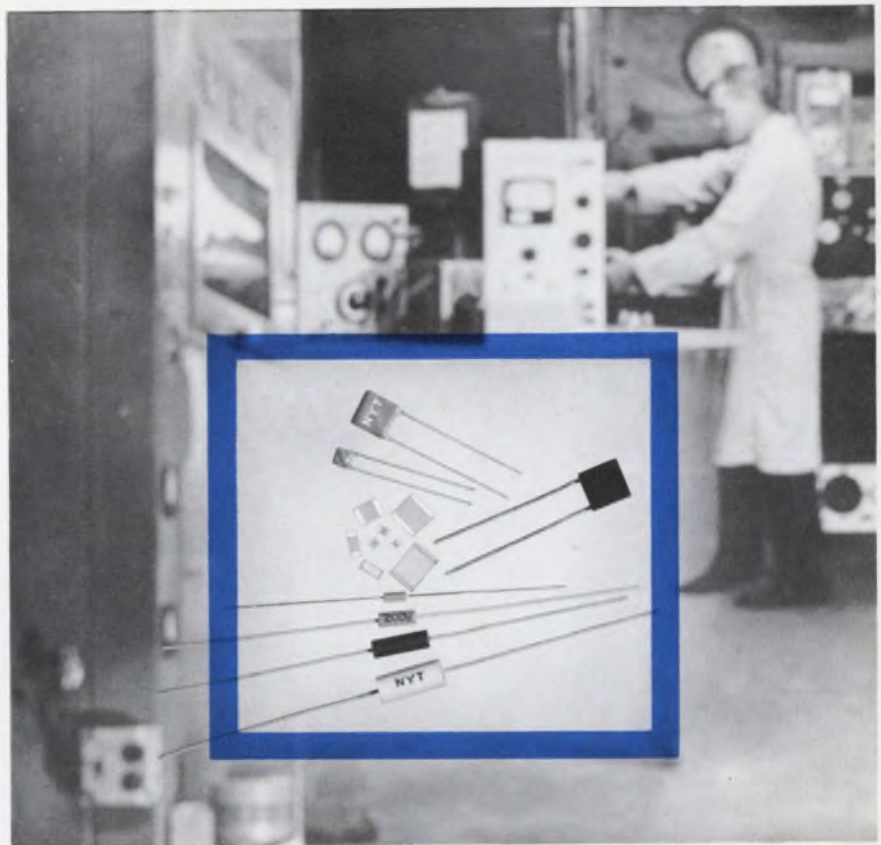

NYT-CAP

The better Ceramic Capacitor that Nytronics R&D built

Nytronics NYT-CAP ceramic capacitors are different. They had to be, because we wanted to make them better. That's why we did not use the same old standard formula. Our R&D people developed our own new formula and methods for a better capacitor—and in the process they eliminated failure modes others don't even know exist.

NYT-CAPS are the most perfect capacitors, designed to meet applicable requirements of MIL-C-11015, 39014 and MIL-C-20. Outstanding K1200 and NPO characteristics, superior humidity resistance, highest insulation resistance, low dissipation factor.

NYT-CHIPS: Uncased for hybrid microcircuit applications. Series of 9 sizes with capacitance up to 1 micro-farad in K-1200 (Type B) dielectric. NPO also available.

DECI-CAPS: 4.7pf. to 27,000pf. in 46 off-the-shelf values. Standard molded axial lead size of .100 inch diameter x .250 inch length for high density cordwood packaging.

MILI-CAPS: Natural outgrowth of Deci-Cap molded series. 10pf. to 3.3ufd. in the 5 molded axial lead sizes of Mil-C-11015 D/20B. Highest

electrical and environmental performance over the entire capacitance range.

HY CAPS: Newly expanded radial lead, high-gloss, epoxy conformal coated line offers higher capacitance density than equivalent molded case units, with no sacrifice in performance. Capacitance range of 4.7pf. to 2.5ufd. in K-1200. Also available in NPO dielectric.

NK 05/06: Encapsulated radial lead Nyt-Cap with 0.200 inch lead spacing for all values is ideal for printed circuit and other automatic insertion applications.

Write today for complete engineering data.



NYTRONICS, INC.

The quality line of standard components

550 Springfield Ave., Berkeley Heights, N.J. 07922 ■ (201) 464-9300 ■ TWX: 710-984-7977

INFORMATION RETRIEVAL NUMBER 17



We make components for guys who can't stand failures.

We make our capacitors and resistors to perform like 40 million people were watching in on the count down.

And we build an extra measure of performance into all of them, to let you make sure your equipment delivers all you designed into it. Because like you and the guys who use your equipment, we can't stand failures either.

Take our glass capacitors, for instance. There's only one reason why they've been designed into the Surveyor, Minuteman, Gemini, Apollo, Saturn, Titan, Syncom, Sparrow, Hawk, and a number of other major aerospace and missile projects. With our glass capacitors, circuit designers could get the proven stability and reliability that these important systems demanded. U.S. Air Force tests have established that our glass capacitors have much better stability and much higher insulation resistance than ceramic and mica capacitors can deliver.

And take our precision tin oxide resistors. They're the best of the metal film class. Because the resistive tin film is completely oxidized and

molecularly bonded to the glass substrate, our tin oxide resistors are impervious to moisture and environmental degradation. No other resistor can deliver the same stability and reliability over load life. They offer guaranteed moisture resistance across all ohmic values to set a standard of reliability that can't be matched by metal film, wire wounds, carbon comps or metal glaze resistors. After a 56-day-long heat test in an environment of extremely high humidity, our tin oxide resistors showed a resistance change of just 0.2 per cent. And in an ambient temperature test—now in its ninth year—not one of the 600 tin oxide resistors being tested has exceeded a resistance change of 1.5 per cent.

But don't only think of Corning for aerospace and other precision applications. We've got something to offer when economy and value are the prime considerations. At Corning we've been active in improving these important capacitor and resistor characteristics, too.

We've developed the Glass-K™ capacitor to give you the volumetric efficiency and economy of mono-

lithic ceramic capacitors, but with the much improved stability and reliability that only a glass dielectric can add.

In resistors, our tin oxide resistors already offer long term economy over metal film, precision wire wound and metal glaze resistors. And our new C3 resistors, in addition to giving you a small case size, compete costwise with carbon comps.

At Corning we make components for guys who can't stand failures. Guys like your most important customers. Guys like you. So, next time you're designing a system, reach for your CORNING® capacitor and resistor catalogs and call your local Corning authorized distributor for off-the-shelf delivery. They'll help you design-in that extra measure of performance.

If you don't have our catalogs, ask your Corning distributor for copies or drop us a line at: Corning Glass Works, Electronic Products Division, Corning, New York 14830.

CORNING
ELECTRONICS



SPECIAL REPORT FROM KOREA

'Portable war' electronics gets first Pacific test



Story and photographs by John F. Mason, Military-Aerospace Editor

On the morning of March 17, khaki-colored parachutes filled the cold, blue sky over the Han River valley of South Korea. Jeeps with built-in AN/VRC-12 vhf fm radios swung back and forth on metal pallets—one twisted on its lines, then spun back for a stable descent. A half-ton truck dropped through the cold sky, slowed finally by a gigantic chute. A 105-mm howitzer landed with a thud, apparently undamaged. Boxes, containing a variety of supplies, touched ground, automatically releasing their chutes by their decreased weight. One such cut-off device failed, and the box dragged slowly after its struggling chute.

Five minutes later, more planes crossed the Han. They were flying at 1200 feet at a slow 110 knots. In irregular streams, 1325 U.S. troops and 580 Koreans bailed out—each with approximately 90 pounds of gear. Radio operators wore parachutist's adjustable equipment bags containing small manpack AN/PRC-25 vhf fm radios, (continued on next page)



Korean frogmen "infiltrators" fly to "safety" after high-altitude air drop into river where they blew up a simulated bridge. Original plan to detonate a cardboard Pueblo was abandoned as being too emotional.



Communications headquarters for the entire Focus Retina exercise were set up on five hills alongside the command center. Waffle-like antennas reveal the old vhf AN/TRC-24 radio as still the Army's workhorse.

uhf PRC-41s and the small, modular vhf PRC-88 squad radio that can be dismantled and slipped into two pockets. This new unit is built by Delco Radio Div. of General Motors in Kokomo, Ind.

Except for a few men who landed in shallow, icy streams there was only one serious mishap: one trooper's chute lines caught on the plane, dragging him around through the below-freezing air and back over the drop zone, where he was cut loose. Other than for temporary shock, he was unharmed.

The exercise, called Focus Retina, was a success. The five-day operation was the Pentagon's first quick reaction, dual-based defense exercise in the Pacific and the most distant airborne assault operation ever held.

It proved to the Pentagon that 2500 Army and Air Force personnel can be rushed with full combat equipment 8500 miles to the aid of an ally in Asia in less time than the ally's own troops can march 40 miles from their base in Seoul.

As for electronics, it proved that existing equipment will do the vital and complicated job required for a joint-nation, multi-service and multi-command operation that must be carried out over great distances and with speed.

But improvements are needed. The men who jumped with radio units and set them up in the field, and who worked in mud-bogged

communications vans, had praise for many of the systems but complaints about others. These opinions, disclosed to ELECTRONIC DESIGN in the snow-covered fields of South Korea in March, may be the specifications of tomorrow.

A constant complaint was that equipment is too big, and, for the airborne troops, too heavy. "The design engineer sitting in his ivory tower has forgotten what a man is able to carry," said Maj. Richard Earle, assistant division signal officer for the 82nd Airborne Div.

But even airborne troops agree that heavy equipment is not entirely industry's fault. Much solid-state, microminiaturized equipment exists and much more is on the drawing boards. But because of the cost of the war in Vietnam, there just hasn't been enough money for procurement or development of all the new systems the men in the field would like.

If, however, Korea continues to be a prime trouble spot, new gear must be brought in.

Another problem is the military's fault, communicators said. Normal Defense Dept. procedures cause leadtime on new items to be so long that a device is sometimes old before the troops get it. "... seven years is the average," one officer said.

Another problem is that equipment is bought in such quantities that the troops have to continue



Outgoing communications are scrambled and incoming, unscrambled in the cryptography van, which is protected by barbed wire, a guard, and—thanks to rain and then snow—by rolling red hills of slippery mud.



All-solid-state vhf/fm PRC-77 sends take-off instructions to chopper pilot leaving communications center.

to use it after newer-generation gear is available at a reasonable price. For example, a multiplexer built to accommodate 12 voice channels "is about the size of half this desk," an Air Force colonel complained, "while Electronic Communications, Inc., over in St. Petersburg, Fla., has a micro-miniaturized multiplexer that accommodates twice as many channels and occupies one cubic foot."

Besides bulk and weight, the men cite problems with radio frequency interference on the ground and in the air, redundant redundancy, awkward antennas and printed circuits that wear out.

For the troposcatter communications gear, however, there was only praise. And as its popularity goes up, vhf's desirability goes down. High frequency is held in even lower esteem, but it will be tolerated until satellite communication gets to the field—a day that may come sooner than many expect.

What it takes to run a war

A conglomerate of electronics is brought together fast in a big assault of this kind.

An Air Lift Communications Center at Osan, Air Force headquarters in Korea, communicated successfully by hf radio with the big C-141 and C-130 troop-carrying planes from the time they left the United States to arrival over the

drop zone in Korea. The center also kept in touch with several subsidiary air-lift stations in jeeps. Besides hf/ssb, their equipment included uhf/a-m and vhf/fm.

With the small, hf KWM-2A radio, using a double antenna and a transmitter power of 175 watts PEP, the center communicated easily with Washington, although once the circuit had to be routed through the Dew Line communications network in Canada.

The 2500 U.S. troops flown over from Fort Bragg, N.C., carried with them vhf, uhf and hf units. The Korean troops and Korean-based U.S. troops they joined on the ground had all this equipment plus troposcatter.

Two more communications elements consisted of an Air Force Forward Air Control team and an Army Combat Control team. Both jumped into the drop zone a few minutes before the big equipment and personnel drop. They carried manpack uhf and vhf radios.

When asked if they jumped with the hf PRC-47, built by Collins Radio, the 82nd Airborne's Major Earle told ELECTRONIC DESIGN: "The Air Force may have used it, but we left that white elephant back at Fort Bragg. It's so heavy, you need two men to carry it. All the PRC-47s the Army bought for the Airborne are still sitting in warehouses, where they'll probably stay."

There were Air Force Tactical Air Control Post teams in jeeps in the battle area to request fighter support by the U.S. and Korean air forces. These requests went by hf radio to an elaborate, but still not-automated, Tactical Air Control Center in Osan, where airmen stand behind Plexiglass boards writing status reports backwards with grease pencils.

Meanwhile, guarding the zone against infiltrators from Communist Korea to the north, American troops watched the scrubby, heavily mined no-man's land at night with infrared Starlight scopes mounted on rifles and with larger night optical devices. They listened and watched for movement via TPS-33 personnel detection radars. And to communicate, they used the vhf/fm PRC-25—which is solid-state except for one tube—or its successor, the PRC-77, which got rid of the tube.

In the air, there was the Air Force Strike Command's C-130 communications-relay plane, called Jack Pot, that circled the drop zone during the equipment and personnel drops to relay line-of-sight communications from any of the ground and airborne elements that wanted to communicate.

Running the show

Controlling the entire exercise was the Eighth Army from a hast-

Flying the North Pacific

"What's that light ahead of us? An island?"

"It's Venus," the pilot shouted back over the din of the jet engines. "The closest islands are 200 miles to the north."

Other faint lights along the horizon then were also stars, not friendly island villages with long runways.

"There's nothing out here but ocean," the pilot added. We had taken off from Elmendorf AFB, Alaska, a half hour before. Korea was 3500 miles ahead.

Black ocean and black skies. There was no moon. Distances and angles were confusing. Our only stable frame of reference was our own crew compartment, round and comfortable, rushing straight and level through the dark skies.

There was order and precision on the flight deck of the Lockheed-built Air Force C-141 transport jet. The two pilots faced an impressive bank of instruments, but neither touched the controls. The automatic pilot was flying the plane while the pilots watched.

On the left, a navigator faced a wall of meters and sensors, and on the right the engineer watched an equally large array. In the rear a two-star general stretched back in a comfortable lounge chair, earphones on. Between naps he half-listened to someone talk halfway around the world. In one of the double-

deck bunks at the rear, an off-duty crew member slept.

The pilots said they did not like their high-frequency radio, which was their only means to give position reports and to make an emergency call.

Only an hour out of Elmendorf and we could hardly hear the tower, nor they us. Much better was the reception from Guam and the Philippines. Drowning out Elmendorf was a pilot asking the tower at Kadena Air Base in Okinawa how much a room would cost at the VOQ. "Two dollars a night," the tower replied.

"I wonder if that will change his plans," our pilot said. "More than a two-dollar room, we need satellite communications. We can't get through on high frequency." He paused, "Sometimes, I can't reach any one. Of if I do, I get a priority number to call in, like number 14. Sometimes I have to relay my position by uhf to another plane."

An all-weather landing system is being installed in all the C-141s. With the automatic pilot it will put the plane down on the runway without the pilot's touching the controls.

The navigator's console consists of some 20 avionics systems operated and interpreted by two computers. All the navigator has to do is take a fix with one of his many navigation aids every

hour and 20 minutes. With it, he checks the running account of the plane's position that both computers continuously calculate and then readjusts the one he decides is more in error.

The main navigation aid is doppler radar, which continuously furnishes ground speed and drift angle. Through a computer, it presents distance-to-go, cross track and track angle error, wind direction and velocity.

The navigator got his first position fix from a VOR station in Anchorage before leaving the Alaskan coast. Departing the coast, he got another line of position with ADF (automatic direction finder). He then let his doppler-computer complex do the work until he crossed over the small island of St. Paul.

Later, after a check with a Loran C station in Japan, the navigator turned on his search radar. "We'll pick up several islands," he said. "This is where Seaboard Airlines got too close to the Russian chain and was forced down by a Russian fighter."

"In a few minutes we should be exactly 210 miles from the first island, at a bearing of 310 degrees" the navigator said.

A row of dots, "spoking," appeared on the scope. "That's Soviet ground radar picking us up," he explained. Soon two more lines of spoking appeared from the other islands. "I hope we're not keeping them up," he said, measuring off the distance on his map for another fix.

One of the most advanced features of the system is the astro tracker. After taking a reading on a handheld sextant through a blister in the aircraft ceiling, the navigator enters the reading into the computer. In seconds, the computer works out the celestial problem and provides a line of position. "When all the information is stored," the navigator said, "it will work out positions for 58 stars."

Suddenly the ground speed dropped off by 50 knots. "We are in the Japanese jet stream," the navigator explained.

The pilot was flying manually for a change. "Why?"

"The cross wind," he said. "The computer would never believe 20 degrees."



C-141 transport jet that flew troops and equipment to South Korea is getting all-weather landing system that permits hands-off touchdown.



Jack Pot communications-relay/command-control system is rolled into C-141 transport jet for flight to Korea. On arrival its four vans, weighing 12 tons, will be put on a specially configured C-130 for the flight.



Airborne communications van carries long and short-haul radios and cryptographic equipment.

ily built headquarters 12 miles from the drop zone near the village of Koju. A small city in itself, the camp was built of new, olive drab tents laid out with military exactness on rolling red hills. Before the exercise, however, it rained and then snowed, changing the red hills to slippery mud (see cover). Communications vans that would serve as the command and control central were pulled or pushed by bulldozers to their hilltop sites.

The day before the air drop, Lt. Col. Morris La Fever, commander of the 304th Signal Battalion of the 8th Army, showed ELECTRONIC DESIGN the communications complex. "During the air drop tomorrow—if this snow ever stops—we will communicate with every element in the exercise through this communications central," he said. "We have about 15 vans grouped in small clusters at five locations."

All five clumps appeared to be within a mile of each other and were visible in spite of the snow. "They are operated and maintained by 500 men," Col. La Fever said.

Rising above the colonel, who stood on the steps of the headquarters van, were waffle-like, square, reflector-dipole antennas, each made up of nine small squares. These small antennas, above all the clusters except the tropo van, revealed that the AN/TRC-24 vhf/fm radio was still the workhorse of Army communications.

"To extend the range of these line-of-sight vhf radios," the colonel said, "we built that little relay station called Tucson, on top of the mountain." He pointed to a low peak some 15 miles away.

In the van a TRC-24 was being discussed. A sergeant, hanging up a telephone, turned to the colonel. "There was trouble with a TRC-24 terminal at the drop zone," he reported. "One link was down for four minutes, but it's repaired now. A coaxial cable was loose and the antenna was wobbling. It had to be taken down and adjusted."

Do these masts cause much trouble?

"Not often," the sergeant said. "Wind is a factor, though, when you use the full-section mast. You just have to guy them firmly to prevent toppling."

The men are looking forward to getting a replacement for the TRC-24, the GRC-50. The GRC-50 will move the Army communicators from the vhf to the less-crowded uhf band (601 - 999 MHz and 1350 MHz - 1850 MHz), but it won't usher them into the world of solid-state. The GRC-50 is primarily built with tubes. In fact, RCA began design on the radio 14 years ago. The first unit was delivered seven years later, in 1962. Future units are being produced by ARF Products, Inc., of Raton, N. M. and Frequency Engineering Laboratory, Farmingdale, N. J.

The basic transceiver is 17.5 inches long, 16 inches wide, 32.5 inches high and weighs 325 pounds.

One of the few changes the Army has called for over the older RCA model is removal of the primary automatic frequency control circuit and use of the secondary afc unit to do the job, according to Robert Scheafer, technical assistant to ARF's vice president. "The two units were always fighting each other in the field," Scheafer said "switching frequencies. With just one unit, it should work better."

Unlike the TRC-24 antenna mast, which must be put together by hand and then hoisted, the GRC-50 mast can be cranked up. The troops in Korea say they look forward to this luxury, but they're concerned that aligning two horn-shaped antennas will be difficult. Scheafer, however, says the beam width is not narrow and alignment will not be a problem.

When is redundancy redundant?

What is the main problem with vhf now?

"Radio interference," was the unqualified reply of several communicators. "In one small area, 100 feet by 100 feet—enough room for one big antenna—we have about 16 different vhf frequencies in use. And this gives us interference. For the vhf/fm radios, we have about

85 frequencies assigned."

The solution? "Cut down on redundancy."

A sergeant explained: "So we'll never be without a circuit, we often have as many as three vhf channels going at once. Right now, we have trouble with two vhf frequencies going to Tucson, up on the hill. According to the book, the frequency separation is more than adequate. Who knows, maybe it's Korea."

"As for equipment reliability, the only problems we have are tubes burning out and wires and

in Seoul to Panmunjom during negotiations for release of the USS Pueblo. The circuits via tropo were much superior to those over the vhf radio operating alongside.

"Tropo has less tendency to drift off frequency than vhf," Colonel Sexton said. "And it requires less alignment and readjustment."

He continued: "There is, however, a longer baking period—the set needs longer to warm up. But once it's working, it requires less attention."

He was describing Collins Radio's AN/TRC-129A.

permits changes in frequency and monitoring of system performance without external test equipment. Tuning time is from five to seven minutes. Normally, fixed plant equipment takes from two to four hours to tune.

Frequency synthesizing techniques provide a total of 12,000 discrete transmitting and receiving frequencies from 4400 MHz to 4555.95 MHz with a channel separation of 50 kHz.

Bigger van makes happier troops

"We also added a teletypewriter and an hf radio and made the shelter a little bigger," Devoll said. The shelter is larger than the one used for RCA's similar unit, the TRC-97A, which is operated by the Air Force in Korea. But this is an advantage, according to Devoll: "The added space gives the operators much needed room."

The two Army operators in the 304th Signal Battalion in Korea did have room and said they were happy with the TRC-129. The van was mounted on a two-and-one-half-ton truck. Behind the van two dish antennas rose like giant sunflowers 25 feet apart. If one figures that for an operating frequency of 4700 MHz a wavelength is 1/4 foot, a 25-foot separation puts the incoming signal paths 100 wavelengths apart. As short as this seems, a signal received by one antenna may be much stronger than one received by the other—both on the same frequency. When the outputs from both are combined electronically, the resulting signal is usually strong.

"All we have to do," one of the operators said, "is to choose the correct location for the antennas, especially in mountainous country like Korea. But with a little moving around and testing we find the best spot." Then he added, pointing to Tucson, the vhf relay station on the small mountain top, "At least we don't need that."

The Army would like to use tropo over very short distances. "This can be done," Devoll said, "but the shorter the range, the more multipath, quick-fading problems you have. The solution is to put more emphasis on faster reaction in the electronic combining function."



Van for tropo communications, AN/TRC-129A, sits on 2-1/2-ton truck in Korea. It's a little bigger than similar units to provide an hf radio, a teletypewriter and more room for the operators, Collins Radio says.

connectors breaking. Last night we had a cable stolen, but I don't think industry can prevent that."

It was not necessary to ask which equipment was the most popular. "Tropo has really proved itself over here," said Lt. Col. Lee Sexton, chief of the communications division and assistant chief of staff of the Eighth Army. "This is only the second time we've actually used it in a real-life situation, but we're convinced it's good."

Tropo's first real-life job in Korea was to transmit communications between Army headquarters

Asked about the TRC-129 back in Dallas where it was built, Charles Devoll, who has worked "most of his life" on Collins' tropo equipment, said: "The 129 evolved naturally from our earlier TRC-90. When solid-state components and tunnel diodes became available, we put them into a new unit."

Operating in the 4.4-5.0 GHz band, the terminal contains multiplexing and radio equipment to provide 24 full-duplex voice channels with 16 narrowband telegraph channels in one voice channel. Integral metering and test equipment

Colonel La Fever said: "For long distances—for example, to call Okinawa to tell the planes that are waiting for the snow here to stop before they take off—there is the GRC-26D hf/am radio. It's big, requiring a 2-1/2 ton truck; it uses tubes and it's old, but it's the best we've got. Eventually, we'll get the newer GRC-122, which uses the hf GRC-106 radio."

The Army says the 122 has a "reliable range of at least 50 miles, with no skip distance and excellent communications up to 1600 miles." It provides 28,000 discrete tuning points with a 1-KHz spacing. The unit rests on a 3/4-ton vehicle.

The ultimate replacement for hf is communications via satellite. Colonel Sexton said: "We'd like to use satellites in a normal division area, 50 miles by 75 miles. This would enable us to get rid of some of our vhf but more of our hf. Vhf fades, but hf, of course, is worse. We'd have more channels, and more units could use the network."

The Joint Service Program for developing tactical communications satellite terminals for all the services—for use in the air, in vehicles and submarines—is now receiving test terminals. All of them should be delivered by the end of summer. Collins Radio is making units to operate in the uhf range and RCA in the shf range. Testing will probably take a year.

Meanwhile at Strike Command headquarters at MacDill AFB, Fla., an effort unrelated to the official program has produced five terminals. Lt. Col. Harold Johnson, aided by engineers from Electronic Communications, Inc., in nearby St. Petersburg, has built the terminals, which can be used on trucks or in aircraft. They operate with the Lincoln Laboratories' uhf Les-6 experimental communications satellite, which is hanging in synchronous orbit over the equator west of Chile, and the Defense Dept.'s uhf/shf tactical communications satellite, TacSat I, also over the equator a little farther west.

Electronic Communications provided much of the equipment for the terminals from instrumentation from the 23 terminals the company built for the military to experiment with Les-5. These terminals operated on submarines, ships, aircraft and mobile vans.

The company is currently building a number of airborne systems to fly in the Air Force's EC-135 Worldwide Airborne Command Post aircraft.

The Electronic Communications terminals operate at 70 MHz, the standard frequency for all Defense Dept. tactical satellite communications. The 60-watt transmitter is all-solid-state, smaller, lighter and more reliable than previous equipment, the company says. Amplifiers produced by Electronic Communications for the Les-5 program are used in the new terminals to

bring power levels up to one-kilowatt.

Each terminal can transmit and receive teletype. Each is equipped with a page printer, keyboard, tape reader and tape reperformator.

A special feature of the data demodulation scheme provides a means for rejecting unwanted radio signals in the receiving system. To accomplish this, the data demodulator samples the modulation frequency of all signals received during its normal automatic frequency control search function. If the wanted modulation frequency,



The Army in Korea favors tropo communications, like this TRC-129A, over hf and vhf and wants to use it over shorter distances. "This can be done," Collins Radio says, "with more work on the electronic combining function."



Tactical Air Control Center at Osan, still not automated, shows status of all aircraft in South Korea, flying and on the ground. Advances in big wall displays could relieve airmen from having to write backwards.

(within very close tolerances) is not present, the receiver rejects it and continues sweeping until a properly modulated carrier is detected. A sweep stop signal is then generated and the vernier automatic frequency control loop takes over, locking onto the wanted signal and subsequently processing the received signal.

One of Strike Command's five terminals will be deployed overseas for tests next month. The others, in keeping with Strike Command's mission, will be available for sending wherever they are needed.

The teletypewriters are capable of transmitting 400 words per minute but will be used in their 100-wpm mode.

A nondirectional discone antenna is used, "so we won't have to worry about where the satellite is—just so long as it's in line of sight," Colonel Johnson said. A digitized voice modem was provided by Sylvania.

Electronic Communications has successfully built and tested, with Les-6 and a nearby ground station, an experimental, handheld transmitter, operating on a battery. It has used antennas ranging from two inches in diameter to a two-foot log periodic.

Patching is no problem

"Mobile vehicles near tent city can communicate with anyone in or out of the area," Colonel La Fever explained. "We have two

RWI [radio wire integration] facilities housed in vans. They contain vhf/fm, uhf/a-m and hf/ssb radios. Anyone in a jeep five miles down the road can ask on his vhf radio to be patched into the telephone switchboard and connected here, or if he's got the priority, to the United States."

Strike Command hopes to update its RWIs soon. "They're about 1-1/2 years old," Colonel Johnson said in his office at MacDill. "There are no hard plans to replace them, but we should start thinking about it." He added: "The RWI should have a uhf built just for it. Airborne ARC-54 radios have been installed, and while good for aircraft, they're not built for the ground. Airborne equipment uses dynamotors—there's a moving parts problem and the maintenance rate is high. Someone should make a transistorized unit for the ground that would put out the same power levels the airborne ARC-54 does."

In the complex in Korea, Colonel La Fever said, "we have 185 telephones and about 3000 calls a day."

"An automated switchboard is badly needed," said Col. Robert C. Doctor, deputy assistant chief of staff for communications and electronics with the Eighth Army in Korea. "A number of transistorized systems have been tested—some at Fort Huachuca, Ariz., at the Army's Electronic Proving Grounds, but we don't have one."

On a brighter note, Colonel Doc-

tor said: "We are getting some new equipment here in Korea, the GRC-103 operating in both vhf and uhf [76 MHz to 1000 MHz and 1350 - 1850 MHz]. This is a fine little tactical radio relay set. It's rapid-moving, not like the MRC-69 [which weighs more than 10 tons, including its shelter and 2-1/2-ton truck]. Two GRC-103s with multiplex and other equipment plus a shelter fit into a one-and-a-quarter-ton truck—all of which weighs about 6400 pounds. The radio can be set up quickly and is easily operated." Its range is between 220 and 1000 MHz; it accommodates up to 24 telephone channels, when used with appropriate PCM equipment, and four channels when used with FDM equipment. Canadian Marconi Co. in Montreal, the developer, is presently the sole-source producer. However, a call for competitive bids has been published.

"Also coming," Colonel Doctor said, "is the MRC-115 radio, vhf extending into uhf [220 MHz - 404.5 MHz]. It's mounted on a 1/4-ton trailer pulled by a jeep." He added: "I don't like a trailer. There's no protection for the crew. I think the radio could be mounted on a one-and-a-quarter ton truck."

View from the air

Strike Command's C-130 Jack Pot, which acted as a communications-relay plane for Focus Retina, would, in a real mission, serve as the command-and-control headquarters for the entire assault operation—especially if the contested ground were held by an enemy. The 12 tons of electronics that Jack Pot carried in four vans warrants a close look, because it is important and, as Colonel Johnson at MacDill says, "it is getting old."

"We've only got three, two of which are four years old and one is three," the colonel noted. "We need a replacement. We have funds earmarked, but we haven't decided what kind of unit it should be.

"Jack Pot requires extensive maintenance. Data display is manual—we use a grease pencil. And we want communications reliability—we want to get through all the time and we want quality circuits. We can't do this with hf radio."

He added: "Besides increased



"Ice cream" parlor at Panmunjom houses communist guards who shout down assorted obscenities at guests.



Infrared Starlight scope on rifle helps American GI and Korean colleague to prevent communist infiltrators from slipping through heavily mined demilitarized zone at night from the mountains of North Korea beyond.

path reliability, we want increased bandwidth."

Jack Pot's four vans can be rolled into a C-130 and be made ready to operate in 30 minutes. On the ground, the vans can be rolled off and set up for operating as a ground station in an hour and a half. The generator operates from jet fuel drained from the C-130 tanks. After 72 hours of ground operation, Strike Command's rules call for flying in a bigger ground station, an AN/TSC-38, to permit Jack Pot to fly back to MacDill to be ready for the next command-and-control mission that comes up.

The communications van contains a switchboard, long- and short-distance radios and cryptographic equipment. It can handle voice and teletypewriter traffic simultaneously between short-range stations while keeping in touch with MacDill or Washington, more than 5000 miles away. The operations van is the command post and teletypewriter center. The accessories trailer contains the antenna equipment, spare parts and two 35,000-BTU air-conditioning units. The generator trailer houses two lightweight 60,000-watt turbine generators, power cables and two collapsible fuel cells.

The communications shelter has one 10-kW radio, two 1-kW and three line-of-sight systems: a uhf/a-m, vhf/a-m and fm. In the air, for long-haul communications, only the 1-kW is activated because of the radiation limitations in the

fuselage and the antennas.

"We split the signal, to give us voice and teletype off the same transceiver," Colonel Johnson said. "On the ground, we set up a whip antenna for the 1-kW system and a sloping V antenna for the 10-kW radio. With the big radio, we can get back to MacDill or to the closest station in the worldwide Defense Communications System, which will patch us in to Washington.

"We use the 1-kW systems to the Air Force and Army commanders in the area, and the line-of-sight radio for little outposts around the Jack Pot station."

What the crew says about it

Jack Pot was not operated on the way to Korea; it rode like eight tons of dead weight in the tail of a C-141. In Korea, it was rolled into its specially configured C-130 and was ready to fly. But on the trip over, the Jack Pot B crew (there are three planes and three crews at MacDill: A, B and C) had time to talk.

"We have to do a lot of our own small repairs because there are so few Jack Pots that no one makes spare parts," a sergeant said.

"Also," another crewman spoke up, "we have to work fast because we never know when the plane will be called for another mission.

"We have a bad radio interference problem that we don't understand," the crew chief said. "Sud-

denly, interference of some kind makes the relays and lights chatter—turn on and off—and the meter indicators move.

"Bad weather may have something to do with it. Or it could be that the antenna coupler is not tuned properly to the antenna."

Another crew member said: "We transmit on a long wire antenna on top of the aircraft, and we receive with the same type antenna on the belly. In bad weather, the signal just wraps itself around and you get all the reflected power on the receiver. We get so much noise sometimes we can't receive the teletypewriter. When we send out 250 watts, we might get 100 of this back in noise."

The problem is serious. Collins Radio, which makes the radio equipment, has not discovered a solution, and the crew hoped Focus Retina would provide clear-cut clues to its real origin.

"The biggest gripe," one crew member said, "is with the hf antenna. It's big and awkward to handle." This is true of the 10-kW hf radio antenna used in Jack Pot on the ground and also with the van that is flown in to replace Jack Pot, the AN/TSC-38.

"To put the antenna up, it takes three men from 45 minutes to one and a half hours. It's about 50 feet high and its two legs are run out about 500 feet each. The mast has to be cranked up, piece at a time, attaching each with a guy line. A small, high-gain antenna for the



Electronics maintenance van is flown into trouble spot, landed, and its sides expanded to create a roomy work

area. "We can do as much here in the field as we can back at the base," repairmen say.



Non-directional discone antenna rises above one of five air-transportable satellite communications terminals built and ready for use by the Air Force at MacDill AFB, Fla., with the aid of Electronic Communications, Inc.

10-kW radio would be welcome."

One of the crew said: "We are facing a problem in the switch-board. We have 200 printed-circuit cards, and they're starting to go bad. We're going to get a printed-circuit power checker, but it isn't ready yet."

The crewman added: "In our multiplexer equipment, we were never issued a polar relay checker. Finally, we made one ourselves. We used a tube socket to hold the relay. We then applied a test message to one of the socket pins. We monitored the performance of the relay with an oscilloscope attached to another pin. It worked."

After the mission, the crew discussed the way their equipment had worked.

How bad was the radio interference?

The crew chief paused. "There wasn't any," he said. This didn't mean a cure had been effected. It meant, they knew no more than they had. "The only clue," he said, "was that bad weather may be the culprit. As you know, today was bright and sunny."

Jack Pot had flown for eight hours—above the drop zone, out to sea to come back to simulate the drop plane's route before they arrived. They communicated with every element in the area and relayed line-of-sight vhf communica-

tions between ground troops separated by hills.

Did they talk to MacDill back in Florida?

"No, but we could have," the crew chief said. It just wasn't in our orders." He added: "Everything worked out just the way it was supposed to."

The TSC-38, which would have been flown in to replace Jack Pot, had it been a real mission, is also old—four years. It provides two radios: one 1-kW hf/ssb and one 10-kW hf/ssb, and a telephone switching central. Collins Radio built the -38 and the 38A and Raytheon is building the 38B.

A TSC-38 radio maintenance man who has worked on a number of systems had praise for the 38's linear power amplifier, the 208U-10. "It tunes fast," he said. "The protection circuits prevent damaging the final amplifiers. And it is automatic."

"All of our hf equipment is protected by error correction devices," Colonel Johnson said. "We use a USC-17V variable data micrologic pack that sends out not only teletype information but also another piece of information on another circuit that is mathematically related to the desired information. At the receiver end the two are glued together, and out of white noise you get a good signal.

"An example of hanging on to old equipment after newer units are on the market is the UCC-1 multiplexer we used in our TSC-65 teletypewriter central. The UCC-1 is a four-channel multiplexer. If you want 24 channels, it comes in a box about the size of an office desk. We use three UCC-1s so that makes 12 channels. And it's transistorized. ECI [Electronic Communications, Inc.] in St. Petersburg makes a micro-multiplexer that is far smaller."

When asked about its company-funded unit, a spokesman for Electronic Communications said: "It's the smallest and lightest ever developed, and it has a mean-time between-failure of 10,000 hours.

"Design highlights include universal channel modems, lower sideband or twin-sideband capability, extensive use of microcircuits [particularly in the amplifiers] and redundancy for all active circuits common to more than one channel.



Technical control van provides quality control for all circuits leaving a center, plus retransmitting doubtful channels on another band.

"A 24-channel package occupies less than one cubic foot. A functional building-block mechanical concept makes possible pyramiding system capacity into 132 channels. A typical 132-channel set would have a volume of only 7.4 cubic feet, including signaling, as compared with 52 cubic feet for present day all-solid-state multiplex sets. Ac power consumption for 132 channels, including signaling, is only 250 watts.

"The principal efforts to reduce the size of the channel modem were directed toward the channel bandpass filter. Early in development it was decided to concentrate on a universal channel modem. This led to a 'pregroup-of-one' channel modulation concept which was implemented by a channel bandpass filter designed to provide minimum delay and ripple and to be identical for all channels. This allows the universal channel modem to be used in all frequency slots."

A brand new van that has just arrived at MacDill will undoubtedly become an important element in the Strike Command package. Designed by Senior M/Sgt. C. C. Andrews at MacDill and built by the Lexington Bluegrass Army Arsenal in Kentucky, the van will provide a central testing point for quality control for all circuits.

"The unit, which we call the technical control van, can handle 300 four-wire circuits plus 50 two-wire to four-wire conversion equipments. This gives a total of 350 four-wire circuits plus all the equipment needed for tests," Sergeant Andrews said. "We have 50 line conditioning devices—that is, level adjustment devices and amplifiers. And in our two-wire to four-wire conversion equipment we have 50 channels available using 2600 cycle ringing. We have the 24-channel order wire capability, push button, hands off type operation.

"The man in this van will have control of all circuits in a remote headquarters. To bring the circuits in, there are 26 pairs of cables on the side of the van, and going out there are 18. All appear on the matrix panel, where they can be patched to any jack we want.

"We have remarkable control. If the tropo, for example, should lose its path, we could store the information and then send it out on another circuit. If any radio becomes inoperative, we can reroute the circuit to a radio with a good circuit. There'll be two vans per field unit when we get them into production."

The prototype Andrews was describing at MacDill has since been deployed in the field. ■■



Cimron's DVM outguns the rest!

We don't believe you can match this second generation digital multimeter for speed, accuracy and stability in this price range. It provides you with the greatest number of options, including sample and hold, AC, millivolts and ohms. With the autorange and combined ohms/millivolt converter plugged in, it can autorange through all 6 DC ranges. For systems applications it has a digitizing rate of 1,000 readings per second, but that's only part of the story. It offers 5 printout options, buffered or non-buffered remote control of all front panel functions and unparalleled

flexibility for interface design. The handles retract so it can be flushmounted in a rack. Pushbutton controls are mounted directly to the master pc board, minimizing hand wiring for even greater reliability. All IC logic and the newest design features insure that it won't be obsoleted before you turn around. The basic Model 6653A, including DC and DC ratio functions with an accuracy of ± 1 digit, is just \$1740. And it all adds up to Cimron *customern concern!* Write to Cimron, Department C-140, 1152 Morena Boulevard, San Diego, California 92110.

LEAR SIEGLER, INC.



CIMRON DIVISION





FAA makes bold 10-year estimate

On the theory, apparently, that if you don't ask, you won't get, Federal Aviation Administration planners are seeking over \$2.1 billion for facilities and equipment and over \$600 million for research and development over the next 10 years. Their requests are outlined in two booklets published recently by the FAA.

The bulk of the requirements, which are, of course, subject to approval of both the President and Congress, involve long-needed airborne and ground electronic systems. For fiscal 1970, FAA is seeking new funds for facilities and equipment totaling \$250 million. Its projections show a jump to \$400 million in fiscal '71 and taper off to more than \$183 million in 1973 and 1974.

Over the next decade the following electronic expenditures are asked: airport surveillance radar and beacon systems, \$192.2 million; collision-avoidance systems, \$19.5 million; communications, \$217.6 million; en route navigation aids, \$60.1 million; FAA aircraft avionics, \$13 million, plus \$19.5 million for associated ground equipment; long-range radar systems, \$196.7 million; and terminal navigation aids, \$224.9 million.

NASA awards contracts on lunar vehicle

A lunar "rover"—a vehicle that would propel astronauts about the moon and later make 600-mile trips on its own for operations up to a year in length—is now under study.

Bendix Corp. and Grumman Aircraft have been selected by NASA to perform preliminary system-design and contract-definition studies for the dual-mode lunar vehicle. And the \$400,000 competitive contracts will be completed within eight months, according to Marshall Space Flight Center, which will direct the program.

The craft will be designed for two operating modes on the lunar surface—one controlled by a single astronaut and the other, unmanned,

Washington Report

CHARLES D. LAFOND
WASHINGTON BUREAU

under remote control from Earth. The craft will be capable of speeds up to 9 mph.

The design of the vehicle must include a capability to carry 100 pounds of instruments for scientific measurements, a television camera, and both the radio and control instrumentation required for remote operation. Power will be provided by heavy-duty batteries. The craft would collect up to 200 pounds of lunar samples and return to a potential Apollo landing site for rendezvous with future astronauts.

Manned program pushed in NASA budget

In amending President Johnson's fiscal 1970 NASA budget request, the Nixon administration has revealed that it intends to strongly support the nation's manned space program. The \$131 million cut in NASA's budget requests has been offset by new increases totaling \$86 million so that there is a net loss to NASA of only \$45 million.

The funding reductions include \$57 million for the Apollo Applications Program (this will cause a one-year deferral, delaying first launch about a half a year); \$41 million for unmanned scientific and applications satellite programs—but with no cut in the new Earth Resources Program; \$20 million for tracking and data acquisition; and \$13 million for advance research and technology projects.

On the positive side, the \$86 million increases include \$40 million for changes in the three Apollo modules to implement extended periods of lunar exploration, and \$46 million for Saturn V launch vehicles.

In describing the budget changes, Dr. Thomas O. Paine, NASA administrator, revealed that he has agreed with Dr. Robert C. Seamans, Jr., Air Force Secretary, on a joint USAF-NASA study of a space-shuttle type vehicle. The two agencies would make an investigation of whether or not a joint development project could produce a system that would meet

Washington Report

CONTINUED

the needs of both the Air Force and the space agency.

Dr. Paine indicated that the USAF-NASA study agreement is in fact looking ahead to a next-generation space station. The space shuttle, he disclosed, would be the first step in this direction. The joint study will be completed by the summer, in time for the fiscal 1971 budget request.

School X-ray hazards to be studied

How dangerous is the radiation-producing equipment used in the science courses in public high schools? The U. S. Public Health Service proposes to find out, through a study by its Bureau of Radiological Health. Some 200 schools have been selected for investigation, according to Commissioner Chris A. Hansen. The survey will be conducted as a joint state-federal project.

In a preliminary look at several schools, investigators have found unshielded X-ray units in use, says Hansen, as well as several types of dangerous hand-held fluoroscopes. Equipment to be checked in the survey includes X-ray machines, Van de Graaf accelerators, and microwave and laser transmitters.

Radar research will clue in on storms

A hard look will be taken at severe storms, this spring, by the Environmental Science Services Administration of the Department of Commerce. Radar technology will play a leading role in the six-week study, an annual task performed by the National Severe Storms Laboratory at Norman, Okla. Seven aircraft, eight upper-air sounding stations, and a variety of ground stations will support the effort to improve storm detection and identification techniques.

Vertical storm sampling will be provided by releasing balloon-borne radiosondes every 30 minutes during the storm. These will be tracked by radars while the balloon instruments, rising at over 1000 feet per minute, will transmit the profile of pressure, temperature and relative humidity.

A 1500-ft. television tower near Oklahoma City has been instrumented at six levels to obtain wind and temperature measurements. And a ground weather-radar system developed by the NSSL will record precipitation intensity at 14,400 different locations within a radius of 100 miles of the laboratory. A recently developed Doppler radar will be used as a means of determining thunderstorm rotation.

Other radar research will attempt to define more clearly air movements within a storm center. Aircraft observations and airborne photography will provide data for correlation with radar observations.

ESSA will use an instrumented B-57 aircraft to dispense aluminized chaff just outside the storm areas for radar studies of air flow surrounding the storm centers.

Scientists seek undersea frequency control

To avert interference due to possible crowding of acoustical frequencies used in future underwater research, a committee has been formed to come up with some solutions. The problem is that sonar and other acoustic systems all operate in the range of 5-100 kHz.

At present, systems are used for ranging, ocean-bottom sounding, navigation and sea-floor mapping, and for communications. In addition, acoustic instruments are used to make detailed measurements of undersea conditions. While there is little interference now, scientists are concerned with the need for frequency management if this country expands its oceanographic efforts to any great extent.

In 1967 the National Marine Council asked the U.S. Coast Guard to look into the problem of marine acoustic-system management. In turn, the Coast Guard has sought assistance from the National Academy of Sciences-National Research Council. The result was establishment of the present Committee on Underwater Telecommunications.

There seems to be common agreement that frequency standardization with respect to particular uses is necessary. However, there also seems agreement that voluntary control should be favored over federal regulation.

One approach considered to ease the problem includes the coding of signals so that a number of different devices might use similar frequencies without intolerable interference.

If you've been thinking about
DVMs and counters,
think about this:



Think about promises
and how they don't
add up to a hill of beans
in specs, service, integrity,
and the resources of
the industry giant to back them up.
Fairchild Instrumentation.
That's the way to the top.

Model 8220/FM01
500 MHz Frequency Counter, \$1,795

Direct reading
7-digit display with memory
Quality IC construction
Convenient operation
Self check

FREQUENCY MODE

Range 10Hz to 50MHz
50MHz to 500MHz (Prescaler)
Gate Time 0.1sec, 1sec, 10sec
Reads In kHz with automatically positioned decimal point

COUNT MODE

Maximum Count Displayed 9,999,999
Maximum Count Rate 50MHz

TIME BASE

Frequency 1MHz
Aging Rate < 3 parts in 10⁷ per week after 1 day continuous operation
Guaranteed < ± 2 parts in 10⁷ per month after 1 month continuous operation (< ± 7 parts in 10⁹ per day)
Temperature Stability < ± 3 parts in 10⁷ over 0°C to +55°C range

INPUT SPECIFICATIONS

Sensitivity 10Hz to 50MHz 50mV rms
50MHz to 500MHz 100mV rms
Impedance 50MHz Approximately 100kΩ in parallel with 40pF
500MHz 50Ω resistive

GENERAL

Dimensions 5¼" H x 9" W x 12½" D
PRICE (including FM01) \$1,795.00
Optional Medium Price \$190.00
Stability 1MHz Oscillator Guaranteed < ± 1 part in 10⁷ per month (< ± 7 parts in 10⁹ per day)
Optional High Price \$350.00
Stability 1MHz Oscillator Guaranteed < ± 3 parts in 10⁸ per month (< ± 1 part in 10⁹ per day)

Model 7000A
4-full Digit Multimeter, .01%, \$1,175

Multifunction — DC volts, DC millivolts, AC volts, ohms, current, BCD
Dual slope integrating
Automatic polarity
Manual and automatic ranging
20% overranging

Specifications:

DC VOLTAGE MEASUREMENTS

Ranges 1.0000V F.S. + 20% overrange to 1000V F.S. in 4 ranges
Accuracy ± (0.01% reading + 0.01% F.S.) @ 23°C ± 1°C for 3 months
Resolution 100μV (10μV DCV only)
Measurement Rate ~ 5 readings per second
Input Impedance 1V > 1kMΩ
10V > 1kMΩ
100V ~ 10MΩ
1000V ~ 10MΩ
Normal Mode Rejection > 30dB at 60Hz
> 40dB at 120Hz
> 50dB at 400Hz
Common Mode Rejection > 100dB at 60cps

OPTIONS

(Options are plug-in cards)
Option 01-Auto Range Price \$125.00
Option 02-AC Volts Price \$450.00
Frequency from 10Hz to 100kHz on all ranges
Option 03-Resistance Price \$110.00
Ranges 1.0000kΩ F.S. to 10000kΩ F.S.
Option 04-DC Current Price \$175.00
Ranges 1.0000mA to 1000.0mA
Option 05-BCD Output Price \$125.00
Option 06-AC Volts Price \$350.00
Frequency from 10Hz to 20kHz on all ranges
Option 07-100mV Price \$175.00
Range Add 100mV F.S. with 20% overrange

GENERAL

Dimensions 5¼" H x 8¾" W x 12" D, Half rack size
PRICE 7000/7000A \$1,175.00
with options 01, 02, 03, 04 or 07 \$1,895.00
with options 01, 03, 04, 06 or 07 \$1,795.00

Model 8050
30MHz Frequency Meter, \$650

Period, Multiple period average, Totalize
5-digit display with memory is standard
Crystal controlled time base
True trigger level control
Input impedance: 1MΩ
Reliable IC construction
Self check

Specifications:

FREQUENCY MEASUREMENTS

Range DC to 30MHz
Display kHz with automatically selected decimal point
Gate Times 10sec, 1sec, 0.1sec, 10ms, 1ms

PERIOD AND MULTIPLE PERIOD AVERAGE RANGE

Single Period Resolution 100μs
Multiple Period Resolution (for 10³ periods) 500ns
Periods Averaged 1, 10, 102, 103

TOTALIZE FUNCTION

Gate is manually opened and closed by function select switch

TIME BASE

Aging Rate < ± 2 parts in 10⁶ per month

INPUT SPECIFICATIONS

Sensitivity 100mV rms sine wave; 300mV peak to peak for pulses
Attenuator: DCX1, X30, ACX1; true trigger level control, AC and DC coupled input
Impedance Approximately 1MΩ shunted by 25pF

GENERAL

Dimensions 3¼" H x 6¾" W x 7¾" D (8¼" D including knobs)
Weight 3½ lbs
Power Requirements 115V ± 10%, 60-400Hz, 11 watts

PRICE

115-60Hz 1-9 \$650.00
10-24 \$635.00

Model 7050
3½ Digit Multimeter, 0.1%, \$354

Multifunction — DC volts, ohms, current
Dual slope integrating
Display storage (non-blinking display)
Automatic polarity
Input impedance: 1000MΩ

Specifications:

FUNCTIONS

DC Volts DC Volts, Ohms, External Current Shunts Available
1.500V F.S. to 1000V F.S. in 4 ranges (1mV resolution)
Input Impedance 1.5V Range: > 1000MΩ
15V to 1000V Ranges: ~10MΩ
Common Mode Rejection Typically > 60dB DC to 1kHz with up to 1KΩ unbalance
Normal Mode Rejection Typically > 40dB at 60Hz
Resistance 1.500k F.S. to 15.00MΩ F.S. in 4 ranges (1Ω resolution)

ACCURACY FOR 6 MONTHS

15°C to 35°C
DC Volts ± (0.1% reading + 1 digit)
kΩ ± (0.2% reading + 1 digit)
MΩ ± (1% reading + 1 digit)

GENERAL

Dimensions 3¼" H x 6¼" W x 7¼" D
Weight Less than 4 lbs
Power 115V ± 10%, 50-400Hz, 7 watts
Alternate Power Models:
Line Voltage 230V ± 10%, 50-400Hz Order Model 7050-230
100V ± 10%, 50-400Hz Order Model 7050-100

PRICE

1-9 \$354.00
10-25 \$324.00

ACCESSORIES

Current Shunts Range 150μA F.S. to 1.5A F.S.
PART #93000259 Price \$50.00
Tilt Stand/Handle PART #93000258 Price \$16.00



This
and price
amount
without
research
an electron
Think about
On i

PURCHASE ORDER

Take a look at our products. Compare our specs and prices with anybody else. Then buy Fairchild because we'll do a little more for you.



Model 8220—500MHz Direct Reading Frequency Counter. 7-digit display with memory. Price: \$1795.00.
(additional specs on reverse side)



Model 7000A—Dual Slope Integrating 4-full Digit Multimeter. 0.01% accuracy. Measures DC volts, DC millivolts ($10\mu\text{v}$ resolution), AC volts, ohms, current, BCD. Price: \$1175.00.
(additional specs on reverse side)



Model 8050—30MHz Frequency/period meter (with 8051 pre-scaler, capability extended to 300MHz). Also measures multiple period average and totalizes. Price: \$650.00.
(additional specs on reverse side)



Model 7050—Dual Slope Integrating 3½-Digit Multimeter. 0.1% accuracy. Measures DC volts, ohms, current. Price: \$354.00.
(additional specs on reverse side)

OK, I looked. I compared. And I decided to buy Fairchild.
Please send me the instruments I've checked.



I'd like another week to decide. Meantime, send your new full-line catalog.

NAME _____

TITLE _____ FIRM _____

ADDRESS _____

CITY _____ STATE _____ ZIP _____

FAIRCHILD
INSTRUMENTATION

Send to: Fairchild Instrumentation, A Division of Fairchild Camera and Instrument Corporation, 974 East Arques Avenue, Sunnyvale, California 94086.
Or call (toll free) 800-538-7901.

FOLD

FIRST CLASS
PERMIT
NO. 329
SUNNYVALE
CALIFORNIA

BUSINESS REPLY MAIL
NO POSTAGE STAMP NECESSARY IF MAILED IN THE UNITED STATES

POSTAGE WILL BE PAID BY

FAIRCHILD INSTRUMENTATION
974 East Arques Avenue
Sunnyvale, California 94086

Our Scotchpar[®] film is playing to capacitor audiences.

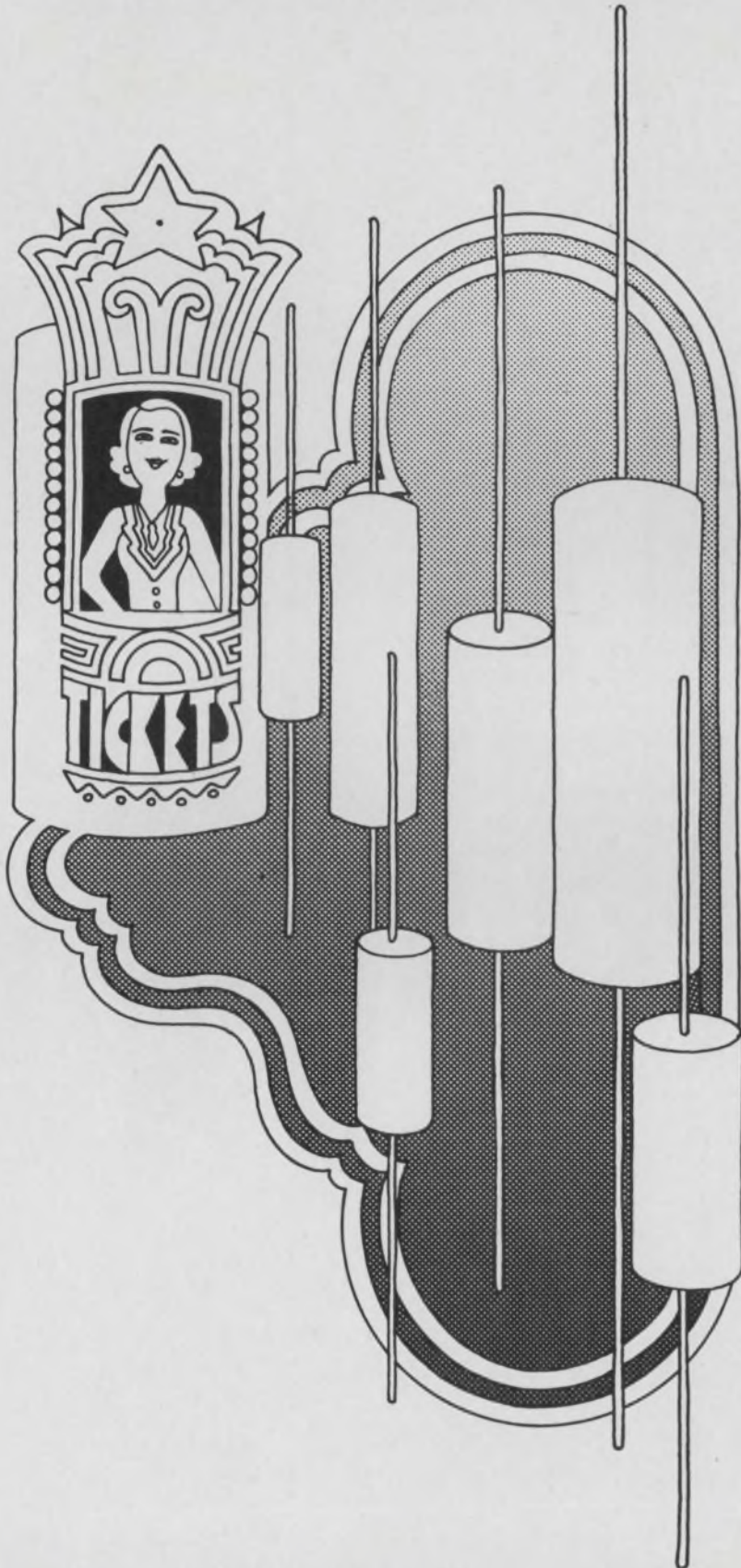

Capacitor makers bought more 3M Scotchpar[®] Brand polyester film this year than last year.

So did motor makers.

And transformer makers.

And wire and cable makers.

This isn't just us thumping our chest. It simply proves again, when you have a great show, you sell more tickets.

And we give you a great show. 3M Scotchpar now comes in a wider variety of thicknesses and types . . . for all these insulating uses. There's even a heat-sealable version (called Scotchpak.[®])

We've made it tough, flexible, stubbornly resistant to moisture, solvents. We've given it excellent dielectric strength, and a tensile ruggedness as great as steel.

And we've given you a choice. There's more than one big-time show in the film business these days.

Have you seen the new one?

Write to 3M Company, Film & Allied Products Division, 3M Center, St. Paul, Minnesota 55101 . . . or the Dielectric Materials Desk at the 3M Office nearest you.

Scotchpar[®]
BRAND POLYESTER FILM



**Reliability is 756 little dents
and one big one.**





The big squeeze.

The heelpiece and frame are the backbone of our Class H relay. The slightest squiggle or shimmy out of either and the whole relay is out of whack.

756 tiny dents on the heelpiece, plus one big one on the frame, make sure this'll never happen.

They're the result of planishing, a big squeeze. Planishing is an extra step we go through in forming the pieces to add strength and stability by relieving surface strain. It also makes the parts extra flat.

This takes the biggest press in the industry and the biggest squeeze. Both exclusively ours.

A different kind of coil.

The heart of a relay is the coil. If ours looks different, it's because we build it around a glass-filled nylon bobbin. It costs us more, but you know how most plastic tends to chip and crack.

Also, moisture and humidity have no effect on glass-filled nylon. No effect means no malfunctions for you to worry about. No current leakage, either.

The coil is wound on the bobbin automatically. No chance of human error here.

We didn't forget the solder.

We use a solderless splice. That's because solderless splice connections are sure-fire protection against the coil going open under temperature changes, stress, or electrolysis.

A solderless splice is more expensive to produce, so it's usually found only on the most reliable relays. AE is the only manufacturer to use this method on all of its relays.

Finally, we wrap the whole assembly with extra-tough, mylar-laminated material. A cover is not really necessary here; but why take chances?

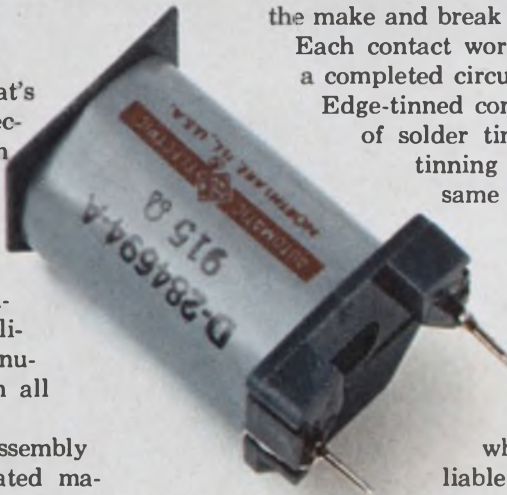

Springs and other things.

We don't take any chances with our contact assembly, either. Even things like the pileup insulators (those little black rectangles) get special attention. We precision mold them. Other manufacturers just punch them out.

It makes a lot of difference. They're stronger, for one thing; and because they're molded, there's no chance of the insulators absorbing even a droplet of harmful moisture. Finally, they'll withstand the high temperatures that knock out punched insulators.



Then there are the contact springs.

Ours are phosphor-bronze. Others use nickel-silver. Our lab gave this stuff a thorough check, but found nickel-silver too prone to stress-corrosion. Atmospheric conditions which cause tarnish and ultimately stress corrosion have almost no effect on phosphor-bronze.



Two are better than one.

Our next step was to make sure our contacts give a completed circuit every time. So we bifurcate both the make and break springs.

Each contact works independently to give you a completed circuit every time.

Edge-tinned contact springs save you the job of solder tinning them later. Also, edge-tinning enables you to safely use the same relay with sockets or mounted directly to a printed circuit board. A simple thing, but it takes a big chunk out of the inventory you have to stock.

Etc. Etc. Etc.

There's a lot more to tell about what makes our Class H relay reliable. Now we're waiting to hear from you. Automatic Electric Company, Northlake, Ill. 60164.

AUTOMATIC ELECTRIC

SUBSIDIARY OF GENERAL TELEPHONE & ELECTRONICS

INFORMATION RETRIEVAL NUMBER 21

Letters

Sorry! We misspelled an important 'word'

Sir:

Your excellent cover story (ED 7, April 1, 1969, p. 112) on our CTL II circuits was great, except that Fairchild was printed as "Fairfield." We at Fairchild try not to misspell words, especially our own fair name.

Jack K. Ayre

Public Relations Dept.
Fairchild Semiconductor
313 Fairchild Drive
Mountain View, Calif.

Nyquist sampling-rate requirement is clarified

Sir:

I wish to comment on the article titled "The FFT Computer: Designer's Missing Link," which appeared in the Dec. 6, 1967 issue of ELECTRONIC DESIGN. On page 26 of the article, the assumption is that the Nyquist sampling-rate requirement is twice as great as the highest frequency of the waveform.

The correct Nyquist rate should be "greater than twice the bandwidth of the waveform." The Nyquist sampling rate requirement has been often misstated in literature as being greater than twice the highest frequency of the waveform; this is only true if the waveform contains all frequencies down to dc. In this case, the highest frequency and the bandwidth have the same value. In the case of high frequency sampling of bandlimited signals, such as radar returns, the carrier frequency may be in the gigacycle region and the individual bandwidths may be reduced by comb filters to be in the kilocycle region. Sampling at a rate greater than twice the comb filter bandwidth (kilocycles) will permit reconstruction of the radar signal.

Henry H. Ho

Hydrotonics
Falls Church, Va.

Take the 'Donald Duck' out of divers' speech

Sir:

Your recent news feature on the Sealab project (ED 2, Jan. 18, 1969) emphasizes the voice communications problems encountered at great depths, particularly the "Donald Duck" effect due to the high partial pressure of helium, which raises the resonant frequency of the human larynx and makes speech practically unintelligible.

A simple solution to the problem, which eliminates the need for complex analyzing equipment, would be to provide the divers with an artificial larynx similar to the type Bell Telephone Laboratories have developed to aid people who have had laryngectomies. The "voice" frequency would be set by the device, not the diver, who would only have to modulate the output of the artificial larynx by mouthing his words, not speaking them. While this approach could be somewhat constraining within the tight confines of a diving mask, it might be perfectly workable within the relatively spacious environment of the Sealab capsule.

R. M. Zilberstein

58 Deerfield Road
Sharon, Mass.

Reader expands slide rule trick

Sir:

I find Mr. Dunbar's Idea for Design on using a slide rule as a handy wire table to be quite useful ("Use Your Slide Rule as a Quick dB Calculator and a Wire Table," ED 4, Feb. 15, 1969, p. 130.) In fact, I have extended this technique for rapidly computing the current-carrying capability of wires in such applications as magnet and transformer windings. My procedure is as follows: proceeding as in Mr. Dunbar's example, set 6 on the "C" scale over 1000 on LL3. Divide the AWG wire size by

10, add 1, and double the resulting number. Set the final result on the "C" scale. The cross-sectional area of the wire in circular mils is the corresponding reading on the LL03 scale times 10^6 .

Now, by using the conservative rule that the current-carrying capability of wires in coils is 1 ampere per 1000 circular mils, the maximum current in amperes is the reading on the LL03 scale times 1000.

These techniques offer good accuracy over the range of AWG sizes of usual interest.

Ernest P. Gagnon

Supervisor, Electronic Systems,
United Aircraft Research Labs.,
East Hartford, Conn.

He tests himself and scores 100%

Sir:

With regard to the "Test yourself exercises" in the article "Don't Wait for Brainstorms" (ED 4, Feb. 15, 1969, p. 105): What about $\sqrt{1} = 1$ as an answer to No. 3?

C. P. Means

Bendix Aerospace Systems Div.
Ann Arbor, Mich. 48107

You're right. That is a solution the author suggested, but unfortunately, it was left out of the magazine—Ed.

Among human beings the respect is mutual

Sir:

Every so often an advertiser will deliberately insert a subtle error in his ads, on the premise that the number of letters pointing out the error will provide an index on how widely the ad is read. I suspect you may have been following a similar line of reasoning when you prepared your editorial of 18 January ["Take a tip from an old slogan: 'the customer is always right,'" ED 2, 1969, p. 47] to

Large reset bar for ease of operation

One-piece, acetal resin frame assures dimensional stability

Simplified design for increased reliability

New pretested figure style for better readability

Frame acts as reset guide and stop

Coil wound directly on frame—AC or DC

Snap-in and standard mounting variations

Push the bar, save some money

It's the Series 7438 counter, part of our new MOD 7400 line. And even though it has push bar reset, it costs less than most rotary reset counters. Because of the simplicity of its design.

The frame is one piece and all working parts affix to it. From the coil to the verge clapper and wheel shaft which seat in molded receptacles. And since the acetal resin frame serves as the reference point for all components in assembly operations, you're assured of close tolerances.

The Series 7438 also offers a multi-purpose frame, and a variety of mounting configurations. It's ideal for test equipment, analytical instruments, control equipment and office machines. (This counter is also available in the nonreset version—Series 7437.)

It's just one of a full line of Veeder-Root counters and controls for data acquisition—mechanical, electrical and electronic. For complete information, write: Veeder-Root, Hartford, Conn. 06102.

V E E D E R - R O O T

INNOVATORS IN NUMERICS: COUNTING/RECORDING/CONTROLLING



Now, with over
800 items...
our "M" series
means the most



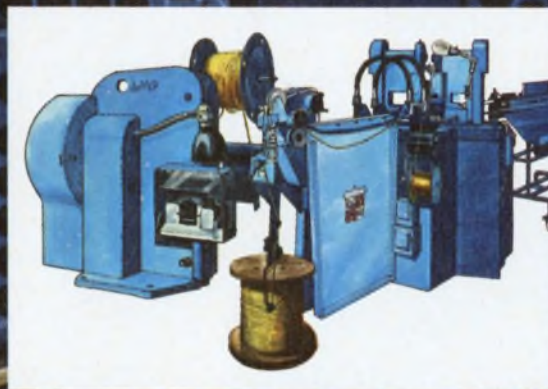

The most choices. The most combinations.

The most reliable connectors to meet your toughest rack and panel specifications. You can choose from the industry's biggest selection of connector types and sizes, pin and socket combinations and related hardware. You also get the most in savings. Because our connectors and our automatic tooling right in your own plant give you the lowest total installed cost.

Our AMP-O-MATIC★ Stripper-Crimper Machine, for example, strips each cabled wire and crimps on pins or sockets — up to 1000 an hour. And our AMPOMATOR★ Automatic lead-making machine feeds, strips and crimps at speeds up to 12,000 finished terminations per hour. That's what we call ECONOMATION . . . economy, reliability and range of choice.

For complete "M" Series Connector information, write to
INDUSTRIAL DIVISION, AMP INCORPORATED, HARRISBURG, PA. 17105.

★ Trademark of AMP Incorporated

AMP
INCORPORATED

SWITCH CRAFT FORUM



Ho-hum, another Forum. What have you got to say about "Multi-Switch"® switches that's new and exciting? Frankly, I get tired of just rehashing old product specs.

So do we. But, just the other day we discovered that a long standing customer of ours didn't know about our "Multi-Lite" pushbuttons that can couple two adjacent stations on a "Multi-Switch" switch.

Two stations?

Right. But, maybe we ought to start from the beginning. A single station can accommodate up to 6PDT circuitry. The "Multi-Lite" arrangement mechanically interlocks two adjacent stations for twice the switching capability without adding to the overall height of the switch stack. And, each station has a total of four lamps for sectionalized or redundant lighting, since we have combined two, dual lighted pushbuttons. Fig. 1. gives a good example of the flexibility we're talking about.

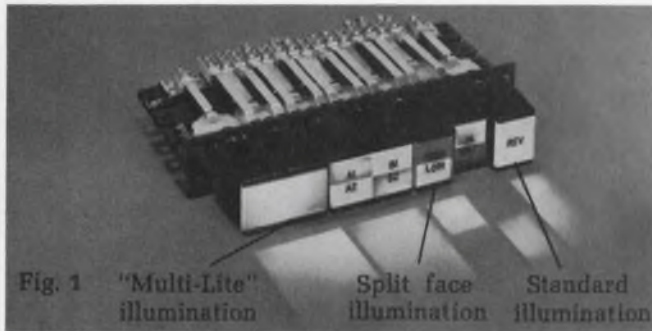

How does the "Multi-Lite" arrangement tie into the mechanics of your switch? I'm talking about lighting circuitry and switch functions.

Lighting circuitry on the Series 37000 & 38000 littel "Multi-Switch" switches is accomplished by means of a lighting stack of the type shown in Fig. 2. The extra-long lighting springs extends the lighting circuit from the lamp terminal to the rear of the switch for convenient wiring to the N.O. or N.C. contacts on the lighting switch stack. Naturally, direct wiring to the pushbutton lights is another alternate.

Regarding switch functions, the coupled stations can be furnished for interlock, momentary, push-to-lock,

Fig. 2

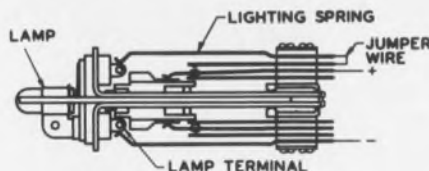

push-to-release, and all-lock operation. Of course, the all-lock arrangement will require a single button for a release station. (Forum readers may obtain complete info on switch functions from our engineering specification catalog. Just circle the reader service number below.)

"Multi-Switch" REGD. T.M.

The increased size of the "Multi-Lite" pushbutton would be ideal for a cancel bar on our new check-writer, but we'll need smaller pushbuttons for most of the other functions. How much legend information can I get on either type? And what about display screen colors and lamps?

The "Multi-Lite" pushbuttons will accept up to 4 lines of 11, 1/8" high characters per line. The smaller pushbuttons provide a 3 1/2" x 1 9/32" rectangular area for hot stamping or engraving. This should accommodate any of your legend requirements for each station. We have nine standard display screen colors plus color inserts to give you unlimited color flexibility.

As a convenience, Switchcraft has available, standard industry lamps #328 (6v.), #718 (6v.) or #327 (28v.). Or if you need zero power consumption on an "illuminated" switch, why not use the Switchcraft "Glo-Button." Available on certain switches, the "Glo-Button" produces a highly visible illumination change by strictly mechanical means without consuming any power.

I must admit we've learned something, but I suspect the Forum won't be dismissed until we've heard a "life & versatility" pitch.

Our catalog tells all about "life & versatility" and how you can specify a "Multi-Switch" switch anywhere from 1 to 18 stations in a row or up to 100 stations in ganged and coupled matrixes. The almost unlimited adaptability of this switch to countless applications is difficult to express. When we sit down to discuss your requirements in detail, the value of a "Multi-Switch" switch will become more apparent. We've dwelled on lighting pretty much, but the total versatility of these units doesn't begin to "shine" until you can see it solving your particular application problems.

Forum dismissed, but but don't forget that we have extra bound copies of "FORUM FACTS on 'Multi-Switch' Switches", that describes these units, their accessories and applications. Just have your engineers drop us a line on your company letterhead, asking for this handbook. We'll also place their name on our mailing list for TECH-TOPICS, our semi-monthly application engineering magazine. Ten-thousand engineers already receive TECH-TOPICS and tell us that the technical stories are interesting and useful.

SWITCHCRAFT
INC.

5529 North Elston Avenue • Chicago, Illinois 60630



for computer and data processing engineers

Now that we're getting down to specifics in my field, I'd like to know if your "Multi-Switch" can handle a power range from "dry" circuits to line power?

No problem. The interchangeable spring stacks are available with gold contacts for micro-power circuits or with snap-act modules that will handle up to 15 amps.

What if I need a different switch function due to programming changes?

Then you'll want our Series 7000 non-illuminated or Series 21000 illuminated "Multi-Switch". Simple mechanical adjustments in the field permit these switches to be changed from interlock to non-lock or all-lock to non-lock for mixed functions on the same switch frame.

Do I need separate indicator lights to display a changed condition on any of my data retrieval channel selectors?

Save your money. Use a Series 38000 "Multi-Switch" with split face, dual color pushbuttons. Color changes can be achieved by remote signalling or pushbutton actuation.

When my stop-function relay operates, it's a whole new ball game. How do I tie this operation into the keyboard using your "Multi-Switches"?

Just use a solenoid release "Multi-Switch." When energized, it restores all the pushbuttons to the non-operated position. It can be easily attached to the 38000 switch frame for electrical release of up to 18 interlock stations.

YOU CAN GET COMPLETE FACTS ON "MULTI-SWITCH" SWITCHES FOR YOUR COMPUTER APPLICATIONS BY SENDING FOR THE "FORUM FACTS" HANDBOOK. JUST CIRCLE THE READER SERVICE NUMBER SHOWN BELOW.

INFORMATION RETRIEVAL NUMBER 24
ELECTRONIC DESIGN 10, May 10, 1969

LETTERS

ascertain how many human factors specialists read *ELECTRONIC DESIGN*. Please be assured that *ELECTRONIC DESIGN* is highly respected among our fraternity, as we rely heavily on electronic instrumentation in many of our studies.

The more dynamic features of our work are concerned with such studies as decision-making, controls and displays, human information processing, communications, perception, driver performance, systems reliability, etc. In fact the very questions you posed are the ones we work on (How do little kids learn? How does a housewife view the controls on her washing machine? Why do air controllers make mistakes?).

The Human Factors Society has over 1500 members, most of them with advanced degrees in psychology, physics, engineering and related sciences. Although we still attend to "knobs and dials," the major part of our work is more involved, and we hope you will expand your impression of our duties.

With best wishes to the editor of an outstanding journal.

*B. H. Finley, H. E. Guttmann,
L. V. Rigby, G. C. Shelton,
R. G. Webster, A. D. Swain*

Sandia Laboratories
Albuquerque, N. M.

Marine Sciences Council updates publication

Sir:

I note that in the ED 1, Jan. 4, 1969 issue you have published another fine article on the potential of the oceans ["Rich, untapped oceans beckon prospectors" pp. 56-59].

On p. 59 there is a reference by Dr. Rechnitzer to a publication produced by the Interagency Committee on Oceanography in December 1965. For your information, the Interagency Committee on Oceanography was formally reconstituted as the Interagency Committee on Marine Research,

Education and Facilities, which is one of five committees under the Marine Sciences Council. In addition, the publication cited has been updated and is now called *University Curricula in the Marine Sciences*.

The latest edition, published in 1967 as ICO #30, is available from our Committee in limited quantities.

I personally have found that the coverage given to marine technology in your magazine has been of great help to us in trying to communicate with the engineering community. I hope, as this emerging area of technology expands, that your coverage will follow.

Edwin B. Shykind

National Council on Marine
Resources and Engineering
Development
Washington, D. C. 20390

Accuracy is our policy

Donald B. Heckman has requested that the following corrections be made in his article "Sense Signal Levels With a Tunnel Diode" (ED 17, Feb. 1, 1969, pp. 48-51):

Page 50, line 34: Change $I_P \leq I_{IN}$ to $I_P > I_{IN}$.

Page 50, line 42: Change $T_P R_D$ to $I_P R_D$.

Page 51, Col. 1, line 47: Change V_B (off) \approx to V_B (off) max-.

Page 51, Col. 2, lines 6 and 7: The equation should read:

$$R_c = \frac{V}{I_{c\ sat}} \approx 1.4 \text{ mA}$$

Page 51, Col. 2, lines 17-20: The equation should read:

$$R_{in(min)} = [V_{T\ min} - (V_{P\ max} + I_{P\ max} R_D)] / I_{P\ max}$$

$$1.5 - [0.8 + (0.55)(0.549)] / 0.55 = 2.04K$$

An error appeared in the logic table of the Idea for Design titled "Two Wires Transmit and Identify Remote Switch Closures" (ED 5, March 1, 1969). The logic table should actually read:

Line	\overline{ABC}	$\overline{A}BC$	$A\overline{B}C$	ABC
1	0	1	0	1
2	0	0	1	1



Honeywell introduces Ultramation for under \$10,000.

It's the new H316 computer. And when Honeywell hangs an under-\$10K* price tag on a 16-bit computer, you get big-computer-company backup for the first time. That means on-time delivery of one H316 or hundreds . . . world wide support . . . a full line of proven peripherals.

That's Ultramation . . . the ultimate in automation by Honeywell computers. The H316 is the newest and smallest member in the Honeywell Series 16 family of computer systems. It's logically identical to the DDP-516 — same organization, instruction repertoire and interface characteristics. Result: More than 500 programs you know will work. And you can grow into larger Series 16 computer systems without costly reprogramming.

Typical applications: industrial, mil/aero and other real-time control systems; research, scientific data acquisition, hybrid, data storage and retrieval, and communications.

Key Specifications:

Word length — 16 bits.

Cycle time — 1.6 μ secs.

Memory size — 4-16K. 72 instructions.

Hardware index register. Multi-level indirect addressing. Dual register shift capability. Power failure interrupt.

See all 3 models at SJCC (Booth 2801). Discover the meaning of Ultramation in an under \$10K computer. Write for complete specs: Honeywell, Computer Control Division, Dept. 20, Framingham, Mass. 01701.

*Rack-mountable version. Table top and pedestal models also available.

Honeywell
A U T O M A T I O N

INFORMATION RETRIEVAL NUMBER 25

'For years I worried about this . . .'

Sir:

May I comment on the editorial, "Technology and politics: Better rapport needed," in the Feb. 15, 1969 issue (ED 4, p. 63)?

There's no doubt as to the misapplication—or lack of application—of our technology. Nor of the need for governmental regulation—at least in some areas, and to some degree. But I'm afraid that much of the blame lies in the lack of cooperation and understanding between areas of technology and science.

To use your own example, noise: We've had experimental data (on test animals) since about 1935, showing that permanent hearing impairment results from too high a noise level for too long a time. Before World War II some of us were trying to sell the idea of noise and vibration (and strain) monitors to provide an inexpensive record of a noise history. Now, at last, we're getting somewhere, largely through labor organization pressure.

Another example—electrical safety: Again, a few of us have worried about this for years, while the need for better grounding procedures, better circuit protection

and the like grew rapidly with the growth of electrical loads. In the last few years, largely because of insurance people and the Underwriters' Laboratories, we're making a good start.

In the general field of hospital and medical instrumentation, we've hardly started, though a rush to install supervisory and monitoring equipment has begun. I hope some good planning is being done.

I think we've failed to educate our own groups—technological, scientific, and managerial—in these areas; we have not until very recently done much about educating the public or legislative bodies—and even now it appears that most of that is being done by lobbyists.

For years I worried about this and could do almost nothing, as a professor of engineering. Now as a private consultant, I'm doing something about both noise control and electrical safety—even a little in air pollution. But we've missed the boat, and catching up will require some mighty hard paddling. Wider understanding of the problem might give us a bigger paddle.

Howard C. Roberts

Industrial Physics—
Instrumentation
Urbana, Ill.

Clock that pulse; watch that gate

Sir:

Re: "Design flip-flops from LSI cells" (ED 12, June 6, 1968, pp. 82-86):

In line 3 of the sequence table (Fig. 1b), the author did not note a change in the output of gate 2.

When a Cp (clock pulse) occurs, it is seen at the inputs of gates 1 and 2. Gate 1 will remain in the "1" state, since gate 3 is in the "0" state. But gate 2 is fed by gate

4's "1", gate 1's "1", and the "1" of the Sd (the direct set).

Therefore, gate 2 will have an output "0", but this will not affect gates 4 or 6.

Also, when the clock pulse is lowered (line 4), gate 2 returns to its original state. This means that we will have another gate delay and another line has to be added.

The corrected and added lines should read as below.

Dale R. Petran

Designer
McDonnell-Douglas Corp.
Long Beach, Calif. 90801

Line	Cp	D1	5(Q)	6(Q)	1	2	3	4	Remarks
3	1	0	0	1	1	0	0	1	Tpd-Stable
4	0	0	0	1	1	0	0	1	Clock-Lowered
4a	0	0	0	1	1	1	0	1	Tpd-Stable

Interested reader bounces back

Sir:

I read with interest the article entitled "Simple circuit eliminates switch contact bounce" in the Jan. 18, 1969, issue of ELECTRONIC DESIGN. We have used the circuit extensively to debounce control switches in the Raytheon Computer 703 and 706 IC computers. (The exact circuit is shown in the accompanying drawing.)

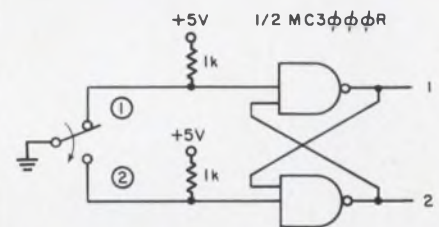
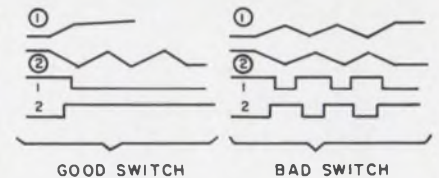

Unfortunately, the topic of excessive switch bounce was not covered in the above-mentioned article. Actually, the circuit produces bounce-free outputs only if the amplitude of the contact bounce is less than the distance between contacts 1 and 2. This case is shown as the "good switch" on the timing diagram (shown below). If the switch strikes both contacts 1 and 2 while bouncing, the output signals will not be bounce-free. This is shown in the diagram as the "bad switch." Therefore, debounce circuits should be selected with this characteristic in mind. And, if the simple dc latches cannot be used, RC networks or one shots must be employed.

J. L. Konsevich

Raytheon Computer
Santa Ana, Calif.

Acknowledgment

The National Radio Astronomy Observatory (see "New Aids For Radio Astronomy," ED 26, Dec. 19, 1968, pp. 25-33) is operated by Associated Universities, Inc., under contract with the National Science Foundation.

**Rectifiers from
the Power House.**

Is it power you need? Our line of power rectifiers and accessories — the world's most complete — is one you can really get your teeth into. Our silicon rectifiers and assemblies give you the exact current level you require: Over 400 standard rectifiers from 400 mA to 500 amperes. And the things you need with them, like surge arrestors, contact protectors and heat sinks.

Our selenium rectifiers provide highest voltage-to-current-density ratios on the market. Milliwatts to megawatts in stacks, cells, cartridges or diodes.

Write for International Rectifier's 32-page Product Selection Guide, covering not only our rectifiers, but SCRs, triacs, zeners and more. From the Power House, 233 Kansas Street, El Segundo, Calif. 90245.

INTERNATIONAL RECTIFIER

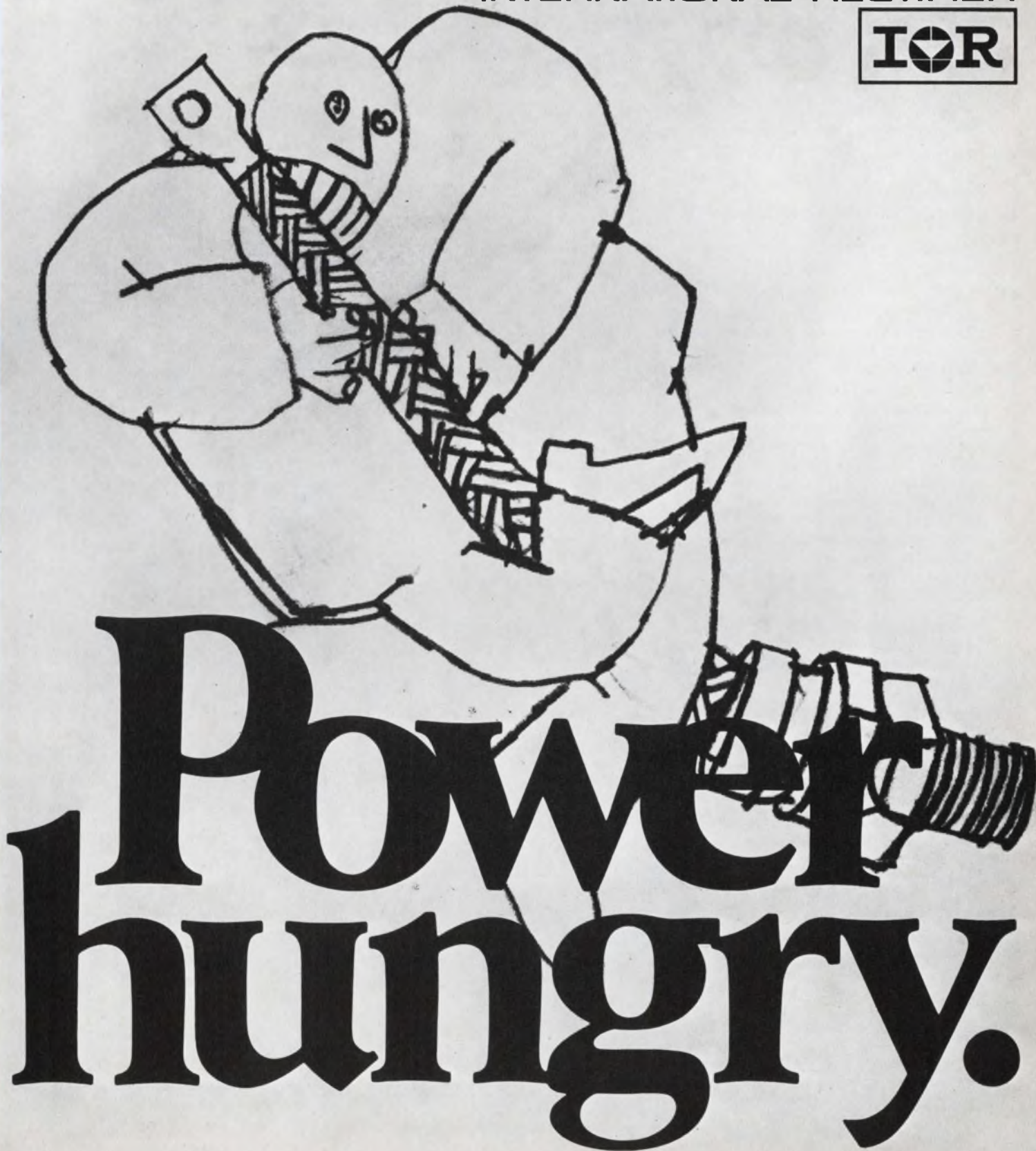

**Power
hungry.**

New Computing Expressway

**DIRECT ACCESS TO ALL AREAS
OF SCIENTIFIC AND ENGINEERING CALCULATION
VIA THE 9100A COMPUTING CALCULATOR**

No more delays
waiting to get on the big computers.
No more bogging down
on stop-and-go side street calculators.
No more detours
converting your problem into computer language.

Now you can go from *data* to *information* in milliseconds...
10 to 50 times faster than previously possible!
And our extensive, growing program library
helps speed you to virtually any computational destination
via such express routes as
second order differential equations...
analysis of variance... Chi-square tests
for goodness of fit... moments of inertia...
real and complex polynomial evaluation...
coordinate geometry... regression analysis...
three dimensional vectors...
numerical integration, and many more.
Also, the 9100A remembers the way!
You can store your programs on
credit-card size magnetic cards that
instantly program the calculator for repeat trips.

Single key strokes perform
all log, trig and math functions...
convert from fixed to floating decimal point...
from rectangular to polar coordinates!

All this—and more—computing capability
is packed into one silent, 40 lb desk top package!
A phone call to any of the 135 worldwide
Hewlett-Packard Sales and Service offices
will expose you to a comprehensive demonstration,
after which you'll probably want
to go the full route!
The one-time toll of \$4900 will put you
on the 9100A Computing Expressway.
Write for your 22-page brochure.
Hewlett-Packard, Box 301,
Loveland, Colorado 80537
Europe: 1217 Meyrin-Geneva,
Switzerland.

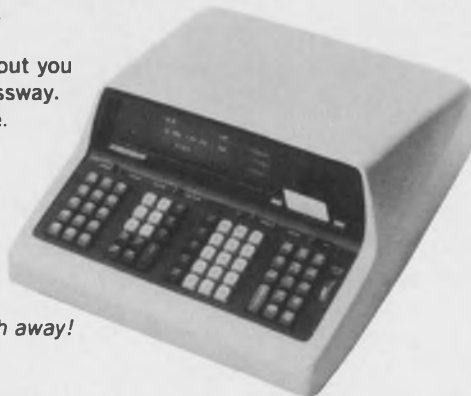

9100A puts answers just a touch away!

HEWLETT  PACKARD

784.8367	z temporary
8.326 848 815	as y accumulate
33.68	x keyboard

Dynamic range 10^{-98} to 10^{99} , nearly 200 decades. Observation of math operations on 3 displayed registers. Up to 16 more registers for data storage.

TO
POLAR

Complex and vector arithmetic simplified with coordinate transformation keys, rectangular-to-polar and vice-versa, in milliseconds.

tan x

Trig functions covering all quadrants and any size angle in degrees or radians.



Branching and looping flexibility provided by "IF" keys expands programming capability.



Edit programs easily. Single-step through programs to check and de-bug. Address an individual step and make corrections without re-entering the entire program.



Program from the keyboard. Record and store 196-step programs on credit-card-size magnetic cards for repeated use.

Designed for expansion. Printer, plotter, electrical data input/output will become available.

Covering Korea, a growing trouble spot

Long before the Pueblo was seized, Military Aerospace Editor John F. Mason was following the mounting tensions in Korea. He watched the growing number of border incidents reported without fanfare in the back pages of the daily press until, with the Pueblo, the unpopular subject moved to the front page. After this came more infiltrators from the north, an attempt on the life of President Park, the shooting of U.S. and South Korean guards at a U.N. post near the DMZ, and finally the downing of an EC-121. When the Defense Department invited John to go to Korea to cover Focus Retina, an airborne assault exercise, he jumped at the chance.

After interviewing officials in Seoul, he went to the forward area camp and lived in a tent in a sea of snow and mud. He photographed communications equipment and interviewed the men, watched the 1905-man airdrop and visited other bases in Korea, including the DMZ.

The trip back involved 40 hours without sleep—21 of them in a crowded C-141—and an overnight wait in Washington, D. C. Finally, unshaven, unshowered and wearing a flight jacket, slacks and a black business overcoat, he sank into a seat on a 7:30 A.M. plane for New York. So dazed was he, it took him several moments to catch the barb in the ingenuous-looking stewardess' "Are you going to a wedding, sir?"

Now turn to Mason's story on p. 34.



Home in Korea for Military/Aerospace Editor John F. Mason (left) was this forward camp, which rain and snow turned to mud.

Pop art from MOS masks

The cover of our 1969 MOS IC Directory, (page 75), was prepared by Art Director Cliff Gardiner from a set of upsize MOS masks, very kindly provided by Motorola Semiconductor Products, Inc., Phoenix, Ariz.

VITREOSIL®
PURE
FUSED
QUARTZ
CLOTH

offers the design engineer a combination of extreme heat resistance, exceptionally low coefficient of thermal expansion and excellent dielectric properties for plastic reinforcement, screening and filtration of molten, non-ferrous metals, high temperature gases and liquids. Also available are Vitreosil Quartz mat and wool of extremely fine diameter fibers which provide excellent thermal insulation barriers (to 2000° F. indefinitely with no degradation).

VITREOSIL
THERMAL AMERICAN
 FUSED QUARTZ CO
 RT. 202 & CHANGE BRIDGE RD.
 MONTVILLE, NEW JERSEY
 ZIP CODE 07045

74

What! Another 8 new counters and pulse generators from CMC?



NO! 8 GREAT CLASSICS

...that can't be beat for price and performance!

You've been hearing a lot about CMC's new state-of-the-art instruments, but maybe you've been overlooking some of our other high-quality precision products. These field-proved and reliable instruments have always been superior to the competition, and now we have improved the performance and reduced the prices of many of them. So before you order something new, check these eight classic instruments from CMC.

Our Model 607 Universal Counter-Timer was a winner at 5 MHz for \$1195. Now—with a 20-MHz range for the same money—our new improved version, the Model 609, has got to be an even better buy! Or take a look at the updated version of our 603 counter—the Model 608. It, too, is the same in everything but performance. Now, for \$740 you get a 15-MHz range instead of 2.5 MHz. And, if you're looking for a high-frequency instrument with a low-frequency price tag, you can't beat our combination Model 738/735.

Here's a fine, field-proved, solid-state frequency meter with a range to 100 MHz that has been selling for \$1775. Now we are offering it to you, complete with a \$350 heterodyne converter plug-in, for less than the old price of the counter alone—just \$1650! Where else can you get 500-MHz performance for such little cost?

So much for counters. But be sure to check our unique target simulator and our pulse and time delay generators. The CMC Model 301 Dynamic Target Simulator is a must for anyone concerned with the calibration or checkout of radar. It's a truly unique off-the-shelf product that may meet your requirements at a fraction of the cost of custom-made special-purpose equipment. And it's almost certain, too, that we have a pulse or time delay generator to meet your needs within your budget.

So for more information and prices on these eight classic instruments from CMC, please turn the page.



Eight Classic CMC Instruments

**ELECTRONIC COUNTERS
PULSE GENERATORS
TIME DELAY GENERATORS
TARGET SIMULATORS**

Newly improved performance and reduced prices make many of these instruments extremely attractive "buys." For full product information, circle the appropriate reader service number.



MODEL 608 Price: \$740.

15-MHz Electronic Counter—Measures frequency and period, determines frequency ratio and totalizes. Frequency range: 2 Hz to 15 MHz. Period and frequency ratio range: 2 Hz to 2.5 MHz. Period average and multiple ratio: 1, 10 and 100. In-line long-life biquinary display. Five decades are standard, a sixth is optional.

CIRCLE NO. 330



MODEL 609 Price \$1195.

20-MHz Electronic Counter—Measures Frequency, period, multiple period average, frequency ratio, time interval, and totalizes. Frequency measurement range: 0 to 20 MHz. Period: 0 to 1 MHz. Multiple period average measurement from 0 to 2.5 MHz, from 10^0 to 10^7 periods in decade steps. 1 MHz crystal time base; stability ± 2 parts in 10^7 per month. Six decade in-line biquinary display, automatically positioned decimal point.

CIRCLE NO. 331

Your local CMC representative will demonstrate these products on your premises at your convenience. Call him or call CMC direct.



MODEL 614 Price: \$1300.

Preset Multi-function Counter—Extends applications to normalizing and multiplication by any preselected constant. Gate time presets to any interval from $10\mu\text{sec}$ to 100 seconds. Gate time presets by remote selection. Direct displays as mph, rpm, ms, per N periods, etc. 614 also measures frequency and period and totalizes. Frequency range: 2Hz to 2.5 MHz. Period and frequency ratio ranges: 2 Hz to 500 kHz. Preset count circuitry operates dependably at frequencies through 300 kHz up to three times as fast as other variable gate time counters. 100 kHz crystal time base; stability ± 2 parts in 10^6 per week. Standard five decade in-line biquinary display (sixth optional) with automatically positioned decimal point.

CIRCLE NO. 332



MODEL 738 Price: (with 735) \$1650.

100-MHz Direct Reading, Frequency Meter Frequency from 10 Hz to 100 MHz measured directly. Seven decade in-line readout. Extends to 500 MHz in 50 MHz steps with Model 735 turret-type, positive switching heterodyne converter.

CIRCLE NO. 333



MODEL 301 Price: \$6330.

Dynamic Target Simulator—Model 301 is a moving target simulator. It is applicable to tracking radars, weapons control systems, or sonar for calibration, production check-out, or operator training.

The standard Model 301 has a target Range from 0 to 1,000,000 feet in one foot increments with 0.1% of setting accuracy. It has a target Velocity from 0.0 to 100,000.0 feet/second in 0.1 foot/second increments with 0.005% of setting accuracy. Target Acceleration can be set from 0.00 to 10,000.00 feet/second/second in 0.01 foot/second/second increments with 0.005% of setting accuracy.

Special versions of the Digital Target Simulator are available with increased accuracies. 301's have also been built with remote-programming capabilities and ruggedized to meet MIL specifications.

CIRCLE NO. 334



A Division of Pacific Industries



MODELS A-10, A-11, A-12 Prices: from \$1070. to \$3120.

Solid-State Delay Generators—A-10 has time delays 0 to 1 sec in 100 nsec increments. Accuracy 0.001% of delay. Jitter less than 1 nsec. Amplitude 10V. Rise time 15 nsec.

A-11 has same features as A-10 with exception of amplitude, 6V and rise time 10 nsec.

A-12 was designed for fail-safe operation in explosives testing or other tests where premature triggering might destroy information. Amplitude, 70V; rise time, 100 nsec.

CIRCLE NO. 335



MODELS B-7B, B-7D, B-7F Prices: from \$695. to \$825.

Basic Pulse Generator—B-7B is a general purpose instrument with repetition rate to 2 MHz and 50V into 50 ohms. Variable rise/fall time control.

B-7D has all specifications of B-7B and simultaneous positive and negative output pulses; separate and independent rise/fall time controls.

B-7F has all B-7B features plus: 2 Hz repetition rate; separate rise/fall time controls; and double pulse output.

CIRCLE NO. 336



MODELS B-14, B-15, B-16 Prices: from \$340. to \$595.

Portable Pulse Generators—Model B-14 is a low cost, portable unit with repetition rate of 20 Hz to 2 MHz. Delay is 0 to 10 msec. Amplitude is 15V into 1k, 8V into 50 ohms. Pulse width of 60 nsec to 10 msec. Rise/fall time is less than 10 nsec fixed.

B-15 has same rise/fall time, delay, and pulse width. Also offers a repetition rate of 5 Hz to 5 MHz.

B-16 offers repetition rate of 20 Hz to 20 MHz. Variable rise/fall times of less than 5 nsec to greater than 200 nsec. Pulse width 15 nsec to 10 msec. Amplitude 10V. Single or pulse pair operation.

Rack mount available for B-14, -15, -16.

CIRCLE NO. 337

12970 Bradley Avenue
San Fernando, California 91342
Phone (213) 367-2161
TWX 910-496-1487

Our private stock isn't private any more.



Motorola's Frequency Control Products are now on the market.

They say that if you want a thing done right, you do it yourself. And so we did. For thirty years, we've been designing and manufacturing our own

frequency control components. Because they had to be good enough to use in our own products.

We've been selfish long enough. Now our precision crystals, oscillators, filters, and tone modules are available to designers and manufacturers throughout the electronics industry. And if the mile-long list of components

isn't long enough, our designers and engineers are ready to go to work on custom projects.

For additional information on existing products and design potentials, write to Motorola Communications & Electronics Inc., 4501 W. Augusta Boulevard, Chicago, Illinois 60651. Ask for Bulletin TIC-3401.



MOTOROLA

INFORMATION RETRIEVAL NUMBER 29

**You
know about
wirewound
trimmers.**

**You've
heard about
cermet.**



This one's called Film-Met.

It's the first major improvement in trimmers since cer-mets. Film-Met™ is an exclusive Amphenol resistance element* completely different from wirewound and cermet types.

Ends Compromise

This new trimmer won't always replace wirewounds and cer-mets, which Amphenol also makes. Their characteristics fit many design parameters perfectly. But not all!

For example: Film-Met offers both infinite resolution and low temperature coefficient. Amphenol's new resistance element also provides excellent high frequency and pulse characteristics along with low current and low thermal noise.

Temperature Coefficient

Film-Met has a low TRC of 100 ppm/°C maximum with 50 ppm/°C available on request. This

is comparable to wire, and better than any other infinite resolution trimmer.

Noise

For applications requiring critical current and thermal-noise levels, Film-Met must be your choice. This is especially true in applications where other components feature low thermal noise. Film-Met is now available for that critical job.

Other Film-Met Features

Film-Met should also be your choice for high frequency and pulse applications because of its excellent performance characteristics in these areas. Due to its high frequency characteristics and infinite resolution, Film-Met can be used for exact impedance matching.

100% Metal Element

Amphenol's exclusive Film-Met element uses the same

vacuum deposition process as metal-film fixed resistors.

Continuous monitoring techniques during deposition assure maintenance of established performance levels.

Amphenol's patented Film-Met elements are 100% protected by noble metal overlays. And they're 100% thermally stabilized to provide ultimate performance.

Film-Met trimmers are available in 3/4" rectangular commercial—3811 series; 1/2" square military—2901 series; and 1 1/4" rectangular military—2851 series.

The Next Step

Now you know a little about Film-Met. What it is, how it performs and how it's made.

Explore the possibilities of this new type of trimmer further.

Write today for evaluation samples and specification sheets. Amphenol Controls Division, Janesville, Wisconsin.

Film-Met™ by



AMPHENOL

THE BUNKER-RAMO CORPORATION

INFORMATION RETRIEVAL NUMBER 47

FOR SPECIAL MEMORIES

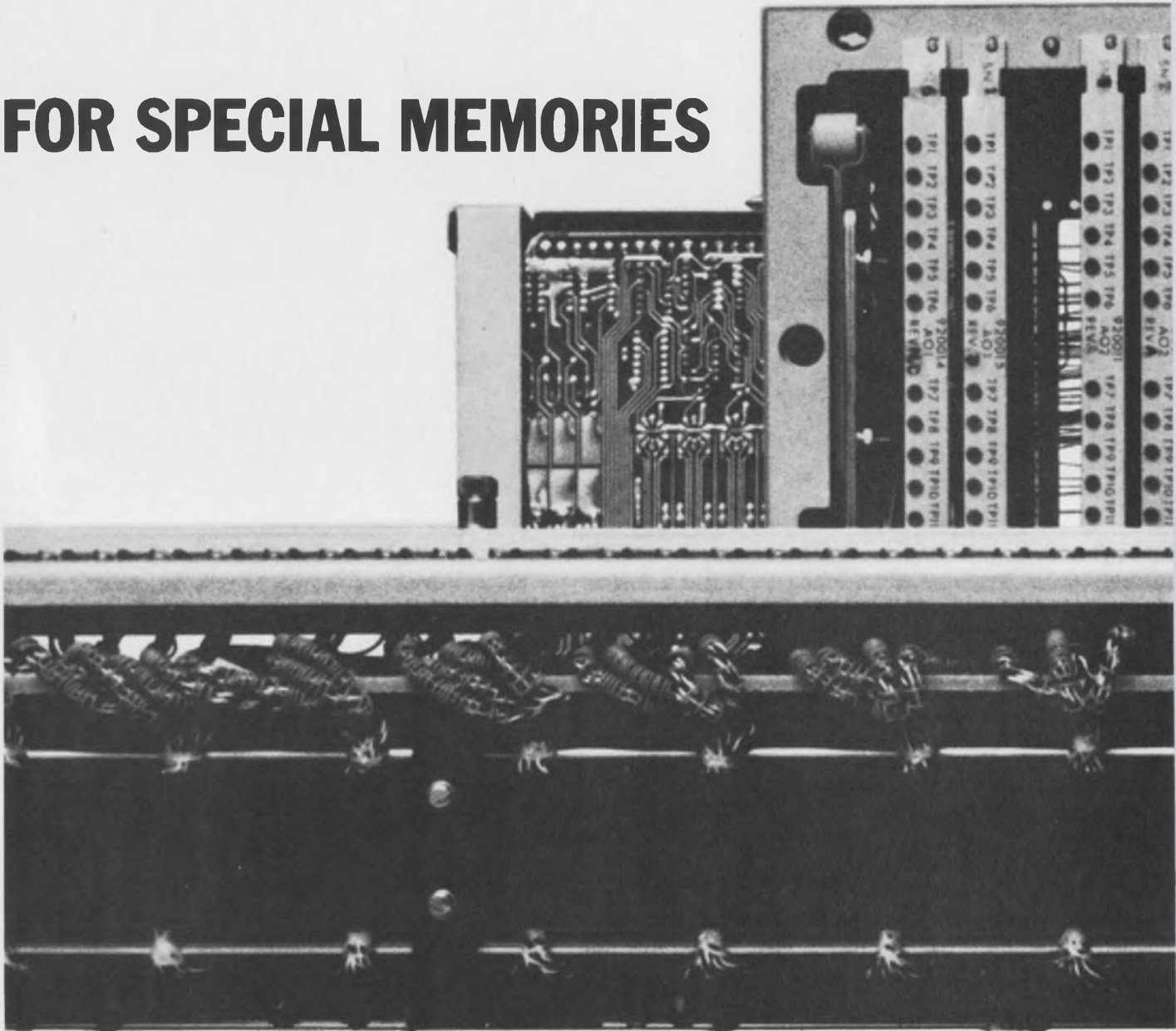

If you're a computer system designer, every one of your systems is special. But that doesn't have to mean costly, custom hardware for implementation. Electronic Memories has the broadest, most versatile memory line in the industry. A complete line of systems, stacks and cores, built for aerospace, military and commercial applications. Chances are good that one of our standard products will fit right into the slot in your system.

A. There's our SEMS 5, built small and reliable for airborne and satellite computing applications. 131,062 bits with a cycle time of $2\mu\text{s}$ in 132 cubic inches. And packaged to meet the applicable portions

of MIL-E-5400, MIL-E-4158 and MIL-E-16400.

B. If you need a ground-based militarized system, look at our SEMS 7. It's not as small as the SEMS 5, but has more storage (327,680 bits with a $2\mu\text{s}$ cycle time). And it meets all the applicable portions of MIL-E-4158, MIL-E-16400 and SCL-6200.

C. For more speed, there's our NANOMEMORY™ 2650 System. It's built with IC electronics, uses a $2\frac{1}{2}$ D drive and stores up to 294,902 bits with a cycle time of 650ns. You can even get it with a built-in self-tester. All in a $2\frac{3}{8}$ cubic foot module that does everything bulkier systems do.

D. And for low cost systems, use

our MICROMEMORY™ 1000. You get up to 32k bits of storage with a cycle time of $2.5\mu\text{s}$ occupying only 400 cubic inches and dissipating 35W. We use a special 3 D technique that both lowers the component count and increases the MTBF. The MICROMEMORY 1000 comes with no case so there are no special cooling requirements, while true random access and a simple I/O interface make for easy integration into your system.

E. If you're starting further back than that, pick one of our stacks. $2\frac{1}{2}$ D or 3 D. Military or commercial. Miniaturized, heated, folded or split into modules. Whatever's exactly right for your application.

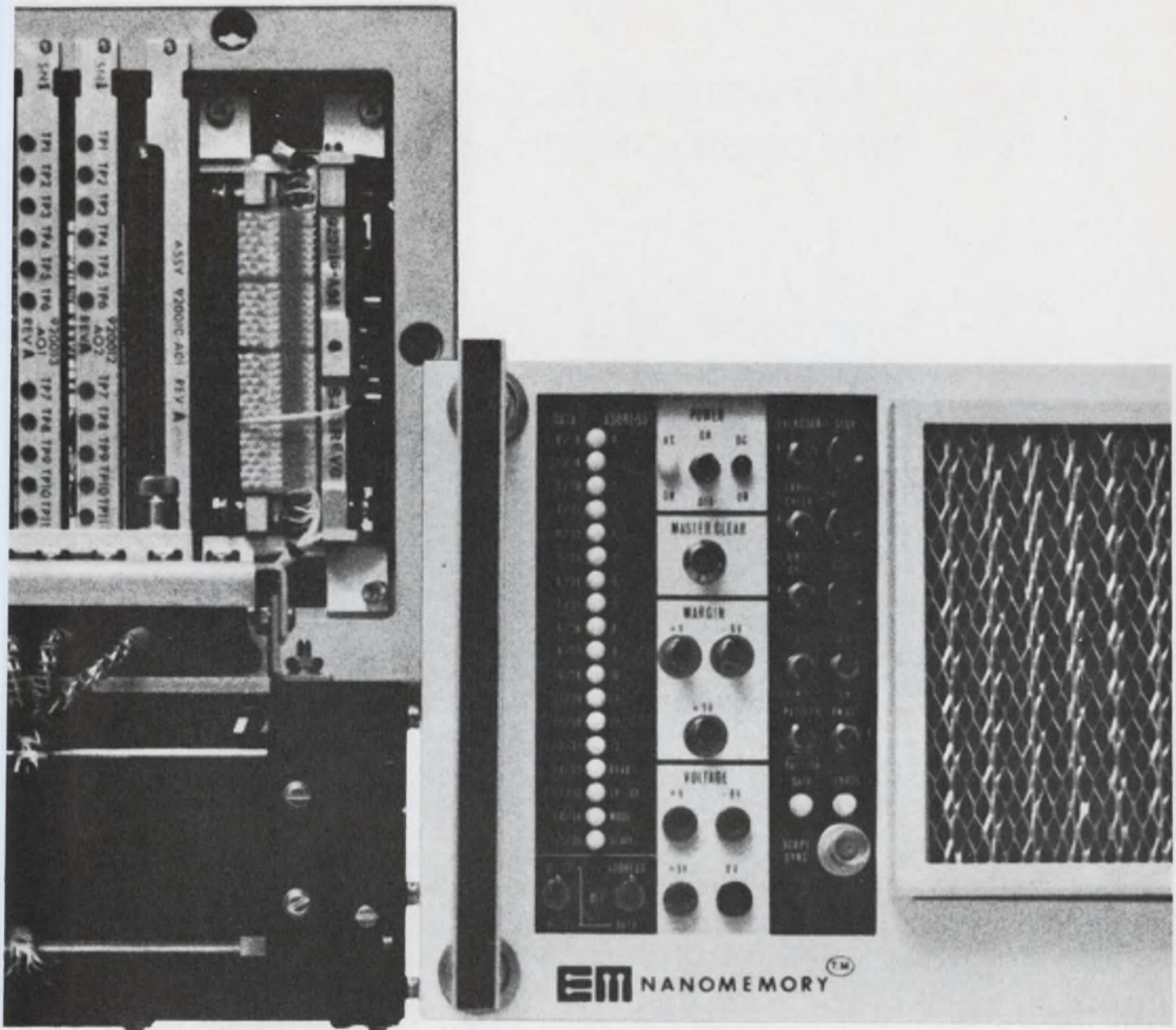

F. Or, if you're working right from scratch, we've got cores. 18 to 80 mil magnesium-manganese cores that operate from 0°C to +65°C, with cycle times that range down to less than 600ns. 18 to 30 mil lithium ferrite cores that operate over the full temperature range from -55°C to +125°C. We've made cores for all the major computer programs and most of the satellites. And we're building them for our own systems. Right now and in volume.

If you need more information, circle the reader service number. We'll send a complete collection of our literature. If you need the hardware, call us collect.

THE MEMORY SQUAD

If you're not at the hardware stage yet, maybe we can help with your design. The group below is our Memory Squad, our senior engineering staff. Write and we'll send you the whole group for a day. They'll give you a one-day seminar on memories in your plant. It will cover

everything from cores to memory systems, with the emphasis on the practical aspects of implementing designs. They've designed and built equipment for the full range of applications from satellites to computers to submarines. Write requesting the seminar and get some of their experience into your systems now. They're standing by.



ELECTRONIC MEMORIES INC.
12621 Chadron Avenue
Hawthorne, California 90250
(213) 772-5201



INFORMATION RETRIEVAL NUMBER 48

Op amps, like girls, are pretty much alike.

Now meet Miss Universe.

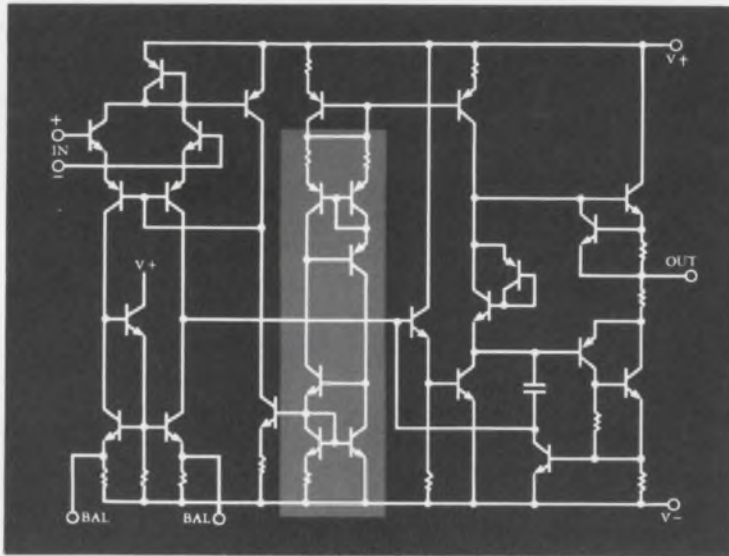

Now, we're not ones to thump the tub much. But this month we're unveiling our RM4131 fully compensated op amp, a pin-for-pin replacement for the good old 709, 101A, 107 and 741, and we felt you ought to know. It's not that the RM 4131 has anything the others don't have. It just has a potfull more of everything.

Figures don't lie.

Here are all the significant figures. Read 'em and weep, you other guys. And they don't even mention things like the RM4131 only needs a 10k ohm trim pot for balancing, not a 5 meg pot like some we could name.

Specification	741	107	4131
Slew rate (v/ μ s) 2k load	0.5	0.5	2.0
Min. voltage gain (dB) @ ± 3 volts	80	80	94
Typ. bandwidth (MHz)	0.8	0.8	4.0
Max. power consumption (mW) @ ± 20 V, 25°C	120	120	64
Max. bias current (nA) @ 25°C	500	75	50
Max. offset current (nA) @ -55 to 125°C	500	20	20
Max. offset voltage (mV) @ -55 to 125°C	6.0	3.0	3.0

Take slew rate.

Compare our 2.0 v/ μ s typical slew rate to 0.5 v/ μ s for the others. And our slew rate is guaranteed 1.5 v/ μ s minimum across the whole ± 3 to ± 20 -volt supply range, while the others peak sharply at ± 15 volts.

And voltage gain.

Time now for a graph. Notice that the 107 shows specified gain only down to ± 5 volts. At ± 3 volts our RM4131 has 94 dB gain, compared to about 80 dB for the others.

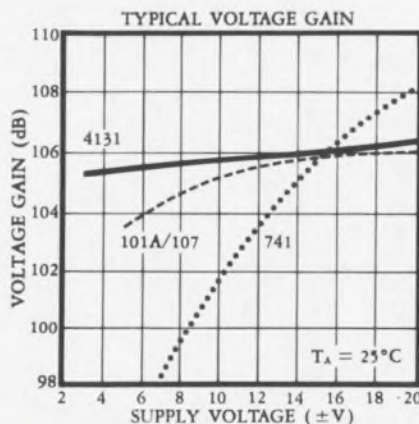

Or bandwidth.

Naturally, frequency response jumps, too. At 25°C, the RM4131 is down 3 dB at 50 kHz, and hits unity gain at 4 MHz. Compare this to 8 kHz and 800 kHz respectively for 107s and 741s. Need we say

more? Well, we will anyway.

How come?

Briefly stated, the RM4131 does all these neat things because of (1) that patent-pending current regulator in the gray patch above. It preserves gain at low voltages. And (2) our handy knack with small geometries, which gives frequency response a kick in the back porch. Plus (3) a winning way with latest process technologies, such as our new silicon nitride passivating layer for superb surface stabilities and high-beta transistors.

And how much.

Price for 100-999, full military version (-55°C to +125°C) is \$20. Commercial versions are also available. So for evaluation quantities of our optimum op amp, see your Raytheon distributor. Or send for data from the company that's delivering the ideas in linear ICs. Raytheon Semiconductor, Mountain View, California. (415) 968-9211.



Publisher

Hugh R. Roome

Editor

Howard Bierman

Managing Editor

Robert C. Haavind

Technical EditorsFrank Egan
Michael J. Riezenman
Raymond D. Speer
Stella Lawrence**Management and Careers Editor**

Richard L. Turmail

Chief News Editor

Ralph Dobriner

Washington News Bureau

Charles D. LaFond, Chief

Military/Aerospace Editor

John F. Mason

East Coast Editor

Jim McDermott

West Coast Editor

Elizabeth deAtley

New Products EditorsRobert Patton
Lucinda Mattera**Copy Editor**

Marion Allen

Editorial ProductionDollie S. Viebig
Phyllis Gura**Art Director**

Clifford M. Gardiner

Art Assistant

William Kelly

Technical IllustratorsWilliam Alvarez
Rita Jendrzewski
Lynn E. Thompson**Production Manager**

Thomas V. Sedita

Asst. Production Manager

Helen De Polo

Production AssistantsBernard Wolinsky
Carl A. Merkin**Circulation Manager**

Nancy L. Merritt

Information Retrieval

Genate Piccinetti

EDITORIAL



Smart engineering, the European way

The so-called technology gap—the long lead that the American electronics industry has over the European—may be hurting European business, but it may also be creating outstanding designers. Tour some of Europe's big electronics plants and talk to their engineering chiefs—as I did recently—and this conclusion is inescapable.

Why?

B. J. Rechter, head of the industrial equipment division at Phillips-Eindhoven, cuts to the core of the matter when he says: "Limited R&D funds, a relatively small military space market, plus U.S. competition, force the European designer to be more cost-conscious and to design a component or instrument with greater sensitivity and refinements. He frequently must design his instrument for more general use."

The American engineer, Rechter indicates, isn't necessarily interested in broad market applications. He may, for example, design a specialized circuit for a heavily funded military program. An extra resistor here or a capacitor there doesn't matter; the circuit is strictly for the military, and economy isn't the overriding goal. The typical European engineer, on the other hand, thinks over carefully every circuit addition before incorporating it into his design. His "specialized" circuit, more often than not, must be adaptable to other applications.

Derek Roberts, head of Plessey Co.'s microelectronics division, notes: "We can't always afford to develop a new process. Rather, we concentrate on one bipolar or monolithic process, get to know it very well and then design around it for a wide variety of applications." This approach, he says, places more emphasis on the circuit designer.

Plessey has a rather unique approach to making sure that its potential customers get the exact microcircuit they want from the company's standard silicon processes.

It offers a three-to-four month course to outside engineers that trains them in the company's silicon technology and layout methods. On completion of the course, the engineer, with the help of Plessey's designers, will have completed a layout with Plessey's process. In effect, he has designed the exact circuit *he* wants to his *own* specs. This approach, says Roberts, gets over the "we-know-how-to-design-your-product problem" so frequently found in industry.

Siemens, Marconi and other European electronics giants have their own tricks for broad-market design. The apparent technology gap is caused more by money and aggressive American management and marketing methods than by differences in engineering know-how. The European designer is just as well-versed in the technology as his American counterpart—and frequently he's forced to be more innovative.

RALPH DOBRINER

New SONY®/TEKTRONIX® portable oscilloscope makes the going easier!



The SONY/TEKTRONIX Type 323 Portable Oscilloscope weighs 7 lbs, is 4 1/4 inches high, 8 1/2 inches wide and 10 5/8 inches deep. It operates from self-contained batteries for up to 8 hours. With this compact, lightweight instrument, a user may move from one remote application to another without concern for power connections.

The Type 323 is especially well suited for maintenance of remote microwave installations, mobile communications equipment, aircraft and marine instrumentation, production control equipment, etc.

Batteries are rechargeable overnight (16 hours) by simply plugging the instrument into an AC outlet. The built-in charger will provide a fresh power source for use the next day. The Type 323 may also be powered from DC, 6 V to 16 V, up to 4.5 watts, and 90 to 136 VAC or 180 to 272 VAC, 48 to 440 Hz, up to 14 watts.

This solid-state portable oscilloscope also provides performance!

Bandwidth is 4 MHz at 10 mV/div deflection factor. For low signal level applications, 1 mV/div at 2.75 MHz is provided. Sweep rates are 1 s/div to 5 μ s/div, extending to 0.5 μ s/div with the X10 magnifier. A single control knob permits automatic or manual level sweep triggering, positive or negative slope. With no input the automatic trigger mode provides a bright baseline reference at all sweep rates. A 6 X 10 (1/4-inch div) internal non-illuminated graticule permits parallax-free measurements.

The Type 323 is designed for severe environments. Performance specifications are maintained within an operating temperature range of -15° C to $+55^{\circ}$ C. It also passes shock, vibration and humidity tests which simulate environments "portable" instruments are likely to encounter.

Your Tektronix Field Engineer will demonstrate the performance of the Type 323 in your application at your convenience. Please call him or write: Tektronix, Inc., P.O. Box 500, Beaverton, Oregon 97005.

Type 323 Portable Oscilloscope (including batteries) \$925
U.S. Sales Price FOB Beaverton, Oregon



Tektronix, Inc.

committed to progress in waveform measurement

Technology



Over 200 short summer courses for design engineers or engineering managers. P. 120

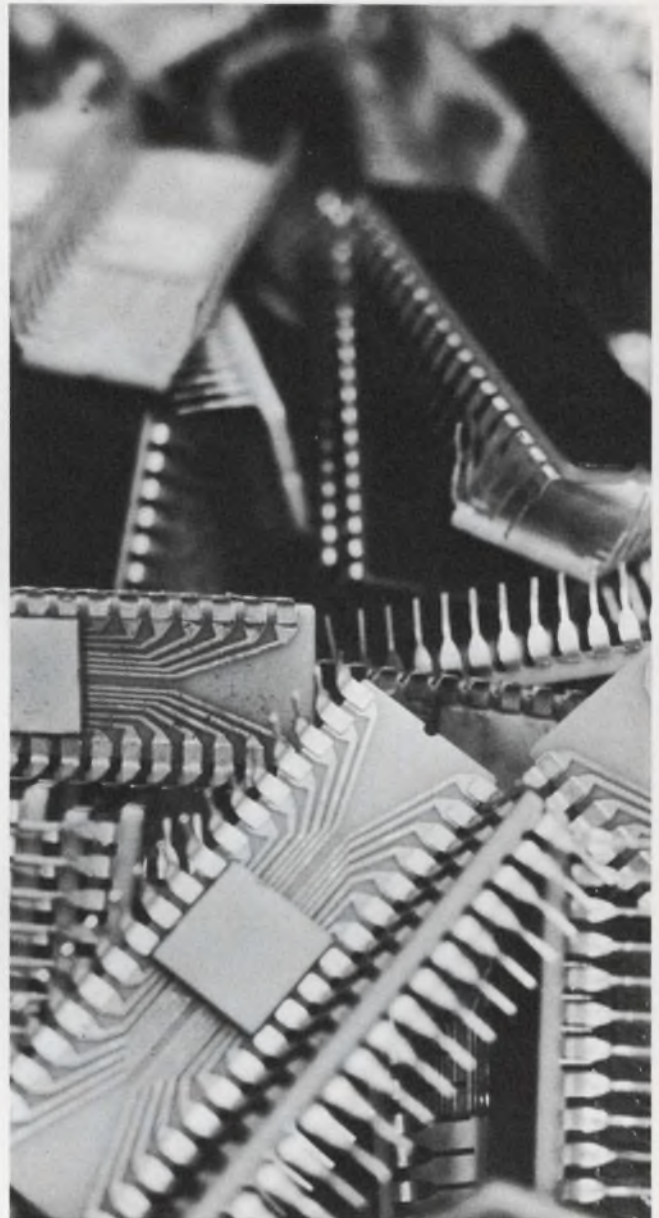

Directory of MOS ICs includes all standard products and their manufacturers. P. 75

Also in this section:

Cut differential-amplifier design time—use handy tables. Page 114

Design and match rf amplifiers, using two QUIKTRAN programs. Page 106

Ideas for Design. Page 130

The wreckless rechargeable.



Sonotone's Fastback[®] battery won't wreck itself. Even under fast charging. Over and over and over again.

Sonotone's new nickel-cadmium sealed cell is called the Fastback because it gets back into action *fast*. In just five minutes, it gets enough charge to start a lawn mower or to operate a camera. So your product goes to work today... not tomorrow.

The Fastback's safe. In laboratory tests, it's been deliberately overcharged for months at the 3-hour rate. Without overheating or blowing its top. Even after that, it delivers full rated output under load.

And there's no need for expensive, bulky external charging apparatus. All

the charging capability is built right into the Fastback. Already, the Fastback's found its place in many consumer products. Should it be in yours? Find out by writing for full specifications and performance charts. Sonotone Corporation, Battery Division, Elmsford, New York 10523.

CLEVITE SONOTONE

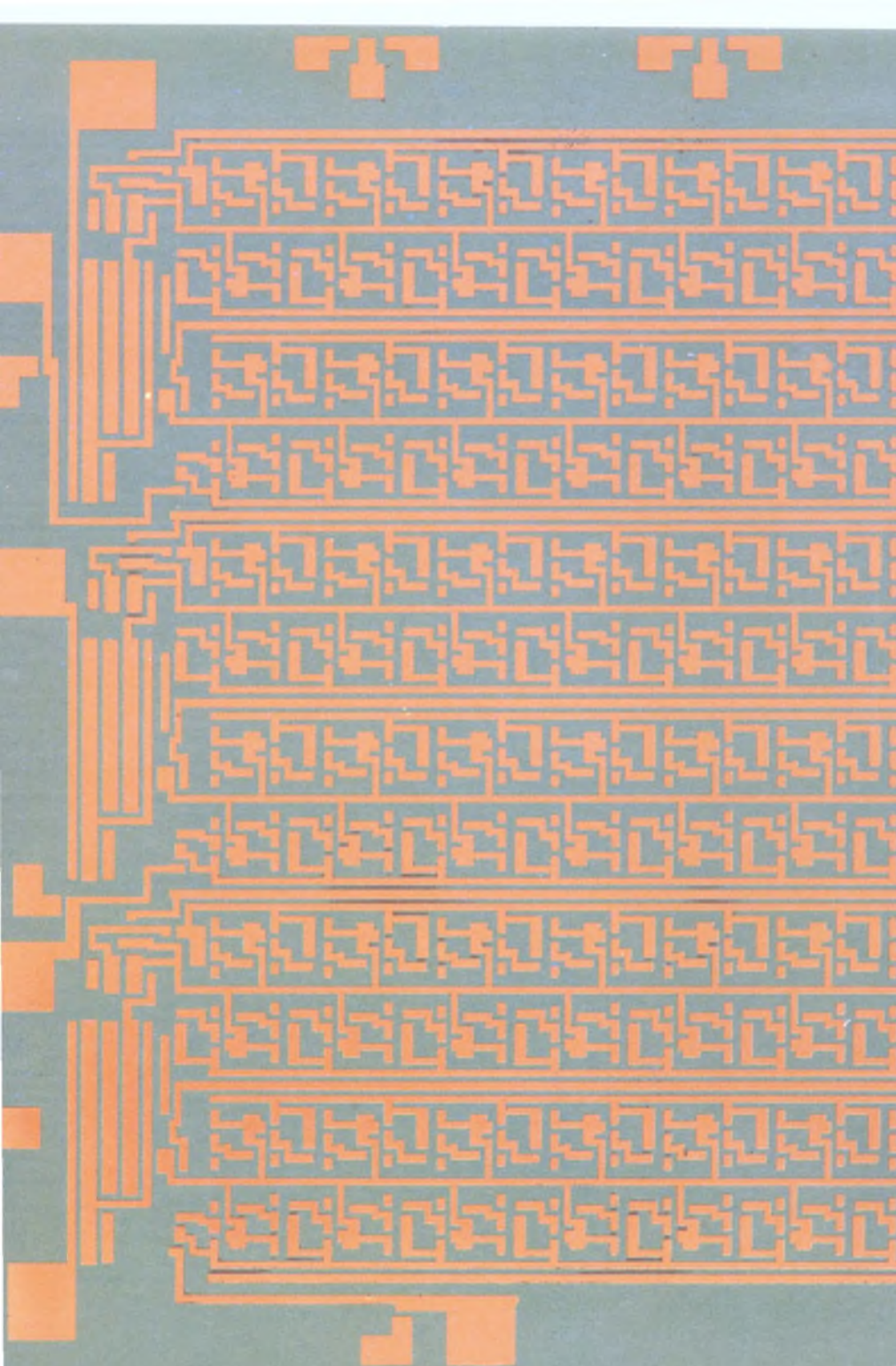



**Electronic Design's
MOS Integrated Circuit
Directory**

MOS Integrated Circuits

Raymond Daniel Speer, Microelectronics Editor

Accumulators

Circuit	Mfr.	Part Number	Operating Temperature (°C)	Frequency Range (MHz)	Clocks Required	Signal Levels			
						Input		Output	
						"0" (V)	"1" (V)	"0" (V)	"1" (V)
8-bit parallel	FCH	3800	0 to +70 -55 to +85	-	-	-	-	-	-
32-bit serial	GI	MEM3032-D2	-55 to +85	0.01 to 2.0	4	-2.0	-10	-2.0	-11
32-bit serial	GI	MEM3032-D5	-55 to +85	0.01 to 5.0	4	-2.0	-10	-2.0	-11
dual 64-bit	NATL	MM410	-55 to +125	to 4.0	2	-2.5	-4.5	-1.5	-8.0
dual 64-bit	NATL	MM510	-25 to +70	to 4.0	2	-2.5	-4.5	-1.5	-8.0
triple 60 +4-bit	NATL	MM415	-55 to +125	0.002 to 1.0	-	+4.0	+0.2	+5.0	-9.0
triple 60 +4-bit	NATL	MM515	-25 to +70	0.002 to 1.0	-	+4.0	+0.2	+5.0	-9.0

Adders

Circuit	Mfr.	Part Number	Operating Temperature (°C)	Frequency Range (MHz)	Clocks Required	Signal Levels			
						Input		Output	
						"0" (V)	"1" (V)	"0" (V)	"1" (V)
dual full	GI	MEM1000	-55 to +85	-	-	-2.0	-10	-0.5	-11
dual full	TI	TMS1A1700AA	-55 to +85	-	-	-	-	-	-

Converters, A/D and D/A

Circuit	Mfr.	Part Number	Operating Temperature (°C)	Package
10-bit	FCH	3750	-55 to +85	36-lead DIP
12-bit	FCH	3751	-55 to +85	36-lead DIP
4-channel element	GI	MEM1051	-55 to +85	TO-87
10-bit element	GI	MEM5014	-55 to +85	40-lead plug-in
system	GI	S-C-100	0 to +70	-
system	GI	S-C-100A	-55 to +85	-
system	GI	S-C-101	0 to +70	-

See page 102 for key to manufacturer's code listing.

The following MOS ICs are standard products, fully characterized by their manufacturers. Data sheets have been prepared for all, and can be obtained by circling the appropriate reader service number (from the MOS manufacturers list, page 102) or by contacting the manufacturer directly.

Please use caution in applying the figures found in the tables to circuit design. We are not able to completely specify the test conditions under which these figures are obtained, and we suggest that you contact the manufacturers for more complete information. Use the handy information retrieval card!

Supply Voltages				Power Dissipation (mW)	Package	Delivery On 1000 Pcs (Weeks)	Comments
V _{DD} (V)	V _{GG} (V)	V _{SS} (V)	Clock (V)				
-	-	-	-	-	36-lead DIP	6	8-bit slice of CPU
-	-	-	-27	-	l.p. 10-lead TO-74; TO-87	1-3	-
-	-	-	-27	-	l.p. 10-lead TO-74; TO-87	1-3	-
-	-18	0	-16	0.5 μW/bit	TO-5	3-4	TTL/DTL compatible
-	-18	0	-16	0.5 μW/bit	TO-5	1-2	TTL/DTL compatible
-	-10	+5	-	0.3 per bit	16-pin DIP	6	direct TTL interface
-	-10	+5	-	0.3 per bit	16-pin DIP	6	direct TTL interface

Supply Voltages				Power Dissipation (mW)	Package	Delivery On 1000 Pcs (Weeks)	Comments
V _{DD} (V)	V _{GG} (V)	V _{SS} (V)	Clock (V)				
-13 ±1	-27 ±1	-	-	55	TO-87	1-3	-
-	-	-	-	-	14-lead flat pack	-	-

Delivery On 1000 Pcs (Weeks)	Description
6	serial or parallel data entry, 0.1% resolution
6	0.1% resolution
1-3	-
2-4	complete logic and analog switching for 10-bit successive approximation A/D converter
2-4	complete 10-bit A/D converter system
2-4	complete 10-bit A/D converter system
2-4	complete 10-bit D/A converter system

Converters, parallel/serial and serial/parallel

Circuit	Mfr.	Part Number	Operating Temperature (°C)	Frequency Range (MHz)	Clocks Required	Signal Levels			
						Input		Output	
						"0" (V)	"1" (V)	"0" (V)	"1" (V)
12-bit serial-in, parallel-out	AMI	SP01C	-55 to +125	dc to 2.0	-	-9	-3	-10	0
12-bit serial-in, parallel-out	AMI	SP51C	-25 to +75	dc to 2.0	-	-9	-3	-10	0
8-bit serial-in, parallel-out	NATL	MM408	-55 to +125	dc to 2.0	1	-2.5	-4.5	-1.5	-8.0
8-bit serial-in, parallel-out	NATL	MM508	-25 to +70	dc to 2.0	1	-2.5	-4.5	-1.5	-8.0
8-bit parallel-in, serial-out	NATL	MM409	-55 to +125	dc to 2.0	1	-2.5	-4.5	-1.5	-8.0
8-bit parallel-in, serial-out	NATL	MM509	-25 to +70	dc to 2.0	1	-2.5	-4.5	-1.5	-8.0
8-bit parallel-in, serial-out	SIL	D108	-55 to +125	0.5 max	1	$V_R - 0.25$	$V_R + 0.25$	-	-

Counters

Circuit	Mfr.	Part Number	Operating Temperature (°C)	Frequency Range (MHz)	Clocks Required	Signal Levels			
						Input		Output	
						"0" (V)	"1" (V)	"0" (V)	"1" (V)
4-stage binary up-down	GI	MEM1050	-55 to +85	dc to 0.16	-	-2.0	-10	-1.0	-11
4-stage binary up-down	GI	MEM1050B	-55 to +85	dc to 2.5	-	-2.0	-10	-0.5	-11
4-stage binary up-down with reset	GI	MEM1055	-55 to +85	dc to 2.5	-	-2.0	-10	-0.5	-11
frequency divider	HUGH	HRM F/2	0 to +85	0 to 1.0	none	-1 to -2	-6 to -27	0 to -1	-8 to -18
7-stage frequency divider	HUGH	HRM2034	-55 to +125	dc to 5	none	-1 to -2	-6 to -27	0 to -1	-8 to -18
decade to 7-bar display	HUGH	HRM3068	0 to +85	dc to 1	none	0 to +1.5	+4 to +6	0 to 0.5	+5
7-stage binary	INTSL	ICM7005	-25 to +70	1 kHz (typ)	-	-	-	0.1 max	1.8 min
BCD decade	PHLCO	pL4C01	-55 to +125	0.1	none	-3.0 max	-9.0 min	-2.0 max	-10.0 min
7-stage binary	RCA	CD4004	-55 to +125	2.5 (typ)	-	(1)	(1)	0.01 max	9.99 min
7-stage binary	RCA	CD4004T	-55 to +125	2.5 (typ)	-	(1)	(1)	0.01 max	9.99 min

Footnotes: (1) $V_{SS} \leq V_{IN}$. $V_{IN} \leq V_{DD}$ (2) +15 to -0.5 V max

Digital Differential Analyzers

Circuit	Mfr.	Part Number	Operating Temperature (°C)	Package
digital differential analyzer	AUTO	DDA1736	-55 to +100	40-lead plug-in
digital differential analyzer	HUGH	HRM2032	-55 to +125	24-lead flat pack

See page 102 for key to manufacturer's code listing.

Supply Voltages				Power Dissipation (mW)	Package	Delivery On 1000 Pcs (Weeks)	Comments
V _{DD} (V)	V _{GG} (V)	V _{SS} (V)	Clock (V)				
-27	-	-	-27	175	22-lead flat pack	4-6	series-shunt output
-27	-	-	-27	175	22-lead flat pack	4-6	series-shunt output
-	-16	0	-16	10 per bit	DIP	4-5	TTL/DTL compatible
-	-16	0	-16	10 per bit	DIP	3-4	TTL/DTL compatible
-	-16	0	-16	6 per bit	DIP	4-5	TTL/DTL compatible
-	-16	0	-16	6 per bit	DIP	3-4	TTL/DTL compatible
15	-	-	-	750	24-lead	4	MOS-bipolar monolithic construction

Supply Voltages				Power Dissipation (mW)	Package	Delivery On 1000 Pcs (Weeks)	Comments
V _{DD} (V)	V _{GG} (V)	V _{SS} (V)	Clock (V)				
-27 ±1	-	-	-	300	16-lead flat pack	1-3	-
-27 ±1	-	-	-	300	16-lead flat pack	1-3	-
-27 ±1	-	-	-	300	24-lead flat pack	1-3	-
-9 to -27	-	0	none	12	4-lead TO-18	1	-
-6 to -24	-9 to -27	0	none	150	14-lead DIP	4	-
0 to -12	-6 to -24	+5	none	150	24-lead DIP epoxy	4	output switches will standoff 45 V
-4.5 to -5.5	-	-	-	50 μW/stage	TO-78	11	fanout of 10
-12.0 ±2.0	-24.0 ±4.0	-	-	100	24-lead flat pack	4	-
(2)	-	(2)	-	5 μW/pkg	14-lead flat pack	3	former developmental number TA5385
(2)	-	(2)	-	5 μW/pkg	12-lead TO-5 style	stock	-

Delivery On 1000 Pcs (Weeks)	Description
6	contains 310 gates using a low-power four-phase clocking scheme
4	pin compatible & electrically similar to GI MEM5021

Drivers

Circuit	Mfr.	Part Number	Operating Temperature (°C)	Frequency Range (MHz)	Clocks Required	Signal Levels			
						Input		Output	
						"0" (V)	"1" (V)	"0" (V)	"1" (V)
single-phase MOS clock driver	NATL	NH0007	-55 to +125	-	-	-	-	-	-
single-phase MOS clock driver	NATL	NH0007C	0 to +70	-	-	-	-	-	-
two-phase MOS clock driver	NATL	NH0009	-55 to +125	-	-	-	-	-	-
two-phase MOS clock driver	NATL	NH0009C	0 to +70	-	-	-	-	-	-
BCD nixie driver	UNCB	NNIX1	0 to +85	0.1	none	0 to +1 max	+10 max	-	-

Interface Circuits

Circuit	Mfr.	Part Number	Operating Temperature (°C)	Package
MOS-to-bipolar interface	AMI	MX04C	-55 to +125	22-lead flat pack
MOS-to-bipolar interface	AMI	UL03C	-55 to +125	22-lead flat pack

Linear Circuits

Circuit	Mfr.	Part Number	Operating Temperature (°C)	Package
dual differential-input amplifier	SIL	L120	-55 to +125	TO-100
RC - coupled audio amplifier	TI	TMS7A7000LA	-55 to +85	TO-18

Logic Elements

Circuit	Mfr.	Part Number	Operating Temperature (°C)	Frequency Range (MHz)	Clocks Required	Signal Levels			
						Input		Output	
						"0" (V)	"1" (V)	"0" (V)	"1" (V)
Flip-Flops									
binary	AMI	LP54A	-25 to +75	dc to 1.0	-	-3.5	-9.0	-3.0	-9.5
binary	AMI	LP04A	-55 to +125	dc to 1.0	-	-3.5	-9.0	-2.5	-10
dual J-K	FCH	3101	-55 to +85	0.25	1	-2.0	-9.0	-1.0	-10
dual J-K	GI	MEM1015	-55 to +85	dc to 1.0	-	-2.0	-10	-0.5	-11
\bar{R} - \bar{S} -T	GI	MEM1005	-55 to +85	dc to 0.5	-	-2.0	-10	-0.5	-11
R-S-T binary	HUGH	HRM8047	-55 to +125	dc to 1.0	none	-1 to -2	-6 to -27	0 to -1	-8 to -18
dual J-K	HUGH	HRM2306	-55 to +125	dc to 1.0	1	-1 to -2	-6 to -27	0 to -1	-8 to -18
gated binary	HUGH	HRM2307	-55 to +125	dc to 1.0	none	-1 to -2	-6 to -27	0 to -1	-8 to -18

See page 102 for key to manufacturer's code listing.

Supply Voltages				Power Dissipation (mW)	Package	Delivery On 1000 Pcs (Weeks)	Comments
V _{DD} (V)	V _{GG} (V)	V _{SS} (V)	Clock (V)				
-	-	-	-	-	TO-5	5	TTL to MOS power translator
-	-	-	-	-	TO-5	4-5	TTL to MOS power translator
-	-	-	-	-	TO-8	5	TTL to MOS power translator
-	-	-	-	-	TO-8	4-5	TTL to MOS power translator
+10	+20	-	none	50	22-lead flat pack	8	directly drives Nixie tubes

Delivery On 1000 Pcs (Weeks)	Description
4-6	-
4-6	-

Delivery On 1000 Pcs (Weeks)	Description
4	monolithic MOS-bipolar, unity gain stable; 20 V/ μ s slew rate; 20 pA leakage
-	-

Supply Voltages				Power Dissipation (mW)	Package	Delivery On 1000 Pcs (Weeks)	Comments
V _{DD} (V)	V _{GG} (V)	V _{SS} (V)	Clock (V)				
-10	-	-	-	0.0001 to 15	8-lead TO-5	4-6	low power, R _L is ext.
-10	-	-	-	0.0001 to 15	8-lead TO-5	4-6	low power, R _L is ext.
-	-27	gnd	-	75.0	16-lead DIP	6	-
-13 \pm 1	-27 \pm 1	-	-	82 per flip-flop	24-lead flat pack	1-3	-
-27 \pm 1	-	-	-	70	L.P. 10-lead TO-74	1-3	-
-6 to -24	-6 to -27	0	none	12	8-lead TO	2	-
-6 to -24	-9 to -27	0	-9 to -27	25	22-lead flat pack	4	-
-6 to -24	-9 to -27	0	none	25	14-lead DIP	4	-

Logic Elements (continued)

Circuit	Mfr.	Part Number	Operating Temperature (°C)	Frequency Range (MHz)	Clocks Required	Signal Levels			
						Input		Output	
						"0" (V)	"1" (V)	"0" (V)	"1" (V)
Flip-Flops (continued)									
J-K	NATL	MM483	-55 to +125	dc to 2.0	-	-1.5	-7	-1	-8
J-K	NATL	MM583	-25 to +70	dc to 2.0	-	-1.5	-7	-1	-8
dual J-K	PHLCO	pL4M01	-55 to +85	.5	none	-3.0 max	-9.0 min	-2.0 max	-10.0 min
binary	PHLCO	pL4M02	-55 to +85	0.4 (typ)	none	-3.0 max	-9.0 min	-2.0 max	-10.0 min
dual D-type	RCA	CD4003	-55 to +125	4 (typ)	1	(1)	(1)	0.01 max	9.99 min
dual D-type	RCA	CD4003D	-55 to +125	4 (typ)	1	(1)	(1)	0.01 max	9.99 min
Gates									
quad NAND	AMI	UL02C	-55 to +125	dc to 1.0	-	-3.5	-9.0	-2.5	-10
expandable NOR	AMI	UL03C	-55 to +125	dc to 1.0	-	-3.5	-9.0	-2.5	-10
gating and storage element	AMI	UL04C	-55 to +125	.001 to 1.0	2	-3.5	-9.0	-2.5	-10
3-input NOR	AMI	LP55A	-25 to +75	dc to 1.0	-	-3.5	-9.0	-3.0	-9.5
3-input NAND	AMI	LP56A	-25 to +75	dc to 1.0	-	-3.5	-9.0	-3.0	-9.5
3-input NOR	AMI	LP05A	-55 to +125	dc to 1.0	-	-3.5	-9.0	-2.5	-10
3-input NAND	AMI	LP06A	-55 to +125	dc to 1.0	-	-3.5	-9.0	-2.5	-10
quad NAND	AMI	UL52C	-25 to +75	dc to 1.0	-	-3.5	-9.0	-3.0	-9.5
expandable NOR	AMI	UL53C	-25 to +75	dc to 1.0	-	-3.5	-9.0	-3.0	-9.5
gating and storage element	AMI	UL54C	-25 to +75	0.01 to 1.0	2	-3.0	-9.0	-2.5	-9.5
dual 5-input	FCH	3100	-55 to +85	0.25	-	-2.0	-9.0	-1.0	-10
dual 3-input	FCH	3102	-55 to +85	0.25	-	-2.0	-9.0	-1.0	-10
dual 3-input NOR	GI	MEM1002	-55 to +85	-	-	-2.0	-10	-0.5	-11
dual exclusive OR/NOT	GI	MEM1008	-55 to +85	-	-	-2.0	-10	-0.5	-11
quad 2-input NOR	GI	MEM1013	-55 to +85	-	-	-2.0	-10	-0.5	-11
quad 2-input AND	GI	MEM1014	-55 to +85	-	-	-2.0	-10	-0.5	-11
triple NOR	HUGH	HRM8036	-55 to +125	dc to 2	none	-2.0	-10	-0.5	-11
triple 3, dual 2 NOR	HUGH	HRM2304	-55 to +125	dc to 2	none	-2.0	-10	-0.5	-11
dual 3-input NOR	NATL	MM480	-55 to +125	dc to 3	-	-1.5	-7	-1	-8
dual 3-input NOR	NATL	MM580	-25 to +70	dc to 3	-	-1.5	-7	-1	-8
dual exclusive OR	NATL	MM481	-55 to +125	dc to 2	-	-1.5	-7	-1	-8
dual exclusive OR	NATL	MM581	-25 to +70	dc to 2	-	-1.5	-7	-1	-8
hex 2-input and dual inverter	PHLCO	pL4G10AC pL4G10C	0 to +70	C=300 ns ⁽³⁾ AC=125 ns	none	-3.0 max	-9.0 min	-2.0 max	-10.0 min

Footnotes: (1) $V_{SS} \leq V_{IN}, V_{IN} \leq V_{DD}$ (2) +15 to -0.5 V max (3) propagation delay

See page 102 for key to manufacturer's code listing.

Supply Voltages				Power Dissipation (mW)	Package	Delivery On 1000 Pcs (Weeks)	Comments
V _{DD} (V)	V _{GG} (V)	V _{SS} (V)	Clock (V)				
-10	-	gnd	-	13	TO-5	3-4	-
-10	-	gnd	-	13	TO-5	2-3	-
-12.0 ±2.0	-24.0 ±2.0	-	-	125	22-lead flat pack 24-lead DIP	4	-
-12.0 ±2.0	-	-	-	1	TO-5 14-lead flat pack	6	low power
(2)	-	(2)	-	50 nW/pkg	14-lead flat pack	3	former developmental number TA5362
(2)	-	(2)	-	50 nW/pkg	14-lead dual in line ceramic	stock	-
-15	-27	-	-	40	22-lead flat pack	4-6	expandable
-15	-27	-	-	120	22-lead flat pack	4-6	4 inverters plus 4 expanders
-15	-	-	-27	60 @ 1MHz	22-lead flat pack	4-6	precharge outputs
-10	-	-	-	0.0001 to 15	8-lead TO-5	4-6	low power, R _L is ext
-10	-	-	-	0.0001 to 15	8-lead TO-5	4-6	low power, R _L is ext
-10	-	-	-	0.0001 to 15	8-lead TO-5	4-6	low power, R _L is ext
-10	-	-	-	0.0001 to 15	8-lead TO-5	4-6	low power, R _L is ext
-15	-27	-	-	40	22-lead flat pack	4-6	expandable
-15	-27	-	-	120	22-lead flat pack	4-6	4 inverters plus 4 expanders
-15	-	-	-27	60 @ 1MHz	22-lead flat pack	4-6	precharge outputs
-	-27	gnd	-	60.0	16-lead DIP	6	-
-	-27	gnd	-	6.0	10-lead TO-5 16-lead DIP	6	-
-27 ±1	-	-	-	35 per gate	l.p. 10-lead TO-74	1-3	-
-27 ±1	-	-	-	60 per gate	l.p. 10-lead TO-74	1-3	-
-13 ±1	-27 ±1	-	-	13 per gate	16-lead flat pack	1-3	-
-13 ±1	-27 ±1	-	-	14 (cir. 1,2,3) 42 (cir. 4)	16-lead flat pack	1-3	-
-13 ±1	-6 to -27	0	-	10 per gate	14-lead flat pack	4	DTL, TTL compatible
-13 ±1	-6 to -27	0	-	10 per gate	22-lead flat pack	3	DTL to MOS level translators
-10	-	gnd	-	10	TO-5	3-4	-
-10	-	gnd	-	10	TO-5	2-3	-
-10	-	gnd	-	10	TO-5	3-4	-
-10	-	gnd	-	10	TO-5	2-3	-
-25.0 ±1.0	-	-	-	50	24-lead flat pack 24-lead DIP	4	2-MHz operation

Logic Elements (continued)

Circuit	Mfr.	Part Number	Operating Temperature (°C)	Frequency Range (MHz)	Clocks Required	Signal Levels			
						Input		Output	
						"0" (V)	"1" (V)	"0" (V)	"1" (V)
Gates (continued)									
dual 4 plus dual 5-input	PHLCO	pL4G11AC pL4G11C	0 to +70	C=300 ns ⁽³⁾ AC=125 ns	none	-3.0 max	-9.0 min	-2.0 max	-10.0 min
dual 9-input	PHLCO	pL4G12C pL4G12AC	0 to +70	C=300 ns ⁽³⁾ AC=125 ns	none	-3.0 max	-9.0 min	-2.0 max	-10.0 min
dual 3-input NOR plus inverter	RCA	CD4000	-55 to +125	-	-	(1)	(1)	0.01 max	9.99 min
dual 3-input NOR plus inverter	RCA	CD4000D	-55 to +125	-	-	(1)	(1)	0.01 max	9.99 min
quad 2-input NOR	RCA	CD4001	-55 to +125	-	-	(1)	(1)	0.01 max.	9.99 min
quad 2-input NOR	RCA	CD4001D	-55 to +125	-	-	(1)	(1)	0.01 max.	9.99 min
dual 4-input NOR	RCA	CD4002	-55 to +125	-	-	(1)	(1)	0.01 max	9.99 min
dual 4-input NOR	RCA	CD4002D	-55 to +125	-	-	(1)	(1)	0.01 max	9.99 min
quad 2-input NOR	SSS	SCL5101	-55 to +125	dc to 1	-	-0.3 to +3	+7 to +10	.05	9.95
quad 2-input NAND	SSS	SCL5102	-55 to +125	dc to 1	-	-0.3 to +3	+7 to +10	.05	9.95
dual 3-input NOR	SSS	SCL5103	-55 to +125	dc to 1	-	-0.3 to +3	+7 to +10	.05	9.95
dual 3-input NAND	SSS	SCL5104	-55 to +125	dc to 1	-	-0.3 to +3	+7 to +10	.05	9.95
dual 4-input NOR	SSS	SCL5105	-55 to +125	dc to 1	-	-0.3 to +3	+7 to +10	.05	9.95
dual 4-input NAND	SSS	SCL5106	-55 to +125	dc to 1	-	-0.3 to +3	+7 to +10	.05	9.95
dual 3-input NOR	TI	TMS1A1702LA	-55 to +85	-	-	-	-	-	-

Footnote: (1) $V_{SS} \leq V_{IN}, V_{IN} \leq V_{DD}$

(2) +15 to -0.5 V max

(3) propagation delay

Miscellaneous

Circuit	Mfr.	Part Number	Operating Temperature (°C)	Package
dual matched devices	AMI	DM01B	-55 to +125	6-lead TO-5
dual matched devices	AMI	DM02B	-55 to +125	6-lead TO-5
dual matched devices	AMI	DM03B	-55 to +125	6-lead TO-5
input/output synchronizer	AUTO	IOS1706	-55 to +100	40-lead plug-in
counter timer	AUTO	CT1711	-55 to +100	40-lead plug-in
selector	AUTO	SEL1716	-55 to +100	40-lead plug-in
clock generator	AUTO	CG1726	-55 to +100	40-lead plug-in
CRT numeric character generator	FCH	3250	-55 to +85	24-lead DIP
10-bit serial/parallel - parallel/serial converter	FCH	3801	0 to +70 -55 to +85	36-lead DIP

See page 102 for key to manufacturer's code listing.

Supply Voltages				Power Dissipation (mW)	Package	Delivery On 1000 Pcs (Weeks)	Comments
V _{DD} (V)	V _{GG} (V)	V _{SS} (V)	Clock (V)				
-25.0 ±1.0	-	-	-	50	24-lead flat pack 24-lead DIP	4	2-MHz operation
-25.0 ±1.0	-	-	-	50	24-lead flat pack 24-lead DIP	4	2-MHz operation
(2)	-	(2)	-	10 nW/pkg	14-lead flat pack	3	former developmental number TA5361
(2)	-	(2)	-	10 nW/pkg	14-lead dual in line ceramic	stock	-
(2)	-	(2)	-	10 nW/pkg	14-lead flat pack	3	former developmental number TA5455
(2)	-	(2)	-	10 nW/pkg	14-lead dual in line ceramic	stock	-
(2)	-	(2)	-	10 nW/pkg	14-lead flat pack	3	former developmental number TA5456
(2)	-	(2)	-	10 nW/pkg	14-lead dual in line ceramic	stock	-
+10	-	-	-	50 nW	TO-86	-	Zener protected inputs
+10	-	-	-	50 nW	TO-86	-	Zener protected inputs
+10	-	-	-	50 nW	TO-86	-	Zener protected inputs
+10	-	-	-	50 nW	TO-86	-	Zener protected inputs
+10	-	-	-	50 nW	TO-86	-	Zener protected inputs
+10	-	-	-	50 nW	TO-86	-	Zener protected inputs
-	-	-	-	-	10-lead TO	-	-

Delivery On 1000 Pcs (Weeks)	Description
4-6	V _{GS1} -V _{GS2} <50 MV for op-amp buffer, source follower applic.
4-6	V _{GS1} -V _{GS2} <100 MV for op-amp buffer, source follower applic.
4-6	V _{GS1} -V _{GS2} <150 MV for op-amp buffer, source follower applic.
6	support for DDA 1736
6	support for DDA 1736
6	support for DDA 1736
6	support for DDA 1736
6	7 segment CRT display - BCD input decode & char. matrix, serializer, on chip
8	25 MHz in serial mode

Miscellaneous (continued)

Circuit	Mfr.	Part Number	Operating Temperature (°C)	Package
9-bit parallel parity detector	GI	MEM1022	-55 to +85	TO-87
digital differential adder element	GI	MEM5021	-55 to +85	24-lead flat pack
servo adder	GI	MEM5031	-55 to +85	TO-87
2-input ΔY adder	GI	MEM5035	-55 to +85	TO-87
variable modulus counter	GI	MEM5048	-55 to +85	24-lead flat pack
BCD to decimal decoder	HUGH	HRM2061	-55 to +125	22-lead flat pack
frequency divider	MOTO	MC1124	0 to +75	14-lead dual in line ceramic
dual voltage translator	NATL	DM7800	-55 to +125	TO-5
dual voltage translator	NATL	DM8800	0 to +70	TO-5
BCD to decimal decoder	PHLCO	pL4G02	-55 to +85	22-lead flat pack 24-lead DIP
2^7 frequency divider	PHLCO	pL4C07AC pL4C07C	0 to +70	14-lead flat pack 14-lead DIP
2^7 frequency divider	PHLCO	pL4C06AC pL4C06C	0 to +70	14-lead flat pack 14-lead DIP
dual complementary pair plus inverter	RCA	CD4007	-55 to +125	14-lead flat pack
dual complementary pair plus inverter	RCA	CD4007D	-55 to +125	14-lead dual in line ceramic

Multiplex Switches

Circuit	Mfr.	Part Number	Operating Temperature (°C)	Frequency Range (MHz)	On Resistance Maximum (Ω)	Input Leakage Maximum (nA)	Signal Levels			
							Input		Output	
							"0" (V)	"1" (V)	"0" (V)	"1" (V)
6-channel	AMI	MX02D	-55 to +125	5	150	1.5	-	-	-	-
10-channel	AMI	MX03C	-55 to +125	5	150	1.5	-	-	-	-
4-channel, 50 ohm	AMI	MX04C	-55 to +125	3	50	10	-9	-3	-	-
6-channel	AMI	MX52D	-25 to +75	5	150	1.5	-	-	-	-
10-channel	AMI	MX53C	-25 to +75	5	150	1.5	-	-	-	-
4-channel, 50 ohm	AMI	MX54C	-25 to +75	3	50	10	-9	-3	-	-
dual	AMI	DM01B	-55 to +125	150	1250	1.5	-	-	-	-
dual	AMI	DM02B	-55 to +125	150	1250	1.5	-	-	-	-
dual	AMI	DM03B	-55 to +125	150	1250	1.5	-	-	-	-
dual w/protective diode	AMI	DM05A	-55 to +125	187	250	1.0	-	-	-	-
dual w/o protective diode	AMI	DM06A	-55 to +125	187	250	1.0	-	-	-	-
single w/protective diode	AMI	DD07K	-55 to +125	187	125	1.0	-	-	-	-

See page 102 for key to manufacturer's code listing.

Delivery On 1000 Pcs (Weeks)	Description
1-3	—
2-4	ternary type DDA performing rectangular integration
2-4	shift register content decision unit used in conjunction with the MEM5021
2-4	2-input delta "Y" summer
2-4	binary counter that counts to the base six, ten, or sixteen
4	output switches $\leq 500 \Omega$
—	field-plate diode protection
4-5	TTL to hi-voltage MOS logic levels
4-5	TTL to hi-voltage MOS logic levels
4	used with pL4C01 for decimal indicator
4	3-2-1-1 configuration, 7 parallel outputs
4	serial output only
3	former developmental number TA5388
stock	—

Supply Voltages				Power Dissipation (mW)	Package	Delivery On 1000 Pcs (Weeks)	Comments
V _{DD} (V)	V _{GG} (V)	V _{SS} (V)	Clock (V)				
—	—	—	—	—	14-lead flat pack	4-6	common source
—	—	—	—	—	22-lead flat pack	4-6	common source
—	—	—	—	—	22-lead flat pack	4-6	series-shunt output
—	—	—	—	—	14-lead flat pack	4-6	common source
—	—	—	—	—	22-lead flat pack	4-6	common source
-25	—	—	—	150	22-lead flat pack	4-6	series-shunt output
—	—	—	—	—	6L - TO-5	2-4	common source
—	—	—	—	—	6L - TO-5	2-4	common source
—	—	—	—	—	6L - TO-5	2-4	common source
—	—	—	—	—	8L - TO-77	2-4	separate sources
—	—	—	—	—	8L - TO-77	2-4	separate sources
—	—	—	—	—	4L - TO-72	2-4	single MUV

Multiplex Switches (continued)

Circuit	Mfr.	Part Number	Operating Temperature (°C)	Frequency Range (MHz)	On Resistance Maximum (Ω)	Input Leakage Maximum (nA)	Signal Levels			
							Input		Output	
							"0" (V)	"1" (V)	"0" (V)	"1" (V)
single w/o protective diode	AMI	DD08K	-55 to +125	187	125	1.0	-	-	-	-
single w/protective diode	AMI	DD09K	-55 to +125	187	250	1.0	-	-	-	-
low V_T single w/protective diode	AMI	DD10K	-55 to +125	200	125	1.0	-	-	-	-
single w/protective diode	AMI	DD11K	-55 to +125	187	700	1.0	-	-	-	-
Hi g_m single w/protective diode	AMI	DD12J	-55 to +125	248	32	1.0	-	-	-	-
Hi g_m single w/protective diode	AMI	DD13K	-55 to +125	248	32	1.0	-	-	-	-
4-channel	FCH	3700	0 to +70 -55 to +125	1.0	270	2.0	+8.0	0	N/A	N/A
6-channel	FCH	3701	0 to +70 -55 to +125	2.0	500	1.0	-20	0	N/A	N/A
8-channel	FCH	3705	-55 to +85	1.0	400	1.0	+5.0	0	N/A	N/A
5-channel (4-channels-common drain)	GI	MEM2002	-65 to +125	-	200 typ	-4.0	<-3	>-6	-	-
4-channel (protective diodes)	GI	MEM2003	-65 to +125	-	200 typ	-4.0	<-3	>-6	-	-
4-channel (no diodes)	GI	MEM2004	-65 to +125	-	200 typ	-5.0	<-3	>-6	-	-
4-channel (dual 2-channels)	GI	MEM2005	-65 to +125	-	200 typ	-4.0	<-3	>-6	-	-
3-channel (2-channels-common drain)	GI	MEM2006	-65 to +125	-	200 typ	-4.0	<-3	>-6	-	-
6-channel	GI	MEM2009	-50 to +125	-	400	-1.0	<-2.5	>-6	-	-
6-channel	GI	MEM2017	-50 to +125	-	1000	-0.5	<-3	>-6	-	-
16-channel random access	GI	MEM5015	-55 to +85	-	-	-	-	-	-	-
16-channel random sequential	GI	MEM5116	-55 to +85	-	-	-	-	-	-	-
4-channel	HUGH	HRM8014D HRM8114D	-55 to +125	0-1	400	10	-	-	-	-
4-channel-common source	HUGH	HRM8052D	-55 to +125	0-1	400	10	-	-	-	-
5-channel with pull down	HUGH	HRM3210	-55 to +125	0-1	300	10	-	-	-	-
6-channel (5 + 1)	HUGH	HRM3211	-55 to +125	0-1	300	10	-	-	-	-
6-channel	HUGH	HRM3212	-55 to +125	0-1	300	10	-	-	-	-
3-pairs with pull down resistors	HUGH	HRM3213	-55 to +125	0-1	300	10	-	-	-	-
6-channel	HUGH	HRM3203	-55 to +125	0-1	300	10	-	-	-	-
quad dpdt	HUGH	HRM2206	-55 to +125	0-1	300	10	-	-	-	-
4-channel commutator	HUGH	HRM8013	-55 to +125	0-1	600	10	+1.0	+5	N/A	N/A
dual 2-channel commutator	HUGH	HRM8068	-55 to +125	0-1	600	10	+1.0	+5	N/A	N/A
8-channel	MOTO	MC1150	0 to +75	0 to 1	500	1000	-2	-10	-	-
dual 4-channel	MOTO	MC1151	0 to +75	0 to 1	500	1000	-2	-10	-	-
4-channel commutator	NATL	MM454F	-25 to +70	N/A	250	40	±10	±10	±10	±10

See page 102 for key to manufacturer's code listing.

Supply Voltages				Power Dissipation (mW)	Package	Delivery On 1000 Pcs (Weeks)	Comments
V _{DD} (V)	V _{GG} (V)	V _{SS} (V)	Clock (V)				
-	-	-	-	-	4L - TO-72	2-4	single MUX
-	-	-	-	-	4L - TO-72	2-4	single MUX
-	-	-	-	-	4L - TO-72	2-4	low voltage drive
-	-	-	-	-	4L - TO-72	2-4	single MUX
-	-	-	-	-	3L - TO-5	2-4	5-ns turn-on
-	-	-	-	-	4L - TO-33	2-4	5-ns turn-on
-35	-35	+8.0	-	75	14-lead flat pack	2	digital or analog MUX available
N/A	N/A	N/A	-	-	14-lead flat pack	2	digital or analog MUX available
-20	-	+5.0	-	200	16-lead DIP	6	digital or analog MUX available
-	-	-	-	-	TO-87	1-3	-
-	-	-	-	-	TO-74	1-3	-
-	-	-	-	-	TO-74	1-3	-
-	-	-	-	-	TO-87	1-3	-
-	-	-	-	-	TO-74	1-3	-
-	-	-	-	900	TO-87	1-3	-
-	-	-	-	300	TO-87	1-3	high drain, source, gate breakdown voltage
-	-	-	-	-	40-lead plug-in	2-4	with address storage and decoding
-	-	-	-	-	40-lead plug-in	2-4	parallel access counter and decoding
-	-	-	-	200	14-lead flat pack 14-lead DIP	1	-
-	-	-	-	200	14-lead flat pack	3	-
-	-	-	-	200	14-lead flat pack	3	-
-	-	-	-	200	14-lead flat pack	3	-
-	-	-	-	200	14-lead flat pack	3	-
-	-	-	-	200	14-lead flat pack	3	-
-	-	-	-	200	14-lead flat pack	3	-
-	-	-	-	200	22-lead flat pack	3	-
-20	-25	+6	none	80	14-lead flat pack	3	inputs DTL, TTL compatible
-20	-25	+6	none	80	14-lead flat pack	3	inputs DTL, TTL compatible
-10	-20	0	-	100	16-pin dual in line ceramic	4	-
-10	-20	0	-	100	16-pin dual in line ceramic	4	-
0	-24	+12	-	-	flat pack	4	hi speed commutation

Multiplex Switches (continued)

Circuit	Mfr.	Part Number	Operating Temperature (°C)	Frequency Range (MHz)	On Resistance Maximum (Ω)	Input Leakage Maximum (nA)	Signal Levels			
							Input		Output	
							"0" (V)	"1" (V)	"0" (V)	"1" (V)
dual diff MOS	NATL	MM450	-55 to +125	N/A	250	40	±10	±10	±10	±10
4-channel MOS	NATL	MM451	-55 to +125	N/A	250	40	±10	±10	±10	±10
4 MOS xistor pkg	NATL	MM452	-55 to +125	N/A	250	40	±10	±10	±10	±10
dual diff MOS	NATL	MM550	-25 to +70	N/A	250	40	±10	±10	±10	±10
4-channel MOS	NATL	MM551	-25 to +70	N/A	250	40	±10	±10	±10	±10
4 MOS xistor pkg	NATL	MM552	-25 to +70	N/A	250	40	±10	±10	±10	±10
dual DTL/TTL compatible	NATL	MM453	-55 to +125	N/A	250	40	±10	±10	±10	±10
dual DTL/TTL compatible	NATL	MM553F	-25 to +70	N/A	250	40	±5	±5	±5	±5
dual digital multiplex	NATL	MM482	-55 to +125	dc to 2	-	-	-1.5	-7	-1	-8
dual digital multiplex	NATL	MM582	-25 to +70	dc to 2	-	-	-1.5	-7	-1	-8
4-channel analog	PHLCO	pL4S01	-55 to +125	-	-	-	+2.0 max	+8.0 max	-	-
10-channel analog	PHLCO	pL4S10	-55 to +125	-	-	-	-6.5 max	-	-	-
16-channel	PHLCO	pL4S16	-55 to +125	-	-	-	-3.0 max	-9.0 max	-	-
4-channel	RCA	TA5460	0 to 100	dc to 1	750	-	-5	+5	10 p-p or +5, -5	10 p-p or +5, -5
5-channel	SIL	G114L G414L	-55 to +125 0 to 70	>1	1000 1000	0.075 0.075	>V _{GS} -2	<V _{GS} -6	0	±10
5-channel	SIL	G116L G416L	-55 to +125 0 to 70	>1	100 125	0.5 1.0	>V _{GS} -2	<V _{GS} -6	0	±10
6-channel	SIL	G117L G417L	-55 to +125 0 to 70	>1	100 125	0.5 1.0	>V _{GS} -2	<V _{GS} -6	0	±10
6-channel	SIL	G118L G418L	-55 to +125 0 to 70	>1	100 125	0.5 1.0	>V _{GS} -2	<V _{GS} -6	0	±10
6-channel	SIL	G119L G419L	-55 to +125 0 to 70	>1	100 125	0.5 1.0	>V _{GS} -2	<V _{GS} -6	0	±10
4-channel	SIL	G122L G422L	-55 to +125 0 to 70	>1	125	0.5	>V _{GS} -2	<V _{GS} -6	0	±10
4-channel	SIL	G123L G423L	-55 to +125 0 to 70	>1	125	0.5	>V _{GS} -2	<V _{GS} -6	0	±10
4-channel	SIL	G124L G424L	-55 to +125 0 to 70	>1	125	0.5	>V _{GS} -2	<V _{GS} -6	0	±10
2-channel driver/switch	SIL	DG110L DG410L	-55 to +125 0 to 70	>1	125	I _{DIOFFEL} 1	0.5	1.3	0	±10
2-channel driver/switch	SIL	DG111L DG411L	-55 to +125 0 to 70	>1	125	1	4.6	1	0	±10
2-channel driver/switch	SIL	DG112L DG412L	-55 to +125 0 to 70	>1	125	1	0.5	1.3	0	±10
4-channel driver/switch	SIL	DG116L DG416L	-55 to +125 0 to 70	>1	125	4	0.5	1.3	0	±10
4-channel driver/switch	SIL	DG118L DG418L	-55 to +125 0 to 70	>1	125	4	4.6	1	0	±10
5-channel driver/switch	SIL	DG123L DG423L	-55 to +125 0 to 70	>1	125	4	0.5	1.3	0	±10
5-channel driver/switch	SIL	DG125L DG425L	-55 to +125 0 to 70	>1	125	4	4.6	1	0	±10
3-channel driver/switch	SIL	DG120L DG420L	-55 to +125 0 to 70	>1	125	3	0.5	1.3	0	±10
3-channel driver/switch	SIL	DG121L DG421L	-55 to +125 0 to 70	>1	125	3	4.6	1	0	±10

See page 102 for key to manufacturer's code listing.

Supply Voltages				Power Dissipation (mW)	Package	Delivery On 1000 Pcs (Weeks)	Comments
V _{DD} (V)	V _{GG} (V)	V _{SS} (V)	Clock (V)				
-	-22	+12	-	-	TO, flat pack	2-3	commutator or sample & hold applications
-	-22	+12	-	-	TO, flat pack	3-4	commutator or sample & hold applications
-	-22	+12	-	-	flat pack	2-3	commutator or sample & hold applications
-	-22	+12	-	-	TO, flat pack	1-2	commutator or sample & hold applications
-	-22	+12	-	-	TO, flat pack	1-2	hi speed commutation
-	-22	+12	-	-	flat pack	2-3	hi speed commutation
-	-22	+12	-	-	flat pack	6	hi speed commutation
-	-20	+10	-	-	flat pack	6	-
-10	-	gnd	-	13	TO-5	3-4	-
-10	-	gnd	-	13	TO-5	2-3	-
-15	-30	+10	-	50	14-lead flat pack 14-lead DIP	4	500 Ω on resistance
-	-	-	-	250/channel	22-lead flat pack 24-lead DIP	4	250 Ω on resistance
-28.0 ± 1.0	-	-	-28.0 ± 2.0	150	34-lead flat pack	6	sequential or random
+8	-	-8	-	0.001	TO-116	2	-
-	-	-	-	750	TO-86	4	common drains, separate sources, Zener protection
-	-	-	-	750	TO-86	4	common drains, separate sources, with pull ups
-	-	-	-	750	TO-86	4	common drains, 5 input channels, 1 output channel, pull ups
-	-	-	-	750	TO-86	4	common drains, separate sources, no pull ups
-	-	-	-	750	TO-86	4	3-channel differential
-	-	-	-	750	TO-86	4	2-channel differential with pull ups
-	-	-	-	750	TO-86	4	4-channel multiplexer with pull ups
-	-	-	-	750	TO-86	4	4-channel multiplexer, common drain, pull ups
-	-	-	-	750	TO-86	4	dual spst switch with drivers - pull ups
-	-	-	-	750	TO-86	4	dual spst switch with drivers - pull ups
-	-	-	-	750	TO-86	4	dual spst switch with drivers - pull ups
-	-	-	-	750	TO-86	4	4-channel spst switch with drivers - pull ups
-	-	-	-	750	TO-86	4	4-channel spst switch with drivers - pull ups
-	-	-	-	750	TO-86	4	5-channel spst switch with drivers - pull ups
-	-	-	-	750	TO-86	4	5-channel spst switch with drivers - pull ups
-	-	-	-	750	TO-86	4	3-channel dpst switch with drivers - pull ups
-	-	-	-	750	TO-86	4	3-channel dpst switch with drivers - pull ups

Multiplex Switches (continued)

Circuit	Mfr.	Part Number	Operating Temperature (°C)	Frequency Range (MHz)	On Resistance Maximum (Ω)	Input Leakage Maximum (nA)	Signal Levels			
							Input		Output	
							"0" (V)	"1" (V)	"0" (V)	"1" (V)
2-channel driver/switch	SIL	DG122L DG422L	-55 to +125 0 to 70	>1	125	3	0.5	1.3	0	±10
1-channel driver/switch	SIL	DG136L DG436L	-55 to +125 0 to 70	>1	125	-	-	-	0	±10
2-channel driver/switch	SIL	DG147L DG447L	-	>1	125	-	-	-	0	±10
2-channel driver/switch	SIL	DG148L DG448L	-	>1	-	-	-	-	0	±10
1-channel driver/switch	SIL	SI3001	-	>1	500	1	-	-	0	±10
1-channel driver/switch	SIL	SI3002 SI3002A	-55 to +125 -55 to +125	>1	200	2	V _R - 1	V _R + 1	0	±10
6-channel switch	TI	TMS1A6009	-55 to +85	-	250	6 (source)	<2.5	>-6	-	-
6-channel multiplexer	UNCB	MULT-6	-55 to +125	-	300	0.4 mA	0	-20	-	-

Random-Access Memory

Circuit	Mfr.	Part Number	Operating Temperature (°C)	Frequency Range (MHz)	Clocks Required	Signal Levels			
						Input		Output	
						"0" (V)	"1" (V)	"0" (V)	"1" (V)
dual 64-word - 1-bit/word	ELEC	EA1400	-55 to +85	1	1 phase	-2	-9	-5	-10
64-bit static	FCH	3530	-55 to +85	0.30	-	-2.0	-9.0	-1.0	-10
32-bit cell	GI	MEM5132	-55 to +85	-	-	-	-	-	-
64-bit	MOTO	MC1170	0 to +75	0 to 1	0	-2	-11	-1	-12
16-bit (NDRO)	RCA	CD4005	-55 to +125	-	-	(1)	(1)	(3)	(4)
16-bit (NDRO)	RCA	CD4005D	-55 to +125	-	-	(1)	(1)	(3)	(4)
256-bit R/W	TI	TMS7A4003MC	-55 to +85	-	-	-	-	-	-

Footnotes: (1) V_{SS} ≤ V_{IN}, V_{IN} ≤ V_{DD} (2) +15 to -0.5 V max (3) "0" dc sense current 20 μA max (4) "1" dc sense current 500 μA min

Read-Only Memory

Circuit	Mfr.	Part Number	Operating Temperature (°C)	Frequency Range (MHz)	Clocks Required	Signal Levels			
						Input		Output	
						"0" (V)	"1" (V)	"0" (V)	"1" (V)
256 by 10	AMI	MA01M	-55 to +125	dc to 1.5	-	0.4	4.0	0.4	4.5
2048 by 1	AMI	MB01M	-55 to +125	0.01 to 1.1	2	-	-	-	-
1024-bit	AUTO	ROM2206	-55 to +125	-	-	-	-	-	-
256-word - 9-bits/word	ELEC	EA3000	-55 to +85	1	2	-2	-9	-0.5	-10
1024-bit static	FCH	3501	0 to +70 -55 to +85	0.25	-	-2.0	-9.0	-1.0	-10
2048-bit	NATL	MM423	-55 to +125	dc to 2	none	+9.3	+3	+10	+1
2048-bit	NATL	MM523	-25 to +70	dc to 2	none	+9.3	+3	+10	+1

See page 102 for key to manufacturer's code listing.

Supply Voltages				Power Dissipation (mW)	Package	Delivery On 1000 Pcs (Weeks)	Comments
V _{DD} (V)	V _{GG} (V)	V _{SS} (V)	Clock (V)				
-	-	-	-	750	TO-86	4	2-channel dpst switch with drivers & pull ups
-	-	-	-	750	TO-86	4	1-channel spdt switch with driver
-	-	-	-	750	TO-86	4	2-channel spst with drivers & pull ups
-	-	-	-	750	TO-86	4	2-channel spst with drivers & pull ups
-	-	-	-	500	TO-100	-	special function
-	-	-	-	500	TO-100	-	spdt switch with driver
-	-	-	-	900	14-lead flat pack	-	6 sources common
-30	-30	-	-	900 μ W	TO-87; flat pack	8	C _{rss} = 1.6 pf C _{iss} = 5.0 pf

Supply Voltages				Power Dissipation (mW)	Package	Delivery On 1000 Pcs (Weeks)	Comments
V _{DD} (V)	V _{GG} (V)	V _{SS} (V)	Clock (V)				
0 to -28	-24	gnd	-24	120 total	16-lead DIP	8	address may be dc; faster units available
-13	-27	gnd	-	225	16-pin DIP	6	decode & buffering included
-	-27	-	-	-	14-lead flat pack	2-4	-
-15	-30	0	-	250 typ	14-pin dual in line ceramic	4	includes decoding & sensing
(2)	-	(2)	-	100 nW/pkg	14-lead flat pack	3	former developmental number TA5406
(2)	-	(2)	-	100 nW/pkg	14-lead DIP ceramic	stock	-
-	-	-	-	-	40-lead DIP	12	200-ns access time

Supply Voltages				Power Dissipation (mW)	Package	Delivery On 1000 Pcs (Weeks)	Comments
V _{DD} (V)	V _{GG} (V)	V _{SS} (V)	Clock (V)				
-12	-	+5	-	250	40-lead DIP	4-12	TTL, DTL interface expandable
-	-	-	-	-	-	-	expandable
-	-	-	-	-	40-lead flat pack	6	silicon on sapphire diode array
0 to -28	-	gnd	-24	80 total	24-lead DIP	10-12	address may be dc; faster units available
-13	-27	gnd	-	120	24-lead DIP	8	-
+12	-12	+12	-	250	24-pin DIP	6	256 by 8 or 512 by 4
+12	-12	+12	-	250	24-pin DIP	6	256 by 8 or 512 by 4

Read-Only Memory (continued)

Circuit	Mfr.	Part Number	Operating Temperature (°C)	Frequency Range (MHz)	Clocks Required	Signal Levels			
						Input		Output	
						"0" (V)	"1" (V)	"0" (V)	"1" (V)
256-bit	NATL	MM420	-55 to +125	dc to 1	1	+9.3	+3	+10	+1
256-bit	NATL	MM520	-25 to +70	dc to 1	1	+9.3	+3	+10	+1
1024-bit	NATL	MM421	-55 to +125	dc to 2	none	+9.3	+3	+10	+1
1024-bit	NATL	MM521	-25 to +70	dc to 2	none	+9.3	+3	+10	+1
1024-bit	NATL	MM422	-55 to +125	dc to 2	none	+9.3	+3	+10	+1
1024-bit	NATL	MM522	-25 to +70	dc to 2	none	+9.3	+3	+10	+1
1024-bit	PHLCO	PM1024A PM1024	-55 to +125	1 μ s 2 μ s	A/R only	-3.0 max	-9.0 min	-2.0 max	-10.0 min
1024-bit	TI	TMS1A4800MB	-55 to +85	-	-	-	-	-	-
2240-bit	TI	TMS2A4842MH	-55 to +85	-	-	-	-	-	-
2660-bit	TI	TMS2A4880MH	-55 to +85	-	-	-	-	-	-
1024-bit	UNCB	ROMIK	-55 to +125	-	none	0 to -2.0 max	-9 min	-1.0 max	-10 min

Shift Registers

Circuit	Mfr.	Part Number	Operating Temperature (°C)	Frequency Range (MHz)	Clocks Required	Signal Levels			
						Input		Output	
						"0" (V)	"1" (V)	"0" (V)	"1" (V)
dual 20-bit	AMI	RD02C	-55 to +125	.001 to 1.0	2	-3.5	-9	-2.5	-10
dual 50-bit	AMI	RD05G	-55 to +125	.001 to 1.0	2	-3.5	-9	-2.5	-10
dual 50-bit	AMI	RD05D	-55 to +125	.001 to 1.0	2	-3.5	-9	-2.5	-10
dual 50-bit	AMI	RD07C	-55 to +125	.001 to 5.0	2	-3.5	-9	-2.5	-10
dual 50-bit	AMI	RD07F	-55 to +125	.001 to 5.0	2	-3.5	-9	-2.5	-10
dual 50-bit w/stream select	AMI	RD08D	-55 to +125	.001 to 5.0	2	-3.5	-9	-2.5	-10
dual 50-bit w/stream select	AMI	RD08F	-55 to +125	.001 to 5.0	2	-3.5	-9	-2.5	-10
dual 50-bit	AMI	RD10C	-55 to +125	.001 to 10.0	2	-3.5	-9	-2.5	-10
dual 50-bit	AMI	RD10F	-55 to +125	.001 to 10.0	2	-3.5	-9	-2.5	-10
low V_T dual 50-bit	AMI	RD12C	-55 to +125	.01 to 1.0	2	1.3	3.3	.5	4.0
low V_T dual 50-bit	AMI	RD12F	-55 to +125	.01 to 1.0	2	1.3	3.3	.5	4.0
low V_T dual 50-bit	AMI	RD12H	-55 to +125	.01 to 1.0	2	1.3	3.3	.5	4.0
triple 66-bit	AMI	RD13G	-55 to +125	.001 to 1.0	2	-3.5	-9	-3.0	-10
low V_T 426-bit	AMI	RD15G	-55 to +125	.002 to 2.0	2	1.3	3.3	.5	4.0
low V_T 426-bit	AMI	RD15D	-55 to +125	.002 to 2.0	2	1.3	3.3	.5	4.0

See page 102 for key to manufacturer's code listing.

Supply Voltages				Power Dissipation (mW)	Package	Delivery On 1000 Pcs (Weeks)	Comments
V _{DD} (V)	V _{GG} (V)	V _{SS} (V)	Clock (V)				
+12	-12	+12	-	250	TO-5	6	-
+12	-12	+12	-	250	TO-5	6	-
+12	-12	+12	-	250	16-pin DIP	6	256 by 4
+12	-12	+12	-	250	16-pin DIP	6	256 by 4
+12	-12	+12	-	250	24-pin DIP	6	256 by 4 or 128 by 8
+12	-12	+12	-	250	24-pin DIP	6	256 by 4 or 128 by 8
-13.0 ±2.0	-25.0 ±3.0	-	A/R -25 ±3	250	24-lead flat pack 24-lead DIP	8	output drives bipolar
-	-	-	-	-	24-lead C-DIP	-	-
-	-	-	-	-	28-lead C-DIP	10	5 by 7 bit character generator
-	-	-	-	-	50-lead C-DIP	-	35 bit character generator
-12	-26	-12	none	170	24-lead flat pack 24-DIP	8	3 dimensional decoding offers 4 organizations

Supply Voltages				Power Dissipation (mW)	Package	Delivery On 1000 Pcs (Weeks)	Comments
V _{DD} (V)	V _{GG} (V)	V _{SS} (V)	Clock (V)				
-15	-	-	-27	48 @ 1 MHz	22-lead flat pack	4-6	precharge out
-15	-	-	-27	50 @ 1 MHz	10-lead TO-5	4-6	PL5R100 equiv.
-15	-	-	-27	50 @ 1 MHz	14-lead flat pack	4-6	PL5R100 equiv.
-15	-	-	-27	50 @ 1 MHz	22-lead flat pack	4-6	precharge out
-15	-	-	-27	50 @ 1 MHz	12-lead TO-5	4-6	precharge out
-15	-	-	-27	50 @ 1 MHz	14-lead flat pack	4-6	precharge out
-15	-	-	-27	50 @ 1 MHz	12-lead TO-5	4-6	precharge out
-15	-	-	-27	50 @ 1 MHz	22-lead flat pack	4-6	precharge out
-15	-	-	-27	50 @ 1 MHz	12-lead TO-5	4-6	precharge out
gnd	-	+5	-5	10 @ 1 MHz	22-lead flat pack	4-6	-
gnd	-	+5	-5	10 @ 1 MHz	12-lead TO-5	4-6	-
gnd	-	+5	-5	10 @ 1 MHz	16-lead DIP	4-6	-
-15	-	-	-27	100 @ 1 MHz	10-lead TO-100	2-4	inverter out
gnd	-	+5	-10	100 @ 1 MHz	10-lead TO-5	4-8	drives LP TTL directly
gnd	-	+5	-10	100 @ 1 MHz	14-lead flat pack	4-8	drives LP TTL directly

Shift Registers (continued)

Circuit	Mfr.	Part Number	Operating Temperature (°C)	Frequency Range (MHz)	Clocks Required	Signal Levels			
						Input		Output	
						"0" (V)	"1" (V)	"0" (V)	"1" (V)
dual 20-bit	AMI	RD52C	-25 to +75	1.0	2	-3.5	-9	-3.0	-9.5
dual 50-bit	AMI	RD55G	-25 to +75	1.0	2	-3.5	-9	-3.0	-9.5
dual 50-bit	AMI	RD55D	-25 to +75	1.0	2	-3.5	-9	-3.0	-9.5
dual 50-bit	AMI	RD57C	-25 to +75	1.0	2	-3.5	-9	-3.0	-9.5
dual 50-bit	AMI	RD57F	-25 to +75	1.0	2	-3.5	-9	-3.0	-9.5
dual 50-bit stream select	AMI	RD58D	-25 to +75	2.0	2	-3.5	-9	-3.0	-9.5
dual 50-bit stream select	AMI	RD58F	-25 to +75	2.0	2	-3.5	-9	-3.0	-9.5
dual 50-bit	AMI	RD60C	-25 to +75	3.0	2	-3.5	-9	-3.0	-9.5
dual 50-bit	AMI	RD60F	-25 to +75	3.0	2	-3.5	-9	-3.0	-9.5
dual 50-bit low V_T	AMI	RD62C	-25 to +75	.01 to 1.0	2	1.2	3.6	.7	4.0
dual 50-bit low V_T	AMI	RD62F	-25 to +75	.01 to 1.0	2	1.2	3.6	.7	4.0
dual 50-bit low V_T	AMI	RD62H	-25 to +75	.01 to 1.0	2	1.2	3.6	.7	4.0
triple 66-bit	AMI	RD63G	-25 to +75	1.0	2	-3.5	-9.0	-3.0	-9.5
426-bit low V_T	AMI	RD65G	-25 to +75	1.0	2	1.2	3.6	.7	4.0
426-bit low V_T	AMI	RD65D	-25 to +75	1.0	2	1.2	3.6	.7	4.0
12-bit serial/parallel conv.	AMI	SP01C	-55 to +125	dc to 2.0	2	-3.5	-9.0	-3.0	-9.5
dual 40-bit	AMI	RS03G	-55 to +125	dc to 1.0	2	-3.5	-9.0	-3.0	-9.5
12-bit serial/parallel conv.	AMI	SP51C	-25 to +75	dc to 1.0	2	-3.5	-9.0	-3.0	-9.5
dual 40-bit	AMI	RS53G	-25 to +75	dc to 1.0	2	-3.5	-9.0	-3.0	-9.5
1024-bit dynamic	AUTO	QSR2131	-50 to +100	1.0	4	-1	-10	-1	-15
variable length 1-64 bit	ELEC	EA1202	-55 to +85	0.010 to 3	2	-1.5	-9	-5	-10
variable length 1-64 bit	ELEC	EA1203	-55 to +85	0.01 to 1	1	-1.5	-9	-5	-10
quad 32-bit dynamic	ELEC	EA1200	-55 to +85	0.01 to 3	2	-1.5	-9	-5	-10
quad 32-bit dynamic	ELEC	EA1201	-55 to +85	0.01 to 1	1	-1.5	-9	-5	-10
256-bit dynamic	ELEC	EA1204	-55 to +85	0.01 to 5	2	-2	-9	-5	-10
256-bit dynamic	ELEC	EA1205	-55 to +85	0.01 to 1	1	-2	-9	-5	-10
quad 32-bit static	ELEC	EA1000	-55 to +85	-	1	-2	-9	-5	-10
25-bit static	FCH	3300	0 to +70 -85 to +85	0.25	1	-2.0	-9.0	-1.0	-10
dual 25-bit dynamic	FCH	3303	0 to +70 -55 to +85	0.500	2	-2.0	-9.0	-1.0	-10
dual 16-bit static	FCH	3304	0 to +70 -55 to +85	1.0	2	-2.0	-9.0	-1.0	-10
64-bit static	FCH	3305/6	0 to +70 -55 to +85	1.0	1	-2.0	-9.0	-1.0	-10

See page 102 for key to manufacturer's code listing.

Supply Voltages				Power Dissipation (mW)	Package	Delivery On 1000 Pcs (Weeks)	Comments
V _{DD} (V)	V _{GG} (V)	V _{SS} (V)	Clock (V)				
-15	-	-	-27	48 @ 1 MHz	22-lead flat pack	4-6	precharge out
-15	-	-	-27	50 @ 1 MHz	10-lead TO-5	4-6	PL5R100 equiv.
-15	-	-	-27	50 @ 1 MHz	14-lead flat pack	4-6	PL5R100 equiv.
-15	-	-	-27	50 @ 1 MHz	22-lead flat pack	4-6	precharge out
-15	-	-	-27	50 @ 1 MHz	12-lead TO-5	4-6	precharge out
-15	-	-	-27	50 @ 1 MHz	14-lead flat pack	4-6	precharge out
-15	-	-	-27	50 @ 1 MHz	12-lead TO-5	4-6	precharge out
-15	-	-	-27	50 @ 1 MHz	14-lead flat pack	4-6	precharge out
-15	-	-	-27	50 @ 1 MHz	12-lead TO-5	4-6	precharge out
gnd	-	+5	-5	10 @ 1 MHz	22-lead flat pack	4-6	DTL - TTL voltage comp.
gnd	-	+5	-5	10 @ 1 MHz	12-lead TO-5	4-6	DTL - TTL voltage comp.
gnd	-	+5	-5	10 @ 1 MHz	16-lead DIP	4-6	DTL - TTL voltage comp.
-15	-	-	-27	260 @ 1 MHz	10-lead TO-100	4-6	inverter out
-6	-	-	-15	100 @ 1 MHz	10-lead TO-5	4-6	drives LP TTL - DTL
-6	-	-	-15	100 @ 1 MHz	14-lead flat pack	4-6	drives LP TTL - DTL
-27	-	-	-27	150 @ 1 MHz	22-lead flat pack	4-6	push-pull outputs
-12	-27	-	-27	80 @ 1 MHz	10-lead TO-5	4-6	common clocks
-27	-	-	-27	150 @ 1 MHz	22-lead flat pack	4-6	push-pull outputs
-12	-27	-	-27	80 @ 1 MHz	10-lead TO-5	4-6	common clocks
-15	-27	0	-27	15	42-lead flat pack	6	-
0 to -28	-24	gnd	-24	1.0/bit	14-lead DIP	4	may be biased to drive TTL directly
0 to -28	-24	gnd	-9	1.2/bit	14-lead DIP	4	may be biased to drive TTL directly
0 to -28	-24	gnd	-24	0.6/bit	14-lead DIP	4	may be biased to drive TTL directly
0 to -28	-24	gnd	-9	1.0/bit	14-lead DIP	4	may be biased to drive TTL directly
0 to -28	-	gnd	-24	0.2/bit	10-lead TO	4	may be biased to drive TTL directly
0 to -28	-24	gnd	-9	0.4/bit	10-lead TO	4	may be biased to drive TTL directly
0 to -28	-24	gnd	-9	1.5/bit	14-lead DIP	4	data shift rates to 1 MHz
-13	-27	gnd	-9.0	50	10-lead TO-5	6	-
-	-	gnd	-27	0.2/bit	10-lead TO-5	6	-
-13	-27	gnd	-27	100	10-lead TO-5	6	-
-13	-27	gnd	-9.0	200	10-lead TO-5 16-lead DIP	6	-

Shift Registers (continued)

Circuit	Mfr.	Part Number	Operating Temperature (°C)	Frequency Range (MHz)	Clocks Required	Signal Levels			
						Input		Output	
						"0" (V)	"1" (V)	"0" (V)	"1" (V)
single 64-bit dynamic	FCH	3320	0 to +70 -55 to +85	2.0	4	-2.0	-10.24	-2.0	-10
5-bit parallel in/parallel out	GI	MEM3005PP	-55 to +85	dc to 1.0	2	-2.0	-10	-1.0	-11
5-bit serial in/parallel out	GI	MEM3005SP	-55 to +85	dc to 1.0	2	-2.0	-10	-1.0	-11
8-bit parallel in/serial out	GI	MEM3008PS	-55 to +85	dc to 1.0	2	-2.0	-10	-1.0	-11
12-bit serial in/parallel out	GI	MEM3012SP	-55 to +85	dc to 0.1	1	-2.0	-10	-1.0	-11
dual 16-bit	GI	MEM3016-2	-55 to +85	dc to 1.0	2	-2.0	-10	-1.0	-11
20-bit	GI	MEM3020	-55 to +85	dc to 1.0	2	-2.0	-10	-1.0	-11
21-bit	GI	MEM3021	-55 to +85	dc to 0.5	1	-2.0	-10	-1.0	-11
21-bit	GI	MEM3021B	-55 to +85	dc to 0.250	1	-2.0	-10	-1.0	-11
6-1 ϕ binary weighted	GI	MEM3032	-55 to +85	dc to 1.0	1	-2.0	-9	-1.0	-11
dual 25-bit	GI	MEM3050	-55 to +85	0.010 to 0.500	2	-2.0	-10	-1.0	-14
64-bit serial accumulator	GI	MEM3064	-55 to +85	0.010 to 5.0	4	-2.0	-10	-2.0	-11
64-bit serial accumulator	GI	MEM3064B	-55 to +85	0.010 to 2.0	4	-2.0	-10	-2.0	-11
dual 64-bit serial accumulator	GI	MEM3064-2B	-55 to +85	0.010 to 2.0	4	-2.0	-10	-2.0	-11
dual 50-bit	GI	MEM3100	-55 to +85	0.010 to 2.0	2	-2.0	-10	-1.0	-11
dual 50-bit	GI	MEM3100A	-55 to +85	0.010 to 2.0	2	-2.0	-10	-1.0	-11
128-bit	GI	MEM3128	-55 to +85	0.010 to 2.0	2	-2.0	-10	-1.0	-11
dual 25-bit	HUGH	HRM2026	-55 to +125	0.010 to 1.0	2	-1 to -2	-6 to -27	0 to -1	-8 to -18
dual 50-bit	HUGH	HRM2027	-55 to +125	0.010 to 1.0	2	-1 to -2	-6 to -27	0 to -1	-8 to -18
dual 16-bit	HUGH	HRM2031	-55 to +125	dc to 2	2	-1 to -2	-6 to -27	0 to -1	-8 to -18
20-bit	INTSL	ICM7000	-55 to +125	1 (max)	2	-	-	-	-
dual 100-bit	INTSL	ICM7002	-55 to +125	1 (max)	2	-	-	-	-
100-bit	INTSL	ICM7003	-55 to +125	1 (max)	2	-	-	-	-
dual 16-bit dynamic	ITT	ITT-216D	-55 to +125	0.010 to 1.0	2	-4.0	-9.0	-3.0	-10.0
dual 100-bit dynamic	ITT	ITT-2100D	-55 to +125	0.010 to 1.0	2	-4.0	-9.0	-3.0	-10.0
dual 16-bit static	ITT	ITT-216S	-55 to +125	dc to 1.0	1 or 2	+1.0	+4.0	1 k Ω to gnd	1 k Ω to +5.0
dual 25-bit	NATL	MM400,401	-55 to +125	0.01 to 1.0	2	-2.5	-4.5	-1.5	-8.0
dual 25-bit	NATL	MM500,501	-25 to +70	0.01 to 1.0	2	-2.5	-4.5	-1.5	-8.0
dual 50-bit	NATL	MM402,403	-55 to +125	0.01 to 1.0	2	-2.5	-4.5	-1.5	-8.0
dual 50-bit	NATL	MM502,MM503	-25 to +70	0.01 to 1.0	2	-2.5	-4.5	-1.5	-8.0
dual 16-bit static	NATL	MM404	-55 to +125	dc to 1.0	1	-2.5	-4.5	-1.5	-8.0

See page 102 for key to manufacturer's code listing.

Supply Voltages				Power Dissipation (mW)	Package	Delivery On 1000 Pcs (Weeks)	Comments
V _{DD} (V)	V _{GG} (V)	V _{SS} (V)	Clock (V)				
—	—	gnd	-27	.2/bit	10-lead TO-5	6	—
-13 ±1	—	—	-27	65	16-lead flat pack	1-3	—
-13 ±1	-27 ±1	—	-27	53	TO-87	1-3	—
-13 ±1	-27 ±1	—	-27	40	16-lead flat pack	1-3	—
-27 ±1	—	—	-27	216	16-lead flat pack	1-3	—
-13 ±1	-27 ±1	—	-27	184	l.p. 10-lead TO-74	1-3	—
-13 ±1	-27 ±1	—	-27	132	TO-78	1-3	—
-27 ±1	—	—	-27	146	l.p. 10-lead TO-74	1-3	—
-27 ±1	—	—	-27	146	l.p. 10-lead TO-74	1-3	—
-13 ±1	-27 ±1	—	-27	238	16-lead flat pack	1-3	—
—	—	-27 ±1	-27	10	l.p. 10-lead TO-74	1-3	—
—	—	—	-27	—	l.p. 10-lead TO-74, TO-87	1-3	—
—	—	—	-27	—	l.p. 10-lead TO-74, TO-87	1-3	—
—	—	—	-27	—	24-lead flat pack	1-3	—
-27 ±1	—	—	-27	162	l.p. TO-74 14-lead DIP	1-3	—
-27 ±1	—	—	-27	162	l.p. TO-73 14-lead DIP	1-3	—
-27 ±1	—	—	-27	108	l.p. TO-74 14-lead DIP	1-3	—
-6 to -24	—	0	-9 to -27	0.8/bit	8-lead TO 14-lead DIP	3	DTL, TTL compatible
-6 to -24	—	0	-9 to -27	0.8/bit	8-lead TO 14-lead DIP	4	DTL, TTL compatible
-6 to -24	-9 to -27	0	-9 to -27	2.0/bit	14-lead flat pack	4	DTL, TTL compatible
-5	-15	—	—	1/bit	TO-78	4	—
-5	-15	—	—	0.25/bit	TO-100	4	—
-5	-15	—	—	0.50/bit	TO-100	4	—
20.0	—	—	-27.0	150 at -55°C	10-lead TO-5	8	—
12.0	—	—	-27.0	660 at -55°C	12-lead TO-5	8	gated input to allow the unit to be commutated
—	-7.0	+5.0	+5/-7	85 at -55°C	10-lead TO-5	8	can be used with TTL or DTL
-10	—	0	16	0.8/bit	TO-5	3-4	TTL/DTL compatible
-10	—	0	-16	0.8/bit	TO-5	1-2	TTL/DTL compatible
-10	—	0	-16	0.8/bit	TO-5	3-4	TTL/DTL compatible
-10	—	0	-16	0.8/bit	TO-5	1-2	TTL/DTL compatible
-10	-16	0	-16	1.2/bit	TO-5	3-4	TTL/DTL compatible

Shift Registers (continued)

Circuit	Mfr.	Part Number	Operating Temperature (°C)	Frequency Range (MHz)	Clocks Required	Signal Levels			
						Input		Output	
						"0" (V)	"1" (V)	"0" (V)	"1" (V)
dual 32-bit static	NATL	MM405	-55 to +125	dc to 1.0	1	-2.5	-4.5	-1.5	-8.0
dual 16-bit static	NATL	MM504	-25 to +70	dc to 1.0	1	-2.5	-4.5	-1.5	-8.0
dual 32-bit static	NATL	MM505	-25 to +70	dc to 1.0	1	-2.5	-4.5	-1.5	-8.0
dual 100-bit	NATL	MM406,407	-55 to +125	0.01 to 1.0	2	-2.5	-4.5	-1.5	-8.0
dual 100-bit	NATL	MM506,507	-25 to +70	-	2	-2.5	-4.5	-1.5	-8.0
dual 25-bit	NPC	MOS400	-55 to +125	0.010 to 1.0	2	-2.5	-7.0	-1.5	-8.0
dual 25-bit	NPC	MOS500	0 to +70	0.010 to 1.0	2	-2.5	-7.0	-1.5	-8.0
dual 16-bit static	NPC	MOS404	-55 to +125	dc to 1.0	1	-2.5	-7.0	-1.5	-8.0
dual 16-bit static	NPC	MOS504	0 to +70	dc to 1.0	1	-2.5	-7.0	-1.5	-8.0
dual 100-bit	NPC	MOS406	-55 to +125	0.010 to 1.0	2	-2.5	-7.0	-1.5	-8.0
dual 100-bit	NPC	MOS506	0 to +70	0.010 to 1.0	2	-2.5	-7.0	-1.5	-8.0
dual 8/16-bit	PHLCO	pL5R32	-55 to +125	0.01 to 1.0	2	-4.0 max	-9.0 min	-3.0 max	-10.0 min
dual 20-bit	PHLCO	pL5R40	-55 to +125	0.01 to 1.0	2	-4.0 max	-9.0 min	-3.0 max	-10.0 min
dual 50-bit	PHLCO	pL5R100	-55 to +125	0.01 to 1.0	2	-4.0 max	-9.0 min	-3.0 max	-10.0 min
dual 64-bit	PHLCO	pL5R128A pL5R128	-55 to +125	0.01 to 5.0 0.01 to 2.0	2	-3.0 max	-9.0 min	-2.0 max	-10.0 min
250-bit dynamic	PHLCO	pL5R250A pL5R250	-55 to +125	0.01 to 5.0 0.01 to 2.0	2	-3.0 max	-9.0 min	-2.0 max	-10.0 min
256-bit dynamic	PHLCO	pL5R256A pL5R256	-55 to +125	0.01 to 5.0 0.01 to 2.0	2	-3.0 max	-9.0 min	-2.0 max	-10.0 min
18-bit	RCA	TA5459	-55 to +125	-	1	(1)	(1)	0.01 max	9.99 min
single 64-bit dynamic	SSS	CDL5300P	-55 to +125	0.001 to 5	2	4	9	0	20
dual 64-bit	SSS	CDL5301P	-55 to +125	0.001 to 5.0	2	4	9	0	20
single 64-bit	SSS	CDL5302P	-55 to +125	0.001 to 10	2	4	9	0	20
dual 64-bit	SSS	CDL5303P	-55 to +125	0.001 to 10	2	4	9	0	20
single 50-bit	SSS	CDL5305P	-55 to +125	0.001 to 5.0	2	4	9	0	20
dual 50-bit	SSS	CDL5306P	-55 to +125	0.001 to 5.0	2	4	9	0	20
single 50-bit	SSS	CDL5307P	-55 to +125	0.001 to 10	2	4	9	0	20
dual 50-bit	SSS	CDL5308P	-55 to +125	0.001 to 10	2	4	9	0	20
single 50-bit	SSS	CDL5300N	-55 to +125	0.001 to 5.0	2	4	9	0	20
dual 50-bit	SSS	CDL5301N	-55 to +125	0.001 to 5.0	2	4	9	0	20
single 64-bit	SSS	CDL5302N	-55 to +125	0.001 to 10	2	4	9	0	20
dual 64-bit	SSS	CDL5303N	-55 to +125	0.001 to 10	2	4	9	0	20
single 50-bit	SSS	CDL5305N	-55 to +125	0.001 to 5.0	2	4	9	0	20

Footnotes: (1) $V_{SS} \leq V_{IN}, V_{IN} \leq V_{DD}$ (2) +15 V to -0.5 V max

See page 102 for key to manufacturer's code listing.

Supply Voltages				Power Dissipation (mW)	Package	Delivery On 1000 Pcs (Weeks)	Comments
V _{DD} (V)	V _{GG} (V)	V _{SS} (V)	Clock (V)				
-10	-16	0	-16	1.2/bit	T0-5	3-4	TTL/DTL compatible
-10	-16	0	-16	1.2/bit	T0-5	1-2	TTL/DTL compatible
-10	-16	0	-16	1.2/bit	T0-5	1-2	TTL/DTL compatible
-10	-	0	-16	0.8/bit	T0-5	3-4	TTL/DTL compatible
-10	-	0	-16	0.8/bit	T0-5	1-2	TTL/DTL compatible,
+0.5 -25	-	-	+0.5 -25	300	T0-5 l.p.	6	-
+0.5 -25	-	-	+0.5 -25	300	T0-5 l.p.	6	-
+0.5 -25	+0.5 -25	-	+0.5 -25	300	T0-5 l.p.	6	-
+0.5 -25	+0.5 -25	-	+0.5 -25	300	T0-5 l.p.	6	-
+0.5 -25	+0.5 -25	-	+0.5 -25	0.8/bit	T0-5 l.p.	6	-
+0.5 -25	+0.5 -25	-	+0.5 -25	0.8/bit	T0-5 l.p.	6	-
-20.0	-	-	-27.0	3.5/bit	T0-5 14-lead DIP	4	dynamic
-20.0	-	-	-27.0	3.5/bit	T0-5 14-lead DIP	4	dynamic
-20.0	-	-	-27.0	3.5/bit	T0-5 14-lead DIP	4	dynamic
-25.0 ±5.0	-	-	-25.0 ±3.0	.2/bit	T0-5 14-lead DIP	6	dynamic
-25.0 ±5.0	-	-	-25.0 ±3.0	.2/bit	T0-5 14-lead DIP	6	output drives bipolar
-25.0 ±5.0	-	-	-25.0 ±3.0	.2/bit	T0-5 14-lead DIP	6	output drives bipolar
(2)	-	(2)	-	100 nW/pkg	14-lead DIP ceramic	2	-
12 to 18	-	-	20	400 μW/bit	T0-5	6	other packages available
12 to 18	-	-	20	400 μW/bit	T0-5	6	other packages available
12 to 18	-	-	20	-	T0-5	6	other packages available
12 to 18	-	-	20	-	T0-5	6	other packages available
12 to 18	-	-	20	-	T0-5	6	other packages available
12 to 18	-	-	20	-	T0-5	6	other packages available
12 to 18	-	-	20	-	T0-5	6	other packages available
12 to 18	-	-	20	-	T0-5	6	other packages available
12 to 18	-	-	20	-	T0-5	6	other packages available
12 to 18	-	-	20	-	T0-5	6	other packages available
12 to 18	-	-	20	-	T0-5	6	other packages available
12 to 18	-	-	20	-	T0-5	6	other packages available
12 to 18	-	-	20	-	T0-5	6	other packages available
12 to 18	-	-	20	-	T0-5	6	other packages available

Shift Registers (continued)

Circuit	Mfr.	Part Number	Operating Temperature (°C)	Frequency Range (MHz)	Clocks Required	Signal Levels			
						Input		Output	
						"0" (V)	"1" (V)	"0" (V)	"1" (V)
dual 50-bit	SSS	CDL5306N	-55 to +125	0.001 to 5.0	2	4	9	0	20
single 50-bit	SSS	CDL5307N	-55 to +125	0.001 to 10	2	4	9	0	20
dual 50-bit	SSS	CDL5308N	-55 to +125	0.001 to 10	2	4	9	0	20
-	SSS	SCL5120	-55 to +125	dc to 2.0	1	3	7	.05	9.95
dual 16-bit	TI	TMS1B3016LA	-55 to +85	dc to 1.0	2	> -2	< -10	> -2	-13
dual 32-bit	TI	TMS7B3001LA	-55 to +85	dc to 2.0	2	> -2	< -10	> -2	-13
dual 25-bit	TI	TMS7B3000LA	-55 to +85	dc to 1.0	2	> -2	< -10	> -2	-13
dual 50-bit	TI	TMS7C3002LA	-55 to +85	dc to 1.0	2	> -2	< -10	> -2	-13
dual 100-bit	TI	TMS7C3003LA	-55 to +85	dc to 1.0	2	> -2	< -10	> -2	-13
dynamic dual 25-bit	UNCB	SRD25	0 to +85	0.01 to 1.0	2	0 to -2.5 max	-7 min	-1.5 max	-8.0 min

MOS Integrated Circuit Manufacturers

Circle the appropriate numbers on the Information Retrieval Card to receive the latest data sheets, catalogs, application notes and other aids. The codes given in the first column are used to identify the manufacturers in the data charts.

Code	Company	Information Offered	Information Retrieval Number
AMI	American Micro-systems Inc. 3800 Homestead Road Santa Clara, Calif. 95051 Contact: Joe Mingione Telephone: (408) 246-0330 TWX: 910-338-0018	Data Sheets Application Notes Price List	250
AUTO	Autonetics Division of North American Rockwell Corp. 3370 Miraloma Avenue Anaheim, Calif. 92803 Contact: William H. Kaermer Telephone: (714) 632-5107 TWX: 714-776-4502	Data Sheets	251
ELEC	Electronic Arrays, Inc. 501 Ellis Street Mountain View, Calif. 94040 Contact: Dick Eiler Telephone: (415) 964-4321	Data Sheets Application Notes Price List	253
FCH	Fairchild Semiconductor 313 Fairchild Drive Mountain View, Calif. 94040 Contact: Harry Neil Telephone: (415) 962-3621	Catalog Data Sheets	254

Code	Company	Information Offered	Information Retrieval Number
GI	General Instrument Corp. 600 W. John Street Hicksville, N.Y. 11802 Contact: T. Esteves Telephone: (516) 681-8000 TWX: 510-221-1866	Catalog Data Sheets Application Notes	256
HUGH	Hughes Aircraft Co. Newport Beach Div. 500 Superior Avenue Newport Beach, Calif. 92663 Contact: Carroll Perkins Telephone: (714) 548-0671 TWX: 714-642-1353	Catalog Data Sheets Application Notes	257
INTSL	Intersil, Inc. 10900 N. Tantan Avenue Cupertino, Calif. 95041 Contact: Don Rogers Telephone: (408) 257-5450	Catalog Data Sheets Price List	258
ITT	ITT Semiconductors 3301 Electronics Way West Palm Beach, Fla. 33407 Contact: Charles Gillies Telephone: (305) 842-2411 TWX: 510-952-6667		

Supply Voltages				Power Dissipation (mW)	Package	Delivery On 1000 Pcs (Weeks)	Comments
V _{DD} (V)	V _{GG} (V)	V _{SS} (V)	Clock (V)				
12 to 18	—	—	20	—	TO-5	6	other packages available
12 to 18	—	—	20	—	TO-5	6	other packages available
12 to 18	—	—	20	—	TO-5	6	other packages available
7 to 13	—	—	7	75 nW typ	TO-5	6	other packages available
-13	-27	0	-2 to -26	147 typ	10-lead TO	4	third-phase generated on chip
-14	-28	0	-2 to -26	280 typ	10-lead TO	4	third-phase generated on chip
-14	-28	0	-2 to -26	252 typ	10-lead TO	5	third-phase generated on chip
-14	-28	0	-2 to -28	1.6/bit typ	10-lead TO	6	third-phase generated on chip
-14	-28	0	-2 to -27	1.6/bit typ	10-lead TO	8	third-phase generated on chip
-10	—	—	-16	50	TO-99 (8 pin)	8	—

Code	Company	Information Offered	Information Retrieval Number
MOTO	Motorola Semiconductor Products 5005 E. McDowell Road Phoenix, Ariz. 85002 Contact: Roger Helmick Telephone: (602) 962-2355 TWX: 910-951-1334	Data Sheets	259
NATL	National Semiconductor 2975 San Ysidro Way Santa Clara, Calif. 95051 Contact: Regis P. McKenna Telephone: (408) 245-4320 TWX: 910-339-9240	Catalog	260
NPC	Nucleonic Products Co., Inc. 3133 E. 12th Street Los Angeles, Calif. 90023 Contact: Fred F. Breen Telephone: (213) 268-3464 TWX: 910-321-3077	Catalog Data Sheets	261
PHLCO	Philco-Ford Microelectronics Union Meeting Road Blue Bell, Pa. 19422 Contact: John F. Kitzrow Telephone: (215) 646-9100 TWX: 510-661-0161	Catalog Data Sheets Application Notes Price List	262

Code	Company	Information Offered	Information Retrieval Number
RCA	RCA Electronic Components 415 S. 5th Street Harrison, N.J. 07029 Contact: David Griswald Telephone: (201) 722-3200	Catalog Data Sheets Application notes	—
SIL	Siliconix Inc. 1140 W. Evelyn Avenue Sunnyvale, Calif. 94086 Contact: Lee Lynberg Telephone: (408) 245-1000 TWX: 910-339-9216	Data Sheets Price List	263
SSS	Solid State Scientific Corp. Montgomeryville, Pa. 18936 Contact: Harry Hellman Telephone: (215) 855-8400	Catalog Data Sheets Application Notes Price List	264
TI	Texas Instruments Inc. P.O. Box 5012 Dallas, Tex. 75222 Contact: Berry Cash Telephone: (214) 238-4046	Data Sheets Application Notes Price List	265
UNCB	Union Carbide Electronics 8888 Balboa Avenue San Diego, Calif. 92123 Contact: Lou Bartning Telephone: (714) 279-4500 TWX: 910-335-1221	Data Sheets	266



**Helipot
Ladder Networks
...60 ppm
accuracy for \$27.00
from stock***

* Model 811-A12, 100 piece price.

Helipot offers the widest variety of off-the-shelf miniature ladder networks. From low cost networks with 9-bit accuracies to precision 14-bit units. Either binary or BCD designs. And with a variety of stock resistance values and a selection of standard temperature ranges.

They typically feature:

- 60 ppm accuracy (initial worst case accuracy at 25°C)
 - 0.6 ppm/°C tempco
- 50 nanosecond settling
- 20 ppm per year stability
 - low profile

They are constructed of Helipot's exclusive cermet thick film passive elements and fused to alumina substrates at extremely high temperatures. By screen printing all resistors on each network simultaneously, uniform electrical characteristics and excellent stability are achieved. In addition, every unit is 100% tested at 5 temperature points and serialized accuracy tapes are available for only \$1.00 more.

For more information, contact your local Helipot Sales Representative or Distributor or circle the Reader Service No.

Beckman®

INSTRUMENTS, INC.

HELIPOT DIVISION

FULLERTON, CALIFORNIA • 92634

INTERNATIONAL SUBSIDIARIES: AMSTERDAM; CAPE TOWN; GENEVA; GLENROTHES, SCOTLAND; LONDON; MEXICO CITY; MUNICH; PARIS; STOCKHOLM; TOKYO; VIENNA

Model 811:
A 12-bit Binary Ladder Network for use in DAC/ADC applications requiring fast switching and high accuracy over a wide temperature range.



Model 812:
A 12-bit R-2R Binary Ladder Network designed specifically for MOSFET switch applications.

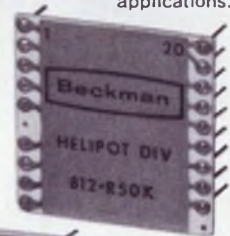

Model 813:
A Conductance Ladder designed to be used with Fairchild's μ A722 10-bit current source.



Model 814:
An Ultraprecision 14-bit R-2R Binary Ladder Network with accuracies to ± 30 ppm from -20° to $+80^\circ$ C.

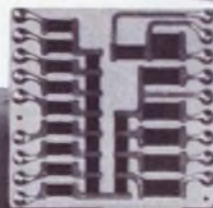

BCD Ladder Networks are also available in many standard configurations.

INFORMATION RETRIEVAL NUMBER 52

Design and match rf amplifiers

using these two QUIKTRAN programs to simplify device analysis and selection of matching network.

The design of transistor rf amplifiers can be made easier by using two QUIKTRAN computer programs for device and matching network analysis. QUIKTRAN,[†] which is based on the FORTRAN language, was used to develop the following design programs:

- RFAMP (Table 1), which analyzes a two-port device in terms of its y -parameters for a given stability factor. The analysis of the device provides optimum source and load admittance, resulting transducer gain, unilateralized gain, stability, sensitivity, and both input and output impedances. Other types of parameters require the writing of an auxiliary program to convert them to y -parameters. If s -parameters are used, the auxiliary program can easily be made to accept measured values $A, B < \phi$ directly.

- ZMATCH, which selects, identifies and determines the components of 28 possible matching networks for given source and load impedances, frequency and required Q . The networks consist of all possible combinations of either two capacitances and a single inductance, or two inductances and a single capacitance.

RFAMP highlights trade-off

To demonstrate the operation of RFAMP, let's use it to solve a typical device analysis problem.

Assume we want to use a 3N128 MOSFET in an rf amplifier. If, during the computer run, the device is found to be potentially unstable, the program will find the optimum terminating impedances for this transistor by using the Stern^{1,2} equations (see box). Using less-than-optimum impedances may, however, provide a simpler matching network design. Let's assume that in this particular application, a straight source-resistance of 300 Ω and a 2-k Ω load resistance would simplify the necessary matching network. We can now use RFAMP to evaluate the loss in gain resulting from our less-than-optimum terminations.

[†] For a description of the QUIKTRAN program see "Fundamentals of QUIKTRAN." Copies of this publication are available through IBM Information Marketing branch offices.

Gunnar Richwell, Staff Engineer, Reflectone Electronics, Stamford, Conn.

The program, normally stored in the computer library, is loaded and started by the simple statements shown in Fig. 1. The program then requests the necessary input data in the order shown. All entries made by the engineer are shown boxed in Fig. 1. The type designation 3N128 isn't required, but may be added at the user's discretion to identify his run; this entry is ignored by the computer.

As shown in Fig. 1 the computer then prints out the results of the programmed computations. Linvill stability criteria are used to determine potential stability. In this case the device is potentially unstable, and the source and load admittances (GS, BS, GL, BL) listed are the Stern solution for the given stability factor of 10. The transducer gain printout is the output power delivered to the load divided by maximum input power available from the source; the unilateralized

Table 1. RFAMP program statements

```

101. = CF PROGRAM RFAMP
102. = C ANALYSIS OF A DEVICE EXPRESSED BY ITS Y PARAMETERS
103. = J=0
104. = 11 FORMAT(F12.4)
105. = PRINT 3
106. = 30FORMAT(5BH ENTER G11, B11, G12, B12, G21, B21, G22, B22, (IN MMHOS
1) / 6MH DESIRED STABILITY FACTOR (STERN'S), FREQUENCY (IN MHZ), (NA
4ME):)

107. = 112 CONTINUE
108. = CF READ D,G11,B11,G12,B12,G21,B21,G22,B22,XK,FREQ
109. = GO TO 111
110. = 101 READ 11,G11
111. = GO TO 100
112. = 102 READ 11,B11
113. = GO TO 100
114. = 103 READ 11,G12
115. = GO TO 100
116. = 104 READ 11,B12
117. = GO TO 100
118. = 105 READ 11,G21
119. = GO TO 100
120. = 106 READ 11,B21
121. = GO TO 100
122. = 107 READ 11,G22
123. = GO TO 100
124. = 108 READ 11,B22
125. = GO TO 100
126. = 109 READ 11,XK
127. = GO TO 100
128. = 110 READ 11,FREQ
129. = GO TO 100
130. = 111 K=0
131. = YR=G12*G21-B12*B21
132. = YM=G12*B21+B12*G21
133. = YMAG=YR**2+YM**2
134. = YMSQ=G21**2+B21**2
135. = C=YMAG**-.5/(2.*G11*G22-YR)
136. = IF(C-1.)10,20,20
137. = 10 DS=((2.*G11*G22-YR)**2-YMAG)**-.5
138. = GS=DS/2./G22
139. = BS=-B11+YM/2./G22
140. = GL=DS/2./G11
141. = BL=-B22+YM/2./G11
142. = PRINT 4,C
143. = 40FORMAT(/29H LINVILL'S STABILITY FACTOR =,F5.2,3NH: DEVICE IS UNCON
4)DITIONALLY STABLE)
144. = GO TO 30
145. = 20 PRINT 5,C
146. = 50FORMAT(/29H LINVILL'S STABILITY FACTOR =,F5.2,32H: DEVICE IS POTEN
4)TENTIALLY UNSTABLE)
147. = GO TO 22
148. = 21 K=1
149. = XK=2.*(G11+GS)*(G22+GL)/(YMAG**-.5+YR)
150. = 22 A=(YMAG**-.5+YR)*XK

```

Amplifier stability

As noted in the reference a major factor in the over-all design of an amplifier is the potential stability of the transistor. This may be determined by computing the Linvill stability factor C , using the following expression:

$$C = |y_{12}y_{21}| / [2g_{11}g_{22} - \text{Re}(y_{12}y_{21})],$$

where $\text{Re}(y_{12}y_{21}) = \text{Real part of } (y_{12}y_{21})$.

When C is less than 1, the transistor is unconditionally stable. When C is greater than 1, the transistor is potentially unstable.

The C factor is a test for stability under a hypothetical worst-case condition; that is, with both input and output transistor terminals open-circuited. With no external feedback, an unconditionally stable transistor will not oscillate with any combination of source and load. If a transistor is potentially unstable, certain source and

load combinations will produce oscillations.

Although the C factor may be used to determine the potential stability of a transistor, the conditions of open-circuited source and load which are assumed in the C factor test are not applicable to a practical amplifier. Consequently it is also desirable to compute the relative stability of actual amplifier circuits, and Stern has defined a stability factor K for this purpose. The K factor is similar to the C factor, except that it also takes into account finite source and load admittances connected to the transistor. The expression for K is:

$$K = [2(g_{11} + G_s)(g_{22} + G_L)] / [|y_{12}y_{21}| + \text{Re}(y_{12}y_{21})]$$

If K is greater than one, the circuit will be stable. If K is less than one, the circuit will be unstable.

```

151. =      E=A+2.*YR
152. =      F=-2.*YM*A**5)
153. =      H=F**2/4.+E**3/27.
154. =      IF(H)40.50,b0
155. =      40 Q=(-(E/3.))**5
156. =      PHI=ARCOS(F/2./E**3./Q)/3.
157. =      Z1=2.*Q*COSE(PHI)
158. =      Z2=-2.*Q*COSE(1.047198-PHI))
159. =      Z3=-2.*Q*COSE(1.047198+PHI))
160. =      D1=Z1**4/4.+E*Z1**2/2.-2.*YM*Z1*A**5+A/2.-YR*YM**2
161. =      D2=Z2**4/4.+E*Z2**2/2.-2.*YM*Z2*A**5+A/2.-YR*YM**2
162. =      D3=Z3**4/4.+E*Z3**2/2.-2.*YM*Z3*A**5+A/2.-YR*YM**2
163. =      IF(D2-D1)41.42,42
164. =      41 IF(D2-D3)43.44,44
165. =      42 IF(D1-D3)45.44,44
166. =      43 Z0=Z2
167. =      GO TO 40
168. =      44 Z0=Z3
169. =      GO TO 40
170. =      45 Z0=Z1
171. =      GO TO 40
172. =      50 Z1=(F/2.))**(1./3.)
173. =      Z2=-2.*Z1)
174. =      D1=Z1**4/4.+E*Z1**2/2.-2.*YM*Z1*A**5+A/2.-YR*YM**2
175. =      D2=Z2**4/4.+E*Z2**2/2.-2.*YM*Z2*A**5+A/2.-YR*YM**2
176. =      IF(D2-D1)51.52,52
177. =      51 Z0=Z2
178. =      GO TO 40
179. =      52 Z0=Z1
180. =      GO TO 40
181. =      60 P=-((F/2.))**4**5
182. =      Q=-((F/2.))**4**5
183. =      IF(P)61,62,62
184. =      61 P=-((P**2)**(1./3.))
185. =      GO TO 63
186. =      62 P=P**(1./3.)
187. =      63 IF(Q)64,65,65
188. =      64 Q=-((Q**2)**(1./3.))
189. =      GO TO 66
190. =      65 Q=0**(1./3.)
191. =      66 Z0=P+Q
192. =      40 QK=XK*(YMAG**5+YR)
193. =      IF(K)91,161
194. =      91 G5=(QK*G11/2./G22)**5-G11
195. =      G1=(QK*G22/2./G11)**5-G22
196. =      GO TO 161
197. =      151 READ 11,G5
198. =      GO TO 100
199. =      152 READ 11,GI
200. =      GO TO 100
201. =      162 IF(C-1.)30,21,21
202. =      161 B5=(G5+G11)*Z0/QK**5-B11
203. =      BL=(GL+G22)*Z0/QK**5-B22
204. =      30 T=G11+G5
205. =      U=B11+B5
206. =      V=G22+GL
207. =      W=B22+BL
208. =      ZK=2.*T*V/(YMAG**5+YR)
209. =      RS=1000./GS
210. =      CS=-((B5*500./3.14159/FREQ)
211. =      RL=1000./GL
212. =      CL=-((BL*500./3.14159/FREQ)
213. =      GT=Y.*G5*GL*YMSQ/((T*V-U*W-YR)**2*(U*V+T*W-YM)**2)
214. =      GT=10.*ALOG10(GT)
215. =      GU=(G21-G12)**2*(B21-B12)**2
216. =      GU=GU/4./((G11*G12)/(G22*G12))
217. =      GU=10.*ALOG10(GU)
218. =      S=(V*GL+W*BL)**2*(V*BL+W*GL)**2
219. =      S=S*(G11**4*(G11*B11)**2)
220. =      YK=YMAG**5/G11*G22
221. =      S=5**5*YK/(V**2+W**2)/(G11**2+B11**2)
222. =      THETA=ATAN(-(YM/YR))*57.24578
223. =      S1=YK*(G11**2*COSE(THETA)+G11*B11*SIN(THETA))/(G11**2+B11**2)
224. =      S2=YK*(G11**2*SIN(THETA)+G11*B11*COSE(THETA))/(G11**2+B11**2)
225. =      S=S/((V/G22+S1)**2*(W/G22+S2)**2)**5
226. =      S=5*100.
227. =      GIN=G11-(YR*V+Y*W)/(V**2+W**2)
228. =      BIN=B11-(Y*V-YR*W)/(V**2+W**2)
229. =      RIN=1000./GIN
230. =      CIN=BIN/2./3.14159/FREQ*1000.
231. =      GOUT=G22-(YR*T+Y*U)/(T**2+U**2)
232. =      BOUT=B22-(Y*Y-T*Y*U)/(T**2+U**2)
233. =      ROUT=1000./GOUT
234. =      COUT=BOUT/2./3.14159/FREQ*1000.
235. =      PRINT 6,ZK,S,GT,GU
236. =      60FORMAT(27H STERN'S STABILITY FACTOR =,F6.2,14X,14H SENSITIVITY =,F
46.2/18H TRANSDUCER GAIN =,F7.3,13X,22H UNILATERALIZED GAIN =,F7.3)
237. =      PRINT 7,GS,BS,GL,BL
238. =      7 FORMAT(4H GS=,F10.3,5X,4H BS=,F7.2,5X,4H GL=,F10.3,5X,4H BL=,F7.2)
239. =      PRINT 8,RS,CS,RL,CL
240. =      8 FORMAT(4H RS=,F10.1,5X,4H CS=,F7.2,5X,4H RL=,F10.1,5X,4H CL=,F7.2)
241. =      PRINT 9,RIN,CIN,ROUT,COUT
242. =      9 FORMAT(4H RIN=,F10.1,5X,4H CIN=,F7.2,5X,4H ROUT=,F10.1,5X,4H COUT=,F7.2)
243. =      IF(J)113,114,100
244. =      100 READ 13,M
245. =      13 FORMAT(12)
246. =      GOO TO (101,102,103,104,105,106,107,108,109,110,151,152,111,113,112
4,162),M
247. =      114 PRINT 12
248. =      120FORMAT(/70H CHANGE PARAMETER BY ENTERING M: M=01 FOR G11, 02 B11,
103 G12, 04 B12,62H 05 G21, 06 B21, 07 G22, 08 B22, 09 XK, 10 FREQ
2, 11 GS, 12 GL, /52H 13 RESTART, 14 EXIT, 15 READ G11-FREQ, 16 CONT
4INUE:)
249. =      J=1
250. =      GO TO 100
251. =      113 PAUSE
252. =      END
253. +READY

```

gain is the gain obtainable when Y_{12} is made zero by feedback, and Y_L is conjugately matched to Y_{OUT} . In addition, sensitivity (defined as percentage change in Y_{IN} divided by the percentage change in Y_L times 100) is included.

Values shown for R_S , C_S , R_L and C_L (used with the ZMATCH program) represent the effective input and output impedances that the device should see, looking into the matching networks. R_1 , C_1 , R_0 and C_0 values are the actual input and output impedances of the device.

The RFAMP program has built-in instructions for modifying, which are subsequently printed out. For example, in order to change G_S , the number 11 is entered followed by the value 3.3333, which corresponds to the reciprocal of 300 Ω ; G_L is changed to 1/2 k Ω by using the address number 12. Finally, the number 16 is entered in order to start the program again.

The resulting stability factor differs from the original 10. The transducer gain, 17.176 dB, can be compared on the basis of the same stability factor. Since the new stability factor is now in the program that supersedes the original one, restarting the program by entering 13 will give optimum gain for this factor. The resulting gain,

17.634 dB, exceeds 17.176 by about 0.5 dB, which is the penalty we've been looking for.

The choice of stability factor (Stern) isn't too critical; it should be higher as the number of stages increase, or when the probability of stray feedback is great, etc. Table 3 shows how gain, input and output impedances change as a function of stability factor for the potentially unstable 2N4957. (2N4957 is unconditionally stable (common emitter configuration) beyond 600 MHz.

Note that the device is stable, although the input impedance goes through infinity at about 5.2 and then goes negative. The source and input resistance in parallel comes out positive, of course, increases to infinity near 1.0 and, as expected, goes negative below 1.0, which defines the region of actual instability.

One merit of the stability factor is the basis it provides for comparing gain between different types of devices.

RFAMP can also be used to examine effects on the stability factor and gain of variation in y -parameter values with fixed G_S and G_L . Table 4 shows the effects of varying each of the eight parameters by plus and minus 20%, and then

```

101. -READY
253. +READY
105. =0 03
105. = 2 ENTER G11, B11, G12, B12, G21, B21, G22, B22. (IN MMHOS),
DESIRED STABILITY FACTOR (STERN'S), FREQUENCY (IN MHZ), (NAME):
108. =I 00 .27 5.5 0. -1.2 7.1 -1.4 .21 1.3 10. 150. 3N128
145. =0 05
145. = 2 LINVILL'S STABILITY FACTOR = 3.09; DEVICE IS POTENTIALLY UNSTABLE
235. =0 06 STERN'S STABILITY FACTOR = 10.00 SENSITIVITY = 0.54
235. = 2 TRANSDUCER GAIN = 16.429 UNILATERALIZED GAIN = 23.608
237. =0 07 GS= 1.852 BS= -6.01 GL= 1.440 BL= -1.70
239. =0 08 RS= 540.0 CS= 6.38 RL= 644.3 CL= 1.80
241. =0 09 RI= 4021.2 CI= 6.38 RO= 5170.1 CO= 1.80
247. =0 12
247. = 2 CHANGE PARAMETER BY ENTERING M: M=01 FOR G11, 02 B11, 03 G12, 04 B12,
247. = 3 05 G21, 06 B21, 07 G22, 08 B22, 09 XK, 10 FREQ, 11 GS, 12 GL,
247. = 4 13 RESTART, 14 EXIT, 15 READ G11-FREQ, 16 CONTINUE:
244. =I 13 11
147. =I 11 3.3333
244. =I 13 12
149. =I 11 .5
244. =I 13 16
235. =0 06 STERN'S STABILITY FACTOR = 7.31 SENSITIVITY = 2.00
235. = 2 TRANSDUCER GAIN = 17.176 UNILATERALIZED GAIN = 23.608
237. =0 07 GS= 3.333 BS= -6.66 GL= 0.500 BL= -1.53
239. =0 08 RS= 300.0 CS= 7.06 RL= 2000.0 CL= 1.62
241. =0 09 RI= 7342.4 CI= 7.06 RO= 5451.0 CO= 1.62
244. =I 13 13
145. =0 05
145. = 2 LINVILL'S STABILITY FACTOR = 3.09 DEVICE IS POTENTIALLY UNSTABLE
235. =0 06 STERN'S STABILITY FACTOR = 7.31 SENSITIVITY = 0.67
235. = 2 TRANSDUCER GAIN = 17.637 UNILATERALIZED GAIN = 23.608
237. =0 07 GS= 1.544 BS= -6.08 GL= 1.201 BL= -1.75
239. =0 08 RS= 647.8 CS= 6.45 RL= 832.9 CL= 1.86
241. =0 09 RI= 4445.9 CI= 6.45 RO= 6359.0 CO= 1.86
244. =I 13 15
108. =I 00 17. 11. 0. -.92 22.8 -44.8 .29 1.91 10. 200. 2N3279
142. =0 04
142. = 2 LINVILL'S STABILITY FACTOR = 0.91; DEVICE IS UNCONDITIONALLY STABLE
235. =0 06 STERN'S STABILITY FACTOR = 20.05 SENSITIVITY = 40.11
235. = 2 TRANSDUCER GAIN = 15.407 UNILATERALIZED GAIN = 20.934
237. =0 07 GS= 37.379 BS= -47.17 GL= 0.638 BL= -2.53
239. =0 08 RS= 26.8 CS= 37.53 RL= 1568.3 CL= 2.01
241. =0 09 RI= 26.8 CI= 37.53 RO= 1568.3 CO= 2.01
244. =I 13 05
118. =I 11 18.2
244. =I 13 13
142. =0 04
142. = 2 LINVILL'S STABILITY FACTOR = 0.87; DEVICE IS UNCONDITIONALLY STABLE
235. =0 06 STERN'S STABILITY FACTOR = 37.88 SENSITIVITY = 38.60
235. = 2 TRANSDUCER GAIN = 14.871 UNILATERALIZED GAIN = 20.586
237. =0 07 GS= 43.263 BS= -39.87 GL= 0.738 BL= -2.40
239. =0 08 RS= 23.1 CS= 31.73 RL= 1355.0 CL= 1.91
241. =0 09 RI= 23.1 CI= 31.73 RO= 1355.0 CO= 1.91
244. =I 13 14
251. =PAUSE
253. +READY
COMMAND

```

1. Sample run of RFAMP demonstrates how the program is used to determine the loss in gain that will result from using other-than-optimum source and load terminations. Entries made by the user are shown boxed.

```

101. -READY
370. +READY
105. =0150
109. =I 00 1000. 5. 80. 40. 150. 20.
334. =0152 K C1.7 C3.9 L2.8.(4.6) (UH)
344. =0153 819 22.49 15.42 0.0531
344. =0153 192 4.79 4.51 0.1882
344. =0153 421 23.11 6.87 0.1682
344. =0153 441 3.59 6.87 0.0865
344. =0153 481 16.38 4.35 0.0531
344. =0153 461 16.38 70.85 0.0826
344. =0153 183 14.82 12.19 0.0833
344. =0153 729 11.63 17.40 0.0860
351. =0154 K C1.9.(3.7) L4.8 L2.6
35b. =0155 821 6.17 0.0667 0.1137
35b. =0155 823 24.13 0.0667 0.1952
35b. =0155 982 13.02 0.1831 0.1194
35b. =0155 782 0.13 8.4022 0.1194
35b. =0155 928 13.02 0.0110 0.0950
35b. =0155 281 10.91 0.2244 0.5123
35b. =0155 128 1.35 0.0215 1.0100
35b. =0155 328 15.06 0.0215 0.0522
35b. =0155 128 1.35 0.0906 1.0946
35b. =0155 328 7.96 0.0906 0.0914
35b. =0155 289 162.76 0.0052 0.1731
35b. =0155 287 0.01 130.8137 0.1731
35b. =0155 289 162.76 0.0059 0.2578
35b. =0155 287 0.00 270.4529 0.2578
35b. =0155 294 21.59 0.0082 0.3803
35b. =0155 618 8.22 0.0152 0.0736
364. =0157 MODIFY PROGRAM BY ENTERING M: M=1 FOR RO, 2 CO,
3 RI, 4 CI, 5 FREQ, 6 G, 9 RO-Q, 7 RESTART, 8 EXIT.
334. =I151 b
334. =I 06 5.
334. =I151 7
351. =0154 K C1.9.(3.7) L4.8 L2.6
35b. =0155 128 7.45 0.0215 0.3242
35b. =0155 128 7.45 0.0906 0.4088
35b. =0155 287 0.12 9.7878 0.1731
334. =I151 9
109. =I 00 430. 6. 7. 150. 150. 5.
361. =0156 SORRY, NO MATCH; CHANGE Q IF POSSIBLE OR USE TWO
361. = 2 NETWORKS MATCHED TO AN INTERMEDIATE, VIRTUAL RESISTANCE.
334. =I151 b
333. =I 06 10.
334. =I151 7
351. =0154 K C1.9.(3.7) L4.8 L2.6
35b. =0155 821 26.22 0.0340 0.0054
35b. =0155 928 16.23 0.0047 0.0468
35b. =0155 928 16.23 0.0182 0.0532
35b. =0155 281 45.60 0.0362 0.2609
35b. =0155 281 45.60 0.0241 0.0601
35b. =0155 294 28.21 0.0349 0.0466
35b. =0155 294 60.03 0.0249 0.2220
334. =I151 8
368. =PAUSE
370. +READY
101. -READY
COMMAND

```

2. Sample ZMATCH run provides a number of possible matching circuits which will satisfy a particular circuit requirement. User's entries are shown in boxes. The entered inputs are shown in Fig. 3.

Table 2. ZMATCH program statements

```

101. = CF PROGRAM ZMATCH
102. = C MATCHING TWO PARALLEL RC NETWORKS WITH CCL OR CLL NETWORKS
103. = C (OUT OF 28 POSSIBLE CONFIGURATIONS).
104. = C K: CAP = ODD NUMBER, IND = EVEN, SHUNT = ABOVE 5, SERIES = BELOW 5
105. = PRINT 150
106. = 150 FORMAT(42H ENTER RO, CO (PF), RI, CI, FREQ (MHZ), Q):
107. = J=0
108. = 9 CONTINUE
109. = CF READ D,R,CO,P,CI,FQ,Q
110. = 7 I=-1
111. = N=0
112. = D=6.2831853*FQ
113. = X=- (1000000./O/CO)
114. = Z=- (1000000./O/CI)
115. = 10 A=R/X
116. = B=P/Z
117. = S=R/(1.+A**2)
118. = U=S*A
119. = T=P/(1.+B**2)
120. = V=T*B
121. = PS=P*S
122. = SS=S**2
123. = QT=Q*T
124. = QV=Q*V/T
125. = GO TO 1
126. = 11 S=P
127. = P=R
128. = R=5
129. = S=2
130. = Z=X
131. = X=5
132. = GO TO 1
133. = 12 IF (P-S)11,13,1
134. = 13 N=N+4
135. = 1 N=N+1
136. = OGO TO (12,14,16,18,20,22,25,11,10,12,28,29,30,31,32,33,34,37,39,42
1.44,46,49,51,53,54,56,58,60,61,65,67,71,11,10,44,74,75,76,77,78,79
4,80,81,82,83,84,85,86,90,92,95,120).N
137. = 2 IF (C)110,110,1
138. = 3 IF (C)115,115,1
139. = 14 K=129
140. = 15 G=-((PS-SS)**.5)
141. = H=PS/G
142. = D=Z*H/(Z+H)
143. = W=O*S
144. = C=U-W-G
145. = GO TO 2
146. = 16 K=140
147. = 17 F=C*W
148. = W=(4.*S+(U+G)**2/S)/O
149. = C=W*F/(W-F)
150. = GO TO 2
151. = 18 K=189
152. = 19 W=P/Q
153. = C=G-U
154. = D=- (1./ (1./H+1./W+1./Z))
155. = GO TO 2
156. = 20 K=169
157. = 21 F=W*W/(W+O)
158. = W=O*P/(4.*(B*(H+Z)/H)**2)
159. = D=F-W
160. = GO TO 2
161. = 22 K=819
162. = 23 W=R/Q
163. = F=R/(1.+A*(X+W)/W)**2)
164. = IF (P-F)1,1,24
165. = 24 G=-((F*(P-F))**.5)
166. = C=-G-F*(Q+A)
167. = D=P*F/(G-B*F)
168. = GO TO 2
169. = 25 K=192
170. = W=OT
171. = F=T*(V+W)**2/T
172. = IF (F-S)1,1,27
173. = 27 C=-((S*(F-S))**.5)-U
174. = D=- (F*S/(U+C*S*QV))
175. = GO TO 2
176. = 28 K=921
177. = GO TO 15
178. = 29 K=941
179. = GO TO 17
180. = 30 K=981
181. = GO TO 19
182. = 31 K=961
183. = GO TO 21
184. = 32 K=918
185. = GO TO 23
186. = 33 K=291
187. = GO TO 26
188. = 34 K=183
189. = G=S**T*(2.+Q**2)-SS-T**2
190. = IF (G)1,35,35
191. = 35 D=S*(QT+G**.5)/(S-T)-U
192. = 36 C=-W-T*(Q+(U+D)/S)
193. = W=(S+(U+D)**2/S)/O
194. = GO TO 2
195. = 37 K=183
196. = IF (G)1,38,38
197. = 38 D=S*(QT-G**.5)/(S-T)-U
198. = GO TO 36
199. = 39 K=729
200. = G=R**P**Q**2-(R-P)**2
201. = IF (G)1,40,40
202. = 40 H=(R-P)/(G**.5/R-Q)
203. = 41 D=X*H/(X-H)
204. = C=-P/(B+R/H+Q)
205. = W=Q*R/(1.+R/H)**2)
206. = GO TO 2
207. = 42 K=729
208. = IF (G)1,43,43
209. = 43 H=(R-R)/(G**.5/R+Q)
210. = GO TO 41
211. = 44 IF (P-S)45,45,1
212. = 45 N=N+8
213. = GO TO 1
214. = 46 K=821
215. = 47 G=(PS-SS)**.5
216. = E=PS/Z
217. = H=B*S
218. = 48 Y=PS/(G-E)
219. = W=Q*S-G-E
220. = C=U-W-G
221. = GO TO 3
222. = 49 K=823
223. = 50 F=C+W
224. = W=(4.*SS+(U+G)**2)/(Q*S-G+E)
225. = C=W*F/(W-F)
226. = GO TO 3
227. = 51 K=821
228. = 52 G=-G
229. = GO TO 48
230. = 53 K=823
231. = GO TO 50
232. = 54 K=982
233. = 55 W=G-U
234. = Y=PS/(S*Q-W)
235. = C=- (1./ (G/PS+1./Y+1./Z))
236. = GO TO 3
237. = 56 K=782
238. = 57 F=Y*C/(Y+C)
239. = Y=PS/(4.*(B+G/S)**2)*(S*Q-W)
240. = C=F-Y
241. = GO TO 3
242. = 58 K=982
243. = 59 G=-G
244. = GO TO 55
245. = 60 K=782
246. = GO TO 57
247. = 61 K=928
248. = 62 C=-P/(A+B*Q)
249. = F=P/(1.+A*(A+Q)**2)
250. = IF (R-F)1,63,63
251. = 63 H=(F*(R-F))**.5
252. = 64 W=F*(A+Q)-H
253. = Y=R*F/(H-F*A)
254. = GO TO 3
255. = 65 K=928
256. = IF (R-F)1,66,66
257. = 66 H=-H
258. = GO TO 64
259. = 67 K=281
260. = 68 C=- (S*OV)-U
261. = F=S*(U+C)**2/S
262. = IF (F-T)1,69,69
263. = 69 W=(T*(F-T))**.5-V
264. = 70 Y=F/(Q-W/T)
265. = GO TO 3
266. = 71 K=281
267. = 72 IF (F-T)1,73,73
268. = 73 W=- (T*(F-T))**.5+V
269. = GO TO 70
270. = 74 K=128
271. = GO TO 47
272. = 75 K=328
273. = GO TO 50
274. = 76 K=128
275. = GO TO 52
276. = 77 K=328
277. = GO TO 50
278. = 78 K=289
279. = GO TO 55
280. = 79 K=287
281. = GO TO 57
282. = 80 K=289
283. = GO TO 59
284. = 81 K=287
285. = GO TO 57
286. = 82 K=829
287. = GO TO 62
288. = 83 K=829
289. = GO TO 66
290. = 84 K=182
291. = GO TO 68
292. = 85 K=182
293. = GO TO 72
294. = 86 K=294
295. = E=1.-T/S
296. = F=U*V+QT
297. = G=SS*U**2-S*T*(1.+QV**2)
298. = H=F**2-E*G
299. = IF (H)1,88,88
300. = 88 W=- (F+H**.5)/E
301. = 89 Y=T*(Q-W/S)
302. = C=- (S*(U+W)**2/S)/(QV+U/S)
303. = GO TO 3
304. = 90 K=294
305. = IF (H)1,91,91
306. = 91 W=(H**.5-F)/E
307. = GO TO 89
308. = 92 K=618
309. = F=R*(Q+B)+P*A
310. = G=R-P*R*(Q+B)**2-P*A**2
311. = H=F**2+(P-R)*G
312. = IF (H)1,93,93
313. = 93 E=(F+H**.5)/(R-P)
314. = W=R/E
315. = Y=P/(Q-E)
316. = C=(R*(Q+A+B)/(1.+E*A)**2)
317. = GO TO 3
318. = 95 K=618
319. = IF (H)1,96,96
320. = 96 E=(F-H**.5)/(R-P)
321. = GO TO 96
322. = 6 FORMAT (F12.4)
323. = 101 READ B,R
324. = GO TO 8
325. = 102 READ B,CO
326. = GO TO 8
327. = 103 READ B,P
328. = GO TO 8
329. = 104 READ B,CI
330. = GO TO 8
331. = 105 READ B,FQ
332. = GO TO 8
333. = 106 READ B,Q
334. = 8 READ 151,M

```

(continued on page 110)

(continued from page 109)

```

335. = 151 FORMAT(11)
336. = GO TO (101,102,103,104,105,106,7,99,9),M
337. = 110 IF(D)111,111,1
338. = 111 IF(I)112,113,99
339. = 112 PRINT 152
340. = 152 FORMAT(5X,2H K,8X,5H C1,7,7X,5H C3,9,4X,16H L2,8,(4,b) (UH))
341. = 113 CC=(1000000./O/C)
342. = CF=(1000000./O/D)
343. = UL=W/O
344. = PRINT 153,K,CC,CF,UL
345. = 153 FORMAT(5X,I3,2F12.2,F12.4)
346. = I=0
347. = GO TO 1
348. = 115 IF(Y)1,116,116
349. = 116 IF(W)1,117,117
350. = 117 IF(I)118,118,119
351. = 118 PRINT 154

```

```

352. = 154 FORMAT(5X,2H K,4X,11H C1,9,(3,7),4X,5H L4,8,7X,5H L2,6)
353. = 119 CC=(1000000./O/C)
354. = UH=Y/O
355. = UL=W/O
356. = PRINT 155,K,CC,UH,UL
357. = 155 FORMAT(5X,I3,F12.2,2F12.4)
358. = I=1
359. = GO TO 1
360. = 120 IF(I)121,122,122
361. = 121 PRINT 156
362. = 156DFORMAT(49H SORRY, NO MATCH; CHANGE Q IF POSSIBLE OR USE TWO./57H N
NETWORKS MATCHED TO AN INTERMEDIATE, VIRTUAL RESISTANCE.)
363. = 122 IF(J)99,123,8
364. = 123 PRINT 157
365. = 157DFORMAT(48H MODIFY PROGRAM BY ENTERING M: M=1 FOR RO, 2 CO./,52H 3
4RI, 4 CI, 5 FREQ, 6 Q, 9 RO=0, 7 RESTART, 8 EXIT.)
366. = J=1
367. = GO TO R
368. = 99 PAUSE
369. = . END
370. +READY

```

Table 3. Effects of varying stability factor

K	G _T	RS	R1	RL	RO
1.0001	106.4	99	99	1976	1.976
1.2	41.8	89	111	1773	2.222
3	27.7	53	317	1051	6.346
4	26.0	45	706	900	14.112
5	24.8	40	4.974	797	99.488
5.20	24.6	39	-357.998	780	-7.160.140
5.21	24.6	39	+147.378	779	+2.947.953
5.3	24.6	39	10.915	772	218.317
6	24.0	36	1.482	722	29.643
7	23.3	33	759	665	15.187
10	21.9	28	412	550	8.233
20	19.1	19	301	383	6.026
50	15.4	12	308	239	6.161
100	12.5	8	336	168	6.720

Gain and termination resistance as a function of stability factor for 2N4957 at 150 MHz.

Table 4. Results of y-parameter variation

	+20%		-20%	
	K	G _T	K	G _T
G11	6.59	23.52	6.40	23.78
B11	6.49	23.65	6.49	23.65
0%*	6.49	23.65	—	—
B12	5.41	23.73	8.11	23.61
G21	5.14	25.39	8.75	21.69
B21	6.90	23.62	6.10	23.71
G22	6.57	23.55	6.42	23.75
B22	6.49	23.65	6.49	23.65
20%**	3.96	26.00	12.08	21.61
10%**	5.01	24.78	8.68	22.59

* Nominal values ** Composite worst case

Stability and Gain as a function of parameter variation for 2N4957 at 150 MHz and GS=25.0, GL=1.6667.

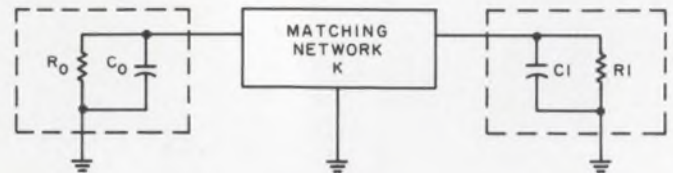

3. These are the variables that the ZMATCH program considers in computing the various suitable combinations of L and C which will make up a suitable matching network, K.

shows the cumulative effect of varying all parameters ±20% and ±10% in the worst-case direction.

Select a matching network

When all effective device input and output impedances in a system have been established and system terminations are known, we're ready to start the design of matching networks. The control of tuning, loaded Q and conditions of maximum power transfer constitute three circuit conditions which must be satisfied; hence there are three variables and a minimum of three reactive components in the matching network.

ZMATCH examines all 28 possible combinations (Fig. 4), many of which have two solutions, infinity at about 5.2 and then goes negative. The for a total of 44 possible readouts. Each configuration is identified by a number, K, consisting of three digits. Capacitors are represented by odd digits, and coils by even digits. Components in series have values below 5, and components in shunt (usually to rf ground) have values above 5, making it easy to identify network type without a chart. Component Qs are assumed to be relatively high with respect to loaded network Q.

Figure 2 shows a sample run (entries by engineer are shown "boxed in"). The entered inputs are defined in Fig. 3, and consist of parallel output and input resistances and capacitances. No less than 24 solutions follow, but most of them have unsuitable component values.

Number 921 is a useful one. It has a series

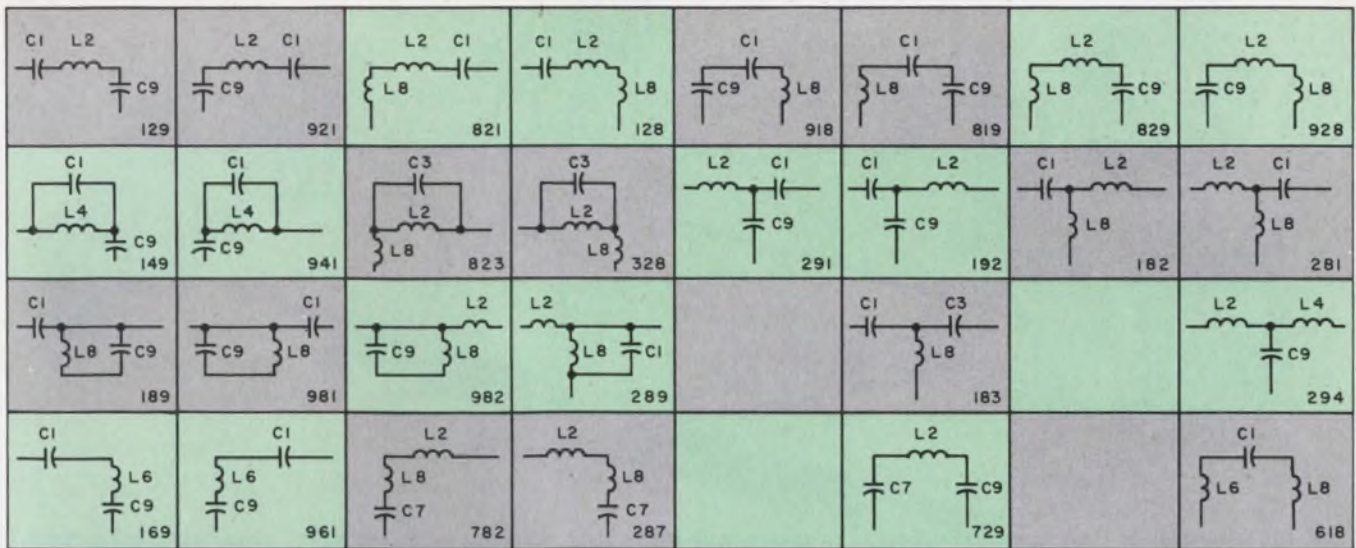

4. All possible combinations of L and C are provided by ZMATCH to fit a specific matching speed.

capacitor (1) for dc blocking, and a series inductor (2). The inductor permits longer leads, including ground return paths, since these leads become natural parts of the network inductance and make the network more physically realizable. There are only two paths of reactive current: one right into the base of the next stage; the other through the shunt capacitor (9), which can be physically close to the first stage, so that this current is confined locally.

Number 618 has the dc blocking capability and saves two rf chokes; but there is a total of three current paths, and the collector coil current must also pass the collector supply bypass capacitor and associated paths back to the emitter.

The sample run shows next a modification in the form of changing Q from 20 to 5. Only three networks are possible. Next, a new set of data are entered, with no solutions, but with a suggestion to change Q . Increasing Q to 10 subsequently produces seven solutions.

The program can also be used to match a resistive load, say a 50- Ω transmission line. The requested capacitance input must then be entered as 0.01 pF, or less, but not zero (which will result in forbidden divisions by zero in the program).

As the sample run suggests, in difficult cases it is possible to use two matching networks matched to an intermediate virtual resistance to obtain the desired Q . The two networks may then have two or more components combined, resulting in a 4-5 component filter having the desirable characteristics. The Q used in each run should be such that the over-all Q is the desired one.

The ZMATCH program can be modified to work with only one desirable network type by simply inserting a statement of the type GO TO (14, 8),

N, where statement 14—in this case—directs the action to filter number 129 and then straight back to read statement 8. The effects of parameter variation on component values for a particular network can then be checked for several runs without having to print out all the other network values. ■■

References:

1. J. C. Linvil and J. F. Gibbons, *Transistors and Active Circuits*, New York: McGraw-Hill Book Co., 1961.
2. "RF Small Signal Design Using Admittance Parameters," Motorola Semiconductor Products, Inc., Technical Information Note AN-215.

Test your retention

Here are questions based on the main points of this article. Their purpose is to help you make sure you have not overlooked any important ideas. You'll find the answers in the article.

1. What type of parameters will the RFAMP program handle?
2. What was the advantage gained by using terminating resistances of less-than-ideal values?
3. What is one advantage to be gained in using the same stability factor in analyzing different transistors?
4. How many possible combinations of L/C matching networks are provided by ZMATCH?
5. In addition to amplifiers, what other types of circuitry can be matched using ZMATCH?

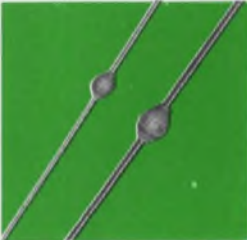

GE's 3 amp hermetic A15 replaces costlier rectifier diodes

GE offers a higher rated companion to its field-proved, 1 amp A14 rectifier at a significantly lower cost than stud or other lead mounted units (depending upon configuration). The A15 is rated 3 amps at 70 C and the 200 to 800 volt models are transient voltage protected up to 1000 watts for 20 μ S in reverse direction.

A15's dual heat sink design means low thermal impedance and easy adaptation to PC board mounting . . . reduced installation cost.

Both the A15 and A14 are hermetically sealed in an all-diffused, glass passivated junction structure. No internal cavity means more resistance to environmental stresses . . . thus increased reliability.

High-power A15 is now available through GE distributors in quantities up to 9999 for applications including time delay circuits, battery chargers, TV damper diodes, communication equipment and small portable appliances. Circle number 784.



Select your instruments from industry's most complete line

● **Panel meters.** Measure a-c, d-c volts and amps. 1½ to 4½-inch sizes in THE BIG LOOK® style. 2½ to 4½-inch sizes in HORIZON LINE® style.

● **Meter relays and pyrometers.** Indicate, monitor and control temperature or other variables directly or with transducers. BIG LOOK and HORIZON LINE style. 2½ to 4½-inch sizes. "Piggy-back" control module.

● **Edgewise meters.** Measure a-c and d-c volts and amps. Miniature type 185, 2¼ inch or large type 180, 6-inch. Both can be multi-stacked vertically or horizontally. Standard accuracy of 2%, 1% optional.

● **Switchboard instruments.** Measure volts, amps, speed, vars, power factor, frequency, phase angle, other variables. 4½ and 8½-inch sizes. Standard one percent accuracy. For full line information, circle 785.



Reduce redesign cycles with reliable GE microwave circuit modules

GE microwave circuit modules (MCM) help reduce design cycles, provide retrofit and lead to improved system performance by optimum integration of active devices. And lower system cost results from circuit simplicity, easy application and longer life.

These rugged GE devices are built to deliver reliable performance in adverse environments of shock, vibration, high altitude and extreme temperatures. MCM's may be designed for use as oscillators, amplifiers, integrated isolators and circulators.

General Electric microwave modules encompass all planar triode and diode uses—from DC to X-band, from milliwatts to kilowatts. For details, circle number 786.



GE wet slug capacitors . . . highest efficiency in half the size

GE 69F900 wet slugs meet high-density application needs with highest volumetric efficiency of any capacitor. We halved the military (CL64) wet slug size, and essentially kept its electrical and performance traits.

The 69F900 has excellent capacitance retention at low temps . . . can be stored to -65 C. Operating range is -55 C to +85 C. It's tough too—withstands vibration to 2000Hz; 15G acceleration!

GE's capacitor is fully insulated; has low, stable leakage current. Ratings are available from 6 to 60 volts; capacitance ranges from 0.5 to 450 μ f. For more information, circle magazine reader card number 787.



New 36 point one-piece Terminal Boards

General Electric has stretched its reliable line of one-piece terminal boards to 36 contact points. And they are available in eight configurations of solder, screw and quick-connect points.

The new expanded line of CR151, Type D1 or D7, is rated 15 amperes with breakdown voltage of 3600. Of course, other designs are still available in ratings up to 30 amperes and breakdown voltage to 7500.

No insulation is required between board and panel because the molded plastic base already provides the protection. Marking strips or stamped markings can be provided on top and/or bottom.

The expanded D1 and D7 boards add just another dimension to what is already the broadest terminal board line on the market. For more information, circle reader card number 788.

10 more

electronic components tailored for designers

General Electric components are engineered for reliability and cost effectiveness. No other single manufacturer offers such a wide selection of quality electronic components as General Electric. Specify GE in your designs.



Complementary power transistors—up to 20W in audio applications

Complementary D27C/D27D silicone-encapsulated, planar, epitaxial power transistors have low collector saturation voltages and offer a dissipation of 8W total power with tab at 70 C. Their 0.5" leads can be formed to fit TO-66 and TO-5 configurations.

Key Characteristics

Collector current
3 amps (continuous)
5 amps (peak)
Collector saturation voltage
D27C: 0.5V typ., 3.0A
D27D: 1.0V typ., -3.0A
Collector-to-emitter voltage
30 and 40 volts
Total power dissipation (with tab)
1.7W (free air at 50 C)
2.1W (free air at 25 C)
8.0W (tab at 70 C)
Forward current transfer ratio
120 max., 200 mA
Gain band width product
D27C: 50MHz typ.
D27D: 40MHz

Their small size and power handling capability offer a great variety of applications including drivers, voltage regulators, power switching, audio output for automobile or phono stereo, TV, radio. And they are color coded for identification. Circle number 789.



Designing a radar? New GE 4-cell tetrode improves bandwidth 300%

Up go electronic bandwidths with GE's unique ZP-1081 "multi-cell" tetrode, a compact, air-cooled transmitting tube that incorporates four high-performance tetrode units in a single vacuum envelope. This innovation leads to very high transconductance and significantly low output capacitance, to provide high gain-bandwidth in amplifier circuits.

Electronic bandwidth of about 120 MHz has been demonstrated under RF power amplifier operation at 475 MHz. Related typical performances includes 70 KW of useful peak power output with a peak drive power of 15KW.

Output efficiency is close to 40%, and low operating voltages are used under RF grid-pulsed amplifier service. Bandwidth achieved is on the order of 200-300% of that available from previous tetrodes and associated circuitry operating at comparable power and frequency. For more information, circle number 790.



GE's Economy Pack... proved thermistors at budget prices

Growing uses of printed circuit boards in new applications have demanded hermetically sealed temperature compensation units at lower cost. And in response to this need, GE has put its proven 1H-Series (negative temperature Coefficient) Thermistors in a new Economy Package.

As low as 16¢ each in OEM quantities, these high-quality units are available in 5%, 10%, 20% and 30% tolerances with Zero-Power Resistance Values from 18K to 56K ohms at 25 C.

1.125 inch gold-plated Dumet leads may be welded or soldered... ideal for PCB designs.

Proved quality at lower cost makes GE thermistors the answer to your PCB needs. For more facts on the GE Economy Package, circle number 791.

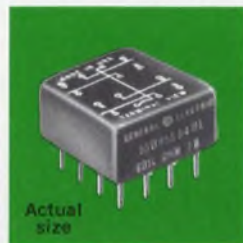

Smallest 4-pole relay available anywhere... GE's 150 grid

The General Electric 150 grid sealed relay is now a better buy than ever. It's the smallest available. And three years of application experience rank it with the most reliable GE sealed relays ever designed.

Low in price, it is even less than GE's standard 4-pole relay which is 4 times larger.

It meets Mil Spec 5757E, rated 2 amps, 250 MW sensitivity, and has all welded construction. Ask for the best 4-pole sealed relay buy on the market—GE's Type 3-SBH 150 grid.

Circle number 792 for more information.



Instant response for driving computer peripherals

When your equipment calls for instant response—inertial time constants low as 1 millisecond—look to GE's new Hyper-Servo* motor. It can accelerate faster than any previous GE design.

The Hyper-Servo motor makes possible new performance capacity in motor-driven peripheral data processing equipment. It is available in 3.4-, 4.6-, 4.8- and 4.9-inch diameters. And look at these performances: torque-to-inertia ratios in excess of 350,000 rad/sec² and; cont torque ratings from 32 oz-in at 2700 rpm to 326 oz-in at 2800 rpm.

These and other high performance characteristics make the Hyper-Servo motor adaptable to nearly every computer peripheral drive application. Circle magazine inquiry card number 793.

* Trademark of the General Electric Company.

Look to General Electric—your best source for more in electronic components.

ELECTRONIC COMPONENTS SALES OPERATION

GENERAL  ELECTRIC

285-47

Cut differential-amplifier design time.

Don't work out equations for each design — use handy tables, based on popular configurations.

The differential amplifier is a versatile circuit used in a variety of applications. Unfortunately, the equations used for design depend on the amplifier's configuration. Considerable design time can be saved if, instead of searching for the appropriate equations each time a differential amplifier is required, the designer uses a handy reference, like Tables 1 and 2. These are based on the following frequently used differential-amplifier configurations:

- One single-ended voltage input
- Two single-ended voltage inputs
- Two single-ended current inputs
- Differential input.

Differential-amplifier input resistance

Figure 1 shows the input circuit of a differential amplifier having one single-ended input. The other input has a resistance, R_s , to ground, so that both inputs see the same impedance. The impedance, Z_3 , seen looking into the base of Q_2 is obtained as follows:

$$Z_1 = h_{ib} + R_s / (\beta + 1)$$

Where Z_1 is the input resistance of Q_1 :

Z_2 is the impedance seen at the constant bias source. It consists of R_e in parallel with the series combination of R_2 and Z_1 . Since R_e is typically much greater than $R_2 + Z_1$

$$Z_2 \approx R_2 + h_{ib} + R_s / (\beta + 1)$$

The impedance Z_3 seen by the external generator is

$$Z_3 = \beta(R_1 + R_2 + 2r_e) + R_s$$

The input circuit, therefore, has the equivalent shown in Fig. 1b.

A voltage source at the other input can be handled in the same manner, with the first voltage source set equal to zero. The results can be combined by using superposition.

Single-ended voltage sources

Figure 2 shows a differential amplifier having two single-ended voltage sources, e_{s1} and e_{s2} .

Sidney A. Friedman, Electronics Engineer, Cardion Electronics, Woodbury, N. Y.

Base current i_{b1} causes collector currents i_a and i_b to flow. Base current i_{b2} causes collector currents i_c and i_d to flow. With e_{s2} set equal to zero, the input is exactly as shown in Fig. 1b. Therefore,

$$i_{b1} = e_{s1} / [2R_s + \beta(R_1 + R_2 + 2r_e)]$$

The resulting collector currents are

$$i_a = i_b \beta e_{s1} / [2R_s + \beta(R_1 + R_2 + 2r_e)]$$

Similarly, when e_{s1} is set equal to zero:

$$i_c = i_d = \beta e_{s2} / [2R_s + \beta(R_1 + R_2 + 2r_e)]$$

Two different load conditions are possible and must be considered. These are:

- Z is an open circuit.
- Z has a finite value.

For Z open-circuited, the following results are obtained, using superposition:

$$e_1 = (i_a - i_b) R_3$$

$$e_1 = \beta R_3 (e_{s2} - e_{s1}) / [2R_s + \beta(R_1 + R_2 + 2r_e)]$$

$$e_2 = (i_c - i_d) R_4$$

$$e_2 = \beta R_4 (e_{s1} - e_{s2}) / [2R_s + \beta(R_1 + R_2 + 2r_e)]$$

Therefore,

$$e_2 - e_1 = \beta(R_3 + R_4) (e_{s1} - e_{s2}) / [2R_s + \beta(R_1 + R_2 + 2r_e)]$$

Table 1 lists the design expressions for voltages e_2 and $(e_2 - e_1)$, along with simplifying expressions for two important cases. An expression for e_1 can be derived from e_2 by changing R_1 to R_3 and taking the negative of the expression.

For a finite value of Z , the following results are obtained using Fig. 2b:

$$i_1 = i_d - i_a = \beta(e_{s2} - e_{s1}) / [2R_s + \beta(R_1 + R_2 + 2r_e)]$$

$$i_2 = i_b - i_c = \beta(e_{s1} - e_{s2}) / [2R_s + \beta(R_1 + R_2 + 2r_e)]$$

and

$$e_1 = \frac{R_3(Z + R_4)}{R_3 + Z + R_4} i_1 + \frac{R_3 R_4}{R_3 + Z + R_4} i_2$$

substituting for i_1 and i_2 and regrouping terms:

$$e_1 = \frac{R_3 Z}{R_3 + Z + R_4} \times \frac{\beta(e_{s2} - e_{s1})}{2R_s + \beta(R_1 + R_2 + 2r_e)}$$

In a similar manner,

$$e_2 = \frac{R_4 Z}{R_4 + Z + R_3} \times \frac{\beta(e_{s1} - e_{s2})}{2R_s + \beta(R_1 + R_2 + 2r_e)}$$

and, therefore,

$$e_2 - e_1 = \frac{(R_3 + R_4) Z}{R_3 + Z + R_4} \times \frac{\beta(e_{s2} - e_{s1})}{2R_s + \beta(R_1 + R_2 + 2r_e)}$$

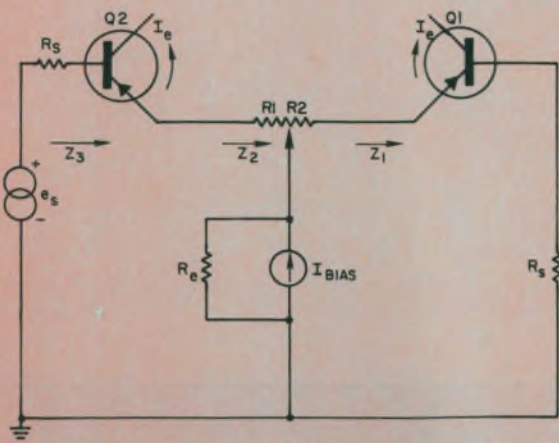

(A)

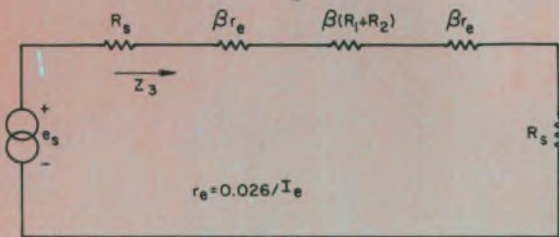

(B)

1. Differential-amplifier input circuit having a single input (A) has the equivalent circuit of (B).

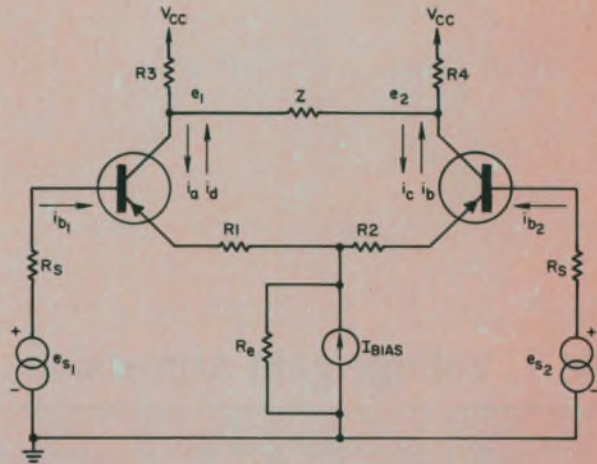

(A)

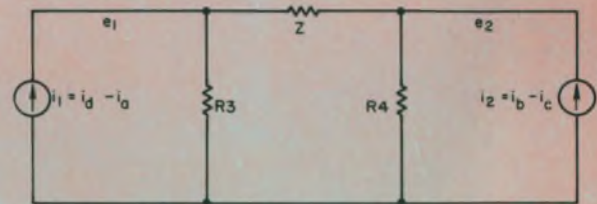

(B)

2. Differential amplifier with single-ended voltage sources (A) has the equivalent circuit of (B).

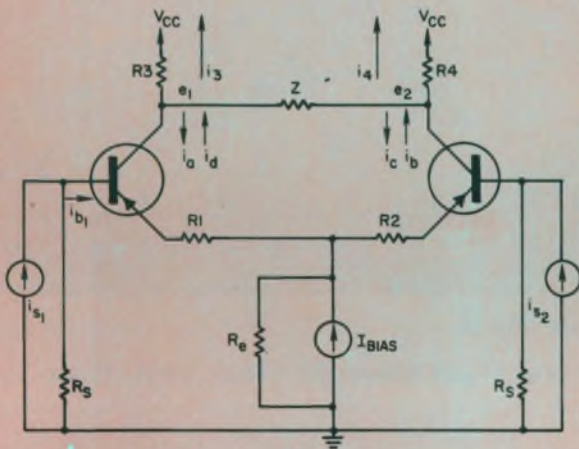

(A)

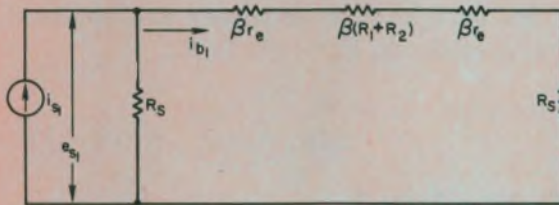

(B)

3. Differential amplifier with single-ended current sources (A) has the equivalent circuit of (B) when $i_{s2} = 0$.

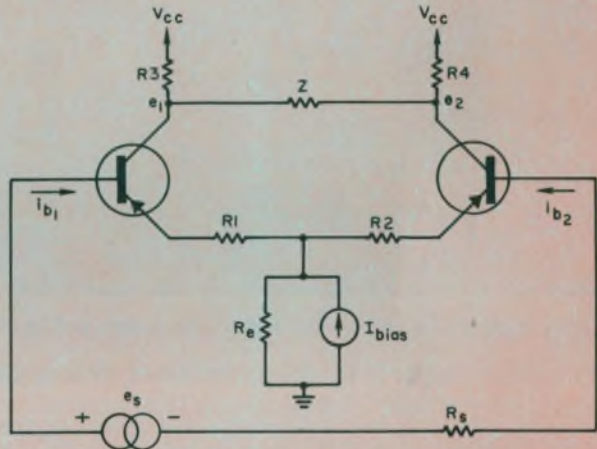

(A)

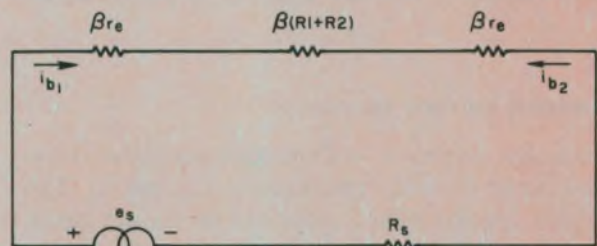

(B)

4. Differential amplifier with floating input (A) has the equivalent of (B). It can be handled with the equations of Table 1, using the appropriate D.

Table 1. Voltage-gain expressions

	Exact value	$r_e \gg \frac{R_1 + R_2}{2} + \frac{R_s}{\beta}$	$R_1 + R_2 \gg \frac{2R_s}{\beta} + 2r_e$
Z open circuited			
e_2	$\frac{\beta R_4}{D} (e_{s1} - e_{s2})$	$\frac{R_4}{2r_e} (e_{s1} - e_{s2})$	$\frac{R_4}{R_1 + R_2} (e_{s1} - e_{s2})$
$e_2 - e_1$	$\frac{\beta (R_3 + R_4)}{D} (e_{s1} - e_{s2})$	$\frac{R_3 + R_4}{2r_e} (e_{s1} - e_{s2})$	$\frac{R_3 + R_4}{R_1 + R_2} (e_{s1} - e_{s2})$
Finite Z			
e_2	$\frac{\beta R_4 Z}{R_3 + Z + R_4} (e_{s1} - e_{s2})$	$\frac{R_4 Z}{R_3 + Z + R_4} (e_{s1} - e_{s2})$	$\frac{R_4 Z}{R_1 + R_2} (e_{s1} - e_{s2})$
$e_2 - e_1$	$\beta \cdot \frac{(R_3 + R_4) \parallel Z}{D} (e_{s1} - e_{s2})$	$\frac{(R_3 + R_4) \parallel Z}{2r_e} (e_{s1} - e_{s2})$	$\frac{(R_3 + R_4) \parallel Z}{R_1 + R_2} (e_{s1} - e_{s2})$

$D = 2(R_s + \beta r_e) + \beta(R_1 + R_2)$ for single-ended voltage inputs (Fig. 2).

$D = R_s + 2\beta r_e + \beta(R_1 + R_2)$ for single-ended current inputs (Fig. 3) and differential voltage input (Fig. 4).

Design expressions for e_2 and $(e_2 - e_1)$ are also given in Table 2 for the case of a finite value of Z.

Single-ended current sources

Figure 3A shows a differential amplifier having two input current generators, i_{s1} and i_{s2} . The equivalent input circuit, with source i_{s2} set equal to zero, is shown in Fig. 3B. Solving for i_{b1} in terms of e_{s1} yields

$$i_{b1} = \frac{e_{s1}}{R_s + \beta(R_1 + R_2 + 2r_e)}$$

Observe that the denominator for a current source is almost the same as for a voltage source. The only difference is that $2R_s$ is replaced by R_s .

This makes Table 1 hold equally for both voltage and current sources, provided that the appropriate denominator is used.

The current gain equations are obtained in a similar manner. For infinite Z:

$$i_c = i_b = i_b - i_c = \frac{\beta R_s (i_{s1} - i_{s2})}{[2R_s + \beta(R_1 + R_2 + 2r_e)]}$$

and for a finite Z:

$$i_c = \frac{Z}{R_3 + Z + R_4} \times \frac{\beta R_s (i_{s2} - i_{s1})}{2R_s + \beta(R_1 + R_2 + 2r_e)}$$

$$i_b = \frac{Z}{R_3 + Z + R_1} \times \frac{\beta R_s (i_{s1} - i_{s2})}{2R_s + \beta(R_1 + R_2 + 2r_e)}$$

The design expressions for the load current, i_L ,

Table 2. Current-gain expressions

	Exact value	$r_e \gg \frac{R_1 + R_2}{2} + \frac{R_s}{\beta}$	$R_1 + R_2 \gg \frac{2R_s}{\beta} + 2r_e$
Z open circuited			
$i_4 = -i_3$	$\frac{\beta R_s}{D} (i_{s1} - i_{s2})$	$\frac{R_s}{2r_e} (i_{s1} - i_{s2})$	$\frac{R_s}{R_1 + R_2} (i_{s1} - i_{s2})$
(For $i_{s1} = -i_{s2} = i_s$)			
$i_4 = -i_3$	$\frac{2\beta R_s}{D} i_s$	$\frac{R_s}{r_e} i_s$	$\frac{2R_s}{R_1 + R_2} i_s$
Finite Z			
$i_4 = -i_3$	$\frac{\beta R_s}{D} \cdot \frac{Z}{R_s + Z + R_4} (i_{s1} - i_{s2})$	$\frac{R_s}{2r_e} \cdot \frac{Z}{R_s + Z + R_4} (i_{s1} - i_{s2})$	$\frac{R_s}{R_1 + R_2} \cdot \frac{Z}{R_s + Z + R_4} (i_{s1} - i_{s2})$
(For $i_{s1} = -i_{s2} = i_s$)			
$i_4 = -i_3$	$\frac{2\beta R_s}{D} \cdot \frac{Z}{R_s + Z + R_4} i_s$	$\frac{R_s}{r_e} \cdot \frac{Z}{R_s + Z + R_4} i_s$	$\frac{2R_s}{R_1 + R_2} \cdot \frac{Z}{R_s + Z + R_4} i_s$

$D = 2 (R_s + \beta r_e) + \beta (R_1 + R_2)$ for single-ended current inputs (Fig. 3)

and i_4 , along with the forms for various simplifying cases, are listed in Table 2.

Differential voltage source

A differential (floating) voltage source applied between the two inputs is illustrated in Fig. 4a. The equivalent input circuit is shown in Fig. 4b. From the circuit,

$$i_{b1} = -i_{b2} = \frac{e_s}{R_s + \beta(R_1 + R_2 + 2r_e)}$$

Thus, the amplifier with a floating voltage source can be treated the same as for two single-ended voltage sources if the denominator, D , is changed to read $D = R_s + \beta(R_1 + R_2 + 2r_e)$. Table 1 can be used with the appropriate change in D . ■■

Test your retention

Here are questions based on the main points of this article. Their purpose is to help you make sure you have not overlooked any important ideas. You'll find the answers in the article.

1. What are the important differential-amplifier input configurations?
2. What do the various configurations have in common?
3. What differences exist between the various configurations?

80 lines per second!

**Clevite's new
hardcopy electrostatic printer
zipped out the facing page
in 1.8 seconds flat.
That's up to seven times
faster than most printers
on the market.**

Eighty lines per second . . . 412,000 characters per minute . . . 4800 lines per minute. No matter how you figure print-out speed, dollar for dollar Clevite 4800 is far and away the fastest and most economical. It's four to seven times faster than most line printers . . . ten to twenty times faster than usual photographic hardcopy techniques. No other print-out system is even in the same ball park.

Words. And pictures.

Clevite 4800 handles both alphanumeric and graphics. Simultaneously. It will reproduce words, numbers, drawings, charts and graphs. Paper is an easy-to-file 8½" wide and page height is infinitely variable up to the full 300' length of the paper supply roll!

More of the fonts you want.

Clevite 4800 generates a wide variety of fonts from the smallest

matrix on up. In an equally wide variety of weights, sizes and styles.

Archival quality.

Clevite 4800 uses a special, high-contrast paper. The electrostatic print-out won't smear. And the paper won't curl, yellow or get brittle in storage. You can write on it with ball point pen, pencil, felt-tip or whatever.

The sound of silence.

Clevite 4800 is an electrostatic printer. So it is quiet. (Think about that next time you're trying to make yourself heard above a chorus of impact-line printers.) And no impact means less wear and tear on the printer, less maintenance and downtime.

Beyond the computer.

Clevite 4800 has uses beyond the computer. In communications it can replace banks of teletypes and prints out data transmitted by telemetry, radio microwave and/or land lines. And it prints out graphic displays from CRT's using a TV raster display memory. The Clevite 4800 whips out full pages of alphanumeric and graphics as fast as signal sources can feed it. You may have other application ideas. Let's kick them around.

A word from the sponsor.

Clevite 4800 is based on proprietary equipment and proprietary paper. There is nothing else quite like it. It's faster, more versatile, quieter and more dependable. Yet, the Clevite 4800 printer's low price will surprise you. Let's talk soon. Clevite Corporation, Graphics Group, 37th and Perkins, Cleveland, Ohio 44114.

CLEVITE

INFORMATION RETRIEVAL NUMBER 53



**Clevite 4800.
The next generation
of high-speed printers.**

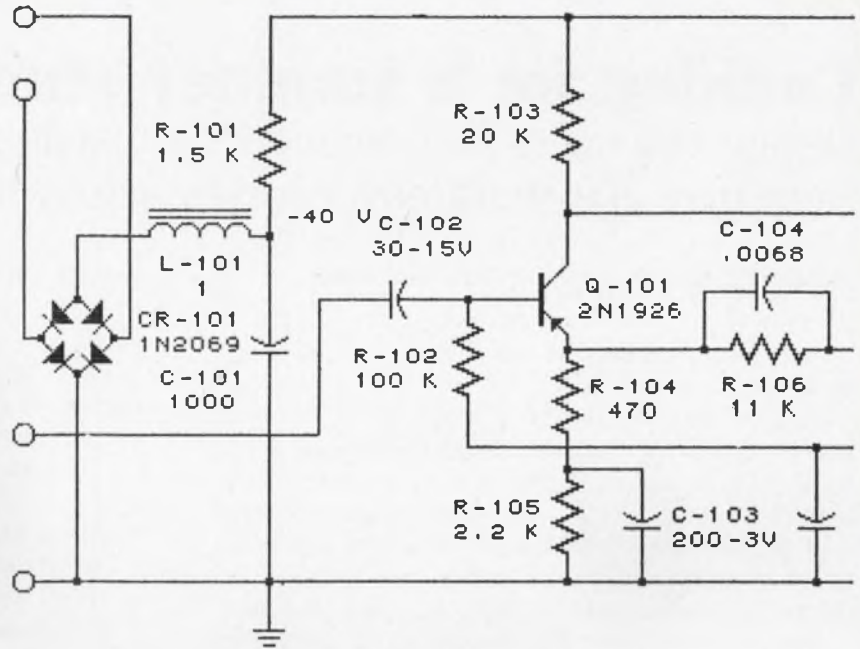
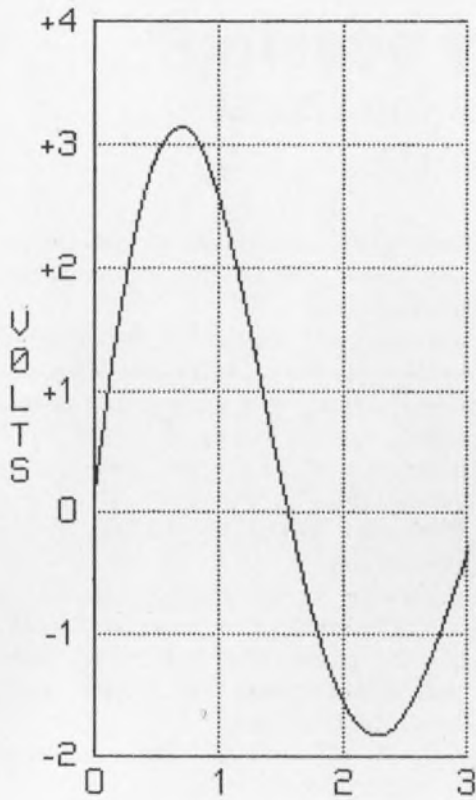

CLEVITE 4800

ABCDEFGHIJ
KLMNOPQRST
UVWXYZ
1234567890

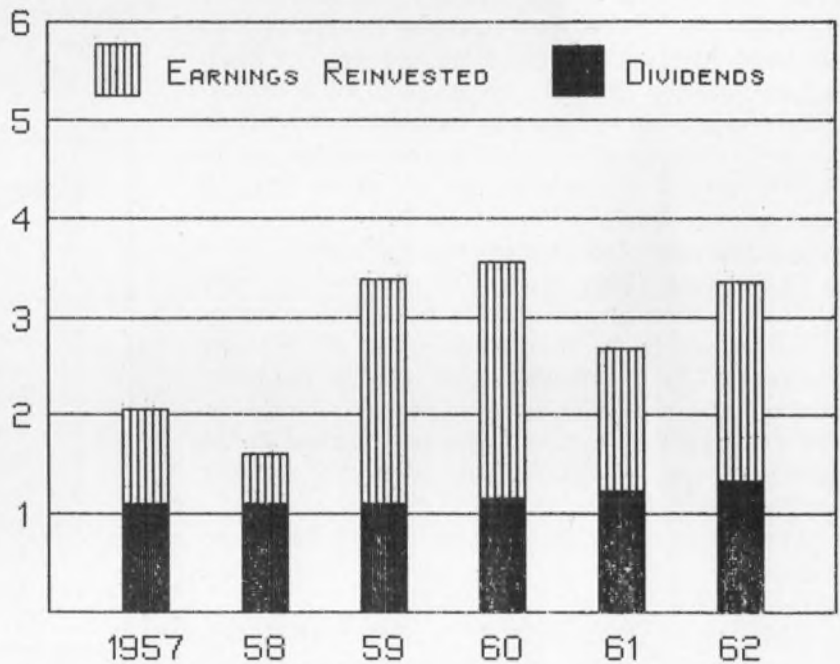

ABCDEFGHIJKLMNØPQRS
TUVWXYZ 1234567890
.,:;%()[]+~*/?='><\$#^"'''x

THESE CHARACTERS ARE NØMINALLY 10 UNITS HIGH BY 7 UNITS WIDE. SOME CHARACTERS ARE 1 UNIT WIDE AND ØTHERS ARE 9 UNITS WIDE.

abcdefghijklmnopqrstuvwxyz
1234567890
.,:;%()[]+~*/?='><\$#^"'''x

THESE CHARACTERS ARE NØMINALLY 10 UNITS HIGH BY 6 UNITS WIDE. THE HEIGHTS VARY FROM 6 TO 14 UNITS. THE WIDTHS VARY FROM 1 TO 9 UNITS.

ABCDEFGHIJKLMNØPQRSTUWVXY
1234567890
.,:;%()[]+~*/?=' \$&^"'''x

THESE CHARACTERS ARE NØMINALLY 6 UNITS HIGH BY 5 UNITS WIDE. THE WIDTHS VARY FROM 1 TO 7 UNITS.

Looking for a summer study session?

Design engineers and engineering managers can choose from over 200 short-term courses across the U.S.

Richard Turmail, Management & Careers Editor

Are you planning to do a little "short-term" studying this summer?

If so, this ELECTRONIC DESIGN guide to summer engineering courses, workshops and seminars will be helpful. The listing contains over 200 short-term (less than one month) courses that will be offered to design engineers and engineering managers in 22 states, the District of Columbia and Canada in June, July and August.

The courses are broken down into 12 categories (see box).

To help you determine what courses are available in your area of the country, the number or numbers that correspond to category numbers in the box have been placed at the end of each school address listing. (Example: Ohio State-Engineering Short Courses, Ohio State University, 2070 Neil Ave., Columbus, Ohio 43210 (1, 3, 6, 10), which means that the school is offering courses in Applied Mathematics, Communications, Infrared and Optics, and Systems.)

The schools listed may offer a wider category of courses than are designated here. The category numbers apply to this guide only. If you are interested in information on several summer courses at a school or schools, you may circle the Information Retrieval Number on the card in the back of the book that corresponds to the number on pages 120-121.

The courses are also listed by alphabetized categories. Dates of the courses are listed chronologically within each category.

The cost of most courses is given. However,

you should check with the schools to determine whether or not these prices include housing, meals and other expenses.

The three management institutes listed offer courses at the following fees: American Management Association (AMA), for each 1-day meeting: members \$55, non-members \$65; for each 2-day meeting, \$110 and \$135; for each 3-day meeting, \$165 and \$190.

Industrial Education Institute (I.E.I.), 1-day seminar, \$65 per person.

Management Center of Cambridge (MCC), 1 to 5 participants, \$70 each; 6 or more, \$65 each.

This listing is the result of a nationwide survey of more than 250 engineering colleges, universities and other institutions.

For a reprint of this course listing, circle No. 255 on the Information Retrieval Card.

Categories:

1	Applied Mathematics	p. 121
2	Automatic Controls	p. 122
3	Communications	p. 122
4	Computers, Computer-Aided Design	p. 122
5	Engineering Management	p. 123
6	Infrared & Optics	p. 124
7	Integrated Circuits	p. 124
8	Reliability	p. 124
9	Semiconductors	p. 124
10	Systems	p. 125
11	Technical Editing, Writing, Etc.	p. 125
12	Miscellaneous	p. 125

Where to write

(Or circle indicated numbers on the Information Retrieval Card for information.)

AMA—American Management Association, 270
Course Register, 135 W. 50th St., New York,
N.Y. 10020 (5)

Arizona—Electrical Engineering Department, 271
University of Arizona, Tucson, Ariz. 85721 (7)

Automation Industries—Boulder, Colo. (6) 272

Cal Tech—Management Development Section, 273

Industrial Relations Center, California Institute of Technology, Pasadena, Calif. 91109 (5)

C-E-I-R, Inc.—Institute for Advanced Technology, 274
5272 River Road, Washington, D.C. 20016
(2, 10)

Colorado—College of Engineering, University of 275
Colorado, Boulder, Col. 80302 (3)

Connecticut—Box U-56, University of Connecticut, 276
Storrs, Conn. 06268 (5, 8)

Cornell—Director of Continuing Education, College of Engineering, Cornell University, 277
Carpenter Hall, Ithaca, N.Y. 14850 (1, 4, 5,
6, 10, 11)

Dartmouth —Thayer School of Engineering, Dartmouth College, Hanover, N.H. 03755 (1, 5)	321	Penn State —Seminars for Engineers, Pennsylvania State University, J. Orvis Keller Building, University Park, Pa. 16802 (5)	290
Geo. Washington —Short Course Program, Electrical Engineering Department, George Washington University, Washington, D.C. 20006 (3, 4, 8, 10, 12)	278	Purdue —Division of Conferences and Continuation Services, Purdue University, 116 Memorial Center, Lafayette, Ind. 47907 (1, 3, 5, 8, 10)	291
Georgia Tech —Department of Continuing Education, Georgia Institute of Technology, Atlanta, Ga. 30332 (5, 12)	279	RCA —Institute for Professional Development, RCA Institutes, Inc., P. O. Box 962, Clark, N.J. 07066 (3, 4, 6, 7, 10)	292
IEI —Industrial Education Institute, 221 Columbus Avenue, Boston, Mass. 02116 (5)	280	Santa Clara School of Engineering , Department of Electrical Engineering, The University of Santa Clara, Santa Clara, Calif. 95053 (4)	293
Iowa State —Electrical Engineering Building, Iowa State University, Ames, Iowa 50010 (4, 12)	281	Texas —Engineering Institutes, College of Engineering, Division of Extension, University of Texas, Austin, Tex. 78712 (5, 7, 9, 10)	294
MCC —Management Center of Cambridge, P.O. Box 185, Harvard Square, Cambridge, Mass. 02138 (5)	282	Texas A&M —Department of Electrical Engineering, Texas A&M University, College Station, Tex. 77843 (10)	295
Michigan —Engineering Summer Conferences, Chrysler Center, University of Michigan, North Campus, Ann Arbor, Mich. 48105 (1, 3, 4, 5, 6, 7, 9, 11, 12)	283	UCLA —Program Promotion, University of California Extension, 6532 Boelter Hall, Los Angeles, Calif. 90024 (1, 2, 3, 4, 5, 6, 8, 9, 10, 12)	296
Mississippi State —EES, P. O. Box M, Mississippi State University, State College, Miss. 39762 (2)	284	University College —Continuing Engineering Studies University College, 610 E. Fayette St., Syracuse, N.Y. 13202 (1, 3, 5, 6, 10)	297
M.I.T. —Summer Session, Room E19-356, Massachusetts Institute of Technology, Cambridge, Mass. 02139 (1, 3, 4, 5, 10)	285	USC —Noncredit Programs, University of Southern California, University College, University Park, Los Angeles, Calif. 90007 (1, 3, 4, 6, 10)	298
N.C.U.I.H. —National Center of Urban & Industrial Health—Cincinnati, Ohio (1)	286	Utah —Summer School, University of Utah, Salt Lake City, Utah 84112 (1)	299
Nevada —Director, Continuing Education, University of Nevada, Reno, Nev. 89507 (6, 11, 12)	287	Washington —Institute for Continuing Education in Engineering and Applied Science, Washington University, St. Louis, Mo. 63130 (2, 5, 8)	267
New Hampshire —Department of Electrical Engineering, Durham, N. H. (2)	288	Washington —Office of Short Courses and Conferences, University of Washington, 336 Lewis Hall, Seattle, Wash. 98105 (8)	268
Ohio State —Engineering Short Courses, Ohio State University, 2070 Neil Ave., Columbus Ohio 43210 (1, 3, 6, 10)	289	Wisconsin —Institute Director, University of Wisconsin, 725 Extension Building, 432 N. Lake St., Madison, Wis. 53706 (1, 4, 12)	269
OPCS —Oyer Professional Computer Service, Inc., 369 Lexington Ave., New York, N.Y. 10017 (4)	322		

Applied Mathematics

Date	Course (and cost)	Location	Date	Course (and cost)	Location
June 2-6	Applied Statistics for Engineers (\$175)	Texas, Austin	June 16-27	Recent Advances in Engineering Mathematics (\$375)	UCLA, Los Angeles
June 4-6	Introduction to the Design of Experiments (\$250)	C-E-I-R, Inc. Wash., D.C.	June 18-20	Topics in Mathematic Programming and Optimization (\$150)	Cornell, Ithaca, N.Y.
June 9-11	Data Analysis (\$250)	C-E-I-R, Inc. Wash., D.C.	June 21-23	Quality Control by Statistical Methods (\$300)	Michigan, Ann Arbor
June 9-13	Environmental Statistics—Sample Size Determination (no fee)	N.C.U.I.H., Cincinnati	June 30-July 11	Decision Analysis for Engineers and Scientists (\$650)	Dartmouth, Hanover, N.H.
June 9-19	Statistical Methods and Advanced Quality Control (\$300)	Purdue, Lafayette, Ind.	July 7-18	Statistical Method in Modern Experimentation (\$450)	M.I.T., Cambridge
June 16-20	Introduction to Elec-Magnetic Theory (\$200)	Wisconsin, Madison	July 7-18	Physiological Systems Analysis for Engineers (\$350)	Michigan, Ann Arbor
June 16-27	Foundations of Information Systems Engineering (\$400)	Michigan, Ann Arbor	July 7-18	Applied Probability and Statistics (\$375)	UCLA, Los Angeles
June 16-27	Numerical Analysis (\$400)	Michigan	July 8-10	Statistical Experimental Design for Engineering (\$120)	University College, Syracuse
June 16-27	Applications of Modern Mathematics (\$375)	UCLA, Los Angeles			

Date	Course (and cost)	Location
July 12	Numerical Methods Using Fortran	Utah, Salt Lake City
July 14-18	Numerical Analysis and Computer Methods in Engineering Systems (\$275)	UCLA, Los Angeles
July 21-Aug. 1	Matrix Error Analysis (\$375)	UCLA, Los Angeles
July 28-Aug. 1	Engineering Application of Modern Operational Mathematics (\$200)	Ohio State, Columbus
July 28-Aug. 8	Mathematical Biosciences (\$375)	USC, Los Angeles
Aug. 18-29	Applied Stochastic Processes (\$375)	UCLA, Los Angeles

Automatic Controls

June 9-11	Nonlinear Programming (\$250)	C-E-I-R, Inc., Wash., D.C.
June 16-21	Digital Control System Design (\$225)	New Hampshire, Durham
July 14-18	Sampled-Data Short Course (\$150)	Mississippi St., State College
July 17-18	Guidance and Control of Missiles Aircraft, Helicopters and Space Vehicles (\$375)	UCLA, Los Angeles
July 21-25	Guidance and Control of Tactical Missiles (\$275)	UCLA, Los Angeles
Aug. 11-15	Introduction to Process Computer Control (\$275)	UCLA, Los Angeles
Aug. 11-22	Optimal Control: Theory and Applications (\$375)	UCLA, Los Angeles
Aug. 18-20	Digital Controls (\$295)	RCA, Palo Alto, Calif.
Aug. 18-23	Current Trends in Automatic Control Theory	Washington, St. Louis

Communications

June 9-11	IEEE International Conference on Communications (\$18-M, \$23-NM)	Colorado, Boulder
June 9-13	Digital Communications (\$390)	RCA, Minneapolis
June 16-20	Communications Systems (\$275)	George Washington, Wash., D.C.
June 23-July 3	Speech Communication (\$450)	M.I.T., Cambridge
July 7-11	Application of Stripline Components to Microwave Signal Processing (\$200)	University College, Syracuse
July 14-18	Digital Communications (\$390)	RCA, Palo Alto, Calif.
July 14-25	Communications Systems (\$375)	UCLA, Los Angeles
July 14-25	Introduction to Statistical and Digital Communication Theory (\$275)	Ohio State, Columbus
July 14-25	Communication Systems: Theory and Applications (\$375)	UCLA, Los Angeles
July 21-25	Digital Communications Systems (\$225)	Michigan, Ann Arbor
July 21-25	Application of State-Variable Techniques to Communications Systems (\$300)	M.I.T., Cambridge

Date	Course (and cost)	Location
July 21-25	Digital Communications (\$390)	RCA, Los Angeles
Aug. 4-15	Digital Communications (\$375)	USC, Los Angeles
Aug. 25-29	Digital Communications (\$390)	RCA, Wash., D.C.

Computers, Computer-Aided Design

June 2-6	Logic Design (\$390)	RCA, Wash., D.C.
June 9-10	Computer Programming for EES; Problem Solving for EES Using Time Shared Computers (\$100 IEEE members; \$110 non-members)	OPCS Chicago
June 9-20	Computer Graphics for Designers (\$450)	Michigan, Ann Arbor
June 9-20	Computer Models and Simulation Techniques for Power System Engineering (\$300)	Wisconsin, Madison
June 16-20	Computer-Aided Circuit Design (\$300)	George Washington, Wash., D.C.
June 16-27	Computer and Program Organization (\$375)	Michigan, Ann Arbor
June 23-27	Automatic Text and Picture Processing (\$200)	Cornell, Ithaca, N.Y.
June 23-27	Computer Methods in Structural Dynamics (\$275)	USC, Los Angeles
June 23-July 3	Advances in Digital Computer Systems Design (\$375)	UCLA, Los Angeles
July 6-Aug. 1	Computer Fundamentals and Data Transmission (\$800)	Iowa State, Ames
July 7-11	Matrix Computer Methods in Engineering Systems (\$275)	UCLA, Los Angeles
July 7-18	Hybrid Computation (\$375)	UCLA, Los Angeles
July 14-18	Logic Design (\$390)	RCA, Boston
July 14-25	Computer Systems Analysis Methodology (\$375)	UCLA, Los Angeles
July 21-25	Computer Oriented Techniques for Pattern Recognition (\$275)	USC, Los Angeles
July 21-25	Introduction to Digital Logic (\$200)	Wisconsin, Madison
July 21-Aug. 1	Modern Computer Systems (\$375)	UCLA, Los Angeles
July 21-Aug. 8	Computer Methods for Power System Analysis (\$400)	Santa Clara, Santa Clara
July 27-Aug. 1	Applications of Computers to Automated Design (\$225)	Michigan, Ann Arbor
July 28-Aug. 1	Computer-Aided Mathematical Modeling (\$250)	University College, Syracuse
July 28-Aug. 1	Fortran Programming & Engineering Applications of Numerical Methods (\$225)	Ohio State, Columbus
July 28-Aug. 1	Computers and Modern Process Control (\$150)	Purdue, Lafayette
July 28-Aug. 8	Computer Applications in Naval Architecture and Ocean Engineering (\$450)	M.I.T., Cambridge
Aug. 4-8	Logic Design (\$390)	RCA, New York

Date	Course (and cost)	Location
Aug. 4-15	Digital Simulation of Avionic Systems (\$375)	UCLA, Los Angeles
Aug. 11-15	Question Answering and Theorem Proving by Computer (\$275)	UCLA, Los Angeles
Aug. 18-29	Computer Methods of Network Analysis (\$375)	UCLA, Los Angeles
Aug. 18-29	Computer Applications with Linear/Nonlinear Programming Optimization Procedures (\$375)	UCLA, Los Angeles

Engineering Management

June 2-4	Data Processing Management	AMA, Los Angeles
June 2-6	Management Dynamics and Effective Decision Making (\$175)	Georgia Tech., Atlanta
June 4	Information Retrieval Systems (\$70)	MCC, Cleveland
June 4-6	Data Processing Management	AMA, Los Angeles
June 5	Information Retrieval Systems (\$70)	MCC, Chicago
June 6	Information Retrieval Systems (\$70)	MCC, Detroit
June 9	Planning and Administering Executive's Development \$300)	Cal Tech., Pasadena, Calif.
June 9	Managing Your Drafting and Design Function More Efficiently	I.E.I. Atlanta
June 9-13	Management for Engineers (\$175)	Georgia Tech.
June 10	Managing Your Drafting and Design Function More Efficiently	I.E.I. Houston
June 11	Managing Your Drafting and Design Function More Efficiently	I.E.I. Dallas
June 15-20	The Twelfth Quality Control Management Institute (\$350)	Connecticut, Storrs
June 15-20	R&D Management Seminar	Pennsylvania State, University
June 16	Managerial Aspects of Supervision (\$300)	Cal Tech., Pasadena
June 16	Coordinating Engineering & Sales Relationships	MCC, Seattle
June 16-18	Data Automation	AMA, Chicago
June 16-18	Documentation	AMA, Chicago
June 16-27	Advanced Topics in Systems Programming (\$375)	Michigan, Ann Arbor
June 16-27	Computer and Program Organization (\$375)	Michigan, Ann Arbor
June 17	Coordinating Engineering and Sales Relationships	MCC, Portland, Ore.
June 17-27	Industrial Dynamics (\$700)	M.I.T., Cambridge
June 18	Coordinating Engineering and Sales Relationships	MCC, San Francisco

Date	Course (and cost)	Location
June 18-20	Computer Programming	AMA, Chicago
June 18-20	Simulation	AMA, Chicago
June 18-20	Real Time	AMA, Houston
June 19	Coordinating Engineering and Sales Relationships	MCC, Los Angeles
June 20	Coordinating Engineering and Sales Relationships	MCC, San Diego
June 23-25	Data Communication Systems	AMA, New York
June 23-28	Management Seminar in Reliability Engineering Operations (\$425)	UCLA, Los Angeles
June 23- July 18	Modern Engineering Concepts for Technical Managers (\$1600)	Cornell, Ithaca, N.Y.
June 23- July 3	Mathematical Programming (\$550)	M.I.T., Cambridge
July 7-9	Data Processing Management	AMA, Chicago
July 7-11	Management of Engineering, Scientific and Technical Personnel (\$375)	Nevada, Reno
July 7-18	Frontiers in Investment Management and Analysis (\$800)	M.I.T., Cambridge
July 7-25	Engineering Management	Nevada, Reno
July 14-16	Data Processing Management	AMA, New York
July 14-18	Management of the Quality Function (no fee)	Washington, St. Louis
July 14-18	Selection of Development Projects to Yield Optimum Returns (\$200)	University College, Syracuse
July 14-18	Managing Technical Personnel (\$150)	Cornell, Ithaca, N.Y.
July 14-18	Material Handling Planning and Management Short Course (\$300)	Purdue, Lafayette, Ind.
July 14-25	Management Science in Marketing (\$700)	M.I.T., Cambridge
July 14-25	Management Applications of Mathematical Programming (\$300)	Georgia Tech., Atlanta
July 16	Estimating and Controlling Engineering Costs	MCC, Toronto
July 16-18	Computer Programming	AMA, New York
July 17	Estimating and Controlling Engineering Costs	MCC, Montreal
July 21-23	Critical Path Method (CPM) (\$120)	University College, Syracuse
July 21- Aug. 1	Models for Financial Management and Long-Range Financial Planning (\$800)	M.I.T., Cambridge
July 28- Aug. 1	Management and Improvement Symposium 1969 (\$200)	Georgia Tech., Atlanta
Aug. 4-6	Data Communication Systems	AMA, New York
Aug. 4-6	Data Processing Management	AMA, New York

Date	Course (and cost)	Location
Aug. 4-6	Data Processing Management	AMA, Chicago
Aug. 4-9	Engineering Design (\$350)	Dartmouth, Hanover, N.H.
Aug. 4-15	Foundation and Tools for Operations Research and Management Sciences (\$400)	Michigan, Ann Arbor
Aug. 6-8	Data Automation	AMA, Chicago
Aug. 6-8	Audits and Control	AMA, New York
Aug. 11-13	Interpersonal Relations for Engineering Managers (\$150)	Texas, Austin
Aug. 11-22	Management Information Systems (\$800)	M.I.T., Cambridge
Aug. 18-29	Computer Applications with Linear/Nonlinear Programming Optimization Procedures (\$375)	UCLA, Los Angeles

Infrared and Optics

June 2-6	Fundamentals of Infrared Technology (\$225)	Michigan, Ann Arbor
June 2-6	Electron Microscopy—Theory and Applications in Solid State Science (\$400)	University College, Syracuse
June 9-13	Advanced Infrared Technology (\$225)	Michigan, Ann Arbor
June 9-13	Modern Optics (\$390)	RCA, Dallas
June 16-20	Infrared Radiometry—Instrument Calibrations and Precision Measurements (\$250)	Michigan, Ann Arbor
June 16-20	Applied Optics (\$200)	Wisconsin, Madison
June 16-27	Lens Design (\$375)	UCLA, Los Angeles
June 23-27	Modern Optics (\$390)	RCA, Palm Beach, Fla.
June 23-27	Materials Evaluation: Infrared (\$200)	Automation Industries, Boulder, Colo.
June 23-27	Fundamentals of Electron Beam Technology (\$320)	University College, Syracuse
June 23-27	Lasers—Quantum Mechanics—Holography (\$275)	UCLA, Los Angeles
July 7-11	Industrial Radiography, X-Ray and Gamma Ray (\$190)	Nevada, Reno
July 14-18	Modern Optics (\$390)	RCA, Chicago
July 14-25	Laser Engineering (\$300)	Ohio State, Columbus
July 14-25	Electron and Light Microscopy (\$400)	Cornell, Ithaca, N.Y.
July 21-22	Applications of Infrared and Thermal Techniques in Material Analysis (\$100)	Nevada, Reno
July 21-22	Fundamentals of Applications of Optical Data Processing and Holography (\$350)	Michigan, Ann Arbor
July 28-29	Modern Optics (\$390)	RCA, Rochester, N.Y.

Date	Course (and cost)	Location
July 28-Aug. 1	Recognition of Two Dimensional Images and Image Processing (\$275)	USC, Los Angeles
Aug. 11-15	Modern Optics (\$390)	RCA, Wash., D.C.
Aug. 11-15	Applications of Optical Methods to Microwave Problems (\$175)	Ohio State, Columbus
Aug. 11-22	Image Processing (\$375)	UCLA
Aug. 25-29	Modern Optics (\$390)	RCA, Los Angeles

Integrated Circuits

June 2-4	Integrated Circuits (\$295)	RCA, Palo Alto, Calif.
June 9-11	Advanced Device and Circuit Modeling (\$180)	Michigan, Ann Arbor
June 9-11	Integrated Circuits (\$295)	RCA, San Diego, Calif.
June 9-13	Integrated Circuits (\$225)	Michigan
July 7-18	The Third Annual Integrated Circuits Summer Institute of Fabrication and Design	Arizona, Tucson
July 14-16	Integrated Circuits (\$295)	RCA, Wash., D.C.
July 28-Aug. 8	The Third Annual Integrated Circuits Summer Institute of Fabrication and Design	Arizona, Tucson
Aug. 4-6	Integrated Circuits (\$295)	RCA, Chicago
Aug. 11-15	Integrated Circuits (\$175)	Texas, Austin
Aug. 25-27	Integrated Circuits (\$295)	RCA, Boston

Reliability

June 1-13	The Ninth Annual Reliability Institute (\$395)	Connecticut, Storrs
June 9-13	Principles of Reliability for Engineers (\$160)	Purdue, Lafayette
June 9-13	Reliability and Failure Analysis (\$375)	George Washington, Wash., D.C.
June 16-27	Systems Safety Analysis (\$350)	Washington, Seattle
June 23-28	Management Seminar in Reliability Engineering (\$425)	UCLA, Los Angeles
July 7-18	Reliability and Maintainability Workshop (\$295)	Washington, St. Louis
July 7-18	Design by Reliability (\$375)	UCLA

Semiconductors

June 2-6	Semiconductor Circuits (\$225)	Michigan, Ann Arbor
July 14-16	Introduction to Solid State Electronic Devices (\$125)	Texas, Austin
July 21-Aug. 1	Radiation Effects on Semiconductors (\$375)	UCLA, Los Angeles
July 28-Aug. 1	Solid State Electronic Devices (\$175)	Texas, Austin

Date	Course (and cost)	Location
Aug. 4-15	Microwave Solid State Electronics (\$350)	Michigan, Ann Arbor
Systems		
June 2-4	Applied Modeling of Engineering Systems (\$150)	Texas, Austin
June 2-6	Pulse Modulation Telemetry Systems (\$200)	Purdue, Lafayette
June 2-6	Digital Systems Engineering (\$390)	RCA, Boston
June 2-13	Advanced APT Programing (\$950)	C-E-I-R., Inc., Wash., D.C.
June 2-20	Short Course Computational Methods for Power Systems Analysis (\$550)	Purdue, Lafayette
June 9-13	Systems Effectiveness (\$275)	George Washington, Wash., D.C.
June 9-20	System Identification (\$375)	USC, Los Angeles
June 16-20	Modern Digital Systems Design (\$150)	Texas A&M, College Station
June 16-27	Polymer Systems (\$350)	Cornell, Ithaca, N.Y.
June 16-27	Large Scale Systems Techniques (\$375)	UCLA, Los Angeles
June 22-28	Management Seminar in System Reliability & Engineering Operation (\$425)	UCLA, Los Angeles
June 23-27	Automatic Text and Picture Processing (\$200)	Cornell, Ithaca, N.Y.
July 7-11	Matrix-Computer Methods in Engineering Systems (\$275)	UCLA, Los Angeles
July 7-11	Digital Systems Engineering (\$390)	RCA, Rochester, N.Y.
July 7-18	Introduction to Fundamental Analytical Methods in Systems Theory (\$375)	UCLA, Los Angeles
July 7-18	Queueing Systems—Theory and Applications (\$375)	UCLA, Los Angeles
July 7-18	Introduction to Fundamental Analytical Methods in Engineering Systems (\$375)	UCLA, Los Angeles
July 14-18	Numerical Analysis and Digital Computer Methods in Engineering Systems (\$275)	UCLA, Los Angeles
July 14-18	Introduction to the Theory of Adaptive, Learning and Pattern Recognition Systems (\$275)	UCLA, Los Angeles
July 14-18	Communication Systems (\$375)	UCLA, Los Angeles
July 21-25	Current Applications of Adaptive Learning, and Pattern Recognitions Systems (\$275)	UCLA, Los Angeles
July 21-25	Material Flow Systems Short Course (\$300)	Purdue, Lafayette
July 21-Aug. 1	Principles of Imaging Radar (\$350)	Michigan, Ann Arbor
Aug. 4-8	Mathematical Modeling of Dynamic Systems (\$200)	Ohio State, Columbus
Aug. 4-8	Strapdown Inertial Navigation and Guidance (\$275)	UCLA, Los Angeles
Aug. 4-15	Space Navigations and Guidance (\$375)	UCLA, Los Angeles

Date	Course (and cost)	Location
Aug. 4-15	Development of Real-Time Computer Systems (\$375)	UCLA, Los Angeles
Aug. 4-29	Digital Systems (\$1000)	M.I.T., Cambridge
Aug. 15-29	Inter-System Electromagnetic Compatibility (\$275)	University College, Syracuse
Aug. 18-22	Display Systems Engineering (\$275)	UCLA, Los Angeles
Aug. 18-22	Design and Application of Measurement Systems (\$200)	Ohio State, Columbus
Aug. 25-29	Information Processing Short Course (\$200)	Purdue, Lafayette

Technical Editing, Writing, Etc.

June 16-20	Technical Communications (\$200)	Cornell, Ithaca, N.Y.
June 17	Technical Writing for Engineers and Scientists	MCC, Los Angeles
June 18	Technical Writing for Engineers and Scientists	MCC, San Francisco
July 21-25	Technical Writing (\$175)	Nevada, Reno
Aug. 4-8	Written Communication for Engineers Scientists and Technical Writers (\$250)	Michigan, Ann Arbor

Miscellaneous

June 2-6	Medical Engineering (\$300)	George Washington, Wash., D.C.
June 2-6	Fundamentals of Electrochemical Engineering (\$225)	Michigan, Ann Arbor
June 9-12	Applications of Engineering Sciences in Surveillance to the Fields of Police, Military and Industrial Intelligence (\$180)	Nevada, Reno
June 9-13	Dynamic Instrumentation (\$275)	George Washington, Wash., D.C.
June 9-13	Maintainability-Failure Analysis (\$275)	George Washington, Wash., D.C.
June 16-27	Principles of Nondestructive Testing (\$285)	Nevada, Reno
June 16-27	Nuclear Propulsion and the Future of Space Flight (\$375)	UCLA, Los Angeles
June 23-27	Fundamentals of Plasmas (\$200)	Wisconsin, Madison
June 30-July 3	Ultrasonics in Material Analysis and Quality Control (\$180)	Nevada, Reno
July 14-18	Introduction to Kalman Filters with Emphasis on Application to Aided Navigation Systems (\$150)	Iowa State, Ames
July 21-Aug. 1	Modern Circuit Theory (\$375)	UCLA, Los Angeles
Aug. 4-15	Remote Sensing of the Environment (\$375)	UCLA, Los Angeles
Aug. 18-22	Electromagnetic Compatibility (\$175)	Georgia Tech., Atlanta
Aug. 18-22	Display Systems Engineering (\$275)	UCLA, Los Angeles

Our new
high energy
silicon power
transistors.
15 Amperes.
80 to 120 Volts.

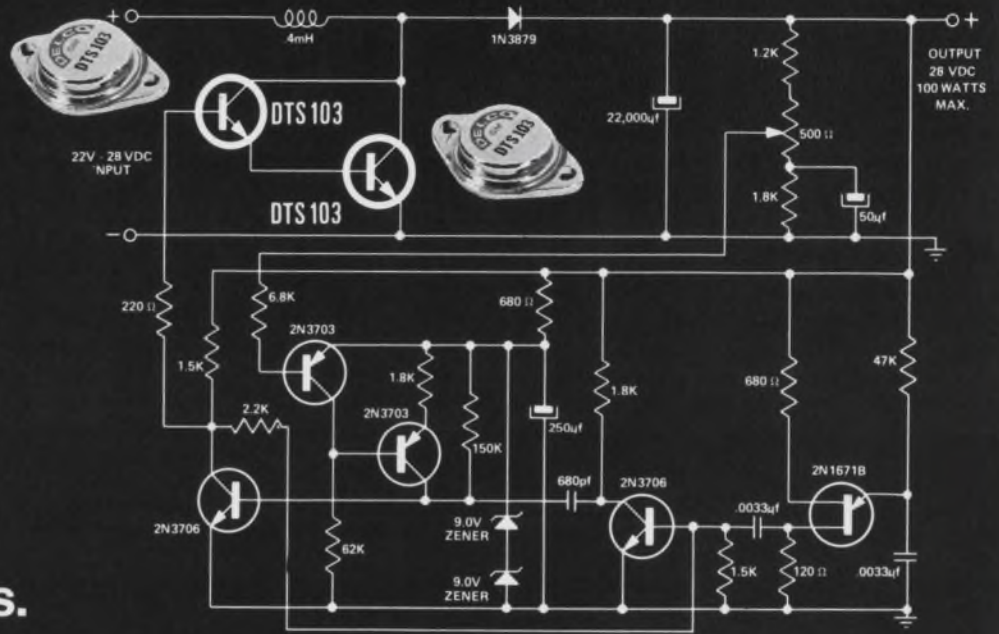

For Switching.

The Delco Radio DTS-100 series. NPN. Triple diffused. Rugged.

All the experience gained from our very high voltage silicon power line has gone into the development of these new transistors.

They were especially designed for the extreme under-the-hood environment of our I.C. voltage regulator. We found these devices ideal for applications requiring high efficiency switching or high power amplification.

The Delco triple sequential diffusion gives the DTS-100 series the high

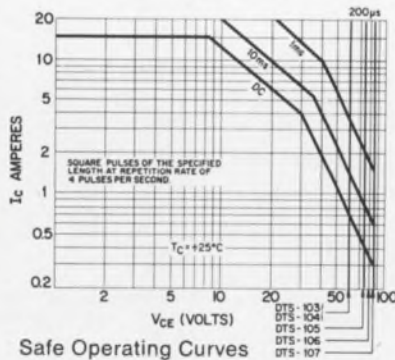

energy reliability that's needed for very tough switching jobs—resistive or inductive. The 28-volt shunt regulator above, for example, is amply handled by the DTS-103 (V_{CEX} of 80 volts). For complete data on this circuit, ask for our application note No. 42.

In the direct coupled audio amplifier above right, the DTS-107 displays the excellent frequency response, gain linearity and transconductance of this family. This circuit is covered in our application note No. 43.

Our solid copper TO-3 package provides maximum thermal capacitance to absorb peak power pulses. Its low thermal resistance ($0.75^{\circ}\text{C}/\text{W}$ Max.) assures the extra reliability you expect from Delco.

Like more information? Just call us or your nearest Delco Radio distributor. All our distributors are stocked to handle your sample orders.

SEMICONDUCTOR DISTRIBUTORS: EAST—BALTIMORE, MD. 21201, Radio Electric Service Co., 5 North Howard St., (301)-539-3835 BINGHAMTON, N.Y. 13902, Federal Electronics, Inc., P. O. Box 1208, (607)-748-8211 CLIFTON, N.J. 07015, Eastern Radio Corporation, 312 Clifton Avenue, (201)-471-6600 NEWTON, MASS. 02195, The Greene Shaw Co., Inc., 341-347 Watertown St., (617)-969-8900 NEW YORK, NEW YORK 10036, Harvey Radio Co., Inc., 2 West 45th St., (212)-582-2590 PHILADELPHIA, PENN. 19114, Almo Electronics, Division of Sterling Electronics, Roosevelt Blvd. at Blue Grass Rd., Northeast Industrial Park, (215)-676-6000 PITTSBURGH, PENN. 15328, RPC Electronics, 620 Alpha Drive, RIDC Park, (412)-782-3770 WOODBURY, L.I., N.Y. 11797, Harvey Radio Company, Inc., 60 Crossways Park West, (516)-921-8700 **SOUTH**—BIRMINGHAM, ALA. 35233, Forbes Distributing Company, Inc., 1416 Fourth Ave., South, (205)-251-4104 MIAMI, FLORIDA 33142, Mountain Electronics, Division of Mountain National Co., 3730 Northwest 36th St., (305)-634-4556 RICHMOND, VA. 23220, Meridian Electronics, Inc., 1001 West Broad Street, (703)-353-6648 WEST PALM BEACH, FLA. 33402, Mountain Electronics, Division of Mountain National Co., 1000 N. Dixie Highway, (305)-833-5701 **MIDWEST**—CINCINNATI, OHIO 45237, United Radio, Inc., 7713 Reinhold Drive, (513)-761-4030 CLEVELAND, OHIO 44125, The W. M. Pattison Supply Co., Industrial Electronics Division, 4550 Willow Parkway, (216)-411-3000 DAYTON, OHIO 45414, F.-J.-R. Ohio, Inc., 5212 North Dixie Dr. (513)-278-9411 INDIANAPOLIS, IND. 46204, Graham Electronics Supply, Inc., 133 S. Pennsylvania St., (317)-634-8486 KALAMAZOO, MICH. 49005, Electronic Supply Corp., P.O. Box 831, (616)-381-4626 KANSAS CITY, MO. 64111, Walters Radio Supply, Inc., 3635 Main Street, (816)-531-7015 MINNEAPOLIS, MINNESOTA 55401, Stark Electronics Supply Co., 112 3rd Ave., North, (612)-332-1325, ROSEMONT, ILL. 60018, F.-J.-R./Midwest, Inc., 9340 William St. (312)-678-8560 SKOKIE,

Great Milestones in Packaging

BEING NUMBER ± 0.00301 IN A "PEOPLE PACKAGING"
SERIES WILLFULLY UNDERTAKEN BY
JONATHAN MANUFACTURING COMPANY



At the Duke's command, a bunch of knights-errant were seeking the one untroubled lass in the domain with nary a problem cluttering her life. Or so the legend goes.



Mounted in typical Early-Medieval fashion, they narrowed the search to a castle where dwelt newly-wed Lady Cordelia, reputed far and wide to be trouble-free. Wearing a smile upon her comely countenance, she prettily satisfied their every inquiry until the quest seemed achieved. Then abruptly she led them to an upstairs closet housing a skeleton, that of her new husband's former rival for her rosy hand. "I try," she said, "to keep my troubles to myself, but every night at bedtime, my spouse compels me to kiss this darned skeleton." Whereupon she wandered away muttering a strangely nostalgic line, "dem bones, dem bones," which later became the basis for a popular camp song.

If you're sheltering a skeleton in the form of a worrisome packaging problem, why not unburden yourself to Jonathan the slide-makers? If you need to rack electronic chassis for accessibility, you may slide it in behalf of service, or quickly-disconnect it for bench repairs. Whatever your requirement, the Jonathan Ultra-Thin full

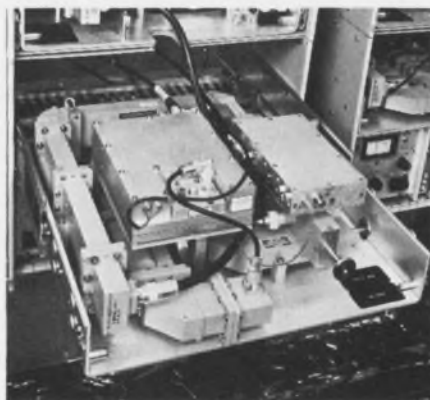

ball-bearing Type 110 Steel Chassis Slides (available in matched pairs beginning at \$6 the set) will most assuredly carry up to 200 lbs., while measuring only $\frac{3}{8}$ " thin. Let Jonathan tuck your problem out of sight!

At Collins Radio Company our little loves are now part of a new independent subsystem design for its MW-109E (i-f heterodyne) and MW-108D (remodulating) series of microwave systems. (see photo) The new Collins design, also incorporated in auxiliary equipment, greatly improves system reliability and simplifies ordering, plant engineering, system expansion, station rearrangements and maintenance procedures.



"KEEP SMILING!"

JONATHAN MANUFACTURING COMPANY

1101 S. ACACIA AVE., FULLERTON, CALIF. 92631 • 1258 TEANECK RD., TEANECK, N.J. 07666

INFORMATION RETRIEVAL NUMBER 55

Certified mix & match



With the Winchester MRAC series you can intermix power, shielded signal and signal circuitry in the same connector, plus polarizing pins. To match your own termination requirements. And our adaptable, easily installed, readily removed contacts are available in crimp, solder, or wire-wrap, to match your production methods.

All certified—hoods, blocks and contacts—to MIL-C-22857.

Which means our MRAC series is not only adaptable and versatile, but highly dependable. And recommended for such applications as computers, shipboard equipment, radar and ground support equipment.

Let us send you specifications and details. Including how our removable contacts offer substantial savings in time and labor. And, great flexibility in your choice of circuitry. Write to: Winchester Electronics, Main St. and Hillside Ave., Oakville, Conn. 06779.

WINCHESTER ELECTRONICS 
LITTON INDUSTRIES

Two VVCs are often better than one—if they're back-to-back

A fundamental disadvantage of the voltage variable capacitor (VVC) is that the drive voltage used to change the capacity of the diode normally appears in whatever circuit configuration is being used. This normally presents quite a problem when a combination of both high frequency and high drive voltages are needed. In some instances elaborate precautions must be taken, especially when working with low-level signals, to eliminate the undesired voltage variation.

If one could utilize two VVCs in a back-to-back configuration, so that the sum of the voltage drop across these diodes would always equal zero, the problem would be eliminated. Figures 1 through 3 illustrate several examples using this technique.

Figure 1 illustrates a solid-state replacement for the electromechanically vibrating capacitor in an electrometer. As in the mechanically driven, or electromechanically driven capacitor electrometer, a variation in capacity from point "A" to the common line modulates the nominally dc source voltage by causing a voltage drop across the large resistor, R_s . The constant frequency ac signal is coupled into a low-noise tuned amplifier and processed in the usual manner.

Diodes $D1$ and $D2$ are the voltage variable capacitors. They are reverse biased to the de-

sired linear portion of their curve by the bias battery and resistors R_b . These resistors can be matched to the desired degree of precision. An intentional mismatch can be utilized to compensate for small nonlinearities in the diodes.

The desired drive signal is transformer coupled to both diodes. Capacitors C_2 and C_3 are matched, and present a capacitance that is small compared with that of the diodes. Capacitor C_1 is large and serves only to isolate the dc signal from the source. Since the same bias and drive voltage is impressed across both diodes, but in opposite polarity, the summation of the voltage drops from the bottom of C_1 to the common point is equal to zero. Point "A" then sees only a capacitance change, and no component of either the bias or drive voltage.

Figure 2 is a frequency modulator, using essentially the same principle as the circuit of Fig. 1. The oscillator is a modified Colpitts type, using the common-base configuration. Its frequency is determined by the inductor in the collector, plus the combination of C_x and the capacitance from point "A" to common. The frequency delivered to the power amplifier is determined by the amplitude of the modulation voltage. In this instance, the bias voltage may be used to control the center

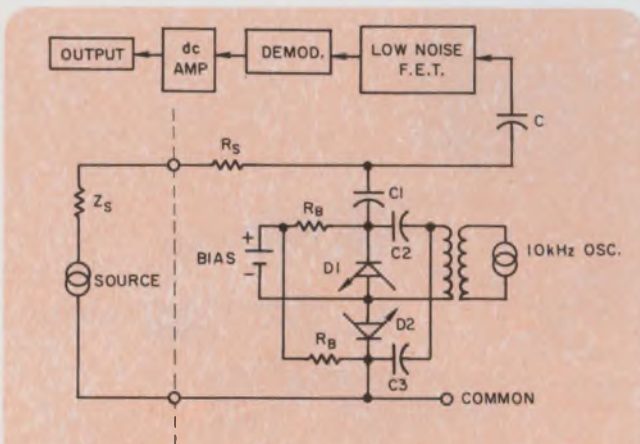

1. Solid-state "vibrating capacitor" electrometer uses two reverse biased, back-to-back voltage variable capacitors.

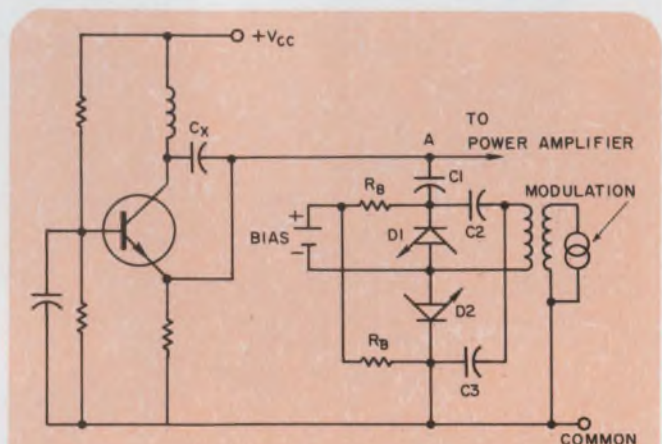

2. Frequency modulator uses the back-to-back VVC configuration to control a modified Colpitts oscillator.

Pick the
BEST IC
 for the job

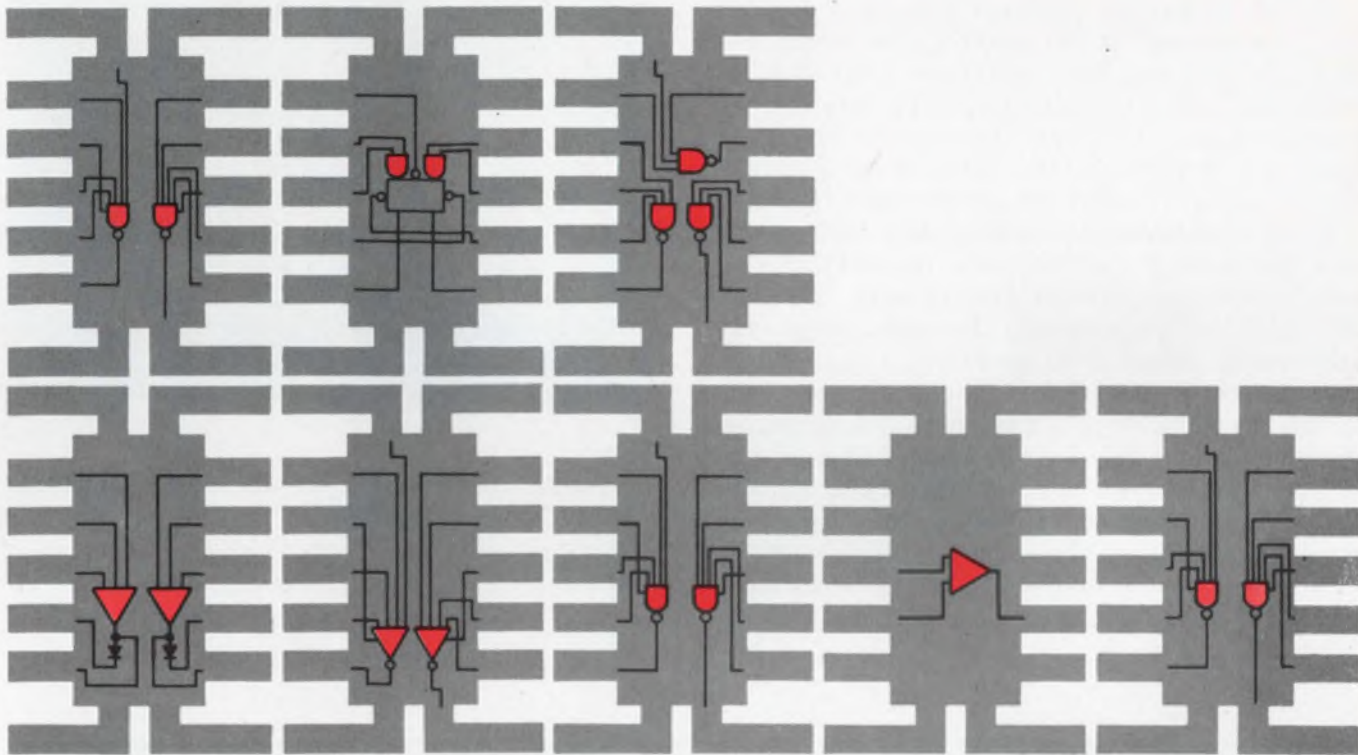

Best line of defense against radiation environment

Radiation offers the circuit designer two orders of magnitude improvement in hardening levels over conventional PN junction devices. This is accomplished by dielectric isolation, thin-film resistors over oxide, small-device geometries, shallow diffusions and other special design techniques. So when you pick the Best IC for a radiation environment application, doesn't it make sense to come to the leader in hardened circuit technology?

Our line of defense consists of 930 series DTL, a level shifter, a line driver and a linear 709. These are not prototype circuits. We can deliver Dual 4 Input; Dual 4 Input Power or Triple 3 Input Gates; Clocked Flip-Flop; Dual 4 Input Buffer; Dual Level Shifter; Dual Line Driver and 709 Operational Amplifiers. With the exception of the Dual Level Shifter and Dual Line Driver, all are plug-in replacements for their non-hardened 930 Series and 709 counterparts. The Hardened Dual Line Driver is a pin-for-pin replacement for Radiation's standard RD 209 Line Driver.

Want more information? Contact your nearest Radiation Sales Representative. He'll give you complete details and help you pick the Best IC for the Job.

WE MAKE THE **BEST IC** FOR THE JOB



RADIATION
 INCORPORATED

SUBSIDIARY OF HARRIS-INTERTYPE CORPORATION
 MICROELECTRONICS DIVISION

RADIATION SALES OFFICES: P. O. Box 476, Lexington, Mass. 02173, (617) 862-1055 • 600 Old Country Road, Garden City, N.Y. 11530, (516) 747-3730 • 2600 Virginia Ave. N.W., Washington, D.C. 20037, (202) 337-4914 • 6151 W. Century Blvd., Los Angeles, Calif. 90045, (213) 870-5432 • Saratoga, Calif., (408) 253-5058 • P. O. Box 37, Melbourne, Fla. 32901, (305) 727-5430 • International Sales: Marketing Department, P. O. Box 37, Melbourne, Fla. 32901, (305) 727-5430

INFORMATION RETRIEVAL NUMBER 57

frequency of the oscillator—if the device is employed in something like an fm transmitter configuration.

Figure 3 shows a nonlinear frequency doubler that can be used in the ultrahigh frequency region. In this case, four diodes are connected, as indicated, with no bias battery. The device operation is similar to that of the electrometer configuration of Fig. 1, with resistor R_s and capacitors C_1 , C_2 and C_3 performing the same function.

In this configuration, during each half of the incoming cycle one of the diodes in each half section of the configuration (for example, D_1 and D_4) is forward biased, and the other two diodes are reverse biased. This results in a capacitance change from maximum to minimum for each half of the incoming cycle. The resultant output is therefore double the drive frequency. Again, the source voltage does not appear in the circuit. Point "A" to common sees only the change in capacitance, and not the change in drive voltage. This device should find use in the 1 to 10 GHz region.

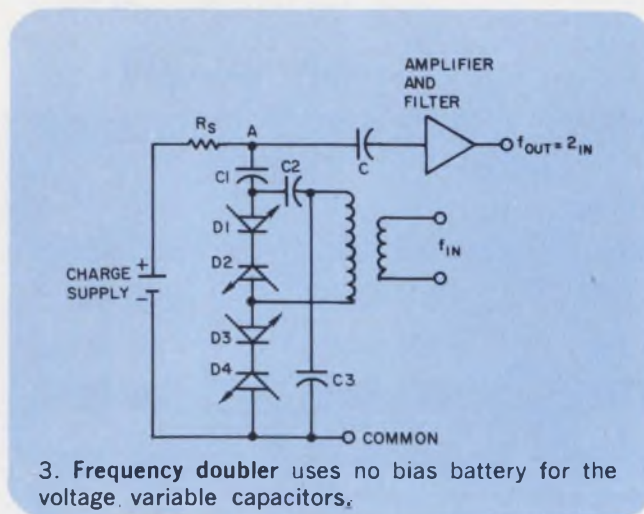

3. Frequency doubler uses no bias battery for the voltage variable capacitors.

It should be noted that the efficiency of all these circuits is extremely high.

William W. Gile, Staff Engineer, California Institute of Technology, Pasadena, Calif.

VOTE FOR 311

Neutralize your differential amplifier with diodes

A common method of extending the bandwidth and increasing the speed of a differential amplifier is to connect a trimmer capacitor from each collector to the opposite transistor's base. By adjusting the trimmers, the collector-to-base capacitance of the transistors may be balanced out, thereby increasing the speed. This method, though, suffers from drawbacks: specifically, the cost and availability of the required trimmers.

A practical alternative is to substitute a common laboratory item for the trimmers—namely, the 1N914 or other low-capacitance diode. When connected as shown, the diodes' reverse capacitance provides the necessary neutralization.

In some cases the diodes themselves may be more costly than the transistors (epoxy types, for example). In these cases, it is recommended that two additional transistors of the same type be purchased. The collector-to-base junction of these can then be used in place of the diodes. These transistors will actually be closer to complete neutralizers than the diodes.

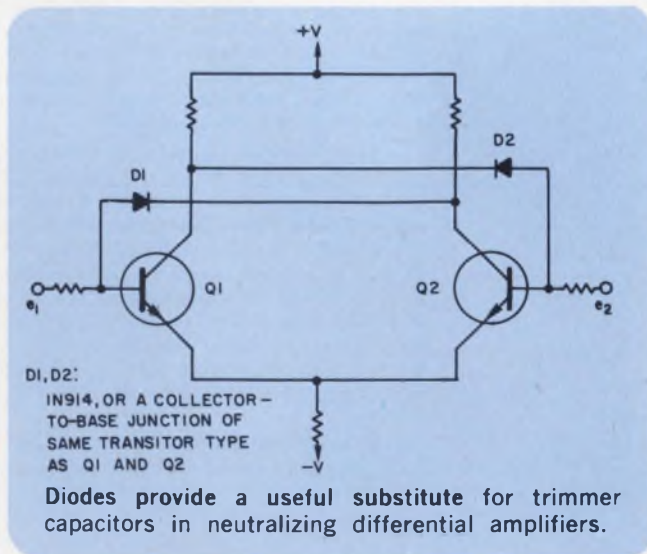

Diodes provide a useful substitute for trimmer capacitors in neutralizing differential amplifiers.

This technique is also suitable for use in linear IC amplifiers, many of which use a differential amplifier in their front end.

William E. Peterson, Associate Engineer, ITL Research Corp., Northridge, Calif.

VOTE FOR 312

Flexmax: custom- designed for designers

FLEXMAX*, the custom-designed, multi-layer circuit simplifies the designer's job. Leads are brought out in the most convenient manner and unscrambled within the circuit matrix. Conductors are not blocked in a single layer; conductors bypass other interlayer connections to achieve high density. This unscrambling effect means complete conductor freedom, fewer layers, and increased reliability.

FLEXMAX terminations can be made on either side of the circuit. Many circuits can be combined into one allowing the use of mass soldering techniques.

FLEXMAX circuits utilize proven plated-through-hole techniques. This means greater circuit density, the elimination of eyelets and tubelets, significant weight and space savings ... and an extremely reliable interface.

FLEXMAX multi-layer construction facilitates serviceability by bringing the termination pads right to the surface for easy component access, installs quickly and easily, and simplifies maintenance.

For more information, contact Sanders Associates, Inc., Flexprint Division, Grenier Field, Manchester, New Hampshire 03103. Telephone: (603) 669-4615 EXT. 201



Circuit generates linear ramp and short duty cycle pulses

Sawtooth and pulse generators are important building blocks in many electronic systems. For example, pulse testing techniques using a short duty cycle are usually employed in transistor parameter testing. To make such tests, positive pulses of approximately 200 μs duration and 15 ms OFF time are often required. Circuit complexity and significant power consumption have usually been the price paid to obtain the desired characteristics.

The simple three-transistor circuit shown provides not only a positive-going pulse of short (2%) duty cycle, but also generates a negative-going ramp voltage of excellent linearity. And it does so while consuming little power.

Transistors Q2 and Q3 in the diagram constitute an emitter-coupled complementary pair, while Q1 is a constant-current source. The value of R_5 is adjusted to give the desired ON time. Final duty-cycle adjustment is accomplished by changing the setting of R_8 .

In the ON state, capacitor C_c discharges to-

ward ground with a time constant

$$t_1 = C_c R_4 R_5 / (R_4 + R_5). \quad (1)$$

When the circuit is reset to the OFF condition, C_c is recharged to its quiescent state with a time constant

$$t_2 = C_c (R_4 + R_6). \quad (2)$$

This time constant must be sufficiently large to allow capacitor C to be completely charged. The voltage across C rises linearly, and a linear ramp voltage is available at the collector of Q1.

Sawtooths as narrow as 1-2 μs have been obtained from the circuit, with the ramp starting accurately from zero voltage, with no step. Output pulse waveforms as short as 1 to 2 μs are possible. Typical waveforms are shown in b.

Uma Shanker Singh, Electronics Engineer, Space Science & Tech. Centre, Trivandrum, India.

This work was performed at the Central Electronics Engineering Research Institute, Pilani (Raj.), India.

VOTE FOR 313

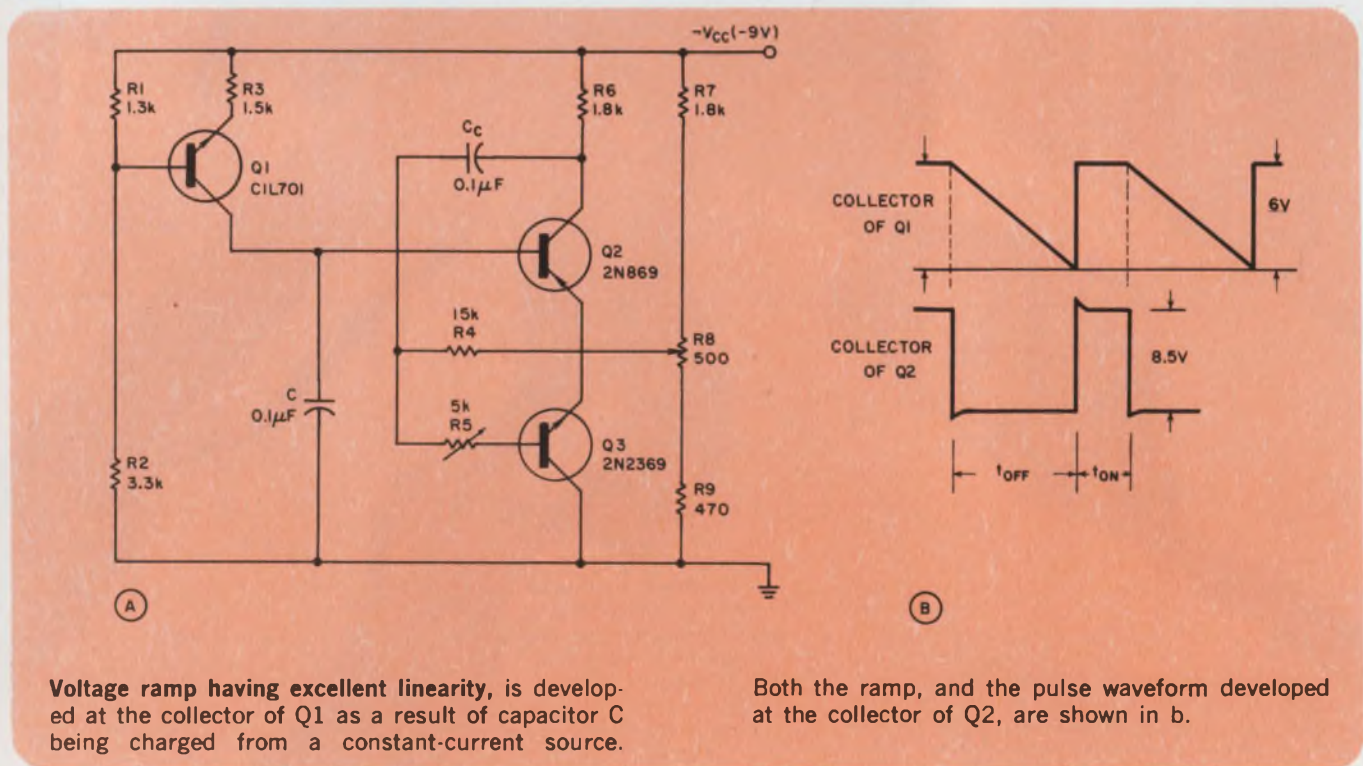

Voltage ramp having excellent linearity, is developed at the collector of Q1 as a result of capacitor C being charged from a constant-current source.

Both the ramp, and the pulse waveform developed at the collector of Q2, are shown in b.

3 That are ready

For Top Quality Testing Performance



I Triplet's Model 630-M Type 1 V-O-M

1. 1,000,000 Ohms per volt DC for greater accuracy on high resistance circuits. 20,000 ohms per volt AC.
2. 1μ a Suspension Meter Movement. No pivots, bearings, or rolling friction. Extremely rugged. Greater sensitivity and repeatability.
3. 61 ranges, usable with frequencies through 100 kHz. Temperature compensated. $1\frac{1}{2}\%$ DC accuracy, 3% AC in horizontal position.

\$220⁰⁰

II Triplet's Model 630-NS V-O-M

1. 200,000 Ohms per volt DC sensitivity for greater accuracy on high resistance circuits. 20,000 ohms per volt AC.
2. Suspension Meter Movement. No pivots, no bearings, no hairsprings; no rolling friction. Extremely rugged.
3. 62 ranges. Temperature and frequency compensated $\pm 1\frac{1}{2}\%$ DC Accuracy, $\pm 3\%$ AC.

\$110⁰⁰



III Triplet's Model 630-NA Type 3 V-O-M

1. One selector switch minimizes chance of incorrect settings and burnouts.
2. 70 ranges: $1\frac{1}{2}\%$ DC accuracy on meter; with mirrored scale and diode overload protection.
3. Temperature and frequency compensation; polarity reversing.

\$93⁰⁰

from the Instrument Makers... Established 1904

TRIPLET

**TRIPLET ELECTRICAL INSTRUMENT CO.
BLUFFTON, OHIO 45817**

TRIPLET

Circuit powers neon lamps from low-voltage sources

In battery operated solid-state equipment it is often difficult to provide a visual "power-on" indicator due to the relatively high power consumption of incandescent lamps. For example, a #47 pilot light consumes about 0.9 watts, which may be more than the circuitry itself requires.

A low-power visual indicator can be constructed by using a simple unijunction transistor oscillator and a transformer to step up the low battery voltage to a value sufficient to operate a small neon bulb. If power consumption is extremely critical, the oscillator frequency and duty cycle can be made low; this results in a flashing operation, which further reduces power requirements.

In the circuit shown, capacitor C_1 charges towards the supply voltage, through R_1 . When the capacitor voltage reaches 0.5 to 0.8 times V_{BB} (the η , or intrinsic standoff ratio, of the UJT) the UJT fires. C_1 then discharges through the primary of T_1 , which is an inexpensive audio transformer.

Almost any UJT will work in the circuit if the

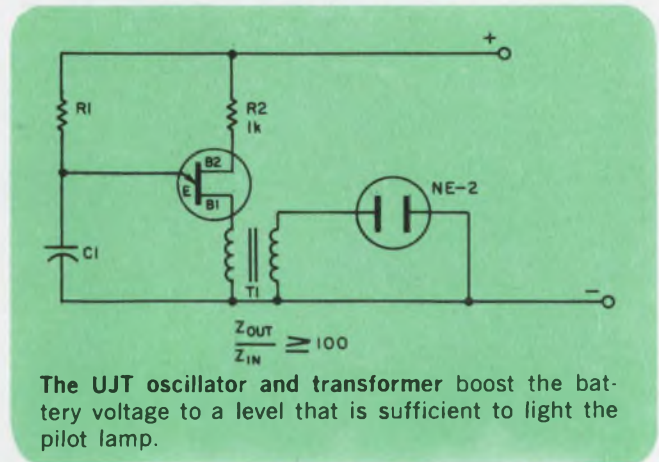

The UJT oscillator and transformer boost the battery voltage to a level that is sufficient to light the pilot lamp.

supply voltage is in the 6 to 40 volt range. For very low voltage operation, a 2N2840 should be used, which will operate with voltages as low as 1.5 V. The values of R_1 and C_1 will determine the frequency of oscillation.

Les Toth, Project Engineer, Cohu Electronics, Inc., San Diego, Calif. VOTE FOR 314

Dc limiter regulates voltage to high-current, low-voltage circuits

Overvoltage protection for high-input-current transistorized devices can be a difficult problem. This is especially true when the power source is a rotary engine-driven supply that services many other units of the same, or considerably larger, current drains that cycle on and off the supply

line. Such load changes may cause the line to rise above an acceptable level for some equipments, causing failure.

A reliable and inexpensive solution to this problem makes use of sensitive relays and zener diodes. These react to voltage changes by switching series resistors into the line to limit the input voltage. As shown, the stages of the limiter are in series, and below the circuit threshold limits no power is dissipated. The resistors are selected to drop the overvoltage to the specific current requirement of the protected equipment.

The circuit illustrated will protect transistorized equipment that requires 22-30 V dc at 35 A. The sensing relays are rated at 2.8 V dc, with low differential between pull-in and drop-out. The 27-V zeners pull in the sensing relays at slightly less than the 30-V line voltage. This opens their respective series power relays (K3-K9), each of which inserts approximately 3 volts of IR drop. In this way the input can rise to 40 V with the output remaining below 30 V. Reaction time of the relays is acceptable, and hunting is not noticeable.

This approach to voltage protection can be

VOTE

VOTE! Go through all Idea-for-Design entries, select the best, and circle the appropriate number on the Reader-Service-Card.

SEND US YOUR IDEAS FOR DESIGN. You may win a grand total of \$1050 (cash)! Here's how. Submit your IFD describing a new or important circuit or design technique, the clever use of a new component or test equipment, packaging tips, cost-saving ideas to our Ideas-for-Design editor. You will receive \$20 for each accepted idea, \$30 more if it is voted best-of-issue by our readers. The best-of-issue winners become eligible for the Idea Of the Year award of \$1000.

When you need clean low-level signals with improved settability, the 204D's built-in step attenuator is a step-saver. It eliminates the aggravating process of hanging an attenuator between the signal source and your system. And, it eliminates the extra problems that extra interconnections create. As a result, you get the clean signals you need for accurate measurements — quicker and easier.

The 204D has the same low distortion, high stability, and wide frequency range of 5 Hz to 1.2 MHz that makes the HP 204C an industry standard. Both models can be operated with line power, mercury battery, or a rechargeable battery pack.

Not all our changes are big ones, but each is intended to help you make better measurements in less time with less effort. Whether you chose a 204C or 204D depends, of course, on your requirements. If you don't need a built-in calibrated

step attenuator, then get the 204C and save the \$75 difference in price.

Whichever you chose, order today by calling your nearest HP order desk. For data sheets, write to Hewlett-Packard, Palo Alto, California 94304. Europe: 1217 Meyrin-Geneva, Switzerland. Price: HP 204C, \$250; HP 204D, \$325.

099/12

HEWLETT  PACKARD
SIGNAL SOURCES

Eliminate the unnecessary... With the 80 dB step-attenuator in the new HP 204D Oscillator

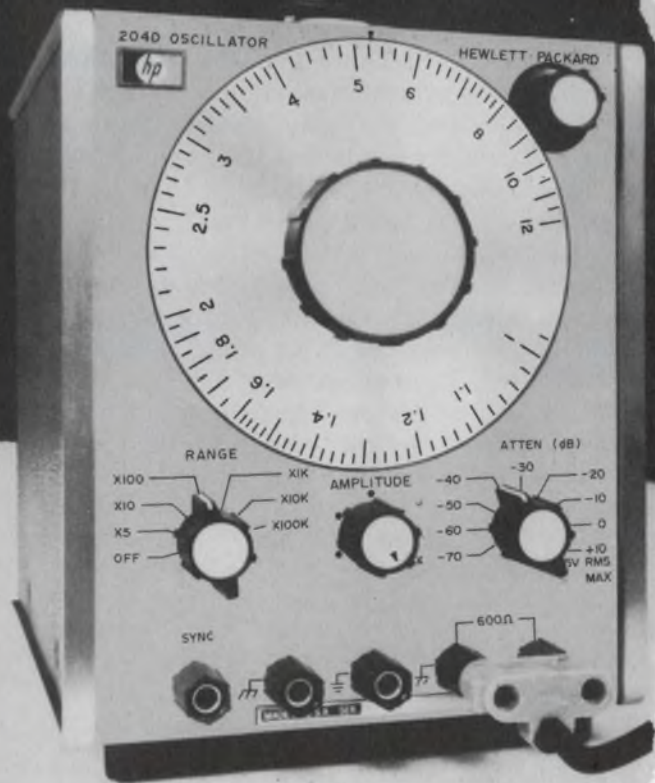

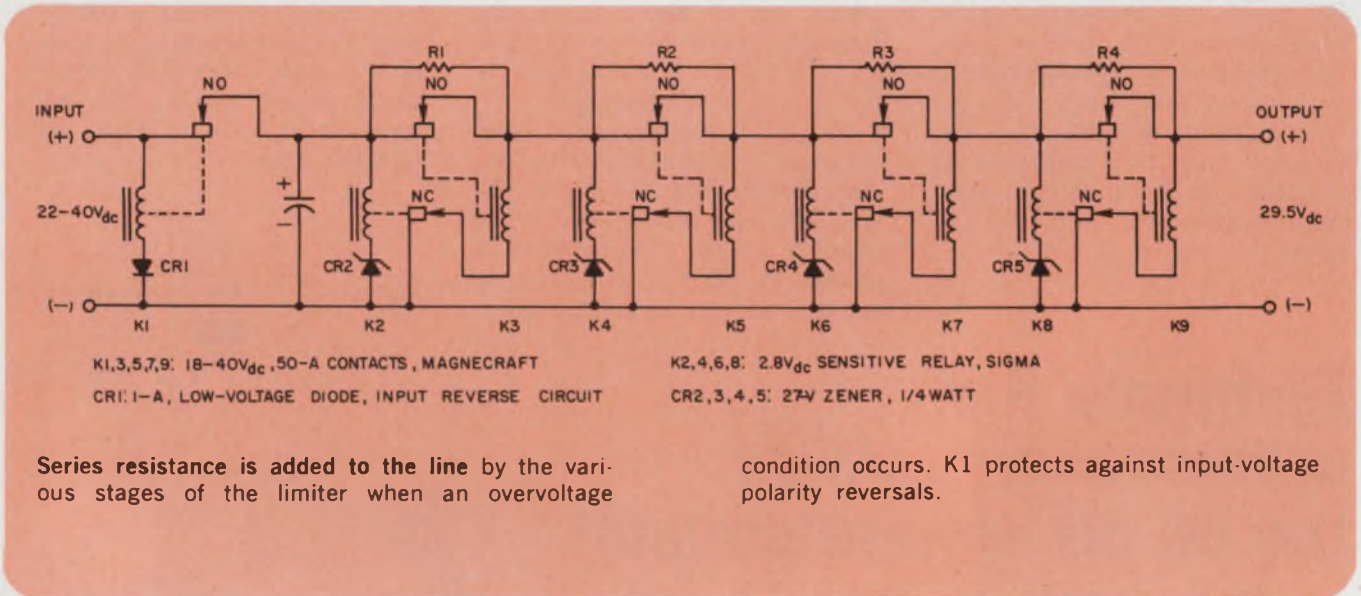

Series resistance is added to the line by the various stages of the limiter when an overvoltage

condition occurs. K1 protects against input-voltage polarity reversals.

applied to systems having other power requirements by changing zeners, power relays, and resistors accordingly.

Howard Cohen, Project Manager, Decitron Electronics Corp., Brooklyn, N.Y.

VOTE FOR 315

Low-cost circuit can protect a boardful of high-cost ICs

Complete protection for a board of expensive IC packages can be provided with a circuit built for less than \$6. The circuit protects against overvoltages due to supply transients or failures, as well as against overvoltages or wrong polarities caused by "human errors."

The 1N4002 diode protects against reverse polarities caused by wrong connections or other causes. In this application, the integrated circuits could tolerate negative levels of -1 V, so that an ordinary silicon diode (the 1N4002) provides enough current to blow the fuse before the reverse voltage harms the integrated circuits.

The 2N1595 SCR has a maximum required

gate voltage of 0.8 V. The 5 per cent 1N4745A zener diode breaks over at a maximum of 16.8 V, so that the SCR turns on at an input voltage of 17.6 V or less, and does so in less than one microsecond. This is compatible with the +18-V limit of the particular ICs being protected.

The capacitor protects the integrated circuits against noise spikes, and also prevents noise spikes from causing unnecessary "crowbar" by the SCR and diode. The value of the capacitor can be decreased. The resistance of the fuse and the capacitor can be designed to form a low-pass filter that will slow the rate-of-rise of the input voltage to a value compatible with the SCR turn-on-time.

Al Geiersbach, Design Engineer, Allis Chalmers, Milwaukee, Wis.

VOTE FOR 316

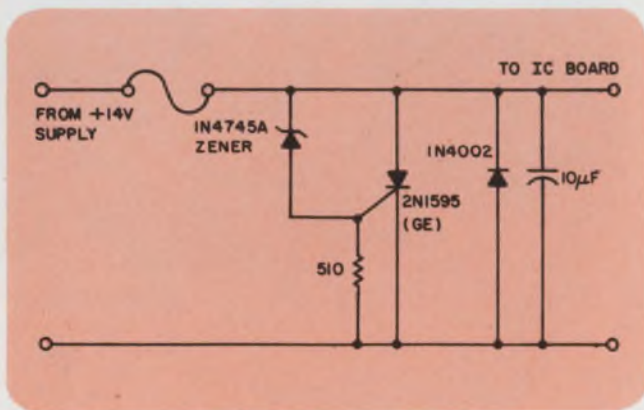

Protection against overvoltage and polarity reversals is provided by this inexpensive circuit.

IFD Winner for January 18, 1969

Thomas E. Skopal, Piscataway, N. J. His Idea, "Feedback technique dynamically resonates tuned circuit," has been voted the Most Valuable of Issue award.

Vote for the Best Idea in this Issue.

First 200 MHz IC Amplifier Array

RCA-CA3049 for -55° to 125°C operating temperature, \$1.95 (1,000 units)

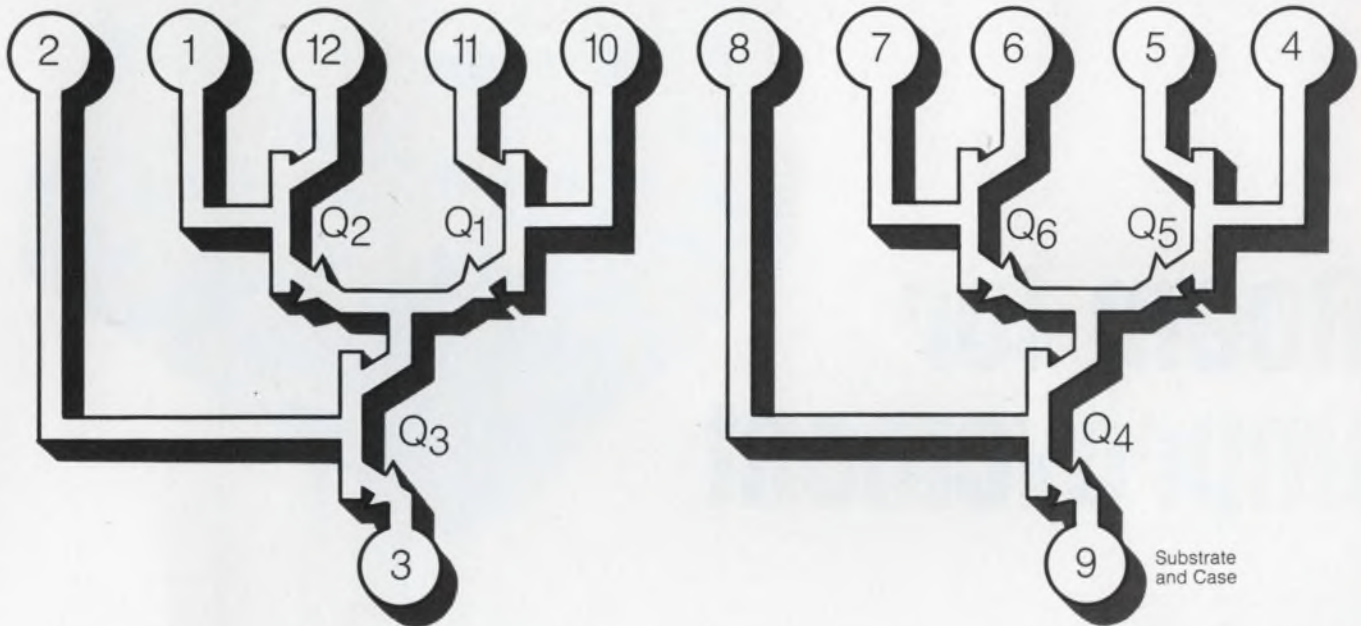

Here's another of RCA's growing family of "building block" IC's—usable as high-speed sense amplifiers, low noise IF and RF amplifiers, balanced mixers, wideband amplifiers, oscillators, and many more.

It's the RCA-CA3049—a pair of differential or cascode amplifiers on a single chip. Each amplifier provides a transducer power gain of 23 dB (typ.) in a cascode connection at 200 MHz with a current of only 2 mA. This unit—useful to 500 MHz—marks another "first" for RCA stemming from new high-frequency IC design and production techniques.

Ask your local RCA Representative or your RCA Distributor for details. Or for complete technical information, write RCA Electronic Components, Commercial Engineering, Section ICG5-1, Harrison, N. J. 07029.

RCA Linear Arrays for Design Flexibility

RCA-CA3018	Two isolated transistors plus Darlington pair	\$ 98 (1000 units)
RCA-CA3018A	Same unit with performance characteristics controlled from $10\ \mu\text{A}$ to $10\ \text{mA}$	1.35 (1000 units)
RCA-CA3026	Dual independent diff amps for DC to 120 MHz	1.25 (1000 units)
RCA-CA3045	3 isolated transistors and 1 diff pair for -55° to $+125^{\circ}\text{C}$ operation, DC to VHF (DIC package)	1.50 (1000 units)
RCA-CA3046	Same as CA3045 but in dual-in-line plastic package (0°C to $+75^{\circ}\text{C}$ operation)	.98 (1000 units)
RCA-CA3050	Two Darlington-connected diff amps with diode bias string: -55° to $+125^{\circ}\text{C}$, DC to 20 MHz operation (DIC)	2.25 (1000 units)
RCA-CA3051	Same circuit for 0°C to $+75^{\circ}\text{C}$ operation (DIP)	1.65 (1000 units)

RCA
Integrated
Circuits

INFORMATION RETRIEVAL NUMBER 61

Room for improvement

General Electric's TO-5² transistor-size sealed relays give you more room for increased power, improved performance

We didn't cut any corners on this high-reliability, transistor-size sealed relay. We left them on so there'd be more room for a more powerful magnet—2½ times more powerful.

This added power means this type 3SBS, 2PDT, 1 amp relay gives you higher contact forces, larger contact gaps, and greater overtravel to minimize mechanical shifts. Shifts which usually increase early-in-life failures.

Though there's more room inside to give you all these advantages, the outside dimensions—top-to-bottom (.275") and side-to-side (.370")—are the same as any transistor-size relay.

So don't cut corners on your next transistor-size relay application. Specify GE's square Type 3SBS. For full details, write General Electric, Section 792-45, Schenectady, New York 12305.



ACTUAL SIZE

GENERAL  **ELECTRIC**

**TICOR III
WINS
ITS
SPURS**



MODEL 32 RENAMED TICOR III AFTER TWO BIG YEARS

Reduced cost, a lower Time Base Error of $\pm 0.4 \mu$ sec, and over-all upgrading in design and performance made Mincom's Model 32 Recorder/Reproducer the heir apparent to TICOR II. Now Model 32, after two successful years of field testing and hard work, has been renamed TICOR III. It will fully replace its famous parent, which in 1964 switched the entire industry to a new course with its low mass flutter suppression, 2 MHz performance and virtually negligible TBE. TICOR III, the latest in IC and packaging design, provides at a lower price its $\pm 0.4 \mu$ sec TBE at 120 ips, 2 MHz on seven or fourteen channels, flutter suppression bandwidth of 270 Hz, optional bidirectional recording, plus interchangeable electronics for Direct 400 Hz-1.5 MHz or 800 Hz-2.0 MHz; DC-80 kHz IRIG FM, DC-500 kHz wideband FM, PDM, NRZ and other data techniques. Write for specifications, or call our Sales Department at (805) 482-1911.

Mincom Division **3M**
COMPANY
300 SOUTH LEWIS ROAD • CAMARILLO, CALIFORNIA 93010

INFORMATION RETRIEVAL NUMBER 63

COMPUTE DIRECTLY with RFI/EMI SYSTEM

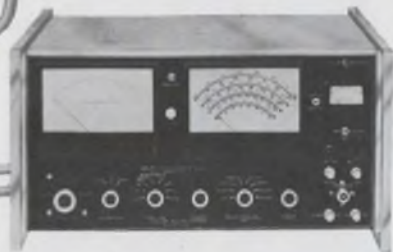

Model NM-37/57 Receiver
30 MHz — 1 GHz

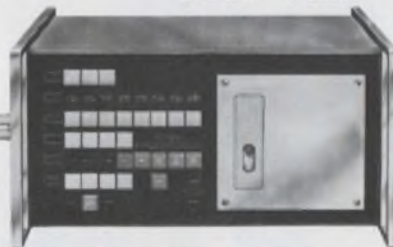

Model P-7 Stored Logic Programmer



Model R/O-7 Digital Readout Module



Request Stoddart's fact-packed 8-page brochure on the Series VII Automated, Direct-Digital RFI/EMI Data Acquisition System.

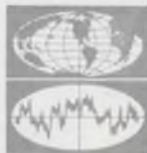

ELIMINATE THE MIDDLEMAN

If you're going to buy RFI equipment, you should get the capability for both automatic operation, and direct tie-in to a digital computer, incremental tape recorder, card punch, or printer. Only the revolutionary Stoddart Series VII System gives you voltage-controlled tuning that permits frequency to be digitized directly. Direct-digital outputs end hours of manual card punching, cut manpower, eliminate errors, free engineering time for creative uses.

OPEN NEW APPLICATIONS

The fully automatic, direct-digital Series VII opens a new vista of applications:

- Compresses the "manual measurement-manual card punch" routine into a one-step automatic process.
- Ends hand comparisons of graphical spectrum signatures.
- Automates search for harmonic and image relationships.
- Increases certainty of electronic environmental surveillance.

ENJOY THESE FEATURES

Electronic programming of receiver selection, tuning, bandwidth, sweeping, bandswitching, detector function, sweep speed, peak hold-time.

Manual tuning of receiver for independent use in lab or field, as a lightweight, solid state, self-powered RFI meter.

Spectrum analysis with up to four stages of r-f pre-selection for superior rejection qualities and overload protection.

ORDER-OF-MAGNITUDE IMPROVEMENT

Whether you're doing specification testing, interference surveys, RF propagation studies, antenna pattern studies, continuous range tracking surveillance, site surveys, satellite tracking, communications studies, circuit design evaluation, frequency/time monitoring, insertion loss measurements, or spectrum analysis — or have an exotic application — the fully automatic, direct-digital Series VII will do the job lots better, faster. More economical, naturally. Write or phone:

STODDART ELECTRO SYSTEMS

A Division of Tamar Electronics, Inc.

2045 West Rosecrans Avenue · Gardena, California 90249

Phone (213) 770-0270

increase ic yield

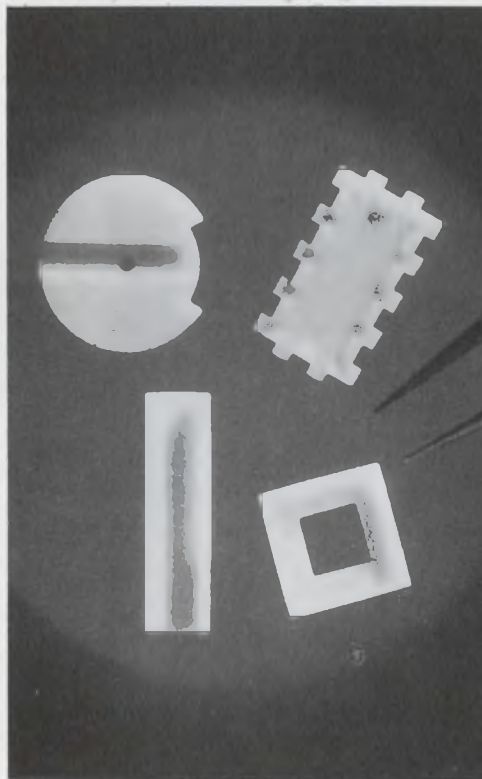

With Coors microceramics. Parts and complete packages. Of alumina and beryllia. Strong, chemically inert, dimensionally stable. Unaffected by age or environment. Part-to-part uniformity from 1st to nth. Precision-ground or as-fired surfaces. Easy to metallize, by you, by us. Most any size, any shape. Fast delivery. Prototype quantities, millions, or anything in between. Get higher yield, more profit. Start with the most reliable circuit packaging. Coors microceramics. Send for data pack.

Coors Porcelain Company
Golden, Colorado 80401



HMES's looking for engineers who fathom more than the state of the art in:

Sonar/radar systems design and analysis
Signal and data processing
Circuit design (digital, audio, servo, video, RF, etc.)
Transducer/antenna design

When your product is major electronics systems for inner-, terra- and outer-space defense surveillance, "the state of the art" becomes a lot more than a nice-sounding generality. It is an everyday necessity. With implications far beyond the technological. It is the foundation for national survival, based on innovations ranging from overall systems concepts to individual circuits and components. All supported by new ideas in reliability and quality control. And it is a tradition, rooted in the earliest U.S. sonar and radar systems. Whose latest descendants—our current projects—could not have been built even five years ago. Projects like the AN/SQS-26 Shipboard Detection and Ranging Sonar—the world's largest. Systems based on concepts like phased-array radiators, adaptive filters and digital signal processing. And PAR, Perimeter Acquisition Radar for the Sentinel ABM system.

You might expect unusual projects like these to create a more-than-ordinary environment for you to work in. And you'd be right. Everyday, multi-disciplinary contact and activity. A lack of technical/managerial pigeonholing that restricts innovation and individual growth. And in-depth participation in



identifying and planning for new business: technically, organizationally . . . even in terms of new personnel. It's nothing more than you might expect in an organization that's technically oriented all the way to the Department Manager, himself an engineer.

There's a lot more you'll want to find out about what HMES's extraordinary environment holds for you in terms of important new projects, environment and personal growth. Why not get the full details on opportunities in any of these areas:

Transducer / Design
Systems Design & Analysis
Systems Integration & Test
Digital/Analog Information Processing
Display Engineering
General Purpose Computer Applications
Engineering & Scientific Programming
Reliability & Maintainability
Logistics Engineering
Transmitter Design
Mechanical & Environmental Engineering
Advanced Techniques Development

• Bow-mounted dome houses transducers for highest powered surface ship sonar in the free world, the Navy's AN/SQS-26, designed and developed by HMES. Capable of multi-mode detection at long range, innovations include (1) first sonar transmitters fully utilizing solid-state devices, (2) digital signal processing, (3) semi-automatic fault location, and (4) transducers that withstand high-impact explosive shock. Ongoing next-generation studies promise even greater challenges to engineers at home in the multi-technological world of sonar.

Please send an informal resume to Mr. J. L. Wool, Manager, Professional Recruiting G.E.Co., Heavy Military Electronics Systems, Sect. 56-C, Court Street, Syracuse, N.Y. 13201.

GENERAL ELECTRIC

An Equal Opportunity Employer M&F

Free Career Inquiry Service

Absolutely Confidential

Respond to the career opportunities advertised in this issue. Fill out and send us this handy resume. **Electronic Design** will do the rest – neatly typed copies of this form will be mailed to the companies of your choice, indicated by the circled Career Inquiry Numbers at the bottom of this page.

10

Name		Home Phone	
Home Address (Street)		City	State
			ZIP Code
Age	U.S. Citizen	Security Clearance	
	<input type="checkbox"/> Yes <input type="checkbox"/> No		

Prime Experience	Secondary Experience

Desired Salary	Availability Date
-----------------------	--------------------------

Employment History – present and previous employers

Company	City, State	Dates	Title
		to	
		to	
		to	

Education – indicate major if degree is not self-explanatory

Degree	College	City, State	Dates
			to
			to
			to

Additional Training – non-degree, industry, military, etc.

Professional Societies

Published Articles

- Career Inquiry Numbers:**
- | | | | | | | | | | | |
|-----|-----|-----|-----|-----|-----|-----|-----|-----|-----|-----|
| 900 | 901 | 902 | 903 | 904 | 905 | 906 | 907 | 908 | 909 | |
| 910 | 911 | 912 | 913 | 914 | 915 | 916 | 917 | 918 | 919 | 925 |

ELECTRONIC DESIGN
 850 Third Avenue
 New York, New York 10022

Outstanding orders for the Lockheed 1011 make up that backlog. Additional on-going Lockheed programs include the Rigid Rotor AH-56A Cheyenne and commercial derivatives, ASW aircraft, and supersonic aircraft development.

Lockheed has a huge backlog of opportunity in: Structural Design and Design of Avionics, Flight Controls, Real-Time Computers, Digital Displays, and EMI. Also openings in Analysis and Reliability Engineering.

These positions require an appropriate degree and experience. Send your resume to: Mr. C. R. Alexander, Employment Manager, Dept. 1705, 3415 N. Hollywood Way, Burbank, California 91503. An equal opportunity employer.

Engineers: You're looking at a 2.6-billion-dollar backlog of opportunity. Look into it!



LOCKHEED-CALIFORNIA COMPANY

A Division of Lockheed Aircraft Corporation

INFORMATION RETRIEVAL NUMBER 902

Book Reviews

Grid-Dip oscillators

How To Use Grid-Dip Oscillators, 2nd. ed., (Rider Series, Hayden Book Co., New York) 111 pp. \$2.95

The revised second edition of *How To Use Grid-Dip Oscillators* concentrates on practical applications that have been proven by experience. It tells how to check L-C circuits, linear and coaxial tanks, how to convert a signal generator or rf test oscillator into a GDO or a GDO into either a conventional or market generator, signal injector, or cw oscillator. It also describes how to use the GDO as a field-strength meter, a signal source for an SWR meter, an rf meter, and in numerous other ways. A complete roundup of commercial GDOs—both assembled and in kit form—and their features is included.

CIRCLE NO. 323

Relativity

Introduction to the Theory of Relativity, Francis W. Sears and Robert W. Brehme, (Addison-Wesley Publishing Co., Reading, Mass.) 216 pp. \$9.75.

It is fairly easy, in most engineering schools, to acquire an EE degree with no more than a minimum knowledge of the general and special theories of relativity. Although this may not affect performance on the job, it is certainly a handicap for anyone who wishes to keep up with the scientific advances of our age.

The authors of this text have developed a method of using geometric diagrams to explain Einstein's theory of relativity. The level of mathematical sophistication is well within the grasp of any electronic engineer.

The first four chapters present the essence of theory, the relativistic treatment of space and time. A full chapter is devoted to electric and magnetic fields and a final chapter covers curved space-time and gravitation.

CIRCLE NO. 324

WE MAKE PRECISION PRE-GAPPED
FERRITE RECORDING HEAD CORES.

Contact Us

ceramic magnetics, inc.



87 FAIRFIELD ROAD • FAIRFIELD, N. J. 07006 • (201) 227-4222

INFORMATION RETRIEVAL NUMBER 66

146

FOR Chemicals

Think

GC

Solve all electronic chemical needs quickly and economically... simply specify GC!

GC manufacturers and stocks cleaners, solvents, cements, lubricants, lacquers and varnishes for in-plant servicing and maintenance needs on all office and production equipment. Packaged, or in bulk, all are available for immediate shipment.



FREE!



Write today for the big GC Electronic Chemical Handbook — \$1.50 value — yours FREE when applied for on your Company letterhead. It's your solution to all chemical problems.

GC Electronics

400 South Wyman Street
Rockford, Ill. 61101

A Division of
GC Hydrometals, Inc.
Shipping warehouses in:
Hicksville, L.I., N.Y.
Los Angeles, California



INFORMATION RETRIEVAL NUMBER 67

ELECTRONIC DESIGN 10, May 10, 1969

where the brains are...

- Where was the world's first operational frequency scan radar developed?
- Where was the world's first operational phased array radar developed?
- Where was the world's first multiple target autotrack radar developed?
- Where are they designing and building the next generation phased array radar?
- Where are they heavily involved with advanced radar programs such as ASMS, SABMIS, IPD-TAS, ADAR, AN/SPS-52 and AWACS?

Join Hughes

Hughes

ADAR 'COLANDER' — More than 16,000 antennas make this eight-foot-diameter antenna of the future ready for the future.

our role will be to apply it.

ENGINEER

Hughes

AN UNUSUAL OPPORTUNITY IN Radar systems

INCENTIVE, EXP. SALARY HIST

An Equal Opportunity Employer

Where are they hiring 200 RADAR EXPERTS in all specialties?

Hughes Ground Systems, that's where!

Call collect to arrange for a personal interview. Join the brain trust at Hughes Ground Systems and find out where radar technology really is. Call 714-871-2321. Weekdays 9 am to 6 pm.



WRITE: RADAR ENGINEERING EMPLOYMENT ■ HUGHES AIRCRAFT CO., FULLERTON, CALIFORNIA 92634

Our new compact oiltight pushbuttons give you up to six functions in a 1 $\frac{7}{16}$ " square.

Size is the only thing that's small about our new compact pushbuttons. They handle full-size jobs.

We've gone square to give them style, and full 600-volt quality and flexibility.

And we've gone small to give you six operating and indicating functions in a 1 $\frac{7}{16}$ " square. You save space, and money.

You also get unlimited flexibility with stacking contact blocks.

And a choice of pushbuttons and indicating lights that doesn't quit—with a virtually unlimited range of sizes, forms and colors of buttons and lenses.

With all you're getting, you still get the same oiltight performance you're used to with full-size Cutler-Hammer oiltight pushbuttons.

Ask your Cutler-Hammer Distributor or Sales Engineer to show you our six packs. Remember, the best things come in small packages.



New Cutler-Hammer compact pushbuttons put a world of control into a 1 $\frac{7}{16}$ " square, and mount in industry-standard 1 $\frac{3}{16}$ " round holes.

Try our 6 pack.

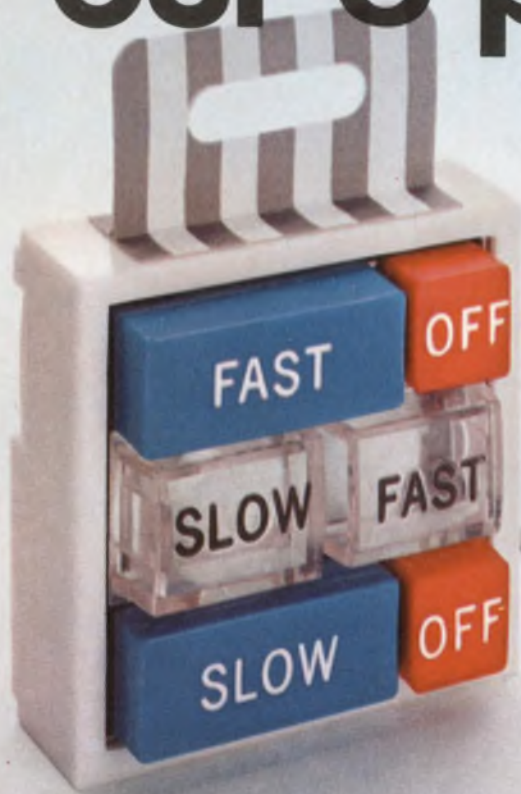

See your Cutler-Hammer Distributor—
the man who has everything



CUTLER-HAMMER

POWER DISTRIBUTION & CONTROL DIVISION, Milwaukee, Wis. 53201

INFORMATION RETRIEVAL NUMBER 68

Products

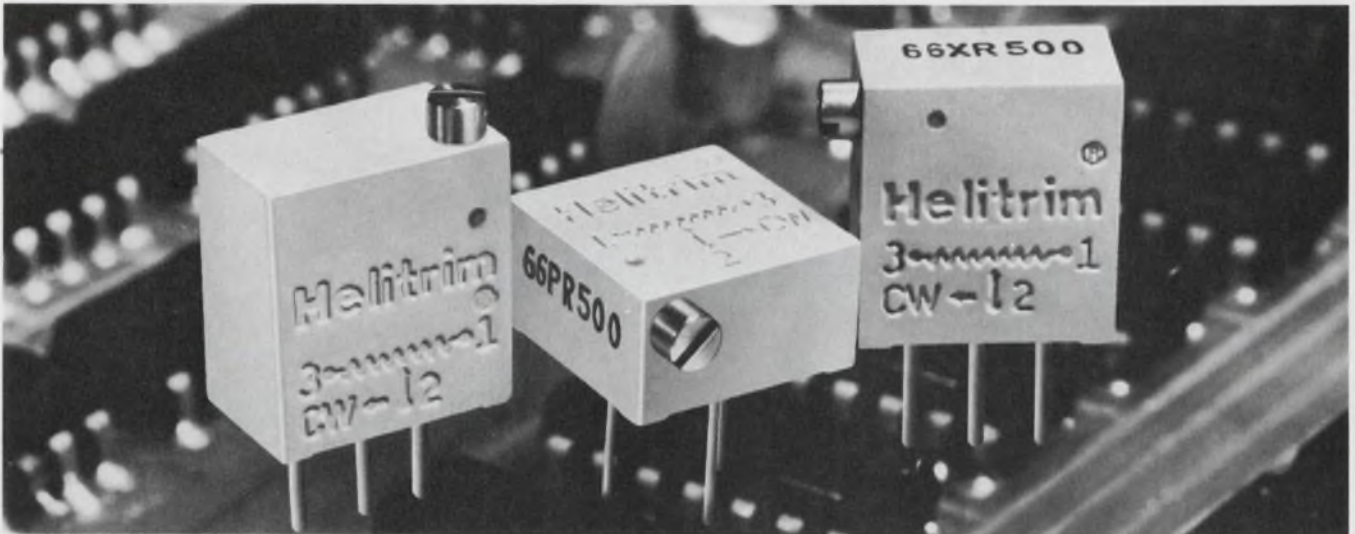

Low-cost 0.5-W cermet trimmers with 3/8-in. square configurations are now available for

industrial applications. Resistances range from 10 Ω to 2 M Ω , p. 150.

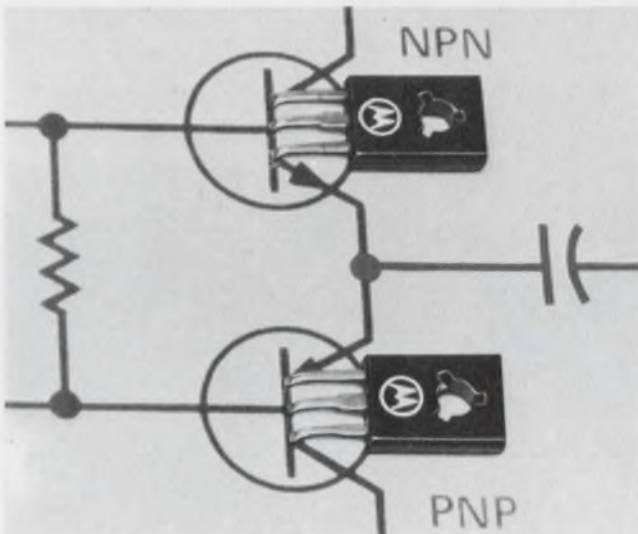

Miniature plastic npn/npn transistor pairs complement 35-W audio amplifiers, p. 158.

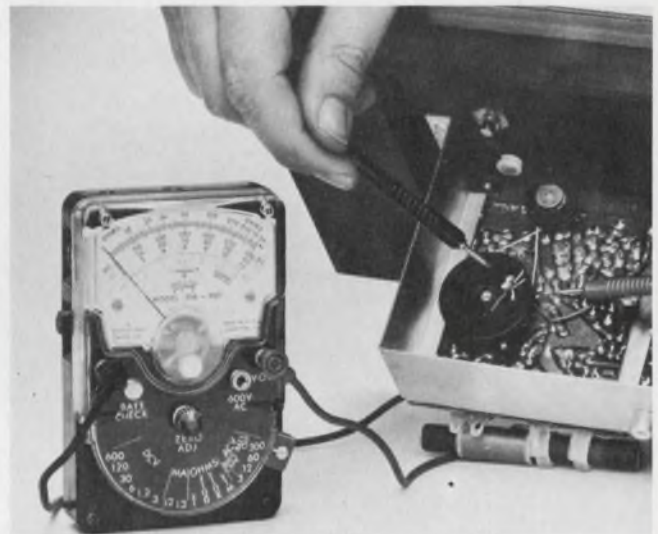

Shirt-pocket battery-operated VOM features constant 10-M Ω FET-input, p. 168.

Also in this section:

Integrated circuit array packs four same-chip independent ac amplifiers, p. 161.

Palm-sized power supply modules drive Nixie tubes with 200 V at 3 mA, p. 182.

Rf power transistors deliver 25-W output with 5-dB gain at 175 MHz, p. 194.

Design Aids, p. 228 . . . Application Notes, p. 230 . . . New Literature, p. 234.

Low-cost trimmer pots are industrial cermet

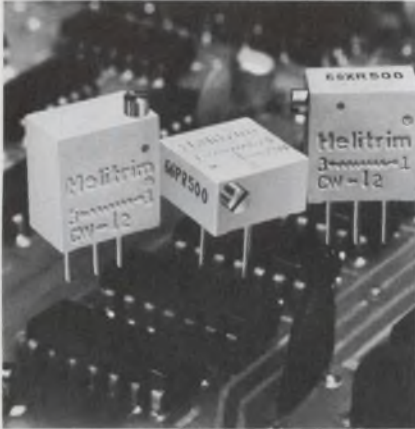

Beckman Instruments, Inc., Helipot Div., 2500 Harbor Blvd., Fullerton, Calif. Phone: (213) 691-0841. P&A: \$3.50; stock.

Offering cermet performance at wirewound prices, a new line of cermet trimming potentiometers is now available in the popular 3/8-in. square configuration. Heralded as the first industrial cermet trimmers with their price tag of \$3.50, series 66 units have a power rating of 0.5 W, derating to 0 W at 105°C, and resistance values ranging from 10 Ω to 2 MΩ.

Leaving the realm of the military, the new trimmers bring the inherent advantages of cermet to the industrial market. These include essentially infinite resolution because cermet is a continuous material, and high reliability since cermet is fused at very high temperatures.

All models have 20 adjustment turns and may be set to a desired voltage within +0.05% of full scale. Maximum input voltage is 200 V, dc or ac rms, and resistance tolerance is ±10 or ±20%, depending on the resistance value. Dielectric strength is 500 V rms, and insulation resistance is 100 MΩ.

Three mounting configurations are available: models 66P, side adjust with pins; models 66X, side adjust with edge-mount pins; and models 66W, top adjust with edge-mount pins.

The units have mechanical stops that use a clutch action at both ends. Their maximum starting torque is 5 oz.-in., and nominal weight is 0.04 oz.

CIRCLE NO. 325

Hybrid readouts sense and amplify

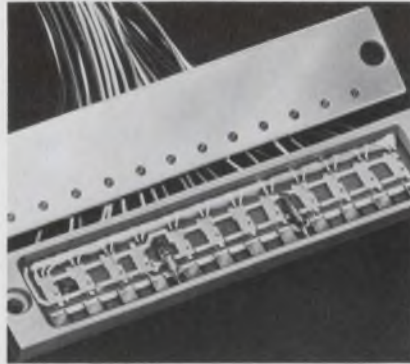

Sensor Technology, Inc., 7118 Gerald Ave., Van Nuys, Calif. Phone: (213) 873-1533.

Thin-film hybrid photovoltaic readout assemblies, which are DTL/TTL compatible, put sensors and amplifying circuits together in a single small package. This arrangement permits the assembly output to be at higher voltages and lower impedances than is usual for this kind of sensor. The arrays are monolithic formations of light-sensitive areas on a common substrate.

CIRCLE NO. 326

Power resistor has radial leads

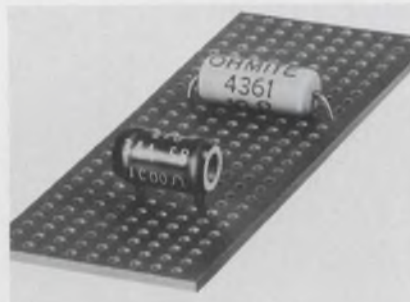

Ohmite Manufacturing Co., 3601 W. Howard St., Skokie, Ill. Phone: (312) 675-2600. P&A: from 24¢; 6 wks.

Supplied in 3-, 5- and 8-W sizes, the first wirewound power resistor with radial leads is now available. By eliminating the need to cut, bend and form leads, model PC-58 can cut labor costs by 21.9% and can increase productivity by 28.1%. It is designed to fit standard 0.1-in. matrix boards with standard 0.046-in.-diameter holes.

CIRCLE NO. 327

Tilting switch rolls to contact



Roltec, Inc., Mound View Rd., River Falls, Wis. Phone: (715) 425-6848. Price: \$9.50.

Using the virtually friction-free rolamite mechanical principle, a new 1-A 125-V electromechanical tilt switch operates at any angle of 15° or greater with any horizontal plane. Rolamite is an elementary mechanism that suspends rollers in such a way that there is virtually no sliding friction. Usually, two cylindrical rollers move freely within the loops of an S-shaped band.

CIRCLE NO. 328

Thirty tiny switches snap into one in.²

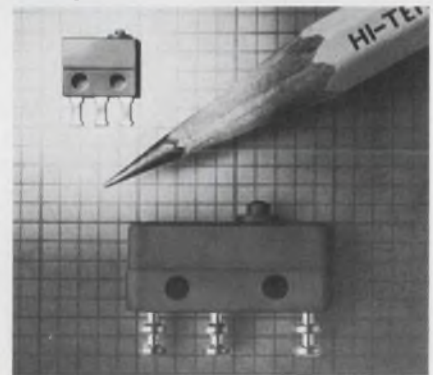

Hi-Tek Corp., Switch Div., 2220 S. Anne St., Santa Ana, Calif. Phone: (714) 540-3520. Price: from 98¢; stock.

Measuring only 0.3 by 0.2 by 0.1 in. (exclusive of terminals), new precision snap-action switches permit stack or matrix mounting on 0.1-in. centers of up to 30 switches in one square inch of space. (Terminal spacing is also on 0.1-in. centers.) Only one-fifth the size of existing subminiature switches, Miniswitch units are rated at 1 A resistive, 28 Vdc or 115/250 Vac.

CIRCLE NO. 329

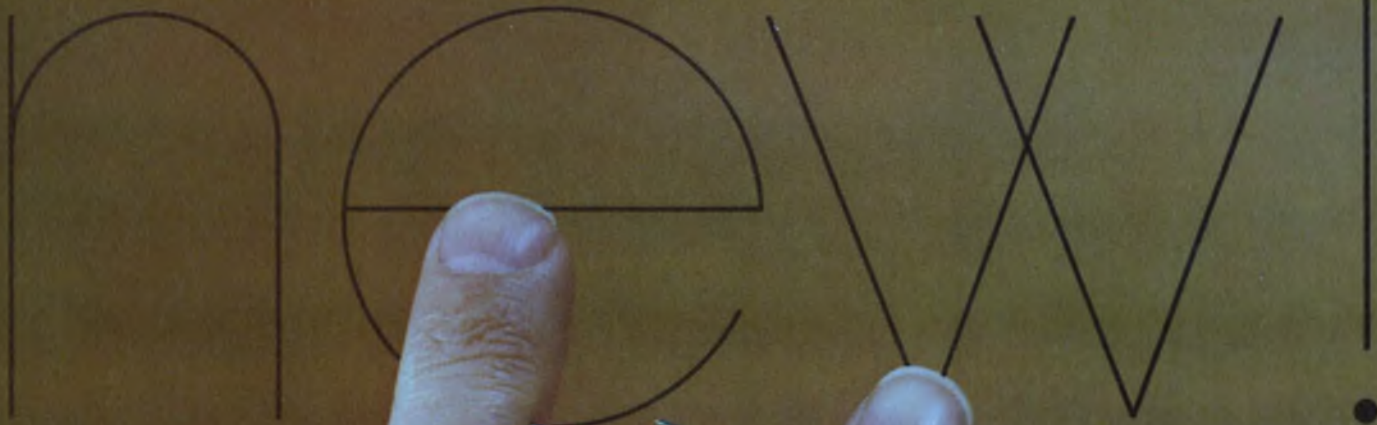

New Allen-Bradley hot-molded Type GD dual variable resistor shown actual size

**TWO
IN
ONE**

Allen-Bradley hot-molded dual variable resistor

Here's the most compact two section variable resistor currently available—the new Allen-Bradley dual Type GD. It's one-half inch in diameter and only a fraction of an inch longer than the popular single section Type G control. The case is dust-tight as well as watertight. ■ Both resistance tracks in the dual Type GD are solid, hot-molded elements, which provide long operating life. As with the single Type G, the noise level is low initially and actually decreases with normal use. Adjustment is smooth at all times with virtually infinite resolution. And low inductance permits operation at frequencies far beyond the usable range of wirewound controls. ■ In addition to standard application, these new dual Type GD controls are ideally suited for use in compact attenuators. ■ Dual Type GD controls are available with nominal resistance values from 100 ohms to 5.0 megohms. For complete specifications on tolerances, tapers, and options, please write Henry G. Rosenkranz, Allen-Bradley Co., 1201 South Second Street, Milwaukee, Wis. 53204. Export Office: 1293 Broad Street, Bloomfield, N.J., U.S.A. 07003. In Canada: Allen-Bradley Canada Limited.



ALLEN-BRADLEY
QUALITY ELECTRONIC COMPONENTS

New Low Power AC Sources.



Prices even lower.

175 VA—\$565

350 VA—\$1120

CML has been making the best low power AC sources around. For years. Now low power hits a new low in price. All with interchangeable oscillator modules for fixed or adjustable output frequencies from 45 to 6000 Hz. All feature excellent frequency stability and load regulation, low distortion, and lightning-fast response. Write or call today.

	Model NS175 (175 VA)	Model NS350 (350 VA)
With fixed 400 Hz oscillator	\$565	\$1120
Adjustable 350-450 Hz	685	1225
Adjustable 45-6000 Hz	785	1385

CML, Inc.

A Subsidiary of
Tenney Engineering, Inc.
350 Leland Avenue
Plainfield, N.J. 07062
(201) 754-5502 • TWX 710-997-9529



COMPONENTS

Universal read-head uses fiber optics

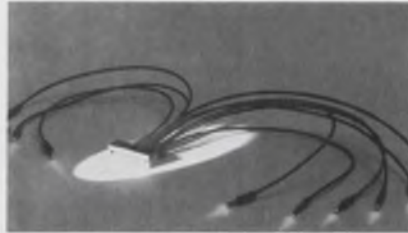

Bendix Corp., Mosaic Fabrications Div., Galileo Park, Sturbridge, Mass. Phone: (617) 347-9191. Price: \$50.

Using flexible optical-quality glass-fiber bundles, a new universal read-head can be used with any currently available paper-tape reader array. This fiber-optic device can modulate each light channel so that coded information can be received at each tape hole. It consists of a machined aluminum case into which individual fiber bundles are potted.

CIRCLE NO. 317

Slide switches double density



Chicago Switch, Inc., 2035 Wabansia Ave., Chicago. Phone: (312) 489-5500. P&A: 50¢ to \$2.50; 4 to 6 wks.

New 4pdt subminiature slide switches can double mounted switch density and increase service life by 500 times over competitive units. Measuring only 1.054 in. long, series 23-004 switches have a stroke of 0.136 in., compared to 0.25 in. for competitive units, and withstand 5,000,000 actuations under signal circuit conditions, versus the usual 10,000 to 20,000 for other units.

CIRCLE NO. 318

Cermet resistor network matches μ A722 source

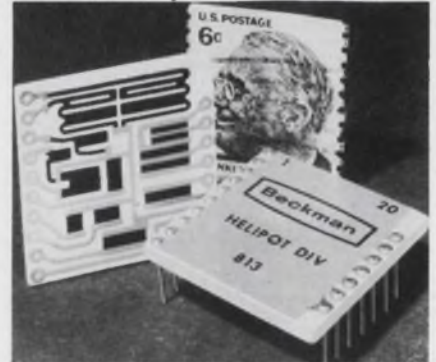

Beckman Instruments, Inc., Helipot Div., 2500 Harbor Blvd., Fullerton, Calif. Phone: (714) 871-4848. P&A: \$14; stock.

Designed specifically for use with Fairchild's μ A722 10-bit current source, model 813 resistor network—a cermet thick-film device—has directly corresponding resistance values and a compatible terminal arrangement. In addition to ten resistors that set the current source levels, three application resistors are included for output buffer scaling. A fourth application resistor facilitates output offsetting for bipolar applications.

CIRCLE NO. 319

Pulse transformer measures 0.5 in.³

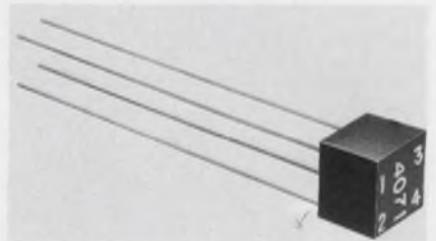

Crescent Technology Corp., SRC Div., 2222 Michelson Drive, Newport Beach, Calif. Phone: (714) 833-2000. P&A: \$4.95; 2 wks.

Completely self-contained in a 0.5-in. cube, the 4071 pulse transformer has a 240-V/ μ s pulse capability into a 25- Ω load. Secondary winding ratings are 6, 12 or 24 V with a standard 24-V primary. Standard risetimes are 100 ns; risetimes down to 15 ns are available.

CIRCLE NO. 320

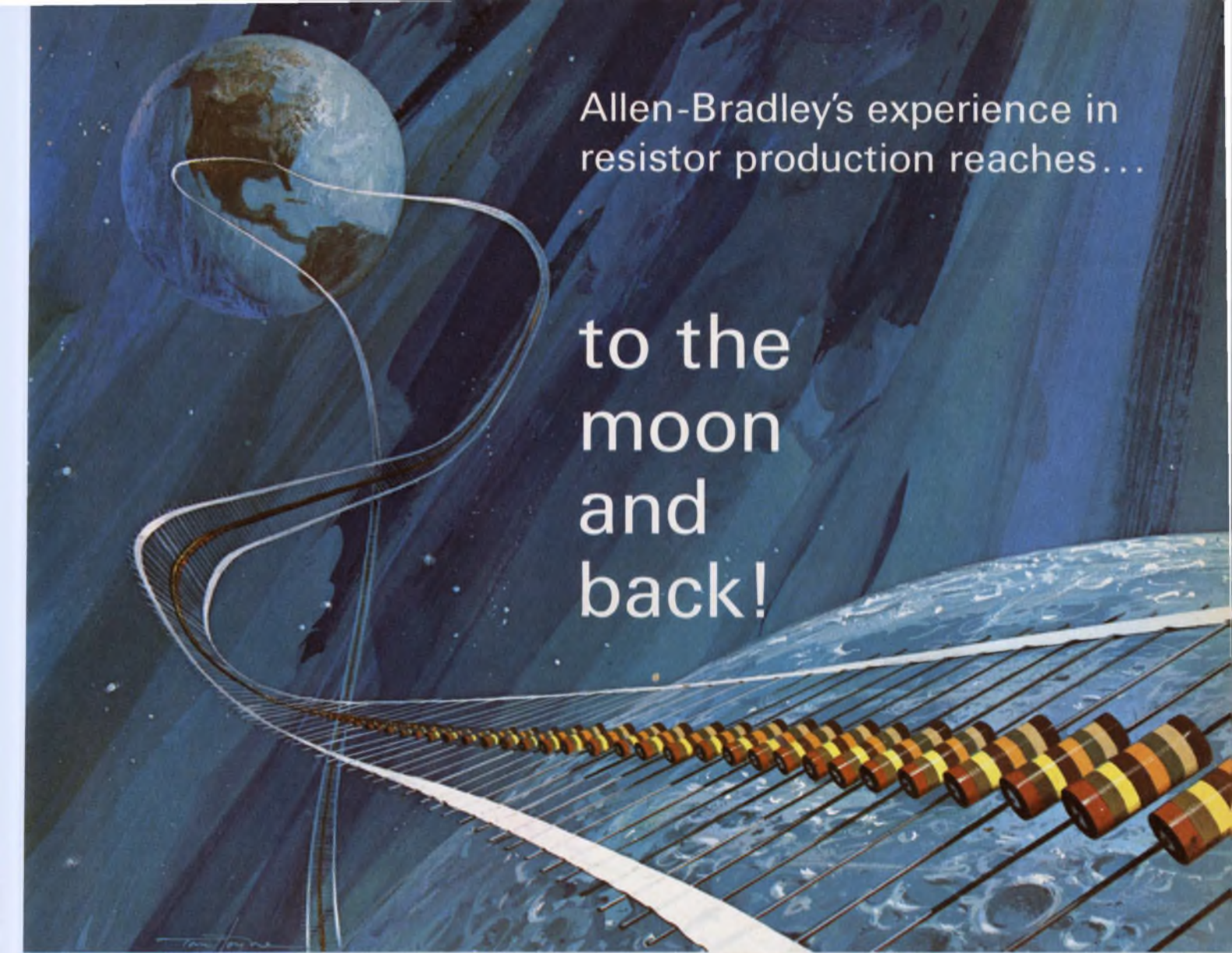

Allen-Bradley's experience in
resistor production reaches...

to the
moon
and
back!



TYPE BB 1/8 WATT



TYPE EB 1/2 WATT



TYPE HB 2 WATTS



TYPE CB 1/4 WATT



TYPE GB 1 WATT

A-B hot-molded fixed resistors are available in all standard resistance values and tolerances, plus values above and below standard limits. **A-B hot-molded resistors meet or exceed all applicable military specifications including the new Established Reliability Specification at the S level.** Shown actual size.

After more than three decades and untold billions of hot-molded resistors, Allen-Bradley has accumulated manufacturing "know-how" which cannot be approached by anyone else. The fact that the resistors made by A-B over the years—if placed side by side—would more than reach to the moon and back, may be impressive. But "how" they are made is the key.

Allen-Bradley resistors are produced by an exclusive hot-molding technique—developed by A-B. They're made by completely automatic machines—also developed, built, and used only by Allen-Bradley. The human element of error is removed. Uniformity is so precise from one resistor to the next—year in and year out—that long-term resistor performance can be closely predicted.

And there has been no known incident of catastrophic failure of an A-B hot-molded resistor.

The reputation for quality and performance established by Allen-Bradley hot-molded resistors is reflected in the fact that they have been an integral part of virtually every U.S. space probe. And they are "on" the moon. No other resistor applications demand a higher measure of reliability.

For detailed specifications on this superior line of hot-molded resistors, please write Henry G. Rosenkranz and request a copy of Technical Bulletin 5000: Allen-Bradley Co., 1201 South Second Street, Milwaukee, Wisconsin 53204. Export Office: 1293 Broad St., Bloomfield, N.J., U.S.A. 07003. In Canada: Allen-Bradley Canada Limited.



filter magic? watch envelope-delay problems disappear!

High-speed data transmission demands Reeves-Hoffman Hi-Fidelity crystal filters with advanced control of envelope delay combined with optimum selectivity!

Available at most IF frequencies

Our Hi-Fidelity crystal filters minimize envelope-delay distortion, and eliminate the need for discrete equalizers.

Describe your requirement

Reeves-Hoffman designs to your specifications. Call, TWX, or write today for delivery and price.

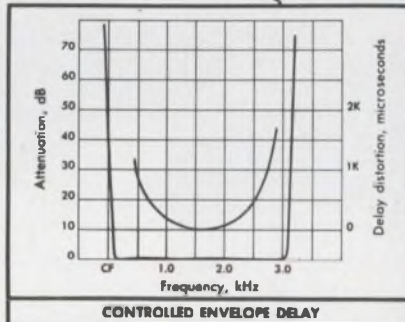
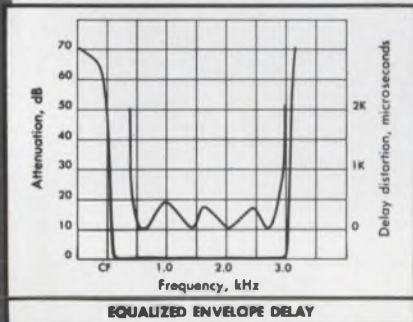

One of 4 channels

1750.000 kHz	Carrier frequency	1750.000 kHz
55dB	Carrier suppression	55dB
1749.745 kHz	1dB point, min.	1749.745 kHz
1746.965 kHz	1dB point, max.	1746.965 kHz
1750.250 kHz	70dB point, min.	1750.100 kHz
1746.750 kHz	70dB point, max.	1746.700 kHz
1.0dB	Passband ripple, 25°C	0.5dB
0dB ± 0.5dB	Insertion loss, 25°C	3.0dB
50 ohms	In and out impedance	200 ohms
+10° to +64°C	Operating temp. range	+5° to +65°C

One of 4 channels

craft-masters in crystal controls

REEVES-HOFFMAN

DIVISION, DYNAMICS CORPORATION OF AMERICA

400 WEST NORTH ST., CARLISLE, PENNSYLVANIA 17013 • 717/243-5929 • TWX: 510-650-3510

INFORMATION RETRIEVAL NUMBER 72

COMPONENTS

Balun transformers shrink over-all size

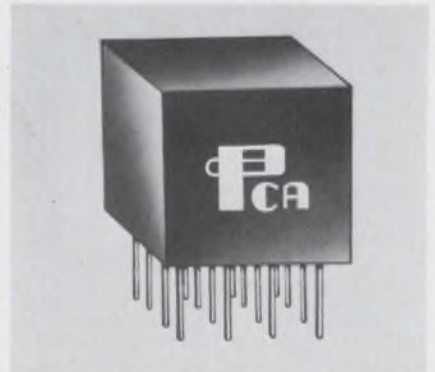

PCA Electronics, Inc., 16799 Schoenborn St., Sepulveda, Calif. Phone: (213) 892-0761. Price: \$2.50.

Designed for low-impedance operation on transmission lines, balanced to unbalanced, a new line of broadband balun transformers are only 0.65 in. long by 0.5 in. wide by 0.7 in. high. Their open-circuit inductance is 350 μ H minimum, and leakage inductance is 0.5 μ H maximum. The units are housed in cases of molded epoxy and are fitted with AWG 24 tinned copper leads.

CIRCLE NO. 338

High-ohm reed switch cuts ringing effects



Hamlin, Inc., Lake and Grove Sts., Lake Mills, Wis. Phone: (414) 648-2361.

Incorporating a backstop to effectively eliminate any motion of the reed after switch opening, a new reed switch minimizes the ringing caused by noise-generating variations in open-circuit capacitance. Type SRR-3 has an open-circuit impedance of 10⁶ M Ω and a dc contact rating of 10 W at 0.5 A. Nominal operating characteristic is 50 to 110 ampere-turns.

CIRCLE NO. 339

when size makes the difference



Adlake makes the size



Adlake's new AWCM and AWDM Mercury Wetted Contact Relays — Sub-Miniature in size for printed circuit board use (see diagram) provides the answer to the high component density question. Small in size, yet made to Adlake's stringent quality requirements. Depend on Adlake's reliability and this new product to help solve your space problems. Available as contact Form C or contact Form D.

Write, please, for BULLETIN No. MW 5.

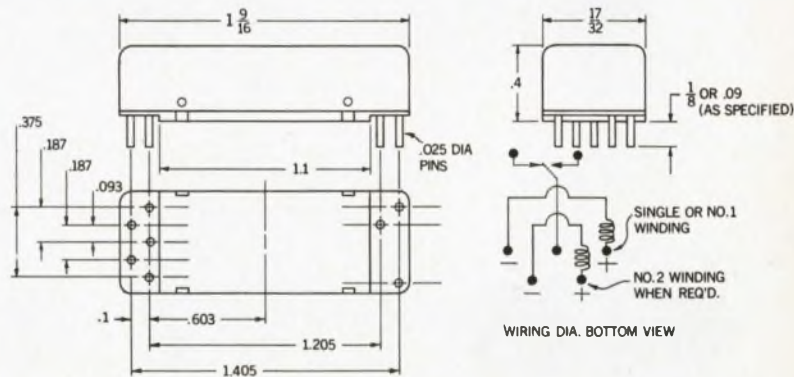

THE ADAMS & WESTLAKE COMPANY

A SUBSIDIARY OF **ALLIED PRODUCTS CORPORATION**

ELKHART, INDIANA 46514 • 219 • 264-1141 • TWX 219 • 522-3102 • TELEX 25-8458 • CABLE ADLAKE

Mercury Relays / Architectural Products / Transportation Equipment / Doors and Entrances / Contract Manufacturing

GOOF-PROOF

... and safe for all semiconductors

AEL's in-circuit semiconductor tester

The AEL Model 245M Test Set measures both low and high power transistors (in or out of circuit) for 1000 cycle Beta (h_{fe}) within a range of 1 to 1000. Also measures resistances emitter-to-base; collector-to-base; and collector-to-emitter.

Yes, Beta and I_{CBO} of transistors out-of-circuit and reverse leakage of diodes and rectifiers as well.

So simple, it's "GOOF-PROOF." (And drip-proof, in a high impact plastic case.) A PNP/NPN switch, function switch and Beta calibration adjust is all you need.

To try it is to buy it. It's so Easy To Read. And To Afford.



AMERICAN ELECTRONIC LABORATORIES, INC.

Main Offices: P.O. Box 552 • Lansdale, Pa. 19446 • (215) 822-2929 • TWX: 510-661-4976 • Cable: AMERLAB • Washington, D.C. Division: 6629 Iron Place, Springfield, Va. 22151 • (703) 354-5700 • California Office: 8939 S. Sepulveda Blvd., Los Angeles, Calif. 90045 • (213) 870-8755
Northern California Office: 486 Eills St., Mountain View, Calif. 94040 • (415) 868-2062

INFORMATION RETRIEVAL NUMBER 74

COMPONENTS

Monolithic filters yield four poles



Damon Engineering, Inc., 115 Fourth Ave., Needham Heights, Mass. Phone: (617) 449-0800.

Four new four-pole monolithic crystal filters are now available with center frequencies of 10.7 or 21.4 MHz. Models 6347MA, 6347MB, 6348MA and 6348MB have 3-dB bandwidths of 6 or 15 kHz minimum and 40-dB bandwidths of 24 or 55 kHz maximum. Maximum ripple is 0.5 or 1 dB, maximum insertion loss is 2 or 3 dB, and operating temperature range is 0 to 60°C.

CIRCLE NO. 340

Military trimmers are 3/8 in. square

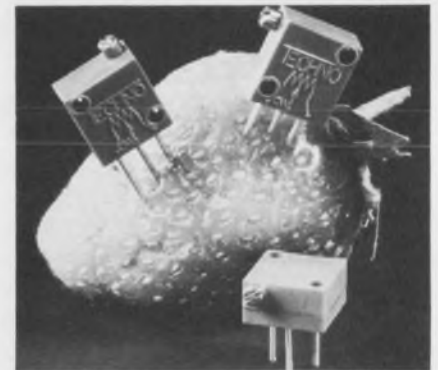

Techno Components Corp., Sub. of Oak Electro/Netics Corp., 7803 Lemona Ave., Van Nuys, Calif. Phone: (213) 781-1642.

A new family of 3/8-in. square trimming potentiometers meet the requirements of MIL-R-39015. Series RTR 24 trimmers are available in the popular P, W, and X configurations with resistance values ranging from 10 to 10,000 Ω . Power rating is 3/4 W at full load with an ambient temperature of 85°C, and insulation resistance is greater than 100 G Ω at 500 V dc.

CIRCLE NO. 341

build with . . .

ALCOSWITCH[®]

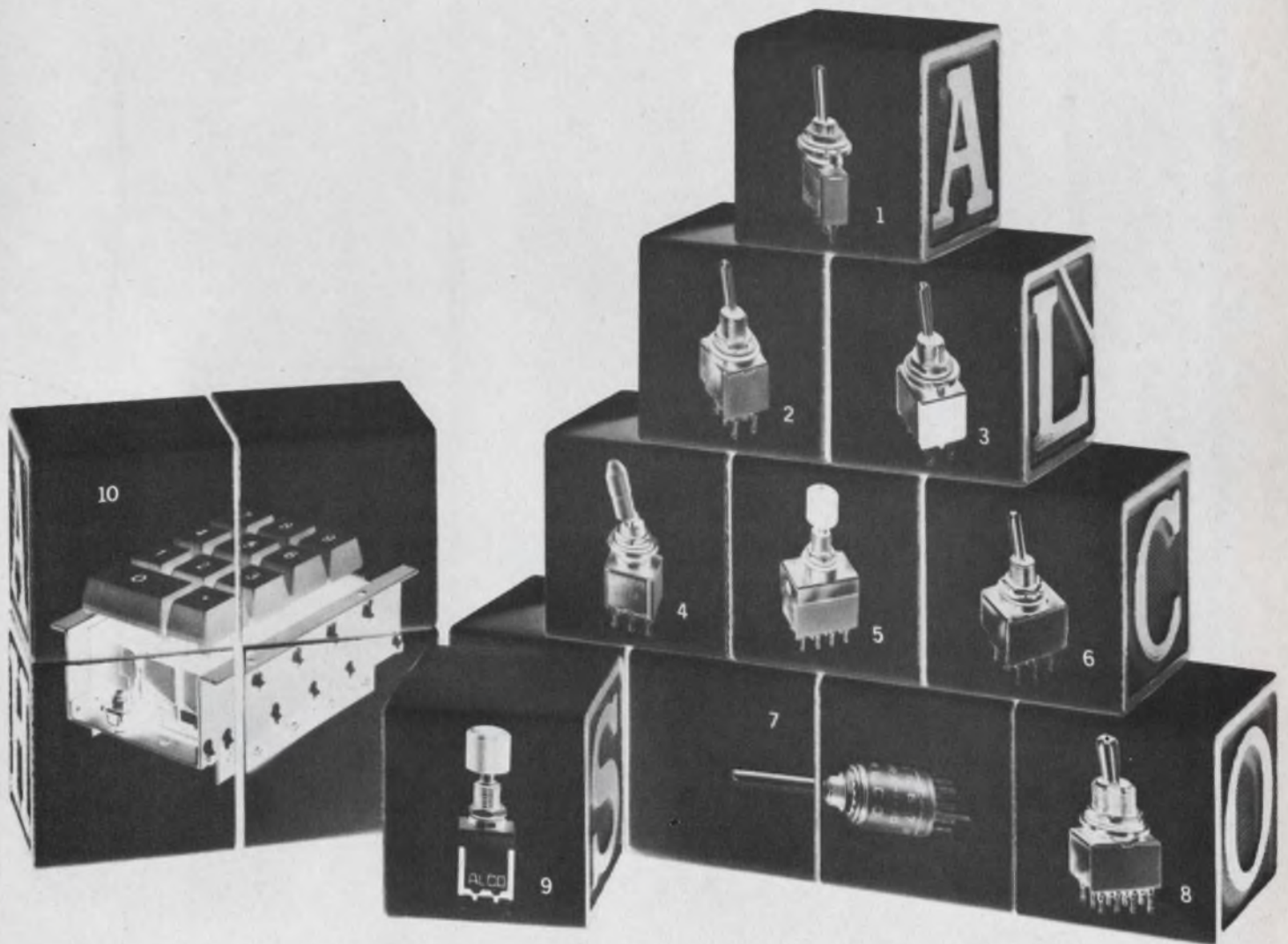

Build quality and reliability into your equipment with a top performing miniature Alcoswitch. Here are typical miniature switches from the many families of Alcoswitch which you can select: 1 — SPDT "A" Series Toggle Switch, 2 — DPDT "E" Series Toggle Switch, 3 — DPDT "MST" Series Toggle Switch, 4 — DPDT Locking Toggle Switch, 5 — 4PDT "E" Series Push Button Switch, 6 —

3PDT "E" Series Toggle Switch, 7 — "E" Series Waterproof Rotary Switch, 8 — 4PDT "Mustang" Toggle Switch, 9 — DPDT "MST" Series Push Button Switch, 10 — Reed Switch Operated Keyboard Assembly. Whatever your design problem or production budget, there is a miniature switch to fit your needs from Alcoswitch . . . the No. 1 choice in the U.S.A.

ALCO[®] ELECTRONIC PRODUCTS, INC. ■ LAWRENCE, MASS.

Circle 129 on reader service card



Encapsulated delay line, used between 8 and 12 Gc, exhibits 100 nanoseconds of delay. Weighs less than 8 pounds, cable is 70 feet long, .270" diameter, 50 ohm impedance.

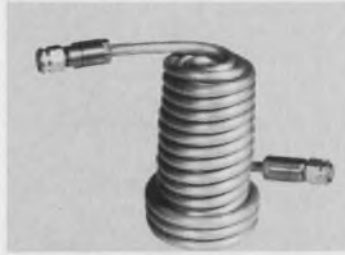

High density delay line, exhibits 20 nanoseconds delay. 13' of cable, .270" diameter with polyethylene dielectric and 50 ohm impedance. Unit is 5" tall.



Dual section potted delay line. Outer race accounts for 980 nanoseconds; an inner nest exhibits 61.1 nanoseconds of delay. 50 ohm coaxial cable .215" diameter. Weight is 25 pounds for the 16" diameter, 3" high package.

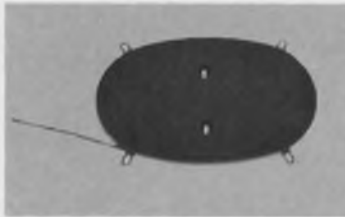

To achieve 122 nanoseconds of delay and fit tight confines, a pancake configuration measuring 11" x 7" x 3/8" containing 45 feet of .141", 50 ohm miniature semi-rigid coax was potted for use with an airborne radio altimeter.



Standard delay line for calibration of oscilloscopes, altimeters, radar systems and similar applications. Measures 8 1/2" x 21" x 19", offers a delay of 500 nanoseconds, calibrated to ± 0.25 nanoseconds.



KU band delay line exhibits loss of less than 30 DB with maximum of 1:3:1 at 13 GHz. Built-in thermal insulation and solid state temperature control. Internal waveguide to coax transitions.

COAXIAL DELAY LINES

Delays up to one microsecond from video frequencies to x-band are easily achieved in small, light-weight packages. Tolerances are tight: impedance to $\pm 1/2$ ohm delay to $\pm .02$ nanoseconds. Lines may be calibrated in nanoseconds or seconds of an electrical degree or, calibrated to ± 0.003 nanoseconds at 1 GHz. You have your selection of decade delay lines with calibrated jumpers, manual or re-

mote switching; input or output connectors of any interface, standard or special, plus, choice of packaging including rack mounting, special cases or encapsulation. You set your design parameters and we meet them.

Want more detail? Write for Bulletin DL Issue 2 to Phelps Dodge Communications Company, 60 Dodge Avenue, North Haven, Connecticut 06473.

PHELPS DODGE COMMUNICATIONS COMPANY 

Plastic npn/pnp pairs handle up to 35 W

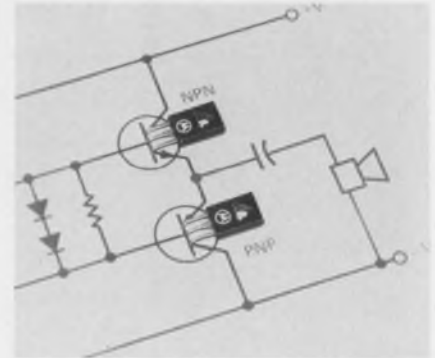

Motorola Semiconductor Products Inc., P.O. Box 20924, Phoenix, Ariz. Phone: (602) 273-6900. Price: \$1.25 to \$1.95.

Encapsulated in a miniature plastic package, four new low-cost silicon transistors are now available for use in 20- and 35-W complementary audio amplifiers. The npn MJE205 and pnp MJE105 are 5-A units, while the npn MJ2801 and pnp MJ2901 are 10-A units. Power dissipation is 65 or 90 W, and current gain ranges from 25 to 100 for collector currents of 2 or 3 A, respectively.

CIRCLE NO. 342

Monolithic source socks out 1 mA



Optical Electronics, Inc., P.O. Box 11140, Tucson, Ariz. Phone: (602) 624-8358. P&A: \$12; stock.

With input current determining its output current, a new monolithic temperature-stabilized source supplies output currents from 100 nA to 1 mA. Model 8106 is a four-lead low-profile device in a TO-5 package. Its bandwidth is 20 MHz, and output impedance is 100 M Ω . Applications include pulse amplifiers, staircase generators and integrator current sources.

CIRCLE NO. 343

Zener

specialists- 10⁷ times a year

**Centralab produces 10,000,000
zeners a year, each hermetically
sealed for reliability**

Production figures prove that buyers have confidence in Centralab zeners. They know, for example, that we originated microglass zener regulators and are still the industry's leading producer and developer. There are hermetically sealed zeners (or passivated chip devices) that meet or exceed hi rel military and demanding industrial requirements, plus others produced for low-cost entertainment applications. Our zener regulators cover thousands of JEDEC numbers, ratings, case styles and applications. Or we can design to your particular requirements. And every order gets special treatment. That's how we got to be the zener specialists — we provide the zener regulators you want, when you want them. Count on us. Call Centralab Customer Service, 213/686-0567.

Find out about Centralab's chip diodes, including an exclusive chip diode kit for lab and short production run applications.

Shown, are reel-packed microglass zeners for high production applications



CENTRALAB

Semiconductor Division
GLOBE-UNION INC.
4501 NORTH ARDEN DRIVE
EL MONTE, CALIFORNIA 91734

M-6907

INFORMATION RETRIEVAL NUMBER 77

Now... the highest concurrent- rated inverter SCR

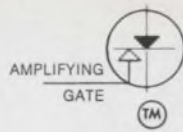

**C398 inverter SCR
utilizes amplifying gate
design for high speed
and high voltage.**

The new C398 is now the highest rated SCR in GE's complete line of inverter thyristors. This new 1200 volt design boasts soft-firing gate, high di/dt and fast turn-off time. These features are the result of over one and a half years of General Electric experience in amplifying gate technology. This structure also permits superior ratings for other Press Pak (C358) and stud-mounted (C158) units.

C398's Press Pak package means simpler installation and increased application flexibility, plus double-side cooling permits a higher current capability. To mount the hermetically-sealed Press Pak, simply insert it into GE's new universal spring clamp assembly. To change polarity, just turn the unit over.

With this latest addition, GE's full line of inverter thyristors includes virtually every rating necessary for total design flexibility... including Press Paks (C354/355, C385, C358, C510, C398) and stud mounts (C141, C154/155, C185, C158).

Also designed for inverter use is the A96 and its Press Pak counterpart, A396. This pair of fast-recovery diodes is specifically designed to complement GE's high-speed SCR's in inverter and chopper applications.

For more information on these and other General Electric semiconductor products, call or write your GE sales engineer or distributor, or write General Electric Company, Section 220-71A, 1 River Road, Schenectady, N. Y. 12305. In Canada: Canadian General Electric, 189 Dufferin St., Toronto, Ont. Export: Electronic Component Sales, IGE Export Division, 159 Madison Avenue, New York, New York 10016.

GENERAL  ELECTRIC



BEST SOURCE
FOR MORE IN ELECTRONIC COMPONENTS

INFORMATION RETRIEVAL NUMBER 78

Four ac amplifiers fit on single chip

RCA/Electronic Components, 415 S. Fifth St., Harrison, N. J. Phone: (201) 485-3900. Price: \$2.45.

Consisting of four independent ac amplifiers on a single silicon chip, model CA3048 circuit array incorporates, for each amplifier, internal dc bias and feedback for temperature-stabilized operation. Each circuit features a typical noise figure of 2 dB at 1 kHz, minimum voltage gain of 53 db, typical input resistance of 90 k Ω and a typical output impedance of 1 k Ω . Minimum undistorted output voltage is 2 V rms, and open-loop bandwidth is 300 kHz typical.

The monolithic array may be used with amplifiers cascaded for high-gain dual-channel operation. It operates from a single-ended power supply and has independently accessible inputs and outputs. Its housing is a 16-lead dual-in-line plastic package; operating temperature range is -25 to +85°C.

Applications include multi-channel or cascade operation, low-level preamplifiers, equalizers, linear multivibrators, ac integrators, as well as other ac circuits where operational amplifiers have been employed previously.

CIRCLE NO. 344

Hybrid semiconductors simplify assemblies

Ferranti Electric Inc., E. Bethpage Rd., Plainview, N.Y. Phone: (516) 293-8383.

Series Micro-E microminiature plastic encapsulated transistors and diodes eliminate many of the difficulties involved in producing active devices suitable for use with thick- and thin-film circuits. Since their leads emerge at each end, the new devices simplify the setting up of automatic assemblies and provide large power dissipation levels at high operating temperatures. They are designed to interface with normal track spacing or thin- and thick-film circuits.

CIRCLE NO. 345



HOW TO IMPROVE SYSTEM PERFORMANCE IN THE HIGH VOLTAGE FIELD...

If your system operates at elevated voltage, the proper high voltage cable can measurably improve its performance. We know from experience, because high voltage cable is our field. A BIW specialist is available to discuss your particular H.V. problem from a total system standpoint.

SILICONE HV CABLE — BIW leads the field in silicone processing technology. Insulating and semi-conducting silicone rubbers are combined to yield cables of extraordinary flexibility and high corona initiation voltage. Suitable for satellite systems, power supplies, radars, Xenon flash tubes, CRT leads and most systems under 100 KVDC where flexibility and ease of termination are required at temperatures to 200°C.

BUTYL HV CABLE — Butyl-rubber-insulated, single and multi-conductor cables combine high dielectric strength and flexibility with low cost. Voltages to 200 KVDC with high reliability for a variety of applications including X-Ray, electron beam welding, electron microscopy and many others.

TFE HV CABLE — An exclusive BIW process combines thin tapes of TFE with high dielectric strength oil and an FEP jacket to produce exceptionally small diameter High Performance cables for use in general high voltage wiring to 30 KVAC. May be used in dielectric coolant systems. Extremely tough and reliable.

LAMINATED SYNTHETIC HV CABLE — Layers of thin irradiated polyethylene tape plus high-dielectric-strength oil result in cables suitable for voltages from 100 KVDC to 1000 KVDC. Designed especially for linear accelerator feeds, electron beam welders, pulse discharge devices, ion separators and other systems requiring extra high voltage cable.

If you have a high voltage wire or cable problem BIW will solve it with a proprietary, pre-engineered cable or will quickly design one to meet your need. Call or write.



Boston Insulated Wire & Cable Co.

54 Bay Street, Boston, Mass. 02125

El Segundo, Calif. 90245; Hamilton, P.O. Canada; Kingston-upon-Thames, U.K.; GEDEBIW, S. A. — Clichy, France



We had big things in mind when we developed our tiny toggle switches.



Things like airplanes,
ware, communications gear and

Things where small size
But where long-life operating

For instance, excellent

position." Our TW toggle switches provide both. The result of a 35° toggle throw and positive detent. And for aircraft applications, there's a new, large bat handle that meets your human factor requirements.

Then there's switching versatility. Both standard 1/4" and our new 15/32" bushing versions are available with a two or three-position, maintained or momentary action and in either one or two-pole circuitry. All can be obtained with standard or pull-to-unlock toggle levers to meet your needs.

Sealed, molded-in solder terminals won't pull out. Go ahead, try.

What this all adds up to is reliability. The kind that's evidenced by meeting MIL-S-3950 requirements for shock, vibration, moisture, corrosion and altitude.

There are accessories, too. Dress hardware, lever caps, boot seals, panel seals. Each improves switch effectiveness as well as panel appearance.

It's all in Product Sheet TW. Plus a lot more. You can get a copy from your MICRO SWITCH Branch Office or Distributor. (They're in the Yellow Pages under "Switches, Electric.") Or write and we'll send a copy. You're sure to find it a big help.

MICRO SWITCH

FREEPORT, ILLINOIS 61032

A DIVISION OF HONEYWELL

INFORMATION RETRIEVAL NUMBER 80

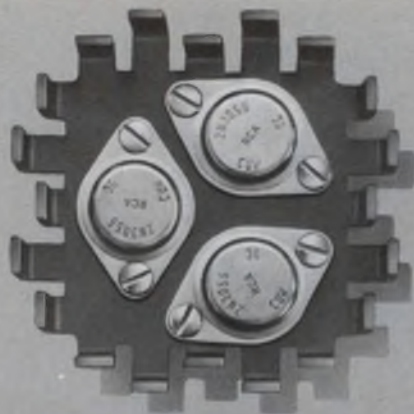

IERC's HP Heat Dissipator is only 1/3 the weight and 2/3 the volume of extrusions—yet it dissipates the same amount of heat.

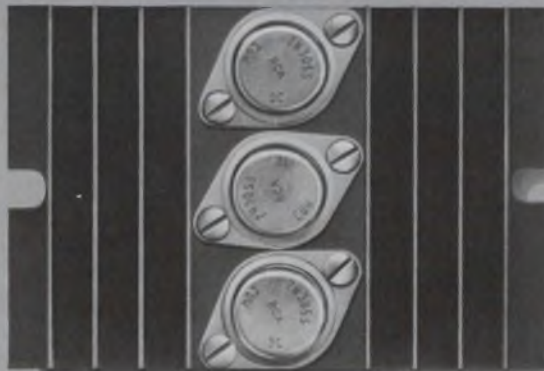

Here's proof.

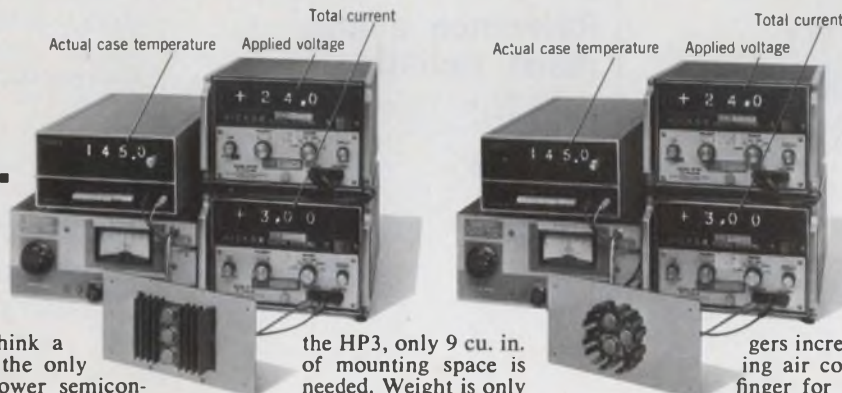

Many circuit designers think a hefty hunk of extrusion is the only thing to use to cool off power semiconductors. Of course, extrusions are big and heavy but that's the price one had to pay. No more.

The test setups shown above prove there is a better way.

On the left: A conventional extruded aluminum heat sink and three TO-3 case silicon transistors. 13.5 cu. in. (3 x 4.5 x 1) are required for mounting. Weight is 4.4 ozs. Total power dissipation is 72 watts with case temperature rise of 120°C (plus 25°C ambient).

On the right: IERC's efficient HP3 Dissipator with three TO-3s. (The HP3 will actually accommodate four TO-3s.) With

the HP3, only 9 cu. in. of mounting space is needed. Weight is only

1.5 ozs. But, as shown, *performance is exactly the same*. It's just that the HP3 does the job with only 2/3 the size and 1/3 the mass!

See the secret? It's the multiple staggered finger design. In still air the separate fingers dissipate, by radiation and convection, directly to the ambient—not to another finger surface. Conversely, extrusion fins radiate to each other. And, the free movement of convection currents is hampered by their being confined in the deep cavities between the fins.

In forced air the HP is even more efficient. The staggered fin-

gers increase turbulence, directing air completely around each finger for maximum dissipation. But with finned extrusions the forced air begins to leave the surfaces immediately. By the time it is part way down the extrusion it is hitting only the top edges of the fins, resulting in minimal dissipation.

Also, extrusions are directional. The HP is not. Mount it in any vertical or horizontal mode. It gives the same high efficiency with forced air from any direction.

Convinced? Then send for Technical Bulletin No. 139 and our new 4-page Short Form Catalog. They're loaded with ways to keep your transistorized circuitry cool and small.



Heat Sinks/Dissipators
for all lead mounted and
case mounted semiconductors

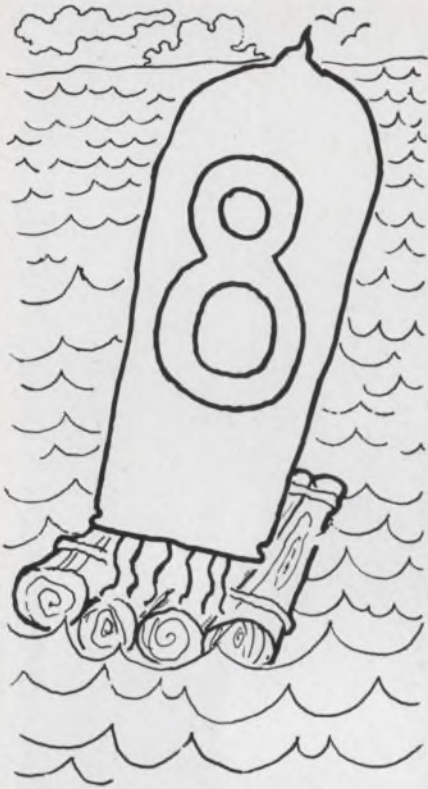

3 ways to keep indicator tube orders from drifting at sea.

Insist on delivery by rocket...submarine... or choose U.S.-made Datavue* Tubes.

Raytheon offers you prompt deliveries of Datavue tubes and fast turn-around service on all custom alphanumeric, decimal, and special character orders. Tubes are U.S.-made, can cost less than \$3.95 each.

All Datavue tubes are produced for 200,000 hours of reliable operation. They feature: straight, stiff leads for fast insertions; fully formed, high-brightness characters for accurate reading; rated for strobing operation. More than 40 different sockets, including right-angle types, are available.

Call your Raytheon distributor or sales office. *Raytheon Company, Industrial Components Operation, Quincy, Mass. 02169.*

*Trademark of Raytheon Company



INFORMATION RETRIEVAL NUMBER 82

ICs & SEMICONDUCTORS

Three vhf/uhf FETs gain 18 dB at 100 MHz

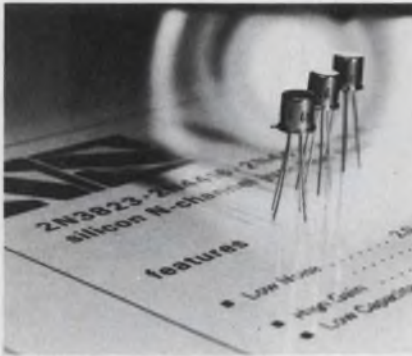

National Semiconductor Corp., 2950 San Ysidro Way, Santa Clara, Calif. Phone: (408) 245-4320. P&A: \$1.70 to \$3.35; stock.

Three new vhf/uhf FETs deliver 18-dB power gain at 100 MHz and 10-dB power gain at 400 MHz. Types 2N3823, 2N4416 and 2N4416A exhibit at low noise figure of 2 dB at 100 MHz, 4 dB at 400 MHz, in addition to a low capacitance of 0.8 pF. Applications for the new devices include amplifiers, mixer and oscillators, and receivers and tuners.

CIRCLE NO. 346

Reference diodes resist radiation



Microsemiconductor Corp., 11250 Playa Court, Culver City, Calif. Phone: (213) 391-8271. P&A: \$8.28; stock to 2 wks.

A new line of radiation-resistant temperature-compensated reference diodes is said to exhibit one order of magnitude more resistance to fast neutron radiation than competitive units. These hardened silicon devices have nominal voltages of 6, 2, 8.4 and 9 V, and temperature coefficients from -50 to $+100^{\circ}\text{C}$.

CIRCLE NO. 347

Linear monolithics compare and amplify

Signetics Corp., 811 E. Arques Ave., Sunnyvale, Calif. Phone: (408) 739-7700. Price: \$3.15 amplifier, \$4.15 comparator.

Two new linear integrated circuits are now available—the 517 dual operational amplifier and the 526 analog comparator. The amplifier is supplied in two versions, a military unit and a commercial/industrial one. It offers a power capability of 75 mW per channel and a typical gain of 15,000.

CIRCLE NO. 348

IC amplifier costs only 49¢

RCA/Electronic Components, 415 S. Fifth St., Harrison, N.J. Phone: (201) 485-3900. Price: 49¢.

Priced at 49¢ in quantities of 1000, a new monolithic differential/cascode amplifier offers exceptional economy for i-f and general-purpose amplifier applications. Model CA3053 features a wide operating-current range and an agc capability. Electrical characteristics include a typical power gain of 39 dB for cascode and 32 dB as a differential amplifier.

CIRCLE NO. 349

Linear multiplier is monolithic IC

Motorola Semiconductor Products Inc., P.O. Box 20924, Phoenix, Ariz. Phone: (602) 273-6900. Price: \$18.

Intended for use in the control, instrumentation, communications, computer and navigation fields, a new monolithic four-quadrant multiplier, said to be the industry's first, provides an output voltage that is a linear product of two input voltages and a constant scale factor. The MC1595 is designed so that the scale factor and the input/output voltage ranges may be adjusted by the user to accommodate a wide variety of applications.

CIRCLE NO. 350

We're only
Second
in ECL II...



BUT IN THIS HORSE RACE – THAT'S NOT BAD !

Although we have a winning line of ECL's—Motorola's still a few circuits ahead. But we're announcing that we can match their 14 most popular MECL II units right now—with more to come!* So if you've been afraid to take advantage of the high-speed characteristics of these unique new ECL devices because you don't like sole-sourcing—relax. Go ECL II with confidence. Now you've got Stewart-Warner to back up Motorola...or vice versa.

STEWART-WARNER ECL II

CIRCUIT FUNCTION	MILITARY -55°C. to 125°C.	INDUSTRIAL 0°C. to 75°C.
Dual 4-input Complementary Gate	SW1204	SW1004
Dual 4-input Complementary Gate	SW1205	SW1005
Dual 4-input Complementary Gate	SW1206	SW1006
Quad 2-input NOR Gate	SW1210	SW1010
Quad 2-input NOR Gate	SW1211	SW1011
Quad 2-input NOR Gate	SW1212	SW1012
85-MHz AC-Coupled J-K Flip-Flop	SW1213	SW1013
Dual R-S Flip-Flop (Positive Clock)	SW1214	SW1014
Dual R-S Flip-Flop (Negative Clock)	SW1215	SW1015
Dual R-S Flip-Flop (Single Rail, Positive Clock)	SW1216	SW1016
Translator—ECL to Saturated Logic	SW1218	SW1018
Dual 2-input Expandable Gate	SW1224	SW1024
Dual 4-5 input Expander	SW1225	SW1025
Dual R-S Flip-Flop (Single Rail, Negative Clock)	SW1233	SW1033

For more information, send for our new ECL II data sheets. And, for off-the-shelf product delivery, call your local Stewart-Warner Microcircuits Distributor.

*We also offer 11 ECL's in the 300 and 350 series.

STEWART-WARNER **COMPANIES**

SYMBOL OF EXCELLENCE

STEWART-WARNER MICROCIRCUITS, INC.

730 EAST EVELYN AVENUE, SUNNYVALE, CALIFORNIA 94086
PHONE 408/245-9200 TWX 910-339-9210

PERFORM WITH CHAMPIONS



ONLY \$44⁹⁵ ppd.

BUY THE BEST MARK TEN[®] CAPACITIVE DISCHARGE IGNITION SYSTEM

DELTA KIT only \$29⁹⁵ ASSEMBLE IT YOURSELF!

Now discover for yourself the dramatic improvement in performance of your car, camper, jeep, truck, boat — any vehicle! Delta's remarkable electronic achievement saves on gas, promotes better acceleration, gives your car that zip you've always wanted. Find out why even Detroit has finally come around. In four years of proven reliability, Delta's Mark Ten has set new records of ignition benefits. No re-wiring! Works on literally any type of gasoline engine.

COMPARE THESE PROVEN BENEFITS...

- ▲ Dramatic Increase in Performance and in Fast Acceleration
- ▲ Promotes more Complete Combustion
- ▲ Points and Plugs last 3 to 10 Times Longer
- ▲ Up to 20% Mileage Increase (saves gas)

Order Your MARK TEN Today Shipped Postpaid at once . . .



P.O. Box 1147 ED • Grand Junction, Colo. 81501
Enclosed is \$_____ Ship ppd. Ship C.O.D.
Please send:

- Mark Tens (Deltakit[®]) @ \$29.95
(12 VOLT POSITIVE OR NEGATIVE GROUND ONLY)
- Mark Tens (Assembled) @ \$44.95
- 6 Volt: Negative Ground only
- 12 Volt: Specify Positive Ground Negative Ground

Car Year _____ Make _____
Name _____
Address _____
City/State _____ Zip _____

ICs & SEMICONDUCTORS

Capacitance diodes vary C by 5:1 ratio

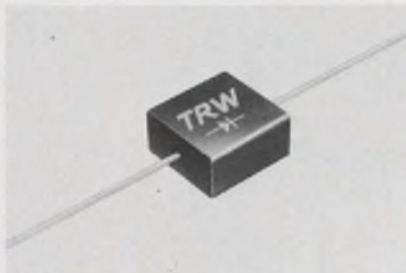

TRW Inc., Semiconductor Div.,
14520 Aviation, Lawndale, Calif.
\$13.70 to \$19.60; stock.

Over the frequency range of 1.6 to 5 MHz, three new high-capacitance diodes feature a 5:1 capacitance ratio between 2 and 90 V. Designed for low-frequency circuits, the devices have less than 1- μ A leakage and a Q factor of greater than 150. Type PQ2150 has a capacitance of 150 pF; type PQ2300, 300 pF; and type PQ2500, 500 pF. Their flat encapsulated package is 0.32-in. square by 0.165 in.

CIRCLE NO. 351

Dual-circuit hybrid is spst FET switch

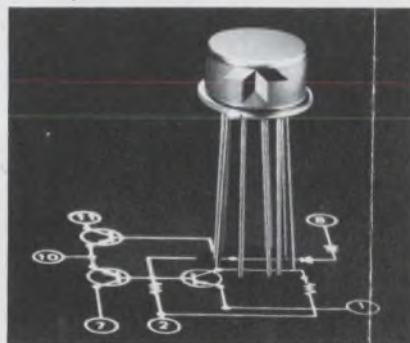

Crystalonics, a Teledyne Co., 147 Sherman St., Cambridge, Mass.
Phone: (617) 491-1670. P&A: \$60; stock.

Containing two complete circuits in a single low-profile TO-5 package, a new spst hybrid FET switch operates directly from DTL or TTL inputs. Designed for analog gating, model CAG13 provides break-before-make switching action. Over the voltage range of ± 9 V, each circuit has a maximum on-resistance of 50 Ω and a typical switching time of 300 ns.

CIRCLE NO. 352

THE GIANT KILLERS

SMALLER TOUGHER



FOR LESS!

Regulated DC Power Supplies designed—and priced—to solve big problems.

The Computer Products family of DC power supplies — 3.6V 250 MA to 180V 10 MA, P.C. and Octal Plug-in, are consistently smaller, tougher and better-performing than competitors' near-equivalents.

Prices are smaller, too. By about 50%.

Here's a sample:

Output Voltage	15VDC
Input Voltage	115 \pm 10VAC
Output Current	100 MA
Line-load Reg. Ea.	\pm 0.02%
Temp. Co./ $^{\circ}$ C	0.02%
Ripple/Noise	0.5 mV RMS
Output Z @ 10KHz	0.2 ohms
Case size	1.75" x 2.25" x 1"
Model No.	PM576
PRICE 1-9	\$24.95

Call or write for complete information . . . or

CALL TODAY FOR 3-DAY SHIPMENT
305/565-9565

Computer Products, Inc.,
2801 E. Oakland Pk. Blvd.
Ft. Lauderdale, Fla. 33306



COMPUTER PRODUCTS[™]

FORT LAUDERDALE

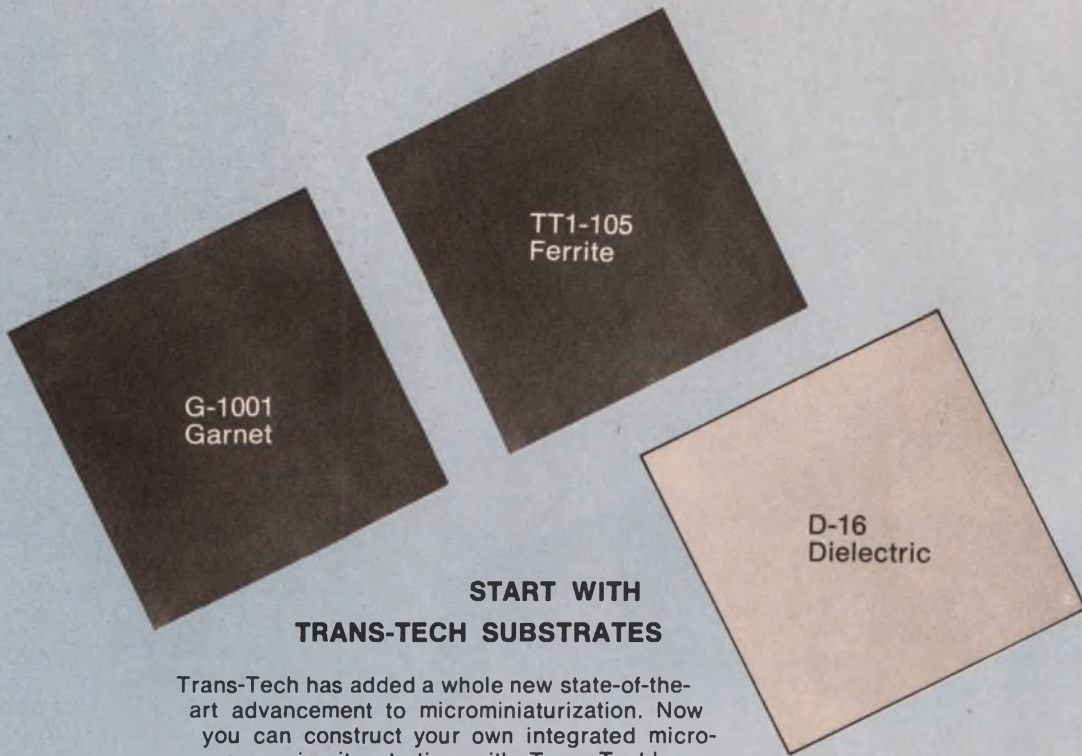

**START WITH
TRANS-TECH SUBSTRATES**

Trans-Tech has added a whole new state-of-the-art advancement to microminiaturization. Now you can construct your own integrated microwave circuits starting with Trans-Tech's own ferrimagnetic or dielectric substrates.

These substrates have the same "high-reproducibility", technical characteristics as all Trans-Tech materials . . . only the form is changed.

Design investigation begins with any one of the three standard substrates listed below. And the beauty of it is you can get into microstrip design economically. Order just one or a few standard substrates for prototype design. Immediate delivery on all orders.

Production orders can be conformed to other custom sizes, surface finishes or other material requirements.

Part No.	Material Type	Surface Finish		Price
		4 π M.	(micro-inches)	
TT S-10101	G 1001 (Garnet)	1200 \pm 5%	\leq 20	\$17.00
TT S-10201	TT1-105 (Ferrite)	1750 \pm 5%	\leq 25	8.00
TT S-10301	D 16 (Dielectric)		\leq 25	5.00

All Substrates are 2.000 \pm 0.010 x 2.000 \pm 0.010 x 0.050 \pm 0.001 inches.

TRANS-TECH, INC. 
12 Meem Avenue, Gaithersburg, Md 20760 / (301) 948-3800

Get into Microstrip Design



Atec's new Model 2400 Bi-Directional Counter lets you count in any direction...and at a modest price.

The Model 2400 is

VERSATILE: It has six operating modes. It counts *up and down* from 0 to 10 MHz. It counts *sideways*: in A quad B mode, input signals are added or subtracted depending on phase relationship. And it offers these other outstanding features:

- BCD output
- Operating power for sensing lamps and amplifier circuits
- Manual or remote programming
- Input sensitivity from 0.01 V RMS to 125 V
- One megohm input impedance
- Four decimal digits (to seven, optionally)
- Only 1 3/4" high in a standard rack mount.

RELIABLE— Jitter-free, coincidence-free circuitry, all solid-state modular design, extensive use of ICs, and a motherboard to minimize wiring.

ECONOMICAL— all this for only \$895!

For complete specifications or a free demonstration call your local Atec engineering-sales representative or write directly to us. A brief description of other Atec instruments is available in the 1969-70 EEM, in section 2200.

Atec, Inc.

1125 Lumpkin Street, Houston, Texas ■ Phone (713) 468-7971
 Mailing Address: P. O. Box 19426, Houston, Texas 77024

INFORMATION RETRIEVAL NUMBER 86

INSTRUMENTATION

Shirt-pocket VOM has FET input



Triplet Electrical Instrument Co., Bluffton, Ohio. Phone: (419) 358-5015. P&A: \$70; stock.

Model 310-FET, a battery-operated volt-ohm-milliammeter, features FET circuitry, 10 MΩ constant input resistance on all dc voltage ranges, and can make resistance readings to 5000 MΩ. The little unit slips easily into a shirt pocket. Dimensions are 2-3/4 × 4-1/2 × 1-1/8 in.; weight is only 14 ounces. It includes a provision for attaching an ac clamp-on ammeter adapter.

CIRCLE NO. 353

Solid-state injector traces circuits



Allied Radio Corp., 100 N. Western Ave., Chicago. Phone: (312) 421-6800. P&A: \$4.95; stock.

A new solid-state signal injector is now available in low-priced, easily assembled kit form. Model KG-644 is completely portable and self-contained. It produces a signal rich in harmonics for tracing audio, rf and i-f circuits. The insulated test probe features a battery condition light and push-button operation. A cylindrical handle houses the circuit, permitting long use without tiring.

CIRCLE NO. 354

The Friden 1150 Digital Printer: fast, reliable— and inexpensive.

The Friden* 1150 Digital Printer has a printing speed of 50 characters a second.

Because it has fewer moving parts than ordinary medium-speed printers, it is easier to maintain. This means less downtime for your OEM product. The unit contains a single 20-character print wheel and a synchronized print hammer. Both are driven across the tape from right to left at a uniform speed.

The hammer's short impact time ensures quality printing from the continuously rotating wheel. Your output looks good and is easy to read. And we have even eliminated ribbons with a disposable ink roller.

Logic requirements are simple, making it easy for you to integrate the 1150 into your OEM product.

The 1150 is a completely tested and proven printer—

a vital component of Friden electronic printing calculators for nearly two years. And Singer's Friden Division provides maintenance backup throughout the world.

With its low initial cost and desirable operating features, the 1150 gives you a price/performance ratio that is unique among OEM printers.

We'd like you to have complete specifications. Just write Friden Division (Component Products), The Singer Company, San Leandro, California 94577. Ask for Specification 1001.

SINGER
FRIDEN DIVISION

Friden Component Products. One way Singer serves OEM.

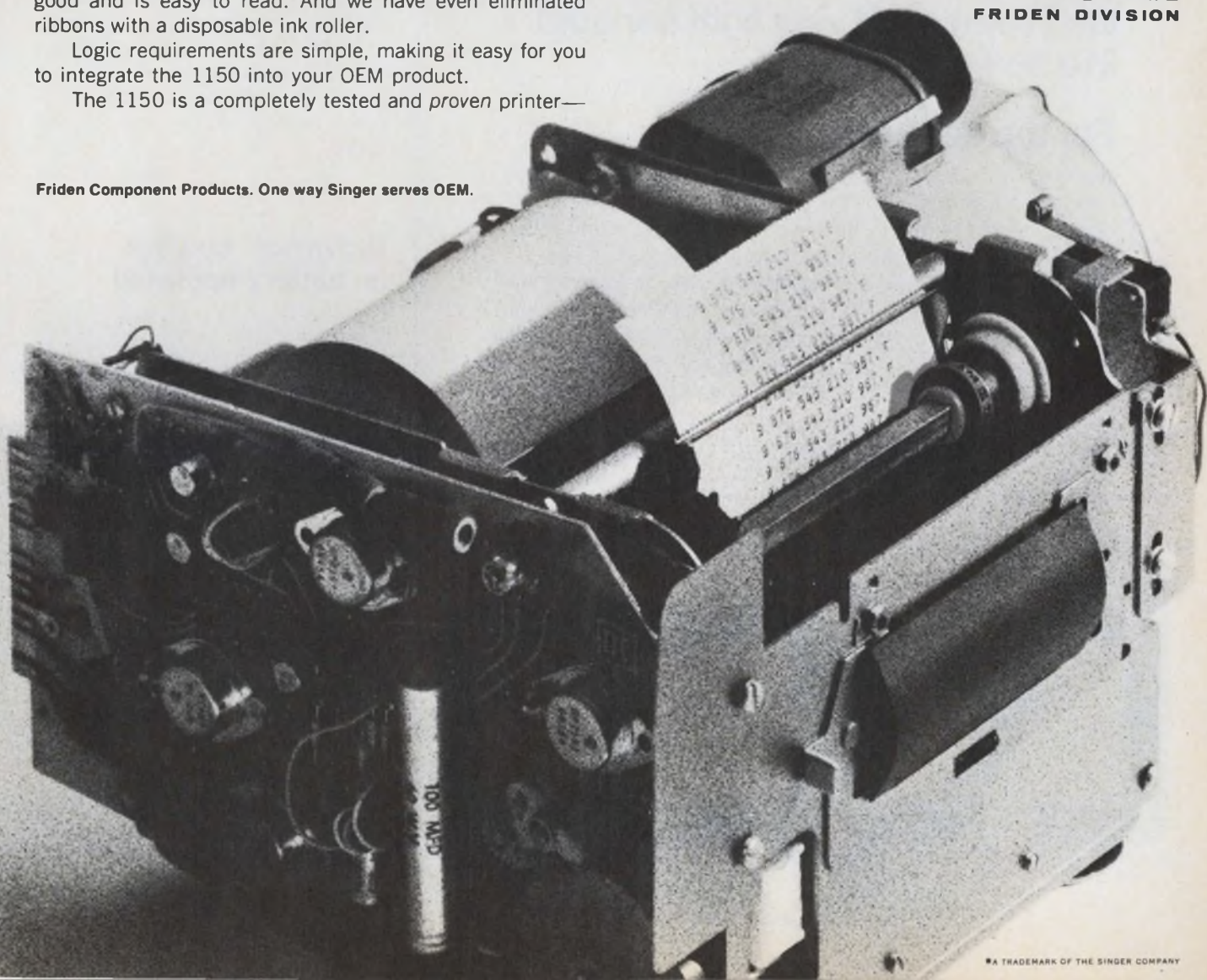

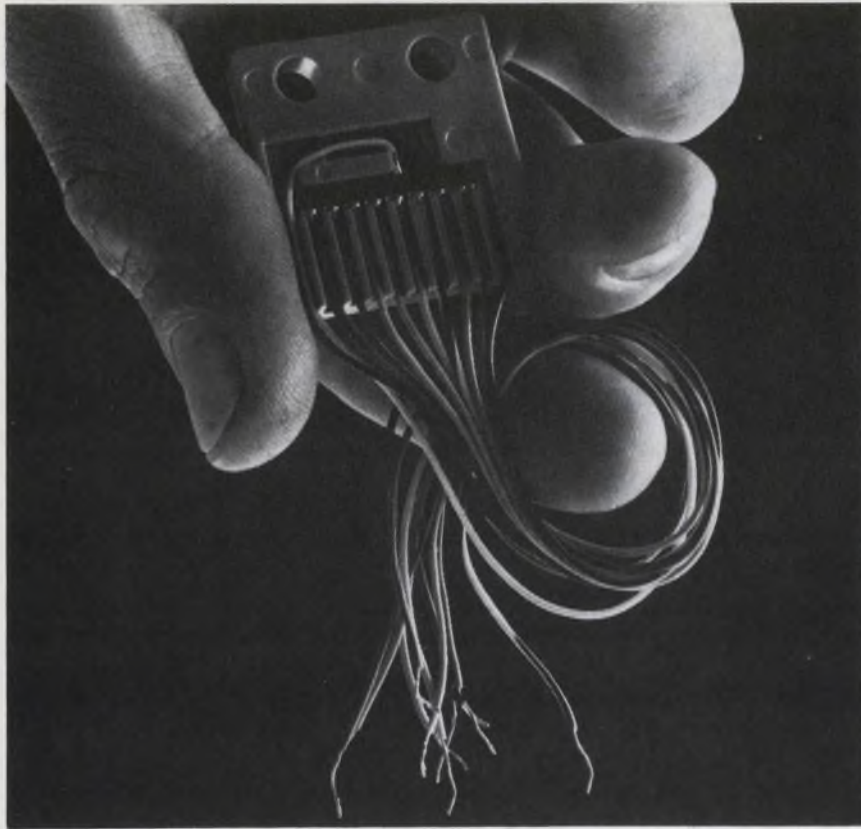

We'll even send your light sensors in a sealed package.

For top security.

That's our specialty. We were the first company to mount fragile light sensor devices in custom-designed, secure, durable packages. And we're the most experienced at producing them for commercial applications. Our skilled personnel use our specially-designed precision equipment to place and wire the sensors in your package. We save you the handling risk . . . and the time. You can buy anything from a single cell in a TO-18 can up to a special 960-position, plug-in, full-card reader. Or an array for a tape reader, or a badge or key recognition system. We'll even design for your special application we may never have heard of before. We'll package it securely, color-code it, design it so it can be easily incorporated into your system. But first we have to know what that is. Send your requirements to the engineering design department of Solar Systems Division, Tyco Laboratories, Inc., 8241 N. Kimball Avenue, Skokie, Illinois 60076. Or phone (312) 676-2040.

TYCO

INFORMATION RETRIEVAL NUMBER 88

INSTRUMENTATION

Handheld probes check logic states

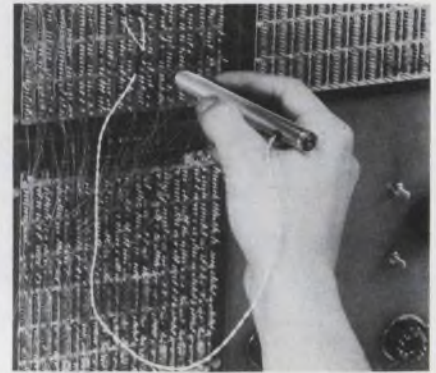

Kurz-Kasch, Inc., 1421 S. Broadway, Dayton, Ohio. Phone: (513) 223-8161. P&A: \$29.97; stock.

Logic levels of integrated circuit systems can be checked at a glance, without removing the module from the unit, by means of a new 6-in. logic probe. The probe visually displays presence or absence of logic current levels for gates, flip-flops, one-shots, etc., without requiring the service technician or inspector to shift his eyes to an oscilloscope screen or voltmeter. Readout is displayed through two circular windows located in the end of the probe.

CIRCLE NO. 355

Universal counter is battery-operated

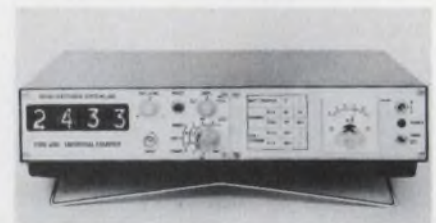

Micro Electronic Systems, Inc., 1275 Bloomfield Ave., Fairfield, N. J. Phone: (201) 228-4472. P&A: \$650; 60 days.

A universal counter and portable battery pack in a single housing, type 4061 B, includes a standard counter with a 100-kHz option. The battery automatically recharges when the unit is connected to the line, and overcharge protection is built in. A panel meter indicates battery condition, and the unit is capable of operation for a minimum of 8 hours.

CIRCLE NO. 356

INFORMATION RETRIEVAL NUMBER 89 ►

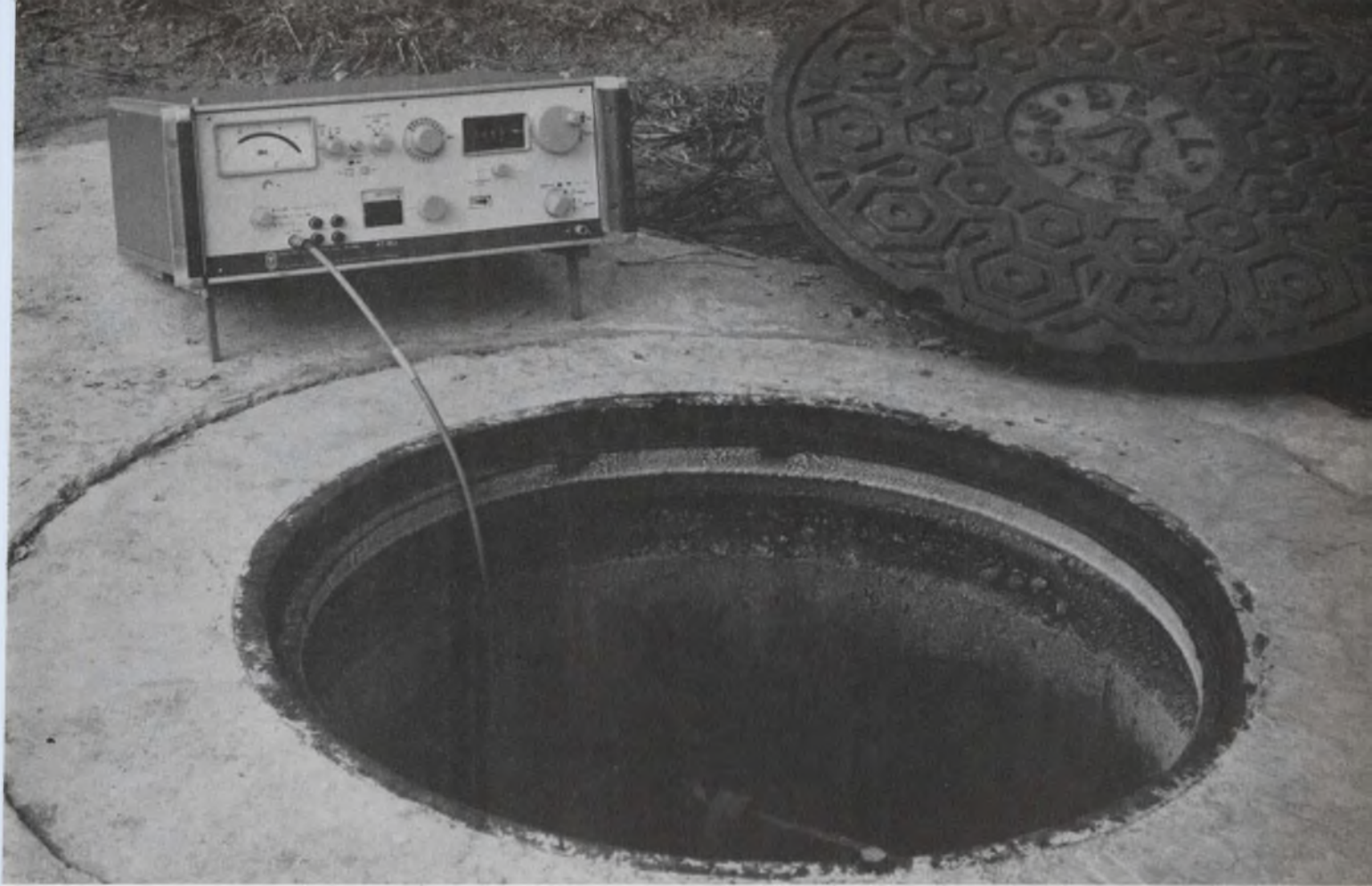

Level Meter Independent from Power Line, with Higher Accuracy

These were the basic requirements for a new selective level meter for balanced and coaxial cables and radio systems. In order to satisfy these demands from manufacturers and operating and service personnel in the carrier frequency field of telecommunications, a new instrumentation concept was developed employing techniques never before utilized. The result: the Selective Level Meter SPM-6 (6kHz to 18.6 MHz).

For example, the unusual measuring accuracy was achieved through automatic level calibration which makes the troublesome manual calibration superfluous and eliminates an additional source of potential error. Once every second the instrument calibration is checked against an internal standard, and, when necessary, automatically corrected. The frequency of the calibration signal is not — as is conventionally the case — constant, but is always tuned to the same frequency as the signal being measured, and applied at the very input. Frequency response and attenuator errors are therefore extremely small, and measurements with high absolute accuracy can be made with no warm up time whatsoever.

Selective Level Meter-SPM-6

**6 kHz to 18.6 MHz
balanced to 620 kHz**

A new type of measuring instrument for the measurement of modern carrier systems: High accuracy, precise frequency setability — operable from AC power or built in internally rechargeable batteries.

Wandel & Goltermann West Germany / represented in U.S.A. by

W & G INSTRUMENTS, INC. 6 Great Meadow Lane. Hanover, N. J. 07936 • (201) 887-8700



JFD UNICERAM - UFP SERIES:

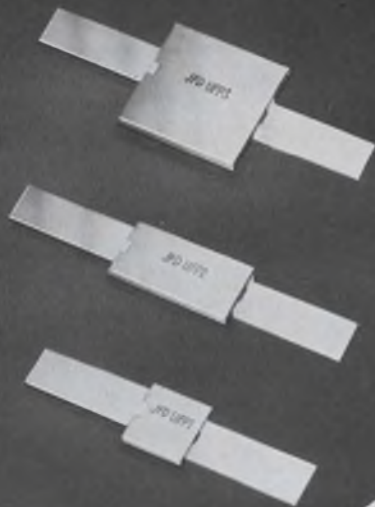

(illus. .65 actual size)

SMALLEST HIGH RF POWER CAPACITORS AVAILABLE!

JFD's Uniceram UFP Series offers the design engineer a broad line of miniaturized high voltage and high current fixed ceramic capacitors for use in RF circuits. These highly stable, small, reliable UFP's have been used up to 200 MHz. They are the ideal 'space-savers' for today's military communications, mobile, commercial broadcast and amateur radio transmitters.

UFP1's measure only $\frac{3}{64}$ " square X $\frac{1}{4}$ " thick. High Q 'Uniceram' proprietary ceramic material with special internal monolithic construction yields high power handling capabilities per unit volume. Glass encapsulation insures a moisture seal. Wide fine silver ribbon leads are used because of their low inductance and high RF current carrying capabilities.

- Capacitance values from 10 pf to 3,000 pf ($\pm .5$ pf for low capacitance values; $\pm 5\%$ and $\pm 10\%$ for higher values).
- Rated at 8 amperes at $+25^\circ\text{C}$ with derating for higher temperatures.
- Voltage rating (Typ.) at $+25^\circ\text{C}$ is 3,000vrms peak for values up to 150 pf (UFP1) and up to 330 pf (UFP3) with derating for higher temperatures.
- Q at 1 MHz and $+25^\circ\text{C}$ for values of 1,000 pf and smaller are 5,000 minimum.
- Typical UFP1 rating is 12 KVAR at $+25^\circ\text{C}$.
- Temperature coefficient at 1 MHz (-55°C to $+125^\circ\text{C}$) is $+95 \pm 25$ PPM/ $^\circ\text{C}$.

For additional information, write for catalog UNM-UFP-68.

"TODAY'S COMPONENTS BUILT FOR TOMORROW'S CHALLENGES"

JFD JFD ELECTRONICS CO. / COMPONENTS DIVISION
15th Ave. at 62nd St. • Brooklyn, N.Y. 11219 / Phone 212-331-1000

Offices and subsidiaries in principal cities, world-wide.

INFORMATION RETRIEVAL NUMBER 90

INSTRUMENTATION

Little black box boosts VOM punch



Integrated Controls, Inc., P.O. Box 17296, San Diego, Calif. Phone: (714) 453-5800. Price: \$50.

A new meter expander increases the voltage and current sensitivity of any VOM by as much as 1000:1. The instrument has selectable gain settings of 10, 100 and 1000. It is connected as a buffer amplifier between the test leads and the VOM. The direct-coupled, integrated circuit buffer amplifier produces a nominal full output of ± 2.5 V and increases the voltage sensitivity of the meter up to 60 dB and the input impedance to more than a megohm.

CIRCLE NO. 357

Oscilloscope plug-in plots characteristics

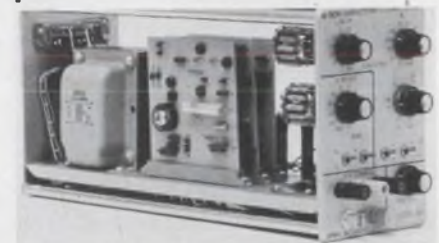

U-Tech, 4190 S. State St., Salt Lake City, Utah. P&A: \$595; stock.

Designed to be used with Tektronix 560-series plug-in oscilloscopes, the model 681 characteristic curve tracer offers substantial savings to users who already own a scope. The 681 displays the dynamic characteristics of both npn and pnp transistors, n- and p-channel junctions, FETs, MOS-FETs, bipolars, unijunctions, diodes, tunnel diodes, and SCRs. It offers curve tracer capability at less than half the price of a separate self-contained instrument.

CIRCLE NO. 358

Nothing eccentric about us

We make fine magnet wire **PERFECTLY CONCENTRIC** within its insulation. No thin spots or thick spots. Which means consistently filled bobbins. Uniform coil diameters. Few reject problems. No shorting. It's what we call "dimensional control." It's unique with Belden (and so is the equipment and processes that produce it). And it makes your quality control a lot easier.

We're also the only people to take raw copper rod and strip off the oxidation before we draw it. This makes it easier to solder or weld. And we ship our ultra fine magnet wire in unique, maximum-protection packages. To make sure you get your wire in perfect shape. All down the line we've problem-proofed Belden fine and ultra fine magnet wire. To give you plenty of good reasons for calling your Belden Representative or local Belden Magnet Wire Distributor (ask him for your copy of the "Belden Magnet Wire Handbook" when you do). Or write: Belden Corporation, P.O. Box 5070-A, Chicago, Illinois 60680.

Yeay! That's ours. A photomicrograph cross-section of dimensionally controlled Belden Fine Magnet Wire. Note the unique, perfect concentricity of the wire within its insulation.

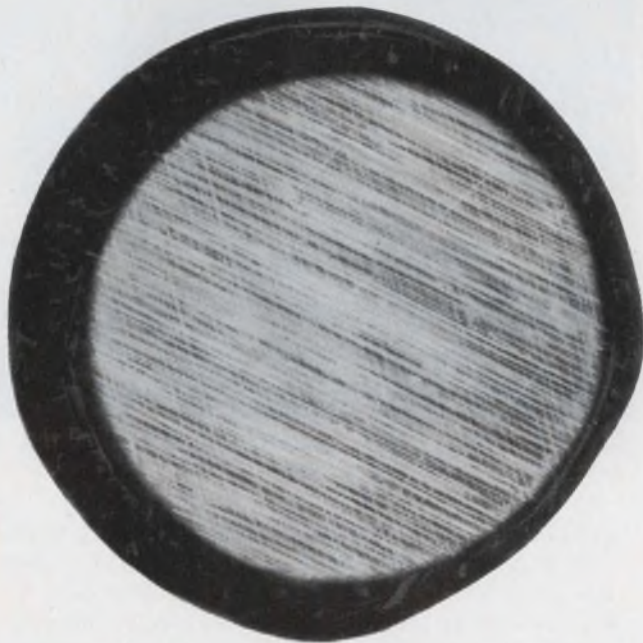
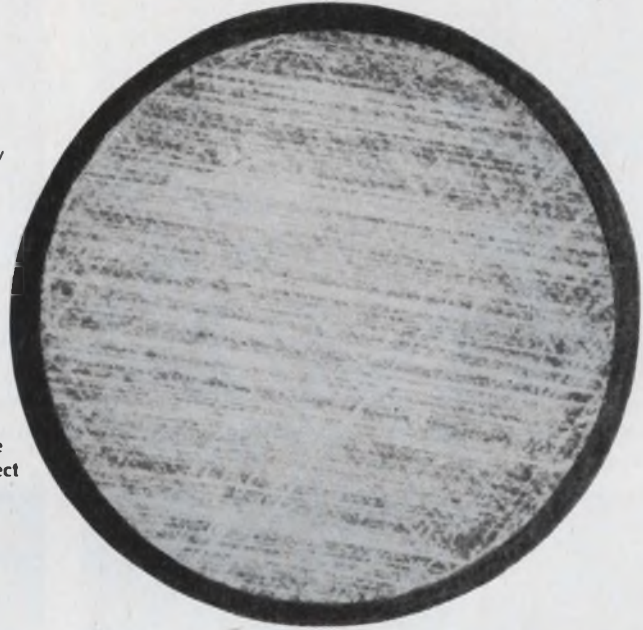

Nay! That's the alternative to Belden—a cross-section of conventionally insulated fine magnet wire. Note the thin spots that can quickly burn through to cause shorting. And the thick spots that cause uneven windings.



...new ideas for moving electrical energy

BELDEN 

1-2-B

INFORMATION RETRIEVAL NUMBER 91

How AO fiber optic light guides solve illumination problems.

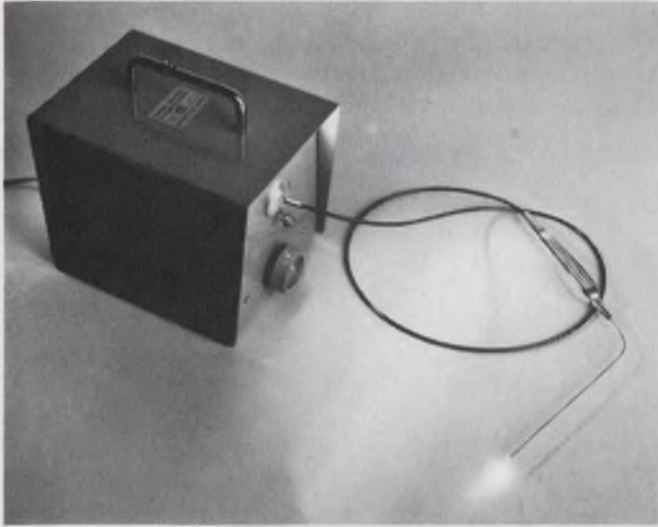

Transmit "cold" light like other forms of energy—by flexible routing to remote or inaccessible locations, hazardous areas, or any abnormal environment.

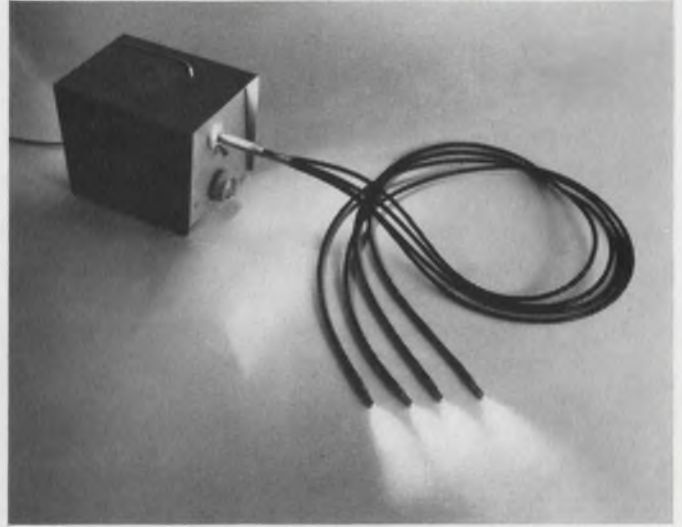

Supply multiple illumination from a single light source, with multi-branched light guides.

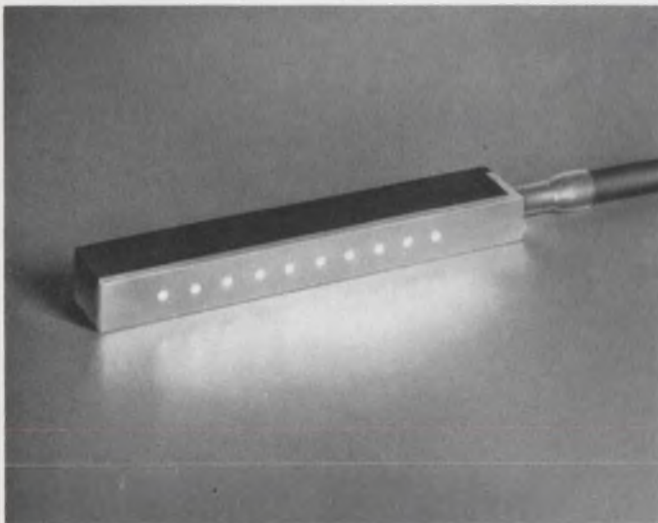

Simplify lighting problems by eliminating lens systems, multiple lamps, complex electrical circuitry.

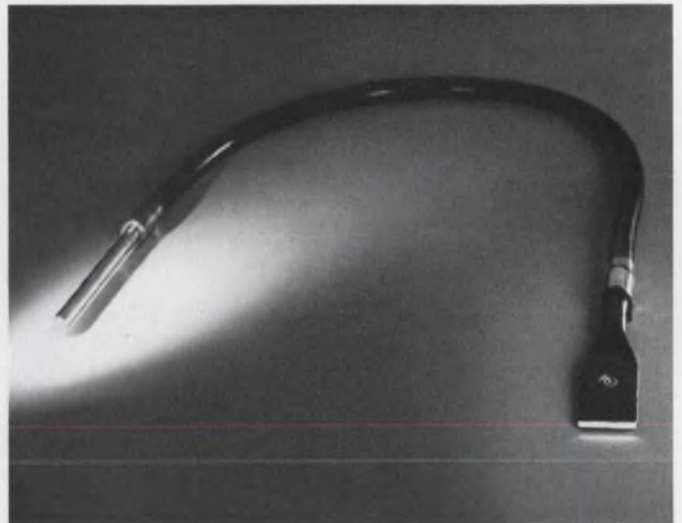

Provide input-output geometry conversions such as round-to-square, round-to-slit, etc.

These are only a few of the ways in which American Optical fiber optic light guides are used to help solve illumination problems. Specific applications range from mark sense readout to electro-optical sensing in data processing, circuit verification, fire control, null detection, light pens, spot illumination, and many others.

Simple, reliable, economical. AO fiber optic light guides are simple, passive elements which remain extremely reliable under normal vibration, temperature or humidity changes, or other environmental fluctuations. This results in long service life with minimum maintenance.

Standard and custom light guides from American Optical have light transmission ranges from 400 to 1500 millimicrons. Standard light guides are

available in bundle sizes from .020" to 1/4", with 30 to 6000 fibers, lengths up to 72", plastic or stainless steel tips, and PVC sheaths. Custom light guides can be supplied in any length desired, with special end tips, sheaths, diameters, input-output face configurations, and branchings.

A leader in optics since 1833, American Optical Company brings a great breadth of related experience to the technology of fiber optics. Our versatility in fiber optics is unmatched by any other manufacturer. In fact, AO scientists already hold more than 200 important patents or patents pending in this relatively new field.

For Fiber Optics Data Kit, write to:



AMERICAN OPTICAL CORPORATION

FIBER OPTICS • SOUTHBRIDGE, MASSACHUSETTS 01550

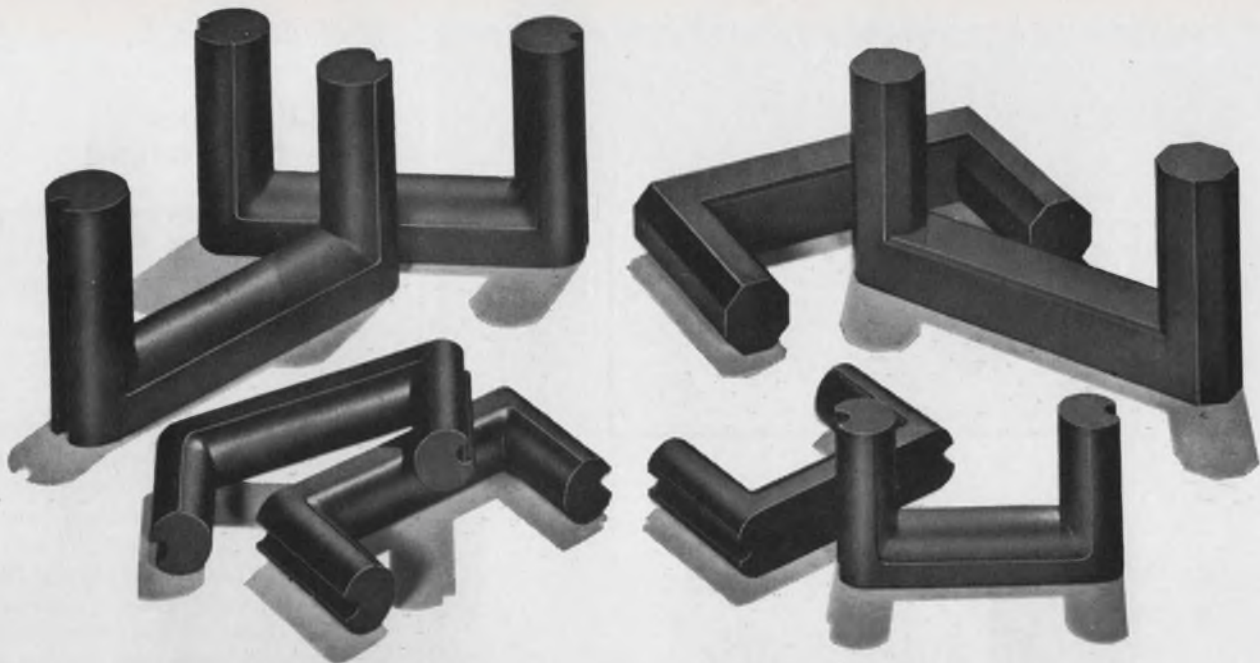

From Stackpole: A New H.O.T. Ferrite Material That Doesn't Lose Its Cool

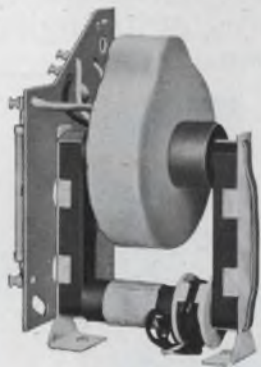

Ceramag[®] 24C was developed by Stackpole engineers especially for Horizontal Output Transformer applications. Because this new material offers an unequalled combination of high power permeability and low power loss under flyback circuitry operating conditions, it provides improved efficiency and cooler operating temperatures.

Excellent electrical and mechanical properties are combined to provide fabricated parts that easily meet standard industry strength and warpage requirements.

The Stackpole Ceramag[®] family of power ferrite materials has been the accepted standard of the television industry for over twenty years. Ceramag[®] 24C is no exception. It features a power permeability of 6200 @ 1800 gauss (typical operating condition), compared to Grade 24B with a permeability of 4200 @ 1800 gauss.

Equally important, the power losses of 24C at operating frequencies and temperatures are 15% lower than those of the widely recognized Ceramag[®] 24A, an industry workhorse.

Stackpole engineering pioneered the first Ceramag[®] horizontal output transformer cores as far back as 1947. Since then, continuous developments have made Stackpole a leading contributor to the growth of black and white, and now color, television technology.

For additional information and

samples of Ceramag[®] 24C, write or call: Stackpole Carbon Company, Electronic Components Division, St. Marys, Pa. 15857. Phone: 814-781-8521. TWX: 510-693-4511.

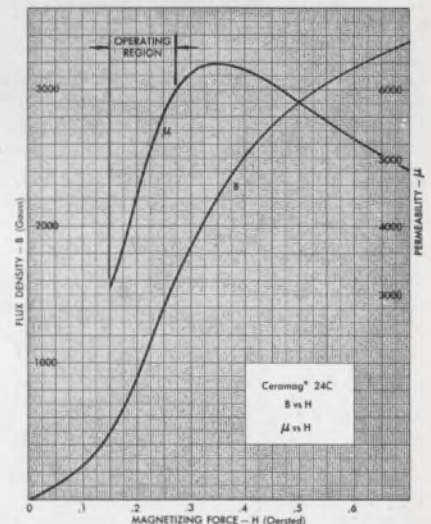

ALSO A LEADER IN THE MANUFACTURE OF QUALITY FIXED COMPOSITION RESISTORS

INFORMATION RETRIEVAL NUMBER 93

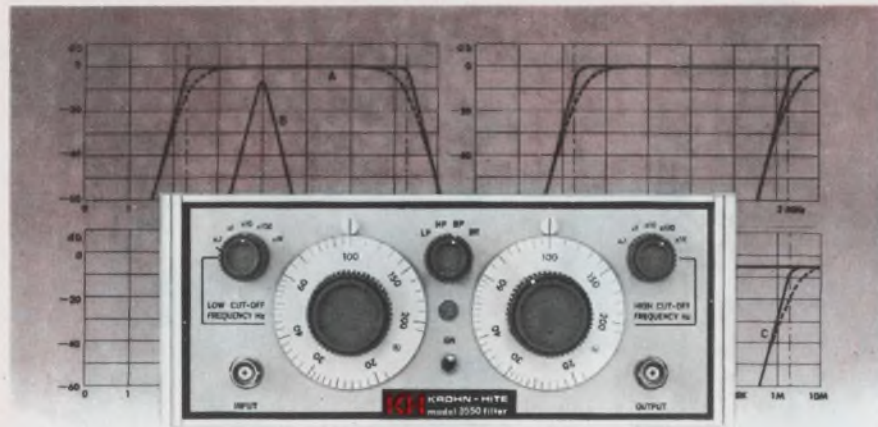

New, low priced all solid-state variable filters

cover 2 Hz to 200 KHz

MODEL 3550 — a new, all solid-state multifunction variable filter covering the 2 Hz to 200 KHz frequency range. Functions include band-pass, high-pass, band-reject and low-pass with 24-db-per octave attenuation slopes extending greater than 60 db. Frequency response can be switched from Butterworth to Low Q (transient free). Low hum and noise (200 μ V rms). Dynamic range of greater than 80 db. Insertion loss 0 db. Bench model: 8 $\frac{5}{8}$ " wide x 3 $\frac{1}{2}$ " high x 13 $\frac{1}{2}$ " deep. Rack model: 19" wide x 3 $\frac{1}{2}$ " high x 13 $\frac{1}{2}$ " deep. Price: \$525

MODEL 3500 — a new all solid-state variable band-pass filter covering the 20 Hz to 200 KHz range. Switches from Butterworth to Low Q. Attenuation slopes: 24-db-per octave extending to greater than 60 db. Hum and noise: 200 μ V rms. Dynamic range greater than 80 db. Insertion loss 0 db. Size: same as above. Price: \$395

See for yourself why these new Krohn-Hite solid-state variable filters make "do-it-yourself" filter design a relic of the past. Write for complete specifications.

OVERSEAS SALES OFFICES: BELGIUM, C. N. Rood s. a. DENMARK, SC Metric A/S; FRANCE, Antares; GERMANY, Nuclotron Vertriebs-GMBH; HOLLAND, C. N. Rood n. v.; ITALY, Dott. Ing. Mario Vianello; SWEDEN, Teleinstrument; ISRAEL, R.D.T. Elect. Eng. Ltd.; JAPAN, Shoshin Shoji Kaisha, Ltd.; AUSTRALIA, Sample Electronics (Vic.) Pty., Ltd.; G. B., B & K Inst. Ltd.

KH KROHN-HITE CORPORATION

580 Massachusetts Ave., Cambridge, Mass. 02139, U.S.A.
Phone: (617) 491-3211 TWX: 710-320-6583

INSTRUMENTATION

Digital clocks have BCD output

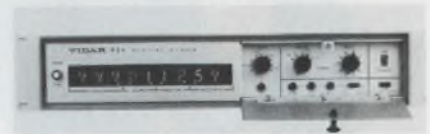

Vidar, 77 Ortega Ave., Mountain View, Calif. Phone: (415) 327-6340.

Series 624 digital clocks display real time for data systems and provide BCD digital output for recording. Timed command pulses can be preselected to occur at one of 70 time intervals ranging from one second to 25 hours. A six-digit version shows hours, minutes and seconds, and a second version has three additional digits for data or manually set data identification.

CIRCLE NO. 359

Digital multimeter features autoranging



Philips Electronic Instruments, 750 S. Fulton Ave., Mt. Vernon, N.Y. Phone: (914) 664-4500. Price: \$1125.

A digital multimeter can make readings as low as 10 μ V and 10 pA, yet combines operating convenience with teleprinter/recorder outputs. The PM2421 multimeter allows the user to select a basic measuring range, after which the instrument will automatically select one of three sub-ranges that displays the reading with best resolution. Dc voltage range is 10 μ V to 1000 V; maximum on ac is 500 V rms. The multimeter reads dc and ac current between 10 pA and 1.4 A, and resistances from 0.01 Ω to 1400 M Ω .

CIRCLE NO. 360

Hi-Reliability from Weston is no put on.

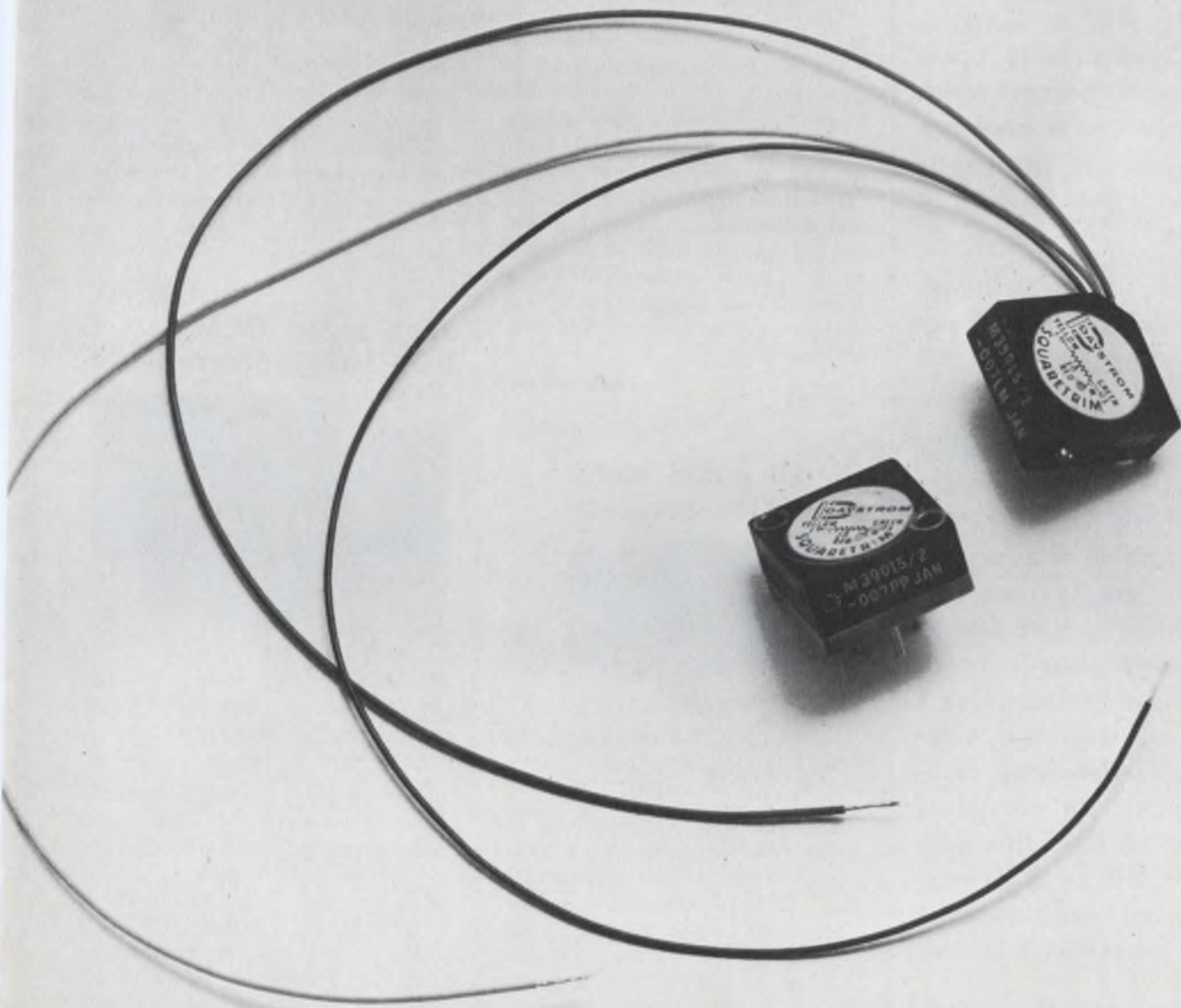

When we say Hi-Reliability, we mean it! Weston offers units designed, manufactured and tested in complete conformance with MIL-R-39015. You'll find a designator stamped on every Weston Squaretrim® Hi-Rel pot in the 200 ohm to 20K range. This number verifies its failure rate and confidence level at full $\frac{3}{4}$ watt operating power. Design, materials

and workmanship must be tops. Not to mention Weston's 45 to 1 adjustment ratio, patented wire-in-the-groove construction, and slip clutch mechanical protection which are standard features of these pedigreed models. Insist on the genuine item—Squaretrim Hi-Rel Model 313-160HS with flexible leads or 318-160HS with pins—in all critical applica-

tions. Contact the factory about other Hi-Rel values available, or see your local distributor. Daystrom potentiometers are another product of WESTON COMPONENTS DIVISION, Archbald, Pa. 18403, Weston Instruments, Inc. a Schlumberger company

WESTON®

**TEST TWO
MILLION
DIODES . . . (IN 24 hrs.)**

**GET A 98%
PACKAGE
YIELD!**

It happens every day with the 2130 multiplexed diode test system. By wafer screening with a Burns & Towne System, only operating diodes are packaged. Results are lower package cost . . . tighter price controls . . . greater testing economy.

This new Burns & Towne System makes 6 dc tests per die and screens over 80,000 per hour.

Testing programs can be changed in seconds merely by dialing in any test parameters at the system console. The system will stay on-line longer due to replaceable plug-in modules. With tolerances like 1 mv per volt and test increments of 1-nanoamp combined with an electrical stability of 1%, the way to go is Burns & Towne modular test and classifier systems for semiconductors.

Call or write for full specifications and price data.

BURNS & TOWNE INC.
SYSTEMS DIVISION 18-36 Granite St.
Haverhill, Mass. 01830. Tel (617) 373-1333

INSTRUMENTATION

**Digital panel meters
have BCD output**



Instrument Displays, Inc., 18-36 Granite St., Haverhill, Mass. Phone: (617) 373-1501.

High-accuracy, low-cost, single-range digital voltage, current, or resistance meters are suitable for a multitude of display and data logging applications. Standard features include 8-4-2-1 BCD output, latching memory circuitry, trigger input for remote-control operation and automatic \pm polarity indication. The instrument is contained in a rugged extruded aluminum housing, and its front bezel can be customized with the user's name or logo.

CIRCLE NO. 361

**Digital panel meter
is $\pm 0.1\%$ accurate**



Triplet Electrical Instrument Co., 286 Harmon Rd., Bluffton, Ohio. Phone: (419) 358-5015.

Model 5000, a 3-1/2-digit digital panel meter with non-blinking display, movable decimal point, automatic polarity and overrange indicator, has sensitivity of 100 mV dc, 100- μ V resolution and an accuracy of $\pm 0.1\%$ full range ± 1 digit. Dual-slope integration is provided. Model 5000 has BCD and decimal outputs to drive remote display or printer units. A 1000 M Ω input resistance reduces loading and improves reading accuracy.

CIRCLE NO. 362

**Tiny digital meter
gauges frequency**



Eldorado Electronics, 601 Chalmar Rd., Concord, Calif. Phone: (415) 686-4200. P&A: \$325; 30 days.

A low-cost digital frequency meter is suited for applications where space is at a premium. Crystal-controlled, the model 224 measures only 2 by 5 by 6.4 inches deep and is available with an optional panel mounting kit. It offers a four-digit display with storage and decimal. Range of the standard instrument is dc to 100 kHz; range to 10 MHz is available.

CIRCLE NO. 363

**High-speed DPM
has 100% overrange**



Preston Scientific Inc., 805 E. Cerritos Ave., Anaheim, Calif. Phone: (714) 776-6400. Price: \$150 to \$225.

A high-speed, 3-digit dc volt-ammeter with 100 per cent overrange and ± 0.1 per cent accuracy is supplied with a wide choice of full-scale ranges: 199 mV to 1999 V, with 19.99 μ A to 199.9 mA. The X-Mod DPM features automatic polarity indication, continuous tracking of 100 readings per second, integral dc power supply and optional positive true output logic levels with true bipolar BCD output code. The instrument features front access to all internal components by means of a hinged door.

CIRCLE NO. 364

**We followed up
our jumbo with
a short-form.**

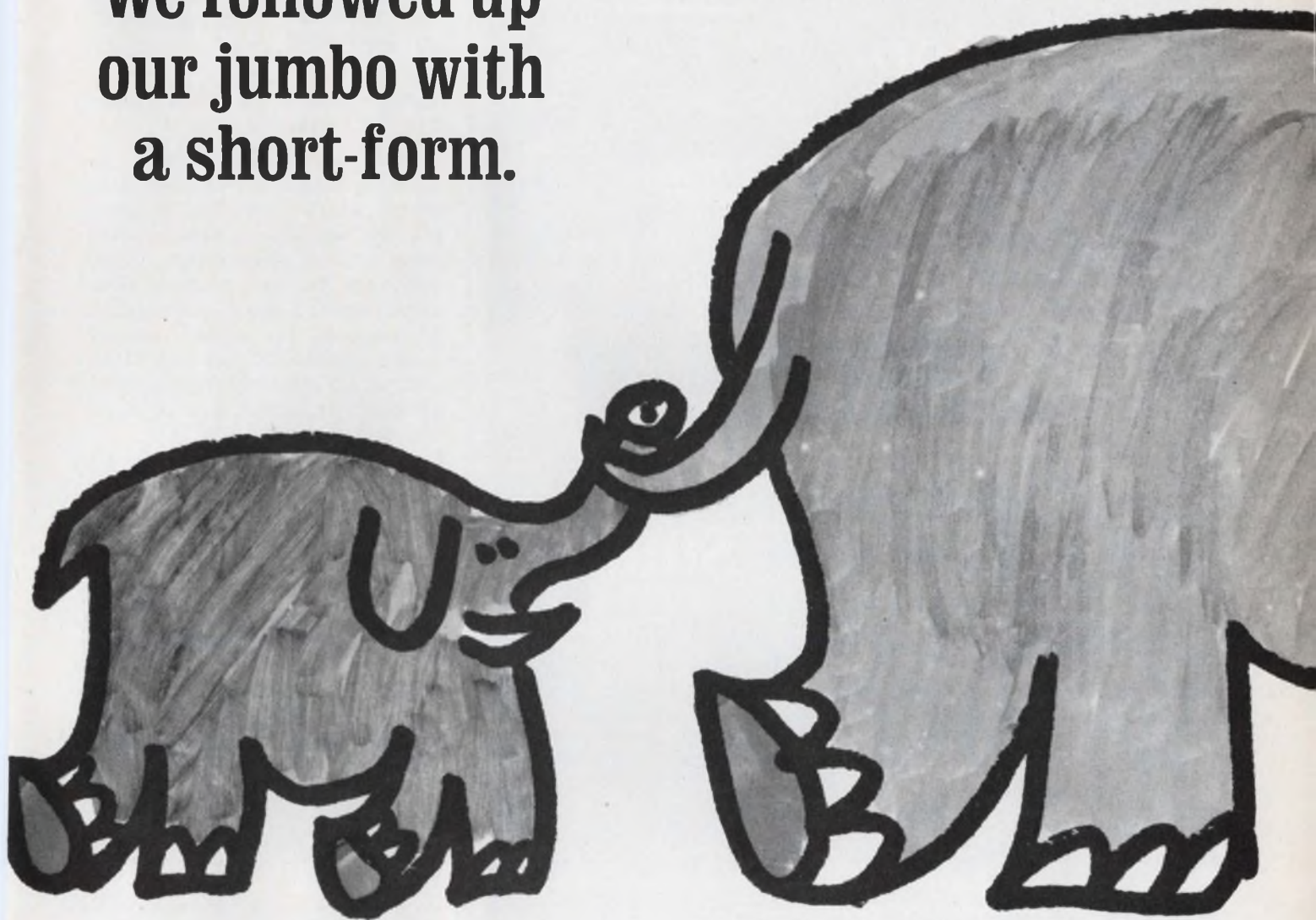

Get one free.

We've gathered information on all our coaxial connectors in the standard series from low-cost UHF types to new MIL-C-39012 versions plus subminiatures, crimps, and adapters of all sorts (over 7000 connectors in all) and combined it in brief form with details on Amphenol RF switches. We call it

our SF-1 Short-Form Catalog. You'll call it a complete, concise reference on connectors, switches and cable.

For your free copy, circle the reader service number, or write Amphenol RF Division, 33 E. Franklin St., Danbury, Conn. 06810.



AMPHENOL
THE BUNKER-RAMO CORPORATION

Here's the DVM they won't dare mention



\$695
Model 350

Why?

Is it because it offers equal or superior performance at a savings of typically \$500?

The 350 performs to:

An ACCURACY of .01% of reading \pm .01% of full scale

A RESOLUTION of 100 microvolts standard (1 microvolt option)

An INPUT IMPEDANCE of 1000 megohms

And, available options include mV, DCV, ACV, ohms and ratio.

Hard to believe? Try us!

Call collect: (415) 321-0551 x 216

 **DATA
TECHNOLOGY
CORPORATION**

1050 East Meadow Circle
Palo Alto, California 94303

INSTRUMENTATION

Digital panel meter achieves bench status



Electro-Numerics Corp., 2191 Ronald St., Santa Clara, Calif. Phone: (408) 248-5020. P&A: \$495; stock.

A new case is now available for a special version of the model 3410 digital panel meter. The result is a very accurate (.01%), 4-1/2 digit, low-cost, single-range digital voltmeter. The unit features automatic polarity, 100% overranging, 10 readings per second, display hold capability, 100 μ V resolution, and >1000 M Ω input impedance. A preamplifier providing 10 μ V resolution is optional.

CIRCLE NO. 365

Vhf digital counter measures pulses



Philips Electronic Instruments, 750 S. Fulton Ave., Mt. Vernon, N.Y. Phone: (914) 664-4500. Price: \$2220 to \$2795.

A 160-MHz digital counter can measure pulse width and delay, as well as frequency, with 10-ns resolution. The PM-6630 counter comes equipped with a temperature-compensated crystal oscillator and six-digit display, stable to ± 5 ppm over a 0 to 45°C temperature range. Engineers who need greater resolution and stability can specify a proportionally controlled oven oscillator and eight-digit display, stable to 2×10^{-6} in 24 hours, and 10^{-7} within seven minutes of turn-on.

CIRCLE NO. 366

TRW Polycarbonates

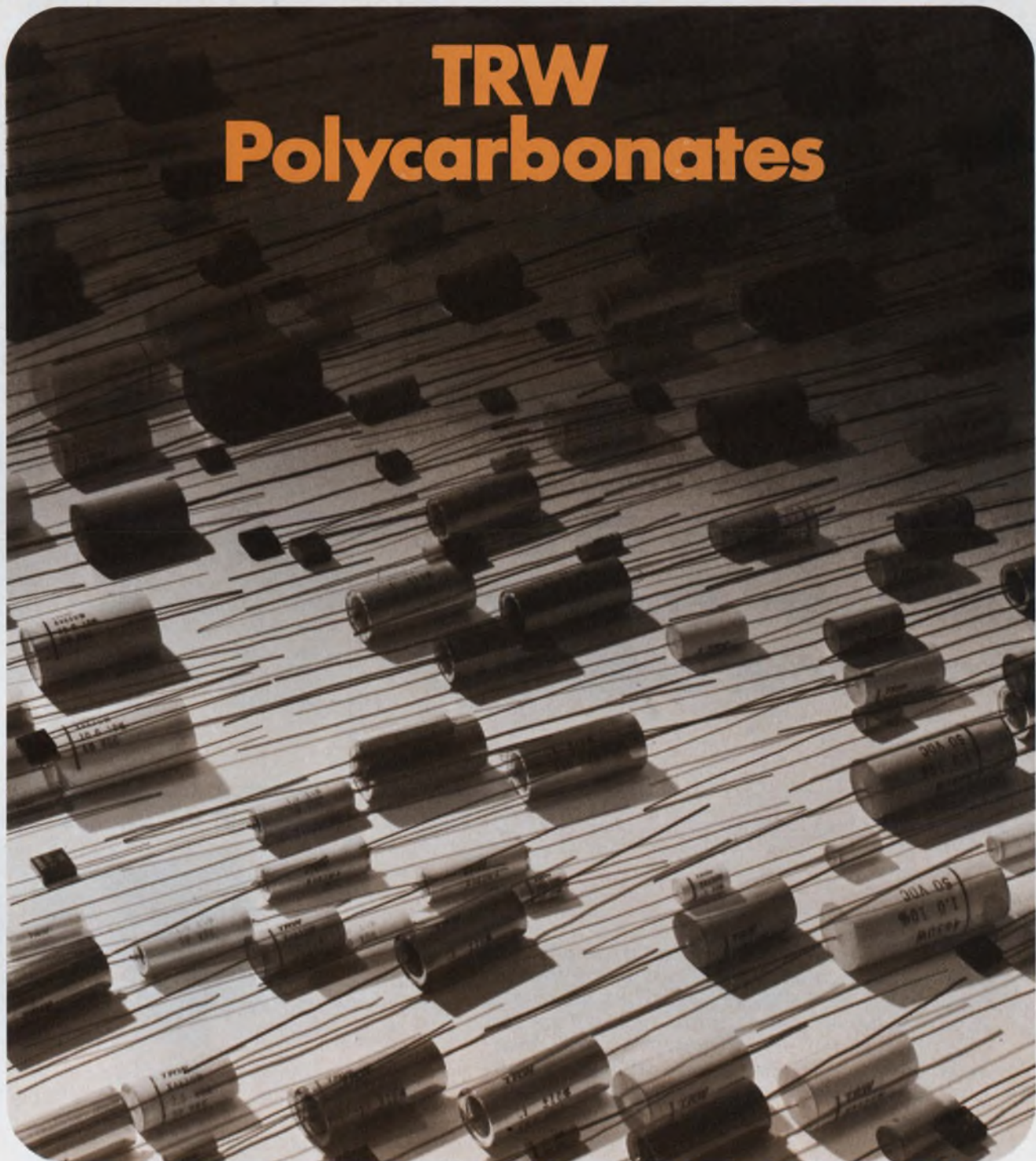

...small answers to big problems

Need capacitors with premium electrical and TC properties...and in the smallest possible package? Polycarbonate capacitors are your answer. And no one knows more about polycarbonates than TRW.

As the pioneer in polycarbonate capacitor development, TRW has the know-how to get that "extra

ounce of performance" out of this remarkable material. We can meet your design requirements with either metallized or foil wound polycarbonates in a wide range of capacitances, voltage ratings, shapes, and sizes. Standard types will solve most design problems...if not, let's talk about your special requirements.

For full information, contact TRW Capacitor Division, Box 1000, Ogallala, Nebraska. Phone: (308) 284-3611. TWX: 910-620-0321.

TRW[®]

INFORMATION RETRIEVAL NUMBER 99

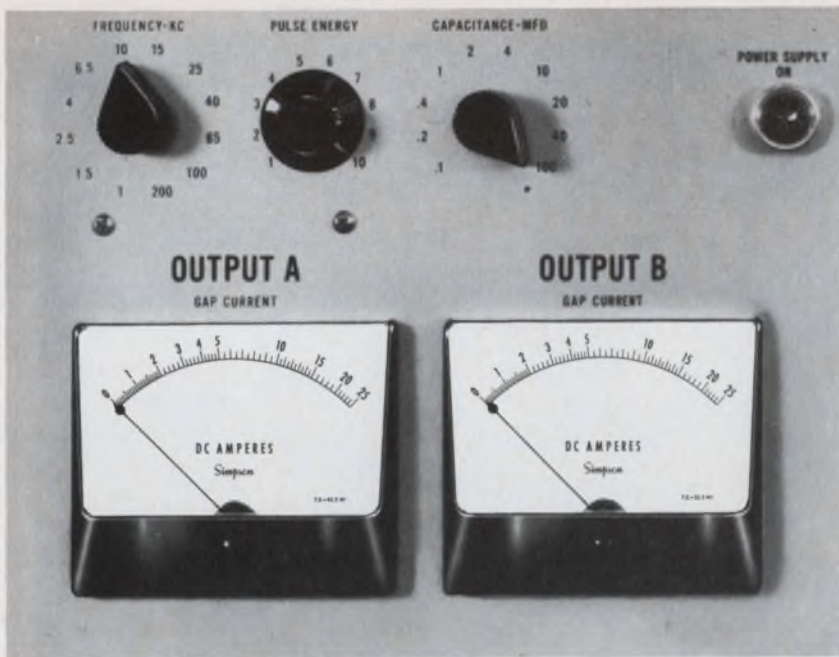

the sure way to let customers know you care about quality...

Simpson panel instruments on your equipment

Simpson's advanced self-shielding annular and core magnet construction provides optimum torque-to-mass ratio. Rugged Taut Band and Pivot & Jewel movements can withstand punishing shock and vibration. Your assurance of an instrument that will *stay* accurate. No wonder so many manufacturers with reputations to protect (or build!) specify Simpson.

Over 1,400 stock ranges, sizes, and types. Get "off the shelf" delivery from your local electronic distributor.

For special needs contact your local Simpson Representative. He's ready to help.

Simpson ELECTRIC COMPANY



5200 W. Kinzie Street, Chicago, Illinois 60644 • Phone (312) 379-1121

EXPORT DEPT.: 400 W. Madison Street, Chicago, Illinois 60606. Cable Simelco
IN CANADA: Bach-Simpson Ltd., London, Ontario • IN INDIA: Ruttonsha-Simpson Private Ltd., International House, Bombay-Agra Road, Vikhroli, Bombay

INSTRUMENTS THAT STAY ACCURATE

INFORMATION RETRIEVAL NUMBER 101

MODULES & SUBASSEMBLIES

Palm-sized supplies drive Nixie tubes

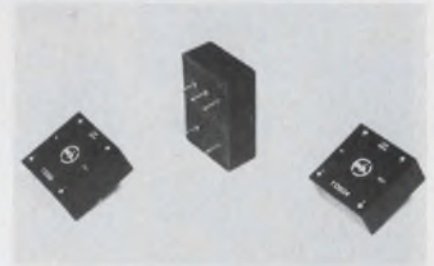

Mil Associates, Dracut Road, Hudson, N. H. Phone: (603) 889-6671. P&A: \$9.95 or \$24.95; stock to 10 days.

Requiring input voltages from 5 to 28 V, a new line of miniature power-supply modules delivers outputs sufficient to drive Nixie tubes. Measuring only 1 by 1/2 in., series TD units supply 200 V at 3 mA to drive a single tube. Series PD units, which measure 1 by 1-1/2 by 1/2 in., can drive four or five tubes with their 200-V 12-mA output. All packages are for PC mounting.

CIRCLE NO. 367

Wideband op amp has 500 V/μs slew rate



Burr-Brown Research Corp., International Airport Industrial Park, Tucson, Ariz. Phone: (602) 294-1431. P&A: \$95; 4 wks.

Model 3260/25 is a wideband dc operational amplifier with a guaranteed slew rate of 500 V/μs that is the highest available in its price range. Settling time to 1% of final value is 100 ns (0.1% in 1 to 2 μs). Used for inverting circuits, the 3260/25 has an FET input stage with very low bias current. This feature becomes important when it is necessary to sample or integrate fast transients and then hold the output for a relatively long time for readout.

CIRCLE NO. 368

The case of Lockheed vs. Lockheed

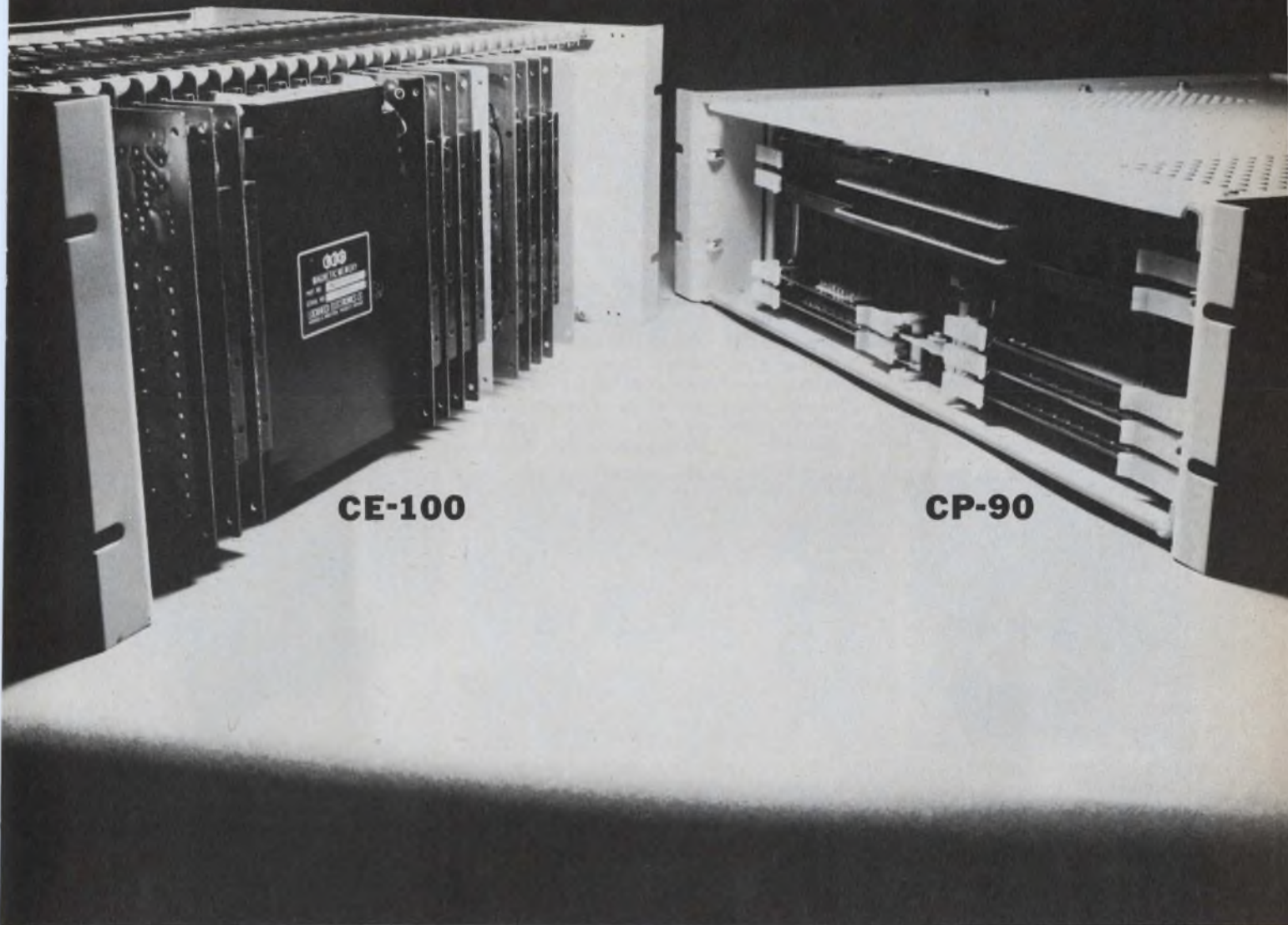

CE-100

CP-90

- 1.** Capacity: 4,096 words x 16 bits.
- 2.** Available in capabilities of 4, 8, 16K with 8 to 32 bits.
- 3.** Size: 19" x 7" x 13".
- 4.** Speed: 1 microsecond.
- 5.** Random access time: 450 nanoseconds.
- 6.** Market Response: Excellent.

- 1.** Capacity: 4,096 words x 16 bits.
- 2.** Available in 4K by 16 or 18 bits.
- 3.** Size: 19" x 5¼" x 13".
- 4.** Speed: 900 nanoseconds.
- 5.** Random access time: 400 nanoseconds.
- 6.** Market Response: Too early to form any sort of judgment.

VERDICT

The CE-100 has been the most successful low-cost memory unit on the market (and with good reason). But since the CP-90 is faster, smaller, and since the 16-bit version costs less — it is our considered opinion that the CP-90 will become one of Lockheed's all-time best-selling memory units.

For further information write: Memory Products, Lockheed Electronics Company,
Data Products Division, 6201 East Randolph Street,
Los Angeles, California 90022. Telephone (213) 722-6810.

LOCKHEED ELECTRONICS COMPANY

90-second look at IEE's wonderful world of readouts

Readouts are our special craft. Using any characters you want. Any colors or color combinations. Any input, BCD or decimal. Any input signal level. Any mounting, vertical or horizontal. Five sizes,

up to 3 3/8". Many configurations, options and accessories. Long lamp life (to 100,000 hours; up to 175,000 hours at reduced voltage). If it doesn't exist and you need it, we'll build it.

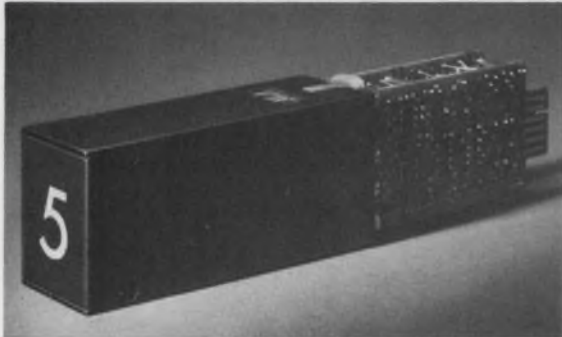

10H—World's most popular readout. And we've improved it. Double condensing lens provides exceptional character brightness. Greater clarity at wider angles and longer distances, even under high ambient light. .937" sq. viewing area. Mil-spec version available.



160H—Exceptionally large viewing area (1.56"H x 1.12"W) for overall size. 45 FL character brightness with a 6.3V \$.20 lamp. Displays messages simultaneously with symbols.



80—Large screen unit suited for annunciator applications such as factory call systems and production control. 3 3/8" character height can easily be read at 100'. 160° viewing angle.



120H—Miniature rear-projection readout (.62" sq. screen) easily read from 30' under high ambient light. Quick-disconnect lamp assembly speeds lamp replacement.



nimo™—First 10-gun CRT single-plane display. Projects numbers, letters and words onto a fluorescent screen. No image ambiguity. No external focusing required. No ambient light worries. Exceptionally wide viewing angle. Ideal for instrument application.



875—Miniature 24-position readout assembly with a cost per display of only \$1.45 each. .620 sq. in. viewing area with overall case size of 1.39"H x .90"W x 3.095"D. Exceptional brightness, clarity. Front panel access.

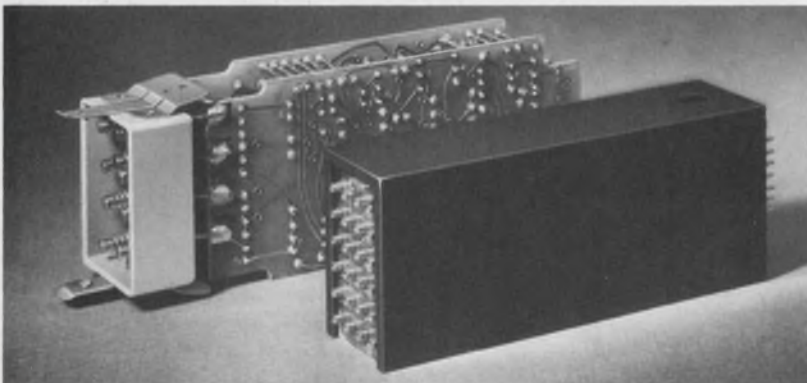

IC Driver/Decoders—Small, reliable units for driving IEE readout incandescent lamps ranging from 250 ma @ 6V to 40 ma @ 28V. Fully compatible with modern IC's. Accept a variety of binary codes for decimal conversion. Require normal signal V., draw less than 2 ma per data input. Internal data storage for pulsed oper.

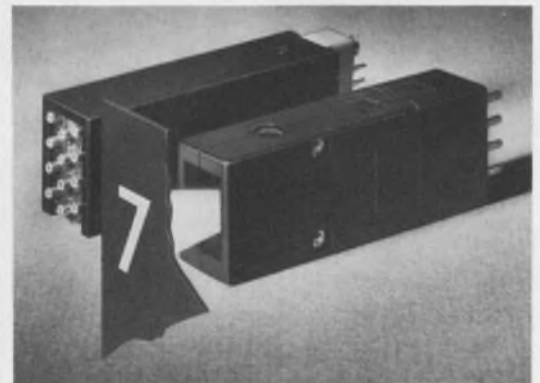

345—IEE's smallest rear-projection readout. Viewing area .38"H x .34"W. Based lamps. Low cost. Individual readouts plug into perm. wired housing for quick message change. Easy front panel access.

Industrial Electronic Engineers, Inc.



7720 Lemona Ave., Van Nuys, California

ELECTRONIC
EXPEDITORS, INC.
6045 N. Green Bay Ave.
Milwaukee, Wisconsin 53209
Phone: 414-374-6666

DRW ELECTRONICS
CORP. OF CALIFORNIA
8339 Hindry Ave.
Los Angeles, California 90045
Phone: 213-673-2200

ELECTRONIX, INC.
214 North Second St.
P.O. Box 188
St. Charles, Missouri 63301
Phone: 314-723-1122

DRW ELECTRONICS
CORPORATION
100 Milbar Blvd.
Farmingdale, Long Island,
New York 11735
Phone: 516-249-2660

PYTTRONIC
INDUSTRIES, INC.
2034 Worcester St.
Baltimore, Maryland
21230
Phone: 301-539-6525

Five places for mil-spec connectors to lose wait.

Getting the Mil-C-26500 and Mil-C-26482 cylindrical connectors you need doesn't take longer any longer.

Now you can get Elco cylindrical connectors, overnight, from any of our six stocking-and-assembling distributors. In any configuration. With from 2 to 61 contacts. Bayonet or threaded.

The connectors are the equal of any mil-spec-meeting cylindrical connector. Only, for you, they're a little more equal. Because you can get them faster without paying extra for the privilege.

And the distributors are as willing and able a group of guys as you'll ever deal with. Give the one closest to you a call; you'll see what we mean.

For more information (like our new cylindrical connector catalog, for instance) or for direct factory assistance, write Elco Corporation, Pacific Cylindrical Connector Div. 2200 Park Place, El Segundo, Cal. 90245, or phone 213-675-3311. TWX 910-325-6602.

ELCO Cylindrical
Connectors

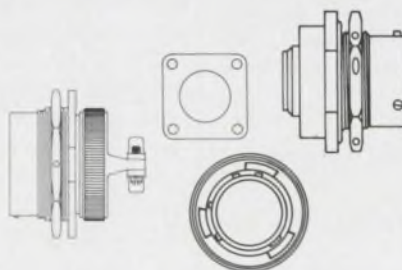

Small Space, Large Range



The Hewlett-Packard 3200B VHF Oscillator, in small space, offers continuous coverage of frequencies from 10 to 500 MHz. The 3200B provides $\pm 0.002\%$ frequency stability over a 5-minute period, a high RF output level and an output attenuator. It is ideal as a general purpose source of CW signals and will also accept external pulse or amplitude modulation. The 3200B may be used with an accessory doubler probe to extend the frequency coverage to 1000 MHz. Size: 7 $\frac{5}{8}$ " wide, 6 $\frac{1}{2}$ " high and 13 $\frac{1}{8}$ " deep. Price: \$525. For more complete information, contact your local Hewlett-Packard field engineer or write: Hewlett-Packard, Rockaway Division, Green Pond Road, Rockaway, New Jersey 07866. In Europe: 1217 Meyrin-Geneva, Switzerland.

HEWLETT  PACKARD

SIGNAL SOURCES

1083A

INFORMATION RETRIEVAL NUMBER 105

MODULES & SUBASSEMBLIES

Stable hybrid op amps hold bias to 5 pA



Data Device Corp., 100 Tec Street, Hicksville, N.Y. Phone: (516) 433-5330. P&A: \$20; stock.

Providing 5 pA maximum bias currents, two new series of FET op amps feature thermal drifts as low as 5 $\mu\text{V}/^\circ\text{C}$ maximum. The lowest hybrid modules, types 008 and 108, are supplied in low-profile cases that measure 0.6 by 0.6 by 0.25 in.

CIRCLE NO. 369

Wideband multiplier powers fully to 4 MHz



Hybrid Systems Corp., 95 Terrace Hall Ave., Burlington, Mass. Phone: (617) 272-1522. Availability: stock to 3 wks.

Without requiring external amplifiers, model 105 wideband (10-MHz 3-dB bandwidth) analog multiplier delivers a full-power response of 20 V pk-pk out to 4 MHz. Its slew rate is 250 V/ μs and accuracy is 1% for four-quadrant operation. The unit's linearity permits distortionless multiplication at output levels from under 100 mV to 20 V pk-pk.

CIRCLE NO. 370

If speed drives you wild, we've got the control.

Our precision Adjustable-Speed Drives will give you precise control over the speed of your application with constant torque regardless of load change. They're infinitely adjustable from 24 to 3600 rpm (150:1 speed range) with load regulation of better than $\frac{1}{3}$ of 1% of rated speed. The Remote Control Head provides precise speed adjustment and continuous monitoring. Built for long service life, the modular plug-in design requires only a screwdriver for servicing. Over 250 models from $\frac{1}{8}$ to 2 hp, with or without gear reduction or braking and reversing.

SERVO-TEK PRODUCTS COMPANY
1086 Goffle Road, Hawthorne, New Jersey 07506.

SERVO-TEK

PRODUCTS COMPANY

Write for our
500/600 Series catalog
and get back
in control.

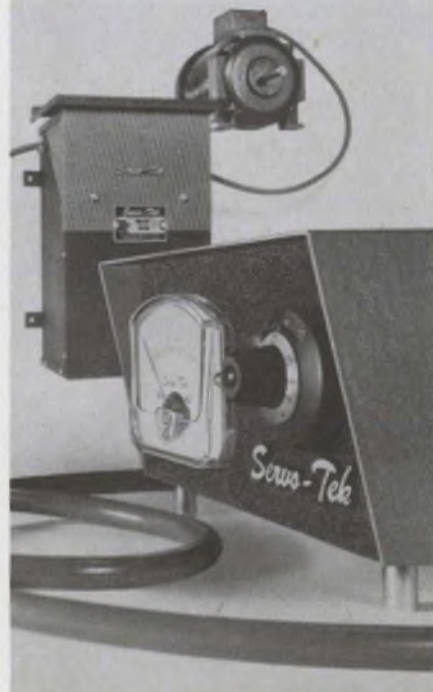

INFORMATION RETRIEVAL NUMBER 106
ELECTRONIC DESIGN 10, May 10, 1969

RZ GLASS

...the big news in sputtering targets...from Owens-Illinois

Owens-Illinois RZ Glass Sputtering Target is a NEW copper alumino-silicate glass readily sputtered on a silicon substrate. After sputter deposition, the RZ glass layer is etched to open up contacts to the silicon substrate. A simple oxidation-reduction process then produces *pure* copper conductive layers on the RZ glass, even in etched undercuts.

RZ glasses are ideal for making single or multilayer interconnections in medium or large-scale integrated circuits. The conductive layer is produced uniformly on RZ-coated substrates regardless of surface geometry.

You now have your choice of *three* sputtering targets from Owens-Illinois . . . 1. NEW RZ copper alumino-silicate, silicon-matching, 2. EE-9 alumino-silicate, silicon-matching, 3. EE-10 alumino-silicate, alumina and gallium arsenide matching.

All three are readily deposited at rates of 250 Å/minute with

standard R.F. sputtering equipment, followed by simple etch when needed. A new manufacturing process holds the sodium content of these glasses below 20 ppm.

Owens-Illinois can supply targets promptly in lengths, widths, and thicknesses to fit your R.F. set-up and substrate dimensions. We'll work with you on materials to meet your special needs.

Complete data, specifications, and sputtering procedures developed in the Owens-Illinois microelectronics research labs will be sent to you promptly on request. Ask for information on these other O-I electronic materials: package sealants, substrate glazes and insulating films, preform materials, glazed IC packaged parts and substrates. WRITE TO:

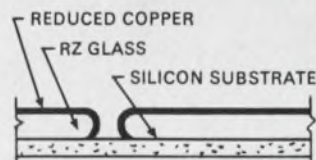

THE O-I FAMILY OF WORK-TOGETHER ELECTRONIC MATERIALS.

INFORMATION RETRIEVAL NUMBER 107

OWENS-ILLINOIS
ELECTRONIC MATERIALS
Toledo, Ohio 43601

new
4 reasons why
USCC
chip capacitors
are best for
hybrid circuits

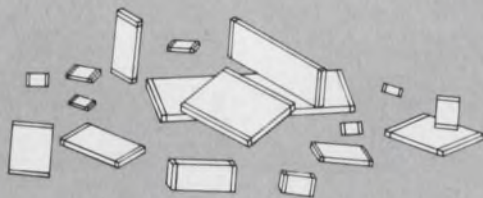

1. HIGH RELIABILITY

100% electrical testing on all units. Power screening available on all high rel units.

2. SMALLEST CHIP SIZES

Featuring the smallest chip available — only .075" x .035" x .040". 16 miniature sizes ranging from 10 pF to 3.3 Mfd.

3. MOUNTING PADS

Self leveling noble metal mounting pads for superior attachment, mounting stability and ultrasonic bonding.

4. MARKED CHIPS

Each chip individually marked for: capacitance value, tolerance and working voltage.

Do you need more reasons to use USCC chip capacitors? Ask your USCC sales representative or call or write us. We have a catalog full of chip information.



U. S Capacitor Corporation, 2151 No. Lincoln Street, Burbank California 91504 • Telephone: (213) 843-4222 • TWX 910-498-2222

MODULES & SUBASSEMBLIES

Miniature relay senses 200 mW

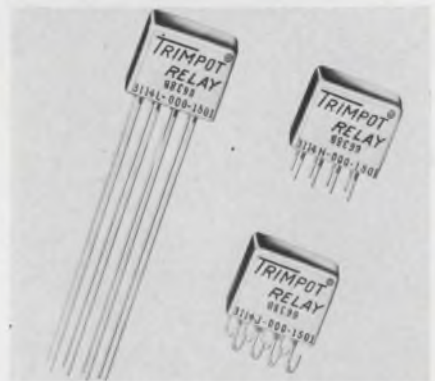

Bourns, Inc., Trimpot Products Div., 1200 Columbia Ave., Riverside, Calif. Phone: (714) 684-1700.

Measuring only 0.23 by 0.5 by 0.4 in., a new dpdt subminiature relay has a pickup sensitivity of 200 mW over an operating temperature range of -65 to +125°C. Model 3114 offers coil resistances from 45 to 980 Ω and a contact rating of 2 A at 28 V dc. The unit meets all requirements of MIL-R-5757/19B and MIL-R-5757/56.

CIRCLE NO. 371

Solid-state timers double outputs

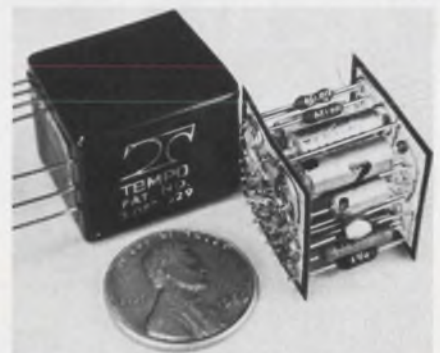

Tempo Instrument Inc., Tempo West Div., 1753 Cloverfield Blvd., Santa Monica, Calif. Phone: (213) 393-0529.

Providing time delays as long as 20 seconds, new miniature solid-state timers have two independent outputs for a variety of output connections in high-reliability applications. For example, two or three timers may be connected together to protect against short-circuit or open-circuit failure modes.

CIRCLE NO. 372

**Five reasons why
more engineers have selected
Clairex photocells
over all others...**

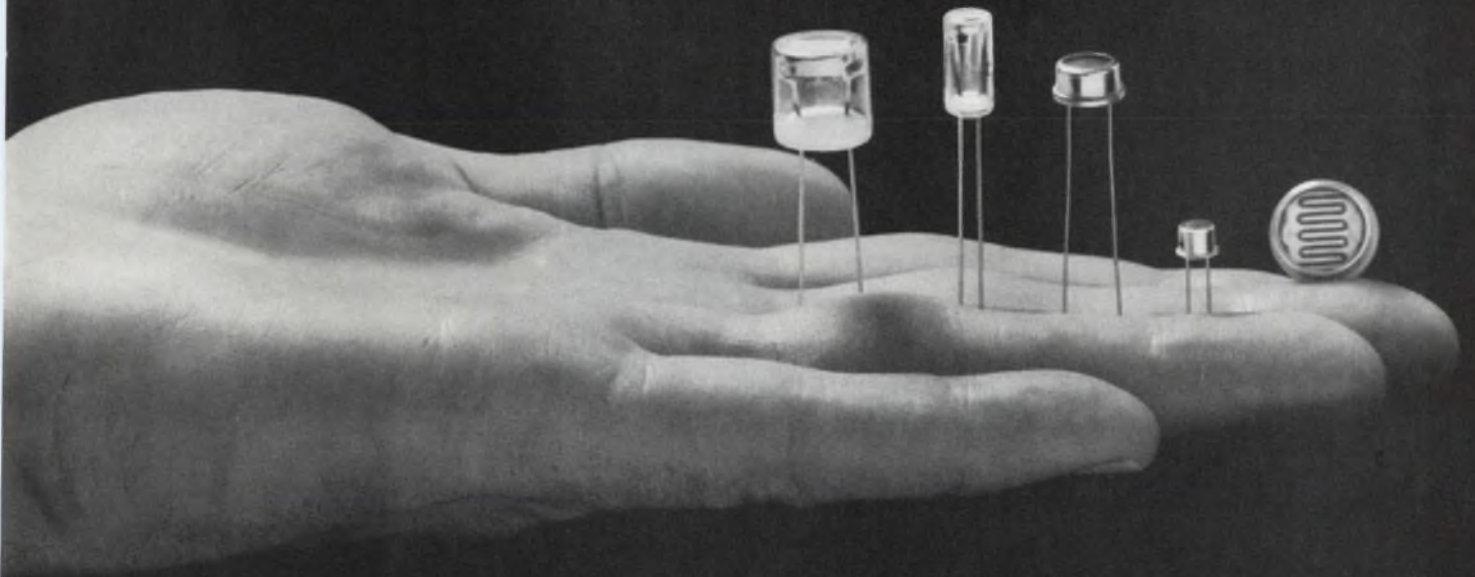

**These basic
Clairex packages cover
98% of all applications...
try one.**

Clairex has more experience supplying more high-quality photocells for more applications than anyone. Let us show you how we can perform in handling your problems. Call (212) 684-5512 or write Clairex, 1239 Broadway, New York, N. Y. 10001.

CLAIREX ELECTRONICS, INC.

**THIS
NEW
PACKAGE
IS A
PIP...**

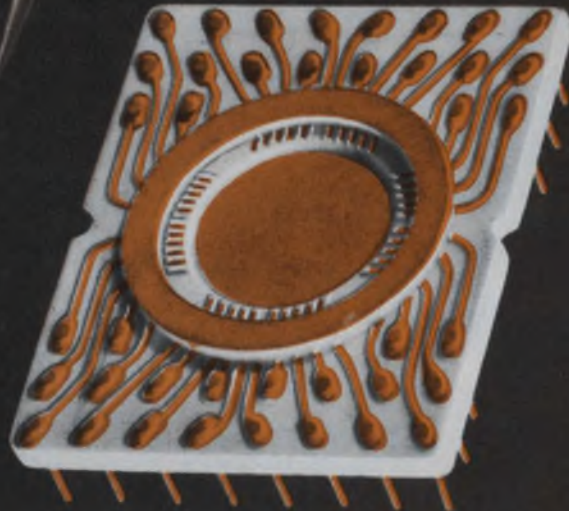

It's a 40-pin Plug-in-Package (PIP) from the Cermetron Division of National Beryllia—30% lighter, and with 8 to 10 times the thermal conductivity of similar packages using other materials, because it is made from BERLOX—Beryllium Oxide.

It is used in a system which saves 25 miles of wiring and 400 pounds weight in aircraft communications.

Beryllium Oxide dissipates heat as fast as most metals, permitting higher power in smaller space, which contributes to lighter weight and further miniaturization of electronic components.

Practical design criteria, combined with precision metallizing, production and assembly techniques, many of them pioneered by National Beryllia, and typified by the 40-pin PIP, can be

major considerations in systems cost effectiveness through higher production yields, reduced installation costs, and greater package reliability.

Cermetron packages for microelectronics are available in plug-in, radial lead flatpack, and dual inline configurations, and in special designs to meet specific requirements.

The Cermetron Division manufactures metallized beryllia components, headers, packages, substrates and assemblies for electronics which require the thermal, electrical and physical properties available only in BERLOX.

You are invited to send for the Cermetron Division Facilities and Capabilities booklet, and to confer with our engineers and research staff on your design problems.

MODULES & SUBASSEMBLIES

Decimal displays use IC logic

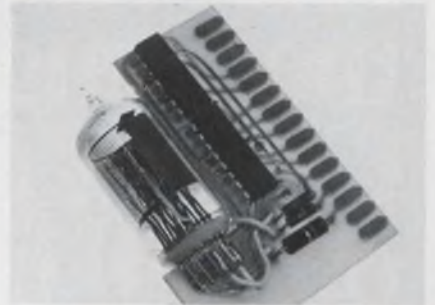

Computer Products Inc., 2801 E. Oakland Park Blvd, Fort Lauderdale, Fla. Phone: (305) 565-9565. P&A: \$25.80 or \$31.80; 3 days.

Series DM500 decimal displays are self-contained plug-in units using IC logic. The DM519 includes a decade counter with BCD outputs for the connector as well as the decoder/driver circuit; the DM529 accepts BCD inputs for decoding and display.

CIRCLE NO. 373

Stable amplifiers take 650-mA surge



Data Device Corp., 100 Tec St., Hicksville, N. Y. Phone: (516) 433-5330. P&A: \$125; stock to 2 wks.

Intended for use in servo, control, and signal conditioning systems, a new series of operational amplifiers maintains a minimum output of ± 280 mA at ± 17.5 V with a 650-mA surge capability. In addition, series D-34 devices feature a current stability of 5 nA/ $^{\circ}$ C, a voltage stability of 30 μ V/ $^{\circ}$ C and a quiescent current of only 30 mA. They are designed for printed circuit mounting.

CIRCLE NO. 374



CERMETRON DIVISION

National Beryllia

Haskell, N.J. 07420 Telephone: 201 • 839-1600

CORP.

10703

INFORMATION RETRIEVAL NUMBER 110



It's new. Our Molex 1820 Switch. You can use one, or a gang of them, for an infinite variety of applications. Its lighted push button can be wired to light independently of the switch. And there are colors galore. But what's really nice is price. About seventy cents in quantity.

It's a good example of the Molex creative approach to design problems. And the ability to design reliability and ease of assembly into a product without letting costs run wild due to over-engineering.

The 1820 is really one you have to see to believe.

And we would like to show it to you. For a free sample of our new switch, write or phone (312) 969-4550.



The Grayhill "Excellent 50's"

Here is an entirely new generation of miniaturized rotary switches that allows you to select your own specifications from all these options:



NUMBER OF POLES:



1 pole



2 poles



3 poles



4 poles

ANGLES OF THROW:

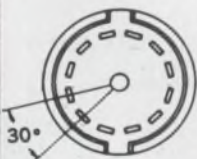

30°

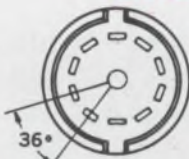

36°



45°



60°

TERMINALS:



Solder Lugs



Printed Circuit

CONTACTS:



Shorting or Non-Shorting



STOPS:

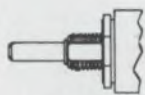

Factory Set

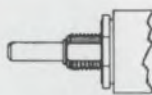

Adjustable

SEAL OPTIONS: Shaft and Panel

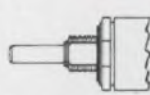

Sealed

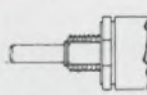

Unsealed



Military
(MIL-S-3786/20)



Commercial

Write for "Excellent 50's" technical data — Switches are available from stock — contact your Grayhill Representative or local Distributor.



565 Hillgrove Avenue
LaGrange, Illinois 60525
Area Code 312, Phone 354-1040

... the Difference Between Excellent and Adequate

MODULES & SUBASSEMBLIES

Neon decoder/display needs only 0.5 in.

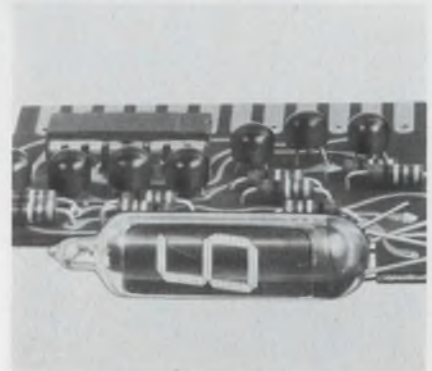

Integrated Circuit Electronics, Inc.,
237 Riverview Ave., Newton, Mass.
Phone: (617) 899-2700. Price: \$18.

Using a seven-segment neon tube, a new decode/display module mounts on 0.5-in. centers on PC boards with all input/outputs from its rear connector. Model D200-7 has a built-in decimal point in the lower right-hand position and a colon in the upper left-hand position. It measures 1-7/8 by 2-11/36 by 0.5 in. wide.

CIRCLE NO. 375

Low-cost op amps hold 5-mA output



Analog Devices, Inc., 221 Fifth St.,
Cambridge, Mass. Phone: (617)
492-6000. P&A: \$24 or \$34; stock.

Two new low-cost differential operational amplifiers deliver a 5-mA output over a 40-V range (± 20 V) and provide a minimum open-loop dc gain of 250,000 at full load. Model 165A has a maximum voltage drift of $20 \mu\text{V}/^\circ\text{C}$, while model 165K offers a $5\text{-}\mu\text{V}/^\circ\text{C}$ drift. Both units have a 1.5-MHz small-signal bandwidth and a 50-kHz full-power response.

CIRCLE NO. 376

How Do You Get A Custom-Designed Receiving System 'Off-The-Shelf?'

The modular design of W-J's RS-125 Receiving System makes it possible. W-J has supplied many variations of the RS-125--each for a specific application. Yet, in most cases, components have been standard versions, right out of stock.

A wide selection of tuners, demodulators, bandwidths and ancillary devices is readily available. So you can order only those components required for the monitoring job at hand. You eliminate obsolescence by adding units as the needs arise.

The RS-125 processes received signals through a demodulator utilizing plug-in modules available in 10 standard bandwidths ranging from 5 kHz to 8 MHz. This highly versatile arrangement of equipments provides AM, FM, CW and pulse reception over a frequency range as wide as 500 kHz to 12 GHz utilizing W-J tuners.

A system covering the range of 10 MHz and above could include tuners with internal motor drives which feature sector scan, enabling the operator to adjust the upper and lower frequency limits of the sector in which he is interested.

It also could include a frequency extender-counter combination which would provide a direct six-digit readout of the tuned frequency, plus Digital Automatic Frequency Control (DAFC.)

Two basic types of the RS-125 are offered: The "B" system for applications requiring low VSWR, and the "C" system for applications requiring maximum sensitivity.

A W-J representative would be glad to assist you in the selection of components for a system to meet your specific requirements. For details write Watkins-Johnson Company, CEI Division, 6006 Executive Boulevard, Rockville, Maryland 20852, or phone Area Code 301-881-3300.

World's largest selection of receiving equipment for surveillance, direction finding and countermeasures



CEI DIVISION

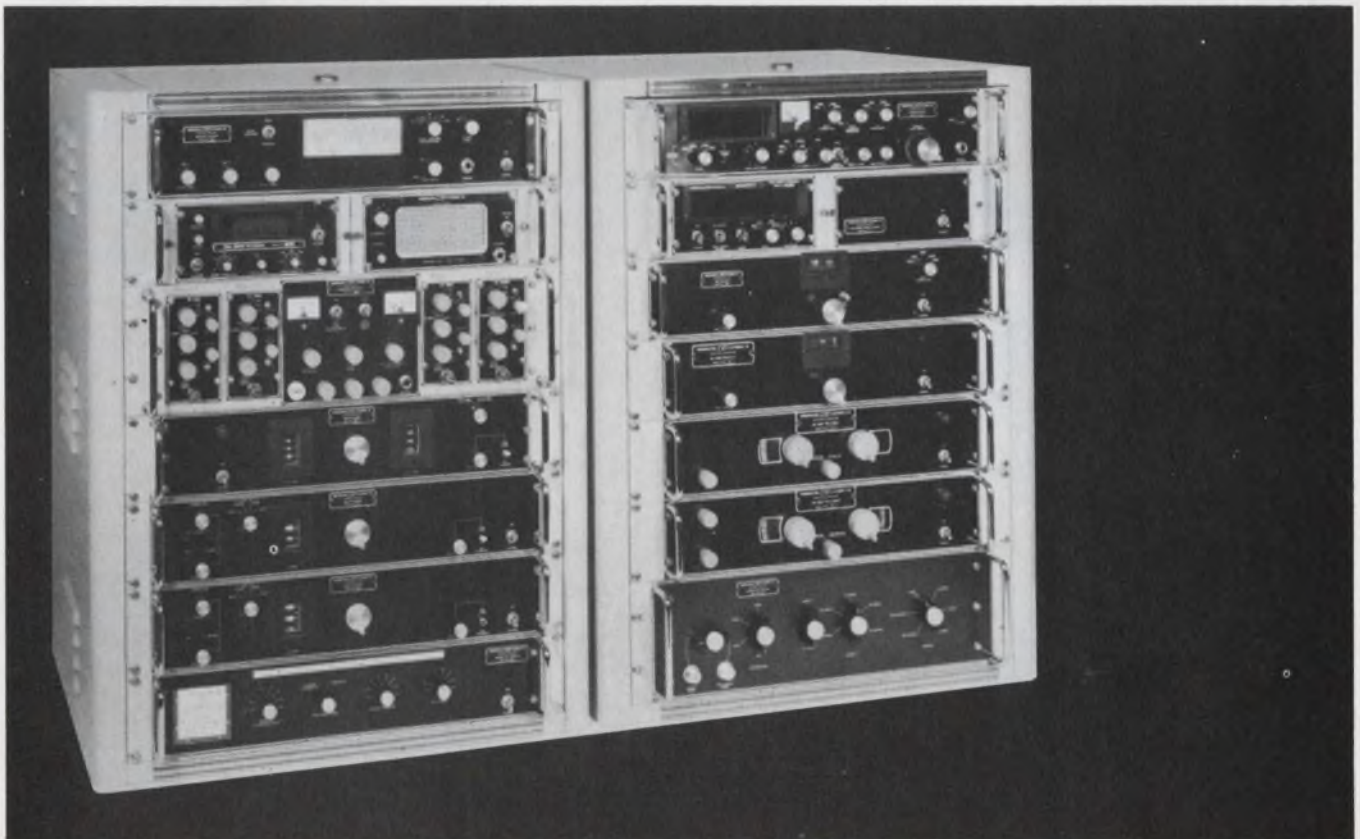

If walls
were any
thinner...
there
wouldn't
be a
part



Some thin walls tell secrets. They leak information. But not Hitchiner thin wall investment castings. Once again, it is what we DON'T give you that counts. No extra weight. No metal to machine away. No assembly problems (because we cast the entire assembly as a single component). When you need thin walls, order them that way . . . and learn the secret for reliable thin walls.



HITCHINER
MANUFACTURING CO., INC.
MILFORD, NEW HAMPSHIRE 03055
Tel. (603) 673-1100, TWX (710) 366-1863

AEROSPACE DIVISION
Wallingford, Connecticut 06492
DELTA MICROWAVE CORP.
Hackensack, New Jersey 07601
FERROUS DIVISION
Milford, New Hampshire 03055
Nashua, New Hampshire 03060
NONFERROUS DIVISION
O'Fallon, Missouri 63366



How about that!



INFORMATION RETRIEVAL NUMBER 114

MICROWAVES & LASERS

Rf power transistors perform at 175 MHz

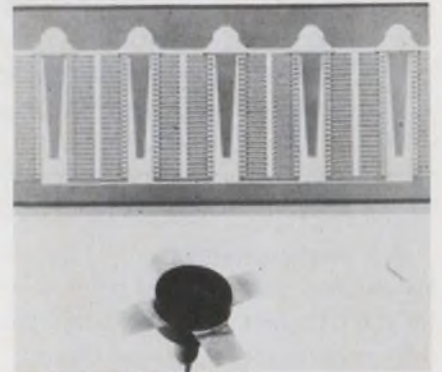

Fairchild Semiconductor, 313 Fairchild Dr., Mountain View, Calif. Phone: (415) 962-3563. P&A: \$36; stock.

A new rf power transistor is guaranteed to operate in mobile radio communication systems at 12 V and 175 MHz. The MSA8506 provides a combination of higher power output and power gain—25 W and 5 dB—than is available from any other single device operating at equivalent conditions. It can handle continuous collector current up to 5 A, and is packaged in a radial lead stripline unit that contributes to its high-frequency performance.

CIRCLE NO. 377

Sweeper accessories allow multiband tests



Kruse-Storke Electronics, 790 Hemmeter Lane, Mountain View, Calif. Phone: (415) 967-2299. P&A: \$1150 and \$390; 60 days.

Multiband programed, cw, or swept-frequency testing is simplified by two new products. Both are used with a solid-state sweep generator and oscillator plug-ins operating from below 10 MHz to above 12 GHz. Model 5090 multiband power unit provides dc power for three plug-in oscillators, and the model 5091 multiband controller is itself a plug-in that connects the sweeper with one or more power units.

CIRCLE NO. 378



for intradyne SYSTEMS

At Intradyne, a new generation of microwave devices and sub-systems with superior performance characteristics is being manufactured in **production quantities** and with **high repeatability** using computers in design, evaluation and checkout. Computerized procedures can provide complete printout data including VSWR, reflection coefficient, attenuation or gain, phase linearity, **group delay** and **h, y, s and z parameters**—for every unit. The printed record is positive assurance of compliance with the most exacting specifications. Use of the Intradyne-owned network analyzer allows our engineering staff to make complete multi-octave tests instantly, thereby increasing time available for creativity. The analyzer can complete—with **high accuracy**—the equivalent of 6 man-days of testing in one hour! Results of this unique approach are illustrated.



SOLID STATE OSCILLATOR

Frequency: — — — — — 8 to 12.4 GHz
FM Noise: 50 Hz, 1 KHz bw 10 KHz from f_0 .
Power Output — — — — — to 100 mW.
Temperature Stability: — — — .05% typical.
Size: See illustrations. Size and weight suitable for flight hardware.
Delivery: Stock to 4 weeks, ARO.



OSCILLATORS ---FULL SIZE

ULTRA LOW NOISE SOLID-STATE AMPLIFIER

Frequency: — — — — — L through S bands.
Noise figure: — — — — — 1.5 to 2db max.

MICRO-MIN, HI-REL DEVICES

Frequency: — — — — — 1 to 12 GHz coverage.
Functions: Customers specified duplexing,
 Low noise receiver front ends,
 Combining networks,
 Switching systems, etc.

Full information on request.

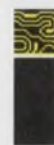

**INTRADYNE
SYSTEMS, INC.**

470 San Antonio Road, Palo Alto, Calif. 94306
 (415) 328-7840

1.0	3.121	-10.44	-978	-69.
1.0	2.31	-71.91	-975	-75.
1.0	1.68	-64.82	-975	-77.
0.0	1.61	-61.35	-968	-81.
0.0	1.53	-58.87	-975	-83.
0.0	1.46	-54.98	-975	-89.
10.0	.72	-50.46	-984	-92.
10.0	.12	-47.76	-994	-95.
10.0	.28	-45.61	-994	-99.
10.0	.37	-42.56	1.089	-99.
10.0	.48	-40.34	1.818	-102.
10.0	.14	-38.87	1.884	-107.
100.0				
400.0				
700.0				
1000.0				
1500.0				
2000.0				
2500.0				
3000.0				
3500.0				
4000.0				
4500.0				
5000.0				
5500.0				
6000.0				
6500.0				
7000.0				
7500.0				
8000.0				
8500.0				
9000.0				
9500.0				
10000.0				
10400.0				
10700.0				
11000.0				
11300.0				
11600.0				
11900.0				
12200.0				
12500.0				
12800.0				
13100.0				
13400.0				
13700.0				
14000.0				
14300.0				
14600.0				
14900.0				
15200.0				
15500.0				
15800.0				
16100.0				
16400.0				
16700.0				
17000.0				
17300.0				
17600.0				
17900.0				
18200.0				
18500.0				
18800.0				
19100.0				
19400.0				
19700.0				
20000.0				

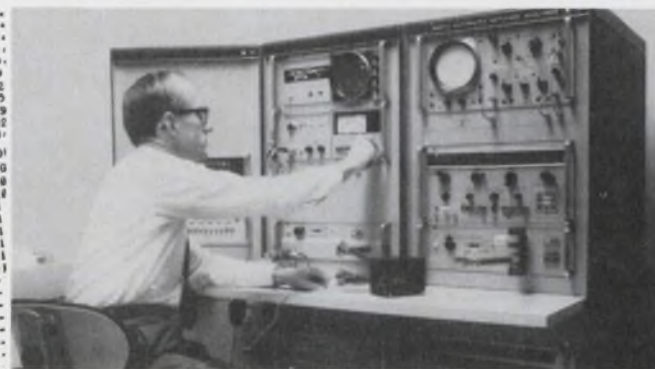

(illustration Intradyne-owned Computer-Controlled Network Analyzer (HP-8540))

Some oscillographs are guaranteed to be trouble-free.

(The product
costs money, but
the trouble is free.)



That's why we
made such a
production out
of the 5-126.

We wanted an industrial light beam oscillograph that would be so reliable you couldn't fault it. Yet so modestly priced you could also afford it.

So we got it. Plus some other advantages too:

- Direct print-out records eliminate the need for chemical processing.
- Nine channels producing distinct data traces on 7-inch-wide paper.
- Simplicity of operation. Due to CEC's automatic front-loading system, no spooling or threading is required.

■ A true portable which may be easily moved from place to place for any application.

Is the 5-126 really the most "graph" for your dollar? You can bank on it.

For all the facts, call our nearest office. Or write Bell & Howell, Pasadena, California 91109. Ask for Bulletin Kit 3315-X1.

CEC/DATA INSTRUMENTS DIVISION



BELL & HOWELL

INFORMATION RETRIEVAL NUMBER 116

MICROWAVES & LASERS

Avalanche diode amp boosts power 40 dB



Sylvania Electric Products Inc., Semiconductor Div., Woburn, Mass. Phone: (617) 933-3500. Price: \$2000.

An avalanche diode amplifier, SYA3250, features up to 40 dB power gain and 75 MHz bandwidth. The three-stage circulator-coupled power amplifier has cw outputs of 50 to 100 mW in X-band, and is designed for use in microwave relay and transponder systems as a transmitter amplifier. The circulators, together with a load isolator at the output, are fabricated integrally on a single ferrite substrate microstrip circuit. Dc power requirements are approximately 100 V at 60 mA.

CIRCLE NO. 379

Microwave synthesizer features Nixie readout



Micro-Power, Inc., 25-14 Broadway, Long Island City, N.Y. Phone: (212) 726-4060.

An L-, S-, C- and X-band frequency synthesizer that was introduced last year (see "Microwave synthesizer has extended range," ED 27, Nov. 7, 1968, p. 102), has been improved by the addition of a Nixie tube display that provides direct frequency readout in both manual and remotely programed modes. Another new feature is an on-frequency light that indicates that the frequency displayed on the front panel is the actual rf output.

CIRCLE NO. 380

INFORMATION RETRIEVAL NUMBER 117 ►

Anyone can think small.



Frankly, we had something bigger in mind.



We built our second generation DPM* to fit into seven square inches of panel. *That's less than any other digital panel meter requires.* But we didn't stop there. The Model 1290 mounts completely from the front of the panel. *The entire chassis pulls out from the front for servicing or replacement.* Even the Nixie** tubes are pluggable! Think of the convenience in continuous systems opera-

tion. Despite the smaller package, Model 1290 has all the features our original DPM is so widely acclaimed for—3-digit plus 100% overrange display, 0.1% ± 1 digit accuracy, circularly polarized window filter, dual slope integration, full-buffered storage display and BCD output. Many of these standard Weston features are still "optional at extra cost" on competitive units. Our new compact

is styled for tomorrow, available today, and priced below \$200 in quantity. Anything else in the industry is just small talk. WESTON INSTRUMENTS DIVISION, Weston Instruments, Inc., Newark, New Jersey 07114.

a Schlumberger company

WESTON®

*U.S. Pat. #3,051,939 and patents pending.

**Registered trademark, Russnuck Co.



Conductive gaskets cast in place

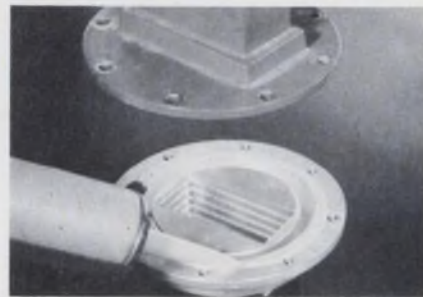

Emerson & Cuming Inc., Canton, Mass. Phone: (617) 828-3300. P&A: \$35/lb; stock.

Conductive gaskets for rf shielding can now be cast in place or made in simple molds. Eccoshield SV-C is a one-part, silicone-rubber composition containing silver particles. It can be cured to a high quality rubber by heating at temperatures as low as 250°F. When fully cured it has a volume resistivity of 0.08 ohm-cm. Gaskets are made by placing the material around an enclosure opening.

CIRCLE NO. 381

Broadband attenuators are current-controlled



Anzac Electronics Co., 121 Water St., Norwalk, Conn. Phone: (203) 853-9411.

A new broadband current-controlled attenuator, designated model AVH-7860-N, provides low VSWRs at all attenuation settings from 0 to 20 dB at 200 to 2000 MHz. Model AVH-7860-N is a 180° hybrid with the side arms terminated in p-i-n diodes. Input and output impedance is 50 Ω, modulation bandwidth is dc to 80 kHz with 10° phase shift, and operating temperature is -54°C to +85°C.

CIRCLE NO. 382

At Last... Broadband AC Digital Voltage Measurements

(with unparalleled sensitivity and programmability)

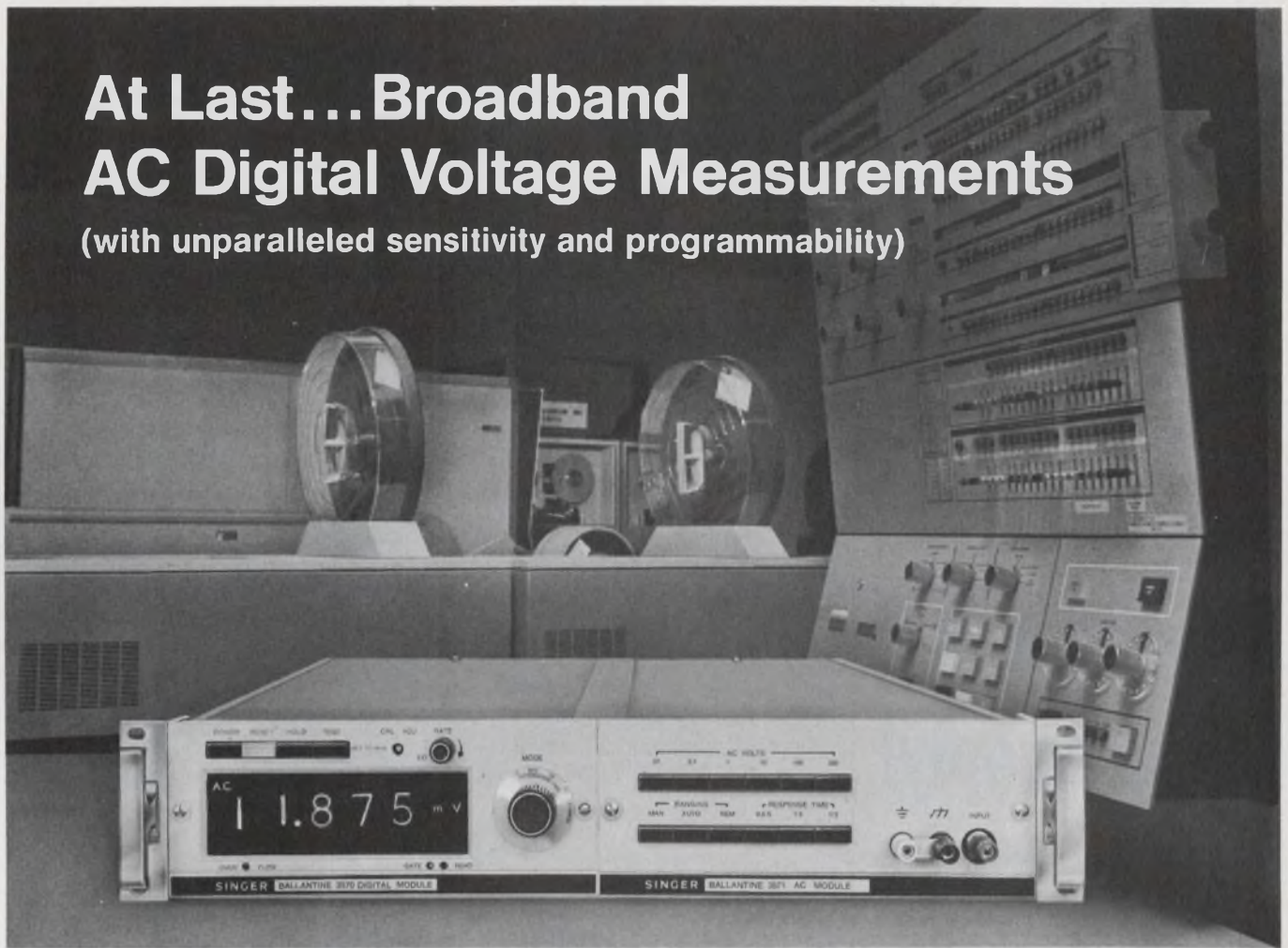

and Ballantine made it possible!

Who else but Ballantine, the recognized leader in Broadband voltage measurement techniques could have introduced the New Model 3570 Series Digital Voltmeter . . . featuring complete programmability and exceptional sensitivity and accuracy for AC and DC digital voltage measurements.

Computer and System Interface is assured by the programmability of all operating functions as well as coded outputs for measurement information.

Full-scale AC sensitivity of 10mv combined with a 10 MHz bandwidth offers a measurement capability not previously available. AC mid-band accuracy is 0.2% RDG + 0.01% FS. DC accuracy is 0.02% RDG + 0.01% FS.

A four digit display with overrange employs dual-slope integration for superior noise rejection.



Optional 20 MHz Frequency Counter capability and Auto-Ranging are also available.

Rack and Stack

Modular packaging makes it possible for system modules to be easily arranged side-by-side for rack mounting or over-and-under for bench use. State-of-the-art versatility is assured as new modules are introduced.

Creative engineering at Ballantine is your assurance that the New Model 3570 Series Digital Voltmeter is more than merely a better voltmeter—for that goes without saying. Ballantine has once more advanced the state-of-the-art in voltmeter technology, and set a new standard in Broadband AC Digital Voltage Measurement.

We invite comparison . . . Write or phone—for additional technical information, The Singer Company, Instrumentation Division, Ballantine Operation, P.O. Box 97, Boonton, New Jersey 07005, (201) 334-1432 or your nearest Ballantine Representative.

SINGER
INSTRUMENTATION



Buy Your Own Power Supply!

\$84.

Our new Model 3564 "Mighty-Mite" is a completely self-contained, all-silicon power supply that delivers 0 to 25V at 200 ma for exciting low level transducers, sensitive IC circuits, or just plain breadboard power. Complete DC and AC isolation has been achieved, with low peak to peak ripple, tight regulation and excellent stability; no small accomplishment in a supply that sells for only \$84 complete. Features include front panel binding post, a heavy-duty six foot power cord and four rubber feet. And in a 1 3/4" x 3 1/2" x 6 1/4" package, the 3564 can be kept in your desk drawer or transported in your pocket. Delivery is from stock.

Complete technical literature on the 3564, as well as the complete family of "Mighty-Mite's" is available from the SRC Division / Moxon Electronics Corp., 2309 Pontius Ave., Los Angeles, California 90064, (213) 477-4573.



SRC DIVISION
MOXON ELECTRONICS

INFORMATION RETRIEVAL NUMBER 119

MICROWAVES & LASERS

Mixer-preamplifiers operate at 2 to 8 GHz

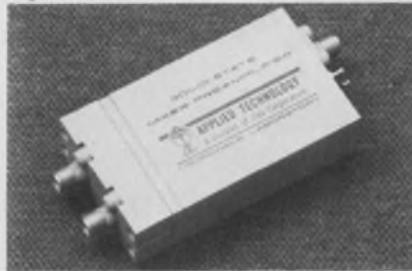

Applied Technology, 3410 Hillview Ave., Palo Alto, Calif. Phone: (415) 321-5135. Availability: 60 to 75 days.

Solid-state mixer-preamplifier models MPS-1 and MPC-1 operate at from 2 to 4 GHz and 4 to 8 GHz respectively with an i-f frequency of 500 to 1000 MHz; lower i-f frequencies are available. The MPS-1 and MPC-1 are available with a gain of 17 dB, and with an input and output VSWR of 2.5 maximum. Both units meet MIL-E-5400 and MIL-E-16400 specifications.

CIRCLE NO. 383

Directional couplers have 12.4 GHz range



I-Tel Inc., 10504 Wheatley St., Kensington, Md. Phone: (301) 946-1800. P&A: \$220; 4 wks.

Directional couplers for the 1 to 12.4 GHz frequency range are available in five degrees of coupling from 3 to 20 dB. Coupling deviation across the frequency band is less than ± 0.5 dB for the 3 dB model and less than ± 1 dB for all other models. Directivity is 10 dB min, typically 15 dB, and VSWR (primary and secondary) is 1.3. Miniature 3-mm (SMA) connectors are standard, with fourth port terminated or unterminated.

CIRCLE NO. 384

Varactor diodes multiply frequency



ITT Corp., 320 Park Ave., New York City: Phone: (212) 852-6000.

New microwave varactor diodes are available in a wide variety of packages including cartridge-type cases, pigtail-led hermetically sealed units, and stud-mounting packages. The devices are usable for frequency multiplication as doublers giving outputs between 250 and 4000 MHz, as triplers multiplying from 450 to 9000 MHz, as quadruplers with outputs of 240 to 1000 MHz, and as high-order multipliers with outputs of 400 to 6400 MHz. Power outputs range between tenths of a watt to 30 watts.

CIRCLE NO. 385

Video output transistors have low capacitance



Fairchild Semiconductor, 313 Fairchild Dr., Mountain View, Calif. Phone: (415) 962-3563. Price: \$1.65 to \$15.

Three npn high-voltage video output transistors are available in a standard TO-39 package. They are designated as: the SE7055, a 220-V unit with a low collector base capacitance of 3 pF; the SE7056, a 300-V unit with a 3.5-pF capacitance; and the SE7057, a 450-V unit with a 2.5-pF capacitance. All feature power dissipation of 7 W at 25°C case temperature (or 1 W in a 25°C ambient temperature).

CIRCLE NO. 386

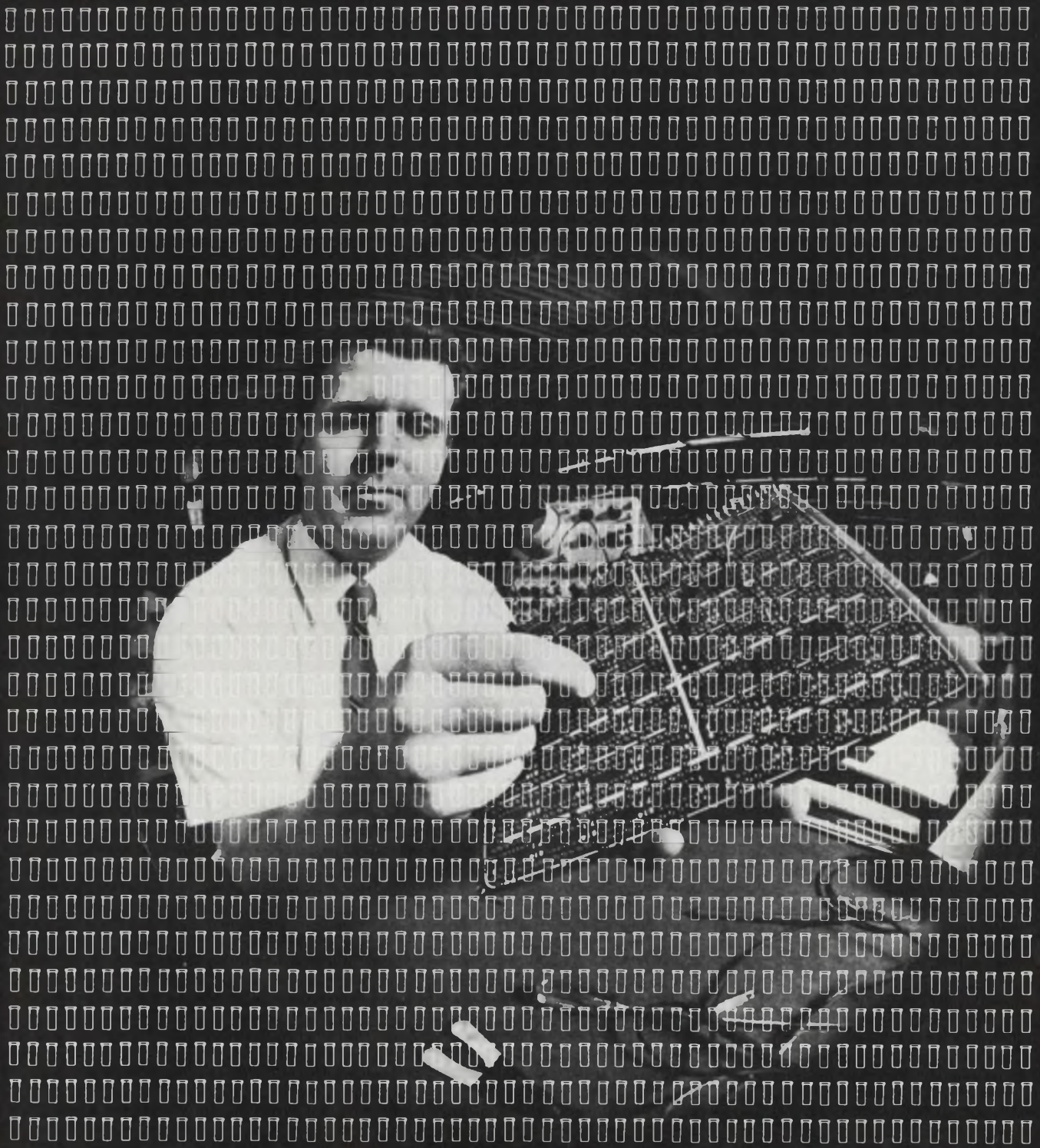

▯▯▯▯ This connector has cycled only 7,393 times

And for at least another 32,607 trouble-free cycles, the fit will be exact . . . to sustain the electrical integrity of the connection. That's because this is a CAMBION Cage Jack. And even if you don't need to push it that far it's nice to know the proven reliability is always there.

But despite such a positive time-after-time grip, CAMBION Cage Connectors are easy to disengage. And you can pick a style for every rugged need . . . patching, testing, breadboarding, mounting components. We make more than 1500 miniature connectors, available from stock in six different sizes from .025" to .080". All with compatible mating plugs.

Our free catalog 700 has all the facts. Write for your copy today. See for yourself how CAMBION's Cage Jack connector can prove to be the **reliable** link in your circuit . . . time after time . . . after time. Cambridge Thermionic Corporation, 445 Concord Avenue, Cambridge, Massachusetts 02138. Phone: (617) 491-5400. In Los Angeles, 8703 La Tijera Boulevard 90045. Phone: (213) 776-0472.

Standardize on

CAMBION[®]
the guaranteed electronic components

New Gritzner DRAWING BOARD TYPEWRITER

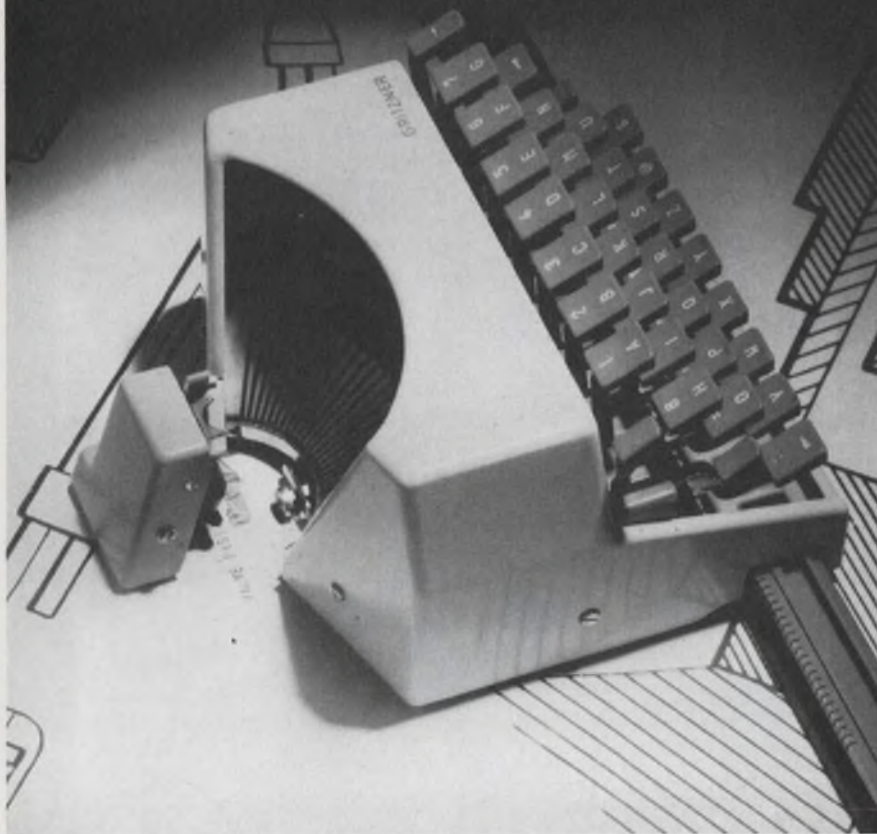

Twice as fast as hand lettering, three times as fast as stenciling!

Remarkable new Gritzner lettering technique provides typewriter-quality dimensions and nomenclatures for your engineering drawings. The Gritzner typewriter sets up easily right on your drawing board, types on all drafting surfaces, including film. Moves in any direction with automatic spacing along indexing rail. Typewriter dimensions 6 x 7 x 3".

The Gritzner drawing board typewriter can increase your drawing production time and efficiency. Tested averages show the Gritzner typewriter to be 1.75 times faster than hand lettering, 3.5 times faster than stenciling. Allows more time for actual drawing. Easy to use without special typing skills.

Uniform block letters comply with Mil. Spec. 100-A, reproduce well in microfilming, diazo and other reproduction methods. Suggested retail price, \$300.00. Special keyboards available.

ABCDEFGHIJKLMNOPQRSTUVWXYZ
VWXYZ 1234567890 @ & /
+ - ± ° = ' : " , ~ * !
ACTUAL SIZE (∅) ← → %

For descriptive folder and name of your Gritzner dealer, write to:

GRITZNER GRAPHICS

3127 Colvin St.,
Alexandria, Va. 22314
(703) 549-3434
East of the Mississippi

620 South 7th St.,
Renton, Wash. 98055
(206) AL 5-8656
West of the Mississippi

INFORMATION RETRIEVAL NUMBER 121

Graphic input devices control CRT displays



Computer Displays Inc., 223 Crescent St., Waltham, Mass. Phone: (617) 899-0480.

Called the Mouse and the Joystick, two new graphic input devices are available for use with CRT display systems. The Mouse is a two-dimensional controller for positioning a cursor on the screen; moving it around causes the cursor to follow in an identical manner. The Joystick, which also provides analog voltage to control the cursor, has switches for selecting solid or dotted line inputs.

CIRCLE NO. 387

Asynchronous modem works at 1800 bits/s



Rixon Electronics, Inc., 2120 Industrial Parkway, Silver Spring, Md. Phone: (301) 622-2121.

Intended to link peripheral units such as CRT displays or card and tape terminals to a central processor, the FM-18 data set operates asynchronously at any speed up to 1800 bits per second. It is a frequency shift keyed modem for use in full-duplex, half-duplex or simplex operations.

CIRCLE NO. 389

LOW COST MULTIPLIER

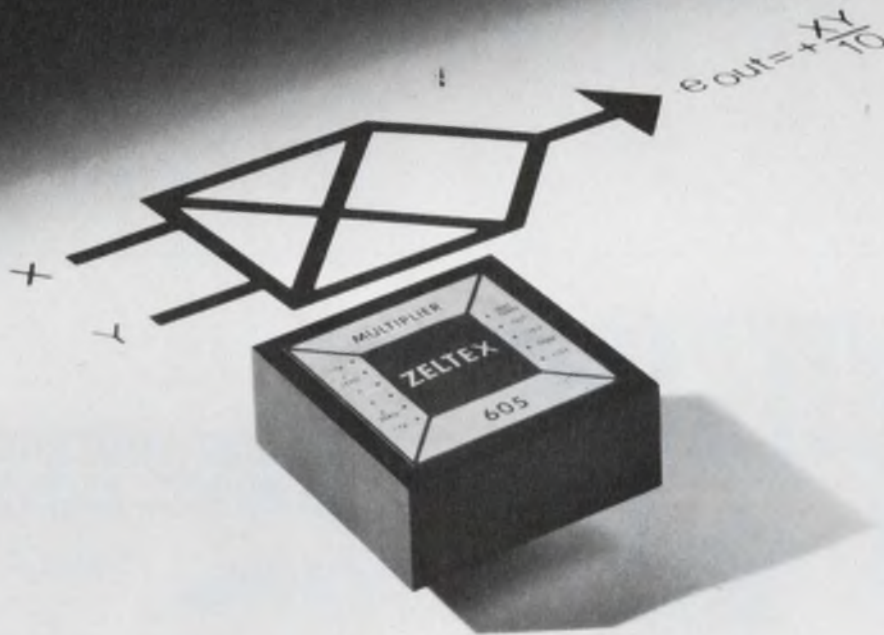

New from
ZELTEK!

A four-quadrant modular multiplier that requires no external amplifiers for

\$48*

- 1% Accuracy
- 10V, 4mA Output
- 1mV rms Noise
- 500 kHz Bandwidth
- 100 kHz Full Output Frequency
- 6V/ μ s Slew Rate

The Model 605 comes to you from the makers of the industry's most accurate multiplier—the Zeltek Model 601 with accuracy within 1mV (0.005%).

For complete information on these or any other Zeltek electronic products, write or phone today.

*In quantity.



1000 Chalomar Road, Concord, Calif. 94520/(415) 686-6660

INFORMATION RETRIEVAL NUMBER 122

Digital intercoupler aids data processing



Daedalus Computer Products Inc.,
P.O. Box 248, N. Syracuse, N.Y.

Model 210 digital intercoupler is a versatile integrated circuit unit for coupling electronic instrument outputs to peripheral equipment, such as Teletype equipment, card punches, incremental magnetic tape recorders, printers and line printers, and typewriters. Capable of receiving coded data from standard measuring equipment, the unit translates the data into a computer-compatible form to drive the readout devices. Depending on the output device, typical operating speeds range from 10 to 1000 characters per second.

CIRCLE NO. 389

D/a 8-bit converter downs drive current

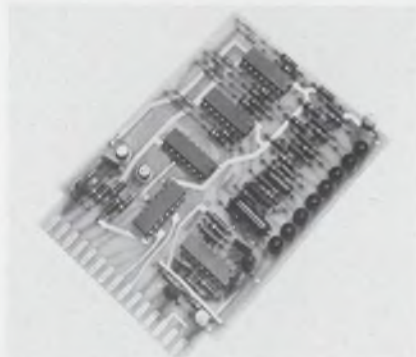

Computer Products, 2801 E. Oakland Park Blvd., Fort Lauderdale, Fla. Phone: (305) 565-9565. P&A: \$99.90; 3 wks.

Permitting series termination, a new 8-bit digital-to-analog converter requires very low input drive currents—less than 0.2 mA source current and less than 0.1 mA sink current. Model DA231 accepts standard TTL logic levels and offers analog output configurations up to ± 10.24 V at 10 mA.

CIRCLE NO. 390

Computer system cycles in 900 ns



Tempo Computers, Inc., 340 W. Collins Ave., Orange, Calif. Phone: (714) 633-3660.

A new modular computer system, which has a basic 4k by 16-word random-access memory with a 900-ns cycle time, consists of a control processor and an ASR 33 Teletype. The model I control processor handles over 100 one- and two-word instructions with 65k addressability. It has seven accumulator/index registers (expandable to 15), multilevel priority interrupts and a 16-bit I/O bus.

CIRCLE NO. 391

TRANSTECTOR

CIRCUIT PROTECTOR



prevents transients from causing "unexplainable" circuit failures.

Don't blame circuit failures on bad luck.

Voltage transients can cause circuits to fail or suffer undetected and progressive damage.

Transtector® circuit protector, a new solid state device, senses transients within nanoseconds, absorbs the surge and resets itself. Gives continuous protection for tubes, transistors, diodes and integrated circuits.

Find out about Transtector Systems from M&T Chemicals Inc., 3025 W. Mission Rd., Alhambra, California 91803.

*Trademark of M&T Chemicals Inc.

M&T Chemicals Inc.
SUBSIDIARY OF AMERICAN CAN COMPANY



INFORMATION RETRIEVAL NUMBER 123

80 MHz WIDEBAND RF POWER AMPLIFIER

MODEL RF-805



- 10 Watts Output into 50 Ω
- 0.1 Volts In — 22.5 Volts Out
- .05 MHz to 80 MHz Broadband
- Low Distortion
- Solid State
- Flat 47 db Gain

The RF-805 is a solid state amplifier, broadband from .05 to 80 megahertz, which produces ten watts with -30 db harmonic and intermodulation distortion. Lower distortion is available at lower output levels. Gain is 47 db minimum, constant within 1 db, so that full output is developed with less than 0.1 volt at the 50 ohm input. Accurate output metering and overload protection is provided.

The RF-805 will raise the power of most manual and swept tuned signal generators and thus extend the usefulness and versatility of available signal generators. Receiver testing, wattmeter calibration, antenna testing, RFI testing, attenuator measurements, and filter and component testing will be aided with the use of this equipment.



R F COMMUNICATIONS, INC.
1680 University Avenue • Rochester, N. Y. 14610

INFORMATION RETRIEVAL NUMBER 124



Monitoring tone level in a multiplexed communications system is easy ... with a Model SSB-50-1 Spectrum Analyzer

1. A high resolution spectrum analyzer allows monitoring of any number of multiplexed channels without repetitive meter readings or painstaking adjustments. As a first operating step, the analyzer's accurately calibrated frequency dial is precisely tuned to the center frequency of the channel.



2. A selector knob sets the frequency scale in one of five settings from 15 Hz/division to 1.4 kHz/division. Interlocked circuit functions in the analyzer automatically optimize the display for any setting of the frequency scale.

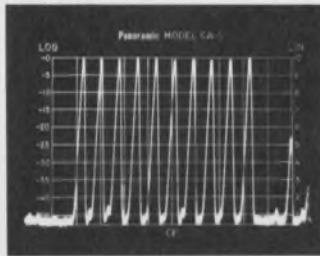

3. The high resolution of the Singer Model SSB-50-1 provides this clear display of the multiplexed channel. The amplitude of each subcarrier is shown as a function of frequency. The display demonstrates complete operational readiness at a glance.

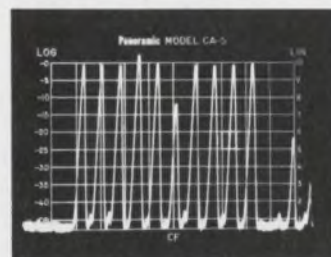

Subcarrier level changes
Often a subcarrier level changes with a resulting communications malfunction. This display on the CRT shows that one subcarrier's level is down 12 dB. Another is over the predetermined acceptable level.

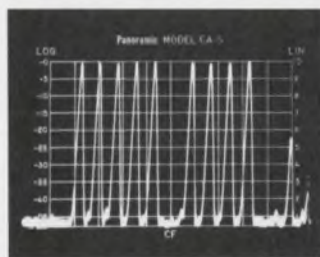

Lost channel
Because the entire spectrum is continuously visible on the display, a lost channel shows up instantly ... A frequency range of 10 Hz to 40 MHz makes the Model SSB-50-1 an invaluable tool for this application and for general laboratory or field use.

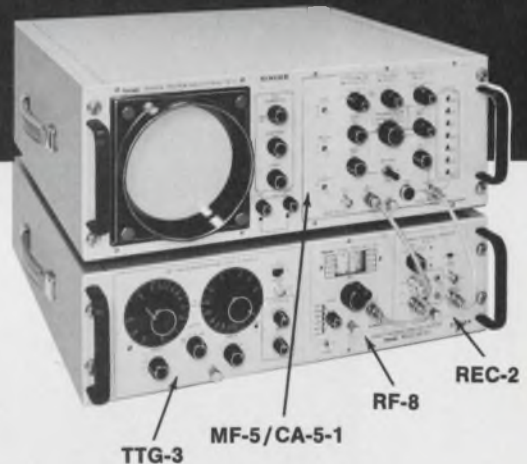

Model MF-5/CA-5-1
Spectrum Analyzer display section
features high resolution/low distortion and 70 dB dynamic range.

Model TTG-3 Two-Tone Audio Generator
20-20,000 Hz frequency range and IM distortion of less than 70 dB for testing single sideband transmitters.

Model REC-2 Range Extending Converter
extends the tuning range down to 10 Hz.

Model RF-8 Tuning Head
is a highly stable LO with coarse and vernier two speed tuning from 2 MHz to 40 MHz ... usable to 200 MHz.

For additional technical information, or for Singer's new Application/Data Bulletin SA-10, contact your nearest Singer Field Representative or write directly to The Singer Company, Instrumentation Division, 915 Pembroke Street, Bridgeport, Conn. 06608.

SINGER

INSTRUMENTATION

COHU'S DESIGN 6000

hi resolution camera

Cohu's 6100 Series high-resolution camera — one of the new look 6000 design series — is designed for continuous unattended duty. Camera functions are remotely controlled from a Cohu solid-state 6900 Series Camera Control that connects with a single multiconductor cable. Add a TV monitor for a complete CCTV system.

The 6100 is housed in a high-strength cast aluminum-alloy housing with a scuff-resistant epoxy finish, brushed chrome rear panel and lens mount. The control unit is a rack mount in 5¼" vertical space. It is available with horizontal scan rates from 525 to 1225 lines and bandwidths to 32 MHz. Performance of the camera is characterized by superior corner resolution and flatness of field.

The circuit design of the 6100 series high resolution camera features the latest integrated circuits for maximum reliability. Maintainability is simplified by modular construction and plug-in etched circuit boards.

For complete details and specifications, contact your nearest Cohu representative or call Bob Boulio direct at 714-277-6700, Box 623, San Diego, California 92112, TWX 910-335-1244.

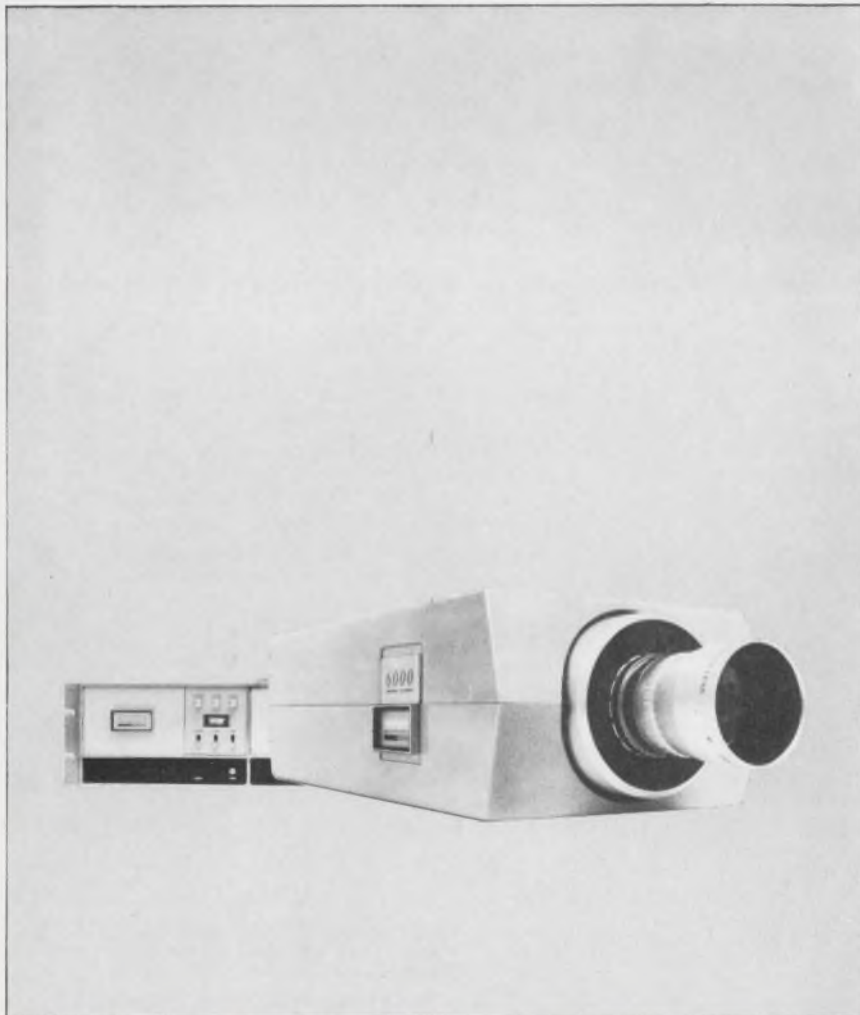

DATA PROCESSING

Portable terminal listens and writes



ComData Corp., 7544 W. Oakton St., Niles, Ill. Phone: (312) 692-6107. Price: from \$1004.

A new mobile terminal and data set combination for time-sharing and data communications consists of a completely portable modified model 33 Teletype and an acoustic data set. This new mobile console offers a large range of options: paper-tape input-output, automatic control of paper-tape reader and/or punch, 74 or 88 columns per line, and separate or built-in acoustic data set.

CIRCLE NO. 392

Magnetic tape stays error free

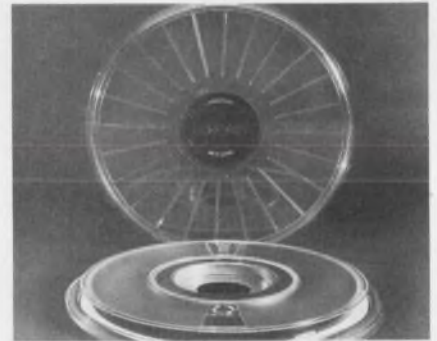

Memorex Corp., Memorex Park, Santa Clara, Calif. Phone: (408) 248-3344. Price: \$27/2400 ft.

Called Quantum, a totally new magnetic computer tape resists chemical decomposition during storage or shipping. This feature reduces the need to reconstruct information lost by errors, the need for checkpoint restarts on major processing and the lost time of shuttling away transient errors. During accelerated aging tests, Quantum showed a net increase of 2.1 permanent errors per reel, compared with the 6.4 and 6.2 increases of two competitive tapes.

CIRCLE NO. 393

**need
quality diodes
or arrays fast?...**



**...we ship our guaranteed
products the day
they're ordered!**



The performance of our products — our laser diodes, our laser diode arrays, our pulse power supplies, and our crystal and epitaxial wafers — is the highest in the industry. We guarantee this. Our prices are the lowest in the industry. Our delivery is the quickest in the industry. And we have the broadest line of gallium-arsenide laser diode arrays.

Performance? You'll find that specifications listed on our data sheets are conservative ratings.

For example, our LD11 single element gallium-arsenide laser diode will, on the average, emit 8 watts. Yet our data sheet cites a conservative 5 watt minimum. And both our LD11 and LD12 single element gallium-arsenide laser diodes are superior to any other diodes available at operation temperatures ranging from —196 degrees C to 70 degrees C. Typically there is no time delay in the emission of laser radiation with respect to the drive current.

Furthermore, these laser diodes are so rugged you can step on them — without affecting their performance.

What does this high performance, low price, ruggedness and immediate delivery mean to you?

It means you now have a source which supplies you with ruggedly packaged diodes that you can operate with a lower cost pulser — while obtaining higher peak power and higher average power — throughout a longer operating life. At lower cost to you. With no waiting for delivery.

- Single Element Gallium-Arsenide Laser Diodes
- Gallium-Arsenide Laser Diode Arrays
- Laser Diode Pulse Power Supplies
- Laser Grade Gallium-Arsenide Crystal and Epitaxial Wafers

*The power at 55°C is typically 60% of the 25°C power value.
For a 5 watt output the derating is 70 milliwatts per °C, while at 10 watts
it is 150 milliwatts per °C.*

TYPICAL PERFORMANCE DATA

		+25°C	+55°C
		1KHZ, 200ns 3 x Ith	1KHZ, 200nsec 2 x Threshold
LD11	Peak Power Threshold	8 Watts 25 Amperes	5 Watts 40 Amperes
LD12	Peak Power Threshold	3 Watts 12 Amperes	2 Watts 20 Amperes



205 Forrest Street, Metuchen, New Jersey 08840

For technical or application information
call (201) 549-7700

A Subsidiary of The United Corporation

INFORMATION RETRIEVAL NUMBER 127

san fernando electric manufacturing company

Electronic components
of proven reliability

Aluminum Electrolytic Capacitors

The rugged CAPACITORS by West-Cap that have built-in reliability and durability. Because of their all-welded construction they will withstand more vibration and shock. The elements are made from 99.99% pure etched aluminum foil sealed in high grade aluminum cases.

SERIES WHC Computer Grade Electrolytic.



A superior line of energy storage and filter electrolytics which meet all the specifications set by MIL-C-62. In addition, this series will meet all the standard telephone quality standards set by the telephone industry. This electrolytic will meet the most exacting ripple standards.

**Ratings: 200 mfd to 100,000 mfd
from 5 VDC to 150 VDC
Voltages in excess of 150 VDC
to 500 VDC on special order**

SERIES MAC Axial Lead Electrolytic.

They are available in miniature size with $\frac{1}{4}$ " x $\frac{5}{8}$ " case and larger.

**Ratings: 2 mfd to 70,000 mfd
from 3 VDC to 150 VDC**



The manufacturing process is completely quality-controlled in West-Cap's modern new facility in the Tucson International Airport Industrial Park. This facility was designed and equipped primarily for the manufacture of high quality electrolytic capacitors at competitive prices.

Call your representative of West-Cap high reliability components, or contact West-Cap Arizona, where service and quality count.

WEST-CAP ARIZONA

SUBSIDIARY OF SAN FERNANDO ELECTRIC MANUFACTURING CO.
2201 EAST ELVIRA ROAD, TUCSON, ARIZONA 85706

INFORMATION RETRIEVAL NUMBER 128

DATA PROCESSING

Compact core memory uses only one supply

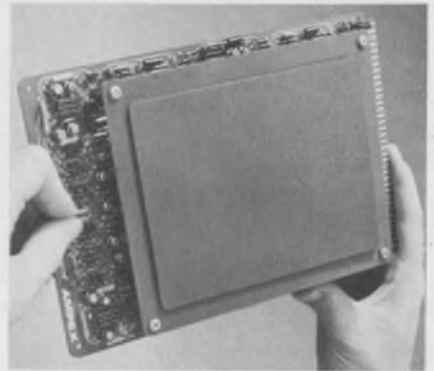

Amper Corp., 9937 W. Jefferson Blvd., Culver City, Calif. Phone: (213) 836-5000. Price: \$330 to \$950.

Requiring only one power-supply voltage, a new magnetic core memory is completely contained on one plug-in module that measures 1.2 in. high by 7 in. wide by 12 in. deep. Model 3DM-3000 is designed for use as a buffer memory in data terminals and acquisition systems, and as a data-refresh memory for display devices. It offers an access time of 1.2 μ s, a half-cycle time of 1.5 μ s and a full-cycle time of 3 μ s.

CIRCLE NO. 394

Three data modems satisfy line needs



Dynatronics, div. of General Dynamics, P.O. Box 2566, Orlando, Fla. Phone: (305) 838-6161.

Three new data modems meet the varied requirements of modern communication systems. The EDX-1402 offers compatibility between international and domestic data transmission systems at data rates to 600 and 1200 bits/s. Designed for high-speed data transmission, the self-equalizing EDX 1403 operates at rates of 4800 bits/s. The medium-speed EDX 1404 provides two-way synchronous transmission at rates of 2400 bits/s.

CIRCLE NO. 395

How to save on relays

A quotation from Line Electric includes lots of values that add to the total savings possible.

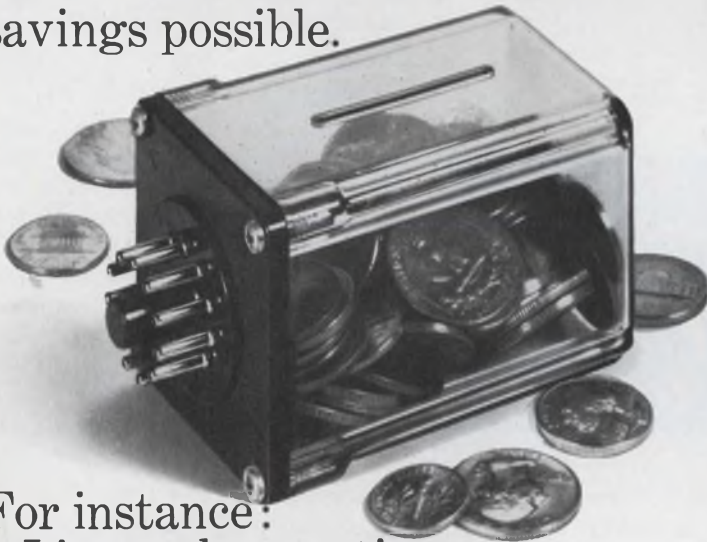

For instance:

- Line makes on-time deliveries to meet your production line schedules.
- Line offers excellent engineering help free.
- Line maintains the highest manufacturing standards in the industry

Add these values together and you get all-round savings on your relay purchases. Not to mention the headaches you can avoid.

Won't you check us out and see how much better you can do at Line? Send for free copy of our new 1969 catalogue containing all the most frequently used industrial type relays. We guarantee you'll learn something to your advantage.



In a hurry, call (201) 887-8200 and ask for Relay Sales Manager. We like to do business by phone.

*LINE ELECTRIC COMPANY, U.S. Highway 287, Parsippany, N.J.
Manufacturers of relays and the best service in the business.
SUBSIDIARY OF THE SINGER COMPANY*



A DELICATE BALANCE

Is the difference between progress and failure for your project, program or company balanced on the point of critical technical decisions?

Would you rest easier if your in-house staff were supplemented and "backstopped" by independent experts?

Would you value a broad, objective analysis of your present direction, your program organization, your human, physical and financial resources?

If your answer is "yes," you need Advanced Technology Consultants Corp. (ADTEC). Whether you require a single authority or an interdisciplinary team for a day or a year, ADTEC is your best source.

From its roster of more than 300 selected Associates, ADTEC can provide assurance your decisions have been right, back up your in-house staff on special projects, or help you plan future programs. Call or write R. F. Horan, Vice President.



ADVANCED TECHNOLOGY CONSULTANTS CORPORATION

Dept. ED
144 South Main Street
Wallingford, Conn. 06492
(203) 265-1638

Consultants in:
Pollution Control
Aerospace Technology
Nuclear Energy
Applied Chemical Technology
Transportation
Oceanography
Medical Electronics
Instrumentation
Computer Sciences
Systems Analysis

INFORMATION RETRIEVAL NUMBER 130



New and Better
Communications with . . .

TELEMATE 300 ACOUSTICAL COUPLER

TELEMATE 300 was designed and developed to specifications of DACC, a time-sharing computer company that knows the needs of users.

That's why Telemate 300 is more compact, more reliable and elegantly styled.

Top Quality • Competitively Priced

- Easily portable
- Data Rate: 300 Baud
- Carrier and on/off lights
- Highly selective tuned oscillator circuit
- Half/full Duplex
- Triple tuned circuitry
- AGC circuit
- Acoustic isolation min. 20 db
- Teletype or EIA Interface
- Optional: Carrying case, originate/answer, cable interface, loud speaker and RS 232B

FULL WARRANTY • WRITE FOR BROCHURE



Use TELEMATE 300 with your telephone and/or your teletype system. Comes in walnut and attractive office decorator colors.



DIRECT ACCESS COMPUTING CORP.
Communications Equipment Group

24175 Northwestern Highway Southfield, Michigan 48075 313/358-5000

INFORMATION RETRIEVAL NUMBER 131

DATA PROCESSING

Bulk core memory is IBM compatible

Memory Products, Lockheed Electronics Co., Data Products Div., 6201 E. Randolph St., Los Angeles. Phone: (213) 722-6810. Availability: first quarter, 1970.

Compatible with IBM 360/50, 65, or 75 systems, a new multi-million-byte bulk core memory has a cycle time of 3.2 μ s with an access time of 2 μ s or less. Memory capacities are one-half, one, and two million bytes for system 360 models. A version for the IBM/67 time-share system is also planned.

CIRCLE NO. 396

Modular core memory accesses in 300 ns

Micro Systems, Inc., 644 E. Young St., Santa Ana, Calif.

Model 140 high-speed core-memory module features a full-cycle time of 900 ns and an access time of 300 ns. Capacity of the module is 4096 words by 8, 9 or 10 bits. It also has full-, half-, and split-cycle modes of operation, random address, control line input/output and TTL integrated circuit interface.

CIRCLE NO. 397

Four-wire 3-D memories vary operating mode

United Telecontrol Electronics, Inc., 3500 Sunset Ave., Asbury Park, N.J. Phone: (201) 988-0400.

A new group of 2- μ s full-cycle memories can operate in a full-, half-, or split-cycle mode with any combination of random, sequential or interlaced access modes. Capacities for series 200 memory systems range from 1536 to 147,456 bits in virtually any address/word organization up to 60-bit word lengths. Their configuration is based on four standard plug-in circuit modules.

CIRCLE NO. 398

DELAY TIMERS



Any mounting style; voltage specification; time cycle; operational method. No special engineering required. Good delivery schedules. Our stock is ample.

**INDUSTRIAL
TIMER**

U. S. Highway 305, Parsippany, N. J.

Subsidiary of the Singer Company

INFORMATION RETRIEVAL NUMBER 132

**The only total portable,
laboratory quality
oscilloscope.**



Model
S1301A

And only \$665.

Goes anywhere you need it. And at \$665,* there's no need for scope sharing. Operates from optional internal battery or 110/220 vac 50 to 400 Hz line. Compact 8½" x 9" x 15" size, weighs less than 20 lbs.

Features include: 20 MHz bandwidth; 17 nsec rise time; 18 sweep speeds; internal voltage calibrator; and triggering stability over 30 MHz.

Write for Bulletin TIC 3316 to Motorola Communications & Electronics Inc., 4501 W. Augusta Blvd., Chicago, Ill. 60651.

*Exclusive of options.



MOTOROLA
Precision Instrument Products

INFORMATION RETRIEVAL NUMBER 133

ELECTRONIC DESIGN 10, May 10, 1969

LSI

**TESTING
IN REAL TIME
WITH**

**ADAR SYSTEMS AND
EXPANDABLE SYSTEMS
COMPONENTS**

• DISCRIMINATORS



- 10mV nS SENSITIVITY. .5mV GRAY AREA. 1MΩ INPUT IMPEDANCE WITH ADAR FET PROBE.
- TWO THRESHOLDS PER CHANNEL WITH ERROR LOGIC AND DISPLAYS

• MOS CLOCK



- 2 or 4 OUTPUT PHASES CAPABLE OF DRIVING 0 to .30V in 20 nS into 100 pF
- OPERATES UP TO 10MHz WITH AUTO PHASE WIDTH TRACKING

• MOS DRIVERS



- EXTENDED OUTPUT PROBESWING. 10-30V in 20 nS INTO 100 pF
- FOUR CHANNELS OF AMPLITUDE, OFFSET, DELAY AND WIDTH CONTROL

• BIPOLAR DRIVERS



- 0 to 8V in 6nS. CODE AND COMPLEMENT OUTPUTS
- CONTROLS FOR DELAY, WIDTH, AMPLITUDE AND OFFSET
- 50 OHM SOURCES

• DATA GENERATORS



- FORMATS OF 3, 6 or 12 BIT PARALLEL, 16, 32, 64 or 128 WORD SERIAL
- WORD RATES UP TO 25MHz WITH REMOTE OR LOCAL LOADING

• MOS SHIFT REGISTER TESTING SYSTEM



- TESTS 2 OR 4 PHASE DYNAMIC OR STATIC QUAD REGISTERS UP TO 999 BITS LONG AT SPEEDS UP TO 10MHz
- DC TESTS INCLUDE LEAKAGE, STRESS, DATA RETENTION, VDD AND VGG MONITORING.
- TEST FUNCTIONAL, RESPONSE TIMES AND THRESHOLD IN REAL TIME

Write today for full information and specifications.

adar
ASSOCIATES, INC

85 Bolton Street, Cambridge, Mass. 02140 - (617) 492-7110

INFORMATION RETRIEVAL NUMBER 134

Real-time system checks software

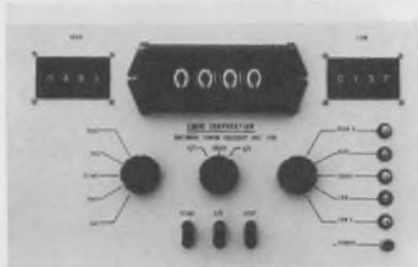

Logic Corp., Haddonfield, N.J. P&A: \$5900; 60 days.

Designed for real-time operating systems, the model 1700 software timing checkout unit permits a complete statistical analysis of any program, routine or subroutine. Time is measured in intervals from 1 μ s to 10 ms; the longest time that can be measured is 9.999 s. The unit measures five critical parameters: actual time period, longest and shortest time period to date, and the number of times the high and low limits have been exceeded.

CIRCLE NO. 399

A/d converters trim package size

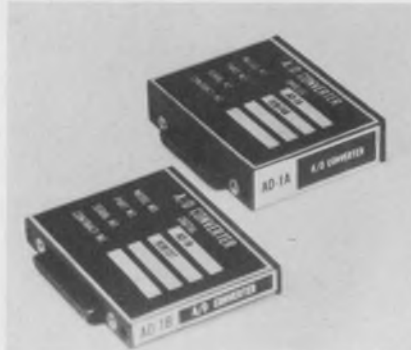

Radix Telemetry Corp., 1600 Orangethorpe Way, Anaheim, Calif.

Designed for airborne applications, a new series of miniature analog-to-digital converters measure only 2 by 2.62 by 2.125 in. with dc-to-dc converter. Final package outline and dimensions are variable to match individual requirements. The units have resolutions from 6 to 10 bits and are either bipolar or unipolar. They can be supplied with a self-contained clock.

CIRCLE NO. 400

Small computer responds quickly

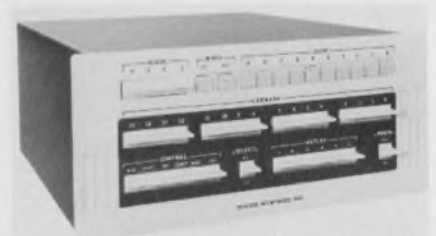

Micro Systems, Inc., 644 Young St., Santa Ana, Calif. P&A: from \$2950; 30 days.

Designed for direct integration into control and processing system applications such as data communication and data acquisition, the model 800 small digital computer offers a 1.1- μ s full-cycle core memory with 220-ns micro-command execution times. Microprogramming (firmware) permits adaptation of internal organization and instruction repertoire to achieve speed and memory efficiency impossible with conventional computers having fixed instructions.

CIRCLE NO. 401

EASTMAN 910[®] Adhesive... bonds bronze to nylon in micro-dial assembly.

To obtain desired micro-dial gear ratios for use in their weighing equipment, Heltzel Steel Form and Iron Company, Warren, Ohio reassembles the gears on standard dials purchased by the company.



In the reassembly, a small naval bronze gear is quickly bonded to a white nylon gear and common bushing with a few drops of EASTMAN 910 Adhesive. The result is a fast setting bond with excellent joint strength and ability to withstand the vibration and torque of the variable, rotating, weight setting device. Not one bond failure has been reported in the three years EASTMAN 910 Adhesive has been used by Heltzel.

EASTMAN 910 Adhesive will form bonds with almost any kind of material without heat, solvent evaporation, catalysts, or more than contact pressure. Try it on your toughest bonding jobs.

For technical data and additional information, write to Chemicals Division, EASTMAN CHEMICAL PRODUCTS, INC., Kingsport, Tennessee. EASTMAN 910 Adhesive is distributed by Armstrong Cork Company, Industrial Products Division, Lancaster, Pennsylvania.

Here are some of the bonds that can be made with EASTMAN 910 Adhesive

Among the stronger: steel, aluminum, brass, copper, vinyls, phenolics, cellulose, polyesters, polyurethanes, nylon; butyl, nitrile, SBR, natural rubber, most types of neoprene; some woods. Among the weaker: polystyrene, polyethylene (shear strengths up to 150 lb./sq. in.).

INFORMATION RETRIEVAL NUMBER 135



There is no adhesive like EASTMAN 910[®] Adhesive

- SETS FAST**—Makes firm bonds in seconds to minutes.
 - VERSATILE**—Joins virtually any combination of materials.
 - HIGH STRENGTH**—Up to 5000 lb./in.² depending on the materials being bonded.
 - READY TO USE**—No catalyst or mixing necessary.
 - CURES AT ROOM TEMPERATURE**—No heat required to initiate or accelerate setting.
 - CONTACT PRESSURE SUFFICIENT.**
 - LOW SHRINKAGE**—Virtually no shrinkage on setting as neither solvent nor heat is used.
 - GOES FAR**—One-pound package contains about 30,000 one-drop applications. (Or in more specific terms, approximately 20 fast setting one-drop applications for a nickel.)
- The use of EASTMAN 910 Adhesive is not suggested at temperatures continuously above 175°F., or in the presence of extreme moisture for prolonged periods.

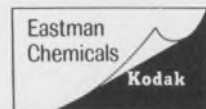

Of all DVM's, only
 Honeywell Digitest gives
 you five functions (DC Voltage,
 AC Voltage,
 DC Current,
 AC Current,
 Resistance),
 a choice of two models, and

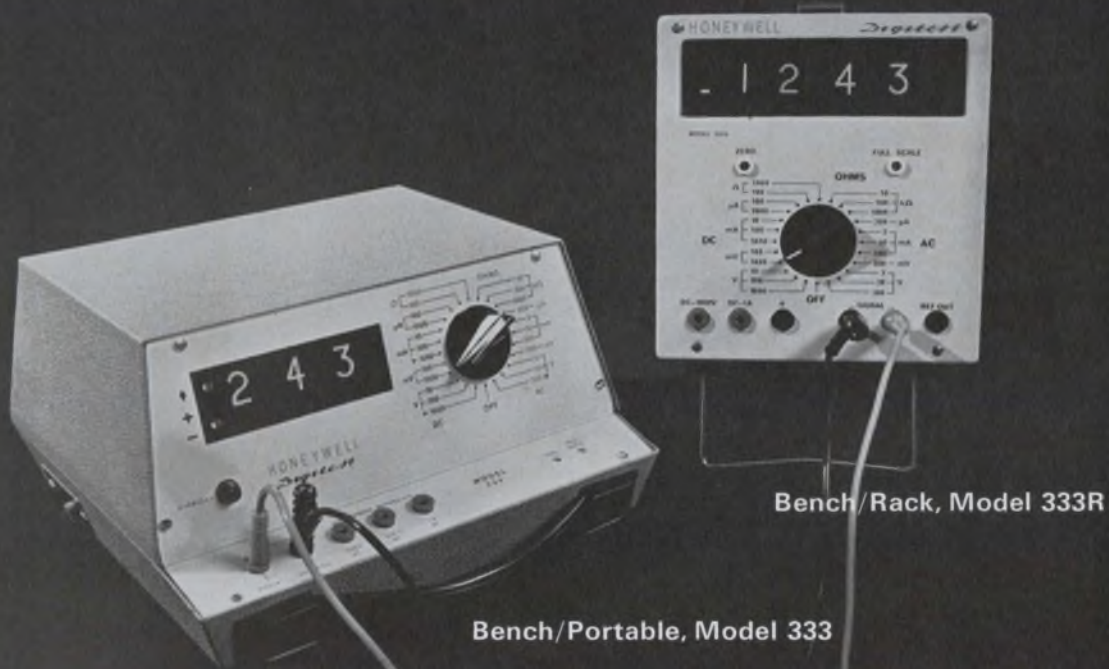

Bench/Rack, Model 333R

Bench/Portable, Model 333

a price tag of only \$395!

With $\pm 0.5\%$ accuracy, $100\mu\text{V}$ resolution, absolutely clear $3\frac{1}{2}$ -digit readout, and simple, foolproof operation, the tough, compact little Digitest makes other low-cost DVM's look overpriced and under-engineered. We won't even mention a comparison with conventional meter-movement instruments.

Both models share the same specs, but Model 333 is completely portable thanks to built-in rechargeable ni-cad battery operation. It operates on AC as well. Both instruments give you $3\frac{1}{2}$ -digit readout, with Model 333R providing an overrange digit while Model 333 employs an overrange indicator.

Compare features, specs, and prices — you'll see that Digitest is your best DVM value. That \$395 price, by the way, is *complete*. There are no shunts or plug-ins to buy, and even leads are furnished. The only option is a set of ni-cad batteries for the portable model at \$33.

Order yours today! Call Don Anderson (collect) at (303) 771-4700, or send your purchase order to Don at Mail Station 222, Honeywell, Test Instruments Division, P.O. Box 5227, Denver, Colorado 80217. Both models are in stock for immediate delivery, so order now!

Honeywell

Honeywell engineers sell solutions

HIGH DENSITY IC PACKAGING PANEL

With Wire Wrap Connector

**HIGH PERFORMANCE
FAST DELIVERY
LOW COST**

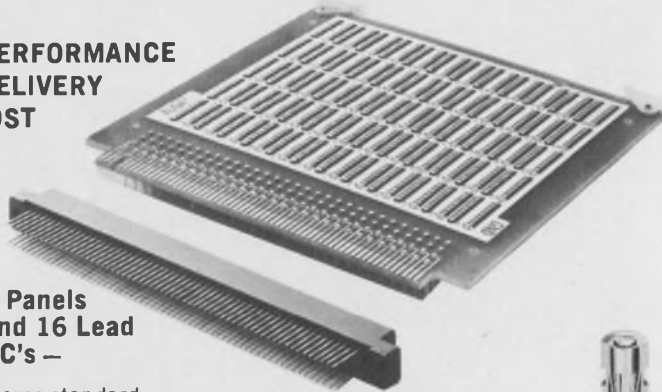

**R-Series Panels
For 14 and 16 Lead
Plug-In IC's —**

- 60 patterns standard
- Accepts Augat's new 120 contact edge connector with Wire Wrap terminations. Connector also supplied separately.
- 1/8" double-sided board has power and ground planes connected to each IC pattern.
- Machined contacts assure high reliability and retention.
- Wire Wrap terminations on IC patterns.

Request Complete I. C. Folder

AUGAT INC.

Tel: 617-222-2202
31 Perry Ave., Attleboro, Mass. 02703



INFORMATION RETRIEVAL NUMBER 137

MDS MODEL 2110R ... THE LOW-COST TAPE PUNCH THAT DELIVERS HIGH-QUALITY SERVICE

When the 2110R Tape Punch is connected in your system, it will accept coded electrical data serially by character and parallel by bit... and record it on tape at speeds up to 30 characters per second.

For that installation requiring a compact, reliable tape punch at low cost... the MDS 2110R is the answer. Switches are provided for error checking, tape backspacing, and other functions. And there are no critical pulse widths or regulated supply levels to worry about.

Check out the MDS 2110R... it's tough, versatile and economical, and could be the answer to your tape punch requirements.



MDS 2110R Paper Tape Punch

The low-cost Paper Tape Punch that makes no compromise with quality

MOHAWK MB
DATA SCIENCES CORPORATION

OEM MARKETING
122 E. Ridgewood Ave. • Paramus, N.J. 07652

Telephone 201/265-7333

Every MDS Office is an OEM Marketing Office
Digital Strip Printers • Buffered Tape Units
High-Speed and Low-Speed Line Printers
Card Punches and Readers



INFORMATION RETRIEVAL NUMBER 138

PRODUCTION

Transistor fixture speeds up testing

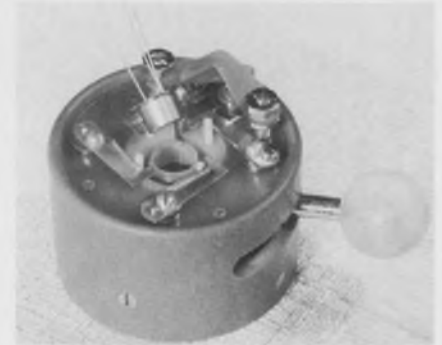

Monterey Engineering, P. O. Box 3083, Granada Hills, Calif. Phone: (213) 780-6953. P&A: \$75; 2 wks.

Able to handle up to 1800 pieces per hour with remote actuation, a new transistor test fixture reduces test time, decreases connection errors and lessens operator fatigue. Transistors are simply dropped into the cup, case down; the fixture is actuated with the slide lever; and lead contact is complete in less than 0.1 seconds. Two models are available, for TO-5 and TO-18 metal cans with three or four leads.

CIRCLE NO. 402

Pivoting magnetic vise chucks 15-mil pieces

Titan Tool Supply Co., Inc., P.O. Box 1682, Dept. 31, Buffalo, N.Y.

A miniature permanent magnet chuck can hold small workpieces as thin as 0.015-in. Called Magna Plate SP-180, the new pivoting tool can rotate 105° in either direction from the horizontal and can be locked in any position by two spring-loaded cam-actuated locking levers.

CIRCLE NO. 403

RUGGED EXTRUDED ALUMINUM HOUSING

BCD OUTPUTS STANDARD



AUTO-POLARITY
STANDARD

UNIQUE FRONT
MOUNTING BEZEL

3 DIGIT + 100% OVERRANGE

LOW COST

DIGITAL PANEL METER



INSTRUMENT DISPLAYS, INC.

A wholly owned subsidiary of BURNS & TOWNE, INC.

18-36 GRANITE ST., HAVERHILL, MASS. 01830

INFORMATION RETRIEVAL NUMBER 139

Take a Good Look

(You'll Never Have To See)
(Traces Like These Again)

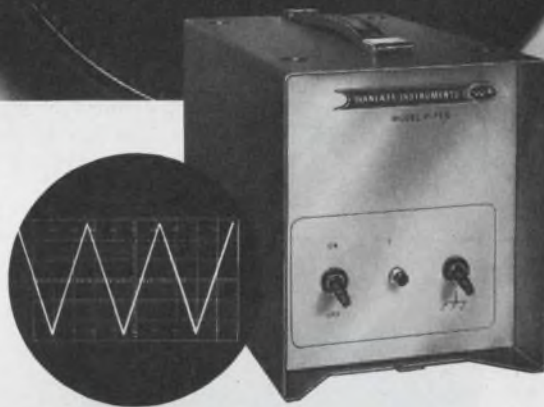
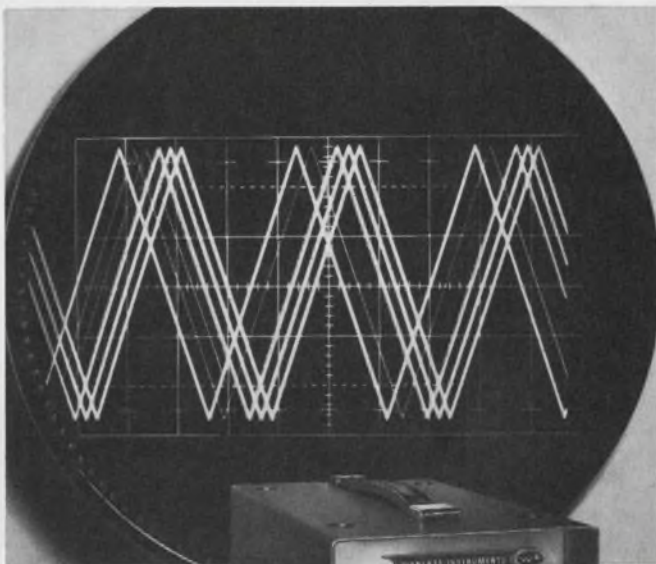

Wanlass Scopac™

Scope Conditioner
Eliminates AC Line Disturbances
From Your Oscilloscope

Merely plug your scope into SCOPAC. Let it provide the necessary noise filtering of 50 db to 1 MHz and line regulation to ¼%. You can proceed immediately with consistent, accurate oscilloscope readings. Gone are problems associated with jitter, zero-line stabilization, false triggering (top photo above), jumping off scale, erroneous signals and readings caused by normal plant or laboratory AC-line disturbances.

SCOPAC Model P-TEK operates all 300, 400 and 500 Tektronix scopes as well as those from Hewlett-Packard, Dumont and other scope manufacturers. Available off-the-shelf, priced at \$375. Contact factory or local representative for literature.

WANLASS INSTRUMENTS

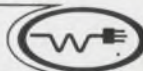

a division of **WANLASS ELECTRIC COMPANY**
A SUBSIDIARY OF **AMBAC INDUSTRIES, INC.**

1540 EAST EDINGER AVENUE ■ SANTA ANA, CALIFORNIA 92707
TELEPHONE (714) 546-1811 ■ TWX: 910-595-1526

INFORMATION RETRIEVAL NUMBER 141

Dramatic new whiteprinter— high speed— low cost.



This little giant 1042 with speeds to 22 feet/minute compares to big printers costing much more.

Makes to 400 "D" size prints per hour. 43¾" throat. Copies cost only about 1½¢ sq. ft. Printer/Developer synchronized. No skill to operate, no warm-up. No service problems. Components production tested for over two years. Blu-Ray is the dependable one with full-year warranty.

BLU-RAY

Send today
for free brochure.

4434 WESTBROOK ROAD, ESSEX, CONN. 06426 PHONE (203) 767-0141

INFORMATION RETRIEVAL NUMBER 140

ELECTRONIC DESIGN 10, May 10, 1969

Tip angle cutter does fine work



ETM Corp., 144 W. Chestnut Ave., Monrovia, Calif. Phone: (213) 359-8102.

Although ruggedly constructed, model 1022 tip angle cutter retains the fine pointed tips needed for close-quarter precision cutting. Able to cut nickel wire up to 0.032-in. dia and nickel ribbon to 0.012 by 0.030 in., the new tool has a stop screw in the shank to prevent overpressure on the tips. It also features tool steel hardened inserted tips and diamond-honed cutting edges.

CIRCLE NO. 404

Lightweight heat gun shrinks tubing in 8 s



Kelvin Halogen Ltd., 500 Sansome St., San Francisco, Calif. Price: \$59.50.

Drawing only 2.08 A, a new hand-held heat gun goes from 0 to 750°F in 10 seconds and processes shrinkable tubing in about eight seconds, a time cycle said to be comparable with hot air blower units. Weighing only 12 ounces, model A250 uses a high-intensity iodine quartz lamp as its energy source. The tool will operate continuously at constant effectiveness for up to 2000 hours, the normal life cycle of the lamp.

CIRCLE NO. 405

High-temp markers identify ceramics

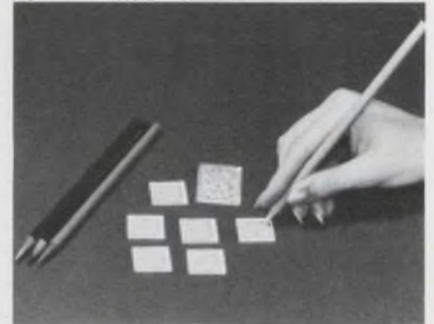

Starnetics Co., 10639 Riverside Drive, N. Hollywood, Calif. Phone: (213) 769-8437. P&A: \$10.75/kit; stock.

Ideal for identifying thick-film substrates, a new line of marking pencils can write on ceramics that are subsequently exposed to high temperatures. Once applied, the pencils' deposit will withstand the high temperatures of print and fire processes. After exposure, the marks are permanent, unable to be removed by any of the commonly employed solvents and cleaners.

CIRCLE NO. 406

The important part is knowing what you need.

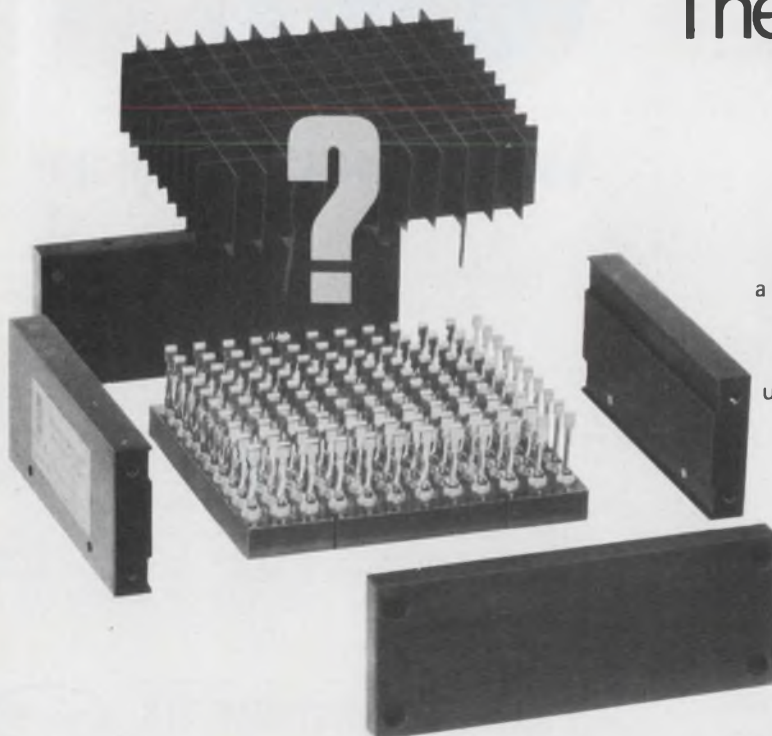

120 holes or 6480 holes? Or, do you have a specific size somewhere in between? We have a shielded patchcord programming system that enables you to cut cost substantially. We use a locking concept with molded conductive shielded board. It saves you money and it's suited for medium and high frequency applications. Back bay paddle contacts are completely isolated from each other to reduce outside interference. With the modular concept you can remove sections of the back bay at the manufacturer's or operator's discretion.

Write today for your catalog and test data.



VIRGINIA PANEL CORPORATION
QUALITY • SERVICE • INTEGRITY

P.O. Box 1106 • Waynesboro, Virginia 22980 • Call Area Code 703 942-8376

PATENT NO. 3,419,842
U.S. AND FOREIGN

INFORMATION RETRIEVAL NUMBER 142

A Page From The History of Surveillance

Geese, highly sensitive by nature to intrusion, were used by the ancients as an enemy detection device. They are credited with saving Rome from invasion by barbarians.

Applied Technology is making history today as a quick reaction developer and manufacturer of sophisticated electronic warfare equipment. Our ECM products are noted for providing maximum utilization, easy upkeep and easy checkout. They have been employed with considerable effectiveness in Vietnam and are credited with saving many lives.

If you would like to be part of tomorrow's ECM achievements, call or write Applied Technology. ATI is conducting a talent search for rare individuals with Ability, Talent and Imagination.

Needed are electronic engineers, designers and technicians.

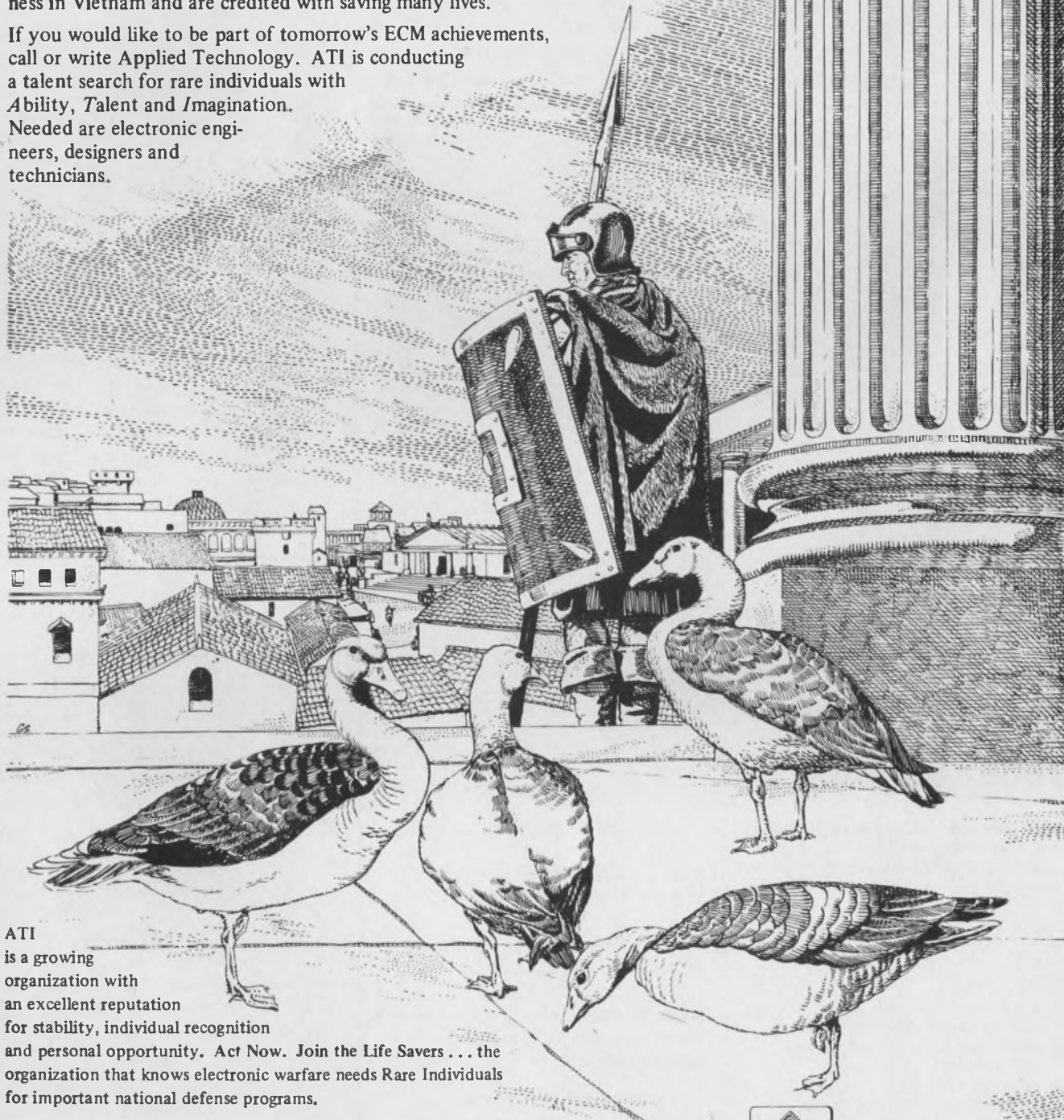

ATI is a growing organization with an excellent reputation for stability, individual recognition and personal opportunity. Act Now. Join the Life Savers . . . the organization that knows electronic warfare needs Rare Individuals for important national defense programs.

APPLIED TECHNOLOGY

A Division of Itek Corporation

3410 HILLVIEW AVE. • STANFORD INDUSTRIAL PARK • PALO ALTO, CALIFORNIA



(415) 321-5135
An Equal Opportunity Employer

ELECTRONIC WARFARE SYSTEMS • MICROWAVE COMPONENTS • SPECIAL COMMUNICATIONS • AIRCRAFT MODIFICATION

INFORMATION RETRIEVAL NUMBER 143

Four-sided tool removes any DIP

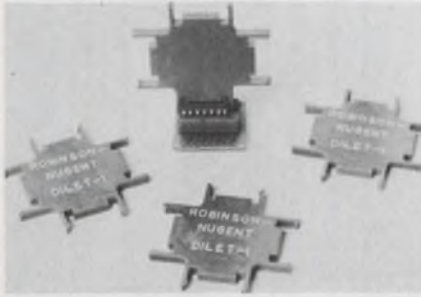

Robinson-Nugent Inc., 802 E. 8th St., New Albany, Ind. Phone: (812) 945-0211.

Called Dilet-1, a new four-way universal DIP extraction tool accepts any 14- or 16-lead dual-in-line package currently available. Each of its four sides is a different size. The device helps keep IC leads from becoming bent or twisted, thereby easing reinsertion.

CIRCLE NO. 407

Thermal wirestripper switches automatically



American Electrical Heater Co., Wassco-Melt Div., 6110 Cass Ave., Detroit. Phone: (313) 875-2505. P&A: \$65; stock.

With automatic on-off switching, model 105137 thermal wirestripper features controlled heat and tweezer-type action. The on-off switching is tray activated, controlled by picking up and replacing the handpiece. This tweezer-type handpiece strips up to 18-gauge wire and has an adjustable stop for setting the length of the strip. A potentiometer control allows dialing of exact power needed.

CIRCLE NO. 408

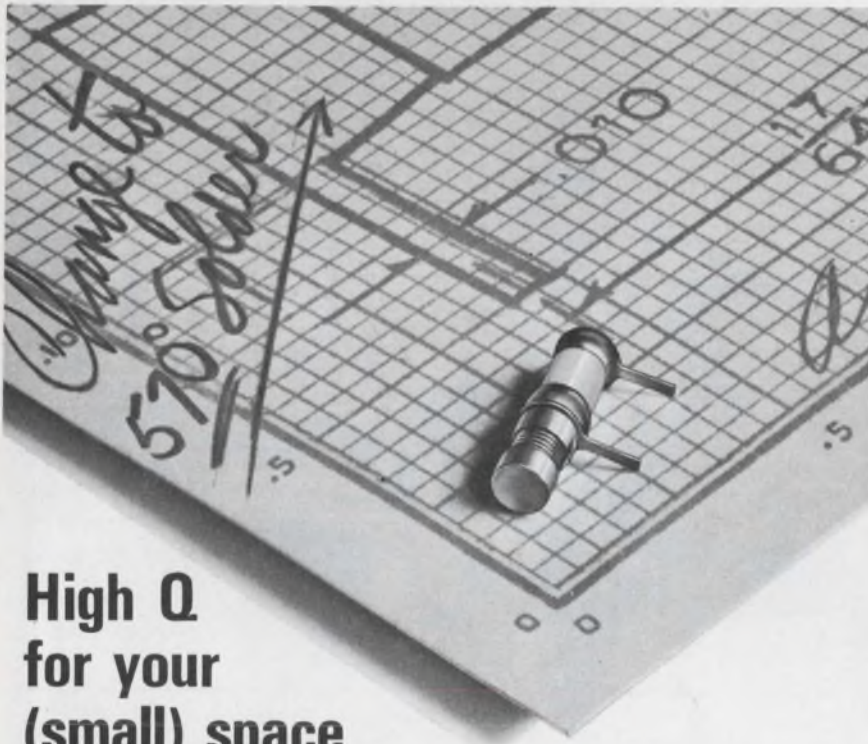

High Q for your (small) space requirements!

The Johanson 4700 Series Variable Air Capacitors provide, in micro-miniature size, the extremely high Q important in demanding aerospace applications. In addition, the ultra-rugged construction of the 4700 Series capacitors assures highest reliability in the most critical environments.

- Available in printed circuit, turret and threaded terminal types.
- Meets Mil Specs for salt spray requirements.
- Features 570° solder, which prevents distortion and is not affected by conventional soldering temperatures.

SPECIFICATIONS

Size: 1/8" diameter, 1/2" length
Q @ 100 MC: > 5000
Q @ 250 MC: > 2000
Capacity Range: 0.35 pF to 3.5 pF
Working Voltage: 250 VDC
 (Test voltage, 500 VDC)
Insulation Resistance: > 10⁶ Megohms
Temp. Ranges: -55°C to 125°C
Temp. Coefficient: 50 ± 50 ppm/°C

WRITE TODAY FOR FULL DATA.

MANUFACTURING CORPORATION

400 Rockaway Valley Road, Boonton, N. J. 07005 (201) 334-2676

INFORMATION RETRIEVAL NUMBER 144

IC wire bonder speeds production



Hughes Aircraft Co., Centinela Ave. & Teale St., Culver City, Calif. Phone: (213) 391-0711. P&A: \$4000; 6 wks.

A pulse-heated thermocompression wire bonder has been designed for large-scale production on all types of microelectronic devices. The model HPB-360 bonder passes a current pulse of extremely short duration directly through the capillary tip.

CIRCLE NO. 409

Free DC motor bulletins



72 performance curves on motors and gearheads

Indiana General has released specifications on custom-designed DC motors, available at off-the-shelf prices. Tolerances on these motors are often held to .0001".

They come in 8, 9, 12, 13 and 15 frame sizes, with delivery in 6 to 8 weeks instead of the normal 12.

For technical details, including performance curve data for each, plus information on gearheads, write: Mr. R. D. Wright, Manager of Sales, Indiana General Corporation, Electro-Mechanical Division, Oglesby, Illinois 61348.

INDIANA GENERAL 

We make it easy for the design engineer.

INFORMATION RETRIEVAL NUMBER 145

PRETTY SMALL FUSE



YOU BETTER BELIEVE IT! THE WORLD'S SMALLEST!

Picofuses by Littelfuse.

Available from 1/8 thru 15 amps, 125V.

Weighs only 1/6 gram.

LITTELFUSE

DES PLAINES, ILLINOIS

INFORMATION RETRIEVAL NUMBER 146

ELECTRONIC DESIGN 10, May 10, 1969

5 days

can do a lot for your next 5 years.

If you're involved in systems and equipment design, research, production or management . . . five days at one of our Seminars may make your next five years—and many more after that—much more productive.

More and more key management and high-level technical personnel from top companies all over the United States are attending RCA Institutes Seminars. Just as they are doing, you'll acquire information and techniques of immediate value in your work. You will also gain the kind of knowledge that can help build your professional standing in the years just ahead.

We believe we can increase your productivity by providing you with a firm grasp of many of the latest engineering techniques. Our experienced staff maintains constant contact with "what's happening" in industry. The texts and audio-visual materials are prepared exclusively by us for each seminar.

You can attend RCA Institutes Seminars around the country the year-round. Check your subject and send along the coupon for your brochure. Now—while you're thinking about it.

RCA

RCA Institutes, Inc. Dept. ELD-59

Institute for Professional Development
Box 962
Clark, N.J. 07066

For FREE descriptive brochure, check the Seminar in which you are interested:

- | | |
|--|---|
| <input type="checkbox"/> Logic Design | <input type="checkbox"/> Information Systems for Executives |
| <input type="checkbox"/> Digital Systems Engineering | <input type="checkbox"/> Digital Communications |
| <input type="checkbox"/> Modern Optics | <input type="checkbox"/> Digital Electronics |
| <input type="checkbox"/> Integrated Circuits | <input type="checkbox"/> Numerical Control Systems |
| <input type="checkbox"/> Reliability of Integrated Systems | |

Name _____

Title _____

Company _____

Address _____

City _____ State _____ Zip _____

INFORMATION RETRIEVAL NUMBER 147

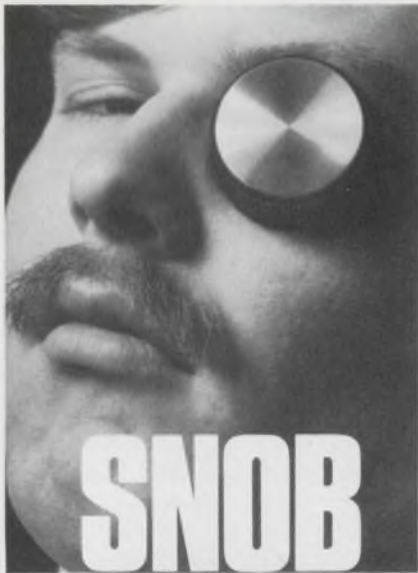

SNOB KNOB

The first new styling innovation in fifteen years!

900 Series Snob Knobs come in four bright, handsome models. Spun aluminum cap. Spun aluminum inlay. Decorative metallic ring. And Black. From 1/2" to 1 1/4" diameter.

Kurz-Kasch is known as the quality knob source by electronics manufacturers the world over. If you're not familiar with the outstanding Kurz-Kasch line, we'll send you a complete catalog. And if you're just anxious to see the new Snob Knob, we'll send you a free sample. Just fill out the coupon below and mail it to Kurz-Kasch.



Kurz-Kasch, Inc.

Standard Parts Division
1415 South Broadway • Dayton, Ohio 45401

Please send me the following:

Free Snob Knob Kurz-Kasch catalog

Name _____ Position _____

Firm _____

Address _____

City _____ State _____ Zip _____

INFORMATION RETRIEVAL NUMBER 148

PRODUCTION

Pneumatic tool ties wire bundles



Kent Corp., 206 Industrial Center,
Princeton, N.J. Phone: (609) 924-3800.

An improved, insulated spot-tie and a redesigned hand-operated air tool for wiring-harness and wire-bundle applications reduce costs and improve quality by eliminating the need to spot-tape or lace harnesses. The tie adjusts automatically to the size of the harness or wire bundle (from two #20 wires to seven #16 wires).

CIRCLE NO. 410

Compact heating tool encapsulates terminals

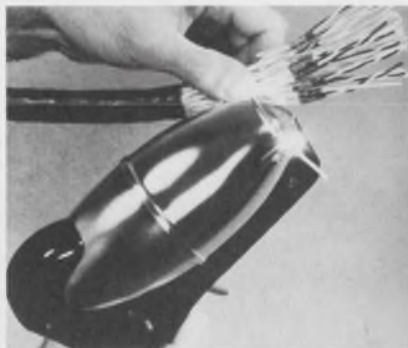

Rayclad Tubes, a sub. of Raychem Corp., 300 Constitution Dr., Menlo Park, Calif. Phone: (415) 324-3333.

Using a modified 500-watt clear tungsten-halogen heat lamp as its energy source, a new tool can quickly create an encapsulated soldered termination of shielded wire. Called the Thermofit Zap Gun, the unit has a solid-state timer that controls the energy cycle and permits adjustments from 1/2 to 4 seconds.

CIRCLE NO. 411



This miniature
mercury relay
operates in

ANY POSITION

It's the new Logcell® Mercury Film Relay and it combines all the advantages of conventional mercury wetted relays with miniature size (0.06 cu. in.), operation in *any* mounting position, and shock and vibration resistance. Use Logcell Relays in computer logic circuits, precision instrumentation, high speed control systems or wherever you need a relay that offers:

- Long life — tested to billions of cycles
- No contact bounce
- Form "C" SPDT contacts
- Operation in any mounting plane
- Fast operating time — 2.5 ms
- No measurable AC contact noise
- Thermal noise less than 0.2 microvolt
- Switches dry circuits to 2 amps
- Inherent memory — requires no latching current (mono-stable models also available)

For complete information on Logcell Relays — and Switches — write Fifth Dimension Inc., Box 483, Princeton, N. J. 08540 or call (609) 924-5990.



FIFTH DIMENSION INC.

INFORMATION RETRIEVAL NUMBER 149

ELECTRONIC DESIGN 10, May 10, 1969

Tantalum Foil



3 ways better
than solid in
non-polar
applications

- smaller than solid tantalum
- more reliable than solid tantalum
- delivers more microfarads than solid tantalum

Design is the big difference between General Electric's Type 29F non-polar tantalum foil capacitor and an equivalent solid tantalum capacitor. A design that's specifically for **non-polar** applications.

GE Type 29F non-polar tantalum foil is about half the case size of an equivalent solid, yet accepts voltage and current variations in either direction. And from one small, single roll that in no way impairs the inherent reliability characteristics of tantalum foil. (Totally unlike its bulky solid counterpart that requires two slugs connected back-to-back and, in most cases, within a single case.)

The difference doesn't end with just size and reliability. Consider microfarads. GE tantalum foil delivers 50 percent more microfarads per case size, in practically all cases, when compared with solid tantalum.

So for your next non-polar application, contact your General Electric Sales Representative and ask to see the Type 29F tantalum foil capacitor. It could make a big difference. In size. In reliability. In microfarads.

Electronic Capacitor and Battery Dept., Irmo, S.C.

430-36

GENERAL  ELECTRIC

Miniature butt splices connect #30 AWG wire



Thomas & Betts, Inc., 36 Butler St., Elizabeth, N.J. Phone: (201) 354-4321.

A new line of miniature butt splices can be used to splice very small wires in single or multisplice operations. The splices are among the smallest manufactured to connect #24- through #30-AWG wires.

CIRCLE NO. 412

Electrical tapes resist solvents



3M Company, 3M Center, St. Paul, Minn. Phone: (612) 733-7251. P&A: \$5.72 to \$11.44; 30 days.

Five new electrical tapes, each coated with a quick curing oil and solvent-resistant pressure-sensitive adhesive, have been introduced. All five tapes employ an acrylic pressure-sensitive adhesive. With proper thermosetting, this adhesive system has high resistance to oils and other hydrocarbon solvents and will neither corrode copper nor degrade the electrical properties of mineral-type transformer oils.

CIRCLE NO. 413

Custom Wound Bobbins ■ In 10 Days

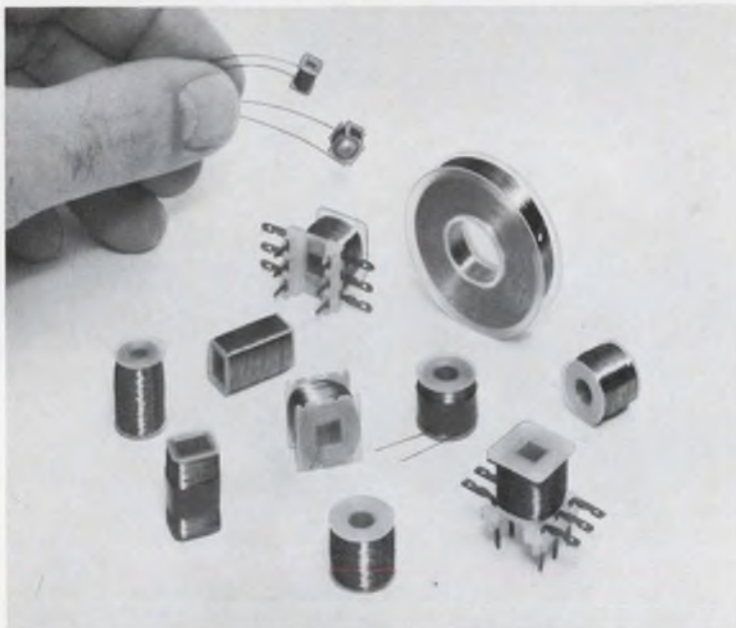

Custom wound bobbin samples are available in ten days; production shipments start within three weeks after sample approval.



Special 16 Pi/30 KV windings for oil-filled high voltage transformers... special coils also are furnished on 10-day sample/3-week production delivery cycle.



Bobbins furnished in wide range of inductance and current ratings. If desired, Miller engineers will make recommendations for optimum performance.



J.W. MILLER COMPANY

P.O. BOX 5825 ■ COMPTON, CALIFORNIA 90224

Write for your copy of the latest full line catalog

Solderless breadboard has spring contacts

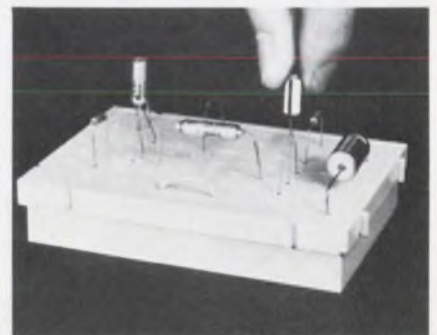

British Aircraft Corp. (U.S.A.) Inc., Intratec Div., 399 Jefferson Davis Highway, Arlington, Va. Phone: (703) 684-6404. Price: \$5.50.

This solderless board offers a simple, direct way to assemble experimental circuits. Component leads up to 0.04 inch in diameter are accepted directly by the board's leaf-spring contact points. Wear and tear on components and board is minimal, and flexibility is a main feature of the system.

CIRCLE NO. 414



**Do you have
the question
to this**



answer?

The only limits to the questions answered by the Siemens Gas-filled Surge Voltage Protector are your needs, and your imagination.

Tiny, lightweight, a handful can protect a ton of sensitive electronic equipment, especially supersensitive solid state circuits. They give you tailor-made protection in hundreds of applications. With current carrying capacities up to 5,000 amps. With DC striking voltages from 90V to 1000V. With reaction speeds in the nanosecond range. And with a cost of less than \$1 in quantity.

Lightning strokes, static charges, internal switching, short circuits—all these transient dangers are guarded against by these tiny, tireless sentries—Siemens Gas-filled Surge Voltage Protectors. If you've got a protection question, call Siemens America Incorporated for immediate protection delivery.

Send us your questions!

SIEMENS AMERICA INCORPORATED
350 Fifth Ave., New York, N. Y. 10001
(212) 564-7674



Now! One new exclusive switch replaces seven

You can easily eliminate tedious design engineering problems—just use versatile Multidex® switches. They're available in thousands of variations...are smaller than the switches they replace...yet provide more contacts (up to 36) at no additional cost.

Crisp Detenting... the patented Unidex™ detent offers uniform "feel" for long life in choices from 10° to 36° throw. Meets MIL-S-3786, SR32 requirements.

Superb Insulation... molded diallyl phthalate meets MIL-M-14 requirements and guarantees electrical continuity between mounting and housing. Glass-alkyd insulation available on request.

Special contacts and clips... Oak-pioneered, double-wiping, self-cleaning contacts assure trouble-free operation. Special AF clips with large windows speed wiring.

What's more, Multidex switches meet commercial and military environmental requirements. Special options available on request. For full details, write today for Bulletin SP-324.



OAK MANUFACTURING CO.
A Division of OAK ELECTRO/NETICS CORP.
Crystal Lake, Illinois 60014
PHONE: 815-459-5000 TWX: 910-634-3353

INFORMATION RETRIEVAL NUMBER 153

Slotted connector meets NAFI specs

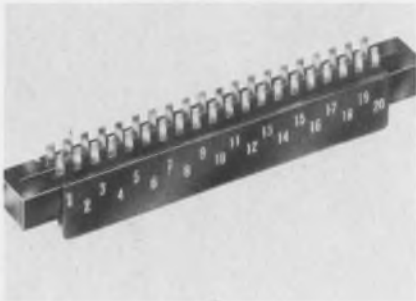

Method Electronics, Inc., 7447 W. Wilson Ave., Chicago. Phone: (312) 867-9600.

Designed and produced to precise NAFI hardware specifications, the new connector is available with either a 0.3- or 0.06-in. slot, enabling the user to mount a heat sink or printed circuit board suited to his specific needs. The standard part is furnished with a molded insulator of glass-reinforced diallyl phthalate, with the contacts set on 0.1-in. centers.

CIRCLE NO. 415

Miniature connectors simplify assembly

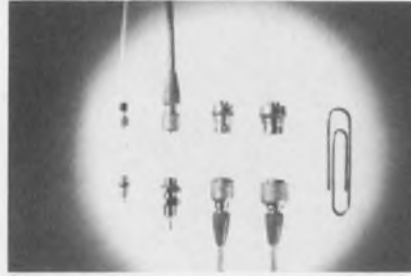

Microtech, Inc., 777 Henderson Blvd., Folcroft, Pa. Phone: (215) 532-3388.

Ultraminiature coaxial connectors and multicontact 4- and 7-pin connectors are designed to meet the needs of high-density packaging applications. To fabricate a coaxial cable assembly, the cable is simply threaded into the plug. To fabricate a multicontact connector and cable assembly, a special multiconductor cable is simply soldered to the socket assembly and snapped into the plug.

CIRCLE NO. 416

Polyimide film tape is temperature stable



Mystik Tape, Borden Inc., 1700 Winnetka Ave., Northfield, Ill. Phone: (312) 446-4000.

A lightweight Kapton polyimide film tape is designed for critical areas where temperature stability and dielectric strength are essential. Mystik 7360 measures only 1.3 to 1.7 mils in total thickness, yet retains its thermal and electrical properties between -110° and $+550^{\circ}$ F. The tape has a tensile rating of 17 pounds per inch; dielectric strength is 4800 to 5400 V.

CIRCLE NO. 417

FREE CATALOG!

OPTICS! SCIENCE! MATH!

GIANT 148 PAGES

1000's OF UNUSUAL BUYS FOR INDUSTRY

Many on-the-job Helps . . . Quality Control Aids! Write for this completely new, 1969 Catalog. New items, new categories, new illustrations, 148 easy-to-read pages packed with hundreds of charts, diagrams, illustrations. A treasure-house of optical and scientific information . . . unusual bargains galore. Optics for industry, research labs, design engineers, experimenters, hobbyists! Instruments for checking, measuring — to speed work, improve quality, cut production costs. We give you facts: what it is — how it works — where it's used!

Comparators, Magnifiers, Microscopes

Hard-to-get war surplus bargains — ingenious scientific tools — imported — domestic. Thousands of components: lenses, prisms, wedges, mirrors, mounts, accessories of all descriptions. Dozens of instruments: magnifiers, stereo, microscopes, telescopes, binoculars, infrared equipment, photo attachments. Shop by mail. No salesman will call. Use the Catalog of America's greatest Optics — Science — Math Mart. Known for reliability. Mail the coupon below to:

Edmund Scientific Co., 300 Edscorp Building, Barrington, New Jersey 08007. Ask for Catalog "DA"

MAIL COUPON FOR FREE CATALOG "DA"

EDMUND SCIENTIFIC CO.
300 EDSCORP BLDG., BARRINGTON, N.J. 08007

Please send FREE Giant 148-page Catalog "DA"

NAME

ADDRESS

COMPANY

CITY STATE ZIP

INFORMATION RETRIEVAL NUMBER 154

Lead Frames for I. C. Packaging

Etched lead frames for integrated circuits. Any configuration can be made adequately framed for support. Leads are flat ribbons down to 0.002 inches wide and from .002, .004, .005 and .010 inches thick. We etch kovar, nickel, alloy 42, copper, aluminum and other metals for microcircuit packaging.

Nickel, copper, silver, and gold plating on lead frames. Thinnest plating is 15 micro inches, thickest is 250 micro inches. We can go beyond this for special orders.

Etching or photoforming to tolerances of $\pm .000039$. Call or write sales manager Bill Amundson for more information.

BUCKBEE - MEARS COMPANY

245 E. 6th St., St. Paul, Minn. 55101 / (612) 227-6371

INFORMATION RETRIEVAL NUMBER 155

ELECTRONIC DESIGN 10, May 10, 1969

AIRPAX

MULTIPOLE PROTECTOR with SINGLE TOGGLE ACTUATION

Airpax multipole APG magnetic circuit protectors operate with a single toggle handle, a feature which greatly simplifies panel mounting and provides a lower cost, compact unit with high operating dependability. Internal coupling assures instant action of all protectors should an overload occur in any protected circuit.



FEATURES

- Current ratings from 20 mA to 30A.
- Voltage ratings to 250 volts, 60 and 400 Hz and to 50 volts dc.
- Series, shunt and relay types, auxiliary switch available on series type.
- Choice of trip delays; trip free operation.
- Individual poles need not have identical characteristics.
- Quick connect or machine screw terminals.
- Available with 1, 2 or 3 poles.
- Electromagnetic operation with magnetic-hydraulic delay.

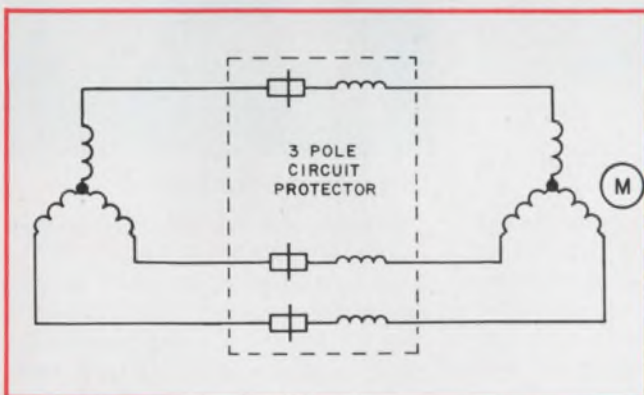

THREE PHASE MOTOR PROTECTION

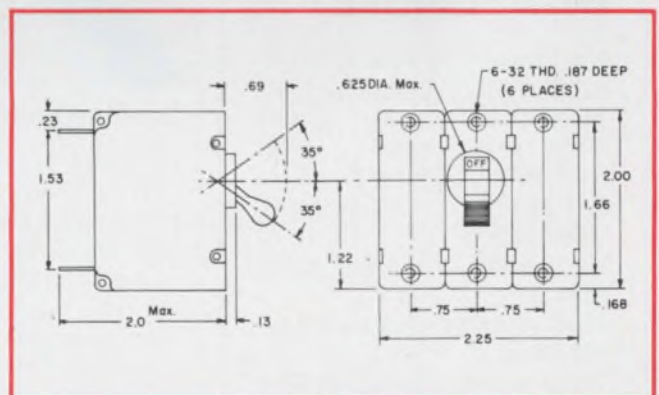

DIMENSIONAL DRAWING

AIRPAX ELECTRONICS

CAMBRIDGE DIVISION, CAMBRIDGE, MARYLAND 21613

PHONE (301) 228-4600

TELEX 8-7715

TWX 710 865-9655

SCHAUER

1%

tolerance

**1 WATT ZENERS
ARE A REAL BUY!**

ANY voltage from 2.0 to 16.0
at the industry's **LOWEST
PRICES!**

Quantity	Price each
1-99	\$1.07
100-499	.97
500-999	.91
1000-4999	.86
5000 up	.82



THE HI-RELIABLE!

No fragile nail heads.
Silicon junction aligned between two, parallel, offset tantalum heat sinks . . . great lead tension strength.
All welded and brazed assembly.
High pressure molded package.
Gold plated nickel-clad copper leads.
Write or phone for Form 68-4 for complete rating data and other tolerance prices.

Semiconductor Division

**SCHAUER
MANUFACTURING
CORP.** 4511 Alpine Avenue
Cincinnati, O. 45242
Ph. (513) 791-3030

Evaluation Samples

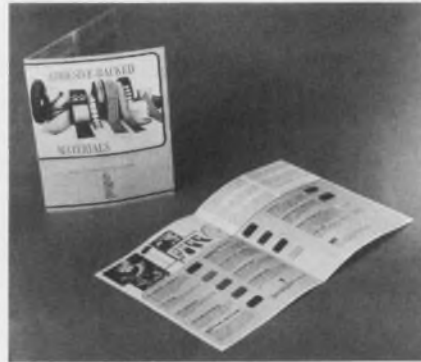

Adhesive-backed materials

Samples of adhesive-backed pressure-sensitive materials are included in a four-page illustrated product catalog. Specifications and suggested uses are listed for each material. In addition, there is a description of the material processing to aid the user in developing new or different applications. Deccofelt Corp.

CIRCLE NO. 418

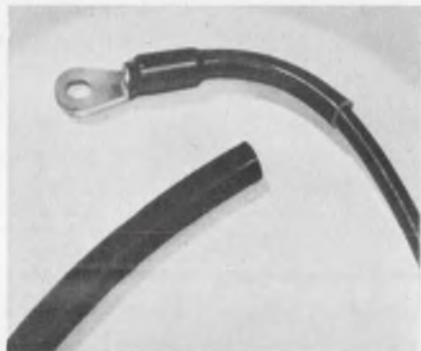

Shrinkable tubing

Flexite Shrinkdown HT-105 is a flexible Class A (105°C) extruded tubing with the capacity to shrink 50% in diameter upon application of heat. Supplied in expanded sizes, the tubing can easily be assembled over irregular shapes, such as splices, connectors, components and cables. After shrinking, it forms a smooth tight-fitting insulation covering for both mechanical and electrical protection. Specially compounded Shrinkdown HT-105 meets the requirements of MIL-I-631D, Grade C, and the test requirements of MIL-I-23053A, Grade 5b. Free samples are available. L. Frank Markel & Sons, Inc.

CIRCLE NO. 419



Non-woven fabrics

Containing sample swatches of non-woven fabrics, a multi-page folder outlines the properties, specifications, advantages and applications of these materials. Known as Webloy, the non-woven fabrics have tensile strengths as high as 50 pounds per inch while weighing only three ounces per square yard. Typical fabrics are made with Nomex nylon, polyester, polypropylene or rayon fibers. Binders can be thermoplastic or thermosetting. Kendall Co., Fiber Products Div.

CIRCLE NO. 420

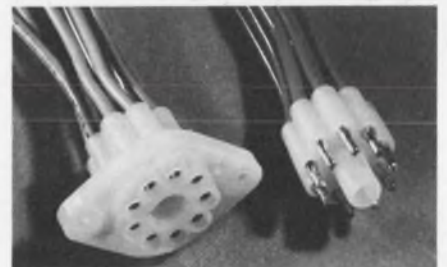

Circular connector

Providing a low-cost dependable circular circuit connector, the 1664-9 plug, coupled to its 1412 socket, has male terminals that snap-lock into their nylon housing and can be easily removed with a simple tool. The socket housing can be screw-mounted, or can be supplied with integrally molded mounting ears for fast snap-in chassis assembly. The plug and socket come in a 9-circuit configuration, but 8- and 11-circuit versions can be provided. Free samples and more information are available. Molex Products Co.

CIRCLE NO. 421

The Readable Little Meters

You can even read the littler little one at arm's length.

(Actual sizes)



The littler little one.



The bigger little one.



Put your left thumb here.



Put your right thumb here.

Honeywell's new Series 80T Panel Meters take up about half the panel space of full-size meters.

But hold this ad out at arm's length and see how easy the meters are to read. (How we ever got such large scales on such small faces without cluttering them, only our designers know.) And we've set the dial up front, so you can see it clearly, even from an oblique angle.

Behind the small face is Honeywell's unique taut-band mechanism - with about

50% fewer parts than a pivot-and-jewel. (One of the parts that's missing is the old space-consuming plastic barrel on the back of the meter.)

The new Series 80T Panel Meters come in 33 standard ranges. And they cost no more than pivot-and-jewel meters. So you don't have to pay a lot to get a little.

(We'd like to send you a catalog. Write Honeywell Precision Meter Division, Manchester, New Hampshire 03105.)

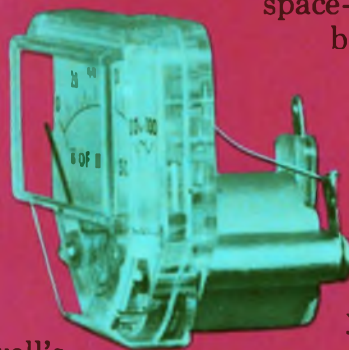

It takes all kinds of meters to make the Honeywell line.

Honeywell

DIALCO DATALITES[®]

mount as close
as 1/2 inch center
to center



SHOWN ACTUAL SIZE

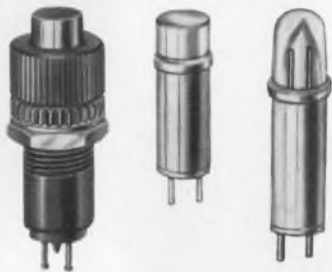

Designed to meet
or exceed requirements of
MIL-L-3661B.

Replaceable plug-in
cartridges: Incandescent for
1.35-120V; neon—high-brightness
operation 110-125V AC, and
standard brightness operation
105-125V AC-DC.

Wide range of lens
shapes, colors and finishes.

Broad selection of
positive or negative legends.

Available off-the-shelf
for prompt delivery.

Send for free catalog



SAMPLES ON REQUEST—AT ONCE
NO CHARGE

Dialight Corporation, 60 Stewart Ave.,
Brooklyn, N. Y. 11237. (212) 497-7600



INFORMATION RETRIEVAL NUMBER 160

Design Aids



Project planner

The PERT system pioneered on the Polaris missile project in 1958 has been related to smaller projects by a new slide-rule system that directly converts elapsed times into calendar dates. The use of this calculator with its accompanying instruction manual eliminates both tedious hand calculations and expensive electronics. The nominally priced system brings PERT/CPM techniques within the reach of small and medium-size operations. Descriptive literature is available. Halcomb Associates.

CIRCLE NO. 422

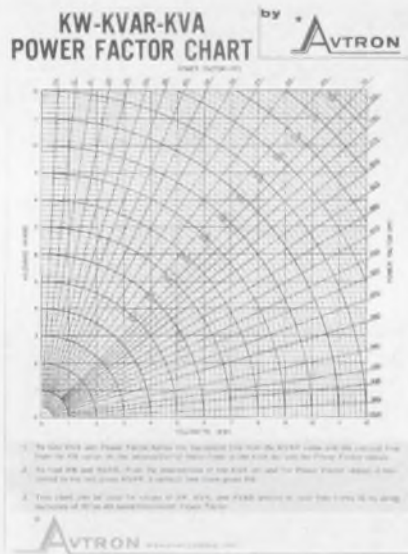

Power-factor chart

A power-factor chart provides a quick, simple means of accurately correlating kilovars, kilowatts and kVA from zero to unity power factor. The chart directly correlates values to 12 kilowatts/kilovars, and may be used for larger values by applying appropriate multiplier factors to each scale. Avtron Manufacturing, Inc.

CIRCLE NO. 423

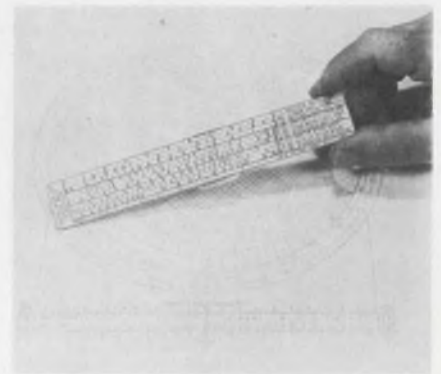

Transmission sliderule

As described in a feature article in the March, 1969, issue of *QST Magazine*, MEGA-RULE—a pocket slide rule—determines transmission-line losses and related quantities by very simple procedures. Ten accurately graduated scales display VSWR, reflection coefficient, return loss, reflection loss, etc., and an attenuation scale, printed in red across the bottom, shows the effect of dissipative losses on all other quantities. The rule is priced at \$3.75, and descriptive literature including reprints of the *QST* article are available without charge. Analog Instruments Co.

CIRCLE NO. 424

PNP SILICON PLANAR POWER TRANSISTORS						
	60 Amp	40 Amp	30 Amp	20 Amp	10 Amp	
	TO-45	TO-45	TO-45	TO-45	TO-45	
60V						
80V						
100V						
120V						

Power-transistor chart

Selection of power transistors is simplified by a useful, two-color chart. Over 200 device types are included in the graphic breakdown. The chart features three sections that cover npn and pnp silicon planar power transistors, as well as complementary devices. To use the chart, one simply starts at a given collector voltage and moves across the page to the appropriate column for desired current capability and package configuration. Transitron Electronic Corp.

CIRCLE NO. 425

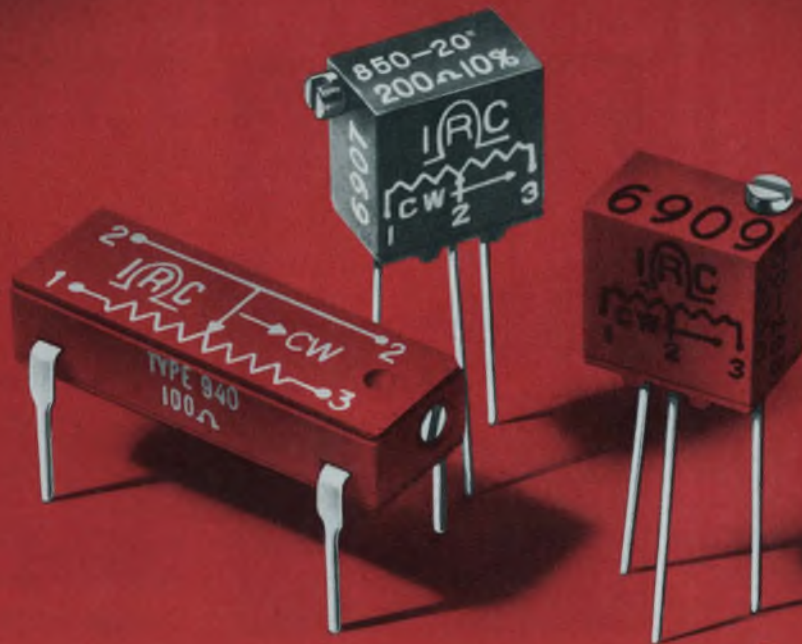

Space-saving trimmers

DIP construction matches IC size. Cuts assembly costs.

5/16" doubles performance of 1/4" trimmer—cuts cost almost in half.

IRC's new precision wirewound trimmer in dual-in-line package simplifies PC board layout. Pin spacing is the same as the popular TO-116 size integrated circuit. It is fully compatible with high-speed automatic inserting equipment.

The sealed, moisture-resistant units meet the environmental requirements of MIL-R-27208. Maximum height is only .200 inches. 1 watt @ 40°C. 10Ω to 20K. ±10% tolerance. TC is ±50ppm/°C.

Pin spacing of these 5/16" square trimmers matches the 1/4" square unit. Only .062" larger on each side, they can cut your cost almost in half and give you three times the power rating of the 1/4" and 40% better resolution.

Two types are available—precision wirewound and infinite resolution Metal Glaze. Both are fully sealed and impervious to common industrial solvents because of a silicone rubber shaft seal and epoxy bonding at all seams.

For data and prices, see your IRC Industrial Distributor or write IRC St. Petersburg Division of TRW INC., 2801 72nd Street, North, St. Petersburg, Florida 33733



DIVISION OF TRW INC.

INFORMATION RETRIEVAL NUMBER 161

Application Notes

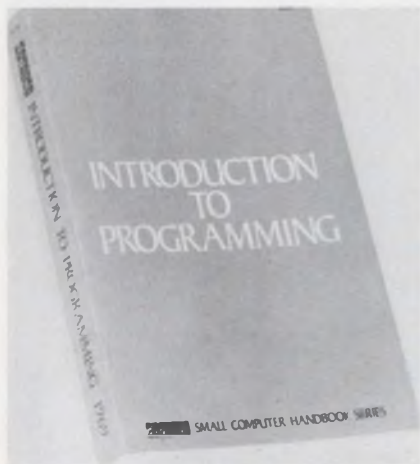

Introduction to programming

A 425-page soft-cover book contains a complete introductory course aimed at university, high school and training school students. Offered free in single copies, the 11-chapter volume includes appendices and index. It is an introduction to programming digital computers, particularly DEC's PDP-8 family. Digital Equipment Corp.

CIRCLE NO. 426

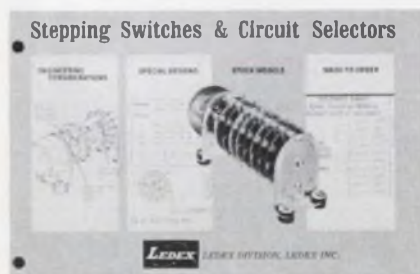

Stepping switches

A 34-page booklet contains extensive data on engineering considerations, control circuits, and the application of basic circuits to solve complex switching problems with stepping switches and circuit selectors. Included are updated specifications for 36 off-the-shelf multiple switches, with choices of 2, 4, 6, 8, 10, 12, 18, 20 and 24 electrical positions. Another section outlines a simplified building block approach for specifying made-to-order switches by part number. Ledex Inc.

CIRCLE NO. 427



Op-amp handbook

A free 32-page handbook combines application information and comprehensive specifications for some 100 operational amplifiers and function modules. At the same time, it introduces 14 new units not described in previous application handbooks. Of special importance to engineers who select or specify operational amplifiers is a specification glossary. Besides discussing the meaning of the more important op-amp specs, this section includes a full-page review of the often-misunderstood question of temperature drift specifications. The butterfly characteristic, used to define the drift performance of high-stability amplifiers, is included in this examination of temperature stability. Analog Devices, Inc.

CIRCLE NO. 428

Stroboscopy primer

A recently published booklet entitled *A Primer of Stroboscopy* explains the fundamental concepts of stroboscopy. It also describes accessories for the electronic stroboscope, tells how it can be used with a simple camera for high-speed photography, and gives a variety of other applications for the instrument. General Radio Co.

CIRCLE NO. 429



Component selector

A new condensed catalog serves as a quick-reference ordering and application guide. A wide variety of resistors, rheostats, potentiometers, transformers, capacitors, solid-state power controls, light dimmers, rf chokes and relays are described. The relay section is especially detailed, with dimensional drawings, mounting illustrations, etc. Ohmite Mfg. Co.

CIRCLE NO. 430



Emi applications

An eleven-page brochure shows how conductive elastomeric gaskets, conductive adhesives, and conductive caulking, potting and coating compounds provide highly effective shielding and sealing in such applications as electronic sub-assemblies, connectors, waveguides and switches. Also described are unique grounding, contacting, and static discharging applications made possible by these materials. Chomerics, Inc.

CIRCLE NO. 431

Low noise for hi-fi (stereo).

Build your stereo preamps with the Fairchild μ A739 Dual Low-Noise High-Gain Op Amp and you've got performance that's as good as any currently available discrete system. Besides getting both amplifiers on a single chip (and at a single chip price), you get channel separation 15dB better than most discrete designs, an output swing high enough to drive the most demanding power amplifier and a power supply rejection ratio so high that you can cut costs even further by relaxing your power supply specs. And check what the high common mode rejection ratio does for distortion.

That's our Second Generation Linear technology in action — proud performance, humble pricing. The μ A739 was specifically tailored for improved performance in any application that requires two high-gain amplifiers. Try it now in your modulators, voltage-to-frequency converters, instrumentation amplifiers or integrators and take advantage of its low noise, non-latching and unity gain crossover frequency of 20MHz. And for more flexible low power operation in military and industrial applications, we'll have it available (second quarter of calendar 1969) as our μ A749 without the internal output stage collector resistors. The μ A739 is available in a DIP; the μ A749 will come in a ceramic DIP, a flat-pak or a TO-5 metal can. Information on both is in our data sheets.

Write for them and our application notes now. Or, just check with your stocking Fairchild distributor.

To order the μ A739, ask for:

TAPE PREAMPLIFIER

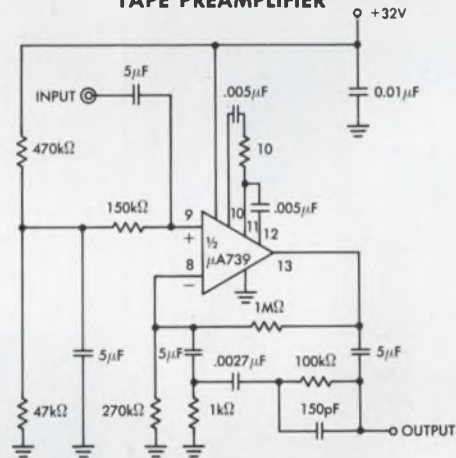

ELECTRICAL CHARACTERISTICS

Large Signal Open Loop Voltage Gain:	80dB
Signal to Noise Ratio:	68dB
Bandwidth:	20 to 20,000 Hz
Output Swing:	10V _{rms}
Power Consumption:	250mW
Input Impedance:	50KΩ
Power Supply Rejection:	75dB
Channel Separation:	60dB
Distortion:	0.025%

*For complete specifications, see data sheets.

PART NUMBER	PACKAGE	TEMPERATURE RANGE	PRICES		
			1-24	25-99	100-999
U6E7739393	DIP	0°C to +70°C	\$4.85	\$3.90	\$3.25

FAIRCHILD
SEMICONDUCTOR

Need Space-Age Precision in Lapping or Grinding? use SPITFIRE!



THE MICRO-LAP 15**

Engineered to standards of the highest quality, the Micro-Lap 15" unit is outstandingly precise in producing laboratory quality work in normal production quantities. Operator fatigue is minimal because of waist-high construction. In addition to handling piece parts 5 1/8" in diameter, the Micro-Lap 15" also provides:

- Optical flatness to 1 light band. — .0000116" or less
- Positive plate flatness and advanced truing action
- Pressurized, infinite variable abrasive feed control
- Fully automatic lapping cycle
- Ample work table . . . controlled stock removal
- High volume production . . . shop proven performance

*All machines equipped with exclusive "caliper adjustment controls" for critically precise operations.

Have You Seen Our NEW MICRO-LAP 12" Machine?

FREE CATALOG . . .
For the full story of CAC (Caliper Adjustment Control) and the entire Spitfire line of automatic lapping or grinding machines up to 96" capacity call or write for new catalog today.



SPITFIRE LAPPING DIVISION
SPITFIRE TOOL & MACHINE CO.

4020 North Tripp Avenue
Chicago, Illinois 60641
Phone 312/286-1610

APPLICATION NOTES



Logic handbook

The fifth edition of the Digital Equipment Corp. guide to its complete line of logic modules, associated hardware and application information is now available. This 16-page, thoroughly illustrated paperback gives general characteristics of positive logic modules, complete with descriptions of power supplies, hardware and accessories and a discussion on how to use these items. Digital Equipment Corp.

CIRCLE NO. 432

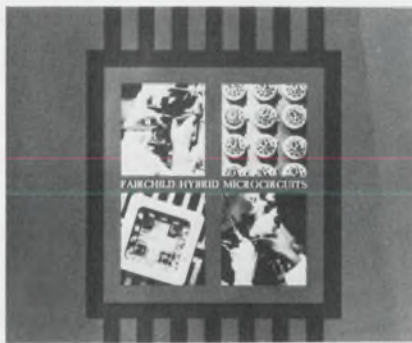

Hybrid design guide

The use of hybrid microcircuits for lightweight and compact packaging designs is the subject of a new 24-page brochure. This illustrated reference guide shows how hybrid technology can achieve design functions that are not possible through monolithic integrated circuitry. The 8-1/2- by 11-inch brochure provides a step-by-step explanation of hybrid manufacture. Featured in the brochure is a hybrid design guide that outlines layout procedures for the creation of special custom products. Fairchild Semiconductor.

CIRCLE NO. 433



Now . . . Amplex offers the world's smallest diamond points! "Micro-points"—electroplated with high-density pure virgin diamond—are available in a diameter range from .001" through .015"* for drilling, reaming, and lapping extremely hard substances such as ceramics. Magnified view shows .005" "Micro-point" compared with the eye of an ordinary needle. Ask for price list.

*Larger sizes also.

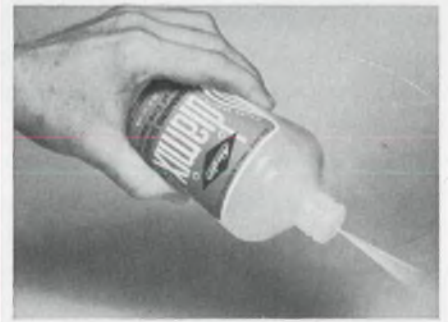

Amplex DIAMIX Diamond Slurry for fine lapping. Increased demand for this product—supplied by Amplex since 1965 for electronic and metallurgical work—indicates its growing acceptance for reasons of economy, convenience, and greater productivity. The diamond is suspended in a special vehicle contained in a handy squeeze bottle. Try this method of applying diamond rapidly and evenly!

COMPLETE LINE OF
INDUSTRIAL DIAMOND PRODUCTS
•
DIAMOND RECLAIMING SERVICE

THE AMPLEX CORPORATION
6 Tobey Road • Bloomfield, Conn. 06002
(NATIONWIDE REPRESENTATION)

INFORMATION RETRIEVAL NUMBER 164
ELECTRONIC DESIGN 10, May 10, 1969

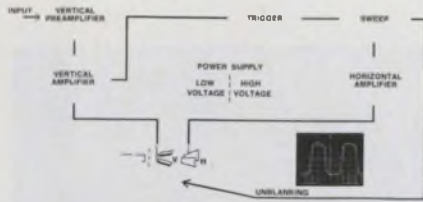

Scope news

The oscilloscope is an excellent tool for self diagnosis. In addition to the CRT display, front-panel indicators and calibrator signals often provide sufficient information to isolate the problem. Besides presenting a concise technique for troubleshooting an oscilloscope, a 16-page issue of TEKscope tells of the ins and outs of curve tracing with the 576 digital readout unit. There is also a discussion of pnp devices. Tektronix, Inc.

CIRCLE NO. 434

Magnetic shields

Helpful hints on magnetic shield design are contained in a 24-page application note. This article takes the witchcraft out of magnetic shield design and shows it to be a science that can be understood by engineers. Hundreds of actual measurements are contained in the booklet and—for the first time—actual measured shielding ratios are published. James Millen Manufacturing Co., Inc.

CIRCLE NO. 435

Frequency-domain method

Methods of performing calibrated frequency-domain measurements using narrowband and wideband signals are discussed in detail in a 12-page note. Methods of calibrating real-time spectrum analyzers are discussed using pure sine-waves and broadband noise to obtain power spectral-density plots. The calibration method described provides accurate, quantitative measurement of noise, vibration, and underwater acoustic signals that have been processed by a power spectral-density system. Federal Scientific Corp.

CIRCLE NO. 436

Reed Relays that deliver more of what you need most...

VERSATILITY - RELIABILITY - ECONOMY



Standard and Miniature Reed Relays



Special Design Reed Relays

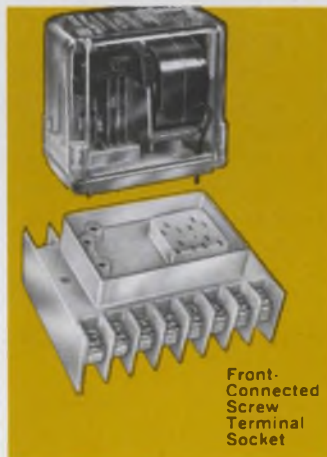

Front-Connected Screw Terminal Socket

Automatic Controls' Reed Relays — standard, miniature, or your special designs — offer individually supported reed switches, magnetic foil wrapped coils, non-magnetic terminals, and rhodium plated contacts, providing peak performance and reliability. Standardized contact configurations assure off-the-shelf delivery and maximum economy. For more of what you need most — specify Automatic Controls' Reed Relays everytime!

NEW from Automatic Controls... Front-Connected Screw Terminal Socket.

Accommodates the Automatic Controls' "family" of general purpose plug-in relays and time delay relays.

Automatic Controls

Division



COOK ELECTRIC

200 East Daniels Rd., Palatine, Ill. 60067



FREE!

Automatic Controls Industrial Relay Booklet.

Send for your copy today!



PUTTING CURRENT-LIMITER DIODES TO WORK

Problem: How to improve the performance of this bipolar series voltage regulator and reduce circuit complexity?

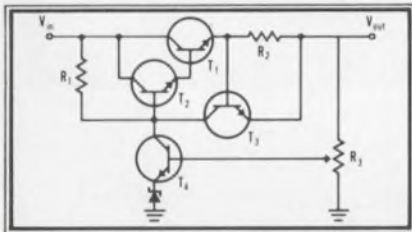

Solution: Replace the darlington pair with a FET and a CL diode.

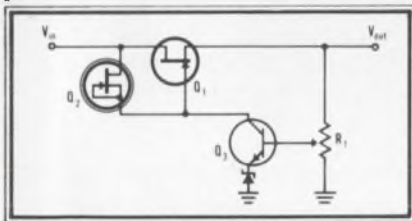

Increases in V_{OUT} are inverted and amplified by Q3. The increased V_{GS} on Q1 reduces the supply current, decreasing output voltage. Current-limiter Q2 (1) acts as a load for Q3 and (2) when the output is short circuited it limits the forward bias current of Q1, limiting short circuit output current to the I_{DSS} of Q1. The use of the FET increases circuit power gain, reducing ripple, and increasing regulation.

For immediate applications assistance call the number below; ask for extension 19.

Siliconix
incorporated

1140 W. Evelyn Ave. • Sunnyvale, CA 94086
Phone (408) 245-1000 • TWX: 910-339-9216

*Applications Power: A broad product line and an in-depth applications team waiting to serve you.

New Literature



Plastic parts

A 72-page illustrated catalog covers a complete line of plastic industrial parts including recessed bumpers, bearings, nylon grommets, spacers and washers, wheels and rollers, plugs and caps, indicator lights, wire clamps and ties, etc. Nine sections featuring 36 distinct product lines and representing thousands of different components have listings and illustrations. A special section illustrates special parts made for specific industries that do not fit into general product lines. Additional information includes descriptions of plastic materials, design points for the engineering of industrial plastic parts and information on manufacturing methods. Plastiglide Manufacturing Corp.

CIRCLE NO. 437

Electron-beam equipment

A new catalog includes several data sheets on positioners and manipulators designed especially for use in vacuum chambers and glove boxes. It also shows electron guns and electron-beam power packages. Prices on most items are included. Brad Thompson Industries, Inc.

CIRCLE NO. 438

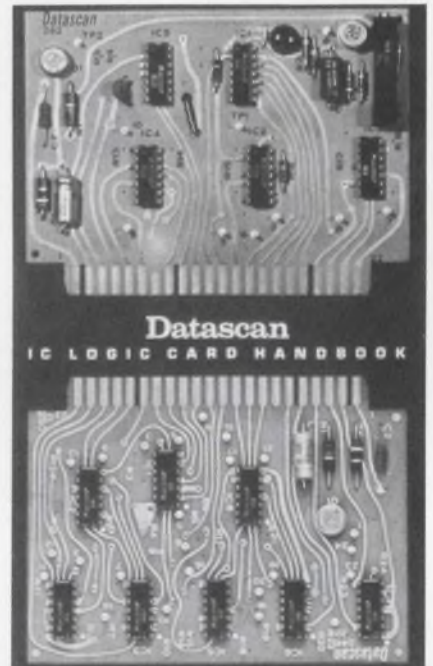

IC logic handbook

A new IC logic handbook features 208 pages with descriptions of each standard module, plus circuit operations, parts lists, specifications, outline drawings, and prices of each module. Power supplies, hardware and accessories are also presented in detail. Datscan.

CIRCLE NO. 439



CCTV encyclopedia

An encyclopedia of closed-circuit TV equipment features nearly 100 pages of CCTV products, helpful technical information, and prices. The catalog includes the latest in cameras, video tape recorders, lenses, and accessories. GBC Closed Circuit TV Corp.

CIRCLE NO. 440

Here's the RF spectrum of an "ideal" synthesizer

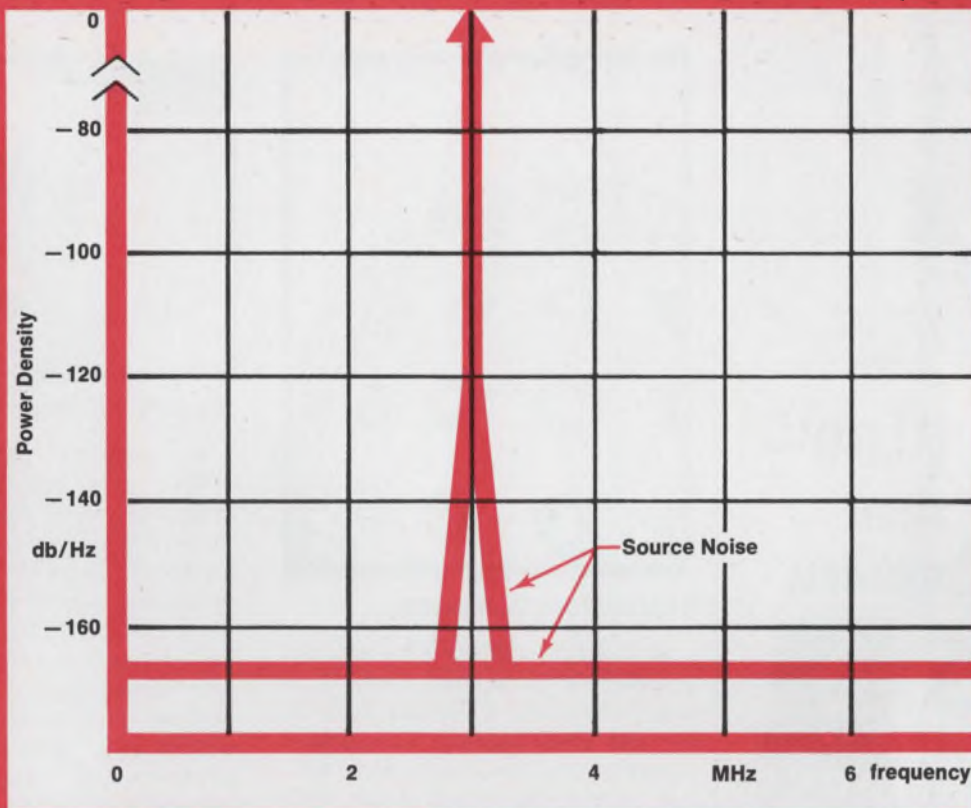

and the closest thing to it!

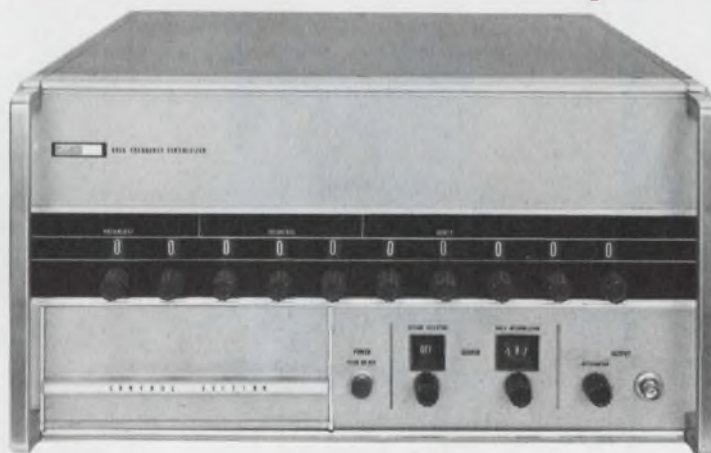

The new Fluke 645A!

The Fluke 645A features symmetrical search oscillator and built-in sweep-marker generator for filter and resonator testing. Automatic remote output leveling for systems applications. Twenty microsecond switching from remote decimal, or BCD program source. Modular design simplifies special configurations to meet your particular needs.

Key Specifications

FREQUENCY: DC to 50 MHz
INCREMENTS: 0.01 Hz
SPURIOUS CONTENT: <100 db
HARMONIC CONTENT: <30 db
NOISE FLOOR: <135 db/Hz at 5 KHz
CLOSE-IN NOISE: <100 db/Hz at 10 Hz offset
PRICE: \$13,500.

Fluke, Box 7428, Seattle, Washington 98133. Phone: (206) 774-2211, TWX: 910-449-2850.
In Europe, address Fluke Nederland (N.V.), P.O. Box 5053, Tilburg, Holland.
Phone: (04250) 70130. Telex: 884-50237. In the U.K., address Fluke International Corp.,
Garnett Close, Watford, WD2 4TT. Phone: Watford, 27769. Telex: 934583.





"Black Magic" FROM Plastic Capacitors

**NEW "LQ" Series
OIL-FILLED
CAPACITORS**
FOR MEDIUM AND HIGH VOLTAGE
APPLICATIONS



- Voltage range, 1000 to 10,000 volts DC
- Power Factor, 0.5% at 60 and 1000 Hz.
- Peak to Peak Ripple Voltage, 20% of DC Voltage Rating
- Designed for continuous operation of 10,000 hours at 65°C
- Black phenolic shell, epoxy end fill
- Axial wire lead terminations
- Excellent corona characteristics

Here's new "Black Magic" from PC, delivering more power and reliability at extremely low cost. Compact size and stability increase their versatility.

Quality construction assures peak performance. Intensive testing to insure field performance applications unlimited.

Write for free samples and complete engineering data today!



**Plastic Capacitors
INC.**

2620 N. Clybourn • Chicago 14, Ill.
DI 8-3735

NEW LITERATURE

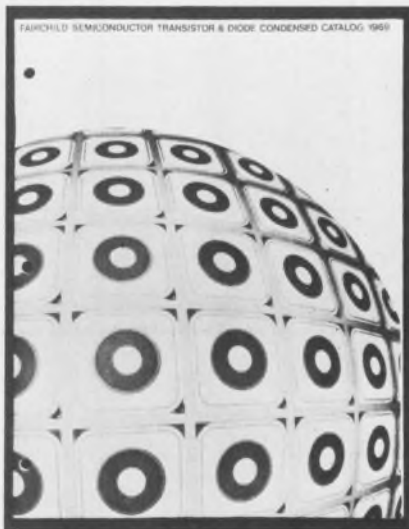

Transistors & diodes

A complete listing of Fairchild Semiconductor discrete devices is now offered in a 64-page transistor and diode catalog. The catalog presents key parameters and package outline dimensions, along with a numerical index that quickly locates the device of interest. Fairchild Semiconductor.

CIRCLE NO. 441



Miniature hardware

Here is a source for miniature taps, dies, screws, nuts, and washers that range in size down to 0000-160. All stock items are listed with prices, including dies, screw gauges, drills, and dowel pins. J. I. Morris Company.

CIRCLE NO. 442



Switch selector

A complete product selection guide lists lighted pushbutton switches, word indicators, fuse holders and circuit breakers as well as unlighted switch assemblies and audio and visual warning and display systems. The six-page guide makes possible a quick selection of the proper switch for a specific application. Included are general descriptions, characteristics, and product and application photographs. Master Specialties Co.

CIRCLE NO. 443

Coax and connectors

Covering miniature coaxial cables and connectors, an eight-page catalog also offers complete descriptions and specifications for miniature cable assemblies and delay lines. In addition, illustrations show how to cut and trim miniature coaxial cable, and other data describes miniature coaxial connectors and SMA miniature microwave connectors. Phelps Dodge Electronic Products Corp.

CIRCLE NO. 444

Time sharing

The use and application of a commercial time-sharing service are described in a new 12-page brochure. The service enables businessmen, engineers and analysts to share economically the full problem-solving capabilities of a central computer over telephone lines from a typewriter terminal in their office. On-line computer service makes computers as convenient and as easy to use as the telephone. General Electric Co.

CIRCLE NO. 445

Lockheed has been making multilayer circuits by the thousands. For years. With the most advanced laminating techniques.

You'll probably want from 3 to 6 layers, but we can make 15 or more layers if you need them. And we'll give you precision flatness—well above industry standards. With all layers perfectly registered. The quality of our lamination will equal or exceed the 2-sided boards you might now be using.

Another comfort. We can provide you with sophisticated multilayer circuits for little more than you're now paying for the standard 2-layer board.

Which means you can get the Lockheed Sandwich for very little bread.

Write for your "Designer's Guide to Multilayer": Printed Circuits, Lockheed Electronics Company, Data Products Division, 6201 East Randolph Street, Los Angeles, California 90022.

Presenting: The Lockheed Sandwich



LOCKHEED ELECTRONICS COMPANY
A Division of Lockheed Aircraft Corporation

INFORMATION RETRIEVAL NUMBER 169

New from the **SPEC-TROLL!**



A 10-TURN INDUSTRIAL WIREWOUND POT WORTH BLOWING OUR HORN ABOUT!

Selling for only \$4.39 in quantity, our new Model 532 features "designed-in" reliability to give you top pot performance at bargain prices. The 532 offers:

- Longer element for "tighter" resolution.
- Precious metal contacts for minimum noise characteristics.
- Improved vibration-resistant slider design and dual slip ring contacts.
- Rugged mechanical stops for dependability.
- Passivated stainless steel shaft.
- A tough industrial design that can handle most of the requirements associated with MIL-R-12934.

Brief Specs

Size:	7/8" diameter
Resistance Range:	15 ohm to 180K
Resistance Tolerance:	±5%
Independent Linearity:	±0.25%
Power Rating:	3 watts @ 40°C

The model 532 is available through your local Spectrol distributor. For full specs, circle the reader service number. Qualified respondents may obtain a sample *free of charge* through their Spectrol representative.



Spectrol Electronics Corporation
A subsidiary of Carrier Corporation
17070 East Gale Avenue
City of Industry, Calif. 91745
Phone: (213) 964-6565
TWX: (910) 584-1314

INFORMATION RETRIEVAL NUMBER 170

NEW LITERATURE



Electromechanical parts

Showing more than 44,000 precision electromechanical components, a 576-page catalog has a 120-page technical section on gear-train design. Another feature is a uniquely arranged series of technical tables that puts at the designer's fingertips information ranging from strength of materials to metric equivalents. Ten product sections cover gears, differentials, speed reducers, clutches and brakes, drive components, shaft accessories, breadboard components, dials, counters, fasteners and electronic hardware. Sterling Instrument, Div. Designatronics, Inc.

CIRCLE NO. 446

Ceramic-metal packages

Ceramic-to-metal components and packages for electronic and mechanical applications are described in a 20-page booklet. These products combine the technologies of ceramics and metallurgy to provide components and assemblies that take advantage of the thermal dielectric and mechanical properties of beryllium oxide in combination with the conductivity and assembly characteristics of metals. Specific information is given on transistor headers for plastic encapsulated devices, hermetic headers and packages, and packages for diodes, logic elements, and other microelectronic circuits. National Beryllia Corp., Cermetrol Div.

CIRCLE NO. 447

NEED LOW COST HIGH RELIABILITY IN THE TERMINAL OUTPUT OF YOUR DATA PROCESSING SYSTEM?



Model 1900 Series Numeric Printer Serial/Parallel Entry Data Printer can add, subtract, totalize and/or print automatically by remote control. Speeds up to 2 lines per second. Up to 10 digits per line.

For details ask for S-113R data sheet



The Model 7000 Numeric Printer features integrated circuitry and mechanical design simplicity.



- Up to 10 lines per second
- Up to 20 columns of data
- Basic Model \$1850.00

Evaluate the Model 7000 for your printer application.

For details ask for S-165 R2 data sheet.

CLARY CORPORATION PRECISION INSTRUMENTS DIVISION

320 West Clary Ave.
San Gabriel, California

91776
(213) 287-6111
Telex 674604

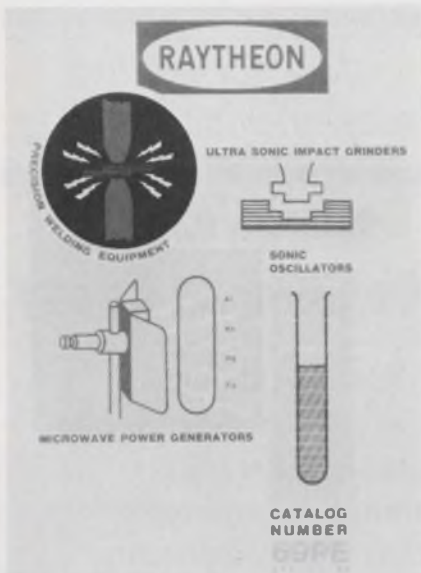

Production equipment

Describing a line of production equipment, an illustrated 16-page catalog lists principal specifications and prices. Included are precision welding equipment, ultrasonic impact grinders, sonic oscillators and microwave power generators. Raytheon Co.

CIRCLE NO. 448



Relay catalog

Providing data on miniature solid-state opto-electronic and reed relays, a 28-page catalog also describes time-delay, time-interval and frequency-sensitive relays. All units utilize a miniaturized strengthened design, and are recommended for military and industrial applications. Solid State Electronics Corp.

CIRCLE NO. 449

NOW!

POWER

HYBRIDS

HYBRIDS

HYBRIDS

HYBRIDS

available from

Soliton

Unlike most hybrid sources, Soliton manufactures its own semiconductor chips. This semiconductor background gives Soliton the distinct advantage of selecting specific devices to best fulfill customer needs. Soliton's selection covers the complete spectrum of semiconductor devices: from 10 μ Amps to 100 Amps, PNP or NPN, 30V to 1000V and frequencies from 1 MHz to 1.2 GHz.

Hybrid capabilities include:

- THICK FILM PROCESSING
- LARGE ALUMINUM WIRE FOR POWER CHIP TO SUBSTRATE BONDING
- UTILIZATION OF EXISTING HI-REL TECHNIQUES ON POWER DEVICES
- SPECIAL THERMAL TRANSFER PACKAGING

For complete information, contact:

Soliton

DEVICES, INC.

1177 BLUE HERON BLVD. / RIVIERA BEACH, FLORIDA / (305) 848-4311 / TWX: (510) 952-6676

INFORMATION RETRIEVAL NUMBER 172

UTMOS

FOR RELIABILITY
PERFORMANCE
& VERSATILITY

Ultra

Thick

Metal

Oxide

Silicon

Transistors

■ AMI's p-channel transistor reliability — 0.001% per 1000 hours. ■ Highest gain bandwidth p-channel MOS devices — 300 MHz. ■ Threshold voltages — 4.3V or 2.0V. ■ Operating temperature to +175°C. ■ Also, available in chip form.

For detailed data write or call:

**American
Micro-systems, Inc.**



3800 Homestead Rd., Santa Clara, Calif. 95051
Tel: (408) 246-0330—TWX: (910) 338-0018

INFORMATION RETRIEVAL NUMBER 180

NEW LITERATURE



Ferrite devices

Outlining a complete selection of coaxial and waveguide ferrite devices for airborne, shipboard and ground-based radar and communication systems, a 12-page catalog covers devices ranging in frequency from uhf to Ka band, handling up to 20 mW of rf power and operating over broad temperature ranges. Included are complete electrical and mechanical specifications and outline drawings representing subminiature circulators, uhf circulators, uhf miniature circulators and gyrators. Microwave Associates.

CIRCLE NO. 450

Relay handbook

Doubling as a useful engineering design handbook, a four-color 36-page catalog covers a broad line of power, rf and signal relays available in over 40 basic design types. The publication contains photographs, line drawings, oscillographs, electrical characteristics and mechanical specifications for all configurations. Besides contact code data for determining size, material and resistive rating, the catalog has a relay parameter selection guide that completes the information necessary for finding the right relay for any given circuit application. Oak Electro/Netics Corp.

CIRCLE NO. 451

NITINEWS

*Now, for potting,
sealing, encapsulating*

Nitine Single Component Epoxy

Mineral oxide filler
thermosetting epoxy resin
plastics for potting,
sealing and encapsulating
electronic components.

- Single component epoxy systems, ready for use. No mixing or blending.
- Low viscosity assures necessary wetting and impregnation.
- Cure temperature less than 100°C.
- Excellent resistance to chemicals, solvents, moisture and heat.
- Excellent adhesion—low shrinkage on curing.
- Pot life over 48 hours at room temperature.
- Frozen material can be held in stock for weeks with complete physical stability.

Write today for complete
Product Information and
grade specifications.



NITINE, INC.
SUBSIDIARY OF SHULTON, INC.
Route 46, Clifton, N. J. 07015
(201) 779-4800

INFORMATION RETRIEVAL NUMBER 181

Hafnium brochure

An eight-page brochure on hafnium discusses the physical and mechanical properties of hafnium and hafnium-base alloys. The purpose of the brochure is to show that hafnium is available in reasonable supply and on a continuous basis, and to point out to design engineers in many fields where research and development have indicated exciting possibilities for the application of hafnium. Amax Specialty Metals, Inc.

CIRCLE NO. 452

Battery sockets

Thirty-nine representative laminated battery sockets and connectors are depicted by dimensional drawings in an eight-page technical bulletin. Bulletin 39B illustrates an extensive line of sockets for commercial and military applications. Contacts and insulations to meet MIL standards are available. Connector Corp.

CIRCLE NO. 453

Springs and strips

A newly revised 24-page precision spring catalog contains complete up-to-date information on beryllium-copper flat and compression coil springs, as well as standard finger-contact strips, rings and rfi/emi-shielding hardware. Characteristics of beryllium-copper alloys used for springs are discussed along with design suggestions. Instrument Specialties Co., Inc.

CIRCLE NO. 454

Microwave instruments

A new 16-page catalog describes a line of microwave oscillators, phase-lock synchronizers, and radar test equipment. Over 100 different models are described, first by major series characteristics, and then by detailed model specifications. Prices are included on the back cover. Sage Laboratories, Inc., Instrument Div.

CIRCLE NO. 455

INFORMATION RETRIEVAL NUMBER 182 ►

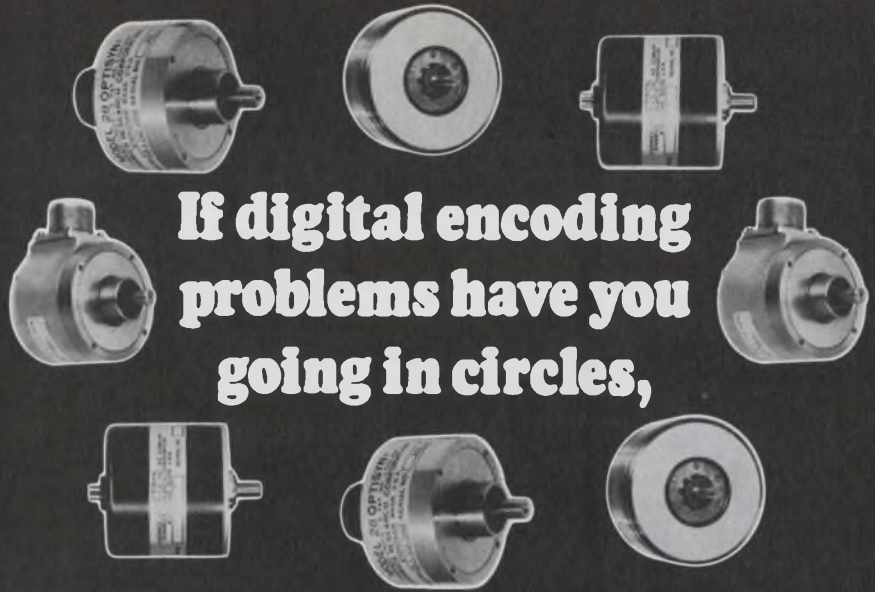

**If digital encoding
problems have you
going in circles,**

maybe you should be straight out



...or vice-versa

Rotary or Linear . . . DRC digital encoders deliver the ultimate accuracy and performance you need at prices that meet your budget for the application. Check your design parameters and see how these DRC units can meet your requirements with standard or specialized encoders.

	ROTARY ENCODERS	LINEAR ENCODERS
Resolution . . .	From 20 counts to 80,000 counts per revolution.	7 standard options — up to 20,000 counts per inch.
Accuracy	As low as ± 0.01 count.	As low as 50μ in. per foot.
Simplicity	Built-in IC electronics provide sine wave, square wave or pulse outputs.	Unique optical system eliminates fussy alignment between head and scale.
Versatility	A variety of optional mechanical configurations fit 90% of industrial and commercial applications without modification.	Fits single or multi-axis applications — reading lengths up to 48 inches available.

Easily interfaced with a variety of N/C or tape controlled peripheral equipment.

Both rotary and linear models are available now for fast delivery. So if you have problems in rate or position measurement, encoding, counting and display, come to DRC. We are the single-source, single-responsibility company that can stop your head from spinning and give you some straight answers to your digital encoding problems.



Control Thru Measurement



DYNAMICS RESEARCH CORPORATION
Stoneham, Mass. 02180 • Tel. (617) 438-3900 • TWX (710) 348-0769

Introducing PLUSISTOR VECO



slayer of dragon-size heat regulation problems



PLUSISTOR is VECO's all-new positive temperature coefficient thermistor for temperature measurement and compensation. A solid state silicon resistor, PLUSISTOR features an average coefficient of $+0.7\%/^{\circ}\text{C}$ which remains virtually constant through the range of -60°C to $+150^{\circ}\text{C}$. These small-but-stalwart heat defenders are available to you in a variety of designs—

- $\frac{1}{4}$ & $\frac{1}{2}$ watt axial lead, molded design
- $\frac{1}{4}$ watt, hermetically sealed can
- $\frac{1}{4}$ watt axial lead, glass body adjacent lead, glass probe

Available in decade multiples of E.I.A. standard resistance values from 10Ω to $10\text{K}\Omega$... 10% standard tolerance or tighter tolerances and special values other than standard where required. PLUSISTOR is just one of a complete line of thermistors from VECO designed to solve the most gigantic of problems.

VECO VICTORY
ENGINEERING
CORPORATION
VICTORY ROAD, SPRINGFIELD,
NEW JERSEY 07081
(201) 379-5900 • TWX 710-983-4430

INFORMATION RETRIEVAL NUMBER 183

NEW LITERATURE



Power systems

A new five-section, 40-page technical catalog covers an extensive line of battery chargers, inverters and converters, dc supplies, ringing and tone supplies and power systems for the communications industry. It presents detailed information on special features, applications, and electrical and mechanical specifications. Electronics Div., North Electric Co.

CIRCLE NO. 456

Power supplies

A 1969 catalog lists over 82,000 ac-to-dc all-silicon plug-in power supplies. Any of these power supplies are guaranteed to be shipped within three days after receipt of order. The 24-page catalog describes and gives prices of regulated single and dual supplies, unregulated supplies, and high-isolation units for strain-gauge applications. Also included is a guide to power-supply selection. Acopian Corp.

CIRCLE NO. 457

Fluidics manual

A new manual offers full information on a complete line of fluidic switches as well as details on their varied applications. The manual offers designers, engineers and builders complete details on the advantages of fluidics—simplicity, reliability, small size and low cost. Complete specifications are also given on switch designations, minimum actuation pressure, maximum continuing pressure, bellows diameter and switch standards. Gagne Associates, Inc.

CIRCLE NO. 458

P/C Reed Relays

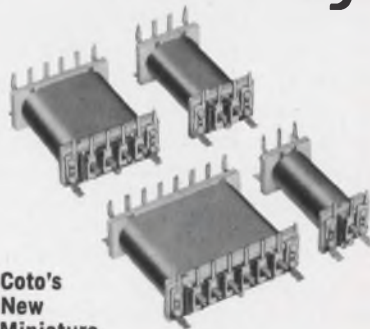

Coto's New Miniature Series 1000

- Especially designed for P/C board applications
- Pin spacing $1\frac{1}{2} \times .150$ centers
- Stock voltages 6, 12, 24, 32 and 48 volts
- Form A contacts, up to 6 poles, ratings 10 watts
- Form C contacts, up to 4 poles, ratings 3 watts
- Form A mercury-wetted, up to 6 poles, ratings 28 watts
- Electrostatic and/or magnetic shields

Special voltages and resistances available, with multiple windings for flip-flop, memory and crosspoint selection applications.



COTO-COIL COMPANY, INC.
54 Pavilion Avenue, Providence, R. I. 02905
Tel: (401) 941-3355

INFORMATION RETRIEVAL NUMBER 189



RF and POWER SWITCHES

A complete line of rotary, high voltage and high current ceramic-type switches for RF and low frequency applications.

Write for catalog, containing information on the mechanical and electrical properties of our standard line of switches.

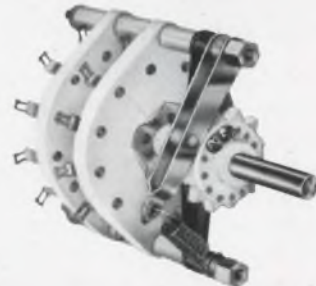

RADIO SWITCH CORPORATION

MARLBORO, NEW JERSEY

Telephone: HOPKINS 2-6100 (Area Code 201)

INFORMATION RETRIEVAL NUMBER 184

ELECTRONIC DESIGN 10, May 10, 1969

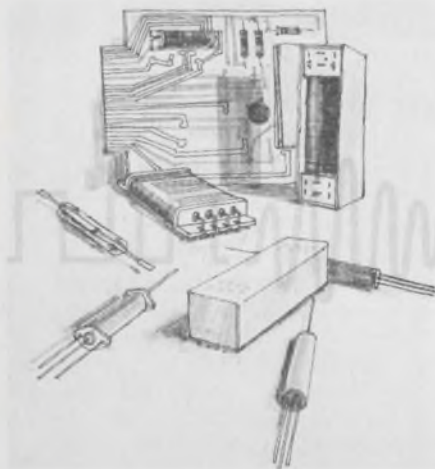

Reed relays

Covering over 160 relays, a 24-page catalog contains detailed information on life and reliability characteristics. The catalog lists detailed electrical, mechanical and environmental specifications, dimensional drawings, photographs, applications and ordering information. Wheelock Signals, Inc.

CIRCLE NO. 459

HV rectifiers

A 20-page bulletin discusses direct plug-in replacement of high-voltage high-current rectifier tubes with stackable rectifier modules. Direct-replacement information on over 120 rectifier tubes is given including maximum tube ratings and recommended module-type replacement. Unitrode Corp.

CIRCLE NO. 460

Power supplies

A 32-page power-supply catalog supplement announces several new products. Described are a new line of militarized integrated-circuit power modules for airborne, shipyard and vehicular requirements; three new power-supply assembly systems accommodating up to 16 multiple dc outputs; and a new line of high-efficiency high-current rack-size power instruments. Also included is a new family of commercial, industrial and military transformers. Lambda Electronics Corp.

CIRCLE NO. 461

NEW DELTA DESIGN!

MODEL 3000 FET VOM



A unique and efficient instrument bridging the gap between a multimeter and a digital voltmeter!

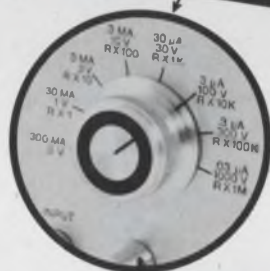

Delta, pioneer of the famous Mark Ten® CD System, now offers a compact, versatile, and extremely sensitive VOM which combines FETs and ICs for extreme accuracy. Compact (6½" W x 8" H x 3½" D), portable, wt. 3¾ lbs. In full production at only

\$74.95
ppd.

Would you believe:

1. Mirror scale 200 μ A D'Arsonval meter
2. Integrated circuit (IC) operational amplifier for extreme accuracy
3. FET input stage with current regulator
4. Two stage transistor current regulator and Zener diode on OHMS for absolute stability and accuracy
5. Voltage clippers for protection of input stage
6. Fully temperature compensated for low low zero drift
7. Ten turns ZERO and OHMS adjust potentiometers
8. Epoxy glass circuit boards and metal case
9. Enclosed switches
10. Uses readily available type AA cells
11. Uses standard test leads for maximum flexibility and ease of measurement
12. 10 Megohms input impedance

Available in Kit form: Feedback network with pre-selected components to eliminate all final calibration. Ready to use when assembled!

Kit: **\$59.95**
Only **ppd.**



DELTA PRODUCTS, INC.

P. O. Box 1147, Grand Junction, Colorado 81501

I enclose \$_____ Please send postpaid:

_____ Model 3000 FET VOMs @ \$74.95 assembled

_____ Model 3000 FET VOMs @ \$59.95 kit form

Name _____

Address _____

City/State _____ Zip _____

DP 8-7

INFORMATION RETRIEVAL NUMBER 84

ELECTRONIC DESIGN's function is:

- To aid progress in the electronics manufacturing industry by promoting good design.
- To give the electronic design engineer concepts and ideas that make his job easier and more productive.
- To provide a central source of timely electronics information.
- To promote two-way communication between manufacturer and engineer.

Want a subscription? ELECTRONIC DESIGN is sent free to qualified engineers and engineering managers doing design work, supervising design or setting standards in the United States and Western Europe. For a free subscription, use the postfree application form inside the back cover. If none is included, write to us direct for an application form.

If you do not qualify, you may take out a paid subscription for \$25 a year in the U.S.A., \$35 a year elsewhere. Single copies are \$1.50 each.

If you change your address, send us an old mailing label and your new address; there is generally a prepaid postcard for this inside the back cover. You will have to requalify to continue receiving ELECTRONIC DESIGN free.

The accuracy policy of ELECTRONIC DESIGN is:

- To make reasonable efforts to ensure the accuracy of editorial matter.
- To publish prompt corrections whenever inaccuracies are brought to our attention. Corrections appear at the end of the Letters column.
- To refuse any advertisement deemed to be misleading or fraudulent.

Microfilm copies are available of complete volumes of ELECTRONIC DESIGN at \$19.00 per volume, beginning with Volume 9, 1961. Work is now in process to complete the microfilm edition of Volumes 1-8. Reprints of individual articles may be obtained for \$2.00 each, prepaid (\$.50 for each additional copy of the same article) no matter how long the article. For further details and to place orders, contact the Customer Services Department, University Microfilms, 300 North Zeeb Road, Ann Arbor, Michigan 48106; telephone (313) 761-4700.

Want to contact us? If you have any comments or wish to submit a manuscript or article outline, address your correspondence to:

Howard Bierman, Editor,
ELECTRONIC DESIGN,
850 Third Avenue,
New York, N.Y. 10022.

Free — Brushless Torque Motor Guide



A comprehensive guide to the Aeroflex line of Brushless DC Torque Motors, DC Moving Coil Torque Motors, DC Tachometers, DC Torquer/Tachometers and DC Torquer Amplifiers. Includes a concise, definitive evaluation of the "Brushless" concept, its benefits and application directions. Complete specification guide of typical types, related performance curves and a "Table of Conversion Factors" provide the Design Engineer of Direct Drive DC Devices with the graphic facts to make specifying decisions.

Aeroflex Laboratories Incorporated
South Service Road
Plainview, L.I., N.Y. 11803

174

NEW 68-PAGE DRAFTING CATALOG — FREE



Bishop Catalog 104 — the most comprehensive manual type catalog of pressure-sensitive electrical/electronic component drafting aids ever assembled. Filled with thousands of printed wiring symbols and patterns to speed artwork preparation time and cut drafting costs. Featuring the latest information on printed wiring drafting techniques. Contains multi-pad component symbols, including flatpacs and dual in-lines. Also, general purpose wiring symbols, logics, schematics, reference designations, tapes, pads, shapes and many, many more. Send today for your free copy and samples.

Bishop Graphics, Inc.
7300 Radford Ave.
North Hollywood, California 91605
Phone: (213) 982-2000

175

Miniature Self-clinching fasteners



PEM miniature self-clinching fasteners are made for permanent mounting on thin panels. Dimensioned to fit into minimum space, they provide strong, self-locking threads equal to MIL-N-25027C. Available in four types for panel thickness as thin as .020", they are always flush with one surface when squeezed into pre-punched or drilled holes. They are offered in thread sizes from #0-80 to 1/4-20 in 303 stainless steel for optimum hardness to imbed into most panel materials coupled with good ductility for smooth, non-galling self-locking characteristics.

Penn Engineering & Mfg. Corp.
Box 311
Dolyestown, Pa. 18901

176

Manufacturers

Advertisements of booklets, brochures, catalogs and data sheets. To order use Reader-Service Card.
(Advertisement)

Terminal Block Selector



A new 24-page, completely illustrated catalog contains photos, descriptions, ratings, engineering drawings, and prices of the complete line of Curtis terminal blocks. Included are printed circuit, insulated feed-thru, quick disconnect, track type, and high current terminal blocks. Handy selection chart quickly locates the perfect block for your particular requirements. Send today for your free copy.

Curtis Development & Mfg. Co.

3236 North 33rd Street
Milwaukee, Wisconsin 53216

177

Quality Fasteners For All Designs



This 8-page catalog provides design data on the complete group of DZUS 1/4-turn self-locking fasteners for standard, high speed and panel applications, as well as universal high strength multiple thread fasteners for high tensile and shear stresses. Dzus stud assemblies, wire forms and receptacles offer an exceptional, wide variety of combinations from stock to fit specific fastening requirements. Diagrams and tables give full details for rapid, unlimited design selection. Condensed or complete Catalog available on request.

Dzus Fastener Co., Inc.

425 Union Boulevard
West Islip, L. I., N. Y. 11795

178

SELF-SEALING FASTENERS



For positive seal against air, gas, fluids. These APM-HEXSEAL products are designed to conform to all Fastener Handbook dimensions and standards, and applicable Military Specifications. The unique feature is a captive O-ring underneath the head (patented). This O-ring guarantees positive sealing against most liquids and gases. Other beneficial features: • Reusable • Pre-assembled • Vibration-resistant • Positive metal-to-metal contact • Seals standard clearance holes • Withstand in excess of 6000 psi internal and external pressures. Available in screw, rivet and bolt version. Write today for free samples, and detailed information.

APM Hexseal Corporation

44 Honeck Street, Englewood
New Jersey 07631 (201) 569-5700

179

Electronic Design

Advertising Sales Staff

New York 10022

Edward F. Clancy
Sales Service Manager
Robert W. Gascoigne
Thomas P. Barth
Samuel M. Deitch
Byron Adams
850 Third Avenue
(212) Plaza 1-5530
TWX: 867-7866

Philadelphia 19066

William C. Repetto
P. O. Box 206
Merion Station, Pa.
(215) MA-3-5888

Boston 01945

Richard Parker
P.O. Box 645
Clifton Station
Marblehead, Mass.
(617) 742-0252

Chicago 60611

Thomas P. Kavooras
Berry Conner, Jr.
200 East Ontario
(312) 337-0588

Cleveland

Thomas P. Kavooras
(Chicago)
(312) 337-0588
(call collect)

Los Angeles 90303

Stanley I. Ehrenclou
John V. Quillman
W. James Bischof
2930 Imperial Highway
Inglewood, Calif.
(213) 757-0183

San Francisco 94022

Arthur R. Shields, Jr.
175 San Antonio Rd., S 243
Los Altos, Calif.
(415) 941-3084

London W. 1

For United Kingdom & Holland
Brayton C. Nichols
44 Conduit Street
Tel: REGent 4714

Verviers, Belgium

For Continental Europe
Andre Jamar
1, Rue Mallar, 1
(087) 253.83 Telex 41563

Tokyo

Yoshihiro Takemura
IPS Group Ltd.
Box 36, Ohsaki Post Office
Phone (431) 5804



Advertisers' Index

Advertiser	Page	Advertiser	Page	Advertiser	Page
AMP, Incorporated	54, 55	Fairchild Camera and Instrument Corporation	4, 5, 48 A—F, 231	RCA Institutes, Inc.	219
APM-Hexseal Corporation	245	Fifth Dimension, Inc.	220	R. F. Communications, Inc.	204
Adams & Westlake Company, The	155	Fluke Mfg. Co., John	235	Radiation, Incorporated	131
Adar Associates, Inc.	211			Radio Switch Corporation	242
Advanced Technology Consultants Corporation	210			Raytheon Company, Industrial Components Division	164
Aeroflex Laboratories, Incorporated	244	G. C. Electronics Co.	146	Raytheon Company, Semiconductor Operation	70
Airpax Electronics, Incorporated	225	General Electric Company, Capacitor and Battery Dept.	221	Reeves Hoffman Division of Dynamics Corporation of America	154
Alco Electronic Products, Inc.	157	General Electric Company, Electronic Components	160		
Allen-Bradley Co.	151, 153	General Electric Company, Electronic Component, Sales Operation	112, 113	SRC Division, Moxon Electronics Corp.	200
American Electronic Laboratories, Inc.	156	General Electric Company, Lamp Metals & Components Dept.	247	Sanders Associates, Inc.	133
American Micro-Systems, Inc.	240	General Electric Company, Relays	140	Schauer Manufacturing Corp.	226
American Optical Corporation	174	General Radio Company	1	Servo-Tek Products Company	186
Amplex Corporation, The	232	Grayhill, Inc.	192	Siemens America, Incorporated	223
Amphenol RF Division, The Bunker-Ramo Corporation	179	Gritzner Graphics	202	Signetics Integrated Circuits, A Subsidiary of Corning Glass Works	27
Amphenol Controls Division, The Bunker-Ramo Corporation	66, 67			Siliconix Incorporated	12, 13, 234
Applied Technology A Division of Itek Corporation	217	Hewlett-Packard	Cover II, 62, 63, 137, 186	Simpson Electric Company	182
Atec, Inc.	168	Hitchner Manufacturing Co. Inc.	194	Singer Company, The Instrumentation Division, Ballantine Operation	199
Augat, Inc.	214	Honeywell, Computer Control Division	58, 59	Singer Company, Instrumentation Division	205
Automatic Controls Division of Cook Electric	233	Honeywell, Precision Meter Division	227	Singer Company, The Friden Division	169
Automatic Electric Company	50, 51	Honeywell Test Instrument Division	213	Soliron Devices, Inc.	239
				Sonotone Corporation, Battery Division	74
Beckman Instruments, Inc., Helipot Division	104, 105	IRC, Division of TRW, Inc.	229	Spectrol Electronics Corporation	238
Belden Corporation	173	Indiana General Corporation	219, 247	Spitfire Tool & Machine Co.	232
Bell & Howell	196	Industrial Electronic Engineers, Inc.	184	Sprague Electric Company	18
Bendix Corporation, The, Semiconductor Division	15	Industrial Timer Corporation	211	Stackpole Carbon Company	175
Bishop Graphics, Inc.	244	Instrument Displays, Inc.	215	Stewart Warner Microcircuits Inc.	165
Blu-Ray Incorporated	215	Interdyne Systems, Inc.	195	Stoddart ElectroSystems, A Division of Tamar Electronics, Inc.	142
Boston Insulated Wire & Cable Co.	161	International Electronic Research Corporation	163	Switchcraft, Inc.	56, 57
Bourns, Inc.	24	International Rectifier Corp.	61	Syston-Donner Corporation, Data Pulse Division	2
Buckhee Mears Co.	224				
Burns & Towne, Inc.	178	JFD Electronics Co./Components Division	172	TRW Inc., Capacitor Division	181
Burroughs Corporation	20	Johanson Manufacturing Corp.	218	Tektronix, Inc., Oscilloscopes	72
		Jonathan Manufacturing Company	128	Teledyne Relays, A Teledyne Company	17
CMC, A Division of Pacific Industries	64A—B			Thermal American Fused Quartz Co., Inc.	64
CML, Inc.	152	Krohn-Hite Corporation	176	Trans-Tech, Inc.	167
Cambridge Thermionic Corporation	201	Kurz-Kasch, Inc.	220	Triplet Electrical Instrument Company, The	135
Centralab, Semiconductor Division, Globe-Union, Inc.	159			Tyco Laboratories, Inc.	170
Ceramic Magnetics, Inc.	146	Laser Diode Laboratories	207		
Cinch-Graphik, Division of United Carr	198	Lear Siegler, Inc., Cimron Division	46	Union Carbide Corporation, Semiconductor Division	8, 9
Clairex Electronics, Inc.	189	Licon, Division Illinois Tool Works, Inc.	6, 7	U. S. Capacitor Corporation	188
Clary Corporation, Precision Instruments Division	238	Line Electric Company	209		
Clevite Corporation, Burgess Battery Division	16	Littlefuse	219	Varian Associates, TWT Division	29
Clevite Corporation, Graphics Group	118, 119	Lockheed Electronics Company	183, 237	Veeder-Root	53
Cohu Electronics, Inc.	206			Victory Engineering Corporation	242
Computer Products	166	3M Company, Film & Allied Products Division	49	Virginia Panel Corporation	216
Coors Porcelain Company	143	3M Company, Mincom Division	141		
Corning Glass Works, Electronic Products Division	32, 33	M & T Chemicals, Inc.	204	W & G Instruments, Inc.	171
Coto Coil Company, Inc.	242	MicroSwitch, A Division of Honeywell	162	Wanlass Instruments, A Division of Wanlass Electric Company	215
Cross Company, H.	10, 11	Miller Company, J. W.	222	Watkins-Johnson, CEI Division	193
Curtis Development & Mfg. Co.	245	Mohawk Data Sciences Corporation	214	West-Cap Arizona, Subsidiary of San Fernando Electric Manufacturing Co.	208
Cutler-Hammer	23, 148	Molex Products Company	191	Weston Instruments, Inc., Newark Division	197
		Monsanto Company	14	Weston Instruments, Inc., Archbald Division	177
Dale Electronics, Inc.	Cover III	Motorola Communications & Electronics, Inc.	65, 211	Winchester Electronics, Litton Industries	129
Data Technology Corporation	180				
Delco Radio, Division of General Motors	126, 127	National Beryllia Corporation	190	Zeltex, Inc.	203
Delta Products, Inc.	166, 243	National Semiconductor Corporation	16 A—B		
Dialight Corporation	228	Nitine, Inc.	240		
Direct Access Computing Corporation	210	Nytronics, Inc.	31		
Dynamics Research Corporation	241				
Dzus Fastener Co., Inc.	245	Oak Manufacturing Co.	223		
		Owens Illinois, Electronic Materials	187		
ETC, Inc.	247				
Eastman Chemical Products, Inc.	212	Penn Engineering & Mfg. Corp.	244		
Edmund Scientific Co.	224	Phelps Dodge Communications Company	158		
Elco Corporation	185	Plastic Capacitors, Inc.	236		
Electronic Memories, Inc.	68, 69				
English Electric Valve Co., Ltd.	160	RCA Electronic Components and Devices	139, Cover IV		
Fairchild Semiconductor, A Division of					

Career Advertising

General Electric Company, Heavy Military Electronic Systems	144
Hughes Aircraft Company, Ground Systems Group	147
Lockheed-California Company	146

New from IGC: sintered form of the industry's best alnico 8.

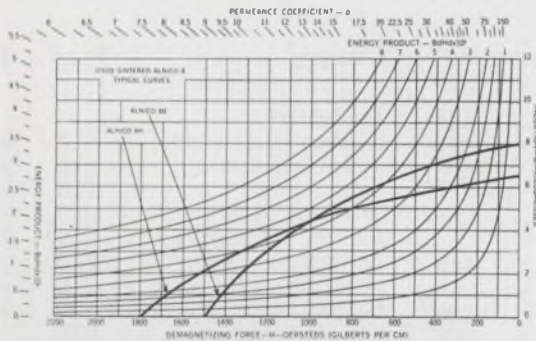

You might be able to get sintered alnico 8 somewhere else—but not like this. Our HyCo 8 has the greatest coercive force of all sintered alnicos. Typically, 1500 oersted for HyCo 8B, and 1800 oersted for 8H.

Sintered alnico 8 is well suited for miniaturized applications requiring a high coercive force. Typical uses include motors, TWTs, polarized relays, reed switches, pick-up cartridges, core meters, and holding and torque transmitting devices. And sintered has it all over cast alnicos when it comes to smoother surfaces, closer tolerances, physical strength, and flexibility of shapes.

For the complete characteristics and further details on sintered HyCo Alnico 8B and 8H, write Mr. C. H. Repenn, Manager of Sales, Indiana General Corporation, Magnet Division, Valparaiso, Indiana.

INDIANA GENERAL  *We make it easy for the design engineer.*

INFORMATION RETRIEVAL NUMBER 186

All the Plastic Platform Headers

you need! . . . to do the job in semiconductors . . . relays . . . photocells . . . fuses and many other applications. General Electric designs and produces plastic platform headers to demanding specifications for high volume production. The insulation available includes a wide range of engineered thermosets and thermoplastics . . . and lead wires of practically any commercial material and finish can be supplied. If you need production quantities of 1 million headers or more, let's get together. Write for design criteria regarding: ■ Plastic platform geometry and size variations ■ Lead wire lengths, diameters, and spacing ranges ■ Material options. *General Electric Company, Lamp Metals & Components Department, 21800 Tungsten Road, Cleveland, Ohio 44117. Tel: (216) 266-2451.*

GENERAL  ELECTRIC

INFORMATION RETRIEVAL NUMBER 187

ELECTRONIC DESIGN 10, May 10, 1969

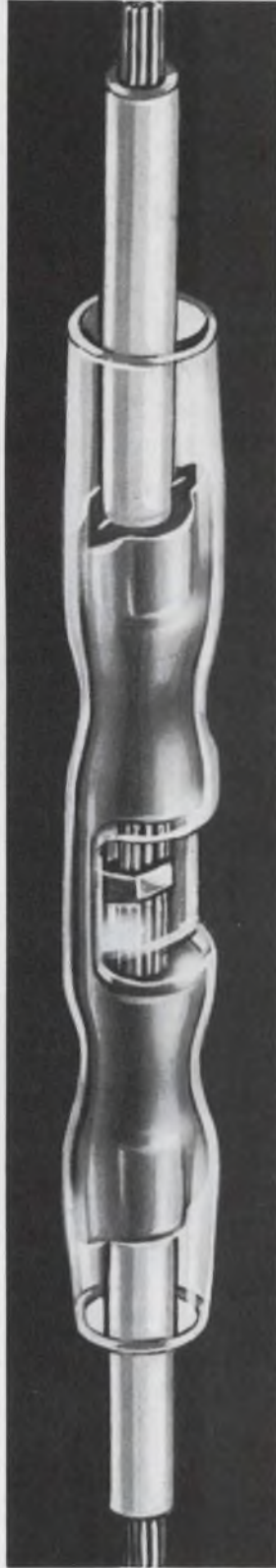

NICE SPLICE

it tells you when to crimp

That's because the see-thru "window" at splice midpoint lets you inspect inserted conductor before crimping. Funneled barrel ends make conductor entry fast and snag-proof . . . reducing installation time. Center wire stop prevents over-insertion of wires. Color-coded transparent nylon sleeve — over one-piece seamless insert — eliminates dielectric flashover. Midpoint indent helps locate splice in crimping tool. (You'll want to see our match-mated tooling, too.) Our Window Butt Splice is *the* answer to structural and tensile stresses, temperature extremes in the #22-10 wire range. For more answers (and evaluation samples) write or call ETC, Inc., Cleveland, Ohio 44103. A subsidiary of International Telephone and Telegraph Corporation.



© 1969 ETC, Inc.

INFORMATION RETRIEVAL NUMBER 188

Information Retrieval Service

All products, design aids (DA), application notes (AN), new literature (NL), and reprints (R) in this issue are listed here with Page and Information Retrieval numbers. Reader requests will be promptly processed by computer and mailed to the manufacturer within three days.

Category	Page	IRN	Category	Page	IRN	Category	Page	IRN
Components			sweeper accessories	194	378	Production		
components (AN)	230	430	synthesizer, microwave	196	380	bonder, microelectronic	218	409
components (NL)	238	446	transistors, video	200	386	chuck, magnetic	214	403
filters, monolithic	156	340	transistors, vhf power	194	377	cutter, angle	216	404
logic handbook (AN)	232	432				extractor, DIP	218	407
logic handbook (NL)	234	439	Instrumentation			fixture, transistor	214	402
read-head	152	317	CCTV encyclopedia (NL)	234	440	harnessing tool	220	410
readout assemblies	150	326	clocks, digital	176	359	heat gun	216	405
resistor, power	150	327	counter, 160-MHz	180	366	heating tool	220	411
resistor network	152	319	counter, portable	170	356	pencils, marking	216	406
switch, reed	154	339	curve tracer plug-in	172	358	production equipment (NL)	239	448
switch, tilt	150	328	frequency measurement (AN)	233	436	wirestripper, thermal	218	408
switches, (NL)	236	443	frequency meter	178	363			
switches, slide	152	318	multimeter, autoranging	176	360	New Literature		
switches, snap-action	150	329	panel meter, digital	178	362	CCTV encyclopedia	234	440
switches, stepper (AN)	230	427	panel meter, digital	178	364	components	238	446
transformer, pulse	152	320	panel meters, digital	178	361	connectors, coax	236	444
transformers, balun	154	338	power-factor chart (DA)	228	423	electron-beam devices	234	438
trimmers, cermet	150	325	power systems (NL)	242	456	ferrite devices	240	450
trimmers, MIL	156	341	probe, logic test	170	355	fluidics manual	242	458
			scope news (AN)	233	434	hafnium	241	452
Data Processing			sensitivity expander	172	357	hardware, miniature	236	442
computer, small	212	401	signal injector	168	354	instruments, microwave	241	455
computer system	204	391	stroboscopy (AN)	230	429	logic handbook	234	439
converter, d/a	204	390	transmission rule (DA)	228	424	packages, ceramic	238	447
converters, a/d	212	400	voltmeter, digital	180	365	plastic parts	234	437
data modems	208	395	VOM, FET-input	168	353	power supplies	242	457
data set	202	388				power systems	242	456
data terminal	206	392	Modules & Subassemblies			production equipment	239	448
graphic input devices	202	387	decoder/display	192	375	relays	239	449
intercoupler, digital	204	389	displays, decimal	190	373	relays	240	451
logic handbook (AN)	232	432	hybrid design (AN)	232	433	semiconductors	236	441
logic handbook (NL)	234	439	logic handbook (AN)	232	432	sockets, battery	241	453
memories, 2- μ s	210	398	logic handbook (NL)	234	439	springs and strips	241	454
memory, bulk	210	396	multiplier, wideband	186	370	switches	236	443
memory, core	208	394	op amp	190	374	time sharing	236	445
memory, core	210	397	op amp, wideband	182	368			
programming (AN)	230	426	op amps	186	369			
project planner (DA)	228	422	op amps	192	376			
software checkout	212	399	op amps (AN)	230	428			
tape, magnetic	206	393	relay, miniature	188	371			
time sharing (NL)	236	445	relays (NL)	239	449			
			relays (NL)	240	451			
ICs & Semiconductors			supplies, Nixie	182	367			
amplifier, ac quad	161	344	timers	188	372			
amplifier, low-cost	164	349						
diodes, capacitance	166	351	Packaging & Materials					
FETs, vhf/uhf	164	346	breadboard	222	414			
d'odes, hardened	164	347	connector, 40-pin	224	415			
ICs, linear	164	348	connector, circular (ES)	226	421			
logic handbook (AN)	232	432	connectors, coax (NL)	236	444			
logic handbook (NL)	234	439	connectors, miniature	224	416			
multiplier, linear	164	350	fabrics, non-woven (ES)	226	420			
semiconductors (NL)	236	441	hafnium (NL)	241	452			
semiconductors, hybrid	161	345	hardware, miniature (NL)	236	442			
supply, current	158	343	materials, adhering (ES)	226	418			
switch, FET	166	352	materials, emi (AN)	230	431			
transistor chart (DA)	228	425	packages, ceramic (NL)	238	447			
transistors	158	342	plastic parts (NL)	234	437			
			shields, magnetic (AN)	233	435			
Microwaves & Lasers			sockets, battery (NL)	241	453			
amplifier, X-band	196	379	splices, butt	222	412			
attenuators, microwave	198	382	springs and strips (NL)	241	454			
couplers, directional	200	384	tape, electrical	222	413			
diodes, varactor	200	385	tape, polyimide	224	417			
ferrite devices (NL)	240	450	tubing, shrinkable (ES)	226	419			
gaskets, castable	198	381						
instruments (NL)	241	455						
mixer-preamps	200	383						

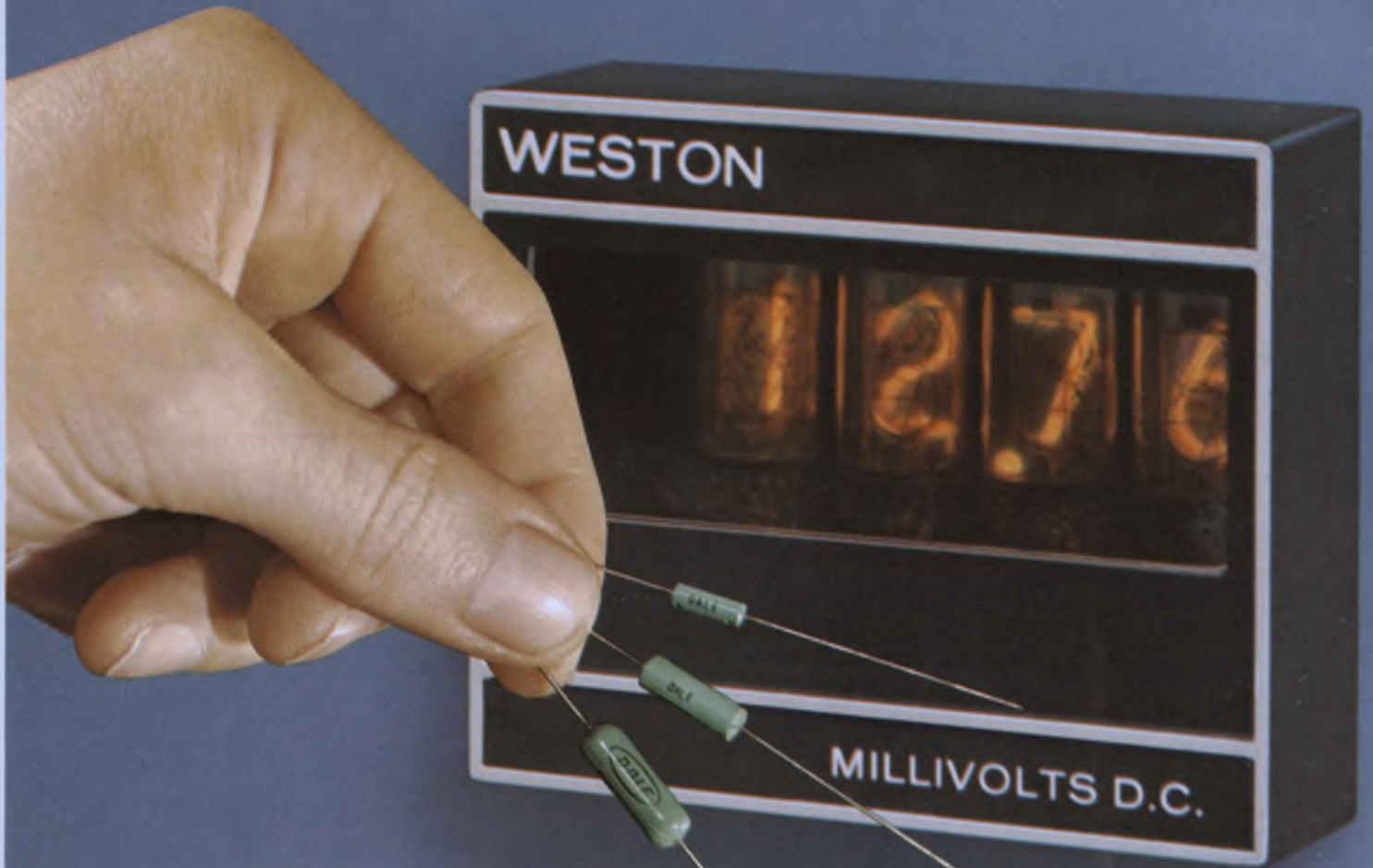

metal film resistors for precision behind the numbers

Wherever precision measurement calls for resistors with good stability, closely-controlled TC and low noise, you're apt to find Dale Metal Film. There are three good reasons: MIL-R-55182, MIL-R-10509 and MIL-R-22684. This versatility has turned a good source into a great one. Whether you want Established Reliability or just want to squeeze more precision into a pennies-per-part budget, Dale Metal Film is the answer.

Call today: 402-564-3131

Weston Instruments growing line of digital panel meters makes broad use of Dale MF resistors. These precision 4-digit meters use Dale RN-60, RN-65 and RN-70 styles to control input resistance and critical bias functions in an amplifier circuit.

DALE MF—THE ALL-PURPOSE LINE

Mil. Spec: MIL-R-55182 = RNR-55, 60, 65; RNC-55, 60, 65; MIL-R-10509 = RN-50, 55, 60, 65, 70, 70F, 75, 80; MIL-R-22684 = RL-07, 20.

Resistance Range: 10 ohms to 10 megohms, depending on size and TC.

Tolerance: MIL-R-55182 = .1% (B), .25%, .5% (D), 1% (F);

MIL-R-10509 = .1%, .25%, .5%, 1%; MIL-R-22684 = 2%, 5%.

Temperature Coefficient: 11 standard TC's available in -55°C to +175°C range.

DALE ELECTRONICS, INC.

1328 28th Ave., Columbus, Nebraska 68601

In Canada: Dale Electronics Canada, Ltd.

A subsidiary of The Lionel Corporation



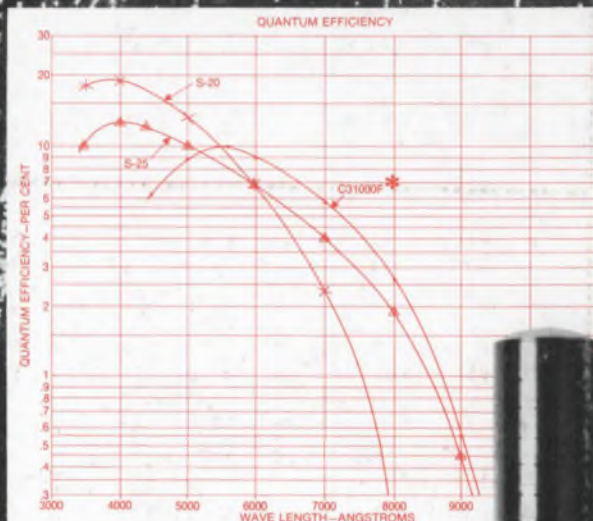
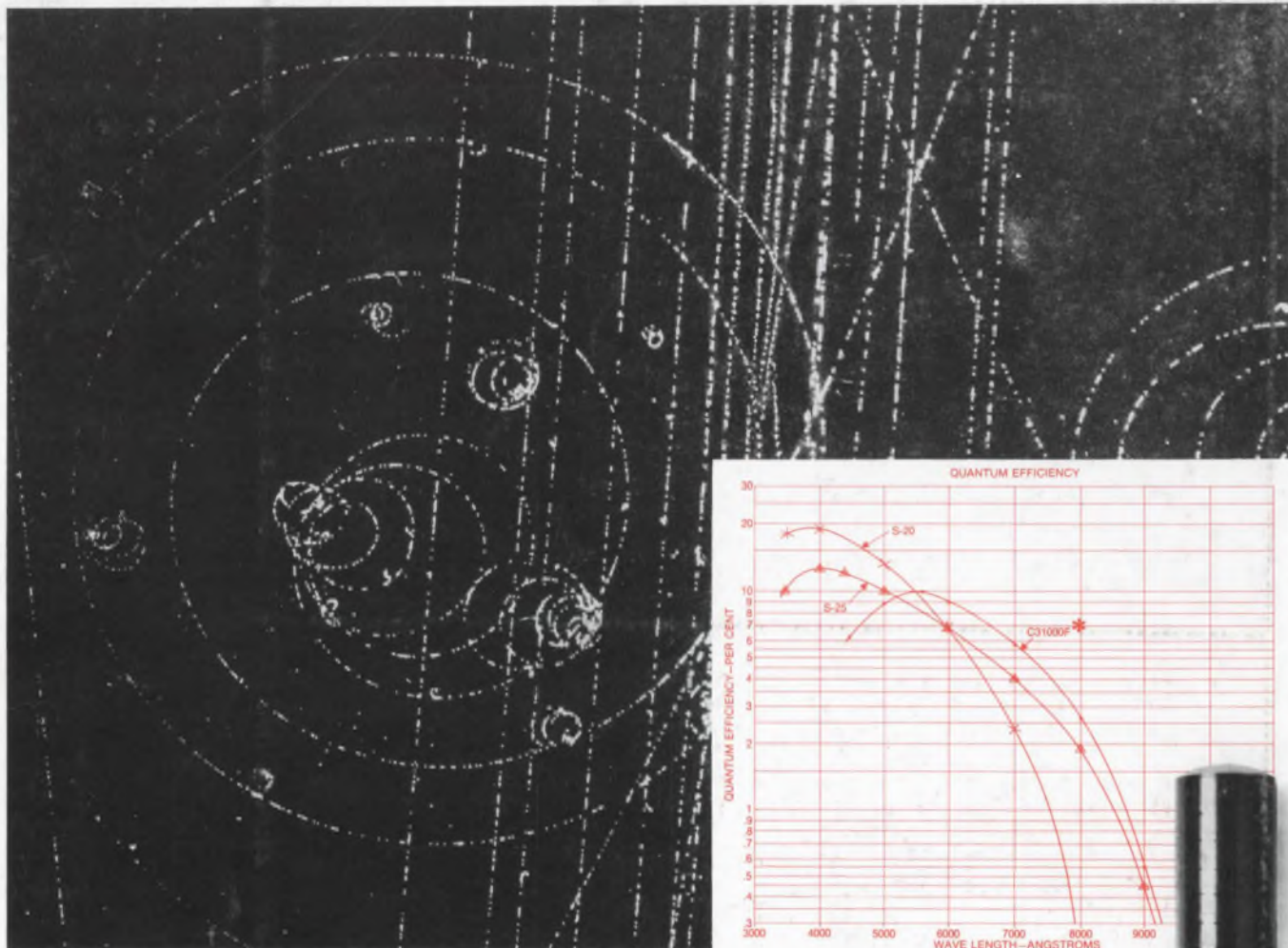

NEW! EXTENDED RED RESPONSE RCA-C31000F QUANTACON PHOTOMULTIPLIER

The C31000F is new! It's an extended-red, multi-alkali cathode version of the previously-announced C31000D. C31000F is recommended for applications in the red area of the spectrum, particularly laser detection and Raman spectroscopy. The latest addition to the RCA QUANTACON photomultiplier family, it is characterized by the use of Gallium Phosphide as the secondary emitting material on the first dynode.

Gallium Phosphide boosts the single electron resolution of this newest RCA QUANTACON photomultiplier as much as 10 times over that of tubes using conventional dynode materials. As a result, it is possible for this 2" dia. light detector, whose prototype is the industry-famous 8575, to discriminate between light-producing phenomena that generate one, two, three, or four photoelectrons.

Developed by RCA, the use of Gallium Phosphide places the C31000F and other RCA QUANTACON photomultipliers at the forefront of devices that can reveal nuclear, astronomical, and biochemical events never seen before.

For more information on this 12-stage device, and other RCA QUANTACON photomultipliers, including the C31000D and the 5-inch C70133B, see your local RCA Representative. For technical data on specific types, write: RCA Electronic Components, Commercial Engineering, Section E18P-1, Harrison, N. J. 07029.

* Minimum Q.E. at 8500 Å is 1%, corresponding to a radiant sensitivity of 7 mA/W. C31000E is the flat-faceplate version of the C31000F which has a curved faceplate.

RECEIVED
MAY 20 1969
CALMA CO.

RCA