

Electronic Design

FOR ENGINEERS AND ENGINEERING MANAGERS

VOL. 17 NO.

6

MARCH 15, 1969

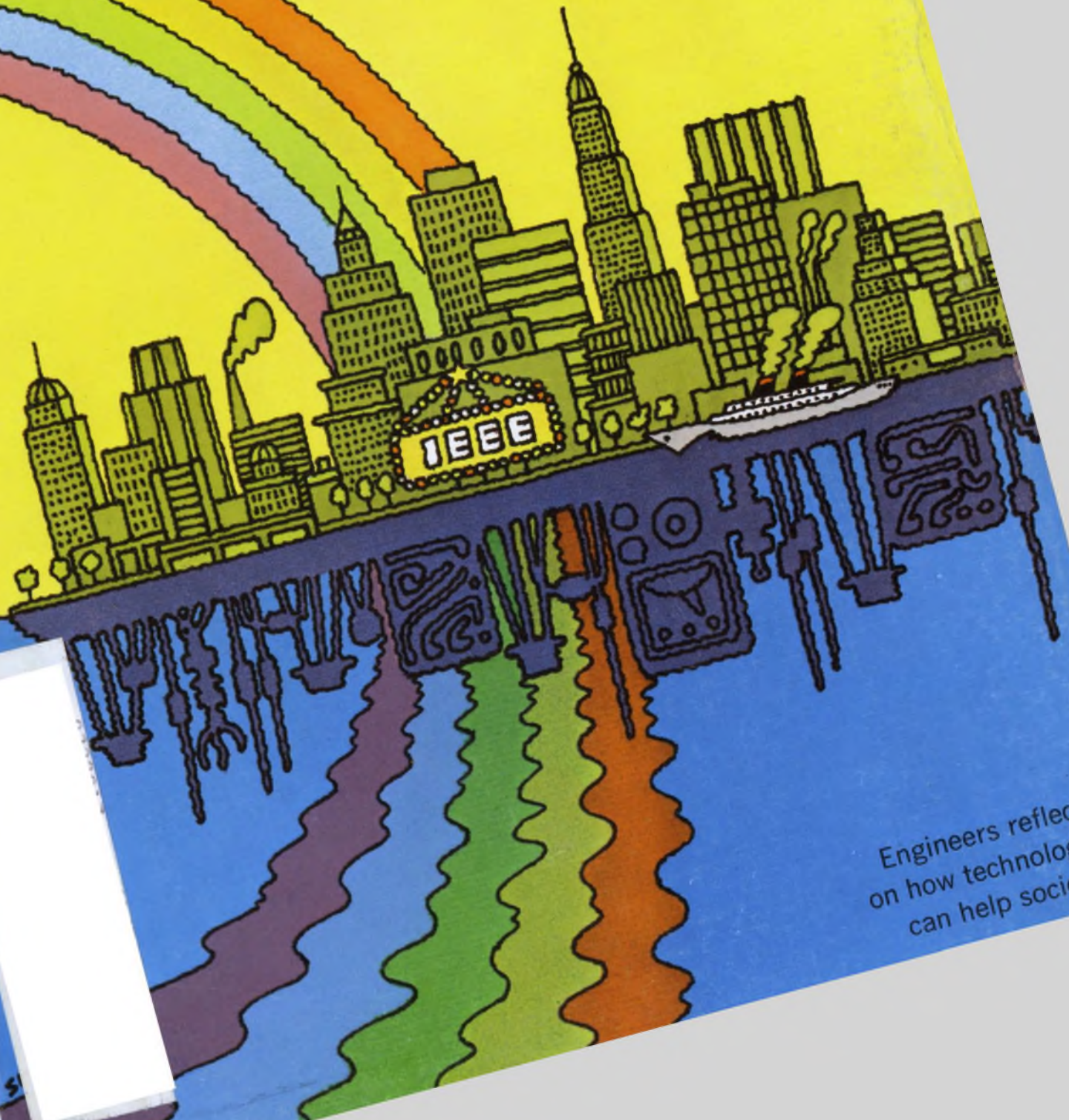

Engineers reflect
on how technology
can help society

We furnish the building blocks... you design your system. You can go from a single generator to a complex system simply by connecting the building blocks.

The new HP 1900 pulse system is a new generation of plug-in pulse generators—a new all-around bench instrument that solves both high and low voltage rise and fall problems. It is especially suitable for testing magnetic memory devices where high current output is required, or testing MOS logic devices requiring high voltages.

The HP 1900 now provides 50 V, 1 amp pulses into 50 Ω up to 100%

duty cycle, variable rise and fall times from 7 ns to 1 ms, 25 Hz to 25 MHz rate, delay from 15 ns to 10 ms—all for a total price of \$2750. For 2 to 16-bit word format, add the 50 MHz HP 1925A Word Generator. You can use this plug-in to create pseudo-random noise or get a word or its complement in return-to-zero or non-return-to-zero modes. An option makes the 1900 system electronically programmable.

And the new 1900A system is no paper tiger! All its specifications are *working* specs — if anything, conservative.

Plug-in design of the 1900A system allows you to select the best performance combination for your requirements — and modify later to

meet your changing needs. Soon-to-come are new modules providing sub-nanosecond rise and fall times, lower power output stages at much lower prices — and more exotic modules with excitingly new state-of-the-art specifications.

Start designing your pulse generator system today with the *expandable* HP 1900A system. Call your nearest HP field engineer for complete specifications. Or, write to Hewlett-Packard, Palo Alto, California 94304. Europe: 1217 Meyrin-Geneva, Switzerland.

It's expandable — the new HP 1900 pulse system for clean, controllable, high-power pulses!



089/1

HEWLETT  PACKARD

SIGNAL SOURCES

INFORMATION RETRIEVAL NUMBER 228

On display at IEEE Show.

New Instrument Showcase



Real-Time Analyzer

The Type 1921 Real-Time Analyzer is a new generation analyzer. It performs real-time one-third octave spectrum analysis in the frequency range from 3.15 Hz to 80 kHz employing a unique digital detection scheme to achieve performance unattainable with analog techniques. The major components of the analyzer are the Type 1925 Multifilter and the Type 1926 Multichannel RMS Detector.

Sweep-Frequency Reflectometer



Reflectometry has been greatly simplified with GR's new 1641. It gives direct, precise readings of SWR and insertion loss (in dB) from 20 MHz to 7 GHz in two ranges in sweep- or single-frequency operation . . . residual SWR typically <1.02 . . . direct reading in SWR and loss . . . all coaxial hardware internal . . . precalibrated, simplified operation . . . complete - add only source and 'scope.

Digital Voltmeter Calibrator



Calibrate your dc digital voltmeters quickly and easily with our highly stable 1822 calibrator . . . 100- μ V to 1111.1-V output . . . 10-ppm stability . . . mobile secondary standard . . . automatic stepping, programmable.

Counter

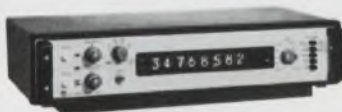

New 35-MHz IC counter-timer (the 1191-B) measures frequency, frequency ratio, time interval, period average, and period between successive pulses . . . 1- μ s minimum display time . . . frequency range extends to 500 MHz with GR scaler . . . 10-mV sensitivity (to 20 MHz) . . . optional high-precision time base and BCD data output.

Pulse Generator



The 1340 is the widest-range pulse generator in its price class, only \$395 in the USA. Extremely useful for testing IC's . . . 0.2 Hz to 20 MHz . . . 2.5 s to 25 ns duration . . . 5-ns rise time . . . 10-V output with ± 1 -V offset . . . amplitude, period, duration modulation.

Impedance Comparator



Versatile new 1654 Impedance Comparator with percent-deviation read-out of magnitude and phase angle . . . 0.003% comparison accuracy . . . 100 Hz, 1, 10, and 100 kHz . . . wide impedance ranges. Addition of new 1782 Analog Limit Comparator increases measuring speed of 1654 up to 4 components per second, provides limit-control settings and display lights for manual sorting. Optional models operate automatic sorting devices.

Random-Noise Generator



GR's new random noise generator, the 1383, generates wide-band noise of uniform spectrum level . . . 20 Hz to 20 MHz, ± 1 dB . . . 30- μ V to 1-V output, open-circuit . . . 50-ohm output impedance . . . meter and 10-dB-per-step attenuator.

Megohmmeters



Introducing two new megohmmeters - both are direct-reading, safe, stable, and easy to operate. The 1863 is the choice for production and inspection uses . . . 5 test voltages: 50 to 500 V . . . 50 k Ω to 20 T Ω ($2 \times 10^{13}\Omega$). The more flexible 1864 is best for the laboratory . . . 200 test voltages: 10 to 1000 V . . . 50 k Ω to 200 T Ω ($2 \times 10^{14}\Omega$).

Also new . . .

An attractive quantity-discount policy. All GR products are subject to a quantity discount ranging from 3% for 2-4 units to 20% for 100 units.

See these and many more exciting new instruments at the IEEE Show, Booth 2E26-2E36.

GENERAL RADIO

New Datapulse 112 gives you higher rep rates (to 125 MHz), faster rise times (1.3ns) and narrower pulses (to 3ns)—yet it costs you hundreds of dollars less.

What's more it has all the pulse parameter control you need to test high-speed circuits: simultaneous $\pm 5V$ outputs, single or double pulses, independent dc offset to $\pm 2V$, widths from 3ns to 5 ms, and delays to 5 ms.

You can control the pulse train with external gating pulses, produce complementary outputs for duty cycles approaching 100%, set the baseline at exact ground with a switch, and reduce rep rate to 10 Hz for low-speed testing.

No other high-speed pulser offers so much for just \$1595.00 . . . and the 112 is being delivered now. For a demo contact Datapulse Division, Systron-Donner Corporation, 10150 W. Jefferson Blvd., Culver City, Calif. 90230 213-836-6100.

Why buy a high-priced 100 MHz pulser? Here's 125 MHz for \$1595!



Oscilloscope photo. 2ns/div, 2v/div.

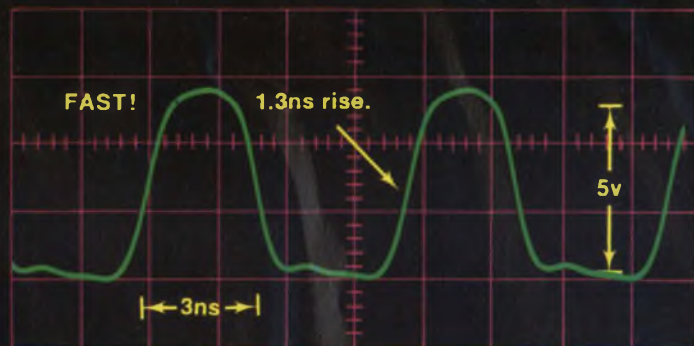

DATAPULSE

SYSTRON  DONNER

Another first. One of 135 Systron-Donner instruments

Electronic counters	Analog computers
Pulse generators	Digital panel meters
Microwave frequency indicators	Microwave signal generators
Digital clocks	Laboratory magnets
Memory testers	Data acquisition systems
Digital voltmeters	Time code generators
Time code generators	Microwave test sets
Data generators	

NEWS

- 21 News Scope
- 25 **IC applications abound at solid-state show**
- 36 **Graphics: The future in design by computer**
- 52 **The friendly grey computer can show you how to put showmanship in your designs.**
- 45 Washington Report
- 62 Letters
- 76 Sidelights of the Issue
- 79 **Editorial: Death of an aquanaut poses touchy questions**

IEEE-USA—A special section

Pages U81-U192

TECHNOLOGY

- 194 **Select the right FET for your rf amplifier** by systematically trading off performance goals. Use separate methods for fixed-gain and agc designs.
- 204 **Reduce radar display clutter** by combining a logarithmic receiver with video processing to achieve gain-time control.
- 210 **Design notch networks the easy way.** Here's a technique for building them with standard fixed-value parts from 10% -tolerance stock.
- 216 **Build stable rf servo loops** that can help reduce both linear and nonlinear temperature drifts. Maximizing the sampled signal is the key.
- 228 **Measure the sweep linearity of fm pulses** accurately with this simple technique. A sampling scope serves as the basis for the test setup.
- 234 **There are many ways to fire an SCR**—but unfortunately there are more bad ways than good. Here's a rundown on firing that should help separate the two.
- 240 **Speed inverse Laplace transform solutions** with a time-shared digital computer program. A three-pole Butterworth filter illustrates the approach.
- 250 Ideas for Design

PRODUCTS

- 290 **Instrumentation:** Universal logic test system integrates computer control.
- 304 **ICs and Semiconductors:** Plastic phototransistors cost less than a dollar.
- 310 Components
- 318 Data Processing
- 322 Modules and Subassemblies
- 328 Packaging
- 335 Microwaves and Lasers
- 340 Production

Departments

- 16 Designer's Datebook
- 286 Books
- 344 Evaluation Samples
- 346 Design Aids
- 348 Application Notes
- 354 New Literature
- 376 Advertisers' Index
- 379 Information Retrieval Service

Information Retrieval Service Card inside back cover
COVER CREDIT: Art Sudduth

CUSTOM CIRCUITS OFF-THE- SHELF...

ALMOST.

With Fairchild's new MOS MICROMOSAIC™ arrays, you get low-cost, custom digital subsystems so fast they're almost off-the-shelf.

The key to this lower cost and rapid turnaround time is the new computer-aided design technology we've developed for our MICROMOSAIC arrays. The entire design sequence — logic simulation and verification, cell selection and placement, artwork and test sequence generation — is performed by the computer directly from a logic diagram. Logic cells for the arrays are selected from a library of more than 45 pre-designed MOS functions (using either high- or low-threshold technology for MOS or bipolar interface compatibility). Each completed MICROMOSAIC array consists of only the logic your application calls for.

With MICROMOSAIC arrays, your small, custom computers and special-purpose logic functions for industrial or military control systems can be competitive with standard products on price and delivery. And way ahead on performance. (It offers so much, we're using MICROMOSAIC for some of our own standard products.)

Take the first step toward getting this technology into your systems. Write for our Micromosaic Array Design Handbook today. It'll tell you how much integration we can apply to your system. And give you an idea of how much time and money we can save you doing it.

FAIRCHILD
SEMICONDUCTOR

Fairchild Semiconductor A Division of Fairchild Camera
and Instrument Corporation Mountain View, California 94040
(415) 962-5011 TWX: 910-379-6435.

INFORMATION RETRIEVAL NUMBER 4

“WHEN IT COMES TO REED RELAYS,

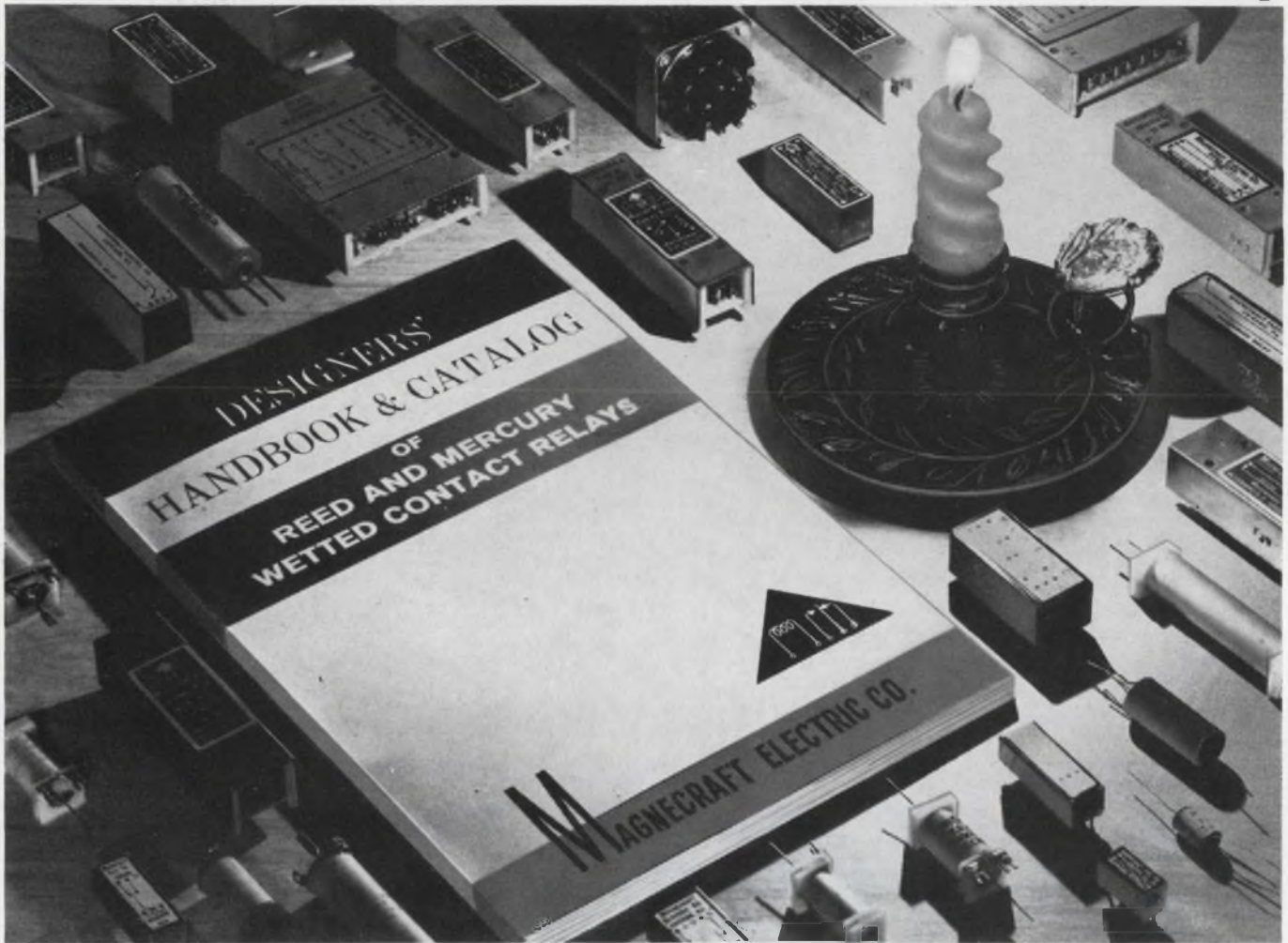

MAGNECRAFT WROTE THE BOOK”!

After developing the largest stock of dry reed and mercury-wetted relays on the market today, we had enough experience to write a book. So, we did! An 80-page handbook, in fact. It starts off with a glossary of terms and carries through to a complete product data section. In addition, there is information on applications and design considerations, how to specify relays, principles of operation and testing procedures.

Free copies are available to qualified circuit designers, engineers and others involved in the electrical or electronic fields. Write for yours. We may never win a Nobel Prize for literature, but if they ever offer one for advancements in reed relay development — well, that's another story.

Manufacturing Stock Relays for Custom Applications

Magnecraft[®] ELECTRIC CO.

5575 NORTH LYNCH AVENUE • CHICAGO, ILLINOIS 60630 • 312 • 282-5500

See us at Booth number 3J16 at IEEE Show

INFORMATION RETRIEVAL NUMBER 5

INFORMATION RETRIEVAL NUMBER 6 ►

One of the toughest demands ever thrown at coaxial cable designers came along with the new high-flying, high performance manned military aircraft such as the F-111, and EA-6B etc. A lightweight, flexible cable with low VSWR and high temperature capability was needed for easy installation in tight locations, to accommodate aircraft length tolerances, and to connect to shock mounted equipment.

Our response was to develop and qualify Flexispline*, a flexible coaxial cable with a TFE air-space dielectric which operates to 12 GHz. It handles high cw power levels at elevated temperatures and altitudes while exhibiting low loss and low VSWR. Straight and right angle connectors of N, TNC and SC types are available. Typical VSWR for a 20-foot cable assembly is 1.25:1 from 4 to 8 GHz and 1.35:1 from 8 to 12 GHz.

Times also furnishes semiflexible coaxial cable having corrugated aluminum outer conductor with TFE air-cell

dielectric (no pressurization required) . . . with even lower loss and higher power-handling capability (see graph). We've won our wings on many tough interconnect problems. Let us work with yours. *Test Data Available

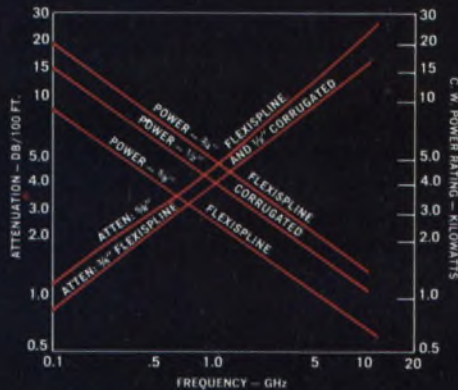

T
TIMES
WIRE & CABLE
 Subsidiary of INSILCO
 Wallingford, Conn.

How We Won Our Wings.

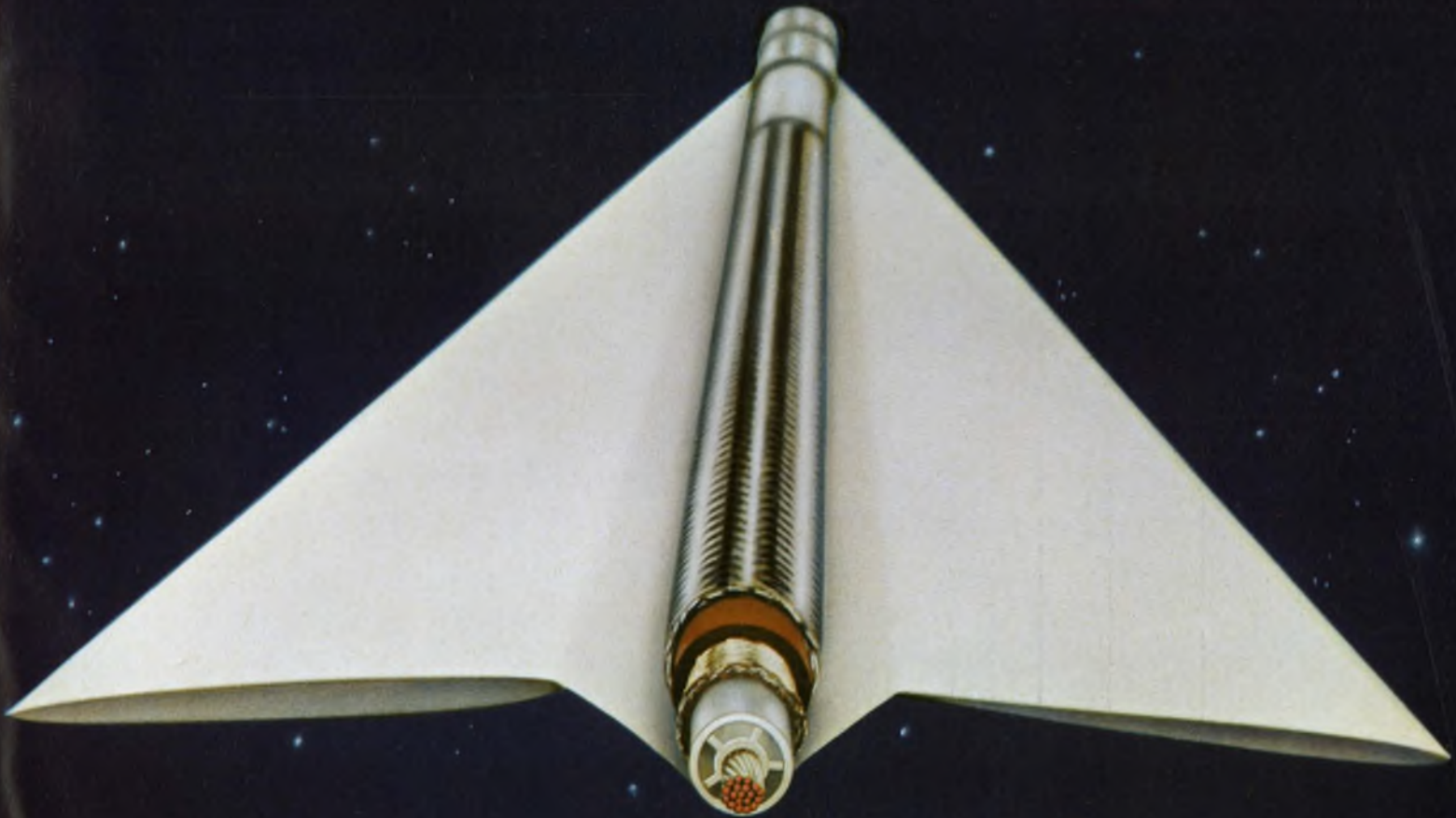

Pick the
BEST IC
for the job

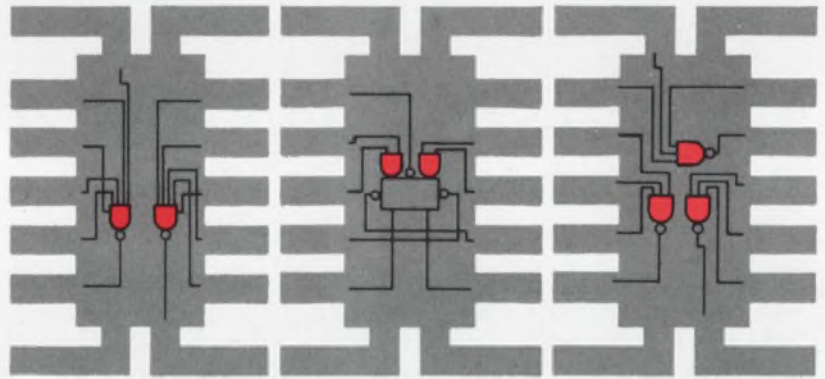

Best line of defense against

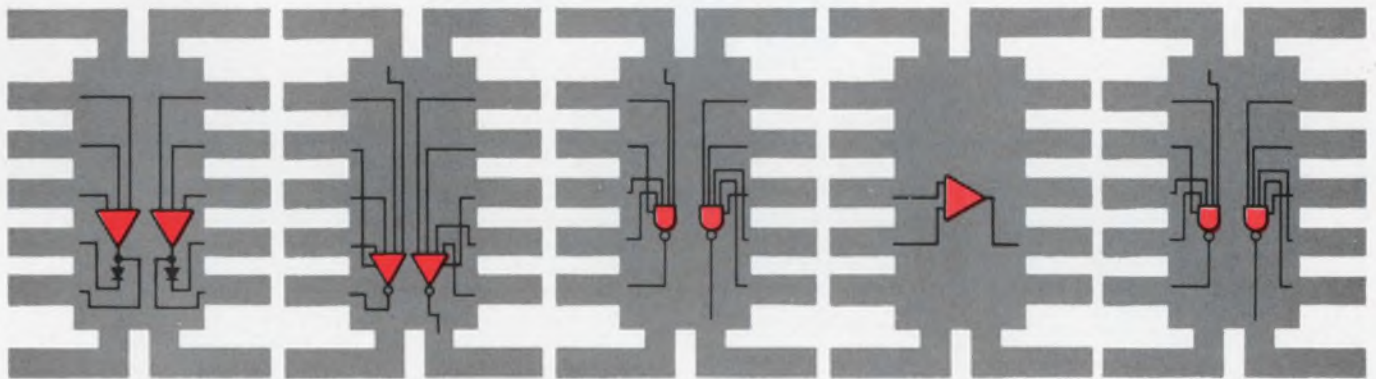

radiation environment

Radiation offers the circuit designer two orders of magnitude improvement in hardening levels over conventional PN junction devices. This is accomplished by dielectric isolation, thin-film resistors over oxide, small-device geometries, shallow diffusions and other special design techniques. So when you pick the Best IC for a radiation environment application, doesn't it make sense to come to the leader in hardened circuit technology?

Our line of defense consists of 930 series DTL, a level shifter, a line driver and a linear 709. These are not prototype circuits. We can deliver Dual 4 Input; Dual 4 Input Power or Triple 3 Input Gates; Clocked Flip-Flop; Dual 4 Input Buffer; Dual Level Shifter; Dual Line Driver and 709 Operational Amplifiers. With the exception of the Dual Level Shifter and Dual Line Driver, all are plug-in replacements for their non-hardened 930 Series and 709 counterparts. The Hardened Dual Line Driver is a pin-for-pin replacement for Radiation's standard RD 209 Line Driver.

Want more information? Contact your nearest Radiation Sales Representative. He'll give you complete details and help you pick the Best IC for the Job.

WE MAKE THE **BEST IC** FOR THE JOB



See these circuits at IEEE Booth 4-H 19-21

RADIATION
INCORPORATED
SUBSIDIARY OF HARRIS INTERTYPE CORPORATION
MICROELECTRONICS DIVISION

RADIATION SALES OFFICES: P. O. Box 476, Lexington, Mass. 02173, (617) 862-1055 • 600 Old Country Road, Garden City, N.Y. 11530, (516) 747-3730 • 2600 Virginia Ave. N.W., Washington, D.C. 20037, (202) 337-4914 • 6151 W. Century Blvd., Los Angeles, Calif. 90045, (213) 670-5432 • Saratoga, Calif., (408) 253-5058 • P. O. Box 37, Melbourne, Fla. 32901, (305) 727-5430 • International Sales: Marketing Department, P. O. Box 37, Melbourne, Fla. 32901, (305) 727-5412

INFORMATION RETRIEVAL NUMBER 8

the lowest priced military-quality IC voltage regulator

\$0.95
each
at quantities of 1000



General Instrument, the "#1 Power" in hybrid micro-circuitry, introduces the NC-531 hybrid voltage regulator, the first and only "Class A" integrated circuit voltage regulator available at a "Class C" price. Internally set to $15V \pm 100 \text{ mV}$, the NC-531, unlike monolithic IC voltage regulators, requires no external components for normal operation. Provisions have been included in the design to allow the user to obtain other voltages and currents easily with a minimum of additional components in order to provide maximum versatility in the widest variety of applications.

The NC-531 in a TO-100 package is immediately available in quantity, off-the-shelf from your authorized General Instrument distributor. For full information on the NC-531 and the broadest line of hybrid ICs available anywhere, write for your "Hybrid Power" data-pak today.

PARAMETER	MAX	MIN
Input Voltage	40	—
Output Voltage (externally adjusted)	38v	8v
Load Current	250ma	0ma
Operating Temperature	+125°C	-55°C
Storage Temperature	+175°C	-65°C
Power Dissipation $T_c = 25^\circ\text{C}$ (without heat sink)	500mw	—



CIRCUIT PERFORMANCE RATINGS:

$T_c = +25^\circ\text{C}$ $V_{in} = +19\text{v}$ $I_L = 40\text{ma}$
(unless otherwise noted)

CHARACTERISTIC	TEST CONDITION	MIN	TYP	MAX	UNITS
Output Voltage	Internally Set	14.9	15.0	15.1	Volts
Input/Output Differential	$V_{in} - V_{out}$ (without external pass transistor)	2	—	—	Volts
Line Regulation	$V_{in} 19\text{v} \pm 10\%$	—	.5	1	%
Load Regulation	0 to 40ma	—	.05	.075	%
Load Regulation	0 to 100ma	—	.1	.25	%
Ripple Rejection		—	40	—	db
Output Z	DC to 100KC	—	.2	.5	Ω
Temperature Coefficient		—	0.9	1.5	mv/°C

(In Europe write: General Instrument Europe S.P.A., Piazza Amendola 9, 20149 Milano, Italy.)



GENERAL INSTRUMENT CORPORATION • 800 WEST JOHN STREET, HICKSVILLE, L. I., NEW YORK



Cimron leapfrogs the DVM industry —and there's a reason!

A number of reasons, to be exact! The all-IC Model 6753 is the next generation in digital multimeters—the lowest-priced autoranging instrument that will read DC from 100 nanovolts to 1099.9 volts and DC ratios. A fast-tracker, too—ideal for systems work. The closed loop tracking logic continually samples output at the rate of 14 readings a second, with accuracies of $\pm 0.001\%$ full scale $+0.005\%$ of reading. Like to learn about automatic desensitization? repetitive mode? out-of-range indication? Just ask how they can

help you. Important to you is the basic design, featuring optional IC plug-ins to extend capability which you can install yourself without technical service! Options include a 4-range AC converter with 10 microvolt sensitivity, a 5-range ohms converter, remote programmability, five print-out options. You can't beat the base price of \$2990! Cimron's **customer concern** continues to provide what you really need at the lowest possible price. Write Cimron, Dept. C-130, 1152 Morena, San Diego, Calif. 92110.

LEAR SIEGLER, INC.



CIMRON DIVISION

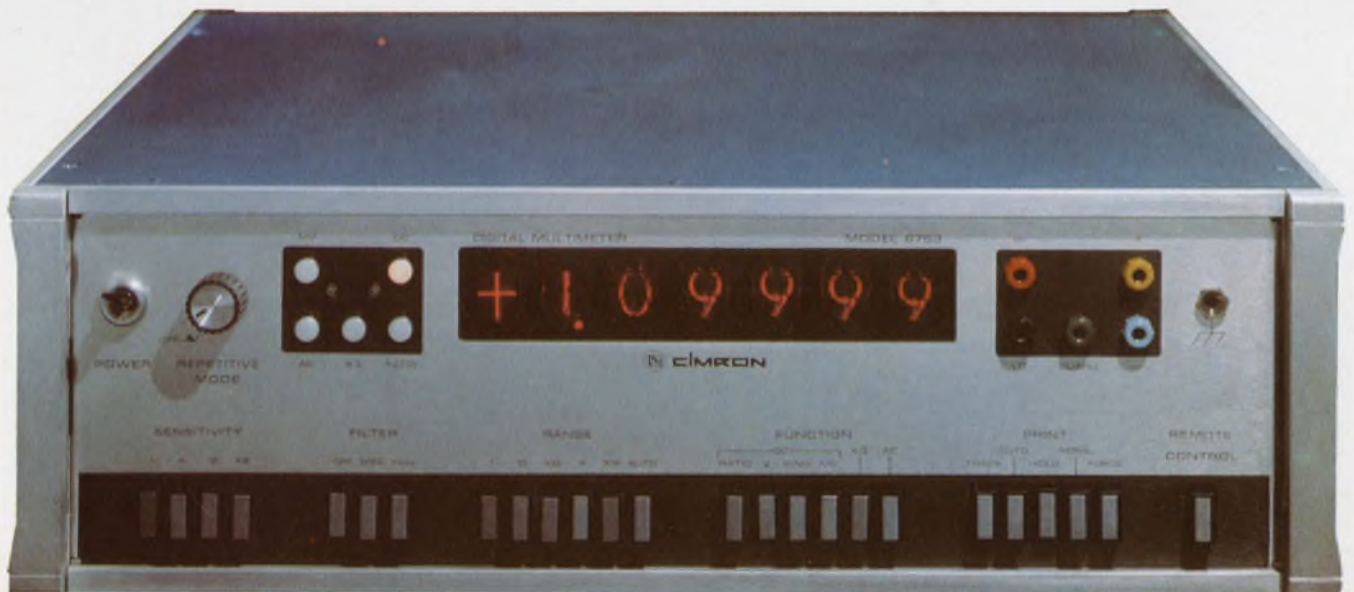

MECL III is still
twice as fast
as the fastest.



- where the priceless ingredient is care!



Now, 10 **MECL III** circuits are available in production quantities

350 MHz Flip-Flops head list of devices in three systems-oriented MECL families

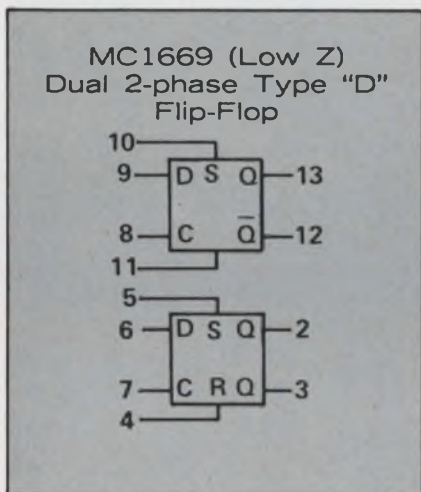
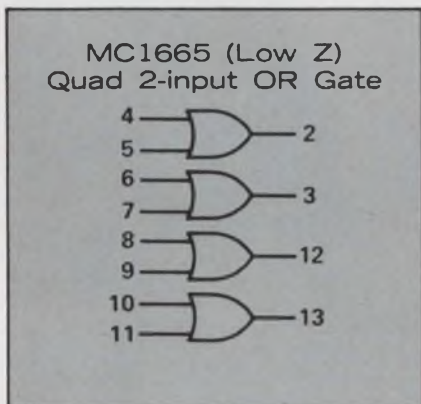

Your digital logic system is still only half as fast as it could be — if you're not using MECL III — the World's fastest, most advanced form of integrated circuit logic. Now you have seven new functions including one-nanosecond gates and a variety of flip-flops with toggle/shift frequencies of 350 MHz — with either high or low impedance inputs. And, they're all available in production quantities, with still many other types in the development stages. Here are the 7 new types:

- MC1661S (Low Z) Dual 4-input OR/NOR Gate
- MC1663S (Low Z) Quad 2-input NOR Gate
- MC1664S (High Z) Quad 2-input OR Gate
- MC1665S (Low Z) Quad 2-input OR Gate
- MC1667S (Low Z) Dual, 2-phase R-S Flip-Flop
- MC1669S (Low Z) Dual, 2-phase, Type "D" Flip-Flop
- MC1671S (Low Z) Dual, Single-phase, Type "D" Flip-Flop

An "Advance Applications Information" brochure is now available to assist you with your MECL III designs. Send for it.

INFORMATION RETRIEVAL NUMBER 91

Compatible MECL II... still faster than saturated logic!

You may not need or want quite as much speed for other sections of your digital system. So, there's a MECL series that offers 4 nS propagation delay and approximately 100 MHz toggle/shift fre-

quencies. That's MECL II. And, now there are more than 65 devices in this unique series, counting the four new ones below:

- MC1028L Dual 4 nS, 4-Channel Data Selector. (The first low-cost multi-layer metal circuit that is commercially-available.)
- MC1039L Quad Level Translator.
- MC1040L Quad Latch.
- MC1043L 3-Bit Binary to One-Of-Eight Line Decoder.

Watch for the introduction of these additional 2 nS MECL II Circuits!

- MC1062 Quad 2-Input NOR Gate
- MC1064 Quad 2-Input OR Gate
- MC1061 Quad Twisted Pair Line Receiver.
- MC1063 Quad Twisted Pair Line Driver. (OR/NOR outputs)
- MC1066 Triple 2-Input Gate With OR/NOR outputs.

All MECL III types (MC1600 series) are currently available from distributor stock in the 14-pin flat pack with stud (for heat sinking).

The MECL II types (MC1000 series) are in the 14 and 16 pin dual in-line ceramic packages. For complete specification data and applications information, circle the reader service number or write to the address below.

INFORMATION RETRIEVAL NUMBER 92

MOTOROLA Integrated Circuits

Motorola Semiconductor Products Inc./P. O. Box 20912/Phoenix, Arizona 85036

Maybe we don't have to run-in every Bodine motor. But why argue with success?

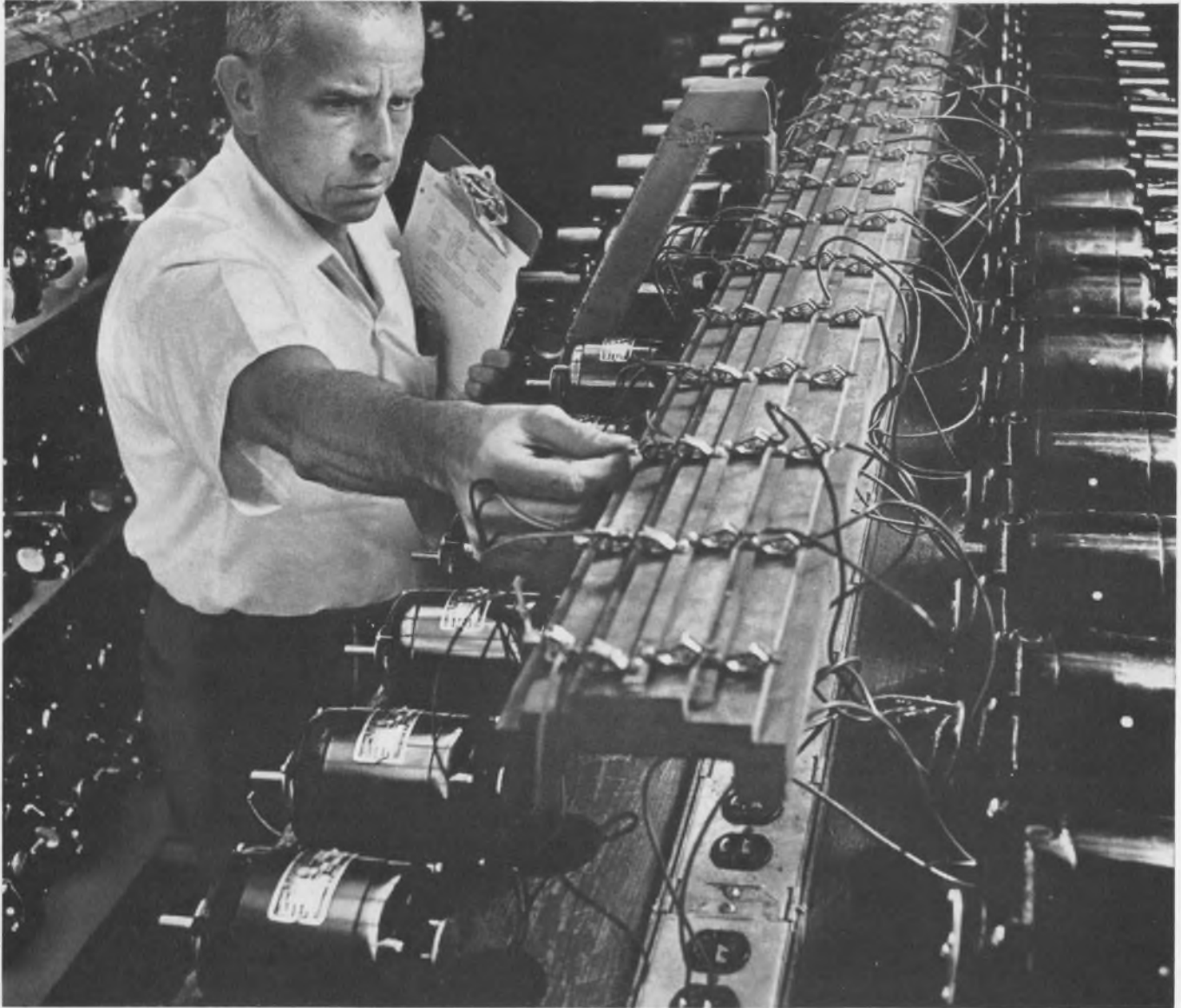

We've always done it this way because customer satisfaction is our main concern.

You expect to receive Bodine fractional horsepower motors whose brushes are seated, whose rotor or armature shafts run free and easy in their bearings. You don't expect to find oil leaks or grounded stator, field or armature windings—for which our run-in department personnel keep a sharp and practiced eye.

You expect to install in your product motors which have been *run*, motors which are *operational*.

Except for non-reducer ball bearing induction types, all Bodine motors undergo run-in of varying durations. We make sure that Bodine motors are in perfect working condition when they leave the factory. They must meet very high standards for quality—the kind Bodine has maintained for over sixty years.

Doesn't your product deserve motors of such quality? Bulletin S describes over 275 stock types and sizes from 1/2000 to 1/6 hp. Write Bodine Electric Company, 2528 West Bradley Place, Chicago, Illinois 60618.



*Bodine motors wear out—
it just takes longer*

BODINE
fractional/horsepower
MOTORS



...the power behind the leading products

telonic's new
log amp detector
has a dynamic range of

105 dB

(without a pit stop)



And that's a long stretch of signal by any standard. This new log amp detector will accept voltage swings as wide as 178,000 to 1, and still provide an output that gives you an on-scale display. Operable over 400 kHz to 130 MHz, the amplifier converts any RF input to a logarithmic value and supplies a linear output for 'scope, meter, or recorder.

Ideal for gain measurement, log plotting, response testing or other applications where the input signal takes wide excursions, this new instrument has built-in Expansion and Zero Offset adjustments to maximize its versatility.

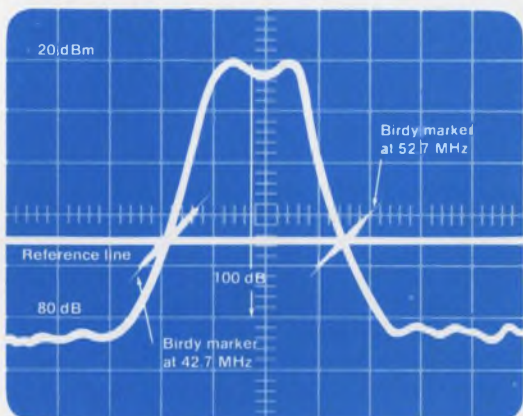

Typical display of narrow band amplifier response indicating 70 dB bandwidth (sensitivity, 20 dB per division)

Other Specifications

Useful Input

Power Range -80 dBm to +20 dBm
 Linear Log Range -70 dBm to +20 dBm
 Departure from Ideal Log Response ± 2 dB
 Tangential Sensitivity -85 dBm

The Model 3353 is a plug-in unit for the 2003 Sweep/Signal Generator System permitting the user to recover swept or CW signals as low as -85 dBm. This allows the user to display wide ranges of input frequencies and power levels without attenuating or changing the oscilloscope sweep settings.



Write For Details — Complete specifications on this new log amp plus the 2003 Sweep Generator are available on request. Write the Marketing Department for File 3353.

TELONIC INSTRUMENTS



A Division of Telonic Industries, Inc.
 60 N. First Avenue
 Beech Grove, Indiana 46107
 Tel: 317 787-3231 • TWX: 810 341-3202

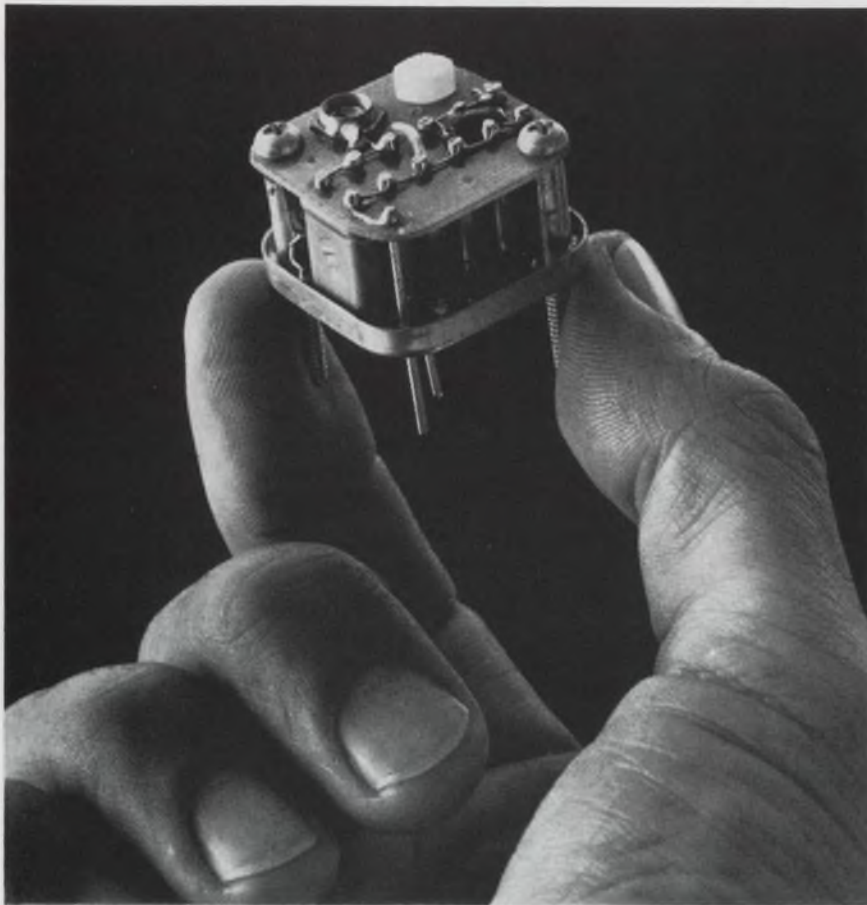

How do you get prototype, special or short-order crystal filters fast?

Listen to Sherold's pitch.

We're right on target with the top-quality crystal technology that assures you of prototypes and short-order specials with the speed and accuracy you need. And the facilities to put your prototypes into low-cost quantity production when the time comes. That's why Sherold is the largest single independent source for both crystal filters and discriminators. And why we've built more PRC and VRC filters than any other supplier. Sherold has the widest range of filter designs in production and the technology to develop and put yours into production, too. From computer-designed monolithic filters to extra-rugged MIL-spec models. Send us the details of your frequency selection problem and we'll listen to your pitch. Write Sherold Crystal Products Group, Tyco Laboratories, Inc., 1510 McGee Trafficway, Kansas City, Mo. 64108. Or phone (816) 842-9792. TWX 910-771-2181.

TYCO

See us at I.E.E. Show - Booth 3E11-14.

INFORMATION RETRIEVAL NUMBER 13

Designer's Datebook

APRIL 1969						
Sun	Mon	Tue	Wed	Thu	Fri	Sat
		1	2	3	4	5
6	7	8	9	10	11	12
13	14	15	16	17	18	19
20	21	22	23	24	25	26
27	28	29	30			

MAY 1969						
Sun	Mon	Tue	Wed	Thu	Fri	Sat
					1	2
3	4	5	6	7	8	9
10	11	12	13	14	15	16
17	18	19	20	21	22	23
24	25	26	27	28	29	30
31						

For further information on meetings, use Information Retrieval Card.

Apr. 16-18

Geoscience Electronics Symposium (Washington, D.C.). Sponsor: G-GE; Maurice Ringebach, Weather Bureau, ESSA. Gramax Bldg., Silver Spring, Md. 20910

CIRCLE NO. 440

Apr. 22-23

Relay Conference (Stillwater, Okla.) Sponsor: NARM & Okla. State Univ.; Dr. D. D. Lingelbach, Engineering and Industrial Extension, Okla. State Univ., Stillwater, Okla. 74074

CIRCLE NO. 441

Apr. 23-25

Southwestern IEEE Conference and Exhiibt (San Antonio, Texas). W. H. Hartwig, Univ. of Texas, EE Dept., Austin, Tex. 78712

CIRCLE NO. 442

Apr. 30-May 2

Electronic Components Conference (Washington, D. C.). Sponsor: G-PMP, EIA; James O'Connell, ITT Hdqs., 320 Park Ave., New York, N.Y. 10022

CIRCLE NO. 443

May 5-7

Electrical & Electronic Measurement & Test Inst. Conference (Ontario, Canada). Sponsor: G-IM; G. E. Schafer, National Bureau of Standards, Boulder, Colo. 80302

CIRCLE NO. 444

May 5-8

International Microwave Symposium (Dallas, Texas). Sponsor: G-MTT; J. B. Horton, POB 5012, Texas Instruments Inc., Dallas, Tex. 75222

CIRCLE NO. 445

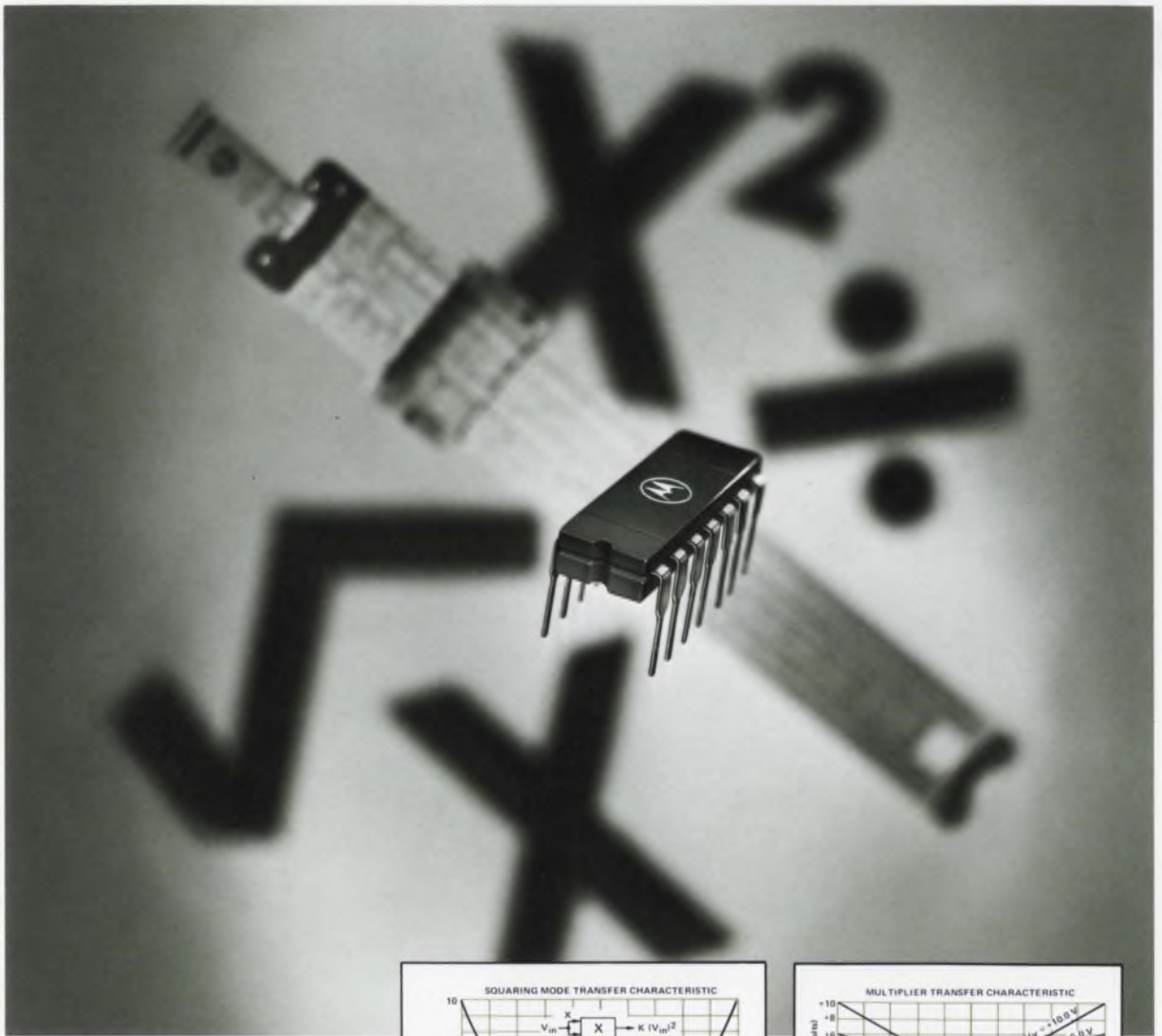

MC1595 is the industry's first true Linear, 4-Quadrant Multiplier IC.

Here is the first element in what promises to be a large family of monolithic, linear multipliers. The MC1595 is designed for uses where the output voltage is a linear product of two input voltages; and, as such, its list of applications is almost limitless, particularly in the control and instrumentation fields.

For example, some of the applications are:

- To Multiply
- To Divide
- To Find Square Root

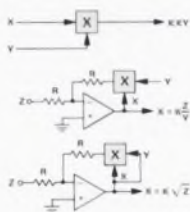

- To Determine Mean-Square

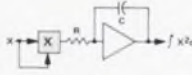

- Frequency Doubling

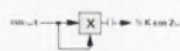

The MC1595 can also be used as a Balanced Modulator/Demodulator, and for Electronic Gain Control among many others. It even has the capability for determining true rms; plus direct power calculations.

- where the priceless ingredient is care!

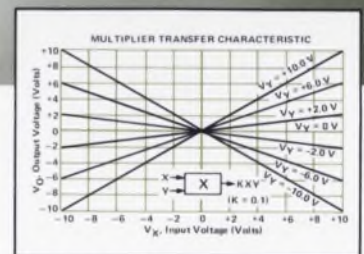
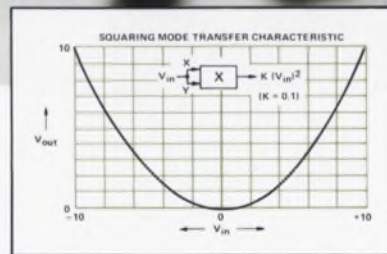

Here are some of the features that contribute to the wide versatility of the MC1595:

- Excellent Linearity — 1% max error "X" input; 2% error max "Y" input.
- Wide Bandwidth — Phase Error $\leq 3^\circ$ from DC to 750 kHz.
- Adjustable Scale Factor.
- Large Input Voltage Range ± 10 V.

For more detailed information, check the specs on the back:



MOTOROLA
Integrated Circuits

Here's detailed data about the first true Linear Monolithic, Four-Quadrant Multiplier... MC1595

Check the specs . . . to see why it's destined to be the new major analog building block.



MOTOROLA Semiconductors
MOTOROLA SEMICONDUCTOR DIVISION

MC1595L

Advance Information

MONOLITHIC FOUR QUADRANT MULTIPLIER

Designed for uses where the output voltage is a linear product of two input voltages. Typical applications include multiply/divide, square root, mean square, phase detector, frequency doubler, balanced modulator/demodulator, electronic gain control.

*When used with an operational amplifier.

- Excellent Linearity - 1% max error on X input, 2% max error on Y input
- Adjustable Scale Factor, K
- Excellent Temperature Stability
- Large Input Voltage Range - ±10 Volts

LINEAR FOUR QUADRANT MULTIPLIER INTEGRATED CIRCUIT

MONOLITHIC SILICON EPITAXIAL PASSIVATED

FEBRUARY 1962 AD-10-1



L-BUFFER CERAMIC PACKAGE CASE 90C P.D. 11B

MC1595L

MAXIMUM RATINGS (T_A = 25°C unless otherwise noted)

Rating	Symbol	Value	Unit
Applied Voltage (V _X - V _Y , V _Y - V _X , V _X - V _{CC} , V _Y - V _{CC} , V _{CC} - V _X , V _{CC} - V _Y)	V _X , V _Y	30	VDC
Differential Input Signal	V _X - V _Y , V _Y - V _X	10	VDC
Maximum Bias Current	I _B	10	mA
Power Dissipation (Package Dissipation)	P _D	750	mW
Operating Temperature Range	T _{OP}	-55 to +125	°C
Storage Temperature Range	T _{STG}	-65 to +150	°C

ELECTRICAL CHARACTERISTICS (V_X = +10 V, V_Y = -15 V, T_A = 25°C, I_B = 1 mA, R_F = R_Y = 15 kΩ, R_L = 11 kΩ unless otherwise noted)

Characteristics	Symbol	Min	Typ	Max	Unit
Linearity					%
Output Error in Percent of Full Scale					
0 ≤ V _X ≤ 10, 0 ≤ V _Y ≤ 15	E _{NS}	—	0.5	1.0	
-10 ≤ V _X ≤ -10, 0 ≤ V _Y ≤ 15	E _{NS}	—	1.0	2.0	
0 ≤ V _X ≤ 10, -15 ≤ V _Y ≤ -15	E _{NS}	—	0.75	—	
-10 ≤ V _X ≤ -10, -15 ≤ V _Y ≤ -15	E _{NS}	—	1.50	—	
Squaring Mode Error	E _{sq}	—	0.5	—	%
Accuracy in Percent of Full Scale after Offset and Scale Factor Adjustment					
T _A = 25°C			0.5	—	
T _A = 55°C to +125°C			0.75	—	
Scale Factor (Adjustable)	K	—	0.1	—	
K = 10 ⁻² to 10 ²					
Input Resistance (R _F = 15 kΩ)	R _{INX} , R _{INY}	—	25	—	M Ohms
Differential Output Resistance (R _L = 11 kΩ)	R _{OUT}	—	25	—	Ω Ohms
Input Bias Current (I _B = 1 mA)	I _B	—	2.0	8.0	μA
Input Offset Current (I _B = 1 mA)	I _{OS}	—	0.2	1.0	μA
Average Temperature Coefficient of Input Offset Current (T _A = -55°C to +125°C)	(TC) _{IO}	—	2.0	—	μA/°C
Output Offset Current (I _B = 1 mA)	I _{OS}	—	10	50	μA
Average Temperature Coefficient of Output Offset Current (T _A = -55°C to +125°C)	(TC) _{OO}	—	20	—	μA/°C
Bandwidth (3 dB)	f _{3dB}	—	2.0	—	MHz
Bandwidth for 1° Relative Phase Shift between V _X and V _Y	f ₉₀	—	700	—	KHz
Common Mode Input Swing (Either Input)	CMV	±11.5	11.5	—	VDC
Common Mode Input Swing (Either Input)	ACM	±8	8	—	VDC
Common Mode Quiescent Output Voltage	V _{CM}	—	21	—	VDC
Differential Output Voltage Swing Capability	V _{OUT}	—	115	—	Vpeak
Power Supply Sensitivity	S _V	—	0.0	—	mV/V
Power Supply Current	I _{CC}	—	8.0	1.0	mA
DC Power Dissipation	P _D	—	130	130	mW

FOUR QUADRANT MULTIPLIER TRANSFER CHARACTERISTIC

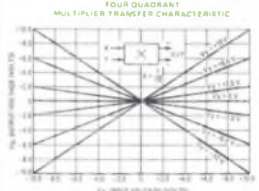

SQUARING MODE TRANSFER CHARACTERISTIC

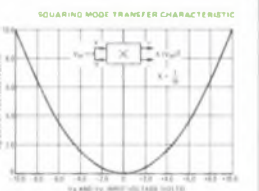

CIRCUIT SCHEMATIC

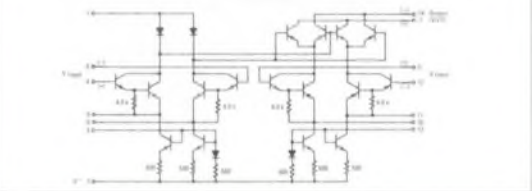

FIGURE 1 - BALANCED MODULATOR (See Note 1)



FIGURE 2 - AMPLITUDE MODULATOR (See Note 1)



FIGURE 3 - BALANCED MODULATOR (See Note 1)



FIGURE 4 - AMPLITUDE MODULATOR (See Note 1)



FIGURE 5 - BALANCED MODULATOR (See Note 1)



FIGURE 6 - AMPLITUDE MODULATOR (See Note 1)



FIGURE 7 - BALANCED MODULATOR (See Note 1)



FIGURE 8 - AMPLITUDE MODULATOR (See Note 1)



FIGURE 9 - BALANCED MODULATOR (See Note 1)



The MC1595 Multiplier is currently available from distributor stock in the 14-pin dual in-line ceramic package. For complete specifications and applications information, circle the reader service number from the preceding page, or write:

The circuitry shown external to Motorola products is for illustration purposes only, and Motorola does not assume any responsibility for its use or warrant its performance or that it is free from patent infringement.



Coming to the IEEE Show? Come to where the ideas happen. Booth 2E47-49.

nimo™

four decade display tube

Now, a new dimension in electronic display at a low, low price. IEE presents the Nimo™ four decade display tube at the unheard of price of \$3.50 a decade.

Single plane presentation, variable brightness, minimum power consumption, temporary data storage, but primarily *four bright legible decades*.

The new four decade Nimo™ display tube is only 1.135" in diameter with

$\frac{3}{8}$ " high characters in various colored phosphors.

We've reduced space requirements 75%, lowered the cost to compete with gas discharge tubes, and put the necessary electronics onto one circuit board boasting features like:

- 100% digital—no analog yoke control problem
- No character generation required
- All inclusive decoding and deflection

- No precision power supplies required
- Only *one* non critical adjustment
- MSI components used throughout

No wonder Nimo™ is called The Uncommon Readout, for IEE has made the unique commonplace. We've been improving on the readout art for many years and feel our four decade Nimo™ display is quite a performer. So will you... at \$3.50 a decade.

P.S. A six decade is on the way.

The uncommon readout.



Industrial Electronic Engineers, Inc.
7720 Lemona Ave., Van Nuys, California 91405
Telephone: (213) 787-0311 • TWX 910-495-1707

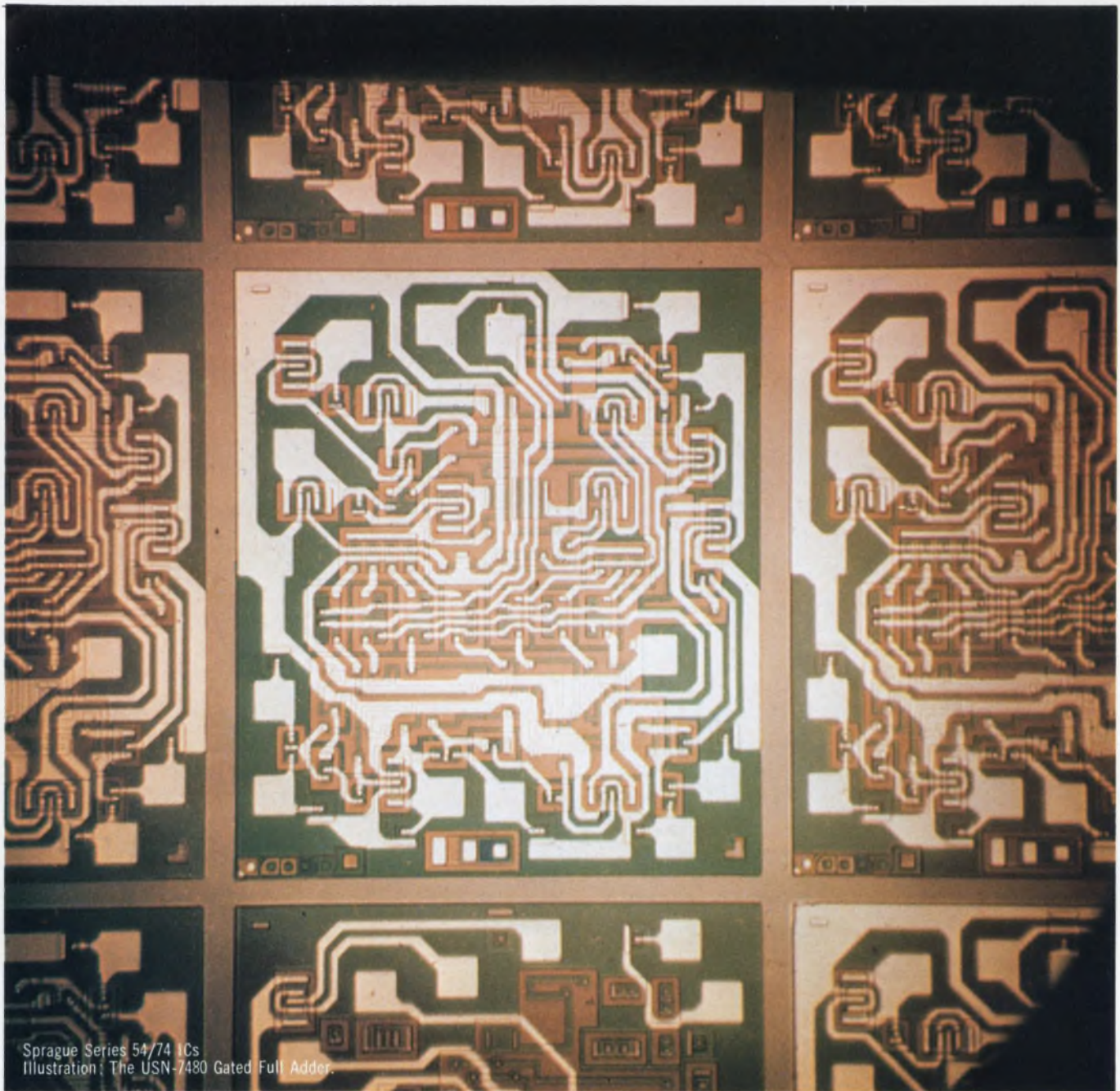

Sprague Series 54/74 ICs
Illustration: The USN-7480 Gated Full Adder.

Look. Look ahead with Series 54/74 arrays.

You reduce package count, simplify design, and lower costs when you design-in the complete Sprague line of Series 54/74 circuits. And make full use of the arrays.

From arithmetic to readout, it makes sense to go Sprague, where you get full line, complete specs, competent service, and on-time deliveries.

OUR ARRAY OF ARRAYS

Decade Counter	USN-7490	4-Bit Binary Full Adder	USN-7483
Divide-By-Twelve	USN-7492	8-Bit Shift Register	USN-7491
4-Bit Binary Counter	USN-7493	BCD Decoder/Driver	USN-7441
Gated Full Adder	USN-7480	Quad Bistable Latch	USN-7475
2-Bit Binary Full Adder	USN-7482		

Call Sprague Info-Central (617) 853-5000 extension 5474.

Or for your copy of Sprague's complete Series 54/74 specification data, circle the reader service number below.

INFORMATION RETRIEVAL NUMBER 16



News

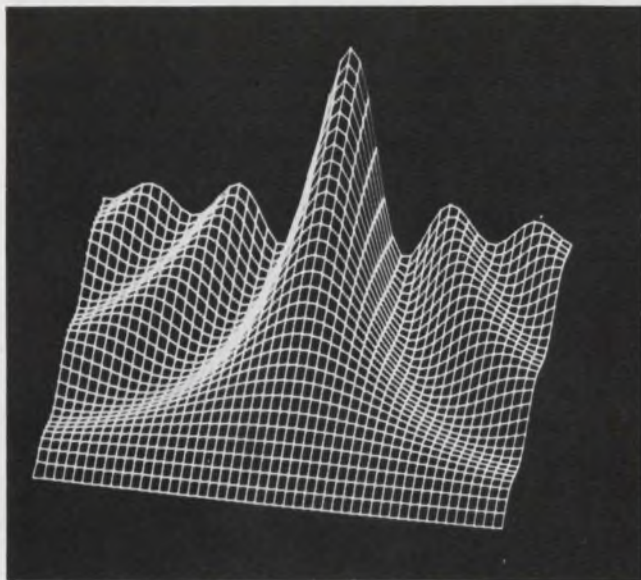

Multiparameter plots show the potential of graphical interactive computing. Page 36.

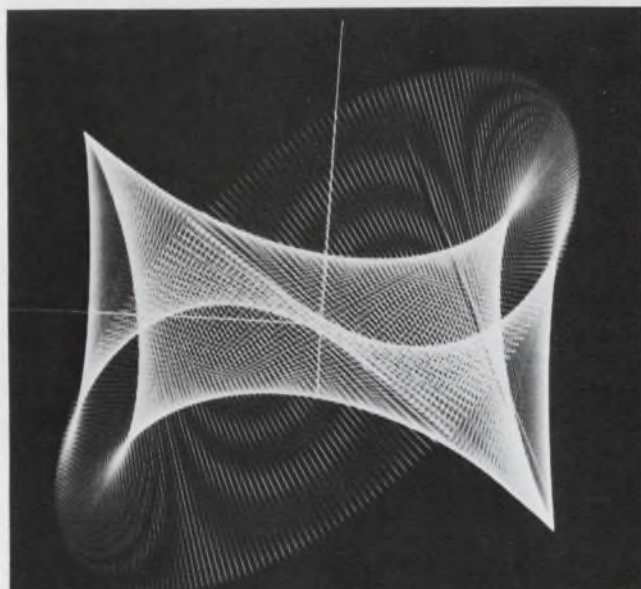

IC memory by IBM, one of several shown at solid-state conference. Page 25.

Also in this section:

Wideband rf voltmeter-comparator is developed by NBS. Page 48

The friendly grey computer puts showmanship in design. Page 52

News Scope, Page 21 . . . **Washington Report**, Page 45 . . . **Editorial**, Page 79

hybrid circuits

from

Burroughs

Burroughs is your preferred source for hybrid circuits

Burroughs, a prime producer of high-volume, high-quality hybrid microcircuits, offers the entire circuit package and its components at competitive prices. Circuits are now available in various configurations with screened resistors and capacitors, as well as discrete components including IC and MSI chips. Burroughs does the whole job, and does it right—enabling you to reduce system size with increased reliability.

Every circuit is custom-designed and fabricated under the eyes of experts in complete in-house semiconductor and hybrid operations—assuring you economy, high reliability, quality control and on-schedule delivery.

Buy your hybrid microcircuits NOW from Burroughs, and discover what Burroughs' one-source circuitry capability can do for you.

We also offer hermetic packaging, computer testing, complete environmental facilities. And we are fully documented to MIL Specs.

Call or write Burroughs Corporation, Electronic Components Division, P.O. Box 1226, Dept. H1, Plainfield, New Jersey 07061.

Tel. (201) 757-5000, or contact your nearest Burroughs representative or sales engineer.

- 1./ *Semi-automatic dual latch hybrid test unit for efficient, high-speed tests.*
- 2./ *High-speed resistor abrading process assures $\pm 1\%$ tolerances.*
- 3./ *Modern, contamination-free diffusion operation, atmospherically controlled for maximum quality assurance.*
- 4./ *Multifunctional computerized system performs all forms of AC & DC tests.*



2./



3./



4./



1./

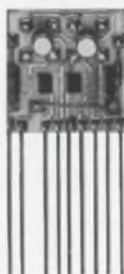

Burroughs



Defense R&D spurs protest and antiprotest

For several years there have been rumblings of dissent at universities in the country by scientists opposed to heavy involvement of science in the country's military preparedness programs. On March 4 work stoppages and panel discussions were held by small groups of protesters at about 20 universities in the country, with 48 professors at the Massachusetts Institute of Technology in Cambridge acting as the unofficial leaders.

"We didn't organize anything; we just wrote our friends around the country, telling them what we were going to do, and they all decided to have panels the same day," said Dr. Herman Feshbach, a theoretical physicist and chairman of the Union for Concerned Scientists at MIT.

Meanwhile a protest against the protest was held at Argonne National Laboratory's High Energy Physics Div. in Argonne, Ill. Fifty-six staff scientists and engineers, opposed to the union's aims, responded with a "work-in." They worked 16 hours on March 4.

The MIT protest was kicked off the evening of March 3 with a meeting to which faculty members and students were invited. The students, Dr. Feshbach said, have their own organization, the Science Action Coordinating Committee. The membership of this student group, according to an MIT official, is limited—80 out of 7000 students.

On March 4 the union held panel discussions all day and into the night. The student group held its own panel discussion in the afternoon. The union's topics of discussion were "Harnessing Science to Socially Useful Ends," "Reconversion and Nonmilitary Research," "Academic Community and Government," "Discussion of Student Problems," and "Arms Control, Disarmament and Nation-

al Security." At night the topic was "Responsibility of Intellectuals."

The objective of the group, Dr. Feshbach said, is to look at "the negative aspects of various things." The negative aspects of the military got the hardest look. The antiballistic missile system, Dr. Feshbach said, "could have the effect not of improving our defense, but, winding us up with serious problems in terms of expense and increasing the arms race."

The group will examine other areas where they feel research should be increased. Dr. Feshbach suggested that the electronics community come up with nonmilitary problems that need to be solved.

The group plans to study the way money is being spent for defense and decide whether to call for cutbacks. Dr. Feshbach cites statements made by Dr. Carl Keyesen, director of the Institute for Advanced Studies in Princeton, N.J. Dr. Keyesen said, according to Dr. Feshbach, that when the war ends, \$20 billion can be channeled into nonmilitary areas.

New imaging system turns sound to color

By producing color changes in temperature-sensitive liquid crystals with ultrasonic energy, two



New image converter (left) turns ultra-sound to color pictures.

researchers have devised an acoustic-imaging color system with potential uses in nondestructive testing, oceanography and undersea military applications.

In its present form the image is essentially a shadowgraph surrounded by a color pattern. According to the researchers—William Sproat associate scientist, and Sherman E. Cohen, senior quality control engineer, of the Lockheed-Georgia Co., Marietta, Ga.—the images are obtained by interposing an object under test between a 1-MHz ultrasonic source and a thermoscopic screen. The latter is formed by coating the outside of a thin (0.005 in.) steel plate with cholesteric crystals and the inside with a special lossy, sound-absorbent material.

The high losses of the viscoelastic material convert impinging ultrasonic energy to a temperature rise. The small increase in temperature is conducted through the steel plate to the liquid crystal layer on the opposite side, producing a change in color in the cholesteric layer.

The experimental system is currently being operated in an immersion tank filled with water; it serves as a heat reservoir to maintain the image-plate temperature close to the color transition range. The thermal bias provided by the water provides immediate color response to slight temperature changes of the color plate for low-power inputs.

The image is retained by controlling the ambient temperature and is erased by cooling the crystal surface. Images can be held up to 10 seconds, Cohen reports.

The system is potentially attractive for nondestructive testing and underwater imaging because of its reduced complexity, compared with present vacuum-tube, electron-beam scanning image converters. The device can supplement high-intensity-light TV systems for observing objects at close ranges in sediment-clouded water.

Radiation-resistant ICs are a growing market

Radiation-hardened components have long been required for strategic weapons vulnerable to unex-

pected nuclear attack. But now the list of equipment that the Defense Dept. believes should remain operable after exposure to radiation may be growing.

Philco-Ford Corp., which has just announced it will follow Radiation, Inc., in making available off-the-shelf radiation-resistant ICs, says the market for dielectrically isolated ICs in 1969 is \$30 million. And in six to eight years, says the company's Micro-electronic Div.'s general manager, Howard T. Steller, this total should increase to \$1 billion.

Radiation, Inc., predicts a similar market.

The Pentagon admits that a program does exist for developing more "hardened components." But radiation-resistant components? No such program, the Pentagon insists.

Some industry sources have been waiting for such a directive to be issued, but others believe the call for more radiation-resistant components will come piecemeal. Certain new programs will require components that can survive exposure to strong radiation, some manufacturers say. How far down the line this philosophy will go, no one knows.

Philco-Ford's first off-the-shelf radiation-resistant circuits will be five 930 digital DTL units, a level shifter and two versions of the 709 operational amplifier.

Radiation's line also includes a family of 930 DTLs, a 709 operational amplifier, a dual level shifter and a dual line driver.

At present radiation-hardened ICs cost about five times more than conventional ICs. This differential, though, is expected to be cut significantly as volume increases.

RCA decides to enter giant-computer field

Radio Corp. of America has joined the ranks of large-scale computer manufacturers with announcement of a Spectra 70/60 series—"a big, new computer de-

signed to handle the massive information processing needs of corporate and governmental data centers."

RCA estimates the domestic market for large computers to be \$1.8 billion a year, of which it hopes to get 10 per cent.

The company now has 4-1/2 per cent of the computer market with its small computer line. Univac is estimated to control about 6 per cent of the market and IBM 70 per cent.

The new Spectra 70/60, three times larger than the largest computer RCA now manufactures, will perform local or remote computing tasks at almost twice the speed of other computers in its price class, according to James R. Bradburn, executive vice president. The Spectra 70/60 will come in various sizes with rent beginning at \$17,000 a month. Shipments are to begin in the second half of 1970.

Burroughs, meanwhile, has announced a new desk-top billing computer, designated the L2000. The company's president, Ray W. Macdonald, describes the new system as "a revolutionary development representing the most fundamental design advance in this size and class of accounting and billing equipment in the last 60 years."

The new line uses integrated circuits, disk memory and a fourth-generation software technique called "firmware"—strings of micro-instructions stored in the disk memory.

New magnetic material promises powerful TWTs

A new magnetic material, said to be four times as strong as most alnicos and twice as strong as platinum cobalt, has been developed at Raytheon's Microwave and Power Tube Div., Waltham, Mass.

The new material, invented by Dr. Dilip K. Das, is made from material based on cobalt and the rare earth element samarium. Samarium cobalt magnets have been manufactured with energy products as high as 20×10^6 gauss-oersteds. By comparison, ferrites produce about 3 million gauss-oersteds, common alnicos about 5 million and platinum cobalt nearly 10 million, according to Dr. Das.

These comparisons are based on the energy product, a figure of merit for magnetic materials that takes into account the material's residual magnetism, after a strong magnetizing field is removed, and its ability to resist subsequent demagnetization in a magnetic field of opposite polarity.

The company says it has already built traveling-wave tubes with the new magnets that are smaller and less costly, and that permit higher power operation than do TWTs with platinum-cobalt magnets.

Raytheon says the new magnetic material may find wide use in gyros and control motors used in space applications.

For a given power it is now possible to make smaller motors, it was noted.

Gunn device generates ultrasonic waves

Japanese scientists have reported the first successful generation of coherent ultrasonic waves from a Gunn oscillator.

Several American laboratories have tried to achieve this, but so far none have reported success.

The successful experiment was conducted by H. Hayakawa, T. Ishiguro, N. Mikoshiba and M. Kikuchi of the Electrotechnical Laboratory in Tokyo and was reported in the January, 1969, issue of Applied Physics Letters.

In the test, a small gallium arsenide Gunn oscillator was bonded to a quartz delay rod. When voltage, which could be varied from 280 to 700 volts, was passed at five pulses per second through the diode, coherent ultrasonic waves at 140 MHz were detected at the end of the quartz rod.

Although the new source of ultrasonic waves may be useful in experimental work, scientists believe it is not likely at this time to replace conventional means of producing coherent sound waves.

The work does, however, confirm earlier predictions that ultrasonic radiation can be produced by Gunn devices. The Japanese scientists say that more quantitative measurements of the acoustical energy are needed to confirm theoretical ideas about these semiconducting devices.

Do you think a bright young engineer should spend his most imaginative years on the same assignment?

Neither do we.

That's why many of our areas are organized by function—rather than by project.

At Hughes, you might work on spacecraft this year, communications satellites next year, tactical missiles the next year.

All you need is an EE, ME or Physics degree, 2-8 years experience, and talent. If you qualify, you may work on several different assignments over a period of a few years.



You may work on specialized assignments, or broad systems-oriented programs.

Or you can choose *not* to change assignments if you'd rather develop in-depth skills in one area.

Either way, we think you'll like the Hughes approach—the chance to be assigned by function, if desired.

It means you'll become more versatile in a shorter time.

(And your salary will show it.)

HUGHES

HUGHES AIRCRAFT COMPANY
AEROSPACE DIVISIONS

Some of the current openings at Hughes.

Microwave & Antenna Engineers
Electro-Optical Engineers
Microcircuit Engineers
Space Systems Engineers
Missile Systems Engineers
Guidance & Controls Engineers
Spacecraft Design Engineers
Weapon Systems Engineers
Components & Materials Engineers
Circuit Design, Development &
Product Engineers

Send resume to:

Mr. Robert A. Martin
Head of Employment, Dept. 72,
Hughes Aerospace Divisions
11940 W. Jefferson Blvd.
Culver City, California 90230

U.S. Citizenship is required
An equal opportunity employer

55 MHz Video Amplifier

RCA-CA3040 now opens a new era in monolithic device design for high-gain, wideband performance. This new linear integrated circuit offers high input impedance, emitter-follower output, and exceptional stability over the full -55°C to $+125^{\circ}\text{C}$ operating temperature range. Check these significant CA3040 performance highlights:

- 37 dB typ. differential push-pull voltage gain
- 31 dB typ. single-ended voltage gain
- 55 MHz typ. -3 dB bandwidth
- useful gain to 200 MHz
- two bias options for temperature compensation
 - constant DC output voltage
 - constant differential voltage gain
- $150\text{ k}\Omega$ typ. input resistance
- $0.5 V_{RMS}$ typ. output swing voltage

Look into CA3040 now for performance and economy in video amplifiers, Schmitt triggers, modulators, IF amplifiers, high-speed sense amplifiers, product detectors, and instrumentation amplifiers.

For details, contact your local RCA Representative or your RCA Distributor. For technical data, write RCA Electronic Components, Commercial Engineering, Section ICG-3-2, Harrison, N.J. 07029

... and Check These RCA Wideband Amplifiers

CA3001	For video, IF, and DC 29 MHz typ. -3 dB BW	\$3.35 (1,000 units)
CA3002	IF and video ampl 11 MHz typ. -3 dB BW	\$2.25 (1,000 units)
CA3021	4 mW power drain @ 6 V 2.4 MHz typ. -3 dB BW	\$1.90 (1,000 units)
CA3022	12.5 mW power drain @ 6 V 7.5 MHz typ. -3 dB BW	\$1.60 (1,000 units)
CA3023	35 mW power drain @ 6 V 16 MHz typ. -3 dB BW	\$1.55 (1,000 units)
CA3020	$\frac{1}{2}$ -watt "Universal" ampl 8 MHz typ. -3 dB BW	\$1.55 (1,000 units)
CA3020A	1-watt "Universal" ampl 8 MHz typ. -3 dB BW	\$1.98 (1,000 units)

RCA
Integrated
Circuits

RCA-CA3040 in 12-lead TO-5 style package
\$2.95 (1000 units)

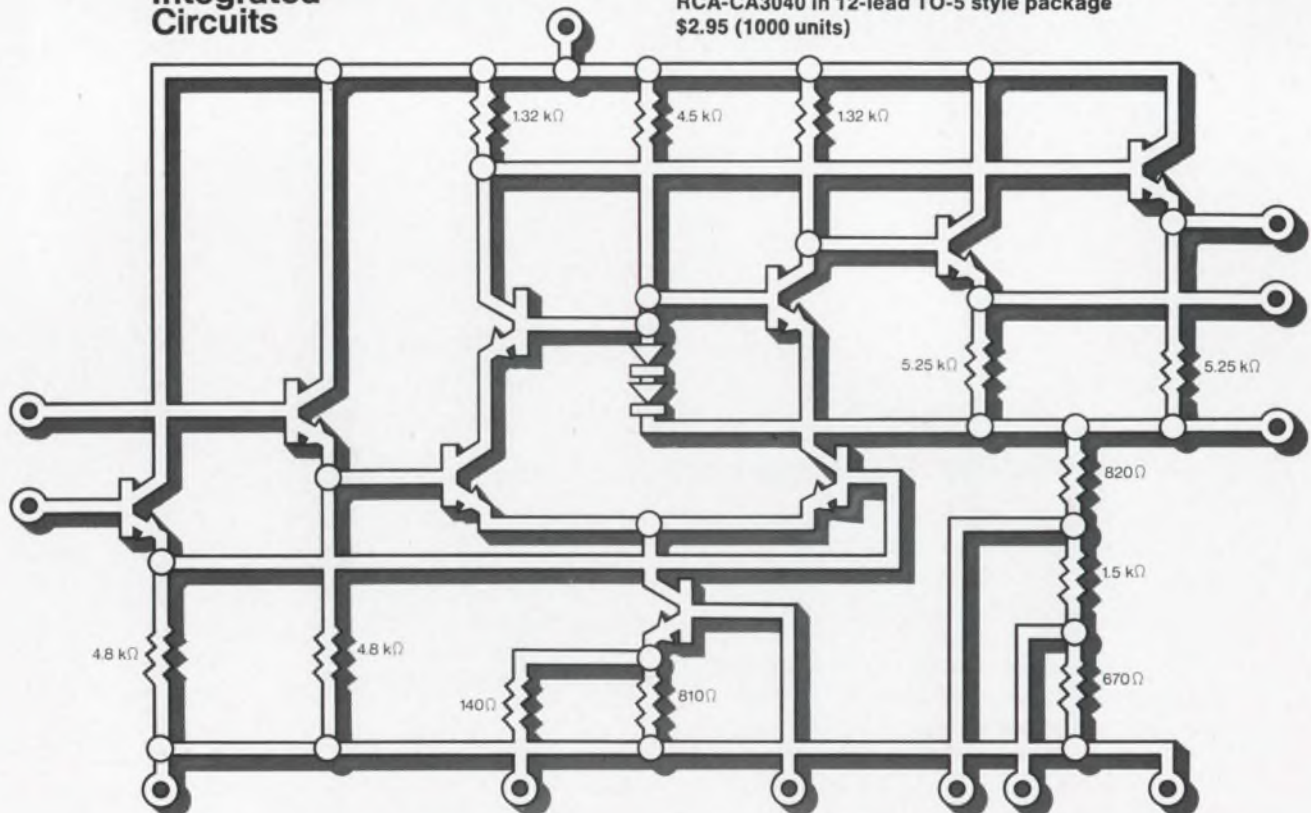

IC applications abound at solid-state show

Semiconductor memories, high-speed op amps and solid-state power devices draw attention

Ralph Dobriner
Chief News Editor

The word at this year's International Solid-State Circuits Conference, held in Philadelphia, was diversity. More than 180 papers and 12 panel sessions zeroed in on such wide-ranging semiconductor topics as current-input differential amplifiers, IMPATT diode oscillators, IC monolithic displays and ultra-high-speed digital techniques.

Three areas appeared to fore-

shadow important design trends: integrated-circuit memories, monolithic operational amplifiers and solid-state power control.

In memories, the trend is to faster cycle times—of less than 100 ns—more storage cells per chip through LSI, and lower power consumption.

In op amps, the search is for high operating speeds—10 times faster than the familiar μ A709 operational amplifier.

In solid-state power control, the drive is for clever IC circuit configurations. The advantages cited include an integrated circuit with a Hall element for power control, an integrated trigger circuit for phase control of Triacs or SCRs, and a pressure-sensitive diode with large resistance variations under applied stress.

A complete ISSCC 69 digest of the technical papers is available at \$15 from H. G. Sparks, Moore School of Electrical Engineering, Univ. of Pennsylvania, Philadelphia, 19104.

In IC memories, the trend is to quicker cycle times

Of the MOS-IC memories developed to date, most operate at relatively low speeds. It has been difficult to fabricate an LSI MOS memory that operates below 100-ns cycle times.

H. Yamamoto, M. Shiraishi, and T. Kurosawa of Nippon Electric Ltd., Tokyo, reported that they have developed a 144-bit (16-word \times 9 bits) memory with a 40-ns write cycle time and a 30-ns read-cycle time. They used n-channel MOS transistors.

The authors observed that an MOS memory using n-channel MOS transistors operates at a higher speed, due to higher effective mobility, than an MOS memory using p-channel or complementary MOS transistors with lower effective mobility.

To achieve the high memory speed, the n-channel enhancement MOS transistors were deposited on a normally doped substrate. On a highly doped substrate (2×10^{18} cm⁻³), high speed would be impossible because of the increase of the effect of source-substrate bias on threshold voltage and the increase of the junction capacitance.

The authors noted that an n-

channel MOS-IC of this type can be operated at a speed that is about three times higher than that of a p-channel MOS IC. In fact, they observed, because of its high effective mobility, the minimum cell area of the n-MOS-IC memory is about half that of the p-MOS-IC

memory when the same output current with the same address voltage is required.

The entire chip of the 144-bit memory is assembled in a 48-lead flat package. With the use of bipolar peripheral circuitry, each wafer operates with a 3-mA digit

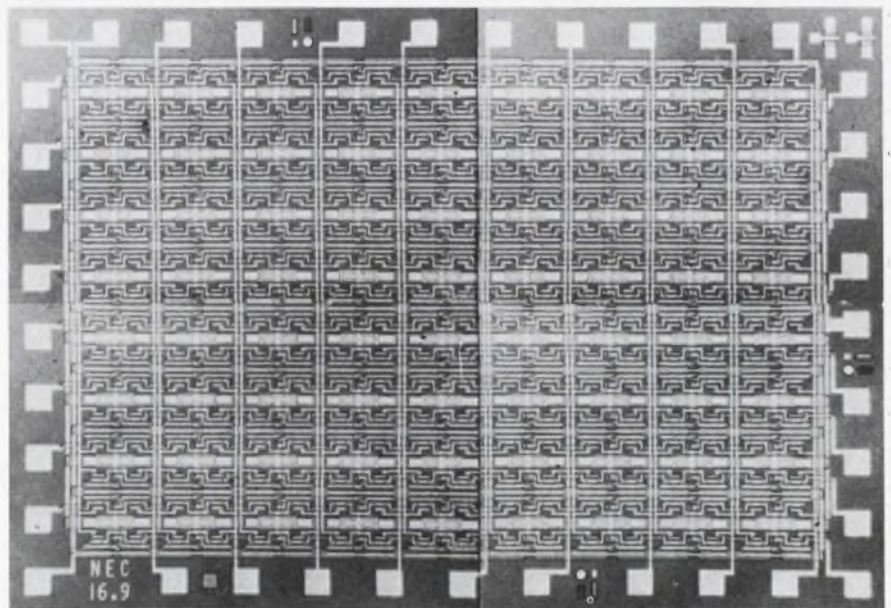

144-bit LSI memory chip, constructed by Nippon Electric Co., has a 30-ns read-cycle time and a 40-ns write cycle time.

output current, 15-ns digit write pulse width, and a 10-ns access time.

IBM shows 40-ns IC memory

A high-speed, three-dimensional semiconductor memory made of bipolar monolithic integrated circuits was described by four IBM engineers: Dr. Benjamin Agusta, John K. Ayling, Richard D. Moore and George K. Tu.

The memory is designed to be used both as the main buffer and as a write-in control store in the company's System/360 Model 85.

The memory is air-cooled, and information can be nondestructively read out of a silicon chip in 7 ns. The writing or entering of information takes 12 ns.

Access time to the complete buffer memory, which can store up to 147,456 data bits, is 40 ns—a speed that is said to be faster than any previous IBM computer memory. The memory is structured into 2048 words of 72 bits each.

Developed at IBM's Components Div., Burlington, Vt., the memory storage circuits are diffused into the surface of a single silicon chip

measuring 112 mils square. Each memory chip contains 664 components, consisting of transistors, diodes and resistors. The chip provides 64 interconnected memory storage cells. Each memory chip operates at 112 mW and provides a ONE signal level of 2 mA into a 20-ohm load.

Functionally, two silicon chips are mounted on a half-inch-square ceramic memory module to provide the basic building block.

Seventy-two storage modules, together with drive and sense circuit modules, are packaged on a 7-by-9-inch multilayered pluggable card with a capacity of 512 memory words of 18 bits each. A larger multilayered printed-circuit board, containing 16 storage and four logic and terminating cards, makes up the basic storage unit. Two storage units form the complete buffer memory with one-quarter megabit capability.

A key factor in achieving performance objectives, the authors said, is the use of a single distribution approach employing terminating resistors. The resistors closely match the loaded characteristic impedance of each line that exceeds

two inches in length on the printed-circuit card. Maximum bandwidth is maintained, and careful wiring layout insures that required signals arrive at any point in the memory within 3 ns of each other, thus permitting the rapid cycle time to be achieved.

The monolithic silicon devices have an npn planar, double-diffused structure with p⁺ junction isolation and 0.2-mil task tolerances. A single-level aluminum interconnection plane is subsequently passivated with a film of sputtered quartz. The 23-chip contact pads are formed by metal evaporation.

Schottky diodes in a memory

Schottky diodes may be the key to faster low-power integrated-circuit memories and other logic circuits in small economical packages.

This is the view of five Bell Telephone Laboratories engineers, D. A. Hodges, M. P. Lepselter, R. W. MacDonald, A. U. MacRae and H. A. Waggner, who reported in a technical paper that they are successfully using two types of Schottky diodes in IC memories.

One type replaces diffused loading resistors in flip-flop memory cells of bipolar transistors. The second links the cells to the digit lines of the memory. This combination, the authors noted, reduces the cost and increases the circuit switching speed.

Reverse-biased Schottky diodes, which have low-energy barriers and

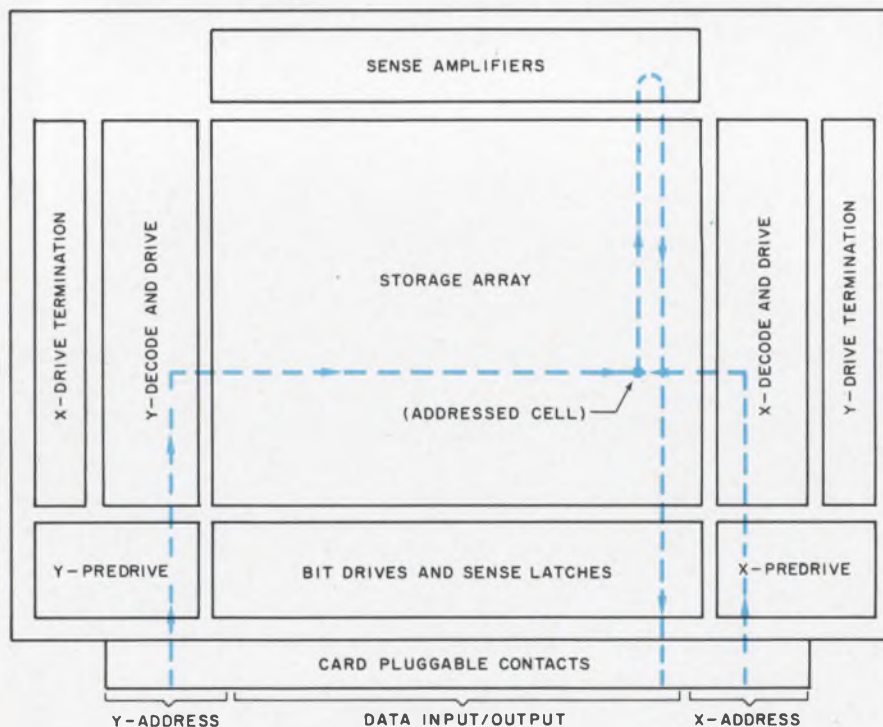

The drive system in IBM's high-density monolithic memory makes use of specially designed current-switch-emitter-follower circuits that provide well-controlled output-signal levels. Low-order address bits are decoded at the inputs of these circuits.



Two identical 64-bit, 3D-organized monolithic memory chips, made by IBM, are mounted, pads down, in a standard module.

Speed costs

particularly when you don't need it.

COST/PERFORMANCE — UTILOGIC II vs "THE OTHERS"

DECISION FACTOR	UTILOGIC II	930 DTL	MC800 RTL	7400 TTL	MC830 DTL	SUHL I TTL	SUHL II TTL
D. C. NOISE MARGIN (mv)							
"0" Level	800	450	300	400	450	650	550
"1" Level	1100	450	300	400	500	600	600
FAN OUT	16	8	5	10	8	6	6
SPEED (ns typical)	25	25	25	13	25	10	6
PRICE (100-up)							
Quad Gates	\$1.07	\$1.55	\$1.25	\$1.55	\$1.55	\$2.40	\$2.65
Dual Binaries	\$1.99	\$4.75	\$2.30	\$3.85	\$4.75	\$5.95	\$6.60

What the chart says is simply this: except where TTL speed is essential, Utilogic II is the best buy in both performance and cost. Utilogic II not only provides fan out up to 16 and noise immunity up to 1.1V (nearly twice what you get in other IC families) but is available in reliable silicone DIPs. In addition, it is the only logic family that allows you to implement functions any way you choose — with AND, OR, NAND or NOR elements. Last thing. Check the prices below.

Now, wasn't that fast?

UTILOGIC ELEMENTS (+10°C to +55°C) IN 14-LEAD DUAL IN-LINE PAK (100-UP)

LU300A	Dual 3-Input Gate Expander	\$0.83
LU301A	Diode Expander	0.83
LU305A	6-Input AND Gate	0.83
LU306A	Dual 3-Input AND Gate	0.83
LU314A	7-Input NOR Gate	0.83
LU317A	Dual 4-Input NOR Gate	0.89
LU321A	Dual J-K Binary	1.65
LU322B	Dual J-K Binary	1.83
LU333A	Dual 3-Input OR Gate	0.89
LU334A	Dual 4-Input OR Gate	0.94
LU337A	Dual 4-Input Expandable NAND Gate	0.94
LU356A	Dual 4-Input Line Driver	1.15
LU370A	Triple 3-Input NOR Gate	0.89
LU374A	Triple 3-Input OR Gate	0.94
LU375A	Triple 2-Input OR Gate	0.94
LU377A	Triple 3-Input NAND Gate	0.94
LU380A	Quad 2-Input NOR Gate	0.89
LU384A	Quad 2-Input OR Gate	0.94
LU387A	Quad 2-Input NAND Gate	0.94

For more information call your nearest Signetics sales office or distributor.

Signetics Integrated Circuits

A SUBSIDIARY OF CORNING GLASS WORKS

811 East Arques Ave., Sunnyvale, California 94086



See us at IEEE, booth number 3A01 to 3A04

INFORMATION RETRIEVAL NUMBER 20

operate as loading resistors, are much smaller than conventional diffused resistors, resulting in more circuits on a chip and hence lower cost per circuit.

Schottky diodes with high-energy barriers, which connect memory cells with pairs of digit lines, permit very fast switching.

In a typical low-power memory cell requiring resistances on the order of 50,000 ohms, a Schottky diode needs only 2 per cent of the area of its conventional diffused-resistor counterpart.

50 ns cycle times achieved

The engineers believe that, with the low capacitances and low leakage currents in these diodes, it is possible to achieve memory cycle times of 50 ns for arrays of several thousand cells. The power required to hold stored information

in such a memory would be about 75 microwatts per bit, a low figure and reportedly not easy to achieve with conventional bipolar transistor integrated circuits.

The low- and high-energy barrier diodes are formed on lightly doped p- and n-type silicon, respectively. Ion implantation and diffusion processes can be used to control the doping of the silicon.

According to the Bell engineers, the Schottky diodes are created in an operation that also forms the ohmic contacts on heavily doped areas and that is part of the beam-lead IC fabrication sequence. The only variation from the standard beam-lead process is the substitution of rhodium for platinum as the first metal deposited. Otherwise, it is compatible with beam-lead technology.

Associative memories are going

to play an increasingly important role in computing and data-handling systems. What is needed is a practical associative memory element—one containing most of the repetitive logic needed to implement a large system.

A step in this direction was reported by R. F. Herlein and A. V. Thompson of American Microsystems, Inc., Santa Clara, Calif. They described an 8-word-by-8-bit, parallel-organized LSI array designed to operate at 1 MHz. The memory contains 1799 p-MOS transistors on a 156-by-144-mil die and is contained in a 40-lead dual in-line package.

The memory system operates in three basic functional modes: read, write and compare. More complex functions, such as sorting, must be accomplished by iterative algorithms.

Researchers pressing for faster operational amplifiers

Monolithic operational amplifiers now perform as well as—and in some cases even better than—discrete units. There really is only one major area where a dramatic improvement in performance is needed: higher operating speeds.

That's what Robert Widlar, chief IC designer for National Semiconductor Corp., says. The input current specifications of discrete amplifiers are so good, he reported in a technical paper, that even FET amplifiers can be replaced with low-cost monolithic circuits in full-temperature-range applications. But present general-purpose amplifiers have rates of only 0.5 V/ μ s and bandwidths of 1 MHz, he noted, and many applications require a tenfold improvement in performance.

Widlar described several new approaches for the design of monolithic amplifiers. One uses cascode connection and bootstrapping circuitry to achieve very low input current—of less than 100 pA over the military temperature range. This, he notes, is more than 10 times better than the LM101A, which is pretty close to the limits

of what can be done with conventional transistors.

The operational amplifier he described uses both standard transistors and low-voltage, high-gain devices. The differential input stage is operated at zero collector-base voltage through use of a bootstrapped cascode connection for the high-gain input transistors. With this type of connection and circuitry, Widlar said, it is possible to take advantage of the best features of both transistor types, forming

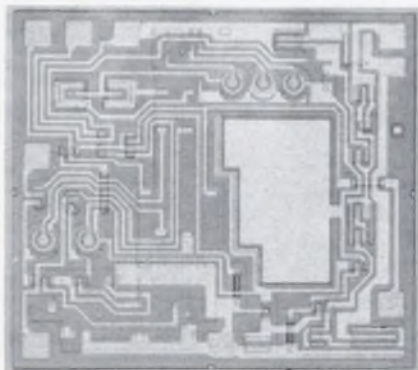

Self-compensated monolithic operational amplifier, developed by Motorola Semiconductor, is contained on a 56-mil-by-63-mil wafer.

the equivalent of a high-gain, high-voltage transistor pair.

Widlar also described the circuit for a high-speed operational amplifier that, with further development, could have a bandwidth of 50 MHz and a 50 V/ μ s slew rate at unity gain. He noted that the major problem in trying for better frequency response from monolithic amplifiers has been the poor frequency characteristics of the lateral pnp, which is used for level shifting. The poor response in level shifting above 2 to 5 MHz puts a practical limit on slew rates of about 5 V/ μ s for unit-gain compensation. High-speed amplifiers will probably have to avoid using the lateral pnp as a gain stage, Widlar remarked.

The high-speed monolithic amplifier he described uses only npn transistors as amplifiers. A standard, differential input stage is employed, and its output is buffered by a pair of emitter followers. A pair of resistors and a current inverter provides the level shifting. The second-stage amplifier drives a complementary emitter follower output stage.

Because the circuit can be made to look like a two-stage amplifier, it is relatively easy to frequency-compensate, making possible the high bandwidth and slew rate.

Another way to higher speed

In further pursuit of high-speed performance—or high slew rate—Fairchild Semiconductor engineers are taking a somewhat different tack.

As E. S. Narayanamurthi observes in his technical paper, since the slew rate and frequency response are related, a monolithic operational amplifier with improved frequency performance should lead to a high slew rate.

The frequency response of monolithic amplifiers, he said, may be limited to such factors as the input capacitance, the f_{TS} of the constituent transistors and problems created in the level shifting stage by the nonavailability of lateral pnps with good frequency characteristics. Even if an amplifier is designed with high gain and good frequency performance, the need for compensation capacitors for closed-loop operation limits the available slew rate, according to Narayanamurthi.

The Fairchild engineer described a new monolithic amplifier in which some of the problems have been overcome without sacrificing dc performance. The closed-loop unity-gain bandwidth is 15 MHz with a voltage gain near 20,000—a performance that, he says, is much better than the celebrated $\mu A709$.

While the necessary gain of an amplifier can be achieved with two stages, the need for compensation in the input stage for closed-loop performance restricts the attainable slew rate, which at a node is approximately:

$$S = A_v I / C,$$

where I is the dc current, C the capacitance and A_v the voltage gain following the node. This suggests, the author noted, that a third gain stage beyond the points where compensation is applied would help to achieve a larger slew rate.

The amplifier has three stages, with an associated level shifting circuit. The input stage consists of a differential cascode with Dar-



Why do engineers hate inductors?

Well, primarily because inductors stubbornly resist integration. Nytronics started taming them about 30 years ago, and our R&D boys have been concentrating on improving their quality and performance ever since. Today we think our line of inductors is the most nearly perfect it is possible to make.

WEE-DUCTOR — Magnetically shielded with inductance range 0.1 to 180,000uH, designed to MIL-C-15305, Grade 1, Class B. Encapsulated Envelope: 0.157" diameter x .450" length.

SUPER WEE-DUCTOR/90537 TYPE — Manufactured in accordance with MS90537, Molded Magnetically shielded with inductance range 0.1 to 100,000uH $\pm 10\%$ tolerance. Molded Envelope: 0.163" diameter x 0.410" length.

SUPER WEE-WEE-DUCTOR — Miniature shielded with inductance range 0.1uH to 10,000uH. Designed to MIL-C-15305, Grade 1, Class B. Epoxy-Molded Envelope: 0.125" diameter x 0.335" length.

DECI-DUCTOR — Subminiature with inductance range 0.1 to 1000uH. Designed to MIL-C-15305, Grade 1, Class B. Molded Envelope: 0.100" diameter x 0.250" length.

S-M-L INDUCTORS — Non-shielded with inductance range 0.1 to 10,000uH. Designed to MIL-C-15305, Grade 1, Class B. Molded Envelope: "S" Type — 0.188" diameter x 0.44" length, "M" Type — 0.25" diameter x 0.60" length, "L" Type — 0.31" diameter x 0.90" length.

VARIABLE INDUCTOR — Unshielded with adjustable range 0.1 to 4700uH. Designed to meet MIL-C-15305, Grade 1, Class B. Encapsulated Envelope: 0.400" diameter x 0.500" length. Vertical or Horizontal mounting.

WEE V-L — Magnetically shielded adjustable range 0.1 to 100,000uH. Designed to MIL-C-15305, Grade 1, Class B. Epoxy Molded 0.300" diameter x 0.400" length.

WEE CHIP-INDUCTOR — Magnetically shielded, wrap-around termination permitting contact to either face or ends. Designed to meet MIL-C-15305, Grade 2, Class B. .280" x .195" x .100". Presently available .15uH to 1000uH.

■ Send for our new 44-page catalog with the quality line of standard components.



NYTRONICS, INC.

The quality line of standard components

550 Springfield Ave., Berkeley Heights, N.J. 07922 ■ (201) 464-9300 ■ TWX: 710-984-7977

INFORMATION RETRIEVAL NUMBER 21

lington inputs. The cascode arrangement, while reducing the input capacitance, helps to increase the bandwidth. Emitter degeneration is provided to improve the stability, and common-mode feedback from the second stage is employed to achieve high common-mode rejection. Compensation is applied at collectors of the cascode, with external capacitors so chosen that the slew rate is not impaired.

The second stage is a simple differential stage, with compensation again being applied at the collectors. Emitter degeneration is again provided for greater stability. Level shifting to the output stage is accomplished by a current source-resistor combination. To improve the frequency response, an internal capacitor is added across the resistor. For good frequency performance, the stage immediately following the current source transistor has a high resistance and small capacitance. This is achieved by using an emitter follower after the current source.

Output stage gain is obtained with a common-emitter configuration, and output is provided by a complementary pair operated in Class AB. A vertical pnp has been chosen rather than an all-npn scheme because of its comparative stability, even though its performance is only adequate.

Narayanamurthi noted that a unique feature of the amplifier is an internal capacitor. The construction of the capacitor is important.

he said, in that the effect of the parasitic capacitance to the substrate must be minimized along with the leakage at the junction. This is done by placing the top (metal) plate at the lower end of the level shifting resistor and the junction plate at the upper end of the resistor. In this way the leakage from the junction plate flows harmlessly through the emitter follower, and the voltage across the junction is at maximum, so that the capacitance is low and changes with signal level are small.

A rival to junction FET inputs

A self-compensated monolithic operational amplifier with low input current and high slew rate was described in a paper by J. E. Solomon, W. R. Davis and P. L. Lee of Motorola Semiconductor Product Div., Phoenix, Ariz.

The performance of the amplifier, according to the authors, rivals that of all junction-FET input configurations in almost all respects. Input current and current drift are about the same for both types of amplifier, but voltage offset and drift are considerably better in the Motorola operational amplifier.

Input current has been reduced by means of a special circuit configuration designed to operate with high-beta (several thousand), low-voltage transistors. These are fabricated simultaneously with standard transistors through the

use of modified diffusions to produce both narrow and wide base-widths on the same wafer. At the same time slew rates have been improved by reducing the rate of first-stage transconductance-to-operating current.

For most well-designed amplifiers, this approach is the only circuit modification (other than forward feed) to improve the speed of operation, the authors said.

The basic amplifier configuration is essentially that of two cascaded voltage-gain stages. The circuit exhibits a typical input current of 2 nA and an input offset current and current drift of 0.3 nA and 2 pA/°C, respectively. The unity gain slew rate is 4 V/μs, and the open-loop voltage gain is 150,000. The input transistors operate with betas of 4000, while the effective first-stage operating current is 50 μA and the input transconductance is 1/2.5 kΩ.

Other characteristics of the amplifier are internal capacitive compensation, input overvoltage and output short-circuit protection. All the circuitry, including the 35 pF MOS compensation capacitor, is contained on a 56-by-63-mil wafer, as shown in p. 28. The large white area is the capacitor.

A second version of the amplifier has been built, the authors reported, with unity-gain slew rates of 30 V/μs, simultaneously with an input offset current of 40 nA, an open-loop gain of 50,000 and a small-signal bandwidth of 2.5 MHz.

Integrated circuits invade the power field

Integrated circuits are being fabricated that may someday find wide use in such power applications as speed-control circuitry for induction motors, pressure sensors, solid-state switches and temperature-control circuits for fans and blowers.

A Hall silicon element, constructed with epitaxial integrated-circuit techniques, has been used with an integrated amplifier as a switching circuit in a dc motor. It replaces

the mechanical brushes. The Hall device, which was described by G. Bosch of Philips Research Laboratories, Eindhoven, The Netherlands, senses the position of the permanent magnetic rotor, and the amplified Hall voltage controls the current of the motor coils.

The element consists of part of the n-epitaxial layer, confined by the p⁺ that forms an island. The sensitivity is given by

$$V_{34} \approx 0.4 \mu B V_{12} = 0.8 B i_{12} / n e d.$$

Here V_{34} is the Hall voltage; V_{12} and i_{12} are the load voltage and current, respectively; B the magnetic field; n the density of free electrons (with charge e), and d the thickness of the epilayer.

For example, if $i_{12} = 2$ mA, $B = 5000$ gauss, $n = 10^{16}$ cm⁻³, $d = 10$ microns, $v_{34} = 50$ mV, while $v_{12} \approx 2$ V.

To avoid starting problems, two Hall elements are placed on different chips at 90-degree positions in

Here's the new 1969 Burr-Brown catalog

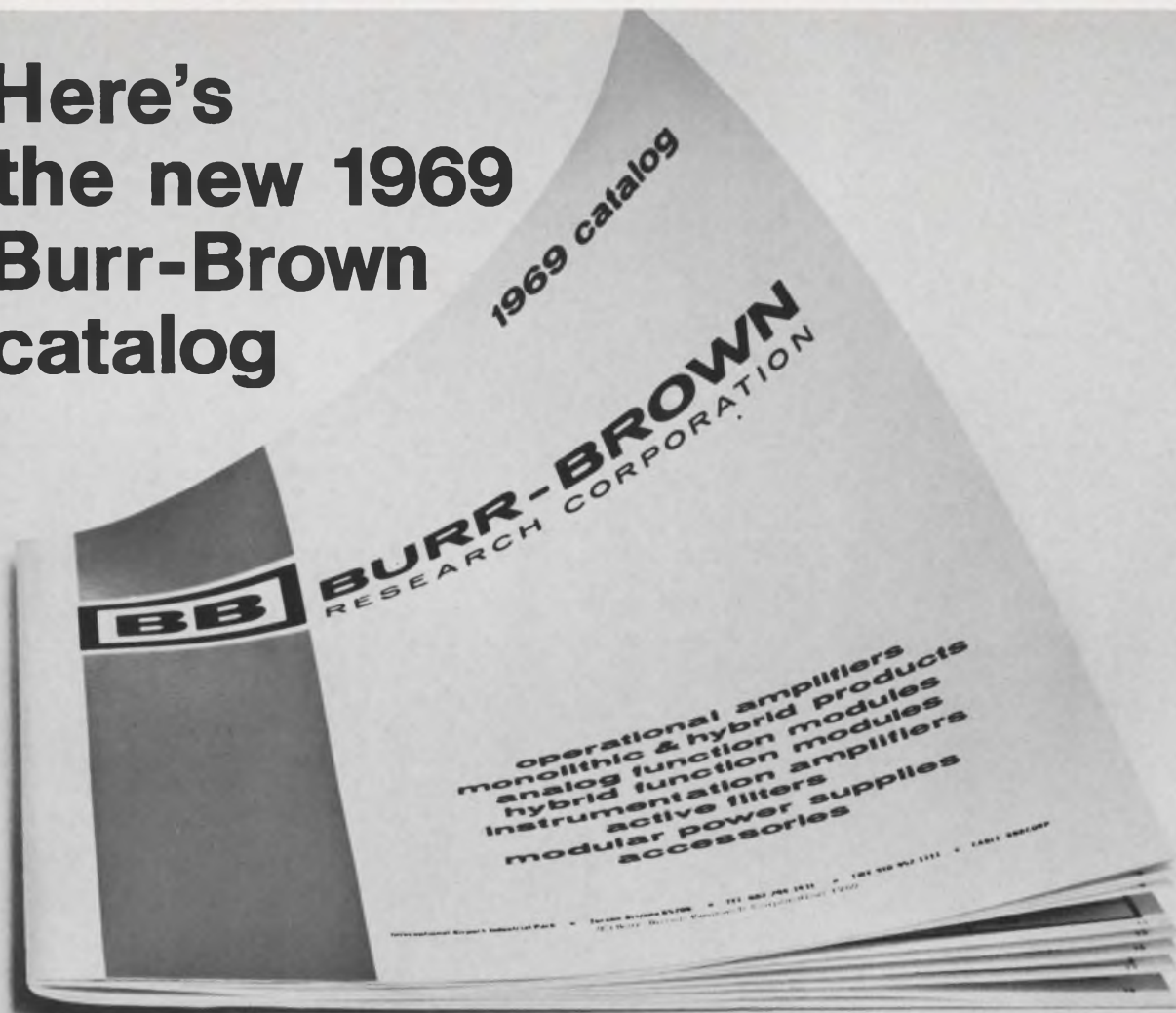

Make sure you get your copy

NEW OPERATIONAL AMPLIFIERS

- Two new, fully compensated, hybrid IC op amps in DIP packages.
- New low quiescent drain (60 μ A) op amp with wide supply range (± 4 to ± 18 V).

NEW INSTRUMENTATION AMPLIFIERS

- New ± 115 volt common mode, wide supply range (± 50 to ± 135 V) unit in 2.40" x 1.80" x .60" encapsulated package.
- New low quiescent drain unit with wide supply range (± 5 to ± 20 V).
- Plus a complete line of small, encapsulated instrumentation amplifiers.

NEW FUNCTION MODULES

- Two new low price, 1.2 MHz multipliers. Only \$75 and \$95 in single unit quantity.
- Plus a wide variety of unique hybrid and analog func-

tion modules including: sample/hold, sin/cos, A/D and D/A converters, multiplexer, and function generators.

ACTIVE FILTERS

- The industry's broadest line of encapsulated active filters offering up to seventh order roll-off characteristics with any cut-off frequency in the 1 Hz to 20 KHz range. Wider frequencies available in custom units.

NEW LOWER PRICES

- On operational amplifiers, instrumentation amplifiers, sample/hold modules, multipliers, and other units.

Make sure you get your copy

Simply check this publication's reader-service card, contact your local Burr-Brown Engineering Representative, or see us at IEEE BOOTH #3826-27.

BURR-BROWN

RESEARCH CORPORATION

International Airport Industrial Park • Tucson, Arizona 85706
TELEPHONE: 602-294-1431 • TWX: 910-952-1111 • CABLE: BBRCORP



Operational Amplifiers
Instrumentation Amplifiers
Function Modules
Active Filters
Power Supplies

ENGINEERING REPRESENTATIVES: ALABAMA, HUNTSVILLE (205) 534-1648 / ARIZONA, PHOENIX (602) 254-6085 / CALIF., LOS ANGELES (213) 665-5181, SAN DIEGO (714) 232-2017, SAN FRANCISCO (408) 244-1505 / COLO., DENVER (303) 399-4391 / CONN., EAST HARTFORD (203) 874-9222 / D.C., WASHINGTON (SEE MARYLAND) / FLORIDA, ORLANDO (305) 425-2764 / ILLINOIS, CHICAGO (312) 286-6824 / MD., SILVER SPRING (301) 588-8134 / MASS., BOSTON (617) 245-4870 / MICH., DETROIT (313) 358-3333 / MINN., MINNEAPOLIS (612) 781-1611 / MO., ST. LOUIS (314) 524-4800 / N.C., GREENSBORO (919) 273-1918 / N.J., CAMDEN (215) 925-8711 / N.M., ALBUQUERQUE (505) 255-1638 / N.Y., ALBANY (518) 489-4777, BINGHAMTON (607)

723-9661, MT. VERNON (914) 664-0080, NEWBURGH (914) 561-4510, NEW HARTFORD (315) 732-3775, ROCHESTER (716) 473-2115 / OHIO, CINCINNATI (513) 761-5432, CLEVELAND (216) 237-9145, DAYTON (513) 277-8911 / PENN., PHILADELPHIA (SEE CAMDEN, N.J.), PITTSBURGH (412) 243-6655 / TEXAS, DALLAS (214) 357-6451, HOUSTON (713) 774-2568 / UTAH, SALT LAKE CITY (801) 466-8709 / VIRGINIA, (SEE MARYLAND) / WASH., SEATTLE (206) 767-4260 / WISC., WAUKESHA (414) 786-2180 / CANADA, DOWNSVIEW, ONT. (416) 636-4910, MONTREAL, QUE. (514) 739-6776, NEW WESTMINSTER, B.C. (604) 524-1161, OTTAWA, ONT. (613) 725-1288, VANCOUVER, B.C. (604) 291-7161

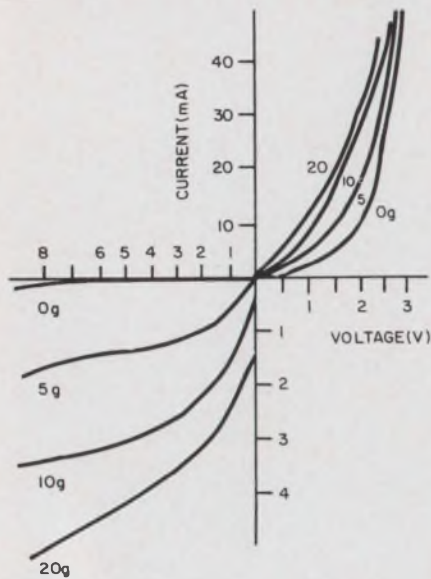

Large changes of current occur when stress is applied to the pressure-sensitive diode.

the motor. One integrated switch-in circuit with a Hall element is shown on page 32, middle.

Diode works well under stress

A pressure-sensitive semiconductor diode that exhibits unusually large variations in electrical resistance when mechanical stress is applied was described by A. Yamashita, M. Tanaka and T. Tsuzaki of Matsushita Electric Industrial Co., Osaka, Japan.

The authors foresaw wide use of the diode as a solid-state switch, solid-state relay, solid-state variable resistor and as a pressure sensor. Use of the pressure-sensitive diode as a switch and as a variable resistor, they predict, may make it possible to construct a

solid-state thyristor system.

The high sensitivity of the diode to stress was achieved by adding deep-level impurities. The deep impurity (copper), highly doped region was formed on the surface of a p-type silicon single crystal. Surface barrier contact was achieved with a niobium metal electrode.

The large changes of current in the forward and reverse directions when stress is applied are shown in the Fig. on page 32, top. These curves were obtained for a diode made on 6×10^{15} boron-impurities/cm³ and 1000 degree copper-diffused semiconductor.

The authors also reported that the diode responds to ultrasonic waves. The temperature coefficient of current without stress is similar to that of a normal silicon Schottky diode. With stress, the temperature coefficient decreases.

The life of the device is obviously determined by the maximum stress applied. At about 2×10^6 g/cm², the life is reported to be 100 million operations.

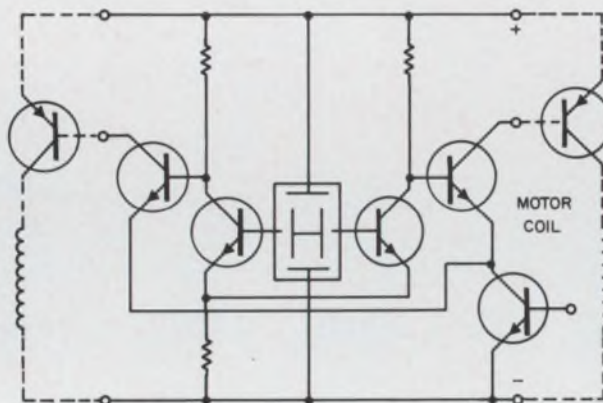

Integrated circuit with a Hall element is used as a switching circuit in a dc motor. It's fabricated by Philips Research Laboratories.

IC controls triacs, SCRs

A high-gain integrated trigger circuit for phase control of triacs or silicon-controlled rectifiers was described by two General Electric engineers, E. K. Howell and J. R. Mullaly.

The monolithic IC circuit has multiple uses: to control the speed of induction motors from a thermistor input signal; to control the temperature of fans and blowers, or as a dc tachometer signal input, for feedback speed regulation.

The circuit features adjustable gain, zener-regulated supply voltage, alternating trigger pulses and inductive load logic.

As shown on page 32, bottom, the input signal establishes a pedestal level, to which is added a ramp that is externally adjustable. The resulting waveform is compared with a reference wave by the comparator, which produces an output signal when the ramp crosses the reference level. The lockout gate blocks this signal from the trigger pulse generator until a blocking voltage appears across the triac. ■■

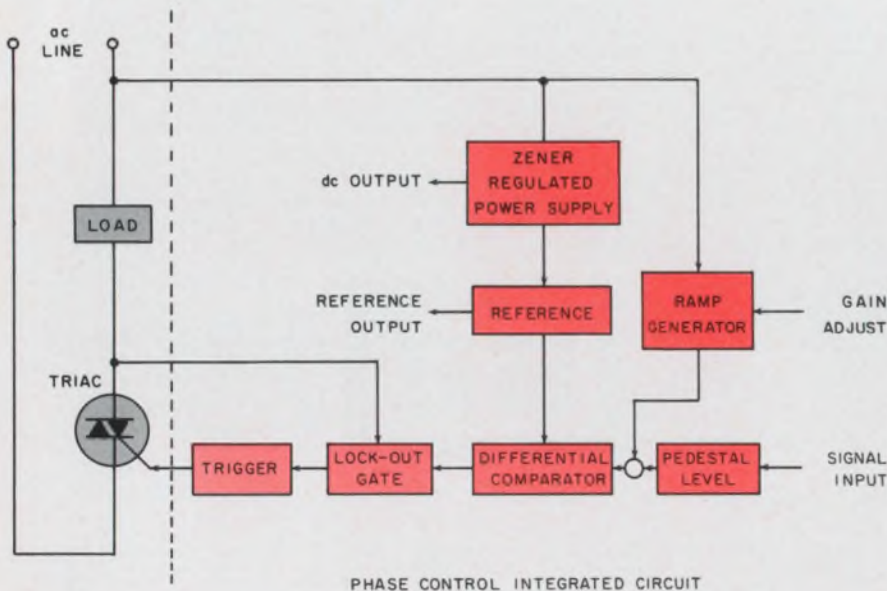

High-gain integrated trigger-circuit, developed by General Electric, is designed for proportional power control applications.

MICROWAVES

Beamlead diodes improve balanced mixer.

State-of-the-art construction boosts ruggedness and reliability of X-band device.

A unique microstrip circuit design and a pair of matched beamlead Schottky diodes combine to make our new SYM-8401 series of X-band balanced mixers a significant improvement in broadband design.

The ceramic substrate microstrip circuit provides low signal path loss, high isolation and broad bandwidth. The matched pair of beamlead Schottky barrier diodes is permanently welded to the microstrip circuit. This construction assures a degree of ruggedness and reliability not obtainable with conventional assembly techniques.

The SYM-8401 operates in a frequency range from 8 to 12 GHz. Single sideband noise figure is 9 dB max. from 8.5 to 11.5 GHz and 10 dB max. from 8 to 12 GHz. A typical noise figure plot is shown in Fig. 1. These measurements include 1.5 dB noise figure of the IF amplifier.

Typical VSWR is shown in Fig. 2. Average VSWR is 2.0:1 at both signal and local oscillator ports. The IF impedance at each IF port is typically 100 ohms. This impedance is shown over the operating frequency range in Fig. 3. Permissible RF input power at signal or local oscillator ports is 400 mW max.

This series of mixers is packaged in a sealed miniature housing with OSM-type connectors at signal, local oscillator and balanced IF ports. CIRCLE NUMBER 300



New type SYM-8401 X-band balanced mixer uses beamlead diode construction.

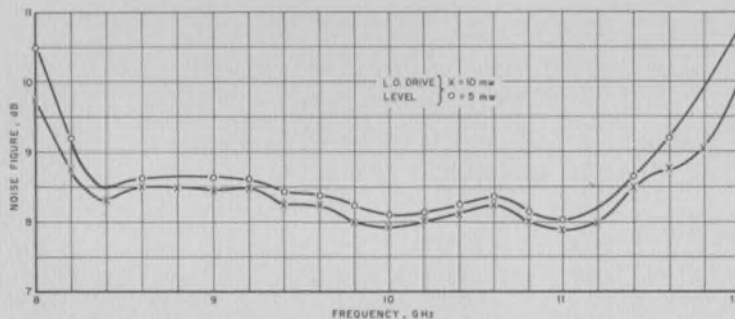

Fig. 1. Typical noise figure plot of X-band mixer over frequency range.

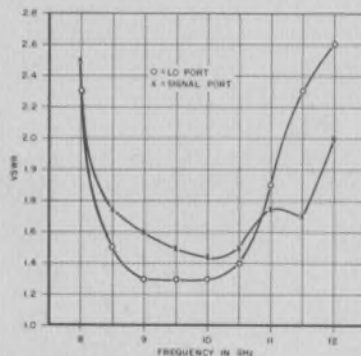

Fig. 2. Plot of VSWR of local oscillator and signal ports at a 5 to 10 mW power level.

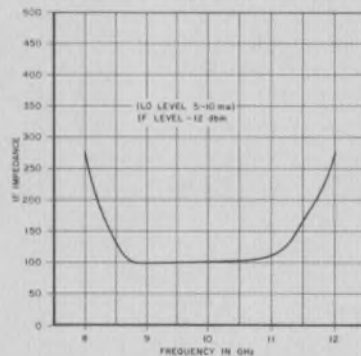

Fig. 3. Typical impedance levels measured at IF ports.

This issue in capsule

Electroluminescent Displays

You've got more choices when you use EL.

CRT Modules

Let our engineers design your CRT display package.

Integrated Circuits

New line/lamp driver cuts reflections on long lines.

Circuit Boards

Need circuit boards? We'll make them for you.

Television

Standard monochrome picture-tube line keeps on growing.

Diodes

High-Q VVCs improve HF amplifier performance.

Manager's Corner

That little extra something: Service.



Digital clock display panel shows six digits and two colons.

EL DISPLAYS

You've got more choices when you use EL.

Electroluminescent displays come in a wide variety of shapes and sizes. At least one should fit your application.

We have the broadest line of EL display devices available anywhere. Numeric displays are off-the-shelf items in sizes from $\frac{3}{8}$ " up to 12". Alphanumeric readouts start at $\frac{1}{2}$ " and go up to 12". Depending on the size you pick, we can put up to 12 characters on a single panel.

For example, we have a display especially designed for desktop calculators that shows twelve $\frac{1}{2}$ -inch characters on a $7\frac{1}{2}$ " by $1\frac{1}{2}$ " panel. Or, for another application, we have a panel of three 5-inch numerals. This panel is now in use to show flight numbers at the baggage pickup center at Chicago's O'Hare airport.

A third design that illustrates the versatility of EL displays is shown in the photograph. This is a readout for a digital clock incorporating six digits and two colons on a $2\frac{3}{8}$ " by 1" panel.

In addition to the wide range of display arrangements that are available, you get many other advantages when you use EL readouts. For example, EL readouts are inherently free from catastrophic failure. Light output gradually decreases, over the life of the device. Use of operational duty cycles increases, rather than decreases, the life of EL devices. This is in rather marked contrast to vacuum or gas type displays where on-off cycling decreases brilliance and increases the chances of sudden failure.

EL devices are also cool running. There are no heat dissipation problems. In addition, the spectral output of EL devices closely matches the response curve of the human eye. And they can be turned on and off faster than the human eye can respond.

If the wide range of devices available in our line doesn't meet your exact needs, don't worry about it. EL offers almost unlimited design flexibility. Within practical limits of size and complexity, any symbol configuration can be formed that can be produced by graphic arts techniques. In short, if we don't have it, we can turn them out in quantity in a short time.

CIRCLE NUMBER 301

Typical electroluminescent readouts

Type No.	Number of Digits	Total Power (mW)	Total Current (mA)	Overall Length (inches)
7 Segment Numeric				
$\frac{3}{8}$ Inch				
NU31A	1	8.8	0.088	0.595
NU35A	5	44.0	0.440	1.990
NU38	8	70.4	0.704	3.700
$\frac{1}{2}$ Inch				
NU51S	1	10.0	0.10	0.685
NU54S	4	40.0	0.40	2.950
NU56S	6	60.0	0.60	4.000
2 Inch				
NU201S	1	90.0	0.90	2.295
NU203S	3	270.0	2.70	7.375
NU206S	6	540.0	5.40	13.685
3 Inch				
NU301S	1	350.0	3.50	3.280
NU303S	3	1050.0	10.50	10.710
NU305S	5	1750.0	17.50	17.010
6 Inch				
NU601S	1	720.0	7.2	6.092
12 Inch				
NU1201A	1	2000.0	20.0	15.000
9 Segment Numeric				
$\frac{1}{2}$ Inch				
NU51T	1	13.0	0.13	0.685
NU73T	3	39.0	0.39	2.435
NU76T	6	78.0	0.78	4.000
$\frac{3}{4}$ Inch				
NU71T	1	26.0	0.26	0.935
NU73T	3	78.0	0.78	3.248
NU76T	6	156.0	1.56	5.608
1- $\frac{1}{2}$ Inch				
NU151T	1	67.0	0.67	1.720
NU153T	3	226.0	2.26	5.748
NU156T	6	427.0	4.27	10.468
14 Segment Alphanumeric				
$\frac{3}{4}$ Inch				
AN71R	1	17.0	0.17	0.935
1 Inch				
AN101R	1	47.0	0.47	1.218
2 Inch				
AN201R	1	135.0	1.35	2.295
5 Inch				
AN501R	1	750.0	7.50	5.155

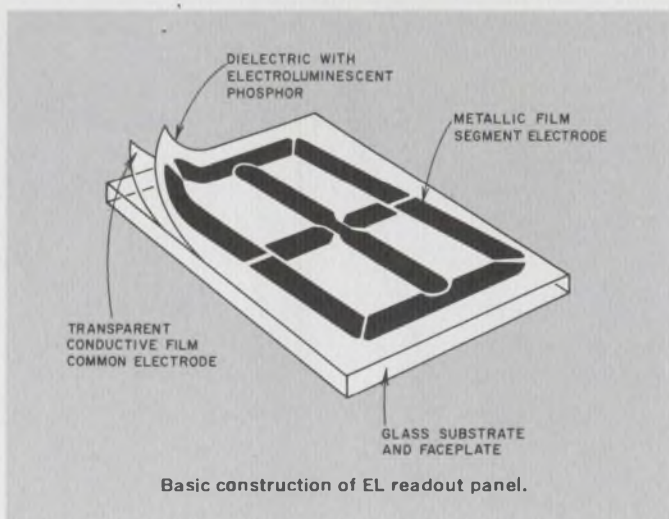

CRT MODULES

Let our engineers design your CRT display package.

We'll save you time and money, and you'll end up with a better system.

Our CRT engineering staff is offering a new service that can give you the best in display systems at minimum cost. We'll build a complete CRT display package, designed to fit your system.

Too often, the design engineer has to make do with the cathode ray tubes available on the market and force them to fit his system requirements. Sylvania has changed all that.

Because we are experts in CRT devices, we can pick the best tube for your system. Because we're experts in interfacing CRT systems, we can give you the best drive circuits to meet your system requirements.

In short, you get the optimum display system for your needs. You get it fast, and in most cases you get it at a lower cost than if you did your own design work.

Sylvania offers integrated display modules in three separate design approaches (see sketches). We can give you a tube system with a separate electronics black box for installation in your own equipment. Or, the module can be supplied as a rack-and-panel assembly. The third form of display module is the complete assembly mounted in a free-standing cabinet. Of course, all types of modifications can be made on these three basic structural designs.

By making Sylvania responsible for both the selection of the CRT and the drive circuitry, you can be sure that the best choice of tube and circuitry will result. Immediate circuitry, such as the anode power supply, bias supply, video amplifier and drive circuits will all be optimized to both the CRT and the associated system.



Typical CRT display package designed and built by Sylvania engineers.

Pricing on our integrated CRT modules is based on a one-time engineering charge and a per-piece price quotation. Why not talk to us about CRT display problems. We'll give you a fast solution.

CIRCLE NUMBER 302

Three basic CRT module configurations are; tube with black box, rack-and-panel assembly and complete CRT module package.

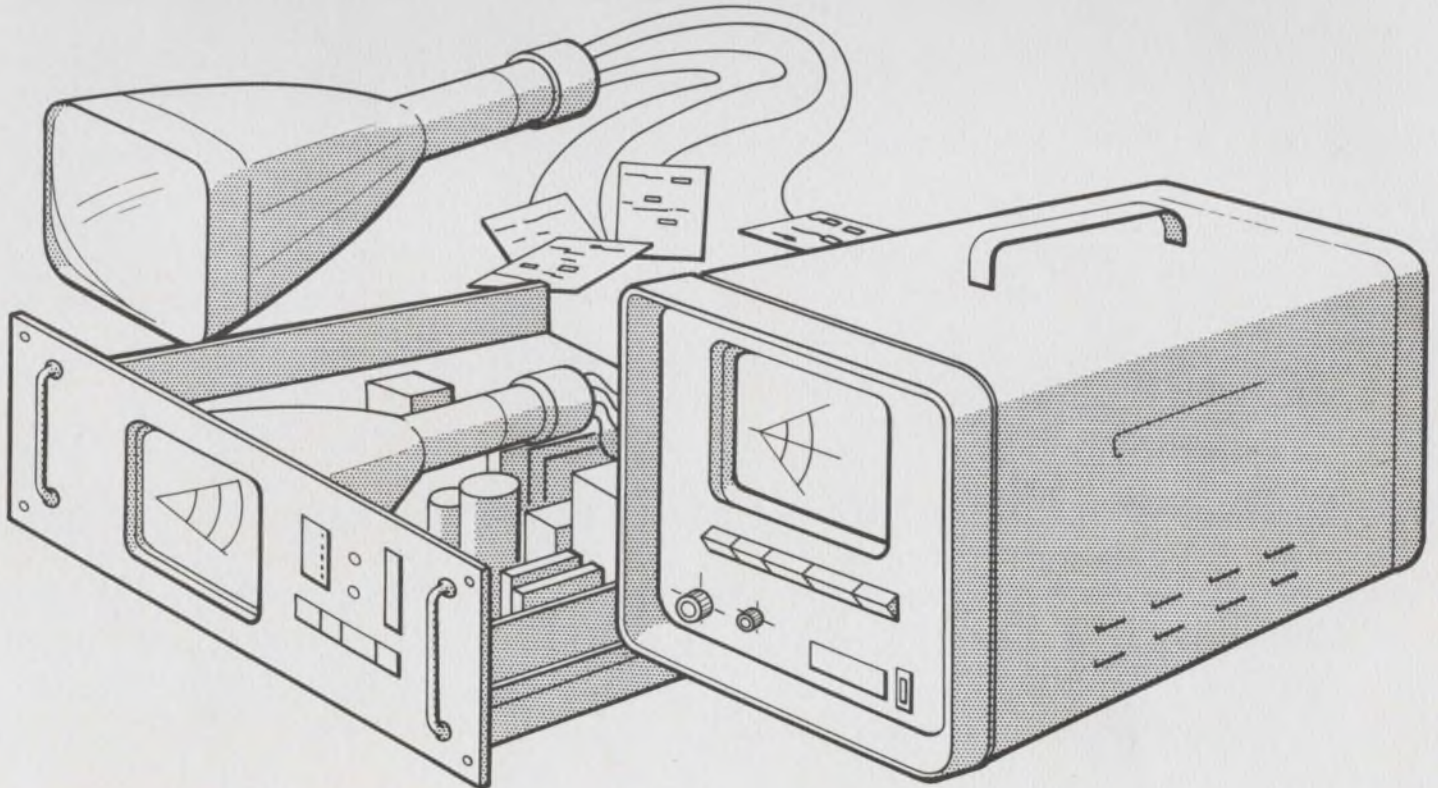

INTEGRATED CIRCUITS

New line/lamp driver cuts reflections on long lines.

High power output permits termination of long lines to eliminate problems caused by mismatching.

Sylvania's new SG-350 quad 2-input line/lamp driver gives you enough power output to drive a terminated line. This means you can eliminate reflections that cause spurious outputs and lower noise immunity. The major difference between the SG-350 (Fig. 1) and other drive circuits such as the SG-140 and SG-220 is that the standard SUHL active pullup network has been removed and the physical size of the output transistor has been increased.

Elimination of the pullup network means that the outputs of the SG-350 can be connected together to perform the wired-OR function. The larger geometry of the output transistor allows higher sink currents so that the circuit

can drive incandescent lamps, bus and terminated long lines, directly.

The "1" level at the output of the device is determined by an external resistor connected to a suitable power supply. For long-line driving applications, the value of this resistor is the same as the characteristic impedance of the line. Turn-off delay time is a function of the RC time constant of the pullup resistor and load capacitance plus the storage time of the device.

The big advantages of having the capability to drive long terminated lines are graphically illustrated in a series of waveform photographs taken using the test setup shown in Fig. 2.

Figure 3a shows system response when the test line is an unterminated twisted pair 20 feet long. (Letters refer to test points on Fig. 2.) Note that the transmitter input pulse is the same width as the delay of the line. When a pulse is transmitted down the line the returning reflections arrive at the transmitter when the output is off (high impedance). This causes the line to ring, particularly at the receiving end. Because of the high voltage excursions on the receiving end, we get spurious pulses at the receiver output. For each transmitted pulse there are five receiver output pulses. The spurious output pulses will continue until the line capacitance charges to the threshold level. If

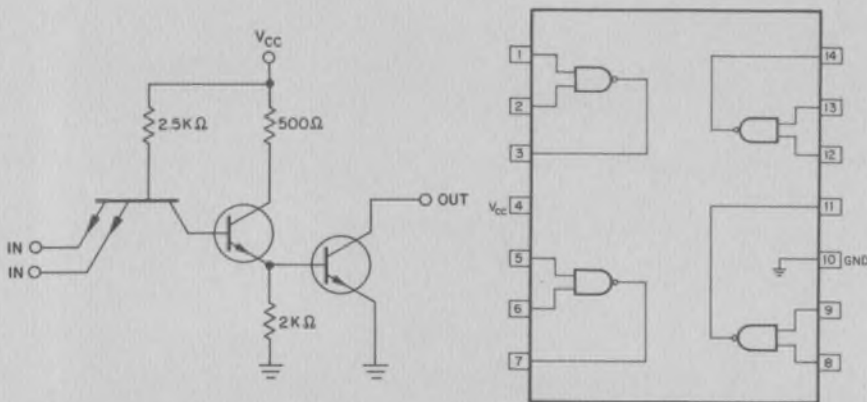
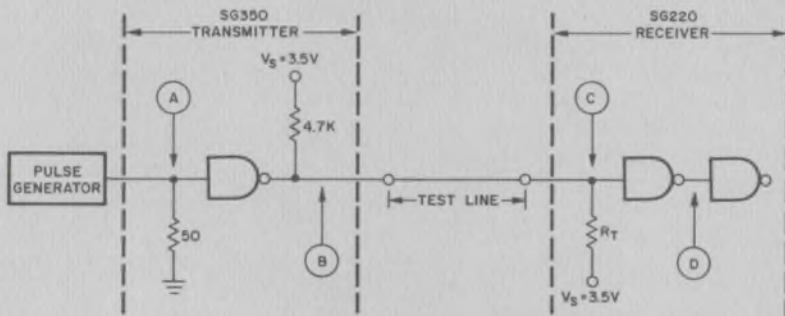

Fig. 1. Circuit and logic diagrams of SG-350 line/lamp driver.



- POINT (A) TRANSMITTER INPUT (TOP TRACE) 5V/cm, 0 AT 1 cm, DOWN.
- POINT (B) TRANSMITTER OUTPUT (2nd TRACE) 5V/cm, 0 AT 2 cm, DOWN
- POINT (C) RECEIVER INPUT (3rd TRACE) 2V/cm, 0 AT 1 cm, BELOW ϕ .
- POINT (D) RECEIVER OUTPUT (4th TRACE) 5V/cm, 0 AT BOTTOM

Fig. 2. Test setup used to obtain waveform photographs.

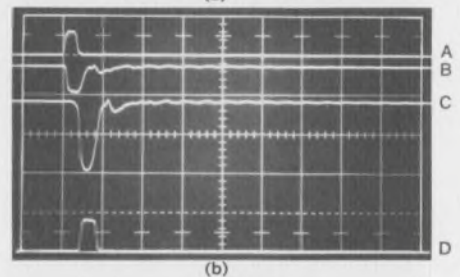
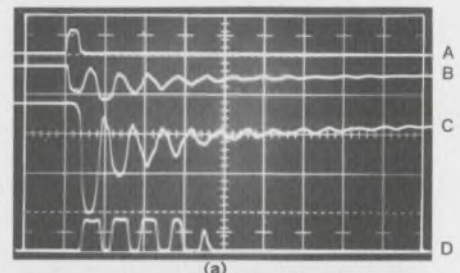

Fig. 3. Waveforms on unterminated (a) and terminated (b) 20-foot length of twisted pair.

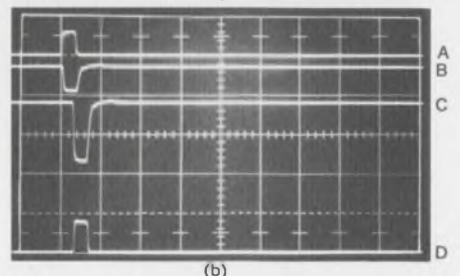
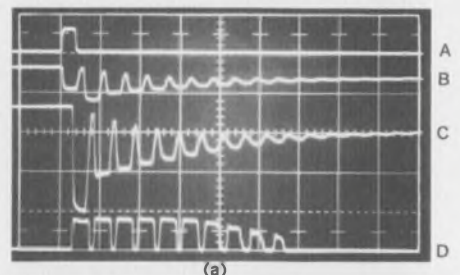

Fig. 4. Waveforms obtained on test of unterminated (a) and terminated (b) 33-foot length of RG-58 A/V coaxial cable.

CIRCUIT BOARDS

Need circuit boards? We'll make them for you.

We've expanded our in-house facility to take care of a growing number of outside customers.

For years, our printed circuit board operation has been supplying the needs of our Electronic Systems Division. Now we've decided to put all the expertise we've acquired to work for you.

Typical of our precision work is the board shown in the photograph. Dimensional tolerances were held within 0.0005" over a span of 20". These boards have been produced at a rate of 1200 boards per day only four weeks after starting production.

Our highly automated production facility is equipped to handle any kind and size of board you need—single sided, double sided or multilayer. And we're able to turn out high reliability, close tolerance boards. For instance, our modern automatic drilling equipment can hold tolerances of 0.001".

We'll work with you starting at any point from the drawing board, breadboard or from your artwork. We'll do prototyping and can give you high or low volume production.

And in production, you can be assured of getting consistent and reliable plated-through holes as well as high-quality circuit plating, thanks to our automatic plating system.

And our services don't stop there. In addition to handling all of your board requirements, we are completely equipped to do fully automated component insertion. We'll have more to tell you about this in a future issue of IDEAS.

If you need circuit boards, why not talk to one of our technically trained sales force. They'll bring our facilities right to your doorstep.

CIRCLE NUMBER 304

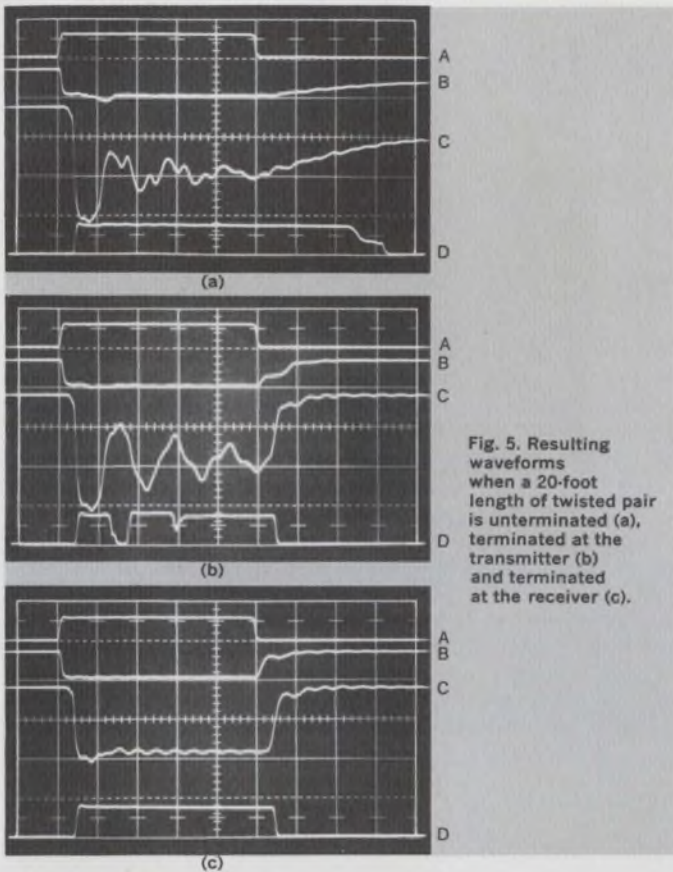

the driving pulses are shorter than the line delay, the number of spurious outputs will increase.

Figure 3b shows what happens when the same line is terminated with a 150-ohm resistor. Note that there is only one output pulse for each input pulse.

A similar comparison is shown in Fig. 4, for 33 feet of RG-58A/U coaxial cable. Fig. 4a shows the unterminated condition and Fig. 4b shows what happens when the line is terminated in 50 ohms.

System response for a 20-foot length of twisted pair is illustrated in Fig. 5. In this case the driving pulse is much longer than the delay time of the line. Figure 5a is the unterminated case where the presence of the driving pulse (which keeps the transmitter in the "O" or "on" condition) tends to clamp the magnitude of the reflections. Note that there are no spurious output pulses in this case, but that the length of the receiver output pulse is much longer than the input to the transmitter. This is caused by the recharge of the line capacitance to threshold level. Also, because of the magnitude of the reflections at the receiver input, the noise immunity is reduced. In higher electrical noise ambients this situation could produce spurious outputs.

Figure 5b shows the system response when the line is terminated at the transmitter end rather than at the receiver. This approach does not suppress the reflections because the termination is in parallel with the output impedance of an "on" transistor.

The results obtained when the line is terminated on the receiving end are shown in Fig. 5c. Note that the receiver output pulse width is the same as the input to the transmitter. Noise immunity is also improved thanks to the lack of reflections at the receiver input.

These results speak for themselves. It's easy to see the advantages you get when you use the SG-350 for terminated line driving applications. Of course, the SG-350 is completely compatible with the rest of the Sylvania SUHL line and has all of the inherent advantages of SUHL logic design.

CIRCLE NUMBER 303

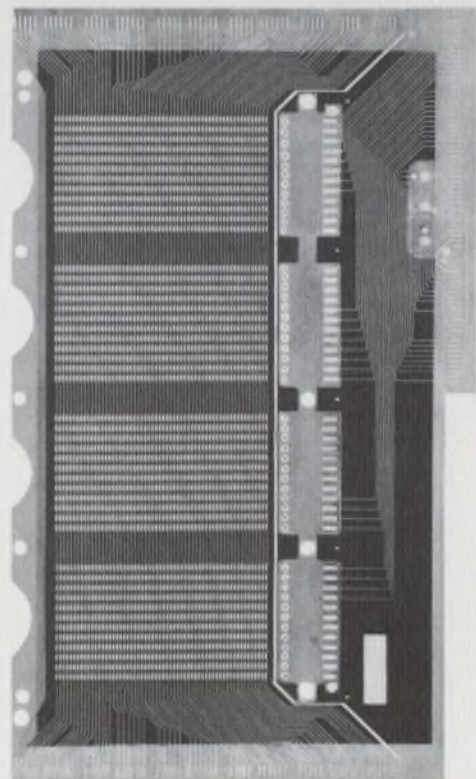

Circuit board holds dimensional tolerance of 0.0005" over 20" span.

TELEVISION

Standard monochrome picture-tube line keeps on growing.

We now have six sizes in the line that offer you the most tube for the least money.

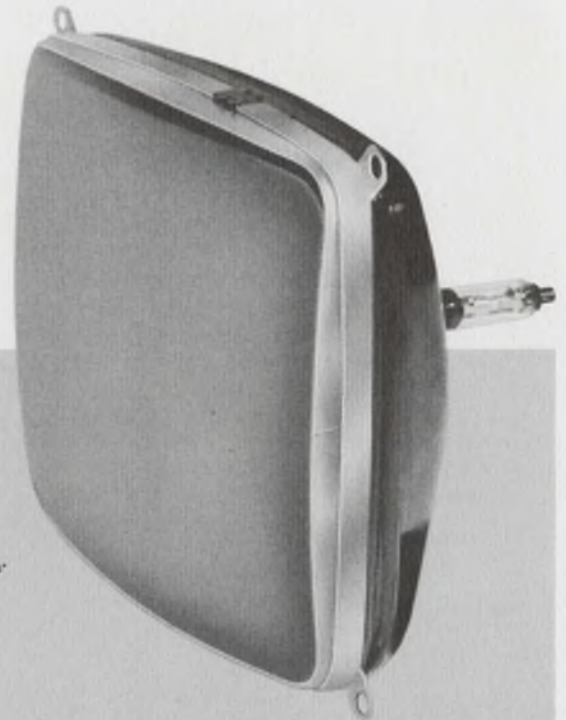

22ZP4 standard tube.

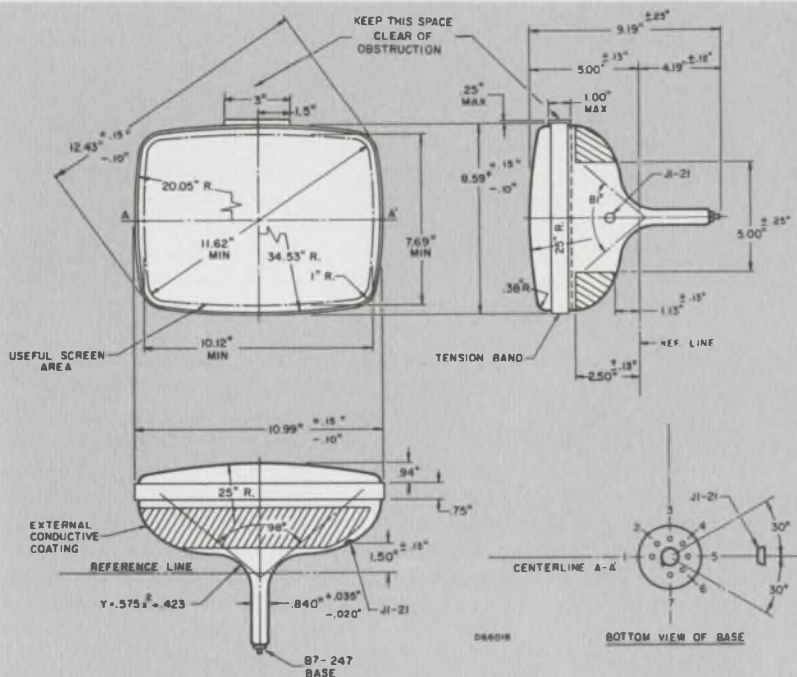

Standard tube types

Type Number	Screen Area (Sq. in.)	Overall Length (In.)	Implosion Protection System	Deflection Angle (Degrees)	EF/IF (Volts/Ma)	Type Focus	Max. Anode Voltage (Volts)	G ₂ Voltage (Volts)
9YP4	40	9.24	T-Band	85	12.6/80	Lo Es*	15,000	100
12DEP4	74	9.19	T-Band	110	6.3/450	Lo Es*	15,000	100
17ESP4	141	11.20	Kimcode	114	6.3/450	Electrostatic	23,000	300
20YP4	184	12.27	Kimcode	114	6.3/450	Lo Es*	23,000	50
22ZP4	229	13.13	Kimcode	114	6.3/450	Electrostatic	23,000	400
23HFP4	282	14.88	Kimcode	110	6.3/450	Lo Es*	23,500	50

*Low Voltage Electrostatic

When we introduced our "standard" 12" B & W picture tube a little over a year ago, we said we could offer lower price through volume production. Apparently, a lot of people believed us. The 12-inch tube has been a roaring success.

Now, we've expanded our standard-tube concept to other sizes including 9", 17", 20", 22", and 23" models (diagonal). A total of six different sizes that can save you money on the single most expensive component that goes into a TV set.

How do we know that these tube types are best for standardization? We made a survey to find out the most acceptable bulb configuration for each size. Then we determined which electronic factors were most important. These included focus and deflection voltages, gun-mount configuration, anode button location and other design considerations.

We put all this information together and came up with a series of tubes that meet the majority of design needs. We developed a series of

tubes that we can sell at the lowest possible price.

Now, you can have a "MADE IN U.S.A." TV set that can be price-competitive with foreign-made sets. And, in addition, you get the full range of field engineering services and technical assistance that only a domestic manufacturer can provide.

Shouldn't you look into our standard tube line for your next set design? We feel sure you will find that the price break and superior Sylvania quality will pay off for you.

CIRCLE NUMBER 305

DIODES

High-Q VVCs improve H-F amplifier performance.

Family of voltage variable capacitors for use in tuned circuits are now available with Qs of 600 and better.

When they couldn't get the special VVCs they needed anywhere, a major manufacturer of communications equipment brought their problem to Sylvania.

They required very high-Q VVCs tightly matched into quads by capacitance change ratio for use as the tuning device in high-frequency amplifiers. Fast action was essential to meet the customer's production schedules.

A special team consisting of the customer engineers and Sylvania's engineering and production groups was rapidly

formed to concentrate on a fast solution to the situation. By working closely with the user, and applying Sylvania's diode know-how, the required quantities were supplied on time. And the result is a new series of VVC diodes in the Sylvania line.

This high-Q series features typical Qs in excess of 600 and a choice of capacitance values from 4.0 pf to 33.0 pf, nominal. Tuning ratios are closely controlled to the typical values shown in the characteristics table.

When it comes to packaging, you can write your own ticket because Sylvania has the flexibility to meet your needs.

Whether you want your VVCs in chip form, DO-7 package or in any other form factor, Sylvania's VVCs offer a greater design margin.

The new series is also available in matched sets of two or more diodes with tightly controlled capacitance and change ratios between units.

When you need VVC diodes, take advantage of Sylvania's specialized design knowledge and our proven ability to deliver the goods.

CIRCLE NUMBER 306

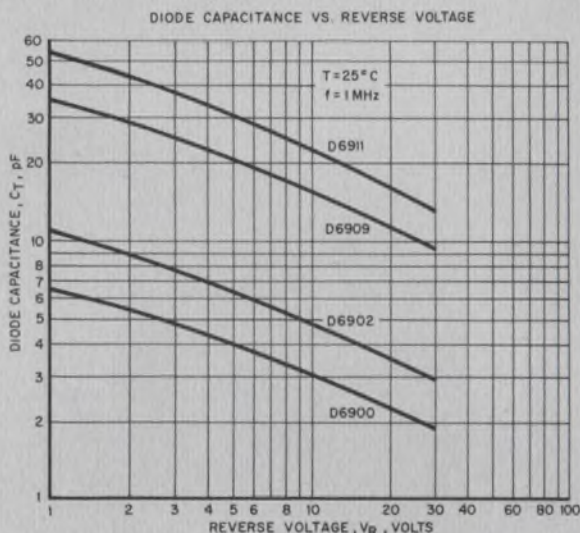

D6900 series high-Q voltage variable capacitors

TYPE	Capacitance (C_T) $V_R = 4VDC$ $f = 1 MHz$ pF (nom.)	Quality Factor (Q) $V_R = 4VDC$ $f = 50 MHz$ (min.)	Capacitance Ratio C_{2V}/C_{30V} $f = 1 MHz$ typical
D6900	4.0	600	2.8
D6901	5.4	600	2.8
D6902	6.8	600	2.9
D6903	8.2	600	2.9
D6904	10.0	600	2.9
D6905	12.0	600	2.9
D6906	15.0	500	2.9
D6907	18.0	500	3.0
D6908	20.0	500	3.0
D6909	22.0	500	3.0
D6910	27.0	500	3.0
D6911	33.0	500	3.1

Breakdown Voltage ($I = 10 \mu A$) = 30VDC

SEE OUR
SPECIFICATIONS IN
VSMF
MICROFILM CATALOG
FILE

Use Sylvania's "Hot Line" inquiry service, especially if you require full particulars on any item in a hurry. It's easy and it's free. Circle the reader service number(s) you're most interested in; then fill in your name, title, company and address. We'll do the rest and see you get further information by return mail.

BUSINESS REPLY MAIL

No Postage Stamp Necessary if Mailed in the United States

FIRST CLASS
Permit No. 2833
Buffalo, N. Y.

POSTAGE WILL BE PAID BY

Sylvania Electric Products Inc.
Sylvania Electronic Components
1100 Main Street
Buffalo, New York 14209

Dept. D 3 3 3 3

MANAGER'S CORNER

That little extra something: Service.

There is one area where foreign TV picture tube manufacturers cannot compete with domestic producers. That area is service to the customer.

By service we mean assuring that you get fast aid and intelligent assistance when problems crop up on your production line.

Sylvania's Commercial Engineering Laboratories are set up precisely to give you that service. The Commercial Engineering Labs work hand-in-glove with field engineering, sales, marketing, quality control, design and development and the manufacturing group to provide a product that is competitive and fulfills the requirements of TV receiver manufacturers.

To do this, Sylvania's Commercial Engineering Labs at Seneca Falls, N.Y. evaluate hundreds of picture tubes made by both Sylvania and our competition on a regular, systematic basis. This evaluation procedure includes a detailed evaluation of all tube characteristics that are important to successful operation in TV receiver. A typical rundown of these characteristics includes emission, cutoff, brightness, ease of setup and registration, screen uniformity, convergence pattern, raster shift and many others.

The instrumentation available in the Lab for this work includes a number of color test stations used to evaluate color tubes under controlled, repeatable operating conditions. A wide range of operating voltages and currents are available at each station for normal and stress testing.

In addition, an Earth's magnetic field environmental chamber is available to analyze tube and receiver performance under various conditions of the earth's magnetic field.

In our labs, we can duplicate the magnetic environment that would be experienced by tubes operating in any part of the United States, Europe, Canada, or Mexico.

This accumulation of data on a regular basis allows Commercial Engineering to quickly analyze the possible causes of problems on a customer's production line or in field operation. It also helps in solving new design and unusual applications problems that are part of the color receiver production business.

In addition to aiding the customer, our Commercial Engineering Lab also aids our own manufacturing division. Because Sylvania sells to all major color set makers in the United States, Europe, Canada and Mexico, it is important that our products meet the varying requirements of a variety of manufacturers. To do this requires a complete knowledge of the operating requirements of many receiver design groups located all over the world.

This knowledge begins with the analysis of new receiver circuits that affect the operation of the picture tube. It includes such things as tube and chassis mounting arrangements as well as the location and characteristics of neck-mounted components. Our search for knowledge of actual operating requirements ends with a life test of the picture tubes in receivers purchased from the customer.

With this kind of data, we can react quickly to customer requirements and analyze production situations thoroughly to obtain quick solutions to problems.

This is the primary function of our Commercial Engineering Laboratories, and is just another example of our efforts to provide the best production and service to the customer.

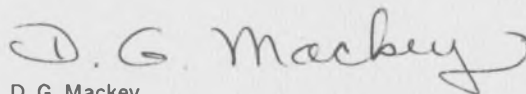

D. G. Mackey
Section Head, Commercial Engineering Lab.

This information in Sylvania Ideas is furnished without assuming any obligations.

SYLVANIA

A SUBSIDIARY OF
GENERAL TELEPHONE & ELECTRONICS

NEW CAPABILITIES IN: ELECTRONIC TUBES • SEMICONDUCTORS • MICROWAVE DEVICES • SPECIAL COMPONENTS • DISPLAY DEVICES

D3

NAME _____

TITLE _____

COMPANY _____

ADDRESS _____

CITY _____ STATE _____ ZIP _____

Circle Numbers Corresponding to Product Item

300 301 302 303 304
305 306

Please have a Sales Engineer call



HOT LINE INQUIRY SERVICE

Need information in a hurry? Clip the card and mail it. Be sure to fill in all information requested. We'll rush you full particulars on any item indicated.

You can also get information using the publication's card elsewhere in this issue. Use of the card shown here will simplify handling and save time.

At Last... Broadband AC Digital Voltage Measurements

(with unparalleled sensitivity and programmability)

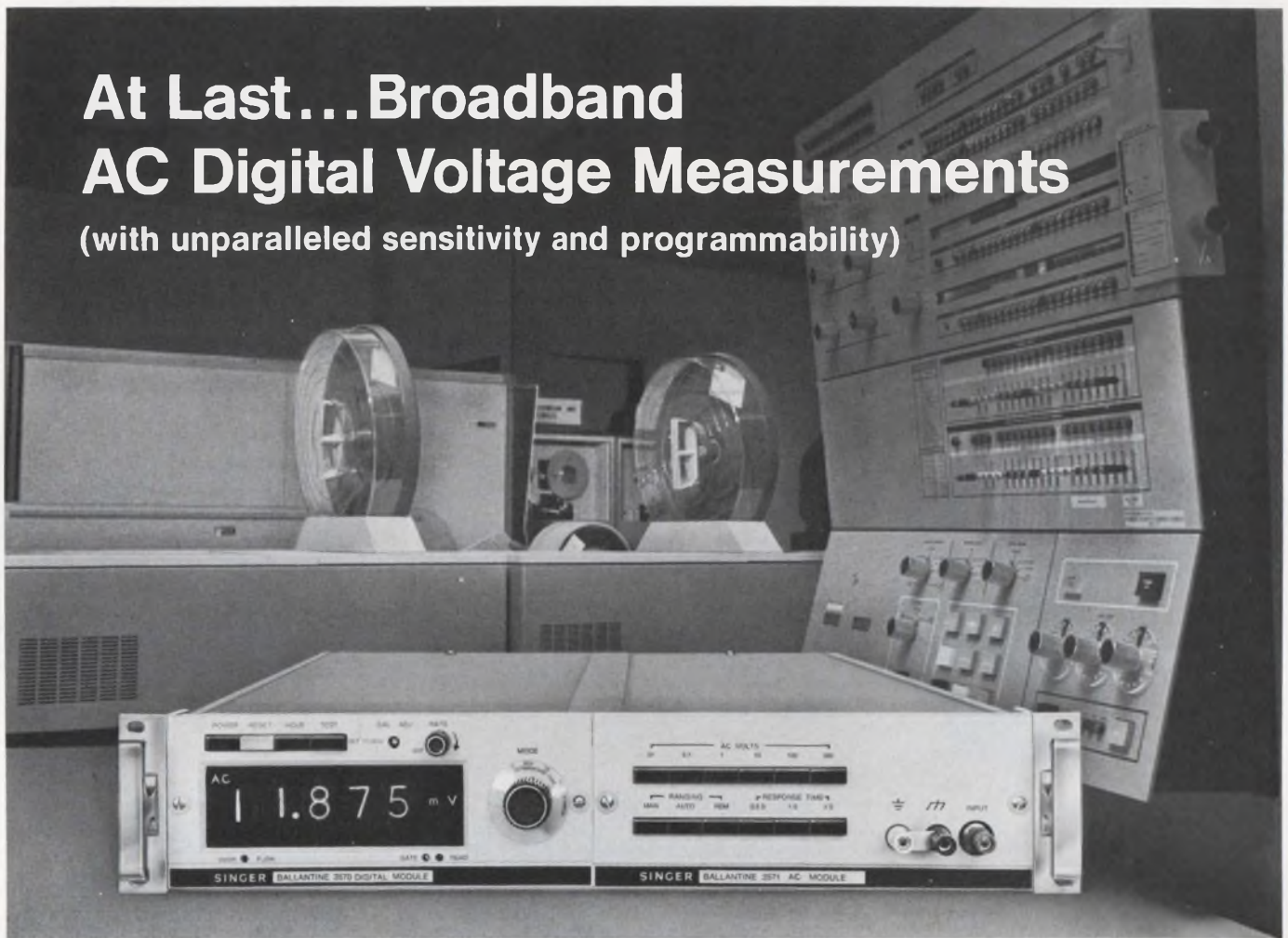

and Ballantine made it possible!

Who else but Ballantine, the recognized leader in Broadband voltage measurement techniques could have introduced the New Model 3570 Series Digital Voltmeter... featuring complete programmability and exceptional sensitivity and accuracy for AC and DC digital voltage measurements.

Computer and System Interface is assured by the programmability of all operating functions as well as coded outputs for measurement information.

Full-scale AC sensitivity of 10mv combined with a 10 MHz bandwidth offers a measurement capability not previously available. AC mid-band accuracy is 0.2% RDG +0.01% FS. DC accuracy is 0.02% RDG +0.01% FS.

A four digit display with overrange employs dual-slope integration for superior noise rejection.



Optional 20 MHz Frequency Counter capability and Auto-Ranging are also available.

Rack and Stack

Modular packaging makes it possible for system modules to be easily arranged side-by-side for rack mounting or over-and-under for bench use. State-of-the-art versatility is assured as new modules are introduced.

Creative engineering at Ballantine is your assurance that the New Model 3570 Series Digital Voltmeter is more than merely a better voltmeter—for that goes without saying. Ballantine has once more advanced the state-of-the-art in voltmeter technology, and set a new standard in Broadband AC Digital Voltage Measurement.

We invite comparison... Write or phone—for additional technical information, The Singer Company, Instrumentation Division, Ballantine Operation, P.O. Box 97, Boonton, New Jersey 07005, (201) 334-1432 or your nearest Ballantine Representative.

SINGER
INSTRUMENTATION

INFORMATION RETRIEVAL NUMBER 23

5 revealing questions to ask hybrid manufacturers:

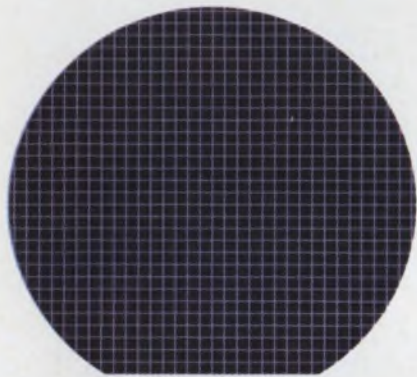

1 Do you manufacture your own chips? Fairchild does. We're the only manufacturer that manufactures, tests and stores our own chips. We test over three million dice in our hybrid facility every month. And we store over 10 million dice, ready to be used right now. Response to any demand is quick and in volume. From Fairchild.

2 How large is your selection of hybrid components? Back to the Fairchild stores, where we've got those 10 million dice. They include everything from simple diodes to complex LSI functions. If you need it, you can get it right now. From Fairchild.

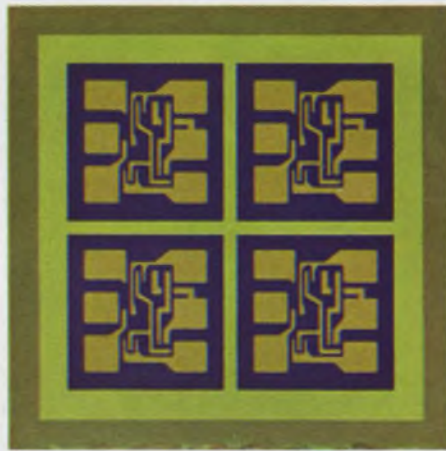

3 Can you offer computer-aided design? Fairchild not only offers, but delivers. If those 10 million single chips in our facility won't do your job best, we give your problem to our CAD group. With our new computer-aided design technology, the whole design procedure

—choosing the logic elements to implement your function, generating diffusion and metalization masks, even setting up functional and electrical test sequences for checking out the completed device —is all handled by the computer. It's just one of the things that



makes our prices the lowest in the industry. Your special functions are available fast and economically. From Fairchild.

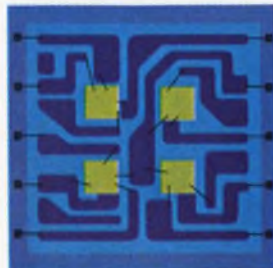

4 Are you limited to any specific technology? Not at Fairchild. We use the technique that's best for you. Thick film for economy. Thin film for accuracy and radiation resistance. Thin film on silicon if the function calls for a lot of active devices—discretes, MOS or LSI—and few passive ones. Whatever's right. From Fairchild.



5 Can you make hybrids in production quantities? At Fairchild, we make so many hybrids we've even got a line of standard hybrid functions priced like discretes. Hybrid production is on an assembly line basis, with the lines split according to the complexity of the functions being manufactured. Skills and equipment are matched exactly to the products. The products are right on price, performance and reliability. From Fairchild.

When all the answers are in, you'll find that Fairchild is the only manufacturer that qualifies as a complete hybrid source. For everything. Packages. Products. Substrates. Volume.

If there are more questions, you can get one brochure that has all the answers. Only from Fairchild. Write for it today!

FAIRCHILD
SEMICONDUCTOR

Fairchild Semiconductor / A Division of Fairchild Camera and Instrument Corporation
313 Fairchild Drive, Mountain View, California 94040 (415) 962-5011 / TWX: 910-379-6435

INFORMATION RETRIEVAL NUMBER 24

Graphics: The future in design by computer

Costs and rudimentary software are holding back wide use, but research progress is quickening

Robert Haavind
Managing Editor

Electronic designers across the nation are using computers regularly to assist them in their work. Yet present methods are only the crude beginnings of design automation, many researchers believe. Cumbersome batch processing techniques (see opposite page), a general lack of available software and unsuitable interfaces between engineer and computer are all holding back automated design.

But despite the drawbacks, the demand for design automation is booming. In the San Francisco Bay area alone, over 80 companies are offering computer services or software support. In addition scores of

companies in the area have their own computer and programming staff, and hundreds of engineers are using in-company equipment for design work. The situation is similar at other electronic and aerospace centers around the country.

It is not surprising, therefore, that dozens of researchers are focusing on an approach that promises to make the computer a much more powerful partner in the design process. That approach is graphical interactive computing.

Graphic terminals allow a designer to work on his problems as he visualizes them. Circuit and block diagrams, sets of curves, blocks of data, wave shapes—these are the language of the electronic designer.

Interaction is also vital, because design is a process that couples intuition and iteration. A designer gets an idea, shapes up a circuit, and then goes through a number of analyses and modifications to make his circuit conform to all requirements. Often these modifications require insight, which can't yet be put into a computer program for batch processing. Also, a step-by-step process like this becomes difficult when hours, even days, go by between the formulation of a design problem and the obtaining of results.

Graphics still aren't common

Despite the great potential, graphic terminals are not yet being used widely for circuit or systems design work. They are expensive, particularly in an interactive mode. The software is still rudimentary, although some important steps forward are being made. Graphical programs that make terminals easy to use take up large blocks of storage, and calculations to manipulate images can tie up a computer while it should be handling more vital computations.

"Lack of standardization is a big thing holding back computer graphics," says John Ward, who designed graphic systems for Project MAC (Multi-Access Computing) at the Massachusetts Institute of Technology, Cambridge, Mass. Important developments at different research facilities cannot be transferred, he explains. Each group must work out the new concepts to fit its own languages, programs and equipment.

A fully interactive graphic terminal costs over \$60,000 and the most common terminal in the industry—the IBM 2250—costs in the neighborhood of \$250,000. Without extensive software development—both to simplify operations between the terminal and the computer and to tailor the capabilities of the system to a particular application—the user finds the graphics approach cumbersome rather than helpful.

At MIT and Bell Telephone Laboratories, Murray Hill, N.J., where much work has been done on developing computer graphics for design work, studies show that some 90 per cent of the design activity on graphic terminals did not make full use of interactive capability. Both MIT and Bell have, as a result, done extensive work on the development of simpler, lower-cost terminals with more limited capability.

This does not mean that fully interactive terminals will not become useful. It just indicates, graphics researchers feel, that the techniques for permitting smooth interaction in difficult, eye-level design problems have not yet been worked out. An examination of some of the difficulties faced in achieving this goal, and of some of the achievements already made, should help clarify their outlook.

Basically an interactive graphic terminal consists of a cathode-ray tube, some device for indicating locations on the screen of the computer, and a variable amount of circuitry to relieve the main com-



At Bell Labs, where over 1400 researchers use computers, graphical interaction is being developed for a wide range of tasks.

BATCH PROCESSING



1. Decide on Circuit approach



2. Draw Equivalent Circuit



3. Prepare problem for Computer solution



4. Submit Problem

5. Compute solution

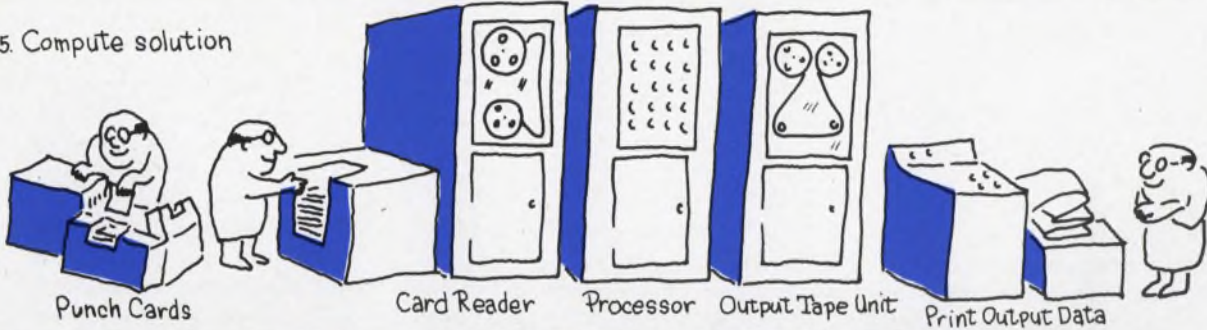

Punch Cards

Card Reader

Processor

Output Tape Unit

Print Output Data

COMPUTER CENTER



6. Receive Output



7. Study Circuit Analysis



If not suitable ...



prepare modified problem for computer solution ... and return to Step 3.

GRAPHICAL INTERACTIVE COMPUTING



1. Decide On Circuit Approach



2. Sit down at Graphic Terminal, Pick up Light Pen



3. Set up desired circuit by choosing items from "menu"

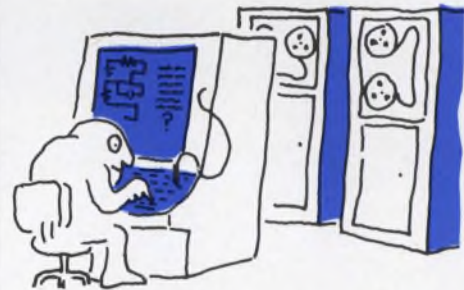

4. Computer asks for missing data, Designer feeds it in.



5. Performance curves printed out.



6. Changes inserted by using light pen and pressing button on keyboard



7. New Performance results displayed



8. Success ACHIEVED!

(graphics, *continued*)

puter of some of the storage and calculations needed to operate the display. Early graphic terminals usually had minimal built-in circuitry. Today many displays have an associated small computer of their own, plus special purpose digital or analog circuits or both.

Every display requires d/a conversion, since commands from the computer are in the form a string of digits and deflection voltages must be analoged.

Most terminals are of the random positioning type, where the beam only traces out the pattern specified. A raster scan that uses an ordinary TV monitor is also possible, and much cheaper, but this approach has drawbacks. The raster display is not as pleasing visually, and it involves program-

ing difficulties, besides not working well with a light pen.

Refreshing—that is, tracing an image over and over many times a second—is required in normal CRTs. This requires display data to be stored and repeatedly cycled. With normal phosphors, such as the P-31, this must be done 30 to 60 times a second to give the appearance of a stationary image. If the picture becomes cluttered, the system isn't able to retrace at such a fast rate, and it begins to flicker.

Why not use long-persistence phosphors? Unfortunately, they are not as bright, are easily burned, and, again, there may be difficulties in using a light pen.

Display functions can be provided in either hardware or software. The configuration of a typical system—the IDIOM offered by Information Displays, Inc., of Mount Kisco, N.Y.—is shown in the block

diagram. The programmable memory and controller is a Varian Data Machine 620-i computer with core capacity for 4000 16-bit words. The display processing unit serves as a mode control, decoding instructions from storage and generating the proper function signals. It also takes care of such tasks as setting up a string of characters across the screen automatically, adjusting positions and spaces, and establishing left and right margins. A number of special functions are built in.

The character generator provides 64 symbols—alphabetic, numeric and special. The vector generator draws lines between specified end points. Circles can be drawn automatically when the user specifies the center and then a point on the perimeter. The blink control allows the user to select a particular portion of his drawing to blink on and



Three-dimensional data can be displayed on this Adage terminal. Built-in circuitry allows scaling, translation and rotation of images. Cost ranges from about \$60,000 for a simple 2-D version, to some \$250,000 for full 3-D capability. This was one of the first systems to have its own computer for refresh and some display computation, which can tie up a main frame computer. Aside from beautiful images, the system can produce useful multiparameter plots, and show dynamic variations continuously. Movie-making equipment will soon be added to the system accessories.

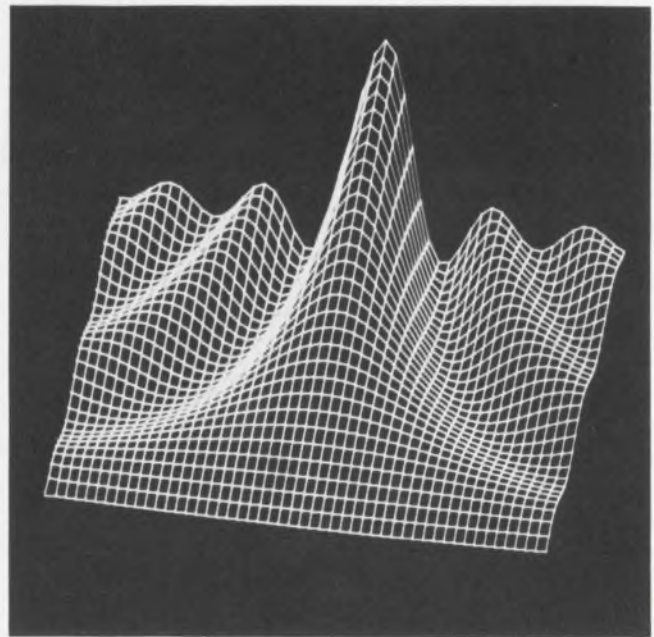
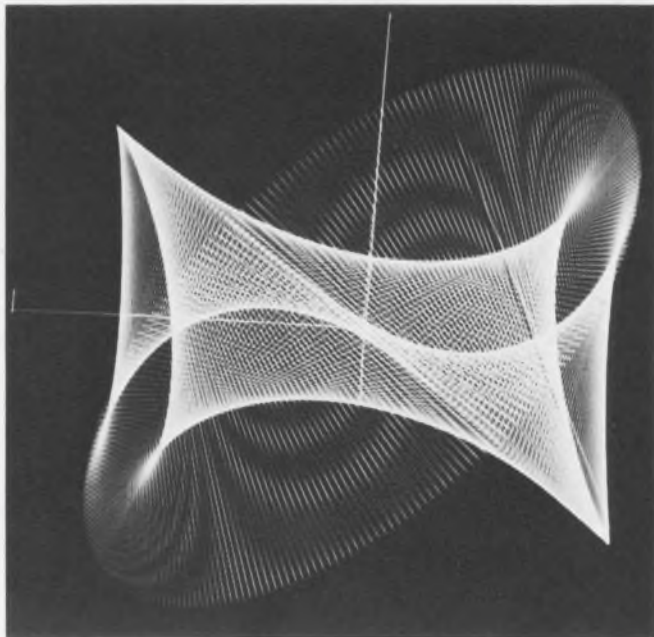

off. The character rotating control permits a string of characters to be rotated 90° counter-clockwise, which is particularly useful for labeling graphs.

The IDIOM system, with a light pen, sells for \$79,000.

The methods used to draw lines and to follow the motion of the light pen were spelled out by Robert Reikert, formerly with IBM and now a display designed for Information Displays. Straight lines can be drawn between specified end points in the same time interval, no matter what the length. But shorter lines will be brighter than long ones. If X and Y deflection voltages are applied at the same rate, the lines will be bowed rather than straight. Thus for an equal-time system, both of these effects must be compensated for. Information Displays chose instead, Reikert explained, to use a time-proportional vector generator.

In the case of the light pen, a photo sensor in the pen senses light at some point on the screen. The time at which the light is sensed tells the computer where the pen is located. A cursor, perhaps a square box, appears on the screen and the light pen is pointed at it.

Then the pen is moved to a desired location, say where a designer wishes a resistor to appear. As the pen moves, it strikes one side of the lighted box, indicating to the computer the direction of motion. Then the cursor is moved in that direction. This takes time, and a fast-moving pen can easily race ahead of the cursor. To aid the



Storage tube display, using a Tektronix 611 CRT, is the poor man's route to graphical interaction. Computer Displays sells this one for \$12,500 with "mouse" (right) or joystick control.

tracking speed, Information Displays uses a predictive technique, advancing the cursor along a projection of the track that the pen has been following.

If a user is willing to sacrifice some interactive features, he can get a display system at much lower cost. Computer Displays, Inc., of Waltham, Mass., for example, sells a storage tube terminal for \$12,500. This system is based on work done at MIT; Robert Stoltz, president of Computer Displays was formerly an MIT graphics researcher.

The ARDS (Advanced Remote Display Systems) terminal will operate with any computer, Stoltz explained, because it has been designed to look like a teletypewriter, except that it will operate at 1200 bits per second or faster. Standard ASCII code, with some special graphic control characters added, aids standardization. The Tektronix 611 storage tube in the terminal is also becoming an industry standard.

A storage display has the advantage of not flickering, no matter how much data is stored. But changes cannot be made as a pattern is built up, unless the entire picture is erased. Corrections can

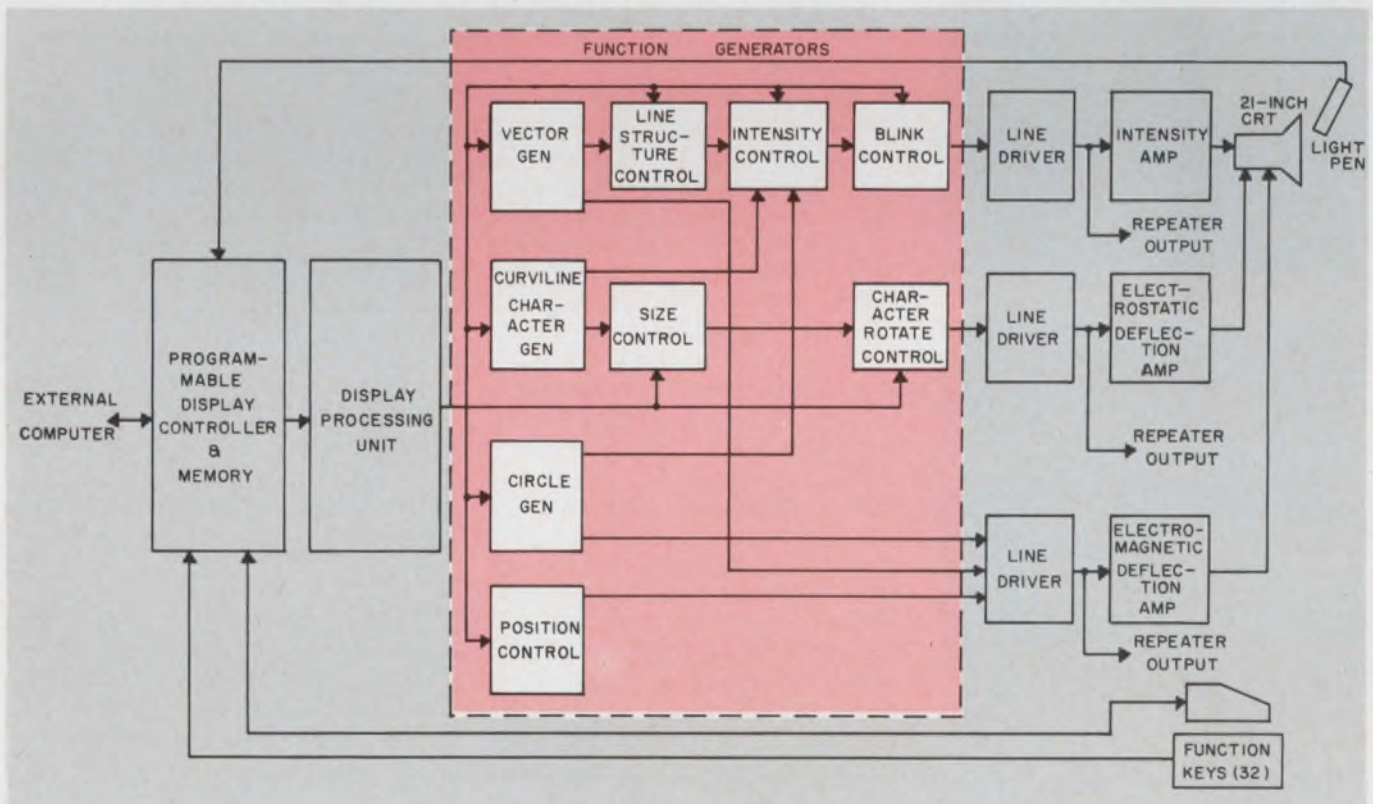

Typical system organization for a refresh-type display console. This IDIOM system allows the user to select a

portion of the display to blink on and off. A Varian 620-i computer is part of the system.

(graphics, continued)

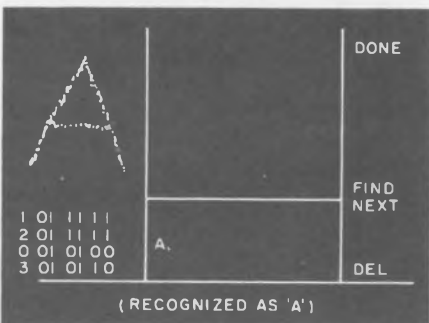
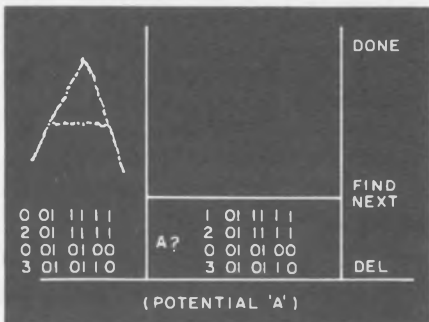
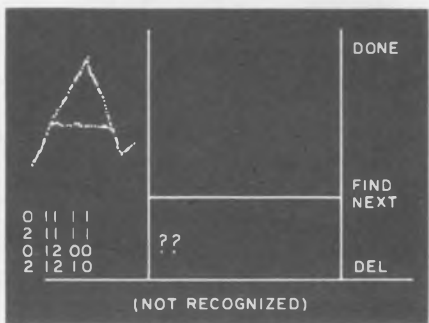
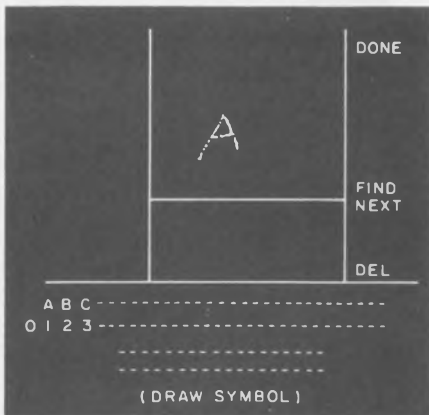

Training the computer to recognize a hand-drawn character is an unusual feature of a Lincoln Lab graphics system. The use of the TX-2 computer with a large, fast, thin-film memory makes this possible. Display at top shows how total character set is shown. The other versions have been simplified.

be made, although the user cannot actually see them on the display.

A user indicates positions on the screen by use of a "mouse" or a joystick. The mouse has two wheels at right angles beneath it, representing x and y directions. The wheels are connected to variable potentiometers. A spot on the screen tracks the motion of the mouse. The joystick operates like an aircraft control, similarly controlling the dot's position.

At the other end of the range of interactive consoles are those offering real-time manipulation of 3-D images. The Adage AGT-50, selling for \$150,000 to \$250,000, is an example. Adage, Inc., of Boston, also offers a simpler version for about \$120,000 (the AGT-30) and a 2-D version (the AGT-10) for \$60,000.

Scaling, translation and rotation to allow 3-D operation are provided by built-in analog circuitry.

IBM, the largest seller of graphics terminals, did not use a display computer with its early 2250 models. But the latest version, the 2250 Mod IV, has an associated IBM 1130 computer. This system sells for about \$250,000.

Graphics for IC masks

IBM 2250s were used in one of the first projects to show the value of graphical interaction for integrated-circuit mask design. A group under Arnold Spitalmy of the United Aircraft Corp. Norden Div., Norwalk, Conn., developed a program to allow ICs to be designed from standard building blocks.

The 2250's screen is split into functional areas, as shown in the diagram. The statistical area shows data concerned with the images in the picture area, where the working drawings are displayed. The computer feedback area helps the user to operate in a proper sequence, by giving him messages like: "Pick a Command." The "menu" area shows a list of operations from which the designer can make choices. Since the program for CADIC (Computer-Aided Design of Integrated Circuits) is large and complex, only portions of it are in the main computer's working memory at one time. Thus the portion concerned with one mode—"placement" for example—will be in working core while that

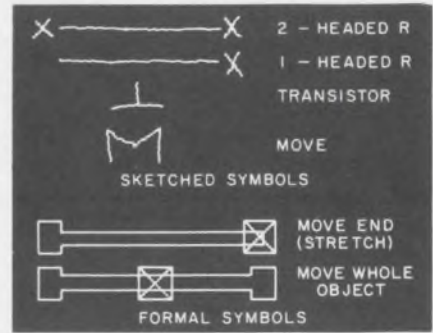

Some of the hand-drawn symbols the Lincoln Lab. system has been trained to recognize are shown above. The central point of the "M" tells the system where the user wants something moved to.

concerned with the other four modes are on discs. A button pushed on a function key set will switch into the "Record" mode, for example, swapping a new portion of the program into working memory. A new menu will appear, and the user can select portions of his display to store away for future use.

Just as Norden was completing work on the system, it stopped its integrated-circuit effort at the Norwalk plant. CADIC is now being sold as a service to IC manufacturers.

Will the automation of the design process eliminate jobs for thousands of design engineers?

"Not at all," says R. W. Wyndrun Jr., supervisor of the exploratory circuit applications group in the Film Circuit and Component Development Dept. of Bell Telephone Laboratories. Instead Wyndrun feels that present designers will be able to work more efficiently and design better circuits.

Wyndrun's group has just begun to move to graphical terminals in addition to the Teletype machines already being used for interactive circuit design work. "In the early days of computer-aided design," he recalls, "every problem had to be carried to the computer room on the fifth floor of the laboratory. Hours, sometimes days, passed before the results came back."

When his group switched over to Teletype machines operating in a time-shared mode, the speed on design problems was increased five to ten times. Now the graphical approach is allowing solutions to be reached five to ten times even fast-

er than that.

"Designs that used to take four days are now done in two or three hours," Wyndrum says.

Engineers will try more alternatives, he explains, and since each can be analyzed so much faster and more thoroughly, a better optimization job can be done.

Another factor that adds to the power of computer-based design, the Bell researcher feels, is that studies have shown that only 10 per cent of a designer's time is spent on reaching a nominal design. The other 90 per cent is devoted to the analysis phase, where values are optimized and then modified to take into account yields, tolerances, variation of temperature and other parameters.

A picture = 1024 words

"A picture is worth 1024 words," jests Lawrence Rosler, supervisor of the Bell Laboratories graphics group that is providing the software backup to Wyndrum and his designers.

A hierarchy of programmers is involved in bringing graphics into wide use, according to Rosler. This starts with the systems programmer, who evolves an operating system like the OS-360 or a compiler, then goes to the graphical systems programmer, then to an applications programmer, and finally to the user of the equipment. Rosler's aim is to wipe out the distinction between the last two in this chain. The approach is to make the programming of a problem for graphical solution no more difficult than FORTRAN programming.

Just as the development of FORTRAN compilers allowed computers to be programmed in the natural language of mathematicians, Rosler says, so will graphical systems allow engineers to work naturally with the computer.

Designing graphical systems where the designer is virtually unaware of the programming is also the objective of a group headed by Dr. William Sutherland at Lincoln Laboratory, Lexington, Mass. A sign on the wall in Dr. Sutherland's cubicle in the basement of the laboratory may indicate his working philosophy:

"Programs are like waffles—throw out the first one."

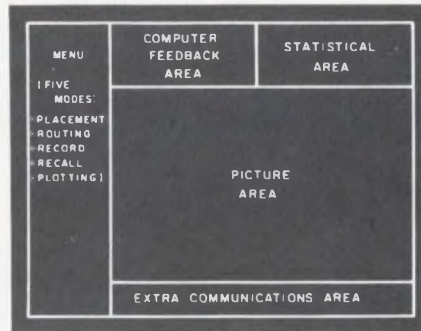

Layout of IBM 2250 display panel as it is used by Norden in developing integrated circuit masks. Standard parts, whether devices or circuits, are put together to structure a mask pattern.

For 18 months he and his group have been developing programs suitable for the layout of integrated-circuit masks.

"We are in the 15th version of the program," he reveals, "And we're not satisfied yet."

Each application for a graphical program turns out to call for different properties, and many of these cannot be determined until real work is done with graphical interaction. Thus the Lincoln Laboratory group is evolving programs that offer an assortment of basic features, and then allow an individual user to build up his own combinations of these features as he proceeds in his work.

In the IC mask case, for example, routines are available to line up the ends of devices with each other or with indicated points on other devices. Line widths and dimensions are automatically taken care of, so that proper values for components are achieved and devices are spaced correctly.

The most unique portion of the Lincoln Laboratory development is an automatic symbol recognition facility for stylus-drawn symbols. An individual user can "train" the system to recognize the symbols he draws with the stylus.

With this technique the user can draw symbols on a square tablet to communicate his desires to the computer. Thus he does not have to divert his attention to a keyset or a keyboard as he works along. Also, the "menu" presentation used in many graphical systems, which takes up screen area, is not required.

Another advantage to the symbol

recognizer is that a user defines his own symbols, and thus can easily remember them.

The recognition capability is provided by a trainer facility (see diagram). The user specifies by means of a typewriter what character or subroutine he wishes the symbols to represent. The example shown is for the letter A, but the system could similarly be trained to recognize the symbol for a subroutine, such as a move command.

Training is performed by repeatedly writing the symbol on the screen in the portion that lies between what appears to be the upper part of a football goal post. Each time that a symbol is drawn, the system notes certain of its properties and attempts to match these to a set of remembered features. These are such things as how many strokes are used, the aspect ratio (length to width) of the character, and how many crossings it makes of a tic-tac-toe grid fitted over the character. At first the machine does not recognize the character at all, so it displays two question marks below the goal posts. The proper character is typed in again and the user writes the symbol again. Finally it makes partial recognition, where the symbol's characteristics are closer to one remembered pattern than to any other. The machine indicates by displaying a character with a single question mark after it. When all the features of the character agree with the remembered pattern, the recognized character is displayed with a period after it.

Just a few of many developments leading toward easy communications between engineer and computer via graphics have been mentioned here. Dozens of projects continue to reduce the drawbacks, including cost. Already graphics terminals are proving economical for making printed-circuit wiring patterns and for integrated-circuit masks. Soon it will become a widely used approach to circuit and systems design. ■■

References:

1. Robert Sproull and Ivan Sutherland, A Clipping Divider, 1968, FJCC Proc., Thompson Book Co., Washington, D.C.
2. John Warnock, A Hidden Line Algorithm for Halftone Picture Representation, Univ. of Utah Technical Report 4-5 (May, 1968).

When Speed, Accuracy and Traceability harmonize in one test system, they're playing our song.

news and innovations in metrology **e|s|i**

The urge to automate components testing and other QC tests—and to provide data logging as well—has produced a three-cornered dilemma, to wit: Can speed be increased indefinitely without sacrificing accuracy and traceability? We think not.

It is probably jet age heresy, but we say there are limits beyond which speed of automation cannot advance without harming accuracy and repeatability. At least for the foreseeable future.

This is not to say we do not believe in automating and simplifying electrical measurements. On the contrary ESI is directed toward that end, but because we are first of all precision metrologists, we start with accuracy and traceability and work toward automation and information storage.

We've been building automated, semi-automated and data logging test systems as long as anybody. As a result of our

vantage from atop the precision metrology pyramid, we think we know as much as anybody about how to harmonize the three corners of the dilemma: Accuracy, Traceability and Speed.

On these pages are three systems which demonstrate ESI's capability in automation and data logging: the Model 70 Programmable Meter Calibrator, Model 500 series of automated resistor testers, Model 242C DL Resistance Measuring System with data logging.

Model 70 Programmable Meter Calibrator



Calibrate a multimeter in 9 minutes by punched card.

How do you automate the calibration lab, where it takes 1½ hours to check and certify the average meter?

ESI answers that question with our Model 70 Programmable Meter Calibrator, which cuts calibration to one-tenth the time it takes for most instruments and meters of all types . . . and at the same time provides complete data printout.

With the Model 70 system a semi-skilled operator can check and certify virtually all common direct-reading analog meters and numerous digital instruments in less than a quarter hour. Voltage, resistance and current are all tested at 0.1% accuracy for the whole system.

A programmed card for each meter controls the calibration test procedure, advancing the system through preselected range and function checkpoints, instructing the operator to adjust the instrument.

Heavily loaded laboratories payout cost of the Model 70 system within 9 to 18 months.

Data logging ohms at 10 ppm . . . and other things.



When a standards or calibration lab man says "automation" he more likely is referring to automated data acquisition analysis and recording, rather than to a speedup in measuring.

ESI pioneered 6 years ago in this field by offering complete data logging and interfacing equipment on our Model 242 Resistance Measuring System. Upgraded today to 10 ppm accuracy over an extremely wide range, the 242C can handle the resistance measurements of most small-to-medium labs and provide complete data acquisition in the bargain.

Data logging on several of our different test systems can be computerized to provide immediate answers to questions of quality, effects of design changes, drift rates, etc. This information can pertain to individual components such as resistors and capacitors, or in a broader scope to temperature measurements, instrument calibration and certification, voltage measurements and environmental and life testing.

ESI provides the complete system, with a variety of input/output devices available together with our own data couplers and guarded four-terminal fixtures and patented test leads. Systems compatible with data logging are as follows:

MODEL	NAME
242	Resistance Measuring System
701	Capacitance Measuring System
951	Temperature Measuring System
721	DC Ratio Measuring System
1071	AC Ratio Measuring System
1045A1	DC Voltage Measuring System
123	Resistance Measuring System



Automated resistor tester logs out deviation plus temp. coefficient.

If you want the ultimate in speed and accuracy (with traceability) in a testing system for precision resistors, you'll find today's answer at ESI in our burgeoning new Model 500 series.

The first of these models was offered last year (shown above) as a semi-automated Resistance Deviation Bridge on which an unskilled operator could test precision resistors at 50 ppm accuracy, one every second. An automatic sorter was added later which further increased speed and reduced operator error to nil. A KELVIN KLAMP® jig accepts the resistor, which is measured and then ejected into one of three tolerance limit bins and automatically counted. A mechanical handler is now available to eliminate manual feeding.

At this month's IEEE show we are featuring a new addition to this model series, which provides temperature-correlated measurements of resistors on a semi-automated batch basis, complete with data logging and computerized readout of temperature coefficients for every resistor tested. Fifty precision resistors are mounted easily on an oven closure. The oven is programmed, automatically on closing, to take the resistors through selected temperature settings. At each heatpoint the resistors are sequentially measured for deviation from nominal value. The results are recorded, analyzed by computer and a temperature coefficient is immediately printed out for each resistor, along with average and mean deviation at any selected temperature.

Much more than a GO-NO-GO unit, the system checks values from 0.1 ohm to 111 megohms and has infinitely adjustable deviation settings from 0.01% to 10% full scale.

e|s|i®

ELECTRO SCIENTIFIC INDUSTRIES, INC.

13900 N.W. SCIENCE PARK DRIVE • PORTLAND, OREGON 97229

SEE us at IEEE—Booth No. 2B02

INFORMATION RETRIEVAL NUMBER 25

Piggy Bank Pac



μ -PAC logic module prices have been reduced. Again. It brings us close to our objective: to provide the most comprehensive and economical digital logic offering in the industry. First, take a look at some typical prices:

Model	Description	Unit Price		New Price per Function
		Old	New	
DI-320	10, two input NAND gates	\$25.00	\$20.00	\$2.00/gate
DN-320	6, three input NAND gates	21.00	16.00	2.66/gate
DF-320	8, three input NAND gates	New	20.00	2.50/gate
FF/320	8 basic flip-flops	New	31.00	3.87/flip-flop
FA/320	4 clocked flip-flops	31.75	25.00	6.25/flip-flop
BC-320	6 stage binary counter	46.50	38.00	6.33/stage
SR-321	8 stage shift register	New	54.00	6.75/stage
AP-335	8 half adders	168.00	129.00	16.12/half adder

We'll give you 102 more price comparisons on request.

Now, focus on those factors most often neglected in a make-or-buy go 'round. μ -PAC modules offer the lowest total system cost because they are more than "a flip-flop mounted on a card." μ -PAC modules are an

integrated system of digital logic electronics with fully compatible mounting hardware and power supplies. I/O circuits and analog circuits. Wire wrap tools and other accessories. The works. Plus support. Like in-depth documentation. Logic design aids. 100% circuit testing. 72-hour Certified Fast Shipment. Even custom designs for your special needs.

Whether your logic needs are large or small, ask your Honeywell PAC man to give you the full story. He'll help you "bank" a nice piece of change. Honeywell, Computer Control Division, Old Connecticut Path, Framingham, Massachusetts 01701.

Honeywell

COMPUTER CONTROL
DIVISION

Problems with circumlunar navigation?



Lunar gravitation still puzzles NASA

Mysterious "mass concentrations" of material beneath the surface of the moon are still causing concern with navigation in the U. S. Apollo program. The unknown material causes significant gravitational variations, and these in turn affect the flight path of an orbiting spacecraft. A shortage of data on this shifting gravitational field makes it impossible to predict accurately the spacecraft's path in orbit. And rather than clearing up the problem, the Apollo 8 lunar mission provided enough data to further complicate what had already been known.

To find out more about the problem, NASA may let Apollo 10—the second manned circumlunar flight, scheduled for launching May 17—stay in orbit above the moon a day longer than planned. The problem and the possible shift in plans were described recently by Christopher C. Kraft, director of flight operations at NASA's Manned Spacecraft Center in Houston.

Apollo 10 is scheduled to go into low lunar orbit with three astronauts. At that time the lunar landing module will be detached and will descend with two men to about 50,000 feet above the lunar surface; the module will then return to a rendezvous with the command section of the spacecraft. Then the lunar module will be left behind, and the command module will return to earth with the astronauts.

Medical electronic hazards charged

Ralph Nader, the self-appointed crusader for consumer protection, charged before the National Commission on

Washington Report

CHARLES D. LAFOND
WASHINGTON BUREAU

Product Safety that 1200 hospital patients each year are electrocuted accidentally. These deaths occur generally, he said, among patients undergoing routine diagnostic tests, long-term monitoring, and even simple treatment. The source for his data, Nader said, is Dr. Carl W. Walter, a clinical professor of surgery at the Harvard Medical School. Dr. Walter also is a surgeon at the Peter Bent Brigham Hospital in Boston.

The accidental electrocutions generally go undetected and are usually listed as cardiac arrests, Nader told the commission. According to Dr. Walter, many of the accidents occur when untrained hospital technicians combine incompatible electronic units. Others, he says, are caused by high voltage surges that leak from poorly designed equipment.

Nader said that Dr. Seymour Ben-Zvi, instrumentation director at the Downstate Medical Center in New York City, had evidence showing that 40 per cent of the equipment coming into the center was defective.

Soviet building more missile subs

The Soviet Union is shifting its strategic military emphasis, Defense Secretary Melvin R. Laird says. It is apparent, he noted, that the Russians have started a crash program to expand their meager fleet of submarines equipped with ballistic missiles. These would be comparable to U. S. Polaris nuclear subs, which launch intermediate-range missiles while submerged.

The Soviet Union now has, according to Pentagon sources, roughly 45

Washington Report

CONTINUED

missile-carrying submarines—most of which can fire only if surfaced. It has only one Polaris-type submarine, armed with 16 missiles, with two more under construction. But under a crash program, Laird notes, the Russians could equal the U. S. force of 41 Polaris submarines by 1973 or 1974. The Secretary points out that the U. S. achieved such a construction rate in 1964.

Laird made these observations at a recent hearing before the Senate Foreign Relations Committee on the nuclear nonproliferation treaty. He also indicated that the Soviet Union either has or is preparing to deploy a form of fractional orbit bombardment system (FOBS).

Laird left no doubt with the committee of his belief in the need for the Sentinel ABM system, at least as a "thin" defense. Some 10 possible defensive applications of Sentinel are being studied by the Pentagon, and chief among these is the use of the ABM system as a coastline shield against submarine-launched ballistic missiles.

Aviation planning study sought

Sen. James B. Pearson (R-Kans.) has introduced a bill that would set up a commission for one year to study air transportation problems in the United States. Called the National Aviation Planning Commission, the body would consist of top officials of every U. S. agency now associated with air travel plus 10 technology experts to be appointed by the Secretary of Transportation. The bill, already endorsed by the Nixon Administration, aims to establish a "comprehensive air transportation policy."

Pearson points to present dispersion of authority for decision-making in aviation affairs—the Civil Aeronautics Board, the Dept. of Transportation and the Federal Aviation Administration. And there is secondary responsibility for R&D activities within NASA and the

Defense Dept., he adds.

The Senator cites these deficiencies in present planning areas:

- A need for a single central clearinghouse for aviation information.
- A need for systematizing R&D activities, with emphasis on the future impact of air traffic congestion, the jumbo jets and supersonic transports, and the integration of air transport with other transportation modes.
- A need for a technical and economic plan to provide the ground facilities for aviation growth.

Noting present congestion in the air traffic system, Pearson asserts: "It is not fair to say that a lack of planning on a national scale is the sole cause of the current condition of our air travel system, but it has played a major role." The nation, he says, simply wasn't prepared for the dynamic growth of the aviation industry.

This is the second attempt by the Senator to set up an aviation commission. He proposed a similar bill in 1967, but it failed to win support.

Navy missile falls short

The Navy's Condor missile, a TV-guided air-to-ground weapon designed to carry conventional explosives 60 miles, may be in trouble. Washington sources indicate that, in recent flight tests, the 2500-pound missile achieved less than half the range desired, and that some difficulty was encountered with the remote-control radio link.

Whatever the reasons, the Navy has delayed a request for production money at least a year.

Built by North American Rockwell's Columbus Div., the Condor is guided by TV. One TV camera in the aircraft's nose "sees" the target and passes the information on to a camera in the missile's nose. The pilot can then fire the missile and begin his own evasive action.

By a TV picture radioed to him from the missile's camera, he is able, with a joystick, to continue guidance inputs to the missile. When close to the target the missile homes in by another, undisclosed, technique.

Cermet

AND THE

Model 3329

POTENTIOMETER

ONLY 0.25" Dia. X 0.18" high

TC 150PPM/°C over entire resistance range 10Ω to 1 Meg.



Bourns presents the first commercial single turn potentiometer to meet or exceed the requirements of MIL-R-22097. Sealed for wave soldering and immersion cleaning... with settability superior to anything on the market today. Manufactured in the tradition of excellence of design and workmanship you have come to expect from Bourns... the leader in the industry.

Write or call the factory, local field office or representative today for technical data.



Army gets multi-display anti-aircraft radar

The Army's forward combat troops are getting a highly versatile mobile radar for detecting high- and low-speed enemy aircraft flying at tree-top levels.

Called Faar (for forward area alerting radar), the system detects aircraft coming from any direction, identifies them as friend or foe, and relays target information to anti-aircraft sites.

Contained in a transportable shelter, the Faar system's console can be operated remotely, out to 150 feet. Targets and their identifications are displayed automatically on the console's cathode-ray tube, in one of a matrix of squares,

each of which represents a specific combat sector. Target information is relayed via a vhf radio link to remote anti-aircraft batteries which are equipped with small 13-pound displays.

Aircraft are indicated on the portable displays by two colored dots—green for friend and red for enemy. As the plane moves, its path can be tracked on the display with a grease pencil.

Faar was designed and developed for the Army Missile Command by the Bedford Div. of Sanders Associates, Inc., in Nashua, New Hampshire. The initial production contract is to \$7.1 million. ■■



Mobile radar detects and identifies enemy planes at tree-top level.

NBS offers wideband rf voltmeter-comparator

In the course of carrying out research on radio noise standards, two National Bureau of Standards engineers have developed a wideband rf voltmeter-comparator for making precise measurements of equipment in the frequency range of dc to 1 GHz and the voltage range of 1 to 15 volts.

The device will be helpful, an NBS spokesman says, in the aerospace, electronic equipment-manufacturing and communications industries, where accurate measurements of rf voltage are needed for research and quality control.

The voltmeter-comparator is a completely passive dual-channel coaxial, 50-ohm feedthrough device, which uses matched diodes as detectors of peak voltage amplitudes. Diode loading is such that negligible power is extracted from the signal.

Because of circuit configuration, the device is basically a differential voltmeter. Its dual-channel design reduces ambient temperature variation effects and allows greater resolution (at least 1 part in 10^5) than do other rf voltmeter types. Absolute values of rf voltage may be measured, however, by using a reference dc voltage in one channel.

The limit of uncertainty, in this case, is less than 1 per cent to 100 MHz and less than 3 per cent to 1 GHz.

The use of diodes as rectifiers in rf voltmeter design is well known. Normally the diodes in such instruments respond to the peak value of the input waveform, and the rectified output is processed and displayed on a meter scale calibrated in rms volts. Many of these voltmeters, however, exhibit poor stability, due to the inherently high temperature coefficients of rectifying diodes. They offer only a low degree of resolution because of limitations in readability of the type of display used.

The new NBS voltmeter-comparator also makes use of rectifying diodes. But thermal stability is greatly enhanced by using two separate detector circuits, arranged so that the temperature coefficients of the individual diodes tend to compensate one another. Also, because the device is completely passive, the internal circuitry is not as prone to suffer drift as are active circuits, such as amplifiers used in some types of voltmeters. Very high resolution (at least 1 part in 10^5) is obtained by essen-

tially bucking the outputs of the two detector networks against each other and by displaying their difference on a sensitive dc voltmeter or potentiometer.

In addition to applications as a voltmeter or as a monitor, the voltmeter-comparator can also be used to indicate when the magnitudes of two voltages are equal—this includes balancing active and passive push-pull networks, center-tapping transformers, and adjusting attenuator networks for equal attenuation.

Because of its wide bandwidth and very flat frequency response, the voltmeter-comparator is useful for certain swept-frequency measurements, such as a sensitive detector for level controlling the output voltage of a swept-frequency oscillator.

Other applications include voltage calibration, systems development and evaluation, and servicing precision laboratory equipment. A set of engineering drawings for the voltmeter-comparator is available upon request from developers L. D. Driver or M. G. Arthur at the National Bureau of Standards' Radio Standards Engineering Div., Boulder, Colo. ■■



A Complete Family of Portable Oscilloscopes

a choice of performance and convenience features

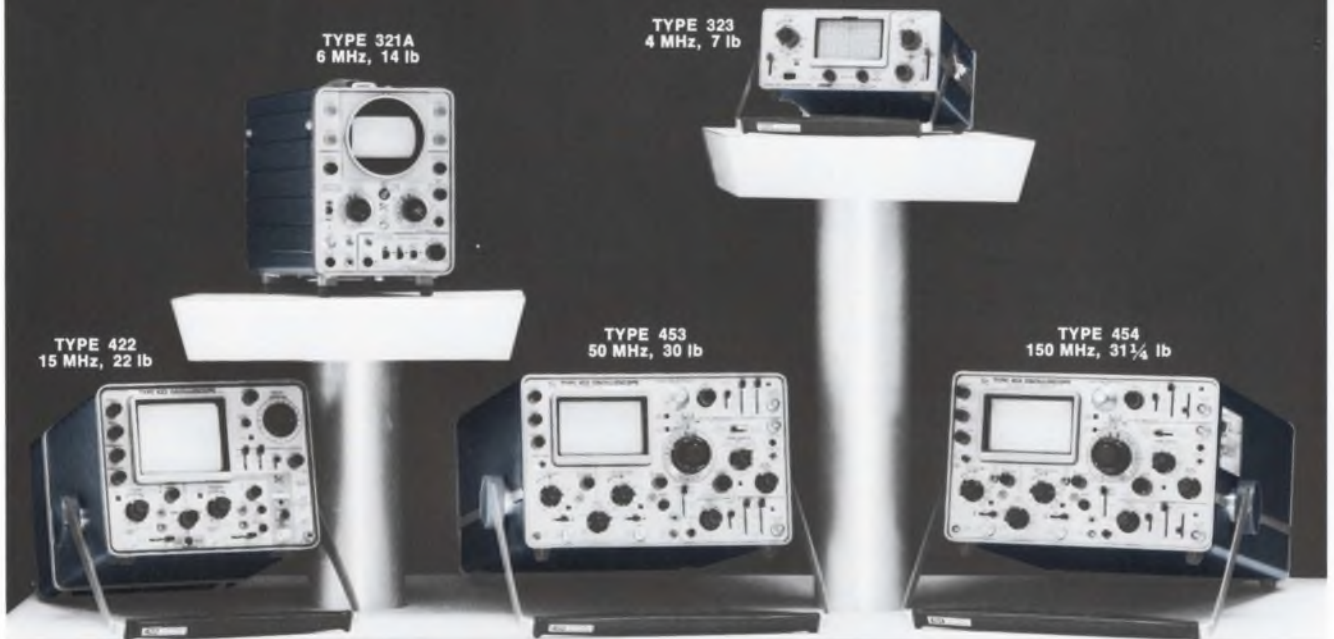

Tektronix portable oscilloscopes provide performance and convenience features which span a wide variety of oscilloscope applications. Bandwidths to 150 MHz, dual-trace vertical amplifiers, delaying sweep and AC, DC or battery operation are some of the features. The Tektronix portable family is designed to permit you to choose the instrument that best suits your application.

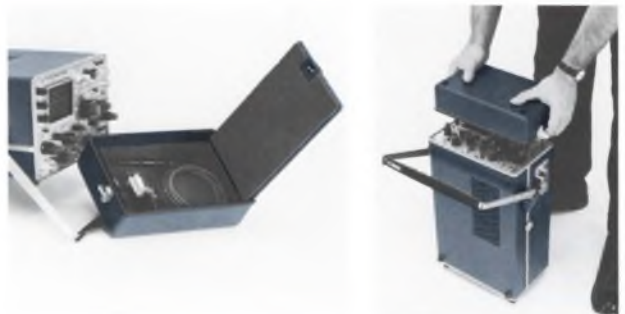

please turn page for additional information

Making the Measurement . . . with Tektronix Portable Oscilloscopes

Each Tektronix portable oscilloscope is a complete measuring system. Necessary accessory items such as probes, adapters, cords, filters, and manuals are included at no extra cost. Additional value is provided by a complete line of optional accessories—voltage probes, current probes, special adapters, cameras, protective covers, and Scope-Mobile® Carts. Your Tektronix Catalog lists all accessories with detailed descriptions.



TYPE 453
DC to 50 MHz
Dual Trace
Delaying Sweep
AC Powered

Dual-trace DC to 50 MHz bandwidth with sweep delay in a compact 30-pound instrument. Rugged environmental capabilities are combined with performance features normally found only in multiple plug-in instruments. Vertical amplifiers provide 7-ns risetime, DC-to-50 MHz bandwidth, from 20 mV/div to 10 V/div deflection factor. At 5 mV/div deflection factor, risetime is 8.75 ns and bandwidth is DC to 40 MHz. Cascading Channel 1 and Channel 2 provides 1 mV/div deflection factor, DC-to-25 MHz bandwidth. The included Type P6010 miniature 10X probes preserve system bandwidth and risetime performance right to the probe tip. Front panel switching logic permits making 5 mV/div X-Y measurements. Jitter, time coincidence, pulse width and other measurements are easily made utilizing the calibrated sweep delay. Sweep rates are 5 s/div to 0.1 μ s/div, extending to 10 ns/div with the X10 magnifier. Solid-state design, with FET vertical inputs, provide low drift and fast stabilization time. AC powered.

Type 453 Oscilloscope \$1950



TYPE 321A
DC to 6 MHz
AC, DC,
or Battery Powered

Bandwidth is DC to 6 MHz and deflection factor is 10 mV/div to 20 V/div. Sweep rates are 0.5 s/div to 0.5 μ s/div extending to 0.1 μ s/div with the X5 magnifier. Rugged mechanical and electrical design plus a choice of AC, DC, or battery power make the Type 321A ideal for field operations requiring accurate waveform measurements. With internal batteries, it weighs 17 pounds; without batteries, it weighs 14 pounds.

Type 321A Oscilloscope
without batteries \$975
Set of 10 NiCd batteries \$ 70

TYPE 454
DC to 150 MHz
Dual Trace
Delaying Sweep
AC Powered



DC-to-150 MHz bandwidth, 2.4-ns rise-time! This oscilloscope is currently the fastest real-time, general-purpose instrument available. Dual-trace amplifiers provide 150-MHz bandwidth at 20 mV/div deflection factor. At 5 mV/div, risetime and bandwidth are 5.9 ns and 60 MHz respectively. Single-trace displays at 1 mV/div deflection factor permit viewing low level signals. The supplied P6047 10X probes preserve the 150-MHz bandwidth right to the tip of the probe. Sweep rates are 5 s/div to 50 ns/div, extending to 5 ns/div with the X10 magnifier. Calibrated sweep delay permits expanding specific portions of your waveform display for examination in detail. A photographic writing speed of 3200 div/ μ s (>2500 cm/ μ s) is provided by the Type 454 Oscilloscope, C-31 Camera, and 10,000 ASA film, without employing film-fogging techniques! X-Y displays, with calibrated deflection factors to 5 mV/div, are possible with the flick of two front panel switches. The Type 454 is mechanically designed to withstand environmental extremes and rough handling. AC powered.

Type 454 Oscilloscope \$2700
C-31-R (Roll-film back) \$ 550

U.S. Sales Prices FOB Beaverton, Oregon

Your Tektronix Field Engineer will demonstrate the performance of the Tektronix portable oscilloscope of your choice, on your premises at your convenience. Please call him or write, Tektronix, Inc., P.O. Box 500, Beaverton, Oregon 97005.

TYPE 422
DC to 15 MHz
Dual Trace
AC, DC,
or Battery
Powered



This compact, rugged oscilloscope combines small size and lightweight with 15-MHz, dual-trace performance. Two models are available. One is powered from AC; the other from AC, DC, or internal rechargeable batteries. The AC version weighs less than 22 pounds including accessories; the AC/DC model with built-in battery recharger weighs 30 pounds including accessories and batteries. Dual vertical input amplifiers cover major use areas with 23-ns risetime and DC-to-15 MHz bandwidth over the 10 mV/div to 20 V/div deflection range. 1 mV/div deflection factor with 5 Hz-to-5 MHz bandwidth is provided on Channel 2. Sweep rates are 0.5 s/div to 0.5 μ s/div, extending to 50 ns/div with the X10 magnifier. The Type 422 is mechanically and electrically designed to withstand rugged environments.

Type 422 Oscilloscope
(AC version) \$1450
Type 422 MOD 125B Oscilloscope
(AC/DC without Battery Pack) . \$1800
Battery Pack for Type 422 MOD 125B
(order 016-0066-02) \$ 125

TYPE 323
DC to 4 MHz
AC, DC,
or Battery
Powered



Internal batteries provide up to 8 hours of continuous operation and are rechargeable from the AC line in approximately 16 hours. The Type 323 may also be powered from the AC line or external DC. Bandwidth is DC to 4 MHz and deflection factor is 10 mV/div to 20 V/div. 1 mV/div deflection factor at 2.75-MHz bandwidth is provided for viewing low-level signals. Sweep rates are 1 s/div to 5 μ s/div extending to 0.5 μ s/div with the X10 magnifier. A single-control knob permits automatic or manual level sweep triggering, positive or negative slope. The compact Type 323 weighs 7 pounds including batteries and is designed for field environments.

Type 323 Portable Oscilloscope
with batteries \$925



Tektronix, Inc.

committed to progress in waveform measurement

How to save on relays

A quotation from Line Electric includes lots of values that add to the total savings possible.

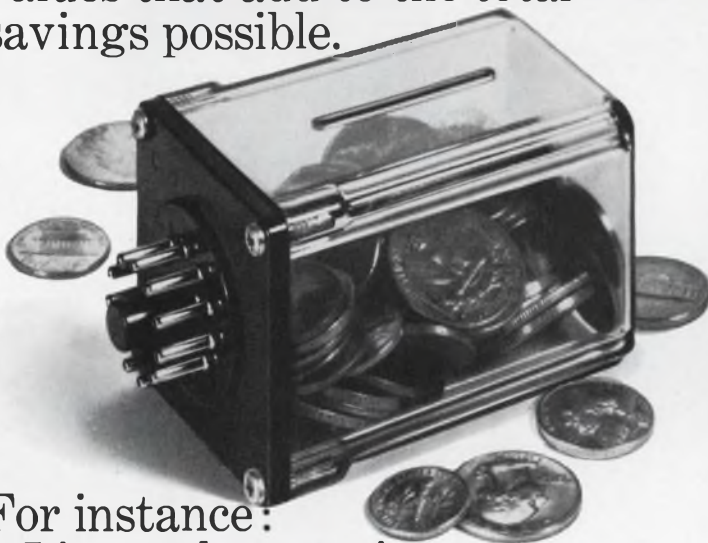

For instance:

- Line makes on-time deliveries to meet your production line schedules.
- Line offers excellent engineering help free.
- Line maintains the highest manufacturing standards in the industry

Add these values together and you get all-round savings on your relay purchases. Not to mention the headaches you can avoid.

Won't you check us out and see how much better you can do at Line? Send for free copy of our new 1969 catalogue containing all the most frequently used industrial type relays. We guarantee you'll learn something to your advantage.



In a hurry, call (201) 887-8200 and ask for Relay Sales Manager. We like to do business by phone.

LINE ELECTRIC COMPANY, U.S. Highway 287, Parsippany, N.J.
Manufacturers of relays and the best service in the business.
SUBSIDIARY OF THE SINGER COMPANY

INFORMATION RETRIEVAL NUMBER 28

MAGNETICS



The Bettmann Archive Inc.

BY ARNOLD

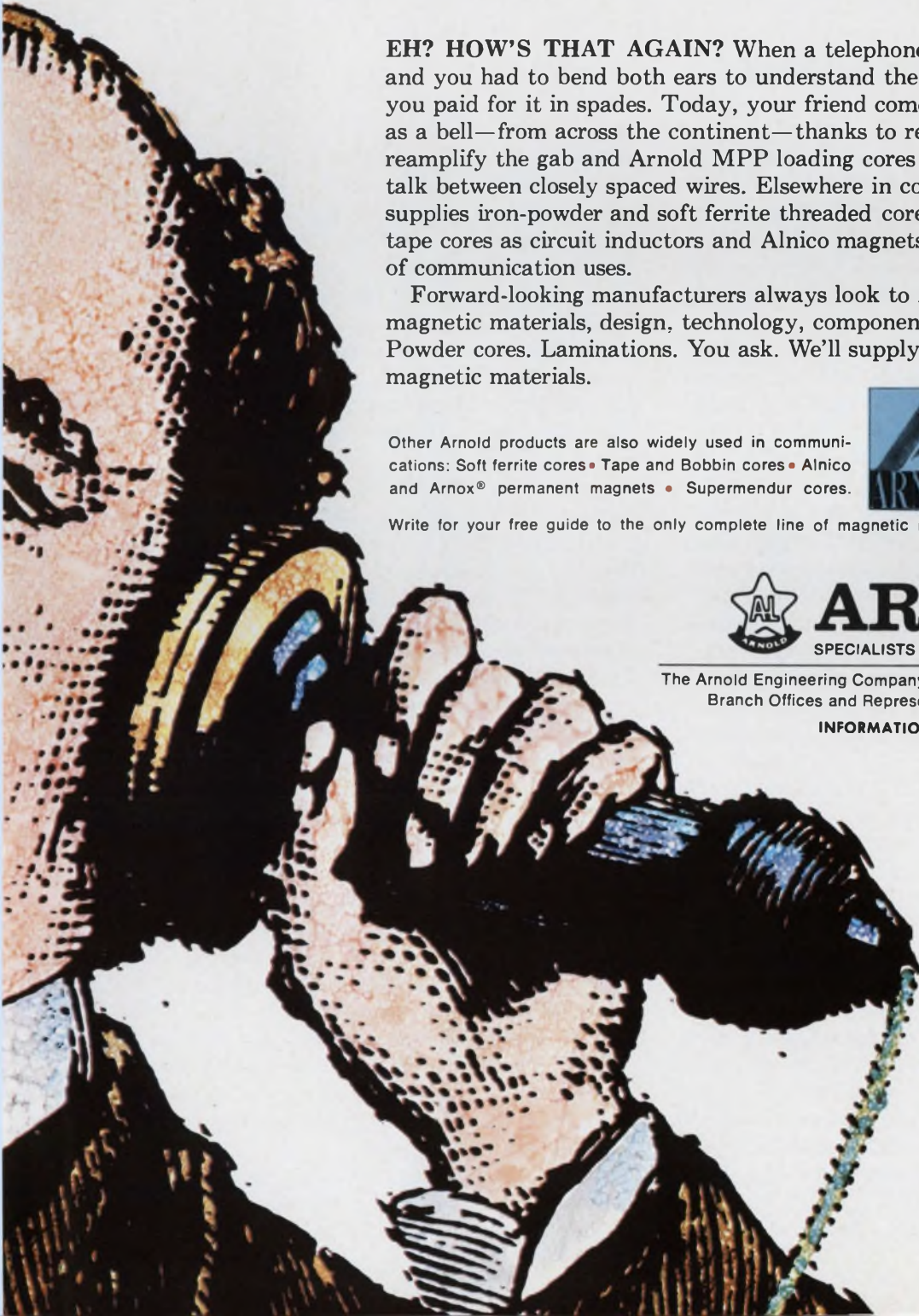

EH? HOW'S THAT AGAIN? When a telephone was truly a luxury and you had to bend both ears to understand the guy on the next block, you paid for it in spades. Today, your friend comes through clear as a bell—from across the continent—thanks to repeater coils that reamplify the gab and Arnold MPP loading cores that eliminate cross talk between closely spaced wires. Elsewhere in communications, Arnold supplies iron-powder and soft ferrite threaded cores for radio/TV, tape cores as circuit inductors and Alnico magnets for a host of communication uses.

Forward-looking manufacturers always look to Arnold for high-quality magnetic materials, design, technology, components. Magnetic cores. Powder cores. Laminations. You ask. We'll supply. The best in magnetic materials.

Other Arnold products are also widely used in communications: Soft ferrite cores • Tape and Bobbin cores • Alnico and Arnox® permanent magnets • Supermendur cores.



Write for your free guide to the only complete line of magnetic materials.



ARNOLD

SPECIALISTS IN MAGNETIC MATERIALS

The Arnold Engineering Company, Main Office: Marengo, Ill.
Branch Offices and Representatives in Principal Cities

INFORMATION RETRIEVAL NUMBER 29

THE FRIENDLY GREY COMPUTER

*can show you how to put showmanship in your designs.
You, too, can lure excited users to your next product.
The secret is 'involving' them in its operation.*

by Roger Kenneth Field

The Friendly Grey Computer isn't friendly, nor is it a computer. Its grey paint is chipped here and there, and streaked where apparently someone once tried to oil it. The aging contrivance contains no logic and no memory. But were it able to tell its tale, what priceless advice it could relate to design engineers.

The Friendly Grey Computer and the other curious devices presented here are early examples of an entirely new design style that has been termed—erroneously, if you stop to think about it—electronic art. Obviously these gadgets will never rank with the great art treasures of Western civilization. And their electronic sophistication hardly gives evidence of NASA funding. But they are entertaining. In fact, entertainment and human involvement are the goals of this quasi-technological semi-art. At more and more museums and galleries these designs are becoming star attractions.

And therein lies the lesson for working engineers. Involvement and entertainment are measures of success for nearly every object used by humans, not just art. What is it about these "art" gadgets that people like? Think of *your* favorite instruments. Do you enjoy watching the flicker of their Nixies? Feeling their probes? Shrinking a waveform as you twiddle a knurled knob? That's what this new design style is all about. Its creators call it *participatory environmental electronics*.

A design engineer, busy with equations in an isolated laboratory, can easily forget that the users of his designs are *people*. And people like excitement—devices that light up, dance or whirl in response to touch. There's a message in this for the designer who would succeed in the marketplace: Is your equipment exciting? Do people become "involved" with it?

Edward Kienholz's Friendly Grey Computer

(1965) is one of the earliest examples of this new design style, and it is still an extremely popular attraction at exhibits of technological art. Recently, for instance, at New York's Museum of Modern Art, Kienholz's homely contraption—standing among Rauschenbergs, Oldenburgs and Tinguelys—was rarely surrounded by fewer than half a dozen spectators. Many waited 15 minutes or more for a chance to read an incredibly complicated set of directions on the computer's soiled faceplate before attempting to extract the solution to a problem.

The absurd directions implored the user to write on the computer's stack of cards a question that lends itself to a "yes" or "no" answer. Next, the user is directed to "program the computer heads (C-20 and G-30) by setting dials in appropriate positions." (The heads are actually shells of an old capacitance-resistance bridge and an old signal generator, both made by General Radio. Just what constitutes an appropriate position is left to the problem solver's imagination.) Then the user speaks his question into the receiver in a clear voice, dings the dinger and waits for an answer. According to the directions:

Flashing yellow bulb indicates positive answer. Flashing blue bulb indicates negative answer. Green jewel button doesn't light, so it will not indicate anything. Computers sometimes get fatigued and have nervous breakdowns; hence the chair for it to rest in. If you know your computer well, you can tell when it's tired and sort of blue and in a funky mood. If such a condition seems imminent, turn rocker switch on for ten or twenty minutes. Your computer will love it and work all the harder for you.

In fact, the blue light is connected to the main switch; consequently the computer appears to meditate until the blinking mechanism warms up



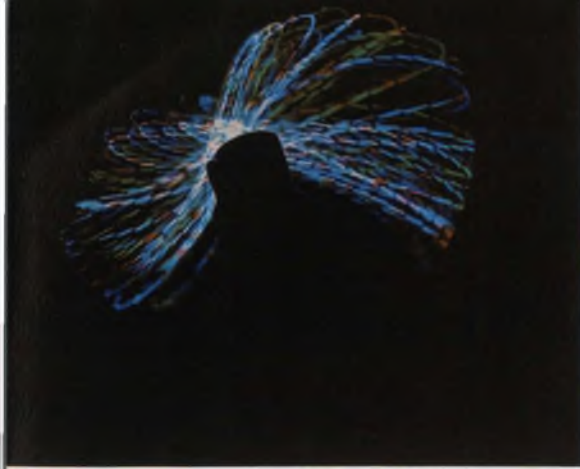

The moving hand holds a permanent magnet that contorts and washes out the patterns on the screen. Called " $\pm\sqrt{\text{Rondo Electronique}}$ " (1966-1968) by its creator, Nam June Paik, the work's complex colorful Lissajous figures entrance onlookers. "Some-day," says the Korean artist, "artists will work with capacitors, resistors and semiconductors as they work today with brushes, violins and junk."

Nudity suggests involvement in a work by artist Robert Phillips and engineer Thorne Macdonald, who created this responsive girl with sculptured plaster, a cathode-ray tube, magnetic tape loop and driver amplifiers. True to the piece's title, "Speak That I May See," the tube displays patterns that explode and implode in time to sound that comes through speakers near the figure's feet.

Flashes catch the undulating rods and the pulsing strobes speed up or slow down, depending on the amount of noise in the vicinity. A loud clap of the hands makes the rods appear to quiver. The work, "Cybernetic Sculpture," was created by artist Wen-Ying Tsai and engineer Frank T. Turner for a recent competition sponsored by EAT (Experiments in Art and Technology).



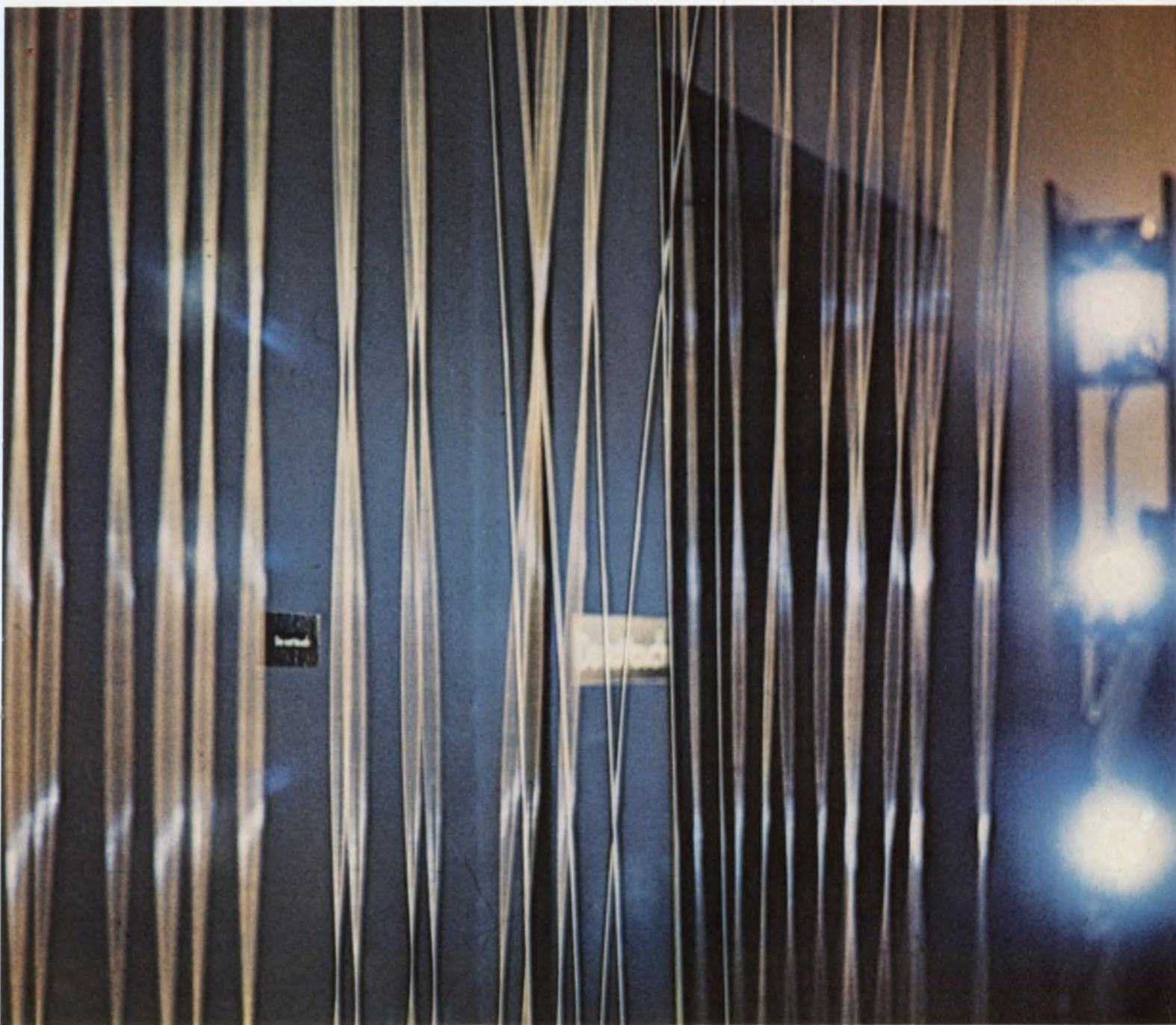
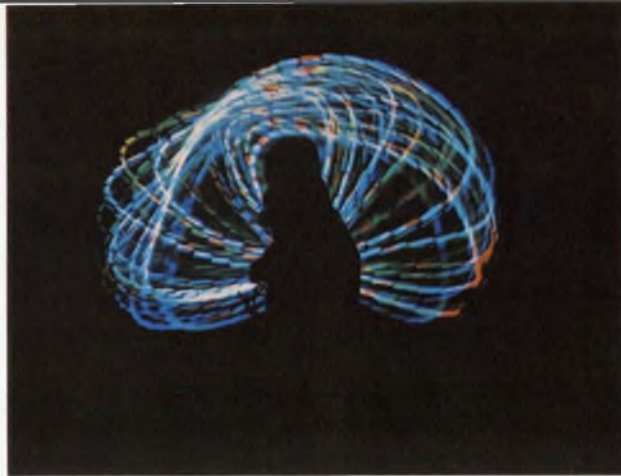

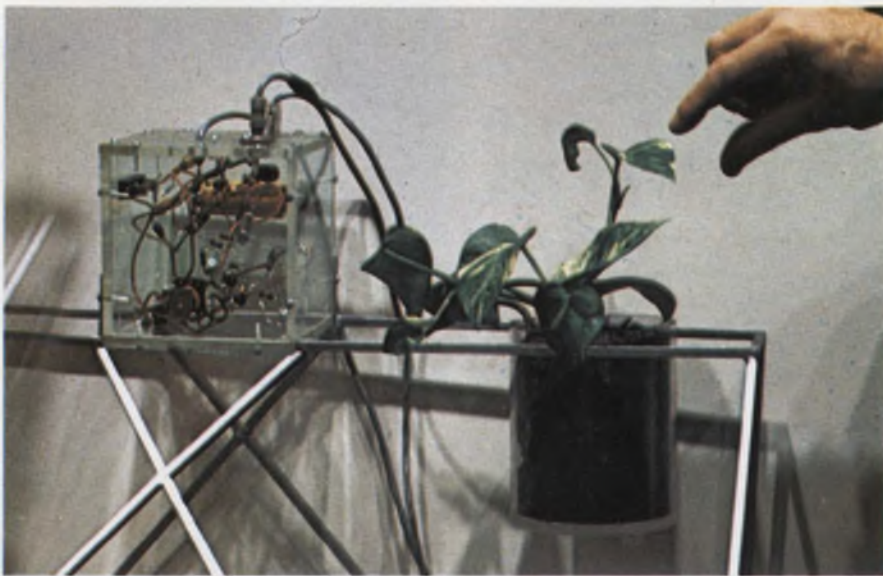

The living switch is a plant that is part of a piece by Thomas Shannon called "Squat." When the leaves are touched, movement of the roots triggers the transparent amplifier, which causes a three-legged erector-set-like structure to undulate.



Music moves the laser beam that shines on a rotating card, producing three-dimensional patterns. "ELLI (Electronic Laser Light Image)" by artist John William Anthes and engineer Tracy S. Kinsel, allows an observer to control the beam with knobs on the panel.

and then answers no to all questions. Yet because of the buttons and knobs, and the complicated instructions, users rarely discover this fact. And fascinated by the intriguing apparatus, they frequently lavish a substantial portion of their museum visit on the computer, fidgeting with its dials, mumbling into the telephone handle (which is electrically connected to nothing whatsoever), dinging the dinger and scrawling urgent questions on the cards, such as the following:

*Did Pamela hurt her knee?
Will I get married? Am I
an idiot for going through
with the directions? Does
Mao Tse Tung smoke pot?
Am I a girl? Are you a
fake? If a radio is broken,
can it still be called a radio?
Are you silly? For all "n,"
are there x, y and z such
that $x^n + y^n = z^n$?*

All the above questions, of course, were answered in the negative, including one that was nervously written on the back of a card: "Am I pregnant?"

The secret to the computer's success at entertaining participants is that it keeps the mind busy and the hands occupied. The written card, for example, serves no purpose other than to send the participant searching for a pencil. The telephone receiver keeps the vocal cords active. And the dinger, otherwise irrelevant to the whole process, attracts attention and lures participants to the computer.

Contortions for cathode-ray tube

There are, of course, more sophisticated ways of encouraging human participation with inanimate objects, and many involve more electronics than dinging dingers. One such method makes use of a cathode-ray tube and is especially effective when a color tube is used to display moving forms (see **The moving hand**). The artist who has been exploring the en-

vironmental use of cathode-ray tubes is a Korean named Nam June Paik. The secret to his design success is that he usually includes a magnet, which the observer can use to alter the displayed pattern should he choose to do so.

Keep your eye on the package

There's no reason to believe that cathode-ray tubes and other electronic components must be placed in rectangular, pastel-colored boxes. In fact, humans tend to gravitate toward colorful rounded packaging configurations, such as those made possible by the use of day-glow paints, molded plastics and pressed metals. To be sure, designers need not exploit the full limit of modern sculpting in their quest for user participation (see **Nudity suggests involvement**), but how about a round oscilloscope with pink knobs, a purple screen and psychedelic decals to keep away evil spirits?

In the blink of a strobe

Another attention-getting feature that has eluded the design engineer is the flickering strobe. Blue-white flashes of light are already an essential visual element in environmental night-clubs, discotheques, happenings and sensory palaces. And they can be just as entertaining in electronic equipment.

The most advantageous way to use strobe lights in a design is as a reward. Wouldn't a lab full of electronic instrumentation be a more interesting place if a good reading on, say, a frequency counter were followed by a volley of dazzling strobe flashes.

Another way to use the strobes (see **Flashes catch the undulating rods**) is to vary their frequency to "extract" various motions from uniform mechanical vibrations. The beauty of changing the strobe frequen-

cy, rather than the frequency of mechanical vibration, is that the former can appear to change the motion instantaneously with no time lag due to inertia of moving parts.

A common theme in participatory environmental electronics is the inclusion in the design of living plants, which always appeal to the natural human instinct to touch vegetables, fruits and flowers. Did you ever see a grandmother buy a cantalope without feeling it? This desire to communicate with nature can be harnessed to encourage use (see **The living switch**), but be careful: Have you ever tried to get a chrysanthemum through quality control?

The dancing laser

One disadvantage to a plant, in addition to the fact that periodically it must be watered, is that vegetation adds an element of "camp," or old fashionedness, to the design. Camp, however, can be offset by modernity—and the addition of a laser display is without question the most modern participatory technique presently in use. The chief advantage of a laser is that between information displays it can be modulated and deflected to entertain observers (see **Music moves the laser beam**). Once again, however, caution is in order: If the beam impinges on the human eye, the laser's power should be less than the maximum level generally recognized as safe—1 milliwatt.

That designs like these will one day reach the marketplace is certain. Even now, while technologically inclined artists are breaking new ground, engineers are in on much of this innovation. And as hardware prices fall, engineers will design with lasers, strobes, sculptured plastics and cathode-ray tubes. A few last words of advice: Always stick to the basic design principle of getting the best effect with the fewest parts. And don't touch any poison sumac. ■■

New Concept AC Regulator Outperforms them all!



Compare!

	ERA SOLID STATE MODELS	CONVENTIONAL MAGNETIC TYPES
Small Size	Yes	No
Light Weight	Yes	No
Wide Freq. Range	Yes	No
Tight Regulation	Yes	No
Fast Transient Response	Yes	No
Silent Operation	Yes	No
Fully Repairable	Yes	No
Stable with Temperature	Yes	No
High Efficiency	Yes	No
Wide Temp. Range	Yes	No
High Surge Rating	Yes	No
Minimum RFI	Yes	No
Series Operation	Yes	No
Remote Sensing	Yes	No
Sinusoidal Output	Yes	Special Order

SPECIFICATIONS

Input: 105-130 VAC, 47-440cps
 Output: 115 VAC nom (See table for power rating)
 Line Regulation: Within $\pm 0.1\%$ for full input change
 Load Regulation: Within 0.2% for full load change
 Frequency Regulation: Less than 0.002% per cycle
 Wave Form Distortion: Less than 5%
 Load Power Factor Range: +0.7 PF through -0.7 PF
 Response Time: Less than 16 millisecond
 Operating Temperature: -20°C to $+71^{\circ}$ free air

STANDARD MODELS

Power Rating	Size (Inches)	Weight	Model	Price*
250 VA	6 $\frac{1}{8}$ x7 $\frac{1}{4}$ x4 $\frac{7}{8}$	13 lbs.	RT250	\$130
500 VA	6 $\frac{7}{8}$ x8 $\frac{7}{8}$ x7 $\frac{1}{2}$	16 lbs.	RT500	\$175
1000 VA	7 $\frac{1}{16}$ x9 $\frac{1}{16}$ x7 $\frac{5}{8}$	22 lbs.	RT1000	\$235

*Liberal Discounts for Larger Quantities



Send for full technical data.

**ELECTRONIC RESEARCH
ASSOCIATES, INC.**

67 Sand Park Road, Cedar Grove, N. J. 07009

INFORMATION RETRIEVAL NUMBER 30

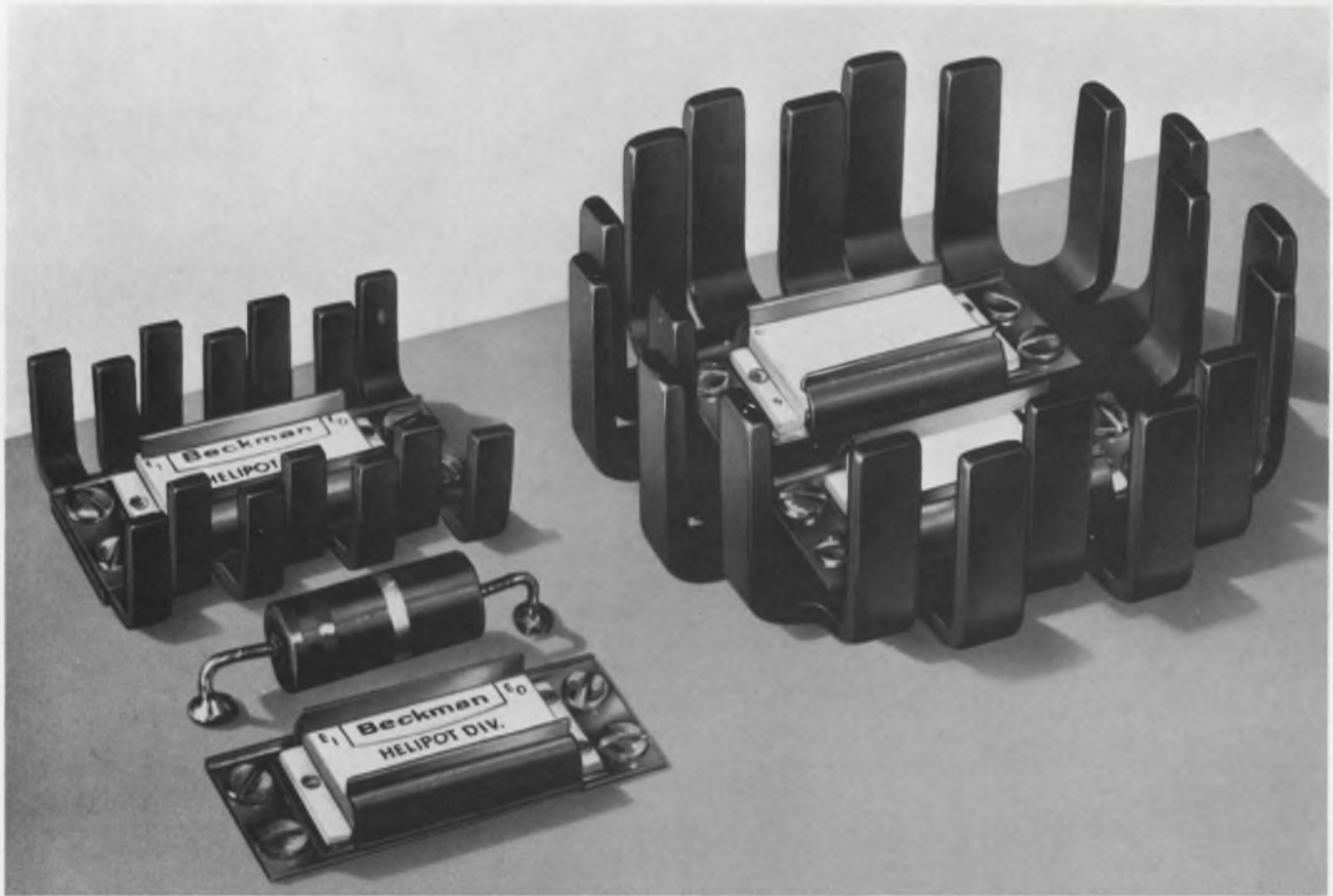

Cool off microcircuit devices with a choice of four new dissipator/retainers. Example: with natural convection, a typical microcircuit device dissipates 1.8 watts with case temperature rise of 103°C.

Add IERC's model LBOC2-61B and you dissipate 5 watts with the same case temperature rise. Retainer-clip may also be used alone to mount package to conduction plane.

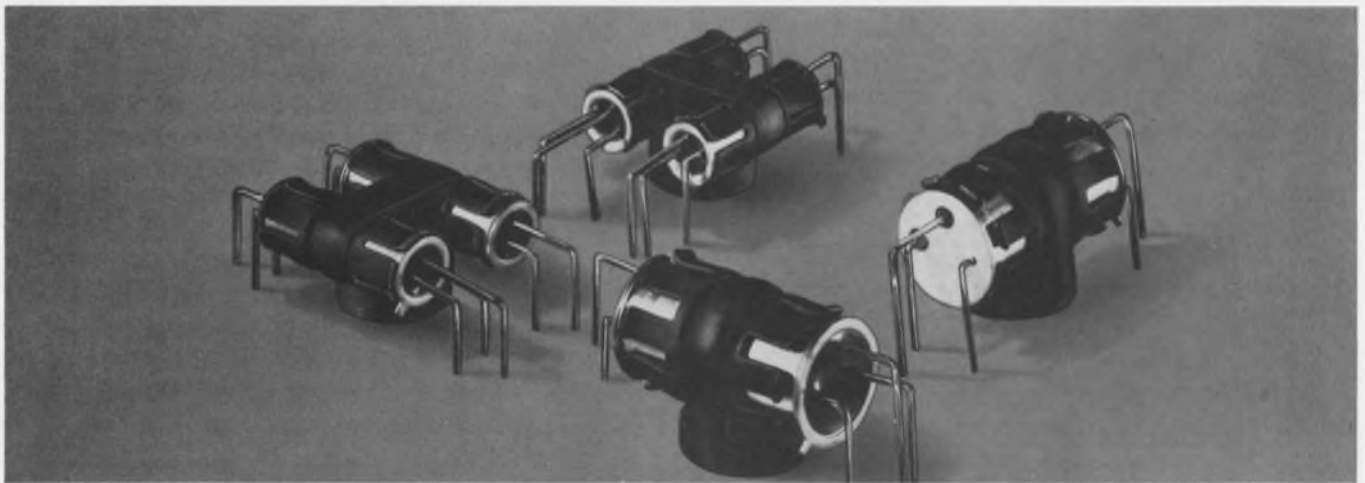

These special dual and quad Therma-Link dissipators permit thermal mating of matched transistors. Therma-Link retainers do exactly as their name says: They provide a thermal link between transistors and the chassis or heat sinks. They are also available with

.060" beryllium oxide washers which have the excellent thermal conductivity of aluminum, are electrically insulative and reduce normal mounting capacitance by $\frac{1}{2}$ to $\frac{2}{3}$. The washer is brazed to a brass slug or hex stud for mounting.

Need a non-hygroscopic finish with excellent dielectric properties, 50 K megohms insulation resistance and high heat emissivity? Use Insulube 448. It also protects against salt spray and fungus and other adverse environments.

Tips on cooling off hot semiconductors and microcircuits

Read on. Find out how circuit designers use IERC heat dissipators to protect and improve circuit performance of semiconductors and microcircuits.

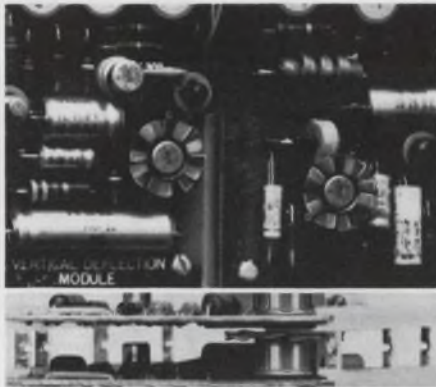

Fan Top Dissipators for TO-5 and TO-18 cases add almost nothing to board height. Don't need much room on the board either. Available for both metal and plastic cases. Spring fingers make installation simple. And Fan Tops cost just pennies.

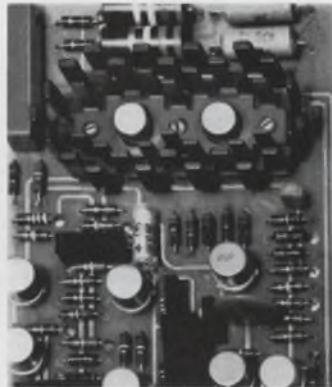

Help low-to-medium power transistors keep their cool with IERC's stagger-fingered LP's. Available in single or dual mounting for thermal mating of matched transistors. They fit both TO-5 and TO-18 cases.

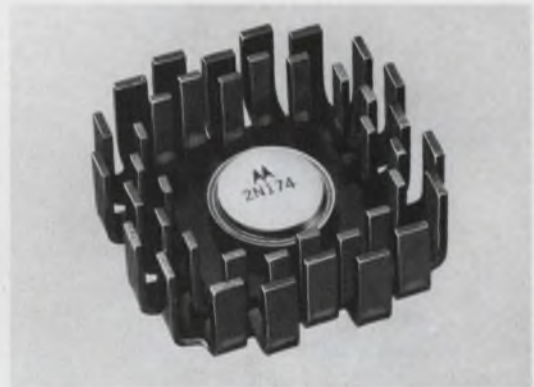

Cool power transistors and diodes with lightweight HP Series devices. High heat transfer rate. HP3 displaces only 9 cu.in. and weighs just 1.5 oz. Yet it dissipates as much heat as many finned extrusions requiring 13.5 cu.in. Two sizes for nesting or back-to-back use.

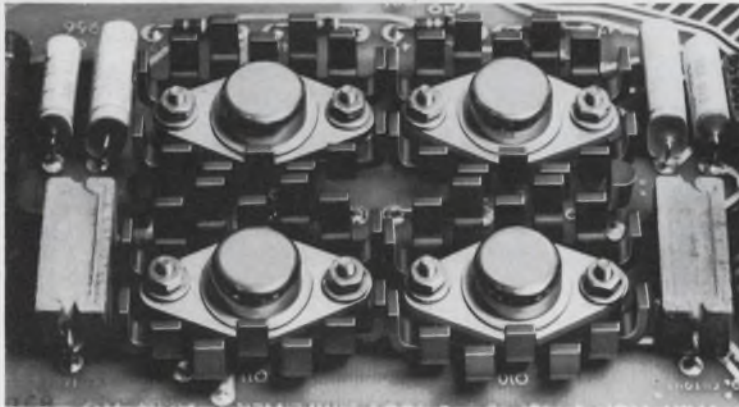

Keep TO-66 transistors cool with any of four IERC dissipators. The application shown is a 100-volt amplifier with four LB66B2B's dissipating 8 watts per transistor. Exclusive staggered-finger design. Choice of finish: black anodize or Insulube® 448 for positive insulation to 500 watts.

Got a tough one? Our engineers welcome your inquiry for more specific information. Write us on your company letterhead, please.



New "Universal" Spade Series for plastic transistors fits all D-case sizes. Spring clip allows for variation in case diameters. Excellent dissipation lets you boost operating power 33%. Both single and dual models as shown.

See us at the IEEE Show Booth #4F 16-18.

ierc
SEMICONDUCTOR
HEAT DISSIPATORS

INTERNATIONAL ELECTRONIC RESEARCH CORPORATION  A corporate division of Dynamics Corporation of America • 135 West Magnolia Blvd. • Burbank, Calif. 91502

INFORMATION RETRIEVAL NUMBER 31

Propensity for density

or: C.I. capacitors cut another space problem down to size

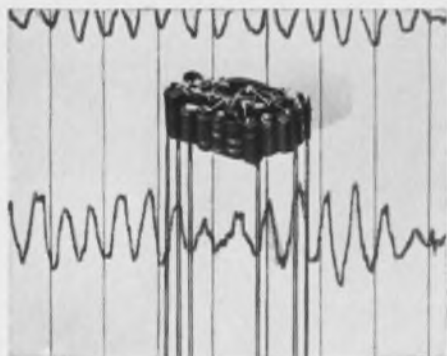

Enlarged approximately 1½ times

When you convince more than 30 discrete components, including 10 electrolytic capacitors ranging from 0.01 to 2.2 mfd., to huddle together in a space somewhat smaller than 1/20 of a cubic inch, you've got yourself some pretty high-density packaging.

That's what engineers did at Signatron, Inc., Gardena, California, when they designed their miniature Model 2300-EEG differential amplifier — a potted, high-reliability unit designed primarily for use in their telemetry devices for physiological monitoring such as electro-encephalographs.

Of course they turned to Components, Inc. for the capacitors because, as

everybody knows, C.I. makes the smallest, most dependable solid tantalum capacitors available . . . anywhere. Results: No capacitor failures, no leakage problems, excellent performance.

The Minitan® Cordwood Series used in this application were specifically designed for miniature equipment. They are available in five different case sizes from 1/8" to 1/4" in length, with radial or axial leads, and capacitance values up to 47 mfd.

Performance is maximum, leakage is minimum, prices are optimum. Full reliability up to 125°C. Non-polar versions available in standard capacitance ratings.

C.I.... space race ace We offer more subminiature case styles and ratings than anyone else in the business. Samples, performance and reliability data, and application assistance are yours for the asking.

First in reliability . . . service . . . delivery. We prove it every day.

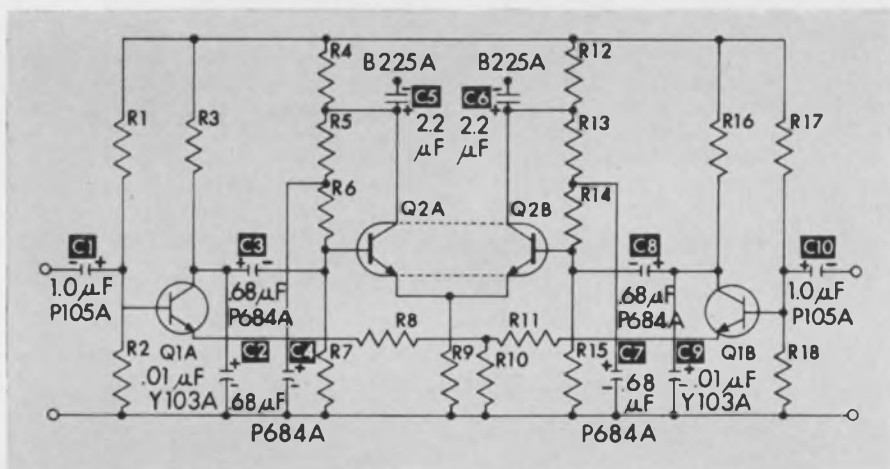

MINITAN MODULAR

(Also available with axial leads)

	U
	F
	M
	L
	S
	J

47 MFD @ 35 VDC to 220 MFD @ 3 VDC
(Cordwood Series available from .01 MFD @ 50 VDC)

(ACTUAL SIZE)

MINITAN CORDWOOD

	Y
	P
	B
	A
	G

01 MFD @ 50 VDC to 47 MFD @ 3 VDC
(Modular Series available to 220 MFD)

(ACTUAL SIZE)



COMPONENTS, INC.

CAPACITOR PRODUCTS

BIDDEFORD, MAINE 04005 — TEL: (207) 284-5956 — TWX: 710-229-1559

LOW PROFILE

hot-molded trimmer for
close circuit board stacking



Basic Type Y unit
shown actual size



With wheel for
side adjustment



With attachment for
horizontal mounting and
wheel for side adjustment



With attachment for
horizontal mounting

New Type Y single turn trimmer is especially designed for use on printed circuit boards. It has pin-type terminals for use on boards with a 1/10" pattern. And the new low profile easily fits within the commonly used 3/8" space between stacked printed circuit boards.

For greater operating convenience, the Type Y can be supplied with an optional thumb wheel for side adjustment, or an optional base for horizontal mounting, or both. The Type Y enclosure is splash-proof as well as dust-tight, and the metal case is isolated to prevent accidental grounding.

While featuring a new low profile, this new Type Y trimmer retains the popular Allen-Bradley solid resistance element, which is produced by A-B's exclusive hot-molding technique. With virtually infinite resolution, adjustment is smooth at all times. Being essentially noninductive, the Type Y can be used at frequencies where wirewound units are inadequate. The Type Y is rated 1/4 watt at 70°C and is available in resistance values from 100 ohms to 5.0 megohms. Standard and special tapers are available.

Let us send you complete specifications on this newest addition to the Allen-Bradley line of quality electronic components. Please write: Allen-Bradley Co., 1201 South Second Street, Milwaukee, Wis. 53204. Export Office: 1293 Broad St., Bloomfield, New Jersey, U.S.A. 07003. In Canada: Allen-Bradley Canada Ltd.

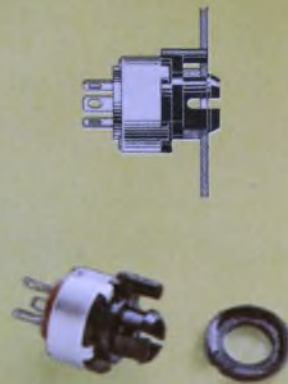

New Type Y with handy
snap-in panel mount,
supplied with spacers for use
on panels up to 1/8" in thickness



Letters

It's faster than we thought

Sir:

Concerning the article by Bert Moskowitz and myself, "Convert Binary to BCD Without Flip-flops" (ED 21, Oct. 10, 1968, pp. 58-64), Mr. Robert D. Lindskog, Leader, Technical Staff, RCA Institute for Professional Development, has written me to point out that the first part of Eq. 4 on page 59 is incorrect. It should read:

$$S_2' = \bar{S}_1 S_8 + S_1 S_2 S_4 + S_1 \bar{S}_4 \bar{S}_8 \\ = S_1'' S_1 + S_1 S_1''$$

The gate cluster of Fig. 4 (p. 61) was developed using the second form of the equation. But, as Mr. Lindskog correctly points out, if we had used the first part, the

worst-case delay would be reduced from 5τ to 3τ . This would make the speed comparison with the sequential converter even better than in the original design.

The improved gate-cluster design is shown below along with a speed comparison table based on the new cluster delay of 3τ . (The table corresponds to Table 2 in the original article.)

As we pointed out in our article, there are many more possible schemes. The wired-OR configuration—to just mention one—would yield even higher speed, and it is up to the MSI manufacturer to decide which one best suits his pro-

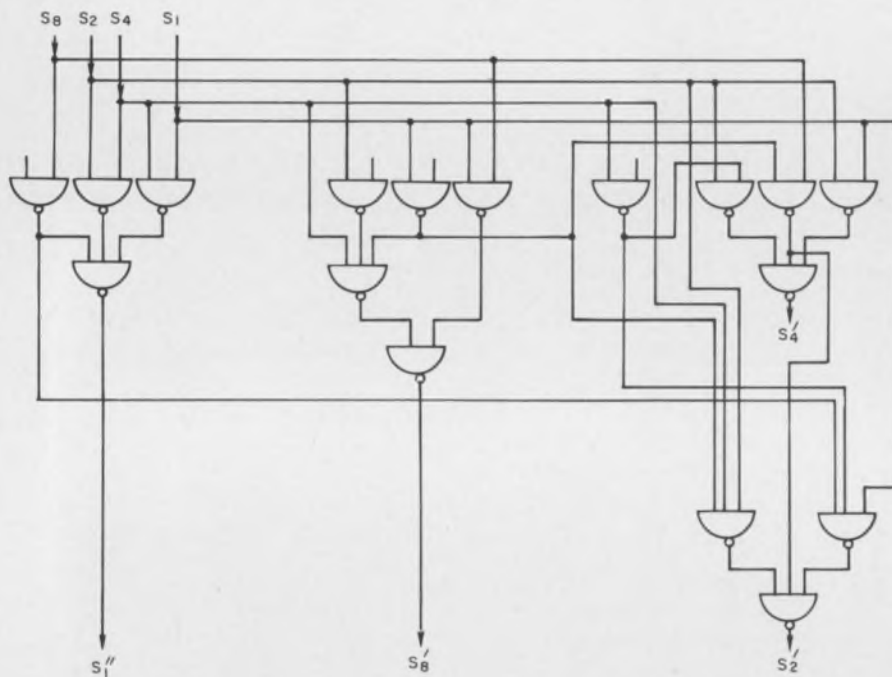

Table. Binary-to-BCD speed comparison

<i>n</i> binary bits	Decoding Time (ns) T_{total}	T_{sync}
		T_{total}
4	39	10.25
5	78	6.41
6	117	5.12
7	156	4.49
8	195	4.10
9	234	3.85
10	273	3.66
11	312	3.52
12	351	3.41
13	390	3.33
14	429	3.26
15	468	3.20
16	507	3.15
17	546	3.11
18	585	3.07
19	624	3.04
20	663	3.01
21	702	2.99
22	741	2.97
23	780	2.95
24	819	2.93
25	858	2.91
26	897	2.90

T_{total} figures are based on a gate delay time of 13 nanoseconds.
 T_{sync} figures are based on a clock rate of 10 MHz.
 Delay of 1 cluster is 3τ

duction capability. Our aim was to show the advantages of static decoding and its feasibility with present day MSI or LSI technology.

Z. Michael Benedek
 Senior Staff Engineer
 Kollsman Instrument Corp.
 Elmhurst, N.Y.

Postscript on 'Schmitt': Watch the loop gain

Sir:

With regard to the article, "Tailor your Schmitt trigger circuit." ED 11, May 23, 1968, p. 84:

An additional point about Schmitt triggers that might be useful to anyone designing for low hysteresis concerns the loop gain.

Unless this comfortably exceeds unity the circuit will not "snap" from one state to the other, but will act more or less as a high-gain

dc amplifier, hitting the end stops when V_{in} either exceeds the upper trip level or is less than the lower trip level. There would in fact be no hysteresis at all.

Any steps taken to reduce hysteresis in a Schmitt trigger (e.g., individual emitter resistors) inevitably lower the loop gain, and the difficulty is knowing how far one can go before the circuit stops behaving properly. Unfortunately,

this limit is not always apparent in design procedures.

A rough estimate of loop gain may be made by imagining the loop broken at the base of the second transistor. The mutual conductance of the long tailed pair is $\alpha I_o q / 4kT$, or approximately $10 I_o$, where I_o is in milliamps. The collector load and resistor coupling then result in an over-all loop gain of $10 I_o R_{c1} R_2 / (R_{c1} + R_1 + R_2)$ at

with your reputation at stake, which resistor line would you specify?

take a close look—there'll be no question

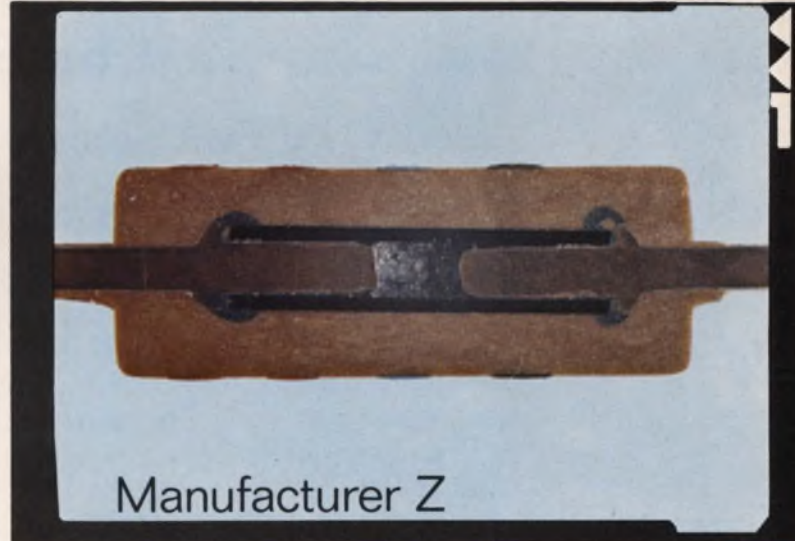

The above illustrations are from unretouched photomicrographs taken of four $\frac{1}{2}$ -watt fixed resistors. Compare the anchoring of the leads, the seal provided by the insulating jacket at the ends, the homogeneity of the resistance material, the sharp color code bands—and decide for yourself.

For more details on Allen-Bradley hot-molded resistors, please write for Technical Bulletin 5000: Allen-Bradley Co., 1201 S. Second St., Milwaukee, Wis. 53204. Export Office: 1293 Broad St., Bloomfield, N.J., U.S.A. 07003. In Canada: Allen-Bradley Canada Ltd.

©Allen-Bradley Company 1967

1067E-4

QUALITY ELECTRONIC COMPONENTS



A-B hot-molded fixed resistors are available in all standard resistance values and tolerances, plus values above and below standard limits. **A-B hot-molded resistors meet or exceed all applicable military specifications including the new Established Reliability Specification.** Shown actual size.



ALLEN - BRADLEY

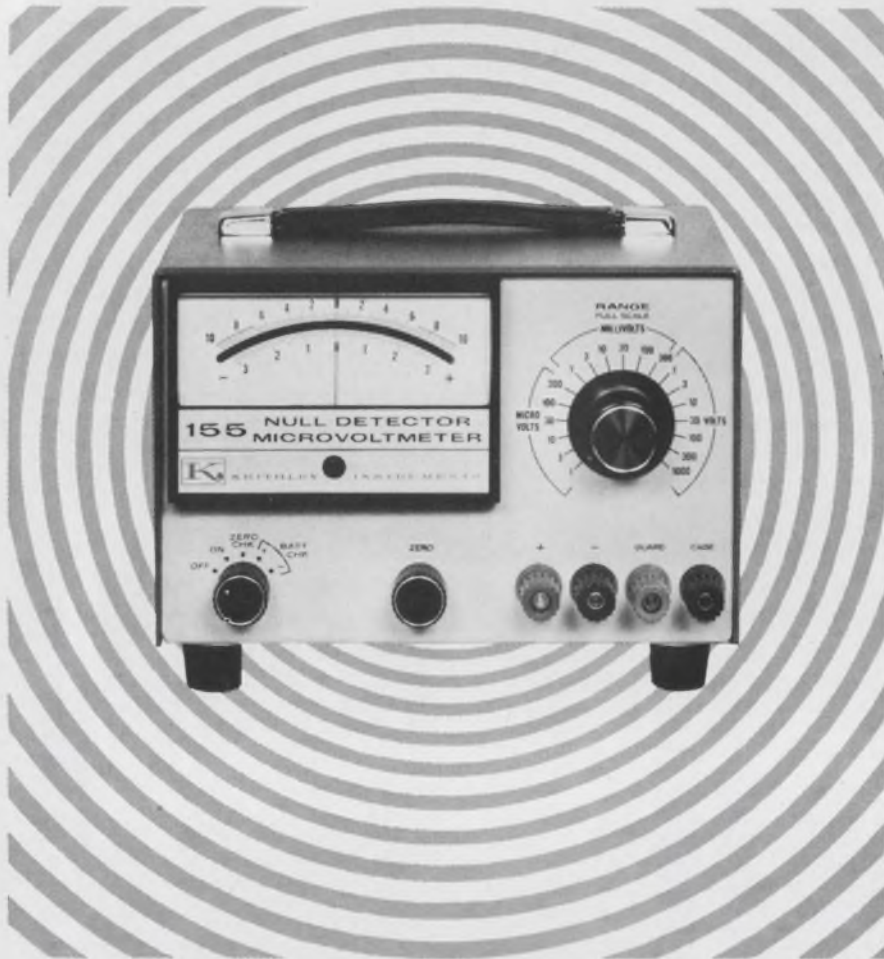

Look what \$325 buys in a 1 μ V Full Scale DC Null Detector/Microvoltmeter

It buys you a portable performer with 0.15 microvolt resolution. It's handy and convenient to use. It's rugged, too—works more than 1000 continuous hours on four carbon-zinc batteries. It's the Keithley Model 155—the lowest-priced electronic null detector on the market today.

The 0.03 μ v rms input noise is quieter than any other in its price class. Coupled with better than $\frac{1}{2}$ μ v per day stability and 1 megohm input resistance at 1 μ v full scale, the 155 is ideal as a null detector for potentiometers, bridges, ratio devices and comparator circuits.

When the Model 155 isn't working as

a null detector, it doubles as a 1 μ v to 1000 volt microvoltmeter with 19 zero center ranges. Use it for measuring thermocouple and thermopile potentials, contact resistance, making Hall Effect studies, or whatever.

See this little giant perform. Call your Keithley Sales Engineer for your demonstration. Or contact Keithley Instruments, Inc. for complete details—28775 Aurora Road, Cleveland, Ohio 44139. In Europe: 14, Ave. Villardin, 1009 Pully, Suisse. Prices slightly higher outside the U.S.A. and Canada.



KEITHLEY

INFORMATION RETRIEVAL NUMBER 36

LETTERS

the most. This figure will then be reduced by individual emitter resistors, if any, and also by finite resistance in the input source.

Mr. Hughes' basic design, with a loop gain of about 30, is clearly on safe ground, but any circuits intended to operate at lower current levels (e.g., 1 mA or so) and/or different voltage specifications may well run into trouble.

Especially with low-current, low-hysteresis designs, it is essential that loop gains be checked before going into production.

T. H. Beeforth

The University of Sussex
Applied Sciences Laboratory
Falmer, Brighton, England

Readers suggest simpler digital comparators

Sir:

Concerning the article "Design Digital Comparators Logically" (ED 23, Nov. 7, 1968), we would like to point out that significant savings in comparator hardware can be realized by a change in logical design.

By recognizing that $(A B + \bar{A} \bar{B}) = (A \bar{B} + \bar{A} B)$, the identity function $A=B$ can be more economically implemented using wired outputs on the IC gates. The $A=B$ (6-bit) comparator (illustrated below) utilizes 6 gates and 6 inverters, compared with 10 gates and 7 inverters used in the original design (p. 55).

The output is true (HIGH) when

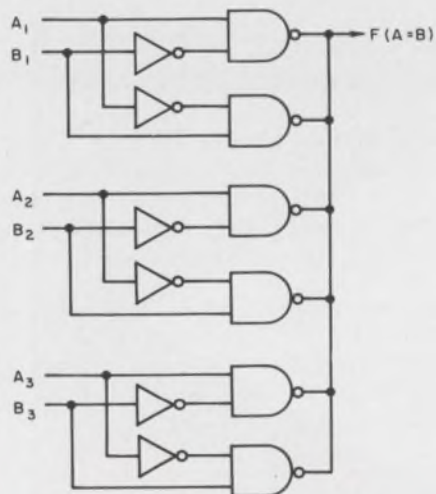

The Case for a *Driftless* Op-Amp

Almost all op-amp applications suffer in one way or another from the effects of offset and drift. Changes in ambient temperature of only a few degrees (or even just the passage of time) can cause drift errors . . . errors which can completely obliterate small signals in circuits built around conventional amplifiers. Now you can forget the whole troublesome problem! Our new model 232 is almost driftless . . . Voltage drift low as $0.1\mu\text{V}/^\circ\text{C}$ and $1\mu\text{V}/\text{month}$ is practically negligible. (In fact, long term tests show drift will never exceed $5\mu\text{V}$!)

Drift performance like this (coupled with only $15\mu\text{V}$ offset to begin with) means that you can forget balance pots (and periodic adjustments) forever. Of course, chopper stabilized amplifiers have been available for some time, but **never** at these prices. The 232 J at just \$54 in OEM quantities means that now all of your designs can be "driftless".

One more thing, this incredible amplifier is in a new "flat pack" case . . . perfect for P.C. card racks.

Check the complete specs on the back, then use the attached "instant action" reply card to request an evaluation sample. No obligation to buy, of course.

\$54

(232 J, 100 lot)

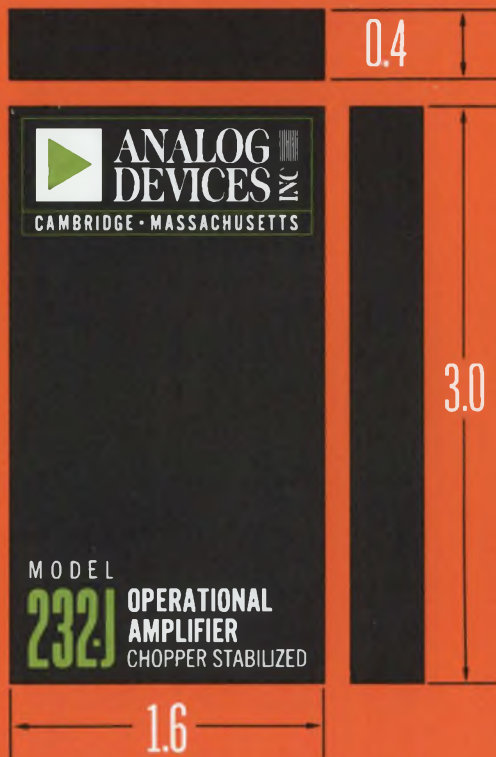

Instant action card
Use for Detailed literature,
new 1969 catalog, evaluation samples.

BUSINESS REPLY MAIL
NO POSTAGE STAMP NECESSARY IF MAILED IN THE UNITED STATES

FIRST CLASS
Permit No. 39342
Cambridge, Mass.

POSTAGE WILL BE PAID BY

ANALOG DEVICES INC

221 FIFTH STREET • CAMBRIDGE • MASSACHUSETTS 02142

Specifications: Model 232

All specifications typical @ 25°C and nominal supply voltage unless otherwise specified.	MODEL 232 (NEW)	
	J	K
OPEN LOOP GAIN		
dc, rated load, min	10 ⁷	
RATED OUTPUT, min		
	+10V @ 4mA*	
FREQUENCY RESPONSE		
Unity gain, small signal	500kHz	
Full power response, min	3kHz	
Slew rate, min	.2V/μsec	
INPUT OFFSET VOLTAGE @ 25°C, max.		
	±15 μV	±10 μV
Average vs. temp 10 to 60°C, max.	±.25 μV/°C	±.1 μV/°C
vs. supply	±.1 μV/%	
vs. time	±1 μV/mo	
INPUT BIAS CURRENT @ 25°C, max		
	±100pA	±50pA
Average vs. temp 10 to 60°C, max	±1 pA/°C	±.5pA/°C
INPUT IMPEDANCE		
Differential	300kΩ	
INPUT NOISE		
Voltage .01Hz to 1Hz p-p	1.5 μV	
5Hz to 50kHz rms	5 μV	
Current .01Hz to 1Hz p-p	10pA	
PRICE		
1-9	\$64.	\$99.
10-24	\$58.	\$90.

*For 25 mA output specify model 231

LONG TERM STABILITY

Actual Test Data, 5 units

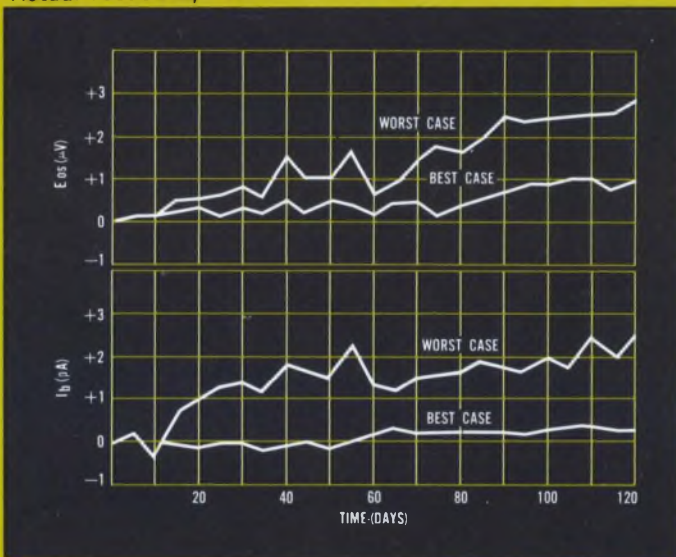

LOW VOLTAGE AND CURRENT NOISE

1Hz Noise Bandwidth

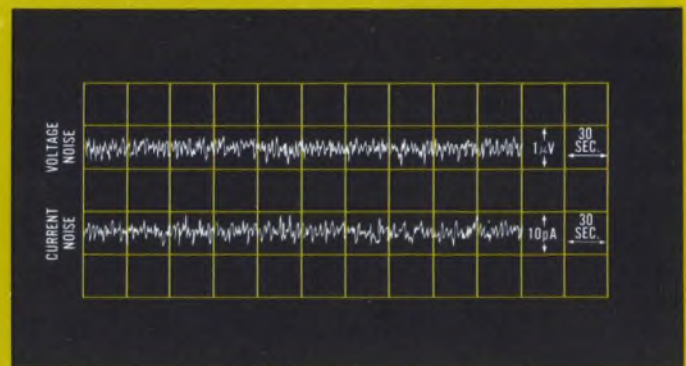

INITIAL OFFSET AND WARM-UP DRIFT

Typically Less Than 1 μV

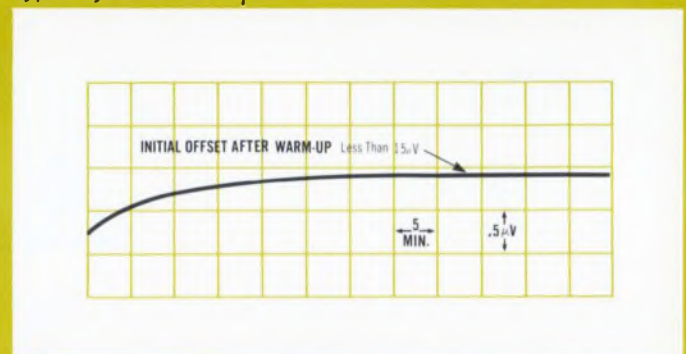

WHY USE CHOPPER STABILIZED AMPLIFIERS?

Some I.C. op-amps (and amplifiers built with "heated substrate" input stages) can yield low voltage drift characteristics, at least as regards temperature drift. The shortcomings of this approach show up in two areas:

- (1) Long term drift (over a period of months)
- (2) Bias current offset and drift (important for high impedance circuits)

For high performance applications the I.C.'s just don't measure up. A chopper stabilized op-amp is the only way to get low voltage and current drift and long term stability. Until now, chopper stabilized amplifiers were large, costly, and suffered somewhat higher noise levels than conventional amplifiers. The new 232 cures all these problems.

MAKE US PROVE IT!

Evaluation samples are now available . . . Use the attached "instant action" card or phone your local representative.

221 FIFTH STREET • CAMBRIDGE • MASSACHUSETTS 02164 • (617) 492-6000 • T W X: (710) 320-0326

INSTANT ACTION REQUEST

Please send 1969 catalog

Please send literature on Model 232J 232K

My interest is for:

231J 231K

Information only

Please send Evaluation Sample 232J 232K

Immediate application

231J 231K

Anticipated application

For 25 mA output specify model 231

Name	Title	
Company		
Dept./Mail Station	Phone	
Address		
City	State	Zip



This new 32 page catalog features 19 brand new products, includes detailed specs and application information on our complete op-amp line. Get your copy free . . . use the INSTANT ACTION card.

LETTERS

every A input is identical to the corresponding B input. If type 930 gates are used, then only 8 outputs can be tied together and drive a following input. If open collector circuits such as the MC858P or SN7401N are used, then the number of outputs that may be paralleled is limited only by speed and leakage currents.

The general technique described here can be used to advantage in other types of comparators.

M. Fishman and D. Horelick
Stanford Linear
Accelerator Center

Sir:

There is a simpler way to compare two 4-bit numbers than that described in "Design Digital Comparators Logically, Part 2" (ED 24, Nov. 21, 1968). If a 4-bit number, say N_1 , is added to the 1's complement of another number, call it N_2 , then the sum of the two 4-bit numbers will be 1111 if $N_1 = N_2$. Four 1's can easily be detected by a single gate. The circuit shown below does everything the circuit [in the article] can do, and requires

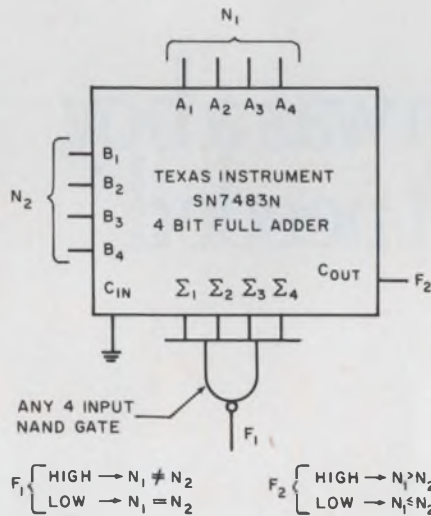

considerably fewer components.

Gregory L. Schaffer

Ames Research Center

[We thank Messrs. Fishman, Horelick and Schaffer for their constructive and useful comments. Although the purpose of the original article was to show one way in which various comparator functions

(Continued on p. 70)



Simpson's NEW solid-state VOM with FET-Input

- **HIGH INPUT IMPEDANCE...**
11 Meg Ω DC 10 Meg Ω AC
- **PORTABLE..... battery operated**
- **7-INCH METER..... overload protected**

Simpson's new 313 gives you high input impedance for accurate testing of latest circuit designs . . . free of line cord connections. Over 300 hours operation on inexpensive batteries. And the new 313 is *stable*, which means positive, simplified zero and ohms adjustments. Protected FET-input handles large overloads. DC current ranges to 1000 mA. Sensitive Taut Band movement and 7-inch meter scale provide superior resolution down to 5 millivolts. Write today for complete specifications.

Complete with batteries, 3-way AC-DC-Ohms probe, and operator's manual **\$100⁰⁰**

Simpson ELECTRIC COMPANY

GET "OFF-THE-SHELF" DELIVERY FROM YOUR LOCAL ELECTRONIC DISTRIBUTOR



5200 W. Kinzie Street, Chicago, Illinois 60644 • Phone (312) 379-1121

EXPORT DEPT.: 400 W. Madison Street, Chicago, Illinois 60606. Cable Simelco
IN CANADA: Bach-Simpson Ltd., London, Ontario • IN INDIA: Ruttonsha-Simpson Private Ltd., International House, Bombay-Agra Road, Vikhroli, Bombay



When Pete Sylvan was a boy,
if an adjustment wasn't needed
it didn't exist.

"Waste not, want not" was the life mode of technology when Pete Sylvan was growing up in Montclair, N.J. Function outranked form. Substance outweighed style. The 'Thirties had no room for extravagance, no patience with overdesign. Planned obsolescence was an alien concept and a phrase unknown.

Today Pete Sylvan designs semiconductor test instruments for Teradyne. His list of innovative patents is as long as your arm. Each one of them is as practical as a shoehorn.

Like Pete Sylvan there's a bit of the 'Thirties in all the designers at Teradyne. Each instrument is created to meet the practical needs of the production line and the quality-control and incoming-inspection operations of the manufacturers, distributors and users of electronic components.

Take adjustments. They don't exist on Teradyne instruments. Not a single trimming potentiometer has ever been used. Calibration is reduced to a simple and infrequent verification procedure.

Circuits with field adjustments are not used either, thereby preventing inevitable, embarrassing and expensive errors or readjustment.

Hard-nosed managers of companies who make, sell or use semiconductors have long since learned a painful axiom: the final cost of one bad electronic component that gets into an assembly is often greater than the purchase cost of the entire lot it came from.

Accept the fact. You're in electronics to make money, not to tickle the creative fancy of an instrument designer. If an adjustment isn't needed, it shouldn't exist. It doesn't at Teradyne, 183 Essex Street, Boston, Massachusetts 02111.

Teradyne makes sense.

The case for our micromemory.

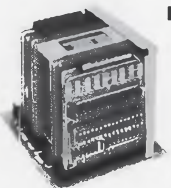

There is none.

Most memories available today come in nice packages. Totally-enclosed, well-protected, and looking like they still belong to the original manufacturer.

We've got one that doesn't look like it belongs to anyone. Our newest system for industrial/commercial applications, the MICROMEMORYTM 1000, provides up to 32K bits of storage with a cycle time of 2.5 usec for less than 7 cents/bit. And it's just as economical with space (400 cubic inches) and power (35 watts maximum).

But it has no case. The system consists of a stack and five cards of electronics that plug into an unenclosed mother board, with a single connector providing the I/O interface for integration into your system. Main-

tainability is enhanced by this configuration even though you'll probably never have to take advantage of it. The same advanced 3D drive technique that gives you the lower price because of a lower component count also yields a correspondingly higher MTBF.

The MICROMEMORY 1000 will fit almost anyplace in your system. Its open construction leaves access unhampered, while its low power dissipation eliminates the need for additional cooling. Mount it upside down or sideways, show it off or hide it. It looks like it belongs in your system because it does.

Price and delivery, true random access and ease of electrical interface all strengthen the case for the MICROMEMORY 1000. Write us for the full story.

EM **electronic memories**

12621 Chadron Ave., Hawthorne, California 90250 • (213) 772-5201

Three ways to improve on the performance, price and delivery of Op Amps like the 709C, 741C and MC 1439.

LM301A/302/307

Our LM301A, 302 and 307 are more than interchangeable with the 709C, 741C and MC1439. They outperform them, are competitively priced and they are readily available. Ideal devices for long-interval integrators or timers, active filters, instrumentation amplifiers or in high impedance applications where noise is critical. All are completely specified for operation over 0° to 70°C temperature range.

LM301A—most versatile general purpose amplifier and comparator. Low input currents, low noise and guaranteed drift characteristics. 10V/ μ sec slew as a summing amplifier. (\$3.45 at 100 pieces)

LM302—fast voltage follower with super-low input currents. Fully compensated. (\$3.00 at 100 pieces)

LM307—internally compensated universal op amp. Same DC specs as LM301A. Direct plug-in replacement for 709-type op amps. (\$3.95 at 100 pieces)

Input for the asking. National Semiconductor Corporation / 2975 San Ysidro Way, Santa Clara, California 95051 / (408) 245-4320 / TWX: 910-339-9240 / Cables: NATSEMICON.

National/Linear

When Designing Your S-Band System, Specify ATI Preamps

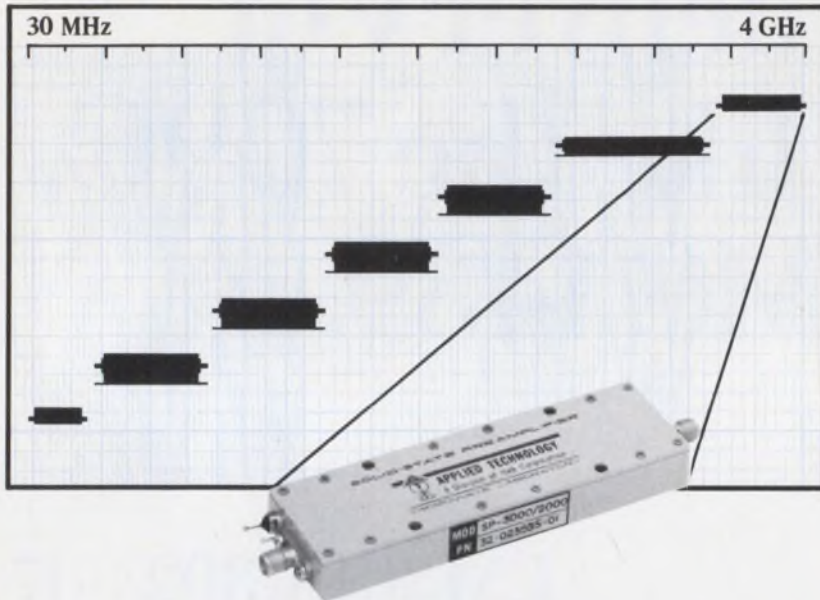

The SP-3000/2000 S-Band preamplifier exemplifies ATI's series of octave bandwidth units covering the frequency range from 30 to 4000 megahertz. Featuring microstrip construction, the SP-3000/2000 is ideally suited for use in communication and radar systems, active and passive ECM systems, telemetry and commercial microwave equipment.

- Frequency Range: 2-4 GHz
- Max. Noise Figure: 10 dB
- Gain: 20 dB
- Gain Flatness: ±2.0 dB
- Intercept Point: +10.0 dBm (3rd order intermod)
- 1 dB compression point: 0 dBm min.
- DC Power: +12 Vdc @ 50 ma
- Size: 2.5 cu. in.

Models with integral power supply for TWT replacement and optional gain increments are also available.

Write or call collect for additional information or application assistance.

Employment Opportunities for Qualified Engineers

An equal opportunity employer.

SOLID-STATE OSCILLATORS • SYNTHESIZERS • PREAMPS • FREQUENCY MULTIPLIERS

MICROWAVE LABORATORY

APPLIED TECHNOLOGY
A Division of Itek Corporation

3410 Hillview • Palo Alto, Calif. • 94304 • (415) 321-5135 • TWX: 910 373-1218



INFORMATION RETRIEVAL NUMBER 41

LETTERS

can be implemented with off-the-shelf ICs, we welcome information on other techniques. We will be glad to publish any that appear useful to our readers.—Ed.]

Accuracy is our policy

The author of the Idea for Design, "Signal-level envelope detector uses dual operational amplifier" (ED 3, Feb. 1, 1969), has brought three errors in the circuit equations to our attention. The correct equations are as follows:

$$V_t(-) = V_2 - |e_{out_5}^{(+)} - V_2| \times \dots \times \frac{R_2}{R_1 + R_2} + V_{os} \quad (1)$$

$e_{out_5}^{(+)}$ = output voltage when e_{out_5} is high (≈ 3.0 V, dependent on load)
 $V_t(+)-V_t(-) = 98$ mV.

Sir:

Thank you for the treatment awarded our new, high-power high-speed model 110 stepping motor (ED 1, Jan. 4, 1969, p. 162).

Although 8000 steps per minute is a respectable speed for a high-power stepping motor, our model 110 actually develops 11 lb-in. of torque at 8000 steps per second.

Gordon Baty

President
Icon Corp.
Cambridge, Mass.

In "Decade Counter Uses No Decoding Matrix" (Ideas for Design, ED 20, Sept. 26, p. 68), the resistors in the base leads of the two transistors shown in Fig. b were incorrectly labeled 33k. The resistor values are actually 3.3k.

A typographical error appeared in author Gunnar Richwell's reply to engineer Ernest Dummermuth in the Letters section of ED 21, Oct. 21, 1968, p. 48. The correspondence concerned Richwell's Idea for Design, "A Few Gates Add to a

Monolithic Voltage Regulators

the complete works now in paperback

Five voltage regulator application notes including two just published; 60 pages of design information on positive and negative voltage regulators. Sixteen pages of specification information including significant graphs of performance characteristics. An eight page Reliability Report encompassing Production Processing, Quality Control, Screening, Life Testing, Environmental Testing and Design Philosophy. The most complete set of design aids in print for monolithic voltage regulators. You can see the performance; send for the book. National Semiconductor Corporation, 2975 San Ysidro Way, Santa Clara, California 95051 (408) 245-4320
TWX: 910-339-9240 CABLES: NATSEMICON

National/Linear

INFORMATION RETRIEVAL NUMBER 42

HOW TO COMMAND A DJINNI.

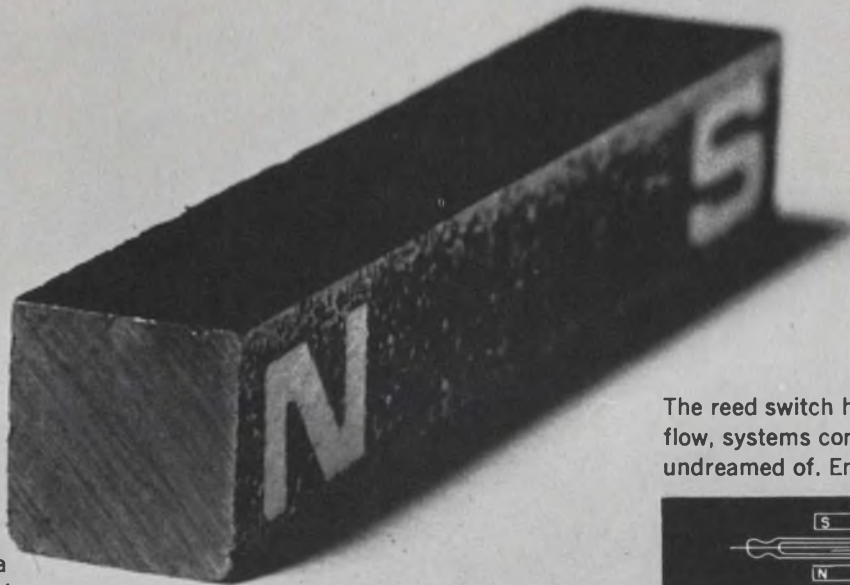

The reed switch, ferromagnetic strips encased in their own little bottle, reacts to a magnetic field. Bring in a bar magnet and . . . snap. You don't even have to rub the bottle. Magnet movement can be designed to actuate the switch for practically every control function conceivable. Magnet

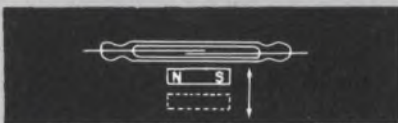

motion can be parallel, perpendicular, pivotal. It can twirl on its own axis, providing two switch closures per rotation. The reed switch, of course, can also be controlled with a coil as in a relay.

Its speed is the closest thing to transistorized logic, with the added advantage of isolation and much lower circuitry cost. It is

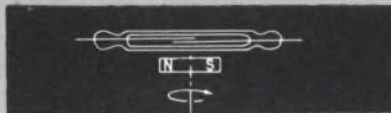

completely practical for RF switching and in its sealed container stays free of dust, damp and corrosion. There are



no armatures, springs or pivots to wear. Life can easily exceed 100 million operations.

The reed switch has machine, flow, systems control uses yet undreamed of. Engineers have

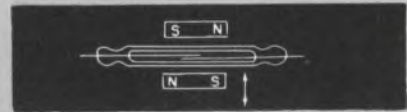

barely scratched the surface in uses for this most versatile electro-mechanical switch yet invented.

If you'd like to know more about it, ask Hamlin. We sell more reed switches to more people than anyone else. Send for our free "switch lab" and practice a little magic of your own. Just write Hamlin, Inc., "Baghdad on the Lake," Lake Mills, Wisconsin 53551.

HAMLIN INC.



You don't even have to rub.

HOW TO SUMMON A DJINNI

These Hamlin distributors carry Hamlin reed switches in stock:

ALLIED ELECTRONICS
Chicago, Illinois (312) 829-9121

Branch Offices:
Arcadia, California (213) 455-4800
(213) 684-0730
Cleveland, Ohio (216) 752-3290
College Park, Maryland (301) 935-6400
Dallas, Texas (214) 826-5101
Dayton, Ohio (513) 298-9831
Denver, Colorado (803) 399-2250
Detroit, Michigan (313) 846-7720
Hewlett, L. I., N. Y. (516) 295-1500
Los Altos, California (415) 941-0524
Milwaukee, Wisconsin (414) 444-2840
Minneapolis, Minnesota (612) 920-5800
Rochester, New York (716) 244-8750
Seattle, Washington (206) 632-5935
Tampa, Florida (813) 877-6791

CAMERADIO COMPANY
Pittsburgh, Pennsylvania (412) 391-4000

CESCO ELECTRONICS, LTD.
Montreal, Quebec, Canada (514) 735-5511
Branch Offices:
Downsview, Ontario, Canada (416) 638-5250
Ottawa, Ontario, Canada (613) 729-5118
Quebec, Quebec, Canada (418) 524-3518

CRAMER ELECTRONICS, INC.
Newton, Massachusetts (617) 969-7700

Branch Offices:
Atlanta, Georgia (404) 892-2632
Baltimore, Maryland (301) 354-0100
Cincinnati, Ohio (513) 563-0570
Elmhurst, New York (212) 478-4000
Fort Lauderdale, Florida (305) 566-7511
(305) 947-6517
Hamden, Connecticut (203) 288-7771
Huntsville, Alabama (205) 536-4493
Philadelphia, Pennsylvania (215) 224-0120
Raleigh, North Carolina (919) 832-6441
Rochester, New York (716) 482-7080
Rockville, Maryland (301) 424-2700
Syracuse, New York (315) 455-6641

WM. DANDRETA & COMPANY
Providence, Rhode Island (401) 861-2800

DIXIE RADIO SUPPLY CO., INC.
Columbia, S.C. (803) 253-5333

Branch Offices:
Anderson, S.C. (803) 226-3421
Charlotte, N.C. (704) 377-5413
Florence, S.C. (803) 669-8201
Gastonia, S.C. (704) 864-3281
Greenville, S.C. (803) 232-5357
Greenwood, S.C. (803) 223-7324
Spartanburg, S.C. (803) 583-3681
Sumter, S.C. (803) 775-2306

ELECTRA DISTRIBUTING CO.
Nashville, Tennessee (615) 255-8444

ELECTRO-STANDARDS LABORATORIES, INC.
Miami, Florida (305) 633-6975

ELMAR ELECTRONICS
Mt. View, California (415) 961-3611
Branch Office:
Oakland, California (415) 834-3311

GRAHAM ELECTRONICS SUPPLY, INC.
Indianapolis, Indiana (317) 634-8486

Branch Offices:
Anderson, Indiana (317) 644-3381
Ft. Wayne, Indiana (219) 742-4346
Lafayette, Indiana (317) 742-4006
Muncie, Indiana (317) 288-8837
Reading, Ohio (513) 733-1661

KIRKMAN ELECTRONICS, INC.
Winston Salem, North Carolina (919) 724-0541

LIBERTY ELECTRONICS NORTHWEST
Seattle, Washington (206) 763-8200

PIONEER STANDARD ELECTRONICS, INC.
Rockville, Maryland (301) 427-3300

R-C-S ELECTRONICS, INC.
Houston, Texas (713) 667-9567

RADIO, INC.
Tulsa, Oklahoma (918) 587-9124

Branch Office:
Oklahoma City, Oklahoma (405) 235-1551

RESCO ELECTRONICS
Philadelphia, Pennsylvania (215) 925-6900

SUMMIT DISTRIBUTORS, INC.
Buffalo, New York (716) 884-3450

TAYLOR ELECTRIC COMPANY
Milwaukee, Wisconsin (414) 964-4321

TERMINAL-HUDSON ELECTRONICS, Inc.
New York, New York (212) 243-5200

R. V. WEATHERFORD CO.
Glendale, California (213) 849-3451

Branch Offices:
Anaheim, California (714) 532-6741
Palo Alto, California (415) 321-5373
Phoenix, Arizona (602) 272-7144
Pomona, California (714) 623-1261
San Diego, California (714) 278-7400
Seattle, Washington (206) 762-4200

LETTERS

Monostable" (published in ED 14, July 4, 1968, p. 102).

The scrambled section of Richwell's letter should read:

"2. If Mr. Dummermuth will examine his data sheets he will find that the -1.6 mA maximum sink current is specified at $V_{in} = 0.4$ V. At 2.4 and 5.5 V the maximum currents are $40 \mu\text{A}$ and 1 mA, respectively. A curve plotted through these three points indicates a non-linear function between input voltage and maximum input current which yields about -0.9 mA at 0.8

V. Therefore, Mr. Dummermuth's assumption that maximum current at 0.8 V is -1.6 mA is erroneous.

3. Similarly, the 0.4 maximum logical 0 output voltage is specified at $I_{out} = 16$ mA. For an output current now of less than 1 mA, the maximum output voltage will be considerably less, as is evident from the TI curves of logical 0 output voltage versus sink current. Therefore, Mr. Dummermuth's assumption that the maximum logical 0 voltage in this case is 0.4 V is erroneous."

In the Idea for Design titled "Divide-by-60 counter uses dual flip-flops" (ED 18, Sept. 1, 1968), a connection between the J and K

inputs of the fourth flip-flop was inadvertently omitted on the schematic. The corrected schematic is shown here.

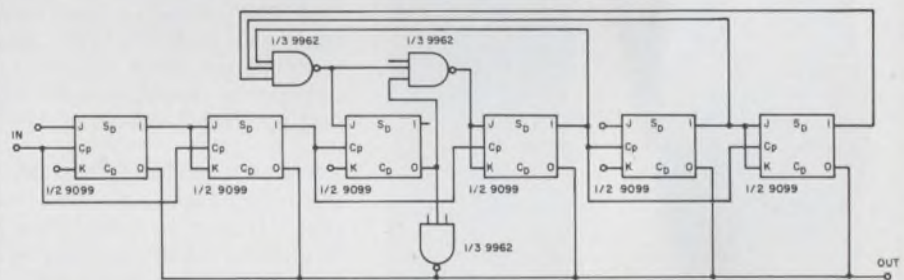

In the Idea for Design titled "TC zener + FET chopper = ac-dc calibrator" (ED 16, Aug. 1, 1968), sev-

eral errors appeared on the schematic diagram. A corrected version of the schematic appears here.

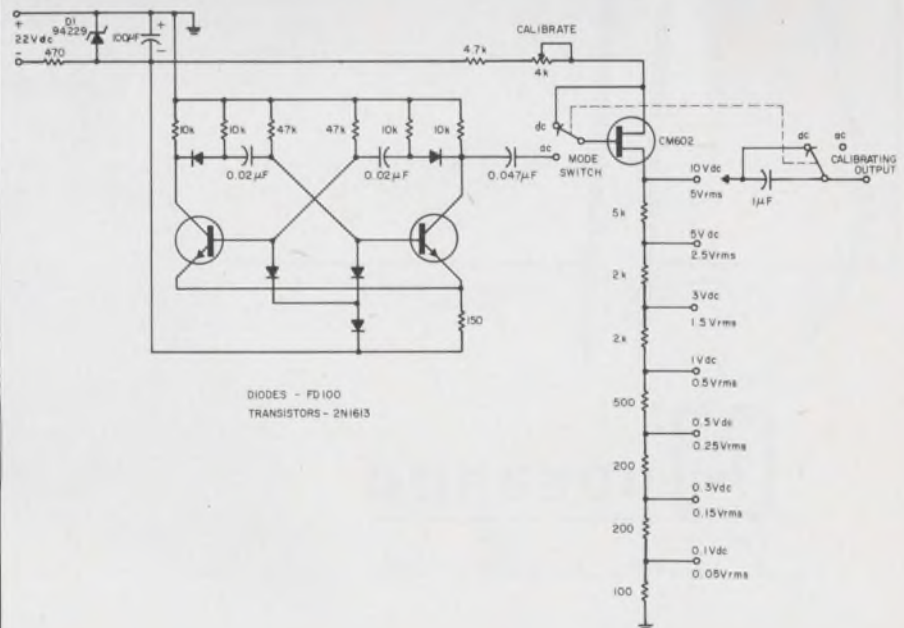

For high speed harnessing
with continuous lacing...

HERE IS THE WORK SPEEDING - MONEY SAVING -

GUDEBROD SYSTEM "C"

GUDEBROD FLAT TAPE BOBBINS—This special packaging of Gudebrod Flat Braided Lacing Tape is highly popular in the harness shop. Whether used in all hand tying or with the Cable-Lacer (for which it was designed) the bobbin makes conveniently available, high quality Gudebrod Tape in most of its many types—all engineered to lie flat, tie tight.

GUDEBROD CABLE-LACER®—This unique harnessing hand tool has proved a production speeder and harness improver. Makes up to 30 knots per minute. While making firmer harnesses with tighter, more uniform knots, it eliminates wear and tear on operator's hands because special brake takes strain of knot setting. Holds bobbin of Gudebrod Tape in handle.

LONGER WIRE HOLDING PINS—They make wire threading much easier, quicker (no repeated wire redressing between pins). In harness tying they preserve the layout while using the Gudebrod Cable-Lacer. Special case hardened pins, nail better, stay straight, no nailheads.

GUDEBROD SWIVEL-TILT HARNESS BOARD MOUNT

—Two dimensional balanced mobility puts every section of the cabling within easy, natural reach of the operator. Work done in this unstrained manner goes faster, is better, all day through.

There it is, the Gudebrod System "C" solving the cable making problems in a speedy, economical, profit improving way. Ask about System "C" (If you use intermittent tying, ask about Gudebrod System "S").

Gudebrod's
Special, Longer
Case Hardened Pins

®T.M.—UNION SPECIAL
MACHINE CO.

GUDEBROD
Electronics Division

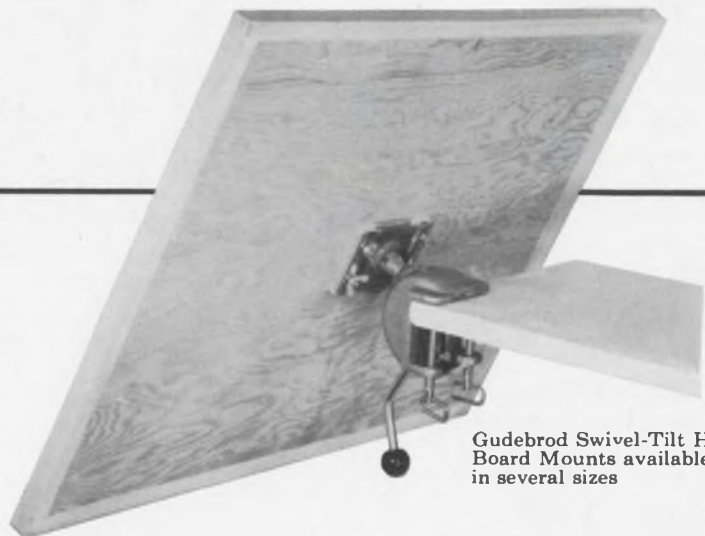

Gudebrod Swivel-Tilt Harness
Board Mounts available
in several sizes

Our line-up of connectors makes them the most wanted in the industry

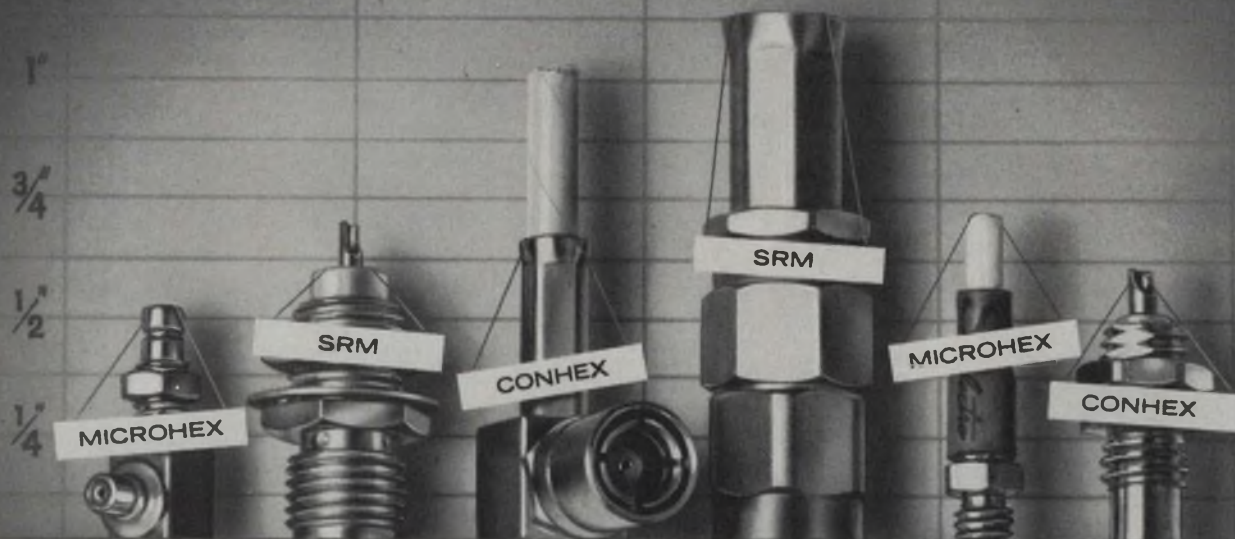

Most wanted because they really perform. Unsurpassed low VSWR across the board. Exceptional reliability and fast delivery. What's more, there is a connector in the Sealectro line for every application requirement . . . Conhex subminiature connectors in every conceivable configuration and meeting MIL-C-22557. SRM stainless steel connectors, compatible with all similar types of subminiature reliable connectors and meeting all requirements of MIL-C-39012, Series SMA.

Microhex microminiature connectors, the industry's smallest. An extensive line of adaptors, terminations and complete cable assembly facilities.

Sealectro subminiature and microminiature connectors cover the spectrum. Hundreds of standard types that are immediately available coast-to-coast through Sealectro Distributors. Get the complete story. Write for our complete technical information and catalog file.

Conhex, Microhex and SRM are Reg. T.M. Sealectro Corp.



RF COMPONENTS DIVISION

SEALECTRO
CORPORATION

MAMARONECK • NEW YORK 10543

PHONE: 914 698-5600 TWX: 710-566-1110

Sealectro Ltd. Portsmouth, Hants, England

Sealectro S.A. Villiers-le-Bel, Paris, France

Visit SEALECTRO at IEEE SHOW, BOOTHS 4E03-4E07

SCHAUER**1%**

tolerance

**1 WATT ZENERS
ARE A REAL BUY!**

ANY voltage from 2.0 to 16.0
at the industry's **LOWEST
PRICES!**

Quantity	Price each
1-99	\$1.07
100-499	.97
500-999	.91
1000-4999	.86
5000 up	.82



THE HI-RELIABLE!

No fragile nail heads.
Silicon junction aligned between two, parallel, offset tantalum heat sinks . . . great lead tension strength.
All welded and brazed assembly.
High pressure molded package.
Gold plated nickel-clad copper leads.
Write or phone for Form 68-4 for complete rating data and other tolerance prices.

Semiconductor Division

**SCHAUER
MANUFACTURING
CORP.**

4511 Alpine Avenue
Cincinnati, O. 45242
Ph. (513) 791-3030

The art of designing electronic art

A magazine story, like a well-wired, smoothly operating electronic circuit, is usually "designed" in some editor's office. Ordinarily the planning is quiet, deliberate and, sometimes, torturous. But consider "The Friendly Grey Computer," by Roger Kenneth Field (p. 52).

It began on the sidewalk when publisher Hugh Roome and managing editor Robert Haavind were strolling along Lexington Avenue, not far from the New York City headquarters of ELECTRONIC DESIGN.

"Hey, it's Roger!" they said.

Roger Field, a former ELECTRONIC DESIGN staff member and now a freelance science writer, turned around, just in time to learn that Haavind had been thinking for days about assigning him to cover some fascinating technological exhibits at the Museum of Modern Art and the Brooklyn Museum. There was only one hitch—was there anything worthwhile in it for electronic designers? Field said he'd take a look.

Armed with a Hasselblad, Field and ELECTRONIC DESIGN's art director, Cliff Gardiner, visited the museums. Not just once. Two, three, four times. They came away with some interesting photos—and also some provocative ideas for designers. Then the sweating started.

Pictures were engraved and then sent back for another engraving to get sharper effects. The story was written, rewritten, rewritten once more and then finally rewritten. Was it worth the effort?

Well, there's an interesting story for designers. A lesson in engineering that artists have stumbled on but that many engineers are inclined to overlook. Now turn to p. 52 and read on.



Hey, lookie, 3D! ED's art director, Cliff Gardiner (left), and Roger Field, science writer getting the low down on electronic art.

Teledyne TO-5 Relays quality & experience

(right...today and tomorrow)

TELEDYNE



TO-5 Relay



Teledyne's reputation for quality demands adherence to the right specifications, the right delivery schedule, the right experience and facilities and the right Q.C. system to eliminate human error.

Right you are, that Teledyne, the originator and world's most experienced producer of quality TO-5 Relays, can meet the needs and standards of tomorrow's designs.

The price is right.

Send for further information and complete catalog.



TELEDYNE RELAYS
A TELEDYNE COMPANY

3155 West El Segundo Boulevard Hawthorne, California
90250 Telephone: (213) 679-2205

THE COUNTER REVOLUTION GOES ON AT HP



the automatic counter's automatic counter

The new Hewlett-Packard 5323A Automatic Counter gives you a more useful automatic instrument than you've ever had before for either automatic systems or visual readout uses. It's considerably ahead of its class — the new class of "reciprocal taking" counters. It provides a greater speed-resolution combination of period measurement for making low frequency measurements (about 1000 times greater for clean signals below 1 kHz). Then, for rapid convenient readout, computing circuits invert period for direct display as frequency. It automatically provides the maximum resolution possible, regardless of measurement time, over the entire 0.125 Hz to 20 MHz range.

But the 5323A provides even more. A host of unique "extra duty" features gives you exceptionally higher performance for a lower price. For example, it can

automatically measure the carrier frequency of pulsed signals. It also has measurement times from 0.01 to 4 seconds, selectable in steps of 1, 2 and 4. Controllable hysteresis prevents jittering about range change points. Remote programming and digital output are standard. Better integrated circuit design keeps input power at a low 35W so there's no fan, and it'll use 50 to 400 Hz power.

This significant new speed, accuracy and convenience in frequency measurement is provided at less cost than similar counters, too. Price is \$2150 — for a uniquely useful instrument for: rapid confident use at the bench or for greater accuracy, speed and automaticity in data acquisition systems, mechanical or electrical testing, control systems or physical, earth or life science investigations.

For more information about an automatic counter worth your immediate attention, call your local HP field engineer. Or write Hewlett-Packard, Palo Alto, California 94304; Europe: 1217 Meyrin-Geneva, Switzerland.

02826

HEWLETT  PACKARD

ELECTRONIC COUNTERS

Publisher

Hugh R. Roome

Editor

Howard Bierman

Managing Editor

Robert C. Haavind

Technical EditorsFrank Egan
Michael J. Riezenman
Raymond D. Speer**Management and Careers Editor**

Lawrence Locke

Chief News Editor

Ralph Dobriner

Washington News Bureau

Charles D. LaFond, Chief

Military/Aerospace Editor

John F. Mason

East Coast Editor

Jim McDermott

West Coast Editor

Elizabeth deAtley

New Products EditorsRobert Patton
Lucinda Mattera**Copy Editor**

Peter Irving

Editorial ProductionDollie S. Viebig
Phyllis Gura**Art Director**

Clifford M. Gardiner

Art Assistant

William Kelly

Technical IllustratorsWilliam Alvarez
Rita Jendrzewski
Lynn E. Thompson**Production Manager**

Thomas V. Sedita

Asst. Production Manager

Helen De Polo

Production AssistantsBernard Wolinsky
Carl A. Merkin**Circulation Manager**

Nancy L. Merritt

Information Retrieval

Genate Piccinetti

EDITORIAL



Death of an aquanaut poses touchy questions

The death of Berry L. Cannon, electronics engineer-aquanaut in the Navy's Sealab III operation off San Clemente Island, Calif., raises disturbing questions. The first explanation was that he had died of cardiac arrest in the icy water 600 feet below the surface—something that could have happened anywhere. Three days later the Navy announced that one of the diving rigs that contained the breathing apparatus the divers were using was equipped with an empty Barylime cannister. Barylime absorbs carbon dioxide, which, of course, is fatal in high concentrations.

Regardless of the final findings—whether human error or equipment failure is at fault—the whole U.S. Man-in-the-Sea program should be carefully examined. Because it has less military priority than other programs, was it adequately funded? Because it lacked the glamor of the manned space program, was safety, unconsciously, given less consideration?

ELECTRONIC DESIGN feels particularly grieved, because we knew Berry Cannon. I first met him in Panama City, Fla., in the summer of 1965, when the aquanauts were training for Sealab II. Cannon was the only electronics engineer in the program, and he patiently briefed me on all the electronic equipment that was to be used.

Before Sealab III, while reporting on the new experiment, I talked extensively by telephone with Cannon after he had arrived at San Clemente Island to await his first dive. The conversation was mainly about Sealab III's electronic equipment, which was disappointingly similar to that used in Sealab II (see "Designing for the Explosive Undersea Depths," ED 2, Jan. 18, 1969, p. 29).

The program, unfortunately, seemed to point to a "stepchild operation" rather than a well-rounded, well-financed program. Equipment problems began developing almost as soon as the aquanauts arrived at San Clemente. The personnel-transfer vehicle, which was to take them 610 feet to the ocean floor, flooded; this took weeks to repair. Then, just before the first team was to descend, helium was discovered leaking from the tank-like habitat that was to be the aquanauts' home for 12 days at a stretch. Cannon and three other men were sent down. Cannon died.

When I interviewed him at San Clemente Island, he did not complain, nor was he pessimistic. Either mood would have been inconsistent with his natural enthusiasm, dedication and professionalism as a design engineer and explorer.

"Are you getting a new sonar that won't collapse at 600 feet?" I asked him.

"Not that I know of," was the reply.

"What about a navigation system?"

"I doubt that it will be ready," Cannon said.

"How do you feel about the operation?"

"Great," Cannon said, "I think it's going to be all right."

JOHN F. MASON

Model LAT-100

The \$6,000* Resistor Trimming System

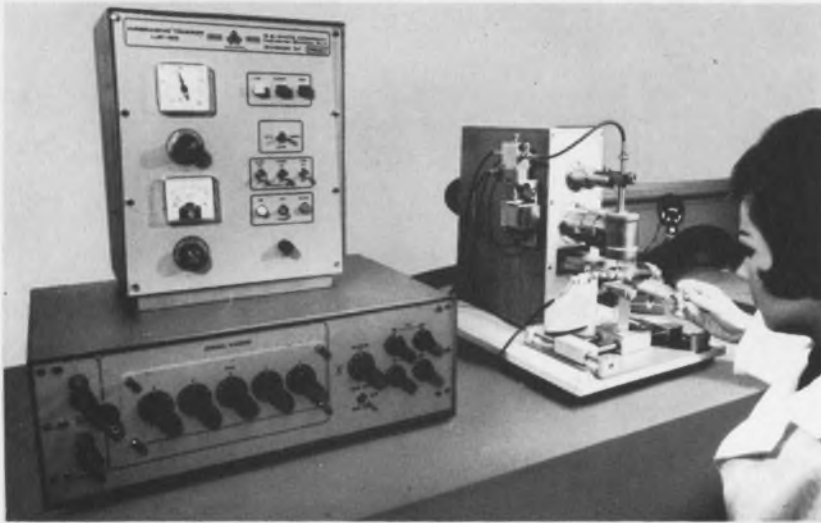

The number to call is 212-661-3320 for a demonstration like this—and you can bring your wife along if you like.

CALL us collect or write to arrange for a demonstration of S. S. White's new LAT-100, the complete, low-cost resistor trimming system for R & D and prototyping.

The LAT-100 automatically trims, monitors, and inspects PAF resistors to tolerances within 1%. That's guaranteed. In tests, 0.5% is often achieved. A precise 4-wire Kelvin bridge is integral to the system, which, with the optional plug-in decade box, permits the system to be programmed through five digits and three multipliers—from 0 to 10K and from 0 to 1M. Tolerances may be programmed from 0 to $\pm 11\%$. Panel controls permit operator to override the automatic cycle at will.

A holding fixture takes substrates up to 2x2 inches. A precise X-Y stage has 4"x4" movement. The trim slide has an automatic fast-return to place it exactly for the start of each trim. Tungsten carbide probes are mounted in a 14-position mounting ring. An efficient dust-removal system permits the LAT-100 to be operated in clean rooms. Installation requires a 110 VAC outlet and a level spot.

*Base price, \$5,950.00 each. With optional decade box, illuminator, foot-switch operation, \$6,350.00.

Without further detail, the LAT-100 does everything it's bigger brothers the AT-701 and AT-704 do—a little less accurately, to be sure, and not nearly as fast—but what can you expect for a trifling \$6,000?

A step up from the LAT-100 is the AT-701, a no-nonsense production machine. The AT-701 can produce 600 trims per hour with guaranteed accuracy of 0.5% and attainable accuracy of 0.1% when



Model AT-701 garners accolades at IEEE show—top scientist says "Gee whiz."

things are going your way. The AT-701 with a decent amount of employment (say 1000 hours per year) produces trims at about $\frac{1}{2}\text{¢}$ each—including labor, materials, maintenance, and amortization. How about *that*?

But say you're big. Really big. We've got our big Bertha model for you, otherwise called the AT-704, which produces 4,000 trims per hour with accuracy and cost similar to those of the AT-701.

S. S. White resistor trimming systems are based on the proven Airbrasive® concept, controlled by precision electronics. The Airbrasive method of removing resistance material produces neither heat nor shock, does not alter substrate—yields of 100% can be attained with any of the S. S. White resistor trimming systems at some sacrifice of speed and tolerance. Each of the systems trims and monitors simultaneously and inspects after each trim.

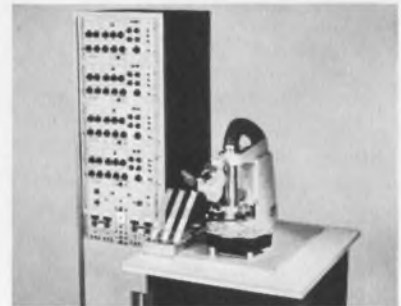

Big Bertha: Model AT 704 trims at 4,000/hour pace for high volume producers.

Up to now we've been able to offer fast delivery on all systems; however the enthusiasm we've encountered over the LAT-100 suggests that you'll be wise to place your order early for this model.

Call us or write to arrange for a demonstration of the LAT-100, the AT-701, or (if you're really big) the AT-704. Or ask for bulletin RT-14—it's great to read on planes.

Inquire, S.S. White Industrial, Dept. 28, 201 East 42nd Street, New York, N.Y. 10017. Telephone 212-661-3320.

S. S. WHITE INDUSTRIAL
A DIVISION OF PENNSALT CHEMICALS CORPORATION

IEEE USA

Come along on a fast tour of the significant
at the world's biggest electronics exhibition



BRANIFF

Canadian
Club
IMPORTED WHISKY

Admiral
TELEVISION
APPLIANCES

Casino

ROAD

BCN

American
Swig

THE
FAIR
LADY

MOON

RT



It's another dazzling show, with the accent on peace

If the IEEE International Convention and Exhibition were seeking an obvious emblem this year, it might easily have used the olive branch and a white dove. The spotlight is on peaceful uses of electronics. Of the 52 technical sessions, eight major ones are devoted to such areas as health services, transportation and city management.

About 64,000 engineers are expected to attend the show from March 24 through 27. To dazzle the visitors, 700 exhibitors are displaying products in the four-story Coliseum in midtown New York.

Cities call on engineers to help them . . . U84

School bells for the smart engineers . . . U90

Design trends in major engineering areas, as reflected in the technical papers U98

Aerospace U98

Communications U100

Computers U102

Materials U105

Medicine U106

Microcircuits U108

Microwaves U110

Systems U113

The timetable for technical papers listed by engineering subject U116

Touring the exhibit areas U138

Outstanding new products

Components U166

Instrumentation U140

Data processing U152

Microwaves & lasers U158

ICs and semiconductors U148

Modules & subassemblies U174

Production U184

Materials & packaging U180

Cities call on engineers to help them

IEEE sessions exploring ways to unsnarl electromagnetic spectrum, relieve congested air and ground transportation, and exploit rich oceans

Charles D. LaFond
Chief, Washington News Bureau

The crushing weight of urban problems has finally produced an intolerable national discomfort.

The radio spectrum is jammed. So are the airway instrument approaches to some major airports. Local and intercity mass surface transportation is largely slow and uncomfortable. Medical costs are skyrocketing, and facilities are crowded.

Many of the nation's industrial and civic leaders are looking to technological innovation for significant remedies to these problems. That the electronics industry figures strongly in this planning is evident in technical sessions of the 1969 IEEE Convention and Exhibition in New York City.

The highlight session centers on "Electronically Expanding the Citizen's World." The panel moderator is James D. O'Connell, Director of Telecommunications Management for the Executive Branch and No. 2 official of the President's Task Force on National Communications Policy.

The panel is examining the current status and future promise of electronic systems that contribute to easing man's workload, to improving the dissemination of information and to providing a fuller life for each citizen.

Other technical sessions are discussing new systems and techniques for bettering communications, transportation and health and for exploiting the seas.

Even the tours associated with the annual IEEE meeting are intended to demonstrate the application of electronic instrumentation to urban ailments. They include visits to the following:

- The new Harlem Hospital electronics laboratory, its patient monitoring system and its time-sharing computer facility.
- The City of New York's time-shared computer and data processing systems, used to support managerial activities.
- The Federal Aviation Administration's air traffic control and communications center at

Kennedy International Airport and an experimental air traffic control system.

Lacking at the IEEE show is exploration of the role that electronics might play in overcoming a growing menace to urban survival: air, sound and water pollution. Detection and control systems are urgently needed. And once such systems are proved experimentally, test programs can be started. Lake Erie, for example, is being proposed as a likely target for an intensive pollution control project sponsored by the Federal Government.

Broadcast changes needed

Many problems will be solved by electronics—but electronics usage also creates problems. The electro-magnetic spectrum is an example. Depletion of it has occurred in some of its most useful bands. The Joint (IEEE/EIA) Technical Advisory Committee report on "Spectrum Engineering—The Key to Progress" and the report of the President's Task Force on National Communications Policy urge new procedures for the use of the radio spectrum. Some experts predict profound effects on public broadcasting, audio and video. For example, the task force report recommends a pilot domestic communications satellite program for television. Comsat Corp. has proposed such a system and is awaiting Federal Communications Commission approval.

Frequency allocations may be modified. The two major reports criticize as inefficient and wasteful the current block-allocation procedures employed by the FCC. If their recommendations are heeded, some existing frequencies for public broadcasting may be reassigned to other users. And the increasing use of satellites for active relay could permit greater usage of the spectrum above 10 GHz.

Some experts in the Presidential task force note that advanced techniques, such as the use of millimeter-wave or laser fiber-optic systems, could have a significant effect on domestic communication satellite operation. Both approaches

could permit high-capacity data transmission without congesting the spectrum.

Session 4F is discussing "Broadcasting Tomorrow" and the impact of new frequency policies on commercial broadcasting. "We're prepared to scare the hell out of the broadcasters," says H. T. Head, the session's organizer, who is a partner in the radio-TV consulting firm of A. D. Ring & Associates. Although broadcasting officials ought to be aware of impending changes, Head notes, they appear largely unconcerned. "We hope to show them that their spectrum allocations are no longer inviolate," he says.

Untying air transport knots

No early solution appears in sight for air traffic congestion over major U.S. cities. Aircraft advances regularly exceed Government abilities to cope with either the increasing speeds or the ever-expanding fleets of airline, business and personal aircraft. The proposed rationing of flights to five airports in New York, Washington, D.C., and Chicago is a stopgap measure.

The problems will steadily worsen. Stuart G.

Tipton, president of the Air Transport Association of America, which represents the airlines, estimates that from 1965 to 1975 U.S. airlines will have invested over \$18 billion for new aircraft and ground facilities. Further, he says, passenger loads will double and cargo will triple by 1971 over last year's totals.

Automation, says Tipton, is helping to ease congestion. The computer investment alone by U.S. airlines is over \$250 million, and second-generation equipment valued at over \$50 million is on order. Automated delivery carts will speed the loading and unloading of cargo and baggage, and automatic ticket and reservation confirmation can reduce service time by 80 per cent, Tipton says.

Automatic data communication is sought to reduce congestion over voice links between aircraft and ground traffic control stations. This would also relieve flight crews of the workload now required in identifying their aircraft, relating position and altitude, and obtaining navigational data.

Pan American is currently testing an experimental automatic communication system, and



Mobile radio communications used by firemen and policemen may be allocated to other frequency bands as a

result of recommendations made by the President's Task Force on National Communications Policy.

both Aeronautical Radio, Inc., and the Radio Technical Commission for Aeronautics have established standards for such data-link transponders and ground equipment.

Automatic data links will help, but the congestion problem stems from an outdated traffic-management system. Gen. William F. McKee, former FAA Administrator, notes: "Essentially, today's air traffic control system is a manual system." Improvements are under way, but the first semiautomatic traffic control system will not go into full operation until May. This will be the Air Route Traffic Control Center at Jacksonville, Fla.

The new 747 jumbo jets are nearing the final development stage at Boeing and soon will be operational. A commercial version of the giant Air Force C-5A Galaxy is under consideration. The supersonic transports are scheduled to follow in the mid-1970s. Little has been done by the FAA or the major airports to accommodate these large aircraft and their immense passenger and cargo loads.

For short-range flight congestion between major cities, particularly over the Northeast Corridor of the United States, better navigational aids and short take-off and landing (STOL) aircraft are being investigated. Eastern Airlines recently completed an experimental operation over a 6-week period using new STOL aircraft in flights between Boston, New York, and Washington. The tests were declared fully successful by Eastern, but officials emphasized the advantage gained by using a Decca navigation system.

A major IEEE session that will delve into air traffic problems of today, look into possible solutions for the 1970s and crystal-gaze into the 1980s is titled "Air Traffic in the 1980s: Order, Chaos or Catastrophe?" The chairman of the session (4G) is J. B. Wiley, aviation director of the Port of New York Authority.

Mass transit needs transfusion

Aircraft traffic problems are complicated by frustrating ground transportation snarls between airports and the nearby cities. Before leaving office, President Lyndon B. Johnson told Congress that this country "lacks a coordinated transportation system that permits travelers and goods to move conveniently and efficiently from one means of transportation to another, using the best characteristics of each." Instead, he said, "people and goods are compelled to conform to the system as it is."

Alan S. Boyd, when he was Secretary of Transportation, frequently emphasized the need for a system-analysis approach to improving the transportation network. He stressed the importance of research, while deploring the minimal invest-

ment in R&D made so far by the transport industry. Once a dominant form of travel, U.S. railroad passenger services have been in steady decline since World War II. Yet, with the addition of new instrumentation and new techniques, a revitalized rail system could relieve today's mass-transit problems and interface with other transport modes.

High-speed trains are coming into test operation. One, for example, is the Metroliner, now in service between New York and Washington. Yet, although capable of speeds up to 160 miles an hour, it is limited at present to 110 because of the 100-year old track bed on which it operates and other facility shortcomings. To lay all new track would be too costly, the experts declare.

Westinghouse has developed a completely automatic high-speed system called Skybus. Computer controlled, it has been in test operation for some time near Pittsburgh.

Other approaches include the Grumman Aircraft concept for an air-cushion vehicle capable of 300 miles an hour on tracks. This study is being supported by the Dept. of Transportation. Huge helicopters may provide effective transport from airports to the central city, but their capacities will be limited.

Session 1F, "Rail Transportation Systems," is presenting five experts on the application of electronics to rail transport improvements.

Biomedical aids and services

A relatively new but rapidly growing realm for electronics is medicine. This year the IEEE show is devoting one session (1A) to "Automation for Health." The session chairman, G. S. Cohen, an electronics instrumentation expert at the National Institutes of Health in Bethesda, Md., indicates a growing emphasis on patient monitoring and on the analysis of body fluids.

For example, Cohen discloses the use of a fully automatic system that monitors and analyzes electrocardiograms of heart patients. Normally such patients are under intensive care and capable of 24-hour electronic observation. If any major change occurs in the electrocardiograph output, the monitoring system provides both an audible and visual alarm.

Another experimental system in use employs computer control for automated medical laboratory services. Blood samples and other body fluids are identified on a punch card and placed in a coded carrier. Samples are subjected to standard biochemical tests, and a composite printout is made for all test results.

Computer techniques also are being used to process physical examination data from a large number of people in minimum of time. The results from each are processed, along with data

from a medical history questionnaire. The computer readout flags all out-of-limit medical statistics for further study by a physician.

Nation turns to the seas

A wealth of food, minerals, rare metals and fossil fuels awaits exploitation beneath the oceans. But the environment is severe, and suitable tools and instrumentation generally are either unreliable or unavailable.

The last decade has seen a largely uncoordinated but many faceted attempt to investigate the potential for working and living below both fresh and saltwater bodies.

The need for a long-term plan was recognized by Congress, and President Johnson established the Commission on Marine Science, Engineering and Resources to study oceanography in its broadest sense and to propose a 10-year national program. This report was completed and delivered to the Nixon Administration in January of this year in a massive document titled "Our Nation and the Sea."

The commission's chairman, Dr. Julius A. Stratton, said in presenting recommendations for a 10-year, \$8-billion program: "We are proposing a national investment of major magnitude in the oceans. And we believe that such an investment in these times or any times can be justified only in terms of the needs of people."

The report, Stratton says, "relates the resources of the oceans to the present and future needs of our society," and it proposes "a strategy of action."

For the average electronic engineer, however, oceanology or oceanography are just words; many find it difficult to relate their control, instrumentation and sensor design efforts to this relatively new field. Session 6E, "Engineering for Oceanography," may help, in that it presents a broad view of the ocean environment, its problems and its needs. The chairman is Gilbert Jaffe of the Naval Oceanographic Office, and tutorial presentations will be interspersed with the views of Prof. William Richardson of the naval office, who is a former scientist with the Scripps Institute of Oceanography in San Diego. ■■

The San Francisco Bay Area Rapid Transportation system will be highly automated (control room shown in photo

left). Rail systems such as this may help relieve transportation snarls between airports and the cities.



The better point-to-point WIRE, SPACE,

Use stranded as well as solid wire. And use less of it. Our TERMI-POINT* Technique uses 25% less wire for the connection than other techniques. Wire is not destroyed in testing, routine maintenance and circuit changes . . . can be re-used.



Clip retains wire and both are affixed to post with straight, forward push of the application tool head. Only slightly larger than the clip itself, the tool head allows for smaller spacing between posts with a density factor of .100". Forward action of tool head on clip and wire causes wire to wipe along the post and create "clean" areas to assure maximum conductivity. Stored memory design of clip exerts constant pressure on post and wire to assure long-life reliability. Non-destructive tensile test of connections can be made with simple, spring-tension hand tool. Maintenance and circuit changes are made with simple hand tool that flips off clip with easy finger-twist motion. Other connections on post are left undisturbed and wire is reusable. New termination, using same wire, is made from top of post after repositioning other connections on post without interfering with their performance and mechanical and electrical stability.

*Trademark of AMP Incorporated

wiring technique saves you **TIME, MONEY**

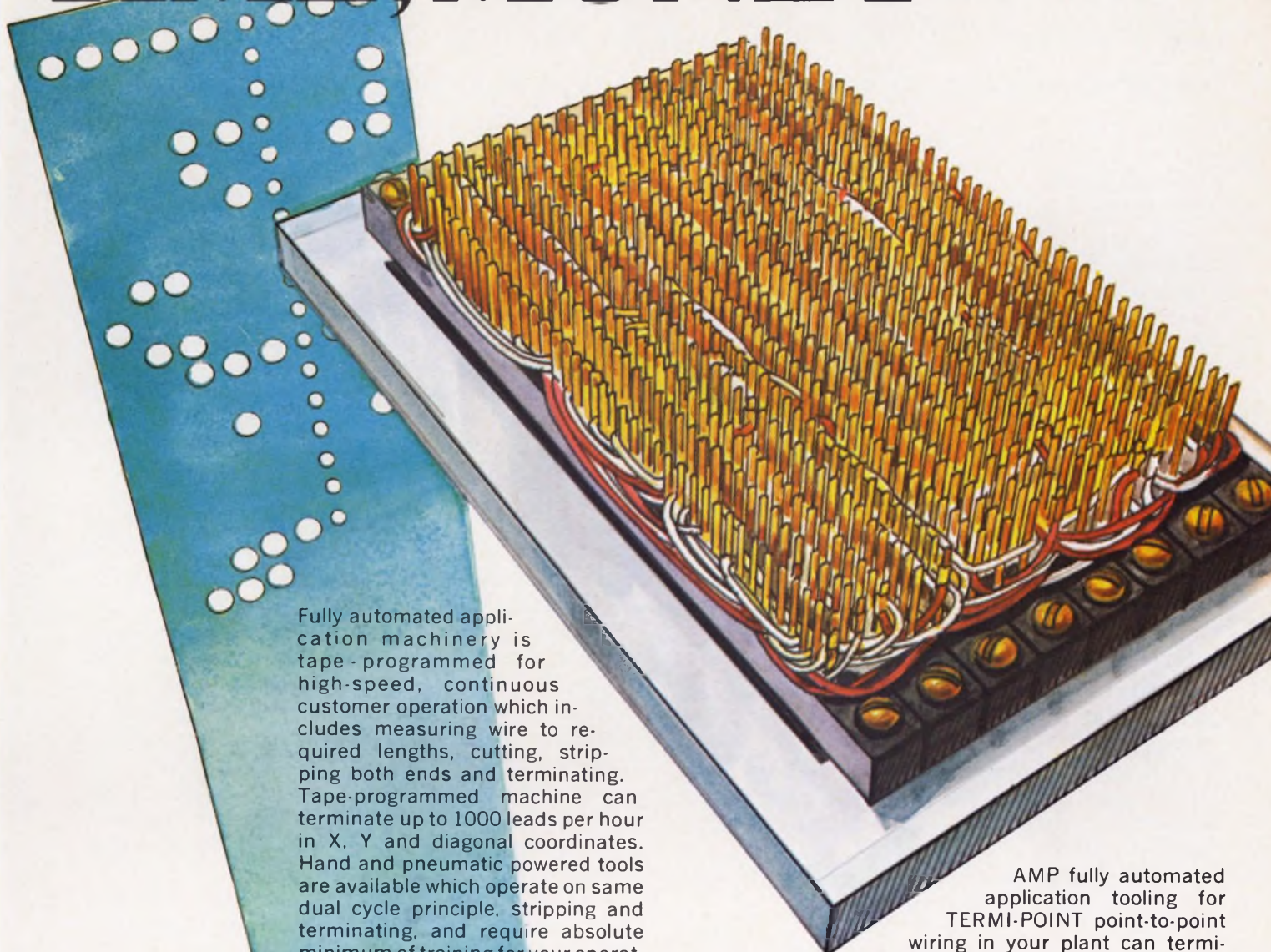

Fully automated application machinery is tape-programmed for high-speed, continuous customer operation which includes measuring wire to required lengths, cutting, stripping both ends and terminating. Tape-programmed machine can terminate up to 1000 leads per hour in X, Y and diagonal coordinates. Hand and pneumatic powered tools are available which operate on same dual cycle principle, stripping and terminating, and require absolute minimum of training for your operating personnel.

AMP fully automated application tooling for TERMI-POINT point-to-point wiring in your plant can terminate an eight inch lead in less than three seconds. This speed plus the high degree of efficiency and reliability which have been engineered into both the tool and the clip contribute to AMP Economization—the greatest number of reliable connections in the least possible time to achieve lowest applied costs. Write for complete information—**INDUSTRIAL DIVISION, AMP INCORPORATED, HARRISBURG, PA. 17105.**

AMP
INCORPORATED

INFORMATION RETRIEVAL NUMBER 50

School bells for the smart engineers

Continuing education is a must for those who would stay abreast, and the wiser electronics companies know it and lend a helping hand

Lawrence Locke
Management and Careers Editor

The man behind the textbook is an electrical engineer. He's busy, he's bothered, and he's often bushed as he pushes ahead in his nocturnal, year-round race to keep abreast of the nation's galloping technology. But he's only part of the story of continuing education in the electronics industry. There are also the companies and the educators.

To take a reading of all this book-cracking activity, an *ELECTRONIC DESIGN* editor got in touch with engineers, the companies and educators around the country. Here's what he found:

- The press for more education is nationwide, growing at a breakneck pace and not always being met adequately.
- The master's degree is emerging as a necessity for the professional engineer.
- Some companies find they are isolated from educational institutions their engineers need to attend.
- When an electronics company considers building a new plant today, the site's proximity to educational institutions is a factor that is weighed seriously.
- Companies want their engineers to have more knowledge of business operations.

Back to school: The pace steps up

That engineers are going back to school in growing numbers is evident if one examines the statistics on the master's degree. In 1953, only one engineer in 10 went on for his master's. Today four out of 10 are coming back full or part time. By 1970, it is estimated, the total returning to school for master's degrees will hit 50 per cent. And by 1980, this figure is expected to reach 66 per cent.

Company estimates of EEs who have returned to school confirm the trend. Donald S. Michels, director of manpower development at Control Data Corp., Minneapolis, says: "About 90 per cent of our EEs in the Twin Cities area are

involved in educational activities of one kind or another—degree programs, seminars, symposiums or short courses."

R. E. Mosher, Head of Bell Telephone Laboratories' Education Dept., Holmdel, N.J., reports: "About 54 per cent of our technical staff is involved in structured education. Another 15 per cent is taking seminar courses."

At first glance, General Precision's Kearfott Group at Little Falls, N.J., would seem to be bucking the trend, with roughly 15 per cent of its EEs going to classes. But not when one finds that of the 85 per cent not going to school, a substantial number already have their master's. Not to mention that most men in the company's Little Falls research group hold Ph.D.s.

Smaller companies, too, have relatively large numbers of their EEs engaged in updating course work. But often the classwork is not accredited. For instance, at Data Technology Corp., Palo Alto, Calif., 70 per cent of the corporation's EEs are updating themselves, but only about 10 per cent are taking accredited courses.

Rather than peaking, the back-to-school trend is accelerating—especially at schools where electrical engineering is—or is becoming—a strong department.

Robert C. Geldmacher, head of the Electrical Engineering Department at Stevens Institute of Technology in Hoboken, N. J., says: "The number of men coming back to Stevens for graduate work is growing very fast. We are adding an average of 50 full-time equivalent students annually—and we expect that rate of increase to move up fast."

Other institutions in the "technology belts" on either the East or West Coast, or within comfortable driving distance of electronics companies anywhere, are attracting scores of EEs to night—and day—school graduate programs.

Some big companies add courses of their own to supplement a school's existing schedule. That's what the Harrison Div. of Hewlett-Packard, Beverly Heights, N.J., is trying to do. Chief Engineer John Blokker explains that while

division engineers go to regular night classes at Stevens, Rutgers and the Newark College of Engineering, the area is not on a par with such educationally rich preserves as those around Boston and San Francisco.

"But our situation definitely is getting better," says Blokker, who is well aware that his plant's situation already is superior to many others.

Part of the improvement the Harrison Div. looks forward to may arise from company plans to work out a co-op program that would allow its engineers paid time off to attend day classes at Rutgers, the Newark College of Engineering and, possibly, Princeton.

The MS moves to the fore

Not only are more and more EEs returning to classrooms. More also are moving directly from undergraduate into graduate work. In 1961, 14 per cent of engineering bachelors went directly to graduate work. By 1967 the figure had jumped to 25 per cent. Extrapolations indicate that the percentage will climb considerably higher before it levels off.

The remarks of college and company personnel make clear the weight given to continuing education in general and to the MS in particular:

"We very much stress continuing education for any engineer we hire"—Michels, Control Data Corp.

"When we hire a recent BS to be a full member of our technical staff, we require that he complete his master's—in three years at the most."—Mosher, Bell Laboratories.

"The master's degree soon will become the electrical engineer's first professional degree."—Geldmacher, Stevens Institute of Technology.

Despite the growing numbers of EEs who are entering graduate school immediately after receiving bachelor degrees, the old pattern remains strong—the majority of engineers still get their BS and take a job. In two or three years they find they need more education as new areas open up. They start returning to school. A good number also see that if they are interested in management posts, they will most likely need a master's in business administration, or at least some management education.

Why do so many EEs move right into jobs? There are several reasons. Some are just fed up with theory and books; they want to get out and dig into the real work. Financial needs force others to stop studying and start earning. And a shrinking minority feel they are primarily "just engineers"—men more interested in what one engineering department chairman characterizes as "the tactile, technician phase."

The student's academic ability is, of course,

Not only are more and more EEs returning to school. Many more also are going into master's work right after they get the BS.



another factor. A professor in the Midwest distinguishes between the job-oriented and the degree-oriented undergraduate.

"Generally," he says, "the good students go right into graduate school. The man who is less intrigued by theory goes directly into industry."

But there is a surprise. "Interestingly," says the professor, "you cannot distinguish between the scores of the man who comes back and the man who went right into graduate school. Why, if the industry man is a less-keen student? I think the answer is his high motivation. He knows that he needs to know."

Many companies are in poor positions to urge continuing education. There are no educational institutions near them. For engineers at these

In 1953, one engineer in 10 went on for his master's. By 1970, five out of 10 are expected to earn that degree.



concerns, any serious pursuit of education means long drives to distant campuses and late hours. When this is repeated three nights a week, with homework on top of it, it's not hard to see why enthusiasm for instruction wanes. Then, too, smaller companies generally are not as generous in aiding their engineers as the larger concerns. Some of the larger companies grant 100 per cent tuition payments, time off, travel expenses.

Because they are educationally isolated, a good many small companies have problems attracting and holding aggressive engineers. They lose them to the glamorous companies that offer all-expenses-paid education plans and more upward mobility.

One solution for these isolated companies is the greater use of short-term updating courses lasting anywhere from a couple of days to two or three weeks. Schools across the land—MIT, UCLA, University of Michigan, University of Florida, to cite a few—are offering a steadily increasing list of such courses. The subjects are keyed to "hot" technical areas, and many courses involve both university and industry authorities as lecturers.

UCLA, for example, is scheduling about 140 courses for 1969. Attendance by about 3600 students is expected, two-thirds with master's degrees and a third with PhDs, according to Robert E. Garrels, head of the Engineering Physical Sciences Extension.

Larger companies consider the proximity of

educational institutions when they select the site for a plant.

"If we are planning a plant that will turn out a product that we think can evolve and change," says Courtney W. Flanders, manager of corporate training and education at Sprague Electric Co., North Adams, Mass., "we want our engineers to evolve and change with it. So the distance to educational institutions is definitely a factor in choosing a plant site."

While nearly all major companies—and many of secondary size—have their own in-house teaching programs, they see these as supplements to, not substitutes for, formal programs at outside institutions.

These companies know that the target of continuing education is graduate work. Ultimately the MS is the thing.

"Most of our Lafayette campus students are aiming at an MS," says David J. LaMothe, associate professor of engineering at Purdue University and coordinator of regional graduate programs in engineering. "But they don't start out that way. They come in as casual shoppers who want something in their work area. Soon enough, the great majority decide to continue on, and they get the degree."

Youth is a dominant trait of the MS candidate. "It's the young engineers who are going back for graduate credit," says Bell's Mosher, "whether or not they are going after the degree immediately. The older engineer—and 30 years of age is roughly the dividing line—is too occupied by other responsibilities, such as his family. This man wants courses that relate directly to his job; he can't spare the time to earn a master's at night. Yet he has 30 to 35 productive years ahead of him. Motivating these men to return to school—that's our constant challenge."

Businessmen needed, too

A common complaint among company spokesmen is that education for the engineer ignores the business side of the electronics industry.

Engineers are part of a business. And they must know something about it," says Ray Underwood, chief engineer of the Instruments Div. of Data Technology Corp., Palo Alto, Calif. "Both graduate and undergraduate education concentrates on the technology to the exclusion of its relation to business and business functions, such as scheduling or cost accounting. Naturally our engineers learn some of this on the job, but they should get the picture much earlier. It affects their whole outlook on management."

R. M. Soria, vice president of research and engineering at the Amphenol Components Group, Oakbrook, Ill., says: "They need a greater mix of disciplines to show what industry needs and how

it operates—for instance, more training in management, product development and more examples of successful product launches. Engineers should know that having a good product does not in itself mean you're going to make money. Over-all, the men are not getting the industry's economic picture—which they need."

From the engineers: a necessary grind

The engineer stands squarely in the middle of the on-going technological turmoil. More and more, he spends his days on the job and several of his nights each week learning how to keep his present post or move into a better one. How does he feel about the night and day demands, that promise to go on for the rest of his professional career? Does he think his job is taking more out of him than it's giving?

Some definitely feel this way—and vociferously so. They say that adding night classes to already busy work days infringes seriously on their time and off-the-job responsibilities. A good number hold off going back to classes for this reason. But these engineers are in the minority—not necessarily in their feelings, but in their refusal to update. Most believe they have no alternative to continuing their education.

And many engineers feel a genuine and exciting interest in their jobs. Naturally, they see the financial and promotion aspects of updating, but they also are curious about their work. They want to be on top of the latest technical developments. They want the increased job satisfaction and the salary increase that more knowledge and authority will give them.

"I don't think you can ever stand still," says Michael W. Black, an engineer with Magnavox Co., Fort Wayne, Ind. He is taking an MSEE at a regional campus of Purdue University, where he learns through courses televised live from the main campus in Lafayette. Classes have direct phone contact with the professor, so engineers can ask questions, as they would in a conventional classroom.

"This degree is going to take me three years,

with eight weeks off each summer, to take nine credits," Black concedes. "The company didn't push me. It looked like a good deal [Magnavox pays 100 per cent of the tuition], so I decided to get my master's. And I probably will go on after getting it. When you stand still, you're going backward in this field."

A section chief with Western Electric in Denver, 31-year-old Joseph T. Dwyer says: "I'm getting my BS this June—after 10 years of going to class. It's been tough, but I'm used to it and find that it keeps me in shape mentally."

Next fall, Dwyer plans to begin graduate work, but he hasn't yet decided whether it will be for an MSEE or an MBA. He started in his management post this year and has until June to decide whether management is for him. Western Electric pays 100 per cent of the tuition, but Dwyer happens to be getting his schooling under the G.I. bill.

Project Engineer James A. Oakes, who works for the Delco Radio Div. of General Motors, Kokomo, Ind., is moving into the last semester of work toward his master's. "It's a long grind—six years for me—but I wanted to get the degree," he says.

Peter R. Schneider, a research staff member with IBM's Watson Research Center, Yorktown, N.Y., notes: "My education, in the near future at least, will be pretty much confined to shorter courses."

Schneider, a 30-year-old Ph.D., recently participated in a five-day institute in computer and information science at the University of Florida in Gainesville. "I take these seminars and institutes to keep up with recent advances," he observes. "In this one, I got an idea of what five other specialists were doing in computers, especially at the universities. They had some ideas I had not heard of before. I gained several points of view."

Schneider also is currently taking a self-study, in-house course in management at IBM. "I am manager of a four-man research group, and I find the management material helpful on the job," he says. ■■

Here's a personal view of updating courses

Robert Haavind
Managing Editor

What can an engineer expect to get from a short-term updating course?

No matter what subject is covered in the course one may choose to attend, there are generally a few things that one can expect. First, the content of the courses usually includes a quick review of funda-

mentals, some brief excursions into many corners of the subject discussed, and a glimpse of some of the latest work in the field. Second is the ability, after the course is over, to read with much better perspective any papers, articles or even books in the area. Perhaps most important of all is the intellectual stimulation provided by a well-presented short course. These intensive courses,

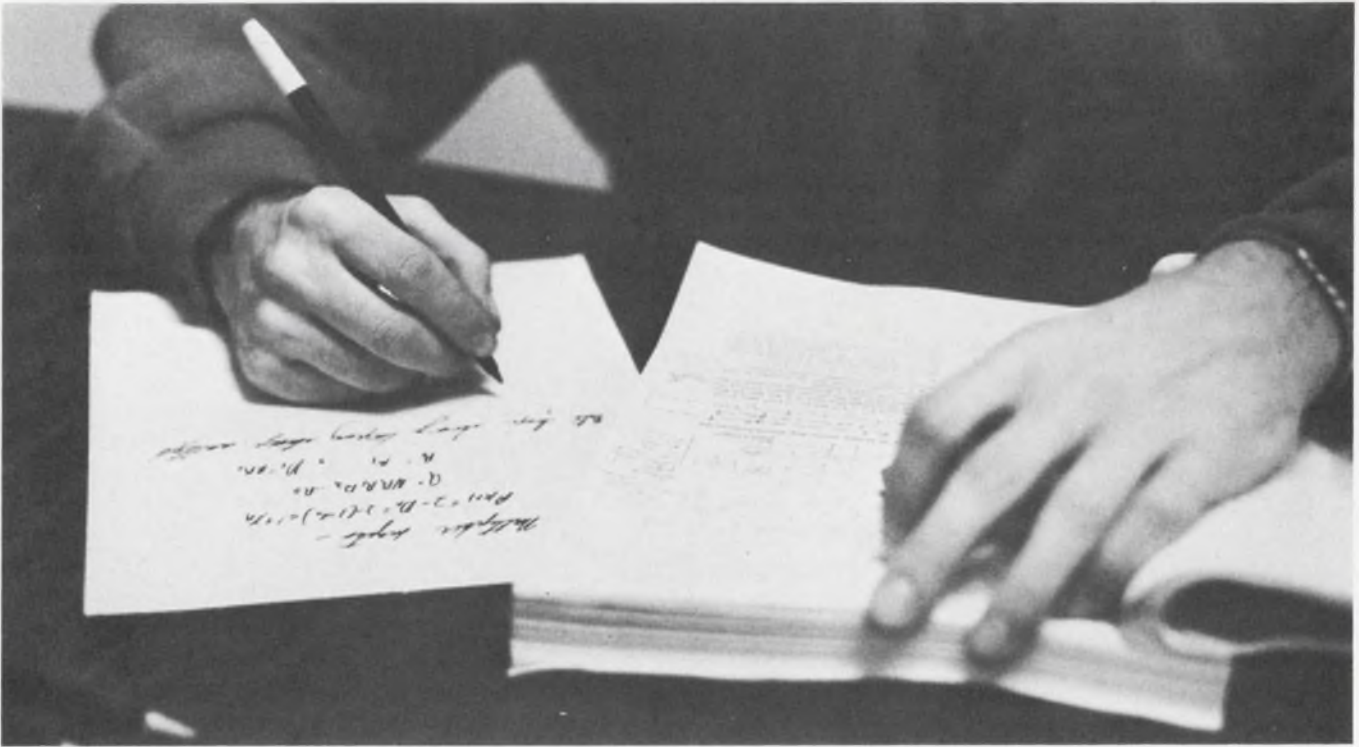

Selected papers from the literature, organized by major topics, were Xeroxed and bound in book form for a course in design of computer arithmetic units at UCLA.

because of the limited time available for covering a large amount of material, steep the student deeply and completely in the subject. Surely no short course can turn an engineer into an expert in any field, but it is amazing to find how far one can progress in such a short time. And if one's curiosity is suitably aroused, the "education" provided is sure to extend far beyond the time of the course.

These views on the values of updating courses are based on personal attendance at three—all in different subjects—plus conversations with numerous classmates. Many of them had gone to several courses.

Course leads to patent proposal

No one felt that the courses were not worthwhile. One student, an electronics research director for a large aerospace company, said that a course on digital communications he had taken at RCA Institutes led to a patent application, based on an insight gained during the course, and to a successful proposal.

It was surprising to note that many of the engineers attending these courses were senior designers or engineering managers. There was no more than a sprinkling of fledgling engineers with only a year or two of experience behind them. Many of the students had master's degrees, and a few were PhDs.

Even the least valuable of the courses, a three-day seminar given by a leading technical university, was quite stimulating despite obvious weak-

nesses. The other two courses, each lasting a week, were outstanding. The efficiency of education, that is, the amount of material learned for the time expended, was much higher than one would find in conventional college engineering courses. A brief rundown of the three courses will give some idea of the routine that can be expected.

The first course, a three-day seminar on a new engineering area that involves a great deal of mathematics, was billed as an introduction. Those who registered were informed of the textbook to be used. It was noted that most of those who attended had not bothered to get the book in advance. It turned out that even leafing through the book was quite helpful in "getting aboard" as the lectures progressed in rapid-fire order. The first couple of talks, serving as an introduction, were the best part of the course. They put a number of difficult ideas into a workable context.

But then the featured lecturer, a very well-known and respected man in the profession, was scheduled to appear. He didn't show up. Other lecturers filled in for him, and proceeded, for the most part, to go through numerous mathematical exercises relevant to their own current research efforts. Unfortunately most of this material was somewhat tangential to the main stream of the subject. Individual papers were passed out at intervals during the three-day period. Some of them were mentioned in the talks; some weren't. One could not help feeling that too much of the seminar was devoted to the lecturers' own interests, rather than the total subject. The level also remained

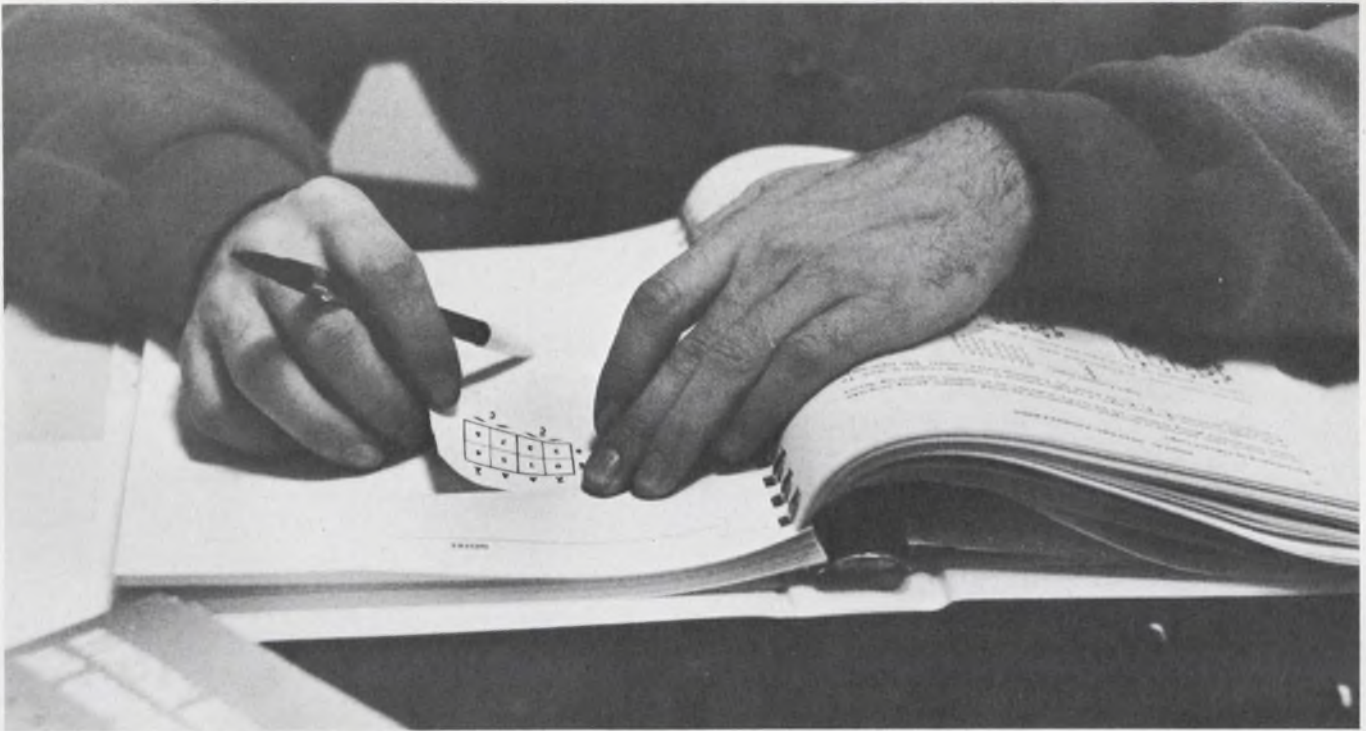

Logic-map-decals make note-taking easier in this manual used in a logic design course at RCA Institutes. Students must take notes to make the printed material meaningful.

highly theoretical, whereas most of the members of the audience were from industry and hoping for somewhat more practical information.

The second course, covering logic design, lasted five days and was given by RCA Institutes. The teaching method was very effective in virtually forcing the student to learn as the course progressed. A large book was provided in which left hand pages had material printed on them and right hand pages were left blank except for the label "NOTES."

The student quickly recognized that he couldn't follow the material in the book unless he took notes. Lecturers used an overhead projector to put the same material that was printed in the book on a large screen. Then, with a marking pencil, they filled in the missing material and pointed to data that they explained verbally. This made note-taking an easy process, and the lecture was paced so that there was plenty of time to take down the required information.

Another clever idea was the use of decals for logic maps. They could be pulled from perforated sheets and pasted into the notes where appropriate, thus saving a lot of time.

Xerox comes to the rescue

The third course, covering the design of digital computer arithmetic units and algorithms, was five-days long and given by the University of California at Los Angeles. It was clearly aimed at a higher level group than the RCA Institutes course

but it was surprising how coherent the presentation was even to a relative neophyte.

The text for this course consisted of a large book assembled from Xerox copies of selected papers from the literature. The papers were arranged under major topics, such as high-speed adders, significance tests, alternate means for representing numbers, and so on. The papers were culled by Dr. Algirdas Avizienis from scores that he reviewed for the course, and were selected either because they gave the germinal ideas or they presented a technique most clearly.

Before each major subsection, Dr. Avizienis gave a précis that described in simple terms the main notions involved in designs for accomplishing the function involved. He used elementary examples to clarify his explanations, and carried from the examples right into some of the major design approaches covered in the literature.

The students were often referred to specific papers in the Xerox manual to get specific details.

One additional point. The engineering manager who doesn't permit his men to attend courses occasionally is doing a disservice to his company as well as to his subordinates. The universities and institutes are doing a good job in helping engineers to keep aware. Those who don't make an effort to keep up-to-date, won't. And the manager might note that if he himself hasn't gone to some courses, he is falling behind his counterparts at competitive companies. In addition, new thinking can bring new products and new design techniques to your company. ■ ■

**Reliability is six things we do
that nobody else does.**

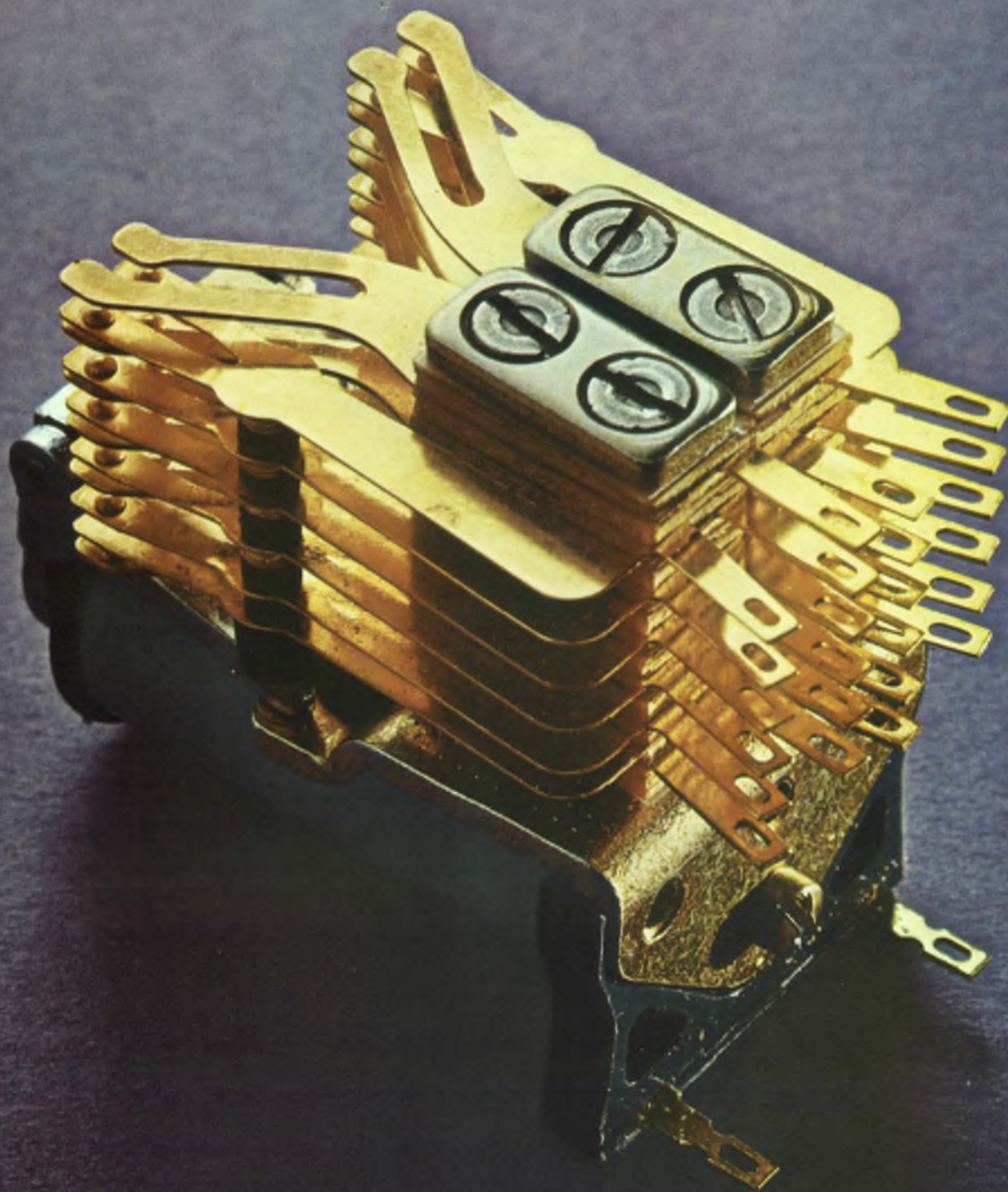



We're fanatics.

We build our relays stronger than we have to. That way, they last longer than they ever have to. Our Class E relay (shown on the opposite page) is a good example of our way of thinking.

The industry's strongest heelpiece.

We make the strongest heelpiece in the industry. A gigantic machine bangs them out extra fat and extra flat.

Extra fat to carry a maximum of flux. To handle big loads. Extra flat so that once an AE relay is adjusted, it stays adjusted.

Since our backstop is part of the heelpiece, it's just as thick and flat. But, tough as it is, the slightest wear here would throw the entire contact assembly out of whack. So, to be safe, we weld two tiny, non-magnetic pads where the armature arms meet the backstop. You might say we created the no-stop backstop.

Three parts that'll wear like crazy.

When you build a relay like a small tank, you have to think of everything. We try. Right down to the tiniest part. For example, we make our armature arms and bearing yoke extra thick.

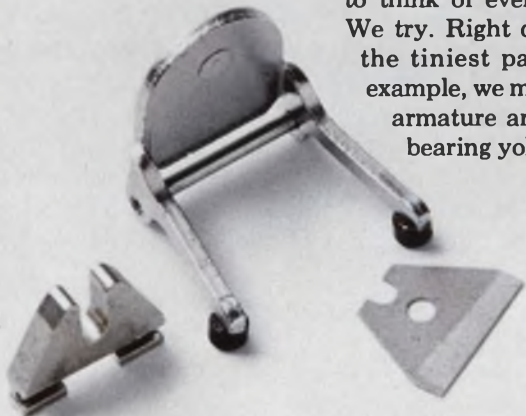

Thicker than years of testing and use say they have to be. Then, to make sure they don't cause wear problems, we insert a hardened shim between the hinge pin and the frame. The pin rides on the shim, instead of wearing into the heelpiece. (You can forget the bearing, it's permanently lubricated.)

Buffers with lots of muscle.

We make our buffers of a special tough phenolic material that lasts. And lasts. And lasts. All without wear or distortion. Another reason why our relays stay in whack.

To make sure our buffers stay in place, we weld the buffer cups to the armature arms. We weld, instead of using rivets, because our lab found that rivets have a habit of falling out.

For the very same reason, we weld buffer cups to the contact springs. And also use the same special tough phenolic buffers.



No, we didn't forget the contact springs.

We have some strong feelings as to what makes a contact spring reliable. Our sentiment is that two contacts are better than one. So, we bifurcate all the springs, not just the make and break. This slotting and the addition of another contact to each spring means you get a completed circuit every time.

We make each set of contact points self-cleaning. The bad stuff doesn't have a chance to build up.

Now, what's different about our bobbin?

Our bobbin is one piece—molded of glass-filled nylon. This provides the maximum in insulation resistance.

Because our bobbin is nylon, we don't have to impregnate with varnish. Moisture and humidity have no effect on the stubborn nylon material. No effect means no malfunctions for you to worry about.



What all this means to you.

What this all adds up to is reliability. The kind of toughness no one else can give you. It means an AE relay works when it's supposed to, longer than it has to.

Isn't this the kind of reliability you really need? Automatic Electric Company, Northlake, Ill. 60164.

AUTOMATIC ELECTRIC

SUBSIDIARY OF GENERAL TELEPHONE & ELECTRONICS

Technology, as the engineers see it

Papers at the IEEE convention point to new directions in electronic design and application, along with problems

Aerospace

Satellite designs offer more than one function

Engineers seeking "gee whiz" advances in aerospace electronics at the 1969 IEEE technical sessions may be disappointed, even though Dr. Werner von Braun is one of the chairmen. But there will be details on several new space system applications and on a current trend toward use of conventional hardware to build multifunctional earth satellites.

Surprisingly, in this first year of real Government funding for an Earth Resources Technology Satellite, there are no IEEE papers on the new project.

One paper, in Session 5F, however, by G. R. Welti of Comsat Corp., looks at a conceptual system for global data collection and relay by satellite as a possible commercial venture by the mid-1970s. It could serve as a complement to an earth resources surveillance effort, says the Systems Analysis Laboratory manager.

W. L. Glomb, director for advanced development at the ITT Defense Communications Div., is heading Session 5F, titled "Expanding Systems Applications Using Satellites." The five papers show a steadily increasing sophistication of new systems for space exploitation. They also point up the growing faith by designers in their ability to cram more circuitry into less volume and to produce remote facilities that will perform better and longer.

An exception to the trend toward increased complexity is Welti's relatively simple spacecraft, coupled by radio link to a large central computer-control facility on the ground. The latter directs the satellite to interrogate, sequentially, a number of unmanned, remote environmental sensor stations, then store the responses and later relay the data back to the main terminal.

Typical data stations, Welti suggests, might be used for obtaining meteorological or hydrological information. The main terminal he proposes would be capable of sending command signals via the satellite to remote sites, to energize or turn off certain instruments. Data rates, he says, might vary from 75 to 2500 bits per second, and an early system would be limited to only one or two channels.

At the other extreme of complexity, John Lazur of the Mitre Corp. describes a large hybrid satellite designed to provide communications relay, navigational signals for position determination, and data collection and relay. (A "CNI" system offering this capability is being considered for use by the Air Force and study contracts have been let from three USAF agencies.)

"The intent ultimately is to reduce the proliferation of black boxes and functional duplication that exists in military aircraft," Lazur says. "These require a large portion of the rf spectrum and use it inefficiently."

The CNI approach attempts to unify systems and use one common frequency. "The problem is worldwide, and a satellite offers the answer to a common grid system [for navigation]," Lazur reports, adding that a demonstration program will be initiated this year.

Lazur also points out that the CNI system approach could be used to solve civil air traffic control problems and to assist in other civil transportation modes.

An educational television system that will relay programs to developed nations via satellite will be tested late in 1971 with the help of a new Applications Technology Satellite (ATS-F), says Albert Whalen, project engineer at NASA's Goddard Space Flight Center. The experiment, called TRUST (for TV Relay Using Small Terminals), will rely on a 30-foot-diameter paraboloidal reflector antenna in the spacecraft. (Competitive spacecraft designs were submitted last month to NASA by General Electric and Fairchild Hiller.) "Until now, space systems have

been power starved, but with the large dish, effective radiated power is such that transmissions can be picked up easily by small receiving antennas," Whalen reports.

As now planned, NASA will transmit wide-band TV and audio from a single ground facility at X-band through a 40-foot antenna (output is from a 2-kilowatt transmitter). The satellite, says Whalen, will relay the program after converting the signals to uhf. At the receiving end, two types of low-cost antennas will be tested—a 15-foot dish (400°-K noise figure) and a simple 10-foot-diameter unit (1000°K). The larger dish would be for community use, with direct monitoring, or for redistribution using uhf. The

smaller dish is for individual monitoring in rural areas.

An increased tempo in the Apollo launching schedule and the impending first lunar landing in May or July should spark audience participation in a special evening session on opening day of the IEEE conference. At the Hayden Planetarium, NASA's Associate Administrator for Space Science and Applications, Dr. John E. Naugle, is leading a discussion on "Manned Lunar Exploration in the 1970s."

The planetarium's assistant chairman, Kenneth Franklin, aided by the planetarium dome, is summarizing past and future exploration of the solar system. Four experts are covering the

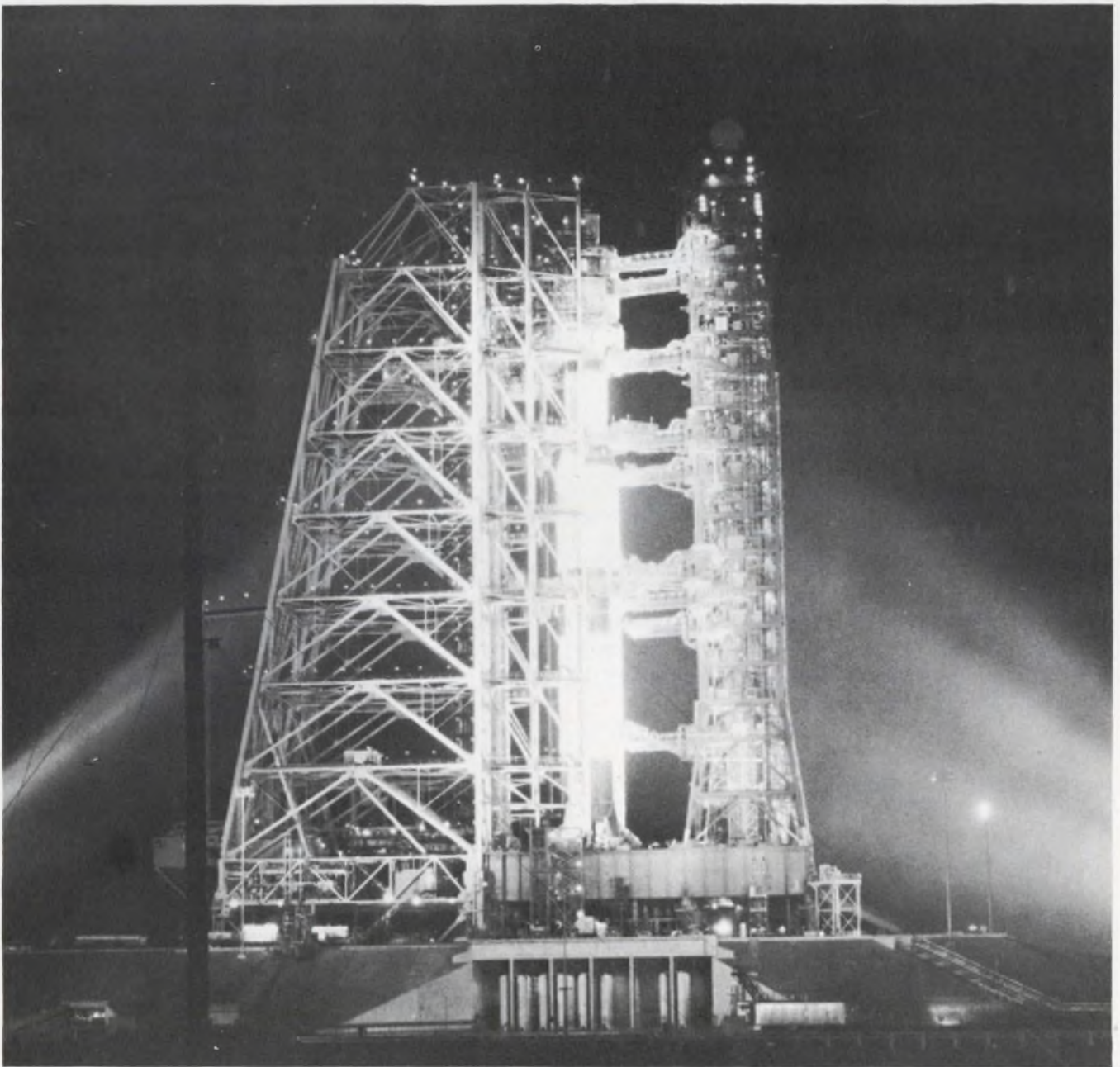

With the first Apollo moon landing scheduled to take place this summer, space scientists are now pondering

the type of manned lunar exploration planned for the 1970s. (Session 2P).

planned lunar-surface exploration by the American astronauts, the tools and instruments they will require, and possible geological determinations that may result following analysis of samples returned to earth. A variety of instruments will be implanted on the lunar surface to relay environmental measurements to earth, including magnetometers, radiometers, seismic devices, and radiation and heat sensors. Nuclear and solar-power generators will be needed for the lunar mission. New vehicles and associated communication systems will be required to increase the mobility of man on the lunar surface.

The problems of "Living and Working in Space" are being covered in Session 2F. Concentrating on manned orbiting space stations, the experts are being led by Dr. von Braun, director of NASA's Marshall Space Flight Center at Huntsville, Ala. He is a strong advocate of continuation of both the NASA and Air Force manned space station programs. Civilian and military goals are different but will complement each other, he maintains. ■■

Communications

ICs simplify solutions in data transmission

The need to transmit more and more information over increasingly greater distances is pressing. Although the television pictures from Apollo 8 were breathtaking, better definition and even color are desired. For unmanned planetary missions, which will depend entirely on pictures, even more emphasis will be placed on how much data can be transmitted and over distances far greater than the mere quarter of a million miles to the moon. Fortunately, techniques that heretofore have been more academic than feasible, because of the large number of components they required, can now be built simply and economically with integrated circuits.

Renewed interest in a number of these techniques is evidenced by the fact that IEEE has scheduled an entire session on "Modern Technology for Signal Handling." The session (3E) is headed by J. J. Stiffler, principal engineer, Raytheon Co., Sudbury, Mass.

The techniques include error-control coding, time-division multiplexing, multiple-accessing and adaptive signal processing. Particular emphasis is placed on using these approaches in practical communications systems.

A look into the future of communication satellites is being offered by W. G. Schmidt, branch manager, Comsat Laboratories, Communication Satellite Corp., Washington, D. C. His subject:

the operation of Intelsat 4 in 1976 in the Atlantic Basin. The satellite will emit both global beams that cover the entire world as well as pencil-point transmissions for specific sites.

Multiple channels will be achieved by time-division multiple access, rather than frequency-division multiple access, Schmidt says. Frequency division has been used for communication satellites because it has been successful in ground communications. Its drawbacks, Schmidt says, are spurring more and more interest in time division. Another drawback frequency division is that it calls for a linear system, which is not compatible with traveling-wave tubes. This cuts down on the power output. Controlling, or equalizing, the power of a number of ground stations is a problem that time division solves, since only one channel is transmitted at a time. A third plus for time division, Schmidt says, is its flexibility. More circuits can be added by simply creating more time divisions rather than using up more frequency bandwidth.

According to another speaker at this session—W. E. Coffrin, senior engineer, Applied Communications Research Dept., Raytheon Co., Norwood, Mass.—adaptive equalization, which has been studied for the last 10 years, can now be put to work transmitting five to eight times more data than present systems. This transfer might be via common carrier between two computers or between a teletypewriter terminal and a computer.

Adaptive equalization is a technique that automatically compensates for a variety of characteristics when communicating over different channels. Equalizers are devices that complement the amplitude and phase distortion of a channel, so that the total distortion of the channel and equalizer is minimum. An adaptive equalizer automatically adjusts its characteristics to compensate for changes in the channel. These changes might be fluctuations in the propagation of a radio link or differences between various hardware channels.

Coffrin's adaptive equalizer works in digital systems where the transmitted pulsed shape and repetition rates are known and relatively constant. Thus the equalizer can control itself by adjusting its characteristics to keep the received pulse shape and repetition rate fixed.

Other sessions for the communications designer include one on "Surface Waves—The Acoustic Signal Processing Technique of the Future." (For a preview of this subject see "Praeter-sonics: Microwaves of the Future?" ED 15, July 18, 1968, page 25.)

In another session (2E) the growth and impact of information theory over the last 20 years is being discussed by speakers from MIT, Dartmouth College, University of Notre Dame, UCLA



Portable air-traffic tower developed by RCA for the Air Force contains advanced communications systems of the

type that will be needed to solve air traffic control problems of the 1980s. (Session 4G).

and the Codex Corp. in Watertown, Mass. Sound and picture broadcasting in the vhf and uhf bands are posing new problems for the broadcast design engineer. The use of satellite relays and even direct broadcasting from satellites to homes will be discussed.

A session on the management and control of communications systems (6F) is being led by the technical director of communications of Mitre Corp., Bedford, Mass. Systems such as the Army's multination Mallard satellite networks and time sharing are being discussed.

For the audio engineer, there is Session 8G on evolutionary advancements in his field. Problems in room acoustics, new techniques for disk and magnetic tape recording, and methods for increasing signal-to-noise ratio and reducing non-linear distortion are covered. One highlight of this session is a paper by J. L. Flanagan of Bell Telephone Laboratories, Murray Hill, N.J., on man-machine communication—the most rapidly expanding field in audio. ■■

Computers

Where the action is: Expansion in 3 areas

There's no slowing down the computer revolution. In communications, graphics and design work, this is especially true. The momentum and resulting problems are reflected in technical sessions at the IEEE show.

Consider the practice of linking two or more distant computers for information interchange. The communications equipment for this operation must be flexible. It must be able to handle short messages of a few bits, as well as large amounts of information; provide both low-speed and high-speed transmissions; accommodate short and long holding times of the transmission channel, and offer single channels and multiple switched channels.

The problems that have arisen are being aired by five engineers in Session 7B, headed by D. C. Evans, director of the Computer Sciences Dept., University of Utah, Salt Lake City.

To design a computer communications system, it is very important to think of the project as a total system, says R. Kerby, manager of advance technology, International Business Machines Corp., Research Triangle Park, N. C. It is not feasible, Kerby reports, to single out the best design features of a communications system and those of a data-processing facility and then try to put them together. The "best" of either won't necessarily make the best combination of the two.

Available techniques in each should be ex-

amined, Kerby says. In communications, for example, switching techniques, data rates, satellite communications and cable links must be considered. For the data-processing facility, such techniques as error correction must be studied and an estimation made of how much intelligence exists at the user's terminal and how much must be handled by a center data-processing facility.

There are trade-offs, and these must be made wisely. A hypothetical case is discussed at the IEEE session, with analysis of the trade-offs and results.

Ways to send more data, more efficiently and economically, from computer to terminal are described by an engineer who has developed successful equipment. He is H. S. MacDonald, assistant director of the Communications Principles Research Laboratory of Bell Telephone Laboratories, Murray Hill, N.J.

MacDonald compares the data rates that are associated with the various types of graphic signals: facsimile, incremental move information and point line and character encoding.

How can one transmit a drawing from a computer to a terminal over a telephone wire most efficiently? If the drawing were on an 8- by-11-inch piece of paper and the entire drawing were transmitted, it would consist of 1,250,000 bits of facsimile information. Transmitting all of it would take several hours. The same picture, stored in a computer that uses point-line and character encoding, however, could be transmitted in less than 10,000 bits. MacDonald discusses ways to decode these signals and to convert them into facsimile data for hard copy output.

The systems aspect of scan converters are also discussed in the light of modern memory technology. And MacDonald gives his views—based on experience at Bell Laboratories—of what, and how much, hardware is needed for the best computer terminal.

What does the use of computer graphics in the design of integrated circuits mean to the designer? Session 8B deals with this question by relating four independently conceived applications of computer graphics to problems in the design of ICs. The problem areas include electrical design, circuit layout, art-work generation and fault diagnosis.

The session chairman, G. L. Baldwin, head of the Computer Graphics Development Dept., Bell Telephone Laboratories, Murray Hill, N. J., says that with the computer, the designer will "design things he couldn't otherwise design." The computer can make routine checks in the evolution of a design that would be too time-consuming and costly for engineers, Baldwin notes, adding: "If the man does the whole thing himself, he'll make so many mistakes he'll never finish the job."

Two engineers from Univac are telling Session



Two best sellers with the same silly problem

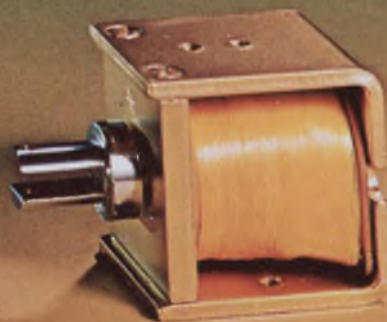

When your 1969 model looks the same as your 1968 model—getting across the engineering advances and improvements that are on the *inside* is a problem.

For instance, in 1966 we started using fully-annealed Armco steel for all Guardian Solenoid plungers . . . an "inside" improvement. Then, to compound the problem, we covered up this improvement with copper/nickel plating.

In 1968 we did it again. We took those

long-life plungers and started running them in a cavity lined with low-friction phenolic. This alone increases operating life by maybe half a million operations.

And there's more: The new acetate-yarn-sealed coil cover that's standard this year means better protection, complies with U/L construction at no extra cost.

Our "bug" changes. Inside. Where an engineering advance makes for a better solenoid. Write for Bulletin G2, TS.

NEW! TUBULAR SOLENOIDS



Eleven new Guardian Tubular Solenoids to fit every application. Practically install themselves. Just insert threaded bushing through installation hole and tighten furnished nut.



GUARDIAN[®]
ELECTRIC

MANUFACTURING COMPANY 1550 W. Carroll Ave., Chicago, Illinois 60607

8B of a cathode-ray tube display system that is controlled by a computer. It produces printed-circuit art work with an accuracy of ± 0.002 inch within an over-all dimension of 15 inches, they report. The engineers—Wayne Huelskoetter, manager of computer graphics marketing support, and Joseph Kimlinger, engineering manager of Univac, Roseville, Minn.—say the display system serves as an output device in a Univac automated design system. A computer in the system, upon receipt of Boolean logic expressions, performs the routine design functions of component placement, wire routing, the drawing of logic diagrams and the layout of printed-circuit patterns.

Philip Hudson, a member of the technical staff of Texas Instruments, Inc., Dallas, describes in the same session how he uses an IBM 2250 computer for the layout design of integrated-circuit masks. The result, he says, is a significant reduction of the design cycle. The procedure calls standard components from a disk library and displays them on the 2250. Resistors are generated by the computer from input parameters. The lead pattern is drawn with a light pen. And

the designer manipulates the components on the screen to produce the desired layout. The output is a tape that drives an optical-mechanical mask generator.

There are solid reasons for designing integrated circuits by computer, says J. A. Narud of Motorola, Inc., Phoenix. The accurate prediction of circuit performance has become increasingly important, both because of the cost of making integrated prototypes and because the models of the elements constituting the integrated circuits are more complex than those in the discrete counterpart of the circuit. Also, Narud tells Session 8B, the demand for a great variety of different circuits, plus the need for quick turn around time, make short design cycle time imperative.

Today's designs are becoming more complicated, Narud points out, because with more complex arrays, it is necessary to design built-in testing and diagnostic procedures. From the standpoint of economics, the computer is the answer.

Narud reviews briefly the typical processes and design requirements—such as limiting factors and layout rules—for designing integrated cir-

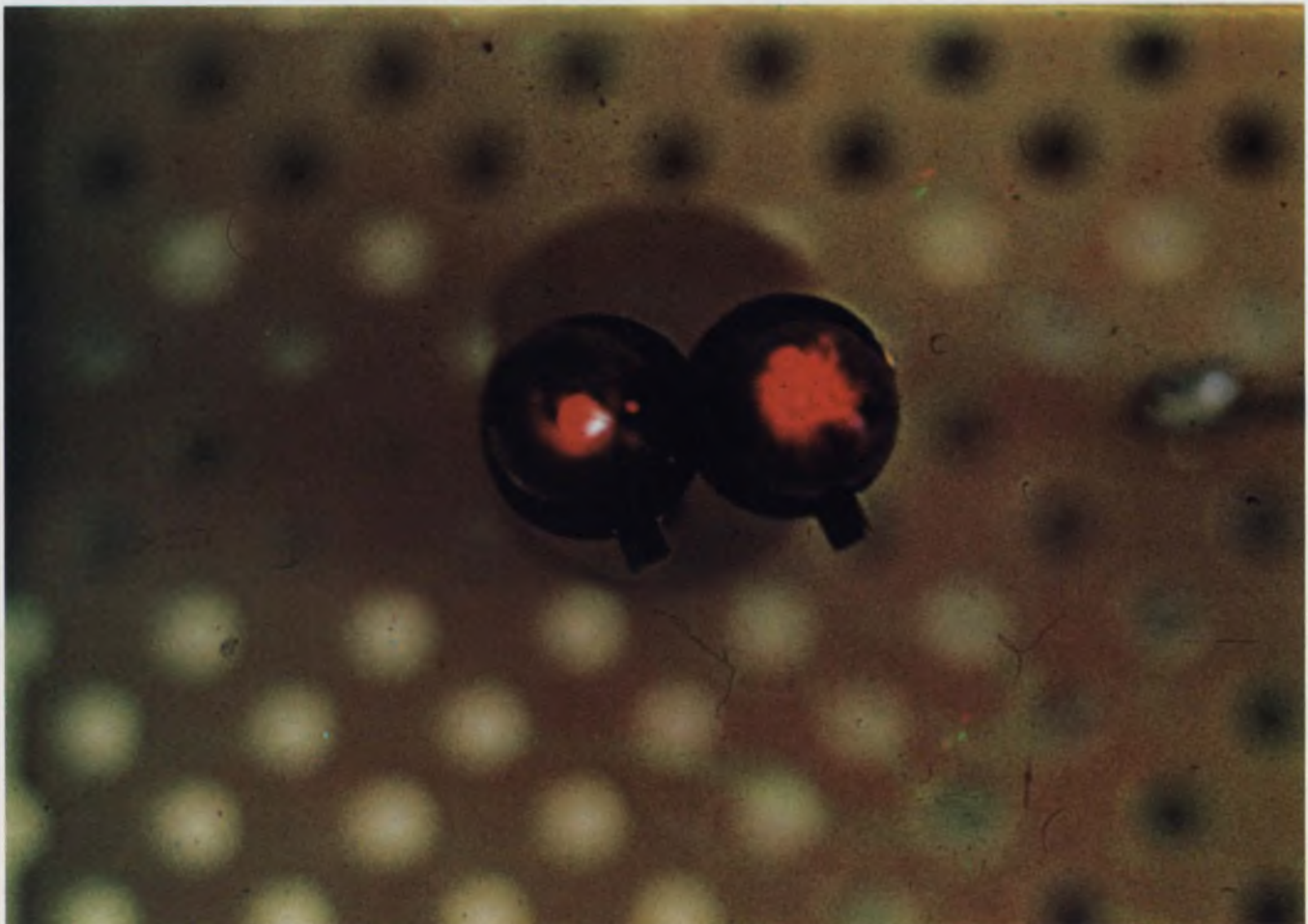

Improved red-light emitting GaAs diode (right), developed by Monsanto (Booth 2F39), has a typical brightness of 1000 foot lamberts at 50 MA. The old diode (left) has a

brightness of 450 foot lamberts at 50 MA. The improvement was made by switching from mesa to planar construction and better materials processing.

cuits. He emphasizes dc analysis—worst-case analysis, statistical analysis (Monte Carlo method), and worst-case statistical analysis. Transient and frequency performance are also covered, as are power and heat dissipation, reliability, computer-aided mask generation, ohmic drops and power supply tolerances, and test and diagnostic algorithms.

Batch, remote-batch and interactive time-sharing systems are examined by Narud, with particular attention to such machine limitations as storage requirements, the number of iterations needed for typical programing routines and design time.

Narud believes that analysis of a complex integrated circuit would exhaust the capacity of even the largest machines today. And even if the machine could handle it, he says, the analysis routine would take too long to be economically feasible to prepare. The solution to this problem, Narud says, is to "microanalyze" the ICs up to the gate or flip-flop level and, from these results, develop a simplified micro model for the circuits. Complex arrays for the application of ICs in systems are then analyzed with the use of the micro model as the basic building block. Narud demonstrates how optimization and interactive design can be achieved with the micro approach.

Five papers in Session 6B are devoted to "Computer Peripherals." Eugene Shapiro Sr., staff member for engineering, Corporate Technical Communications, IBM Corp., Armonk, N. Y., is chairman of the session. Three papers deal with ways to improve the performance of tape drives and related components, and the two others look at future trends in displays. The mix, Shapiro says, should interest a wide variety of electronic design engineers. ■■

Materials

Radiation peril spurs search for 'defenses'

What happens when semiconductors are subjected to intense radiation? Enough potential damage to cause one manufacturer at this year's IEEE show to offer what is billed as the first commercially available line of radiation-hardened ICs. And enough designer concern to prompt a noteworthy session (7G, "Radiation Damage and Hardened Device Development") on the effects of radiation on semiconductor devices. This should be a valuable session for many designers, in view of the importance of radiation resistance in military, space and nuclear instrumentation systems.

The authors of the session papers describe both the transient and permanent effects of radiation on a variety of semiconductor types. Bipolar transistors show degraded current gains and increased saturation voltages and leakage currents. Diodes, on the other hand, leave increased forward-voltage drop and leakage current when damaged by radiation. And radiation effects on integrated circuits, which are probably of most concern today, include changes not only in the transistor characteristics but in the resistor values as well.

In addition to damage, most of the session authors will also discuss the radiation tolerances of today's semiconductors. Of particular interest to those who use or contemplate the use of MOS devices is a paper, "The Radiation Tolerance of MOS Devices," by C. W. Gwyn of Sandia Laboratory.

"Investigations have shown," Gwyn says, "that ionizing radiation produces a trapped space charge in the insulator of MOS devices, which causes a large shift in the gate turn-on potential and operating characteristics."

The characteristics of this trapped charge are

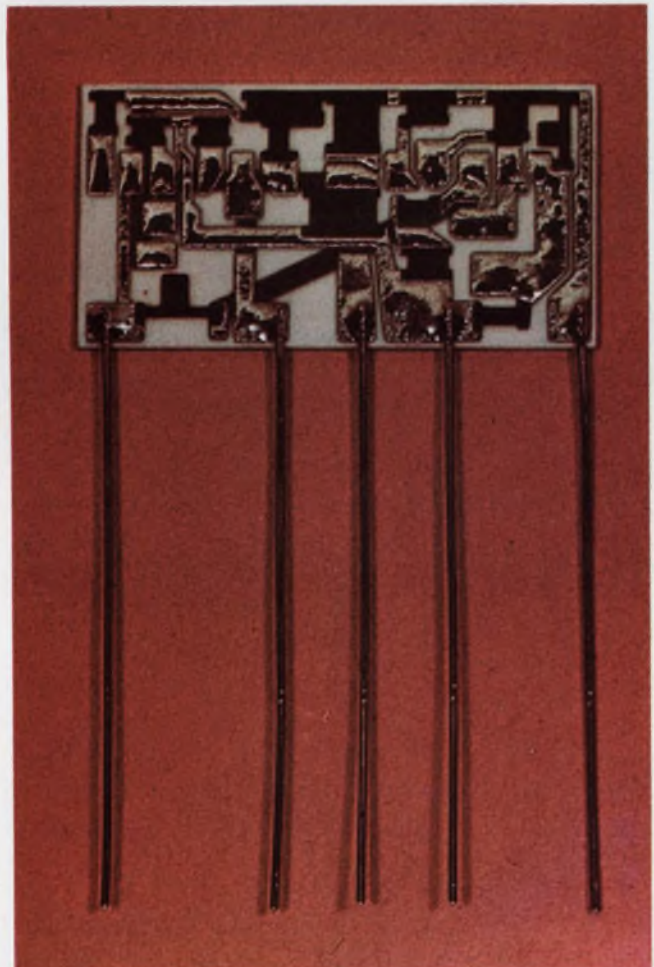

Screened film resistor substrate with two-layer metalization, by Sprague Electric, is typical of current hybrid device research (Session 3G).

discussed with the use of models, developed for describing the shift in device operating point as a function of radiation exposure.

After sitting in on Session 7G, many designers will want to stop off at Booth 4H19-21 in the Coliseum, where Radiation Inc. is showing the line of radiation-hardened ICs. It consists of a family of 930 Series DTL circuits, including gates, a buffer, a power gate and a clocked flip-flop; a 709 operational amplifier; a dual level shifter, and a dual 4-input line driver.

According to W. R. Weir, director of marketing for Microelectronics Div. of Radiation, "The devices incorporate dielectric isolation, thin-film resistors over oxide (rather than diffused resistors), small device geometries, shallow diffusions and other special device and circuit design techniques to obtain high performance in a total radiation environment."

The circuits, which are packaged in TO-86 flat packs, are said to exhibit radiation hardness that is two orders of magnitude better than conventional junction ICs.

Although other IC manufacturers are also producing radiation-hardened devices, they are doing so under contract to major Government subcontractors. One of these manufacturers, Fairchild Semiconductor, expects to be offering radiation-hardened DTL devices for the general market by the second quarter of this year and TTL units during the third quarter. The company is also doing research work on operational amplifiers and hybrid circuits.

As for other materials-oriented technical sessions at the show, diversity seems to be the keynote. The papers range from the theoretical to extremely practical. And they cover such subjects as common as glass (Session 6G, "Glasses in Electronics") and as state-of-the-art as the laser (Section 3C, "The Laser Comes of Age"). ■■

Medicine

Even unseen symptoms yield to electronics

In the medical world envisioned by electronic researchers, ultrasonic beams will one day be used routinely to locate hidden cancers in the human body. This will be possible because a nodule in a breast, or other organ, reacts with an acoustical impedance that is different from that of the normal tissue alongside it.

Studies like this are part of a growing number that design engineers are finding themselves involved in as interest in medical electronics continues to spurt in the nation. Three sessions are devoted to medicine at this year's IEEE show.

Dr. W. F. Konig Jr., head of the Biomedical Engineering Laboratories at Riverside Research Institute in New York, is telling about the use of ultrasonic beams in diagnostic work (Session 3D, "Ultrasonic Visualization"). Doctors can inject agents into the body to enhance the difference in ultrasonic impedances between cancerous and normal tissue, Dr. Konig reports. If gold is treated with radioisotopes and injected, for example, the mixture goes to the liver. Then, with an electronic scanner, a map of the liver can be produced. If the distribution of radioisotopic emission is erratic, an abnormality is present. To examine the thyroid, doctors can use the same diagnostic procedure, with radioisotopic iodine as the agent. Details of the procedure are being described by Dr. David Kuhl of the University of Pennsylvania.

At the same session, a paper by Dr. T. L. Hayes of the Hospital of the University of Pennsylvania, describes a scanning electron microscope that magnifies biologic tissue for examination. Instead of using lenses to form the image—as is done in the light microscope or the conventional electron microscope—the scanning electron microscope forms its image by a time sequence of points, as in a television system. The main advantage of the scanner over conventional devices is not that it can see smaller objects but that it sees more about the object. For example, it can produce three-dimensional pictures of entire living organisms.

X-ray images of cerebral blood flow were obtained by injecting radioactive xenon-133 into the carotid artery of a patient. The exposures are one-fifth of a second each. (Session 3D).



Medical devices that use X-rays and electronic imaging are being described by Dr. M. M. Ter-Pergossian of Washington University, St. Louis. One device is a TV system that shows a rapid sequence of X-rays. Special image amplifier tubes are needed for this application.

Session 3D is being led by Dr. E. C. Gregg, professor of radiology at Case Western Reserve University, Cleveland.

Another session (1A), headed by Dr. G. S. Cohen, chief of the Electrical and Electronics Engineering Section, Biomedical Engineering and Instrumentation Branch, National Institutes of Health, Bethesda, Md., is presenting five papers on automated health care. Some of the subsystems discussed are already in operation, such as one that automatically analyzes blood chemistry. Various refinements of this system, plus totally new ways to analyze blood, are being discussed. One subsystem still in the conceptual stage is an automated system for anesthesia. Not only will it aid the anesthetist by giving him important real-time data, but it will also permit doctors in remote parts of the hospital to monitor the anesthetic procedure and the patient's reactions to it.

The third session (2D) deals with "Sensory Aids for the Handicapped" and is headed by another National Institutes of Health official, Dr. R. J. Pettit, who holds degrees in both engineering and medicine. Half the session is covering aids to the blind and the other half aids to the

deaf. For the uninitiated engineer, each topic is being preceded by an introductory paper to acquaint the engineer with what has already been done and what is needed. Although academic training in physiology and psychology are helpful, electronics engineers can work well in this growing field, Dr. Pettit says, by collaborating with specialists in the medical disciplines. A thorough understanding, for example, of the factors that affect a blind person's use of other senses to compensate for his loss of sight is enough background to enable an electronics engineer to design a useful aid.

Mobility for the blind is being discussed by R. W. Mann, a professor at the Massachusetts Institute of Technology. Human factors underlying the design of reading aids (where much work is needed, Dr. Pettit says) are being discussed by P. W. Nye of the California Institute of Technology in Pasadena.

For the deaf, speech communications aids and residual auditory capacity are covered in a paper by J. M. Pickett, director of sensory communications and professor of speech communications Gallaudet College, Washington, D. C.

P. B. Denes of Bell Telephone Laboratories, Murray Hill, N.J., describes ways to help the deaf understand speech. The aids range from simple acoustic amplifiers to sophisticated devices that transform articulatory or acoustic cues about speech into a more suitable acoustic signal or into visual form. ■■

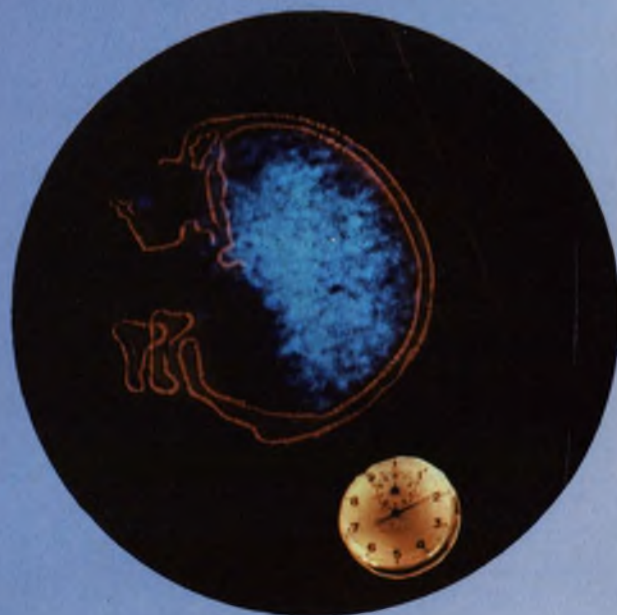

Films, memories, LSI: A time to take stock

Progress is still rapid in microelectronics—in thin and thick films, IC memories and LSI arrays. But exactly what have we accomplished? What are our capabilities? It's time to take stock, to evaluate the manufacturing processes, and to survey the products and the ways they can be used. And a good place to start are the sessions on microelectronics at the IEEE show.

Film circuitry, the subject of many heated arguments, is featured in Session 3G. David McLean, director of the Components Lab, Bell Telephone Laboratories Inc., Allentown, Pa., in organizing the session, purposely avoided making this a debate. He argues that while both thick and thin films have their place, debates tend to pit the proponents of one type of film against the other. "We will clearly define the specific advantages and disadvantages of each type of film," he says, "and outline applications in which each type performs well.

"We will provide immediately useful information for engineers who are working with hybrid circuitry," he says. "We want engineers to understand where we are today, and how they can use film circuitry to fill their own special requirements." Particularly interesting are two applications papers by two of his colleagues, Morton Topfer, head of Hybrid Circuit Subsystems, and David Feldman, head of Film Circuits and Component Development, both of Bell Laboratories in Murray Hill, N.J.

The real problem and real successes of LSI in systems applications are scheduled to be discussed in Session 6A, organized by C. Thornton, director of Research and Development, Philco Ford Corp., Blue Bell, Pa. Thornton feels that engineers have heard enough "blue-sky"—that the time has come to get practical. "We've heard enough talk," he says, "about how big LSI is going to be, how great it's going to be, how many devices will be put on a chip, and how the costs are going to come down. In this session," he emphasizes, "we are going to hear from people who are now at work *applying* LSI to systems."

Thornton is skeptical about the extent of LSI use today. "There still isn't any LSI (100 gates per chip) in systems being built and sold," he says. But there actually are companies actively engaged in LSI development. Accordingly, Thornton has arranged for speakers from National Cash Register Co., Litton Systems, RCA Laboratories, and Texas

Instruments.

Thornton speaks very highly of the work done at National Cash Register. "These people became very active in MOS and MOS LSI about three years ago," he says. "They've made long-range company plans to convert to LSI, and are now able to computer-simulate a system and partition it for fabrication. They use computer aids to do the layout and artwork, and to generate computer-test types for the use of the LSI vendor." Jack Field, assistant manager of Materials and Design Services of Engineering, National Cash Register, Dayton, Ohio, is to discuss their computer-aided design procedures.

Joe Campeau, of the technical staff at Litton's Guidance and Control Division, Woodland Hills, Calif., is scheduled to discuss LSI array processing. "The people out at Litton," says Thornton, "have put a lot of effort into learning how to work with LSI design rules, how to use MOS LSI, and how to organize a computer to use the technology." Campeau is set to explore array processing and LSI.

Papers by G. Herzog, director of Data Processing at RCA Laboratories, Princeton, N.J., and W. Wickes, manager of Advanced Integration Programs, Texas Instruments, Dallas, Tex., explore demonstration applications of LSI in practical systems.

Up to now the IEEE hasn't provided a good forum for the exchange of ideas among manufacturing engineers, according to J. Singleton, organizer of Session 7A, "Manufacturing Technology for Microelectronics." He says: "The IEEE has done a great job in the past for design engineers, but what about the engineer who has to take a design and make a million products from it, and do it economically? He's been forgotten!"

For the manufacturing engineer, Singleton assembled speakers on the effect of ICs on manufacturing logistics, telephone equipment manufacturing, and high reliability and avionic systems. Attending engineers are to get a picture of the many changes that other companies have made in their manufacturing techniques, in their parts inventory system and in their assembly-area arrangements. The session affords an excellent opportunity for engineers who may work to assess their own achievements in adjusting to the use of ICs.

C. Crain, dept. chief of Thin Film Development Engineering, Western Electric Corp., Indianapolis, Ind., contrasts the type of manufacturing shop used for wired discrete-component equipment with the setup used for production with ICs. The differences are numerous, and their effect on production costs can be dramatic.

In more exotic areas, Joe Frissora, president of Space and Tactical Systems Corp., Burlington, Mass., discusses equipment design for special systems—notably spacecraft and medical electronics—and J. Murtha and J. Hudson, advisory engi-

**VISIT HUDSON'S
"ELECTRI-CITY"
AT THE IEEE SHOW
N. Y. C. BOOTHS 1D07-1D11**

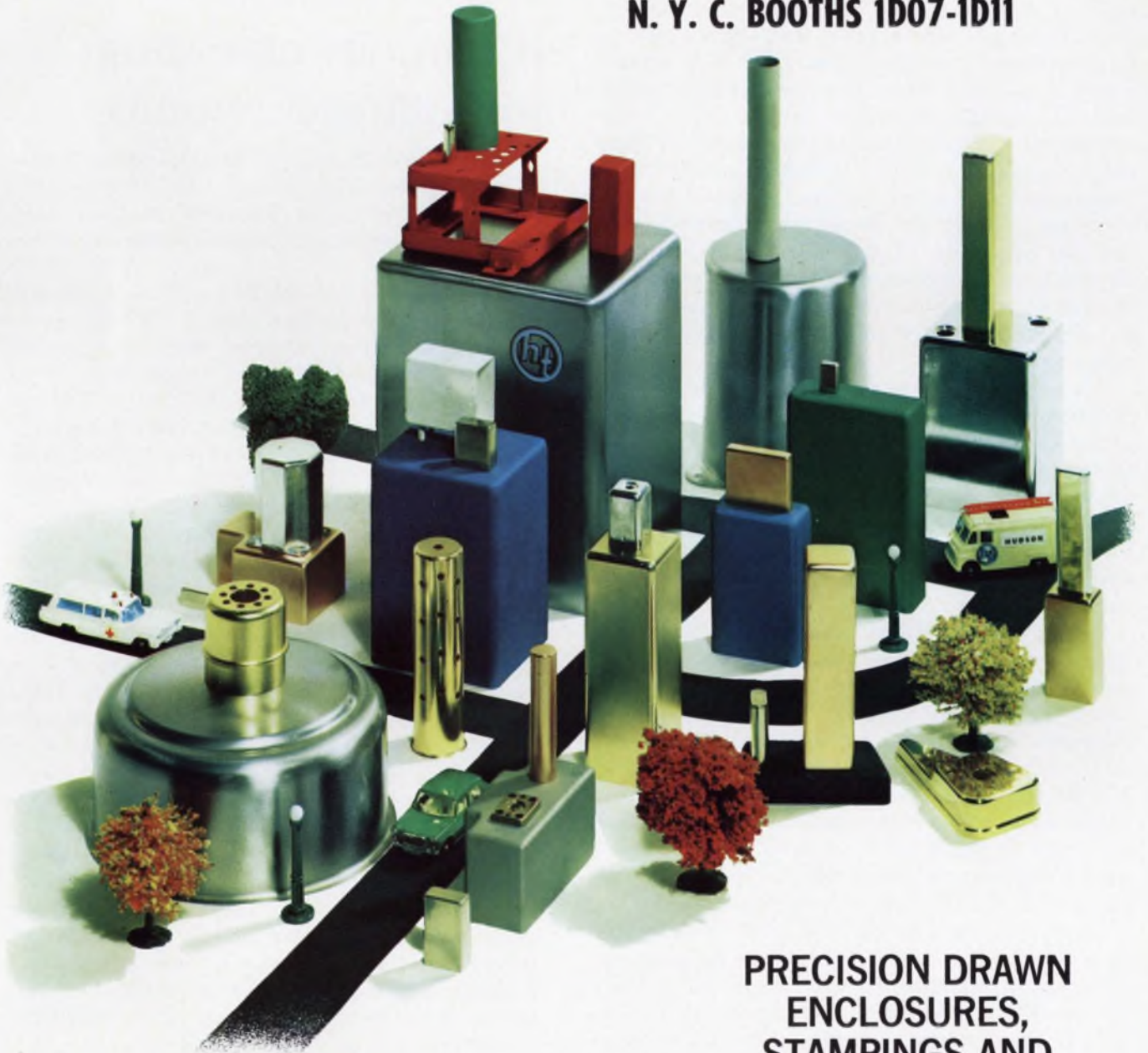

**PRECISION DRAWN
ENCLOSURES,
STAMPINGS AND
ASSEMBLIES**



HUDSON
TOOL & DIE COMPANY, INC.
18 MALVERN STREET, NEWARK, N.J. 07105 — U.S.A.

neers for the Aerospace Division of Westinghouse Electric Corp. in Baltimore, Md., explore the problems of incorporating ICs into military systems. A. Gellert, development engineer at RCA, Camden, N.J., discusses the impact of microelectronics in manufacturing logistics.

Gordon E. Moore, vice president of Intel Corp., Mountain View, Calif., opens the session with a review of the several ways that semiconductor memories are being used. "Semiconductor memories," he says, "are extremely flexible. They should not be considered simply a replacement for core memory." Moore feels that semiconductor memories should be used instead for their unique capabilities—they offer easy parallel addressing, because they can be broken up into many small chunks of memory and because less expensive MOS memories can be combined with high speed bipolar structures to get a system that combines the advantages of each. But, he warns, semiconductors are still expensive. "People who are planning to use semiconductor memories," he says, "need a lot of faith in vendors' cost projections. So far, in any but the smallest or highest speed systems, magnetics are cheaper."

For engineers whose specific interest is in semiconductor memories, Jim Goldey, director of the Materials and Process Technology Laboratory at Bell Telephone Labs, Inc., Allentown, Pa., has organized Session 5G, "Semiconductor Memory."

Goldey, too, emphasizes the practical approach. "We will talk about actual memories that have been designed and built—at least to the prototype stage," he says.

Goldey has obtained speakers—from IBM's Memory Product Design and Special Studies System Development Groups, Bell Laboratories Semiconductor Memory Division, and RCA's Applied Research Lab.—who are scheduled to describe and compare the bipolar monolithic, p-channel IGFET, and complementary MOSFET approaches to semiconductor memory. In this session, comparisons will be made of the speeds, power requirements and costs of these approaches, from both the device and the systems viewpoints.

If your interest is ICs in general, if you'd like to brush up on the physics and processing of microelectronics, linear and digital circuits, and on their incorporation in electronic equipment, be sure to attend the Tutorial Seminar "Fundamentals of Integrated Circuits." Organized by Dr. Fred A. Lindholm, professor of electrical engineering at the Univ. of Florida, the course stresses the fundamentals underlying IC technology and includes a discussion of the incorporation of ICs into electronic equipment.

Drs. Lindholm, Chenette, and Broderon of the Univ. of Florida are to discuss physical fundamentals, devices and linear circuits. Dr. D. K.

Lynn, Motorola Semiconductor Products, Inc., Phoenix, Ariz. and Clive Ghest, Fairchild Semiconductor, Mountain View, Calif., are to discuss digital ICs and the incorporation of ICs into electronic equipment. For a down-to-earth practical education in IC technology, attend the IEEE show! ■ ■

Microwaves

IC circuits emerging for military avionics

The broadening scope of the microwave field—from computer-aided design, to IC microwave components, to recent advances in microwave materials—is apparent in technical sessions at the IEEE show.

For engineers who want a rapid state-of-the-art review, a four session conclave is being sponsored at the Coliseum for the second year by the IEEE Group on Microwave Theory and Techniques. Organized by D. H. Temme of Lincoln Laboratory, Massachusetts Institute of Technology, Lexington, Mass., the review includes computers, microwave testing, low-noise receivers and high-power microwave tubes.

A worthwhile, across-the-board look at the past, present and future of microwave ICs, based largely on Air Force experience and prognostication, is being offered at Session 1C in the New York Hilton. W. J. Edwards, chief of the Air Force Avionics Laboratory, Microwave Group, Wright-Patterson Air Force Base, Dayton, Ohio, is the session's organizer. "Anyone who attends," he says, "should be able to understand—from this session more than any other in the past—why the Air Force wants integration and what ICs can do for systems in this area."

A paper that Edwards recommends is "The Impact of Integrated Microwave Circuits on Avionics Systems," by R. D. Alberts, staff engineer at the Air Force Avionics Laboratory. It presents, according to Edwards, "one man's philosophical outlook on avionics systems—where they're going in the future and what role microwave ICs might or might not play."

For engineers seeking breakthroughs in microwave IC technology, Edwards points to "Integrated Circuits for Airborne Communications Arrays," by G. R. Harrison, engineering manager of microwave integrated circuits, and R. C. Aucreman, engineering section head of microwave modules, Microwave Electronics Div., Sperry Rand Corp., Clearwater, Fla.

Sperry is, according to Harrison, engaged in

an Air Force program to develop an "airborne phased array for communication purposes." The array will be on board aircraft for communication with a synchronous Air Force satellite. The satellite will see nearly a whole hemisphere, so each plane will be able to communicate with any ground station, or any other aircraft or satellite directly in the line-of-sight of the communications satellite.

"The interesting thing about this, from the microwave standpoint," Harrison points out, "is that the array will be operating at X-band.

"And there are quite a few things we're doing that have not been done before. For example, the array is to be comprised of some 300 microwave IC modules, working with microstrip transmission lines, all combined into a plug-in package approximately 1 inch square by 3 inches long. One of the inch-square surfaces will be a radiating element."

Of considerable significance, Harrison notes, is the fact that "each transmitter module performs as a direct-dc-input to an 8-GHz-output element in the array; its avalanche transit-time oscillator produces about 1 watt cw output."

Within each module, Harrison explains, there will be the transmitter, a receiver and a duplexer,

all operating at microwave frequencies. Modulation will be impressed on each module by running the 8 GHz transmitters in a frequency-locked mode.

"What we do," Harrison says, "is to impose on all the transmitters a 10-milliwatt, 8-GHz, locking signal containing the audio modulation. The 1-watt, 8-GHz output of each transmitter module follows the shift of the locking signal input."

As to how far Sperry has advanced, Harrison says: "We have demonstrated, independently, the feasibility of the transmitter and also the receiver. The duplexer is not difficult.

"We're satisfied with the performance of the individual circuits. Right now, we're interweaving all together in a complete module, and our next task will be to make them work together."

As to the future use of microwave ICs, Harrison indicates that the application of this type of module in an array will have a big impact on airborne systems, because they can be made "small, light and less costly."

Beyond semiconductor devices

To date, the microwave IC elements that the Air Force, Sperry and others have been working

Experimental gallium arsenide LSA oscillator mounted on top of cleaved chip with a single mesa structure was

built by Bell Telephone Laboratories. It's typical of the new types of microwave semiconductors (Session 2G).

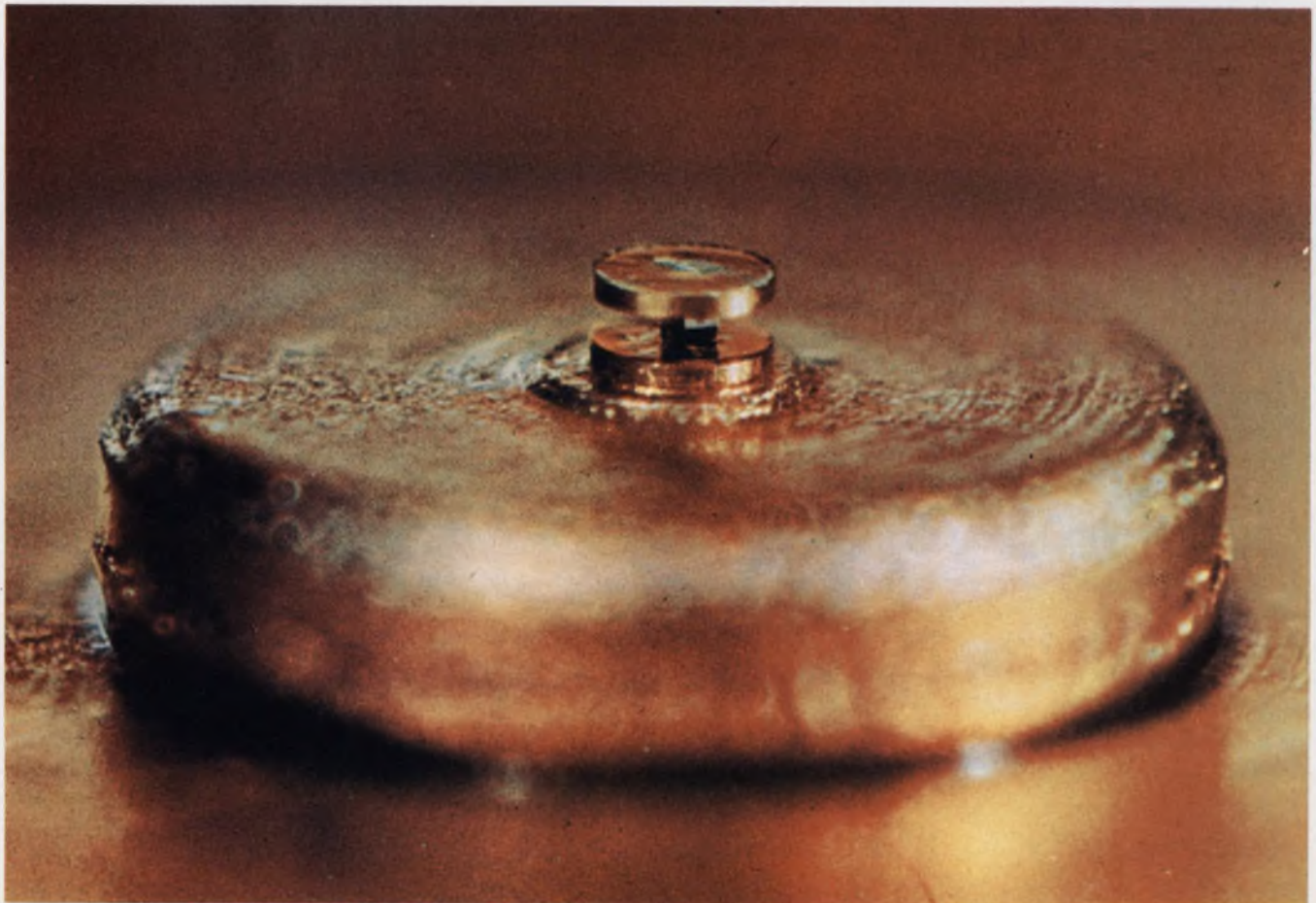

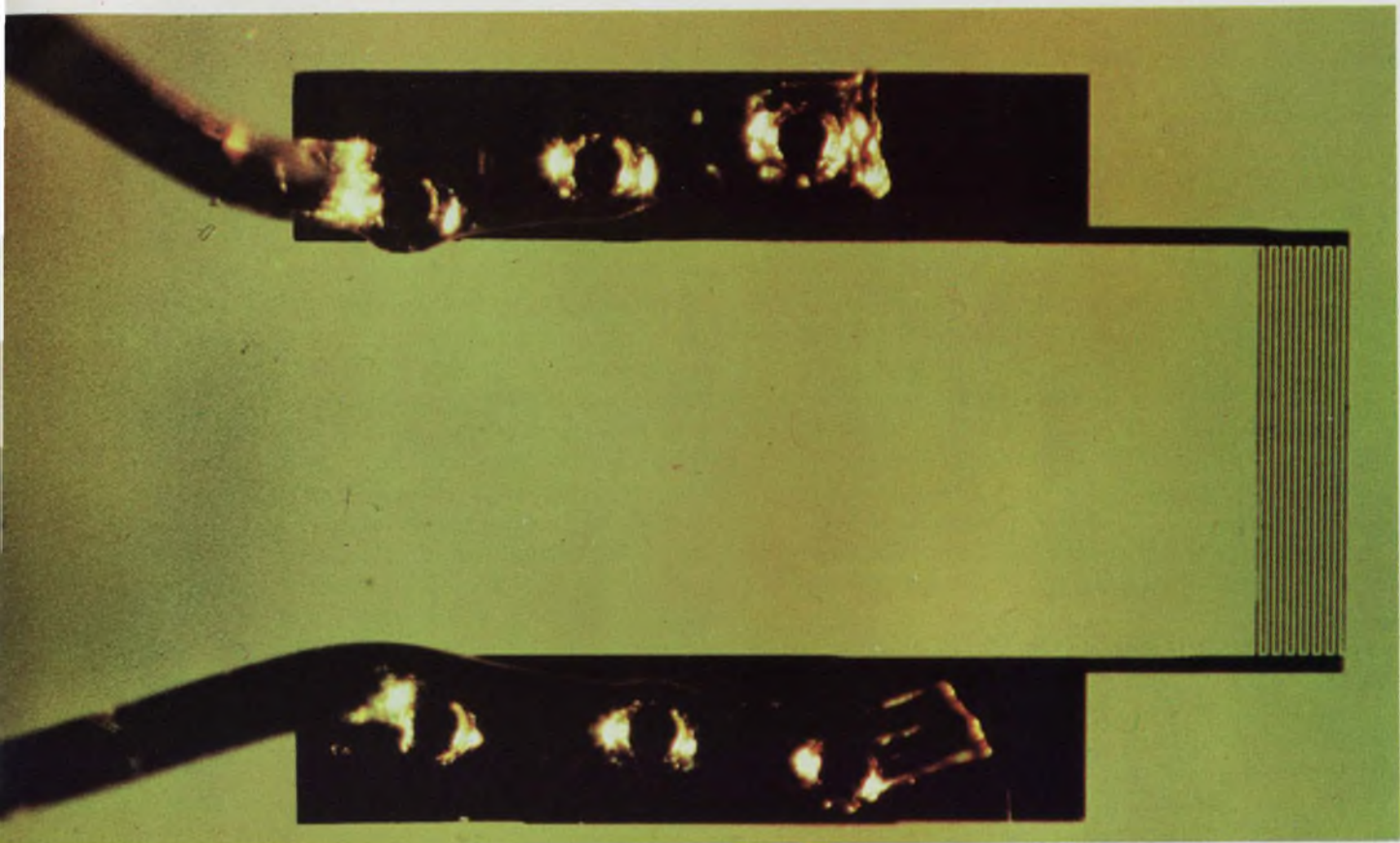

Surface wave transducer fabricated of "gold fingers" on a substrate of lithium niobate operates in the 400-to-500-MHz region. The spacing between the fingers is five

μm . The microsound component was fabricated at MIT's Lincoln Laboratory. The delicate machining was done by electron beam. (Session 2C).

on include varactor diodes, Gunn devices, and IMPATT (avalanche transit-time) oscillators. But these are an extension of the silicon-based technology, and inherent limitations are imposed on them by the materials and processes. As for three-terminal, X-band devices, there are at present no good ones.

To bridge this technology gap, Dr. Gene Strull, manager of Westinghouse's Science and Technology Div., Baltimore, presents a paper detailing other avenues of exploration. In "The Influence of Innovation on Microwave Integration," he discusses possible uses of pretersonic, magnetic and other esoteric devices.

"What I have to say," he says, "is concerned with the directions the future systems might take. The question is: To make the electrically scanned array, are we going to use silicon-based ICs, or will we look at acoustic, magnetic and other electronic and physical phenomena?"

"A new look will have to be taken at signal processing. We'd like to do more on a real-time basis. Emphasis will, however, be on phased arrays."

Progress in materials

A more favorable outlook is taken in another

paper on the performance of gallium arsenide LSA oscillator diodes in the microwave and millimeter-wave region. The author is J. A. Copeland, a member of the technical staff and supervisor of Bulk Effects Studies Group, Bell Telephone Laboratories, Murray Hill, N. J. His paper, "The Potential of Semiconductors for Millimeter or Submillimeter Wave Generation," is scheduled for Session 2G on "Materials for Spanning the Infrared to the Microwave Gap."

He notes that Cornell University has obtained, with LSA diodes, 1500 watts of peak pulse power at 9 GHz and 3 watts at 50 GHz. Bell Laboratories has obtained strong oscillations on a 90-GHz fundamental and "measurable" outputs at 180 GHz, Copeland says. He adds that the theoretical upper limit of the GaAs LSA diodes is still not clear, although a claim has been made that it extends to 1000 GHz.

The make-or-buy problem

Whether to make microwave ICs in-plant or buy them outside is an important decision, and as an aid in reaching a conclusion, Session 1C offers two papers: "Fabrication and Testing of Large Numbers of Integrated Microwave Circuits," by R. H. Jackson, MERA program man-

ager at Texas Instruments, Inc., Dallas, and "The Make or Buy Decision in an Emerging Technology," by Dr. Melvin Aarons, Microwave Group, Sanders Associates, Nashua, N. H. ■■

Systems

Technology providing aid to troubled cities

Like it or not, engineers are being drawn more and more into the political and economic life of this country. In the last few decades, technological progress has been promoted by the national defense and also by the requirements of consumer and industrial markets. But today, a knowledge of just how the large-scale application of technology can be made to broad areas of government problems is urgently needed to aid the engineer in adapting his own specialties to the problems facing the urban areas.

The basic answer lies in systems technology—an effective method to produce order out of chaos. Session 3A considers the role of the engineer and systems technology in five areas: health care, education, transportation, communication, and urban development.

The session's organizer, A. M. Bennett, sub-department head in the Systems Development Div., Mitre Corp., McLean, Va., says:

"The major factors that make this session important lie in the new considerations that are necessary for the large-scale introduction of technology in these fields of the future. These factors are somewhat different than have been present in the pure industrial applications, and also, particularly in military applications. The problems of traditional technology are very closely tied with the problems of making both social and political mechanisms ready to accept technology, and also to have them in a position of implementing it.

"One difficulty, for example, is that you have so many more customers for something like education, say, than you do for the military, where you have a few large-scale buyers. In the educational field, you're talking about thousands upon thousands of local school boards. And you just can't afford to talk R&D programs to each of these individually.

"You're going to have to, somehow, create a market in which you get a large number of these boards to cooperate in some fashion and to agree in advance upon a general type of technology, whether it be computer-type aids for instruction or some other form.

"Whatever it is, you're going to have to generate this larger market to get some reasonable

price, for your products. You're going to deal necessarily with a great number of groups that are interested, such as labor, local school boards, state boards, city councils, mayors, city managers, and various planning groups.

"The interaction of interested groups may be very widespread. As a result, it is hoped that from these IEEE sessions, the electronic engineer will understand that his technology is going to have to take a great deal more appreciation of these kinds of interactions and problems than previously, when he had a reasonably sophisticated set of customers.

"Also, in the IEEE session, he'll have an opportunity to see what technology has already been applied to these fields, and what inroads are successful, and what are not."

Urban development needs doers

The message for electronic engineers attending the system technologies session is, according to Dr. Manfred Altman, director of science and technology, Utilization Center for Urban Research and Engineering, University of Pennsylvania: "Don't put all your efforts in electronics. Find out what the rest of the world is doing and figure out where you can make contributions."

The big problem, Dr. Altman points out in a paper on "Impact System Technology on Urban Development," is the critical lack of people who can implement what the planners plan. A part of the over-all problem, he says, is the fact that "our society is a rather pragmatic one, and planning is usually ignored as long as possible. Planners plan and politicians do, and the relationship between the two is not even coincidental."

But time is running out for us, Dr. Altman says, and "before very long 80 per cent of us will live in an urban environment where all the problems that technology has generated will come to a head." The big problem is: "What are we going to do about it?"

In the past, transportation planners planned transportation, communications planners planned communications, "and for some reason or other, it never occurred to anyone that you could list eight major technical applications areas crying for contributions as far as the urban environment is concerned," Dr. Altman says.

"But," he warns, "they are not separate. People who worry about waste disposal and clean water need inputs from the people that worry about power. And people who work in communications are doing things which may well make it unnecessary to spend so much money on transportation."

Only recently has it been recognized that major technological applications areas cannot be treated

as separate entities. But this is a new concept and neither Washington nor the states or cities know how to find a common bond for them. What doesn't need to be done is to figure out what needs to be done. That's already well known.

"Instead," according to Dr. Altman, "we need to develop people at the universities, particularly those who are comfortable in the area of not only applications, but of implementation as well."

"While the universities know how to educate people in the disciplines," Dr. Altman asserts, "they haven't the foggiest notion of how to go about preparing people for a completely interdisciplinary environment. The guy must be as much at home in the hard as in the soft sciences, like the behavioral-type sciences.

"Sessions like this one at the IEEE show are useful in laying the foundation for action that eventually will be required by the national, state and local governments."

An eyebrow-raising concept for children's education is described in a paper on "The Impact of System Technology on Education," by Arthur Barber, president of the Institute for Politics and Planning, Arlington, Va. He is convinced we must bring teaching competition into the education picture, together with concepts of cost management.

Briefly, his idea is this: In the traditional education system, the teachers get paid whether the pupils learn or not. But under the new concept there would be heavy reliance on teaching machines, and the suppliers of the machines would get paid only if the student satisfactorily learned the elements of a given course of study. Payment would be geared to each student's progress.

"The teaching machines or computer-aided instructions, or whatever the contractor wanted to use, would be entirely up to him," Barber explains, "—the children would be tested when they entered the course and again when they finished."

Pay-as-you-learn under test

With educational performance on a service basis, Barber, along with others, is convinced that the learning level would be substantially increased for every dollar spent. In fact, he points out that one successful school has already been set up in Gainesville, Ga., and others will be introduced in some of the large cities within the next six months. These are private schools.

Barber says that parents will spend \$100 to \$200 per subject to raise their children's educational level. As he explains it, Junior can be taught to improve his grade level in reading by one year, according to objective tests of the New York Regents, for \$100 to \$200.

This new system, as Barber envisions it, will

provide a framework for substantial expansion of educational TV and computer-aided instruction. And most important, he argues, if the student is accepted on a pay-only-if-the-student-learns basis, it will provide a rigorous and tight management for the Raytheon's, the IBM's, the Litton's, and others who say, "This system has the potential."

As a former Air Force R&D man who handled Government contracts, Barber contends that the educational system has been negligent in not always getting what it has contracted to buy.

"And what it wants," he insists, "is educational performance and nothing else. It shouldn't be buying books, buildings, or anything else. Instead, it should be buying educational performance on a service contract. And when that happens, it will change the whole education market, and I think, to the benefit of the electronics industries."

Electronics brains needed for health care

In health care, "engineering is probably going to cause a significant change in the practice of medicine within the next 10 or 15 years," according to Dr. C. A. Cacerers of the Medical Systems Development Laboratory, National Center for Health Services, Washington, D. C. "It's already beginning to show a significant impact," he adds.

Dr. Cacerers, co-author with J. Landoll of a paper on "The Impact of System Technology on Health Care Delivery," says that more and more people in the medical field are becoming aware of engineering systems techniques.

"They've begun to see that following such techniques makes it possible to decrease manpower requirements, making existing manpower much more efficient," Dr. Cacerers notes. "It increases the quality of medical care, and helps to keep the cost of care at a level commensurate with the cost of living."

Dr. Cacerers points out that some systems to meet the needs of medicine are now available. "For example," he says, "we're beginning to utilize computers in the direct practice of medicine to do things that otherwise we'd have to spend our own time on, such as the analysis of signals. This includes electrocardiograms, spiograms (lung function tests) or any number of other things."

This makes it possible to augment the quantity of physicians available, because one computer can now easily do the work of from five to seven highly trained men.

Computers are also viewed as aids in teaching medicine because the clinical tests, as interpreted by the computer, give cold, printed data, and not another doctor's opinion, human as it is. This

has the advantage that the computer data gives the same answers for the same inputs, thus eliminating the variability of human interpretation.

The use of other, newer laboratory devices that can process a multiplicity of signals at very low cost—for example, chemical analyzers for blood tests—are making a tremendous impact at the present time in diagnostic medicine, Dr. Cacerers claims.

“What they really show is that any number of other things can be done in the same fashion, so that this is just the beginning in the evolution of most tests currently performed.”



Systems techniques are being increasingly applied in developing advanced medical electronics equipment such as the automatic EKG machine by Marquette Electronics, Milwaukee (Session 3A).

With computers to do certain types of chemical tests and automated chemical analyzers to do others, Dr. Cacerers says that “it is now possible to do pre-screening of patients for physicians at ‘multi-phasic’ health screening clinics.”

“This will mean that patients can get a screening examination at work, or other places convenient to them, and at reasonable cost,” Dr. Cacerers says. “And this system will give the physicians better data to work with in the future.”

From computer pools and automation techniques, total systems are being developed for pre-screening. This means that in the future the physician will be able to see his patients at a more efficient rate and still provide high-quality care at a realistic cost. These multi-phasic screening clinics are now being tested in San Francisco and other places in the country.

In the next decade, Dr. Cacerers feels that the full impact of systems technology is going to make the practise of medicine more a science than an art. And he emphasizes that the electronic engineer can contribute in all phases of this evolution.

“This is going to be a partnership,” he says, “in which the electronic engineer works in the same environment as the physician, and it will be from the engineer that the physician will be given some of the ideas and directions. In effect, the engineer will do the systems analysis.

“The engineer will determine what is being done and what is necessary in medicine. He’ll see what is available in technology and fit it together to provide a better system. The physician is the ultimate person in the delivery of health service, but the planning and implementation is an engineer’s job.

“Already we transmit electrocardiograms via phone lines from hospitals in Knoxville, Tenn., and Hartford, Conn., to Washington D.C., for diagnostic analysis. These phone connections are excellent for diagnostic work and we’re beginning trial monitoring of patients, by phone, in intensive-care suites. The data is conveyed by phone to the computer, where it is analyzed.

“In this type of system we need engineers to develop transducers. We’re using whatever we have at the moment, but there are better ones. Engineers must develop the systems to send the telemetry signals. The computing systems have to be more compact and reliable. And, finally, we have to have display devices to convey the data back to the physician.”

The health market, Dr. Cacerers estimates, is considered “somewhere around \$50 billion per year. And the inroads that can be made in the better utilization of this 50 billion dollars, by engineering techniques, appears to be significant.” ■■

The timetable for technical papers

Here's the complete program at the show, listed by subjects and giving the who, what, when and where for sessions

Airborne Electronics

Principles of Self-Organization and Learning Systems—Heinz Von Foerster, University of Illinois, Urbana, Ill. (1B.1, Mon./a.m./M)

Innate Structure for Self-Organization and Learning Systems—P. H. Greene, University of Chicago, Ill.; H. L. Oestreicher, Wright-Patterson Air Force Base, Ohio (1B.2, Mon/a.m./M)

Pattern Recognition and Self Organization—J. K. Hawkins, Robot Research, La Jolla, Calif. (1B.3, Mon./a.m./M)

Self-Organization Flight Control Systems—R. L. Barron, Adaptronics, Inc., McLean, Va. (1B.4, Mon./a.m./M)

The Impact of Integrated Microwave Circuits on Avionics Systems—R. D. Alberts, Wright-Patterson Air Force Base, Ohio (1C.1, Mon./a.m./SN)

Integrated Microwave Circuits for Airborne Communications Arrays—G. R. Harrison, R. C. Aucremann, Sperry Rand Corp., Clearwater, Fla. (1C.3, Mon./a.m./SN)

Sizing Up the Problem—J. D. Blatt, Dept. of Transportation, Washington, D. C. (4G.1, Tues./p.m./G)

Second Generation Systems in ATC: Requirements and Approaches—L. Goldmuntz, Department of Transportation, Washington, D. C. (4G.2, Tues./p.m./G)

Controlling Ground Movement of Air Traffic—Louis Achitoff, The Port of New York Authority, N.Y. (4G.3, Tues./p.m./G)

People Handling: Uncorking the Bottleneck—R. J. Sutherland, American Airlines, New York (4G.4, Tues./p.m./G)

What Role for General Aviation?—Crocker Snow, Boston Logan Airport, East Boston (4G.5, Tues./p.m./G)

Antennas and Scattering Techniques

Infrared Astronomy—F. J. Low, Tucson, Ariz. (1E.1, Mon./a.m./N)

Pulsars—Frank Drake, Cornell University, Ithaca, N.Y. (1E.2, Mon./a.m./N)

Long-Baseline Interferometry—M. H. Cohen, California Institute of Technology, Pasadena (1E.3, Mon./a.m./N)

Large Radio Antennas—J. D. Findlay, N.R.A.O., Charlottesville, Va. (1E.4, Mon./a.m./N)

Solar Radio Bursts and Activity Centers—Jules Aarons, J. Casteau, P. M. Kalaghan, L. G. Hanscom Field, Bedford, Mass. (1E.5, Mon./a.m./N)

Circuits

Modern Low Noise Microwave Technology—Michikyki Uenohara, Nippon Electric Ltd., Kawasaki, Japan C.1, Wed/a.m./CM)

Modern Schottky Barrier Mixers in 1969—Arthur Solomon, Sylvania Semiconductor Div., Woburn, Mass. (C.2, Wed./a.m./CM)

Parametric Amplifiers and Masers in 1969—Peter Lombardo, Airborne Instruments Lab., Melville, N.Y. (C.3, Wed./a.m./CM)

Low Noise Transistors and Tunnel Diode Amplifiers in 1969—V. G. Gelnovatch, U.S. Army Electronics Command, Fort Monmouth, N.J. (C.4, Wed./a.m./CM)

Ultra Low Noise TWT and the Impact of the Low Noise Transistors in 1969—J. Norman Nelson, Watkins-Johnson, Palo Alto, Calif. (C.5, Wed./a.m./CM)

Circuit Theory

The Impact of Integrated Microwave Circuits on Avionics Systems—R. D. Alberts, Wright-Patterson Air Force Base, Ohio (1C.1, Mon./a.m./SN)

The Fabrication and Testing of Large Numbers of Integrated Microwave Circuits—R. H. Jackson, Texas Instruments Inc., Dallas (1C.2, Mon./a.m./SN)

Integrated Microwave Circuits for Airborne Communications Arrays—G. R. Harrison, R. C. Aucremann, Sperry Rand Corp., Clearwater, Fla. (1C.3, Mon./a.m./SN)

Technical papers are grouped in these categories:

Airborne Electronics	Medical Electronics
Antennas and Scattering Techniques	Microelectronics
Circuits	Microwaves
Circuit Theory	Military Electronics
Communications	Oceanography and Underwater Systems
Components	Power Generation and Control
Computer-Aided Design	Reliability
Computers	Sensing and Measuring
Electro-optical	Signal Processing
Engineering Education	Solid-State Devices and Theory
Industrial Electronics	Space Electronics
Lasers	System Engineering
Management	Test Equipment and Techniques
Materials and Packaging	Transportation
	Urban Technology

Communications

Modern Low Noise Microwave Technology—Michikyki Uenohara, Nippon Electric Ltd., Kawasaki, Japan (C.1, Wed./a.m./CM)

Modern Schottky Barrier Mixers in 1969—Arthur Solomon, Sylvania Semiconductor Div., Woburn, Mass. (C.2, Wed./a.m./CM)

Parametric Amplifiers and Masers in 1969—Peter Lombardo, Airborne Instruments Lab., Melville, N.Y. (C.3, Wed./a.m./CM)

Low Noise Transistors and Tunnel Diode Amplifiers in 1969—V. G. Gelnovatch, U.S. Army Electronics Command, Fort Monmouth, N.J. (C.4, Wed./a.m./CM)

Ultra Low Noise TWT and the Impact of the Low Noise Transistors in 1969—J. Norman Nelson, Watkins-Johnson, Palo Alto, Calif. (C.5, Wed./a.m./CM)

Trends and Limitations of Microwave Tubes—J. M. Osepchuk, Raytheon Research Div., Waltham, Mass. (D.1, Wed./p.m./CM)

High-Power Gridded Tubes—1968—T. E. Yingst, RCA Electron Tube Div., Lancaster, Pa. (D.2, Wed./p.m./CM)

High-Power Linear Beam Tubes—1968—Grant St. John, Raytheon MPTD, Waltham, Mass. (D.3, Wed./p.m./CM)

High-Power Crossed-Field Tubes—G. K. Farney, Varian SFD Labs., Union, N.J. (D.4, Wed./p.m./CM)

The Impact of Integrated Microwave Circuits on Avionics Systems—R. D. Alberts, Wright Patterson Air Force Base, Ohio (1C.1, Mon./a.m./SN)

Integrated Microwave Circuits for Airborne Communications Arrays—G. R. Harrison, R. C. Aucremann, Sperry Rand Corp., Clearwater, Fla. (1C.3, Mon./a.m./SN)

Information Theory: The First Ten Years—Peter Elias, M.I.T., Cambridge, Mass. (2E.1, Mon./p.m./N)

Information Theory: The Second Ten Years—R. G. Gallager, M.I.T., Cambridge, Mass. (2E.2, Mon./p.m./N)

The Influence of Information Theory on Digital Communication Systems—A. J. Viterbi, U.C.L.A., Los Angeles, Calif. (2E.3, Mon./p.m./N)

Some Current Applications of Coding to Real Burst Channels—Arthur Kohlenberg, Codex Corp., Watertown, Mass. (2E.4, Mon./p.m./N)

Some Applications of Information Theory to Other Disciplines—My-

ron Tribus, Thayer School of Engineering, Dartmouth College, Hanover, N.H. (2E.5, Mon./p.m./N)

Impact of System Technology on Health Care Delivery—C. A. Caceres, J. Landoll, National Center for Health Services, Washington, D.C. 3A.3, Tues./a.m./T)

Time Division Multiple Access for Large Users and Small—W. G. Schmidt, Communication Satellite Corp., Washington, D.C. (3E.1, Tues./a.m./N)

Data Modems with Integrated Digital Filters and Modulators—P. G. van Gerwen, P. van der Wurf, Phillips Research Lab., Eindhoven, The Netherlands (3E.2, Tues./a.m./N)

Same Frequency Repeater Techniques—Morton Parker, David Trask, Thomas Gluszcak, Raytheon Co., Sudbury, Mass. (3E.3, Tues./a.m./N)

Adaptive Equalization—Optimum and Practical Design—W. E. Coffrin, Raytheon Co., Norwood, Mass. (3E.4, Tues./a.m./N)

The Evaluation of Planetary Communication Technology—R. C. Tausworthe, Jet Propulsion Lab., Pasadena, Calif. (3E.5, Tues./a.m./N)

Issues of Spectrum Management Related to Broadcast Services: An Up-Dating on the JTAC Report on Spectrum Engineering—The Key to Progress—R. P. Gifford, General Electric Co., Lynchburg, Va. (4F.1, Tues./p.m./MH)

The Future of Wire Distribution of Radio and Television Broadcast Programs—A. S. Taylor, Taylor and Associates, Washington, D.C. (4F.2, Tues./p.m./MH)

Space Satellites for Television Relaying—W. L. Pritchard, COMSAT Labs., Washington, D.C. (4F.3, Tues./p.m./MH)

Radio and Television Broadcasting from Space Satellites—R. P. Haviland, General Electric Co., Philadelphia, Pa. (4F.4, Tues./p.m./MH)

The Influence of Solid-State Devices and Microcircuitry on Broadcast Technology—W. C. Morrison, RCA, Camden, N.J. (4F.5, Tues./p.m./MH)

Sizing Up the Problem—J. D. Blatt, Department of Transportation, Washington, D.C. (4G.1, Tues./p.m./G)

Second Generation Systems in ATC: Requirements and Approaches—L. Goldmuntz, Department of Transportation, Washington, D.C. (4G.2, Tues./p.m./G)

Controlling Ground Movement of Air Traffic—Louis Achitoff, The Port of New York Authority, N.Y. (4G.3, Tues./p.m./G)

External Electrostatic Field Systems—G. T. Gerlach, A. B. Dick Co., Chicago, Ill. (5A.1, Wed./a.m./T)

Electrographic Systems—Renn Zaphiropoulos, Varian Associates, Palo Alto, Calif. (5A.2, Wed./a.m./T)

Electrographic Systems—H. E. Clark, Xerox Corp., Rochester, N.Y. (5A.3, Wed./a.m./T)

System Concepts for Global Data Relay Via Satellite—G. R. Welti, COMSAT Corp., Washington, D.C. (5F.1, Wed./a.m./MH)

CNI—The Integrated Information Environment—J. Lazur, The MITRE Corp., Bedford, Mass. (5F.3, Wed./a.m./MH)

System Consideration for a Canadian Satellite Communication System—John Almond, Dept. of Industry (Canadian Govt.), Ottawa, Canada (5F.4, Wed./a.m./MH)

Communications and Displays—H. S. MacDonald, Bell Telephone Labs., Inc., Murray Hill, N.J. (6B.5, Wed./p.m./M)

Circuit Switched Network Management: Philosophy and Implementation—W. S. Hayward, Bell Telephone Labs., Inc., Holmdel, N.J. (6F.1, Wed./p.m./MH)

Network Control for Stored and Forward Systems—Bernard Rider, Western Union, Arlington, Va. (6F.2, Wed./p.m./MH)

MALLARD System Control—Its Need and Function—T. A. Pfeiffer, Jr., U.S. Army Electronics Command, Fort Monmouth, N.J. (6F.3, Wed./p.m./MH)

Network Control for Multiple Access Communications Satellite Systems

Guide to abbreviations

Session locations in the New York Hilton are:

G —Gramercy Suite
MH—Murray Hill Suite
M —Mercury Ballroom
N —Nassau Suite
SN —Sutton Ballroom North
SS —Sutton Ballroom South
T —Trianon Ballroom

Session location in the Coliseum is:

CM—Microwave Hall, First Mezzanine

Numerals refer to sessions and to papers in a session—for example, 8.2 is paper 2 of session 8.

The hours of the technical sessions, Monday through Thursday are: 10:00 a.m.-4:30 p.m.

—D. F. Parkhill, The MITRE Corp., Bedford, Mass. (6F.4, Wed./p.m./MH)

Communications and Scheduling in Time Shared Systems—J. C. Castle, General Electric Co., Bethesda, Md. (6F.5, Wed./p.m./MH)

Computers and Communications—What's the Problem?—D. C. Evans, University of Utah, Salt Lake City (7B.1, Thurs./a.m./M)

Research Sharing Computer Network—L. G. Roberts, Dept. of Defense, Washington, D.C. (7B.2, Thurs./a.m./M)

Communications for Interactive On-Line Computer Systems—Gerald Estrin, U.C.L.A., Los Angeles, Calif. (7B.3, Thurs./a.m./M)

Data Communication Requirements of Computer Systems—R. Kerby, IBM Corp., Research Triangle Park, N.C. (7B.4, Thurs./a.m./M)

Computers from the Communications Viewpoint—E. E. David Jr., Bell Telephone Labs., Inc., Murray Hill, N.J. (7B.5, Thurs./a.m./M)

Active Room Acoustics—J. E. Volkman, RCA Labs., Princeton, N.J. (8G.1, Thurs./p.m./G)

Disk and Magnetic Tape Recording—B. B. Bauer, CBS, Labs., Stamford, Conn. (8G.2, Thurs./p.m./G)

Speech Communication and Processing—J. L. Flanagan, Bell Telephone Labs., Inc., Murray Hill, N.J. (8G.3, Thurs./p.m./G)

Applications of Electronics to Musical Instruments—E. L. Kent, C. G. Conn Ltd., Elkhart, Ind. (8G.4, Thurs./p.m./G)

Components

Modern Schottky Barrier Mixers in 1969—Arthur Solomon, Sylvania Semiconductor Div., Woburn, Mass. (C.2, Wed./a.m./CM)

Parametric Amplifiers and Masers in 1969—Peter Lombardo, Airborne Instruments Lab., Melville, N.Y. (C.3, Wed./a.m./CM)

Low Noise Transistors and Tunnel Diode Amplifiers in 1969—V. G. Gelnovatch, U.S. Army Electronics Command, Fort Monmouth, N.J. (C.4, Wed./a.m./CM)

Ultra Low Noise TWT and the Impact of the Low Noise Transistors in 1969—J. Norman Nelson, Watkins-Johnson, Palo Alto, Calif. (C.5, Wed./a.m./CM)

Trends and Limitations of Microwave Tubes—J. M. Osepchuk, Raytheon Research Div., Waltham, Mass. (D.1, Wed./p.m./CM)

High-Power Gridded Tubes—1968—

Highlight Session: Electronically Expanding the Citizen's World (Tues./8:00-10:30 p.m./Grand Ballroom)

Session moderator: J. D. O'Connell, Director, Telecommunications Management, Special Assistant to the President.

Panelists:

J. H. Hollomon, President, University of Oklahoma and former

Assistant Secretary of Commerce for Science and Technology.
E. G. Fubini, Vice President and Group Executive, IBM Corp.
K. G. McKay, Vice President, Engineering AT&T.
J. Hillier, Executive Vice President, Research and Engineering, RCA.

T. E. Yingst, RCA Electron Tube Div., Lancaster, Pa. (D.2, Wed./p.m./CM)

High-Power Linear Beam Tubes—1968—Grant St. John, Raytheon MPTD, Waltham, Mass. (D.3, Wed./p.m./CM)

High-Power Crossed-Field Tubes—G. K. Farney, Varian SFD Labs., Union, N.J. (D.4, Wed./p.m./CM)

Principles of Self-Organization and Learning Systems—Heinz Von Foerster, University of Illinois, Urbana, Ill. (1B.1, Mon./a.m./M)

Innate Structure of Self-Organization Systems—P. H. Greene, University of Chicago, Ill.; H. L. Oestreicher, Wright-Patterson Air Force Base, Ohio (1B.2, Mon./a.m./M)

Pattern Recognition and Self-Organization—J. K. Hawkins, Robot Research, La Jolla, Calif. (1B.3, Mon./a.m./M)

Self-Organization Flight Control Systems—R. L. Barron, Adaptronics, Inc., McLean, Va. (1B.4, Mon./a.m./M)

Thyristor Converter for HVDC Transmission to Gotland—Lennart Jansson, K. E. Olsson, Erich Spicar, ASEA, Sweden (3F.1, Tues./a.m./MH)

Water Cooled Silicon Rectifiers of the Compact Type for Electrolytic Plants—H. A. Horst, Siemens A. G., Erlangen, Germany (3F.2, Tues./a.m./MH)

Thyristor Application for Electric Rolling Stock—Yoshimitsu Anoda, Izawa Shoji, Kawakami Naoue, Hitachi Ltd., Hitachi City, Japan

Thyristor AC Switch for Induction Heating Power Control and Protection—E. M. Pollard, C. W. Flairty, M. E. Hodges, J. A. Laukaitis, General Electric Co., Philadelphia, Pa. (3F.4, Tues./a.m./MH)

Materials and Component Capabilities of Thick Films—Darnall Burks, Sprague Electric Co., North Adams, Mass. (3G.2, Tues./a.m./G)

Materials and Component Capabilities of Thin Films—Leon Maissel, IBM Corp., East Fishkill, N.Y. (3G.3, Tues./a.m./G)

Simple Active RC Filters—G. H. Danielson, General Electric Co., Syracuse, N.Y. (7F.1, Thurs./a.m./MH)

The Gyrator—Active Filter Workhorse—P. R. Geffe, Westinghouse Electric Corp., Baltimore, Md. (7F.2, Thurs./a.m./MH)

Digital Filter Techniques—L. Weinberg, City College of New York, N.Y.; V. Belevitch, University of Louvain, Brussels, Belgium (7F.4, Thurs./a.m./MH)

Computer-Aided Design

Uses of Programmable Desk Calculators—John Wicklund, Harry Diamond Labs., Washington, D.C. (A.1, Tues./a.m./CM)

The Economics of Computer Access—Joseph Salerno, Data Sciences, Inc., Concord, Mass. (A.2, Tues./a.m./CM)

Why and What to Compute: Limitations, Time, Cost, Models—Nathan Sokal, Design Automation Inc., Lexington, Mass. (A.3, Tues./a.m./CM)

Computer Solution of Microwave Problems—Peter Green, Sanders Associates, Nashua, N.H. (A.4, Tues./a.m./CM)

Computers Can Help Solve Your Microwave Problems; Discussion, Questions and Answers—Chairman and Speakers (A.5, Tues./a.m./CM)

Computer Workload Evaluation as a Guide for Future Requirements—H. R. Bruijnes, Lawrence Radiation Lab., University of California, Livermore; Richard Brown, University of Illinois, Urbana (3B.1, Tues./a.m./M)

Operational Computer-Aided System and MOS LSI Design Procedures—J. Orson Field, National Cash

Our new AC Designer Line switches come in an endless variety of colors, sizes and styles.

Sure, we know you'd never order a switch with a painted body. Or a style quite like this.

But our turned-on switch helps demonstrate the customizing possibilities these new Designer Line AC switches offer. The choices just don't quit.

Three types of terminals. In 1-, 2-, 3-, and 4-pole models. With special configurations like momentary-contact and center-off.

As for the lever, pick one to your liking and we'll deliver. Our unique design permits our Distributors to supply a broad array of sizes, shapes and colors. Or have our factory build them to your

own design at a truly modest tooling cost.

Select attractive new decorator nuts, too. Two smart styles, four stock colors. Dozens of other colors on request.

But we're not playing the numbers game. Just giving you unmatched flexibility to design our new AC switches into your products. Plus capacities from low-power dry circuits up to 25 amps, and Cutler-Hammer quality you know and expect.

Write for Brochure LA-136-A217, or call your Cutler-Hammer Sales Office or Stocking Distributor. Even our off-the-shelf delivery will turn you on.



These are the building blocks that provide new flexibility in designing with Cutler-Hammer AC Designer Line Switches.

The switched-on switch



Switch
to No. 1

More than just switches:
prompt availability,
field help, innovation,
quality assurance too.

INFORMATION RETRIEVAL NUMBER 54



CUTLER-HAMMER

Milwaukee, Wisconsin 53201

- Register Co., Dayton, Ohio (6A.1, Wed./p.m./T)
- Man-Machine Test Pattern Generator—R. G. Carpenter, L. K. Lange, IBM Corp., East Fishkill, N.Y. (8B.1, Thurs./p.m./M)
- Ultra Precision Artwork Generated with a CRT Display—Wayne Huelskoetter, Joseph Kimlinger, UNIVAC, Roseville, Minn. (8B.2, Thurs./p.m./M)
- Interactive Graphics for Integrated Circuit Layout Design—Philip Hudson, Texas Instruments, Inc., Dallas (8B.3, Thurs./p.m./M)
- Interactive Computer-Aided Design of Integrated Circuits—J. A. Narad, Motorola Inc., Phoenix, Ariz. (8B.4, Thurs./p.m./M)

Computers

- Uses of Programmable Desk Calculators—John Wicklund, Harry Diamond Labs., Washington, D.C. (A.1, Tues./a.m./CM)
- The Economics of Computer Access—Joseph Salerno, Data Sciences, Inc., Concord, Mass. (A.2, Tues./a.m./CM)
- Why and What to Compute: Limitations, Time, Cost, Models—Nathan Sokal, Design Automation, Inc., Lexington, Mass. (A.3, Tues./a.m./CM)
- Computer Solution of Microwave Problems—Peter Green, Saunders Associates, Nashua, N.H. (A.4, Tues./a.m./CM)
- Computers Can Help Solve Your Microwave Problems; Discussion, Questions and Answers—Chairman and Speakers (A.5, Tues./a.m./CM)
- The Health Care Technology Program—B. D. Waxman, Research and Mental Administration, Arlington, Va. (1A.1, Mon./a.m./T)
- One View of Automation for Patient Clinical Care—G. N. Webb, R. J. Johns, Johns Hopkins Hospital, Baltimore, Md. (1A.2, Mon./a.m./T)
- Computerization of Medical Laboratory Services—W. R. Kirkham, Perth Amboy General Hospital, Perth Amboy, N.J. (1A.3, Mon./a.m./T)
- Interactive Data Handling for Multi-test Facilities—H. R. Oldfield, E. B. Rawson, H. A. Haessler, Medidata Sciences, Inc., Waltham, Mass. (1A.4, Mon./a.m./T)
- Application of On-Line Information Handling to Anesthesiology—R. G. Bartlett, Jr., D. W. Benson, Johns Hopkins Medical School, Baltimore, Md. (1A.5, Mon./a.m./T)

- Structuring Languages for Efficient Programming—E. T. Irons, Institute for Defense Analysis, Princeton, N.J. (2B.1, Mon./p.m./M)
- Improvements in Computational Power Through New Concepts in Computer Architecture—J. P. Anderson, Independent Consultant, Ambler, Pa.; E. L. Glaser, Case Western Reserve University, Cleveland, Ohio; R. A. Worsing, Control Data Corp., Minneapolis, Minn. (2B.2, Mon.&p.m./M)
- Real-Time Optical Image Processing—Michael Faiman, University of Illinois, Urbana (5C.3, Wed./a.m./SN)
- Holographic Data Storage—John La Macchia, Bell Telephone Labs, Inc., Murray Hill, N.J. (5C.4, Wed./a.m./SN)
- Enhancement of DC and AF Precision Measurements by Computer—J. C. Riley, Electro Scientific Industries, Inc., Beaverton, Ore. (5E.1, Wed./a.m./N)
- A 3700-4200 MHz Computer Controlled Measurement System for Loss, Phase, Envelope Delay and Reflection—D. Leeds, Bell Telephone Labs., Inc., Holmdel, N.J. (5E.2, Wed./a.m./N)
- Experience and Status of Computer Test Equipment Systems in DOD/NASA—D. M. Goodman, School of Engineering and Science, New York University, N.Y. (5E.3, Wed./a.m./N)
- Use of Computers with Factory Test Equipment—S. N. Levy, RCA, Camden, N.J. (5E.4, Wed./a.m./N)
- Semiconductor Memories—Device Aspects—G. E. Moore, Intel Corp., Mountain View, Calif. (5G.1, Wed./a.m./G)
- Monolithic Memory—Progress and Potential—J. A. Ayling, IBM Components Div., Poughkeepsie, N.Y.; Benjamin Agusta, IBM Components Div., Essex Junction, Vt. (5G.2, Wed./a.m./G)
- P-Channel IGFET Memories—E. J. Alexander, Bell Telephone Labs., Inc., Allentown, Pa. (5G.3, Wed./a.m./G)
- Complementary MOSFET Memories—G. B. Herzog, RCA, Princeton, N.J. (5G.4, Wed./a.m./G)
- The Systems Approach to the Design of Magnetic Tape Equipment—W. B. Phillips, IBM Corp., Boulder, Colo. (6B.1, Wed./p.m./M)
- Electromechanical Actuators for Computer Peripherals—G. C. Newton, M.I.T., Cambridge, Mass. (6B.2, Wed./p.m./M)
- Problems in the Evaluation of Tape-Head Dynamics—F. R. Hertrich, IBM Corp., Boulder, Colo. (6B.3, Wed./p.m./M)

- Applying a Low-Cost Graphics Display—J. E. Ward, M.I.T., Cambridge, Mass. (6B.4, Wed./p.m./M)
- Communications and Displays—H. S. MacDonald, Bell Telephone Labs., Inc., Murray Hill, N.J. (6B.5, Wed./p.m./M)
- Communications and Scheduling in Time Shared Systems—J. C. Castle, General Electric Co., Bethesda, Md. (6F5, Wed./p.m./MH)
- Computerized Process Control in the Manufacture of Hybrid Circuits—A. W. Gellert, RCA, Camden, N.J. (7A.1, Thurs./a.m./T)
- Computers and Communications—What's the Problem?—D. C. Evans, University of Utah, Salt Lake City (7B.1, Thurs./a.m./M)
- Research Sharing Computer Network—L. G. Roberts, Department of Defense, Washington, D.C. (7B.2, Thurs./a.m./M)
- Communications for Interactive On-Line Computer Systems—Gerald Estrin, U.C.L.A., Los Angeles, Calif. (7B.3, Thurs./a.m./M)
- Data Communication Requirements of Computer Systems—R. Kerby, IBM Corp., Research Triangle Park, N.C. (7B.4, Thurs./a.m./M)
- Computers from the Communications Viewpoint—E. E. David, Bell Telephone Labs., Inc., Murray Hill, N.J. (7B.5, Thurs./a.m./M)
- Man-Machine Test Pattern Generator—R. G. Carpenter, IBM Corp., East Fishkill, N.Y. (8B.1, Thurs./p.m./M)
- Ultra Precision Artwork Generated with a CRT Display—Wayne Huelskoetter, Joseph Kimlinger, UNIVAC, Roseville, Minn. (8B.2, Thurs./p.m./M)
- Interactive Graphics for Integrated Circuit Layout Design—Philip Hudson, Texas Instruments, Inc., Dallas (8B.3, Thurs./p.m./M)
- Interactive Computer-Aided Design of Integrated Circuits—J. A. Narud, Motorola Inc., Phoenix, Ariz. (8B.4, Thurs./p.m./M)

Electro-Optical

- Interaction Between Light and Sound: An Introduction—Robert Adler, Zenith Radio Corp., Chicago, Ill. (1G.1/Mon./a.m./G)
- Acoustical Holography—A. F. Methereil, McDonnell Douglas Advanced Research Labs., Huntington Beach, Calif. (1G.2/Mon./a.m./G)
- The Study of Liquids and Glasses by Light Scattering—C. J. Montrose, Catholic University of America,

A black cable assembly is draped over a wooden hanger. The cable has several connectors, including a large circular one and a smaller one with a threaded cap. A white tag is attached to the cable with the text "Alterations slightly more." printed on it. The background is a plain, light-colored wall.

**Alterations
slightly
more.**

But our customers wouldn't have it any other way. Tailoring a cable assembly to individual needs assures you of performance equal to the task.

For instance, we built a harness with a 30-minute life expectancy in one mission and another to stay reliable over extended storage periods of 3 to 5 years.

There were lots of other special cable assemblies, too: a miniature one for a plug-in communications system; a large, complex umbilical; cable assemblies resistant to high or low temperatures and corrosion hazards like ozone, salt water, chemicals, jet and rocket fuel; EMI, RFI and EMP shielded cable assemblies.

We even simplified one for a customer through value engineering—from 3 separate cable assemblies to one master harness like the one above that reduced overall cost and improved reliability.

If you need a cable assembly tailored to your needs, write or call Bennett Brachman for a fitting. Amphenol Space and Missile Systems, Amphenol Connector Division, Chatsworth, California 91311. (213) 341-0710. See us at IEEE, Booths 3F11-15.



AMPHENOL

THE BUNKER-RAMO CORPORATION

Special Microwave Presentations Coliseum, Microwave Hall, First Mezzanine

Session A. Computers Can Help Solve Your Microwave Problems Tuesday, March 25, 10:30 A.M.-1:00 P.M.

Uses of Programmable Desk Calculators, J. Wicklund, Harry Diamond Labs., Washington, D.C.
The Economics of Computer Access, J. Salerno, Data Sciences, Inc., Concord, Mass.
Why and What to Compute: Limitations, Time, Cost, Models, N. Sokal, Design Automation, Inc., Lexington, Mass.
Computer Solution of Microwave Problems; Discussion, Questions and Answers, Chairman and Speakers.

Session B. Microwave Reflectometry Tuesday, March 25, 2:30 P.M.
Band-Pass Time-Domain Re-

flectometer, C. E. Muehe, M.I.T. Lincoln, Lab., Lexington, Mass.
Recent Developments in Time-Domain Reflectometry, J. L. Johnson, The Hewlett-Packard Co., Colorado Springs, Colo.
A New Frequency-Domain Reflectometer Provides High-Accuracy for Sweep Measurements in Coax., T. E. MacKenzie, General Radio Co., Boston, Mass.

Session C. Low Noise Receivers Wednesday, March 26, 10:30 A.M.

Modern Low Noise Microwave Technology, M. Uenohara, Nippon Electric Ltd., Kawasaki, Japan.
Modern Schottky Barrier Mixers in 1969, A. Solomon, Sylvania Semiconductor Div., Woburn, Mass.
Parametric Amplifiers and Masers in 1969, P. Lombardo, Airborne

Instruments Lab., Melville, N.Y.
Low Noise Transistors and Tunnel Diode Amplifiers in 1969, V. G. Gelnovatch, Ft. Monmouth, N.J.
Ultra Low Noise TWT and the Impact of the Low Noise Transistors in 1969, J. Norman Nelson, Watkins-Johnson, Palo Alto, Calif.

Session D. High Power Microwave Tubes Wednesday, March 26, 2:30 P.M.

Trends and Limitations of Microwave Tubes, J.M. Osepchuk, Raytheon Co., Waltham, Mass.
High-Power Gridded Tubes—1968, T.E. Yingst, RCA, Lancaster, Pa.
High-Power Crossed-Field Tubes—1968, Grant St. John, Raytheon, Waltham, Mass.
High-Power Cross-Field Tubes—G.K. Farney, Varian SFD Labs., Union, N.J.

Washington, D. C. (1G.3/Mon./a.m./G)

Optical Modulation by Acoustoelectric Domains in Piezoelectric Semiconductors—Ralph Bray, D. L. Spears, Purdue University, Lafayette, Ind. (1G.4/Mon./a.m./G)

Acousto-Optical Approaches to Radar Information Processing—W. T. Maloney, Sperry Rand Research Center, Sudbury, Mass (1G.5/Mon./a.m./G)

Applications of Holography to Microscopy and Ophthalmology—Raoul Van Ligten, American Optical Corp., Framingham, Mass (5C.1/Wed./a.m./SN)

Scanning Laser Beam Imaging and Display—B. J. Thompson, University of Rochester, N. Y. (5C.2/Wed./a.m./SN)

Real-Time Optical Image Processing—Michael Faiman, University of Illinois, Urbana, Ill. (5C.3/Wed./a.m./SN)

Holographic Data Storage—John La Macchia, Bell Telephone Labs., Inc., Murray Hill, N. J. (5C.4/Wed./a.m./SN)

Engineering Education

Panelists: What Edge Does Formal Engineering Management Offer?—R. I. Cole, The American University, Washington, D.C. (4B.1, Tues./p.m./M)

Is Technical Proficiency a Prerequisite for Engineering Management?—L. A. deRosa, Philco-Ford Corp., Philadelphia, Pa. (4B.2, Tues./p.m./M)

Formal Managerial Training: A Requirement for Managerial Positions—S. W. Cochran, RCA, Princeton, N.J.; D. K. Chinlund, Western Electric Co., Atlanta, Ga. (4B.3, Tues./p.m./M)

Industrial Electronics

AC Propulsion Capabilities and Comparisons—D. R. Scholtes, The Louis Allis Co., Greendale, Wis. (1F.2, Mon./a.m./MH)

Automatic Train Control for Transit Expressway—G. M. Thorne-Booth, R. H. Perry, Westinghouse Electric Corp., East Pittsburgh, Pa. (1F.3, Mon./a.m./MH)

The Future of Electric Motor Traction Systems—K. L. Lawson, Dept. of Commerce, Washington, D.C. (1F.5, Mon./a.m./MH)

Industrial Lasers and Applications—K. B. Steinbruegge, L.A.C. Weaver, W. N. Platte, Westinghouse Research Labs., Pittsburgh, Pa. (3C.1, Tues./a.m./SN)

Thyristor Converter for HVDC Transmission to Gotland—Lennart Jansson, K. E. Olsson, Erich Spicar, ASEA, Sweden (3F.1, Tues./a.m./MH)

Water Cooled Silicon Rectifiers of the Compact Type for Electrolytic

Plants—H. A. Horst, Siemens A. G., Erlangen, Germany (3F.2, Tues./a.m./MH)

Thyristor Application for Electric Rolling Stock—Yoshimitsu Onoda, Izawa Shoji, Kawakami Naoe, Hitachi Ltd., Hitachi City, Japan (3F.3, Tues./a.m./MH)

Thyristor AC Switch for Induction Heating Power Control and Protection—E. M. Pollard, C. W. Flairty, M. E. Hodges, J. A. Laukalis, General Electric Co., Philadelphia, Pa. (3F.4, Tues./a.m./MH)

Power Thyristor High Frequency Limits—R. L. Davies, General Electric Co., Auburn, N.Y. (4D.1, Tues./p.m./SS)

Laminated Overlay Power Structures—A New Technological Approach to High Frequency-High Power—R. Amantea, H. W. Becke, J. P. White, RCA, Somerville, N.J. (4D.2, Tues./p.m./SS)

RSR—A New High Power Solid State Switch—P. Mlynar, J. Phillips, Westinghouse Electric Corp., Youngwood, Pa. (4D.3, Tues./p.m./SS)

High Voltage, High Temperature P-N-P-N Inverter Switch—R. A. Kokosa, General Electric Co., Auburn, N.Y. (4D.4, Tues./p.m./SS)

An Ultra-High Power Zener Diode—J. E. Reynolds, General Motors Corp., Kokomo, Ind. (4D.5, Tues./p.m./SS)

Thick Film Circuits in Power Control—R. W. Nolan, A. W. Winkley,

A sampling

Category	Type	Description	Experience
Discrettes	HRN1030	General Purpose, Insulated Gate, Switch	4 years
	HRN8318D	General Purpose, Gate Diode Protected, Switch	4 years
Multiplexers	HRM8014D	General Purpose Quad, Gate Diode Protected	3 years
	HRM2206	8-Channel Switch, Gate Diode Protected	2 years
D-A & A-D Converters	HRM8013	4-Channel Multiplexer with Drive Logic	3 years
	HRM8068 HRM2302	Dual DPDT Analog Switch with Drive Logic A/D and D/A Converter Elements	3 years 2 years
Counters	HRM F/2	Low Cost Frequency Divider	1 year
	HRM2034	Seven Stage Binary Counter	2 months
Combinational Logic	HRM2304	Triple 3 Input, Dual 2 Input NOR Gates	2 years
Shift Registers	HRM2026	Dual 2 ϕ 25 Bit Shift Register	3 months
Arithmetic	HRM2032	Differential Digital Analyzer	new

THE TOMORROW MOSFETS. TOMORROW.

We call our line "The Tomorrow MOSFETS" because they have features that, someday, all MOSFETS will probably have.

Features like lower threshold voltage with the ability to operate at higher voltage levels; lower channel resistance; and the lowest $1/f$ noise in the industry.

These features result in more design freedom, in faster operating speeds, in lower power consumption, and in the elimination of level translators.

But there's another reason we call them The Tomorrow MOSFETS.

They're built for tomorrow. The longer they're used, the more applications they find.

You can see from the sampling up above that the oldies are still the goodies.

And that's just a sample. We have more where those came from.

Write Hughes, MOSFETS, 500 Superior Ave., Newport Beach, Calif. 92663. Phone (714) 548-0671. TWX (714) 642-1353.



Joseph Lucas Electrical Ltd., Birmingham, England (4D.6, Tues./p.m./SS)

Use of Computers with Factory Test Equipment—S. N. Levy, RCA, Camden, N.J. (5E., Wed./a.m./N)

U.S.S.R. Power Systems Today: Which Way Are They Heading?—J. J. O'Connor, McGraw-Hill, Inc., New York, N.Y. (6C.1, Wed./p.m./SN)

How We Look Upon Systems Reliability—L. S. Lindorf, A. M. Nekrasov, U.S.S.R., Presented by W. J. Neiswender, Sr., Western Electric Co., Inc., Princeton, N.J. (6C.2, Wed./p.m./SN)

Reliability Insurance: When Is It Practical?—W. A. Weddendorf, Multi-Amp Corp., Cranford, N.J. (6C.3, Wed./p.m./SN)

Improved Reliability by an Industrial and Utility Interconnection—F. P. Sener, The Cleveland Electric Illuminating Co., Ohio; A. M. Killin, Ashtabula, Ohio (6C.4, Wed./p.m./SN)

Computerized Process Control in the Manufacture of Hybrid Circuits—A. W. Gellert, RCA, Camden, N.J. (7A.1, Thurs./a.m./T)

The Impact of Microelectronics on Manufacturing Logistics—E. F. Shepter, IBM Corp., Endicott, N.Y. (7A.2, Thurs./a.m./T)

Microelectronics Impact on the Manufacture of Telephone Equipment—C. C. Crain, Western Electric Co., Indianapolis, Ind. (7A.3, Thurs./a.m./T)

Hybrid Microelectronics as Used in the Manufacture of Special High Reliability Systems—J. R. Frisora, Space and Tactical Systems Corp., Burlington, Mass. (7A.4, Thurs./a.m./T)

Impact of Microelectronics on the Manufacture of Avionic Systems—J. C. Murtha, J. R. Hudson, Westinghouse Electric Corp., Baltimore, Md. (7A.5, Thurs./a.m./T)

Lasers

Interaction Between Light and Sound: An Introduction—Robert Adler, Zenith Radio Corp., Chicago, Ill. (1G.1/Mon./a.m./G)

Acoustical Holography—A. F. Methereil, McDonnell Douglas Advanced Research Labs., Huntington Beach, Calif. (1G.2/Mon./a.m./G)

The Study of Liquids and Glasses by Light Scattering—C. J. Montrose, Catholic University of America, Washington, D. C. (1G.3/Mon./a.m./G)

Optical Modulation by Acoustoelectric Domains in Piezoelectric Semi-

conductors—Ralph Bray, D. L. Spears, Purdue University, Lafayette, Ind. (1G.4/Mon./a.m./G)

Acousto-Optical Approaches to Radar Information Processing—W. T. Maloney, Sperry Rand Research Center, Sudbury, Mass. (1G.5/Mon./a.m./G)

Industrial Lasers and Applications—K. B. Steinbruegge, L. A. C. Weaver, W. N. Platte, Westinghouse Research Labs., Pittsburgh, Pa. (3C.1/Tues./a.m./SN)

A Review of Laser Machining of Integrated Circuits—M. I. Cohen, Bell Telephone Labs., Inc., Murray Hill, N. J. (3C.2/Tues./a.m./SN)

The Application of the CO₂ Laser to Cutting Ceramic Substrates—J. Longfellow, D. J. Oberholzer, Western Electric Co., Princeton, N.J. (3C.3/Tues./a.m./SN)

Semiconductor Component Fabrication Using Lasers—H. Brent Mount, W. A. Murray, Texas Instruments, Inc., Dallas, Texas (3C.4/Tues./a.m./SN)

Pulsed Laser Welding of Transistor and Other Electronic Component Parts—F. P. Gagliano, Western Electric Co., Princeton, N. J.; D. H. Lockhart, Western Electric Co., Redding, Pa. (3C.5/Tues./a.m./SN)

LIDAR—R. T. H. Collis, Stanford Research Institute, Menlo Park, Calif. (4C.1/Tues./p.m./nN)

Hologram Systems for Particle Size Analysis—J. H. Ward, Technical Operations, Inc., Burlington, Mass. (4C.2/Tues./p.m./SN)

Laser Recording Applications—D. J. Woywood, RCA, Camden, N. J. (4C.3/Tues./p.m./SN)

Laser Metrology—Sheldon Minkowitz, Perkin-Elmer Corp., Wilton, Conn. (4C.4/Tues./p.m./SN)

Application of Holography to Microscopy and Ophthalmology—Raoul Van Ligten, American Optical Corp., Framingham, Mass. (5C.1/Wed./a.m./SN)

Scanning Laser Beam Imaging and Display—B. J. Thompson, University of Rochester, N. Y. (5C.2/Wed./a.m./SN)

Real-Time Optical Image Processing—Michael Faiman, University of Illinois, Urbana, Ill. (5C.3/Wed./a.m./SN)

Holographic Data Storage—John La Macchia, Bell Telephone Labs., Inc., Murray Hill, N. J. (5C.4/Wed./a.m./SN)

Management

Panelists: What Edge Does Formal Engineering Management Offer?—

R. I. Cole, The American University, Washington, D.C. (4B.1, Tues./p.m./M)

Is Technical Proficiency a Prerequisite for Engineering Management?—L. A. deRosa, Philco-Ford Corp., Philadelphia, Pa. (4B.2, Tues./p.m./M)

Formal Managerial Training: A Requirement for Managerial Positions—S. W. Cochran, RCA, Princeton, N.J.; D. K. Chinlund, Western Electric Co., Atlanta, Ga. (4B.3, Tues./p.m./M)

Materials and Packaging

Interaction Between Light and Sound: An Introduction—Robert Adler, Zenith Radio Corp., Chicago, Ill. (1G.1, Mon./a.m./G)

The Study of Liquids and Glasses by Light Scattering—C. J. Montrose, Catholic University of America, Washington, D.C. (1G.3, Mon./a.m./G)

Lasers for Submillimeter Wave—P. D. Coleman, University of Illinois, Urbana (2G.1, Mon./p.m./G)

The Potential of Semiconductors for Millimeter or Submillimeter Wave Generation—J. A. Copeland, Bell Telephone Labs., Inc., Murray Hill, N.J. (2 G.2, Mon./p.m./G)

Detectors, Thermal and Free Carrier—Frank Arams, Airborne Instrument Labs., Melville, N.Y. (2G.3, Mon./p.m./G)

Cryogenic Devices—Kenneth Rose, Rensselaer Polytechnic Institute, Troy, N.Y. (2G.4, Mon./p.m./G)

Nonlinear Effects and Harmonic Mixing—L. O. Hocker, M.I.T., Cambridge, Mass. (2G.5, Mon./p.m./G)

Introduction of the Subjects—R. E. Thun, Raytheon Co., Bedford, Mass. (3G.1, Tues./a.m./G)

Materials and Component Capabilities of Thick Films—Darnall Burks, Sprague Electric Co., North Adams, Mass. (3G.2, Tues./a.m./G)

Materials and Component Capabilities of Thin Films—Leon Maissel, IBM Corp., East Fishkill, N.Y. (3G.3, Tues./a.m./G)

Application of Thick Films to Microelectronics—Morton Topfer, Bell Telephone Labs., Inc., Murray Hill, N.J. (3G.4, Tues./a.m./G)

Application of Thin Films to Microelectronics—David Feldman, Bell Telephone Labs., Inc., Murray Hill, N.J. (3G.5, Tues./a.m./G)

Infrared Transmitting Glasses—R. E. Johnson, C. E. Jones, Texas In-



Optima enclosures...

For information, call or write,
Optima, Box 13654,
Atlanta, Georgia, 30324
Telephone 404-938-2930

A product of
Scientific-Atlanta

- struments, Inc., Dallas (6G.1, Wed./p.m./G)
- Ovonic Components and Their Applications—D. L. Nelson, S. R. Ovshinsky, Energy Conversion Devices, Inc., Troy, Mich. (6G.2, Wed./p.m./G)
- Glass Lasers—Elias Snitzer, American Optical Co., Southbridge, Mass. (6G.3, Wed./p.m./G)
- Electron Multiplication Devices Based on Glass—Dominic Ruggieri, Floyd Jensen, J. T. Doherty, Varian Associates, Palo Alto, Calif. (6G.4, Wed/p.m./G)
- Crystallizable Thick Film Dielectrics—L. C. Hoffman, E. I. du Pont de Nemours & Co., Wilmington, Del. (6G.5, Wed./p.m./G)
- Precipitation of Ferrites from Glasses and Their Properties—Robert Steinitz, General Telephone and Electronics Labs., Bayside, N.Y. (6G.6/Wed./p.m./G)
- Contributions of Mechanics and Chemistry to Electronic Design—G. Reethof, Pennsylvania State University, Pa. (7E.3/Thur./a.m./N)
- The Effects of Radiation on Material and Device Parameters—O. L. Curtis, Northrop Corporate Labs., Hawthorne, Calif. (7G.1/Thur./a.m./G)
- The Radiation Tolerance of Today's Semiconductor Devices—J. G. Aiken, J. S. Crabbe, W. T. Matzen, Texas Instruments, Dallas, Texas (7G.2/Thur./a.m./G)
- Defect Annealing in Irradiated Devices—B. L. Gregory, H. H. Sander, Sandia Lab., Albuquerque, N.M. (7G.3/Thur./a.m./G)
- The Effects of Ionizing Radiation in Junction Semiconductor Devices—D. J. Fitzgerald, Fairchild Semiconductor, Palo Alto, Calif. (7G.4/Thur./a.m./G)
- The Radiation Tolerance of MOS Devices—C. W. Gwyn, Sandia Lab., Albuquerque, N.M. (7G.5/Thur./a.m./G)

Medical Electronics

- The Health Care Technology Program—B. D. Waxman, Research and Mental Administration, Arlington, Va. (1A.1/Mon./a.m./T)
- One View of Automation for Patient Clinical Care—G. N. Webb, R. J. Johns, Johns Hopkins Hospital, Baltimore, Md. (1A.2/Mon./a.m./T)
- Computerization of Medical Laboratory Services—W. R. Kirkham, Perth Amboy General Hospital, Perth Amboy, N. J. (1A.3/Mon./a.m./T)

Interactive Data Handling for Multi-test Facilities—H. R. Oldfield, E. B. Rawson, H. A. Haessler, Medidata Sciences, Inc., Waltham, Mass. (1A.4/Mon./a.m./T)

Application of On-Line Information Handling to Anesthesiology—R. G. Bartlett, IBM Corp., Bethesda; D. W. Benson, Johns Hopkins Medical School, Baltimore, Md. (1A.5/Mon./a.m./T)

An Introduction to Problems of Sensory Aids for the Blind—L. D. Harmon, Bell Telephone Labs., Inc., Murray Hill, N. J. (2D.1/Mon./p.m./SS)

Mobility Aids for the Blind—Environmental Detection, Information Processing, and Substitute Sensory Modality Display—R. W. Mann, M.I.T., Cambridge, Mass. (2D.2/Mon./p.m./SS)

Human Factors Underlying the Design of Reading Aids for the Blind—P. W. Nye, California Institute of Technology, Pasadena, Calif. (2D.3/Mon./p.m./SS)

An Introduction to Problems of Sensory Aids for the Deaf—Peter Denes, Bell Telephone Labs., Inc., Murray Hill, N. J. (2D.4/Mon./p.m./SS)

Speech Communication Aids and Residual Auditory Capacity—J. M. Pickett, Gallaudet College, Washington, D. C. (2D.5/Mon./p.m./SS)

The Impact of System Technology on Education—A. Barber, Institute for Politics and Planning, Arlington, Va. (3A.2/Tues./a.m./T)

X rays and Electronic Imaging—M. M. Ter-Pogossian, Washington University, St. Louis, Mo. (3D.1/Tues./a.m./SS)

Ultrasonic Visualization—W. F. Konig, Jr., Riverside Research Institute, New York, N. Y. (3D.2/Tues./a.m./SS)

Radionuclid Scanning—David Kuhl, Hospital of the University, New York, N. Y. (3D.3/Tues./a.m./SS)

Scanning Electron Microscopy—T. L. Hayes, University of California, Berkeley, California (3D.4/Tues./a.m./SS)

Microelectronics

The Impact of Integrated Microwave Circuits on Avionics Systems, R. D. Alberts, Wright-Patterson Air Force Base, Ohio (1C.1/Mon./a.m./SN)

The Fabrication and Testing of Large Numbers of Integrated Microwave Circuits—R. J. Jackson, Texas Instruments, Inc., Dallas, Texas (1C.2/Mon./a.m./SN)

Integrated Microwave Circuits for Airborne Communications Arrays—G. R. Harrison, R. C. Aucremann, Sperry Rand Corp., Clearwater, Fla. (1C.3/Mon./a.m./SN)

The Make or Buy Decision in an Emerging Technology—M. Aarons, Sanders Associates, Nashua, N. H. (1C.4/Mon./a.m./SN)

The Influence of Innovation on Microwave Integration—Gene Strull, Westinghouse Electric Corp., Baltimore, Md. (1C.5/Mon./a.m./SN)

Introduction to the Subjects—R. E. Thun, Raytheon Co., Bedford, Mass. (3G.1/Tues./a.m./G)

Materials and Component Capabilities of Thick Films—Darnall Burks, Sprague Electric Co., North Adams, Mass. (3G.2/Tues./a.m./G)

Materials and Component Capabilities of Thin Films—Leon Maisse, IBM Corp., East Fishkill, N. Y. (3G.3/Tues./a.m./G)

Application of Thick Films to Microelectronics—Morton Topfer, Bell Telephone Labs., Inc., Murray Hill, N. J. (3G.4/Tues./a.m./G)

Application of Thin Films to Microelectronics—David Feldman, Bell Telephone Labs., Inc., Murray Hill, N. J. (3G.5/Tues./a.m./G)

Thick Film Circuits in Power Control—R. W. Nolan, A. W. Winkley, Joseph Lucas Electrical Ltd., Birmingham, England (4D.6/Tues./p.m./SS)

The Influence of Solid State Devices and Microcircuitry on Broadcast Technology—W. C. Morrison, RCA, Camden, N. J. (4F.5/Tues./p.m./MH)

Semiconductor Memories-Device Aspects—G. E. Moore, Intel Corp., Mountain View, Calif. (5G.1/Wed./a.m./G)

Monolithic Memory-Progress and Potential—J. A. Ayling, IBM Components Div., Poughkeepsie, N. Y.; Benjamin Agusta, IBM Components Div., Essex Junction, Vt. (5G.2/Wed./a.m./G)

P-Channel IGFET Memories—E. J. Alexander, Bell Telephone Labs., Inc., Allentown, Pa. (5G.3/Wed./a.m./G)

Complementary MOSFET Memories—G. B. Herzog, RCA, Princeton, N. J. (5G.4/Wed./a.m./G)

Operational Computer-Aided System and MOS LSI Design Procedures—J. Orson Field, National Cash Register Co., Dayton, Ohio (6A.1/Wed./p.m./T)

Array Processing and Large Scale Integration—J. O. Campeau, Litton Systems, Woodland Hills, Calif. (6A.2/Wed./p.m./T)

The LIMAC-An LSI Demonstration Vehicle—G. B. Herzog, RCA, Princeton, N. J. (6A.3/Wed./p.m./T)

LSI in Use-The Practical Approach—W. E. Wickes, Texas Instruments, Inc., Dallas Texas (6A.4/Wed./a.m./T)

Computerized Process Control in the Manufacture of Hybrid Circuits—A. W. Gellert, RCA, Camden, N. J. (7A.1/Thur./a.m./T)

The Impact of Microelectronics on Manufacturing Logistics—E. F. Shepter, IBM Corp., Endicott, N. Y. (7A.2/Thur./a.m./T)

Microelectronics Impact on the Manufacture of Telephone Equipment—C. C. Crain, Western Electric Co., Indianapolis, Ind. (7A.3/Thur./a.m./T)

Hybrid Microelectronics as Used in the Manufacture of Special High Reliability Systems—J. R. Frisora, Space & Tactical Systems Corp., Burlington, Mass. (7A.4/Thur./a.m./T)

Impact of Microelectronics on the Manufacture of Avionic Systems—J. C. Murtha, J. R. Hudson, Westinghouse Electric Corp., Baltimore, Md. (7A.5/Thur./a.m./T)

Design of Linear Active Integrated Circuits—R. W. Newcomb, Stanford University, Calif. (7F.3/Thur./a.m./MH)

The Radiation Tolerance of Today's Semiconductor Devices—J. G. Aiken, J. S. Crabbe, W. T. Matzen, Texas Instruments, Inc., Dallas, Texas (7G.2/Thur./a.m./G)

The Radiation Tolerance of MOS Devices—C. W. Gwyn, Sandia Lab., Albuquerque, N. M. (7G.5/Thur./a.m./G)

Interactive Graphics for Integrated Circuit Layout Design—Philip Hudson, Texas Instruments, Inc., Dallas, Texas (8B.3/Thur./p.m./M)

Interactive Computer-Aided Design of Integrated Circuits—J. A. Narud, Motorola Inc., Phoenix, Ariz. (8B.4/Thur./p.m./M)

Microwaves

Uses of Programmable Desk Calculators—John Wicklund, Harry Diamond Labs., Washington, D. C. (A1/Tues./a.m./CM)

The Economics of Computer Access—Joseph Salerno, Data Sciences, Inc., Concord, Mass. (A2/Tues./a.m./CM)

Why and What to Compute: Limitations, Time, Cost, Models—Nathan Sokal, Design Automation, Inc., Lexington, Mass. (A3/Tues./a.m./CM)

The 100,000,000,000 ohm Nanosecond Switch



Model MCD 1 shown actual size

This new photodiode coupled pair offers the designer 5 ns rise and fall times together with over 3,000 volts isolation between input and output. The IR emitter and companion detector are optically coupled through clear epoxy—as seen here. The unit is then encased in opaque epoxy for

maximum dark resistance. It's ideal for high speed isolated switching and high voltage isolation

For additional information and applications write or call Monsanto Electronic Special Products, 10131 Bubb Road, Cupertino, Ca. 95014 (408) 257-2140.

Monsanto

INFORMATION RETRIEVAL NUMBER 58

Computer Solution of Microwave Problems—Peter Green, Sanders Associates, Nashua, N.H. (A4/CM)

Computers Can Help Solve Your Microwave Problems; Discussion, Questions, Answers—W. J. Getzinger, M. I. T. Lincoln Lab., Lexington, Mass. et.al. (A4/Tues./a.m./CM)

Band-Pass Time-Domain Reflectometry—C. E. Muehe, M. I. T. Lincoln Lab., Lexington, Mass. (B1/Tues./p.m./CM)

Recent Developments in Time-Domain Reflectometry—J. L. Johnson, The Hewlett-Packard Co., Colorado Springs, Colo. (B2/Tues./p.m./CM)

A New Frequency-Domain Reflectometer Provides High-Accuracy for Sweep Measurements in Coax—T. E. MacKenzie, General Radio Co., Bolton, Mass. (B3/Tues./p.m./CM)

Modern Low Noise Microwave Technology—Michikyki Uenohara, Nippon Electric Ltd., Kawasaki, Japan (C1/Wed./a.m./CM)

Modern Schottky Barrier Mixers in 1969—Arthur Solomon, Sylvania Semiconductor Div., Woburn, Mass. (C2/Wed./a.m./CM)

Parametric Amplifiers and Masers in 1969—Peter Lombardo, Airborne Instruments Lab., Melville, N. Y. (C3/Wed./a.m./CM)

Low Noise Transistors and Tunnel Diode Amplifiers in 1969—V. G. Gelnovatch, U. S. Army Electronics Command, Fort Monmouth, N. J. (C4/Wed./a.m./CM)

Ultra Low Noise TWT and the Impact of the Low Noise Transistors in 1969—J. Norman Nelson, Watkins-Johnson, Palo Alto, Calif. (C5/Wed./a.m./CM)

Trends and Limitations of Microwave Tubes—J. M. Osepchuk, Raytheon Research Div., Waltham, Mass. (D4/Wed./p.m./CM)

High-Power Gridded Tubes-1968—T. E. Yingst, RCA Electron Tube Div., Lancaster, Pa. (D2/Wed./p.m./CM)

High-Power Linear Beam Tubes-1968—Grant St. John, Raytheon MPTD, Waltham, Mass. (D3/Wed./p.m./CM)

High-Power Crossed-Field Tubes—G. K. Farney, Varian SFD Labs, Union, N. J. (D4/Wed./p.m./CM)

The Impact of Integrated Microwave Circuits on Avionics Systems—R. D. Alberts, Wright-Patterson Air Force Base, Ohio (1C.1/Mon./a.m./SN)

The Fabrication and Testing of Large Numbers of Integrated Microwave Circuits—R. H. Jackson, Texas

Instruments Inc., Dallas, Texas (1C.2/Mon./a.m./SN)

Integrated Microwave Circuits for Airborne Communications Arrays—G. R. Harrison, Sperry Rand Corp., Clearwater, Fla. (1C.3/Mon./a.m./SN)

The Make or Buy Decision in an Emerging Technology—M. Aarons, Sanders Associates, Nashua, N. H. (1C.4/Mon./a.m./SN)

The Influence of Innovation on Microwave Integration—Gene Strull, Westinghouse Electric Corp., Baltimore, Md. (1C.5/Mon./a.m./SN)

Infrared Astronomy—F. J. Low, Tucson, Ariz. (1E.1/Mon./a.m./N)

Long Baseline Interferometry—M. H. Cohen, California Institute of Technology, Pasadena, Calif. (1E.3/Mon./a.m./N)

Large Radio Telescopes—J. D. Findlay, N.R.A.O., Charlottesville, Va. (1E.4/Mon./a.m./N)

Acoustic Bulk-Wave Components for Signal Processing—Leo Young, A. J. Bahr, I. N. Court, Stanford Research Institute, Menlo Park, Calif. (2C.1/Mon./p.m./SN)

The Status and Future of Microsound Technology—J. H. Collins, Rockwell Corp., Anaheim, Calif. (2C.2/Mon./p.m./SN)

The Fabrication of Microsound Components—H. I. Smith, M. I. T. Lincoln Lab., Lexington, Mass. (2C.3/Mon./p.m./SN)

Lasers for Submillimeter Wave—P. D. Coleman, University of Illinois, Urbana, Ill. (2G.1/Mon./p.m./G)

The Potential of Semiconductors for Millimeter or Submillimeter Wave Generation—J. A. Copeland, Bell Telephone Labs., Inc., Murray Hill, N. J. (2G.2/Mon./p.m./G)

Microwave Power Transmission—D. J. Goerz, Jr., Bechtel Corp., San Francisco, Calif. (8C.4/Thur./p.m./SN)

Military Electronics

The Impact of Integrated Microwave Circuits on Avionics Systems—R. D. Alberts, Wright-Patterson Air Force Base, Ohio (1C.1/Mon./a.m./SN)

The Fabrication and Testing of Large Numbers Integrated Microwave Circuits for Airborne Communications Arrays—G. R. Harrison, R. C. Aucremann, Sperry Rand Corp., Clearwater, Fla. (1C.3/Mon./a.m./SN)

MALLARD System Control—Its Need and Function—T. A. Pfeiffer, Jr.

U. S. Army Electronics Command, Fort Monmouth, N. J. (6F.3/Wed./p.m./MH)

Oceanography and Underwater Systems

An Overview of Electronics in Oceanography—William Richardson, U. S. Naval Oceanographic Office, Washington, D. C. ((6E.1/Wed./p.m./N)

Electronics Navigation—T. J. Hickley, U. S. Coast Geodetic Survey, Rockville, Md. (6E.2/Wed./p.m./N)

Electronics Instrumentation for Temperature and Salinity—Neil Brown, Beosett-Berman Co., San Diego, Calif. (6E.3/Wed./p.m./N)

Power Generation and Control

U.S.S.R. Power Systems Today: Which Way Are They Heading?—J. J. O'Connor, McGraw-Hill, Inc., New York, N. Y. (6C.1/Wed./p.m./SN)

How We Look Upon Systems Reliability—L. S. Lindorf, A. M. Nekrasov, U.S.S.R Presented by W. J. Neiswender, Western Electric Co., Inc., Princeton, N. J. (6C.2/Wed./p.m./SN)

Reliability Insurance: When Is It Practical?—W. A. Weddendorf, Multi-Amp Corp., Cranford, N. J. (6C.3/Wed./p.m./SN)

Improved Reliability by an Industrial and Utility Interconnection—F. P. Sener, The Cleveland Electric Illuminating Co., Ohio; A. M. Killin, Consulting Engineer, Ashtabula, Ohio (6C.4/Wed./p.m./SN)

Power Generation for the Megalopolis—Alexander Kusko, Alexander Kusko, Inc., Cambridge, Mass. (7C.1/Thur./a.m./SN)

Power Transmission Systems for the Future—Walter Weeks, Purdue University, Lafayette, Ind. (7C.2/Thur./a.m./SN)

Electric Cities of the Year 2000—Edwin Vennard, Edison Electric Institute, New York, N. Y. (7C.3/Thur./a.m./SN)

Electric Systems Reliability—F. C. Scheppe, M. I. T., Cambridge, Mass.; Gerald Stillman, American Electric Power Service Corp., New York, N. Y. (7C.4/Thur./a.m./SN)

Economics of AC Overhead Transmission—H. L. Lowe, Ebasco Services, Inc., New York, N. Y. (8C.1/Thur./p.m./SN)

Now—200 μ A Turns On 4 A—@—95°C—Case SCR Power Control At Low Cost!

MCR406 — turn it on with only 200 μ A . . . to 4 A RMS . . . to 95°C . . . for only 51¢!

Designed for low-cost, high-current applications in your rugged consumer, commercial and light industrial speed, light and heat control designs, this new SCR series has "better thyristor value" written all over it:

- High, 4 A RMS operation to 95°C case temperature (75°C higher than the nearest equivalent) — less costly, simpler heat sinking and thermal design considerations are possible because of this unique, higher-current-at-higher-temperature capability.
- Low, 200 μ A triggering — economical, low-level gate triggering is afforded from photo cells, thermistors and other small signal devices without additional stages of sensor signal amplification.
- Compact, Thermopad* packaging — the only plastic SCR package furnishing the shortest—0.032"—chip-to-heat-sink thermal path and low, 2.0°C/W thermal resistance for minimum derating.
- Exclusive, Annular† construction — maximum, long-term reliability and performance stability over a —40° to 110°C operating temperature range is ensured through oxide-passivated junction protection.
- Low, 1.6-volt-@ 4-ampere-@-110°C forward voltage — a traditional Motorola SCR advantage ensuring low power loss and minimum heat generation in all designs.

Scores of high-performance, new-design application possibilities can now be turned on with this new SCR — and, you have your choice of *two* economy price ranges for the widest possible cost/performance considerations!

Series	V_{FXM}/V_{RXM} —Volts	I_F —Amps	I_{FM} (Surge) —Amps	I_{GT} (max) @ 25°C — μ A	V_{GT} (max) @ 25°C —Volts	Price, 1000-Up
MCR406	30, 60, 100, 200	4	30	200	.8	\$.51†
MCR407	30, 60, 100, 200	4	30	500	1.0	.47‡

‡30 V unit

For immediate technical data response—

Circle the reader service number below and we'll send you complete specs on the new MCR406/407 series sensitive gate SCR's . . . do it now!

For a personalized MCR406 design evaluation kit—

Write on your company letterhead specifying voltage desired — 30, 60, 100 or 200 V — and you'll receive a free device-design kit including specs and SCR ready for prototyping from one of our 64 franchised North American distributors. Send for one today!

Box 20912, Phoenix 85036

*Trademark Motorola Inc. †Annular semiconductors patented by Motorola

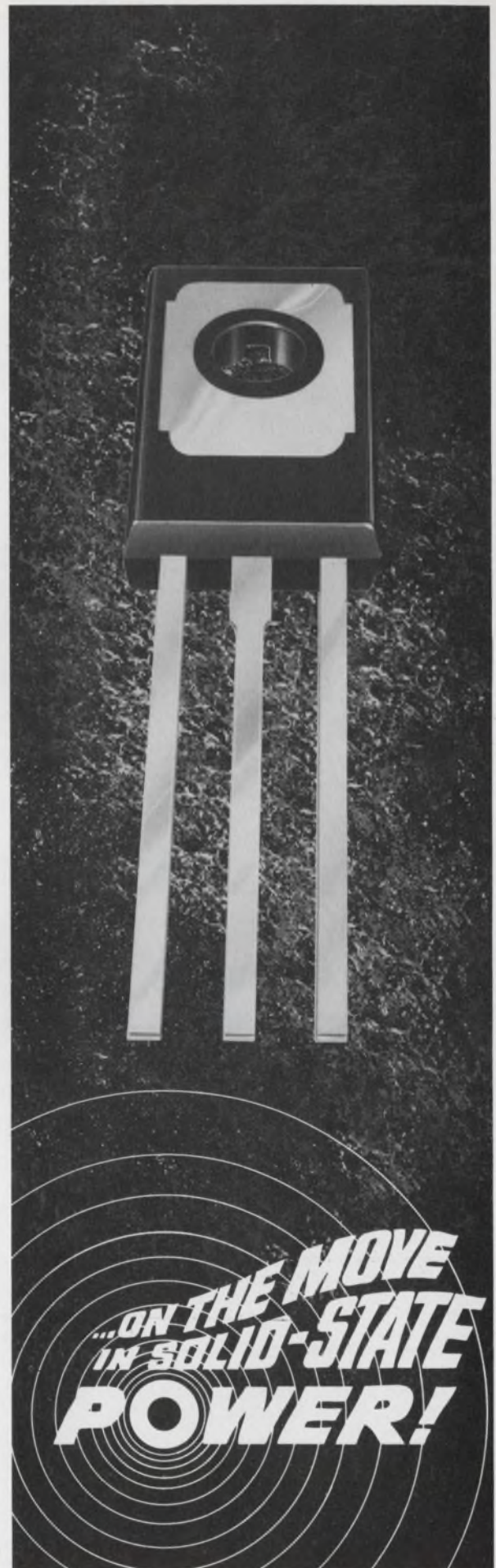

MOTOROLA
Silicon Controlled Rectifiers

INFORMATION RETRIEVAL NUMBER 59

- HVDC Transmission Applications—G. D. Breuer, General Electric Co., Schenectady, N. Y. (8C.2/Thur./p.m./SN)
- Future Developments in EHV Underground Cable—E. D. Eich, Anaconda Wire & Cable Co., Hastings-on-Hudson, N. Y. (8C.3/Thur./p.m./SN)
- Microwave Power Transmission—D. J. Goertz, Jr., Bechtel Corp., San Francisco, Calif. (8C.4/Thur./p.m./SN)
- Cryogenic Power Transmission—S. H. Minnich, General Electric Co., Schenectady, N. Y. (8C.5/Thur./p.m./SN)

Reliability

- Electric Systems Reliability—F. C. Schweppe, M.I.T., Cambridge, Mass. (7C.4/Thur./a.m./SN)
- How We Look Upon Systems Reliability—L. S. Lindorf, A. M. Nekrasov, U.S.S.R. Presented by W. J. Neiswender, Western Electric Co., Inc., Princeton, N. J. (6C.2/Wed./p.m./SN)
- Reliability Insurance: When Is It Practical?—W. A. Weddendorf, Multi-Amp Corp., Cranford, N. J. (6C.3/Wed./p.m./SN)
- Improved Reliability by an Industrial and Utility Interconnection—F. P. Sener, The Cleveland Electric Illuminating Co., Ohio; A. M. Killin, Consulting Engineer, Ashtabula, Ohio (6C.4/Wed./p.m./SN)

Sensing and Measuring

- Band-Pass Time-Domain Reflectometry—C. E. Muehe, M.I.T. Lincoln Lab., Lexington, Mass. (B1/Tues./p.m./CM)
- Recent Developments in Time-Domain Reflectometry—J. L. Johnson, The Hewlett-Packard Co., Colorado Springs, Colo. (B2/Tues./p.m./CM)
- A New Frequency-Domain Reflectometer Provides High-Accuracy for Sweep Measurements in Coax—T. E. MacKenzie, General Radio Co., Bolton, Mass. (B3/Tues./p.m./CM)
- Enhancement of DC and AF Precision Measurements by Computer—J. C. Riley, Electro Scientific Industries, Inc., Beaverton, Ore. (5E.1/Wed./a.m./N)
- A 3700-4200 MHz Computer Controlled Measurement System for Loss, Phase, Envelope Delay and Reflection—D. Leeds, Bell Telephone Labs., Inc., Holmdel, N. J. (5E.2/Wed./a.m./N)

- Experience and Status of Computer Test Equipment Systems in DOD/NASA D. M. Goodman, School of Engineering and Science, N.Y.U., New York (5E.4/Wed./a.m./N)
- Use of Computers with Factory Test Equipment—S. N. Levy, RCA, Camden, N. J. (5E.4/Wed./a.m./N)

Signal Processing

- Optical Modulation by Acoustoelectric Domains in Piezoelectric Semiconductors—Ralph Bray, D. L. Spears, Purdue University, Lafayette, Ind. (1G.4/Mon./a.m./G)
- Acousto-Optical Approaches to Radar Information Processing—W. T. Maloney, Sperry Rand Research Center, Sudbury, Mass. (1G.5/Mon./a.m./G)
- Acoustic Bulk-Wave Components for Signal Processing—Leo Young, A. J. Bahr, I. N. Court, Stanford Research Institute, Menlo Park, Calif. (2C.1/Mon./p.m./SN)
- The Status and Future of Microsound Technology—J. H. Collins, Rockwell Corp., Anaheim, Calif. (2C.2/Mon./p.m./SN)
- The Fabrication of Microsound Components—H. I. Smith, M.I.T. Lincoln Lab., Lexington, Mass. (2C.3/Mon./p.m./SN)
- Information Theory: The First Ten Years—Peter Elias, M.I.T., Cambridge, Mass. (2E.1/Mon./pm./N)
- Information Theory: The Second Ten Years—R. G. Gallager, M.I.T., Cambridge, Mass. (2E.2/Mon./p.m./N)
- The Influence of Information Theory on Digital Communication Systems—A. J. Viterbi, U.C.L.A., Los Angeles, Calif. (2E.3/Mon./p.m./N)
- Some Applications of Information Theory to Other Disciplines—Myron Tribus, Dartmouth College, Hanover, N. H. (2E.4/Mon./p.m./N)
- Time Division Multiple Access for Large Users and Small—W. G. Schmidt, Communication Satellite Corp., Washington, D. C. (3E.1/Tues./a.m./N)
- Data Modems with Integrated Digital Filters and Modulators—P. G. van Gerwen, P. van der Wurf, Phillips Research Lab., Eindhoven, The Netherlands (3E.2/Tues./a.m./N)
- Same Frequency Repeater Techniques—Morton Parker, David Trask, Thomas Gluszcak, Raytheon Co., Sudbury, Mass. (3E.3/Tues./a.m./N)
- Adaptive Equalization-Optimum and Practical Design—W. E. Coffrin,

Raytheon Co., Norwood, Mass. (3E.4/Tues./a.m./N)

The Evaluation of Planetary Communication Technology—R. C. Tausworthe, Jet Propulsion Lab., Pasadena, Calif. (3E.5/Tues./a.m./N)

Speech Communication and Processing—J. L. Flanagan, Bell Telephone Labs., Inc., Murray Hill, N. J. (8G.3/Thur./p.m./G)

Solid-State Devices and Theory

- Modern Low Noise Microwave Technology—Michikyki Uenohara, Nippon Electric Ltd., Kawasaki, Japan (C1/Wed./a.m./CM)
- Modern Schottky Barrier Mixers in 1969—Arthur Solomon, Sylvania Semiconductor Div., Woburn, Mass. (C2/Wed./a.m./CM)
- Low Noise Transistors and Tunnel Diode Amplifiers in 1969—V. G. Gelnovatch, U. S. Army Electronics Command, Fort Monmouth, N. J. (C4/Wed./a.m./CM)
- Ultra Low Noise TWT and the Impact of the Low Noise Transistors in 1969—J. Norman Nelson, Watkins-Johnson, Palo Alto, Calif. (C5/Wed./a.m./CM)
- Optical Modulation by Acoustoelectric Domains in Piezoelectric Semiconductors—Ralph Bray, Purdue University, Lafayette, Ind. (1G.4/Mon./a.m./G)
- Acoustic Bulk-Wave Components for Signal Processing—Leo Young, A. J. Bahr, I. N. Court, Stanford Research Institute, Menlo Park, Calif. (2C.1/Mon./p.m./SN)
- The Status and Future of Microsecond Technology—J. H. Collins, Rockwell Corp., Anaheim, Calif. (2C.2/Mon./p.m./SN)
- The Fabrication of Microsecond Components—H. I. Smith, M.I.T. Lincoln Lab., Lexington, Mass. (2C.3/Mon./p.m./SN)
- The Potential of Semiconductors for Millimeter or Submillimeter Wave Generation—J. A. Copeland, Bell Telephone Labs., Inc., Murray Hill, N. J. (2G.2/Mon./p.m./G)
- Detectors, Thermal and Free Carrier—Frank Arams, Airborne Instrument Labs., Melville, N. Y. (2G.3/Mon./p.m./G)
- Semiconductor Component Fabrication Using Lasers—H. Brent Mount, W. A. Murray, Texas Instruments, Inc., Dallas, Texas (3C.4/Tues./a.m./SN)
- Pulsed Laser Welding of Transistor and Other Electronic Component Parts—F. P. Gagliano, Western

HYBRIDS

bridge the op amp generation gap



Philbrick/Nexus combines the best of monolithic and discrete technologies to create the now generation of op amps — the hybrids. They're micro-miniature and low cost, yet their overall performance is equal to or better than their discrete predecessors. And, built-in stabilization simplifies circuit design by eliminating external components.

1402 — high performance FET for battery applications

The 1402 features a quiescent current drain of only 500 μ A with a power supply voltage range of ± 4 V to ± 24 V, full output frequency of 80 KHz and output capability of ± 14 V at ± 5 mA with ± 15 V power supply. TO-8 case; 0.5" diameter, 0.14" high. Price: \$75 each in 1-9 quantity.

Other hybrids offering interesting performance characteristics:

1404 offers the lowest power drain (50 μ A) of any general purpose hybrid on the market. ± 2.5 to ± 15 volt operation. Produces 1 mA output. Size: 0.75" \times 0.45" \times 0.20" high. Price: \$58 each in 1-9 quantity.

1406 is a small (TO-8 case) fast general purpose op amp. Price: \$36 each in 1-9 quantity.

1407 is a low cost high performance FET which features a gain bandwidth product of 30 MHz. Full output frequency is 100 KHz. TO-8 case. Price: \$63 each in 1-9 quantity.

1408 is a low cost differential FET input. Size: 0.6" \times 0.6" \times 0.25" high. Price: \$30 each in 1-9 quantity.

Q25AH is a wideband, high reliability FET. 1,000,000 hours logged without a single failure. TO-8 case. \$180 each in 1-9 quantity.

No other manufacturer offers as wide a variety. Ability to innovate, design and manufacture will continue to provide a greater variety of hybrids from Philbrick/Nexus than you'll get from any other single source.

For complete specifications and technical assistance, contact your Philbrick/Nexus field-engineering representative or write, Philbrick/Nexus Research, 46 Allied Drive at Route 128, Dedham, Mass. 02026.

VISIT US AT THE IEEE
BOOTHS 2A32, 2A34 and 2A36.



PHILBRICK/NEXUS RESEARCH

A TELEDYNE COMPANY

- Electric Co., Princeton, N. J.; D. H. Lockhart, Western Electric Co., Redding, Pa. (3C.5/Tues./a.m./SN)
- Power Thyristor High Frequency Limits—R. L. Davies, General Electric Co., Auburn, N. Y. (4D.1/Tues./p.m./SS)
- Laminated Overlay Power Structures—A New Technological Approach to High Frequency-High Power—R. Amatea, H. W. Becke, J. P. White, RCA, Somerville, N. J. (4D.2/Tues./p.m./SS)
- RSR-A New High Power Solid State Switch—P. Mlynar, J. Philips, Westinghouse Electric Corp., Youngwood, Pa. (4D.3/Tues./p.m./SS)
- High Voltage, High Temperature P-N-P-N Inverter Switch—R. A. Koska, General Electric Co., Auburn, N. Y. (4D.4/Tues./p.m./SS)
- An Ultra-High Power Zener Diode—J. E. Reynolds, General Motors Corp., Kokomo, Ind. (4D.5/Tues./p.m./SS)
- Thick Film Circuits in Power Control—R. W. Nolan, A. W. Winkley, Joseph Lucas Electrical Ltd., Birmingham, England (4D.6/Tues./p.m./SS)
- The Influence of Solid State Devices and Microcircuitry on Broadcast Technology—W. C. Morrison, RCA, Camden, N. J. (4F.5/Tues./p.m./MH)
- Semiconductor Memories-Device Aspects—G. E. Moore, Intel Corp., Mountain View, Calif. (5G.1/Wed./a.m./G)
- Monolithic Memory-Progress and Potential—J. A. Ayling, IBM Components Div., Poughkeepsie, N. Y.; Benjamin Agusta, IBM Components Div., Essex Junction, Vt. (5G.2/Wed./a.m./G)
- P-Channel IGFET Memories—E. J. Alexander Bell Telephone Labs., Inc., Allentown, Pa. (5G.3/Wed./a.m./G)
- Complementary MOSFET Memories—G. B. Herzog, Applied Research Lab., RCA, Princeton, N.J. (5G.4/Wed./a.m./G)
- The Radiation Tolerance of Today's Semiconductor Devices—J. G. Aiken, J. S. Crabbe, W. T. Matzen, Texas Instruments, Dallas Texas (7G.2/Thur./a.m./G)
- The Effects of Ionizing Radiation in Junction Semiconductor Devices—D. J. Fitzgerald, Fairchild Semiconductor, Palo Alto, Calif. (7G.4/Thur./a.m./G)

Space Electronics

- Principles of Self-Organization and Learning Systems—Heinz Von Foerster, University of Illinois, Urbana, Ill. (1B.1/Mon./a.m./M)
- Innate Structure for Self-Organization Systems—P. H. Greene, University of Chicago, Ill.; H. L. Oestreicher, Wright-Patterson Air Force Base, Ohio (1B.2/Mon./a.m./M)
- Pattern Recognition and Self-Organization—J. K. Hawkins, Robot Research, La Jolla, Calif. (1B.3/Mon./a.m./M)
- Self-Organization Flight Control Systems—R. L. Barron, Adaptronics, Inc., McLean, Va. (1B.4/Mon./a.m./M)
- Infrared Astronomy—F. J. Low, Tuscon, Ariz. (1E.1/Mon./a.m./N)
- Pulsars—Frank Drake, Cornell University, Ithaca, N. Y. (1E.2/Mon./a.m./N)
- Long-Baseline Interferometry—M. H. Cohen, California Institute of Technology, Pasadena, Calif. (1E.3/Mon./a.m./N)
- Large Radio Telescopes—J. D. Findlay, N.R.A.O., Charlottesville, Va. (1E.4/Mon./a.m./N)
- Solar Radio Bursts and Activity Centers—Jules Aarons, J. Casteau, P. M. Kalaghan, Air Force Cambridge Research Lab., L. G. Hanscom Field, Bedford, Mass. (1E.5/Mon./a.m./N)
- Living and Working in Space—Werner Von Braun, NASA, Huntsville, Ala. (2F/Mon./p.m./MH)
- X rays and Electronic Imaging—M. M. Ter-Pogossian, Washington University, St. Louis, Mo. (3D.1/Tues./a.m./SS)
- The Evaluation of Planetary Communication Technology—R. C. Tausworthe, Jet Propulsion Lab., Pasadena, Calif. (3E.5/Tues./a.m./N)
- Space Satellites for Television Relaying—W. L. Pritchard, COMSAT Labs., Washington, D. C. (4F.3/Tues./p.m./MH)
- Radio and Television Broadcasting from Space Satellites—R. P. Haviland, General Electric Co., Philadelphia, Pa. (4F.4/Tues./p.m./MH)
- Radio and Television Broadcasting from Space Satellites—R. P. Haviland, General Electric Co., Philadelphia, Pa. (4F.4/Tues./p.m./MH)
- System Concepts for Global Data Re-

lay Via Satellite—G. R. Welti, COMSAT Corp., Washington, D. C. (5F.1/Wed./a.m./MH)

- TRUST-TV Relay Using Small Terminals—Albert Whalen, NASA, Goddard Space Flight Center, Greenbelt, Md. (5F.2/Wed./a.m./MH)
- Precision Navigation Over Wide Areas Using Satellites—J. B. Woodford, Advanced Orbital Systems, P. W. Soule, Aerospace Corp., El Segundo, Calif. (5F.3/Wed./a.m./MH)
- CNI-The Integrated Information Environment—J. Lazur, The MITRE Corp., Bedford, Mass. (5F.4/Wed./a.m./MH)
- Network Control for Multiple Access Communications Satellite Systems—D. F. Parkhill, The MITRE Corp., Bedford, Mass. (6F.4/Wed./p.m./MH)

System Engineering

- Principles of Self-Organization and Learning Systems—Heinz Von Foerster, University of Illinois, Urbana, Ill. (1B.1/Mon./a.m./M)
- Innate Structure for Self-Organization Systems—P. H. Greene, University of Chicago, Chicago, Ill. (1B.2/Mon./a.m./H)
- Pattern Recognition and Self-Organization—J. K. Hawkins, Robot Research, La Jolla, Calif. (1B.3/Mon./a.m./M)
- Self-Organization Flight Control Systems—R. L. Barron, Adaptronics, Inc., McLean, Va. (1B.4/Mon./a.m./M)
- The Impact of System Technology on Transportation—W. A. Seifert, M.I.T., Cambridge, Mass. (3A.1/Tues./p.m./T)
- The Impact of System Technology on Education—A. Barber, Institute for Politics and Planning, Arlington, Va. (3A.2/Tues./a.m./T)
- Impact of System Technology on Health Care Delivery—C. A. Caceres, J. Landoll, National Center for Health Services, Washington, D. C. (3A.3/Tues./a.m./T)
- Impact of Technological Advance on the National Telecommunication System—Leland Johnson, Rand Corp., Santa Monica, Calif. (3A.4/Tues./a.m./T)
- Impact of System Technology on Urban Development—Manfred Altman, University of Pennsylvania, Philadelphia, Pa. (3A.5/Tues./a.m./T)

the **NOW**

generation of
DPM's...



SPECIAL OFFER

*This offer good during the IEEE Conference and up to April 15th. Don't forget, order your DPM before you pay your taxes!

...is on our shelves

A new circuit, a new face, new performance. We've taken the best features of all Digital Panel Meters, plus many of our own innovations, and have come up with a new generation of DPM's. The new circuit gives you high accuracy and long life stability over a wide operating temperature range. You get non-blinking, 3-digit in-line readouts, 100 microvolt resolution, full scale reading (999), computer compatibility and BCD outputs. The stylish, one-piece black bezel has no visible mounting hardware. For those who swing, we'll make your DPM in any color you want — special quantities only.

There are 10 models from which to choose in 3 versions, Model 510 Unipolar, Model 520 Autopolarity and Model 530 High Input Impedance Isolated.

We'll have a new 4-digit DPM shortly — same high quality at hard-to-beat prices. Write for complete information.

SEE IT AT IEEE — BOOTH 3A14-15

Datascan

DATASCAN, INC.
1111 Paulison Avenue, Clifton, N. J. 07013
Telephone 201-478-2800

Other Datascan Products Include: I.C. LOGIC CARDS • EQUIPMENT & SYSTEMS

The Systems Approach to the Design of Magnetic Tape Equipment—W. B. Phillips, IBM Corp., Boulder, Colo. (6B.1/Wed./p.m./M)

U.S.S.R. Power Systems Today: Which Way Are They Heading?—J. J. O'Connor, McGraw-Hill, Inc., New York, N. Y. (6C.1/Wed./p.m./SN)

How We Look Upon Systems Reliability—L. S. Lindorf, A. M. Nekrasov, U.S.S.R. Presented by W. J. Neiswender, Western Electric Co., Inc., Princeton, N.J. (6C.2/Wed./p.m./SN)

Reliability Insurance: When Is It Practical?—W. A. Weddendorf, Multi-Amp Corp., Cranford, N. J. (6C.3/Wed./p.m./SN)

Improved Reliability by an Industrial and Utility Interconnection—F. P. Sener, The Cleveland Electric Illuminating Co., Ohio; A. M. Killin, Consulting Engineer, Ashtabula, Ohio (6C.4/Wed./p.m./SN)

Systems Analysis—George Luchak, Princeton University, N. J. (7E.1/Thur./a.m./N)

Systems Engineering Management Planning—Keith Sargent, Arinc Corp., Santa Ana, Calif. (7E.2/Thur./a.m./N)

Contributions of Mechanics and Chemistry to Electronic Design—G. Reethof, Pennsylvania State University, Pa. (7E.3/Thur./a.m./N)

The Impact of New Technology—James Vollmer, RCA, Camden, N. J. (7E.4/Thur./p.m./N)

Test Equipment and Techniques

Band-Pass Time-Domain Reflectometry—C. E. Muehe, M.I.T. Lincoln Lab., Lexington, Mass. (B1/Tues./p.m./CM)

Recent Developments in Time-Domain Reflectometry—J. L. Johnson, The Hewlett-Packard Co., Colorado Springs, Colo. (B2/Tues./p.m./CM)

A New Frequency-Domain Reflectometer Provides High-Accuracy for Sweep Measurements in Coax—T. E. MacKenzie, General Radio Co., Bolton, Mass. (B3/Tues./p.m./CM)

Experience and Status of Computer Test Equipment Systems in DOD/NASA—D. M. Goodman, N.Y.U., N.Y. (5E.3/Wed./a.m./N)

Use of Computers with Factory Test Equipment—S. N. Levy, RCA, Camden, N.J. (5E.4/Wed./a.m./N)

Modern Transit System Vehicle Per-

formance—Kaare Thorn-Olsen, Parsons Brinckerhoff-Tudor-Bechtel, San Francisco, Calif. (1F.1/Mon./a.m./MH)

AC Propulsion Capabilities and Comparisons—D. R. Scholtes, The Louis Allis Co., Greendale, Wis. (1F.2/Mon./a.m./MH)

Automatic Train Control for Transit Expressway—G. M. Thorne-Booth, R. H. Perry, Westinghouse Electric Corp., East Pittsburgh, Pa. (1F.3/Mon./a.m./MH)

Revenue Collection Systems—W. D. Gootnick, Advanced Data Systems, Beverly Hills, Calif. (1F.4/Mon./a.m./MH)

The Future of Electric Motor Traction Systems—K. L. Lawson, Dept. of Commerce, Washington, D. C. (1F.5/Mon./a.m./MH)

The Impact of System Technology on Transportation—W. A. Seifert, M. I.T., Cambridge, Mass. (3A.1/Tues./a.m./T)

Urban Technology

The Impact of System Technology on Transportation—W. A. Seifert, M. I. T., Cambridge, Mass. (3A.1/Tues./a.m./T)

The Impact of System Technology on Education—A. Barber, Institute for Politics and Planning, Arlington, Va. (3A.2/Tues./a.m./T)

Impact of System Technology on Health Care Delivery—C. A. Cacers, J. Landoll, National Center for Health Services, Washington, D. C. (3A.3/Tues./a.m./T)

Impact of Technological Advance on the National Telecommunication System—Leland Johnson, Rand Corp., Santa Monica, Calif. (3A.4/Tues./a.m./T)

Impact of System Technology on Urban Development—Manfred Altman, University of Pennsylvania, Philadelphia, Pa. (3A.5/Tues./a.m./T)

Modern Transit System Vehicle Performance—Kaare Thorn-Olsen, Parsons Brinckerhoff-Tudor-Bechtel, San Francisco, Calif. (1F.1/Mon./a.m./MH)

AC Propulsion Capabilities and Comparisons—D. R. Scholtes, The Louis Allis Co., Greendale, Wis. (1F.2/Mon./a.m./MH)

Automatic Train Control for Transit Expressway—G. M. Thorne-Booth, R. H. Perry, Westinghouse Electric Corp., East Pittsburgh, Pa. (1F.3/Mon./a.m./MH)

Revenue Collection Systems—W. D. Gootnick, Advanced Data Systems, Beverly Hills, Calif. (1F.4/Mon./a.m./MH)

The Future of Electric Motor Traction Systems—K. L. Lawson, Dept. of Commerce, Washington, D. C. (1F.5/Mon./a.m./MH)

The Health Care Technology Program—B. D. Waxman, National Center for Health Services, Arlington, Va. (1A.1/Mon./a.m./T)

One View of Automation for Patient Clinical Care—G. N. Webb, R. J. Johns, Johns Hopkins Hospital, Baltimore, Md. (1A.2/Mon./a.m./T)

Computerization of Medical Laboratory Services—W. R. Kirkham, Perth Amboy General Hospital, Perth Amboy, N. J. (1A.3/Mon./a.m./T)

Interactive Data Handling for Multi-test Facilities—H. R. Oldfield, Jr., E. B. Rawson, H. A. Haessler, Medidata Sciences, Inc., Waltham, Mass. (1A.4/Mon./a.m./T)

Application of On-Line Information Handling to Anesthesiology—R. G. Bartlett, Jr., IBM Corp, Bethesda, Md., D. W. Benson, John Hopkins Medical School, Baltimore, Md. (1A.5/Mon./a.m./T)

Issues of Spectrum Management Related to Broadcast Services: An Up-Dating on the JTAC Report on Spectrum Engineering—The Key to Progress—R. P. Gifford, General Electric Co., Lynchburg, Va. (4F.1/Tues./p.m./MH)

The Future of Wire Distribution of Radio and Television Broadcast Programs—A. S. Taylor, Taylor and Associates, Washington, D. C. (4F.2/Tues./p.m./MH)

Sizing Up the Problem—J. D. Blatt, Dept. of Transportation, Washington, D. C. (4G.1/Tues./p.m./G)

Next Generation of ATC: Requirements and Approaches—L. A. Goldmuntz, Dept. of Transportation, Washington, D. C. (4G.2/Tues./p.m./G)

Controlling Ground Movement of Air Traffic—Louis Achitoff, The Port of New York Authority, N. Y. (4G.3/Tues./p.m./G)

People Handling: Uncorking the Bottleneck—R. J. Sutherland, American Airlines, New York, N. Y. (4G.4/Tues./p.m./G)

Power Generation for the Megalopolis—Alexander Kusko, Alexander Kusko, Inc., Cambridge, Mass. (7C.1/Thur./a.m./SN)

Power Transmission Systems for the Future—Walter Weeks, Purdue University, Lafayette, Ind. (7C.2/Thur./a.m./SN)

Electric Cities of the Year 2000—Edwin Vennard, Edison Electric Institute, New York, N. Y. (7C.3/Thur./a.m./SN)

WHEREVER LARGE VOLUMES OF AIR

MUST BE HANDLED

INEXPENSIVELY

AND RELIABLY...



THE Dolphin^(T.M.) FAN

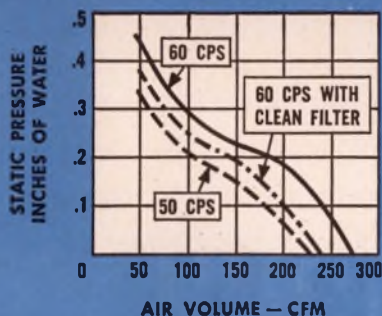

- Delivers up to 265 CFM air volume.
- Measures only 7" diameter by 2-7/16" axial depth.
- Molded of high impact polycarbonate plastic
- Multi-slot induction motor with sleeve bearings.
- 115VAC, 50-60 Hz, Single phase operation.
- Low Low Cost — Most economical 7" diameter fan available.
- Designed to meet U. L. requirements
- Easily mounted with clips on clamping rims
- Airflow reversible by mounting on either face

Add to the outstanding listing of features above a cost savings of approximately 25% over comparable fans and you have a truly outstanding performer for flushing computer consoles, power supplies, relay racks and just about any piece of electronic gear that can only spare a little room for a cooling device. Venturi molded of blue polycarbonate with a charcoal gray propeller, the Dolphin Fan is as attractive as it is efficient and reliable. Send today for complete descriptive literature to Rotron, Inc., Woodstock, New York 12498



Visit ROTRON at IEEE SHOW, BOOTHS 4B05-4B09.

"Select-don't-design" your

take up to eight units from



and obtain up to 16 separate outputs from one of these



Use of standard component power supplies and

YOU CAN OBTAIN:

1. Up to 8 separate outputs in a 1¾" high rack adapter.
2. Up to 16 separate outputs in a 3½" rack adapter.
3. Up to 16 separate outputs in a 5¼" rack adapter.
4. Use of standard mass-produced power supplies and accessories gives lower unit costs.
5. Fast delivery. No waiting for custom design.
6. Maximum flexibility for later design changes.
7. Substantial discounts are available to Original Equipment Manufacturers under the Lambda Commercial Purchase Plan.
8. Guaranteed 5 years whether you assemble or Lambda assembles.

See these Systems at IEEE Show Booth 2E02-04-06

own Power Supply Systems

these eleven standard modules

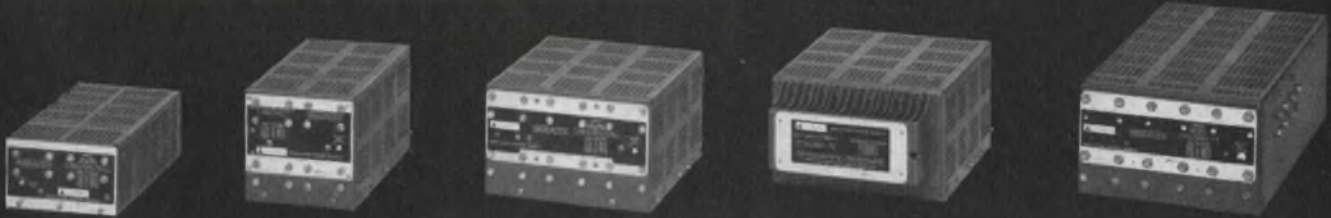

four rack-mounted power supply assembly systems.

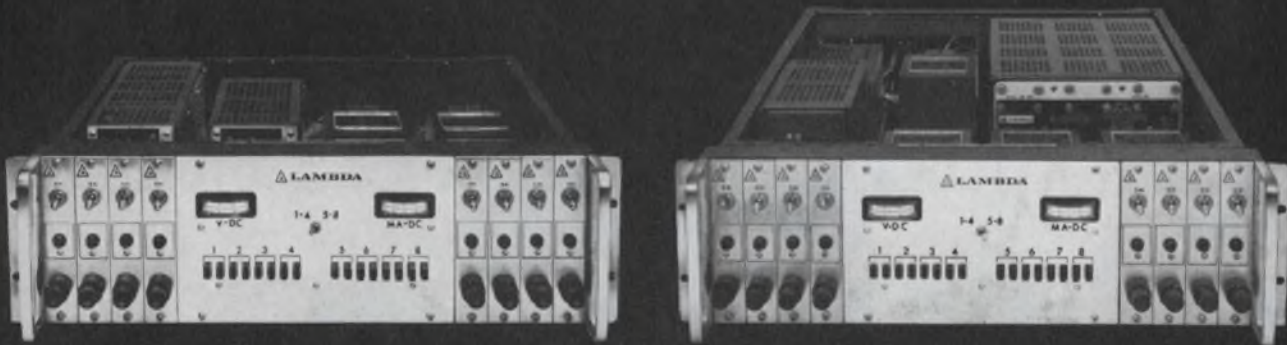

accessories speeds delivery, slashes costs.

How to take advantage of LAMBDA's new "Select-don't-design" Power Supply System Concept.

1. List your power supply requirements.
2. Select the modules you need for proper voltages and currents . . . remember, you can series/parallel units.
3. Select the smallest rack adapter that will house your modules.
4. Select the necessary power control panels and metering panel.
5. Select the overvoltage protection units if required.
6. Select the cables you need.
7. Order the units or ask LAMBDA to assemble your system.

Write, wire, or call to order direct, for information, or for new Lambda Power Supplies catalog. LAMBDA Electronics Corp., 515 Broad Hollow Road, Melville, L. I., New York 11746, TEL. 516-694-4200, TWX 510-224-6484.

 **LAMBDA**

Touring the Exhibit Area

Step right up folks. The show is about to begin. This IEEE extravaganza boasts hundreds of exhibits and thousands of products. See ICs that scoff at radiation and a desk calculator billed as the strongest on earth. All at IEEE '69.

Components	U166
Instrumentation	U140
Data processing	U152
Microwaves & lasers	U158
ICs and semiconductors ...	U148
Modules & subassemblies..	U174
Production	U184
Materials & packaging	U180



Programmable desktop calculator, which uses ICs extensively, can compute complicated functions within milliseconds. With single keystroke action,

it can directly find logarithms and most trigonometric functions. Its 120 storage registers enable programs with up to 960 steps, p. U152.

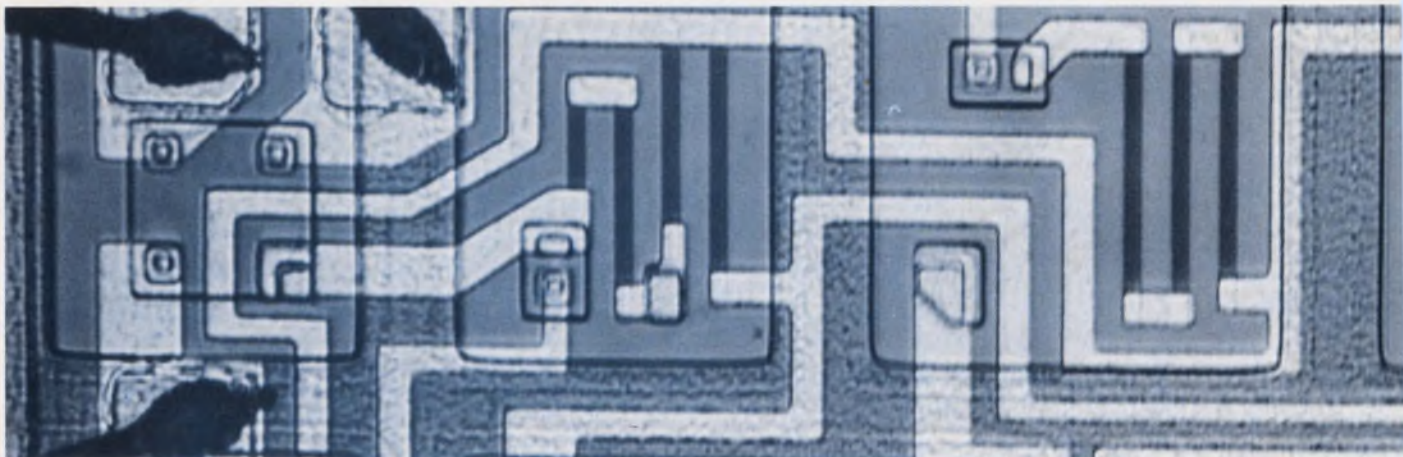

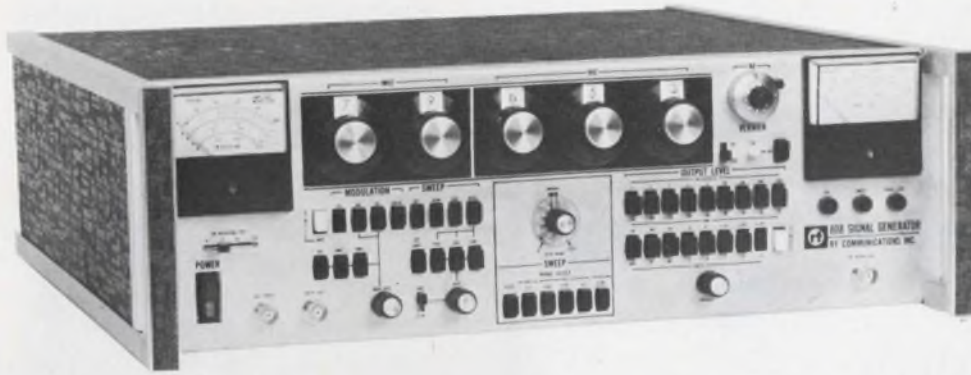

Multiple-function generator packs three instruments in a single cabinet—a synthesizer, a sweeper, as well as a standard signal generator. Over the frequency range of 0.05 to 80 MHz, this new unit features full remote programmability, high power output, frequency and audio modulation, and automatic and manual sweep. It uses integrated circuits throughout and has a pushbutton front-panel attenuator in 10-dB steps; see p. U140.

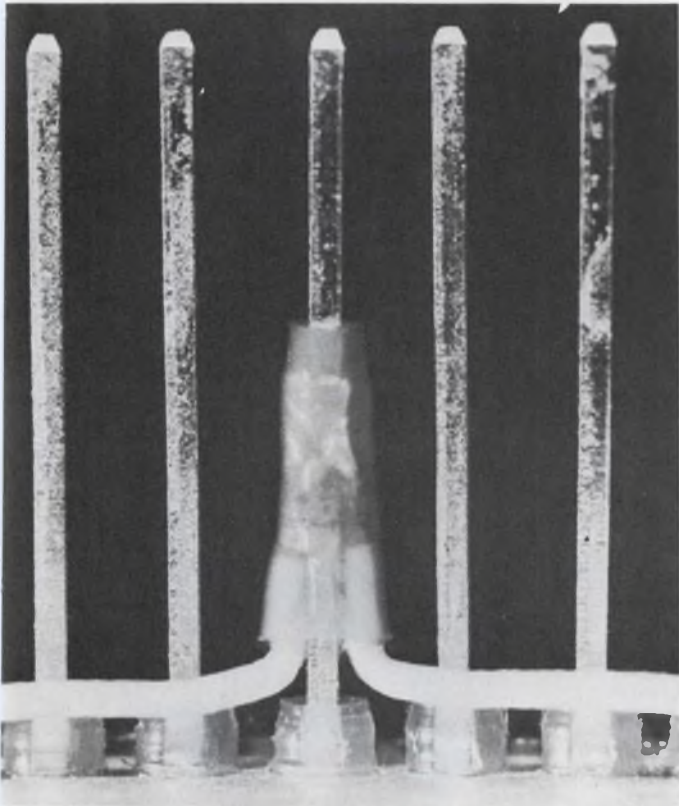

Point-to-point wiring system can produce soldered, insulated, or strain-relieved joints, while simultaneously terminating all wires on a post at the same level, p. U184.

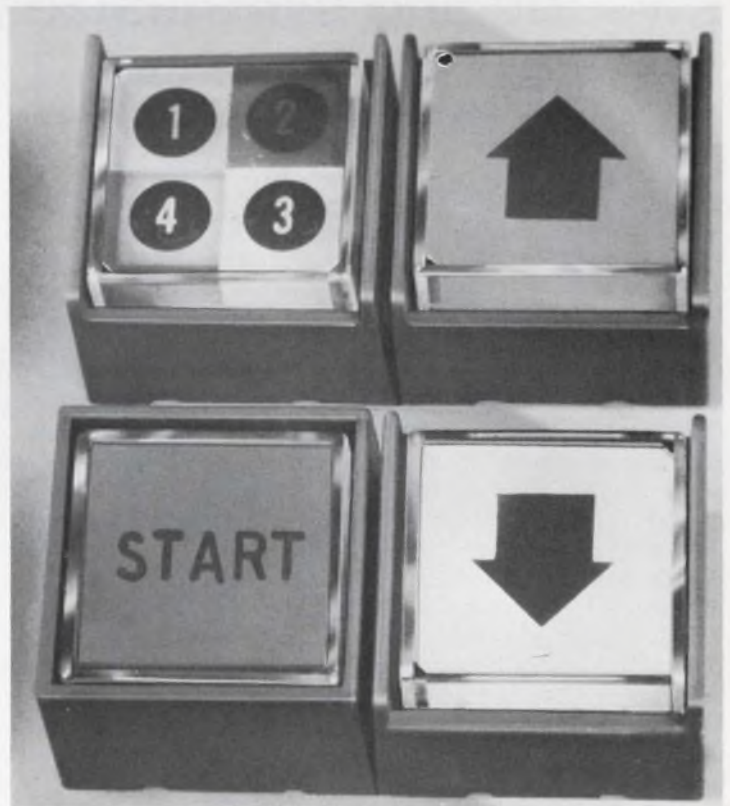

Lighted pushbutton switches and indicators with on-the-face legends and snap-action operation have display areas that are 0.9-in. square. These interchangeable modules provide up to four spdt circuits in a single package, p. U166.

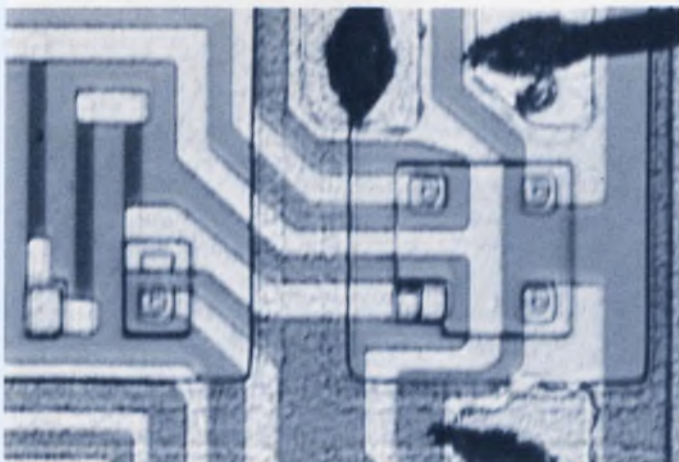

Radiation-hardened integrated circuits use dielectric isolation to stabilize performance in total radiation environments. Now available as off-the-shelf devices, these new circuits include many popular logic functions. In addition, they can operate from -55 to $+125^{\circ}\text{C}$, p. U148.

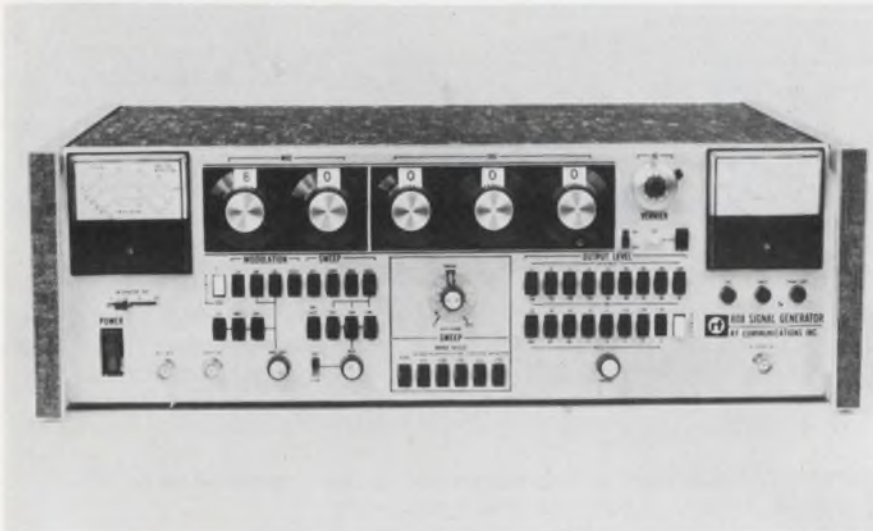

Multiple-function generator sweeps and synthesizes

RF Communications Inc., 1680 University Ave., Rochester, N.Y. Phone: (716) 244-5830. P&A: \$2980; July, 1969.

Providing three functions in a single package, a new instrument is a synthesizer and sweeper as well as a standard signal generator that covers the frequency range of 0.05 to 80 MHz. Model 808 features full remote programmability, high signal power output, frequency audio modulation, and automatic and manual sweep. In addition, it has a dial transfer mechanism for digital frequency setting that automatically indexes the next higher decade as the frequency knob is moved.

The instrument is designed so that digital synthesizer performance can be attained with a standard signal generator while retaining the manual and vernier tuning and low-spurious-output features of a conventional signal generator. It is intended for bench use, but a rack-panel adapter is available requiring only 5-1/4 in. of rack space.

The solid-state instrument uses integrated circuits extensively. It provides internal modulation frequencies of 400 or 1000 Hz for both a-m and fm modes, and may be externally modulated by frequen-

cies up to 100 kHz. A-m modulation up to 100% and fm deviations up to 375 kHz can be used with good linearity.

A front-panel pushbutton attenuator varies the output in 10-dB steps from 0.1 μ V to 10 V into 50 Ω . A vernier knob adjusts the output level between these 10-dB steps, while an output level meter indicates volts and dBm. Rf output is automatically leveled over the entire frequency range.

The basic frequency-generator function of the unit is provided by a frequency synthesizer that is locked to an internal 1-MHz crystal frequency standard. Phase-locked loops are used in the frequency generating scheme. A linear mixer design and an advanced synthesis scheme yield an output frequency that is spurious and noise free.

There are two general types of sweep, symmetrical and video, in manual or automatic modes. The sweep-frequency range and mode are selected by means of panel pushbuttons. Both fast and slow sweep speeds allow X-Y recorders and oscilloscopes to be used. External triggering is also possible, and a one-shot front-panel pushbutton is available for a single sweep.

Booth No. 2C01 Circle No. 405

Electronic galvanometer has floating input



The London Co., 811 Sharon Dr., Cleveland. Phone: (216) 871-8900.

Electronic galvanometer, GVM30, is a small battery-operated universal meter that features floating input terminals. It measures full scale currents as small as 30 pA up to 300 μ A, voltages from 1 mV to 300 V full scale, and resistance from 1 k Ω to 300 M Ω full scale. Accuracy is three per cent for current and voltage, five per cent for resistance.

Booth No. 2H26 Circle No. 385

Miniature supply has 50-W output



NJE Corp., 20 Boright Ave., Kenilworth, N.J. Phone: (201) 272-6000.

A miniature dc power supply has 50-W output and features three IC plug-in cards for dependability and easy maintenance. A stable source of regulated dc power, it offers electronic current and voltage regulation. Scale multiplier switches on the front panel give up to 5x magnification of voltage and current meter resolution.

Booth No. 2B25 Circle No. 375

Two instruments stress performance



Marconi Instruments, 111 Cedar Lane, Englewood, N.J. Phone: (201) 567-0607.

A new device for systems analysis, the JM1861 pseudo-random signal generator provides precisely repeated pseudo-random sequences at clock rates from 0.01 Hz to 1 MHz. Sequence lengths ($2^n - 1$) are variable from 31 to 1,048,575, corresponding to register lengths (n) of 5, 6, 7, 9, 10, 15 and 20. Probability distributions can be set up at 128 levels rectangular or 3, 4, 9 and 17 levels binominal. A special feature of the unit is the ability to adjust delay up to 999 clock periods using a three-decade readout, or to sweep the delay, incrementing delay by an adjustable number of clock periods. Output is ± 10 V peak adjustable; power for any given pseudo-random signal can be precisely determined. An optional plug-in offers a third order Butterworth response filter with -3 dB points at 0.1 Hz to 30 kHz switchable in a 1, 3 sequence. Programmable start/stop facilities are built in. JM1861 is suitable for many applications in process control analysis, closed-loop systems tests, multi-level signal simulation and vibration and materials analysis.

Basically a statistical voltmeter, the JM1860 time domain analyzer is a dc-coupled true rms voltmeter capable of computing mean, mean modulus, rms or correlation factor on signals of any wave form, whether random or repetitive up to 10 kHz. As an ordinary voltmeter, exponential time constants of 0.1, 1, 10 and 100 seconds can be selected. Voltage range is from 100 mV to 300 V on a three-decade digital display.

Booth No. 2D02 Circle No. 386

MODULAR TYPE IC PACKAGING PANEL

For High Density

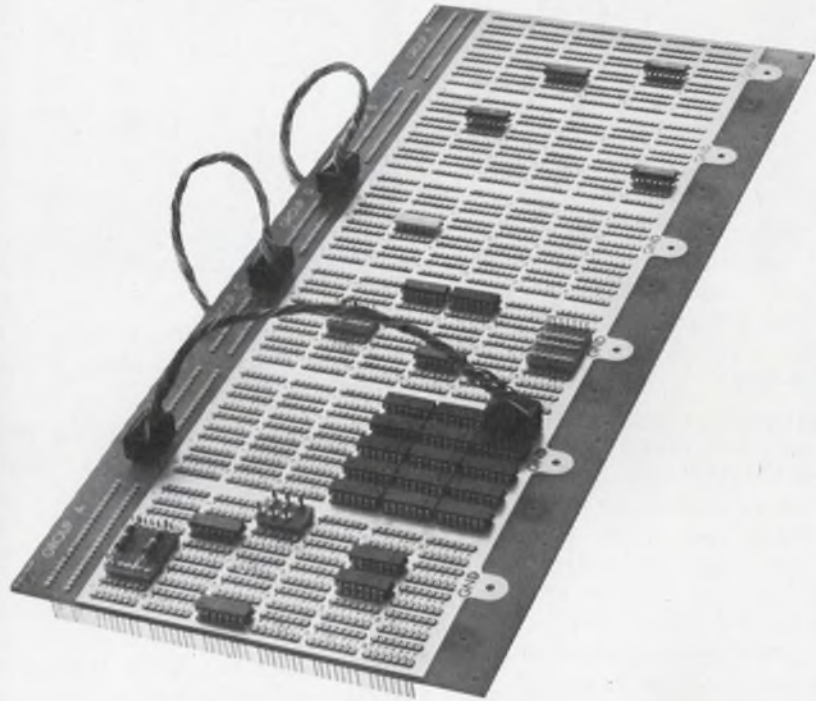

Simplifies design and production operations. Saves time and space. Direct mounting chassis eliminates need of logic cards — increases flexibility in prototyping, production and field service. A unique two dimensional approach to IC packaging with these outstanding features:

Multiple of 30 pattern sections, up to 180 patterns.

Two pins of each pattern tied directly to power and ground planes.

Provisions for input-output plugs and adaptor plugs for discrete components.

Excellent contact retention of flat lead dual-in-line (.022 max.) with machined closed entry design.

Choice of Wire-Wrap® or solder pocket terminations.

Three levels of connection on Wire-Wrap pins.

©Trademark Gardner-Denver Co.

Request Complete I. C. Folder

AUGAT

TEL: 617/222-2202
INC. 31 PERRY AVE., ATTLEBORO, MASS. 02703

IEEE BOOTHS 4H12-14

Scope pack filter regulates line



Wanlass Instruments, 1540 E. Edinger Ave., Santa Ana, Calif. Phone: (714) 546-1181. P&A: \$325; stock.

Designed to enhance the performance and operation of oscilloscopes and CRT-type devices, a new instrument provides 50 dB filtering to 1 MHz and 0.25% regulation. Problems normally experienced in scope use such as pre-triggering, jumping off scale, false signals, jitter, zero level stabilization, and erroneous readings caused by line disturbances are virtually eliminated.

Booth No. 4D11 Circle No. 293

Signal generator times ac gating



Dranetz Engineering Labs., Inc., 1233 North Ave., Plainfield, N.J. Phone: (201) 755-7080.

Engineered for manual or programmable operation, the series 206 gating/timing generators feature accurately timed gating of ac signals for automatic component measurement. Additional independently delayed pulses can be used for triggering sampling voltmeters or oscilloscopes and for on-off control of gated receivers. All timing is controlled by digital countdown from a master clock.

Booth No. 2B06 Circle No. 294

Multifunction instrument gauges pA, kV, TΩ



Philips Electronic Instruments, 750 S. Fulton Ave., Mt. Vernon, N.Y. Phone: (914) 664-4500. Price: \$1100.

The PM 6509 meter is the first and only leakage current, breakdown voltage terohm meter that performs all three functions without auxiliary assemblies. Current measurements down to 3 pA, breakdown voltage up to 1000 V and resistance measurements up to 100 terohms can be simply and accurately performed with complete safety.

Not merely a new semiconductor analyzing instrument, the PM 6509 employs a new measuring technique. Previously available instruments performed measurements in the pico and nanoampere regions only with the addition of special assemblies, including switching facilities, a highly sensitive dc micrometer, a stable leakage-free power supply, auxiliary power supplies for third and fourth connections, and resistance blocks. The complexity of this arrangement created many operational problems, inaccuracies and the risk of damaging the semiconductors under test. The PM 6509 solves all of these problems without auxiliary equipment.

Measurements are made by simply connecting the semiconductor to the meter, adjusting voltage and current limits, and reading off the quantities. The PM 6509 is ideally suited for lot sample testing as well as detailed analysis of diodes, transistors and other semiconductors, including silicon devices.

Booth No. 2B15 Circle No. 250

Active filters cover 9.99 kHz

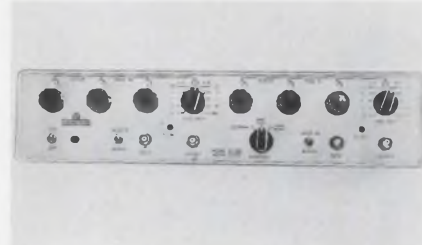

Multimetrics, Inc., 401 Concord Ave., Bronx, N.Y. Phone: (212) 665-6484.

AF-400 series active filters are available in the single-channel model AF-410 and the dual-channel AF-420. Cutoff frequency range is 0.01 Hz to 99.9 kHz \pm 2%; attenuation characteristics are Butterworth or T/D, 24 or 48 dB/octave; maximum attenuation is 80 dB. Operating from 115/230 V ac or battery, the digital units are suitable for fixed or portable use.

Booth No. 2B40 Circle No. 376

Data normalizer aids ratio meter



Weinschel Engineering, Gaithersburg, Md. Phone: (301) 948-3434. P&A: \$1985; June.

Model 1815 data normalizer combines with the model 1810 rf ratio meter to provide a system of Cartesian coordinates that reads directly in dB vs frequency on standard rectilinear chart paper. This permits direct reading of the unknown without time-consuming subtractions or interpolations. Equal spacing is accomplished by means of logarithmic output circuits. This allows any single reference line to represent the frequency-sensitive reference for all dB values in a given test setup.

Booth No. 2L01 Circle No. 382

We've submini-priced subminiature switches

and the deal's OFF...

Or on. Or off-again-on-again-off-again. Or on-again-on-again-on-again. Now, you can order both subminiature push button switches and subminiature toggle switches at the tiniest prices on the market. How mini? Submini! Now how many?

Submini-Price List of Pushbutton and Toggle Switches

TOGGLE-SWITCH MODELS	TOGGLE-SWITCH MODELS			
	1-24	29-99	100-499	500-999
7101	\$ 1.65	\$ 1.10	\$.96	\$.82
7103, 5, 7, 9	1.95	1.30	1.16	.97
7201	2.15	1.43	1.28	1.07
7203, 5, 7, 9	2.55	1.70	1.52	1.27
7211	2.85	1.90	1.70	1.41
7213	3.15	2.10	1.87	1.55
7215	3.45	2.30	2.06	1.71
7301	3.85	2.57	2.30	1.92
7303, 5, 7, 9	4.80	3.20	2.87	2.38
7401	4.85	3.28	2.90	2.43
7403, 5, 7, 9	6.05	4.10	3.61	3.00
7411, 13, 15	6.90	4.30	4.11	3.41

PUSHBUTTON SWITCH MODELS	PUSHBUTTON SWITCH MODELS			
	1-24	25-99	100-499	500-999
P8121	\$ 2.55	\$ 1.70	\$ 1.52	\$ 1.27
P8221	3.45	2.30	2.06	1.71
P8321	4.80	3.20	2.87	2.38
P8421	6.05	4.10	3.61	3.00

Call or write for quantity prices:

CK COMPONENTS, INC.
103 Morse Street,
Watertown, Mass. 02172 tel.: (617) 926-0800

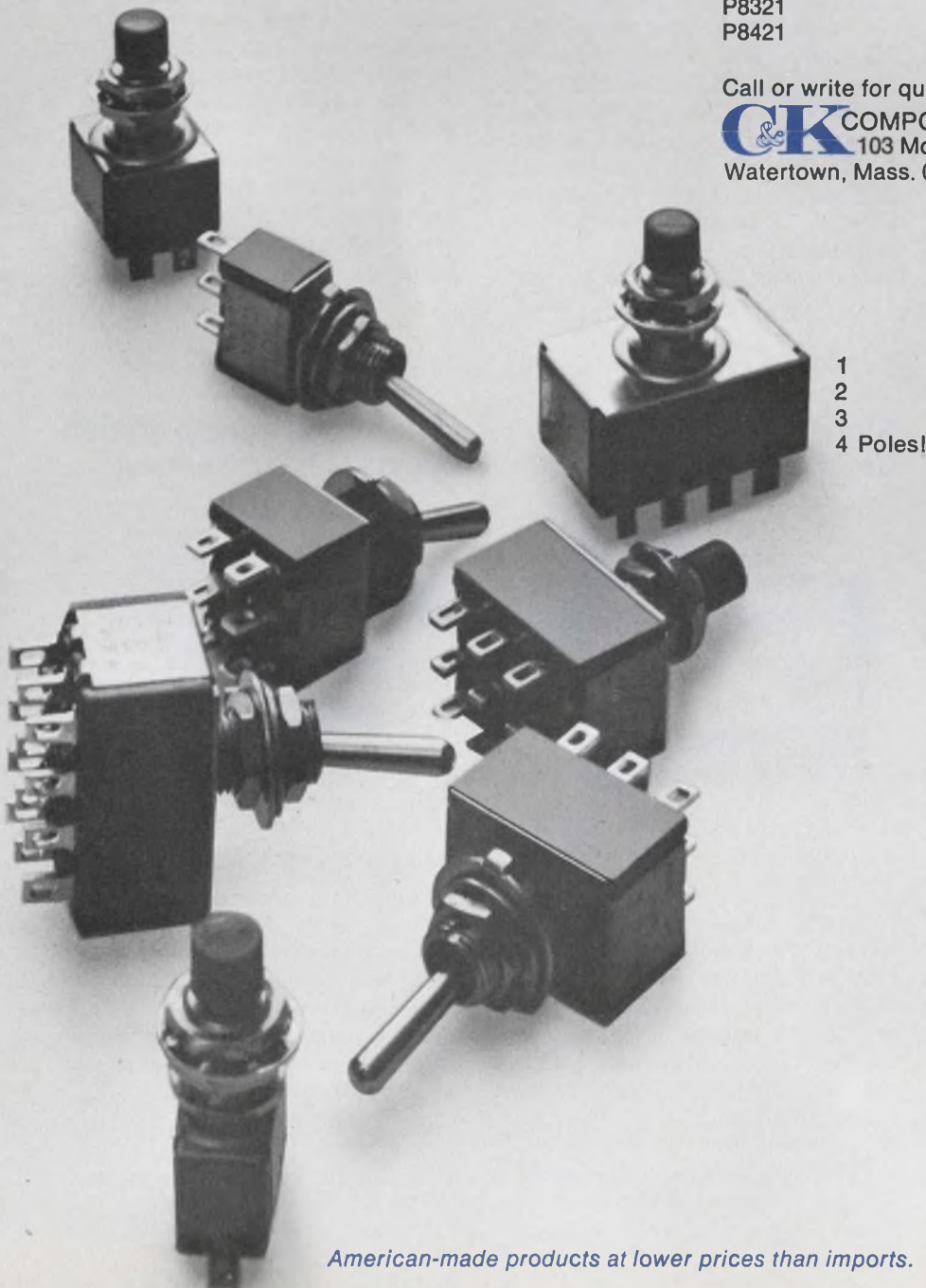

American-made products at lower prices than imports.

Solid-state scope covers dc to 25 MHz

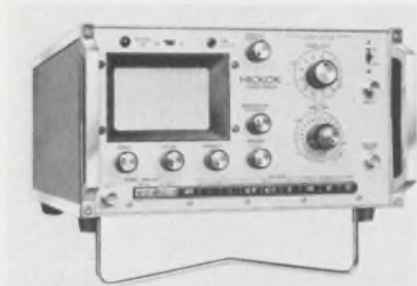

Hickok Electrical Instrument Co., 10514 Dupont Ave, Cleveland. Phone: (216) 541-8060. P&A: \$650; stock.

Model CRO 5000 oscilloscope features all-solid-state design and a bandwidth of dc to 25 MHz ± 3 dB. Response above 25 MHz is essentially Gaussian for optimum pulse reproduction and the scope is usable to 50 MHz. Sweep speeds and trigger response are consistent with this requirement, assuring stable 50-MHz displays with adequate horizontal expansion.

A built-in vertical delay line permits viewing the leading edge of pulse displays when triggered internally and provides nearly 50 nanoseconds of baseline prior to start of the pulse display. Vertical sensitivity is 10 mV per division and 12 calibrated steps accommodate a broad range of input signal levels. Input circuitry is overload protected.

To facilitate critical viewing or measurement, waveforms may be increased to five times screen height with essentially zero distortion. Vertical positioning range permits shifting the display vertically to view any portion of this display. Sweep delay is provided; a displayed waveform may be continuously delayed up to 40 divisions by means of a multiturn horizontal position control, allowing the operator to obtain full screen presentation of small portions of the input waveform. Sweep linearity is unaffected.

A 4-in. flat-faced CRT with 3.8-kV accelerating voltage provides a bright, crisp trace. The high precision, photographically-produced graticule scales a display area of 6×10 divisions, each 0.8 cm.

Booth No. 2C18 Circle No. 290

Volt/amp calibrator regulates to 2 ppm



John Fluke Mfg. Co., Inc., P.O. Box 7428, Seattle, Wash. Phone: (206) 774-2211.

Model 3330A programmable volt-amp/current calibrator maintains a line and load regulation of 5 ppm of output or 2 ppm of range. The instrument holds ripple and noise to less than $50 \mu\text{V}$ rms and has an accuracy of $\pm 0.005\%$ of the range setting. There are three output ranges, 10 and 100 V at 100 mA and 1000 V at 50 mA. Programing time is on the order of tens of milliseconds.

Booth No. 2C02 Circle No. 395

Angle readout handles 15 bits



AstroSystems Inc., 6 Nevada Dr., New Hyde Park, N.Y. Phone: (516) 328-1600.

Ideally suited for applications where a precise indication of angle is required, a 15-bit synchro/resolver digital angle readout has an accuracy of 40 seconds of arc at high tracking speeds. The unit accepts three-wire synchro or four-wire resolver inputs at 11.8, 26, 90 or 115 V, 400 Hz. Inputs are converted to a 15-bit parallel binary output without using rotating components.

Booth No. 2C15 Circle No. 353

Ac/dc transfer standard is accurate to 0.01%



Singer Co., Instrumentation Div., 915 Pembroke St., Bridgeport, Conn. P&A: \$3500; stock.

Model ATS ac/dc transfer standard converts a dc digital voltmeter, potentiometer, or any dc measuring system to a true rms measuring system with an accuracy of 0.01%. Its rated accuracy covers the range of 0.25 to 1000 V from 2 Hz to 30 MHz. The instrument can make true rms measurements to standards accuracy on virtually any ac wave shape. It is automatically protected against accidental overload.

Booth No. 2B30 Circle No. 337

Differential phase meter boosts response time



Wiltron Co., 930 East Meadow Dr., Palo Alto, Calif. Phone: (415) 321-7428. P&A: \$11.90; 8 wks.

Audio-video phase measurements with an active RC filter for increased response time are provided in a new model 351 differential phase meter. Balanced or unbalanced inputs permit phase measurements on transmission lines, lattice filters, etc., without additional circuitry. Input sensitivity, is 1 millivolt per channel. A new input circuit arrangement reduces pickup of extraneous signals.

Booth No. 2C30 Circle No. 296

DIGIVAC S/G[®]

a new
vacuum fluorescent
readout
from
TUNG-SOL[®]



\$255 each
in quantities of 1000.

(Also available with decimal \$2.95)

Write for complete information.

TUNG-SOL DIVISION
WAGNER ELECTRIC CORPORATION

One Summer Avenue, Newark, N.J. 07104 • Telephone: (201) 484-8500

© T.M. Wagner Electric Corporation

INFORMATION RETRIEVAL NUMBER 66

IBM Circuit Design and Packaging Systems

- Control system demands reliability
- Compact packaging system reduces costs
- Simplified power supply drives relay systems

Control system demands reliability

IBM wire contact relays were originally designed for data processing use. Now they are also being used extensively in machine tool and assembly applications. One of these assembly applications is a numerically-controlled component insertion machine. It sequentially inserts random combinations of up to 24 different types of axial lead resistors and diodes into printed circuit boards. Such

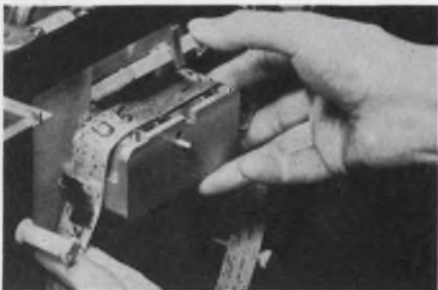

Instructions from an 8-channel punched paper tape provide the logic-input to the assembly machine relay gate that employs both 6- and 12-pole IBM wire contact relays.

machines have been widely used, often on a round-the-clock, three-shift basis, in IBM's electronic assembly operations.

Insertion rates range from 3,000 to 4,500 components per hour, depending upon the type of components being inserted.

Instructions from an 8-channel punched paper tape provide the logic-input to the relay gate. The gate employs three rows of 6- and 12-pole IBM wire contact relays. These relays control the movement of each printed circuit board through the X and Y axis positioning of the board for each component insertion. They also control the component feed, component insert, and cut-and-clinch cycles for each insertion operation of assembly.

IBM wire contact relays can perform in excess of 200 million operations with an operate speed as fast as 4.5 ms, a release time of 5 ms

maximum. The product line includes 4-, 6-, and 12-pole Form C relays, 4- and 6-pole latch models, all with compact, solderless, pluggable mountings...with coil-voltages up to 100 VDC.

Compact packaging system reduces costs

Performance Measurements Co., Detroit, Michigan, reports significant savings in packaging their new electronic

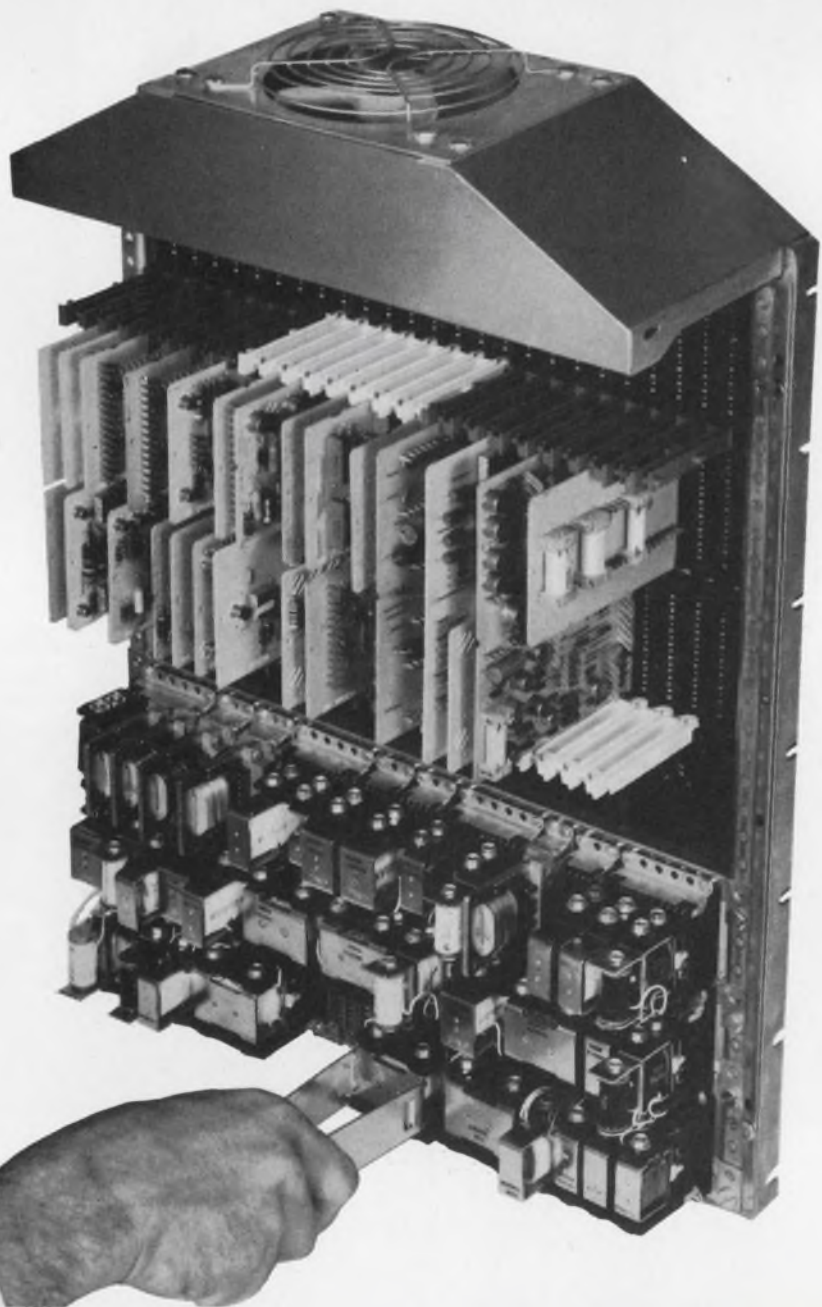

recording system. The packaging method previously employed required two gates to mount the components in the main console. Now, with IBM's modular packaging, only one gate is needed. That's because the IBM technique makes the most efficient use of console space with compactly mounted and connected circuit boards, relays and hardware.

Mounting time has been saved, too. Pluggable components, low-cost card receptacles and interlocking card guides have so simplified the packaging job, that Performance Measurements now saves 70% on the cost of mounting hardware. Fewer and shorter wires are needed in the compact console—eliminating three feet of 1½-inch cable and shortening a second cable by eight inches. The modular chassis gives designers freedom to experiment freely with various mounting configurations. It also permits easy access for servicing and diagnostic analysis.

The same design freedom, plus significant hardware and labor savings are available in many applications.

IBM components and packaging can help you in timing control, digital logic testing, telemetering, process or numerical control.

IBM's pluggable components, low cost card receptacles and interlocking card guides allow design freedom, simplify packaging and make servicing easy.

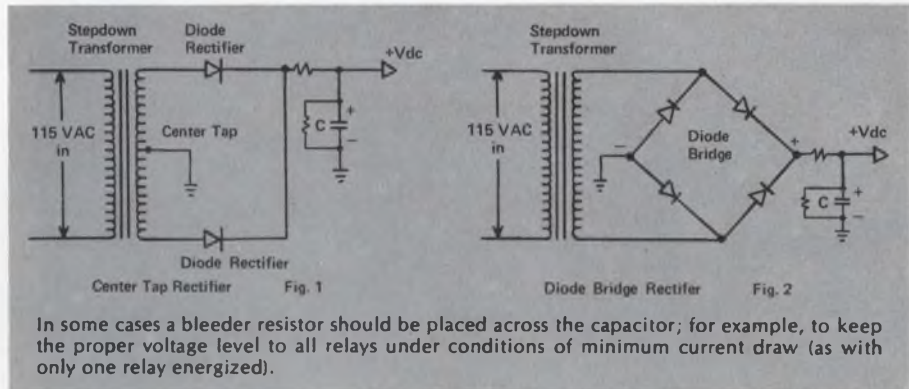

In some cases a bleeder resistor should be placed across the capacitor; for example, to keep the proper voltage level to all relays under conditions of minimum current draw (as with only one relay energized).

Simplified power supply drives relay systems

IBM wire contact relays operate by direct current. This type of current is preferred to alternating current in most switching applications because it offers several advantages, including:

- High speed: a requirement in many logic circuits.
- Smaller size: for compact packaging.
- Ease of arc suppression: diode suppression can be used.
- Safety: non-dangerous voltage levels are commonly used.
- Compatibility with transistor circuitry.

The supply of DC power to the wire

contact relays may be obtained from a simply-made rectifier, as shown in Figs. 1 and 2, either type being acceptable.

Capacitor size for a given current draw on the supply can be determined by the following equation:

$$C = \frac{I}{V} (15,000)$$

Where C is in microfarads

V is in volts

I is in amperes

A guide to the selection of rectifiers and transformers can be found in the electronic manufacturers' manuals describing such devices. In some cases entire bridge circuits may be purchased in one compact package.

**IBM Industrial Products Marketing Dept. ED315
1271 Avenue of the Americas
New York, New York 10020**



I am interested in further information on:

- IBM wire contact relays**
- IBM standard modular packaging system**

name _____

position _____

company _____

address _____

city _____ state _____ zip _____

Radiation-hardened integrated circuits are off-the-shelf commercial devices

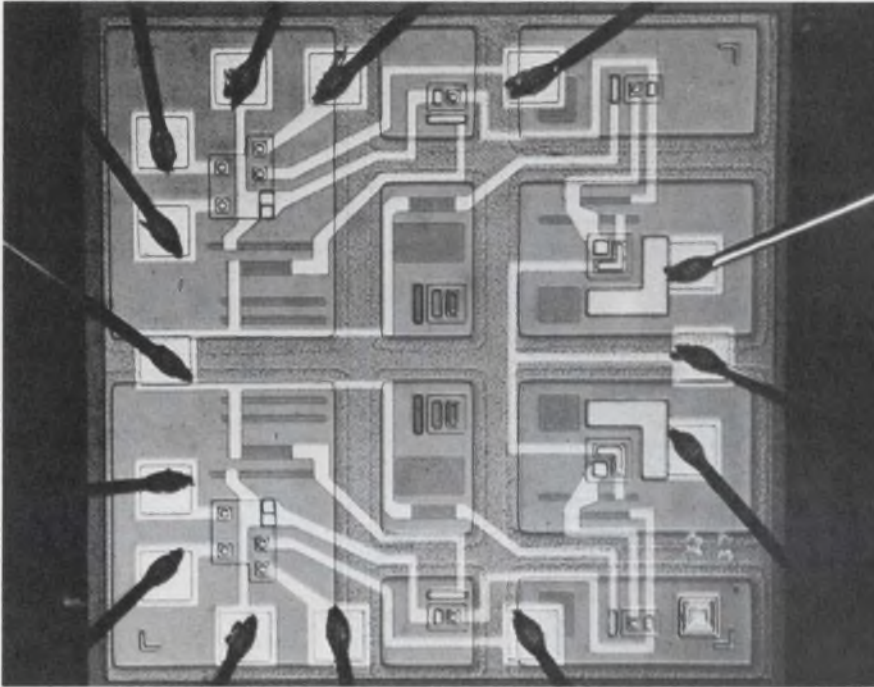

Radiation Inc., Microelectronics Div., sub. of Harris-Intertype Corp., Melbourne, Fla. Phone: (305) 727-4000. P&A: 5 times that of non-hardened devices; April, 1969.

The first commercial lines of radiation-hardened integrated circuits is now available with radiation tolerance levels that are two orders of magnitude greater than those of conventional p-n junction ICs. The new circuits are expected to fill a growing demand by weapon systems designers for high-performance circuits that function effectively in radiation environments.

Representing an extension of the series 930 DTL family from Radiation Inc., the new circuits include: an operational amplifier (709R), a dual level shifter (RD-980R), a dual four-input line driver (RD-981R), a dual four-input gate (RD-930R), a dual four-input buffer (RD-932R), a dual four-input power gate (RD-944R), a clocked flip-flop (RD-945R), and a triple three-input gate (RD-962R).

With the exception of the dual level shifter and the dual line driver, all the circuits are plug-in replacements for the 930 DTL non-hardened series. In addition, all the

new devices operate over the full military temperature range of -55 to $+125^{\circ}\text{C}$.

The principal effect of gamma rays is the production of photocurrent. To prevent failures at high radiation levels, the hardened devices employ thin-film resistors over oxide rather than the diffused resistors commonly used in junction isolated circuits. Dielectric isolation is used to stop photocurrent flow between the collector and substrate regions by eliminating the largest junction that is the principal contributor to photocurrent flow in p-n isolated circuits.

Test results show that the new circuits can drive worst-case loads after exposure to neutron levels in the order of 3×10^{14} neutrons per square centimeter. The devices also perform satisfactorily at gamma dot levels of 5×10^9 rads per second after exposure to these neutron fluence levels. In addition, no latch-up phenomena has been observed as a result of gamma tests performed to date. Although precise gamma dot destruct levels have not been determined, Radiation Inc. believes the circuits will not exhibit catastrophic failure modes when exposed to dose levels in excess of 10^{12} rads per second.

While the photocurrent effect caused by gamma rays is transient, or temporary, in nature, the effects of neutron bombardment are permanent. The principal effect of neutron radiation is degradation of current gain in active devices resulting from the formation of defect clusters. These clusters act as recombination centers and cause a decrease in minority carrier lifetimes which, in turn, reduce the base transport factor. In order to guard against these effects, the hardened circuits employ small geometry designs, shallow diffusions, selective gold doping, and minimum bulk material.

The new radiation-hardened ICs are housed in TO-86 packages, 1/4 by 1/4-in. flatpacks.

Booth No. 4H19 Circle No. 401

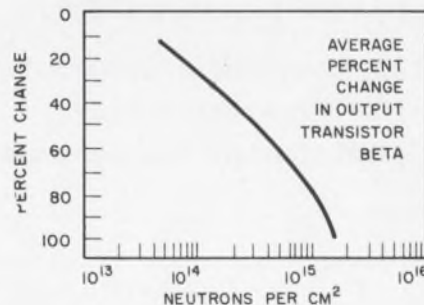
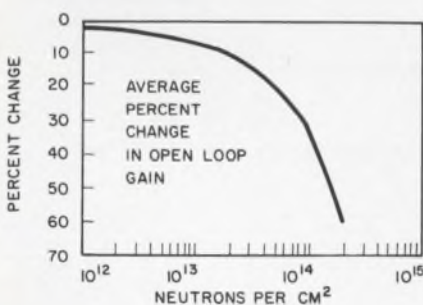

Using dielectric isolation and small device geometries, a new line of radiation-hardened integrated circuits stabilize performance in total radiation environments. The above plots show expected effects of neutron bombardment on open-loop gain and output-transistor current gain.

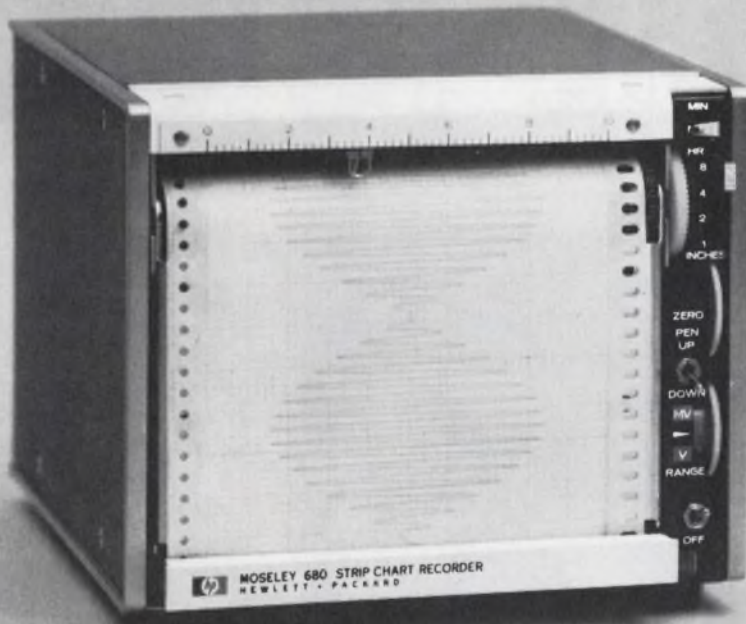

Leave it Alone

Let's face it. There are places where even the *best* strip-chart recorder could be improved. Like in the desert, on mountains or undersea. Anywhere there's dust, moisture or high humidity. Jobs that demand wear-free, corrosion-free reliability.

That's why Hewlett-Packard developed a unique photoslidewire (Option 17) for the HP 680 Strip-Chart Recorder. Users around the world tell us it has one outstanding feature: you can leave it alone. The photoslidewire combines a proven

null balance technique with optical coupling to eliminate mechanical contacts. A narrow light source on the stylus and HP-made photoconductor strips replace the mechanical slidewire contacts which balance the positioning servos. Photoslidewire (Option 17) cuts down preventive maintenance time and need for trained personnel. Price: Model 680 plus Option 17, \$850. And for long-term unattended operation, where a standard pen system is not practical, add HP's exclusive electric writing (Option 15) for

crisp, clean, permanent recording, \$75. Call your local HP field engineer for details on this extra measure of reliability. Or write Hewlett-Packard, Palo Alto, California 94304; Europe: 1217 Meyrin-Geneva, Switzerland.

HEWLETT  PACKARD
GRAPHIC RECORDERS

INSURE against EMI with DANEX raceways



Eliminate electromagnetic interference with Danex shielded ducts and fittings. Danex Shielded Raceways Systems are modular in design and can be used to protect lines of any length against radio frequency interference.

Raceways are 14 gauge high-strength, low carbon galvanized steel with high magnetic permeability and excellent attenuation. Wide variety of adapters available for transition to enclosures.

DANEX
CORPORATION

60 Tomlinson Road
Huntingdon Valley, Penna. 19006
(215) 947-4225



128A

See us at IEEE SHOW 3/24-28, Booth 1C31-5.
INFORMATION RETRIEVAL NUMBER 95

INSURE against EMI with ACE shielded enclosures



Eliminate electromagnetic interference with Ace shielded enclosures. From a workbench top-shielded test enclosure to an entire computer complex, Ace meets your military and commercial requirements.

Ace offers all standard types of shielded enclosures, plus the exclusive Lindsay construction which is guaranteed maintenance-free. With computers and sophisticated electronic equipment Ace eliminates your problems caused by RFI/EMI ambients.

ACE
SHIELDED PRODUCTS CORP.

60 Tomlinson Road
Huntingdon Valley, Penna. 19006
(215) 947-1900



128A

See us at IEEE SHOW 3/24-28, Booth 1C31-5.
INFORMATION RETRIEVAL NUMBER 94

ICs AND SEMICONDUCTORS

Gas-filled diodes protect MOSFETS



Victoreen Instrument Div., Components Dept., 10101 Woodland Ave., Cleveland. Phone: (216) 795-8200.

Able to protect MOSFETs like those used in high-input-impedance amplifiers, new gas-filled diodes are ideal protective elements that provide fast firing, low leakage current and relatively low firing voltage. The diodes have an inherent firing voltage of 80 to 89 V, but can be triggered at lower voltages by using appropriate biasing. They have a high leakage resistance of greater than 3.5×10^8 M Ω .

Booth No. 3B08 Circle No. 388

High-power drivers need no regulation

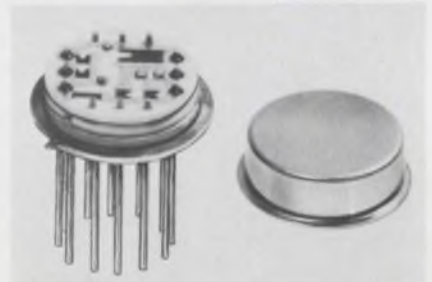

CTS Corp., Elkhart, Ind. Phone: (219) 523-0210. Availability: stock.

Series 850 and 851 high- and medium-power drivers feature high power capabilities at low cost. These drivers need no regulated supply and can be used as dual gate devices. Hermetically sealed, both units are supplied in TO-8 packages. Control input can be either TTL or DTL circuitry. Operating from a 4- to 35-V supply, the drivers are usable at ambient temperatures between -55 and $+125^\circ\text{C}$.

Booth No. 3B48 Circle No. 378



- **Wide Range:**
4-1000 MHz
- **Stability:**
Better than
15 PPM/15 minutes
- **Non-Microphonic**
- **No Range Change
Drift**
- **Fully Solid State**

the clean FM Signal Generator

F.M. Signal Generator TF 2006 is another "first" in the field of wide-range solid-state signal generators. Based on separate high Q resonant-line transistor oscillators, this instrument provides wide deviation f.m. on highly stable carriers up to 1 GHz. Rigid mechanical construction ensures that the precision oscillators have very low drift and microphony. Automatic levelling maintains constant r.f. output over the entire carrier frequency range, which extends down to 4 MHz, and accurate step attenuators offer a dynamic range of 120 db. Electrical fine tuning and f.m. may be simultaneously applied by the drive circuitry. As a result of their electrical relationship within the instrument f.m. as well as the fine tuning may be adjusted to a higher accuracy against the comprehensive crystal calibrator. This oven-controlled calibrator indicates carrier frequencies by meter nulls at 10, 1 or 0.1 MHz intervals and therefore provides almost 10,000 check points of the carrier frequency.

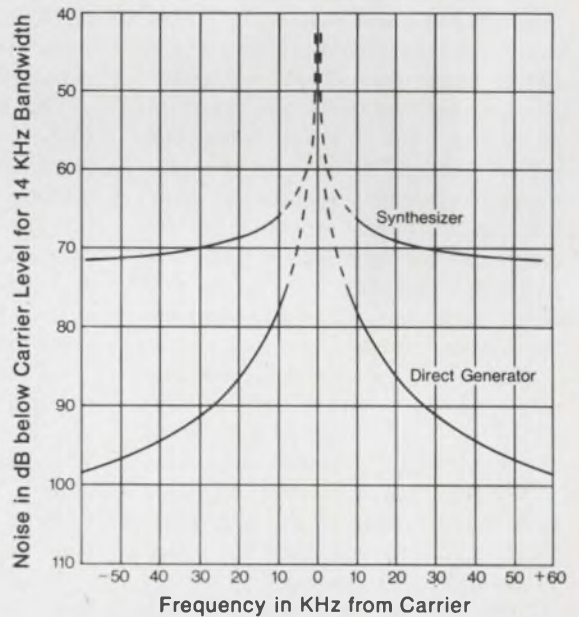

Comparison of Synthesized and Direct Frequency Signal Generator U.H.F. Spectra.

mi MARCONI
INSTRUMENTS
DIVISION OF ENGLISH ELECTRIC CORPORATION

111 CEDAR LANE □ ENGLEWOOD, NEW JERSEY 07631
TELEPHONE: (201) 567-0607



AVAILABLE UPON REQUEST...
Detailed specification brochure including operating principles, mechanical, electrical and environmental specifications.

SEE US AT IEEE — BOOTH #2D-02-08

INFORMATION RETRIEVAL NUMBER 70



Desk top IC calculator performs in milliseconds

Wang Laboratories, 836 North St., Tewksbury, Mass. Phone: (617) 851-7311. P&A: \$4900; summer, 1969.

Making extensive use of ICs, a new programmable desktop calculator operates within milliseconds—faster than any other calculator known—and solves complicated functions with a single keystroke action. Model 700 directly provides many hardware operations (like logs to the base e or the base 10, as well as the functions e^x and 10^x), handles programs with up to 960 steps, and has 120 data storage registers.

It is a self-contained typewriter-sized package with a simple keyboard for input and control. From the keyboard, it learns programs by storing the keystroke sequence in a built-in 8192-bit core. A rear-panel connector provides for plug-in addition of an output/writer, which will be available shortly along with other output devices.

Special keys on its front deck allow the 700 to make fast single-keystroke calculations of many functions: sine, cosine, tangent, arcsine, arccosine, arctangent, hyperbolic sine, hyperbolic cosine, hyperbolic tangent, hyperbolic arc-

sine, hyperbolic arccosine, hyperbolic arctangent, polar conversion, and rectangular conversion. Other special functions may be readily substituted by the user without difficulty and at no extra cost. These include mean, variance, and standard deviation.

The new calculator is extremely fast. It can add in 300 μ s, floating point multiply in 3 ms, divide in 3.5 ms and find logarithms in 15 ms. Each trigonometric function is completed in 250 ms. The 700 will also execute loops, branches and subroutines; four decision-making tests are provided.

All of the 120 data storage registers can add, subtract, multiply and divide. In addition, the 700 has a capacity of 12 digits plus a two-digit exponent (range -98 to +99) with a dual Nixie-type display.

Programs are run from the core, and, for permanent storage, may be transferred to magnetic tape using a built-in cassette recorder and snap-in tape cassettes. Programs are handled in variable-length blocks, and up to 10 blocks of 960 steps each may be stored on one cassette.

Booth No. 2B16 Circle No. 387

Compact d/a converter holds 0.25% linearity



Monsanto Electronics, Electronics Technical Center, 620 Passaic Ave., West Caldwell, N.J. Phone: (201) 228-3800. P&A: \$650; 4 wks.

A new digital-to-analog converter combines 0.2% conversion accuracy with 0.25% linearity from one quarter-scale to full scale; linearity below one-quarter scale is 0.5%. Model 503A has a half-track package that measures 4-1/4-in. high by 7-1/2-in. wide by 9-in. deep. Any three consecutive digits from one to nine may be selected for conversion, with address in BCD 8-4-2-1 parallel entry format.

Booth No. 2F39 Circle No. 390

Logic circuits gate and count

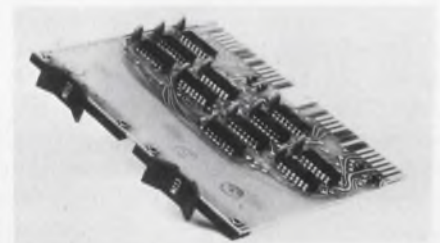

Digital Equipment Corp., Maynard, Mass. Phone: (617) 897-5111. P&A: \$35 or \$86; stock.

Two new series M logic circuit boards, the M169 gating module and the M213 BCD up/down counter, are now available. The gating module, which can be used as a four-output multiplexer, has a maximum input-to-output propagation delay of 45 ns. The BCD up/down counter can be used to construct multi-digit synchronous counters with a maximum counting rate of 5 MHz.

Booth No. 2G02 Circle No. 389

have you met...

the saver

The OmniTester™ 1000 will save you more time and money faster than any other automatic circuit tester ever made.

Circuit-testing time is money. And that makes the OmniTester a real money saver. When it comes to high speed automatic test capability, you can match the OmniTester's time-saving credentials against anything else in the field: it whizzes through as many as 100,000 termination points in a single test sequence. And it's self-programming. And it tests dynamically for required voltages, currents or impedances. And it prints out the results in permanent record form.

What would such a machine be worth in your production program?
Much more than its cost.

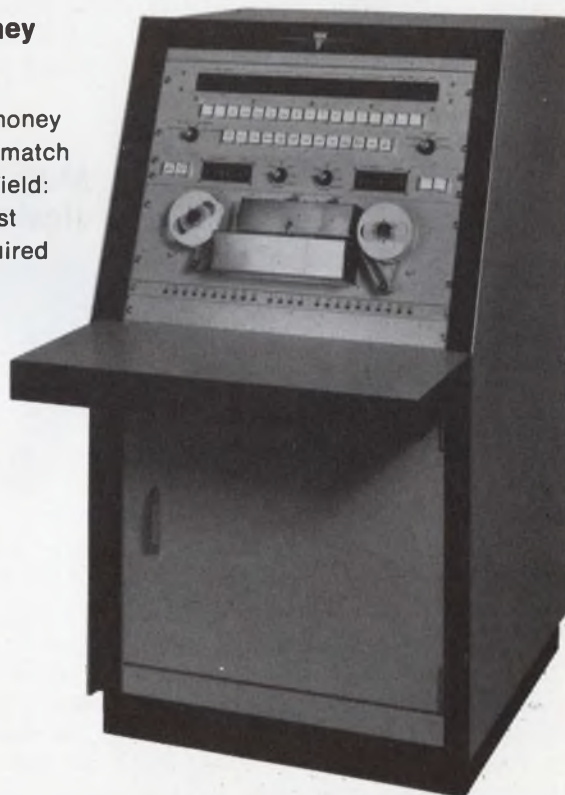

OMNITESTER™ 1000 CIRCUIT TESTER

IEEE BOOTH 2F46

TeleSciences INC. 351 NEW ALBANY RD., MOORESTOWN, N.J. 08057
FORMERLY TELEPRODUCTS INC. (609) 235-6227

INFORMATION RETRIEVAL NUMBER 71

Photoelectric reader sees 400 characters/s

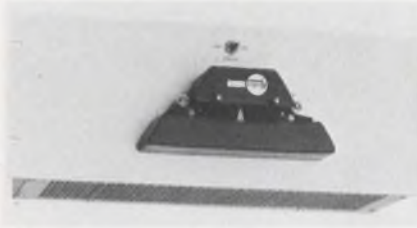

Remex Electronics, Div. of Ex-Cell-O Corp., 5250 West El Segundo Blvd., Hawthorne, Calif. Phone: (213) 772-5321. P&A: \$875 or \$995; 9 wks.

A photoelectric punched tape reader, in both unidirectional and bidirectional models, features speeds as fast as 400 characters per second. Model RR-3000 offers automatic compensation of outputs, in real time, for varying tape opacities up to 70% transparent. Optional hybrid modules are also available for negative or positive outputs up to 15 V at 10 mA.

Booth No. 2H29 Circle No. 333

Multiplexed converter selects on command



Astrosystems, Inc., 6 Nevada Dr., New Hyde Park, N.Y. Phone: (516) 382-1600. P&A: \$3000 to \$5000; 60 days.

Designed for aerospace applications, a new multiplexed synchro-to-digital conversion system can select one of five specified synchro inputs from an external address command signal. After selection, the synchro under test is converted to a resolution and accuracy of 13 bits. Maximum conversion time for a 180° change of input angle is 10 ms.

Booth No. 2C15 Circle No. 279

Microfilm data system converses with user



Specialized Business Services, Inc., 400 Jericho Turnpike, Jericho, N.Y. Phone: (516) 935-3311.

Called AIM System II (Automated Information Management), a new microfilm information retrieval system uses a verbal format to exchange data with the user. By simply picking the system's telephone handset, the user is in immediate voice communication with this information center. He can search the central files, have special material given to him verbally, or request the inclusion of new material in the file. AIM System II contains over one million pages of material.

Booth No. 1K13 Circle No. 282

Magnetic tape eraser clears 100 reels/h



Ferranti Electric Inc., East Bethpage Rd., Plainview, N.Y. Phone: (516) 293-8383.

Designed to accommodate fully loaded magnetic tape reels with dimensions up to 1-3/8 by 16 in., model 9 magnetic tape bulk eraser can erase saturated tapes at rates as fast as 100 reels per hour. All recorded data, audio pulses or any kind of signal, from dc to video, is efficiently erased to better than 80 dB below saturation recording level.

Booth No. 3H00 Circle No. 406

Multi-state data sets transmit 100 bits/s



RFL Industries, Inc., Boonton, N.J. Phone: (201) 334-3100. P&A: from \$350; 4 to 5 wks.

Able to connect directly to standard telephone lines, series 2056 data sets are two- and three-state devices (suited to return to zero operation) that operate at bit rates of 60, 85, 110, 150, 300, 600, 1200 or 1800 bits per second. They provide digital interfaces to meet specific requirements, such as positive neutral, negative neutral or polar (EIA/RS 232B).

Booth No. 2D09 Circle No. 391

Magnetic-tape cleaner replaces cartridges

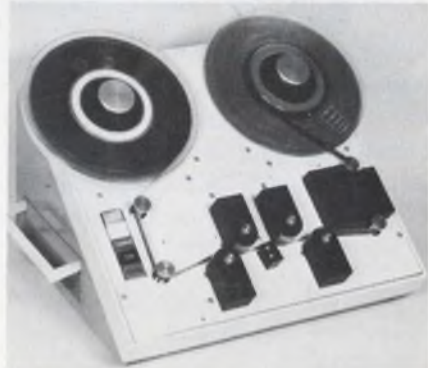

Virginia Panel Corp., P. O. Box 1106, Waynesboro, Va. Phone: (703) 942-8376.

Model 27 tape cleaner is a faster operating cleaner, with a more sophisticated cabinet. Model 27 features incremental indexing, a tension-control device and automatic stopping tape at the end of the sensor, which prevents snapping or uncontrolled winding when the tape is completely rewound. Two tape-drive motors are provided to assure constant torque and tension. Disposable tissue cartridges clean 70 tapes before replacement.

Booth No. 4D07 Circle No. 260

LAB POWER

New PVC Power Supply



The
Maxi
Line

Voltage	Current	
	0-10V DC	2A
0-20V DC	1A	2A
0-50V DC	0.5A	1.0A

with these features

- Voltage / Current Crossover
- Three (3) Range Voltmeter
- Three (3) Range Ammeter
- Plug-in Amplifiers with I. C.
- Precision Current Regulation
- Mil-T-27A Transformer
- Remote Voltage or Resistance Programming
- Master Slave Series / Parallel
- Available in Singles & Duals

NJE CORPORATION

Electronic Development & Manufacturing

Kenilworth, New Jersey 07033 / (201) 272-6000

TELEFAX: FFP • TWX: (710) 996-5967

A subsidiary of **CONDEC** Corporation

See the new PVC Power Supplies on Display in our Booth 2B25-2B27, Burlingame Territory, IEEE.

Meet the Best Contacts!

**IN BARNES MINIATURE
MF SOCKETS FOR TESTING
"TO" PACKAGED I.C.'S**



Can a small but hard-working "TO" socket speed up your operation? You bet it can! The reliable Barnes Series MFQ sockets have large pyramidal entrances and spring-tempered, wiping type contacts that mean fast insertion and fast withdrawal — as well as positive contact. Their small size, 50,000 insertion life, and easy board-mounting features, have found them ready employment... in test, breadboarding, aging and burn-in applications. Write for details.

barnes
CORPORATION

Lansdowne, Pa. 19050 • 215/MA2-1525

barnes / THE FIRST WORD IN CARRIERS, CONTACTORS & SOCKETS FOR I.C.'S

INFORMATION RETRIEVAL NUMBER 73

GRIDPAK®

Thru-Connection

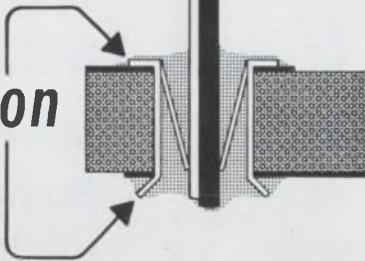

Gridpak® is a Gridcraft idea superimposed on a circuit board. Unique features — including special grip-type terminals and grid-oriented design — provide state-of-the-art advantages for electronics systems producers: simplicity, ease of assembly, flexibility, reliability, and real economies for both short and long orders... even if changes become necessary. GCI provides printed circuit terminal boards in all materials, sizes, configurations and quantities; one or two sided, with or without edge connectors; .050", .070", or .090" terminals on grids as small as .100", or random spaced to your specifications.

- Locked-In Circuitry
- Firm Component Holding
- Multi-Lead Placement
- Space and Time Savings
- High-Reliability Hand or Flow Soldering
- Faster Delivery Cycles
- Grid-Oriented Design Flexibility
- New Economies from Standard Tooling

Send for technical data.

GRIDCRAFT INC.

2217 South Anthony Boulevard
Fort Wayne, Indiana 46803

INFORMATION RETRIEVAL NUMBER 74

DATA PROCESSING

**Fast digital computer
operates at 860 ns**



Redcor Corp., Decade Computer Corp., 7457 Lorge Circle, Huntington Beach, Calif. Phone: (213) 380-8030. Price: \$12,800.

Decade 70 is a high-speed digital computer that performs within an 860-ns period. It has a 16-bit memory word, a standard 4k memory field that is expandable to 16k, memory parity, a memory-protect function, and direct memory access. Available in both rack-mount and desktop versions, the new computer is designed for real-time applications.

Booth No. 3A23 Circle No. 280

Data terminals offer variety

Olivetti Underwood Corp., One Park Ave., New York. Phone: (212) 679-3400.

A new line of telecommunication equipment includes a complete family of teleprinters as well as on-line real-time data terminals. Over 30 different models accommodate conventional telegraphic operations and connections to computers over telegraph or high-speed telephone lines. Series TE 300 consists of heavy-duty teleprinters, while series TC includes general-purpose alphanumeric printing terminals, CRT display terminals, and a 40-character/s serial printer.

Booth No. 2F03 Circle No. 393

The wreckless rechargeable.



Visit us at the IEEE Show
Booth numbers 4E19-4E21

Sonotone's Fastback[®] battery won't wreck itself. Even under fast charging. Over and over and over again.

Sonotone's new nickel-cadmium sealed cell is called the Fastback because it gets back into action *fast*. In just five minutes, it gets enough charge to start a lawn mower or to operate a camera. So your product goes to work today... not tomorrow.

The Fastback's safe, too. In laboratory tests, it's been deliberately overcharged for months at the 3-hour rate. Without overheating or blowing its top. Even after that, it delivers full rated output under load.

And there's no need for expensive, bulky external charging apparatus. All

the charging capability is built right into the Fastback. Already, the Fastback's found its place in many consumer products. Should it be in yours? Find out by writing for full specifications and performance charts. Sonotone Corporation, Battery Division, Elmsford, New York 10523.

CLEVITE **SONOTONE**

INFORMATION RETRIEVAL NUMBER 75

Sampling oscilloscope handles 18 GHz

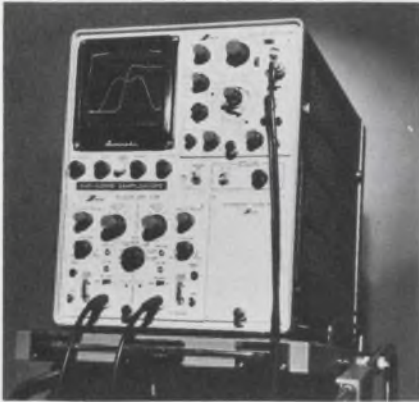

E-H Research Labs, Inc. 515 11th St., Oakland, Calif. Phone: (415) 834-3030.

The 5009B sampling oscilloscope features 7-GHz bandwidth with the type V9-B vertical plug-in unit, and 18-GHz bandwidth with the V9-F. Horizontal plug-ins include the H9-Y which features sweep speeds to 10 ps/cm and hf sync to above 7 GHz. The H9-W contains an automatic feature which allows auto-triggering to 18 GHz.
Booth No. 2C29 Circle No. 287

Frequency calibrator produces rf spectrum



Motorola Communications and Electronics Inc., 1301 Algonquin Rd., Schaumburg, Ill. Phone: (312) 358-7900.

Using a fast-warm-up high-stability oscillator as the source, the S1315A solid-state frequency calibrator generates a spectrum of precise frequencies from 100 kHz to 500 MHz. This spectrum of frequencies includes all assigned frequencies within the band defined by the channel switch.
Booth No. 2H34 Circle No. 398

Digital power meter measures 30 nW to 3 W



General Microwave Corp., 155 Marine St., Farmingdale, N.Y. Phone: (516) 694-3600.

When used with series 420 thin-film thermoelectric power heads, a digital microwave power meter measures modulated, pulsed, and cw signals from 2 MHz to 40 GHz at power levels ranging from 30 nW to 3 W. Model 467 provides a digital readout that is accurate to $\pm 0.5\%$ of the reading, ± 1 count.
Booth No. 3K26 Circle No. 345

TDR measuring system has 35-ps risetime



Hewlett-Packard Co., 1501 Page Mill Rd., Palo Alto, Calif. Phone: (415) 326-7000. Price: \$3975/system.

A new time domain reflectometer, model 1815A, has an over-all system risetime of less than 35 ps when used with Hewlett-Packard's series 180 oscilloscopes and feed-through samplers. With this fast response, it is possible to distinguish impedance discontinuities that are spaced only a few millimeters apart.
Booth No. 3K28 Circle No. 373

Spectrum analyzer spans 10 MHz to 40 GHz

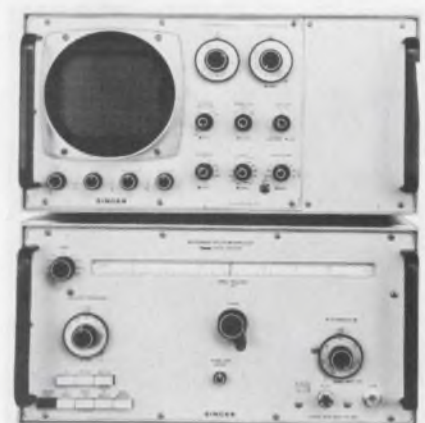

Singer Co., Instrumentation Div., 915 Pembroke St., Bridgeport, Conn. Phone: (203) 366-3201. Price: \$9900.

A new spectrum analyzer that covers the frequency range of 10 MHz to 40 GHz has a 3-GHz dispersion with no in-band multiple responses up to 9 GHz. In addition, model SPA-3000 offers greater than 2-GHz dispersion with no in-band multiple responses from 9 to 40 GHz.
Booth No. 2B34 Circle No. 354

MIC balanced mixer matches barrier diodes

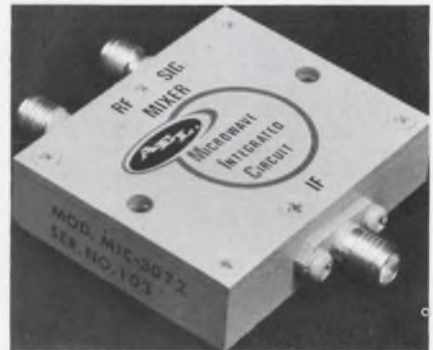

American Electronic Labs., Inc., Colmar, Pa.

Model MIC-3072 is a microwave integrated circuit balanced mixer that has a matched pair of low-noise silicon Schottky barrier diodes on an alumina substrate. The balanced configuration cancels local-oscillator noise while maintaining low input VSWR. Operating over the temperature range of -20 to $+70^\circ\text{C}$.
Booth No. 3K21 Circle No. 348



Need a wild card to complete your logic system?

... gray code logic, arithmetic/logic, pulse synchronizers, excess 3 counters, multi-function cards ... all the wild ones are *standard* with CAMBION. Our constantly expanding deck currently contains over 300 different logic assemblies, enough to build complete systems without ever having to design that special card. Fast — money-saving.

The CAMBION pack won't go out-of-play either. It's designed with medium scale integration capabilities built right in. The exclusive 70-pin input/output edge connector gives you tighter packaging, more functions per card, and tomorrow's product today.

All CAMBION logic assemblies are functionally and physically compatible. Because we put more on a card, you use fewer cards, need

less racks, fewer panels, less cabinets, less space and fewer bucks in the total.°

You'll want the right manual to learn the latest rules of the game. If hardware is your requirement, we've got still another book for that. Just circle the number below or write us direct. They're Free, of course. Cambridge Thermionic Corporation, 445 Concord Avenue, Cambridge, Massachusetts 02138. Phone: (617) 491-5400. In Los Angeles, 8703 La Tijera Boulevard, 90045. Phone: (213) 776-0472.

Standardize on

CAMBION[®]
the guaranteed logic assemblies

**Now you can revise your thinking
about the size of latching relays!**

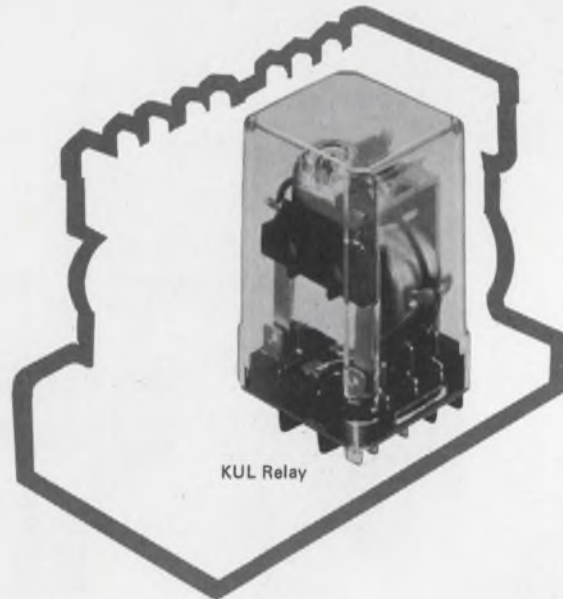

New P&B magnetic latching relay cuts mounting space in half

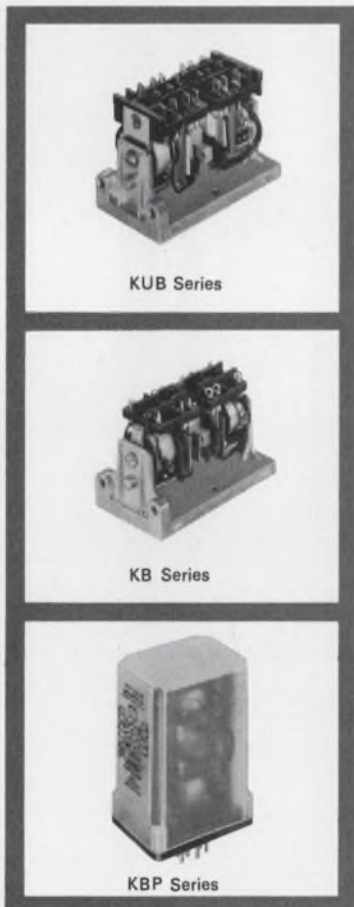

Our new KUL takes up only about half the chassis area of mechanical interlocking latching relays. Only one relay is used, not two. The price (starting at \$6.05) is a lot less, too.

The secret? A unique magnetic circuit design. Voila! A small latching relay with excellent memory stability . . . one designed for continuous duty but which will stay latched without power on the coil. And remember, there are no mechanical interlocking members to wear out.

Single or dual-wound (polarized) coils are available for DC operation to 110 volts. Single coil, two-input, AC units (to 120 volts) employ diodes for pulse separation. Contact arrangements up to 3 Form C are available for switching 5 or 10 amperes. Quick-connect/solder terminals fit nylon socket rated for 10 amperes.

KUL relays are recommended for a host of commercial applications such as process controls, business machines, alarm systems, battery chargers and the like.

Wide Choice of P&B Latching Relays

KUB SERIES. Latching relay employs two KU relays. Quick-connect/solder terminals. Coils operate on same or different voltages. Exceptionally rugged, die-cast zinc base.

KB/KBP. Two KA relays with mechanical interlocking feature. Solder terminals (KB) or octal-type plug and nylon case (KBP).

Need more information? Call your local P&B sales engineer or the factory direct. Potter & Brumfield Division American Machine & Foundry Company, Princeton, Indiana 47570. Telephone: (812) 385-5251.

AMF

POTTER & BRUMFIELD

Gunn oscillator develops 9.4 GHz

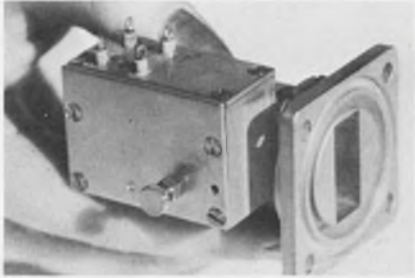

Mullard Ltd., Mullard House, Torrington Place, London W.C. 1, England. Phone: 01-580-6633.

Among the microwave semiconductor devices on display will be the type CL8310 Gunn oscillator. Particularly suitable as a replacement for low-power klystrons in many applications, the device has a mechanical tuning range of over 100 MHz and an electronic tuning range of better than 200 MHz. Nominal mean operating frequency is 9.4 GHz; power output is 5 mW. Booth No. 3B13 Circle No. 323

Stripline dielectric is aluminum backed

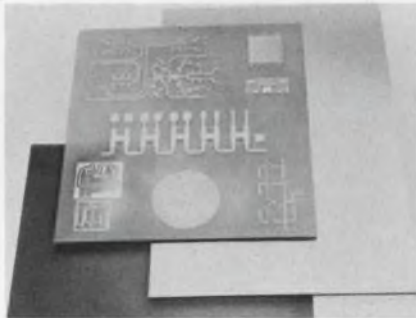

Polymer Corp., 2120 Fairmount Ave., Reading, Pa. Phone: (215) 929-5858.

Designed for microwave stripline circuits, a polyphenylene-oxide dielectric material, which is called Z-Tron, now has an aluminum backing. This material is a sandwich of copper cladding over the dielectric and laminated to aluminum for fine-line close-tolerance etching without sacrificing tolerances on subsequent operations. It is designed to be photo-etched by standard procedures without subsequent machining.

Booth No. 1E18 Circle No. 343

S-band paramp is hybrid MIC

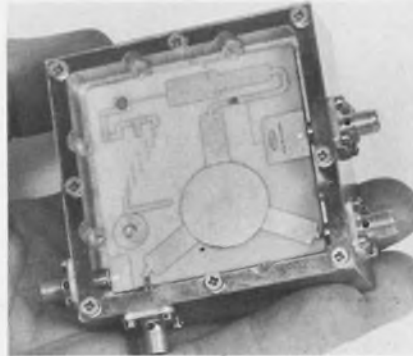

American Electronic Labs., Inc., Colmar, Pa.

Entirely solid state in construction and built on a single substrate with hybrid MIC techniques, an S-band parametric amplifier contains an avalanche-diode oscillator pump source and achieves low noise figures of 2.5 dB maximum. The principal components of the amplifier include a ferrite junction circulator, input matching networks, a high-cutoff-frequency varactor diode, pump and idle frequency filters.

Booth No. 3K21 Circle No. 347

Digital attenuator has dial display

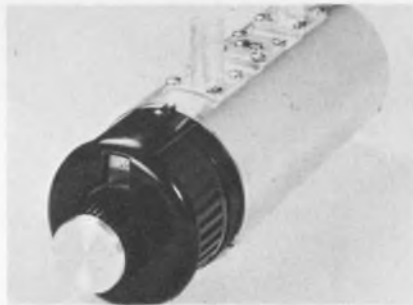

Texscan Corp., 2446 N. Shadeland Ave., Indianapolis, Ind. Phone: (317) 357-8781. P&A: \$165; 2 to 3 wks.

Providing 11-dB attenuation in 0.1-dB steps, a dual concentric rotary attenuator digitally displays the total attenuation level on its dial, thus eliminating the need for cumbersome gear trains and cam arrangements. Model RA-534 has an accuracy of ± 0.3 dB at 500 MHz. Booth No. 2H16 Circle No. 372

**LOOKING
BEYOND
THE
"SPECS"
WITH P&B**

*Daily millions of these
P&B Power Relays
prove their reliability*



The granddaddy of all P&B relays. Millions in use throughout the world . . . starting motors, controlling elevators, doing a multitude of heavy duty jobs, reliably. Here are some reasons why.

Floating Contact Carrier Provides Wipe

A full floating carrier for the movable contacts provides an abundance of wipe to keep the contacts scrubbed on every operation. Large 5/16" diameter contacts switch 25 ampere non-inductive loads or 1 HP at 120/240V AC, single phase.

A wide variety of contact arrangements is available. Coil voltages range from 6 to 440 volts AC and 6 to 110 volts DC. Magnetic arc-quenchers are also available for DC loads over 28V DC.

Many Are Listed by U/L and CSA

Underwriters' Laboratories (File No. E22575) and Canadian Standards Association (File 15734). CSA listing covers AC relays only.

PLUS P&B Capabilities and Facilities that insure

- **Controlled Quality**
- **Reliability**
- **Long Life**
- **On Time Deliveries**



Five plants in the United States and one in Canada, provide the production capacity to handle large orders with on-time deliveries.

AMF
POTTER & BRUMFIELD
Division of American Machine & Foundry Co.
Princeton, Indiana 47570

INFORMATION RETRIEVAL NUMBER 78

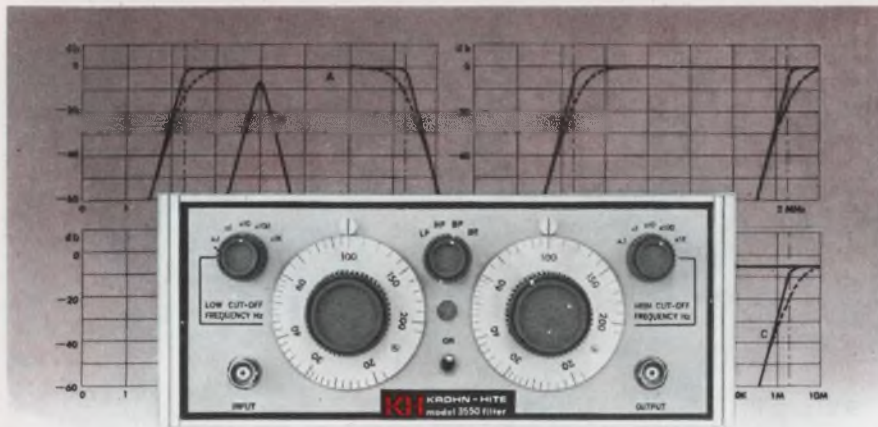

New, low priced all solid-state variable filters

cover 2 Hz to 200 KHz

MODEL 3550 — a new, all solid-state multifunction variable filter covering the 2 Hz to 200 KHz frequency range. Functions include band-pass, high-pass, band-reject and low-pass with 24-db-per octave attenuation slopes extending greater than 60 db. Frequency response can be switched from Butterworth to Low Q (transient free). Low hum and noise (200 μ v rms). Dynamic range of greater than 80 db. Insertion loss 0 db. Bench model: 8 $\frac{5}{8}$ " wide x 3 $\frac{1}{2}$ " high x 13 $\frac{1}{2}$ " deep. Rack model: 19" wide x 3 $\frac{1}{2}$ " high x 13 $\frac{1}{2}$ " deep. Price: \$525

MODEL 3500 — a new all solid-state variable band-pass filter covering the 20 Hz to 200 KHz range. Switches from Butterworth to Low Q. Attenuation slopes: 24-db-per octave extending to greater than 60 db. Hum and noise: 200 μ v rms. Dynamic range greater than 80 db. Insertion loss 0 db. Size: same as above. Price: \$395

SEE THEM AT IEEE — Booth No. 2H30-32. See for yourself why these new Krohn-Hite solid-state variable filters make "do-it-yourself" filter design a relic of the past.

OVERSEAS SALES OFFICES: BELGIUM, C. N. Rood s. a. DENMARK, SC Metric A/S; FRANCE, Antares; GERMANY, Nucletron Vertriebs-GMBH; HOLLAND, C. N. Rood n. v.; ITALY, Dott. Ing. Mario Vianello; SWEDEN, Teleinstrument; ISRAEL, R.D.T. Elect. Eng. Ltd.; JAPAN, Shoshin Shoji Kaisha, Ltd.; AUSTRALIA, Sample Electronics (Vic.) Pty., Ltd.; G. B., B & K Inst. Ltd.

KH KROHN-HITE CORPORATION

580 Massachusetts Ave., Cambridge, Mass. 02139, U.S.A.
Phone: (617) 491-3211 TWX: 710-320-6583

Oscillators / Filters / AC Power Sources / DC Power Supplies / Amplifiers

INFORMATION RETRIEVAL NUMBER 79

U162

MICROWAVES & LASERS

Plug-in generator sweeps to 300 MHz



Wiltron Co., 930 East Meadow Dr., Palo Alto, Calif. Phone: (415) 321-7428. P&A: \$950; 4 wks.

Performing both as a sweeper and as a signal generator from 1 to 300 MHz, model 6106 plug-in achieves an amplitude modulation of 85% with less than 3% distortion. This modulation is attained with a leveled 1-V rms output and a peak voltage of 2 V rms. Other modulation capabilities include a built-in 1-kHz square wave with better than 60-dB on/off ratio, plus fm capabilities either direct coupled or ac coupled. Booth No. 2C30 Circle No. 370

Diode attenuator drives itself



General Microwave Corp., 155 Marine St., Farmingdale, N.Y. Phone: (516) 694-3600. P&A: \$525; stock.

By incorporating a driver module with a logarithmic transfer function, a new p-i-n diode attenuator/modulator permits its attenuation level to be controlled with a single dc voltage at the rate of 10 dB per volt. Model N172AL operates over the frequency range of 0.05 to 8 GHz with a dynamic attenuation range in the matched mode approximating 35 dB.

Booth No. 3K26 Circle No. 346

INFORMATION RETRIEVAL NUMBER 80 ►

Interface accidents are on the rise.
And maybe we can help.
We've set up a new department
at Hughes. Our R F Sub-Systems
Department.

We did it to develop microwave
generation and amplification equipment
that can be integrated into transmitters
without incident.

To overcome the perils of interface.
Our winning ways with tubes
have led to several microwave packages
guaranteed to be "face-free."

Like the 10 mW multi-channel

crystal controlled solid-state source and
the 20 W medium power CW TWTA
package below.

Designs are available which cover
the power range from milliwatts to



kilowatts. Frequency ranges from L through
Ku-band.

We specialize in such diverse fields
as low noise sources, space environment
TWT's, pulsed and CW TWT's,
solid-state power converters and
modulators, and special cooling methods
involving air, liquid and heat pipe
techniques.

Tell us your specifics. We believe
in saving face.

Write Electron Dynamics Division
of Hughes, 3100 West Lomita Boulevard,
Torrance, California 90509.

A word of caution to microwave engineers.



HUGHES
HUGHES AIRCRAFT COMPANY
ELECTRON DYNAMICS DIVISION

Small wonder!



New air variable capacitors only 0.310" in diameter for vertical or horizontal tuning.

Johnson introduces these new Type "T" subminiature air dielectric capacitors for trimming applications that call for small size (0.310" diameter), high Q (greater than 1500 at 1 MHz), low TC, and low cost. Mounting dimensions of vertical mount "T" are identical to common 3/8" diameter PC mount ceramic disc trimmers.

Nominal capacities available range from 1.3 pF minimum to 15.7 pF maximum. Minimum voltage breakdown is 250 VDC. End frame is 95% alumina, grade L624 or

better, DC200 treated. Metal parts are silver plated and Iridited to inhibit discoloration.

Plates are precision machined from brass extrusions and offer exceptional uniformity, stability, and absolute freedom from moisture entrapment. Temperature coefficient is plus 30 ± 15 ppm/°C. Retrace characteristics are excellent. Outstanding stability during vibration from 10 to 2000 Hz. These new capacitors meet or exceed EIA-RS 204 and MIL Standard 202C Methods 204A and 201A.

- Please rush a sample of your new Type "T" capacitors, detailed specs and prices.
 Include Catalog 701 covering the entire E. F. Johnson component line.

NAME _____ TITLE _____
 FIRM _____ ADDRESS _____
 CITY _____ STATE _____ ZIP _____



E. F. JOHNSON COMPANY

3303 Tenth Avenue S. W., Waseca, Minnesota 56093

Providing nearly a half-century of communications leadership

INFORMATION RETRIEVAL NUMBER 81

Wideband sweeper is programmable



Alfred Electronics, 3176 Porter Dr., Palo Alto, Calif. Phone: (415) 326-6496.

A new pushbutton programmable sweeper is capable of accepting up to ten different oscillator heads for complete coverage of the frequency range from 250 MHz to 40 GHz. The new system consists of the 650 front plug-in sweeper, any combination of up to ten series 650 plug-in oscillator units, model 9510 pushbutton control unit, and model 9511 plug-in container unit.

Booth No. 2C12 Circle No. 361

Precision connectors couple 36-GHz signals



Alford Mfg. Co., 120 Cross St., Winchester, Mass. Phone: (617) 729-8050.

Precision 3.5-mm sexless connectors can be used at up to 36 GHz. The CA-54 connector features low VSWR and high repeatability. These connectors are rugged, long lasting and easy to use. A variety of adapters, terminations, filters, directional couplers are among the complementary components offered.

Booth No. 2D46 Circle No. 253

BUS BARS

... for PC CARDS

... eliminating
the need
for a
multilayer
card

... using a
laminated
BUS BAR
with distributed
capacitance
for power
and ground
distribution.

VISIT US AT OUR BOOTHS
4G12 & 4G14

we're introducing
off-the-shelf
BUS BARS



IEEE '69
EXHIBITION
MARCH 24th to 27th, 1969
NEW YORK CITY

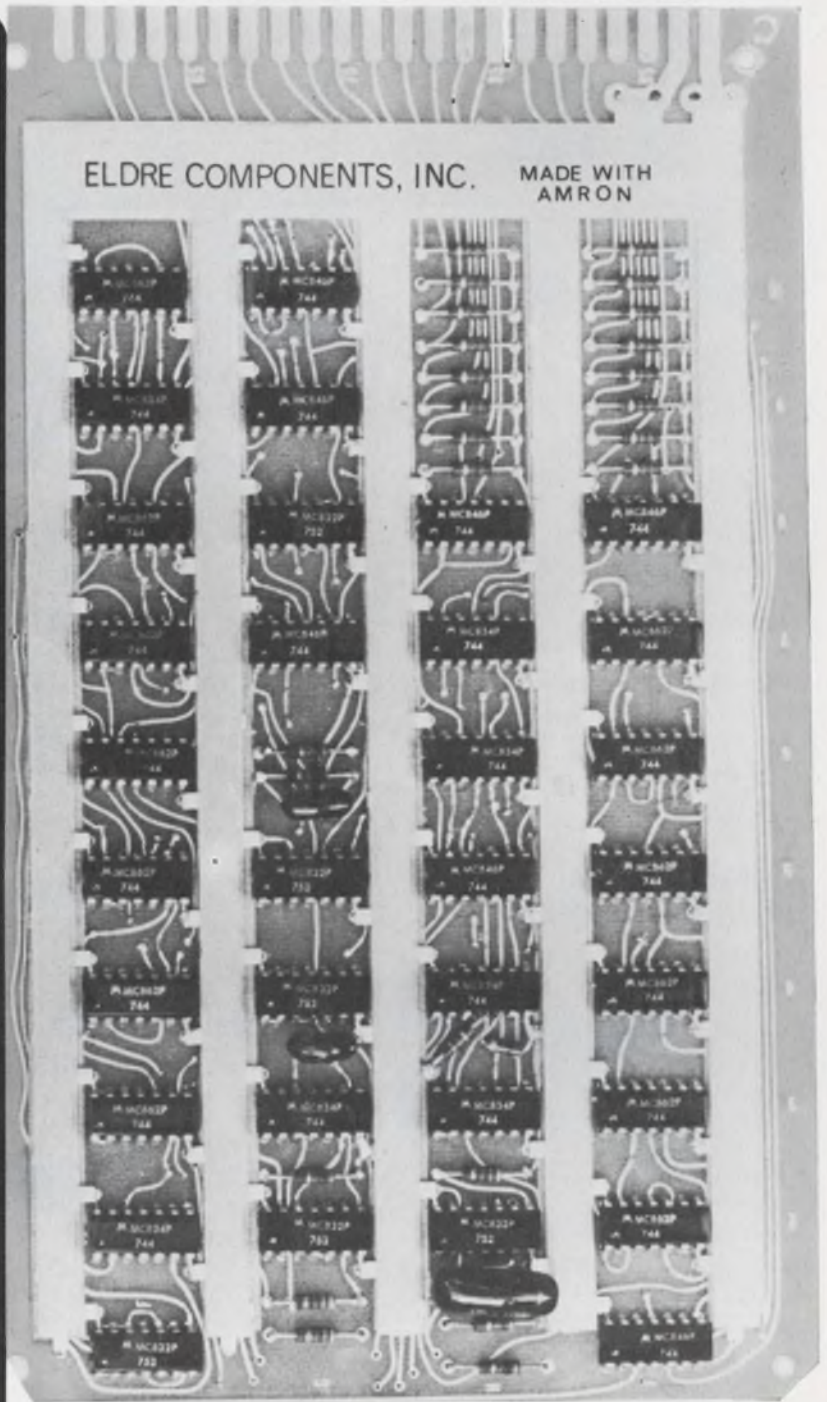

ELDRE

COMPONENTS, INC.

1239 University Ave.
Rochester, N. Y. 14607

716 244-2570

INFORMATION RETRIEVAL NUMBER 82

Lighted pushbuttons have 0.9-in. display

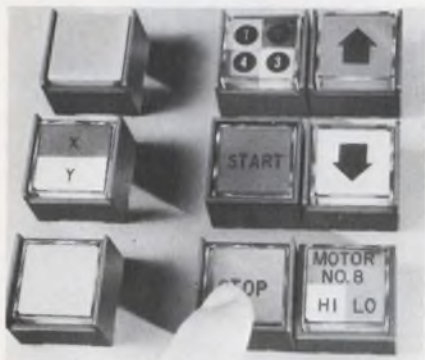

Honeywell Inc., Micro Switch Div., 11 W. Spring St., Freeport, Ill. Phone: (815) 232-1122.

A new line of oiltight pushbuttons and indicators with 0.9-in. square display areas features on-the-face legends and snap-acting operation. Series PM modules offer a wide variety of interchangeable switching elements, thereby providing up to four spdt (form C) circuits, with either momentary or alternate action, on a single device. Each unit uses up to four lamps. Booth No. 2G48 Circle No. 331

Digital readout has dual display



Pinlites Inc., 1275 Bloomfield Ave., Fairfield, N.J. Phone: (201) 226-7714. Price: \$40.

To meet the long mean-time-between-failure requirements of military systems, a new seven-segment digital readout offers a redundant second-level backup display. Within one display head, the unit contains two electrically and mechanically separate sets of seven light bars. These are concentrically arranged for two character sizes—5/16 in. for the primary one, 1/4 in. for the secondary one.

Booth No. 3B22 Circle No. 299

Single-phase readout challenges Nixie

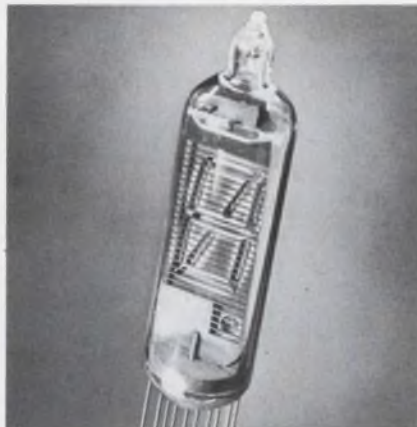

Alco Electronic Products, Inc., P.O. Box 1348, Lawrence, Mass. Phone: (617) 686-3887. P&A: \$2.99 to \$4.95; stock.

A single-plane numeric readout device, the mosaic type Elfin, is available as an alternative to the Burroughs Nixie. The Elfin readout has an extremely simplified electrode structure, so that it can be mass-produced. Cold cathodes corresponding to mosaic type numbers and decimal points are placed on the same plane. The new tube is particularly suited for use with ICs.

Booth No. 4G23 Circle No. 254

PC rotary switch holds 12 positions

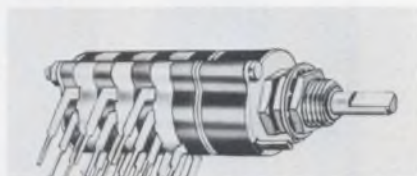

Grayhill, Inc., 561 Hillgrove Ave., La Grande, Ill. Phone: (312) 354-1040.

Designed for printed circuit applications, a new 12-position multi-deck rotary switch with gold-plated terminals readily adapts to conventional wave soldering techniques. Series 9 switches can continuously carry 4 A or make and break an inductive load at 0.25 A, 115 V dc. Initial insulation resistance is 50,000 MΩ and breakdown voltage is 1000 V ac.

Booth No. 4G03 Circle No. 275

Elapsed time meter logs running hours



Curtis Instruments, Inc., 200 Kisco Ave., Mt. Kisco, N.Y. Phone: (914) 666-2971.

A low cost elapsed time indicator is intended for such applications as warranty or service time logging. Minimum accuracy is 3% of reading. Units are available in a 120 series that operates directly from a current source; in a 420 series that contains integral current-limiting resistors designed to operate from dc voltage; and in a 520 series that operates directly from the ac line and contains a zener diode power supply to rectify and regulate the input.

Booth No. 2B11 Circle No. 295

Tiny transformers fit 0.2-in. cube



Essex International, Inc., Controls Div., 3501 W. Addison St., Chicago. Price: \$7 to \$12.

Called the Stancor Pico series, a new line of miniature transistor transformers and reactors have volumes that range from 0.215 to 1-3/16 in³. There are 242 basic units including approximately 900 configurations to suit a number of mounting variations. Each unit features high efficiency plus a wide range frequency response of -5 dB to -4 dB at 300 Hz and +0.5 dB to +1.5 dB at 50 kHz.

Booth No. 4F12 Circle No. 321

The Great Panel Discussion over Honeywell's new VT-100 digital meter...

... a discussion that's making the VT-100 one of the most talked-about panel meters around!

The VT-100 3½-digit panel meter calls a halt to the expensive problem of service and stocking different meters for different functions. And this deserves discussion.

Now, you need only the low-cost VT-100 with its plug-in card feature. Change its range and function to any one of 20 different configurations – AC and DC volts, AC and DC current and resistance parameters with three-five ranges each – by simply changing the input card. Or, use your own input card for scale factoring, readout in engineering units, etc. Spare plug-in cards provide immediate, on-the-spot repair.



You get quick, accurate, full-scale calibration and automatic zero. It also provides 100% over-range with an overrange digit reading to 1999 (4000 count option to 3999), BCD outputs, remote encoding, print command and an accuracy of .2% of reading ± 1 digit.

Innovative? Yes. Practical? Definitely. At only \$245. (quan. of 1-24 units)

Order your VT-100's today! Call Don Anderson (collect) at (303) 771-4700.

Or write for more information to Mail Station 222, Honeywell, Test Instruments Division, P. O. Box 5227, Denver, Colorado 80217.

Honeywell

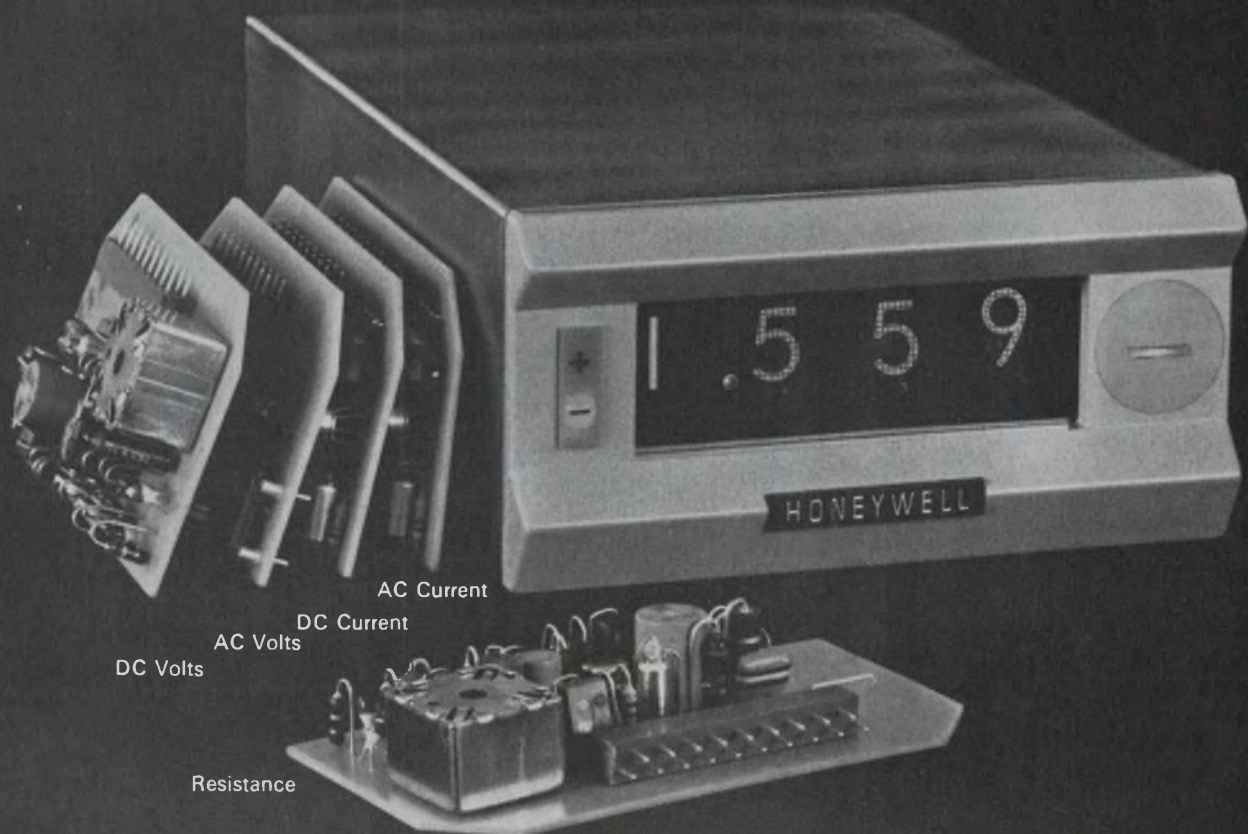

Honeywell engineers sell solutions

See us at the IEEE Show – New York Coliseum, March 24-29. Booths 2G39 to 2G43.

INFORMATION RETRIEVAL NUMBER 83

TRYGON HAS THE POWER

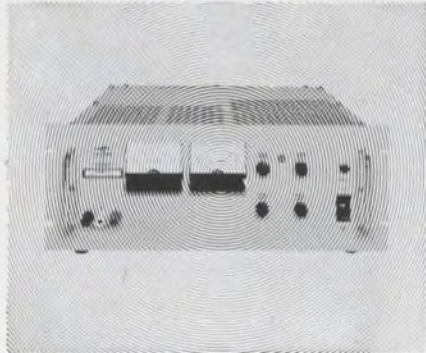

**to deliver wide
range constant voltage
constant current
performance for
every lab and system
application.**

- All silicon design—precision performance
- Wide voltage ranges—currents to 100 amps
- Positive convection cooling—no derating
- Overvoltage and ultra-high stability options
- Automatic load share paralleling
- Priced from \$575.

"Super-Mercury from TRYGON . . . the competitively-priced series of fully programmable wide-range power supplies, power and value packed.

Super-Mercury: Designed for bench or rack installation with slide provisions at no extra cost . . . in ranges up to 160 volts and up to 100 amps. Regulation of 0.005% and 0.015% stability are standard (0.005% stability optional) as is MIL Spec, RFI-free performance. Total ripple and noise: less than 1 mV RMS; Master-slave tracking, auto-load share paralleling and remote sensing and programming also standard. Write for the full TRYGON power story

TRYGON DOES HAVE THE POWER!



TRYGON POWER SUPPLIES

111 Pleasant Avenue, Roosevelt, L.I., N.Y. 11575
Trygon GmbH 8 Munchen 60, Haidelweg 20, Germany
Write for Trygon 1968 Power Supply Handbook.
Prices slightly higher in Europe.

INFORMATION RETRIEVAL NUMBER 84

U168

COMPONENTS

Monolithic filters pack 12 poles



Tyco Labs, Inc., Bear Hill, Waltham, Mass. Phone: (617) 899-2400. P&A: \$1/pole; 30 to 60 days.

Monolithic crystal filters in 2- to 12-pole configurations have center frequencies from 5 to 22 MHz with fractional bandwidths of 0.01 to 0.4%. The devices offer up to 6 poles in one package and 12 poles in two 6-pole packages placed in tandem. A typical 8-pole monolithic filter with a 10.7-MHz center frequency and 7-kHz bandwidth will meet 2:1 shape factors at 60:6 dB. Spurious responses are down at least 90 dB.

Booth No. 3E11 Circle No. 276

Single-unit switches control multi-circuits



Cherry Electrical Products Corp., 1650 Old Deerfield Rd., Highland Park, Ill. Phone: (312) 831-2100. P&A: \$2.90 to \$8.10.

By combining from two to five switches into a single unit, series E62 subminiature switch modules achieve multi-circuit switching control and space economy. The new series includes two-, three-, four- or five-gang units that are thinner than standard subminiatures fastened side-by-side. They are double-throw circuits with ratings of 10.1 A, 1/4 hp, 125 V ac.

Booth No. 4B17 Circle No. 399

Miniature inductors attach to hybrids

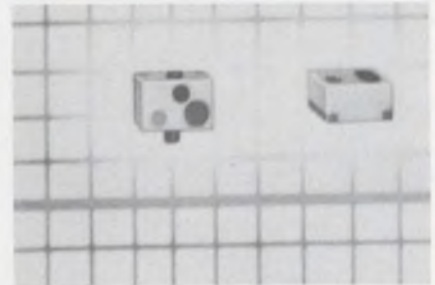

Cambridge Thermionic Corp., 445 Concord Ave., Cambridge, Mass. Phone: (617) 491-5400.

Semi-fixed and fixed microminiature inductors, models 1052 and 1053 are engineered for bonding to thick-film substrates. These inductors offer an inexpensive technique for producing hybrid circuits, utilizing chip integrated circuits. Part number 1054, the smallest of this microminiature line, is designed for use in hybrid circuitry, where fixed inductances are necessary.

Booth No. 3H15 Circle No. 257

Lighted pushbuttons carry 6 A at 125 V

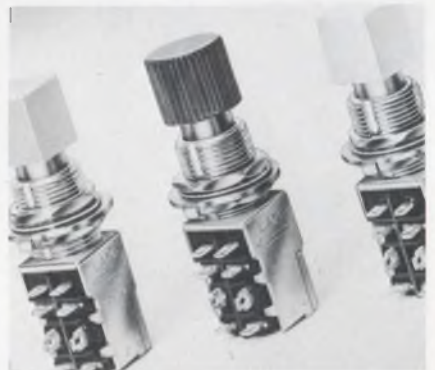

Alco Electronic Products, Inc., P.O. Box 1348, Lawrence, Mass. Phone: (617) 686-3887. P&A: \$4.80; stock.

Series MSPN lighted snap-action pushbutton switches can handle currents as high as 6 A at 125 V ac. They provide dpdt action in a miniature case, while allowing separate connections for the lamps. They use standard T-1-3/4 grooved lamps that can be easily replaced from the front. Side terminals are supplied for printed circuits or wired installations.

Booth No. 4G23 Circle No. 297



ZELTEX Model 830, the FIRST fet 'op amp' in a dual-in-line package...

try that on for size

The big news in miniature amplifiers is the ZELTEX 830—the industry's first in a DIL package—and the first in a new ZELTEX family of DIL analog functions. What's more, the 830 is fully compensated and short circuit-proof. Performance? The spec's tell the story. ■ Voltage gain is 300,000 ■ $20\mu\text{V}/^\circ\text{C}$ drift ■ input



bias current of 15 pA ■ $6\text{V}/\mu\text{sec}$ slew rate ■ 10 volt common mode voltage, and ■ output of 10 volts at 5 mA. Available from stock, too. Size up the 830 now. Write for complete data and prices. ■ 1000 Chalomar Rd., Concord, Ca. 94520. Phone (415) 686-6660.

IEEE Booth 2C06-2C08

INFORMATION RETRIEVAL NUMBER 85

New Victoreen MOX Resistors Now values to 2500 megohms in a compact package only 1/4 OD x 5" long

Now — by specifying new Victoreen metal oxide glaze resistors — you can buy resistance by the inch.

Based on our standard 1/4" OD size, Victoreen Series MOX resistors, per inch of lineal length, give up to 7.5 kv ratings . . . 500 megohms resistance . . . 2.5 watts power dissipation. Tolerances are $\pm 2\%$ or $\pm 5\%$ right across the board up to the 5" size . . . $\pm 1\%$ and $\pm 0.5\%$ in some sizes. Stability is exceptional, too — less than 1% full-load drift in 2000 hours . . . shelf life drift less than 0.1% per year.

Victoreen MOX Resistors are available right now in sizes and ratings that make them near-perfect — for HV probes with DVMs, meter multipliers, HV plate load resistors and similar circuits. And still more new sizes and ratings are on the way, too.

A-1962

VICTOREEN INSTRUMENT DIVISION
10101 WOODLAND AVENUE • CLEVELAND, OHIO 44104
IN EUROPE: GROVE HOUSE, LONDON RD., ISLEWORTH, MIDDLESEX, ENGLAND

See us at IEEE Booth 3B08

INFORMATION RETRIEVAL NUMBER 86



COMPONENTS

Metal film resistor fits miniature circuits



American Components, Inc., Eighth Ave. at Harry St., Conshohocken, Pa. Phone: (215) 828-6240. P&A: 57¢ to \$2.18; stock to 4 wks.

A molded precision metal film resistor, 0.05-in. in diameter and 0.13-in. long, featuring end-cap construction, can be used in miniature circuit assemblies. The resistor, type MRE-1/20, conforms to all the environmental requirements of MIL-R-10509F in tolerances to $\pm 0.1\%$ and temperature coefficients as low as 0 ± 25 ppm/°C. Standard resistance range is 25 Ω to 25 k Ω . Power rating is 1/20 W at 100°C and 1/40 W at 125°C.

Booth No. 4G15 Circle No. 262

Four-wire terminals are dip soldered

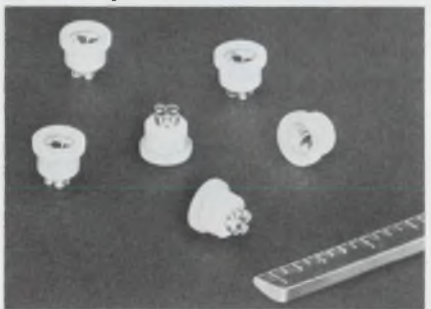

Sealelectro Corp., 225 Hoyt St., Mamaroneck, N. Y. Phone: (914) 698-5600.

Terminals designed to bring users the economy of dip-soldering with metal chassis construction provide economical, yet uniformly perfect solder joints by dip soldering with metal chasses. The unique configuration permits the insertion of four or more wires and provides an optional center pin post for the attachment of additional components after the dip soldering operation is complete.

Booth No 4E03 Circle No. 271

There's no gamble involved with MICOM's new system. It's a combination of specialized test equipment designed to meet the specific needs of people who calibrate and align magnetic tape recorders. Each instrument is human engineered to meet system requirements. The wilderness of dials, knobs, and switches associated with conventional systems is gone. The system's simplicity increases operator efficiency, assures correct test results, eliminates errors in operation that result from repetitive testing, and substan-

tially reduces panel space requirements.

A system made up of MICOM's specialized test instruments can drastically reduce the alignment and calibration time for magnetic tape recorder systems. This leads directly toward increased profit, since overhead can be considerably reduced without sacrificing accuracy.

A MICOM system can be as simple as one of our Model 8300 IRIG Standard Flutter Meters, our Model 6100 Test Set, our Model 6200 FM Calibrator, our Model 6300 Select-

able Stepping Oscillator, variable tuned filter, switch panel, pulse generator, and an oscilloscope.

Our engineers can work with you to develop a MICOM system to meet your specific requirements. For further information, contact us at 855 Commercial Street, Palo Alto, California 94303. Telephone: (415) 328-2961. TWX: 910-373-1179.



Take a look at our system... You can't beat it!



INFORMATION RETRIEVAL NUMBER 87

CABLES



CABLES



CABLES



CABLES

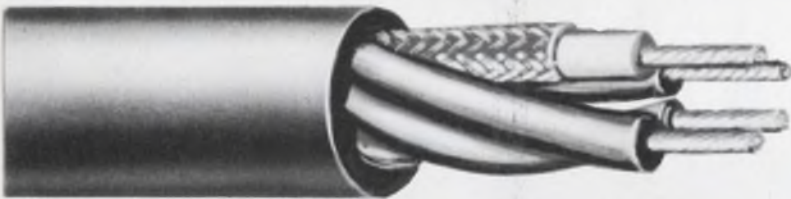

CABLES



All produced by **LENZ!**

Yes, Lenz makes cables of all styles and sizes—to suit innumerable varieties of applications.

Since 1904 Lenz has been making cables—long before the advent of radio.

Lenz has the facilities and experience to service your cable requirements. We invite you to take advantage of this experience to help solve your cable design problems—at no obligation.

Write for catalog!



LENZ ELECTRIC MFG. CO.

1755 No. Western Ave., Chicago, Ill. 60647

In Business Since 1904

INFORMATION RETRIEVAL NUMBER 88

COMPONENTS

Miniature rotaries are 1/2-in. around



Grayhill, Inc., 565 Hillgrove Ave., La Grange, Ill. Phone: (312) 354-1040.

Miniature rotary switches with 1/2- and 9/16-in. diameters provide the following features usually found only in larger diameter switches: solder-lug or printed-circuit terminals; one, two, three or four poles; commercial or military versions (MIL-S-3786/20); 30, 36, 45 or 60° angles of throw; and adjustable or factory-set stops. Series 50 switches are available with shorting or non-shorting contacts. They will make and break a 200-mA load at 115 V ac for 10,000 full (360°) cycles.

Booth No. 4G03 Circle No. 274

Subminiature switch differentiates 1 mil



Honeywell Inc., Micro Switch Div., Chicago & Spring Sts., Freeport, Ill. Phone: (815) 232-1122.

A new subminiature switch that has a differential travel of 0.001 in. needs only half as much travel as the most sensitive of its miniature predecessors to complete its switching cycle. Electrical ratings of model 11SX1-T are 28 V dc at 3 A resistive, 2 A inductive, and 115 V ac at 3 A. The spdt switch operates over the temperature range of -100 to +250°F.

Booth No. 2G48 Circle No. 298

***Riedon's new
trimming potentiometer
with patented
spring ring wiper***

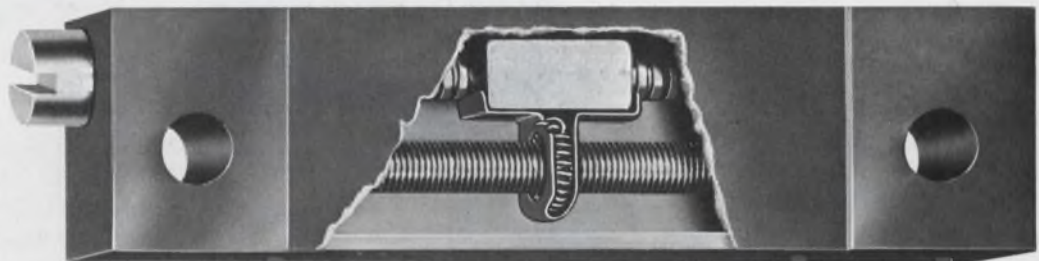

***gives you
twice the
resolution
less than
20 ohms noise***

If you'd like to know more about these remarkable new trimming potentiometers, write for our new catalog. **It's free.**

Quiet-trim* is a remarkable new trimming potentiometer that uses a ring of multiple contacts around the resistance element as the wiper. During adjustment, this ring makes many sequential contacts on each turn of resistance wire. As a result of this light but constant contact, resolution is increased and the unit is essentially noiseless even under extreme shock and vibration.

Designed for both military (per MIL-R-27208) and industrial applications, these rugged trimming potentiometers are available in lead, pin or panel mounts; interchangeable with most standard designs. They feature a dual metal end clutch, 50 ppm/°C temperature coefficient and virtually zero end resistance.

* Patented

	RIEDON DIVISION
INDUSTRIAL TECHNOLOGY CORPORATION 7932 HASKELL AVENUE / VAN NUYS / CALIFORNIA 91406 PHONE (213) 873-3464	

Or drop by our booth 4E36 and 4E38 at the IEEE Show and see our gigantic cutaway.

INFORMATION RETRIEVAL NUMBER 89

Pushbutton modules customize keyboards

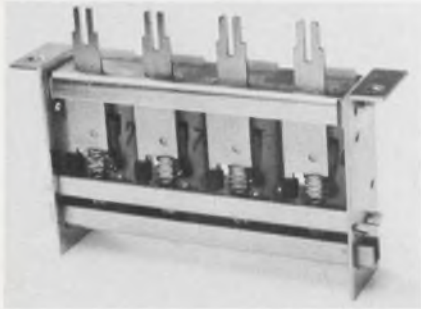

Alco Electronic Products, Inc., P.O. Box 1348, Lawrence, Mass. Phone: (617) 686-3887. P&A: \$2.90 to \$5.80; stock.

Allowing the design engineer to create his own custom keyboard layouts, series SB pushbutton modules use single-pole normally-open reed switches to achieve positive data input. The basic module allows use of one to three switches in either momentary or alternate push-on-push-off action. Stacking allows any number of these switch sections to be used.

Booth No. 4G23. Circle No. 284

Low-noise amps adjust gain

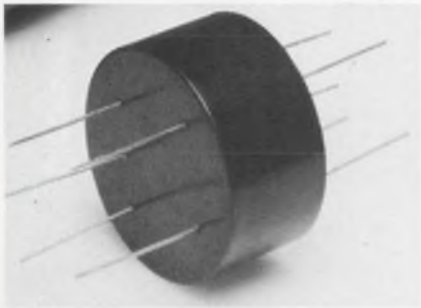

American Machine & Foundry Co., Applied Cybernetics Products, 1025 North Royal St., Alexandria, Va. Phone: (703) 548-7221. P&A: \$89.50; 30 days.

Designed for oceanographic and hydrophone preamplifiers, series Uni-Amp universal amplifiers hold noise levels down to -168 dBV per cycle. The units have a gain that is adjustable from 20 to 60 dB by selecting the appropriate external feedback resistor. They recover from overloads in less than 10 ms.

Booth No. 3F01. Circle No. 335

Logic power supply drives 500 gates



Analog Devices, Inc., 221 Fifth St., Cambridge, Mass. Phone: (617) 492-6000. P&A: \$49; stock (sample quantities).

Model 903 dc power supply is an encapsulated PC-card mounting unit designed to operate IC logic circuits. The unit develops 5 V, 500 mA and measures 2.5-in. wide by 3.5-in. long by 1.25-in. high.

The new power supply might typically be used to supply the full complement of dc power for a digital instrument, such as a counter, frequency meter, or other device based on extensive arrays of digital circuitry. Since a logic gate absorbs roughly 1 mA, the supply could operate a system using up to 500 such gates.

The power supply's key specifications are 5 V, 500 mA output, 105 to 125 V, 58 to 420 Hz input $\pm 1\%$ output voltage accuracy, 0.02% maximum temperature coefficient, 0.3% warm-up drift (with no overshoot or turn-on), 0.15% maximum line regulation, 0.3% maximum load regulation (from zero to full load), 1 millivolt maximum rms ripple, 25 M Ω output impedance at 10 kHz, and temperature derating of 5 mA/ $^{\circ}\text{C}$ below 25 $^{\circ}\text{C}$ and 12 mA/ $^{\circ}\text{C}$ above 50 $^{\circ}\text{C}$.

The power supply can handle short circuits without internal damage, is protected against reversed output polarity, and has a fail-safe circuit that prevents overvoltage in the event of internal component malfunction.

Booth No. 4E26. Circle No. 264

Oscilloscope module uses 3/4-in. tube

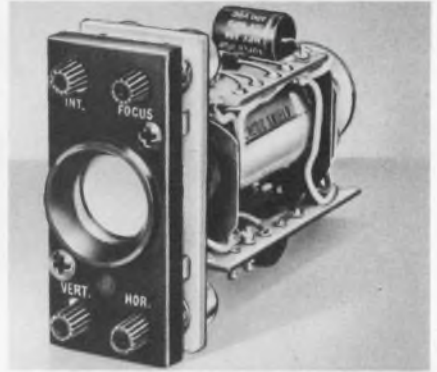

James Millen Mfg. Co., Inc., 150 Exchange St., Malden, Mass. Phone: (617) 324-4108. Price: \$40.

Built around a 3/4-in. cathode ray tube, the 90975 oscilloscope module is designed to be built into equipment as a qualitative monitor. Occupying a minimum amount of panel space, the over-all dimensions of the miniaturized instrument are 1-1/4 by 2-3/4 by 3-1/2-in.-deep behind the panel. The unit is supplied without the National Union type 1DP1 cathode ray tube that is required for operation.

Booth No. 2D35. Circle No. 384

Caption modules display six at once



Dialight Corp., 60 Stewart Ave., Brooklyn, N.Y. Phone: (212) 497-7600.

Series 711 caption modules can display from one to six messages simultaneously, selectively, or in any combination. Any symbol that can be reproduced on photographic film may be mounted in the lighted display area. Each message display area has its own individually controllable lamp. When not illuminated, messages may be either hidden or visible, depending upon whether the viewing screen is non-glare or polished.

Booth No. 3H14. Circle No. 324

We invented a circular subminiature connector.



And created an instant shortage.

We knew we had a good thing with our BULLS-EYE circular subminiatures.

Without sacrificing size or spacing, we'd increased contact density 50 to 200%. Mounting density 33%.

The orders came flying. And BULLS-EYE connectors got scarce.

But now we think we've got the problem licked. For a while, at least.

Now you can get 102 contacts in a size 18 shell that tucks away in a standard MS cutout. But much closer to-

gether than other circulars.

It's our PolarHex center-mounted jackscrew that lets you mount more connectors per panel and *guarantees* positive alignment and mating.

The BULLS-EYE incorporates the same crimp snap-in contact design and retention system that made Hughes rectangulars famous. Housed in featherweight stainless steel shells.

They're available in sizes 8 through 18. In four styles with 14 to 102 contacts. All in non-environmental, environmental, or potting versions.

Write before there's another run on them.

Write Hughes Aircraft Co., Connecting Devices, 500 Superior Ave., Newport Beach, Calif. 92663. Phone (714) 548-0671. TWX (714) 642-1353.

CD Connecting Devices, part of Hughes Circuit Technologies. Including: Contour™ Cable; Semiconductors; Flip Chips/Equipment; Frequency Control Devices; Microelectronic Circuits: MOSFETs.

HUGHES

HUGHES AIRCRAFT COMPANY

If it's happening in connectors,
it probably started at Hughes.

Low-level scanner uses ICs throughout



Cunningham Corp., Honeoye Falls, N.Y. Phone: (716) 624-2000. Price: \$4000.

A low-level instrumentation type scanner features a new control design and uses ICs throughout. The unit is available with a cross-bar module enclosed in a single chassis, but for applications where the signal sources are at a great distance from the control location, the cross-bar module can be separated easily from the electronic portion. Model 409 is capable of speeds to 60 channels per second.

Booth No. 3A12 Circle No. 325

High-voltage source supplies stable power



Power Designs, Inc., 1700 Shames Dr., Westbury, N.Y. Phone: (516) 333-6200. Price: \$2250.

Designed for the high-resolution high-voltage operation of character-generator, display CRTs and other similar devices, a new power source furnishes highly stable low-noise corona-free voltages between 10 and 30 kV. Model 1579 contains completely encapsulated modular high-voltage blocks. Its regulation is 0.0025% for line or load variations and peak-to-peak ripple is less than 250 mV.

Booth No. 2G10 Circle No. 286

Reference standards have 4- or 6-V output



Instrulab, Inc., 1205 Lamar St., Dayton, Ohio. Phone: (513) 223-2241. P&A: \$125 to \$250; stock.

A new series of miniature high reliability voltage reference standards comprises two units. Part number 7-196-PPK-4 features an output of 4 V dc $\pm 0.015\%$. Part number 7-194-NT-34 offers an output of 6 V dc $\pm 0.035\%$. Both units operate over the temperature range of -55 to $+85^\circ\text{C}$. Input voltage for both is 15 V dc $\pm 2\%$ at 30 mA max.

Booth No. 2H44 Circle No. 288

Dc power supplies offer 5 or 24 volts



Wanlass Electric Co., 2175 S. Grand Ave., Santa Ana, Calif. Phone: (714) 546-8990. P&A: \$37.50 (10 units); stock.

Mark III low cost, regulated dc power supplies for low-voltage applications, are available in 5- or 24-V versions. They feature a series-regulator circuit that operates from an ac input of 115/230 V $\pm 10\%$, single phase, 47 to 53 Hz, and provides a regulation of $\pm 0.1\%$ for line and load with ripple of 3 mV rms max. The units feature automatic current limiting.

Booth No. 4D11 Circle No. 261

Readout modules plug in and out

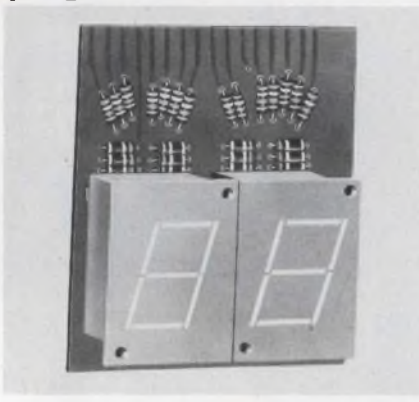

Dialight Corp., 60 Stewart Ave., Brooklyn, N.Y. Phone: (212) 497-7600.

Directly mounted on a plug-in PC board for convenient installation, series 718 seven-segment numeric readout assemblies have 1-in.-high characters with from two to eight modules. They use high-brightness neon lamps and come supplied with the required series and shunt resistors. Modules can display plus-minus, decimal, colon, or special captions. Each one presents a total of 20 characters.

Booth No. 3H14 Circle No. 278

Seven crystal oscillators interchange easily



Vectron Laboratories, Inc., 146 Selleck St., Stamford, Conn. Phone: (203) 324-9225. P&A: \$100 to \$300; stock.

CO-211-series proportional oven-controlled crystal oscillators range in stability from 1×10^{-9} per day to 1×10^{-7} per day. These seven plug-in modules are electrically and mechanically interchangeable.

Booth No. 2F07 Circle No. 269

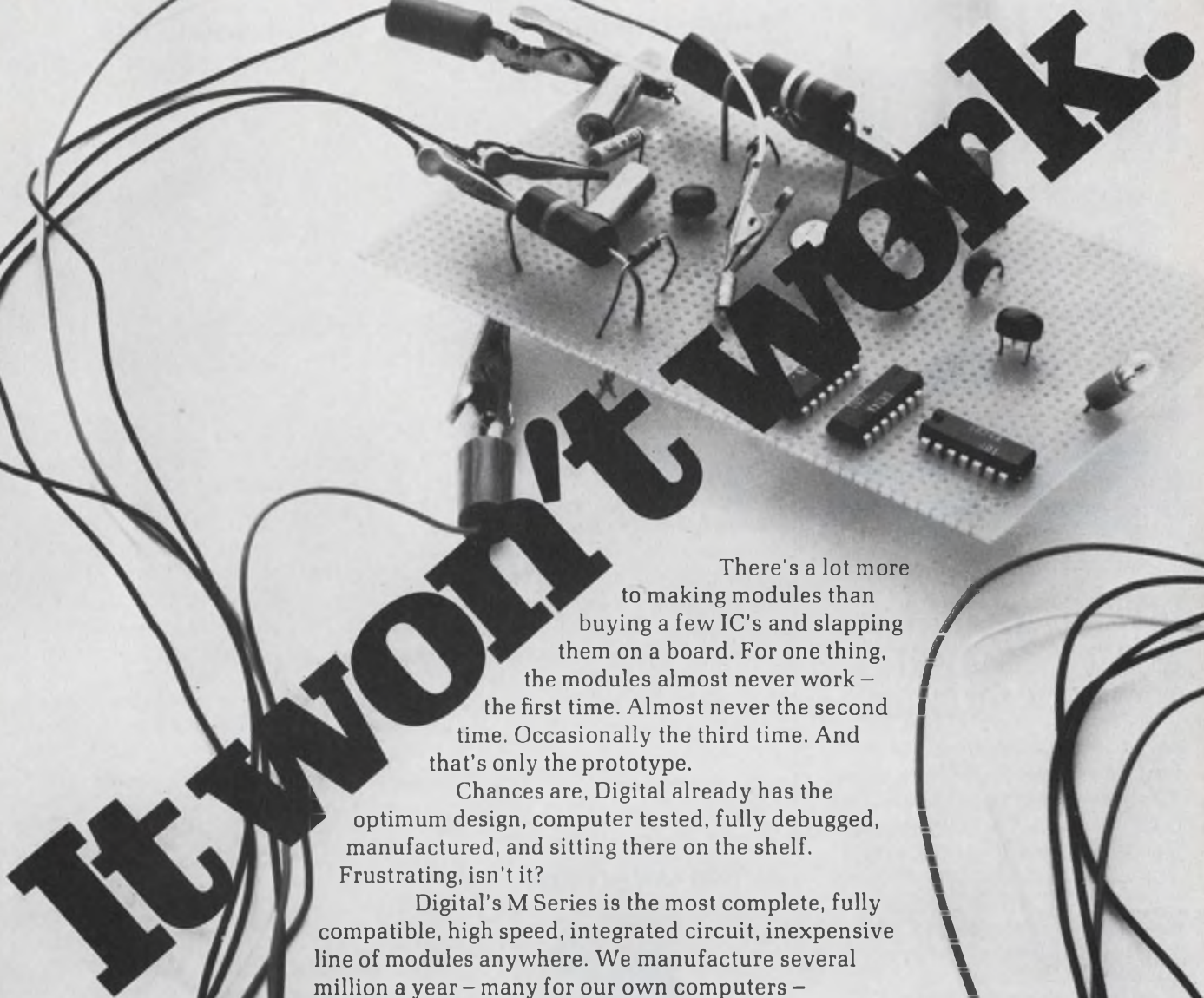

It won't work.

There's a lot more to making modules than buying a few IC's and slapping them on a board. For one thing, the modules almost never work — the first time. Almost never the second time. Occasionally the third time. And that's only the prototype.

Chances are, Digital already has the optimum design, computer tested, fully debugged, manufactured, and sitting there on the shelf. Frustrating, isn't it?

Digital's M Series is the most complete, fully compatible, high speed, integrated circuit, inexpensive line of modules anywhere. We manufacture several million a year — many for our own computers — and know how.

Send for our new Logic Handbook. It tells you what, why, and how to build logic systems from modules. But, alas, not how to build the modules themselves.

DIGITAL EQUIPMENT CORPORATION, Maynard, Massachusetts 01754. Telephone: (617) 897-5111 / Cambridge, Mass. / New Haven / Washington, D.C. / Parsippany, Palisades Park, N.J. / Princeton, N.J. / Rochester, N.Y. / Long Island, N.Y. / Philadelphia / Pittsburgh / Cleveland / Dayton / Huntsville / Cocoa, Fla. / Chicago / Denver / Ann Arbor / Salt Lake City / Houston / Albuquerque / Los Angeles / Palo Alto / Seattle. INTERNATIONAL, Carleton Place and Toronto, Ont. / Montreal, Quebec / Edmonton, Alberta, Canada / Reading and Manchester, England / Paris, France / Munich and Cologne, Germany / Oslo, Norway / Stockholm, Sweden / Sydney and West Perth, Australia.

digital
MODULES • COMPUTERS

Trim your high-voltage capacitor costs



NEW JOHANSON MODEL 7169 QUARTZ TRIMMER CAPACITORS

are your best low-cost replacements for high RF voltage vacuum capacitors. They'll do the job reliably and cost a lot less. Check these specs then write or call for prices:

SPECIFICATIONS

Capacitance: 1.0 pF to 15.0 pF
(models available to 25 pF)
Q at 30 MHz: 2000 min.
Temp Coefficient: 0 ± 100 ppm/ $^{\circ}$ C
Voltage: RF 4300 volts peak at 30 MHz
Dielectric Strength: 20,000 volts DC
Operating Temp: -55° C to $+150^{\circ}$ C
Torque: 1 — 10 in. —oz.

APPLICATIONS

- Neutralizing Capacitors
- Tuned Power Amplifiers
- Fixed and Variable Power Oscillators
- Tank Circuits with High Circulating Currents
- Dielectric Heating Matching Networks
- Output and Input Matching Networks
- Coupling and Bypass

MANUFACTURING CORPORATION

400 Rockaway Valley Road
Boonton, N.J. 07005 • (201) 334-2676
Electronic Accuracy Through Mechanical Precision

INFORMATION RETRIEVAL NUMBER 102

U178

MODULES & SUBASSEMBLIES

Solid-state modules condition ac signals



Astrosystems, Inc., 6 Nevada Dr., New Hyde Park, N. Y. Phone: (516) 328-1600.

A series of ac signal-conditioning modules have been specifically designed for applications requiring accurate signal recovery, high immunity to noise and unloading of the source. Typical operating parameters include 50 M Ω input impedance, up to 125 V rms input voltage and typical common mode rejection of 80 dB at 400 Hz. Outputs are designed as an ideal current generator with a typical output impedance of 0.05 Ω .

Booth No. 2C15 Circle No. 267

Time-delay relays switch 10 amps

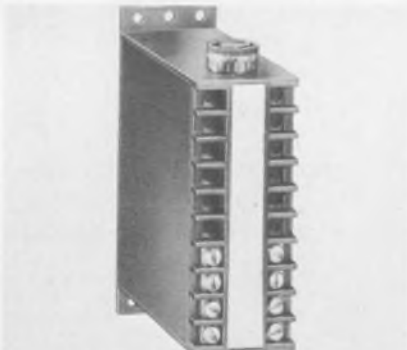

Magnecraft Electric Co., 5575 North Lynch Ave., Chicago. Phone: (312) 282-5500.

Series 212M solid-state time-delay relays combine hybrid circuitry for the timing function with an electromechanical relay for 10-A output switching. The units are equipped with an adjustable knob and calibrated dial for each timing range down to seconds. Two basic models provide six timing functions by simply adding a jumper wire to the appropriate terminals.

Booth No. 3J16 Circle No. 285

Crystal oscillators are temperature stable



Bliley Electric Co., 2545 West Grandview Blvd., Erie, Pa. Phone: (814) 838-3571. P&A: \$37.50 to \$43.50; stock.

Two temperature-compensated crystal oscillators for standard time base frequencies at 1 MHz and 10 MHz have guaranteed stability of 2 ppm over 0 to 60 $^{\circ}$ C range. Both oscillators feature sealed crystals processed for low aging. Standard module size is approximately 2 by 2 by 0.5 in. with pin terminals for PC board mounting and operation from a 12 V dc supply.

Booth No. 3F17 Circle No. 322

Rack-mount supply regulates to 0.005%

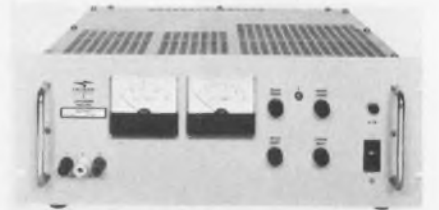

Trygon Electronics, Inc., 111 Pleasant Ave., Roosevelt, L.I., N.Y. Phone: (516) 378-2800.

Within a 7-in. panel height, model M7C160-15 power supply provides 0.005% regulation and 0.015% stability from 0 to 160 V dc and 0 to 15 A. The unit supplies full power to 60 $^{\circ}$ C without derating and has a ripple voltage of less than 1 mV rms. It performs per military specifications to vibration, shock, line voltage, emi and quality requirements.

Booth No. 2H47 Circle No. 283

Capacitors

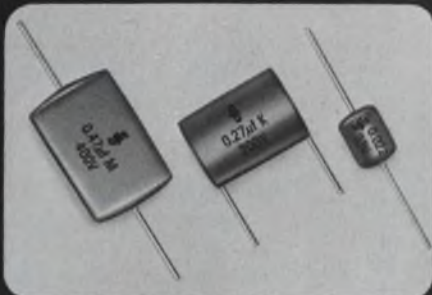

POLYESTER—33-400 V d.c., 1000 pF
—0.47 MF

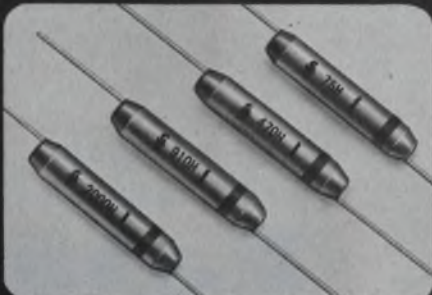

POLYSTYRENE—33-630 V d.c., 1-25,000 pF

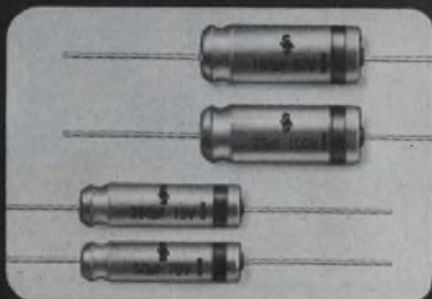

ALUMINUM ELECTROLYTICS
3—100 V d.c., 0.5—10,000 MF

*A Full Range of Capacitance
And Voltage Ratings In
Four Types -- Designed With
Your Application In Mind.*

You can rely on Siemens to provide a wide range of precision built capacitors. High performance units that are available now in four major types designed to match your circuit requirements.

In addition, you can call on Siemens experienced engineers to assist you with your application problems involving the capacitors shown, as well as: Tantalum and Polycarbonate capacitors, Ferrite materials, Semiconductors, and many other products.

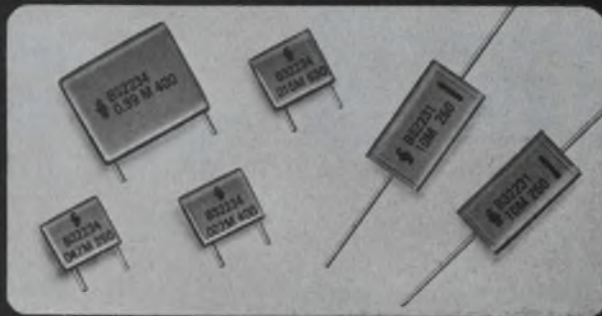

METALLIZED POLYESTER
100-630 V d.c., 0.068—10 MF

For technical information or assistance, contact:

Siemens America Incorporated, Components Division

685 Liberty Avenue, Union, New Jersey 07083 (201) 688-5400

"A tradition of craftsmanship and service since 1847"

Visit us at IEEE Show, Booths 2J45-2J49, 4J20-4J22.

INFORMATION RETRIEVAL NUMBER 103

Plastic blocks handle 600 V

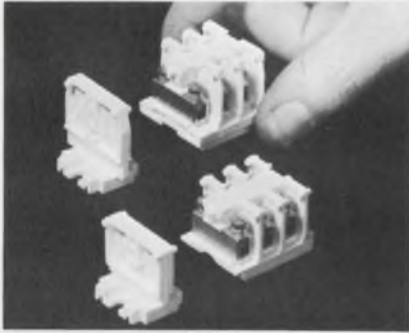

Buchanan Electrical Products Corp., 1065 Floral Ave., Union, N.J. Phone: (201) 289-8200.

Preassembled in 25 snap-fit contact sections for quick assembly, two new polypropylene terminal blocks can handle voltages as high as 300 and 600 V, respectively. The new blocks permit 32 circuits per foot with 3/8-in. center-to-center spacing and will accept wire sizes up to AWG #8. Circuits may be added or subtracted to meet specific requirements.

Booth No. 3B45 Circle No. 367

PC-card bus bar cuts production cost

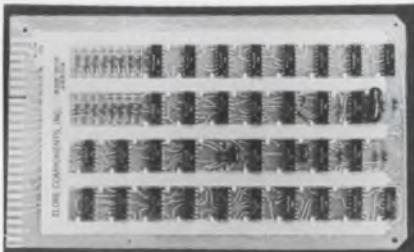

Eldre Components, Inc., 1239 University Ave., Rochester, N. Y. Phone: (716) 244-2570. Price: \$2.75 to \$10.

A PC-card bus bar eliminates the need for multilayer card construction, thus reducing the cost of design and construction. The bus bar brings power and ground out on the PC card, with distributed capacitance. The PC card and bus bar can be flow soldered together. Each conductor is 0.01-in.-thick copper, separated with insulation that has a dielectric strength of 500 V dc.

Booth No. 4G12 Circle No. 259

Solder preforms are flux coated

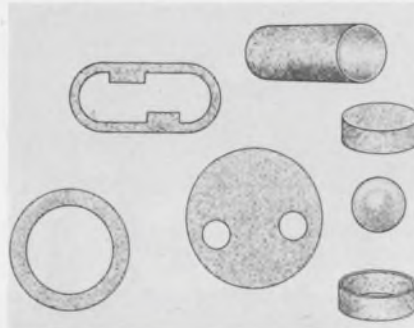

Alpha Metals, Inc. 56 Water St., Jersey City, N. J. Phone: (201) 434-6778.

Flux coated preforms are pre-shaped solder parts coated on the outer surface with the finest grade of water-white rosin flux. When heat is applied, the flux on the outer surface liquefies first, and flows onto the base metal before the solder. With flux-filled preforms, on the other hand, the solder must be at least partially melted before the flux can escape. Liquid solder may thus come in contact with the metal surface before it has been properly cleaned.

Booth No. 1F08 Circle No. 266

Rf connectors go to 18 GHz



Sealectro Corp., RF Components Div., 225 Hoyt St., Mamaroneck, N.Y. Phone: (914) 698-5600.

Series SRM miniature rf connectors, which conform to the requirements of MIL-C-39012, deliver a low VSWR of 1.05 throughout the frequency range of dc to 18 GHz. Styles include: straight and right-angle cable plugs and jacks for 0.141-in. semi-rigid and flexible coaxial cables; bulkhead panel and right-angle jack receptacles;

Booth No. 4E03 Circle No. 332

Woven ribbon cable folds and twists

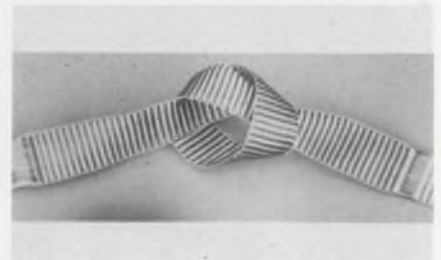

Zippertubing Co., 13000 S. Broadway, Los Angeles. Phone: (213) 321-3901.

Reducing costs for interconnections by 50% over laminated printed cables, a new flexible woven ribbon cable can be folded, rolled, twisted, or even tied in knots with no tendency to delaminate or change impedance. FCR controlled impedance cable maintains 80-Ω impedance with less than ± 10% deviation and reduces crosstalk below 10%. By simply following a folding procedure, one length of cable can accommodate all interconnect levels.

Booth No. 1B28 Circle No. 396

Standard NAFI modules house magnetic devices



Polyphase Instrument Co., E. 4th, Bridgeport, Pa. Phone: (215) 279-4660.

Offering new packaging possibilities for magnetic component circuits, Polymod NAFI modules combine special precision molding techniques with proprietary epoxy formulations to meet the ultra-precise specifications of NAVORD-WS 6116D. These new packages accept filters, transformers, power supplies and networks that have been designed with NAFI configurations.

Booth No. 4E08 Circle No. 364

Anyone can think small.



Frankly, we had something bigger in mind.

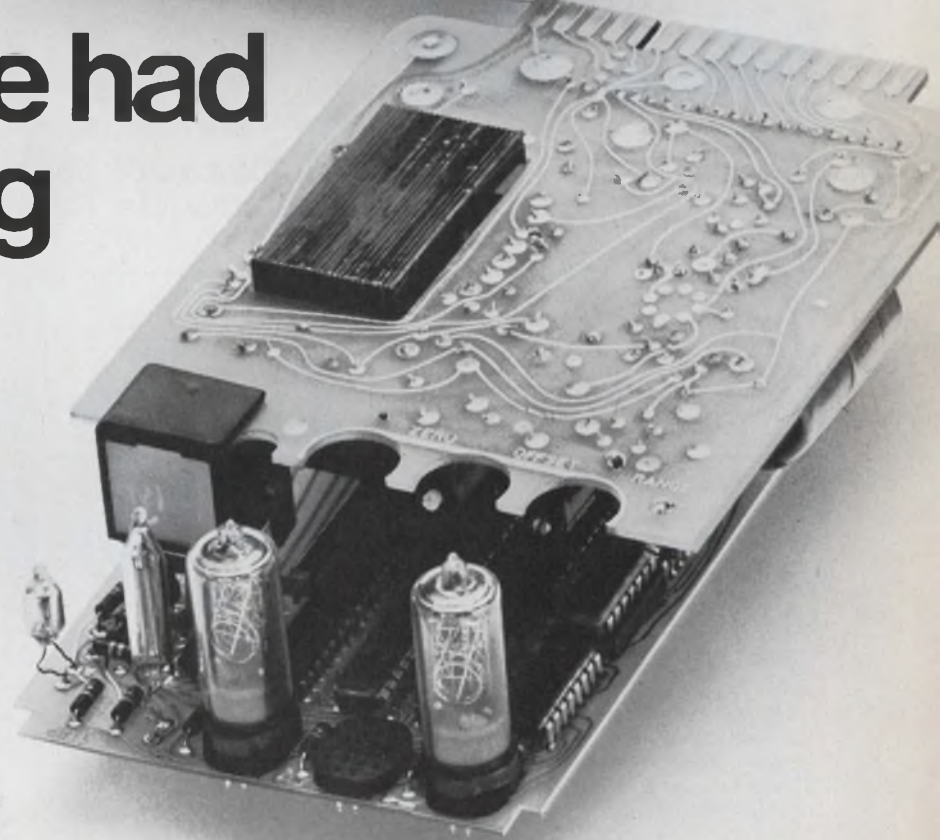

Model 1290 DPM will be on display at IEEE Booths 2C-39—50. Watch us plug it in and play your favorite numbers.

We built our second generation DPM* to fit into seven square inches of panel. *That's less than any other digital panel meter requires.* But we didn't stop there. The Model 1290 mounts completely from the front of the panel. *The entire chassis pulls out from the front for servicing or replacement.* Even the Nixie** tubes are pluggable! Think of the convenience in continuous systems opera-

tion. Despite the smaller package, Model 1290 has all the features our original DPM is so widely acclaimed for—3-digit plus 100% overrange display, 0.1% ± 1 digit accuracy, circularly polarized window filter, dual slope integration, full-buffered storage display and BCD output. Many of these standard Weston features are still "optional at extra cost" on competitive units. Our new compact

is styled for tomorrow, available today, and priced below \$200 in quantity. Anything else in the industry is just small talk. WESTON INSTRUMENTS DIVISION, Weston Instruments, Inc., Newark, New Jersey 07114.

a Schlumberger company

WESTON®

*U.S. Pat. #3,061,939 and patents pending.

**Registered trademark, Burroughs Corp.

SWEPT MEASURE- MENTS



\$1,985

Make fixed or swept frequency insertion loss, VSWR, and gain measurements rapidly, accurately, and inexpensively using the new Model 1810 Stabilized RF Ratio Meter and its recommended accessory, the Model 1852 Broadband Microwave Head. The Model 1810 eliminates errors due to source instability and puts an end to sweeper leveling. Features include: less than 1.5 dB noise figure, better than 0.005 dB/°C overall stability, better than 0.002 dB/dB reference level rejection, logarithmic output, and automatic switchover between single channel and dual channel (ratio) operation. When used with the Model 1852 Head, measurements can be made from 100 MHz to 12.4 GHz, with a dynamic range of 40 dB.

The surprisingly low price of the Model 1810, coupled with Weinschel standards-lab performance, makes it ideal for production lines, inspection and quality control, and engineering labs. For complete specifications and prices, contact your local Weinschel representative, or write:

See this and other Weinschel Products at Booths 2L01, 2L02, IEEE Show, New York, March 24-27 and at Isle 19, Booth 50, Salon International des Composants Electroniques, Paris, France, March 28-April 2.

Designers and
Manufacturers of Precision
Microwave Equipment
**WEINSCHEL
ENGINEERING**
Gaithersburg, Md. 20760
Tel: (301) 948-3434
TWX: 710-828-9705

INFORMATION RETRIEVAL NUMBER 105

PACKAGING & MATERIALS

Edge connectors polarize PC cards



*Continental Connector Corp., 34-63
56th St., Woodside, N.Y. Phone:
(212) 899-4422.*

Able to accept 1/16-in. printed circuit cards, series 600-6PC50 card-edge connectors contain a center barrier in their single-piece molded body that can be used for polarization of a PC board. They are microminiature units with 100 terminals on 0.05-in. center-to-center contact spacing. There is a choice of straight or right-angle-bend terminations.

Booth No. 4G08 Circle No. 363

Printed-circuit cards accommodate DIPs



*Scanbe Mfg. Corp., 1161 Monterey
Pass Rd., Monterey Park, Calif.
Phone: (213) 264-2300.*

Printed-circuit cards designed for either 14- or 16-lead dual-in-line packages are the first high-density completely integrated packaging available for IC components. Using the new system, the PC dual-in-line packs may be inserted directly into cards for dip-solder applications. Power supply leads are not bussed together, allowing for maximum versatility when using dual-in-line packages of various pin configurations.

CIRCLE NO. 379

Heat sink/clamps mount flat SCRs

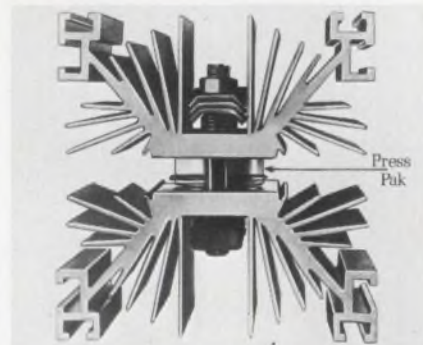

*Wakefield Engineering, Inc., Audu-
bon Rd., Wakefield, Mass. Phone:
(617) 245-5900.*

To meet the need for proper mounting and heat dissipation of flatpack and disc-type SCRs, a new line of heat sink/clamps accepts these SCR packages with up to 2.25-in. diameters. Five styles of extruded heat sinks are available, including standard bolt-size T-slots for mechanical and electrical mounting of busswork or supports. They provide uniform contact pressure.

Booth No. 4B06 Circle No. 362

Signal cables transmit pulses

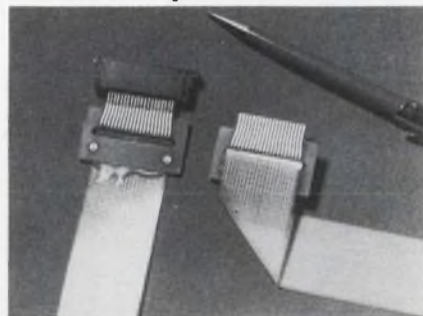

*W. L. Gore & Associates, Inc., 555
Paper Mill Rd., Newark, Del.
Phone: (302) 368-0651.*

Fabricated with homogenous TFE Teflon insulation and silver-plated copper conductors, a new family of transmission line component assemblies transmits digital pulses through precisely controlled parallel wire cables. The multi-signal cables are terminated to PC boards that either plug into standard card-edge connectors or have standard connectors mounted on them.

Booth No. 1F18 Circle No. 394

The first

SEISMIC DATA from the

MOON



OPERATIONAL FILTER



HI/LO FILTER



DUAL HI/LO FILTER

...will be analyzed
by these
**VARIABLE FREQUENCY
ELECTRONIC FILTERS**

by **Rockland Laboratories**

NASA's Spacecraft Center and several university data centers will use these filters for real time processing and magnetic tape analysis of seismic data transmitted from the Apollo lunar landing site. Some reasons for choosing Rockland are listed below.

OPERATIONAL FILTER

- Functions as a variable filter or sine wave oscillator
- Tuning range: .001 Hz to 11 KHz (bandpass DC to 100 KHz)
- High pass, low pass (DC coupled), band pass and band reject responses with digital frequency selection
- Adjustable rolloffs (0, 6, 12, 24, db/octave)
- Butterworth or RC response
- Variable gain (0, 6, 20, 40 db)
- Zero suppression
- 2% frequency setting accuracy
- Silicon solid state
- AC (115/230 V) or DC operation
- Bench/rack convertible
- Price range:
\$1325.00 to \$1650.00

HI/LO FILTER

- High pass or low pass (DC coupled) response with digital frequency selection
- Tuning range: .001 Hz to 111 KHz (bandpass DC to 1 MHz)
- Rolloff: 24 db/octave
- Butterworth or RC response
- Variable gain (0, 20 db)
- 10 megohm input impedance
- 2% frequency setting accuracy
- Silicon solid state
- AC (115/230 V) or DC operation
- Bench/rack convertible
- Price range:
\$695.00 to \$745.00

DUAL HI/LO FILTER

- Two identical and independent filters in one chassis. Sections can be used separately or connected in series or parallel
- High pass, low pass, band pass and band reject responses with digital frequency selection
- Tuning range: .001 Hz to 111 KHz (bandwidth DC to 1 MHz)
- Rolloff: 24 or 48 db/octave per filter section
- Butterworth or RC response
- Variable gain (0, 20 db per section)
- 10 megohm input impedance
- 2% frequency setting accuracy
- Silicon solid state
- AC (115/230 V) or DC operation
- Bench/rack convertible
- Price range:
\$1325.00 to \$1425.00 for 24 db/octave rolloff
\$1825.00 to \$2025.00 for 48 db/octave rolloff



ROCKLAND LABORATORIES, INC.

POST OFFICE BOX 57 • TAPPAN, NEW YORK 10983 • TEL: 914-359-1818

Precision instruments for engineering and the physical sciences

Which relay
is the
International
Standard?

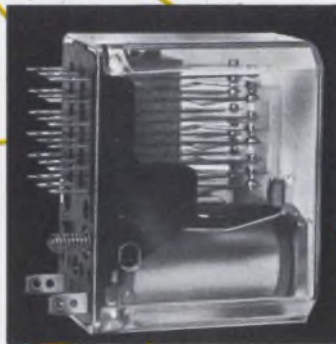

SERIES 430



SERIES 420

Both relays shown actual size

No matter which American Zettler relay you choose, you won't be wrong. Over 12 MILLION Series 420 relays have been sold in the past 10 years...seeing service in industrial control and business data systems throughout the world. Now, joining the Series 420, is a whole new family of 6PDT relays, the Series 430.

Both the Series 420 and 430 offer these outstanding features:

- Life expectancy more than 100 million operations
- Low level bifurcated, 2 amp or 5 amp contacts
- Plug-in, solder or pc terminals
- Round core and larger coil volume provides greater magnetic circuit efficiency
- Requires less than **ONE CUBIC INCH** of space
- Balanced, spring-held armature allows dependable operation in any operating position
- Molded cradle eliminates phenolic dust
- Overtravel assures sufficient wiping action
- Priced as low as **\$1.80 EACH** in production quantities

Whatever or wherever your application, AZ's pacesetter, international standard relays will do the job — and you'll be getting the world's best.

Write today for a free evaluation sample of the Series 420 or 430 and complete technical information on all of AZ's relays, switches and miniature solenoids. Find out why American Zettler can handle all of your switching requirements...from A to Z!



American Zettler, Inc.

697 Randolph Avenue • Costa Mesa, California 92626 • Phone (714) 540-4190 CABLE: ZETELEC
INFORMATION RETRIEVAL NUMBER 107

U184

PRODUCTION

Point-to-point wirer insulates and solders

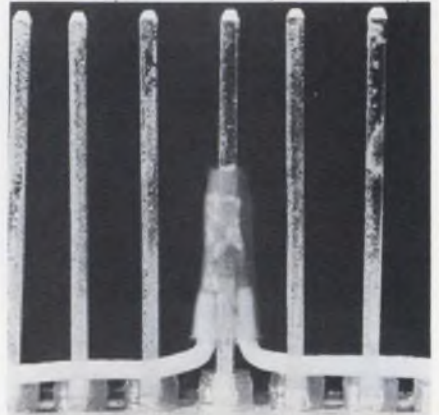

Raychem Corp., 300 Constitution Dr., Menlo Park, Calif. Phone: (415) 324-3333.

Designated Termatrix, a new point-to-point wiring system, which can produce soldered, insulated, or strain-relieved joints, simultaneously terminates all wires on a post at the same level. It consists of an automatic installation head and tape-fed solder sleeves.

Booth No. 1E22 Circle No. 360

High-speed marker uses offset printing



Markem Corp., 150 Congress St., Keene, N.H. Phone: (603) 352-1130.

Demonstrating a new concept in high-speed component printing, a new marking system uses rotary offset printing techniques to achieve variable speeds up to 16,000 per hour. Model U-1185 can mark components such as plastic or metal transistors and integrated circuits in or out of the carrier. It is designed for in-line mounting to print vertically down, vertically up, or horizontally.

Booth No. 1E12 Circle No. 359

ELECTRONIC DESIGN 6, March 15, 1969

RF power devices in hermetic stripline packages



TYPICAL DEVICES AVAILABLE

Power Rating	Device Number		Similar to
	ungrounded emitter	grounded emitter	
1w@1GHz	S3042	S3043	2N4429
2.5w@1GHz	S1007	S1008	2N4430
5w@1GHz	S1009	S1010	2N4431
15w@400MHz	S3512	S3511	2N5016
10w@1GHz	S1054	S1055	S1050

- Single chip reliability
- Choice of grounded or ungrounded emitter
- Available from the shelf in quantity
- Wide variety of devices available upon request

FOR MORE INFORMATION, CONTACT:

Electronic Components DIVISION OF **United Aircraft**
®

TREVOSE, PENNSYLVANIA

Tel. 215-355-5000 TWX: 510-667-1717

IN THE WEST: 128 E. KATELLA AVE., ORANGE, CALIF., (714) 639-4030

INFORMATION RETRIEVAL NUMBER 108

Comparisons are Beautiful...and Easy...



with the new Atec 3200 DIGITAL COMPARATORS!

Automation of your "Go/No-Go" or "Hi-In-Low" measurements is now made easier with greater reliability, flexibility and lower cost, with the new Atec 3200 series Digital Comparators.

Here's your own off-the-shelf minicomputer. Measurement comparisons are made by parallel computation as opposed to coincidence logic, permitting either moving or static BCD inputs to be compared to pre-established limits. The 3200 Series is specifically designed for local or remote limit programming and occupies only 1 $\frac{3}{4}$ " of height in a standard 19" rack.

You interface with a wide variety of BCD inputs, including all the Atec 2000 and 3000 series of electronic counters, bi-directional totalizers, time interval meters, and an infinite variety of digital measuring devices.

Programming limit values? That's just as easily accomplished, again with no interface problems. Set manual limits from front panel decimal switches; or enter the limits from a complete spectrum of sources: tape and card readers, external measuring instruments—you tell us!

All logic levels for inputs and limits are standard saturated IC voltages (TTL). Choose from four models:

3200 Dual Limit, unsigned data	\$625
3201 Single Limit, unsigned data	425
3202 Dual Limit, signed data	825
3203 Single Limit, signed data	525

Like all Atec products the 3200 comparators are ruggedly constructed and feature modular plug-in assemblies using readily available IC's.

Atec sales engineers are ready to serve you. Phone, wire or write.

Atec, Inc.

1125 LUMPKIN STREET, HOUSTON, TEXAS • PHONE (713) 468-7971
MAILING ADDRESS: P.O. BOX 19426 • HOUSTON, TEXAS 77024

INFORMATION RETRIEVAL NUMBER 109

PRODUCTION

Twin-blade stripper has single adjust

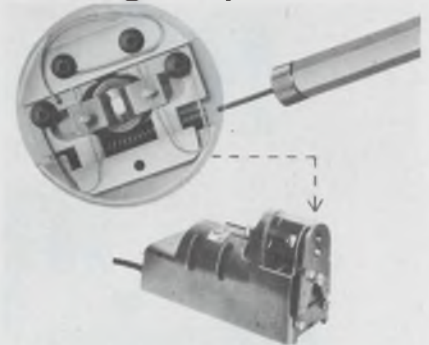

Carpenter Mfg. Co., Inc. Fairgrounds Dr., Manlius, N.Y. Phone: (315) 682-9176. P&A: \$275; stock.

A new bench top rotary-action wire stripping machine adjusts its twin-swing blades simultaneously, precisely, and concentrically by means of a single synchronized adjusting screw. Previously, the blades in a twin-blade machine had to be adjusted separately. Model 70 effectively strips both stranded and single-conductor wires as well as shielded cables.

Booth No. 1H07 Circle No. 358

Cabling tools work uniformly

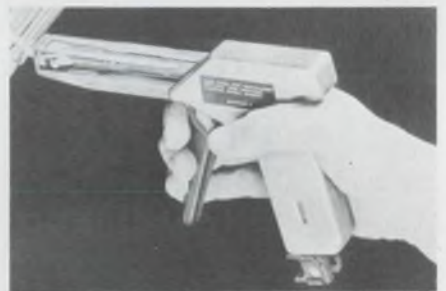

Panduit Corp., 17301 Ridgeland Ave., Tinley Park, Ill. Phone: (312) 532-1800.

Two new cabling tools provide uniform tensing for all of the company's Sta-Strap cable ties, clamps and markers. The GS2B cabling tool ties nine different miniature, intermediate and standard sizes of cable hardware; the CS4H handles ten standard and heavy duty sizes. Both tools automatically tighten a cable tie to a uniform pre-set tension, cut it flush, and eject the cut-off portion.

Booth No. 1C12 Circle No. 356

DIGI ▲ EC panel meters...

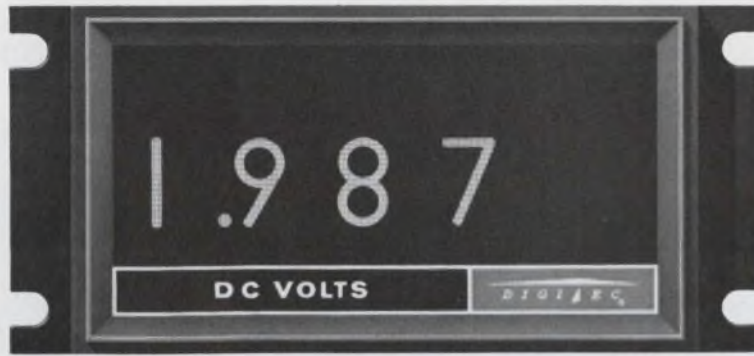

Series 270

\$195

QTY. 1-9

\$129

QTY. 100

& set points...



Model 282

\$149

QTY. 1-9

\$110

QTY. 100

...speak for themselves

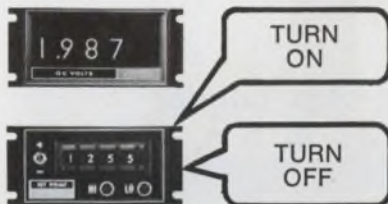

PROCESS CONTROL

Temperature, flow, pressure, torque ... virtually any parameter convertible to a DC signal may be controlled through the on/off, latching or non-latching, contact outputs from the Series 270/Model 682 combination. Set-points are directly set on thumbwheel switches, or may be remotely programmed through an optionally available feature.

**SEE US
AT BOOTH
2K21-22
IEEE SHOW**

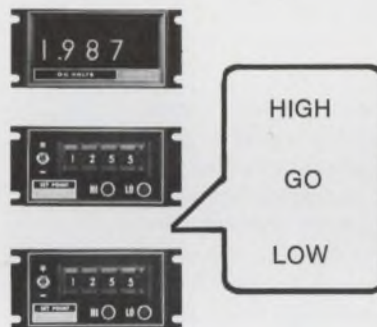

QUALITY CONTROL

Component tolerances, dimensional limits, and other grading information may be quickly checked against pre-set values, with contact outputs connected to activate associated control or alarm equipment. Ease of set-point adjustment minimizes set-up time for new tests.

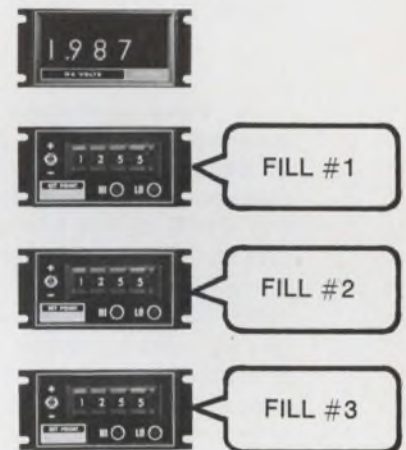

BATCHING

Multi-ingredient batching processes are readily instrumented with the Series 270 Digital Panel Meter and Model 682 Set-Points. Up to four set-points may be driven from a single panel meter, with control contacts arranged so as to produce an automatic, sequential batching cycle.

DIGI ▲ EC

by **UNITED SYSTEMS CORPORATION**

For Complete
Specifications
request new
catalog D69

918 Woodley Road • Dayton, Ohio 45403 • (513) 254-6251
Stocking Representatives Throughout the World

INFORMATION RETRIEVAL NUMBER 110



AM, FM, SSB, CW, MCW, FSK Signals From 1 to 1600 kHz

W-J's new Type DMS-105 Demodulator tunes from 1 kHz to 600 kHz and 540 kHz to 1600 kHz in two bands. Four IF bandwidths are available for reception of upper or lower sideband signals: 2.5, 3.5, 4 and 8 kHz. For other operating modes, bandwidths of 150 Hz, 1, 5, 7, 8 and 16 kHz are provided.

A digital automatic frequency control circuit provides high stability by locking the tuner's local oscillator to the electronic counter circuits. In addition to providing high local oscillator stability, the DAFC circuit acts as a frequency synthesizer, providing the equivalent of 160,000 crystal-controlled frequencies. The frequency to which the DMS-105 is tuned is shown on a 5-digit Nixie tube display reading to the nearest 100 Hz. A decimal shift mode displays the tuned frequency to the nearest 10 Hz. The DMS-105 thus can be locked to a frequency whether or not a signal is present. The unit is standard 19-inch rack size, 5.25 inches high.

CEI DIVISION



WATKINS-JOHNSON

6006 Executive Boulevard, Washington Science Center
Rockville, Maryland 20852 (301) 881-3300

See us at our applications engineering suite at the Barbizon Plaza during IEEE week.

World's largest selection of receiving equipment for surveillance, direction finding and countermeasures.

INFORMATION RETRIEVAL NUMBER 111

PRODUCTION

DIP sorting system tests 5000 ICs/h



Daymarc Corp., 40 Bear Hill Rd.,
Waltham, Mass. Phone: (617) 894-2105.

Providing automatic magazine-to-magazine testing for dual-in-line ICs, type 852 sorter, in conjunction with suitable test equipment, automatically tests and sorts over 5000 devices per hour. DIPs fed from the magazine are transferred to an eight-station index table, then advanced to a probe station for dc or dynamic testing. The dc probe has 32 Kelvin terminal connections for 16-lead ICs.

Booth No. 1H21

Circle No. 357

Flip-chip bonder cycles in 5 s



Hugle Industries, 750 North Pastoria Ave., Sunnyvale, Calif.
Phone: (408) 738-1700.

Completely self contained with integrated circuit control logic and separate pneumatic control for bump leveling and clamping force, a new flip-chip bonder has a total cycle time of less than five seconds. Model 2000 achieves high production rates with an automatic dice pickup and positive alignment by the use of an optical mirror system. It will accommodate multi-dice sizes from 1/4 to 3-in. square.

Booth No. IC23

Circle No. 336

Audio Amplifier? AC Power Supply?

the Compact
NA Series
gives you
both!



The NA Series of AC Power Supplies are exceptionally flexible sources of audio power. Each power supply consists of a Regulated Audio Power Amplifier with interchangeable fixed or variable Plug-In Oscillators for a wide range of precision AC power

applications. The Amplifier has a full power range of 45-6,000 cycles. With the incorporation of a CML Plug-In Oscillator precise fixed or adjustable output frequencies are available anywhere within this range. For complete information, write today.

CML, Inc. 

A subsidiary of Tenney Engineering, Inc.
350 Leland Avenue - Plainfield, New Jersey
(201) 754-5502 • 70 997-9529

INFORMATION RETRIEVAL NUMBER 112

Faster, easier set-ups with



advanced "AGREE" chambers

Tenney's "AGREE" Chambers have always offered the utmost in performance to meet and exceed all test levels of MIL-Std-781A. Now you also get the utmost in operator convenience. Tenney's exclusive "Redi-Seal" (patent applied for) provides a soft cushion of foam to seal between the chamber and L.A.B. or comparable vibration testing machines. No more cumbersome diaphragms...no removable chamber sections...just roll the table in place. Save set-up time. Fully automatic operation of chamber, vibrator, and test item. Make it easy for yourself. For complete information on the latest in "AGREE" testing, write or call



Tenney
ENGINEERING, INC.

1090 Springfield Rd., Union, N. J. 07083 • (201) 686-7870
Western Div.: 15721 Texaco St., Paramount, Calif. 90723

INFORMATION RETRIEVAL NUMBER 113

ELECTRONIC DESIGN 6, March 15, 1969

RELAY CONTACT PROTECTION

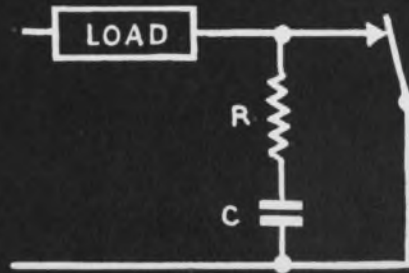

FOR THE ULTIMATE
IN RELAY LONGEVITY

R-C Networks designed to meet your individual requirements. Standard Condenser Arc Suppressors reduce damaging build-up on relay contacts and will greatly prolong the life of relays in your equipment.

Standard Condenser guarantees complete R-C Network compatibility with your present or proposed system.

Send specifications or, if you desire further information, write:

Standard

CONDENSER CORPORATION

Dept. ED-9, 1065 W. Addison St.,
Chicago, Ill. 60613 • 312-327-5440

INFORMATION RETRIEVAL NUMBER 114

U189

BIG FAMILY of SUB-MINIATURE TOGGLE SWITCHES

(and still growing)

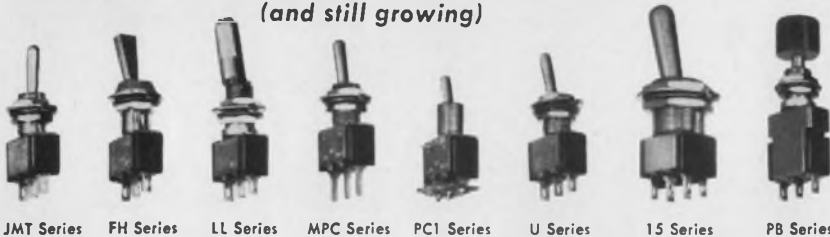

Manufactured at New Haven, Conn., by J-B-T Instruments, Inc., these sub-miniature toggle switches have virtually the same trouble-free characteristics as J-B-T standard size Government quality toggles, in spite of drastic reduction in size and weight. Single-pole types are $\frac{1}{4}$ " thin and weigh only 0.19 oz.; double-pole types are less than $\frac{1}{2}$ " square and weigh a bare 0.32 oz.; 3- and 4-pole types are correspondingly compact, yet they all have a nominal rating of 5 amp. resistive at 125 VAC. Catalog 448, Thomas Micro-Catalogs and Radio-Electronic Master.

& COUSINS

Also made by J-B-T, and on display at the IEEE Show will be the J-B-T line of MIL and NON-MIL types of standard-size toggle switches, both medium and heavy-duty. And at the same time, same place, instrument-type rotary selector switches, and lever switches; "Match Maker" frequency and elapsed time meters including new style "Big Look" frequency meters.

If you can't make it to the Show, be sure to request Catalog 568. It's free. Or look us up in Radio Electronic Master.



J-B-T INSTRUMENTS INC.

NEW HAVEN, CONNECTICUT 06508
(203) 772-2220

Booth 4G11 at the IEEE Exposition, March 24-27, 1969
INFORMATION RETRIEVAL NUMBER 115

IT'S HERE! The one supply to fill all your AC POWER REQUIREMENTS

Need a precision 250 VA single phase supply?
HERE IT IS!

Requirements change to 500 VA single phase or two phase?
ADD A SECOND UNIT!

A three phase job coming up?
ADD A THIRD UNIT!



Powertron SERIES 250S SOLID STATE AC POWER SUPPLIES

The built-in facility for interconnecting Series 250S units to provide single phase, two phase or three phase output power, plus the numerous full power output voltage ranges and wide variety of fixed frequency, variable frequency, single phase and poly-phase plug-in oscillators make this the most versatile AC supply around. Compare its specifications. Write for catalog #1068.

PRICE
\$595⁰⁰
(less plug-in oscillator)



INDUSTRIAL TEST EQUIPMENT CO., Inc.
20 BEECHWOOD AVE. • PORT WASHINGTON, N. Y. 11050
Phone: (516) PO 7-5253

See it at IEEE Show Booth 2D33
INFORMATION RETRIEVAL NUMBER 116

PRODUCTION

PC soldering system handles 14-in. boards



Hollis Engineering, Inc., Nashua, N. H. Phone: (603) 889-1161.
Price: \$4350.

Series TDB bench-mounted soldering systems handle PC boards up to 14-in. wide, in a solder wave that is $\frac{3}{4}$ -in. deep. Features of the new system include close control on the oil/solder intermix meter; larger solder base capacity (450 lb); two remote control panel options for positioning up to 10 ft from solder base; preheater with variable temperature settings; and 13 speed settings on the inclined conveyor from 12 in./min. to 75 in./min.

Booth No. 302 Circle No. 255

Impedance comparator sorts 4000 per hour

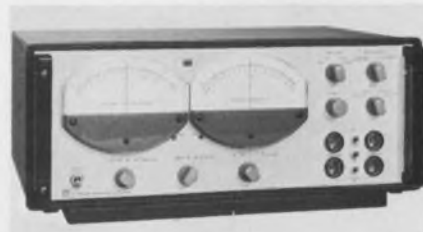

General Radio Co., 300 Baker Ave., W. Concord, Mass. Phone: (617) 369-4400.

Type 1654 impedance comparator indicates the difference in magnitude and phase angle between two external impedances, usually a standard and an unknown. It provides 0.003% impedance difference resolution and can sort over 4000 components per hour when used with a new analog limit comparator that is also being introduced. The analog limit comparator displays go or no-go lights for manual sorting, or can provide an optional relay-contact output.

Booth No. 2E26 Circle No. 374

Double duty Double metals

H. A. Wilson Thermometals® are thermostatic bimetals that (1) change shape with temperature and (2) build up force with change of temperature when constrained.

They can be used for Temperature Indication, Temperature Control, Temperature Compensation or Sequence Control.

The many varieties of Thermometal available offer a choice of properties for an unlimited number of applications.

Thermometals can be rolled to any thickness, formed into almost any shape . . . plated, brazed or welded.

We have more engineering know-how and manufacturing facilities than anyone in this field. For information and/or technical assistance call or write the H. A. Wilson Technical Service Department.



ENGELHARD
 ENGELHARD INDUSTRIES DIVISION
 ENGELHARD MINERALS & CHEMICALS CORPORATION
 2655 U. S. ROUTE 22, UNION, NEW JERSEY 07083

See us at the IEEE Show, Booths 1B15 and 1B17.
 INFORMATION RETRIEVAL NUMBER 117



No ripples. No bows. No twists. Result: no wafer rejects **AMERSIL** fused quartz epitaxial reactors

Bubble content is extremely low, for greater mechanical strength. Purity is extremely high. Absolute absence of interior ripples, bows, and twists minimize loading and unloading difficulties. Uniformly heavy walls assure greater ease of handling and longer useful life.

Therefore . . . Amersil epitaxial reactors eliminate product rejects and increase furnace output.

Squares. Rectangles. Ovals. Amersil fused quartz epitaxial reactors are available in the shape you need through a wide range of flange possibilities to your particular requirements.

STANDARD SIZES

Square: 1" to 6"
 Rectangular: 2" x 4" 2" x 6" 3" x 6"
 3" x 7" 3" x 9"

For complete information,
 write or call today.

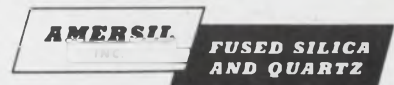

685 RAMSEY AVENUE
 HILLSIDE, NEW JERSEY 07205

See us at the IEEE Show, Booths 1B15 and 1B17
 INFORMATION RETRIEVAL NUMBER 118



THE PARTY'S JUST BEGINNING

A year ago, no one ever heard of a BBR* distributor. As a matter of fact, no one ever heard of BBR.

We announced it at the 1968 IEEE show — the complete line of Brand-Rex approved electronic products marketed by Birnbach, through selected local distributors, under the BBR label.

During the past year, Birnbach took a great deal of time and effort in choosing just the right distributors for just the right areas. We think we chose well.

Today, there are 18 exclusive BBR distributors in 25 locations from Coast to Coast, North and South, including Canada. This means you can buy the full range of Brand-Rex wire and cable, in the full range of quantities, right in your own back yard, wherever you are.

Happy Birthday To Us!

*Brand Rex wire marketed by Birnbach

Hyer Electronics Co./ Jim Williamson
3300 South Mill, Tempe (Phoenix), Ariz. 85009

Hollywood Radio & Electronics/Don Ruddell
5250 Hollywood Blvd., Hollywood, 90028

Terminal Hudson Elect. Inc. of Calif./Donald Dubin
880 Maude Ave., Mt. View, Calif. 94040

Saynor Electronics/William Saynor
99 Scarsdale Road, Toronto, Don Mills, Ontario, Canada

Hyer Electronics Co./ Jim Bourcy
8101 E. Prentice Avenue, Englewood, Colo. 80110

Lykes Financial Corp. Thurow Div./Felix Camp
121 South Waters Street, P.O. Box 1529, Tampa, 33601

Newark Electronics/Frank McAllister
500 North Pulaski Rd., Chicago, 60624

Pace/Avnet/Robert Zaleske
3901 Pace Court, Schiller Park, Ill. 60176

Newark/New Orleans Electronic Corp./Larry G. Brister
100 Jefferson Highway, New Orleans, 70121

Electrical Supply/Addison L. Sandford
205 Alewife Brook Pkwy, Cambridge, Mass. 02138

Newark-Minneapolis Electronics Corp./Bruce Johnson
336 Hoover Street, N.E., Minneapolis, 55413

R.E.D. Electronics/Gene DeLonais
2404 E. Hennepin, Minneapolis, 55413

State Electronic Parts Corp./Joseph Noonan
36 Route 10, Hanover, N.J. 07936

Hyer Electronics Co./Lloyd McNeil
130 Alvarado, N.E., Albuquerque, N.M. 87108

Arrow Electronics/Herb Brody
900 Broadhollow Rd. (Rt. 110), Farmingdale, N.Y. 11735

Summit Distributors/George Seidman
916 Main Street, Buffalo, N.Y. 14202

Westchester Elect./Marty Blaustein
602 Mamaroneck Ave., White Plains, N.Y. 10605

Midway Industrial Electronics/Bernie Cohen
15 West 45th Street, New York, 10036

Terminal Hudson Electronics/Irwin Hecht
236 West 17th Street, New York, 10011

Newark-Herrlinger Electronics/Ron Sanderson
112 E. Liberty Street, Cincinnati, 45210

Radio Electric Service Co./Marty Grossman
7th and Arch Street, Philadelphia, 19106

Newark/Dallas Electronic Corp./Don Smith
707 Easy Street, Garland, Tex. 75040

W.H. Bintz Co./Robert R. Connely
433 W. 3rd Street, Salt Lake City, 84110

Hyer Electronics Co./Ted Richards
1425 S. 2nd West, Salt Lake City, 84115

Almac/Stroum Electronics/Samuel Stroum
5811 Sixth Avenue, South, Seattle, 98108



WRITE FOR YOUR B.B.R. CATALOG

BIRNBACH BRAND-REX, 177 Hanse Ave., Freeport, NY 11520 (516) 223-8400 TWX: 510-225-3676

INFORMATION RETRIEVAL NUMBER 119

Technology



Speed inverse Laplace transform solutions with a time-shared digital computer. A three-

pole Butterworth filter illustrates the approach. Turn to p. 240.

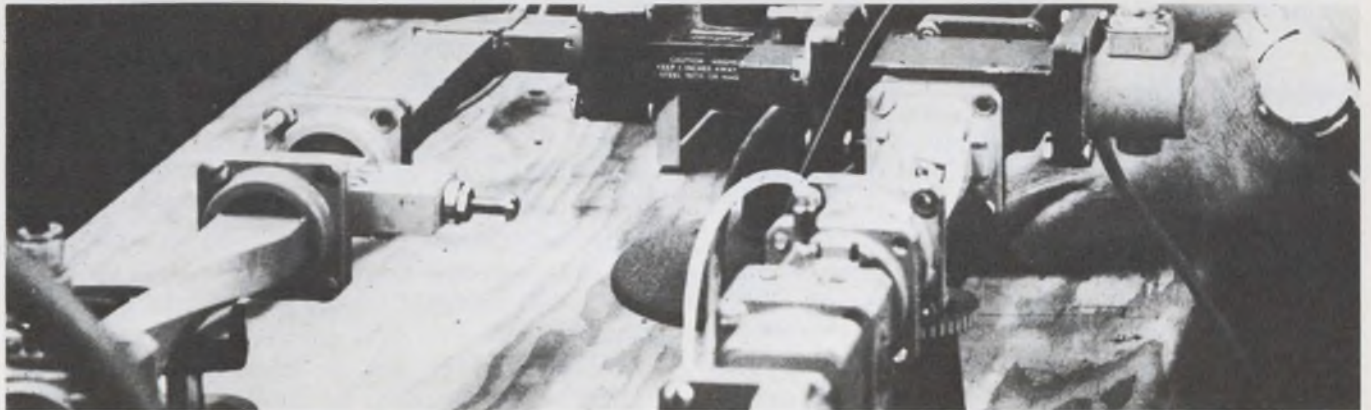

Measure the sweep linearity of fm pulses accurately with an easy-to-use technique. A

sampling scope serves as the basis for the test setup. Start on p. 228.

Also in this section:

Control radar gain from video, Page 204 . . . **Design notch networks** the easy way, p. 210
Firing is never easy, not even with SCRs, Page 234 . . . **Ideas for Design**, Page 250

Select the right FET for your rf amplifier

by systematically trading off performance goals. Separate methods are needed for fixed-gain and agc designs.

Selecting a FET for an rf amplifier designed to be used in such applications as TV front ends can be a very tricky job, and here are some reasons why:

If the input mismatch causes too high a VSWR, multiple reflections may cause ghosts; if there is too much cross-modulation, adjacent channels may interfere with each other. The complete list of specifications that you must actually consider when selecting a FET for an rf amplifier should include any or all of the following items:

- Overload
- Intermodulation
- Cross-modulation
- VSWR
- Noise figure
- Gain
- Bandwidth
- Agc range
- Skewing with application of agc

The priorities which you give to considerations of these specifications depend upon whether the amplifier is to have fixed gain or is to incorporate agc in its design.

Fixed-gain designs

The first two specifications to consider for a fixed-gain design are *overload* and *intermodulation*.

To prevent overload, just make sure that you select a device that won't be driven into saturation or cutoff by the peaks of the largest signal it will have to handle.

For junction FETs—but not for MOSFETs—you must also be careful not to forward-bias the gate and saturate the FET. For silicon p-channel FETs, this means that gate voltage must be kept above -0.6 V; for n-channel units, it must be kept below $+0.6$ V.

Some intermodulation distortion is unavoidable in a FET, because the device's drain current varies as the square of the gate voltage. The intermodulation products generated by the second

derivative of the transfer characteristic are usually removed by the selectivity of an i-f amplifier. The modulation products generated by the third derivative, on the other hand, can be minimized by the same techniques of device selection and circuit design employed to minimize cross-modulation.

Cross-modulation—the transfer of modulation from a carrier at one frequency to a carrier at another frequency—is the next item to consider in a fixed-gain design. The transfer occurs when the two carriers are processed through a device whose transfer characteristic has a non-zero third derivative. Since the undesired modulation is put right on the desired carrier, it cannot be removed by i-f filtering; it must be dealt with by preventing its generation.

Typical curves of cross-modulation vs bias are shown for two junction FETs in Fig. 1 and for a typical dual-gate MOSFET in Fig. 2. These curves plot the amount of 30-per cent modulated interfering voltage that is required to produce one per cent of cross-modulation as a function of the attenuation that results from the negative bias applied to the gate: the higher the required interfering voltage, the lower the cross-modulation effect. The peaks on the curves, corresponding to nulls in cross-modulation, occur at bias points where the transfer characteristic has no third derivative. Not all FETs exhibit these nulls; unfortunately, cross-modulation curves are not provided on FET data sheets. The manufacturers do, however, designate certain FETs as being notable for low cross-modulation. Therefore, the best you can do, when low cross-modulation is important, is to restrict your choice to one of these FETs and then measure the cross-modulation yourself. You can then choose an operating point at one of the nulls; for multiple nulls, that one which yields maximum gain should be chosen.

High conductance means low cross-modulation

A FET with a high input conductance, $\text{Re}(y_{11})$, is desirable because cross-modulation is proportional to the square of the interfering signal

Sam M. Weaver, Senior Engineer, Texas Instruments, Inc., Dallas, Texas.

voltage; matching to a high conductance means a low voltage at the input.

This need for high input conductance ordinarily calls for a common-gate amplifier, except where a cascode circuit or a dual-gate device would be selected because of gain-bandwidth considerations. But the common-source configuration should not automatically be ruled out, however; it can provide excellent performance near zero gate-to-source bias to voltage, where the gain is also highest.

The common-gate configuration should also be considered when low VSWR is important, because most signal sources that need careful matching have low impedances, and because networks for matching low source impedances to the high input impedance of the common-source configuration sometimes are physically impractical.

Gain-bandwidth requirements

The last two requirements to consider in selecting a FET for a fixed-gain amplifier are *gain* and *bandwidth*. Any discussion of the gain capabilities of an active device must take into account the possibility of instability (oscillation or regeneration). The equation for maximum available gain under conditions of unconditional stability, is:

$$G_{av} = \frac{|y_{21}|^2}{2\text{Re}(y_{11})\text{Re}(y_{22}) - \text{Re}(y_{12}y_{21})} \dots \dots + \{ [2\text{Re}(y_{11})\text{Re}(y_{22}) - \text{Re}(y_{12}y_{21})]^2 \dots \dots - |y_{12}y_{21}|^2 \}^{1/2} \dots \dots \quad (1)$$

Conditions for unconditional stability are met when¹

$$2\text{Re}(y_{11}y_{22}) - \text{Re}(y_{12}y_{21}) > |y_{12}y_{21}| \quad (2)$$

In most single-gate FETs in the common-source configuration, conditions for unconditional stability are not met at the lower radio frequencies; therefore, neutralization or mismatching to provide stability must be considered. (Of course, if the frequency is high enough, any amplifier will be stable since gain drops as frequency goes up.)

When the amplifier bandwidth is narrow enough, so that the gain is no longer limited by the gain-bandwidth product, neutralization should definitely be considered as a means of maximizing the gain. When perfect neutralization (unilateralization) is accomplished, by inserting an admittance between input and output whose admittance matrix is given by

$$Y = \begin{vmatrix} y_{12} & -y_{12} \\ -y_{12} & y_{12} \end{vmatrix},$$

the reverse transfer admittance of the combined network, y_{12}' , then disappears and the other admittances are modified as follows: $y_{11}' = y_{11} + y_{12}$; $y_{21}' = y_{21} - y_{12}$; and $y_{22}' = y_{22} + y_{12}$. The maximum gain reduces to²

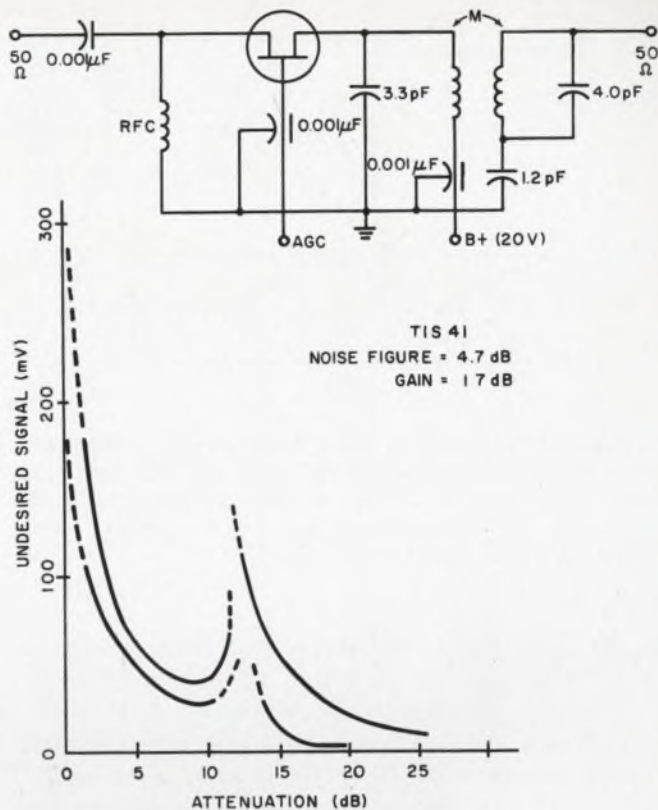

1. The cross-modulation performance of a junction FET (TI S-41) is shown here as a function of bias level. The ordinate shows the amount of 30% modulated interfering signal (at 188 MHz) needed to produce 1% of cross-modulation on the (200-MHz) carrier.

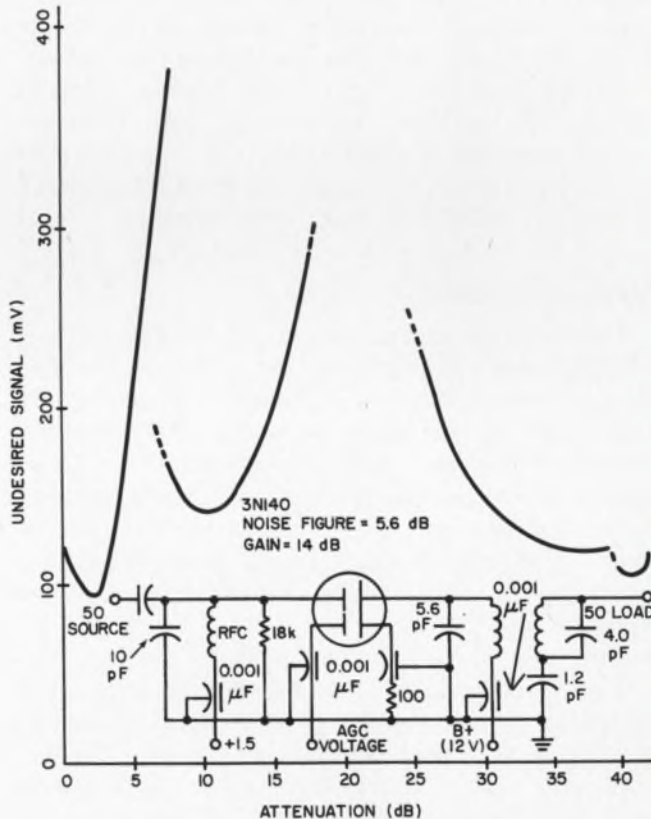

2. This double-valued cross-modulation curve was obtained from a dual-gate MOSFET (3N140). The curve is double valued because, at some points, the amount of undesired signal required to cause 1% of cross-modulation was high enough to change the bias level.

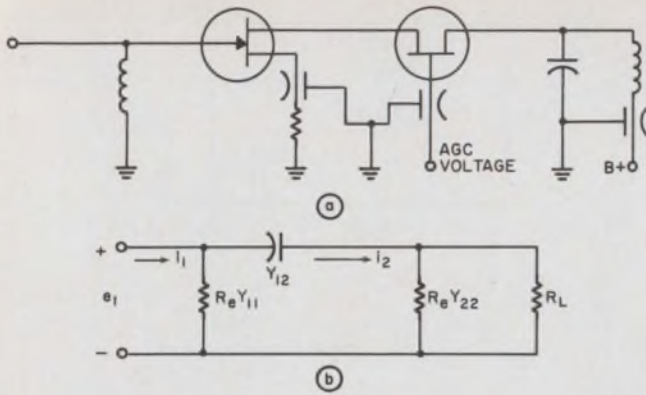

3. Excellent isolation of input from output is provided by this cascode configuration (a). The common-gate stage supplies drain current for the common-source input stage. The equivalent circuit (b) is a good model under full cutoff conditions.

$$G_{av} = |y_{21} - y_{12}|^2 / 4 \operatorname{Re}(y_{11} + y_{12}) \operatorname{Re}(y_{22} + y_{12}).$$

In this case, the selection of parameters becomes rather straightforward, especially if cross-modulation requirements have already dictated the lower limit of $\operatorname{Re}(y_{11})$. It should be noted that there are also practical lower limits to the value of $\operatorname{Re}(y_{22})$ for the following two reasons: the process of neutralization becomes much more critical with lower values, and matching a load to an extremely high output impedance may be physically impractical. The above equations, of course, imply a conjugate match of source to input impedance and of output impedance to load.

Often, because it provides a higher value of $\operatorname{Re}(y_{11})$ and a lower value of y_{12} than does the common-source configuration, the common-gate configuration can eliminate the need for neutralization at the higher radio frequencies.

Stable or unstable?

If the band of frequencies to be amplified is greater than about 10 per cent of the center frequency, neutralization becomes impractical. In this case, a potentially unstable FET can be stabilized by the addition of shunt resistors across the input and the output. This effectively increases $\operatorname{Re}(y_{11})$ and $\operatorname{Re}(y_{22})$ until the conditions of Eq. 2 are met. Under these conditions (just on the verge of instability) the maximum gain is

$$G_{av} = |y_{21}/y_{12}|. \quad (4)$$

For a preliminary selection, that is, as a figure of merit, this expression is very useful. However, the actual gain that may be obtained may be considerably higher, if mismatching is used to provide stability. Selection of a FET for gain can then be made on the basis of Eq. 4 and the comparative values of $\operatorname{Re}(y_{11})$ and $\operatorname{Re}(y_{22})$. From Eqs. 1 and 2 we see that as $\operatorname{Re}(y_{11})$ and $\operatorname{Re}(y_{22})$ increase, the gain goes down but the margin of

stability increases.

For potentially unstable devices, given equal $|y_{21}/y_{12}|$, the device with the higher input and output conductances— $\operatorname{Re}(y_{11})$ and $\operatorname{Re}(y_{22})$ —should be selected because the external shunt resistors would raise the conductance of the lower-conductance device, anyhow. Furthermore, the lower conductance device will be more sensitive to stray capacitance because of its higher impedance.

For unconditionally stable devices, the lower values should be selected, except as this selection may be modified by bandwidth considerations, as we shall soon see.

Stability limits the gain

From a practical standpoint, the power gain of a broadband stage is limited by stability criteria; the losses in the input and output tuned circuits, or the additional loading required to obtain the desired bandwidth. Quite often FETs are specified by guaranteeing a minimum gain at a specific frequency with a given bandwidth, in a given circuit.

The maximum bandwidth of an amplifier, adjusted for maximum gain, with the input and output coupled to the source and load by inductances, is limited by the input or output Q , whichever is greater. Q_{in} is given by: $Q_{in} = \omega C_{in} [R_{source} R_{in} / (R_{source} + R_{in})]$, and Q_{out} is given by: $Q_{out} = \omega C_{out} [R_{out} R_{load} / (R_{out} + R_{load})]$. In preceding equations, $\omega C_{in} = \operatorname{Im}(y_{in})$; $R_{source} = 1/\operatorname{Re}(y_{source})$; and $R_{in} = 1/\operatorname{Re}(y_{in})$. From Gartner³, $y_{in} = 1/z_{in} = [y_{11} + (y_{11}y_{22} - y_{12}y_{21})Z_L] / (1 + y_{22}Z_L)$.

When the feedback parameter, y_{12} , is small, this equation reduces to $y_{in} = y_{11}$ and a similar expression reduces to $y_{out} = y_{22}$. Therefore, for unconditionally stable devices, the bandwidth at maximum gain is limited by the ratio $\operatorname{Im}(y) / 2\operatorname{Re}(y)$ where $y = y_{11}$ or y_{22} depending upon whether the bandwidth is limited at the input or output. For stabilized devices, where the tuned-circuit losses dominate, the bandwidth at maximum gain is limited by the ratio $\operatorname{Im}(y) / [\operatorname{Re}(y_T) + \operatorname{Re}(y)]$, where $\operatorname{Re}(y_T)$ is the tuned-circuit loss represented as a conductance.

For other stabilized devices, the bandwidth at maximum gain is limited by the ratio $\operatorname{Im}(y) / [G_o + \operatorname{Re}(y)]$, where G_o is the equivalent transformed load or source conductance required to ensure stability. (G_o must include the swamping resistors when they are used.)

If this fixed bandwidth for maximum gain is too small for the required application, then further loading of whichever tank circuit (input or output), is limiting the bandwidth is required. Gain will be sacrificed, of course.

For these reasons, a FET for a broadband

Measuring cross-modulation

A commonly used method for specifying cross-modulation is to state the undesired signal voltage that is required to cause one per cent modulation on the desired carrier. The depth of modulation on the undesired carrier must be specified since the cross-modulation is proportional to it.

A test setup for measuring cross-modulation

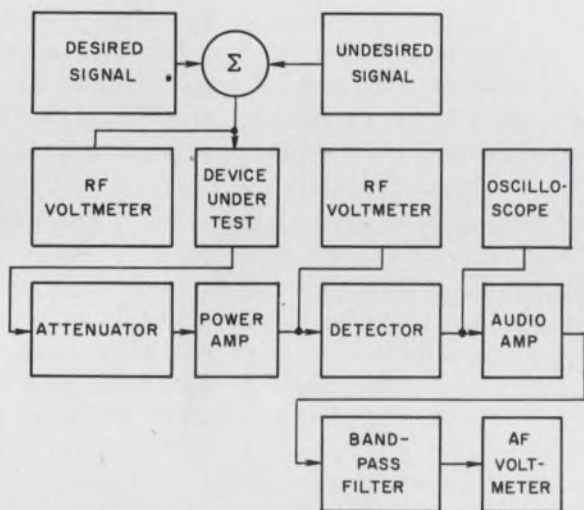

is shown in the block diagram. The desired-signal generator simply generates an unmodulated signal at the carrier frequency. The undesired-signal generator supplies a modulated signal at the frequency of a potentially interfering carrier. The two signals are combined in a resistive summer and applied to the input of the device under test.

Measuring the level of the undesired signal can be a problem: when the system is adjusted to provide a good match at the desired-signal frequency, it will in most cases, provide a large mismatch at the frequency of the undesired signal. Therefore, to accurately measure the interfering voltage at the input to the device under test, the probe of the rf voltmeter must be attached as closely as possible to the device.

The percentage of cross-modulation is essentially independent of the desired carrier voltage, so long as the desired carrier is small enough to cause no change in the bias of the devices under test.

Calibrate the detector

The accuracy of the percentage of modulation can be obtained by calibrating the detector and

then using it to check the signal generators. First, a characteristic curve of dc output vs rf input must be plotted, as in the graph. Then the

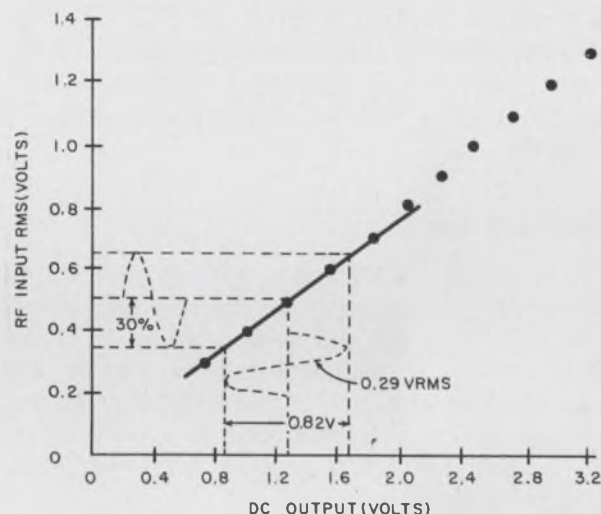

envelope of the modulated carrier should be plotted on the rf amplitude scale for the desired depth of modulation. (In the example, 30% modulation is used.) This envelope should be plotted at a point in the center of the most linear portion of the curve. The envelope can then be transferred to the dc scale and the detector output signal corresponding to, say, 30% modulation can be read off. The oscilloscope on the output of the detector can then be used to monitor the signal while the modulation depth is being adjusted.

The desired carrier voltage at the input to the detector must be maintained at the value found to give the best detector linearity, 0.5 V rms in this case. If various levels of desired signal level are needed at the device under test, the attenuator and/or power amplifier can be employed to keep the detector voltage fixed.

The af voltmeter, used to indicate the percentage of modulation on the desired carrier, can be calibrated by adjusting the gain of the audio amplifier. The procedure is to adjust the gain so that the voltmeter reads some convenient value when the desired carrier, with 30% modulation, is fed into the detector. The af amplifier must be a high-impedance type to prevent loading of the detector. The bandpass filter is used to eliminate any noise that may be introduced by the power amplifier.

circuit must have a small $\text{Im}(y_{11})$ and a small $\text{Im}(y_{22})$. However, we should note that, for a given specified value of maximum available gain (often to be found on data sheets), the device with the larger value of y_{21} will have a larger value of $\text{Re}(y_{11})$ and/or $\text{Re}(y_{22})$. (This comes right out of Eq. 1.) This, in turn, means that this device can tolerate larger values of $\text{Im}(y_{11})$ and $\text{Im}(y_{22})$ for a given bandwidth than can a device with a lower value of y_{21} .

If the generator or load is matched into the FET with a coupling capacitor, rather than with an inductance (usually a transformer), the bandwidth will be further limited. In this case, the equivalent parallel capacitive susceptance of the source or load and its coupling capacitor must be added to $\text{Im}(y_{11})$ and $\text{Im}(y_{22})$ in calculating the bandwidth.

Designs with agc

In specifying a FET for a variable-gain amplifier, the first parameters to consider are *cross-modulation*, *VSWR*, and *noise figure*. If cross-modulation is a prime consideration in the design, the performance of the FET over its entire range—from maximum gain to cutoff—is important. For best performance two conditions should be met:

- The transfer function (drain current vs gate voltage) must have a small rate of change of curvature over the entire operating range.

- The device must have an input admittance with a large real part over the operating range.

FETs meet the first condition rather nicely and, although they are not as good as bipolar transistors with regard to the second condition, they can provide good performance if a cascode configuration is used (see Fig. 3). Good cross-modulation characteristics are attained by applying a negative agc voltage to the gate of the second (common-gate) device, leaving zero bias

on the first (common-source) one. The first device is thus driven into the triode region where it acts like a linear resistor—providing attenuation without cross-modulation. The second device is operated with a very low input voltage, which keeps the cross-modulation low.

When VSWR is an important consideration, the antenna transmission line must be well-matched to y_{in} over the full agc range. A mismatch in the direction to optimize noise figure will degrade the cross-modulation performance. Similarly, cross-modulation can be improved by mismatching at the expense of VSWR, noise figure and gain.

Next, consider the *gain*. The equations given earlier for the fixed-gain designs apply equally well for amplifiers with agc. However, since the additional requirement of very low feedthrough for reasonable agc ranges requires that y_{12} be very small, this parameter can usually be neglected in the gain equation which becomes

$$G_{av} = |y_{21}|^2 / 4\text{Re}(y_{11})\text{Re}(y_{22}). \quad (5)$$

Now let's turn our consideration to the *range of agc* that a given FET can provide. Since y_{12} , $\text{Re}(y_{11})$, and $\text{Re}(y_{22})$ change very little with changes in gate voltage in the cascode configuration, the equivalent circuit of Fig. 3b is adequate to derive the expression for maximum gain reduction. To derive this expression we must assume that: $\text{Re}(y_{11}) \simeq \text{Re}(y_{in})$; $\text{Re}(y_{22}) \simeq \text{Re}(y_{out})$; $i_2 \ll i_1$; and $2\text{Re}(y_{22}) \gg |y_{12}|$. These assumptions can be shown to be valid when y_{12} is small enough to allow a reasonable reduction in gain.

In addition to the above assumptions, let's assume a conjugate match so that $\text{Im}(y_{11})$ and $\text{Im}(y_{22})$ are tuned out. Now we can write:

$$P_{in} = e_1^2 \text{Re}(y_{11}), \text{ and } i_2 = e_1 y_{12}.$$

Thus, $P_{out} = [(1/2)i_2]^2 / \text{Re}(y_{22}) = (1/4)e_1^2 |y_{12}|^2 / \text{Re}(y_{22})$. The agc gain reduction, from unity gain, expressed as the ratio of input to output power is given by

$$P_r = 4\text{Re}(y_{11})\text{Re}(y_{22}) / |y_{12}|^2.$$

Finally, we can rewrite this to explicitly yield the value of $|y_{12}|^2$ needed to achieve a given gain reduction:

$$|y_{12}|^2 = 4\text{Re}(y_{11})\text{Re}(y_{22}) / P_r. \quad (6)$$

To see if a particular FET meets the specified bandwidth requirements, form the ratio $\Delta f_o = 2f_o \text{Re}(y_{22}) / \text{Im}(y_{22})$, where f_o is the center frequency. If Δf exceeds the required bandwidth, add a capacitor in parallel with $\text{Im}(y_{22})$ to decrease it. If Δf is less, the load may be mismatched to provide a larger conductance. Then $\Delta f = f_o [\text{Re}(y_{22}) + \text{Re}(y_L)] / \text{Im}(y_{22})$, where $\text{Re}(y_L)$ is the conductance of the load referred to the FET output.

If a double-tuned output is required to obtain the desired frequency response, and the primary unloaded, uncoupled Q is too high, then an ex-

Table. Vhf TV rf amplifier specs.

Gain	≥ 20 dB
Frequency	200 MHz
Bandwidth (transformer primary, 3 dB)	3.5 MHz
Noise figure	≤ 5.0 dB
Agc range	≥ 55 dB
Skewing	≤ 1.0 dB
Cross-modulation (1%)	≥ 80 mV
VSWR	≤ 3.0

ternal resistance must be added across y_{22} and the gain recalculated from Eq. 5. This procedure assumes that the bandwidth is limited in the output circuit. If the input circuit limits the bandwidth, excessive skewing is almost certain to result when the agc voltage is applied.

Skewing of the bandpass characteristic results when $\text{Im}(y_{11})$ or $\text{Im}(y_{22})$ changes with the agc voltage and detunes the associated tuned circuit. Junction FETs are subject to considerable skewing unless the external capacitance is large enough to swamp out the internal variations.

The amount of skewing can always be reduced by adding a swamping capacitor and then restoring the bandwidth with a shunt resistor. Here, of course, the gain will be decreased.

The cascode configuration with agc voltage applied to the second gate has much less skewing than other circuits using one single-gate device. However, an appreciable change in $\text{Im}(y_{11})$, and to some extent in $\text{Im}(y_{22})$, with changing agc voltage occurs in the cascode circuit and care must be exercised to keep the frequency response within the specified limits. If the input circuit bandwidth is large with respect to the output, minimum skewing will be achieved.

In any event, whether the cascode circuit or swamping capacitor is used, a low input Q (large value of $\text{Re}(y_{11})/\text{Im}(y_{11})$) is required.

Let's try an example

To see how the preceding discussion can be of help in selecting a FET for a particular application, let's select one for a vhf television rf amplifier. The design goals are listed in the table.

Step 1. The cross-modulation requirement dictates the use of a cascode device or configuration. In checking the noise-figure specification, we must make sure that it is given at a mismatch ratio of three, or less, in order to satisfy our VSWR requirement.

Step 2. From Eq. 5, a family of curves can be plotted to show the y -parameter relationships needed to give 20 dB of gain. In Fig. 4 we have assumed different values for $\text{Re}(y_{11})$ and plotted y_{21} against reasonable values of $\text{Re}(y_{22})$.

Step 3. For an agc range of 55 dB, with 20 dB of gain, 35 dB of gain reduction is needed. Using Eq. 6, and assuming the same values of $\text{Re}(y_{11})$ as in step 2, $|y_{12}|^2$ can be determined. The value of y_{12} is converted into picofarads at 200 MHz and plotted against $\text{Re}(y_{22})$ in Fig. 4.

Step 4. Checking the bandwidth requirements, we see that for matched conditions, $\text{Im}(y_{22}) = (2)(200)\text{Re}(y_{22})/3.5$. However, the skewing considerations of Step 5 require that we add an external circuit capacitance of 2.5 pF to y_{22} . Therefore 2.5 pF was subtracted from the values of capacitance that were obtained by converting $\text{Im}(y_{22})$ to picofarads at 200 MHz. The graph of

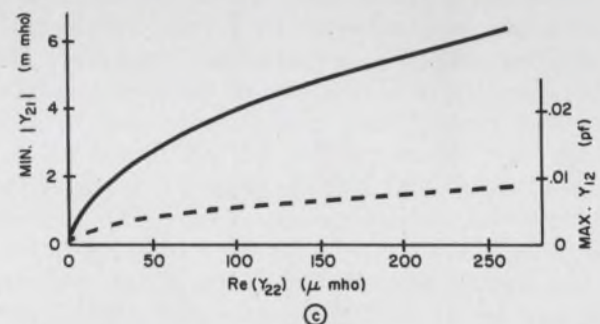
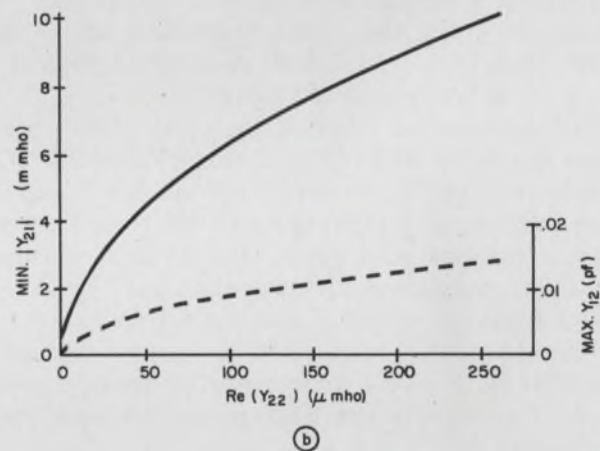
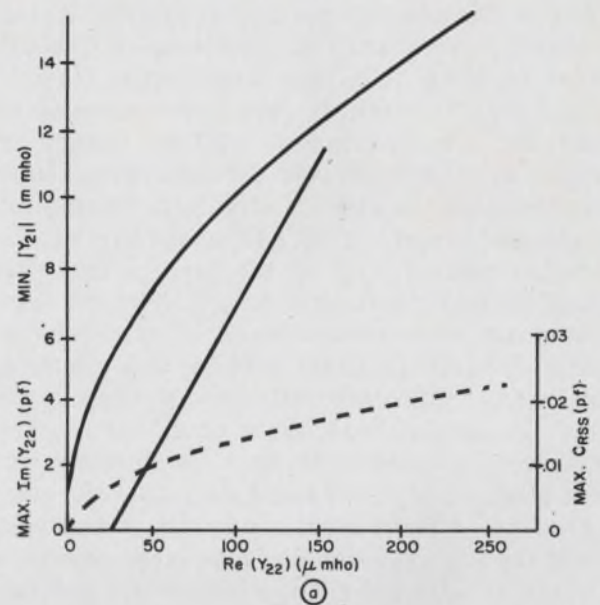

4. To get 20 dB of gain, $|y_{21}|$ must exceed the minimum values shown by the solid lines. The dashed lines show the maximum values of $C_{1,ss}$ that must not be exceeded if the 55-dB agc range is to be achieved. Both of these curves are plotted for three different values of $\text{Re}(y_{11})$: in (a) 2.5 mmho; in (b) 1.0 mmho, and in (c) 0.4 mmho. The third line shows the maximum allowable values of $\text{Im}(y_{22})$, converted to picofarads at 200 MHz, that can be tolerated if the amplifier is to have the desired bandwidth. The curve is only drawn once since it does not depend on $\text{Re}(y_{11})$.

$\text{Im}(y_{22})$ vs $\text{Re}(y_{22})$ is plotted in Fig. 4a and is not repeated since it does not depend on $\text{Re}(y_{11})$.

Step 5. Skewing is specified in this application as the relative change in amplitude of the two peaks resulting from the overcoupled, double-tuned output circuit. It could be controlled by specifying the maximum relative change in $\text{Im}(y_{22})$ and $\text{Im}(y_{11})$ over the agc range. However, the usual solution is simply to swamp out the change in $\text{Im}(y_{22})$ by adding parallel capacitance, to make the Q of the input circuit low enough so that its changes do not affect the overall response more than allowed by the specification. Following the usual method, and assuming that $\text{Im}(y_{22})$ will vary very little in the cascode circuit, a parallel capacitance of 2.5 pF, including strays, is added to $\text{Im}(y_{22})$. To minimize the effect of skewing in the input circuit on the overall response, a large input bandwidth is desirable. But, if the input bandwidth is too large, excessive amounts of adjacent-channel signal will get into the FET and cross-modulation will increase. A commonly used compromise is a bandwidth of about five times the over-all response, say ≥ 20 MHz. Then $Q = f/\Delta f = 200/20 = 10 = \text{Im}(y_{11})/\text{Re}(y_{11})$, or $\text{Im}(y_{11}) \geq 10 \text{Re}(y_{11})$.

One device that comes close to meeting these specs is the TI SFB 8970, a dual-gate MOSFET that is very similar to the 3N140 but one that has built-in protection from damage due to static discharge through the gates. The typical parameters, at recommended bias, are: $y_{11} = 0.4 + j4.0$ mmho; $y_{22} = 0.2 + j2.0$ mmho; $y_{21} = 6.0 + j5.0$ mmho, and y_{12} (specified as C_{rss}) = 0.01 pF. Since $\text{Re}(y_{11}) = 0.4$ mmho, Fig. 4c may be used to see how closely the FET meets the gain and agc goals.

At $\text{Re}(y_{22}) = 0.2$ mmho, a minimum $|y_{21}|$ of 6 mmho is required. The typical device should exceed this requirement. In a test circuit optimized for vhf TV performance, however, the gain was only 16 dB because of the cross-modulation requirement that made it necessary to mismatch the input to the VSWR limit of 3.0 (1.28-dB loss) and because of other losses in the double-tuned output circuit. To get the desired agc range (assuming 20-dB gain) requires a C_{rss} of less than 0.008 pF. The range of the test circuit was 48 dB, or 7-dB short of the goal.

The goals, however, were set high. They represent the best performance available in consumer TV today. It is evident that FETs are rapidly approaching them. ■■

References:

1. W. W. Gaertner, *Transistors: Principles, Design, and Applications*, Princeton, N.J.: D. Van Nostrand, 1960, pp. 368-381.
2. Texas Instruments, Inc., *Transistor Circuit Design*, New York: McGraw-Hill Book Co., 1963, p. 273.
3. W. W. Gaertner, *Transistors: Principles, Design, and Applications*, Princeton, N.J.: D. Van Nostrand, 1960, pp. 232.

Reading the data sheet

The discussion in this article has been based on the description of a two-port network in terms of its short-circuit admittances. This description is very general and, in order to translate the various admittances into terms that can be found on a data sheet, you must specify the circuit configuration.

For example, $\text{Im}(y_{11})$ is the reactive component of the input admittance. This is usually given as a capacitance, which must be converted to an admittance at the frequency of interest. In a common-source configuration, this capacitance is given by C_{rss} . In the common-gate configuration the capacitance is given by C_{rgr} .

In the triple-subscript notation used above, the first subscript designates the measuring terminal, the second tells which terminal is grounded, and the third (which is often omitted) tells whether the remaining terminal is open (*o*) or shorted (*s*). Sometimes the input terminal is simply designated *i* and the output *o*.

The transfer admittances y_{12} and y_{21} are specified as forward (*f*) or reverse (*r*) parameters. Thus y_{fs} , the forward transfer admittance in the common-source configuration, represents y_{21} . Similarly y_{12} is usually specified as C_{rss} , the reverse transfer capacitance. This is done because the real part of y_{12} is usually negligible and the capacitance is quite frequency-independent. Thus, the admittance is a function of frequency but the capacitance can be specified over all frequencies with just one number.

Test your retention

Here are questions based on the main points of this article. Their purpose is to help you make sure you have not overlooked any important ideas. You'll find the answers in the article.

1. What is cross-modulation?
2. When cross-modulation must be kept down, is it better to use FETs with high input conductance or low input conductance? Why?
3. Which parameter is most important in determining the agc range of a FET?
4. Why does the cascode configuration provide low cross-modulation?



Flight Companion

417—the lightweight recorder you carry on the plane

It's the one data recorder you don't have to waste time crating and shipping, or possibly having damaged by baggage-style handling. The compact 417 flies with you, safely under the seat, ready to work when you step off the plane.

Only 6"x14"x15", the rugged 417 weighs just 28 pounds—50 pounds less than any comparable recorder. Works in any position, under roughest vibration conditions, for dependable data gathering in plants, labs, on and under the seas, or out in the wilds.

Maintenance-free mechanism has exclusive low-mass differential capstan drive for precision opera-



LOCKHEED ELECTRONICS COMPANY
A Division of Lockheed Aircraft Corporation.

tion. Phaselock servo for precise speed control, with accuracy matching large rack machines. Records on 7 channels, IRIG compatible. Runs on 110/220v AC/DC or internal battery. Power consumption as low as 10w. Frequency response: 100 kc direct, 10 kc FM.

Priced as low as \$7,000.

Send for our catalog containing full details on the 417, one of a family of precision data recorders for land, ocean, air and space applications. Write: Boyd McKnight, Dept. ED-3F, Lockheed Electronics Company, Plainfield, New Jersey.

Have questions on data recording? Call us at (201) 757-1600.



For environmental protection... silicone encapsulating resins

Whatever the operating conditions — heat, cold, moisture, or other harsh environments... there's a Dow Corning silicone encapsulating resin to provide protection for your electronic equipment.

Sylgard® brand encapsulating resins from Dow Corning are ideally suited for filling, potting, coating, impregnating and embedding. Processing flexibilities include room

temperature cure, heat accelerated cure, one-part and two-part systems. All provide these unique properties:

- cure in thick section without reversion
- no damaging exotherm during cure
- are self-extinguishing
- provide excellent dielectric strength
- have excellent resistance to moisture, ozone and oxygen

- maintain constant physical and electrical properties from —65 to 200 C or better
- excellent thermal shock resistance

Regardless of your encapsulating protection problems... Dow Corning offers a silicone resin to meet your needs. Find out by writing Dept. F-8474, Dow Corning Corporation, Midland, Michigan 48640, or call 517-636-8940.

DOW CORNING



New premixed, ready-to-use white Sylgard silicone encapsulating resin flows freely around components and provides virtually unlimited working time at room temperature... cures in one hour at 135 C and in two hours at 100 C... no post cure required... no reversion... low water absorption... self-extinguishing.

New shock absorbing Sylgard silicone resins are ideal encapsulants for delicate electronic equipment subject to high G shock loads and continuous vibration. These low bayshore materials dampen out external forces with little internal reaction... available in either clear or black... deep section cure without reversion.



INFORMATION RETRIEVAL NUMBER 122

Reduce radar display clutter

by combining a logarithmic receiver with video processing to achieve gain-time control

In most ATC/IFF radar beacon interrogators, as well as in certain classes of radars, a manual range-dependent sensitivity control is usually provided in the receiver to reduce display clutter from unwanted antenna side lobe responses or second-time-around returns. However, this function can be implemented automatically since range is specified as a function of time with respect to the transmitted interrogation. Such a function is generally called Gain-Time Control (GTC) or Sensitivity-Time-Control (STC).

In normal practice, the system trigger causes the receiving system to be desensitized from normal operating sensitivity to some level determined by both the antenna-receiver parameters and the target characteristics. The receiver sensitivity is then permitted to recover to normal at a rate of 6 dB per time octave for a one-way return (corresponding to the inverse square range relationship), as shown in Fig. 1. For such a function to be implemented into a radar receiver (double path length), the recovery rate would be increased to 12 dB per time octave.

For dual-channel receiving systems, the use of log receivers permits direct signal power measurement by simply subtracting logarithms.

If the receiving system is of limited dynamic range, the application of GTC provides clutter reduction and also prevents receiver overload from responses of close-in targets. For the linear receiver, this requires that the GTC/STC function be implemented by controlling the gain of the rf or i-f stages through some form of bias control. Since the gain versus control-bias characteristic of the typical rf or i-f amplifier is rarely a simple linear function, it is usually necessary to generate a complex waveform to obtain the desired sensitivity-versus-time characteristic shown in Fig. 1. Furthermore, if it is desired to change the initial desensitization level, extensive alteration of the GTC bias waveform—which requires making numerous shaping adjustments—

becomes necessary. For this reason, the GTC/STC function has always been difficult to implement and maintain.

Comparator controls log receiver

This situation is readily overcome by the use of a wide-dynamic-range logarithmic receiver. Such a receiver has an rf to video (envelope) amplitude transfer characteristic, as shown in Fig. 2. The accuracy of this response can readily be maintained within ± 1 dB (referred to the input) over a dynamic range of input signals typically on the order of 80 dB. For such a system, no receiver saturation or overload will occur for any response, irrespective of signal strength. Since the slope of the amplitude transfer characteristic, as shown in Fig. 2, is linear when expressed in V/dB, it is convenient and simple to compare the amplitude of the received signal with a threshold level that represents the receiver sensitivity level. For this reason, signal amplitudes below the threshold (sensitivity) level will not be processed for display, while signal amplitudes above the threshold will be processed for display.

This threshold can be an adjustable dc level representing a manually-controlled sensitivity level, or, in the case of GTC, a time-varying waveform providing a variation of sensitivity with time. This is done by comparing the magnitude of the receiver video to a threshold level (shown in Fig. 3), which, in the case of GTC, is time varying. In this arrangement, the comparison is performed in a differential comparator that provides a fixed output level (enable) when the signal magnitude exceeds the magnitude of the time-varying GTC reference waveform. The comparator output enable gate allows a display video output when in coincidence with the processed video. The function of the video processor, as shown in Fig. 3, is to condition the log video to a fixed amplitude and proper pulse width.

The shape of the reference waveform must be logarithmic for the log receiver. This is readily evident when the receiver amplitude transfer

Alan J. Brown, Program Manager, and Albert Haeberle, Senior Electrical Engineer, Hazeltine Corp., Little Neck, N.Y.

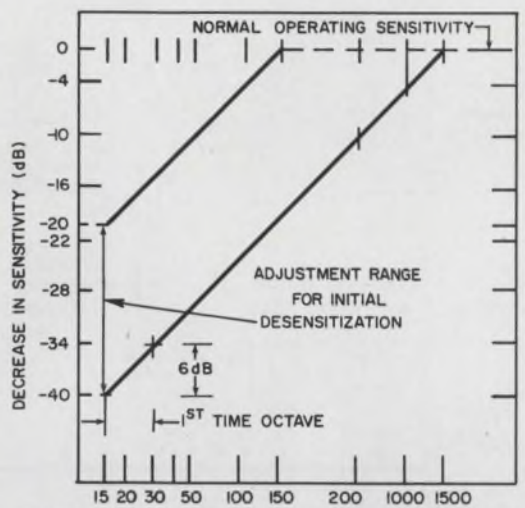

TIME (MEASURED FROM SYSTEM TRIGGER IN MICROSECONDS)

1. Initial desensitization level adjustment, from -20 to -40 dB, is necessary to accommodate various system parameters relating to antenna and decoder characteristics.

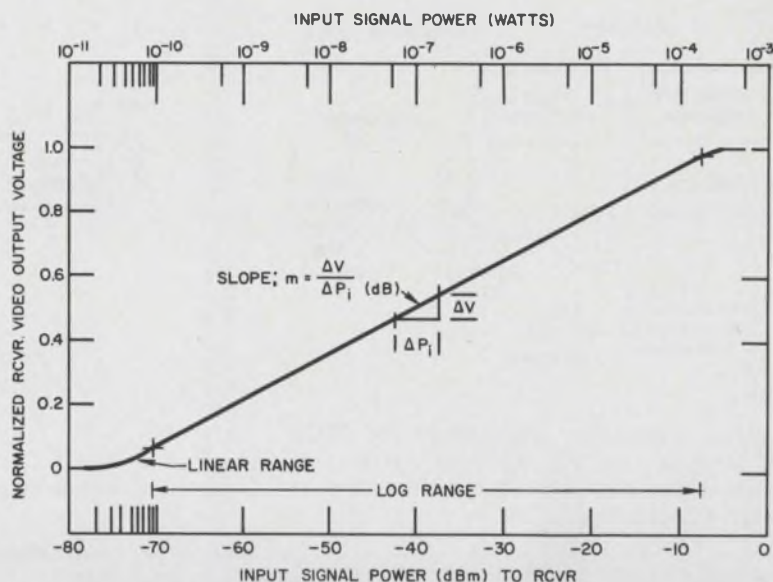

2. Amplitude transfer characteristic for a typical log receiver has slope expressed in volts per decibel. The small linear range is useful since it permits recovery of weak signals in the vicinity of thermal noise.

Typical radar system with air-traffic-control radar beacon

Since a radar system is capable of providing only range and bearing information, an auxiliary system that operates in conjunction with the radar is used to provide positive target identification. Such a system is generally known as a radar-beacon system or an ATC/IFF beacon. (ATC denotes Air Traffic Control, whereas IFF, its military counterpart, denotes Identification Friend from Foe.) The typical beacon system illustrated consists of an interrogator located at the radar site and a cooperative transponder mounted in properly equipped aircraft. The beacon-interrogator antenna is slaved to the radar antenna for proper azimuthal orientation. The interrogator is synchronized to the radar such that a pulse-coded interrogation is time coincident with the radar transmission. Upon receipt of the

interrogation by the aircraft, a pulse-coded reply that has unique identification characteristics is transmitted back to the receiver portion of the interrogator. This reply is decoded and presented on the radar display along with the radar return.

Where the required operating range is about 250 miles or more, it can be expected that the range of input signals to the receiver will be in the order of 70 to 90 dB. If the receiver sensitivity is great enough to receive the weaker signals, then severe display clutter problems are experienced because of antenna side-lobe responses, second-time-around return, as asynchronous returns generated by other installations that illuminate the target aircraft. The radar receiver would also be susceptible to overloading due to responses from close-in targets.

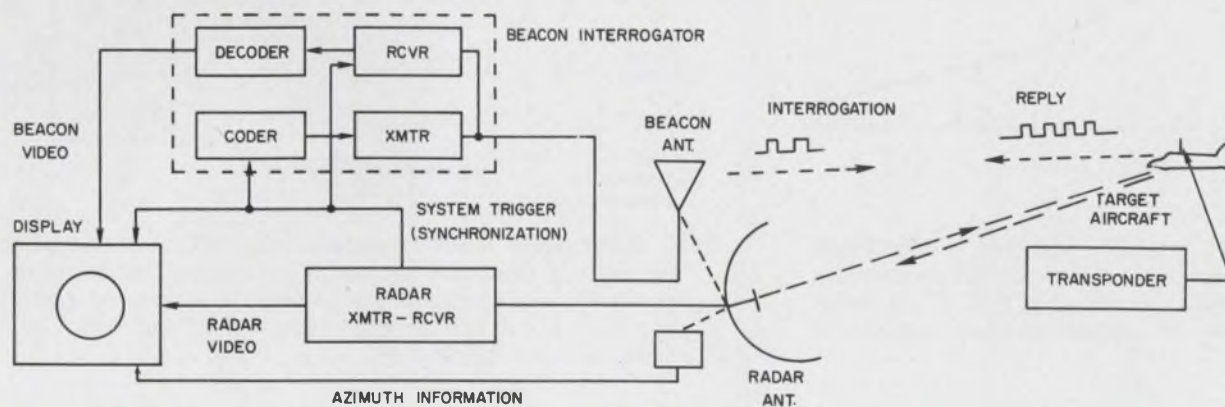

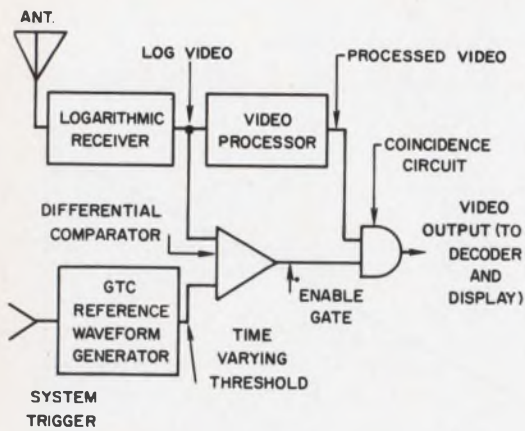

3. Video comparator arrangement for GTC/STC permits the GTC function to be performed at the receiver output rather than at the rf/i-f section.

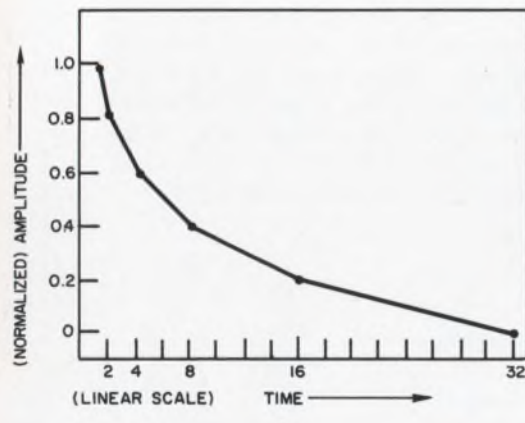
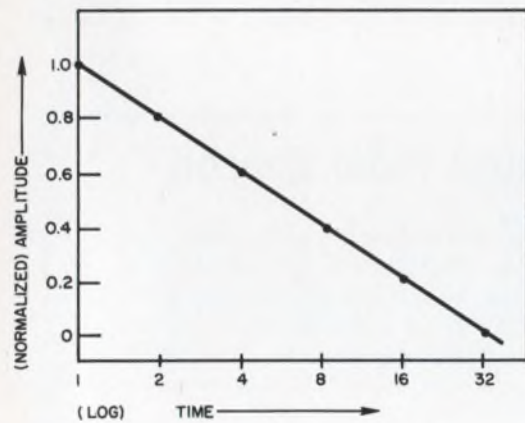

4. The GTC reference waveform is logarithmic (a) to meet the receiver amplitude transfer characteristics as shown in Fig. 1. The waveform shown on a linear time base appears in (b).

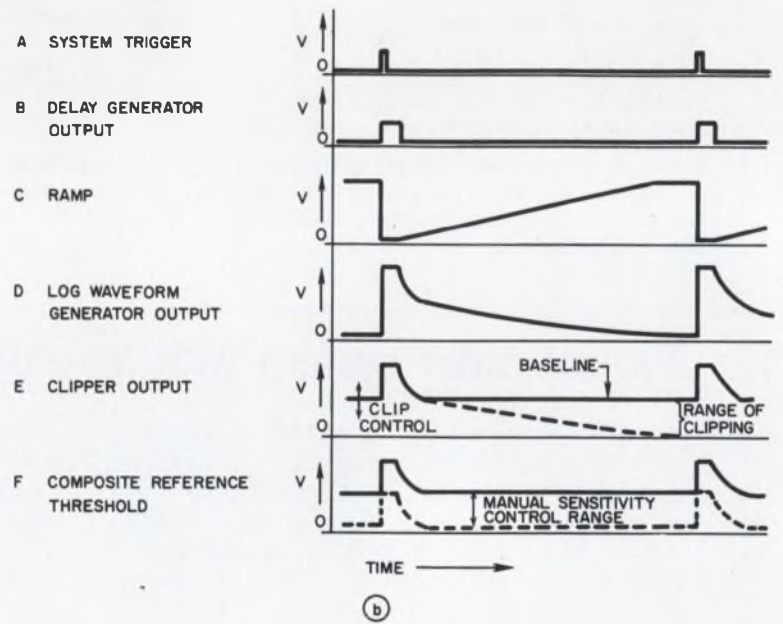
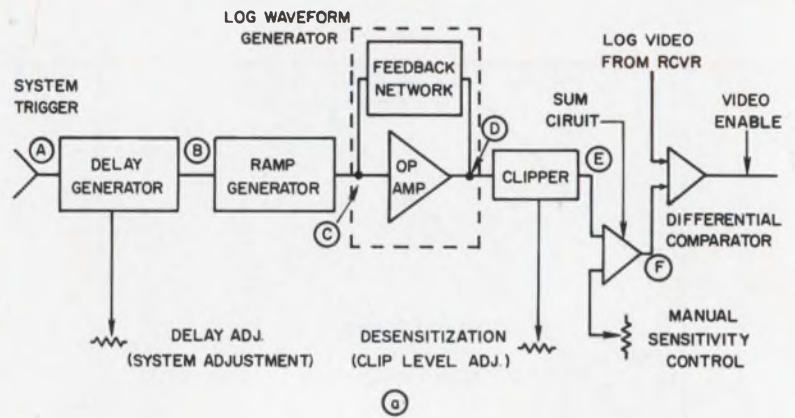

5. The comparison waveform generator (a) includes an adjustable delay to provide time coincidence of the system and the manual sensitivity control. Waveforms at various points are shown in (b).

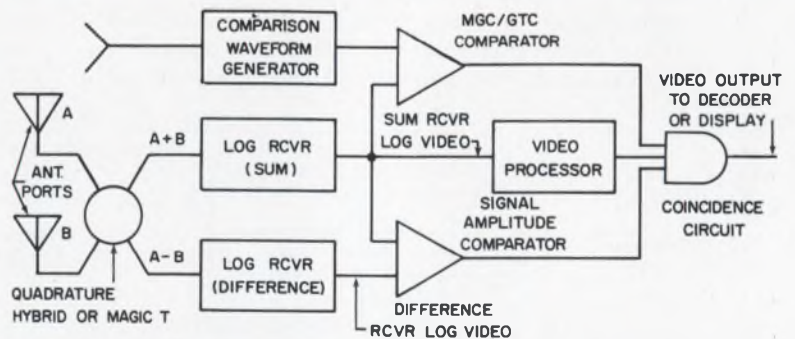

6. Dual-channel receiving system using GTC and manual gain control permits beam sharpening by comparing amplitude of signals received through separate ports. Only the amplitude transfer characteristics of the two receivers require matching, which is a simple matter with the log receiver.

characteristic is considered. From Fig. 2 it is noted that a 6-dB change in signal power at the input to the receiver results in a fixed increment in the magnitude of the receiver video output, within the log range of the receiver. Thus, to provide maximum desensitization, the reference GTC waveform must decay at a rate equal to the incremental change of receiver video output for a 6-dB input signal change, for each time octave. This requires a waveshape that has an incremental decrease in amplitude against a logarithmic time base. Such a waveshape is translated to a linear time base, as shown in Fig. 4. Note that this curve is logarithmic.

The reference voltage for the comparator must be developed in a log function generator. There are several such standard circuits available, each with certain advantages and disadvantages. One such arrangement that has been successfully used combines an op-amp with a feedback network that consists of different resistances in parallel—each controlled by different prebiased diodes. As the input voltage increases, the diodes sequentially conduct; this causes more of the resistances to be in parallel and lowers the gain for an increasing input voltage. When such a shaping circuit is driven by a voltage ramp, a segmental log curve is produced. This curve can approximate the desired log functions with fairly good accuracy; in addition, ranges of many decades can be easily obtained. The number of segments required is primarily determined by the accuracy required.

A block diagram of a basic GTC waveshape generator with required operational functions and its waveforms is shown in Fig. 5. This arrangement includes an adjustable time delay, adjustable desensitization level and a manual sensitivity control. The adjustment of desensitization level is accomplished by baseline clipping the GTC waveform to obtain only the desired portion of the logarithmic curve. The portion used must always commence with the first time octave. Initiation of the GTC-STC action is provided by a system trigger, shown as waveform A. A variable delay is then provided to permit adjustment of the exact time that the GTC action is to start. During this delay time, a switch is closed that inhibits operation of the following ramp generator circuit. The delay gate is shown in waveform B. At the end of the delay period, a linear ramp is generated as shown in waveform C and applied to the log waveform generator. The log waveform thus generated (waveform D) is in turn fed through an adjustable baseline clipper to provide the variable amplitude waveform E with a preserved rate of slope corresponding to 6 dB/time octave. Simple summing

of the log waveform with a variable dc level (representing manual sensitivity control) provides the combined MGC-GTC threshold level for the differential comparator.

Matching unnecessary in dual-channel systems

This arrangement reduces the GTC desensitization adjustment to a single control. Because there is no direct connection between the GTC/STC function and the operation of the rf and i-f portions of the receiver, service or replacement can be achieved without need for system readjustment. The significance of such an arrangement becomes even greater when applied to a dual-channel receiving system (see Fig. 6) used for antenna beam shaping. In this system, the relative strength of the signal received from the sum and difference patterns of a dual-feed antenna are compared to determine whether or not the target lies within the main lobe of the antenna pattern. If GTC were applied to the rf or i-f stages of such a system, channel-to-channel matching would be necessary to prevent antenna beamwidth errors, thereby generating an irresolvable problem of obtaining simultaneous matched adjustments between the channels. For the simple video comparison scheme, however, the function need be performed only in the sum (or main lobe) channel. The use of the logarithmic receiving systems, in this case, also permits direct signal power ratio measurement by subtraction of logarithms. ■■

Test your retention

Here are questions based on the main points of this article. They are to help you make sure you have not overlooked any important ideas. You'll find the answers in the article.

1. *What is the advantage of implementing to GTC function at the receiver video rather than the rf or i-f?*

2. *How is the receiver video amplitude compared with a time-varying reference?*

3. *Why is the shape of the reference waveform logarithmic?*

4. *How does the described GTC arrangement simplify receiver service or parts replacement?*

5. *How does the described GTC scheme improve dual-channel receiving systems?*

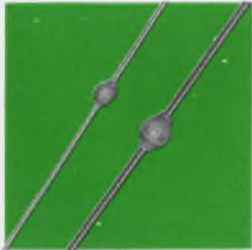
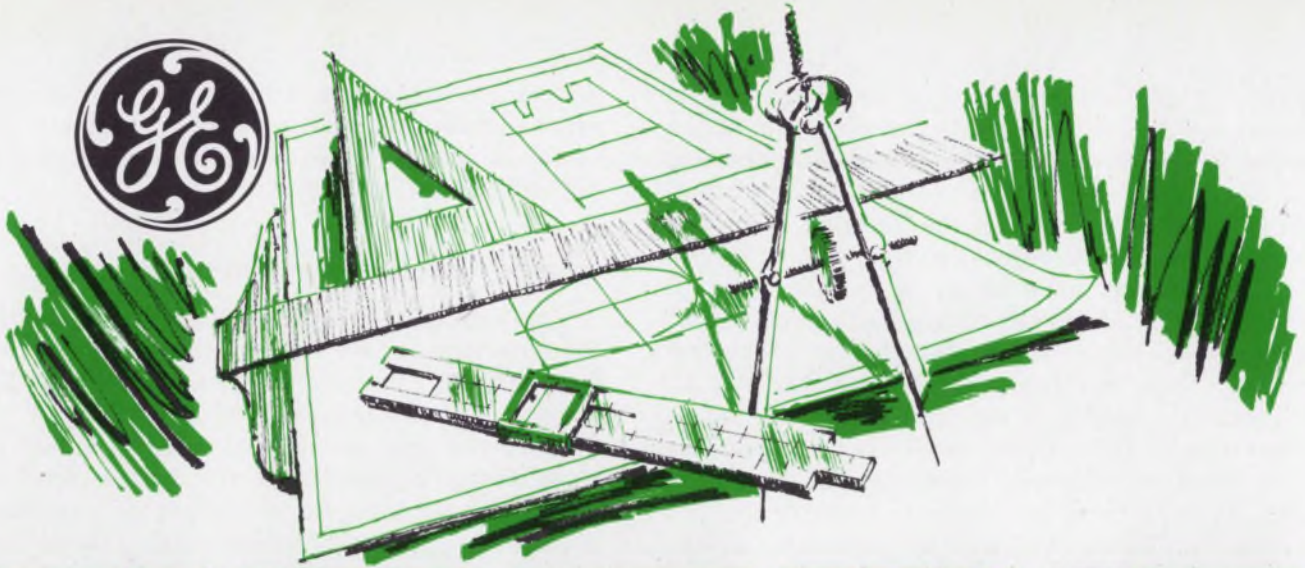

GE's 3 amp hermetic A15 replaces costlier A14 rectifier diodes

GE offers a higher rated companion to its field-proved, 1 amp A14 rectifier at a significantly lower cost than stud or other lead mounted units (depending upon configuration). The A15 is rated 3 amps at 70 C and the 200 to 800 volt models are transient voltage protected up to 1000 watts for 20 μ S in reverse direction.

A15's dual heat sink design means low thermal impedance and easy adaptation to PC board mounting . . . reduced installation cost.

Both the A15 and A14 are hermetically sealed in an all-diffused, glass passivated junction structure. No internal cavity means more resistance to environmental stresses . . . thus increased reliability.

High-power A15 is now available through GE distributors in quantities up to 9999 for applications including time delay circuits, battery chargers, TV damper diodes, communication equipment and small portable appliances.

For more information, circle number 801.



Select your instruments from industry's most complete line

● **PANEL METERS.** Measure a-c, d-c volts and amps. 1½ to 4½-inch sizes in THE BIG LOOK® style. 2½ to 4½-inch sizes in HORIZON LINE® style.

● **METER RELAYS AND PYROMETERS.** Indicate, monitor and control temperature or other variables directly or with transducers. BIG LOOK and HORIZON LINE style. 2½ to 4½-inch sizes. "Piggyback" control module.

● **EDGEWISE METERS.** Measure a-c and d-c volts and amps. Miniature type 185, 2¼ inch or large type 180, 6-inch. Both can be multi-stacked vertically or horizontally. Standard accuracy of 2%, 1% optional.

● **SWITCHBOARD INSTRUMENTS.** Measure volts, amps, speed, vars, power factor, frequency, phase angle, other variables. 4½ and 8½-inch sizes. Standard one percent accuracy. For full line information, circle 802.



Reduce redesign cycles with reliable GE microwave circuit modules

GE microwave circuit modules (MCM) help reduce design cycles, provide retrofit and lead to improved system performance by optimum integration of active devices. And lower system cost results from circuit simplicity, easy application and longer life.

These rugged GE devices are built to deliver reliable performance in adverse environments of shock, vibration, high altitude and extreme temperatures. MCM's may be designed for use as oscillators, amplifiers, integrated isolators and circulators.

General Electric microwave modules encompass all planar triode and diode uses—from DC to X-band, from milliwatts to kilowatts. For details, circle number 803.



GE wet slug capacitors . . . highest efficiency in half the size

GE 69F900 wet slugs meet high-density application needs with highest volumetric efficiency of any capacitor. We halved the military (CL64) wet slug size, and essentially kept its electrical and performance traits.

The 69F900 has excellent capacitance retention at low temps . . . can be stored to -65 C. Operating range is -55 C to +85 C. It's tough too—withstands vibration to 2000Hz; 15G acceleration!

GE's capacitor is fully insulated; has low, stable leakage current. Ratings are available from 6 to 60 volts; capacitance ranges from 0.5 to 450 μ f.

Circle number 804



New 36 point one-piece Terminal Boards

General Electric has stretched its reliable line of one-piece terminal boards to 36 contact points. And they are available in eight configurations of solder, screw and quick-connect points.

The new expanded line of CR151, Type D1 or D7, is rated 15 amperes with breakdown voltage of 3600. Of course, other designs are still available in ratings up to 30 amperes and breakdown voltage to 7500.

No insulation is required between board and panel because the molded plastic base already provides the protection. Marking strips or stamped markings can be provided on top and/or bottom.

The expanded D1 and D7 boards add just another dimension to what is already the broadest terminal board line on the market. For more information, circle reader card number 805.

10 more

electronic components tailored for designers

General Electric components are engineered for reliability and cost effectiveness. No other single manufacturer offers such a wide selection of quality electronic components as General Electric. Specify GE in your designs.



Complementary power transistors—up to 20W in audio applications

Complementary D27C/D27D silicone-encapsulated, planar, epitaxial power transistors have low collector saturation voltages and offer a dissipation of 8W total power with tab at 70 C. Their 0.5" leads can be formed to fit TO-66 and TO-5 configurations.

Key Characteristics

Collector current
3 amps (continuous)
5 amps (peak)
Collector saturation voltage
D27C: 0.5V typ., 3.0A
D27D: -1.0V typ., -3.0A
Collector-to-emitter voltage
30 and 40 volts
Total power dissipation (with tab)
1.7W (free air at 50 C)
2.1W (free air at 25 C)
8.0W (tab at 70 C)
Forward current transfer ratio
120 max., 200 mA
Gain band width product
D27C: 50MHz typ.
D27D: 40MHz

Their small size and power handling capability offer a great variety of applications including drivers, voltage regulators, power switching, audio output for automobile or phono stereo, TV, radio. And they are color coded for identification. Circle number 806.



Designing a radar? New GE 4-cell tetrode improves bandwidth 300%

Up go electronic bandwidths with GE's unique ZP-1081 "multi-cell" tetrode, a compact, air-cooled transmitting tube that incorporates four high-performance tetrode units in a single vacuum envelope. This innovation leads to very high transconductance and significantly low output capacitance, to provide high gain-bandwidth in amplifier circuits.

Electronic bandwidth of about 120 MHz has been demonstrated under RF power amplifier operation at 475 MHz. Related typical performances includes 70 KW of useful peak power output with a peak drive power of 15KW.

Output efficiency is close to 40%, and low operating voltages are used under RF grid-pulsed amplifier service. Bandwidth achieved is on the order of 200-300% of that available from previous tetrodes and associated circuitry operating at comparable power and frequency. For more information, circle number 807.



GE's Economy Pack ... proved thermistors at budget prices

Growing uses of printed circuit boards in new applications have demanded hermetically sealed temperature compensation units at lower cost. And in response to this need, GE has put its proven 1H-Series (negative temperature Coefficient) Thermistors in a new Economy Package.

As low as 16¢ each in OEM quantities, these high-quality units are available in 5%, 10%, 20% and 30% tolerances with Zero-Power Resistance Values from 18K to 56K ohms at 25 C.

1.125 inch gold-plated Dumet leads may be welded or soldered ... ideal for PCB designs.

Proved quality at lower cost makes GE thermistors the answer to your PCB needs. For more facts on the GE Economy Package, circle number 808.

Look to **General Electric**—your best source for more in electronic components.

ELECTRONIC COMPONENTS SALES OPERATION

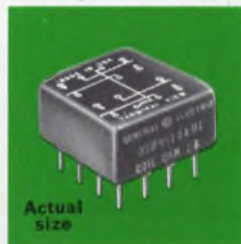

Smallest 4-pole relay available anywhere ... GE's 150 grid

The General Electric 150 grid sealed relay is now a better buy than ever. It's the smallest available. And three years of application experience rank it with the most reliable GE sealed relays ever designed.

Low in price, it is even less than GE's standard 4-pole relay which is 4 times larger.

It meets Mil Spec 5757E, rated 2 amps, 250 MW sensitivity, and has all welded construction. Ask for the best 4-pole sealed relay buy on the market—GE's Type 3-SBH 150 grid.

Circle number 809 for more information.



Instant Response for Driving Computer Peripherals

When your equipment calls for instant response—inertial time constants low as 1 millisecond—look to GE's new Hyper-Servo* motor. It can accelerate faster than any previous GE design.

The Hyper-Servo motor makes possible new performance capacity in motor-driven peripheral data processing equipment. It is available in 3.4-, 4.6-, 4.8- and 4.9-inch diameters. And look at these performances: torque-to-inertia ratios in excess of 350,000 rad/sec² and; cont torque ratings from 32 oz-in at 2700 rpm to 326 oz-in at 2800 rpm.

These and other high performance characteristics make the Hyper-Servo motor adaptable to nearly every computer peripheral drive application. Circle magazine inquiry card number 810.

* Trademark of the General Electric Company.

GENERAL ELECTRIC



Design notch networks the easy way.

Here's a technique for building them with standard fixed-value parts from 10%-tolerance stock.

Standard design techniques for RC twin-T notch networks—as most designers know—often lead to networks that require oddball or expensive components. This problem can be overcome by a relatively simple technique that allows the networks to be designed and constructed with six fixed-value components from a 10% tolerance stock.

Essentially the method gives the designer wide latitude in the selection of four of the notch-network components and then “fine tunes” the network performance with the last two components.

To understand the fundamentals of this technique, examine the circuit of the basic parallel-T notch network in Fig. 1. The values of the three resistors are indicated by the coefficients a , b , and c , while the three capacitor values are indicated by d , e and f . If resistance units are in megohms, then capacitance units are microfarads. Table 1 shows the design basis for a network with a null at frequency F_n . The equations for the network elements are expressed in terms of the input resistor coefficient, a .

Other terms used in the equations of Table 1 are ω_n , where $\omega_n = 2\pi F_n$ (with F_n in Hz), and the attenuation null sharpness parameter, or symmetry parameter, m . Here, m is defined as the ratio of the resistance used at the network output terminal to that used at the input terminal. For the circuit of Fig. 1, therefore, $m = bR/aR = b/a$.

The attenuation characteristic of a notch network for a value of $m = 1$ is shown in Fig. 2. Improved notch sharpness occurs with increasing values of m up to about a practical value of $m = 10$. This can be seen from Fig. 3, which shows the percentage transmission of a network as a function of frequency ratio, F/F_n , for various values of m . Here, F is the input frequency and F_n is the design null frequency.

Studying the notch network itself (Fig. 1), we see that zero attenuation will result at very

low and at very high frequencies, even though the values of individual parts deviate from the design values. This is clear from the fact that the network contains no resistance divider (thus no low-frequency loss) and no capacitive divider (thus no high-frequency loss). Similarly the chosen value of the symmetry parameter, m is the principal factor controlling the attenuation notch sharpness.

Step-by-step procedure

The preceding observations lead to the conclusion that the depth of the attenuation notch and the frequency of maximum attenuation are the only factors that need be considered. Clearly, then, there are six variables (the network parameters a , b , c , d , e and f) and only two constraints (notch depth and frequency) involved in constructing a network.

The problem is thus reduced to this: For a certain frequency of maximum attenuation and a notch sharpness defined by some value of m , what six parts will satisfy the design? The following step-by-step procedure shows how this can easily be done (it is assumed that a resistance and a capacitance bridge are used to measure component values as parts are taken from stock:

Step 1: Select the input resistor from stock. Bridge the part to determine the parameter a .

Step 2: Using the value determined for parameter a , calculate the desired input capacitor value, d . (Use the equations given in Table 1 for this and all other calculations.) Measure a few capacitors and select one with a value near that calculated.

Step 3: Repeat step 1 for the output resistor, b , and measure the part to find ma .

Step 4: Repeat step 2 for the output capacitor, e , using the measured value of ma .

Up to this point in the procedure, no exact component values have been required. Instead, an effort has been made to realize the design RC product at both the input and the output termi-

How are notch networks used?

Notch networks are used to selectively attenuate electrical signals or noise in a band of frequencies. The attenuated frequency band may be narrowed if the passive network is in a positive feedback loop of an amplifier. When incorporated into a negative feedback amplifier, a bandpass characteristic is obtained. With increased gain, the amplifier then becomes an oscillator.

The oscillators in a touch-tone telephone subset are an example of the use of notch networks. For each tone, the oscillating frequency is determined by a parallel-T notch filter in an amplifier feedback circuit.

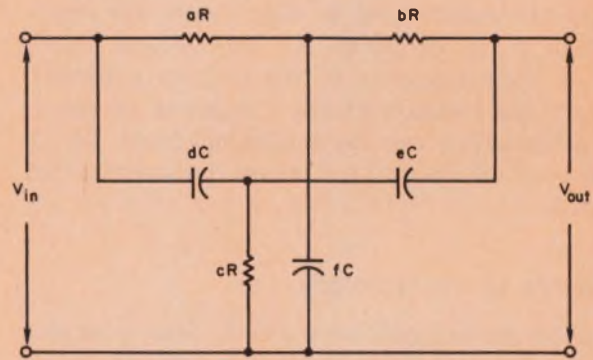

1. Component values of the parallel-T network can be expressed by the coefficients a through f.

Table 1. Network component values

Network element	Network parameter	Symmetrical design (m=1)	Improved sharpness design (1 < m ≤ 10)
Input resistor	a	a	a
Input capacitor	d	1/(ω _n a)	1/(ω _n a)
Output resistor	b	a	ma
Output capacitor	e	1/(ω _n a)	1/(ω _n ma)
Shunt resistor	c	a/2	ma/(m+1)
Shunt capacitor	f	2/(ω _n a)	(m+1)/(ω _n ma)

nals, but component values near the design values have been accepted. The formulas in Table 1 for calculating the shunt resistor, c, and shunt capacitor, f, values are based upon the assumption that all other network elements have the exact design values. However, deviations in value have been allowed for the two resistors and two capacitors already selected. The remaining two network elements must therefore have close tolerance, which will be met if the following equations are simultaneously satisfied:

Null function:

$$a b f / (a + b) c (d + e) = 1 \quad (1)$$

Frequency function:

$$(d + e) / (a + b) a b c d^2 e^2 f = 16\pi^2 F_n^4, \quad (2)$$

which can be solved for the unknowns c and f as follows:

$$c = 1 / [(a + b) d e 4 \pi^2 F_n^2]. \quad (3)$$

$$f = (d + e) / (a b d e 4 \pi^2 F_n^2). \quad (4)$$

Step 5: Calculate the two shunt element values c and f, using Eqs. 3 and 4. Then select parts from stock as close to these values as possible.

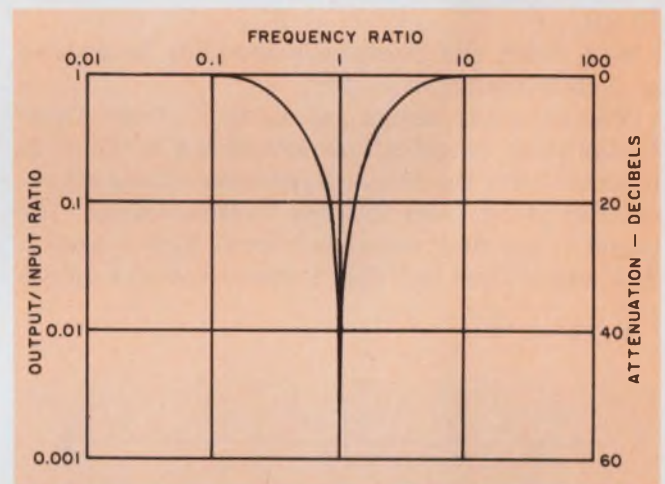

2. Symmetrical null characteristic of a notch network is shown here for a symmetry parameter of m=1.

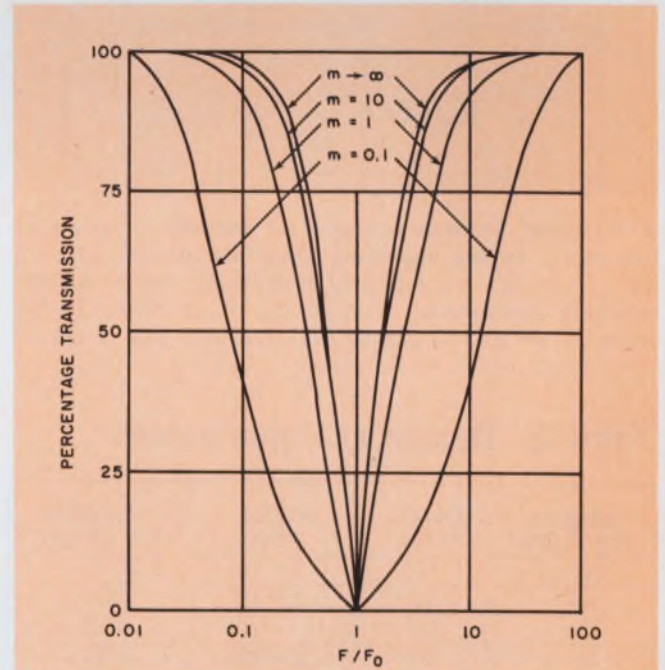

3. Notch sharpness increases as the value of symmetry parameter m is increased.

The effect of deviations from the calculated values can be determined using Eqs. 1 and 2.

If the measured values of the selected components are substituted in Eq. 1 and the result is within 0.1% of unity, an attenuation notch depth of approximately 60 dB may be expected. Similarly the location of the frequency of maximum attenuation can be estimated from Eq. 2.

The over-all design procedure is summarized in Fig. 4.

An example of the technique

As a design example of the technique, consider the case where the following notch network specifications are to be satisfied:

- A null at 1000 radians per second (approximately 6283 Hz),
- An input resistor, aR , of approximately 10 k Ω ,
- A notch sharpness corresponding to a value of approximately $m = 10$.

The resulting design calculations (from Table 1) for these specifications are shown in Table 2, together with the actual component values selected from stock. Note that the "Actual Values" for c and f are first calculated from Eqs. 3 and 4. The last column in Table 2 shows how the values

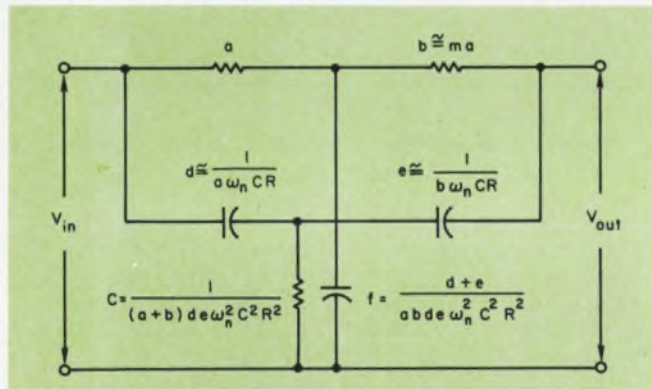

4. Practical selection criteria for network components are shown by the equations. Elements aR , bR , dC and eC can deviate considerably from these values without affecting performance. The effects of deviations in the values of cR and fC can be evaluated with Eqs. 1 and 2.

Table 2. Design example values

Element parameter	Design value	Actual value	% Deviation from design
a	10^4	$0.9 \cdot 10^4$	-10
d	10^{-7}	$0.9 \cdot 10^{-7}$	-10
b	10^5	$1.1 \cdot 10^5$	+10
e	10^{-8}	$1.2 \cdot 10^{-8}$	+20
c	$10^5/11$	$10^5/12.852$	-16.8
f	$11 \cdot 10^{-5}$	$9.54 \cdot 10^{-5}$	-13.3

of the final network components deviate from the theoretical design values of Table 1.

A word of explanation on how the final network satisfies the design specifications: The parallel-T is a three-terminal network that has the same RC product at each of the terminals when the component design values are realized. In the "Design Value" column of Table 2 we note that the RC products $aRdC$, $bReC$, and $cRfC$ all equal 10^{-3} (the reciprocal of $\omega = 10^3$). The values in the "Actual Value" column, though, do not produce these identical time constants. Another way of explaining this is to state that the voltage transfer function zeros have been kept at the design frequency, but the poles have been allowed to move.

Computer simplifies design of many networks

For the production of large numbers of notch networks, whether for identical frequencies or otherwise, systematic measurements can be made of a large number of potential components for each of the six network elements. These values—for example 10 for each element—may be used in trial combinations until Eq. 1 and then Eq. 2 are satisfied to within prescribed tolerances. With the suggested number of 10 possible parts for each network element, though, as many as 10^6 combinations are possible. Such a repetitive calculation, although virtually impossible to do manually, can be performed readily by a digital computer. For such computer calculations, null function and frequency function limits may be prescribed, and the computer can be programed to stop when a suitable combination has been found. ■■

Test your retention

Here are questions based on the main points of this article. Their purpose is to help you make sure you have not overlooked any important ideas. You'll find the answers in the article.

1. What is the significance of the symmetry parameter, m , in the design of a notch network?
2. Why is a computer necessary in selecting components for large numbers of notch networks?
3. In the technique described in the article, what are the only two constraints involved in selecting suitable component values for a network?

When reliability is the rule

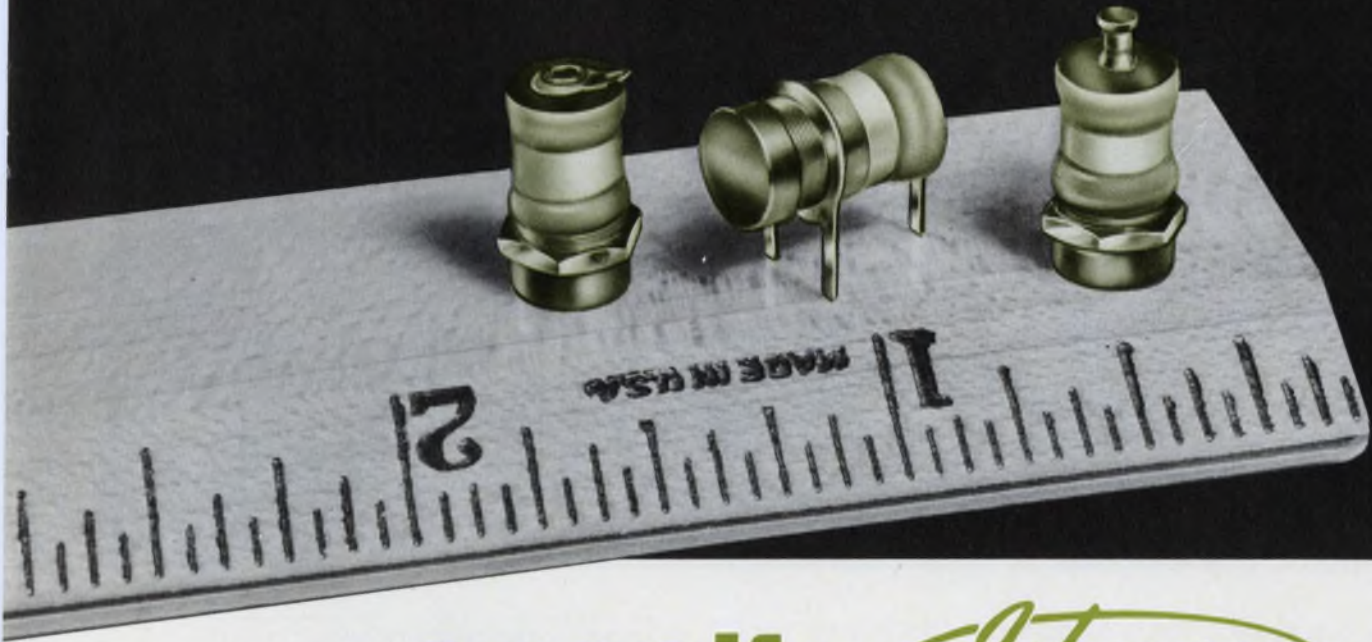

...specify *Johanson*

HIGH Q, HIGH FREQUENCY VARIABLE AIR CAPACITORS

An extra margin of reliability is built into Johanson Miniature Variable Air Capacitors.

This versatile series provides, in miniature size, exceptionally high Q, superior ruggedness for protection against shock and vibration, -55°C to $+125^{\circ}\text{C}$ operating temperature range, protection against fungus, salt spray and humidity . . . plus all the other construction and performance features that have made Johanson capacitors the industry standard for excellence.

No compromise is made in materials, design or workmanship assuring, in all cases, the finest performance available for the price.

Test Johanson capacitors yourself — under your worst-case test conditions.

Write Today for Complete Catalog, Prices.

Features 570° Solder
Prevents distortion. Not affected by
conventional soldering temperatures.

**THE JOHANSON
2950 SERIES
VARIABLE AIR CAPACITORS
(ILLUSTRATED)**

SPECIFICATIONS:

CAPACITANCE RANGE: . . . 0.8 — 10.0 pf.
DIELECTRIC
WITHSTANDING VOLTAGE: Rating 250 vdc
Breakdown > 500 vdc
Q: > 2000 @ 100 mc
TEMPERATURE
COEFFICIENT: 0 ± 20 ppm/ $^{\circ}\text{C}$
INSULATION RESISTANCE: $> 10^6$ megohms @
500 vdc
ROTATIONAL LIFE: > 800 revolutions
rotor screw
THERMAL SHOCK: 65°C to $+125^{\circ}\text{C}$
SHOCK: 50 g's 11 millisec.
VIBRATION: 15 g's 10-2000 cps

Complete data available on request.

The Complete Johanson line includes variable air capacitors ranging from .1-1 pf to 6.0 — 325 pf. also high-reliability and non-magnetic types.

Johanson **MANUFACTURING CORPORATION**

400 Rockaway Valley Road, Boonton, N. J. 07005

Phone (201) 334-2676

DARCY DVM DELIVERY COMES IN 3 CONVENIENT SPEEDS

FAST



FASTER



NOW



Not too long ago you had to be patient for delivery of the two hottest DVMs in the industry, the Darcy DM 440 and DM 330.

Things have changed — You won't have to wait any more. Darcy DVM production has been DRAMATICALLY increased.

Just mark your order — **FAST, FASTER, or NOW!**

One of our delivery girls demonstrates above the 3 convenient speeds from our stockroom of standard DM 330s and DM 440s, ready to go.

FAST (1 week ARO) — Available **NOW!**
FASTER (3 days ARO) — Available **NOW!**
NOW (same day) — Available **NOW!**

Capsule specs at right tell you why customers were willing to be patient.

Give us a call. We'll turn our switch to the speed most convenient to you. Or, write to us for the whole story.

DARCY — DVMs JUST FOR GOOD MEASURE

DM 330 SPECIFICATIONS—3 DIGITS

ACCURACY.....	.1% of reading + 1 digit.
SPEED.....	10 readings per second or 1 reading per second-selectable.
INTEGRATING.....	Infinite Noise rejection at 60 Hz.
RANGE.....	DC Volts- 1 mv/digit to 1000 V DC Full Scale. K Ω - 1 Ω /digit to 10 meg. Full Scale. DC CURRENT- 1 NA/DIGIT TO 10MA. FULL SCALE. AC volts- 1 mv/digit to 1000 V Full Scale. 1% of reading \pm 1 digit. 50 Hz - 10 KHz.
CURRENT RESOLUTION.....	1 na/digit
OVERRANGE.....	Reads to 150% of Full Scale.
GUARDED.....	100 DB COMMON MODE REJECTION, DC TO 1 KHZ.
PRICE.....	\$389 with AC, \$349 without AC.

DM 440 SPECIFICATIONS—4 DIGITS

ACCURACY.....	\pm 0.01% of reading \pm 1 digit.
STABILITY.....	Accuracy will remain as specified for not less than 90 days from calibration over temperature range of 15°C to 35°C.
COMMON MODE REJECTION.....	Infinite at DC, 140 dB at all frequencies up to 1 KHz with up to 1 K Ω source imbalance in either input lead. Common Mode Voltage up to 1000 VAC.
RANGE.....	To 1000 volts DC.
SYSTEM ORIENTED OPTIONS.....	DCmV (1 μ V resolution), K Ω (Kelvin), AC, DC, Ratio, and over 15 other options.
PRICE.....	\$995, basic DC unit.

If you're attending IEEE we'll prove it to you. Bring a PO with you . . .

DARCY INDUSTRIES

1723 CLOVERFIELD BLVD. • SANTA MONICA, CALIF. 90404 • Phone (213) EX 3-9611 • TWX (910) 343-6963

INFORMATION RETRIEVAL NUMBER 126

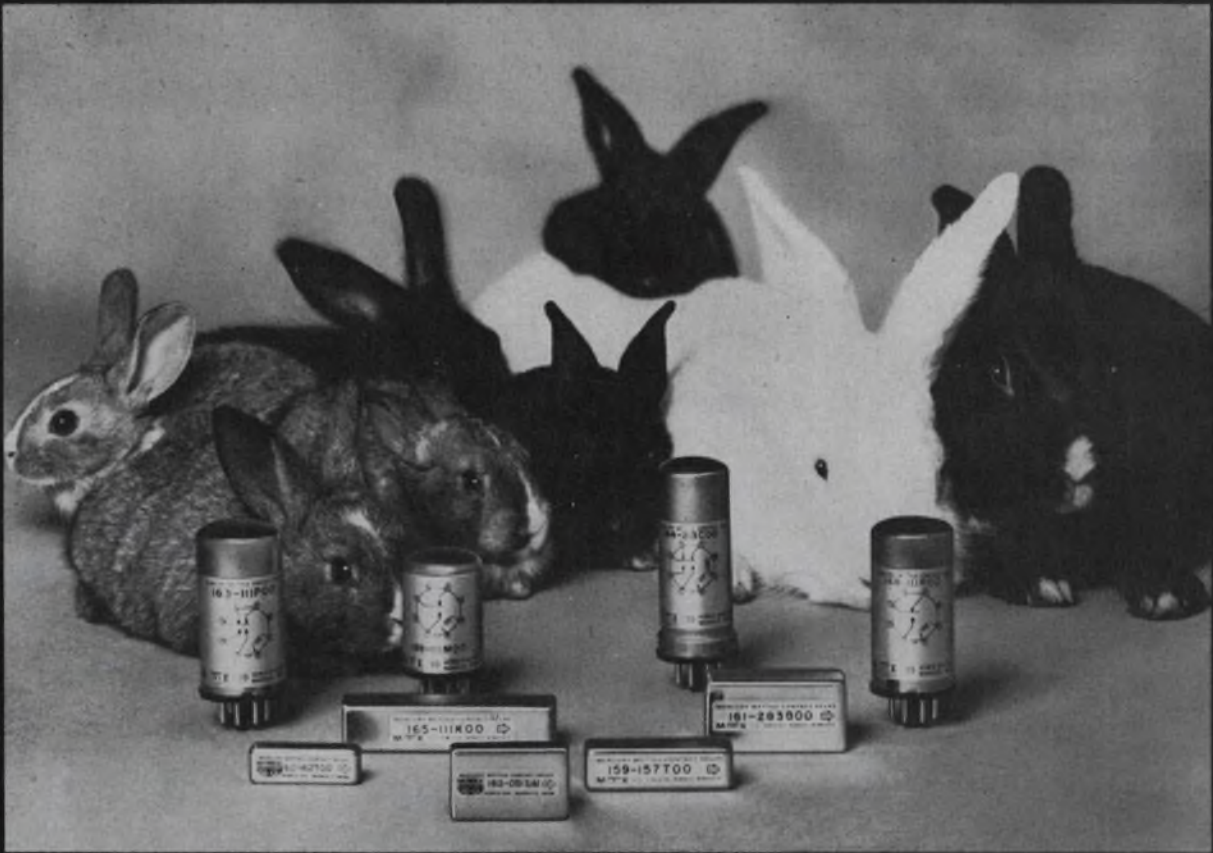

Once you understand the basic technology,
you can produce the whole Mercury Family.

We do...and did!

No family planning problem here. We wanted a big Mercury family. We've got it!

Are you interested in a 2 amp SPDT, PCB module? We've got it! (Type 159.) Or miniature version of it? We've got it! (Type 160.) How about a 2 amp octal plug? We've got it! (Type 168.) A low level DPDT PCB module? Got that too! (Type 161.) You need husky 5 amp octal plug workhorses? Got them too! (Type 163 and 164.) Need something for direct PCB mountings? We've got it! (Type 165.) Miniature octal plug? Mini-DPDT

low level? Got 'em! (Type 169 and 162.)

Now you have another choice when specifying Mercury relays. A choice that is willing to show you some old-fashioned hustle! Talk to us about Mercury prices. Talk to us about delivery dates. Talk to us about your own tough Mercury problem. We'll show you what we mean!

At Midtex it's one big happy Mercury family . . . and there may be more to come . . . lately our design department has taken to ordering in dill pickles and strawberry ice cream for coffee breaks.

MIDTEX 
INCORPORATED

AEMCO DIVISION

10 STATE STREET
MANKATO, MINNESOTA 56001

PROGRAMMERS/TIME DELAY RELAYS/MINIATURE COAXIAL RELAYS/INDUSTRIAL RELAYS/MERCURY-WETTED CONTACT RELAYS

INFORMATION RETRIEVAL NUMBER 127

Build stable rf servo loops that can help reduce both linear and nonlinear temperature drifts. Maximizing the sampled signal is the key.

Part 2 of a two-part article

The design of a servo system to control the power level of a microwave source poses some unusual problems for the design engineer. For example, the filters needed for the rf circuitry will affect the stability of the loop. We will investigate this stability problem using Routh's criterion and the root-locus method.

In Part 1 of this article (ED 5, March 1, 1969, p. 60) design equations were developed to describe the static performance of the system. Primed equation numbers will be used in this part of the article to distinguish them from those in Part 1.

Keep the poles on the left

For a servo loop to be stable, its transfer function must have no poles in the righthand-half of the s -plane. This means that the characteristic equation, $1 - A_L(s) = 0$, must have no roots in the right-half plane.¹ A quick way to check this is to apply Routh's criterion to the characteristic equation. Before this can be done, however, we must develop an expression for $A_L(s)$, the loop gain.

A schematic diagram of the loop, Fig. 1, is drawn with sufficient detail to permit calculation of the frequency dependence of the loop gain. In making the calculation, we will assume that:

- The transistor feedback capacitances are small and may be neglected.
- The input impedance of the dual transistor circuit is high enough to have no effect on the sensing diode voltage ($V_{D'}$ is independent of Z_x).
- The phase delays of the rf chain and the sensing diode are negligible (A_D and A_ϵ are independent of frequency).
- The dual transistor, $Q1$, is perfectly symmetrical, and R_E is large enough to be ignored.

Let's proceed from the output of the chain back to the input and derive an expression for the quantity P_{OB}/P_{OA} . (This is equivalent to traversing the

loop in a counterclockwise direction.) Referring to Fig. 1, we see that the ratio is given by

$$\frac{P_{OB}}{P_{OA}} = \frac{P_{OB}}{V_\epsilon} \frac{V_\epsilon}{V_{b'e2}} \frac{V_{b'e2}}{V_{b'e1}} \frac{V_{b'e1}}{V_x} \frac{V_x}{P_{OA}} = A_L(s)$$

The first factor in this expression is simply A_ϵ , the transfer function of the rf chain, which we are assuming to be independent of frequency.

To evaluate the second factor, we note that

$$V_\epsilon = [-V_{b'e2}/r_{e2}] [r_L/(1 + sC_L r_L)].$$

$$\text{Therefore, } \frac{V_\epsilon}{V_{b'e2}} = -\frac{r_L}{r_{e2}} \cdot \frac{1}{1 + s/p_1},$$

where $p_1 = 1/r_L C_L$.

Similarly, study of Fig. 1 yields:

$$\frac{V_{b'e2}}{V_{b'e1}} = -\frac{\beta_2 r_{e2}}{r_{e1}} \cdot \frac{1}{1 + s/p_4}, \text{ where } p_4 =$$

$$[1/C_{b'e2} \beta_2 r_{e2}] = \omega_{T2}/\beta_2;$$

$$\frac{V_{b'e1}}{V_x} = \frac{-r_{e1}}{[(R_B + r_D + 2r_{bb1'})/\beta_1] + 2r_{e1}} \cdot \frac{1}{1 + s/p_3}$$

where $p_3 = [\omega_{T1}/\beta_1] [1 + 2\beta_1 r_{e1}/(R_B + 2r_{bb1'})]$, and $\omega_{T1} = 1/C_{b'e1} r_{e1}$; and

$$\frac{V_x}{P_{OA}} = \frac{A_D}{1 + s/p_2}, \text{ where } p_2 = 1/r_D C_D.$$

Now, we can multiply our expression for the four factors together to get

$$\begin{aligned} P_{OB}/P_{OA} &= A_L(s) \\ &= A_L/(1 + s/p_1) (1 + s/p_2) (1 + s/p_3) (1 + s/p_4); \end{aligned} \tag{1'}$$

where $A_L = A_\epsilon A_C A_D$; and

$$A_C = -\frac{\beta_2 r_L}{\frac{R_B + r_D + 2r_{bb1'}}{\beta_1} + 2r_{e1}} \tag{1a'}$$

For convenience, we can rewrite Eq. 1' as

$$A_L(s) = K_L/(s + p_1) (s + p_2) (s + p_3) (s + p_4), \tag{2'}$$

where $K_L = A_L p_1 p_2 p_3 p_4$.

Since Eq. 2' is an all-pole function, the loop is potentially unstable. Instability will occur if the loop gain is high enough to move the pole closest to the origin into the right-half plane when the

Arpad D. Vincze, Senior Design Engineer, Philco-Ford Corp., Palo Alto, Calif.

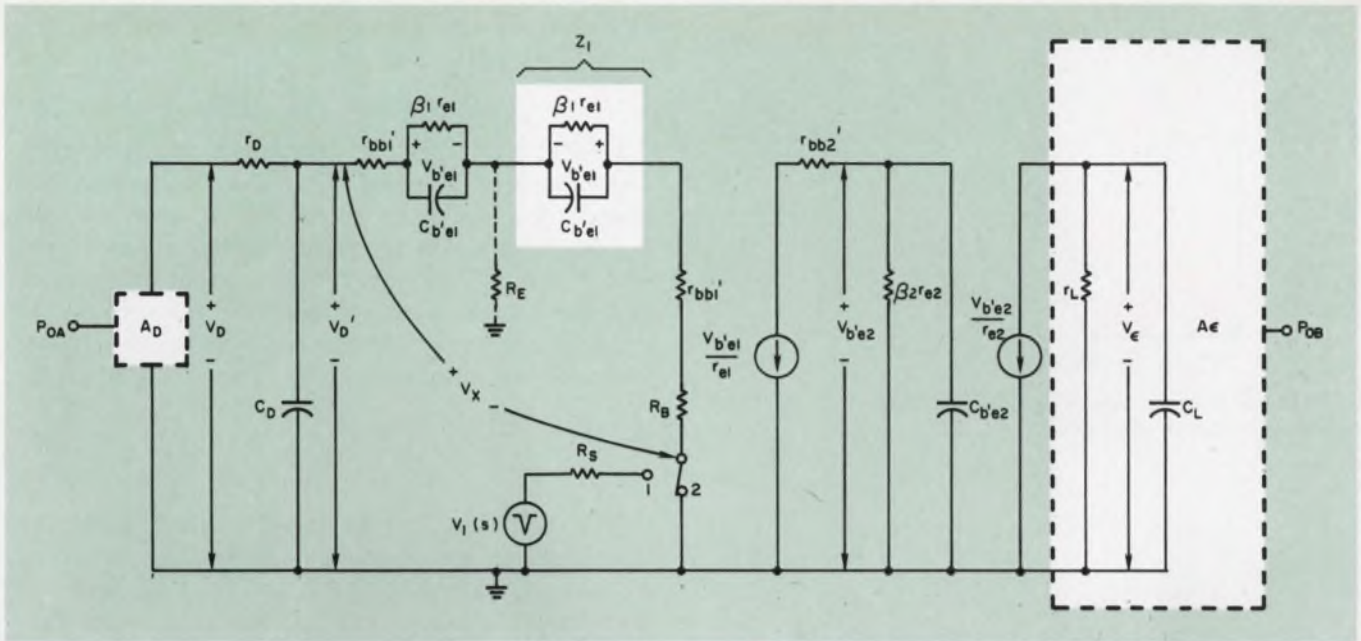

1. The frequency dependence of the loop gain is calculated from this equivalent circuit. R_B is the parallel equivalent resistance of R_1 and R_2 of Fig. 6 (in Part 1 of this article);

r_D is the combined parallel resistance (load and internal resistance) of the sensing diode. The switch is normally in position 2; it is put in position 1 for impulse testing.

loop is closed. This pole is called the *dominant pole* and its position is the chief determinant of the loop response; hence, it serves the function of loop-filter pole. It is advantageous to place the three other open-loop poles away from the dominant pole for better control and faster response speed.

Since a certain amount of rf filtering is necessary, we are saddled with the other three poles that result from filter bypass capacitors and transistor characteristics. These limit the response speed achievable by moving the loop-filter (dominant) pole away from the origin. This limiting speed cannot be increased without introducing instabilities, unless the loop gain is reduced. Reduced gain, of course, means looser control. Therefore, there exists an optimum design compromise that combines stability, fast response and tight control, and it's our job to find it.

First check stability

First we apply Routh's test to the characteristic equation. If we substitute Eq. 2' into the characteristic equation, we get

$$s^4 + As^3 + Bs^2 + Cs + D - K_L = 0, \quad (3')$$

$$\text{where: } A = p_1 + p_2 + p_3 + p_4, \quad (4a')$$

$$B = p_1p_2 + p_3p_4 + (p_1 + p_2)(p_3 + p_4), \quad (4b')$$

$$C = (p_1 + p_2)(p_3p_4) + p_1p_2(p_3 + p_4) \quad (4c')$$

and

$$D = p_1p_2p_3p_4. \quad (4d')$$

The Routh test² indicates that the system will be stable so long as

$$B > C/A \quad \text{and} \quad (5')$$

$$C > A^2(D - K_L)/(AB - C). \quad (6')$$

Eq. 5' is always satisfied as can be verified by substituting Eqs. 4a', 4b', and 4c' into it. Thus Eq. 6' determines the loop stability. If we recall (from Eqs. 2' and 4d') that $K_L = DA_L$, we can rewrite Eq. 6' as

$$|A_L| < \frac{C}{D} \left[\frac{B}{A} - \frac{C}{A_2} \right] - 1. \quad (7')$$

If this condition is not met, the loop will oscillate with a frequency, f_o , given by $f_o = (1/2\pi)(C/A)^{1/2}$. This expression is obtained by setting the imaginary part of Eq. 3' equal to zero and letting $s = j2\pi f_o$.

To properly define the response (either steady-state or transient) of a closed loop, it is necessary to specify the excitation function and the points of excitation and observation. One important specific response is the effect of power supply ripple on the output power level. Since the power supply line filter will be designed on the basis of this data, we might as well calculate it right at the outset.

A simplified block diagram of the loop, suitable for determining the ripple effects, is shown in Fig. 2. We can define the open-loop sensitivity of the system to changes in supply voltages as

$$A_V = \left. \frac{dP}{dV_s} \right|_{P = P_o}. \quad (8')$$

With the loop closed, a small disturbance in the supply voltage, dV_s , will cause a change in output power given by $dP_o = A_V dV_s + A_\epsilon dV_\epsilon$. But since

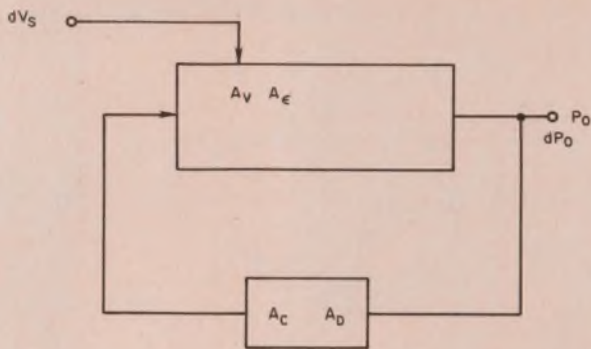

2. Power supply ripple can be analyzed with this simplified block diagram.

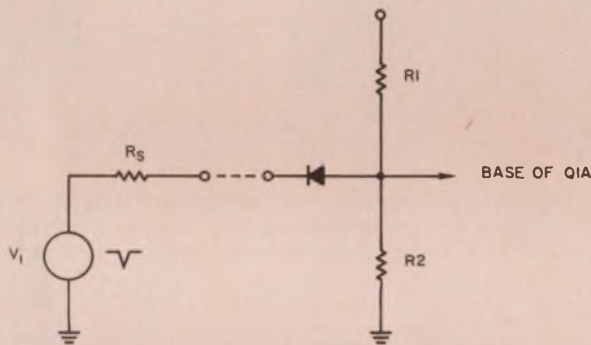

3. The diode isolates the loop from the loading of the pulser so that the natural response of the loop, alone, can be measured.

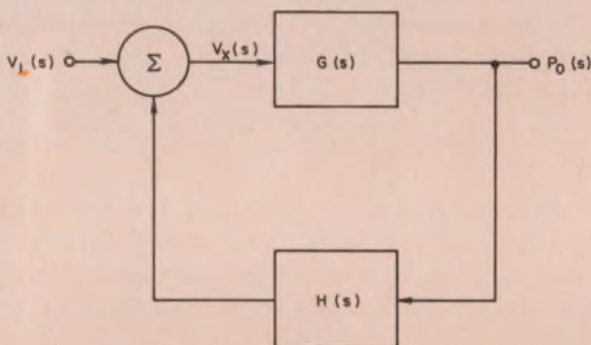

4. The summing junction has been formed by breaking the loop into two parts at the signal-injection point.

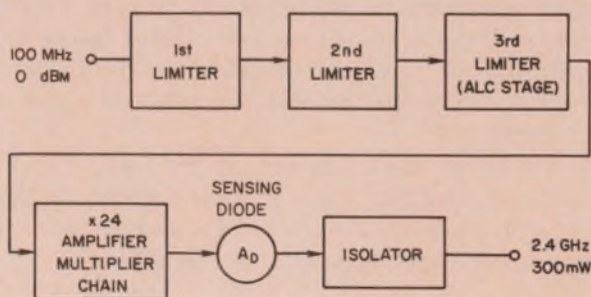

5. Input power variations are reduced by preceding the level-control stage with two stages of limiters. The amplifiers that follow the alc stage must be linear for the loop to have a linear control characteristic.

$dV_\epsilon = A_C A_D dP_o$, we can substitute this into the preceding equation to get

$$dP_o = dV_s A_V / (1 - A_L). \quad (9')$$

To find the frequency response, the frequency dependence of A_V and A_L must be known. We already know $A_L(s)$ from Eq. 2' and we can assume that A_V is frequency independent if the power supply has a very low output impedance and the elements in series with it, such as rf chokes, have negligible reactance at the low ripple frequencies. Substituting Eq. 2' into Eq. 9' yields

$$\frac{dP_o}{dV_s}(s) = \frac{A_V (s + p_1) (s + p_2) (s + p_3) (s + p_4)}{(s + p_1) (s + p_2) (s + p_3) (s + p_4) - K_L} \quad (10')$$

This equation can be used to find both the transient and steady-state responses by factoring the denominator with the Root-Locus method and then applying a conventional analysis to the factored equation.

Alternatively, we can actually measure the frequency response experimentally by modulating the supply voltage with a sinusoidal signal and monitoring the output power with a video detector. This will require the use of a linear, small-signal modulator capable of handling the total current drawn by the rf chain. The modulator's output impedance must be very low, or else instabilities may occur due to negative resistance effects as will be explained at the end of the article.

To determine the transient response of the system, a more practical approach is simply to inject a sharp pulse at the base of one of the transistors in the control amplifier. A diode is all that is needed to do this, as shown in Fig. 3. When the pulse (negative-going) goes below the base voltage on Q1A, the diode turns on and allows the pulse to affect the system. Then, when the pulse ends, the diode isolates the pulse generator from the rest of the circuitry, allowing the loop to provide its natural response.

Look at the transient response

To analyze the transient response, the system block diagram of Fig. 4 can be used. The loop has been split into two blocks to provide an input at the point of excitation and an output at the observation point. The input to the control amplifier is the summing junction, where the signals from the sensing diode and the pulse generator are added together.

It is clear from Fig. 4 that $P_o(s) = V_x(s)G(s)$ and that $V_D'(s) = P_o(s)H(s)$. It is also clear that $V_x(s) = V_1(s) + V_D'(s)$, which, by substitution, becomes $V_x(s) = V_1(s) + P_o(s)H(s)$. If we combine this result with our initial expression for $P_o(s)$, we get $P_o(s) = G(s)[V_1(s) + P_o(s)H(s)]$. If we isolate the $P_o(s)$ terms on the left hand side

and divide by $V_1(s)$, we get

$$\frac{P_o(s)}{V_1(s)} = \frac{G(s)}{1 - G(s)H(s)} = \frac{G(s)}{1 - A_L(s)} \quad (11')$$

To see how $A_L(s)$ is factored into $G(s)$ and $H(s)$, we note that $H(s)$ contains only pole p_2 of Eq. 2' and that $G(s)$ contains the rest. Thus $H(s) = A_D p_2 / (s + p_2)$ and $G(s) = A_C A_C p_1 p_3 p_4 / (s + p_1)(s + p_3)(s + p_4)$. Substituting these expressions and our expression for K_L into Eq. 11' yields

$$\frac{P_o(s)}{V_1(s)} = \frac{(K_L / A_D p_2)(s + p_2)}{(s + p_1)(s + p_2)(s + p_3)(s + p_4) - K_L} \quad (12')$$

The transient response of the system can be calculated from Eq. 12' by Laplace transformation, after the denominator is factored.

Let's try a design example

With all of the necessary design equations at hand, we are ready to tackle a specific problem. Let's say we have to design a solid-state driver for a TWT. The specifications are given in Table 1.

Glancing at the specs, we know right away that our output power must be able to exceed 300 mW under the worst-case conditions, which, experience tells us, will occur at $+75^\circ\text{C}$ with -3 dBm input power and -24 V supply voltage.

With the above requirements in mind, the rf chain of Fig. 5 was constructed. A line filter (whose characteristics will be determined later) is included but not shown. The two limiting stages preceding the alc stage are used to reduce input power variations. Since ample power will be available, the chain will be fully controlled (this concept is discussed in Part 1). The sensing diode has been placed before the output isolator to isolate it from possible high VSWRs caused by load variations. Thus, this analysis will ignore the temperature variations of the isolator's forward loss.

Before designing the servo system, the rf chain was tested and adjusted until it would operate without any instabilities under all operating conditions. This is a common rf design procedure and will not be covered here. We mention it at this time to make it clear that this trouble-shooting should be done before the problems associated with a servo loop are tackled.

Now that the rf chain is operating properly, we can measure the operating characteristics that we will need to design the servo loop. The required data include:

- A family of P vs V_ϵ curves at -25°C , $+25^\circ\text{C}$ and $+75^\circ\text{C}$, as shown in Fig. 6.
- A curve of V_D vs P , as shown in Fig. 7.
- K_D , the diode temperature drift constant; this turned out to be 1 mV/ $^\circ\text{C}$.
- A curve of r_L vs V_ϵ (Fig. 8), which was obtained from a plot of I_ϵ vs V_ϵ .

Table 1 TWT driver specifications

Output power	Adjustable 200 to 300 mW
Power level setting tolerance at 25°C	± 0.5 dB
Output frequency	2.4 GHz
Input frequency	100 MHz
Input power	0 dBm ± 3 dB
Temperature range	-25°C to $+75^\circ\text{C}$
Maximum allowable output power variation	± 0.25 dB
Power supply voltage	-25 Vdc ± 1 V
Maximum power supply ripple	10 mV
Ripple frequency range	0 — 1 MHz
Maximum allowable a-m	0.05%

Table 2 Control amplifier data

Parameter	2N3801 (Q1)	2N1613 (Q2)
Range of $\beta(h_{fe})$	300-900	30-100
Range of ω_T	$2\pi \times 10^6(30-500)$	$2\pi \times 10^6(60-300)$
r_o (estimated)	50 Ω	1 Ω
$r_{bb'}$ (estimated)	0.5 k Ω	0.5 k Ω
$C_L = 1200$ pF, $C_D = 120$ pF, $R_o = 10$ k Ω , $R_B = 4$ k Ω , $r_D = 2$ k Ω		

■ r_D , the sensing diode load and internal resistance.

Note that the curves of Fig. 6 flatten out at about $V_\epsilon = -15$ V. Thus it is pointless to design the control amplifier to produce any more voltage than that. We can further observe from Fig. 6 that the output power becomes increasingly temperature sensitive as the power level goes up from 200 to 300 mW. The largest variation is from 300 mW at $+25^\circ\text{C}$ to 160 mW at $+75^\circ\text{C}$, a difference of 140 mW. Since the maximum allowable deviation from 300 mW is 0.25 dB or 18 mW, this means that the loop will have to provide $10\log(140/18) = 8.95$ dB of suppression.

In taking data for the curve of Fig. 8 it was observed that the peak occurred near the value of V_ϵ at which the alc stage was tuned. Since A_L is directly proportional to r_L , it is desirable to tune the stage for maximum power near the middle of the V_ϵ dynamic range.

Designing the control circuit

Referring to Fig. 6 of Part 1, a 2N1613 was chosen for Q2, and a dual 2N3801 was chosen for Q1. $I_{\epsilon(max)}$ is about 30 mA and Q2 has a minimum

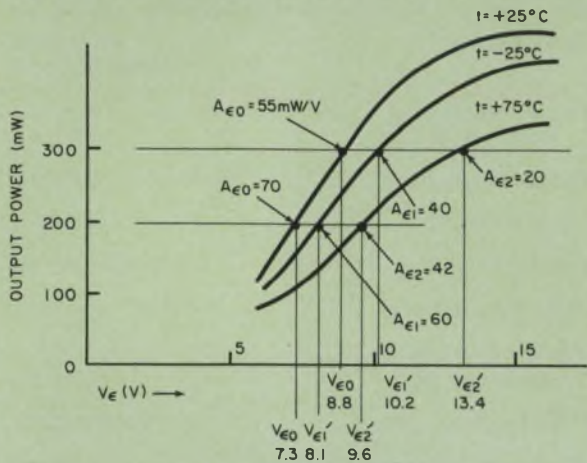

6. The temperature sensitivity of the rf chain is shown here under worst-case conditions. The input power is -3 dBm, and $V_{cc} = -24$ Vdc.

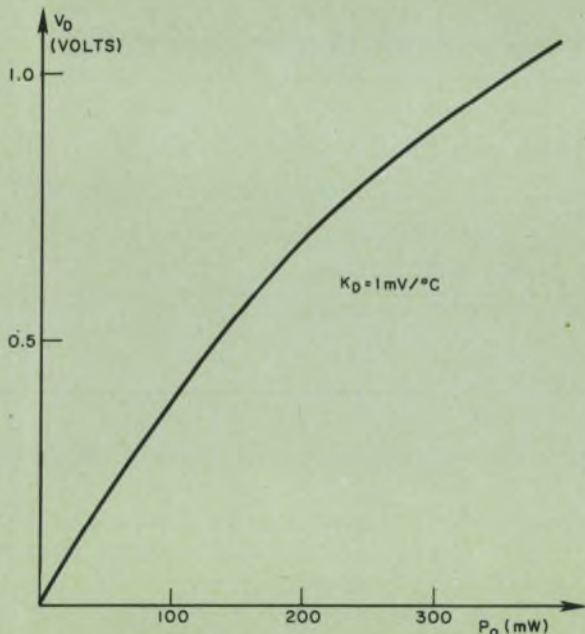

7. The sensing diode transfer constant, A_D , is given by the slope of this curve of V_D vs P . The slope at 200 mW is $1/400$ V/mW; at 300 mW, $1/500$ V/mW.

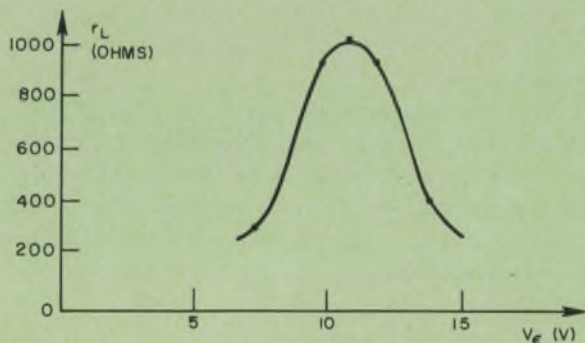

8. Tuning is critical in determining the location of the peak in this curve of r_L vs V_e . The peak is near the value of V_e at which the alc stage is tuned.

β of about 30. The bias network was therefore designed for a total current of 1 mA through R_E . The zener voltage V_Z was selected to be 15 V since we have already seen that a higher voltage would do nothing but increase the dissipation in Q_2 .

To increase A_C , the base-biasing resistors of Q_1B have been bypassed by a large capacitor, putting the junction of R_3 and R_4 at ac ground. The amplifier gain can be adjusted by putting resistors in the emitter legs of Q_1 , or by changing R_B ($R_1 || R_2$). The second method must be used with care: too high a value of R_B will degrade the dc bias stability.

Analyze the loop stability

The transistor parameters and other pertinent data on the control amplifier are summarized in Table 2. Using this data, the normalized pole values were found to cover the following ranges: $p_1 = (0.47 - 1.40)$; $p_2 = (4.15)$; $p_3 = (3.33 - 62.8)$; and $p_4 = (3.8 - 62.8)$, where all of the values have been normalized by dividing them by 10^6 .

Even if we restrict ourselves to considering only the extreme values of the poles, there are $2^3 = 8$ separate configurations that must be evaluated. This has been done, although space does not permit reproducing all of the results here. Instead, we will just reproduce the results for the worst case and the best case, from the point of view of stability. But, how do we tell a good case from a bad one? Easy. Refer to Eq. 7' and replace the inequality sign by an equal sign. The value of A_L that results is called the *critical loop gain*, A_{LC} . If A_L exceeds A_{LC} , the loop is unstable. Thus, a useful figure of merit, the stability margin, SM , can be defined as

$$SM = 20 \log (A_{LC}/A_L) \quad (13')$$

If SM is negative, the loop is unstable.

With this criterion in mind, A_{LC} was calculated from Eq. 7' for each pole arrangement. The maximum value of the product $A_e A_D$ was also calculated; it was determined to be 0.14 V/V and was obtained at $P = 200$ mW and $t = +25^\circ\text{C}$. Next, A_C was found, for each pole arrangement, by using Eq. 1a'. Finally, A_L was formed by multiplying the values of A_C by 0.14 , in accordance with Eq. 1'.

With this procedure, the two extreme cases were determined. A summary of the data on these two

Table 3 Extreme-case parameters

	β_1	β_2	Pole values	A_{LC}	A_L	SM
Worst case (unstable)	900	100	$p_1 = 1.40$; $p_2 = 4.15$; $p_3 = 3.33$; $p_4 = 3.8$	-4.9	-130	-24 dB
Best case (stable)	300	30	$p_1 = 0.47$; $p_2 = 4.15$; $p_3 = p_4 = 62.8$	-79	-34.2	+7.3 dB

cases appears in Table 3. Out of the eight combinations that were investigated, only the "best case" was stable. All of the others had negative stability margins. Since a usable system must be stable under all operating conditions, something must be done. But what?

The stability margin can always be improved by reducing A_L . This is not a good solution, however, because it degrades the static performance. A better approach is to adjust the position of the dominant pole to assure a sufficiently large stability margin and then adjust the other loop parameters, if necessary, to meet the static performance requirements.

Adjust the dominant pole

We have found our worst-case value of A_L to be -130 (Table 3). If we arbitrarily decide to have a gain margin of 6 dB, we will need a minimum value of $|A_{LC}|$ of 260 in the worst case. This means multiplying A_{LC} by a factor of 53, from -4.9 to -260. As a first guess, this means that p_1 should be moved closer to the origin by a factor of 1/53, or about 0.02. We can use this first guess to simplify Eqs. 4' by assuming that $p_1 \ll p_2, p_3,$ and p_4 .

We can now calculate the values of A, B, C and D of Eq. 4' using the worst-case pole values from Table 3 and neglecting p_1 in the terms involving sums. The results are: $A = 11.3, B = 42.3, C = 53.3 + 29.5p_1,$ and $D = 53.3p_1$. Since $A_L \gg 1$ and $B/A \gg C/A^2$, Eq. 7' reduces to

$$|A_{LC}| = BC/AD = 3.75/p_1. \quad (14')$$

If we plug in our value of 260 for $|A_{LC}|$ and solve Eq. 14' for p_1 , we get a value of $p_1 = 0.0144$. This justifies our assumption that it is negligible, compared with the other poles.

We can now proceed with the construction of a root-locus plot which we will use to set the damping factor, ξ , of our loop. One might ask why we are concerned with the damping factor, when we have already guaranteed that the loop is stable? The answer is that undesirable, damped oscillations may be caused by any noise that gets into the loop unless there is sufficient damping to prevent them. The root-locus analysis is made fairly easy

because the dominant pole is already known to be so close to the origin that it has very little effect on the geometry of the locus. Thus, we can perform our analysis with the assumption that p_1 is zero and then use the results to calculate p_1 , without introducing any significant error.

The locus is plotted in Fig. 9, using conventional methods¹, with the definition $[K_L/(s+p_1)(s+p_2)(s+p_3)(s+p_4)] = 1/180^\circ$. The asymptote angle, θ_A , is given by

$$\theta_A = \pm 180/[\# \text{ of poles} - \# \text{ of zeros}] = \pm 180/(4-0) = \pm 45^\circ.$$

The breakaway point, b , is given by

$$b = [\sum \text{poles} - \sum \text{zeros}]/[\# \text{ of poles} - \# \text{ of zeros}] = A/4 = 11.3/9 = 2.82.$$

And, the critical frequency, ω_c , is given by

$$\omega_c = (C/A)^{1/2} = 2.18 \text{ rad/sec.}$$

To keep our system reasonably well-damped, a good value of maximum overshoot is 5%. If we assume that our loop has an approximately second-order response, this corresponds to $\xi = 0.707$, which is obtained from a set of standard tables.¹ Since $\xi = \cos\theta, \theta = 45^\circ$. When we draw a 45° line from the origin on Fig. 9, it intersects the locus at $K_L = 32$. Now, we know that $K_L = p_1(p_2p_3p_4)A_L$ and that the worst-case value of A_L is 130, so we can plug in $K_L = 32$ and $p_2p_3p_4 = 53.3$ and solve for p_1 . The result is $p_1 = 0.0046$.

Now we can calculate the exact value of A_{LC} from Eq. 7' by substituting our value for p_1 into our expressions for $A, B, C,$ and D . The numbers are: $A = 11.3, B = 42.3, C = 53.4$ and $D = 0.246$. This leads to a value of $|A_{LC}| = 722$. Since the worst-case value of $|A_L|$ is 130, SM becomes +14.85 dB. We can safely assume that all other pole combinations will yield even higher values of stability margin.

All four closed-loop poles are shown in Fig. 9 for the case of $K_L = 32$. Thus, for this case, we can write Eq. 12' in factored form. Before doing so, we can denormalize the poles by multiplying them by 10^6 . Eq. 12' then becomes

$$T(s) = \frac{P_o}{V_i}(s) \quad (15')$$

$$= \frac{3.85 \times 10^{21} (s + 4.15 \times 10^6)}{(s^2 + 9.8 \times 10^6 s + 25.80 \times 10^{12}) (s^2 + 1.59 \times 10^6 s + 1.25 \times 10^{12})}$$

Table 4 Temperature-variation data

Set Power Level	Temp.	V_{ϵ}'	r_L	A_c	A_D	A_{ϵ}	A_L	$\frac{A_{\epsilon}A_c}{1-A_2}$
$V_{e_0} = 7.3 \text{ V}$ $P_o = 200 \text{ mW}$	- 25° C	8.1 V	0.47 k	- 114	$\frac{1}{400}$	60	- 17.1	- 378
	+ 75° C	9.6 V	0.92 k	- 224		42	- 23.5	- 384
$V_{e_0} = 8.8 \text{ V}$ $P_o = 300 \text{ mW}$	- 25° C	10.2 V	1.0 k	- 243	$\frac{1}{500}$	40	- 19.4	- 477
	+ 75° C	13.4 V	0.44 k	- 107		20	- 4.27	- 405

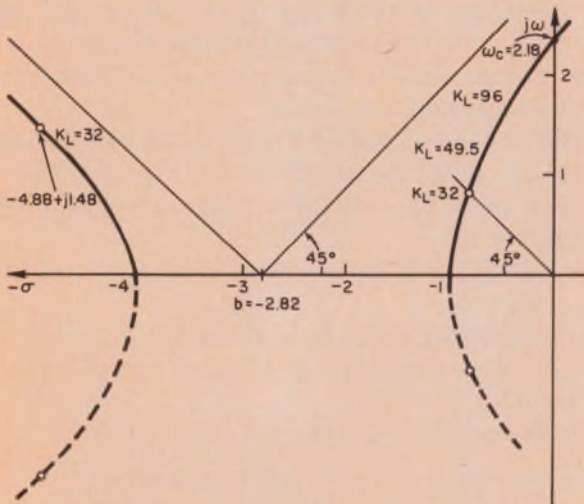

9. This root-locus plot is intersected at $K_L=32$ by the $\theta=45^\circ$ line. The locations of the four closed-loop poles are shown as small circles.

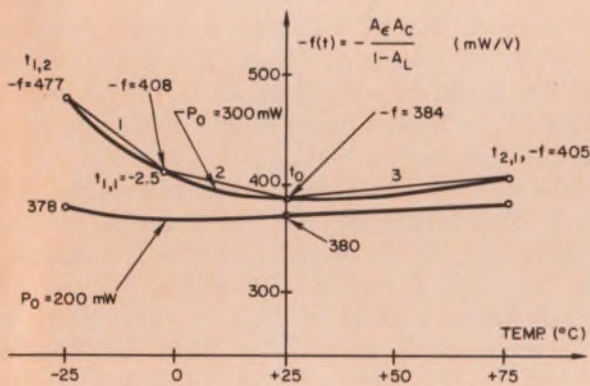

10. Graphical techniques are used to solve for the linear temperature drift when low loop-gain makes the drift equation coefficient a function of temperature.

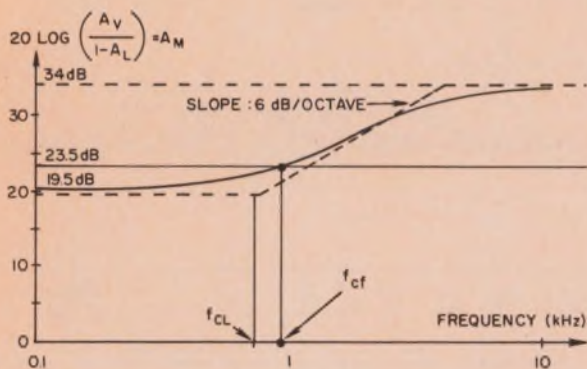

11. Eliminate line ripple by choosing a line filter whose cutoff frequency is $< f_{cf}$. In this case, with A_M specified as 23.5 dB, with $A_L = -4.7$ V/V and with $A_V = 50$ mW/V, $f_{cf} = 920$ Hz.

which can be solved with Laplace transforms to yield the step response.

Next check the static performance

In the preceding section we found a value for P_1 (which essentially tells us how to choose C_L , the loop filter capacitor) that guarantees that our loop is stable and adequately damped. We must now check to see that the loop also holds the output power within its allowed range.

The two components of static drift power are ΔP_ϵ and $\Delta P_{\epsilon D}$, which are given by Eqs. 20 and 16, respectively, in Part 1 of this article. We will now calculate the nonlinear power drift at the two temperature extremes. The necessary data are presented in Table 4. For worst-case conditions, $A_{C(min)}$ should be used, so the lowest beta values for both transistors will be employed: 300 for Q_1 and 30 for Q_2 . Those values, and the resistances listed in Table 2, can be substituted into Eq. 1a' to yield A_C as a function of r_L ; $A_C = -0.243 r_L$.

The data in Table 4 were calculated from Figs. 6, 7 and 8; from Eq. 1a, and from the formula

$$A_L = A_C A_D.$$

It is a perfectly straightforward matter to plug the appropriate values into Eqs. 16 and 20 and to come up with the results of Table 5. Not quite so simple is the calculation of the linear temperature drift.

The trouble is that, in most of the cases, the loop gain is too low for us to use Eq. 16c; thus we must use Eq. 16b, in which the factor $f(t) = A_\epsilon A_C / (1 - A_L)$ is a function of temperature. Thus, Eq. 16b is essentially a differential equation with a variable coefficient, $f(t)$. It can be rewritten as

$$dP_{\epsilon D} - K_D f(t) dt = 0. \quad (16')$$

The solution is

$$P_{\epsilon D} = K_D \int_{t_{ref}}^t f(t) dt, \quad (17')$$

where t_{ref} is a lower limit temperature.

The integral can be evaluated graphically, using the trapezoidal rule, once we obtain a plot of $f(t)$ vs t . The points in the last column of Table 4 provide a beginning, and the curve is presented, for two power levels, in Fig. 10.

To evaluate $\Delta P_{\epsilon D}$ for the case of 300 mW, we represent the curve of Fig. 10 by three line segments, as indicated. The area under each segment, multiplied by $K_D (= +0.001 \text{ V}/^\circ\text{C})$, gives $\Delta P_{\epsilon D}$ for that interval.

$$\begin{aligned} \Delta P_{\epsilon D1} &= P_{t(1,2)} - P_{t(1,1)} \\ &= \left[f(t_{1,1}) + \frac{1}{2} [f(t_{1,2}) - f(t_{1,1})] \right] K_D [t_{1,2} - t_{1,1}] \end{aligned}$$

Table 5 Nonlinear static drift

	- 25° C	+ 75° C
200mW	$V_{\epsilon_1} = 8.0 \text{ V}$ $\Delta P_{\epsilon_1} = - 2.65\text{mW}$	$V_{\epsilon_2} = 9.55 \text{ V}$ $\Delta P_{\epsilon_2} = - 3.95\text{mW}$
300mW	$V_{\epsilon_1} = 10.1 \text{ V}$ $\Delta P_{\epsilon_1} = - 2.75\text{mW}$	$V_{\epsilon_2} = 12.5 \text{ V}$ $\Delta P_{\epsilon_2} = - 17.0\text{mW}$

$$= [- 408 + \frac{1}{2} [- 477 - (- 408)] 10^{-3} [- 25 - (- 25)]$$

$$\Delta P_{\epsilon_{D1}} = + 10 \text{ mW.}$$

Similarly, $\Delta P_{\epsilon_{D2}} = + 10.9 \text{ mW}$ and $\Delta P_{\epsilon_{D3}} = - 19.7 \text{ mW}$. The output power at -25°C , therefore, increases by 20.9 mW, while, at $+75^\circ\text{C}$, it decreases by 19.7 mW.

Despite the nonlinearity of the $f(t)$ curve, there is only a slight difference between the power changes due to heat and cold. Thus, we are justified in letting $f(t) = \text{const.} = -380 \text{ mW/V}$, for the $P_o = 200 \text{ mW}$ calculation. If we do that and plug directly into Eq. 16b, we get:

$$\Delta P_{\epsilon_D} = + 19 \text{ mW @ } - 25^\circ\text{C} \text{ and } \Delta P_{\epsilon_D} = - 19 \text{ mW @ } + 75^\circ\text{C.}$$

The combined linear and nonlinear static power drifts, ΔP_{ϵ_T} , are presented in Table 6. A quick glance at the table shows that three out of the four values are out of spec. And the fourth one only made it by 0.01 dB.

Shall we use linear compensation?

Since a large part of the drift is due to the linear component, one way to improve the performance is to use a series compensating diode in the emitter leg of $Q1A$ as shown in Fig. 6 of Part 1. Diode $D1$ is a silicon diode with a negative temperature coefficient. Therefore, as t increases, the voltage across $D1$ decreases, which is equivalent to saying that the base-to-ground voltage of $Q1A$ increases. Thus, $Q1A$ becomes more forward biased and the collector currents of both $Q1A$ and $Q2$ increase. This in turn, causes an increase in V_ϵ , which, in turn, causes an increase in P as temperature rises. Thus ΔP_{ϵ_T} can be reduced by using the correct amount of compensation. Unfortunately, this solution has the drawback of requiring individual temperature runs for the adjustment of each unit and is, thus, extremely time-consuming and costly.

A better solution is to increase A_D . For example, to meet our specs at 200 mW, ΔP_{ϵ_T} should not exceed 12 mW. This requires an increase in A_D by roughly a factor of $23/12 \cong 1.9$. To maintain the loop stability, A_C must be reduced by the same factor, so that A_L stays constant.

Table 6 Total static power drift

	Temp	ΔP_{ϵ} (mW)	ΔP_{ϵ_D} (mW)	ΔP_{ϵ_T} (mW)	ΔP_{ϵ_T} (dB)
$P_o = 200 \text{ mW}$	-25°C	-2.65	+19	+16.35	+0.33
	$+75^\circ\text{C}$	-3.95	-19	-22.95	-0.52
$P_o = 300 \text{ mW}$	-25°C	-2.75	+20.9	+18.15	+0.24
	$+75^\circ\text{C}$	-17.0	-19.7	-36.7	-0.49

This procedure may be called *proportioning of the loop gain*. Its merit is that it improves the static performance without degrading the dynamic performance. In our laboratory, the necessity for maintaining a high value of A_D has impressed us so strongly that we used a value of about 1/150 V/mW at 200-mW output power in our designs for the Mariner 1969 spacecraft.

Don't forget the line filter

We mentioned earlier that a line filter would have to be designed to remove any ripple that might otherwise get into the system from the power supply. This filter must be a low-pass type, with a cutoff frequency slightly below that of the loop itself, so that, between the loop and the filter, all ripple is eliminated. It is important that the line filter have a very low ohmic loss because of the high currents that will generally be passing through it. Thus, from the point of view of the line-filter design, we want the loop to have the highest possible cutoff frequency: the higher we can make the filter's cutoff frequency, the lower we can make its ohmic loss.

To calculate the worst-case cutoff frequency of the loop, we want to study the frequency vs magnitude plot of Eq. 10' with the pole configuration that gives the lowest loop cutoff frequency.

For $\omega \ll 1$, Eq. 10' becomes

$$\frac{dP}{dV_s}(0) = \frac{A_V}{1 - A_L} \tag{18'}$$

and for very high frequencies, it becomes

$$\frac{dP}{dV_s}(\infty) = A_V. \tag{19'}$$

These two equations define the upper and lower level lines of Fig. 11.

In factored form, for the worst case mentioned before, Eq. 10' becomes

$$A_M = \frac{dP}{dV_s}(j\omega) = A_V \left[\frac{(j\omega + 0.46 \times 10^{-2})(j\omega + 4.15)(j\omega + 3.36)(j\omega + 3.8)}{(9.8j\omega - \omega^2 + 25.80)(1.5j\omega - \omega^2 + 1.25)} \right]$$

$$A_M = \frac{A_V}{132}$$

$$\left[\frac{\left(1 + \frac{j\omega}{0.46 \times 10^{-2}}\right) \left(1 + \frac{j\omega}{4.15}\right) \left(1 + \frac{j\omega}{3.36}\right) \left(1 + \frac{j\omega}{3.8}\right)}{\left(1 + \frac{9.8j\omega - \omega^2}{25.80}\right) \left(\frac{1.5j\omega - \omega^2}{1.25} + 1\right)} \right], \quad (20')$$

where $A_V/132 = A_V/(1-A_L)$.

For $\omega \ll 1$, Eq. 20' becomes

$$A_M = \frac{A_V}{1 - A_L} \left[\frac{j\omega}{0.46 \times 10^4} + 1 \right] = \frac{A_V}{1 - A_L} \left[\frac{j\omega}{\omega_{CL}} + 1 \right] \quad (21')$$

where p_1 has been denormalized by multiplying it by 10^6 .

Using the upper-and-lower level lines of Fig. 11, and our knowledge of f_{CL} from Eq. 21', we can sketch Eq. 21'. Since we want a worst-case analysis, we will use $A_{L(\min)}$ ($=-4.27$), and a measured value of $A_V = 50$ mW/V. This means that the upper level line is given by $20 \log A_V = 20 \log 50 = 34$ dB. The lower level line is given by $20 \log [A_V / (1 + 4.27)] = 19.6$ dB. And the specified level line is found as follows: We are allowed a maximum of 0.05% a-m at 300 mW, which is 0.15 mW and there may be up to 10mV of ripple on the line. Thus, we want an A_M of $20 \log (0.15/0.01) = 23.5$ dB.

The loop cutoff frequency is determined by p_1 to be $4.6 \times 10^3 / 6.28 = 733$ Hz.

With this data we can sketch the loop frequency response and specified A_V level. Their point of intersection gives the line filter cutoff frequency of 920 Hz, max. A one-pole filter will suffice, since it only has to overcome the 6-dB/octave slope of the single-pole loop filter.

One final question concerns the load impedance that the filter should be designed for. To understand why this is a problem, we must note that the output power of the rf chain varies with the supply voltage. Thus, when the closed loop lowers the drive to the chain, and lowers the total current, the voltage drop in the line filter will decrease and give rise to an incremental negative resistance. Any reactive elements in the line can then give rise to parasitic oscillations. The effect is particularly bad, if the power supply regulation is poor, and if the loop filter has a high reactance. A resonant system may then exist involving even the power supply filter capacitor.

This problem can be avoided by not using power supplies near their limits where regulation may be degraded, and by avoiding the use of large filter capacitors. Instead, the loop should be designed for high f_{CL} , and rf decoupling chokes should be used between the rf circuits and the power supply buss.

If oscillations still exist, a small resistance can

be put in series with a large capacitor and connected between the junction of the line filter and the rf supply lead and ground. The resistance should be decreased slowly until oscillations stop. Then, the line filter terminating impedance becomes $Z_{LF} = dV_s/dI_s$ in parallel with the damping resistance.

In closing, perhaps we should mention that this servo approach is much better suited to amplifier/multiplier chains than to simple power amplifiers. The reason is simply that for a straight amplifier, poles p_1 and p_2 will move closer to each other because they will be filtering the same frequencies. This will degrade the stability of the loop and will require the use of bulky and inefficient line filters. In these cases, other leveling techniques such as open loop compensation, might be a better choice. ■ ■

References:

1. R. N. Clark, *Introduction to Automatic Control Systems*, New York: John Wiley & Sons, 1962, pp. 185-249.
2. — — p. 190.

Bibliography:

- Phares, R. L., and Darroch, R. D., "Solve quartic equations quickly," *ELECTRONIC DESIGN* 5, Mar. 1, 1968, pp. 72-76.
- Klein, G., "Nomogram: Relating A-M sidebands to vibration and ripple," *MICROWAVES*, April 1968, pp. 64-65.
- Pettit, I. M., and Whorter, M. M., *Electronic Amplifier Circuits, Theory and Design*, New York: McGraw-Hill Book Co., 1961, pp. 32-81.
- Shinners, S. M., *Control System Design*, New York: John Wiley & Sons, 1964, pp. 215-223.
- Hewlett-Packard, *Solid-State Devices Handbook*, 1968, pp. 57-106.

Acknowledgement:

The author is indebted to the Jet Propulsion Laboratory, Pasadena, Calif., for granting permission to publish this article, and to Mr. H. F. Verse, Section Head, Philco-Ford SRS, for his encouragement and helpful suggestions.

Test your retention

Here are questions based on the main points of this article. Their purpose is to help you make sure you have not overlooked any important ideas. You'll find the answers in the article.

1. *Despite the fact that the power level is specified at the output of the isolator, the sensing diode is placed in front of it. Why?*
2. *Why does the dominant pole have only a negligible effect on the geometry of the root-locus plot?*
3. *What is meant by "proportioning the loop gain?"*
4. *Is the technique discussed in this article suitable for leveling the output power level of a straight rf amplifier? Why?*
5. *What design procedure is suggested for ensuring the dynamic stability of the servo loop?*

CROWBAR...?

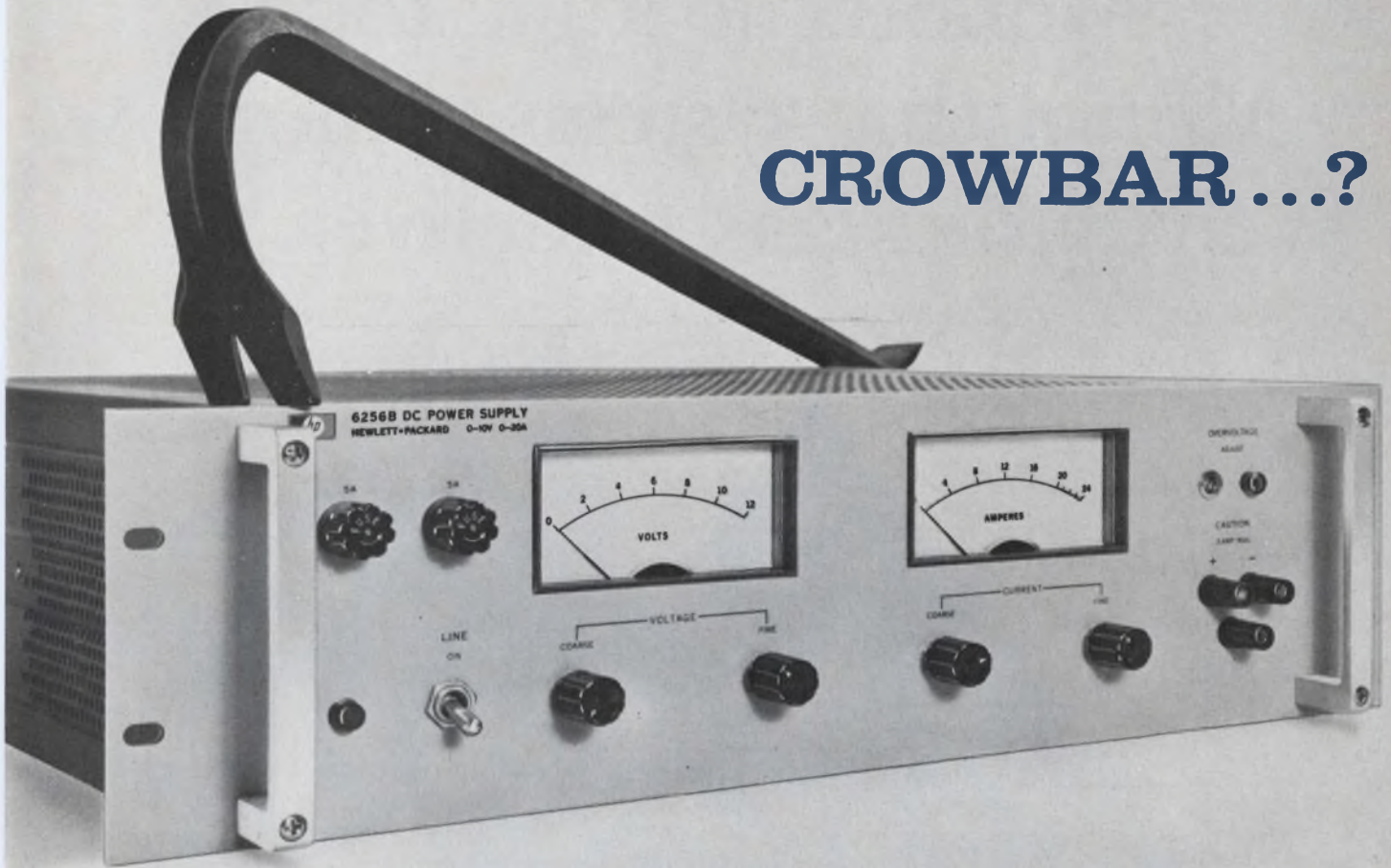

The One Inside is FREE

Not so many years ago, the prudent transmitter engineer discharged a high voltage capacitor bank by dropping a shorting "crowbar" across its terminals. Today's "crowbar" is a protective overvoltage circuit found on DC power supplies — usually at extra cost. Now HP includes a crowbar as standard on its recently updated series of low-voltage rack supplies . . . at no change in price.

Long established as preferred system supplies for component aging production testing and special applications, these supplies have now been redesigned and expanded to meet the stringent demands of today's power supply user. Advantages include low ripple (peak-to-peak as well as rms), well-regulated constant voltage/constant current DC with outputs to 60 volts and 100 amps.

Where loads are critical and expensive, the extra pro-

tection — say, against inadvertent knob-twiddling — from a crowbar is invaluable. On all internal crowbars in this series, the trip voltage margin is set by screwdriver at the front-panel.

Pertinent specifications are: triggering margins are settable at 1V plus 7% of operating level; voltage ripple and noise is 200 μ V rms/10mV peak-to-peak (DC to 20 MHz); current ripple is 5 mA rms or less depending on output rating; voltage regulation is 0.01%; resolution, 0.25% or better; remote programming, RFI conformance to MIL-I-6181D.

Prices start from \$350. For complete specifications and prices, contact your local HP Sales Office or write: Hewlett-Packard, New Jersey Division, 100 Locust Avenue, Berkeley Heights, New Jersey 07922 or call (201) 464-1234 . . . In Europe, 1217 Meyrin, Geneva.

*Additional data sheets
available upon request*

HEWLETT  PACKARD

POWER SUPPLIES

SEE US AT IEEE SHOW—BOOTH #3K28-29, 2F25-36.

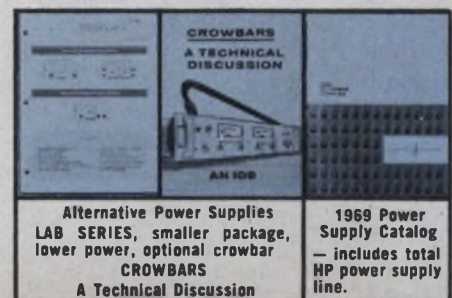

Monolithic logic today.
Monolithic systems tomorrow.
We've got ideas to deliver.

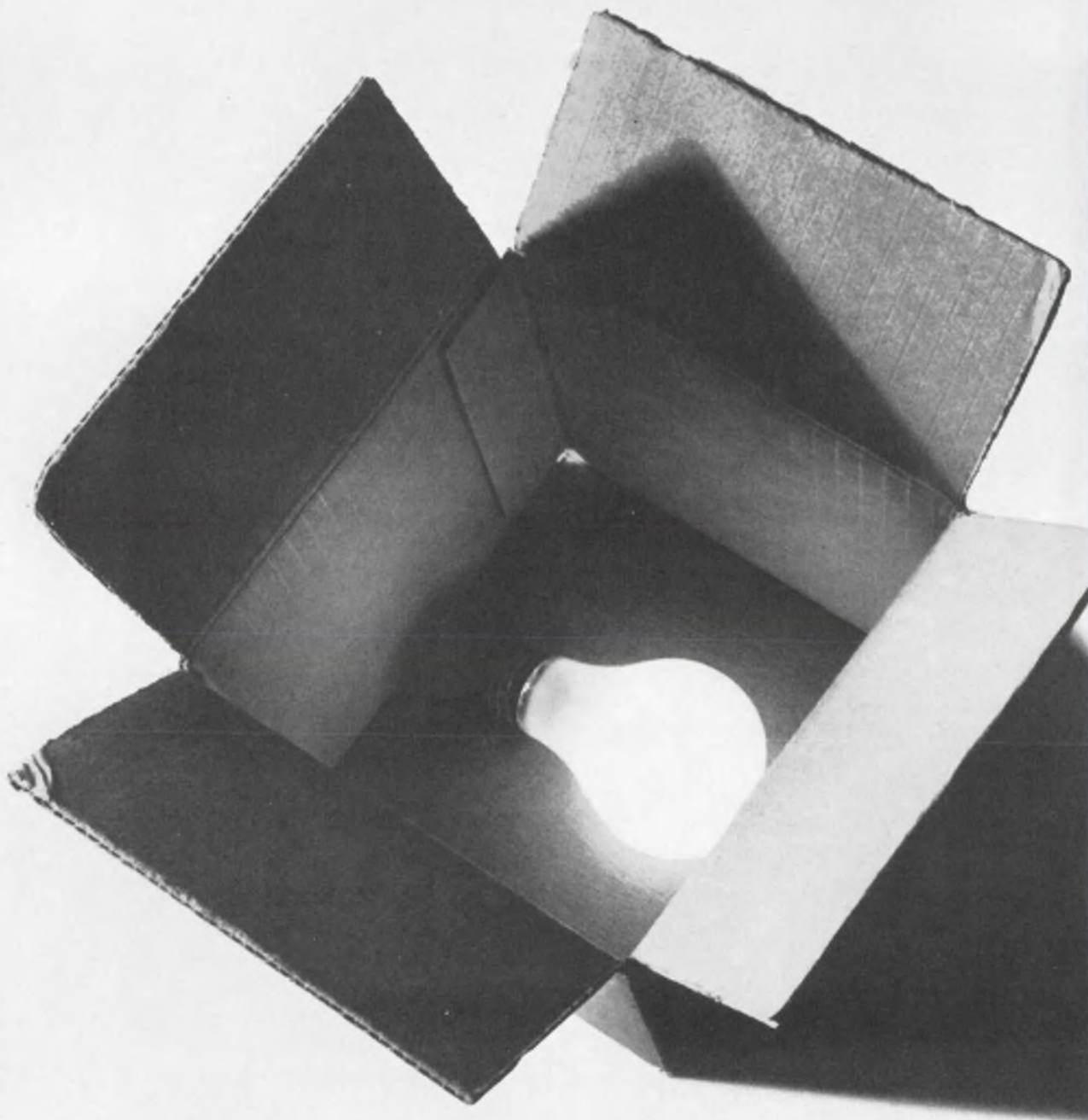

Many wafers ago Raytheon drafted a blueprint for success in the semiconductor industry. It's drawn around some very sharp idea men to nudge the state-of-the-art ever forward. Plus a production line that can turn ideas into products and pour them out en masse and on time. Here's a roll call of results, delivered and on the way.

Products for now

DTL: Over 95 circuits in Series 200, 930 and 1000.

TTL: More than 100 circuits in our industry's-fastest Ray III, and our SUHL-equivalent Ray I and II.

MSI: We're booming in TTL types, with 18 production circuits based on Ray I and II, 54/74 and 64/84 logic. And more coming fast.

Linears: Industry's broadest line of popular types. 17 circuits, including standard and 'A' versions of 100, 4100, 700 and 4700 Series.

Transistors: More than 400 standard and high-rel mil types. Switches, drivers, choppers. And amplifiers—general purpose, low level, high frequency, differential, dual and Darlington.

Diodes: 1800 types of switching and general purpose diodes, ranging from IN91 to IN4308, at speeds down to 1.0 nanoseconds.

And ideas for tomorrow

But the best is yet to come. Here's what's cooking for delivery within one year. Beam lead, of course. Plus 2-layer metal interconnects. 64-bit random access memories. 256-bit read-only memories. Multi-chip memory arrays. Very high speed logic. High speed NPN and PNP single and quad core drivers. Monolithic diode arrays. RF transistors.

And we've got even brighter things docketed for a little more distant delivery. Advanced packages—up to 78 leads, using beam lead and multi-layer substrates. Bipolar and MOS LSI. Computer-controlled LSI design. Radiation hardened circuitry. Low power ECL MSI.

Just promises? Not so. We're working on everything on that list, logging day-by-day progress toward production. So keep your eye on us. Because we intend to be getting the ideas—and delivering them—for a long time to come.

Browse through one of our detailed, just-completed catalogs. Yours for the asking. Raytheon Semiconductor, Mountain View, California, (415) 968-9211.



Measure the sweep linearity of fm pulses

accurately with this easy-to-use technique. A sampling scope serves as the basis for the test set up.

Measuring the linearity of short, frequency-swept fm pulses can often be a perplexing problem. Usually, the job is done using fm discriminators, pulse-compression methods, or graphical techniques involving photographs and recordings of the fm pulse. Unfortunately, all of these methods suffer from lack of accuracy as well as the ability to produce meaningful numerical results.

A much more effective solution to the problem is a technique that uses a sampling oscilloscope, a digital voltmeter, miscellaneous hardware and some digital computer time. If a computer isn't available, a desk calculator can suffice.

Once assembled, this test setup can be used to measure the linearity of a swept fm pulse from about 50 ns to 100 μ s in length, and having frequency dispersion into the hundreds of megahertz. The technique has been used, for example, to measure the phase linearity of a one-microsecond long, wideband fm transmitter pulse to an accuracy of ± 2 degrees.

Sampling scope is key

The nature of a linear fm pulse is described in the accompanying box; Eqs. 1 and 3 represent the frequency, phase and time relationship of the pulse. If any one of these variables can be measured with respect to another at selected points along the fm pulse waveform, a measurement of waveform linearity is possible. The method used here employs Eq. 3 and allows one to find values of time, t , for corresponding values of phase, θ .

When considering the pulse waveform (Fig. a), it is apparent that if each positive-going (or negative-going) zero crossing of the signal could be measured in time as it occurred, then a value of time would be known for each 360° phase increment. However, since the fm pulse may occur in microseconds—or less—this measurement is a practical impossibility where any amount of accuracy is expected. But if the fm pulse somehow could be "time-stretched" to

where these time measurements *could* be made, the problem would be solved. Fortunately, such a time-stretcher does exist—the sampling scope.

The Hewlett-Packard 185B Sampling Oscilloscope, for example, can sample a repetitive signal having a duration of microseconds—or even nanoseconds—and can display that signal on a new time base of up to one minute. The displayed signal is also available at rear terminals for recording purposes. Therefore, if this recorder signal is connected to a zero-crossing detector, the time interval between each detected crossing—which is now on the order of seconds—may be measured. Such a scheme is shown in Fig. 1.

A workable phase linearity measurement system

Although the measurement scheme of Fig. 1 is certainly usable when good linearity measurement accuracy is not a necessity, it has been shown here primarily to demonstrate the basic measurement principle. In practice, this scheme is limited by the fact that the horizontal sweep of the sampling scope introduces time nonlineari-

Nature of the fm pulse

A linearly swept fm pulse is shown in the two figures below. Diagram (a) shows the pulse as it would appear on an oscilloscope, and (b) is the frequency-versus-time plot of the same signal.

The frequency at any time during the duration of the pulse can be stated as:

$$2\pi f = at + b, \quad (1)$$

where b is the starting frequency at t_0 , and a is the rate of change of frequency, df/dt .

Since the phase at any time during the duration of the pulse may be expressed as:

$$\theta = \int 2\pi f dt, \quad (2)$$

the phase of the swept pulse may be found at any time, t , by combining the two equations above: Thus:

$$\theta = \int (at + b) dt, \text{ or,} \quad (3)$$

$$\theta = a_1 t^2 + bt + c,$$

where c is the initial phase at t_0 .

Richard F. Cutler and Raymond C. Monk, Senior Engineers, Goodyear Aerospace Corp., Litchfield Park, Ariz.

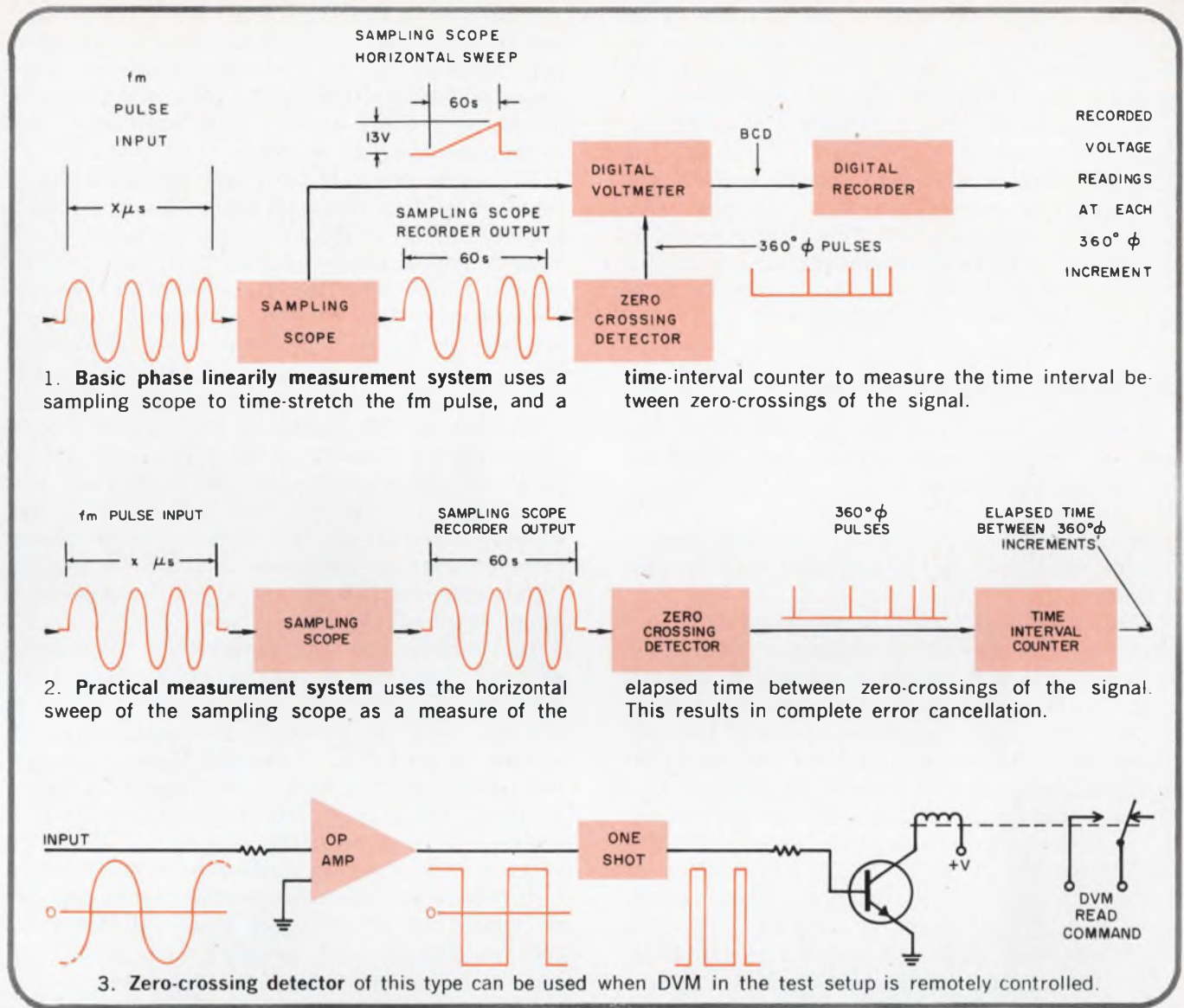

ties, which can cause many degrees of phase-time measurement error. This problem can be overcome, however, if the horizontal sweep of the sampling scope, rather than time itself, is used as a measure of elapsed time between signal zero-crossings. Such a scheme is shown in Fig. 2.

Figure 2 represents a phase-linearity measurement system in which a DVM voltage measurement of the sampling scope's horizontal sweep-voltage is taken at each desired zero crossing of the fm pulse. Since any time nonlinearity associated with the horizontal sweep will produce time errors at both the DVM and the zero-crossing detector, complete error cancellation results.

The horizontal sweep of the sampling scope is available at terminals on the rear, and rises from zero to approximately 13 Vdc during the sweep. A remotely-controllable DVM is commanded by the zero-crossing detector to read this voltage. If the number of zero crossings is sufficient to cause difficulty in reading the DVM (which can take several measurements a second)

a digital recorder can be used.

The zero-crossing detector can be anything from a humble Schmitt-trigger circuit to an elaborate, commercially available voltage comparator, depending on the amount of accuracy desired. Excellent results have been obtained using an integrated-circuit operational amplifier in an open-loop configuration, with the output triggering a pulse-generator relay circuit (the DVM that was used here required a contact closure as a remote read command). A block diagram of this circuit is shown in Fig. 3.

Further improvements are possible

Several features can be added to the test setup of Fig. 2 to further increase the accuracy of the measurements. The first of these is a horizontal sweep generator.

Since any DVM has a finite input impedance, and since the horizontal sweep output of the sampling scope is isolated from the scope's de-

flexion amplifier by about 20 k Ω , some signal loading by the DVM will occur. Generation of the horizontal sweep by a circuit external to the sampling scope will eliminate this problem.

Another device that will help is a smoothing filter. The recorder (vertical) output of the sampling scope is not a continuous waveform but is made up of many discrete voltage steps. Although this ordinarily will not bother a recorder, it does give the zero-crossing detector some indecision. The inclusion of a filter before the zero-crossing detector solves the problem.

Calculations can become involved

Returning now to the box, it can be seen that with the measurement system, just described, Eq. 3 must be changed to:

$$\theta = aV^2 + bV + c,$$

where V is the sampling scope's horizontal ramp voltage, and a , b and c represent entirely new constants.

Since a value of V may be measured and tabulated for a number of corresponding values of θ (every 360° zero crossing), a number of approximate simultaneous equations in θ and V may be written. These equations contain the unknowns a , b and c . The equations may be solved in several ways, but it must be emphasized that this is a problem requiring some sort of numerical averaging. This is because no solution will exactly satisfy all of the equations—unless, of course, no phase nonlinearities have been measured. Good results can be obtained using the "least squares" method, where all of the tabulated data are fitted to the best-fit curve (a parabola) represented by the equation.

The least squares method, as well as other similar methods of solution, require extensive manipulation of large numbers. So a programmable digital computer becomes a practical necessity, if more than a very few linearity measurements are to be made.

When the constants have been calculated, represented by those numbers that will come closest to satisfying all of the equations, the phase error at each sample point can then be found. This is done by simply inserting the appropriate voltage measurement, V_n , into the completed equation and solving for θ_n . The amount by which this phase deviates from the appropriate (n th) multiple of 360° is the phase error at that point.

Throughout this discussion we have been considering only linearly swept pulses having a parabolic phase-time relationship. One of the advantages of the measurement method described, however, is its ability to make phase measurements on nonlinear signals. As long as the fm dispersion of the signal can be expressed by an equation, the method will work.

To calibrate the test arrangement described, all that is required is a stable cw oscillator that can produce about the same number of zero crossings when displayed on the sampling scope as does the particular fm signal. If the measurement system is perfectly linear, the DVM readings will change by exactly the same incremental amount. Any system nonlinearities will show up as proportional voltage-measurement nonlinearities, from which the measurement errors may be calculated. All of the other system parameters, such as measurement accuracy and resolution, can also be checked using a cw input. ■■

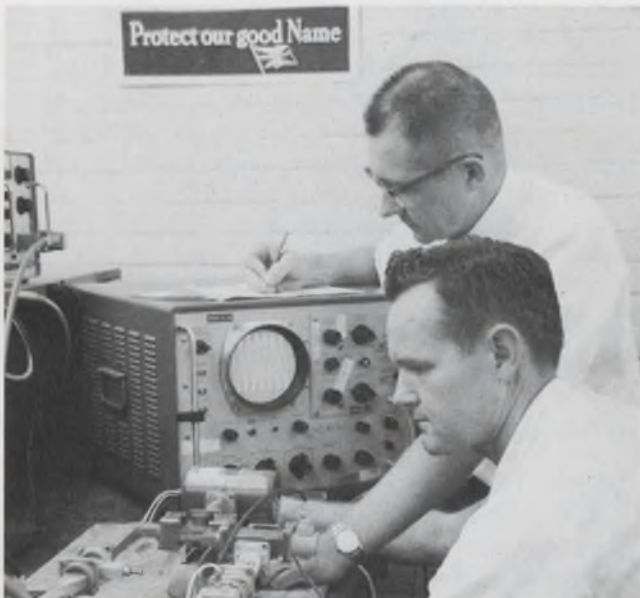

Authors Raymond Monk (in foreground) and Richard Cutler spend many hours of test and measurement time as part of their radar development work.

Test your retention

Here are questions based on the main points of this article. Their purpose is to help you make sure you have not overlooked any important ideas. You'll find the answers in the article.

1. *What is the basic equation that expresses the phase of a swept fm pulse at any time, t ?*

2. *Why does the measurement technique described use the horizontal sweep of the sampling scope as a measure of elapsed time between zero-crossings of the signal?*

3. *Why must numerical averaging techniques be used when solving the simultaneous equations generated by the measurements?*



Look to the future. Plug-In Oscillators for use above 1 GHz and with multi-octave coverage coming soon.

From Alfred Electronics a new 10 MHz to 1 GHz Solid State Sweeper.

It's the nicest thing that ever happened to your swept and single frequency measurements.

Front plug-in sweeper—maximum flexibility. The new Model 6151 Sweep Oscillator with Oscillator Plug-In Units gives you swept and stable single frequency coverage from 10 MHz to 1 GHz. Here is a sweeper with two independent sweeps, three single frequency outputs which also include the Accentuated Comb Marker.

Compare output power—100 mw or 2.24 volts. The 100 mw (2.24 volt rms) into 50 Ω leveled output

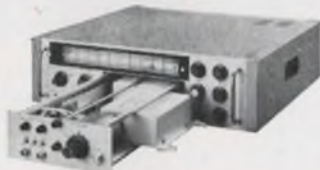

Model 6151 shown with plug-in drawer capable of holding all dc to 1 Gc oscillators.

allows this sweeper to be used in place of signal generator amplifier combinations.

Sawtooth or triangular. Sawtooth sweep with fast flyback. Triangular sweep provides forward and return sweeps of equal duration for hysteresis and memory measurements.

Complete independence of controls. The exclusive Alfred slide rule dial includes F_1 start and F_2 stop, F_0 and ΔF controls. F_1 and F_2 controls pass each other for up or down sweep. ΔF sweeps around the F_0 frequency and is accurately calibrated in frequency.

Unique F_0 control. Serves as frequency marker, the center of the symmetrical sweep, and as a single frequency.

Choice of three preset single frequencies. A single frequency output may be set with the F_1 , F_2 and F_0 controls for precise component evaluation.

Choice of leveling. Internal or external leveling.

Modulation for every application. Internal 1 KHz squarewave for reflectometer and SWR measurements and 1 KHz sine wave for amplifier response testing. Model 6151 also may be externally amplitude and frequency modulated.

Accentuated Comb Markers. The optional Accentuated Comb Markers use crystals to generate precise and stable 1, 5 and 25

MHz signals for frequency identification during swept operation. Amplitude of the 1 MHz and 5 MHz is respectively 1/3 and 2/3 of the 25 MHz marker.

Prices

1. Basic Oscillator	6151	\$1290
2. Plug-In Drawer 10 MHz - 1000 MHz with Attenuators, DC - 1 GHz, 0-50 dB in 1 dB steps with Marker, Comb, 1, 5, 25 MHz	6151-1	\$140
	Option A1	250
	Option M1	375
3. Oscillator Modules		
10 to 20 MHz	Q01	\$200
20 to 50 MHz	Q02	200
50 to 125 MHz	Q03	200
125 to 250 MHz	Q21	250
250 to 500 MHz	Q22	250
500 to 1000 MHz	Q23	900

For a Demonstration and Complete Information

Please call your local full service Alfred Sales Engineer (listed in EEM) or write Alfred Electronics, 3176 Porter Drive, Palo Alto, California 94304. Phone: 415-326-6496. TWX: 910-373-1765.

ALFRED ELECTRONICS

BELDEN...new ideas for moving electrical energy

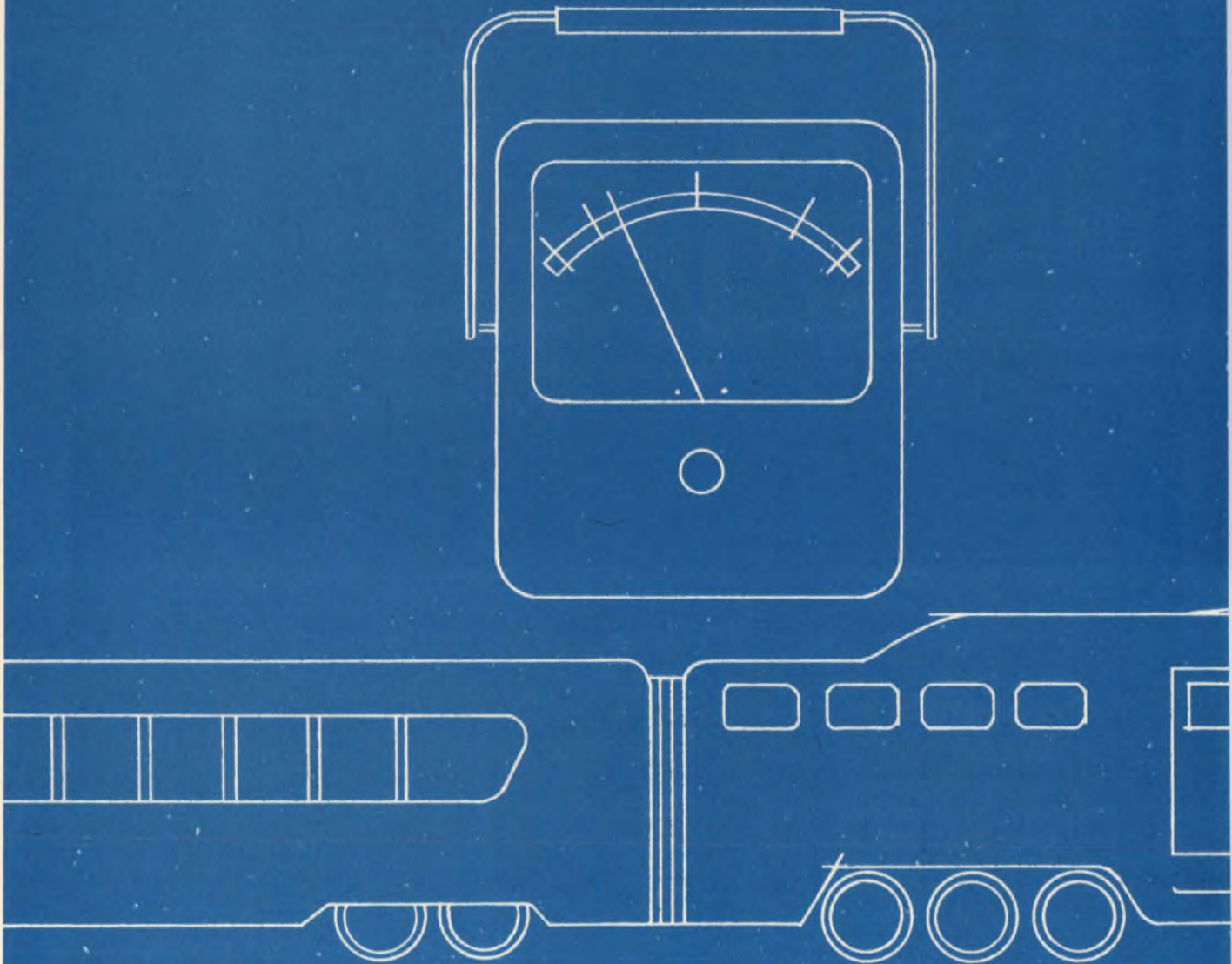

Belden's systems savvy is

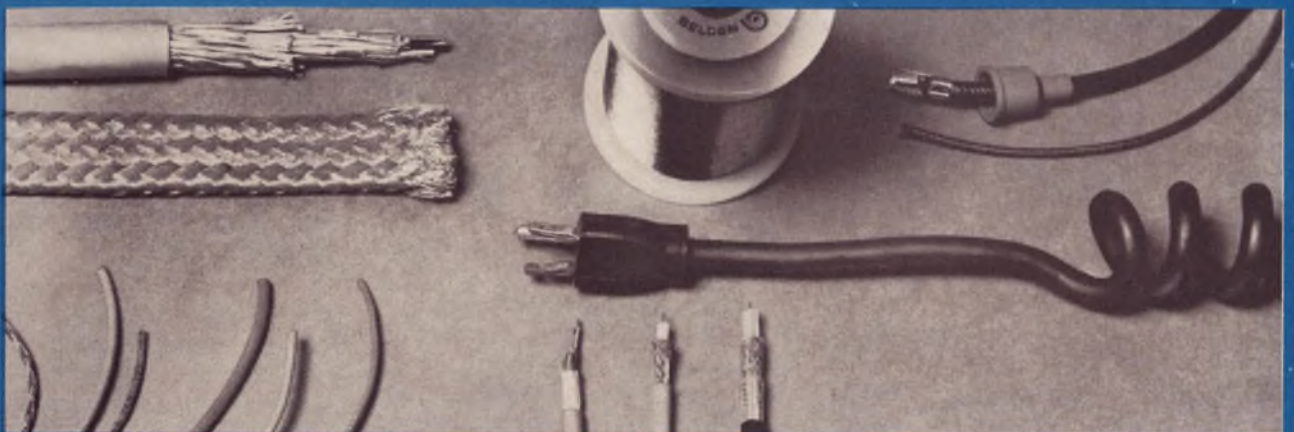

BELDEN

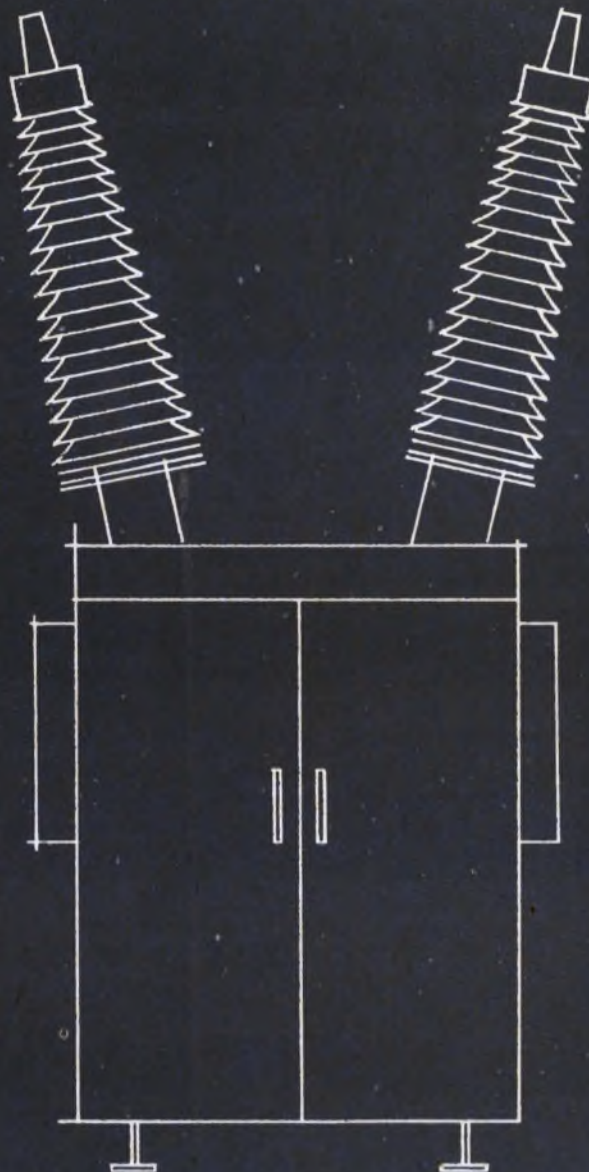
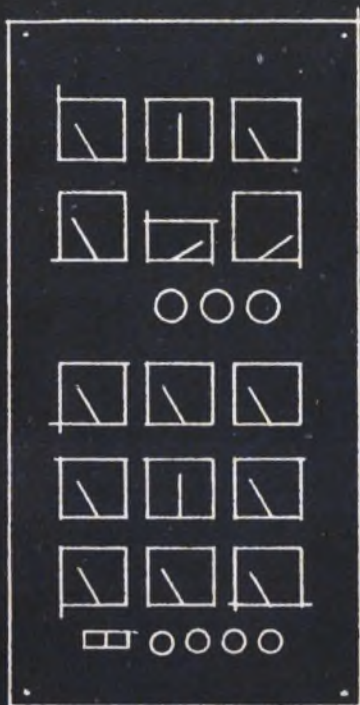

no big deal

It's a lot of little deals, that add up to something big. Like lower costs. Fewer production headaches. Enhanced product reliability. By poking and probing into your product's electrical system and the way it's manufactured and used, Belden Wire Systems Specialists may be able to suggest a wire or cable that costs less. Or that lasts longer, or that takes up less space*. Or maybe they'll suggest a different put-up that saves you assembly time. Or a solution to a stripping problem. They'll also offer you one responsible source for all your wire needs. Because we're the

people who make all kinds of wire for all kinds of systems. So if you're making plans or having problems, get yourself a good deal. Call or write: Belden Corporation, P.O. Box 5070-A, Chicago, Illinois 60680. And ask for our catalog, and the reprint article, "Key Questions and Answers on Specifying Electronic Cable."

*For example: Beldfoil® shielding in Belden cable. It isolates conductors better than anything yet. And it's thinner. You can pack more conductors into a conduit . . . hold down size and weight.

G-2-8

There are many ways to fire an SCR— but unfortunately there are more bad ways than good. Here's a rundown on firing that should help separate the two.

Part 2 of a two-part article

Misapplication of SCRs arises primarily from improper selection or faulty firing. The parameters involved in selecting a device for a particular application were analyzed in Part 1 of this article (ED 5, March 1, 1969). Here in Part 2, the firing characteristics and requirements of the SCR are covered. The recently introduced avalanche-gate SCRs are not included, since their firing characteristics are considerably different.

Gate firing depends on di/dt requirements

When an SCR is gated, it does not switch ON immediately. Instead, a distinct—measurable—time is associated with initial conduction. The first portion of this time, T_d , is the delay time from initial gating until conduction begins. The second portion, T_r , is the risetime, or the time required for the anode-cathode voltage to drop from 90% to 10% of its steady-state forward blocking voltage.

When considering the di/dt limitations of a particular SCR at turnon, the risetime, T_r , is of paramount importance. If the device is gated with the minimum specified gate trigger current, I_{gt} , conduction starts from the weakest point along the gate-cathode region and propagates at a rate of 0.1 mm/ μ s until the entire cathode region is in conduction. This is shown in Fig. 1a, where G, C, and A are respectively the gate, cathode and anode regions of the SCR. Note that at the time of initial propagation, only a very small portion of the cathode is available for load conduction.

If hard gate firing is used, as explained in Part 1 of this article, conduction starts from the entire gate-cathode junction of the SCR; this is shown in Fig. 1b. As a result, a much larger cathode area is available for load conduction. This prevents localized heating, or hot spots, from occurring at the cathode-anode junction. Under high di/dt applications such localized heating can result in device degradation or burnout.

A photograph of an SCR that was destroyed by insufficient gate rise for the load di/dt is shown in Fig. 2. It can be seen from the shape and position of the burned-out area that spot-conduction propagation occurred rather than ring propagation.

Since damage resulting from severe di/dt applications occurs along the gate-cathode region of an SCR, slow degradation resulting from slightly excessive di/dt will leave its mark along the same junction. If it is questionable in a particular design whether a device will be slowly degraded by slightly excessive di/dt , then prior to actual installation gate-cathode information should be recorded.

To do this, the device should first be held at a constant temperature, a fixed dc current passed through the gate-cathode junction, and an accurate recording of the forward gate-cathode voltage drop made. Then, after considerable operating time in the circuit, the same test should be performed again. Any appreciable change in the forward voltage drop will indicate degradation of the borders of the gate-cathode region.

Another method for determining such degradation is to measure the forward breakdown voltage of the SCR before and after extensive operation. This is done by applying an adjustable dc anode-cathode voltage that is current limited, so that the device will not be destroyed at the breakdown point. The forward breakdown voltage is recorded both before and after extensive operation in the circuit, and here again appreciable changes indicate device degradation.

A disadvantage of the second method is that any degradation indicated may have occurred anywhere on the cathode region and have been, in fact, due to other modes of failure. The first method has a higher probability of indicating failure due to excessive di/dt . With either method it is important that the tests be conducted under constant temperature, since the measured parameters vary with temperature.

The relationship between allowable load di/dt and required gate-drive current, as it appears on a typical specification sheet, is shown in Fig. 3. The horizontal axis represents peak gate current, normalized with respect to the specified mini-

Wendell W. Ritchey, Senior Project Engineer, and Ronald H. Randall, Project Engineer, Acme Electric Corp., Cuba, N.Y.

imum gate trigger current, I_{gt} . In other words, 1.0 on the horizontal axis represents the specified value of I_{gt} .

The vertical axis represents normalized anode di/dt , where 1.0 corresponds to the rated di/dt for minimum gate current, I_{gt} . The family of curves thus represents anode di/dt versus peak gate current for a given gate-current rise time. From Fig. 3 it can be seen that a minimum gate current that reaches its peak value in $1.0 \mu s$ will gate the SCR properly for the di/dt listed on the specification sheet. For higher gate current values and/or faster risetimes, higher di/dt values can be handled by the device. Conversely, lower di/dt ratings are obtained for smaller gate current values and slower risetimes.

Very often the anode di/dt must be determined, to insure that it is compatible with the type of gating to be employed. This can be done relatively easily for simple dc circuits, of the type shown in Fig. 4. In the illustration, R_L is the load resistance and L is the distributed lead and source inductance. If the SCR is gated at time t_0 , the load current $I(t)$ then becomes the classic solution of the equation

$$I(t) = (V/L)(1 - e^{-RT/L}), \text{ or}$$

$$di/dt = (V/L)(e^{-RT/L}).$$

Thus, the maximum di/dt occurs at t_0 , and is equal to V/L . If the RC voltage-spike suppression network, shown in dotted lines, is used, then it also must be considered in the total di/dt .

Gating an SCR into any di/dt load requires the proper gate-current waveshape (Fig. 5). In the illustration, I_1 represents the maximum gate current that will not fire the device, while I_2 is the minimum gate current that will fire it. The value nI_2 represents the normalized peak gate current required for a given anode di/dt . Thus, from Fig. 3, if a di/dt of 1.3 times rated is required, and a gate rise of $1.0 \mu s$ is available, then the proper value of normalized peak gate current is 2.0. The risetime from I_1 to nI_2 , namely T_1 , would then be $1.0 \mu s$. T_2 is the time from gate rise nI_2 until the gate current decays to I_2 . This time should be greater than $10 \mu s$; ideally $20 \mu s$ or greater.

T_3 represents the time that the minimum gate current must be sustained for conduction into



1. **Insufficient gate drive** results in spot propagation (a) of the conduction region outward from the small point that first becomes conductive. With hard gate firing (b), ring propagation of the conduction region occurs, since essentially many points around the gate-cathode junction become conductive simultaneously.



2. **Spot propagation of the conduction region** resulted here from insufficient gate drive for the load di/dt .

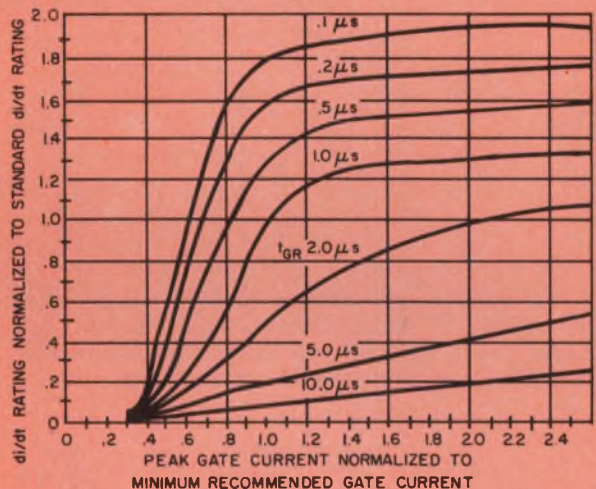

3. **Gate current characteristics** are related to the di/dt rating of an SCR by families of curves, such as these for Westinghouse devices.

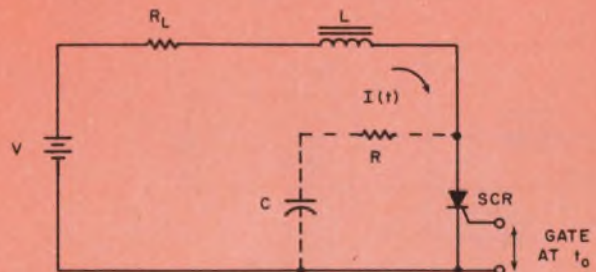

4. **Maximum di/dt occurs at t_0** and can be calculated from V/L , in simple dc circuits such as this.

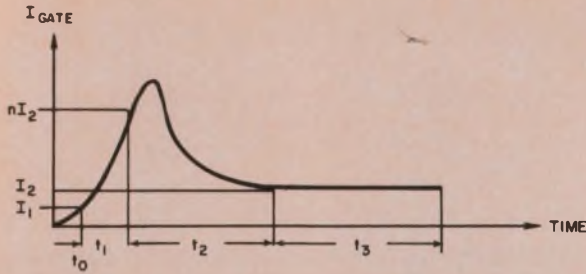

5. Proper hard gate firing of an SCR requires a gate-current waveshape that rises rapidly to the normalized peak current, nI_2 , and then decays gradually to the minimum gate current required for firing, I_2 .

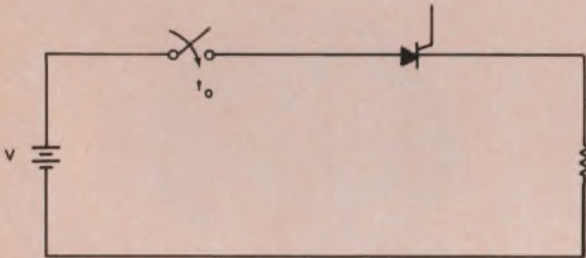

6. dv/dt firing can occur when the SCR is required to suddenly block the full supply voltage, such as would occur here at t_0 , when the switch is closed.

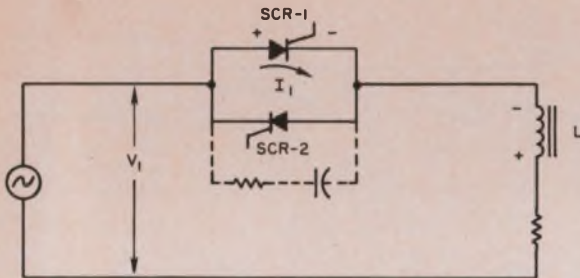

7. The sudden application of forward voltage, after the release of energy stored in the inductor, can cause dv/dt firing of the SCRs. The addition of the RC circuit can overcome this problem.

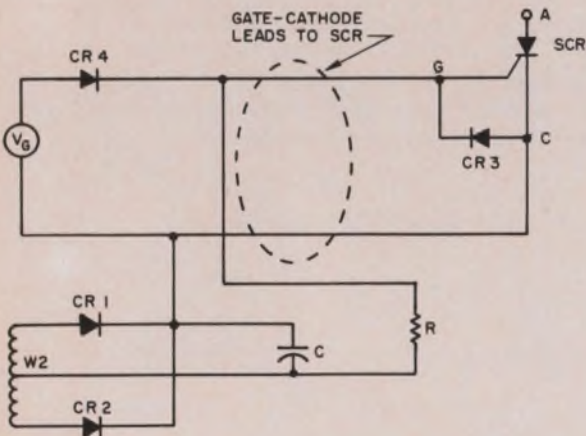

8. Back-bias current circuit applies a reverse bias across the gate-cathode junction that is sufficient to overcome extraneous signals induced onto the SCR gate leads.

inductive loads. For such loads, it is important that gate current be present long enough for the anode current to reach the latching value, which is the value required for the SCR to remain in the ON-state after removal of the gate current.

In some circuitry, such as an SCR 3-phase full-wave bridge, it is necessary that either the gate current be present for 60 electrical degrees, or that double gating be incorporated to enable the circuit to phase smoothly back to zero-volts output. This is necessary, since, for short conduction angles, a device conducts first with one phase and then, after a delay angle, conducts with another phase. Without the long gate pulse or double gating, the device would recover and block the second conduction period.

dv/dt must often be limited

All pn junctions have an associated distributed capacitance—and so does the pnpn SCR. If a ramp voltage is impressed, anode (+) and cathode (-), across an SCR, a current $I = C dv/dt$ will flow, where C is the junction capacitance and dv/dt is the slope of the voltage ramp. If I is sufficient to bring the SCR into the "gain equals 1" region, the device will switch to the ON state. This is called dv/dt firing.

There are two main circuit conditions that bring on dv/dt firing, and its unwanted circuit turnon. These are (1) initial circuit energization in such a way that the SCR is required to suddenly block the full supply voltage, and (2) re-applied forward voltage after the reverse recovery period.

The first of these conditions is illustrated in Fig. 6, where at time t_0 full voltage is applied to the SCR as a step function. The problem may be solved in this case by adding series inductance and parallel RC suppression into the circuit. The SCR anode-cathode voltage will then rise at a maximum rate set by the LC resonant frequency.

The second mode of dv/dt failure is illustrated in Fig. 7. To understand its occurrence, assume that SCR-1 is conducting during the increasing positive portion of the input cycle. As the input, V_1 , now begins to fall (go less positive), the voltage V_L across the inductor assumes the polari-

ty shown. This maintains *SCR-1* in conduction until the inductive energy stored in *L* reaches zero. At this time, V_L immediately goes to zero and the voltage across the two SCRs steps to the value of V_1 . This then applies a rapid dv/dt in the forward direction across *SCR-2*.

The problem may be corrected in this case again by placing an RC network across the two SCRs so that the value of dv/dt is set by the resonant frequency of the LC combination. Care must be taken, though, so that the value of *R* does not allow high currents to circulate during turnon of the devices, thus creating a di/dt problem.

Cross firing can cause device damage

The term cross firing, or cross talk, is used to describe the misfiring of SCRs due to extraneous noise spikes induced or radiated onto the gate leads. There are two very important undesirable results of cross firing. One, obviously, is that when an SCR is misfired, the end function of the circuit in which it is contained is not met.

The second undesirable result of cross firing is that the misfiring signal generally consists of a high frequency, low-energy spike, which renders only a small portion of the gate-cathode junction in the conduction state. This type of gate signal can result in the same destructive effects to the SCR as occur with insufficient gate drive for a high di/dt anode-cathode current. When misfiring occurs, the deterioration of the SCR junction is a slow process. And, although the circuit may appear to be working satisfactorily for a considerable time, the SCR may finally fail after operating six months or longer.

The most effective means of preventing cross firing is to supply the gate-cathode junction of the SCR with a reverse bias sufficient to overcome any extraneous signals that may be induced or radiated onto the gate leads. A typical circuit that may be used to provide this back-bias effect is shown in Fig. 8.

In the circuit, V_g and diode *CR4* make up a normal gate-supply-voltage source. The reverse-bias circuit consists of a centertapped transformer winding, *W2*, rectifying diodes *CR1* and

CR2, filter capacitor *C*, diode *CR3* and current limiting resistor *R*. The purpose of the center-tapped transformer, of diodes *CR1* and *CR2*, and of filter capacitor *C* is to supply a voltage that will cause a reverse current to flow through the gate-cathode leads that connect the SCR gate circuit to its normal source of gate current. The purpose of *CR3* across the gate-cathode junction of the SCR is to clamp the reverse voltage seen by the gate-cathode junction to a value equal to the forward drop of the diode.

The current limiting resistor, *R*, is used to set the value of the back-bias current flowing through the gate leads. The value of *R* must be sufficiently small to offset any extraneous currents that may flow into the gate of the SCR because of induced or radiated fields, or noise.

In addition to the use of a back-bias current circuit, there are other ways in which misfiring caused by extraneous gate signals can be minimized. One is to take care in the placement of gate leads. Another method is to use shielded wires to deliver the gate current to the SCR. This can be effective in cutting down on the amount of radiated noise picked up by the gate leads. ■■

Test your retention

Here are questions based on the main points of this article. Their purpose is to help you make sure you have not overlooked any important ideas. You'll find the answers in the article.

1. *How can it be determined whether an SCR is being slowly degraded by slightly excessive di/dt ?*

2. *What circuit conditions can cause dv/dt firing of an SCR?*

3. *How can an SCR be damaged by cross firing?*

4. *What is the purpose of a back-bias current circuit?*

Model
LD-2 System

Automatic



the Solution for End-to-End

on Data Transmission Circuits...

Group Delay plays an important role in high speed data transmission where maximum system capacity is to be utilized.

Measurement of Group Delay (as a function of measuring frequency) in the laboratory poses no problem as transmission of the reference phase is easily accomplished.

But how do you solve the problem if the circuit under test is hundreds of miles long and cannot be looped?

Even the best crystal oscillator has a drift which superimposes itself on the measurement if transmitting and receiving ends are not synchronized. Can you afford a two hour wait while the crystal temperature reaches its assigned value? Will you tolerate constant phase readjustments to compensate for instability in your measuring instrumentation or for the changing value of the absolute delay of the measured circuit (as in the case of a satellite transmission)?

You have more important things to do. You can insist that your group delay measuring instrumentation

be operable immediately upon turn-on and that it yield reproducible, stable results. You can because W & G has now developed a measurement technique which eliminates the drawbacks of all former methods of measurement.

Based on the measuring set to 14 MHz (Model LD-1) which has proven itself as the only instrument available for measurements on video tape recorders, a group delay measuring instrument was developed for the frequency range from 200 Hz to 600 kHz. Only one, fixed, modulation frequency of 40 Hz is used for the entire frequency range — in spite of this the instrument attains the remarkable sensitivity of 1 μ s at all measuring frequencies.

You can sweep or measure point by point; the result is always exactly reproducible.

The results are displayed on three meters simultaneously: Frequency; Attenuation; and Group Delay. You can connect an X-Y-Recorder and immediately have a permanent record of the test results. Obviously solid state — Naturally 19" Rack Mountable.

Wandel & Goltermann

W. Germany

• Represented in U.S.A. by

Phase Control



Measurements of Envelope Delay

PRINCIPLE:

Nyquist principle, modulation frequency 40 Hz, therefore, no beat with the line frequency.

READOUT:

Simultaneous, separate, meter displays of frequency and group delay and attenuation distortion; or frequency and absolute group delay and attenuation—for either point by point or sweep measurement. Output for X-Y-Recorder available.

DIAL TONE ELIMINATION:

Provisions are incorporated in the generator to avoid unwanted actuation of dial tone receivers within a system under test.

FREQUENCY RANGE:

200 Hz to 600 kHz. Accurate frequency adjustment assured by an 8 foot long projection scale with sub-ranges 200 Hz to 60 kHz and 10 kHz to 600 kHz.

PHASE CONTROL:

The receiver is automatically phase synchronized to the generator via a phase reference transmitted through the circuit under test, thus assuring repeatable measurements without warmup or preliminary phase adjustments.

RESOLUTION:

1 μ s for group delay measurements; 0.05 dB for attenuation.

SENSITIVITY:

Transmitter output level +10 to -35 dB. Receiver sensitivity +10 to -50 dB. Dynamic range of the receiver 40 dB.

IMPEDANCES:

75, 150, 600 ohms; plus 0 Ω (generator) and 10 k Ω (receiver).

SWEEP:

Sweep width from 400 Hz to 600 kHz continuously adjustable. Sweep time from 0.3 second to 1 hour.

POWER SUPPLY:

Operation from AC line or a 24 volt battery.

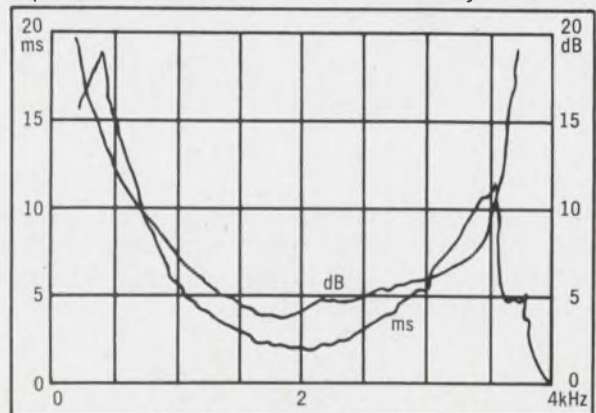

Typical diagram of a telephone connection recorded by an X-Y Recorder connected to the output.



W&G INSTRUMENTS, INC. 6 Great Meadow Lane, Hanover, N.J. 07936 • (201) 887-8700

INFORMATION RETRIEVAL NUMBER 133

Speed inverse Laplace transform solutions with a time-shared digital computer program. A three-pole Butterworth filter illustrates the approach

Although the Laplace transform is a powerful tool for synthesizing systems in the frequency domain, the difficulty of relating frequency response to transient or time-domain response continues to plague many a design engineer. A major stumbling block is the complexity of taking the inverse of the transform. But the problem is resolved neatly with the help of the time-shared digital computer.

The manual method of taking the inverse transform involves evaluation of the line integral that encloses all the singularities of the transfer function on the complex plane. This results in a time function that may be evaluated at selected time increments. Solution by computer requires a different attack.

Because the digital computer works numerically, rather than algebraically, the time function is not as easily generated as with the classical approach. Instead, at each time increment, the method of residues is used to evaluate the line integral, and a resulting value is established. By hand, this repeated calculation, at each time increment, would prove to be unprofitably laborious; by computer, the process becomes simple.

Organization of program

Assume the transfer function to be in polynomial form:

$$F(s) = \frac{\sum_{n=0}^{\sigma} A(n) s^n}{\sum_{n=0}^{\tau} B(n) s^n}, \quad (1)$$

where the limits on the number of terms in numerator and denominator reflect arbitrary choices of maximum limits used in the program. The inversion integral can be written as

$$f(t) = \frac{1}{2\pi j} \oint \frac{e^{st} F(s) ds}{s} \quad (2)$$

This is the inversion integral for the so-called "s-multiplied" transform system, in which the transform of a constant is a constant. This inversion of the transfer function yields the response to a unit step function directly. A pole is therefore added at $s = 0$ (or the order of any existing pole at $s = 0$ is increased by 1) by the integration kernel.

Because residues must be evaluated at each pole, it is first necessary to find the roots of the denominator of Eq. 1.

After the poles are found, the manner of evaluating the residues depends on the order of the pole. The program provides for first-, second- and third-order poles, with an error message if a higher-order pole exists. The following formulas are used for residue computation, where $P(s)$ is the numerator and $Q(s)$ is the denominator of the complete integrand of Eq. 2.

Single pole at $s = A$

$$\text{Residue} = \left. \frac{P(s)}{Q'(s)} \right|_{s=A} \quad (3)$$

Double pole at $s = A$

$$\text{Residue} = \left. \frac{d}{ds} \left(\frac{(s-A) e^{st} P(s)}{s \cdot Q(s)} \right) \right|_{s=A} \quad (4)$$

Triple pole at $s = A$

$$\text{Residue} = \left. \frac{1}{2} \frac{d^2}{ds^2} \left(\frac{(s-A)^2 e^{st} P(s)}{s \cdot Q(s)} \right) \right|_{s=A} \quad (5)$$



Author Durnal has fingertip access to the central processor from his time-sharing terminal.

R. G. Durnal, Fellow Engineer, Aerospace Div., Westinghouse Defense and Space Center, Baltimore, Md.

Because evaluation is done in terms of a complex variable, addition and subtraction are accomplished in rectangular form, multiplication and division in polar form. To eliminate rewriting these procedures, it is convenient to establish subroutines for performing the conversion from one form to another. Another subroutine may be established from consideration of the polynomial nature of numerator and denominator. Because a polynomial derivative is also a polynomial, a properly established routine can perform the required differentiation. These procedures (in INVLA 2), are called "polar," "rectangular" and "sigma," respectively.

Choice of language

A program method chosen by Westinghouse permits use of conversation-oriented computer terminals available to the individual engineer. The system available to the design group offered a program length limit of 6200 characters. Thus it was necessary to break the program into two linked parts. This procedure is permissible in the language called Algol. The first part, called INVLA 1, accepts the input data and uses Bairstow's method to compute the roots of the polynomial comprising the denominator of Eq. 1. Since Algol is a somewhat difficult language, the inputs are phrased in conversational form. No specialized knowledge of programming in Algol is thus required to enter data. The roots and input data are written on the disc "scratchpad memory" to preserve them; the second part of the program, "INVLA 2," then performs the calculations and prints out the results.

As an example, consider the 3-pole Butterworth filter with its poles on the unit circle. The equation for such a filter is given by

$$F(s) = \frac{1}{(s+1)(s^2+s+1)} = \frac{1}{s^3+2s^2+2s+1} \quad (6)$$

Part "a" of the figure shows the conversational input mode and results for this program. Note that where a certain number of coefficients are called for, that number must be entered, using zeros for the missing high order values. The plot of the results are shown in part "b" of the figure.

The phrase "Dartmouth Algol" in the printout indicates that a program has been processed through the computer's input processor. The second printing of this phrase indicates the successful transfer to the second of the linked programs. The tabulation shows the response of this Butterworth filter to a unit step function.

The complete program follows:

Bibliography:

- Churchill, Ruel V., "Complex Variable and Applications," New York: McGraw-Hill Book Co., Inc., 1960.
 McCracken, Daniel D., "A Guide to Algol Programming," New York: John Wiley & Sons, 1966.
 Hildebrand, F. B., "Introduction to Numerical Analysis," New York: McGraw-Hill Book Co., Inc., 1956.

INVLA1

DARTMOUTH ALGOL.

WHAT ARE THE 6 COEFFICIENTS OF THE NUMERATOR,
 IN ASCENDING ORDER
 71,0,0,0,0,0

WHAT ARE THE 8 COEFFICIENTS OF THE DENOMINATOR,
 IN ASCENDING ORDER
 71,2,2,1,0,0,0,0

WHAT ARE THE TIME INTERVAL AND TIME INCREMENT
 720,.5

DARTMOUTH ALGOL.

TIME	RESPONSE	TIME	RESPONSE
0	0	10.5	.998
.5	1.61185 \$-2	11	1.00046
1	9.86124 \$-2	11.5	1.00186
1.5	.251447	12	1.00235
2	.445388	12.5	1.00219
2.5	.643809	13	1.00167
3	.816973	13.5	1.00104
3.5	.947677	14	1.00045
4	1.03122	14.5	1.00001
4.5	1.07234	15	.999737
5	1.0812	15.5	.999624
5.5	1.06964	16	.999628
6	1.04841	16.5	.999702
6.5	1.02573	17	.999804
7	1.00673	17.5	.999904
7.5	.993732	18	.999983
8	.986949	18.5	1.00003
8.5	.985285	19	1.00006
9	.987072	19.5	1.00006
9.5	.990623	20	1.00005
10	.994569		

TIME = 1 MINS. 5 SECS.

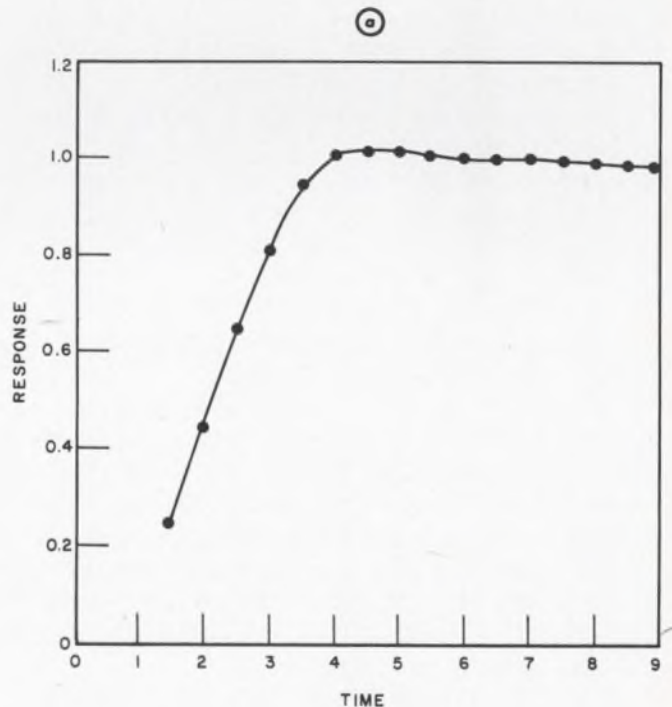

Converse signal input mode and results of the inverse Laplace transform program are listed in a. The plot of the results is shown in b.

INVLA1

```

100 BEGIN COMMENT THIS PROGRAM AND ITS COMPANION, INVLA2, ARE USED TO
110 COMPUTE THE TIME RESPONSE OF A SYSTEM BY TAKING THE INVERSE OF
120 THE LAPLACE TRANSFORM. IN THIS PROGRAM THE POLES OF THE TRANSFER
130 FUNCTION ARE EVALUATED BY BAIRSTOW'S METHOD. IN THE SECOND PROGRAM
140 THE RESIDUES ARE EVALUATED AT THE POLES AND SUMMED TO GIVE THE
150 RESPONSE AT EACH TIME INCREMENT. IMPORTANT***DUE TO THE LENGTH
160 OF THESE PROGRAMS, IT WAS NECESSARY TO WRITE THEM IN DARTMOUTH
170 ALGOL. THEREFORE THE COMMAND 'SYS:ALG' IS NECESSARY BEFORE
180 RUNNING THEM. IN ALGOL, THE NOTATION '5E3' WOULD BE REPLACED BY
190 THE NOTATION '5$3'. THE SECOND PROGRAM IS AUTOMATICALLY CALLED UP.;
200 REAL D1,F,F1,K1,P,P1,Q,Q1,R,S,T,T1,T2,W,W1;
210 INTEGER N,N1,Z,I;
220 REAL ARRAY A(0:5),B,C,D(0:7),X,Y(1:7);
230 K1:=1;
240 PRINT("WHAT ARE THE 6 COEFFICIENTS OF THE NUMERATOR, IN ASCENDING
250 ORDER");
260 READATA (TELETYPE,A(0),A(1),A(2),A(3),A(4),A(5));
270 PRINT("WHAT ARE THE 8 COEFFICIENTS OF THE DENOMINATOR, IN ASCENDING
280 ORDER");
290 READATA (TELETYPE,B(0),B(1),B(2),B(3),B(4),B(5),B(6),B(7));
300 PRINT("WHAT ARE THE TIME INTERVAL AND TIME INCREMENT");
310 READATA (TELETYPE,T1,T2);
320 RESTORE(SCRATCH);
330 FOR I:=0 STEP 1 UNTIL 5 DO
340 WRITEFILE(SCRATCH,A(I));
350 FOR I:=0 STEP 1 UNTIL 7 DO
360 WRITEFILE(SCRATCH,B(I));
370 WRITEFILE(SCRATCH,T1,T2);
380 FOR N:=7 STEP -1 UNTIL 1 DO BEGIN
390 GOTO IF B(N)=0 THEN NXT ELSE N1SET;
400 NXT:END;
410 N1SET:N1:=N;
420 FOR Z:=1 STEP 1 UNTIL 7 DO BEGIN
430 X(Z):=0;Y(Z):=0;END;
440 DSET:FOR Z:=0 STEP 1 UNTIL N DO
450 D(Z):=B(Z);
460 GO TO IF D(0)=0 THEN ZER ELSE IF N=1 THEN SINGLE ELSE IF N=2 THEN
470 QUADRATIC ELSE IF N/2=N\2 THEN EVENS ELSE ODDS;
480 COMMENT CALCULATION OF ROOT OF FIRST ORDER EQUATION;
490 SINGLE:X(1):=-B(0)/B(1);GOTO CALLOUT;
500 COMMENT CALCULATION OF ROOTS OF QUADRATIC EQUATION;
510 QUADRATIC:P:=D(N-1)/D(N);Q:=D(N-2)/D(N);
520 DISCRIM:D1:=P^2-4*Q;
530 GOTO IF D1<0 THEN COMPLEX ELSE SIMPLE;
540 SIMPLE:D1:=SQRT(D1);X(N):=(-P+D1)/2;X(N-1):=(-P-D1)/2;
550 N:=N-2;GOTO IF N=0 THEN CALLOUT ELSE EVENS;
560 COMPLEX:D1:=SQRT(-D1);X(N):=-P/2;X(N-1):=-P/2;
570 Y(N):=D1/2;Y(N-1):=-D1/2;N:=N-2;
580 GOTO IF N=0 THEN CALLOUT ELSE EVENS;
590 COMMENT CALCULATION OF ONE ROOT OF ODD ORDER EQUATION;
600 ODDS:W:=IF D(N-1)=0 THEN -D(0)/D(N) ELSE -D(N-1)/D(N);
610 LOOP:F:=0;F1:=0;
620 FOR I:=0 STEP 1 UNTIL N DO BEGIN
630 GOTO IF D(I)=0 THEN NXTI ELSE IF I=0 THEN FSET ELSE F1SET;
640 F1SET:F1:=F1+I*D(I)*W^(I-1);
650 FSET:F:=F+D(I)*W^I;
660 NXTI:END;

```



```

670 W1:=W-F/F1;
680 GOTO IF ABS(W/W1-1)<1E-6 THEN CONT ELSE WSET;
690 WSET:W:=W1;GOTO LOOP;
700 ZER:W:=W1:=0;
710 CONT:X(N):=W1;B(N-1):=D(N);
720 FOR I:=N-2 STEP -1 UNTIL 0 DO
730 B(I):=D(I+1)+W*B(I+1);N:=N-1;GOTO DSET;
740 COMMENT CALCULATION OF PAIR OF ROOTS OF EVEN ORDER EQUATION;
750 EVENS:P:=IF ABS(B(2))<1E-25 THEN B(1) ELSE B(1)/B(2);
760 Q:=IF ABS(B(2))<1E-25 THEN B(0) ELSE B(0)/B(2);
770 CSET:FOR I:=0 STEP 1 UNTIL N DO
780 C(I):=B(I);
790 C(N-1):=C(N-1)-P*C(N);
800 FOR I:=N-2 STEP -1 UNTIL 1 DO
810 C(I):=C(I)-P*C(I+1)-Q*C(I+2);
820 FOR I:=2 STEP 1 UNTIL N DO
830 D(I):=C(I);
840 R:=C(1);S:=B(0)-P*C(1)-Q*C(2);
850 C(N-1):=C(N-1)-P*C(N);
860 FOR I:=N-2 STEP -1 UNTIL 1 DO
870 C(I):=C(I)-P*C(I+1)-Q*C(I+2);
880 W1:=-P*C(2)-Q*C(3);D1:=C(2)^2-C(1)*C(3);
890 GOTO IF ABS(D1)>1E-25 THEN FWD ELSE PRT;
900 PRT:PRINT("POLES OF FUNCTION UNOBTAINABLE BY BAIRSTOW METHOD.");
910 GOTO LAST;
920 FWD:P1:=P+(R*C(2)-S*C(3))/D1;Q1:=Q+(S*C(2)-R*C(3))/D1;
930 GOTO IF ABS(P)>1E-25 THEN P1TEST ELSE IF ABS(P1)
940 >1E-25 THEN P1TEST ELSE IF ABS(Q)>1E-25 THEN Q1TEST ELSE PSET;
950 P1TEST:GOTO IF ABS(P1/P-1)>1E-6 THEN PSET ELSE Q1TEST;
960 Q1TEST:GOTO IF ABS(Q1/Q-1)<1E-6 THEN BSET ELSE PSET;
970 PSET:P:=P1;Q:=Q1;GOTO CSET;
980 BSET:FOR I:=0 STEP 1 UNTIL N-2 DO
990 B(I):=D(I+2);GOTO DISCRIM;
1000 COMMENT OUTPUT SEQUENCE;
1010 CALLOUT:WRITEFILE(SCRATCH,N1,K1);
1020 FOR I:=1 STEP 1 UNTIL N1 DO
1030 WRITEFILE(SCRATCH,X(I),Y(I);
1040 LINK(L50175INVLA2);
1050 LAST:END

```

INVLA2

```

100 BEGIN COMMENT THIS PROGRAM IS NOT INTENDED TO BE USED ALONE. THE
110 PROGRAM INVLA1 PROVIDES INPUT DATA ON THE DISC 'SCRATCHPAD
120 MEMORY' FOR READOUT IN THIS PROGRAM. THE TWO PROGRAMS ARE
130 AUTOMATICALLY LINKED. WHEN INVLA1 IS COMMANDED TO 'RUN', IT WILL
140 COMPUTE ROOTS AND THEN TRANSFER THEM TO THIS PROGRAM AND RUN.;
150 REAL U,U0,U1,U2,V,V0,V1,V2,T,T1,T2,R,R1,R2,R3,R4,O,O1,O2,O3,O4,
160 U3,U4,V3,V4,RR,O0,R5,O5,K1;
170 INTEGER I,J,Z,N,N1;
180 REAL ARRAY A(0:5),B,X,Y(0:7);
190 INTEGER ARRAY G(0:7),FACTORIAL(0:10);
200 PROCEDURE POLAR(R,O,U,V);REAL R,O,U,V;BEGIN
210 R:=SQRT(U^2+V^2);
220 O:=IF U>0 THEN ARCTAN(V/U) ELSE IF U=0 THEN 3.14159/2*SIGN(V)
230 ELSE(IF V=0 THEN -3.14159 ELSE ARCTAN(V/U)+3.14159*SIGN(V));
240 END OF POLAR;
250 PROCEDURE RECTANGULAR(R,O,U,V);REAL R,O,U,V;BEGIN

```

INVLA2 CONTINUED

```

260 U:=R*COS(O); V:=R*SIN(O);END OF RECTANGULAR;
270 PROCEDURE SIGMA(R,O,RR,OO,B,FACTORIAL,N2,N3,N4);
280 REAL R,O,RR,OO;REAL ARRAY B;
290 INTEGER N2,N3,N4;INTEGER ARRAY FACTORIAL;
300 BEGIN REAL U,V,UO,V0;INTEGER Z;
310 UO:=O;V0:=O;
320 FOR Z:=O STEP 1 UNTIL N2 DO BEGIN
330 R:=IF Z=O THEN FACTORIAL(N3)*B(N4) ELSE FACTORIAL(Z+N3)/FACTORIAL(Z)
340 *B(Z+N4)*RR;Z:=O+Z;
350 RECTANGULAR(R,O,U,V);
360 UO:=UO+U;V0:=V0+V;END;
370 POLAR(R,O,UO,V0);END OF SIGMA;
380 FACTORIAL(O):=1;
390 FOR I:=1 STEP 1 UNTIL 10 DO
400 FACTORIAL(I):=I*FACTORIAL(I-1);
410 RESTORE(SCRATCH);
420 FOR I:=O STEP 1 UNTIL 5 DO
430 READFILE(SCRATCH,A(I));
440 FOR I:=O STEP 1 UNTIL 7 DO
450 READFILE(SCRATCH,B(I));
460 READFILE(SCRATCH,T1,T2,N1,K1);
470 FOR I:=1 STEP 1 UNTIL N1 DO
480 READFILE(SCRATCH,X(I),Y(I));
490 X(O):=Y(O):=O;
500 COMMENT IDENTIFICATION OF TYPES OF POLES;
510 FOR J:=O STEP 1 UNTIL N1 DO
520 G(J):=1;
530 FOR I:=O STEP 1 UNTIL N1-1 DO BEGIN
540 FOR J:=I+1 STEP 1 UNTIL N1 DO BEGIN
550 GOTO IF G(I)=O THEN NEXTI ELSE XTEST;
560 XTEST:GOTO IF X(I)=X(J) THEN YTEST ELSE NEXTJ;
570 YTEST:GOTO IF Y(I)=Y(J) THEN GALT ELSE NEXTJ;
580 GALT:G(I):=G(I)+1;G(J):=O;
590 NEXTJ:END;NEXTI:END OF POLE IDENTIFICATION LOOP;
600 PRINT("TIME","RESPONSE");PRINT(" ");
610 COMMENT MAIN COMPUTATION SEQUENCE;
620 FOR T:=O STEP T2 UNTIL T1 DO BEGIN
630 U1:=U2:=V1:=V2:=O;
640 FOR I:=O STEP 1 UNTIL N1 DO BEGIN
650 POLAR(RR,OO,X(I),Y(I));
660 GOTO IF G(I)=O THEN NXTI ELSE IF G(I)=1 THEN SINGLE ELSE
670 IF G(I)=2 THEN DOUBLE ELSE IF G(I)=3 THEN TRIPLE ELSE HIGHER;
680 HIGHER:PRINT("POLE OF HIGHER THAN THIRD ORDER PRESENT AT","",
690 X(I),"",""+J*"",","",Y(I));
700 GOTO LAST;
710 COMMENT COMPUTATION OF RESIDUE AT SINGLE POLE;
720 SINGLE:SIGMA(R1,O1,RR,OO,A,FACTORIAL,5,O,O);
730 R1:=R1*EXP(T*X(I));O1:=O1+Y(I)*T;
740 SIGMA(R2,O2,RR,OO,B,FACTORIAL,N1,1,O);
750 R:=R1/R2;O:=O1-O2;
760 RECTANGULAR(R,O,U,V);
770 U2:=U2+U;V2:=V2+V;
780 GOTO NXTI;
790 COMMENT DOUBLE POLE CALCULATION SEQUENCE;
800 COMMENT CALCULATION OF NUMERATOR;
810 DOUBLE:SIGMA(R1,O1,RR,OO,A,FACTORIAL,5,O,O);
820 R1:=R1*EXP(T*X(I));O1:=O1+Y(I)*T;
830 COMMENT CALCULATION OF 1ST DERIVATIVE OF NUMERATOR;

```

```

840 R2:=T*R1;
850 RECTANGULAR(R2,01,U3,V3);
860 SIGMA(R2,02,RR,00,A,FACTORIAL,4,1,1);
870 R2:=R2*EXP(T*X(I));O2:=O2+Y(I)*T;
880 RECTANGULAR(R2,02,U4,V4);
890 U3:=U3+U4;V3:=V3+V4;
900 POLAR(R2,02,U3,V3);
910 COMMENT CALCULATION OF 2ND DERIVATIVE OF DENOMINATOR;
920 SIGMA(R3,03,RR,00,B,FACTORIAL,N1-1,2,1);
930 COMMENT CALCULATION OF 3RD DERIVATIVE OF DENOMINATOR;
940 SIGMA(R4,04,RR,00,B,FACTORIAL,N1-2,3,2);
950 COMMENT CALCULATION OF RESIDUE FOR 2ND ORDER POLE;
960 R:=2*R3*R2;O:=O2+O3;
970 RECTANGULAR(R,O,U,V);
980 R:=2/3*R1*R4;O:=O1+O4;
990 RECTANGULAR(R,O,U0,V0);
1000 U3:=U-U0;V3:=V-V0;
1010 POLAR(R1,01,U3,V3);
1020 R:=R1/R3^2;O:=O1-2*O3;
1030 RECTANGULAR(R,O,U,V);
1040 V2:=V2+V;U2:=U2+U;
1050 GOTO NXTI;
1060 COMMENT CALCULATION OF RESIDUES AT TRIPLE POLE;
1070 COMMENT CALCULATION OF NUMERATOR;
1080 TRIPLE:=SIGMA(R5,05,RR,00,A,FACTORIAL,5,0,0);
1090 R1:=R5*EXP(T*X(I));O1:=O5+T*Y(I);
1100 COMMENT CALCULATION IF 1ST DERIVATIVE OF NUMERATOR;
1110 SIGMA(R4,04,RR,00,A,FACTORIAL,4,1,1);
1120 RECTANGULAR(R4,04,U1,V1);
1130 RECTANGULAR(T*R5,05,U4,V4);
1140 U1:=U1+U4;V1:=V1+V4;
1150 POLAR(R2,02,U1,V1);
1160 R2:=R2*EXP(T*X(I));O2:=O2+T*Y(I);
1170 COMMENT CALCULATION OF 2ND DERIVATIVE OF NUMERATOR;
1180 SIGMA(R3,03,RR,00,A,FACTORIAL,3,2,2);
1190 RECTANGULAR(R3,03,U,V);
1200 U:=U+T*U4+2*T*U1;V:=V+T*V4+2*T*V1;
1210 POLAR(R3,03,U,V);
1220 R3:=R3*EXP(T*X(I));O3:=O3+T*Y(I);
1230 COMMENT CALCULATION OF THIRD DERIVATIVE OF DENOMINATOR;
1240 SIGMA(R4,04,RR,00,B,FACTORIAL,N1-2,3,2);
1250 COMMENT CALCULATION OF 4TH DERIVATIVE OF DENOMINATOR;
1260 SIGMA(R5,05,RR,00,B,FACTORIAL,N1-3,4,3);
1270 COMMENT CALCULATION OF 5TH DERIVATIVE OF DENOMINATOR;
1280 SIGMA(R,0,RR,00,B,FACTORIAL,N1-4,5,4);
1290 COMMENT CALCULATION OF RESIDUE;
1300 R3:=3*R3/R4;O3:=O3-O4;
1310 R2:=6*R2*R5/R4^2;O2:=O2+O5-2*O4;
1320 R:=3*R1*R/R4^2;O:=O1+O-2*O4;
1330 R1:=R1*6*R5^2/R4^3;O1:=O1+2*O5-3*O4;
1340 RECTANGULAR(R3,03,U4,V4);U2:=U2+U4;V2:=V2+V4;
1350 RECTANGULAR(R2,02,U,V);U2:=U2-U;V2:=V2-V;
1360 RECTANGULAR(R1,01,U,V);U2:=U2+U;V2:=V2+V;
1370 RECTANGULAR(R,O,U,V);U2:=U2-U;V2:=V2-V;
1380 GOTO NXTI;
1390 NXTI: END OF ILOOP;
1400 U2:=IF ABS(U2)<1E-3 THEN 0 ELSE U2;
1410 PRINT(T,K1*U2);
1420 END OF TLOOP; GOTO LAST;
1430 LAST:END

```

ELIMINATE DOWN-TIME ON ROTARY & THUMBWHEEL SWITCHES

and also get accurate, precise control

UNLIMITED APPLICATIONS

CDI switches offer fast sure settings and quick read-out for computer, automated and control equipment, and for test and programming applications, etc.

QUICK SERVICEABILITY

Unique 5-second wafer replacement obsoletes other switches. Simply lift out old wafer, slip in new wafer. No unsoldering . . . no disassembling . . . no wire removing.

EXTREME VERSATILITY

Regardless of size or shape needed CDI is well prepared to meet your every switch requirement.

THUMBWHEEL SWITCHES



Digital and Binary. Meet MIL-S-22710. For critical reliability applications. Available with internal lighting MIL-L-25467A. Switch modules with panel and switching elements separately sealed for complete protection are available. Bezel types have no visible screws when rear mounted.

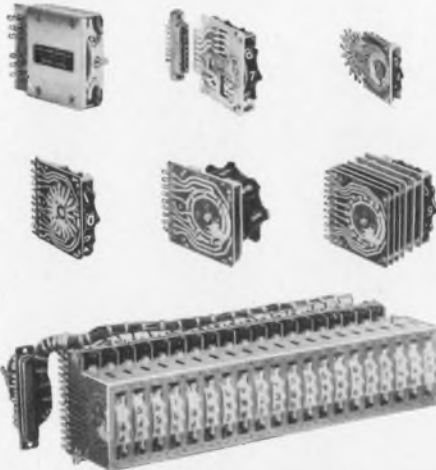

PUSHBUTTON SWITCHES

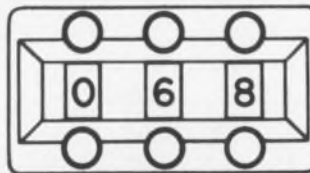

NEW MINI 10-POSITION ADD/SUBTRACT

Retrofits most miniature thumbwheel switch panel openings. 8 & 12 positions available. Simply push one button to add, the other to subtract. Each decade mounts on 1/2" centers. Over 1,000,000-operation service life.

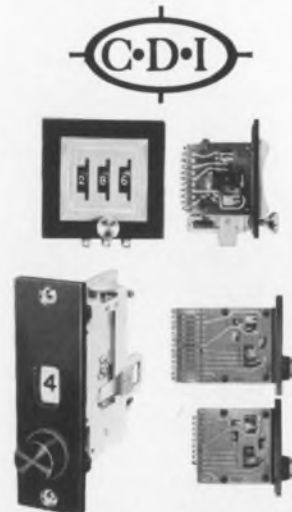

ROTARY SWITCHES

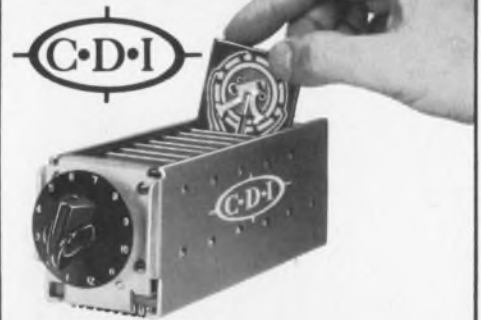

For critical reliability applications. Meet MIL-S-22710. Removable wafers permit quick changing of programs, configurations, circuits. CDI patented switches with dust covers available in sizes 2" x 2", 3" x 3" and 4" x 4" with lengths to accommodate up to 36 wafers. Operation may be manual, motor or solenoid.



Mfd. under Tabel U. S. Patents 2,841,660, 2,971,066, 3,015,000, 2,956,131, 2,988,607



CHICAGO DYNAMIC INDUSTRIES, INC.

PRECISION PRODUCTS DIVISION 1725 Diversey Blvd., Chicago, Illinois 60614 Phone 312, 935-4600

The custom-designed assembly-line circuit.

Custom-designed Flexprint* circuitry meets exact parameters—for temperature, flexibility, tensile strength, distributed capacitance, shielding, dielectric constant, and current carrying capability—and even simulates coaxial matched impedance characteristics.

High-speed, high-volume Flexprint production facilities maintain top circuit quality while providing the economy of the assembly line.

Flexprint circuitry is available in single layer, multilayer, or in combination with hardboard...in a wide range of conductor, shielding, and insulation materials, including FEP Teflon* and Kapton* (H-Film).

Flexprint plated-through-hole technology maximizes circuit density, eliminates eyelets and tubelets, and provides state-of-the-art reliability in the termination pads of circuits—and still offers the economies of mass production.

When it comes to counting, recording or controlling, come to Veeder-Root



The 7102 Digi-Flex® Predetermining Counter: Electrically driven. Off-the-shelf. Both versatile and economical. Ideally suited for control applications in industrial environments.



The 7122 Econo-Flex® Preset Counter: One or two rows of presets. Reliable integrated circuitry. Operates from a selection of inputs. For critical control problem areas: coil winding, weighing, blending.



The 7108 Digi-Clock Time Display: Offers a wide range of features for computer input. Self-contained desk unit or component of larger systems. Readout code: decimal or BCD.

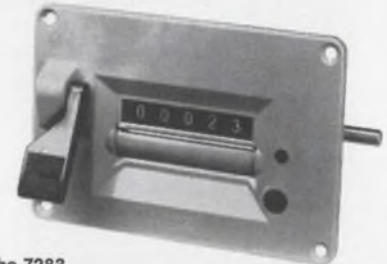

The 7283 Predetermining Counter: Rapid reset counter with positive electrical knock-off. Features a positive interlock and base or panel mount. Recommended for industrial precision control.



The 1669 Visicounter® Totalizer: Ruggedly-built counter with distinct figures. Ideal for use on heavy equipment like power presses and industrial machines.



The 7272 Reset Counter: For indoor and outdoor use where small size, accuracy, and legible figures are essential. Features acetal resin components and a corrosion-resistant case.

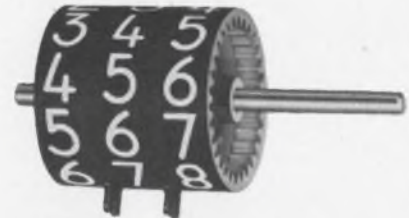

The 7170 Precision Instrument Odometer: Light yet durable counter with modular wheel construction, providing flexible design opportunities. High speed 500 rpm. Meets applicable Mil Specs.



The 7162 Jewel Bearing: Features individual wheel and pinion supports. Sturdy aluminum frame and wheels keep weight low. For use in servopneumatic altimeters. Exceptionally low torque 0.0002 oz-in.

The 7437 Electric Counter: A low cost electric counter featuring a one piece frame construction for greater reliability and simplicity of design. Ideal for office machines or coin-operated equipment. Available with 5 or 6 figures and a variety of mounting configurations. AC or DC.



The 7438 Electric Reset Counter: Offers the convenience of push-button reset with the economy of rotary reset. Simple, one piece frame construction assures reliability. Ideal for test equipment, control equipment and office machines. Available with 5 figures and a variety of mountings. AC or DC.



The 1969 Veeder Decade® Totalizer: Single wheel, electric counter with electric readout, transfer and reset. Features narrow width with large figures for outstanding readability.

See us at the IEEE Show—Booth 2H40. March 24-27.

*Trademark of Veeder-Root

Veeder-Root always comes through with the finest equipment you can buy.

In fact, our line of counters is so complete, it'll solve any application problems you may have.

For further information on our full line of mechanical, electrical and electronic totalizers and controls, write to: Veeder-Root, Hartford, Connecticut 06102.

V E E D E R - R O O T

INNOVATORS IN NUMERICS: COUNTING/RECORDING/CONTROLLING



Veeder-Root World-Wide: Argentina: Buenos Aires•Australia: Melbourne•Brazil: Sao Paulo
England: New Addington, Surrey•Scotland: Dundee•West Germany: Neuhausen/Filder•Canada: Toronto

General Electric introduces a faster, more convenient and less costly technique for production line encapsulating and potting. And the RTV's used in the process are as tough as any previously available.

Called the RTV-800 series, the new liquid silicone rubbers do not need a catalyst to activate them, so no premixing is needed.

They cure at temperatures ranging from 200°F to 450°F, so pot life is far longer than is customary with RTV's. A typical deep section cure would be one hour at 300°F. For really rapid cure, components can be preheated and dipped into the RTV.

These three new products are supplied in both opaque and clear grades, with viscosities ranging from very pourable to pourable. They can be blended with one another to suit your particular encapsulating job.

For more information about these new encapsulating RTV silicones (they also make good short-run molding-

materials), write Section 300, Silicone Products Dept., General Electric Company, Waterford, N.Y. 12188.

TYPICAL PROPERTIES

Uncured	RTV-815	RTV-830	RTV-835
Color	Clear	Beige	Beige
Consistency	Easily pourable	Pourable	Easily pourable
Viscosity, cps	3500	200,000	8000
Specific Gravity	1.02	1.28	1.18
Solids, %	100	100	100
Shelf Life, months	4	4	4
Cured, ± 1 hr. @ 150°C	RTV-815	RTV-830	RTV-835
Hardness, Shore A durometer	35	50	35
Tensile Strength, psi	700	800	500
Elongation, %	150	250	200
Tear Strength, lb/in.	15	100	20

GENERAL  ELECTRIC

Now. Heat-curing,
no-mixing, high-strength
RTV silicones.

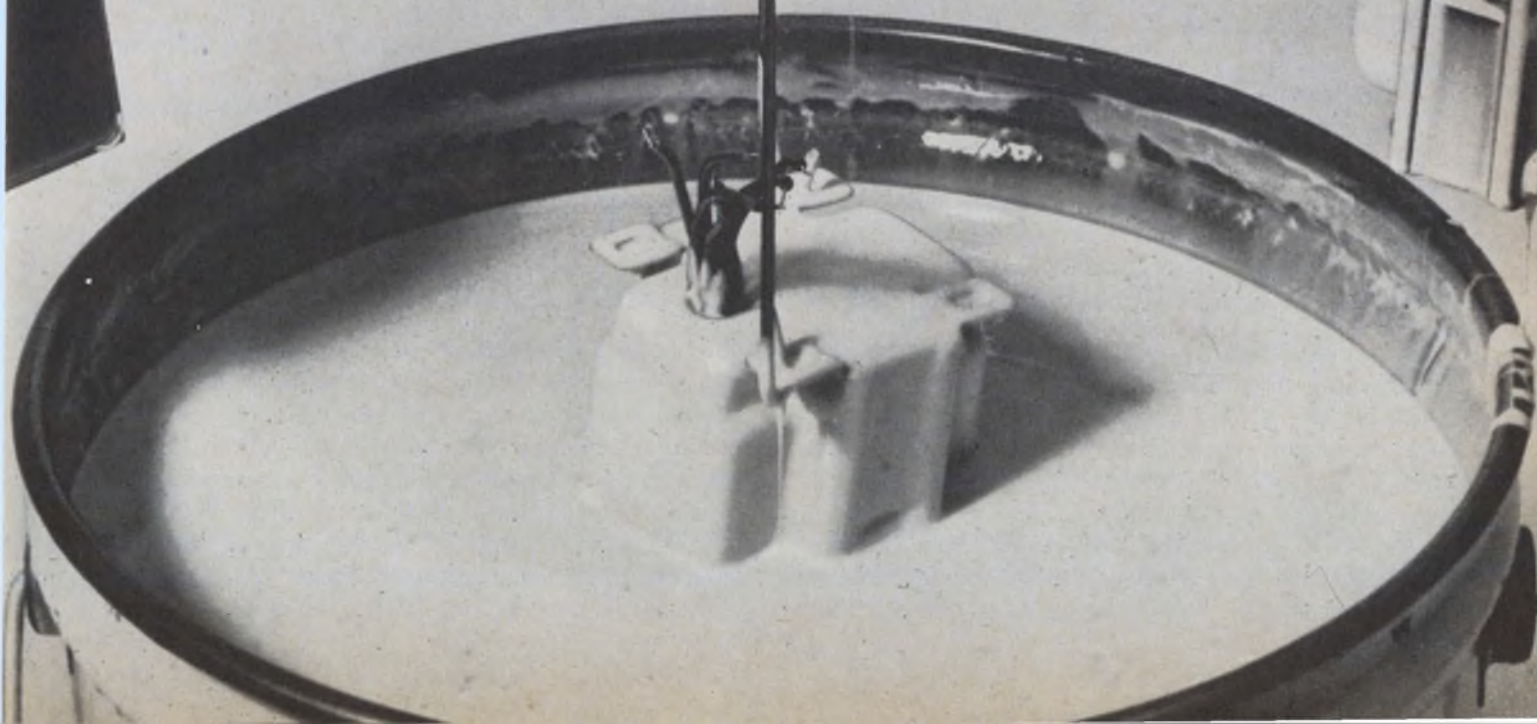

Low-noise, gain-stable amplifier uses only five components

An amplifier that uses only five components (three resistors, a dual transistor and a coupling capacitor) performs well enough to be used in applications that require low-noise, gain-stable ac amplification. Although originally designed for signal-summing applications, it lends itself to many other ac applications as well.

When used with a 500-ohm source resistance (R_s), it has an equivalent input noise of only 1 μ V for a 20-kHz equivalent noise bandwidth, and stable gain of 20 V/V. Other features:

- The input impedance is less than 0.35 ohms. Thus the input is an excellent current summing junction.
- The bandwidth is greater than 600 kHz.
- The amplifier draws only 1 mA of bias current and is bias-stabilized by its own internal dc feedback loop.

The amplifier consists of a common-base amplifier ($Q1$) and an input impedance reducing amplifier ($Q2$). Alternating current voltages present at the input (the emitter of $Q1$) are amplified by $Q2$ and applied out-of-phase to the base of $Q1$. $Q2$ thus reduces the input impedance by attempting to maintain the input at zero volts. An approximate equation for the input impedance is:

$$Z_{in} \approx \left(\frac{h_{ie}(Q2)}{h_{fe}(Q1)} \right) \left(\frac{R_2 + h_{ie}(Q1)}{h_{ie}(Q2) R_2 + h_{ie}(Q1)} \right)$$

Gain of the amplifier is almost exactly equal to R_L/R_S . The dc bias current for $Q1$ is approxi-

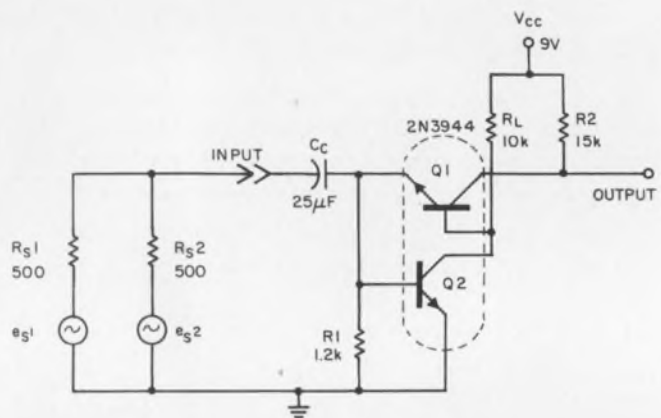

Exceptionally low input-impedance makes the input of this amplifier an excellent current summing junction.

mately equal to $V_{BE}(Q1)/R_1$, and the dc bias current for $Q2$ is approximately equal to $[V_{cc} - V_{BE}(Q1) - V_{BE}(Q2)]/R_2$.

Although the operating points of the transistors will vary somewhat with changes in supply voltage and temperature, the amplifier will remain active with voltages as low as 6.5 V and throughout the MIL temperature range of -55°C to $\pm 125^{\circ}\text{C}$.

The amplifier was originally designed as a low-noise, low-power, compact transducer output-signal-summing amplifier.

Ralph Anderson, Systems Engineer, Perkin-Elmer Corp., Pomona, Calif.

NOTE FOR 420

Voltage-controlled monostable uses IC comparator

The main features of this voltage-controlled monostable multivibrator are excellent linearity between the timing period and the output voltage; accurate definition of the triggering point, and a very short recovery time which allows a high duty cycle.

A $\mu\text{A}710$ high-speed differential comparator, with known offset voltage limits, is used as the gain element. In the untriggered state, $Q2$ and

$Q3$ are both conducting, and the comparator output is negative. Diode $D3$ protects $Q2$ from excessive base current, and $D4$ ensures that the noninverting input (2) is held below the inverting input due to $Q3$. Capacitor C_1 is discharged by the inverted and overdriven emitter follower, $Q2$. With a suitable transistor, and I_2 greater than I_1 , this discharging ensures that the $Q2$ emitter-collector voltage, V_{EC} , is close to zero.

MSI HYBRIDS

In 1967 we started taking the circuit design out of system designing by making MSI available off-the-shelf. Since then, we've developed a series of 12 digital MSI building blocks that do the work of a hundred IC's.

Now we've even one-upped ourselves with MSI hybrids. We pack several MSI chips on a single substrate using multi-layer ceramic for the interconnections. You need fewer external connections to your system, so reliability goes up, and fewer packages, so space needs go down. And our MSI hybrids come to you fully assembled, fully tested, so total system costs go down.

We started on our MSI hybrids by doubling up on our reliable 9304, a Dual Full Adder with a carry propagation delay of only 8ns. Shown are three examples of what this does for you. They're all available now from your stocking Fairchild distributor. Write for complete specifications.

New product number **64.**

SH8080 4-BIT ARITH- METIC UNIT

The SH8080 is a 4-bit ripple carry adder with a built in holding register. Typical carry propagation delay is 32ns and the noise margin is one volt. Several units may be connected in series to handle longer words.

The SH8080 uses two Fairchild 9304 dual full adders and two Fairchild 9020 dual JJK flip-flops interconnected on a multi-layer substrate. It is fully compatible with all Fairchild CCSL devices.

The SH8080 is available in a 32-lead flat pack and operates over the full military and industrial temperature ranges. You can get it from your Fairchild distributor today. Write for complete specifications.

To order the SH8080, ask for:

Part Number	Temperature Range	Prices		
HB80801XX	-55°C to +125°C	1.24	25.99	100.999
HB80809XX	0°C to +70°C	\$120.00	\$96.00	\$79.25
		46.00	35.80	30.80

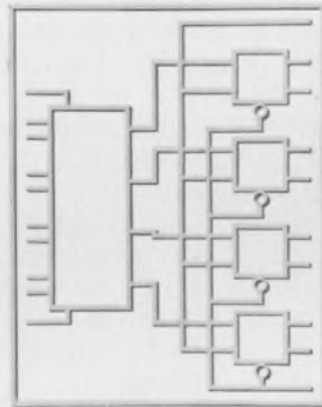

New product number **65.**

SH2204 BYTE PARITY GENERATOR/ CHECKER

The SH2204 Byte Parity Generator/Checker generates parity for an 8-bit byte or checks parity over 9 bits with a typical delay of only 35ns from input to odd parity. For longer words, just connect additional units in parallel.

The SH2204 uses two Fairchild 9304 dual full adders interconnected on a multi-layer substrate. It is fully compatible with all Fairchild CCSL devices.

The SH2204 is available in a 3/4" x 3/4" 14-lead flat pack and operates over the full military and industrial temperature ranges. It's in stock at your Fairchild distributor now. Write for complete specifications.

To order the SH2204, ask for:

Part Number	Temperature Range	Prices		
HBK22041XX	-55°C to +125°C	1.24	25.99	100.999
HBK22049XX	0°C to +70°C	\$68.00	\$54.00	\$48.00
		32.00	26.00	22.00

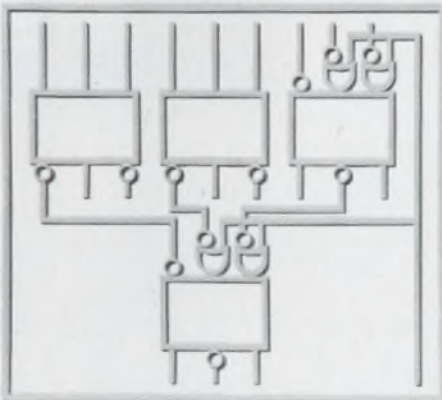

New product number **66.**

SH2205 RIPPLE- CARRY ADDER

The SH2205 is a ripple-carry parallel addition (or subtraction) function block containing four full adders. Typical carry propagation delay is 80ns per bit. The circuits are high speed, high fan out TTL with input diode clamping.

The SH2205 uses two Fairchild 9304 dual full adders interconnected on a multi-layer substrate. It is fully compatible with all Fairchild CCSL devices.

The SH2205 comes in a 16-pin ceramic DIP and operates over the full military temperature range. Your Fairchild distributor has it in stock now. Write for complete specifications.

To order the SH2205, ask for:

Part Number	Temperature Range	Prices		
HBK22051XX	-55°C to +125°C	1.24	25.99	100.999
HBK22059XX	0°C to +70°C	\$63.00	\$50.00	\$44.00
		32.00	26.00	22.00

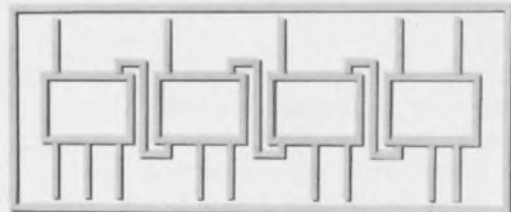

FAIRCHILD
SEMICONDUCTOR

FAIRCHILD SEMICONDUCTOR A Division of Fairchild Camera and Instrument Corporation Mountain View, California 94040, (415) 962-5011 TWX: 910-379-6435

INFORMATION RETRIEVAL NUMBER 137

The inverted connection is used to minimize the optimum base current.

When a positive trigger pulse is applied, Q3 cuts off, allowing the noninverting input to rise to V_1 , through R_1 . As the output, V_o , goes positive, Q2 unclamps C_1 , which charges positively with a constant current from Q1. Resistor R_2 compensates for the bias current flowing through R_1 .

When the voltage across C_1 reaches a level equal to V_1 , modified by the comparator's offset current I_{BB} and input offset voltage V_{BB} , the comparator changes state. Q2 now discharges C_1 , and the monostable is ready for the next trigger pulse.

The timing period, t , of the circuit is given by $t = [(V_1 \pm V_{EC} \pm V_{BB} \pm (I_{BB} R_1)] C_1 / I_1$.

Typical circuit values are

$$\begin{aligned} V_{EC} &= \pm 5 \text{ mV} & R_1 &= 1 \text{ K} \\ V_{BB} &= \pm 2 \text{ mV} & C_1 &= 0.01 \text{ } \mu\text{F} \\ I_{BB} &= \pm 1 \text{ } \mu\text{A} & I_1 &= 1 \text{ mA} \end{aligned}$$

which give, for $V_1 = 3 \text{ V}$, an error of $\pm 0.27\%$ for a stable known I_1 and C_1 . A plot of t vs V_1 indicates a linearity of better than 0.1% from 0 to 3 V, and from t_1 , which is a function of the trigger duration, to 35 μs . Recovery time, which depends on the current gain of Q2 and R_3 , is 4 μs for the circuit as built.

If Q2 is connected normally, with the collector grounded, the increased current gain reduces the recovery time to 1 μs and, with $V_1 = 3 \text{ V}$, the maximum repetition frequency approaches 30 kHz with a duty cycle of nearly 97%.

The μA710 comparator was chosen for its short

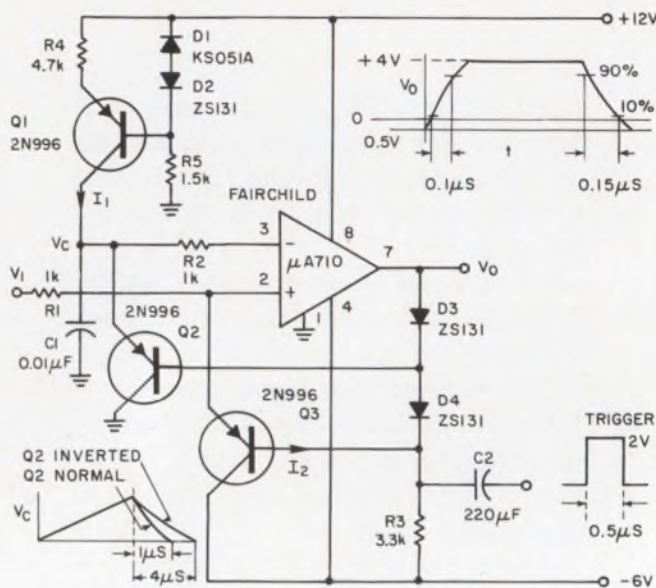

Output is delivered from this monostable circuit when an input trigger causes voltage V_c to rise above V_1 .

response time. However, if a larger input range and greater output swing are desired at the expense of switching speed, suitable operational amplifiers can be employed—again, with defined switching offsets. Since such amplifiers, like the comparator, would be operated only in their two overdriven states, the usual compensation networks that limit frequency response, are not necessary.

John M. Morrison, Senior Research Engineer, Ferranti Ltd., Edinburgh, Scotland

VOTE FOR 421

A grease pencil marks oscilloscope photographs

When you take oscilloscope photographs do you record identifying or descriptive data on the photographic print? If so, you may save time in the future by writing the data directly on the oscilloscope screen with a simple grease-pencil. A fine-point, white pencil gives the best results. The trace may be erased by your finger tip or with a soft, lint-free cloth.

When using this technique, the camera lens opening must be chosen for a bright picture of the reticle, since the pencil's trace refracts the same light that illuminates the reticle.

L. M. Dossi, Electronic Engineer, Padova, Italy
VOTE FOR 422

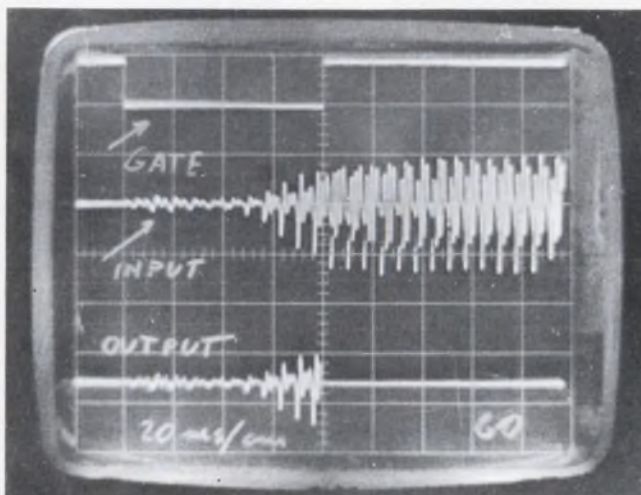

White grease pencil makes easy-reading data-markings on oscilloscope photographs.

R-Series
2-sizes: 3-1/2", 4-1/2"



TRIPLET

"CLEAN SWEEP" PANEL INSTRUMENTS

A fresh approach to ultra-modern instrument design provides a "clean sweep" of the pointer over the full scale.

- 1** You get instant readability easier and at greater distances—plus more attractive designs to integrate into your equipment.
- 2** Self-shielded, accurate, reliable D.C. instruments have the exclusive Triplet BAR-RING movements.
- 3** Whatever your panel instrument requirement, look to Triplet for the right size and style, the right capability at the right price.



G-Series
5 sizes: 1 1/2", 2 1/2", 3 1/2", 4 1/2", 5 1/2"



MODEL 120 Edgewise Panel Meters

SHIELDED BAR-RING MOVEMENTS

ALNICO MAGNET IS MOUNTED INSIDE SOFT IRON RING; FULLY SELF-SHIELDED

Not affected by magnetic panels or substantially by stray magnetic fields for D.C.

More Torque

Lower Terminal Resistance

Faster Response

Exceedingly Rugged and Accurate

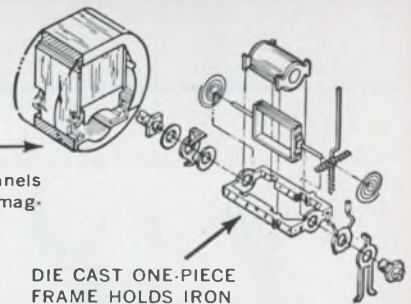

DIE CAST ONE-PIECE FRAME HOLDS IRON CORE IN EXACT ALIGNMENT

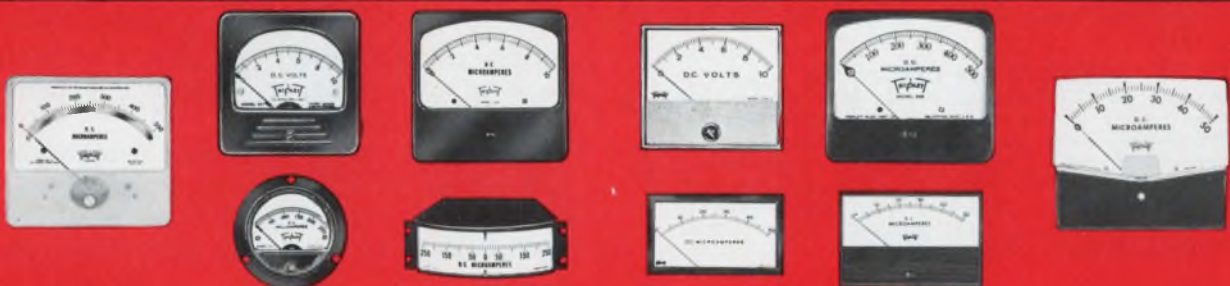

TRIPLET ELECTRICAL INSTRUMENT COMPANY, BLUFFTON, OHIO

Constant-current source is stable and inexpensive

A 40-mA constant-current source having better than 0.1% regulation over a wide range of power supply, temperature and load conditions can be constructed at a parts cost of only \$5.

The basic circuit is that of a biased transistor, Q3, whose collector current is determined by R4. The bias for Q3 is a very stable voltage with a temperature coefficient that matches the V_{BE} of Q3. The basic reference voltage is provided by zener diode, D1, which is driven by a constant current. This current is determined by the characteristics of Q4 and its source resistance, R1. If desired, R1 and Q4 may be replaced by a 1N5297, or similar current limiting diode. The temperature coefficient of D1 is canceled by diode D2.

The reference voltage is buffered by Q1, which is an emitter-follower driven by constant-current source Q2. The V_{BE} of Q1 and Q3 track and cancel one another, providing over-all temperature compensation. The equation for output current from the supply is

$$I_o = 6.8/R_4$$

With the component values shown, the circuit is designed to drive a coil with a constant current of 40mA. Temperature dependence is approximately 0.02%/°C. The output impedance of the circuit was measured two different ways and found to be 20,000 ohms.

Power supply sensitivity, expressed in terms of output current, is 30μA/V on the negative supply,

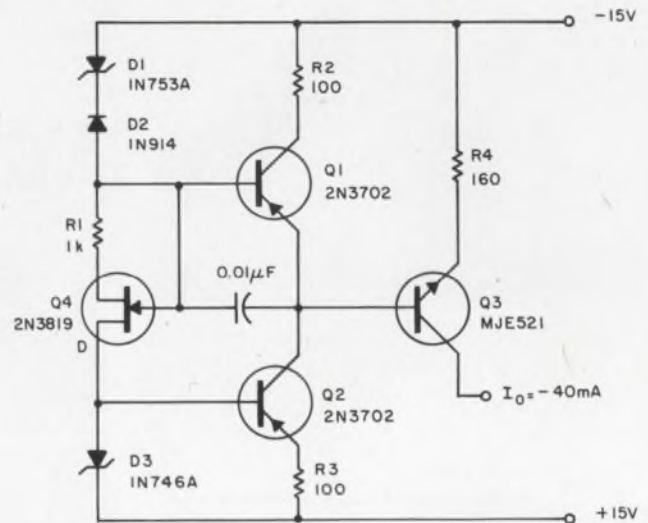

Constant current flows in the collector circuit of Q3, despite variations in the load and power supplies.

and 3μA/V on the positive supply. With reasonably regulated supplies, the output current can be held to within 0.1% of nominal over ambient temperature variations.

The supply can be designed for positive output currents by reversing all diode connections and transistor polarities.

Richard C. Gerdes, President, Optical Electronics Inc., Tucson, Arizona.

VOTE FOR 423

VOTE

VOTE! Go through all Idea-for-Design entries, select the best, and circle the appropriate number on the Reader-Service-Card.

SEND US YOUR IDEAS FOR DESIGN. You may win a grand total of \$1050 (cash)! Here's how. Submit your IFD describing a new or important circuit or design technique, the clever use of a new component or test equipment, packaging tips, cost-saving ideas to our Ideas-for-Design editor. You will receive \$20 for each accepted idea, \$30 more if it is voted best-of-issue by our readers. The best-of-issue winners become eligible for the Idea Of the Year award of \$1000.

360° video phase shifter uses no transformers

Continuously variable phase-shifting of video-frequency signals over a range greater than 90 degrees usually involves complicated transformers or switching sequences. A much simpler technique, using double-balanced modulators, can provide a continuously variable phase-shifting range of 360° without requiring inductive or mechanical components.

The circuit consists of two double-balanced modulators, with their outputs paralleled. The frequency, ω, whose phase is to be shifted, is applied at one input, and the same signal, shifted in phase by 90°, is applied to the other input.

***Accelerated Cathode Excitation
SCR from the Power House.**

Meet the tradeoff eliminator: our new 80-ampere-average ACE[®] SCR in a TO-94 case. Now you can toss out complex hard firing circuits, get more power output per SCR. In other words, get maximum power at lowest system cost.

The ACE SCR allows low amplitude soft firing, and has the industry's highest di/dt (800 A/ μ s per JEDEC #7) along with high frequency performance to 10 kHz (250 amperes peak at 60 Hz and 210 amperes peak at 5 kHz). It's rated to 1200 V and provides 200 V/ μ s dv/dt with 40 μ s turnoff time. Advance specifications from the Power House, 233 Kansas St., El Segundo, Calif. 90245. Phone (213) 678-6281.

INTERNATIONAL RECTIFIER



**Super
ace***

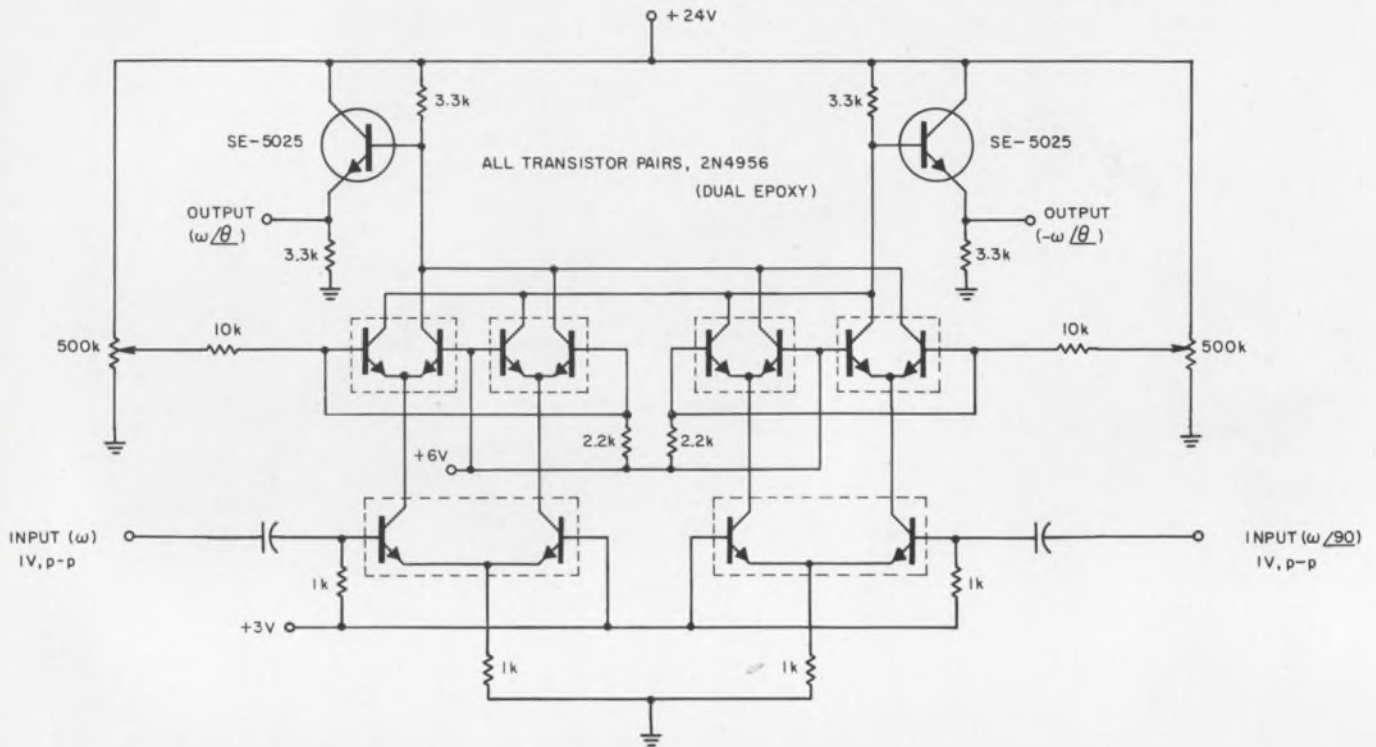

Any output phase angle between 0 and 360° can be selected by the 500-kΩ potentiometers.

The signal currents thus available for mixing in the output loads represent ω , $\omega/180$, $\omega/90$ and $\omega/270$. The amount of each of these currents that are added is determined by the imbalance introduced by the two 500-kΩ potentiometers. Therefore any output phase angle between 0° and 360°, at an amplitude between zero and 10 V peak-to-peak, can be selected by the proper combination of the potentiometer settings.

If the potentiometers are mounted in a "joy-

stick" arrangement, as is used on some oscilloscopes for trace shifting, the joystick attitude can be made to represent the phase and amplitude of the output frequency.

With the use of matched pairs of a suitable transistor, the circuit functions well over the video-frequency range.

Norman Doyle, Design Engineer, Fairchild Semiconductor, Mountain View, Calif.

VOTE FOR 424

Do-it-yourself curve tracer checks diodes in laboratory

Laboratories must sometimes check and select diodes when a commercial curve tracer is not available. A checking device that has been found entirely satisfactory can be built from components usually found in the lab.

The circuit (see Fig. 1) uses a 100-ohm resistor for current sensing (R_2) and an inexpensive resistor substitution box for the current limiter (R_1). The transformer, T_1 , is, in this case, a small power transformer of "unknown ancestry," useful at first thought. However, experience has shown that the high-voltage winding is used mostly. The low-voltage windings are sometimes

used for measuring forward characteristics.

In the laboratory where the tester was built, a Tektronix 503 oscilloscope, with calibrated hori-

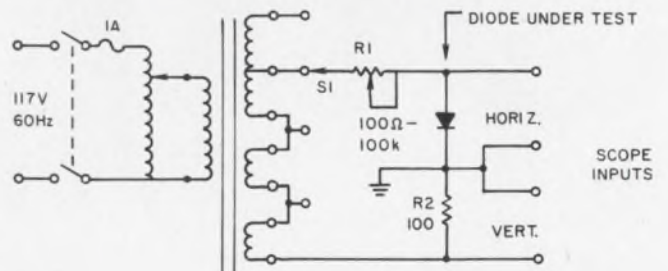

1. Diode curve tracer can be built from miscellaneous "junk box" parts.

Centralab's got your Zener number

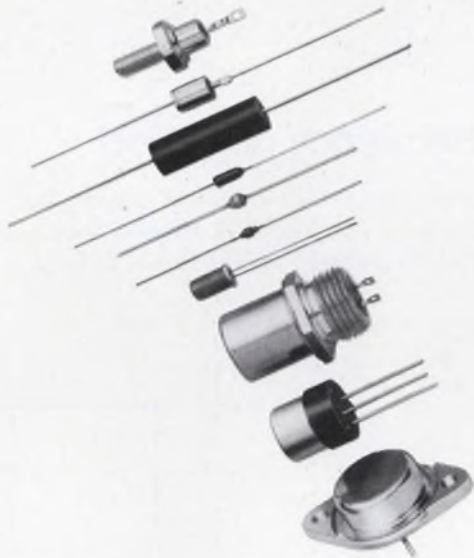

Centralab's broad range of zener regulators covers almost every conceivable JEDEC number, rating, case style and application. From 150mW to 50 watts. From Hi Rel military types and precise industrial types to quality, low-cost units for entertainment applications. Plus all the case styles shown. And, we'll work with your engineers to design a zener to match your specific parameters.

For further information and samples, call the zener specialists, Centralab Customer Service Engineering, (213) 686-0567. Now you've got *our* number.

The following is a list of 2,234 parts for direct replacement but represents a far greater number of additional replacement possibilities.

1N200 - 1N222 • 1N225 - 1N239 • 1N225A - 1N229A • 1N429 • 1N430, A, B • 1N431 • 1N465, A, B - 1N470, A, B • 1N471, A - 1N475, A • 1N702, A - 1N707, A • 1N708, A - 1N745, A • 1N746, A - 1N759, A • 1N761 - 1N769 • 1N821 - 1N829 • 1N821A, 1N823A, 1N825A, 1N827A, 1N829A • 1N935, A, B - 1N940, A, B • 1N941, A, B - 1N946, A, B • 1N957, A, B - 1N992, A, B • 1N1313, A - 1N1327, A • 1N1351, A, R, RA - 1N1375, A, R, RA • 1N1530, A • 1N1591, A - 1N1598, A • 1N1602, A - 1N1609, A • 1N1735, A - 1N1742, A • 1N1766, A - 1N1802, A • 1N1804, A, R, RA - 1N1815, A, R, RA • 1N1816, A, R, RA - 1N1836, A, R, RA • 1N1957, A, B - 1N1980, A, B • 1N1981, A, B - 1N2005, A, B • 1N2008, R - 1N2012, R • 1N2043 - 1N2049 • 1N2498, A, R, RA - 1N2500, A, R, RA • 1N2804, A, B, R, RA, RB - 1N2846, A, B, R, RA, RB • 1N2937 • 1N2970, A, B - 1N3015, A, B • 1N3016, A, B - 1N3051, A, B • 1N3112 • 1N3154, A - 1N3157, A • 1N3181 • 1N3477, A • 1N3506 - 1N3534 • 1N3553 • 1N3558 • 1N3763 • 1N3779 - 1N3784 • 1N3785, A, B - 1N3820, A, B • 1N3896 - 1N3898 • 1N3949 • 1N4095 - 1N4135 • 1N4295, A • 1N4296, A • 1N4321 • 1N4370, A - 1N4372, A • 1N4460 - 1N4496 • 1N4535 • 1N4565, A - 1N4584, A • 1N4611, A, B, C - 1N4613, A, B, C • 1N4765, A - 1N4774, A • 1N4775, A - 1N4784, A • 1N4954 - 1N4990 • 1N5118 - 1N5128 • C4011 - C4029* • CZ4097, A,* CZ4098, A* • CZ4881, A* • CZ4883, A* • CZ5063, A - CZ510, A* • HM6.8, A, B - HM200, A, B* • HR2.3 - HR11.0* • HS6 - HS14* • HW6.8, A, B - HW200, A, B* • JAN 1N429 • JAN 1N746A - 1N759A • JAN 1N821, 1N823, 1N825 • JAN 1N935B, 1N937B • JAN 1N962B - 1N973B • JAN 1N2979B, RB - 1N3004B, RB • JAN 1N3016B - 1N3032B

*Centralab house part numbers. Ask for our new catalog which defines the electrical parameters of these zener regulators



THE
ZENER
SPECIALISTS

CENTRALAB

Semiconductor Division
GLOBE-UNION INC
4501 NORTH ARDEN DRIVE
EL MONTE, CALIFORNIA 91734

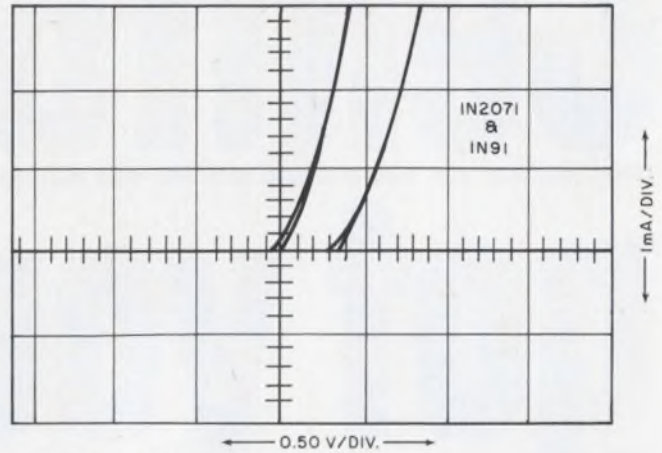
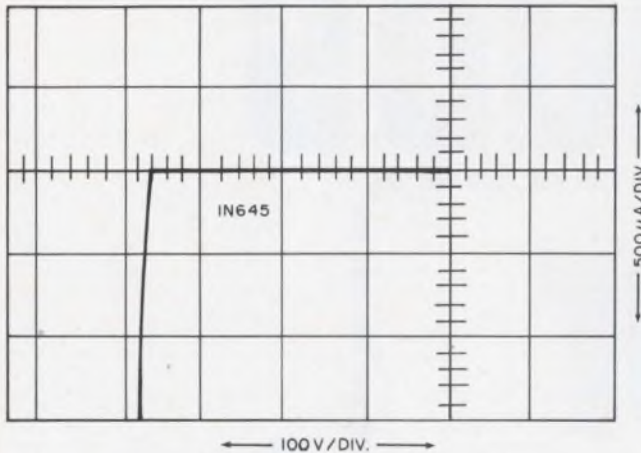

2. Traces demonstrate the versatility of the improved diode curve tracer.

zontal and vertical amplifiers, was used. However, any laboratory oscilloscope should work properly if both deflection axes can be calibrated.

Two typical traces made with the device are

shown in Fig. 2.

Richard W. Cummings, Design Engineer, University of California, Berkeley.

VOTE FOR 425

Circuit converts two analog quantities to frequency or period

Circuits that produce output signals with a frequency or period proportional to one or more analog quantities find widespread use in control and measurement systems.

One such circuit for converting two analog quantities, X and Y , into an output signal that has a frequency $f = kY/X$ or a period $T = kX/Y$ is shown in simplified form in Fig. 1. The circuit inputs, derived from the analog quantities, are current I and voltage V .

In operation, the input current I charges capacitor C through resistor R_1 . When the potential of point M reaches that of point N , the amplifier output, initially at some positive voltage $+E_1$, switches to a negative voltage $-E_2$. This forward biases diode D and switches transistor Q on.

As a result, point N abruptly drops very close to ground potential, and C discharges through the forward biased diode. When the discharge of C again brings point M to the same potential as N , the amplifier output switches back to $+E_1$. This reverse biases D and turns Q off, so the circuit is prepared for the next cycle. The amplifier, therefore functions as a dual-level voltage comparator. A necessary condition for operation of the circuit is that the discharge time for C be very short compared to the charging time.

It is clear from the preceding description that the duration of one cycle is proportional to the voltage V and inversely proportional to the current

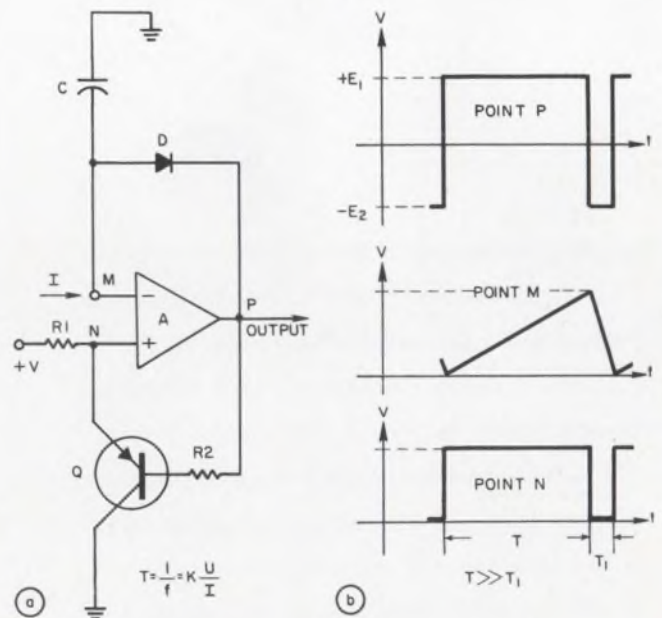

1. Amplifier A functions as a dual-level comparator (a). It compares the voltages at points M and N, and switches the output level at P each time they are equal (b).



DC to 40 MHz in Seven Inches! 90 db Clean.

Up above, you see just one member of Fluke's exciting new family of frequency synthesizers. Model 644 covers DC to 40 MHz. Model 633 covers DC to 11 MHz. Model 622 covers DC to 2 MHz range.

All three units feature exceptionally low spurious content, high signal to phase noise ratio, modern packaging in minimum panel height, in-line, in-plane frequency readout and fast remote programming to give you synthesizers with the right figure of merit.

Want a demonstration? Your full service Fluke sales engineer will be glad to arrange a demonstration of any or all of these high performance new synthesizers. Or write or call us here at the factory for more information.

Brief Specifications

Model	644	633	622
Frequency Range	DC - 40 MHz 0.1 Hz Steps	DC - 11 MHz 0.1 Hz Steps	DC - 2 MHz 0.1 Hz Steps
Non-Harmonic Spurious	At least 90 DB Below the Fundamental	-90 DB to 5.5 MHz -80 DB to 6.5 MHz -60 DB to 11 MHz	-90 DB
Harmonics	At least 30 DB Below the Fundamental	-35 DB	-35 DB
Internal Standard	1 part in 10 to the 8th per day stability Higher stabilities optional		
Size	7" high, 17" wide, 23" deep Mounting ears fit standard 19" rack		
Power	100/115/200/230 VAC plus or minus 10% 50 - 400 Hz 75 watts max.		
Price	\$10,490	\$7,090	\$6,490

Fluke, Box 7428, Seattle, Washington 98133. Phone: (206) 774-2211. TWX: 910-449-2850.
In Europe, address Fluke Nederland (N.V.), P. O. Box 5053, Tilburg, Holland.
Phone: (04250) 70130. Telex: 884-50237. In the U. K., address Fluke International Corp.,
Garnett Close, Watford, WD2 4TT. Phone: Watford 27769. Telex: 934583.



See us at IEEE

I , or

$$T = 1/f = k(V/I).$$

So the circuit converts either V/I to period or I/V to frequency. If the current I is held constant, then $T = kV$. Similarly if V is constant, $f = kI$.

Under the condition $T \gg T_1$ (Fig. 1b), conversion error in the circuit arises only from the finite value of V_{CE} for the switching transistor. Likewise, conversion stability depends only on the stability of the V_{CE} value. If a transistor is used that has a V_{CE} less than 10 mV and good high temperature stability, the conversion error of the circuit can be less than 0.1%.

A complete circuit of this type, suitable for practical applications, is shown in Fig. 2. Measurements have shown it to be stable, accurate and linear, with errors on the order of 0.1% for input quantity variations of more than 40 dB.

Borislav M. Stojanovic, Design Engineer, Belgrade, Yugoslavia.

VOTE FOR 426

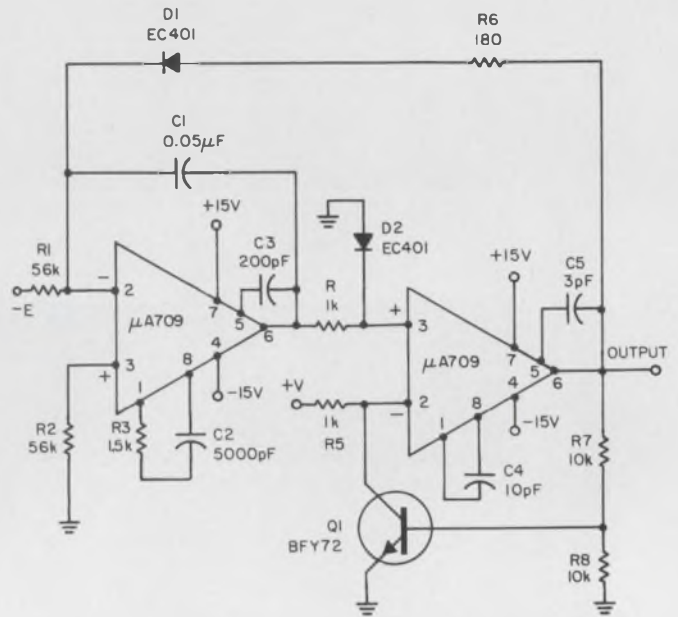

2. Two monolithic operational amplifiers are used in a practical version of the converter.

Circuit detects zero crossings of full-wave rectified ac

Zero crossings of a full-wave rectified signal can be accurately detected with this circuit (see Fig. a).

Q1 is a reverse-biased npn transistor with an emitter that is connected to a higher potential than its collector. With the positive output of the diode bridge driving its base, Q1 delivers a pulse

to point B for each half cycle of the ac signal. As shown in Fig. b, each pulse at B is an inverted replica of the full-wave rectified ac signal a few degrees on either side of the crossover point for each half cycle.

The output of Q1 is fed into a two-stage amplifier for amplification and shaping. The amplitude

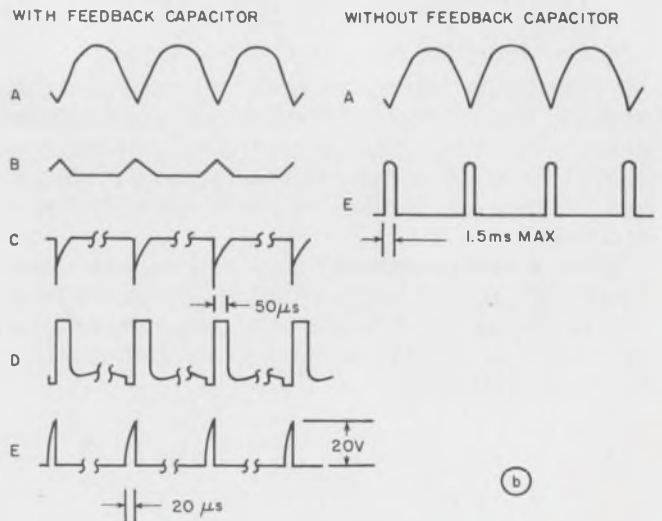
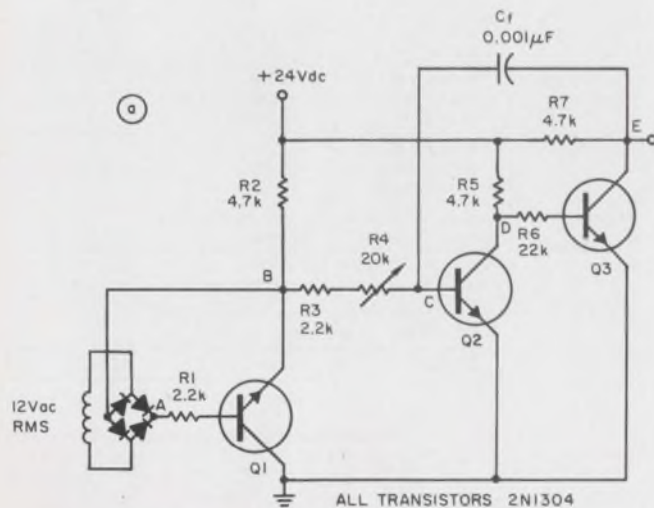

Each zero crossing of the rectified ac produces a narrow output pulse at point E.



gotta hand it to ya!

But that's no compliment if you're still spending time and money to develop and build your own DC servo amplifiers. Don't duplicate Inland Controls' years of amplifier design and manufacturing experience which has produced this new MA series.

The MIL-SPEC MA amplifiers are designed to meet MIL-E-5400 including MIL-STD-704. They relieve you of design and development headaches and solve your component reliability problem, yet are priced to be below the cost of building your own. And we provide off-the-shelf delivery. The MA-1 is only 3" x 2" x 0.4" but can be configured to produce a massive 300 watts or more. The MA-1 offers unique packaging flexibility while the MA-2

MODEL	MAX. POWER RATING	PRICE (100 LOT)	DELIVERY
MA-1	25 Watts <i>(See Note)</i>	\$ 125.	In Stock
MA-2	200 Watts	\$175.	In Stock
MA-3	300 Watts	\$250.	In Stock

NOTE: The MA-1 output is configured to drive an external NPN bridge to an output of 300 watts or more.

and MA-3 give real packaging convenience. Flexibility or convenience — it's your decision.

The MA series amplifiers are ideally suited for driving DC torque motors. Designed with this in mind, they eliminate amplifier-motor interface problems frequently associated with "build your own" amplifiers.

If you want to draw upon our amplifier savvy, then turn the problem over to us. We'll be glad to help, with no obligation on your part.



**INLAND
CONTROLS**

A DIVISION OF
KOLLMORGEN

342 WESTERN AVENUE
BOSTON, MASSACHUSETTS 02135

Telephone: 617 254-0442
TWX: 710 330-0143

and width of the output pulse at point *E* is adjusted by resistor R_1 , if capacitive feedback is not used.

If feedback capacitor C_f is installed between points *C* and *E*, R_1 adjusts the number of pulses that occur at point *E*. When R_1 is adjusted so that the circuit delivers only one output pulse at

crossover, very slight additional adjustment will cause either the leading or the trailing edge of the 20 μ s output pulse to coincide with each crossover point.

Jack H. Still, President, Stilco, Inc., Laurens, S.C.

VOTE FOR 427

Standard TTLs yield one-shot that is variable two ways

Two standard TTL packages and five discrete components can be used to build a one-shot pulse generator having variable pulse width and variable delay. The circuit is shown in (a), together with a typical TTL gate structure.

In operation, a positive timing pulse applied to input *A* allows capacitor C_1 , on input *B*, to charge through the 4-k Ω base resistor of the gate. R_1 is used to control the charge rate. When the logic circuit threshold is reached (approximately 2 V), output *C* goes from +4.8 V to 0.3 V. This negative-going pulse is applied to C_2 , discharging it for a period of time determined by the values of C_2 , R_2 , R_3 and the base resistor of the second gate. Output *E* will go positive during the time that the input to the second gate, *D*, is below the threshold level.

The circuit values shown will yield a variable delay of 100 to 200 ns and an output pulse width of 10 to 150 ns. Circuit waveforms are shown in (b).

Edwin P. Fisher, Design Engineer, Honeywell EDP, Waltham, Mass.

VOTE FOR 428

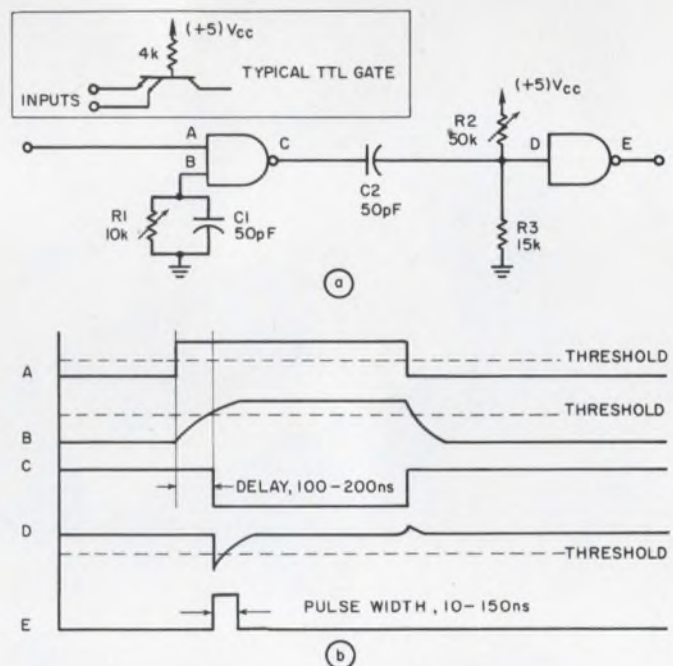

Variable one-shot (a) has a delay that is controlled by R_1 , and an output pulse width determined by C_2 , R_2 , R_3 and the base resistance of the second gate. Circuit waveforms are shown in (b).

Simple technique measures op amp input impedance

Measuring the input impedance of an operational amplifier can be troublesome. The most common technique is the bridge method, in which the amplifier is measured in an open-loop configuration. But this is extremely cumbersome. External biasing is required to maintain dc stability, and the circuit must be well-shielded to prevent limit cycling at a 60-Hz rate. Other common methods are usually limited by the input impedance or sensitivity of the test equipment.

A simple circuit that overcomes these problems is shown in the illustration. Driving the output of the amplifier under test (AUT) for maximum undistorted output swing, the signal at the summing point is

$$\epsilon = e_o / -A_o = \epsilon' Z_{in} / (Z_{in} + R_3),$$

where A_o is the open loop gain and Z_{in} is the input impedance of the AUT. If we assume that the two instrumentation amplifiers have identical closed-loop gains and that the measurement is

IMMEDIATELY AVAILABLE!

12.5V

RF KITS

from **Soliton**

Soliton's silicon RF power kits are now available in power ranges from 12 to 40 Watts in TO-5, TO-60 and plastic stripline cases. These kits are designed to operate on 12.5V mobile supply at a frequency of 175 MHz. They are directly interchangeable with popular interdigitated structure devices currently in use.

175 MHz - 12.5 VOLT SUPPLY

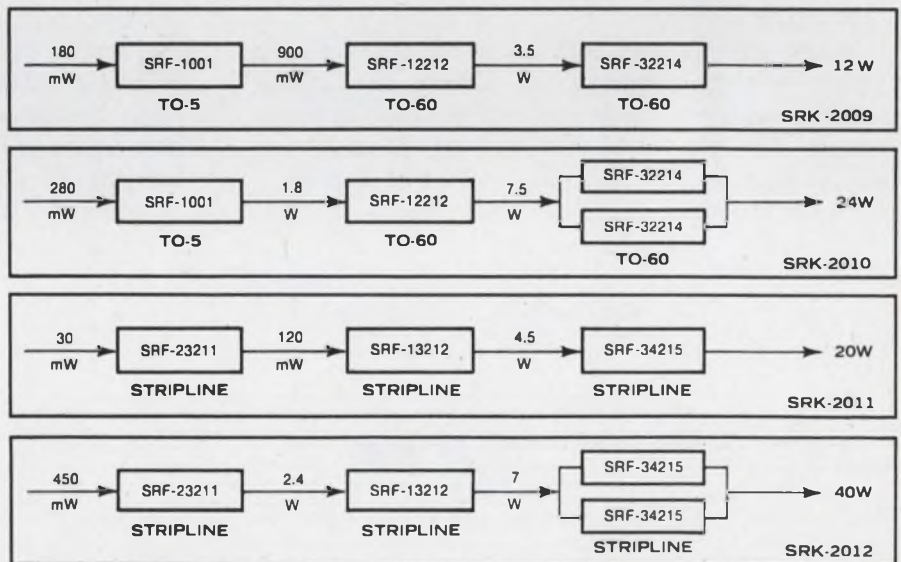

Also immediately available from Soliton are the 2N3375, 2N3632, 2N3733, 2N4040, 2N4041, 2N4440, 2N5090 and 2N5108. Other discrete RF transistors are available in varying package configurations for operation at frequencies up to 1 GHz. Contact us today for complete information.

Dial 1-800-327-3243 for a "No Charge" telephone call and further information

Soliton DEVICES, INC.

1177 BLUE HERON BLVD. / RIVIERA BEACH, FLORIDA / (305) 848-4311 / TWX: (510) 952-6676

INFORMATION RETRIEVAL NUMBER 143

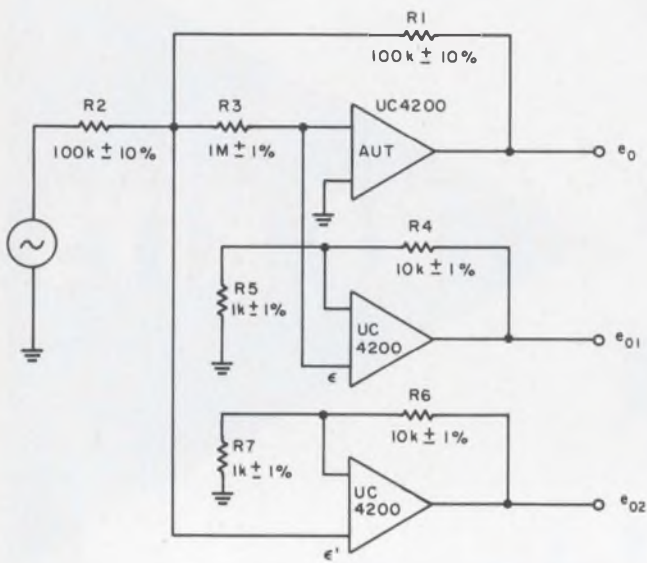

Input impedance of the amplifier under test (AUT) is a function only of resistance R_3 and the output voltages e_{01} and e_{02} .

carried out at a frequency at which the amplifiers have several dB of loop gain, then

$$Z_{in} = R_3 / [(e_{02}/e_{01}) - 1]$$

The circuit shown was used at a frequency of 1 kHz. To go to lower frequencies, the gain of the instrumentation amplifiers should be increased, while still maintaining 20-40 dB of loop gain to insure a higher input impedance than the AUT. It may be desirable to use a wave analyzer at the lower frequencies, where the input impedance is purely resistive, since the signal-to-noise ratio is rather low. At higher frequencies both the phase and amplitude of the instrumentation amplifiers can be adjusted for identical response at the frequency of interest. This can be done through use of a slightly different feedback network.

Gene Haviland, Design Engineer, Union Carbide Corp., Mountain View, Calif.

VOTE FOR 429

Ball-point pen converts to vacuum pencil for IC handling

A ball-point pen converted into a vacuum pencil makes a handy tool for picking up and handling integrated circuit chips and thin-film substrates.

Start with a ball-point pen of the common plastic variety. Remove the plastic cap at the end, and pull out the ink cartridge. The cartridge usually has an outer diameter of about 3 mm and a very small inner diameter. Cut a piece 7 cm long from the cartridge and remove the ink.

Carefully drill a 3-mm hole through the plastic cap, as shown in the illustration, and insert the 7-cm piece of cartridge through it.

Next, drill a 3-mm hole through the body of the pen, 3 to 4 cm from the tip. Obtain a piece of brass tubing 15-20 cm long, and having an outer diameter as large as the diameter of the hole in the tip of the pen and an inner diameter less than 1 mm. Insert the tubing into the pen through the tip, as shown.

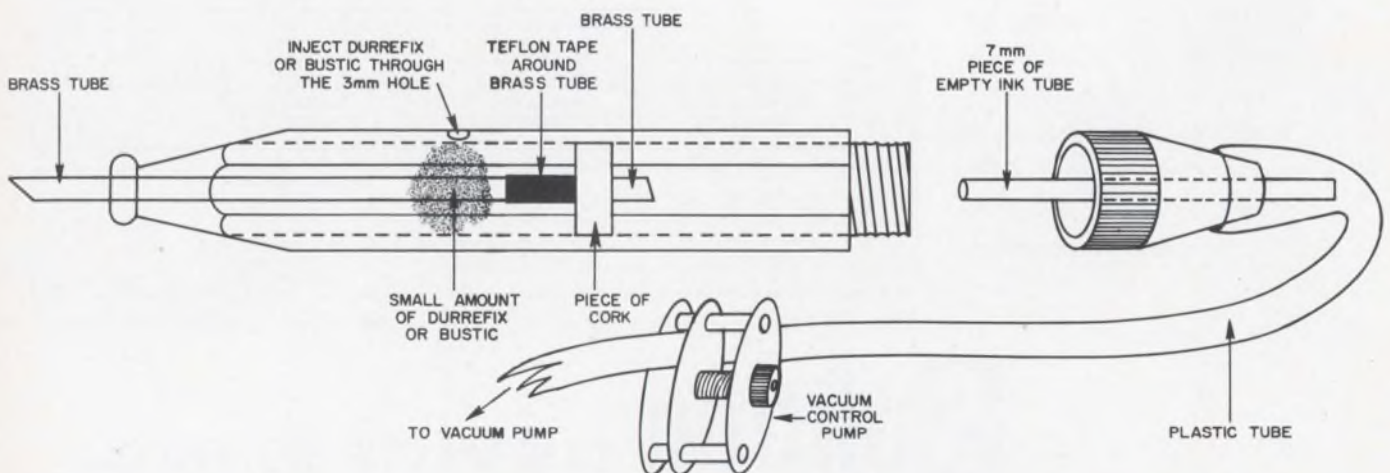

Common ball-point pen can be converted into a vacuum pencil by following the steps illustrated.



That's right. It's a commercial connector. Our Molex Standard. Millions are finding their way into some of the most exciting circuitry man can imagine. For that's our business: creating connectors that simplify wiring. Speed production. Assembly. Installation. Servicing.

For the men who are looking for new ideas and ways to cut costs.

In the area of one circuit to sixty connections or more, Molex has the product. And the design and engineering capabilities to solve the most complex wiring and production problems . . . fast! We'd like to talk to you about it.

If you would like a free sample of our Molex connector, please write or phone (312) 969-4550. You can make connections at . . .



Cut a piece of cork so that it can just fit into the plastic body of the pen. Then insert the brass tube through the cork and wrap a small piece of teflon tape around the brass tube directly in front of the cork. Insert the free end of the brass tube through the pen from the rear, and push the cork piece through the plastic body by means of a thick wire or a piece of wood. Be careful that the cork does not slip off of the brass tube.

Push the cork down into the pen until it is just in back of the 3-mm hole. Then insert the tip of a tube of glue, such as Durrefix or Bustic, into the 3-mm hole and inject a small amount of glue. Quickly push the cork toward the front of the pen until it is about 1/2 cm in front of the 3-mm hole. Next, clean away any glue that is clogging the 3-mm hole. The end result is that the glue accumulates at the tip end of the pen

to make it vacuum tight, while the 3-mm hole is open. The brass tube can be cut and shaped, as required, so that when holding the pen the end of the brass tube will be perpendicular to a flat IC chip.

To use the finished device, screw the cap on, and connect the pen to a vacuum pump by means of a plastic tube. A screw clamp should be used to adjust the vacuum, so that when a finger is placed on the 3-mm hole the sucking action at the tip of the brass tube is not excessive. The pen is then used by covering the 3-mm hole with a finger to pick up objects, and uncovering the hole to release the objects. By adjusting the screw clamp, various weights can be lifted.

T. K. Tawfiq, Design Engineer, Smakkegardsvvej 1P, 2820 Gentofte, Denmark. VOTE FOR 430

Circuit checks heaters for shorts while protecting fuses

In the manufacture of a unit containing a heater, it was found necessary to run the heater on each unit for about one hour to check heater operation. Because of the way they were assembled, the heaters would frequently short out when first heated up. After one hour of continuous operation, they usually performed satisfactorily.

The circuit shown is designed to drive the heater during the test. With it, the shorted heaters do not blow fuses; instead a light is turned on to indicate a short. The circuit can be used for other similar applications, through the use of suitable component values.

Operation of the circuit is as follows: As the voltage increases each half cycle, a current flows through the "short indicator" and heater. If the heater is not shorted, a voltage of about 0.8 V is developed across the heater by the time the applied voltage reaches 30 V. Since the triac gate is referenced to ground, this 0.8 V is applied to the gate and fires the triac. Almost full power is then furnished to the heater.

If the heater is shorted, no firing voltage is produced and only the "short indicator" draws current, thus indicating a short without blowing a fuse. The 2 Ω resistor is a surge protector, in case the heater shorts at the peak of the input wave. In this case, the triac turns OFF at the end

of that half cycle and, in following half cycles, no longer receives firing voltage. The gate lamp is an indicator that shows power is being applied to the circuit.

A. G. Richardson, Supervisor, Automated Specialties, Charlottesville, Va. VOTE FOR 431

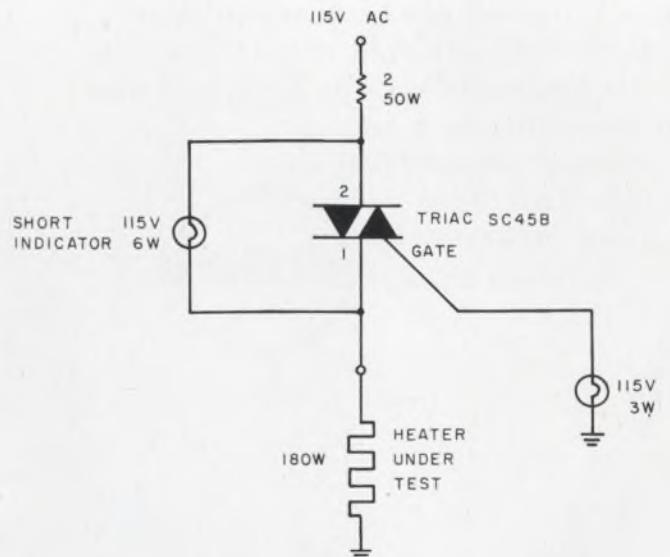

Triac is turned ON by voltage drop across the heater. Should the heater short, the triac receives no gate voltage and the "short indicator" glows.

Tear out this page.



This Dialight demonstrator unit (shown actual size) is available for your personal evaluation.

*Place it next to any readout
you're now considering.
Then walk back 30 feet and
prove to yourself that low-cost
Dialight readouts are easier to read.*

The only way to be sure is to compare Dialight readouts with others. This little test will give you a rough idea of the difference. But it's not quite as convincing as the actual demonstration we'll be happy to provide you with on request.

Dialight readout modules cost as little as \$3.99 each (less lamps in 1000 lot quantities). They operate on 6, 10, 14-16, 24-28 volts AC-DC, 150-160 volts DC and 110-125 volts AC. Caption modules are available; each is capable of displaying up to six messages at one time.

Windows are of non-glare type in a choice of colors.

Options: universal BCD to 7-line translator driver, 10-line to 7-line converter for decimal input, RFI-EMI suppression screen. Custom translators available.

To arrange to borrow a Dialight demonstrator unit, write us on your company letterhead.

For copy of our current catalog, circle reader service number below. Dialight Corporation, 60 Stewart Ave., Brooklyn, N.Y. 11237. (212) 497-7600.



DIALIGHT

Circuit provides protection for shunt-type voltage regulator

An active current source is often used with a shunt regulator when better regulation against line voltage changes and better ripple rejection is required. Such an arrangement, though, must be protected against accidental shorting to ground.

For example, consider the circuit of (a), in which the shunt element can be a simple zener diode or a more complex circuit with a reference source and an error amplifier. The current source, Q1, delivers about 100 mA. During normal operation, Q1 dissipates

$$P_c = (30 \text{ V} - 4.3 \text{ V} - 20 \text{ V}) \times 0.1 \text{ A} = 0.57 \text{ W}$$

Should the output be accidentally shorted to ground,

$$P_c = (30 - 4.3) \times 0.1 = 2.57 \text{ W}$$

For safe operation, therefore, Q1 must be rated for this latter figure and an appropriate heat sink provided.

A better alternative, as shown in (b), uses the same circuit, except that a saturated transistor, Q2, turns on the base of Q1. Now, if the output is grounded, CR1 clamps the anode of CR2 one diode-drop above ground, and Q2 turns off, also turning off Q1. Here, Q1 need be rated for only

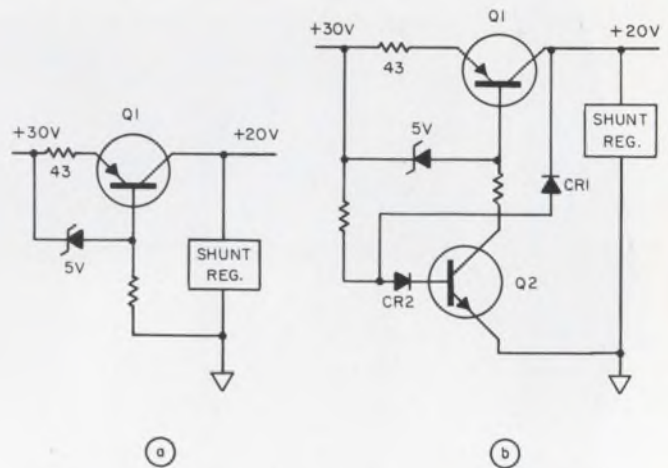

Shunt regulator with active current source (a) is susceptible to accidental shorting to ground. Addition of transistor Q2 (b) provides the required protection without the need for a heat sink and high-wattage current source.

0.57 W and no heat sink is required.

George Corbeil, Design Engineer, Information Control Corp., El Segundo, Calif. VOTE FOR 432

Peak-sensing circuit measures a-m modulation directly

Direct-indicating metering circuits for measuring the depth of amplitude modulation in the output waveform of amplitude-modulated rf signal generators must cover a very wide range of modulating and carrier frequencies. The circuits used in commercially-available instruments usually employ one of the following principles:

- Measurement of the increase in output power with modulation.
- Measurement of the level of the modulating signal.

Each method has inherent advantages and disadvantages.

A somewhat different technique, to be described here, uses a peak-sensing electronic voltmeter circuit that incorporates a zener stabilized voltage supply for obtaining a back-bias that is proportional to a standard carrier level. This type of circuit has the inherent advantage of proper expansion of the modulation metering

scale, as well as higher accuracy of both carrier and modulation-depth-level readings. It can also be adapted easily for different frequency ranges by making suitable changes in component values.

In the circuit, the modulated rf is fed to the input diode, D1, and the rectified and filtered output at point A is compared with the reference level at point B. The level at B, which is stabilized by zener diode Z6, can be chosen arbitrarily to correspond to 1 V or 2 V of carrier level, as required in the actual signal generator. In the circuit shown, resistors R5 and R6 set the level at B to approximately 1.41 V, which corresponds to the peak value of a carrier level of 1 V.

With a 1-V carrier level as reference, therefore, the increase in output level of meter M, that corresponds to a value "m" of the degree of modulation, is proportional to $m\sqrt{2}$ volts. Hence the increase in output voltage is directly proportional to the modulation depth.

Let us throw you a curve

If you've problems with LC circuits, Magnetics' new Iso-Q contour curves speed ferrite pot core selection.

No more squinting at tangles of curves on log paper to find the ferrite pot core size you need. Magnetics' new Iso-Q contour curves let you zero in on your target size in seconds. We've plotted over 100 of these time-savers to handle more than 90% of normal design

requirements. They're all contained in our new Ferrite Cores Catalog, first of its kind in the industry.

Magnetics' high purity ferrites cover frequencies up to 2 megahertz. Linear temperature coefficients on 750, 1400 and 2000 permeability materials are guaranteed from -30° to $+70^{\circ}\text{C}$. Flat temperature coefficient on 2300 perm material is guaranteed from $+20^{\circ}$ to $+70^{\circ}\text{C}$.

Magnetics' wide selection of ferrites comprises eight international standard sizes and five additional sizes—175 part numbers for design freedom. We can give you quick

delivery from our large inventory that includes both gapped and ungapped cores in your most asked-for sizes. Of course, we provide one-piece clamping hardware for most sizes. Finally, we offer you a complete choice of tuning assemblies, bobbins and shapes—toroid, E, U and I.



Get your set of our new Iso-Q Curves. You'll like their curvilinearity. Magnetics Inc., Butler, Pa. 16001



Tape, Powder, Bobbin, Ferrite Cores • Laminations • Photo-etched Parts • Specialty Metals • Engineered Control Systems

INFORMATION RETRIEVAL NUMBER 146

The unit can also be used as a separate modulation-depth measuring unit, which can be operated on a small ac supply (6 or 8 V) obtained from the ac line through a suitable stepdown transformer.

Detecting-diode $D1$ must have a low forward resistance; hence a gold bonded diode like the 0A5 (or any good detector diode) is preferred. The filter, formed by the combination of R_3 , R_4 , R_5 , R_M and C_1 , must be such that the modulation envelope corresponding to the lowest frequency of modulation can be properly detected. Thus the charging time constant for the input circuit is approximately

$$t = C_1 \times [(R_1 + R_M + R_5) || R_3]$$

Since R_3 can be chosen to be very large, and R_5 is small compared to R_4 , the time constant can be simplified to $C_1 (R_1 + R_M)$. This should be roughly one hundred times larger than the period of the smallest modulating frequency.

Since the meter is connected in a comparison circuit, the over-all accuracy and sensitivity of the unit is dependent on the meter sensitivity. Hence, a meter with a fairly high sensitivity—one that also has the inherent advantage of avoiding circuit loading—should be used. In the circuit shown, the meter has a resistance of 1540 Ω . Any suitable meter can be used, provided that the series resistance is adjusted accordingly.

The complete metering circuit shown in the illustration was designed for use in a standard rf signal generator having a carrier frequency range of 30 kHz to 30 MHz and a modulating frequency range of 50 Hz to 10 kHz. Since the back-biasing level for the unit is set at approximately 1.41 V dc under actual working conditions, the “zero” of the modulation-depth-indicating meter corresponds to 1 V rms input of the carrier level.

Initially, the carrier level is adjusted to a value of 1 V rms, which is the “zero” read-

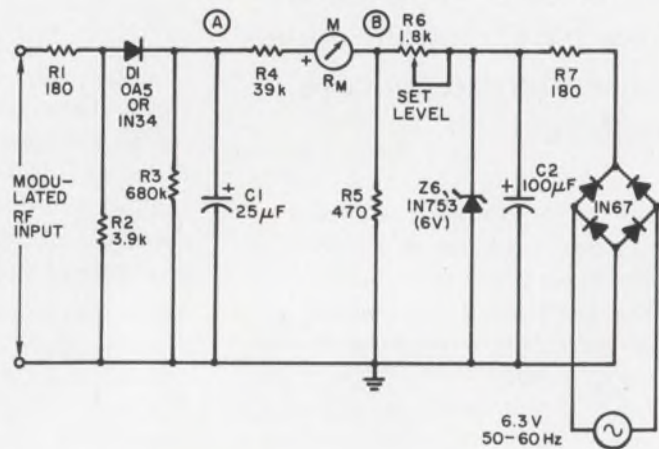

Peak sensing circuit measures rf carrier and modulation-depth level.

ing on the indicating meter (equivalent to the set-carrier level). Further increments in the readings of the meter then correspond to various values of percentage depth, so that the meter can be marked directly in values of percentage depth. The over-all accuracy of depth-indication for distortionless modulation is on the order of $\pm 5\%$ depth over the entire carrier and modulation frequency ranges. The “zero” indication of the meter, which serves as an indicator of standard 1-V carrier level, has an over-all accuracy of better than $\pm 5\%$ over the entire frequency coverage.

Acknowledgment:

The authors wish to express their sincere thanks to Dr. Amarjit Singh, Director, Central Electronics Engineering Research Institute, Pilani, India, for his encouragement and help in this project and also for his kind permission to publish this work.

S. K. Mendiratta, S. P. Mahendroo, and G. N. Acharya, Design Engineers, Central Electronics Engineering Research Institute, Pilani (Rajasthan), India

VOTE FOR 433

Efficient current regulator uses IC differential amplifier

The LM171/911CE rf/i-f amplifier is a general-purpose differential amplifier. But, by using its internal current-source transistor at minimum V_{ce} , the unit can be converted to a minimum voltage-drop current regulator that can handle higher supply potentials than the basic device itself.

In the circuit, $Q1$ and $Q2$ are monolithically matched devices; thus their transconductances are very nearly equal. If a constant current, I_1 , is forced through the diode-connected $Q1$, parallel-connected $Q2$ conducts an identical current, I_2 . Since $Q2$ still exhibits transistor action at zero V_{cb} , the minimum voltage at the base of $Q3$ or



How to
CHARGE-
CONTROL
A PULSE
-AND FAST.

New, from Microwave Associates (West) – a P²S picosecond pulse diode characterized for speed. The MA-4B200 is the first of a series which, by using advanced techniques of surface passivation and junction profile control, offer unmatched switching speed, and guaranteed pulse performance over wide temperature ranges. For variable pulse delays, pulse sharpening, impulse generation, very wide band pulse counting discrimination and amplification. Compatible with TTL circuits.

Model Number	Minimum Breakdown Voltage (V)	Total Capacitance	Turn Off Time
MA-4B200	70	3 pF min. 5 pF max.	300 ps. max.

Write or call Microwave Associates (West), 999 East Arques Avenue, Sunnyvale, California (408) 736-9330

P²S Diodes for pulse conversion, MA – West Style



MICROWAVE ASSOCIATES

Burlington, Massachusetts

Subsidiaries: Microwave Associates (West) Inc., Sunnyvale, Cal.

Microwave Associates, Ltd., Luton, Beds, England.

Q4 is two diode drops above the common negative supply line.

A precision divider establishes a reference voltage at the base of Q3 by dividing the regulated -12-V supply voltage. Load current passes through the sensing resistor at the base of Q4, and develops an identical comparison voltage to maintain closed-loop regulation.

The flexibility of the circuit can be extended to accommodate a much higher voltage compliance than the breakdown voltage of the IC by adding grounded-base element Q5. Since the requirements of Q5 are minimal (V_{cbo} mode and very low β required), it can be a 10-cent plastic type, and adds negligible cost in comparison to its function.

Power stage Q6 handles the load current; if more power is required, it can be cascaded with another power stage.

The circuit has the potential of being very efficient, since the sensing voltage is essentially two diode drops. In addition, Q6 can operate all the way to saturation before regulation is lost.

Walter G. Jung, Engineer, MTI, Div. of KMS Industries, Inc., Cockeysville, Md.

VOTE FOR 434

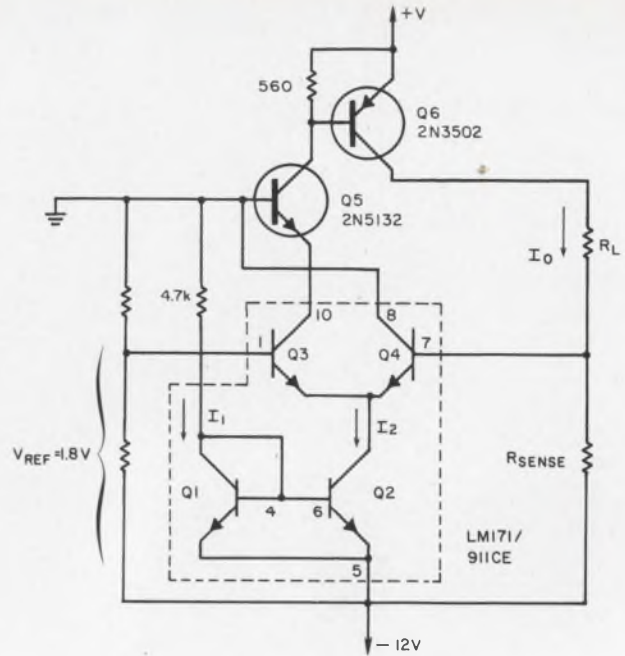

$$R_{L\text{MAX}} = \frac{+V + |-V| - (V_{CE\text{SAT}} Q6 + 1.8V)}{I_O}$$

$$R_{L\text{MIN}} = \text{DETERMINED BY } \phi_{J-A} \text{ OF } Q6$$

$$R_{\text{SENSE}} = \frac{V_{\text{REF}}}{I_O} = \frac{1.8}{I_O}$$

Differential amplifier forms the heart of this current regulator, which can handle higher supply potentials than the basic IC itself.

Get wide-range or VCO capability from the basic astable multi

The emitter-coupled astable multivibrator is not only an inexpensive circuit; it is an extremely versatile one as well. Two uses that it can easily be adapted for are a voltage-controlled oscillator (VCO), and, by the addition of a few components, a wide-range oscillator.

In the basic emitter-coupled astable circuit (Fig. 1), the following approximations are valid, assuming that Q1 saturates when it is ON and that neither of the two base-emitter junctions reach the breakdown voltage at cut-off:

$$T_1 = T_2 = T/2 \quad (1)$$

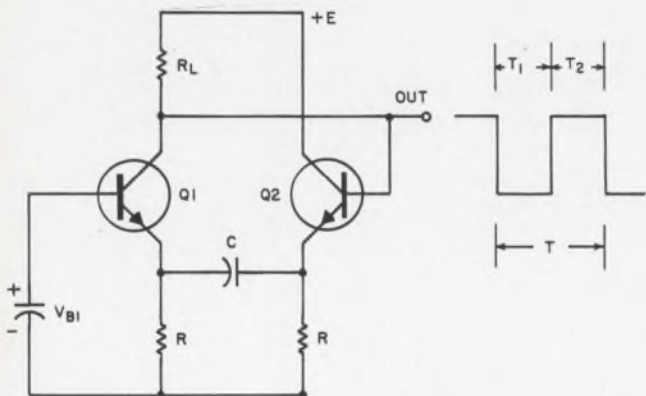

1. Basic emitter-coupled astable multivibrator circuit produces a symmetrical (50% duty cycle) square-wave output at the collector of Q1.

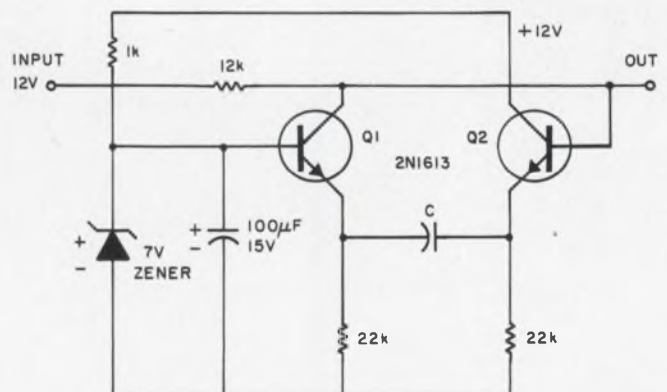

2. Wide frequency range is possible with this astable configuration by changing the value of capacitor C. Frequency coverage can exceed 7 decades.

How our Variplate™ connecting system keeps your fifty-cent IC's from becoming four-dollar headaches.

IC's don't cost much. Until you use them. You can buy, say 20,000 IC's for the innards of a compact computer, packed in the transistor cans, flat packs, or Dual-in-Line (DIP) packages, for a unit cost of less than fifty cents.

Great.

But then you have to connect them.

Not so great.

Because those 20,000 IC's have anywhere from 200,000 to 280,000 leads waiting to be connected. Fine leads. Closely spaced. And, of course, you want to pack the IC's as densely as possible. So it's really no surprise that your *in-place* cost of an IC can climb to \$4.00.

Fortunately, we have a system that can keep your in-place cost down: the Variplate interconnection system.

With the Variplate system, you can pack those IC's—and all the pc boards and other components you have—as densely as the application demands. You can do it on automated equipment—and we'll even do the wiring for you.

All the components you need.

The system begins with the base plate, a self-supporting structural member. It carries the insulated contact modules, accommodates secondary components and hardware, and provides for mounting to support framework.

The plate can be a single metal sheet that provides a ground plane, or it can be a sandwich that provides both volt-

age and ground planes for common bussing.

For the next layer in your electronic sandwich, we have all the header plates, card-edge receptacles and guides, and bushings you're likely to require. (For unlikely requirements, we'll come up with something new.)

And the connectors. Of course. Our own respected Varimate™, Varicon™, and Varilok™ connectors, or standard fork-and-blade, terminal stud, card-edge, or bus strip contacts. Your choice.

No holes barred.

We put all these components together in any size, any shape, and almost any density of package you require. Plates can be any size. Contacts can be spaced on .100", .125", .150", or .200" centers, in square or offset grids—on non-standard configurations where you need them.

What you get is a solid electrical and mechanical foundation for your electronic network, so precisely made that any automated assembly equipment can take over from there.

However.

You'll save time and money if you let us go one step further and wire your network for you. Our

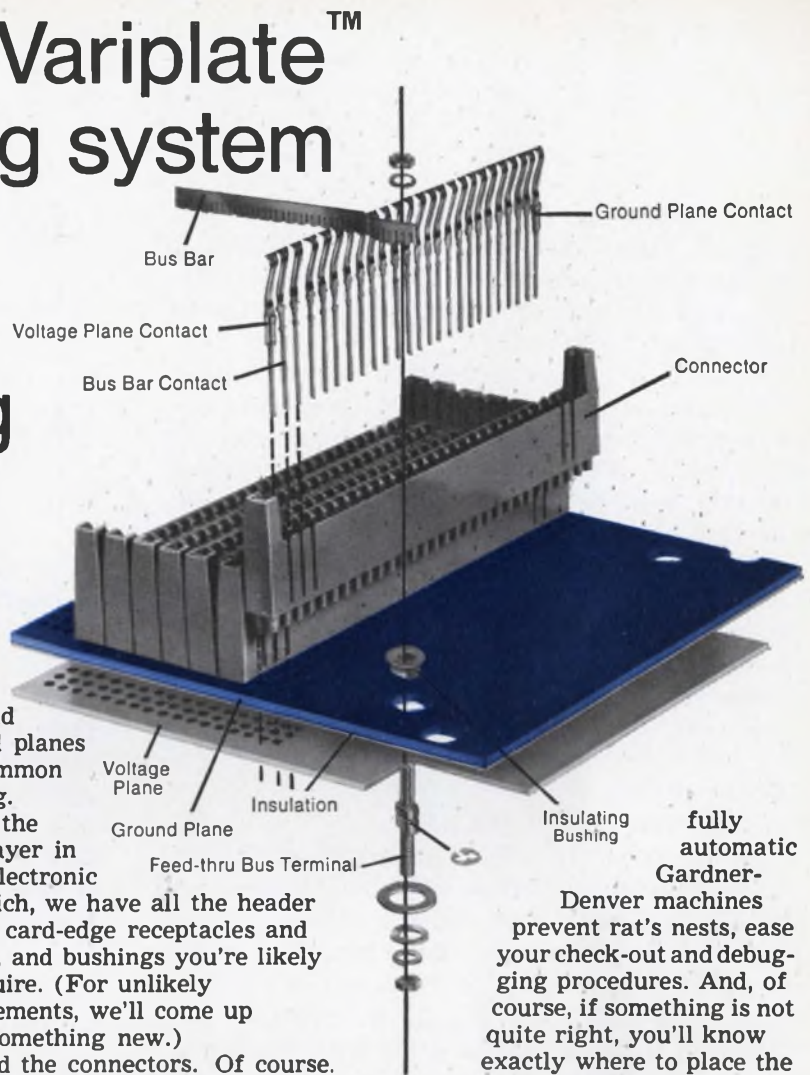

fully automatic Gardner-
Denver machines prevent rat's nests, ease your check-out and debugging procedures. And, of course, if something is not quite right, you'll know exactly where to place the responsibility.

Altogether, it's quite a system. And worth all the work we've put into it. Because if we can save you just a nickel on the cost of installing each of your 20,000 IC's you can add a thousand dollars to

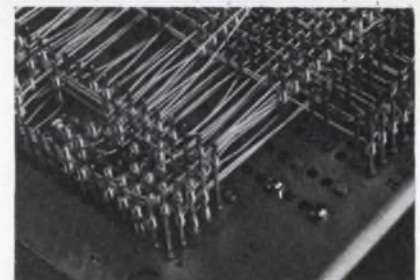

your company's profits.

We're sure we can save you that nickel, and more. For more information, write, wire, call, or TWX us for our Variplate interconnecting systems catalog. Elco Corporation, 155 Commerce Drive, Fort Washington, Pa. 19034. 215-646-7420; TWX 510-661-0



ELCO Variplate
Connectors

$$T = 2RC \log_e [V / (V_{B1} - V_{BE})] , \quad (2)$$

where T_1 and T_2 are the intervals of conduction for $Q1$ and $Q2$, respectively, V is the collector voltage of $Q1$ in the OFF-state, and V_{BE} is the $Q1$ base-emitter forward bias.

Figure 2 is a practical realization of a square-wave, wide-range generator. The frequency can be changed over a wide range by replacement of capacitor C . The upper frequency limit, about 100 kHz, is achieved with a value of C near 350 pF. The lower bound is fixed only by the maximum allowable physical dimensions of the capacitors. For example, a 4000- μ F value for C will produce a period of about 100 s (1/100 Hz); therefore the frequency band covered will exceed 7 decades.

For any value of C , the circuit frequency is $f = 40.5 \cdot 10^6 (1/C) \text{ Hz}$ (C in pF), and the period is

$$T = 24.6 C \text{ ms} \quad (C \text{ in } \mu\text{F}) .$$

The square-wave output amplitude of the circuit is always constant at 5 V. Both transistors, though, must have a breakdown voltage, V_{EB} , of more than 6 V. If an electrolytic capacitor is used for C , its polarity must be as shown in Fig. 2.

As is evident from Eq. 2, the multivibrator frequency is supply-voltage dependent, which sug-

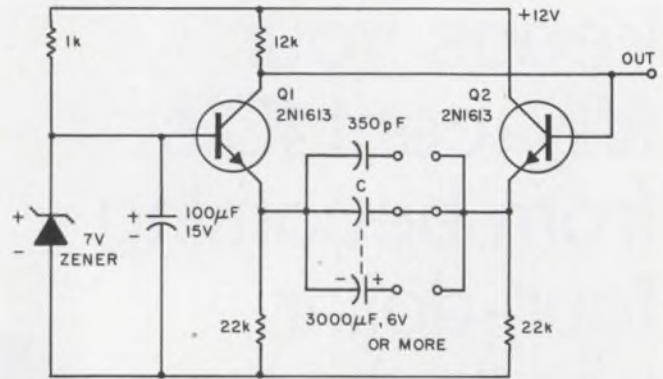

3. Input voltage changes produce output frequency changes in this VCO version of an astable multivibrator.

gests its use for a VCO. This application is satisfied by the configuration of Fig. 3, where an increase in the input voltage above 12 V results in a square-wave frequency shift at the output. The modulation sensitivity, Δ (in Hz/V), is obtained as the derivative of the expression for frequency, f , deduced from Eq. 2, where $f = 1/T$. It is

$$\Delta = -6.15 \cdot 10^6 (1/C) \text{ Hz/V} \quad (C \text{ in pF}) .$$

Sergio Zangrillo, Design Engineer, Milan, Italy.

VOTE FOR 435

ICs provide variable delay for digital waveforms

Variable, fractional-bit delay times for digital waveforms can be obtained by using "bogus" one-shots made up of IC NAND-gates. As shown in Fig. 1, the J-K master-slave flip-flop

VOTE

VOTE! Go through all Idea-for-Design entries, select the best, and circle the appropriate number on the Reader-Service-Card.

SEND US YOUR IDEAS FOR DESIGN. You may win a grand total of \$1050 (cash)! Here's how. Submit your IFD describing a new or important circuit or design technique, the clever use of a new component or test equipment, packaging tips, cost-saving ideas to our Ideas-for-Design editor. You will receive \$20 for each accepted idea, \$30 more if it is voted best-of-issue by our readers. The best-of-issue winners become eligible for the Idea Of the Year award of \$1000.

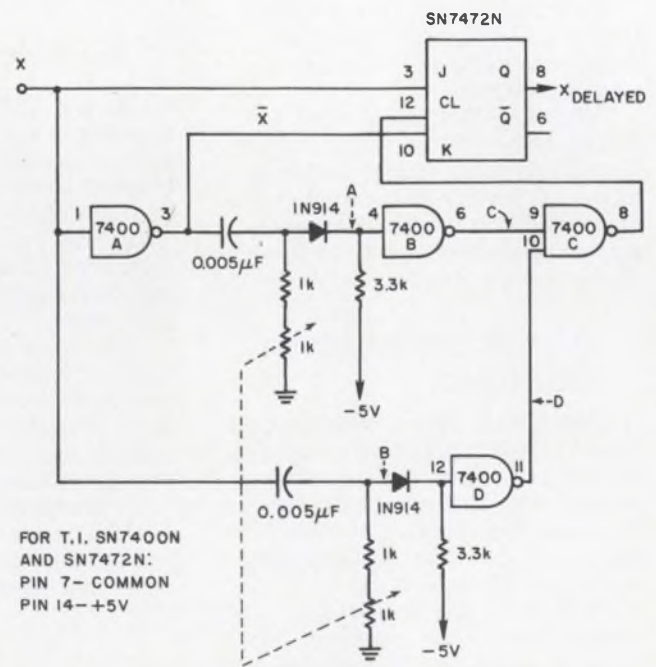

1. Circuit functions as delay line for digital signals.

For Capacitors with **GREATER RELIABILITY ...**

Choose

EL-Menco

The Capacitors You Find Wherever There's Electronics!

EL-MENCO DUR-MICA CAPACITORS

Only 1 Failure Per 43,000,000 Unit-Hours!

- It has been computed that "debugged" DM30, 10,000 MMF units, when subjected to 257,000 hours of life at 85°C with 100% of the rated DC voltage applied, will yield only 1 FAILURE PER 43,000,000 UNIT-HOURS!
- DM15, DM16, DM19, DM20 . . . perfect for miniaturization and for new designs using printed wiring circuits. Also available in DM30, DM42 and DM43.
- New "hairpin" parallel leads insure easy application.
- Exceed all electrical requirements of military specification MIL-C-5A.

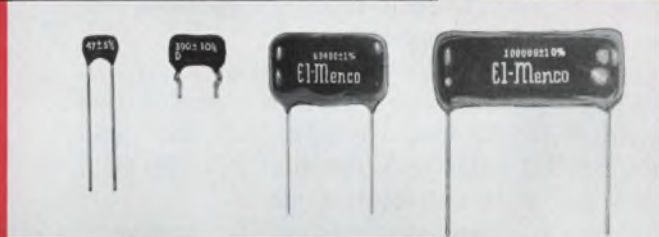

EL-MENCO TRIMMERS & PADDERS

Design Versatility!

- Available in 350 VDC and 500 VDC as well as other test voltages.
- All bases are of low-loss steatite.
- Special lugs are obtainable for printed circuitry.
- Miniature units are available.
- Solder Lugs can be bent in any position without affecting the capacity setting due to the rigid construction.
- Various types of mounting brackets are available for all trimmers.
- Units can be constructed for special applications.

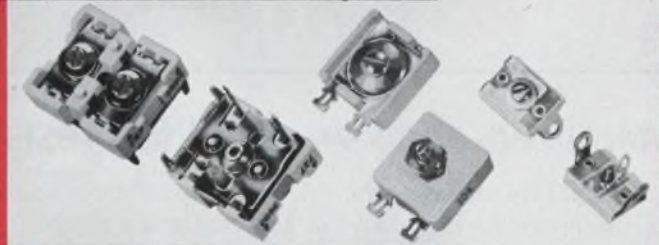

EL-MENCO *MYLAR-PAPER DIPPED CAPACITORS

Only 1 Failure in 7,168,000 Unit-Hours!

- Life tests at 100°C with rated voltage applied have yielding only 1 FAILURE PER 716,800 UNIT-HOURS for 1 MFD. Since the number of unit-hours of these capacitors is inversely proportional to the capacitance, 0.1 MFD Mylar-Paper Dipped capacitors will yield only 1 FAILURE PER 7,168,000 UNIT-HOURS!
- Working volts DC: 200, 400, 600, 1000 and 1600.
- Durez phenolic resin impregnated.
- Tolerances: ± 10% and ± 20% (closer tolerances available).
- Dielectric strength: 2 or 2½ times rated voltage, depending upon working voltage.
- Exceed all electrical requirements of E.I.A. specification RS-164 and military specifications MIL-C-91A and MIL-C-25A.

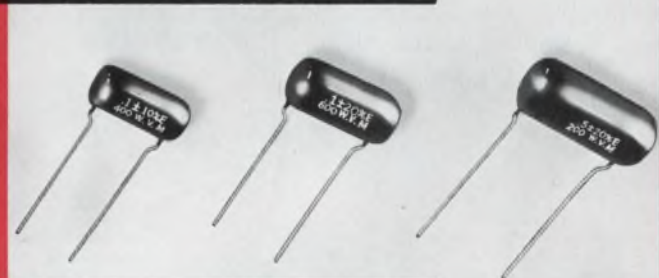

EL-MENCO MOLDED MICA CAPACITORS

Superior Performance!

- Unmatched for excellent stability, dielectric strength, high insulation resistance, extremely high "Q" and correspondingly low power factor.
- Units can be subjected to a short "debugging" life test at elevated voltage and temperature for removal of early life failures and for improved reliability.

Write for Free Samples and Booklets on Any of The Above Capacitors

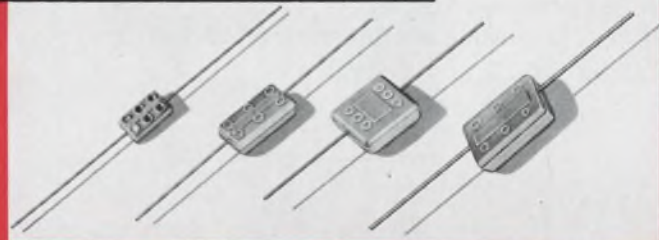

THE ELECTRO MOTIVE MFG. CO., INC.

WILLIMANTIC, CONNECTICUT 06226

Dipped Mica • Molded Mica • Silvered Mica Films • Mica Trimmers & Padders
Mylar-Paper Dipped • Paper Dipped • Mylar Dipped • Tubular Paper

West Coast Manufacturers contact: COLLINS & HYDE CO., 900 N. San Antonio Rd., Los Altos, California 94022
5380 Whittier Blvd., Los Angeles, California 90022

ALSO SOLD NATIONALLY THROUGH ELECTRONIC PARTS DISTRIBUTORS

changes state on the falling edge of the clock waveform. The delay is controlled by varying the circuit RC time constants with the ganged potentiometers, and making use of the input thresholds of the IC gates. For the type SN7400N shown, the output changes state when the input is about 1.4 V. With the values given in the diagram, the delay time that can be realized with the circuit is 3 to 4 μ s. The 3.3 k Ω resistor to -5 V is necessary to sink 1.6 mA from the gates at the logical ZERO input level.

Waveform timing for the circuit is shown in Fig. 2. Delay-line circuits of this type for two independent inputs would require only two quad 2-input NAND gates and one dual J-K flip-flop, and the few external components.

G. S. Harlem, Electrical Engineer, Itek Corporation, Lexington, Mass.

VOTE FOR 436

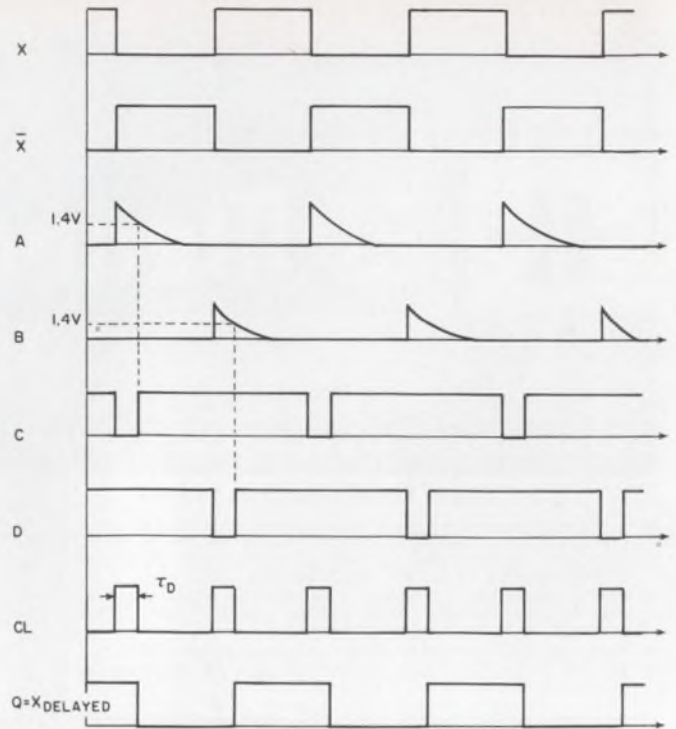

2. Signal produced at the Q output of the flip-flop is delayed 3 to 4 μ s from input signal X.

Generalized analysis simplifies resistor summing network design

Under general analysis, the solution for resistive summing networks may take an extremely simple form. Consider the resistive summer shown in (a), where k_i is the gain from the i th input, with all other inputs grounded. Equating currents for a voltage, V , applied to the i th input, with all other inputs grounded, gives

$$V(1 - k_i)/R_i = k_i V [1/R_o + \sum_{\substack{j=1 \\ j \neq i}}^n 1/R_j] \quad (1)$$

or

$$1/k_i R_i = [1/R_o + \sum_{j=1}^n 1/R_j] = 1/R_{\text{parallel}} \quad (2)$$

which is a constant. Hence,

$k_i R_i = C =$ parallel combination of all resistors. Combining Eqs. 3 and 2 yields

$$R_o = C/(1-k) \quad (4)$$

where $k = \sum_{j=1}^n k_j$

From Eq. 4, it can be seen that R_o approaches infinity as k approaches 1, and that R_o goes negative for k greater than 1. By superposition, with all inputs connected together, the gain is k . Physically this means that the gain cannot be greater than 1 in a resistive network.

By connecting each i th input to a voltage, V_i , we

get, also by superposition,

$$V_o = \sum_{i=1}^n k_i V_i \quad (5)$$

which shows that we have a resistive summing network.

Note the particularly simple form of Eqs. 3 and 4. With them, it is possible to either choose the R_i s and solve for R_o , or to choose R_o (the input impedance of an amplifier, for instance) and solve for the R_i s.

As an example of their use, consider the D-to-A converter network of (b). The required gain of each input is proportional to the bit weight, as

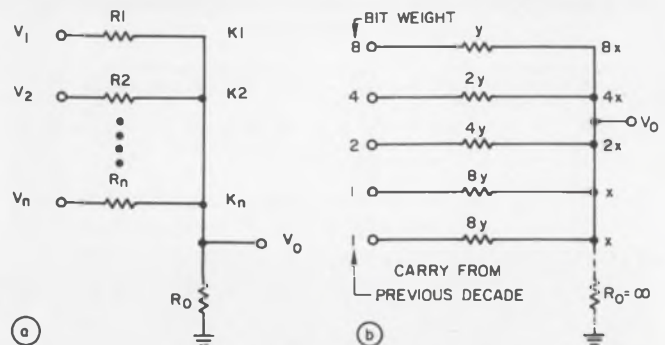

In the basic resistive summing network (a), each input produces a gain, K_i , at the summing point when all other inputs are grounded. In (b), the resistor values are set by the particular application and the problem is to find the gain constants and R_o for the least significant decade.

Quick Guide to contacts and terminals for USC UPCR and UPCR-D printed circuit card connectors

Let USC sock it to your printed circuit connector problems.

UPCR and UPCR-D p.c. card connectors come in a wide variety of contact and terminal types in phosphor bronze or beryllium copper* materials and standard or special finishes. Name it and you've got it.

Whether you choose our UPCR single row or our UPCR-D double row connectors, they deliver constant contact pressure, positive wiping action, low insertion force, foolproof contact alignment — plus USC Established Reliability. And they comply with all applicable provisions of latest revision of MIL-C-21097.

Write for our UPCR-A catalog. Better still, call us and see what USC can do for you!

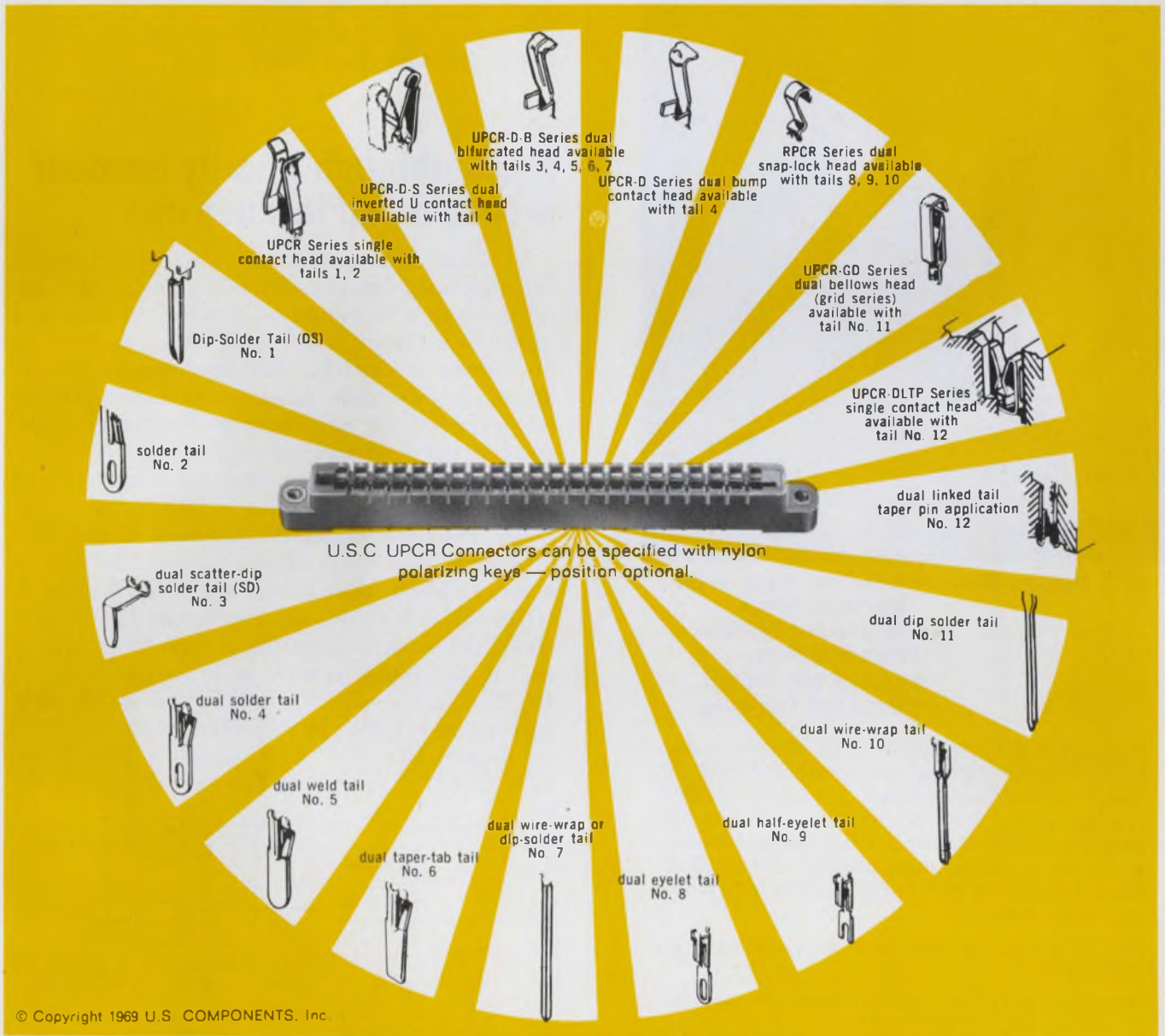

© Copyright 1969 U.S. COMPONENTS, Inc.

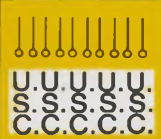

U. S. Pat. 2, 853. 689. 2, 909, 755

U.S. COMPONENTS INC.

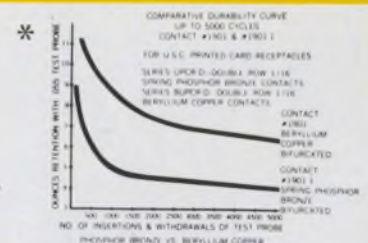
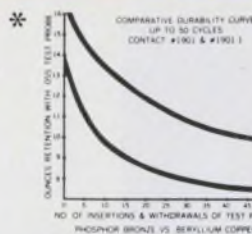

1320 ZEREGA AVENUE • BRONX, N.Y. 10462 or use TWX: 710-593-2141 • Tel. 212-824-1600 TELEX: 1-2411 • or Cable: COMPONENTS N.Y.K.
Please visit us at the IEEE Show Booths 3K30-3K31.

INFORMATION RETRIEVAL NUMBER 150

IC's or *PCCL's?

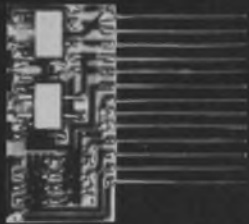

*
Spacetac hybrid MICROPOWERED PULSE-COUPLED
COMPLEMENTARY LOGIC Modules.

- PCCL Modules Offer:
- Quiescent Power in the Microwatt Range
 - No Thermal Problems
 - High Reliability
 - Ease of Interconnect
 - Simplified Packaging

PCCL modules are hybrid thick film microelectronic circuits utilizing complementary logic design. Construction Features: deposited resistive and capacitive networks; discrete ceramic flat-pack transistors and miniature diodes mounted on a ceramic substrate measuring 1.2" x 0.6" x 0.10" thick. A maximum of 15 leads emanate from one of the longer sides.

Send for detailed technical manual describing theory and application.

Challenging assignments exist for experienced digital and analog engineers. Send your resume.

See us at the IEEE SHOW booth Nos. 3A34 and 3A35.



SPACETAC SPACE AND TACTICAL
SYSTEMS CORPORATION

ONE GARFIELD CIRCLE • BURLINGTON, MASS. 01803 • (617) 272-6161

INFORMATION RETRIEVAL NUMBER 151

IDEAS FOR DESIGN

shown, and from Eq. 3 we know that the resistor values will be as shown (for $C=8xy$). Since we want R_o to be infinity, we know that $k = 16x = 1$, which gives $x = 1/16$ and $C = y/2$. The fifth input resistor includes the output resistance of the previous decade ($y/2$), so its actual value will be $7.5y$. For the least significant decade, we do not have the fifth input. Thus, $k = 15/16$ and $R_o = C/(1-k) = (y/2)/(1/16) = 8y$.

If the output drives a finite impedance, then k must be less than one and C will change.

Robert L. Montgomery, Design Engineer, Tasker Industries, Van Nuys, Calif.

VOTE FOR 437

Ripple-through priority encoder is simple and inexpensive

In digital systems there is often a requirement for a priority encoder. This is a device that accepts input information on a series of lines and produces a binary word, which may be used as an address designating the most significant input. Such an encoder can be used in establishing interrupt priority and in address-pointing to the start of the interrupt subroutine.

The priority encoder makes the output, P_i , of the most significant active (HIGH) input, I_i , LOW. The encoded binary address is then generated by using a series of OR gates. If input \bar{I}_0 is active (HIGH), then P_0 will go LOW, forcing P_1 HIGH. Signals P_2, P_3 , etc. are forced HIGH by a ripple OR scheme using the μ logic 9936 inverters. If the input pattern is $I_0 = \text{LOW}$, $I_1 = \text{HIGH}$, and $I_2 = \text{LOW}$, then P_1 will be the only output that is LOW; so the output at $2^0, 2^1, 2^2$ will be binary 100. The logic equation for P_i is: $P_i = I_i \cdot \bar{I}_{i-1} \cdot \bar{I}_{i-2} \cdot \dots \cdot \bar{I}_0$ which shows the de-

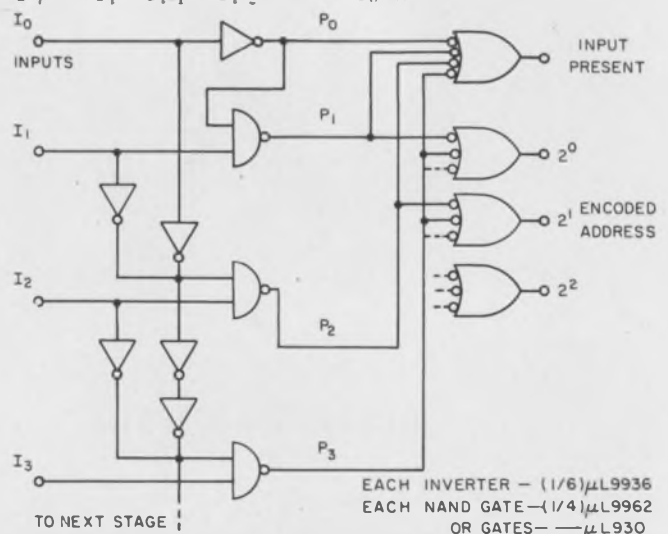

Priority encoder selects the output address corresponding to the most significant active input, I_i .

pendence of P_i upon previous input stages.

An extra OR gate can be used, as shown, to indicate the presence of any active input signal.

R. C. Ghest, Design Engineer, Fairchild Semiconductor, Mountain View, Calif.

VOTE FOR 439

Photo-FETs make multivibrator respond to incident light

If the base resistors of a conventional astable multivibrator are replaced by a pair of photo-FETs (photosensitive field-effect transistors) a variety of control and monitoring applications are possible with the resulting circuit.

The currents passed by the photo-FETs, which act as constant-current sources, are dependent upon both the positions of the preset potentiometers (see illustration) and the incident light received by each photo-FET. If the two photo-FETs are matched, the frequency of the multivibrator is a function of the "common-mode" light level that is incident on both.

Also, for matched photo-FETs, any difference in light level that appears between them will result in a change in mark/space ratio. Thus, a common-mode light-signal results in a frequency change, and a difference light-signal results in a change in mark/space ratio. The two phenomena can be monitored separately by conventional methods.

If the photo-FETs are not matched, a mark/space ratio of unity can be achieved for one specific light level by adjustment of the preset potentiometers. Then, any change in light level will result both in a change in frequency and in mark/space ratio.

Joseph Watson, Engineer, University of California, Davis, Calif.

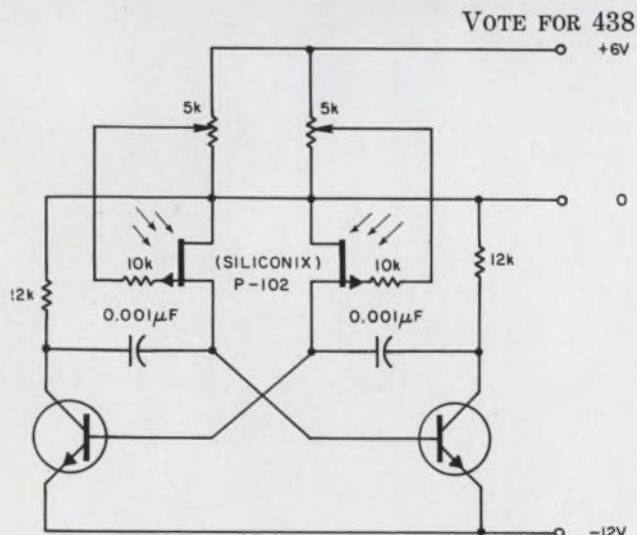

Photo-FETs used in place of the base resistors of an astable multivibrator make the frequency and mark/space ratio of the circuit sensitive to the incident light.

can you spare 250 mW ?



A/D Converter



PCM Encoder



Digital Computer



Core Memory

If so... we can build you an A/D Converter, Data Encoder, PCM Encoder or a Memory.

Feed us a few more mW and we'll build you a general purpose digital computer.

Spacetac uses a family of hybrid thick film micro-electronic modules in a unique high density package to obtain very low power, high reliability, small size and low weight. Spacetac systems have logged over 8 million module hours of operation in space without failure.

Send for technical literature.

Challenging assignments exist for experienced digital and analog engineers. Send your resume.

See us at the IEEE SHOW booth Nos. 3A34 and 3A35.



The Book.

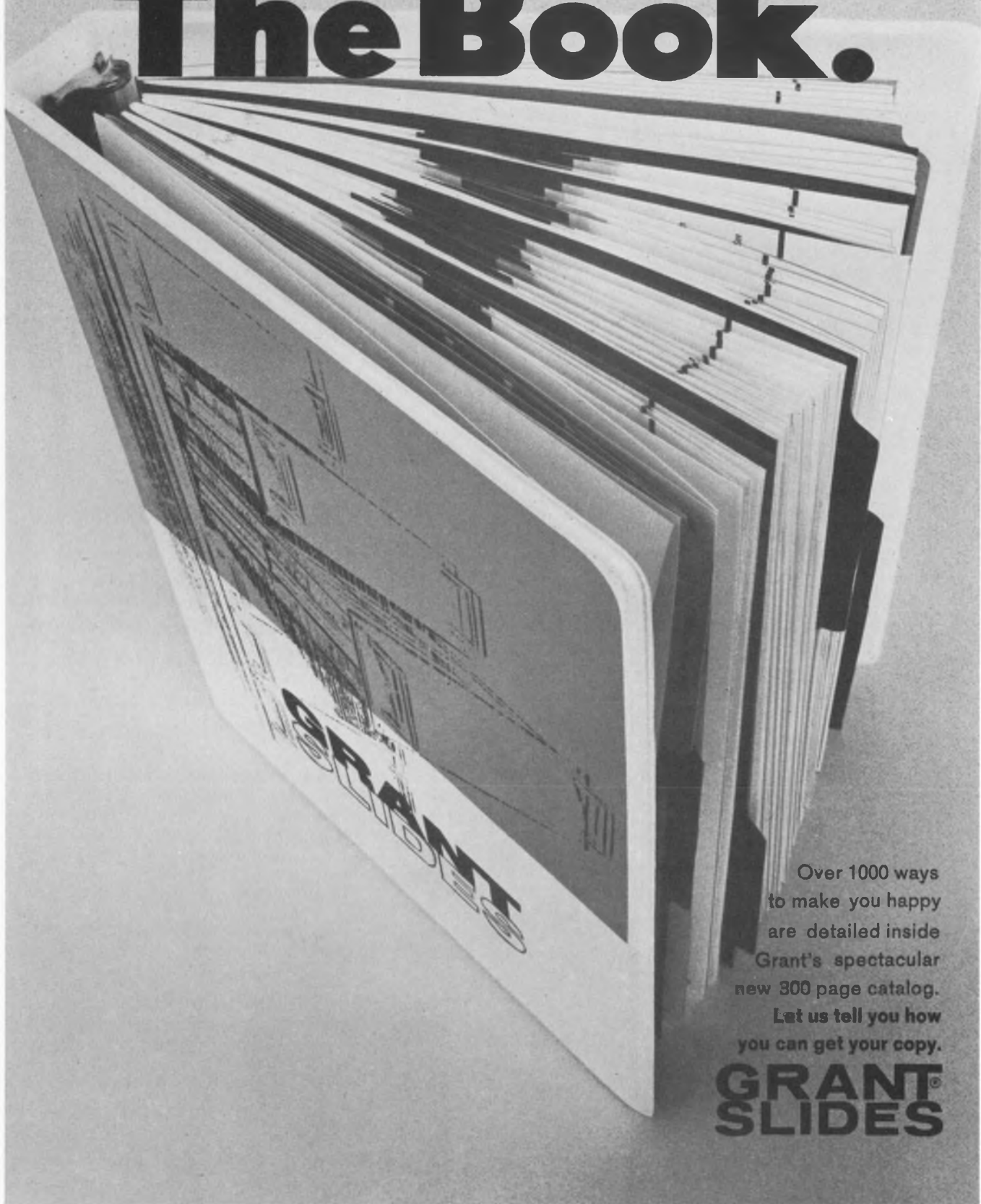

Over 1000 ways
to make you happy
are detailed inside
Grant's spectacular
new 300 page catalog.
Let us tell you how
you can get your copy.

**GRANT®
SLIDES**

GRANT PULLEY & HARDWARE CORPORATION, 21 High St., W. Nyack, N.Y./944 Long Beach Ave., Los Angeles, Calif.

INFORMATION RETRIEVAL NUMBER 153

HELP YOURSELF TO ANY FUSITE SECRET IN GLASS TECHNOLOGY

Here's how electronic component engineers, designers, and specifiers get quick-response help from Fusite to solve any problem in sealing glass applications: they simply send specs and state the problem.

We automatically go first to our twenty-five year file experience, extract the problem-solution, and send it to you. Free of charge. If your glass problems can't be answered from the files, we put one or a team of Fusite engineers to work.

Either way, you can depend on us to come up with a solution. Next time you have a routine or crash program with a sealing problem, call Fusite first. Another thing you should know about Fusite: we're the *only* sealer with formulation, smelting, and preforming experience in technical glasses. Learn to lean on our glass knowledge.

Call Fusite in Cincinnati or any Fusite foreign plant! Fusite N.V., Konigweg 16, Almelo, Holland; Fusite-Japan, Gotemba, Japan; Terminal Products, Hormigueros, Puerto Rico; or, Fusite GmbH, Dieselstrasse 5, Karlsruhe, West Germany. Fusite Corporation, 6000 Fernview Ave., Cincinnati, Ohio 45212 . . . phone (513) 731-2020.

FUSITE
GLASS-TO-METAL HERMETIC TERMINALS
GLASS/GLASS-CERAMIC PREFORMS & SUBSTRATES

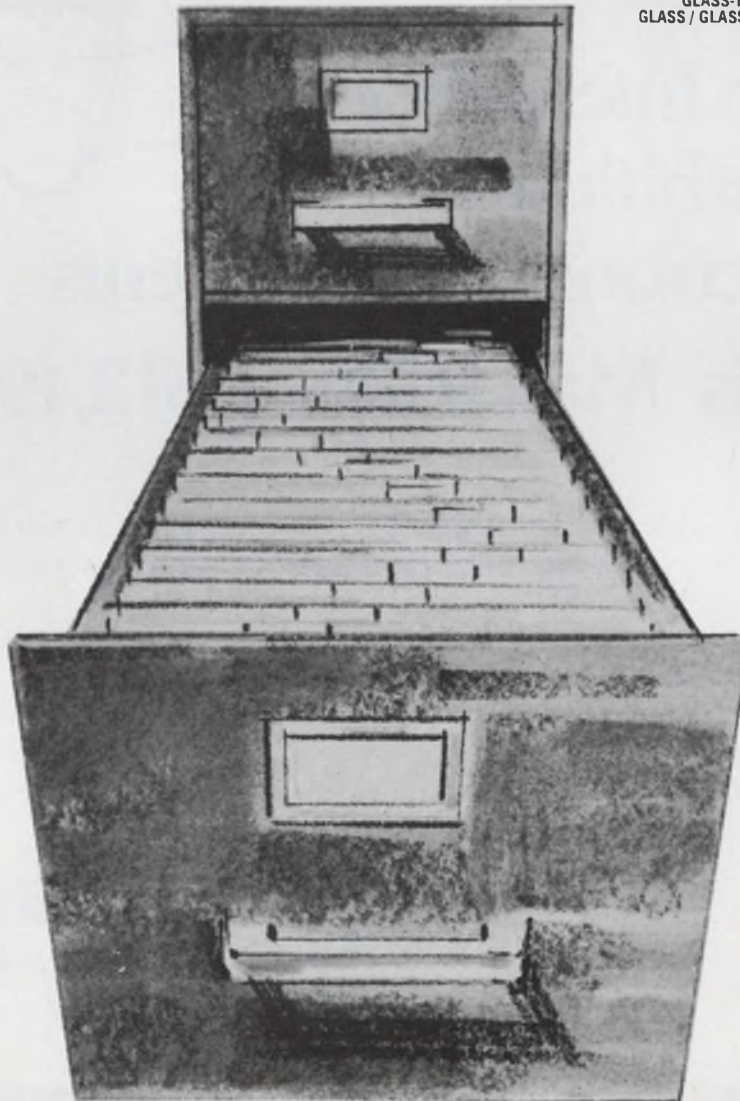

INFORMATION RETRIEVAL NUMBER 154

The Air France guide to European markets

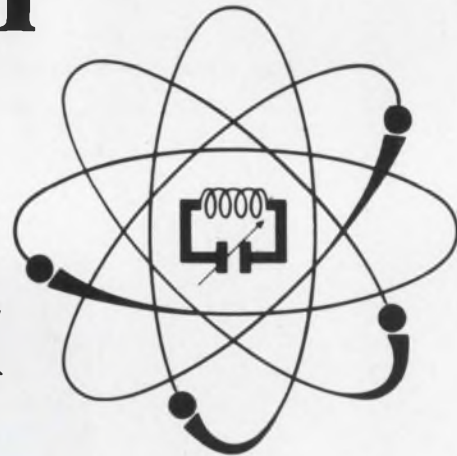

The International Exhibition of Electronic Components

Paris March 28-April 2, 1969

Once again Air France is happy to be the official carrier for the Show, with a ticket reservation and Welcome Service counter on the Show grounds for overseas visitors.

Fly to Paris on Air France 707 Intercontinental jets and enjoy the finest in French food and wines, and unexcelled service.

Direct service from New York, Chicago, Los Angeles, Washington and Boston.

For information and reservations, see your travel agent or call the Air France office nearest to you.

AIR FRANCE

We know where you're going.

Got a BIG FILTER problem?

SOLUTION:



LITTLE HYBRID ACTIVE FILTERS

PROBLEM:

If your requirement is a garden variety type such as the standard 1 thru 5 pole pair Butterworth or Chebyshev bandpass responses, you need the WM1 Active Filter.

SOLUTION 1: WM1 ACTIVE FILTER

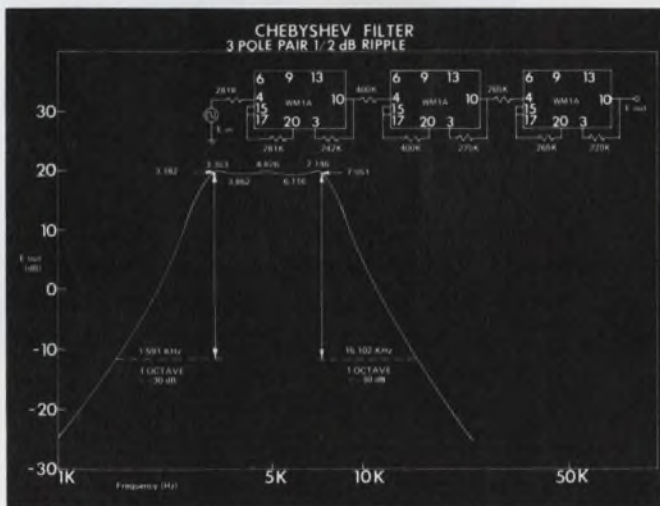

PROBLEMS:

- Lowpass filter with Q up to 100
- Bandpass filter with Q up to 100
- Highpass filter with Q up to 100
- Lowpass, Bandpass, Highpass at the same time
- Delay Line 32 μ s - 100 ms delay
- Electronic crossover network
- 2,4,6,8,10 pole filters
- Analog computer block for solving 2nd order differential equations
- 1 Hz to 15 KHz tuneable notch filter

SOLUTION 2: WM3A ACTIVE FILTER

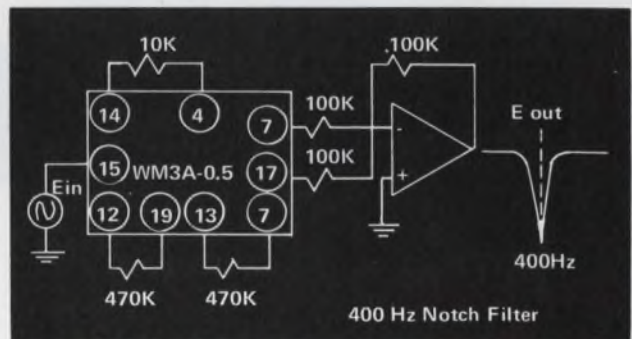

	FREQ. RANGE	PACKAGE	Q RANGE		PRICE 1-24
WM1A	1 Hz to 20 KHz	Flat Pak - 0.8" x 0.65" x 0.15"	1/2 to 10	Q and center frequency externally adjustable	\$44.00 ea.
WM1C	1 Hz to 20 KHz	TO-8	1/2 to 10		\$32.50 ea.
WM3A	1 Hz to 15 KHz	Flat Pak - 0.8" x 0.65" x 0.15"	1/2 to 100		\$84.00 ea.

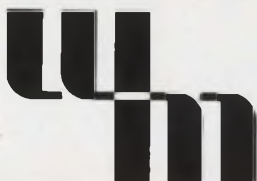

Western Microwave

Hybrid Microcircuits Group

16845 Hicks Rd., Los Gatos, California 95030

Telephone (408) 266-4820 TWX 910-338-0032

INFORMATION RETRIEVAL NUMBER 156



Tomorrow, Paul Barr may even get to his desk

Paul Barr is a hard man to catch. He may be at the bench sweating over a prototype circuit . . . or have his head under a car lift surveying the built-in problem. He's got lab people hopping and test drivers in and out of spins. A couple of friction experts shake their heads when they see him coming. But wherever development engineering leads on a sophisticated new braking system, Paul Barr's on his way. And no two Mondays ever start alike. The question is . . . can you say the same? Take a good look at how your career shapes up, compared with Paul's and his colleagues' at Delco. You might even call us collect. Area Code 317/459-2808. Or, write: Mr. C. D. Longshore, Supervisor, Salaried Employment, Dept 502, Delco Radio Division of General Motors, Kokomo, Indiana.

**DELCO
RADIO**



AN EQUAL OPPORTUNITY EMPLOYER
DIVISION OF GENERAL MOTORS
KOKOMO, INDIANA

INFORMATION RETRIEVAL NUMBER 901

Free Career Inquiry Service

Absolutely Confidential

6

Respond to the career opportunities advertised in this issue. Fill out and send us this handy resume. **Electronic Design** will do the rest – neatly typed copies of this form will be mailed to the companies of your choice, indicated by the circled Career Inquiry Numbers at the bottom of this page.

Name				Home Phone	
Home Address (Street)			City	State	ZIP Code
Age	U.S. Citizen <input type="checkbox"/> Yes <input type="checkbox"/> No		Security Clearance		
Prime Experience			Secondary Experience		
Desired Salary			Availability Date		
Employment History – present and previous employers					
Company					
City, State					
Dates	to		to		to
Title					
Specialty					
Education – indicate major if degree is not self-explanatory					
Degree					
College					
City, State					
Dates	to		to		to
Additional Training – non-degree, industry, military, etc.					
Professional Societies					
Published Articles					

Career Inquiry Numbers:

900 901 902 903 904 905 906 907 908 909
 910 911 912 913 914 915 916 917 918 919

ELECTRONIC DESIGN
 850 Third Avenue
 New York, New York 10022



**WHY SHOULD YOU
SPECIFY
MECATORN®
SPUN
REFLECTORS?**



The exclusive Torngren Mecatorm® hydraulically controlled spinning process has produced thousands of spun-to-specification "dishes" in use today by both military and commercial communication networks — at substantial savings over other more costly fabricating methods.

If you have a requirement for parabolic reflectors from 4 inches to 16 feet in diameter call Torngren today for complete details on the cost saving and metallurgical advantages of the Mecatorm® process.

Send for a free copy of our new capabilities brochure today!



C.W.

TORNGREN
COMPANY INC.

INFORMATION RETRIEVAL NUMBER 157

Book Reviews

Physics handbook

CRC Handbook of Chemistry and Physics, 49th Ed., (Chemical Rubber Publishing Co., Cleveland), 2100 pp.

For years the Chemical Rubber handbook has been the standard reference for chemistry and physics data. The new edition is no less definitive than its predecessors. From the standpoint of the electronics engineer the sections on mathematics and general physical constants are perhaps the most useful. The handbook contains over 200 pages of new material including tables of semiconductor properties.

CIRCLE NO. 418

Scientific encyclopedia

Van Nostrand's Scientific Encyclopedia, 4th Edition (D. Van Nostrand Co., Inc., Princeton, N.J.),

This massive volume is probably the most concentrated dose of general scientific knowledge available anywhere. Here in one 9 by 12 by 4-in. package are 16,500 articles that cover the scientific spectrum from physics to biology. Such topics as electrocardiography, the electron microscope, new developments in plastics and medical applications of the laser are clearly and competently summarized. At a time when so many of the fastest moving areas in electronics are intertwined with other disciplines, a general reference like this can be particularly valuable to the engineer.

The distinctive feature of this one-volume encyclopedia is that it doesn't talk down to any one. Definitions are of necessity brief, but never superficial, and mathematics is used whenever appropriate. An extensive system of cross-references adds to the utility of the remarkable volume. This is a must for every reference library.

CIRCLE NO. 419



ELECTRICAL ENGINEERS — Will deal with a wide variety of solid state devices, laboratory test equipment, using basic logic theory to design control logic. Responsibilities include all phases of electrical layout, packaging and documentation such as: system power, interconnector, circuit layout, component specification, and liaison with vendors, drafting and manufacturing. BSEE required with a minimum of 4 years' related experience.

MECHANICAL & ELECTRICAL DESIGNERS — Generate original and creative machine design concepts. Prepare complete and accurate design layouts to resolve design or redesign problems identified by Engineers, Scientists, Sr. Designers and Managers. Mechanical design in areas of complex mechanisms, castings, cams, gears, drive systems, optics, sheet metal and plastics. Electrical design in areas of schematics, printed circuit boards, integrated circuits, cable harnesses and wire lists; familiarity with controls logic, etc. At least 8-10 years' experience in mechanical and electrical development practices. Good working knowledge in applying geometric dimensioning including true positioning desirable, for both development and production programs.

MECHANICAL DEVELOPMENT ENGINEERS — Will generate novel approaches in the development of new products; develop and prove product concepts through design, test and evaluation of appropriate models of products for quantity production. Previous design and development experience of consumer products such as business machines, appliances, photographic equipment, printing machines, instruments, light machinery, or automotive equipment. BS or MS in ME, EE, or Engineering Sciences.

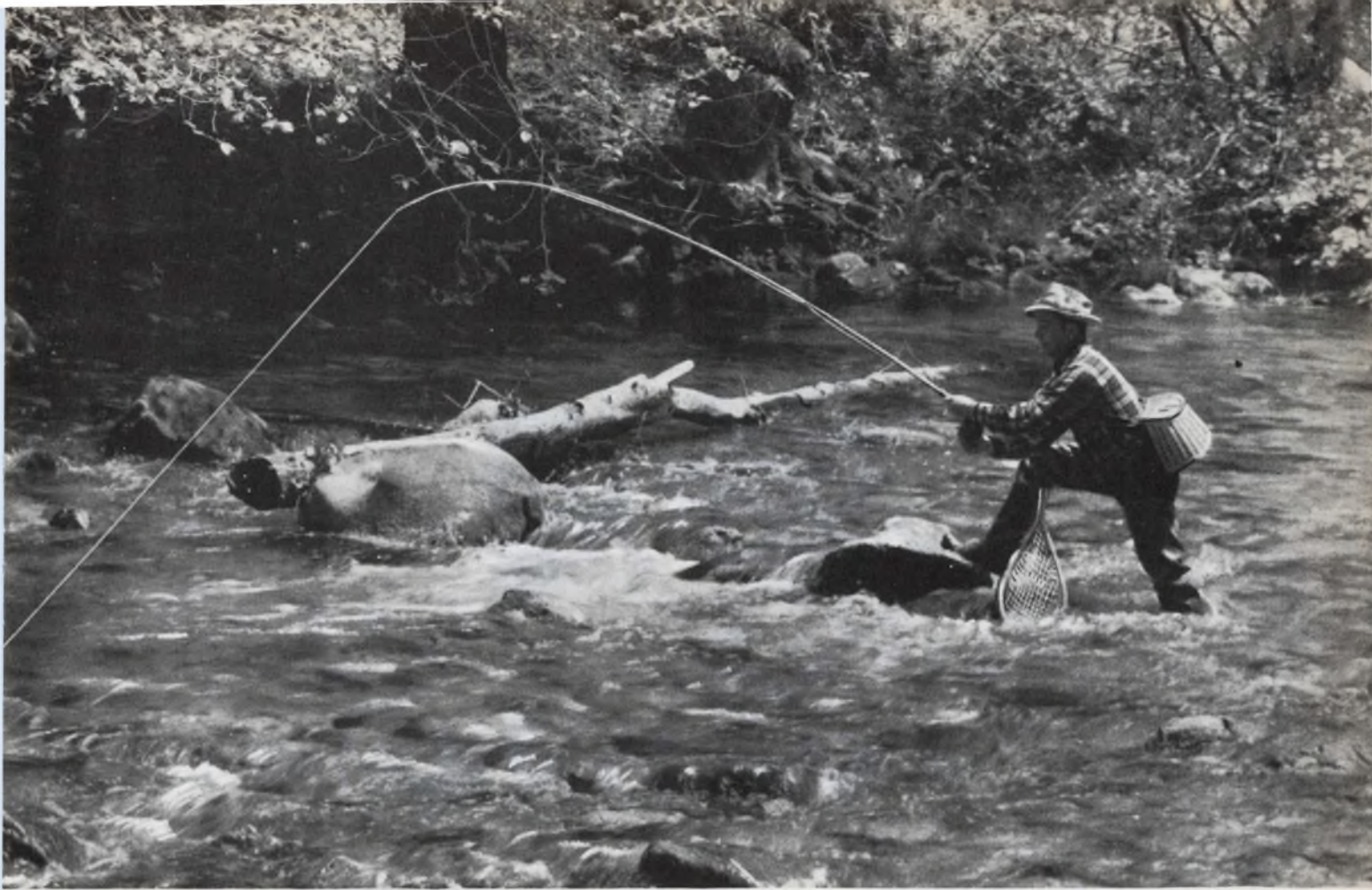

Can there be this kind of excitement in engineering?

Try Xerox and see



An engineer operates the keyboard of an experimental information storage and retrieval system.

The water's cold, insistent rush... surface dappled by a late sun. A brown hackle* touches down, lightly, perfectly, bobs briskly for a moment and—bam! That indescribable minor explosion that means you've hooked into something big.

Nobody can really define the excitement of trout fishing. It is highly personal, unstructured, yet unmistakable. And so it resembles, we think, the excitement an engineer should find in doing what he has been highly educated to do... but which so many engineers, apparently miss.

At Xerox, the exciting professional environment is real. Proof? See what it has done for our growth. In 1960, we had 3,000 people on our payroll. As we entered 1969, the number exceeded 25,000. We earned 14¢ a share in '60. In '68, it rose to \$5.18.

Find out for yourself. Specific openings at our suburban Rochester, New York facilities are outlined at the left. Please forward your resume to Mr. Richard L. Melnotte, Dept. MZ-32-C2, Xerox Corporation, P.O. Box 1995, Rochester, New York 14603. An Equal Opportunity Employer (m/f).

*Half an hour from Rochester are some of the world's finest trout streams. Also abounding: lake trout, bass, walleyed pike and muskie.

XEROX

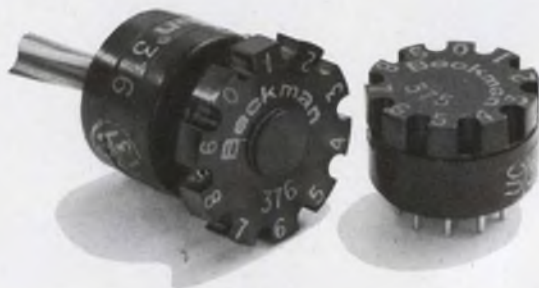

Switch to The Switchables.

Helipot's new miniature rotary switches always give you precise, positive switch settings.

Only Helipot's new rotary precision switches have rugged, positive action detent. That's why they're the Switchables ... because they always switch to the precise position you switch them to.

They come in two, single pole-10 position models. Helipot Model 376 with six-inch leads is designed for instrument panel applications. And Helipot Model 375 with 10 gold plated terminals is for direct installation on printed circuit boards. Both have a black insulated plastic housing with easy-to-read contrasting index marks, have a contact current rating of 250 ma at 28 V DC, and are the economical choices for all applications



requiring rapid changes in settings such as test equipment and timing devices.

For all the details, specs and schematics, get in touch with your local Helipot Representative. He'll show you why Helipot's new miniature rotary precision switches are the Switchables.

Beckman

INSTRUMENTS, INC.

HELIPOT DIVISION

FULLERTON, CALIFORNIA • 92634

INTERNATIONAL SUBSIDIARIES: AMSTERDAM; CAPE TOWN; GENEVA; GLENROTHES, SCOTLAND; LONDON; MEXICO CITY; MUNICH; PARIS; STOCKHOLM; TOKYO; VIENNA

Products

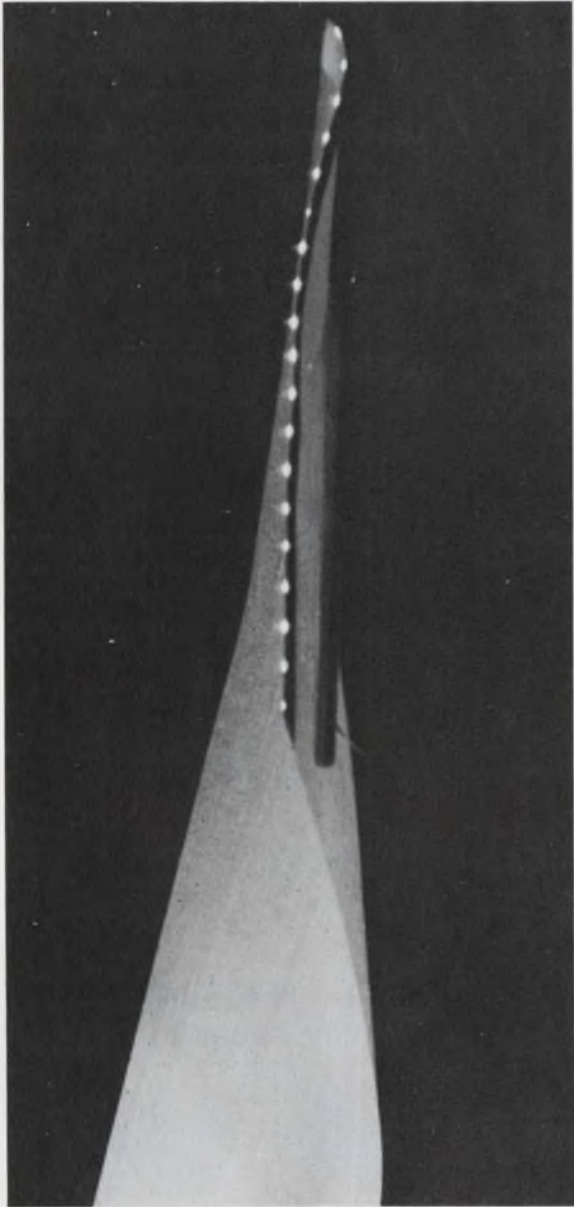

Fiber-optic ribbon cables now come in 6-in. widths and 10-ft lengths, p. 328.

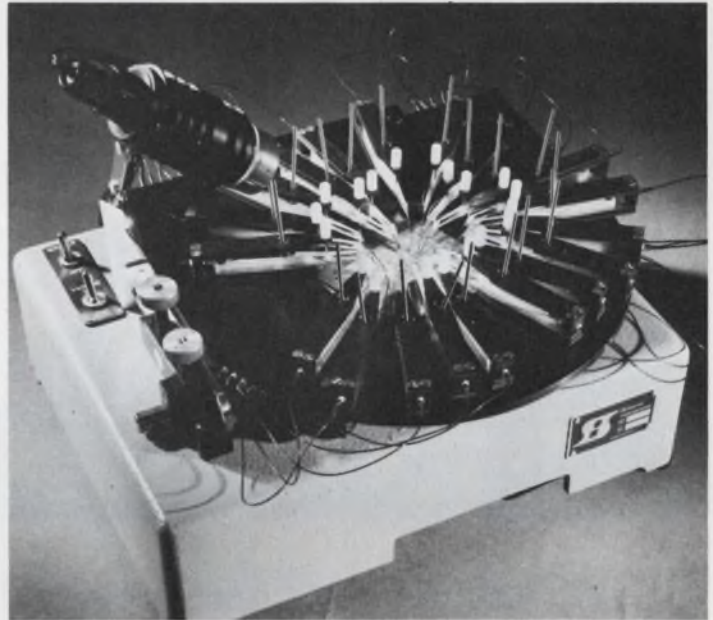

Probing system for thick- and thin-film hybrid assemblies covers 4-in. diameter substrates, p. 340.

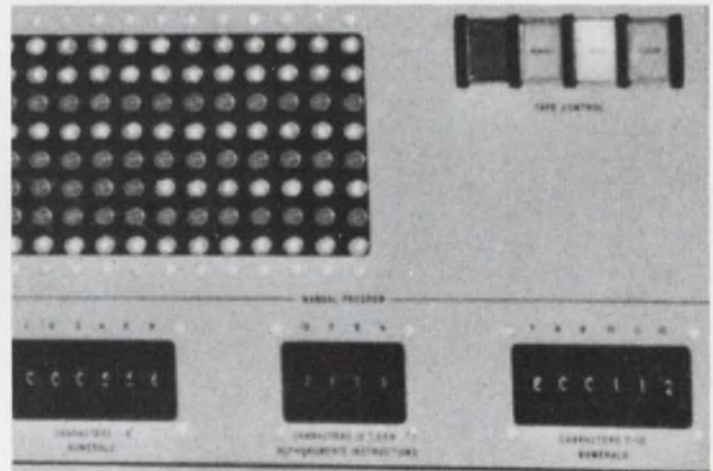

Universal logic test system with integral computer control checks any digital device, p. 290.

Also in this section:

Plastic phototransistors sell for less than one dollar, p. 304.

Single-envelope readout tube displays fourteen decades, p. 310.

FET-input op amp draws only 60- μ A quiescent current, p. 322.

Design Aids, p. 346 . . . **Application Notes**, p. 348 . . . **New Literature**, p. 354.

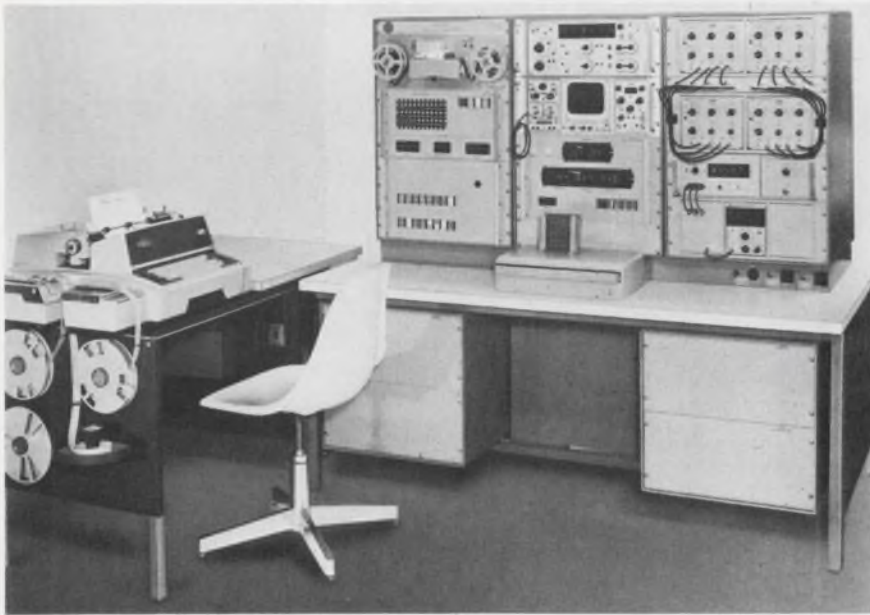

Computerized test setup checks any logic system

Automation Dynamics Corp., 35 Industrial Parkway, Northvale, N.J. Phone: (201) 768-9200. P&A: \$7700; 90 days.

Requiring no external computer control, the QC 363 universal, automated, logic test system provides complete static and dynamic checkout of all digital devices, products and systems. This tape-programmed system, with integral card fixture and programmer, is designed to test 64 terminations; it expands to groups of 80 pins.

Able to test virtually every type of logic, the QC 363, in essence, is like a real-time computer.

The basic system consists of: a control computer and switching matrix; teletypewriter and punch; optical tape reader; programmable pulse generator and digital oscilloscope; digital voltmeter and electronic counter; a fixture and program board, and the necessary power supplies.

This new system does not simply compare logic cards with a known good-quality logic card, as in relative testing; it makes absolute tests within programmable limits. It can be used to test one-shot operation; fan-in and fan-out

characteristics; risetime, falltime and delay time; as well as to verify truth tables, and pattern and frequency responses.

In static testing, the QC 363 checks for bridging, grounding and other problems that could damage the logic system of the test system itself. During static testing, it performs strictly as a go/no-go unit.

Operating speed of the QC 363 is dependent on the type of test, the number of specified test steps, and the number of output points to be scanned per test. Typically, verification in dynamic testing of the complete truth table of a logic card, with 48 logic inputs in 36 combinations, requires less than three seconds.

The self-contained computer system controls matrix switching; sets testing limits; makes go/no-go decisions for all tests; controls data logging, and verifies test matching with the test program board. Coded punched tape, read by a high-speed optical tape reader, supplies the programmed commands.

Several options are also available to expand and customize the new test system.

CIRCLE NO. 446

Op amp evaluator performs 14 tests



Signetics Corp., 811 E. Arques Ave., Sunnyvale, Calif. Phone: (408) 739-7700. P&A: \$7000; 60 days.

Model 1410 op amp tester displays information digitally as a percentage of a pre-programmed limit. The tester has three basic modes of operation and performs 14 dc and dynamic tests automatically, to better than one per cent accuracy. Slew-rate tests are included. Each of the 14 tests may be independently programmed by a single plug-in board with a Barnes test socket. The tester is desktop size, weighs 25 pounds and requires no external equipment or adjustments.

Booth No. 3A01 Circle No. 380

Digital readout systems display linear motion



Data Graphics Corp., P.O. Box 18324, San Antonio. Phone: (512) 655-7611. P&A: from \$1698; 30 days.

Digital readout systems are useful in any situation where an operator wants a digital readout of linear motion, whether on a production line, a weighing scale, or anywhere else. The DGC-200 system gives readout in two axes. Each axis is driven by an incremental encoder that is mechanically interfaced to the specific machine being read out.

Booth No. 2B40 Circle No. 273

How to build a \$1000 A/D converter for less than \$200.

Start with the Fairchild $\mu A722$ 10-bit A/D-D/A Converter Current Source at \$65. Add \$30 for ten precision resistors*, \$15 for a comparator and \$25 for logic, then spend \$10 tying all these together and testing the completed assembly. For \$145 you've just built a successive approximation A/D Converter that will give you a conversion accurate to 8 bits in $10\mu s$. If you need more accuracy and can give up some speed, tailor the resistors and cut your clock rate — you'll get 10-bit accuracy with a $20\mu s$ conversion time.

The $\mu A722$ is our first linear MSI IC. The chip contains a reference supply and 10 current sources connected to a single summing line through 10 current-steering switches. The built-in reference

saves you money; the current steering prevents ringing and yields a switching time of 600ns.

Besides A/D conversion, you can use the $\mu A722$ Current Source for D/A conversion, logarithmic D/A conversion and high-speed hybrid multiplication and division. It will handle more data faster than any comparable system. You can get the $\mu A722$ from your stocking Fairchild distributor. Or, if you're not ready for it yet, send for the complete specs and application notes. They'll give you all the design information you need.

To order the $\mu A722$, ask for:

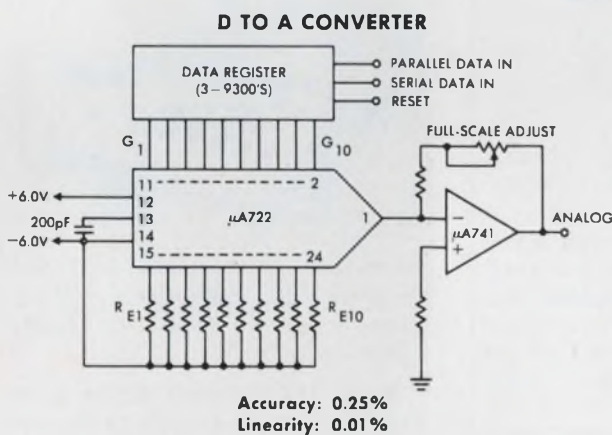

PART NUMBER	PACKAGE	ACCURACY	TEMPERATURE	PRICES		
				1-24	25-99	100-999
U3M7722333	Flatpak	8-bits $\pm 1/2$ LSB	0°C to +55°C	\$97.	\$79.	\$65.
		7-bits $\pm 1/2$ LSB	-20°C to +85°C			
U3M7722334	Flatpak	7-bits $\pm 1/2$ LSB	0°C to +55°C	75.	60.	50.
		6-bits $\pm 1/2$ LSB	-20°C to +85°C			

*Packaged precision networks compatible with the $\mu A722$ are available off the shelf from major resistor manufacturers.



Solid-state wattmeter holds 0.02% linearity



Hallmark Standards Inc., 145 Library Lane, Mamaroneck, N.Y. Phone: (914) 698-8460. P&A: \$1500; 75 to 90 days.

Converting input frequencies from dc to 2 kHz into $\pm 0.02\%$ linear dc outputs, a new solid-state wattmeter can be used from unity power factor down to zero power factor with less than 0.02% degradation. Model 2885 is available as a watt converter, digital wattmeter, or a complete ac/dc wattmeter/power-factor calibration console. It has a standard input range of 150 V at 5 A for a 1-V output. Booth No. 2E07 Circle No. 400

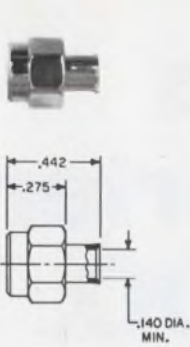

STRAIGHT PLUGS
Reusable. Shipped assembled.
No snap ring.

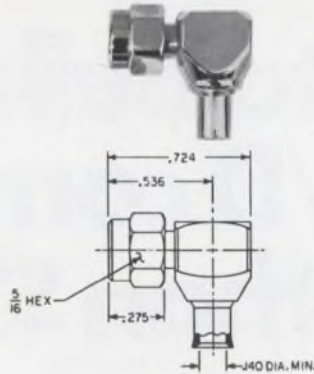

RIGHT ANGLE PLUGS
Non-interrupted center contact eliminates discontinuities.

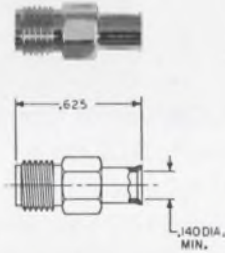

STRAIGHT JACKS
No solder-on center contact. Shipped assembled.

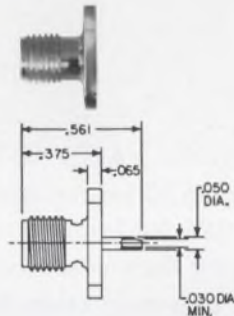

BULKHEAD RECEPTACLES
No epoxy-fill captivation. No openings for RF energy leakage.

Somebody had to do something about miniature microwave connectors

So we did.

For more reasons than one.

Actually, we had two. First, we've been in the connector business for years. We know what's good, pretty good and not so good. A long hard look at the current situation in miniature microwave types and we saw that there was a demanding need for genuine improvement and innovation. That's reason number one. The other? We make semi-rigid miniature coaxial cable. The addition of compatible connectors now gives us total capability in the miniature field.

With our new PDM line of miniature microwave connectors, the design breakthroughs are, we think, very significant. Take our straight plugs, for instance. The inefficient

snap ring design has been completely eliminated. Our coupling nut fits over the back, up against the shoulder, and will withstand torque up to 20 inch pounds without pull-off or distortion. Imagine too, being able to receive connectors of this type shipped already assembled. And, consider, for a moment, the tremendous convenience of being able to reuse the connector.

Can we tell you more? Write today and ask for all the details on PDM Miniature Microwave Connectors. Phelps Dodge Electronic Products Corporation, 60 Dodge Avenue, P. O. Box 187, North Haven, Connecticut 06473.

High-speed IC tester makes 1024 checks



Microdyne Instruments Inc., 225 Crescent St., Waltham, Mass. Phone (617) 893-8210. P&A: \$3990; 30 days.

Model 721 IC tester makes up to 1024 sequential dc and functional measurements in 100 milliseconds. Go/no-go lamps are provided for readout with a digital panel meter included for reading the out-of-tolerance parameter. Such MSI circuits as full adders, decade counters, and decoder-drivers can be fully tested in less than 100 milliseconds. All test power supplies with the exception of the collector supply are precision-constant current supplies.

Booth No. 2E45 Circle No. 381

PHELPS DODGE ELECTRONIC PRODUCTS CORPORATION

INFORMATION RETRIEVAL NUMBER 160

**We're only
Second
in ECL II...**



BUT IN THIS HORSE RACE – THAT’S NOT BAD !

Although we have a winning line of ECL's—Motorola's still a few circuits ahead. But we're announcing that we can match their 14 most popular MECL II units right now—with more to come!* So if you've been afraid to take advantage of the high-speed characteristics of these unique new ECL devices because you don't like sole-sourcing—relax. Go ECL II with confidence. Now you've got Stewart-Warner to back up Motorola...or vice versa.

STEWART-WARNER ECL II

CIRCUIT FUNCTION	MILITARY -55°C. to 125°C.	INDUSTRIAL 0°C. to 75°C.
Dual 4-input Complementary Gate	SW1204	SW1004
Dual 4-input Complementary Gate	SW1205	SW1005
Dual 4-input Complementary Gate	SW1206	SW1006
Quad 2-input NOR Gate	SW1210	SW1010
Quad 2-input NOR Gate	SW1211	SW1011
Quad 2-input NOR Gate	SW1212	SW1012
85-MHz AC-Coupled J-K Flip-Flop	SW1213	SW1013
Dual R-S Flip-Flop (Positive Clock)	SW1214	SW1014
Dual R-S Flip-Flop (Negative Clock)	SW1215	SW1015
Dual R-S Flip-Flop (Single Rail, Positive Clock)	SW1216	SW1016
Translator—ECL to Saturated Logic	SW1218	SW1018
Dual 2-input Expandable Gate	SW1224	SW1024
Dual 4-5 input Expander	SW1225	SW1025
Dual R-S Flip-Flop (Single Rail, Negative Clock)	SW1233	SW1033

For more information, send for our new ECL II data sheets. And, for off-the-shelf product delivery, call your local Stewart-Warner Microcircuits Distributor.

** We also offer 11 ECL's in the 300 and 350 series.*

STEWART-WARNER COMPANIES **SW**
SYMBOL OF
EXCELLENCE

STEWART-WARNER MICROCIRCUITS, INC.
730 EAST EVELYN AVENUE, SUNNYVALE, CALIFORNIA 94086
PHONE 408/245-9200 TWX 910 339 9210

Now! TCXO's from Bulova!

Stability:
 ± 0.5 PPM



Now you can get Temperature Compensated Crystal Oscillators from Bulova, with all the quality and dependability that have made Bulova the leader in frequency control products. Our new Model TCXO-5 is just four-cubic-inches, consumes only 50 mW, and employs a computer-selected-and-optimized compensation network designed to maintain frequency stability over wide temperature ranges without the need for an oven (± 0.5 PPM from -40°C to $+70^{\circ}\text{C}$). Perfect for aerospace and military applications where power, space and weight restrictions are severe.

SPECIFICATIONS

Frequency Range: 2MHz to 5MHz
 Frequency Stability: ± 0.5 PPM from -40°C to $+70^{\circ}\text{C}$
 Output: Sine Wave, 1V-P-P into a 1000 OHM Resistive Load
 Input: 50 mW
 Size: Just 4 cu. in.
 Weight: Only 5 oz.

Other frequencies, output wave shapes, output levels and load impedances can also be supplied.

Write today for more information about Bulova's new TCXO-5, or assistance with any Crystal Oscillator problem. Address: ED-27.

Try Bulova First!

FREQUENCY CONTROL PRODUCTS

ELECTRONICS DIVISION
OF BULOVA WATCH COMPANY, INC.

61-20 WOODSIDE AVENUE
WOODSIDE, N.Y. 11377, (212) DE 5-6000

INFORMATION RETRIEVAL NUMBER 162

INSTRUMENTATION

Multichannel indicator measures strain

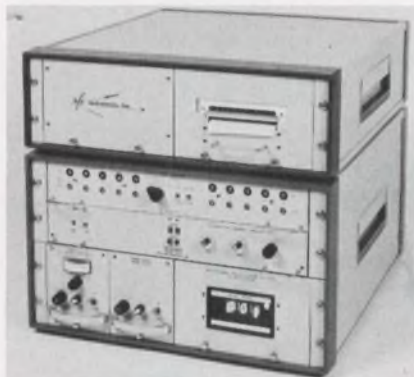

B & F Instruments, Inc., Cornwells Heights, Pa. Phone: (215) 639-7100.

Truly portable, a multichannel digital strain indicator for strain gage outputs provides the test engineer with the latest in digital techniques for strain gage readouts. Complete with excitation power supply, input conditioning, control unit amplifier, voltmeter and printer, model 161 is readily expandable from 10 to 100 channels by merely adding plug-in modules. The unit is furnished with individual balance and gage factor controls for each channel.

Booth No. 2K27 Circle No. 265

Universal counter/timer has 50-MHz range



Racal Electronics Ltd., 26 Broad St., Wokingham, Berks., England.

Model 815 universal counter/timer has a 50-MHz frequency range and measures frequency, period, ratio, and time interval. It also scales and totalizes by decades up to 10^4 . Trigger adjustment is variable from -100 V to $+100$ V. Provision is made for Z modulation of an oscilloscope for precise identification of actual trigger points on input waveform. Timebase stability reaches 1 in 10^7 within three minutes of switch-on.

CIRCLE NO. 351

Reference junction powers itself



Omega Engineering Inc., P.O. Box 4047, Stamford, Conn. Phone: (203) 322-1666. P&A: \$75 to \$80; 30 days.

A new self-powered thermocouple reference junction, which completely eliminates the need for ice baths and ovens, contains both solid-state circuitry and a power source within its epoxy-encapsulated package. Model X CJ is available in 16 different calibrations with color-coded cases for immediate identification. It is 3-in. long by $3/4$ in. in diameter.

Booth No. 4H25 Circle No. 342

Strip-chart recorder has 17 input ranges

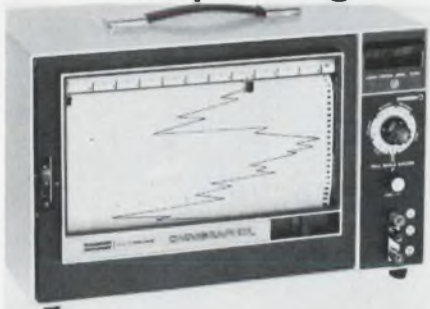

Houston Instrument, Div. of Bausch & Lomb, 4950 Terminal Ave., Bellaire, Tex. Phone: (713) 667-7403. Price: \$995.

Offering 17 standard input ranges, a new 10-in. strip-chart recorder reads dc millivolts, volts, ohms, milliamperes and microamperes. Omnigraphic 10 has five chart speeds, from 0.05 to 20 inches per minute, and a built-in event-and-speed mark pen. Additional standard features include a 0.5-s full-scale pen response, remote pen and chart control, 1-mV full-scale sensitivity and $\pm 0.25\%$ full-scale accuracy.

Booth No. 2H25 Circle No. 338

We frame up some of the biggest people in the industry.

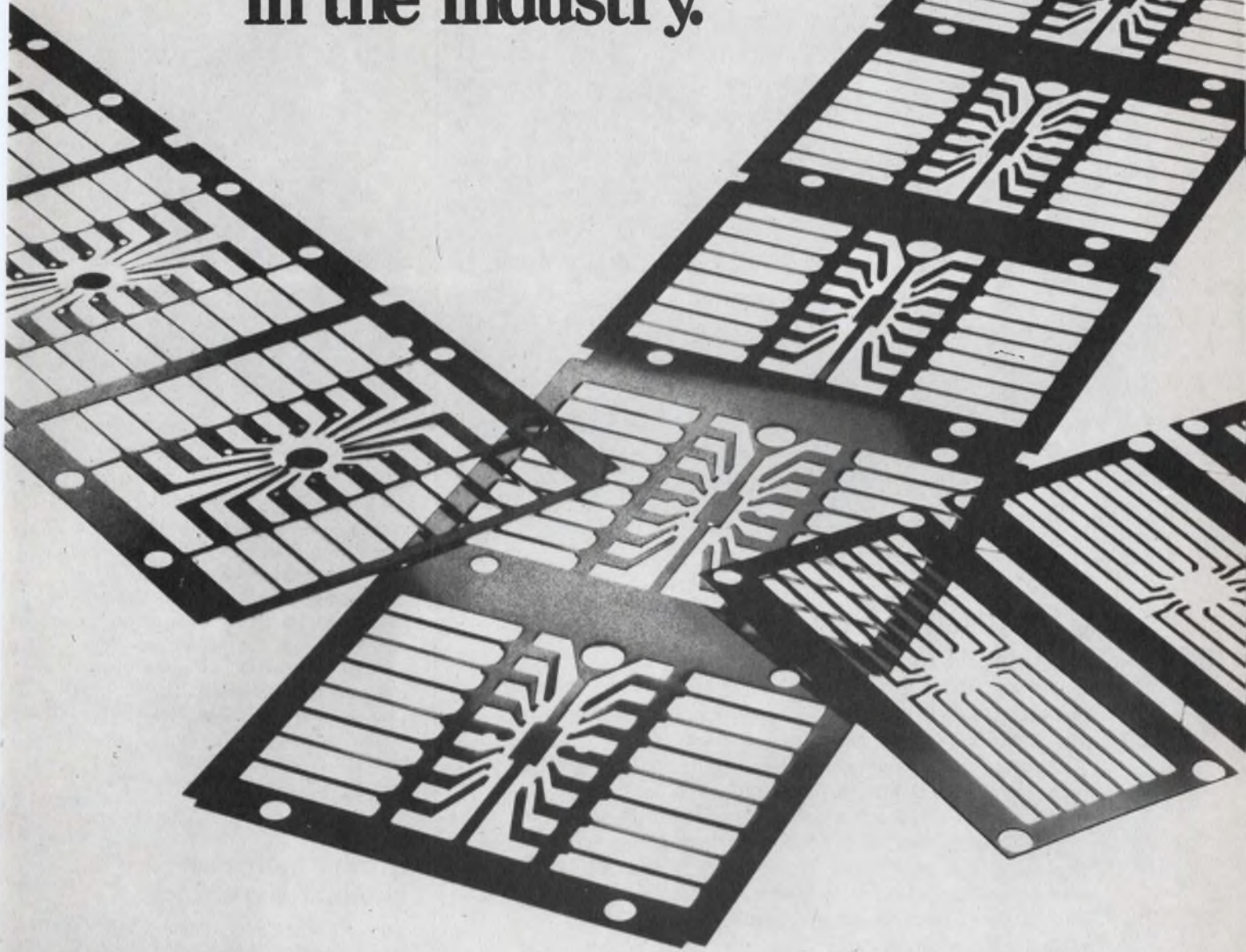

Our lead frames are used by most of the major semiconductor manufacturers. And there are good reasons why.

They've learned that they can depend on Sylvania. For a quality product. For fast service in large production quantities. (We turned out more than 100-million frames last year).

We make lead frames for all types of semiconductor packages—flat packs,

dual-inline packages and plastic encapsulated types.

We make them out of nickel, steel, Rodar,[®] and other glass-sealing alloys.

We make them fast and we make them accurate.

And we're the only supplier that can give you a choice of photo-chemical machined parts or die-stamped parts. Whichever suits your needs the best.

That's why some of the biggest people in the industry like being framed up by us. Wouldn't you?

Sylvania Metals & Chemicals, Parts Division, Warren, Pa. 16365.

SYLVANIA
A SUBSIDIARY OF
GENERAL TELEPHONE & ELECTRONICS

How to select production equipment for multi-component compounds

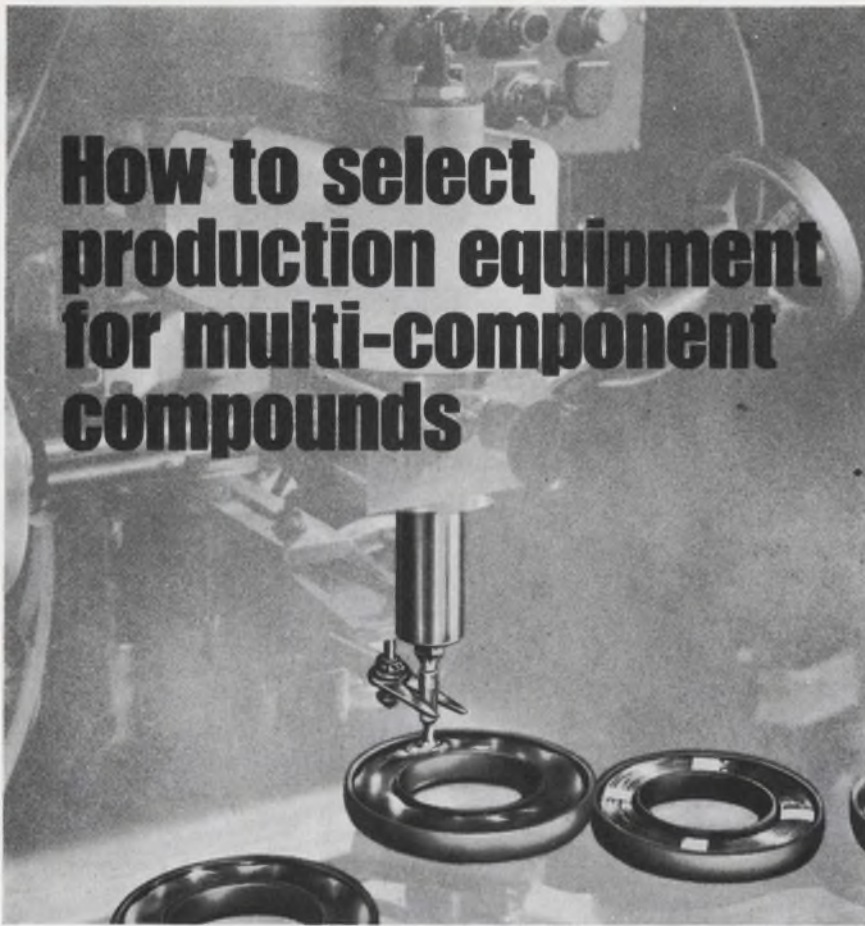

Start with HARDMAN

Handling epoxy and other multi-component resins in production is a complex affair that demands special attention and specialized *experience*. When you work with Hardman you're sure you're getting the most for *your* production.

Hardman has helped many major firms of all types by supplying system design services and/or the necessary equipment . . . from 1) the compounds themselves to 2) pre-heating and de-aerating devices to 3) *Triplematic*® mixing, metering, dispensing machines to 4) automated jigs and fixtures for product positioning to 5) conveyerized devices for carrying your product to the dispensing point and beyond and 6) post-heating or curing devices.

Send for your catalog of available equipment and services today.

6 ways Hardman can help your production

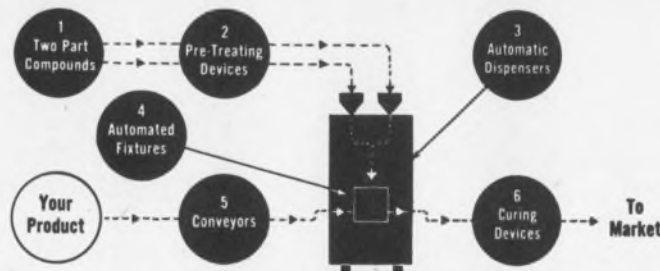

HARDMAN INCORPORATED
BELLEVILLE, NEW JERSEY 07109 (201) 751-3000

INFORMATION RETRIEVAL NUMBER 164

Sound level meter varies damping



Cosmocord Limited, Eleanor Cross Rd., Waltham Cross, Hertfordshire, England.

Measuring 4 by 8-1/2 by 2-1/4 inches, including its microphone, a new sound level meter has fast and slow meter damping capabilities for measuring both peak and average levels. Model SLM 3 provides an output socket for a pen recorder, as well as provision for the checking and adjustment of its calibration level in the field. The microphone capsule is removable and can be used with an extension cable.

Booth No. 3B27 Circle No. 340

IR thermometer eliminates contact

Raytek, Inc., 1277 Terra Bella Ave., Mountain View, Calif. Phone: (415) 961-1650.

Requiring no physical contact, a new infrared thermometer can spot-check and continuously monitor the temperature of electronic components. ThermoProbe T-1000 utilizes a lightweight pencil-like probe to measure temperature in four switch-selectable ranges from 20 to 500°C. Emissivity compensation is 0.2 to 1 on all ranges, to provide accurate readings for a variety of surfaces. The instrument also features a light spot to exactly pinpoint the target area being measured.

CIRCLE NO. 447

ZM1000
READOUT
TUBE
NOW

\$ 2.95

IN THOUSAND LOTS



The Amperex ZM1000 is the first digital numerical indicator tube, designed from the ground up for high-volume applications. It provides big economies, not only in initial cost but also in application. Its low price of \$2.95 in thousand lots is only part of the story... in volume, the ZM1000 sells for less than \$2.00.

We scrapped every notion about how to make numerical indicator tubes and developed a completely new design that offers unsurpassed performance and reliability at mass-production prices.

Every ZM1000 has a built-in decimal-point indicator. Use it if you wish — or ignore it... in either case, there's no additional cost for the decimal-point. The ZM1000's large numerals are clearly legible at 35 feet, yet an 8-digit readout can be installed in only 6 inches of panel.

Superior design makes the ZM1000 more economical to use, too; its high-temperature base is designed to plug directly into a printed circuit board or an inexpensive, readily available socket.

IMPORTANT FEATURES

- Dynamic life expectancy..... 200,000 hrs.
- Height of numeral..... 0.6"
- Tube diameter..... 0.75"
- Height of tube..... 1.67"

For complete data and comprehensive application bulletin on indicator-driver circuits for the ZM1000, write: Amperex Electronic Corporation, Semiconductor and Microcircuits Division, Slatersville, Rhode Island 02876.

Amperex[®]

TOMORROW'S THINKING IN TODAY'S PRODUCTS

A NORTH AMERICAN PHILIPS COMPANY

Hickok CRO 5000 25 MHz Oscilloscope (all solid state)

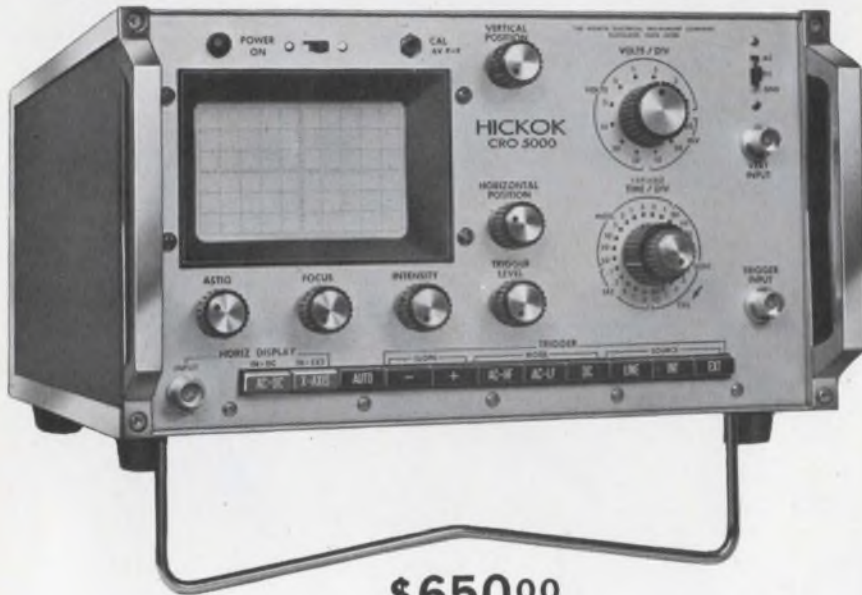

\$650⁰⁰

This high-precision laboratory oscilloscope equals the basic performance of higher priced, sophisticated 'scopes, yet meets the industry need for such performance in the \$600 price range. Emphasis has been placed mainly upon those characteristics most important in precise measurements, eliminating some of the more exotic and somewhat superfluous functions found in higher priced instruments. The result is an all-solid-state instrument in the medium price range with extraordinary stability, sensitivity, bandwidth, sweep-speed range, trigger capability, reliability, and ruggedness.

- 25MHz vertical bandwidth (to 3db down points)
- Usable to 50MHz
- All solid state for high stability and reliability
- 12 calibrated vertical attenuator ranges
10 mv/div to 50 volts/div ($\pm 3.0\%$ accuracy)
- 24 calibrated sweep ranges
0.05 microseconds/div to 2 sec/div ($\pm 3.0\%$ accuracy)
- Vertical delay line assures viewing of full leading edge of pulses
- "Sweep Delay" of up to 40 divisions
- Sweep speed continuously variable between ranges
- X-axis channel bandwidth DC — 5MHz
- 4" flat-faced CRT, 6 x 10 division graticule
- 3.8 kv HV provides sharp, bright trace
- Vertical amplifier will handle overloads, with negligible distortion of waveforms increased to 5 times screen height
- Internal 1.0% calibration squarewave
- Fast, convenient push-button selection of trigger modes
- Positive, solid triggering on all displays
- Small — 11 $\frac{1}{4}$ " W, 6 $\frac{7}{8}$ " H, 19" D; 24 pounds

HICKOK ELECTRICAL INSTRUMENT COMPANY, 10514 Dupont Ave., Cleveland, Ohio 44108
INFORMATION RETRIEVAL NUMBER 166

INSTRUMENTATION

Wideband recorder has 2-MHz response

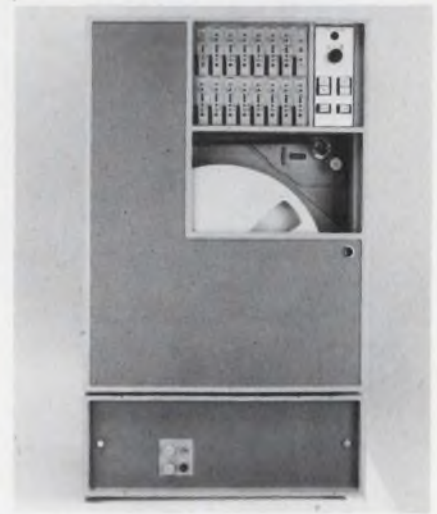

Sangamo Electric Co., P.O. Box 359, Springfield, Ill. Phone: (217) 544-6411.

The series 3570 wideband magnetic tape recorder offers a frequency response of 1.6 MHz or 2 MHz with any combination of tape speeds from 1-7/8 to 120 inches per second. Greater tape storage and higher recording density provide seven times the recording time found on most other portable records. Precision magnetic heads provide 7 tracks on 1/2-inch tape or 14 on 1-in. tape.

Booth No. 2C26 Circle No. 292

Cold-probe system cools 2 W at -55°C

EG&G Inc., Electronic Products Div., 160 Brookline Ave., Boston. Phone: (617) 267-9700.

Designed for testing and maintaining integrated circuits, solid-state devices and other small components at controlled temperatures between -55 and $+180^{\circ}\text{C}$, a new cold-probe system can cool approximately 2 W when temperature is as low as -55°C . Called Thermo-spot, this multi-stage system eliminates the long connecting leads and lengthy stabilization times associated with environmental chambers. It does not require attachments to a water, liquid nitrogen or carbon dioxide supply.

CIRCLE NO. 448

**TEFLON: all by itself
the most thoroughly proven,
high-reliability
insulation**

**But look at the
extra performance
you can get
with TEFLON plus
mineral fillers**

Insulations of Du Pont TEFLON fluorocarbon resins have proven their reliability for more than 20 years, particularly in demanding aerospace applications. But did you know there are also mineral-reinforced constructions of TEFLON, whose extra toughness and abrasion resistance protect against cut-through and installation damage?

These mineral-reinforced insulations of TEFLON are available in a wide range of colors and are rated for use over a wide temperature range—up to 260°C. They offer the nonflammability, resistance to chemical corrosion and the optimum dielectric quality you expect from insulations made with TEFLON.

Consider composite insulations of TEFLON plus mineral fillers (or composites using polyimides or polyvinylidene fluorides plus TEFLON) for your next design.

For additional information, write us and let us know about the specific application you have in mind. Write: Du Pont Company, Room 7296, Wilmington, Del. 19898.

DU PONT
REG. U.S. PAT. OFF.

TEFLON[®]
fluorocarbon resins

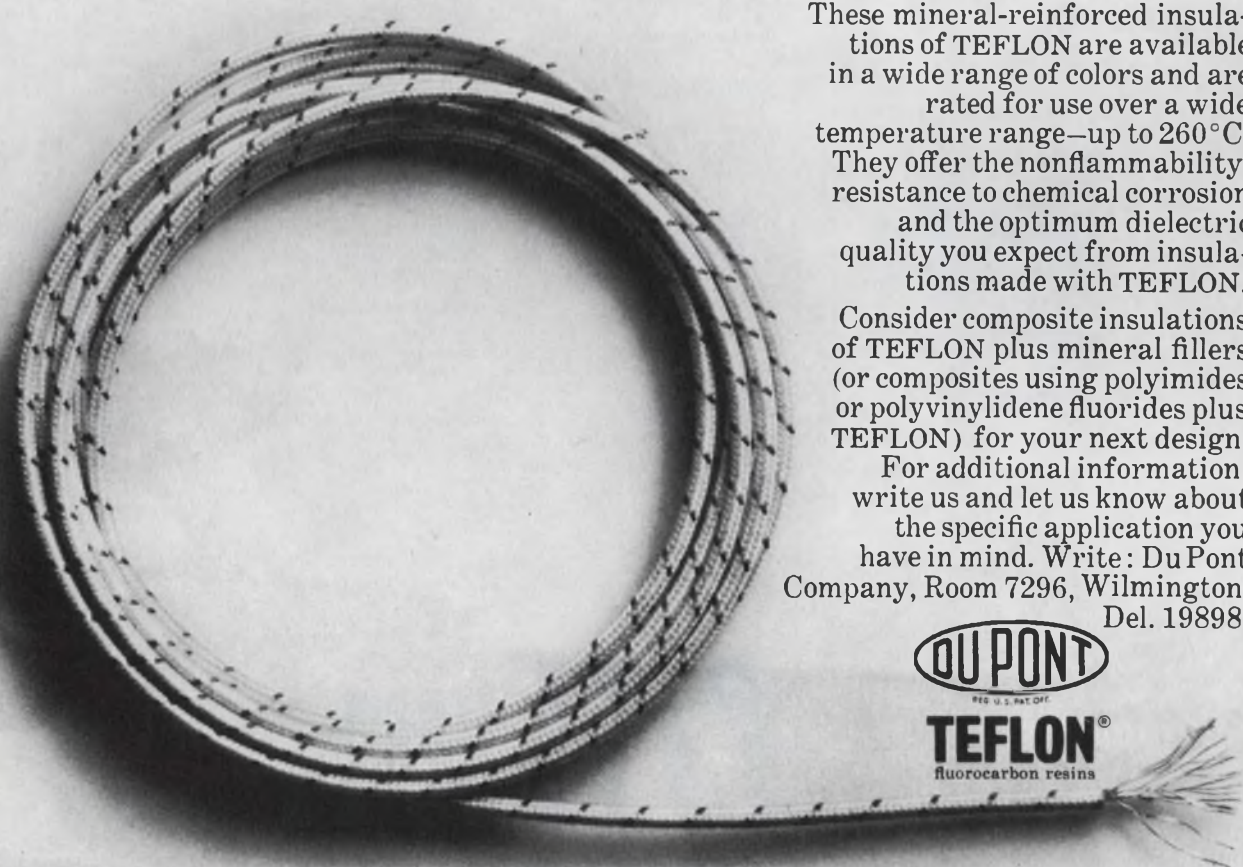

INSTRUMENTATION

L, C, R bridge balances itself



Marconi Instruments, Englewood, N.J. Phone: (201) 567-0607. Availability: 60 days.

A fully-automatic L,C,R, bridge, capable of autoranging and self balancing, measures 0.01 pF to 11 μ F, 0.01 Ω to 11 M Ω and 1 μ H to 110 H. Operating on the transformer ratio-arm principle, it uses electronic nulling. Reading time is less than two seconds for a single sample; 2-1/2 to 10 seconds variable or auto sample, and 40 ms per digit on continuous track after establishing balance.

Booth No. 2D02 Circle No. 291

Solid-state VCO spans 218 MHz



Kay Electric Co., Maple Ave., Pine Brook, N.J. Phone: (201) 227-2000.

A solid-state, VCO sweep generator offers fundamental frequency output from 2 to 220 MHz in twelve overlapping ranges with a direct-reading, calibrated, frequency dial. The PC860H is designed as a plug-in for the KAY 1500C or 860H sweep generators. It provides an rf output of 1 V rms and is flat to ± 0.25 dB. Performance characteristics include line-lock 0.01-to-1000-Hz repetition rate, manual control, cw operation and external modulation.

Booth No. 2D25 Circle No. 263

NATIONAL SALES OFFICE

Walter Andrews
American Micro Systems, Inc.
3800 Homestead Road
Santa Clara, California 95050
408-246-0330 Ex: 211 (Office)
408-252-9022 (Home)

Dempsey Farrier
American Micro Systems, Inc.
3800 Homestead Road
Santa Clara, California 95050
408-246-0330 Ex: 212 (Office)
408-356-7836 (Home)

AMI FIELD APPLICATION ENGINEERS

Bill B. Holmes
320 - 45th Street
Manhattan Beach, California
213-545-3978 (Home) 90266
213-375-6148 (Ans. Service)

Richard J. Konrad
503 W. Haven
Arlington Heights, Illinois
312-437-6496 (Ans. Service)

Martin G. Landin
149-45 - 82nd Street
Howard Beach, New York 11414
212-835-5514 (Home)
212-899-1000 (Ans. Service)

Thomas J. Murphy
7600 Shadywood Road
Bethesda, Maryland 20034
301-469-9597 (Home)
202-425-5312 (Ans. Service)

Hilliard E. Puckett
P.O. Box 20654
Orlando, Florida 32814
305-425-9697 (Home)
305-425-5312 (Ans. Service)

Daniel W. Yoder
6101 Monero Drive
Palos Verdes Peninsula, California
213-377-3787 (Home) 90274
213-375-6148 (Ans. Service)

Richard Wittman
Louise F. Luther Drive, RFD 2
Cumberland, Rhode Island 02864
401-333-2310 (Home)

AMI REPRESENTATIVES

20th Century Marketing, Inc.
2603 Artie Street S.W.
Suite 12
Huntsville, Alabama 35805
205-536-1596

Williams Associates
1110 E. McDowell Road, Suite A-2
Phoenix, Arizona 85006
602-254-6085

Black & Strong, Inc.
1728 S. La Cienega Blvd.
Los Angeles, California 90035
213-870-9191

Williams Associates
4971 Jackson Street
Denver, Colorado 80216
303-388-4391

William R. Lehmann, Company
1010 Executive Center Drive
P.O. Box 20275
Orlando, Florida 32814
305-841-4901

J. A. Dougherty Sales Company
320 Hillen Road
Towson, Maryland 21204
301-832-0431

Circuit Sales Company
One Militia Drive
Lexington, Massachusetts 02173
617-861-0567

Lowry Dietrich Company
600 Michigan Bldg.
Detroit, Michigan 48226
313-961-4540

Williams Associates
420 Washington Street S.E.
Albuquerque, New Mexico 87108
505-255-1638

Bowser & Sapecky Associates
4541 Main Street
Buffalo, New York 14226
716-839-4170

Electro Rep., Inc.
380 N. Broadway
Jericho, New York 11753
516-938-0540

Bowser & Sapecky Associates
4317 E. Genesee Street
Dewitt, New York 13214
315-446-5920

Bowser & Sapecky Associates
806 Main Street
Poughkeepsie, New York 12601
716-839-2044

Byrd & Barbour Sales, Inc.
P.O. Box 30
Smithfield, North Carolina 27577
919-934-8136

Lowry Dietrich Company
316 Marion Bldg.
Cleveland, Ohio 44113
216-781-1855

Lowry Dietrich Company
333 W. First Street
Dayton, Ohio 45402
513-223-6042

Lowry Dietrich Company
90 Clairton Blvd.
Pittsburgh, Pennsylvania 15236
412-892-2992

Arnold Barnes Company
3230 Mercer Street
Houston, Texas 77027
713-622-3620

Arnold Barnes Company
P.O. Box 709
Richardson, Texas 75080
214-235-4541

Arnold Barnes Company
E106 Petroleum Center
San Antonio, Texas 78209
512-828-1323

Williams Associates
2461 S. Main Street
Salt Lake City, Utah 84115
801-466-8709

Arneson Associates
5950 Sixth Avenue
Seattle, Washington 98108
206-762-7664

Arneson Associates
Suite 4C
200 N.E. Canyon Road
Beaverton, Oregon 97005
503-646-3416

FOREIGN REPRESENTATIVES

Radio Television Francaise
73 Avenue De Nevilly
92 Nevilly Sur Seine
Paris, France
tel: 722 70-40
telex: 21933

AMI DISTRIBUTORS

Black & Strong
1728 S. La Cienega Blvd.
Los Angeles, Calif. 90035
213-870-9191 (Phone)
910-340-6369 (TWX)

Cramer Electronics, Inc.
320 Needham Street
Newton, Mass. 02164
617-969-7700

Cramer/Eastern, Inc.
Pickard Bldg.
E. Molloy Road
Syracuse, N. Y. 13211
315-455-6641

Cramer Electronics
96-10 - 23rd Avenue
Elmhurst, N. Y. 11369
212-478-4000

Cramer/Florida, Inc.
4141 N.E. 6th Avenue
Ft. Lauderdale, Fla. 33308
305-566-7511

Cramer/Huntsville, Inc.
2222 North Memorial Pky
Huntsville, Ala. 35801
205-536-4493

Cramer/Washington, Inc.
692 Lofstrand Lane
Rockville, Md. 20850
301-424-2700

Cramer/Baltimore
922-24 Patapsco Avenue
Baltimore, Md. 21230
301-354-0100

Cramer/International
96-10 - 23rd Avenue
Elmhurst, N. Y. 11369
212-478-5383

Cramer/Atlanta
3130 Marian Drive
Atlanta, Georgia 30040
404-541-5421

Cramer/Raleigh, Inc.
3331 North Blvd.
Raleigh, N. C. 27604
919-832-6441

Cramer Electronics, Inc.
35 Dodge Avenue
North Haven, Conn. 06512
203-239-5641

Cramer Tri-States, Inc.
666 Redna Terrace
Cincinnati, Ohio 45215
513-771-6441

Cramer Pennsylvania, Inc.
7300 Route 130
Pennsauken, N. J.
609-662-5061

Cramer Rochester, Inc.
3259 Winton Road South
Rochester, N. Y. 14623
716-275-0300

Waco Electronics
4975 Jackson Street
Denver, Colorado 80216
303-388-4391



**American
Micro-systems, Inc.**

3800 Homestead Road Santa Clara, Calif. 95051 (408) 246-0330

**new
dimensions
with mos
technology**

AMI delivers

**66 off-the-shelf LSI circuits
immediately available.**

AMI's recognized quality Mil. Spec.
line plus a new commercial/industrial
line includes:

- Shift Registers
 - Memories
 - Multiplexers
- Standard Arrays
- Low Power Arrays
 - Discretes

Call or write for your copy of AMI's
new Short-Form Catalog Today!

American Micro-systems, Inc.

3800 Homestead Road, Santa Clara, California 95051, Tel: (408) 246-0330
TWX: (910) 338-0018

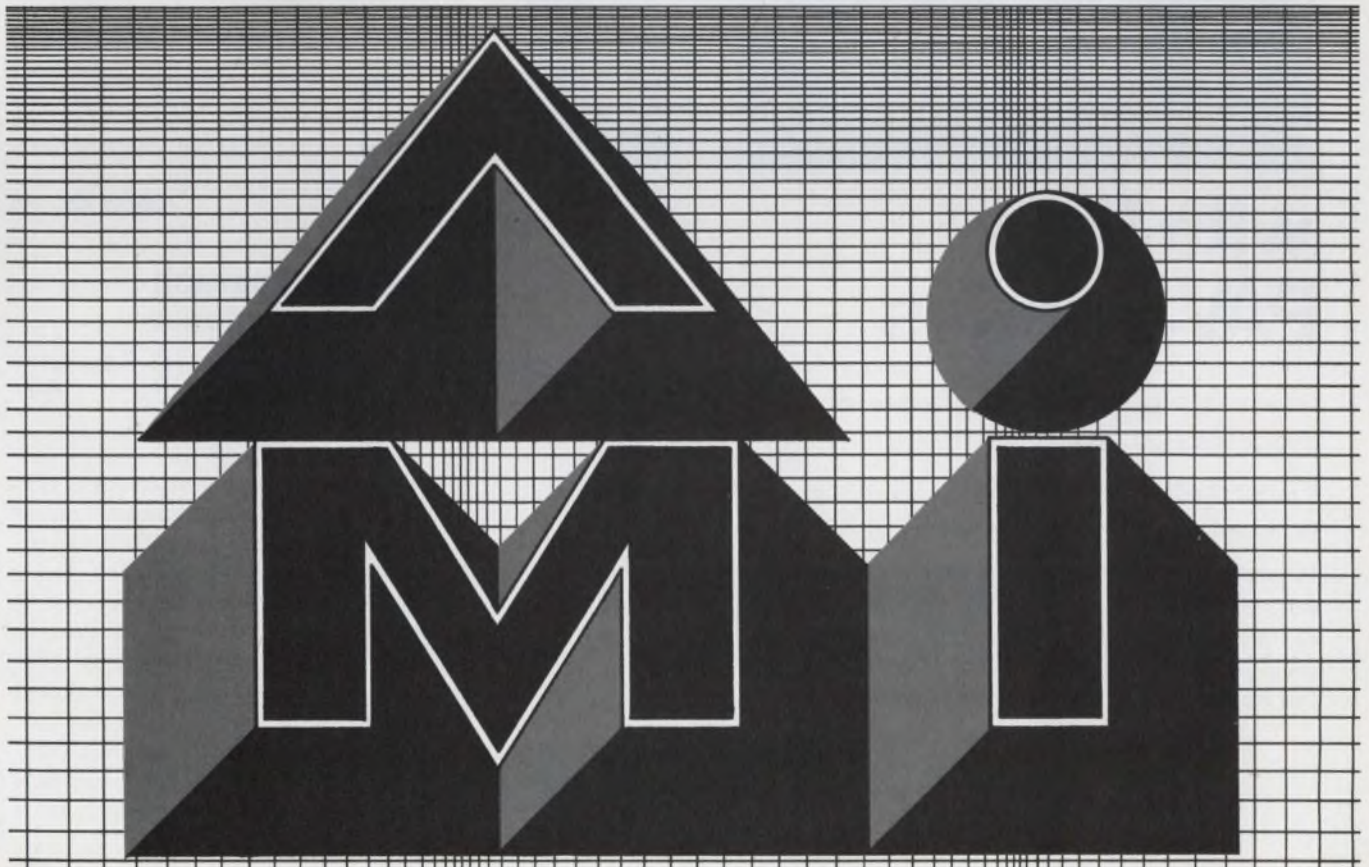

INFORMATION RETRIEVAL NUMBER 169

solid state phase angle voltmeter for phase sensitive and phase angle measurements



easy as ...

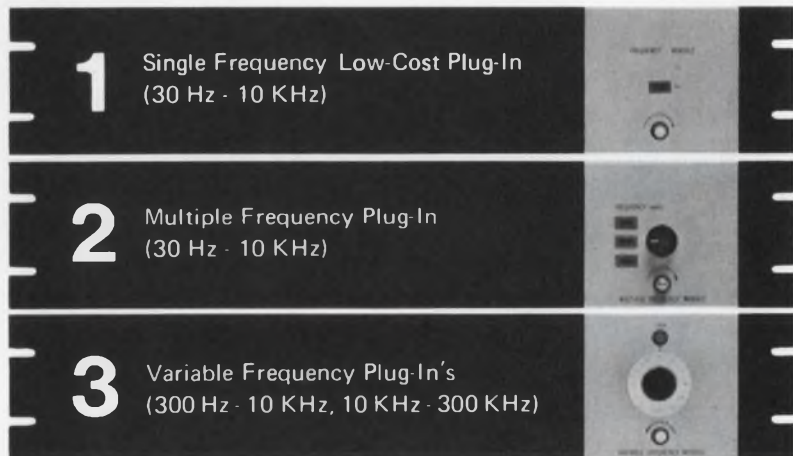

with the PAV-4 series

Optional 10 megohm signal and reference isolation

300 μ V full scale range

0.1 degree phase angle resolution

DC analog outputs for computer interface

For a demonstration, or for full technical details, call your local Singer Instrumentation representative or contact us directly at the Singer Company, Instrumentation Division, Gertsch Operation, 3211 S. La Cienega Blvd., Los Angeles, Calif. 90016, (213) 870-2761.

SINGER
INSTRUMENTATION

INFORMATION RETRIEVAL NUMBER 182

INSTRUMENTATION

Thermocouple reference compensates junctions

Omega Engineering, Inc., P.O. Box 4047, Stamford, Conn. Phone: (203) 332-1666. P&A: \$85 to \$95; 30 days.

Introducing a new concept in cold-junction reference sources, a new thermocouple compensator eliminates messy ice baths, warm-up time delays and cumbersome instruments. Model CJ plugs directly into any standard thermocouple panel board, potentiometer, readout meter or probe assembly. It is highly reliable, uses solid-state circuitry and has a self-contained battery.

Booth No. 4H25 Circle No. 341

Digital clock system uses stable reference

Racal Electronics Ltd., 26 Broad St., Wokingham, Berks., England.

Model 812 digital clock system uses a high-stability reference standard or line-frequency reference. It has a time-base failure alarm, and fast and slow correction facilities. Digital time indications are in hours, minutes and seconds, and synchronization and set-time functions are included. There are also four separate timing program pulses with BCD or decimal outputs.

CIRCLE NO. 350

Sweep diagraph plots impedance

Rohde & Schwarz, 111 Lexington Ave., Passaic, N.J. Phone: (201) 773-8010. \$8895; 60 days.

Whether you call it a sweep diagraph or an impedanzwobbler, this 10 to 480-MHz instrument measures impedances, admittances, attenuation, and phase. The basic unit contains sweep generator, oscilloscope, measuring circuitry and power supply. Directional couplers and mixer heads are coupled to the basic unit with multiple cables. The instrument gives a complex display of reflection coefficient and transmission factor on a Smith chart.

Booth No. 2H03 Circle No. 383

Bidirectional counter programs remotely

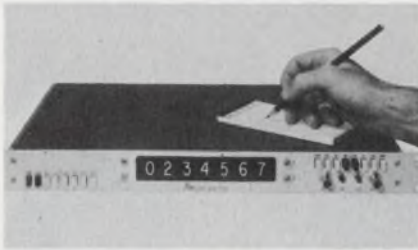

Atec, Inc., 1125 Lumpkin Ave., Houston, Tex. Phone: (713) 468-7971. P&A: \$895; 30 days.

Featuring anti-coincidence integrated circuitry and modular design, a 10-MHz bidirectional counter can be remotely programmed for external control of function, starting count, gate control and display-clear. Model 2400 provides a BCD output to drive a digital printer or tape punch. Its front-panel lamps show the status of the count gate by indicating the algebraic polarity of the count total or that the display capacity has been exceeded.

CIRCLE NO. 449

BCD drum printer interfaces easily

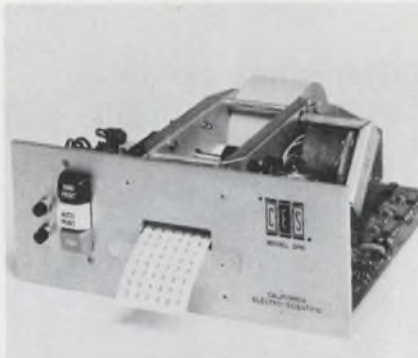

California Electro Scientific, 2203 South Grand Ave., Santa Ana, Calif. Phone: (714) 546-9550. Price: \$660.

Featuring floating decimal and automatic printout of range and polarity, a new BCD drum printer is tailored so that it interfaces directly with an unusually wide variety of instrumentation and data acquisition systems. Model DP6 operates at the rate of two lines a second. Its print drum/drive mechanism is directly and synchronously driven from any 60-Hz line.

Booth No. 2A07 Circle No. 339

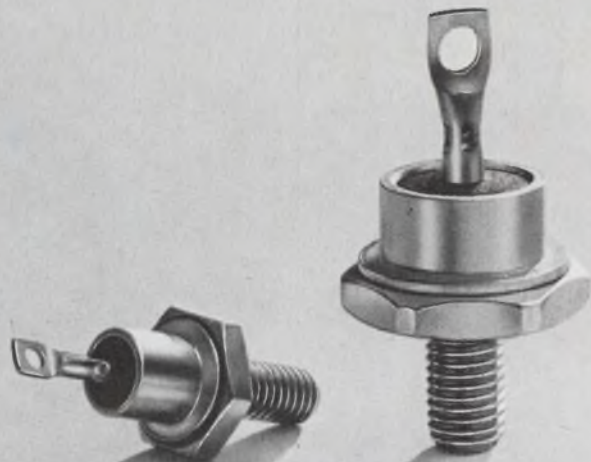

Solitron DO-4 and DO-5 packages

...the glass passivated ones.

Up to now, junctions of DO-4 and DO-5 stud rectifiers were coated with conventional materials: plastic, epoxy or varnish. The possibility of contamination was always present.

Now Solitron has incorporated its Solitron chip into these two configurations. The Solitron's glass passivated junction withstands temperatures of up to 1000° C., giving higher-than-ever reliability. High temperature reverse bias is no longer a problem due to the elimination of the effects of ionic migration. These packages exceed the applicable environmental requirements of MIL-S-19500E.

Solitron DO-4 and DO-5 packages are available in normal and fast-switch versions, with recovery speeds of 250 and 400 nanoseconds, depending upon voltage. Peak inverse voltages of up to 1000 volts per junction are available.

The DO-4 is available in the following types: 1N3879 to 3883; 1N3889 to 3893; and 1N3909 to 3913. The DO-5 is available in these types: 1N1183 to 1190; 1N1193; 1N1195 to 1198; 1N248B to 250B; 1N3208 to 3214; and 1N3899 to 3903. Reverse polarity types are available in both packages.

New specification sheets are now available.



256 OAK TREE ROAD
TAPPAN, N. Y. 10983
PHONE (914) 359-5050
TWX: 710-576-2654
TELEX: 13-7346

INFORMATION RETRIEVAL NUMBER 183

FOR 8-TRACK RECORDING ON 1/4" TAPE

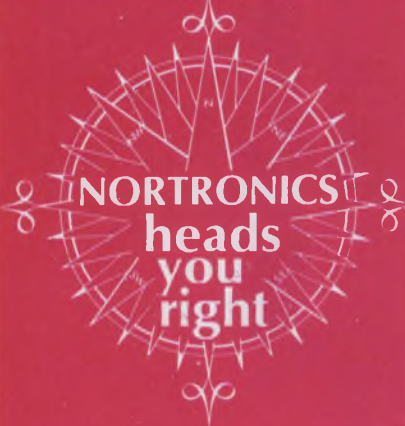

Since we pay a lot of attention to everybody's magnetic recording needs, we can readily understand both how and why yours are different. That's why we offer not only a tremendous range of tape heads, but also the expert counsel that guides you to the most effective specifications.

Study our technical literature on these 8-track heads (available free on request):

MODEL B2L



The basic head of the 8-track stereo industry, for record and/or playback. Response through 15Khz at 3.75 ips.

MODEL ZJ2L



First Combo head for 8-track stereo. Record, playback, and erase in a single unit. Eliminates assembly tolerance, track alignment and pressure pad problems. Simplify circuitry: internal automatic biasing.

MODEL P-BQL



For duplicating or instrumentation applications. Maximum information storage at minimum cost. Four in-line tracks. A staggered pair provides 8 tracks on 1/4" tape.

Which one fits your needs? Nortronics, the world's largest tape head manufacturer, has what it takes to analyze your requirements and to recommend the right head...for any audio or instrumentation application.

When you have a tape head need, head for Nortronics. We'll head you right.

Nortronics
COMPANY, INC.

8101 Tenth Avenue North
Minneapolis, Minnesota 55427
Phone—(612) 545-0401

Sales Offices throughout the world

INFORMATION RETRIEVAL NUMBER 184

ICs & SEMICONDUCTORS

Molded phototransistors break price barrier

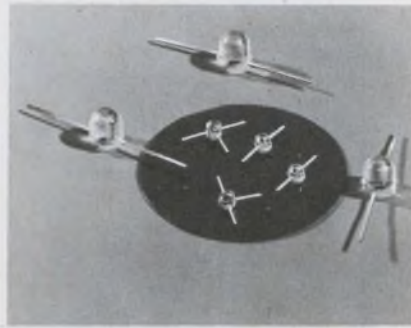

Motorola Semiconductor Products Inc., P.O. Box 20924, Phoenix, Ariz. Phone: (602) 273-8466. Price: 80¢ to \$1.

Three new, low-cost phototransistors in molded plastic packages include model MRD450, a two-leaded unit with an integral lens for high sensitivity and definition; and models MRD100 and MRD150, subminiature units for applications that require high-density mounting. The devices can fill needs, for which earlier devices proved prohibitively expensive.

CIRCLE NO. 450

Rectifier diodes carry up to 12 A



Solitron Devices, Inc., 256 Oak Tree Rd., Tappan, N.Y. Phone: (914) 359-5050.

Medium-power rectifier diodes that can handle currents as high as 6 or 12 A are now supplied in DO-4 or DO-5 packages. The double-diffused units have a peak reverse voltage rating of 1000 V maximum, while the fast-recovery units are rated at 600 V maximum. All the devices use a double hermetic seal to ensure stability and withstand rugged environmental conditions.

Booth No. 4G20 Circle No. 392

Lock-fit transistors cut assembly cost

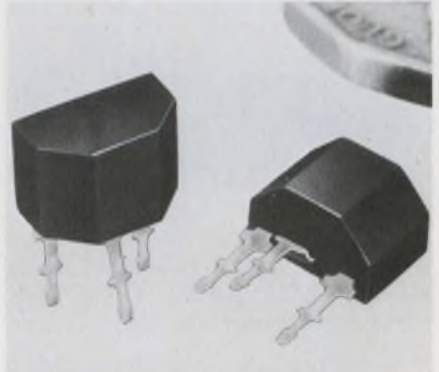

Mullard Ltd., Mullard House, Torrington Place, London, W.C. 1, England. Phone: 01-580-6633.

Lock-fit transistors offer equipment manufacturers reduced assembly time and lower production cost. Their regular outline simplifies machine handling and mounting on printed circuit boards. The series includes npn types BC147, BC148, and BC149, and pnp types BC157, BC158, and BC159. Devices suitable for the high frequency stages of radio and television receivers are types BF194 and BF195.

Booth No. 3B13 Circle No. 289

Differential op amp has matched input



Opamp Labs., 172 S. Alta Vista Blvd., Los Angeles, Calif. Phone: (213) 934-3566. Price: \$30.

Model 435 differential dc operational amplifier contains a matched pair of low-noise input transistors coupled to an op amp to provide class AB output power. The unit, which has no output crossover distortion, boasts a high output voltage and current capability. It can be used at any supply voltage from ± 6 to ± 25 V. Its unity-gain bandwidth is 2 MHz.

CIRCLE NO. 451

How much space can I save by using the new "tini-telephone" jack panels and accessories?

You can figure on a fifty-percent reduction in space by using the Switchcraft "tini-telephone" patching system. And, we do mean system!

These aren't just scaled-down versions of standard-size patching components. The "tini-telephone" jack panels and accessories (see Fig. 1.) were designed from scratch to offer quality and convenience features never before available. (Just circle the reader service number to receive complete information.)

Sounds good, but how about the accessories? I don't want any compatibility problems in matching components from different vendors.

Let's take the accessories one-by-one and you'll see what we mean by "tini-telephone" system:

PATCH CORDS —

Circuit-wise, you can have two or three conductor single plug patch

cords or three or five conductor twin plug patch cords in a variety of cable lengths. The cable is high quality stranded plastic-jacketed type with shielding rated at 70-80%. All connections are soldered, and improved strain relief is accomplished by crimping a long tubular metal sleeve 360° around the cable jacket and plug sleeve.

Flexible, molded PVC handles minimize cable breakage and absorb any tolerance variations between twin plugs and mating panel jacks. Terminating, dummy and looping plugs are also available.

SWITCHES —

A gusseted extra-strength frame is provided on "tini-telephone" switches. Plenty of throw is provided to assure contact wipe and required pressure for low contact resistance. The switches are rated 2 amps 200 watts max., A.C. non-inductive load with circuit configurations up to 2C (or 3A) and momentary or push-pull actuation may be specified.

LAMP JAX —

"tini-telephone" lamp jax accept standard bi-pin lamps and offer convenient front panel relamping. Special heat sink fins dissipate heat and a unique jewel and sleeve

assembly eliminates the need for special insertion or withdrawal tools when relamping. (See Fig. 2.)

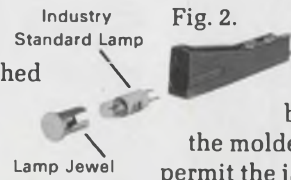

Fig. 2. The jack panel, itself, has an extra wide flange for better rigidity and the molded panel inserts permit the jack bushings to

protrude slightly from the panel face for more positive electrical continuity in the sleeve circuit with the mating jack. Then there's the snap-on designation strips and reusable marking strips for fast, frustrationless nomenclature changes. Additional accessories such as, blank panel inserts, opaque-black hole plugs, plus designation strip kits gives you the most versatile, compact patching system ever designed.

Looks like you've thought of everything. I'll need complete specifications for my engineering group.

Just request our "FORUM FACTS" catalog on "tini-telephone" jack panels & accessories on your company letterhead. **You can also see these products at Switchcraft IEEE Booth 4G30-4G32.**



5529 North Elston Avenue
Chicago, Illinois 60630

Fig. 1.



SWITCHCRAFT FORUM

Introducing the new "tini-telephone" patching system

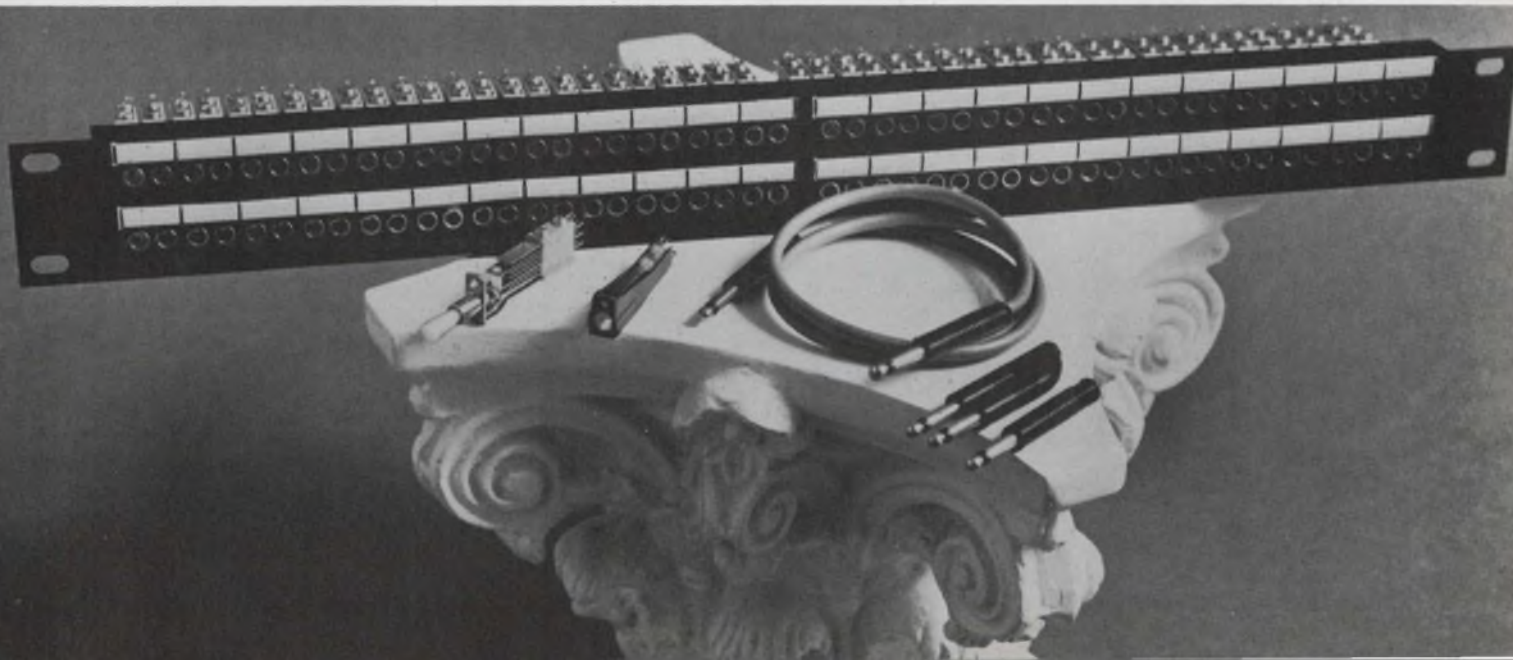

san fernando

electric manufacturing company

Electronic components
of proven reliability

INTRODUCES AN OUTSTANDING RFI FILTER



Actual Size

TYPE CF MINIATURE RFI LOW PASS
FILTER SERIES DEVELOPED BY WEST-CAP®

▶ PACKS MORE INSERTION LOSS IN A
SMALLER UNIT THAN EVER BEFORE

Plus all these features:

MINIATURE SIZE • LOW WEIGHT • LOW D.C. RESISTANCE • HIGH
ATTENUATION • HERMETICALLY SEALED • BROADER RANGE OF
VALUES • GOLD OR SILVER PLATED, STEEL CASE • HIGHER CUR-
RENT RATINGS (TO 15 AMPS.)

Dimensions (inches)

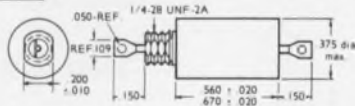

NOTE: Supplied with nut and lockwasher

Ordering information

CF	4	A	PO6	1	G
TYPE	CIRCUIT	VOLTAGE	CURRENT	MOUNTING STYLE	TERMINAL STYLE

Voltage

A	50 VDC
B	100 VDC
C	200 VDC (115 VAC)

Circuit

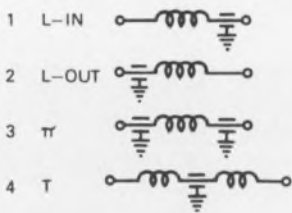

Mounting Style

1	.312	NO FLATS
2	.312	2 FLATS
3	.190	NO FLATS
4	.190	2 FLATS

Terminal Style

G	90° LUG
L	LEADS

Current in Amperes

PO6	.06 Amps.
P15	.15 Amps.
P25	.25 Amps.
P50	.50 Amps.
1PO	1.0 Amps.
2PO	2.0 Amps.
3PO	3.0 Amps.
5PO	5.0 Amps.
10P	10.0 Amps.
15P	15.0 Amps.

Call your representative of West-Cap high-reliability
products or contact West-Cap Division—where service
and quality count.



WEST-CAP DIVISION

1501 First Street, San Fernando, California
Telephone: (213) 365-9411 TWX (213) 764-5963

STANWYCK WINDING
NEWBURGH, NEW YORK

WEST-CAP ARIZONA
TUCSON, ARIZONA

GENERAL SCIENTIFIC
SAN FERNANDO, CALIFORNIA

INFORMATION RETRIEVAL NUMBER 186

ICs & SEMICONDUCTORS

DIP amplifier spans 60 MHz

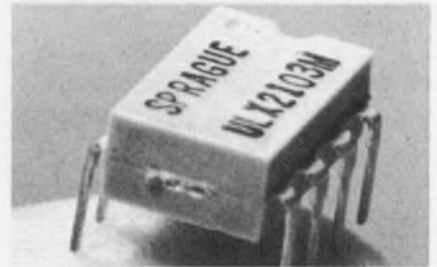

Sprague Electric Co., 347 Marshall
St., North Adams, Mass. Phone:
(413) 664-4411.

Housed in an 8-lead plastic dual-
in-line package, a new integrated
circuit broadband amplifier fea-
tures a 60-MHz bandwidth with a
30-dB typical voltage gain over the
temperature range of 0 to +85°C.
Type ULNX-2103M, which pro-
vides a current gain of 10 is
ideally suited for current amplifica-
tion.

CIRCLE NO. 454

Press-pak SCR carries 300 A



General Electric Co., Semiconduc-
tor Products Dept., 1 River Rd.,
Schenectady, N.Y. P&A: \$300; 30
days.

Said to be the world's highest
concurrent-rated inverter SCR, a
new press-pak SCR is rated at
1200 V with an average current of
300 A and an inrush current of 800
A/μs. Designated model C398, the
device contains a unique gate struc-
ture that makes possible a superior
rated thyristor, optimized for in-
verter and chopper applications.
Other features include frequency of
up to 5 kHz for square waves and
10 kHz for sine waves, gate drive
of 225 mA, and typical turn-off
time of 25 μs.

CIRCLE NO. 455

Timing-circuit chip compares and powers



Optical Electronics Inc., P.O. Box 11140, Tucson, Ariz. Phone: (602) 624-8358. P&A: \$27; stock.

On a single chip, a new monolithic timing circuit contains dual matched current sources and a precision analog voltage comparator, to suit a variety of timing applications—from monostable delay circuits to turn-on delays. Model 7100 features time delays from 10 μ s to 1 hour and requires only one to two external components for most timing applications. Output is compatible with 10-V analog, MOS, RTL, DTL and TTL circuits.

CIRCLE NO. 456

Automatic system tests linear ICs

Optimized Devices, Inc. Pleasantville, N. Y. Phone: (914) 769-6100. P&A: \$50,000; 90 days.

An automatic system for high-speed testing of linear IC and discrete component circuits provides both go/no-go and four digit measurement data on linear circuits at the rate of 20 tests per second. The system tests circuit components, applies power to the circuit, and actively tests the functioning circuit in one program. The circuit under test is not energized if passive tests fail. Primary areas of application include production testing and incoming inspection. Basic measurement capabilities of the 5000PC include dc voltage (single ended and differential), dc current, ac voltage, impedance, dc resistance, diode transistor orientation, and in-circuit beta tests.

Booth No. 2C13 Circle No. 268

What can you do with a blower motor offering up to 7 stages and 3 psi?

With speeds up to 7500 rpm for the WINDJAMMER 9.5 Belt-Driven Blower, and an "airpower" range as wide as the one shown below?

You can obviously solve a wide range of air-moving problems, and fit these solutions exactly to your requirements. Which is just what Lamb Electric's new WINDJAMMER Blower line is designed to do. A stock of standard modular components allows Lamb Electric to build just the power system you need by adding stages (up to seven), with a choice of motor windings, face or foot mountings plus important optional features. These modular components are already engineered and tooled to eliminate excessive costs and to allow for rapid delivery. And expensive air valves and bleed devices are eliminated by the WINDJAMMER Blower "add on" design.

So while there are no "customizing" costs, Lamb can still exactly satisfy your air-moving requirements in a wide variety of applications. And at the same time reduce the "cost per hour of operation" in computers, business machines, magnetic tape transports, card readers and sorters, fluidic devices....

In fact, there are very few problems you can't solve with the WINDJAMMER Blower line working for you. Size problems? We've got a tough 5.7-inch model for you. Noise? The WINDJAMMER is one of the quietest blowers made. Weight? The typical five-stage unit is 18 pounds. Life? It'll go for over 20,000 hours.

For complete specifications and performance data on the entire WINDJAMMER Blower line, write us today: Ametek, Inc., Lamb Electric Division, Kent, Ohio 44240.

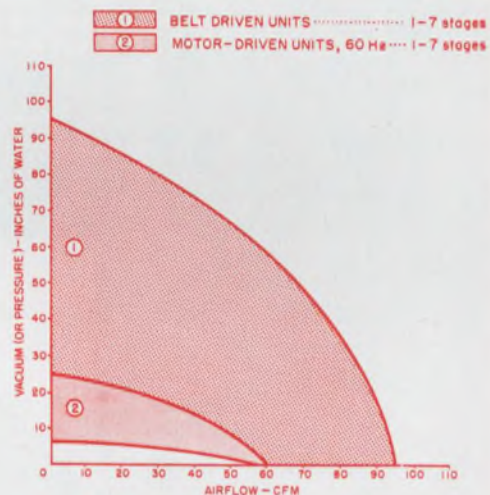
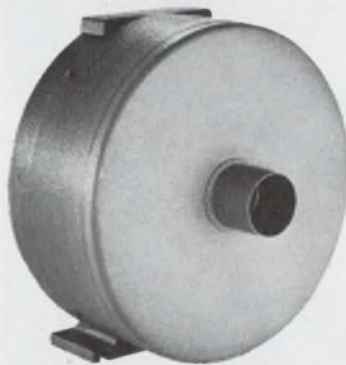
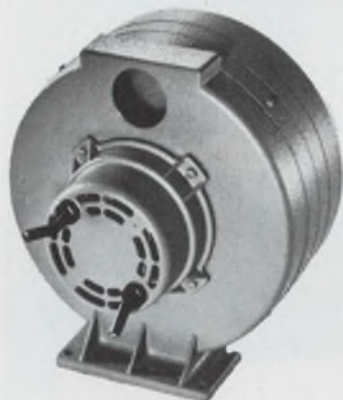

AMETEK / Lamb Electric

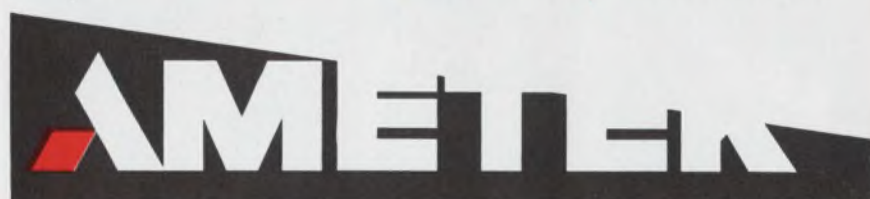

INFORMATION RETRIEVAL NUMBER 187



Keeping the hot ones cool— Eastern Industries

When an electronic system aboard a high-performance military aircraft blows its cool, the mission gets scrubbed. Sometimes the whole aircraft too.

So it figures that the big names in airborne electronics go to the first name in environmental control: Eastern. Eastern's track record in this specialized field goes back 20 years.

In addition, Eastern's new heat exchanger manufacturing facility means that you can call on us as your single source for all components of an integrated cooling system.

For full information, write today for Bulletin 1364.



The laser range finding system of the Cheyenne AH56A is kept on the target by this compact cooling system.



EASTERN INDUSTRIES

A Division of Laboratory For Electronics, Inc.
100 Skiff Street • Hamden, Connecticut 06514

BRANCH OFFICES: Boston, Mass., Lyndhurst, N.J., Wilmington, Del., Chicago, Ill.
Torrance, Calif. Also available in Canada

INSTRUMENTATION

Zener diode chip kit comprises 30 ratings



Globe Union Inc., Centralab Semiconductor Div., 4501 N. Arden Dr., El Monte, Calif. Phone: (213) 686-0567. P&A: \$187.50; stock.

Specifically designed for hybrid microcircuits, for development projects or small production runs, a zener diode chip kit contains 50 chips each of the 30 most popular zener voltages. Offering easy access as well as physical and environmental protection, the kit consists of a walnut box filled with 30 plastic trays.

CIRCLE NO. 452

Compensated op amp drifts only 25 $\mu\text{V}/^\circ\text{C}$



Zeltex, Inc., 1000 Chalomar Rd., Concord, Calif. Phone: (415) 686-6660. Price: \$23.

Providing internal frequency compensation, a dual-in-line differential operational amplifier features an input bias current of 25 nA and a maximum input voltage drift of 25 $\mu\text{V}/^\circ\text{C}$. At 100 kHz, model 820 supplies a full output of $\pm 10\text{ V}$ at 5 mA. It is packaged in a standard 14-pin case.

CIRCLE NO. 453

Report from

**BELL
LABORATORIES**

A simple, better microphone

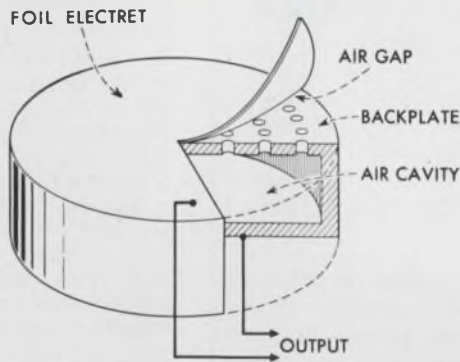

Essentials of the new microphone: The microphone's diaphragm is a charged dielectric foil upon which a thin metal layer has been deposited; it is called a foil electret. The electret touches a metal backplate in several places and, due to surface irregularities, air pockets form between the electret and the backplate. The backplate is perforated so that the air layer can communicate with the larger cavity, increasing the vibration amplitude (and thus the sensitivity) of the system.

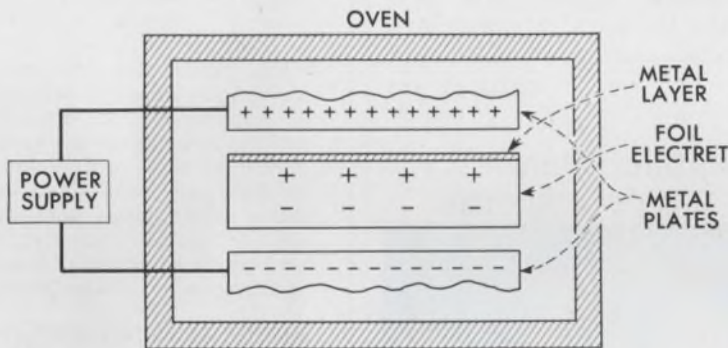

Simplified cross-sectional diagram showing how microphone "electrets"—permanently charged dielectric foils—are made. The metallized foil is heated to about 200°C while between a pair of charged metal plates which create an electrostatic field of between 10 and 100 kV/cm. Charges, identical in sign to the adjacent plates, migrate from the plates to the electret, where they remain after cooling. This method of foil electret preparation was announced by Bell Laboratories in 1962.

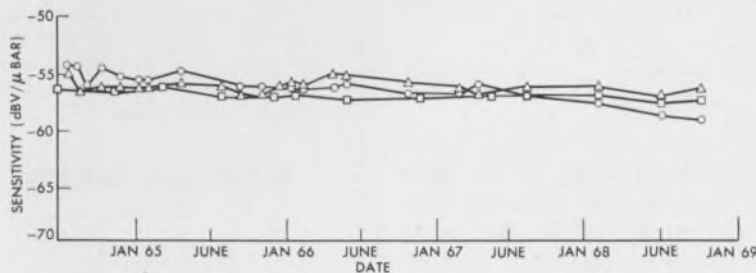

Sensitivity of electret microphones using fluorocarbon foils is nearly constant. Extrapolated lifetime is about 100 years.

A new kind of condenser microphone with several valuable features has been invented by Gerhard M. Sessler and James E. West of Bell Laboratories. It has the excellent sound fidelity of former types of condenser microphones, but does not need a d-c supply, and has much lower electrical impedance; this permits good low-frequency response without the need for special circuits.

Like previous designs, the new microphone depends on a varying capacitance—produced as sound vibrations impinge on one flexible plate of a capacitor. But there's a difference: here, the flexible plate is a "foil electret"—a thinly metallized sheet of fluorocarbon or polycarbonate. The electret contains a permanent static charge. As the electret moves, it varies the electrostatic field across the air gap (drawing). This produces a varying voltage at the output. Thus, the microphone needs no d-c supply.

In any capacitor, the thinner the dielectric, the higher the capacitance. Dielectric films can be made 0.00012 to 0.001 inch thick. So, the capacitance of the electret microphone is about triple that of conventional types of condenser microphones, and the impedance is comparably lower. This simplifies accompanying circuitry.

The microphone is inexpensive, exceptionally rugged, and immune to wide temperature fluctuations.

As the graph (left) shows, the microphone's sensitivity remains essentially constant for very long periods. This is due to an inherent compensation only possible with thin-film electrets: as the charge on the electret decays—and measurements indicate that it will take about 100 years to fall 50 percent—electrostatic attraction between electret and backplate is reduced. This diminishes the restoring force on the electret, allowing it to vibrate at greater amplitude. Electrical output remains, therefore, nearly constant.

As with all promising devices the electret microphone is being evaluated by our development and systems engineers. Because of its simple construction and low cost it may well find application in future telephones.



Bell Telephone Laboratories
Research and Development Unit of the Bell System

LAPPING or GRINDING takes a

"Turn for the better"

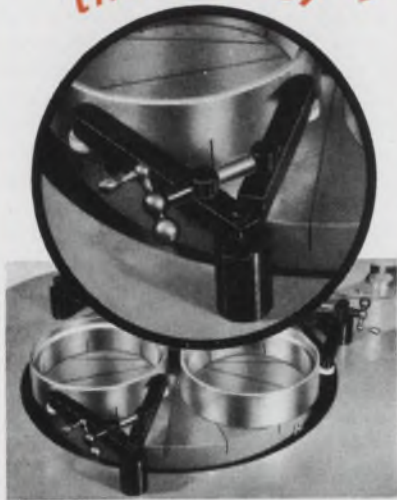

with

CALIPER

ADJUSTMENT

CONTROL



by *Spitfire*

With Caliper Adjustment Control, new lapping precision and profits start with a turn of the screw crank.

Spitfire's unique new caliper designed holding arms, fitted with nylon-tire bearings, cradle part retainer and conditioning rings . . . hold them securely in a fixed position on the lapping plate for maximum lapping results. All adjustments are crank-controlled . . . all can be made while the machine is in cycle to eliminate down-time, increase production.

Best of all, there's a Spitfire machine sized to match your needs precisely — from 12" to 96" in diameter — and all available with "CAC".

FREE CATALOG . . . For the full story on "CAC" and the entire Spitfire line, call or write for this new catalog today!



SPITFIRE LAPPING DIVISION

SPITFIRE TOOL & MACHINE CO.

4020 North Tripp Avenue

Chicago, Illinois 60641 Phone: 312/286-1610

COMPONENTS

Numerical readout displays 14 decades

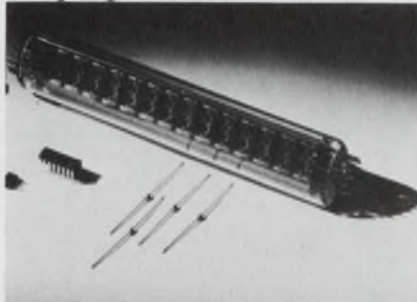

Philips Electronic Components and Materials Div., distributed by Amperex Electronic Corp., Providence Pike, Slaterville, R.I. Phone: (401) 762-9000.

Called the Pandicon, a multi-decade numerical indicator tube displays 14 decades from a single cylindrical envelope that is only 180-mm-long and 28-mm in diameter. Taking full advantage of modern IC driving techniques, model ZM 1200 needs only 27 external connections, compared with the 168 external connections normally required to display 14 decades with single-decade tubes. Power consumption for a full 14-decade display varies from 1.5 to 2 W.

CIRCLE NO. 457

Monolithic filters give 2-pole response

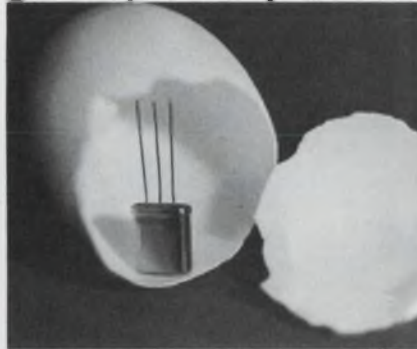

Piezo Technology Inc., 2400 Diversified Way, P.O. Box 7877, Orlando, Fla. Phone: (305) 425-1574. P&A: \$5; stock.

Designated as Comline, a new series of integrated crystal filters features a two-pole response characteristic at 10.7 MHz. The monolithic filters are available in 6-dB bandwidths of 15 kHz or 30 kHz. They are packaged in an HC-18/U enclosure.

CIRCLE NO. 458

important

and up-to-date
from McGraw-Hill

TRANSMISSION LINES FOR DIGITAL AND COMMUNICATION NETWORKS.

By RICHARD E. MATICK.

This book brings together in one volume all the relevant information and important concepts required for an up-to-date understanding and use of transmission lines. Those not acquainted with transmission lines can very easily acquire the basic concepts using nothing more than simple ac circuit analysis. Topics covered include velocity of propagation, skin effect, superconducting transmission lines, transformers and parameters, and more!

384 pp., \$14.50

PRINCIPLES OF HIGH-RESOLUTION RADAR.

By AUGUST W. RIHACZEK.

This is the first book published in the radar field which deals specifically with one of the field's most demanding problems — adequate resolution performance. It stresses principles rather than the ever-changing equipment, developing an understanding of the theory without resorting to high-level math, and limiting discussions to those aspects of resolution theory which either have immediate practical applications or a strong possibility of future applications.

498 pp., \$19.50

MICROWAVE SEMICONDUCTOR DEVICES AND THEIR CIRCUIT APPLICATIONS.

By H. A. WATSON.

This practical book covers the entire field of microwave solid-state circuits and microwave semiconductor devices. The early chapters survey important background material necessary to understand the operation of the devices described in later chapters. Also highlighted are the physical and technological limitations that restrict device and circuit performance.

At your local bookstore
or write

**McGRAW-HILL
BOOK COMPANY
Dept. 23-ED-369**

330 W. 42nd St., New York, N.Y. 10036

Variable delay line uses reed switches

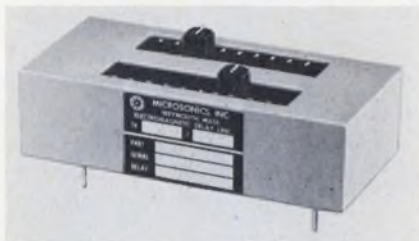

Sangamo Electric Co., Microsonics Div., 60 Winter St., Weymouth, Mass.

A hermetically sealed variable delay line for computer applications accomplishes tap switching with an internal series of magnetically activated reed switches. It incorporates two rows of 10 switches to provide delays from 0 to 180 ns in 8-ns steps. The switches are actuated by permanent magnets mounted on sliding plastic blocks that are, in turn, guided by tracks machined on the outside of the case. The delay line can be operated under unusually severe environmental conditions.

CIRCLE NO. 459

Printed circuit socket accepts bi-pin lamps

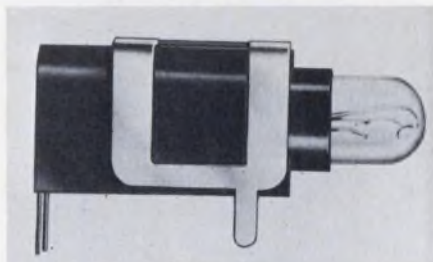

Grayhill, Inc., 561 Hillgrove Ave., La Grange, Ill. Phone: (312) 354-1040.

For display or readout purposes, a new PC bi-pin lamp socket permits instant replacement of most T-1-3/4 bi-pin base lamps. The socket accommodates lamps with various voltage, current and intensity ratings. It has a four-point mounting for insertion into the board terminals at the rear and tabs on its bracket or saddle at the front. The terminals are gold plated and the saddle is lead-tin plated for ease of soldering.

Booth No. 4G03 Circle No. 277



Don't let them fool you.

**There's a definite difference
in Edal high voltage
silicon rectifiers.**



MULTIPLE CIRCUIT PACKAGES
ten circuits available
1500 to 30,000 volts PIV
20 mA to 6 amps

Series N . . . optional configurations
in one modular design . . . Bulk
Avalanche . . . double diffused, passi-
vated junctions . . . fewer lead
connections . . . faster assembly.



HALF WAVE CARTRIDGES
Bulk Avalanche construction
1500 to 30,000 volts PIV
20 mA to 1 amp

Series L . . . minimum size, maximum
power . . . double diffused, passi-
vated, Bulk Avalanche rectifiers
protect against voltage transients
. . . faster assembly.



SUBMINIATURE EPOXY
body .250" long, .115" diameter
1000 to 6000 volts PIV
200 to 1000 mA

Series B 223 . . . meet MIL spec
moisture resistance requirements . . .
smaller . . . tubular construction . . .
excellent thermal conductivity.

We were absolutely amazed to learn that several outfits selling high voltage silicon rectifiers were admitting that their units were pretty much like everyone else's. The only thing we can figure is that they didn't know about ours. Otherwise, their attitude is

very understandable.

There is a difference in our units. And we can prove it. Better still, you can prove it. Send for samples or, for full descriptive literature or, ask that our Tech Representative right in your area drop in to talk to you.

EDAL

Rectifiers
Silicon
Selenium
Copper Oxide

Edal Industries, Incorporated
4 Short Beach Road, East Haven, Connecticut 06512

WE MAKE MORE DIFFERENT TYPES OF RECTIFIERS THAN ANYONE IN THE WORLD
INFORMATION RETRIEVAL NUMBER 193

COMPONENTS

**Cycling drum timers
program 60 points**

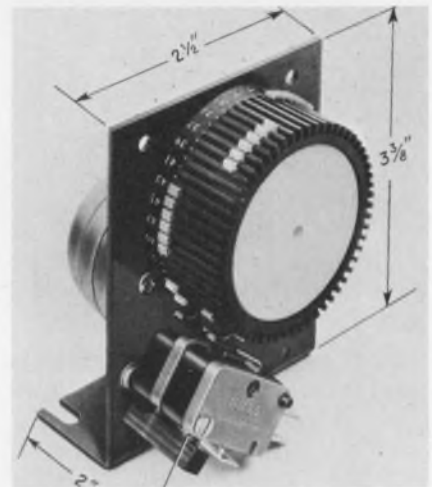

*Sealectro Corp., Programming
Devices Div., 225 Hoyt Ave.,
Mamaroneck, N.Y. Phone: (914)
698-5600.*

Single- and double-contact cycling timers for low-cost programming applications feature a 60-position drum that accepts both cam and point-to-point actuators. Their numerical drum-position indicator provides instant visual recognition of program progress and aids in making quick program changes in the field. The double-contact unit has two microswitch contact assemblies.

Booth No. 4E03 Circle No. 368

**Thin-film resistors
drift only 1 ppm/°C**

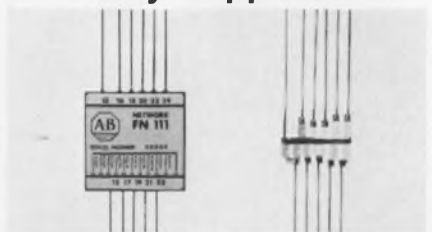

*Allen-Bradley Co., 1201 S. Second
St., Milwaukee, Wis. Phone: (414)
671-2000.*

Designed for use with Fairchild's type $\mu A722$ circuit, two precision thin-film resistor arrays feature a resistance ratio tolerance of $\pm 0.01\%$ and a low ratio temperature coefficient of ± 1 ppm/°C. Model FN111 is intended for binary operation; model FN112 is for BCD binary operation.

CIRCLE NO. 460

Our film has the biggest cast in the business.

Just being big isn't necessarily being good, but we fixed that, too. (Had to because we aren't all that big.)

Our sales cast is made up of more electrical engineers and electrical insulation experts than you'll find in the "big name" film outfit.

And their role is to help manufacturers of motors, capacitors, wire and cable

and transformers get better performance out of the film they buy from us.

The story line is fascinating: Scotchpar® Brand polyester film gives you toughness, flexibility, indestructibility, thinnesses down to .25 mils, maximum resistance to voltage, solvents, moisture, high temperature. Every virtue a film can have, including heat-sealability if you order Scotchpak® film.

When you'd like to see our great cast in action, write to 3M Company, Film & Allied Products Division, 3M Center, St. Paul, Minnesota 55101 . . . or the Dielectric Materials Desk at the 3M Office nearest you.

Scotchpar® 3M
BRAND POLYESTER FILM COMPANY



INFORMATION RETRIEVAL NUMBER 194

you don't
have to
hack
out...
what we
cast in



We specialize in giving you air space . . . holes that don't have to be drilled, slots that don't have to be milled, cam tracks that don't have to be profiled. You save machining time and machining money. We think you'll like the idea of hacking out dollars — not metal.



HITCHINER
MANUFACTURING CO., INC.
MILFORD, NEW HAMPSHIRE 03055
Tel. (603) 673-1100, TWX (710) 366-1863

AEROSPACE DIVISION
Wallingford, Connecticut 06492
DELTA MICROWAVE CORP.
Hackensack, New Jersey 07601
NONFERROUS DIVISION
O'Fallon, Missouri 63366

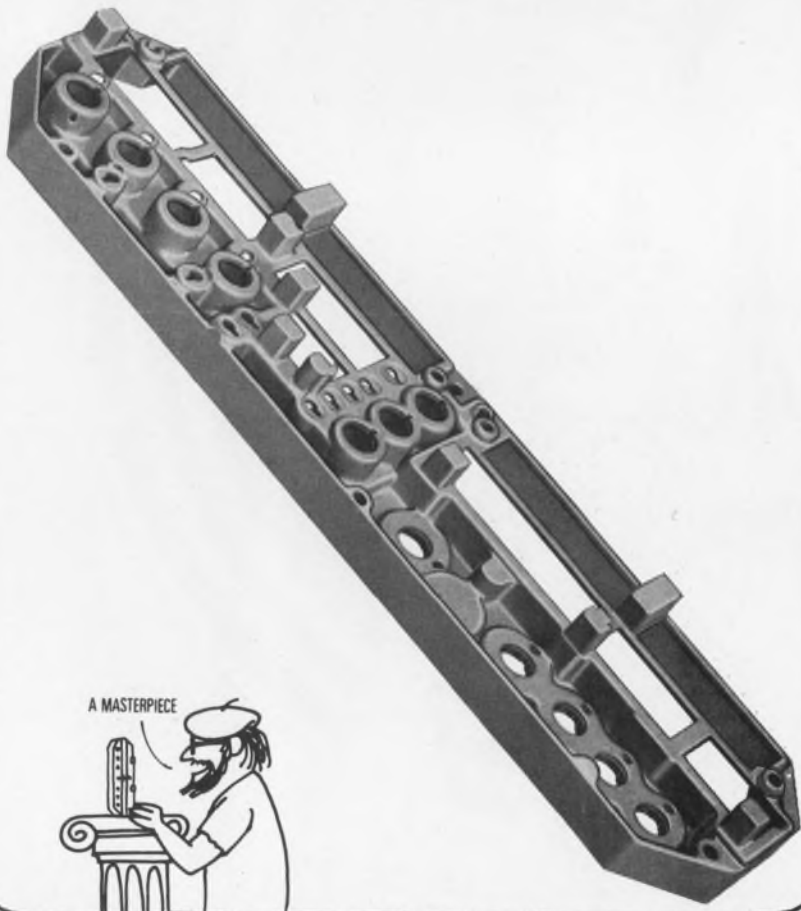

INFORMATION RETRIEVAL NUMBER 195

COMPONENTS

Semiconductor protector responds in 500 ns

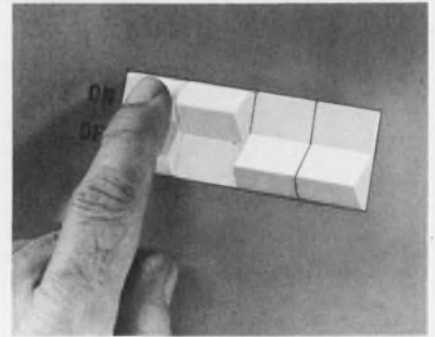

Heinemann Electric Co., 248 Magnetic Dr., Trenton, N.J. Phone: (609) 882-4800.

Part of a large line of OEM circuit breakers and protectors, the JA/Q electronics protector cuts off a transient peak and drops voltage to a safe level within 500 ns. Especially designed for semiconductor circuits, it provides overvoltage nanosecond protection against transients. The JA/Q also incorporates an overcurrent sensing mechanism. *Booth No. 4F11 Circle No. 369*

Power tuning capacitors handle 2000 V

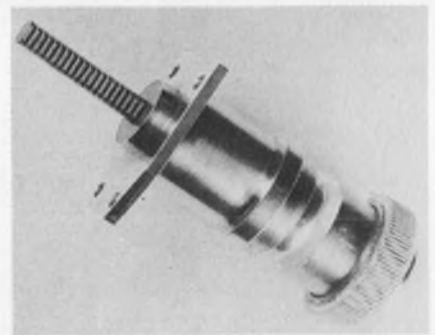

JFD Electronics Corp., Components Div., 15th Ave at 62nd St., Brooklyn, N.Y. Phone: (212) 331-1000.

Power-C tuning capacitors can handle up to 2000 V and 16 A at 30 MHz. Utilizing push-pull tuning that may be gear driven for servo applications, power-Cs are available with capacitance up to 50 pF and down to 2 pF minimum. Also available are non-rotating piston trimmer capacitors with a patented mechanism that assures minimum backlash and maintains torque over the entire life cycle.

Booth No. 4D35 Circle No. 252

Component loader lights the way



Carlton Design & Mfg. Co., P.O. Box 81, Big Hats, N.Y. Phone: (607) 562-3113. P&A: \$6194; 10 wks.

Designed to deliver miscellaneous components in a sequenced program, model CBL 50 component loader indicates, by a light system, the location and polarity for placing the component on the printed circuit board. The machine is automatically cycled from a variable preset timer, pacing the operator, and loads between 15 and 20 components a minute. It can be equipped with two operator positions and programmed for loading up to 100 components on a single, circuit board.

CIRCLE NO. 461

Fluidic hardware switches and selects

Corning Glass Works, Fluidic Products Dept., Corning, N.Y. Phone: (607) 962-4444. P&A: \$10.75 or \$12; 2 wks.

A fluidic pushbutton and a two-position selector switch are now available as hardware accessories for fluidic industrial control modules. The pushbutton is a two-way, normally closed, in-line valve. It is manually operated and spring-loaded. The selector switch is also a manually operated two-way in-line valve. Unlike the pushbutton, however, the selector switch has a sustained input. Changing the switch position changes the back-pressure switch output until the selector is manually returned to its prior position.

CIRCLE NO. 462

New

Grayhill "Excellent 50's"

A new generation of Tiny Rotary Switches with practically unlimited variations

"Excellent 50's"

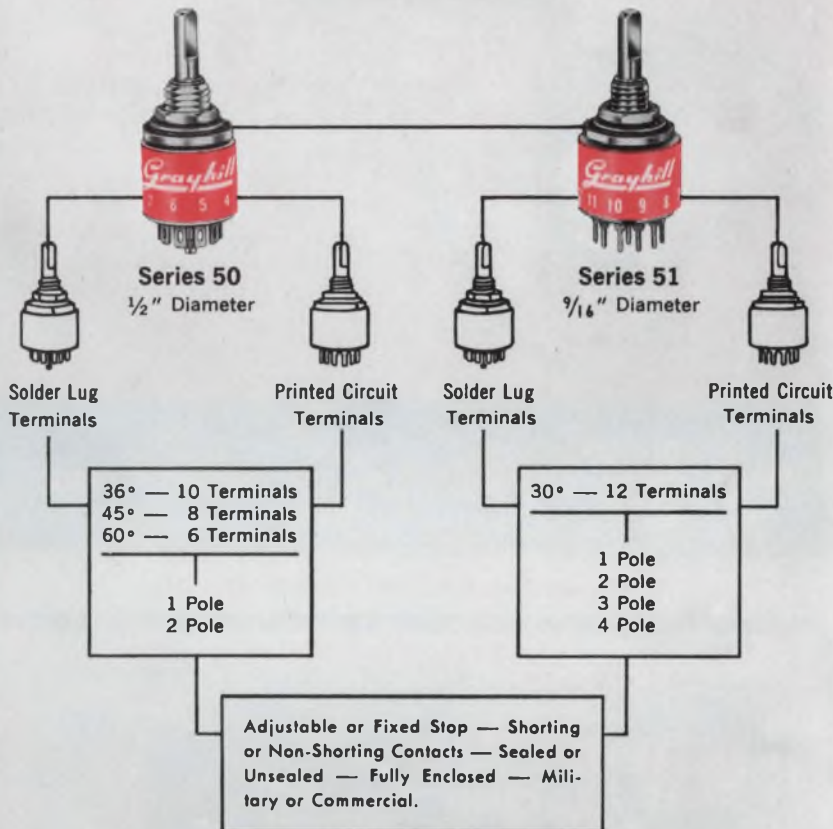

Meets requirements of MIL-S-3786/20



Send for technical sheets fully describing the Grayhill "Excellent 50's".

Another Grayhill innovation developed to unusually exacting criteria required by a highly classified application.

NOW — the proven superiority of this new, versatile generation of Grayhill Rotary Switches — the "Excellent 50's" — is being made available to the commercial market through increased facilities. They are available from stock.



565 Hillgrove Avenue
LaGrange, Illinois 60525
Area Code 312, Phone 354-1040

... the Difference Between Excellent and Adequate

Service... Engineering... Experience

MAKE THE **BIG** DIFFERENCE
BETWEEN A YOKE SPECIALIST
AND A YOKE SUPPLIER



1" ID 12 oz. Single Gap
Shielded Dynamic/Static
Focus Coil

Syntronic Yoke Specialists have more yoke knowledge and provide more engineering assistance than anyone else in the field.

The most extensive line of deflection yokes available is offered by Syntronic... in production quantities or custom designed to special requirements. See the BIG Difference for yourself the next time you specify a yoke.

Syntronic

INSTRUMENTS, INC.

100 Industrial Road, Addison, Illinois Phone 312, 543-6444

INFORMATION RETRIEVAL NUMBER 197

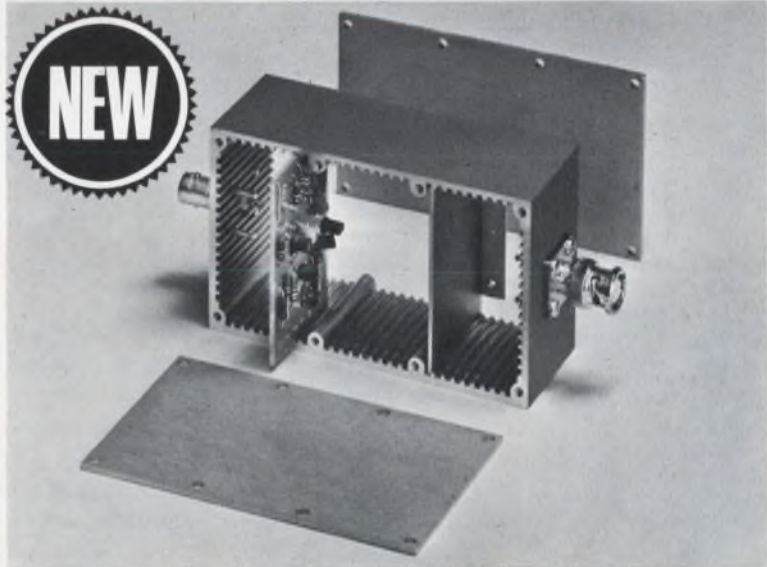

SHIELDED BOXES with CARD GUIDES

Rugged die-cast aluminum boxes, slotted to accept $\frac{1}{16}$ " circuit boards and shielding dividers. Excellent for packaging electronic circuitry. Boxes have removable top and bottom covers. Useable inside space: 4"x2"x1 $\frac{1}{2}$ ". Several models with various connectors.

Featured at IEEE booth 4H27



POMONA ELECTRONICS CO., INC.
1500 E. Ninth Street, Pomona, California 91766

INFORMATION RETRIEVAL NUMBER 198

COMPONENTS

Fluidic trigger varies set point

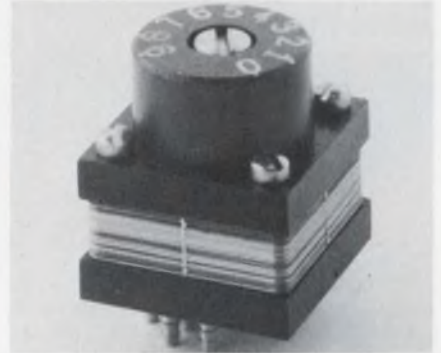

General Electric Co., Specialty Fluidics Operation, Section 37-209, Schenectady, N.Y. Phone: (518) 374-2711.

A fluidic Schmitt trigger that employs an adjustable set point to select the desired trigger pressure can be used as a pressure-limit selector (high- or low-pressure sensor), a signal amplitude limiter, or as an adjustable relay switch. Model HT11 is a completely integrated functional module.

CIRCLE NO. 463

T-1 incandescent lamps work at 1.2 to 32 V



Precision Lamp Engineers, 25 Wayland St., San Francisco. Phone: (415) 333-5466.

Based and unbased incandescent T-1 lamps now include 14 operating voltages from 1.2 to 32 V. Also included as a part of this standard line are lamps with current ratings as low as 8 mA for use with solid-state microcircuitry, as well as lamps with a mean spherical candlepower of 0.25 for high-brightness applications. All lamp bases and lead wires, except those made of platinum, are gold-plated to provide superior contact and reduce oxidation and corrosion.

CIRCLE NO. 464

HEARD THE LATEST?

As an engineering editor for Electronic Design you will be sure to learn about the latest developments in technology as they happen. An editor:

- *Attends the major conferences in his specialty.
- *Talks to top design engineers and scientists about their work.
- *Solicits and edits articles describing new design techniques.
- *Writes by-lined articles about new developments in electronics.

Interested?

If your background is in computers, circuit design or systems work we are especially interested in you. Even if your expertise is in other areas, but you enjoy writing, we may have a good spot for you.

Call or send resume to Robert Haavind,
Managing Editor, Electronic Design,
850 Third Avenue, New York,
New York 10022. (212) PL 1-5530.

or

arrange for an interview at the IEEE Show
We're at booth 1K01-1K03.

Introducing the most versatile vidicon camera ever built— Cohu's new 3200 series!



IT'S A CCTV CAMERA—completely self-contained. Just add a single coaxial cable to any video monitor and it's ready to operate. Want high resolution? Plug in one of four optional integrated-circuit sync generator boards for 525-, 729-, 873-, or 945-line scan patterns.

IT'S A BROADCAST CAMERA, TOO! Add a "mounts-in-minutes" 5-inch viewfinder and the Cohu 3200 is ideal for studio, education, or remote applications. An optional film chain adapter further enhances its versatility and provides all necessary remote controls.

For prices, delivery and full details, contact Cohu engineering representatives in major cities throughout the United States and Canada.



Box 623
San Diego, California 92112
Phone: 714-277-6700

INFORMATION RETRIEVAL NUMBER 202

DATA PROCESSING

Digital comparators compute in parallel



Ateco, Inc., P.O. Box 19426, Houston, Tex. Phone: (213) 371-6567. Price: \$425 to \$825.

Series 3200 digital comparators for local or remote programming operate with parallel computation, as opposed to coincidence logic, so that moving or static BCD inputs can be compared to pre-established limits. This technique provides excellent noise rejection and the capability of monitoring data received from such instruments as high-speed counters.

CIRCLE NO. 465

Programmable generator speeds logic testing



Tau-Tron Inc., 685 Lawrence St., Lowell, Mass. Phone: (617) 458-6871. P&A: \$11,950; 4 wks.

Designed to facilitate high-speed logic subsystem testing and to provide excitation functions for computer-controlled dynamic testing of high-speed semiconductor circuits, as well as for testing high-quality transmission cable, model WG-100 data generator operates at bit rates of from less than 1 Hz to greater than 125 MHz. The output of the standard model consists of two 16-bit words or one 32-bit word, in both return-to-zero and non-return-to-zero formats. Logical complements of all words are provided, and other word lengths are available. Each bit may be independently set to either 0 or 1 by front panel switches or by an external program.

CIRCLE NO. 466

ELECTRONIC DESIGN 6, March 15, 1969

Data-entry systems control electronically



Struthers Wells Corp., 630 Fifth Ave., New York. Phone: (212) 757-7272.

Designed for keyboard data entry, either to an IBM-compatible magnetic tape or directly to a computer, series R1 data-entry systems are fully electronic central controls that allow data to be entered on a keyboard exactly as in key-punching. The data is transmitted to the central controller.

CIRCLE NO. 467

Portable phone terminal has slip on coupler



Metroprocessing Corp. of America, 64 Prospect St., White Plains, N.Y. Phone: (914) 949-0890. P&A: \$145; third quarter, 1969.

Featuring the full alphabet on its standard 12-button tone dial, a new, low-cost portable computer telephone terminal uses a slip-on acoustic coupler for ruggedness and reliability. Fully compatible with regular Touch-Tone systems, model FT-1240 requires no other controls or adjustments. Voice or tone responses from the computer can be heard over the telephone receiver in the usual manner.

CIRCLE NO. 468

We're growing



and at the same time improving our quick-reaction capabilities to better serve your program requirements.

Our Electronics Division will design or build your circuit and wiring assemblies, structures and system packages for space vehicles, satellites, missiles, aircraft and ground applications.

We offer modules based on Navy standard hardware concepts, logic sticks and a variety of soldered or welded interconnect techniques. Why design artwork and wait for multilayer boards? Let us show you our unique, quick turn-around method of thru-insulation welding for back-wiring IC, LSI, MSI and discrete planar assemblies. Provides interconnect repositioning flexibility. Logic diagrams to complete units in three weeks.

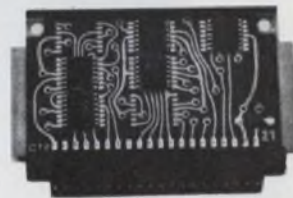
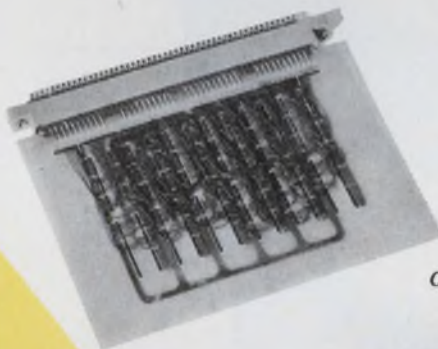

Circuit Subassemblies



System Packages

For more information or immediate assistance, contact . . . Marketing Manager, The SIPPICAN Corporation, Marion, Massachusetts 02738 Tel 617 748-1160

SIPPICAN

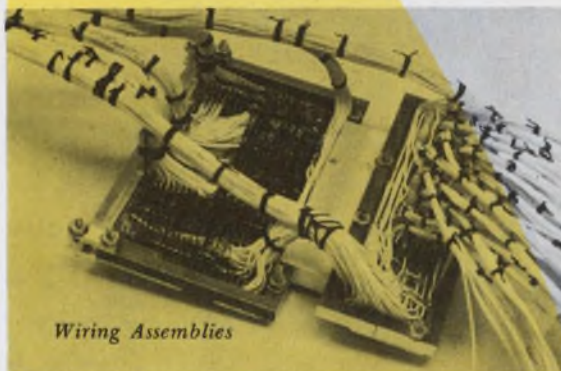

Wiring Assemblies

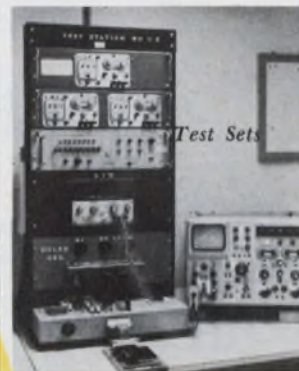

Test Sets

INFORMATION RETRIEVAL NUMBER 203

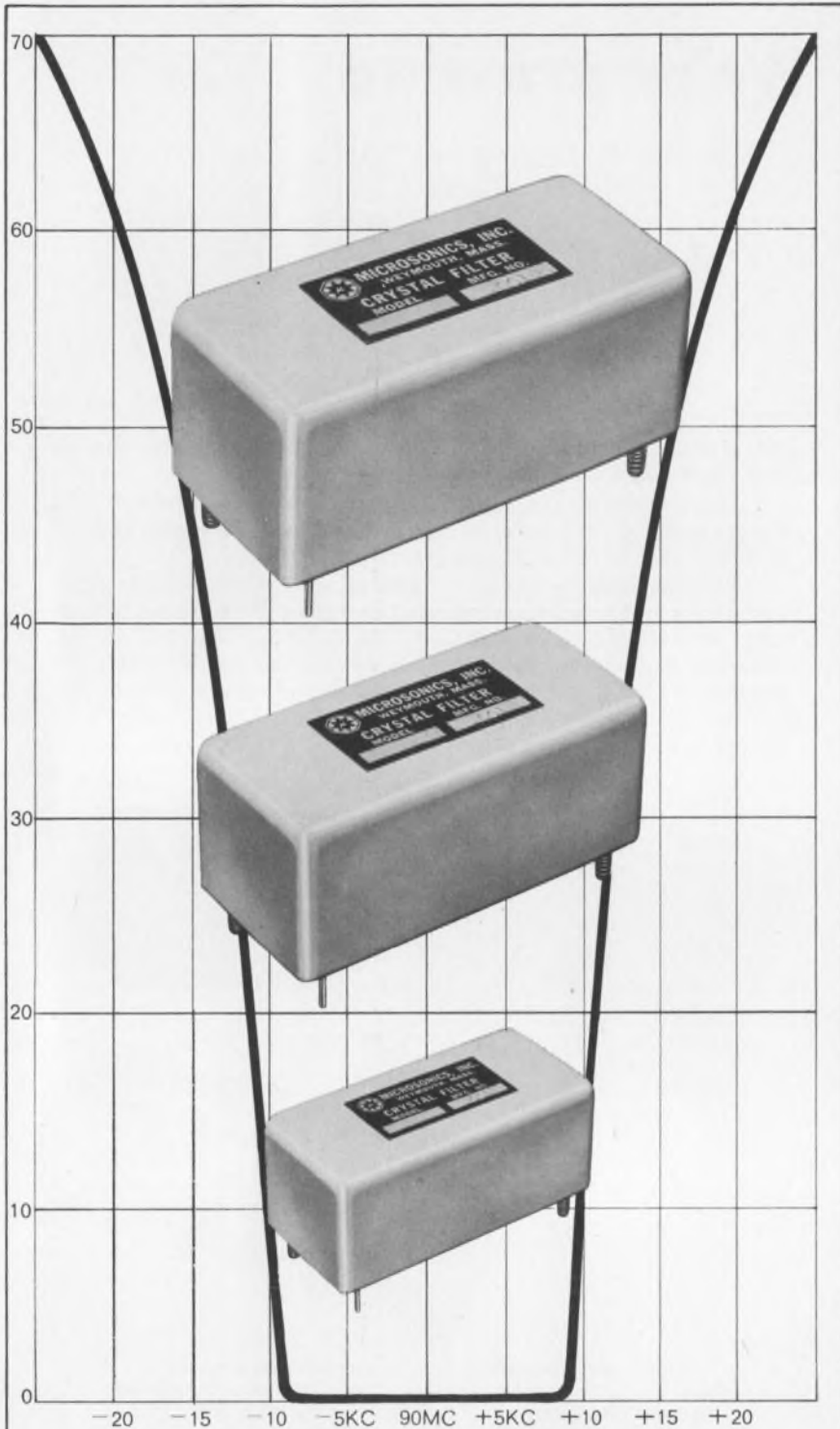

MICROSONICS
*for proven design, reliability &
 performance in*
CRYSTAL FILTERS



Write for Bulletins today
MICROSONICS
 60 Winter Street, Weymouth, Mass. 02188
 Tel: 617 337-4200
 A division of the Sangamo Electric Company

DATA PROCESSING

Data quality monitor equalizes modems



Rixon Electronics, Inc., 2120 Industrial Parkway, Silver Spring, Md. Phone: (301) 622-2121. Price: \$250.

When used with the company's Sebit-48C data modem, a new data-quality monitor greatly simplifies line equalization and completely eliminates the need for oscilloscope equalization. Using the DOM, even inexperienced personnel can quickly and easily adjust the equalizer. The Sebit-48C is a synchronous data modem designed for high-speed (4800 bits per second) voice-channel data communications.

CIRCLE NO. 469

Rack-mount memory cycles in 1 μ s



Information Control Corp., 1320 E. Franklin Ave., El Segundo, Calif. Phone: (213) 322-6930. Availability: 60 days.

Contained in a 19-in. rack-mount chassis, a random-access core memory features a full-cycle time of only 1 μ s. ComRac 200 has bit capacities of 4k by 72 that are expandable to 8k by 36. Using integrated circuits, 20-mil lithium cores, and 3-D selection, the new memory achieves high speed, high reliability and high density. Functional plug-in boards are accessible from the front panel.

CIRCLE NO. 470

OK gang.
It's "see the little boxes" time again.

See the little boxes.



See what they can do.
Sine, square, triangle, ramp,
tone burst, trigger, sweep,
sine² phase lock, VCG_W plus
analog & digital control of
frequency & amplitude.

See the little boxes work
at IEEE, booth 2A18.

WAVETEK
WAVETEK CORPORATION

See the little boxes.



See what they can do.
Measure voltage and frequency.
Generate sine, square, triangle,
ramp, tone burst, trigger, sweep,
sine² phase lock, VCG_W plus
analog and digital control of
frequency and amplitude.

See the little boxes work at
Wescon, booth 2417.

WAVETEK
WAVETEK CORPORATION

See the new little boxes.



Now see what they can do.
Sweep from two hours to 1GHz.
Measure voltage and frequency.
Generate sine, square, triangle,
ramp, tone burst, trigger, sweep,
sine² phase lock, VCG_W plus
complete digital remote control.

See the little boxes work at
Wescon, booth 1710-11.

WAVETEK
WAVETEK CORPORATION

Except we now box phasemeters,
sweep/signal generators to 1GHz
and pulse samplers in addition to
voltmeters and generators.

See the little boxes work at IEEE,
booth 2F49.

WAVETEK[®]

9045 Balboa Ave., San Diego, Calif. 92123; Tel. 279-2200
P. O. Box 651, San Diego, Calif. 92112; TWX 910-335-2007

INFORMATION RETRIEVAL NUMBER 205

looking
for
a
low
price
quality
lamp?



IEE has 'em!

Search no more for quality high performing subminiature lamps. We have them in stock at 1/2 the price of competitive lamps.

All our lamps are aged and selected, possessing hand placed filaments, stabilized to assure uniform brightness. They meet all standard Mil-Specs, and you can count on 40,000 to over 100,000 hours life.

For as low as 29 cents per lamp we can supply your needs on T-1 lamps. Search no farther than your local IEE representative.

Coming to the IEEE Show?
Let us lighten your day.
Booth 2E 47-49.



Industrial Electronic Engineers, Inc.
7720 Lemona Avenue, Van Nuys, California 91405

INFORMATION RETRIEVAL NUMBER 206

MODULES & SUBASSEMBLES

Low-power op amp
drains only 60 μ A

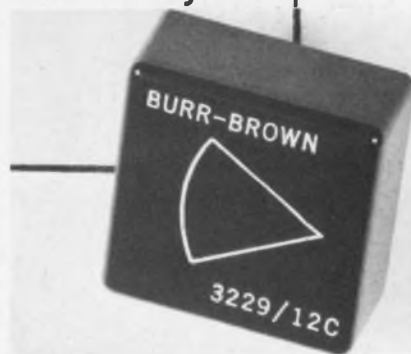

Burr-Brown Research Corp., International Airport Industrial Park, Tucson, Ariz. Phone: (602) 294-1431. Price: \$49.

Operating over a wide range of power-supply voltages, from ± 4 to ± 18 V, a new FET-input operational amplifier performs with a low quiescent drain of only ± 60 μ A maximum. Model 3229/12C has an output swing that is 3-V less than the supply (± 1 to ± 15 V), with an output current of ± 1 mA. Its gain is 90 dB minimum.

CIRCLE NO. 471

Dc-dc signal isolator handles low levels



Solid State Electronics Corp., 15321 Rayen St., Sepulveda, Calif. Phone: (213) 894-2271.

Model DCI-178 dc-to-dc low-level signal isolator is intended specifically for the isolation of low-level dc signals. A special design has been utilized to lower the noise level to approximately 200 μ V (including ripple). Input signals ranging from zero to ± 50 mV dc or 100 mV peak-to-peak ac can be isolated and transferred to an isolated two port.

CIRCLE NO. 472

new... SAMPLING VOLTMETER

LETS YOU FORGET PEAK DETECTION
AND STORAGE OSCILLOSCOPES!

Model 215 Can measure the average value of an AC signal at a predetermined time with sampling periods as short as 100 microseconds.

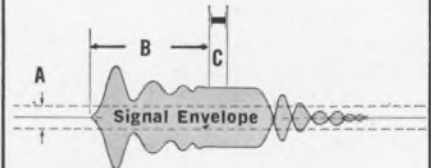

- A. Adjustable threshold 4 - 20% of full scale
- B. Count cycles or provide a delayed trigger and sample after initial transient
- C. Sampling periods of 0.1, 1.0 and 10 milliseconds depending upon signal frequency, 100 Hz to 1 MHz

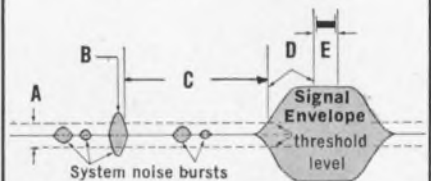

- A. Adjustable threshold 4 - 20% of full scale
- B. If this noise burst exceeds the threshold, provide a trigger any time in C
- D. Sample 3 to 30 cycles after threshold
- E. Sampling period

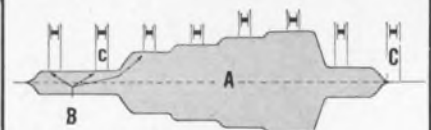

- A. Signal envelope as the result of programmed voltage, current, frequency, etc.
- B. Provide a delayed or coincident trigger for each programmed step or initiate the next step automatically after sampling
- C. Sampling period



Write or call today for complete details — or Booth 2B06. IEEE.

DRANETZ

ENGINEERING LABORATORIES, INC.
1233 North Ave., Plainfield, N.J. 07062
Telephone Area Code: (201) 755-7080

IMPEDANCE — ADMITTANCE METERS ■ PHASE METERS ■ TRANSFER FUNCTION COMPUTERS ■ INSTRUMENT TRANSFORMERS ■ OSCILLATORS ■ SAMPLING VOLTMETERS ■ PULSE INSTRUMENTATION ■ FROM SINGLE INSTRUMENTS TO COMPLETE SYSTEMS

INFORMATION RETRIEVAL NUMBER 207

Small switching module houses six components

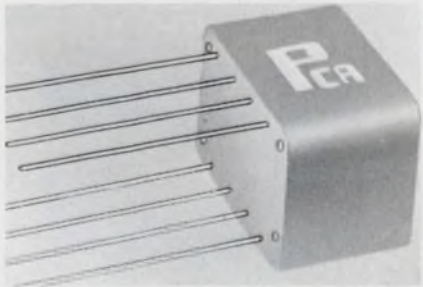

PCA Electronics, Inc., 16799 Schoenborn St., Sepulveda, Calif. Phone: (213) 892-0761. Price: \$10; 2 wks.

Designed for telemetry, computer and process-control applications, a new integrated double-switch module consists of two pulse transformers, two silicon switching transistors and two damping resistors. The hermetically sealed unit measures only 0.65-in.-long by 0.5-in.-wide by 0.4-in.-high. Each transformer has a minimum primary inductance of 225 μ H.

CIRCLE NO. 473

Analog multiplier covers 400 kHz



Transmagnetics, Inc., 134-25 Northern Blvd., Flushing, N.Y. Phone: (212) 539-2750. P&A: \$105; stock.

Operating in all four quadrants with a linearity of 0.5%, a new solid-state analog multiplier offers a full-power bandwidth from dc to 40 kHz and a small-signal bandwidth of 400 kHz. Model 375 is a short-circuit-proof device that functions without external potentiometers or amplifiers. Its input and output ranges are ± 10 V, and input impedance is 100 k Ω .

CIRCLE NO. 474

Bring your design to life... ... just plug it in!

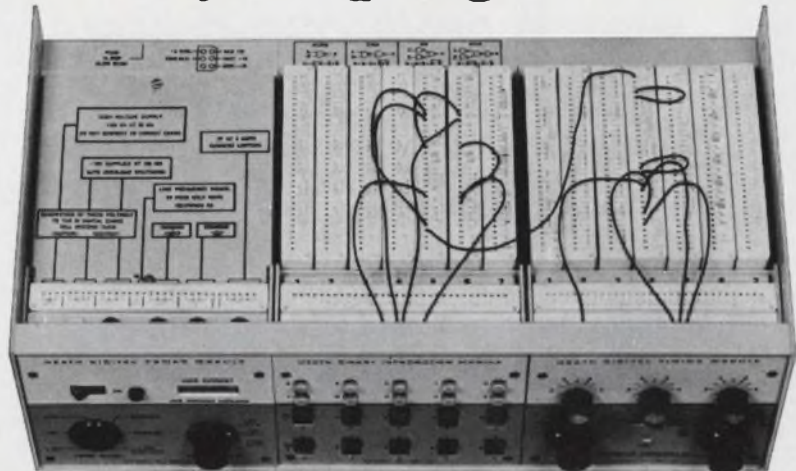

Heath Analog Digital Designer only ... \$435*

Achieve virtually anything you wish in digital and analog circuitry: design your own Counters, Frequency Meters, DVM, Precision Timers, Frequency Standards, Digital Interfaces . . . and hundreds of other digital instruments. You can also investigate Counter, Scaling and DVM circuits, Adders, Subtractors, Digital Analog Interfaces and special circuits of your own. All you have to do is plug-in a few circuit cards and connect them . . .

The Heath/Malmstadt-Enke Analog Digital Designer (ADD) EU-801A is a unique method of system and circuit "breadboarding" for experimentation. The ADD includes three factory-assembled modules (power supply, binary information and digital timing) and 13 TTL IC logic cards: Nand gates, J-K flip-flops, Comparator, V/F Converters, Monostable Multivibrators, Operational Amplifiers and Relays.

The cards plug into the modules and feature "wire-patch" solderless color coded connector boards to accept ordinary hook-up wire and component leads for simple and rapid assembly of your design.

The ADD may easily be expanded as new modules and cards are available. The Analog Digital Interfaces enable the ADD to accept and process external information. 10 lamp binary readout is built-in . . . digital readout will be available shortly.

Just plug *your* design into the ADD . . . optimize it and use the solution directly . . . for only \$435. (Cards and modules are included, but may also be purchased separately.)

Many cards from the Heath EU-805 Universal Digital Instrument (UDI) may be used in the ADD increasing its capabilities. The UDI combines in one package a 12.5 MHz Multi-Purpose Counter/Timer and a 0.05% accuracy Integrating Digital Voltmeter to measure frequency, period, time interval, ratio, count events, and perform as a DVM and voltage integrator with unmatched versatility.



<p>For more information send for the NEW HEATH Scientific Instrumentation Catalog</p>		<p>HEATH COMPANY, 580 21 Benton Harbor, Michigan 49022</p>
	<p><input type="checkbox"/> Please send FREE New Scientific Instrumentation Catalog.</p> <p>Name _____</p> <p>Address _____</p> <p>City _____ State _____ Zip _____</p> <p>Prices & specifications subject to change without notice. EK-266</p> <p>* Mail order prices; F.O.B. factory.</p>	

INFORMATION RETRIEVAL NUMBER 208



filter magic? watch envelope-delay problems disappear!

High-speed data transmission demands Reeves-Hoffman Hi-Fidelity crystal filters with advanced control of envelope delay combined with optimum selectivity!

Available at most IF frequencies

Our Hi-Fidelity crystal filters minimize envelope-delay distortion, and eliminate the need for discrete equalizers.

Describe your requirement

Reeves-Hoffman designs to your specifications. Call, TWX, or write today for delivery and price.

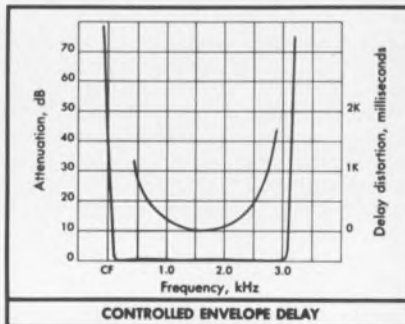
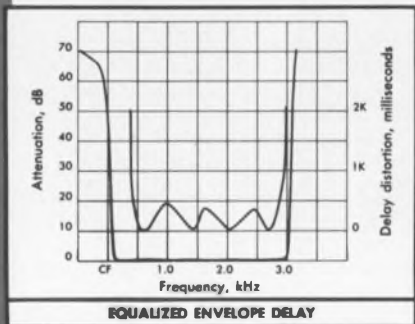

One of 4 channels

1750.000 kHz	Carrier frequency	1750.000 kHz
55dB	Carrier suppression	55dB
1749.745 kHz	1dB point, min.	1749.745 kHz
1746.965 kHz	1dB point, max.	1746.965 kHz
1750.250 kHz	70dB point, min.	1750.100 kHz
1746.750 kHz	70dB point, max.	1746.700 kHz
1.0dB	Passband ripple, 25°C	0.5dB
0dB ± 0.5dB	Insertion loss, 25°C	3.0dB
50 ohms	In and out impedance	200 ohms
+10° to +64°C	Operating temp. range	+5° to +65°C

One of 4 channels

craft-masters in crystal controls

REEVES-HOFFMAN

DIVISION, DYNAMICS CORPORATION OF AMERICA

400 WEST NORTH ST., CARLISLE, PENNSYLVANIA 17013 • 717/243-5929 • TWX: 510-650-3510

INFORMATION RETRIEVAL NUMBER 209

MODULES & SUBASSEMBLES

Instrumentation amp varies gain by 1000



Burr-Brown Research Corp., International Airport Industrial Park, 6730 S. Tucson Blvd., Tucson, Ariz. Phone: (602) 294-1431. P&A: \$85; stock to 4 wks.

Providing a low-drift FET-input stage in a miniature, encapsulated package, a differential dc instrumentation amplifier adjusts its gain from 1 to 1000 by means of one external resistor over a common-mode input range of ±8 V. Model 3154/25 has an input impedance of 10⁵ MΩ.

Booth No. 3A26 Circle No. 403

Power modules handle 211 A

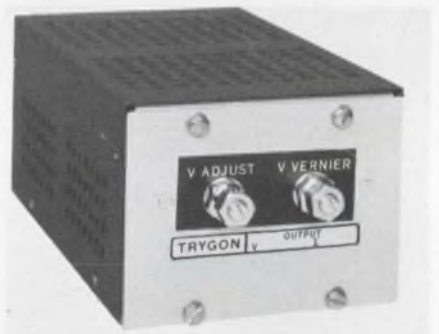

Trygon Electronics, Inc., 111 Pleasant Ave., Roosevelt, N.Y. Phone: (516) 378-2800.

Compact LVS-series power modules are available in ranges from 2.5-5.5 V dc to 115-161 V dc and up to 211 A. An optional rear-mounting overvoltage protection module is available for the new units. OVS-1, OVS-2 and OVS-3 are intended for convenient mounting where the ultimate in protection is required for sensitive circuits. These units are designed to latch up in the overvoltage mode and reset upon removal of power.

Booth No. 2H47 Circle No. 330

Electronic Design Reprint

"A practical design guide
for A/D and D/A conversion"

By Herman Schmid, Senior Engineer,
General Electric Company.

Electronic Design Reprint

serial indirect parallel digital-to-
-ac multistage parallel-feedback
A serial-feedback high-speed, hi
gh-accuracy ultrasonic speed log
arithmic automatic offset correc
ion multistage parallel serial i
ndirect digital-to-ac multistage
parallel
a/d and d/a
serial converters
gh-speed high-accuracy ultrasonic
gh-speed logarithmic automatic i

This Electronic Design reprint contains complete, up-to-date design information covering all aspects of A/D and D/A converters. Here are just some of the subjects covered: A/D Converter Types-Successive Approximation; Charge Equalization; Indirect; Serial Feedback; Ultra-High Speed; D/A Converter types-Parallel; Serial; Indirect; Digital-to-A/C. Also covers automatic offset correction and time sharing.

To get your copy, order now at \$2.75 each. To keep the price of this valuable reprint as low as possible, we must ask your check or money order be included with the request.

Reader Service Department,
Electronic Design
850 Third Ave., N.Y., N.Y. 10022

Gentlemen:

Please send me copy(ies) of
"A Practical Design Guide For A/D
and D/A Conversion." (\$2.75 each.
This includes all mailing and handling
charges.) Enclosed is Check
 money order.

Checks payable to Electronic Design.

Name _____

Company _____

Address _____

City _____

State _____

Zip _____

Electronic Engineers

Convair, located in smog-free San Diego, has a number of outstanding opportunities for graduate electronic engineers experienced in any one of four important areas.

Avionic System Pre-Design

Creative engineering specialists to synthesize and establish pre-design and design parameters for advanced aircraft avionic systems.

Microwave Solid-State Circuit Design

Applicants should have 5 or more years of responsible experience, including new-proposal development. Will have broad lead function. Opening is for senior specialist in microwave solid-state circuit design.

ASW Avionics Design

Applicants should be specialists in advanced ASW design and conceptual work and be interested in the development of unique and novel ASW systems. Emphasis will be on analytical considerations rather than on detailed design.

Computerized Aerospace Ground Equipment Design

Requires 1 to 5 years experience in design/programming of computer-controlled test equipment or design of computerized Aerospace Ground Equipment. To work on test and support activities for major military aircraft programs.

Please send your resume to:

Mr. J. J. Tannone
Supervisor, Professional
Placement & Personnel
5656 Kearny Villa Road
San Diego, California 92110

GENERAL DYNAMICS

Convair Division

An Equal Opportunity Employer, Male or Female

ON CAREER INQUIRY FORM, P. 285, CIRCLE NUMBER 906



No monkey biz when you buy Security Filters from Captor

Captor Corporation is a specialist in the manufacture of communications, security and shielded room filters. Our goal is to satisfy the industry's long-standing needs: the need for a supplier who makes on-time deliveries... whose sales promises are fulfilled... whose products meet all applicable specifications... who gives good overall service. Captor offers one of the industry's most complete line of security filters, including units capable of carrying very large power line loads. Our security filters meet even more rigorous specifications than EMC filters, including DCA and FED-STD-222. If your requirements are unusual or unique, Captor engineers are available to evolve special filter designs. Now that you have an alternative, let Captor bid on your next security filter requirement!

Captor Corporation manufactures miniature filters... communications and security filters... custom-design filters, and other electronic components.

CAPTOR CORPORATION

APPLICATION ENGINEERING DEPT.
5040 Dixie Highway, Tipp City, Ohio 45371

INFORMATION RETRIEVAL NUMBER 212

MODULES & SUBASSEMBLES

FET dc amplifier gains 3×10^5 V/V

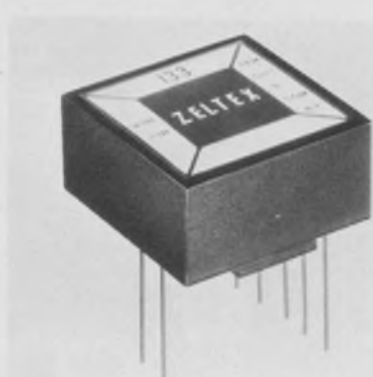

Zeltex, Inc., 1000 Chalomar Rd., Concord, Calif. Phone: (415), 686-6660. P&A: \$30; stock.

A new, low cost, FET-input, differential operational amplifier features a dc voltage gain of 300,000 V/V. In addition, model 133 has an input bias current of only 15 pA and an input impedance of 10 M Ω . The new unit is able to slew at a rate of 6 V/ μ s.

Booth 2C06 Circle No. 402

Active bandpass filters down noise to -70 dB

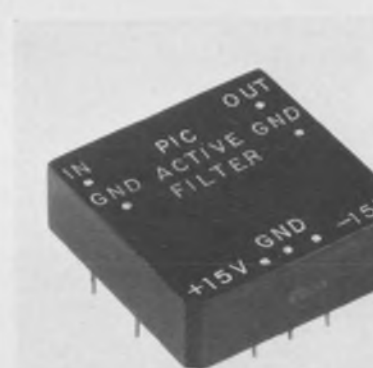

Polyphase Instrument Co., Bridgeport, Pa. Phone: (215) 279-4660. Price: \$50 to \$100.

With input levels of 7.75 V rms, two new series of active bandpass filters, which have bandpass center frequencies from 10 Hz to 100 kHz, hold noise levels in the rejection region to less than -70 dB. Series 9 units have 3-dB bandwidths of 5% from their center frequency, and attenuation slopes that fall off sharply at -80-dB rates. Series 99 units are similar; their bandpass width is 16%.

Booth No. 4E08 Circle No. 404

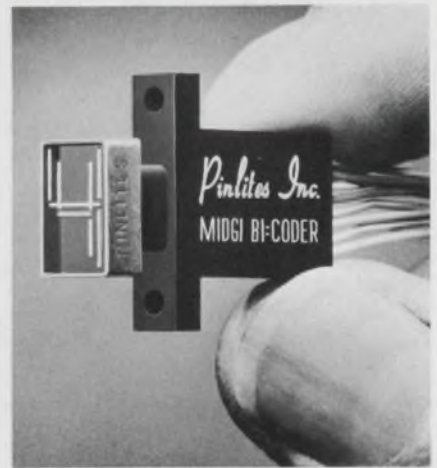

Redundancy?

Had any luck lately in designing extra reliable readout displays? Most approaches have been to double everything; weight, cube, power, cost, etc. The Midgi-Lite Bi-Filament is a seven segment digital display with a difference - redundancy. There are two sets of electrically separate filaments. Each filament set is independent of the other. The Midgi Bi-Coder decodes 8-4-2-1 BCD to seven segment display in two separate Channels - one for each segment set. The rest is up to you.



World's Smallest

MIDGI CODER LITE: The world's smallest decoder/driver seven segment display package.

All translation from 8-4-2-1 BCD Code to seven segment display is performed within the display head. The digital character is 5/16" high and is formed by seven, directly viewed, tungsten filaments. With the inherent reliability of I.C.'s and a design life of 100,000 hours per display segment, the M6-1C offers new levels of performance.

Pinlites Inc.

Call or write Bruce A. Bundy, Sales Manager for a design data folder. Pinlites Inc., 1275 Bloomfield Avenue, Fairfield, New Jersey 07006. Area Code - 201 Telephone # 226-7724.

INFORMATION RETRIEVAL NUMBER 213

Lampholder arrays simplify designs

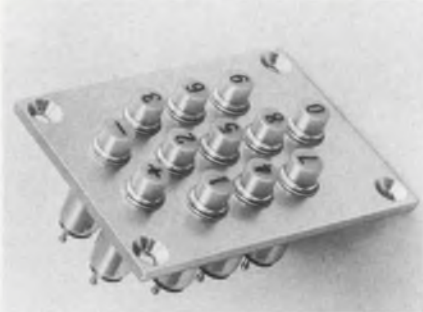

Eldema Div., Genisco Technology Corp., 18435 Susana Rd., Compton, Calif. Phone: (213) 774-1850.

Type DHH lampholder assemblies, in standard strip configurations or custom grid arrangements, simplify the installation of multiple lamps and make panel fabrication easier. The assemblies include standard strip spacings of 1/2-in. between centers, with other spacings available to a minimum of 7/16 in. They are clear anodized aluminum with a high-dielectric phenolic insulation and a choice of terminal styles.

CIRCLE NO. 476

Instrumentation amp has wide agc range

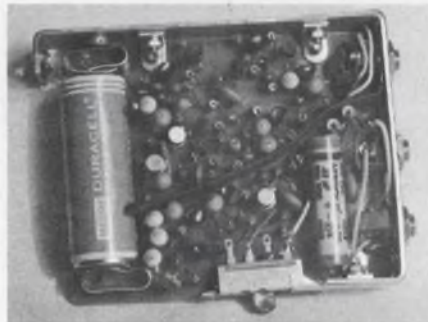

Roveti Instruments, Annapolis, Md. Phone: (301) 269-0919.

Model MN-120AG is a general-purpose audio and instrumentation amplifier with a wide automatic-gain-control range capable of recovering very low signal levels. The amplifier produces a 0.5-V rms output into a 600- Ω load from inputs of 25 μ V to 25 mV with 0.5-dB accuracy. A three-position input attenuator switch extends the dynamic range of the unit to 25 V rms at the input.

Booth No. 2H35 Circle No. 377

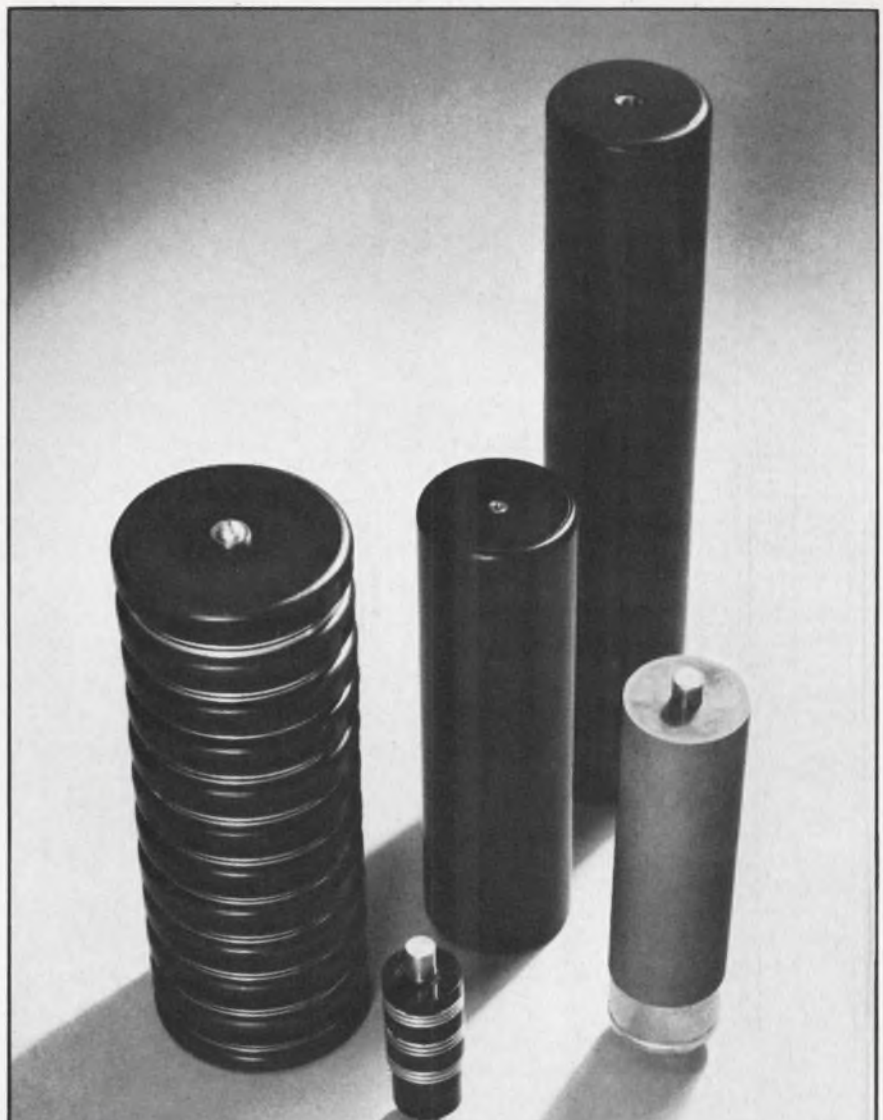

Let us build a solid state, long life, high voltage rectifier to your...

***atmospheric / critical weight / critical size
voltage / configuration
and switching speed requirements.***

After all, we've been custom-building new equipment and replacement tubes for over 8 years. Normal switching speeds up to 15 nanoseconds. Fast switching speeds up to 200 nanoseconds. Voltages up to 180 Kv. Currents to 12 Amps. Fully encapsulated or non-encapsulated. Completely corona-free. Compact, lightweight packaging. For specifications write to the address below.

Solitron DEVICES, INC.

TELEX: 13-7346
TWX: 710-576-2654
PHONE: (914) 359-5050

256 OAK TREE ROAD, TAPPAN, N. Y. 10983

Four reasons why Remex readers cost less.

The lower cost of a Remex will show up in its long life. Simplified maintenance. Adaptability. Our Model RRS 3000 photoelectric reader/spooler is a perfect example:



First, there's the fiber optic distributor and sensor fiber optic face plate. No other reader has it. Fiber optics collimate light so that punched tapes of up to 70% transparency can be read without adjustment. That makes Remex the most perceptive. Most sensitive. Most reliable. The eyes of a complex system have to be sharp.



Then only Remex equips its readers with a self-cleaning, vibration-proof quartz lamp. That means unvarying illumination for 15,000 hours. (And that's just a conservative estimate. Actual calculated life is 60,000 hours.) And during this extra-long life span, no costly downtime.



All I.C. circuitry. Power supplies, drive, brake and read components are mounted on two printed circuit cards. Pluggable. In card cages. With card locks and extractors.



More tape capacity (up to 1,240 feet) on 7½-inch reels than on a standard NAB 8-inch reel.

Call us at 213-772-5321 or write for free literature: Remex Electronics, 5250 W. El Segundo Blvd., Hawthorne, California 90250. Designing computers, numerically controlled systems, or automatic test equipment? Give our best to your customers.



See us at the I.E.E.E. Show, Booths 2H-29 through 2H-31.



REMEX ELECTRONICS
A UNIT OF EX-CELL-O CORPORATION 

INFORMATION RETRIEVAL NUMBER 215

Flexible ribbon cables contain fiber optics

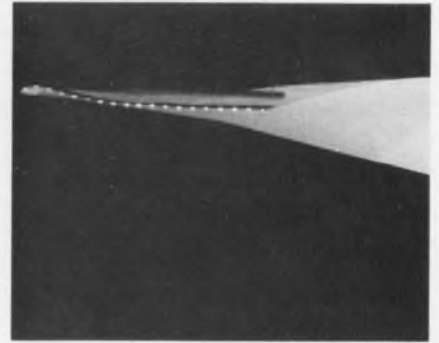

Albion/Rank Taylor Hobson, 260 North Route 303, West Nyack, N.Y. Phone: (914) 358-4450.

Available in sizes up to 6-in.-wide by 10-ft.-long, fiber-optic ribbon cables consist of 0.006-in.-diameter glass fibers, laid out tangentially and held together by means of a water-soluble paste. The user can shape these new ribbons to his needs; they can be rolled, twisted, and even compressed when necessary. Special cables are also available up to 12-in.-wide and 20-ft.-long.

CIRCLE NO. 477

Hermetic package cuts weight by 1/3

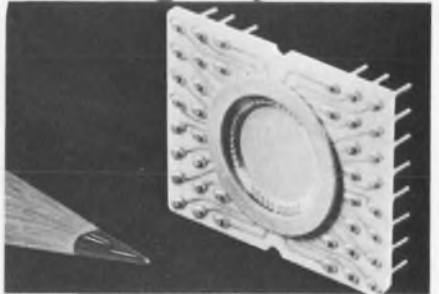

National Beryllia Corp., Haskell, N.J. Phone: (201) 839-1600.

Intended to increase reliability and lower cost for a variety of IC applications, a new 40-pin plug-in hermetic package with a base of high-purity beryllium oxide is 30% lighter than similar hermetic packages. It offers superior thermal conductivity, eight to ten times greater than that of alumina packages. The new package also extends flexibility with its large die mount area (0.345-in. dia) and its large number of available leads.

Booth No. 4F43 Circle No. 366

Charles Vatterott



didn't just stand there.

Mr. Vatterott is a builder and developer in the St. Louis area.

A dozen years ago he decided that everyone would have an equal opportunity to buy the homes he constructed. *Everyone*. Needless to say, it wasn't a popular move. But he saw his duty and made his decision. And stuck to it.

The hard fact is, the right decision isn't always the easy one. It takes strength to stand up and be counted. To find it, you must often go outside yourself.

To your place of worship, perhaps. Here you're able to get a true measure of your life. To hold up a mirror to yourself. To take comfort—and courage—from learning you're not alone.

It's an experience that can turn men of good will into men of good deeds.

Ask somebody who's tried it.

Somebody like Charles Vatterott.

HOW CAN YOU HELP? Write for free booklet, *Solving the Crisis in Our Cities, Religion in American Life*, 184 Fifth Avenue, N.Y., N.Y. 10010.



Advertising contributed for the public good



TODD

cost cutting system power supplies



MMS Series

Slot Range

\$69⁰⁰*

FEATURING THE TODD FORMULA FOR SYSTEM POWER SUPPLY ECONOMY

More watts/in³/°C/\$

More watts / cubic inch

Space saver—only 3³/₄" x 3²¹/₂" x 4¹/₂"

More watts / °C

71°C operating temperature. Designed to meet MIL environmental SPECS.

More watts / cost dollar

M Series—your best buy in a system power supply.

7 series — 33 amperes max.

18 models per series

Outputs to 150 Vdc

.01% regulation

.5 mV rms ripple

Remote sensing/programming

5 year warranty — parts & labor

*Slight increase in price for higher voltage units

For complete information, contact your local Todd representative or:

ATC

TODD PRODUCTS CORP.
28 Laurel Street, Hicksville, N.Y. 11801
(516) 822-0784

INFORMATION RETRIEVAL NUMBER 217

PACKAGING & MATERIALS

High-density hardware mounts standard DIPs

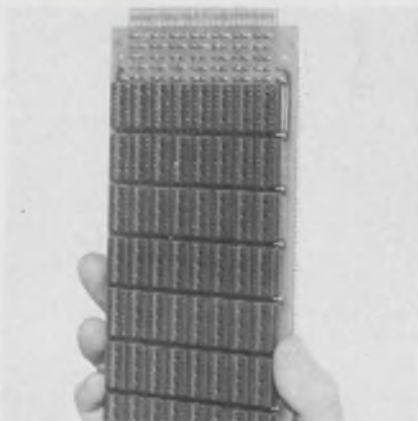

Cambridge Thermionic Corp., 445 Concord Ave., Cambridge, Mass. Phone: (617) 491-5400. Price: cards, \$46.50 to \$100.40; files; \$48.80 to \$177.

To accommodate the ever-increasing number of DIP digital products, high-density wire-wrap socket cards and card files accept most of the standard dual-in-line IC packages now in use. Types 705-1075-01 through 705-1084-01 pluggable socket cards accept up to 64 16-pin in-line sockets. The card files, types 706-9000-01 through 706-9005-01, and 706-1031-01 and 706-7015-01, accept up to 728 ICs.

Booth No. 3H15 Circle No. 365

Rubber wire junction eliminates splicing

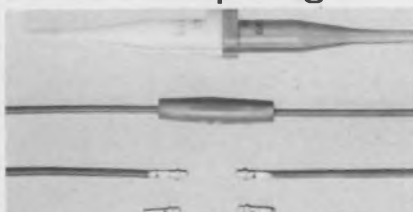

Deutsch Co., Electronic Components Div., Municipal Airport, Banning, Calif. Phone: (714) 849-6701.

A new single-wire junction allows strong environmental connections to be made without actually splicing. Completed in seconds, the union is stronger than the original uncut wire and is better insulated and more resistant to moisture. Called Jiffy Junction, the new device is made of lightweight rubber.

CIRCLE NO. 478

Specify  RSC
FOUNDED 1933

RF and POWER SWITCHES

A complete line of rotary, high voltage and high current ceramic-type switches for RF and low frequency applications.

Write for catalog, containing information on the mechanical and electrical properties of our standard line of switches.

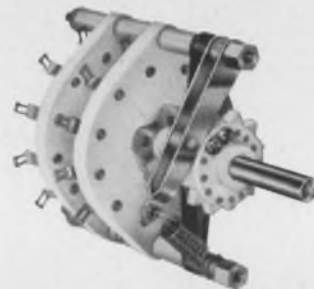

RADIO SWITCH CORPORATION

MARLBORO, NEW JERSEY

Telephone: HOpkins 2-6100 (Area Code 201)

INFORMATION RETRIEVAL NUMBER 218

DC to DC CONVERTER TRANSFORMERS



M 8100 SERIES

E_{IN} 13.6 and 28VDC

E_{OUT} 28,70 and 500VDC

P_{OUT} 5 and 50VA

FROM STOCK!

SEND FOR APPLICATION BULLETIN F162
COVERING COMPLETE LINE

MICROTRAN

VALLEY STREAM, NEW YORK 11582

See us at the IEEE Show-Booth 3F18
INFORMATION RETRIEVAL NUMBER 219

ELECTRONIC DESIGN 6, March 15, 1969

Conformal coatings spray on work



Columbia Technical Corp., Humi-seal Div., P.O. Box 86, Woodside, N.Y. Phone: (212) 932-0800. Price: \$10/32 oz.

Two new, conformal insulating coatings are now packaged in aerosol containers. Designated types 1A27 (polyurethane base) and 1B15 (acrylic base), the coatings are particularly suited for application on printed-wiring boards and electronic components.

CIRCLE NO. 479

Polyvinyl tubing zips and shrinks



Zippertubing Co., 13000 S. Broadway, Los Angeles. Phone: (213) 321-3901.

A shrinkable heavy-duty tubing made of polyvinyl chloride features an easy zip-on closure and inside overlap to meet military requirements. Designated as type HRV, the tubing has a wall thickness of 0.05-in. for up to 2-in. diameters, and a 0.08-in. wall in larger sizes. Its dielectric strength is 1050 V/mil and operating temperature range is -29 to $+221^{\circ}\text{F}$.
Booth No. 1B28 Circle No. 397

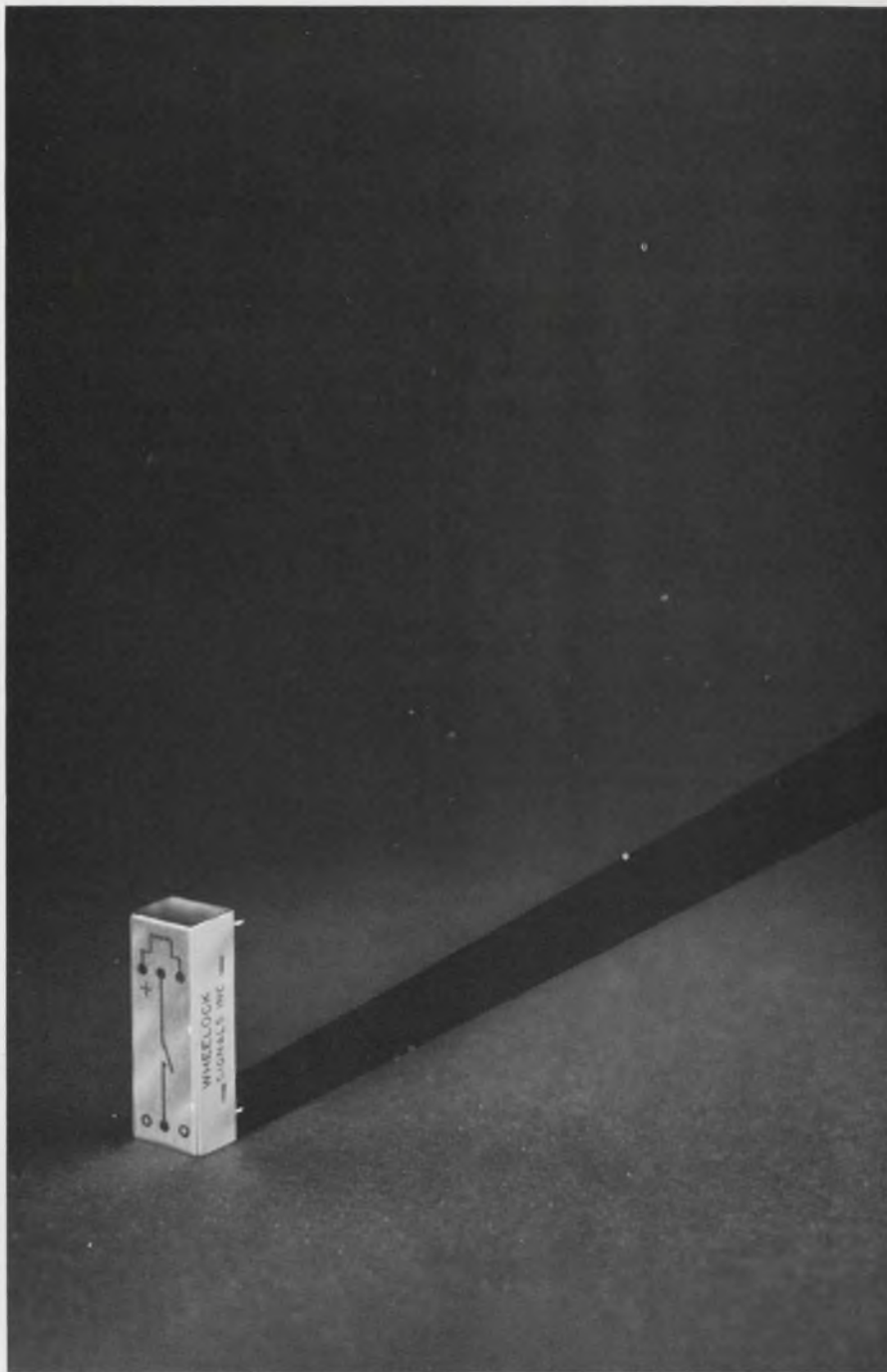

THE FIRST SIGNIFICANT STANDARD
REED RELAY IN THE INDUSTRY—THE

502 BY
Wheelock

- Standard grids:
(1.00" x .100") (1.00" x .150")
- Low cost . . . immediate delivery
- Coil voltages: 6, 12, 24, 48VDC
- Contacts: Forms A, B or True C

WHEELOCK SIGNALS, INC.
273 BRANCHPORT AVENUE
LONG BRANCH, N.J. 07740
(201) 222-6880

93

INFORMATION RETRIEVAL NUMBER 220

USCC

announces: a dependable 50 WVdc RFI Filter

Don't design trouble in. USCC's new Low Pass L Section filter is a beefed-up miniature built tough to stay reliable. It's designed to give extremely high attenuation with minimal power loss and negligible heat buildup—and to do it for a long, long time.



ACTUAL SIZE

This is a unit engineered to reduce interference from conducted noise in dc power lines. Hermetically sealed, these filters are available off the shelf in 60 models in 6 current ratings. Operating range is from 10 kHz to 10 GHz, at -55° to $+125^{\circ}\text{C}$. Line transients can be accommodated up to 100 Vdc.

Design trouble out by specifying USCC L2000 Series filters. For evaluation samples and complete technical data, contact: U.S. Capacitor Corporation, 2151 North Lincoln Street, Burbank, California 91504. Telephone: (213) 843-4222. TWX: 910-498-2222.

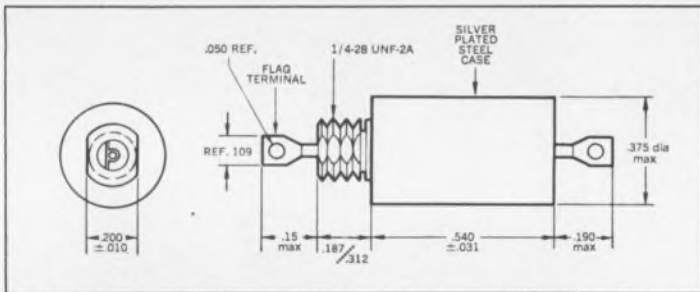

TYPICAL ATTENUATION CURVE AT 25°C

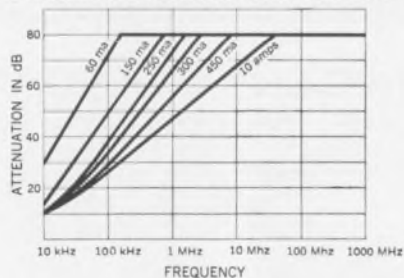

SCHEMATIC

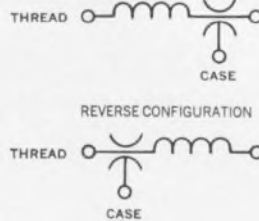

STOCKED AND DISTRIBUTED BY:

JACO

ELECTRONICS, INC.

ENGINEERS ROAD • HAUPPAGUE, L.I., NEW YORK 11787 • TEL: 516-273-5500 • TWX: 510-227-6232
20723 DEARBORN ST. • CHATSWORTH, CALIFORNIA 91311 • TEL: 213-341-6020 • TWX: 910-494-1923

INFORMATION RETRIEVAL NUMBER 222

PACKAGING & MATERIALS

Aerosol degreaser cleans ultrasonically



Chemtronics Inc., 1260 Ralph Ave., Brooklyn, N.Y. Phone: (212) 629-1300. Price: \$3.25.

Originally developed for cleaning television tuners, an aerosol cleaner and degreaser, called Tun-O-Wash, is now recommended for switches, relays, printed-circuit boards and contacts of all kinds. According to the company, the new formula provides cleaning action equivalent to that obtained by an ultrasonic bath.

CIRCLE NO. 480

Conductive epoxy replaces solder

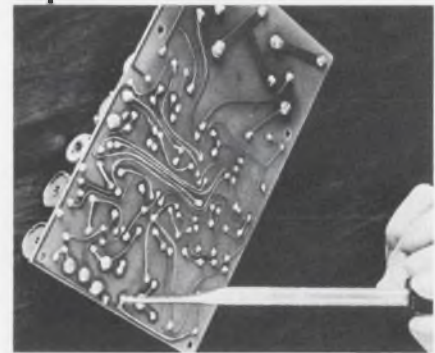

Epoxy Technology, Inc., 65 Grove St., Watertown, Mass. Phone: (617) 926-1949. Price: \$12/2 oz.

Dispensed from a disposable medicine dropper for making solderless connections on PC boards, a two-component silver-bearing epoxy compound, combines very low viscosity with high electrical conductivity in a 100% solids formula. The viscosity of Epo-Tek 410-LV is 14,600 centipoises, and its electrical conductivity, which is highly reproducible, is held between 0.001 and 0.003 $\Omega\text{-cm}$.

CIRCLE NO. 481

These NEW Bench Supplies will make you smile 3 ways!

- 1 Excellent regulation .01% and —ripple only 250 mv!
- 2 Same Day Shipment. No annoying wait
- 3 Low Price. You can buy several

The BP-89 and BP-118 both give you a regulation of supply within 0.01% and ripple is 250 microvolts. Silicon differential amplifiers and stable voltage references result in excellent stability. They are short circuit and overload protected, and feature MIL spec performance. At such low prices, you can afford to have several of these fine power supplies available. Stop waiting in line to use the more expensive one, and smile!



BP-89 \$89
0-34 volts at 0.5 amps for



BP-118 \$118
0-34 volts at 1.5 amps for

SPECIFICATIONS

OUTPUT: 0-34Vdc, BP-89 — 0-500mA BP-118 1.5Amp
INPUT: 105-125Vac, single phase, 50-400Hz
LOAD REGULATION: Less than $\pm 0.01\%$ plus 1mV output voltage change for a load current change equal to the current rating of the supply.
LINE REGULATION: Less than $\pm 0.01\%$ output voltage change for a change in line voltage from 105 to 125 (or 125 to 105) volts at any output voltage and current within rating.

RIPPLE AND NOISE: Less than 200 μ V RMS/1mV p-p
TEMPERATURE COEFFICIENT: Output voltage change per degree centigrade is less than 0.02% plus 1mV after 30-minutes warmup.
STABILITY: The total drift for 8 hours (after 30 minutes warmup) at a constant ambient is less than 0.1% plus 5mV.
CONSTRUCTION: All metal case with baked enamel finish.



POWER/MATE CORP.
163 CLAY STREET
HACKENSACK, N. J. 07601

SAME DAY SHIPMENT

INFORMATION RETRIEVAL NUMBER 223

SOLID STATE ELECTRONIC TIMERS

Complete line
now available
from
one source



Ready now are: six models—five in the Delay Timer and one in the Interval categories. You have a choice of portable, plug-in or dial adjustable, panel mounting types. Request Bulletin 308.

**INDUSTRIAL
TIMER
CORPORATION**

U.S. Highway 287, Parsippany, N.J.

Subsidiary of the Singer Company

INFORMATION RETRIEVAL NUMBER 224

ELECTRONIC DESIGN 6, March 15, 1969

Step on it!



Send for your FREE Catalog of Amalco deep drawn aluminum cases today!

Amalco carrying cases for industrial or commercial applications give you:

- immediate delivery on 8 standard sizes up to 8½" W x 12" L x 8½" H
- light weight with protective strength
- full protection against dust, sprays and rust
- special sizes to comply with MIL-C-4150F

Get all the facts now by writing:



Dept. 1

**AMERICAN ALUMINUM
COMPANY**

Manufacturers of Aluminum Products for Industry Since 1910.

230 Sheffield St., Mountainside, N. J. 07092
Phone (201) 233-3500

INFORMATION RETRIEVAL NUMBER 221

invaluable

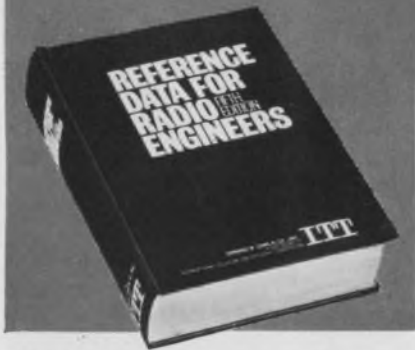

NEW 5TH EDITION OF THE WORLD-FAMOUS Reference Data for Radio Engineers

Now contains 50% MORE DATA to include major information developed over the past 12 years. Prepared by an outstanding group of practicing engineers, professors, and industry and government experts, under the direction of the International Telephone and Telegraph Corporation staff.

OVER 160,000 COPIES SOLD
IN THE FOURTH EDITION

The new FIFTH EDITION of this widely used reference work has been completely revised and updated. It provides in a single volume comprehensive data on all basic phases of electronics, including tables, formulas, standards, and circuit information —PLUS— all-new data on microminiature electronics, space communications, navigation aids, reliability and life testing, international telecommunication recommendations, switching networks and traffic concepts, and quantum electronics. 45 data-packed chapters provide invaluable information for practicing radio and electronics engineers. Includes over 1300 charts, nomographs, diagrams, tables, and illustrations. 1155 pages, plus 41-page index.

10-Day Free Examination

Howard W. Sams & Co., Inc. Dept. ED-3
A Subsidiary of International Telephone and Telegraph Corp.
4300 W. 62nd St., Indianapolis, Ind. 46268

Send me REFERENCE DATA FOR RADIO ENGINEERS for 10-day examination, without cost or obligation.

If I decide to keep the volume, I will send:
 \$20.00 (plus postage), or \$7.00 (plus postage) in 10 days, and \$6.50 per month for 2 months. Otherwise, I will return the book postpaid within 10 days.

\$20 payment enclosed. Send my copy postpaid with full 10-day return privilege. (Include sales tax where applicable.)

Name _____

Company _____

Address _____

City _____ State _____ Zip _____

INFORMATION RETRIEVAL NUMBER 225

PACKAGING & MATERIALS

Room-temp stripper dissolves resins

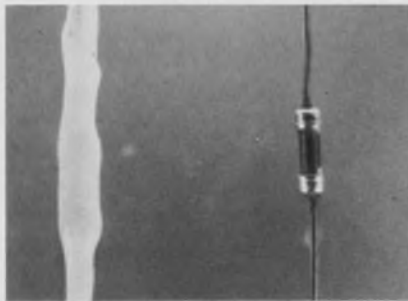

Possis Machine Corp., Corporate Research Group, 825 Rhode Island Ave. South, Minneapolis, Minn. Phone: (612) 545-1471.

At room temperature, resistors and other electronic components can be completely cleaned of resins with E-Z Off cold stripper. The solution strips hydrocarbon deposits, epoxy resins, polymer vinyls, acrylic paints, thermoplastic adhesives and other hard-to-strip substances. Coatings lift off in the rinse water instead of dissolving in the stripper solution, thereby eliminating contamination.

CIRCLE NO. 482

Standard connector is 40-pin module

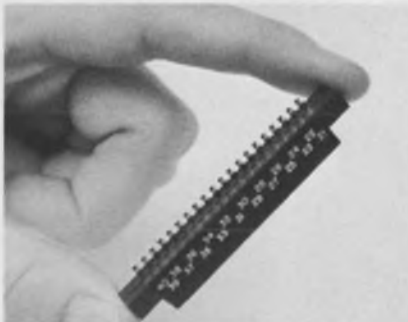

Sylvania Electric Products, Inc., Parts Div. 12 Second Ave., Warren, Pa.

A new commercial connector, a 40-pin male module, can meet the requirements of the U.S. Naval standard hardware program. The new unit is designed for electronic modular packaging applications and can accommodate substrates or printed-circuit cards. It is particularly suited for PC boards utilizing flatpack ICs. The connector is molded of diallyl phthalate and fabricated with aluminum contact shields bonded in place.

CIRCLE NO. 483

STABILITY & QUALITY

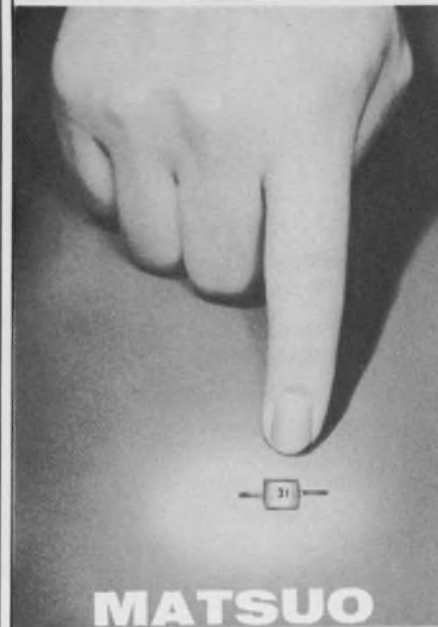

SOLID TANTALUM CAPACITORS FOR HYBRID ICs - "MICROCAP"-

Capacitance exceeding 10,000 picofarads obtained despite miniature size. "MICROCAP" features excellent heat resistance, solderability and mechanical strength comparable to conventional discrete components, for easy use in hybrid integrated circuits.

Specifications:

Operating Temperature Range: -55°C to $+85^{\circ}\text{C}$
Standard Voltage Rating: 6.3, 10, 16, 20, 25, 35 VDC
Standard Capacitance Value: .001 to 22MFD (E6 series)
Standard Capacitance Tolerance: $\pm 20\%$ (M)

MATSUO'S other capacitors include:

Metalized Polyester Film Capacitors:

Type FNX-H mylar wrapped.

Solid Tantalum Capacitors:

Type TAX hermetically sealed in metallic case, Type TSX encased in metallic case and sealed with epoxy resin, Type TSL encased in metallic case and sealed with epoxy resin. Polyester Film Capacitors:

Type MFL epoxy dipped, Type MFK epoxy dipped, non inductive, Type MXT encased in plastic tube, non inductive.



For further information, please write to:

MATSUO ELECTRIC CO., LTD.

Head Office: 3-5-3-chome, Sannari-cho, Toyonaka-shi, Osaka, Japan
Cable: "NCCMATSUO" OSAKA Telex: 523-4164 OSA
Tokyo Office: 7, 3-chome, Nishi-Gotanda, Shinagawa-ku, Tokyo

INFORMATION RETRIEVAL NUMBER 226

ELECTRONIC DESIGN 6, March 15, 1969

Coaxial fittings twist and rotate



Hewlett-Packard, 1501 Page Mill Rd., Palo Alto, Calif. Phone: (415) 326-7000. P&A: \$115 or \$180; stock.

Two new coaxial fittings allow three-dimensional movements in hookups that use rigid coaxial air-dielectric lines, while preserving the stability and repeatability of the lines. One of the new devices is a rotary joint, model 11588A, that bends through a full 360° range; the other is a rotary air line, model 11606A, that can be twisted through 360°. When used together, the fittings permit movement in three dimensions. SWR is less than 1.1.

CIRCLE NO. 484

He-Ne gas laser sells for \$100



Bausch & Lomb, 25568 Bausch St., Rochester, N.Y. Phone: (716) 232-6000. Price: \$100.

Costing less than \$100, a new, high-quality, helium-neon gas laser is a rugged, simple, low-power unit that is ideal for industrial research applications. The new unit, which has a 0.1-mW output, features a one-year guarantee on the laser tube. There are no adjustment knobs or controls; the laser simply plugs into a wall socket for operation.

CIRCLE NO. 485

Slim Down Painlessly with

AEL's NEW TUBULAR BAND PASS FILTERS

Now you needn't compromise to meet tight space requirements! AEL's new 3/8" diameter filters provide performance equivalent to 1/2" filters in the 100-1,000 MHz range—with superior quality at no increase in price!

To start enjoying new design freedom immediately, contact our Washington, D.C., Division or your AEL representative for complete information and prices on both stock and custom designs, and . . .

See it at IEEE
Booth 3K-21 & 22

Filter Capability Now

American **E**lectronic **L**aboratories, Inc.

Main Offices: P.O. Box 552 BL Lansdale, Pa. 19446

(215) 822-2929 • TWX: 510-661-4976 • Cable: AMERLAB

Washington, D.C. Division: 6629 Iron Place, Springfield, Va. 22151 • (703) 354-5700

California Office: 8939 S. Sepulveda Blvd., Los Angeles, Calif. 90045 • (213) 670-8755

INFORMATION RETRIEVAL NUMBER 227



814

RMC DISCAPS

the complete Ceramic Disc line

Over the years Radio Materials Company has maintained its leadership in the production of ceramic disc capacitors. A complete line offering outstanding quality has been the key to continuing growth.

STANDARD

Type C, B, BA, JF, JL and JE

SUBMINIATURE

Type SM, BT, TA and Magnacaps

GREENCAPS

Type CG, JG, and BG

SPECIAL

U.L. Listed Discaps, T.C. High Voltage, High K High Voltage and Dual Section By-Pass

SOLDER-IN T.C. DISCAPS

For application in equipment where lead inductance effects must be reduced to an absolute minimum.

If your application requires special physical or electrical characteristics, contact RMC's Engineering Department.

U.L. LISTED T.C. DISCAPS

Should be specified when the use is an integral part of an antenna coupling network where compliance with Underwriters' Laboratories specifications are required.



DISCAP
CERAMIC
CAPACITORS



RADIO MATERIALS COMPANY
A DIVISION OF P. R. MALLORY & CO., INC.
GENERAL OFFICE: 4242 W. Bryn Mawr Ave., Chicago 46, Ill.
Two RMC Plants Devoted Exclusively to Ceramic Capacitors
FACTORIES AT CHICAGO, ILL. AND ATTICA, IND.

INFORMATION RETRIEVAL NUMBER 601

MICROWAVES & LASERS

Modulator/attenuator goes to 12.4 GHz



Alfred Electronics, 3176 Porter Dr., Palo Alto, Calif. Phone: (415) 326-6496.

Model E150 p-i-n diode modulator-and-controller combination operates over the frequency range of 250 MHz to 12.4 GHz. The modulator unit provides electronically controllable attenuation and modulation in a single package, and features wide dynamic range as well as low SWR at all attenuation levels. The controller unit provides control and power signals for one or two modulator units.

Booth No. 2C12 Circle No. 349

Signal generator goes to 1 GHz



Marconi Instruments, 111 Cedar Lane, Englewood, N.J. Phone: (201) 567-0607.

Permitting measurements on virtually all types of fm receivers, a new solid-state signal generator accepts any four of five oscillators extending from 4 MHz to 1 GHz. Model 2006 features a crystal calibrator with frequency integrator for visual indication of zero beat, as well as a counter output of 100 mV into 50 Ω to 600 MHz and 50 mV to 1 GHz.

Booth No. 2D02 Circle No. 352

NEW miniature waveform generator

smallest size! biggest performance!

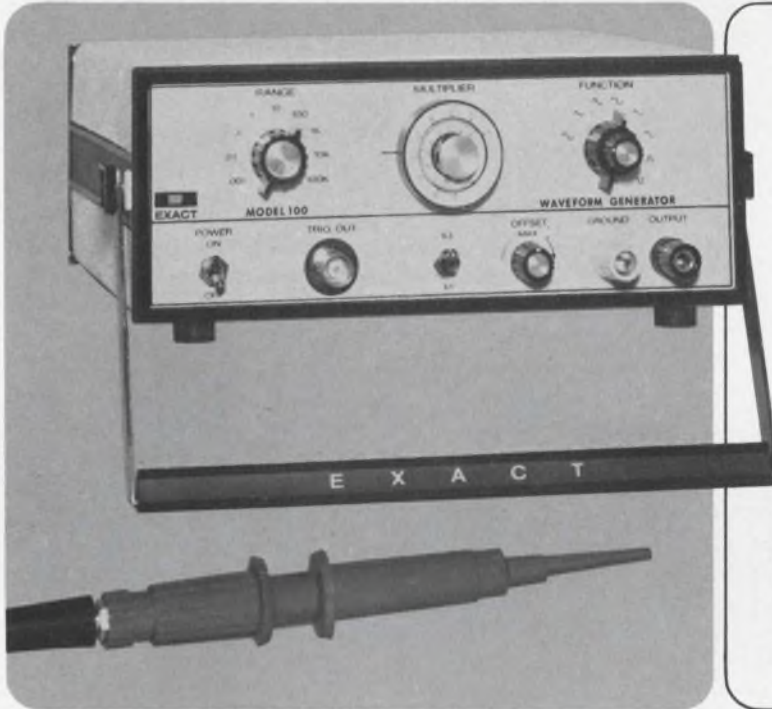

- Less than 3 inches high
- Five basic waveforms
- Also a pulse generator
- 0.001 Hz to 3 MHz*
- Variable DC offset
- Resetability equal to a 5" dial
- Only \$445

*5 MHz on square and triangle outputs

Exact's new Model 100 take-anywhere waveform generator is only 2 7/8" high, 7 3/8" wide and 8 1/2" deep, yet it gives you the versatility of 5 basic waveforms and wide frequency range. Convenient handle/tilt stand, too. Waveform outputs:

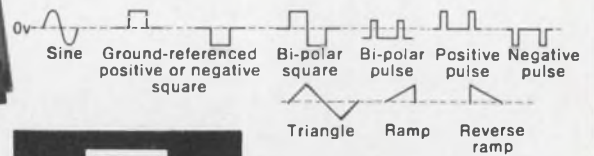

Box 160
Hillsboro, Oregon 97123
Telephone (503) 648-6661

EXACT electronics, inc.

SEE US AT IEEE—Booth 3A31

INFORMATION RETRIEVAL NUMBER 602

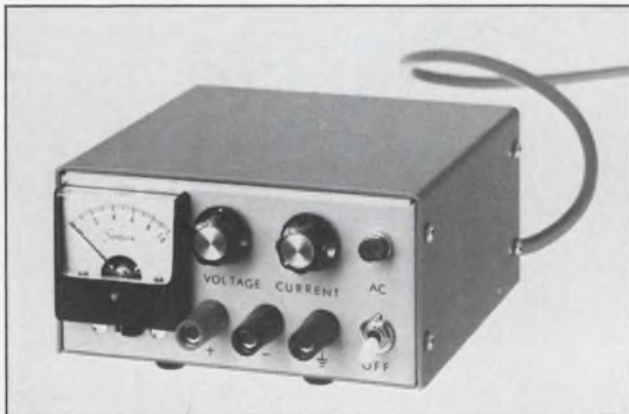

20 watts of regulated dc
2 1/2 x 5 x 5 inches / \$98.95

Now available from Pacific Radionics—five new POWER-PACTS which produce a full 20 watts of clean, spike-free power regulated to 0.01%. Voltage ranges from zero to 10, 20, 50, 100 and 150. Ripple is only 0.2 mV rms. The variable current-limited output can be operated continuously into a short circuit without damage. □

For complete specifications circle the information retrieval number below or contact...



581 Division St. • Campbell, Calif. 95008 • (408) 379-3280

INFORMATION RETRIEVAL NUMBER 603

ELECTRONIC DESIGN 6, March 15, 1969

SNOB KNOB



Black

Decorative metallic ring

Spun aluminum cap

Spun aluminum inlay

The first new styling innovation in fifteen years!

900 Series Snob Knobs come in four bright, handsome models. Spun aluminum cap. Spun aluminum inlay. Decorative metallic ring. And Black. From 1/2" to 1 3/4" diameter.

Kurz-Kasch is known as the quality knob source by electronics manufacturers the world over. If you're not familiar with the outstanding Kurz-Kasch line, we'll send you a complete catalog. And if you're just anxious to see the new Snob Knob, we'll send you a free sample.



Kurz-Kasch, Inc.

Standard Parts Division • 1415 S. Broadway
Dayton, Ohio 45401 • Phone 223-8161

INFORMATION RETRIEVAL NUMBER 604

**Directional coupler
loses only 0.05 dB**

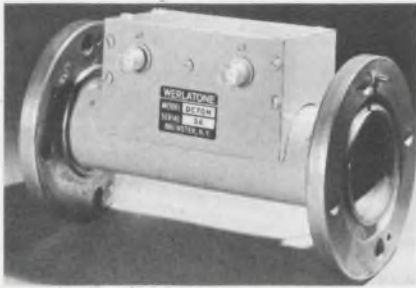

Werlatone Inc., East Branch Ave., Brewster, N.Y. Phone: (914) 279-8621.

Providing a means of continuously comparing forward and reflected power in the frequency range between 2 and 32 MHz, a new directional coupler handles a maximum power of 10 kW while holding insertion loss to 0.05 dB maximum. Model DC70H operates with a flatness of 0.5 dB, a directivity of 30 dB minimum and a coupling of 70 dB typical.

CIRCLE NO. 486

**Conductive rubber
has 100-dB loss**

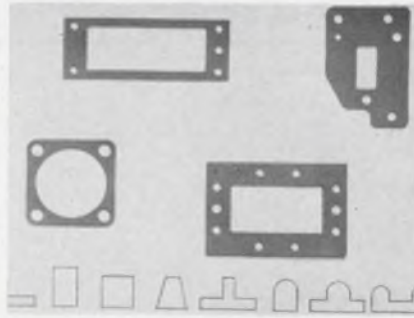

Emerson & Cuming, Inc., Microwave Products Div., Canton, Mass. P&A: \$20/sheet; stock.

Intended to give the optimum trade-off between cost and shielding effectiveness, a silver-loaded silicone rubber for gasket applications yields insertion losses as high as 100 dB. Eccoshield SV-P, which has a volume resistivity of 0.05 Ω -cm, is supplied in sheets and gasket shapes, custom molded to customer specifications.

CIRCLE NO. 487

**Low-noise amplifier
puts out 20 dBm**



Avantek, Inc., 2981 Copper Rd., Santa Clara, Calif. Phone: (408) 739-6171. P&A: \$1000 to \$1200; 30 to 45 days.

Over the frequency range of 10 MHz to 1 GHz, a new, transistorized amplifier maintains a low noise figure of 6 dB with an output power of +20 dBm. Model AWP-1000T features a gain of 30 dB with a flatness of ± 1 dB. Its VSWR, both in and out, is 2, while maximum input power is 24 V dc at 300 mA. The unit weighs 10 oz.

CIRCLE NO. 488

**NOT ONLY
LOW COST**

**BUT
THE MOST
COMPLETE
FAMILY OF
INTEGRATED
CIRCUIT
COUNTERS
AVAILABLE**



PRACTICAL because they are small, completely packaged and housed in a rugged, aluminum extruded enclosure.

AVAILABLE as timebase, frequency, preset, bi-directional and totalizing counters.

VERSATILE because any combination of 2-9 count positions are available.

INSTRUMENT DISPLAYS, INC.



A wholly owned subsidiary of
BURNS & TOWNE, INC.

18-36 GRANITE ST.,
HAVERHILL, MASS. 01830 U.S.A.

INFORMATION RETRIEVAL NUMBER 605

**HYBRID CIRCUIT
CERAMIC CHIP CAPACITORS...**

...THAT ARE REALLY THUMBTHING!

Put your finger on those so-and-so design problems with a selection of type K 1200's. Capacitance range is 10 pF to 2.5 Mfd. Dissipation factor is less than 2% @ 1 kHz. Working voltages available, 25 thru 200 WVDC and more. Tempco is $\pm 15\%$ max. -55°C to 125°C . Our full line meets the applicable portions of MIL-C-11015 and MIL-C-39014.

Want a complete description, characteristics curves, etc? . . . write us for our latest pattern K-1200.

Monolithic
Dielectrics Inc.



P.O. Box 647
Burbank, Calif. 91503
Phone 213 848-4465

INFORMATION RETRIEVAL NUMBER 606

GaAs varactors reach Ku band

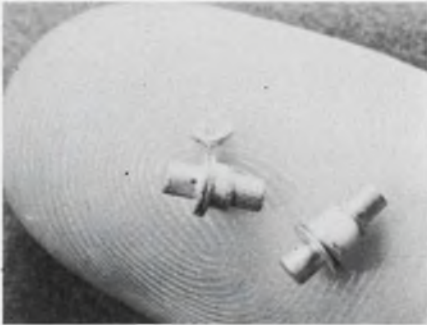

Varian Bomac Div., Solid State Microwave, 8 Salem Rd., Beverly, Mass. Phone: (617) 922-6000.

Advancing the state of the art in parametric amplifier diodes, gallium-arsenide varactors offer operating frequencies from uhf through Ku band and a cut-off frequency of 400 GHz. They have a minimum reverse breakdown voltage of 6 V and a maximum power dissipation of 250 mW. There is a broad selection of frequency ranges, package styles, series inductances and case capacitances.

CIRCLE NO. 489

Laboratory wattmeter gages rf peaks



Bird Electronic Corp., 30303 Aurora Rd., Cleveland. Phone: (216) 248-1200.

Model 4345 rf peak wattmeter for pulsed transmission systems samples forward or reflected power in an accurately machined 50- Ω reference line section. Full scale power is selected in five values from 250 W to 5 kW. Frequency range is 950 to 1300 MHz. VSWR with connectors is less than 1.08.
Booth No. 2B40 Circle No. 258

HOW TO IMPROVE SYSTEM PERFORMANCE IN THE HIGH VOLTAGE FIELD...

If your system operates at elevated voltage, the proper high voltage cable can measurably improve its performance. We know from experience, because high voltage cable is our field. A BIW specialist is available to discuss your particular H.V. problem from a total system standpoint.

SILICONE HV CABLE — BIW leads the field in silicone processing technology. Insulating and semi-conducting silicone rubbers are combined to yield cables of extraordinary flexibility and high corona initiation voltage. Suitable for satellite systems, power supplies, radars, Xenon flash tubes, CRT leads and most systems under 100 KVDC where flexibility and ease of termination are required at temperatures to 200°C.

BUTYL HV CABLE — Butyl-rubber-insulated, single and multi-conductor cables combine high dielectric strength and flexibility with low cost. Voltages to 200 KVDC with high reliability for a variety of applications including X-Ray, electron beam welding, electron microscopy and many others.

TFE HV CABLE — An exclusive BIW process combines thin tapes of TFE with high dielectric strength oil and an FEP jacket to produce exceptionally small diameter High Performance cables for use in general high voltage wiring to 30 KVAC. May be used in dielectric coolant systems. Extremely tough and reliable.

LAMINATED SYNTHETIC HV CABLE — Layers of thin irradiated polyethylene tape plus high-dielectric-strength oil result in cables suitable for voltages from 100 KVDC to 1000 KVDC. Designed especially for linear accelerator feeds, electron beam welders, pulse discharge devices, ion separators and other systems requiring extra high voltage cable.

If you have a high voltage wire or cable problem BIW will solve it with a proprietary, pre-engineered cable or will quickly design one to meet your need. Call or write.



**Boston Insulated
Wire & Cable Co.**

54 Bay Street, Boston, Mass. 02125

El Segundo, Calif. 90245; Hamilton, P.O. Canada;
Kingston-upon-Thames, U.K.; GEDEBIW, S. A. — Clichy, France

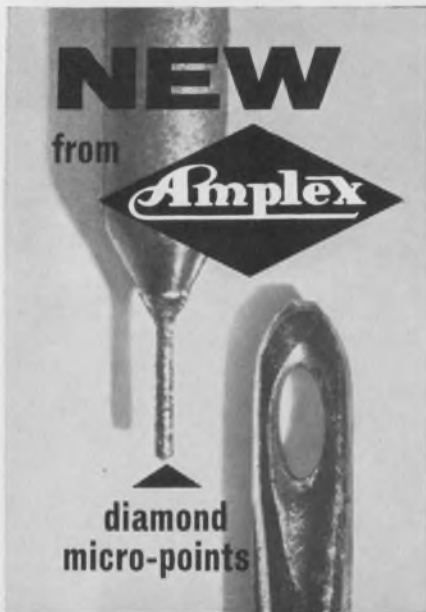

NEW

from

Amplex

**diamond
micro-points**

Now . . . Amplex offers the world's smallest diamond points! "Micro-points"—electroplated with high-density pure virgin diamond—are available in a diameter range from .001" through .015"* for drilling, reaming, and lapping extremely hard substances such as ceramics. Magnified view shows .005" "Micro-point" compared with the eye of an ordinary needle. Ask for price list.

*Larger sizes also.



FOR A FAST, MIRROR FINISH, Amplex Diamond Compounds are unexcelled! Newly developed electronically automated equipment—exclusive with Amplex—assures the highest degree of precision grading. Particles are 100 percent working diamond of uniform blocky shape for maximum cutting action. Available in a wide variety of grades and concentrations. Request Form 116.

**COMPLETE LINE OF
INDUSTRIAL DIAMOND PRODUCTS
•
DIAMOND RECLAIMING SERVICE**

THE AMPLEX CORPORATION
6 Tobey Road • Bloomfield, Conn. 06002
(NATIONWIDE REPRESENTATION)

INFORMATION RETRIEVAL NUMBER 608

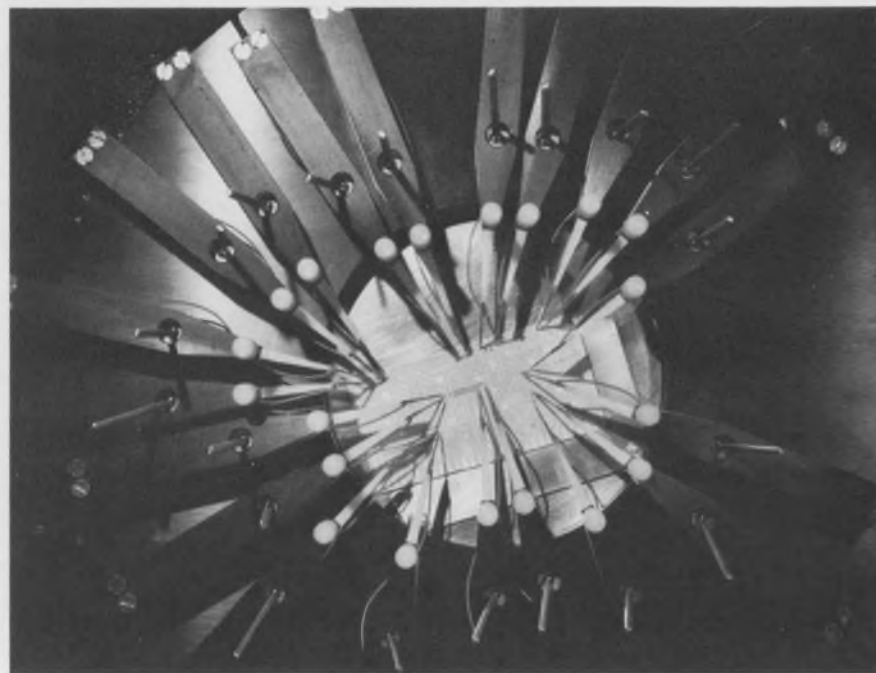

Hybrid-circuit probing system covers 4-in. circular area

Siliconix Inc., 1140 W. Evelyn Ave., Sunnyvale, Calif. Phone: (408) 245-1000. P&A: \$2800 for 20 points, plus optic; 30 days.

Eliminating the need for repetitive probing to cover a large substrate, the first complete probing system for hybrid assemblies, using either thick-film or thin-film depositions, can accept ceramic substrates as large as 3-in. square. Called the Classic 4, the new prober contains as many as 25 manipulator points to cover up to a 4-in.-diameter circle.

Substrates are identically positioned on the unit's 4-in.-diameter vacuum chuck by an L-shaped jig. Repetitive substrates can be tested by moving the vacuum chuck in both X and Y directions with a precision, single-handed microscope stage.

A foot-switch control initiates the probe head down-motion, bringing all preset and planerized points into contact with the circuit under test. Substrate thickness variations can be offset by a self-contained micrometer.

The probe manipulator points are magnetically based for preposition-

ing into any area on the substrate. A vernier control provides for fine positioning, while high-resistivity delrin springs allow low-leakage and high-frequency measurements to be made. The delrin springs use parallelogram action to eliminate point scrubbing of the bonding pads.

Each probe point can be electrically connected through the equipment base with the jumpers provided.

CIRCLE NO. 490

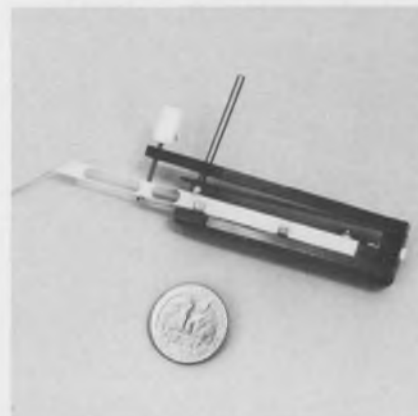

Manipulator point of new large-substrate prober makes both low-leakage and high-frequency measurements.

POWER/MATE CORP. UNI-88

UNIVERSAL POWER SUPPLY

- * 0 to 34 volts at 1.5 AMPS.
- * .005% Regulation
- * 250 Microvolts ripple
- * Meets MIL-E-5272 specs
- * 100,000 hours MTBF
- * 5 year warranty

\$99.⁰⁰



SAME DAY SHIPMENT



POWER/MATE CORPORATION

163 Clay St. ■ Hackensack, N. J. 07601
(201) 343-6294 ■ TWX (710) 990-5023

See us at Booth 4C04 I.E.E.E.

INFORMATION RETRIEVAL NUMBER 609

For the Computer Industry

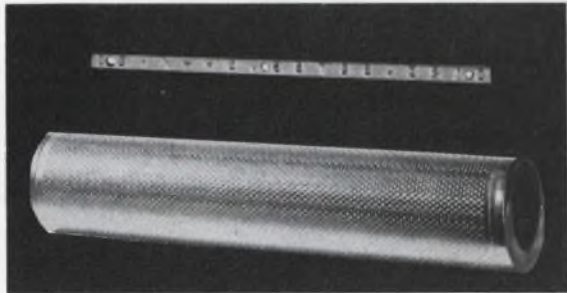

Print Bars and Drums

At Buckbee-Mears we etch the entire drum in one operation. Costly assembly problems are eliminated because there are no segments to line up. We are also geared to etch print bars faster at lower costs. Our print drums and bars are made of hardened tooled steel for extra long life.

For more information, see your nearest Buckbee-Mears representative. Or contact Bill Amundson, our industrial sales manager. You'll be glad you did.

**BUCKBEE-MEARS
COMPANY**

245 E. 6th St., St. Paul, Minn. 55101 / (612) 227-6371



INFORMATION RETRIEVAL NUMBER 610

MINIATURE MEGOHM RESISTORS

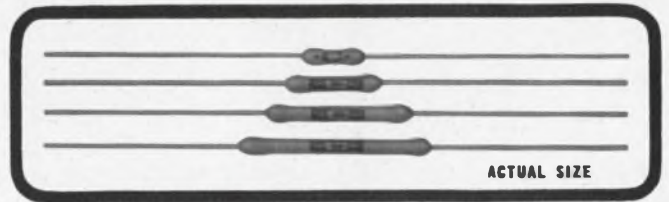

ACTUAL SIZE

T.C. Absolute: 80 PPM/°C*

T.C. Tracking: to 5 PPM/°C on special order.

Applications include high voltage dividers, high resistance networks, precision RC timing circuits, etc. We specialize in network sets with matched characteristics. Facilities available to perform Hi Rel screening.

Model No.	Wattage	Max. Voltage	Dielect Str'gth	Resistance		Dimensions		
				Min.	Max.	Length	Dia.	Lead Dia.
MG 650	.5	600	750	500 K	5 meg	.313 ±.020	.094 ±.015	.025 ±.002
MG 660	.6	1000	750	1 meg	10 meg	.500 ±.030	.094 ±.015	.025 ±.002
MG 680	.8	1500	750	1 meg	15 meg	.750 ±.030	.094 ±.015	.025 ±.002
MG 710	1.0	2000	750	1 meg	20 meg	1.000 ±.040	.094 ±.015	.025 ±.002
MG 721	2.0	2500	1000	1 meg	30 meg	1.000 ±.050	.240 ±.030	.040 ±.002
MG 750	3.0	3000	1000	3 meg	150 meg	2.125 ±.060	.315 ±.030	.040 ±.002
MG 780	5.0	4000	1000	4 meg	220 meg	3.125 ±.060	.315 ±.030	.040 ±.002

*Temperature Coefficient: 80 ppm/°C referenced to 25°C, ΔR taken at -15°C and +105°C. Maximum operating temperature: 225°C. Resistance Tolerance: ±1% (tolerances to .2% on special order). Insulation Resistance: 100 megohms, minimum. Overvoltage: 1.5 times working voltage for 5 seconds, R shift .8% max. Thermal Shock: MIL-STD-202, method 107, cond. C, R shift .5% max. Moisture Resistance: MIL-STD-202, method 106, R shift .8% max. Loadlife: 1000 hours at rated power, R shift .8% max. Encapsulation: Silicone Conformal. Leadwire: Gold Plated Dumet 1½" long ±½".

MICRONOX™ Resistance Films

Micronox resistance films are produced exclusively by Caddock Electronics. They are composed of complex oxides fired in air at temperatures above 1400°F. The resulting films are relatively insensitive to high ambient temperatures and thermal shock. Films show negligible effect from moisture.

This totally new approach to precision resistors and networks opens new design possibilities because of the wide resistance range, precise temperature characteristics, and high temperature and power capability. Temperature coefficient can be accurately reproduced (within ±10 ppm/°C of curve if required). The typical curve shown below will vary slightly with resistivity of the film and configuration of the substrate.

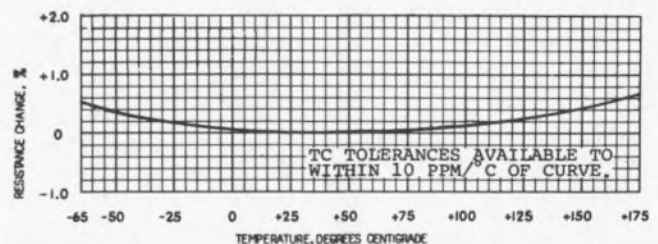

CADDOCK ELECTRONICS

3127 Chicago Avenue, Riverside, California 92507 • Telephone: (714) 683-5361

INFORMATION RETRIEVAL NUMBER 611

Printing machines mark semiconductors

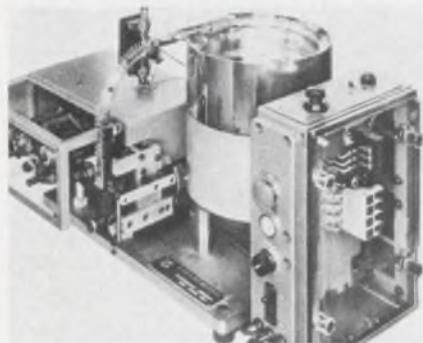

Eastern Marking Machine Corp., 30 Alabama Ave., Island Park, L.I., N.Y. Phone (516) 889-9090

Developed to satisfy the constantly changing concepts and designs of electronic components, two new marking machines are now available. Model RD/3-VA for printing TO-92 transistors is fully automatic with hopper feed. It can also be supplied for printing TO-5 and TO-18 transistors at better than 100 units per minute. Model R4/FR marks integrated circuits.

Booth No. 1H27 Circle No. 355

Component marker feeds and prints

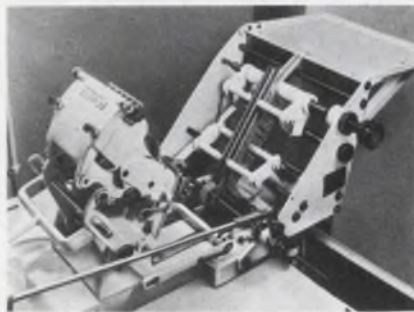

Popper & Sons, Inc., 300 Park Ave. S., New York City. Phone: (212) 674-5500. P&A: \$2165; 90 days.

The FA-72 Mark II automatic offset printer will feed and print axial lead components at a rate of up to 60 per minute. It features built-in easy adjustments for rapid changeovers, assuring high output. This model also comes equipped for color banding. A wide range of other models is also available for marking applications, including hand-operated machines for prototype and short-run production.

Booth No. 1G27 Circle No. 256

Automatic wave dipper coats non-axial leads

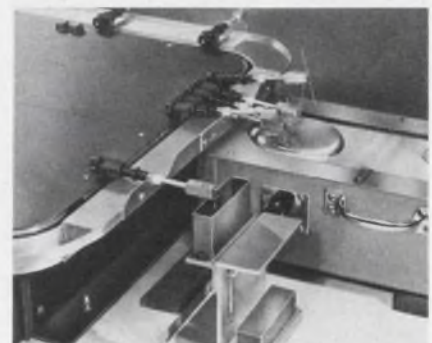

Electrovert Inc., 86 Hartford Ave., Mt. Vernon, N.Y. Phone: (914) 664-6090.

Designed basically for solder-coating both axial and non-axial component leads, an automated rotary dipping apparatus features a conveyor system that carries components around its circumference. It also permits automatic lowering and raising of the components in a vertical plane, plus simultaneous rotation in 90° increments.

Booth No. 1J13 Circle No. 251

NEW SPECIAL PURPOSE RESISTOR PROTECTION



- Currently in use on lightning arrestors, circuit breakers, spark plugs.
- Available in rods, sleeves, rings, special shapes, up to 15" in length and 5" in diameter.
- Ceramic composition favors high voltage applications with high surges.
- Organic Special Purpose Resistors are inexpensive solution where heat dissipation is necessary.
- Both ceramic and organic available in wide range of resistivity values.
- Write for technical assistance.



INFORMATION RETRIEVAL NUMBER 612

SOLVE NOISE AND FILTERING PROBLEMS WITH CERAMAG® FERRITE BEADS



- Ceramag® ferrite beads are low cost, easy to install, and save space.
- Effective r.f. decoupling, shielding and parasitic suppression without sacrificing low-frequency power or signal level.
- Installed by simply sliding one or several over conductor leads.
- Beads can, but need not, be grounded.
- Sizes from .040" ID — .100" OD — 100" L.
- Sample quantities available.



INFORMATION RETRIEVAL NUMBER 613

CERAMAG® FERRITE MATERIALS CONSISTENT IN PERFORMANCE, QUALITY



- Select from over 30 grades.
- Available in toroids; cup, insert and thread cores; bobbins; sleeves; transformer cores; deflection yokes; and rectangular solids.
- A wide range of sizes held to exact tolerances.
- Maximum permeability and high Q.
- Tooling available for hundreds of parts.
- Offers the advantage of complete moldability.
- Write for bulletin.



INFORMATION RETRIEVAL NUMBER 614
ELECTRONIC DESIGN 6, March 15, 1969

Sputtering process doubles production

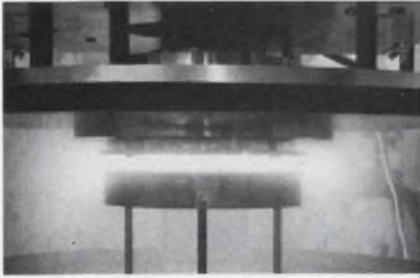

Materials Research Corp., Orangeburg, N.Y. Phone: (914) 359-4200. P&A: from \$7000; April.

A new sputtering process doubles or triples the production rates of sputtering equipment now available and in addition produces better uniformity and other characteristics. "Plasmatomic" sputtering will drastically improve the economics of electronic microcircuit production and will extend the capabilities of sputtering into many electronic areas now best served by vapor deposition and by thick-film processing.

Booth No. 4C08 Circle No. 272

Probe systems index and test

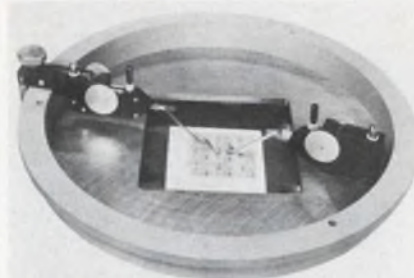

CGS Units, Inc., 73 Saginaw Dr., Rochester, N.Y.

A new family of probing, testing and adjusting devices for micro-electronic components consist of 30-point stations that permit a variety of testing operations during various processing stages. Each probe station allows sequential indexing and testing, either manually or automatically, of similar circuits on a single substrate. Pressure at the probe tip is adjustable from a few tenths of a gram to 20 grams.

CIRCLE NO. 491

Sorting system feeds and probes

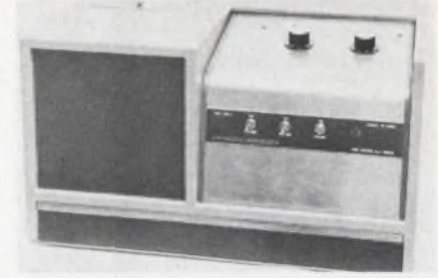

A-B Tool and Mfg., Inc., Engineered Automation Div., High Bridge, N.J., Phone: (201) 638-8555. Availability: 4 to 6 wks.

A new automatic feed and probing system, designated as AUTOSORT 001, handles all standard monolithic chip, disc and multilayer capacitors, as well as resistors and diodes, without any limitations on physical size. Production operating speeds range from 5000 to 15,000 parts per hour, depending on the part configuration and the number of test parameters required.

CIRCLE NO. 492

ENVIRONMENT PROOF ROTARY SWITCHES

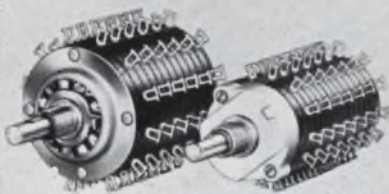

Series 600 1 1/2" Dia.—Series 100 1 1/8" Dia.

- Both index mechanism and electrical sections are completely enclosed.
- Corrosive atmospheres, dust, dirt and moisture are permanently sealed out, lubricants sealed in.
- Solder or quick-connect terminals molded permanently into position minimize production damage.
- Standard index angles include 15°, 30°, 36°, 60° and 90°, special angles available on request.
- Write for engineering bulletin.

 **STACKPOLE**
COMPONENTS COMPANY
P. O. Box 14466
Raleigh, N. C. 27610

INFORMATION RETRIEVAL NUMBER 615

ELECTRONIC DESIGN 6, March 15, 1969

UNEXCELLED QUALITY FOR LESS THAN 4¢

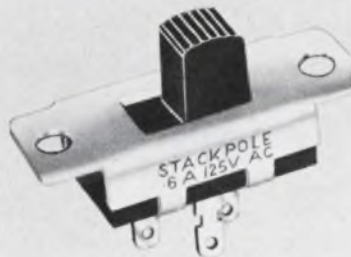

- Listed by UL AND CSA, 1 to 10 amps at 125V AC.
- 7960 slide switch combinations—23 basic types.
- New rugged solder lug terminal, designed for use with quick connectors.
- Uniform quality assured by automated assembly.
- Electro-silver plated terminals and contacts—shorting and non-shorting.
- Phenolic or nylon triggers in a variety of colors.
- Write for engineering literature.

 **STACKPOLE**
COMPONENTS COMPANY
P. O. Box 14466
Raleigh, N. C. 27610

INFORMATION RETRIEVAL NUMBER 616

UNIQUE DESIGN ADDS VALUE AND APPEAL

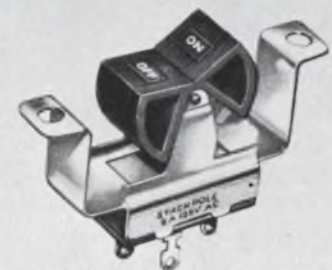

- 23 rocker switch configurations, including 2-3 positions, spring return and center-off.
- Variety of rocker designs available in a spectrum of colors and hot-stamped lettering.
- Listed by UL AND CSA, 1 to 10 amps at 125V AC.
- Solder lug, space saver, quick-connect or printed circuit terminals.
- Field-proven quality same as famous Stackpole slide switches.
- Prices start at less than 15¢.
- Write for engineering literature.

 **STACKPOLE**
COMPONENTS COMPANY
P. O. Box 14466
Raleigh, N. C. 27610

INFORMATION RETRIEVAL NUMBER 617

Evaluation Samples

Drafting vellum

Incorporating modern plastic technology, a new drafting vellum is unique in that the plastic transparentizer is cross-linked to 100 per cent rag fibers by a new curing process. The new drafting material takes skip-free erasable ink lines without feathering or belling. Drawings will not discolor or lose transparency, even after years of storage. Free samples of the vellum are available for test and evaluation. The material is available in sheet and roll sizes at a cost comparable to other premium vellums. Frederick Post Co.

CIRCLE NO. 493

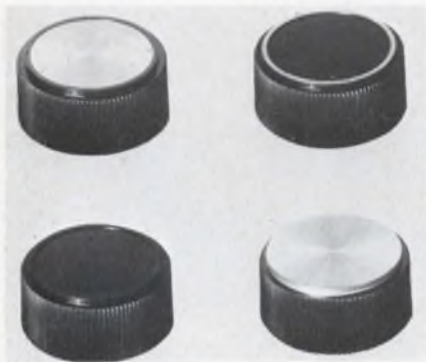

Instrument knobs

One basic knob design has been developed in four totally different styles, ranging from a standard undecorated version to one with a deluxe spun aluminum cap. Depending on the style, the series is suitable for commercial product applications, or for more functional uses in standard form on instrument and control panels. In standard form the knob is flat with a molded recess on top. In a second style the knob may be specified with a metallic ring around the top. A third version has a spun aluminum inlay inserted in the recess. The final decorative variation is provided with a spun aluminum cap that covers the top of the knob. All knobs in the series have serrated sides. Descriptive literature and sample knobs are available from the manufacturer. Kurz-Kasch, Inc.

CIRCLE NO. 494



Drafting aids

Samples of electronic component drafting aids are offered with a 68-page catalog that features complete listings of shapes, symbols and tapes for use in master artwork preparation, assembly layouts and schematic drawings. Such time-saving innovations as multipad configurations of complete component symbols are featured. These ready-to-use patterns eliminate the necessity for positioning individual pads. Also included are pads, elbows, corners, tees, ells, tapes, connector strips, reference numbers, letters and schematic symbols. Bishop Industries Corp.

CIRCLE NO. 495

Shielding gasket material

Three data sheets describe a new conductive silver/silicone emi/rfi shielding and moisture seal gasket material. The material is a fine network of continuously contacting pure silver particles, whose openings are filled with a resilient silicone rubber. Total shielding effectiveness is better than 100 dB in an electric field from 14 KHz to 10 GHz. Volume resistivity is between 0.001 and 0.01 ohm-cm³. Sheets and molded parts can be produced with a wide range of compressibility, from below 0.3 to over 80 durometer. Tensile strength exceeds 300 lb/in.² and elongation ranges from 60 to 150% at rupture. A free 2-in.² sample will be sent to any interested engineer. Technical Wire Products, Inc.

CIRCLE NO. 496

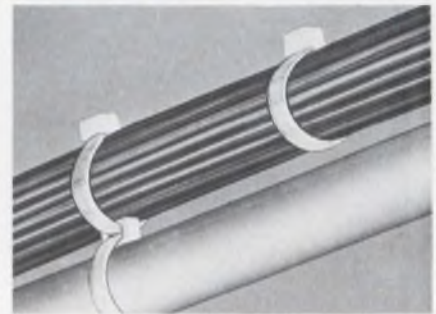

Connector rings

Used for mounting wiring harnesses to conduit, a new connector ring accessory eliminates the need for saddle clamps. The connector ring is used with standard cable ties. It also can be applied to gang main and auxiliary harness and cable assemblies. Two sizes are available, both designed to exceed the minimum loop tensile strength of the cable tie used. Free samples and further information are available from the manufacturer. Panduit Corp.

CIRCLE NO. 497

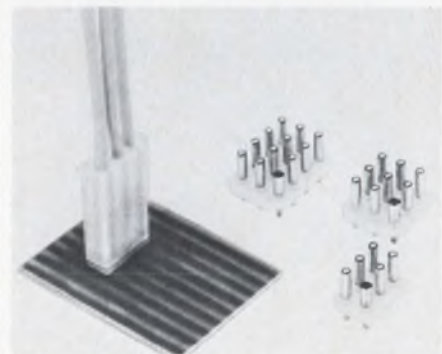

PC connectors

A new connector, W a f e r c o n ₂ speeds production, testing and servicing with printed circuit connections. The connector is a series of nylon wafer receptacles supplied with preassembled terminals and ready for press-fitting to a printed circuit board or for fountain or wave soldering. Positive polarity is guaranteed by intermixing male and female terminals in the wafer receptacle and the mating plug. Additional information and a free sample of the connector are available. Molex Products Co.

CIRCLE NO. 498

New Computer-Automated wiring service for EECoLogIC[®] 2...

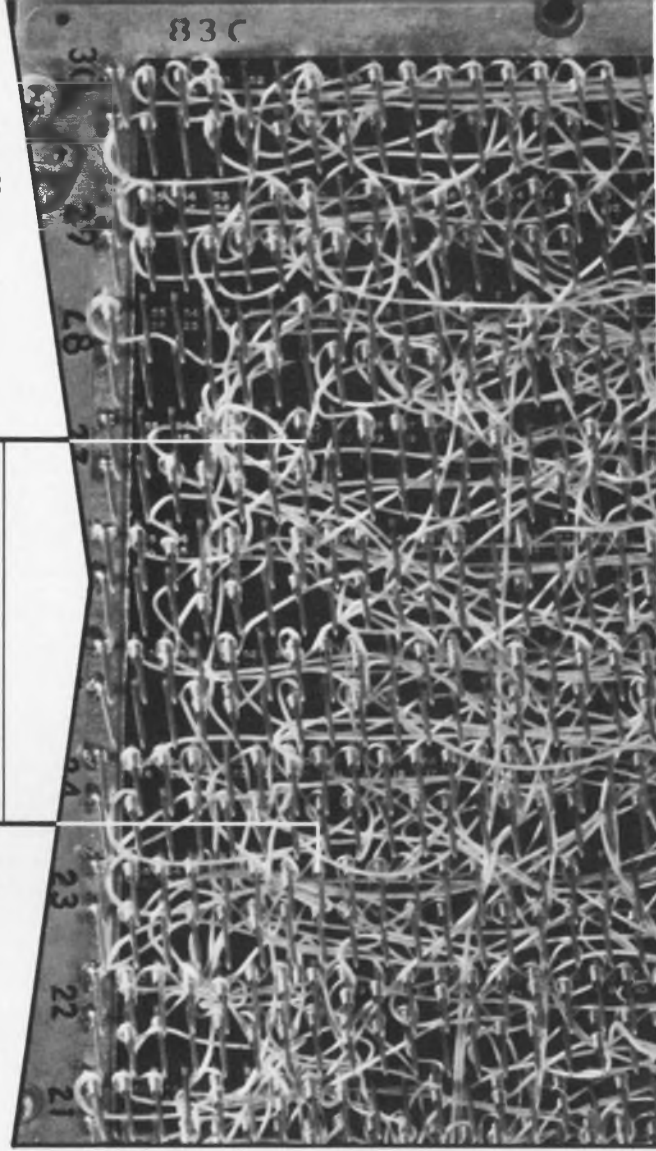
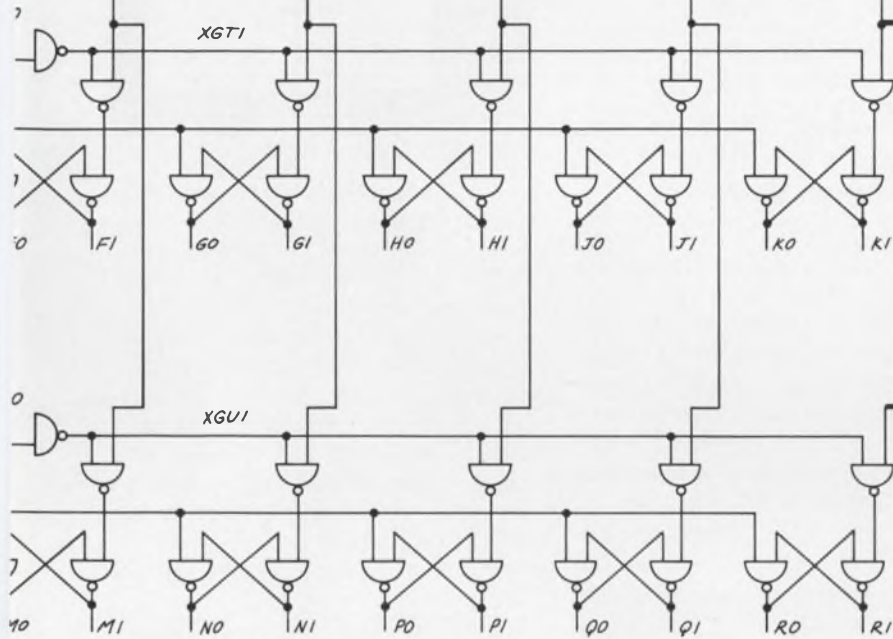

converts lines on paper to wires on hardware



EECO's entire EECoLogIC[®] 2 line of digital logic cards is designed with automatic machine wiring capability. Send for catalog.



SAVES YOU TIME & MONEY — You supply a simple PIN LOGIC LIST* (not a costly and time-consuming wire list). Making a Pin Logic list for 1000 wires takes but 1 working day to complete.

FLEXIBLE — We will provide wired EECoLogIC[®] 2 hardware using Termi-Point[®] or Wire-Wrap[®] techniques...or you can do the wiring on your machine ...or use any qualified vendor.

LOW COST — Typical costs for prototype: 20 cents per wire
for production: 15 cents per wire

Send for an illustrated brochure today.

*You simply choose the module and write the signal name by each pin number. You don't worry where the wires go or the order of listing.



COMPONENTS DIVISION

ELECTRONIC ENGINEERING COMPANY OF CALIFORNIA

1441 EAST CHESTNUT AVENUE · SANTA ANA, CALIFORNIA 92702 · (714) 547-5651

RZ GLASS

...the big news in sputtering targets...from Owens-Illinois

Owens-Illinois RZ Glass Sputtering Target is a NEW copper alumino-silicate glass readily sputtered on a silicon substrate. After sputter deposition, the RZ glass layer is etched to open up contacts to the silicon substrate. A simple oxidation-reduction process then produces *pure* copper conductive layers on the RZ glass, even in etched undercuts.

RZ glasses are ideal for making single or multilayer interconnections in medium or large-scale integrated circuits. The conductive layer is produced uniformly on RZ-coated substrates regardless of surface geometry.

You now have your choice of *three* sputtering targets from Owens-Illinois . . . 1. NEW RZ copper alumino-silicate, silicon-matching, 2. EE-9 alumino-silicate, silicon-matching, 3. EE-10 alumino-silicate, alumina and gallium arsenide matching.

All three are readily deposited at rates of 250 Å/minute with

standard R.F. sputtering equipment, followed by simple etch when needed. A new manufacturing process holds the sodium content of these glasses below 20 ppm.

Owens-Illinois can supply targets promptly in lengths, widths, and thicknesses to fit your R.F. set-up and substrate dimensions. We'll work with you on materials to meet your special needs.

Complete data, specifications, and sputtering procedures developed in the Owens-Illinois microelectronics research labs will be sent to you promptly on request. Ask for information on these other O-I electronic materials: package sealants, substrate glazes and insulating films, preform materials, glazed IC packaged parts and substrates. WRITE TO:

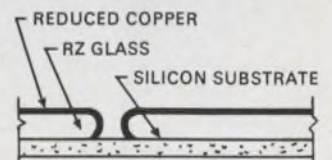

THE O-I FAMILY OF WORK-TOGETHER ELECTRONIC MATERIALS.

OWENS-ILLINOIS
ELECTRONIC MATERIALS
Toledo, Ohio 43601

INFORMATION RETRIEVAL NUMBER 620

NEW, COMPLETE DATA ON ECCOSORB® "FREE-SPACE" MICROWAVE ABSORBERS



Physically/electrically-tapered "building blocks" for anechoic chambers; conformable, flexible foams to reduce radar cross-section. 12 different high-performance types are described in new bulletin.

INFORMATION RETRIEVAL NUMBER 247

ECCOMAX HI-Q LOW-LOSS DIELECTRICS



18 low loss systems are described in new folder and chart. Casting resins, impregnants, coatings, adhesives, rod & sheet — some foams — some Hi K — all with dissipation factors below 0.001. For RF, UHF, VHF and microwaves — capacitors, coils, etc.

INFORMATION RETRIEVAL NUMBER 248

NEW, COMPLETE DATA ON ECCOSORB® "HIGH-LOSS" DIELECTRICS



Microwave absorbers for waveguide and coax terminations, attenuators, etc. Suppress surface waves; reduce reflectivity. Machineable rod & sheet, casting resins, flexible sheets, high-temp ceramics described in new bulletin with application selector and fold-out properties chart. Send for free copy.

INFORMATION RETRIEVAL NUMBER 249

Emerson & Cuming, Inc.



CANTON, MASS.
GARDENA, CALIF.
NORTHBROOK, ILL.
Sales Offices
in Principal Cities

EMERSON & CUMING EUROPE N.V., Devel, Belgium

Application Notes

PEP talk

A discussion of pitfalls encountered in the accurate measurement of peak envelope power (PEP) of video, pulse, a-m, and other envelope modifying modulations is the subject of a new 3-page application note. The essay traces the potential cumulative errors involved in present methods of applying a correction factor to average power measurement to get PEP, and introduces a servo amplifier concept to gauge maximum modulation excursion directly. Bird Electronic Corp.

CIRCLE NO. 695

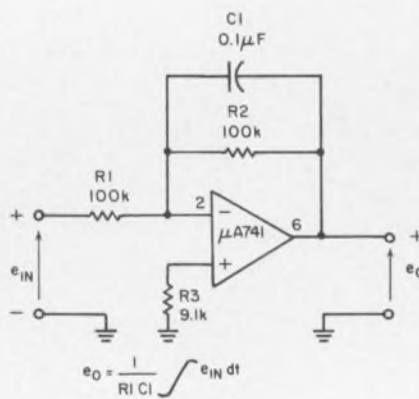

Linear IC applications

A 28-page brochure can help electronics engineers solve complex design problems with linear integrated circuits. The brochure is organized into three parts. Section I describes seven off-the-shelf devices and provides all the information needed to incorporate them into circuits. Section II discusses applications for these products, while Section III outlines electrical characteristics and parameters. The contents are abundantly illustrated with photographs, charts and circuit diagrams. One such circuit is the integrator reproduced above. When a 5-V, 1-kHz squarewave is applied at the input, e_o is a 2.5-V triangular waveform with linearity $\leq 1\%$ that corresponds to the integral of the squarewave. Fairchild Semiconductor, Distribution Services.

CIRCLE NO. 696

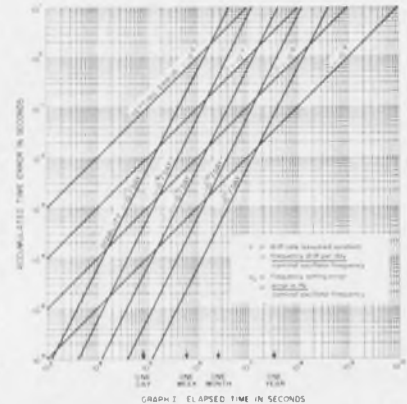

Timing error

An illustrated 2-color application bulletin discusses cumulative error in timing systems. The long-term stability of the timebase oscillator in a timing system is determined by the accumulated count of cycles of the oscillator compared to the accumulated count of an external time reference. A comparison procedure determines the time the system has lost or gained and an average rate of error can be calculated. A method is presented, with theory and equations, for determining the total error in a precision timing system. Flow Corp., Special Products Div.

CIRCLE NO. 697

VTM injection locking

Capable of both fixed-frequency and swept-frequency operation, voltage-tunable magnetrons are important microwave signal sources because they produce more power than most other types of fixed-frequency oscillators. In fixed-frequency operation, however, it has been difficult to hold frequency variation to less than 0.6%. Injection locking, as described in a new application engineering bulletin solves the frequency-variation problem. The bulletin points out that a VTM can be forced to oscillate at the frequency of a low-level, stable locking signal. This can be done without elaborate circuitry. The method of injection locking, frequency modulation, and noise reduction are also discussed in the bulletin. Varian Bomac Div.

CIRCLE NO. 698

The case of Lockheed vs. Lockheed

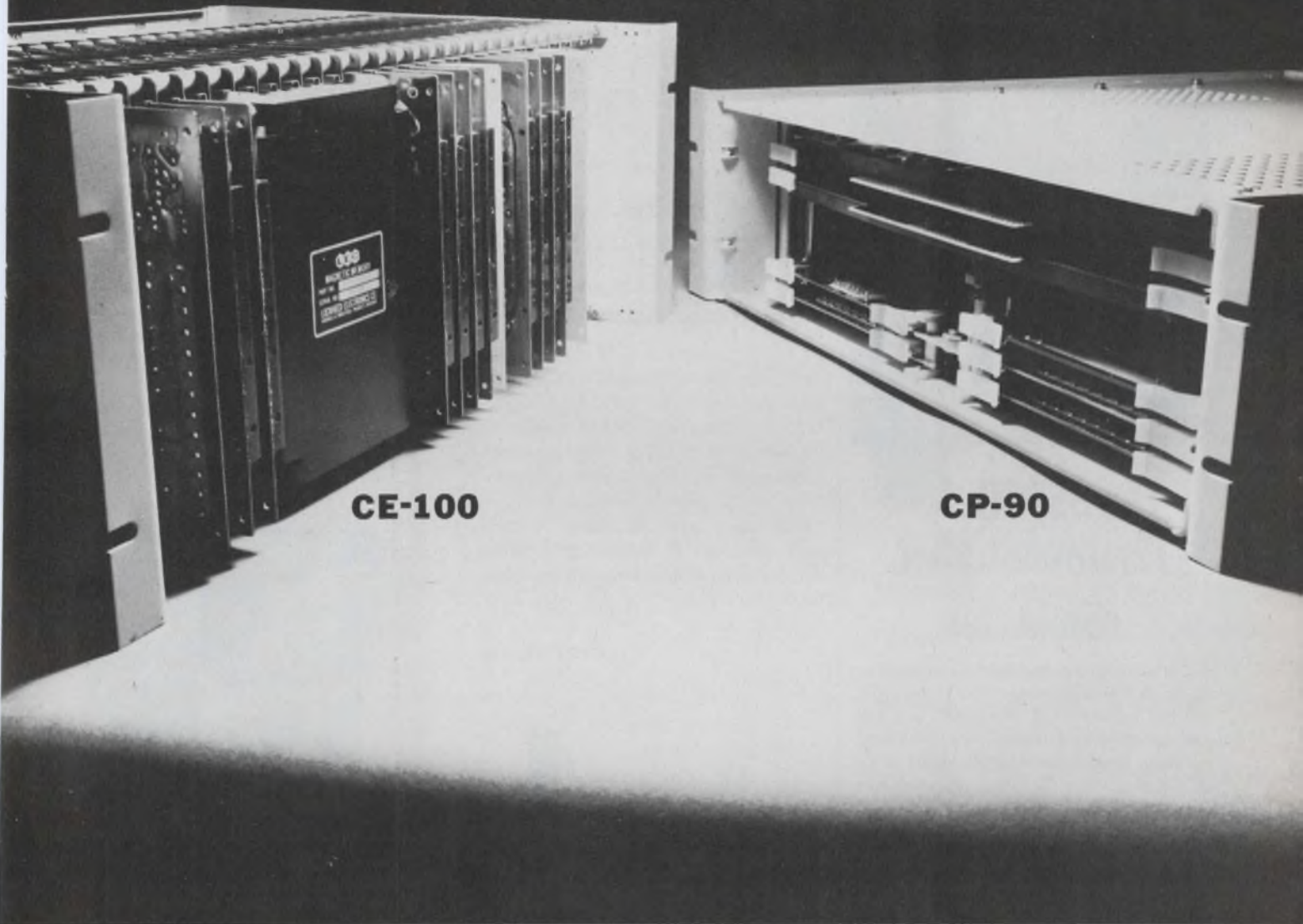

CE-100

CP-90

- 1.** Capacity: 4,096 words x 16 bits.
- 2.** Available in capabilities of 4, 8, 16K with 8 to 32 bits.
- 3.** Size: 19" x 7" x 13".
- 4.** Speed: 1 microsecond.
- 5.** Random access time: 450 nanoseconds.
- 6.** Market Response: Excellent.

- 1.** Capacity: 4,096 words x 16 bits.
- 2.** Available in 4K by 16 or 18 bits.
- 3.** Size: 19" x 5¼" x 13".
- 4.** Speed: 900 nanoseconds.
- 5.** Random access time: 400 nanoseconds.
- 6.** Market Response: Too early to form any sort of judgment.

VERDICT

The CE-100 has been the most successful low-cost memory unit on the market (and with good reason). But since the CP-90 is faster, smaller, and since the 16-bit version costs less — it is our considered opinion that the CP-90 will become one of Lockheed's all-time best-selling memory units.

For further information write: Memory Products, Lockheed Electronics Company, Data Products Division, 6201 East Randolph Street, Los Angeles, California 90022. Telephone (213) 722-6810.

LOCKHEED ELECTRONICS COMPANY

LEC A Division of Lockheed Aircraft Corporation



$$\lambda = 1,650 - 8,500 + A^\circ$$

$$EMI = 2 \times 10^{-13} \text{ Im.}$$



The 9558Q Photomultiplier eliminates

...the nuisance of multiple detectors! One EMI photomultiplier type 9558Q covers UV, visible and infra red. The 9558Q is a two inch diameter end window tube with eleven venetian blind dynodes having highly stable CsSb secondary emitting surfaces. The Spectrasil window gives better transmission of UV than natural quartz. The photocathode is the S-20 (tri-alkali) type employing unique EMI geometry. The results are high quantum efficiency (23-25% at peak) and exceedingly low dark current, (typically .002uA. at 200 A/L). Where the exact wavelength is unknown, or the entire spectrum is under investigation, the 9558Q enables the work to proceed without changing detectors.

Where the red sensitivity of the tri-alkali photocathode is most important, and the UV region is not, the 9558B, with a pyrex window (but all the other desirable characteristics of the 9558Q) may be substituted at much lower cost. Tubes can be specially selected for difficult astronomical tasks, laser range finders, red channels of flying spot scanners, etc.

Write for details on S-20 tubes in a complete range of sizes.



GENCOM DIVISION

80 Express St., Plainview, L. I., N. Y.
516-433-5900 TWX 516-433-8790
*EMI ELECTRONICS, LTD.

INFORMATION RETRIEVAL NUMBER 622

APPLICATION NOTES

Video Transmission Techniques



Video transmission

An informative 51-page book explains the technicalities of video distribution. The profusely illustrated publication tells how to solve problems in routing video through cable and provides design information for a multitude of systems—unbalanced and balanced, simple and complex. It covers everything from cable types to complex electronic terminations. Dynair Electronics, Inc.

CIRCLE NO. 699



Light measurement

An application note on light measurement terminology provides simplified formulas and definitions of both photometric and radiometric terminologies. The note deals with various source configurations (line, point or plane) and the various types of measurements that can be made of these sources in both photometric and radiometric terms. This approach allows calculation of radiance (luminance) from irradiance (illuminance) data or any other cross calculation, provided the geometry of the measurement is known. EG & G, Electronics Products Div.

CIRCLE NO. 700

Avalanche diodes

General purpose low-voltage avalanche diodes are described in a four-page illustrated technical bulletin. The brochure includes curves that show typical breakdown characteristics, typical temperature coefficients and typical dynamic impedances for the GLA series. Also included are oscilloscope trace comparisons of the sharpness of breakdown between a GLA unit and a typical 1N751A diode. Typical applications are discussed and basic circuitry for four such applications is shown. These circuits include a parallel regulator, a series regulator, an op amp regulator and a differential clamp. Computer Diode Corp.

CIRCLE NO. 701

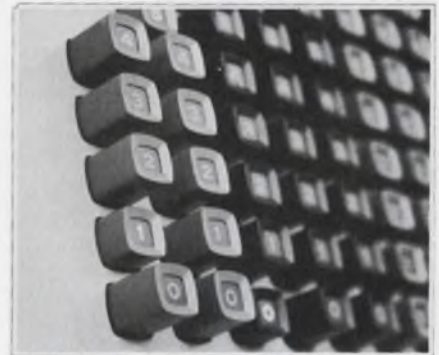

Frequency synthesis

A 26-page application note describes the principles of operation, and the applications of fast-switching direct frequency synthesizers that can derive up to five billion, spectrally pure, discrete frequencies from a single standard-frequency oscillator. Application areas discussed include production testing of frequency-sensitive devices; stability studies; secure communications; nuclear magnetic resonance apparatus; radio sounding and doppler frequency measurements for determining spaceship velocity. The note also has a section on spectral purity, and how to measure it; a section describing the programmable, fast-switching capabilities of direct synthesizers; and what limitations there are on switching speed. Hewlett Packard Co.

CIRCLE NO. 702

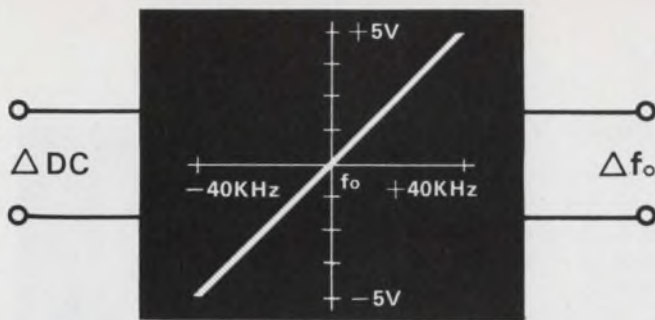

The VCXO with guts!

The Hallicrafters' VCO-501A voltage controlled oscillator is capable of exceptionally high deviations at low distortion—typically 80 kHz at 20 MHz.

- Frequency: 5 MHz to 25 MHz
- Deviation: $\pm 0.2\%$
- Linearity: 2%
- Modulation: DC to 30 kHz
- Z input: 50 kilohms

Hallicrafters' VCXOs are currently being designed into a new generation of telemetry, doppler, tracking and fire control systems. You are invited to ask us to quote your specific application. Write to dept. 4532.

the hallicrafters co.

SUBSIDIARY OF NORTHROP CORPORATION
600 Hicks Road, Rolling Meadows, Illinois 60008

INFORMATION RETRIEVAL NUMBER 623

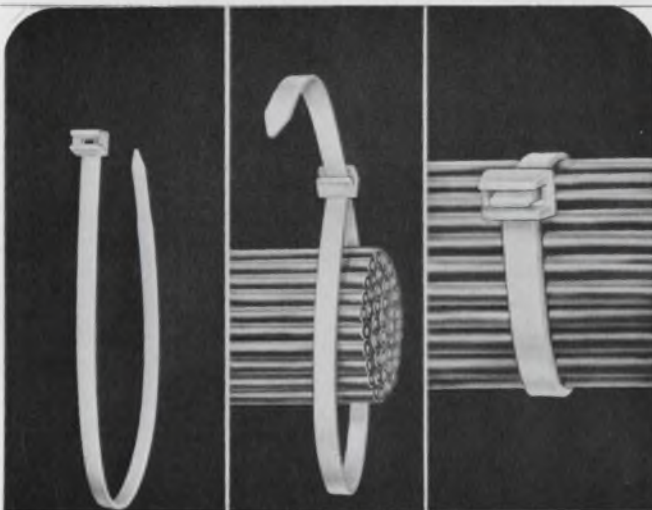

NEW CABLE TIES

Completely new ties with improved locking mechanism. Easily applied by hand. Wrap . . . Cinch . . . Cut. Each tie infinitely adjustable within its size range. Provides permanent, non-twisting, neat harnessing. Molded of tough, virgin nylon, in white, black and assorted colors and sizes.

Send for Free Samples

ELECTROVERT INC.

Components Division
86 Hartford Ave., Mt. Vernon, N. Y. 10553
Milwaukee, Wis. • Burbank, Calif.



SOLD COAST-TO-COAST THROUGH AUTHORIZED DISTRIBUTORS

Visit ELECTROVERT at IEEE SHOW, BOOTH NO. 1D16

INFORMATION RETRIEVAL NUMBER 624

**PROVEN RELIABILITY—
SOLID-STATE POWER INVERTERS,
over 260,000 logged operational hours—
voltage-regulated, frequency-controlled,
for missile, telemeter, ground support,
135°C all-silicon units available now—**

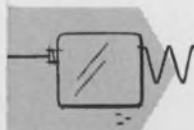
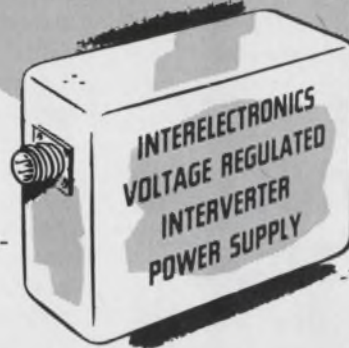

Interelectronics all-silicon thyatron-like gating elements and cubic-grain toroidal magnetic components convert DC to any desired number of AC or DC outputs from 1 to 10,000 watts.



Ultra-reliable in operation (over 260,000 logged hours), no moving parts, unharmed by shorting output or reversing input polarity. High conversion efficiency (to 92%, including voltage regulation by Interelectronics patented reflex high-efficiency magnetic amplifier circuitry.)



Light weight (to 6 watts/oz.), compact (to 8 watts/cu. in.), low ripple (to 0.01 mv. p-p), excellent voltage regulation (to 0.1%), precise frequency control (to 0.2% with Interelectronics extreme environment magnetostrictive standards or to 0.0001% with fork or piezoelectric standards.)



Complies with MIL specs. for shock (100G 11 mlsc.), acceleration (100G 15 min.), vibration (100G 5 to 5,000 cps.), temperature (to 150 degrees C), RF noise (I-26600).



AC single and polyphase units supply sine waveform output (to 2% harmonics), will deliver up to ten times rated line current into a short circuit or actuate MIL type magnetic circuit breakers or fuses, will start gyros and motors with starting current surges up to ten times normal operating line current.



Now in use in major missiles, powering telemeter transmitters, radar beacons, electronic equipment. Single and polyphase units now power airborne and marine missile gyros, synchros, servos, magnetic amplifiers.

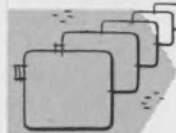

Interelectronics—first and most experienced in the solid-state power supply field produces its own all-silicon solid-state gating elements, all high flux density magnetic components, high temperature ultra-reliable film capacitors and components, has complete facilities and know how—has designed and delivered more working KVA than any other firm!

**INTERELECTRONICS CORPORATION
550 U. S. Route 303, Congers, N. Y.
Telephone: 914 ELmwood 8-8000**

INFORMATION RETRIEVAL NUMBER 625

KEPCO

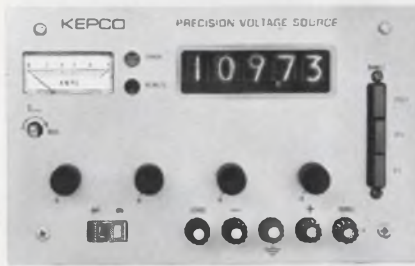

Model PVS 100-1M-Price \$875.00

DIGITALLY CONTROLLED VOLTAGE

KEPCO'S PRECISION VOLTAGE SOURCE features a 4½ digit voltage readout with four rotary selectors and a three-button decade range switch. The combination provides 100 microvolt sensitivity in ranges of:

- 0.0000 — 1.0999 volts
- 00.000 — 10.999 volts
- 000.00 — 109.99 volts

Model PVS 100-1M is a husky power supply capable of delivering 100 watts with a source impedance less than 1 milliohm at d-c. Line variations (105-125V a-c) have less than 0.0005% effect on the output setting and the oven-controlled reference, reduces temperature effects to 0.005% per °C.

The overall accuracy of 0.02% qualifies the Precision Voltage Source as a working standard for low cost voltage calibration.

For systems, the output can be programmed by remote 1-2-4-8 BCD switch closures.

For more information, write Dept. CA-05 for Kepco's new catalog supplement.

**with KEPCO
IT'S CONTROL!**



131-38 SANFORD AVENUE • FLUSHING, N.Y. 11352

(212) 461-7000 • TWX # 710-582-2631

Visit us at IEEE Show-
Booths 2E-56 & 57

INFORMATION RETRIEVAL NUMBER 626

APPLICATION NOTES

Computer-aided design

The use of an analog/hybrid computer in mechanical linkage design is the subject of a 12-page application note. The text presents a basic method to simulate a five-bar, geared linkage. The study illustrates the math derivation—using the steepest descent technique—and gives a detailed mechanization of the problem on an analog/hybrid computer. It includes a scaled computer diagram, employing parallel hybrid control and high-speed, repetitive operation. The method can be readily adapted for any mechanical linkage problem. Electronic Associates, Inc.

CIRCLE NO. 703

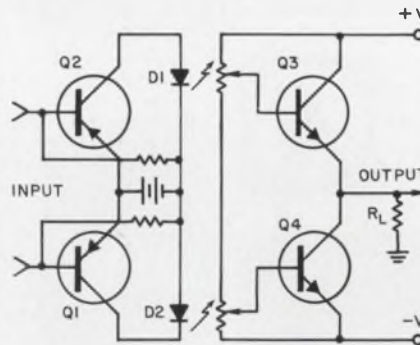

Phototransistor theory

Phototransistors are the subject of a 12-page note that covers basic theory, device characteristics and applications. Most of the principles discussed apply to all phototransistors. The typical application, illustrated above, is a small-signal amplifier that uses phototransistors and light-emitting diodes. Technical Information Center, Motorola Semiconductor Products Inc.

CIRCLE NO. 704

Power control

Phase-angle control and synchronous firing control are described in a new, 10-page, illustrated folder on power control units. The specific advantages and disadvantages of these types of proportional control are explained in tables, schematic drawings and other graphics. Magnetics Inc., Industrial Control Div.

CIRCLE NO. 705



Antenna errors

A nine-page application note describes a simplified but accurate method of measuring radome-induced antenna boresight and/or beamshift errors. The method uses a network analyzer to detect phase differences in a pair of receiving antennas; compared with traditional methods that use custom-design equipment, the techniques described are easy to set up, yet give accuracies within ±0.1 milliradian. The application note describes three test-range systems and gives the result of typical measurements, using each of these systems. Hewlett-Packard Co.

CIRCLE NO. 706

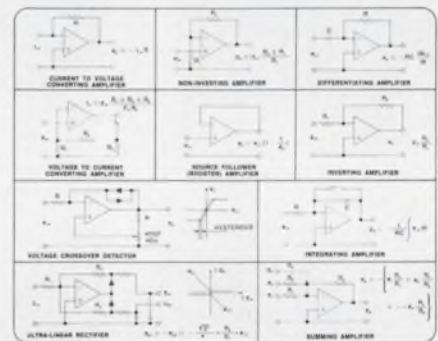

Dc op amps

A 16-page catalog describes a complete line of dc solid-state operational amplifiers. The operational amplifier line includes a wide range of high-performance economy models, microminiature units, high voltage and current models, minimum bias current and minimum voltage drift models. Detailed electrical and mechanical specifications are given for all units. Typical applications are illustrated by schematic drawings. Photos, block diagrams and general terminology information are included. Melcor Electronics Corp.

CIRCLE NO. 707

When Only Excellent is Adequate TURN to Grayhill

WHAT'S NEW ABOUT THIS SWITCH?

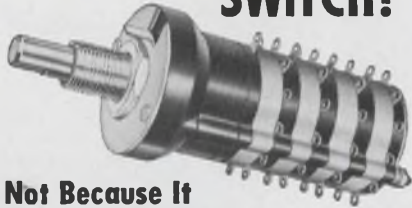

It's Not Because It

- 1) is explosion proof.
- 2) has up to 12 positions/deck.
- 3) could have up to 6 poles/deck.
- 4) comes in shorting or non-shorting versions.
- 5) is available in sealed, military or standard versions.

No...These are Standard Grayhill Rotary Switch features.

IT'S NEW BECAUSE

one or more positions may be ISOLATED from normal shaft turning techniques. It has its own built-in shaft turning SAFETY feature.



For details on this and other Switches Ask for Catalog G-304-A



565 Hillgrove Avenue
LaGrange, Illinois 60525
Area Code 312, Phone 354-1040

The Difference Between Excellent and Adequate

INFORMATION RETRIEVAL NUMBER 627



Reliability at moderate cost is the key to the Lundey Clinch-Loc[®] Line of feed-thru terminals

The new #609-TH is the smallest, for mounting on centers as close as 7/32"

Utilizing the superior properties of Teflon,* the 609TH is designed for components which must meet MIL-T-27 and other military specifications. It is rated at 2KV-RMS test voltage. (If you have any terminal problem—let us help you solve it.)

*Dupont Trademark

SEND FOR FREE SAMPLE KIT AND LITERATURE
another quality product in **THE LUNDEY LINE**

LUNDEY ASSOCIATES, INC.
694 Main Street Waltham, Massachusetts 02154

INFORMATION RETRIEVAL NUMBER 628

ELECTRONIC DESIGN 6, March 15, 1969



New from Maxwell!

**High voltage DC power supplies
0-150 kV 0-20 kW**

Maxwell Laboratories, Inc., a recognized leader in high voltage products and systems, now introduces a new line of high voltage DC power supplies. Manufactured with today's most advanced techniques, they are designed to provide long term reliability in industrial and lab applications. Each of the 75 different models is conservatively rated and features grain-oriented transformer cores, epoxy impregnated coil windings, and solid state circuitry for long life and dependable service.

- Voltage and current trip circuits
- Safety engineered
- Rugged modular construction
- All solid state circuitry
- Taut band meters with three ranges
- Epoxy-impregnated transformers
- Complete controls, indicators, protective features

For details, contact:



MAXWELL LABORATORIES, INC.
9244 Balboa Ave., San Diego, California 92123
714/279-5100

INFORMATION RETRIEVAL NUMBER 629

New Literature



Transistor catalog

A 74-page catalog describes nearly 400 types of high reliability silicon transistors. This 1969 edition contains tabulated specifications for transistors used as general-purpose medium and high speed amplifiers; low level amplifiers; ultrahigh speed logic switches; core drivers; choppers; differential and dual amplifiers, and Darlington amplifiers. Also included are new listings and specifications of special poly chip devices, npn/pnp complementary duals, uhf high power amplifiers, and NASA approved types. Maximum ratings and electrical characteristics are given for each of these units, along with geometry drawings and characterization graphs. Raytheon Co.

CIRCLE NO. 708

Fastener-hole costs

An 8-page survey details the estimated cost of hole-making, and evaluates the methods for producing fastener holes. These include punching, drilling, piercing, molding and burning, and self-drilling fasteners, as a suggested practical solution for many applications. The report takes each basic method in turn, and arrives at cost figures per thousand. Shakeproof Division Illinois Tool Works Inc.

CIRCLE NO. 709



Preferred semiconductors

A new preferred semiconductors and components catalog contains detailed specifications on 285 preferred products, plus a listing of 1800 standard Texas Instrument discrete devices, with information cross-referenced to products made by other manufacturers. Application ideas are included. Texas Instruments Inc.

CIRCLE NO. 710



Analytical instruments

A new 20-page illustrated booklet describing a family of laboratory data processing systems provides a clear, concise description of computer-based systems that can be used to automate research and analytical laboratories. Supported by 21 illustrations, graphs, and diagrams, the text outlines the equipment capabilities and briefly explains how the system operates. Sections of the booklet discuss major advantages, system hardware, software, ease of operation, and applications. Varian Data Systems.

CIRCLE NO. 711



Precision hardware

Hundreds of precision components never before catalogued are among the 25,000 stock items listed in a new 522-page catalog. Included are gears, bearings, shaftings, fasteners, clutches, brakes, dials, tool components, collars, spacers, speed reducers, differentials and instrument plates. PIC Design Corp.

CIRCLE NO. 712

Electron tube data

A 1969 abridged data booklet contains details on almost 600 types of special electronic tubes, and an equivalents index listing nearly 2000 types. The range is wide: some types can operate at frequencies as high as 40 GHz; others have outputs as high as 250 kW. Three main sections of the booklet list power tubes, microwave tubes and light conversion devices. A fourth section covers associated products like vacuum capacitors, lasers and flash tubes. A thumb index allows any product range to be found immediately. Basic electrical data is on the left-hand pages; the right-hand pages show outline drawings printed to scale on a background of grid lines. English Electric Valve Co., Ltd.

CIRCLE NO. 713

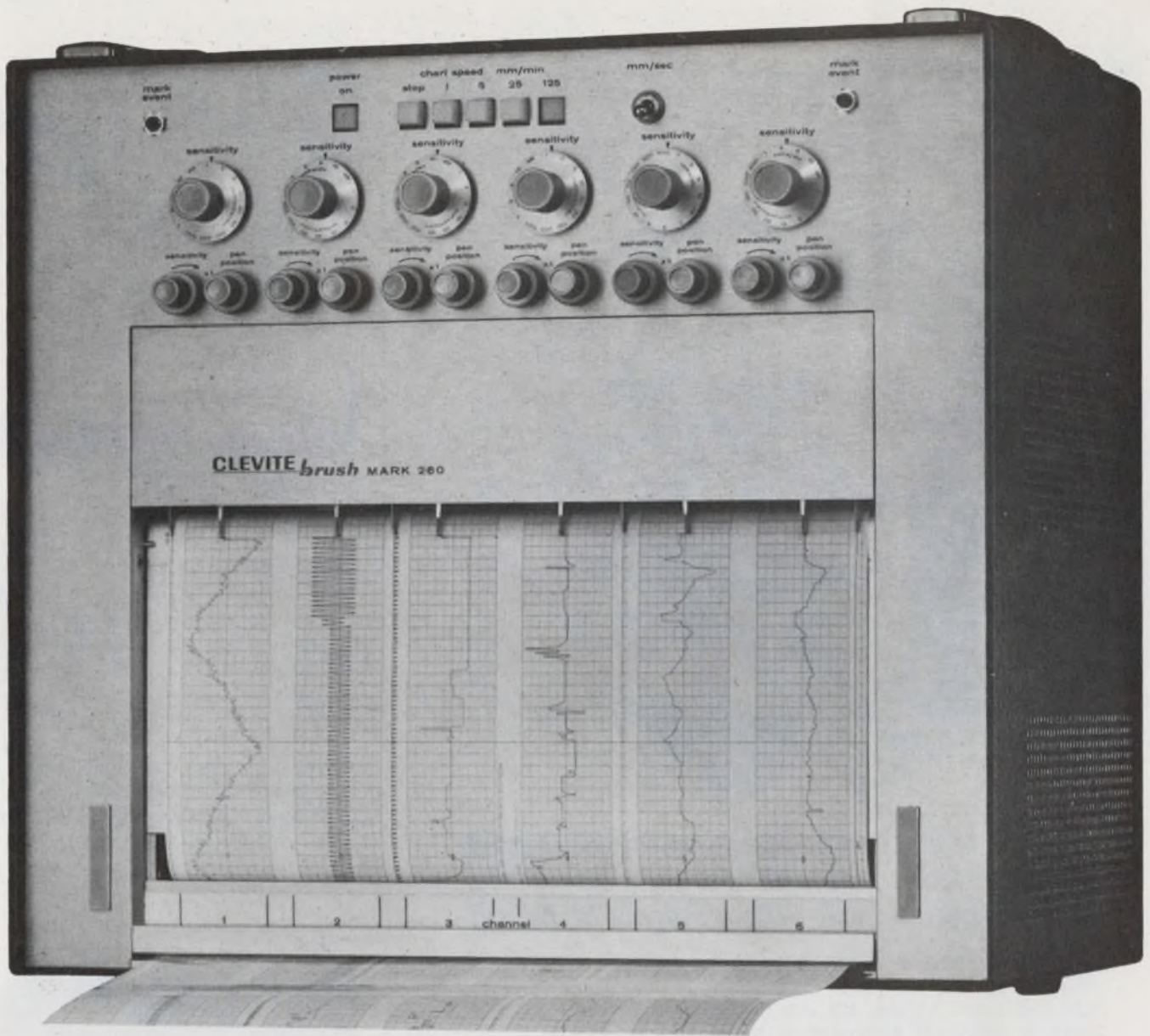

The Mark 260 tells it like it is.

That's because we've taken the fooling out of recording. This high-performance six-channel portable delivers more fact and less fiction than any other make you can buy.

The Mark 260 eliminates the things that can fool you. First, it's accurate — better than 99.5% accurate. It's the only recorder of its type with a foolproof *position feedback* system that enforces accuracy regardless of the pen's position on the chart. Second, its resolution is fully equal to its accuracy. The Brush patented pressure-fluid writing system produces thin, sharply defined traces that cannot smudge and cannot be misread. No fooling about exact reading of point-to-point values; no fooling about even the most complex wave-forms.

And no fooling with recalibration every time you change a setting. Calibration is factory fixed, drift free and constant — no matter how often you change your mode of recording. You can be certain your data is valid . . . you save time and

chart paper. Just plug it in, set it up, and you're in business. No fooling.

Six analog channels and four event channels in a package you can carry and use anywhere. Performance that's better than many recorders twice its size . . . and twice as expensive. That's what the Mark 260 delivers.

More fact and less fooling.

We'd like to send you sample charts that "tell it like it is"—or better yet, demonstrate the Mark 260 right in your plant. Write Clevite Corporation, Brush Instruments Division, 37th and Perkins, Cleveland, Ohio 44114.

CLEVITE BRUSH



DEPENDABLE DURANT COUNT/CONTROL

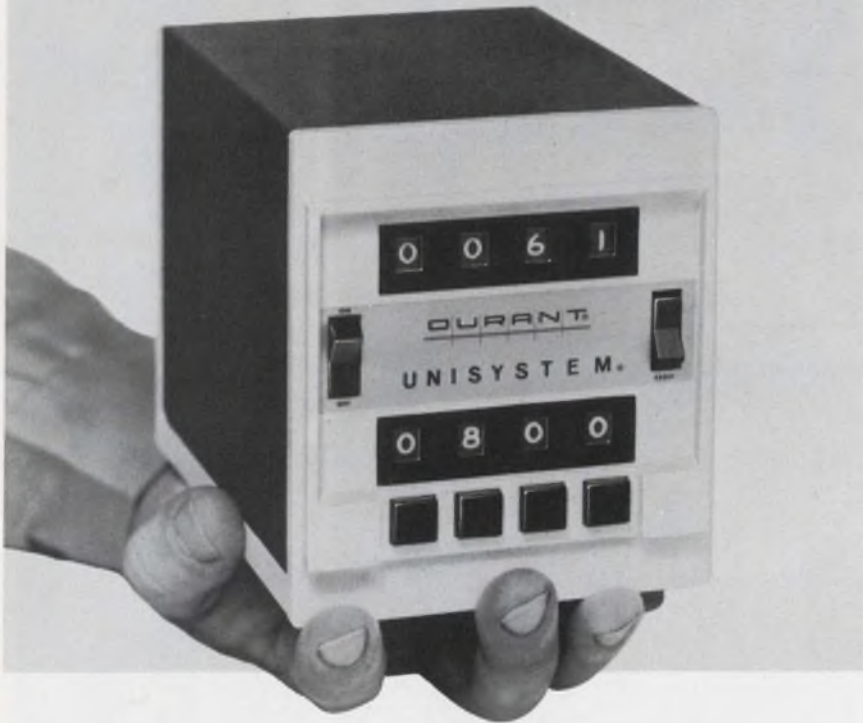

- Easiest to preset • Easiest to mount and connect
- Most readable • Lowest cost per million counts of any comparable unit • Count speeds to 300 cps

With the 49600 and 49800 Unisystems, you get a design that eliminates "bounce" and filters noise — no miscounts. Preset and count values are retained even if power fails. You have a choice of automatic or manual recycling and 2-, 3-, or 4-digit predetermining and count levels. To change function, all you do is rearrange the wiring on the rear terminals, using the simple jumpers provided.

There are two basic models, both available in optional splash and dustproof versions:

49600 Series has a variable predetermined number, starts its count at zero and adds. When the count reaches the predetermined number, the unit generates an electric output signal, which will actuate any operation.

49800 Series begins its count at a variable predetermined number and subtracts. At a fixed, factory-wired prewarn value, the unit generates one electric output signal, and another when the count reaches zero. This makes the 49800 series ideal for operations requiring two-stage shut-down or stop. It can be used for timing with prewarn, using time base contact closures. Variable prewarn is optional.

No other count/control system gives you as much. If you like, we'll demonstrate both models right on your desk. Write for specifications. 622 North Cass St., Milwaukee, Wisconsin 53201.



INFORMATION RETRIEVAL NUMBER 631

NEW LITERATURE

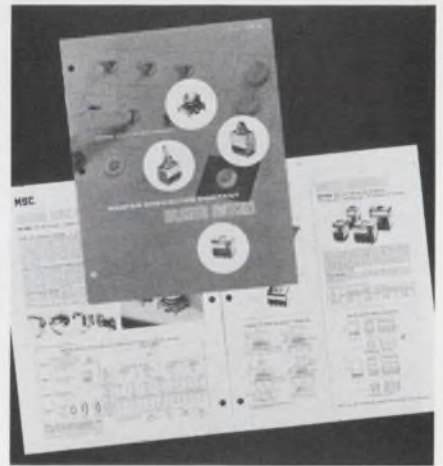

Unlighted switches

Unlighted manual switches in seven series are detailed in catalog 2023. Design data includes electrical and mechanical characteristics, dimensions and ordering information for panel-mount pushbutton and toggle switch assemblies, building block pushbutton switch assemblies and snap-on switch assemblies, plus data on four optional terminal types, including turret, wire-wrap and quick connect configurations. Master Specialties Co.

CIRCLE NO. 714



Engineering thermoplastics

Design properties of an entire line of fortified thermoplastic engineering materials are given in a 4-page brochure. Aimed specifically at assisting design engineers in preliminary screening of glass fiber fortified thermoplastics for various applications, the booklet lists physical, mechanical, thermal and electrical properties for 17 base polymers with 30% glass-fiber fortification. The best compound for each property value is highlighted for easy selection. LNP Corp.

CIRCLE NO. 715

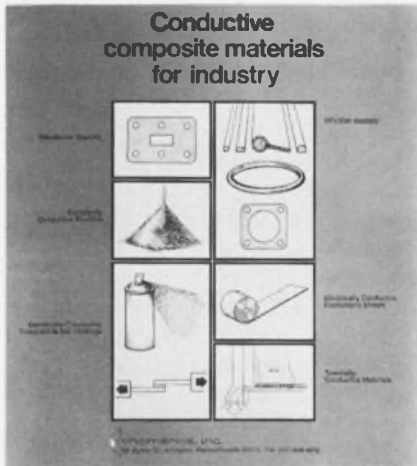

Conductive materials

A four-page brochure describes a complete line of electrically conductive elastomers, epoxies, and powders. Also described are a series of rfi/emi gaskets for shielding, grounding, contacting and sealing. These gaskets are available as O-rings, D-rings, strips and die-cut or custom molded parts. Chromerics, Inc.

CIRCLE NO. 716

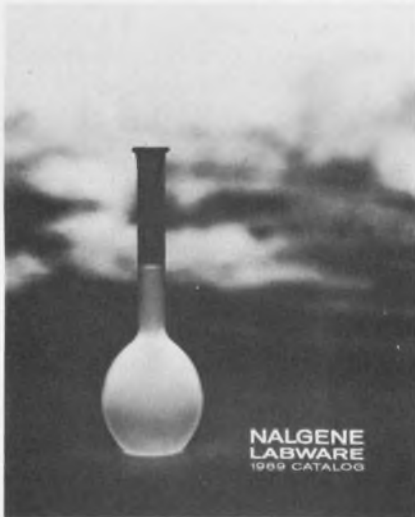

Labware catalog

A dozen new plastics labware products are featured in a 1969 labware catalog. These include the world's first plastics volumetric flasks, a vacuum desiccator of revolutionary design, a desiccator plate, autoclavable carboy, wide-mouth centrifuge bottle, and disposable sample tubes. Nalge Co.

CIRCLE NO. 717

Choose from 44 styles of film capacitors... There's one to meet your exacting requirements

HERMETICALLY-SEALED METAL CASE TUBULAR CAPACITORS



BARE METAL CASE

Style LP8, metallized polycarbonate film
Style LM8, metallized PETP-polyester film
Style LS8, metallized polystyrene film
Style AP8, polycarbonate film
Style AM8, PETP-polyester film
Style AS8, polystyrene film
Style AF8, PTFE-fluorocarbon film

METAL CASE WITH INSULATING SLEEVE

Style LP9, metallized polycarbonate film
Style LM9, metallized PETP-polyester film
Style LS9, metallized polystyrene film
Style AP9, polycarbonate film
Style AM9, PETP-polyester film
Style AS9, polystyrene film
Style AF9, PTFE-fluorocarbon film

INFORMATION RETRIEVAL NUMBER 231

WRAP-AND-FILL ROUND TUBULAR CAPACITORS



Style LP66, metallized polycarbonate film
Style LM66, metallized PETP-polyester film
Style LS66, metallized polystyrene film
Style AP66, polycarbonate film
Style AM66, PETP-polyester film
Style AS66, polystyrene film

INFORMATION RETRIEVAL NUMBER 233

HERMETICALLY-SEALED METAL CASE RECTANGULAR CAPACITORS



Style CML, high voltage paper/PETP-polyester film, inserted tab construction.

INFORMATION RETRIEVAL NUMBER 235

HERMETICALLY-SEALED GLASS CASE TUBULAR CAPACITORS



Style GML, high voltage paper/PETP-polyester film, 85 C
Style GTL, high voltage paper/PETP-polyester film, 125 C

INFORMATION RETRIEVAL NUMBER 237

EPOXY-CASE RECTANGULAR CAPACITORS

AXIAL-LEAD



Style LP7A, metallized polycarbonate film
Style LM7A, metallized PETP-polyester film
Style LS7A, metallized polystyrene film
Style AP7A, polycarbonate film
Style AM7A, PETP-polyester film
Style AS7A, polystyrene film

RADIAL-LEAD



Style LP7S, metallized polycarbonate film
Style LM7S, metallized PETP-polyester film
Style LS7S, metallized polystyrene film
Style AP7S, polycarbonate film
Style AM7S, PETP-polyester film
Style AS7S, polystyrene film

INFORMATION RETRIEVAL NUMBER 232

WRAP-AND-FILL OVAL TUBULAR CAPACITORS



Style LP77, metallized polycarbonate film
Style LM77, metallized PETP-polyester film
Style LS77, metallized polystyrene film
Style AP77, polycarbonate film
Style AM77, PETP-polyester film
Style AS77, polystyrene film

INFORMATION RETRIEVAL NUMBER 234

HERMETICALLY-SEALED CERAMIC CASE TUBULAR CAPACITORS

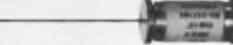

Style SML, high voltage paper/PETP-polyester film, inserted tab construction.
Style SMLE, high voltage paper/PETP-polyester film, extended foil construction.

INFORMATION RETRIEVAL NUMBER 236

EPOXY CASE RECTANGULAR CAPACITORS



Style EFX, high voltage paper/PETP-polyester film.

INFORMATION RETRIEVAL NUMBER 238

For engineering bulletins on the capacitor styles in which you are interested, write to Dearborn Electronics, Inc., Box 530, Orlando, Fla. 32802.

Dearborn Electronics, Inc.
(a subsidiary of the Sprague Electric Company)

FOREMOST IN FILM CAPACITORS

Uncommonly good sense

from our Tachometer Generators. They're temperature-compensated, miniaturized, and perfect for precision indicators and velocity servos requiring a highly linear speed/voltage relationship with minimum ripple. Linearity from 0 to 12,000 rpm is better than 1/10 of 1% of voltage output at 3600 rpm. The ripple value will not exceed 3% rms of the D-C value at any speed in excess of 100 rpm. The low-driving torque makes them excellent as damping or rate signals in all types of servos. Brushes and commutators are guaranteed for 100,000 hours of operation — more than ten years — at 3600 rpm. Various models are available with outputs as high as 45v/1000 rpm and can be supplied with an indicator as a complete Speed Indicating System.

SERVO-TEK PRODUCTS COMPANY
1086 Goffle Road, Hawthorne, New Jersey 07506.

SERVO-TEK
PRODUCTS COMPANY

For full technical details
write for Catalog 1163
with Test Report
and show
good sense.



INFORMATION RETRIEVAL NUMBER 632

NEW LITERATURE

Allied 1969 supplement

A 1969 industrial catalog supplement contains an up-to-date directory of semiconductors and integrated circuits. Detailed data and the latest prices are given for new devices, over 2000 integrated circuits and 6000 semiconductors. Many new industrial products are presented for the first time. Included are digital readout meters and measuring system accessories, miniature switches, module and delay timers, newly-designed relays, trimmers, potentiometers, capacitors and resistors, miniature lamp indicators, integrated circuit boards and kits, low-pass filters, high-voltage reed switches and other components. Allied Electronics Corp.

CIRCLE NO. 718



Fiber optics

Four pieces of fiber optic literature are available in standard catalog size. An illustrated, four page two-color brochure explains the configurations of light rods, non-coherent and coherent bundles, multi-fiber rods and face plates. The brochure covers acceptance angle and numerical aperture, light transmission and spectral transmission; environmental protection, flame resistance, temperature range; bending radius, length distortion, sterilization, sleeves/ferules, and resolution of coherent fiber bundles. Three other catalog sheets deal, respectively, with guides, image conduits and contain an engineer's kit that is offered to assist R&D people in fiber optic experimentation. Albion/Rank Taylor Hobson.

CIRCLE NO. 719

High-purity materials

A detailed listing of high-purity metals, salts and compounds as well as products manufactured from these materials is available in a new catalog. Excellent for reference and ordering information, the booklet includes prices for more than 1500 different substances. All materials are listed in their usual, as well as allotropic forms, and all the purity levels for the various substances (0.99 to 0.999999) are given along with their exact stoichiometric structures. Hall Laboratory Products Corp., High Purity Materials Div.

CIRCLE NO. 720

Tubeaxial fans

An illustrated 4-page catalog presents detailed electrical and mechanical specifications, performance curves, dimensions and wiring data for a full line of slim-profile tubeaxial fans. All units feature high aspect ratio (ratio of diameter to thickness is greater than 2:1). Their wrap-around design (impeller blades overhang the motor) greatly facilitates mounting, provides lower noise levels and improves unit efficiency; excellent cooling is provided through the motor's proximity to the fan. IMC Magnetics Corp.

CIRCLE NO. 721

Transducers

A new technical bulletin features large easy-to-read diagrams and tabular data for a complete family of precision low-pressure transducers. The manual describes the functional characteristics of the bonded strain gauge pressure transduction concept. The manual contains performance characteristics, environmental capabilities, application features, fluid frequency response characteristics, outline drawings of 18 configurations and an ordering code. Standard Controls, Inc.

CIRCLE NO. 722

TERMINAL BLOCKS

CURTIS



SEP



SEIF

SEP - for connections to printed circuits

SEIF - for miniature insulated feed-thru

SEF - for miniature feed-thru

SES - for miniature surface contacts

All types of "SE" blocks include:

- Only 1/4" center-to-center terminal spacing
- Bright tin plated screw machine inserts
- #2-56 terminal screws for up to 16 AWG wire
- Molded black phenolic base
- Choice of 1-18 poles
- 300 volts — 5 amps

Send Today for Further Information
CURTIS DEVELOPMENT & MFG. CO.
 3236 N. 33rd St. • Milwaukee, Wis. 53216



See us at Booth 4E12 IEEE Show & Booth 3735 Design Eng. Show

INFORMATION RETRIEVAL NUMBER 633

New 10-Channel, Transit-Guard SHOCK RECORDER

DIRECT READING



Operates
Unattended for
30 days

Tape-records Time and Magnitude of
Shocks experienced by Fragile Product during Shipment

10 Channels available for continuous, permanent recording on direct-reading, pressure-sensitive tape of all shocks and Times of Occurrence encountered by products in transit. Transit-Guard Shock Recorder features selective combination of Sensor Transducers that can be contained within the unit; or used remotely to record shocks at different locations. The sensors will indicate:

- Magnitude of Shocks from 0.1 to 1000 G's
- Shock Direction from Unito Omni-directional

TWO MODELS:

TG 508 with Self-contained Battery Pack TG, 510 uses 12 V.D.C. External Power Supply.

Write today for data sheets and prices.

INERTIA SWITCH Inc.
 311 West 43rd Street, New York, N.Y. 10036
 (212) 586-5880



INFORMATION RETRIEVAL NUMBER 634

ELECTRONIC DESIGN 6, March 15, 1969



Now
we've got the
biggest line
of tiny
Snap-Actors



LM
Series

With the introduction of the new LM subminiature series, Unimax now offers you the widest choice of snap-acting subminiature and miniature subminiature switches in the industry. Designed to meet applicable military specifications, the entire line offers extra long life and a complete range of forces and motions. Sub-miniatures are rated to 10 amps at 250 volts AC and are available in any of 10 standard terminal configurations. Miniature subminiatures are rated at 7 amps and can be supplied with differential motion as low as .0005" max. Integral actuators are available on all models and a wide variety of toggle and push button assemblies are standard.



Unimax Switch

Division of Maxson Electronics Corporation / Wallingford, Connecticut 06492

INFORMATION RETRIEVAL NUMBER 635

359

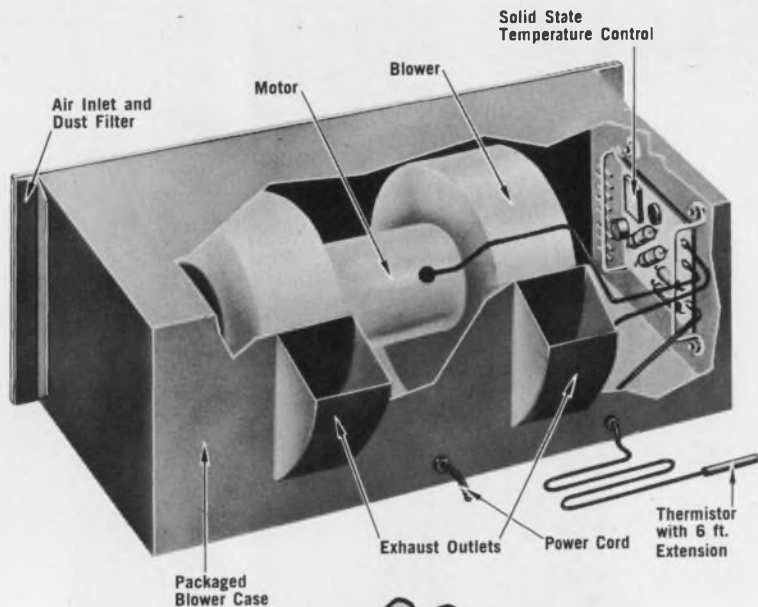

THE QUIET ONE

McLEAN'S SOLID STATE MOTOR CONTROLLER PROVIDES THE ANSWERS TO NOISY COOLING

Now you can cut audible noise level in system cooling to a bare minimum. McLean's transistorized control and modulating thermostatic probe sense component or outlet air temperatures. Together they automatically slow down blower speed to meet the exact requirement for cool air to maintain constant thermal stability. The slower blower speed results in quietest operation, efficient cooling, and longer life for components and blowers. Write for Data Sheet No. SSC700.

FEATURES:

WHISPER QUIET • AUTOMATIC • MAINTAINS 80°F TO 90°F RANGE • COSTS LESS THAN AIR CONDITIONING • SYSTEMS STAY DRIFT FREE

Send for our 1969 Catalog

McLEAN ENGINEERING LABORATORIES



Princeton Junction, New Jersey 08550 • Phone: 609-799-0100 • TELEX: 84-3422

See us at the I.E.E.E. Show, Booth 4K12
INFORMATION RETRIEVAL NUMBER 636

NEW LITERATURE

Microscope catalog

Microscopes for scientific, industrial and educational applications are described in a new, pocket-sized catalog. The 40-page booklet describes a basic microscope system, with and without built-in Koehler illumination, and the numerous variations possible with interchangeable body tubes and stages. It covers the full complement of accessories and attachments available. Among these are a differential interference attachment, fluorescent and polarization attachments, illuminators, comparison bridge and photomicrographic equipment. More than 60 photographs plus system diagrams and charts are included in the booklet. It provides a survey of available equipment, an invaluable aid in selecting the instruments best suited to a particular application. Instrument Div., Nikon, Inc.

CIRCLE NO. 723

Dc voltage standard

A 4-page data sheet describes the world's first 0.001% dc voltage standard. The two-color sheet gives specifications, special features and typical systems for the high-accuracy instrument. Cohu Electronics, Inc.

CIRCLE NO. 724

Electrolytic capacitors

Axial-lead aluminum electrolytic capacitors are described in two new bulletins. Covered in a 12-page bulletin is a unit available in capacitances ranging from 2.4 to 15,000 μ F, in cases with diameters ranging from 0.5 to 1 in. and lengths from 1.125 to 3.625 in. The other bulletin is 16 pages and discusses a computer-grade capacitor. This unit is available with capacitances ranging from 5 to 2000 μ F. The bulletins provide complete design and performance data and several pages of standard listings. Sangamo Electric Co., Capacitor Div.

CIRCLE NO. 725

High-voltage rectifiers

High-voltage rectifiers are the subject of two 4-page brochures, sized for standard catalog insertion. Information is given on PIV ratings, transient measurement and suppression, construction techniques for reliability, environmental capabilities, surge ratings, input frequency and waveshape, modulator diodes, and mechanical details. Charts give specifications for both regular and fast-recovery rectifier series. Graphs show output current vs ambient temperature, and non-repetitive surge current ratings. Solitron Devices, Inc.

CIRCLE NO. 726

Nickel-cadmium batteries

Specifications for medium-rate nickel-cadmium storage batteries are included in a new bulletin. These pocket plate batteries are particularly suited to emergency power applications requiring normal current drains for intermediate discharge periods. The 4-page brochure includes performance data for both plastic and steel container cell types, in capacities from 13 to 1180 ampere-hours. Discharge characteristic curves are also included, making it easy to determine the current available from the batteries from 1 minute to 10 hours of discharge. A sample specification covers inverter applications to aid consulting engineers and other specifiers. NIFE Inc.

CIRCLE NO. 727

Servomotors

Two new product sheets discuss two high-performance, direct-current servomotors. The product sheets emphasize the exceptionally fast response and low mechanical time constant characteristic of both servometers: Descriptions of the housing, magnets, shaft, rotor, tachometer, commutator, and end brackets are included, along with weight and dimensional data. Honeywell Inc.

CIRCLE NO. 728

Who's the largest maker of the smallest lamps?

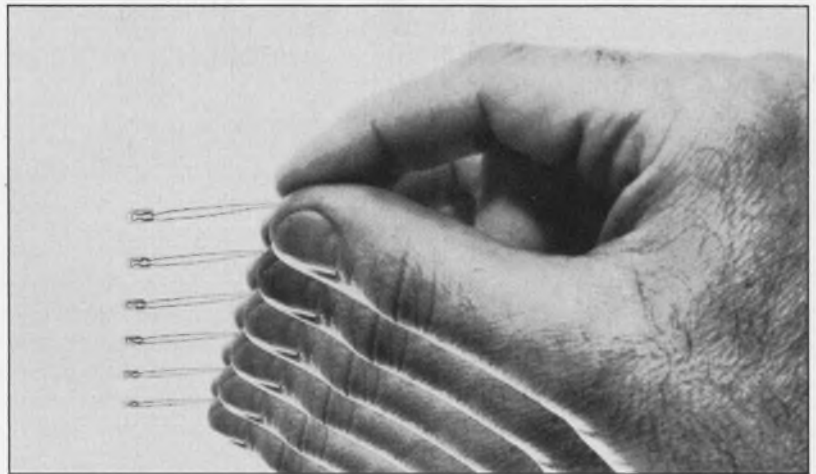

You're wrong!

The correct answer: LAMPS, INCORPORATED. More subminiature and microminiature lamps sold today are LAMPS than any other kind.

Didn't know that? That's why we're advertising. Because, if you use subminiature or microminiature lamps, you should know our name, and some unusual facts like these:

We're fanatic about uniformity. For example, filaments for all LAMPS of each manufacturing lot are drawn from the same ingot of tungsten. Sound fanatic? Not when you see what it does for the uniformity of your LAMPS.

How about this? You can't buy new LAMPS. We use them first. 98% of all subminiature and microminiature lamp failures occur during the first 16 hours of use. So, LAMPS spend those 16 hours in our equipment, not yours.

And, we make a specialty of doing things the experts tell us can't be done. Like a standard MSCP variation of $\pm 15\%$ (Industry practice: $\pm 25\%$.) We perfected the first T-1 and T- $\frac{3}{4}$ neon lamps, the world's only T- $\frac{1}{2}$ and T- $\frac{3}{8}$ production capability, and the first practical 28V T-1 lamp for airborne use.

There are lots of other reasons why we sell more subminiature and microminiature lamps than anyone else. We'd like to tell you about them, too.

Write to us or contact your LAMPS representative. He has all the facts about the 130 types of LAMPS and their thousand or so design variations. More models to choose from than any second-hand lamp dealer in town.



Lamps Incorporated 17000 So. Western Ave., Gardena, Calif. 90247

INFORMATION RETRIEVAL NUMBER 637

Superimposed Noise Problems Solved!



-TR-5589L 250MHz Universal Counter

This counter employs a unique **ANS Circuit** (Automatic Noise Suppressor...patent pending) in its input circuit. If a large signal to be measured and superimposed noises are fed to a counter, the counter may count both the signal and noise since the trigger threshold level is extremely narrow.

The **ANS** solved the noise problems by keeping the input signal level constant at all times regardless of the magnitude of the input, thereby maintaining the trigger threshold level at the optimum value.

When considered from the input side, the trigger threshold level will increase when a large signal is received, or decrease when a small signal is received. These operation reduces the error due to noise mixed in the input signal. Since the counter has an input sensitivity of 10mV rms, frequency measurement of an extremely low voltage signal is possible, and measurement of 100V rms signal is also possible with the single range without the use of an attenuator because of the 80dB dynamic range.

FREQUENCY RANGE—Counts directly up to 250 MHz in decimal, up to 500 MHz with prescaler plug-in unit, covers 10 Hz to **12.5 GHz** with frequency converter plug-in unit.

HIGH STABILITY—Long term stability **5 parts in 10¹⁰** per day.

HIGH SENSITIVITY—10mV to 100V rms in a single range—wide dynamic range—80dB.

DISPLAY—9-digit storage display.

BCD OUTPUT—8-4-2-1 code output.

PLUG-IN VERSATILITY—8 plugin units increase the counter's versatility as required.

Universal Counter, Digital Voltmeter, Digital Integrator, Electrometer, Frequency Counter, Frequency Synthesizer, Frequency Standard, Data Acquisition System, Operational Amplifier.



Takeda Riken Industry Co., Ltd.

1-32-1, Asahi-cho, Nerima-ku, Tokyo, 176, Japan. Tel: Tokyo 930-4111 Telegrams: TRITRONICS TOKYO

Agents:

Litton Precision Products International Inc.—(West Germany, France, Belgium, Switzerland, England)
Ing. S & Dr. Guido Belotti Ltd.—(Italy) Nares & Co.—(Finland)
Ingenjersfirma Carl-Eric Larsson AB—(Sweden)
Semco Semlar & Co.—(Denmark)

NEW LITERATURE



Antenna catalog

A new, 64-page antenna catalog describes systems that cover the frequency range of 2 to 1100 MHz. Most items are available for off-the-shelf delivery, in kit form, as systems, or installed. The catalog essentially includes all antenna configurations that are suitable for field use. Hy-Gain Electronics Corp.

CIRCLE NO. 776

High-vacuum products

A new 24-page brochure on two dozen high-vacuum gauging products is now available. The brochure describes gauge controls, thermocouple gauge controls, discharge gauge controls, and combinations of these. A full description of each product is given, including specifications, dimensions, and controller circuitry. Veeco Instruments Inc.

CIRCLE NO. 777

Transistor data

A 4-page folder describes polychip transistors, differential amplifiers, dual amplifiers, npn/npn complementary duals and Darlington amplifiers. The literature describes electrical characteristics, voltage ratings, tracking, frequency, and case size in specially prepared tables. A dual and Darlington transistor substitution chart is included as a guide for selecting replacement units. Raytheon Co., Semiconductor Operation.

CIRCLE NO. 778

Capacitor data

New data on cylindrical-body cast mica capacitors for operation up to 125°C is now available. Type 375M, 380M, 385M, and 390M capacitors use a so-called solid impregnant. This impregnation method eliminates all air voids and makes it possible to obtain the highest insulation resistance, Q, and voltage breakdown parameters. Rf current ratings for each standard catalog rating and complete performance characteristics are given. Sprague Electric Co.

CIRCLE NO. 732

Semiconductor products

A 5-color, 16-page, condensed catalog covers semiconductor products and modular amplifiers. A useful feature of the catalog is a color-keyed transistor applications guide that relates all products listed to specific user applications. There is also a directory of current application notes and aids available from the company. Catalog contents include summary specifications on lines of field-effect transistors, dual field-effect transistors, dual bipolar transistors, linear and digital integrated circuits, and modular operational amplifiers. Union Carbide, Semiconductor Dept.

CIRCLE NO. 733



Machine tools

A 100-page machine tool directory, broken down into three easy reference sections, contains a listing of products, a cross-referenced listing of companies by products, and a listing of both current and obsolete trade names. National Machine Tool Builders' Association.

CIRCLE NO. 734

Quick Henry,
the prints!



If you need quick copies, stop waiting and start saving with the Blu-Ray 146 whiteprinter.

With the Blu-Ray 146 semi-automatic, diazo printer-developer, you make check prints on-the-spot—fast and cheap—much cheaper than sending out for blueprints.

The table-top 146 is inexpensive to buy, yet a rugged performer that will work for you all day long. It's the sturdy, quality machine in the compact whiteprinter field and backed by Blu-Ray's exclusive 1-year warranty.

Anyone (even Henry) can operate the table-top 146, just set it up where it's handiest and its 47" throat will take up to 46-inch wide prints and expose and develop them sharply for 1c per sq. ft.

Send today for Free brochure and/or a demonstration by one of our 600 dealers coast to coast.

BLU RAY
INCORPORATED

3734 Westbrook Road
Essex, Conn. 06426
Phone (203) 767-0141

INFORMATION RETRIEVAL NUMBER 639

See GRC at the IEEE Show • Booth #1C09-1C11

Another tiny parts
FIRST from

GRC[®]

Now join 2 different plastics
in a single small part



MOVABLE-ELEMENT PARTS SEPARABLE PARTS — Multi-part units that combine controlled separability with variable fit.

TWO-COLOR PARTS AND NUMBERED OR LETTERED PARTS Make possible dual-color parts without secondary assembly costs.

COMBINATION OF MATERIALS — Join different plastics — in a single part for a combination of properties.

Write today for "Inter mold" samples and detailed bulletin

GRIES REPRODUCER CO.

Division of Coats & Clark Inc.

world's foremost producer of small die castings & plastic moldings

40 Second St., New Rochelle, New York 10802 (914) 633-8600
Plants in: New Rochelle, N. Y.; Warren, R. I.; Toccoa, Ga.
In Canada: Gries Div., Dynacast Ltd. Lachine, Que.

New molding process—"Inter mold"—is GRC's exclusive patented method of producing multi-part components automatically mold-assembled in one high-speed operation. Eliminates assembly, achieves production savings and enhances performance.

GRIES[®]

INFORMATION RETRIEVAL NUMBER 640

ELECTRONIC DESIGN 6, March 15, 1969

take
your pulses
anywhere

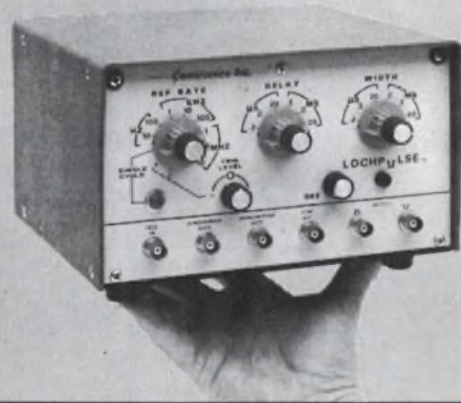

Now you can drive RTL, DTL and TTL circuits in the lab or in the field. The Contronics Lochpulse™ units feature 100% duty cycle, 6 ns rise and fall time, simultaneous complementary outputs, 1 Hz to 10 MHz rep rate, half-rack size and weight of only 6 pounds.

Order the model most suited to your needs today.

MODEL	DESCRIPTION	PRICE
CPG-200-1	AC/Battery, constant amplitude	\$310.00
CPG-200-2	AC/Battery, adjustable amplitude	335.00
CPG-200-3	AC only	335.00

I have an application for Lochpulse _____

- Please send me: CPG-200-1, CPG-200-2, and/or CPG-200-3. Purchase order enclosed.
- Please send me information about your 10 day free trial.

Send this coupon with your name and address to:

International **Contronics Inc.**

1038 W. Evelyn Ave. Sunnyvale, Calif. 94086 (408) 736-7620

INFORMATION RETRIEVAL NUMBER 641

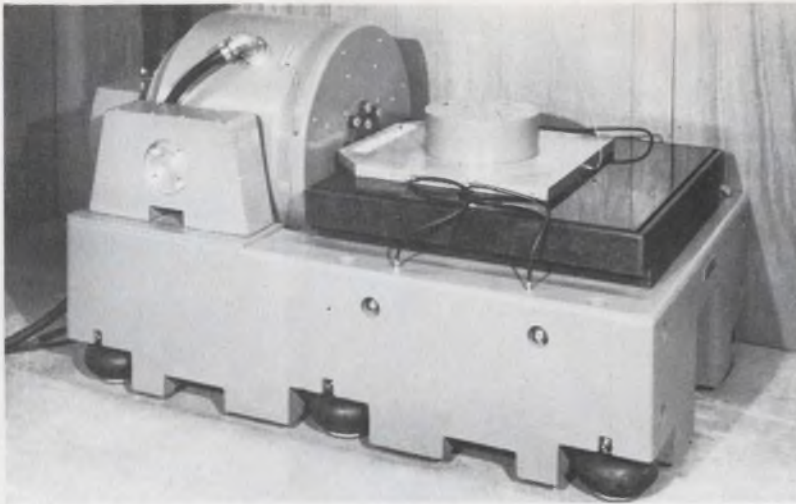

Unholtz-Dickie vibration slip table system eliminates costly installation

Shaker and slip table are a complete unit with one common base to minimize motion between shaker body and slip table. The complete assembly is permanently aligned at factory and is ready for immediate operation when delivered. Four cylinder positive lubricator floats slip plate. For complete technical data, write for Bulletin CSTA-11-66.

manufacturers of shaker systems, advanced instrumentation, and accelerometers

UNHOLTZ-DICKIE CORPORATION

3000 WHITNEY AVE. / HAMDEN, CONN. 06518 / (203) 286-3358

INFORMATION RETRIEVAL NUMBER 642



175 amp, 235 amp, 470 amp Regenerative Gate* SCRs

Regenerative Gate SCRs operate with lower switching losses and higher continuous di/dt than any other SCR. Low power gate drive. No sacrifice required in any other characteristic.

Continuous Rating at 60 Pulses Per Second, 90°C**

rms Current Rating	Pulse Width	Peak On-State Current
235 amp	100 μ sec.	3300 amps
470 amp	150 μ sec.	6000 amps

**Verified by long-term life test.

Also available in 55 amp and 110 amp. Request Bulletin.

**NATIONAL
ELECTRONICS, INC.**

a varian subsidiary
GENEVA, ILLINOIS 60134
PHONE (312) 232-4300

*A National® exclusive.
Patent Pending.

INFORMATION RETRIEVAL NUMBER 643

NEW LITERATURE

Electronic counters

A 6-page catalog on a complete line of electronic solid-state counters and frequency instruments is now available. This latest 2-color catalog contains complete specifications and prices of solid-state counters, including counter-timers, bidirectional counters, variable-time-base counters, and preset counters. Over 40 standard and special application instruments are described. Contained are descriptions and prices including dc-to-frequency converters, frequency-to-dc converters, frequency detecting switches, frequency meters and frequency deviation meters. Anadex Instruments Inc.

CIRCLE NO. 729

Mil fasteners

A 102-page price book of government-specification MS-NAS-AN fasteners includes prices for bolts, screws, clamps, clips, grommets, handles, hinges, keys, nuts, pins, retaining rings, rivets, spacers, springs, studs, terminals and washers. Prices are arranged by dash number for each specification. Items are arranged numerically according to MS, NAS and AN number. Supplementary material in the volume includes tables of government specification materials, platings and finishes, illustrations of screw head and point styles, and weights of rivets. Century Fasteners Corp.

CIRCLE NO. 730

PCM telemetry systems

A new 8-page brochure contains a complete description of modular pulse-code-modulation telemetry systems. Data includes the electrical, input, output, power requirement and environmental specifications. Module drawings and package configurations are also included. Sixteen types of functional modules are discussed, as is a typical system block diagram. Radix Telemetry Corp.

CIRCLE NO. 731

*Got an 'over heat'
problem?*

COOL IT!

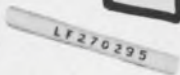

Get Littelfuse miniature heat fuses for thermal overload protection. 7/8" L x 7/64" dia. Fully insulated. Crimp style connections.

LITTELFUSE
DES PLAINES, ILLINOIS

INFORMATION RETRIEVAL NUMBER 645
ELECTRONIC DESIGN 6, March 15, 1969

*FOR THE LATEST IN ADVANCED
TECHNICAL MATERIALS*

Ask for the new AREMCO Catalog



Here is a new, 46-page technical catalog that gives you the technical data, process instructions, illustrations, and pricing for each of over 500 products on (1) high temperature materials, (2) microelectronic tooling and equipment, (3) high temperature furnaces, (4) crystals, (5) high vacuum attachments and components. Most of these products are available to you immediately as off-the-shelf items.

Send for your *FREE* Aremco catalog today . . .



Aremco Products, Inc.
P.O. Box 145
Briarcliff Manor, New York 10510

INFORMATION RETRIEVAL NUMBER 646

UNIVERSAL AD-YU PHASE STANDARD TYPE 209

ACCURACY TRACEABLE TO NBS

- ACCURACY TO 0.015°
- RESOLUTION IN MICRODEGREES BY SETTING TO 7 DIGITS
- SELF CALIBRATING
- NO ERROR FROM LOADING OUTPUT

IEEE SHOW BOOTHS 2J41-2J43

DESIGNERS AND MANUFACTURERS OF PRECISION
PHASEMETERS, PHASE STANDARDS, PHASE DETECTORS
FROM AUDIO TO GHz; DELAY LINES & ACCESSORIES

UNIVERSAL AD-YU ELECTRONICS, INC.

249 TERHUNE AVENUE, PASSAIC, N.J. 07055

PHONE (201) 472-5622 CABLE: ADYU PASSAIC

A SUBSIDIARY OF UNIVERSAL TELEPHONE, INC.

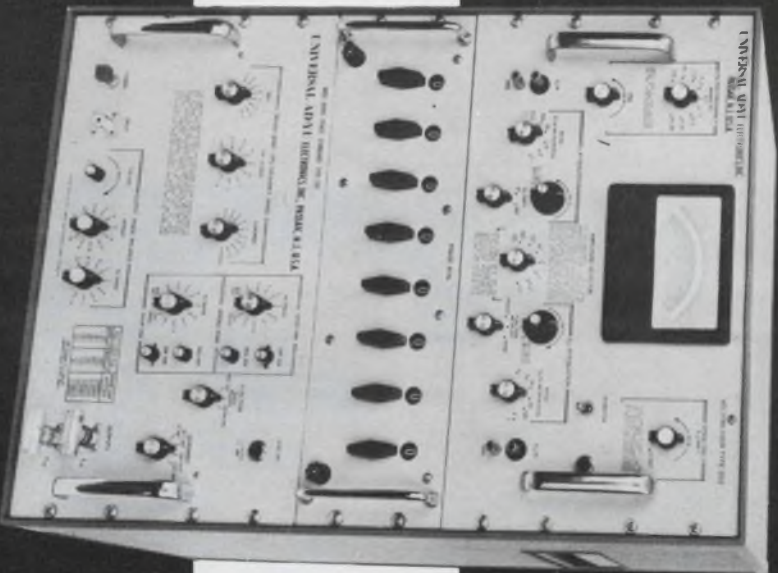

New from the **SPEC-TROLL!**



A LOW-COST INDUSTRIAL WIREWOUND POT WITH PREMIUM FEATURES

Welded termination—With heavy-duty ribbon taps welded to several turns of wire, the new single-turn Model 132 can better withstand high-level vibrations and short-term overloads.

Unitized design—With only 4 major subassemblies — a stainless-steel shaft and rotor, a coil, a molded housing, and a rear lid — the 132 offers a new simpler design for greater reliability, with rear terminals for better packaging.

Rugged construction—The materials used in the 132 have been selected for their ability to withstand impacts and abrasions during assembly or maintenance to assure the customer a trouble-free, serviceable pot.

Low cost—For less than \$6 (in quantity)—you can buy this precision industrial pot! Also, heavy-duty stops (8 in. lb. static) are optional at no extra cost.

For full specs, circle the reader service card. Qualified respondents requesting a sample will receive a Model 132 free of charge from their local Spectrol representative.



Spectrol Electronics Corporation
A subsidiary of Carrier Corporation
17070 East Gale Avenue
City of Industry, Calif. 91745
Phone: (213) 964-6565
TWX: (910) 584-1314

INFORMATION RETRIEVAL NUMBER 647

NEW LITERATURE

High-Q ferrites

Magnetic properties of nickel-zinc ferrite materials are presented in three new two-page bulletins. The materials exhibit good low-loss characteristics at frequencies up to 150 MHz. Typical performance data curves are drawn for toroidal shapes; tables of characteristics are listed for initial and maximum permeability, saturation flux density, residual magnetism, coercive force, temperature coefficient, curie point, volume resistivity, loss factor and frequency range. Indiana General Corp.

CIRCLE NO. 735

Instrument directory

Listed in a comprehensive new directory are instrumentation products, services and 94 sales and service offices throughout the United States and Canada. The pocket-sized 48-page booklet features general descriptions of major product lines and gives a numerical index to specific products. Purchasing information and useful technical reference data are also included. Beckman Instruments, Inc.

CIRCLE NO. 736

Synchro converters

A new 8-page 2-color technical brochure on a complete line of synchro conversion products and signal conditioning systems and components has just been completed. The brochure contains complete specifications on synchro-to-linear dc converters, synchro-to-sine/cosine converters, synchro-to-digital converters, phase sensitive amplifier-demodulators, phase sensitive modulators and demodulators, and transducer amplifiers and systems. Over 250 standard and special models are described. Each page contains electrical, environmental and mechanical specifications in addition to a list of options available for each product. Natel Electronics.

CIRCLE NO. 737

Radiation shielding

Boral, a neutron-shielding material available in sheet and plate form and capable of absorbing thermal neutrons without production of hard gamma rays, is the subject of an 8-page illustrated technical data bulletin. The booklet reviews this highly specialized material, a dispersion of boron carbide in aluminum with an 1100 aluminum cladding. Information presented includes a brief discussion of the use of boron carbide for thermal neutron-shielding; present and potential applications; mechanical and physical properties; shielding characteristics; typical design suggestions; recommended fabrication methods, and selected additional reference sources. Brooks & Perkins, Inc.

CIRCLE NO. 738

Pulse generator

Model 110B, a general-purpose pulse generator that offers rep rates to 50 MHz, risetime to 4 ns, ± 10 V outputs, full baseline offset, and full control over other major pulse parameters is described in detail in an 8-page booklet. In addition to complete specifications, a panel photo, and liberal use of waveform photos, the booklet offers an explanation of the unit's timing and output sections, complete with simplified circuit diagrams. Data-pulse Div., Systron-Donner Corp.

CIRCLE NO. 739

Stepping motors

Each of three new product bulletins describes one of a series of bidirectional stepping motors. Two of the instrument-type motors, which convert digital pulse inputs to analog shaft-output-motion, step in 18-degree increments; the third steps in 15-degree increments. Stepping speeds range from 300 to 450 steps per second; stepping torques range from 120 g-cm to 395 g-cm. Sigma Instruments, Inc.

CIRCLE NO. 740

POWER/MATE CORP. UNI-76

UNIVERSAL POWER SUPPLY

- * 0 to 34 volts at 0.5 AMPS.
- * .005% regulation
- * 250 Microvolts ripple
- * Meets MIL-E-5272 specs
- * 100,000 hours MTBF
- * 5 year warranty



SAME DAY SHIPMENT

\$76.00



POWER/MATE CORPORATION

163 Clay St. ■ Hackensack, N. J. 07601
(201) 343-6294 ■ TWX (710) 990-5023

See us at Booth 4C04 I.E.E.E.
INFORMATION RETRIEVAL NUMBER 648

Many Mini Pins

...for many applications. Order a million or more of General Electric's miniature pins for axles, connectors, contacts, keys, hinge pins, one-part leads, rollers, shafts or stops. We roll them to your specifications from any ductile metal. Straight pin diameter, .015 to .050 inch; lengths to .625 inch maximum. Stepped pins available too. Send for Product Data Sheet 6200-a. *General Electric Company, Lamp Metals & Components Department, 21800 Tungsten Road, Cleveland, Ohio 44117. Tel. (216) 266-3472.*

GENERAL  ELECTRIC

INFORMATION RETRIEVAL NUMBER 649

ELECTRONIC DESIGN 6, March 15, 1969

5 days can do a lot for your next 5 years.

If you're involved in systems and equipment design, research, production or management . . . five days at one of our Seminars may make your next five years—and many more after that—much more productive.

More and more key management and high-level technical personnel from top companies all over the United States are attending RCA Institutes Seminars. Just as they are doing, you'll acquire information and techniques of immediate value in your work. You will also gain the kind of knowledge that can help build your professional standing in the years just ahead.

We believe we can increase your productivity by providing you with a firm grasp of many of the latest engineering techniques. Our experienced staff maintains constant contact with "what's happening" in industry. The texts and audio-visual materials are prepared exclusively by us for each seminar.

You can attend RCA Institutes Seminars around the country the year-round. Check your subject and send along the coupon for your brochure. Now—while you're thinking about it.

RCA

RCA Institutes, Inc. Dept. ELD-39A

Institute for Professional Development
132 West 31st Street
New York, New York 10001

For FREE descriptive brochure, check the Seminar in which you are interested:

- | | |
|--|---|
| <input type="checkbox"/> Logic Design | <input type="checkbox"/> Management Information Systems |
| <input type="checkbox"/> Digital Systems Engineering | <input type="checkbox"/> Digital Communications |
| <input type="checkbox"/> Modern Optics | <input type="checkbox"/> Digital Electronics |
| <input type="checkbox"/> Integrated Circuits | <input type="checkbox"/> Numerical Control Systems |
| <input type="checkbox"/> Reliability of Integrated Systems | |

Name _____

Title _____

Company _____

Address _____

City _____ State _____ Zip _____

INFORMATION RETRIEVAL NUMBER 650

They said it couldn't be done!



**a CONTROL
METER RELAY
with 50%
savings
and high performance**

WELL, THEY WERE WRONG! After a year of customer use in the field, our customers report that our units are consistently providing high accuracy and high reliability — and they must be right because they are re-ordering and pocketing cost savings of up to 50%. Why not join our increasing list of satisfied customers now?

Beede's Non-Contacting Control Meter Relay was initially designed to offer a wide choice of design options for the greatest application versatility. For instance:-

- 8 or more choices of power supply
- 4 choices of fail-safe configuration
- 10 or more choices of output mode
- 9 choices of alarm lights and reset switches
- Many special features such as tamper-proof units, fixed set pointer stops, etc.
- Pyrometers and resistance thermometers

Write for complete literature today!

BUY VALUE / BUY BEEDE

BEEDE
ELECTRICAL INSTRUMENT CO., INC.
PENACOOK, NEW HAMPSHIRE
Area Code: 603-753-6362

INFORMATION RETRIEVAL NUMBER 651

NEW LITERATURE



Precision molded parts

A 6-page bulletin describes capabilities for producing precision injection molded parts. The folder describes techniques for designing and building precision molds. A dozen typical applications are illustrated. G-W Plastics.

CIRCLE NO. 741

Digital data conversion

Describing an ultrahigh speed, low-cost data conversion service, a two-color brochure covers the operation of optical scanning equipment that converts graphical data to digital form at speeds hundreds of times faster than other methods. Also explained is how the service operates to process graphical data for computer input. CompuScan, Inc.

CIRCLE NO. 742

Story of tin

A new, 48-page book explains why and how modern industry uses tin. An important section of the book is devoted to major uses, other than tinplate. It illustrates the dependability of solder and covers tin's stake in bronze, babbitt and other traditional uses. The book also devotes considerable attention to new uses for tin and provides detailed material on the use of tin in iron and steel, in electroplated coatings, in plastics and in paints. Malayan Tin Bureau.

CIRCLE NO. 743

Microwave catalog

An eight-page catalog lists more than 100 types of germanium and gallium-arsenide mixer, video-detector, oscillator, switching and amplifier diodes. Included are diode-housing dimensions, parameters, junction capacitance, negative and video resistance, shot noise and figure of merit. Microphase Corp.

CIRCLE NO. 744

Fastener tooling

An 8-page brochure describes a universal tool system for installing fasteners. The illustrated brochure contains detailed information on how the new system, using a building block concept, provides maximum operating flexibility in conjunction with small, light, compact installation tools. Huck Manufacturing Co.

CIRCLE NO. 745

Measurement and control

A short form catalog covers a complete product line of precision instrumentation for measurement and control. Included in this catalog is information on potentiometer pressure transducers, digital pressure gages, high accuracy pressure transducers and power supplies, among others. Robinson-Halpern Co.

CIRCLE NO. 746

Functional fluids

Over fifty different fluids, including a variety of esters, ethers, fluorinated oils, special hydrocarbons, all types of basic silicones, (as well as chlorinated and fluorinated versions) and natural oils are listed in a four-page brochure. The new catalog lists the fluids, physical data on each, and prices on small containers that range in size from 1/2-ounce bottles, for the more costly fluids, to gallon pails for less valuable items. William F. Nye, Inc.

CIRCLE NO. 747

Design automation

An 8 page descriptive brochure details services, capabilities and equipment of computerized design and production automation centers. The literature describes computer-aided design techniques, production automation computer-aided design techniques, graphic-to-digital generation, digital-to-graphic artwork generation, numerically controlled drilling and solderless wire tapping. Microsystems Technology Corp.

CIRCLE NO. 748

Tantalum capacitors

A new, 28-page general catalog covers a diversified line of solid tantalum capacitors. The publication provides complete data and specifications for microminiaturized, hermetically sealed, epoxy-sealed and epoxy-dipped capacitor lines, both polar and nonpolar, in a variety of packages. Capacitor Products Div. of Components, Inc.

CIRCLE NO. 749

High-vacuum components

A 28-page brochure on high-vacuum components is now available. Described are diffusion pumps, mechanical pumps, cold traps, water baffles, dewars, quick couplings, flanges and other high-vacuum hardware. Prices are included. Veeco Instruments Inc.

CIRCLE NO. 750

Laser coatings

A complete range of laser-quality optical coatings, components and mounts are featured in a new 6-page short-form catalog. Information includes prices and detailed characteristics of more than 250 optical components for laser-oriented products and systems. Spectra-Physics, Optics Dept.

CIRCLE NO. 751

build with ALCOSWITCH

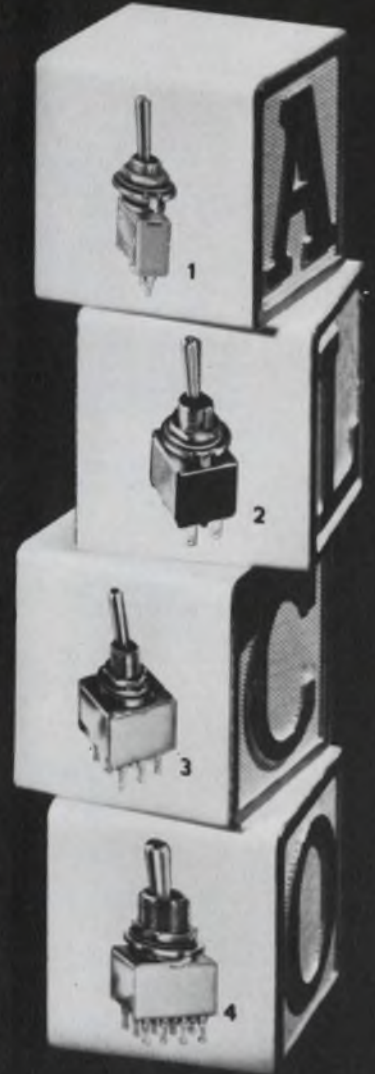

Build quality and reliability into your equipment with top performing ALCOSWITCH® miniatures. Here are representative models from the many families of ALCOSWITCH® which you can select:

- #1 — SPDT "A" SERIES
- #2 — DPDT "MST" SERIES
- #3 — 3PDT "E" SERIES
- #4 — 4PDT "MUSTANG"

If you are looking to build a fine product you'll find the answer in the broad ALCOSWITCH® line.

There is a miniature switch to fit your particular budget and design.

ALCO

ELECTRONIC PRODUCTS, INC.

Lawrence, Massachusetts 01843

The New Mini Boxer

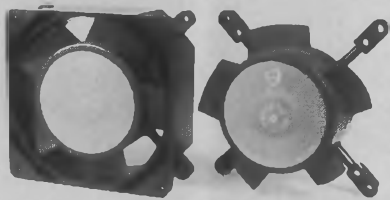

dressed or undressed, fits places too small for the full-size Boxer fan.

Small and vigorous. Measures only 3.625 square by 1.5 inches deep, yet the Mini Boxer delivers a lusty 46 cubic feet of air per minute.

Durable. Ball bearing models survive difficult environments for five years and more, due to patented extra-large lube reservoir. Sleeve type Grand Prix (pat. pending) bearings run cool and reliably, offering exceptional life at low cost. Rugged metal frame won't crack under stress like plastic.

Versatile too, in skeleton or venturi version it flips to reverse airflow, mounts easily anywhere. Special skeleton version fits within 3.5-inch square for standard racks.

Available. It's at your nearest distributor.



IMC Magnetics Corp., New Hampshire Division
Route 16B, Rochester, N.H. 03867. Tel: (603) 332-5300

INFORMATION RETRIEVAL NUMBER 653

This was the result of an IMC reducing plan.

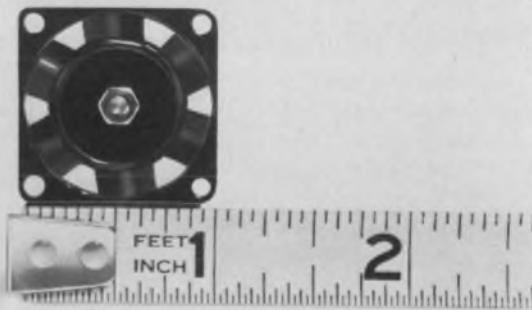

Moves more than 11,000 times
its own volume of air each minute.

For spot cooling of miniaturized equipment.

Cools micro-circuits, transistor heat sinks, airborne computers and instrumentation . . . de-fogs radomes and optical equipment.

Delivers 6.5 cubic feet of cooling air per minute, yet this precision engineered vaneaxial fan weighs only 1 ounce and measures just 1 inch on a side.

Meets demanding environmental,

performance, and reliability specifications, operating efficiently for 1000 hours at 125° C, much longer at lower temperature ranges.

Standardized, for low cost and easy mounting, IMCube fans are readily placed throughout a system, whether it's already completed, or still in design stage.

IMCube fans with cylindrical housing optionally available.



IMC Magnetics Corp., Eastern Division, 570 Main St., Westbury, N.Y. 11591
Phone (516) 334-7070 or TWX 510 222-4469

INFORMATION RETRIEVAL NUMBER 654

NEW LITERATURE

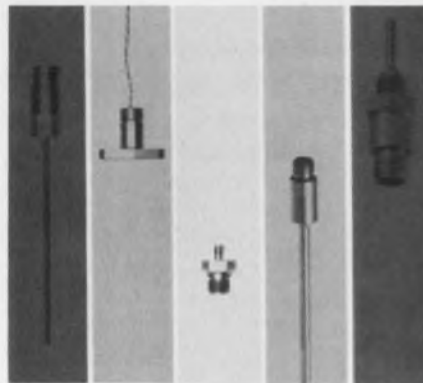

Temperature transducers

Six new bulletins describe a complete family of temperature transducers. The bulletins describe the design features and give the complete performance specifications of immersion and surface-type temperature transducers, each individually configured for specific applications. Electronic Instrumentation Group, Bell & Howell Co.

CIRCLE NO. 756

Rubber tubing

An 81-page natural and synthetic rubber tubing catalog offers 49 pages of tubing information and 8 pages describing O-ring cords. This issue also features a complete stopper section and describes miscellaneous items such as suction cups, rubber bands, mallets and buckets. Of special interest are sections on the exotic and hard-to-find tubings made of compounds such as butyl, polysulfides, silicones and ethylene propylenes. Minor Rubber Co., Inc.

CIRCLE NO. 757

Transformers and chokes

An expanded line of standard transformers and chokes is featured in a new catalog that contains dual secondary power transformers with outputs from 5 to 300 V at 0.1 to 200 A. In addition, standard step-up and step-downs, chokes from 0.1 to 1000 A, high-current transformers, printed-circuit plug-in transformers, and a large variety of constant voltage transformers are listed. Signal Transformer Co., Inc.

CIRCLE NO. 758

Microwave switches

A 4-page pamphlet describes a line of microwave integrated switches and limiters. The colorful pamphlet describes in detail the dimensions, characteristics and capabilities of microwave insert switches, insert limiters, integrated switches and limiters, integrated limiters, mixers, and custom rf assemblies. Diagrams, charts, and photographs of the integrated components are included. Raytheon Co., Micro State Electronics Operation.

CIRCLE NO. 759

Lafayette catalog

Lafayette Radio's new 100-page 1969 spring catalog, containing the latest electronic equipment, is now available. It features receivers, amplifiers, tuners, tape recorders, and two-way radio equipment. Also displayed are large selections of antennas and accessories, camera equipment, power tools, and optical equipment. Lafayette Radio Electronics Corp.

CIRCLE NO. 760

Microfilm system

A 16-mm microfilm system for handling service records is described in a 2-page brochure. It includes a schematic flow chart and a comparison of microfilm storage costs for various types of carriers. Microseal Corp.

CIRCLE NO. 761

Molding compounds

A new bulletin describing transfer and compression molding compounds includes newly available flow and cure-time curves, along with other technical data on epoxy compounds for encapsulating electronic and electrical components. Mineral-filled, glass-filled, and mineral-filled/glass-reinforced compounds are discussed. Epoxy Products Co., Div. of Allied Products Corp.

CIRCLE NO. 762

Mercury film switches

A description of the operation and applications of mercury film switches are described in a five-page booklet. A new concept in switching, the mercury film switch offers the versatility of dry reed switches coupled with the long life and reliability of conventional mercury devices. The mercury film switch has no bounce and features self-healing contacts that virtually eliminate contact wear. Unlike conventional mercury switches it can be mounted in any position. Fifth Dimension, Inc.

CIRCLE NO. 763

Wire drawing

A 20-page, two-color brochure explains the techniques of wire drawing and strip rolling. Included are quick-reference weight tables for wire, rod and strip, mill limits, and a complete listing of alloys and welding wire. Techalloy Co., Inc.

CIRCLE NO. 764

Harness lacing

An 8-page bulletin illustrates and discusses two lacing systems for electronic gear: spot tying systems that utilize pre-cut lengths of lacing tape, and handheld snips; and a new swivel-tilt harness board mount. Gudebrod Bros. Silk Co., Inc.

CIRCLE NO. 765

Power supplies

A six-page catalog includes a new line of subminiature power supplies that operate from a standard line. Each is no larger than 1-5/8 by 1-7/8 by 1-5/8 in. Also included is a new line of miniature, unregulated power supplies which can be coupled with integrated circuits, and a new line of power supplies with two unsymmetrical voltage outputs. Ferrotran Electronics Co., Inc.

CIRCLE NO. 766

press... action

Press small buttons to control heavy currents with a compact **ALCOSWITCH!** Snap-action mechanisms allows quick make-and-break along with solid silver contacts for efficient switching capabilities.



NEWEST

Alco development—the illuminated push button Type MSPN is made to handle heavier currents. Over 50 varied buttons in colors and sizes to fit your specific applications. DPDT only. 6 amps @ 125 VAC.



NEW

"Mustang" features a miniature body with a standard 15/32" bushing and colored button. High Impact case. Extra wide silver contacts. DPDT only. 6 amps @ 125 VAC.



WATERPROOF

"E Series" made to specifications exceeding industry standards. Miniature in size, and yet rugged. Available as momentary, or Push-ON or Push-OFF, in one, two and 4PDT models. 6 amps @ 125 VAC.



ORIGINAL

snap-action MSP push buttons are our smallest, lightweight models. SPDT and DPDT. Rated 5 amps @ 125 VAC. lightweight models. SPDT and DPDT. Rated 5 amps @ 125 VAC.

ALCO

ELECTRONIC PRODUCTS, INC.

Lawrence, Massachusetts 01843

NEW! smallest axial shielded inductor available the "NANO-RED"

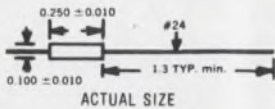

Range: 0.10 μ h to 1,000 μ h in 49 stock values
Size: 1/10 dia. by 1/4 lg.
Inductance Tolerance: \pm 10%

This new "NANO-RED" offers the highest inductance to size ratio available in an axial shielded inductor. Exceptional "Q" and self-resonance characteristics. Max. coupling 2% units side by side. Non-flammable envelope. Designed to MIL-C-15305C. Operating temperature -55°C to 125°C.

Other Lenox-Fugle Subminiature Shielded Inductors:

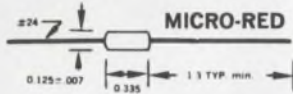

The "Micro-Red" is a shielded inductor that offers the largest inductance range in its size: 0.10 μ h to 10,000 μ h. "Q" to "L" ratio unsurpassed, with excellent distributed capacity. Inductance tolerance \pm 10%. Designed to MIL-C-15305C. Stocked in 61 predesigned values.

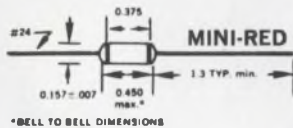

The "Mini-Red" offers the highest "Q" to "L" ratio available over inductance range 0.10 μ h to 100,000 μ h in its size. Inductance tolerance \pm 10% measured per MIL-C-15305C. Stocked in 73 predesigned values.

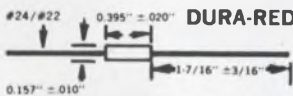

The "Dura-Red" is designed to MS-90537 with inductance range 0.10 μ h to 100,000 μ h with tolerance \pm 10%. Stocked in 73 predesigned values.



Data Sheets: write or phone

LENOX-FUGLE ELECTRONICS, INC.

100 Sylvania Place, South Plainfield, N.J. 07080

Telephone: Code 201, 756-1164

INFORMATION RETRIEVAL NUMBER 656

NEW LITERATURE



Signal processing

A 4-page 1969 short-form catalog covers a complete line of wide-band signal processing components. Products covered in this catalog are wideband hybrid junctions, power dividers, directional couplers, double and single balanced mixers and phase shifters covering the 10 kHz to 2000 MHz range. Werlatone Inc.

CIRCLE NO. 767

Dc power supplies

An eight-page illustrated catalog on a series of modular, wide range, convection-cooled dc power supplies for system applications is now available. A complete line of 29 models with optional rack adapters is described in a table that gives values for voltage and current output, voltage regulation, resolution, optional overvoltage protection, temperature coefficient, transient response time and output impedance. Raytheon Company.

CIRCLE NO. 768

Mixers, hybrids, couplers

A series of subminiature hybrid devices for use with printed circuit board, strip and ministrip transmission line mounting are described in a new brochure. The devices include subminiature power dividers and combiners, mixers, hybrid junctions and directional couplers packaged in one of several standard TO-5 configurations. Both specifications and prices are included for over 35 subminiature hybrid devices. Anzac Electronics.

CIRCLE NO. 769

BUILD MDS "DATA-RECORDER QUALITY" INTO YOUR SYSTEMS



MDS BUFFERED
TAPE UNIT

Transcription . . . verification . . . all the advantages of magnetic tape . . . in the MDS 701 and 901 Buffered Tape Units. These units are buffered magnetic tape transports; each providing three modes of operation . . . Write, Read and Search.
MDS 701 . . . Handles data on 7-channel tape at 200 bpl.
MDS 901 . . . Handles data on 9-channel tape at 800 bpl.
Input and output communication between a parent machine and the magnetic tape is via a program controlled buffer. The controller is your own, designed to fit your application.
Easy integration with a system is made possible through the asynchronous bit parallel, character serial interface provided with the 701 and 901. And you get the high speed, solid state electronics, quiet operation and versatility that are engineered into all MDS Data-Recorders.

Ask for: Folder file on MDS 701/901 Buffered Tape Units
FOR MORE — MEET YOUR MAN FROM MDS

MOHAWK MB DATA SCIENCES CORPORATION

OEM MARKETING
122 E. Ridgewood Ave. • Paramus, N.J. 07652

Telephone 201/265-7333
Every MDS Office is an OEM Marketing Office
Digital Strip Printers • Buffered Tape Units
High-Speed and Low-Speed Line Printers
Card Punches and Readers

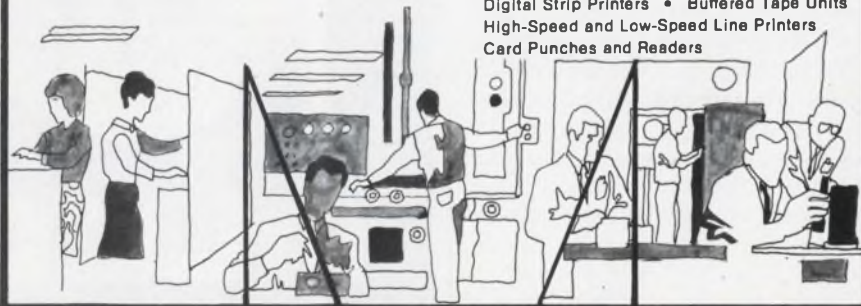

INFORMATION RETRIEVAL NUMBER 657



Ultrasonic switchbonders

Ultrasonic switchbonders for microelectronics manufacturers are discussed in an eight-page bulletin. Specifications for two high-production units are presented in the two-color bulletin, as well as system capabilities and details on system components. Of special interest is a section on workholders that are available with the bonders; these include some eight different designs. Lindberg Hevi-Duty Div., Sola Basic Industries.

CIRCLE NO. 770

Industrial fasteners

Descriptions, specifications and special features of a line of die-cast zinc alloy industrial fasteners are given in a new, fully illustrated bulletin. The fasteners are available in a complete range of sizes and threads in many wing nut, cap nut, thumb and wing screw types, as well as in several special-purpose configurations that are fully detailed in the two-color bulletin. Gries Reproducer Co., Div. of Coats & Clark Inc.

CIRCLE NO. 771

Drafting equipment

A new 100-page catalog covers a complete line of drafting furniture, fixtures, accessories and supplies, of interest to draftsmen, engineers and purchasing agents. Prices of all items are given and order blanks are included. Frederick Post, A Teledyne Co.

CIRCLE NO. 772

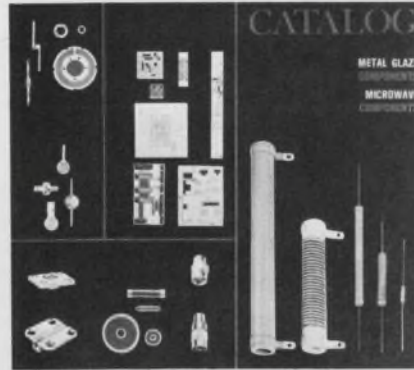

Microwave components

A new capabilities brochure also provides complete data on a line of metal glaze and microwave components. The 28-page catalog describes metal-glaze power film resistors and networks, hybrid thick-film devices, general microwave components, coaxial components and stripline devices. It provides technical data on more than 150 components and features nearly 100 photographs, charts and schematics. EMC Technology, Inc.

CIRCLE NO. 773

High-temp machining

A new pocket handbook, *Machining of High Temperature Metals*, provides practical guidance for the shopman. The 38-page booklet was researched and written by one of the leading machining specialists in the country. It fills a great need for practical information, to assist those machining high temperature metals. Universal-Cyclops Specialty Steel Div., Cyclops Corp.

CIRCLE NO. 774

Thermistor data

A four-page illustrated brochure describes a positive, temperature coefficient thermistor. The new device is a solid-state, silicon resistor with an approximate $0.7\% / ^\circ\text{C}$ temperature coefficient of resistance, which is almost constant from -60 to $+150^\circ\text{C}$. Available dissipation ratings include $1/4$ and $1/2$ W at 25°C . This two-color brochure also includes test curves, application notes and electrical specifications. Victory Engineering Corp.

CIRCLE NO. 775

designer's keyboard

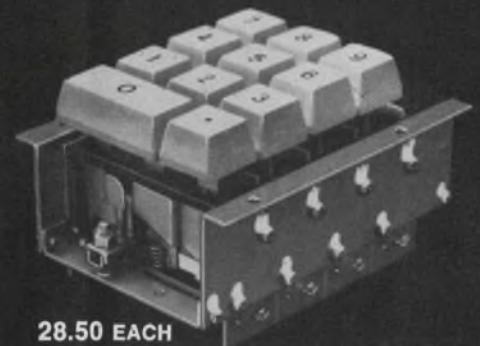

28.50 EACH

SB-033 — INTERLOCK
SB-034 — MOMENTARY

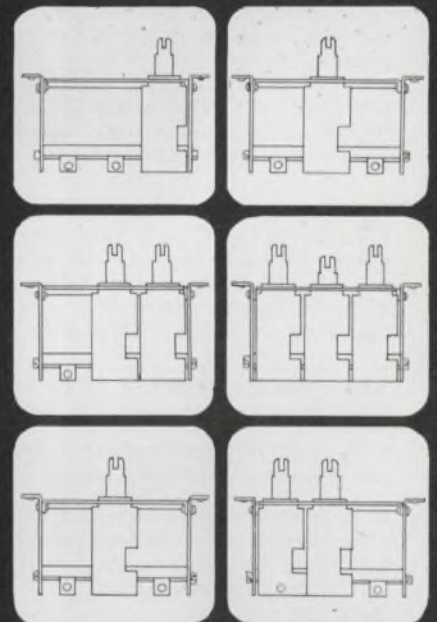

The ALCO modular idea is a simple concept for the design engineer to create his own custom push button layouts from "stock" switch modules and assemblies.

The basic modules allow use of one to three (or four) switches per section. A designer may stack any number of these switch sections in a group by themselves or in conjunction with the ALCO mating 12-segment keyboard assemblies.

Highly efficient, single pole "normally open" reed switches are used throughout, thus assuring reliability and extremely long life expectancy.

For design-service assistance call (Area 617) 686-3887.

ALCO

ELECTRONIC PRODUCTS, INC.

Lawrence, Massachusetts 01843

ELECTRONIC DESIGN'S function is:

- To aid progress in the electronics manufacturing industry by promoting good design.
- To give the electronic design engineer concepts and ideas that make his job easier and more productive.
- To provide a central source of timely electronics information.
- To promote two-way communication between manufacturer and engineer.

Want a subscription? ELECTRONIC DESIGN is sent free to qualified engineers and engineering managers doing design work, supervising design or setting standards in the United States and Western Europe. For a free subscription, use the postfree application form inside the back cover. If none is included, write to us direct for an application form.

If you do not qualify, you may take out a paid subscription for \$25 a year in the U.S.A., \$35 a year elsewhere. Single copies are \$1.50 each.

If you change your address, send us an old mailing label and your new address; there is generally a prepaid postcard for this inside the back cover. You will have to requalify to continue receiving ELECTRONIC DESIGN free.

The accuracy policy of ELECTRONIC DESIGN is:

- To make reasonable efforts to ensure the accuracy of editorial matter.
- To publish prompt corrections whenever inaccuracies are brought to our attention. Corrections appear at the end of the Letters column.
- To refuse any advertisement deemed to be misleading or fraudulent.

Microfilm copies are available of complete volumes of ELECTRONIC DESIGN at \$19.00 per volume, beginning with Volume 9, 1961. Work is now in process to complete the microfilm edition of Volumes 1-8. Reprints of individual articles may be obtained for \$2.00 each, prepaid (\$.50 for each additional copy of the same article) no matter how long the article. For further details and to place orders, contact the Customer Services Department, University Microfilms, 300 North Zeeb Road, Ann Arbor, Michigan 48106; telephone (313) 761-4700.

Want to contact us? If you have any comments or wish to submit a manuscript or article outline, address your correspondence to:

Howard Bierman, Editor,
ELECTRONIC DESIGN,
850 Third Avenue,
New York, N.Y. 10022.

NEW 68-PAGE DRAFTING CATALOG — FREE



Bishop Industries Corp.

7300 Radford Ave.
North Hollywood, California 91605
Phone: (213) 982-2000

174

Solid-Jacketed MicroCoax Cable



MicroDelay Division's new Bulletin 202C describes miniature solid-jacketed coaxial cable providing total shielding and improved environmental stability. Seamless tubular jackets of copper, aluminum and stainless steel eliminate crosstalk and attenuation problems. More than 25 MicroCoax combinations of solid metal jackets, dielectrics and conductors, as catalogued in this bulletin, are stocked in O.D.'s from 0.390" to 0.008" for immediate shipment.

MicroDelay Division

UNIFORM TUBES, INC.
Collegeville, Pa. 19426

175

Self-clinching, Floating Fasteners



PEM self-clinching, floating fasteners, with and without self-locking threads permit up to 1/32" adjustment for misalignment of mating holes. Easily squeezed into punched or drilled holes in metal panels as thin as .040". They provide permanently mounted threaded holes with high torque and push-out resistance, and a patented feature of the PEM floater brings the threads through the retainer shank to minimize gaps associated with other makes. Non-locking fasteners are available in thread sizes #2 to 1/4", and self-locking fasteners are available in thread sizes #4 to 1/4". Send for Free Bulletin

Penn Engineering & Mfg. Corp.

Box 311
Doylestown, Pa. 18901

176

Manufacturers

Advertisements of booklets, brochures, catalogs and data sheets. To order use Reader-ServiceCard (Advertisement)

Terminal Block Selector



A new 24-page, completely illustrated catalog contains photos, descriptions, ratings, engineering drawings, and prices of the complete line of Curtis terminal blocks. Included are printed circuit, insulated feed-thru, quick disconnect, track type, and high current terminal blocks. Handy selection chart quickly locates the perfect block for your particular requirements. Send today for your free copy.

See us at IEEE Show-Booth 4E12 and Design Eng. Show-Booth 3735

Curtis Development & Mfg. Co.

3236 North 33rd Street
Milwaukee, Wisconsin 53216

177

MANUAL ON TRIGONOMETRIC MODULES



A new design manual, illustrating more than 45 applications for trigonometric modules, is available free for engineers.

The "building block" modules, around which the manual is based, allow designers to develop all solid state computing systems. The devices replace synchro or resolver servos or provide interfacing with them.

The manual contains nearly two dozen applications, complete with drawings and diagrams, for analog systems and subsystems and digital applications.

Transmagnetics, Inc.

134-25 Northern Blvd.
Flushing, New York 11354

178

Clamp or Tie Wire Bundles In Seconds!



Six-page catalog contains complete ordering information for CAB-L-TITE® clamps and BUND-L-TITE® straps, devices which provide a fast and reliable means of securing wires and wire bundles. Units withstand loadings greater than 50 G's, are removable in seconds for re-routing wires, and are self-locking—no tying, no knots, no hitches to come loose. Lightweight Du Pont Zytel meets MIL-P-17091 and MIL-P-20693. Proved in aircraft and missiles. Photos, dimensional drawings, tables, physical properties, specifications, price list. Request catalog A.

Dakota Engineering, Inc.

4315 Sepulveda Blvd.
Culver City, California 90230

179

Electronic Design

Advertising Sales Staff

New York 10022

Robert G. Drake
Sales Manager
Edward F. Clancy
Sales Service Manager
Robert W. Gascoigne
Thomas P. Barth
Samuel M. Deitch
Byron Adams
850 Third Avenue
(212) Plaza 1-5530
TWX: 867-7866

Philadelphia 19066

William C. Repetto
P. O. Box 206
Merion Station, Pa.
(215) MA-3-5888

Boston 01945

Richard Parker
P.O. Box 645
Clifton Station
Marblehead, Mass.
(617) 742-0252

Chicago 60611

Thomas P. Kavooras
Berry Conner, Jr.
200 East Ontario
(312) 337-0588

Cleveland

(216) 247-7670

Los Angeles 90303

Stanley I. Ehrenclou
John V. Quillman
W. James Bischof
2930 Imperial Highway
Inglewood, Calif.
(213) 757-0183

San Francisco 94022

Arthur R. Shields, Jr.
175 San Antonio Rd., S 243
Los Altos, Calif.
(415) 941-3084

London W. 1

For United Kingdom & Holland
Brayton C. Nichols
44 Conduit Street
Tel: REGent 4714

Verviers, Belgium

For Continental Europe
Andre Jamar
1, Rue Mallar, 1
(087) 253.83 Telex 41563

Tokyo

Yoshihiro Takemura
IPS Group Ltd.
Box 36, Ohsaki Post Office
Phone (431) 5804



Advertisers' Index

Advertiser	Page
AMP, Incorporated	U88, U89
Ace Shielded Products Corp.	U150
Ad-Yu Electronics, Inc.	365
Air France	282
Alco Electronic Products, Inc.	369, 371, 373
Alfred Electronics	231
Allen-Bradley Co.	61, 63
American Aluminum Company	333
American Electronic Laboratories, Inc.	335
American Micro-Systems, Inc.	300, 301
American Zettler, Inc.	U184
Amersil, Inc.	U191
Amperex Electronic Corporation	297
Amplex Corporation, The	340
Ametek, Inc. Lamb Electric	307
Amphenol, The Bunker-Ramo Corporation	U121
Analog Devices, Inc.	64 A-B
Applied Technology A Division of Ittek Corporation	70
Aremco Products, Inc.	365
Arnold Engineering Company, The	50, 51
Atec, Inc.	U186
Augat, Inc.	U141
Automatic Electric, A Subsidiary of General Telephone & Electronics	U96, U97
Barnes Corporation	U156
Beckman Instruments, Inc., Helipot Division	288
Beede Electrical Instrument Co., Inc.	368
Belden Corporation	232, 233
Bell Telephone Laboratories	309
Birnback Brand Rex	U192
Bircher Corporation, The	346
Bishop Industries Corp.	374
Blu-Ray Incorporated	363
Bodine Electric Company	14
Boston Insulated Wire and Cable Co.	339
Bourns, Inc.	47
Buckbee Mears Co.	341
Bulova Electronics Division of Bulova Watch Company	294
Burns & Towne, Inc.	338
Burr-Brown Research Corporation	31
Burroughs Corporation	20
C & K Components, Inc.	U143
CEI Division of Watkins-Johnson	U188
CML, Inc.	U189
Caddock Electronics	341
Captor Corporation	326
Cambridge Thermionic Corporation	U159
Centralab, the Electronics Division of Globe-Union, Inc.	257
Chicago Dynamics Industries, Inc.	246
Cinch-Graphik, Division of Unted-Carr Incorporated	311
Clevite Corporation, Brush Instruments Division	355
Clevite Sonotone	U157
Cohu Electronics, Inc.	318
Components, Inc.	60
Curtis Development & Mfg. Co.	359, 375
Cutler-Hammer	U119
Dakota Engineering, Inc.	375
Dale Electronics, Inc.	Cover III
Danex Corporation	U150
Darcy Industries	214
Datascan, Inc.	U133
Dearborn Electronics, Inc.	357
Delco Radio Division, General Motors	284
Dialight Corporation	267
Digital Equipment Corporation	U177
Dow Corning Corporation	202, 203
Dranetz Engineering Laboratories, Inc.	322
Du Pont Company	299
Durant Digital Instruments	356
ESI/Electro Scientific Industries, Inc.	42, 43
Essern Industries, A Division of Laboratory for Electronics, Inc.	308

Advertiser	Page
Edal Industries, Incorporated	312
Elco Corporation	273
Eldre Components, Inc.	U165
Electro-Motive Mfg. Co., Inc., The	275
Electronic Design	317, 325
Electronic Engineering Co. of California	345
Electronic Memories, Inc.	68
Electronic Research Associates, Inc.	57
Electrovert, Inc.	351
Emerson & Cuming, Inc.	348
English Electric Valve Co., Ltd.	320 A
Exact Electronics, Inc.	337
Fairchild Semiconductor, A Division Fairchild Camera and Instrument Corporation	4, 5, 34, 35, 251, 291
Fluke Mfg. Co., Inc., John	259
Fusite Corporation, The	281
General Dynamics	325
General Electric Company	208, 209
General Electric Company, Lamp Metals & Components Dept.	367
General Electric Company, Silicone Products Department	249
General Instrument Corporation	10
General Radio Company	1
Grant Pulley & Hardware Corporation	280
Grayhill, Inc.	315, 353
Gridcraft, Inc.	U156
Gries Reproducer Co.	363
Gudebrod Bros. Silk Co., Inc.	74
Guardian Electric Manufacturing Company	U103
Hallcrafters Co., The	351
Hamlin, Inc.	72, 73
Hardman, Incorporated	296
Heath Company	323
Hewlett-Packard	Cover II, 78, U149, 225
Hickok Electrical Instrument Co., Inc., The	298
Hitchner Manufacturing Co., Inc.	314
Honeywell, Computer Control Division	44
Honeywell Test Instrument Division	U167
Hudson Tool & Die Company, Inc.	U109
Hughes Aircraft Company Connecting Devices	U175
Hughes Aircraft Company, Electronic Dynamics Division	U163
Hughes Aircraft Company, Mosfet Devices	U123
Hughes Aircraft Company, Industrial Electronics Group	23
IBM Industrial Products	U146, U147
IMC Magnetics Corporation	370
Industrial Electronic Engineers, Inc.	17, 322
Industrial Technology Corporation	U173
Industrial Test Equipment Co.	U190
Industrial Timer Corporation	333
Inertia Switch, Inc.	359
Inland Controls, A Division of Kollmorgen	261
Inland Motor Corporation of Virginia	377
International Contronics, Inc.	363
Interelectronics Corporation	351
International Electronic Research Corporation	58, 59
International Rectifier Corp.	255
J-B-T Instruments, Inc.	U190
Jaco Electronics, Inc.	332
Johanson Manufacturing Corp.	U178, 213
Johnson Company, E. F.	U164
Keithley Instruments, Inc.	64
Kepeco, Inc.	352
Krohn-Hite Corporation	U162
Kurz-Kasch, Inc.	337

Advertiser	Page
Lambda Electronics Corp	U136, U137
Lamps, Incorporated	361
Lear Siegler Inc. Cimron Division	11
Lenox Fugle Electronics, Inc.	372
Lenz Electric Manufacturing Co.	U172
Line Electric Company	49
Littlefuse	365
Lockheed Electronics Company	201, 349
Lundey Associates, Inc.	353
3M Company	313
McGraw Hill Book Co.	310
McLean Engineering Laboratories	360
Magnecraft Electric Co.	6
Magnetics, Inc.	269
Marconi Instruments Division of English Electric Corporation	U151
Matsuo Electric Co., Ltd.	334
Maxwell Laboratories, Inc.	353
Micom	U171
Microsonics, Inc.	320
Microtran Company, Inc.	330
Microwave Associates, Inc.	271
Midtex, Incorporated Aemco Division	215
Mohawk Data Sciences Corporation	372
Molex Products Company	265
Monolithic Dielectrics, Inc.	338
Monsanto Company	U127
Motorola Semiconductor Products, Inc.	12, 13, 16 A-B, U129
NJE Corporation	U155
National Electronics, Inc.	364
National Semiconductor Corporation	69, 71
Nortronics Company, Inc.	304
Nytronics, Inc.	29
Owens-Illinois, Electronic Materials	347
Pacific Radionics	337
Phelps Dodge Copper Products Corporation	292
Philbrick/Nexus Research, A Teledyne Company	U131
Penn Engineering & Mfg. Corp.	374
Pinlites, Inc.	326
Pomona Electronics Co., Inc.	316
Potter & Brumfield, Division of American Machine & Foundry Company	U160, U161
Power/Mate Corp.	333, 341, 367
RCA Electronic Components and Devices	24, Cover IV
RCA Institutes, Inc.	367
Radiation, Incorporated	8, 9
Radio Materials Company	336
Radio Switch Corporation	330
Raytheon Company, Semiconductor Operation	226, 227
Reeves Hoffman Division of Dynamics Corporation of America	324
Remex Electronics Division of Exello Corporation	328
Rockland Laboratories, Inc.	U183
Rotron Inc.	U135
Sams & Co. Inc., Howard	334
San Fernando Electric Manufacturing Company	306
Sanders Associates, Inc.	247
Scientific Atlanta, Inc.	U125
Sealectro Corporation	75

it's your choice

mounted or . . .



frameless



closed loop servo drives

These unique high performance DC servo motors occupy only one cubic inch of space when mounted or less than 1/2 inch in axial length when frameless. yet they offer the same smooth performance and high resolution found in all INLAND torque motors.



TORQY SAYS:

One of the outstanding features of these devices is the high efficiency of useable output torque vs. input power. We have over 500 models available in frame sizes under 3.7" O.D. providing a wide range of torque and packaging selections.

They are ideally suited for precision closed loop applications where space, weight, reliability, high acceleration, fast response, and superior damping are major considerations. These motors are designed for closed loop servo systems where precise positioning or drive rate of components is required. Accurate and effective positioning is achieved without backlash or other compliance problems usually associated with gear mechanisms.

LESS THAN \$30.00 per unit in quantity.

Also available, a large selection of D.C. tachometers in matching frame sizes or integrally mounted with the motor.

To obtain delivery and price information for your quantity requirements, or more complete data on these unique torque motors . . . write or call your nearest representative or our Sales Engineering Staff.

501 First Street,
Radford, Virginia 24141
Tel: 703-639-3973
TWX 710-875-3740

Advertiser Page

Servo-Tek Products Company	358
Shauer Manufacturing Corp.	76
Siemens America, Incorporated	U179
Signetics Integrated Circuits,	
A Subsidiary of Corning Glass Works	27
Simpson Electric Company	65
Singer Company, The Instrumentation	
Division, Gertsch Operation	302
Singer Company, The Instrumentation	
Division, Ballantine Operation	33
Sippican Corporation, The	319
Solitron Devices, Inc.	263, 303, 327
Solatron Electronic Group	320-B
Spacetac	278, 279
Spectrol Electronics Corporation	366
Spitfire Tool & Machine Co.	310
Sprague Electric Company	18
Stackpole Carbon Company	342
Stackpole Components Company	343
Standard Condenser Corporation	U189
Stewart Warner Microcircuits Inc.	293
Switchcraft, Inc.	305
Sylvania Electric Products, Inc.	32 A-H, 295
Syntronic Instruments, Inc.	316
Systron-Donner Corporation	2

Takeda Riken Industry Co. Ltd.	362
Tektronix, Inc., Oscilloscopes	48 A-B
Teledyne Relays, A Teledyne Company	77
TeleSciences, Inc.	U153
Telonic Instruments, A Division of	
Telonic Industries, Inc.	15
Tenney Engineering, Inc.	U189
Teradyne	66, 67
Times Wire and Cable, Subsidiary of	
Insilco	7
Todd Products Inc.	330
Torngren Co., Inc., C. W.	286
Transitron Electronics Corporation	378
Transmagnetics, Inc.	375
Triplett Electrical Instrument Company	253
Trygon Power Supplies	U168
Tyco Laboratories Inc.	16
Tung Sol Division, Wagner Electric	
Corporation	U145

Unholz-Dickie Corp.	364
Uniform Tubes, Inc.	374
Unimax Switch, Division Maxon	
Electronics Corporation	359
United Aircraft Corporation,	
Electronic Components Division	U185
United Systems Corporation	U187
U. S. Capacitor Corporation	332
U. S. Components, Inc.	277
Universal Ad Yu Electronics, Inc.	365

Veeder-Root	248
Victoreen Instrument Division	U170

W & G Instruments, Inc.	238, 239
Wavetek	321
Weinschel Engineering	U182
Western Microwave Laboratories, Inc.	283
Weston Instruments, Inc.	U181
Wheelock Signals, Inc.	331
White Industrial, S.S.	80
Whittaker Corporation, Gencom Division	350
Wilson, H. A.	U191

Zeltex, Inc.	U169
--------------	------

Career Advertising

Delco Radio,	
Division of General Motors	284
General Dynamics Convair Division	325
Hughes Aircraft Company,	
Aerospace Division	23
Xerox Corporation	286, 287



INLAND MOTOR

CORPORATION OF VIRGINIA

RADFORD, VIRGINIA
703-639-3973

DIVISION OF **KOLLMORGEN**

Information Retrieval Service

(continued on p. 380)

All products, design aids (DA), application notes (AN), new literature (NL), and reprints (R) in this issue are listed here with Page and Information Retrieval numbers. Reader requests will be promptly processed by computer and mailed to the manufacturer within three days.

Category	Page	IRN	Category	Page	IRN	Category	Page	IRN
Components			ICs & Semiconductors			timing error (AN)	348	697
Allied catalog (NL)	358	718	amplifier	306	454	transducers (NL)	370	756
batteries (NL)	361	721	diode chips, zener	308	452	transfer standard	U144	337
capacitors (NL)	360	725	diodes (AN)	350	701	VCO, vhf	300	263
capacitors (NL)	362	732	diodes, gas-filled	U150	388	voltage standard (NL)	360	724
capacitors (NL)	369	749	diodes, rectifier	304	392	wattmeter	292	400
capacitors, tuning	314	252	drivers, TO-8	U150	378			
circuit breaker	314	369	FET selector (DA)	346	692	Microwaves & Lasers		
component loader	315	461	IC notes (AN)	348	696	amplifier	338	488
components (NL)	369	750	ICs, hardened	U148	401	antenna errors (AN)	352	706
delay line	311	459	op amp, differential	304	451	attenuator, diode	U162	346
design chart (DA)	346	691	op amp, DIP	308	453	attenuator, rotary	U161	372
fans (NL)	358	721	phototransistors	304	450	calibrator, rf	U158	398
filters, monolithic	U168	276	phototransistors (AN)	352	704	components (NL)	369	744
filters, monolithic	310	458	rectifiers (NL)	361	726	components (NL)	372	769
fluidic hardware	315	462	SCR, press-pak	306	455	components (NL)	373	773
inductors, miniature	U168	257	semiconductors (NL)	354	712	connectors, 36-GHz	U164	253
Lafayette catalog (NL)	371	760	semiconductors (NL)	362	733	coupler, directional	338	486
lamps, T-1	316	464	tester, IC	307	268	dielectric, stripline	U161	343
motors, stepping (NL)	366	740	thermistors (NL)	373	775	fittings, coaxial	335	484
readout, bi-filament	U166	299	timing circuit	307	456	generator, signal	336	352
readout tube	U166	254	transistor (NL)	354	708	generator, sweep	U162	370
readout tube	310	457	transistors, lock-fit	304	289	instruments	366	736
resistor, metal-film	U170	262				laser, low-cost	338	485
resistors, thin-film	312	460	Instrumentation			laser coatings (NL)	369	751
servomotors (NL)	361	728	altitude chart (DA)	346	693	light measurement (AN)	350	700
socket, T-1-3/4	311	277	bridge, L, C, R	300	291	magnetrons (AN)	348	698
switch, rotary	U166	275	calibrator	U144	395	mixer, MIC	U158	348
switch, subminiature	U172	298	clock, digital	302	350	modulator	336	349
switch modules	U168	399	cold probe system	298	448	oscillator, Gunn	U161	323
switches (NL)	356	714	compensator, thermal	302	341	oscilloscope	U158	287
switches (NL)	371	763	converters (NL)	366	737	paramp, S-band	U161	347
switches, lighted	U166	331	counter, 10-MHz	303	449	power meter	U158	345
switches, pushbutton	U168	297	counter/timer	294	351	rubber, conductive	338	487
switches, rotary	U172	274	counters (NL)	364	729	signal processing (NL)	372	767
terminals, four-wire	U170	271	data normalizer	U142	382	spectrum analyzer	U158	354
time meter	U166	295	data recorder	298	292	sweeper system	U164	361
timers	312	368	filter, oscilloscope	U142	293	switches	371	759
transducers (NL)	358	722	filters, active	U142	376	TDR system	U158	373
transformers	U166	321	galvanometer	U140	385	varactors, GaAs	339	489
transformers (NL)	370	758	generator, gating	U142	294	wattmeter, rf peak	339	258
trigger, fluidic	316	463	generator, pulse (NL)	366	739			
tubes (NL)	354	713	generator, signal	U140	405	Modules & Subassemblies		
			generators, signal	U141	386	Allied catalog (NL)	358	718
Data Processing			indicator, strain	294	265	amplifier	324	403
calculator, desk	U152	387	instruments (NL)	354	711	amplifier	327	377
comparators, digital	318	465	instruments (NL)	369	746	amplifiers	U174	335
computer, 860-ns	U156	280	logic test system	290	446	caption modules	U174	324
computer terminal	317	468	meter, multipurpose	U142	250	filters, active	326	404
CAD (AN)	352	703	microscopes (NL)	360	723	isolator, signal	322	472
CAD (NL)	369	748	oscilloscope, 25-MHz	U144	290	Lafayette catalog (NL)	371	760
converter, d/a	U152	390	PEP talk (AN)	348	695	lampholder arrays	327	476
converter, synchro	U154	279	phase meter	U144	296	multiplier, analog	323	474
converters, data (NL)	368	742	power supply, 50-W	U140	375	op amp	322	471
data entry systems	317	467	printer, drum	303	339	op amp	326	402
data generator	318	466	readout, angle	U144	353	op amps (AN)	352	707
data monitor	320	467	readout, digital	290	273	oscillators	U176	269
data sets	U154	391	recorder	294	338	oscillators, crystal	U178	322
data system	U154	282	sound meter	296	340	oscilloscope, module	U174	384
data terminals	U156	393	sweep diagram	302	383	power modules	324	330
logic circuits	U152	389	synthesis (AN)	350	702	power supplies (NL)	371	766
memory, core	320	470	telemetry systems (NL)	364	731	power supplies (NL)	372	768
microfilm system (NL)	371	761	tester, IC	292	381	power supply	U178	283
reader, tape	U154	333	tester, op amp	290	380	power supply, CRT	U176	286
tape cleaner	U154	260	thermocouple junction	294	342	power supply, dc	U176	261
tape eraser	U154	406	thermometer, IR	296	447	power supply, logic	U174	264

Can a low-cost trimmer succeed in a high-class job like this?



Mohawk Data-Recorders speed input preparation by transferring data direct from source document to computer-compatible magnetic tape. Dale Econo-Trims are used here to control gain in a number of amplifier circuits.

Dale Econo-Trims do!

Specify Dale Econo-Trims for handling important circuit adjustments at a budget price. They combine dependability with prices that start under a dollar. Mohawk Data Sciences uses the 2317 Econo-Trim to control gain in vital tape readback amplifiers. Sealed to withstand automatic soldering, fluxing and total immersion, this 1/2-watt wirewound is noted for its good setting stability. It's just one of 12 Econo-Trim models now available. You can select from 1/2, 3/4 or 1 watt models...film or wirewound elements...sealed or unsealed. Count on good delivery, too—less than 2 weeks in 1,000 piece quantities. Give Econo-Trims the chance to succeed in your circuits. They can help you get ahead, too!

SPECIFICATIONS

2300-2400 Series/Wirewound 8300-8400 Series/Film

Dimensions: 2300 & 8300 = .36" H x .28" W x 1.00" L;
2400 & 8400 = .31" H x .16" W x .75" L

Standard Resistance: Wirewound models = 10 ohms to 50K ohms;
film models = 10 ohms to 2 Meg.

Resistance Tolerance: Wirewound models = $\pm 10\%$; film models = $\pm 10\%$
100 ohms thru 500K ohms, $\pm 20\%$ all other values

Power Rating: 2300 = 0.5 watt at 25° C; 2400 = 1 watt at 40° C;
8300 & 8400 = .75 watt at 25° C

Operating Temperature Range: 2300 & 8300 = -55° C to 105° C;
2400 & 8400 = -55° C to 125° C

Mechanical Adjustment: 2300 & 8300 = 15 turns; 2400 & 8400 = 20 turns

Mechanical Stops: None. Clutch permits overtravel without damage

Models: Sealed or unsealed. Gold-plated PC terminals or gold-plated hook type solder lugs (2300/8300 only).

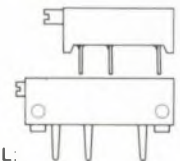

Get samples and a quote quick—
Call Dale Now: 402-564-3131



DALE ELECTRONICS, INC.

1328 28th Ave., Columbus, Nebr. 68601
In Canada: Dale Electronics Canada, Ltd.



All New Cermolox Designs for VHF-TV and FM Broadcasts

Working in VHF-TV? Try RCA-8792, RCA-8806 and RCA-8807... new broadcast tubes from RCA that meet the high linearity and high gain requirements of up-to-date, reliable VHF-TV. If FM service suits you, choose RCA-8792, 8793 and 8794. All are Cermolox[®] tubes, developed from proved, in-use designs. They feature new lows in feed-through capacitance and screen and cathode inductance plus superb IM values. Available at surprisingly

low cost, many of these RCA broadcast tubes lend themselves well not only to VHF-TV and FM, but to SSB, CW, and UHF Linear service as well. Investigate these RCA tubes for your needs. See your local RCA Representative or your RCA Distributor for details, including prices and delivery.

For technical data on specific types, write: RCA Electronic Components, Commercial Engineering, Section Q 19C, Harrison, N.J. 07029.



RCA-8807 (top), 20 kW Peak Sync.
RCA-8806 (center), 12.5 kW Peak Sync.
RCA-8792 (lower), 1 kW FM 1.5 kW Peak Sync.

RCA