

Electronic Design

FOR ENGINEERS AND ENGINEERING MANAGERS

VOL. 16 NO.

3

FEB. 1, 1968

Don't just gum up your circuits— use plastics creatively as a part of your designs. In aerospace or aquaspace, embedding resins are more than just a package. They

can enhance thermal specs, raise power ratings and shrink package size and weight. You don't have to be a chemist to analyze the special report starting on p. 49.

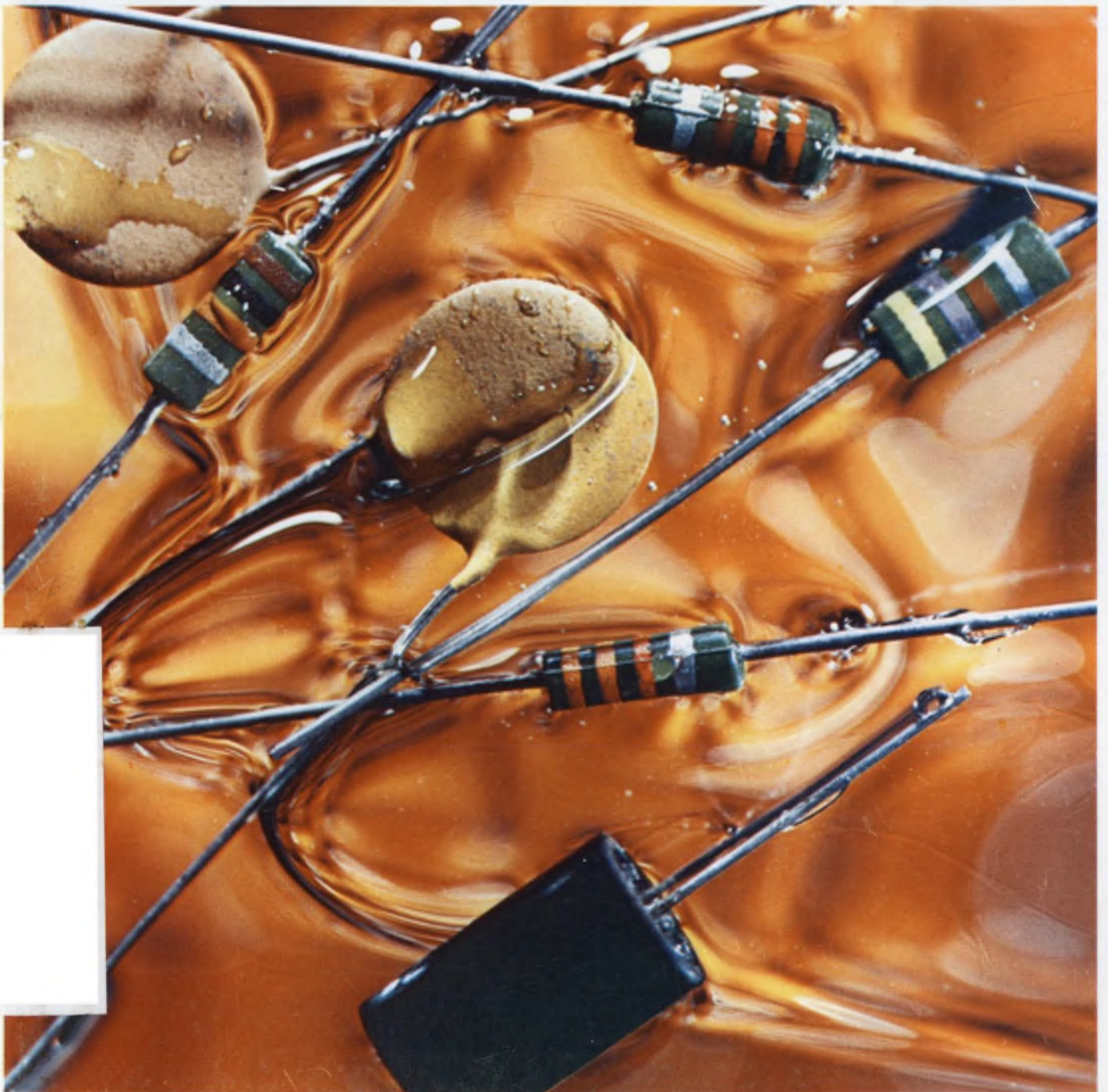

TRW Metallized Capacitors



...stand tall

Type X601PE Metallized Mylars typify TRW's stature in advanced metallized dielectrics.

They're smaller and lighter... *metallized!* Tough and rugged...

epoxy sealed! Ideal for printed circuits...*save space!*

TRW offers many additional styles and dielectrics for demanding Military and Industrial needs.

Product information is available from TRW Capacitor Division, TRW INC., Box 1000, Ogallala, Nebraska. Phone (308) 284-3611. TWX: 910-620-0321.

FROM HP—THE SWEEPER THE USER DESIGNED

For the sweep mode you need, just press a button



PRESS THE START/STOP BUTTON

The dial lights immediately identify the sweep mode, and the corresponding START and STOP frequency pointers indicate the frequency limits of the sweep. Frequency settings are independently adjustable over the full 13-inch scale for sweeping up or down, wide or narrow. Accuracy and sweep linearity are better than 1%.



PRESS THE MARKER SWEEP BUTTON

Now the M1 and M2 lights signify that you've selected a completely independent sweep mode whose frequency dial pointers provide a full range of adjustment. Use it to bracket a frequency segment of interest. Frequency accuracy and linearity, again, are better than 1%. In all sweep modes, the SWEEP light is "on" while the sweep is in progress, extremely convenient for slow sweep speeds.



PRESS THE ΔF BUTTON

The CW and ΔF lights now indicate you have a fully calibrated narrow-band sweep symmetrical about the setting of the CW frequency pointer. Sweep width, indicated by the ΔF pointer, is adjustable from 0 to 10% of the band. The full-width frequency scale affords high resolution.

The Hewlett-Packard 8690A Sweep Oscillator is the sweeper the user designed—engineered for greatest operating convenience and to eliminate errors encountered with complex dial arrangements and hard-to-read panels. Plug-in design results in a front panel free from congestion, yet the instrument is only 8 $\frac{3}{4}$ " high. There's an RF plug-in for 0.1 to 110 MHz and microwave plug-ins from 1 to 40 GHz. PIN diode modulation/leveling is available from 1 to 12.4 GHz. Model 8690A main frame is \$1600, the RF plug-in is \$950 and microwave plug-ins start at \$1575.

For more information call your local HP field engineer or write Hewlett-Packard, Palo Alto, California 94304; Europe: 54 Route des Acacias, Geneva.

HEWLETT  PACKARD
SWEEP OSCILLATORS

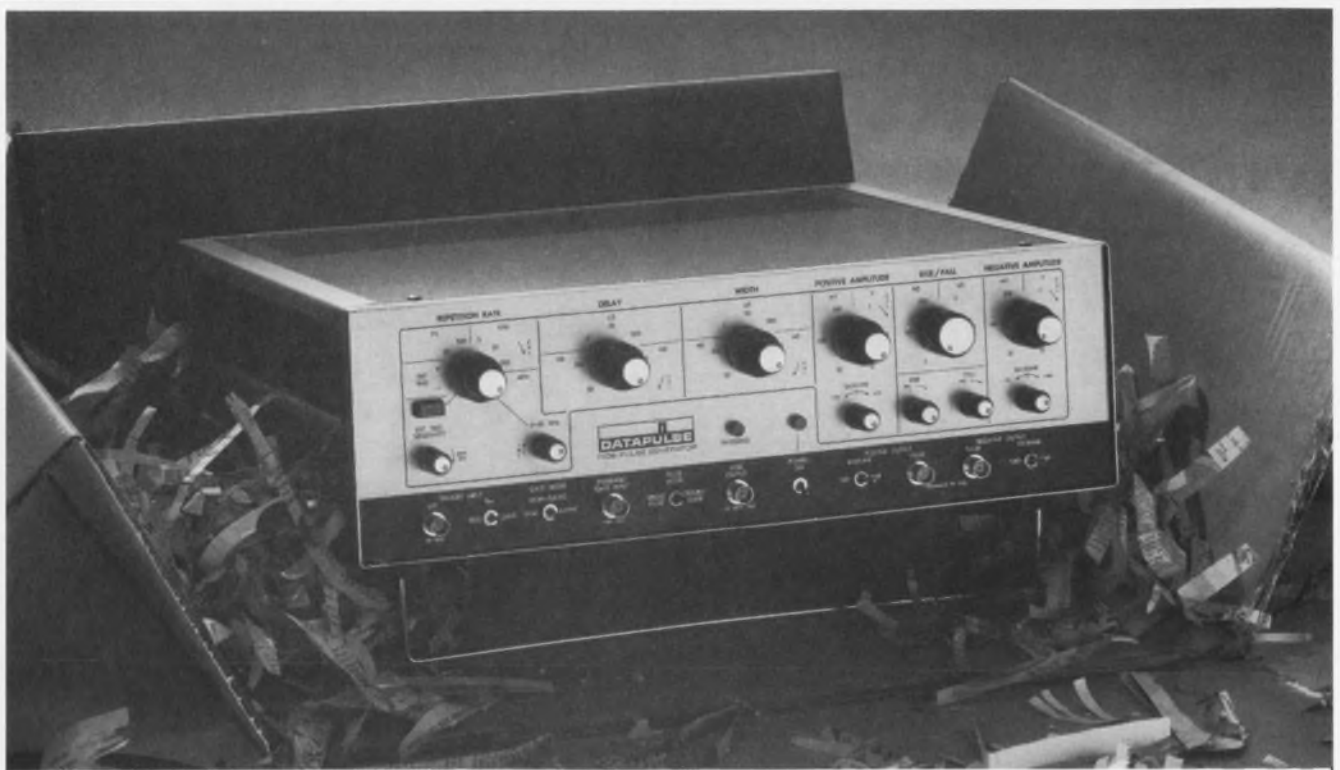

NEW

110B Pulse Generator

More for the Money!

The Datapulse 110A was a great pulse generator — about the best general purpose instrument money could buy. The 110B is better!

Why? Some of the reasons are easy to spot: the attractive new cabinet styling, the new front panel design with streamlined controls, and the completely new internal packaging. Other reasons are less obvious — until you look at some 110B pulses. Then you see faster rep rates, improved dc baseline offset, and the cleanest pulses ever to come down the pike. The 110B also gives you both synchronous and asynchronous gating, and there's a triggered indicator on the front panel. You'll discover many more reasons why you'd want to own a 110B when you've seen the data sheet and a demonstration.

So, if you've recently ordered a Datapulse 110A, don't be concerned if you receive a 110B. It won't cost you a penny more and you'll get everything you expected and then some.

Fully Controllable Fast Pulses

Ask for a demonstration of the 110B's fully controllable fast pulses: linear rise times to 4 ns, rep rates to 50 MHz, 10V regulated dc baseline offset, $\pm 10V$ simultaneous outputs, single or double pulses, 10 ns to 5 ms pulse widths, 10 ns advance to 50 ms delay. Price: Still only \$1250.00.

Write for complete specifications and applications information!

Datapulse welcomes technical employment inquiries.

Datapulse is the leading producer of solid state pulse instrumentation. 48 technical sales offices and 7 field service centers in 18 countries.



Datapulse Incorporated — A Subsidiary of Systron-Donner Corporation, 10150 West Jefferson Blvd., Culver City, California 90230. Telephone: (213) 836-6100, 871-0410. TWX: 910-340-6766. CABLE: Datapulse • Microwave Division: DeMornay-Bonardi.

NEWS

- 21 News Scope
- 25 **Milliwave systems make solid advances**
New rf sources and components expand use of ehf band.
- 33 **Rx for weapons problems: Fast, fast design**
Air Force welcomes those who can solve Vietnam equipment troubles in 6 months.
- 34 **Laser-scanned MOS detects infrared**
MIT scheme improves night vision by converting radiation into video signals.
- 37 Washington Report
- 40 Letters
- 42 Sidelights of the Issue
- 45 **Editorial: Congress has so far found only the top of the iceberg.**
-

TECHNOLOGY

- 49 **Special Report: Resin embedment of electronic assemblies**
- 50 Make early decisions count—choose the proper process.
- 54 Materials for embedment: the epoxies head the list.
- 62 Materials for embedment: silicones and urethanes.
- 70 Need improved properties? Tailor them with fillers.
- 74 The proof of the potting: selection, design, testing.
- 82 **Many digital functions can be generated** with a rate multiplier. A few components and a counter will produce many arithmetic operations.
- 88 **Combine a couple of thermistors** to get rid of nonlinearities over wide temperature ranges and still keep the sensitivity of each device.
- 94 **Cut wiring-system tests exponentially** by using binary-group checks to indicate and locate faults. It's even easier with a computer.
- 102 **Manage your time or it will boss you!** Make each working day more productive by putting priorities on all tasks that come to you for action.
- 115 Semiannual Index of Articles: July to December, 1967.
- 126 Ideas for Design
-

PRODUCTS

- 138 **Semiconductors:** Dielectrically isolated op amp needs no external compensation.
- 150 **Systems:** CRT display system shows 144 characters.
- 168 **Test Equipment:** Versatile electrometer stable to 20 $\mu\text{V}/\text{day}$.
- 174 **Production Equipment:** Ultrasonic tools cut any shape.
- 182 **Microelectronics:** Linear monolithic op amp gets matched FETs.
- 186 Materials 192 Microwaves
-

Departments

- | | |
|------------------------|-----------------------------------|
| 16 Designer's Datebook | 198 New Literature |
| 110 Book Reviews | 206 Advertisers' Index |
| 196 Design Aids | 208 Reprints Available |
| 197 Application Notes | 208 Information Retrieval Service |
- Information Retrieval Service card inside back cover
-

Here are the winning totals

To be a Grand Prize Winner you should
have submitted ALL of these figures:

CIRCUIT FAMILY	NUMBER OF CIRCUITS
MDTL* (diode-transistor logic)	13
MECL* (emitter-coupled logic)	18
MHTL* (high-threshold logic)	4
MRTL* (resistor-transistor logic)	9
MTTL* (transistor-transistor logic)	15
I/C Operational Amplifiers	5
I/C Differential & Sense Amplifiers	1
I/C Video, RF & IF Amplifiers	2
<hr/>	<hr/>
Grand Total	67

If you had the correct Grand Total, even though your totals for the individual circuit categories were inaccurate (or if you were among the 100 closest entries), you are still a winner of the Frank Sinatra hit album that features, "It Was A Very Good Year."

Yes! 

It was a very good
year for integrated
circuits... at Motorola

-where the priceless ingredient is care!



In Motorola's "It was a very good year" Integrated Circuits Contest

With 67 new and different linear and digital functional circuit elements added to the line this year alone, there should be little doubt that . . .
MOTOROLA MAKES THEM ALL! And, there's also little doubt that Motorola offers you the greatest design flexibility in the industry, through its broadest-of-all integrated circuit line. In fact, if we were to count all of the package and temperature-range variations, on just those circuits shown below, we could say that we've introduced 226 new integrated circuits during the past year. So, when you're considering the advantages of integrated circuit design . . . think Motorola — where you can depend on complete freedom of circuit choice!

Here is the complete list of *all* Motorola integrated circuits, introduced during the 12-months preceding the close of the contest — by family group, type number and circuit function.

MRTL

MC774G, MC874G, MC974G J-K Flip-Flop
MC775P, MC875P Dual Half Adder
MC776F/P, MC876F/P, MC976F Dual J-K Flip-Flop (mW)
MC778F/P, MC878F/P, MC978F Dual Type D Flip-Flop (mW)
MC783P, MC883P Dual Half Shift Register
MC784P, MC884P Dual Half Shift Register (w/o Inverters)
MC791P, MC891P Dual J-K Flip-Flop
MC881G, MC981G Dual Buffer
MC882G, MC982G J-K Flip-Flop

MECL

MC1001P, MC1201F Single 6-Input Gate (3 OR/3 NOR with pulldowns)
MC1002P, MC1202F Single 6-Input Gate (3 OR with pulldowns; 3 NOR without pulldowns)
MC1003P, MC1203F Single 6-Input Gate (3 OR/3 NOR without pulldowns)
MC1007P, MC1207F Triple 3-Input Gate (3 NOR with pulldowns)
MC1008P, MC1208F Triple 3-Input Gate (1 NOR with pulldowns; 2 NOR without pulldowns)
MC1009P, MC1209F Triple 3-Input Gate (3 NOR without pulldowns)
MC1014P, MC1214F Dual R-S Flip-Flop (Positive Clock)
MC1015P, MC1215F Dual R-S Flip-Flop (Negative Clock)
MC1016P, MC1216F Dual R-S Flip-Flop (Single Rail)
MC1017P, MC1217F Translator (Sat. Logic to MECL)
MC1018P, MC1218F Translator (MECL to Sat. Logic)
MC1019P, MC1219F Full Adder
MC1020P, MC1220F Quad Line Receiver
MC1021P, MC1221F Full Subtractor
MC1023P Dual 4-Input Clock Driver
MC1024P, MC1224F Dual 2-Input Expandable Gate
MC1025P, MC1225F Dual 4- and 5-Input Expander
MC1027P 120 MHz AC Coupled J-K Flip-Flop

MTTL

MC400F/P, MC450F/P, MC500F, MC550F Dual 4-Input Gate
MC401F/P, MC451F/P, MC501F, MC551F Expandable Quad 2-Input Gate
MC402F/P, MC452F/P, MC502F, MC552F 8-Input Gate
MC403F/P, MC453F/P, MC503F, MC553F Dual 3-Input Gate (w/complement)
MC404F/P, MC454F/P, MC504F, MC554F Expandable Triple 3-Input Gate
MC405F/P, MC455F/P, MC505F, MC555F Expandable Dual 4-Input Gate
MC406F/P, MC456F/P, MC506F, MC556F Expandable 8-Input Gate
MC408F/P, MC458F/P, MC508F, MC558F Quad 2-Input Gate
MC409F/P, MC459F/P, MC509F, MC559F Quad 2-Input Expander
MC410F/P, MC460F/P, MC510F, MC560F Dual 4-Input AND-OR Expander
MC411F/P, MC461F/P, MC511F, MC561F Dual 4-Input AND Expander
MC412F/P, MC462F/P, MC512F, MC562F Triple 3-Input Gate
MC413F/P, MC463F/P, MC513F, MC563F R-S Flip-Flop
MC415F/P, MC465F/P, MC515F, MC565F J-K AND Flip-Flop
MC416F/P, MC466F/P, MC516F, MC566F J-K OR Flip-Flop

MHTL

MC660P Dual 4-Input Gate (Active Pullups)
MC661P Dual 4-Input Gate (Passive Pullups)
MC663P Dual J-K Flip-Flop
MC664P Master Slave R-S Flip-Flop

MDTL

MC834F/P, MC934F Hex Inverter
MC836F/P, MC936F Hex Inverter
MC837F/P, MC937F Hex Inverter
MC838F/P, MC938F Decade Counter
MC839F/P, MC939F Divide-by-16 Counter
MC843G, MC943G 4-Input AND Driver (w/ NOR Strobel)
MC849F/G/P, MC949F/G Quad Inverter
MC852F/P, MC952F Dual J-K Flip-Flop
MC853F/P, MC953F Dual J-K Flip-Flop
MC855F/P, MC955F Dual J-K Flip-Flop
MC856F/P, MC956F Dual J-K Flip-Flop
MC861F/G/P, MC961F/G Dual 4-Input Gate
MC863F/G/P, MC963F/G Dual 2-Input Gate

I/C Diff./Sense Amplifiers

MC1710CF/CG/CP/F/G Sense Amplifier

Video, RF & IF Amplifiers

MC1314G TV Sound IF Amplifier & Discriminator
MC1510F/G Video Amplifier

I/C Operational Amplifiers

MC1435F/G/P, MC1535F/G Dual Operational Amplifier
MC1437P Dual Operational Amplifier
MC1520F/G Operational Amplifier
MC1709CF/CG/CP/F/G Operational Amplifier
MC1712CF/CG/F/G Operational Amplifier

Thanks for joining in the fun of Motorola's "It Was A Very Good Year" integrated circuits contest! Prizes are on the way to the winners. For a list of winners, simply send a self-addressed, stamped envelope to P.O. Box 955, Phoenix, Arizona 85001.

*MDTL, MECL, MHTL, MRTL, MTTL are trademarks of Motorola Inc.

MOTOROLA Semiconductors

RCA supersedes the 2N681-690 SCR family with better performing devices at "mind-changing" prices!

			
2N690 2N689	2N3899 \$6.50	2N3873 \$6.35	Voltage 600 V
2N688 2N687 2N686	2N3898 \$4.50	2N3872 \$4.35	400 V
2N685 2N684	2N3897 \$3.25	2N3871 \$3.10	200 V
2N683 2N682 2N681	2N3896 \$3.00	2N3870 \$2.85	100 V
25 A	35 A	35 A	RMS current

Prices in quantities of 1,000 and up

If you're using conventional SCR's in the mid-current range... RCA's 35-amp types offer greater protection from voltage transients, better performance... and just check the prices!

RCA's 2N3870-2N3873, 2N3896-2N3899 35-amp power-rated SCR's offer you a choice of press-fit or stud-mounted packages... and your circuits will not only be more reliable, they'll be a good deal less expensive! Just check the performance advantages of RCA's "mind-changing" SCR's over those of the 2N681-690 family:

	<u>2N681-690</u>	<u>RCA</u> <u>2N3870-2N3873</u> <u>2N3896-2N3899</u>
Forward Current	25 A	35 A
Peak Surge Current	150 A	350 A
Gate Power	5 W	40 W (for 10- μ s duration)
Gate Current	2 A	Any value giving maximum gate power is permissible.
Gate Voltage	10 V	
Thermal Resistance	0.9°C/W	2°C/W

Of course, if your design requirements call for the famous 2N690 family, RCA can still deliver more performance for less cost. Your RCA Field Representative can give you complete details. For additional technical data, write RCA Commercial Engineering, Section RG2-1, Harrison, N.J. 07029. See your RCA Distributor for his price and delivery.

RCA

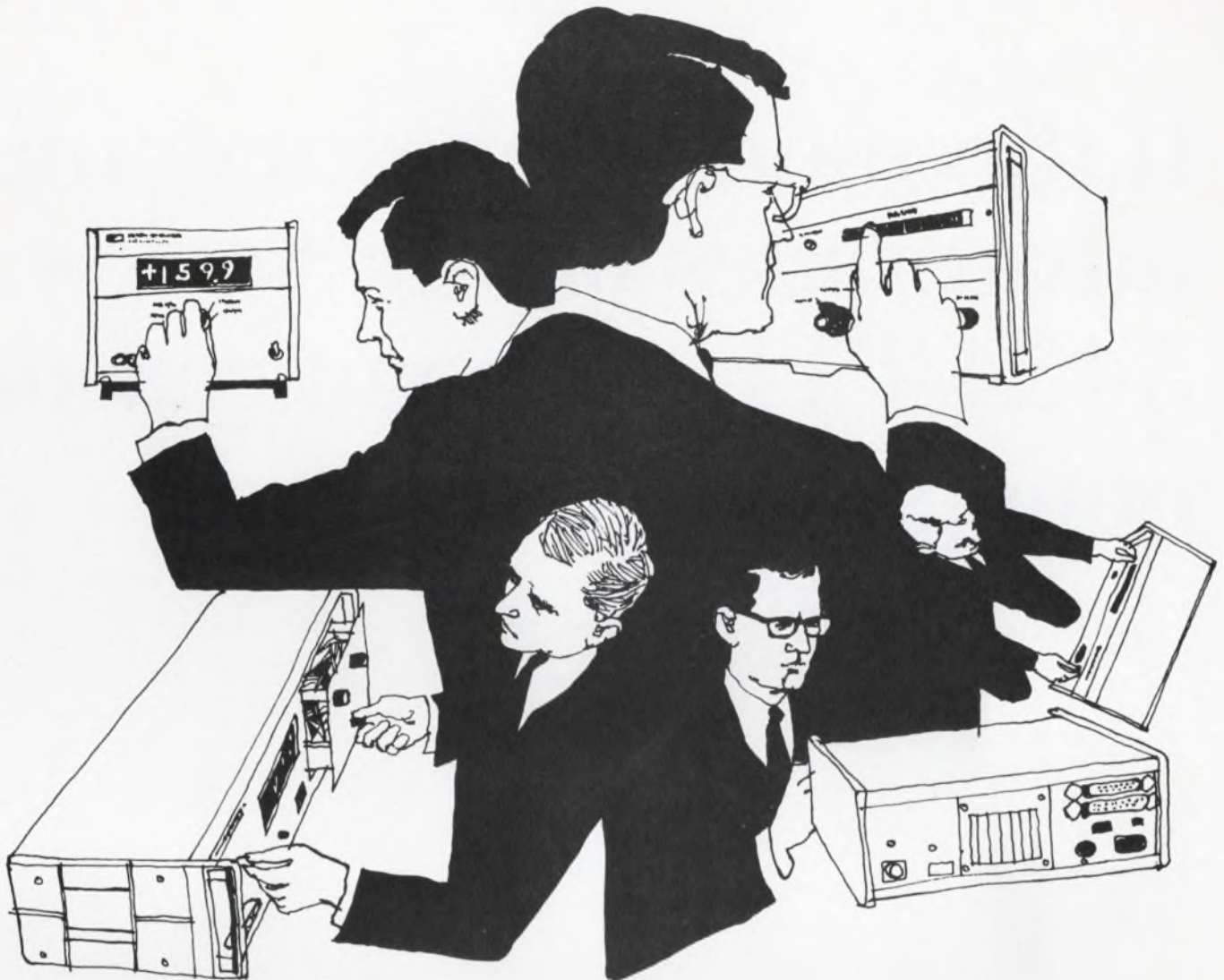

LOOKING FOR MORE RETURN ON YOUR DVM DOLLAR?

Hewlett-Packard gives you more capability per measurement dollar with the widest choice of DVM's in the industry! Choose from 3, 4, 5, and 6-digit instruments with a variety of accuracies, sensitivities, functions and prices.

+ 159.9

Looking for Economy?

There's the three-digit hp 3430A for measurements within $\pm(0.1\% + 1 \text{ digit})$ and a sensitivity of $100 \mu\text{V}$, with up to 60% overranging capability indicated by a fourth digit. Low price of only \$595.

+ 99.99

Looking for Plug-In Capability?

It's yours with the four-digit hp 3440A. Six plug-ins give ac volts, dc volts, dc current and ohms. Basic dc accuracy is $\pm 0.05\%$ of reading $\pm 1 \text{ digit}$. The 3440A has BCD printer output and rear terminals in parallel. Price: hp 3440A, \$1160; plug-ins, \$40 to \$575. For bench use, get lower-priced hp 3439A (no BCD outputs), \$950.

+ 1.19999

Looking for Accuracy and Speed?

For laboratory precision and systems speed, try the five-digit (plus a sixth digit for 20% overranging) hp 3460B. It has $\pm 0.004\%$ of reading $\pm 0.002\%$ full scale accuracy. The 3460B

has $10 \mu\text{V}$ sensitivity and makes automatic and remote-controlled dc measurements at up to 15 readings per second. The guarded 3460B has high common mode rejection, and $>10^{10}\Omega$ input resistance at balance on the 1 V and 10 V ranges (minimum 10 M Ω). On the 100 V and 1000 V ranges, input resistance is 10 M Ω . Price: hp 3460B, \$3600; hp 3459A, (no BCD outputs), \$2975.

+ 1.199999

Looking for Highest Accuracy and Sensitivity?

hp HO4-3460A gives resolution of 1 part in 1.2×10^6 , sensitivity of $1 \mu\text{V}$, accuracy of $\pm 0.005\%$ of reading or $\pm 0.0005\%$ of full scale . . . with six-digit readout and seventh digit for 20% overranging. The guarded HO4-3460A has 160 dB effective common mode rejection at dc, and uses integration to reduce effect of superimposed noise. Automatic, manual or remote operation is possible. Instrument has BCD printer output. Price: hp HO4-3460A, \$4600.

For full details on the hp DVM that fits your needs—contact your nearest hp field engineer. Or, write to Hewlett-Packard, Palo Alto, California 94304. In Europe: 54 Route des Acacias, Geneva.

097/17

HEWLETT  PACKARD

INFORMATION RETRIEVAL NUMBER 6

If the modest engineering advantages of our Series 54/74 TTL's are not reason enough to order...

our delivery is.

Here's our line-up.

We	They	Description	Modest Engineering Advantages
SN 5473N/7473N	SN 5473N/7473N	Dual JK Flip Flop	15ns clock skew, clock line clamp
SN 5474N/7474N	SN 5474N/7474N	Dual D Flip Flop	Tight hold time specification
SN 5400N/7400N	SN 5400N/7400N	Quad 2-input Gate	Input voltage clamps
SN 5410N/7410N	SN 5410N/7410N	Triple 3-input Gate	Input voltage clamps
DM 7800/8800	— none —	Dual TTL/MOS Translator	Up to 33V output swing
NS 7673	— none —	Lamp/Relay Driver	250mA output drive capability

to be continued

for additional information write National Semiconductor,
2975 San Ysidro Way, Santa Clara, California 95051. (408) 245-4320.

National Semiconductor

INFORMATION RETRIEVAL NUMBER 7

EIMAC has a rugged 500 watt tetrode that is ready to talk before you are.

We knew you weren't satisfied with ordinary push-to-talk mobile and airborne UHF/VHF communications systems. Why? They took up to 60 seconds to warm-up. You needed more power and you needed it with "instant talk" speed.

The EIMAC metal ceramic X2099B is the only tetrode combining 500 watts of plate dissipation with instant warm-up. The quick-heat cathode in the X2099B takes only 250 milliseconds to warm up to half power or 70% of peak current. You can drive the X2099B with low level solid state, and you can air cool it.

The X2099B is available only at EIMAC. We're ready to talk whenever you are. (415) 592-1221.

Contact your nearest distributor or Varian Field Office for further information. Offices are located in 16 major cities. Ask information for Varian Electron Tube and Device Group.

TYPICAL OPERATING CHARACTERISTICS Class AB₁ Radio Frequency Linear Power Amplifier

	DC Plate Voltage		V
	1600	2600	
DC Screen Voltage	200	250	V
DC Grid Voltage	-24	-34	V
Zero-Signal Plate Current	250	225	mA
Max Signal DC Plate Current	455	370	mA
PEP or CW Plate Output Power	400	500	W
Third Order Intermodulation Distortion	-36	-38	dB
Fifth Order Intermodulation Distortion	-54	-46	dB
Filament Voltage	2.5	2.5	V
Filament Current	10.0	10.0	A
Warm-up Time (to half power)	250	-	ms

EIMAC

Division of Varian
San Carlos, California 94070

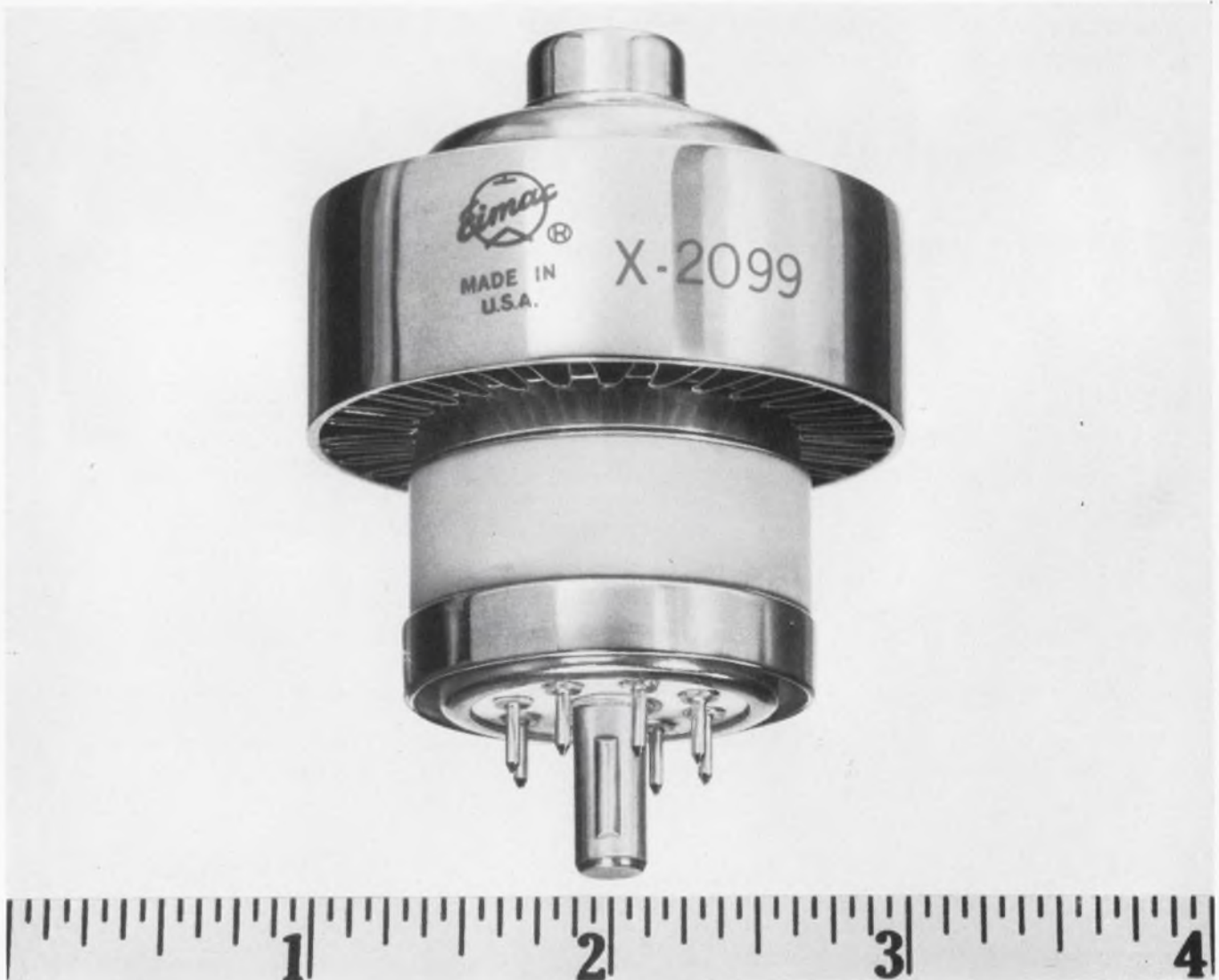

**THIS IS THE WIDEST SELECTION of
MINIATURIZED CERAMIC CAPACITORS
IN THE INDUSTRY!**

New
RED CAPS



AVAILABLE IN EVERY
STANDARD TEMPERATURE COEFFICIENT
...and in SEVEN DIFFERENT HI-K[®] Formulations

- *Red Caps meet or exceed all applicable requirements of MIL-C-20 and MIL-C-11015 per MIL-STD-202*

RED CAPS feature **JET-SEAL** ENCAPSULANT
ERIE'S EXCLUSIVE NEW

- Erie's new *Jet-Seal* excels in mechanical and electrical ruggedness
- Provides excellent moisture protection • Maintains electrical and mechanical stability at temperatures from -55°C through 150°C • *Jet Seal*'s bright color and gloss finish will be outstanding in even the most sophisticated equipment.



WRITE FOR SAMPLES on your company letterhead
ERIE TECHNOLOGICAL PRODUCTS, INC.
State College, Pennsylvania
Attention: Applications Engineering



Erie, Pennsylvania

MEAN DISTANCE: 238,857 MILES.
HIGH-RELIABILITY, QUALITY PRODUCTS NEEDED
EVERY MILE OF THE WAY



The Model 2600 Push-Button Rotary Switch is designed for only those applications requiring the highest of reliability and quality.

UNIQUE

Several interesting engineering accomplishments have made this push-button switch unique.

It is totally enclosed . . . and explosion proof.

It has a readout that can display numbers, symbols, color, and binary codes.

It even has its own light.

No other push-button switch has had so much designed into so little a package.



The Model 2600 is so small it has been nicknamed the "Space-Saver." And a Space-Saver it is . . . Only .350 wide x 1.00 high. This adds up to panel space savings.

APPLICATIONS

The Space-Saver represents tomorrow's push-button state of the art today.

It was designed for only those applications needing the finest

quality push-button switch. *It was designed for applications where function and performance outweigh all other criteria.*

When your project calls for nothing but the finest, high-reliability, push-button rotary switch manufactured, you can rest assured that it is available at Janco Corporation.

And we mean available . . . even for the mean distance and back!



JANCO
CORPORATION

3111 Winona Avenue, Burbank, California 91504

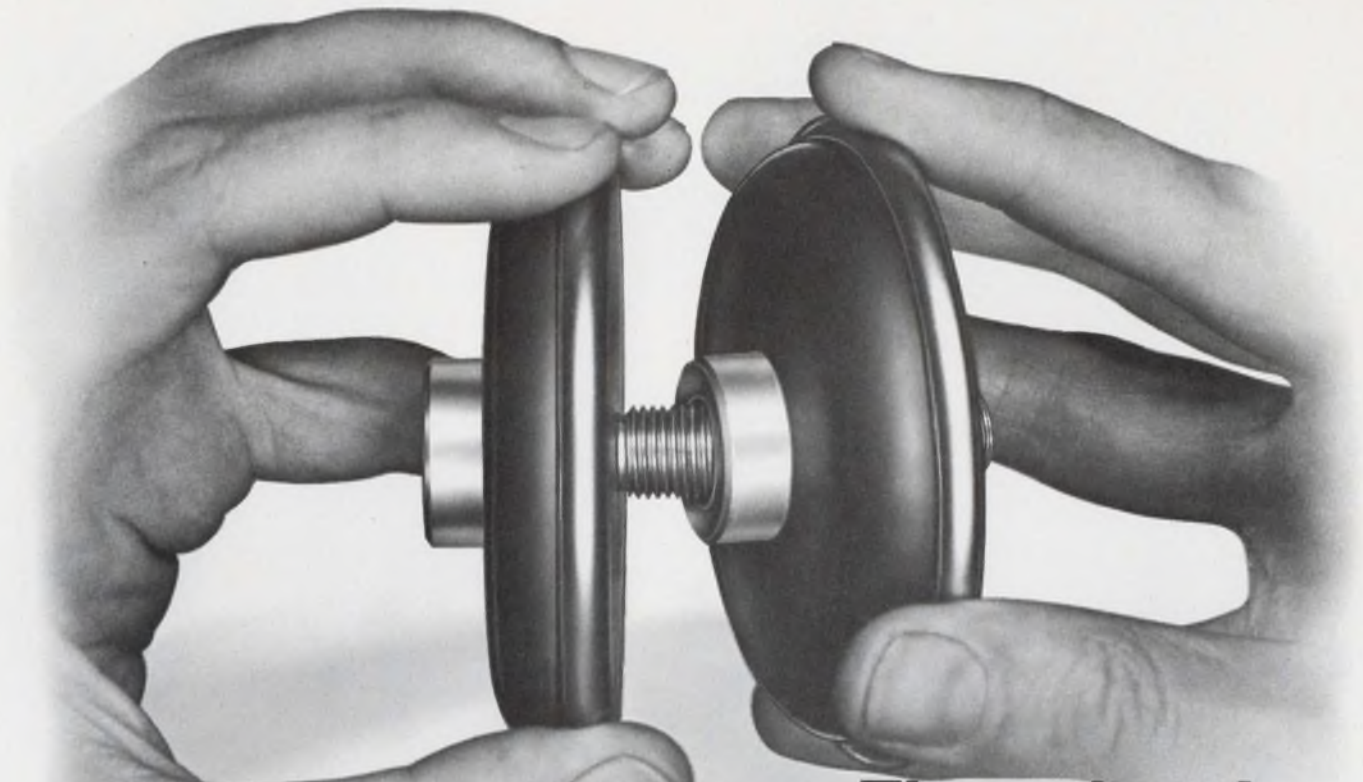

**These hands
are designing
a 50 KV–5 amp rectifier
that is virtually fail-proof.**

It's no oversimplification. They do work, they don't fail, and you can screw together almost any assembly you need up to 600 KV from the 14 stackable modules we have on the shelf. PIV's from 2.5 KV to 15 KV and currents to 10 amps. The men who designed these modules were high-voltage engineers. They knew the high-voltage engineering had to be done in the module before you started stacking. That's why they built in protection against transient surges. That's why they built in things like an anti-corona ring, shunt capacitance and controlled gradients. And that's why we haven't seen a legitimate failure of one of these devices in 3 years. Look . . .



**THE DOORBELL RECTIFIER MODULE BY
UNITRODE**

580 Pleasant St., Watertown, Mass. 02172, (617) 926-0404



Get yourself a complete set of specs that give you all kinds of information too detailed to put in this ad. Circle the reply card number.

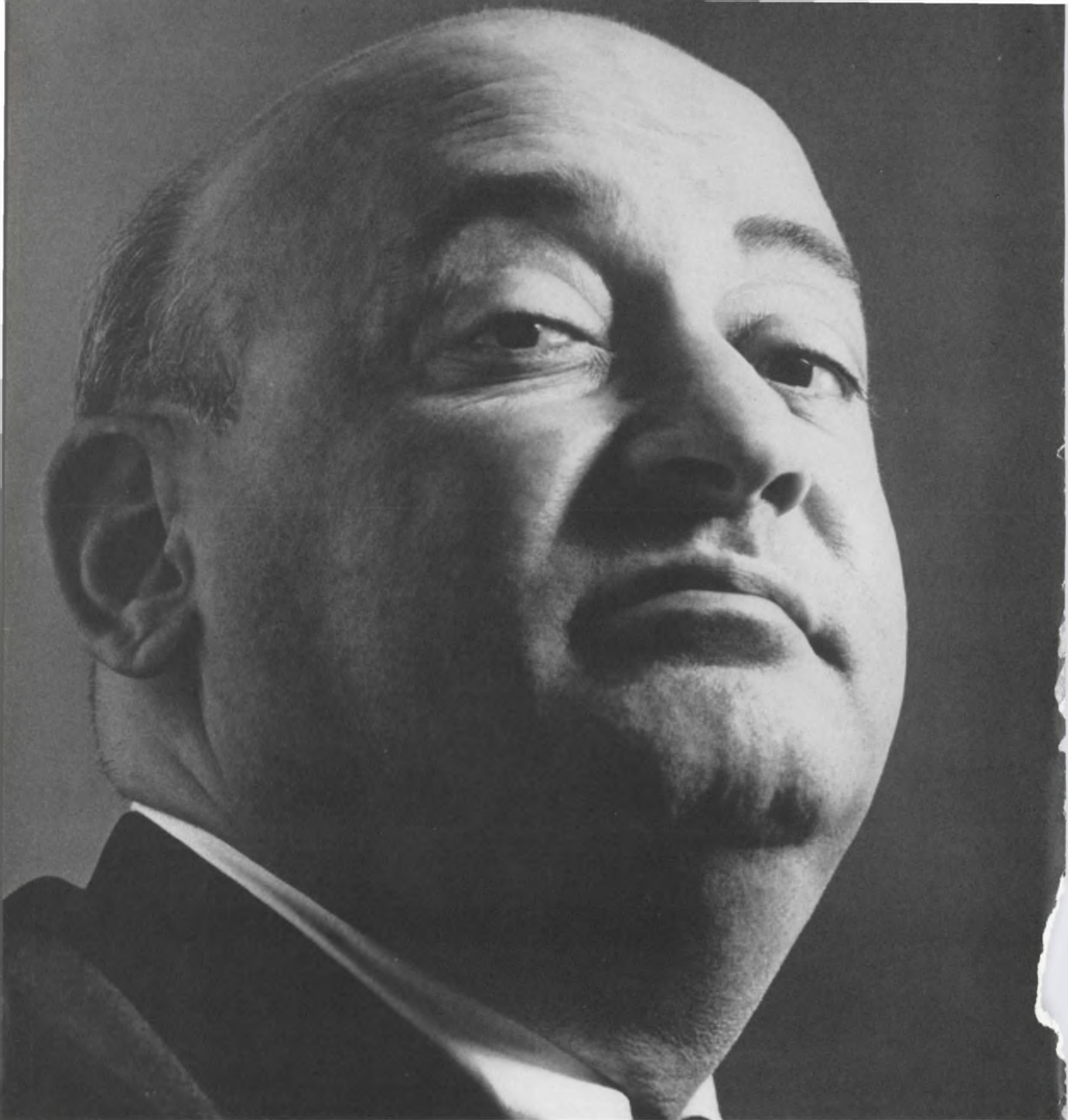

Why do so many people come to us when there's GE, Westinghouse and Tung-Sol?

Hudson designs and makes a full line of great miniature, sub-miniature and micro-miniature lamps—millions of them. But we're not giant-killers for that alone. Our product is lamps. Our business is service.

We climb beanstalks for our customers. If you need lamps—a box of ten or a carload—there's nothing more important to us than getting them to you on time,

in quantity. And if you need a bulb that's off the beaten path, we'll supply it without fuss or bother. At the right price. Soonest.

Next time you get a giant pain in your bulb supplier, ask for Hudson. (We get more new customers that way!) Hudson Lamp Company, 528 Elm Street, Kearny, New Jersey 07032. Telephone: (201) 997-1850.



LAMP COMPANY
Hudson

Free: a new Hudson Catalog (The Giant-Killer)

20 AMP

PNP SILICON POWER TRANSISTORS



TO-61 ISOLATED

from **Solitron**

Type Number TO-61 Isolated	MAXIMUM RATINGS			PRIMARY ELECTRICAL CHARACTERISTICS ($T_c = 25^\circ\text{C}$)					
	V_{CEX} Volts	V_{CEO} Volts	V_{EBO} Volts	h_{FE}		$V_{CE(sat)}$ Volts	$V_{BE(sat)}$ Volts	I_{CEX} μA	f_T MHZ
				$I_C = 20\text{A}$ $V_{CE} = -5\text{V}$	$I_C = 10\text{A}$ $V_{CE} = -5\text{V}$	$I_C = 10\text{A}$ $I_B = 1.0\text{A}$	$I_C = 10\text{A}$ $I_B = 1.0\text{A}$	$V_{CE} =$ Rated V_{CEX}	$I_C = 1.0\text{A}$ $V_{CE} = -10\text{V}$
				Min.	Range	Max.	Max.	Max.	Min.
SDT 3101	-40	-40	-6	5	30-90	-1.75	-2.5	10	30
SDT 3102	-60	-60	-6	5	30-90	-1.75	-2.5	10	30
SDT 3103	-80	-80	-6	5	30-90	-1.75	-2.5	10	30
SDT 3104	-100	-100	-6	5	30-90	-1.75	-2.5	10	30

Solitron has now assumed the leadership of PNP Silicon Power Transistors with the introduction of 20-Amp devices. These transistors are the highest current units of their type presently available in the industry. Identified as the SDT3101-4 family, they were developed with the same HIGH RELIABILITY standards of quality and performance associated with Solitron. Packaged in the popular Isolated TO-61 case, they have a voltage breakdown range of 40 to 100 Volts. A few of their many applications include power supplies, audio amplifiers, inverters, converters, relay drivers and series regulators.

Dial 1-800-327-3243 for a "No Charge" telephone call and further information

*When you think of semiconductors...
think Solitron!*

Solitron DEVICES, INC.

1177 BLUE HERON BLVD. / RIVIERA BEACH, FLORIDA / (305) 848-4311 / TWX: (510) 952-6676

INFORMATION RETRIEVAL NUMBER 13

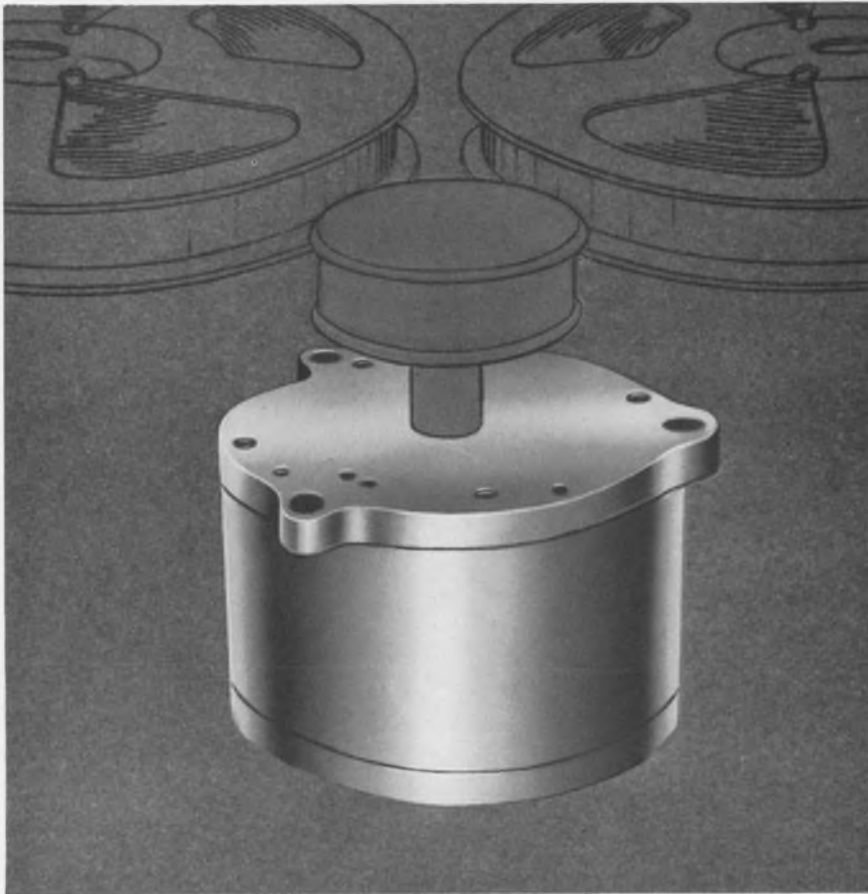

Inland Direct-Drive Torque Motors for CAPSTAN and REEL DRIVES

Inland torque motors provide precise speed control, low power consumption and high tension/rate accuracy in magnetic tape drives, spooling mechanisms and winders and magnetic wire take ups.



FOR REEL DRIVES

Where reel drives must have the capability of keeping up with the high reliability of a capstan, Inland d-c direct-drive Torque Motors meet the necessary requirements. Compact, light weight Inland torquers, with low power consumption, can be precisely controlled over a wide range of speeds and torques.

Frameless Inland torque motors, directly attached to the driven load save space, give high speed and efficiency with the complete absence of "backlash".



FOR CAPSTAN DRIVES

Many design applications call for critically small space limitations, without the loss of accuracy in driving the capstan at a precise speed to maintain constant tape tension at various selected speeds. Along with a truly accurate drive, an error sensing transducer to provide velocity damping for immediate response is also needed.

Inland's torque motor-tachometer generator combination units answer these requirements. These "tach-torquer" units, consisting of a standard torque motor and tachometer generator in a common housing, give you truly accurate speed and velocity damping in a single compact package.



TORQY SAYS:

If you would like complete information on using torque motors for either capstan or reel drives, just drop us a line . . .
No obligation, of course.



INLAND MOTOR
CORPORATION
OF VIRGINIA
RADFORD, VIRGINIA
703-638-3973
SUBSIDIARY OF **KOLLMORGEN**

Designer's Datebook

MARCH						
S	M	T	W	T	F	S
					1	2
3	4	5	6	7	8	9
10	11	12	13	14	15	16
17	18	19	20	21	22	23
24	25	26	27	28	29	30

APRIL						
S	M	T	W	T	F	S
		1	2	3	4	5
6	7	8	9	10	11	12
13	14	15	16	17	18	19
20	21	22	23	24	25	26
27	28	29	30			

For further information on meetings, use Information Retrieval card.

Feb. 14-16

International Solid-State Circuits Conference (Philadelphia) Sponsor: IEEE; Lewis Winner, 152 W. 42 St., New York, N.Y. 10036.

CIRCLE NO. 251

Feb. 28-Mar. 1

Scintillation and Semiconductor Counter Symposium (Washington, D. C.) Sponsor: IEEE, NBS, Atomic Energy Commission; W. A. Higinbotham, Brookhaven National Laboratories, Upton, N.Y. 11973.

CIRCLE NO. 252

Mar. 18-21

IEEE International Convention and Exhibition (New York) Sponsor: IEEE; J. M. Kinn, IEEE, 345 E. 47 St., New York, N.Y. 10017.

CIRCLE NO. 253

Apr. 3-5

International Conference on Magnetism (INTERMAG) (Washington, D.C.) Sponsor: IEEE; Philip Cohen, Magnetics, Inc., Butler, Pa. 16001, or J. M. Lommel, General Electric R&D Center, Schenectady, N.Y. 12301.

CIRCLE NO. 254

Apr. 9-11

National Telemetry Conference (Houston) Sponsor: IEEE; Lewis Winner, 152 W. 42 St., New York, N.Y. 10036.

CIRCLE NO. 255

Apr. 16-18

National Symposium on Law Enforcement Science and Technology (Chicago) Sponsor: U.S. Dept. of Justice; S. A. Yefsky, IITRI, 10 W. 35 St., Chicago, Ill. 60616.

CIRCLE NO. 256



“This is
Mariner V
now passing Venus”

Allen-Bradley hot-molded resistors
helped make the message “loud and clear”



TYPE BB 1/8 WATT



TYPE EB 1/2 WATT



TYPE HB 2 WATTS
Not used on Mariner V



TYPE CB 1/4 WATT



TYPE GB 1 WATT

A-B hot-molded fixed resistors are available in all standard resistance values and tolerances, plus values above and below standard limits. **A-B hot-molded resistors meet or exceed all applicable military specifications including the new Established Reliability Specification.** Shown actual size.

After a historic 217,000,000-mile journey, Mariner V probes the mysteries of Venus from a closer vantage point than ever before. The data from this successful venture into deep space will add immeasurably to our knowledge of Venus, and aid in planning future space missions.

As with numerous other missions, Allen-Bradley hot-molded resistors again justified the confidence placed in them. Their faultless performance was essential to the “loud and clear” report of the fly-by.

Allen-Bradley resistors are made by an exclusive

hot-molding process—developed and used only by Allen-Bradley. The resulting uniformity from resistor to resistor—billion after billion—enables long-term performance to be accurately predicted. And over the years, there has been no known instance of catastrophic failure.

For complete specifications on Allen-Bradley hot-molded resistors, please write for Technical Bulletin 5000: Allen-Bradley Co., 222 W. Greenfield Ave., Milwaukee, Wis. 53204. In Canada: Allen-Bradley Canada Ltd. Export Office: 630 Third Ave., New York, N. Y., U.S.A. 10017.

1067E-7

QUALITY ELECTRONIC COMPONENTS



ALLEN-BRADLEY

tricky tapers...

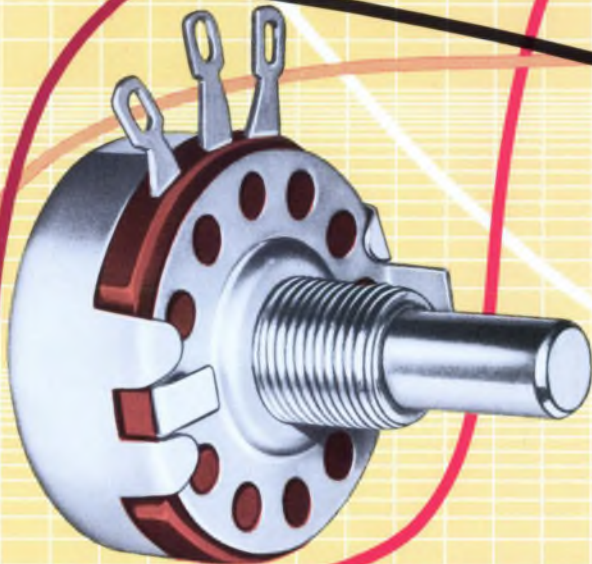

Allen-Bradley Type J
hot molded variable resistor
shown twice actual size

Allen-Bradley Type J potentiometers offer tapers designed to your special needs!

■ When standard tapers fail to provide the control you desire, Allen-Bradley Type J potentiometers have the unique capability to provide a virtually limitless variety of curves to meet your specialized requirements. While not a precision device that is continuously taper-trimmed to very close tolerances, Allen-Bradley's control of the resistance-rotation characteristics during production assures a high degree of conformity.

Allen-Bradley Type J potentiometers have a solid hot molded resistance track made by an exclusive process which was pioneered and perfected by A-B. This solid resistance track assures smooth adjustment at all times—with none of the discrete changes in resistance that are encountered in wire-wound units. And being essentially noninductive, Type J controls can be applied in high frequency circuits where wire-wound units are useless.

Furthermore, A-B's solid molded resistance track assures low noise and long life. On accelerated tests, Type J potentiometers exceed 100,000 complete operations with less than 10% change in resistance.

For more complete details, please write: Allen-Bradley Co., 222 W. Greenfield Ave., Milwaukee, Wis. 53204. In Canada: Allen-Bradley Canada Limited. Export Office: 630 Third Ave., New York, N.Y., U.S.A. 10017.

ADDITIONAL ALLEN-BRADLEY HOT MOLDED VARIABLE RESISTORS

TYPE G CONTROLS are only 1/2" in diameter. Quiet, stepless operation. Rated 1/2 watt at 70°C. Values to 5 megohms. Type L are similar in construction but rated 1/2 watt at 100°C.



TYPE F TRIMMERS are for mounting directly on printed wiring boards by means of their terminals. Rated 1/4 watt at 70°C. Values to 5 megohms. Type O are similar but rated 0.4 watt at 70°C.



TYPE R ADJUSTABLE RESISTORS for trimming applications are built to withstand environmental extremes. Only 1/4" in length. Have stepless adjustment. Watertight and can be encapsulated. Rated 1/4 watt at 70°C. Values to 2.5 megohms. Type N for less severe environments are rated 1/3 watt at 50°C.



ALLEN-BRADLEY
QUALITY ELECTRONIC COMPONENTS



A bold step forward in meter design . . .

The all-electronic digital panel meter

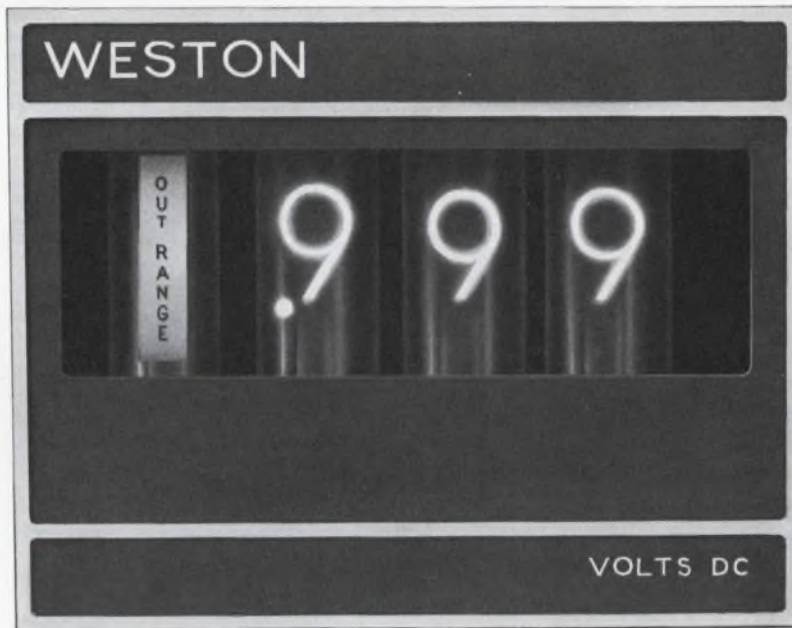

actual size

Model 1270 DPM* is the biggest advance in meter technology since Weston introduced the first panel meter in 1911. Conceived and built for panel use, it combines the accuracy of digital display with solid-state reliability for the first time in a compact OEM styled instrument. Dual slope integration provides 0.1% accuracy and long-term stability at a price competitive with bench units. User options include direct readout of analog information, linearization, and customized magnetic name plates. Write for full details . . . today.

Standard Features and Ranges

- Accuracy: 0.1% \pm 1 digit
- Automatic indication of over or under range
- Nixie® replacement from front panel
- Chassis depth (behind front panel): 4½ in.
- BCD 1-2-4-8 coded output (3 decades)
- Weight: less than 3 pounds

DC VOLTAGE

0-100 mv @ 10K
 0-1.00 v @ 100K
 0-10.00 v @ 1 meg Ω
 0-100 v @ 1 meg Ω
 0-1000 v @ 1 meg Ω

DC CURRENT

0-10 μ a @ 10K
 0-100 μ a @ 1,150 Ω
 0-1 ma @ 99 Ω
 0-10 ma @ 10 Ω
 0-100 ma @ 1 Ω

*Patents pending. NIXIE® Burroughs Corporation

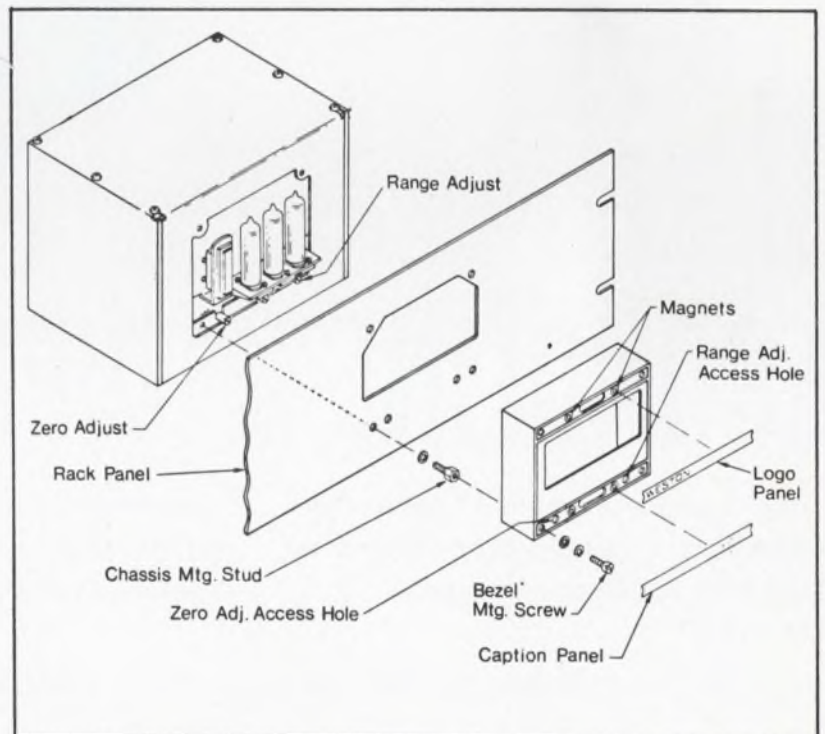

Weston Instruments, Inc., Weston-Newark Division, 614 Frelinghuysen Avenue, Newark, N.J. 07114, a Schlumberger company

WESTON® prime source for precision... since 1888

INFORMATION RETRIEVAL NUMBER 15

First from Sprague Electric!

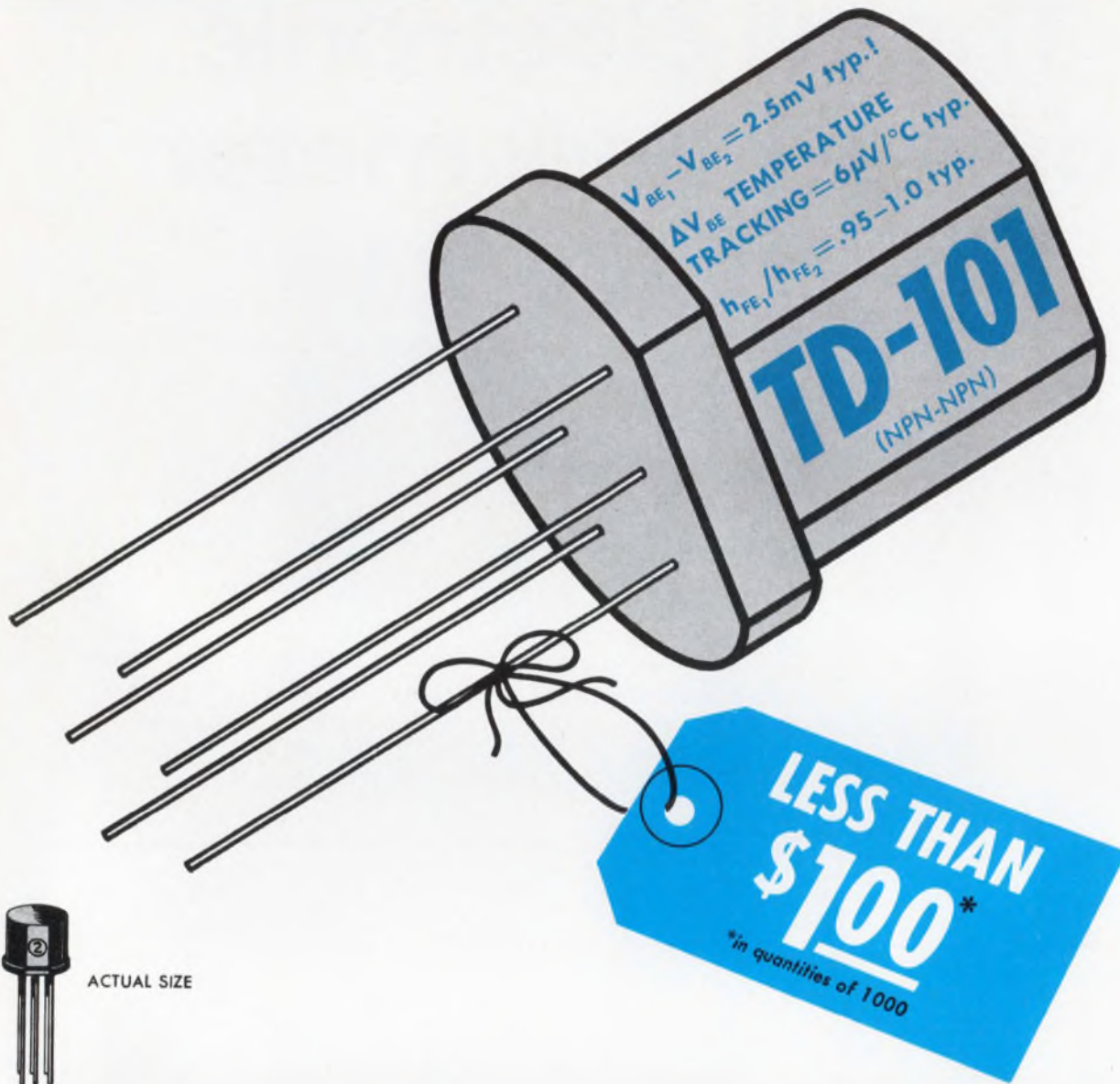

ECONOLINE[★] SILICON PLANAR PLASTIC DIFF AMP PAIRS

Other Sprague Econoline[★] differential amplifier transistor pairs available as PNP-PNP and NPN-PNP types.

[★]Trademark

For samples and complete technical data, call your Sprague district office or representative, or write on your letterhead to Sprague Electric Co., Concord, N.H. 03301.

Now available for fast delivery from your Sprague Industrial Distributor

SPRAGUE COMPONENTS

TRANSISTORS
INTEGRATED CIRCUITS
THIN-FILM MICROCIRCUITS
CAPACITORS
RESISTORS
485-713911

PULSE TRANSFORMERS
INTERFERENCE FILTERS
PULSE-FORMING NETWORKS
TOROIDAL INDUCTORS
ELECTRIC WAVE FILTERS

CERAMIC-BASE PRINTED NETWORKS
PACKAGED COMPONENT ASSEMBLIES
BOBBIN and TAPE WOUND MAGNETIC CORES
SILICON RECTIFIER GATE CONTROLS
FUNCTIONAL DIGITAL CIRCUITS



Sprague and 'S' are registered trademarks of the Sprague Electric Co.

INFORMATION RETRIEVAL NUMBER 16

News



Stress is put on the millimeter-wave region of the rf spectrum as a result of pressure to

expand the available spectrum and the advent of improved solid-state devices. Page 25

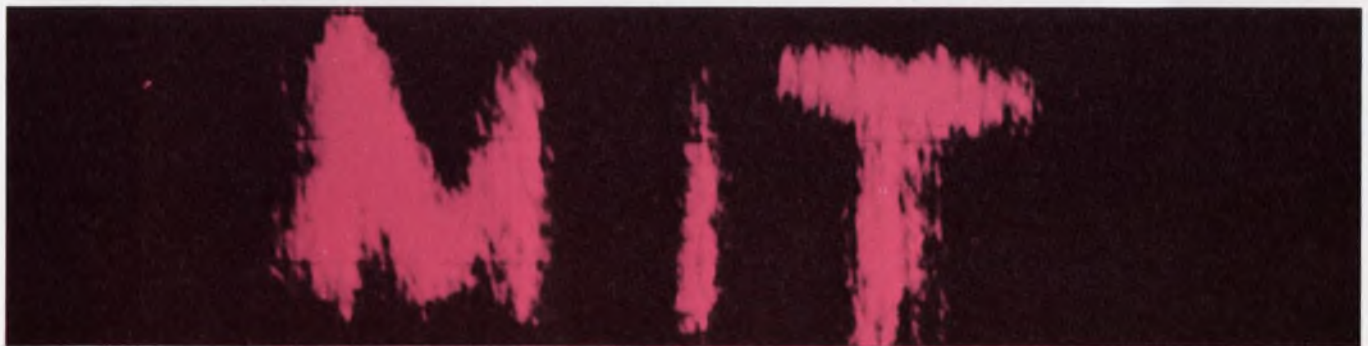

Taking pictures in the dark may be possible with a scheme that uses a laser-scanned

MOS to detect infrared images which then are converted into video signals. Page 34

Also in this section:

Air Force seeks engineers to cure its Vietnam weapons problems in 6 months. Page 33
News Scope, Page 21 . . . Washington Report, Page 37 . . . Editorial, Page 45

Now from Sprague!

QUALITY
STABILITY
RELIABILITY
SMALL SIZE

All the advantages of tantalum in one **LOW COST** capacitor!

EPOXY-DIPPED TANTALEX® CAPACITORS...

For industrial, commercial, and entertainment electronic applications where tantalum capacitors were previously too expensive!

—Type 196D Solid-electrolyte Tantalum Capacitors have special epoxy-dip coating which keeps costs down without sacrifice in dependability. Positively seals capacitor section while providing excellent electrical insulation. Protects against mechanical damage in handling.

—Radial lead design for plug-in mounting on printed wiring boards. The .250" lead spacing will fit standard .125" grids.

—High stability—very little capacitance change, even at outer limits of operating temperature range.

—Low dissipation factor of these capacitors permits higher ripple currents.

—Meet environmental test conditions of Military Specification MIL-C-26655B.

—Prime capacitance and voltage ratings. Based on rating popularity of other types of solid tantalum capacitors.

—Designed for continuous operation at temperatures from -55°C to $+85^{\circ}\text{C}$.

For complete technical data, write for Engineering Bulletin 3545 to Technical Literature Service, Sprague Electric Company, 347 Marshall Street, North Adams, Massachusetts 01247.

Now available for fast delivery from your Sprague Industrial Distributor

SPRAGUE COMPONENTS

CAPACITORS
TRANSISTORS
RESISTORS
INTEGRATED CIRCUITS
THIN-FILM MICROCIRCUITS
45C-4138R1

PULSE TRANSFORMERS
INTERFERENCE FILTERS
PULSE-FORMING NETWORKS
TOROIDAL INDUCTORS
ELECTRIC WAVE FILTERS

CERAMIC-BASE PRINTED NETWORKS
PACKAGED COMPONENT ASSEMBLIES
BOBBIN and TAPE WOUND MAGNETIC CORES
SILICON RECTIFIER GATE CONTROLS
FUNCTIONAL DIGITAL CIRCUITS

SPRAGUE®
THE MARK OF RELIABILITY

'Sprague' and '®' are registered trademarks of the Sprague Electric Co.

INFORMATION RETRIEVAL NUMBER 17

Defense Dept. orders multiple warheads

The Defense Dept. is now committed to multiple, independent-reentry-vehicle (MIRV) warheads for U.S. intercontinental ballistic missiles and is sponsoring their development. High accuracy is claimed for the devices, which would disperse to hit a number of targets simultaneously.

Since each MIRV would carry a lesser nuclear payload than single warheads, the blast radius of the nuclear weapons would be smaller, and accuracy demands would be far more stringent.

The Pentagon says that the new warheads will be "far more accurate" than the present operational warheads, such as Avco Corp.'s Mark 11 for Minuteman 2. Defense experts are so convinced of this that they are canceling the Avco Mark 17 program, which was to have resulted in a big, new nuclear warhead for the Minuteman 3 missile.

The Mark 17 program called for expenditure of \$175 million by the end of fiscal 1970. Approximately \$45 million has already been spent, and technical improvements will be incorporated into the Mark 11.



Missile silos like this are standing by for MIRV

Meanwhile Avco is proceeding with the development of advanced penetration aids and multiple warheads. Some \$65 million has been allocated, and the work will be spread over approximately 20 months, according to Avco.

The means for dispersing multiple warheads has not been identified, but one plausible method is the use of spring-released bodies expelled under control of a timing mechanism. This approach has already been used for dispersing piggyback defense satellites.

One scheme that has been suggested to increase accuracy is the patterning of the smaller warheads around a single hardened target. Multiple-reentry vehicles ordinarily involve wider dispersal to cover, say, several different cities.

In the light of the U.S. decision, a well-known nuclear scientist and author, Dr. Ralph E. Lapp, has called the Soviet Union's efforts to protect its cities against nuclear attack a "lost cause."

Speaking at Washington and Jefferson College, Washington, Pa., Dr. Lapp said that "if half of our 1710 strategic missiles are converted to multiwarhead configurations, the United States will have 18 times the kill capacity required to knock the Soviet Union out of the twentieth century."

Lunar Module Makes Good First Flight Test

The first flight test of the Apollo Lunar Module, LM-1, on Jan. 22 was a qualified success, according to space officials. It essentially met its key objectives:

- To exercise the descent propulsion system, which will bring the module out of lunar orbit and land it on the Moon.

- To try out the ascent engines, which will put the module back into orbit and bring it to a rendezvous with its command module for return to Earth.

- To fire the ascent engines while the descent engines were in operation, to simulate an abortive attempt to land on the Moon.

The flight also proved the RCA electronic control systems for each propulsion stage and partially tested the module's guidance system. During the first test, however, the Raytheon guidance computer shut down the descent engine after only four seconds instead of the planned 38. For this reason it was not used for later engine control. Officials pointed out that, had astronauts been aboard, they could have remedied the premature shutdown.

They stated after the flight that sufficient data were obtained to be able to consider it a success.

The next Apollo launching, that of the unmanned Apollo 6, will take place as scheduled during the first quarter of this year—probably next month.

Computers of the '70s given a sneak preview

The design of computer X—International Business Machines Corp.'s computer of the Seventies—is the subject of M. O. Paley's paper for the International Solid-State Circuits Conference in Philadelphia Feb. 14 to 16.

Computer X, purportedly 1000 times more powerful than the IBM 360 series, is said to require gates with a delay of one-third nanosecond and propagation times of one nanosecond. Achieving this speed will entail large-scale integration (LSI) on the order of 200 circuits/in.². Improved LSI memory units as well as improved logic are anticipated.

One big problem looms: how to interface high-speed computers with low-speed peripherals (for example, cathode-ray tubes, photographic printers, data communication links). The peripherals foreseen for the computer X are expected to be only 50 times faster than those of the 360 series.

While LSI may pay off best in computer memory units, where the tiny dimensions facilitate short

propagation times, the desirability of a brute-force approach to computer design is questioned by Tudor Finch of Bell Telephone Laboratories, Murray Hill, N. J.

Finch comments that it takes tens of millions, if not hundreds of millions, of bits to produce useful information for our technological society. There has been no breakthrough beyond storing every single bit. Therefore, the emphasis is on higher speed, capacity and integrity, coupled with lower cost.

"But," Finch says, "life is getting so complicated that I'm not sure we're going to be able to do with the binary bit as we know it."

He complains that we don't know how to store information in the form of a single bit. What is needed, he says, is a new bit that would express the content of, say, 10 binary bits.

According to M. G. Stickler of Bell Telephone Laboratories, Allentown, Pa., more and more computer-aided design will be needed for LSI because of the complexity of interconnections and functions. Stickler says there are two major problems associated with the use of LSI in systems:

- The vendor-customer relationship—how to reduce the amount of discussion on how it will look and what will go on the chip. In effect, the customer may be asking the vendor to build his computer.

- Testing on two levels—the functional (logic) and the device (currents, voltage levels, turnoffs).

Surveyor 7 photographs laser beams from earth

In one of the last experiments conducted by Surveyor 7 before it was shut down for the 2-week lunar night late last month, the spacecraft photographed and returned to earth images from two laser beams that were flashed from the Kitt Peak National Observatory near Brightwood, Calif.

The beams which were two inches wide at the earth spread out to several miles at the Moon's surface.

Three to four watts were used by each laser. One of the experimenters, Prof. C. O. Alley of the University of Maryland said that the Moon's distance could now be measured to an accuracy of six inches, far greater accuracy than is possible with radar.

Apollo astronauts will mount reflectors on the lunar module when it lands on the Moon's surface. Then Professor Alley's group will try to pinpoint the spacecraft by beaming lasers at the reflectors.

Corona discharge may quiet sonic booms

The application of electrostatic forces to the forward end of a supersonic aircraft body may alter the atmospheric flow pattern and so reduce or eliminate sonic boom, according to two Northrop Company aerodynamicists.

In a paper, "Electroaerodynamics in Supersonic Flow," presented during a meeting of the American Institute of Aeronautics and Astronautics in New York, M. S. Cahn and G. M. Andrew described laboratory corona-discharge tests during the past two years that tend to support this conclusion. According to the Norair Div. experts, wave drag may be reduced far enough to decrease the aircraft thrust power needed for a given speed, including the added power required for the on-board electrostatic generators.

The authors pointed out that in subsonic motion a pressure signal precedes a moving body, causing air particles to change direction and bypass the body in a smooth flow. In supersonic flow, these advanced signals are absent because the moving body's velocity exceeds that of the pressure signals. As a result, air particles approaching the aircraft change direction abruptly, forming shock waves and the sonic boom that sweeps across the ground below.

Their tests, in both liquids and aerodynamic test chambers, have shown that, if a very high electrostatic potential is applied to a supersonic aircraft's forward structure and the charge is the same as that of the oncoming air, the charged air particles anticipate the moving vehicle and respond

much as with a subsonic craft.

Studies will be continued at Northrup, to determine the best way to apply electrostatic forces to minimize shock-wave propagation.

Federal standards due for radiation hazards

Senate Commerce Committee hearings resume this month on the Radiation Control for Health and Safety Act. The bill, introduced last July by Sens. Edward L. Bartlett (D-Alas.) and Robert C. Byrd (D-W. Va.), aims to make the Federal government responsible for setting standards for the use of ionizing and electromagnetic radiation. The main concern at present is to control X-radiation and gamma-ray emissions. A similar bill has been introduced for study by the House of Representatives.

Both bills would have the Secretary of Health, Education and Welfare draw up regulations to protect public health from hazardous radiation by electronic products. They would also demand a program of research into the short- and long-term biological effects of all types of radiation.

During Senate hearings last August, Dr. Karl Z. Morgan of the Oak Ridge National Laboratory estimated that between 3500 and 29,000 deaths a year were attributable to some degree of irradiation.

Teflon in Microcircuits

A General Electric paper to be delivered at the International Solid-State Circuits Conference in Philadelphia this month will reportedly announce a new integrated-circuit process that uses a Teflon film as a bonding medium and dielectric. It is said to increase reliability and reduce interconnection problems in both linear and digital devices.

F-111 cut makes waves

Britain's cancellation of its order for 50 F-111 jet fighters is expected to affect a broad segment of the U.S. electronics industry, since about 40% of each aircraft's nearly \$7 million cost is for electronics.

PROBE
AND READ
IN-CIRCUIT
MEASUREMENTS



RF Vector Impedance Meter with direct readout simplifies testing



**A COMPANION INSTRUMENT COVERS THE
5 Hz to 500 kHz RANGE**

The Hewlett-Packard 4800A Vector Impedance Meter measures impedance in seconds. It does for AC measurement what the ohmmeter does for DC testing. Just plug it in and read it. Price: \$1,490.00. Complete specifications are yours on request.

The Hewlett-Packard 4815A RF Vector Impedance Meter provides fast, direct reading measurements of impedance and phase angle over the frequency range from 500 kHz to 108 MHz. The convenience of probe measurement and direct readout make the instrument equally useful for laboratory, receiving inspection or production line measurements. The 4815A reads complex impedance over its full frequency range without charts, data interpretation or a slide rule. As a result, it offers fast, accurate evaluation of the complex impedance of both active circuits and components.

The 4815A is an all solid-state integrated vector impedance *system* that reads out directly in Z and θ . Low-level signal strength minimizes circuit disturbance and prevents overloading the test component. Price: \$2,650.00. For complete specifications, contact your local Hewlett-Packard field engineer or write Hewlett-Packard, Green Pond Road, Rockaway, N. J. 07866.

HEWLETT *hp* PACKARD
measuring instruments
for science and industry

IMPEDANCE INSTRUMENTS



One shot with parylene covers everything.

There are a lot of ways to make a "conformal" coating. Dipping, spraying, fluid bed . . . you name it.

But only one way, vapor deposition, gives you a *perfect* conformal coating all over in one shot, every time. No matter how dense the circuitry or how complex the component, a uniform and continuous coating is deposited. (Vapor deposition of BAKELITE parylene is an exclusive process from Union Carbide.)

Here's why. With parylene, you're not coating with a liquid. You're vapor-depositing a polymer. There are no solvents to

evaporate, no opacifying fillers, no additives, no baking, no drying. And no multiple coatings are needed to make sure it's pin-hole free. (This means that you can save as much as 10 hours in coating time.)

Parylene conformal coatings can be as thin as 0.002 mil or as thick as 3 mils or more. And they won't, they can't run, sag, bloom, blister, wrinkle or blush.

What else? As a conformal coating, parylene is a primary dielectric, an unsurpassed moisture barrier, resists softening at high temperatures, and its chemical resistance is outstanding.

If you have a circuit or component that you think might benefit from this new plastic why not let our development custom coating service make a trial run for you. Why take our word for it?

(If you haven't heard, parylene production units for your own use are available, with a license, from Union Carbide.)

For additional information about our BAKELITE parylene, please write to Union Carbide Corporation, Dept. ED-2, 270 Park Avenue, New York, New York 10017.



Milliwave systems make solid advances

New rf sources and components expand use of ehf band for communications and science

Neil Sclater
East Coast Editor

Renewed activity is evident in the "attic" of radio frequencies — the millimeter-wave region. Long dormant, the relatively unexplored region is receiving new emphasis because of two developments:

- Pressure to expand the available frequency spectrum.
- Improved solid-state sources and components.

The new direct-conversion power sources — avalanche-transit-time, limited - space - charge - accumulation (LSA) and Gunn-effect diode oscillators — plus improved solid-state frequency multipliers promise escape from the problems of power, weight, reliability and the high cost of microwave-tube sources, long impediments to milli-

meter-wave applications.

The integrated-circuit approach, combined with microstrip transmission lines, will yield smaller, cheaper, yet precise, components that eliminate waveguide fabrication problems at high frequencies.

Increasing interest apparent

Evidence of activity is seen from the following system efforts:

- NASA is sponsoring a development program in millimeter-wave monolithic integrated circuitry for a horizon-sensing system.
- Martin Marietta Corp. is building millimeter links for NASA's Applications Technology Satellite to be launched next year.
- Bell Telephone Laboratories has announced construction of

solid-state repeaters for guided transmission at millimeter frequencies. The company's interest has picked up lately after lying dormant for a number of years.

▪ Sylvania Electric Products, Inc., recently built a short-range, highly directional military communications system that operates at millimeter frequencies.

Pressure for escape from the crowded neighboring microwave bands is increasing, but millimeter-wave systems applications have not increased for a number of reasons. The high cost of currently available hardware does not justify many practical applications at this time, say most industry observers. They report that power sources and components are difficult to make and test, and are unreliable.

Others cite such reasons as the diversion of government money from research because of the Viet-

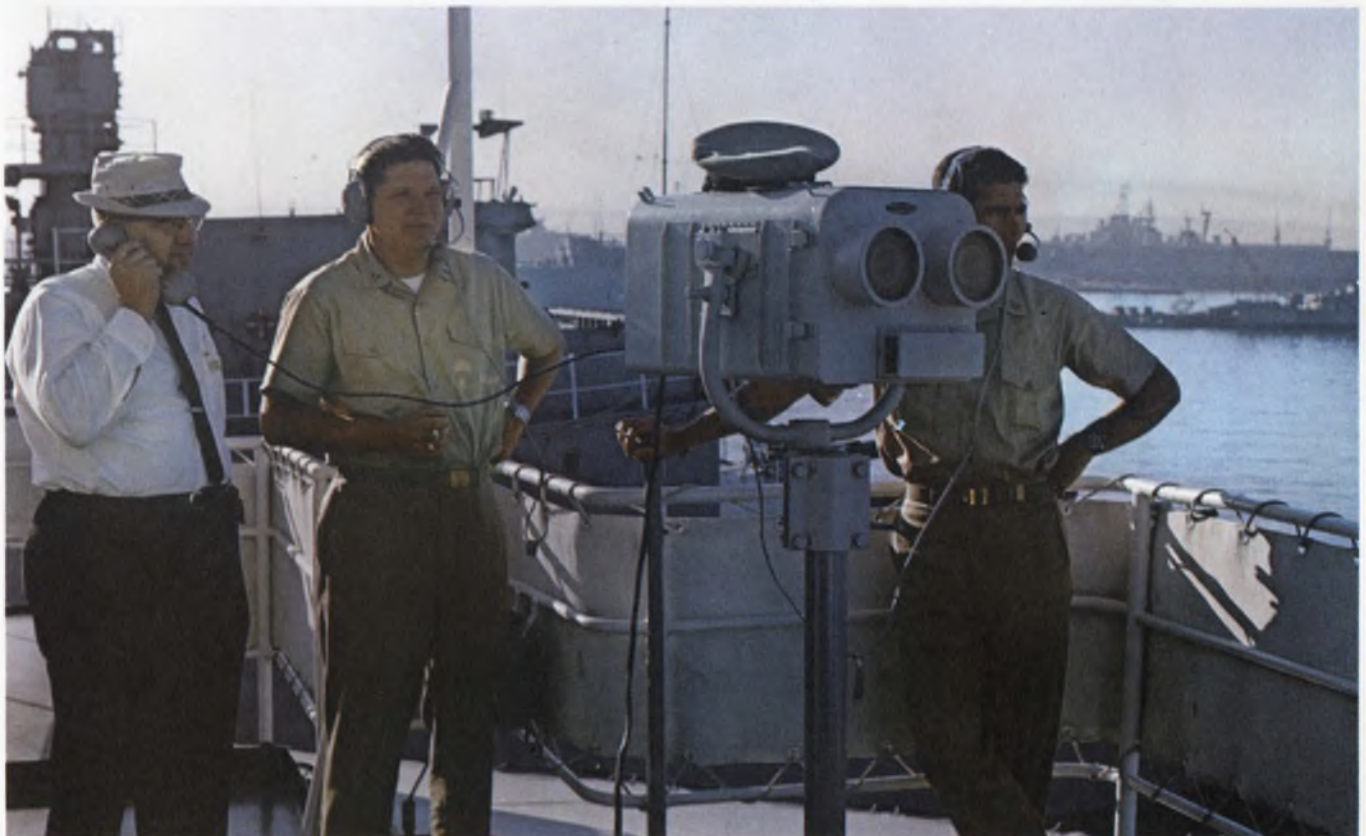

A solid-state, narrow-beam, millimeter-wave transceiver is at one end of a ship-to-ship communication link. It uses harmonic generation to reach the 36-to-38-GHz

region for secure signaling. The Sylvania system has a 15-mile range. Identical horn and lens antennas are used for sending and receiving.

(Millimeter systems, continued)

nam war and the lack of low-cost, high-quality commercial millimeter band test instruments to support development efforts.

The millimeter region is the extremely high frequency or ehf band that lies between the top of the microwave band, 30 GHz, and the bottom of the infrared band, at 300 GHz. These correspond to 10 mm and 1 mm, respectively.

Most practical system work is now going on in the 30-to-100-GHz region. The main emphasis is on the lower end because of the similarity of the technology to that used in the adjacent microwave K band.

Relief for spectrum crowding

Since millimeter waves offer wider bandwidths than those available in the microwave region, they make efficient space and earth-to-space communications links possible.

The shorter wavelengths permit smaller, more highly directional antennas with resultant higher resolution. There is also the possibility that transmitting and receiving equipment can be made lighter and

more compact than is practical at microwave frequencies.

Millimeter waves, however, are more subject to absorption, refraction, dispersion and other problems than lower frequencies.

Absorption a problem

The most severe problem in millimeter-wave propagation is absorption through the atmosphere. At some frequencies it is so high that the atmosphere is opaque for all practical purposes.

Fortunately there are frequency regions where atmospheric absorption is relatively low (see figure). These regions, termed windows, occur at about 30 to 40 GHz and at about 90 to 100 GHz.

Absorption is caused by the coupling of an electromagnetic wave with oxygen and water-vapor molecules. Investigations of absorption effects have been carried out by the University of Texas, Bell Telephone Laboratories, U.S. Air Force Cambridge Research Laboratories, Martin Marietta Corp., and elsewhere.

Researchers have found that as the elevation angle of propagation increases and less of the atmosphere is traversed, absorption decreases.

This means that for horizontal transmission, attenuation due to absorption, refraction dispersion, etc., becomes more of a problem over long distances than it would at high elevation angles, even at the window frequencies.

If, however, both transmitter and receiver are above the atmosphere in space, these restrictions are not imposed. Also, if the transmission is confined to a waveguide, which is controlled by the removal of water vapor and oxygen, the full millimeter band can be used.

Atmospheric absorption can prove helpful if one wants secure transmission, according to Dr. James Wiltse of Martin Marietta Corp.'s Millimeter and Microwave Laboratory, Orlando, Fla. By operating at or near an absorption frequency, a transmission can be made secure because the signal does not overreach its destination.

He added that the very narrow bandwidths possible with millimeter-wave antennas also enhanced link security.

Equipment already in use

Fixed ground-station equipment in the 30-to-40-GHz range is al-

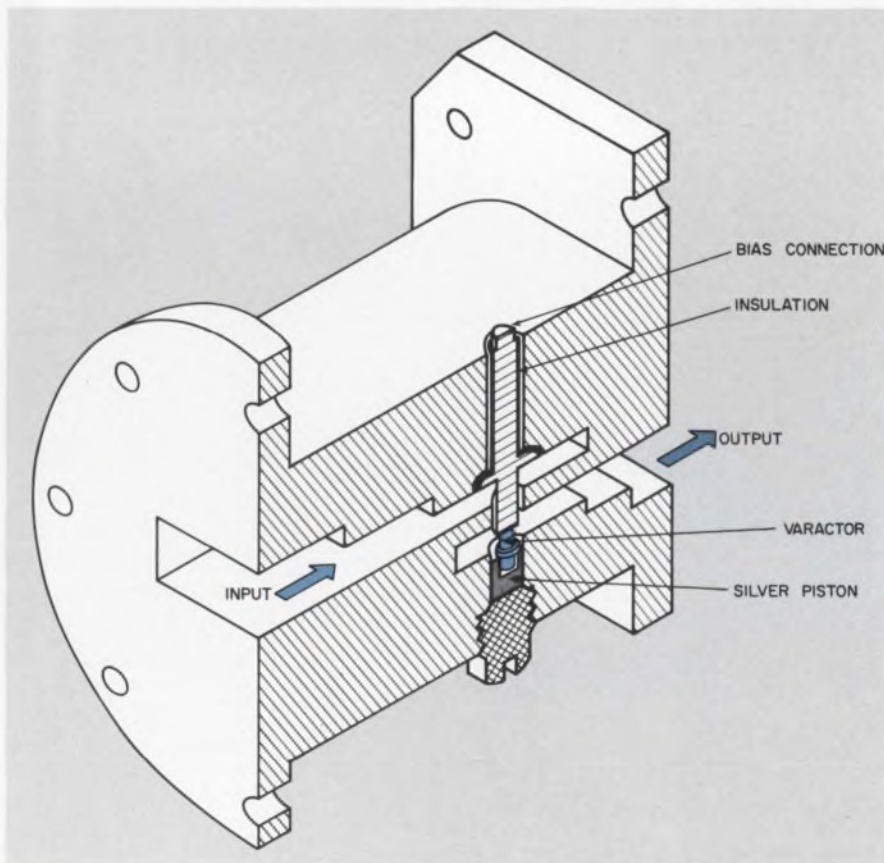

A three-stage multiplier made by Sylvania develops 5 mW at 94 GHz. The driver is an 11.75-GHz, 500-mW source. Cutaway (left) shows the middle doubler that raises the 23.5-GHz output of the first stage to 47 GHz. All waveguide components are electroformed so precisely that tuners have been eliminated.

From Monsanto: 130,000,000 discrete frequencies with almost perfect purity.



Computer-aided design and integrated-circuit construction in this new Frequency Synthesizer bring a new level of perfection to signal generation. The new "4th generation" Model 3100A Digital Frequency Synthesizer obsoletes just about every current concept of general purpose signal sources. Pick your frequency from 0.01 Hz to 1.3 MHz in 0.01 Hz steps. The result—signal purity you can get only from Monsanto, with a stability of 1 part in 10^9 / day. Other refinements include: internally supplied rapid or slow sweep and provision for

external sweep; dc coupled output permitting internally supplied offset; continuous control of output level over a 90 dB range; provision for amplitude modulation; and, in the remotely programmable version, switching time of less than 20 microseconds. Best of all, you can put this *better way* of signal generation to work for you for only \$3,950*. Call our field engineering representative in your area for full technical details, or contact us directly at: Monsanto Electronics Technical Ctr., 620 Passaic Ave., W. Caldwell, N.J. 07006. Ph. (201) 228-3800; TWX 710-734-4334.

*U. S. Price, FOB West Caldwell, N. J.



ELECTRONICS

(Milliwave systems, continued)

ready available, Dr. Wiltse explained. High-power transmitters using traveling-wave tubes are in use, and he said that at least eight ground stations in various parts of the country were already equipped with low-noise receiving equipment for tracking or radio astronomy.

Satellite and portable equipment, on the other hand, poses more of a problem, he said. Restrictions on power, weight and volume impose these limits. Furthermore, he said, most components are not built to function outside a laboratory. More rugged components are needed for space use.

The power-source problem is the most serious, according to Dr. Wiltse. Sources, now available include klystrons and solid-state harmonic generators. They require input power of 10 to 80 watts to give only milliwatts of millimeter power.

Reflex klystrons, the workhorses of the laboratory bench, are not satisfactory for most satellite and portable telecommunications systems, Dr. Wiltse said, because of high-cost, high-voltage requirements and low predicted lifetimes.

Solid state holds promise

The systems engineer looking for a solid-state millimeter-wave

source is faced with a dilemma. Theoretically three devices are available for direct dc to rf conversion—the avalanche-transit-time oscillator, the Gunn-effect oscillator and the LSA oscillator. But they are still in the process of development and the engineer may not have time to wait for a definitive outcome before making his choice.

As a result, he will probably look to the varactor harmonic generator to multiply the frequency of a transistor driver in order to reach the millimeter range.

Even the solid-state experts cannot agree on the best replacement for the harmonic generator, considered by most as a stopgap. But further development is expected to set a clear order of preference among the direct dc-to-millimeter sources. The impact avalanche-transit-time diode oscillator, called IMPATT by the Bell Telephone Laboratories, is a strong contender in the millimeter region, ranks high in all performance areas. Because the diodes can be made from silicon and germanium as well as gallium arsenide, they appear to have an edge over devices that depend on the characteristics of gallium arsenide alone.

The oscillator circuit contains a pn junction diode that is reverse-biased into the avalanche breakdown in an external circuit. The interaction between the delay caused by the avalanching and the

carrier transit time set by the diode's thickness can cause conditions for oscillation. Voltage and current can be set at 180° out of phase, to give the diode the negative-resistance characteristic.

Reliability has not been proven

Within recent years much has been written about the glamorous Gunn-effect and LSA devices as microwave power sources (see "Solid-state microwave power growing up," ED 20, Sept. 27, 1967, pp. 17-19). They have been explored theoretically and many sample devices have been built and tested. But the experts still are not sure about their long-term reliability. Gallium arsenide, a material that has not yet proven its stability, life and reproducibility, may gradually degrade in use.

Both devices depend on variations in the spatial mobility of carriers in doped GaAs within a dc electric field—a phenomenon that does not occur in silicon.

The characteristic voltage-current curve of GaAs includes a negative slope, indicative of negative resistance. The devices are biased to operate in that region.

The oscillation frequency of a Gunn-effect device depends on the thickness of the active region, whereas the LSA oscillator does not depend on this carrier transit-time relation.

Selection of the doping level of the bulk GaAs and close control of the dc bias enable the LSA device to operate within the negative-resistance region of the GaAs in a way that is independent of material length. As a result the LSA device can be as much as 20 times thicker than the Gunn device.

Since the LSA device is thicker, it can withstand higher input power and so produce higher output power.

Solid-state multipliers praised

Many of the current millimeter transmission systems use harmonic generation to reach the desired frequency. The initial power source can be either a microwave tube or solid-state source.

Arthur Solomon, Sylvania Electric Product Inc.'s Semiconductor Div., Woburn, Mass. says:

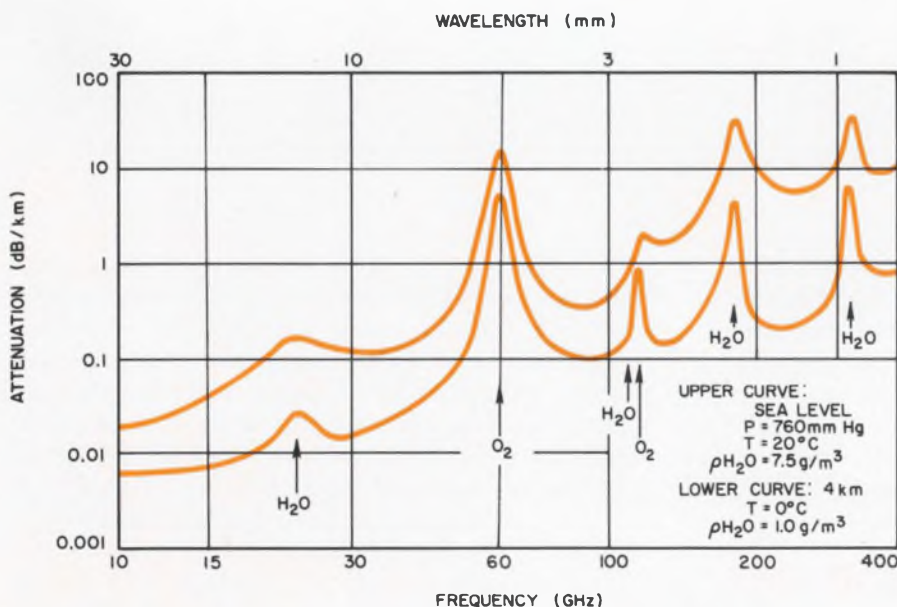

Attenuation per kilometer for horizontal propagation of millimeter waves varies with altitude and is affected by oxygen and water vapor. P indicates barometric pressure, T atmospheric temperature and ρ_{H_2O} the water vapor density.



KEPCO'S NEW 3 in 1 POWER SOURCE

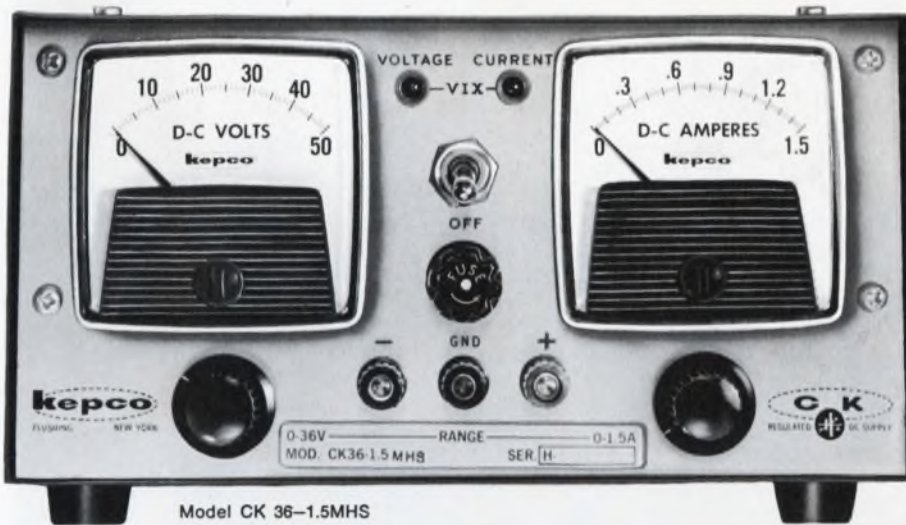

- **UNIPOLAR AMPLIFIER**
- **FAST POWER SUPPLY**
- **QUICK RECOVERY CURRENT REGULATOR**

Three different product descriptions; just one instrument! Kepeco's new fast programming CK-HS group offers three distinct instrument capabilities in five models, all similar except for their volt-ampere ratings from 0-8 volts at 5 amperes to 0-60 volts at 0.5 amperes. All offer the features that have made the regular Kepeco CK Power Supplies popular.

- Ten-turn voltage and current controls
- True automatic crossover, twin voltage/current regulators
- 0.01% performance in both voltage and current modes
- VIX® mode indicators

Plus — a whole host of new capabilities based on the fast programming ability

- Operational amplifier-like feedback characteristics
- Current mode recovery at better than 10 microseconds per volt*
- Modulation capability for use as a d-c instrumentation amplifier
- Fast settling programmability for automatic test equipment sequencing or stepping. The slewing rate is 10⁵ volts per second (measured as the chord to a single time constant)

*The 0-18 volt, 3 ampere model will recover through the entire 18 volt compliance in less than 180 microseconds.

The new CK-HS are described in a new way, too — using the powerful *voltage amplifier offset ratings* to describe performance in precise, unambiguous terms. For a look at these specs and a description of their meaning, check the new — white cover — Kepeco Catalog B-678.

If you haven't already gotten your copy
write Department N-5



KEPCO, INC. • 131-38 SANFORD AVENUE • FLUSHING, N.Y. 11352
(212) 461-7000 • TWX # 710-582-2631
Telex: 12-6055 • Cable: KEPCOPOWER NEWYORK

INFORMATION RETRIEVAL NUMBER 21

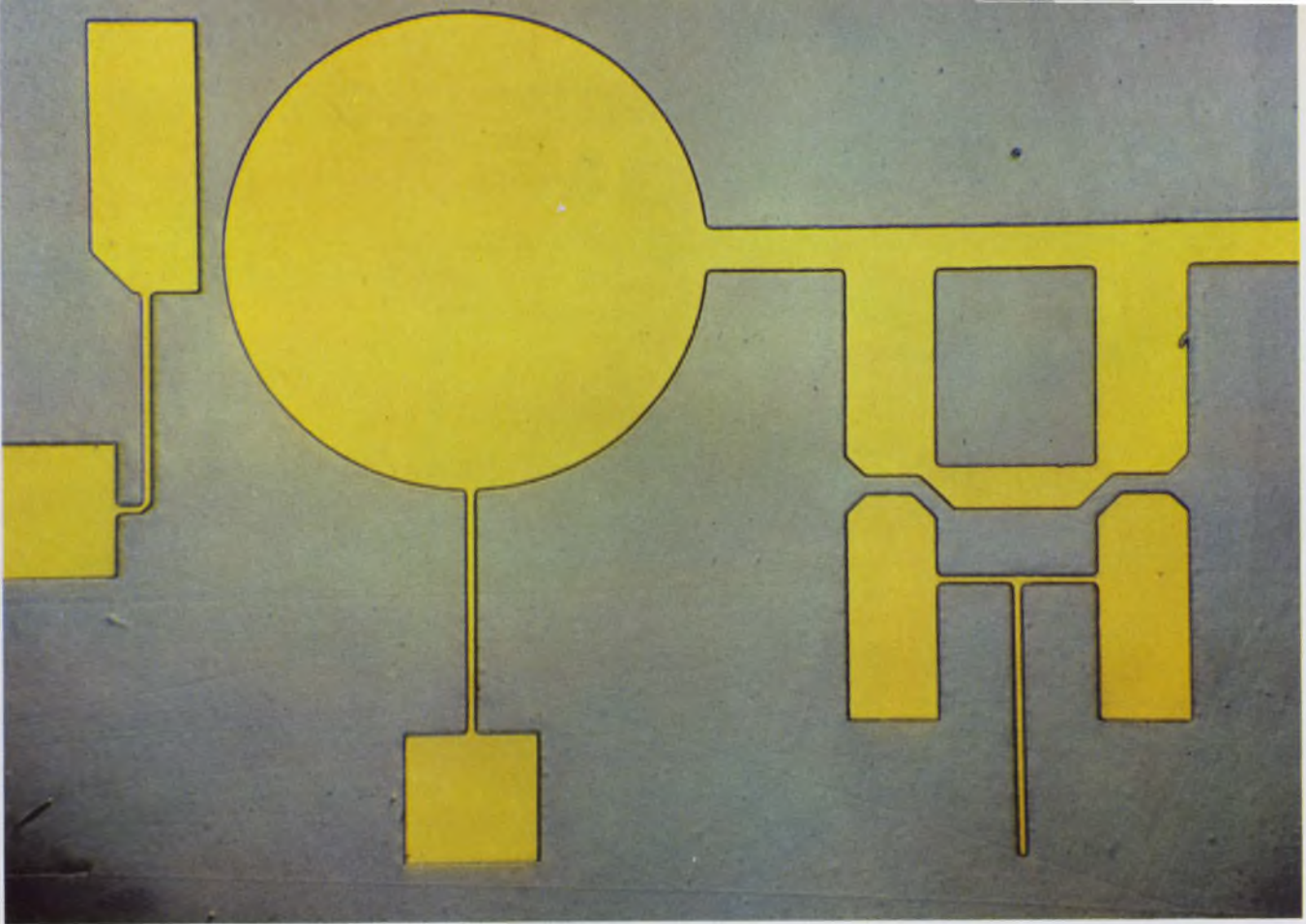

An epitaxial growth mask for a 60-GHz monolithic integrated-circuit receiver front end shows the stage layout. An LSA diode will be grown between the strip and circu-

lar cavity (left) to form the local oscillator. Schottky diodes are grown in gaps (right) to form the balanced mixer portion of the Texas Instruments receiver.



Detail of the Texas Instruments monolithic IC shows a Schottky barrier diode between a strip-line directional coupler and a matching section of the receiver front end.

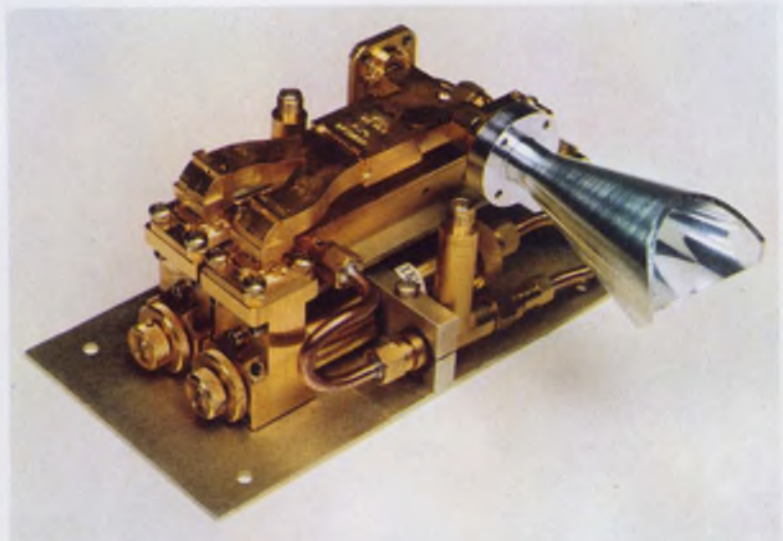

Horn antenna and mixer for NASA's ATS-E satellite millimeter-wave experiment. The horn radiates a 20° conical beam. Up link of the Martin Marietta equipment is at 31.65 GHz, down link at 15.3 GHz. Separate experiments will be performed at the two frequencies.

(Milliwave systems, *continued*)

"We expect that the newer, direct-generation devices will play a very important role in millimeter-wave power generation in the future. However, today the most reliable millimeter-wave, solid-state source that one can buy is the varactor multiplier chain, driven by a transistor oscillator amplifier."

Millimeter ICs for systems

NASA is sponsoring a development program at Texas Instruments, Inc., Dallas, to furnish monolithic integrated circuits for use in a horizon-sensing instrument. The circuit is a receiver front end or head that includes a direct dc-to-rf millimeter-wave source and a balanced mixer stage.

The 60.8-GHz receiver is being built for NASA's Electronics Research Center at Cambridge, Mass. The 60.8-GHz frequency was selected because it coincides with a high-absorption region in the millimeter spectrum (see chart), necessary for the operation of the instrument.

At this frequency, atmospheric oxygen absorbs the rf energy. By building a passive receiver at this frequency into the horizon sensor, NASA investigators hope to develop a lightweight navigation instrument to determine the true vertical reference for spacecraft.

The NASA project engineer, Janis Vilcans of the Electromagnetics Guidance and Control Branch, explains that the millimeter-wave horizon sensor will be used in a manner similar to an infrared horizon sensor. But it is expected to be accurate to one minute of arc rather than the infrared limit of 0.2 degree.

Vilcans says the final receiver front end will likely consist of a 15.2 GHz Gunn oscillator quadrupler stage and balanced mixer. All microstrip circuit elements will be grown on a 100-mil-thick gallium arsenide chip. It is expected to require 1 watt of input power.

An alternate design called for an LSA-diode local oscillator that would generate 4 mW of cw power at 60.8 GHz directly from 4 V dc.

The gallium arsenide chip will



TC/VCXO

FREQUENCY STABILITY

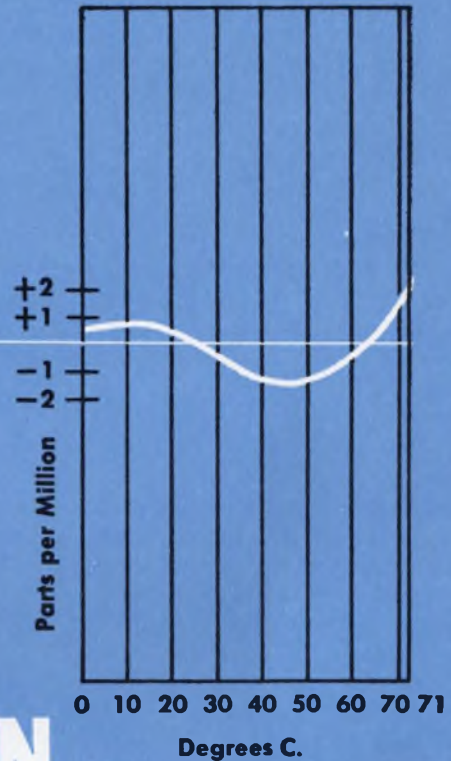

NO OVEN

TC/VCXO

Frequency Stability within $\pm 2 \times 10^{-6}$ over 0 to 71°C range



Typical TC/VCXO Model 5968WA
Center Frequency: 6.8 MHz
Size: approx. 2 1/2" L x 1 1/4" W x 3/4" H

If space and power are limited in your telecommunication system, consider the advantages of the Damon Temperature Compensated Voltage Controlled Crystal Oscillator (TC/VCXO). This rugged, miniaturized unit provides a frequency deviation of ± 100 Hz about center frequency and maintains a stability comparable to that of an "ovenized" unit without the need for added circuitry and power.

The illustration, above, shows a frequency stability curve for a simple Damon TC/VCXO. To achieve comparable frequency stability an "ovenized" unit would require more space and more power.

Tight temperature compensation is only one example of Damon VCXO capability. Low noise, small size and increased reliability are other Damon VCXO accomplishments. Perhaps your telecommunication system suggests new VCXO problems? Consultations between circuit designers and Damon engineers are the best route to proper VCXO selection. As a starter, may we invite you to write for the Damon VCXO Brochure. Damon Engineering, Inc., 115 Fourth Avenue, Needham Heights, Mass. 02194 (617) 449-0800.

DAMON

(Milliwave systems, continued)

be fitted to a miniaturized waveguide antenna-matching section in the prototype radiometer receiver. The complete component would weigh 30 grams and have a volume of 1/4 cubic inch.

NASA experiment planned

NASA's Applications Technology Satellite, ATS-E, to be launched early in 1969, will contain a millimeter-wave study experiment to explore satellite communications.

The objective of the experiment is to determine statistically the propagation variables that are important in communication links in the 15- and 31-GHz regions. Martin Marietta Corp. is building three sets of satellite equipment to be delivered to the Goddard Space Flight Center this spring under a \$1.1 million contract.

The satellite will be placed in a synchronous, 19,357-nautical-mile orbit over the equator near Hawaii. Four ground stations will be equipped with 15.3-GHz receivers and two or three with 31.65-GHz transmitters.

The 29-pound satellite equipment will consist of a separate receiver and transmitter that permit separate tests at the different frequencies (see diagram).

The satellite's 15.3-GHz transmitter will be a crystal-controlled varactor multiplier chain delivering 300 mW. Phase modulation will be introduced by biasing a multiplier stage varactor. Local-oscillator power will be derived from another stage of the chain.

The 31.65-GHz receiver will be a dual conversion superheterodyne unit.

Both satellite antennas will be conical segmented horns that will radiate 20-degree circular beams large enough to include the entire Earth from the synchronous orbit.

Satellite vs ground links

The Bell Telephone System proposed to the Federal Communications Commission in 1966 that it be allowed to use part of the millimeter band. It wants to use unassigned frequencies in the 18-GHz

and 30-GHz range for domestic satellite communications.

Bell Telephone Laboratories, meanwhile, is looking even further to the future. Although there have been no proposals for the use of guided transmissions, many scientists suggest the possibility of ground links in buried ducts that use larger portions of the millimeter band.

Researchers at BTL have also recently completed and tested an all-solid-state millimeter-wave repeater that operates at a carrier frequency of 51.7 GHz. It transmits binary pulse-code-modulated data at a 306-Mb/s rate.

The experimental repeater includes all the active circuitry for a complete repeater, and it contains channel filters of the type needed to separate and combine the many

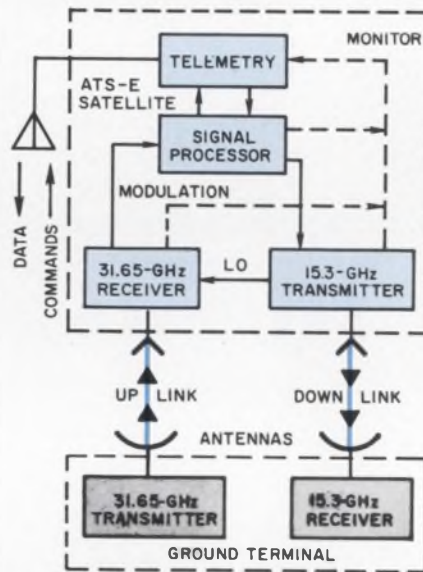

The millimeter-wave experiment with NASA's ATS-E satellite is organized so atmospheric effects on up and down links can be studied separately.

Goal for cw solid-state sources

(Predicted for 30-40-GHz)

Type	Cw Power	Power conv. efficiency	Noise rating
IMPATT (Silicon)	0.8 W	8%	3
Gunn effect	20 mW	5%	2
LSA	3.0 W	10%	1
Harmonic generator	350 mW	35%	2

* Compared to Klystron

channels of an actual system.

The experiment was intended to demonstrate the feasibility of millimeter-wave repeaters for guided communications systems.

The Bell researchers used three different power sources: a 50.4-GHz LSA diode, a 12.6-GHz IMPATT feeding a frequency quadrupler, and a 50.4-GHz IMPATT.

The Bell researchers reported that they had obtained enough gain from the experimental repeater to permit 15-mile repeater spacing in a circular waveguide with a 2-inch inside diameter.

Sylvania testing own system

A solid-state, millimeter-wave, frequency-modulated ground communications system has been built by the Sylvania Electronics Systems Div., Williamsville, N.Y. The work was done under a company-sponsored program to demonstrate the feasibility of narrow-beam, secure military communications.

Multiplier circuits have been used to raise the low frequency of a transistor driver amplifier to the transmitting frequency of 36 to 38 GHz and to achieve a power output of 100 mW.

Sylvania engineers say they have demonstrated the system as a ship-to-ship link at ranges in excess of 15 miles. They found no noticeable reduction in signal strength or adverse effects on voice when the system was operated in light rain, snow or fog. ■■

Bibliography:

- Altshuler, Edward E. *Earth-to-Space Communications at Millimeter Wavelengths*. ("USAF Office of Aerospace Research Physical Sciences Research Papers," No. 125.) Springfield, Va.: Clearinghouse for Federal Scientific and Technical Information, 1965.
- Dees, J. W. *Millimeter-Wave Propagation Experiments from Satellites*. Orlando, Fla.: Martin Marietta Corp., 1967.
- Electromagnetic Spectrum Utilization—The Silent Crisis*. ("Publications of the U.S. Dept. of Commerce.") Washington, D.C.: U.S. Government Printing Office, 1966.
- Hubbard, W. M., et al. "A Solid-State Regenerative Repeater for Guided Millimeter-Wave Communication Systems," *Bell System Tech. J.*, XLVI, No. 9 (November 1967), 1977-2018.
- Wacker, R. W., and Mao, S. *Surface-Oriented GaAs Gunn Oscillators and Schottky-Barrier Diodes*. Dallas: Texas Instruments, Inc., 1967.

Rx for weapons problems: Fast, fast design

Air Force welcome mat is out for engineers who can solve Vietnam equipment troubles in 6 months

John F. Mason
Military-Aerospace Editor

The U.S. Air Force in South Vietnam will soon have a radar for helicopters that will provide the pilot with a picture good enough to reveal roads and trails. Its resolution will make it thoroughly adequate for finding downed pilots in the ocean and even on land. If the pilot is carrying a beacon, it can lead his rescuers to him even though he's covered by brush.

The Army is examining the same radar for its hunt-and-kill operations; the resolution is fine enough to reveal convoys or even a clump of Vietcong moving across an open field at night. And the Coast Guard is interested in the radar for spotting submarine periscopes.

Other airborne weapons being tested for use in Vietnam include one that will home on ground searchlight complexes, just as infrared missiles home on heat and radiation seekers zero in on ground radar. Although the details are classified, presumably air-to-ground missiles are being rigged up to knock out enemy searchlight batteries, thereby making Air Force night missions safer.

Directorate seeks solutions

The developments are part of an intense program at the Air Proving Ground Center at Eglin Air Force Base, Fla., under sponsorship of the Air Force Directorate of Technical Applications for Southeast Asia. The directorate, which has been in existence only four months, was set up to solve weapons problems that are arising in Vietnam. Twenty-eight projects are currently being pressed.

Solutions for the directorate's problems must be attainable within six months — a year at the most — and existing hardware and tech-

nology must be used. To test its solutions, the directorate awards contracts to industry to build prototypes, which are then operated and analyzed at Eglin. Approximately 100 company representatives have found their way to the small directorate office at Eglin.

The rotor-blade radar that has interested three of the military services uses high frequency (Ku band between 16 and 20 GHz) and a high cursor rate to achieve its excellent resolution. The transmitting antenna, which is in the trailing edge of one of the helicopter's rotary blades, moves at six to seven revolutions a second, or about 60 times as fast as a conventional antenna on a helicopter might scan. The lag between scans is therefore nonexistent to the eye, and a steady picture is presented at all times. The maximum range provides a picture of terrain that is 15 miles in diameter.

Despite the high frequency, the radar penetrates bad weather if it's "less than pea soup fog or less than heavy rain," according to an official of the directorate.

Besides its search function, the radar provides precise altitude information and can be used for terrain avoidance, weapons delivery, landing, and station-keeping.

The antenna, which has been placed in the trailing edge of the blade because the leading edge is subject to erosion, is pressurized and hermetically sealed to prevent a moisture build-up.

Two radars have been tested at Eglin. One was built by the team of Texas Instruments, Inc., Dallas, and Bell Helicopter Co. in Fort Worth. Lockheed Electronics Co., Plainsfield, N. J., built the other. The directorate at Eglin expects to award a contract soon for one of the radars.

Lockheed is also developing an advanced version of the radar sys-

tem, using integrated circuits and a phased-array antenna. The bigger, improved model, which will deliver 30 kW of power, will be tested aboard a Hiller FH-1100 helicopter.

A further extension of the radar at Lockheed will result in a phased-array system for the leading edge of a fixed-wing plane.

Detonating by infrared

Another important project being set up at Eglin is to develop an optical proximity fuse for fire bombs. Since fire bombs are more effective when detonated high enough above the ground to spread over a wide area, a device to measure a set distance above the ground is crucial.

The contractor will be asked to build a fuse that transmits from the righthand side of the nose of the bomb an extremely narrow beam of infrared light toward the ground. The beam will be aimed slightly toward the left. Several inches from the transmitter, on the lefthand side of the bomb, a photoelectric device, pointed slightly to the right, will monitor a point of the transmitted beam at precisely the distance from the bomb at which detonation is desired. When the bomb reaches this distance above the ground, the photoelectric device will receive a pulse of transmitted light, rather than a continuous beam — the first reflection from the ground that it will receive. This will detonate the bomb.

A contract with the Picatinny Arsenal, Dover, N.J., calls for improved infrared decoys to mislead the enemy's heat-seeking missiles from attacking the Air Force's F-105 and F-4 fighter planes.

The Directorate of Technical Applications for Southeast Asia was set up to provide a link between the operational commands, the research and development organizations of the Air Force and industry. The object is to provide quick solutions to technical problems that arise in Vietnam. Thailand and elsewhere in Southeast Asia. ■■

Laser-scanned MOS detects infrared

MIT scheme improves night vision by converting heat radiation into video signals for display

Richard N. Einhorn
News Editor

A novel way of taking pictures in the dark and displaying the images on such devices as oscilloscopes may result from a discovery by two scientists at MIT.

By scanning an indium antimonide metal-oxide-semiconductor (MOS) structure with a laser beam, the scientists have detected infrared images focused onto the structure. In addition they have found that images can be stored, nondestructively read out, and erased.

Dr. John O. Dimmock, of MIT's Lincoln Laboratory, who collaborated with Dr. Robert J. Phelan Jr. in the discovery, says:

"By focusing a scene through lenses onto the infrared detector, you might be able to use it for nighttime reconnaissance."

Phelan and Dimmock explain that

the electrical characteristics of an MOS structure can be modified by radiation. When a uniform MOS structure has been exposed to infrared radiation, the image causes a change in the photo-response if the structure is scanned with a spot of visible light.

Phelan points out that the principle is not limited specifically to InSb MOS detectors; nor must a laser be used for optical readout.

As the infrared source in one of their experiments (see figure), Phelan and Dimmock have used a warm plate masked by a metal sheet with the block letters MIT cut out. The radiant energy is collected by a spherical mirror and focused onto the detector.

The detector consists of a semi-transparent nickel film-oxide layer-InSb sandwich cooled to 77°K. Two leads are fastened to the detector. One runs from a copper heat sink

that is attached to the semiconductor. The other lead goes to a gold tab evaporated on the metal film.

The detector is scanned with a 1-mW, 0.63- μ m helium-neon laser focused to about a 0.3-mm spot. The laser beam is deflected by two rotating mirrors, one of which is driven at a 10-Hz rate by a loud-speaker and the other at 1 kHz by a tuning fork. The amplifiers used for electrical excitation of the drivers also feed the vertical and horizontal inputs, respectively, of the oscilloscope, to synchronize the sweep. This gives a reasonably continuous display, with some flicker.

The output of the detector is amplified and discriminated. Signals above a preset threshold are applied to the internal input of the oscilloscope and modulate the electron beam. The result is an image on the cathode-ray tube corresponding to the infrared image.

Collection efficiency high

Phelan and Dimmock say that InSb MOS structures exhibit this infrared photovoltaic response because of generation of electron-hole pairs in the depletion region of the n-type InSb at the InSb-oxide interface. Collection efficiency is high because the depletion region is at the semiconductor surface.

According to the two scientists, two other effects of radiation can be used for detecting images:

- Charging of electron states in the oxide or at the InSb-oxide interface by radiation in the vicinity of 1 μ m.

- Modification of these states by ultraviolet radiation (possibly through the induced photoconductivity of the oxide).

No bias other than the field-effect bias of the trapped charge is used. In fact, the scanning laser enhances the trapped charges and fixes it at a steady-state value. Images can be stored for more than an hour and erased by raising detector temperature or by saturating the detector with radiation from a mercury lamp. ■■

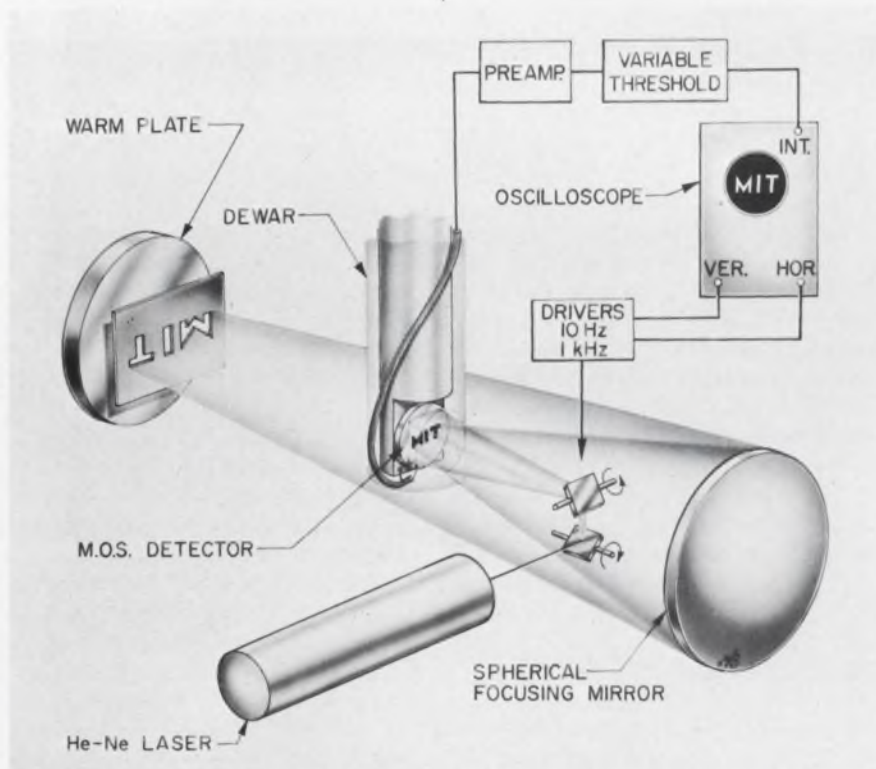

InSb MOS structure detects infrared image when scanned by laser beam. Infrared radiation changes the photoresponse of the detector, producing an electrical output. The oscilloscope sweep is synchronized with the laser beam.

**Now — A Wideband
I/C op amp
With Differential
“Inputs” And “Outputs”**

Here's a new integrated circuit operational amplifier that adds a new level of flexibility to the designers' tools. The differential input gives the MC1520 extremely good common-mode rejection ratio of 90 dB (typ) — making it an excellent choice for use in instrumentation, communications and computer equipment.

The MC1520 also offers high differential gain of 70 dB (max) — numerically 3,000 — giving it wide applications potential as a general purpose operational amplifier. (Other comparable circuits offer a gain of less than 1000.) It's particularly useful in wideband applications that require large output voltage swings at high frequencies — especially those requiring differential outputs.

- Wide closed-loop bandwidth — 10 MHz.
- High input impedance — 2 Megohms.
- Low output impedance — 50 Ohms.
- Full output voltage swing to greater than 2 MHz.
@ $V_e = 100$

**Versatility of MC1520
Discussed
in New Note**

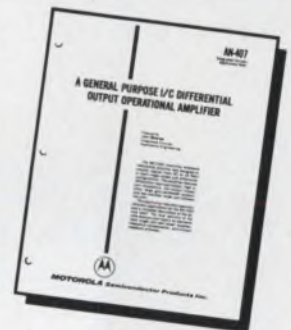

Motorola Application Note AN-407 familiarizes the designer with the electrical characteristics, operation and the unusual versatility of the MC-1520 amplifier and describes stage-by-stage operation of the device. Applications discussed include: wideband non-inverting operational amplifiers, wideband inverting operational amplifiers and differential amplifiers (with both differential inputs and differential outputs).

The MC1520 is available *now* from distributor stock, in both the TO-99 metal package and the TO-91 ceramic flat pack. For complete specifications and a copy of AN-407, write P.O. Box 955, Phoenix, Arizona 85001.

—where the priceless ingredient is care!



MOTOROLA Semiconductors

MOTOROLA SEMICONDUCTOR PRODUCTS INC. / P.O. BOX 955 / PHOENIX, ARIZONA 85001 / (602) 273-6900 / TWX 910-951-1334

INFORMATION RETRIEVAL NUMBER 23



The new Fluke 853A: The only complete multimeter.

Accuracy, measurement capability, and low cost have been a long time coming in the multimeter field. Now, they're here with the introduction of the new Fluke 853A. □ These specs are guaranteed for one year without recalibration. DC volts 0.2%. AC volts, 0.5%. Range, 0 to 1.1 kv. DC amps, 0.2%. AC amps, 0.5%. Range, 0 to 11 amps. Ohms, 0.2%. Range, 0 to 110 megohms. All this plus complete overload protection. Price, \$445. □ Does this data bit give you just a hint why we also call the Fluke 853A, "the only complete multimeter"? Write or call for complete information.

Fluke, Box 7428, Seattle, Washington
98133. Phone: (206) 774-2211.
TWX: (910) 449-2850.



In Europe, address Fluke International Corporation, P.O. Box 5053, Ledeborstraat 27, Tilburg, Holland. Telex: 844-50237. In U.K., address Fluke International Corporation, P.O. Box 102, Watford Herts, England.

See us at IEEE, Booths 2C02-2C04



Military money level; NASA down

The Administration's budget for fiscal year 1969, released last month, can expect a mixed reaction and some surgery from an austerity-bent Congress. Insiders foresee two likelihoods—that the request for military finances will probably go fairly unscathed but will certainly elicit torrents of caustic comment on the floor of both chambers; and that NASA will find that even Congressional friends will be unable to prevent its appropriations from being cut to \$4 billion or less. The previous year's Congressional paring of over \$500 million has proved to NASA's opponents that their resistance to high space expenditures can be effective.

In at least two instances the Executive has already wielded an ax. The Apollo Applications Program will be forced to limp along with minimal money, so that an effective space follow-up to Apollo lunar exploration will be seriously delayed. The result will be an emasculated program with far fewer missions than planned. NASA will also be denied the chance to initiate the Earth-Resources Orbiting Satellite, despite the backing of the Secretaries of Interior, Agriculture and Commerce. EROS is intended for long-term observations of such natural phenomena as forestry and crops, fish migration, water pollution and ice flow.

The military has already felt the pinch on its equipment-procurement dollars. But while it may have trouble starting new, marginal programs, little cutback is anticipated in the purchase of major weapons systems. Most new-aircraft programs will be unaffected. The emphasis will continue on missiles for advanced warheads and guidance-and-control techniques. One possible change could occur in the Sentinel program—rumors about difficulties with the development of Sprint persist and the program could see a change to accommodate use of a new, higher-acceleration vehicle.

Washington Report

CHARLES D. LAFOND
WASHINGTON BUREAU

Military electronic procurement and R&D financing is expected to continue at the same level as in fiscal 1968, or to be slightly higher (to reflect the effect of an inflated dollar) (see "Electronic sales still rise, but at a slower rate," ED 1, Jan. 4, 1968, pp. 25-30).

AWACS contractors narrowed

It appears now that only two firms will be asked to respond with proposals for the contract-definition phase of the Airborne Warning and Control System (AWACS) — Boeing and McDonnell Douglas. Lockheed Aircraft has been denied the opportunity to re-enter the competition by the Dept. of Defense. (Lockheed at first considered entering its C-141 aircraft, then withdrew, then attempted to re-enter with its C-5A aircraft.)

It has been learned from the Pentagon, however, that the Dept. has been receptive to Lockheed's arguments and may reconsider its denial. The C-5A Galaxy will be capable of very long-sustained operation and of carrying massive loads. Forty-two C-5As are said to be able to do the same job as the 62 aircraft that would be required from either Boeing or McDonnell Douglas. The C-5A will also be operational by late 1969 or early 1970, making it available at the same time as AWACS is scheduled to be deployed.

TV X-radiation studied in Washington

The Public Health Service is using the color-television-set owners among its 20,000 employees in the Washington area for a study over several weeks of undesirable X-ray emissions. It has indicated that arrangements have been made through the Electronic Industries Association for the full cooperation of the industry in the survey.

The present project follows a pilot survey carried out last year in Pinellas County, Fla. (see "TV X-ray hazard to get nationwide attention." ED 26, Dec. 20,

Washington Report

CONTINUED

1967 p. 22). The aim is to determine the effectiveness of a manufacturer's program (believed to General Electric's) to modify specific large-screen color sets to eliminate excessive downward radiation from shunt regulator tubes. The Washington project will be more comprehensive and is intended to evaluate the potential hazards to health of any X-radiation from a variety of color-television receivers. TV-set manufacturers will assist teams of experts from the National Center for Radiological Health here.

In the Pinellas County survey, the manufacturer's TV-set modification was found effective. During the survey 25% of the 155 sets tested were discovered to emit excessive X-radiation from one side or the rear of the set. (Maximum radiation recommended by the National Council on Radiation Protection and Measurement is 0.5 mR/h.)

Communications project gets Army money

The Army has announced award of an additional \$3.6 million to Martin Marietta Corp.'s Orlando Div. to begin third-phase development of its random-access discrete address (RADA) communications program. In development for several years, the RADA concept is intended to provide automatic, high-capacity, dial radio-telephone service for military tactical forces. The digital system is also being considered for possible use in the four-nation Mallard tactical digital communications system.

The third-phase effort involves fabrication of advance-development equipment based on the breadboard models produced to date. The RADA program is directed by the Army Electronics Command and the new award is part of \$12.3 million authorized for it.

Navy to prove Omega network

The Navy has given approval for operational evaluation of its four-station Omega Navigational Network. The hyperbolic navigation system operates somewhat as Loran, but use of high-powered, low-frequency radio transmission considerably extends

the stations' range. The Navy has indicated that a worldwide system could be set up with only eight transmitting stations. In experimental use at reduced power since 1966, the present four stations are located at Forestport, N.Y.; Bratland, Norway; Port of Spain, Trinidad; and Haiku, Haw. One fourth of the world is covered by those four stations.

The system will operate on any one of three frequencies: 10.2, 11.3 and 13.6 kHz. Optimum frequency is 10.2 kHz. To be used by submersibles, surface ships and aircraft, the system provides an accuracy to one mile by day and to two miles at night, the Navy claims. Operational status, with eight transmitting stations in use, is planned for the 1970s.

The present evaluation will provide data for comparison with other systems to be tested in the formulation of a National Navigation Plan. The Dept. of Transportation, in July, 1967, was assigned responsibility for developing such a plan.

The Naval Air Systems Command, developer of the Omega system, is expected to select a contractor to develop and build the aircraft Omega receiver soon. Six companies have bid for the hardware development phase. The winner can expect ultimate production of several hundred systems over the next 2 to 3 years.

Intelsat III back on course

Despite serious delays that have put off scheduled delivery of the Intelstat III vehicle from March to July, officials of the Communications Satellite (Comsat) Corp. assert that the vehicle can still be put into orbit in time for this year's Olympic Games in Mexico City. Present plans call for launching in September, followed by a rapid systems checkout so that the satellite is available for operational use in October.

TRW Systems, Inc., has been plagued with delays in the delivery of satisfactory key subsystems from several subcontractors. Sylvan Electric ran into difficulty in developing an electronically despun antenna. This was subsequently changed to a mechanically despun antenna and finally to a simpler design. ITT Corp. also had trouble in delivering communications transponders. Comsat's plans to make an emergency purchase of a modified off-the-shelf vehicle from Hughes Aircraft Co., have been canceled, but the threat remains.

NOW...a full-sized **VOM** in a palm sized "package"

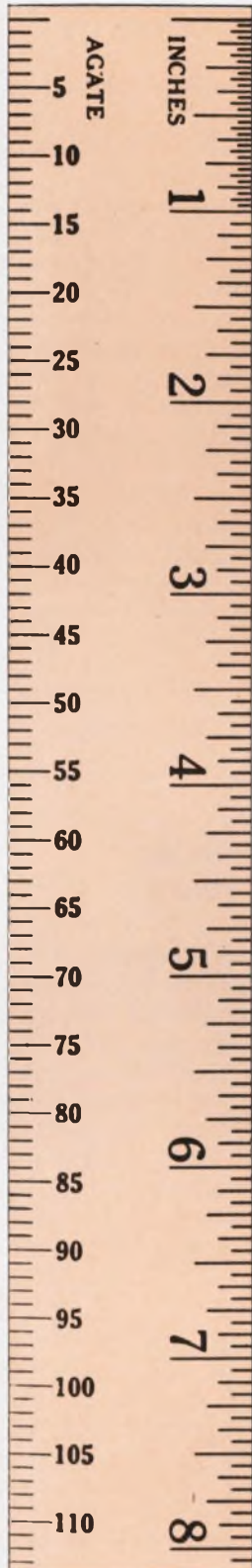

160 Volt-Ohm-Milliammeter
Complete with alligator clip
leads and operator's manual.
..... \$53.00



Carrying Case—
Cat. No. 2225..... \$10.00
Accessory Leads—
Probe Tip Lead—
Cat. No. 2055..... \$3.00

Simpson 160 Handi-VOM[®]

Simpson Handi-VOM gives you the ranges, the time-saving conveniences and the sensitivity of a full-sized volt-ohm-milliammeter—yet it's only 3-5/16" wide, weighs a mere 12 ounces. Recessed range-selector switch never gets in the way . . . polarity-reversing switch saves fuss and fumble. Self-shielded taut band movement assures high repeatability and freedom from external magnetic fields. Diode overload protection prevents burn-out—permits safe operation by inexperienced employees and students. The demand is BIG, so get your order in to your electronic distributor, TODAY!

RANGES

ACCURACY: $\pm 3\%$ FS DC, $\pm 4\%$ FS AC
DC VOLTS: 0-0.25, 1.0, 2.5, 10, 50, 250, 500, 1000 @ 20,000 Ω/v
AC VOLTS: 0-2.5, 10, 50, 250, 500, 1000 @ 5000 Ω/v
DC MICROAMPERES: 0-50
DC MILLIAMPERES: 0-1, 10, 100, 500
DB: -20 to +10, -8 to +22, +6 to +36, +20 to +50
"0" REFERENCE: 1 MW into 600 Ω
RESISTANCE: Rx1, Rx10, Rx100, Rx100, Rx10K
(30 Ω center)



DIVISION



SIMPSON ELECTRIC COMPANY

5200 W. Kinzie Street, Chicago, Illinois 60644 • Phone: (312) 379-1121
Export Dept: 400 W. Madison Street, Chicago, Illinois 60606, Cable, Simelco

IN CANADA: Bach-Simpson Ltd., London, Ontario

IN INDIA: Ruttonsha-Simpson Private Ltd., International House, Bombay-Agra Road, Vikhroli, Bombay

Representatives in Principal Cities
... See Telephone Yellow Pages

WORLD'S LARGEST MANUFACTURER OF ELECTRONIC TEST EQUIPMENT

INFORMATION RETRIEVAL NUMBER 25

The easiest way to cut component costs.

Farm them out!



Read why in Art Wire's New Bulletin 501

Learn why Art Wire consistently produces wire forms, small parts stampings and cut tubing at considerable savings over your in-plant costs. And how we can go into high-speed automatic production even faster. For your copy use the inquiry card. If you're in a hurry, call 201-621-7272.

ART WIRE & STAMPING CO.
17 Boyden Place, Newark, N. J. 07102

Letters

Congressman applauds editorial suggestion

Sir:

Your editorial of October 25 ["The great American brain drain: It's time to stop," ED 22, p. 61] gave me a great deal of pleasure. Informed criticism from within the industry may be the only way to obtain a true picture of the deficiencies and needed improvements in our space and other efforts.

My investigation of the circumstances surrounding the Apollo fire showed that individual personnel within the space program are exceedingly astute about what needs to be done in the way of improvement, but that the channels for communication with top management seem quite closed. In fact, an atmosphere of reprisals, more so than a fear of employment cut-backs that you mention, goes unexpectedly far in choking off the possibility of effective internal (let alone public) constructive criticism. I earnestly hope that this situation, which both contributes, and is partly due, to the reluctance of technical personnel to speak out, will change.

While your editorial is not a critique of management procedures, I think the question of funding policy is equally crucial to the development and sustenance of serious deficiencies in our large technical programs, both civilian and military. There is also the obvious jeopardy to important programs in times of financial stress, when sincere but uninformed budget-cutters attempt to perform financial surgery. That potential recipients of large budgets, and their spokesmen, would hesitate to point out or criticize the tendency to overfund glamorous programs is self-evident. Thus I am all the more impressed by your statement.

On May 4 I called for the establishment of a Presidential commission to make an independent evaluation of NASA management, which might point to some of the root causes, rather than particular details, of the Apollo disaster. Your emphasis in suggesting a "Hoover-type" commission seems to be

more on the question of adequate investigation of funding policies as a basis for more rational decision-making by Congress and the Executive. It would appear that we share certain basic objectives, and I judge both issues equally important and ultimately inseparable.

I know of no current plans for Congressional action along the lines you suggest. My own proposal for a high-level commission was received quietly and produced no immediate action. I would certainly support your proposal, and I hope that your thoughts on needed improvements will be repeated, expanded and widely circulated. My expectation is that no serious and far-reaching investigation will be attempted unless there is a distinct public clamor for it, and I do not believe that this is likely to occur without the guidance of continuing commentary and suggestion from within the industry itself.

I have inserted your editorial into the *Congressional Record* of November 28.

William F. Ryan
House of Representatives
Washington, D.C.

Current regulator in use two years

Sir:

Allan Lloyd may be interested to know that we have been using the current regulator circuit (see below) shown as Fig. d in his Idea for Design ["Constant-current regulator has low dissipation," ED 18, Sept. 1, 1967, pp. 86-88] for two years. It holds the igniter current in our combustion heater within 15% of 10 amps for a supply-voltage swing from 20 to 30 volts dc.

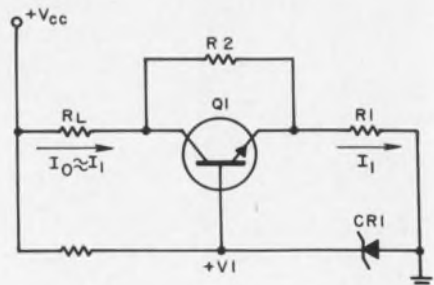

Our objective was to achieve this with minimum cost and the circuit answers the need quite well. As with most things, however, nothing is for

free. Adding the bypass resistor means that transistor current is no longer constant and regulation accuracy suffers somewhat.

K. Staiger

Manager Advance Design
Stewart-Warner Corp.
South Wind Div.
Indianapolis

New approach confirms 'ideal rectifier' design

Sir:

The "ideal rectifier" of Fig. b [in "Ideal rectifier uses equal-value resistors" in the Ideas for Design section in ED 13], June 21, 1967, p. 96, is correct as shown.

[Nathan Sokal and Myron Wolf claimed in the Letters column of ED 21, Oct. 11, 1967, p. 46, that the circuit would not work with component values shown. Several correspondents have since taken different approaches to showing why the critics' contention was at fault.—Ed.]

The point missed by N. O. Sokal and M. S. Wolf is that the differential voltage of A_2 must be ≈ 0 and therefore the effective feedback resistance of $A_1 = R_3 \parallel (R_2 + R_4)$. Current feedback to A_1 is not by R_3 alone, but also by $R_4 + R_2$. If $R_3 = R_4 = R_2$, the effective feedback impedance to $A_1 = 2/3 R_3$. The gain for the negative half cycle is:

$$G = [R_3/R_1][R_2 + R_4 + R_5] \div (R_2 + R_3 + R_4),$$

and for equal resistors it is:

$$G = 1.$$

William B. Crittenden

Electrical Engineer
Electrical Design Dept.
Westinghouse Electric Corp.
Baltimore

Accuracy is our policy

In the box "Radar rebounds over the horizons," ED 26, Dec. 20, 1967, p. 26, line 9, over-the-horizon radar was said to hit the ionosphere and bounce back "hundreds of thousands of miles away." The "of" should have been "or," making the line read "hundreds or thousands of miles away."



... AND GET PREMIUM PERFORMANCE WITH BEEDE'S NEW NON-CONTACTING CONTROL METER RELAY

Beede has greatly simplified the design of the optical meter relay, significantly reducing the number of parts incorporated in the unit.

In addition to the substantial price savings, this development provides the increased accuracy of direct drive set pointers and a control meter relay with high reliability.

Some of the features available:

- Single or Double Set Point
- Taut Band Meter Sensitivities
- Front or Behind Panel Mounting
- High Style "Centurion" Case Design
- Complete Package Switching 5 amps or Optical Element only

Send for complete literature today.

BUY VALUE / BUY BEEDE

BEEDE
ELECTRICAL INSTRUMENT CO., INC.
PENACOOK, NEW HAMPSHIRE
Area Code: 603-753-6362

AMPERITE

Thermostatic DELAY RELAYS

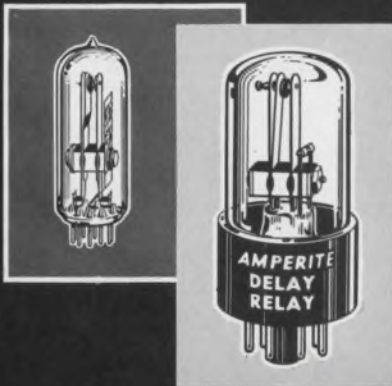

Only a glass seal
offers true hermetic sealing
... assuring maximum stability and life!

Delays: 2 to 180 seconds . . . Actuated by a heater, they operate on A.C., D.C., or Pulsating Current . . . Being hermetically sealed, they are not affected by altitude, moisture, or climate changes . . . SPST only—normally open or normally closed . . . Compensated for ambient temperature changes from -55° to $+80^{\circ}$ C. . . Heaters consume approximately 2 W. and may be operated continuously . . . The units are rugged, explosion-proof, long-lived, and—inexpensive!

TYPES: Standard Radio Octal, and 9-Pin Miniature.
List Price, \$4.00

PROBLEM? Send for Bulletin No. TR-81

AMPERITE

BALLAST REGULATORS

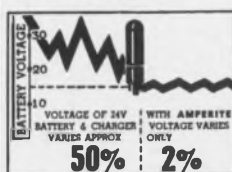

Hermetically sealed, they are not affected by changes in altitude, ambient temperature (-50° to $+70^{\circ}$ C.), or humidity . . . Rugged, light, compact, most inexpensive . . . List Price, \$3.00.

Write for 4-page Technical Bulletin No. AB-51

AMPERITE

600 PALISADE AVE., UNION CITY, N.J.

Telephone: 201 UNION 4-9503

In Canada: Atlas Radio Corp., Ltd.,
50 Wingold Ave., Toronto 10

SIDELIGHTS OF THE ISSUE

Materials come under scrutiny

The spotlight in this issue falls on the resin embedment of electronic devices. A special report on the materials and processes involved is the outcome of collaboration between materials editor David H. Surgan, a graduate of the Polytechnic Institute of Brooklyn, N.Y., and Charles A. Harper, a fellow engineer with the Aerospace Div. of Westinghouse Electric Corp., Baltimore, and author of *Electronic Packaging with Resins and Plastics and Electronics*. The picture on the cover of the magazine, which was supplied by Dow Corning of Midland, Mich., shows an amber-colored silicone resin flowing over several devices. On p. 49, the cover of the special report itself, which shows a white resin being poured into a mold, was furnished by the Failure Mechanisms Branch, Qualifications & Standards Laboratory, NASA/Electronics Research Center, Cambridge, Mass.

Engineer moves into top spot

Hugh R. Roome, who combines engineering training with wide experience in the publishing field, has become sole publisher of *ELECTRONIC DESIGN*. His former co-publisher, James S. Mulholland, Jr., himself an MIT engineer, is now president of Hayden Publishing Co.

Roome—like most of the magazine's editors—graduated as an engineer. His school was the Stevens Institute of Technology, Hoboken, N.J. After active service in World War II, he became publisher of *Design News* with the Rogers Publishing Co. in Chicago, and then publisher of *What's New in Home Economics* for the Reuben H. Donnelly Corp.'s Magazine Div. in New York. Most recently, Roome was general sales manager of the National Yellow Pages Service for Donnelley.



Hugh Roome takes over as publisher of *ELECTRONIC DESIGN*

Philco-Ford puts logic in a box



Now, you'll be pinning down your control system designs faster, easier, and with far greater economy

Over 200 micromodules from Philco-Ford's WDL Division stand ready to accept your system challenge. In compatible 5 to 40 MHz logic, standard DTL and T²L circuits, they contain some of the most sophisticated designs in today's state-of-the-art, including multiplexers, operational amplifiers, D-to-A and A-to-D circuits, and an extensive array of computer interfaces.

The micromodules employ monolithic IC's, using thin-film and discrete components only where necessary. A hard nylon cover keeps out dust, protects circuits against damage. Clearance holes at the top of the micromodule provide fast front-panel access to all input/output terminals. No need to troubleshoot from the back! A color-

coded label identifies module type at a glance.

The micromodule's modest dimensions, coupled with the complexity of the logic it contains, permits highly effective packaging density. A 180-module system can be mounted in a drawer only 3½" high by 19" wide. Modular systems fit readily into rack mounts, bench mounts, or portable instruments. In service for over three years at NASA's Manned Space Flight Center in Houston, WDL micromodules have compiled an excellent record of performance reliability. Write Product Sales Manager, WDL Division, Philco-Ford Corp., Mail Station C-41, 3939 Fabian Way, Palo Alto, California 94303. Or telephone (415) 326-4350, extension 6017.

ADD (Automated Design and Documentation) This Philco-Ford computer-programming service generates system documentation at a cost significantly below that of hand-prepared equivalents. The computer program error checks design input data, optimizes the arrangement and sequence of wiring instructions, calculates wire lengths, provides wire lists sorted by length and by name, and maintenance lists. The program is available to all users of Philco-Ford micromodules.



PHILCO-FORD CORPORATION
WDL Division • 3939 Fabian Way
Palo Alto, California • 94303

Oak's design engineers are impatient . . . nothing is ever quite good enough. They figure improved products today mean better circuits tomorrow. Take these: ♦ Oak-manufactured Rotary Solenoids and Selectors for multiple switching functions in limited space under severe operating and environmental conditions. ♦ Molded Pushbuttons designed specifically for computers, communications and other panel equipment. ♦ Rotary Switches with molded diallyl phthalate stators and rotors, Unidex™ indexing. ♦ Lever Switch with molded diallyl phthalate type "A" stator for miniaturization, versatility in a small area. Plus these—Rocker Thumbwheel, Pushbuttons, Lever and Slide Switches. Oak offers widest selectivity in quality switches for industrial, commercial or military requirements. In fact, Oak has more switches that meet MIL-S-3786 than all other manufacturers combined—over 24 switch products. The next switch manufacturer has six. In addition, Oak offers sub-assembly service to save you production time and costs. These are only highlights of a small part of the complete Oak line of components. Send today for Catalog 24.

**DESIGNED FOR TOMORROW'S
CIRCUITS!**



Ph: 815-459-5000 TWX: 910-634-3353

OAK

CABLE ADDRESS: OAKMANCO

MANUFACTURING CO.

A DIVISION OF **OAK ELECTRO/NETICS CORP**

CRYSTAL LAKE, ILLINOIS 60014

INFORMATION RETRIEVAL NUMBER 31

Publisher

Hugh R. Roome

Editor

Howard Bierman

Managing Editor

Robert C. Haavind

Technical EditorsJeffrey N. Bairstow
Peter N. Budzilovich
David H. Surgan**Management and Careers Editor**

Howard S. Ravis

News EditorsRalph Dobriner, Chief
Richard N. Einhorn**Washington News Bureau**

Charles D. LaFond, Chief

Military/Aerospace Editor

John F. Mason

East Coast Editor

Neil Sclater

West Coast Editor

Ron Gechman

New Products Editor

Steven B. Futterman

Copy Editor

Peter Beales

Editorial ProductionDollie S. Viebig
Phyllis Gura**Art Director**

Clifford M. Gardiner

Art Assistant

William Kelly

Technical IllustratorsCheh Nam Low
Sheila F. Ward
William Alvarez**Production Manager**

Thomas V. Sedita

Asst. Production Manager

Helen De Polo

Production AssistantsBernard Wolinsky
Gregory A. Bannon**Circulation Manager**

Nancy L. Merritt

Information Retrieval Service

Diane Mandell

EDITORIAL



Congress has so far found only the top of the iceberg

Sen. William Proxmire (D-Wis.) hit the front pages across the nation recently with his disclosure that defense contractors were buying equipment at government expense, and then using it for commercial production either at inadequate rentals or at no rental at all.

At the same time the House Armed Services Committee's Special Investigations Subcommittee has discovered that the Pentagon's supercomputerized cost-accounting system has swallowed a number of fat gold bricks. Cheap catalog items have been bought on government contracts at hugely inflated prices in dozens of instances uncovered by the General Accounting Office.

What has so far been revealed, we believe, is just the top of the iceberg. Some of our views on wasteful practices were spelled out in an editorial, "The great American brain drain: It's time to stop" (ED 22, Oct. 25, 1967, p. 61), which was read into the *Congressional Record* on Nov. 28 (p. A5844).

In a letter to *ELECTRONIC DESIGN*, Rep. William F. Ryan (D-N.Y.) commented on the editorial, bringing up a serious point that he has confirmed by his own investigations of the space program—the apparent lack of communication between management and the technical people working on major projects. This has led to inefficient planning, poor decisions and costly mistakes. Ryan feels that fear of reprisals silences many people who are aware of mistakes being made and flaws in design. His letter appears in the Letters column on p. 40.

If this sort of situation is widespread in the industry, it must be causing a great deal more waste than a few overcharges and misappropriations of government equipment. Have some engineers really become closemouthed followers who simply go along with management's instructions, even when they are wrong ones? Has the penalty for outspokenness really become so heavy that it is better to hide mistakes and work on toward inevitable failure?

Furthermore, it is increasingly common to talk to engineers who have taken jobs only to find that they have nothing to do for weeks on end. Sometimes they have been told to "look busy," so that many hours of overtime can be charged to the contract.

Congressional investigators would do well to look beyond the ledger sheets to see what company practices may be wasting valuable brainpower as well as taxpayers' dollars.

We are curious about our readers' experiences on space and defense projects. Let us know specific cases of waste in which you were personally involved. Please sign your letters; we shall withhold names from publication if you ask us to.

ROBERT HAAVIND

evaluating
semiconductors?

use one of these Tektronix transistor curve tracers to meet your needs

The performance range of the Type 575 enables you to evaluate the dynamic characteristics of most semiconductor devices.

Several transistor characteristic curves may be displayed including the collector family of NPN or PNP devices in a common base or a common emitter configuration with forward or reverse biasing. The Type 575 features collector sweep supply ranges continuously variable from 0 to 20 V at 10 A, or 0-200 V at 1 A. A base or emitter step generator, operating at either 2 or 4 times the line frequency, provides 4 to 12 steps per family of characteristic curves in single or repetitive display modes. The step generator provides voltage increments from .01 V/step to 0.2 V/step or current increments from .001 mA/step to 200 mA/step.

Choose the Type 575 MOD 122C transistor curve tracer for evaluating higher voltage devices.

The Type 575 MOD 122C has the same features of the Type 575 plus the capability of diode breakdown test voltage variable from 0 to 1500 V at 1 mA and a much higher collector supply voltage of up to 400 V at 0.5 A.

For a demonstration, contact your nearest Tektronix field engineer or write: Tektronix, Inc., P. O. Box 500, Beaverton, Oregon 97005.

For evaluating high current semiconductors, add the Type 175 High Current Adapter to either of these curve tracers.

The Type 175 features collector sweep supply ranges of 0-200 A at 0-20 V and 0-40 A at 0-100 V. The Type 175 step generator provides current ranges from 1 mA/step to 1000 mA/step and voltage steps from 0.5 to 10 V/step with driving resistance selectable from 11 values ranging from 0.5 ohms to 1 k ohm. Other resistance values may be added externally.

- Type 575 Transistor Curve Tracer (including accessories) \$1100
- Type 575 Transistor Curve Tracer MOD 122C (including accessories) \$1365
- Type 175 High Current Adapter (including accessories) \$1570

U. S. Sales Prices, f.o.b. Beaverton, Oregon



Worldwide operations
serving customers
in more than 50 countries



... part of the Tektronix commitment
to continuing customer service

Technology

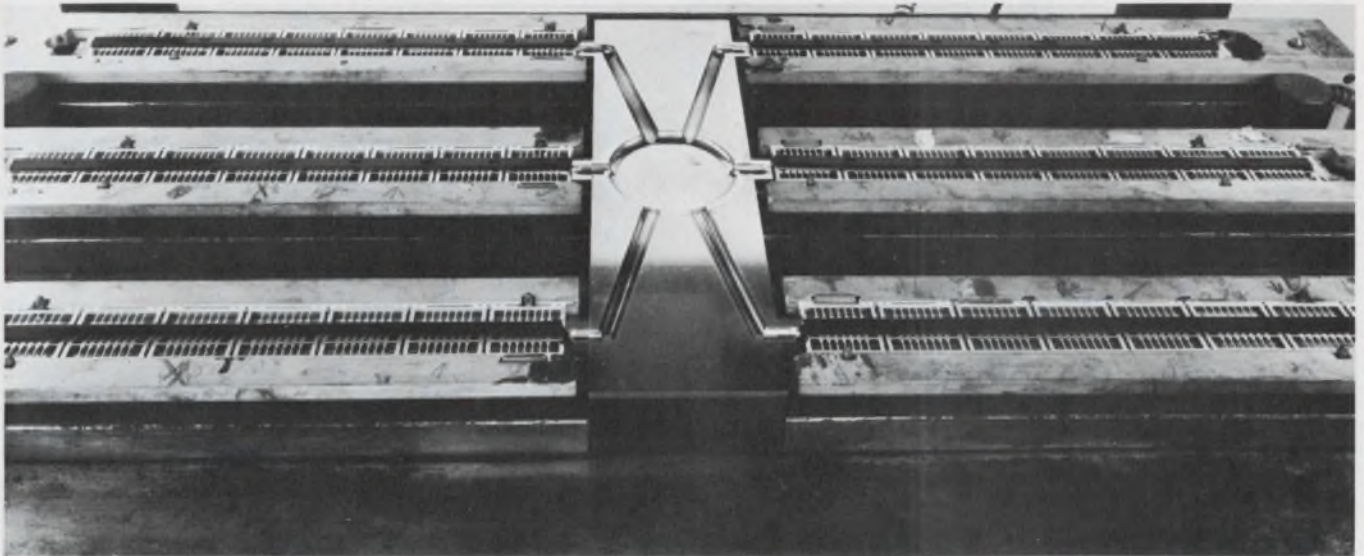

Resin embedment of electronic systems—
a transfer-molding machine like this may be

used—is a multifarious technology. To help
find your way through the maze, see p. 49



Manage your time well or
it'll boss you. Page 102



Many digital functions can be generated by a rate multiplier, a
basic circuit that gives a pulse train from two inputs. Page 82

Also in this section:

Two thermistors combine to end nonlinearities without affecting sensitivity. Page 88

Binary-group testing reduces the number of wiring-system checks exponentially. Page 94

Semiannual index of articles for July through December, 1967. Page 115

Ho-hum, another Forum. What have you got to say about "Multi-Switch" switches that's new and exciting? Frankly, I get tired of just rehashing old product specs.

So do we. But, just the other day we discovered that

The increased size of the "Multi-Lite" pushbutton would be ideal for a cancel bar on our new check-



SWITCH CRAFT FORUM

a long standing customer of ours didn't know about our "Multi-Lite" pushbuttons that can couple two adjacent stations on a "Multi-Switch" switch.

Two stations?

Right. But, maybe we ought to start from the beginning. A single station can accommodate up to 6PDT circuitry. The "Multi-Lite" arrangement mechanically interlocks two adjacent stations for twice the switching capability without adding to the overall height of the switch stack. And, each station has a total of four lamps for sectionalized or redundant lighting, since we have combined two, dual lighted pushbottons. Fig. 1. gives a good example of the flexibility we're talking about.

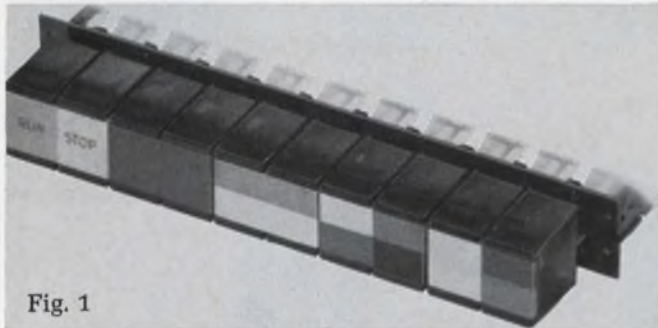

How does the "Multi-Lite" arrangement tie into the mechanics of your switch? I'm talking about lighting circuitry and switch functions.

Lighting circuitry on the Series 37000 & 38000 little "Multi-Switch" switches is accomplished by means of a lighting stack of the type shown in Fig. 2. The extra-long lighting springs extends the lighting circuit from the lamp terminal to the rear of the switch for convenient wiring to the N.O. or N.C. contacts on the lighting switch stack. Naturally, direct wiring to the pushbutton lights is another alternate.

Regarding switch functions, the coupled stations can be furnished for interlock, momentary, push-to-lock,

Fig. 2

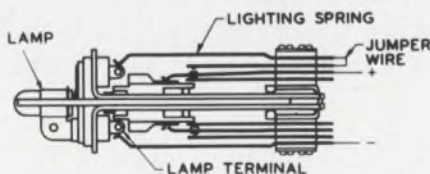

push-to-release, and all-lock operation. Of course, the all-lock arrangement will require a single button for a release station. (Forum readers may obtain complete info on switch functions from our engineering specification catalog. Just circle the reader service number below.)

writer, but we'll need smaller pushbuttons for most of the other functions. How much legend information can I get on either type? And what about display screen colors and lamps?

The "Multi-Lite" pushbuttons will accept up to 4 lines of 11, $\frac{1}{8}$ " high characters per line. The smaller pushbuttons provide a $3\frac{1}{32}$ " x $1\frac{9}{32}$ " rectangular area for hot stamping or engraving. This should accommodate any of your legend requirements for each station. We have nine standard display screen colors plus color inserts to give you unlimited color flexibility.

As a convenience, Switchcraft has available, standard industry lamps #328 (6v.), #718 (6v.) or #327 (28v.). Or if you need zero power consumption on an "illuminated" switch, why not use the Switchcraft "Glo-Button." Available on certain switches, the "Glo-Button" produces a highly visible illumination change by strictly mechanical means without consuming any power.

I must admit we've learned something, but I suspect the Forum won't be dismissed until we've heard a "life & versatility" pitch.

Our catalog tells all about "life & versatility" and how you can specify a "Multi-Switch" switch anywhere from 1 to 18 stations in a row or up to 100 stations in ganged and coupled matrixes. The almost unlimited adaptability of this switch to countless applications is difficult to express. When we sit down to discuss your requirements in detail, the value of a "Multi-Switch" switch will become more apparent. We've dwelled on lighting pretty much, but the total versatility of these units doesn't begin to "shine" until you can see it solving your particular application problems.

Forum dismissed, but but don't forget that we have extra bound copies of "FORUM FACTS on 'Multi-Switch' Switches", that describes these units, their accessories and applications. Just have your engineers drop us a line on your company letterhead, asking for this handbook. We'll also place their name on our mailing list for TECH-TOPICS, our semi-monthly application engineering magazine. Ten-thousand engineers already receive TECH-TOPICS and tell us that the technical stories are interesting and useful.

SWITCHCRAFT

5529 North Elston Avenue • Chicago, Illinois 60630

An Electronic Design Special Report

RESIN EMBEDMENT of ELECTRONIC ASSEMBLIES

Charles A. Harper, Fellow Engineer, Westinghouse Electric Corp., Aerospace Div., Baltimore



Edited by David H. Surgan, Technical Editor

MAKE EARLY DECISIONS COUNT— CHOOSE THE PROPER PROCESS

To pot, to mold or to cast? To embed, encapsulate or impregnate? You have probably designed with embedded assemblies, components or modules, and you have probably designed assemblies to be embedded. But chances are you're a bit puzzled about which technique is which.

One thing is certain, though. Resin embedding is an extremely valuable technique in packaging electronic assemblies for aquaspace, aerospace, and many other environments. The materials are devised by chemical engineers, applied by mechanical engineers, and depended on by design engineers. Yet the myriad techniques, materials, trade names, modifications and design considerations can overwhelm even a specialist. A basic understanding of resin embedment systems is something the design engineer usually leaves to the "packaging boys," at times with disastrous consequences.

The aim here is to clear some of the fog, so that the electronic engineer may make optimal design and manufacturing decisions at an early stage. The next time you tell the packaging engineer your troubles and he says "Don't worry, epoxy can be cured," it won't be an "in" joke.

The embedding process—which is which?

No matter which process is used, no matter what terminology is applied, low-temperature-, low-pressure-reacted resins are the materials used. They can be converted from a liquid to a solid (cured) at near-atmospheric pressures and near-room temperatures. It is the low temperature and pressure that make these materials and processes so attractive. Low pressure is perhaps the more important of the two, since high-pressure processes involve expensive tooling.

Embedding and *encapsulating* are terms frequently used interchangeably. Generally, embed-

ding implies complete encasement in some uniform external shape. A high volume of the package is made up of the embedment material. Encapsulation, on the other hand, is a coating. This normally involves dipping the part (Fig. 1) in a high-viscosity or thixotropic material (a gel that liquefies only when agitated and so will not drip) to obtain a conformal, 10-to-50-mil-thick coating. The primary protection is a seal against atmospheric contaminants, although the encapsulant often confers some mechanical strength too.

Embedding and encapsulating can be differentiated another way. Embedding is usually performed with the components housed in a mold or case. The embedding material is then poured in, completely surrounding the component. The mold holds the material during curing, resulting in a smooth, uniform surface. With encapsulation, the final surface is irregular, although it may be smooth, since it does not conform to a mold or case.

Embedment may be broken into three narrower categories: casting, potting, and molding.

In *casting*, a mold is prepared to give the proper dimensions to the finished part. The mold and assembly are each designed to provide minimum internal stresses as the resin shrinks during curing. The resin and catalyst combination is mixed and poured slowly into the mold (Fig. 2). The process may be performed in a vacuum to avoid air entrapment. The entire assembly is then cured either at room temperature by its own exothermic heat, or in an oven. Finally, the part is released from the mold.

Potting is similar except that the shell or can is not separated from the finished part. If the container is metal rather than plastic, a sheet of insulating material between the assembly and the can may be needed to prevent shorting in case some of the conductors are too close to the inside of the can. The higher-voltage the application, the more stringent is the requirement. In potting, a clear plastic shell can often be used, making some defects visible as soon as they occur. Conversely, a colored shell can be used to

Free reprints

Free reprints of this report are available, while supplies last. Circle Reader-Service number 260.

Table. Summary of embedding processes

Method	Advantages	Limitations
Encapsulating consists of coating (usually by dipping) a part with a curable or hardenable coating. Coatings are 10 to 50 mils thick.	Requires a minimum of equipment and facilities.	Obtaining a uniform, drip-free coating is difficult. Specialized equipment for spraying on coatings overcomes this problem.
Casting consists of pouring a catalyzed or hardenable liquid into a mold. The entire assembly takes the shape of the mold. The mold is removed for reuse.	Requires a minimum of equipment and facilities. Ideal for short runs.	For large-volume runs, molds, handling and maintenance can be expensive. Assemblies must be positioned so they do not touch the mold during casting. Patching of surface defects can be difficult.
Potting is similar to casting except that the catalyzed or hardenable liquid is poured into a shell or housing which becomes a part of the unit.	Excellent for large runs. Tooling is minimal. Shell or housing ensures that no components are exposed as in casting.	Some materials may not adhere to shell or housing. Shorting to the housing can occur if the housing is metal.
Transfer molding is the process of transferring a catalyzed or hardenable material, under pressure, from a container into the mold which contains the part.	Most economical for large-volume operations	Initial facility and mold costs are high. Care required so that parts of assemblies are not exposed. Pressure and processing temperatures are higher than for other techniques.
Impregnating consists of completely immersing a part in resin so that all interstices are thoroughly soaked and wetted. Vacuum and/or pressure are used.	Best method for obtaining total embedding in deep or dense assembly sections such as transformer coils.	Vacuum or pressure equipment can be costly. In curing, material tends to run out of the assembly creating internal voids unless an encapsulating coating has first been applied.

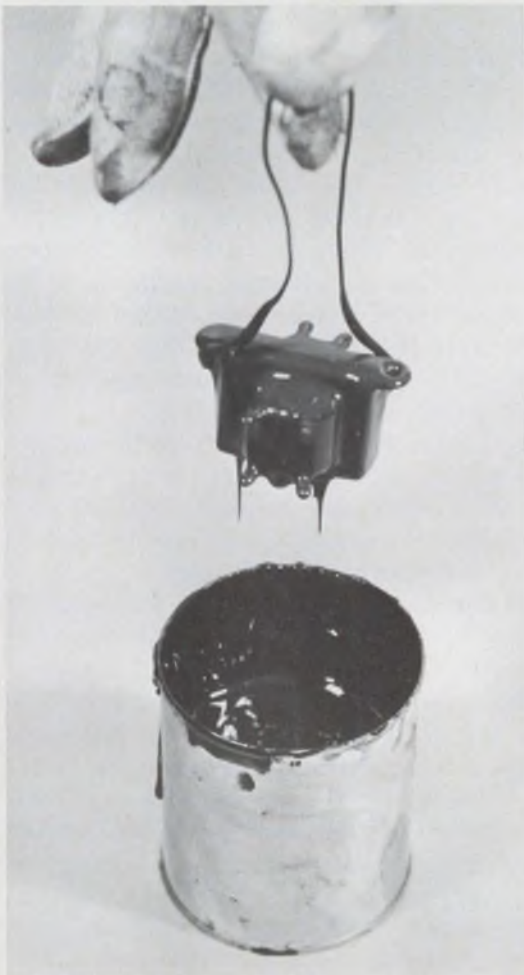

2. Typical casting operation involves slowly pouring the resin-catalyst combination into the mold containing the assembly. A low-cost slush-casting mold is used here to minimize tool costs.

1. Typical encapsulation operation consists of dipping and curing the thixotropic resin to obtain a 10-to-50-mil coating.

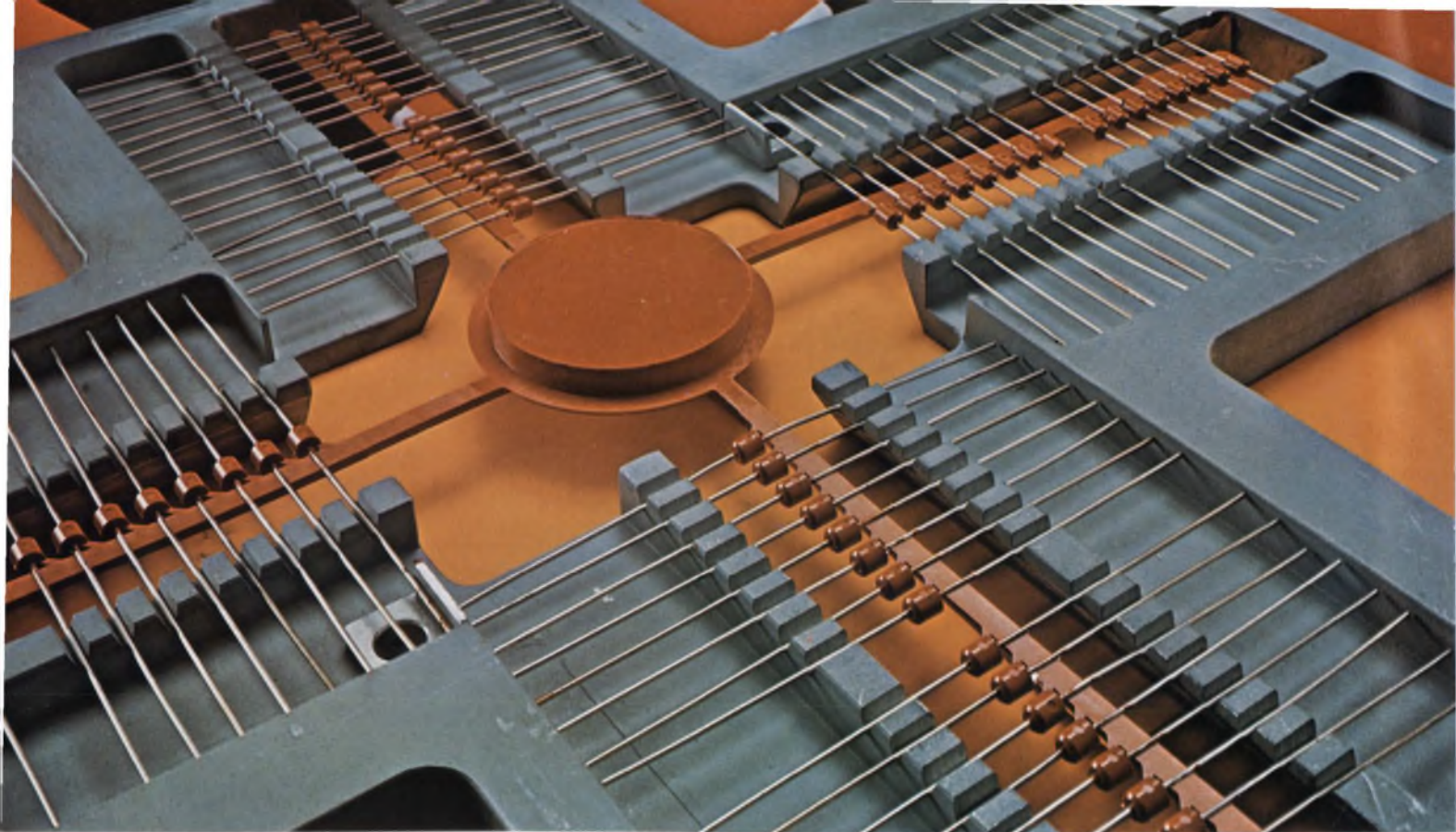

Transfer-molded diodes are smaller, lighter and less costly than metal-and-glass-sealed devices. Those above,

positioned in a handling fixture, are embedded in Dow Corning silicone compound.

hide minor surface blemishes which are functionally unimportant but aesthetically undesirable.

In cases where adhesion to the can is poor, a mechanically weak package is the result, since the can or shell may separate from the rest of the unit. To obviate this, the plastic shell can be chosen to bond chemically with the potting resin, or adhesion can be enhanced by abrading or vapor-blasting the shell's inside surface. An example of a good combination of plastic shell and potting resin is a polystyrene or modified polystyrene shell used with a polyester resin.

The same product shape can be produced by either casting or potting. Cost is possibly the greatest single consideration. Potting is cheaper since the mold-release step is eliminated. Its main drawback is that it is difficult to repair; an advantage is its controlled skin thickness.

In *transfer molding*, a dry, solid molding powder or pellet is heated in a press until it melts. It then flows (is transferred) under pressure into a heated mold that contains the assembly to be embedded. The resin remains in the mold until it is cured, and then the assembly is removed.

Transfer molding is more economical and allows higher rates of production than casting or potting. There are fewer processing steps and curing time is shorter. Transfer-molding materials cure in minutes; casting and potting resins usually require hours. Tool costs are lower for large runs, and material costs can be cut because

housings are unnecessary. On the other hand, an assembly must be able to withstand molding pressures of 50 to 250 lb/in.² and curing temperatures of 250° to 350°F. Production volume must also be large enough to offset the higher initial outlay (a press can cost from \$5000 to \$50,000).

Multicavity molds are a major economy in large-volume runs. It takes no longer to fill many cavities than one. When a variety of shapes is required, cavities of different contour can be built into the molding machine or special inserts can be fitted into the machine's molding cavities. The only limitation on presses is the amount of molding compound that they can hold.

Impregnation is an entirely distinct technique. It involves forcing liquid resin into all the internal voids of a component or assembly. It may be an independent operation, or it may be used in conjunction with any other technique.

Impregnation is accomplished by submerging the assembly in a catalyzed resin and then applying vacuum, pressure, or a sequence of the two. The length of the impregnating cycle varies according to the degree of impregnation required, the amount of entrapped air that can be tolerated, the viscosity of the impregnant, and the size of the orifice or the type of surface barrier that the resin has to pass through to enter the assembly. Impregnation is sometimes done by centrifugal casting. In that case the part is positioned in a mold, the mold is filled with resin,

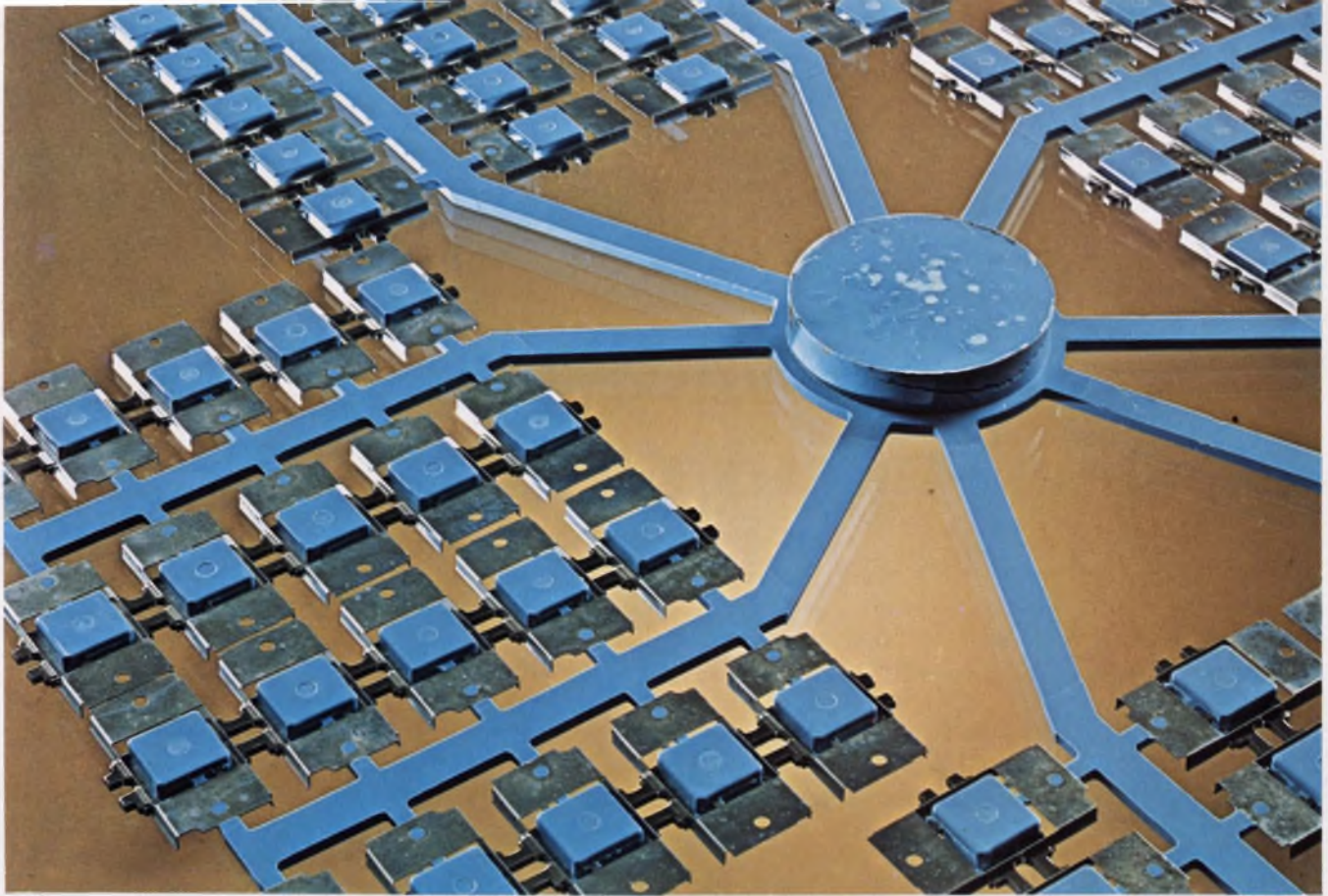

The 'octopus' ties RCA power IC packages together. Made of Dow Corning silicone molding compound, it is

waste material left after the molded assembly has been removed from the transfer mold.

and the whole assembly is spun at high velocity.

When both encapsulation and impregnation are required, as for some transformers, the encapsulant is applied first and a hole left in the coating. A low-viscosity impregnant is forced through the hole after the encapsulant has been cured. This provides a container for the impregnant and prevents it draining off during curing.

The Table on p. 51 summarizes all processes.

Test your retention

Here are questions based on the main points of this article. They are to help you see if you have overlooked any important ideas. You'll find the answers in the article.

1. *What is a thixotropic material?*
2. *How do potting and casting differ?*
3. *How can you improve adhesion of the can or shell to the rest of an embedded assembly?*
4. *If an assembly is to be transfer-molded it must be able to withstand certain extremes. What are they?*

5. *How is impregnation accomplished?*



Twenty-five-watt pill transistor molded of silicone dwarfs its metal-can counterpart. Device is Bendix B-5000 power transistor. Material is a Dow silicone.

MATERIALS FOR EMBEDMENT: THE EPOXIES HEAD THE LIST

There are a half-dozen resins used for electronic embedment. To the average user, however, there is only one: epoxy. When he equates epoxy with "plastic" or "encapsulant," he's right 85% of the time.

The ubiquitous epoxies have gained their role owing to a unique combination of properties:

- **Low viscosity.** The liquid resins and curing agents form low-viscosity systems that are easy to process and modify.

- **Easy cure.** Epoxy resins cure quickly at practically any temperature from 50° to 150°C, depending on the curing agent.

- **Low shrinkage during cure.** Phenolics show high shrinkage since they give off water. So do acrylics and polyesters, which rearrange and reorient considerably in the liquid and semigel phases. Epoxies react with very little rearrangement and release no water or volatile byproducts.

- **High adhesive strength.** Because of the presence of polar hydroxyl and ether groups, epoxies are perhaps the strongest adhesives obtainable. Since they cure with little shrinkage, contacts between the liquid epoxy and the adherent surfaces are not disturbed (Fig. 1).

- **Good mechanical properties.** Due to the low shrinkage, the strength of epoxy resins usually surpasses other resins'.

- **High electrical insulation.** Epoxy resins are excellent electrical insulators with dielectric constants generally under 4.

- **Good chemical resistance.** Outstanding resistance to any chemical can be obtained by specifying the proper material and curing agent. Most resins have extremely high caustic resistance and good-to-excellent acid resistance.

- **Versatility.** The basic properties of epoxies may be modified in many ways—by blending resin types, by selecting curing agents, and by using modifiers and fillers.

The basic epoxy resin can be liquid or solid; it can be completely unreacted or partially reacted (B-staged). In the A-stage, the material is still soluble in certain liquids and is fusible. B-staged materials have the curing agent already added when the user receives them. The curing mechanisms are similar.

Since the basics are similar, the focus here will be on the use of unreacted liquid resins, the more general case. Some specific properties of liquid epoxy resins and epoxy transfer-molding compounds are given in Table 1.

Which epoxy with which curing agent?

There are three major classes of epoxies and four of curing agents.

Bisphenol epoxies—The bisphenols are available as solids or as liquids over a wide viscosity range. In the liquid state bisphenols are syrupy with viscosities ranging from 7000 to 25,000 centipoises. They react readily with catalysts and curing agents.

Novolac epoxies—These epoxies maintain their properties at high temperatures—more than 200°C. They combine the excellent thermal stability of the phenolics with the versatility and reactivity of the bisphenols. Because their average epoxide functionality* is greater than 3 or 4, tightly crosslinked structures are readily formed, producing cured masses that exhibit higher heat-distortion temperature, better chemical resistance and better adhesion than bisphenol epoxies. The latter have a functionality of about 2. The functionality of Union Carbide's novolac epoxy ERR-0100 averages about 5 and that of Dow Chemical's D.E.N. 438 is about 3.3. Viscosity of many novolac epoxies is originally high but is reducible. They generally require postcuring—an additional high-temperature cure.

Free reprints

Free reprints of this report are available, while supplies last. Circle Reader-Service number 260.

*Average epoxide functionality is the average number of epoxide or epoxy groups per molecule. Since crosslinking is through the epoxy group, higher functionality means more crosslinking, more rigidity, and more resistance to thermal degradation. Unfortunately, it often means great brittleness and tendency to crack.

Table 1. Properties of epoxy embedding resins

	ASTM test	Liquid resins			Transfer-molding resins	
		Rigid (no filler)	Rigid (silica)	Flexible (no filler)	Mineral filled	Glass filled
Mold shrinkage (in./in.)	—	0.001-0.004	0.0005-0.002	0.001-0.004	0.004-0.010	0.004-0.003
Specific gravity (density)	D792	1.11-1.40	1.6-2.0	1.05-1.35	1.7-2.1	1.7-2
Specific volume (in. ³ /lb)	D792	24.9-20	13.9-17.3	20.5	14	14
Impact strength (ft-lb/in. of notch) (1/2x1/2-in. notched bar, Izod test)	D256	0.2-1.0	0.3-0.45	3.5-5	0.3-0.45	0.5-2.0
Hardness (Rockwell)	D785	M80-M110	M85-M120	—	M100-112	M100-112
Thermal conductivity (10 ⁴ cal/s/cm ² /°C/cm)	C177	4-5	10-20	—	4-10	4-10
Thermal expansion (10 ⁻⁵ /°C)	D696	4.5-6.5	2.0-4.0	2-10	3-6	3-5
Heat resistance, contin. (°F)	—	250-550	250-550	250-300	300-450	300-450
Volume resistivity, 50% RH, 23°C (ohm×cm)	D257	10 ¹² -10 ¹⁷	10 ¹³ -10 ¹⁶	1.3-15×10 ¹⁴	>10 ¹⁴	>10 ¹⁴
Dielectric strength, step-by-step, 1/8-in. thick (V/mil)	D149	380	—	235-400	250-400	250-400
Dielectric constant at 1 kHz	D150	3.5-4.5	3.2-4.0	3-5	3.5-5.0	3.5-5.0
Dissipation factor at 1 kHz	D150	0.002-0.02	0.008-0.03	0.012-0.050	0.01	0.01
Arc resistance (s)	D495	45-120	150-300	50-180	120-180+	120-180-

Cycloaliphatic diepoxides—These materials do not contain the phenolic rings common to most epoxy resins. They afford the unusual combination of low viscosity, low vapor pressure and high reactivity toward acidic curing agents. A wide range of properties is possible, depending on the particular epoxide and hardener chosen. The cured resins may be either rigid or flexible. Since they are free of aromatic structures, they are very resistant to carbonization under an electrical arc and discoloration by ultraviolet light. Developed by Union Carbide, the family is designated as Bakelite ERL-4050, ERL-4052, ERL-4201, ERL-4221, ERL-4280, and ELS-4071.

Aliphatic-amine curing agents—These agents blended with a resin yield a mixture with a relatively short working life since it cures quickly at room or near-room temperatures. Aliphatic-amine-cured resins usually develop the highest exothermic temperatures of all during curing. Consequently, cracking or even charring of the resin system may result if too large a mass is



1. Thixotropic high-viscosity epoxy may be applied with an air gun. Epoxy is used as a nonflowing localized embedding material to hold wire to minimize breakage.

Table 2. Common epoxies and curing agents

Resin type	Characteristics	Typical materials
Bisphenol epoxies	Available as solids or liquids over a wide viscosity range, they can be used for a wide variety of property requirements depending on the curing agent and modifiers.	Epon 828 (Shell) Araldite 5010 (Ciba)
Water-clear bisphenols	Essentially the same as the bisphenols except that they are water-clear. They can be used only with supplier-recommended curing agents and curing cycles since discoloration occurs easily.	Maraset (Marblette) D.E.R. 332 (Dow Chemical)
Novolac epoxies	Offering the best high-temperature properties, novolacs can be cured with most of the curing-agent systems that are used with bisphenols. Generally, novolacs have a higher viscosity than bisphenols, but viscosity can be reduced.	D.E.N. 438 (Dow Chemical) ERR-0100 (Union Carbide)
Cycloaliphatic diepoxides	Offer good retention of electrical properties, particularly loss factor, as temperature increases. They have low viscosity.	Bakelite ERL-4050 (Union Carbide)
Curing agent	Characteristics	Typical materials
Aliphatic amines	Allow curing at room temperature. Resins cured with aliphatic amines, however, usually develop the highest exothermic temperatures during curing and therefore the mass of material which can be cured is limited. Resins cured with aliphatic amines show the greatest degradation of electrical and physical properties at high temperatures	Diethylene triamine (DETA) Triethylene tetramine (TETA)
Aromatic amines	Systems have a longer working life than aliphatic-amine-cured epoxies and usually require a high-temperature cure. Many of these curing agents are solid and must be melted into the epoxy which makes them relatively difficult to use. The cured resin systems, however, can be used at much higher temperatures than aliphatic-amine-cured systems	Metaphenylene diamine (MPDA) Methylene dianiline (MDA) Diamino diphenyl sulfone (DDS or DADS)
Catalytic	Have a working life better than aliphatic amine curing agents. Like the aromatic amines, they normally require curing of the resin system at a temperature of 200°F or above.	Piperidene Boron trifluoride-ethylamine complex Benzl dimethylamine (BDMA)
Acid anhydrides	Easy to work with. Have minimum toxicity problems compared with amines, and offer optimum high-temperature properties of the cured resin.	Nadic methyl anhydride (NMA) Dodecanyl succinic anhydride (DDSA)

mixed and cured at one time. Their physical and electrical properties also tend to degrade as operating temperature increases. Aliphatic-amine-cured epoxies find their greatest use where small masses are being dealt with, where room-temperature curing is desirable, and where the operating temperature is to be below 100°C.

Aromatic-amine curing agents—Working life of systems cured with aromatic-amine agents is considerably longer than that of aliphatic-amine-cured epoxies; they also operate at much higher temperatures. They must, however, be cured at 100°C or higher. They are less easy to work with

than other agents because many of them are solids and must be melted into the epoxy. Some (such as MPDA) sublime when heated, causing strains and residue deposition.

Catalytic curing agents—These, too, have longer working lives than the aliphatic amines and, like the aromatic amines, normally require cure at 100°C or higher. Resins cured with these agents maintain their properties unchanged at higher temperatures than aliphatic-amine-cured epoxies. With some catalytic curing agents, the larger quantity of resin mixture, the higher the exothermic reaction becomes.

Acid-anhydride curing agents—Their high-temperature properties are better than those of aromatic-amine-cured resin systems. Some anhydride-cured systems maintain many of their electrical properties above 150°C and are only slightly affected physically even after prolonged aging at 200°C. Compounds with pyromellitic dianhydride (PMDA), a common solid anhydride agent, suffer only a 5% weight loss, for instance. Liquid acid anhydrides are easy to work with—they blend easily with the resins and reduce the viscosity of the resin system. Working life of the systems is longer than that of aliphatic-amine-resin mixtures. Amine promoters such as benzyl dimethylamine (BDMA) or tridimethylaminomethylphenol (DMP-30) can hasten curing.

A summary of resin and curing-agent types is given in Table 2.

Epoxy viscosity is key to use

One of the most important qualities of epoxy resins and of all liquid resins is viscosity. When it is too high, the compound is difficult to mix and to pour, and it does not flow properly around inserts or components. A high-viscosity resin is usually too thick for all the air to escape, and so causes cavities. On the other hand, a resin that is too thin may leak through openings.

Extremely low viscosities—100 centipoises or less—are desirable for impregnation under vacuum, but in practice, viscosities up to 1000 centipoises are often used. The higher the viscosity is, the longer the cycling time and/or the higher the vacuum for complete impregnation.

For casting or potting, there are no upper or lower limits of viscosity, provided that the mold or container is tight enough to prevent leakage. If impregnation is not required and components are not tightly packed, 1000-to-5000-centipoise viscosity is usually satisfactory.

Encapsulation calls for a thixotropic material with an extremely high viscosity, since the part is dipped and cured without a mold or container. The coating must not flow off.

Viscosity of common liquid resins must be reduced for practical application. This is done by adding diluents or more commonly by heating. As temperature rises steadily, viscosity drops increasingly slowly. When it is wished to use a resin system at room temperature, dilution is customary. Some common diluents are xylene, styrene oxide and allyl glycidyl ether. Diluents have to be used with caution because they can permanently impair electrical properties, especially under extremes of temperature and humidity. Viscosity reduction by heat is preferable since the effect of heat on critical electrical parameters is temporary.

Like most polymeric resins used for embed-

ment, the epoxies have an exothermic or exergonic, curing reaction—that is, heat is produced as the reaction progresses. Exothermic properties of a particular system must be predictable to be controllable. Too much heat can cause the resin to crack during cure and can affect heat-sensitive components. Exothermic heat is a function of such variables as curing agent, curing agent concentration, mass of resin and curing temperature. The exothermic reaction is a characteristic and closely reproducible time-temperature relationship for any compound and any set of operating conditions. Often exothermic curves are established as a quality-control tool for a process.

Curing agent ups high-temperature specs

The thermal stability of bisphenol systems is generally increased more by aromatic-amine curing agents than by aliphatic amines, and even more by anhydrides. Heat-distortion temperatures range from 75° to as high as 260°C for a system cured with PMDA.

Like thermal stability, high-temperature electrical stability is a function of the curing agent. As a corollary, those compounds that have the better thermal stability also have the better high-temperature electrical stability—especially with respect to dissipation factor and resistivity. Figure 2, p. 58 shows the dielectric constant and dissipation factor as a function of temperature and frequency for a bisphenol epoxy cured with piperidene, a catalytic agent. A set of high-temperature electrical data for PMDA-cured epoxy appears in Table 3, which shows the improved electrical stability with temperature and more stable resistivity values that are obtained with high-temperature curing agents. Insulation re-

Table 3. PMDA-cured properties

Property	Unfilled	Filled*
Dielectric constant		
Room temperature	3.47	4.22
100°C	3.91	4.52
150°C	3.81	4.31
200°C	3.77	4.12
Dissipation factor		
Room temperature	0.0080	0.0231
100°C	0.0042	0.0254
150°C	0.0043	0.0228
200°C	0.0055	0.0168
Surface resistivity Ω		
Room temperature	$>1 \times 10^{13}$	$>1 \times 10^{13}$
100°C	$>1 \times 10^{13}$	$>1 \times 10^{13}$
150°C	$>1 \times 10^{13}$	$>1 \times 10^{13}$
200°C	3×10^{12}	3×10^{12}

*Filled with hydrated aluminum silicate 25% based on weight of resin. All values are at 1 kHz.

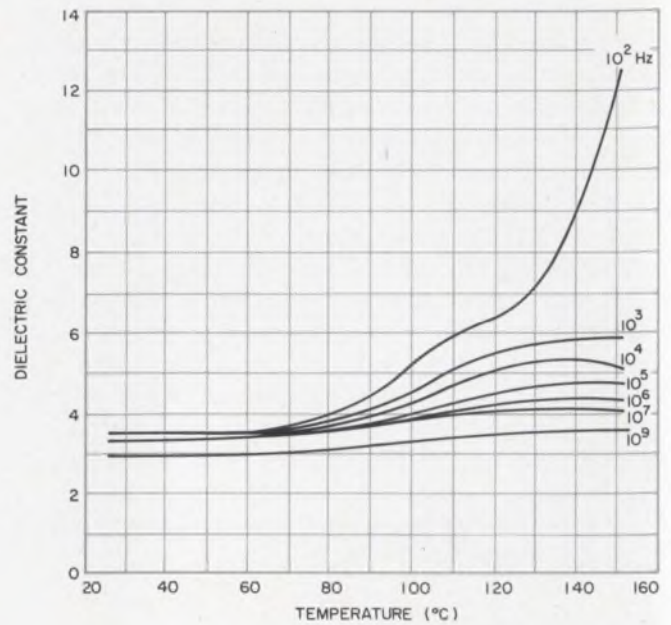
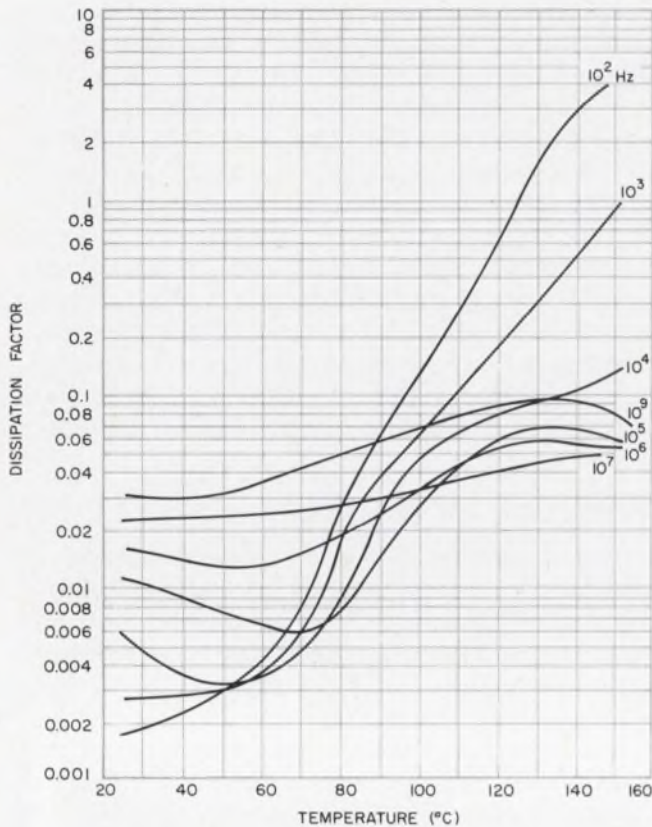

2. Temperature plays a role in epoxies' electrical stability. Dissipation factor (left) and dielectric constant (above) are plotted for bisphenol cured with 5% piperidine, a catalytic curing agent.

sistance drops with temperature; with the degree dependent on curing agents. Again, anhydride-cured epoxies show higher values than piperidine-cured epoxy.

Add bounce to your resin

Many package designers specify flexibilizers to lessen the basic hardness and rigidity of epoxy.

Certain flexibilizers reduce exothermic radiation and, in some cases, shrinkage. They reduce internal strains during cure, making possible castings of larger volume and greater complexity. They can improve unmodified epoxies' adherent properties, peel strengths, low-temperature performance and low-temperature crack-resistance.

As a higher and higher proportion of flexibilizer is used, extremely pliant rubberlike compounds result. With lower ratios, the material is more resilient, impact-resistant. Within the practical compounding range, there are numerous adhesives, coatings and castings that can be formed for applications where rigid epoxies are unsuitable (Fig. 3).

Military applications are a prime area for flexibilized systems. There, flexibilizers serve to reduce the cracking tendency of epoxy resin during curing and cooling or during temperature cycling. The latter usually involves extremes ranging from -55° to -65°C at the lower end to $+85^{\circ}$ to $+125^{\circ}\text{C}$ at the higher end. A flexibilized resin will absorb shrinkage and thermal-expansion forces better than a rigid resin.

Two other design factors that can benefit from a flexibilized resin are impact strength and cut-through resistance. Cut-through resistance is important if it is desired to cut into the cured material to salvage, replace or repair an expensive embedded component.

Despite the advantages, there are some serious disadvantages to flexibilized epoxies in certain applications. As hardness decreases, electrical properties degrade, loss factor and dielectric constant increase, and resistivity decreases. Moreover, hardness and physical strength decrease as use temperature goes up. For these reasons, it is generally wise to use the hardest or most rigid cured resin that will give the required crack resistance, impact strength or cut-through properties. Flexibilized compounds should not be used in high-temperature and high-frequency applications.

There are many flexibilizers and flexibilized epoxies on the market, and new ones frequently become available. Suppliers should be consulted for specific design problems. Four classes of flexibilizers are commonly used—polyamides, polysulfides, polyurethanes and linear polyazelaic poly-anhydrides (PAPA).

Most problems are things of past

Many of the earlier disadvantages of epoxy have been overcome by the extensive development work that has been done. A system can now generally be found or formed to skirt nearly every drawback that epoxy once had. One of the



3. Flexible epoxy-cast module can be repaired by cutting out the resin, replacing the defective component and reapplying the casting resin. The adhesion of epoxy is excellent, making such a repaired unit as good as new.

initial limitations, for example, was the high viscosity of the epoxy resins. Resins are now available with viscosities as low or as high as any packaging application requires. Cost was once a major obstacle. Although somewhat higher than that of polyesters, the cost of epoxy is often ignored because of its advantages. This is particularly true when fillers are used, since filled systems cost less than base resins alone.

Odors, toxicity and health hazards were an erstwhile problem; low-irritation curing agents and automatic mixing and dispensing equipment have largely done away with this. The vapors and fumes emitted by solid anhydrides were objectionable; current liquids are practically odorless.

Flame resistance was poor; flame-retardant systems are now available. Large castings could not be made because of the speed and magnitude of exothermic reaction, which cracked parts and occasionally caused a spontaneous fire. Now many resin systems have been designed specifically for big parts.

Guidelines narrow the choice

The number of combinations of properties is too large to recommend a particular epoxy or curing agent without detailed specifications for each application. Some generalized conclusions can, however, help with selection.

An epoxy should be considered in preference to other resins in the following situations:

- In military-environment systems when less costly resins do not meet environmental requirements.
- When the cost of the package is immaterial or the selling price of the finished product far exceeds the cost of the epoxy.
- Where close dimensional control is required.
- Where the embedment material must adhere to the components, as in sealing out moisture around terminals.

In choosing a curing agent, the following general guidelines will help:

- If a room-temperature cure is desired, use aliphatic-polyamine curing agents.
- If operation above 125°C is required, use aromatic-polyamine or acid-anhydride curing agents. The liquid and low-melting point acid anhydrides are easier to handle than solids and afford excellent high-temperature properties to above 180°C.
- For optimum high-temperature properties, consider cycloaliphatic diepoxides, novolac epoxies, epoxidized polyolefins, as well as bisphenols. Cycloaliphatic diepoxides are virtually unaffected by ultraviolet light. Novolacs have a higher functionality than bisphenols and so offer better chemical resistance and adhesion. Epoxidized polyolefins allow low-temperature curing with acid-anhydride curing agents and have relatively low specific gravity.
- For slow curing, boron trifluoride catalyst systems are best.
- When cost is the prime consideration, use phthalic-anhydride-cured systems.

Fortunately for the user of epoxies, there is a set of standardized tests. The Epoxy Resin Formulators Division of the Society of Plastics Industries, 250 Park Ave., New York, has developed two dozen standards for a wide range of the major properties of the epoxies.

And, the ASTM has two standards, one covering plastics and the other insulating materials. Both can be purchased from the ASTM, 1916 Race St., Philadelphia.

Test your retention

1. *What is epoxy functionality? Which end-use properties does it affect?*
2. *How can epoxy viscosity be altered?*
3. *What are some of the effects of a flexibilizer?*
4. *How can the thermal stability of an epoxy be altered?*
5. *What are some of the prime application areas for an epoxy resin?*

PATENT NO. 2,840,657

INFORMATION RETRIEVAL NUMBER 34

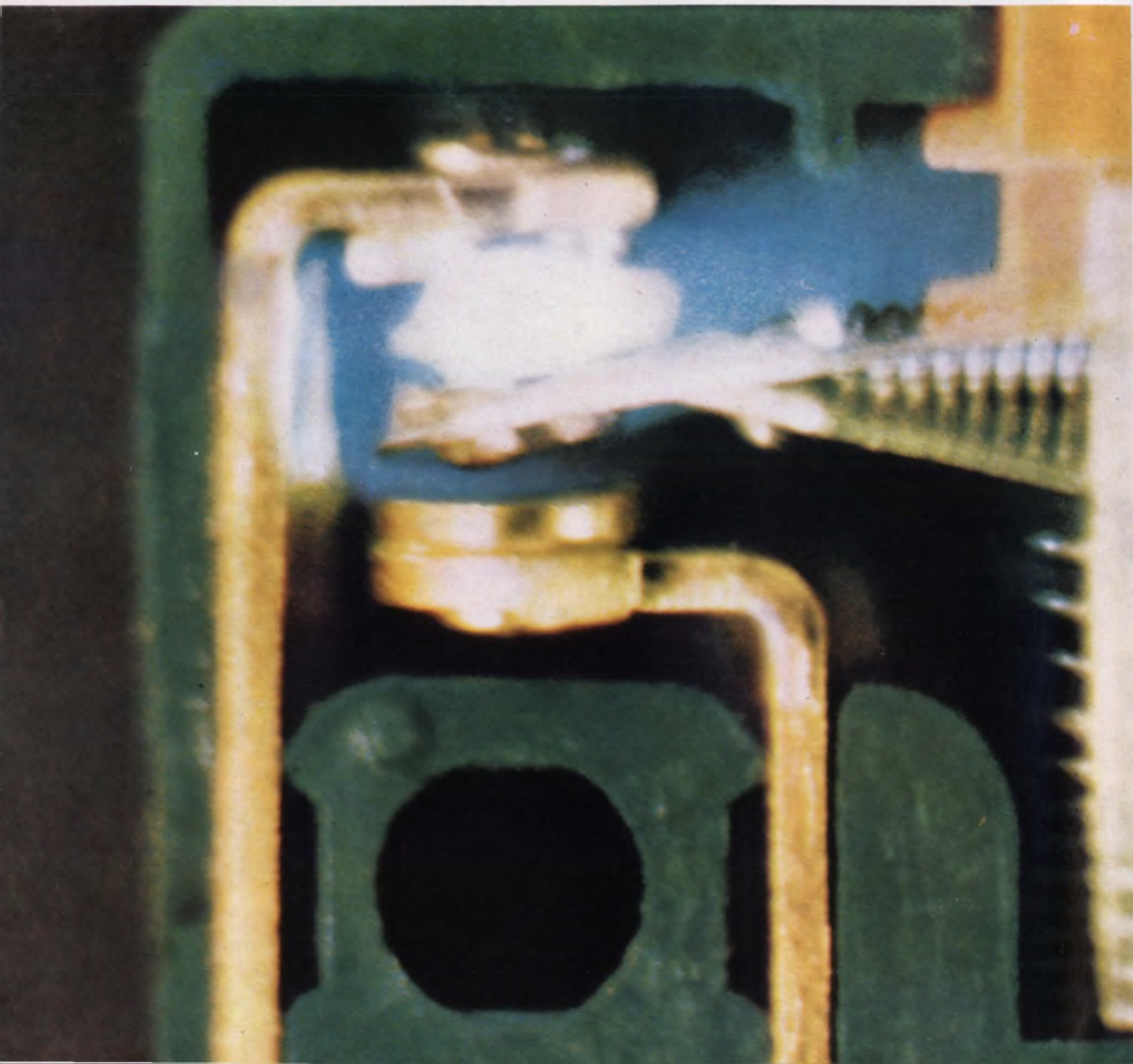

"Impossible!" people said. "Companies that are bigger than Licon and older than Licon can't do it—why, it's just like trying to put ten pounds of features in a five pound container!"

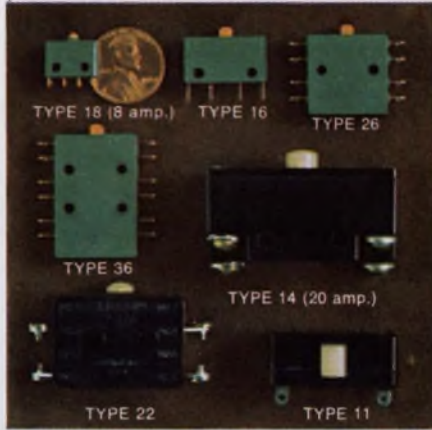

We took a lot of kidding. Then, after a lot of hard work, we took our design to the U.S. Patent Office. They don't kid around: If it's completely different, totally unique, you get what you came for. That's what happened: Patent No. 2,840,657.

We also took the photograph below (TYPE 16 nearly 400 times actual size) to show the impossible in action. Then we started supplying just about every engineer around with the switch that size-for-size has twice the advantages of the "standard" single break switches.

A Licon Butterfly® Double Break Switch gives you twice as many contact gaps, twice as many contact surfaces, two transfer blades instead of one. *Double everything* (and, generally speaking, that includes *double the electrical rating*) in the same size package. (If necessary, you can even control two isolated electrical cir-

LICON

cuits with a single switch.)

Even when subjected to extremes of vibration and shock, this exclusive Licon design gives substantially longer life: *twenty million* mechanical cycles without alteration of original switch characteristics!

The complete double break switch story—and the wide range of sizes available—would fill a book. So we wrote one. You can get a free copy by return mail just by writing on your company letterhead to: LICON, Division Illinois Tool Works, Inc., 6615 West Irving Park Road, Chicago, Illinois 60634.

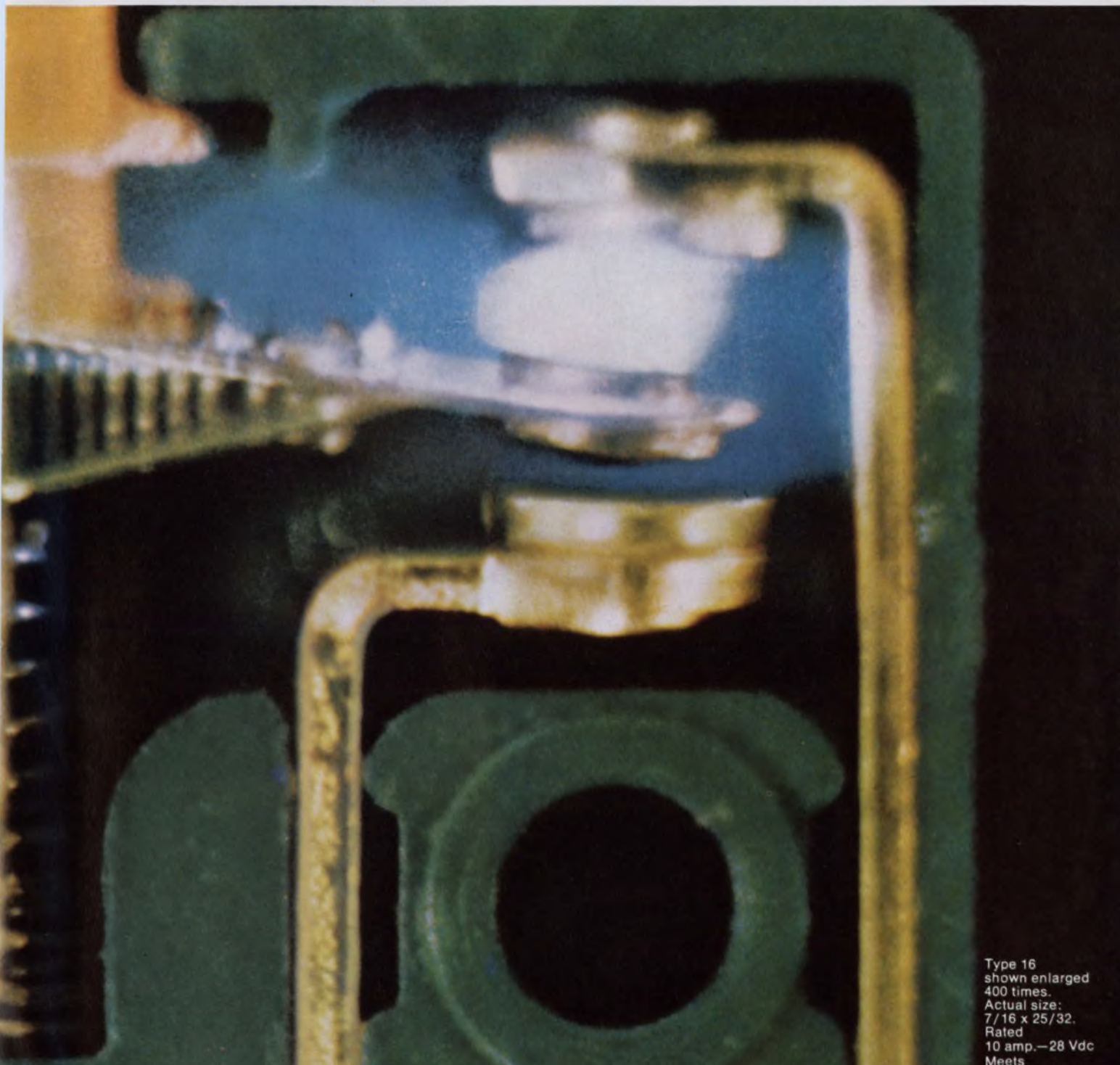

Type 16
shown enlarged
400 times.
Actual size:
7/16 x 25/32.
Rated
10 amp.—28 Vdc
Meets

MATERIALS FOR EMBEDMENT: SILICONES AND URETHANES

Although the epoxies are the resins most used for embedding, other resins also have important roles. Silicones, polyurethanes, polyesters, thermosetting hydrocarbons and acrylics, and polysulfide polymers—all have their place in electronics. Silicones in particular, are becoming increasingly popular. And for weight reduction, the foams of all resins are in wide use.

Silicones best when environments are worst

Silicones, based on silicon, are by no means an organic resin. But, they must be included since they are of extreme importance as an embedment material.

Silicone resins have a number of strong points:

- They are very convenient to use, are available over a wide range of viscosities, and most of them can be cured either at or near room temperatures. They are not exothermic.
- They are stable over a wide temperature range, generally maintaining their properties from approximately -65° to over 200°C , and in some cases up to 300°C .
- Their electrical properties are excellent. Silicones have very low electrical losses.

There are three classes of silicones: RTV silicones and flexible resins, silicone gels, and rigid solventless resins. All three are of growing importance in transfer-molding electronic assemblies, especially microcircuits and semiconductors.

RTV silicones and flexible resins—RTV, or room-temperature-vulcanizing silicones and flexible silicone resins are the most widely used class of silicones. They are resilient, with excellent thermal shock resistance and low internal curing stresses. Some cure at room temperature; others slightly above. While most are colored, there are also clear, flexible ones that have most of the desirable properties of the pigmented materials

(Fig. 1). The change in electrical properties of colored RTVs with increasing temperature is shown in Fig. 2. Typical properties of cured RTVs and flexible resins are shown in Table 1, p. 65. This class of silicones has excellent stability in vacuum conditions, so that it is well suited to deep-space applications. Weight loss is generally under 1% at 10^{-6} torr.

Silicone gels—As the name implies, these materials exist in a gel state after curing. They are, however, very tough and withstand considerable breaking force. Because of their gel nature, they are commonly used in a can or case.

Test probes can be inserted through the gel to check circuits and components. After withdrawal of test probes, the gel has sufficient "memory" to heal the section that has been pierced by the probes.

Rigid solventless silicones—The least used group, rigid solventless silicones do not have the good thermal shock and crack resistance of the flexible materials, and are not so convenient to work with as room-temperature-curing materials. They can be used, however, where the properties of silicones are desired and rigidity is preferred. They are available in a variety of viscosities for both impregnating and casting or potting.

Polyurethanes adhere better than silicones

Polyurethanes, or urethanes, are very tough, have high tear strength, very good thermal shock resistance, and are easy to use. Like silicones, they are cured at or near room temperatures, but unlike silicones, their adhesion to most materials is excellent. When it comes to operating temperatures, however, there is no comparison. Polyurethanes are generally limited to operation below 150°C . Careful drying of parts to be embedded is required to prevent bubbles from forming when polyurethanes react with moisture. A newer type of polyurethane, based on ricinoleate polyols, has a much lower dielectric constant (as low as 3 at 100 Hz) than polyester and polyether-based urethanes. And, volume resistivity is as much as two

Free reprints

Free reprints of this report are available, while supplies last. Circle Reader-Service number 260.

orders of magnitude higher.

Polyesters cost the least

Polyesters are two-component systems: a low-molecular-weight polyester and a vinyl-type monomer, generally styrene. Other monomers used are triallyl cyanurate (TAC) and diallyl phthalate. TAC is used to give a polyester system the highest possible thermal stability. Major advantages of polyesters are:

- Handling is easy for both small- and large-volume applications.
- Strength and electrical properties are excellent.
- Only a short low-temperature curing cycle is needed for the catalyzed polyester resin.
- Little or no pressure is needed for curing.
- The catalyzed polyester is completely reactive. Special processing for elimination of by-products is unnecessary.
- Material cost is low compared with most other embedding materials.

A catalyst makes the polyesters durable at moderate temperatures; a promoter used with the catalyst causes polymerization at room temperature. Rigid or flexible polyesters are available, based on the specific linear polyester used in the polyester resin system. Properties of a rigid and a flexible polyester are given in Table 2, p. 65.

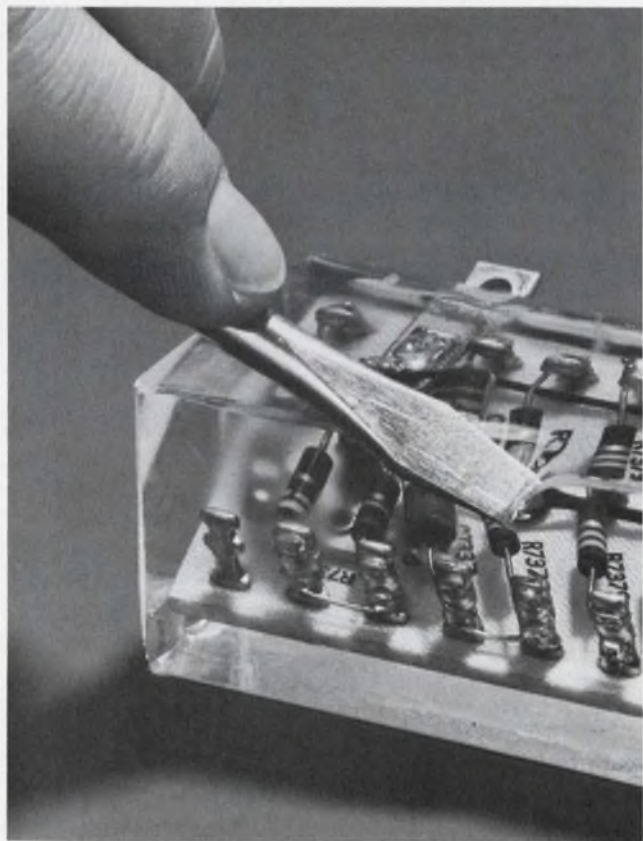

1. Clarity and resilience of a clear, flexible silicone are demonstrated by the "screwdriver test." Clear silicones have most of the properties of the pigmented resins.

The speed and temperature with which polyesters can be cured varies from room heat for less than 5 minutes to 200°F for many hours. Because the base polyester resin can be highly diluted with a reactive monomer such as styrene, viscosities range from very low for impregnating to high enough for encapsulation.

Cure at or near room temperature is usually aided by an aldehyde or ketone peroxide catalyst such as methyl ethyl ketone peroxide or cyclohexanone peroxide.

A common higher-temperature catalyst is benzoyl peroxide. Pure benzoyl peroxide is a solid and dissolves rather slowly in polyester resins. It is easier to use if dissolved in a small amount of styrene before addition to the polyester resin. Benzoyl peroxide catalyst pastes of 50% benzoyl peroxide and 50% tricresyl phosphate disperse very easily in polyester resins.

The optimal amount of catalyst to use depends on the type of resin, the desired speed of cure, and the dimensions of the cured piece. The practical range is usually between 0.1% and 2% peroxide, based on the weight of the styrene-polyester mix received from the supplier.

A promoter or activator is often used to speed the reaction. The effect is a faster oven cure or even its elimination. Promoters can also act as driers to give a surface that is not tacky.

Cobalt octoate, hexoate and naphthenate are

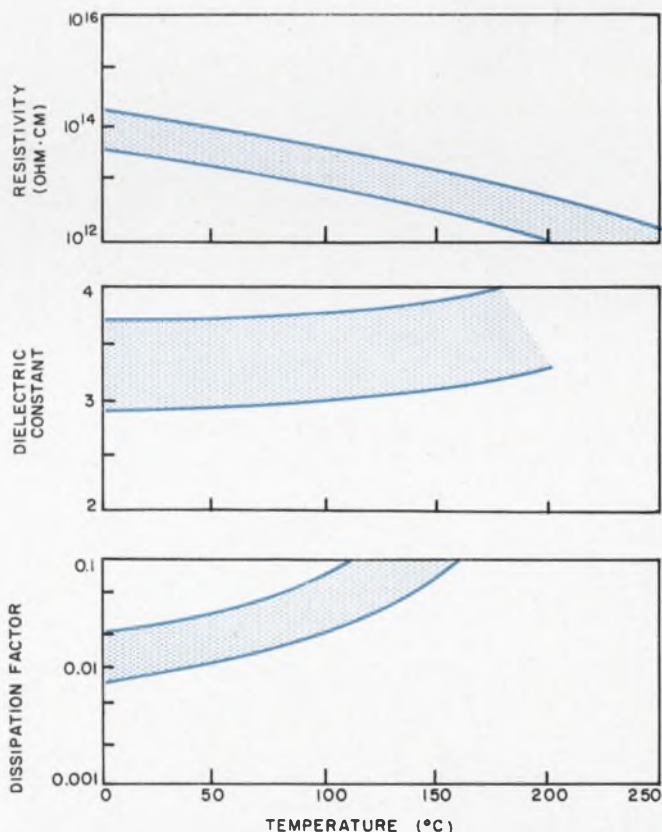

2. Electrical properties of pigmented silicones degrade somewhat with increasing temperature. Silicones maintain most of their properties beyond 250°C.

good general-purpose promoters for use with ketone peroxides. They give a fast cure at room temperature. The pot life of a given polyester can often be varied from minutes to hours by varying the peroxide-cobalt naphthenate ratio, but the usual concentrations again range from 0.1% to 2%. Cobalt has a tendency to tint the cured polyester bluish, but in low concentrations this is hardly noticeable.

Promoters used with such acyl peroxides as benzoyl peroxide are tertiary amines such as diethylaniline and dimethylaniline, and mercaptans such as lauryl mercaptan. Amines are fast and have a tendency to discolor; the mercaptans are less fast but leave resins colorless. Concentrations often range 0.05% to 0.5%. Catalysts, promoters and activators are never directly mixed together—they would explode with peroxides.

The polymerization of a polyester-styrene combination is highly exothermic; the amount of heat depends on the type of resin and, in particular, on the degree of unsaturation. The temperature inside the polymerizing mass is governed by the difference between the speed at which heat is evolved and the rate at which it is led away. The thermal conductivity of the mass and the mold (if one is used), the dimensions of the article, the heat-transfer coefficient

to mold or air, and the temperature of the surroundings will all influence dissipation.

Thermosetting hydrocarbons excel electrically

Typical thermosetting hydrocarbon resins are Buton A-500 and Buton 100, two butadiene-styrene copolymer products of Enjay Chemical Co., New York. They can be compounded as flexible cured resins over a fairly wide range of flexibility or hardness, have excellent electrical properties and absorb little moisture. The cured resins are transparent, and if they are flexible, they can be cut open for repairing an embedded assembly. Some important properties of cured thermosetting hydrocarbon resins are shown in Table 3.

Thermosetting acrylics operate at 260°C

The outstanding property of thermosetting acrylic resins is good temperature resistance up to 260°C. This approaches that of the best epoxy resin systems. Relatively low weight losses (about 10%) have been recorded after 1000 hours at 500°F. Like other resins, thermosetting acrylics are solventless and yield no byproducts during curing. Like polyesters, they can be modified with monomers such as styrene. Their electrical properties are comparable to those of polyesters—quite good in their operating temperature range. Dielectric constant and dissipation factor both are little affected as temperature varies.

Polysulfides used in connectors

Available in liquid resins and as catalyst systems, polysulfides are widely used for potting electrical connectors. The cured polysulfide rubber is flexible and is very resistant to solvents, oxidation, ozone and weathering. Gas permeability is low, and electrical insulation properties are good at temperatures between -65° and +300°F. At 25°C, cured polysulfide rubber has a volume resistivity of 10^9 ohm-cm and a 1-MHz dielectric constant of 7.5.

Polysulfide rubber resins are of the same chemical class as the polysulfide rubber resins used in modifying epoxy resins. They are not as good as silicones in electrical and thermal properties, but their adhesion is generally better.

Low-density foams cut package weight

Most of the liquid resins can be made into low-density foams by adding selective foaming or blowing agents. Generally foams have lower electrical losses, dielectric strength, thermal conductivity and mechanical strength than high-density resins, and generally, those changes in their properties (Fig. 3) are an almost direct function of

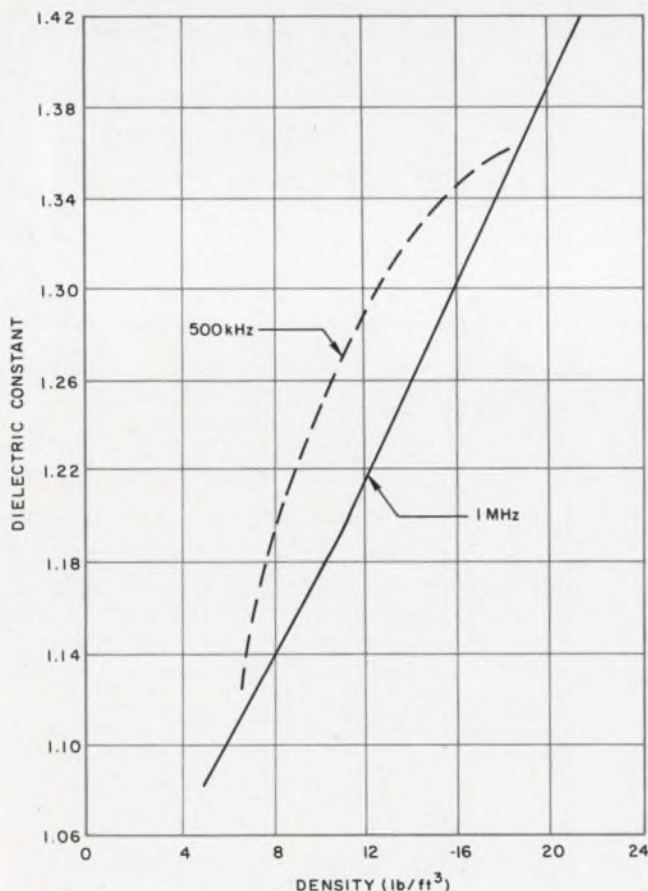

3. Dielectric constant of a urethane foam goes up with resin density. Frequencies are 1 MHz and 500 kHz (dashed line). Material is Nopco Chemical Co.'s Lock-foam series A at 72°F.

Table 1. Basic properties of silicone resins

Property	ASTM test	RTV	Flexible
Shrinkage, 7 days at 25°C (%)	—	0.4-0.6	—
Specific gravity (density)	D792	1.17-1.50	1.02
Viscosity at 25° (centipoises)	D445	12,500-45,000	4000-6500
Useful temperature range (°C)		-60 to 300	—
Thermal shock (10 cycles MIL-16923C)		pass	—
Hardness (Shore A)	D676	40-60	30
Thermal conductivity (10 ⁻⁴ cal/s/cm ² /°C/cm)	C177	5-7.5	3.5-7.5
Thermal expansion (10 ⁻⁵ /°C)	D696	0.5-0.8	25-30
Volume resistivity (ohm×cm)	D257	1×10 ¹⁴ -3×10 ¹⁴	1×10 ¹³
Dielectric strength (V/mil)	D149	525-600	500
Dielectric constant at 1 MHz	D150	2.8-3.6	2.88
Dissipation factor at 1 MHz	D150	0.003-0.005	0.002
Arc resistance (s)	D495	90-125	115-130

Materials are Dow Corning 3110, 3112, 3116, 3118 and 3120 RTV silicone, and Sylgard 184 flexible resin.

Table 2. Basic properties of polyester resins

Property	ASTM test	Rigid polyester	Flexible polyester
Specific gravity (density)	D792	1.10-1.46	1.01-1.20
Specific volume (in. ³ /lb)	D792	19.0-25.2	23.0-27.4
Impact strength (ft-lb/in. of notch)	D256	0.2-0.4	>7.0
Hardness (Rockwell)	D785	M70-M115	84./94 (Shore)
Thermal conductivity (10 ⁻⁴ cal/s/cm ² /°C/cm)	C177	4	—
Thermal expansion (10 ⁻⁵ /°C)	D696	5.5-10	—
Volume resistivity (ohm×cm)	D257	10 ¹⁴	—
Dielectric strength, step-by-step, 1/8-inch thick (V/mil)	D149	280-420	170
Dielectric constant at 1 kHz	D150	2.8-5.2	4.5-7.1
Dissipation factor at 1 kHz	D150	0.005-0.025	0.016-0.050
Arc resistance (s)	D495	125	135

Table 3. Basic properties of thermoset hydrocarbon resins

Property	ASTM test	Resin A*	Resin B*	Resin C*
Mold (linear) shrinkage (in./in.)	—	0.05	0.06	0.05
Hardness (Shore)	—	100	90	85
Volume resistivity (ohm×cm)	D257	2.8×10 ¹⁵	2.6×10 ¹⁵	—
Dielectric constant at 1 kHz	D150	2.5	2.6	2.6
Dissipation factor at 1 kHz	D150	0.002	0.002	0.002

*Resins are Enjay Chemical Co. compounds. A contains 80% styrene-butadiene copolymer (Buton 100 or A-500), 20% vinyl toluene and 1%-3% Lupersol 101 catalyst. B contains the same resins, 1% Lupersol and 1% dicumyl peroxide. C again contains the same resins with 0.5% tert-butyl perbenzoate and 1% di-tert-butyl peroxide.

Table 4. Characteristics of nine embedding resins

Resin	Characteristics	Typical materials
RTV and flexible silicones	Easy to use. Most can be cured at or near room temperatures. Cured resins, being flexible, have minimal effect on critical components, and are more readily repairable than rigid resins. Excellent properties up to 500°F. Some are water clear.	RTV (Dow Corning, General Electric) LTV (General Electric) Sylgard (Dow Corning)
Silicone gels	Cure into a tough gel. Test probes can be inserted through the gel for checking circuits and components. The gel has sufficient memory to heal where it is pierced by the probes.	Dielectric Gel (Dow Corning)
Rigid silicones	Optimum high-temperature properties. Available in a variety of viscosities for impregnating, casting, or potting. Somewhat brittle and require fillers for crack resistance.	DC Resins (Dow Corning)
Polysulfides	Very good flexibility, excellent adhesive properties, and excellent resistance to solvents and oxidation. Handled like RTV silicones, but have much less thermal stability. Electrical properties degrade with increasing temperature. Used for connector potting.	Thiokol (Thiokol Corp.) PRC (Products Research Corp.)
Polyurethanes	Flexible, tough, and have excellent crack-resistance. Can be cured at or near room temperatures. In some cases, replacing polysulfides for connector potting.	Adiprene (Du Pont) Polycin (Baker Castor Oil) Vorite (Baker Castor Oil)
Polyesters	Easy to use. Among the lowest cost liquid resins. Widely used for large-volume commercial applications. Have higher shrinkage than epoxies and are not as good in adhesion. Also, resistance to extreme environments is not so good as epoxies. Electrically good.	Selectron (Pittsburgh Plate Glass); many others. Metron flame-retardant resins (Hooker Chemical Co.)
Thermosetting hydrocarbons	Excellent electrical properties and low moisture absorption. Can be formulated as flexible cured resins over a fairly wide range of flexibility or hardness. Cured resins are transparent and easily cut for repair.	Buton (Enjay)
Thermosetting acrylics	Relatively new resins that have good temperature resistance up to 500°F. Electrical properties are good.	Stypol (Freeman Chemical)
Low-density foams	Used for lowest-possible-weight packages. While nearly any resin can be foamed with some blowing agent, polyurethane foams are most widely used because of their ease of handling. While not as good environmentally as the low-density resins, foams provide adequate protection for many applications.	Lockfoam (Nopco) Isofoam (Isocyanate Products) Eccofoam (Emerson & Cuming)

foam density. Although epoxy and silicone foams are used in many applications, the polyurethanes are the most popular of all.

The latter cure at room temperature or a low baking temperature and are relatively easy to work with. They can be foamed in place after mixing, since the gas required for foaming is generated by the curing reaction; no blowing agents or other additives are required. The rigidity of the foam can be closely controlled to obtain a specific stability under specified shock and vibration conditions. Densities as low as 2 lb/ft³ are possible with polyurethanes, although

4 lb/ft³ is a more general lower limit.

Epoxies can be foamed by adding gas-generating or blowing agents to the resin mix. When the mix is heated to the proper temperature, the gas is liberated by the blowing agent to form a cellular structure. If the curing rate at the blowing temperature is too slow, the gas bubbles will rise and slow the foaming action. If the curing rate is too rapid, the resin will gel before full gas liberation has occurred. Exact conditions must be maintained between epoxide, hardener, blowing agent, viscosity and temperature.

Silicone foams can be produced in rigid or

flexible form with the same excellent thermal and electrical properties as regular silicones. Silicone foam resins are available as compounded one-component solids, requiring no other preparation before use. On heating, the components melt and expand. Simplicity of handling makes the silicone foams ideal for production-line use, although their relatively high cost can be a drawback if the superior properties of silicones are inessential. Foam density can be controlled by adjusting the temperature.

Two-component systems are also available for room-temperature curing. Pot life of the mixed materials is approximately 20 to 30 minutes at room temperature. Foam density of 20 to 25 lb/ft³ is somewhat higher than that of the thermally expansible one-component compounds.

Polystyrene can be foamed in place by thermal treatment of properly compounded resins. The compounded resins are available as small beads that are placed in a cavity and heated to 230° to 270°F. Foam densities as low as 1 lb/ft³ are attainable. Polystyrene has excellent electrical properties but the foams are rigid and have the low thermal resistance of the thermoplastic polystyrene base material. The useful temperature limit of polystyrene is approximately 170° to 175°F.

What about radiation resistance?

In choosing a resin, one important additional factor must be considered: Will the package be operating in an environment alien to anything that can be created in the laboratory? In particular, what are the radiation effects on the chosen resin? For example, consider a silicone.

Silicone resins maintain their properties after doses of 1000 Mrad of gamma radiation. On the other hand, silicone rubber becomes brittle after exposure to 100-500 Mrad. The usefulness of silicone rubber therefore depends on the flexibility required.

Slab samples of silica-filled R-7521 (Dow Corning) rigid solventless silicone resins were exposed to up to 1000 Mrad of gamma radiation. After irradiation, color, flexural strength, electric strength, dissipation factor, dielectric constant, volume resistivity, and arc resistance were examined. The radiation was found to have affected most of these properties.

- Color was slightly darkened.
- Rapid-rise dielectric strength was increased by irradiation from 500 to 1000 Mrad.
- Low-frequency dissipation factor was slightly increased.
- Dielectric constant was slightly increased.
- Moisture resistance was decreased on the surface.
- Arc-resistance measurements became more

consistent and were low in value.

■ Dielectric losses during irradiation were large and were a strong function of the dose ratio. They are much greater during irradiation than prior to or immediately after it.

The addition of fillers can improve the radiation resistance of resins. Better yet, antirads may be used. Antirads, or antiradiation substances, can improve radiation stability to the extent that a material will retain as much as 99 per cent of its tensile strength and 80 per cent of its elasticity.

In defining radiation resistance, the engineer should be able to differentiate between gamma radiation, gamma neutrons, electrons, protons, soft and hard X-rays. Effects of any of these forms of radiation differ on any given resin system. Gamma radiation might be encountered in cobalt-60 environments, among separated fission products or spent reactor-fuel elements. Gamma neutrons emanate from reactors, electrons from, say, a Van de Graaff accelerator, protons from a cyclotron and X-rays, obviously, from X-ray machines.

Is material compatible with components?

The lack of compatibility between resin and component often causes product problems at a late stage of development or production. The cure of some resins, for example, is inhibited by materials commonly used in electronic assemblies, and some plastic materials commonly used in electronic assemblies are attacked by certain resins. Some polyesters and some clear flexible silicones inhibit curing to a certain extent. Molded polycarbonate insulators are crazed by some of the amine curing agents used with epoxy resins. Certain silicones will corrode some metals, particularly copper. Many unreacted urethanes react with moisture in the air. Some polyesters polymerize in contact with metals. Epoxies are generally immune to extremes of these problems.

Characteristics of all of the resins covered in this article are given in Table 4.

Test your retention

1. *What are the outstanding properties of the silicones?*
2. *Where do the polyurethanes outdo the silicones? What about ricinoleate urethanes?*
3. *How can the cure of a polyester be accomplished at low or room temperature?*
4. *Where do foams better their higher-density parent resins?*
5. *Which property of silicone is most directly affected by exposure to, say, 500 Mrad of gamma radiation?*



optimity...

"The condition or fact of being best or for the best."*

That's the industry-wide reputation established by Clare relays, stepping switches, pushbutton switchlights, current sensors, static timers, and other control devices. The reasons—as varied as the users. The Clare line is complete—there's no make-do, no compromise performance. Versatile—wherever and whenever you need contact switching, Clare puts you in control. Engineered to high standards of reliability. Widely recognized for precise performance, without undue maintenance or change in operating characteristics.

For optimity in your system—for advanced capability based on long life, high reliability, and maximum economy—let Clare put you in control.

For complete product information, specify your areas of interest . . . Write Group 2A2



C. P. Clare & Co., Chicago, Illinois 60645 . . . and worldwide

a GENERAL INSTRUMENT company

*Webster

- 1—*Pushbutton switchlights by Clare-Pendar*
- 2—*Telephone-type relays*
- 3—*Polar relays*
- 4—*Military-type (crystal can) relays*
- 5—*MicroClareed relays*
- 6—*Stepping switches*
- 7—*Coaxial relays*
- 8—*Mercury-wetted contact relays*
- 9—*Timers and time-delay relays by Clare-Electrodeal*
- 10—*Clareed relays*
- 11—*Current Sensors by Clare-Electrodeal*

No-Break AC Stand-By Power by Clare-Electrodeal

For orderly control of critical process, start-up, or shut-down during emergency power loss situations. Dependable power for computer memories and other applications demanding an absolute source of AC power.



... for optimity in industrial process control, electronic data processing, aerospace and ground support, communications, and instrumentation

NEED IMPROVED PROPERTIES? TAILOR THEM WITH FILLERS

Embedding resins do have limitations, but designers can modify many of them through the judicious use of fillers. Major alterations can be made to such basic properties as thermal conductivity, coefficient of thermal expansion, shrinkage, thermal shock resistance, density, exothermic generation, viscosity, and cost. The number of different embedding materials can be increased to the almost combinatorial number of resin-filler systems.

Different fillers affect a resin property in varying degrees, but the nature and direction of their effect is often similar regardless of which filler is used. That is, the magnitude of the effect is mainly a function of the amount of filler.

Fillers can help beat the heat

Nowhere are the effects of fillers more significant than in the modification of thermal properties.

A major problem with most resin systems is their tendency to crack because of the difference in the thermal expansions of the embedded electronics and the embedment material (Fig. 1). Sufficient filler, however, can lower the thermal expansion of epoxy resins to the same range as that of some metals. Although the effect of most fillers is similar, specific fillers vary to some degree in their effect.

Fillers can also increase a resin's thermal conductivity and decrease its weight loss during heat-aging. The more filler incorporated in a resin system, the less its weight loss. Although the resin portion of the system does degrade with heat-aging, the system's over-all performance is almost always improved.

Another benefit of fillers is to reduce a system's exothermic heat during curing. This plus

reduced shrinkage and thermal expansion often minimizes resin cracking and can make available for use a system that would otherwise be unsatisfactory because of its tendency to crack.

Pot life can also be modified by fillers. The filler's thermal conductivity transfers some of the heat from a unit being cured, so extending pot life.

Fire resistance, too, can be improved. Burning rate is considerably reduced or even eliminated in many cases by the addition of such a filler as antimony oxide. Certain phosphates reduce the flammability of resins, but may rapidly raise dielectric constant and dissipation factor above 100°C.

Thermal conductivity gets a big boost

One advantage of embedding electronic packages in resin is the range of thermal conductivity that is possible. Resin compounds may have either good thermal conductivity or good thermal insulation—whichever is desired for a given package design. In power-generating devices that call for minimum size for maximum power output, the high-thermal-conductivity resin systems are of prime value.

Such mechanical approaches to improving heat transfer as heat sinks or forced cooling have inherent shortcomings: they may increase costs and weight or reduce yields or reliability. Fillers, on the other hand, lend themselves particularly well to obtaining the highest possible thermal conductivity.

The thermal conductivity in cal/cm/s/cm²/°C of some high-thermal-conductivity fillers are: mica, 0.0012; sand, 0.0028; aluminum, 0.497, and copper, 0.918. Such powdered metallic fillers as copper or aluminum may appear to give a resin system the highest possible thermal conductivity, but this is not entirely true. Compounds prepared with coarse-grain sand and tabular alumina, for instance, have a slightly higher thermal conductivity than compounds that use fine-mesh aluminum as a filler, despite aluminum's better ther-

Free reprints

Free reprints of this report are available, while supplies last. Circle Reader-Service number 260.

mal conductivity (Table 1). On the other hand, a compound filled with 30-mesh aluminum has better thermal conductivity than a sand-and-fine-mesh-aluminum-filled compound. Moreover, the copper-filled compound in Table 1 has lower thermal conductivity than the 30-mesh aluminum compound, even though copper has a much higher thermal conductivity than aluminum.

One reason for these apparent anomalies is the particle type and size of the filler. Particle type and size determine the amount of filler that can be mixed with a resin and still give a compound of low enough viscosity to be poured. The specific gravity of the filler is another reason.

The volume concentration of filler rather than the weight concentration is what determines by how much thermal conductivity can be increased. Maximum thermal conductivity is achieved by using the highest-thermal-conductivity filler that will allow the greatest volume concentration of filler in the compound.

The main reason why the sand-filled compound has better thermal conductivity than the aluminum-filled compound in Table 1 is the *bulk effect*. That is, an increase in a filled compound's thermal conductivity depends more on the quantity of filler than on the type of filler used, so long as the filler is of the same particle type. Table 1 shows that both the mica-filled compound and the aluminum-filled compound contains 40% of filler by weight, yet the aluminum-filled material has much higher thermal conductivity. The sand-filled compound on the other hand, contains 70% of sand by weight. There is then a much higher concentration of filler in the sand-filled compound both by weight and volume.

At this point practical design trade-offs enter into consideration. Fine-mesh fillers such as fine mica powder and fine-mesh aluminum powder yield a highly viscose compound (at 70°C) with poor flow properties at 40% weight concentration. In fact, a 40% concentration of fine-mesh aluminum filler is almost unworkable. A sand-filled resin, however, is still very workable at a 70% weight concentration. Similar results are obtained with tabular alumina, magnesium oxide, and other highly conductive, large-grain fillers, but an electrical grade of sand is usually much more economical. Although the copper-filled compound in Table 1 has a relatively high thermal conductivity, copper powder is less convenient to use because of its high density. It is quite difficult to keep powdered copper in suspension without settling to the bottom long enough for the compound to cure. The lower the compound's viscosity and the longer the pot life are, the greater the settling problem.

The most likely explanation for the bulk effect is that resins, being good insulators, form an insulating barrier between each filler particle. The good thermal conductivity through the particles is tempered by the lower conductivity through the resin layers. Over-all thermal conductivity is best increased by adding more filler particles or, more specifically, by increasing the volume concentration of filler. This results in a shorter conductivity path through the resin, a longer conductivity path through the filler, and an over-all reduction in the resistance to conductive heat flow. The upper limit on filler concentration is the practical working viscosity.

There is one case where the addition of more

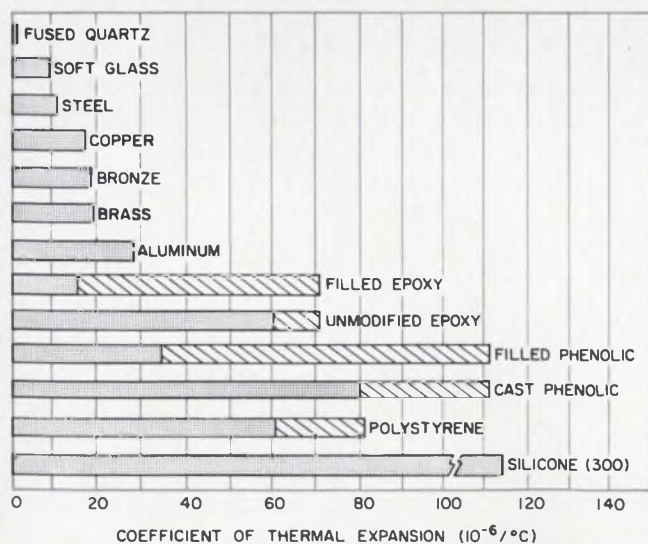

1. Coefficient of thermal expansion of epoxy and phenolic can be brought down to that of metals with fillers. Shaded areas represent range of values. For example, an unfilled epoxy ranges from 60 to about 70. Use filler and the range is 15 to 70, compatible with metals.

Table 1. Thermal conductivity data

Filler	% filler by weight	Thermal conductivity (W × in. / in. ² / °C)
Copper powder	90	0.040
30-mesh aluminum	80	0.064
Fine-mesh aluminum	40	0.022
Coarse-grain sand	70	0.025
Tabular alumina	80	0.026
Coarse-grain magnesium oxide	80	0.032
325-mesh mica	45	0.013
325-mesh silica	55	0.019
None (epoxy)	0	0.005
Hollow phenolic speres	15	0.003
Unfilled urethane foam, 5 lb/ft ³	0	0.001

Epoxy and urethane foam are shown for comparison.

Table 2. Filler costs and effects

Type of filler	Approx cost (¢/lb)	Property increase					Property decrease					
		Thermal conductivity	Thermal-shock-resistance Impact resistance	Compressive strength	Arc resistance	Machinability	Electrical conductivity	Cost	Cracking	Exothermic generation	Coefficient of expansion	Density
Bulk												
Sand	1	●		●			▲		●	●		●
Silica	1 to 2	●		●			▲		●	●		●
Talc	1 to 4					▲	●		●	●		●
Clay	1 to 3	●		●		▲	●	●	●	●		●
Calcium carbonate	0.5 to 5					▲	●		●			●
Calcium sulfate (anhydrous)	2 to 4	●		●	▲		●		●	●		●
Reinforcing												
Mica	3 to 9	●	▲				●	●				
Asbestos	2 to 5	●	▲				●	●				
Wollastonite	2 to 3	●	▲				●	●				
Chopped glass	45	●	▲				●	●				
Wood flour		●	●			●	●				▲	
Sawdust		●	●			●	●				▲	
Specialty												
Quartz	2 to 5	●	●	●				●		▲		●
Aluminum Hydrate alumina	5 to 15	●	●	●				●	●	▲		●
Li-Ai silicate	3 to 6				▲							
Beryl		●		●				●	●	▲		●
Graphite	6 to 30					●	▲					
Powder metals		●	●	●	●	●	●	●	●	●		●
Low-density spheres	75 to 150										▲	

▲ denotes most significant use. Particle sizes are 200-mesh or finer, except for sand, spheres and reinforcing fillers that depend on configuration for their effect.

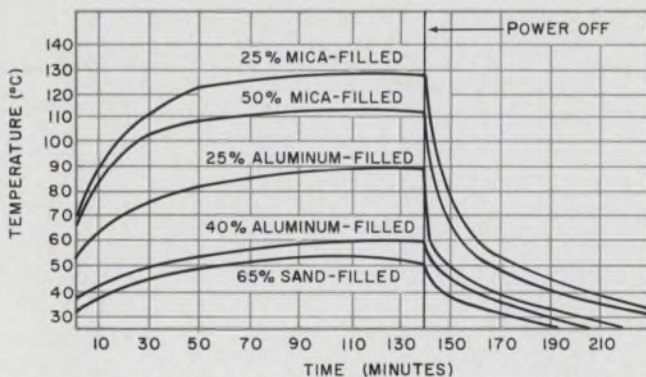

2. Heat dissipation from a localized source is plotted for epoxy with different fillers. Source is a 24-W resistor under a 4-W load. Sand-filled epoxy shows smallest temperature rise and quickest fall after power is removed.

filler decreases thermal conductivity. This is where the filler is hollow spherules rather than solid particles. In Table 1 note the extremely low thermal conductivity of the spheroid-filled epoxy. The hollow fillers are usually filled with air or gas. Added spheroid filler reduces conductivity through the insulator, since air and gas may be considered to be optimum insulators. Such fillers are used to reduce specific gravity.

Design for localized heat sources

To check the effect of fillers, consider a package designed for localized heat sources—24 watt resistors under 4-watt loads. The tubular resistors are cast in a cylinder approximately 3-1/2-inches in diameter by 3 inches high. Temperatures were measured by a copper-constantan thermocouple bonded to the body of the resistors. The actual heat dissipation curves (Fig. 2) agree very well with the thermal-conductivity data in Table 1. Internal heat rise, for example, is reduced by increasing the filler in both the mica-filled and the aluminum-filled compound. While aluminum-filled compounds have better thermal conductivity than mica-filled compounds, the important point is that the sand-filled compound has far better heat dissipation than either, especially where the mica and aluminum concentration is low enough to yield a workable viscosity.

From the data in Table 1, tabular alumina might be expected to give results equivalent to sand, and 30-mesh aluminum or magnesium oxide to produce even less internal temperature increase. Sand's real value is seen in the fact that temperature rise is about 75°C less in the sand-filled compound than in the mica-filled compound.

Design for gradient heat sources

Gradient heat sources are more typical variable-temperature sources than localized ones. Take, for example, the electrical load in a 2-inch ID by 3-inch OD by 1/2-inch high toroidal magnetic core dissipating 10 watts. The core was cast into a 3-1/2 inch diameter, 3-inch high cylinder. A copper constantan thermocouple is mounted at the geometrical center of the core. The cores are embedded in unfilled, mica-filled and sand-filled epoxy to compare the low-, medium-, and high-thermal-conductivity cases. The difference in temperature rise, shown by the heat dissipation curves of Fig. 3, supports the data of Table 1. The improvement in temperature rise depends somewhat on the power load and on the type of heat source—localized or gradient. The temperature curves, however, are similar in all cases.

If an overload is applied, the improved heat transfer of the sand-filled epoxy compound im-

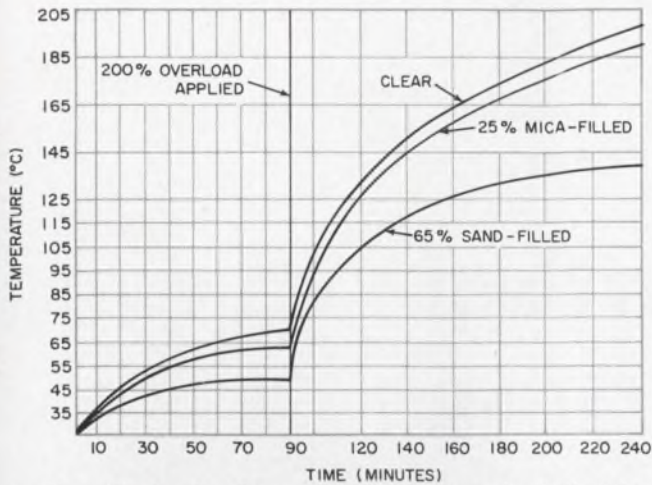

3. Heat dissipation from a gradient source is plotted for different epoxy-filler systems. Source is a toroidal magnetic core under a 10-W load. Sand-filled epoxy shows lowest rise before and during 200% overload.

mediately shows up as a slower temperature rise. Moreover, the final difference in temperature rise between the sand-filled and mica-filled material is much greater during overload than under normal power loading. On top of all that, the temperature rise is slower with the sand-cast material and the drop off when the overload is removed is greater.

Less effect on mechanical properties

The effect of some fillers on the mechanical properties of cured systems can be considerable. With reference to their effects on mechanical properties, fillers are often classified as reinforcing and nonreinforcing, or fibrous and nonfibrous. Nonreinforcing or nonfibrous fillers are also known as bulk fillers. Some typical bulk fillers are sand, silica, talc, clay and calcium carbonate. They generally cost the least—less than five cents per pound. Typical reinforcing fillers are mica, asbestos, chopped glass and wollastonite. Specialty fillers are the most expensive—they are used to tailor a specific resin property.

As a general rule, hardness is increased and machinability lessened by bulk fillers, especially such abrasive ones as silica and sand. Impact strength and tensile strength can be increased by the use of reinforcing fillers, decreased by bulk fillers.

Milled or chopped glass fibers in screen sizes of 1/32, 1/16, 1/8, and 1/4 inch are especially good fibrous fillers. In cases where it is difficult to control resin seepage from a mold, 5% milled glass fibers, particularly the 1/32-inch fibers, can provide an effective control.

Binders or size are commonly applied to glass fibers to improve their adhesion to the resin. A starch, silane or chromic chloride (Dupont Volan) treatment are among those used. In general, a

starch size tends to allow moisture to penetrate along the fibers and reduces the insulation resistance of a glass-filled compound, particularly if the compound is subjected to humidity. This is less true with the other two finishes.

Watch out for electrical degradation

Although certain electrical characteristics can be improved with fillers, resin systems are less affected electrically than thermally or mechanically. Dielectric strength, for instance is not normally improved by filler addition. In fact, it may even be decreased if the filler has absorbed any moisture or contaminant. Dissipation factor and dielectric constant can be controlled by using such low-density fillers as titanates.

Fillers cut system costs

A major advantage of fillers is that, in most cases, they cost much less than the base resins. Where economy is a consideration, the largest practical concentration of filler should be used. For a low-density casting or potting resin, low-density fillers can be employed. Although it is not possible to make density as low as that of foams, a sizable density reduction is possible with minimal sacrifice of other properties. A resin may then be preferable to foams in some cases.

Colloidal silica and other thixotropic fillers tend to increase viscosity at a very low filler concentration. They are used for encapsulating, where they provide a sturdy, thick dip coating. This type of filler generally has a very high surface area and a very small particle size. Some typical ones are Cab-O-Sil, Santocel, and Bentone 34 produced by Cabot, Monsanto, and National Lead, respectively.

A tabulation of costs and application effects of commonly used fillers is given in Table 2.

Test your retention

1. What is the most outstanding application for a filler?
2. What is the bulk effect?
3. Which mechanical properties can be improved with fillers?
4. Which electrical properties generally suffer from the use of a filler?
5. Low-density fillers may be used to obtain a resin that is preferable to a foam. Why would one do this?

THE PROOF OF THE POTTING: SELECTION, DESIGN, TESTING

There are as many design checkpoints to consider in establishing the design of an assembly to be embedded as there are materials and processes. Many, however, can be broadly stated:

- Give special attention to sensitive and critical components. They may require protection by a coating, such as silicone.

- Minimize stress points—they will be points of potential cracking. Typical crack locations are around the fillets of protruding terminals, on thin flat areas where the bond to the substrate is faulty, at transitions between thick and thin resin sections, and where there are sharp variations in the shape of the component.

- Minimize stresses by precoating the assembly or by embedding it in low-stress materials.

- Check properties of the resin system at operating temperatures. Many resins change properties drastically, both mechanically and electrically, as a function of temperature.

- Bear in mind reparability or maintainability. Most resin systems are not easy to repair because of hardness, inertness to solvents, etc.

- Calculate tooling and housing costs versus volume, and review the advantages and disadvantages of various housings, shells and molds.

- Consider resin conditions during cure, as they affect components (high exothermic temperatures, rapid-cure stresses), as they affect handling (resin gets too thin during heat curing) and viscosity as it affects flow.

- Consider the compatibility of the resin and the components to be embedded.

Turn theory into practice

It's easy to specify and design on paper, but harder in practice. Five design examples follow

Free reprints

Free reprints of this report are available, while supplies last. Circle Reader-Service number 260.

to demonstrate how electronic requirements are translated into material and process realities.

Problem: Embed a small, welded cordwood assembly of resistors, inductors and ceramic capacitors. The completed module must have good environmental resistance, and good general electrical and dimensional properties. Mechanical rigidity is a must. The circuit is to be produced in very large volume. Manufacturing efficiency is to be kept high, costs are to be held down.

Solution: Embed the module by transfer-molding with epoxy. Ensure first that the components are able to withstand 3 to 10 minutes molding time at 275° to 325°C. The epoxy will meet the rigidity, environmental and electrical requirements. The transfer molding technique will meet the manufacturing requirements.

Problem: Embed an assembly of rather expensive components. It must be possible to dissect the finished module for failure analysis, repair or recovery. Since the electronics are intended for a deep-space application, the lowest possible weight is necessary. Only a few units will be needed. Design for good electrical properties and for a rigid package.

Solution: Use a rigid urethane foam to minimize weight. This foam is easy to cut open and repair, and is easily dissolved in commercially available solvents. Urethane foam also has excellent electrical properties. For a uniform foam structure, use automatic mixing and metering equipment. Embedded units should be postcured, possibly even in a vacuum, to minimize out-gassing in deep-space environments.

Problem: Embed a microwave assembly. Electrical losses must be held to the barest minimum. The package should be able to cushion the delicate components and should be flexible and repairable. The completed module must be capable of operation to 175°C for short intervals. Only a small run will be needed.

Solution: Use a flexible silicone resin. It has low electrical losses, which do not change drastically at up to 175°C or higher. Flexible silicone is easy to cut open and repair, and serves as an

excellent cushion.

Problem: Embed an electrical connector. The assembly must be rigid and the embedment material must provide a good general-purpose insulation for commercial use. Units are to be produced in one size in large volume at high production rates.

Solution: Pot the connectors with a silica-filled polyester resin in a styrene-based shell. This combination yields a low-cost filled resin that meets the insulation requirements. The styrene-based shell gives rigidity and affords optimum adhesion by the resin, also styrene-based.

Problem: Design a mechanically rigid package that exhibits optimal resistance to thermal shock and humidity. The package must provide property retention at 125° to 150°C and ensure good thermal conductivity. Limited quantities are required; the finished units are to have two dimensions constant and one variable.

Solution: Cast the assembly in a silica-filled bisphenol epoxy cured with a liquid anhydride. The bisphenol ensures rigidity and resistance to

humidity. A relatively high concentration of silica secures thermal conductivity and the liquid-anhydride curing agent gives the required thermal endurance properties. For even better thermal shock resistance, add a small amount of reactive flexibilizer. Use an aluminum master mold with the variable dimension determined by a mold insert. This keeps tooling costs down.

The designer should now be able to match resin, curing agent and filler combination to his objectives. Table 1, p. 77, matches design objectives to various resin systems.

Once the best combination of resin, curing agent and filler has been decided, the next step is embedment, right? Not just yet. There are several useful nondestructive before-the-fact environmental tests for resin systems.

Humidity hurts electrically

Humidity adversely affects the electrical properties of resins. Humidity aging will degrade insulation resistance and the dissipation factor.

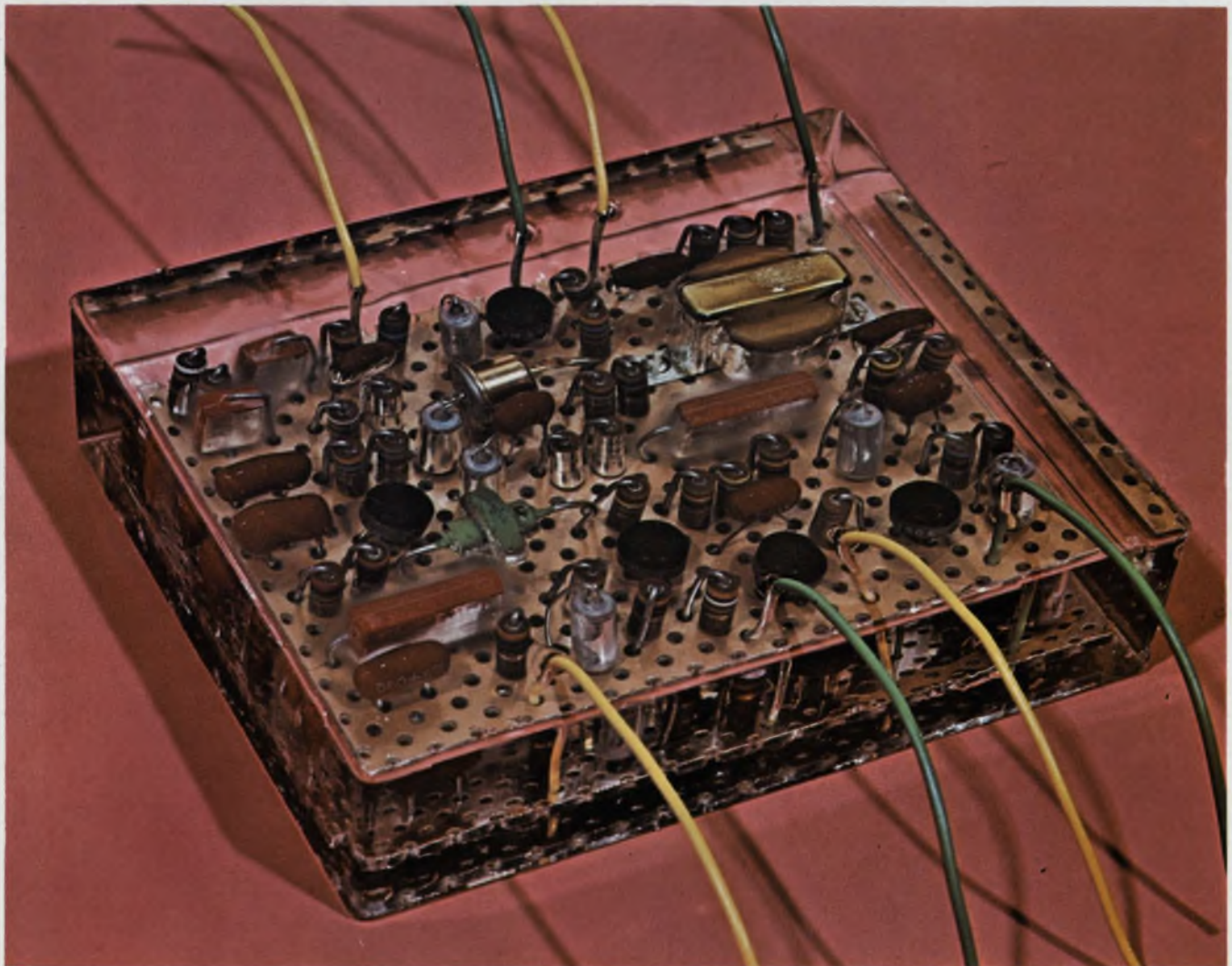

(Courtesy of Failure Mechanisms Branch, Qualifications & Standards Lab, NASA/Electronics Research Center, Cambridge, Mass.)

See-through resin system is used for this NASA prototype casting. Care must be taken to ensure the compatibility

of this material with the insulation on the wire and other embedded components (see table 2, p. 78).

It is monitored by an embedded electrode test, for which four 3/32-inch steel electrodes are embedded in a 1/2-inch diameter cylinder of resin. The sample is positioned in a 25-mm test tube containing 1-inch of water and aged at 70°C.

Although epoxies generally prove to be superior, there are wide differences in the performance of different epoxies depending on the filler used. Fillers generally degrade electrical properties in humid conditions (Fig. 1).

Low temperatures and thermal shock are often serious obstacles to the use of many resins. The thermal expansion of most embedding materials is considerably higher than that of the glass, ceramic, and metals used in components. Severe stresses can be set up because of the differential in the rates of expansion.

A specific problem can be solved by the use of flexibilized resin systems or selective filler-resin systems. But wide differences in crack resistance for different compounds, package constructions and test procedures usually force the use of the specific embedded package as the test piece. This does, of course, provide the most positive test results for a given material under a specific set of conditions, but it may not be a notably nondestructive test.

Since it is extremely difficult to make crack tests on any package and use the results as a definite recommendation for another application, the military has devised the hex-bar test of MIL-I-16923. A section of hexagonal 3/4-inch steel bar stock 1-inch long is supported centrally in a 1-inch diameter, 1-1/2-inch-high cylindrical glass mold. The bar is then embedded in a resin composition. Five such setups are heated to a predetermined temperature (90°, 105°, 130°, or 155°C) and then plunged into a -55°C alcohol bath. The cycle is repeated ten times. If four out of five units remain intact, the material passes.

An even more severe testing device has been reported by Olyphant.* It makes a comparison between those crack-resistant compositions that pass the hex-bar test. The test piece is basically a 1.25-inch-diameter washer with a 7/16-inch-diameter hole. The washer may be 1/8- or 1/4-inch thick. Four equally spaced feet around the periphery of the washer protrude 3/32 inch above and below. The feet maintain a definite resin thickness under the washer and are set back from the hole to eliminate their effect on the stress in the hole.

The two foregoing crack-test devices do not provide quantitative data on the degree of cracking of a particular material. In an attempt to overcome this, Black has invented a vaned-core

crack tendency tester that yields a numerical crack index.† The device (Fig. 2) consists of a radially slotted steel cylinder with six hardened and pointed vanes at 60° angles. This cylinder is mounted on a spindle inside a shell. The vanes are constructed so that gaps of predetermined progressive distances are formed between the vane edges and the wall of the shell. These fractional gap distances can be varied in an arithmetic or geometric progression.

When resin is poured into the space between the core and shell and then cured, the shrinkage is usually sufficient to break one or more of the thin sections in the smallest gaps. Cooling the sample to progressively lower temperatures usually causes further breaks. Since the thicknesses of the bridge can be in either arithmetic or geometric progression, according to the gap design, a direct numerical comparison of cracking tendency is available between successive tests. A relative cracking index can be expressed by the dimensions, in thirty-seconds of an inch, of the thickest web broken. For example, if the webs up to 4/32-inch thickness are broken, the material is said to have a cracking index of 4.

Comparisons of this method and the hex-bar test show that materials with an index of 2 or lower on this device will pass the hex-bar test; those with an index of 3 or higher will fail.

Test for internal stresses

It is possible nondestructively to test internal stresses on embedded packages. The method of Sampson and Lesnick‡ employs strain gauges. After the sensing element is cast in resin, stresses on the unit are calculated from readings taken during thermal cycling of the casting.

The Islietson and Swanson method§ works on the principle that if pressure is put on the bulb of a thermometer, the mercury forced up the stem will be an indicator of that pressure. The relationship between pressure and thermometer reading has been calculated for a mercury thermometer (Central Scientific No. 19283-5) from -40° to 200°F.

The thermometer is embedded in the middle of the 150-cm³ mass of resin with a thermocouple next to, but not touching, the bulb. The thermom-

†R. G. Black, "A New Test Device for Determining the Resistance of Cast Resin Compositions to Thermal Shock and Shrinkage Stress," *Proceedings, Society of Plastic Engineers Regional Technical Conference* (Fort Wayne, Ind., 1959). U.S. Patent 2,821,082 was issued on the device Jan. 28, 1958, and titled "Method of the Device for Determining the Relative Resistance of Various Casting Resins to Cracking."

‡"Strain Gauge Evaluation of Casting Resins," *Proceedings, Society of Plastics Engineering Annual Technical Conference* (Detroit, 1958).

§"Embedment Stresses," *Electrical Insulation Conference* (Chicago, 1963).

*M. Olyphant, "Thermal Shock Tests for Casting Resins," *Proceedings, First National Conference on the Application of Electrical Insulation* (Cleveland, 1958).

Table 1. Design objectives matched to materials

Objective	Candidate materials
Adhesion of resin to assembly	Epoxies and urethanes. Primers and cleanliness of parts can improve adhesion.
Low dielectric constant and/or loss	Silicones and thermosetting hydrocarbons. Silicones retain their good electrical properties at high temperatures and frequencies.
Thermal stability	Silicones, novolac epoxies, anhydride-cured or aromatic-amine-cured epoxies, and thermosetting acrylic resins. Thermal stability, with respect to weight loss and retention of mechanical properties, can be increased with fibrous fillers.
Cost	Polyesters. Other possibilities are low-density foams and epoxy heavily loaded with low-cost fillers.
Room-temperature cure	Silicone rubbers and resins, urethanes, polyesters, epoxies and polysulfides.
Low-temperature flexibility	Silicone rubbers and flexible silicone resins.
Rigidity	Epoxies and polyesters. Some tradeoffs between hardness, toughness, brittleness and crack resistance must be made.
Flexibility	RTV silicone rubbers, urethane resins, and polysulfide rubbers are the most flexible. However, flexible resins are produced from rigid resins by addition of flexibilizers or modification of the base material, and epoxies and polyesters are available in flexible formulations.
Clarity	Epoxy, polyester, and silicone. Clear epoxies are normally rigid; clear silicones soft and flexible. Most other resins, while not water clear, are amber or light colored so that parts can be seen.
Repairability	Flexible materials or silicone gels. Rigid resins can only be repaired by first softening or dissolving in solvents.
Low weight	Low-density foams. Urethanes are most common, both rigid and flexible. Low-density fillers can also be used with resins. Density of these resin systems is higher than that of foams, but physical and environmental properties are better.
High thermal conductivity	Use large amounts of such large-particle fillers as coarse sand, aluminum oxide, magnesium oxide or beryllium oxide with any resin.

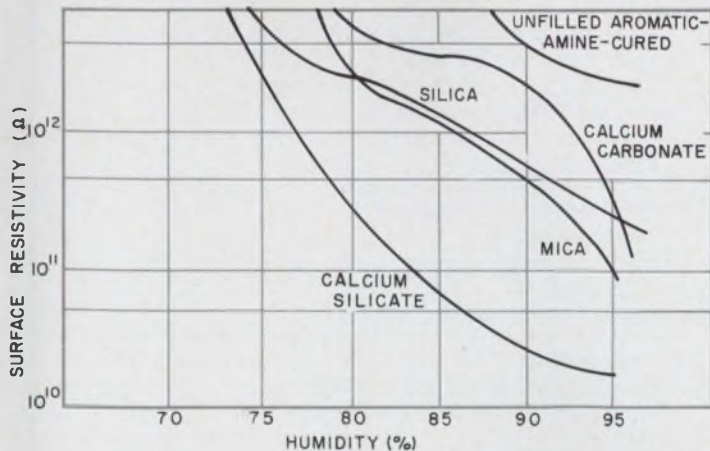

1. Under high humidity, fillers tend to degrade such electrical properties as surface resistivity. The unfilled aromatic-amine-cured system shows the smallest decrease; the calcium-silicate-filled epoxy the largest.

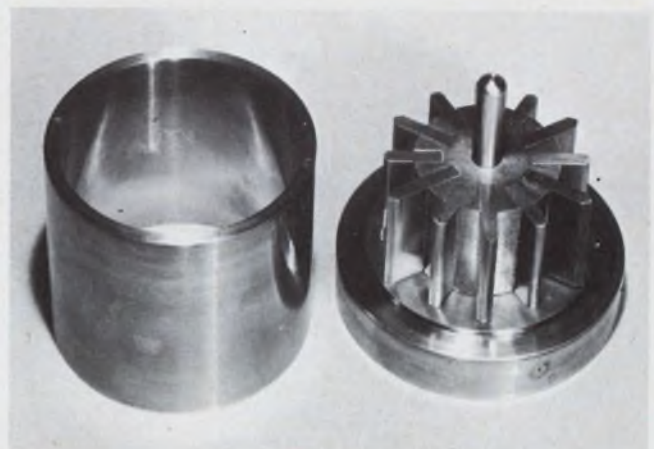

2. Vane-core crack tester has gaps which increase arithmetically or geometrically between vane edges and wall. Dimensions of the thickest web broken, in thirty-seconds of an inch, is the relative cracking index.

Table 2. Troubleshooting embedded assemblies

Appearance	Probable cause	Corrective action
Surface exhibits fine cracks, ripples or roughness	Cure too hot Too large a mass (primarily high-exothermic systems)	Reduce oven temperature in 10°C stages Pour casting in stages, allow first to gel before pouring second
Resin appears burned, especially in center	Cure too hot—mass of high-exothermic resin too large	Reduce cure temperature, reduce mass of resin, or use external cooling with room-temperature cure systems
Resin releases from components at edges, corners, terminals	Contamination of surfaces with oil, grease, mold-release agent, skin oil Nonbondable surfaces Oxidized metal surfaces (resin bonds to oxide which releases from metal)	Grease component before casting, handle with gloves Replace or prime surfaces Abrade or chemically clean surface just prior to casting or use primers
Casting warps or distorts from mold shape	Cure temperature too hot Insufficient resin Poor design Excessive shrinkage	Reduce cure temperature, keep mold-temperature uniform Allow larger sprue volume or recap casting Keep resin wall thickness uniform, add ribs Use more filler. In extreme cases, pack mold with porous filler, impregnate with resin
Resin remains liquid or very soft and sticky	Cure temperature too low Cure time too short Mix ratio incorrect Insufficient mixing Separate parts not mixed Contamination	Increase oven temperature Extend cure time Check mixing process, adjust equipment Mix thoroughly; color, if the resin is pigmented, should be uniform Stir separate system constituents before blending Keep parts, mold and resin clean
Casting appears normal at room temperature but becomes liquid or tacky at high temperatures (resin not completely cross-linked)	Mix ratio incorrect Excess mold release Moisture Contamination Incompatible insulation	Same as above Use release agents sparingly Dry component thoroughly before casting Check resin area for oils, dirt, greases, waxes Check component for plasticized films, such as vinyl or acetate, thermoplastics that liquefy at operating temperatures of component, tar, or waxes. Dissect unit while hot and replace questionable insulation, with compatible material
Casting opens; liquid oozes out of fissure or around terminals, lugs	Moisture Incompatible insulation	Dry component thoroughly. Paper or fiber parts are prime suspects Same as above
Surface rough or spotted	Rough mold surface Excess mold release	Clean or polish mold Use thin release, such as Garan 225 (Ram Chemical Co., Gardena, Calif.)
Exterior of casting has soft or sticky areas, possibly with voids	Excess mold release Dirty mold	Use release agents sparingly, dilute with solvent Clean after use
Bubbles or holes in surface	Rough mold surface Leaky molds (air enters during vacuum cycle) Poor mold design, horizontal "shelf" areas trap air	Polish surface Seal molds, polish joints, replace gaskets, and release vacuum slowly Redesign mold, taper "shelves" for air exit
Bubbles, voids or "dry" areas in casting, low corona-starting voltage	Insufficient resin Insufficient vacuum Resin cured before air escaped Resin too thick Poor component design	Provide for a "head" of resin over component to allow for escaping air Evacuate resin and part prior to casting and pour under vacuum. Apply lower vacuum or extend time; try pressure after vacuum Use slower curing system or lower temperatures Heat component, mold, and resin to reduce viscosity, or use thinner resin Modify component layout
All or part of mold difficult to remove	Undercuts in mold Insufficient mold release Mold not "broken in" Rough mold surface Permanent-type release agent worn or abraded	Remove undercuts and repolish mold Reapply release agent Reapply release agent before each casting, use mold several times Polish surface Reapply or regrid Teflon-type coatings
Fissures develop during cure, cooling, or subsequent thermal shock	Resin not cured Sticking Wrong resin Oven too hot Gel temperature too high Poor component or mold design	Increase cure time Resin damaged during mold removal. Recast Flexible or filled resins should be considered Check oven temperature Use lowest possible temperature to minimize stresses Design so that resin thickness is uniform around component, (1/16 in. minimum). Fillet sharp internal corners with heavily filled resin before casting, reinforce crack areas with glass cloth or glass-reinforced tape

eter reading is taken at various ambient temperatures and the difference between the reading on the thermometer and the actual temperature measured by the thermocouple is recorded. This differential is related to the hydraulic pressure required to produce the readings on the test thermometer.

A third method, that of Dallimore, Stucki and Kasper,[¶] involves the use of a solid-state transducer capable of measuring 0 to 20,000 lb/in.². It is basically a small (0.05-inch diameter) ferromagnetic, linearly pressure-sensitive device, electrically operated as a transformer. Its output, varying inversely with pressure, can be read directly off a scope. The transducer, driven by pulse or ac carriers operating up to 100 kHz with an intrinsic response time of 1 μ s, is temperature-insensitive over a wide range and relatively radiation-insensitive.

Shocking a resin system by immersing the resin in a liquid bath at certain critical temperatures from -55° to -196° C, has shown that the rapidly increasing internal stresses exceed the total strength of the resin and cause cracking. There is a sharp change in the stress curve at a specific critical point. Curves obtained by thermally shocking RTV-coated samples differed considerably from curves obtained without the RTV-silicone-coated samples. The sharp transition characteristic of the curve for an uncoated test transducer was completely absent from the curve for an RTV-coated transducer. The technique confirms that silicone rubber coatings function effectively as a cushion.

Zero in on zero defects

Logical decisions have been made at every step along the way and yet the finished product has large cracks in it. Or it may be charred or burnt. What has happened? It is impossible to troubleshoot all packages as you would a car or television set. But the data of Table 2 can serve as a guide in 95% of the malfunctions. It gives possible causes and remedies for some very typical product problems. ■■

Bibliography:

- Beach, Norman E. *Glossary of Plastic Terms: A Consensus*. Dover, N.J.: Plastics Technical Evaluation Center, 1966.
- Buchoff, L. S., and Botjer, C. H. "Effect of Humidity on Surface Resistance of Filled Epoxy Resins," *Proc. SPE 16th Annual Tech. Conf., Chicago, 1960*, paper 34.
- Dosser. "Trouble-Shooting Defects in Epoxy Resin Castings," *Insulation*, November 1962.
- Fekete, F., "New Family of Thermosetting Acrylic Resins," *Plastics Technology*, XIX, No. 3 (1963), 42-44.
- , et al. "Electrical Properties of Thermosetting Acry-

- lic Resins," *Proc. 5th Nat. Conf. on Application of Electrical Insulation, Chicago, 1963* (New York: AIEE-NEMA, 1963).
- Formo, J., and Isleifson, R. "Producing Special Properties in Plastics with Fillers," *Proc. SPE Regional Tech. Conf., Fort Wayne, 1959*.
- Frados, Joel (ed.). *Modern Plastics Encyclopedia*. New York: McGraw-Hill, publ. annually.
- Graves and Pizzino. "Effects of High Humidity on Dielectric Properties of Casting Resins," *Electro-Technology*, LVII, No. 4 (April 1956).
- Hanson, W. M., and Tuzinski, J.R. "Strain Gauge Evaluation of Flexible Epoxy Resins," *Tech. Papers, 2nd Nat. Conf. on Application of Electrical Insulation, Washington, 1959* (New York: AIEE-NEMA, 1959), pp. 129-132.
- Harper, Charles A. *Plastics for Electronics*. Chicago: Kiver Publications, 1964.
- . *Electronic Packaging with Resins* ("Engineering Books for Industry" Series). New York: McGraw-Hill Book Co., 1961.
- Hinkley. "Resins for Packaging Electronic Assemblies," *Electro-Technology*, LXXV, No. 6 (June 1965).
- Javitz, Alex E. "Impact of High-Energy Radiation on Dielectrics," *Electro-Technology*, LV, No. 6 (June 1955).
- . "Compatibility of Epoxy-Embedded Magnet Wire Systems," *Electro-Technology*, LXVII, No. 3 (March 1961).
- Johnson. "Epoxy Resin Stress Behavior at Low Temperatures," *Electrical Shorts* (St. Paul, Minn.: 3M Co.).
- Johnson, L. I., and Ryan, R. J. "Encapsulated Component Stress Testing," *Proc. 6th Electrical Insulation Conf.* (New York: NEMA-IEEE, 1965), pp. 11-15.
- Lee, Henry, and Neville, Kris. *Handbook of Epoxy Resins*. New York: McGraw-Hill Book Co., 1967.
- Lee, M. M. "Heat-Resistant Encapsulating Resins," *Proc. SPE 15th Annual Tech. Conf., New York, 1959*, paper 22.
- Molzon, Arnold E. *Encapsulation of Electronic Parts in Plastic*. Dover, N.J.: Plastics Technical Evaluation Center, 1967.
- Parr. "Low-Density Fillers with Epoxy Resin for Embedding Airborne Electronic Circuits," *Proc. Amer. Chem. Soc., Div. of Paint, Plastics and Printing Ink Chem. Conf., Atlantic City, 1959*.
- Parry, Carey and Anderson. "Effect of Fillers on High-Humidity Insulation Resistance of Epoxy Resins," *Proc. SPE Regional Tech. Conf., Lowell, Mass., 1957*.
- Peters, Robert L. "Dielectric Constants Are Quickly Found," *ELECTRONIC DESIGN*, XV, No. 20 (Sept. 27, 1967), 62-63.
- Piser, John. "Pick Plastics for High-Speed Circuits," *ELECTRONIC DESIGN*, XV, No. 17 (Aug. 16, 1967), 246-248.
- Ringel, Samuel. "Decapsulate Components Undamaged," *ELECTRONIC DESIGN*, XV, No. 12 (June 7, 1967), 62-64.
- Samelson, Lincoln R. (ed.). *Insulation Directory/ Encyclopedia Issue*, publ. annually.
- Scheid, C. C. "The Dielectric Strength of Epoxy Embedding Compounds," *Tech Papers, 4th Nat. Conf. on Application of Electrical Insulation, Washington, 1962* (New York: AIEE-NEMA, 1962), p. 197.
- Schuh. "Thin Insulation Hookup Wire," *Product Engineering*, XXXIV, No. 24 (Nov. 25, 1963).
- Wolf, D. C. "Trends in the Selection of Liquid Resins for Electronic Packaging," *Proc. Nat. Electronic Packaging and Production Conf., New York, 1964* (Chicago: Kiver Publications, 1964), pp. 243-249.

Test your retention

1. How can the chance of cracks in a completed assembly be minimized?
2. What are the long-term effects of humidity on a resin?
3. How does the vanded-core tester work?
4. How can internal stresses be monitored?

[¶]"Measurements of Internal Stress in Electronic Encapsulating Resins With a Small Solid-State Transducer," *SPE Journal*, June 1964.

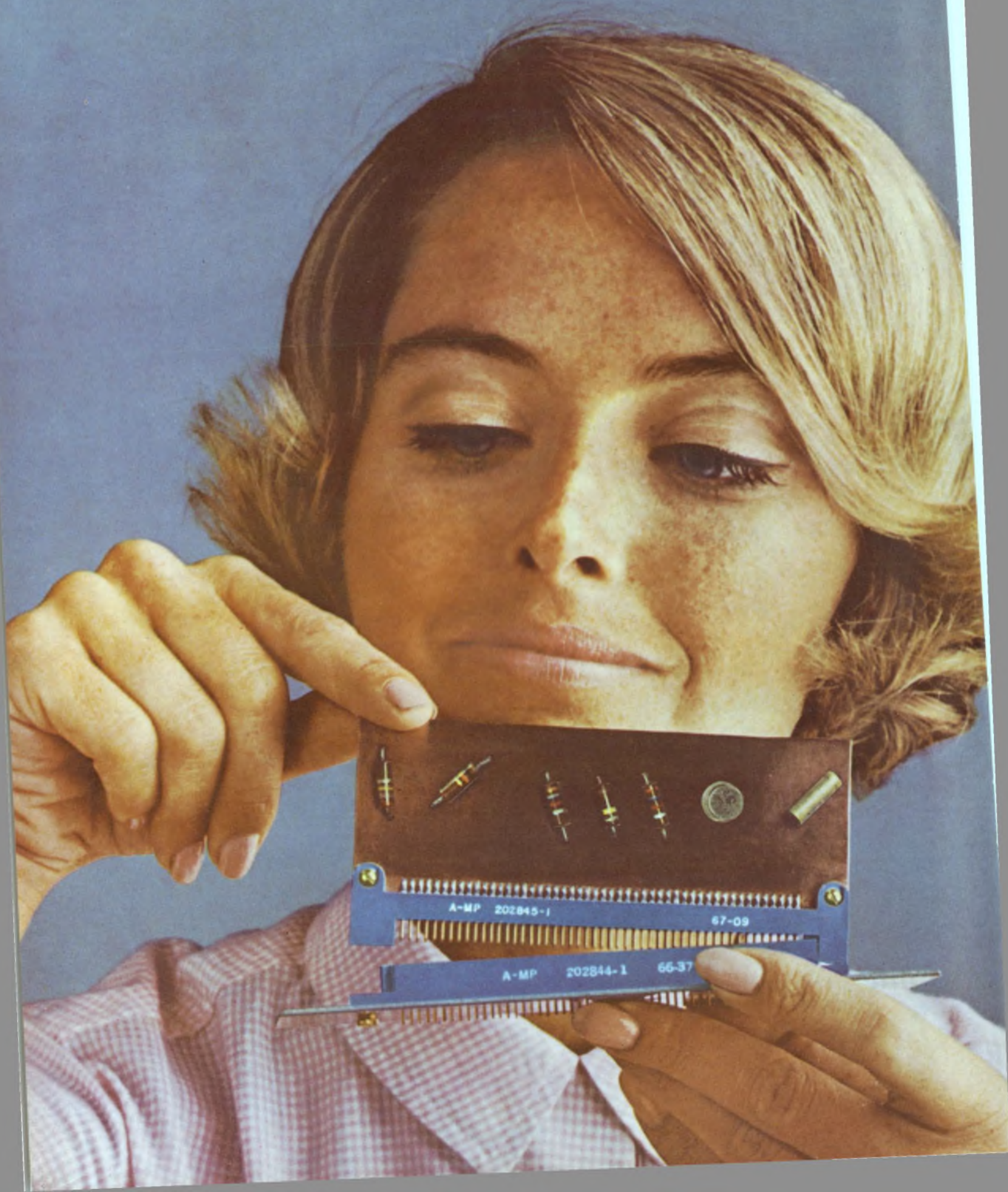

Dense, hand mated, and very tolerant.

Maintainable contact on .075" centers. Solder, weld or wrap. Unique elliptical spring contact design. Only four-ounce insertion, one-ounce extraction per contact. Vibration-proof continuity. Forgives misalignment. Two-piece in-line (10 to 180 contacts), two-piece right angle (up to 77 contacts). No guides, no hardware, no sweat. Designed for airborne navigation and radio black boxes, computers, ground support equipment. Ask about it.

AMP
INCORPORATED
Harrisburg, Pennsylvania
INFORMATION RETRIEVAL NUMBER 36

Many digital functions can be generated with a rate multiplier. A few components and a counter will produce many arithmetic operations.

Have you ever needed a basic circuit that could generate a whole range of digital functions? The rate multiplier, so called because it gives a pulse train that is the product of two inputs, is a simple device that can be used to add, subtract, divide, raise to a power, and solve algebraic and differential equations.

In many cases all that is needed is a shift register plus a few gates and an up/down counter.

How the rate multiplier works

The rate multiplier (Fig. 1a) is an assembly of flip-flops and gates. There are two inputs. One is a pulse frequency, f (the rate input), the other is a parallel binary number, X , in the range $0 \leq X < 1$ (the number input). The output of the rate multiplier is a variable-frequency pulse train. The output frequency is the product of X times f , the number multiplied by the rate, hence the name rate multiplier.

Consider a binary ripple counter each stage of which toggles on the falling edge of its input. Assume there are three stages $F1$, $F2$, and $F3$ with $F1$ the most significant (Fig. 1b). A pulse waveform, P , with a frequency, f , is connected to the input of $F1$. AND gate $G1$ has its inputs P and the inverted output of $F1$, thus forming the logical product $P\overline{F1}$; AND gate $G2$ has the inputs P , $F1$ and $F2$; AND gate $G3$ has the inputs P , $F1$, $F2$ and $F3$. From the three AND gate outputs (Fig. 2), two things become evident:

- The output frequency of $G1$ is half that of P , or $f/2$; the output frequency of $G2$ is $f/4$; the output frequency of $G3$ is $f/8$.

- No pulse of any of the trains ever coincides with a pulse of another train. This property is the key to the operation of the rate multiplier, for it allows two or more of the pulse trains to be ORred together to obtain an output with a frequency that is the simple algebraic sum of the frequencies of the inputs. This would be impossible if coincidence ever occurred.

Now, the function of the rate multiplier is to generate an output frequency equal to f times X . Binary number X is sitting in the three-stage register. If its three bits are $X1$, $X2$, and $X3$, where $X1$ is most significant, and since X is a fractional number, $X1$ has weight 2^{-1} , $X2$ has weight 2^{-2} , and $X3$ has weight 2^{-3} . Suppose that each of the gates $G1$, $G2$, and $G3$ has provision for one additional input, and $X1$ is connected to the spare input of $G1$, $X2$ to the spare input of $G2$, etc. The output of any particular gate, G_i , now will either occur or not occur according to whether the corresponding bit, X_i , is 1 or 0. Connect the outputs of the three AND gates to the inputs of an OR gate, and the output of this OR gate is the output of the rate multiplier (Fig. 1b). The frequency out of $G1$ —when it occurs—is $f/2$, which means that, in general, it is $X1(f/2)$. Similarly the frequency out of $G2$ is $X2(f/4)$, and so forth. Since the frequency out of the OR gate, f_o , will be the sum of the input frequencies, then:

$$\begin{aligned} f_o &= X1(f/2) + X2(f/4) + X3(f/8) \\ &= f(X1/2 + X2/4 + X3/8) \\ &= fX \end{aligned}$$

In other words, the output of a rate multiplier has a frequency equal to the product of its rate input and its number input. Since the pulse-to-pulse spacing in the output train is generally not uniform, however, it would be more precise to speak of the average frequency of the output.

In the rate multiplier the number of binary stages (three in the examples) is spoken of as the size, or the resolution. This determines the accuracy with which any problem can be handled.

Negative numbers can be used

The rate multiplier can deal with negative numbers and negative frequencies. In order that X may assume negative values, another sign bit is included with the existing bits $X1, \dots, X_n$. It is denoted $S(X)$ and its weight is -1 ; X is then represented in so-called 2's complement form. The bits $X1, \dots, X_n$ are spoken of collectively as $F(X)$, or the fractional part of X . The notation is illustrated by the examples in the Table, which is also based on a

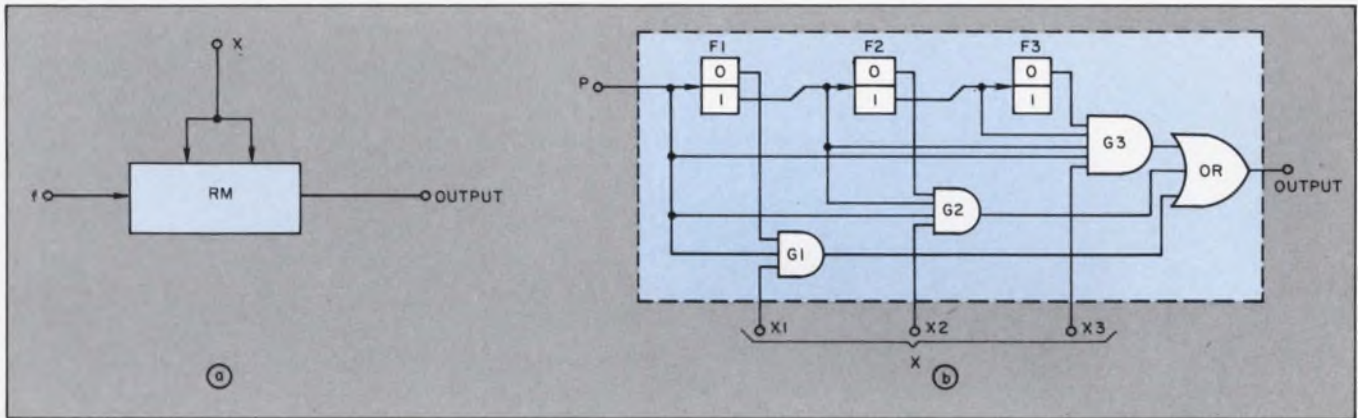

1. The basis of a rate multiplier is a binary ripple counter. It may be shown symbolically (a) with a rate

input (f) and a number input (X). Three stages are used in (b). The number of stages limits the accuracy.

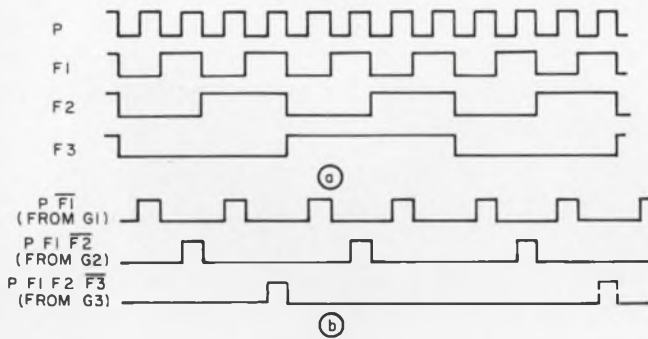

2. Gating the three flip-flop outputs (a) produces waveforms with frequencies that are binary fractions of the rate input (b). ORring these three outputs together gives a rate multiplier output equal to the product of the rate input and the number input.

Table. 2's complement format for X

X number inputs	S(X) sign bit	F(X)		
		X1	X2	X3
7/8	0	1	1	1
3/8	0	0	1	1
1/8	0	0	0	1
0	0	0	0	0
$-(1/8) = -1 + 7/8$	1	1	1	1
$-(1/4) = -1 + 6/8$	1	1	1	0

three-stage register.

Consider multiplying an input frequency, f , by a general number X (Fig. 3a). $F(X)$ is the number input of the rate multiplier and the rate input of both the rate multiplier and the AND gate, G . $S(X)$, the sign bit, is the AND gate's other input. The output frequency is interpreted as the difference between the frequency out of the rate multiplier and that out of the AND gate. g denotes the net output frequency, positive or negative; g^+ is the frequency out of the rate multiplier and g^- the frequency out of the gate. g^+ and g^- are both nonnegative numbers although their difference may be either positive or negative.

This may be written:

$$\begin{aligned}
 g^+ &= fF(X) \\
 g^- &= fS(X) \\
 g &= g^+ - g^- = f [F(X) - S(X)] \\
 g &= fX
 \end{aligned}$$

This shows that the output frequency is still the product of input frequency and the input number, but without a polarity restriction on the latter.

The preceding example assumed that the input frequency was positive. In general this is not so. Suppose now that the input frequency comes on two lines with respective frequencies of f^+ and f^- . f is

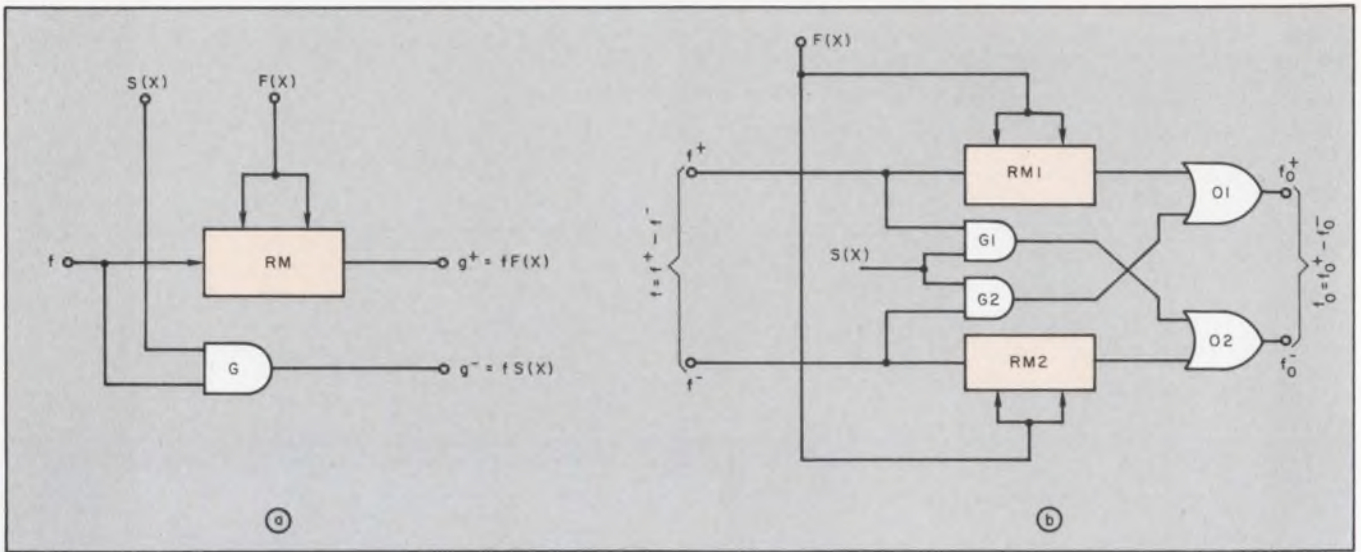

3. Negative numbers need an extra gate to handle the sign bit (a). The number itself $F(X)$ is represented in 2's

complement notation. If both inputs to the rate multiplier are negative, two rate multipliers will be needed (b).

interpreted as the difference between f^+ and f^- . Assume that f is multiplied by a general number X (Fig. 3b). $F(X)$ is fed as the number input to both $RM1$ and $RM2$. $S(X)$ is applied as one input to each of the AND gates $G1$ and $G2$. Since the frequency out of an OR gate (such as $O1$ and $O2$) is the sum of the input frequencies, and if the output frequency is f_0 , then:

$$\begin{aligned} f_0^+ \text{ (frequency out of } O1) &= (f^+)F(X) + (f^-)S(X) \\ f_0^- \text{ (frequency out of } O2) &= (f^+)S(X) + (f^-)F(X) \\ f_0 &= (f_0^+) - (f_0^-) \\ &= f^+ [F(X) - S(X)] - f^- [F(X) - S(X)] \\ &= [f^+ - f^-] [F(X) - S(X)] \\ &= fX \end{aligned}$$

How to use the rate multiplier

With an up/down counter, the rate multiplier may be used to obtain the ratio of two frequencies. In Fig. 4a the counter is shown symbolically with serial input and parallel output. The ratio of the two input frequencies, X , is obtained as the output of a closed loop in which the counter acts as a null detector. An increase in output X tends to increase the frequency into the down input. That ensures that the loop will be stable and that X is set at the value that equalizes the two input rates, f_2 and Xf_1 . An up/down counter must never receive pulses simultaneously at both inputs, for then its behavior cannot be predicted, so care must be taken that the two input trains are not coincident. There are well-known techniques to ensuring that, such as using a one-shot multivibrator to delay one pulse train by half a clock period. This precaution is taken for granted in all cases where it is relevant.

Another simple application using an up/down counter in conjunction with a rate multiplier is the digital integrator. In that case the required func-

tion may be expressed as:

$$Z(u) = \int X du,$$

where the simplest case is assumed, that is, that X is positive and u is monotonically increasing.

Suppose each pulse at the rate input to the rate multiplier increases u by one unit. Then if f is the frequency:

$$f = du/dt.$$

The frequency out of the rate multiplier is $X(du/dt)$. If that is fed to a counter C with a parallel output Z (Fig. 4b), then:

$$\begin{aligned} X du/dt &= dZ/dt, \\ X du &= dZ, \\ Z &= \int X du. \end{aligned}$$

One last operation deserves mention—that of addition. It was not included among the “primary” operations, because it is merely a way of combining the outputs of two rate multipliers, rather than a basically different way of using a single one. Suppose a frequency f and two numbers $X1$ and $X2$ are given and a frequency is to be generated equal to $f(X1 + X2)$, where the sum in parentheses is an arithmetical sum, not a logical one (Fig. 4c). The two rate inputs are equal in frequency but must not be coincident.

Forming roots and products

The rate multiplier may be used to generate roots and products in a similar way to the use of a multiplier in an analog computer to perform division and function generation. An up/down counter and one or more rate multipliers are used in a feedback loop so that the required function is generated when the two counter inputs are equal.

As an example suppose the product XY is to

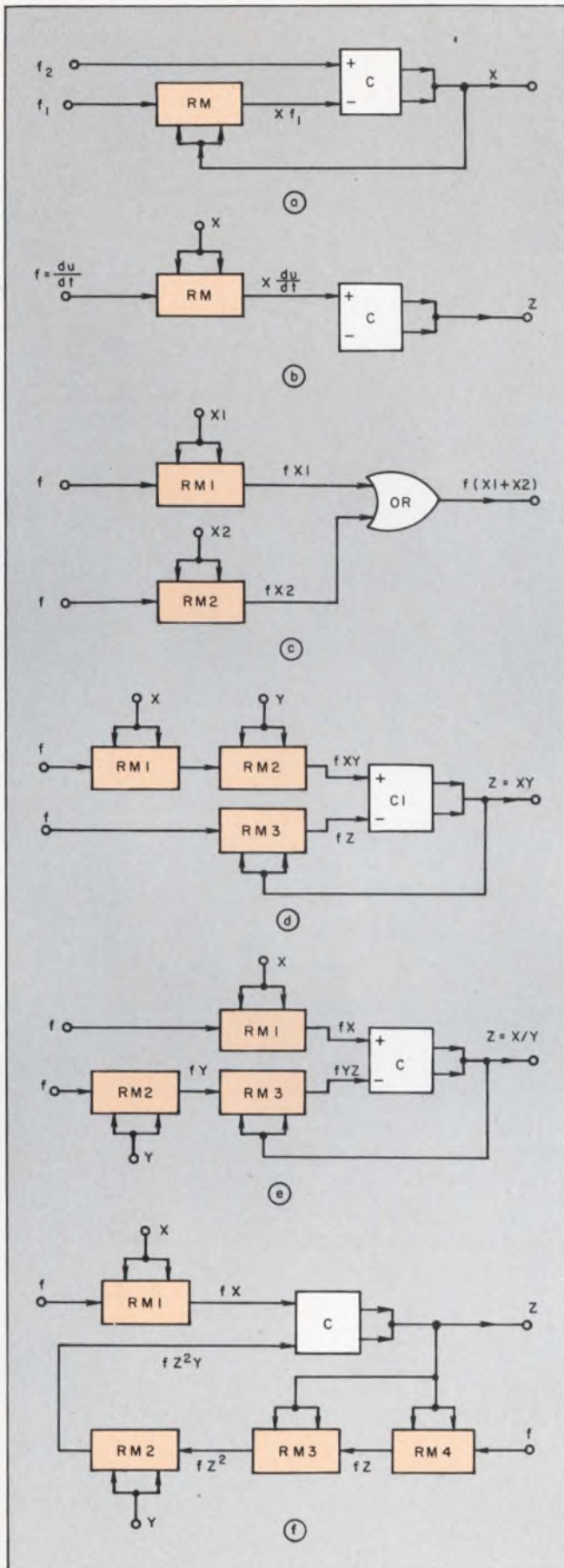

4. The rate multiplier is easy to use. Examples are a frequency ratio indicator (a), a digital integrator (b) and an adder (c). Feedback loops are used to derive products (d), quotients (e) and powers (f).

be found. Z is the parallel output of counter $C1$ (Fig. 4d). The closed loop sets Z at the value that equalizes the counting rates fXY and fZ . The choice of f is irrelevant to the final result, though it affects the time required to arrive at it. It plays a role as the gain of the loop.

As another example, assume that $Z = X/Y$ is to be found. If the counter output is Z , then the two inputs will be fX and fYZ . When the two counting rates are equal, $fX = fYZ$, or $Z = X/Y$.

Take as a final example the computation of $Z = (X/Y)^{1/2}$. Fig. 4f shows a mechanization of that problem. The action is clearer if the expression is first rewritten as $Z^2 Y = X$. If the counter output is Z , then $RM3$ and $RM4$ generate fZ^2 , which is multiplied by Y to give fYZ^2 . The two inputs to the counter are fX and fYZ^2 . When the two counting rates are equal, $fX = fYZ^2$, or $Z = (X/Y)^{1/2}$.

Solving differential equations

The ability to perform digital integration means that differential equations can be handled, and since the rate multiplier can be used for multiplication, division, etc., it is not restricted to linear equations. The technique for solving differential equations resembles that used for arithmetic problems, for there is a closed loop in which one counter acts as a null detector. The parallel output of that counter is considered to be the highest derivative, and is integrated to obtain lower derivatives and the dependent variable. With these, frequencies are formed to represent the various terms of the equation, and from them, sums to represent the two sides of the equation. The two sums are fed in the form of frequencies to the up and down inputs of the null detector, with care to do so in such a way that the loop is kept stable. ■ ■

Acknowledgment:

The author wishes to recognize the contribution of Henry W. Schrimpf, Director of Engineering at Laboratory for Electronics, Inc., who first told him of the rate multiplier.

Test your retention

Here are questions based on the main points of this article. They are to help you see if you have overlooked any important ideas. You'll find the answers in the article.

1. What determines the accuracy of a rate multiplier?
2. Why is the pulse-to-pulse spacing of the rate multiplier nonuniform?
3. In a feedback type of circuit using a rate multiplier and an up/down counter, what precaution must be observed?
4. How would you mechanize the function $Z = YX^{1/2}$?
5. How would you mechanize the differential equation $d^2y/dx^2 = -X$?

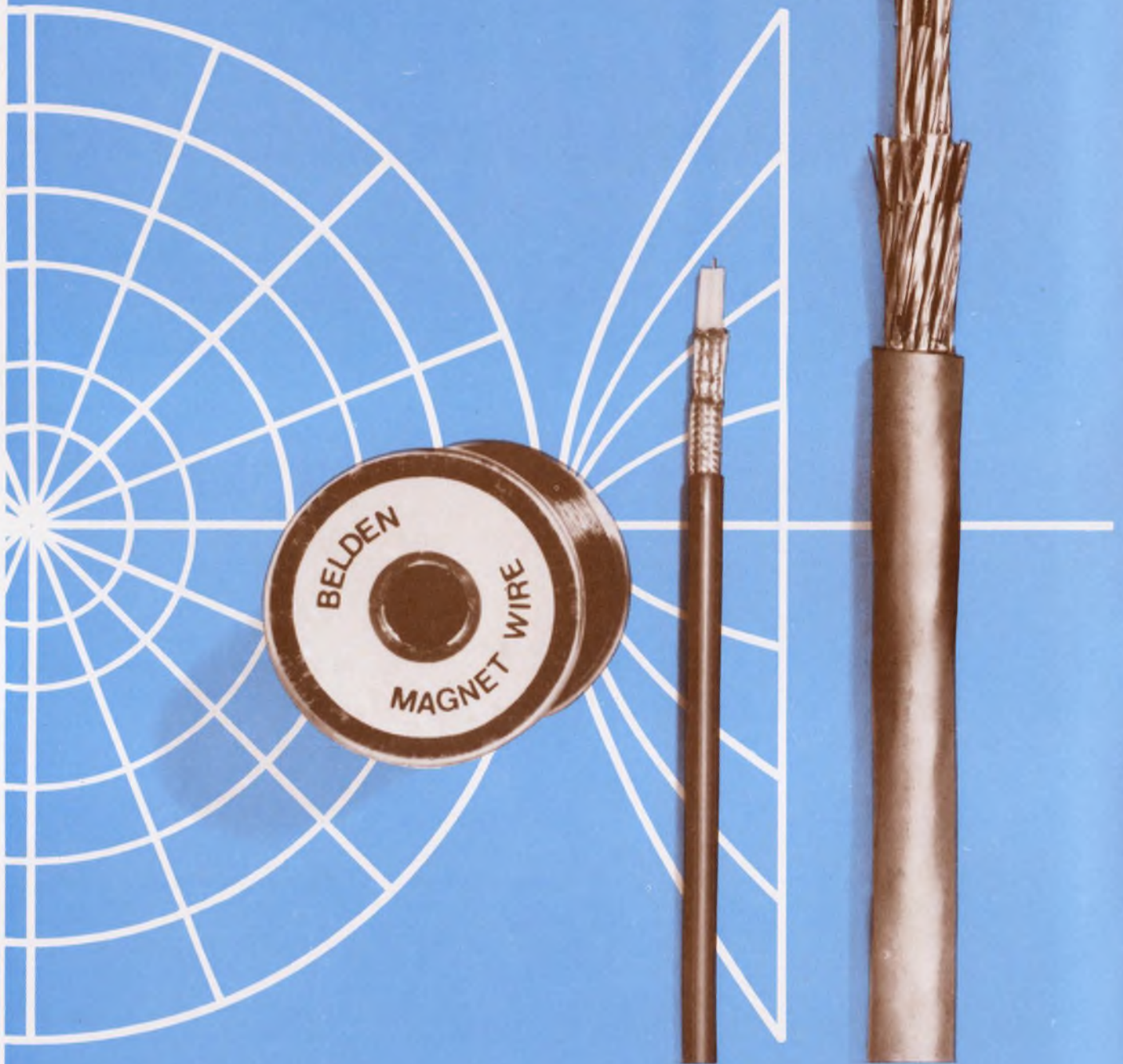

Belden's Wire Specialists know that as systems become more exotic and their functions more difficult, wire becomes more important. Wire carries the messages...conveys the power...links components into true systems. And they know that wire can make a big difference in how well the completed product operates. They know that by prescribing the right wire or cable to

The advertisement features a blue background with white line art. At the top, a power cord with a two-pronged plug and a coiled section is shown. Below it, a multi-core cable is depicted. In the center, a connector with a threaded end is shown. At the bottom, a cable with a braided shield is visible. The text "new ideas for moving electrical energy" is at the top, "Belden thinks systems" is in the middle, and a paragraph of text is at the bottom. The page number "87" is in the bottom right corner.

new ideas for moving electrical energy

Belden thinks systems

link each component, they can help simplify designs, enhance reliability, save internal space, even reduce assembly costs. That's worth investigating, isn't it? Then get together with the wire men who think systems. You can reach them at the place that makes all kinds of wire for all kinds of systems—Belden Corporation, P.O. Box 5070-A, Chicago, Illinois 60680.

G-3-7

Combine a couple of thermistors

to get rid of nonlinearities over wide temperature ranges and still keep the sensitivity of each device.

Thermistors have long been recognized as valuable temperature transducers. Their physical size and sensitivity make them particularly useful where space is at a premium and in applications that require precision measurements over long leads. Their electrical characteristic however—nonlinear resistance vs temperature—makes the reduction of resistance data to meaningful temperature difficult, especially when the temperature range is wide.

Linearizing this relationship simplifies the presentation of data and will not reduce their sensitivity if it is properly executed. This corrective method yields an additional advantage: a linear thermistor makes differential temperature measurements over a wide ambient range practical.

Don't trade sensitivity for linearity

Most methods of linearizing thermistor response result in lower thermistor sensitivity and are based on adding passive series and shunt resistors.

But if two or more thermistors are combined,¹ their working range is extended both as temperature compensators and as resistance thermometers, without appreciably affecting their sensitivity.

Consider a typical circuit in which a thermistor might be used: the voltage divider of Fig. 1. The output voltage E_o is a nonlinear function of R_2 :

$$E_o = E_{in} [1 + (R_1/R_2)]. \quad (1)$$

If R_2 is a nonlinear function of resistance vs temperature and varies as the inverse of the curve of Fig. 1, the result will be a linear relationship between E_o and temperature.² Figure 2 depicts an R_2 curve that will produce linear response and a typical thermistor curve.

If the thermistor curve of Fig. 2 is broken into portions to be used at will, and the remainder essentially ignored, the desired R_2 curve could be approximated quite well. One solution is the network in Fig. 3, which approximates any portion of the desired R_2 curve. With properly chosen com-

ponents, the output of the combination of R and T_2 , approximates the desired curve in the lower portion of the temperature range and becomes virtually ineffectual at high temperatures. T_1 approximates the desired curve at the higher temperatures and becomes ineffectual at low temperatures. In the middle temperature range, T_1 and the combination of R and T_2 contribute nearly equally.³

The proper values for the elements of Fig. 3 can be chosen by solving the set of equations:

$$E_o - n \Delta E_o = E_{in} \frac{R_{T_1} (R_{T_2} + R)}{R_{T_1} (R_{T_2} + R) + R_1 (R_{T_1} + R_{T_2} + R)}, \quad (2)$$

where:

$$n = 0, 1, \dots, E_o/\Delta E_o,$$

$$R_T = R_{T_0} \exp [B(1/T - 1/T_0) + C(1/T - 1/T_0)^2]$$

= thermistor resistance at a temperature T (degrees Kelvin),

B and C = constants (different for each thermistor type).

Solving this set of equations is toilsome, to say the least.

Computer helps select components

The problem of assigning values can be simplified by a modified trial and error method. The thermistor values to be used are selected and then R_1 and R are determined by computer.

Selecting the thermistor involves the questions of having stability and the ready availability of components having the same characteristics and initial resistance at a given temperature. Experience has shown that for a temperature span of, say, 50° to 100°C, the ratio R_{T_1}/R_{T_2} at 25°C should be about 5 to 1 for best results. For narrower spans, the ratio should decrease and for wider spans, increase. For a span of 140°C, for example, a ratio of about 10 to 1 works well.

The computer that calculates R and R_1 may be one of a number of different types. The author initially adopted a simple laboratory-constructed "analog" device, consisting of a power supply, variable resistance boxes and a relatively precise

Ray W. Harruff, Manager, Systems and Special Products Group, Yellow Springs Instrument Co., Inc., Yellow Springs, Ohio.

voltage measuring device. Then values for R and R_1 were chosen and tried, as R_{T1} and R_{T2} were varied through their range of values. This has since been formulated into a digital computer program based on a least-squares fit.

For a temperature range of 0° to 100°C , the maximum deviation from linearity is $\pm 0.2\%$ of the range, or $\pm 0.2^\circ\text{C}$ with these component values :

$$\begin{aligned} R_{T1} &= 30 \Omega \text{ at } 25^\circ\text{C}, & R &= 6250 \Omega, \\ R_{T2} &= 6 \text{ k}\Omega \text{ at } 25^\circ\text{C}, & R_1 &= 3200 \Omega. \end{aligned}$$

Table 1 is an expression of network performance in terms of the required R_2 function versus the generated R_2 function.

If the concept of the two parallel elements is extended to a third element (Fig. 4), the maximum linearity deviation can be greatly improved. For example, in the range from 0° to 100°C , the following values yield a maximum linearity deviation of $\pm 0.04\%$:

$$\begin{aligned} R_{T1} &= 45 \text{ k}\Omega \text{ at } 25^\circ\text{C}, & R_1 &= 2160 \Omega, \\ R_{T2} &= 15 \text{ k}\Omega \text{ at } 25^\circ\text{C}, & R_2 &= 4031 \Omega, \\ R_{T3} &= 3 \text{ k}\Omega \text{ at } 25^\circ\text{C}, & R_3 &= 9025 \Omega. \end{aligned}$$

Table 2 is a list of values for a three-element network in terms of the required R_2 function versus the generated R_2 function.

Table 1. Components for two-thermistor circuit

Temperature ($^\circ\text{C}$)	Required $R_2(\Omega)$	Generated $R_2(\Omega)$
0	20,510	20,325
5	16,600	16,685
10	13,790	13,895
15	11,684	11,740
20	10,040	10,046
25	8719	8702
30	7643	7611
35	6741	6713
40	5980	5962
45	5326	5320
50	4759	4763
55	4262	4271
60	3824	3836
65	3435	3445
70	3086	3092
75	2773	2772
80	2488	2483
85	2227	2221
90	1991	1984.5
95	1777	1771
100	1578	1580

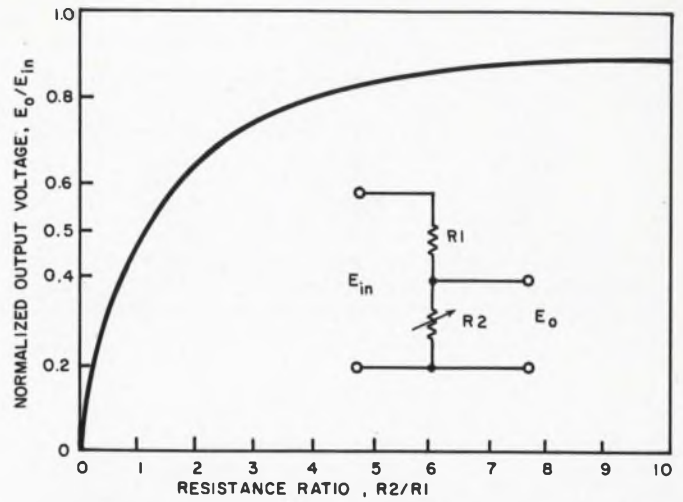

1. The output voltage is a nonlinear function of R_2 and therefore of the resistance ratio, R_2/R_1 , in this simple voltage divider circuit. Resistance R_2 is temperature-sensitive in this case.

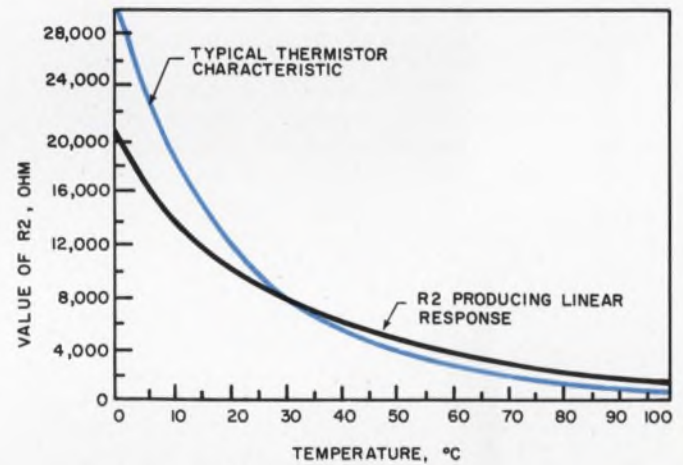

2. To obtain a linear relationship between the output voltage and R_2 , the resistance of R_2 should be a nonlinear function of temperature, as shown by the curve in black. A thermistor's response curve closely approximates this nonlinear relationship, as shown by the curve in color. But in most design cases, only a portion of the thermistor curve is needed, to cover some specified temperature range, and the rest of the response curve should be suppressed.

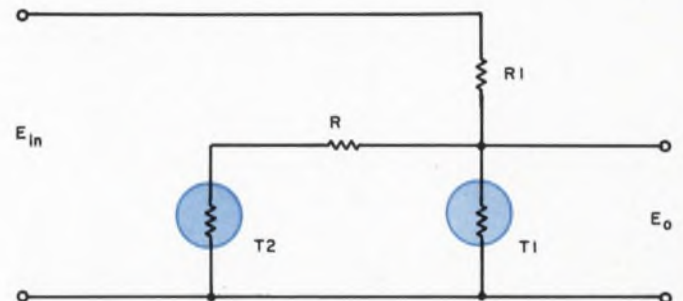

3. A network approach to the generation of any desired portion of a thermistor's response curve uses two thermistors. The response of the combination T_2 and R takes care of low temperatures, and the output of T_1 approximates the desired curve at high temperatures. In the middle, both contribute about equally. The deviation from linearity is about 0.2% .

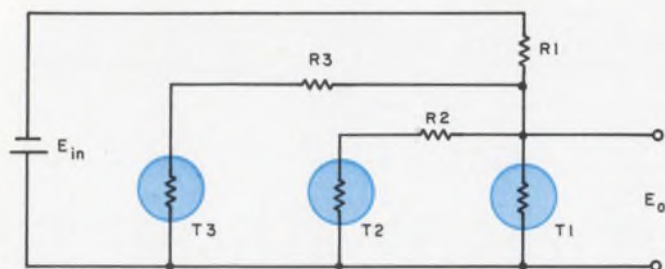

4. A combination of three thermistors reduces the deviation from linearity to a negligible amount—down to 0.045%.

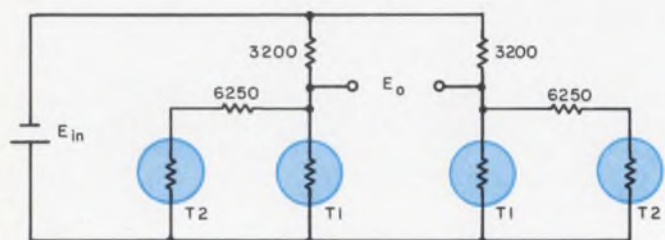

5. The circuit is designed to monitor temperature differences from 0° to 10°C over the ambient temperature range from 0° to 100°C. The choice of the input voltage is determined by the recording instrument, which in this case is a 100-mV strip-chart recorder. This requires an input voltage of 1.87 V.

Table 2. Variation in R_2 for three-thermistor circuit

Temp. (°C)	Required $R_2(\Omega)$	Generated $R_2(\Omega)$
0	12,392	12,375
5	10,579	10,581
10	9164	9171
15	8034	8035
20	7108	7106
25	6336	6334
30	5684	5679
35	5122	5118
40	4638	4633
45	4211	4208
50	3837	3833
55	3502	3500
60	3206	3203
65	2935	2935
70	2694	2692
75	2471	2472
80	2270	2271
85	2085	2086
90	1914	1915
95	1756	1758
100	1612	1612

A case of differential measurement

To illustrate the utility of a linearized network, consider the problem of monitoring a temperature difference of 0° to 10°C over an ambient range of 0° to 100°C, with a 100-mV strip-chart recorder.

The network is to operate in the 0°-to-100°C range. A combination of two thermistors is sufficiently accurate. For purposes of design, the behavior of the network may be described by the equation:

$$E_o = 0.5348\% E_{in}/^{\circ}\text{C}(T) + 0.8650 E_{in}$$

This equation is in the form of the classic straight-line equation: $Y = mX + b$, where m , or the slope, is $0.5348\% E_{in}/^{\circ}\text{C}$.

The schematic of the circuit is shown in Fig. 5. The two sets of thermistors needed for differential measurements are placed at the sensing points and are connected to the remainder of the circuit by three conductor cables which may be quite long without appreciably affecting accuracy. E_o is connected to the recorder input and the only thing that remains is the choice of E_{in} .

The requirement that 10°C be equal to the 100-mV recorder span dictates the choice of value for E_{in} . The device equation states that $E_o = 0.5348\% E_{in}/^{\circ}\text{C}(T)$ or, in terms of the problem: $100 \text{ mV} = 0.5348\% E_{in}/^{\circ}\text{C}(10^{\circ}\text{C})$. Therefore, E_{in} is about 1.87 volts.

With the application of the proper E_{in} , the recorder and circuit become a direct-reading 10°C full-scale differential thermometer. ■ ■

References:

1. L. F. Koerner, U.S. Patent No. 2,764,731.
2. R. W. Harruff, "Linear Temperature Scales from Thermistor Sensors," *Instrumentation Technology*, June 1967.
3. H. W. Trolander and R. W. Harruff, "A Wide-Range, Linear Output Thermistor Sensor for Biological Temperatures" in the *pre-publication Digest of the 6th International Conference on Medical Electronics and Biological Engineering, 1965* (Tokyo).

Test your retention

Here are questions based on the main points of this article. They are to help you see if you have overlooked any important ideas. You'll find the answers in the article.

1. What is meant by trading sensitivity for linearity?
2. Why do two thermistors help to improve linearity without sacrificing sensitivity?
3. Why should a computer be used for selecting thermistors?
4. Where can a linearized thermistor network be best used?



Forget me not

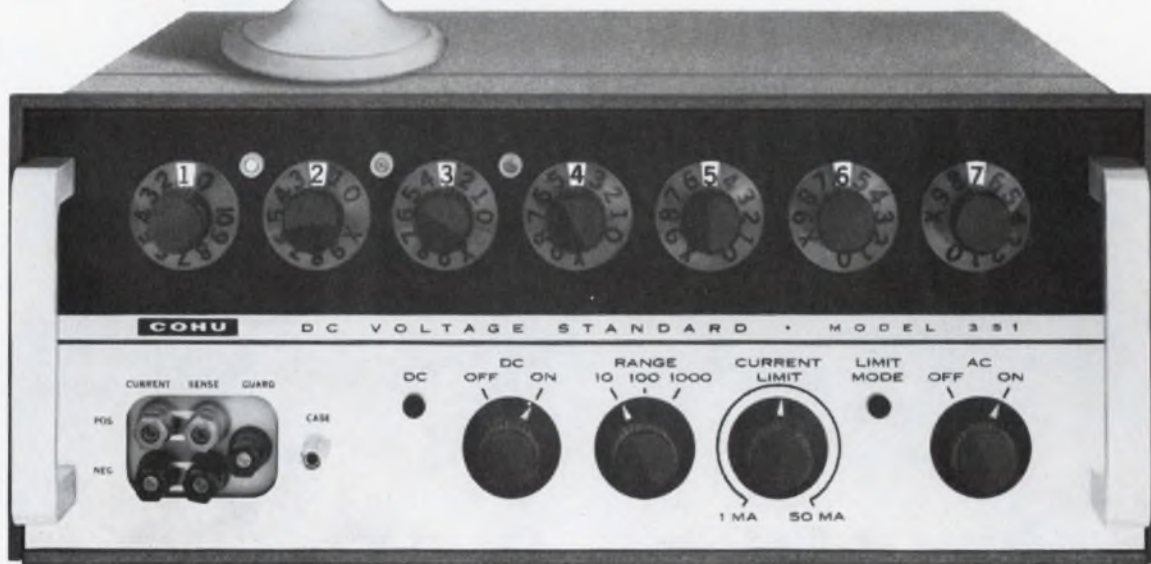

Cohu's new 351 DC Voltage Standard

If it weren't so easy, you'd probably forget how to calibrate the new 351. It's only required once a year due to new, improved solid state circuit design. Major features include modular, plug-in construction, improved reliability with redundant switch sections, and a unique method of voltage preregulation that eliminates the need for series output stage transistors. Output voltages are provided from 0 to ± 1100 volts in three ranges with a basic accuracy within 0.003% of setting. RMS noise voltage less than 20 μV on the lowest

range. Output current up to 50 mA at any voltage setting.

The 351 is a precision voltage source for the design, construction and control of accurate and stable electronic circuits and for certifying the characteristics of DC digital voltmeters, DC voltage amplifiers, voltage controlled oscillators and variable DC supplies. Price—an unforgettable \$1995—less than any other quality DC voltage standard available. For full details, contact your Cohu engineering representative.



Box 623 • San Diego, Calif. 92112 • Phone: 714-277-6700

INFORMATION RETRIEVAL NUMBER 38



Silicones can mean Survival!

Electronic equipment in use on the ground, sea and in the air is one of the tactical keystones of our military strategy and potential. Yet, this basically fragile equipment must operate in the full range of harsh environments inherent to worldwide conditions: mud, cold, heat, repeated jolts, sea water, salt spray, desert dryness, high humidity, ozone, age and—in tropical rain forests—everpresent mildew.

Silicone materials from Dow Corning are providing new ways to fight

these natural enemies. Through the technology of modern chemistry, an entire family of protective dielectrics are now available. They are silicone fluids, grease-like compounds, gels, rubbers, adhesive/sealants, solventless resins, molding compounds and surface coatings.

All provide the outstanding physical and dielectric properties typical of silicone materials. For example: resistance to water (sea or fresh) and humidity; high and low temperatures (–60 to 300 C);

continuous heat aging (10,000 hours at 250 C); and nonnutrient to fungi.

Dow Corning silicone materials are already proven in a wide range of electronic applications. Cited in our *Military Electronics Design Guide to Silicones* are filling, potting, encapsulating, embedding, packaging, coating and numerous other uses. If you are involved in the survival of military electronic equipment, write for your copy to Dept. A-8466, Dow Corning Corporation, Midland, Michigan 48640.

DOW CORNING

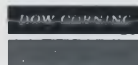

Sylgard® brand encapsulating resins cure to a flexible silicone protection for electronic equipment in unlimited thick sections. New, tough, tear resistant Sylgard resins are now available.

Dow Corning® 3140 conformal coating and 3145 RTV adhesive/sealant are a family of noncorrosive, one-part, silicone materials for use in corrosion sensitive electronic equipment.

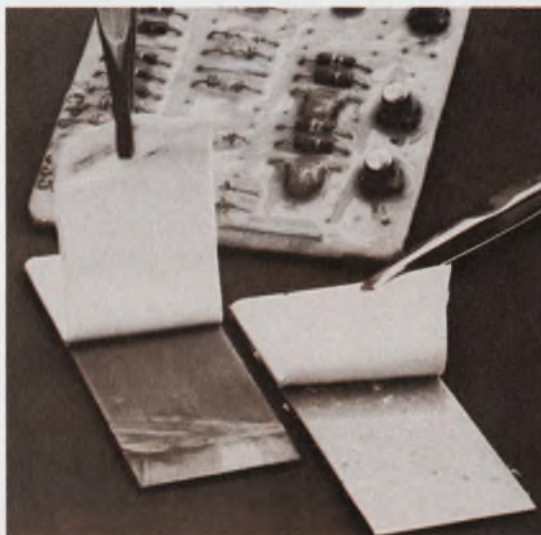

Cut wiring-system tests exponentially

by using binary-group checks to indicate and locate faults. It's even easier with a computer.

Checkout becomes more important and time-consuming as a system increases in size and complexity during its development from an original concept to functioning equipment. One way to ease the burden of checkout would be to automate it, but just automating the old methods is not enough.

Take, for example, a common way of checking for shorts in a cable: checking every wire against every other. In a system with 10,000 interconnections at one test a second it would take a year and a half to check out every wire.

The following method of testing by groups arranged in binary patterns would cut the number of tests required for the above example to 14. It is a technique that can easily be programmed for a computer to do the checkout automatically.

Short tests can take a long time

Checking the wiring of a harness requires two types of test:

- *Resistance or continuity tests* — these verify that the resistance of all conductive paths is not above the permissible maximum.

- *Leakage or short-circuit tests* — This checks every conductor for undesired leakage current to every other conductor in the system. This is needed to find out whether any conductor is incorrectly shorted to any other conductor and to check for any insulation breakdowns.

Leakage tests involve checking every possible short to ensure that none exists. To determine how many possible shorts (S_p) may exist in a cable or wiring harness, the possible shorted wires are considered as groups of size r chosen from a cable of n wires.

For a group of n objects, any set of r of the objects, regardless of their order, is a combination of n objects taken r at a time. The number of possible combinations is:

$${}_n C_r = \frac{n(n-1)(n-2)\dots(n-r+1)}{r!} \quad (1)$$

Only two wires need to be considered for a possible short, so r is equal to two. The number

of shorts possible, when $r = 2$ is substituted into Eq. 1, is:

$$S_p = {}_n C_2 = n(n-1)/2. \quad (2)$$

The B-52 bomber, for example, has approximately 25,000 connections. Allowing two terminations per wire, Eq. 2 gives:

$$S_p = (12,500 - 1)(12,500)/2 = 78,118,750. \quad (3)$$

This illustrates the need for a more efficient procedure than straightforward checkout. Either the number of tests or the time to perform a single test must be reduced. It is likely that a tester using electromechanical switching would be limited to a rate of approximately one test per second. It is possible, however, to reduce the number of tests by checking in binary groups instead of pairs.

Three tests check an eight-pin cable

A cable with only wires and connectors (no diodes, resistors, etc.) is essentially a binary device, for either continuity does exist between any two terminations or it does not exist. It follows then that some method of uniquely defining the electrical configuration of a cable by binary techniques is feasible. This method or "designation number" technique can best be explained by an example. As a simple case, consider an eight-wire cable with wires that terminate on a single eight-pin connector; the pins are labeled *A* through *H*.

The cable's eight pins are each assigned a different three-digit binary number (designation number) as shown in Table 1. All the pins with a 0 in the *Test number 1* column (*A*, *C*, *E* and *G*) are wired together for the first test. All pins with a 1 in the *Test number 1* column (*B*, *D*, *F* and *H*) are similarly connected together (Fig. 1a). The two groups are then tested for a short between them. If no short is found, then no short exists between pins *A*, *C*, *E* or *G* and *B*, *D*, *F* or *H*.

For the second test all test points with a 0 in the *Test number 2* column (*A*, *B*, *E* and *F*) are connected together. All test points with a 1 in the *Test number 2* column (*C*, *D*, *G* and *H*) are connected together (Fig. 1b) and the two groups are tested for a short. If no short is found, none exists between test points *A*, *B*, *E* or *F* and *C*, *D*, *G* or *H*.

David L. Sauder, Senior Group Engineer, Conduccion Corp., St. Charles, Miss.

The third test is performed by checking all pins with a 0 in the *Test number 3* column (A, B, C and D) against all the pins with a 1 in the *Test Number 3* column (E, F, G and H) (Fig. 1c). If no short appears, then none exists between test points A, B, C or D and E, F, G or H.

If none of these three tests shows a short, then it has been established that no short exists between any two of the eight test points.

Three tests have established that none of the twenty-eight (8C_2) possible shorts existed. The number of tests needed is the highest power of two used to define each wire uniquely. In the example, the number of wires is 8, or 2^3 , so three tests are necessary. If T is the total of tests required, then:

$$n = 2^T \text{ or } T = \log_2 n. \quad (4)$$

For systems in which n is not an integral power of 2, T must be rounded off to the next higher integer so that enough binary numbers are available to define each wire.

Binary group testing is thus a very powerful tool, particularly for systems that contain a large number of test points. Consider a cable containing 10,000 different wires. Testing each wire one at a time against all the remaining wires together involves 10,000 tests. By binary-group testing for unwanted shorts, the number of tests required, from Eq. 4, is,

$$T = \log_2 10,000 \quad (5)$$

$$= 14 \text{ (rounded off to the next higher integer).}$$

A very considerable reduction!

When binary-group-testing a cable that has some pins common, only one pin of a common group needs to be tested. The other pins are tested for short circuits indirectly by virtue of being common with the pin selected. Thus common pins must be assigned identical designation numbers.

Leakage may give false results

Binary-group testing always checks one half of the test points against the other half. This is satisfactory for smaller systems. With large systems on days when there is high relative humidity, however, connecting many test points in parallel may cause the aggregate leakage current to be greater than the maximum allowable for any two test points, so the resistance-measuring device would indicate a leakage fault (short circuit). The entire group of test points would then be scanned in an attempt to isolate a single leakage path, even though no single test point alone has excessive leakage current. Considerable time can be wasted "false scanning" for a fault that does not exist.

The possibility of false scanning can be minimized by reducing the number of test points that are group-tested simultaneously. Unfortunately, the fewer the number of test points group-tested, the greater the number of tests required.

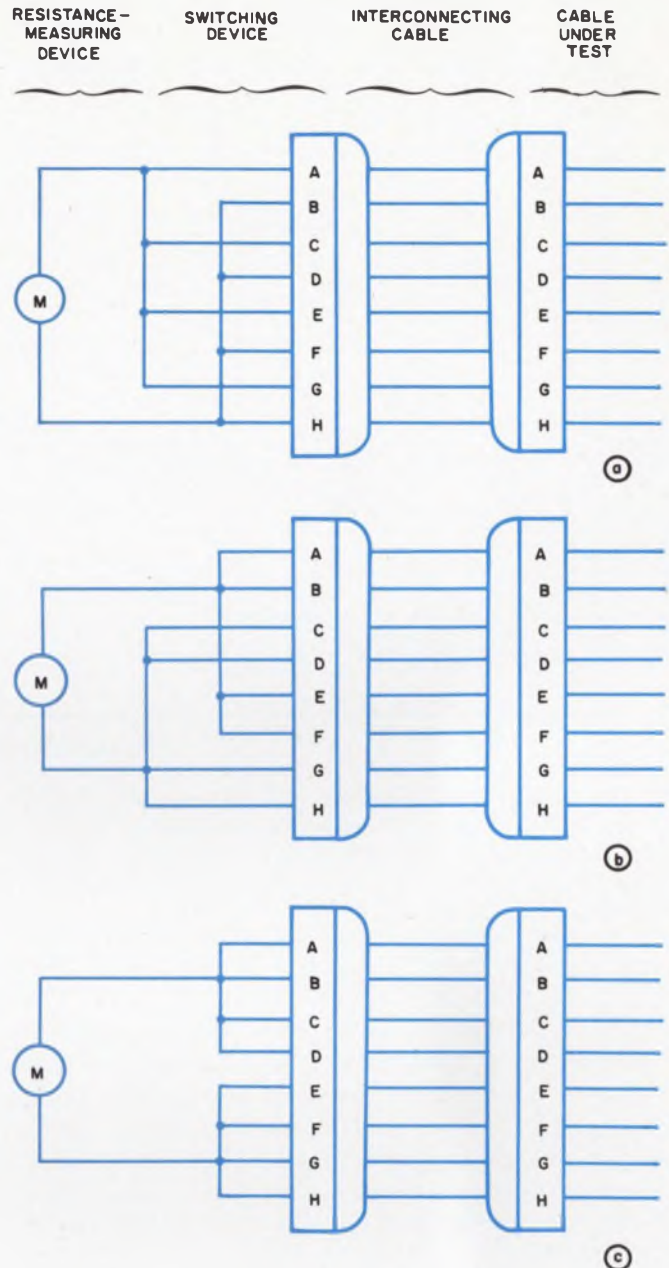

1. To check out an eight-wire cable, only three tests are needed. The first test (a) checks for a short between A, C, E or G and B, D, F or H. The second (b) and third (c) tests similarly test one group of four against another group.

Table 1. Designation numbers

Cable test point (pin number)	Designation number		
	Test number		
	3	2	1
A	0	0	0
B	0	0	1
C	0	1	0
D	0	1	1
E	1	0	0
F	1	0	1
G	1	1	0
H	1	1	1

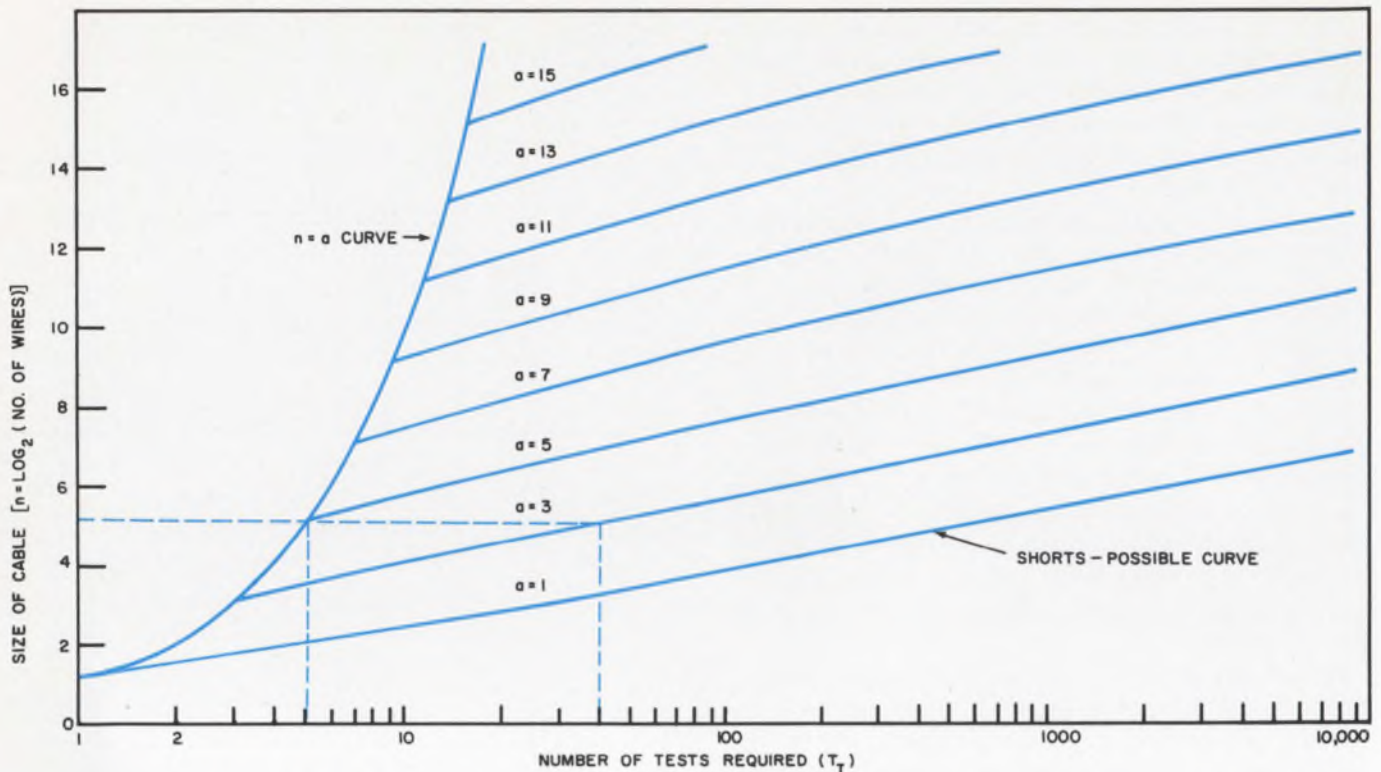

2. The number of tests needed in binary-group testing is shown in this diagram. For example, testing a 32-(or 2⁵)-wire cable requires five tests if all the test points can be

tested simultaneously ($n = a = 5$). If only eight (or 2³) of the wires can be tested simultaneously ($n = 5, a = 3$), then 36 tests will be needed

Consider again the eight-pin pigtail cable as an example. Suppose the number of test points that can be group-tested simultaneously is four. The cable is divided in half; each half is called a "minor" cable and contains four test points. Test points A, B, C and D comprise minor cable I and test points E, F, G and H, minor cable II. Each minor cable is binary-group-tested for shorts. Each has only four test points, so two binary-group tests are required for each of the two minor cables (Table 2).

Tests numbers 1, 2, 3, and 4 establish whether shorts exist between test points A, B, C and D or E, F, G and H. It is also necessary to check for shorts between minor cable I and minor cable II. These "inter-cable tests" are performed by checking half of minor cable I against half of minor cable II. Four tests complete inter-cable testing.

The total number of tests (T_T) needed for a system is easy to determine. The size of the minor cables and the entire cable will be expressed in powers of 2. Let:

2^n = total number of test points, that is, the total number of wires in the cable.

2^a = number of test points that can be tested simultaneously, that is, the size of each minor cable.

T_c = number of inter-cable tests.

T_m = number of minor-cable tests.

S_{pi} = number of shorts possible between all minor cables.

T_T then is the sum of the number of tests required to binary-group-test all the minor cables plus the number required to test for shorts between each minor cable (inter-cable tests). Hence:

$$T_T = T_c + T_m. \quad (6)$$

The number of minor cables is:

$$2^n / 2^a = 2^{n-a}. \quad (7)$$

The number of binary-group tests for each minor cable, from Eq. 4, is a . By Eq. 7, multiplying the number of minor cables by a yields:

$$T_m = 2^{n-a} a. \quad (8)$$

Inter-cable tests are performed by isolating one minor cable at a time from the remaining minor cables. Since half a cable is tested at a time, it takes four tests to verify that no short exists between any two minor cables. Therefore:

$$T_c = 4 S_{pi}. \quad (9)$$

Substituting 2^{n-a} for n in Eq. 2 gives:

$$S_{pi} = (2^{n-a} / 2) (2^{n-a} - 1), \quad (10)$$

Combining Eqs. 9 and 10 gives:

$$T_c = (2^{n-a} + 1) (2^{n-a} - 1). \quad (11)$$

Substituting Eqs. 8 and 11 into Eq. 6 yields:

$$T_T = 2^{n-a} (a - 2 + 2^{n-a} + 1). \quad (12)$$

To test for the worst case, substitute $a = n$ into Eq. 12. This then reduces to:

$$T_T = n. \quad (13)$$

Now substitute $a = 1$ into Eq. 12. This reduces to:

$$T_T = 2^n / 2 = 2^n - 1. \quad (14)$$

This is the relationship from Eq. 2 for the number of possible short circuits in a cable with 2^n test points. Equation 14 shows that, if only two test

points can be checked at a time, all possible shorts must be checked for one at a time.

To estimate the total test time required for any particular cable for different values of a , Fig. 2 is used instead of Eq. 12.

Automatic tester uses three-state switches

For binary-group tests, a switching unit is needed that can switch a test point to either terminal of the leakage tester or allow the test point to remain open. This is so that the switched condition of the test point is independent of the condition of any and all other test points. Each test point, then, must have its own independent control of its three different states. Conventional multicontact, large-capacity switching devices such as crossbar switches, stepping switches, and multipole relays do not have this characteristic.

A suitable relay would have two contacts and a central off position. For pulse operation, three coils with magnetic latching are needed. One coil operates the common contact to the up position, a second coil operates the common contact to the down position, and a third coil resets the common contact from either the up or down position (depending on the polarity of voltage applied to this coil) to the central off position. Fig. 3 shows the set-up for the eight-pin cable used previously as an example.

A method of controlling the relays in the switching unit for a 16-by-16-relay matrix is illustrated by Fig. 4. To operate a particular relay, a positive voltage is applied to the desired Y coordinate (Y_0, Y_1, \dots or Y_{15}). Simultaneously, the X coordinate (X_0, X_1, \dots or X_{15}) of the desired relay is grounded. This will energize K_{YX} and no other.

Only one of the relays, K_{12} , is actually shown in Fig. 4; the remaining sixty-three relays are connected similarly. The blocking diode in series with each coil prevents the relays that are not selected from activating. Relays must be switched serially (one at a time) until all the desired switching has been accomplished.

The three-state relay-switching unit is only one way of performing the switching. Other methods, notably solid-state, that may prove superior for a specific application are or will be available.

Fault isolation needs extra tests

Fault isolation scanning during binary-group testing may be significantly reduced by taking advantage of previous test results. For example, Table 3 shows that each of the three tests will detect 16 of the 28 possible shorts. Therefore, after the first test some of the interconnections previously tested for possible shorts are retested. The second test tests for 16 shorts, but eight of these were already checked during the first test. The third test also

Table 2. Minor-cable binary group

Minor cable I			Minor cable II		
Test point	Test number		Test point	Test number	
	3	1		4	2
A	0	0	E	0	0
B	0	1	F	0	1
C	1	0	G	1	0
D	1	1	H	1	1

Table 3. Shorts of an 8-pin cable

Possible short	Test number	Possible short	Test number
A-B	1	C-E	2,3
A-C	2	C-F	1,2,3
A-D	1,2	C-G	3
A-E	3	C-H	1,3
A-F	1,3	D-E	1,2,3
A-G	2,3	D-F	2,3
A-H	1,2,3	D-G	1,3
B-C	1,2	D-H	3
B-D	2	E-F	1
B-E	1,3	E-G	2
B-F	3	E-H	1,2
B-G	1,2,3	F-G	1,2
B-H	2,3	F-H	2
C-D	1	G-H	1

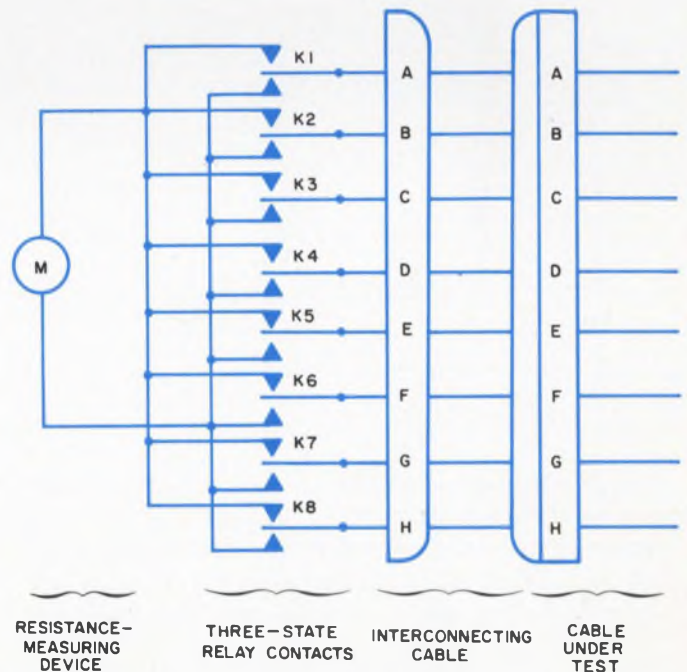

3. To automate a testing sequence, each wire must have a three-state relay so that the condition of any one test point is independent of the condition of any other.

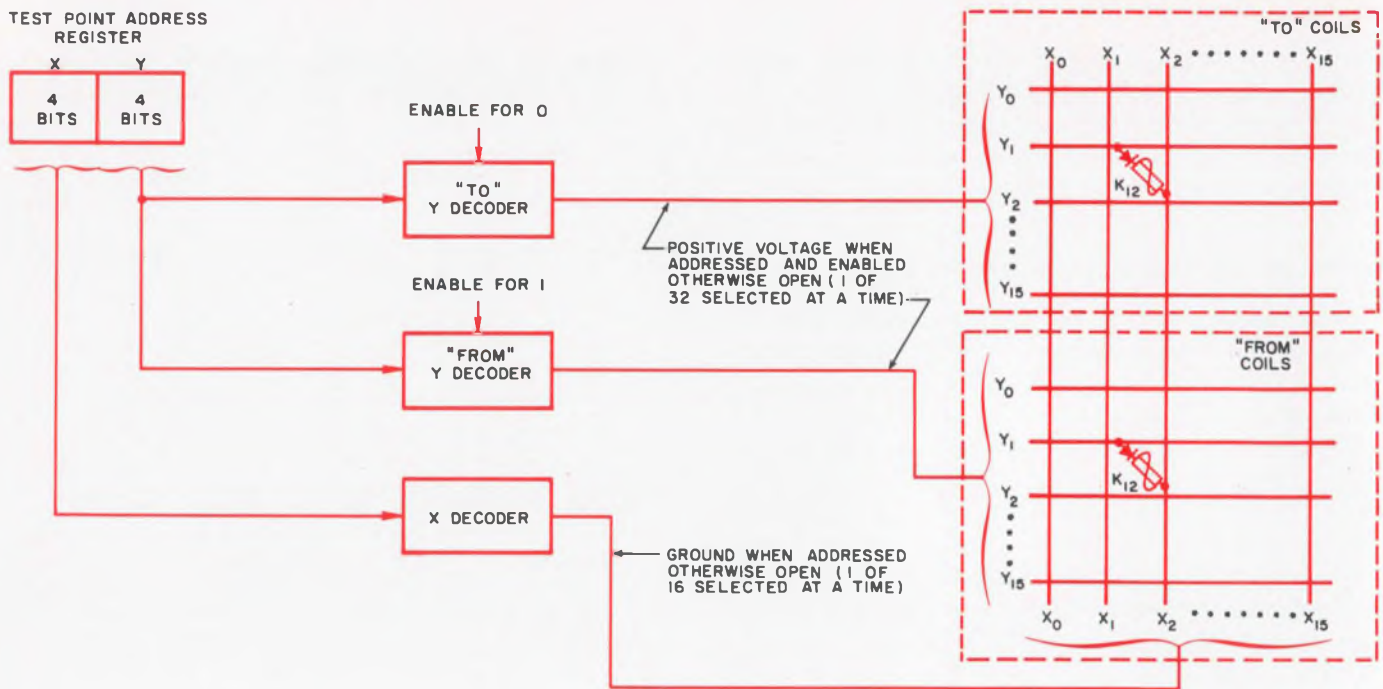

4. A crossbar matrix can be used to switch the two coils of each relay in the switching unit. To operate a particular

relay, the desired Y coordinate is energized at the same time as the X coordinate is grounded.

Table 4. Fault isolation requirements

Test point designation number <i>t</i>	Test points, <i>f(b,t)</i>			
	Binary group test number, <i>b</i>			
	1	2	3	4
0	1,3,5,7,9,11,13,15	2,6,10,14	4,12	8
1		3,7,11,15	5,13	9
2	1,3,5,7,9,11,13,15		6,14	10
3			7,15	11
4	1,3,5,7,9,11,13,15	2,6,10,14		12
5		3,7,11,15		13
6	1,3,5,7,9,11,13,15			14
7				15
8	1,3,5,7,9,11,13,15	2,6,10,14	4,12	
9		3,7,11,15	5,13	
10	1,3,5,7,9,11,13,15		6,14	
11			7,15	
12	1,3,5,7,9,11,13,15	2,6,10,14		
13		3,7,11,15		
14	1,3,5,7,9,11,13,15			
15				

tests for 16 shorts, but 12 were checked either in the first or second test, or both. If a group short is detected by the second or third test, it is not necessary to scan all the test points to isolate the short circuit. Only those possible shorts not previously checked for have to be tested.

In a 16-test-point cable, assume, for example, that a short is detected during the second binary-group test ($b = 2$). In the second test points 0, 1, 4,

5, 8, 9, 12 and 13 are tested against points 2, 3, 6, 7, 10, 11, 14 and 15, so to isolate the fault, each of the points in the first group must be individually tested against each of the points in the second (Table 4). The first-fault isolation scan will consist of test point 0 ($t = 0$) against points 2, 6, 10 and 14. Then test point 1 will be tested against points 3, 7, 11 and 15. This process continues until test point 13 is tested against points 3, 7, 11 and 15. This will locate the short indicated by the second binary-group test. Binary tests 3 and 4 are then made, and their own fault-isolation scans are performed if either group test indicates a short.

Table 4 shows the tests that have to be made for each fault-isolation scan. The numbers in Table 4 can be determined by the formula:

$$f(b,t) = 2^{b-1} + L_t + K(2^b), \quad (15)$$

where:

b is the number of the binary-group test,

t is the test point designation number,

$f(b,t)$ is a numerical series of test point numbers that must be individually tested against each test point (The limits of $f(b,t)$ are from 1 to 2^{n-1} and $f(b,t)$ is not defined if the b^{th} binary digit of t is a 1.);

K is an integer and varies from 0, 1, 2, . . . , etc.,

L_t is a function of t and is equal to the numerical value of t , considering only the $b - 1$ least significant binary bits of t .

Equation 15 is valid for any size system in which the total number of test points equals 2^n .

One important consideration must be emphasized for the application of this relationship to the testing of any cable, irrespective of electrical configuration. The relationship $f(b,t)$ is defined to mean the low-

est numbered (addressed) test point that has its assigned designation number equal to the numerical value of $f(b,t)$. Likewise, t is the lowest numbered test point that has its designation number equal to the value of t . Only in a cable where all wires are pigtailed will the test point numbers and the respective designation numbers be of the same numerical value. ■■

Bibliography:

- "An Automatic Checkout Equipment," *Electronic Engineering*, XXXIV, No. 408 (Feb. 1962), 102.
- Brink, Raymond W. *A First Year of College Mathematics*. New York: Appleton-Century-Crofts, Inc., 1937.
- DIT-MCO Model 610 Automatic Circuit Analyzer. Kansas City, Mo.: DIT-MCO Electronics Div.
- Dobbins, Willis E. "A Tester for Wiring Shorts," *Electronic Industries*, XXII, No. 4 (April 1963), 216-220.
- FACT—Flexible Automatic Circuit Tester. Los Angeles: Hughes Aircraft Co.
- Feller, W. *Introduction to Probability Theory and Its Application*. New York: John Wiley & Sons, Inc., 1950.
- Ledley, Robert S. *Digital Computer and Control Engineering*. New York: McGraw-Hill Book Co., 1960.
- Mansey, R. "An Automatic Checkout and Recording Network," *Electronic Engineering*, XXXIII, No. 399 (May 1961), 284-290.
- Novotny, George V. "An Automatic Checkout Equipment for Today's Complex Systems," *Electronics*, XXXV, No. 28 (July 13, 1962), 37-44.
- Pennachio, D. G. "Automatic Checkout for Automated Wiring," *Electronic Industries*, XXI, No. 9 (Sept. 1962) 104-107.
- Sobel, Milton, and Groll, Phyllis A. "Group Testing to Eliminate Efficiently All Defectives in a Binomial Sample," *Bell System Tech. J.*, XXXVIII, No. 5 (Sept. 1959), 1179-1252.
- Space Manual (Space IV). East Rochester, N.Y.: Brooks Research, Inc. (Publication No. 90001-0).
- Space (Operation and Maintenance). East Rochester, N.Y.: Brooks Research, Inc. (Publication No. 950111-002.)
- A System for Computerized Wiring Verification. Los Angeles: Hughes Aircraft Co.
- Tape Programmed Automatic Circuit Analyzer. Kansas City, Mo.: DIT-MCO Electronics Div.
- Test Set, Electrical Cable, AN/USM-185, MIL-T-38218 (USAF) (Military Specification). Philadelphia: U.S. Naval Supply Depot, Sept. 25, 1963.
- Toffer, J. E. "Design of Automatic Test Equipment," *Electronic Industries*, XX, No. 1 (Jan. 1961), 76-80.
- Wakeen, Kenneth. "Automatic Circuit Tester," *Electronics*, XXXVII, No. 21 (July 27, 1964), 76-80.

Test your retention

Here are questions based on the main points of this article. They are to help you see if you have overlooked any important ideas. You'll find the answers in the article.

1. Assuming a testing rate of one test per second, how long would it take to perform leakage tests on a system with 5000 interconnections by (a) checking each wire against every other and (b) by binary-group testing?

2. What factors could cause an apparent fault during leakage testing and how can these apparent faults be avoided?

3. How many leakage tests are needed to check out a 60-wire cable, using binary-group testing (a) where all wires may be tested together, and (b) with minor-cable groups of 10?

4. How can the number of scans required for fault isolation be reduced when binary-group testing?

JUST HOW SMALL CAN YOU MAKE A SUB-MINIATURE POWER RESISTOR?

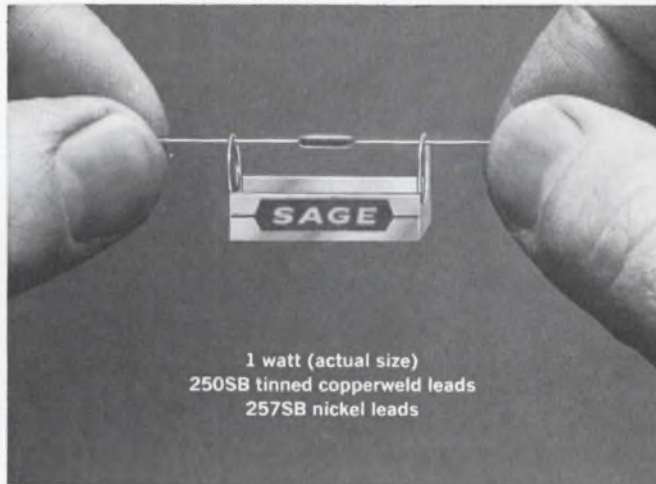

PRETTY SMALL!

Consider this SAGE SILICOHM® 1 watt unit in comparison to the vintage grid leak drip pan* pictured above. What's more, this tiny resistor, designed to operate hot, provides stability and precision features ordinarily associated with the finest of low power precision resistors.

SAGE Type SB styles feature superior heat dispersion by means of beryllium oxide cores, as first used in Advanced Minuteman parts. Assigned wattage ratings are 1 to 15 watts at 25°C ambient, thus offering dramatic new circuit miniaturization possibilities for commercial and regular military applications.

*As a matter of fact, we don't make grid leak drip pans.



Write for complete details.



SAGE ELECTRONICS CORP.

Subsidiary of Gulton Industries, Inc.

BOX 3926 ROCHESTER, N. Y. 14610

Phone: (716) 586-8010

INFORMATION RETRIEVAL NUMBER 39



It is rare indeed for a components company to develop an expertise in more than one technology. But when it happens, the products which result are usually impressive. Wedding

the superb advantages of solid state electronics to those of electro-mechanical switches has already improved performance in several industries where precise timing is required.

Consider a missile launch program, aircraft

check-out equipment, an automotive test stand, or an industrial manufacturing process. All have one thing in common — a need for accurate control, either sequentially or simultaneously, of multiple events.

A newly-developed programmer provides that kind of control. It combines the functions of high current electro-mechanical relays with an appropriate network of solid state electronics which coordinates a memory unit and an automatic timer.

How the Programmer Works: Each basic control function or event is represented by an independent channel in the electronic

system. Timing data for each event is key punched on cards or tape and fed into a reader. The data is then stored in a volatile memory (magnetostrictive delay line) and held there until a fresh set of cards is entered with different data or until the timer is shut off. The contents of the memory are examined every second and compared with the elapsed time for each program which is also stored in the memory. When an exact comparison is made between a program's elapsed running time and the pre-programmed instruction for a specific channel, the output relay for that channel switches instantly.



As many as eight on/off operations can be programmed in for each channel and held in the circulating memory until used. The unused portion of the memory makes it possible to extend the cycle time for any channel to practically any length needed. This is accomplished by punching the correct data on new cards and plugging them into the reader. However, the total size of the memory determines the maximum operating period, the maximum number of controlled channels and the maximum number of operations per channel.

Reliable Performance: This programming system is far more reliable than any of the

hundreds of purely mechanical systems in use today. Consistent performance at high switching accuracies to a few milliseconds can be obtained in contrast to the minimum resolution of several seconds delivered by conventional systems.

It is more economical and flexible than an entirely solid state unit. Semiconductors provide accurate logic while the use of relays for the higher current output minimizes heating and provides isolation.

Performance is enhanced still further by the use of relays with 100,000 cycle or more life capability. Literally, this means years

of faultless operation free of the expense of scheduled maintenance.

Whatever the application, the basic benefits will always be there: operation is simple and flexible because the timing cycle is established by punched cards or tape. Starting times and sequencing are always under precise control. Programming is so uncomplicated that downtime during change-over is minutes. Maintenance costs are minimized.

Write for a copy of our Brochure on Electronic Programmed Timers. Leach Corporation,

LEACH

Relay Division, 5915
Avalon Blvd., Los Angeles,
California 90003.

Just Married!

Manage your time or it will boss you!

Make each working day more productive by putting priorities on all tasks that come to you for action.

Do nothing today that you can just as well put off until tomorrow!

A startling premise? You'll find your workload as a manager greatly diminished and your time better organized if you adopt it as a motto. It's not a plea for procrastination, but rather a useful technique that allows you to make better use of your valuable time.

There are four overlapping techniques to help you make it work:

1. Fixing priorities.
2. Delegating responsibilities.
3. Rationing time.
4. Scheduling work.

Fixing priorities

Most of us set our work priorities in a rough, catch-as-catch-can way, postponing what we can, doing what we must, without realizing the tremendous advantages of a systematic approach.

First, you must discard, or at least question, these attitudes:

1. First come, first served.
2. A request from a higher level must always take precedence over one from a lower level.

The prime objection to the first-come-first-served approach is that others run your affairs, to the extent that they, not you, are determining the order of your business.

And if your job is truly managerial, rather than nominally so, then you must discard the second attitude—that higher-level demands always require higher-priority handling. Naturally, requests from superiors should be attended to as expeditiously as your workload permits, but they should not have automatic precedence over other matters that you consider more important.

Now, let's put our opening premise to work: Do nothing today that you can just as well put off until tomorrow.

Add to this another, less startling, premise: Perspective is essential to clear thinking.

Don Fuller, Director, Engineering Div. Industrial Education Institute, New York.

Given a set of factors, circumstances, tasks or duties, each has a particular value relative to the others in the context of your job. You must determine an order of priority for each.

Let's see how you can do this practically. Set aside a day in the near future for an experiment. (You can't afford the time, you say? That one day you will give up for this test can prove to be one of the most worthwhile days you've ever spent in terms of future benefits.) On this day, exercise great restraint, doing absolutely nothing that does not call for your immediate attention. List all the things you are postponing.

Now you are ready to put to use a simple, but effective, method to help you analyze and determine the relative importance of the postponed actions—in other words, to help you rate the priority you will give in accomplishing these tasks. This method is called the emphasis curve.

It is a series of comparisons, a comparison being the simplest and most likely to be correct of all measurements.

Putting the emphasis curve to work

The emphasis curve is a four-step sequence:

1. The scope.
2. The triangle of pairs.
3. The tabulation of results.
4. The ranking of results.

The scope is simply a list of all the factors to be considered in the analysis (see Fig. 1). In this instance, it will be all the tasks you are postponing. Do not attempt at this point to make any pre-judgments as to what is more or less important.

The triangle pairs each item number—each of which represents a task—with every other number (see Fig. 2). You analyze each pair of tasks from the viewpoint of priority. As you come to each pair, ask yourself, "If I have to postpone one or the other, which one will I *not* postpone?"

Take the first pair, items 1 and 2, in your scope. These might be, as shown in Fig. 1: (1) Check with controller's office on new budget, and (2) Prepare monthly engineering report. The



“If two high-priority items demand your attention and you only have time for one, you must delegate the other.”

SCOPE (TASKS POSTPONED)

1. Check with controller's office on new budget.
2. Monthly engineering report (due this week).
3. Prepare and circulate vacation schedule.
4. Agenda for meeting with staff.
5. Discuss with Jones his problems with rush IC design job.
6. Review résumés of applicants for engineering vacancy.
7. What's holding up big components project?
8. Draft paper for IEEE conference.
9. Review new government contracts.
10. Fill out new company insurance forms.

1. Preparing the scope is the first step in working the emphasis curve. It involves making a list of all items

that will be considered in the priority rating. In this example, the items are the tasks that are to be postponed.



TABULATION

A	B
1	5
2	7
3	0
4	3
5	9
6	6
7	8
8	2
9	4
10	1
45	

(a)

RANKING

TIMES CIRCLED IN PAIRINGS	ITEM NUMBER ON SCOPE
10	
9	5
8	7
7	2
6	6
5	1
4	9
3	4
2	8
1	10
0	3

(b)

2. The second step is the triangle of pairs, where each number is matched against every other number, with each number representing an item on the scope.

3. In these final two steps, list the number of times each item has been circled (a) and then rank them in order (b). Now you have your work priority.

engineering report is due by the end of the week, while there is no immediacy to check on the budget. Thus item 2 is circled (Fig. 2) in this pairing. Go on to the next pair, items 1 and 3, and make a similar analysis. Do this with all the pairs as shown in Fig. 2.

It is important that you actually make every comparison. Do not make the mistake of deciding that some item is of outstanding importance and circle straight across the line without bothering about the comparison.

Next, tabulate the times each number—that is, each task—has been circled, and write it in column B of the tabulation (Fig. 3a), opposite the appropriate item in column A. For example, item 1 has been circled five times; thus "5" will be written in column B, opposite No. 1 in column A.

The final step, the ranking, is completed by transferring this tabulation to Fig. 3b. The left column indicates the number of times an item has been circled, while the right column will show the item number from the scope circled that amount of times. For example, item 5 was circled nine times; thus, the "5" is written opposite No. 9. When the ranking is completed, you will have the priority items running down to the lowest in the right column.

The next day you tackle the jobs in the order of priority (or very close to it, some adjustment of order to suit your convenience being permissible).

While working from today's list, you are also making up tomorrow's scope, listing items not calling for immediate attention on this second day. At the end of the day, add to the scope for tomorrow any unfinished business from today's priority listing, not at the top but as items that will have to take their chances with the rest of the analysis (remember, we have discarded the first-come-first-served theory).

After having used this process for a week or so, you will discover items you have never gotten to, and there seems little likelihood that you ever will, for they seem to remain at the bottom of your priority list.

Such items represent the drag on your efficiency. It is not enough to identify the drag and try to get rid of it; it is equally important to find out how it got into your workload and how it can be kept out in the future.

You may discover, for example, that certain items, if postponed long enough, get done by the people who should have done them in the first place. These probably reached you by intentional or unintentional buck-passing, usually upward from a subordinate.

There may be other items for which you are clearly responsible, and at the same time, they are far down on the priority list. They must be

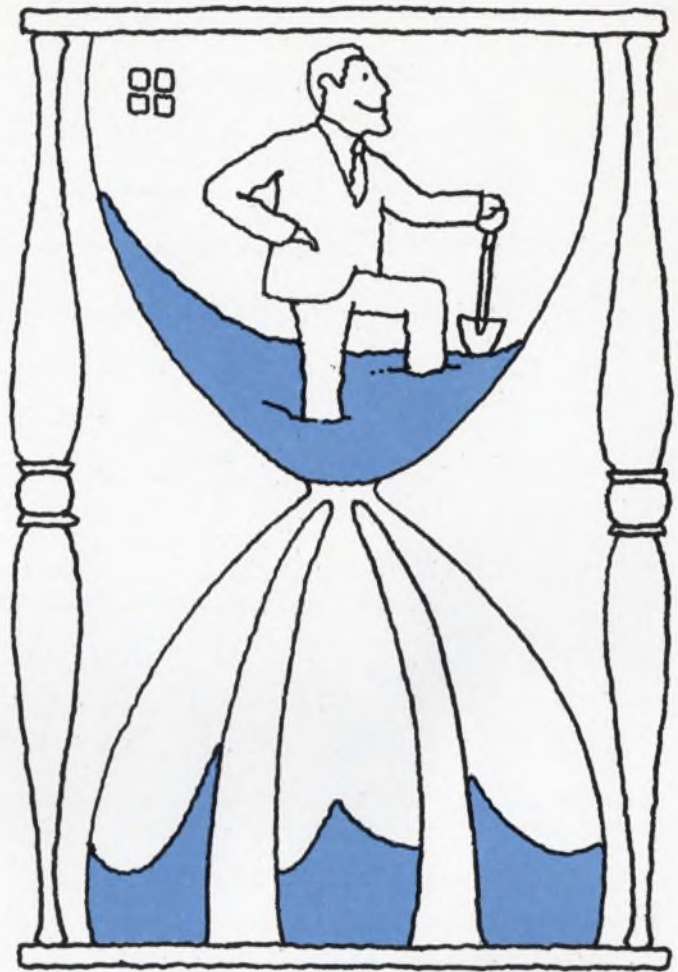

Ration your time: When you begin to budget your time, you realize how little of it there really is.

delegated. Examine to see if they show a pattern—a number coming from the same source, a number treating the same or closely related subjects, a number headed for the same destination. Perhaps, with some slight change in procedure, you can automatically delegate some matters before they even arise—matters that do not really require your personal attention.

Delegating is the solution

Lower priority leftovers are not the only things you delegate; these are the things you must delegate. But some high-priority items might be delegated as well. For example, if two high-priority items demand your attention and you have time for only one, you must delegate the other task.

Most managers will say they favor delegating authority, but too many substitute lip service for action. In true delegating, you, as a superior, fix an objective for the subordinate and then completely disinvolve yourself, leaving it to him to decide when he should come to you for guidance.

Don't make the mistake of confining your delegation of tasks to one or two persons, or



Schedule your workload: The most important things to control are the "interruptions," the matters which—

though they may be very important—serve to bring your own activities to a halt.

using only the proven few. Don't overlook the "average" engineer. He is likely to be capable of much more than average if given a chance. You probably have subordinates with talents beyond their present jobs. Discover these unused abilities and start using them. Nothing builds up a man's confidence like delegation.

In selecting subordinates, do a lot of "second-choicing." Your first choice is usually the best-trained man, the one who has done the job before or perhaps the handiest person. Taking such a ready course has its dangers: the willing horse gets overloaded; the impression of favoritism may generate jealousy; an often-selected man may get the impression that he is a crown prince. Second-choicing may call for more explaining and instructing, and the results may come a little slower at first, but, as each individual masters a new job, total efficiency is increased immeasurably.

Rationing your time

Another effective technique to increase your managerial efficiency is to time-budget your tasks, followed by an analysis of actual performance against estimated performance.

When you go shopping, you usually have an idea of what you want to or can afford to spend. If you plan to spend \$100 for an item and find it costs \$150, you must decide whether it is worth the additional money to you and, if so,

where the extra money will come from. Assume that same attitude toward your office time, wondering, when you are asked to spend more time than you planned, "Is it worth it?"

Think of time in 15-minute segments. There are 32 such segments in an eight-hour day. Notice that you are thinking in terms of "how much" and not "when." You are budgeting, not scheduling.

Assign so many segments of time to each item in your scope—the amount of time that you feel will enable you to handle each matter without undue pressure or waste.

After assigning time values, critically watch your performance against these self-imposed allotments. If you spend three segments on a two-segment item, was the increase due to a delay that you could not foresee or was it because of your inability to assess its proper worth? If you allotted three segments and the work was done in two, why less?

When you begin to budget time, you will realize how little of it there is and how relatively few matters you, as a manager, can handle personally. You cannot compensate for a shortage of time by rushing. Rushing lowers efficiency, by keeping mind and body at a fever pitch, and you become slipshod as you work against the clock.

Categorizing your budget

Next, study your personal work budget in

terms of broad categories: routine matters, supervising, planning, outside matters, meetings and conferences, rendering staff support. What percentage of your time are you devoting to each? The key categories for managers are supervising, planning and rendering staff support to other areas. Unless you are spending at least 75 per cent of your time in these areas, take immediate steps to delegate more routine work that others can handle or be trained to handle. At the lowest management level, the bulk of this 75 per cent is supervising. As you move up, the emphasis shifts to planning, and at the top, the major emphasis is on rendering staff support.

Budgeting time is an important part of planning. Organized planning keeps you moving from one logical step to the next—not aimlessly, but with fixed purpose. Henry J. Kaiser said that a man who has planned his time in advance has his job half done.

Take the analysis a step further by classifying items as: (1) Essential, (2) Important, if there is time, and (3) Basically nonessential.

You may have already asked, "How did items in the last category get into my workload?" If the analysis is made honestly, many of these "nonessentials" will be things you like to do, because it is an almost universal weakness of managers that they spend a disproportionate amount of time on things they like to do because they do them well. They hang on to them long after the time when they should have relinquished them has passed. The rest of the non-essentials will be things you continue doing from sheer habit or because you haven't figured out how to stop doing them or how to get someone else to do them.

Scheduling your workload

Fixing priorities has undoubtedly occasioned some revelations about your job, pointing up how relatively minor matters are often handled at the expense of major ones. Budgeting has probably made you more aware of how your time is really spent as opposed to how you have thought it was being spent. But scheduling gets right down to the immediate problem: how best to handle your workload in the next hour, the next day, the next week. It isn't what you do, but what gets done that counts.

Using your priority and time-budgeting analyses, fit the items into your schedule—plotting them as far in advance as your information permits, and being as specific about timing as you can. The basic goal of scheduling is control and self-discipline.

Know something about two important daily (and weekly) cycles—your own effectiveness and that of outside demand. All of us have a

pattern of effectiveness—times of the day and days of the week when we are at our sharpest and best. During the course of each day, mental and physical efficiency varies. And your daily pattern probably will have a counterpart in your weekly pattern. Adjust your work to your efficiency pattern.

But, like counterpoint in music, the pattern of your environment is played against your own. The demands made upon you by your superiors and others are quite likely to show a very consistent "shape." Identify this as early as you can. Does the boss usually call you in at mid-morning, mid-afternoon or just before quitting time? If spotty, is he sharp and critical in the morning and receptive in the afternoon?

Discover the loading-times for outside demand. Begin with a full schedule and then note the "postponements"—the items of your work that you had to drop to meet outside demands. Then, see that these dropable items are scheduled for peaks of outside demand, so they can be dropped if need be.

Finally, develop little time-saving habits. For example, keep an "away from the desk" folder. The idea here is to take advantage of waits and delays when you are away from your desk. Instead of just sitting and waiting, you can be reading a report, doing some minor clerical work or the like.

Some managers also make it a point to alternate pressure jobs with softer demands, so as not to wear themselves out. ■■

Test your retention

Here are questions based on the main points of this article. They are to help you see if you have overlooked any important ideas. You'll find the answers in the article.

1. Work out the emphasis curve by making a list of tasks awaiting your action, following the four steps as outlined in the article.

2. Once you consciously start rationing time, how would you check how successful you have been, and how can you improve on budgeting your time?

3. In scheduling your workload, with whose daily and weekly work cycles must you become familiar, and what is the relationship of your workload to these cycles?

4. What are the benefits of effective delegation for the manager, and how is it best carried out?

Introducing the second generation circuits & packaging engineers

The second-generation Circuit Design Engineer is a man of many talents. A capable generalist: part theoretician, technologist, businessman, diplomat, humanist. And all innovator.

In a multi-faceted world of advanced components, sophisticated equipment and exotic systems. Of macro-involvement and microelectronics. But most of all a world of change.

The engineer as a creative professional

GE Ordnance Department is one of those rare places where engineers create in the broadest sense. Taking responsibility for the total equipment package on projects like POSEIDON's Fire Control System. Surface-ship digital data links. A fire-on-the-move gun stabilizer for the M60 Tank. And other demanding projects for every weapon system environment. All of these programs involve the heavy use of microelectronic techniques.

There are paradoxes for engineers to resolve whose implications can be life-and-death. How to stabilize positioning servos operating within the mechanical resonance bandwidth of a vibrating structure. Create precision, responsive servos to withstand 1500 g's. Hermetically-sealed, ebullient-cooled packages that are field-maintainable. Responder-con-

trollers working at a lower data rate than the motion frequencies for which they compensate.

The engineer as a customer-relations specialist

Another facet of the work helps engineers develop faster: eyeball-to-eyeball customer contact. No red tape intermediaries or procedural static. Just the opportunity to suggest improvements, like a set of universal, field-programmable power supply and digital modules. Or anticipate problems in high-power circuits having 5000-hour MTBF.

The engineer as a businessman

Most important to their career development, the decision-making authority of GE circuit design engineers has direct bearing on the Department's profit and loss. They evaluate cost/performance and reliability/performance tradeoffs that determine Weapon Systems products' salability and cost effectiveness over a programmed lifetime of two decades or more. Acting as full partners with the military, they must analyze cost-to-install and cost-to-maintain, interfacing with both the customer, inhouse manufacturing and Q/C organizations. Which is the kind of operational overview and participation that can be a prelude to other things.

Finding second-generation engineers isn't easy. The combination of skills is unusual. But so are the rewards we offer.

IMMEDIATE OPENINGS EXIST FOR BOTH SUPERVISORY AND LESS EXPERIENCED ENGINEERS.

If you're a circuit designer with experience in electronic circuits or packaging design, why not investigate one of these positions:

Group Leader—Circuit Design (MSEE preferred). DC, low frequency AC, servo, and/or instrumentation circuit design for high reliability military hardware, including microelectronic techniques, understanding of component selection, standards, specification of performance and circuit analysis. 6-10 years' circuit design including some project and/or supervisory experience.

Engineers—Circuit Design (BSEE). 1-5 years' in field described above.

Group Leader—Electronic Packaging (MSME preferred). Direct development and application of advanced technology in electronic packaging for military equipment.

Needed is a leader with 6-10 years' experience designing microelectronics in soldered, welded and potted assemblies for severe environmental applications.

Engineers—Electronic Packaging (BSME). 1-5 years' in field described above.

Engineers—Computer Applications (BSEE). 1-5 years' experience in both circuit design and computer applications. To develop and implement computer analysis and design techniques.

Pittsfield, Massachusetts is a prime New England location—famous for skiing in the Winter and the Berkshire Music Festival at Tanglewood in the Summer.

If your qualifications and interests are in line with the above requirements, please send full details, including salary requirements, to: Mr. J. K. Handler, Rm. 59-B, Ordnance Dept., General Electric Company, 100 Plastics Ave., Pittsfield, Mass. 01201. An equal opportunity employer (m/f).

Ordnance Department

GENERAL  ELECTRIC

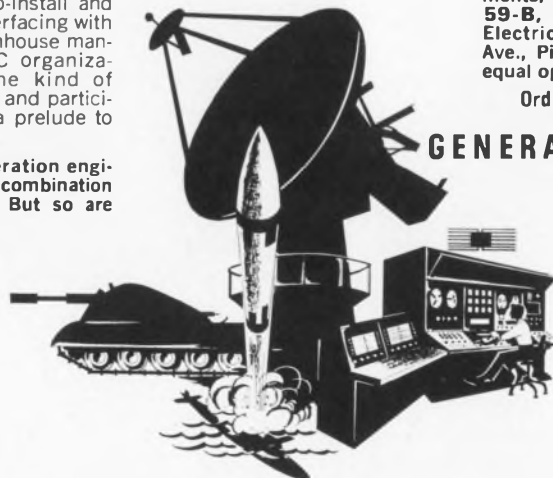

Free Career Inquiry Service

Absolutely Confidential

Respond to the career opportunities advertised in this issue. Fill out and send us this handy resume. **Electronic Design** will do the rest – neatly typed copies of this form will be mailed to the companies of your choice, indicated by the circled Career Inquiry Numbers at the bottom of this page.

3

Name				Home Phone			
Home Address (Street)			City		State		ZIP Code
Age	U.S. Citizen		Security Clearance				
	<input type="checkbox"/> Yes	<input type="checkbox"/> No					
Prime Experience				Secondary Experience			
Desired Salary				Availability Date			
Employment History – present and previous employers							
Company							
City, State							
Dates		to		to		to	
Title							
Specialty							
Education – indicate major if degree is not self-explanatory							
Degree							
College							
City, State							
Dates		to		to		to	
Additional Training – non-degree, industry, military, etc.							
Professional Societies							
Published Articles							

Career Inquiry Numbers:

900 901 902 903 904 905 906 907 908 909
 910 911 912 913 914 915 916 917 918 919

ELECTRONIC DESIGN
 850 Third Avenue
 New York, New York 10022

Innovative microelectronics engineers

urgently needed
at Bendix Kansas City

A new program to produce breakthroughs in design, fabrication and packaging of thin film microcircuit components is now getting underway at Bendix, Kansas City Division. The project is being sponsored by the Atomic Energy Commission. Custom engineering will be done by Bendix at its 70 acre/one roof Kansas City plant, which combines the broadest scope of engineering talent and the widest range of technological facilities in the United States.

The challenges of the long-term, high reliability program call for microelectronics engineers (or professionals in Physics), preferably with advanced degree or innovative flair.

Engineers to be selected will use a separate microelectronics laboratory to investigate various thin film deposition techniques used in fabricating microcircuit resistors and capacitors and will explore sophisticated packaging techniques needed in the application of integrated circuit technology. They'll also initiate production processes for fabrication of thin film microcircuit components and help design automated and computer-controlled test data entry and retrieval systems for microcircuits.

The project requires knowledge of process variables and controls associated with high production rates of thin film components using different metal systems, including refractory types . . . plus experience in fine line photolithographic work. Engineers with know-how in continuous process vacuum deposition equipment will be especially valuable to this engineering team, advancing the present state of microelectronics art.

Microelectronic engineers who need greater individual responsibility and who would welcome the opportunity to develop in a professional environment unaffected by proposals or consumer marketing campaigns are urged to contact Mr. W. H. Schaperkötter, Professional Placement Representative, Bendix Kansas City, Box 303-GT, Kansas City, Mo. 64131.

Bendix Kansas City is a prime contractor of the AEC and an equal opportunity employer.



Kansas City Division

INFORMATION RETRIEVAL NUMBER 902

110

Book Reviews

MOSFET basics

Characteristics and Operation of MOS Field-Effect Devices, Paul Richman (McGraw-Hill Book Co., New York), 150 pp. \$10.00.

This is a straightforward approach to the operation of MOSFETs and related devices. It begins with the theory of the field effect and illustrates the processes by which current can flow in a semiconductor. The electrical characteristics of the MOSFET are then separated into three regions: the linear-variable-resistance region, the saturated-current region and the avalanche-breakdown region, each of which is discussed in detail.

The book then deals with MOSFET fabrication and the technological problems associated with it, and the uses of the MOSFET

in p-channel and complementary digital systems.

The work is aimed at the circuit designer interested in MOSFET capabilities and MOS circuitry and at the engineer who wants a self-teaching course in MOS fabrication.

CIRCLE NO. 474

Robot hunt

The Search for the Robots, Alfred J. Cote, Jr. (Basic Books, New York) 243 pp. \$5.95.

A frightening forecast to some, and an exciting illumination to others, this book is a study of the rapidly growing world of automata. In using the designation robots, the author is referring to that aspect of scientific research that is creating machines with growing powers that threaten to surpass man's, both intellectually and physically. This book is a survey of the research done in this challenging and important field.



Electronics Engineers

Lockheed Missiles & Space Company is one of the largest electronics firms in the San Francisco bay area. Openings exist in a broad range of specialties and skills. Lockheed, in Sunnyvale, is deeply involved in many exciting, long-range programs in space, on land, and undersea. Such programs as Poseidon, Agena, Polaris, Deep Submergence Rescue Vehicle and advanced land vehicle systems; requiring people in all disciplines, at all levels. And, never before have benefits been more attractive. For more complete information, you are invited to write Mr. R. C. Birdsall, Professional Employment Manager, Post Office Box 504, Sunnyvale, California 94088. **LOCKHEED** MISSILES & SPACE COMPANY A GROUP DIVISION OF LOCKHEED AIRCRAFT CORPORATION Lockheed is an equal opportunity employer.

INFORMATION RETRIEVAL NUMBER 903

ELECTRONIC DESIGN 3, February 1, 1968

At ECI in St. Petersburg, Florida . . .
Digital Communications Opportunities

For a special breed of engineer

If you're one of that special breed of communication engineers who finds a challenge in projects beginning with applied research and advanced development and continuing through prototype and product design, you may well be the kind of person we're looking for.

Check this partial list of digital engineering activities at ECI. If you'd like to help push the state-of-the-art in any of these or other areas in communications, send us your resume. You'll design systems and equipment for satellite communications, multiplexing, electronic switching, command and control and advanced radio communications for some of the nation's major defense and space programs.

Digital Communication Engineering Activities:

- Frequency Synthesis
- MODEM Technology
- Microelectronic Applications
- Error Control Coding
- Electronic Switching
- Time Division Multiplexing
- Reliability Techniques

CHALLENGE, GROWTH . . . and LOCATION TOO!

At ECI your job will be challenging. At ECI you'll find real opportunity for growth instead of just another confining groove — two-thirds of all advanced development is done in regular engineering development areas. And, at ECI you'll like where you're living just as much as you'll like your job. We'll match subtropical, sunny St. Petersburg against any location in the U. S. for stimulating, comfortable living.

SEND YOUR RESUME TODAY — in confidence — to K. N. Nipper, Supervisor of Professional Placement, Electronic Communications, Inc., P. O. Box 12248, St. Petersburg, Florida 33733.
(An equal opportunity employer, M & F.)



ELECTRONIC COMMUNICATIONS, INC.
ST. PETERSBURG DIVISION

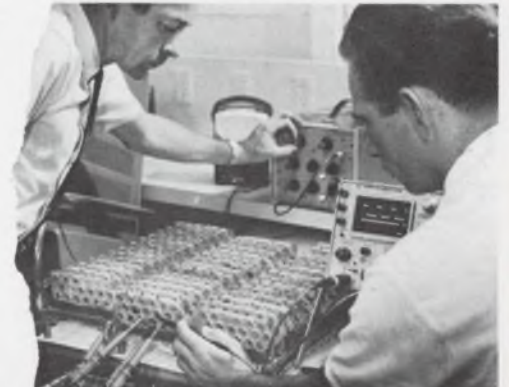

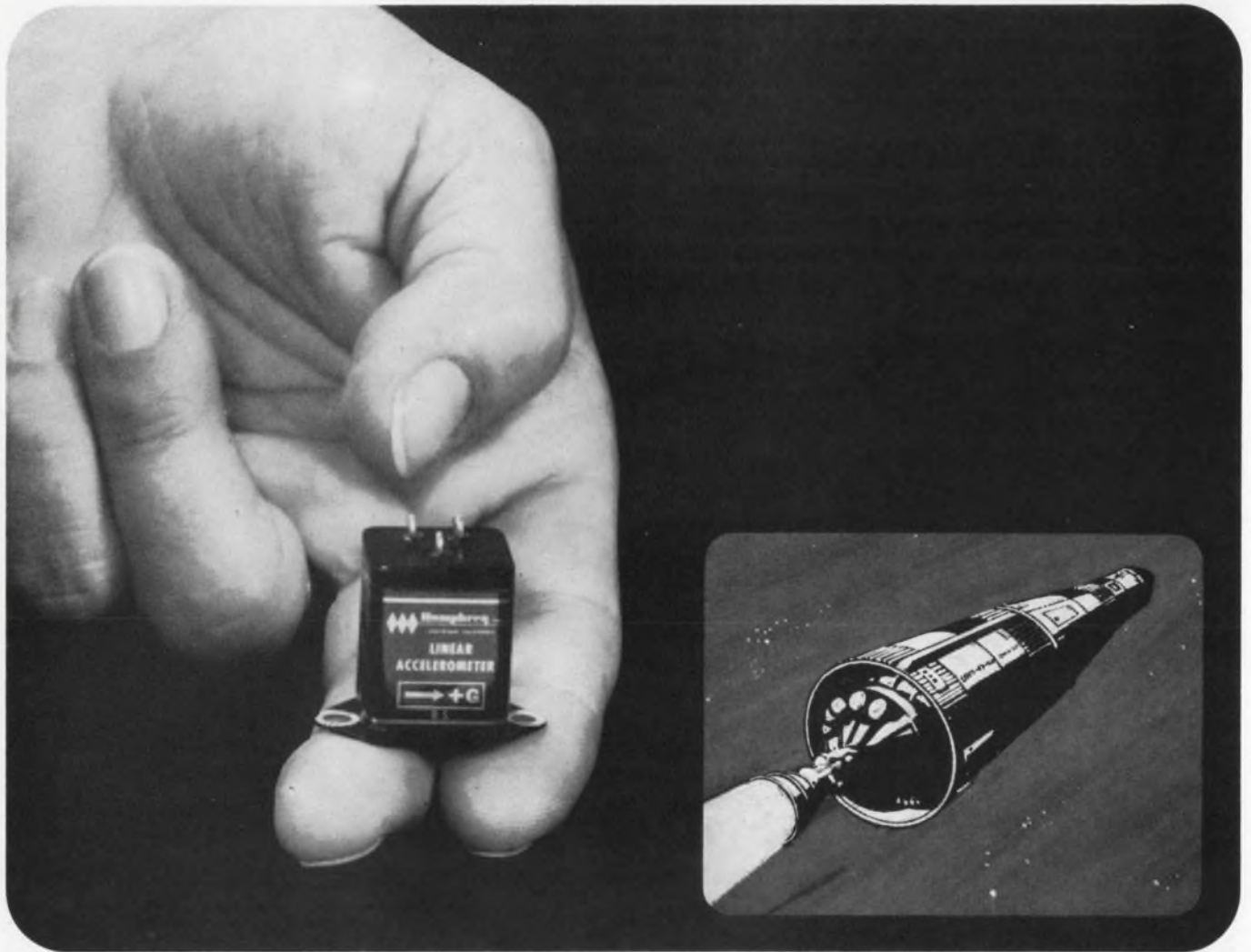

Humphrey Micro Accelerometer... world's smallest...with widest range of G values

This extra-miniature production accelerometer (LA45), manufactured by Humphrey, is the smallest in the world with potentiometer pick-off. It is now available in full scale ranges of $\pm 2G$ to $\pm 300G$.

The Micro LA45 measures only $\frac{3}{4}$ " square by 1" long and weighs less than 1.5 ounces. Reliability has been proven with production applications in a variety of missile systems.

The LA45 has a hermetically sealed, steel case and a precision 5000 ohm potentiometer output. Dry gas damping assures performance over wide temperature ranges.

Humphrey, Inc., has many other accelerometers suitable for a variety of precision flight control systems and instrumentation. These units may be furnished as bi-

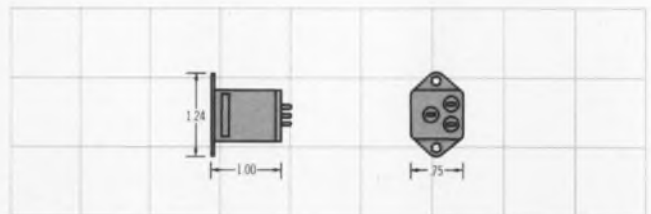

Humphrey Micro LA45 Accelerometer

directional or unidirectional sensors. Additional mountings or connector configurations can be made available.

Write for *free brochure* and information on special requirements. Humphrey, Inc., Dept. ED-2, 2805 Canon Street, San Diego, California 92106.

HUMPHREY, INC.

2805 Canon St., San Diego, Calif. 92106 Phone: (714) 223-1654

EASTERN OFFICE: North Philadelphia Airport, Philadelphia, Pa. 19114. Phone (215) 676-1654 • EXPORT: Aeromaritime, Inc. • Cable: Avionics, Washington, D.C.

INFORMATION RETRIEVAL NUMBER 41

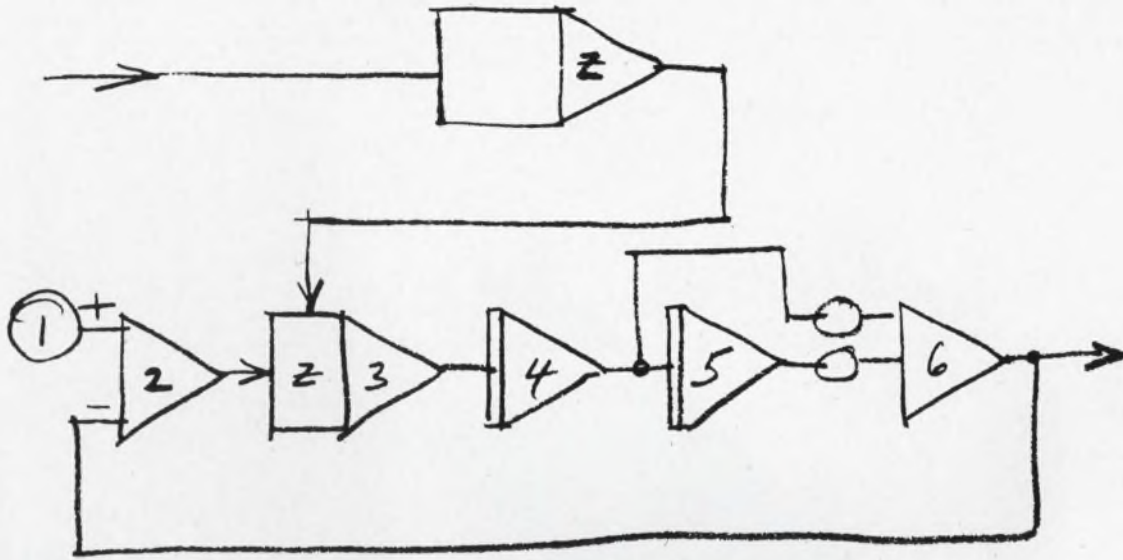

It's this easy to tell your simulation problems to an IBM computer.

Just describe the system dynamics in simple block diagram language. Outline your system. Define any necessary special functions. And you're ready to go.

Continuous System Modeling Program (CSMP) makes it this easy to communicate with either the desk-size 1130 computer or the more powerful SYSTEM/360. IBM computer simulation gives you an accurate analysis of the system long before it's operating. And it lets you modify parameters that affect system performance.

You compress days, weeks, even months of real-life operation into a few minutes of computer time. You see the results either plotted or in tabular form. Then you decide—modify, re-analyze, optimize—until you're satisfied. You're more productive and your designs are closer to optimum.

Get the story on the computer as a tool for system

design or analysis. Call your local IBM sales office or send us this coupon today.

IBM Data Processing Division, Dept. 805-110
112 East Post Road, White Plains, N. Y. 10601

Please send me information on:

- CSMP/360 SYSTEM/360
 CSMP/1130 1130 Computer System

Name _____
Title _____
Company _____
Division _____
Address _____
City _____ State _____ Zip _____

IBM

INFORMATION RETRIEVAL NUMBER 42

MINIATURE SIZE RELAY □ **CONTACT RATINGS:** Contact Material: Rhodium. Maximum Voltage (Volts): 50 VDC, 150 VAC. Maximum Current: Switch, .500 amp. Carry, 2.5 amps. Maximum Power (Watts, DC): 6 Watts. Resistive or properly suppressed (VA, AC): 10 VA. Maximum Resistance Initial: 100 milliohms. End-of-life: 2 ohms. Peak Breakdown Voltage: 300 volts rms. Life & Reliability At Rated Load: 20×10^8 operations. Dry Circuit: 500×10^8 operations. **OPERATING PARAMETERS:** Speed: Depending on sensitivity and number of poles, the speed for miniature size relays is from 1 msec to 2½ msec, including contact bounce and coil time. Insulation Resistance: Coil to ground: 50 megohms (min). Coil to contact: 500 megohms (min). Temperature Range: -50°C to +105°C. Vibration: 10G @ 10-55 cycles/sec (open or closed). Shock: 15G (min).

STANDARD SIZE RELAY □ **CONTACT RATINGS:** Contact material: Rhodium. Maximum Voltage (volts): 150 VDC, 250 VAC. Maximum Current: Switch, 1.5 amps. Carry, 6 amps. Maximum Power (Watts, DC): 25 watts. Resistive or properly suppressed (VA, AC): 40 VA. Maximum Resistance, Initial: 50 milliohms. End-of-life: 2 ohms. Peak Breakdown Voltage: 500 volts rms. Life & Reliability, At Rated Load: 20×10^8 operations. Dry Circuit: 500×10^8 operations. **OPERATING PARAMETERS:** Speed: Depending upon sensitivity and number of poles, the speed for standard size relays, including contact bounce and coil time, is: 2½ msec to 6 msec. Insulation Resistance, Coil to ground: 100 megohms (min). Coil to contact: 2000 megohms (min). Temperature Range: -50°C to +105°C. Vibration: 10G @ 10-55 cycles/sec (open or closed). Shock: 15G (min).



**NEXT TIME YOU
NEED A DRY REED RELAY**

**THERE'S A BRAND NEW SOURCE
WHERE YOU CAN GET IT FASTER**

It's Adlake—the company you call on for mercury relays. We now supply dry reed relays in standard and miniature sizes; single, double, and 4-pole. And we promise you the same fast delivery that made us the leader in mercury-displacement and mercury-wetted relays.

There's no compromise with quality. Our dry reed relays have the most accurately-wound coils and the most reliable switches you can find anywhere. They are specially recommended for such applications as automatic numerical machine controls, telephone and telegraph switchgear, and data processing.

Write today for our new catalog. And don't forget that at Adlake we always stand ready to assist you with design and engineering.



THE ADAMS & WESTLAKE COMPANY

A SUBSIDIARY OF **ALLIED** PRODUCTS CORPORATION

Elkhart, Indiana 46514 • 219 264-1141 • TWX 219 522 3102 • TELEX 25-8458 • CABLE ADLAKE

INFORMATION RETRIEVAL NUMBER 43

ELECTRONIC DESIGN

semiannual index of articles

July-December 1967

The articles in each section of this index are grouped under key words, which are intended to indicate the general topic to which the articles refer. The same article may be listed more than once if its main concern is more than one of these generalized topics.

Automatic Controls and Servos

AUTOMATIC CHECKOUT: Automatic checkout heads for an era of growth SR, ED 24, p. 49
 Barriers to automatic checkout SR, ED 24, p. 58
 Better displays emerging as data volume mounts SR, ED 24, p. 60
 Computers point the way to more versatile ACE SR, ED 24, p. 52
 Passive sensors needed for ACE of the future SR, ED 24, p. 64

CLEAN ROOMS: Light-system counts dust to clean up clean rooms NASA, ED 22, p. 128

FLUID CONTROL: Fluid control circuit operates on low power NASA, ED 19, p. 136

HELICOPTERS: Hovering helicopter's cargo weighed electronically NEWS, ED 15, p. 20

INDICATORS: Monitor your equipment with a 'forget me not' circuit IFD, ED 23, p. 116

MOTOR SPEED: Motor-speed change time is computed graphically IFD, ED 18, p. 86

PHASE CORRECTION: Logical clock phase correction for PCM data IFD, ED 14, p. 106

POST OFFICE: USPO drives to streamline nation's mailing operations NEWS, ED 18, p. 13

PROGRAMMER: Servo programmer generates linear on and off ramps IFD, ED 23, p. 118

PULSES: Simple circuit recognizes pulse width and amplitude IFD, ED 14, p. 110

SWITCHES: On-off solid-state switch is simple and inexpensive IFD, ED 20, p. 70

TEMPERATURE: Temperature monitor tracks voltage drifts IFD, ED 14, p. 110

VOLTAGE CONTROL: Modified feedback simplifies programmable voltage supply IFD, ED 15, p. 102
 Switching transistor controls DC voltages NASA, ED 14, p. 116

WEAPON FIRING: Command system aids firing of nuclear devices NEWS, ED 19, p. 14

Careers and Management

ADVANCEMENT: How can YOU become a chief engineer? C&M, ED 21, p. 86
 'Let's smooth the path to management' C&M, ED 22, p. 114

ASSOCIATIONS: Amateur radio producers' group to merge with EIA NEWS, ED 14, p. 14

BUDGETING: Good budgeting can boost profits C&M, ED 24, p. 88
 Rising sales don't always raise profits C&M, ED 25, p. 104

COST ANALYSIS: Profit by learning cost analysis C&M, ED 23, p. 96

EDUCATION: MBA degree shown to be most rewarding NEWS, ED 22, p. 14

LISTENING: Listen! Don't just hear C&M, ED 26, p. 90

MANAGING: Pit your engineering management skill against these actual problem situations C&M, ED 16, p. 76
 Suddenly, you're a manager C&M, ED 17, p. U84

QUIZ: Are you a quiz whiz? Try this test C&M, ED 18, p. 74

SALARIES: Go West, young man, but buy a round-trip ticket

. NEWS, ED 24, p. 24

Circuits & Mathematical Analysis

AGC: Build a fast, wide-range agc system ART, ED 24, p. 70

AMPLIFIERS: Boost FET amplifier gains ART, ED 19, p. 98
 Build complementary-symmetry amplifiers ART, ED 21, p. 52
 Composite amplifier has improved dc bias stability

. IFD, ED 14, p. 102
 Cut operational-amplifier noise ART, ED 19, p. 104

Design better agc FET amplifiers ART, ED 18, p. 66
Evaluate operational-amplifier errors ART, ED 16, p. 54

Feedback loop provides high dc stability IFD, ED 18, p. 82
Mini-noise amplifier has FET input stage IFD, ED 17, p. 276

Notch amplifier built with a single IC IFD, ED 26, p. 108
Output impedance is cut in a transistor amplifier

. IFD, ED 21, p. 104
Reduce delay distortion at the source ART, ED 19, p. 116

Single class-B stage yields low-distortion 500-mA drive

. IFD, ED 22, p. 132
Stable summing amplifier has low input impedance

. IFD, ED 23, p. 110
The op-amp conjurer strikes again SR, ED 15, p. 70

The '709': Model T of the op amps SR, ED 15, p. 58
Varactor's agc widens amplifiers' dynamic range IFD, ED 15, p. 101

ANTENNAS: CRT displays antenna patterns ART, ED 17, p. 260
Curve gives minimum-weight design for waveguide-fed horns

. IFD, ED 25, p. 120

SEMIANNUAL INDEX

- BAILING CIRCUITS:** Electronic bailing circuit is all solid state IFD, ED 17, p. 266
- BATTERIES:** Fail-safe unit operates from NiCad batteries or ac line IFD, ED 21, p. 98
- BUFFERS:** FET buffers output of voltmeter or counter IFD, ED 17, p. 272
- CHARACTER GENERATOR:** An inexpensive character generator ART, ED 17, p. 242
- CHOPPER CIRCUITS:** Transformerless chopper circuit built with a differential amplifier IFD, ED 21, p. 106
- COMPARATORS:** Go/no-go digital comparator uses complementary addition IFD, ED 17, p. 274
Make IC digital frequency comparators ART, ED 14, p. 62
- COMPRESSORS:** Volume compressor needs no power supply IFD, ED 26, p. 110
- COMPUTER-AIDED DESIGN:** A FET model for computer design NASA, ED 17, p. 283
Computer analysis spots twin-T filter troubles IFD, ED 18, p. 84
Computer talks to the circuit designer ART, ED 21, p. 58
Diode model is analyzed by computer ART, ED 14, p. 80
Simulate ICs with analog black boxes ART, ED 24, p. 75
Small computers analyze circuits NASA, ED 25, p. 113
Transient analysis generator simulates electrical networks NASA, ED 26, p. 100
- CONVERTERS:** Here's a dc-to-pulse-width converter ART, ED 16, p. 66
Matched bipolars replace FETs in a simple squaring circuit IFD, ED 17, p. 264
Simple circuit converts any waveform into a sawtooth IFD, ED 26, p. 110
Solid-state converter combines two functions NASA, ED 17, p. 278
Voltage-to-frequency converters built with one UJT oscillator IFD, ED 25, p. 122
- COUNTERS:** Counter designs swing without gates ART, ED 25, p. 82
Design a high-speed counter ART, ED 22, p. 90
Five-bit counter saves a package IFD, ED 14, p. 112
Fluid logic in counter NASA, ED 15, p. 110
Level synchronizer uses two J-K flip-flops IFD, ED 15, p. 100
Photoconductors stabilize neon-tube solid-state ring counter IFD, ED 16, p. 86
Ring counter uses optical triggering IFD, ED 18, p. 89
Ring counter uses SCSs and neon tubes IFD, ED 17, p. 270
Stop your counter from 'hanging up' because of noise ART, ED 15, p. 86
- COUPLING CIRCUITS:** Voltage follower has high impedance, can handle large signals IFD, ED 19, p. 124
- CURRENT GENERATORS:** Grounded-load current source uses one operational amplifier IFD, ED 16, p. 94
Microcurrent generator accurately controls 1 pA NASA, ED 14, p. 114
- DELAYS:** Reduce delay distortion at the source ART, ED 19, p. 116
Time delay touch switch uses body stray voltage IFD, ED 15, p. 106
Which delay line is best? ART, ED 21, p. 66
- DETECTORS:** An 'operational' peak detector captures very narrow pulses IFD, ED 22, p. 138
Error detecting codes are simple ART, ED 19, p. 90
Level detector has independently adjustable hysteresis and trip point IFD, ED 21, p. 98
Linear demodulator combines high output and phase sensitivity IFD, ED 21, p. 100
Simple circuit recognizes pulse width and amplitude IFD, ED 14, p. 110
Solid-state phase detector replaces transformer circuit NASA, ED 22, p. 126
- DIFFERENTIATORS:** How good is your differentiator? ART, ED 26, p. 82
- DIGITAL ICS:** Build filters with MOS chips SR, ED 18, p. 55
Digital roads to analog functions SR, ED 18, p. 42
From theories to hardware SR, ED 18, p. 48
Resolve angles with samples SR, ED 18, p. 61
- FILTERS:** Bandpass filter has asymmetrical response shape IFD, ED 22, p. 134
Build filters with MOS chips SR, ED 18, p. 55
Computer analysis spots twin-T filter troubles IFD, ED 18, p. 84
Graphs speed two-section filter design ART, ED 22, p. 104
- FLOW GRAPHS:** Use the signal flow graph technique ART, ED 17, p. 254
- FLUIDICS:** Fluid control circuit operates on low power NASA, ED 19, p. 136
Fluidic logic takes to the air SR, ED 17, p. U108
- FUNCTION GENERATORS:** A simple generator produces linear sawtooth IFD, ED 26, p. 106
Lf triangular wave generator has

Subject listing	Industrial Electronics	Power Sources
Automatic Controls and Servos	Materials	Production Processes and Cooling
Careers and Management	Medical Electronics	Radio Frequency Interference
Circuits and Mathematical Analysis	Microelectronics	Reliability
Communications	Microwaves	Research and Development
Computers and Data Processing	Military Electronics	Semiconductors
Consumer Electronics	Missiles and Space	Telemetry
General Industry	Navigation and Guidance	Test Equipment and Measuring
	Oceanology	Tubes
	Packaging	

just a few components IFD, ED 24, p. 105
 Transistors compensate diodes in triangle-to-sine converter IFD, ED 26, p. 102

GATING: Coincidence gate generates first-field reference trigger IFD, ED 20, p. 66
 RDL used to smooth IC gating circuit IFD, ED 15, p. 104

ICS: The tricks of the linear trade SP, ED 15, p. 54

INDICATORS: Monitor your equipment with a 'forget me not' circuit IFD, ED 23, p. 116
 Simple circuit solves position display problem IFD, ED 23, p. 122

INTEGRATORS: Low-cost op-amp integrator has range from dc to over 1 MHz IFD, ED 24, p. 104

INVERTER: 40-kHz inverter uses mini-filters NEWS, ED 24, p. 33

LADDER NETWORKS: Ladder networks are easy to design for D/A and A/D converters ART, ED 14, p. 68

LARGE-SCALE INTEGRATION: In the LSI era, extra circuits may lower cost NEWS, ED 24, p. 20

LOGIC CIRCUITS: Low-cost parallel subtracter made with simplified logic IFD, ED 16, p. 86
 Speed up binary-to-decimal conversion ART, ED 20, p. 50
 Undercover signals are unmasked ART, ED 17, p. 236
 Use discrete-component logic circuits ART, ED 23, p. 68

MEMORIES: MOS-FET memory stores signal for 10⁶ s NASA, ED 14, p. 114

MODULATION: Dc voltage modulator uses line frequency IFD, ED 14, p. 102
 Multiply width of pulse in two easy steps NASA, ED 17, p. 280

MULTIVIBRATORS: Circuit permits

remote programing of multivibrator IFD, ED 24, p. 100
 Get sharp edges from an astable multivibrator waveform IFD, ED 19, p. 128
 IC in logic one-shot ends contact bounce IFD, ED 20, p. 70
 Inexpensive IC comprises low-power flip-flop IFD, ED 23, p. 122
 Long-duration monostable fabricated with ICs IFD, ED 25, p. 128
 Reed relay one-shot uses three components IFD, ED 20, p. 72
 Reliable one-shot has high repetition rate IFD, ED 25, p. 120
 Wide-range multivibrator uses IC flip-flop IFD, ED 24, p. 102

NETWORKS: Synthesize resistor-thermistor networks ART, ED 14, p. 74

NOISE: Mismatching for low noise in amplifiers ENG DATA, ED 14, p. 86

OSCILLATORS: FET subcarrier oscillator is temperature-compensated NASA, ED 26, p. 98
 Pin diode switches microwave oscillator IFD, ED 14, p. 104
 Transformer synchronizes UJT relaxation oscillator IFD, ED 15, p. 101
 Ultrawide-range VCO uses op amp and UJT IFD, ED 20, p. 66
 Voltage-controlled oscillator uses an integrated circuit IFD, ED 15, p. 102

PHASE SHIFTERS: A continuous phase shifter for 60 Hz uses a Selsyn IFD, ED 15, p. 104
 Logical clock phase correction for PCM data IFD, ED 14, p. 106
 Multioutput phase shifter uses one transistor IFD, ED 22, p. 130

PHONOCARDIOGRAM: Circuit duplicates sound of heart NASA, ED 25, p. 113

PHOTOCELLS: Amplify photocell output with a FET source follower IFD, ED 22, p. 140
 True Lambert-law response obtained from a photocell IFD, ED 23, p. 110

PLATE CHOKE: Rf plate choke uses simple components IFD, ED 18, p. 88

PLOTTING: Transfer function plotted on a storage oscilloscope IFD, ED 14, p. 108

POWER TRANSISTORS: Switch high loads with power transistors ART, ED 17, p. 224

PROGRAMMER: Servo programmer generates linear on and off ramps IFD, ED 23, p. 118

PROTECTION CIRCUITS: Go/no-go short detector for printed circuits is simple and reliable IFD, ED 24, p. 98
 Simple circuit protects loudspeaker and audio amplifier

. IFD, ED 25, p. 124

PULSE COMPRESSION: Compress or expand pulses with a simple circuit IFD, ED 25, p. 122

PULSE GENERATOR: A/D multiplier/divider has UJT as relaxation oscillator IFD, ED 19, p. 124
 Build a pulse generator with four components IFD, ED 26, p. 106
 Constant-pulse-width generator is built with integrated circuits IFD, ED 22, p. 134
 Get high input, low output impedances from a fast pulser IFD, ED 23, p. 114
 Simple circuit gives fast, high-current pulses to drive a GaAs laser pulser IFD, ED 26, p. 102
 Single IC generates wide-range variable-width pulses IFD, ED 19, p. 134
 UJTs generate quasi-random pulses IFD, ED 16, p. 90
 Versatile pulse generator made by combining three ICs IFD, ED 18, p. 82

RADARS: Statistics speed video bandwidth design ART, ED 26, p. 72

RAMP GENERATORS: Symmetrical ramp generator uses new devices IFD, ED 23, p. 114

REFERENCE SOURCE: Inexpensive 6-V reference is also temperature-stable IFD, ED 23, p. 112

REGULATORS: Constant-current regulator has low dissipation IFD, ED 18, p. 86
 Efficiency raised to 94% in switching regulator NASA, ED 23, p. 104
 Foolproof dc regulator uses minimum of components IFD, ED 17, p. 260
 Integrated circuit is key to foolproof voltage regulator IFD, ED 21, p. 104
 Modified feedback simplifies programmable voltage supply IFD, ED 15, p. 102
 Regulate voltages with varistors ART, ED 24, p. 81
 Stabilize voltage regulator by replacing Zener with a FET IFD, ED 20, p. 72
 Switching transistor controls dc voltages NASA, ED 14, p. 116
 Voltage regulator has built-in delay time IFD, ED 21, p. 102
 Zener diodes are not enough in a voltage regulator ART, ED 16, p. 60

RELAYS: UJT and SCR reset self-latching relay IFD, ED 18, p. 89

SWITCHES: A 2-kV, 0.1-A switch uses mesa transistors IFD, ED 21, p. 102
 Bistable dc-coupled switch has a 5-nanosecond rise time IFD, ED 23, p. 120
 Hybrid solid-state switch replaces power types NASA, ED 24, p. 94
 Magnetic reed switch handles 1875 VA at 125 V ac

Departments key

ART	Technical Article
C&M	Careers and Management
DD	Design Directions
ENG DATA	Engineering Data
IFD	Ideas for Design
NASA	NASA Tech Briefs
PF	Product Feature
SR	Special Report

- PF, ED 23, p. 126
On-off solid-state switch is simple and inexpensive..... IFD, ED 20, p. 70
- SWITCHING CIRCUITS:** Micropower fast switching circuits..... ART, ED 15, p. 94
Switch your ac loads at zero voltage or current..... IFD, ED 19, p. 128
Switching circuit has hysteresis..... IFD, ED 16, p. 88
- TEMPERATURE:** Temperature monitor tracks voltage drifts..... IFD, ED 14, p. 110
- THRESHOLD LOGIC:** Practical guide to threshold logic..... SR, ED 22, p. 65
Use tunnel diodes in threshold logic..... ART, ED 25, p. 92
- TIMING CIRCUITS:** FET is used to give simple timing circuit..... IFD, ED 20, p. 68
- VARACTORS:** Put the varactor's inductance to use..... ART, ED 21, p. 78
- ZENER DIODES:** Simple Zener-diode tester uses single transistor..... IFD, ED 22, p. 140
- Communications**
- AMPLIFIERS:** Reduce delay distortion at the source..... ART, ED 19, p. 116
- COMPUTERS:** Computer keyboard plugs in telephone..... NEWS, ED 18, p. 34
Telephone networks claimed ready for future computers..... NEWS, ED 14, p. 13
Time-sharing systems found to be inadequate..... NEWS, ED 19, p. 14
- COMSATS:** Communication Satellite is planned in Europe..... NEWS, ED 14, p. 14
New 'bird,' Pacific II, hovers over Hawaii..... NEWS, ED 21, p. 14
- DELAY DISTORTION:** Reduce delay distortion at the source..... ART, ED 19, p. 116
- ERROR DETECTION:** Error detecting codes are simple..... ART, ED 19, p. 90
- MILITARY:** Far-out communications for unorthodox wars..... NEWS, ED 14, p. 22
- RESEARCH & DEVELOPMENT:** Bell Labs study group rethinks transmission..... NEWS, ED 24, p. 14
- SATELLITES:** Business data is sped to Europe by satellite..... NEWS, ED 15, p. 14
NATO is considering satellite communications..... NEWS, ED 15, p. 13
- SOVIET UNION:** Soviet electronics: Hot theory, cold hardware..... NEWS, ED 23, p. 17
- TELECOMMUNICATIONS:** LBJ orders full review of U.S. telecommunications..... NEWS, ED 18, p. 13
Telecommunications face growth problems..... NEWS, ED 16, p. 14
- TELEPHONY:** FCC weighs wider use of telephone attachments..... NEWS, ED 23, p. 13
Revised telephone rules may spur digital facsimile..... NEWS, ED 23, p. 35
- Components**
- AMPLIFIERS:** Photodiode and op-amp share same TO-5 can..... PF, ED 26, p. 114
- BOLOMETER:** Thin-film capacitor is a sensitive bolometer..... NEWS, ED 26, p. 34
- CHOKE:** Rf plate choke uses simple components..... IFD, ED 18, p. 88
- CONNECTORS:** Miniature coaxial contacts start to finish in 20 seconds..... PF, ED 25, p. 160
- CORES:** Iron out ferrite core design wrinkles..... ENG DATA, ED 26, p. 76
- DELAY LINES:** Which delay line is best?..... ART, ED 21, p. 66
- DIODES:** For sale: LSA diodes yielding 100 W in X band..... PF, ED 23, p. 164
Photodiode and op amp share same TO-5 can..... PF, ED 26, p. 114
Picosecond diode takes a 450-volt jolt..... NEWS, ED 22, p. 40
Tiny light-emitting diode has 40-foot-lambert visible output..... PF, ED 19, p. 148
- FAILURE ANALYSIS:** Don't blame the component vendor every time a circuit fails..... ART, ED 15, p. 90
- INVERTERS:** 40-kHz inverter uses mini-filters..... NEWS, ED 24, p. 33
- MAGNETS:** 125-kG supercooled magnet weighs 40 lb..... NEWS, ED 19, p. 32
- MODULES:** Power circuits deliver 30- to 100-watt outputs in 1/2-in.³, 3/4-oz. package..... PF, ED 14, p. 130
- PUSHBUTTONS:** Lighted pushbuttons simplify mounting and maintenance..... PF, ED 16, p. 98
- RELAYS:** Bifilar winding on relays suppresses high transients..... IFD, ED 19, p. 136
Mini-relay in TO-5 skirts adjustment..... PF, ED 25, p. 144
- TRANSDUCERS:** There's solid-state pressure on transducers..... NEWS, ED 16, p. 22
- Computers and Data Processing**
- ACCOUNTING MACHINES:** Low-cost electronic unit vies in business field..... NEWS, ED 17, p. 14
- AUTOMATIC CHECKOUT:** Computers point the way to more versatile ACE..... SP, ED 24, p. 52
- BALLISTICS:** 'Detective' computer matches bullets to guns..... NEWS, ED 21, p. 38
- COMPUTER-AIDED DESIGN:** Computer analysis spots twin-T filter troubles..... IFD, ED 18, p. 84
Computer talks to the circuit designer..... ART, ED 21, p. 58
Diode model is analyzed by computer..... ART, ED 14, p. 80
A FET model for computer design..... NASA, ED 17, p. 283
In goes schematic; out comes PC art..... NEWS, ED 17, p. 32
New group to foster design by computer..... NEWS, ED 26, p. 21
Simulate ICs with analog black boxes..... ART, ED 24, p. 75
Small computers analyze circuits..... NASA, ED 25, p. 113
Transient analysis generator simulates electrical networks..... NASA, ED 26, p. 100
- CONVERTERS:** Speed up binary-to-decimal conversion..... ART, ED 20, p. 50
- DATA TRANSMISSION:** Air Force conducts fm-digital 'contest'..... NEWS, ED 19, p. 52
Computer keyboard plugs in telephone..... NEWS, ED 18, p. 34
- DIGITAL SYSTEMS:** Core buffer sizes are defined rapidly..... ENG DATA, ED 16, p. 72
DDC is prospering despite \$500,000 prices..... NEWS, ED 16, p. 17
- DISPLAYS:** Computer display shows 3-D pictures..... NEWS, ED 19, p. 33
Low-cost display tested for computer 'utilities'..... NEWS, ED 14, p. 36
- ERROR DETECTION:** Error detecting codes are simple..... ART, ED 19, p. 90
- FAST FOURIER TRANSFORMS:** The FFT computer: Designer's 'missing link'..... NEWS, ED 25, p. 25
- FLUIDICS:** Fluid digital systems are found practical..... NASA, ED 25, p. 114
Fluid logic in counter..... NASA, ED 15, p. 110
Fluidic logic takes to the air..... SR, ED 17, p. U108
- GOVERNMENT:** 2500 computer projects indexed by Government..... NEWS, ED 19, p. 14
- ILLIAC IV:** ILLIAC IV: route to parallel computers..... ART, ED 26, p. 64
- LARGE-SCALE INTEGRATION:** LSI

and the computer: new designs predicted. . . . NEWS, ED 25, p. 21

LOGIC CIRCUITS: Use discrete-component logic circuits. . . . ART, ED 23, p. 68
Use single printed circuit for several logic card types. . . . IFD, ED 21, p. 106

MEDICAL: PHS may pool data on hospital computers. . . . NEWS, ED 22, p. 14

MEMORIES: Billion-bit holographic memories by 1970? . . . NEWS, ED 23, p. 38
Faraday effect gives new twist to laser memory. . . . NEWS, ED 24, p. 22
Plated wires cut ferrites to the core. . . . NEWS, ED 17, p. 23
'See through' ceramics create optical memory. . . . NEWS, ED 23, p. 26
Which fm recording method is best? . . . ART, ED 23, p. 78

METEOROLOGY: Computers enlisted for weather research. . . . NEWS, ED 22, p. 13

MILITARY: Nike-X: A merger of radars and computers. . . . NEWS, ED 22, p. 17

PROCESS CONTROL: Red-hot arc furnaces tamed by computer. . . . NEWS, ED 20, p. 24

SOVIET UNION: Soviet computers: A 'sterile flower' blooms. . . . NEWS, ED 23, p. 22

SUBTRACTOR: Low-cost parallel subtracter made with simplified logic. . . . IFD, ED 16, p. 86

TAPES: Improved signal/noise ratio reported with new tape medium. . . . NEWS, ED 15, p. 36
Tape producers spurred by advent of Crolyn. . . . NEWS, ED 19, p. 14

TIME-SHARING: Telephone networks claimed ready for future components. . . . NEWS, ED 14, p. 13
Time-sharing systems found to be inadequate. . . . NEWS, ED 19, p. 14
Low-cost display tested for computer 'utilities'. . . . NEWS, ED 14, p. 36

WESCON: The technical side of Wescon. . . . SR, ED 17, p. U88

Consumer Electronics

ACCOUNTING MACHINES: Low-cost electronic unit vies in business field. . . . NEWS, ED 17, p. 14

AIR POLLUTION: NASA joins battle against air pollution. . . . NEWS, ED 22, p. 14

BALLISTICS: 'Detective' computer matches bullets to guns. . . . NEWS, ED 21, p. 38

BUGGING: Government bars most Federal eavesdropping. . . . NEWS, ED 15, p. 13

MARKET: Civilian markets beckon

microwave ICs. . . . NEWS, ED 25, p. 34

MEDICAL ACCESSORIES: Laser cane helps blind avoid objects. . . . NEWS, ED 14, p. 44
Reading machine spells out aloud to the blind at 80 words a minute. . . . NEWS, ED 17, p. 62

MOVIES: TV set plays prerecorded photographic film. . . . NEWS, ED 20, p. 36

POST OFFICE: Post Office looks to voiced mail-sorting. . . . NEWS, ED 20, p. 33
USPO drives to streamline nation's mailing operations. . . . NEWS, ED 18, p. 13

RECORDING: Improved signal/noise ratio reported with new tape medium. . . . NEWS, ED 15, p. 36
Tape producers spurred by advent of Crolyn. . . . NEWS, ED 19, p. 14
The Dolby black box opens—just a little. . . . NEWS, ED 24, p. 17

SHOWS: Eye-catchers on display. . . . NEWS, ED 15, p. 22

STANDARDS: Transistor radio makers must give honest count. . . . NEWS, ED 16, p. 14

TELEPHONY: FCC weighs wider use of telephone attachments. . . . NEWS, ED 23, p. 13
Revised telephone rules may spur digital facsimile. . . . NEWS, ED 23, p. 35

TELEVISION: Color TV equipment drops 90% in price. . . . NEWS, ED 22, p. 32
Process flashes color on monochrome TV. . . . NEWS, ED 19, p. 38
RCA expands in Italy as color TV grows. . . . NEWS, ED 14, p. 14
Sony shows 7-in. color TV with chromatron tube. . . . NEWS, ED 14, p. 14
TV X-ray hazard to get nationwide attention. . . . NEWS, ED 26, p. 22

General Industry

AIR POLLUTION: NASA joins battle against air pollution. . . . NEWS, ED 22, p. 14

ASSOCIATIONS: Amateur radio producers group to merge with EIA. . . . NEWS, ED 14, p. 14
EIA and AEM merger comes to nothing. . . . NEWS, ED 16, p. 14

BUGGING: Government bars most Federal eavesdropping. . . . NEWS, ED 15, p. 13

COMSAT: Comsat ready to give up ruling vote in global body. . . . NEWS, ED 22, p. 13

EMPLOYMENT: Go West, young man, but buy a round-trip ticket. . . . NEWS, ED 24, p. 24
Seamans to quit NASA. . . . NEWS, ED 21, p. 14
Vietnam buildup creates a million new jobs. . . . NEWS, ED 20, p. 14

LITERATURE: New thesaurus to list 23,000 technical terms. . . . NEWS, ED 14, p. 14
Post Office planning new abstract journal. . . . NEWS, ED 14, p. 14
2500 computer projects indexed by Government. . . . NEWS, ED 19, p. 14

MARKET: Civilian markets beckon microwave ICs. . . . NEWS, ED 25, p. 34
IC market due for big jump by 1973. . . . NEWS, ED 23, p. 14
Israel invades U.S.; its goal—business. . . . NEWS, ED 17, p. 13
Microwave unit set up by Texas Instruments. . . . NEWS, ED 19, p. 14
Semiconductor makers see strong 1968 sales. . . . NEWS, ED 25, p. 21
Top electronic firms boost sales in 1966. . . . NEWS, ED 15, p. 13

MERGERS: EIA and AEM merger comes to nothing. . . . NEWS, ED 16, p. 14
ITT-ABC merger hits new stumbling block. . . . NEWS, ED 16, p. 14

PURCHASING: Get bargains in power transistors. . . . ART, ED 19, p. 110

RESEARCH & DEVELOPMENT: Bell Labs study group rethinks transmission. . . . NEWS, ED 24, p. 14
New group to foster design by computer. . . . NEWS, ED 26, p. 21

SHOWS: Eye-catchers on display. . . . NEWS, ED 15, p. 22
Industrial Design Awards: The best in product design. . . . SR, ED 17, p. U210
The technical side of Wescon. . . . SR, ED 17, p. U88

SOVIET UNION: Soviet computers: A 'sterile flower' blooms. . . . NEWS, ED 23, p. 22
Soviet electronics: Hot theory, cold hardware. . . . NEWS, ED 23, p. 17
What the Soviet is not doing in ICs. . . . NEWS, ED 23, p. 25

STANDARDS: Congress seeks general radiation safety standard. . . . NEWS, ED 19, p. 13
Defense Dept. rules out standards for IC types. . . . NEWS, ED 21, p. 13
EIA publishes standards for quality assurance. . . . NEWS, ED 16, p. 14
Transistor radio makers must give honest count. . . . NEWS, ED 16, p. 14

Industrial Electronics

AIR POLLUTION: NASA joins battle against air pollution. . . . NEWS, ED 22, p. 14

CONTROL SYSTEMS: DDC is prospering despite \$500,000 prices. . . . NEWS, ED 16, p. 17
Fluidic logic takes to the air. . . . SR, ED 17, p. U108
Motor-speed change time is computed graphically. . . . IFD, ED 18, p. 86

SEMIANNUAL INDEX

- Red-hot arc furnaces tamed by computer. NEWS, ED 20, p. 24
- HELICOPTERS: Hovering helicopter's cargo weighed electrically. NEWS, ED 15, p. 20
- POST OFFICE: Post office looks to voiced mail sorting. NEWS, ED 20, p. 33
USPO drives to streamline nation's mailing operations. NEWS, ED 18, p. 13
- TEMPERATURE MONITORING: Simple circuit monitors thermostat arcing when its contacts open. IFD, ED 15, p. 100
- ### Materials
- CATHODES: Whiskered cathodes are cool emitters. NEWS, ED 21, p. 36
- CERAMICS: Elastic dielectric is feat of clay. NEWS, ED 26, p. 38
'See through' ceramics create optical memory. NEWS, ED 23, p. 26
- CHOLESTERYL: Liquid crystals plot the hot spots. ART, ED 19, p. 71
- CRYSTALS: 70 million lb/in.² elasticity in single-crystal sapphire. PF, ED 24, p. 108
- FERRITE: Iron out ferrite core design wrinkles. ENG DATA, ED 26, p. 72
- FOIL: Adhesive foil electrodes aid biomedical applications. IFD, E D16, p. 94
- MAGNETIC TAPE: Improved signal/noise reported with new tape medium. NEWS, ED 15, p. 36
Tape producers spurred by advent of Crolyn. NEWS, ED 19, p. 14
- METALS: Choose metals for compatibility. ART, ED 17, p. 250
- PAPER: The paper is as mighty as the pen. ART, ED 21, p. 72
The static recorder writes, only the paper moves on. PF, ED 17, p. U148
- PLASTICS: Clear epoxy acts as can and lens in Darlington photo-amplifier. PF, ED 16, p. 102
Dielectric constants are quickly found. ENG DATA, ED 20, p. 62
Pick plastics for high-speed circuits. ART, ED 17, p. 246
- SEMICONDUCTORS: Gallium arsenide phosphide used in 450-fL diode. PF, ED 22, p. 144
GHz current oscillations produced in bulk germanium. NEWS, ED 15, p. 36
Raw IC chips bought from random samples. NEWS, ED 18, p. 33

SHOWS: The technical side of Wescon. SR, ED 17, p. U88

Medical Electronics

- ARTHRITIS: Aerospace group helps fight disease. NEWS, ED 23, p. 33
- AUDIOLOGY: Army tests hearing aids that bypass the ears. NEWS, ED 26, p. 30
- BLINDNESS: Japanese device corrects color blindness. NEWS, ED 19, p. 46
Laser can help blind avoid objects. NEWS, ED 14, p. 44
Reading machine spells out aloud to the blind at 80 words a minute. NEWS, ED 17, p. 62
- COMPUTERS: PHS may pool data on hospital computers. NEWS, ED 22, p. 14
- DESIGN: The tiny flaws in medical design can kill. NEWS, ED 18, p. 22
- ELECTRODES: Adhesive foil electrodes aid biomedical applications. IFD, ED 16, p. 94
- PHONOCARDIOGRAMS: Circuit duplicates sound of heart. NASA, ED 25, p. 113
- SOVIET UNION: Soviet electronics: Hot theory, cold hardware. NEWS, ED 23, p. 17
- ULTRASONICS: New uses for medical ultrasonics reported. NEWS, ED 17, p. 42
- WESCON: The technical side of Wescon. SR, ED 17, p. U88

Microelectronics

- AMPLIFIERS: Beam leads, air isolation push 703 past 1 GHz for unity gain. PF, ED 17, p. 192
Notch amplifier built with a single IC. IFD, ED 26, p. 108
Op-amp conjurer strikes again. SR, ED 15, p. 70
Radiation may announce new one-chip 709 unit. NEWS, ED 25, p. 22
Second-generation IC op-amp compensation in 30 puffs. PF, ED 14, p. 180
'709': Model T of the op amps. SR, ED 15, p. 58
- COMPARATORS, FREQUENCY: Make IC digital frequency comparators with just a few flip-flops and gates. ART, ED 14, p. 62
- COMPUTER-AIDED DESIGN: Simulate ICs with analog black boxes. ART, ED 24, p. 75
- DIGITAL ICS: Build filters with MOS chips. SR, ED 18, p. 55
Digital ICs eye markets where analogs fall short. DD, ED 17, p. 220
Digital roads to analog functions. SR, ED 18, p. 42

From theories to hardware. SR, ED 18, p. 48
Resolve angles with samples. SR, ED 18, p. 61

- LARGE-SCALE INTEGRATION: Auto-netics to offer custom LSI chips. NEWS, ED 23, p. 14
Complementary MOS ICs bring LSI a bit closer. PF, ED 19, p. 174
In the LSI era, extra circuits may lower cost. NEWS, ED 24, p. 20
LSI and the computer: new designs predicted. NEWS, ED 25, p. 21
- LASERS: Laser deposits wiring on a microcircuit chip. NEWS, ED 17, p. 26
- LINEAR ICS: Off the shelf? Or off your design board? SR, ED 15, p. 62
The second microcircuit revolution. SR, ED 15, p. 50
The tricks of the linear trade. SR, ED 15, p. 54
- LOGIC CIRCUITRY: Open the gate to nanopower IC logic. ART, ED 19, p. 81
Practical guide to threshold logic. SR, ED 22, p. 65
RDL used to smooth IC gating circuit. IFD, ED 15, p. 104
- MARKET: Civilian markets beckon microwave ICs. NEWS, ED 25, p. 34
IC market due for big jump by 1973. NEWS, ED 23, p. 14
Raw IC chips bought from random samples. NEWS, ED 18, p. 33
- MASKS: Write your own IC masks with light pen. NEWS, ED 24, p. 36
- MEMORIES: MOSFET memory stores signal for 10⁶ s. NASA, ED 14, p. 114
- MULTIVIBRATORS: IC in logic one-shot ends contact bounce. IFD, ED 20, p. 70
Inexpensive IC comprises low-power flip-flop. IFD, ED 23, p. 122
- OSCILLATORS: Voltage-controlled oscillator uses an integrated circuit. IFD, ED 15, p. 102
- PULSE GENERATORS: Design a pulse generator with ten ICs. ART, ED 23, p. 90
Single IC generates wide-range, variable-width pulses. IFD, ED 19, p. 134
Versatile pulse generator made by combining three ICs. IFD, ED 18, p. 82
- RELIABILITY: Integrated-circuit reliability: myth or fact? NEWS, ED 22, p. 26
- SOVIET UNION: What the Soviet is not doing in ICs. NEWS, ED 23, p. 25
- STANDARDS: Defense Dept. rules out standards for IC types.

NEWS, ED 21, p. 13

SWITCHES: Hybrid solid-state switch replaces power types. NASA, ED 24, p. 94

TESTING: Designers' IC testing costs head downward. NEWS, ED 21, p. 17
Production line IC testers: lightning strikes twice. PF, ED 14, p. 174

VOLTAGE REGULATORS: Integrated circuit is key to foolproof voltage regulator. IFD, ED 21, p. 104
Voltage regulator has built-in delay time. IFD, ED 21, p. 102

WESCON: The technical side of Wescon. SR, ED 17, p. U88

Microwaves

ANTENNAS: CRT displays antenna patterns. ART, ED 17, p. 260
Curve gives minimum-weight design for waveguide-fed horns. IFD, ED 25, p. 120

BULK-EFFECT DEVICES: GHz current oscillations produced in bulk germanium. NEWS, ED 15, p. 36

DIODES: For sale: LSA diodes yielding 100 W in X band. PF, ED 23, p. 164
Pin diode switches microwave oscillator. IFD, ED 14, p. 104

FILTERS: Trimming improves response of waveguide band-reject filter. IFD, ED 23, p. 116
Trimming screw adjusts TEM resonators' coupling. IFD, ED 20, p. 74

LASERS: GaAs laser hits 150-W peaks without cracking. NEWS, ED 19, p. 36
Lease-a-laser laboratory offered by Westinghouse. NEWS, ED 18, p. 14
U.S. studies costly 'suicides' among lasers. NEWS, ED 19, p. 42

MARKET: Civilian markets beckon microwave ICs. NEWS, ED 25, p. 34
Microwave unit set up by Texas Instruments. NEWS, ED 19, p. 14

PHASED ARRAYS: Phased-array power increased by 100. NEWS, ED 19, p. 22

RADAR: Army chooses radar altimeter for copters. NEWS, ED 19, p. 48
Block-long array radar to track space objects. NEWS, ED 26, p. 21
New 'chirping' schemes sharpen radar returns. NEWS, ED 19, p. 23
Nike-X: A merger of radars and computers. NEWS, ED 22, p. 17
No winner yet in AF troposcatter competition. NEWS, ED 26, p. 22
Over-the-horizon radars scan skies for FOBS. NEWS, ED 26, p. 25
Solid-state microwave power growing up. NEWS, ED 20, p. 17

Statistics speed video bandwidth design. ART, ED 26, p. 72
Troposcatter radar to face Soviet FOBS. NEWS, ED 24, p. 14
U.S. Army favors TWTs for Nike-X arrays. NEWS, ED 25, p. 22

RECTIFIERS: Quartz disk detects powerful microwaves. NEWS, ED 17, p. 58

RESEARCH: Rain data array aids microwave studies. NEWS, ED 14, p. 48

TRANSISTORS: Destroy your microwave transistors. ART, ED 22, p. 98

WAVEGUIDES: O ring improves operation of waveguide tuning screw. IFD, ED 23, p. 114
Trimming improves response of waveguide band-reject filter. IFD, ED 23, p. 116

WESCON: The technical side of Wescon. SR, ED 17, p. U88

Military Electronics

AUTOMATIC CHECKOUT: Automatic checkout heads for an era of growth. SR, ED 24, p. 49
Barriers to automatic checkout. SR, ED 24, p. 58
Better displays emerging as data volume mounts. SR, ED 24, p. 60
Computers point the way to more versatile ACE. SR, ED 24, p. 52
Passive sensors needed for ACE of the future. SR, ED 24, p. 64

COMMUNICATIONS: 'Caissons rolling along' — now guided by Tacfire. NEWS, ED 24, p. 13
Command system aids firing of nuclear devices. NEWS, ED 19, p. 14
Far-out communications for unorthodox wars. NEWS, ED 14, p. 22

DATA TRANSMISSION: Air Force conducts fm-digital 'contest'. NEWS, ED 19, p. 52

DISPLAYS: Neon illuminates aircraft display. NEWS, ED 16, p. 32

ECM: Army tests hearing aids that bypass the ears. NEWS, ED 26, p. 30
Electronics to get watchdog war role. NEWS, ED 20, p. 14

ELECTROMAGNETIC INTERFERENCE: DOD to put teeth into RFI program. NEWS, ED 16, p. 13
Systems solution to EMI problem sought. NEWS, ED 17, p. 17

EXPLOSIVE: Plastic explosive built into military subsystems. NEWS, ED 26, p. 22

HELICOPTERS: Army chooses radar altimeter for copters. NEWS, ED 19, p. 48
Hovering helicopter's cargo weighed electronically. NEWS, ED 15, p. 20

MAPPING: Airborne system forms instant maps. NEWS, ED 16, p. 33

MATERIEL: Air Force stressing electronics for today. NEWS, ED 21, p. 13
Army unveils its combat electronics at 'fair'. NEWS, ED 21, p. 24
New missile defense to replace the Hawk. NEWS, ED 23, p. 13
Vietnam buildup creates a million new jobs. NEWS, ED 20, p. 14

RADARS: Block-long array radar to track space objects. NEWS, ED 26, p. 21
Nike-X: A merger of radars and computers. NEWS, ED 22, p. 17
No winner yet in AF troposcatter competition. NEWS, ED 26, p. 22
Over-the-horizon radars scan skies for FOBS. NEWS, ED 26, p. 25
Troposcatter radar to face Soviet FOBS. NEWS, ED 24, p. 14
U.S. plans 8 to 10 sites in its missile defense. NEWS, ED 20, p. 13
U.S. Army favors TWTs for Nike-X arrays. NEWS, ED 25, p. 22

RESEARCH: Air Force to modify KC-135 for IR studies. NEWS, ED 15, p. 14

SATELLITES: Commercial firms jump at navy satellite. NEWS, ED 18, p. 17
NATO is considering satellite communications. NEWS, ED 15, p. 13
Navy satellites to be used by commercial shipping. NEWS, ED 17, p. 14

STANDARDS: Defense Dept. rules out standards for IC types. NEWS, ED 21, p. 13

TESTING: Fluidic tester developed for weapon circuitry. NEWS, ED 21, p. 23
Navy acts to automate its avionics testing. NEWS, ED 21, p. 13

Missiles and Space

AUTOMATIC CHECKOUT: Automatic checkout heads for an era of growth. SR, ED 24, p. 49
Barriers to automatic checkout. SR, ED 24, p. 58
Better displays emerging as data volume mounts. SR, ED 24, p. 60
Computers point the way to more versatile ACE. SR, ED 24, p. 52
Passive sensors needed for ACE of the future. SR, ED 24, p. 64

COMMUNICATIONS: Business data is sped to Europe by satellite. NEWS, ED 15, p. 14
Communications satellite is planned in Europe. NEWS, ED 14, p. 14
Comsat ready to give up ruling vote in global body. NEWS, ED 22, p. 13
Domestic comsats face tough price competition. NEWS, ED 24, p. 14
NATO is considering satellite communications. NEWS, ED 15, p. 13
New 'bird,' Pacific II, hovers over

- Hawaii NEWS, ED 21, p. 14
- DEFENSE SYSTEMS:** Block-long array radar to track space objects NEWS, ED 26, p. 21
New missile defense to replace the Hawk NEWS, ED 23, p. 13
Nike-X: A merger of radars and computers NEWS, ED 22, p. 17
U.S. plans 8 to 10 sites in its missile defense NEWS, ED 20, p. 13
- EROS:** New camera system for geophysical satellites NEWS, ED 22, p. 13
- FLUIDICS:** Fluid digital systems are found practical NASA, ED 25, p. 114
- INFRARED MAPPING:** Air Force to modify KC-135 for IR studies NEWS, ED 15, p. 14
Balloon telescope maps far-infrared NEWS, ED 17, p. 33
Flying laboratory to study atmospheric IR NEWS, ED 17, p. 36
Infrared horizon-mapping urged in space NEWS, ED 20, p. 22
IR-scanning satellite proposed by Honeywell NEWS, ED 19, p. 13
- MEDICAL:** Aerospace group helps fight disease NEWS, ED 23, p. 33
- MEMORIES:** Satellite memory goes to sea on buoy NEWS, ED 22, p. 33
- MOON:** Explorer 35 reports on Moon's environment NEWS, ED 16, p. 13
Latest moon findings show no new hazards NEWS, ED 26, p. 22
What's moon made of? Surveyor 5 may tell NEWS, ED 20, p. 13
- NASA:** Seamans to quit NASA NEWS, ED 21, p. 14
- NAVIGATION:** Commercial firms jump at navy satellite NEWS, ED 18, p. 17
Navy satellites to be used by commercial shipping NEWS, ED 17, p. 14
Project Profile aims at better space navigation NEWS, ED 18, p. 14
Satellite traffic control of ocean flights urged NEWS, ED 20, p. 14
- RELIABILITY:** U.S. moves to stem missile malfunctions NEWS, ED 17, p. 13
- SATURN:** Saturn test spurs hope for manned flight in '68 NEWS, ED 24, p. 13
- TELESCOPE:** Federal funds sought for huge radio telescope NEWS, ED 15, p. 14
- TELEVISION:** Satellite to film earth's profile in color TV NEWS, ED 16, p. 36
Two-pound TV camera for space applications NEWS, ED 15, p. 14
- VENUS:** Mariner V spacecraft on course for Venus NEWS, ED 14, p. 13
More details on Venus 4 revealed in Soviet press NEWS, ED 25, p. 22
Upside-down Mars craft heading for Venus NEWS, ED 15, p. 17
U.S. and Soviet agree on Venus—almost NEWS, ED 23, p. 14
- WELDER:** Electron-beam welder developed for use in space NEWS, ED 15, p. 20
- Navigation and Guidance**
- AIR-TRAFFIC CONTROL:** More electronics sought for air safety NEWS, ED 21, p. 14
- DISPLAYS:** Neon illuminates aircraft display NEWS, ED 16, p. 32
- MAPPING:** Airborne system forms instant maps NEWS, ED 16, p. 33
- SATELLITES:** Commercial firms jump at navy satellite NEWS, ED 18, p. 17
Infrared horizon-mapping urged in space NEWS, ED 20, p. 22
Navy satellites to be used by commercial shipping NEWS, ED 17, p. 14
Project Profile aims at better space navigation NEWS, ED 18, p. 14
Satellite traffic control of ocean flights urged NEWS, ED 20, p. 14
- Oceanology**
- DOLPHINS:** Dolphins challenge the designer SR, ED 25, p. 49
- MEASUREMENT:** New triple-data unit spurs sea research NEWS, ED 15, p. 33
- MEMORIES:** Satellite memory goes to sea on buoy NEWS, ED 22, p. 33
- Packaging**
- CABINETS:** Check cabinet requirements ART, ED 22, p. 110
- DISPLAYS:** Neon illuminates aircraft display NEWS, ED 16, p. 32
- LOGIC CIRCUITS:** Use single printed circuit for several logic card types IFD, ED 21, p. 106
- POWER SOURCES:** Power circuits deliver 30- to 100-watt outputs in 1/2-in.³, 3/4-oz. package PF, ED 14, p. 130
- TO-5 CANS:** Photodiode and op-amp share same TO-5 can PF, ED 26, p. 114
- WAVEGUIDES:** O ring improves operation of waveguide tuning screw IFD, ED 23, p. 114
Trimming improves response of waveguide band-reject filter IFD, ED 23, p. 116

Power Sources

- BATTERIES:** Fail-safe unit operates from NiCad batteries or ac line IFD, ED 21, p. 98
Li-Te cell puts out 500 watts a pound NEWS, ED 18, p. 32
- CURRENT SOURCES:** Grounded-load current source uses one operational amplifier IFD, ED 16, p. 94
Microcurrent generator accurately controls 1 pA NASA, ED 14, p. 114
- INVERTER:** 40-kHz inverter uses mini-filters NEWS, ED 24, p. 33
- MINIATURIZATION:** Power circuits deliver 30- to 100-watt outputs in 1/2-in.³, 3/4-oz. package PF, ED 14, p. 130
- SWITCHING:** Efficiency raised to 94% in switching regulator NASA, ED 23, p. 104
Switch high loads with power transistors ART, ED 17, p. 224
- VOLTAGE SUPPLY:** Modified feedback simplifies programmable voltage supply IFD, ED 15, p. 102
Regulate voltages with varistors ART, ED 24, p. 81

Production Processes and Cooling

- CLEAN ROOMS:** Light system counts dust to clean up clean rooms NASA, ED 22, p. 128
- DIGITAL SYSTEMS:** DDC is prospering despite \$500,000 prices NEWS, ED 16, p. 17
- HEATING:** How 'hot' are you on thermal ratings of power transistors ART, ED 23, p. 74
Red-hot arc furnaces tamed by computer NEWS, ED 20, p. 24
- MICROCIRCUITS:** Laser deposits wiring on a microcircuit chip NEWS, ED 17, p. 26
Write your own IC masks with light pen NEWS, ED 24, p. 36

Radio Frequency Interference

- ELECTROMAGNETIC INTERFERENCE:** DOD to put teeth into RFI program NEWS, ED 16, p. 13
Systems solution to EMI problem sought NEWS, ED 17, p. 17

Reliability

- INTEGRATED CIRCUITS:** Integrated-circuit reliability: myth or fact? NEWS, ED 22, p. 26
- MISSILES:** U.S. moves to stem missile malfunctions NEWS, ED 17, p. 13
- STANDARDS:** Congress seeks general radiation safety standard NEWS, ED 19, p. 13
Defense Dept. rules out standards for IC types NEWS, ED 21, p. 13
EIA publishes standards for qual-

ity assurance. NEWS, ED 16, p. 14

Research and Development

AUTOMATIC CHECKOUT: Passive sensors needed for ACE of the future. SR, ED 24, p. 64

BIONICS: Dolphins challenge in designer. SR, ED 25, p. 49

FLUIDICS: Fluid digital systems are found practical. NASA, ED 25, p. 114
Fluid logic in counter. NASA, ED 15, p. 110
Fluidic logic takes to the air. SR, ED 17, p. 108
Fluidic tester developed for weapon circuitry. NEWS, ED 21, p. 23

HOLOGRAPHY: Billion-bit holographic memories by 1970? NEWS, ED 23, p. 38
Holography uses are deemed 'illusory'. NEWS, ED 15, p. 26
Split beams deepen holograms to 4 feet. NEWS, ED 18, p. 21
The sound of holography is ultra. NEWS, ED 19, p. 17

INFRARED MAPPING: Air Force to modify KC-135 for IR studies. NEWS, ED 15, p. 14
Balloon telescope maps far-infrared. NEWS, ED 17, p. 33
Flying laboratory to study atmospheric IR. NEWS, ED 17, p. 36
IR-scanning satellite proposed by Honeywell. NEWS, ED 19, p. 13

LASERS: Explosive pumping of lasers studied. NEWS, ED 20, p. 32
Faraday effect gives new twist to laser memory. NEWS, ED 24, p. 22
'Flame laser' requires no electrical supply. NEWS, ED 14, p. 26
GaAs laser hits 150-W peaks without cracking. NEWS, ED 19, p. 36
Laser beam shifted ± 45 GHz by crystal. NEWS, ED 24, p. 32
Laser cane helps blind avoid objects. NEWS, ED 14, p. 44
Laser deposits wiring on a micro-circuit chip. NEWS, ED 17, p. 26
Lease-a-laser laboratory offered by Westinghouse. NEWS, ED 18, p. 14
Opaque ruby passes pulsed laser beam. NEWS, ED 14, p. 32
Picosecond light pulses go begging. NEWS, ED 14, p. 17
U.S. studies costly 'suicides' among lasers. NEWS, ED 19, p. 42

MEMORIES: Billion-bit holographic memories by 1970? NEWS, ED 23, p. 38
Faraday effect gives new twist to laser memory. NEWS, ED 24, p. 22
'See through' ceramics create optical memory. NEWS, ED 23, p. 26

METEROLOGY: Computers enlisted for weather research. NEWS, ED 22, p. 13

MICROWAVES: Rain data array aids microwave studies. NEWS, ED 14, p. 48

SATELLITES: New camera system for geophysical satellites. NEWS, ED 22, p. 13
Satellite to film earth's profile in color TV. NEWS, ED 16, p. 36

SEMICONDUCTORS: Carrier control is key to solid-state future. NEWS, ED 21, p. 33
Sound-s c a n n e d semiconductor emits light. NEWS, ED 20, p. 26

SOVIET UNION: Soviet electronics: Hot theory, cold hardware. NEWS, ED 23, p. 17

STRAIN GAUGES: Ape's panting gauged to 300 picostrain. NEWS, ED 20, p. 38

SUPERCONDUCTION: 125-kG super-cooled magnet weighs 40 lb. NEWS, ED 19, p. 32

TELESCOPE: Federal funds sought for huge radio telescope. NEWS, ED 15, p. 14

ULTRASONICS: The sound of holography is ultra. NEWS, ED 19, p. 17

Semiconductors

AMPLIFIERS: Beam leads, air isolation push 703 past 1 GHz for unity gain. PF, ED 17, p. 192
Design better agc FET amplifiers. ART, ED 18, p. 66
Photodiode and op amp share same TO-5 can. PF, ED 26, p. 114
Radiation may announce new one-chip 709 unit. NEWS, ED 25, p. 22
'709': Model T of the op amps. SR, ED 15, p. 58
Two op amps on one chip: one header is better than two. PF, ED 16, p. 110
Varactor's agc widens amplifiers' dynamic range. IFD, ED 15, p. 101

BULK-EFFECT DEVICES: GHz current oscillations produced in bulk germanium. NEWS, ED 15, p. 36

DIODES: Diode model is analyzed by computer. ART, ED 14, p. 80
For sale: LSA diodes yielding 100 W in X band. PF, ED 23, p. 164
Gallium arsenide phosphide used in 450-fL diode. PF, ED 22, p. 144
Microplasmas stifled in avalanche diodes. NEWS, ED 15, p. 32
Photodiode and op amp share same TO-5 can. PF, ED 26, p. 114
Picosecond diode takes a 450-volt jolt. NEWS, ED 22, p. 40
Pin diode switches microwave oscillator. IFD, ED 14, p. 104
Tiny light-emitting diode has 40-

foot-lambert visible output. PF, ED 19, p. 148

FAILURE ANALYSIS: Don't blame the component vendor every time a circuit fails. ART, ED 15, p. 90

MARKET: Microwave unit set up by Texas Instruments. NEWS, ED 19, p. 14
Semiconductor makers see strong 1968 sales. NEWS, ED 25, p. 21
Raw IC chips bought from random samples. NEWS, ED 18, p. 33

OSCILLATORS: Pin diode switches microwave oscillator. IFD, ED 14, p. 104
Transformer synchronizes UJT relaxation oscillator. IFD, ED 15, p. 101

PHOTOELECTRIC DEVICES: Clear epoxy acts as can and lens in one Darlington photoamplifier. PF, ED 16, p. 102
Sound-s c a n n e d semiconductor emits light. NEWS, ED 20, p. 26
True Lambert-law response obtained from a photocell. IFD, ED 23, p. 110

SOLID STATE: Carrier control is key to solid-state future. NEWS, ED 21, p. 33
Microwave power growing up. NEWS, ED 20, p. 17
There's solid-state pressure on transducers. NEWS, ED 16, p. 22

SWITCHING: A 2-kV 0.1-A switch uses mesa transistors. IFD, ED 21, p. 102
Micropower fast switching circuits. ART, ED 15, p. 94

TEMPERATURE: Liquid crystals plot the hot spots. ART, ED 19, p. 71
How 'hot' are you on thermal ratings of power transistors? ART, ED 23, p. 74

THRESHOLD LOGIC: Use tunnel diodes in threshold logic. ART, ED 25, p. 92

TRANSISTORS: Destroy your microwave transistors. ART, ED 22, p. 98
Get bargains in power transistors. ART, ED 19, p. 110
Plastic high-frequency FETs priced under a dollar. PF, ED 16, p. 109
Resonant-gate transistor spans 3 to 30 kHz. PF, ED 20, p. 90
Stabilize voltage regulator by replacing Zener with a FET. IFD, ED 20, p. 72
10 transistor leakage currents are used in manufacturers' specifications. ART, ED 15, p. 76

VARACTORS: Put the varactor's inductance to use. ART, ED 21, p. 78
Varactor's agc widens amplifiers' dynamic range. IFD, ED 15, p. 101

VOLTAGE CONTROL: Modified feed-

SEMIANNUAL INDEX

- back simplifies programmable voltage supply IFD, ED 15, p. 102
Regulate voltages with varistors ART, ED 24, p. 81
- WESCON: The technical side of Wescon SR, ED 17, p. U88
- ### Telemetry
- DATA-COMPRESSION: Parallel approach to data-compression NASA, ED 22, p. 126
- DATA-RECORDING: Which fm recording method is best? ART, ED 23, p. 78
- MAGNETIC TAPE: Improved signal/noise ratio reported with new tape medium NEWS, ED 15, p. 36
- MILITARY: Command system aids firing of nuclear devices NEWS, ED 19, p. 14
'Caissons go rolling along' — now guided by Tacfire NEWS, ED 24, p. 13
- PHASE CORRECTION: Logical clock phase correction for PCM data IFD, ED 14, p. 106
- RADARS: Statistics speed video bandwidth design ART, ED 26, p. 72
- SAMPLED-DATA SYSTEMS: Undercover signals are unmasked ART, ED 17, p. 236
- SATELLITES: New camera system for geophysical satellites NEWS, ED 22, p. 13
Two-pound TV camera for space applications NEWS, ED 15, p. 14
- ### Test Equipment and Measurement
- ANTENNAS: CRT displays antenna patterns ART, ED 17, p. 260
- AUTOMATIC CHECKOUT: Automatic checkout heads for an era of growth SR, ED 24, p. 49
Barriers to automatic checkout SR, ED 24, p. 58
Better displays emerging as data volume mounts SR, ED 24, p. 60
Computers point the way to more versatile ACE SR, ED 24, p. 52
Navy acts to automate its avionics testing NEWS, ED 21, p. 13
Passive sensors needed for ACE of the future SR, ED 24, p. 64
- CHARTS: The paper is as mighty as the pen ART, ED 21, p. 72
The static recorder writes, only the paper moves on PF, ED 17, p. U148
- COMPARATORS: Go/no-go digital comparator uses complementary addition IFD, ED 17, p. 274
Make IC digital frequency comparators ART, ED 14, p. 62
- CONVERTERS: Ac/dc converter widens dynamic and frequency range PF, ED 14, p. 150
- COUNTERS: Counter designs swing without gates ART, ED 25, p. 82
Design a high-speed counter ART, ED 22, p. 90
FET buffers output of voltmeter or counter IFD, ED 17, p. 272
Five-bit counter saves a package IFD, ED 14, p. 112
Fluid logic in counter NASA, ED 15, p. 110
Level synchronizer uses two J-K flip-flops IFD, ED 15, p. 100
Stop your counter from 'hanging up' because of noise ART, ED 15, p. 86
- DETECTORS: Go/no-go short detector for printed circuits is simple and reliable IFD, ED 24, p. 98
Portable detector shows helium leakage rates NASA, ED 15, p. 110
- DIELECTRIC CONSTANT: Dielectric constants are quickly found ENG DATA, ED 20, p. 62
- DISPLAYS: Take your eye off the needle: panel meters go digital PF, ED 16, p. 114
- DISTORTION: Three ways to read distortion NEWS, ED 20, p. 56
- FLUIDICS: Fluidic tester developed for weapon circuitry NEWS, ED 21, p. 23
Fluid logic in counter NASA, ED 15, p. 110
- FORCE CURVES: Explosive motor characteristics are measured without difficulty IFD, ED 17, p. 270
- FUNCTION GENERATORS: Lf triangular wave generator has just a few components IFD, ED 24, p. 105
- ICS: Designers' IC testing costs head downward NEWS, ED 21, p. 17
Production line IC testers: lightning strikes twice PF, ED 14, p. 174
Tester analyzes 40-IC pins, with option for dynamic scope PF, ED 21, p. 116
- MODULATORS: Dc voltage modulator uses line frequency IFD, ED 14, p. 102
- MULTIMETERS: New triple-data unit spurs sea research NEWS, ED 15, p. 33
Portable French multimeter offers 23 ranges PF, ED 21, p. 114
- PHASE MEASUREMENT: Dual-range device measures rf phase NASA, ED 17, p. 284
Logical clock phase correction for PCM data IFD, ED 14, p. 106
- PULSERS: All electronic kV pulser sparks to life in 50 ns PF, ED 23, p. 170
Constant-pulse-width generator is built with integrated circuits IFD, ED 22, p. 134
Design a pulse generator with ten ICs ART, ED 23, p. 90
Measure high-power pulse accurately ART, ED 23, p. 84
Simple circuit recognizes pulse width and amplitude IFD, ED 14, p. 110
Small fuses measure pulse duration IFD, ED 19, p. 132
- RADARS: Rain data array aids microwave studies NEWS, ED 14, p. 48
Which delay line is best? ART, ED 21, p. 66
- RESEARCH & DEVELOPMENT: What makes test instruments tick? SR, ED 20, p. T6
- SPECTRUM ANALYZERS: Adjustable marker calibrates spectrum analyzers rapidly NASA, ED 23, p. 104
Analyzer converter displays to 90 GHz PF, ED 25, p. 132
- STRAIN GAUGES: Ape's panting gauged to 300 picostrain NEWS, ED 20, p. 38
- TEMPERATURE: Liquid crystals plot the hot spots ART, ED 19, p. 71
Simple circuit monitors thermostat arcing when its contacts open IFD, ED 15, p. 100
Temperature monitor tracks voltage drifts IFD, ED 14, p. 110
- VIDICONS: Plotter design measures vidicon transfer characteristic NASA, ED 26, p. 98
- VOLTAGE SOURCE: Digital voltage source delivers 50-W output PF, ED 24, p. 120
- VOLTMETERS: FET buffers output of voltmeters or counters IFD, ED 17, p. 272
Honeywell to market French digital voltmeter NEWS, ED 19, p. 14
Potentiometric voltmeters are given a logic assist PF, ED 15, p. 116
- X-RAYS: Instant X ray uses Polaroid film to give insight on your project PF, ED 20, p. 84
- ZENER DIODES: Simple Zener-diode tester uses single transistor IFD, ED 22, p. 140

Now you can put long-term reliability into precision resistor applications.

Because Corning made a production of precision.

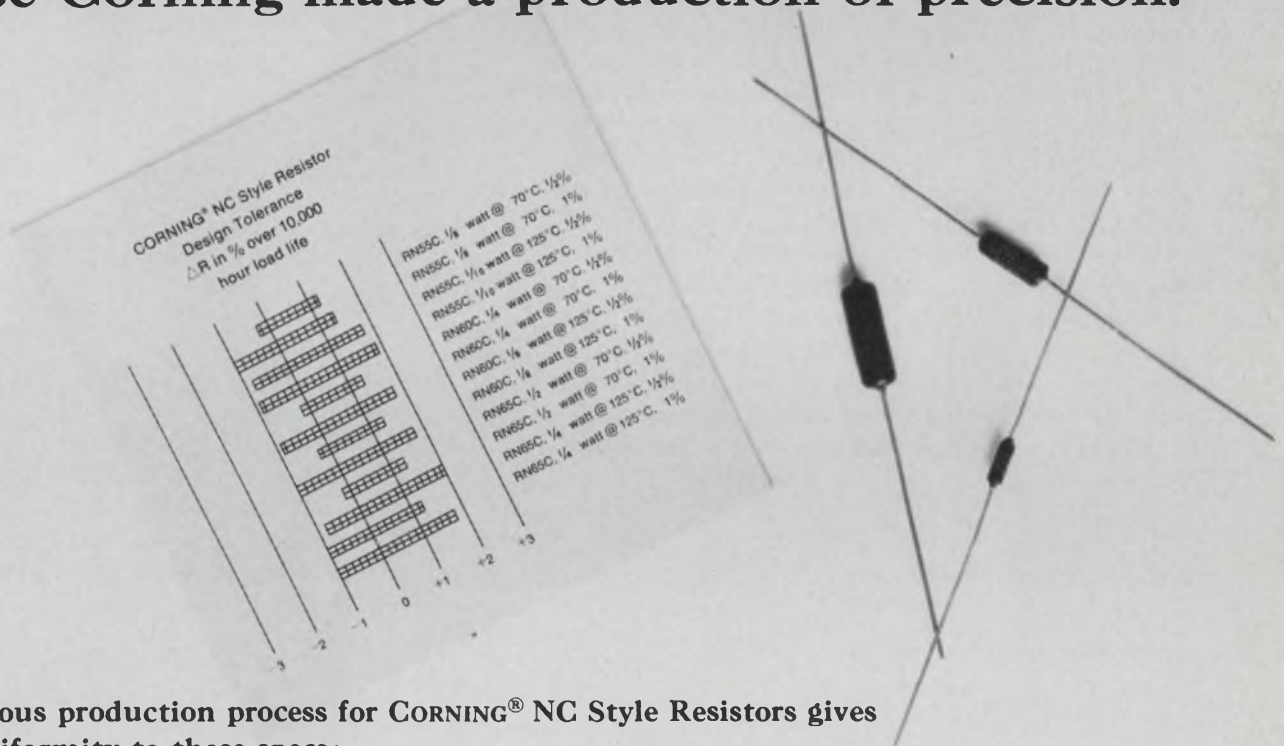

The continuous production process for CORNING® NC Style Resistors gives you total uniformity to these specs:

- Predictable end-of-life design tolerances from +1.8% to -1.0%.
- Molecular bonding of metal oxide film and glass substrate.
- Matching TC's of film and glass.
- <math><1/2\%</math> load life ΔR .
- Overall TC of ± 50 ppm.
- Mil-R-10509E, Char. C conformance.

Get this precision again and again. Specify CORNING NC Style Resistors.

In three sizes, with these ratings at 125°C.: 1/10 watt in 49.9 ohms to 301K, 1/8 watt in 49.9 ohms to 1 meg, and 1/4 watt in 49.9 ohms to 2 meg.

Precise data is yours for the asking from your Corning distributor, or by writing to: Corning Glass Works, Electronic Products Division, Corning, N. Y. 14830.

CORNING

Helipot rings up the twelve dollar C. P. pot.



The new Model 3351 conductive plastic potentiometer is our twelve dollar solution to your age-old budget problem. It's a new low price for a non-wirewound precision potentiometer, and yet performance and quality have not been sacrificed. This new model excels wherever high precision and long, trouble-free life are needed at minimum cost.

If you like the \$12.00 price, then check these specs. ■ Essentially infinite resolution. ■ Standard resistance range; 1K to 75K ohms. ■ Long life. ■ Linearity; $\pm 0.5\%$.

■ Power rating; 0.75 watts at 70°C. ■ Resistance tolerance; $\pm 10\%$. ■ Operating temperature range; -65°C to $+125^{\circ}\text{C}$. ■ Factory stocked.

Also, Helipot has other all-new non-wirewound pots to satisfy most every application. Standard servo mount models with either conductive plastic or cermet resistance elements are available in 7/8" and 1-1/16" diameter. And they are priced under \$25.00.

Ask your local Helipot sales representative for the complete non-wirewound pot story... now.



Beckman

INSTRUMENTS, INC.
HELIPOT DIVISION

FULLERTON, CALIFORNIA • 92634

INTERNATIONAL SUBSIDIARIES: GENEVA; MUNICH; GLENROTHES,
SCOTLAND; TOKYO; PARIS; CAPETOWN; LONDON; MEXICO CITY

The problem with merely shorting video information to ground is that it upsets the monitor background or raster level. Since the video signal is capacitively coupled in the monitor, the inhibited signal will look like a video signal of either the white or black level, depending on the way the signal is fed to the cathode-ray tube.

The circuit shown obviates this difficulty when a video signal is inhibited. Q1 is an emitter-follower with unity gain that drives Q2, which acts as a dc-to-20-MHz switch. Resistor R1 adjusts the dc level of Q1 so that Q2 will just pass the minimum video level as well as the maximum. Now if the video is inhibited by grounding CR1, Q2 opens and the monitor video amplifier responds as if it had the minimum signal level. At the same time the raster level is controlled by the monitor contrast and brightness controls.

Joseph R. Owen, Electronics Technician, Naval Training Device Center, Orlando, Fla.

VOTE FOR 312

Wide-band oscillator uses a quartz crystal

A simple transistor oscillator can be frequency-controlled by quartz crystals over a range from 1 to 20 MHz. The crystal oscillates in parallel resonance, fundamental mode. The simplicity of the oscillator and the lack of tuning circuits result in very low frequency drift due to aging or to external ambient variations.

The oscillator (see figure) is similar to a solid-state Pierce oscillator with an emitter-follower, Q1, placed between the crystal and the base of Q2. The emitter-follower increases the input impedance seen by the crystal looking into the base of Q2 which is usually small compared with crystal characteristics. The two emitters' bias circuits help to reduce gain attenuation as frequency

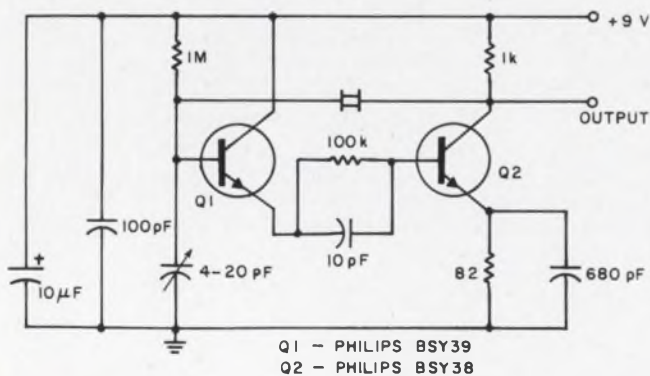

Wide-band oscillator (1 to 20 MHz) uses a crystal and two transistors.

increases.

Small changes in frequency can be obtained by varying the 4-to-20-pF trimmer.

If better frequency stability is required (few parts per million), it is advisable to stabilize the supply voltage with a Zener diode. Transistors Q1 (Philips BSY39) and Q2 (Philips BSY38) can be replaced by 2N708, 2N914 or similar types, with a cutoff frequency of about 500 MHz.

Any crystal similar to Philips B-series can be used, depending on the desired frequency.

Dr. Roberto Bedarida, Engineer, Betron I.R.E., S.p.a., Leghorn, Italy.

VOTE FOR 313

Resistor-diode D/A converter uses one operational amplifier

When extreme precision is inessential, it is often sufficient to have a digital-to-analog (D/A) converter that does not require many different voltage supplies or numerous transistors. To that end, the accompanying circuit was developed. The actual unit required only six voltage levels above zero, but the circuit has been generalized to include $2^n - 1$ levels.

The unit is made with diode gates, a resistor-divider matrix, a current-summing amplifier, and a constant-current source. The current source determines the maximum current that is to be am-

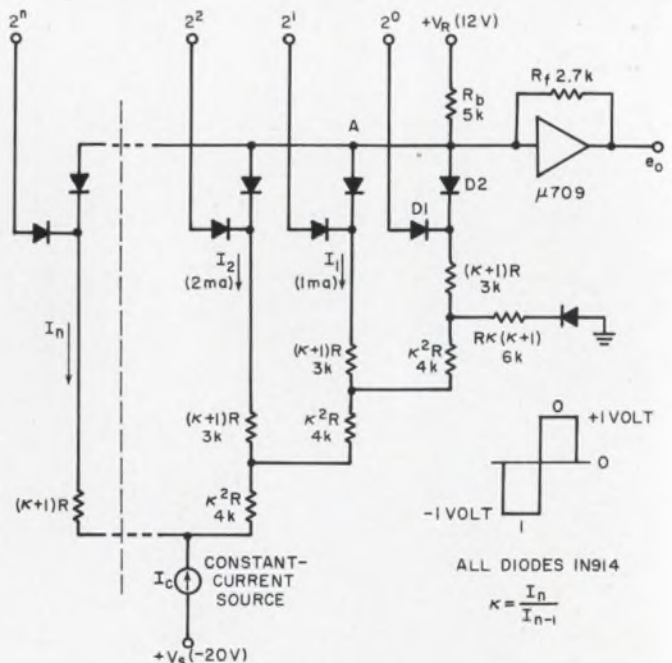

A digital-to-analog converter uses a single operational amplifier and a number of resistors and diodes that depend on the number of bits in the digital code.



**Frequency
synthesizers
custom made...
at off-the-shelf prices**



Think you need a frequency synthesizer? A note of caution . . . it can be expensive. You can end up buying a lot more synthesizer than you really need or can use. Why not select one that's essentially custom built to your requirements?

With the GR series of 1160 Frequency Synthesizers you can do just that . . . your choice is not limited by a lack of variety. Start with any of four basic models; dc to 100 kHz, dc to 1 MHz, 30 to 12 MHz, or 10 kHz to 70 MHz. Next, select the amount of resolution you need; you can start with as few as three decades of resolution and add more later as your requirements expand, to give you up to nine significant figures. Need programmability? You can have that too, in up to 1-MHz steps. How about sweep and search func-

tions? Choose it if you need it. There are over 80 different combinations to select from, and the price of your "custom-built" synthesizer can be as low as \$3640.

For complete information or a demonstration, write General Radio Company, W. Concord, Massachusetts 01781; telephone (617) 369-4400.

GENERAL RADIO

plified by the current-summing device; the diode gates and resistor matrix select the combinations of current paths. The operation of the unit is as follows:

Point A is clamped to zero volts by the action of the high negative feedback of the amplifier, which is biased through R_n . With no inputs, a positive voltage is applied to D1 (and its counterparts) which conducts and causes diodes D2 to be back-biased. Under such conditions, the current through the resistor-divider network is supplied by the drivers of the preceding stage. Thus the current-summing amplifier receives only the bias current through R_n .

When any combination of digital 1s is applied to the unit, the D1 diodes are reverse-biased, switching the current of the "switched" legs to the summing-amplifier circuit. The three different values of resistors in the matrix are selected to divide the currents through the legs, such that:

$$I_n = kI_{n-1}$$

The generalized resistor values are indicated on the schematic as well as the actual values used to produce current-doubling toward the most significant bits.

This type of D/A converter has certain intrinsic disadvantages that may be reduced by careful design. They are that a significant number of bits can create loading problems in the preceding stages, and that overdrive voltages of the 0s can create currents that so unbalance the unit that the least significant bits are masked out.

The extreme simplicity of the unit suits it to IC construction. Six-bit or larger units can be built in flat-pack form for easy assembly into more complex, standardized units.

Anthony C. Caggiano, Technical Advisor, Ridge, N.Y.

VOTE FOR 314

Comb-line band-pass filter eliminates capacitive loading

Good coupling between full-quarter-wave ($\lambda/4$), direct-coupled comb-line resonators permits band-pass filters to be designed with bandwidths up to about five per cent.

Conventional comb-line band-pass filter structures employ additional capacitive loading to shorten resonator lengths and achieve appreciable coupling between adjacent resonators. Capacitive loading, however, degrades the resonators, unloaded Qs and increases filter insertion losses. It is recommended, nevertheless, because ideal, uniform, full quarter-wave comb-line resonators with

no open-circuit fringing capacitances are decoupled by the cancellation of equal electric and magnetic fields of opposite phase. Recent experiments have demonstrated that useful coupling is possible between adjacent comb-line resonators. This stems from the use of nonuniform resonators (compound center conductors) and the existence of residual fringing capacitance at the

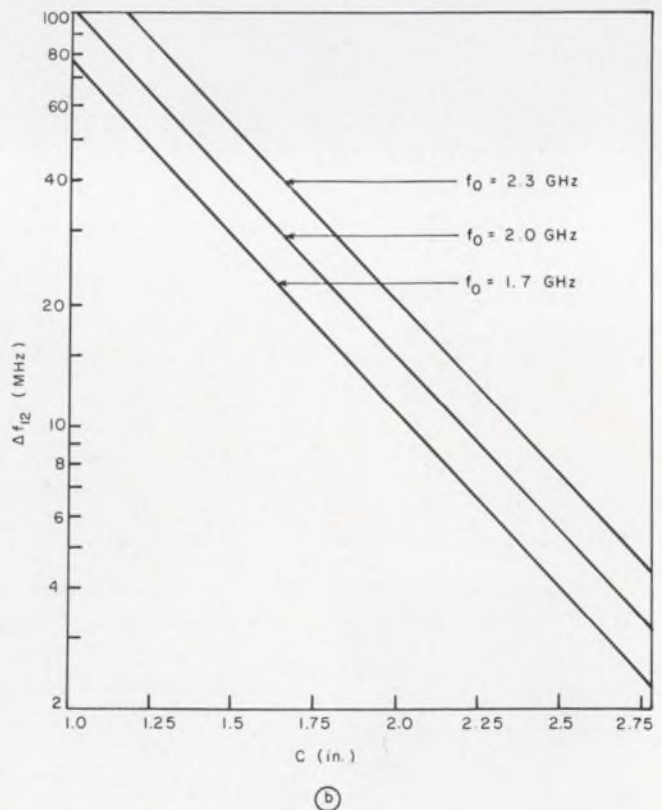
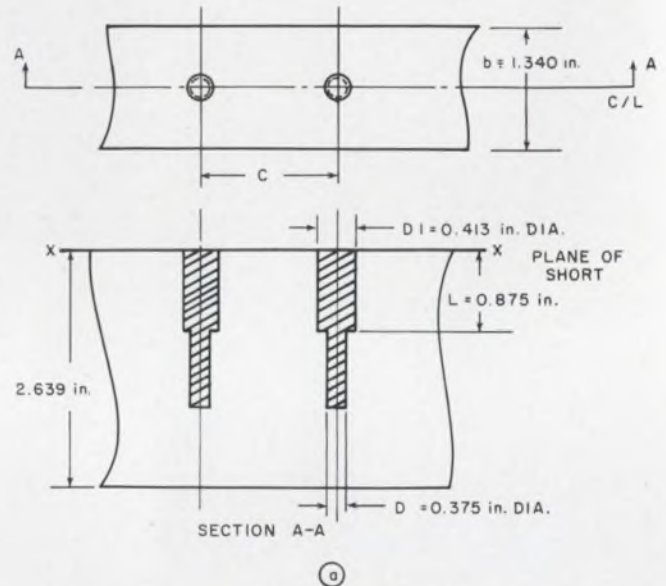

Comb-line filter structure (a) permits good coupling between full quarter-wave resonators. Coupling bandwidths for several center frequencies are plotted in (b) as a function of the resonator spacing.

resonator open-circuit ends.

The cross section of a practical comb-line structure is shown in Fig. a. Slab transmission line is used; ground-plane spacing $b = 1.340$ inches. A tunable slug ($D_s = 0.375$ inch diameter) makes contact with a fixed chuck ($D_f = 0.413$ inch diameter) at a point L located 0.875 inch from the plane of the short. For various resonator center-to-center spacings, c , the coupling bandwidth, $\Delta f_{1,2}$, has been measured. Adjacent resonator coupling bandwidths for center frequencies, f_0 , of 1.7, 2.0 and 2.3 GHz are plotted in Fig. b. The coefficient of coupling $K_{1,2}$ is related to the coupling bandwidth by the following equation:

$$K_{1,2} \cong \Delta f_{1,2} / f_0.$$

Similar data are obtained for other center frequencies and resonator cross sections. Comb-line structures with direct-coupled full quarter-wave resonators permit construction of high-quality microwave band-pass filters with small-percent-age bandwidths. Costs are cut by the elimination of additional resonator capacitors.

Richard M. Kurzrok, Consulting Engineer, New York.

VOTE FOR 315

Oscilloscope functions as chart recorder amplifier

When recording test signals with sensitive equipment, such as light-beam oscillographs, the use of an oscilloscope with vertical output can be very helpful.

Many oscilloscopes with this feature provide an output signal with an amplitude proportional to the oscilloscope trace amplitude and position. The Tektronix type 536, for example, provides a 15-volt peak-to-peak signal at the vertical output connections, with the trace centered and adjusted for full graticule display. The amplitude of the signal at the vertical output connections is independent of the input sensitivity of the oscilloscope. The vertical

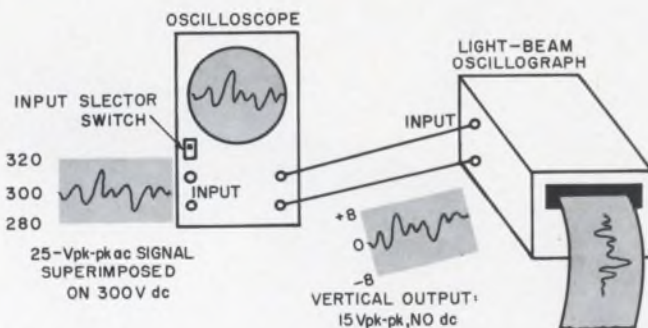

Ac signal superimposed on a dc level is recorded by using an oscilloscope to adjust and center the trace.

position control provides a dc offset potential at the vertical output.

This oscilloscope can be used as an amplifier, or a pad, or for dc isolation. Thus it is possible to record on a chart recorder signals of high amplitude or low-level ac signals riding on high dc potentials. The chart recorder needs only one setting for sensitivity and position. Succeeding recordings can be positioned as the signal is viewed on the oscilloscope.

It must be noted that all oscilloscopes with vertical output facilities do not have the same control features. On some of these the vertical position control on the oscilloscope does not affect the output signal.

Use of the vertical output saves time that otherwise would be used designing amplifiers, pads, or isolation circuits.

Gene M. Presson, Design Engineer, Corning Glass Works, Raleigh, N.C.

VOTE FOR 316

Single U bracket makes panel tamper-proof

The addition of a slip-on U bracket permits relay rack panels to be padlocked against unauthorized removal. Use of the bracket does not mar paint finish.

The simple design allows fabrication either on the bench or in the field. The dimensions shown accept an inexpensive Master No. 66 key-locked

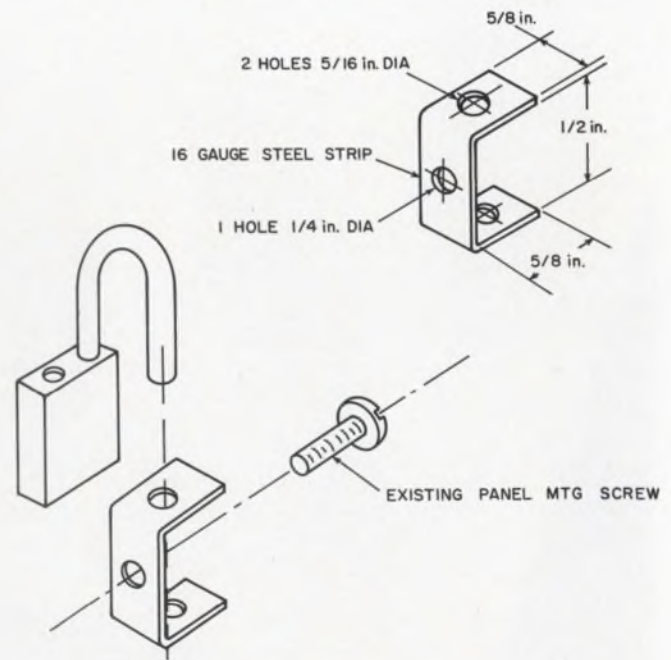

Relay rack panel is tamper-proofed with addition of a single inexpensive bracket.

popularity has gone to its head

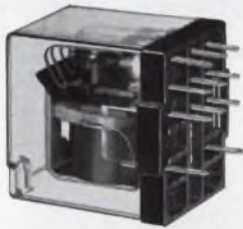

**the versatile Series 1220 relay has grown
a manual reset
an electrical reset
and a solid state
time delay.**

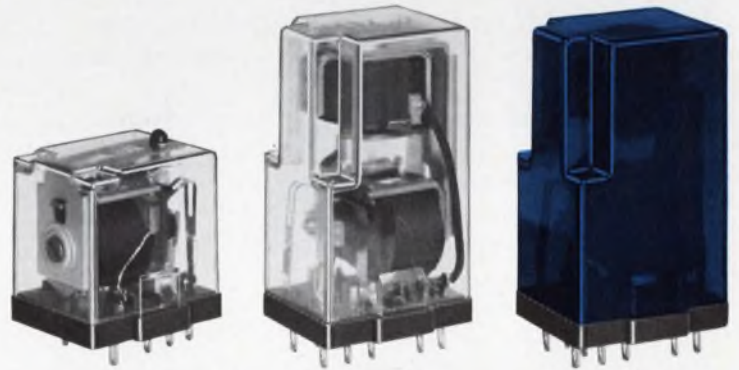

Now the Series 1220 10 amp relay is modular. All four versions give you the three ways to connect and four ways to mount that made the basic 1220 relay a runaway favorite in its class.

Now when you need a manual or electrical reset or a time delay, you can count on the same performance characteristics that led you to choose the basic 1220. No need to fool around with relays that use radio-type plugs or mount only one way.

The basic 1220 is available DPDT or 3PDT, AC or DC. The new members in the family are all DPDT, AC or DC. All of them feature our new "Uni-Guard" one piece switch that eliminates internal solder connections for reduced contact circuit resistance (and reduced price, too). Get the specs on all four Series 1220 relays for your file today. Write Guardian Electric Manufacturing Company, 1550 West Carroll Avenue, Chicago, Illinois 60607.



GUARDIAN ELECTRIC

INFORMATION RETRIEVAL NUMBER 48

padlock, but they can be varied to accommodate other padlocks.

The bracket is installed by removing an existing panel-mounting screw, slipping the screw through the clearance hole in the back of the bracket, and replacing the screw. The padlock shackle is then inserted through the parallel side holes in the bracket, blocking withdrawal of the screw and locking the panel in place.

The padlocking bracket may be applied to any type of screw fastener where a simple means of tamper-proofing is required.

Marshall K. Kessie, Design Specialist, Atomic International, Canoga Park, Calif.

VOTE FOR 317

Current generator made with four parts

A very simple and inexpensive current generator is built with only four components.

Current drains or sources are often needed for current-feeding Zener diodes, integrating capacitors of relaxation oscillators, differential amplifiers, etc. Often the current generator need not have a very low temperature coefficient or infinite output impedance.

Emitter current of *Q1* (see schematic) is regulated by a negative feedback loop that controls its base current. The voltage drop of *Q1* emitter current across *R1* is compared with the quasi-constant V_{BE} of *Q2*. Current drained or fed by the collector of *Q1* is almost equal to the emitter current, when high-gain silicon transistors are used.

The regulated output current is approximately:

$$I_{out} = 0.6/R1.$$

Voltage applied across *Q1* may go down to less than one volt. The current through *R2* must be at least 0.1 of I_{out} and is approximately:

$$I_2 = (V_{cc} - 1.2)/R2.$$

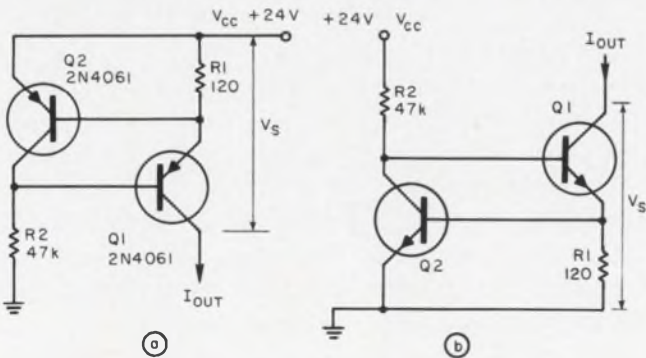

1. Current source (a) or drain (b) can be built with only four components.

The measured circuit performance is:

$$I_{out} = 4.85 \text{ mA.}$$

$$\text{Temperature coefficient of } I_{out} = 0.3\%/^{\circ}\text{C,}$$

$$\Delta I_{out}/I_{out} \text{ at } V_s \text{ between } 1 \text{ V to } V_{cc} = 4 \times 10^{-3},$$

$$\text{Regulation factor } (\Delta I_{out}/I_{out})/(\Delta V_{cc}/V_{cc}) = 1/25.$$

The circuit improves performance of many circuits operating at very low-voltage power supply. It was used, for example, to current-feed a reference diode from a voltage source only one volt larger than the diode drop.

Dr. Alberto Anzani, Electronic Engineer, Varese, Italy.

VOTE FOR 318

Simple circuit puts out input's absolute value

A single IC operational amplifier and a matched diode pair (see figure) provide an output equal to the absolute value of the input.

Depending on its polarity, the input signal will see a forward-biased *D1* and unity-gain inverting amplifier. A positive signal will see a forward-biased *D2* and a unity-gain voltage follower.

D3 prevents a latch-up condition in the voltage-follower mode. *D4* compensates for the input diodes' forward drop and minimized temperature effects. *R1*, *C1* and *C2* form the frequency-compensation network, selected for 0-dB closed-loop gain and a particular output voltage swing.

Don Atlas, Project Engineer, General Precision, Inc., Little Falls, N.J. Work was done when the author was with Avion Electronics, Inc.

VOTE FOR 319

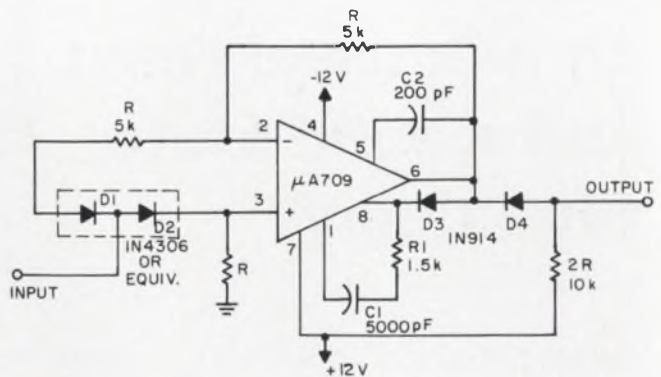

Absolute value of the input is obtained at the output, regardless of the input's polarity.

IFD Winner for October 25, 1967

Allan G. Lloyd, Project Engineer, Avion Electronics, Inc., Paramus, N.J.

His Idea, "Multioutput phase shifter uses one transistor," has been voted the \$50 Most Valuable of Issue Award.

Cast Your Vote for Best Idea in this Issue.

AFTER 10 MILLION SUCCESSFUL PERFORMANCES, WHAT DO YOU DO FOR AN ENCORE?



Bring on Utilogic® II.

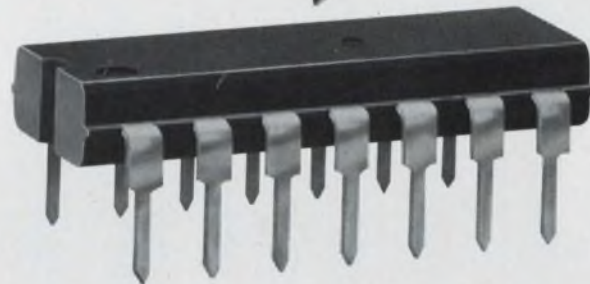

Signetics' new Utilogic II is a real show stopper—the most flexible, reliable, economical line in the business! Look at these features:

New - DIP. You asked for it, so we put the entire Utilogic II series in dual in-line silicone packages. Now you have convenience and ease of handling, in addition to the performance proven by over ten million Utilogic elements in the field.

New - Multi-Function Elements. Utilogic II now provides dual J-K binaries and triple and quadruple gates. Utilogic system design is now simpler, faster, more flexible ... and requires fewer packages.

New - Low Prices. Believe it or not, Utilogic II is actually priced at RTL levels! See for yourself:

TYPE NO.	DESCRIPTION	PRICE 1000-UP
300A	Dual 3-Input Expander	\$.75
305A	Single 6-Input AND Gate	.75
306A	Dual 3-Input AND Gate	.75
314A	Single 7-Input NOR Gate	.75
317A	Dual 4-Input Expandable NOR Gate	.81
321A	Dual Master Slave J-K Binary	1.50
322B	Dual Master Slave J-K Binary (in 16 pin package)	1.66
333A	Dual 3-Input Expandable OR Gate	.81
370A	Triple 3-Input NOR Gate	.81
380A	Quad 2-Input NOR Gate	.81
356A	Dual 4-Input Buffer Element	1.25

Those figures should bring a standing ovation. But hold the applause—because we'd like to give you a hand! For data sheets giving all the facts and figures on Utilogic II, just write Signetics, 811 East Arques Avenue, Sunnyvale, California 94086.

This production brought to you by:



SIGNETICS SALES OFFICES: Fort Lee, New Jersey (201) 947-9870; Syracuse, New York (315) 469-1072; Richardson, Texas (214) 231-6344; Beverly Hills, California (213) 272-9421; Garden Grove, California (714) 636-4260; Wakefield, Massachusetts (617) 245-8200; Silver Springs, Maryland (301) 946-6030; Collingswood, New Jersey (609) 858-2864; Clearwater, Florida (813) 726-3734; Rolling Meadows, Illinois (312) 259-8300; Sunnyvale, California (408) 738-2710.

DISTRIBUTORS: Compare at all locations listed below. Semiconductor Specialists, Inc. (312) 279-1000; Terminal Hudson Electronics (212) 243-5200; Wesco Electronics (213) 684-0880; Wesco Electronics (405) 968-3475; Hammond Electronics (305) 241-6601; Avnet Electronics Corp. of Massachusetts (617) 272-3060; Pioneer Standard Electronics Inc. (301) 427-3300; Kieruluff Electronics (206) RO 3-5510; G. S. Marshall (213) 684-1530.

DOMESTIC REPRESENTATIVES: Jack Pyle Company (415) 349-1266. Compare Corporation at the following locations: Alabama (205) 539-8476; Arizona (602) 947-4336; California (213) 245-1172; California (415) 697-6244; Colorado (303) 781-0912; Connecticut (203) 288-9276; Florida (305) 855-3964; Illinois (312) 692-4125; Maryland (301) 484-5400; Massachusetts (617) 969-7140; Michigan (313) 357-5369; Minnesota (612) 922-7011; Missouri (314) 542-3399; New Jersey (609) 429-1526; New Mexico (505) 265-1020; New York (518) 436-8536; New York (607) 723-8743; New York (516) 921-9393; North Carolina (919) 724-0750; Ohio (216) 333-4120; Ohio (513) 878-2631; Texas (214) EM 3-1526; Texas (713) 667-3420; Washington (206) 763-1711.

INTERNATIONAL SALES: France, Germany, Italy, Belgium, Holland, Luxemburg, Spain—Sovcor Electronique, 11, Chemin de Ronde, Le Vesinet, (S & O) France. United Kingdom, Ireland, Sweden, Denmark, Norway, Switzerland, Austria, Portugal—Electrosil Ltd., Lakeside Estate, Coinbrook-By-Pass Slough, Buckinghamshire, Great Britain. Australia—Corning, 1202 Plaza Building, Australia Square, Sydney, N.S.W. 27-4318. Canada—Corning Glass Works of Canada, Ltd., Leaside Plant, Ontario, Canada (416) 421-1500. Israel—Optronix, P.O. Box 195, Ramat Gan, Israel 724-437. Japan—ASAHI Glass Co., Ltd., Corning Products Sales Dept. No. 2, 3 Chome Marunouchi, Chiyoda-ku, Tokyo, Japan.

INFORMATION RETRIEVAL NUMBER 49

A609343-C
BOARD 3

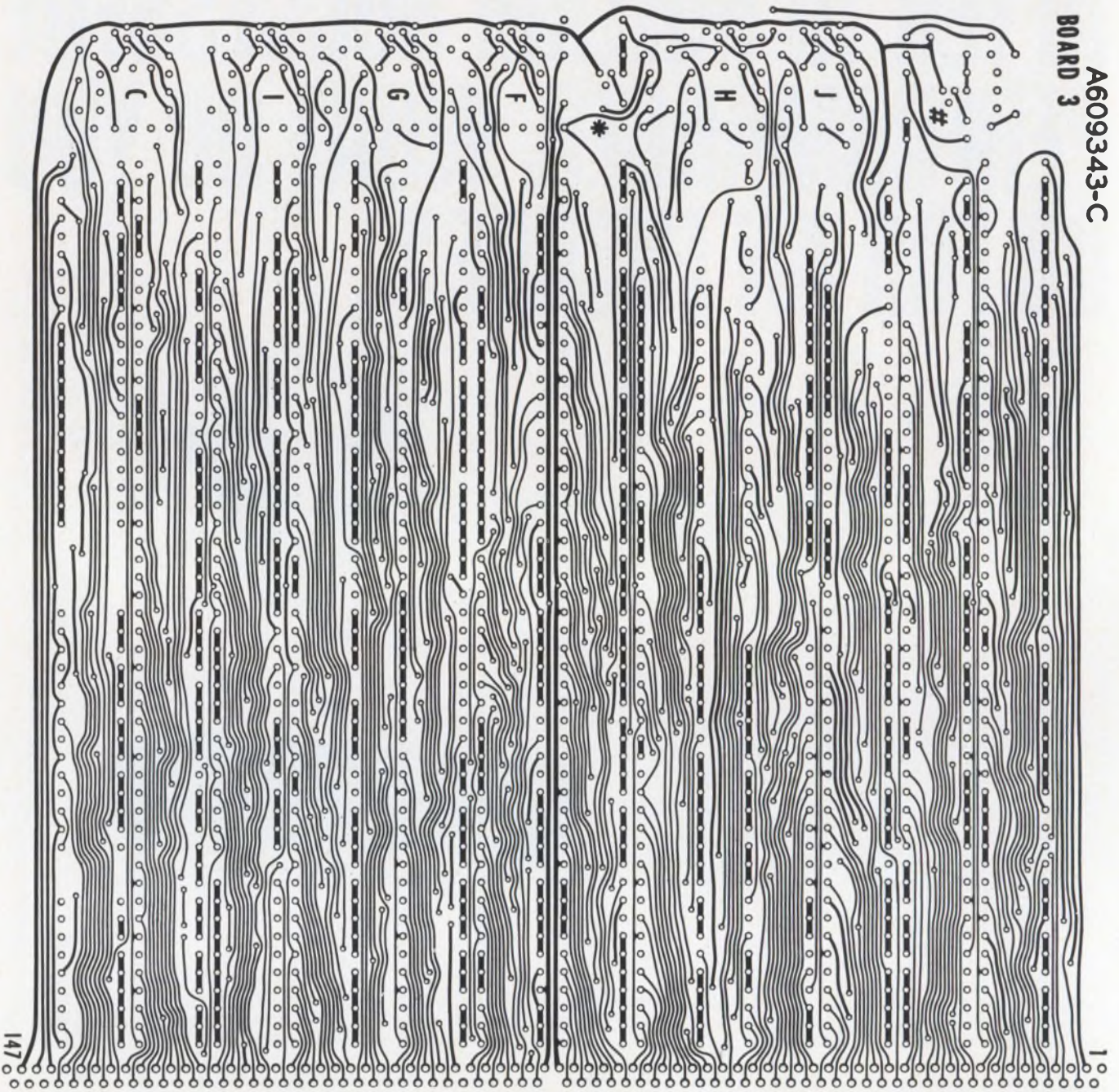

Our printed circuits speak for themselves

...by the millions. Write for "An Engineer's Guide to Printed Circuit Board Design." Address: Printed Circuits, Lockheed Electronics Company, 6201 East Randolph Street, Los Angeles, Calif. 90022.

LOCKHEED ELECTRONICS COMPANY

A DIVISION OF LOCKHEED AIRCRAFT CORPORATION

INFORMATION RETRIEVAL NUMBER 50

Products

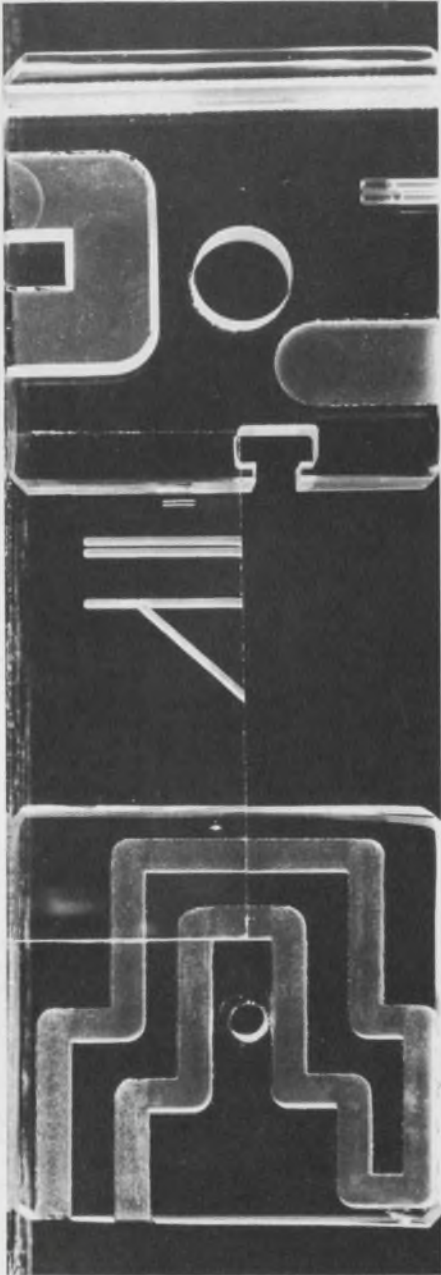

Ultrasonic equipment shapes future of materials. Page 174

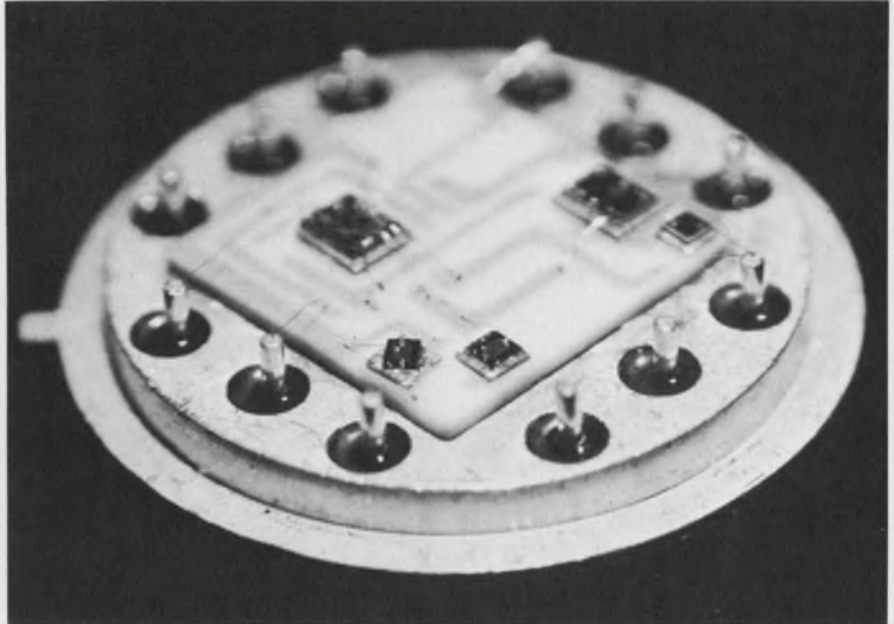

Linear monolithic operational amplifiers and film resistors welcome matched FETs to their sealed package. Page 138

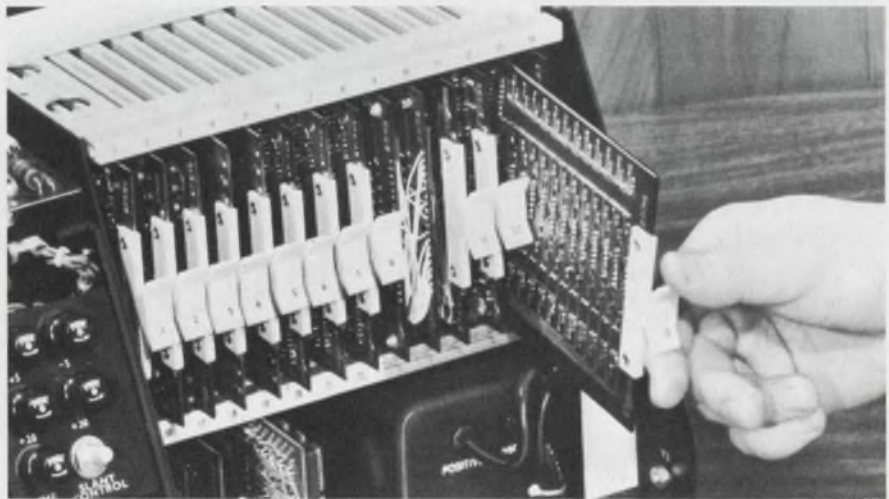

Data display system offers 144 alphanumeric messages and symbols. It will interface with any 8-level code. Page 150

Also in this section:

Vibrating-capacitor electrometer measures potentials as low as one microvolt. Page 168

Trimmer capacitors with dual variable elements are individually tunable. Page 154

Design Aids, Page 196 . . . **Application Notes**, Page 197 . . . **New Literature**, Page 198

Linear monolithic operational amplifier gets matched FETs for high input impedance

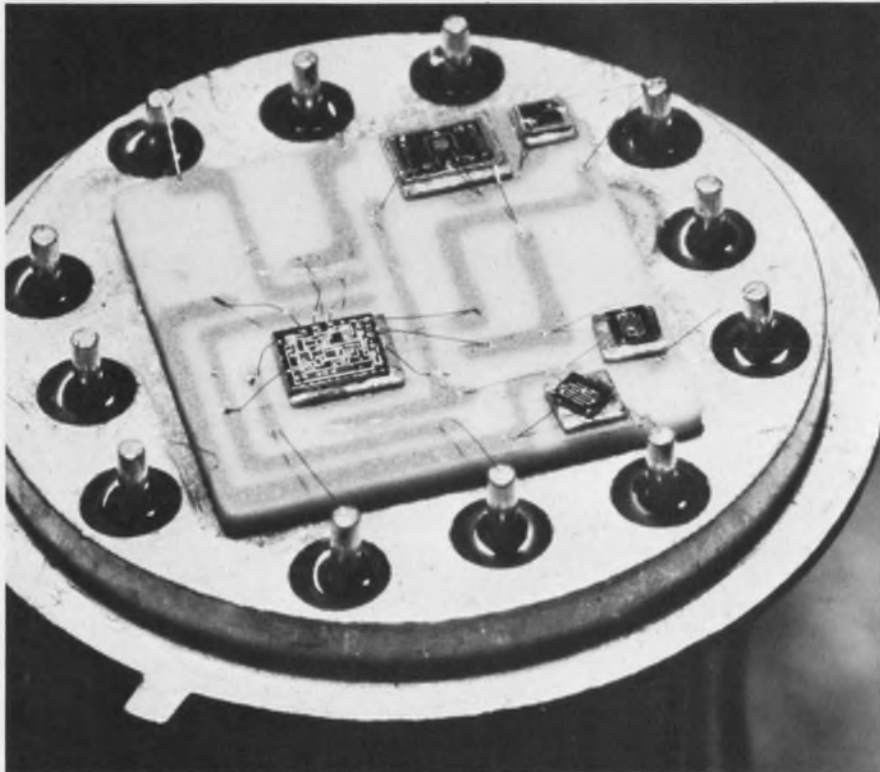

Amelco Semiconductor, 1300 Terra Bella Ave., Mountain View, Calif. Phone: (415) 968-9241. P&A: 2709 \$45 (1 to 24), 2809 \$37 (1 to 24), stock.

Two matched FETs have been added to the front end of a linear

monolithic operational amplifier with thin-film resistors. The result: higher input impedance and curtailed thermal gradients.

The devices, listed as models 2709 and 2809 have these advantages over discrete linear monolithic units: reduced input bias cur-

rent, reduced input bias current change vs temperature, reduced input offset current, reduced input offset current drift and increased input impedance (100 kMΩ typical). Applications include high impedance buffer stages. The most useful application is in circuits that have high source impedances.

For example, a low-bandpass filter now requires bulky large capacitors and small value resistors. With a 2809 or 2709, smaller capacitors and larger value resistors can be used. These devices can be used to convert from a high source impedance to a low output impedance in active filters and power supplies.

The testing program for these units includes a pre-testing of individual components, pre-seal tests of assembled units and post-seal tests. In addition, mechanical testing includes fine hermetic seal test, gross hermetic seal test, cycling 5 times from 65°C + 150°C, temperature stabilizing at 150°C for 60 hours and shock testing. The trend with devices of this sort seems to be towards more and more off the shelf hybrids and to combinations of monolithic circuits and discrete components.

CIRCLE NO. 268

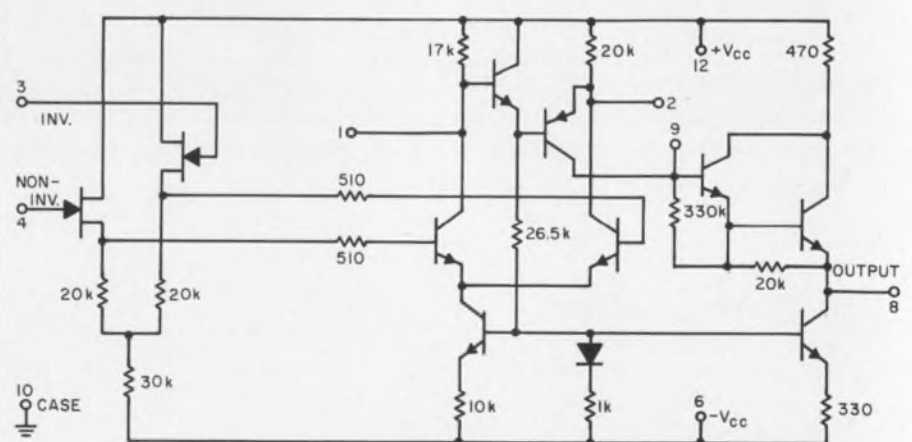
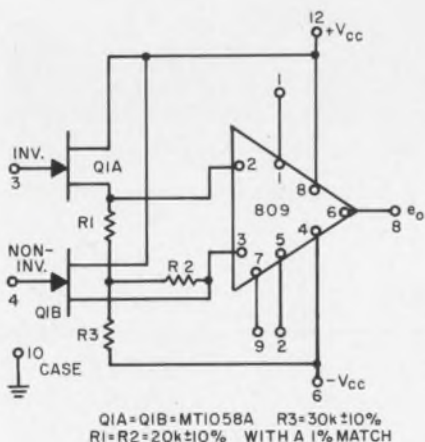

Starting life as a linear monolithic operational amplifier with integral thin-film resistors this device has undergone a change which centers around two matched FETs on the

input. This was done to reduce thermal gradients and to increase input impedance to 100 kMΩ typical. Chip layout and schematic are shown for comparison.

4 breakthroughs: new NIXIE® tube

1

size

.530" dia. x 1.5" for IC compatibility — largest numeral height provides best readability.

2

anode strobing

new design permits all like-numerals to be driven in parallel for time sharing operation with improved brightness.

3

pin spacer

simplifies both PC board layout and tube insertion.

4

price

in quantities of 1,000 — only **\$395** each.

This new tube, type B-5750, has been engineered to achieve all these outstanding breakthroughs in a single design. The new slim-line tube not only has two internal decimal points but also has an "in-line" lead arrangement which is compatible with dual in-line IC's. In addition, the numeral aspect ratio has been designed to provide the optimum in readability and viewing distance.

The movable pin spacer — standoff, which is used to align the tube pins for ease of PC layout and insertion, is part of the tube assembly.

The anode strobing/time sharing operation permits substantial reduction in driver costs for many multi-digit display applications. For more information on these and other features contact your nearest Burroughs representative or sales engineer, or write: *Burroughs Corporation, Electronic Components Division, P.O. Box 1226, Department N6, Plainfield, New Jersey 07061 TEL: (201) 757-5000.*



ACTUAL SIZE

Burroughs

DiGiGATOR[®]

A WHOLLY INTEGRATED
PRODUCT LINE



SERIES 10



SERIES 16



SERIES 13

NUMERIC READOUTS

Discon's DiGiGATOR Display Readout series are 7 segment, incandescent lamp, low voltage type readouts, featuring a host of exclusive design and performance characteristics. Here is a bright-white display, clearly readable under all ambient lighting conditions . . . a truly wide angle display without parallax or distortion. Its unique construction allows easy disassembly for quick replacement of lamps.

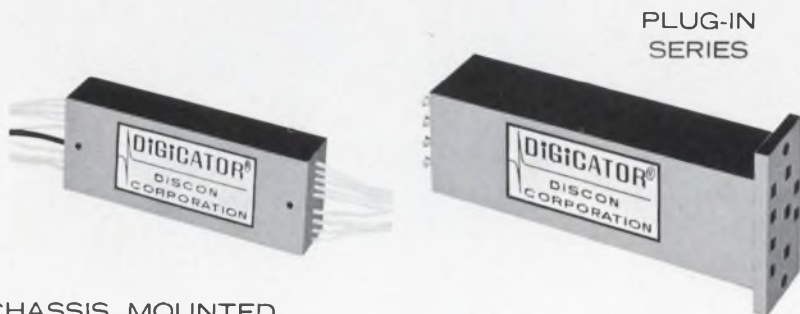

CHASSIS MOUNTED
SERIES

PLUG-IN
SERIES

DECODER/DRIVERS

Miniaturized DiGiGATOR Decoder/Driver Modules convert BCD or Decimal output signals into the input voltages necessary to drive 7 segment numeric displays. Integrated decoder circuitry, featuring the unique use of decoder flat-pack elements, controls high current incandescent lamps with signals as small as 2.0 milliamps. Through the use of separate logic and lamp supply circuits, high voltage lamps can be controlled with low logic voltage inputs. The entire series of drivers are now available with latching memory. These features, plus the complete compatibility of the DiGiGATOR Driver with most available 7 segment, bar type, numeric readouts, make DiGiGATOR a truly versatile line of components.

DISCON CORPORATION

4250 NORTHWEST 10th AVE. • FT. LAUDERDALE, FLORIDA 33309
PHONE: (AREA CODE 305) 565-5511

INFORMATION RETRIEVAL NUMBER 52

SEMICONDUCTORS

Glass rectifiers handle to 5000 PIV

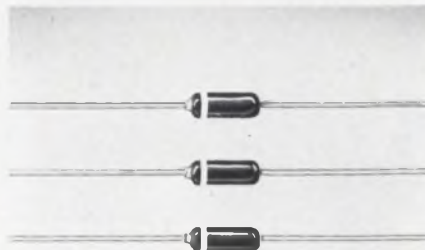

Electronic Devices, Inc., 21 Gray Oaks Ave., Yonkers, N.Y. Phone: (914) 965-4400. Price: 1G3 \$1.10 each (100 lots).

Two series of 1000-to-5000-PIV silicon rectifiers in hermetically sealed D0-7 glass packages are for use in cathode-ray tube supplies, electrostatic instrumentation, dc-dc converters and low-power traveling-wave tube power supplies. Designated Series 1G1 through 1G5 and 5G1 through 5G5, the rectifiers are 0.1 in. in diameter and 0.3 in. in length.

CIRCLE NO. 257

Bridge rectifiers control to 3000 V

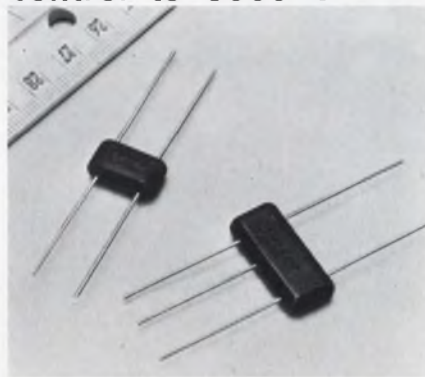

Semtech Corp., Newbury Park, Calif. Phone: (805) 498-2111.

Subminiature medium-power and three-phase full-wave bridge rectifiers have been put on the market. Specifications include a full-wave bridge ranging from 1.5 A, 50 to 1000 V, to 360 mA, 1500 to 3000 V; three-phase full-wave bridge ranging from 2 A, 50 to 1000 V, to 500 mA, 1500 to 3000 V. Also available in the Compac series are fast-recovery bridges from 50 to 600 V with reverse recovery of 150 ns and 1 μ s.

CIRCLE NO. 258

A better V-F Converter? Look no farther.

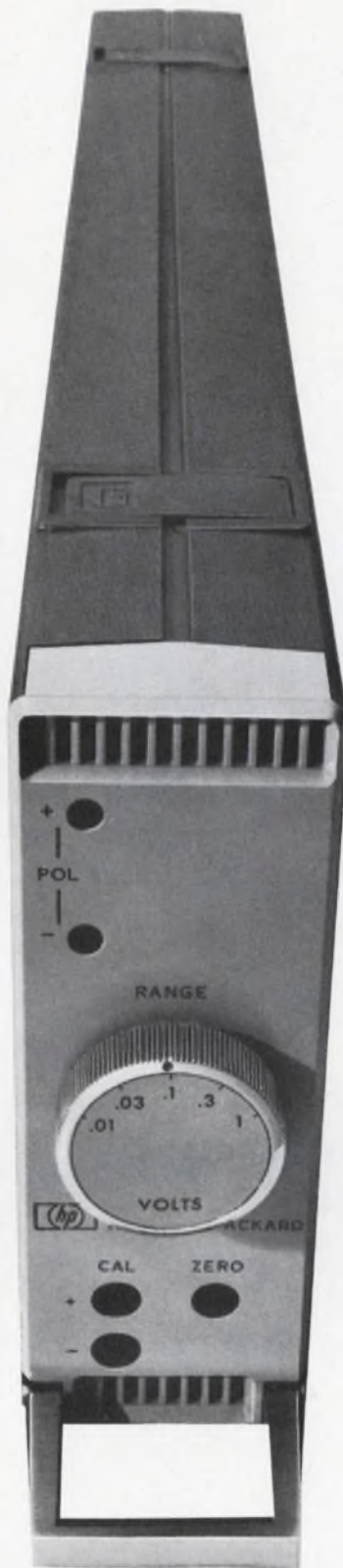

Take this voltage-to-frequency converter, couple it with your electronic counter—and you have a highly accurate, low-level integrating digital voltmeter with high rejection of superimposed and common mode noise. Use it with a preset counter and you can scale or normalize analog signals. Or integrate signals crossing zero with a reversible counter. Use two converters for ratio.

The Hewlett-Packard 2212A is more accurate, stable and linear, faster responding, smaller than any other V-F converter on the market. Input ranges down to 10 mV for 100 kHz output. Bipolar response with polarity output. 120 dB common mode rejection. And the 2212A is immediately available. Price, \$995.

Call your local HP field engineer for complete specifications, or write Hewlett-Packard, Palo Alto, California 94304; Europe: 54 Route des Acacias, Geneva.

HEWLETT  PACKARD

06720

INFORMATION RETRIEVAL NUMBER 53



This could be the world's most important lightning arrester!

Dale's LA24 provides lightning protection for airborne units in an important Air Force low frequency communications system. This special system insures uninterrupted communications under almost any condition. The LA24 uses Dale's patented surge arrester mechanism to protect radio equipment—provided by Westinghouse—against the high degree of lightning attraction of a low frequency antenna. The LA24 was specially selected for its ability to bypass repeated lightning strokes without significantly altering break-down voltage.

SOLVE YOUR SURGE PROBLEMS—from sophisticated antenna systems to low-cost secondary power line arresters, Dale can engineer a better solution to your transient voltage problems.

Call 605-665-9301 or write:



DALE ELECTRONICS, INC.
SIoux DIVISION Dept. ED
 Yankton, South Dakota 57078

Write for New Facilities Report

Producers of: Toroids, Series Resonant Traps, Variable Pitch Inductors, Miniature High Frequency Inductors, Degaussing Coils, Industrial and Military Coils, Sub-Miniature Coils, Surge and Lightning Arresters, Custom Assemblies, Motor Driven Potentiometers.

INFORMATION RETRIEVAL NUMBER 54

SEMICONDUCTORS

Triode thyristors span 15 to 25 A rms



Texas Instruments, Inc., 13500 N. Central Expwy., Dallas, Tex. Phone: (214) 238-2011. Price: \$5 to \$16 (100 to 999).

A family of Triac semiconductors is designed for proportional power control in the medium power range between 15 and 25 A rms. The silicon bidirectional triode thyristors are rated at 200, 400 and 600 V. The devices can provide switching and phase control of ac power up to 10 kW.

CIRCLE NO. 259

N-channel FET spans dc to 400 MHz



Motorola Semiconductor Prod., Inc., P.O. Box 955, Phoenix, Ariz. Phone: (602) 273-6900. P&A: \$3.35 (100 up); stock.

Although specified primarily for vhf and uhf amplification, this n-channel FET works in low-noise, high-gain amplifiers from dc to above 400 MHz. At 100 MHz, its noise figure is typically 1.3 dB and 2 dB max with power gain of 18 dB at the same frequency. In addition, the device features a low output capacitance of 2 pF max at 1 MHz and a transconductance of 4000 μ mhos min at 400 MHz. It comes in a TO-72 package with isolated chip.

CIRCLE NO. 261

Are you ready for the new sweep generation?

There's an entirely new way to sweep test now — with the Model 2003 brought to you by Telonic. That name alone means it's an instrument backed by a wealth of design experience, highest quality construction, and engineering way ahead of the field. What other sweep generator can offer these features —

Total plug-in versatility



The 2003 is all modular, permitting a wide selection of frequency ranges, frequency marking systems, attenuation, and output control. As your test requirements vary, the 2003 can instantly be oriented for the new application.

5 to 1500 MHz in one sweep

Five different plug-in oscillators available for the 2003 permit frequency coverage from 100 kHz to 1500 MHz. One oscillator, No. 3305, is capable of sweeping a width over its entire range, 5 to 1500 MHz, providing a complete trace of frequency response.



Tiling frequency markers



This output plug-in for the 2003 allows control of frequency marker height and angle, providing sharp determinations on near-vertical traces.

This is the 2003 story — Accuracy, Versatility, Reliability — details and specifications may be found in catalog 70-A together with a number of helpful Sweep Generator Applications. Write for your copy.



Telonic INSTRUMENTS

A DIVISION OF TELONIC INDUSTRIES, INC.

60 N. First Ave., Beech Grove, Ind. 46107
Tel.: (317) 787-3231 TWX: 810-341-3202

Representatives throughout the U.S. and Foreign countries. Factory offices in Maidenhead, England, Frankfurt, Germany, and Milan, Italy.

No.

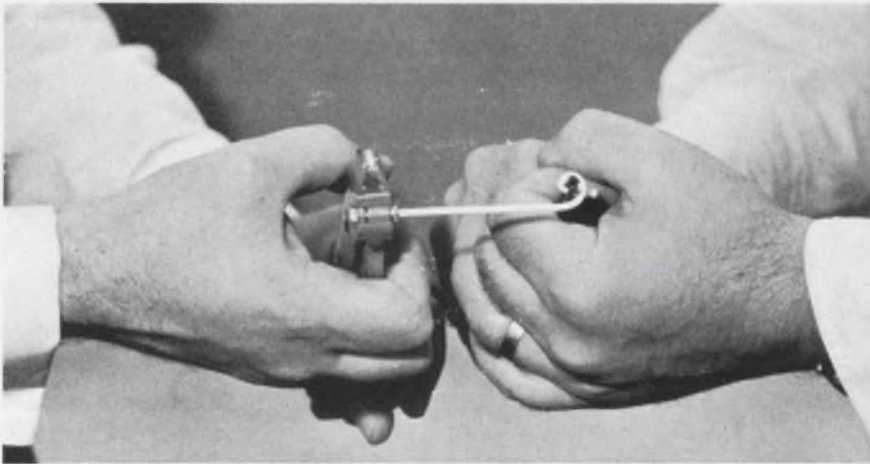

You cannot pull the cable out of our Emlock[®] connectors.

No tricks. Our claim is that it is impossible to pull the cable out of one of our Emlock[®] compression fit, miniature connectors. Disengagement will be caused only by failure of the braid, not pullout of the compression. We believe this extraordinary capability beats crimped type connectors all hollow. Yes, and competitive compression types, too.

Prove it to yourself. Have one of our Technical Representatives call on you. He'll attach any one of our stock Emlock[®] connectors to a section of braided cable. Then, as he holds the connector body with a pliers, he'll hand you the chain nose, and you pull! The assembly will break away, of course. He will then disassemble the

connector and show you that there is still enough wire trapped to prove that Emlock[®] compression held and the braid failed!

Here's your chance to gain a new concept in miniature connector reliability. Remember, only Emlock[®] connectors offer this basic capability and only we have Emlock[®].

Write for the name of our Technical Representative in your territory. He'll phone for an appointment and give you a chance to prove it to yourself. *While you are about it, why don't you ask for Bulletin MMC, Issue 1 describing the complete line of Emlock[®] connectors? Phelps Dodge Electronic Products Corporation, 60 Dodge Avenue, North Haven, Connecticut 06473.*

PHELPS DODGE ELECTRONIC PRODUCTS CORPORATION 

INFORMATION RETRIEVAL NUMBER 56

SEMICONDUCTORS

Silicon rectifiers carry from 1.5 to 3 A

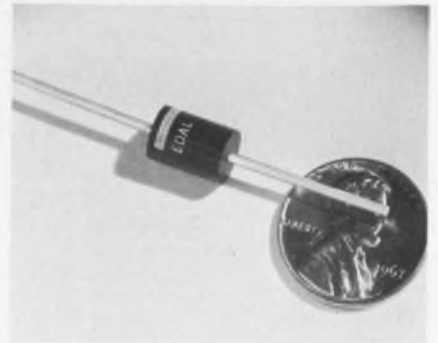

Edal Industries, Inc., 4 Short Beach Road, East Haven, Conn. Phone: (203) 467-2591.

Medium-current silicon rectifiers meet moisture resistance of MIL Standard 202A, method 106. Designated Series M, they offer stable, uniform electrical characteristics as the result of the use of a passivated, double-diffused junction technique. Standard and bulk avalanche types are available in voltage ratings from 50 to 1000 V PIV and currents range from 1.5 to 3 A.

CIRCLE NO. 262

General-use op amp compensated at 30 pF

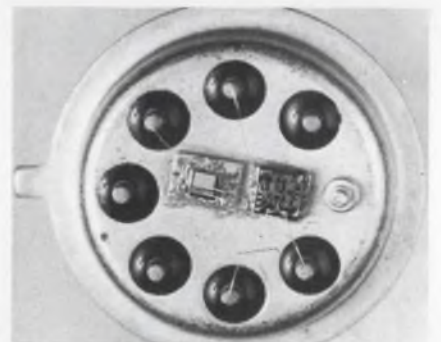

National Semiconductor Corp., 2950 San Ysidro Way, Santa Clara, Calif. Phone: (408) 245-4320. P&A: \$17 to \$70 (1-24).

A unity-gain-compensated version of the LM101 general-purpose operational amplifier provides a 30-pF compensation MOS capacitor and the LM101 IC in a single package. The LH101 has the same pin configuration as the LM101 and the LM709. Operation is from supply voltages from ± 5 V to ± 20 V. It is available in an 8-lead, low-profile TO-5 package.

CIRCLE NO. 263



**YOU'LL JUMP
FOR JOY...**

**when you see the complete specs
and prices on our new**

**“PIXIEPOT”™
POTENTIOMETER!**

Never before in the history of the pot industry have you been able to get a TEN-TURN, WIRE-WOUND PRECISION potentiometer at prices like these. The Duncan Model 3253 “PIXIEPOT” is yours for as low as \$3.97 each in production quantities and only \$5.95 each for 1-24 units.

Match the following “PIXIEPOT” features with any other similar pot on the market.

- Length: ONLY 3/4"
- Diameter: ONLY 7/8"
- Linearity: ±0.25%
- Resistance Range: 100 ohms to 100K ohms
- Power Rating: 2 watts @ +20°C
- Temperature Range: -25°C to +85°C
- Resolution: Better than ANY wirewound pot TWICE its size!
- Slotted Stainless Steel Shaft

A Duncan “PIXIEPOT” can save you dollars on your instrument and system requirements. If you want to know just how many, call or write us today. The full story on the “PIXIEPOT” will be in the mail to you within 24 hours. And when it arrives, be prepared to jump for joy!



DUNCAN electronics, inc.

A DIVISION OF SYSTRON-DONNER CORPORATION

2865 FAIRVIEW ROAD, COSTA MESA, CALIFORNIA 92626



*if you don't like
to compromise...*

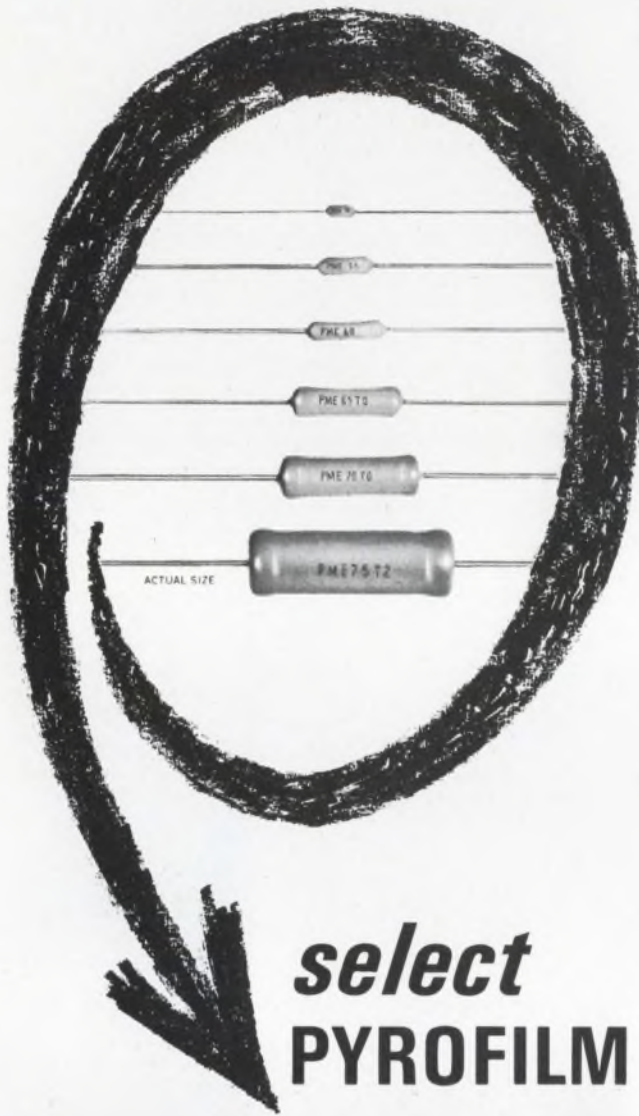

select
**PYROFILM
HIGH VALUE
METAL FILM
RESISTORS**

Part No.	R/N	Power	Ohms	Temp. Coef.
PME 50	50	1/20W	1M	T-0 to T-9
PME 55	55	1/10W	3M	
PME 60	60	1/8W	8M	
PME 65	65	1/4W	15M	
PME 70	70	1/2W	30M	
PME 75	75	1W	50M	

Send for fact-filled literature sheet 70

**PYROFILM RESISTOR
COMPANY, INC.**
3 SADDLE ROAD • CEDAR KNOLLS, N. J. 07927 • 201-539-7110

INFORMATION RETRIEVAL NUMBER 58

SEMICONDUCTORS

**30-A transistor
has isolated collector**



Solitron Devices, Inc., Riviera Beach, Fla. Phone: (305) 848-4311.

This 30-A npn silicon power transistor is packaged in an isolated TO-61 case. It handles 100 W power dissipation at 100°C. The devices are available with sustaining voltages up to 120 V (collector-to-base voltages greater than 150 V). There are three gain categories at 10-A collector current: 20 min, 40 to 120, and 100 min. The saturation voltages are 1 V max collector to emitter and 1.5 V max base to emitter. Applications include inverters, converters, high-frequency amplifiers and power supplies.

CIRCLE NO. 264

**Dual FET hybrid ICs
operate from + logic**

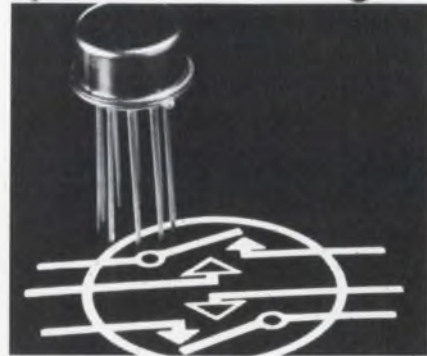

Crystalonics, 147 Sherman Street, Cambridge, Mass. Phone: (617) 491-1670. P&A: \$50 up (100-999); stock.

Four hybrid microcircuits designated CDA2-1, CDA2-2, CDA2-3, and CDA2-4 are designed for applications such as current-summing (D/A or A/D), integrator reset, and series-shunt choppers. The CDA2 hybrid comprises two completely separate FET switches with integral drivers. These ICs operate directly from all positive logic.

CIRCLE NO. 265

Impatt in X and Ku bands

Bomac's new line of solid state Impatt oscillators, operating at klystron efficiencies, delivers 100 milliwatts of power in a wide variety of X-band applications (with similar performance in Ku-band designs).

Requiring only 70 volts nominal at 40 milliamperes, the Bomac BIO line simplifies power requirements and achieves solid state dependability in a low-noise Impatt configuration with inherent freedom from spurious outputs.

Typical uses for these compact Bomac devices include parametric-amplifier pumping, lightweight transponders,

fuzing, guidance and other local oscillator applications now requiring klystrons or crystal-controlled multiplier chains.

Other options of the BIO line include ± 20 kHz/ $^{\circ}$ C stability, an integral current limiter, and either mechanically tunable coax or waveguide output configurations.

For more information, contact Varian Associates, Bomac Division, Salem Road, Beverly, Massachusetts 01915, or any of the Varian Electron Tube and Device Group Sales Offices throughout the world.

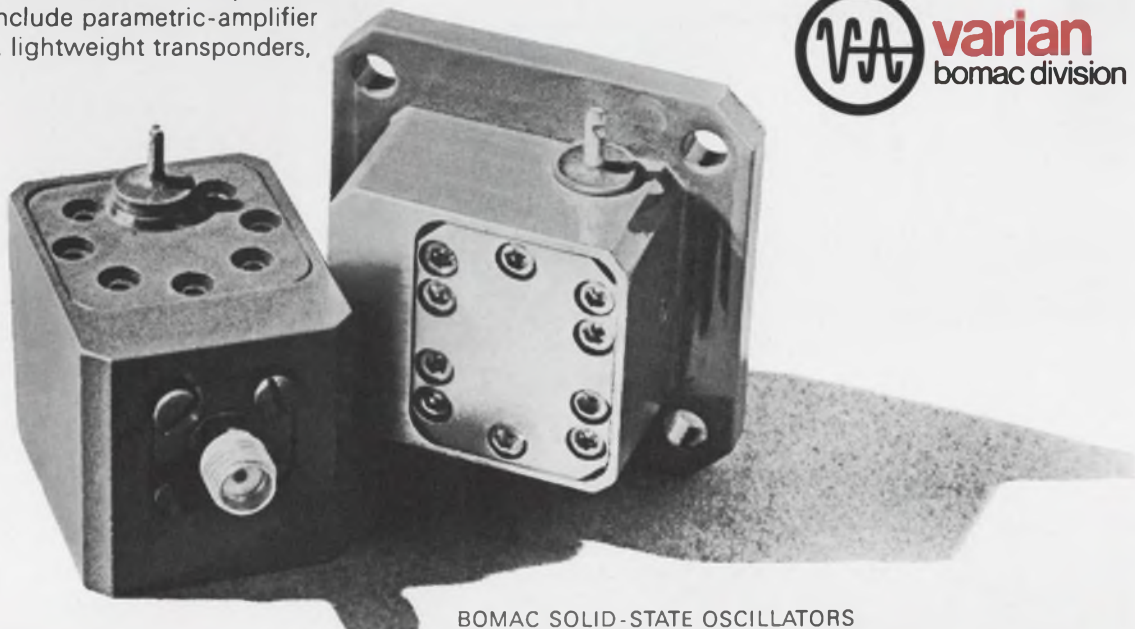

BOMAC SOLID-STATE OSCILLATORS

INFORMATION RETRIEVAL NUMBER 59



McLEAN'S DON HAY HAS DEVELOPED A COOLING SYSTEM MORE RELIABLE THAN AIR CONDITIONING (And it Costs Less to Buy and Operate)

McLean Engineering Vice President Don Hay isn't against air conditioners — far from it — but he considers it wasted energy to kill a beetle with a baseball bat.

Take McLean's water-cooled Heat Exchanger, for example. It's designed to maintain an interior cabinet temperature at a maximum of 80°F with 1 KW heat dissipation. It employs chilled water within a range of 66°F to 70°F. Air is recirculated within the cabinet and cooled by the unit installed in the blower case. It does not use room ambient air nor does it exhaust warm inside cabinet air into the atmosphere. Substantially more cooling may be obtained by using refrigerated water or direct expansion of a refrigerant. Compared to air conditioning, it is just as reliable, costs less to buy, install and operate, requires less space and is quieter.

Write for full details on this advanced new development — or come to Princeton and visit with Don Hay in his air-conditioned office.

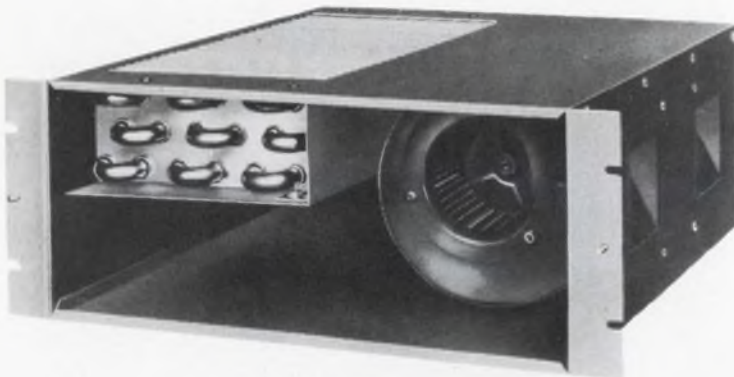

SEND FOR
NEW CATALOG



**McLEAN ENGINEERING
LABORATORIES**

Princeton Junction, New Jersey 08550
Phone 609-799-0100 • TELEX 84-3422



SEMICONDUCTORS

High-Q diodes have variable capacitance

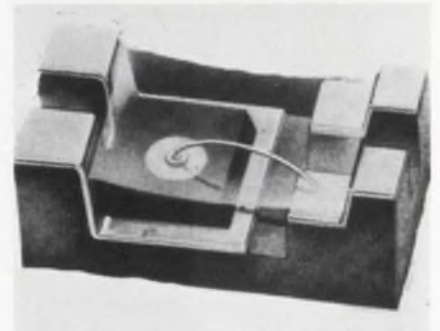

MSI Electronics Inc., 34-32 57th St., Woodside, N.Y. Phone: (212) 672-6500. P&A: \$2.75 to \$10 (1-99); 2 weeks.

Diodes for voltage-variable capacitor applications are available in capacitance ranges from 6.8 pF to 47 pF at voltages from 30 to 100 V. The tuning ratios of these devices vary from 3:1 at 30 V to 5:1 at 100-V reverse voltage. The *Q* of the devices range up to 800 measured at 50 MHz and at 4-V reverse voltage. By special order, several chips can be mounted on one lid.

CIRCLE NO. 266

Glass diodes switch in 2 ns



MicroSemiconductor Corp., 11250 Playa Court, Culver City, Calif. Phone: (213) 391-8271. P&A: 22¢ up; (100 lots) stock.

Micro and Mini-Micro glass diodes come in doubly hermetically sealed packages designed to meet or exceed the requirements of MIL-S-19500 specifications. Device characteristics spanning the entire range possible with silicon can be supplied in either package from 2-ns, 2-pF switching devices to 1000-V rectifiers, including Zener diodes from 5.5 V up.

CIRCLE NO. 267

Giant Killers

Third in the series



Summer, 1956 . . . the eyes of the world were focused on Melbourne, Australia, as Murray Rose swam his way to immortality. At 17 he became the youngest triple gold medalist in modern Olympic Game history, later setting world records in every freestyle swimming event from 200 meters to one mile—a true giant killer of sports.

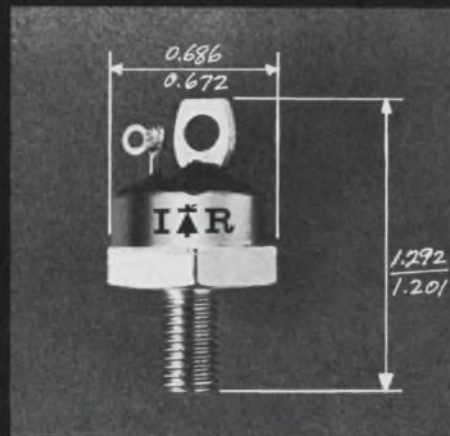

In the low cost, medium current SCR race, the industry giants used to pick up all the medals. But no more.

Now we have a 40-ampere encapsulated SCR, Type 40RCS, with size, price and power advantages over anything the big boys offer. About all you used to get were de-rated 70-amp monsters or smaller units rated up from 16 ampere devices. But the 40RCS is a product designed for its intended application. Mounted, it's only about $\frac{3}{4}$ -inch high; it weighs one ounce, yet sports a large diameter junction. Plastic encapsulation provides moisture resistance, yet allows operation from -40°C to 105°C . Quantity prices range from less than \$20 to about \$8 each, for ratings from 600 to 50 volts.

The 40RCS is available now, for economical compact power control. Check with the giant killer—IR, developers of the 200 ampere power logic triac—for product bulletin and complete specs.



INTERNATIONAL RECTIFIER

Digital computer cycles in 2 μ s



Elbit Computers Ltd., P.O. Box 5390, Haifa, Israel. Phone: 64613. Price: \$5000.

The Elbit 100 is a new low-cost digital computer designed specifically for integration into a system or control loop. The basic price includes a 1024-word, 12-bit core memory with 2- μ s cycle time, a 256-word fixed memory with 400-ns access time, control panel, all power supplies and interface with any standard teletypewriter or mechanical tape reader.

CIRCLE NO. 270

Can you

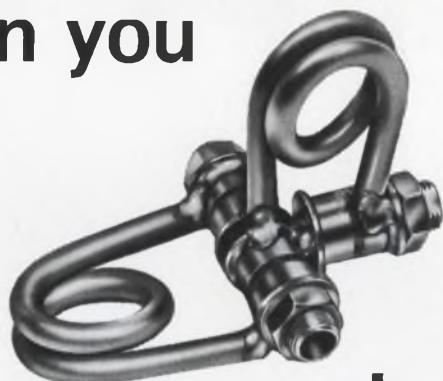

do this?

These new Johanson glass capacitors are designed to bridge the gap between conventional trimmers and high frequency air capacitors. They have high Q—low inductance; they have high RF current characteristics, they can be soldered together with components to simplify circuitry and they are *strong*.

Models include:



SG11054

Series II: High RF voltage *low cost* units with $Q > 1200$ and TC; 0 ± 50 ppm.



GQ11115

Johanson GQ11115: High voltage quartz capacitors which feature 7000 VDC; 2500 V peak RF at 30 mc and current capacity > 2 amps.

Also available are:

- Tuners and ganged tuners; linear within $\pm 0.3\%$
- Differential capacitors
- Mil spec capacitors
- Microminiature capacitors .075" diameter and .1-1 pf

Write today for full catalog.

Johanson MANUFACTURING CORPORATION

400 Rockaway Valley Road, Boonton, N. J. 07005 (201) 334-2676

Electronic Accuracy Through Mechanical Precision

INFORMATION RETRIEVAL NUMBER 62

CRT display system shows 144 characters



Transistor Electronics Corp., Box 6191, Minneapolis. Phone: 941-1100. Price \$5000 to \$7000.

Called the TEC DATA-SCREEN display system, this plastic-cased desk-top unit offers flexible key arrangement and key legends on an optional keyboard. It will interface with most computer systems, hard-copy devices, and standard communications links, including Dataphone and Teletype.

The CRT screen can be located on the left or right or in the center of the unit. The unit will accommodate up to 144 fixed alphanumeric messages and special symbols, visible only when illuminated. The system's character repertoire includes 26 alpha, 10 digits and six punctuation marks, plus a flashing cursor for character and line indication. The operator can add, change or delete data as desired. When several units are used as inquiry terminals tied to a single computer, selective programing can be established, so that confidential or restricted information is communicated only to the proper stations.

The package with 8-level code compatibility (including ASCII, IBM, EBCDIC) includes character generator, 8-bit/character refresher, core memory and control logic. The eight-inch rectangular tube displays 128 bold, stroke-written characters $3/8$ in. high in eight rows of 16 characters, with 63-Hz repetition to eliminate visible flicker. Displays of 200 and 512 characters are also available as standard models. The unit operates from 115 Vac, 50 to 400 Hz. Stroke-written characters are highly visible because of the black screen in the display area.

CIRCLE NO. 269



.000500" GOLD

This is not a typographical error. Burndy's new printed circuit receptacle springs are clad to this thickness at point of contact.

Burndy has found a way to boost the reliability of ultraminiature connectors (.050" contact spacing) without unduly increasing the price.

Specially developed for a major computer manufacturer, the unusually thick gold coating is concentrated

on the springs at point of contact. Applied by Burndy's special "cladding" method, it makes possible a pore-free diffusion-proof surface, unequalled for corrosion resistance. Formed of gold flashed beryllium copper wire, the clad spring provides a connection with unusually stable contact resistance.

Burndy also makes a full line of PSE printed circuit connectors with springs gold plated to .000030 minimum for less critical applications. Samples of both are available for comparison tests.

Just write:

 **BURNDY**
NORWALK, CONNECTICUT

INTERNATIONAL SALES HEADQUARTERS AND MANUFACTURING FACILITIES:

CANADA: Scarboro, Ontario / ENGLAND: St. Helens, Lancs. / BELGIUM: Mechelen / MEXICO: Naucalpan de Juarez / BRAZIL: Sao Paulo / JAPAN: Tokyo / Sales Offices in Other Major Cities

Faster, easier set-ups with



advanced "AGREE" chambers



Tenney's "AGREE" Chambers have always offered the utmost in performance to meet and exceed all test levels of MIL-Std-781A. Now you also get the utmost in operator convenience. Tenney's exclusive "Redi-Seal" (patent applied for) provides a soft cushion of foam to seal between the chamber and L.A.B. or comparable vibration

testing machines. No more cumbersome diaphragms... no removable chamber sections... just roll the table in place. Save set-up time. Fully automatic operation of chamber, vibrator, and test item. Make it easy for yourself. For complete information on the latest in "AGREE" testing, write or call



Tenney
ENGINEERING, INC.

1090 Springfield Rd., Union, New Jersey 07083 • (201) 686-7870
Western Division: 15721 Texaco St., Paramount, Calif. 90723

488

SYSTEMS

Time-code generator has 9 data channels



Sierra Research Corp., Buffalo, N.Y. Phone: (716) 632-8823.

Dataplexer model 6711 incorporates a time-code generator and reader that provide 9 channels of analog data and 9 of time information. Compatible with all IRIG standard tape-recorder speeds, the unit may also be modified to give 18 channels of analog data or any combination of time and data channels. Its 0.01% time-code unit records and displays time in days, hours, minutes and seconds.

CIRCLE NO. 271

Data amplifier ranges to 100 kHz



Neff Instrument Corp., 1088 E. Hamilton Road, Duarte, Calif. Phone: (213) 357-2281. P&A: \$525; 30 days.

Designed to amplify low-level signals for tape recorders, oscillographs, and data systems, this unit has continuously variable gains of 1 to 2500, a bandwidth of $\pm 1\%$ to 10 kHz, and is down less than 3dB at 100 kHz over the entire gain range. Full output capability of ± 10 V at 100 mA is maintained from dc to 100 kHz. Input impedance is greater than 100 M Ω at all gains and the terminal linearity is 0.005%.

CIRCLE NO. 272

Come and get 'em

Now we have a full line of Terminal Junctions and Feedthroughs available for immediate delivery. Five different wire sizes: 8, 12, 16, 20 and 22. Many different bussing arrangements in each wire size, off the shelf—lots more to order. Many different frame lengths. Environmental and non-environmental types. Take your pick.

Every Deutsch Terminal Junction and Feedthrough is top quality—for maximum reliability and performance. Connections are crimped with a standard MS 3191 tool and inserted and locked in place (and removed)

with an expendable plastic tool that will break before it damages the module.

Companion components including Jiffy Junctions® (to replace single wire splices), adaptor junctions (to eliminate component solder lugs and other terminations), and grounding junctions are also available.

For more information, call your Deutschman, or write Deutsch, Electronic Components Division, Municipal Airport, Banning, California 92220.

DEUTSCH



Terminal Junctions and Feedthroughs

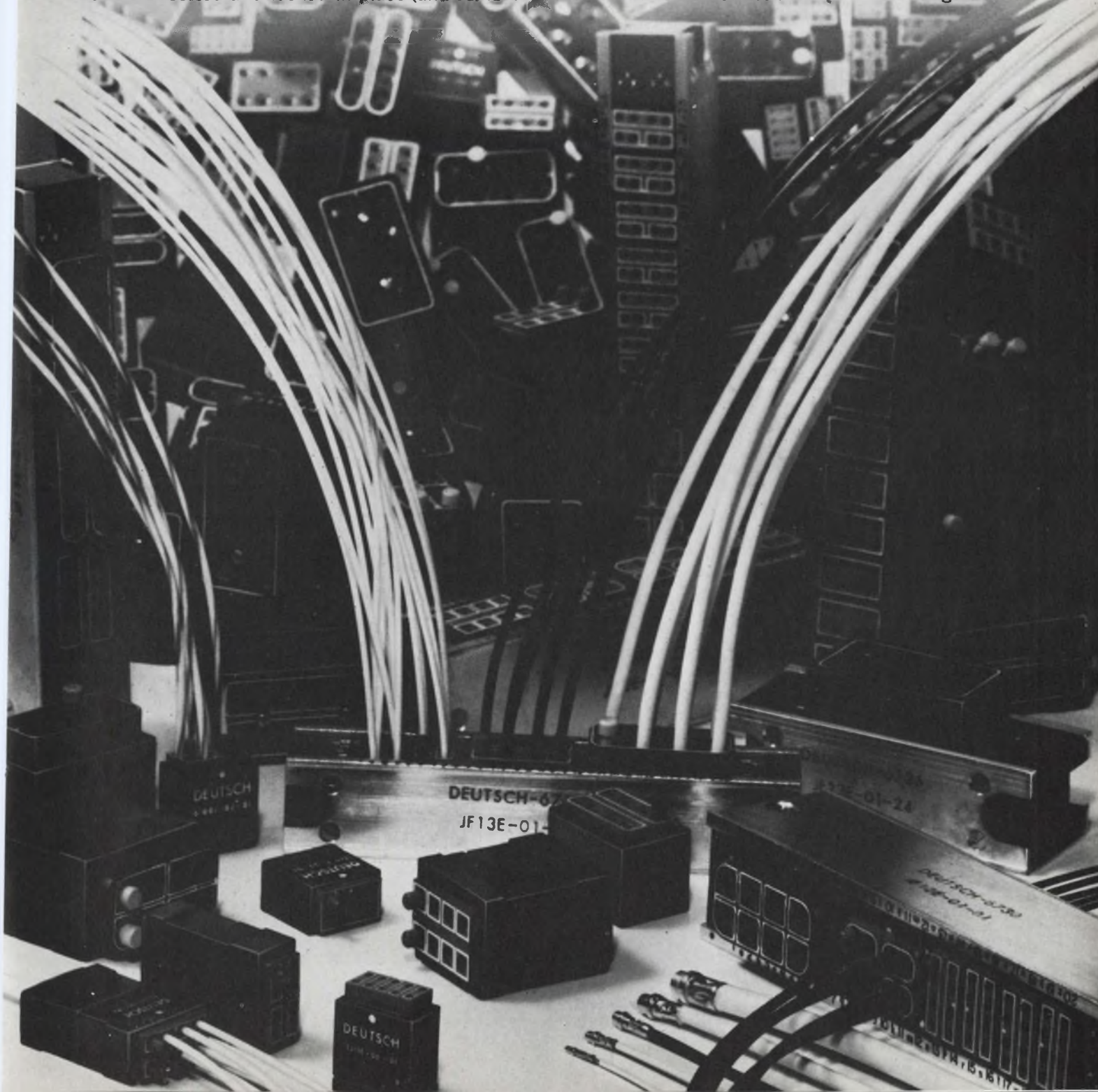

COMPONENTS

Operational amplifier drifts 0.2 nA/°C

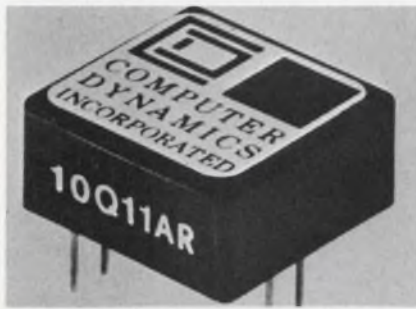

Computer Dynamics Inc., 179 Water St., Torrington, Conn. Phone: (203) 482-7621. P&A: \$8.50; 2 wks.

This operational amplifier has a differential input drift of 10 μ V and 0.2 nA/°C. Its differential input resistance is 250 k Ω and its bias current is less than 150 nA. It has a gain of 90 dB with a cross-over frequency of 2 MHz, a full output frequency of 15 kHz and an output of ± 10 V, 2 mA.

CIRCLE NO. 274

Dual capacitors tuned independently

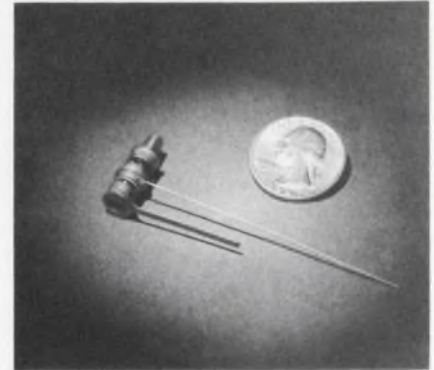

Voltronics Corp., Hanover, N.J. Phone: (201) 887-1517. P&A: \$14 each (500-999).

Trimmer capacitors with dual variable elements are individually tunable from each end. This combination reduces the space needed for two capacitors and the number of circuit connections. While any combination of capacitance values is possible, three standard units are offered at 2 to 15 pF and 5 to 30 pF, 5 to 50 pF and 2 to 15 pF, and 4 to 12 pF and 2 to 4 pF. For all units Q is 700 at 1 MHz, 600 at 20 MHz. The units are supplied with one ribbon lead, one wire lead and a threaded mounting bushing. Any combination of leads is also available. With a nonrotating piston, the tuning screw does not move in and out. Linearity is $\pm 1\%$ with no capacitance reversals. Temperature coefficient is ± 100 ppm/°C. Both ends of all units are sealed. Insulation resistance at 25°C is 10^6 M Ω .

CIRCLE NO. 273

NEW SECON type "5" ultra quality lead bonding wire for semiconductors

The new Secon type "5" technique produces wire that is more uniform and reproducible than ever before. Type "5" also handles more smoothly in wire feed mechanisms. Secon now supplies all lead bonding wire to its customers in the type "5" quality classification.

This new level of controlled quality is the culmination of over a year

of intensive technical and metallurgical research in cooperation with several of the semiconductor industry's largest consumers of finely engineered wire. If you haven't sampled type "5", it's time you did.

For additional information, or technical assistance, please write on your letterhead to — Secon Metals Methods Engineering Department.



7 INTERVALE STREET, WHITE PLAINS, NEW YORK 10606 • (914) 949-4757

INFORMATION RETRIEVAL NUMBER 66

FET op amp gives 40-V output swing

Analog Devices, 221 Fifth St., Cambridge, Mass. Phone: (617) 491-1650; P&A: \$75 stock.

Differential FET operational amplifier has a 40-V output swing (± 20 V) at 2.5 mA. It combines the high input impedance and low current drift associated with FET amplifiers with a large output drive, so that separate booster amplifiers are not needed. The model 145 specifications include a 50,000 dc gain, 1.5-MHz bandwidth, 10-kHz full-power response and 30 μ V/°C drift.

CIRCLE NO. 347

**You know Alfred single range sweepers cost less.
Now you know Alfred single range sweepers feature
PIN diode leveling, grid leveling and internal attenuators.**

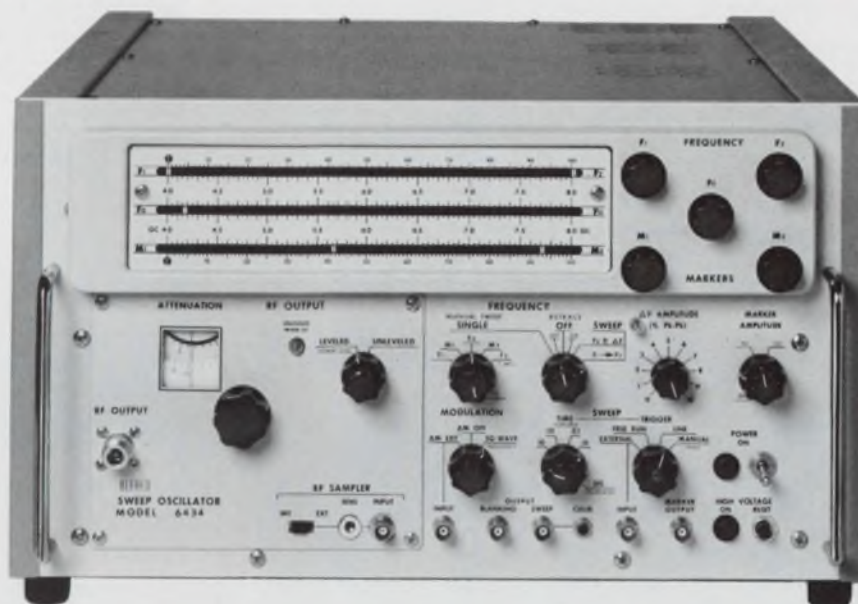

Call Alfred for frequency ranges not listed here.

Frequency GHz	Grid Leveled				PIN Diode Leveled			
	Model	Power Output mw	Power Variation leveled db	Price	Model	Power Output mw	Power Variation leveled db	Price
1 to 2	6410	80	—	\$3050	6412	60	—	\$3275
	6411	70	±0.3*	3325	6413	60	±0.3*	3550
	6414	20	±0.5**	3590	6415	15	±0.5**	3825
1.4 to 2.5	6410-1	80	—	3300	6412-1	60	—	3575
	6411-1	70	±0.3*	3600	6413-1	60	±0.3*	3875
	6414-1	20	±0.5**	3800	6415-1	15	±0.5**	4075
2 to 4	6420	60	—	2850	6422	40	—	3100
	6421	50	±0.3*	3140	6423	40	±0.3*	3390
	6424	15	±0.5**	3340	6425	10	±0.5**	3590
1.7 to 4.2	6420-1	35	—	3150	6422-1	15	—	3425
	6421-1	30	±0.5*	3480	6423-1	15	±0.5*	3750
4 to 8	6430	30	—	2850	6432	20	—	3125
	6431	25	±0.5*	3230	6433	20	±0.5*	3500
	6434	5	±0.5**	3490	6435	5	±0.5**	3775
3.5 to 6.75	6430-1	40	—	3290	6432-1	20	—	3575
	6431-1	30	±0.4*	3800	6433-1	20	±0.4*	4075
	6434-1	5	±0.5**	3900	6435-1	5	±0.5**	4175
3.7 to 8.3	6430-2	10	—	3150	6432-2	5	—	3425
	6431-2	10	±0.5*	3530	6433-2	5	±0.5*	3800
7 to 11	6440	20	—	2900	6442	10	—	3200
	6441	15	±0.5*	3300	6443	10	±0.5*	3600
7 to 12.4	6440-1	20	—	3100	6442-1	10	—	3400
	6441-1	15	±0.75*	3500	6443-1	10	±0.75*	3800
8 to 12.4	6450	60	—	2900	6452	20	—	3200
	6451	50	±0.5*	3300	6453	20	±0.5*	3600
10 to 15.5	6460	35	—	3850				
12.4 to 18	6470	40	—	3000				
	6471	25	±0.8*	3500				
18 to 26.5	6480	10	—	3650				
26.5 to 40	6490	5	—	5300				

*Internally leveled.

**Attenuator continuously variable over 50 db.

For complete information or a demonstration, call your Alfred engineering representative or write us at 3176 Porter Drive, Stanford Industrial Park, Palo Alto, California 94304. Phone (415) 326-6496. TWX: (910) 373-1765. *Project responsibility opportunities are available for qualified engineers on Alfred Electronics' growing technical staff. An equal opportunity employer.*

See us at IEEE, Booths 2C12 & 2C14

INFORMATION RETRIEVAL NUMBER 67

ALFRED ELECTRONICS

**Push-pull, push-pull, push-pull, push-pull,
push-pull, push-pull, push-pull, push-pull,
push-pull, push-pull, push-pull, push-pull,
push-pull, push-pull, push-pull, push-pull,
push-pull, push-pull, push-pull, push-pull.
That's the monotony of reliability.**

Monotonous reliability characterizes IMC's solenoids, even at 4 millisecond speeds. There's a whole catalog of them in stock at IMC's Western Division, in sizes and configurations for avionics, instrumentation, computer peripherals and other systems.

If you need to push-pull, or to Indicate, Measure, and Control using steppers, synchros, resolvers, flag indicators or solenoids, contact the Applications Section at 6058 Walker Ave., Maywood, Calif., 90270. Phone (213) 583-4785 or TWX 910 321 3089.

For the catalog or data sheets contact the Marketing Div., 570 Main St., Westbury, N.Y. 11591 or circle the inquiry number.



INFORMATION RETRIEVAL NUMBER 68

The New Mini Boxer



**dressed or undressed,
fits places too small for the
full-size Boxer fan.**

Small and vigorous. Measures only 3.625 square by 1.5 inches deep, yet the Mini Boxer delivers a lusty 46 cubic feet of air per minute.

Durable. Ball bearing models survive difficult environments for five years and more, due to patented extra-large lube reservoir. Sleeve type Grand Prix (pat. pending) bearings run cool and reliably, offering exceptional life at low cost. Rugged metal frame won't crack under stress like plastic.

Versatile too, in skeleton or venturi version it flips to reverse airflow, mounts easily anywhere. Special skeleton version fits within 3.5-inch square for standard racks.

Available. It's at your nearest distributor.



IMC Magnetix Corp., New Hampshire Division
Route 16B, Rochester, N.H. 03867. Tel: (603) 332-5300

INFORMATION RETRIEVAL NUMBER 69

COMPONENTS

Keyboard switches have 1 or 2 functions

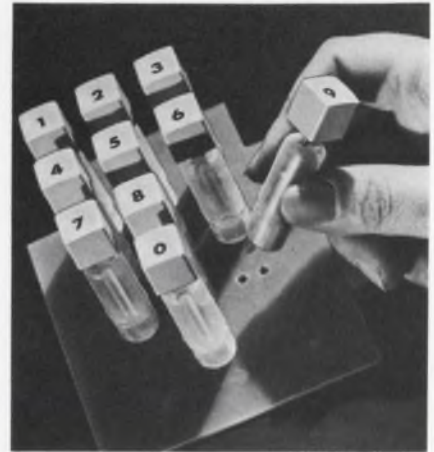

Raytheon Co., Industrial Components Operation, Fourth Ave., Burlington, Mass. Phone: (617) 272-9600.

Keyboard switches with the action and touch of a typewriter are designed for use in alphanumeric keyboards for the control of computers and other electronic equipment. Easy to mount and solder, the switch lends itself to flow-soldering techniques. The switch is available as either mechanical or reed and with either one or two switching levels. The KBSM-1 is an all-mechanical wipe-action switch. The wipe-action design ensures minimum contact bounce, and it works in less than 10 ms. The KBSM-2 provides a second contact level near the bottom of the stroke for double-function applications. The second contact can only be reached by increasing pressure to six times that required to reach the first contact level. The KBSR-1 is a single-level dry-reed-type keyboard switch, similar in design to the mechanical switch except that contacts are hermetically sealed in glass and actuated by a moving permanent magnet. The touch of the reed-type switch is identical to the mechanical type and offers the additional reliability and minimum bounce inherent in a reed switch. The KBSR-2 is a double-level reed-type switch similar in design to the KBSR-1 except for the second level. The mechanical-switch pressure contacts are made of beryllium; the sliding contact employs stainless steel. The reed-switch contacts are noble metal.

CIRCLE NO. 275

INFORMATION RETRIEVAL NUMBER 70 ►

R-TX

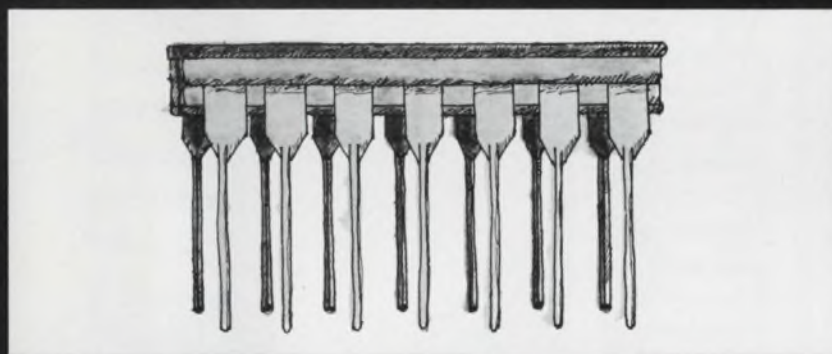
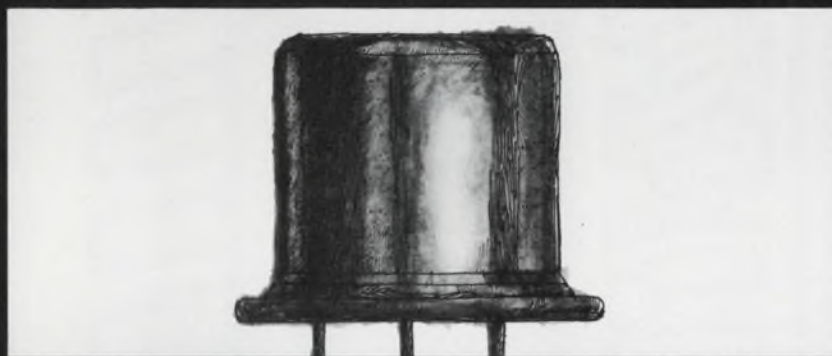
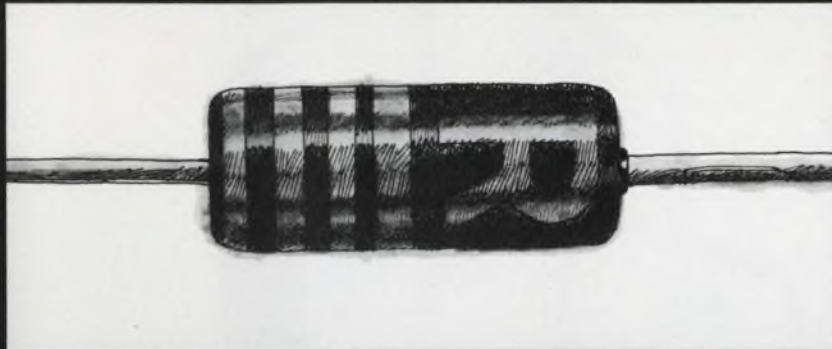

R-TX is Raytheon's equivalent of JAN-TX, extended to cover Raytheon diodes, transistors and IC's for which no JAN-TX standard has been established. For complete details, send for your Raytheon R-TX Standards on diodes, transistors and IC's today. And for complete information on Raytheon's standard line of diodes and transistors, send for our latest Catalogs as well.

Raytheon Company, Semiconductor Operation, 350 Ellis Street, Mountain View, California 94020. (415) 968-9211.

RAYTHEON

Now, Winchester military-type performance

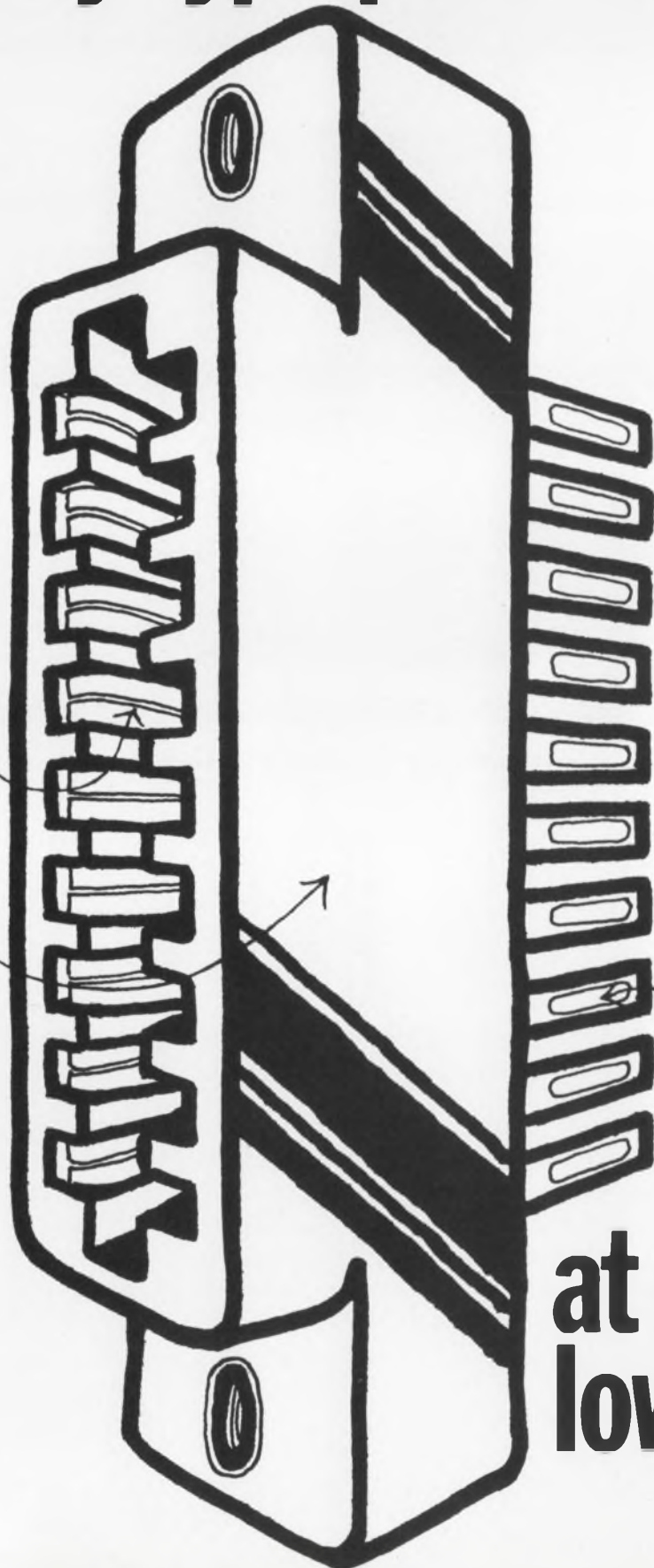

Bifurcated contacts
copper alloy plated
gold over tin-nickel.
Maintain constant,
non-damaging interface
with PC board even during
shock and vibration.

Green glass-filled alkyd
dielectric material.

New Winchester HK/HKD
Series meets all the
dimensional requirements
of MIL-C-21097.

Single and double row
terminations with
from 6 to 43 contacts
for use on 1/16"
boards on .156 contact
centers.

Choice of solder eyelet
or dip solder contacts,
each with a current
rating of 5.0 amps.

**at a nice
low price.**

Reed relay includes built-in diode

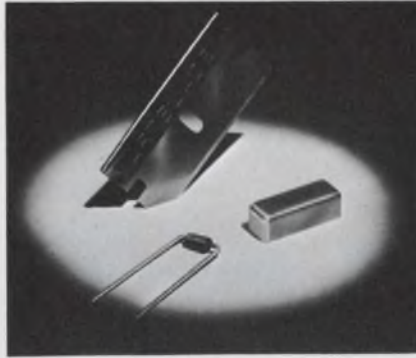

Wheelock Signals, Inc., Long Branch, N.J. Phone: (210) 222-6880.

Solid-state reed relay switching systems come in a 0.05 in.³ package. The series 442SS relay incorporates a blocking or arc-suppression diode. The size of the relay allows 40 two-pole relays to be mounted on a 5-1/2 × 4-1/2-in. printed-circuit board. The height is 0.25 in. It is available in 1-, 2-, 3- and 4-pole models. Contacts are rated at 7 W.

CIRCLE NO. 276

Ceramic-chip capacitors have multilayers

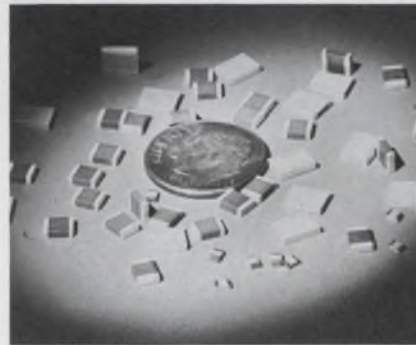

Cornell Dubilier Electronics, 50 Paris St., Newark, N.J. Phone: (201) 624-7500.

Ceramic multilayer chip capacitors are useful for microelectronic applications. These unencapsulated multilayer devices are suited for use in hybrid, integrated and discrete-component circuits. The chip is composed of thin ceramic sheets with noble-metal electrodes, which are stacked, pressed, and fired to form a single, compact chip capacitor.

CIRCLE NO. 277

Analog divider has 3-dB bandwidth

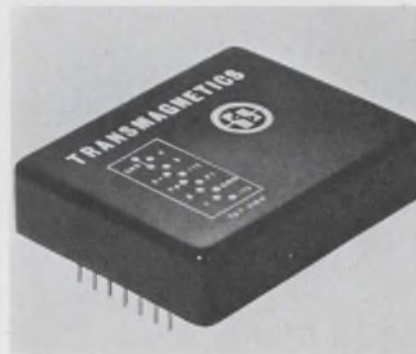

Transmagnetics, Inc., 134-25 Northern Blvd., Flushing, N.Y. Phone: (212) 539-2750. P&A: \$345 (1 to 9 units); stock.

This analog divider has a 3-dB bandwidth from dc to 20 kHz. The device, designated model 480, is accurate to 1% or 40 mV, whichever is greater. It provides a voltage output equal to $-10x/y$, where x is -10 to $+10$ V into 5 k Ω min, and y is always minus, $10 < /y / < x$, into 5 k Ω min. Output stability is 2.5 mV/ $^{\circ}$ C.

CIRCLE NO. 278

Op-amp modules rise in 50 ns

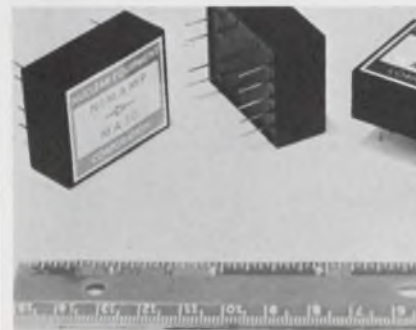

Nuclear Equipment Corp., 931 Terminal Way, San Carlos, Calif. Phone: (415) 591-8203. Price: \$20 up.

Operational amplifiers for nuclear applications rise in less than 50 ns over the dynamic range of ± 10 V. An output impedance of less than 1 Ω suits them for nuclear linear-pulse-handling applications. The series has both common-emitter and differential input versions.

CIRCLE NO. 279

There's no sense in paying for connectors that are certified to MIL-C-21097. Unless you have to. But there's lots of sense in Winchester's new HK/HKD Series that provides the same geometry. Because they're low cost—built to Winchester quality standards.

The fact is, we keep the cost of the HK/HKD Series down by using a different molding material and contact plating. This makes our new HK/HKD Series your best buy for computers, ground support equipment and other applications where you need a really good, dependable connector. But you don't want to spend a fortune.

The HK/HKD Series is promptly available from your nearby Winchester distributor. So is a helpful new brochure called "Commercial Printed Circuit Connectors." Winchester Electronics, Main St. and Hillside Avenue, Oakville, Connecticut 06779.

WINCHESTER ELECTRONICS
LITTON INDUSTRIES

control/alarm time-cut

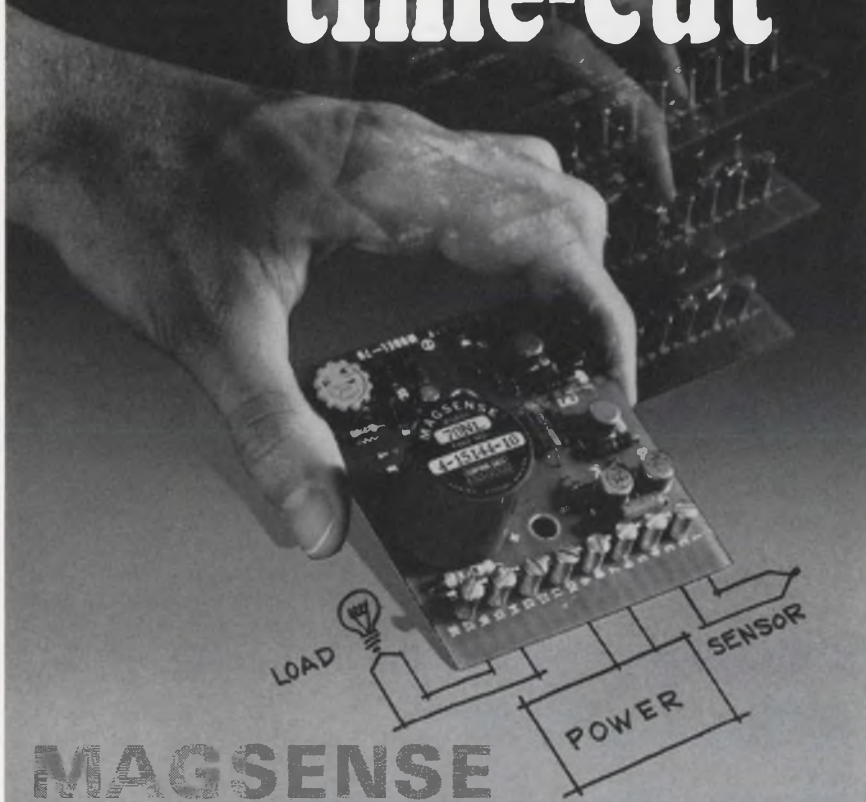

MAGSENSE

control/alarm for temperature, pressure, speed, flow

Here's how to cut the time it takes to solve your control/alarm problem. Hook up sensor, load and power source to a MAGSENSE® control/alarm module and adjust the setpoint. That's it. No time wasted designing and debugging a circuit. And while you're saving time you'll be saving money, getting *proven-in-service* reliability.

Capabilities? All MAGSENSE modules offer 100-billion power gain, accept inputs as low as 10 microvolts or 1 microamp *directly* without preamplification. Completely isolated inputs are unaffected by common mode voltages as high as 110vac, 60Hz, or overloads as large as 1000-times full scale input. Typical accuracy is $\pm 0.5\%$ full scale. And they all

operate from a *single* DC power source (either 28v or 12v).

Options? The list includes remote and dual setpoints, adjustable hysteresis, choice of output action, transducer excitation voltage, and cold junction and copper compensation on thermocouple models. There's a MAGSENSE model for your application.

Price? Get MAGSENSE control/alarm modules for as little as \$35 in quantity. Compare that with the cost of developing and building your own circuit.

More information? Write or call, or circle the reader service number and we'll send you complete specifications and prices.

CONTROL DATA
CORPORATION

4455 Eastgate Mall, La Jolla, Calif.

INFORMATION RETRIEVAL NUMBER 72

MAGSENSE Sales, Dept. 237
Analog-Digital Systems Division
Control Data Corporation
4455 Eastgate Mall
La Jolla, Calif. 92037
Phone 714/453-2500

COMPONENTS

Short-arc lamp produces 200 W

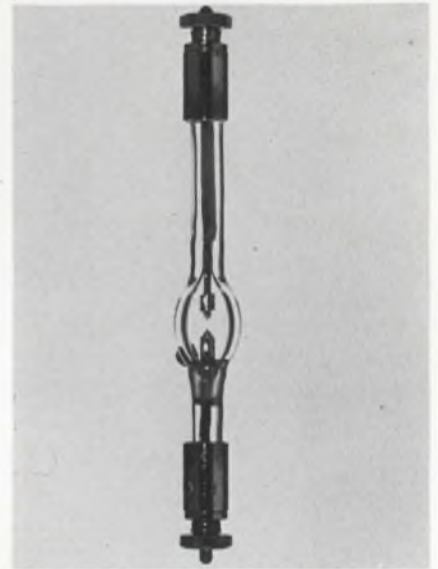

PEK, Inc., 825 E. Evelyn Ave., Sunnyvale, Calif. Phone: (408) 245-4111. P&A: \$29.50; stock.

This 200-W mercury short-arc lamp is for applications in semiconductor manufacture, optical systems, photography, direct-printing systems and laboratory instrumentation. The lamp, Model PEK-210, is specifically designed for dc operation. It is mechanically compatible with most existing 2-electrode 200-W mercury short-arc lamps.

CIRCLE NO. 280

Neon pilot-lights use 0.187-in. terminals



Industrial Devices, Inc., Edgewater, N.J. Phone: (201) 943-4084.

Miniaturized neon pilot lights have 0.187-in. quick-connect terminals. Designated the 2180 series, the units provide a 5/16-in.-dia light. They come in seven lens shapes in a wide choice of colors including red, amber, clear and white translucent. The housings are of a tamper-proof design.

CIRCLE NO. 281

PROTECTION...a New England Tradition

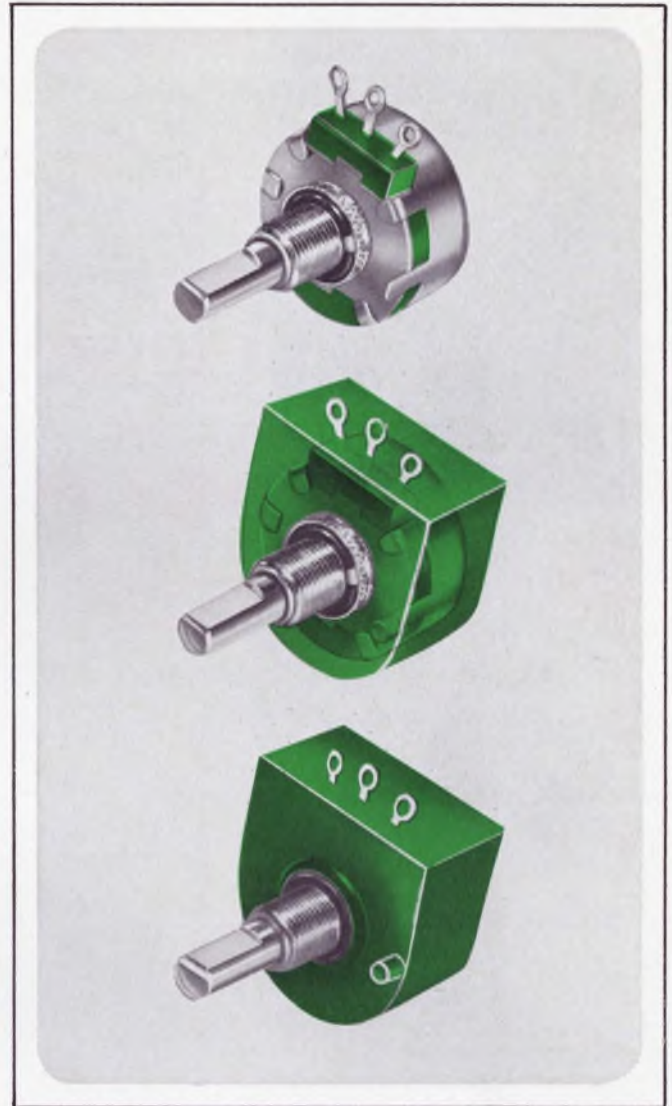
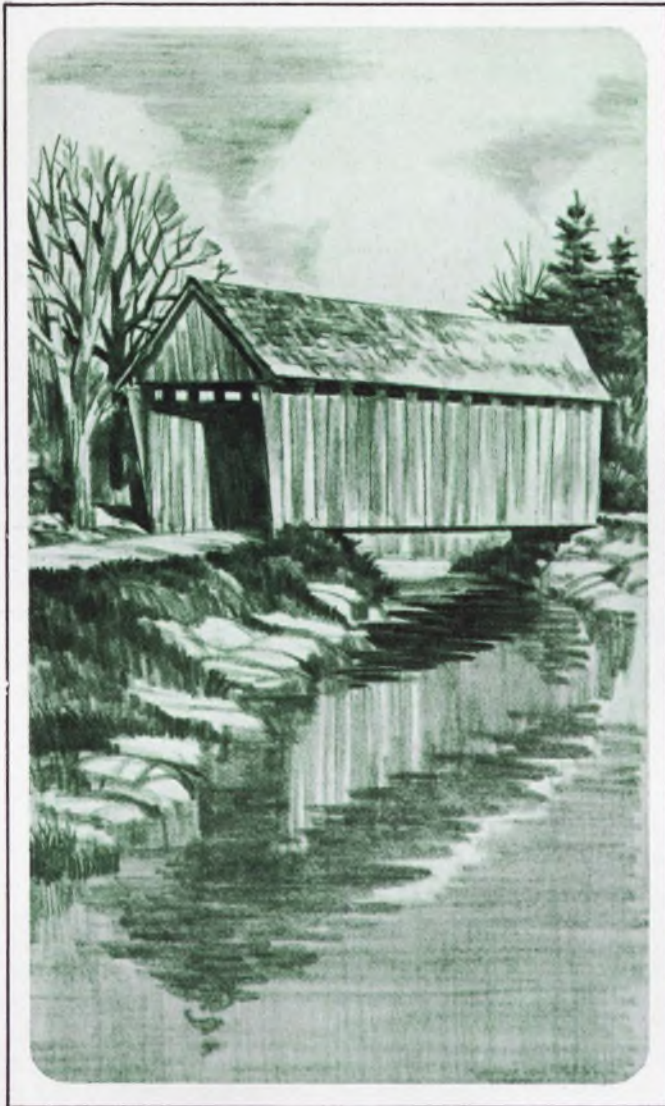

A TRADITION AT CLAROSTAT TOO is the engineering of components to withstand the harshest atmospheric conditions and variations in temperature. Today, the New England tradition of designing for protection against environmental hazards is expressed in Clarostat Potentiometers. No matter how critical your applications—computer—space—industrial—military—our molded potentiometers give complete protection—provide total immunity from moisture, shock, heat and other hostile, efficiency robbing elements. If the job calls for a potentiometer, resistor or switch, call for the component built to maintain a reputation in the craftsman tradition—call for...

CLAROSTAT

CLAROSTAT MFG. CO., INC., DOVER, NEW HAMPSHIRE 03820

INFORMATION RETRIEVAL NUMBER 73

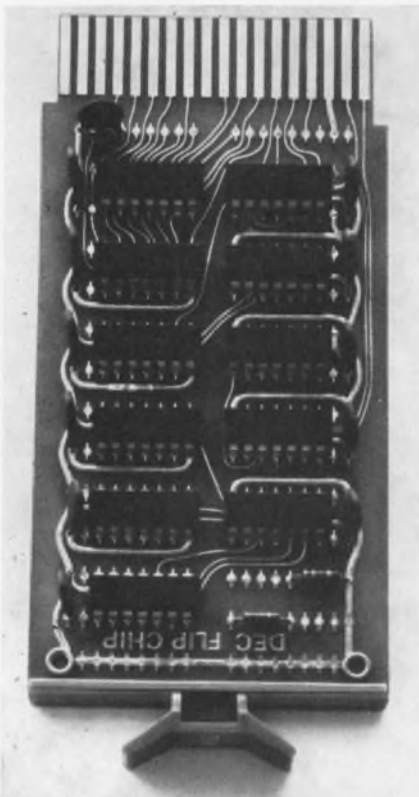

Complete 10 MHz IC shift register at \$10.50 per stage

M-208 is an 8-stage digital logic shift register, complete. It, like all 25 modules in the M Series, works at 10 MHz. And it, like all other modules in the series, is designed for a cost/performance ratio that is the best in the industry. The M-208 sells for \$84, unless you buy large quantities. Then it's less.

M-208 control lines are buffered, eliminating complex loading rules. Provision is made for parallel loading of bits. TTL integrated circuits, the latest and best available, are used exclusively. Typical dc noise margin is 1 volt at either logic 1 or logic 0 levels.

M Series modules, including the M-208, and several other series of compatible modules, are fully described in the new Logic Handbook. Write for a free copy.

digital
MODULES · COMPUTERS
Maynard, Mass.,

INFORMATION RETRIEVAL NUMBER 74

COMPONENTS

Chip capacitors span 100 to 10,000 pF

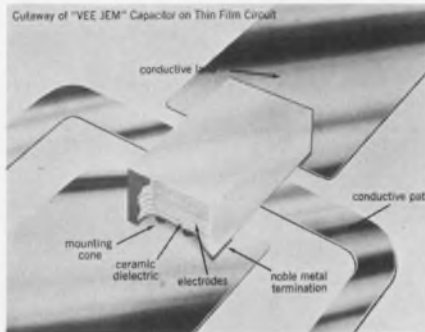

Vitramon, Inc., Box 544, Bridgeport, Conn. Phone: (203) 268-6261.

Subminiature chip capacitors measuring 0.085 in. long × 0.055 in. wide × 0.040 in. thick are designed expressly for thin-film and thick-film hybrid microcircuits. The chips are available with capacitance values from 100 to 10,000 pF with ratings of 50 and 25 V dc and tolerances of ±10% and ±20%. They operate within the temperature range of -55°C to +125°C.

CIRCLE NO. 282

Miniature male jack has integral filter



Phelps Dodge Electronics, 60 Dodge Ave., North Haven, Conn. Phone: (203) 239-3311.

A miniature bulkhead-mounted male jack with integral low-pass filters can feed a dc bias voltage to microwave diode switches incorporated into the line. For other applications, the connector may be supplied with high-pass or band-pass filters. As a standard connector, the model 9340 will attenuate in excess of 50 dB over signals of 100 MHz.

CIRCLE NO. 283

Cartridge heater explosion-resistant

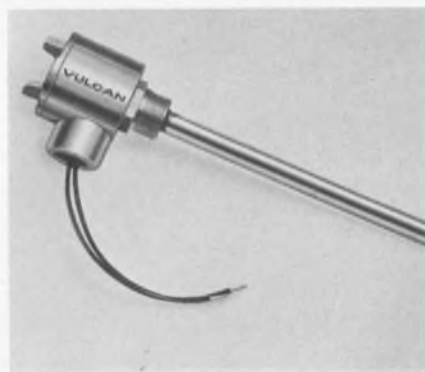

Vulcan Electric, Dept. BV, Danvers, Mass. Phone: (617) 774-1730.

A density cartridge heater is available in an explosion-resistant model in conformance with NEMA standards. It provides localized, concentrated heat in hazardous areas. When the sheath is exposed to hazardous conditions, a protective well can be used. Specifications include outside diameters from 1/4 in. to 15/16 in., lengths from 1 in. to 48 in., voltage rating up to 440 V, watt density from 90 to 600 W/in.² and a variety of terminals.

CIRCLE NO. 284

Crystal oscillators mount on printed circuit

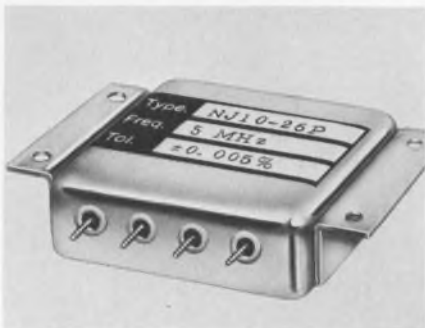

Accutronics, Inc., 628 North St., Geneva, Ill. Phone: (312) 232-2600. Price: \$90 to \$180.

Crystal oscillators are designed to drive all types of IC logic. Typical output voltages are 0 V ±0.5 V to 2 V and 5 V peak, square-wave with 60 ns rise and fall times. These amplitudes are typical when supplied with a power source of 3.6 V dc to 5 V dc. Stabilities from ±0.1% to ±0.001% depend on ambient temperatures.

CIRCLE NO. 285



High Strength Dielectric

Coors Alumina Ceramics were originally developed to provide high mechanical strength insulators used in extremely high voltage applications. With Coors Ceramics you have high dielectric strength, plus a material with physical properties far superior to porcelain, glass or plastic. They are good structural materials, compressive strengths extend to 380,000 psi. They are inert, have long endurance at high voltages, are impervious to moisture or fungus, and are stable under intense radiation. Use Coors Ceramics, in sizes from micro wafers to large 24" x 60" cylinders. They can be glazed for easy-to-maintain cleanliness, or metalized for brazed ceramic-metal assembly. Faced with a high potential design decision? Get on-the-spot answers, dial Coors—303/279-6565, Ext. 361. For complete design criteria, write for new Coors Alumina and Beryllia Properties Handbook 952.

*consider
Coors
ceramics*

Coors

CERAMICS

ALUMINA • BERYLLIA • MAGNESIA • SPECIAL OXIDES

Coors Porcelain Co., Golden, Colo.



CHOPPERS • RELAYS • TRANSFORMERS • SWITCHES

JAMES

ISOLATES NOISE WITH SHIELDED TRANSFORMERS

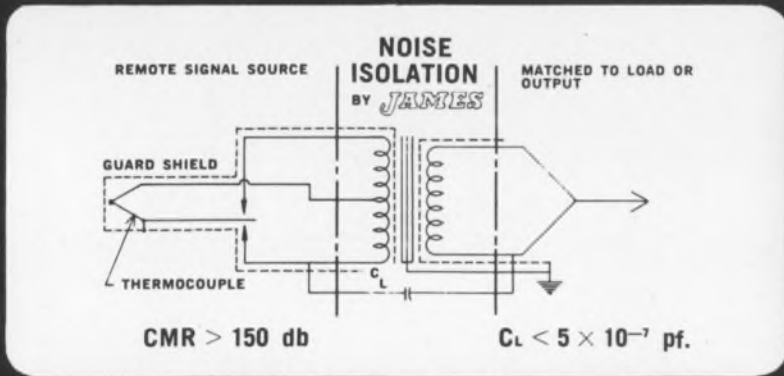
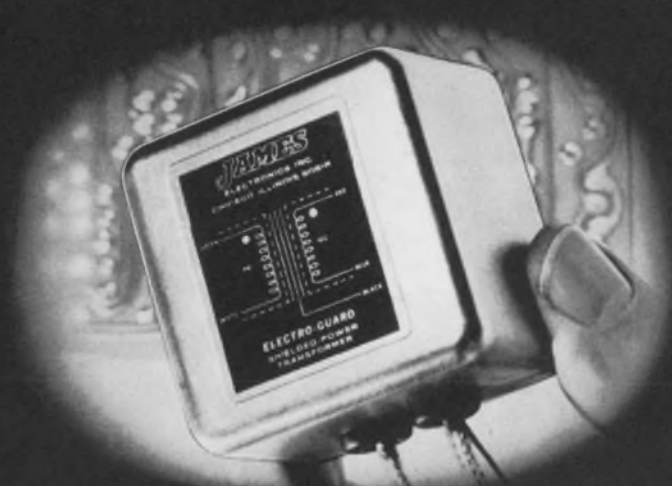

150 db COMMON MODE REJECTION

SIGNAL-GUARD TRANSFORMERS

Low and Medium Frequency (DC to 100KHz) response

Designed for use in analog acquisition and computation equipment. James Signal-Guard provides isolation, voltage comparison, impedance matching, and common mode rejection.

DATA-GUARD TRANSFORMERS

High Frequency Signal (1KHz — 40MHz)

Designed and shielded to isolate and terminate high frequency signal data in the form of pulses. AM and FM modulated carriers, multiplexed signals, and other low to high frequency data.

ELECTRO-GUARD TRANSFORMERS

Power (1 watt to 100VA)

Electrostatically shielded for use in signal conditioners, bridge supplies, and Zener reference supplies to isolate circuits from noise transients and undesirable common mode voltage commonly carried on power lines.

WRITE FOR FULL TECHNICAL DETAILS

JAMES® ELECTRONICS INC.

4044 North Rockwell
Phone 312-463-6500

• Chicago, Illinois 60618
• FAX — JML

COMPONENTS

Numerical readouts stand 1.635 in. high



National Electronics, Inc., Geneva, Ill. Phone: (312) 232-4300.

Numerical-readout tubes have flat tops and fit existing sockets. The NL-900 series are sideview tubes with 0.61-in. characters and a dynamic operating life in excess of 200,000 hours. Max over-all length is 1.635 in. and max seated height is 1.375 in. Max dia of 0.75 in. allows less than 0.8-in. center-to-center spacing. They require a min dc supply of 170 V at a max cathode current of 3 mA average, min 1.5 mA average.

CIRCLE NO. 286

Pressure transducers use thin-film process

Statham Instruments, Inc., 12401 W. Olympic Blvd., Los Angeles, Calif. Phone: (213) 272-0371.

Thin-film transducers employ as their sensing element a vacuum-deposited-film strain gauge a few millionths of an inch thick. Ceramic film deposited onto the stainless-steel diaphragm of each unit provides electrical insulation for the bridge elements. Four strain gauges, vacuum-deposited on the insulator, are electrically connected into a bridge circuit. The model PA 493 draws less than 10 mA current at 28 V dc and is suited for applications in space vehicles. An optional feature with the model PA505 is single- and double-point internal calibration, by application of an external short.

CIRCLE NO. 287

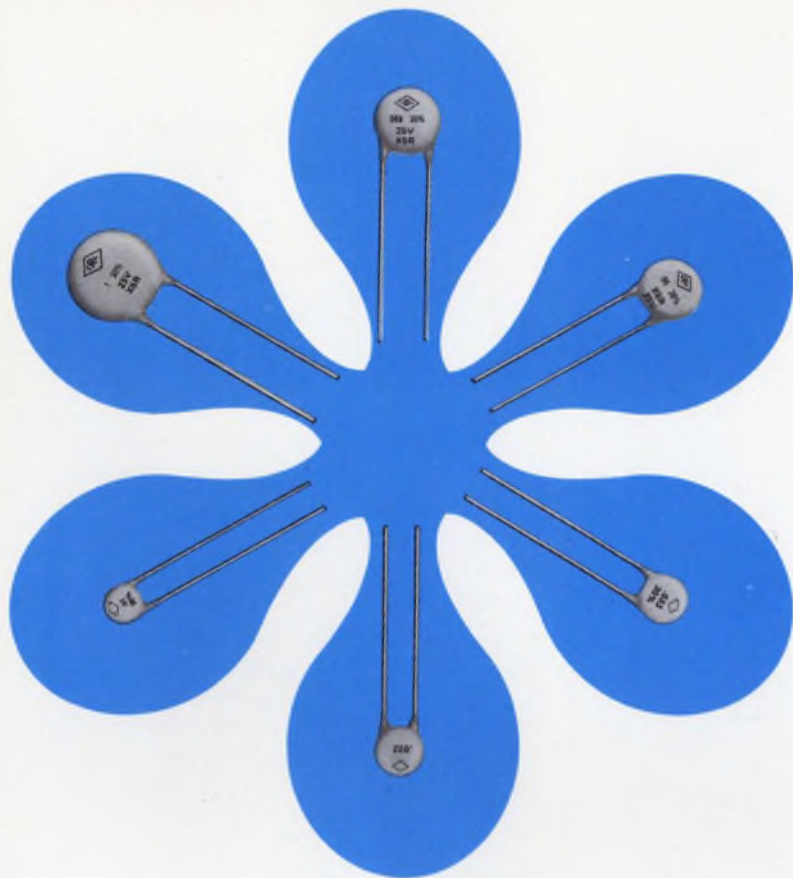

Centralab's "Ultra" Ultra-Kaps[®] put new capacity in shrinking design space

Smaller Size...Outperforms Other Capacitors...Costs Less, Too!

"Inner space" continues to shrink in this trend to transistorization... but not the capacitance values you need in your design applications.

Centralab's answer: an improved 25V Ultra-Kap Disc Capacitor... smaller in size but not in performance.

This "ultra" Ultra-Kap goes one-up on previous Ultra-Kaps (which feature 100 times the capacitance of conventional ceramic dielectrics). Now you can use the Ultra-Kap instead of monolithic ceramic capacitors or mylar capacitors. It even replaces many 50V disc capacitors! Features improved temperature compensation characteristics, too—X5R (−55° to +85°C ±15% from 25°C).

All this at lower cost than with other capacitors, adding an extra touch of economy to your design applications... whether for consumer entertainment, communications, the military—or for medical, instrumentation and computer markets.

Get full details about the "ultra" Ultra-Kap... and the complete Ultra-Kap line of ceramic disc capacitors... from your Centralab representative or drop us a line.



CENTRALAB

Electronics Division

GLOBE UNION INC.

5757 NORTH GREEN BAY AVENUE
MILWAUKEE, WISCONSIN 53201



Here's why they're "Ultra" Ultra-Kaps!

RANGE CHART				
Maximum Dissipation Factor 5% @ 1 kHz				Minimum Insulation Resistance At Rated Voltage
Nominal Lead Spacing	Capacitance MFD	Maximum Diameter*	Tolerance	
.250	.01	.290	IMPROVED ULTRA-KAPS	10 MEGS
.250	.022	.405	16 Volt 25 Volt	10 MEGS
.250	.033	.405	+80-20% (Z) ±30%	10 MEGS
.250	.05	.515	or	10 MEGS
.375	.068	.590	±20% (M)	10 MEGS
.375	1	.760		10 MEGS

*All Ultra-Kaps have a maximum thickness of .156 inches.

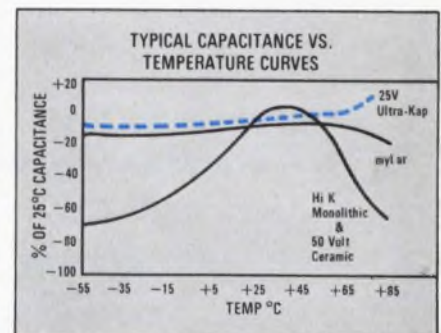

M-6723R

INFORMATION RETRIEVAL NUMBER 77

UNMATCHED ACCURACY
AND RELIABILITY WITH
MIDGI-TRIM[®]
1/2" and 3/8" SQUARE TRIMMERS



MIDGI-TRIM wirewound-square trimming potentiometers have acknowledged acceptance in the industry for accuracy and reliability. They meet or exceed the most demanding requirements of applicable missile and aerospace specs, including MIL-R-27208B.

MIDGI-TRIM pots are designed with fewer moving parts than most conventional square trimmers. A drive wheel replaces six parts or functions common to other square trimmers and functions as a mechanical actuator, slip ring, spring preload, slip clutch, and positive rotating stop.

MIDGI-TRIM pots feature a stainless steel adjustment screw insulated from the contact mechanism, which makes the case completely non-conductive.

MIDGI-TRIM pots contain precious metal alloys of platinum, silver, and gold, together with low-temperature coefficient resistance material, that provide minimum resistance change over wide temperature ranges.

MIDGI-TRIM pots offer many other features that can't be found in other square trimmers:

- Encapsulating problems are eliminated
- No loose lead screws
- No loose pins
- No open windings

A new four-page, two-color brochure details these features. Write for yours today — no obligation, of course.

CONELCO COMPONENTS

Subsidiary of **SYSTRON**  **DONNER**
CORPORATION

wirewound/slidewire/multi-element/cermet/metalfilm trimming potentiometers

465 W. FIFTH ST., SAN BERNARDINO, CALIF. 92401
PHONE: (714) 885-6847, TWX (910) 390-1157

INFORMATION RETRIEVAL NUMBER 78

COMPONENTS

Rectangular trimmer has a glazed element

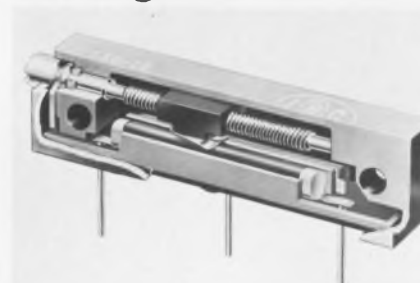

IRC Inc., 401 North Broad Street, Philadelphia. Phone: (215) 922-8900. P&A: \$3.75 ea (100-249); 4 weeks.

An infinite-resolution rectangular trimmer, MIL style RJ-11, has a metal-glaze resistance element. It exceeds the environmental and life requirements of MIL-R-22097C. All models are housed in moisture-sealed, high-temperature diallyl phthalate cases. The units are rated 3/4 W at 85°C and are available over a resistance range of 100 Ω to 10 kΩ ± 5% tolerance.

CIRCLE NO. 288

Connector assemblies set on 0.1-in. centers



Connector Div., Methode Electronics, Inc., 7447 W. Wilson Ave., Chicago. Phone: (312) 867-9600.

Double read-out connector assemblies have contacts set on 0.1-in. centers. Adaptable to all standard 1/16-in. printed-circuit boards, the eight connectors in the series range from 16 to 72 contacts. Contacts, each capable of accepting three No. 24 wires, are gold-plated beryllium-copper for high reliability. Molded insulators, green in color, are glass-reinforced diallyl phthalate, with stainless-steel float bushings and 0.125-in.-dia clearance holes for 4-40 screws.

CIRCLE NO. 289

NIKON HASN'T MADE MICRO-CIRCUIT MASK-ALIGNMENT EASY.

JUST EASIER.

Mask alignment is still the painstaking visuo-mechanical procedure it always was. The Nikon Mask-Alignment Microscope hasn't changed that. But it has reduced the element of human error to where relatively unskilled personnel, with minimum training, can be relied upon for higher registration accuracy in less time.

The reasons are inherent in the basic design of the Nikon Mask-Alignment Microscope. First, the quality of optics: the use of special, high-resolution lenses which give maximum visual acuity with minimum distortion, eyestrain and fatigue. Second, the use of an integrated, point light source on the optical axis of each objective system for optimum illumination efficiency. And third, the degree of flexibility provided by the operating controls.

The optical head, for example, is equipped with two objective lenses and a split-field prism. This prism has a push-pull rod control which permits the user to blank out the image of either of the objectives, or to observe both adjacent to each other in any ratio of field coverage he may desire. Furthermore, the distance between the two objectives can be continuously varied from 0.475" to 1.535", axis to axis.

The binocular eyepiece head, furnished as standard equipment, is inclined at an angle of 45° to the optical axis. It can be rotated 360° to any position most favorable for viewing, and is supplied with matched wide-field, high-eye-point oculars. It also offers facilities for interpupillary adjustment and diopter compensation. Monocular and trinocular heads can be interchanged for photographic and other special applications.

Four interchangeable eyepieces are available (5X, 10X, 15X and 20X), and three interchangeable pairs of objectives (4X, 10X, 13X and 20X) for an overall magnification range from 20X to 400X. A ball bearing, rack-and-pinion focusing mount is also available, where required. In addition, the left objective can also be individually adjusted for focus to provide precise tracking of both objectives.

Price of the basic Nikon Mask-Alignment Microscope is \$806 including step-down transformer equipped with power switch and pilot light. For complete details, write: Nikon Inc., Instrument Division, Garden City, N.Y. 11530 Subsidiary of Ehrenreich Photo-Optical Industries, Inc. (In Canada: Anglphoto Ltd., Instrument Division, Ont.)

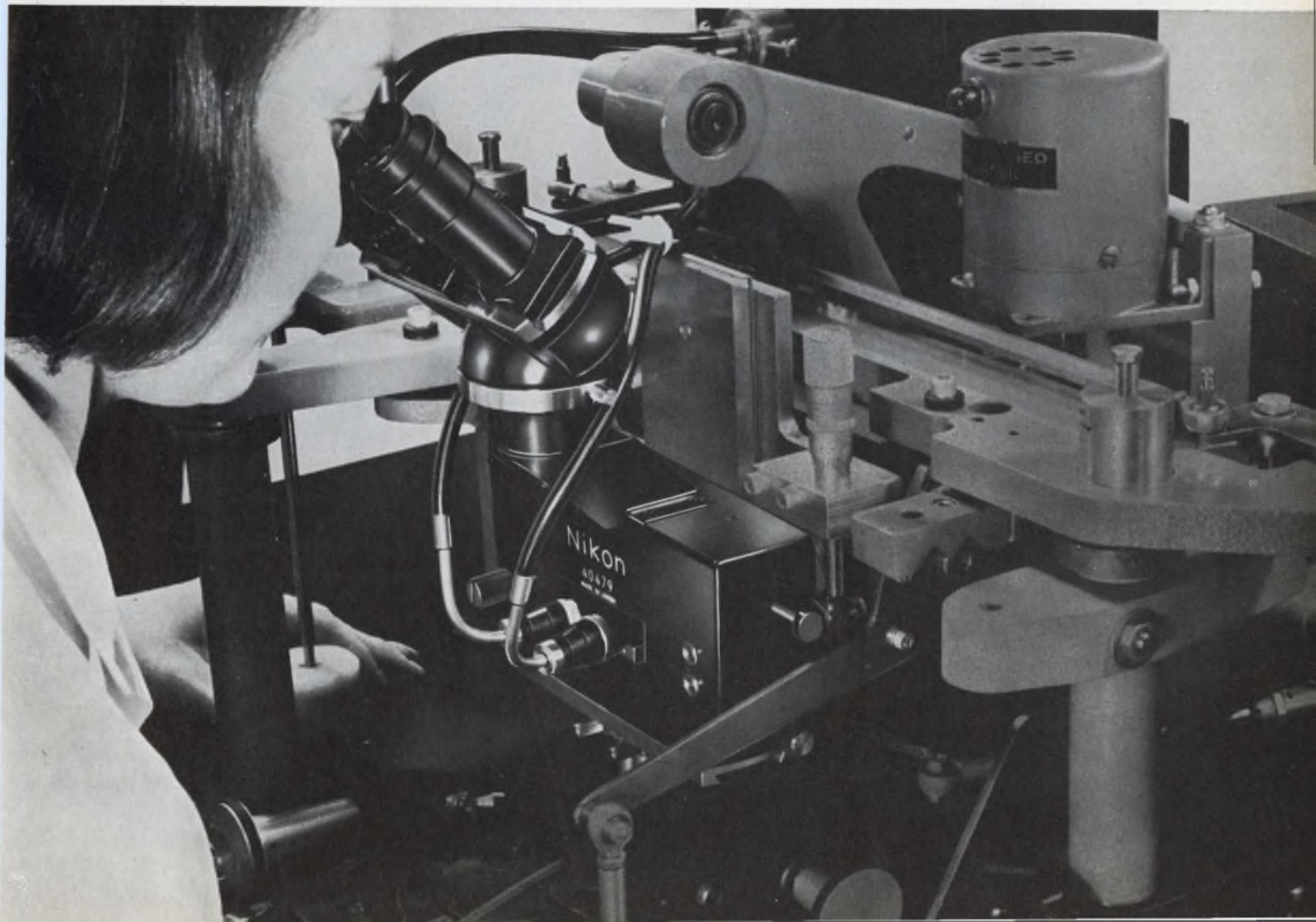

high reliability coatings for printed circuits

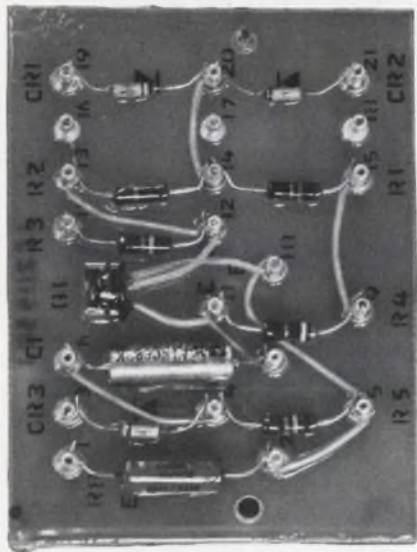

wide range of easy-to-process economical urethanes & epoxies

CONATHANE® and CONAPOXY circuit board coatings include compounds and systems for practically any application method or property requirement.

There are formulations for dipping, spraying, brushing, flow coating, or spin coating. Solution coatings, high solids and 100% solids coatings. Screenable coatings with excellent flow control and adhesion. Coatings that cure at room temperature or elevated temperatures.

Films can be applied to meet virtually all requirements: excellent resistance to abrasion, impact, chemicals, fungus, and exterior weathering; good electrical properties; good dip-tank stability; uniformity of coating thickness. They'll protect assemblies from water, high humidity, contamination, and other severe environmental conditions, making them ideal for the most critical applications including space electronic gear. They can be provided to ruggedize units against shock and vibration and to meet MIL-1-46058, Type PUR, requirements.

Most are easily repairable. Connections can be soldered or unsoldered through these coatings without degradation or discoloration. Spot recoating is a simple matter and special kits are available for field repairs.

Request Bulletin C-110 for complete information and inquire about low cost evaluation kits. Conap, Inc., Allegany, N. Y. 14706.



Epoxies and urethanes for potting, encapsulating, insulating, bonding, sealing, and coating

INFORMATION RETRIEVAL NUMBER 80

TEST EQUIPMENT

Versatile electrometer is stable to 20 μ V a day

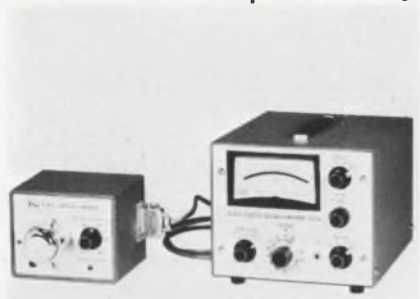

Keithley Instruments, Inc., 28775 Aurora Road, Cleveland, Ohio. Phone: (216) 248-0400. Price: \$1875.

A vibrator capacitor electrometer that can measure voltage, current and charges, is stable to 20 μ V per day. The unit permits long-term measurements and recording of luminescence, mass peaks, Hall potentials, hydrogen ion concentrations in chemical solutions, and many other chemical and electrical phenomena.

As a voltmeter, the Model 640 has an accuracy of $\pm 1\%$ over a range of 30 μ V to 30 V, with selectable input impedance to $10^{16}\Omega$. Its sensitivity enables it to measure potentials as low as 1 μ V. In addition to drift of less than 20 μ V per day, the unit's rise time is 10 ms with an accuracy of 1%.

As an ammeter, the Model 640's range is 10^{-17} A (using a built-in $\pm .25\%$, 20-pF capacitor for rate-of-charge method). The resistors include 10^6 , 10^8 , 10^{10} and $10^{12}\Omega$.

As a coulombmeter/current integrator, the instrument offers a measurement range of 6×10^{-16} to 6×10^{-10} coulombs, with an accuracy of 20 pF $\pm 0.25\%$.

When used as an amplifier, the unit has a variable gain range of 0.033 to 3.3×10^4 , with an output of ± 1 V, 1 mA. It can also be operated as a unity-gain instrument. Built-in, rechargeable batteries supply emergency power and are then returned to full charge by a built-in device upon restoration of line power.

Other built-in features include (4-resistor input switching; selectable voltage, current and integrate modes) as well as choice of grounded or floating input and a universal input connector with a uhf adapter.

CIRCLE NO. 290

Resistance amplifier has dual outputs



Motorola Instrumentation and Control, Inc., P.O. Box 5409, Phoenix, Ariz. Phone: (602) 959-1000.

This dual-output resistance amplifier will operate with any type of variable resistance device. It is particularly suitable for platinum resistance elements as a temperature sensor to produce voltage and current signals. The solid-state unit meets requirements of narrow and broad spans (5 to 600 Ω) for single-point or differential temperature applications.

CIRCLE NO. 291

Transistor tester is air-operated

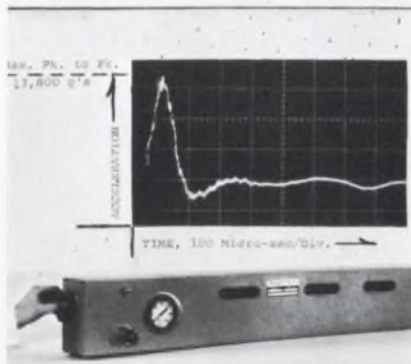

Mechanization Associates, 2622 Frontage Road, Mountain View, Calif. Phone: (415) 967-4262. P&A \$325; stock.

A transistor, integrated circuit or other device in a standard TO-5 or TO-18 header is inserted into the venturi section of a long tube. Acceleration down the tube is determined by air pressure. By varying the pressure and the striker-plate mass and resilience, the device can be made to undergo various peak shock loadings or durations.

CIRCLE NO. 292

Sequential tester accepts 10 conductors



Associated Research, Inc., 3777 W. Belmont Ave., Chicago. Phone: (312) 267-4040. P&A: \$1975; 90 days.

A test set permits timed automatic sequential testing of cables, plugs and other components that have up to 10 conductors. The unit has a test output of 0 to 4000 V ac and an adjustable capacity from 0.3 to 3 mA. The output terminates in 10 high-voltage banana jacks and one ground jack on the rear of the unit.

CIRCLE NO. 293

Oscilloscope camera uses 35-mm film

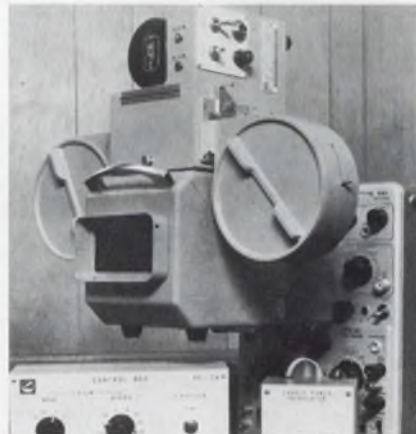

Lehigh Valley Electronics, Inc., Box 125, Fogelsville, Penn. Phone: (215) 285-4211. Price: \$1440.

This camera is designed for mounting directly on the face of an oscilloscope. A built-in reflex lens system permits simultaneous waveform-viewing and photography. Sixteen separate drive speeds are provided. It will store 200 feet of 35-mm film (with or without drive holes) or oscillographic paper. The system also offers a remote control.

CIRCLE NO. 294

Two Ballantine Voltmeters for Laboratory, Production, and Q.C. Needs

Ballantine solid state, wide-band voltmeters, one average-responding and one true-rms responding, feature exceptionally wide frequency ranges, high accuracy over entire 5-inch log scales, and operation from built-in rechargeable battery or line



BALLANTINE VOLTMETER

2 Hz to 6 MHz

Battery or line-powered --
1% accuracy at midband

MODEL 303

- Voltage range 300 μ V to 330 V (models with 20 dB probe, 1 mV to 1000 V) ● 1% accuracy, 30 Hz to 1 MHz
- Logarithmic indicator for uniform accuracy over entire 5 inch scale ● Average responding ● Built-in rechargeable battery (models for line only) ● Isolated signal ground ● 40 dB amplifier, 2 Hz to 6 MHz ● PRICES: Model 303 (Battery/line/no probe) \$360; Model 303-01 (line only/no probe) \$305; Model 303-50 (Battery/line/with probe) \$410; Model 303-51 (line only/with probe) \$355.

BALLANTINE TRUE RMS VOLTMETER

10 Hz to 20 MHz

Battery or line-powered

MODEL 323

- Voltage range 300 μ V — 330 V (as null detector to 70 μ V) ● 2% accuracy 50 Hz to 10 MHz ● Logarithmic indicator for uniform accuracy over entire 5 inch scale ● True-RMS responding ● Built-in rechargeable battery (optional model for line only) ● Isolated signal ground ● DC output of 0.1 - 1.0 V for each 10 dB range for application to recorder or DVM where output is proportional to mean square of input ac voltage. ● PRICES: Model 323 (Battery/line) \$560; Model 323-01 (line only) \$505.



Write for brochures giving complete details



BALLANTINE LABORATORIES INC.

Boonton, New Jersey

CHECK WITH BALLANTINE FIRST FOR DC AND AC ELECTRONIC VOLTMETERS/AMMETERS/OHM METERS, REGARDLESS OF YOUR REQUIREMENTS. WE HAVE A LARGE LINE, WITH ADDITIONS EACH YEAR. ALSO AC/DC LINEAR CONVERTERS, AC/DC CALIBRATORS, WIDE BAND AMPLIFIERS, DIRECT-READING CAPACITANCE METERS, AND A LINE OF LABORATORY VOLTAGE STANDARDS FOR 0 TO 1,000 MHZ.

INFORMATION RETRIEVAL NUMBER 81

BRANSON

DPDT 1/6 SIZE

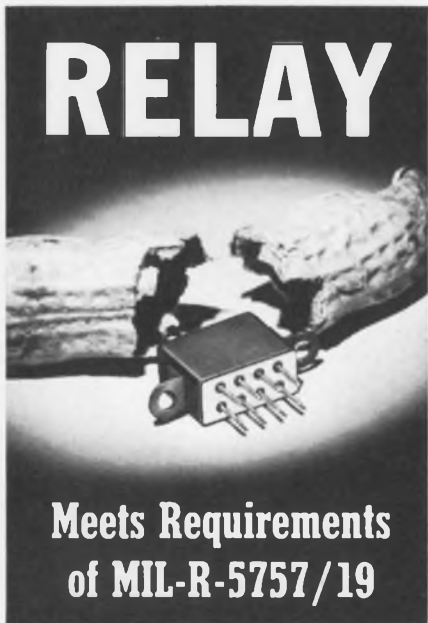

**Meets Requirements
of MIL-R-5757/19**

NEW FROM BRANSON

This small 1/6 crystal can size DPDT relay, Type JR, handles low level up to 1 full ampere . . . withstands high shock and vibration . . . meets MIL-R-5757/19. Coil and header styles available to meet all applications!

OTHER BRANSON PRODUCTS



TIME DELAY
RELAYS



SOLID STATE
TIME DELAY RELAY



6 POLE CRYSTAL
CAN RELAY



4PDT HALF CRYSTAL
CAN RELAYS

*Relays...
Our Only Business*

BRANSON CORP.

VANDERHOOF AVENUE
DENVER, NEW JERSEY
(201) 625-0600

INFORMATION RETRIEVAL NUMBER 82

TEST EQUIPMENT

Vhf sweep generator tracks automatically



Telonic Instruments, 60 N. First Ave., Beech Grove, Ind. Phone: (317) 787-3231.

For production testing and aligning vhf tuners and receivers, this 5-to-250 MHz sweep generator automatically tracks variations in test frequency. The model 1011 employs a voltage-variable capacitor in the swept-signal source. It supplies 0.5 V rms into 75 Ω with linearity of 1:1.5. Sweep width is variable from 5 to 30 MHz over the entire 5-to-250-MHz tuning range.

CIRCLE NO. 295

Integrated amplifier reaches 10 V pk-pk

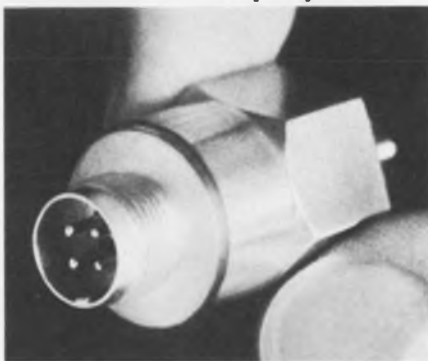

Gulton Industries, Inc., 212 Durham Ave., Metuchen, N.J. Phone: (201) 548-2800.

With an output of 10 V pk-pk, a series of subminiature composite accelerometer-amplifiers for flight-test and test-stand applications are unsusceptible to rf pick-up. Sensitivity is 30 mV/g over the frequency range from 5 Hz to 10 kHz in the basic model. The instruments withstand vibration of 200 g peak and shock to 1000 g for 1 ms half-sine in temperatures from -100° to $+250^{\circ}$ F.

CIRCLE NO. 296

Stereo microscopes span 10 to 200 power



William J. Hacker & Co., Inc., P.O. Box 646, W. Caldwell, N.J. Phone: (201) 226-8450.

Stereo microscopes are for inspection of all opaque and translucent materials in reflected light. They can be equipped for magnifications from $\times 10$ to $\times 200$ to provide free working distances ranging to 100 mm. The inclined observation tubes are rotatable through 360° . They can be supplied with mains-type or a low-voltage lamp.

CIRCLE NO. 297

Integrating device handles ± 100 mV



Curtis Instruments, Inc. 200 Kisco Ave., Mount Kisco, N.Y. Phone: (914) 666-2971. Price: \$395.

This integrator integrates both positive and negative input signals to 100 mV with output in the form of an electrical analog of the integral. The model 922 has infinite memory, permanently storing the last recorded integral until reset. Output is displayed on a 4-1/2-in. taut-band meter. It may also be connected to a recorder.

CIRCLE NO. 298



Now you can really afford to put solid tantalum quality and reliability into tv's, hi-fi sets, organs, computers, communications equipment...

Dipatan is Here!

Solid-electrolyte tantalum capacitors priced within reach of numerous quality production items. What's more, Dipatan features the new square design with greatly strengthened leads guaranteed to withstand 3 pounds of pull. All this means you can finally build solid tantalum ruggedness, performance and space-saving compactness into scores of mass-produced sound systems, instruments, business machines and communications equipment. Epoxy dip-coated Dipatan is offered in five sizes. All are of radial lead construction. All are rated for operation between -55°C and $+85^{\circ}\text{C}$ at full-rated voltages ranging from 6 VDC to 50 VDC. Capacities from .15 to 250 mfd. Dipatan—a product of Components, Inc., your highest assurance of fair pricing, prompt delivery and superior reliability in electronic components. For additional information and literature, contact the nearest dealer or write: 3536 W. Osborn Road, Phoenix, Arizona 85017. Phone 602-272-1341.



COMPONENTS, INC.
ARIZONA DIVISION

Save space, time and money with RIB-LOC™ insulated terminals

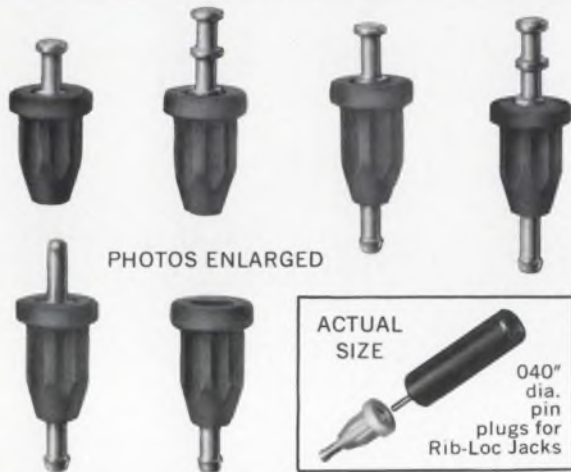

New stand-offs, feed-thrus, tip jacks and plugs press in, provide secure mounting

Johnson RIB-LOC polyamide insulated components make it possible for your commercial equipment designs to reflect size reductions formerly limited to military equipment because of cost. The RIB-LOC line offers advantages over TFE insulated types at a substantially lower price. Though lower in cost, RIB-LOCs provide considerably better retention than most widely used TFE insulated types.

RIB-LOC components include single turret stand-off, double turret stand-off, single turret feed-thru, double turret feed-thru, .040" tip plug, and tip jack for .040" plug. All press into .136" dia. panel holes.

Terminals are brass, silver-plated and Iridited for good solderability. Available in six colors to Federal Standard 595: white, red, black, green, yellow and blue. Pullout force 21 lbs.; turning torque 18 oz. in.; capacitance (.050" panel at 1 MHz) 1.00 pf.; flash-over voltage 5300 DC; max. temp. 250° F.; leakage current (at 3500 VDC) only .01 ua.

FREE CATALOG includes detailed specs and prices on these and other high quality E. F. Johnson components. See your E. F. Johnson representative or write for your copy today.



E. F. JOHNSON COMPANY

3351 Tenth Ave. S.W., Waseca, Minn. 56093

Providing nearly a half-century of communications leadership

INFORMATION RETRIEVAL NUMBER 84

TEST EQUIPMENT

Lamp power supply operates 75-W arcs

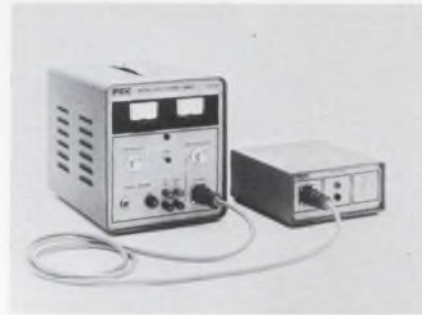

Pek, Inc., 825 E. Evelyn Ave., Sunnyvale, Calif. Phone: (408) 245-4111. P&A: \$1350; 4 wks.

A modulated power supply is designed to operate 3-electrode 75-W xenon arc lamps for laboratory use and light study applications. Identified as model 402A, the unit provides lamp starting pulse and boost voltage for starting. Adjustable modulation depth offers 90% or better current modulation. Frequency response is 5 Hz to 30 kHz. Average output current is 6 A.

CIRCLE NO. 299

Angle readout accurate to 0.01°



Astrosystems, Inc., 6 Nevada Dr., New Hyde Park, N.Y. Phone: (516) 328-1600.

A readout accuracy of 0.01° and slew speeds up to 25,000°/s are features of this digital angle readout. Not more than 0.01° error is guaranteed with 20% voltage and frequency variations. The new unit is designed to function as a precise angle converter for synchro resolver inputs. A visual readout displays the input angle on an in-line 5-decade decimal display.

CIRCLE NO. 321

Thank you friend, whoever you are.

Out there among all you engineers, we have a friend. And we have a statistic to prove it!

About a year ago one of those magazine polls asked whom you would think of when buying relays and timing devices. You guys wrote down the names of all those giants.

Except our friend. He remembered us.



And he wrote down our name just as plain as can be, "MIDTEX/AEMCO."

That may not sound like much to you, but we sure did appreciate it. It's one thing to get only one mention, but to be shut out completely would have been terrible.

In fact, we so appreciate it that if we could find our faithful friend, we'd invite

him right down here to Mankato. We'd set aside our relays and timers and our new mercury wetted relays, and go out and kick up our heels a little bit. He'd enjoy it too, because our customers like RCA, General Dynamics and Westinghouse tell us Mankato really is Fun City U.S.A.

Come to think of it, we'll make the same offer to you. Next time somebody says, "Who can solve our relay problems," just blurt out "MIDTEX/AEMCO," and you're on your way to Mankato.

Fun fun fun.

But remember, when somebody says "relays" or "timers" you have to shout "MIDTEX/AEMCO!" just as quick as a wink.

Start training yourself now and we'll get ready for you here in Mankato.

By the way, if you plan to come down on the weekend, we'd appreciate hearing from you ahead of time. The movie show gets pretty crowded on a Saturday night you know!



AEMCO DIVISION
10 STATE STREET
MANKATO, MINNESOTA 56001

PROGRAMMERS/TIME DELAY RELAYS/MINIATURE COAXIAL RELAYS/INDUSTRIAL RELAYS/MERCURY-WETTED CONTACT RELAYS

INFORMATION RETRIEVAL NUMBER 85

New from NITINE

NITINE EPOXY SINGLE COMPONENT

for Potting-
Sealing-
Encapsulating

Mineral oxide filled thermosetting epoxy resin plastics for potting, sealing and encapsulating electronic components.

- Single component epoxy systems, ready for use. No mixing or blending.
- Low viscosity assures necessary wetting and impregnation.
- Cure temperature less than 100°C.
- Excellent resistance to chemicals, solvents, moisture and heat.
- Excellent adhesion — low shrinkage on curing.
- Pot life over 48 hours at room temperature.
- Frozen material can be held in stock for weeks with complete physical stability.

Write today for complete Product Information and grade specifications.



NITINE, INC.

45 So. Jefferson Road,
Whippany, N. J. 07981
Telephone (201) 887-6000

Edison, N. J. ■ Anaheim, Calif.
Scottsdale, Ariz. ■ Shannon, Ireland

INFORMATION RETRIEVAL NUMBER 86

PRODUCTION EQUIPMENT

Ultrasonic tool shapes ceramics

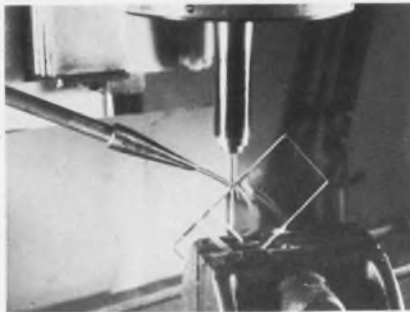

Branson Sonic Power Co., 50 Miry Brook Road, Danbury, Conn. Phone: (203) 744-0760. P&A: \$7000 (depending on options); 8 to 10 wks.

A rotary ultrasonic machine tool combines the advantages of a high-speed rotary cutting tool and a reciprocating ultrasonic tool. This machine technique can be used for drilling, internal and external grinding, end milling, internal and external thread-forming and for trepanning of hard, brittle, materials such as high-alumina ceramics, technical ceramics, ferrites, porcelain, glass and boron tungsten laminates. The simultaneous rotation and ultrasonic vibration of the diamond abrasive cutting tool reduces friction between the tool and the work piece, making for fast cutting and extending tool life. This technique, using lower tool pressure, also permits the machining of delicate components without cracking and with minimum shelling at the point of entry. Deep holes can be drilled to close tolerances at relatively high speeds without taper, since no abrasive slurry is required.



Ultrasonic tool can cut and ream ceramics into intricate shapes.

CIRCLE NO. 322

Mask aligner holds 0.1- μ m plot



Micro Tech Mfg., Inc., 703 Plantation St., Worcester, Mass. Phone: (617) 755-5215.

A mask-to-wafer aligning machine with an x - y axis positioning capability of 0.1 μ m has an angular positioning capability of 0.000025 rad. The x - y positioning range of the model 2025L exceeds 0.75 in. and the angular positioning range is 15°. The mask can also be optically positioned to 1 μ m. It accepts masks from 2 in.² to 4 × 5 in. The ultraviolet light source is close to the work area for maximum intensity.

CIRCLE NO. 323

Axial-lead components inserted together



Universal Instruments Corp., E. Frederick St., Binghamton, N.Y. Phone: (607) 772-1710.

A dual-head numerically controlled machine automatically inserts axial-lead components into two printed-circuit boards simultaneously. The machine feeds and inserts reel-packaged components that can be all the same part or unlimited programmed sequences of components of varying size and value. Intended for high-volume assembly operations, the model 6022 enables a single operator to insert up to 8000 components an hour.

CIRCLE NO. 324

If you don't have one... let's hope you never need it

Valuable taped data can be erased or partially destroyed by unexpected exposure to magnetic fields... generated by electrical equipment, electronic gear, air transport instrumentation, electrical storms, etc. Such loss is costly and inconvenient. The data may even be irreplaceable.

Avoid these hazards

Use NETIC Tape Preservers

for storing and transporting your valuable tape data. They provide ideal insurance against such potential hazards. Available in numerous sizes and shapes to fit your needs.

Delivery from stock. Request catalog No. TP-1

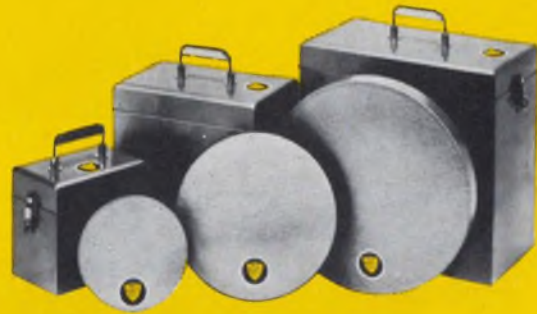

MAGNETIC SHIELD DIVISION

Perfection Mica Company

1322 N. ELSTON AVENUE • CHICAGO, ILLINOIS 60622

Phone 312. EV 4-2122 • TWX 910 221-0105

INFORMATION RETRIEVAL NUMBER 87

EASTMAN 910® Adhesive.... reduces assembly time of airborne data system.

Encoder assemblies for digital recording systems manufactured by Lockheed Aircraft Company, Ontario, California are assembled with EASTMAN 910 Adhesive at a significant time saving. The completed system supplies data on in-flight engine performance and other important functions.



One half of a ferrite "E" core transformer is bonded to a glass epoxy board with one drop of EASTMAN 910 Adhesive. Coding wires are installed around the core. The second half of an "E" core is bonded to the first with two droplets of the adhesive. Bonding procedures take from 10-15 seconds.

EASTMAN 910 Adhesive will form bonds with almost any kind of material without heat, solvent evaporation, catalysts, or more than contact pressure. Try it on your *toughest* bonding jobs.

For technical data and additional information, write to Chemicals Division, Eastman Chemical Products, Inc., Kingsport, Tennessee. EASTMAN 910 Adhesive is distributed by Armstrong Cork Company, Industry Products Division, Lancaster, Pa.

Here are some of the bonds that can be made with EASTMAN 910 Adhesive

Among the stronger: *steel, aluminum, brass, copper, vinyls, phenolics, cellulose, polyesters, polyurethanes, nylon; butyl, nitrile, SBR, natural rubber, most types of neoprene; most woods.*
Among the weaker: *polystyrene, polyethylene (shear strengths up to 150 lb./sq. in.).*

INFORMATION RETRIEVAL NUMBER 88



There is no
adhesive
like
**EASTMAN
910®
Adhesive**

SETS FAST—Makes firm bonds in seconds to minutes.
VERSATILE—Joins virtually any combination of materials.
HIGH STRENGTH—Up to 5000 lb./in.² depending on the materials being bonded.
READY TO USE—No catalyst or mixing necessary.
CURES AT ROOM TEMPERATURE—No heat required to initiate or accelerate setting.
CONTACT PRESSURE SUFFICIENT.
LOW SHRINKAGE—Virtually no shrinkage on setting as neither solvent nor heat is used.
GOES FAR—One-pound package contains about 30,000 one-drop applications. (Or in more specific terms, approximately 20 fast setting one-drop applications for a nickel.)

The use of EASTMAN 910 Adhesive is not suggested at temperatures continuously above 175°F., or in the presence of extreme moisture for prolonged periods.

See Sweet's 1968 Product Design File FAS-5/En.

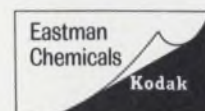

Batch-type sputtering aids thin-film process



Consolidated Vacuum Corp., 1775 Mt. Read Blvd., Rochester, N.Y. Phone: (716) 458-2550.

This Plasma-Vac batch-sputtering system is used for depositing thin-films in pilot-production quantities. It will handle up to sixty-four 1-1/4-in. wafers per run with thickness variations of only 2% from substrate to substrate. The drive mechanism of the fixture rotates the work pieces over the target in either direction. Rotation speed is adjustable.

CIRCLE NO. 325

Sputtering sources are 99.9% pure



Aremco Products, Inc., P.O. Box 145, Briarcliff Manor, N.Y. Phone: (914) 762-0685.

Hot-pressed rf sputtering for thin-film deposition sources in over 77 different materials are 99.9% pure. Materials available include oxides, silicides, sulfides, borides, carbides, fluorides, nitrides and metals, hot-pressed from high-purity powders to form uniform, dense, mechanically strong targets 3-, 4-, and 5-in. in dia and 1/4 in. thick.

CIRCLE NO. 326

Production centrifuge generates 40,000 g



Trio Tech, Inc., 2435 North Naomi St., Burbank, Calif. Phone: (213) 846-9200.

Centrifugal accelerator is designed for production-testing of semiconductors and integrated circuits. It will safely test ICs and TO cases to 40,000 g at the rate of 3800 pieces per hour. It is equipped with seven different protective circuits for complete safety. Standard and special rotors and block are available for a variety of testing applications.

CIRCLE NO. 327

SPRING BUYERS DESIGN ENGINEERS MAINTENANCE ENGINEERS

FREE

Our new Catalog has over 2500 spring designs. **IMMEDIATE DELIVERY** Compression — Extension — Torsion. Complete engineering data on each spring. All orders received by 2 pm EST will be shipped same day.

OVER 2500 STOCK SPRINGS with complete Engineering data on each spring.

LEE SPRING COMPANY
DIVISION OF LEETRONICS, INC.
30 MAIN STREET, BROOKLYN, N.Y. 11201 212-855-7163 TWX 212-643-9349
50 YEARS OF EXPERIENCE

INFORMATION RETRIEVAL NUMBER 89

GET THIS HANDBOOK/CATALOG



Dispensing Machines for Epoxy, Silicone, Urethane

Descriptions, Specifications, Data, Uses, Prices . . . Write Today

HARDMAN INCORPORATED

600 CORTLANDT STREET, BELLEVILLE, NEW JERSEY 07109 (201) 751-3000

INFORMATION RETRIEVAL NUMBER 90

ELECTRONIC DESIGN 3, February 1, 1968

announcing

... **JFD**

compactuner compactuner

compactuner



JFD is pleased to announce a new line of miniaturized Long Life Modular Tuners, for both straight line capacitance and straight line frequency applications.

JFD has always featured a line of specially designed and built tuners to meet custom applications. Now available is a standardized tuner designed with all the versatility of the custom built units. This is made possible by two new mechanical packages that allow up to eight independent capacitor elements to be tuned simultaneously. This standardization results in a high quality, precision tuner at moderate cost.

Two basic models are available both featuring ten full turns of adjustment for precise tuning and excellent resolution. One model will accommodate up to four cylinders; the other from five to eight cylinders. These cylinders are available in a wide choice of dielectric materials and metalized patterns allowing almost unlimited design freedom. They can all be made as straight line capacitance, straight line frequency, special function, split stator, differentials, etc. or any combination can be specified on a single tuner.

The use of solid dielectrics with their inherent stability and high voltage ratings allow tuners to be built in smaller sizes than have even been achieved before. Wide capacitance ranges or frequency ratios can be achieved in packages that will withstand the severe environmental conditions that today's equipment requires.

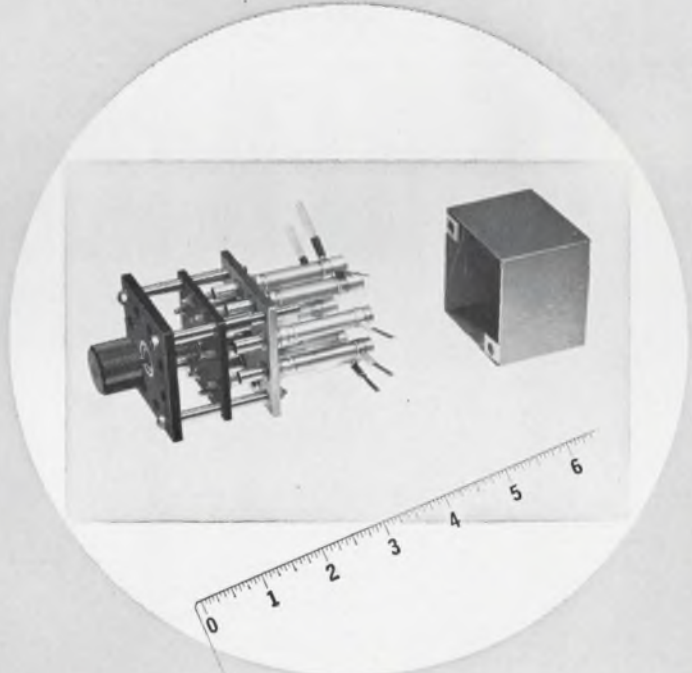

For additional information, write for catalog LLT-68.

"TODAY'S COMPONENTS BUILT FOR TOMORROW'S CHALLENGES"

JFD

JFD ELECTRONICS CO. / COMPONENTS DIVISION / 15th Avenue at 62nd Street / Brooklyn, New York 11219 / Phone 212-331-1000
Offices and subsidiaries in principal cities, world-wide.

INFORMATION RETRIEVAL NUMBER 91

SMALL BARGAIN!

**BARNES LOW-PROFILE
DIP SOCKETS...
SMALL SIZE!
SMALL PRICE!**



Wish you could squeeze more dual-in-lines onto a P.C. board—for production mounting or breadboarding? Try the low-cost, low-profile Barnes Series 041 DIP sockets. Designed for easy device insertion, yet excellent lead retention, the sockets are only a little larger than the device itself . . . and fit on the same centers. The low body height (only .135") gives you greater packing density between boards. Write or call for more data, and ask for a free sample.



Lansdowne, Pa. 19050 • 215/MA2-1525

barnes / THE FIRST WORD IN CARRIERS, CONTACTORS AND SOCKETS FOR I.C.'S

INFORMATION RETRIEVAL NUMBER 92

SEALED / POWER MODULES

**NUCOR NPS
POWER MODULES** are sealed to provide absolute assurance from dust, humidity, salt spray—uniquely designed, they will operate under the severe military environment of MIL-E-16400, MIL-E-5400, MIL-T-21200, MIL-E-4158.

- **TEMPERATURE TO 100° C**
No Derating
- **MTBF 100,000 HOURS**
Mean Time Between Failure
- **RIPPLE 250 μV RMS**
Typical
- **REGULATION 4 mV**



NUCOR POWER SUPPLIES ARE
DIRECT RETROFITS IN
YOUR EQUIPMENT.

485 standard models available



Write today to
NUCLEAR CORPORATION OF AMERICA
2 RICHWOOD PLACE, DENVILLE, NEW JERSEY 07834

INFORMATION RETRIEVAL NUMBER 93

PRODUCTION EQUIPMENT

**Mask to substrate with
0.0005-in. accuracy**

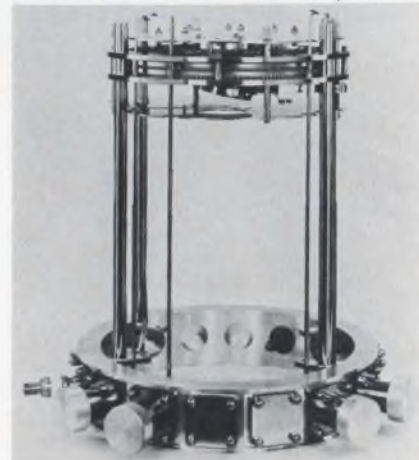

*Allen Jones/Vacuum Technology,
17171 S. Western Ave., Gardena,
Calif. Phone: (213) 327-0710.*

Microcircuit - mask - to - substrate registration accuracies are within 0.0005 in. with this mask changer. It is ready for installation in any standard 18-in.-dia-by-30-in. bell jar system and accommodates six substrates up to 2-1/4 in. square and six conventional masks. Masks and substrates are independently mounted in separate holders that are removable from an edge-driven carrier.

CIRCLE NO. 328

**High-vacuum system
encapsulates in epoxy**

*Red Point Corp., 105 W. Spazier
Ave., Burbank, Calif. Phone: (213)
849-1057.*

High-vacuum encapsulation system carries out all phases of the encapsulating process, each independently of the other, and at different levels of vacuum and pressure. The system will heat, mix and deaerate resins, heat, dry and deaerate work pieces, and fill molds under high vacuum. Processed by these integrated techniques, components undergo complete outgassing. Many sizes of work pieces can be accommodated, each indexed so that it is centered under the filling head. A range of pressures is provided up to 100 lb/in². The unit handles two- or three-part epoxies, with or without abrasive fillers.

CIRCLE NO. 329

small



smaller



smallest



G.E.'s new wet slug tantalum capacitor gives you the performance of the CL64 in only 1/2 the case size

Get the highest volt-microfarad product per unit weight and volume of any capacitor you can buy with General Electric's new 69F900 wet slug tantalum capacitor. How? General Electric reduced the case size of the military type (CL64) wet slugs by 1/2 (it's even smaller when compared to solids). Electrical characteristics and performance remain essentially the same. G.E.'s new 69F900 answers the need for a commercial wet slug capacitor with the high volumetric efficiency demanded by modern high density applications.

G.E.'s new addition to its complete line of tantalum wet slug capacitors has excellent high capacitance retention at low temperatures and can be

RATING	CASE SIZE	VOLUME
50V, 30μf		
solid (CS12)	.341 x .750	100%
wet slug (CL64)	.281 x .681	58%
69F900	.145 x .600	15%
15V, 80μf		
solid (CS12)	.341 x .750	100%
wet slug (CL64)	.281 x .681	58%
69F900	.145 x .600	15%
6V, 180μf		
solid (CS12)	.279 x .650	100%
wet slug (CL64)	.281 x .641	100%
69F900	.145 x .600	25%

stored to -65°C . Its wide operating range is -55°C to $+85^{\circ}\text{C}$. And it meets the parameters of larger military wet slugs: vibration to 2000 Hz, 15g acceleration!

The new sub-miniature 69F900 capacitor is fully insulated and has a low, stable leakage current. Voltage ratings are available from 6-60 volts; capacitance ranges from 3.3-450 microfarads.

Choose from a complete line of G-E wet slug tantalum capacitors to fill your slim, trim circuit needs. Write for GEA-8369 for details about the 69F900 and the other capacitors in General Electric's complete wet slug tantalum line, or ask your G-E sales engineer. Capacitor Department, Irmo, South Carolina.

ELECTRONIC COMPONENTS DIVISION

GENERAL ELECTRIC

430-28A

INFORMATION RETRIEVAL NUMBER 94

PRODUCTION EQUIPMENT

Eddy-current tester sorts magnetic parts



Automation Industries, Inc., Shelter Rock Rd., Danbury, Conn. Phone: (203) 748-3581. Price: \$7250.

A multitest eddy-current instrument tests and sorts ferromagnetic parts under laboratory or production conditions. Parts can be checked for physical and metallurgical differences according to material composition, heat treatment, hardness, case depth and structure. The instrument is used where deep penetration is necessary.

CIRCLE NO. 330

Spray etcher handles 30-in. items

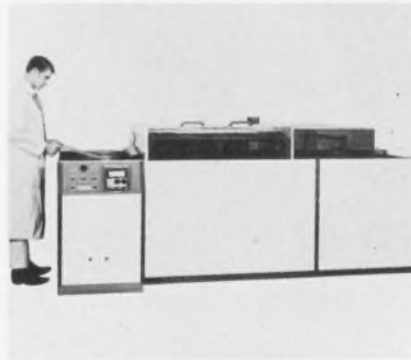

Pemco, Inc., 4930 W. 35th, St. Minneapolis, Minn. Phone: (612) 927-9905.

This etcher permits double-sided etching of material up to 30 in. wide. The workpiece is loaded on a conveyor at the front end of the machine and is automatically conveyed through etching chambers on O rings stretched between titanium drive shafts. Moving spray manifolds with fixed nozzles spraying straight down give complete acid-spray coverage.

CIRCLE NO. 331

Solder dip masks overcome 700°F

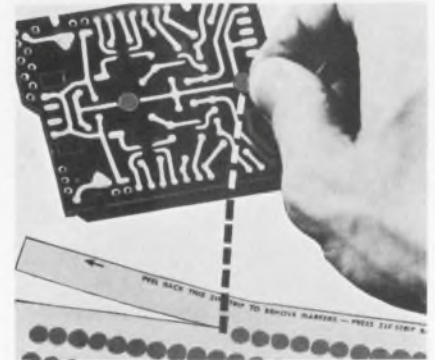

W. H. Brady Co., 727 W. Glendale Ave., Milwaukee. Phone: (414) 332-8100.

Self-sticking solder dip masks withstand up to 700°F. soldering temperatures for 6 s. Masks are precut circles 0.01 in. thick made of crepe-backed tape. They mask off index holes, component mounting holes and pad areas on printed-circuit boards during all types of soldering operation. They are available from 1/8 in. through 1 in. in dia and are mounted on cards.

CIRCLE NO. 332

**FREE BULLETINS
72 PERFORMANCE CURVES ON
DC MOTORS AND GEARHEADS.**

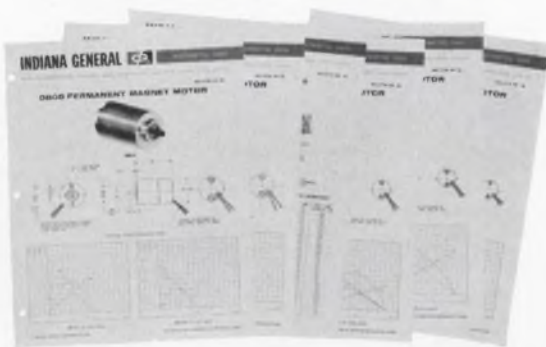

Indiana General has just released specifications on custom-designed DC motors at off-the-shelf prices. These precision motors are produced under a "Zero Defects" program, and assembled in a "clean room." Tolerances are often held to .0001".

They come in 8, 9, 13, and 15 frame sizes with delivery in 6 to 8 weeks instead of the normal 12.

For technical details, including performance curve data for each, plus information on gearheads, write: Mr. R. D. Wright, Manager of Sales, Indiana General Corporation, Electro-Mechanical Division, Oglesby, Illinois.

INDIANA GENERAL 

INFORMATION RETRIEVAL NUMBER 95

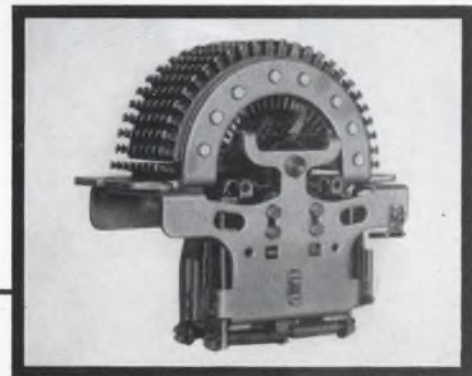

**2 WAY
Genalex Precision Stepping Switch**

for circuits which require a switch that steps positively, in either direction, around a bank of 25 contacts.

FEATURING:

- self-cycle or remote control operation
 - 65 steps per second on self-interruption
 - bridging or non-bridging wipers
 - 20 steps per second from external impulses
- Over 10,000,000 steps in each direction without replacement.**

for complete data on this and other unique GENALEX switches, write:



P.O. BOX 46, 151 MYSTIC AVE., MEDFORD, MASS. 02153
U.S. Agents for the General Electric Company, Ltd. of England

INFORMATION RETRIEVAL NUMBER 96

ELECTRONIC DESIGN 3, February 1, 1968

Analog Devices Announces the New Model 183 CHOPPERLESS Operational Amplifier

1.5uV/°C \$65
3uV/°C \$45
5uV/°C \$35



LOW DRIFT DIFFERENTIAL- CHOPPER-LIKE PERFORMANCE

- LOW CURRENT DRIFT
 .05nA/°C
- HIGH INPUT IMPEDANCE
 1000MΩ, CM
- LOW NOISE
 1μV p-p, dc to 1Hz
- LOW PROFILE
 .4" height

SPECIFICATIONS

Open Loop Gain	200,000 min.
Rated Output	±10V @ 5mA
Unity Gain Response	0.5MHz
Full Power Response	5kHz
Current Drift (Differential)	0.05nA/°C max.
CMRR (±10V)	100,000
Warm Up Drift	20μV (10 minutes)
Noise (dc to 1Hz)	1μV, peak to peak

Offset Voltage	Model J	Model K	Model L
@ 25°C, max.	3mV	.5mV	.5mV
vs. temp., max.	5μV/°C	3μV/°C	1.5μV/°C
Price (1-9)	\$35	\$45	\$65

HIGH INPUT IMPEDANCE

Unlike most chopper types, true differential input of 183 permits connection as non-inverting amplifier for input impedance of 1000MΩ. All other configurations are also possible with 183.

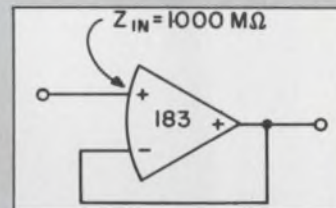

IMMUNITY FROM TEMPERATURE GRADIENTS

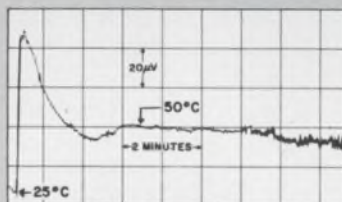

Thermal shock curve measures sensitivity to temperature gradients. Special components & design effect an order-of-magnitude improvement over most differential amplifiers previously available.

LOW NOISE

Most chopper amps exhibit high "flicker" (low frequency) noise, as well as spike noise at the chopping frequency. Chopperless 183 has only 1μV p-p (dc-1Hz). Spike noise is non-existent.

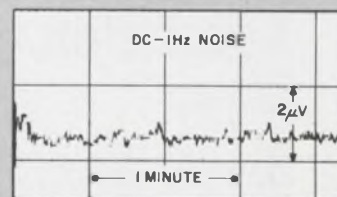

For complete specifications, application notes or evaluation samples write or phone collect to Mr. Bill Miller at Analog Devices, Inc. or contact your local representative.

ANALOG DEVICES INC. 221 FIFTH STREET, CAMBRIDGE, MASS. — 617/492-6000

One company designs and builds RF shielded enclosures with visual appeal as well as high DB attenuation.

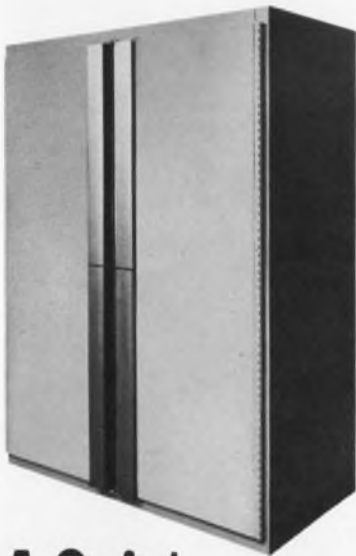

A Quiet Revolution from Electronic Enclosures Inc

225 South Aviation Boulevard
El Segundo, California 90245
(213) 679-0181

7825 Airport Highway
Pennsauken, New Jersey
(609) 665-6810

WRITE FOR COMPLETE INFORMATION

INFORMATION RETRIEVAL NUMBER 98

Dielectrically isolated op amp needs no compensation

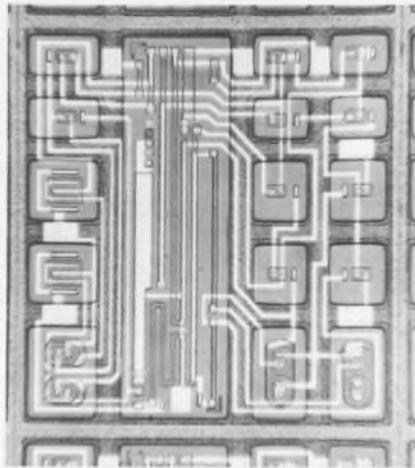

Radiation, Inc., P.O. Box 37, Melbourne, Fla. Phone: (305) 727-5412. P&A: RA-909 \$37.50; RA-2909 \$32; stock.

Requiring no external frequency compensation, these dielectrically isolated operational amplifiers incorporate vertical pnp and npn transistors in the same monolithic structure. The RA-909 comes in a TO-86 package and the RA-2909 comes in a TO-99 can. They permit pin-to-pin replacement of the industry's standard 709 and 101 operational amplifiers in the eight-lead TO-5 package and the TO-86 flat pack. Both have blank leads where the 709 and 101 require compensation. This allows them to be used as a replacement unit, even when compensation networks are already on the circuit board. The use of dielectric isolation makes possible the fabrication of pnp and npn transistors in a vertical arrangement, combining all elements within a single chip. It also isolates the device from stray capacitance that might come through the substrate. The frequency response of the device would be altered if this happened. Materials can also be diffused down from the top instead of having to make holes.

The dielectrically isolated monolithic amplifier contains six verti-

cal transistors and 13 other transistors, and a total of approximately 100 k Ω of resistance. The open-loop gain-frequency characteristic at +15 or -15-V supply has its 3-dB frequency at 250 Hz and the high-frequency portion falls at the 6-dB-per-octave rate to a unity gain value of 7 MHz without need of external compensation.

One RA-909 has a slew rate at unity gain of 5 V/ μ s. It provides an output voltage swing into a 2000- Ω load which is in excess of 85% of the applied voltage. In addition, it has a maximum equivalent input noise of 5 μ V compared with a typical range of 50 to 100 mV for competitive monolithic circuits. Nominal power dissipation for the RA-909 is only 52 mW. Its maximum dissipation is 75 mW at a supply voltage of ± 15 V—an improvement of better than 2 to 1 over the 709. Radiation says the improvement is accomplished without compromises in other performance parameters. The RA-909 will maintain its prime performance characteristics over a supply voltage range of ± 5 V to ± 25 V—a considerable improvement over standard pn-isolated amplifiers currently on the market.

Gain stability has long plagued monolithic linear circuits. Radiation's process technology now offers an amplifier with a nominal voltage gain variation of 15% over the full military temperature range of -55°C to +125°C. The RA-909 features a 40-ns rise time with only 15% overshoot at an output voltage of 200 mV into a 2000- Ω , 100-pF load when operating uncompensated in the worst-case unity-gain configuration. The new device joins an existing family of uncompensated operational amplifiers for broad-band (RA-239), high-gain (RA-240), and general-purpose (RA-238) applications.

CIRCLE NO. 336

Tech labs 2A* Tap Switch

YOU CAN'T BUY

- MORE PRECISION
- LOWER CONTACT RESISTANCE
- HIGHER CURRENT CARRYING CAPACITY
- LONGER LIFE



FOR THE PRICE

*Available in remote controlled versions, open or hermetically sealed. SEND FOR FREE CATALOG.

TECH LABORATORIES, INC.
Palisades Park, New Jersey

INFORMATION RETRIEVAL NUMBER 99

Audio Amplifier? AC Power Supply?

the Compact
NA Series
gives you
both!



The NA Series of AC Power Supplies are exceptionally flexible sources of audio power. Each power supply consists of a Regulated Audio Power Amplifier with interchangeable fixed or variable Plug-In Oscillators for a wide range of precision AC power

applications. The Amplifier has a full power range of 45-6,000 cycles. With the incorporation of a CML Plug-In Oscillator precise fixed or adjustable output frequencies are available anywhere within this range. For complete information, write today.

CML, Inc.



A subsidiary of Tenney Engineering, Inc.
350 Leland Avenue - Plainfield, New Jersey
(201) 754-5502 - 710-997-9529

INFORMATION RETRIEVAL NUMBER 100

ELECTRONIC DESIGN 3, February 1, 1968

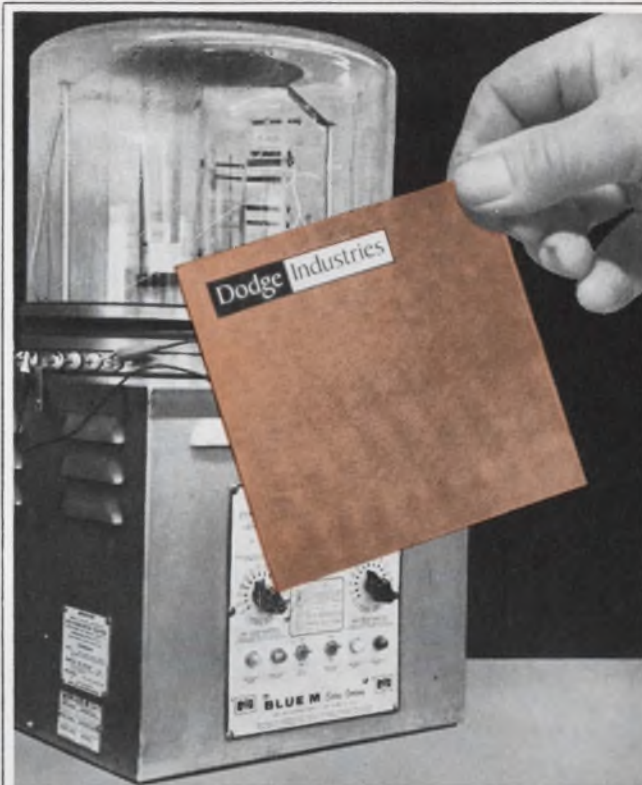

THIS PTFE-GLASS LAMINATE KEEPS PRINTED CIRCUITS IN FOCUS . . .

E. 601 Fluorglas® Copper Clad laminates have lowest moisture absorption of any laminate, extremely low coefficient of thermal expansion.

For high-performance circuits, where slight changes in physical dimensions can shift them out of focus, Dodge Industries E-601 PTFE-Glass Laminates (copper clad or unclad) provide a stable answer. Here's proof:

- Moisture Absorption — .07
- Coefficient of Thermal Expansion — $1.85 \times 10^{-5}/^{\circ}\text{C}$
- Temperature Range — -400F to 500F
- Arc Resistance — Will not carbonize
- Copper Peel Strength — 4#/in. @ 500F

Sound interesting? Why not contact us now for complete technical data. Dodge Industries specializes in PTFE and PTFE glass tapes and laminates. Chances are we have the answer for your high-performance printed circuit or insulating tape application. A call from you will bring a prompt reply. Just write to Dodge Industries, Hoosick Falls, New York 12090.

Dodge Industries

INFORMATION RETRIEVAL NUMBER 101

Voltage regulators produce 5 to 6 V



Beckman Instruments Inc., 2500 Harbor Blvd., Fullerton, California Phone: (714) 871-4848

Regulators are available with either standard fixed outputs of 5 or 6 V or with special outputs tailored to any voltage in the 3-to-9-V range. These hybrid thick-film devices have $\pm 0.1\%$ regulation, 0.5-A current-handling capability, 5-W power dissipation at $+25^\circ\text{C}$ with heat sink, and a maximum output voltage temperature of $\pm 0.02\%/^\circ\text{C}$ over the -55°C -to- $+125^\circ\text{C}$ operating temperature range.

CIRCLE NO. 337

Hybrid op-amp sustains 5-mA output

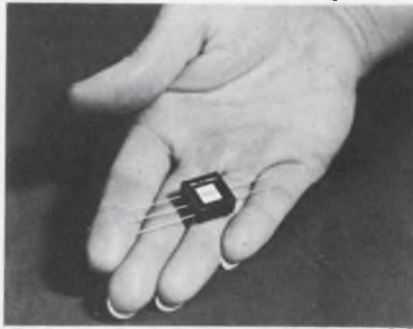

Bell & Howell Co., 700 Bostwick Ave., Bridgeport, Conn. Phone: (203) 368-6751. P&A: \$15 (1000 lots); 2 wks.

Hybrid op-amp has internal phase compensation, trimmed offsets, a 5-mA output capability and complete input and output protection. An offset of less than 1 mV and 150 nA combined with common-mode rejection of typically 100 dB at dc makes the unit useful in wide-band noninverting differential applications. The IC measures $0.6 \times 0.6 \times 0.25$ in.

CIRCLE NO. 338

MOS analog switch has six channels

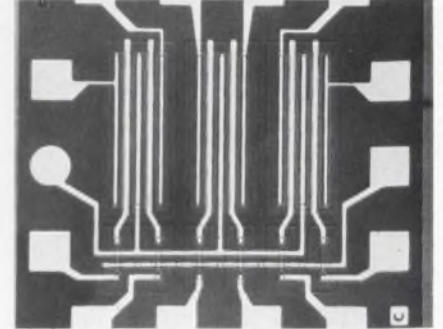

Fairchild Semiconductor, 313 Fairchild Dr., Mountain View, Calif. Phone: (415) 962-2530. P&A: \$40 stock.

This MOS 6-channel analog switch, the 3701, has a low on resistance. It is an enhancement-mode monolithic IC built by Planar technology. The device is characterized by low input and output leakage current, typically 10 pA and 100 pA respectively, and may be operated over a temperature range from -55° to $+85^\circ\text{C}$. It is available in a 14-lead pack.

CIRCLE NO. 339

When Only Excellent is Adequate TURN to Grayhill

for **TOTALLY ENCLOSED ROTARY SWITCHES. TEMPERATURE TO 125°C . MULTI-POLE. 30° , 36° , 45° , 60° , and 90° ANGLE OF THROW. 100,000 OPERATIONS.**

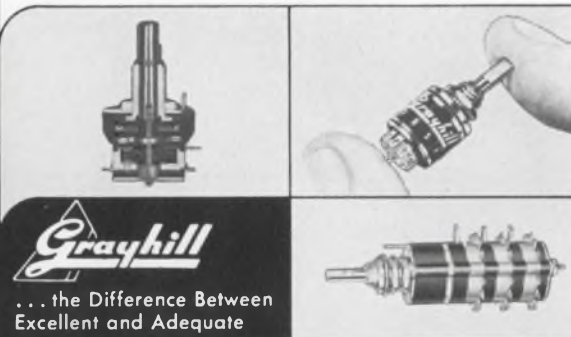

Grayhill

... the Difference Between Excellent and Adequate

Typical Specifications

- Explosion Proof
- Contact Resistance 10 Milliohms
- Make or Break $\frac{1}{4}$ Amp. to 15 Amps., 115 VAC Resistive
- 1 to 6 Poles per Deck
- 2 to 12 Positions per Pole
- 1 to 12 Decks

Send for Engineering Catalog G-304-A

Grayhill

565 Hillgrove Avenue
LaGrange, Illinois 60525
Area Code 312, Phone 354-1040

"PIONEERS IN MINIATURIZATION"

INFORMATION RETRIEVAL NUMBER 102

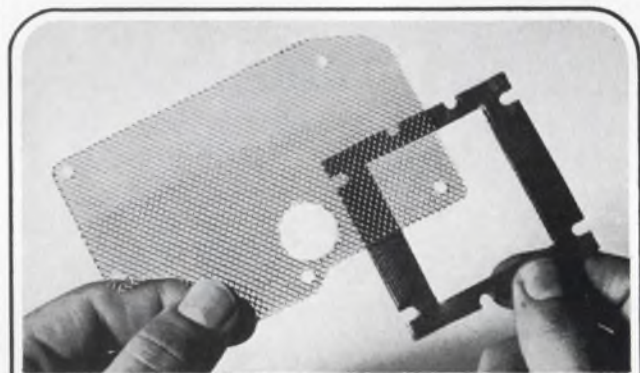

U.S. PATENT NUMBER 3,206,536

NEW TECKSPAN! FOR THIN EMI/RFI GASKETS

Shield and/or seal with over 200 contacts/square inch. Monel expanded metal, aluminum optional, both .031 and .020 in. thick, produced unfilled or filled with silicone rubber — TECKNIT's new Teckspan EMI/RFI gasketing. Produced in 4" or 8" rolls and available either as cut gaskets or in bulk. Write today for Information No. 113.

TECHNICAL WIRE PRODUCTS, INC.

TECKNIT

East Division • 129 Dermody St., Cranford, N.J. 07016 (201) 272-5500
West Division • 427 Olive St., Santa Barbara, Calif. 93101 (805) 963-1887

"SEE US IN THOMAS REG. AND EEM."

INFORMATION RETRIEVAL NUMBER 103

ELECTRONIC DESIGN 3, February 1, 1968

The Authority.

Free.

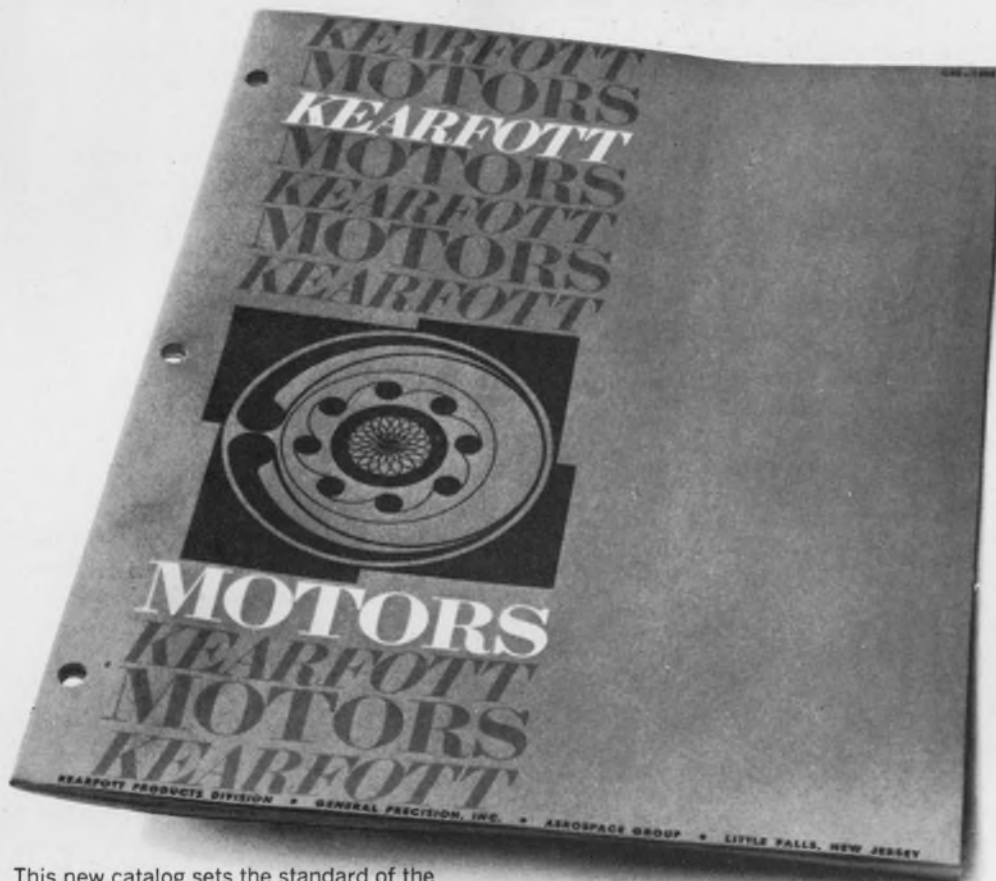

This new catalog sets the standard of the industry.

It thoroughly describes the finest motors you can buy. All types of Kearfott motors.

Open it and look at the listing. We offer stepper motors, drivers and logic. Synchronous motors. Viscous-damped, inertial-damped and braked servo motors in sizes 5 through 23. Special-purpose AC motors that meet some really way-out application needs.

Some of the designs we call standard others might call extraordinary.

Take our permanent magnet stepper motors. They're as much as 40% shorter than conventional units with no sacrifice in torque. Which means you can keep your designs small.

Our variable reluctance stepper motors are the shortest per unit torque

available. They require the least power for rated operation, and they're non-resonant without using external resistive or mechanical damping circuits.

Our standard hysteresis synchronous motors are the most stable for those applications where hunting and jittering can't be tolerated.

No other source offers such a complete variety of motors providing precision and reliability developed during 20 years of experience.

You'll find all the details in our comprehensive 32-page brochure. Pictures. Descriptions. Tables of characteristics. Dimensional drawings. Wiring schematics. Even a summary of design formulas.

Free. Write for it today. Kearfott Products Division, General Precision Systems Inc., Kearfott Group, 1150 McBride Ave., Little Falls, New Jersey 07424. Dept. 3-1450.

**GENERAL
PRECISION
SYSTEMS INC.**

KEARFOTT PRODUCTS DIVISION
A SUBSIDIARY OF GENERAL PRECISION EQUIPMENT CORPORATION

INFORMATION RETRIEVAL NUMBER 104

Delay Lines

MAGNETOSTRICTIVE
DELAY LINES

SOLID
DELAY LINES
(Glass or Quartz)

LC and DC
DELAY LINES

DISPERSIVE
DELAY LINES

DIGITAL
DELAY LINES

for proven
reliability in
Delay Lines and
Serial Memory Systems
for military and
commercial
applications, it's ...



MICROSONICS, INC.
60 Winter Street
Weymouth, Mass. 02188
Tel: 617 337-4200

A subsidiary of the Sangamo Electric Company

MATERIALS

Beryllium wire stronger than steel

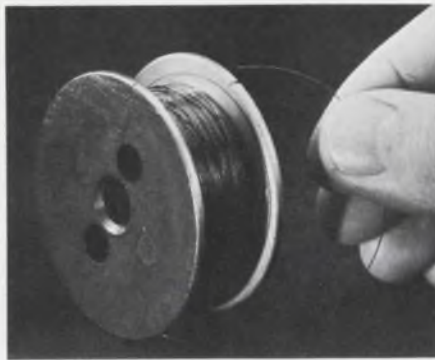

General Electric Co., 21800 Tungsten Rd., Cleveland, Ohio. Phone: (216) 266-2121. Price: \$70 to \$1000 (for 1000 ft.).

An unusual combination of light weight and stiffness is provided by beryllium wire. Beryllium has a modulus of elasticity of 42×10^6 lb/in.², substantially greater than steel although it weighs less than 1/4 as much. Electrical conductivity is a relatively high 40% of International Annealed Copper Standard.

CIRCLE NO. 340

Circuit boards molded of Cycloc

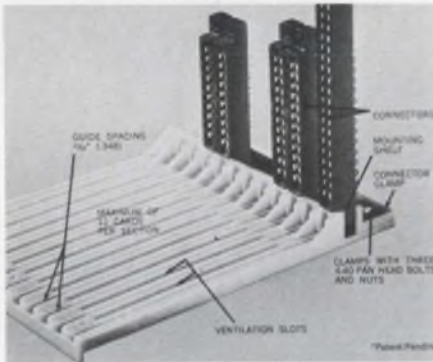

Buckeye Stamping Co., 555 Marion Rd., Columbus, Ohio. Phone: (614) 443-9458.

Circuit-board guides molded of Cycloc and incorporating 12 guides or tracks spaced 11/32 in. apart are offered in two sizes, for either 4-1/2-in.- or 6-in.-long circuit boards. Connectors are laid over alignment studs on the guide mounting shelf and held in place with a one-piece connector clamp. The clamp is secured with three 4-40 pan head nuts and bolts.

CIRCLE NO. 341

Alumina material makes IC packages



Glass Beads Co., P.O. Box 266, Latrobe, Pa. Phone: (412) 537-7791. P&A: \$50 (1000-piece sample); 3 wks.

Preforms made in Hybralex, a hybrid-alumina sealing material, are used for dual-in-line IC packages. The material has better thermal conductivity and mechanical strength than sealing glasses, and is much less expensive and easier to work with than high-alumina ceramic. The material can be sealed directly to Kovar lead frames.

CIRCLE NO. 342

Void-free diode chips plated with nickel

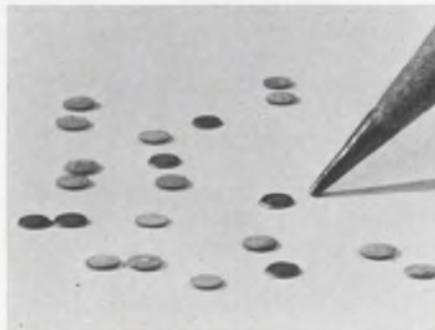

Solitron Devices, Inc., 256 Oak Tree Rd., Tappan, N.Y. Phone: (800) 431-1850.

A choice of contact metal is available on a series of void-free passivated diode chips. Excellent solderability of the chips is achieved by applying a primary plating of nickel, followed by a secondary plating of gold. The chips are also available with silver plating or they can be tin-dipped.

CIRCLE NO. 343

What makes the new monolithic "VEE CAL" 1.0 mfd Ceramic Capacitor so different?

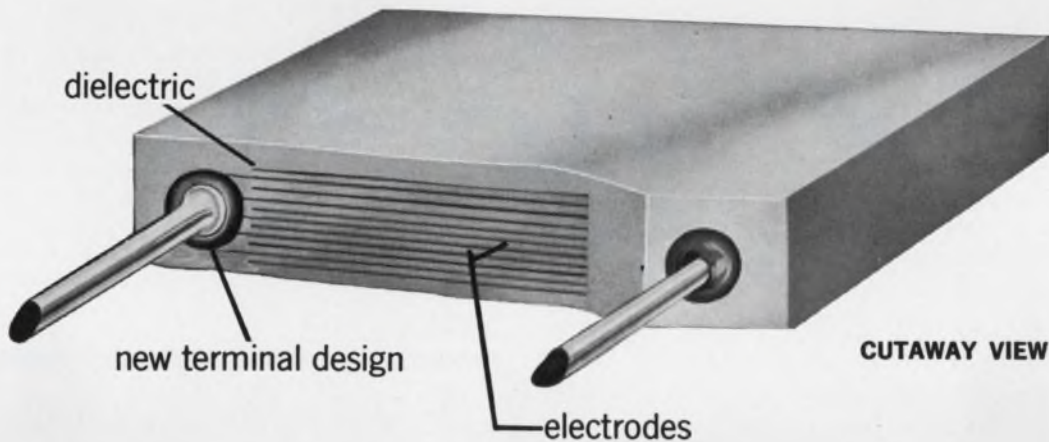

determination.

Our determination to build the **best** 1.0 mfd ceramic capacitor offered.

Best from build-up to termination.

Sure, the new "VEE CAL" has capacitance values from .12 mfd to 1.0 mfd in a compact CK06 size. Voltage ratings of 100, 50 and 25 vdc. A BX temperature characteristic.

But what makes the difference is our determination.

Our determination to increase the reliability of 1.0 mfd ceramic capacitors — by utilizing all available volume, permitting thicker dielectric layers.

Our technology has produced millions of other monolithic capacitors over the years. And now, our determination and proven technology have created the first truly monolithic 1.0 mfd ceramic capacitor — with a completely new termination.

For instant information, call Vitramon, Inc. (203) 268-6261, or write for Data Sheet C20.

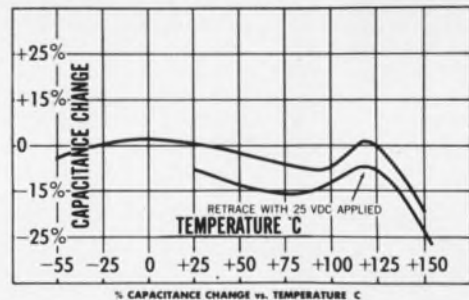

These reliable capacitors are readily available

Vitramon

VITRAMON, INCORPORATED
BOX 544
BRIDGEPORT, CONN. 06601

In Greater Europe Contact:
VITRAMON EUROPE
Wooburn Green, Bucks, England

INFORMATION RETRIEVAL NUMBER 106

Structural adhesive dries transparent



3M Co., St. Paul, Minn. Phone: (612) 733-1110.

Structural adhesive 2216 B/A clear amber is a nearly invisible two-component synthetic resin adhesive that provides strength with flexibility. The adhesive bonds rubber, wood and masonry products and most metals. The adhesive maintains high strength properties over a service temperature range of -67° to $+180^{\circ}$ F. Shear strengths of aluminum-to-aluminum assemblies are 3000 lb/in.².

CIRCLE NO. 344

Conductive silicone sticks to metal



Chomerics, Inc., 85 Mystic St., Arlington, Mass. Phone: (617) 648-8650.

A metal-filled form stable electrically conductive silicone for bonding silicone to metal and metal to metal has a dc volume resistivity of $0.01 \Omega \text{ cm}$ under a uniform load of 15 psi and a minimum tensile strength of 150 psi. The metal filler is a heat stable silver plated granular copper particle varying between 0.0005 and 0.004 in. CHO-Bond 3591-31 has a peel strength (MIL-C-4003) of 9 lb/in.

CIRCLE NO. 345

Standoff insulators withstand 500 V



Ceramics Intl. Corp., 39 Siding Pl., Mahwah, N.J. Phone: (201) 529-2800. Price: 35¢ up.

Eight variations of standoff insulator have lugs guaranteed not to break off and seals that will not break under any cantilever force applied to the arm. The insulators withstand a 500-V breakdown test. They are offered in two different sizes of hook standoffs, two different sizes of solid pins and four different sizes of flattened and pierced lugs.

CIRCLE NO. 346

TWO NEW PRODUCTS with EXCEPTIONAL MERIT from

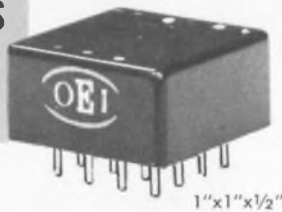

1"x1"x1/2"

UHF OPERATIONAL AMPLIFIER for VIDEO APPLICATIONS

Optical Electronics' Model 9186 produces closed loop Gain-Bandwidth products of 1 GHz. A slewing rate of 600 Volts/Microsecond and an Open Loop Gain of 60db minimum from DC-2 MHz allows full closed loop performance to 10 MHz. Attractively priced (\$95, 1-9) the 9186 is in stock for immediate delivery. The amplifier may be plugged into an OEI Model 11016 Socket (\$6) or soldered onto a printed circuit board. If FET inputs are required, ask for Model 9245 (\$115, 1-9), also in stock.

FOUR-QUADRANT ANALOG MULTIPLIER OFFERS TOP-LEVEL PERFORMANCE



3"x2 1/2"x2"

Optical Electronics' Model 5109 yields a true product of the two inputs to within $\pm 1\%$ of full scale (10 Volts). One input is differential making the 5109 ideal for watt-meter applications. Bandwidth is DC-10 MHz in all quadrants providing full performance to 1 MHz. Attractively priced (\$484, 1-9) and in stock for immediate delivery, the 5109 features solid state design for highest reliability. For lower cost applications, ask about Model 5122, in stock at \$115, 1-9.



All prices FOB Tucson, Arizona

Optical Electronics Inc.

P. O. Box 11140, Tucson, Arizona 85706, (602) 624-3605

INFORMATION RETRIEVAL NUMBER 107

Newest-McDONNELL Dual Action Flow Switch

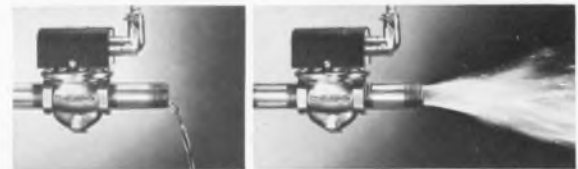

Actuated by a trickle . . . delivers a torrent . . .

Makes or breaks an electric circuit when flow in a pipe starts or stops

The McDonnell FS6 Series combine these unique capabilities: 1, actuation by flow rates as low as 0.12 gpm; 2, large volume flow-through capacity. Other features include:

- Easily adjustable for sensitivity to flow
- Available in 3/4" or 1" pipe size
- For pressures to 100 psi, temperatures to 225° F.
- Underwriters Listed

McDonnell Flow Switches can be used to start or stop alarms, signal lights, burners, motors, metering devices. Models available for pipe sizes 1/2" and larger, pressures to 1000 psi.

Write for complete information

McDONNELL & MILLER, Inc.
3500 N. Spaulding Ave., Chicago, Ill. 60618



INFORMATION RETRIEVAL NUMBER 108

New miniature PC Correeds

Here's the pee wee edition of our famous dry-reed switches. Same efficient magnetic shielding as their big brothers. Same soggy-proof bobbins—made of glass-reinforced nylon.

All this with a low, low silhouette (just 0.350 inch above mounting surface).

MPC Correeds measure as small as $1\frac{1}{32}$ by 1.350 inch. We located the terminals on 0.050 inch centers to match your board grids. You can stack them tightly in your racks—without magnetic interaction.



These space-saving little switches are perfect for high-speed applications. They're readily driven from transistors (their self-inductance is lower than their profiles). They give you an ideal interface between electronic and electromechanical circuitry.

Want some helpful new technical information? Just write to the Director, Electronic Control Equipment Sales, Automatic Electric, Northlake, Illinois 60164.

AUTOMATIC ELECTRIC

SUBSIDIARY OF GENERAL TELEPHONE & ELECTRONICS



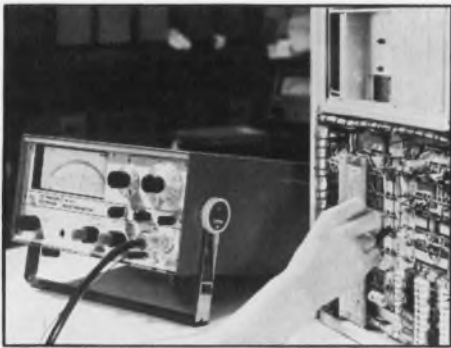

**EXTREMELY
HANDY,
TAKEDA'S
-TR-8651
ELECTROMETER
IS BOTH
ACCURATE AND
ECONOMICAL**



FEATURES:

-TR-8651 ELECTROMETER is conveniently used for:
 Measurements of ● Semiconductor resistivity ● Insulation ● Piezo-electric charge ● Photo-electric current
-TR-8651 ELECTROMETER measures:
 ● **Voltage** from 1 mV to 100 V f.s. (11 range) with $\pm 0.5\%$ accuracy ● **Charge** from 10^{-12} to 10^{-5} coulomb f.s. ● **Current** from 10^{-14} to 0.3 A f.s. ● **Resistance** from 100 to $10^{14} \Omega$ f.s.

SPECIFICATIONS:

RANGE:
 ● **Voltage:** 1, 3, 10, 30 mV, 0.1, 0.3, 1, 3, 10, 30 and 100 V f.s. ● **Charge:** 10^{-12} to 10^{-5} coulomb f.s. (1x and 3x overlapping ranges) ● **Current:** 10^{-14} to 0.3 A f.s. (1x and 3x overlapping ranges) ● **Resistance:** 10^2 to $10^{14} \Omega$ f.s. on linear 1x and 3x overlapping ranges.

For further details, write to:



**Takeda Riken
Industry Co., Ltd.**

285, Asahi-cho, Nerima-ku, Tokyo, Japan.
 Cables: TRITRONICS TOKYO Phones: 930-4111

MATERIALS

**Reactive solvent
dissolves silicones**



Dynaloy, Inc., 7 Great Meadow Lane, Hanover, N.J. Phone: (201) 837-9270.

This reactive solvent will dissolve cured transfer-molded silicones. The solvent makes it possible to do failure and reliability analysis on plastic-packaged semiconductors. It will remove cured transfer-molded silicones, such as Dow Corning DC 306, and anhydride-cured epoxies from ICs, power transistors, diodes and hybrid circuits.

CIRCLE NO. 348

**Molded nylon screws
socket or hex headed**

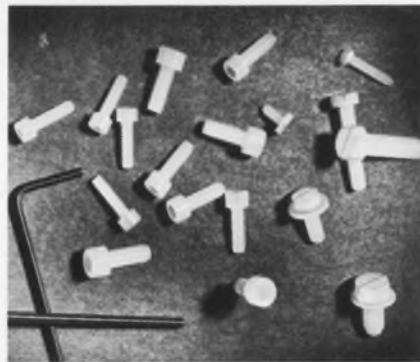

Coats & Clark, Inc., New Rochelle, N.Y. Phone: (914) 633-8600.

Molded nylon fasteners with either socket head cap screws or hexagonal-head screws are available. The socket head cap screws, designed for assembly with head wrench, are molded in 4-40, 6-32, 8-32, 10-32, 10-24 and 1/4-20 thread sizes with lengths from 3/16 to 1 in. The hexagonal-head screws, with either plain or washer base heads, both slotted, are intended for assembly with a wrench.

CIRCLE NO. 349

**Plastic adhesive
withstands 400°F**

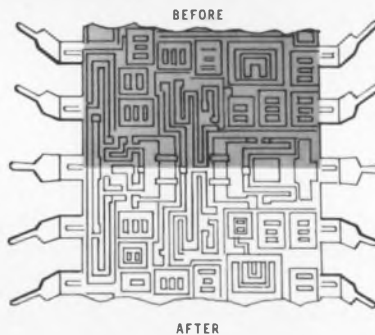

Aremco Products, Inc., P.O. Box 145, Briarcliff Manor, N.Y. Phone: (914) 762-0685. Price: \$29.50 per quart.

Aremco Bond 515, a single-component plastic adhesive for use at temperatures up to 400°F, can bond dissimilar materials such as ceramics, glass, metals and plastic. It requires no weighing, mixing or activator. Heat-curing takes place at temperatures as low as 330°F in 45 minutes or 450°F in 15 minutes. The material comes in a pre-mixed paste and is thixotropic.

CIRCLE NO. 350

**Lubrication kit
contains samples**



EverLube Corp. of America, 6940 Farmdale Ave., N. Hollywood, Calif. Phone: (213) 875-0101. Price: \$5.

The EverLube lubrication kit includes bonded solid-film lubricants, fortified greases, liquid dispersions, antiseize compounds, lubricating powders, corrosion- and abrasion-resistant coatings, and sealants and adhesives. Also available in convenient applicator-brush bottles, brush-type cans and squeeze-type containers.

CIRCLE NO. 351

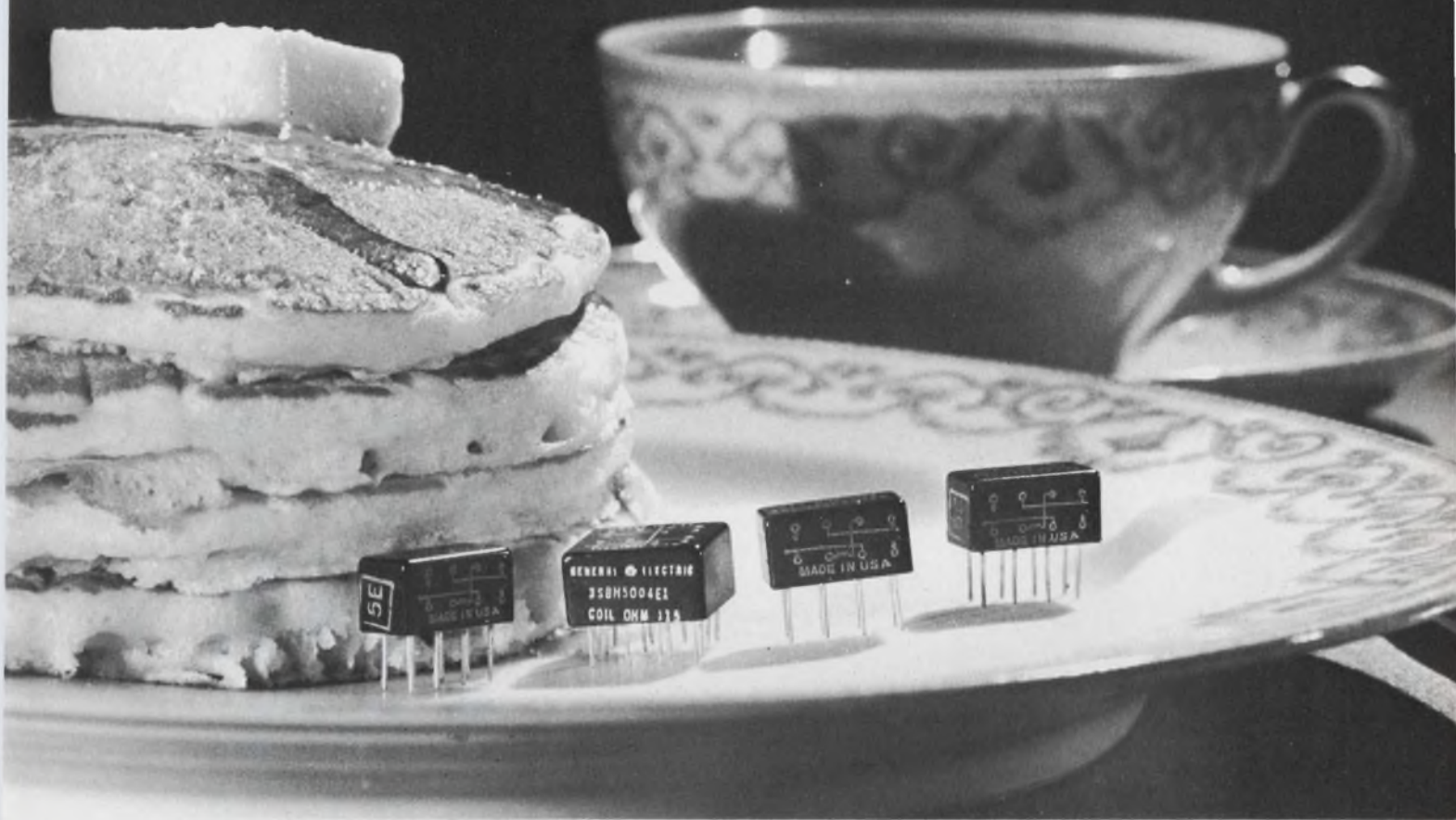

Flat as a pancake . . . and selling like hotcakes

And why not?

General Electric's new high performance 150-grid sealed relays are smallest where it counts most—only 0.320" high. What's more they come in 4 versions: 4 Form C, 2 Form C, 4 Form C AND-logic type, and a 50 milliwatt sensitivity 1 Form C (or 1A+1B).

Result: for the first time you can get really small size, a variety of forms to choose from, and exceptional performance all in one relay type.

These General Electric 150-grid space relays meet or exceed the environmental and mechanical specs of much larger Mil Spec micro-miniature relays. And compared to relays of comparable size, GE 150-grid space relays have 3 times the magnetic force and over twice the contact force of the nearest competitor.

Outstanding features include:

- High vibration capability
- Excellent minimum current switching ability
- Excellent thermal resistance
- High overload capability—can withstand 5 amps each contact and make and carry 10 amps for short periods
- No flux contamination because of all-welded construction and design.

For more information on the small relay that's going over big, contact your General Electric Electronic Components Sales Engineer. He can tell you more about them and help with your individual application. Or write for bulletin GEA-8042B, Section 792-41, General Electric Company, Schenectady, New York 12305.

Specialty Control Department, Waynesboro, Virginia

GENERAL  **ELECTRIC**

-MATSUO-

THE SPECIALIST OF FILM AND TANTALUM CAPACITORS

POLYESTER FILM CAPACITORS

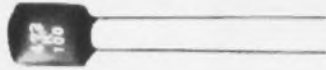

Type MFL epoxy dipped
Standard voltage rating : 35V, 50V, 100V, 200V D.C.
Standard capacitance value : .001 MFD to .22 MFD (E-6 series)



Type MFK epoxy dipped, non inductive
Standard voltage rating : 100V, 200V, 400V, 600V D.C.
Standard capacitance value : .01 MFD to .47 MFD (E-6 series)



Type MXT encased in plastic tube, non-inductive
Standard voltage rating : 100V, 200V, 400V, 600V D.C.
Standard capacitance value: .001 MFD to .22 MFD (E-6 series)

METALIZED POLYESTER FILM CAPACITOR

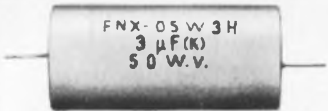

Type FNX-H mylar wrapped
Standard voltage rating : 100V, 200V, 400V, 600V D.C.
Standard capacitance value : .33 MFD to 10 MFD

SOLID TANTALUM CAPACITORS

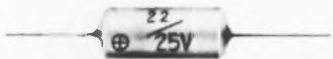

Type TAX hermetically sealed in metallic case
MIL-C-26655B
Standard voltage rating : 6V, 10V, 15V, 20V, 25V, 35V, 50V, D.C.
Standard capacitance value : 1 MFD to 220 MFD (E-6 series)



Type TSX encased in metallic case and sealed with epoxy resin
Standard voltage rating: 3V, 6V, 10V, 15V, 20V, 25V, 35V D.C.
Standard capacitance value : 1 MFD to 220 MFD (E-6 series)

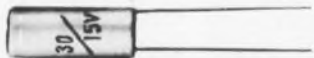

Type TSL encased in metallic case and sealed with epoxy resin
Standard voltage rating: 3V, 6V, 10V, 15V, 20V, 25V, 35V D.C.
Standard capacitance value : 1 MFD to 220 MFD (E-6 series)

For further information, please write to:

MATSUO ELECTRIC CO., LTD.

Head Office: 3-5-3-chome, Sennari-cho, Toyonaka-shi, Osaka, Japan
Cable "NCC MATSUO OSAKA" Telex: 523-4164 OSA
Tokyo Office: 7, 3-chome, Nishi-Gotanda, Shinagawa-ku, Tokyo

INFORMATION RETRIEVAL NUMBER 112

MICROWAVES

Coaxial-switch hermetically sealed



Daico Industries, Inc., 1711 W.
135th St., Gardena, Calif. Phone:
(213) 532-7621.

This hermetically sealed reed relay has a frequency span from dc to 400 MHz, a VSWR of 1.25:1, cross talk of 48 dB min and insertion loss of 0.15 dB max. It is a direct replacement for the solenoid-operated fail-safe switch used in vhf communications equipment. Designed for remote antenna selection or for use as a transmit-receiver switch in a-m or fm equipment, the construction is suitable for ground or airborne use. Fail-safe operation, fast switching time and low power consumption are other features.

CIRCLE NO. 352

TWT amplifier produces 20 W



Servo Corp. of America, 111 N.
South Rd., Hicksville, N.Y. Phone:
(516) 938-9700.

A 20-W, solid-state traveling-wave-tube amplifier features a frequency range of 1 to 18 GHz, covered in 5 bands. In the range of 1-12.4 GHz, units are available with either 10- or 20-W power output. In the range of 12.4-18 GHz, units are available with 10-W power. Other features include a signal gain of 40 dB.

CIRCLE NO. 353

BEST

FOR PROTECTIVE CUSTODY



SERIES SIXTY CABINET RACKS

● The most attractive and practical cabinet rack yet designed for housing a single piece of equipment or a large instrumentation system. All-welded, monolithic frame is capable of supporting the heaviest loads without structural fatigue or distortion.

Ordering Bud Series 60 Cabinet Racks eliminates the frustrating and time consuming procedure of selecting components to complete an enclosure. No assembly costs are incurred.

Bud Series 60 Cabinet Racks are available in 17 sizes. They are delivered ready for immediate use from your Bud Distributor. Ask him to tell you about Series 60. Write us for literature.



BUD RADIO, INC.
Willoughby, Ohio 44094

your product
Belongs in a BUD cabinet

INFORMATION RETRIEVAL NUMBER 113
ELECTRONIC DESIGN 3, February 1, 1968

He-Ne gas laser exceeds 150 mW

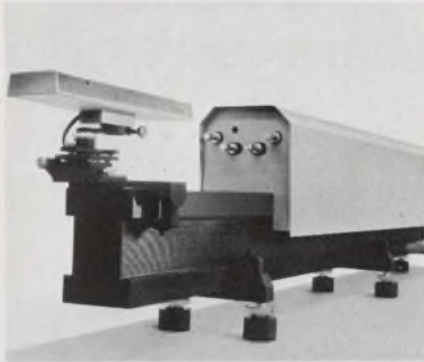

Meltzer, Aron & Lemen, Inc., 165 Post St., San Francisco. Phone: (415) 982-5877.

This continuous-wave laser has an output exceeding 150 mW in multimode operation, and exceeding 75 mW in single-mode operation. It fluctuates only about 1% pk-pk. The laser has two in-series operating plasma tubes mounted on bench carriers. The mirrors are fixed in adjustable supports, and slide along the axis of the bench. In this way a cavity working space of about 3 ft is provided.

CIRCLE NO. 354

Passive isolators span 100 to 600 MHz



Melabs, 3300 Hillview Ave., Stanford Industrial Park, Palo Alto, Calif. Phone: (415) 326-9500.

Nonreciprocal passive isolators and circulators provide isolation with low insertion loss at any center frequency in the 200-to-400-MHz range. Comparable in size to a vhf power transistor, the device is for such applications as isolating transistor oscillators or amplifiers from varying load impedances without reduction of useful transistor output power.

CIRCLE NO. 355

BUD enclosure says something important about the DINADE by MICROLAB/FXR

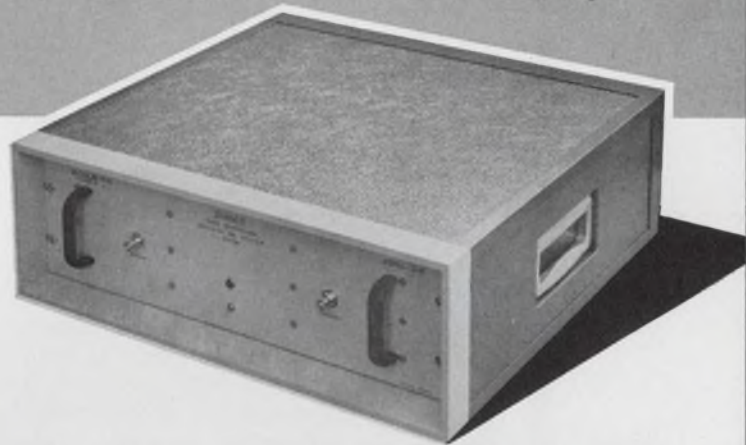

CLASSIC CABINETS

After this important producer of electronic systems developed this sophisticated instrument, Bud Classic Cabinet was selected as the most distinguished enclosure to best portray the character of the device.

Classic Cabinets provide extra sales appeal by presenting an image designed to enhance the value of the contents. They offer an unusual opportunity for builders of electronic equipment to house their products to the best advantage. Available from stock in a selection of 15 sizes and two attractive vinyl textured finishes.

These cabinets are but one of thousands of our standard enclosures available for immediate delivery. Bud service also includes modifying standard products to meet your specific requirements and creating entirely new housings from your prints. Let your Authorized Bud Distributor outline what we have to offer. Our catalog is available upon request.



BUD RADIO, INC.
Willoughby, Ohio 44094

your product *Belongs* in a BUD cabinet.

EPOXIES IN BIPAX



ACCURATE SAFE-EASY

Epoxy adhesive and encapsulating systems in a two-compartment flexible package

- Ready to use
- Precisely pre-measured
- Stops Mixing Mistakes
- Ends Epoxy Mess

Effective systems for modern bonding and potting applications, or your own formulations, are available in BIPAX.

Call or write for technical information on any Epoxy application or problem.



POLYMERS FOR INDUSTRY

55 NORTH STREET · MEDFORD, MASS. 02155
(617) 395-7520
INFORMATION RETRIEVAL NUMBER 116

Replace Costly AC/DC Circuits!

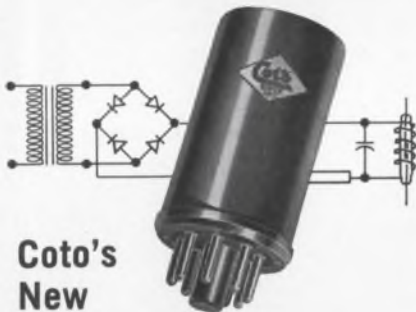

Coto's
New

A.C. Reed Relay

Designed to Operate on Standard 60 Hz input

Contacts: Forms A, B, C with single or multiple poles.

Ratings: To 3 amperes or up to 5000 volts D.C.

Inputs: 50-400 Hz voltages available.

Physical: Available in steel or plastic octal base housings for plug-in mounting.

Write for complete specifications. For special requirements, give complete details for quotation.

Coto-Coil COMPANY, INC.
Pavilion Ave.
Providence, R. I. 02905
Phone (401) 941-3355

INFORMATION RETRIEVAL NUMBER 117

MICROWAVES

Tuners and extenders cover 1 to 12 GHz



Communication Electronics Inc.,
6006 Executive Boulevard, Rockville, Md. Phone: (301) 881-3300.
Price: \$4200 up.

Tuners and frequency extenders covering the range from 1 to 12 GHz are for surveillance applications. The range is covered in four bands: 0.95 to 2, 2 to 4.5, 4 to 8, and 8 to 12 GHz. Over-all bandwidth in each case is 8 MHz. Each band employs a tunable four-section YIG preselector, which provides high rejection of spurious responses. All units include a mechanically tuned ceramic-triode local oscillator for stability.

CIRCLE NO. 356

Plug-in decoders permit tone changes



TRF, Inc., 6627 Backlick Rd.,
Springfield, Va. Phone: (703) 451-5131. P&A: \$150 to \$1000, 45 days.

Plug-in telemetry decoders permit rapid changes of tone channels in telemetry systems. Standard IRIG and nonstandard tone channel frequencies are available. Each module contains a two-section tone decoder filter, amplifier and relay. Standby power is 0.5 mA per channel. Solid-state or conventional relays are available. The capacity is 2 A at 20 to 32 V.

CIRCLE NO. 357

Buy Bonds where you work.

They do.



They work for freedom. And more than seven out of ten of them are supporting freedom with their dollars, too — through investment in U.S. Savings Bonds. When *you* buy Bonds, you can save up for a rainy day, a home, a free and comfortable future — and at the same time show these brave men you're on their side. Join the Payroll Savings Plan where you work or buy Bonds where you bank. You'll walk a bit taller.

New Freedom Shares

Now, when you join the Payroll Savings Plan or the Bond-a-Month Plan, you are eligible to purchase new Freedom Shares. They pay 4.74% when held to maturity of just four-and-a-half years (redeemable after one year), and are available on a one-for-one basis with Savings Bonds. Get the facts where you work or bank.

Join up. America needs your help.



The U.S. Government does not pay for this advertisement. It is presented as a public service in cooperation with the Treasury Department and The Advertising Council.

Waters SHAFT LOCKS

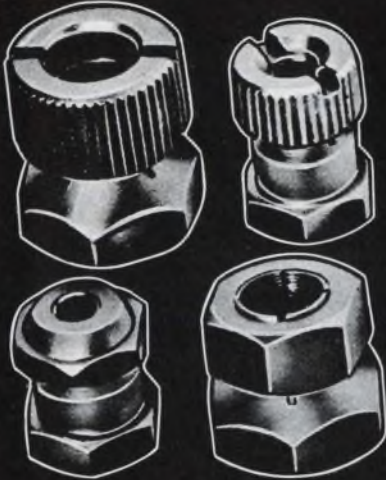

*For bushing
mounted controls*

Waters Shaft Locking assemblies are designed for bushing-mounted controls with 1/4-32" or 3/8-32" threaded bushings accommodating 1/8" and 1/4" shafts. For use with all type components (potentiometers, switches, condenser trimmers, etc.) they provide full variations of the most popular shaftlocks . . . acorn, tapered, jam and hand locking knurled nuts. Of brass, nickel-plated to government specifications, Waters Shaft Locks conform to our every high standard of design and controlled quality.

Complete data on all Waters Shaft Locking Devices immediately available on request.



WATERS
MANUFACTURING INC.
WAYLAND, MASSACHUSETTS

Receiver-demodulator for telemetry signals



Electrac, Inc., 1614 Orangethrope Way, Anaheim, Calif. Phone: (714) 879-6021.

Designed to demodulate satellite telemetry signals for the NASA Goddard STADAN network, the solid-state, phase-lock polarization receiver and demodulator provides continuous polarization and Doppler tracking (200 kHz). A dual-channel, ratio predetection combining system using both third- and second-order loops gives high signal sensitivity and a 1.5-kHz data bandwidth.

CIRCLE NO. 358

Uhf notch filters combat interference



Peninsula Microwave Laboratories, 855 Maude Ave., Mountain View, Calif. Phone: (415) 969-3303.

A type of narrow-band reject (notch) filter has been developed to help combat the rising incidence of radio interference in the uhf band. Multiple high-Q cavities are used to achieve high peak rejection and cutoff rate, coupled with low pass-band insertion loss. The cavities are arranged in a compact configuration, minimizing size and weight.

CIRCLE NO. 359

A Waters PATENT

POT HOOK PANEL MOUNTS

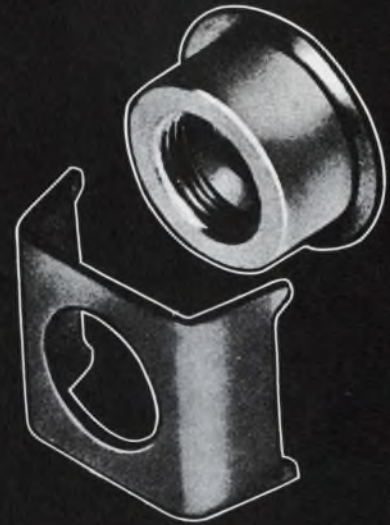

*For easy flush or
recessed mounting
of panel controls*



*Typical "Pot
Hook"
mounting
on
1/8" panel.*

Waters POT HOOK panel mounts provide an ingenious means of installing potentiometers, switches, trimmers, etc., that permits their slotted shafts to be either recessed or set flush with the panel. Comprising a nickel-plated brass bushing and a stainless steel clip, standard POT HOOK mounts are designed for 1/8" and 1/4" shafts in 1/8" panels. Complete data available on request.

Control-sealing POT HOOK mounts can be supplied with rubber "O" rings and Neoprene gaskets. A front-adjusting Set Screw may also be specified.

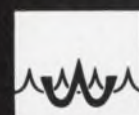

WATERS
MANUFACTURING INC.
WAYLAND, MASSACHUSETTS

PROTECT YOUR INSTRUMENTS WITH AMALCO ALUMINUM CARRYING CASES



Amalco aluminum carrying cases are perfect for carrying instruments safely. Tightly sealed to prevent dust, sprays and dirt to enter, these cases are ruggedly constructed to sustain unusual abuse. The Amalco carrying cases come in eight economical sizes and can be modified to suit your specific needs.

Write for descriptive literature and specifications on the Amalco Aluminum Carrying Cases.

OTHER PRODUCTS & SERVICES OF AMERICAN ALUMINUM

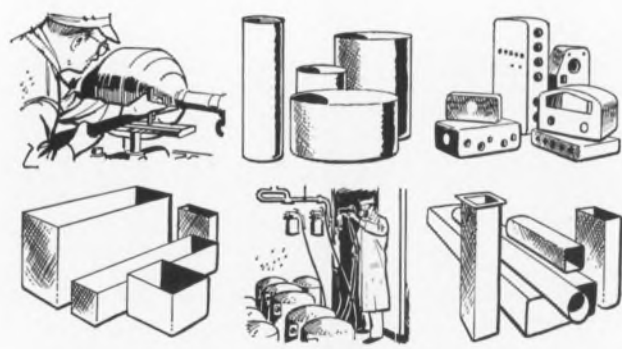

SPECIALISTS IN CONTRACT MANUFACTURING OF ALUMINUM

COMPLETE FABRICATING FACILITIES FOR DEEP DRAWING, HEAT TREATING, SPINNINGS, ASSEMBLY, SHEET METAL, STAMPINGS, ANODIZING, WELDING, FINISHING.



Send for brochure "Aluminum Fabricating For Industry"

AMERICAN ALUMINUM COMPANY

Manufacturers of Aluminum Products for Industry since 1910

230 Sheffield St. • Mountainside, N. J. • 201-233-3500

INFORMATION RETRIEVAL NUMBER 121

Design Aids



Spiral slide rule

With 66-inch-long scales, this slide rule gives six times the resolution of an ordinary slide rule. It contains only the two basic scales most frequently used; one of the scales is double-length so that the number of settings in a series is minimized. Anyone familiar with the operation of an ordinary slide rule will be able to use this one efficiently in minutes. It is a cylindrical device 6 in. long by 1-1/2 in. in dia when closed. Available for \$19.85 from INFO, Inc., Box 305, Newton, Mass.

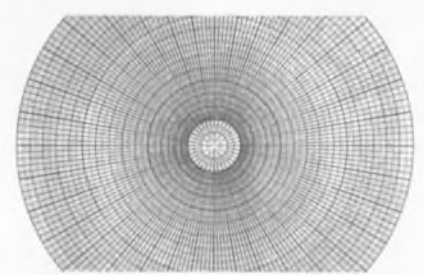

Special graph paper

These papers have divisions for either linear or logarithmic functions; for sine, tangent and hyperbolic functions; for functions in probabilities, etc. They also show triangular, polar-coordinate and other divisions. Coordinate papers are suitable for various developments in graphical presentations; in the graphical solution of numerous equations; in making calculating tables and in statistics; in the solution of astronomical, meteorological, physical, chemical, technical and industrial problems; in nautical and aeronautical studies; and in science and industry. A booklet with samples of the many types of paper available will be sent free. Carl Schleicher & Schuell Co.

CIRCLE NO. 361

Application Notes



Power conversion

An 8-page brochure describes the manufacturer's parametric power invention for converting energy. Called "Parax," it is claimed to be the most significant development in the field since introduction of the ferro resonant transformer in 1938. The device is understood to be passive and to give complete bilateral transient noise rejection. It has a unique overload protection, produces phase-like voltage output, and is said to be ultrareliable. Wanlass Electric Co.

CIRCLE NO. 362

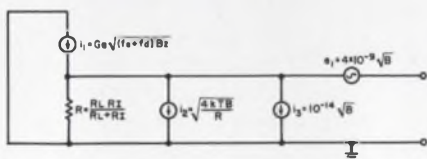

Lock-in amplifiers

The lock-in amplifier method is often very useful for recovering a signal from noise. It chops or interrupts the signal at a frequency appreciably above the information-carrying frequencies of the signal, amplifies at this chopping frequency, and then synchronously demodulates this amplified output in order to recover the original signal information. The purpose of this note is to discuss the considerations involved in applying the lock-in amplifier technique to the processing of signals from light detection with a photomultiplier. Princeton Applied Research Corp.

CIRCLE NO. 363

REJECTED? YES... BUT ONLY ONCE IN TEN YEARS!



waldom solderless terminals & connectors

Our pretty miss should never be rejected . . . but, it may comfort her to know it also happened to us. Waldom Solderless Terminals and Connectors have been distributed for more than ten years, have been used in millions of circuits and installations and we, too have had a rejection. Just once. That's quality. But there are other good reasons for you to specify Waldom...

- * Broad selection including Quick Disconnects
- * All constructions styles
- * Absolute dependability
- * Saves time and labor
- * Easier servicing
- * All types made to military specs.

Fast delivery from your electronics or electrical distributor. Write for FREE Waldom catalog listing more than 3000 electronic hardware items.



waldom
ELECTRONICS, INC.

4643 West 53rd Street, Chicago, Illinois 60632

INFORMATION RETRIEVAL NUMBER 122

New Literature



Precut designations

A list of reference designations, all precut, for capacitors, transformers, transistors, inductors, resistors, switches and semiconductor devices is available in a 12-page catalog. It includes instructional material on the four main uses for precut drafting aids in electronic-circuit and assembly methods. Photos of typical layouts are given. Bishop Industries Corp.

CIRCLE NO. 364

Resistor alloys

Precision resistance wire, noted for its stability at temperatures up to 300°C (572°F), is described in a 12-page booklet. Containing data on physical and electrical properties, as well as information on handling, aging and winding characteristics, the booklet may serve as a useful guide for designers of precision resistors, potentiometers and instruments. Kanthal Corp.

CIRCLE NO. 365

Metal plate connectors

Design information for various metal plate connectors is contained in a 28-page manual. Definitions of the metal plate interconnection concept and discussions of grid patterns, plate size, plate layout, dimensioning and clearances are given. A typical plate assembly drawing is included for clarity. Also included is a choice of components used for base plates and headers. Elco.

CIRCLE NO. 366



Low-drift op-amp

Operational amplifiers with 15-pA max bias current and 2 $\mu\text{V}/^\circ\text{C}$ max voltage drift are described in a 4-page fold-out brochure. Methods for improving closed-loop stability and for isolating capacitive loads are suggested. Various widely used circuits are described and evaluated comparatively. Analog Devices.

CIRCLE NO. 367



Time-saving devices

Descriptions of slide and circular calculators, drafting templates, handbooks, manuals, technical books, curves, slide rules and converters are contained in this 1968 catalog. The catalog provides quick answers for many engineering design and manufacturing problems. TAD Products Corp.

CIRCLE NO. 368

Deviation test bridges

Deviation test bridges for testing resistors, capacitors and inductors in the laboratory and on the production line at speeds up to 3600 per hour are discussed in a catalog. Information on basic instrument features including a 6-in. illuminated meter, interchangeable calibrated meter scales, built-in calibration adjustments, and measurement accuracy of 0.03% is included. Block diagrams and application examples are given. B&K Instruments, Inc.

CIRCLE NO. 369



Source data entry

Simplified systems for source data entry are discussed in a 12-page bulletin, which describes the operation of the computer data entry keyboard and its use by persons unfamiliar with data-processing equipment. Information on keyboard operation is given along with data on how systems can be developed with the use of optional equipment. Colorado Instruments, Inc.

CIRCLE NO. 370

'Digits Unlimited'

A catalog describes and defines the specifications for 7-segment incandescent-lamp-type numeric readouts and universal decoder drivers of both plug-in and chassis-mounted configuration. Discon Corp.

CIRCLE NO. 371



The Electronic Countermeasures System, a valuable penetration and survival tool for B-52's, posed a tough isolator problem which was successfully solved by Sperry.

What was so tough about the isolator spec? Among other things were power handling capability (400W CW, 4kW peak); isolation VSWR limited to 1.18:1; insertion loss (only 1 db permitted), and RFI shielding to prevent interference with other aircraft systems. All parameters had to be met at altitudes up to 60,000 feet and over the temperature range of -55°C to $+55^{\circ}\text{C}$ without cooling.

Sperry met the challenge with Model No. D-44S9, a specially engineered isolator that helps assure the reliability of B-52 ECM.

Is there a particularly difficult isolator problem Sperry can solve for you? There's a broad line of standard items, plus plenty of engineering talent if you need it. For full details, contact your Cain & Co. man or write Sperry Microwave Electronics Division, Sperry Rand Corporation, Box 4648, Clearwater, Florida 33518.



SPERRY

MICROWAVE ELECTRONICS AND
ELECTRONIC TUBE DIVISIONS
SPERRY RAND CORPORATION
CLEARWATER AND GAINESVILLE, FLORIDA

When B-52's count on ECM, they count on isolators from Sperry . . . the first name in microwaves.

INFORMATION RETRIEVAL NUMBER 123

Backlighted
Multi-Colored
Modular

Graphic Display System

Please Check ✓

A System? _____

Mass-produced assembly of standardized precision components, wired to terminal blocks in our factory.

Graphic Display? _____

Reports completely on the status of any process system.

Modular? _____

Panels interchangeable for easy modification or enlarging as required by varying applications; only simple hand tools needed.

Multi-Colored? _____

Eight colors, four for any given symbol.

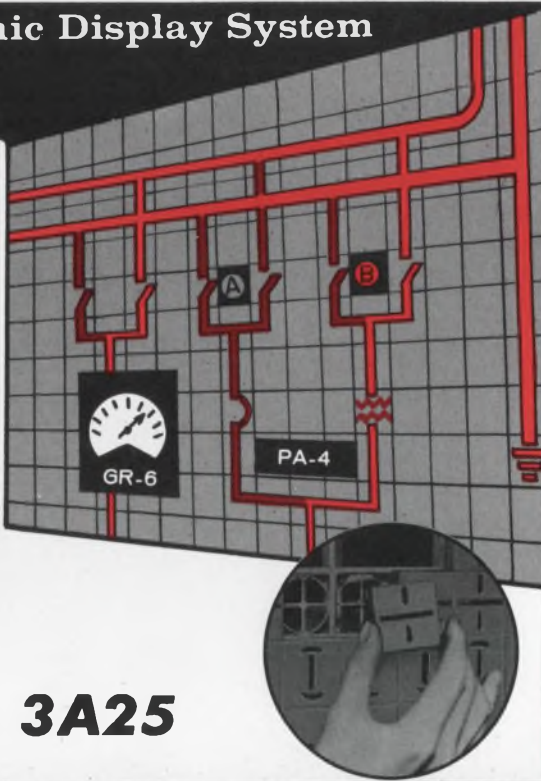

IEEE BOOTH 3A25

KCC SHOKAI LTD.

4-71 Kita-dori, Nada-ku,
Kobe, Japan
Cable: Wmkkc Kobe

U.S.A.-Canada:
Gail B. Rathbun Co., Inc.
1250 Space Park Way
Mountain View, Calif. 94040
Tel: 415-969-1155

INFORMATION RETRIEVAL NUMBER 124

NEW LITERATURE



Adhesives properties

Describing adhesives offered by Emerson & Cuming, Inc., the Ecobond chart, 1968 version, helps make the selection of adhesive for a given job. Products with similar properties—such as general purpose liquid epoxy adhesives, epoxy pastes or electrically conductive adhesives are grouped together. For each adhesive in these categories, values for properties such as bond strength, service temperature, dielectric strength and volume resistivity are listed. Emerson & Cuming, Inc.

CIRCLE NO. 378

IC directory

Allied's 1968 Industrial Catalog Supplement, contains a directory of semiconductors and integrated circuits. Prices are listed in the directory which covers over 1000 different integrated circuits and 7500 semiconductors made by Conant, G.E., International Rectifier, IRC, Motorola, RCA, Sprague, Sarkes-Tarzian, Sylvania, Texas Instruments, Thomas Ramo Woolridge and Varo. Allied Electronics Corp.

CIRCLE NO. 379

Tuning diode

A six-page note describing the use of a wide-capacitance-range tuning diode for tuning communications circuits in the frequency range from 50 MHz to 1 GHz. The diode features high Q and a wide capacitance-to-voltage ratio. Use of the diode provides a simple means of tuning vhf and uhf communications circuits. Matching of diode sets allows exact tuning repetitiveness with pushbutton selection. ITT Semiconductors.

CIRCLE NO. 380

PROGRESS IN AN EXPLODING TECHNOLOGY

EXHIBITS
NEW YORK COLISEUM

TECHNICAL SESSIONS
NEW YORK HILTON

Monday through Thursday

- 48 GENERAL SESSIONS at the New York Hilton. Hours: 10:00-12:30; 2:00-4:30.
- FOUR FLOORS OF EXHIBITS at the N. Y. Coliseum including over 750 firms. Hours: 10 a.m.-8 p.m. 4 Days.
- GALA ANNUAL BANQUET—Wednesday 7:15 p.m. N. Y. Hilton Grand Ballroom—\$16.00.
- FREE SHUTTLE BUSES between the Hilton and the Coliseum—every few minutes.

- REGISTRATION—Good all days—General Sessions and exhibits. In and out privileges.—IEEE Members \$3.00. Non-members \$6.00. Ladies \$1.00. High School Students \$3.00 if accompanied by an adult—One student per adult; Thursday only—limit of 3 students per adult.
- REG-IDENT CARD speeds request for exhibitors' literature. Ask for one when registering.
- ESCALATORS/EXPRESS ELEVATORS to the Fourth Floor.



IEEE Exhibition MARCH 18-21, 1968

INFORMATION RETRIEVAL NUMBER 125

KEMET
PRODUCT CATALOG

NEW!

MONOLITHIC CERAMIC CAPACITORS

Union Carbide's new Kemet monolithic ceramic capacitors are the finest available. Electrode, microstructure, and materials, these capacitors are of the quality which you have come to expect of the Kemet Brand. They can be used in consumer, industrial, control, precision devices, tele-phones and military electronic equipment.

Check these features...

- Capable of meeting or exceeding MIL-C-11015C and MIL-C-20014.
- Controlled PTC reaction provides a more homogeneous and "drier" capacitor. Less chance of failure due to dielectric breakdown, degradation of moisture resistance and high dielectric factor.
- Outstanding lead integrity from solder having melting point in excess of 220°C.
- Superior glasscoat stop enables clean leads extraction and separation.
- Extensive Distributor network throughout the country to serve you better.
- Request model Every combination.

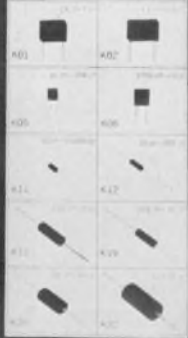

Ceramic capacitors

Literature on Kemet monolithic ceramic capacitors is available. The capacitors are molded in moisture-resistant epoxy cases and are manufactured to meet the requirements of MIL-C-11015C. Available in four-radial- and eight-axial-lead configurations, they are ideally suited for bypass, filtering and coupling in low-voltage and solid-state circuits. Capacitance range is 10 pF to 2 μ F in working voltages of 50, 100 and 200 V. Union Carbide Corp.

CIRCLE NO. 372



SIGNATRON INCORPORATED
1924 S. Western Ave., Redwood City, CA 94061-4024

Industrial and Physiological Signal Conditioners, Miniature Telemetry Systems

Telemetry components

This catalog shows the company's capabilities in the medical, research and industrial miniature telemetry component and systems field. Complete technical information is listed along with a useful frequency chart that is included on the inside cover. Signatron Inc.

CIRCLE NO. 373



Pick a number, any number. Fast.

With a Digitran thumbwheel switch, you can dial in any number between zero and the national debt. Fast, easy, and error-free. Digitran's modular design lets you program any number of digits.

Digitswitch® and Miniswitch® look great, read great, and save panel space. (Up to 50% over rotary switches.) Their great simplicity means great reliability. And although simple in design, they handle complex electronic functions.

Digitran pioneered the thumb-

wheel switch. In the process, we accumulated the world's largest library of application notes. This means we can save you money in design time.

If you've a switching problem, send for our catalog. We'll send help. Fast.

THE DIGITRAN COMPANY
Subsidiary of Becton, Dickinson and Company 
855 S. Arroyo Pkwy./Pasadena, Calif. 91105
Tel: (213) 449-3110/TWX 910-588-3794

INFORMATION RETRIEVAL NUMBER 126

IC BREADBOARD AND TEST PANELS

TIME SAVING • FLEXIBLE



PANELS FOR:
Flat Packs
TO-5 Case size units
Dual-In-Line packages

- Solderless interconnection concept throughout
- 10 to 50 patterns standard
- Fast loading and operation — easy IC interchangeability
- Single pattern units provide interchangeability of all three packages
- Power and ground connection at each pattern
- Panel plugs into 36 position edge connector with contacts spaced on .156 centers
- 6" x 17" panels (50 patterns)

Request IC Folder
Tel: 617/222-2202

AUGAT INC. 31 PERRY AVE., ATTLEBORO, MASS. 02703

INFORMATION RETRIEVAL NUMBER 127

TEMESCAL high vacuum VALVES

- Valve sizes from 1/2" to 60" — and larger on special order
- Angle or gate valves capable of being mounted in any position
- Forged brass, cast aluminum, fabricated steel

"The World's Largest Manufacturer of High Vacuum Valves"

AIRCO Temescal

A DIVISION OF
AIR REDUCTION COMPANY, INCORPORATED

2850 Seventh Street
Berkeley, California 94710
Telephone 415 841-5720



INFORMATION RETRIEVAL NUMBER 129

DC and AC INPUT SERVO REPEATERS 900 SERIES



- With single, 3 or 10 turn pots
- Operate from 117V. 60 or 400 cps line
- Different gear ratio options

A versatile line of unitized pot Repeaters, easy to apply and ruggedly built.

WRITE FOR OUR GENERAL CATALOG describing our complete line of Servo Systems, Servo Amplifiers and Servo Testers

INDUSTRIAL CONTROL COMPANY
CENTRAL AVENUE FARMINGDALE, L. I., N. Y.
AT PINELAWN 516-694-3000

INFORMATION RETRIEVAL NUMBER 130

Your Heart Fund Fights

HEART ATTACK
STROKE
HIGH BLOOD
PRESSURE
INBORN HEART
DEFECTS



NEW LITERATURE

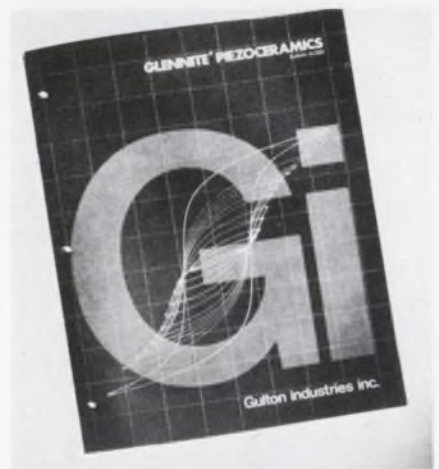

Piezoceramics

Nine piezoelectric materials including the barium titanates, lead zirconate titanates and lead metaniobates are described in this 25-page handbook. Provided are complete specifications, data on temperature and time versus electrical properties, and a primer of information on piezoelectric ceramics. This includes a table of vibrational modes, application formulas, curves for electrical and mechanical coupling and other background information. Gulton Industries.

CIRCLE NO. 374



Tunable capacitors

Specifications are given for piston trimmer and tuning capacitors. The 24-page catalog includes miniature telescopic, subminiature and ultraminiature trimmer capacitors. Over 3000 designs are available, including units with ceramic, glass and quartz dielectrics. JFD Electronics Co.

CIRCLE NO. 375

Electronic Design

ELECTRONIC DESIGN's function is:

- To aid progress in the electronics manufacturing industry by promoting good design.
- To give the electronic design engineer concepts and ideas that make his job easier and more productive.
- To provide a central source of timely electronics information.
- To promote two-way communication between manufacturer and engineer.

Want a subscription? ELECTRONIC DESIGN is sent free to qualified engineers and engineering managers doing design work, supervising design or setting standards in the United States and Western Europe. For a free subscription, use the postfree application form inside the back cover. If none is included, write to us direct for an application form.

If you do not qualify, you may take out a paid subscription for \$25 a year in the U.S.A., \$35 a year elsewhere. Single copies are \$1.50 each.

If you change your address, send us an old mailing label and your new address; there is generally a prepaid postcard for this inside the back cover. You will have to requalify to continue receiving ELECTRONIC DESIGN free.

The accuracy policy of ELECTRONIC DESIGN is:

- To make reasonable efforts to ensure the accuracy of editorial matter.
- To publish prompt corrections whenever inaccuracies are brought to our attention. Corrections appear at the end of the Letters column.
- To refuse any advertisement deemed to be misleading or fraudulent.

Microfilm copies are available of complete issues of ELECTRONIC DESIGN and individual articles, published since the beginning of 1961. Complete issues cost 4¢ a page, articles cost 50¢ a page; shipping and handling charges are extra. The minimum charge is \$3. For further details and to place orders, contact University Microfilms, Inc., 300 N. Zeeb Road, Ann Arbor, Mich. 48106; telephone (313) 761-4700.

Want to contact us? If you have any comments or wish to submit a manuscript or article outline, address your correspondence to:

Howard Bierman, Editor,
ELECTRONIC DESIGN,
850 Third Avenue,
New York, N.Y. 10022.

NEW! *smallest axial shielded inductor available* the "NANO-RED"

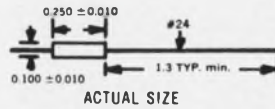

Range: 0.10 μ h to 1,000 μ h in 49 stock values
Size: 1/10 dia. by 1/4 lg.
Inductance Tolerance: $\pm 10\%$

This new "NANO-RED" offers the highest inductance to size ratio available in an axial shielded inductor. Exceptional "Q" and self-resonance characteristics. Max. coupling 2% units side by side. Non-flammable envelope. Designed to MIL-C-15305C. Operating temperature -55°C to 125°C.

Other Lenox-Fugle Subminiature Shielded Inductors:

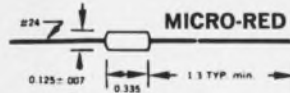

The "Micro-Red" is a shielded inductor that offers the largest inductance range in its size: 0.10 μ h to 10,000 μ h. "Q" to "L" ratio unsurpassed, with excellent distributed capacity. Inductance tolerance $\pm 10\%$. Designed to MIL-C-15305C. Stocked in 61 predesigned values.

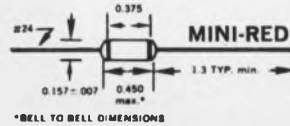

The "Mini-Red" offers the highest "Q" to "L" ratio available over inductance range 0.10 μ h to 100,000 μ h in its size. Inductance tolerance $\pm 10\%$ measured per MIL-C-15305C. Stocked in 73 predesigned values.

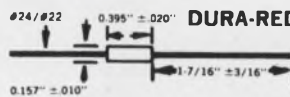

The "Dura-Red" is designed to MS-90537 with inductance range 0.10 μ h to 100,000 μ h with tolerance $\pm 10\%$. Stocked in 73 predesigned values.



Data Sheets: write or phone

LENOX-FUGLE ELECTRONICS, INC.

475 Watchung Avenue, Watchung, N. J. 07060

Telephone: Code 201, 756-1164-1165

INFORMATION RETRIEVAL NUMBER 131

Last year
we sold hundreds of thousands
of miniature precision bearings
to engineers who ordinarily
would've specified ball bearings.



The main problem was, they hadn't known about Northfield miniature bearings. They'd thought that to get miniature bearings that would meet close dimensional tolerances, they had to get ball bearings or nothing.

Then we showed them that Northfield sintered bronze miniature bearings could do just about everything ball bearings could do, and at 1/3 the cost. They're made of sintered bronze per MIL-B-5687 Type 1, Comp A. They have an extremely low coefficient of friction, and are vacuum impregnated with instrument oil per MIL-L-6085A. Northfield precision miniature bearings are directly interchangeable with miniature precision ball bearings.

They come in a full range of miniature sizes — flanged and sleeve types. Call or write for complete catalog and prices.

Northfield Precision Instrument Corp., 4400 Austin Blvd., Island Park, L. I., New York 11558. Tel.: (516) 431-1112.

Maybe you've been overspending for years.



INFORMATION RETRIEVAL NUMBER 132

Design Data from Manufacturers

Advertisements of booklets, brochures, catalogs and data sheets. To order use Reader-Service Card.
(Advertisement)

New Instruments, Technical Data, Applications



The new 1968 "dynamic instrumentation catalog" provides complete information on both Kistler's new and standard instruments for measurement of dynamic pressure, high-intensity sound, force, impact, tension, shock, and vibration. Included also are performance data, theory of operation, and application information for quartz piezoelectric transducers, low-impedance Piezotron® accelerometers, non-pendulous Servo-Accelerometers, electrostatic charge amplifiers, and associated electronic components.

Kistler Instrument Corporation
8969 Sheridan Drive
Clarence, N.Y. 14031

171

Quality Fasteners For All Design Applications



This 8-page catalog provides design data on the complete group of DZUS 1/4-turn self-locking fasteners for standard, high speed and panel applications, as well as universal high strength multiple thread fasteners for high tensile and shear stresses. Dzus stud assemblies, wire forms and receptacles offer an exceptional, wide variety of combinations from stock to fit specific fastening requirements. Diagrams and tables give full details for rapid, unlimited design selection. Condensed Catalog No. S-2 or comprehensive Catalog No. D-3 are available on request.

Dzus Fastener Co., Inc.
Division 32
425 Union Boulevard
West Islip, L. I., N. Y. 11795

172

A FREE Cross Reference Guide



to better Printed Circuit drafting

No engineer or draftsman should be without the NEW 1968 By-Buk Printed Circuit Drafting Aids P-45 Catalog with color-coded MIL-SPEC sizes. Also contains over 2000 pads, shapes, tapes, transistor tri-pads, spaced integrated circuit terminal pad sets and many other drafting aids for faster, more accurate, distortion-free printed circuit master drawings. Send for your FREE catalog.

By-Buk Company
4326 West Pico Blvd., Los Angeles, Calif. 90019
Telephone: (213) 937-3511

173

Electronic Design

Advertising Representatives

New York 10022
Robert W. Gascoigne
Thomas P. Barth
Samuel M. Deitch
Byron Adams
850 Third Avenue
(212) PLaza 1-5530
TWX: 867-7866

Philadelphia
William C. Repetto
P. O. Box 206
Merion Station, Pa. 19066
(215) MO 4-1073

Boston
Richard Parker
40 Webb Street
Salem, Mass. 01970
(617) 742-0252

Chicago 60611
Thomas P. Kavooras
Berry Conner, Jr.
720 N. Michigan
(312) 337-0588

Cleveland
(216) 247-7670

Los Angeles 90303
Stanley I. Ehrenclou
Terrence D. Buckley
W. James Bischof
2930 W. Imperial Highway
Inglewood, Calif.
(213) 757-0183

San Francisco
Ashley P. Hartman
175 South San Antonio Rd
Ste. 243
Los Altos, Calif. 94022
(415) 941-3084



Southwestern 75206
Tommy L. Wilson
6200 North Central Expressway
Dallas, Tex.
(214) EMerson 1-2311

London W. 1
Brayton C. Nichols
44 Conduit Street

Verviers, Belgium
Andre Jamar
1, Rue Mallar, 1
(087) 253.85

Tokyo
Yoshihiro Takemura
International Planning
Service, Inc.
Room 231 Tokyu-Mita Bldg.
1, Shiba-Mita Koun-cho
Minato-ku, Tokyo

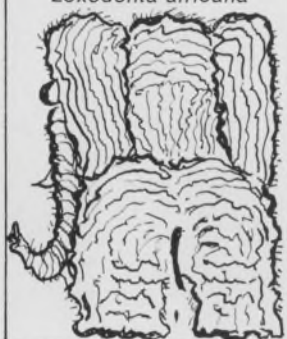

<h1>DUR- ABIL- ITY!</h1>	<i>Testudo pardalis</i> 
	<i>Gordos reed switch*</i> 
<i>Loxodonta africana</i> 	

*If you demand over 10,000,000 perfect switching operations, a Gordos reed switch is your best beast. Send for color catalog.

GORDOS CORPORATION
 250 Glenwood Ave., Bloomfield, N.J. 07003 • 201-743-6800

INFORMATION RETRIEVAL NUMBER 135

NOW! 2 SUPERIOR DRY FILM LUBRICANTS tailored for your specific industrial needs!

<h1>1</h1>	FEL-PRO C-300 Air-dries and cures in 1 hour while offering -65°F. to 1200°F. protection	<p>← NEW</p> <p>Push Button Can</p> 
<h1>2</h1>	FEL-PRO C-200 Bakes on to give outstanding performance throughout -65°F. to 2400°F. range	

High-temperature and low-speed lubricating problems? Forget oils, greases and other short-life lubricants! These non-corrosive FEL-PRO products brush or spray on quickly, then dry to a solid yet slick film that fights friction, wear, abrasion, fretting. Either type provides positive, long-life protection for all metals and their derivative alloys. Ideally suited for heavy-load, low-speed applications that require excellent adhesion and extreme pressure resistance. Try C-300 or C-200 once . . . and you'll never settle for less!

Write on your letterhead for free sample, technical data, and price information. Please state which product desired and intended application.



FEL-PRO FEL-PRO, INC., A Division of Felt Products Mfg. Co.
 7450 N. McCormick Blvd., Dept. ED, Skokie, Ill. 60076

INFORMATION RETRIEVAL NUMBER 136

ELECTRONIC DESIGN 3, February 1, 1968

Best Value Meters Come From Heath!

Heathkit IM-25 Solid-State Volt-Ohm-Milliammeter		Kit \$80 Wired \$115
Heathkit IM-16 Solid-State Volt-Ohm-Meter		Kit \$44.95 Wired \$64.95
Heathkit IM-13 Bench Type VTVM		Kit \$34.95 Wired \$52.95

● 9 DC and AC volts ranges — 150 millivolts full scale to 1500 volts ● 7 Resistance ranges measure from one ohm to 1000 megohms ● 11 Current ranges — 15 uA full scale to 1.5 A. ● Response to 100 kHz ● 11 megohm DC input impedance, 10 megohm on AC ● Battery or AC power

● 8 DC & AC volts ranges — 500 millivolts full scale to 1500 volts ● 7 Resistance ranges measure from one ohm to 1000 megohms ● 11 megohm DC input impedance, 1 megohm on AC ● Battery or AC power

● 7 DC & AC volts ranges — 1.5 volts full scale to 1500 volts ● 7 Resistance ranges measure from one ohm to 1000 megohms ● Response 25 Hz to 1 MHz ● 11 megohm DC input impedance, 1 megohm on AC ● AC powered

	Kit \$26.95 Wired \$44.95	Heathkit IM-11 Standard VTVM
	Kit \$37.50 Wired \$52.95	Heathkit IM-21 Lab AC VTVM
	Kit \$29.95	Heathkit MM-1 Portable Volt-Ohm Milliammeter
	Kit \$19.95	Heathkit IM-17 Solid-State Volt-Ohm-Meter

● 7 DC & AC volts ranges from 1.5 volts full scale to 1500 volts ● 7 Resistance ranges measure from one ohm to 1000 megohms ● Response 25 Hz to 1 MHz ● 11 megohm DC input impedance, 1 megohm on AC ● AC powered

● 10 AC volt ranges measure from 0.01 to 300 volts RMS full scale ● Decibel range -52 to +52 total in ten ranges ● Response 10 Hz to 1 MHz ● 10 megohm input impedance ● AC powered

● 7 DC & AC volts ranges from 1.5 volts full scale to 5000 volts ● 5 Direct current ranges from 150 uA full scale to 15 A. ● 3 Resistance ranges measure from 0.2 ohm to 20 megohms ● 20,000 ohms per volt sensitivity

● 4 AC & DC volts ranges from one volt full scale to 1000 volts ● 4 Resistance ranges measure from 0.1 ohm to 1000 megohms ● 11 megohm DC input impedance, 1 megohm AC ● Response 10 Hz to 1 MHz ● Battery powered ● Includes all probes and portable case

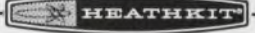

HEATH COMPANY, Dept. 520-26
 Benton Harbor, Mich. 49022
 In Canada, Daystrom Ltd.

Please send my FREE 1968 Heathkit Catalog.

Enclosed is \$ _____, plus postage.

Please send model(s) _____

Name _____

Address _____

City _____ State _____ Zip _____

Prices & Specifications subject to change without notice. TE-173

INFORMATION RETRIEVAL NUMBER 137

*it's small . . .
and
lightweight too!*



Merrimac's New Variable Microwave Attenuator

The AUM-15A is a variable microwave attenuator designed for modern and future electronic systems. It is small. It is rugged. And it is reliable.

This broadband attenuator covers the frequency range 2 GHz to 8 GHz. At 4 GHz, the attenuation range is more than 0-20 db with an insertion loss of less than 0.5 db. The AUM-15A is designed for miniaturized 50-ohm coaxial systems and exhibits a VSWR of less than 1.5:1. The AUM-15A is the first miniaturized mem-

ber of Merrimac's broad lineup of variable attenuators. The entire family covers DC to 12 GHz with attenuation ranges from 0-15 db to more than 0-80 db. For more details on Merrimac's micrometer-driven, direct reading, and electronically-controlled attenuators, be sure to write or phone us.



MERRIMAC RESEARCH AND DEVELOPMENT, INC.

41 FAIRFIELD PLACE, WEST CALDWELL, N. J. 07006 • 201-228-3890

INFORMATION RETRIEVAL NUMBER 134

Here's how to measure CW, FM or pulsed frequencies from 50MHz to 18GHz -

THE EASY WAY:

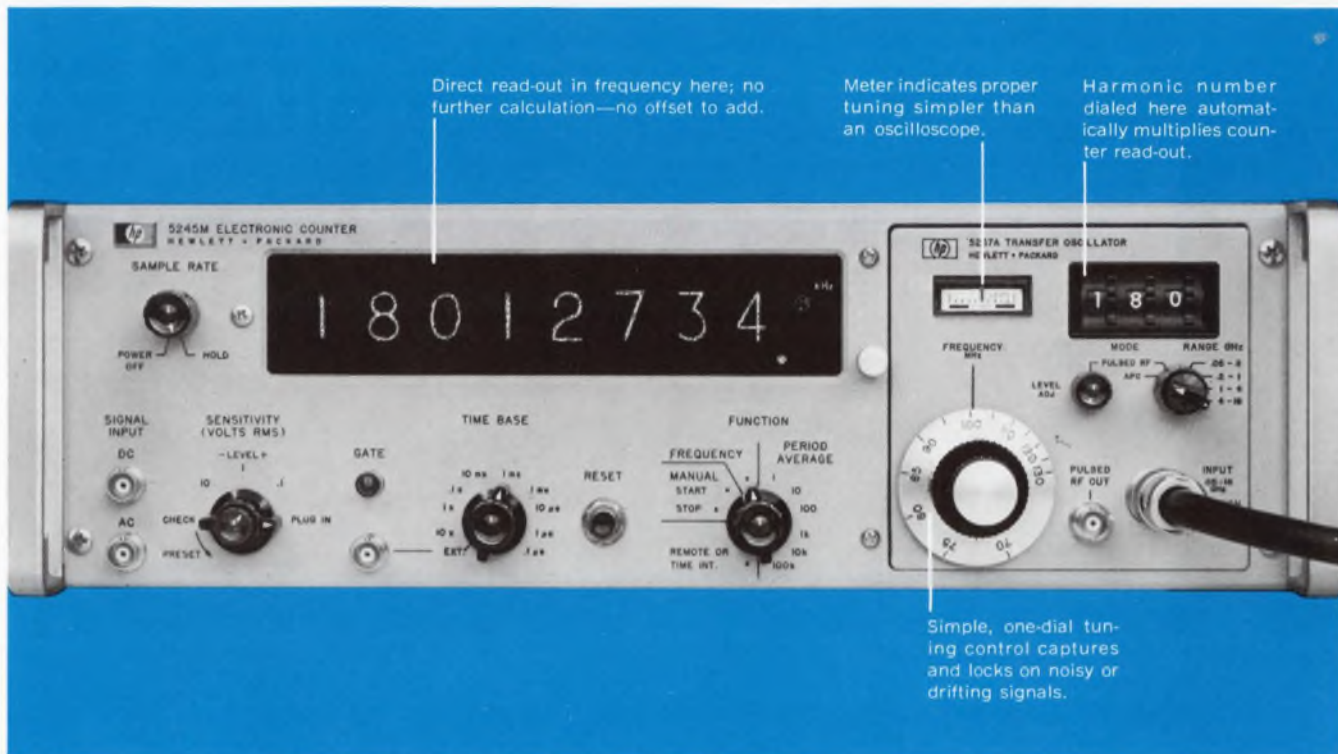

Hewlett-Packard's Model 5257A Transfer Oscillator extends the range of HP high-frequency counters all the way to 18 GHz for pulsed, CW or FM signals. Yet it's the easiest to use of any manual transfer oscillator.

For CW signals, just pick your frequency range, sweep with the tuning dial, set the level control and dial in the proper harmonic number. Then read the unknown frequency directly from the counter without further calculation.

A deflection on the tuning meter tells you when you've captured your signal—a lock-on that's much easier to detect than with complex scope patterns. And lock-on is sure, even on noisy signals or those drifting as much as $\pm 0.2\%$. If the signal drops out, the counter returns to zero; when the signal returns, the count is displayed again without re-tuning. And measurement of pulsed

carrier frequencies is just as easy: in pulsed RF mode, sweep dial till meter peaks, adjust level control and read counter.

A new transfer oscillator technique using a broadband sampler in a phase-locked loop gives the 5257A outstanding input sensitivity—typically -23 dBm at 50 MHz to -8 dBm at 18 GHz (-7 dBm to -4 dBm guaranteed, worst case). It also eliminates bothersome manual tuning of input mixers. Prices: 5257A Transfer Oscillator, \$1850. Electronic Counters: 5245L, \$2450; 5246L, \$1750.

For more details on the 5257A, 11 other plug-ins, and four compatible HP counters, call your local HP field engineer or write Hewlett-Packard, Palo Alto, California 94304; Europe: 54 Route des Acacias, Geneva.

HEWLETT  PACKARD

ELECTRONIC COUNTERS

INFORMATION RETRIEVAL NUMBER 213

02729

**At RCA our new
corporate symbol
is really a minor change
compared with
the innovations
it will signify
in decades to come.**

RCA